

Electronic Design 17

VOL. 24 NO.

FOR ENGINEERS AND ENGINEERING MANAGERS

AUG. 16, 1976

This DMM keeps on working while it is being calibrated. A plug-in reference assembly goes to the cal lab, not the meter itself. Work for this unit means

more than just measurements. Keyin numbers, and a μ P performs mathematical computations. Still another μ P corrects for errors. Meet this multimeter on p. 105.

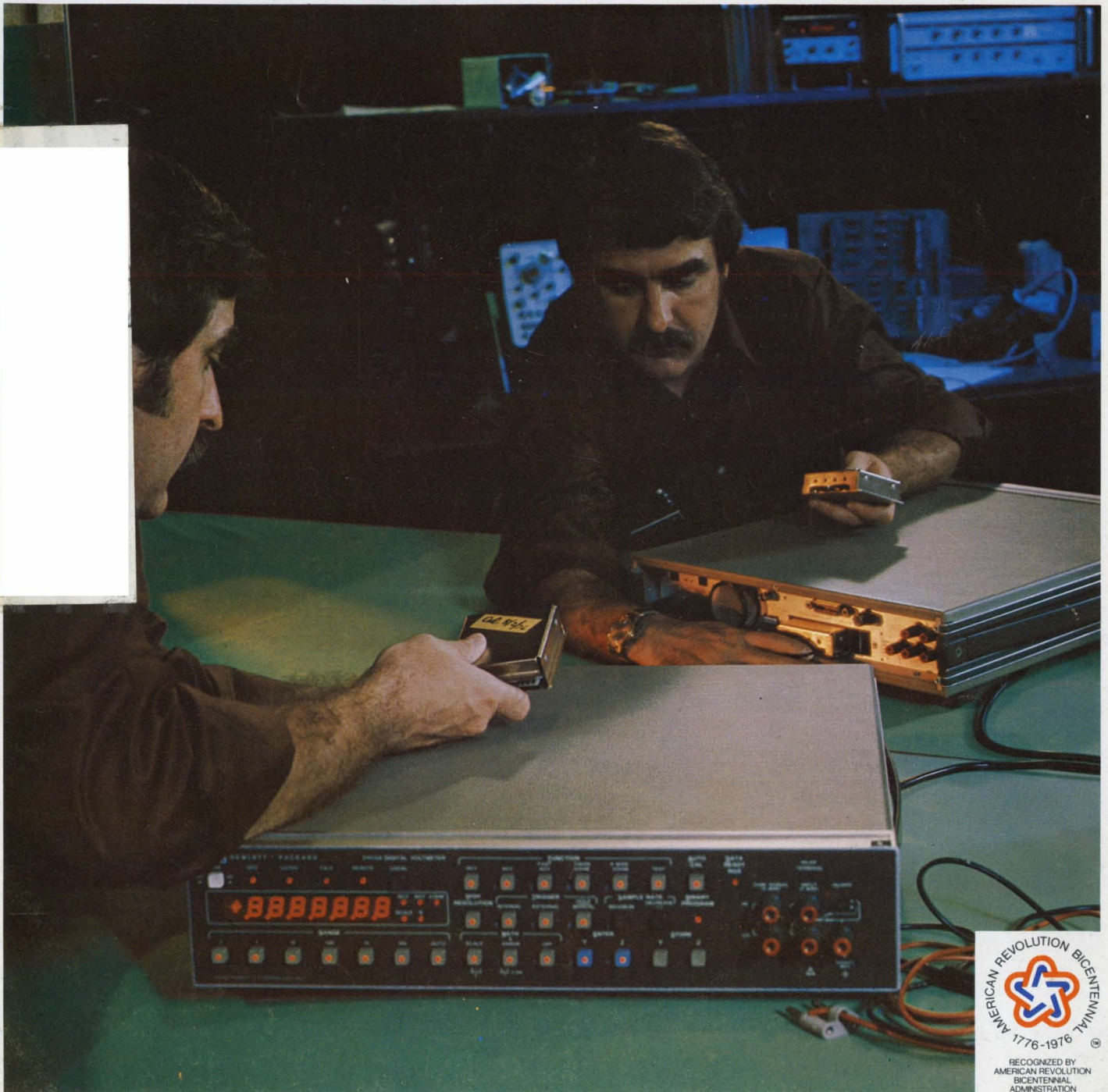

the **DIP** **HIGH** **SIP**

Now in the only full line of super low profile SIP Resistor Networks.

If you haven't designed in Single In-line Package resistor networks because of their high profile, take another look. THE HEIGHT ON BOURNS SIPs IS ONLY .190 INCH! And that's standard for all 6, 8 and 10 pin configurations with:

- 5, 7 or 9 resistors and 1 common pin
- 3, 4 or 5 isolated resistors
- 12 resistors, dual terminator (8 pin)

Now you can fit the same number of resistors into less area and yet maintain close P.C. Board spacing. Something you can't do when using other SIP networks with .250 or .350 inch high profiles.

And only Bourns SIPs offer the same reliable Krimp-Joint™ lead termination design as our DIP packages, high-copper alloy leads and uniform molded package design. With added features like MACHINE INSERTABILITY, COMPETITIVE PRICING AND DISTRIBUTOR AVAILABILITY —

Why specify other than Bourns?

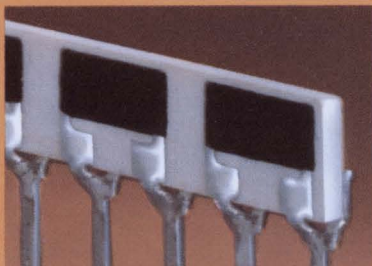

Bourns Krimp-Joint™ offers both a mechanical and electrical bond that lap or butt joint construction can't provide. The lead is crimped on the network element and a high-temp, reflow-resistant solder is used to prevent failure during wave soldering and in circuit thermal cycling and vibration.

FREE SIP and DIP SAMPLES!

Write on your company letterhead and let us know your requirements, we'll rush you a SIP or DIP resistor network sample and complete specifications.

TRIMPOT PRODUCTS DIVISION, BOURNS, INC., 1200 Columbia Avenue, Riverside, California 92507. Telephone 714 781-5415 — TWX 910 332-1252.

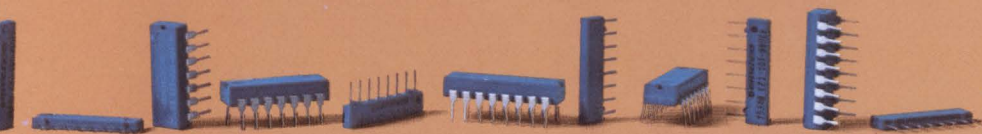
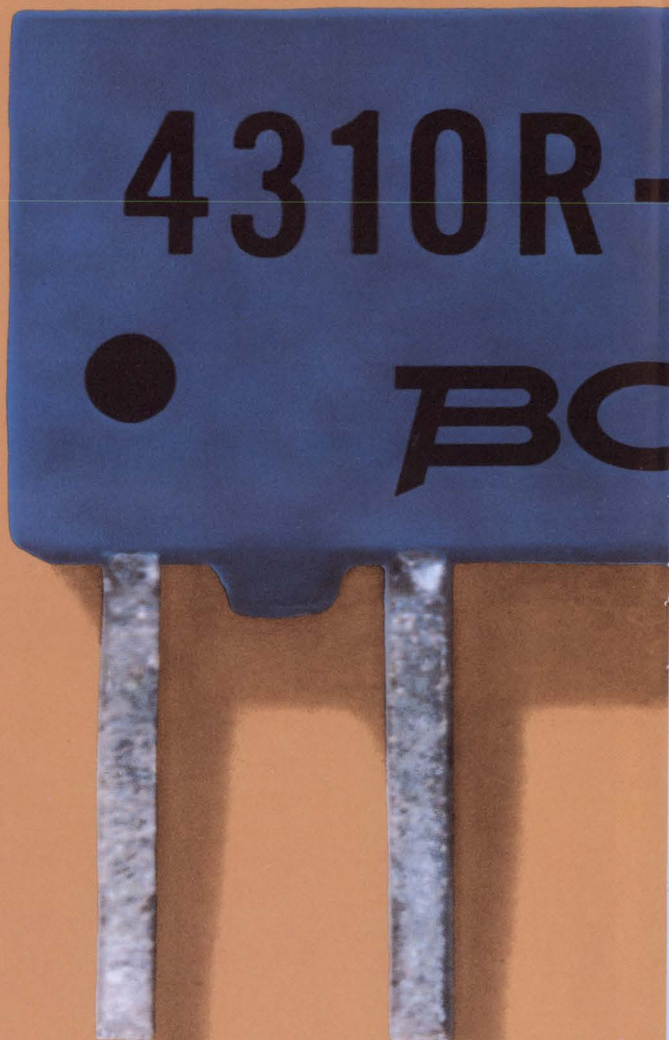

Int'l Sales Offices: European Hdqtrs. — Switzerland, 042/23 22 42 • Belgium 02/218 2005 • France 01/2039633 • Germany 0711/24 29 36
• Italy 02/32 56 88 • Netherlands 070/88 93 18 • United Kingdom 01/572 6531 • Japan 075 92 1121 • Australia 86 9410 • Brazil 257-3535

CIRCLE NUMBER 252

SURPRISE!



High Speed, High Reliability, High Gain Isolators from Hewlett-Packard!

Hewlett-Packard now offers you a broad family of high-performance optically-coupled isolators. These devices are ideal for telephone, computer, medical, process control and instrumentation applications. Our high-speed isolators can handle data at a rate of up to 10 Mbits per second. The high-reliability isolator is a dual-channel unit, hermetically sealed. Our high-gain, low-input isolator requires 0.5 mA of input. And, best of all, they are all in stock at any of our franchised distributors.

In the U.S., contact Hall-Mark, Schweber, Wilshire or the Wyle Distribution Group (Liberty/Elmar) for immediate delivery. In Canada, contact Bowtek Electronics Co., Ltd., Schweber Electronics or Zentronics, Ltd.

It's time to get to know Hewlett-Packard's family of high-performance isolators.

HEWLETT  **PACKARD**

Sales and service from 172 offices in 65 countries.
1507 Page Mill Road, Palo Alto, California 94304

TO-5 RELAY UPDATE

The world's smallest RF relay

Inherently low inter-contact capacitance and contact circuit losses have established the Teledyne TO-5 relay as an excellent subminiature RF switch for frequencies up through UHF. Typical RF performance: 45db isolation and 0.1db insertion loss at 100MHz.

Added to this, our TO-5 relay requires very low coil power compared to other miniature relays — as much as 75% less than a half crystal can relay.

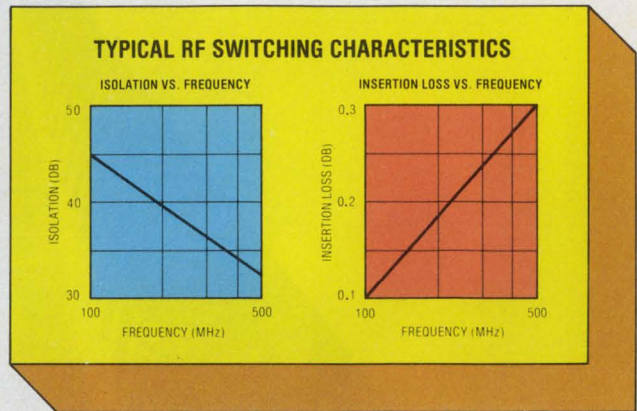

For hand held radio transceivers, for example, where battery power drain as well as good RF performance are key factors, Teledyne's TO-5 relay is the logical choice for T-R switching.

Our complete line of TO-5 relays includes military and commercial/industrial types, with virtually all military versions qualified to established reliability MIL specs. For complete data, contact Teledyne Relays — the people who pioneered the TO-5 relay.

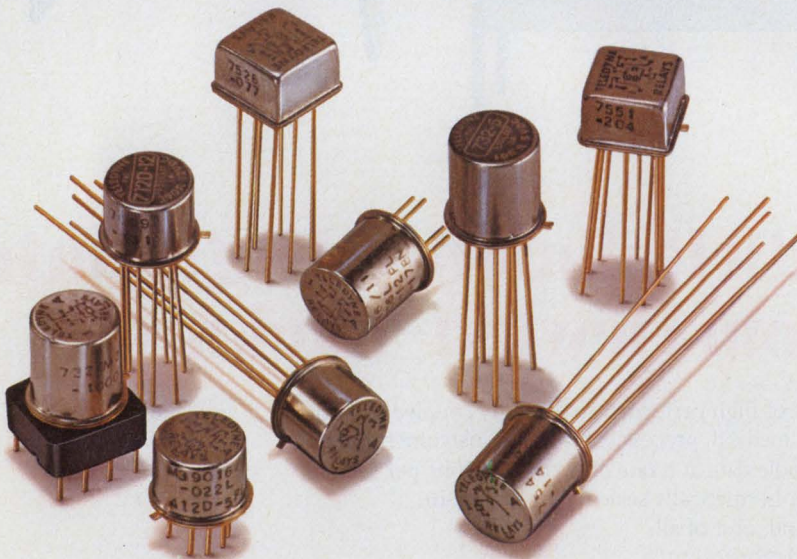

- **Hybrid "T" Series**
SPDT & DPDT types with internal transistor driver and suppression diode. Military and commercial/industrial versions.
- **"D" and "DD" Series**
With internal suppression and steering diodes. Military and commercial/industrial versions.
- **Maglatch Series**
SPDT, DPDT, and 4PST magnetic latching types. Military and commercial/industrial versions.
- **Centigrad® Series**
World's smallest relay—only .225" (5.72mm) high x .370" (9.40mm) square. DPDT, with optional internal suppression and steering diodes.
- **Hi-Rel Series**
Screened versions for space flight applications (NASA qualified)
- **High Environment Series**
Hi-temperature, Hi-shock, and Hi-vibration types

 **TELEDYNE RELAYS**

3155 West El Segundo Boulevard, Hawthorne, California 90250
Telephone (213) 973-4545

CIRCLE NUMBER 3

ELECTRONIC DESIGN 17, August 16, 1976

NEWS

- 21 **News Scope**
- 26 **The cathode ray tube is still alive and kicking** and it's finding new areas of application—An Electronic Design special report.
- 38 **Pedal exerciser with built-in μ P** quickly reveals your fitness level.
- 45 **Washington Report**

TECHNOLOGY

- 51 **MICROPROCESSOR DESIGN**
- 62 **Enhance LED visibility** under high ambient light levels by using bandpass and other optical filters to boost contrast.
- 72 **Head off dc/dc-converter problems.** You can attack cross-current conduction—an enemy of converter performance—in three ways.
- 82 **Pick the right p-i-n diode** for transceiver antenna switches. Some simple equations and approximations ease selection and prevent overload damage.
- 90 **Measure signal peaks accurately** despite low rep rates and narrow pulse widths. This 'go-fast' technique can do things the usual peak circuits can't.
- 96 **Ideas for Design:**
Ensure uniform LED-display brightness with these simple design tips. 555 one-shot circuit features negative output with positive triggering. State diagrams for a 555 timer aid development of new applications. Staircase generator divides frequencies by large factors.

PRODUCTS

- 105 **Instrumentation:** Smart DVM stays on the job while its plug-in reference is calibrated.
- 108 Modules & Subassemblies
- 112 Data Processing
- 116 Integrated Circuits
- 120 Power Sources
- 122 Packaging & Materials
- 126 Components
- 130 Microwaves & Lasers
- 132 Discrete Semiconductors

DEPARTMENTS

- 59 **Editorial:** We want to be better.
 - 7 Across the Desk
 - 134 Application Notes
 - 134 Bulletin Board
 - 135 Vendors Report
 - 136 New Literature
 - 142 Advertisers' Index
 - 144 Product Index
 - 144 Information Retrieval Card
- Cover:** Photo by Allen Howe, courtesy of Hewlett-Packard, Loveland Instrument Div.

Programmable, parallel I/O lets you define the direction and data transfer characteristics of six 8 bit I/O ports. Reconfigure the interface or entirely alter the I/O structure by changing no more than four program instructions.

Plug-in standard TTL drivers or line terminators to easily tailor the I/O interface to meet your system requirements.

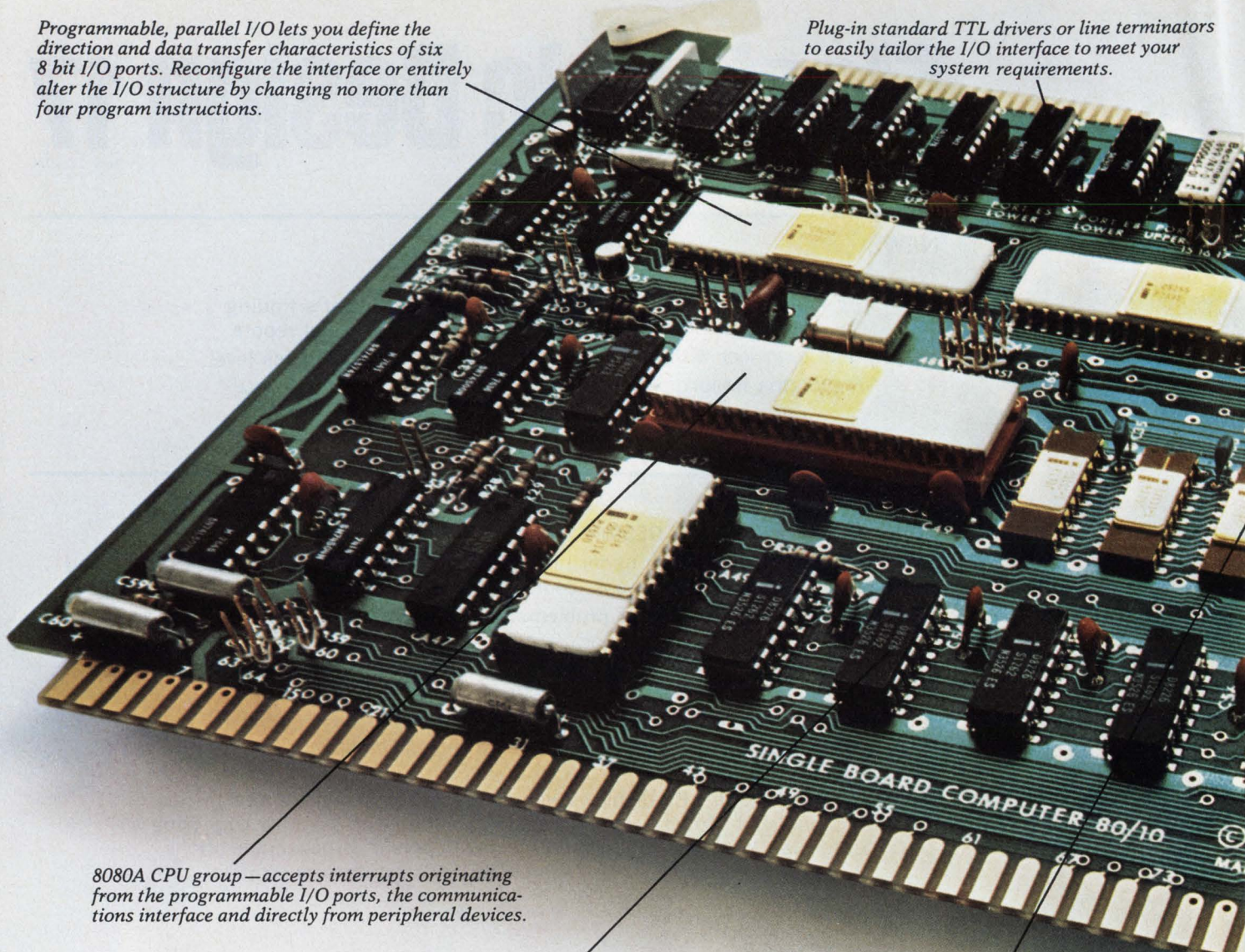

8080A CPU group—accepts interrupts originating from the programmable I/O ports, the communications interface and directly from peripheral devices.

Drivers provided for memory and I/O expansion. Simply plug any of the SBC 80 RAM, EPROM/ROM, I/O or Combination expansion boards into the standard SBC 80 card cage.

1K bytes of high speed, low power static RAM.

The first complete single

The Intel® SBC 80/10 Single Board Computer, with programmable I/O, is designed for the profit conscious OEM in a hurry. The SBC 80/10 is the fastest and lowest cost way of getting your products to market. And when your equipment sales increase to the point where it makes sense to build your own Single Board Computer, we'll make arrangements for you to use our bill of material, fab and assembly drawings, and artwork.

Now it's possible to standardize on one computer board for all your products. Everything you need—CPU, ROM, RAM and I/O is on a single 6.75" x 12"

board. And since we've extended the programmable nature of the CPU to the I/O interface you can use the same board even when you make an interface change or completely redesign your product's input/output section. Just initialize the programmable I/O devices with the appropriate program instructions and you have individually defined the direction and data transfer characteristics of the six on-board ports. Programmable I/O makes your products more versatile and cuts parts cost and development time.

Cut development costs even more with the Intellec

Programmable serial interface lets you choose virtually any asynchronous or synchronous communications technique. Data format, control character format, parity, and asynchronous serial transmission rates are all under program control.

Both teletypewriter and RS 232C interfaces are included, choose the one you need.

Selectable baud rate generator—pick the communications frequency you want.

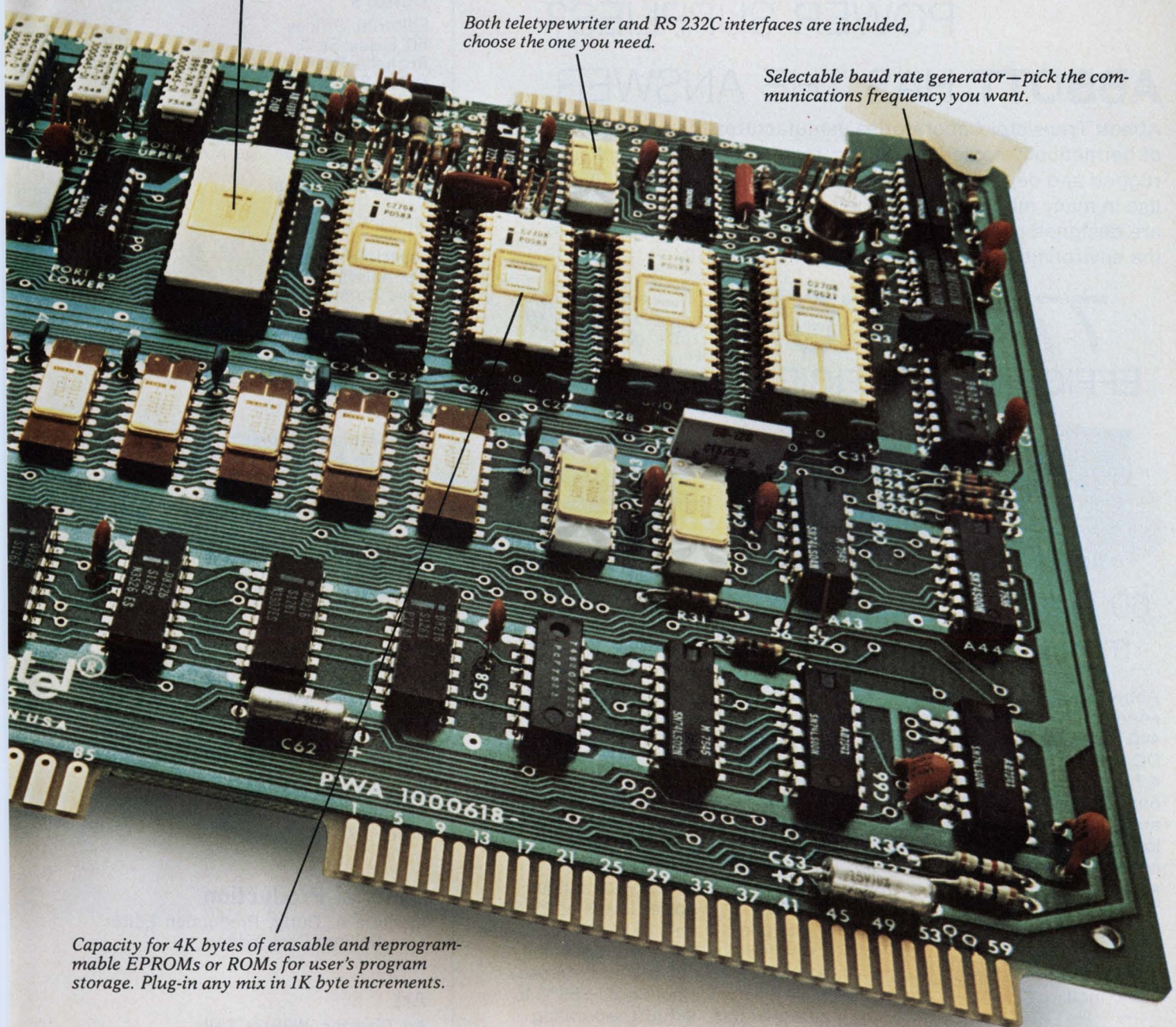

Capacity for 4K bytes of erasable and reprogrammable EPROMs or ROMs for user's program storage. Plug-in any mix in 1K byte increments.

board computer for \$295.*

MDS™ Microcomputer Development System with optional Diskette Operating System and unique ICE-80 In-Circuit-Emulator. Develop and debug your system software directly on the SBC 80/10 using the symbolic debugging capability of ICE-80.

The 80/10 is supported by macroassemblers, text editor, Intel's PL/M™ compiler, a user's library with over 150 programs, and comprehensive documentation.

Training is available at training centers or scheduled at your plant. For additional technical assistance contact your Intel Field Applications Engineer.

The Intel® SBC 80/10 is available from distributor stock. To order contact: Almac/Stroum, Component Specialties, Components Plus, Cramer, Elmar, Hamilton/Avnet, Industrial Components, Liberty, Pioneer, Sheridan, or L.A. Varah.

For your copy of the SBC 80/10 brochure, use the bingo card or write: Intel Corporation, 3065 Bowers Avenue, Santa Clara, California 95051.

intel® delivers.

CIRCLE NUMBER 4

INTERESTED IN HIGH EFFICIENCY POWER SUPPLIES?

ABBOTT HAS THE ANSWER

Abbott Transistor Laboratories manufactures three complete lines of hermetically sealed, switching regulated power supplies. These rugged and dependable power modules have already found wide use in many military, aerospace and industrial applications. All units are designed to meet the EMI requirements of MIL-STD-461 and the environmental requirements of MIL-STD-810.

77%
EFFICIENT

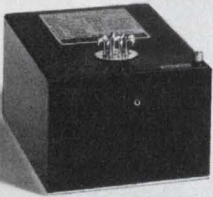

**60 Hz to DC
model VN**

Abbott's Model VN series converts 47 to 440 Hz AC lines to any DC voltage between 4.7 and 50 VDC at output powers of 25, 50 and 100 watts. Line and load regulation are controlled to 0.4% with a peak-to-peak ripple of 100 mV. Efficiencies of 77% are achieved with power densities of greater than 1 watt per cubic inch.

70%
EFFICIENT



**400 Hz to DC
model UN**

Designed to operate from 380 to 420 Hz AC lines, Abbott's Model UN series offers output powers of 25, 50 and 100 watts at all popular voltages between 5 and 50 VDC, including ± 12 and ± 15 . The full load operating temperature range is -55°C to $+100^{\circ}\text{C}$. Peak-to-peak ripple of 100 mV and load regulation of 0.5% are just a few of the standard features of this line of 70% efficient power modules.

70%
EFFICIENT



**DC to DC
model BN**

Wide range DC inputs of 20 to 32 VDC can be accommodated by Abbott's BN line of high efficiency DC to DC converters. All popular output voltages between 5 and 50 VDC, including ± 12 and ± 15 , are available at output power levels of 25, 50 and 100 watts. 0.5% line and load regulation, 100 mV peak-to-peak ripple and -55°C to $+100^{\circ}\text{C}$ operating temperature range are a few of the standard features of the BN line.

Complete electrical specifications, size charts and prices for these units are listed in our new 60 page free catalog. Also listed are 12 additional line of power modules, including —

60 A to DC
400 A to DC
DC to DC
DC to 60 A
DC to 400 A

For immediate complete information on Abbott Modules, see pages 1037-1056 Vol. 1 of your 1975-76 EEM Catalog or pages 612-620 Vol. 2 of your 1975-76 GOLD BOOK.

Sr. Vice President, Publisher
Peter Coley

Editors

Editorial Offices
50 Essex St.
Rochelle Park, NJ 07662
(201) 843-0550
TWX: 710-990-5071
Cable: Haydenpubs Rochellepark

Editor-in-Chief George Rostky

Managing Editors:

Ralph Dobriner
Michael Elphick

Associate Editors:

Sid Adlerstein
Dave Bursky
Samuel Derman
Jules H. Gilder
Morris Grossman
John F. Mason
Stanley Runyon
Michael Shunfenthal

Contributing Editors:

Peter N. Budzilovich, John Kessler
Alberto Socolovsky, Nathan Sussman

Editorial Field Offices

East

Jim McDermott, Eastern Editor
P.O. Box 272
Easthampton, MA 01027
(413) 527-3632

West

David N. Kaye, Senior Western Editor
8939 S. Sepulveda Blvd., Suite 510
Los Angeles, CA 90045
(213) 641-6544
TWX: 1-910-328-7240

Jim Gold, Western Editor

1537 Shasta Ave.
San Jose, CA 95128
(408) 279-8588

Editorial Production

Marjorie A. Duffy, Production Editor
Tom Collins, Copy Editor

Art

Art Director, William Kelly
Richard Luce, Anthony J. Fischetto

Production

Manager, Dollie S. Viebig
Helen De Polo, Anne Molfetas

Circulation

Director, Barbara Freundlich
Trish Edelman, Gene M. Corrado

Information Retrieval

Peggy Long

Advertising Promotion

Susan G. Apolant

abbott transistor
LABORATORIES, INCORPORATED

Send for our
new 60 page
FREE catalog —

GENERAL OFFICES

5200 W. Jefferson Blvd.
Los Angeles, CA. 90016
(213) 936-8185
Telex 69-1398

EASTERN OFFICE

1224 Anderson Ave.
Fort Lee, N.J. 07024
(201) 224-6900
Telex 13-5332

"SEE US AT WESCON/76 SHOW IN LOS ANGELES, BOOTH NO. 1057"

CIRCLE NUMBER 5

Across the Desk

Ceramic package looks OK, but for how long?

We are considering ceramic-covered thick-film hybrid circuits in which the ceramic cap is cemented in place by an epoxy compound. We are evaluating this approach for use in commercial telecommunications equipment, against the use of a standard metal hermetic package.

Although our tests so far show no discernible difference between the two sealing methods we are worried about degradation of the epoxy seal during the long service life of the units (5 to 10 years).

We would be grateful to receive pertinent information that you might have handy, or at least, indication where such data may be obtained.

*H. Livni
Reliability Engineer
Development Dept.*

Tadiran, Telecommunications Div.
P.O. Box 500
Petah-Tivka 49100
Israel

Ed Note:

Can anyone out there help Mr. Livni?

Solar-cell progress is ground for optimism

Samuel Derman's article (ED No. 6, March 15, 1976, p. 24) is an excellent survey of the state of the art of photovoltaic conversion. It skillfully presents both the advantages and the problems that will have to be overcome before it can be applied on a large scale.

Because this method represents

one of the most important ways of performing the useful conversion of solar energy, there seems to be reasonable ground for optimism that with the efforts beginning to be devoted to this field, significant advances will be achieved.

The substantial work on a Satellite Solar Power Station that is being carried out by NASA and industry has been directed to resolve the technical challenges. As the article pointed out, the reduction of transportation costs is one of the most significant areas of activity, and one that is already receiving attention by Boeing and Grumman, working in behalf of NASA/JSC.

The environmental effects are also being identified. So far we have found that the environmental impact could be minimized by appropriate choices of technology. For example, interactions with the ozone layer can be reduced to acceptable levels by substituting liquid propellants for the solid propellants to be used in the space shuttle.

*Peter E. Glaser
Vice President*

Arthur D. Little, Inc.
Acorn Park
Cambridge, MA 02140

Wrong name

We really blew it in our Advertiser's Index for the June issues. We failed properly to identify two ads as being from NEC Microcomputers, Inc., of Lexington, MA. The company is a wholly owned subsidiary of Nippon Electric Co., Ltd.

(continued on page 10)

Electronic Design welcomes the opinions of its readers on the issues raised in the magazine's editorial columns. Address letters to Managing Editor, Electronic Design, 50 Essex St. Rochelle Park, N.J. 07662. Try to keep letters under 200 words. Letters must be signed. Names will be withheld on request.

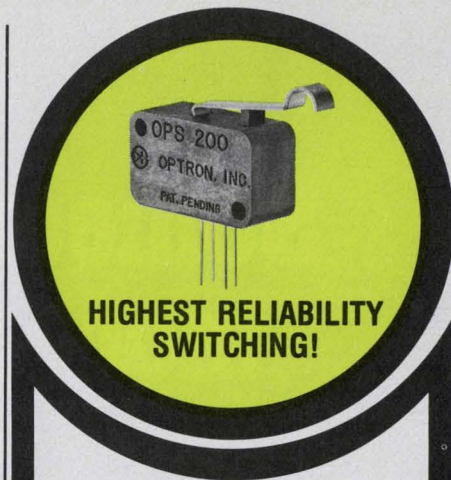

HIGHEST RELIABILITY SWITCHING!

OPTICALLY COUPLED LIMIT SWITCHES

OPTRON OPS 200 SERIES SWITCHES MEET SPECS AFTER 100,000 HOURS OF OPERATION

Even after 100,000 hours of operation at rated currents, OPTRON's new high reliability OPS 200 series optical limit switches will still meet specifications.

New OPS 200 and OPS 200A limit switches combine the non-contact switching feature of popular optically coupled interrupter modules with the convenient mounting and actuating features of conventional mechanical switches to provide solid-state reliability in a mechanical switch package.

An optical shutter controlled by a snap-action mechanism interrupts the light path between a gallium arsenide infrared LED and a silicon photosensor. The condition of the photosensor, either illuminated or dark, determines the ON (closed) or OFF (open) state of the switch.

There is no contact bounce or contact contamination. Interfacing with high speed logic circuitry is possible without the buffering stage required with conventional switches. Both the OPS 200 and OPS 200A eliminate arcing and are unaffected by magnetic fields.

The OPS 200 has a high gain N-P-N phototransistor output. In the closed condition with a LED drive current of 30 mA, a minimum output of 1.6 mA at 0.4 volts assures TTL compatibility. In the OPS 200A, a photodiode sensor followed by a Schmitt trigger circuit with 140 mA output sink capability eliminates the need for amplifiers in most applications.

Both new limit switches are available from stock in either normally open or normally closed conditions.

Detailed technical data on OPTRON 200 series limit switches and other OPTRON optoelectronic products... chips, discrete components, reflective transducers, isolators and interrupter assemblies... is available from your nearest OPTRON sales representative or the factory direct.



OPTRON, INC.

1201 Tappan Circle
Carrollton, Texas 75006, U.S.A.
TWX-910-860-5958
214/242-6571

Someone has developed a more efficient resistor.

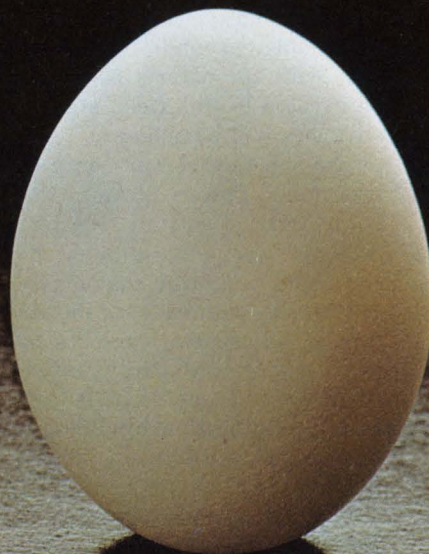

THE new Dale resistors are more efficient to buy. A network of computer terminals throughout our three resistor plants gives you more useful production information than you've ever been able to get—from anyone.

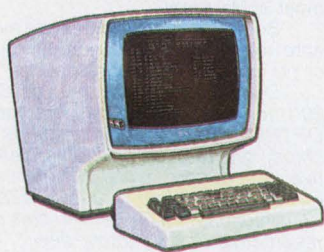

Place an order and in seconds we can tell you whether it can be shipped from stock. Inquire about an existing order and we can tell you its exact production status equally as fast. Discover a need for earlier delivery and we can instantly mark your order for expediting. That's

resistor efficiency you can use. It's part of an expansion program that has seen our floor space devoted to resistors grow from 300,000 square feet in 1970 to more than 400,000 square feet today. And much of this expansion has been devoted to automated facilities. Multi-station winders let you specify the stability and power of wirewounds at a lower cost than ever...and batteries of laser spiralling machines turn out RN-style metal film parts at machine-gun speed. We're making the most efficient resistors you can buy—and we're ready to prove it.

The new Dale resistors are made from more efficient materials than ever. Sophisticated equipment, like this scanning electron microscope, gives us state of the art capability for analyzing, identifying and specifying component materials. It's part of an integrated materials improvement, performance testing and quality control program we initiated 15 years ago in the early days of the Minuteman High Reliability Development Program. Today, one out of every 10 Dale employees is directly involved with Quality Control. Tangible results include: More than 100 separate QPL listings for wirewound and metal film resistors; the world's most reliable wirewound resistor (proven failure rate .000021%/1000 hours). The new Dale resistors will give you less trouble—before and after purchase—than any others you can buy—and that's efficiency! Call 402-564-3131 for wirewound and 402-371-0080 for metal film.

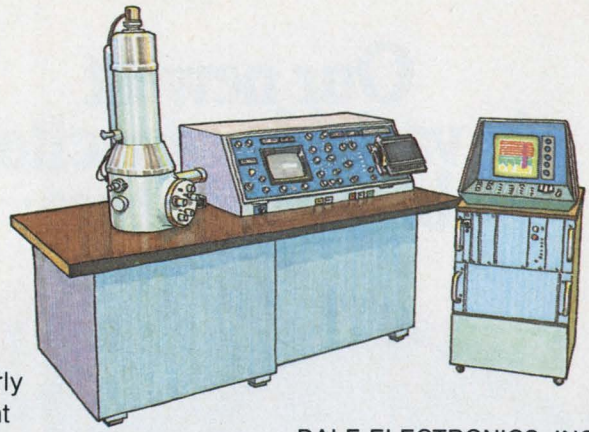

DALE ELECTRONICS, INC.
 1300 28th Avenue, Columbus, Nebraska 68601
A subsidiary of The Lionel Corporation
 In Canada: Dale Electronics Canada Ltd.
 In Europe: Dale Electronics GmbH,
 8 München 60, Falkweg 51, West Germany



Our complete product line can be found in Electronic Design's GOLD BOOK.
 CIRCLE NUMBER 7

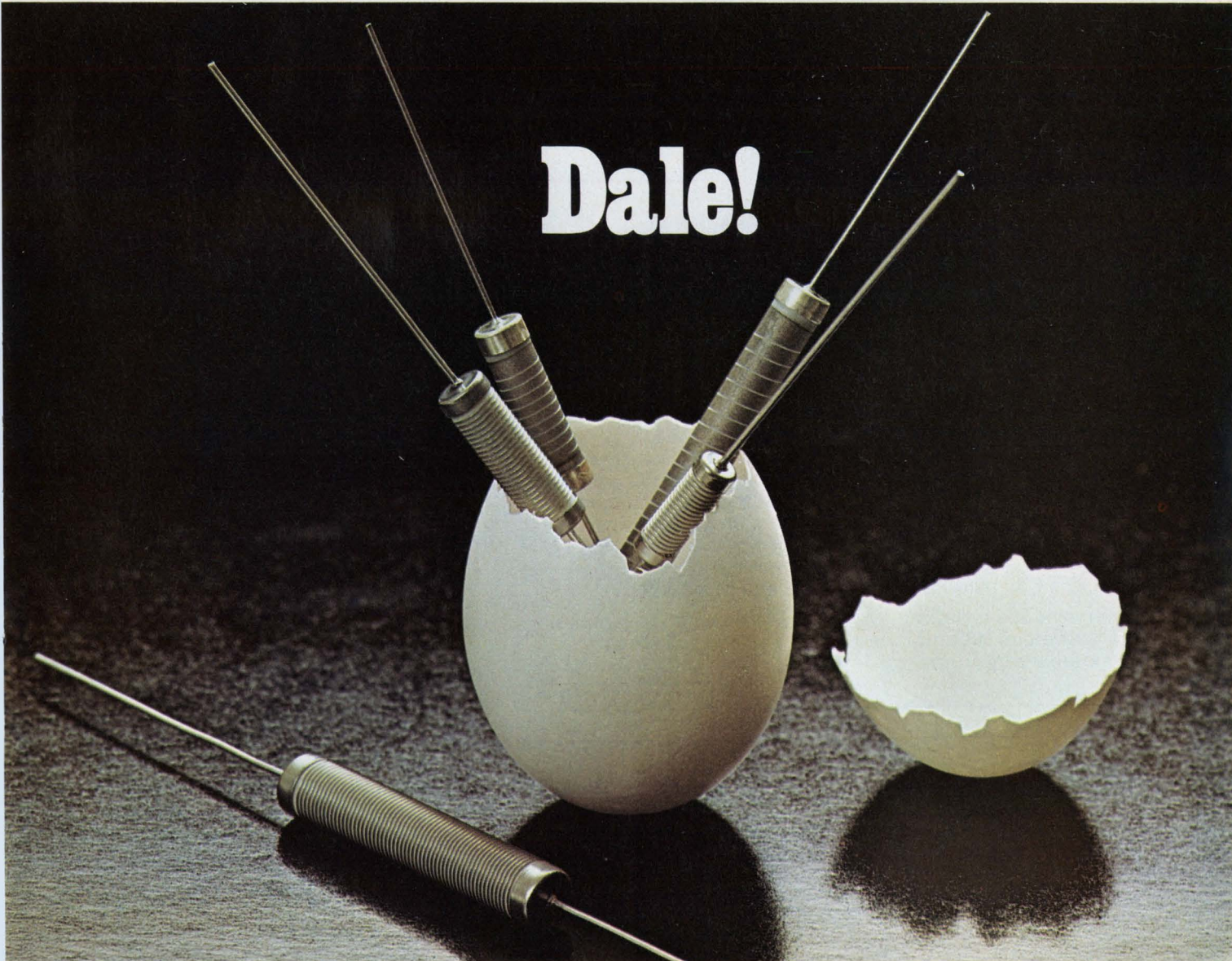

Our newest air variable capacitor's biggest feature:



It's small size.

As you can plainly see, our new air variable capacitor is nearly as small as many sub-miniature ceramic trimmers. It also features the same mounting configuration which means you can use it in many of the same applications.

But small size isn't the only reason for buying our new Micro T™ capacitor. Because it's air variable, it offers you

great stability. Q is typically 1000 at 100 MHz. TC is ± 45 PPM/°C. And it's available in maximum capacities of 3, 6.5, 12.7, and 19.0 pF in either vertical or horizontal tuning PC and stripline mounting versions. What's more, it gives you all this for a very small price.

E. F. Johnson Company/Dept. E.D., Waseca, MN 56093

Please send me technical information on sub-miniature air variable capacitors.

Please send me samples. You can call me at _____

Name _____

Firm _____

Address _____

City _____ State _____

Zip _____

For fast service, contact your local Johnson Distributor.



JOHNSON
®

CIRCLE NUMBER 8

ACROSS THE DESK

(continued from page 7)

of Japan, a 77-year-old company with recent sales volume exceeding \$1.5 billion.

The NEC Microcomputers advertisements featured MOS memories with MTBFs exceeding 1100 years and bipolar memories with life expectancies a few centuries longer.

Interested?

CIRCLE NO. 319

A matter of a 0.1-V range not quite as expected

We built the op-amp scale expander described in "Ideas for Design" (ED No. 21, Oct. 11, 1975, p. 94). Unfortunately, trusting souls that we are, we did not check the arithmetic, the example given appeared so convincing.

Well, it works in full agreement with the formula for the A_1 output voltage. However, the input attenuator divides by M, both the input voltage and its changes. Consequently only 0.1, the input range of 1 V, appears at the input of A_1 . Since the over-all gain of A_1 and A_2 is unity, there is no way to get a 1-V output range.

The example works if one has a multirange voltmeter with a 0.1-V dc full-scale sensitivity. I do not know of any.

Any suggestions what to do with our expander?

Alex Azelickis
Vice President, Technical Relations
Oak Industries Inc.
CATV Div.
Crystal Lake, IL 60014.

The author replies:

Mr. Azelickis is correct in his statement that a 0.1-V full-scale-sensitivity meter is required, and I apologize for my failure to catch the decimal-point omission when proofreading.

The circuit was originally used in conjunction with a Heath IM-104 VOM which has a 0.1-V range, as do many VOMs and VTVMs including RCA's and several imports. However, if such equipment is unavailable it is merely necessary to

(continued on page 16)

ELECTRONIC DESIGN 17, August 16, 1976

Sharpen your competitive edge.

Use an HP computing calculator for design, analysis, control, and test.

In the highly competitive, high-technology electronics business, everything counts: keeping costs in line, exploring promising design alternatives, shortening lead times, product and prototype testing, increasing productivity. That's where HP computing calculators, software, peripherals, and interfacing capabilities come in. They can help you get and maintain a competitive edge.

Three computing calculators and plenty of peripherals: it's your choice. Three different models—the low-cost HP 9815, the powerful HP 9825 and the all-purpose HP 9830—offer a range of computing power.

HP peripherals include paper tape punch and readers, printers, storage devices, a digitizer, a CRT, and an X-Y plotter. You choose the model and I/O options to configure a system just right for you.

Software, specialized and generalized, helps you look at more alternatives. HP engineers developed software to optimize designs and analyze engineering problems quickly. There's a State Variable package for control system analysis. There's CNAP for circuit design and analysis, BAMP for microwave design and analysis, and Digital Simulation for state and timing analysis.

You can add other programs, too—commonly needed math routines and statistical programs to name but two. Programs are also available for accounting applications, report generation, and financial analysis.

Automate your instruments. We make the connection friendly. From simple data logging to complex integration, our programming commands and interface cards make instrument interfacing easy. Whether your instruments require BCD, bit-parallel, RS-232-C, or HP-IB (HP's implementation of IEEE Standard 488-1975), you plug the correct interface into the calculator and connect the cable to your instrument. It's the friendly connection.

HP computing calculators: from initial design to final test. Whether you're in research, design, production, or test—or all four—we can provide the computing power and programs to help you increase productivity and sharpen your competitive edge. Our new brochure for electronic engineers will show you how. Get a copy from your HP representative, or circle our reader service number in this magazine.



HP desktop computing systems put the power where the problems are.

HEWLETT  PACKARD

Sales and service from 172 offices in 65 countries.

P.O. Box 301, Loveland, Colorado 80537
 For assistance call: Washington (301) 948-6370, Chicago (312) 677-0400,
 Atlanta (404) 434-4000, Los Angeles (213) 877-1282, Toronto (416) 678-9430

CIRCLE NUMBER 9

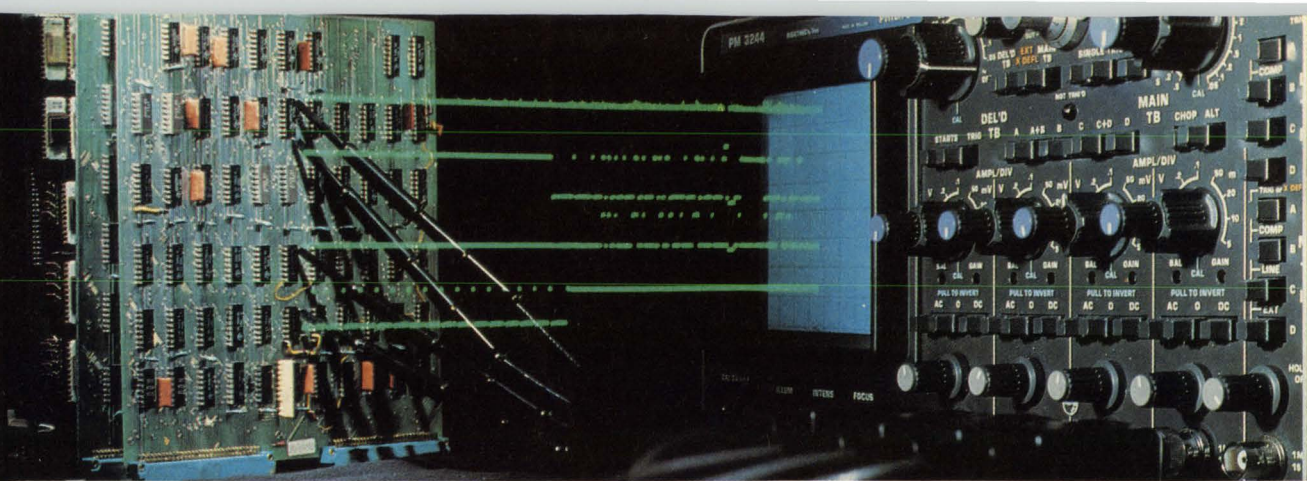

Four 50 MHz channels. Unique triggering facilities.
Ideal for parallel data analysis.

Zero in on

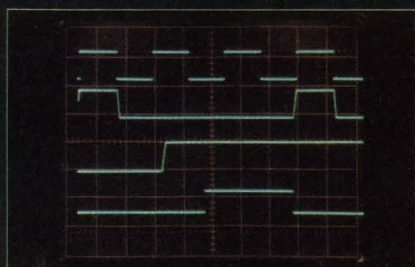

As illustrated on the front panel detail, triggering is fully independent and multi-sourced. This gives a number of unique triggering possibilities and is just as useful for more conventional dual-trace measurements.

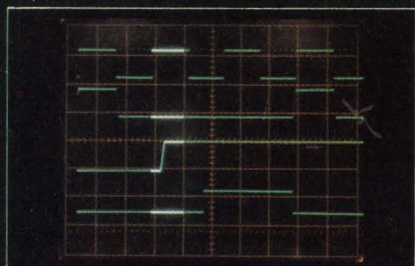

Here the main and delayed timebases are triggered from different channels, one example of the PM 3244's unique triggering facilities. Signals can therefore be shown even when they are not related to the main timebase.

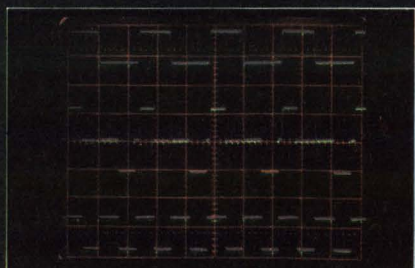

Differential measurements can be made on the PM 3244 in the conventional manner or by using the composite triggering mode.

Four traces give you the logic story: show the relationships at a glance. But only the PM 3244 gives you four traces and fully independent triggering of main and delayed timebases. Thus the main timebase can be triggered on any of the four channels plus composite, external and line. The delayed timebase can be triggered on any of the four channels plus composite: independently! This gives a number of unique triggering possibilities, for example showing relationships that are not directly related to the main timebase, like the information in a data line when the main timebase is triggered on an address line.

Doubles for dual-trace with extra performance.

PM 3244 is the world's first four-channel compact and all channels have full display facilities i.e. sensitivity, attenuation, invert, etc. It can therefore be used to make isolated or differential measurements and when you need conventional dual-trace displays, this scope also gives them, with two traces in reserve plus unmatched triggering facilities.

All displays are on a large 8 x 10 cm screen and the compact construction weighs in at a mere 9.6 kg (21 lb). The price is rather compact too!

Write for more details. Read opposite about another data breakthrough.



Test & Measuring
Instruments

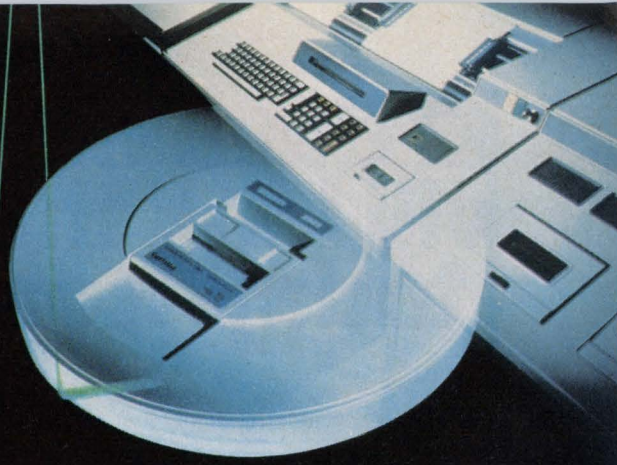
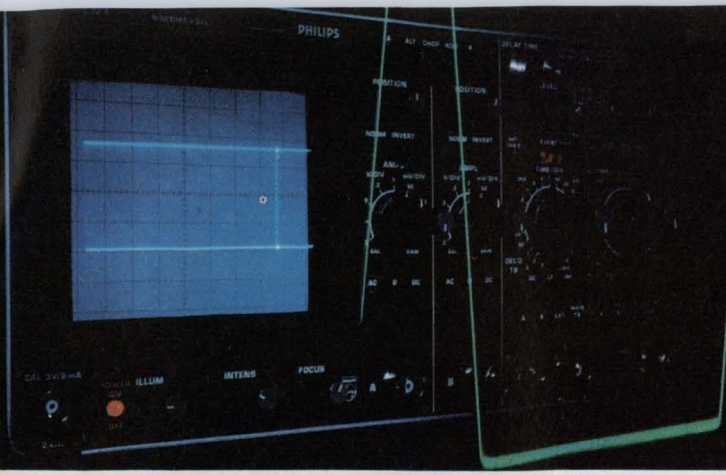

120 MHz with digitally delayed triggering to over 200 MHz.
Ideal for serial data.

ones and zeros

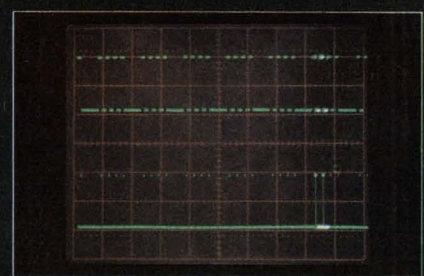

As illustrated on the front panel detail, one push button and one control knob are all that's needed to operate the digital delay. The required event in the data stream 'lights up', as shown, and can then be displayed using the normal delayed timebase in order to make accurate time interval measurements.



The PM 3261 is another world first. In addition to conventional triggering facilities, the instrument features a digitally delayed timebase that can be set to trigger on a particular pulse in a data stream, the position being displayed on the built-in, five-digit LED. This facility allows individual events to be located quickly and accurately in data streams of up to 100,000 bits and then be 'trapped' for detailed display.



The event is located using the illustrated delay counter, which can be set to count up or down at an adjustable speed as low as one step every two seconds. Specific sections can thus be examined and the counting stopped and stepped back to pick up and locate any irregularities.

The digitally delayed counter also overcomes problems of jitter, such as occur in mechanical systems like disk memories, tape drives, etc. In such cases, if the jitter is longer than one period, a conventional delayed timebase cannot be effectively employed. Once that display has been trapped, accurate time interval measurements can be made using the normal delayed timebase controls.

In addition, the main timebase has a TTL triggering facility to eliminate triggering problems on preshoot, overshoot, ringing, etc.

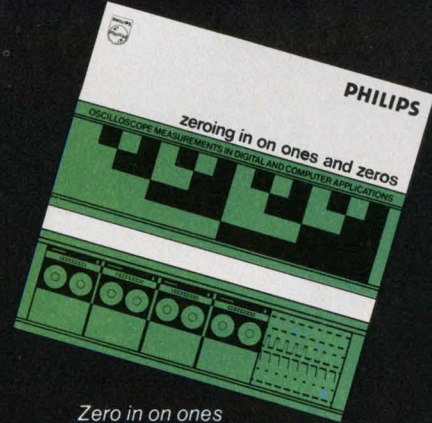

Zero in on ones and zeros with the aid of this useful 64-page booklet. For further information simply circle the reader service number.

In the United States:
400 Crossways Park Drive
Woodbury, New York 11797
(516) 921-8880

In Canada:
6 Leswyn Road
Toronto, Ontario Canada M6A1K2
(416) 789-7188

Philips Test & Measuring Instruments, Inc.
A NORTH AMERICAN PHILIPS COMPANY

PHILIPS

17 days from now this trace will look the same as it does today. Now that's storage!

The Gould OS-4000 Digital Storage Oscilloscope . . .

will store any signal up to 450 kHz for as long as you need, while providing the performance of a conventional 10 MHz scope as well. The OS-4000 opens the door for entirely new viewing possibilities involving low frequency measurements. It is ideal for displaying and recording transient waveforms for medical, electrical, vibration, dynamic testing and pulse testing applications.

The digital storage capability provides a non-flickering, full trace at low frequencies and a unique "Dot Joining" technique.

The OS-4000 will allow you to simultaneously view stored and real time signals. These may even be superimposed to reveal small changes.

The OS-4000 also allows you to examine a single event trace prior to, as well as after, a trigger point; and it's stored indefinitely as long as power is supplied to the unit.

If you'd like a hard copy of a stored trace, you can record it in either analog or digital form on your recorder by using the Gould 4001 Output Unit.

Find out how the unique Gould OS-4000 Digital Storage Oscilloscope and the companion 4001 Output Unit can make your work more efficient and easier. Call your nearest Gould Sales Engineer for details. Or write Gould Inc., Instrument Systems Division, 3631 Perkins Avenue, Cleveland, Ohio 44114.

PHONE TOLL FREE FOR BROCHURE (800) 325-6400.
(In Missouri (800) 342-6600)

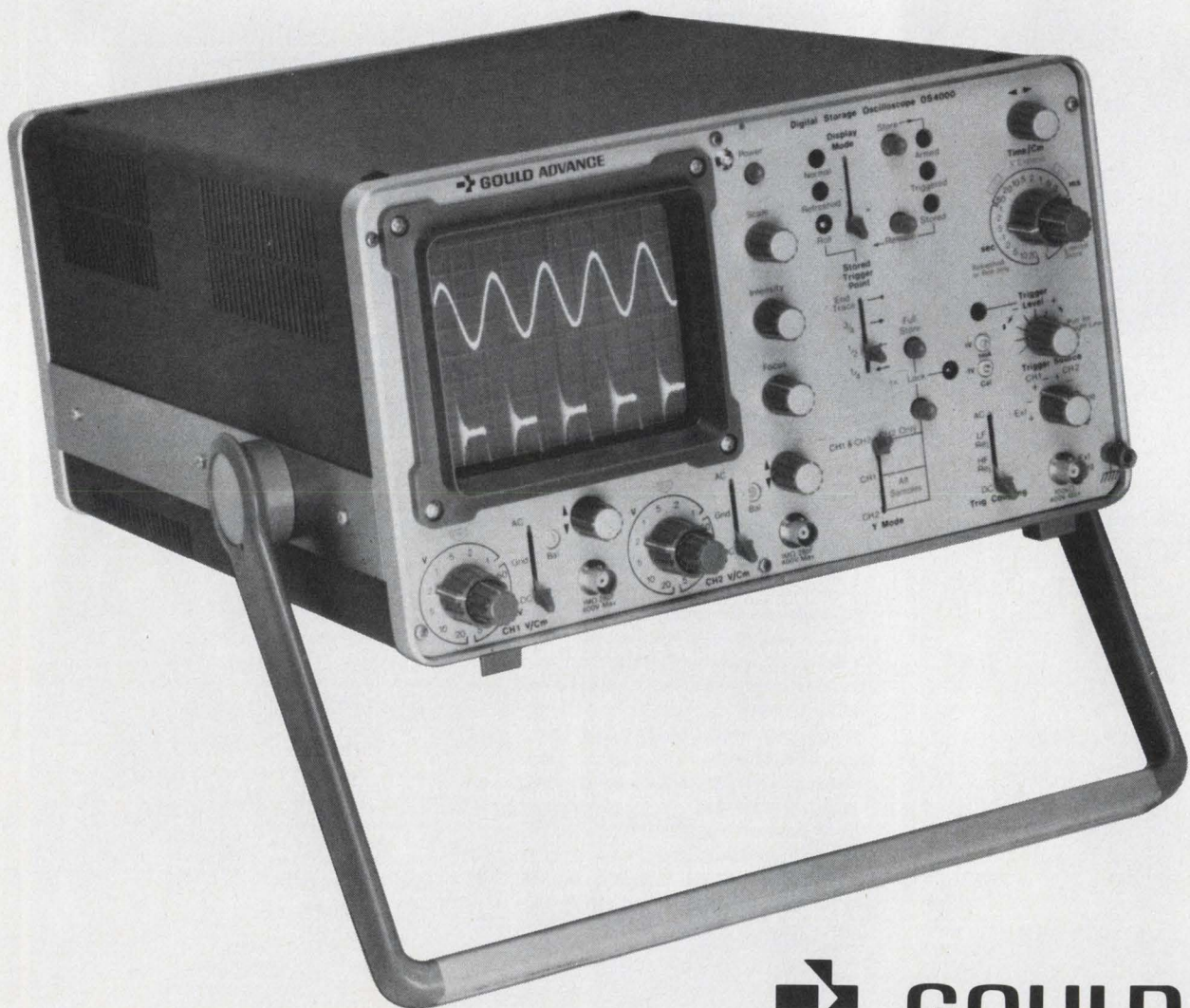

 **GOULD**
The product development company

CIRCLE NUMBER 11

ELECTRONIC DESIGN 17, August 16, 1976

Designed to do the dirty work.

Dust, dirt, moisture, fluids. These new Cutler-Hammer environmentally-sealed switches, designed for commercial application, seal out contaminants—and keep on working. Ideal for industrial, food processing and farm machinery, off-road equipment, recreational vehicles and any other demanding uses.

The unique unitized seal is molded silicone rubber. Bonded to both lever and bushing; it also provides complete base-to-frame seal. And specially molded-in terminals complete the total sealing of the switch.

Cutler-Hammer also offers sealed rocker-operated switches with similar advantages.

Available with standard bat lever toggle or "Designer Line" caps in many styles and colors.

All-in-all, you won't find better-sealed commercial switches—or better values. For handling the dirty work, call your Cutler-Hammer Sales Office.

 **Switch to No. 1**

CUTLER-HAMMER
SPECIALTY PRODUCTS DIVISION, Milwaukee, Wis. 53201



It's new It's flexible

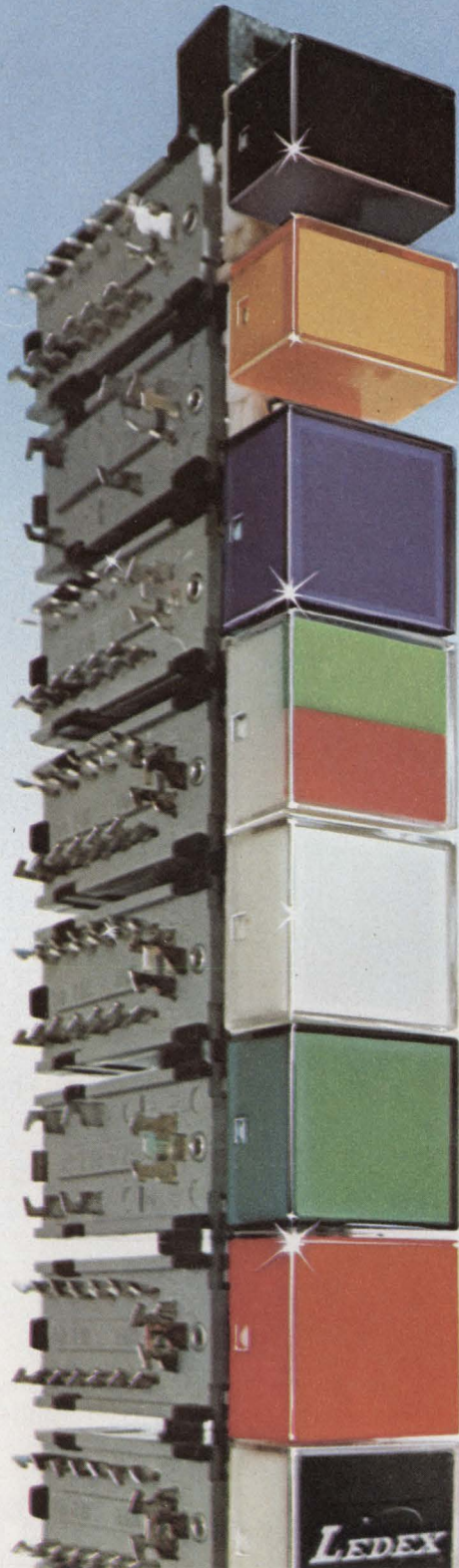

It could be the answer to your complex switching needs.

It's the Series 1800 from Ledex Inc. Mix both **high** and **low** current switch modules in one ganged assembly!

Wiping contacts in the low current modules keep the switching surfaces clean so they can handle from 10mA/5 volts to as much as 1A/60 volts.

Rugged bridging contacts, in the high current modules, let you switch from 10mA/20 volts to 6A/250 VAC.

There's circuit flexibility too! Select 2p2t or 4p2t circuits with self-cleaning contacts. Bridging contacts provide 2NO, 2NC or 1 NO + 1NC circuits.

Program up to 20 modules per assembly with interrelated switching action.

Momentary, push/push, interlock, reciprocal, master and reciprocal + master release functions are available.

For front panel flexibility, choose either unlighted, single or dual bulb illumination; square or rectangle caps with full or split lens. Horizontal or vertical mounting plus a wide range of legends and cap colors lets you design that "just right" look for your new product.

Ask for catalog B-5508 and see if the Series 1800 is the answer to **your** complex switching needs.

LEDEX INC.

123 Webster Street
Dayton, Ohio 45401
(513) 224-9891

License rights by RAFI of West Germany

CIRCLE NUMBER 13

ACROSS THE DESK

(continued from page 10)

change the feedback resistor of op-amp A_2 to yield the desired gain.

For example, if the feedback-resistor, R_f , is changed from 2 to 20 k Ω , the resulting gain of 10 allows using a 1-V range. Similarly, a gain of 25 allows use of a 2.5-V range.

Misplaced Caption Dept.



Don't ever take my scope again without telling me.

Sorry. That's Antonio Pollaiuolo's "Hercules and Antaeus," which hangs in the Uffizi in Florence.

Me an editor?

Maybe. If you would enjoy interviewing industry authorities and writing about the latest technological developments, you might enjoy being an editor. ELECTRONIC DESIGN needs one in Los Angeles. Interested? Call Dave Kaye at (213) 641-6544.

If you can't take western smog, try the smog in New Jersey. We have an opening at our home office in Rochelle Park, NJ. Call Mike Elphick at (201) 843-0550.

Introducing HP's \$335* DMM.

The right DMM Decision means added performance:

Hewlett-Packard's new 3435A 3½ digit, five function digital multimeter, with full one-year accuracy specifications, is the right decision for your general purpose bench or field needs because it has . . .

Autoranging and manual modes: AC voltage, DC voltage and resistance can be measured either on autorange or manually selected ranges. Select autorange to speed readings and minimize reading error . . . the LED readout always displays appropriate units. For repetitive readings, or AC and DC current measurements, use the manual mode, selecting from at least five ranges for each function . . . again the appropriate units will be automatically displayed.

Wide AC bandwidth, low-range ohmmeter: Eliminate the need for both a high frequency AC voltmeter and a low-range ohmmeter. The 3435A operates over a bandwidth five times greater than most comparably priced DMM's . . . measure AC voltages from 30 Hz up to 100 kHz, with midband accuracy of 0.3% of reading plus three digits. Or, test resistance from a new low range of 20Ω up to 20MΩ. DC voltages up to 1200V are measured with a full-year best accuracy figure of 0.1% of reading plus one digit. AC and DC current ranges extend from 200 μA to 2A. All inputs are protected, polarity is automatically sensed and displayed, and autozero occurs before each reading.

Autoranging and manual modes,

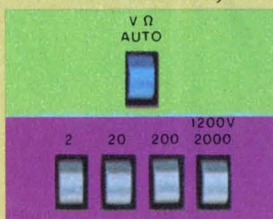

Wide measurement ranges,

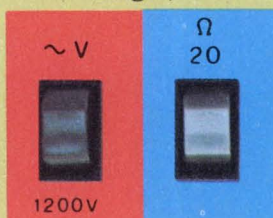

And touch-hold probe accessory.



Special application accessories: For accurate measurements in hard-to-reach spots, use the new 34112A touch-hold probe for only \$40.* You can concentrate on your circuit, conveniently hold the measurement and read the display after removing the probe. You're confident of measuring at the right point without accidentally shorting the circuit. The full line of 3435A accessories also includes probes for measuring AC voltage at frequencies as high as 700MHz and DC voltage up to 40 kV.

Low cost: The standard 3435A priced at \$400* is AC line or battery operated and includes batteries and recharging circuitry. If you don't need battery operation, option 001 gives you line operation only for just \$335.*

Functional design: Low power consumption means fully charged batteries last up to ten hours. And a four-hour charge prepares them for a full eight hours of portable operation. With the modern, rugged case and handle, the 3435A is perfectly suited to demanding field conditions. LSI technology and only three circuit chips mean less down time, greater reliability. A rack mounting model is also available. Of course, the 3435A is backed by HP's service organization. For more information, contact your local HP field sales engineer.

*Domestic U.S.A. price only.

**HP DVM's-
the right decision**

096/45

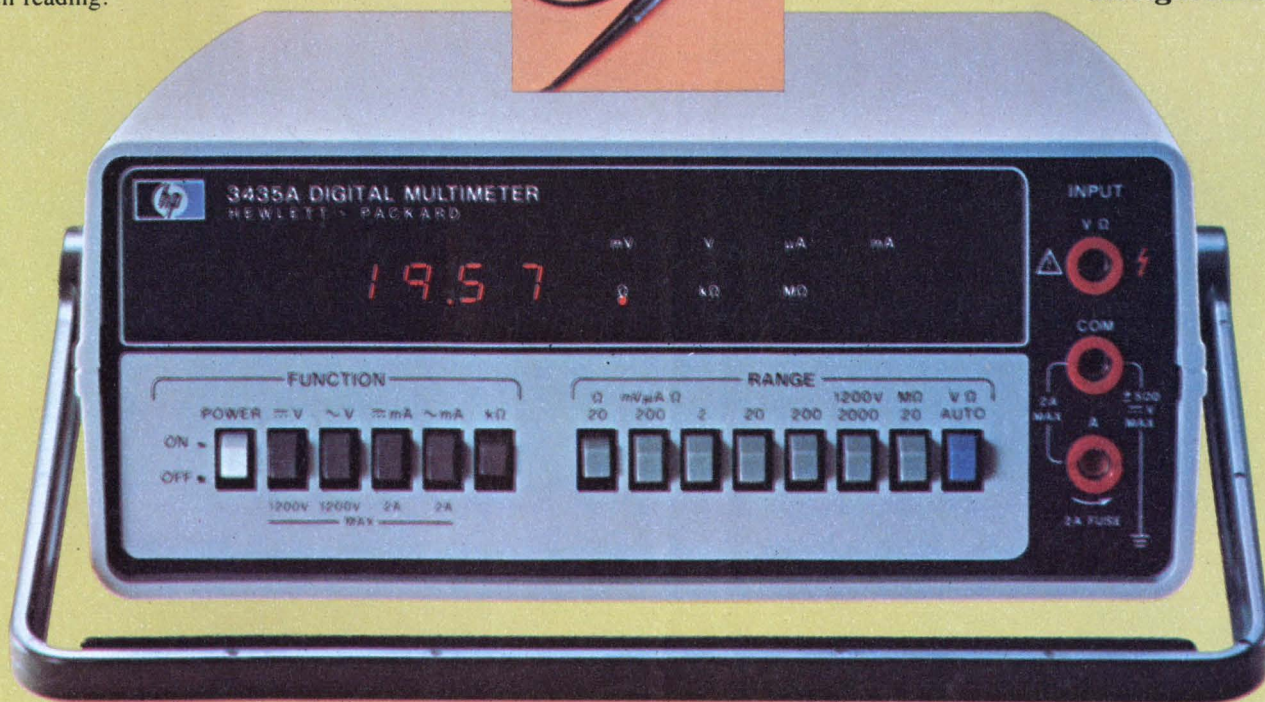

HEWLETT **hp** PACKARD

Sales and service from 172 offices in 65 countries.

1507 Page Mill Road, Palo Alto, California 94304
For assistance call Washington (301) 948-6370, Chicago (312) 677-0400,
Atlanta (404) 434-4000, Los Angeles (213) 877-1282, Toronto (416) 678-9430.

CIRCLE NUMBER 14

Ah, alone

at last.

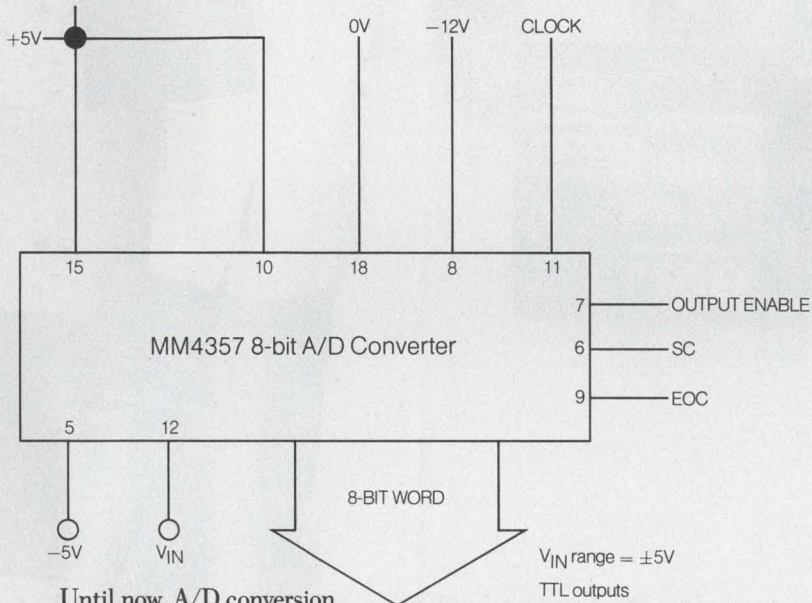

Until now, A/D conversion was a three-ring circus. An 8-bit D/A converter, an 8-bit successive approximation register, a comparator — it took all of them to turn analog into digital.

But now, for as little as \$7.95, you can substitute our 20-microsecond MM4357 8-bit A/D Converter for all that mishmash.

And for a 13¢ stamp and an envelope, you can mail the coupon for data sheets on the MM4357 and another item we're announcing. Our DA1200 12-bit D/A Converter, with internal reference and fast amplifier. As part of the deal, you also get details on our buffered and precision references, our panel meter chips and our 8-bit and 12-bit successive approximation registers.

So, we may be alone in fast single-component A/D conversion.

But back at National, that component has company.

National Semiconductor
 2900 Semiconductor Drive, Santa Clara, CA 95051

Gentlemen:
 Send me those data sheets. I'd hate to be alone in my field without them.

Name _____ Title _____

Company _____

Address _____

City _____ State _____ Zip _____

National Semiconductor 

Here's why REI can rent you what you want when you want it.



Our inventory. It's the biggest in the industry, with over 8,000 items of electronic test equipment in stock and ready to go. And it's getting better all the time, because we add more state-of-the-art equipment every month. This means we can deliver one special instrument... or a dozen... within hours of the time you place your order.

Now, more than ever, renting makes sense... to stretch your equipment budget, to fill temporary needs, and to avoid the long delivery lead times associated with purchasing. And renting from REI makes even more sense... because we're better equipped to fill your needs than any other rental company.

REI is backed by the tremendous resources of the PepsiCo organization, which gives us the financial strength to keep on hand whatever test equipment you may need. And renting from us helps *your* financial strength,

too. Since you pay only for the time you have your instruments, you'll never have to spend your money on idle equipment.

Send for our catalog today for a description of our rental, rental/purchase and leasing plans, and for our low rental prices. Or call the instant inventory center nearest you for immediate assistance.

Rental Electronics, Inc.,
99 Hartwell Avenue, Lexington, Mass. 02173.
Please send me your free instrument rental catalog:

Name _____ Title _____

Company _____

Address _____

City _____ State _____ Zip _____

Tel. Number _____

Rental Electronics, Inc.

A PEPSICO LEASING COMPANY

Burlington, MA (617) 273-2770 • Gaithersburg, MD (301) 948-0620 • Oakland, NJ (201) 337-3757 • Ft. Lauderdale, FL (305) 771-3500
Des Plaines, IL (312) 827-6670 • Dallas, TX (214) 661-8082 • Mountain View, CA (415) 968-8845 • Anaheim, CA (714) 879-0561
Rexdale, Ontario (PLC Leasing Ltd.) (416) 677-7513

SEE US AT WESCON/76 IN L.A., SEPTEMBER 14-17, BOOTH #493

CIRCLE NUMBER 16

AUGUST 16, 1976

Old and new techniques guided Viking to Mars

The guidance system that put the Viking Lander down so neatly on the surface of Mars has been in the works for seven and a half years, says Michael K. Mann, Subsystem Lead at Martin-Marietta's Lander Support Office in Denver, which had responsibility for the Lander's guidance package.

Proven techniques were used "whenever possible, but innovative approaches were also incorporated.

"The strapdown inertial system was not a common approach when we began to put the system together," Mann recalls. "And it worked well." The inertial system was supplied by the Hamilton Standard Div. of United Aircraft.

The Terminal Descent Landing Radar, built by Teledyne-Ryan, also used a novel approach, and it too has been a success. The unit is a four-beam Doppler system that measures the rate of descent. The transmitter is an Impatt diode oscillator that supplies dc to 13.3 GHz output. The output of each radar transmitter is 150 mW. "This device is considerably lighter than other transmitters that we considered at the time," Mann says.

The altimeter radar, also built by Teledyne-Ryan, "is certainly one of a kind," he adds. Its operational range is from 435,000 feet down to 135 feet. "And although the reading beyond 435,000 feet is ambiguous the altimeter accurately detected and measured the Martian surface at 800,000 feet. Due to the system's known ambiguity at such distances, however, the navigator did not accept the information."

The altimeter transmitter, which operates at 1 GHz, works in four modes. "We actually switched antennas between the first and second mode," Mann says. The first mode—when the lander is decelerating in the atmosphere—uses a



The Viking Lander's 10-lb uhf radio is used for high data rate traffic from the surface to the Orbiter, where it is converted to S band.

phased-array antenna that is built into an aeroshell, which is a 70-degree cone covered with an ablative material to protect the Lander from the heat during entry. The aeroshell was ejected at about 19,000 feet and the antenna went with it. Then the system switched to another antenna, on the bottom of the Lander, which was an inverted disc cone, and used it down to the 135-foot point.

The radar altimeter had two "electronic countermeasures-like" problems to cope with, Mann explains. It had to distinguish between the ground and two pieces of discarded hardware—the aeroshell and the back of the lander, which was ejected later with a parachute. The problem was solved with special logic in the software, Mann says.

The guidance computer, built by Honeywell Aerospace, is similar to one still functioning in NASA's ATS satellite. It uses a 2-mil plated-wire 18-k memory—"a technique

that evolved during the development of the Viking," says James Doubek, Honeywell's technical director of the Viking Lander's computer and storage memory.

The only plated-wire memories used prior to this were 5-mil wire memories that went into the ATS and the Minuteman ICBM.

"One thing we're proud of," Mann says, "is that the guidance worked without ever having an integrated flight test. We had wanted to flight test all the components together but due to time and money restraints, we weren't able to. The design was verified by computer simulation."

High-speed FFT chip set under development

Fast Fourier Transform (FFT) analyzers that sell for several thousand dollars may soon have some stiff competition from an FFT chip set under development at TRW.

The ICs, being produced under contract for the Air Force, can perform a multiplication and three addition operations on a 12-bit parallel word—in only 240 ns. When used to perform a Fourier Transform, the set can complete the task on 1024 points in only 2.5 ms. More sample points or higher speed can be achieved by cascading devices and adding a larger external memory.

The three chips in the set are fabricated with a triple-diffusion process that permits very-large-scale integration, according to James Buie, an engineer working on the project at TRW's Redondo Beach, CA facility. The main IC of the set is the signal-processing arithmetic unit (SPAU), which contains 15,000 devices on a 350 by 310-mil chip—the equivalent of roughly 3000 gates.

The SPAU replaces about 55 conventional TTL/MSI ICs, Buie says. Among other things, the architecture of the SPAU provides for register transfers, parallel multiplication and simultaneous addition.

The second chip in the set is the signal-processing address-control chip (SPAC). This device controls accessing of the memory that stores the FFT data points. It also

controls the accessing of SIN and COS look-up-table ROMs.

SPAC chips may be cascaded to extend the total number of FFT sample points that can be handled. One SPAC can provide 32 points, two will accommodate 1024 points, and with three SPACs up to 32,768 points may be sampled.

The final chip in the set is called a signal-processing delay line or SPDL for short. It is basically a shift register composed of 60 D-type flip-flops plus input/output control circuitry. The SPDL can accept digital words that are 12-bits wide and 5 bits long and is used to make data available to the processor when they are needed.

In addition to being used as a Fast Fourier Transform analyzer, the SPAU can also be used to filter and digitize all types of complex signals, Buie reports. Specific frequency components of a given signal can be filtered with greater speed and accuracy by FFT techniques than with other filtering methods.

The chip is not yet available, but should be on the market by the first quarter of next year, Buie notes. And although there is no firm pricing available yet, Buie estimates that the 3-chip set will probably sell for about \$300. Considering that the 55 military-grade MSI devices the SPAU alone replaces cost about \$750, that's a bargain.

Another benefit of the new FFT chip set is a significant savings in the cost of assembly. Much smaller PC boards—with a five-to-one reduction in the total number of interconnections—can be used.

Ocean seismic device smaller, uses less power

A new underwater seismic detection system designed with MOS and CMOS circuitry uses less than one-fifth the power required for earlier tape-loop systems.

Also, the combined battery volume and weight have been cut to 1/25th by the use of lithium batteries placed inside a small pressure hull along with the electronics, instead of being placed outside the hull in a large and costly pressure housing.

The new submersible earthquake-

sensing device, developed by MIT researchers, uses CMOS analog and digital circuitry for amplification and control along with the MOS memory, which replaces the continuously running tape loop normally used.

The system can remain on the bottom for up to 30 days, providing eight hours of seismic-event recording on a 9-track tape recorder. Digital timing circuits release the system after 30 days, and on-board flotation spheres lift to the surface the pressure-hull cylinder with its circuitry, tape recorder and batteries.

The tape recorder is turned on only to record a peak of seismic activity, but to avoid missing critical data occurring before the peak the input signals are digitized and passed on to thirty 1-k MOS registers that are operated at a low voltage to reduce current drain. These registers replace the tape loop of earlier systems.

The 30 registers provide 18 seconds of signal delay from the seismic-sensor inputs.

Solar cells power carts at nation's summer fete

Sun-powered vehicles are on display this summer in Washington, DC, and may be enjoyed along with the traditional customs and activities of the Festival of American Life, where they will be in operation.

The two vehicles resemble golf carts and belong to the National Park Service. One is fitted with a vacuum cleaner powered by a 1.6 hp motor, and is used to scoop up paper and trash at the festival site. In between morning and afternoon use it is plugged into a solar-cell array for recharging.

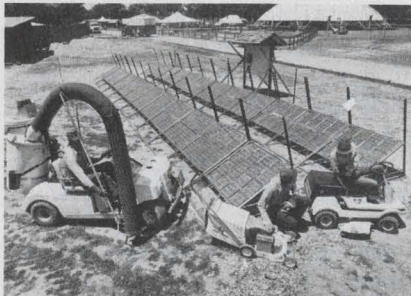

Sun-powered trash collector and go-cart are recharged from 24-panel solar array.

The second vehicle is a cart used by Park Service personnel for transportation around the grounds. During idle periods it, too, is connected to the charging panels.

Both are equipped with six standard 36-V batteries that are recharged by a 24-panel array of silicon photovoltaic cells. The panels, mounted on aluminum stands, can be tilted to obtain maximum array output.

The 24 panels contain a total of 3456 3-in. diameter solar cells, with an active area of 176 ft².

The modules in the Washington experiment were produced by Solarex Corp., Rockville, MD, for an average cost of about \$21 per peak-watt output.

Microwave oven contains a calculator chip

The latest application for calculator chips is in the kitchen—in Litton's new microwave oven. Dubbed the Memorymatic Model 420, the new oven uses a Mostek calculator chip—the MK50285N—to make possible two programmable cooking cycles.

The chip acts as a countdown timer and allows the user to program the oven to operate for two different periods of time at two different power levels, according to Verle Blaha, vice president of engineering at Litton's Microwave Cooking Products Div. in Minneapolis, MN.

For example, a user can program the oven to defrost frozen food for a certain period of time and then automatically switch to a cooking operation. The amount of time a particular operation is programmed for is displayed on a four-digit LED display.

The oven has ten different buttons to control the amount of power used for cooking. The maximum power available is 650 W, and the buttons are preset at 10% intervals. However, it is possible to obtain intermediate values of power by pushing two buttons in sequence.

For example, pressing 5 would give 50% power while pressing 5 and then 6 would give 56% of the maximum power. Power is controlled by a triac triggered by a digital signal.

We saw your microprocessor

coming. So we designed an entire family of socket homes for it. Socket cards for card file mounting, and we've even got the card files. Socket boards for LSI mounting in frames, drawers, and racks,

and we've even got the frames, drawers, and racks. Our socket cards, the 3D Series, come with built-in test points, a ceramic monolithic bypass capacitor

at each socket, and solder tab connection to pins on LSI chips. Our socket boards, the 2D Series,

offer a good selection of socket complements, and are compatible with other boards for hybrid installations. We also offer automated wiring service. We're ready for you.

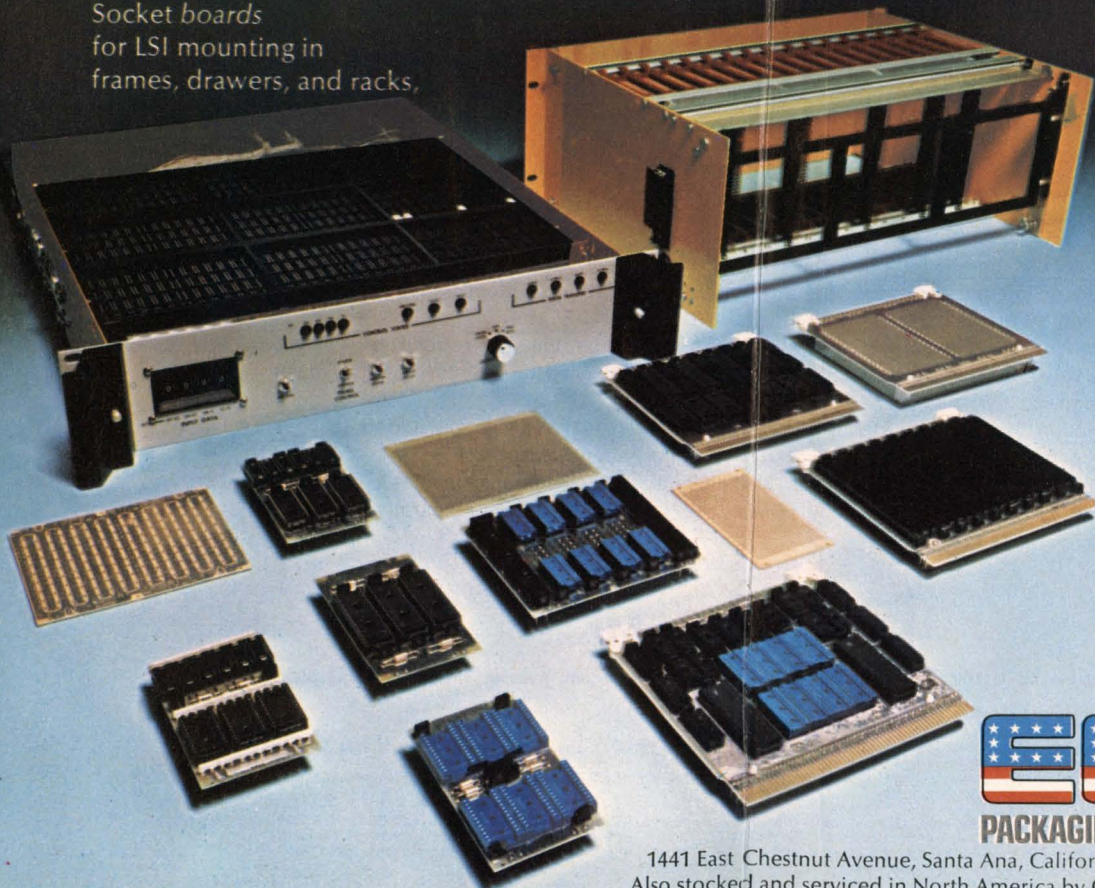

EECO

PACKAGING/SWITCHES/READERS

1441 East Chestnut Avenue, Santa Ana, California 92701 Phone 714/835-6000
Also stocked and serviced in North America by G. S. Marshall, R-A-E, Zentronics.

The 100 nsec static 4K RAM...

we've been producing and delivering them for 6 months

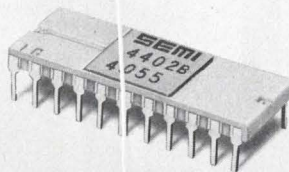

100 nsec, access time. The SEMI 4402B is the fastest 4K RAM available today. Now you can build a 150 nsec. access memory system with 4K chip density, and minimum worry about soft bit errors.

Fully static. You can design systems without losing valuable time for refresh, or wasting board space with costly refresh circuitry. The simpler timing requirements mean an easy interface design.

Data protection. Brownout protection or battery backup features can be added to your memory, since the 4402B retains data at low voltage and power levels.

The SEMI 4402B, at 100 nsec. access and 300 nsec. cycle time is available now for immediate delivery. Contact your local EMM SEMI sales office, representative or distributor today.

EMM SEMI

A subsidiary of Electronic Memories & Magnetics Corp. • 3883 North 28th Avenue, Phoenix, Arizona 85017
(602) 263-0202

EMM OFFICES: WESTERN REGION, Regional Office, San Francisco (408) 247-9711, Los Angeles Area (213) 644-9881, Orange County Area (714) 639-5811; EASTERN REGION, Regional Office, Boston (617) 861-9650, Chicago Area (312) 297-7090, New York Area (516) 423-5800, Cleveland Area (216) 842-8920; INTERNATIONAL OFFICES, European Headquarters, United Kingdom (01) 751-1213, West Germany (089) 714.30.40.

REPRESENTATIVES: Gentry Associates, Orlando (305) 894-4401, Huntsville (205) 534-9771, Burlington, N.C. (919) 227-3639. In Canada: Cantec, Toronto (416) 457-4455, Montreal (514) 620-3121, Ottawa (613) 225-0363. In Sweden: Svensk Teleindustri, QB-890435. In Great Britain/Ireland, MEMAC Whitchurch (029 664) 366/7/8. In Netherlands/Belgium, Famatra, Benelux 076-133457. In Norway, Henaco A/S (02) 15 75 50. In Japan, Nissho Electronics (03) 544-8396.

CIRCLE NUMBER 18

7 IMPORTANT REASONS FOR MOSTEK'S NEW TONE DIALERS.

They're all standard features in MOSTEK's new DTMF tone generating CMOS circuits. High-performance characteristics of the MK 5085 and MK 5086 allow greater flexibility for integration into a broad range of communication applications, whether you're designing or re-designing. More functions are provided on-chip, resulting in fewer interface components, and obvious reduced system cost.

1 Utilizes low cost 3.58 MHz crystal. The MK 5085 uses the relatively inexpensive television color burst crystal (3.579545 MHz) as its reference. Because it's available in the compact HC-18 case both cost and space savings are possible.

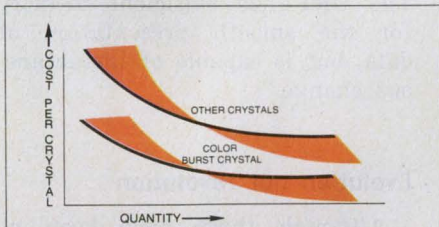

2 Direct-Line drive. The low impedance emitter follower output of the MK 5085/6 can directly drive a telephone line, or other low impedance loads down to 400 ohms.

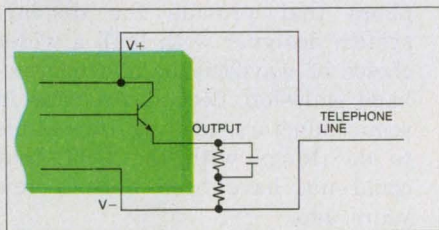

3 On-chip tone regulation. The MK 5085/6 mixes and regulates both high and low group tones on chip. This means less interface circuitry for the user and an output tone level virtually independent of supply voltage. Therefore, supply need not be regulated.

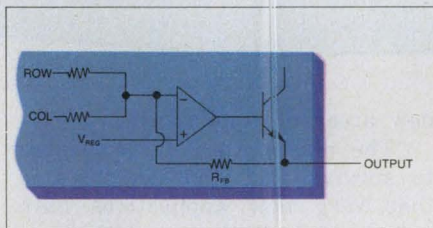

4 No external filtering. The low distortion digitally synthesized sine wave of the MK 5085/6 meets U.S. telephone standards with no external wave form filtering. Other industry devices require filtering.

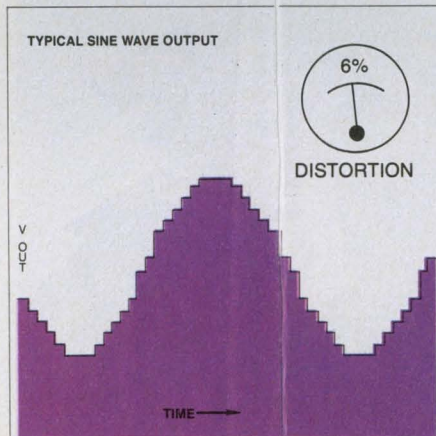

5 Two outputs rather than one. The MK5085/6 has two outputs that switch to opposite polarities when

a keyboard button is pushed. One output can source 40 mA, 10 times as much as the nearest industry rival.

6 Crystal oscillates only when activated. The 3.579545 MHz crystal reference only oscillates when tones are being generated, reducing power supply current and noise.

7 Keyboard may have high contact resistance. An input resistance of up to 1K ohm allows the use of low-cost contacts, a savings over tone dialers requiring low resistance gold or silver plated contacts.

Reason enough? Get in touch with your MOSTEK distributor. MOSTEK's MK5085 and MK5086 tone generators are available now in 16-pin plastic packages. See your MOSTEK distributor for complete device specifications or contact your MOSTEK representative.

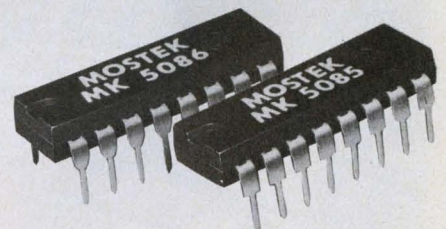

Visit MOSTEK — Exhibits 1087-1089
 Wescon/76 Silver Celebration
 September 14-17, 1976
 Los Angeles Convention Center

MOSTEK

1215 W. Crosby Rd., Carrollton, Texas 75006 214/242-0444
 In Europe, contact:
 MOSTEK GmbH, TALSTR. 172, 7024 Filderstadt-1, West Germany
 Telephone: (0711) 701096

CIRCLE NUMBER 19

Whether the input is analog or digital, in displays the CRT is still No.1

Despite the promise of such young technologies as LEDs, liquid crystals and gas-discharge cell arrays, the venerable cathode ray tube continues to survive and find

new areas of application.

"The reason the CRT continues to survive and find new uses is that very few applications have fully exploited the capabilities of this device," according to Jim Wurtz, senior applications engineer for Litton Industries, Electro-Optics Dept., San Carlos, CA.

Ralph Dobriner
Managing Editor

The CRT, he notes, provides a virtually inertialess point of light whose brightness can be controlled over a great range and which can be randomly placed anywhere in a two-dimensional plane.

"Neither the data source nor the order of information is important. The CRT has sufficient memory for the smooth presentation of data, but is capable of instantaneous change."

Evolution not revolution

Although there have been no dramatic breakthroughs in recent years, CRT technology continues to be marked by slow and steady improvements.

Two of the most significant trends in recent years are the advent of new and brighter phosphors that provide the display-system designer with both a wider choice of wavelengths and narrow-band emission. Second, progress in semiconductors, making it possible to do things with the CRT that could not have been done a few years ago.

Finally, new electron emission systems now under development may hold the key to longer cathode life, lower heater power and higher emission density.

Today, there are more than 50 different CRT phosphor screens registered with the JEDEC Tube



High-resolution, 5-in.-round, film-recording CRT (upper left) and line-scan fiber-optic CRT—both available from Litton's Electron Tube Div.—are shown amidst some of the imagery recorded with these tubes.

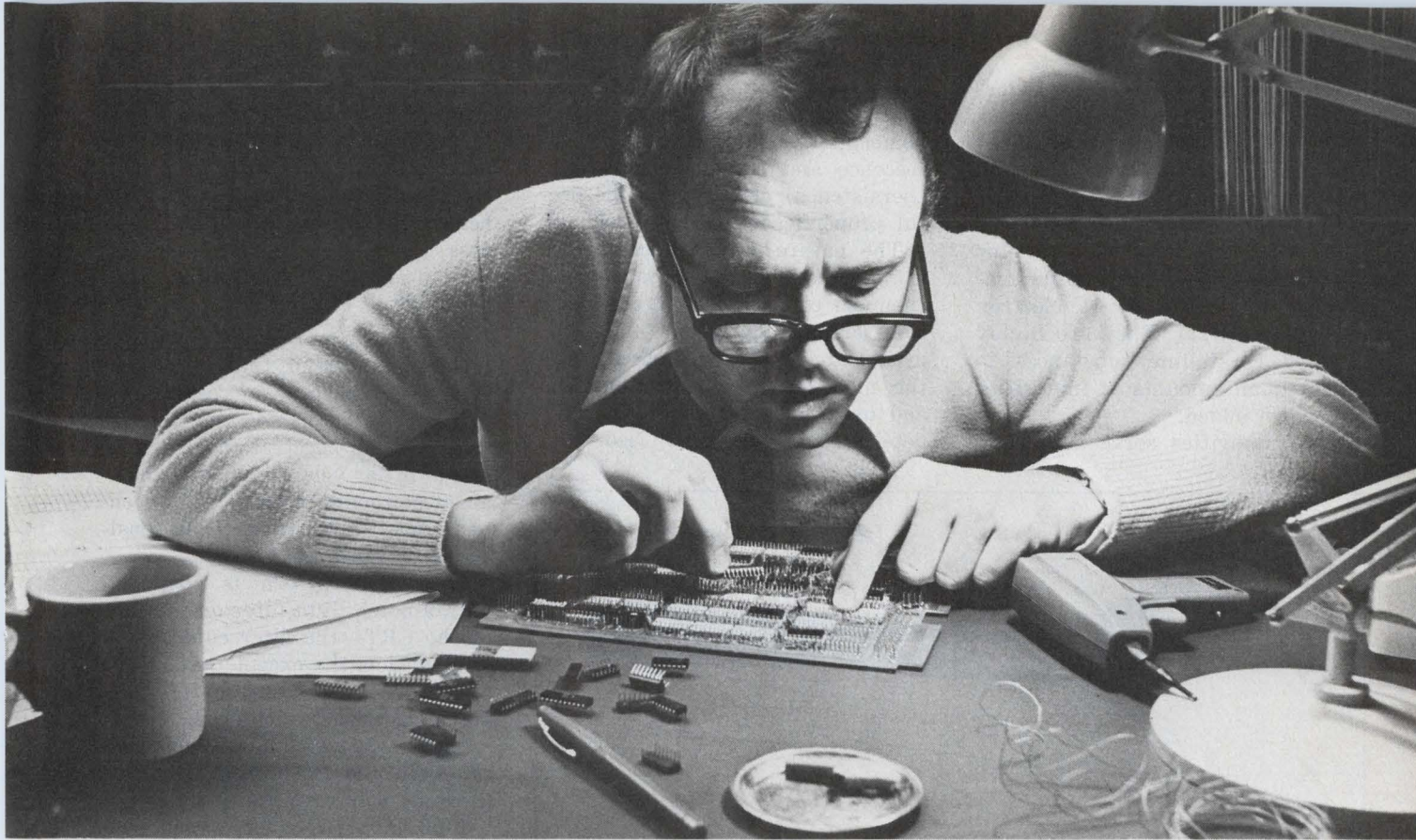

Buy our boards now if you want to stop buying them later.

If you're thinking of making your own micro-computer boards sometime in the future, ours are the only boards to buy right now.

Because the chips on our microNOVA boards are the same ones you can buy in the microNOVA chip set.

Which means you can switch from microNOVA boards to our microNOVA chips anytime you want.

The microNOVA board is a full 4K micro-computer. With a number of standard features. Like power-fail/auto-restart. Real-time clock. NOVA instruction set with hardware stack. Hardware multiply/divide. Data channel logic.

Yet all the above computer costs only \$589, in OEM quantities of 100*.

Which is a lot of computer for a little money.

Because it's a NOVA computer, the microNOVA board comes with powerful run-time software. Like

RTOS, our NOVA-compatible, field proven realtime executive. And it runs both Assembler and FORTRAN.

And because the microNOVA board comes from Data General, it comes with the manuals, technical publications, services, training courses and seminars you'd expect from a large minicomputer company.

Yet the microNOVA 4K board is only one member of an entire family. Besides the board (and all the supporting boards), you can get complete development systems. Or you can get completely packaged MOS minicomputers. Or chip sets that include the mN601 CPU, plus all the supporting chips.

So if you want to end up in the chips, call our toll free number, 800-225-9497. (Unless you're in Massachusetts. In which case, call 1-617-485-9100, EXT. 2509.)

microNOVA:

A giant reduction in the NOVA line.

DataGeneral

Data General, Route 9, Southboro, Mass. 01772 (617) 485-9100. Data General (Canada) Ltd., Ontario. Data General Europe, 15 Rue Le Sueur, Paris 75116, France. Data General Australia, Melbourne (03) 82-1361

*Prices quoted are FOB Southboro and apply to the U.S. Taxes excluded. NOVA is a registered trademark of Data General Corporation.

Council of the Electronic Industries Association. And, of course, there are unregistered specialized phosphors in use or under development by various CRT manufacturers.

By definition, phosphors for CRTs are inorganic crystalline materials that can convert electron energy into light. They are highly purified crystalline substances to which small amounts of impurities have been added.

The impurities serve as activa-

tors and, in combination with the host crystals, promote the phenomenon of luminescence. Fluorescence and the phosphorescence (persistence) characterize the useful properties of these phosphors.

The nature of the luminescence is affected by the physical and chemical properties of a phosphor, the screen application and tube processing techniques used, and the mode of tube operation. The end use requirements of the CRT determine the phosphor used.

Practically all of the money spent for phosphor research comes from the entertainment TV tube business. But, Wurtz points out, there's also a lot of fallout that has helped the rest of the CRT business.

Progress in phosphors

He cites in particular P-43 (see table), a phosphor that is getting wide use, especially in cockpit displays. P-43 is a line emitter, in that its peak spectral energy is located in a very narrow band—about 550 nanometers—that is centered fairly close to the peak sensitivity of the human eye.

If a P-43 screen is combined with a notch light filter on the face of the CRT—the filter cuts out all the wavelengths except that of the phosphor—a net gain in the display's contrast is achieved.

Two relatively new phosphors are P-50 and P-51. Both are used in multicolor displays.

P-50 is a two-color screen consisting of red and green phosphor components. With low-voltage operation (8 kV) the screen is red. At high-voltage operation (15 kV) the screen's color changes to green. Intermediate colors are obtained at voltages between these levels.

P-51 is similar, except that red is obtained with only 6-kV operation and green with 12 kV.

Engineers thinking of purchasing a CRT for a particular application are sometimes not aware of the essential specs or tradeoffs among the various phosphors.

First, the customer must decide whether he wants a white screen or green. If he decides on white, then there are several choices—either a couple of the traditional P-4 phosphors or the newer P-45 material.

P-4 really consists of two materials, one blue and one yellow. In fact, if you hold a microscope to the face of your black and white TV screen you'll see that it is composed of little blue and yellow flecks which add up to white.

On the other hand, P-45 is a single-constituent white material that is brighter than the P-4 phosphor.

If the customer decides on a green display, he could use P-1, P-43 or P-31. Jim Wurtz, of Litton, explains:

"Each of these has different

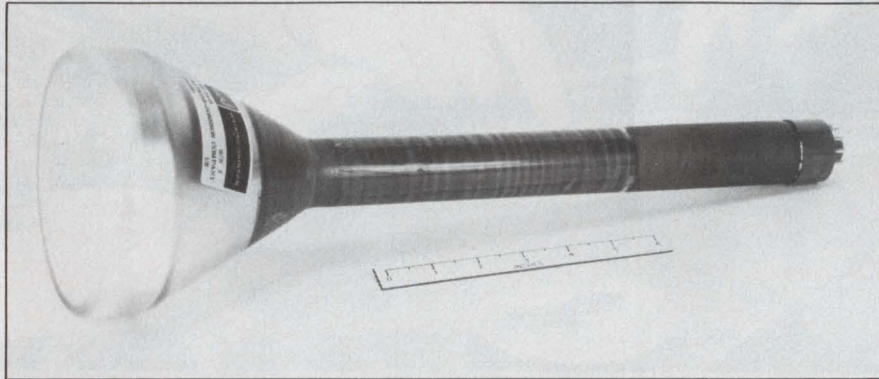

A contrast in display tubes: Above, Raytheon's 23-in. CRT used in air-traffic-control displays. Left, 5-in. projection CRT available from Watkins-Johnson, Palo Alto, CA.

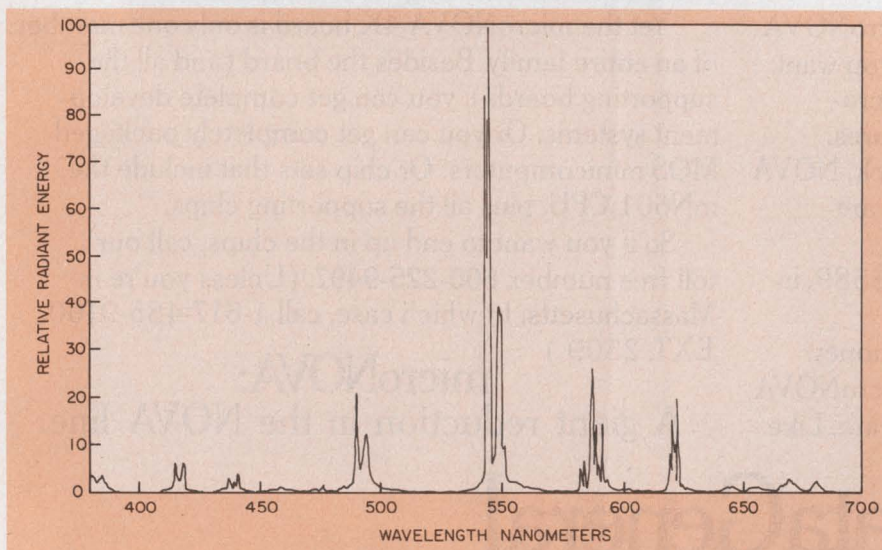

Peak spectral energy of phosphor type P-43 is located in a very narrow band centered close to the peak sensitivity of the human eye.

THE SWITCHING SUPPLY HAS TANTALIZED YOU LONG ENOUGH!

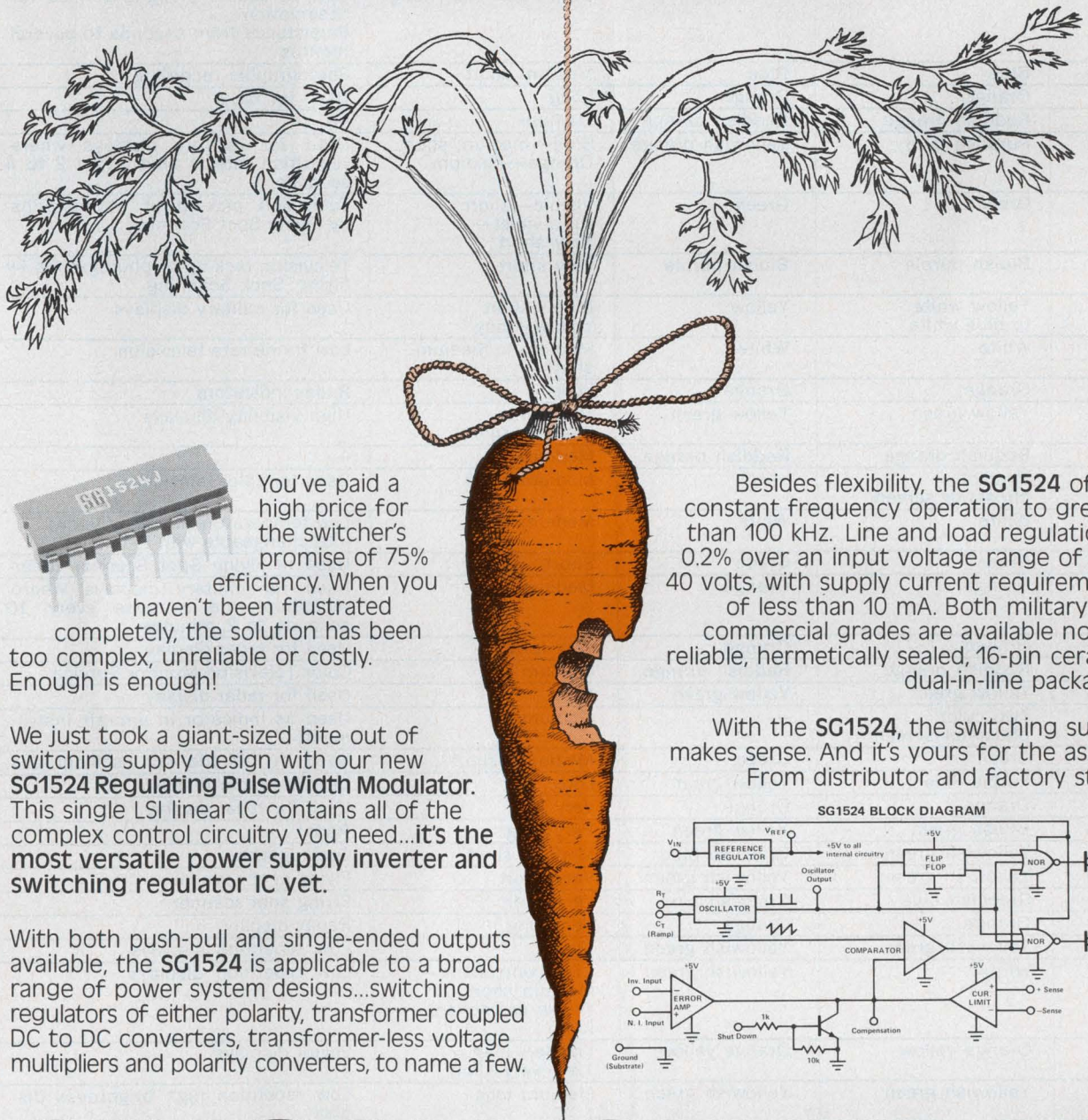

You've paid a high price for the switcher's promise of 75% efficiency. When you haven't been frustrated completely, the solution has been too complex, unreliable or costly. Enough is enough!

We just took a giant-sized bite out of switching supply design with our new **SG1524 Regulating Pulse Width Modulator**. This single LSI linear IC contains all of the complex control circuitry you need...it's the most versatile power supply inverter and switching regulator IC yet.

With both push-pull and single-ended outputs available, the **SG1524** is applicable to a broad range of power system designs...switching regulators of either polarity, transformer coupled DC to DC converters, transformer-less voltage multipliers and polarity converters, to name a few.

Besides flexibility, the **SG1524** offers constant frequency operation to greater than 100 kHz. Line and load regulation is 0.2% over an input voltage range of 8 to 40 volts, with supply current requirements of less than 10 mA. Both military and commercial grades are available now in reliable, hermetically sealed, 16-pin ceramic dual-in-line packages.

With the **SG1524**, the switching supply makes sense. And it's yours for the asking. From distributor and factory stock.

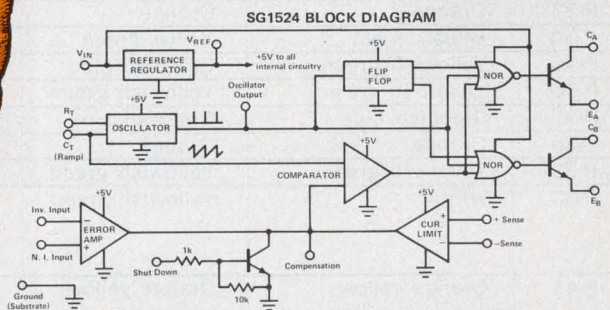

SILICON GENERAL

THE IC REGULATOR LEADER

7382 Bolsa Avenue · Westminster, CA 92683 · (714) 892-5531 TWX: 910-596-1804

CIRCLE NUMBER 21

Phosphor characteristics (Standard JEDEC registered phosphors)

E.I.A. Phosphor	Emission color fluorescence	Emission color phosphorescence	Persistence	Application
P-1	Yellowish green	Yellowish green	Medium	Used in cathode ray oscillograph and radar
P-2	Yellowish green	Yellowish green	Medium	Used in cathode ray oscillographs
P-3	Yellowish orange	Yellowish orange	Medium	—
P-4	White	White	Medium to medium short	Used in monochrome television picture tubes
P-5	Blue	Blue	Medium short	Photograph recording
P-6	White	White	Short	Obsolete—Originally used in television receivers
P-7	White	Yellowish green	Blue—medium short Yellowish green—long	Used for radar
P-8	Obsolete	Replaced by P-7	—	—
P-9	Obsolete	—	—	—
P-10	—	—	Dark trace—Very long	Outside source of light is used for observation Persistence from seconds to several months
P-11	Blue	Blue	Medium short	Photographic recording
P-12	Orange	Orange	Long	Used for radar
P-13	Reddish orange	Reddish orange	Medium	—
P-14	Purplish blue	Yellowish orange	Blue—medium short Orange—medium	Used for military displays where repetition rate is once every 2 to 4 seconds
P-15	Green	Green	Visible—short Ultra-violet— Very short	Television pick-up of photographs by Flying Spot Scanning
P-16	Bluish purple	Bluish purple	Very short	Television pick-up of photographs by Flying Spot Scanning
P-17	Yellow white to blue white	Yellow	Blue—short Yellow—long	Used for military displays
P-18	White	White	Medium to medium short	Low frame rate television
P-19	Orange	Orange	Long	Radar indicators
P-20	Yellow green	Yellow green	Medium to medium short	High visibility displays
P-21	Reddish orange	Reddish orange	Medium	—
P-22	Tricolor phosphor screen	—	Medium short	Used for color television
P-23	White	White	Medium short	Low temperature white—(Sepia) Interchangeable with P-4
P-24	Green	Green	Short	Used in Flying Spot Scanner tubes
P-25	Orange	Orange	Medium	Used for military displays where repetition rate is once every 10 seconds to 2 minutes
P-26	Orange	Orange	Very long	Used for radar display
P-27	Reddish orange	Reddish orange	Medium	Color Television Monitor Service
P-28	Yellow green	Yellow green	Long	Used for radar display
P-29	Two color phosphor screen	—	Medium	Used as indicator in aircraft instruments
P-31	Green	Green	Medium—short	Used in cathode ray oscillographs
P-32	Purple-Blue	Yellow green	Long	Used for radar display
P-33	Orange	Orange	Very long	Used for radar display
P-34	Bluish green	Yellow-green	Very long	Radar
P-35	Yellowish green	Greenish blue	Medium short	Oscillograph
P-36	Yellowish green	Yellowish green	Very short	Flying spot scanner
P-37	Greenish blue	Greenish blue	Very short	Flying spot scanner
P-38	Orange	Orange	Very long	Radar display
P-39	Yellowish green	Yellowish green	Long	Low repetition displays
P-40	White	Yellowish green	Blue component— Medium short Yellow component— long	Low repetition displays
P-41	Orange yellow	Orange yellow	Visible—long UV—very short	Visual displays
P-42	Yellowish green	Yellowish green	Medium long	Low repetition high brightness display
P-43	Yellowish green	Yellowish green	Medium	Visual displays
P-44	Yellowish green	Yellowish green	Medium	Visual displays
P-45	White	White	Medium	For applications requiring high brightness
P-46	Yellowish green	Yellowish green	Very short	High efficiency for scanning and recording

(continued on page 32)

Announcing the 1740A... a new 100MHz scope with fresh measurement ideas.

In the time domain—Push the third channel trigger display button, release, and you have a simultaneous display of the trigger waveform *plus* channel A and B traces. Now you can make accurate timing measurements from the trigger signal to events on either or both channels.

A X5 vertical magnifier provides 1 mV/div sensitivity on both channels to 40 MHz, without cascading, so you can monitor low-level signals directly. Signals such as the output of read/write heads of disc or mag tape units, low-level ripple on power supplies, or medical sensor and electro-mechanical transducer outputs.

In the data domain—You can combine the 1740A with HP's 1607A Logic State Analyzer and use the analyzer's pattern trigger or delayed trigger output for external scope triggering. Add the "Gold Button" (an optional logic-state push-button in lieu of A versus B) for just \$128* and (with the 1607A) you have the convenience of logic-flow display or real-time display at the push of a button.

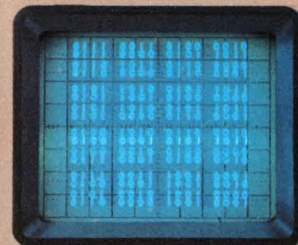

That means you can view the logic states of operational circuitry directly for pinpointing a program problem. Then—with a push of a button—take a look at the waveforms you've selected at that specific point in time.

Add to all this, features such as selectable input impedance (1 megohm or 50 ohms) and the time-tested 8 x 10 cm CRT used in our 180 System lab scopes for bright, easy-to-read displays. Priced at just \$2,095*, the 1740A with its new ideas, simplifies both

real-time and data-domain measurements. When you get your hands on this scope—you'll know you're working with a quality instrument. Give your local HP field engineer a call today.

*Domestic U.S.A. price only.

**Data/Time Domain
Oscilloscopes**

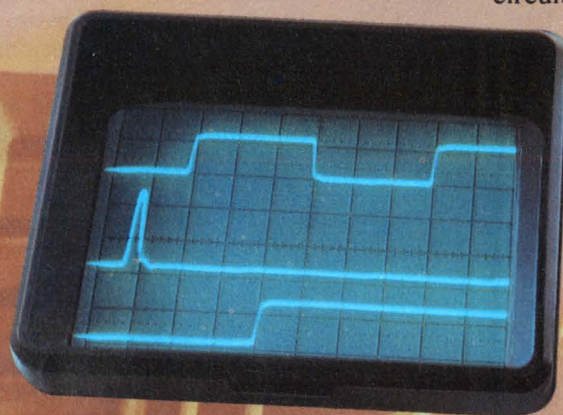

STATE
DSPL

TRIG
VIEW

HEWLETT  PACKARD

Sales and service from 172 offices in 65 countries.
1507 Page Mill Road, Palo Alto, California 94304

CIRCLE NUMBER 22

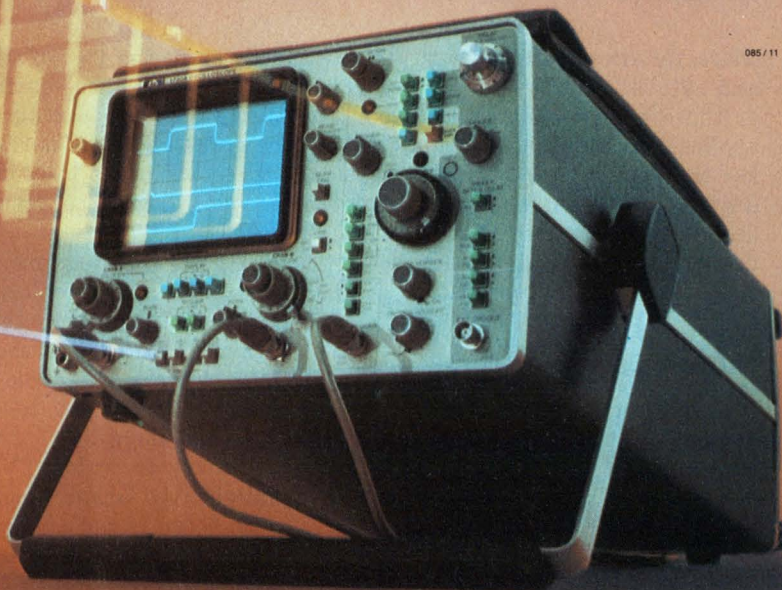

Phosphor characteristics *(continued)*

E.I.A. Phosphor	Emission color fluorescence	Emission color phosphorescence	Persistence	Application
P-47	Purplish blue	Purplish blue	Very short	High efficiency for scanning and recording
P-48	Yellowish green	Yellowish green	Very short	Flying spot scanners
P-49	Green, red	Green, red	Red—medium Green—medium	Graphics and alphanumeric displays
P-50	Two color screen Red at 8 kV; Yellow green at 15 kV	Red and Yellow green	Red—medium Green—medium short	Multicolor displays
P-51	Two-color screen Red at 6 kV; Green at 12 kV	Red and Yellow green	Red—medium Green—medium short	Multicolor displays

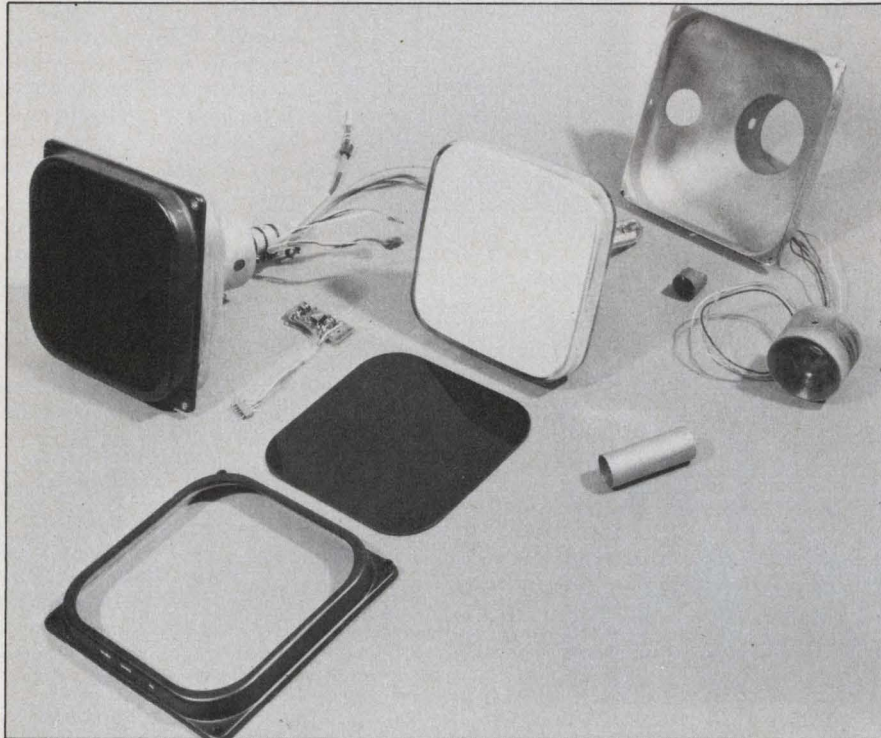

For displays subject to severe environmental conditions, the trend is toward integrated CRT assemblies in which the deflection yoke is prelocated on an electrostatic-focus CRT. Shown are the components and CRT for a ruggedized airborne display made by Raytheon's Industrial Components Operation, Quincy, MA.

characteristics. The decay time and saturation may vary one way or the other. For a simple display application the buyer could just ask the supplier for a bright green display. On the other hand, if he's designing a cockpit display with limited lighting conditions the decision is a lot more critical."

Improving the contrast ratio

A continuing effort is underway by tube manufacturers to increase the contrast ratio of the CRT image.

The outside surface of almost every CRT is glass, and glass typ-

ically reflects 4% of the energy that strikes each surface. Since energy has to pass through both the front and back surfaces of the CRT faceplate, the information transmitted can be reduced by as much as 8%.

In many applications that presents no major problem. For instance, in home TV, the room is normally dark and the contrast ratio between the room and CRT image is sufficient to provide a very good image.

But, try to watch TV in bright sunlight, the image washes out because there is not enough contrast to differentiate the projected im-

age from the background. In other words, the glare is so strong it makes the picture unreadable.

Although most people don't watch TV outdoors there are many applications where CRTs are viewed in direct sunlight or in conditions of very high ambient light.

What methods are tube manufacturers using to increase the contrast ratio of the image—besides increasing phosphor brightness that is?

The major method is to increase the contrast ratio of the CRT image by reducing the glare on the glass faceplate. Such efforts normally concentrate on the implosion panel required for most CRT applications.

The following are some of the ways to increase the contrast ratio of the implosion panel.

- **Acid etch.** The surface of the glass implosion panel is etched to diffuse the light. This is a cheap process and is typically used in low-cost, high-volume CRT applications.

- **Plastic.** Plastic panels are mechanically brushed or molded to diffuse light. They come in many colors, are also cheap, and are used in low-cost, high-volume applications.

- **Gray glass.** Again, it is low in cost, but offers limited CRT image improvement because of high front surface reflections.

- **Coating.** In this process the implosion panel is vacuum coated with an antireflection coating. It has a higher cost and much higher performance. Coated faceplates are widely used in military displays, air traffic control monitors, oscilloscopes and other critical display applications.

- **Laminating.** This process involves laminating (between sheets

TEAMWORK.

P&B pro teamwork keeps your control assembly costs down...simplifies 'make or buy' decisions.

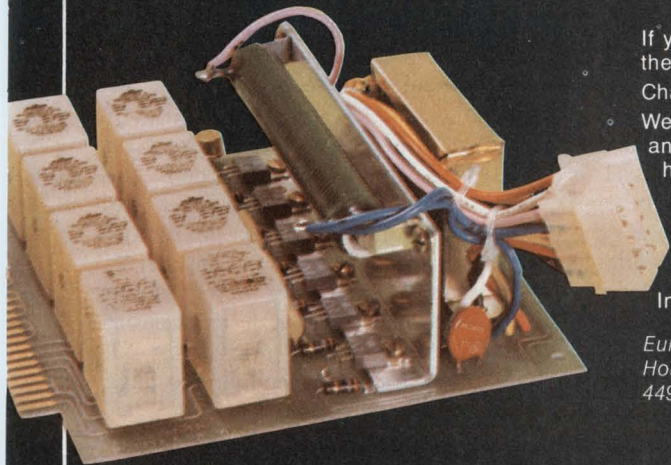
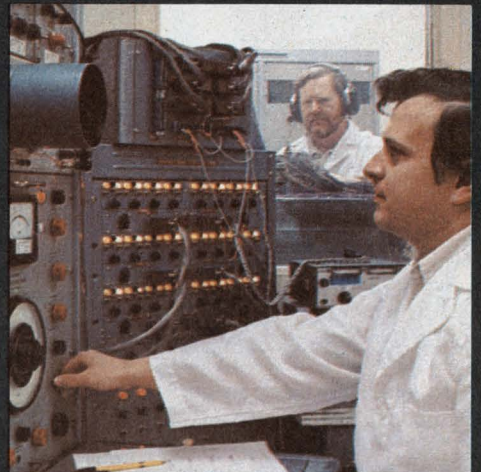
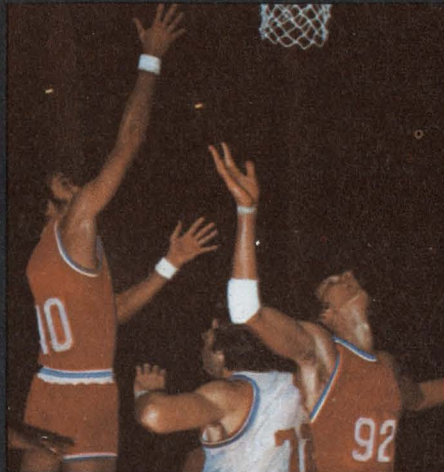

If your equipment requires a control assembly, compare a quote from us with the investment you'll make for in-house production.

Chances are, the bottom line will convince you to go with the P&B Pro Team. We're set up to do the complete job for you. Specialized production equipment and assembly tools. Test equipment. Skilled personnel. Floor space. Engineering help. All the major investments you won't have to make.

And we'll deliver your assemblies to your pre-determined schedule, 100% functionally tested.

For complete information on control assemblies, see your Potter & Brumfield sales representative or contact Potter & Brumfield Division AMF Inc., Princeton, Indiana 47671. Telephone: 812-385-5251

European address: Electrical Products Group, AMF International Limited, AMF House, Whitby Road, Bristol BS4 4AZ, England. Telephone: (0272) 778383. Telex: 449481, AMMAFOCO, BRISTL.

Go with the Pros and you can't go wrong.



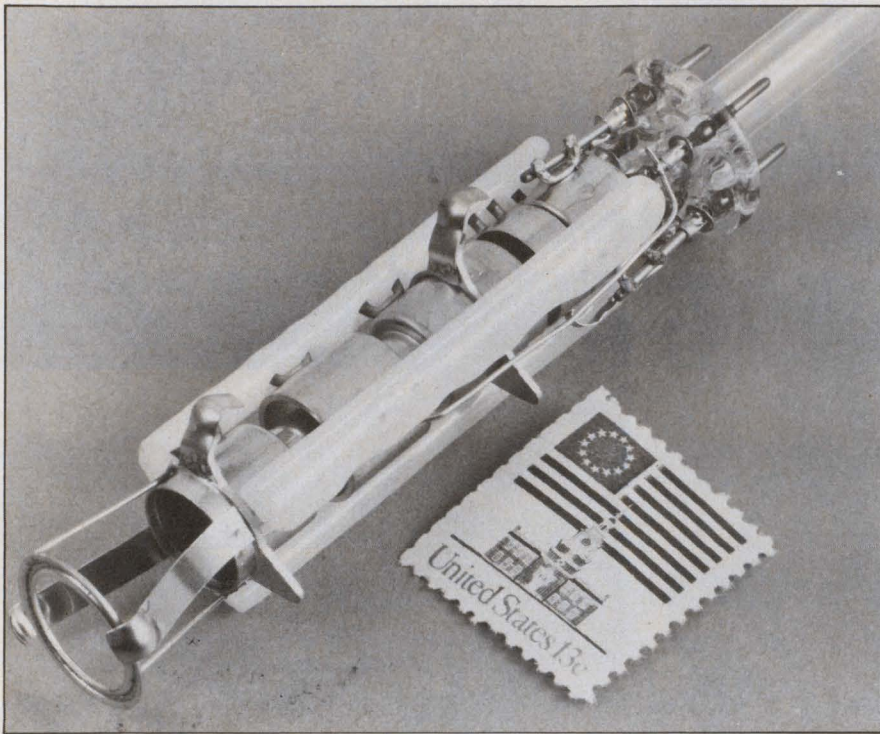

Ruggedized electron gun for CRT 22-mm neck is made by Raytheon.

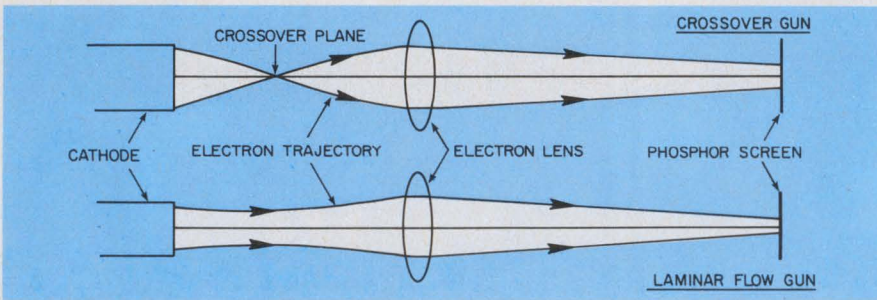

1. The differences between the Watkins-Johnson laminar-flow electron gun and the traditional crossover gun is apparent in the diagram.

of glass or plastic) a colored plastic film or polarizing film. Frequently, the plastic sheets are covered with an antireflection coating to reduce the front surface reflections. This method is more expensive than the etching or gray glass approach, but is said to provide the best CRT images.

Mike Larro of Optical Coating Laboratory, Santa Rosa, CA believes that the best CRT image can be obtained by designing a bright phosphor and then enhancing the contrast with vacuum-deposited thin-film coatings.

The company has developed, what it calls, a High Efficiency Antireflection (HEA) coating that "has gained wide acceptance for customers with critical light-sensitive CRT applications." HEA, says Larro, can be applied to either

glass or plastic substrates to reduce surface reflection by a factor of 10 to one.

A solid boost for CRTs

The impact of solid-state technology on CRTs is twofold. Because solid-state memories, microprocessors and information handling circuitry have become smaller, better and cheaper, the data to be displayed are available at higher rates. More important, the circuits and components for driving the tube itself have become smaller, faster, cheaper, more stable and more efficient.

Deflection amplifiers, high-voltage supplies, video drivers and shaping circuits have shrunk from vacuum tubes to discretes and then to ICs.

Solid-state memories and logic arrays, which enable the information to be arranged in optimum form, have had the greatest effect on CRT use.

For example, programmable read-only memories are now able to perform linearity correction in high precision displays.

If one tried to generate a perfect square on a magnetically deflected CRT it would tend to have a pin-cushion shape (with bulging, distorted sides) because of the geometric difference between the sine and tangent of the angle of deflection. In the past, pin-cushion or barrel correction was approached by placing permanent magnets around the neck of the tube. In fact, this is still done in low-resolution displays.

One of the problems with this approach is that magnets can inadvertently deflect the beam. As a result, this beam correction is now being done electronically rather than magnetically, by analog function modules available from such companies as Intronic, Newton, MA. It also can be done digitally, by means of PROMs, ROMs or microprocessors, where the desired mathematical functions are programmed into circuitry that automatically corrects for any distortions.

An example of one area of progress in drive circuitry is the cathode ray tube plotters now in operation that have sufficient accuracy and stability to generate circuit-board artwork, interconnect patterns for large-scale integrated circuits, and even diffusion masks.

Electron-gun design has not changed much over the years, although there have been many improvements in the precision of assembly and cathode materials.

Two important innovations in gun technology have been the laminar-flow gun pioneered by Watkins-Johnson a few years ago and the development of multiple-beam guns announced by Sylvania. Sylvania has since withdrawn from the industrial and military CRT business, but other companies have picked up its technology.

Currently the single-gun multi-beam CRT is being used for a multi-element infrared display that sweeps together up to 20 beams—each less than 25 microns in

Burr-Brown's New SDM 853.

10mV to 10V full scale

Now That's a

Data Acquisition System!

Instrumentation Amplifier
— gain-programmable, but
uncommitted. Up to 1000
gain, if you need it, for
low-level inputs.

Internal A/D converter—
throughput rate 30kHz
with full 12-bit resolution.

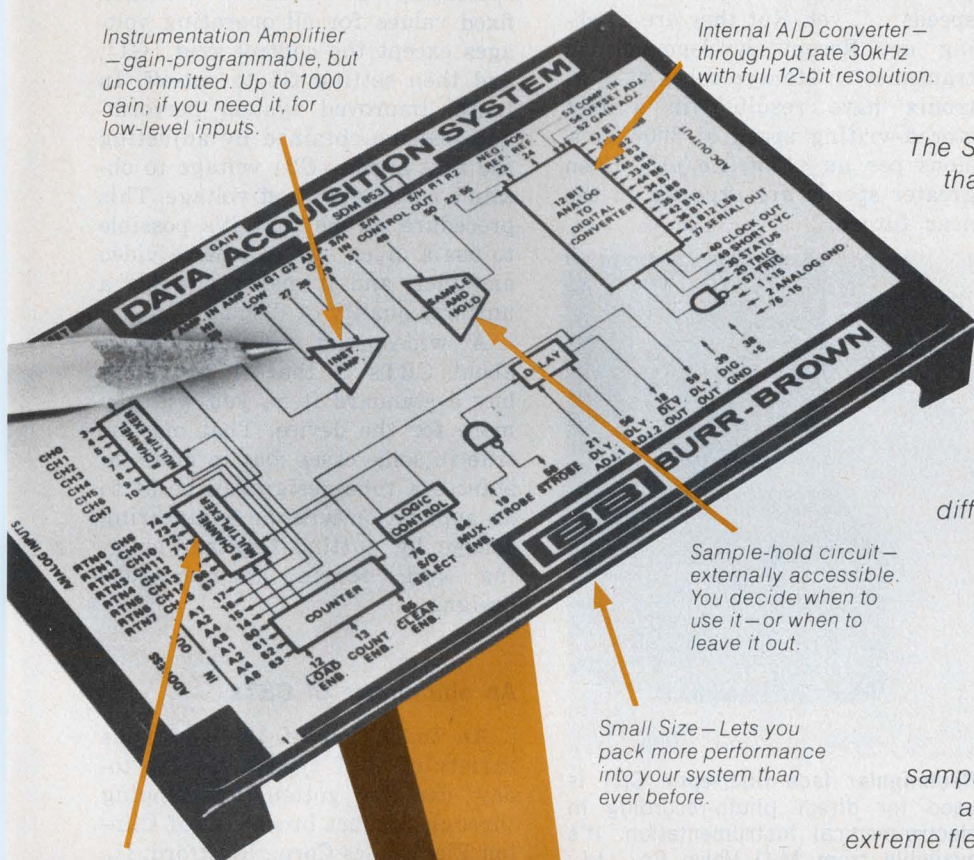

The SDM 853 gives you performance that was hard to come by in off-the-shelf systems—before now. And it's available in a smaller package, just 4.6" x 3.0" x 0.375", at a lower price than you would expect—only \$170 each in orders of 100 or more.

Analog multiplexer inputs can be connected in 16-channel, single-ended or 8-channel differential modes. A programmable unity-to-1000-gain

instrumentation amplifier gives you low-level signal handling capability that was not available before—down to 10mV full scale. Accuracy is 0.025% F.S.

Accuracy is 0.025% F.S.

Multiplexer, amplifier, sample/hold, and 12-bit A/D converter are separately accessible for extreme flexibility. Input channel expansion is unlimited. Throughput

rate for the system, 30kHz for 12-bit resolution, can be increased to 45kHz for 8-bit resolution:

The SDM 853 is a lot of system.

Find out more about it—
contact us today.

Burr-Brown, International
Airport Industrial Park,
Tucson, Arizona 85734.
Telephone (602) 294-1431.

Expandable Input
— up to 16 multi-
plexed channels
provided internally.
Externally ex-
pandable to any
size you need.

Sample-hold circuit—
externally accessible.
You decide when to
use it—or when to
leave it out.

Small Size—Lets you
pack more performance
into your system than
ever before.

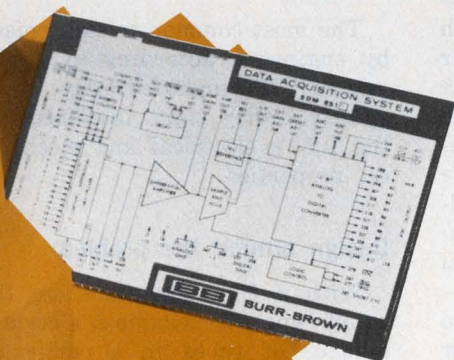
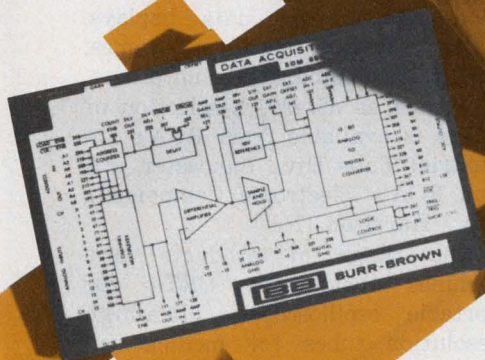

**Specialists in
Data Acquisition**

size and each individually modulated. Another use for this device is in high-speed alphanumeric character generation.

Fig. 1 shows the essential differences in electron-beam trajectory and electric-field lines between the Watkins-Johnson laminar-flow electron gun and the traditional cross-over gun.

The laminar-flow-gun CRT is said to have reduced grid drive requirements, increased resolution, increased brightness and reduced deflection focusing. The company says it has achieved spot sizes as small as 0.8 mil and brightness in excess of 20,000 foot-lamberts.

Focus on scope CRTs

So far the discussion has centered on CRTs for a broad range of display applications, from the simple low-end computer terminal to the more sophisticated airborne cockpit displays.

One area of application that has probably spurred more advances in CRT design than any other is the oscilloscope.

Although some CRTs made today are not much different from those contained in the first scopes nearly 40 years ago, the capabilities of some of the latest CRTs have actually outpaced the electronics used in scope design.

The leading scope manufacturers—firms like Tektronix and Hewlett-Packard—have placed such stringent requirements on their CRTs that they prefer to make their own. In selecting a CRT, the scope designer has to consider deflection factor, bandwidth, storage capability, reliability, display quality (which includes screen dimensions), trace brightness, spatial resolution and distortion.

Among these, the biggest spur to design innovation is the quest for higher bandwidths. In 1955, a 30-MHz laboratory scope was considered exceptional. Today, 350-MHz portables and 500-MHz lab units are in common use. Special models have been built that operate into the gigahertz range.

Although storage CRTs have been around a long time, tube performance is continuing to improve.

Tektronix oscilloscopes use three types of storage CRTs—the proprietary bi-stable phosphor storage

tube, a variable persistence tube (sometimes called halftone storage) and a new fast-transfer tube. The last device can also provide operating modes that are similar to the simpler bi-stable and variable-persistence types.

Storage writing speeds are not quite as fast as conventional CRT speeds . . . yet. But they are catching up. Recent developments in transmission storage tubes at Tektronix have resulted in a fast stored-writing speed of 3000 divisions per μs (1350 cm/ μs). Even greater speeds are expected in the near future.

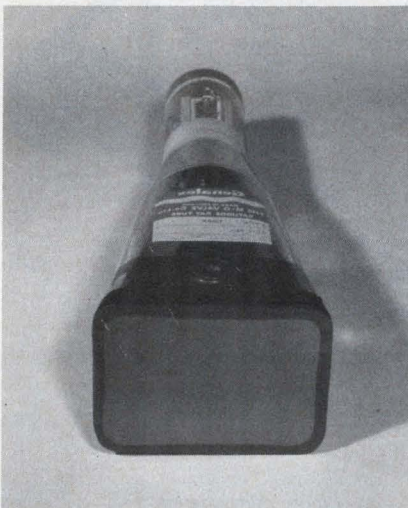

Rectangular face fiber-optic CRT is used for direct photo-recording in electro-medical instrumentation. It's available from M-O Valve Co. Ltd., London.

The most common mistake made by engineers, according to a survey of CRT manufacturers, is to specify overly tight tolerances on the tube's electrical and mechanical properties.

Design around the problem

With a tight tolerance, on the cutoff range, for example, a certain number of tubes in a particular production run will fall outside the range. And since it is not possible to get inside the vacuum envelope to make changes, the tube must be thrown away.

It is far more economical to design the circuitry to allow for a wide cutoff range to begin with.

In spite of advances in tooling, according to one manufacturer, it is still difficult to hold element spacings within the gun to tolerances that allow a narrow specifi-

cation of some of the operating voltages. Fortunately, this situation is easily allowed for in the drive circuitry without affecting the tube performance. The CRT envelope is obviously inviolable after it is made.

The traditional approach to specifying CRTs is to establish fixed values for all operating voltages except the control grid (G1), and then setting G1 to cut-off. In truth, improved system performance can be obtained by adjusting the first anode (G2) voltage to obtain a constant cut-off voltage. This procedure means that it's possible to use a much less expensive video amplifier, and it makes possible a uniform quality of display.

A widespread misconception about CRTs is that if you don't buy a standard item, you will pay more for the device. That may be true in some cases, but in most instances a tube design can be fit to an application with no engineering charge by putting together existing gun, screen and envelope designs.

An abundance of CRTs

An indication of the enormous variety of CRT types available today can be gotten by flipping through product brochures of Clinton Electronics Corp., Rockford, IL.

One of the largest manufacturers of magnetic deflection black and white CRTs, the company turns out some two-million picture tubes—varying in size from 5 in. to 23 in.—each year.

Clinton says it has developed 500 distinct tube types and over 200,000 variations to meet a variety of applications. These include alphanumeric data displays, video monitors, electronic games, projection photography and others.

Almost as diverse a selection of CRTs is available from RCA's Industrial Tube Div., Lancaster, PA and RCA's Electronic Components Div., Harrison, NJ.

The range of products here includes instrument CRTs for portable oscilloscopes, ultra-high resolution tubes for medical instrument applications, flying-spot scanner CRTs, and special-purpose display storage tubes for military uses such as airborne weather radar. ■■

if it's a meter or meter relay,

Simpson

Stock or Special . . .
Digital, Analog, AnaLed . . .

makes it.

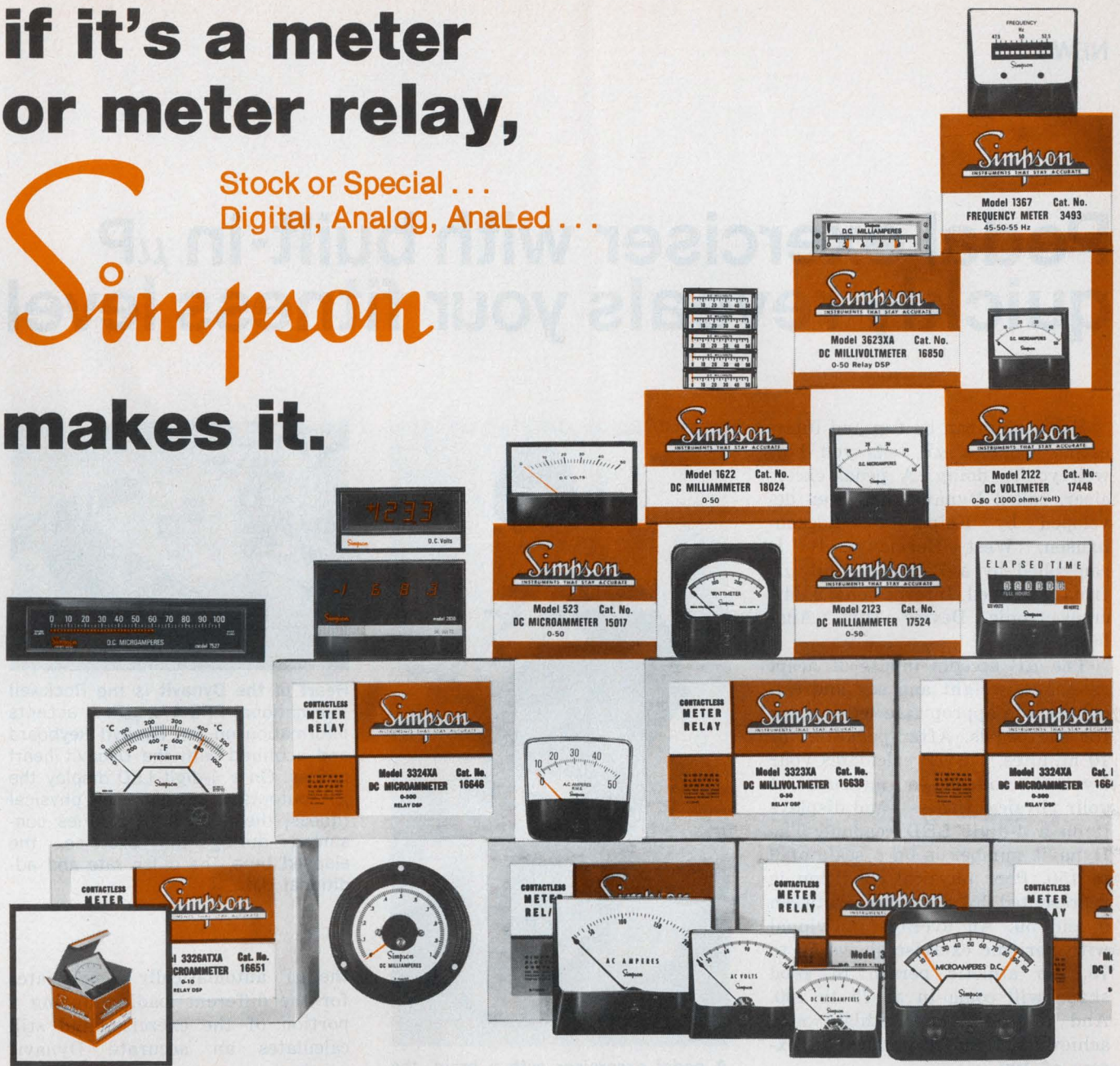

Stock:

Simpson distributors nationwide stock over 2,000 types, ranges, styles and sizes of panel meters, relays and controllers. They're all listed in our new Catalog. Write for your free copy.

Special:

Need a special or unusual meter? Let Simpson help you custom design it. Send us your specs and we'll send you a quote. But check our catalog first—that "special" may be a standard Simpson stock item.

Get off-the-shelf delivery from your local electronics and electrical equipment distributors.



SIMPSON ELECTRIC COMPANY
853 Dundee Avenue, Elgin, Illinois 60120
(312) 697-2260 • Cable: SIMELCO • Telex: 72-2416

IN CANADA: Bach-Simpson, Ltd., London, Ontario
IN ENGLAND: Bach-Simpson (U.K.) Limited, Wadebridge, Cornwall
IN INDIA: Ruttonsha-Simpson Private, Ltd., Vikhroli, Bombay

KATY INDUSTRIES



Ask your distributor about the new Simpson "Name These Digitals" contest.

CIRCLE NUMBER 25

Pedal exerciser with built-in μ P quickly reveals your fitness level

Exercising can be fun and interesting when a μ P tells you how well you're doing. A pedal exerciser, called Dynavit, has been developed by Keiper of Rockenhausen, West Germany. It is controlled by a PPS-4/2 4-bit μ P from Rockwell International's Microelectronic Device Div., Anaheim, CA.

The μ P accepts inputs of heart rate, age, weight and sex and calculates the appropriate leg loading for the pedals. After pedaling for 10 minutes, the μ P calculates your Dynavit number—a measure of your physical fitness—and displays it on a 4-digit LED readout. The Dynavit number is on a scale of 0 to 150. Poor physical condition is represented by a reading between 0 and 50. An average individual with periodic exercise shows 50 to 75. An athletic person in good shape will come in at 75 to 100. And a professional athlete may achieve a Dynavit number in excess of 100.

It displays your specs

In addition to displaying the Dynavit number, the LED readout can display your age, weight, sex, the elapsed time, the loading on the pedals (in pounds), your pulse rate and the number of calories consumed while exercising.

Weight, age and sex are punched in on the Dynavit keyboard. Heart rate is fed into the μ P with either of two sensors. The optional sensors are an electro-optical earlobe clip that senses the blood flowing through the capillaries in the earlobe, and a three probe set of sensors that attaches either on the arms or the chest.

Resident in ROM is an algorithm that calculates the heart rate

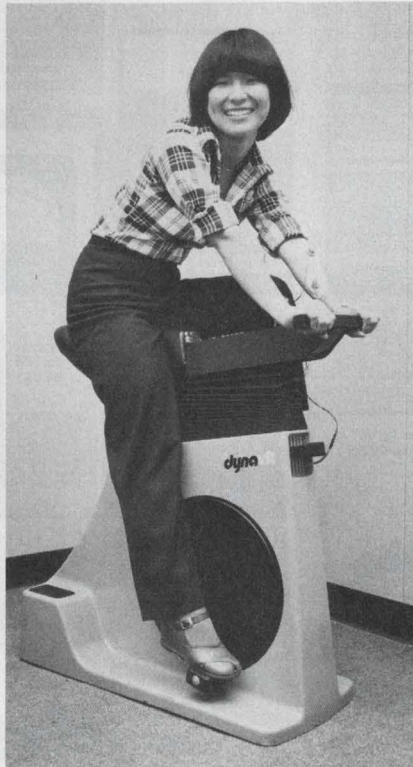

A pedal exerciser with a brain, the Dynavit has a μ P that monitors heart rate and combines it with age, weight and sex to provide the proper leg resistance on the pedals. After a 10-min. exercise, the μ P calculates a number and displays it. The number is a measure of physical fitness.

that is dangerous for the person on the Dynavit. The algorithm is based on age, weight, sex and initial heart rate. During normal operation, the Dynavit flashes a green LED at the rider.

If the rider's pulse rate slips into the danger zone, a red LED is flashed and the rider is thus warned to either stop or, by pushing a button on the console, to reduce the leg loading. If the option is taken to reduce the leg loading and complete the 10-min exercise,

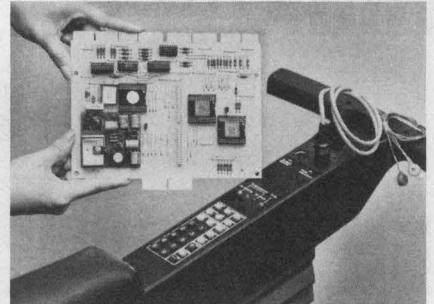

Heart of the Dynavit is the Rockwell International PPS-4/2 μ P. It accepts information on the Dynavit keyboard and acquired with the Dynavit heart probes. On a 4-digit LED display the μ P outputs a measure of physical fitness, the number of calories consumed during the exercise, the elapsed time, the pulse rate and additional data.

the μ P automatically compensates for the different loading during a portion of the exercise, and still calculates an accurate Dynavit number.

The PPS-4/2 μ P set in the Dynavit contains a CPU, an I/O chip, a 4-k \times 8 ROM and a 256 \times 4 RAM. A rechargeable battery allows the machine to start. The pedals operate an alternator that drives the electronics, recharges the battery and drives the resistive pedal load.

Although the current Dynavit sells for \$600 and is meant for home use, a hospital version currently under development will have a remote console and a minicomputer that can control from 20 to 50 exercise units, notes Robert Browning of Rockwell International.

At the moment, Dynavit can only be bought in Germany. However, within the next 6 months it is expected to be introduced in the United States. ■■



UNIVERSAL'S NEWEST MODEM

For two-wire, full-duplex operation at 1200 BPS, Universal Data Systems proudly announces the Model 12-12, the newest addition to the UDS family of data modems. The unit operates synchronously or asynchronously over unconditioned dial-up or private telephone lines.

Terminal interface discipline with the 12-12 is identical to that commonly used for 103/113 modems. Using experience-proved phase shift modulation techniques, the UDS-12-12 transmits at 1200 BPS or any integral sub-multiple rate, without restrapping or adjustments.

The 12-12 is insensitive to word length, and it includes integral provision for automatic remote and local loopback testing. Delivery: 45 days ARO. For technical details contact UDS today.

\$600 Single Unit Price.



universal data systems

member of
IDCMA

4900 Bradford Drive • Huntsville, Alabama 35805 • Telephone (205) 837-8100 • TWX 810-726-2100

Created by Hall & McKenzie Advertising, Winter Park, Florida

CIRCLE NUMBER 26

Solderless bus connector

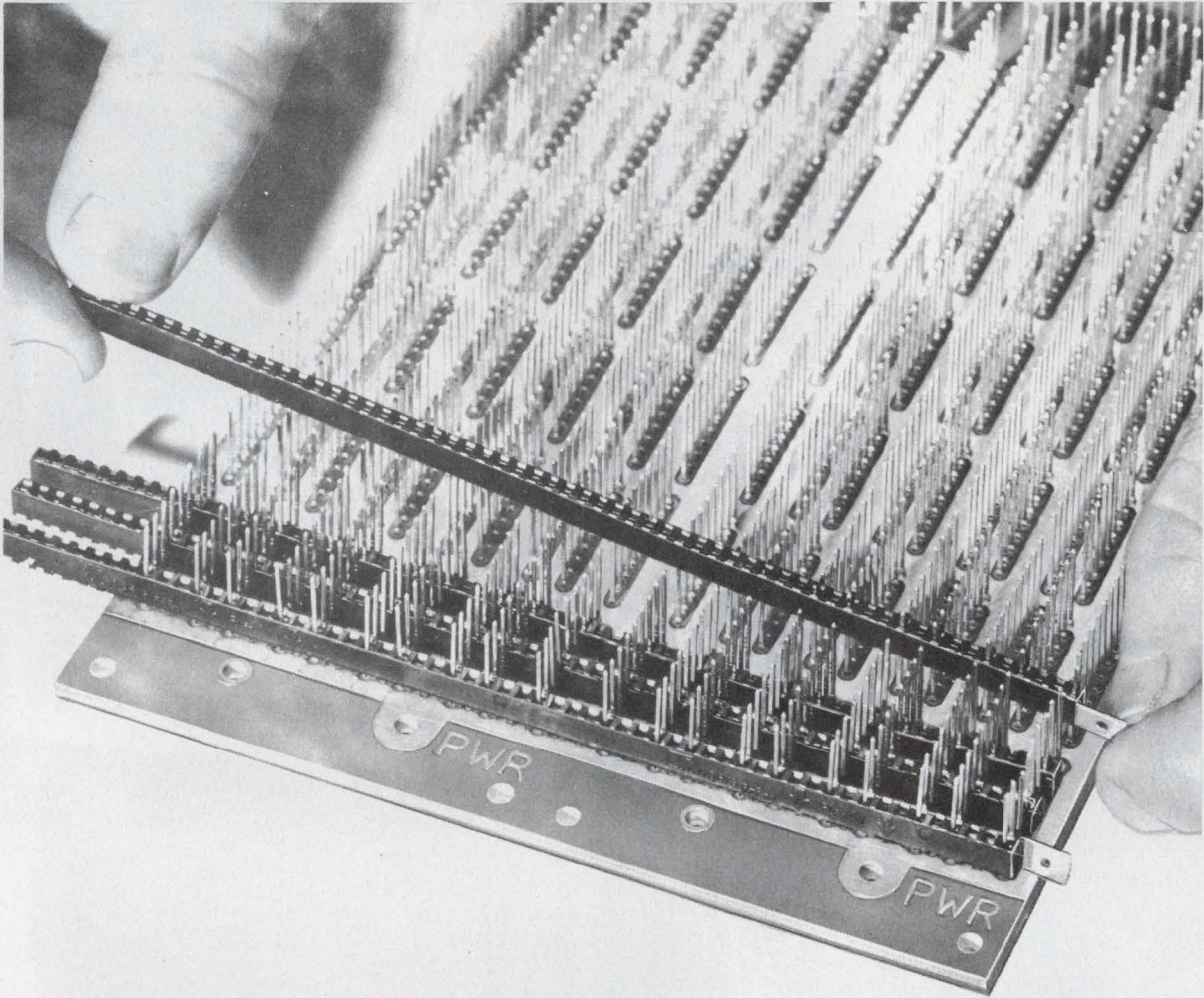

QUIK/STRIP

The new, fast, low cost method of connecting in-line pins on DIP socket boards and connector arrays.

- low installed cost*
- 18 gauge current capacity
- contacts fully insulated and protected in glass filled nylon housing
- extremely reliable — shock and vibration resistant
- can be used on pin densities as high as $.100'' \times .100''$
- two or more strips stacked for higher capacity

* Installed cost runs between 2.5¢ and 11¢ per connection.

For a free sample, write on company letterhead; for more information, contact product specialist.



Rogers Corporation Chandler, AZ 85224 Phone: (602) 963-4584
EUROPE: Mektron NV, Ghent, Belgium. JAPAN: Nippon Mektron, Tokyo.

CIRCLE NUMBER 27

Everything about these new AMP miniature UHF connectors is smaller.

Except their performance.



And that's where these new
plugs and jacks really shine.

In characteristics ranging from V.S.W.R. and
insulation resistance to cable retention and
vibration, you get top performance and then some.

At low cost.

AMP specifically designed these new UHF
miniatures to accommodate RG 58/U coaxial
cable. They handle frequencies to 2.5 GHz with
typical V.S.W.R. of 1.07 at 1 GHz and peak
voltages of 335 v. And they do it easily. Over an
operating temperature range of -55° to $+85^{\circ}\text{C}$.

Their threaded, fitted couplings prevent rocking
to assure stable, trouble-free interconnection.

With all of these outstanding performance features,
AMP UHF miniatures are ideal for applications
such as mobile radio, instrumentation, CB radio
and more. In fact, for practically any coaxial
cable application, you can count on AMP for the
right connection.

Call us and find out for yourself about AMP
UHF miniature connectors. Our Customer
Service number is (717) 564-0100. Or write
AMP Incorporated, Harrisburg, PA 17105.

AMP

INCORPORATED

CIRCLE NUMBER 28

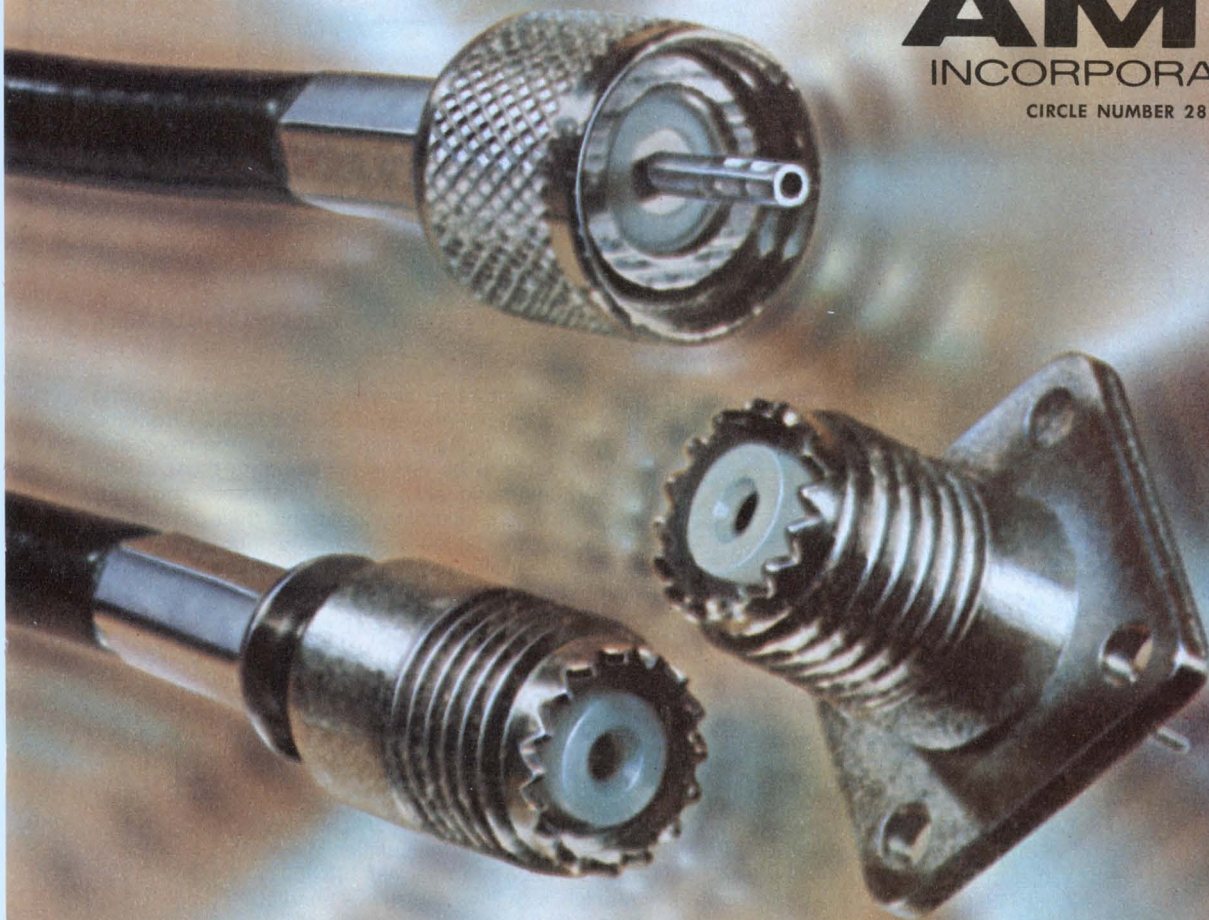

Electronic Design

in cooperation with ~

electronica 76

announces a special Oct. 25 preview issue of

**the World's Largest
Electronics Show — EVER!**



MUNICH
GERMANY. NOV. 25 — DEC. 1, 1976
20 EXHIBITION HALLS PACKED
WITH 1,600 EXHIBITS AND STANDS
FROM OVER 2,500 ELECTRONICS
FIRMS FROM 23 NATIONS.

This year's ELECTRONICA is going to be a stellar event. It's the "show of shows," largest in the world.

Our editors are already deeply involved to bring you a special preview of ELECTRONICA from the design engineer's point of view...the news and products to be unveiled (including those at the 7th International Congress on Microelectronics).

If you're planning to attend, take advantage of our special low-cost package tours to MUNICH — see right. If you're staying home, watch for ELECTRONICA 76 PREVIEW — October 25 in *Electronic Design*.

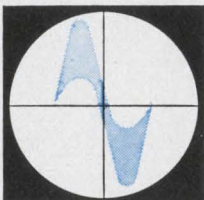

Note: Alert your Sales & Marketing People

October 25 can be your company's opportunity to *sell* at ELECTRONICA, in Europe, to the U.S. and the world! It's going to have the largest circulation in our history — 10,000 bonus distribution at Munich, 24,000 international, 103,500 in all. Tell them about the low cost tours to Munich, too. They can save a bundle!

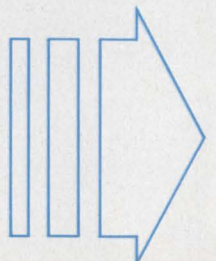

Electronic Design in cooperation with

electronica 76 announces 1976

Travel Tours to Munich

departing from New York, Boston or Chicago



A FULL WEEK OR TWO-WEEK STAY FOR ONLY SLIGHTLY MORE THAN REGULAR AIR FARE ALONE

8 DAYS/7 NIGHTS

Included: **Air travel**, economy class via Swissair regularly scheduled flights with complimentary meal service aloft.

Transfer by deluxe motor coach from airport to hotel, and return, including baggage handling.

First class hotel accommodations (double occupancy) at Eden Hotel Wolff — one of Munich's finest — within walking distance of the fair grounds; all rooms with bath, breakfast and service.

Champagne reception co-sponsored by *Electronic Design* and ELECTRONICA 76 management.

Admission to the ELECTRONICA Exhibition.

Tour accompanied by U.S. representative of the Munich Fair Authority.



14 DAYS/13 NIGHTS

Included: All features of shorter tour except accompaniment by U.S. rep. Half-day sightseeing tour of Munich.

All tours are predicated on 10 or more participants; air fares are subject to change. All participants must depart and return with the group to qualify for this low group airfare. Regular airfare for less than 14 days is \$748.00!

8-DAY PACKAGE

\$698⁰⁰

From N.Y.
or Boston

(\$819 from Chicago.)
Subject to change.

DEPART: NOV. 24, 1976
RETURN: DEC. 2, 1976

Rates based on double occupancy.
Single supplement: \$40.

14-DAY PACKAGE

\$938⁰⁰

From N.Y.
or Boston

(\$1059 from Chicago.)
Subject to change.

DEPART: NOV. 19, 1976
RETURN: DEC. 3, 1976

Rates based on double occupancy.
Single supplement: \$90.

RESERVE NOW DEPOSIT REQUIRED

\$100⁰⁰

Returnable before
October 1, if cancelled.

DEADLINE FOR FINAL
PAYMENT:

OCT. 30

(for both tours)

NAME _____

TITLE _____

COMPANY _____

ADDRESS _____

CITY, STATE, ZIP _____

PHONE _____ DEPART FROM: NEW YORK BOSTON CHICAGO

Specify ELECTRONIC DESIGN/ELECTRONICA 1976 TOUR TO MUNICH. Make checks payable to "Kallman Associates" (U.S. Electronica representatives). Tel: 201-653-3304. Mail to: Kallman Associates, 30 Journal Square, Jersey City, New Jersey 07306.

four important reasons to specify the KEPCO **PCX** power supply

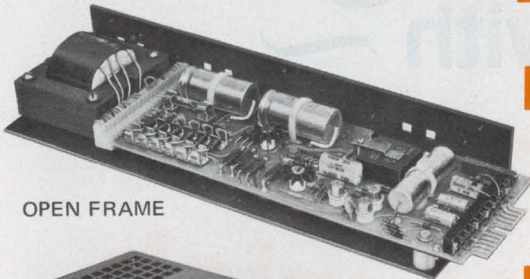

OPEN FRAME

1 FOR THE OEM, PCX are available as an open frame module with a massive heat sink that requires no other cold plate for non-derated operation to +71°C.



ENCASED MODULE

2 FOR THE ACCESSIBLE INSTALLATION, PCX are available with a perforated metal enclosure. In either the open frame or dust cover configurations, all input-output programming connections can be made via a printed circuit edge connector, or parallel barrier-strip.

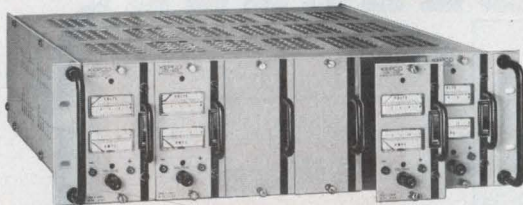

6-IN-A-RACK PLUG-IN

3 FOR THE SYSTEM DESIGNER, PCX are available in a convenient plug-in configuration. You can mount six instruments side-by-side in a 5¼" X 19" rack panel, configured either as remotely programmed modules or as metered instruments with 10-turn high resolution voltage controls and full metering.

BENCH INSTRUMENTS



SINGLE

DUAL

4 FOR THE LAB BENCH EXPERIMENTER, PCX can be configured as single, dual or triple output power supplies, each with separate, recessed dual-scale voltmeters and ammeters, plus 10-turn voltage controls.



TRIPLE

In any of these configurations, the Kepco PCX is a first-rate **high performance** voltage stabilizer offering better than 0.0005% immunity to source (mains) variations, less than 0.005% output change for a 100% load shift, and a real quiet output whose ripple and noise is under 0.1 mV rms (3 mV p-p measured 20 Hz–10 MHz). They're fully adjustable and programmable 0–7V, 0–15V, 0–21V, 0–40V, 0–72V and 0–100V. 6 models offering approximately 20 watts of honest power with no derating necessary up to +71°C.

PCX

is the multi-purpose voltage stabilizer that you can depend upon.

For complete specifications and Applications Notes, write Dept. FC-05

KEPCO®

KEPCO, INC. • 131-38 SANFORD AVENUE • FLUSHING, N.Y. 11352 U.S.A.
(212) 461-7000 • TWX #710-582-2631 • Cable: KEPCOPOWER NEWYORK

CIRCLE NUMBER 31

Washington Report

Navy tests new contractor-freedom policy

Firms bidding on government contracts will have more elbow room to suggest their own ideas—rather than remain tied to rigid specifications—if a policy being sponsored by the Office of Federal Procurement policy catches on.

The test case is the Navy's Shipboard Intermediate Range Combat System (SIRCS) in which industry could propose any technological approach—"even bows and arrows," quipped one program official—as long as it did the job. SIRCS is an integrated system of weapons and fire control planned for ships of 1000 tons and larger. It would be a self-defense system—probably including missiles, various guns, radars and computers, although the exact mix would be up to the winning contractor.

If the SIRCS experience demonstrates that contractors can produce better hardware—without driving up costs—by relying on their own innovation, the Pentagon would like to apply the approach to other military missions.

Sunspot effect on CB said not so bad as feared

The Commerce Dept.'s Office of Telecommunications has backed off from its earlier dire warnings that upcoming sunspot activity would jeopardize citizens-band radios transmitting at the assigned 27 MHz.

CBers became alarmed by the possibility that sunspots would render their radios useless. The FCC conceded that CB users depending on long-distance communications may be inconvenienced, but pointed out that FCC regulations prohibit using CB radio service for communications beyond 150 miles.

The issue centers on the relationship of sunspots to what is called skywave, or skip, interference, which occurs when radio waves reflected from the ionosphere "skip" several hundreds miles and interfere with local signals operating at the same frequency. Sunspot activity will be at its peak for the next three years.

LCDs: solution seeking a problem?

Both the Air Force and Navy are continuing their search for liquid crystal displays (LCDs) that can replace conventional cathode ray tube (CRT) displays in aircraft cockpits, but LCD technology has not progressed sufficiently to dislodge CRTs.

Although in-house Navy studies have indicated LCDs would cut weight, volume and power requirements to half those of CRTs, neither service has enough confidence to commit LCDs to operational aircraft. The two new fighters, the Air Force's F-16 and Navy's F-18, are using CRTs and so is the experimental Air Force flight-control system, the Digital Avionics Information System (DAIS).

Principal beneficiary of the search has been Hughes Aircraft Co., which developed a 5 by 7-in. LCD screen to display alphanumeric data for the Naval Air Development Center and a 2-in.-square LCD capable of generating a black and white TV picture for the Air Force Avionics Lab. Both of them have remained in the laboratory.

Now Hughes is trying again with a combination LCD-holographics lens that could be used in a head-up display (HUD). Under contract to the Avionics Lab, Hughes will deliver a brassboard unit in which holographic flight data will be displayed right in front of a pilot's eyes. The holographic lens uses a laser operating at a wavelength of 530 nm to generate green symbols. However, the lab is not sure whether it will proceed to flight tests.

Navy computer embroiled in controversy

The Navy's proposed new standard computer for future aircraft and missiles, the AN/AYK-14 (ED No. 14, Washington Report, July 5, 1976), is caught in a crossfire.

Two of the six finalists in the competition have dropped out and McDonnell Douglas, which would be the major user, is quietly trying to scuttle the program. Meanwhile, Congress is asking the Navy embarrassing questions about why it can't use an off-the-shelf computer instead.

H. Tyler Marcy, assistant secretary of the Navy for research and development—and a former IBM executive—defended the program on the grounds that the AYK-14 was needed to check the proliferation of airborne computers. Marcy also denied that the development competition was rigged for Univac, which benefited from the Navy's decision to require compatibility with the Univac AN/UYK-20 shipboard computer.

McDonnell Douglas has publicly complained that using a new computer would increase total costs of that program, and the House-Senate conference committee on the FY '77 defense authorization bill criticized the Navy plan to develop new systems where hardware already exists, and singled out the AYK-14 for special mention. The Navy was directed to study the possibility of procuring an off-the-shelf computer and report back its findings.

Marcy made it clear, however, that the Navy intends to proceed with the new computer.

Capital Capsules: The Environmental Protection Agency plans to develop a tunable diode laser spectroscope to measure gaseous sulfuric acid. The lasers will measure line strength of the vapor in the 870-895 and 1210 to 1240-cm spectral regions. . . . The Energy Research and Development Administration has begun operation of its 10 mW Argus laser at the Lawrence Livermore Laboratory of the University of California. The neodymium glass laser, used in gaseous plasma research, is the forerunner of the 25 GW Shiva laser due to be operational in 1978. Shiva will be built by joining Argus lasers into an array that may eventually consist of 32 individual 10 MW lasers. . . . The Coast Guard is ordering five more PPS-109 radars from AIL Div. of Cutler-Hammer for monitoring vessel traffic after two years of successful tests in San Francisco harbor. The new high-resolution, dual-channel radars will go into the harbors of Valdez, AK, Houston and Galveston, TX and New York.

The Great



SEND FOR THE NEW CELCO YOKE GUIDE
LISTING OVER 175 TYPES. SELECT THE
ONE YOKE FOR YOUR SPECIAL DISPLAY APPLICATION.

American YOKE Company

CONSTANTINE ENGINEERING LABORATORIES COMPANY
1150 E. Eighth Street, Upland, CA 91786

70 Constantine Drive, Mahwah, N J 07430



CIRCLE NUMBER 32

Who's the performance winner in 16k and 32k memory systems?

Check the specs.

Fabri-Tek has packed more speed and total performance into single-board 16K and 32K memory systems than anybody else in the business. Compare our 696 and 698 systems against the competition, and you'll see what we mean. We'll not only beat them in specifications — we're the only company that offers you total upward compatibility to 32K. At competitive prices, too. It's what you'd expect from a company with years of leadership in the memory business. Go with the winner — call us today for the best in both off-the-shelf and custom memory systems.

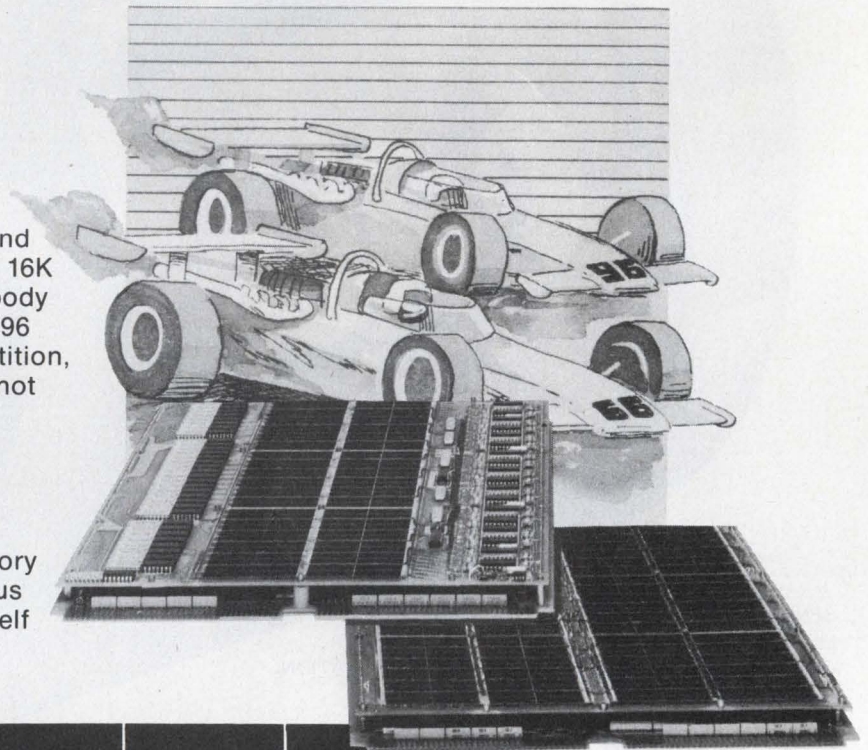

MODEL	FABRI-TEK		EMM		DATA PRODUCTS		DATARAM	
	696	698	Micro 3000 D.D.	Micro 3000 Q.D.	Store 1680		DR-103	DR-103
MEMORY SIZE	16K	32K	16K	32K	16K	32K	16K	32K
CYCLE TIME	650	650	650	850	650		650	750
ACCESS TIME	250	250	270	300	280		265	300
PHYSICAL SIZE	11.75x15.4 x1.0	11.75x15.4 x1.0	11.75x15.4 x1.0	11.75x15.4 x1.0	11.75x15.4 x1.0		11.5x13.7 x1.0	11.5x13.7 x1.0
COMPATIBILITY 16K TO 32K	YES		NO		NO		NO	



FABRI-TEK INC.
COMPUTER SYSTEMS

5901 South County Road 18 • Minneapolis, MN 55436 • (612) 935-8811

SALES OFFICES:

Boston
(617) 969-5077
Tom Fitzgerald

Chicago
(312) 437-4116
Bruce Richardson

Dallas
(214) 661-3155
Al Yarnell

Hawthorne, Calif.
(213) 973-0484
Wally Harrison
Don deVries

San Jose, Calif.
(408) 246-8391
John French

Minneapolis
(612) 935-8811
Jack Graham

CIRCLE NUMBER 33

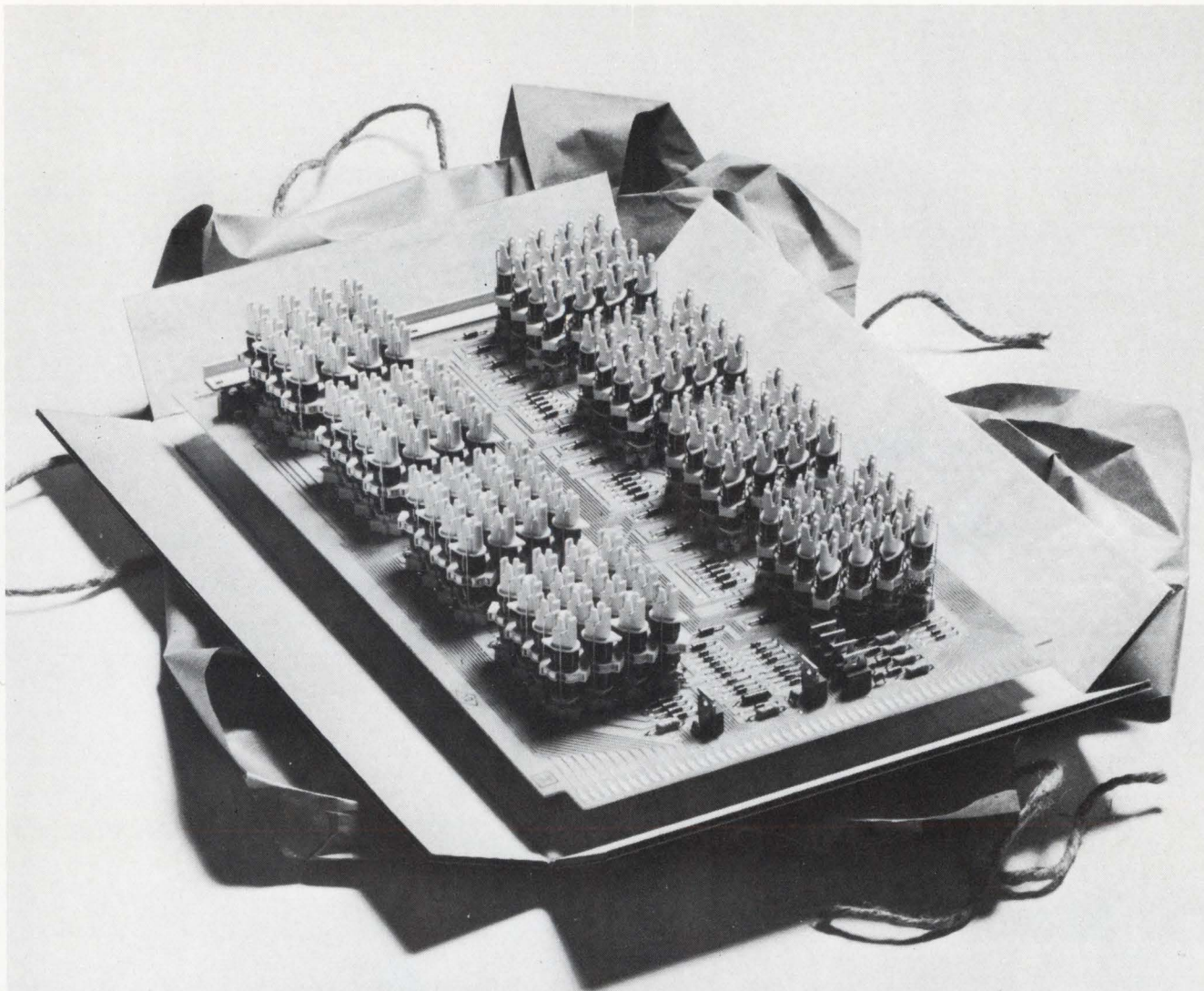

Hot signal switching to go.

Here's a shortcut to your next state-of-the-art voice and data switching system. Our standard matrices and high-rise Correeds.

They help you design your system without long lead time or a big budget. And because they're standard items, you get the components you need fast.

Many matrix configurations are available, with either magnetically latched or electrically held crosspoints. You can create single- and multi-stage networks of any size by connecting two or more matrices together. Or, just buy our Correered crosspoints and build your own matrices, if you wish.

Correeds make the most of any matrix design. They give you high-density packaging. Millisecond switching speed. Very low insertion loss, noise and crosstalk. And millions of

trouble-free operations.

Why start from scratch? Start at THE SOURCE: GTE Automatic Electric.

For more information on matrices or Correeds, send the coupon below. Or call John Ashby at (312) 562-7100, ext. 250.

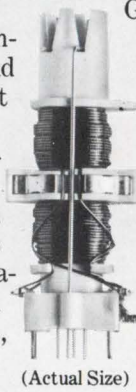

(Actual Size)

Please send more information on Correeds and matrices.

on _____ of _____
(Quantity) (Product)

Name _____ Title _____

Company _____

Address _____

City _____ State _____ Zip _____

Telephone _____

Mail to: Mr. J.D. Ashby, B-4, GTE Automatic Electric, Northlake, Illinois 60164

GTE AUTOMATIC ELECTRIC

**Here
come
the
Twenties!**

Here. Advanced Micro Devices.

Registers. Inverters. Buffers. Decoders. Counters. All twenty pins. The nicest thing to happen to TTL logic since low-power Schottky.

The twenty-pin configuration not only makes better packages. It makes better ideas. Eight in. Eight out. Power supply. Ground. And two pins to tell it what to do. Perfect for use with 8-bit wide microprocessors.

No more Too-Much Twenty-Fours. Too much board space. Too much handling difficulty.

No more Not-Enough Sixteens. Not enough functional capability.

The Twenties just happen to be the magic blend of size and logic. Like the Am25LS23. It's an 8-bit serial in/parallel out universal shift register with synchronous clear and three-state outputs. (The Am25LS299, our asynchronous version, is also available.)

Call, write or wire Advanced Micro Devices. The Twenties are here!

Here:

Am25LS SERIES	54/74LS SERIES	FUNCTION	AVAILABILITY
Am25LS15		Quad Serial Adder/Subtractor	Now
Am25LS22		Eight-Bit Register with Sign Extend	Now
Am25LS23		Eight-Bit Shift Register, Synch. Clear	Now
Am25LS240	Am 54/74LS240	Octal Bus Buffer	4th Q.
Am25LS241	Am 54/74LS241	Octal Bus Inverter	4th Q.
Am25LS273	Am 54/74LS273	Octal D-Type Register	4th Q.
Am25LS299	Am 54/74LS299	Eight-Bit Shift Register, Asynch. Clear	Now
	Am54/74LS322	Second Source to Am25LS22	Now
	Am 54/74LS323	Second Source to Am25LS23	Now
Am25LS373	Am 54/74LS373	Octal Transparent Latch	4th Q.
Am25LS374	Am 54/74LS374	Octal D-Type Register	4th Q.
Am25LS377	Am 54/74LS377	Octal D-Type Register	4th Q.
Am25LS381	Am 54/74LS381	Four-Bit Arithmetic Logic Unit	3rd Q.
	Am 54/74LS385	Second Source to Am25LS15	Now
Am25LS2517		Four-Bit Arithmetic Logic Unit	3rd Q.
Am25LS2526		Four-Bit Register (Dual Outputs)	4th Q.
Am25LS2537		One-of-Ten, Three-State Decoder	1st Q.
Am25LS2538		One-of-Eight, Three-State Decoder	1st Q.
Am25LS2539		Dual One-of-Four, Three-State Decoder	1st Q.
Am25LS2568		Four-Bit, Three-State Up-Down Counter	1st Q.
Am25LS2569		Four-Bit, Three-State Up-Down Counter	1st Q.
Am25LS2540		Octal Bus Buffer	4th Q.
Am25LS2541		Octal Bus Inverter	4th Q.
Am2900 SUPPORT			
	Am2907	LSI Bus Transceiver (O.C.)	Now
	Am2911	Microprogram Sequencer	Now
	Am2913	Priority Interrupt Expander	3rd Q.
	Am2917	LSI Bus Transceiver (Three-State)	3rd Q.

Advanced LP/Schottky



Advanced Micro Devices • 901 Thompson Place, Sunnyvale, California 94086 • Telephone (408) 732-2400 • Distributed nationally by Hamilton/Avnet, Cramer and Schweber Electronics.

CIRCLE NUMBER 122

Interested in network variety? Select from a spectrum of 347 standards.

Allen-Bradley has the popular configurations you need. Pull-ups, Pull-downs. Line Terminators. Networks to complement Core Memory Sense Amplifiers. TTL to ECL Translators. O-Pad Attenuators. All styles available from your Allen-Bradley *Electronic Distributor*. Call for specs or check your EEM Catalog. If you need specials, contact your local Allen-Bradley district office for fast turn-around. Ask for Publication 5840. A-B is an experienced twin-film manufacturer, i.e. precision thin film and thick film.

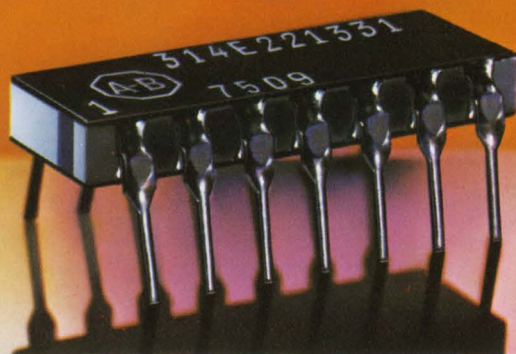
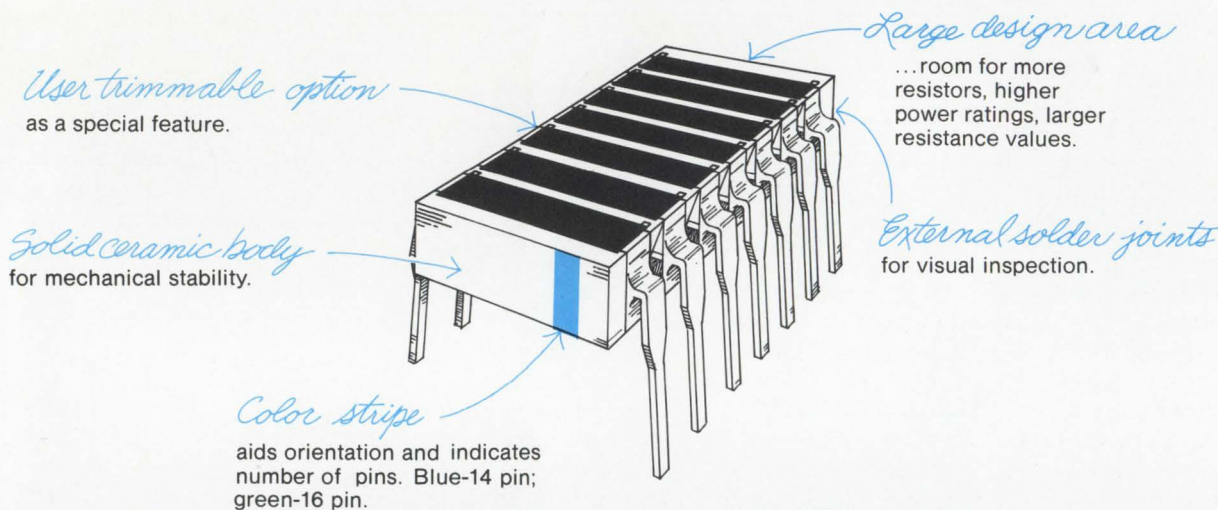

Quality in the best tradition.



ALLEN-BRADLEY
Electronics Division
Milwaukee, Wisconsin 53204

CIRCLE NUMBER 123

EC111

Published from time to time by SEMTECH CORPORATION • 652 Mitchell Road, Newbury Park, California 91320 / Phone: (805) 498-2111

Technology Breakthrough!

HIGH VOLTAGE CERAMIC CAPACITORS

This breakthrough in high voltage — high temperature ceramic capacitors provides the equipment designer ways to achieve new goals in design and reliability. Semtech high voltage capacitors were initially developed to meet stringent in-house requirements utilized in the manufacture of our industrial and military type solid state high voltage assemblies and multipliers. The resulting products have exceeded our most optimistic expectations. We have now set a new standard of excellence for high voltage ceramic capacitors. As a result of the many inquiries for these devices from our rectifier customers, we have

established a production capability and we are now able to offer these new "state-of-the-art" capacitors for sale to the industry. These devices are now available in quantity from stock at pricing low enough for use in commercial applications.

"MONO-CAP" Chips

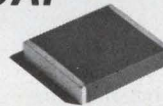

Construction: Monolithic with end terminations
Voltage: 1, 2, 3, 4 & 5KV
Capacitance: 18pF to .39 μFd
Dimensions: (Body) from .23"L x .19"W x .15" to .65"L x .60"W x .25"T



"GOLD CAP" Radials



Construction: Monolithic radial leaded and dip coated
Voltage: 1, 2, 3, 4 & 5KV
Capacitance: 18pF to .39 μFd
Dimensions: From (Body) .38"L x .29"H x .25"T to .80"L x .70"H x .68"T

Two Dielectric Types Available!

	X7R	NPO
Temperature Coefficient (T.C.)	0 ± 15% -55 to +125°C	Less than 30 ppm/°C; -55°C to +125°C
Dissipation Factor (D.F.)	2.5% max 1 KHZ 1 VAC, 25°C	Less than .0015 (.15%) at 1 KHZ, 1 VAC, 25°C
Insulation Resistance (I.R.)	100 K megΩ or 1000 megΩ microfarads, whichever is less (25°C, 500 VDC)	100K megΩ or 1000 megΩ microfarads, whichever is less (25°C, 500 VDC)
Aging	1% per decade	0
Dielectric Withstanding Voltage	1.2 Times Rated Voltage*, at 25°C	1.2 Times Rated Voltage*, at 25°C
Voltage Coefficient (V.C.)	Less than 7% at 50V per mil.	0
Dimensional Tolerance	± .010 or 5%, whichever is greater	± .010 or 5%, whichever is greater

*Dielectric Withstanding Voltage Test on Monolithic Chips and Gold-Caps is conducted with charging current limited to 10 mA and the discharge current limited to 5A.

Custom-Cut High Voltage Capacitors at your finger tips!

You can custom design your own capacitor for size and capacitance and maintain corona-free characteristics by cutting with either a diamond saw or laser. Ideal solution for R & D and prototype designs.

Voltage ratings from 2KV - 15KV
Higher ratings available on special request
Corona Inception Voltage rated at 50 Volts/Mil
Single layer construction
Sized from .6" x .6" to 1.80" x 1.80"
Capacitance values from 325pF to 23,000pF
X7R and NPO temperature characteristics

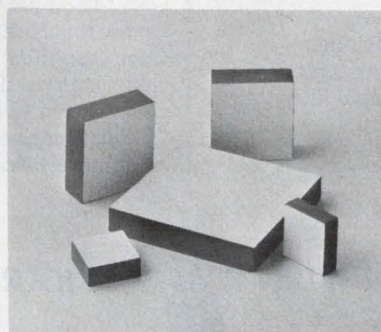

PROTOTYPE KITS
also available for sale!

Contact your nearest Semtech office for our new High Voltage Capacitor Catalog.

1975 NATIONAL SBA SUBCONTRACTOR OF THE YEAR

SEMTECH
CORPORATION

652 Mitchell Road, Newbury Park, California 91320
(805) 498-2111 • (213) 628-5392 • TWX: 910-336-1264

CHICAGO: (312) 352-3227 • DALLAS: (214) 387-3551
FLORIDA: (305) 644-5404 • MARYLAND: (301) 424-6663
NEW JERSEY: (201) 654-4884 • SAN FRANCISCO: (415) 494-0113
EUROPEAN SALES: Bourns AG Zug, Switzerland (042) 232-242

The Universal Counter.

NOW go to 1300 MHz!

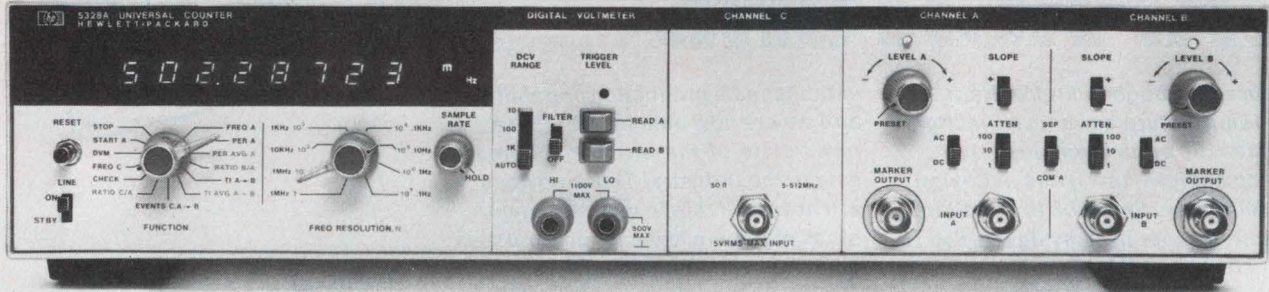

Everything you're likely to need. The HP 5328A.

Here's a counter so versatile, it can really be called universal. You get high accuracy, operating ease and a low price tag of just \$1300.* It's modular so you can buy the capability you need. Not more. Not less. Start with the basic 8-digit instrument with 100 MHz frequency range and 100ns single shot T.I. resolution. You also get period, 10 ps time interval averaging, ratio, scaling and totalizing. Then you can add more: 512 MHz* with 9 digits and 15 mv sensitivity; time base aging $<5 \times 10^{-10}$ /day; and 10 ns single shot time interval with improved averaging. But look what else you get:

***Or now to 1300 MHz with 20 mV sensitivity!**

UNIQUE TRIGGER LIGHTS

tell you what's happening. They're on when the input is greater than trigger level and vice versa. And they blink when the input channel is triggering from 0 to 100 MHz. Standard.

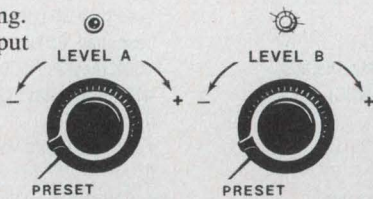

UNIQUE BUILT-IN DVM

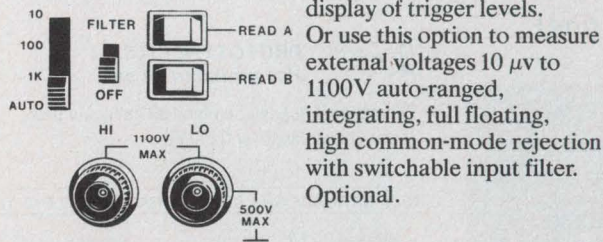

gives an instant accurate digital display of trigger levels. Or use this option to measure external voltages 10 μ V to 1100V auto-ranged, integrating, full floating, high common-mode rejection with switchable input filter. Optional.

HIGH SPEED MARKERS show just what your counter is doing with your input waveform. Use the markers on the second channel of your scope to see where the counter is triggering. Really useful thanks to the 5328A's 100 MHz ECL outputs. Standard.

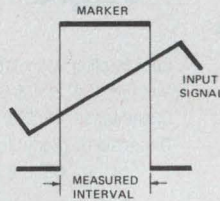

EASY SYSTEMS INTERFACE with the HP Interface Bus simplifies integration of the counter into a system. You get this program-mability plus standard format data output with a single connector. Optional.



ARMED MEASUREMENTS solve difficult dynamic measurement problems. The counter goes to work when your command tells it to. Ideal for burst frequency or sweep generator linearity measurements. Standard.



These are just a few things, of course. There are many more thoughtful engineering innovations that combine to give you everything you're likely to need in a general purpose, medium-priced counter for a long time to come. We talk about them in our 12 page booklet. Write for one or ask your nearby HP field engineer for a copy. We want you to find why we call this universal counter universal.

*Domestic US Price only.



Sales and service from 172 offices in 65 countries.
1501 Page Mill Road, Palo Alto, California 94304

CIRCLE NUMBER 35

Microprocessor Design

Microprocessor analyzer enhances operator interaction with development systems

Microprocessor test equipment is finally catching up in sophistication with the product it's supposed to test. That's the message signaled by the AO6800, a 6800- μ P analyzer and development tool from AO Systems.

The AO6800 doesn't just grab and display information—it allows the operator to intervene in the μ P-system's operation.

Into the AO6800 and its various displays come address, data and status information. Out of the AO6800 go signals to run, halt, single-step or reset the μ P.

With these capabilities, you can execute one program instruction and display both the op code of that instruction and the present value of the program counter. Or you can set in an address, and the analyzer will halt the μ P when an address match occurs.

In the AO's monitor mode, the address display becomes a resettable counter, which provides a totalization of monitored address matches, while the data display shows memory or I/O read-write information.

Another feature, a memory-speed simulator, lets you simulate and adjust for slow memories in your prototype system. A zone control

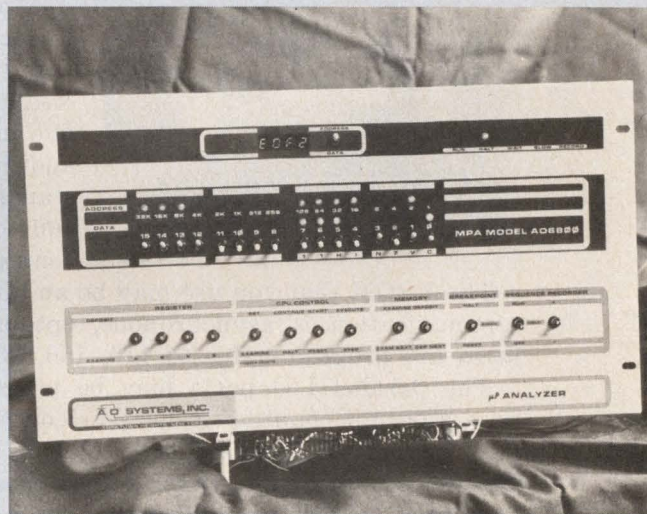

partitions the memory into two sections: slow and normal.

Read-write capability of the AO Systems unit extends beyond the memory and I/O ports (65 k addresses) to the program counter and the internal registers of the 6800 (A, B, X, S).

With the AO's three-state buffering, negligible bus loading and choice of positive-true or

(continued on page 52)

National Semiconductor offers the 8080A μ P for \$19.95

The 8080A 8-bit microprocessor family is being offered by National Semiconductor, with its price set at \$19.95 (100-up).

The microprocessor, called the INS8080A, is a direct pin-for-pin and function-for-function replacement for the Intel device.

"We decided to build and market the 8080A because it has clearly become the industry's most popular general purpose microprocessor," Bill Baker of National says.

Also available is the INS8224 clock generator, which provides timing signals for the CPU and the system, and the INS8228, which provides system control and data bus buffering.

National Semiconductor Corp., 2900 Semiconductor Dr., Santa Clara, CA 95051.
(408) 737-5000.

CIRCLE NO. 501

MICROPROCESSOR DESIGN

(continued from page 51)

negative-true signals, you can connect to practically any system configuration.

A number of options give the AO6800 even more test power. For example, an optional sequence recorder stores up to 128 instrument

addresses in either of two modes, so you can trace through and debug programs. Other options include a hexadecimal display.

The cost of the basic AO6800? A surprising \$695; you can get one from stock to 6 weeks.

AO Systems, 1736 Front St., Yorktown Heights, NY 10598. (914) 962-4264.

CIRCLE NO. 502

Microcomputer card comes in European standard card size

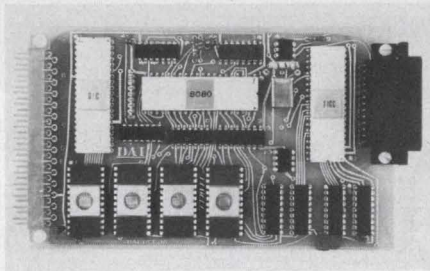

A new 8080-based microcomputer card conforms to Eurocard physical dimensions and pinouts. The card, called the DCE-1, packs an 8080 μ P, 512 bytes of RAM, 24 ports of parallel I/O, 2 ports of serial I/O, five interval timers, sockets for 4-k bytes of PROM, and additional communications control circuitry. The Eurocard standard, used in common market countries, specifies 100 \times 160-mm card dimensions and standard edge connectors.

The PROM that you use may be an ultraviolet-erasable type 2708 or 2704. The serial I/O communication is asynchronous, opto-isolated, and uses a full or half-duplex mode. Baud rates are programmable to 110, 150, 300, 1200, 2400, 4800, or 9600 with one or two stop bits.

The parallel I/O ports may be programmed to input or output data. The interval timers permit countdown delay or control of five independent events. Time periods may be programmed from 64 μ s to 16.3 ms; longer periods are attainable by cascading timers. The interrupts generated by these timers are fully vectored—the CPU program counter is loaded from different locations in memory depending upon which timer interrupt occurs. The 100-piece-unit price of the card is \$374.

N. V. Data Applications International S.A., Dreve Des Renards 5, 180 Brussels, Belgium.

CIRCLE NO. 503

8080-based development system sells for \$1976

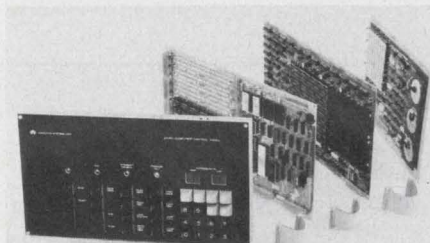

A microcomputer development system contains a card with an 8080 μ P, a control panel, development software and memory. The whole system, dubbed the 8080⁺ Development Station, sells for \$1976.

The microcomputer card contains address and data buffers, and a section for additional circuitry.

The control panel, which may command the system, contains a hexadecimal entry keyboard, function/control keys, status indicators and a 4-digit hexadecimal address/data display. Control of the computer system may also be accomplished through a teletypewriter terminal for which an interface is provided.

Development software has been programmed into CMOS RAMs that contain a nickel-cadmium battery for data retention during shipping. Additionally, the programs come on paper tape that may be loaded via a teletypewriter into the RAMs. The software consists of an editor and assembler, debug instructions, and file creation and edit capabilities.

System memory consists of 1-k words of RAM on the microcomputer board, plus 14-k words of available memory on a separate board (an additional 2-k words on the same

(continued on page 54)

No. Galileo is not the little old Napa Valley winemaker.

Galileo Electro-Optics Corp. isn't little nor relatively old. And no, we don't make wine either. Galileo is simply one of the world's largest producers of optical communication cable.

Our new Galite™ family consists of five completely different types of optical communication cable. Because the Galite family is the widest range of cables available anywhere, we can thus service your particular needs best.

All Galite cables are immune to electromagnetic interference (EMI/RFI), are much lighter than coaxial cable, eliminate cross talk between channels and have a higher information carrying capacity than conventional cable. And all are available right now from current stock.

Galite 3000 is a truly new and unique optical communication cable. And because of our exclusive



rights to a patented glassmaking process, Galileo is its only source in North America. These fibers are constructed of high purity glass to reduce attenuation. The cladding glass, deposited by this patented process, is impervious to organic solvents and retains its unique properties at temperatures where plastic fibers deteriorate.

Galite 3000 is a step index optical fiber for transmitting data primarily from 70 to 330 meters/230 to 1100 ft. This range accommodates most current market applications such as link-

ing computer terminals, shipboard and aircraft communication and control systems, and automated process controls.

For more information, write: Galileo Electro-Optics Corporation, Galileo Park, Sturbridge, Mass. 01518. Or call us at (617) 347-9191.

Imagine what we could be doing for you right now.

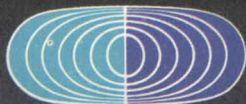

Galileo Electro-Optics Corp. Galileo Park, Sturbridge, Massachusetts 01518, (617) 347-9191

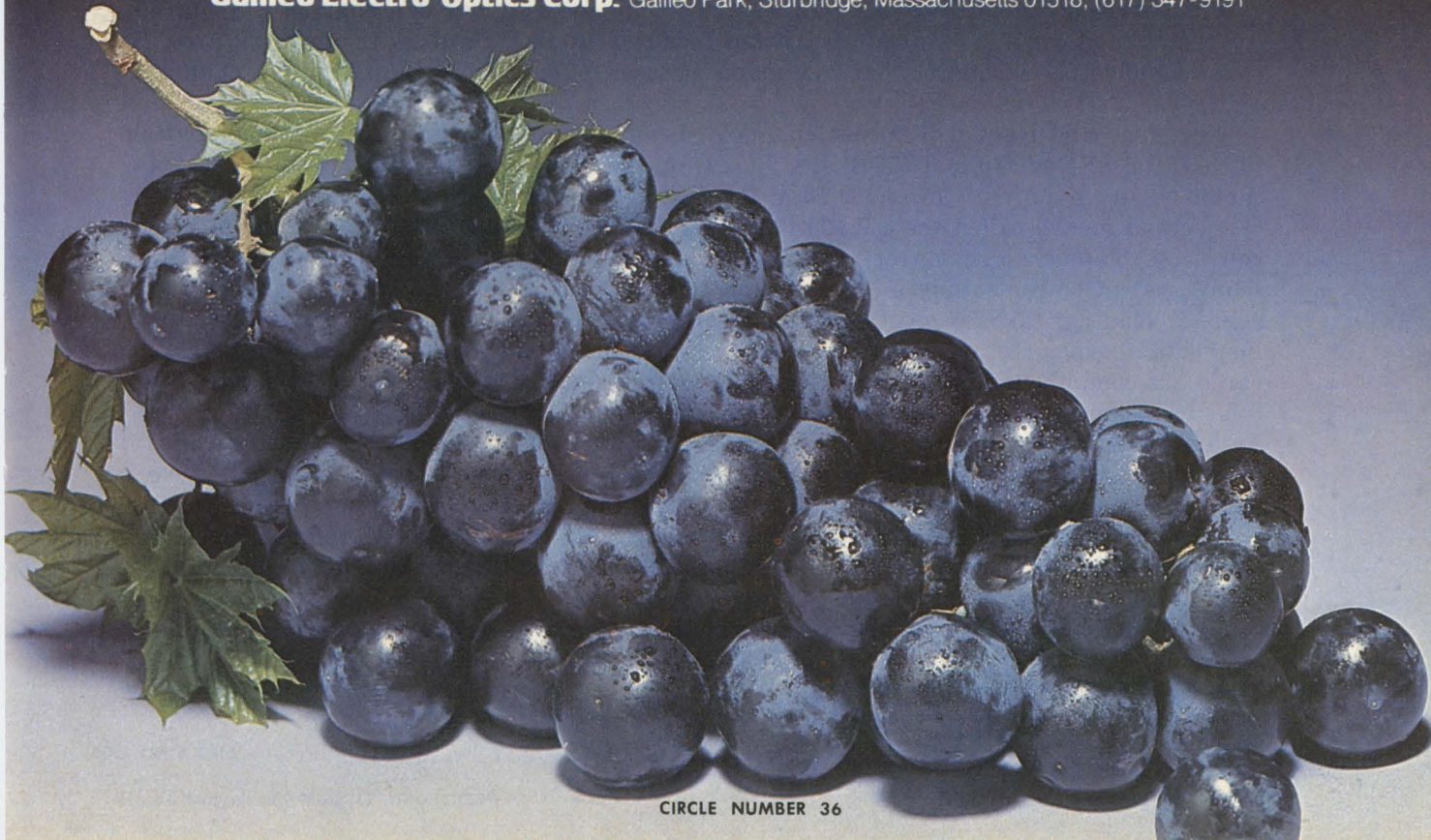

MICROPROCESSOR DESIGN

(continued from page 52)

board is required by the system software). The 4-k words of CMOS RAM containing the operating system may also be used if additional memory space is required.

The development system requires about 6.7 A at 5 V and 0.65 A at 12 V.

Monolithic Systems Corp., 14 Inverness Dr. East, Englewood, CO 80110. (303) 770-7400.

CIRCLE NO. 504

Machine simulates an EPROM and is keyboard programmable



By simulating a 1702-type EPROM, yet remaining programmable, the Precision Electronics PROM Simulator speeds up microprocessor program development. Each 8-bit address is programmed individually via a hexadecimal keyboard. The unit connects to a microprocessor system via a 24-pin connector that plugs into a 1702 socket.

Two models of the PROM Simulator are available. The S702A (\$290) contains NMOS RAMs and a socket for an external battery. The S702B (\$370) has CMOS

RAMs and an internal rechargeable battery that allows a specific program-hold period of 1000 hours.

Precision Electronics, 24 Copenhagen St., London N1, England.

CIRCLE NO. 505

4 and 8-channel d/a converter cards mate with the SBC-80/10

When microprocessor systems control industrial processes, one d/a channel is required for each a/d channel for computer-assisted feedback control. Cards with up to 32 a/d channels have been available but few manufacturers offered more than two d/a channels on the card.

Now, four and eight d/a output channels sit on a peripheral card that is pin-compatible to the Intel SBC-80/10 and MDS CPU bus. One, the Model ST-800-DA8, provides 8 d/a channels, and requires -15 and $+15$ V for power from an external source.

A second model, called the ST-800-DA4, has four d/a channels and an integral dc/dc converter. The dc/dc converter generates its own ± 15 V from the $+5$ V bus so only the $+5$ V system power supply is needed. The settling time of each d/a converter, including register loading, takes $4 \mu\text{s}$. Depending on the programming mode, two or more 2-byte instruction sequences are required to update each output channel. Both the 4 and 8-channel cards are complete, stand-alone, addressable I/O systems. They include a hard-wired 8-bit base-address decoder and a jumper-programmable interrupt level.

The processor can load all channels sequentially without specifying the address for each channel. A word counter is automatically incremented with each data-output cycle and compared to the preloaded last channel. When the last channel is reached, the processor is notified by way of a hard-wired interrupt level. Both cards contain an interval clock to initiate update scans by generating an interrupt. This scan timer uses a logic clock that may be adjusted up to one second.

The 8 and 4-channel systems are both built on $12 \times 6.75 \times 0.375$ -in. cards compatible to Intel's CPU bus pinout. Model ST-800-DA8 costs \$695 (single quantities) and the Model ST-800-DA4 costs \$595 (single quantities).

Datel Systems, Inc., 1020 Turnpike St., Canton, MA 02021. (617) 828-8000.

CIRCLE NO. 506



Select from this family of aluminum electrolytic capacitors designed for output filtering in switching power supplies



TYPE 672D

- Suitable for parallel stacking
- Plug-in PWB mounting
- Low to medium ripple current capability



TYPE 604D

- True 4-terminal isolation
- Low profile PWB mounting
- Medium ripple current capability



TYPE 622D

- Best ESR in std. construction
- 1st with symmetrical ESR and capacitance tol.
- High ripple current capability



TYPE 432D

- Lowest available ESR and impedance
- Bus-bar mounting
- Maximum ripple current capability

Construction	Rolled-Section		Rolled-Section		Rolled-Section		Stacked-foil	
Terminal Configuration	2 terminals, wire pins		4 terminals, wire leads		2 terminals, low or high female threaded		2 terminals, strip-line, female threaded	
Case Size Range (D. x L.)	.326" x .505" to 1.000" x 1.625"		.750" x 1.625" to 1.000" x 3.625"		1.375" x 2.125" to 1.375" x 5.625"		1.375" x 2.125" to 3.000" x 5.625"	
Operating Temperature Range	-55°C to +105°C		-55°C to +105°C		-55°C to +85°C		-40°C to +85°C	
WVDC Range	6.3 to 100		5 to 200		5 to 55		6 to 50	
Capacitance (Range μ F)	4.7 to 6800		50 to 16,000		2,800 to 67,000		470 to 100,000	
Capacitance Tolerance	-10, +100%		thru 50 V: -10, +75% over 50 V: -10, +50%		\pm 20%		-0, +100%	
Max. Inductance (@ 1 MHz & within .125" of capacitor)	20 nH		2 nH		20 nH		2 nH	
Max. ESR (@ 25°C and 120 Hz)	1200 μ F @ 6.3 WVDC	.11 ohm	16,000 μ F @ 5 WVDC	.022 ohm	67,000 μ F @ 5 WVDC	.004 ohm	100,000 μ F @ 6 WVDC	.0015 ohm
RMS Ripple Current (@ 85°C)		2.61 A @ 100 kHz		7.00 A @ 10 kHz		19.5 A @ 20 kHz		54.6 A @ 1 kHz
Max. Impedance (@ 25°C)		.06 Ω @ 100 kHz		.017 Ω @ 10 kHz		.010 Ω @ 10-40 kHz		.001 Ω @ 10 kHz
Engineering Bulletin	3452		3458A		3459		3443A	
	Check 281 on Reader Service Card		Check 282 on Reader Service Card		Check 283 on Reader Service Card		Check 284 on Reader Service Card	

For complete technical data, write for Engineering Bulletin(s) (see table for bulletin numbers) on the capacitor(s) in which you are interested to: Technical Literature Service, Sprague Electric Company, 347 Marshall St., North Adams, Mass. 01247.

THE BROAD-LINE PRODUCER OF ELECTRONIC PARTS



Datatron's New LSI tests wafers 3 to



Delays at the wafer-probe stage of LSI testing once proved costly. But no more. Not with Datatron's new 10MHz clock-rate test system. Credit our *patented parallel parametric capability* for speeding up wafer-probe testing by 300 to 400 percent. This feature alone makes the LSI-800 an attractive investment for today's heavy LSI manufacturer or user.

Comparing the Testers

To find out how the LSI-800 fares against competition, take a look at these tabulated wafer-probe test results:

WAFER-PROBE TESTS

The Testers	7495 Register			8080 μ pu		
	Prober Time (msec)	Tester Time (msec)	2-Station System Throughput (items/hour)	Prober Time (msec)	Tester Time (msec)	2-Station System Throughput (items/hour)
Datatron LSI-800	80	150	24,000	150	900	4,000
All Others	80	550	6,500	150	4,000	900

In final test too, the LSI-800 clobbers the competition. Items-per-hour throughput topped all others by almost 450 percent — as the following numbers testify:

FINAL TESTS

The Testers	7495 Register			8080 μ pu		
	Handler Time (msec)	Tester Time (msec)	2-Station System Throughput (items/hour)	Handler Time (msec)	Tester Time (msec)	2-Station System Throughput (items/hour)
Datatron LSI-800	500	150	14,400	500	900	4,000
All Others	500	550	6,500	500	4,000	900

800 Test System 4 times faster!

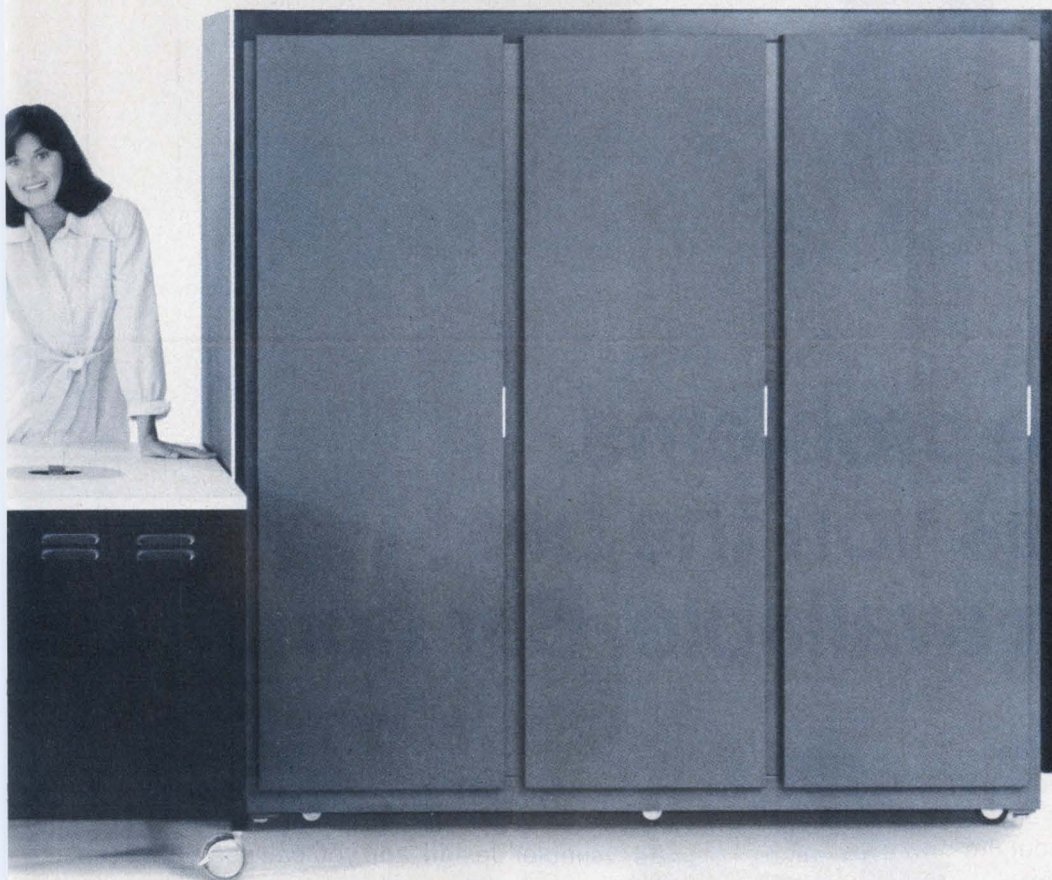

Throughput Rises with Pin Count

LSI-800 throughput soars as pin count (of devices under test) increases. The LSI-800 is so fast, in fact, that it's usually through with parametric wafer tests before competitive systems complete wafer continuity checks. So an LSI-800 can test more devices more comprehensively and faster. Result: Defective devices can be weeded out sooner.

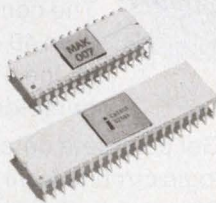

100% of the Capability, 28% of the Price

To keep pace with an LSI-800, you need *four* of "their" testers (at \$300,000 each) plus *four* wafer-probe testers (at \$20,000 each). Total investment: \$1,280,000 for their system versus \$370,000 for an LSI-800-based system.

Other Reasons for Choosing an LSI-800

Need other reasons for choosing an LSI-800? Well, an LSI-800 can generate exotic test patterns, enabling it to perform an infinite variety of tests on all classes of LSI devices. Multidimensional software

lets you do device characterization. Production testing too. And you get instant access (via telephone) to the LSI programs in Datatron's Central Program Library (CPL). So you'll spend less money for programming support.

We can give you still other compelling reasons for choosing an LSI-800. To further pin us down, call or write today. Datatron, Inc., Test Systems Division, 1562 Reynolds Avenue, Irvine, CA • (714) 540-9330 • TWX 910-595-1589 • Mailing Address: P.O. Box 11427, Santa Ana, CA 92711.

Datatron, Inc.

CIRCLE NUMBER 38

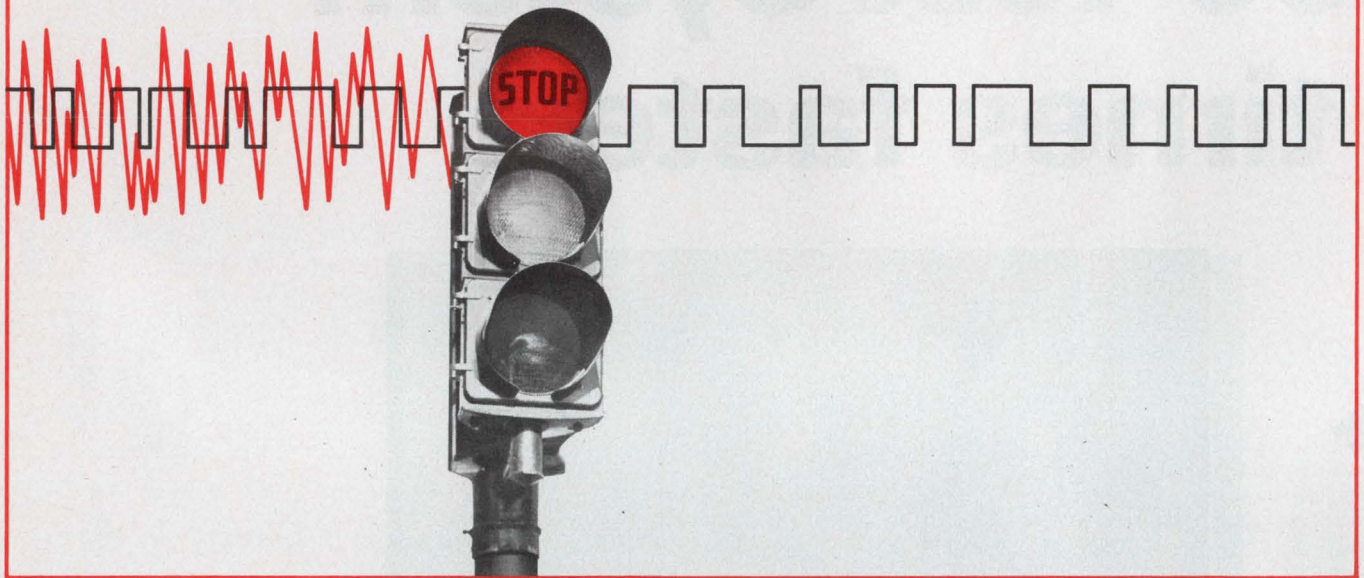

Stop noise problems. HiNIL gives you the best protection available. Bar none.

Noisy environments simply cease to be a problem when you design with High Noise Immunity Logic from Teledyne. HiNIL provides high immunity to any and all types of electrical noise, without the cost and inconvenience of special filtering or shielding.

Use HiNIL in place of your conventional I/O logic. It interfaces easily with TTL, DTL, MOS and CMOS. It will protect your CMOS inputs against static charge damage and SCR latchup. And it gives you a guaranteed dc noise margin of 3.5 V (as compared to 1.0 V for CMOS

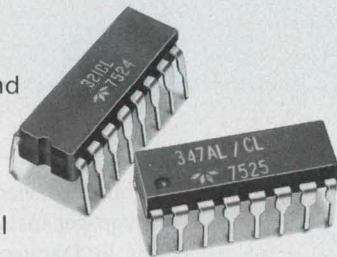

and 0.4 V for TTL) without added filter circuits or tight supply regulation. Or design entirely with HiNIL. You will get even better noise protection and a simpler design, and you can use a low cost, loosely regulated power supply. The complete HiNIL family includes more than 40 devices, with more being added all the time. They're available in ceramic or molded plastic DIPs.

Get complete details on the full family of HiNIL logic circuits from your local Teledyne Rep or Distributor. Or contact us at the address below.

TELEDYNE SEMICONDUCTOR

1300 Terra Bella Avenue, Mountain View, California 94043 Tel: (415) 968-9241 TWX: 910-379-6494 Telex: 34-8416

SALES OFFICES:

DOMESTIC: Salem, N.H. (603) 893-9551; Stony Brook, N.Y. (516) 751-5640; Des Plaines, IL (312) 299-6196; Los Angeles, CA (213) 826-6639; Mountain View, CA (415) 968-9241 • INTERNATIONAL: Hounslow, Middlesex, England (44) 01-897-2503; Triengen, West Germany 7741-5066; Kowloon, Hong Kong 3-240122; Tokyo, Japan 03-405-5738

CIRCLE NUMBER 39

We want to be better

As far as I know, we run more corrections than any other technical magazine. That's not because we make more mistakes—I think we make far fewer—but because we shout about them more.

As a matter of policy, some publications never make mistakes or, at least, they close their eyes to them. It's well known that eye-closing makes bad things go away.

An amusing example took place some years ago, when one publication wrote a searing article about the layoffs at Motorola's Semiconductor Div. The situation was so bad, the article pointed out, that Motorola had to drop out of the tantalum-capacitor business. That was a good trick since Motorola had never been in that business. When this gaffe was pointed out, the magazine—which was never wrong—simply published a follow-up article telling the world how great things were at Motorola.

We'll never do that to you. When we blow one, we'll tell you—right away. We know you can't work with faulty information, so we want to give you the best available—not only in our editorial pages, but in our advertising pages as well.

That's why we make such a fuss about our mistakes and why we've published an accuracy-policy statement in every issue for the past 17 years. (It's on page 138 in this issue.) And though we feel we have the most accurate magazine in our field, we'd like to make it even more so. You can help.

If we make a mistake, or if an advertisement is not quite as accurate as one might prefer—perhaps because of excess enthusiasm on the part of the manufacturer—please let us know, so that we can investigate and take appropriate measures. We make it easy by providing space for your comments on the Reader Service Card. But we welcome your letters and phone calls, too.

We always do.

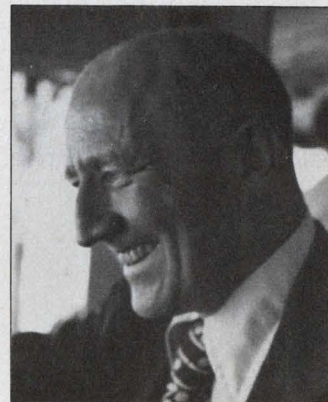

RECOGNIZED BY
AMERICAN REVOLUTION
BICENTENNIAL
ADMINISTRATION

ELECTRONIC DESIGN is deeply honored to have received official recognition as a participant in the American Revolution Bicentennial Celebration, with authority to display the Bicentennial Symbol.

A handwritten signature in dark ink that reads "George Rostky". The signature is fluid and cursive.

GEORGE ROSTKY
Editor-in-Chief

THESE LOW-COST CASSETTE PROGRAM LOADERS DELIVER TOP PERFORMANCE FOR YOUR MICROPROCESSOR BASED SYSTEMS.

All four of these program loaders use EPI's patented Speed Tolerant Recording (STR®) technique to give you bit error rates of less than 1 soft error in 10^7 bits and less than 1 hard error in 10^8 bits. With STR, you get high data reliability in read and write modes while using a relatively low-cost recorder

and inexpensive tape cassettes.

Interfacing is similar to most paper-tape reader/punch units now in use. And with better data reliability, faster loading, more storage, lower price, and briefcase or rack mounting, EPI cassette program loaders make sense for both the

end user and OEM.

For more information on these low-cost alternatives to paper tape loading, contact Electronic Processors Inc., 1265 West Dartmouth Ave., Englewood, Colorado 80110. Phone (303) 761-8540.

**ELECTRONIC PROCESSORS
INCORPORATED**

See Megatronix Ltd. Booth 212

Custom designs, like this STR-110T for the Texas Instruments 5TI Programmable Control System, can handle your special loader needs. You can get an intelligent loader... automatic verification in both read and write modes... remote control. Tell us what you need. Chances are an EPI STR loader can handle it.

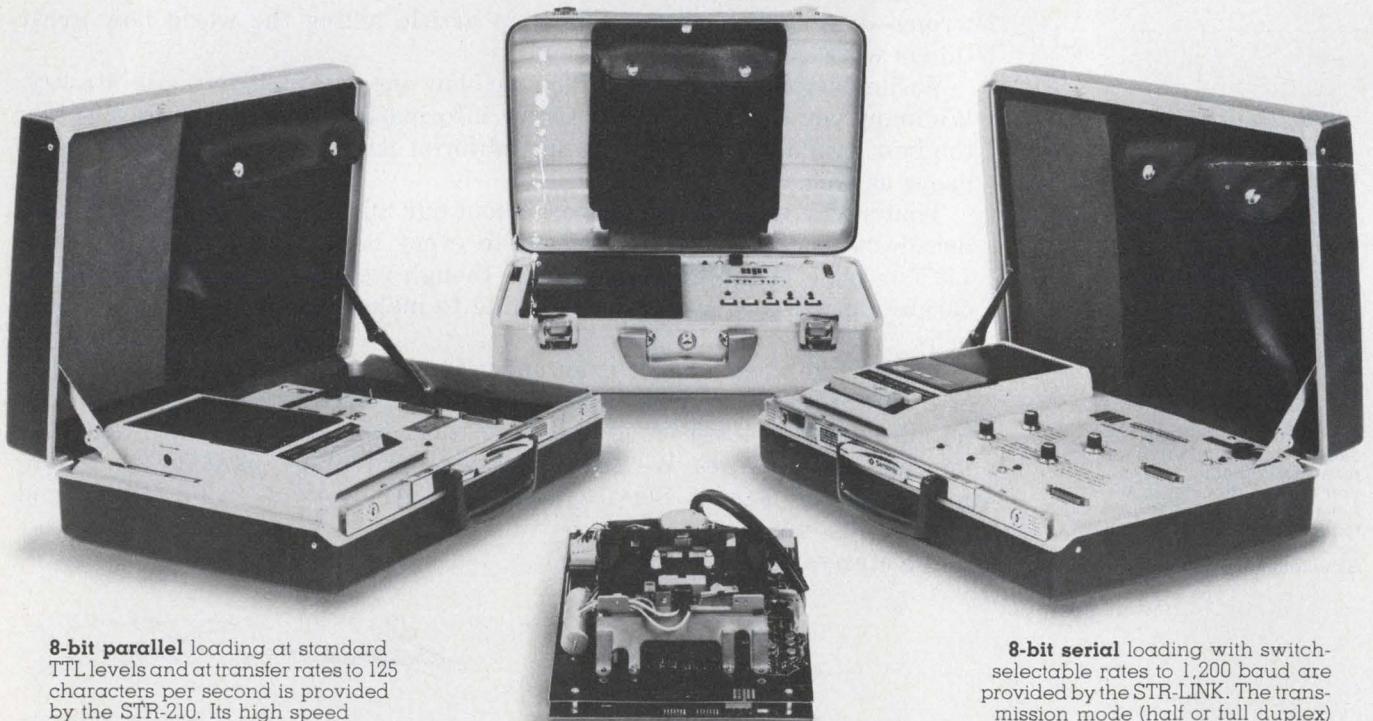

8-bit parallel loading at standard TTL levels and at transfer rates to 125 characters per second is provided by the STR-210. Its high speed and storage capacity of 100,000 characters on a 300-foot cassette makes it ideal for memory dumps as well as program loading. Priced at just \$700.

OEM systems recorder, the STR-100, is a complete tape-drive unit that provides full remote signal or character control of all transport functions. It includes read-write electronics, control and timing logic, and motor-control logic. All you need to supply is a mounting location, power supply, and an interface with the controlling I/O device and you have a reliable unit for program storage and retrieval.

CIRCLE NUMBER 40

8-bit serial loading with switch-selectable rates to 1,200 baud are provided by the STR-LINK. The transmission mode (half or full duplex) is also switch selectable for maximum flexibility. Data capacity is 100,000 characters on a 300-foot cassette. Priced at \$1,190.

The Ansley "D" Connector...

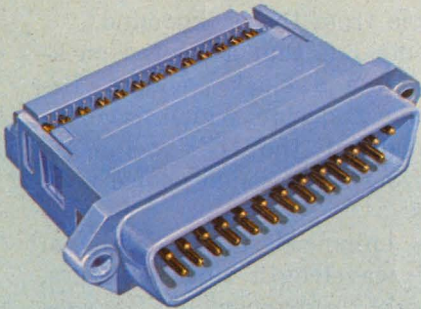

Our new series of male and female "D" connectors offer you a cost effective external mass termination cable and connector system second to none. Its uniqueness begins with a one-piece "D" connector package that meets industry standards for size, pin spacing, and contact reliability. With no loose parts to match up, positive cable-to-contact alignment is assured. Conductors are mass terminated in seconds with our standard BLUE MACSTM hand or bench tools. The results? Faster installation, higher reliability.

Contact pins are spaced on .054" centers — a perfect fit for any standard inter-cabinet "D" type connector application. Our new "D" connectors are designed to mate with standard 50 mil pitch flat cable as well as our new, improved jacketed cable — the only flexible flat cable engineered specifically for out-of-cabinet use.

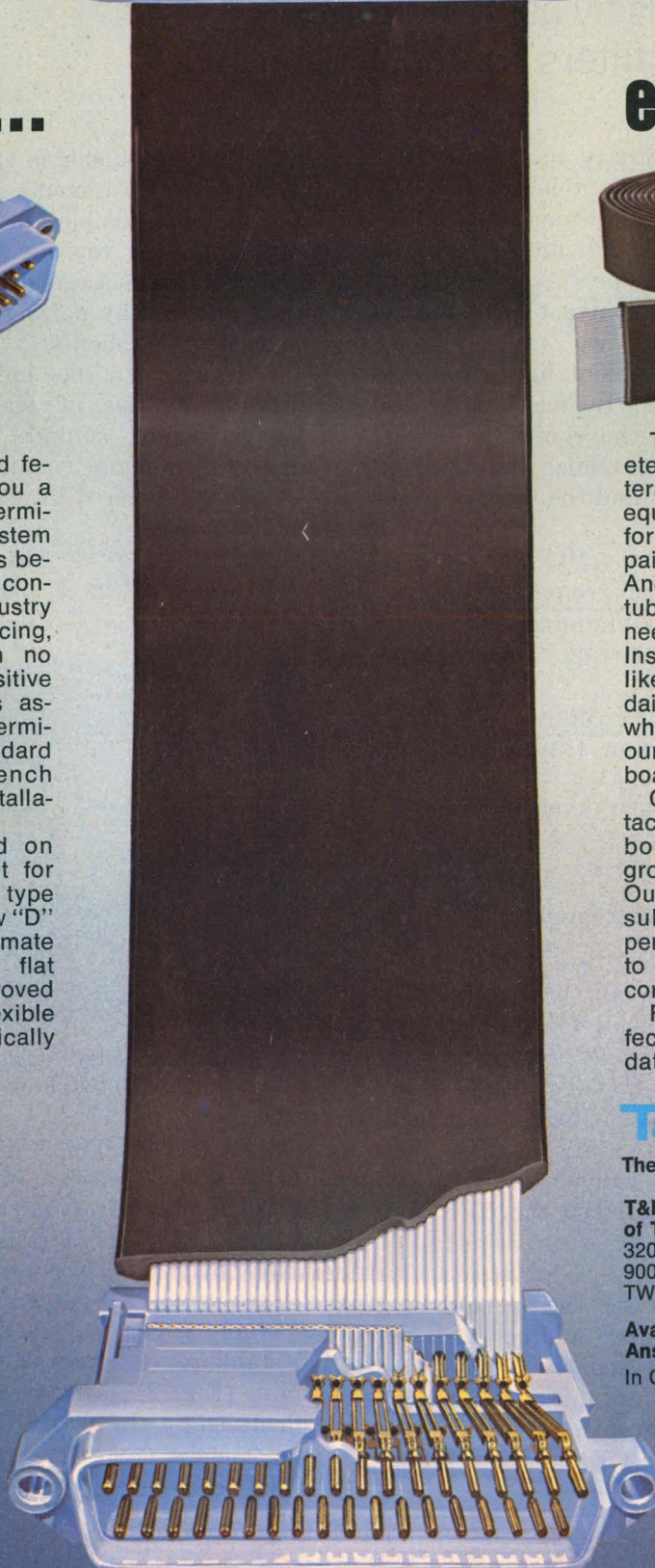
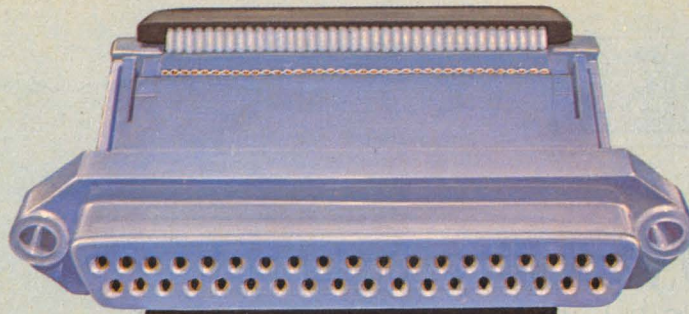

a new meaning to cost effectiveness.



The Ansley BLUE MACSTM jacketed cable is U.L. listed for external interconnection of electronic equipment. Electrically, it outperforms standard jacketed twisted pairs in typical I/O applications. And there's no special zipper lock tubing required — reducing the need for an extra cable accessory. Installation is faster, easier. And like all Ansley connectors, you can daisy chain our "D" types anywhere in the cable — along with our DIP socket, card edge, or pc board connectors.

Cable alignment and high contact reliability is assured — because both cable and connector are grooved for absolute alignment. Our patented TULIP™ 4-point insulation-displacing contacts are permanently fixed and sealed-in to provide a reliable, gas-tight, corrosion-free mass termination.

For the full reliability/cost effectiveness story and technical data, call or write:

T&B / Ansley

The mass termination company.

**T&B/Ansley Corporation • Subsidiary
of Thomas & Betts Corporation**
3208 Humboldt St. • Los Angeles, CA
90031 • Tel. (213) 223-2331 •
TWX 910-321-3938

**Available through authorized
Ansley distributors**

In Canada: T&B/Ansley, Ltd.
700 Thomas Ave.,
Industrial Park
Iverville, P.Q.

Enhance LED visibility under high ambient light levels by using bandpass and other optical filters to boost contrast.

Artificial lighting or ordinary bright daylight can turn a LED display into a lackluster eye-strain. But the contrast in the same display can be restored with an optical filter—bandpass, polarizer, louver or other type.

Such filters enhance the contrast between the ON and OFF conditions in two ways: (1) By minimizing the reflected ambient light from the face of the display, and (2) By maximizing the emitted light that reaches the eye of a viewer. An additional goal is to maximize the contrast between the OFF segments and the display package and background.

The contrast ratio, CR, is defined as:

$$CR = \frac{\text{Source luminance} - \text{Background luminance}}{\text{Background luminance}}$$

The contrast-improvement ratio, CIR, is therefore given by

$$CIR = \frac{CR(\text{with filter})}{CR(\text{without filter})}$$

It is desirable to have as high a CR as possible. Improvements in contrast are revealed by measurement of the CIR.

Segment contrast vs display background

The term "contrast ratio" is usually applied to the whole face of a display. With stretched-segment displays, it is difficult to obtain a high value of segment ON/OFF contrast while effectively "concealing" the display package from view. For example, a display with a black package is easily concealed; however, the OFF segments will be visible. This can be traced to the difference in reflectivity between the OFF segments and the black package.

You can reduce the difference in reflectivity between the OFF segments and the package of a stretched-segment display by adding a small amount of dye to tint the segments. You can also color the display package to match the OFF-segment color. With an appropriate optical filter in front of the display, the OFF segments tend

to be indistinguishable from the background.

One point to remember is that a colored package is more visible than a black package. Because of this, you must decide which is more important—concealment of the OFF segments or of the display package. The usual choice is to conceal the segments.

Contrast can be enhanced under artificial lighting by use of wavelength optical filters. Under bright sunlight, enhancement becomes more difficult and requires additional techniques—such as louvered filters combined with shading of the display.

The effect of a wavelength optical filter is illustrated in Fig. 1. The filtered portion of the

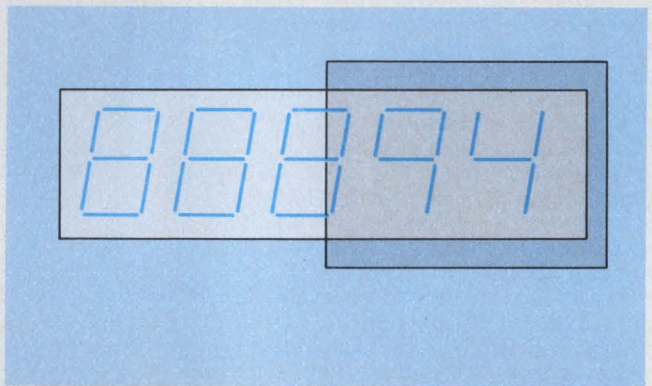

1. "Before and after" comparison demonstrates what an optical filter can do to enhance LED display visibility.

display can be read easily, while the OFF segments are not readily apparent. By comparison, it's difficult to read the unfiltered portion of the display.

The 1931 CIE (Commission Internationale De L'Eclairage) observer curve, also called the photopic curve, represents the eye response of a standard observer to various wavelengths of light (Fig. 2). The vivid color ranges are also identified in the figure. The curve peaks at 555 nanometers (nm) in the yellowish-green region. This peak corresponds to 680 lumens (lm) of luminous flux per watt of radiated power.

Two wavelengths of LED emission are important to the user: the peak (λ_p) and the

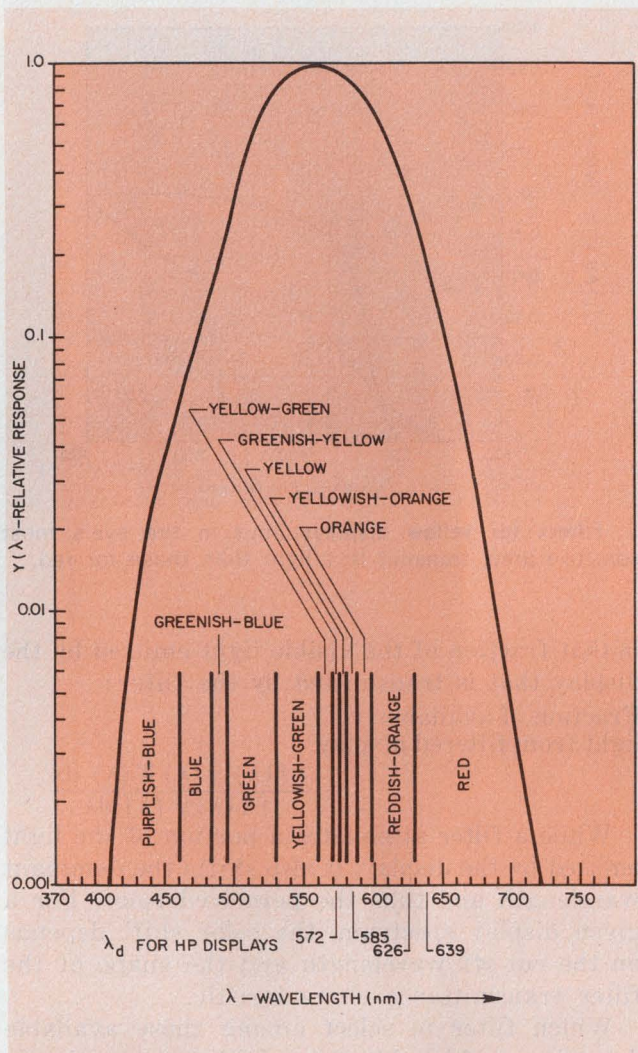

2. How the average eye responds to light of various wavelengths is shown by the photopic, or CIE curve (International Commission for Light Standards).

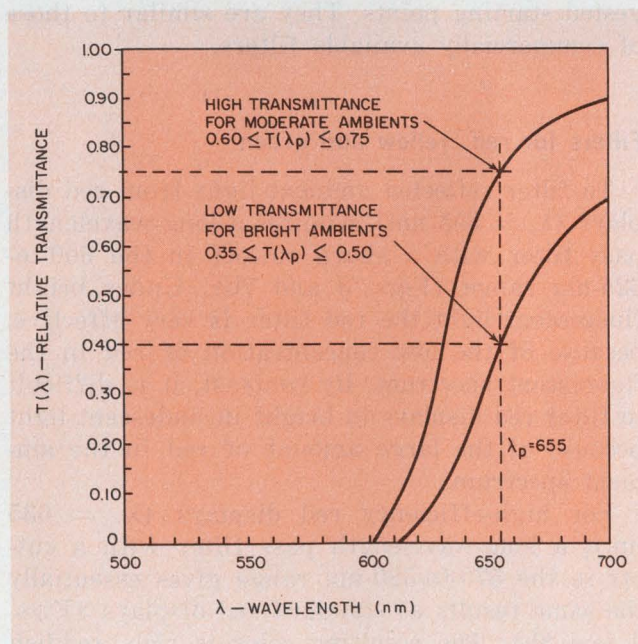

3. Typical filter transmittance curves are for use with standard (HP) GaAsP red LED displays.

dominant (λ_d). The former is the wavelength at the radiated peak of the emitted spectrum and can be used to estimate the approximate amount of emitted light passed by an optical filter. For example, if a filter has a relative transmission of 40% at a given λ_p , approximately 40% of the emitted light at the peak wavelength will pass through the filter, while 60% will be absorbed. This gives a designer an initial estimate of the amount of light lost.

Two important wavelengths

The dominant wavelength, λ_d , defines the color of a LED display. Since a LED approximates a monochromatic light source, λ_d can be defined as that single wavelength that is perceived by the eye to match the total radiated spectrum of the device.

For example, the λ_d of Hewlett-Packard's "yellow" display—which has a peak wavelength of 583 nm—is 585 nm. As shown in Fig. 2, the color corresponding to $\lambda_d = 585$ nm is yellowish-orange. Therefore an optimum filter for yellow LEDs will be yellowish-orange, or amber. Both peak and dominant wavelengths are usually listed on the data sheets of LED displays and lamp products.

Wavelength filters

Most manufacturers of wavelength filters also provide relative transmittance curves for their products. The relative transmittance of an optical filter with respect to wavelength is given by:

$$T(\lambda) = \frac{\text{Luminous flux with filter at wavelength } \lambda}{\text{Luminous flux without filter at wavelength } \lambda}$$

Sample transmittance curves are presented in

Figs. 3 through 6. They represent approximate filter characteristics for various ambient light levels. The over-all curve shape and wavelength cut-off points are chosen in direct relationship to the LED-radiated spectrum. Each filter curve shown is empirically determined and is similar to commercially available products.

The higher the ambient light, the more optically dense the filter must be to absorb the light reflected from the face of the display. Because the emitted light is also strongly absorbed, the display must be driven at a relatively high average current to be readily visible. In dim ambients—where the emitted light is much higher than the ambient—the filter can have a high value of transmittance and the display can be driven at a lower average current.

Note that dim ambients fall in the range of 3 to 20 foot-candles (32 to 215 lux), moderate ambients in the range of 20 to 100 foot-candles

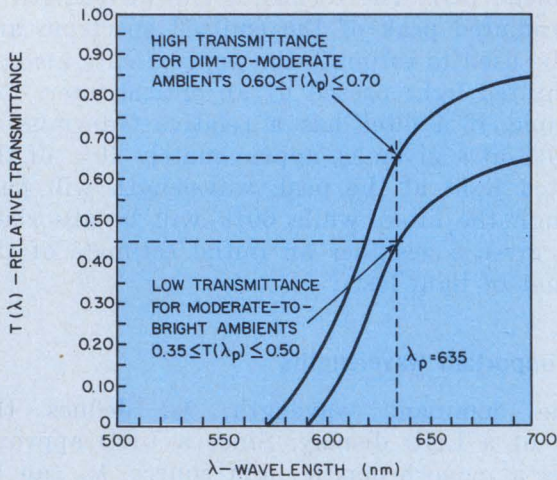

4. High-efficiency red LEDs need filters with slightly lower cut-off points than standard LEDs.

(215 to 1076 lux), and bright ambients in the range of 100 to 500 foot-candles (1076 to 5382 lux). Remember that a foot-candle = lm/ft^2 and a lux = lm/m^2 .

Listed on each filter transmittance curve (Figs. 3, 4, 5 and 6) are empirically selected ranges of relative transmittance values (at the peak wavelength) that may give satisfactory filtering. For instance, a filter to be used with a yellow display in moderate ambient lighting might have a transmittance value at the peak wavelength $T(\lambda_p)$ of between 0.15 and 0.30. For best results, the filter wavelength cut-off should therefore occur between 530 and 550 nm.

Wavelength filters predominate

When you select a filter for optimum enhancement, carefully consider the transmittance curve shape, the attenuation at the peak wavelength and the wavelength cut-off—all in relation to the LED radiated spectrum and the ambient light level.

Wavelength filters are the most effective, and hence the most widely used, method of enhancement under artificial lighting. However, because of the high ambient level, these filters are not very effective in daylight. Here, louvered filters are best.

Figs. 7 through 10 show the relationships between artificial light, daylight, fluorescent and the spectra of LED displays, both unfiltered and filtered. The photometric spectrum (shaded curve) is obtained by multiplication of the LED-radiated spectrum $f(\lambda)$ by the photopic curve, $y(\lambda)$. The filtered photometric spectrum is what the eye perceives when it views a display through a filter. Thus the filtered spectrum = $f(\lambda) y(\lambda) T(\lambda)$. The ratio of the area under the filtered spectrum to that under the unfiltered spectrum

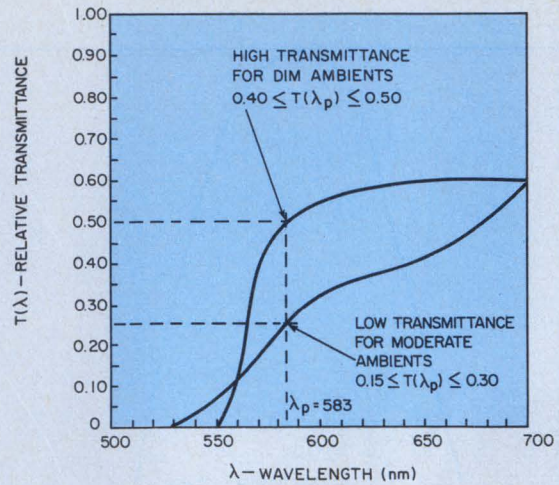

5. Filters for yellow displays emit in the eye's most sensitive area, transmit less light than those for red.

is that fraction of the visible light emitted by the display that is transmitted by the filter:

$$\text{Fraction of available light from filtered display} = \frac{\int f(\lambda) y(\lambda) T(\lambda) d\lambda}{\int f(\lambda) y(\lambda) d\lambda}$$

While a filter attenuates a portion of the light emitted by the display, it also shifts the dominant wavelength and thus the perceived color. For a given display spectrum, the color shift depends on the cut-off wavelength and the shape of the filter transmittance characteristic.

Which filter to select among those available depends on which filter and LED combination is most pleasing to the eye. You must experiment with filters, since you can't pick the best from the transmittance curves alone. Thus the filter spectra of Figs. 3 through 6 are merely suggested starting points. They are similar to those of commercially available filters.

Filters for red, yellow and green

To filter reflected ambient light from red displays ($\lambda_p = 655 \text{ nm}$) requires a long-wavelength pass filter with a sharp cut-off in the 600-to-625-nm range (Figs. 3 and 7b). Under bright fluorescent light the red filter is very effective, because of the low concentration of red in the fluorescent spectrum. By contrast, it is difficult to filter red displays in bright incandescent light because of the large amount of red in the ambient spectrum.

For high-efficiency red displays ($\lambda_p = 635 \text{ nm}$), a long-wavelength pass filter with a cut-off in the 570-to-590-nm range gives essentially the same results as standard red displays (Figs. 4 and 8b). The resulting color is rich, reddish orange.

The peak wavelength of a yellow LED ($\lambda_p =$

583 nm) falls in that region of the photopic curve in which the eye is most sensitive (Fig. 9a). Since there is a high concentration of yellow in the spectrum of fluorescent light, and a lesser amount in incandescents, filters of greater density than red ones at the peak wavelength are required for yellow displays. Most effective filters are the dark yellowish-orange, or dark amber (Fig. 5).

A low-transmittance, yellowish-orange filter, as shown in Fig. 9b, gives a color similar to that of a gas-discharge display. Note that pure yellow filters provide very little contrast enhancement.

With green displays—in which the peak wavelength of 565 nm is only 10 nm from the peak of the eye's response—effective filtering is difficult (Fig. 10a).

The long-wavelength pass filter used for red and yellow displays is not effective, and you must combine the dyes of short and long-wavelength filters to form a good bandpass yellow-green filter with a peak at 565 nm (Fig. 6). The best filters for green LEDs are yellow-green bandpass types. Those peak at 565 nm and drop off rapidly between 575 and 590 nm. The filter passes 550 to 570 nm while sharply reducing the longer wavelengths in the yellow region (Fig. 10b). Pure green filters aren't recommended because they peak at 520 nm and drop off rapidly in the 550-to-570-nm range.

To filter green LED displays in fluorescent light, a filter with a low transmittance value at the peak wavelength is needed. This is because of the high concentration of green in the fluorescent spectrum. It is easier to filter green displays in bright incandescent lighting because of

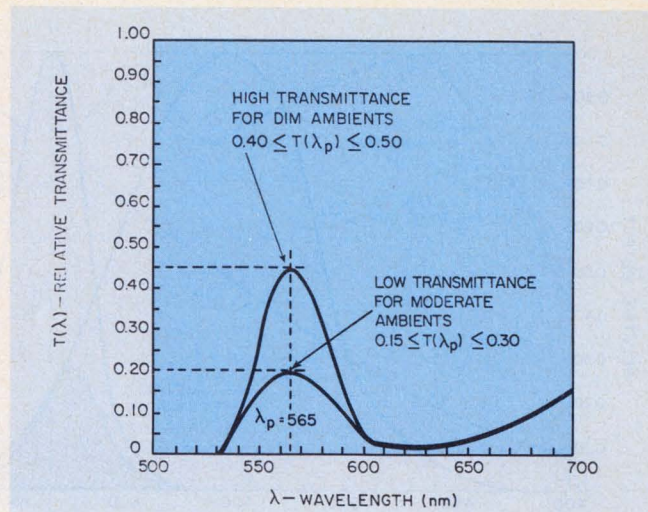

6. Green displays are most difficult to filter. Best results are obtained from yellow bandpass types.

the low concentration of green in the ambient spectrum.

Manufacturers of wavelength filters include Panelgraphic Corp. (Chromafilter), SGL Homalite, and Rohm & Haas (Plexiglas). Others are listed in Table 1. Table 2 lists filter products, with recommended applications.

Daylight requires different tack

To reduce artificial light or daylight reflected from the face of a display—without a substantial reduction in display-emitted light—check into louvered filters (Fig. 11). Inside a plastic sheet are thin, parallel louvers that can be angled (during manufacture) with respect to the surface normal. In the zero-degree filter the louvers are

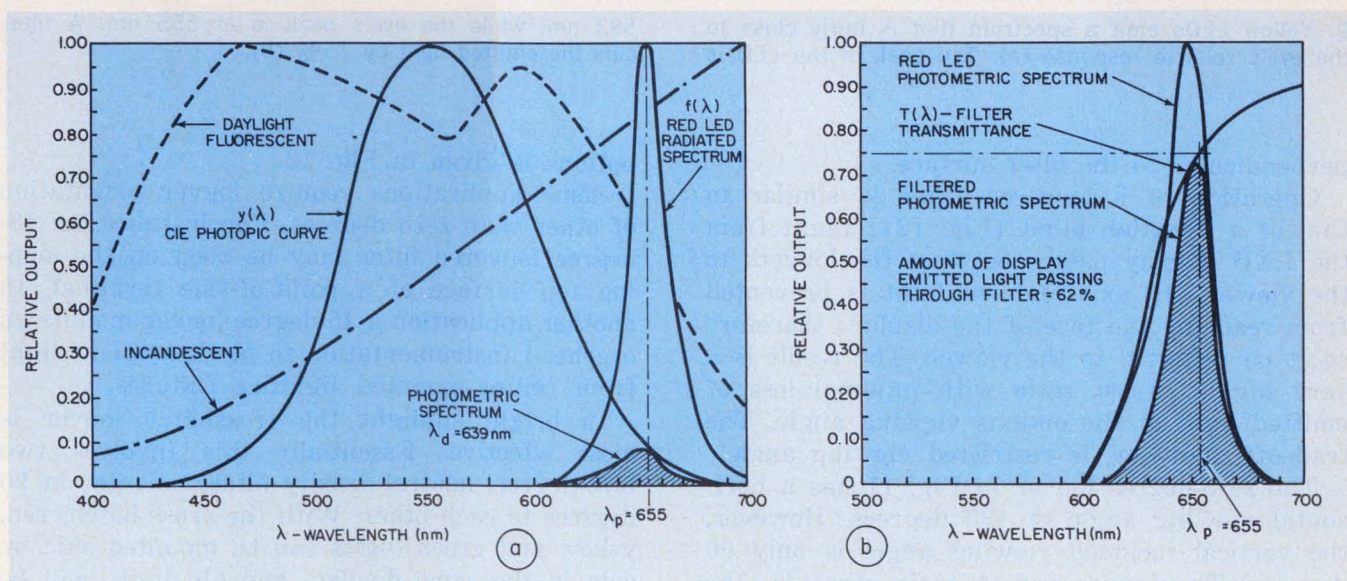

7. Where the emitted wavelengths of a red LED fall with respect to various light sources and the eye's re-

sponse (a). After filtering with a long-wavelength filter, the eye perceives the spectrum shown in "b."

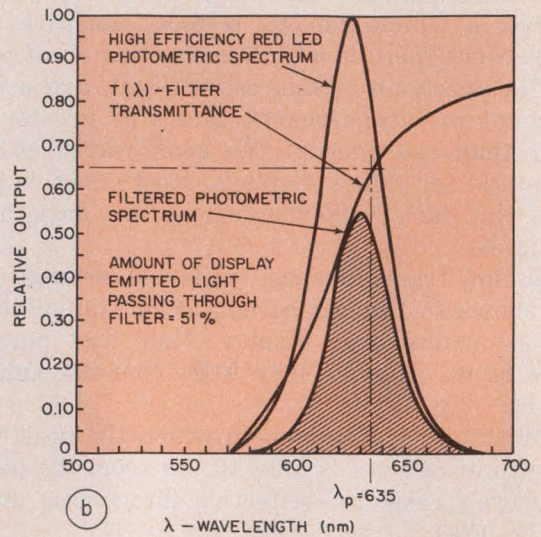
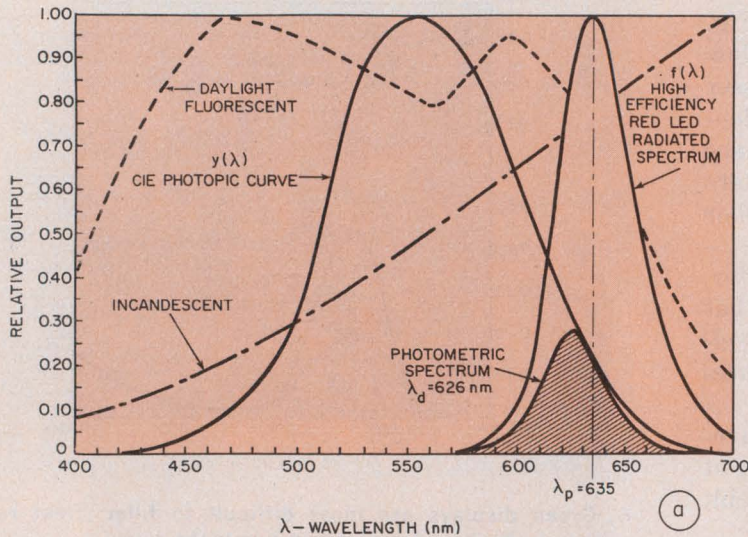

8. The relationship of various light sources to the photometric spectrum of the eye and the radiated spec-

trum of high-efficiency red LEDs (a). A long-wavelength pass filter has the effect shown in "b."

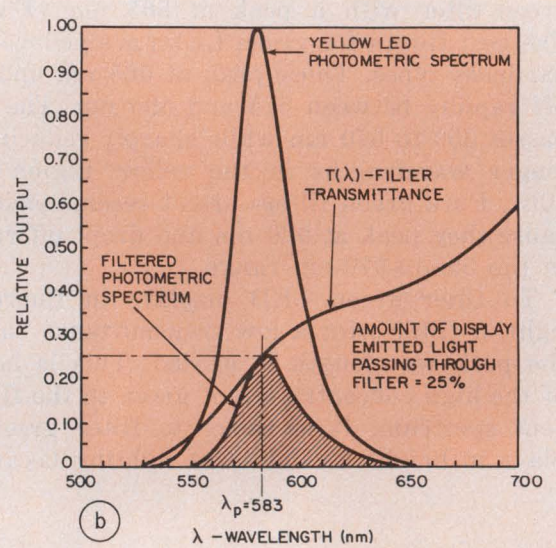
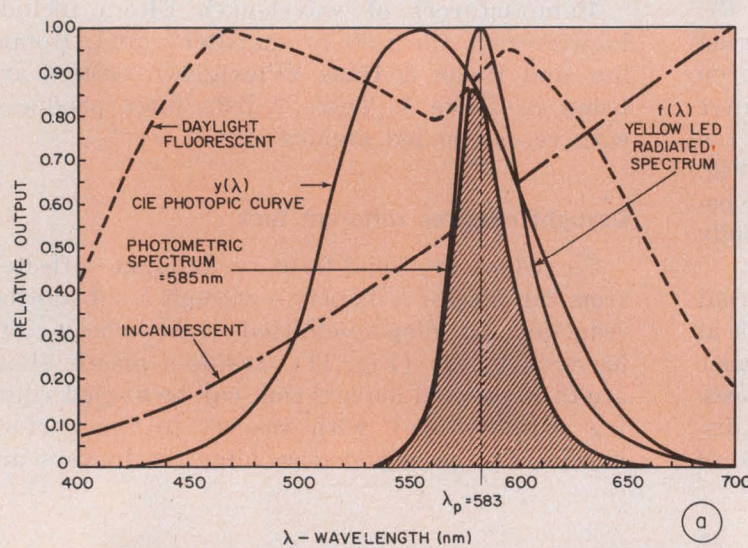

9. Yellow LEDs emit a spectrum that is fairly close to the eye's relative response (a). The peak of the LED is

583 nm, while the eye's peak is at 555 nm. A filter cuts the emitted light by 75% (b).

perpendicular to the filter surface.

Operation of a louvered filter is similar to that of a Venetian blind (Fig. 12): Light from the LED display passes between the louvers to the viewer. Off-axis ambient light is prevented from reaching the face of the display; therefore can't be reflected to the viewer. The result is a very high contrast ratio with minimal loss of emitted light at the on-axis viewing angle. The tradeoff, however, is restricted viewing angle.

The zero-degree louver in Fig. 11 has a horizontal viewing angle of 180 degrees. However, the vertical included viewing angle is only 60 degrees. The louver aspect ratio—that is, the ratio of louver depth to distance between louvers—determines the viewing angle. A list of louver

options is given in Fig. 12.

Some applications require louver orientation of other than zero degrees. For instance, an 18-degree louvered filter may be used on the sloping top surface of a point-of-sale terminal. In another application a 45-degree louver mounts on overhead instrumentation to block ambient light from ceiling-mounted lighting fixtures.

In bright sunlight the crosshatch louver is most effective. Essentially this involves two zero-degree, neutral-density filters oriented at 90 degrees to each other. With the cross-hatch, red, yellow and green digits can be mounted side by side in the same display, and all digits will be clear in bright sunlight—so long as the sunlight is not parallel to the viewing axis. Again, this

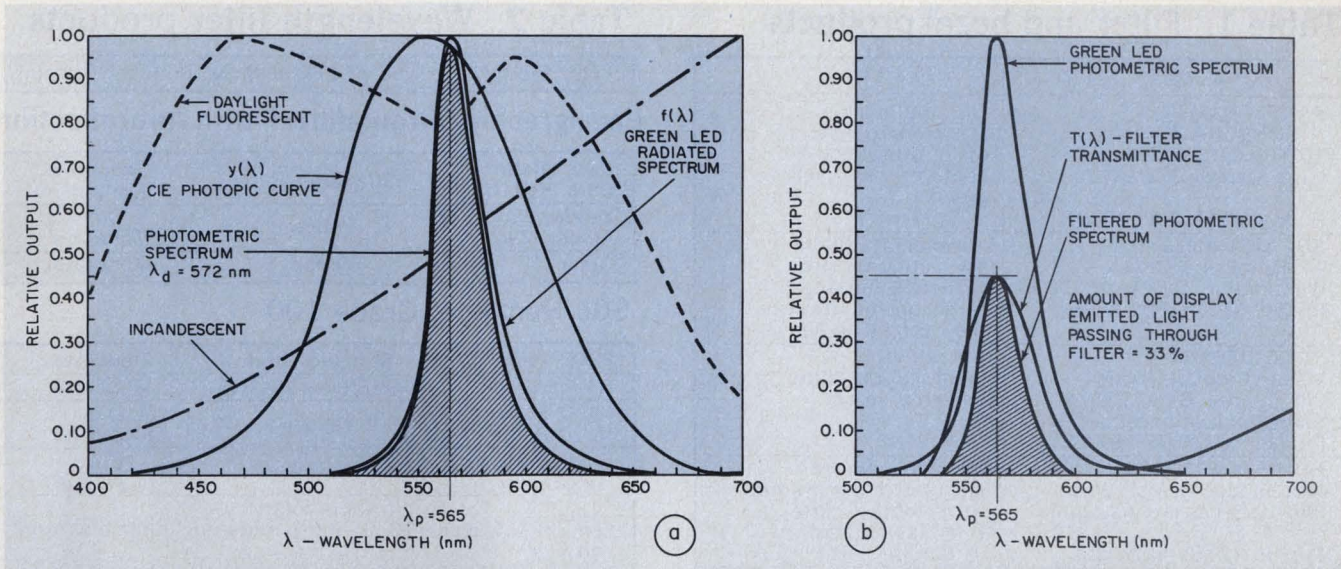

10. Closest to the photopic curve is the radiated spectrum of green LEDs, almost an exact fit (a). For this

reason, green LEDs are the most difficult to enhance and require a passband filter (b).

technique restricts vertical and horizontal viewing. The effective viewing cone is an included angle of 40 degrees for a filter aspect ratio of 2.75:1.

Neutral-density louvered filters work in most bright ambients without the aid of a secondary wavelength filter. However, colored louvered filters can give additional filtering—but at the expense of emitted light.

The Light Control Div. of the 3M Co. offers louvered filters for LED displays under the trade name "Light Control Film."

What about specular light?

Another filter, the circular polarizer, cuts light reflected specularly from front surfaces—that is, light that reflects without scattering. Polished glass or plastic faceplates belong to this category.

A circular polarizer consists of a laminate of a linear polarizer and a quarterwave plate (Fig. 13). The latter's optical axis is parallel to the flat surface of the polarizer and is oriented at 45 degrees to the linear polarization axis.

In operation, nonpolarized light first is linearly polarized into X and Y components. As the light passes through the quarter-wave plate, these polarized components emerge 90 degrees out of phase with each other and form a helical pattern with respect to the optical path. The emerging light—termed "circularly polarized"—is reflected from the specular surface, which reverses the direction of the circular polarization.

When the light passes back through the quarter-wave plate, it becomes linearly polarized at 90 degrees to the linear polarizer, and the reflected ambient light is blocked.

In this way the circular polarizer slashes am-

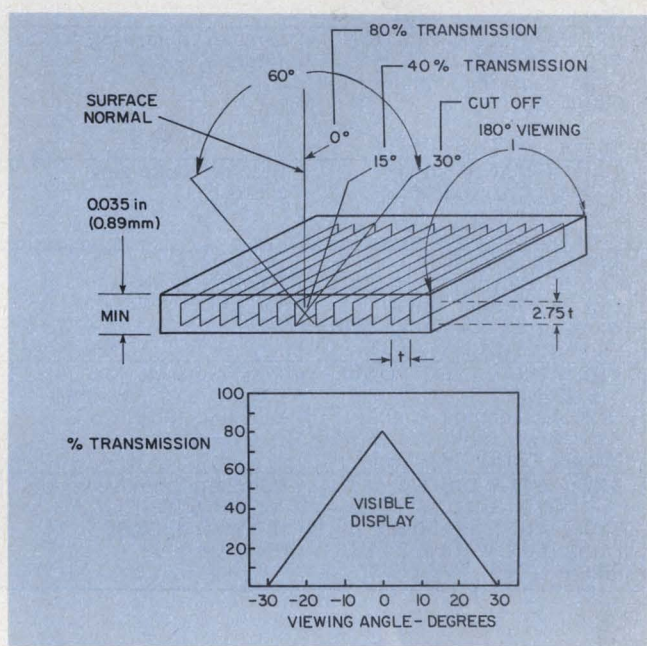

11. A neutral-density louvered filter can reduce reflected light without cutting into that emitted.

bient light by more than 95%. However, emitted light passing through the polarizer is also reduced—by approximately 65% at the peak wavelength. This necessitates increased drive current for the display—more than that required for a wavelength filter.

Be cautious with sunshine

To obtain additional selective filtering, circular polarizers are normally colored. But caution: Since prolonged exposure to ultraviolet light will destroy the filter's polarizing properties, outdoor applications require an ultraviolet filter in front of the polarizer.

Table 1. Filter and bezel products

Manufacturer	Product
PANELGRAPHIC CORPORATION 10 Henderson Drive West Caldwell, New Jersey 07006 Phone: (201) 227-1500	Chromafilter®—Wavelength Filters with antireflective coating—red, yellow, green
SGL HOMALITE 11 Brookside Drive Wilmington, Delaware 19804 Phone: (302) 652-3686	Wavelength filters; Two optional anti-reflective surfaces; three plastic grades; red, yellow, green
3M COMPANY Visual Products Division 3M Center, Bldg. 235-2E Saint Paul, Minnesota 55101 Phone: (612) 733-5747	3M-brand Light control film; louvered filters
ROHM AND HAAS Independence Mall West Philadelphia, Pennsylvania 19105 Phone: (215) 592-3000	Plexiglas; Sheet and molding powder; wavelength filters; sold as Oroglas in Europe
ROEHM, GmbH Chemische Fabrik 6100 Darmstadt Kirschenallee West Germany Phone: (06161) 8061	Plexiglas; Wavelength filters
POLAROID CORPORATION Polarizer Division 549 Technology Square Cambridge, Massachusetts 02139 Phone: (617) 864-6000	Circular polarizing filters
E. KASEMANN GmbH D 8203 Oberaudorf West Germany Phone: (08033) 342	Circular polarizing filters
NORBEX DIVISION Griffith Plastics Corporation 1027 California Drive Burlingame, California 94010 Phone: (415) 344-7691	Digibezel®; Plastic bezels for LED displays
INDUSTRIAL ELECTRONIC ENGINEERS, INC. 7720-40 Lemona Avenue Van Nuys, California 91405 Phone: (213) 787-0311	Plastic bezels for 0.30-inch (7.62 mm) tall LED displays
ROCHESTER DIGITAL DISPLAYS, INC. 120 North Main Street Fairport, New York 14450 Phone: (716) 223-6855	Complete mounting kits for HP 5082-7300, -7700 and -7600 displays.

In the United States circular polarizers can be purchased from the Polaroid Corp. In Europe, E. Kaseman of West Germany produces high-quality units.

Reducing glare is important

A filtered display still may not be readable if glare is present on the filter surface. Glare can be reduced by the addition of an antireflection surface to the filter. Both sections of the display in Fig. 14 are filtered, but the lefthand filter has an antireflection surface while the righthand filter does not.

Basically an antireflection surface is a mat, or textured, finish or coating that diffuses incident light. But emitted light is also diffused. The filter should be mounted as close to the display as possible to prevent a fuzzy image.

Table 2. Wavelength filter products

Filter Product	Type of LED display	Ambient lighting
----------------	---------------------	------------------

Panelgraphic Chromafilter® with Antireflection

Ruby Red 60 Dark Red 63	Standard Red	Moderate Bright
Yellow 25 Amber 23	Yellow	Dim Moderate
Green 48	Green	Moderate

SGL Homalite, Grade 100

H100-1605	Standard Red	Moderate
H100-1670	High-Efficiency Red	Moderate
H100-1726 H100-1720	Yellow	Dim Moderate
H100-1425 H100-1440	Green	Dim Moderate

Antireflection
LR-72: 0.5 inch (12.70 mm) mounting distance from display
LR-92: Up to 3.0 inch (76.20 mm) mounting distance from display

Rohm & Haas

Plexiglass 2423 Oroglas 2444	Standard Red	Moderate
Molding 38168 Powder	Green	Moderate

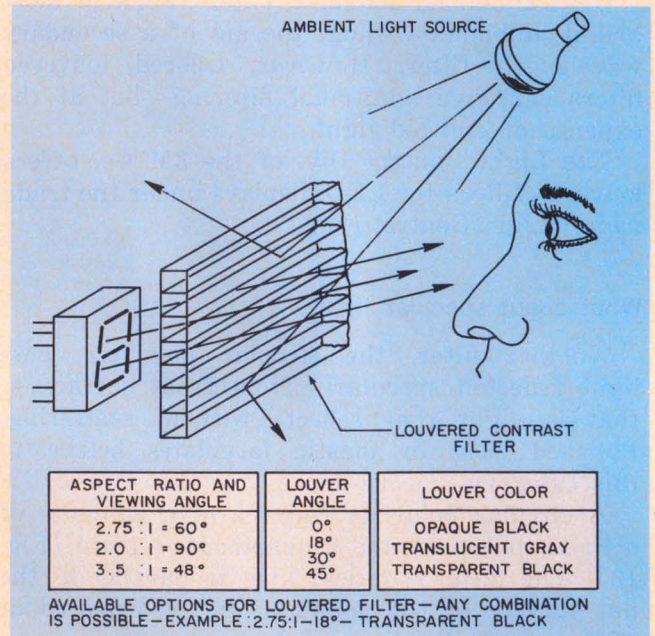

12. To change the performance with louvered filters, combine any of the characteristics listed in the table.

Panelgraphic Corp.'s Chromafilters come with an antireflection coating, while SGL Homalite offers two grades of a molded antireflection surface. And both 3M Company and Polaroid offer antireflection options for specialized applications.

Optical coating companies will apply antireflection coatings, though this is usually expensive. Among such companies are Optical Coating Labs, Inc., Santa Rosa, CA; Optics Technology, Inc., Redwood City, CA; and Valpey

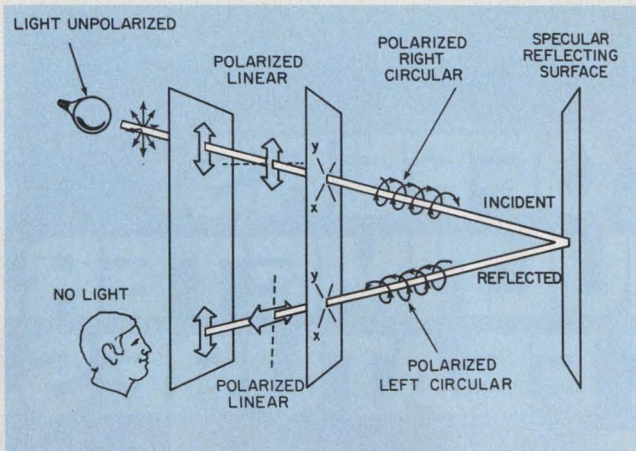

13. Circular polarizers cut light specularly reflected from glass or plastic front faces, and thus reduce glare.

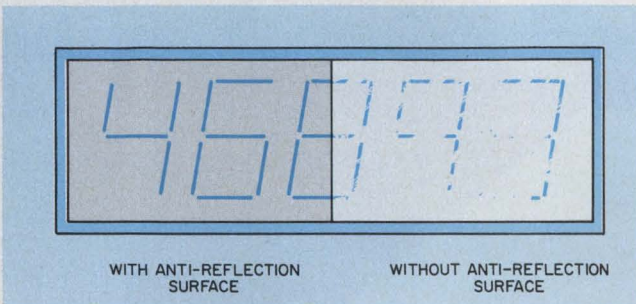

14. Still another way to cut glare is to give a filter an anti-reflection coating that diffuses incident light.

Corp., Holliston, MA.

Note the improved appearance of a front panel that has a display set off by a bezel. A black-plastic, satin-chrome or brushed-aluminum bezel can accent the display and attract the viewer's eye. For best effect, look into custom bezels. Commercial black-plastic bezels for digits up to 0.3-in. high (7.62 mm) are available (Table 1).

Other steps may also improve a display's visibility. Consider recessing the display and filter—from 0.25 in. (6.35 mm) to 0.5 in. (12.7 mm)—to add shading. If a double-sided printed-circuit board is used, keep traces away from the viewing area or cover the top-surface traces with a dark coating so they can't be seen. ■■

Bibliography

Wyszecki, Gunter and Stiles, W.S., "Color Science Concepts and Methods, Quantitative Data and Formulas," John Wiley & Sons, New York, 1967.

Billmeyer, Fred W., Jr., and Saltzman, Max, "Principles of Color Technology," Interscience Publishers, Division of John Wiley & Sons, New York, 1966.

Pucilowski, J., Schuman, R. and Velasquez, J., "Contrast Enhancement of Light-Emitting Diode Displays," *Applied Optics*, Vol. 13, No. 10, October, 1974, pp. 2248-2252.

Ralston, J. M., "Filter Considerations For Light Emitting Diode Displays," *Proceeding of the SID*, Third Quarter 1973, Vol. 1413, pp. 81-86.

Allyn, M.K., Dixon, R.W. and Bachrach, R.Z., "Visibility of Red and Green Electroluminescent Diodes for Color-Anomalous Observers," *Applied Optics*, Vol. 11, No. 11, November, 1972, pp. 2450-2454.

Application Note 945, "Photometry of Red LEDs," Hewlett-Packard, October, 1973.

CIRCLE NUMBER 42 ▶

4 volt thru 120 volt interchangeability

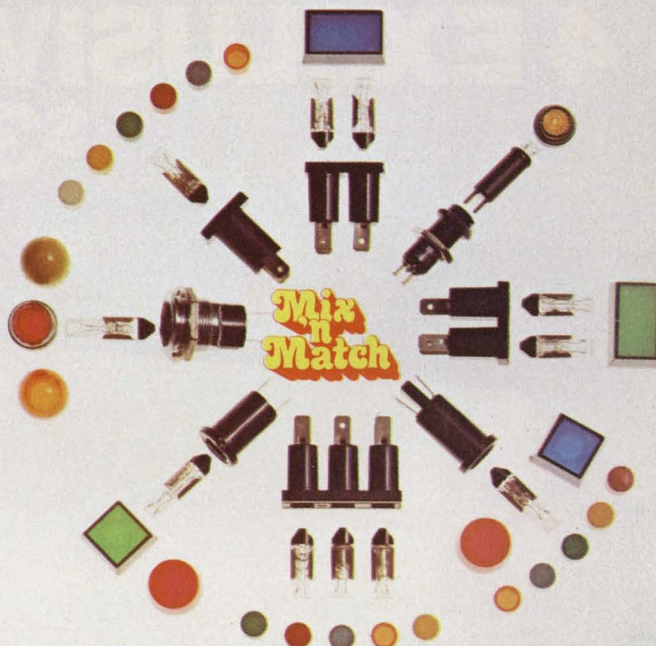

For the widest selection without overspecifying or overstocking, Sylvania offers you the universal parts flexibility of its "Mix 'n Match" lamp, socket, and lens system built around two series of T-2 slide base lamps. One is the *Pilot Lamp* series (5 to 120 volts), the other the *Indicator Lamp* series (4 to 48 volts). All of the lamps in each series are physically identical—hence sockets and lenses in each series are fully compatible with all of the lamps in its series. Use coupon below to order free 17"x22" Product Selector.

Try out your bright idea for \$5

- Get the money-saving
- Experimenter's Kit packed
- with twelve T-2 slide base lamps
- of assorted or specific voltages,
- a complete range of
- sockets, lenses and color
- caps, and the unlimited
- inspiration of a 56-page
- Design Data Handbook.

Enclosed is our check for \$5 for Experimenter's Kit & Design Data Handbook.

(If you prefer lamps of a specific voltage, please indicate preference below.)

4V 6V 10V 12V
 24V 48V 60V 120V

Please send free "Mix 'n Match" Product Selector

NAME _____

COMPANY _____

STREET _____

CITY _____

STATE _____

ZIP _____

Please make checks payable to: GTE Sylvania Incorporated
 Mail To: W. Main St., Hillsboro, N. H. 03244

We're helping you make it.
GTE SYLVANIA

**KEITHLEY OFFERS:
A 3½-DIGIT MULTIMETER.
4 EXCLUSIVE FEATURES.
\$315.**

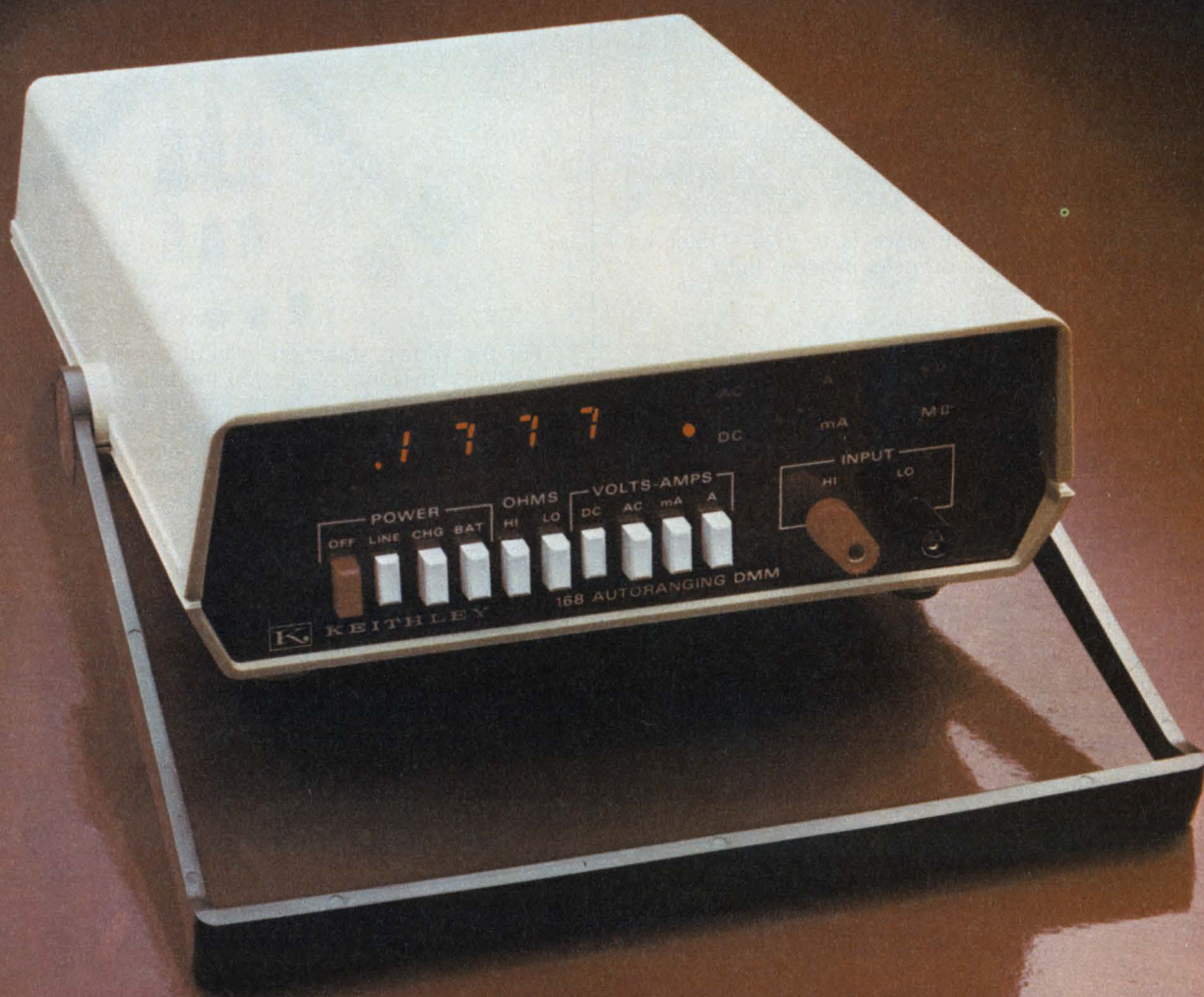

The Keithley 168 Digital Multimeter gives you every key performance feature offered by other first-line 3½-digit DMMs.

But only the Keithley 168 gives you 4 extra features—all useful and all at a competitive price. Compare our 3½ with the others and you'll come to an inescapable conclusion: the 168 is the best buy in 3½-digit DMMs.

For \$315: a superior DMM

For openers, you get a rugged, reliable, easy-to-read, general-purpose, 5-function DMM with more ranges than you'll normally need. Measure from 100 microvolts to 1000 volts dc, 100 microvolts to 500 volts ac, 100 milliohms to 20 megohms, 100 nanoamps to 1 amp, ac or dc. Basic accuracy is 0.1%. All modes fully overload protected. The 168 brings Keithley quality to general-purpose measurement.



4 extra features, no extra cost.

- *Automatic ranging* gives you the most accurate reading, with decimal in the right place, faster than you could do it with switches. Saves you time every time you make a measurement.
- *HI-LO Ohms* lets you turn on a semiconductor junction to see if it's good or measure an in-circuit resistance without turning on a semiconductor.
- *2-terminal input* for all measurements on all functions. You can't get it wrong. Terminals accept banana plugs, alligator clips, spade lugs or bare wire.
- *Lighted function indicator* so you know precisely what you're measuring, instantly.

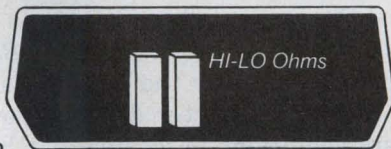

Surprise: more valuable features.

That's not all. We've packed even more value into the 168. Optional battery pack that you buy now or add later. Patented A-D converter to simplify circuitry. No-nonsense, full-year guarantee on parts, workmanship, and specs—including accuracy. Convenient calibration instructions right inside the cover. Light weight for easy portability.

Full complement of accessories.

Use these optional accessories to make your Keithley 168 DMM even more versatile: Wide-range RF probe. Test lead sets. Clamp-on ammeter. 50-amp shunt. High-voltage probe. Carrying case. Rack mount kit.

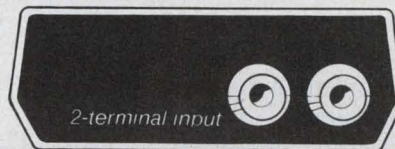

Now the logical choice.

The 168 is out-front in value. And it's backed up by our reputation for quality. Don't you wish all decisions were this easy?

Ordering a 168 is easy, too. Just contact: Keithley Instruments, 28775 Aurora Road, Cleveland, Ohio 44139. (216) 248-0400. Europe: D8000 München 70, Heighhofstrasse 5, West Germany. (089) 7144065.

DMMs for all your needs.

We know you have a variety of measurement requirements. So we offer a growing family of DMMs to meet your application and price objectives. Send for our Selector Guide.

180: 4½-digits, 30 nV sensitivity.

190: 5½-digits, high-stability, outstandingly low price.

171: 4½-digits, wide ranging 5-functions.

616: dc, 3½-digits, down to 0.1 picoamp full scale!

160B: dc, 3½-digits, high-sensitivity, low price.

KEITHLEY
The measurement engineers.

Head off dc/dc-converter problems.

You can attack cross-current conduction—an enemy of converter performance—in three ways.

Converter designers, rest easy. You can overcome the number-one killer of dc/dc converters—cross-current conduction. In fact, three solutions are possible:

- Minimize the storage time of the switching transistors.
- Delay turn-on of one transistor until its complement turns off completely.
- Limit the cross-current peak by increasing the source impedance to current transients.

An effective cure usually requires some combination of the three.

Without adequate precautions, any driven dc/dc converter will have a transitory period in which the two opposite-ended transistors conduct simultaneously. The phenomenon, known as cross-current conductance (CCC) or “through current,” can slash reliability, diminish efficiency and boost EMI.

Even worse, CCC causes high current transients through the converter's power transistors. Up to 100 times the steady-state current can flow, causing severe thermal stresses. In time, CCC can destroy the transistors.

The probability of catastrophe increases at high ambient temperatures when transistor gain goes up, and raises CCC transients even more. The results: thermal runaway and eventual destruction.

Designers sometimes try to counter the effects of CCC by resorting to higher power transistors and more massive heat sinks, both of which increase the circuit's ability to survive—at the expense of cost and size.

Understanding storage time

For a transistor to turn off, excess charge must be removed. The faster the discharge rate, the shorter the storage time.

An exact computation of storage time, t_s , is rather complicated and relies on charge-control concepts. However, two widely used equations for

t_s reveal the influencing elements. The first equation is given by:

$$t_s = T_x - \frac{(I_{B1} - I_C/\beta_o)}{I_{B2} + \frac{I_{B1} + I_C/\beta_o}{2}}, \quad (1)$$

where T_x is the lifetime of the excess charges in the base. For the case in which $I_C/\beta_o \ll I_{B1}$ (the worst case relative to storage time), Eq. 1 can be reduced to:

$$t_s = T_x \frac{1}{\frac{I_{B2}}{I_{B1}} + \frac{1}{2}} \quad (2)$$

Another formula often found is:

$$t_s = T_x \ln \frac{I_{B1} + I_{B2}}{I_C/\beta_o + I_{B2}} \quad (3)$$

Both equations give approximately the same results, with the best agreement obtained at $I_{B1}/I_{B2} < 4$.

To reduce t_s , the focus shifts to I_{B1} , I_{B2} , I_C/β_o and the associated variations in these parameters with temperature. Except for β_o , the parameters are largely under the designer's control.

In most converter designs, you avoid marginal gain conditions by ensuring a base drive significantly higher than that required to bring the transistor to the verge of saturation—that is, higher than I_C/β_o . Thus, Eq. 2 offers a workable approximation to the actual storage time, and the equation shows that storage time is directly proportional to T_x and inversely to I_{B2}/I_{B1} .

How to minimize storage time

To keep t_s down, select a transistor with as low a T_x as possible. Unfortunately, this parameter is not supplied by semiconductor manufacturers.

However, since T_x is inversely related to the forward alpha-cutoff frequency, you can select a device with a high cutoff frequency or a low storage time. The latter is specified by most manufacturers, and some vendors supply curves of storage time vs. base drive.

For a given transistor the most effective way to eliminate t_s is to keep the transistor out of saturation. This can be done fairly easily. But in most switching, high-current applications, the resulting extra dissipation cannot be tolerated.

Aron Levy, Power-Supply Group Leader, The Bendix Corporation, Guidance Systems Div., Teterboro, NJ 07608.

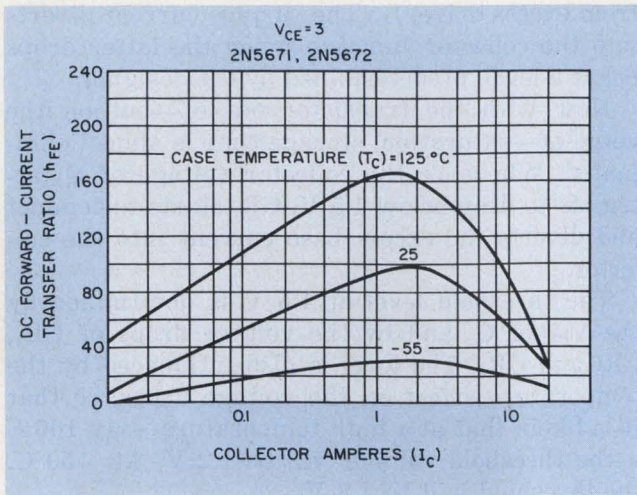

1. As temperature goes up, so does transistor gain. The resulting higher beta produces excess base-drive current, and so significantly boosts storage time. At low temperatures, a reverse effect occurs.

You should then attack the term I_{B2}/I_{B1} in Eq. 2, and reduce t_s by increasing this ratio as much as possible. To do so, you can reduce I_{B1} or increase I_{B2} . The former implies drastically less drive current—which can mean marginal gain conditions at low temperatures. It is therefore more practical to increase I_{B2} to 5 to 10 times the forward drive current.

In any given circuit, significant changes in storage-time duration can occur with gain or temperature variations. It is quite important to anticipate these changes before selecting a solution, and particularly for worst-case designs.

The quantities of I_{B1} and I_{B2} are usually controlled by the base-drive source and the series resistance in the base circuit. Within a given circuit, the currents are substantially fixed and not likely to change.

Gain variations between transistors or temperature fluctuations will alter I_C/β_0 significantly. As the gain changes so does the storage time, as can be seen clearly from Eq. 3.

For fixed base currents, storage time becomes inversely proportional to I_C/β_0 or directly proportional to the dc gain, β_0 . The smaller the I_{B2} , the higher the dependency of t_s on β_0 .

The dependency of t_s on the dc gain is easily explained in terms of excess charge in the base junction of the saturated transistor. The charge, which is directly responsible for storage time, is a function of I_{BX} , the surplus base current. Since $I_{BX} = I_{B1} - (I_C/\beta_0)$, its magnitude depends on β_0 .

In the extreme, where $\beta_0 = \infty$ or $\beta_0 = 0$, I_{BX} approximately equals I_{B1} or zero, respectively. In the latter case, storage time is nil.

Actually, with a given test condition, gain variations of $\pm 50\%$ can exist in transistors carrying the same JEDEC number. Even worse, a tempera-

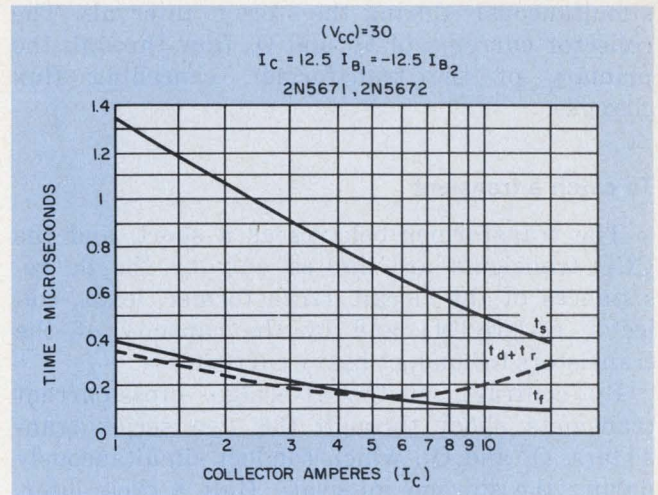

2. Note the drop in storage time as collector current increases, and how large the variations in t_s are compared with other switching parameters. The variations must be accounted for in design.

ture variation from 25 to 125 C can double the gain; if the temperature swings from 25 to -55 C, the gain can be chopped in half (Fig. 1).

One design, one solution

When a circuit must survive such large variations, a solution that eliminates CCC for one transistor at one temperature will not necessarily work for other transistors (even of the same type) or at other temperatures.

You must try to boost I_{B2} as high as possible to diminish the effects of worst-case β_0 variations. Also you must validate your solution empirically, since variations in β_0 are given for a typical case, and, by and large, are not guaranteed by manufacturers.

Gain changes with temperature variations are compounded by temperature-induced changes in the forward base-emitter voltage drop, causing the storage time to increase even more. Typical tempco for most silicon transistors is $-2 \text{ mV}/^\circ\text{C}$.

Thus the base-drive source, E_b , should be much larger than V_{BE} , so that I_{B1} varies negligibly with changes in V_{BE} . A drive source of 4 to 5 V is adequate. As a further precaution, use a base-drive series resistor that changes as a function of temperature, and so keeps I_{B1} or I_{BX} fixed.

Fortunately, storage time drops sharply as collector current, I_C , increases (Eq. 3). The exact relationship between these two parameters depends on the initial I_{BX} , on I_{B2} and on temperature.

Figure 2 shows t_s as a function of I_C , with $\beta_0 = 12.5$ and $I_{B1} = I_{B2}$. Here, a change of collector current from 1 to 15 A drops t_s from 1.4 to 0.4 μs . Such a change must be accounted for in selecting a solution.

What actually occurs in the circuit? In the case of the push-pull converter, Q_1 and Q_2 conduct

simultaneously during the storage intervals. The collector currents of Q_1 and Q_2 flow through the primary of the transformer, cancelling flux changes.

To catch a transient

The transformer behaves as a short, and the CCC transients are limited only by the dc resistances of the circuit (transformer, leads, collector resistivity) and by the capacity of the transistors to conduct heavy current.

By contrast, in the H-bridge, cross-current transients shoot through the two series transistors, Q_1 and Q_2 , which conduct simultaneously during the storage intervals. Half a cycle later, the transient shoots through Q_3 and Q_4 . In both cases, a virtual short is placed momentarily on the B+ line.

There are several possible ways to minimize storage time (Fig. 3). The main idea is to prevent transistor saturation by starving the base

from excess drive, I_X . The surplus current diverts into the collector junction when the latter drops below a level, predetermined by the designer.

Now with the transistor out of—but on the verge of—saturation, storage time is almost eliminated. Whenever the collector voltage of Q_1 attempts to drop below 1.5 V, CR_1 starts to conduct and diverts the excess base current into the collector.

The threshold level of 1.5 V is determined by the V_{BE} of Q_1 and by the voltage drops of CR_1 , CR_2 and CR_3 . The level is also influenced by the temperature effect on the voltage drops, so that it is likely that at a high temperature—say 100 C—the threshold voltage will be 1.2 V. At -50 C, the threshold will be 1.8 V.

The circuit in Fig. 3b is similar except that a resistive divider, R_1 and R_2 , determines the threshold value below which the collector voltage will not drop. This value is approximately $E_{CC}R_2/R_1h_{fe}$ for the case where E_{CC} is much greater than V_{CE} (threshold). The dependency on temperature is

What is cross-current conduction?

Cross-current conduction stems mainly from storage in a converter's switching transistors. The phenomenon appears as a stretching out of the saturated conduction period after base drive is removed. In a sense, CCC can be viewed as a transistor turn-off delay.

In comparison with turn-on delay, t_{di} , however, storage time, t_s , is typically 10 times or more in duration, and is also more sensitive to collector current, ambient temperature and other biasing conditions.

The figure shows the collector switching characteristic of a typical silicon transistor. Four transitions are of interest: delay time, t_{di} , rise time, t_r , storage time, t_s , and full time, t_f . Reverse base current I_{B2} (equal to I_{B1}) flows after

forward base drive I_{B1} is removed.

Despite the negative base-current pulse, the transistor remains in hard saturation for a period, t_s , before the fall-time occurs. This storage time can stretch if I_{B2} is prevented from flowing.

Consider now the correlation between the switching times of the two push-pull transistors. The collector voltages of Q_1 and Q_2 are shown synchronized to the base drive. Overlap periods t_{s1} and t_{s2} result from the storage times of Q_1 and Q_2 .

During these periods, the B+ line is almost shorted, causing the high collector current spikes shown at the bottom of the figure. Note that the turn-on delay time and the rise and fall

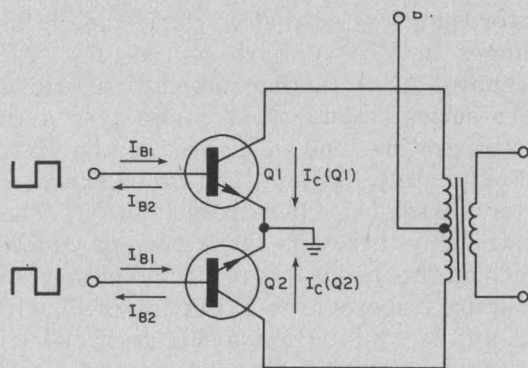

PUSH-PULL CONVERTER

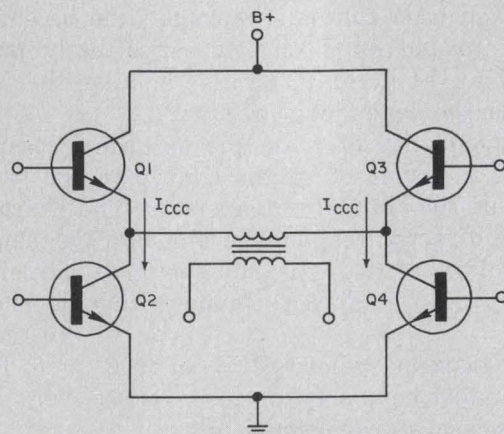

H = BRIDGE CONVERTER

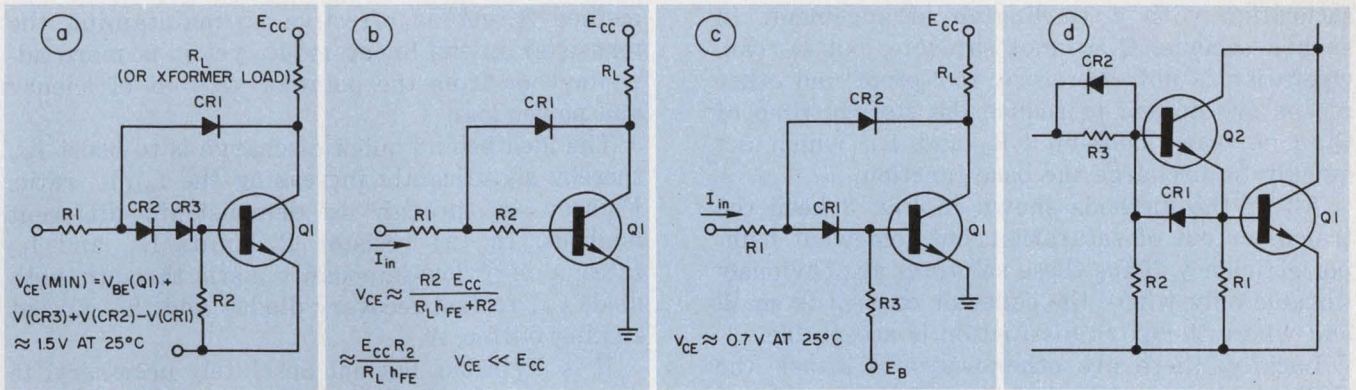

3. How to avoid transistor saturation: various diode clamping circuits shunt excess base current into the

collector (a, b, c). In (c) the collector is clamped to 0.7 V. Another circuit, the Darlington, does the same job (d).

less than that of the circuit of Fig. 3a, and the use of a voltage divider permits more freedom in design.

In still another circuit, only one biasing diode, CR₁, is needed (Fig. 3c). Hence, the thresh-

hold, V_{CE}, is approximately equal to the V_{BE} of the transistor, that is, 0.7 V. Temperature variations are half as much as those in the circuit of Fig. 3a.

Finally, the circuit in Fig. 3d keeps Q₁ out of

times are neglected.

Storage time is a phenomenon associated solely with the state of collector saturation. It results from the transistor being driven into saturation by a base drive greater than that required to produce the collector current limited by V_{CC}/R_C. In such a case, the gain is forced to be lower than actually required to produce the limited current, that is, I_{B1} > I_C/β₀.

In this mode, the collector voltage drops below that of the base, and both the collector-base and base-emitter junctions are forward biased. The collector now injects carriers into the base, and the excess carriers form a charge that accumulates in the base region (and in the collector if its resistivity is appreciable).

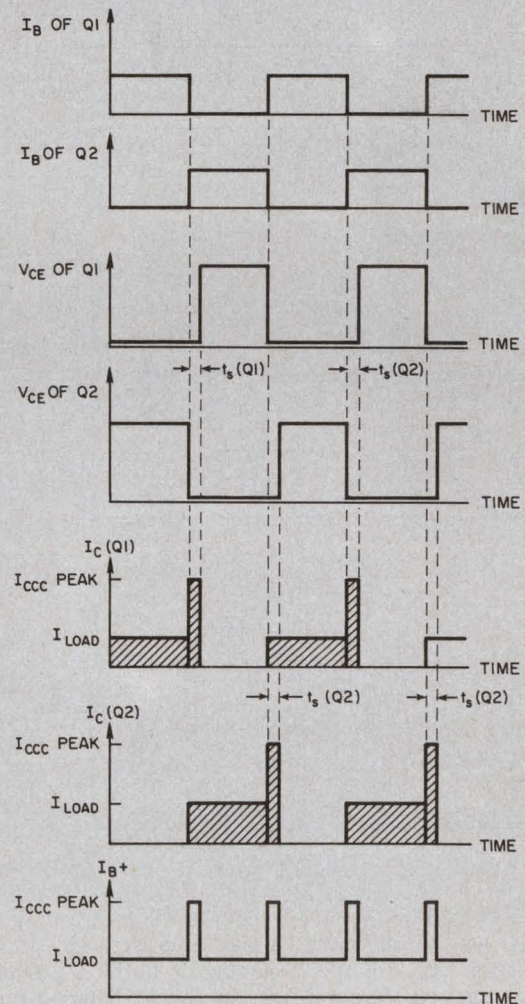
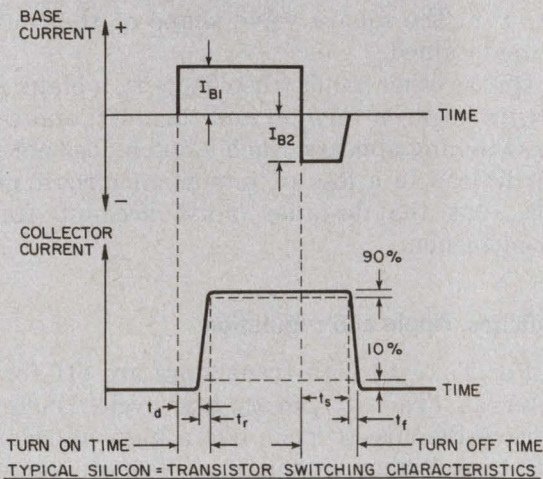

saturation with a Darlington arrangement. In such a scheme, Q_1 cannot saturate, but Q_2 can. Operation is not, therefore, fool-proof and other means are needed to reduce the storage time of Q_2 . One way: hook-up CR_2 and R_3 , which act quickly to discharge the base junction.

All of the methods shown in Fig. 3 keep the transistor out of saturation, but somewhat hamper efficiency. Thus these solutions are obviously suitable only where the collector current is small and where the extra dissipation is acceptable.

Luckily, there are other ways to attack the CCC problem—quick discharge of the base junction, for one.

A speedy solution

Quick discharge of the base junction can drastically shorten storage time without necessarily keeping the transistor out of saturation. The

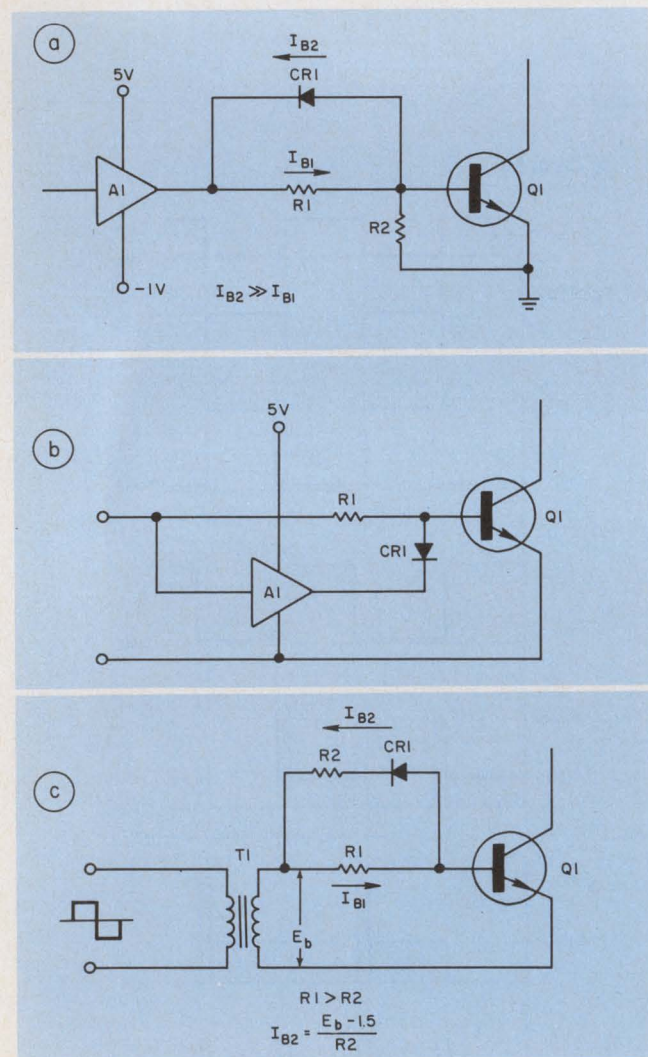

4. Another way to minimize storage time is to get rid of base charges fast. In one variation, a buffer A_1 sinks current to the -1-V source (a). In (b) A_1 handles just I_{B2} . Another quick-discharge method uses a transformer to apply a negative pulse during the off period (c).

method is not as effective as maintaining the transistor in the linear mode, yet it is more advantageous from the point of view of efficiency and power loss.

The idea behind quick discharge is to boost I_{B2} , thereby significantly increasing the I_{B2}/I_{B1} ratio. Figures 4a through 4c demonstrate different methods. In (a) resistor R_1 limits I_{B1} , and I_{B2} faces a very low-impedance path through both diode CR_1 (a fast recovery diode) and the current sinking buffer, A_1 .

It is desirable, but not absolutely necessary, to return the negative side of the buffer to -1 V so that Q_1 sees a negative pulse at turn off.

In Fig. 4a, R_2 doesn't have to be small since, to increase the base drive efficiency, the discharge path is actually through CR_1 . In fact, R_2 can be eliminated altogether.

In Fig. 4b, fast discharge occurs when A_1 sinks the base charges through CR_1 . Sinking buffer A_1 handles only the reverse current I_{B2} , not I_{B1} . Consequently, the thermal stress of A_1 is reduced.

In yet another improvisation, R_2 limits I_{B2} to the desired value, and a drive transformer T_1 , provides a positive voltage, E_b , for turn on and an equal negative voltage for turn off. Resistor R_1 fixes I_{B1} , and R_2 determines the reverse current (Fig. 4c).

The circuits of Fig. 4 don't solve the CCC problem completely. To render the coupe de grace requires a fool-proof method to delay one transistor's turn on until the other transistor turns off completely.

The artificial delay time, T_D , so introduced should be somewhat longer than the anticipated worst case t_s . Remember, worst case occurs at the high temperature extreme, where β_0 is a maximum.

Admittedly, when T_D equals t_s at high temperature the storage time increases over its value at room temperature (or that of a low-gain transistor). Also T_D greatly exceeds t_s when the latter reaches a minimum at a low temperature. When $T_D = t_s$, the square wave shape of the converter is maintained.

On the other hand, when $T_D > t_s$, a blank period occurs between turn-on and turn-off, and a notch in switching appears. Such a notch does not necessarily lead to a loss of important circuit properties, but the designer must account for this phenomenon.

Notches, ripple and regulation

For $T_D > t_s$, both transistors are off for some interval, $(T_D - t_s)$, every half cycle. During this period, the circuit looks like a high impedance to the transformer secondaries. Voltage spikes can result if the secondaries store energy, with no outlet for discharge.

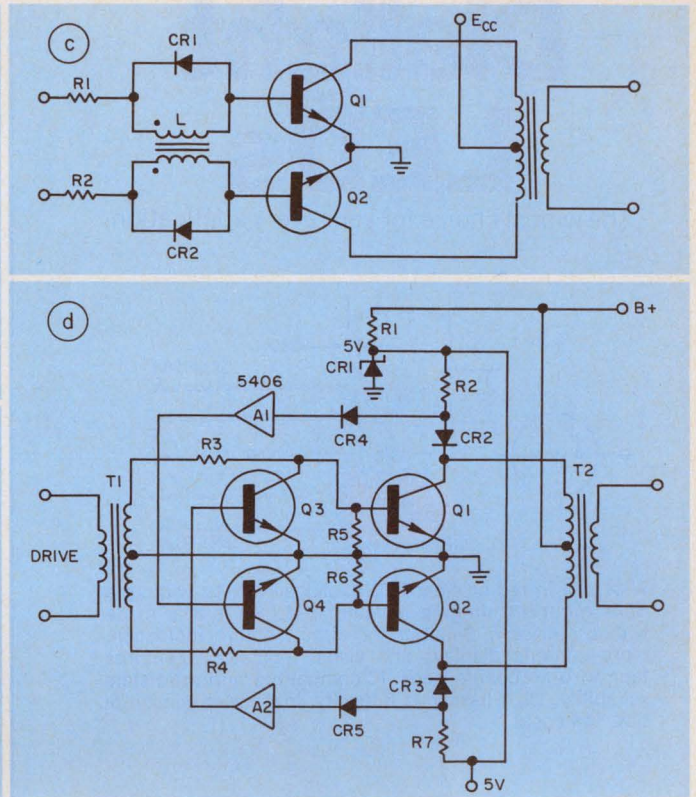
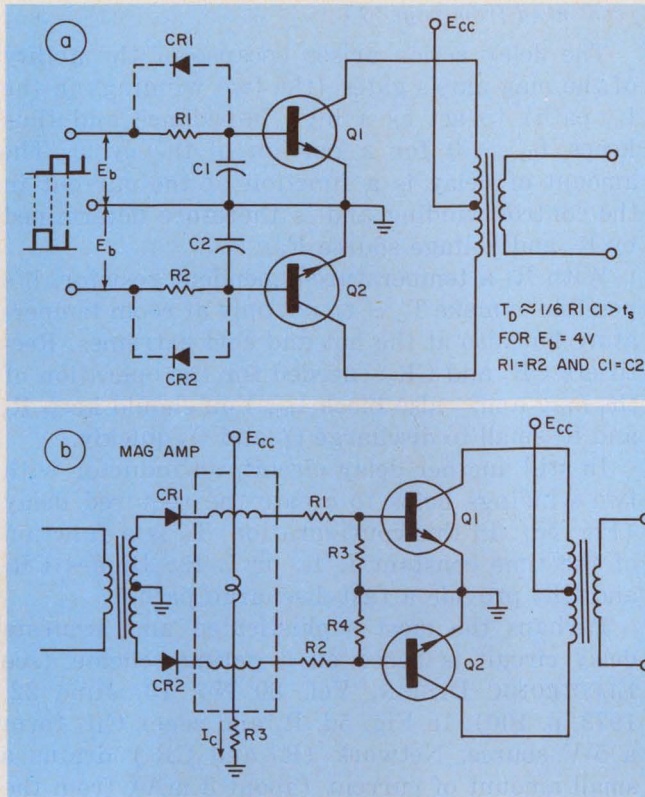

5. Best method to avoid CCC is to keep one transistor off until the other turns off entirely. In the push-pull converter, R_1 , R_2 , C_1 , C_2 do the trick, and the diodes provide fast turn off (a). Other ways to get delay: use

a mag amp (b) or an inductive time constant (L/R) as in (c). A more sophisticated circuit uses feedback to guarantee that delay time equals storage time under all operating conditions (d).

Furthermore, the notch in the conduction period increases the ripple component of the rectified-and-filtered secondary voltage. However, with a free-wheeling diode in the inductive filter of the secondary, you can neglect the impact of $T_D > t_s$.

When $(T_D - t_s) > 0$, consider an important additional effect on regulation. Assume a converter is energized from a regulated B+ line and it provides a fixed load current from the secondary. Suppose also, that an L-C circuit, with a relatively small inductor, filters the output.

Since the line is regulated and the load is fixed, once the voltage losses in the transformer, rectifiers and filters are accounted for, the output voltage will be as well regulated as the B+ line.

The regulation of the outputs will, however, be disturbed when T_D starts to exceed t_s , and a blank period in the wave shape occurs. As the difference between T_D and t_s grows, the outputs can drop by as much as $2(T_D - t_s)/T$, where T is the cycle duration.

The shorter the cycle (higher switching frequency), the higher will be the impact of each microsecond of notch on the wave shape. For a 25-kHz system, each $1/2 \mu s$ of excess delay can cause a 2.5% change in the output voltage. It is crucial, therefore, to first minimize t_s , and then do the same to $(T_D - t_s)$. A third option: keep the operating frequency as low as possible.

One simple way to introduce a delay is with an R-C network in the drive path (Fig. 5a). Components R_1 and C_1 delay the turn-on of Q_1 —and R_2 and C_2 do the same for Q_2 . The actual delay depends on the RC values, the amplitude of the square-wave drive signal and the threshold of the transistor.

In most cases, T_D will equal some fraction of the R-C time constant. For instance, when E_b equals 4 V, T_D is approximately 1/5 to 1/6 of RC. Note the two fast-recovery diodes, CR_1 and CR_2 , in Fig. 5a. These provide the quick discharge of the base junction and minimization of t_s .

The advantage of the mechanism of Fig. 5a is its simplicity; the major disadvantage, however, is the circuit's loose accuracy. But the circuit will probably be adequate for 95% of applications.

Actually, selection of tighter tolerances and the use of temperature-compensation can provide better accuracy.

Remember the mag amp?

Another delay method is the magnetic amplifier (Fig. 5b). Since the mag amp controls a delay in the 1 to 3- μs range, and since the applied voltage, ($E_b \approx 4 V$) is small, it can be only slightly larger than can fit into a TO5 case.

(continued on page 78)

Dialight LEDs

The widest choice for your every application.

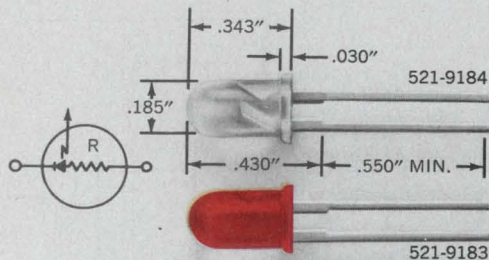

Available in red or clear LED packages with or without a built-in current limiting resistor. Red LED is also made without resistor. Suitable for circuit status indication, alpha-numeric displays and visual indicators. Features long wire-wrappable leads. IC compatible with solid state reliability. High luminous intensity, low power consumption, low cost.

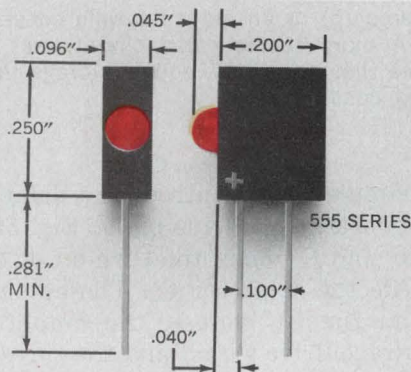

LED logic state fault indicators available in 14 models with voltage ratings from 1.7 to 14. Suitable for dense packaging on printed circuit boards—up to 10 units to the inch—IC compatible. With built-in series resistor. Polarity identified. Low power consumption.



Dialight, the company with the widest choice in switches, LEDs, indicator lights and readouts, looks for needs . . . your needs . . . and then they develop solutions for your every application. No other company offers you one-stop shopping in all these product areas. And no other company has more experience in the visual display field. Dialight helps you do more

with these products than any other company in the business, because we are specialists that have done more with them. Talk to the specialists at Dialight first. You won't have to talk to anyone else. Send for your free new copy of Dialight's current catalog.

DIALIGHT

Dialight, A North American Philips Company
203 Harrison Place, Brooklyn, N. Y. 11237
(212) 497-7600

See Dialight.

CIRCLE NUMBER 43

(continued from page 77)

The delay action arises because of the ability of the mag amp's gates (the two windings in the I_{B1} path) to act as a high impedance and thus keeps $I_{B1} \approx 0$ for a portion of the cycle. The amount of delay is a function of the current in the control winding and is therefore determined by R_3 and voltage source E_C .

With R_3 a temperature-dependent resistor, it's possible to make $T_D \approx t_s$, not only at room temperature but also at the hot and cold extremes. Rectifiers CR_1 and CR_2 —needed for the operation of the mag amp—also block I_{B2} . You should keep R_3 and R_4 small to discharge Q_1 and Q_2 quickly.

In still another delay circuit, an inductor with two windings helps to create the required delay (Fig. 5c). In this configuration, T_D is a function of the time constant L/R_1 or L/R_2 . Diodes CR_1 and CR_2 provide a fast-discharge path.

Perhaps the most sophisticated and accurate delay circuit is based on a gating scheme (see ELECTRONIC DESIGN, Vol. 20 No. 13, June 22, 1972, p. 100). In Fig. 5d, R_1 and zener CR_1 form a 5-V source. Network (R_2 and CR_2) drains a small amount of current (about 3 mA) from the source through Q_1 when the latter saturates.

Foolproof circuit guarantees results

At saturation, the voltage on the anode of CR_2 drops below 1 V and is recognized by inverter A_1 as a low. As a result, A_1 's output goes high, and Q_4 is driven into hard saturation, preventing Q_2 from turning on.

When Q_1 ends its saturation period (composed of conduction plus storage time), its collector voltage jumps to twice the $B+$ voltage. Then CR_2 becomes back biased, and the voltage on its anode rises to 5 V. Inverter A_1 sees a high input, puts out a low, and drives Q_4 off.

The arrangement guarantees that Q_2 is starved of base-drive current—as long as Q_1 conducts—and that no cross-conduction occurs. The circuit for Q_2 is identical.

The circuit is fool-proof because feedback "watches over" the transistor state of conduction. The only disadvantage is the relative complexity: Packaging can be a problem with the circuit in discrete form. But IC vendors, take note—monolithic design is certainly feasible.

The third method—limiting transient current during CCC by insertion of an impedance in the $B+$ line—is not highly recommended. In this method, an inductor is connected in series with the center tap of the transformer or in the emitter leads of both push-pull transistors.

A diode across the inductor allows reset of the flux. However, an inductor in the high-current path implies higher power losses and a slow down of turn on and turn off. ■■

HP announces pulse-parameter control in a word generator

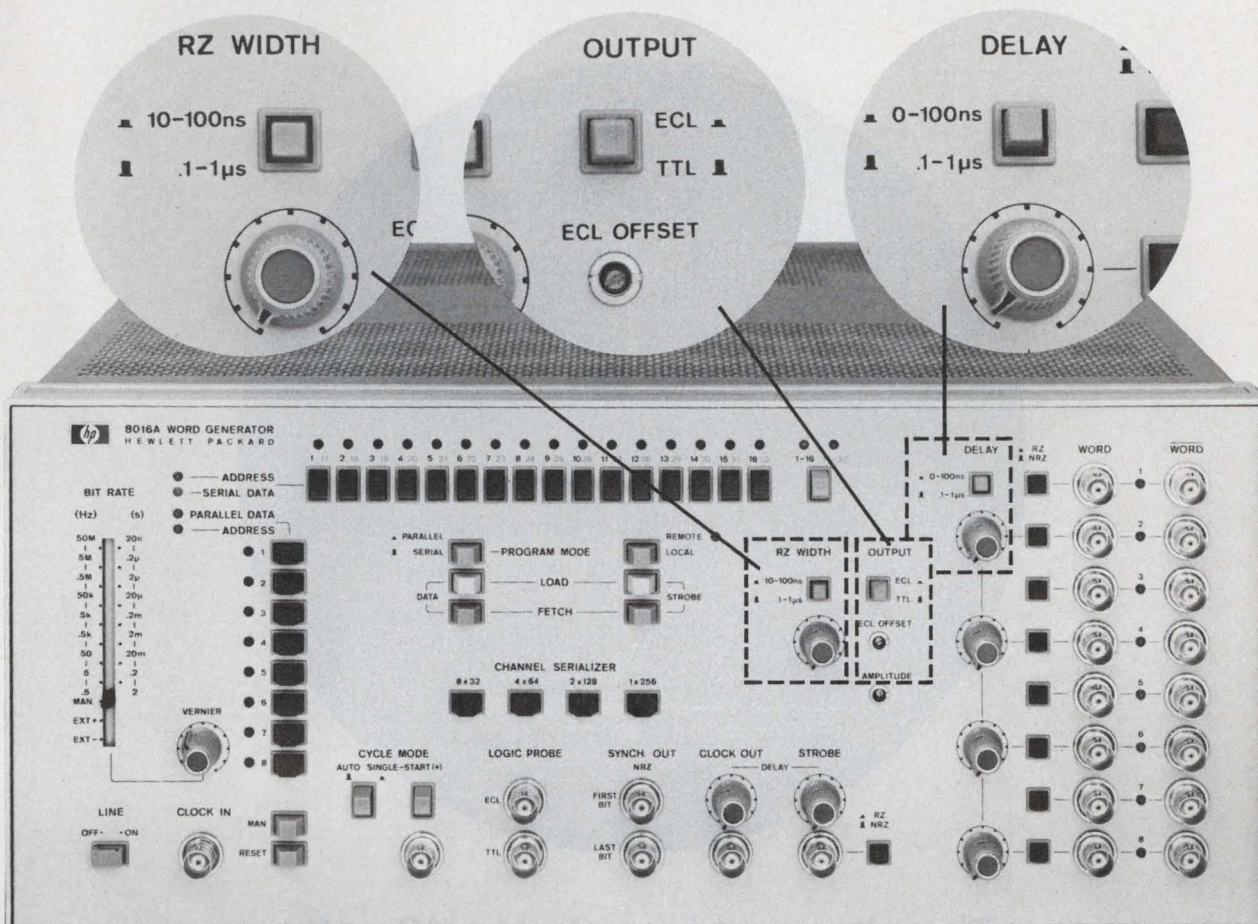

That means an end to building arrays of pulse and word generators to do complex digital testing in the lab or production. HP's new 8016A gives you the digital stimuli you need for IC development or testing, for digital circuit evaluation, for microprocessor system troubleshooting, and for interface evaluation—at data rates to 50 MHz.

Now you can vary pulse width, height, and delay for worst-case or parametric testing such as set-up and hold-time measurements, as well as functional testing. Add HP's new 1600A Logic State Analyzer to your system and you have the ideal combination for observing your logic circuits in action.

Parallel and serial data selection. In the parallel mode, output is 32 bytes, each 8-bits wide. In the serial mode you get up to eight 32-bit words. Or you can serialize outputs for word length up to 256 bits. You have complementary outputs and a selection of RZ/NRZ formats on each channel.

Programming options. Manual data loading is simple with the pushbutton matrix and LED indicators. And a remote programming option allows fast

loading with an HP Interface Bus compatible card reader, calculator, or minicomputer—a valuable option for on-line testing where speed and accuracy are important.

There's still more. The 8016A includes manual clocking for single step testing; a strobe channel to use as a ninth data channel or serial qualifier; clock and sync outputs; ECL and TTL logic-probe power outputs; and other features to provide flexibility and ease of use.

Your local HP field engineer can give you all the details on this powerful new word generator, which is priced at \$6,400*. Or, write for our 10-page data sheet. It gives all the specs, output timing diagrams, and includes application information.

*Domestic U.S.A. price only.

085/13

HEWLETT  PACKARD

Sales and service from 172 offices in 65 countries.
1501 Page Mill Road, Palo Alto, California 94304

CIRCLE NUMBER 44

When battery life is critical, there's nothing even close to a TRW LVA zener

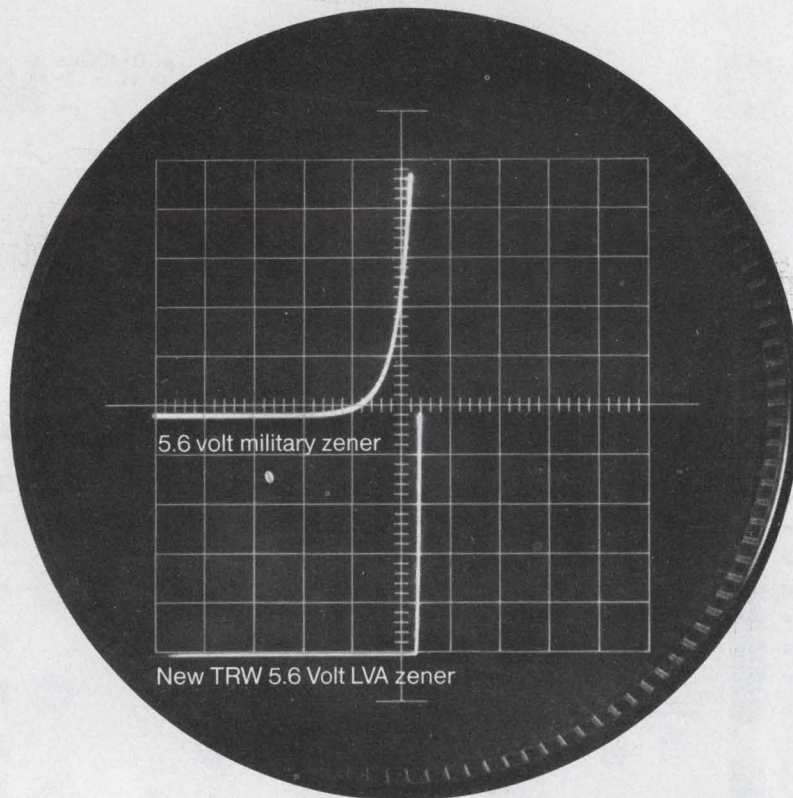

**The sharpest knee below 10 volts
for up to 10 times the battery life.**

In medical equipment, testing devices, watches, pocket pagers—wherever battery life is critical—no other zener can approach a TRW LVA.

TRW's Low Voltage Avalanche zeners are also ideal for instrumentation and logic circuitry where as highly stable zeners they provide extremely constant reference voltage yet draw as little as 50 microamps. True, they cost more. But where battery life is more important than a dollar or so, or when you have to load in transistors and resistors to minimize battery drain, it pays to use TRW LVA's. For your convenience, they're available in several package configurations and chips.

For immediate action and applications assistance, call John Power (213) 679-4561.

TRW Power Semiconductors,

An Electronic Components Division of TRW, Inc.,
14520 Aviation Boulevard, Lawndale, California 90260

- Please send me data sheets on TRW's LVA zeners.
- I would like a quote on _____ of _____ volt devices.
(Quantity) (Voltage)
- Please have representative call _____
(Phone Number)

Name _____
Company Name _____
Address _____
City _____ State _____ Zip _____

ED

TRW POWER SEMICONDUCTORS

ANOTHER PRODUCT OF A COMPANY CALLED TRW

CIRCLE NUMBER 45

Creeping up on daylight

We've just brought the integrated dc-to-daylight frequency synthesizer a couple of steps closer to reality.

The new Plessey IC's offer a quick and easy way to lower synthesizer costs while increasing loop response and channel spacing all the way from dc through the HF, VHF, UHF and TACAN bands.

Start with one of our IC prescalers. They feature input ports for VHF and UHF, self-biasing clock inputs, TTL/MOS-compatibility and variable input hysteresis for wideband operation.

Then add one of our two-modulus dividers. All of them provide low power consumption, low propagation delay and ECL-compatibility, and most of them are available in commercial and MIL-temp versions.

Finally, to make things even simpler, add the Plessey SP8760 control chip and phase lock your synthesizer to any crystal up to 10 MHz. All the stability you need with none of the usual headaches and hassle.

If it all sounds too good to be true, contact us today for details and application notes.

Once you've seen the data, you'll see the light.



PLESSEY SEMICONDUCTORS

1674 McGaw Avenue, Irvine, CA 92714
Tel: (714) 540-9945. TWX: 910-595-1930
Represented world-wide.

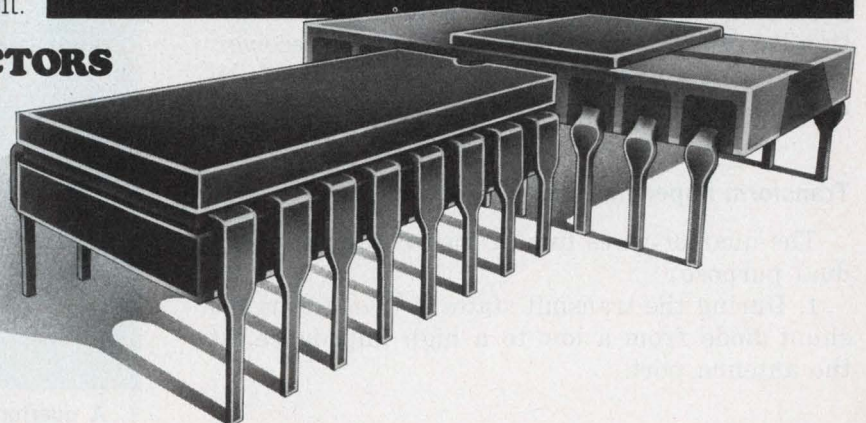
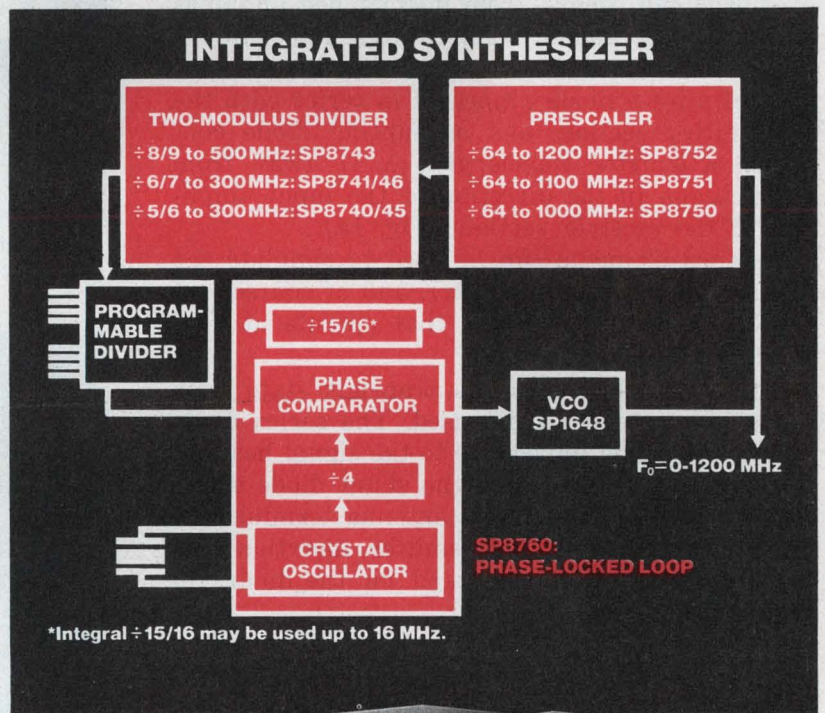

State-of-the-art brought down to earth

Fixed and programmable dividers □ Linear and digital communications circuits

CIRCLE NUMBER 46

Pick the right p-i-n diode for transceiver antenna switches. Some simple equations and approximations can make selection easy and prevent overload damage.

When p-i-n diodes are used as antenna switches, they offer higher reliability, better ruggedness and faster switching speeds than electromechanical relays.

For most low-power transceivers (those with less than 2-W rf output) diode switches can be designed without paying much attention to power limitations. Such restrictions do become important at higher power levels, where damaging overloads can occur—from mismatched antennas or extreme operating temperatures, for example.

The basic circuit for an electronic switch consists of a p-i-n diode connected in series with the transmitter section, and a shunting diode connected a quarter wavelength ($\lambda/4$) away from the antenna in the direction of the input amplifier of the receiver section (Fig. 1a).

Lumped elements can be used to simulate the $\lambda/4$ section (Figs. 1b and 1c), and of course, are preferable for transceivers that operate at long wavelengths.

When switched into the transmit state each diode becomes forward biased. The series diode appears as a low impedance to the signal heading towards the antenna, and the shunt diode effectively shorts the receiver's antenna terminals to prevent overloading. Transmitter insertion loss and receiver isolation depend on the diode resistance, R_D .

In the receive condition, the diodes are at zero or reverse bias and present essentially a low capacitance, C_T , which creates a direct low-insertion-loss path between the antenna and receiver. The off transmitter is isolated from this path by the high-impedance series diode.

Transform impedances with $\lambda/4$ sections

The quarter-wave line in the antenna serves a dual purpose:

1. During the transmit states it transforms the shunt diode from a low to a high impedance, at the antenna port.

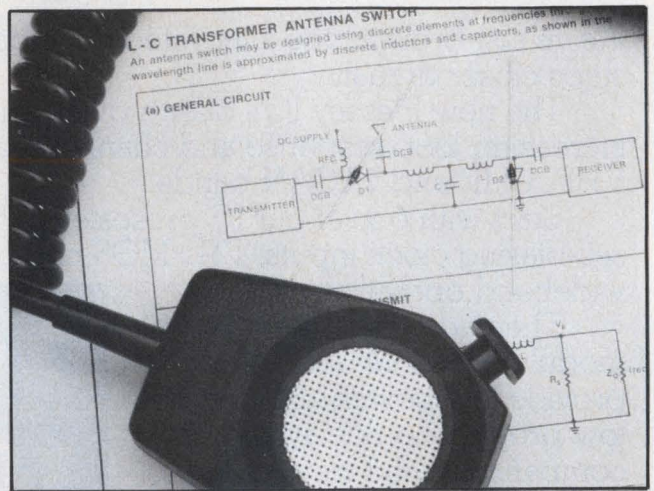

P-i-n diodes can be used as antenna switches if you follow a few simple design rules.

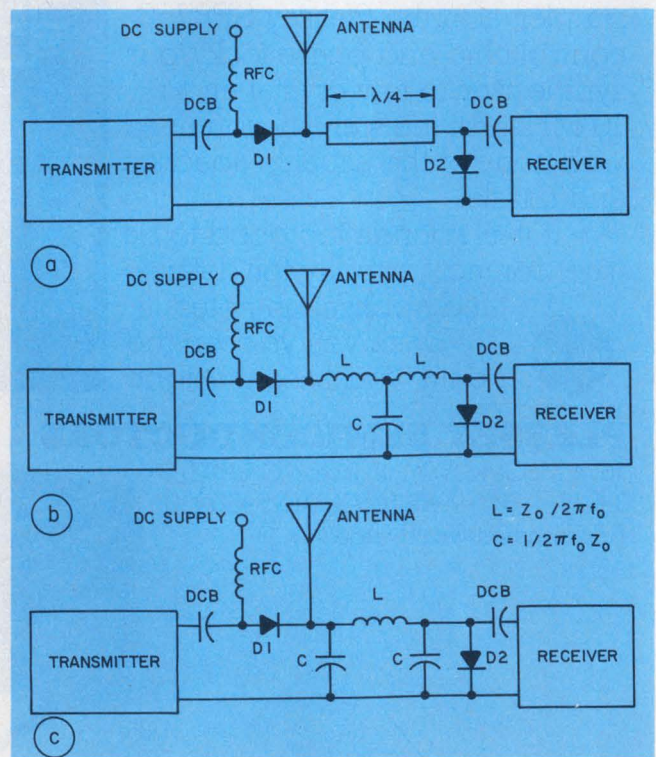

1. A quarter-wave section of transmission line is used to separate the transmit and receive sections of a transceiver (a). For transceivers using long-wavelength frequencies, lumped elements eliminate the long lengths of transmission line (b and c).

Gerald Hiller, Director of Microwave Engineering, Uni-trode Corp., 580 Pleasant St., Watertown, MA 02172.

2. During the receive state it presents a low-loss, low-reflection path to the receiver port.

The amount of power dissipated by the diodes in the transmit state must be determined. Power dissipation in the p-i-n diode is simply the square of the rf current multiplied by R_D .

You can easily analyze the switch performance for conditions such as transmitter power, worst-case antenna standing-wave ratio (SWR) and ambient temperature. First, you should redraw

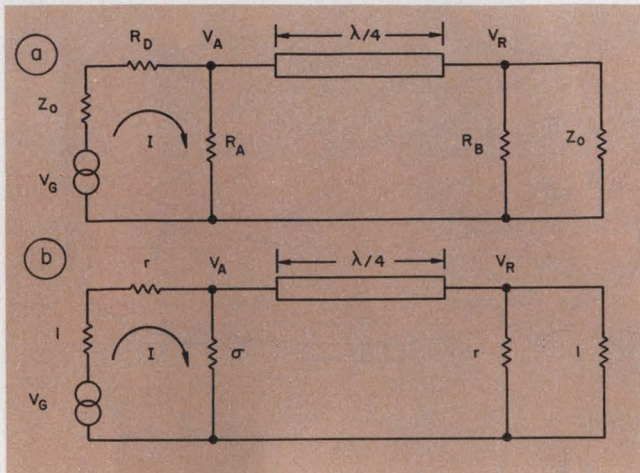

2. The equivalent circuit of the antenna switch (in the transmit state) represents the diode as simple resistances (a). To make calculations easier you should normalize all circuit elements (b).

the circuit of Fig. 1a to the form shown in Fig. 2a; this lets you define and calculate the rf-signal relationships that occur at the design frequency of the quarter-wave transformer. (Most transceivers are relatively narrow band, within $\pm 10\%$, and the accuracy lost by using the relationships across the entire bandwidth is insignificant.)

The transmitter can be represented by a voltage source, V_g , that has an internal impedance, Z_0 . The maximum available power from the generator can be found by:

$$P_{AV} = V_g^2 / 4Z_0 \text{ watts.} \quad (1)$$

The diode resistances are considered equal and each has a value of R_D . You can represent the antenna impedance at R_A and the receiver impedance, for perfect matching, as Z_0 . The quarter-wave transformer is also assumed to have a characteristic impedance of Z_0 .

To simplify and generalize the analysis, let's normalize the component values of the circuit to the nominal transmission-line impedance, Z_0 (Fig. 2b). The circuit elements are now identified as follows:

$$r = R_0 / Z_0 \text{ (normalized diode resistance)} \quad (2)$$

$$\sigma = R_A / Z_0 \text{ or } Z_0 / R_A \text{ (antenna SWR)} \quad (3)$$

The antenna SWR, σ , represents a resistive mismatch. The series diode is highly stressed

when a mismatch stresses the low impedance appears at the antenna junction; similarly, the shunt diode is highly stressed when a high impedance appears at the antenna junction. In most transceivers, and particularly in those for mobile units, the worst-case SWR is used because the distance between the true reflection plane and the antenna junction varies whenever the vehicle moves.

Since the switch has a finite resistance, it will cause a loss in rf output power. The loss, in decibels, can be calculated by:

$$\text{insertion loss} = 10 \log \left\{ 4\sigma / [(\sigma + 1)^2 + (r + 1)^2] \right\} \text{ dB} \quad (4)$$

Graphically, you can plot this equation for antenna SWR values of 1, 1.5, and 2 (Fig. 3a). At all SWR values for $r = 0$, the insertion loss is the same as the mismatch loss. Eq. 4 shows that the insertion loss is theoretically small—less than 0.2 dB for values of r less than 0.02 ($R_D = 1\Omega$ in a 50Ω system). The improvement is small by reducing the diode resistance to less than 1Ω .

Diode isolation affects performance

How well the diodes isolate the receiver section of the transceiver can also be calculated:

$$\text{receiver isolation} = 10 \log \left\{ 4r^2 \sigma^2 / [(\sigma + 1)^2 (r + 1)^4] \right\} \text{ dB} \quad (5)$$

Plots at Eq. 5 show the effect of SWR on receiver isolation and clearly depict the 6-dB degradation in receiver isolation that occurs when the transmitter is totally mismatched. The degradation must be included when you design the receiver protection. The isolation for values of r less than 0.02 is about 34 dB when the antenna is matched.

Higher isolation values are theoretically possible but are not generally achievable due to other circuit losses and radiation effects. Inductance in the shunt diode path will also be detrimental to isolation. If you need higher isolation, just add quarter-wave sections to the circuit.

The power dissipated by the series and shunt diode can be found from two formulas:

$$P_{D(\text{series})} = 4r P_{AV} \left\{ (\sigma r + r + \sigma) / [(r + 1)(\sigma r + \sigma + r + 1)] \right\}^2 \text{ W} \quad (6)$$

$$P_{D(\text{shunt})} = 4r \sigma^2 P_{AV} / [(\sigma + 1)^2 (r + 1)^4] \text{ W} \quad (7)$$

For $r \ll 1$, Eqs. 6 and 7 reduce to:

$$P_D = 4r \sigma^2 P_{AV} / (\sigma + 1)^2 \text{ W} \quad (8)$$

Eq. 8 is a handy approximation of the power dissipation in both the series and shunt diodes. It implies an R_D that is much less than the typical 50Ω Z_0 . And, any inaccuracy that Eq. 8 introduces results in a more conservative estimate of diode dissipation; and you won't end up with an underrated device (Fig. 4).

Even though diode resistance has little effect on insertion loss, it can greatly affect the amount of power the switch will dissipate. From matched

antennas to totally mismatched units, power dissipation increases by four times.

You can find the maximum-allowable transmitter power $P_{T(max)}$, by solving Eq. 8 for P_{AV} and then substituting $P_{D(max)}$, the maximum-allowable diode dissipation for P_D . If you're working in 50- Ω systems you can simplify the equation even fur-

ther (assuming infinite SWR):

$$P_{T(max)} = 12.5 P_D / R_D W. \quad (9)$$

As a p-i-n diode handles rf power, its junction temperature rises. The temperature reached depends on P_D , the ambient temperature (T_{AMB}) and the thermal resistance between the diode junction and the external (Θ_{JA}). The transmitter

Basics of p-i-n diode operation

P-i-n diodes operate as rf and microwave resistors whose resistance values are controlled by forward current levels. A p-i-n diode is built from high resistivity (low conductivity) silicon and has an intrinsic layer sandwiched between a p and an n layer (Fig. A). When the diode has a forward current, holes and electrons are injected in the i-region. They do not completely recombine, but instead form some quantity of stored charge. The stored charge causes the effective resistivity of the i-region to be much lower than intrinsic resistivity.

The amount of stored charge, Q , is governed by the recombination time in the i-region (commonly called the carrier lifetime), τ , and the level of the forward current, I_f . The relationship between these three terms can be expressed simply as:

$$Q = I_f \times \tau \text{ coulombs.} \quad (A)$$

The resistance of the i-region, R_D , is inversely proportional to Q and can be expressed³ as:

$$R_D = w^2 / 2\mu Q \text{ ohms,} \quad (B)$$

where w is the i-region width and μ the ambipolar carrier mobility in silicon.

Note that the resistance of the diode is ideally only affected by carrier lifetime and i-region width, not by the junction area of the diode. In practical devices, a reduction of carrier lifetime occurs when the chip area is reduced.

Eqs. A and B indicate that diode resistance is inversely proportional to the applied dc forward current. The dc voltage-current characteristics of a p-i-n diode are similar to those of a conventional p-n junction diode.

For example, a UM4001B p-i-n diode, at 25 C, has a forward voltage of 0.75 V at a current of 0.1 A and 0.85 V at 1 A. The total power dissipated is the sum of the dc power and the rf power (Fig. B). However, dc power levels are usually much lower than rf levels and can be ignored in all but marginal applications.

When zero or reverse biased, the p-i-n diode appears as a capacitor, C , in parallel with a resistance, R_p . At rf frequencies, the capacitance is independent of reverse voltage and can be represented as:

$$C = \epsilon A / w \text{ farads,} \quad (C)$$

where ϵ is the dielectric constant of silicon, A the area of the i-region and w the width of the i-region.

R_p depends on both reverse voltage and fre-

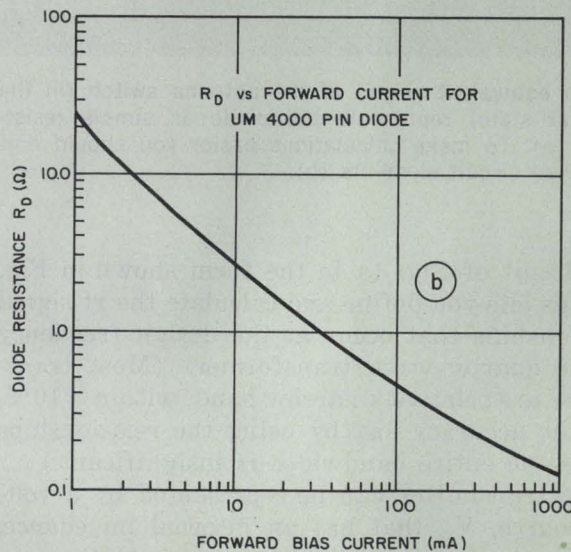
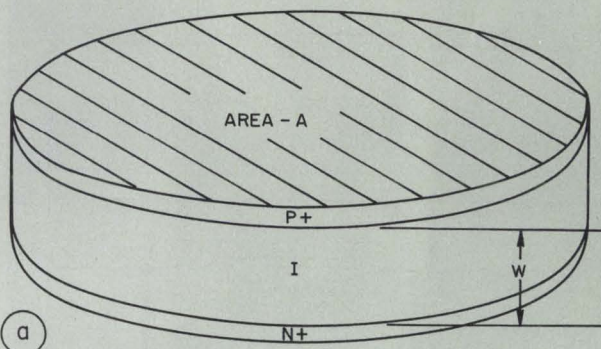

quency. Its value, to a large extent, is determined by the resistivity of the i-region material.

The ideal p-i-n diode for power switching should have a long carrier lifetime for low resistance and a thick i-region to keep the capacitance per unit area low. Thus a large thermal contact area is available without increasing the capacitance to a level that makes the diode useless at high frequencies.

Electrical specs for p-i-n diodes often give the diode resistance at a specific forward current, and the diode capacitance at a specific reverse voltage and frequency. Also, curves are usually available on the data sheet to present parameters as a function of frequency and forward current.

power the diode handles should not raise the junction temperature above its maximum allowable value, $T_{J(max)}$.

When the thermal resistance and maximum junction temperature are specified for a diode, the maximum power dissipation can be found:

$$P_{D(max)} = (T_{J(max)} - T_{AMB}) / \theta_{JA} \text{ W.} \quad (10)$$

Often, though, p-i-n diodes have their $P_{D(max)}$ specified for an ambient temperature of 25 C and a maximum junction temperature. In such cases, a derating factor (the inverse of the thermal resistance) should be included in your calculations.

For diodes mounted in threaded-stud packages, the thermal-resistance rating indicates how well the heat can be transferred from the junction to an infinite heat sink to which the stud is attached. The θ_{JA} rating assumes that no heat is removed from the terminal not connected to the stud.

Stud mounted p-i-n diodes are available with either the p or n sides connected to the stud. These types can be used for the shunt section of the switch. Diodes are available with a beryllia insulator placed between the diode and the case to permit total electrical isolation and still provide a good thermal path. Totally isolated diodes, of course, are used as the series switch elements.

Include lead length in power calculations

The power rating of diodes in axial-lead packages is a little more difficult to compute because the leads are part of the heat-flow path. The rating depends on the lead material and geometry, which in turn determine the θ_{JA} of the leads. For example, the UM4001B from Unitrode has 0.04-in. diameter silver leads. The graph in Fig. 5a shows how the thermal resistance changes as lead length increases.

The slope of the graph line is 37 C/W per inch of lead length, which is one half the θ_{JA} of the lead material since the device is thermally symmetrical. To compute the $P_{D(max)}$, any thermal resistance in the interface between the lead and heat sink must be included.

Fig. 5b shows the power ratings of a leaded UM4001B compared with a stud-mounted UM4001C ($\theta_{JA} = 6 \text{ C/W}$) and a stud-mounted, beryllia-isolated UM4001D ($\theta_{JA} = 8 \text{ C/W}$). The maximum junction temperature of these diodes is 175 C and all ratings assume no heat is removed by convection.

Another potential thermal limitation of p-i-n diodes is the maximum allowable current. This rating is usually given if there is a possibility of fuse action occurring within the diode package at a current level lower than the diode power rating.

If a maximum current rating is given, make sure that the maximum rf current, at worst-case SWR, doesn't exceed that rating. For instance, a

15-W transmitter would probably supply approximately 1.1 A of rf current at total SWR mismatch; a 1-A diode obviously can't handle the potential overload.

Design procedures are simple

Let's look at some full design examples. A 50- Ω diode switch must handle 500 W at an antenna SWR of 2 and a heat-sink temperature of 90 C. The series diode in the switch must dissipate most of transceiver power loss, so let's evaluate its requirements first. At a 90-C ambient the UM4001D has a maximum P_D of 10.5 W (Fig. 5b).

(continued on page 86)

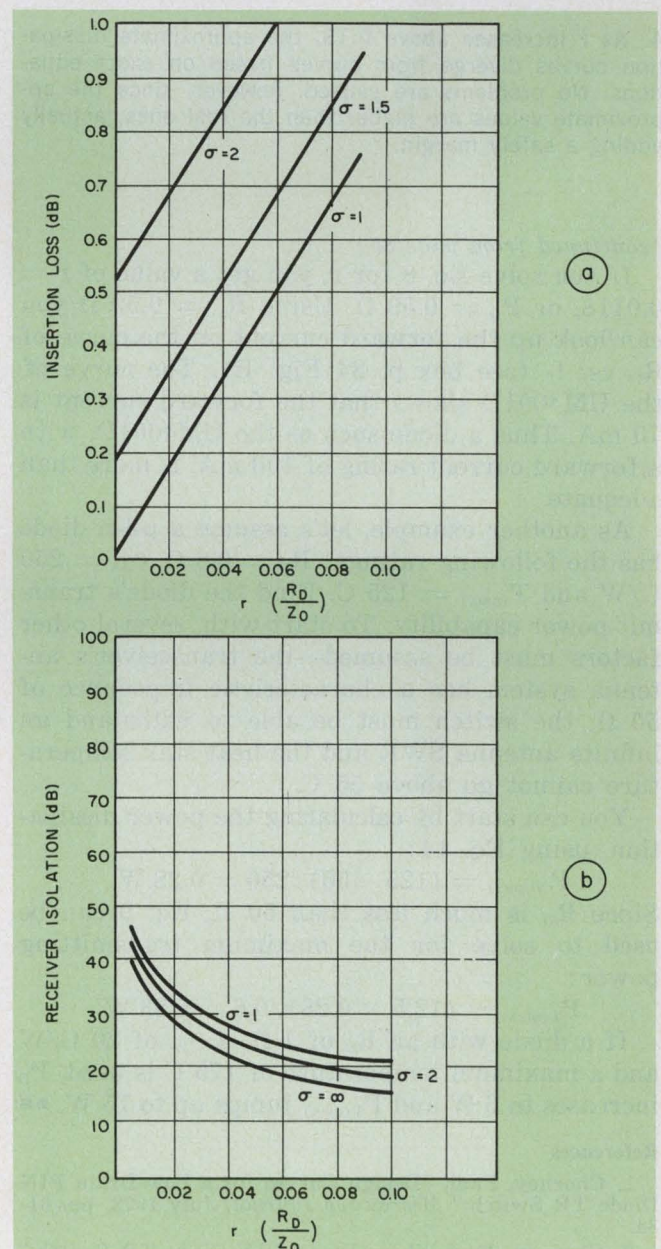

3. You can calculate insertion loss (a) or receiver isolation (b) by finding r and σ . Insertion loss increases with r , and receiver isolation improves as r decreases.

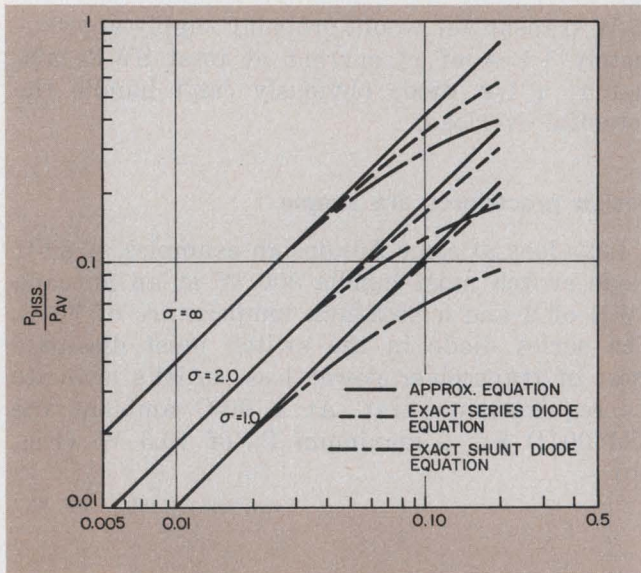

4. As r increases above 0.13, the approximate dissipation curves diverge from curves based on exact equations. No problems are caused, however, since the approximate values are higher than the real ones, actually adding a safety margin.

(continued from page 85)

If you solve Eq. 8 for r , you get a value of $r = 0.0118$, or $P_D = 0.59 \Omega$. Using $R_D = 0.50 \Omega$ you can look up the forward current on the curve of R_D vs. I_f (see box p. 84 Fig. B). The curve of the UM4001D shows that the forward current is 70 mA. Thus a diode such as the UM4001D, with a forward current rating of 100 mA, is more than adequate.

As another example, let's assume a p-i-n diode has the following ratings: $R_D = 0.6 \Omega$, $\theta_{JA} = 250 \text{ C/W}$ and $T_{(max)} = 125 \text{ C}$. Find the diode's transmit-power capability. To start with, several other factors must be assumed—the transceiver's antenna system has a characteristic impedance of 50Ω , the switch must be able to withstand an infinite antenna SWR and the heat sink temperature cannot go above 55 C .

You can start by calculating the power dissipation, using Eq. 14:

$$P_{D(max)} = (125 - 55) / 250 = 0.28 \text{ W.}$$

Since R_D is much less than 50Ω , Eq. 9 can be used to solve for the maximum transmitting power:

$$P_{T(max)} = (12.5 \times 0.28) / 0.6 = 5.83 \text{ W.}$$

If a diode with an R_D of 1Ω , a θ_{JA} of 20 C/W and a maximum temperature of 175 C is used, P_D increases to 6 W and $P_{T(max)}$ jumps up to 75 W . ■■

References

1. Chorney, Paul, "Design Curves for a Low-Drain PIN Diode TR Switch," *Microwave Journal*, July 1972, pp. 31-34.
2. Chorney, Paul, "Low Drain PIN-Diode TR Switch," *Microwave Journal*, February, 1973, pp. 16-20.
3. Leenov, D., "The Silicon PIN Diode as a Microwave Radar Protector," *IEEE Transactions on Electronic Devices*, Vol. 11, 1964, pp. 53-61.

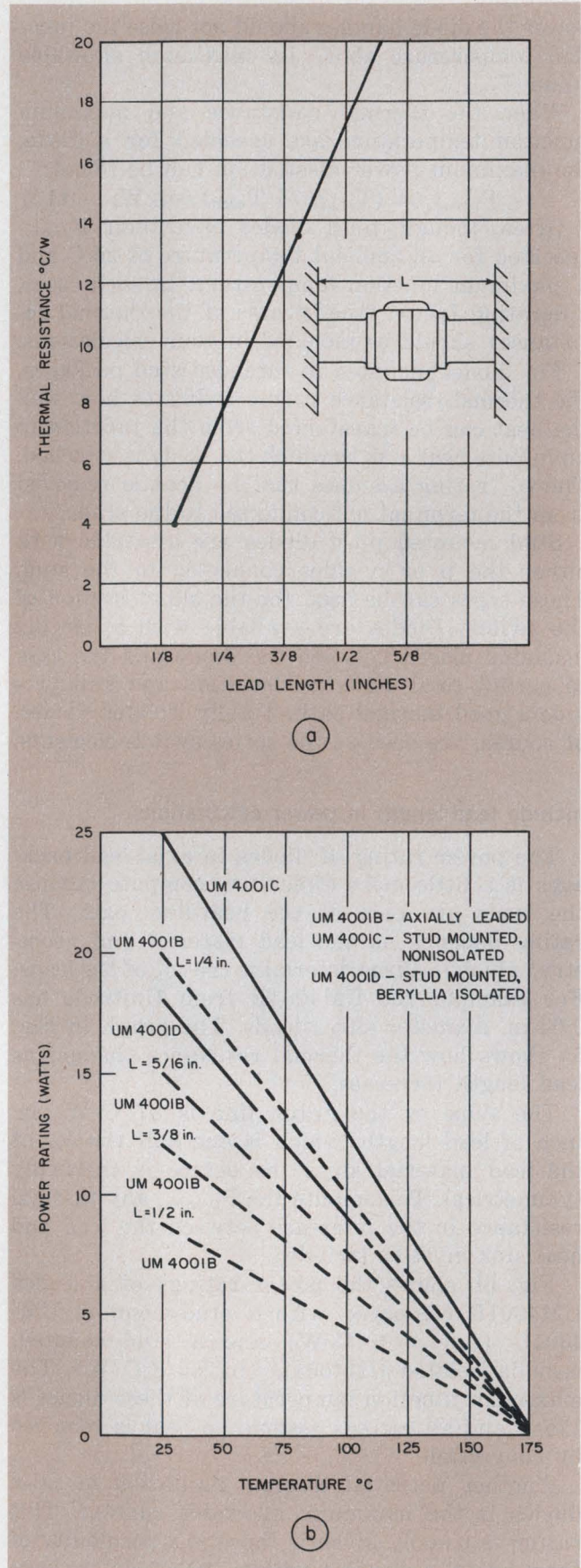

5. The thermal resistance of leads on axial-lead diodes must be included in many power dissipation calculations (a). Some typical power-rating curves of the UM4001 series of leaded and stud-mounted p-i-n diodes show the improvement in power dissipation possible just by using short leads or a stud-mount package (b).

12 reasons why *only* Buchanan® Terminal Blocks provide **Lowest Total Applied Cost!**

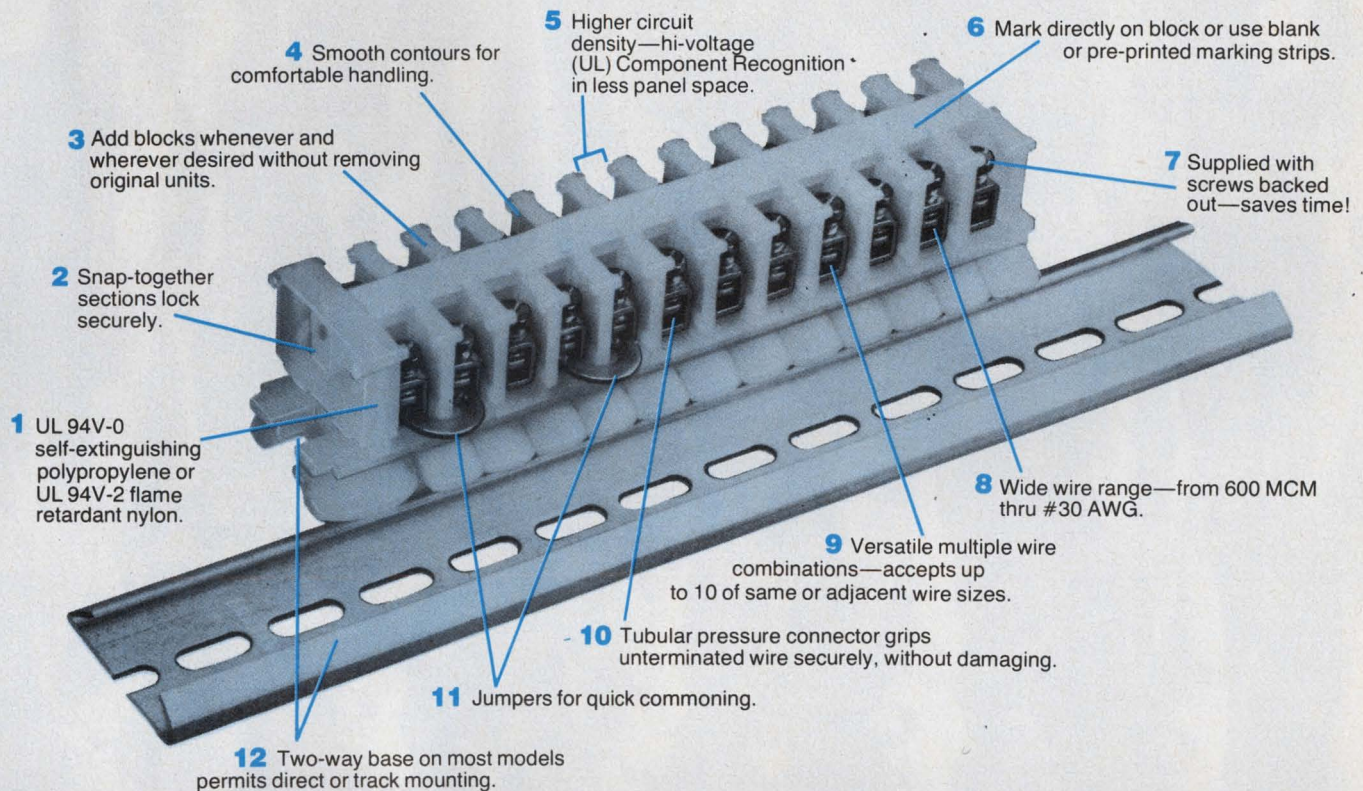

AND—you can get 'em when you need 'em!

No matter how many advantages offered by a specific terminal block, you can't get the advantages if you can't get the block!

Which is why we make sure Buchanan blocks are stocked in ample quantities throughout the country. Buchanan has anywhere from twice to eight times as many stocking distributors as other manufacturers—so you can get the blocks you need *when* you need them.

And only Buchanan distributors can give you *all* the advantages shown above.

Copper tubular contacts that really grip . . . higher circuit density . . . ease of assembly and add-on . . . everything that works together to provide Lowest Total Applied Cost!

Next time you order terminal blocks, specify Buchanan and be sure of *all* the advantages, *plus* prompt delivery. In the meantime, send for our handy Selector Chart and Catalog. Use the Reader Service Card. (If you have a special application, call one of our Regional Offices shown below.)



**CONTROL PRODUCTS
DIVISION**

Amerace Corporation
Control Products Division
2330 Vauxhall Road
Union, N. J. 07083, U.S.A.
Telex 138-978

16



The big memory family. In MOS, Bipolar and CCD together, nobody?

Or better. Because Fairchild is the memory leader.

So when you buy our memories, you get a lot more than a handshake and a carnation for your lapel.

You get at least 7 very tangible advantages.

And here they are.

1. You get more choice.

It's a fact. Of the five major sources today, no one gives you more choice in memory than Fairchild.

More off-the-shelf availability in both leadership parts and volume parts in all three of the technologies you need—MOS, Bipolar and CCD.

2. You get more ways to save.

One-stop Fairchild shopping means a lot more than convenience, too.

It means you can realistically package all of your memory requirements together for extra buying leverage—and important dollar savings.

3. You get more performance.

Leadership performance in every technology. In MOS, for example, our 16-pin 4K RAM and 2102 1K RAM are the n-channel industry standards.

In Bipolar, there's our industry standard 93415 1024X1 TTL RAM. Our unique 93422 256x4 TTL RAM. Plus our fastest-in-the-industry 2K and 4K PROMs. And our volume-production RAM in ECL.

Not to mention our CCD

450 1Kx9 Shift Register and CCD460 16K LARAM.

4. You get extra reliability.

— Take our 16-pin 4K MOS RAMs. We 100 percent torture-test to assure against field failures—ask for our documented reliability brochure.

Or take our 93415 1K Bipolar RAMs. With 12,000,000 hours of test data, some customers have simply stopped incoming inspection.

Now *that's* confidence.



bigger than Fairchild.

5. You get it ahead of the game.

Fairchild is the leader in memory technologies.

So as new developments come along in memory technology—1³L, 16K MOS RAMs, 4K Static Bipolar RAMs—we'll bring you the devices you need to help you compete. And keep ahead.

6. You can get it when you need it.

Today, you'll find virtually every significant memory device

in volume production at Fairchild.

So if you need it in a hurry, we're the first place to call.

And when heavy market demand makes delivery hard to get, Fairchild's commitment to volume production and uninterrupted delivery can mean even more.

7. You get it at the best price.

Last, but not least, the way we look at pricing is this. To be expensive in the memory business is to be out of business.

So when we say we're competitive, we mean *competitive*.

For complete data on Fairchild MOS, Bipolar, and CCD memories, write or call your Fairchild Sales Office, Distributor or Representative today.

Fairchild Camera & Instrument Corp., 464 Ellis Street, Mountain View, CA 94042. Telephone (415) 962-4401. TWX: 910-379-6435.

The big memory family. Who else?

FAIRCHILD

WHO ELSE?

Measure signal peaks accurately

despite low rep rates and narrow pulse widths. This 'go-fast' technique can do things the usual peak circuits can't.

Accurately measuring peak voltages is a difficult design challenge, full of pitfalls for the unwary. Component limitations pose severe problems for simple designs.

The solution: an advanced design called the "Go-Fast" peak detector. It accurately measures the peaks of repetitive signals—or even single pulses—of almost any shape, rise time or duration. The circuit's range extends from slowly varying dc to narrow pulses that have durations as short as 500 ns. It can also handle a wide signal-voltage range—from 20 mV to 10 V peak.

Sharp rises are troublesome

Factors of particular importance in the design of peak detectors include the input signal's characteristics—rise time, dwell, repetition rate and dynamic range—and the detector's ability to capture and retain a measurement long enough to transfer it to a more permanent storage.

Sharp signal rise, for example, is a major reason peak detectors overshoot. Narrow, single-shot signals and those with low repetition rates require high charging currents to fully charge a temporary storage capacitor.

Such currents are not easily achieved for 500-ns signals. A wide signal range (40 dB or more) requires a low detection threshold with good linearity, which is hard to get.

Further, once the signal is detected, the detector's output must be able to hold its measurement until the data can be transferred to a more permanent recording or metering system. Thus, output "droop" is a significant design constraint.

The basic circuit (Fig. 1) is reasonably accurate for relatively slow rise times, long-duration pulses and repetitive waveforms. But it suffers serious errors with both single, narrow pulses and wide, repetitive pulses—if the pulse train has fast leading-edge rise times.

To overcome dynamic-range limitations im-

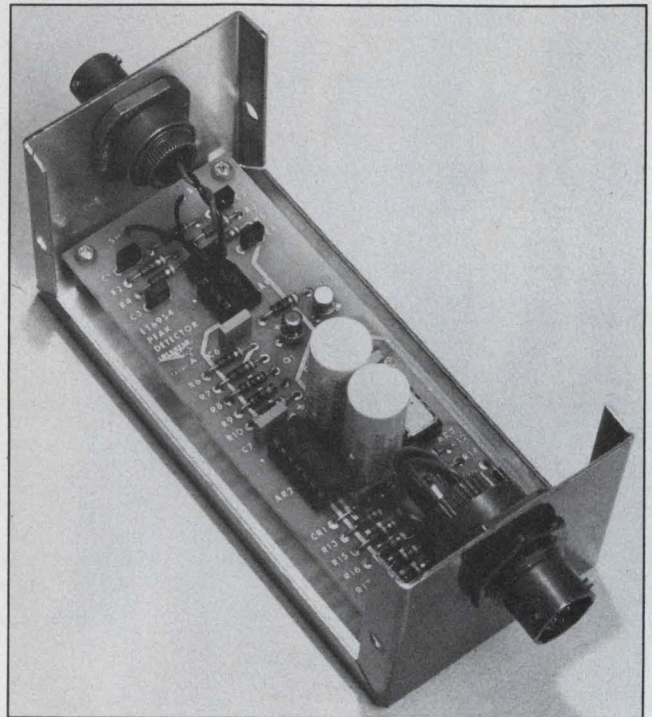

This peak detector, designed around the "Go-Fast" technique, monitors acoustic emissions from fatigue cracks in an aircraft-materials-testing system.

posed by the diode's forward-voltage drop, the designer might resort to a preamplifier to increase signal levels so that the drop is negligible. But, a 40-dB range requires signal levels of over 100 V—not practical with most standard solid-state components.

A better approach is to insert the diode into a feedback loop (Fig. 2). That way you cure the problems caused by the forward-voltage drop, and improve the diode's linearity at the same time. However, a multitude of problems remain.

Slew rate is limited

When the input preamplifier can't follow the input signal, the peak detector will register a peak reading far below the true value.

For example, in a preamplifier that has a slew

rate of $10 \text{ V}/\mu\text{s}$, a signal input pulse of 6 V and 500-ns wide will drive its output to only 5 V. In addition, the drop in D_1 allows only about 4.3 V to be stored in capacitor C_s . As a result, a false reading as low as 71% of the true value is obtained. Further, a 500-ns input signal with a 10-V peak would also store only 4.3 V, giving an error greater than 50%.

Many op amps have a current-limit safeguard designed-in to protect against short-circuit conditions. Others are current limited by their components.

Current limits pose a problem. The reasonably large capacitor needed to store voltage requires

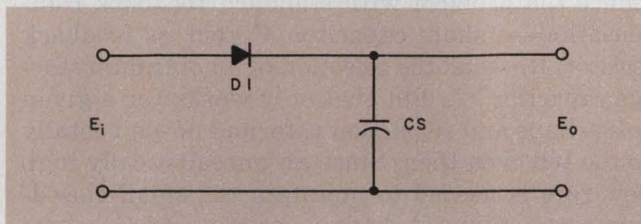

1. The basic peak-detector circuit has very limited capability. It can only be used to measure signals that have high levels and high repetition rates.

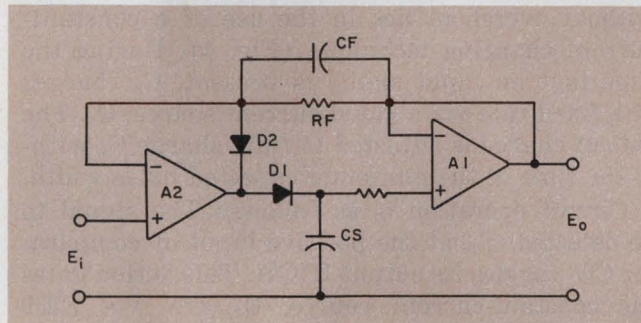

2. To overcome some of the limitations inherent in a simple diode peak detector, the diode can be included in the feedback loop of an op-amp circuit. Many problems still remain though, so a more sophisticated circuit is needed to attain accurate results.

an appreciable current to avoid excessive delay in the feedback circuit. A large capacitor keeps down the effects of the drift from offset-bias current in the post amplifier, A_1 , and leakage in diode D_1 . A fast charging rate is mandatory; delays contribute to overshoot.

For example, suppose the amplifier has a slew rate sufficient to reach the peak value of a 10-V pulse in 500 ns. With its output current limited to perhaps 10 mA, a $0.01\text{-}\mu\text{F}$ capacitor can only charge to about 1 V—1/10 of the true reading—even in a period as long as $1 \mu\text{s}$.

With a 500-pF capacitor, the circuit could charge to 10 V in 500 ns. But all is still not well: The 500-ns delay in the feedback loop can cause a huge overshoot, because the preamplifier is driven hard into saturation for the full charge period. It then takes at least another 500 ns to

recover its maximum slew rate. Up to 100% overshoot occurs in some cases.

Diodes are far from ideal

The effects of D_1 's forward capacitance are largely compensated for by feedback action; thus, forward capacitance is of little consequence.

Far more important are the effects of the diode's reverse capacitance. The main feedback loop is disabled when an input pulse drops to a negative value, and a new feedback loop is established through D_2 . This action causes a sudden drop in voltage on D_1 's anode that capacitively couples a negative spike into the storage-capacitor circuit. At best, the spike reduces the stored voltage. At worst, it propagates through the feedback loop, driving the preamplifier on again and producing ringing and measurement errors.

And, of course, other nonideal characteristics of diodes also take their toll of a peak-detector circuit's performance. Such problems include reverse-recovery time, T_{RR} , forward-recovery time, T_{FR} , forward-voltage drop and leakage current.

Charge is stored in a diode when forward current flows. When the diode bias is suddenly reversed, this stored charge maintains a reverse current flow. Reverse current may flow only 200 ns in fast-recovery diodes and many microseconds in ordinary diodes (Fig. 3a). Unfortunately, reverse current discharges the storage capacitor to a lower voltage.

Perhaps less troublesome is forward-recovery time (Fig. 3b). When forward voltage is first applied to a diode, current carriers need a finite time to cross the junction; thus, most of the input voltage drops across the diode for the first few hundred nanoseconds. High-voltage diodes typically have long forward-recovery times, T_{FR} .

Once recovered, a forward-voltage drop of from 0.2 to 1 V still remains. This drop is the only adverse diode characteristic almost fully corrected by feedback.

A problem not helped by feedback is diode leakage. Leakage current causes droop in the stored voltage. Highly dependent on temperature, droop rate, because of this leakage, doubles approximately every 10-C temperature rise.

The designer could use a transistor connected in a diode configuration to significantly improve this leakage problem. A better solution, however, is to use junction FETs, D_1 and D_2 , connected as shown in Fig. 4; both leakage and junction-capacitance effects are thereby improved.

Capacitors aren't ideal either

The single major problem source most often overlooked in storage capacitors is the tendency for some types to have "memory." Ceramic capac-

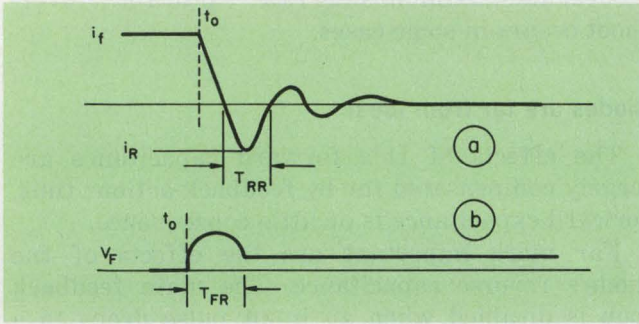

3. Reverse-recovery time, T_{RR} , and forward-recovery time, T_{FR} , take a toll of a peak-detector's performance.

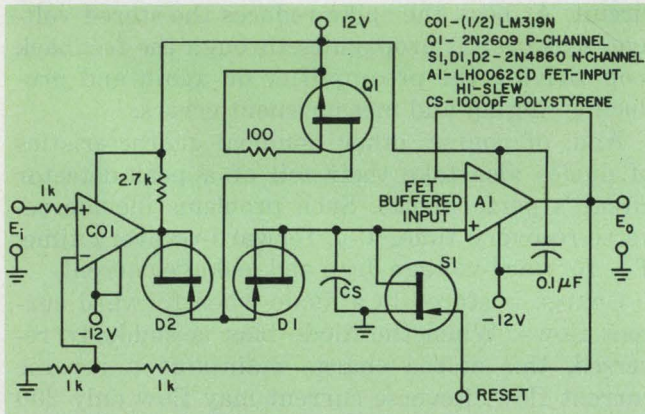

4. A "Go-Fast" peak-detector circuit that uses a comparator preamplifier, FET diodes, a FET-input feedback op amp, a constant-current charging source and a high-quality polystyrene storage capacitor, can accurately measure the peak voltage of even a single 500-ns pulse.

itors, in particular, tend to store charge within the dielectric. Over a period of time, a charge on a capacitor tends to "soak" into the dielectric and a decrease in the capacitor's terminal voltage results.

If the capacitor is then partially discharged and isolated, some of the soaked-in charge migrates out and raises the voltage slightly. The recovered voltage is proportional to the voltage originally impressed.

In peak detectors, this memory effect appears during peak-voltage storage time as voltage droop, and after reset as zero-voltage creep, which is proportional to the last stored voltage. In peak detectors, therefore, stay away from ceramic capacitors. Instead, consider polycarbonate or polystyrene units.

Unfortunately, the storage capacitor's voltage also can be changed by the post amplifier's bias currents—and discharged by its input impedance. A FET-input op amp can help with both of these problems. Because a FET has low offset-bias characteristics and an extremely high input impedance, charge on C_S would remain undisturbed.

Even though the post amplifier doesn't supply current to the storage capacitor, its slew-rate and current-limit characteristics are still very important. This amplifier provides feedback to the preamplifier, and any delays because of slew-rate limiting may cause overshoot. If the output amplifier must drive appreciable load capacitance, the amplifier's current-limit performance must be able to handle the load.

Current switching makes the detector go fast

Even with suitable pre and post op amps, overshoot remains a major stumbling block. You can reduce the problem with standard feedback compensation—a shunt capacitor, C_F , across feedback resistor, R_F —and the selection of an optimum storage capacitor, C_S . But that only works for a given pulse shape and repetition rate, and doesn't totally do the job even then. Since an unrealistically high slew rate is needed to maintain the small closed-loop error required during charging of C_S , some other capacitor-charging technique must be used to avoid overshoot.

The solution to charging the storage capacitor without overshoot lies in the use of a constant-current charging technique (Fig. 4). During the time that an input signal is present, C_S charges at a fixed rate via a gated current source, Q_1 . The rate of charge is adjusted to fully charge C_S within the time of the minimum expected pulse width.

Circuit operation is as follows: The signal to be detected, E_i , at the positive input of comparator CO_1 toggles its output HIGH. This action gates the constant-current source, Q_1 , ON via FET junction-diode, D_1 , to charge the storage capacitor, C_S .

When the voltage across C_S reaches a level equal to E_i the comparator toggles LOW because of feedback from the FET-buffered amplifier, A_1 . This diverts Q_1 's output through FET-diode D_2 to be "sunk" into the comparator's output.

With C_S now isolated, its charge is held by the reverse-biased D_1 junction and the very-high input impedance of the FET-buffered amplifier, A_1 . Once A_1 's output measurement is taken, FET-switch S_1 can momentarily discharge C_S , thus resetting the circuit for another peak detection.

The fast comparator provides very-high switching rates and low delays. FET diodes and their symmetrical connection eliminate the previously explained diode problems, and a high-speed FET-input amplifier allows the use of a small polystyrene capacitor for C_S . Therefore, in Fig. 4 stored peak-signal droop is practically nonexistent. And even the power supply for the circuit is surge free, because the charge current from Q_1 is diverted, not switched off. ■■

Have we got Ceramic Capacitors for you!

How about a ceramic capacitor that when used with your automatic insertion equipment, puts the in-place-cost lower than other capacitors.

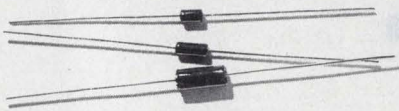

This axial leaded glass encapsulated beauty, called the Green Goddess, offers a wide range of capacitances (10pF to .56mFd) in three dielectric formulations (COG, X7R & Z5U).

O.K. so you don't have automatic insertion equipment, you've got to look into our Clover Cap line of radial leaded capacitors with capacitances from 5.6pF to 4.7mFd. The series is epoxy coated for durability and available in a variety of dielectrics.



Speaking of radials...I'll bet you didn't know that we make MIL-C-11015 qualified CKO5's and CKO6's?...That's right, we make them for those special applications where military qualified components are required.



With your automatic insertion equipment, the in-place cost of the Varadyne Green Goddess capacitor can be lower than other capacitors.

You don't need leaded devices?

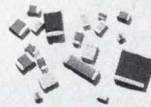

How about ceramic capacitor chips, with capacitances from 1pF to 2.2mFd, for those thick film hybrid circuits? We've sold millions of them for commercial, industrial and military qualified applications.

When it comes to quality ceramic capacitors...we have your capacitor. Drop us a line and get the literature you need. And remember, if you have a special request or technical question, our Applications Engineering department is here to help.

Varadyne

Varadyne Industries, Inc. 1520 Cloverfield Blvd. Santa Monica, California 90404
(213) 829-2984 — TWX (910) 343-6856

CIRCLE NUMBER 50

Interdata presents the first OEM Minicomputer Buyer's Guide in Memory.

If you're an OEM in the market for minicomputers, we say let memory be your guide.

Interdata memory that is. Especially if you're interested in high performance, low-cost production hardware and software—in configurations that exactly fit your needs. You can have it all plus superior Interdata architecture, construction, and reliability. And minicomputer technology that gives you the competitive edge, no matter what quantity you buy.

Here's how to take advantage of these benefits:

For 8KB to 16KB remember the Interdata 5/16.

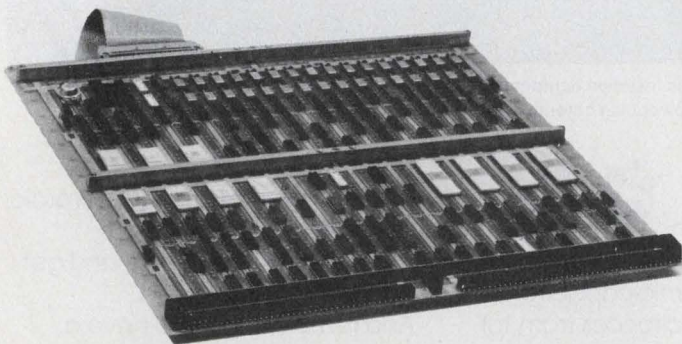

When you select the 5/16, you get the CPU built for high-volume OEM buyers, who want the best of both the minicomputer and microprocessor worlds.

With the 5/16, you get a complete Interdata computer with MOS main memory on a single board. It includes a full 16-bit processor with 16 general purpose registers, 114 instructions. 8KB

of NMOS dynamic random access memory expandable up to 64KB. And a memory cycle time of 600 nanoseconds. You also get minicomputer performance and upward compatibility to the complete Interdata family of 16- and 32-bit minicomputers with our standard Multiplexor Bus.

The 5/16, Interdata's lowest cost processor, bridges the gap between the mini and the micro with its unique new Micro Bus which helps system designers maximize performance while minimizing total system cost.

For 16KB to 32KB remember the Interdata 6/16.

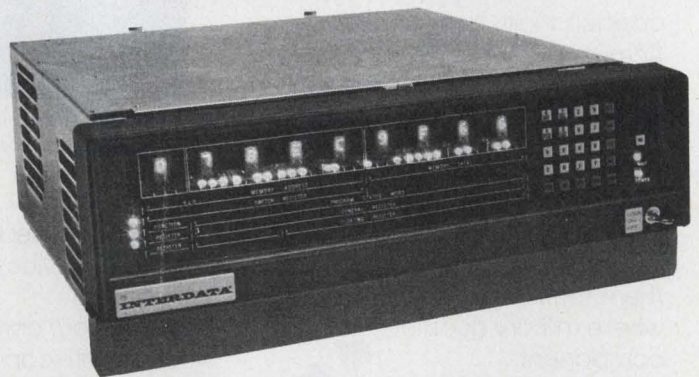

With the 6/16, you get either 600 nanosecond MOS memory or 1000 nanosecond core memory. Plus superior Interdata construction and ruggedness. And unmatched performance in its price range.

The Model 6/16 accepts all Interdata high- and low-speed peripherals and is available either in an economic package, or in a low cost board set.

For 32KB to 64KB remember the Interdata 8/16.

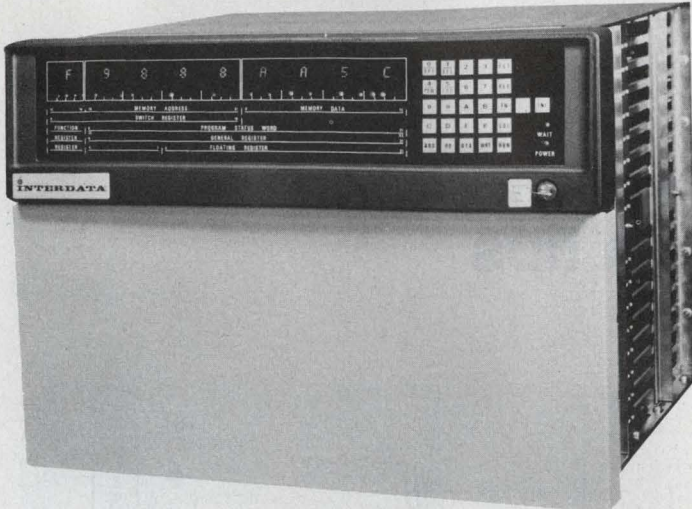

When you select the 8/16, you get the highest performance member of Interdata's 16-bit OEM product line. Perfect for the user who needs high performance capabilities, the 8/16 gives you register-to-register instructions in 750 nanoseconds and special instructions for real-time applications. And, it's available in low-cost packages with popular options such as single and double precision floating point hardware.

For 64KB to 1 Megabyte remember the Interdata 7/32 and 8/32.

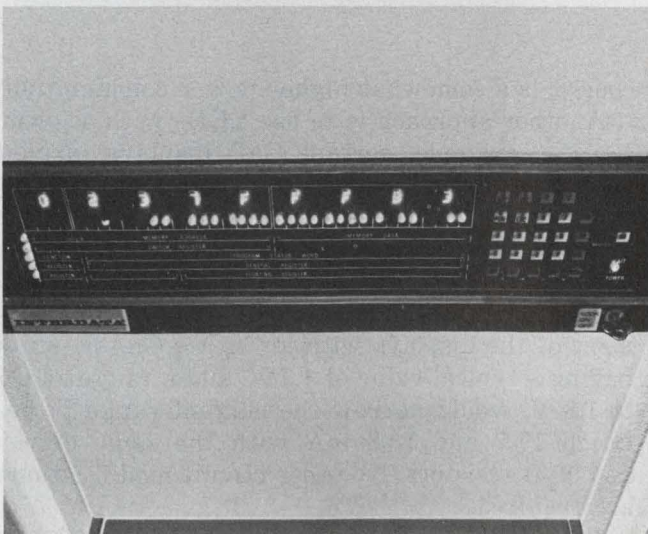

If you're an OEM interested in large memory, you should consider Interdata's 32-bit line of minicomputers.

Our 7/32 is an economical machine with a directly addressable main memory expandable up to a million bytes of 750 nanosecond core. It performs either 16-bit or 32-bit arithmetic and logical manipulations.

The Interdata 8/32 Megamini™ offers you an unequalled combination of power, flexibility and reliability in a compact package. It includes direct addressing to one million bytes. Full 32-bit hardware with performance enhancers such as dual instruction look-ahead stacks. Multiple register sets. Writable control store. Interleaved 32-bit memory. And fast, floating point hardware. The 8/32 delivers performance characteristics you'll find only on large scale, more costly computers.

For OEM minicomputers remember Interdata.

Even before you decide on a minicomputer, let Interdata field sales engineers and systems analysts help you plan your computer-based product. Our ready-to-use, packaged development systems are designed to help you get your product to market early. The entire Interdata family of hardware products includes a broad range of peripherals ideally suited for the OEM. In addition, Interdata offers a family of software products designed to deliver a dynamically balanced framework for running your application programs.

Remember, with Interdata you get high performance, low-cost production hardware and software—in quantity configurations that exactly suit your requirements. And it's all backed by Interdata's unique Computer Life Support program. Send for more information about Interdata's OEM Minicomputers. Or call us. When you remember Interdata, we remember you.

INTERDATA®

Interdata, Inc.
Subsidiary of PERKIN-ELMER
Oceanport, N.J. 07757
(201) 229-4040.

Interdata and Megamini are trademarks of Interdata, Inc.

CIRCLE NUMBER 52

Ensure uniform LED-display brightness with these simple design tips

Ever hook up a LED display and have it look like a patchwork quilt with almost every segment at a different brightness?

Consider the plight of the engineer who designs an instrument with a readout of several segmented numerical displays. Each display uses two LED chips per segment with a forward-voltage drop per segment, V_f , specified at 20 mA to have a typical value of 3.4 V and a maximum of 4 V.

The segments, when driven from a regulated 5-V supply, lose 0.8 V across the decoder-driver. The engineer therefore chooses a 40- Ω limiting resistor to obtain the 20-mA drive,

$$0.02 = \frac{5 - 0.8 - 3.4}{40}$$

That, of course, is the classic load-line solution. But a 40- Ω load and 5-V source is the wrong solution.

At 20 mA, each segment of the display does give nearly identical brightness. But a 40- Ω load resistor, starting from a 5-V supply can't provide each segment with 20 mA.

The V_f across individual segments in the display may cluster closely around the typical 3.4 V—at 3.2 to 3.6 V, for example. However, the drive current will vary from 25 to 15 mA over this V_f range, and down to 5 mA at the rated maximum of 4 V.

Obviously, a higher-voltage supply source and a larger load resistance can solve the problem. An unregulated 9-V source and 240- Ω load resistors will minimize the effect of spread in V_f . For the typical 3.4-V segment,

$$\frac{9 - 0.8 - 3.4}{240} = 20 \text{ mA.}$$

Now the variations range from 20.8 mA for a 3.2-V segment to 19.2 mA for a 3.6-V segment, a current ratio of less than 1.1:1. Even a 4-V segment would be driven at 17.5 mA.

The cost of greater brightness uniformity, of

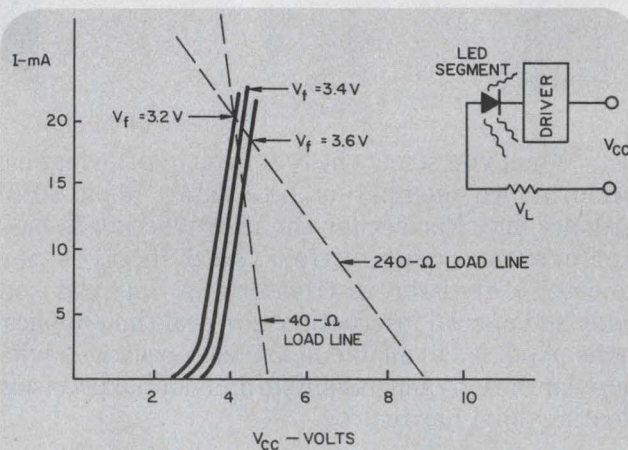

A high source voltage relative to V_f allows use of larger load resistances. Current and illumination variations are thus reduced over the normal spread of V_f , but power dissipation increases.

course, is a somewhat higher power consumption.

Another approach is to use LEDs with a lower V_f . For example, certain GaP displays, driven from 5 V through a decoder-driver and 90- Ω resistors, pass 10 mA at a typical V_f of 2.5 V. But since V_f ranges from 2.3 to 2.7 V, the current varies widely from 7.7 to 12.2 mA—much too widely for a uniformly bright display. Replacement of the displays with lower V_f , GaAsP units having a typical value of 1.7 V, and a range of 1.6 to 1.8 V, would narrow the current range to between 17.7 and 18.8 mA with the same driver and 90- Ω resistors. No other circuit modifications are required.

Bob Woods, Product Reliability Manager, Litronix, 19000 Homestead Rd., Vallco Park, Cupertino, CA 95014.

CIRCLE No. 311

If you need
top-quality
panel
instruments
 with a clean,
 modern look...

Buy
Triplett's
Series GL
 or **GL/B**

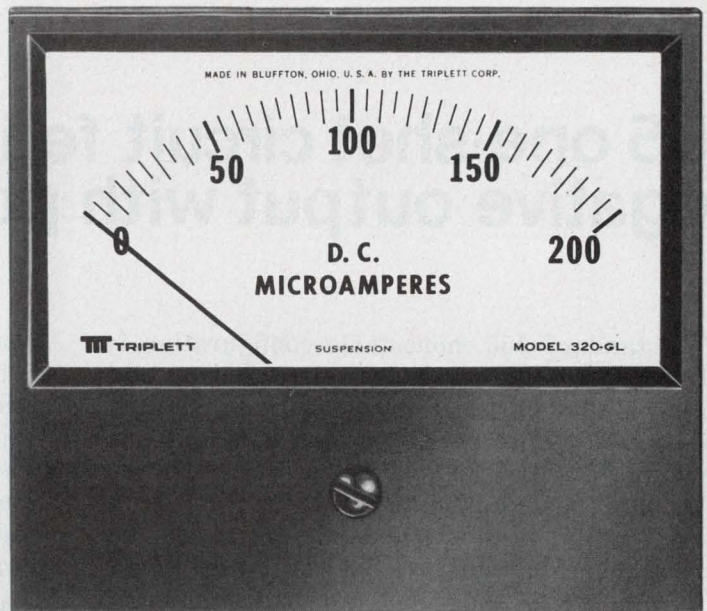

GL

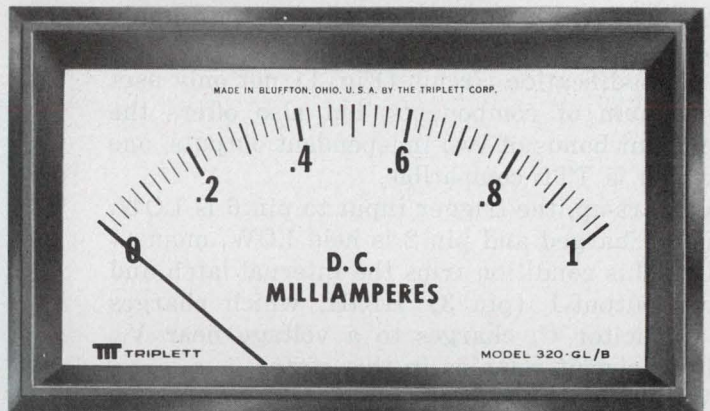

GL/B (mounted appearance)

Triplet's newest panel instruments, the Series GL and GL/B, feature glass windows, matte-finish phenolic cases and a dial design that can readily accommodate multiple scales. They are available in 3½", 4½" and 5½" sizes.

The GL Series features a standard 2-stud mount with 3- and 4-stud mounts available. The feature of the GL/B Series is behind-the-panel mounting with a bezel which is an integral part of the case.

There's a choice of more than 275 stock sizes and ranges — in DC microammeters, milliammeters, ammeters, millivoltmeters and voltmeters; AC milliammeters, ammeters, and voltmeters; RF thermoammeters; dB meters and VU meters. For those who need special instruments . . . custom dials, pointers, scales, accuracy, tracking, resistance, response time or practically any combination of unusual specs can be put into these new cases. For quick, dependable delivery

of small quantities of these adaptable new instruments, contact your Triplet Sales/Service/Modification Center or distributor. For prototypes or production quantities, contact your Triplet representative. Triplet Corporation, Bluffton, Ohio 45817.

TRIPPLETT
 BLUFFTON, OHIO 45817
 Manufacturers of the World's
 most complete line of V-O-M's

"See All of the Triplet Panel Meters and Testers at WESCON Booths 604-606"

CIRCLE NUMBER 53

555 one-shot circuit features negative output with positive triggering

The standard 555 monostable configuration is well known for its negative-level triggering and positive output pulses. But the same device may also be used with positive-going triggering to provide negative output pulses.

The new configuration may be said to be a mirror image of the standard one shot—but their timing equations are identical because of the symmetry of the 555's internal-comparator levels.

$$T = 1.1 \cdot R_t C_t$$

The pulse width is independent of the supply voltage.

The modification circuit (Fig. 1) not only uses a minimum of components, but also offers the significant bonus of two independent outputs, one of which is TTL compatible.

At start-up, the trigger input to pin 6 is LOW, C_t is discharged and pin 2 is held LOW, momentarily. This condition trips the internal latch and forces output-1 (pin 3) HIGH, which charges C_t . Capacitor C_t charges to a voltage near V_{cc} and the circuit remains in this state.

With a positive-going input trigger greater than $+2/3 V_{cc}$, which is the threshold level for pin 6, output-1 is forced LOW. This action effectively grounds the point between R_t and R_1 . Capacitor C_t then begins to discharge through R_t towards ground, until the voltage reaches $1/3 V_{cc}$, which is the pin-2 threshold level. When this level is reached, output-1 switches HIGH again, quickly recharging C_t to V_{cc} via D_1 and R_1 .

An advantage of this new configuration is the availability of the pin-7, open-collector output-2; it's uncommitted in this design. Pin 7 may be used as a 5-V TTL drive, regardless of the timer's supply voltage; it has a drive-current capability similar to that of pin 3.

Both outputs may be used simultaneously, but if the best possible timing accuracy is desired only output-2 should be used. Loading of pin 3 can affect timing, particularly at low supply voltages.

If desired, R_1 may be deleted with a slight sacrifice in timing accuracy. In the absence of R_1 , pin 3 can't pull-up to V_{cc} , and therefore C_t

won't charge fully between output pulses.

Like the standard one shot, this mirror-image configuration requires an input trigger pulse whose width is less than that of the output pulse. The range of permissible R_t values, however, is somewhat less than in the standard one shot because the bias current at pin 2 is five times larger than that of pin 6.

Walter G. Jung, Pleasantville Labs, 1946 Pleasantville Rd., Forest Hill, MD 21050.

CIRCLE No. 312

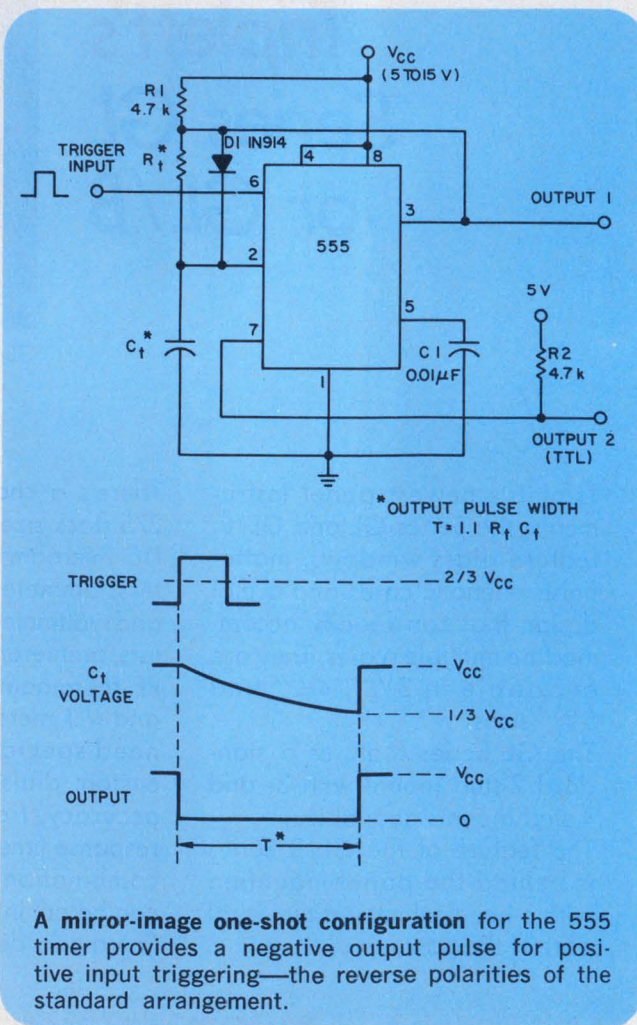

Opening new frontiers with electro optics

High resolution CRTs: 1 to 2 mil line widths. Fine choices for photorecording.

Get the most from your COM, photocomposition or medical imaging system with RCA CRTs. Clear, sharp photographic records result from our special combination of electron gun design, phosphor material synthesis and fine-grain phosphor deposition. And you can count on us to meet your volume needs. The 5" dia. 4869 or 4870, with 1-2 mil line widths, have optically flat faceplates, magnetic deflection and electrostatic or magnetic focusing. Special needs? See us — we have others to suggest.

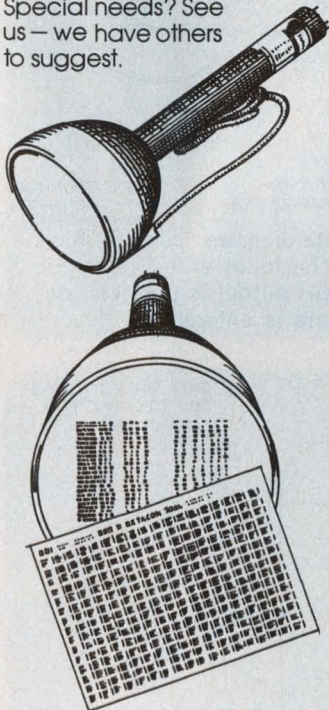

Circle 291

See more with the most sensitive RCA photomultiplier tube.

Astronomers and spectroscopists, RCA has 2" dia., 11-stage PMTs with the characteristics you need. For critical photon counting applications, the GaAs C31034A has the highest known photocathode responsivity over its entire 200-930 nm spectral range, plus dark noise of only 100 cps max. at -20°C. You can also get lower dark count rates, to 12 cps max. With InGaAs types you get extended spectral ranges, to 1030 nm. These are just a few of RCA's wide line of PMTs for all types of low-light-level detection systems.

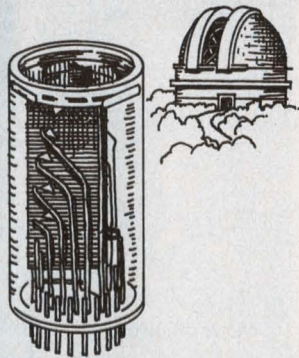
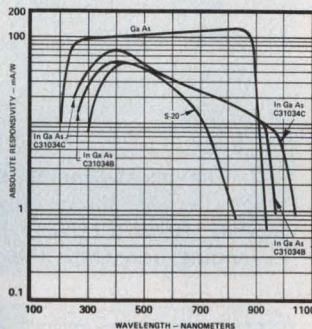

Circle 292

Projection kinescopes for clear, bright large-screen TV.

From our 3-in. dia. tubes for small meeting rooms to the big 7-in. dia. size for theaters and other larger viewing areas: RCA gives you one of the broadest lines to choose from. We offer electrostatic and magnetic focus types for Schmidt and dioptric systems, for color and monochrome. All with the power needed for bright, clear images. If you have unusual system requirements, we can help.



Circle 293

How to make your CCTV camera so sensitive it can see by starlight.

Apollo astronauts used cameras with RCA Silicon Intensifier Tubes to take TV pictures even within the moon's dark shadows. These tubes may be ideal for your new CCTV camera, too...whether it's for surveillance, astronomy or other uses where scene light levels can range down to 1×10^{-4} fc. Our line, the industry's broadest, includes 16, 25 and 40 mm types. 16 mm tubes are available with a new target that minimizes blooming effects. In fact, no matter how unusual your application, chances are we have the camera tube for it.

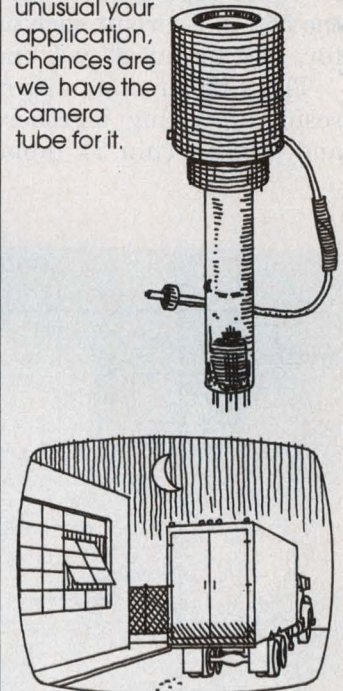

Circle 294

If electro optics can solve your problem, remember: EO and RCA are practically synonymous. No one offers a broader product spectrum. Or more success in meeting special needs. Call on us for design help or product information. RCA Electro Optics, Lancaster, PA 17604. Phone 717-397-7661.

RCA

State diagrams for a 555 timer aid development of new applications

The NE-555 timer finds its way into many diverse applications. Unfortunately, the specifications usually supplied by its manufacturers don't tell the whole story of how the 555 operates. An analysis of the state diagrams of the 555 can greatly help the design of new applications.

Fig. 1 is a simplified block diagram of the 555. The device has three inputs and two outputs. A negative-going voltage to the so-called trigger input, TR, can affect both outputs when the input drops to less than one-third of the supply voltage, V_{cc} . A positive-going voltage labeled the threshold input, TH, can affect both outputs when the threshold rises above two-thirds of V_{cc} . A negative-going reset voltage, R, resets the outputs when the reset signal drops below 0.4 V.

The 555 contains internal memory, a set-reset flip-flop. Thus, its behavior must be described by sequential logic, which is best depicted with a state diagram that shows the possible transitions. Fig. 2 presents the state diagram of the timer's most general configuration, the one with its three inputs all available. It applies to use of the 555 in a circuit such as a one-shot multivibrator, and to any as yet undiscovered applications.

The simpler state diagram in Fig. 3 shows the result of wiring together the threshold (pin 6) and trigger (pin 2) inputs. The two inputs that

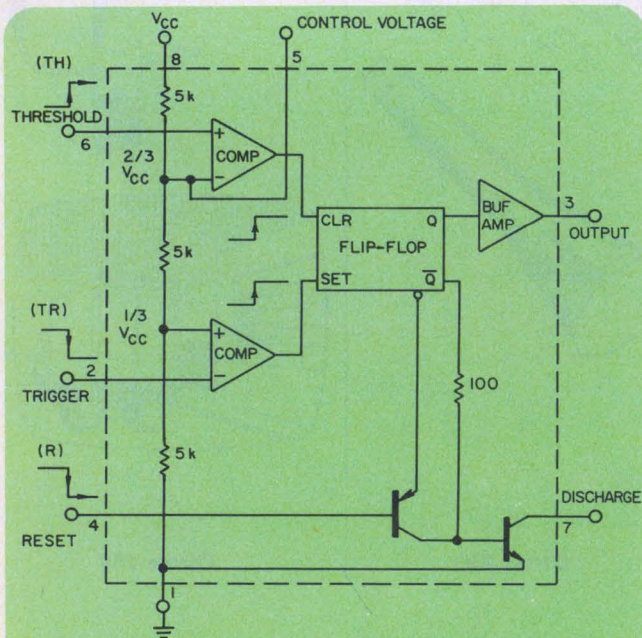

1. This simplified block diagram of the 555 shows the two signal inputs, two outputs and reset input that the timer provides.

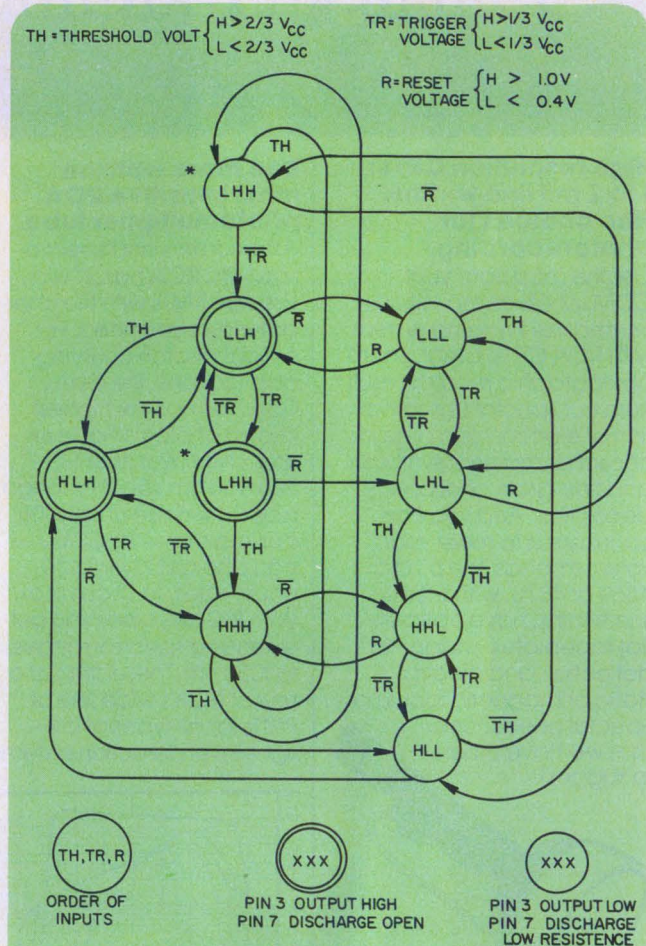

2. The most-general state-diagram configuration for the 555 shows only one input state, LHH, for which either a LOW or HIGH output is possible, depending upon how the state is entered.

T·T = THRESHOLD AND TRIGGER $\left\{ \begin{array}{l} H > 2/3 V_{cc} \\ L < 1/3 V_{cc} \end{array} \right\}$ ONLY WHEN PIN 2 & 6 ARE TIED TOGETHER
 R = RESET VOLTAGE $\left\{ \begin{array}{l} H > 1.0 V \\ L < 0.4 V \end{array} \right\}$

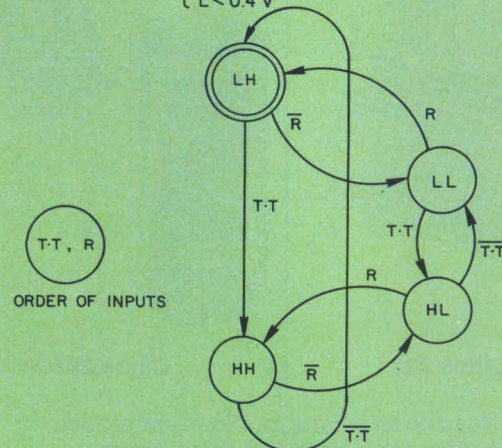

3. When the TR and TH inputs are connected, they form the combined input labeled T·T, and a simplified state diagram results.

Ise introduces five new ways to make the competition turn green.

Your competition probably already thinks they're using the perfect display in whatever it is they make. Let them keep thinking it. While you prove them wrong with a new Itron display. They're designed to make the competition turn green. Which also happens to be the color of the segments.

All 17 of them on the 17-digit Itron. All 5 on the FG-512A1. Next comes an Alfa-Numerical Itron. A Linear-Analog Itron. And a Digital Clock Itron. Five ways to be heartless if you put a little heart into it.

itron[®]

Alfa-Numerical Display



FG209M2

ef=10V
ec=eb=40Vp-p
ic=10mA-p-p
ib=8mA-p-p
Wd. 205mm
Lg. 40mm
Segment 9mm

Instruments & Large Calculator Display



FG179F2

ef=7V
ec=eb=35Vp-p
ic=7mA-p-p
ib=5.5mA-p-p
Wd. 170mm
Lg. 40mm
Segment 9.5mm

Instruments & Terminal Units Display



FG512A1

ef=3.5V
ec=eb=24Vp-p
ic=4mA-p-p
ib=3mA-p-p
Wd. 100mm
Lg. 40mm
Segment 12mm

Digital Clock Display

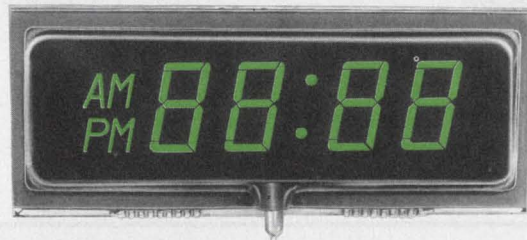

FG425A1

ef=5.5V
ec=eb=35Vp-p
ic=8mA-p-p
ib=6.5mA-p-p
Wd. 140mm
Lg. 59mm
Segment 25mm

Linear Analog Display

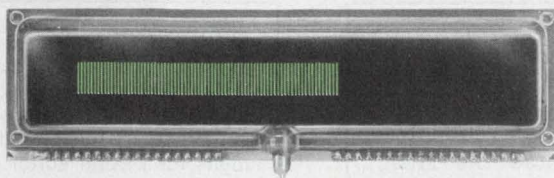

FG120S1

ef=5.5V
ec=eb=35Vp-p
ic=4mA-p-p
ib=0.2mA-p-p
Wd. 140mm
Lg. 40mm
Segment 8mm

NORITAKE CO., LTD.

Electronics Office (U.S.A.)
22410 Hawthorne Blvd. Torrance California 90505,
U.S.A.
Phone: (213) 373-6704.
Telex: "230674910"

Electronics Division

1-1, Noritake-Shinmachi, Nishi-ku, Nagoya-City,
Japan.
Phone: NAGOYA (052) 561-7111.
Telex: J59738 NORITAKE

ISE ELECTRONICS CORP.

London Office
c/o NORITAKE (U.K.) LTD
Noritake House 2, York Street W1H 1 Be., England
Phone: (01) 935-7543 Cable: "LUCTUAL" LONDON
Munachen Office
c/o NEUMULLER GmbH, 8 Muenchen 2, Karlstrasse 55,
West Germany. Phone: 592-421 Telex: 522106

Hong Kong Office
Room 1403 Shing Loon Bldg
24~26 Stanley Street, Hong Kong
Phone: 5-232420 Telex: HX83151
Taipei Office
72-9 SEC. 2, JEN AI RD., Taipei
Phone: 351-0293 Telex: 11176

CIRCLE NUMBER 55

now remain are designated T·T and R. This simplified state diagram applies to astable-multi-vibrator use.

In each state diagram, only one input is allowed to change at a given time to avoid ambiguities and race conditions.

All possible combinations of the input states with L for low and H for high are enclosed in circles—a double circle for HIGH outputs and single for LOW. The ordering of the input variables in the circles is TH, TR, and R. Transitions between states are shown by directed lines.

A HIGH input means that a particular input variable is above its previously described threshold level. LOW means that it is below. A HIGH output means pin 3 is near V_{cc} and the discharge output at pin 7 is open circuited; LOW means near-zero volts at pin 3 and a low-resistance discharge path at pin 7.

Burt Sandberg, Engineer, Fermi National Accelerator Laboratory, P.O. Box 500, Batavia, IL 60510.

CIRCLE No. 313

Staircase generator divides frequencies by large factors

An up/down staircase generator can divide square-wave frequencies by large factors. The circuit in the figure divides by 12 over the frequency range of 300 Hz to 14 kHz. It needs no reset pulse and is cascadable. By stepping both up and down, it doubles the dividing range; a staircase generator that steps only one way would need twice the dynamic-voltage range. This range doubling is especially valuable for circuits with low power-supply voltages.

Amplifier A_1 is pumped up via resistor R_2 , when gating transistor Q_1 is on; down via R_1 , when Q_1 is off.

The down pulses are twice as large as the up pulses ($R_1 = R_2/2$); thus with Q_1 off, a down pulse via R_1 not only cancels an up pulse, but also provides a net down step. Amplifier A_2 is a Schmitt-trigger circuit that samples the output voltage of A_1 to control Q_1 and also provides a square-wave output.

Because of the 1:2 relationship of R_1 and R_2 , frequencies are divided by even values. Changing C_1 or C_2 changes the dividing factor. An increase in differentiating-capacitor C_1 decreases the divisor; an increase in C_2 increases it. Odd-

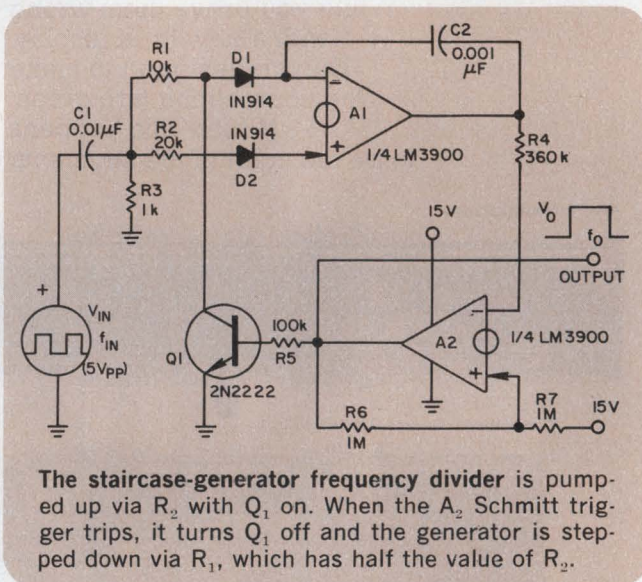

The staircase-generator frequency divider is pumped up via R_2 with Q_1 on. When the A_2 Schmitt trigger trips, it turns Q_1 off and the generator is stepped down via R_1 , which has half the value of R_2 .

integer division, if desired, is possible by upsetting the 1:2 relationship of R_1 and R_2 .

Tom Frederiksen, Design Engineer, National Semiconductor, 2900 Semiconductor Dr., Santa Clara, CA 95051.

CIRCLE No. 314

IFD Winner of April 12, 1976

David Ludington, Engineer, General Electric Co., Aircraft Equipment Div., Utica, NY 13503. His idea "Digital Circuit Detects Frequency-Modulated Signals" has been voted the Most Valuable of Issue Award.

Vote for the Best Idea in this issue by circling the number for your selection on the Reader Service Card at the back of this issue.

SEND US YOUR IDEAS FOR DESIGN. You may win a grand total of \$1050 (cash)! Here's how. Submit your IFD describing a new or important circuit or design technique, the clever use of a new component or test equipment, packaging tips, cost-saving ideas to our Ideas for Design editor. Ideas can only be considered for publication if they are submitted exclusively to ELECTRONIC DESIGN. You will receive \$20 for each published idea, \$30 more if it is voted best of issue by our readers. The best-of-issue winners become eligible for the Idea of the Year award of \$1000.

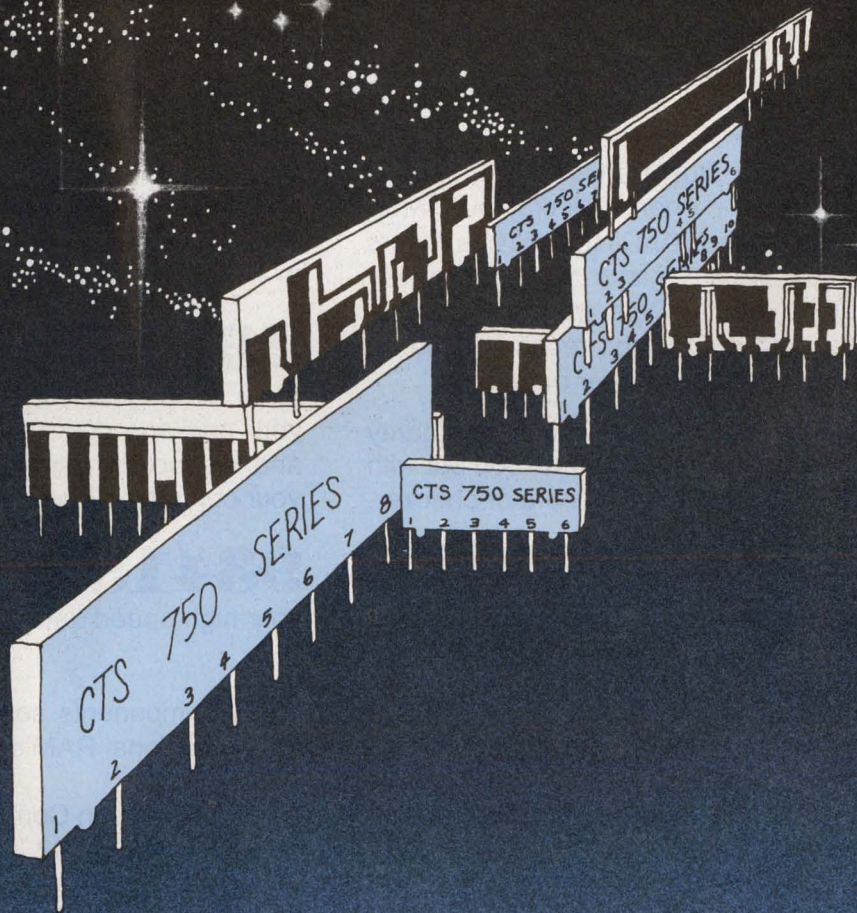

CTS conquers space.

And has for *well over a decade* with space saving Series 750 SIP cermet resistor networks. And with space a very important commodity in modern systems, you'll want to make CTS a very special source for your network needs.

You conserve valuable PCB space, enjoy greater system reliability, use fewer components, install easier—automatically, cut handling costs and derive faster inspection. CTS experience, technology and production capacity insure the highest quality, fastest delivery available.

Where one of our more than 130 *standard* off-the-shelf SIP's won't meet your circuit require-

ments, we'll custom design the resistor network you need in either conventional or low profile package configurations.

Be assured of ultra-high stability and reliability. Over 900 million hours of test data prove CTS reliability with an established failure rate of only 0.00051% per 1000 hours @ 95% confidence level—considerably superior to military failure level S of established reliability specs.

For your copy of our reliability report or complete resistor network data, write: **CTS OF BERNE, INC.**, 406 Parr Road, Berne, Indiana 46711. Phone (219) 589-3111.

CTS CORPORATION
Elkhart, Indiana

A world leader in cermet variable resistor technology.



The Raytheon 2900 family gains five new members

Whereas: Raytheon is the established alternate source for the Am2901 and Am2909, (franchised distributors stocked), and,

Whereas: Raytheon brought you RAYASM, the powerful micro-assembler available on the NCSS computer network,

Now Therefore: Raytheon announces five additional 2900 family components, giving us a total of seven, To Wit:

2901 A 4-bit Microprocessor Slice—the fastest, most powerful LSTTL microprocessor in the world. With its cycle-saving two-address architecture, the 2901's speed can't be touched.

2905 A 4-bit Bus Transceiver— general purpose open collector bus interface device. Data to the 100 milliamperere bus drivers is provided by a 4-bit register with a two-way multiplexer at its inputs. Data from the bus receiver may be held in the 4-bit receiver latch on its way to the three state receiver outputs.

2906 A 4-bit Bus Transceiver with parity —is equivalent to the 2905 but with the addition of an on-chip parity generator/checker.

2907 A 4-bit Bus Transceiver—similar to the 2906 with the two-way multiplexer at the input to the bus driver register elimi-

nated to allow the device to be packaged in the space saving 20-pin DIP.

2909 A Microprogram Sequencer—that can branch anywhere in memory, perform sub-routines, then return with up to four levels of sub-routine nesting. The device is a cascadable 4-bit slice which allows addressing of up to 4K words of microprogram with three devices.

2918 A General Purpose 4-bit Register—with two sets of outputs: TTL and three state. This useful combination can reduce your package count for those status, command, and instruction registers which must drive both your control logic and a data bus.

93415 A 1024 × 1-bit Fully Decoded Random Access Memory—for your high-speed data and control stores.

Raytheon LSI is on the move. More 2900 family components soon to come include PROM's, sequencers, look-ahead carry generators, additional RAM's, and other goodies now in process.

For complete details, contact your local distributor or Raytheon Company, Semiconductor Division, Dept. 2900, 350 Ellis Street, Mountain View, CA 94042, (415) 968-9211.

Am 2900 SOLD & SUPPORTED HERE



SEMICONDUCTOR DIVISION

CIRCLE NUMBER 57

New Products

Smart DVM stays on the job while its plug-in reference is calibrated

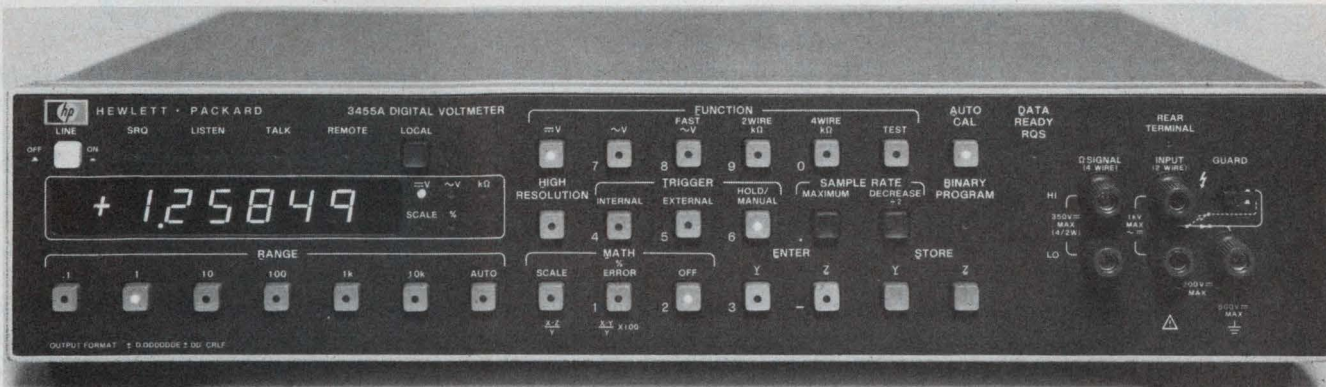

Hewlett-Packard, 1501 Page Mill Rd., Palo Alto, CA 94304. (415) 493-1501. See text.

Glance at Hewlett-Packard's new system DVM and you'll surely ask: that's a voltmeter? Not only does the 3455A look different, it acts like no other commercial DVM.

- No other DVM checks its dc and ohms calibration against a removable reference and then corrects itself for errors.

- No other DVM offers 5 or 6-digit resolution at the push of a button. In the high-resolution mode the unit can measure at a fast rate of six readings each second.

To top it all off, the HP unit—though not exactly a mathematical wizard—can scale voltage or resistance measurements into readings in other units (like rpm) or in percentage error.

Key to the HP performance is the use of two μ Ps—one for computation and programming, the other for error correction. To calibrate the unit—for dc and ohms only—you unplug the reference and make just four adjustments. To keep the meter working during calibration, plug in a previously calibrated spare reference (\$150 each). The meter will then correct itself against the reference.

Also included in the 3455A's \$3200 price is remote program-

ming via IEEE 488, the industry standard for instrument interfacing.

Basic capabilities of the fully guarded instrument include five ranges of dc and ac volts (0.1 to 1000 V) and six ranges of resistance. Range selection allows automatic, manual or remote operation, with 50% overrange readings (excluding the 1000-V range).

The 90-day dc accuracy of the HP unit is specified at $\pm(0.005\%$ of reading +1 digit) on the 10-V range, and this accuracy holds up even at the unit's top speed of 24 readings/s. At that speed, the normal-mode rejection (NMR) is better than 60 dB. Also specified are the 24-h, six-month and one-year accuracies.

To put the NMR into perspective, remember that in DMMs, the faster you go, the less noise immunity you usually get. Some DVMs do let you flip in a filter to cut noise down—but at the cost of speed.

On its ac function, the 3455A's true-rms converter reads out to 1 MHz with crest factors of 7:1 at full scale. If you don't want true rms, order option 01, take \$200 from the price, and you'll get average readings instead.

In remote operation, the 3455A's front panel tells you what range

and function you're on and gives the status of the IEEE bus. To speed up programming, just set the controls, and a bus instruction will send out the settings in the form of four 8-bit words. You can then use the same words as an input to reprogram the DVM to the previous settings.

Actually, the HP unit isn't the first smart DVM. Systron-Donner's Model 7115 took that honor last September at Wescon.

The 5-1/2-digit 7115 has a lot in common with the HP 3455A: it automatically calibrates itself and diagnoses itself for internal failures, and it also crunches numbers.

But whereas the HP box performs relatively simple arithmetic, the Systron unit—with an optional keyboard—solves third-order equations (for normalization or linearization), averages 10 or 100 readings, compares for high/low limits, and does even more.

The basic 7115—which measures dc volts and dc/dc ratio only—sells for \$2500, compared with the HP's \$3200 price. But resistance, true-rms and ac volts are all optional in the 7115, as is the IEEE interface.

Delivery of the HP 3455A is stock to 30 days.

For Hewlett-Packard

For Systron-Donner

CIRCLE NO. 301

CIRCLE NO. 302

INSTRUMENTATION

3-1/2-digit DMM sports low price tag



B & K Precision, 6460 W. Cortland Ave., Chicago, IL 60635. (312) 889-9087. \$170.

Model 283 3-1/2-digit multimeter uses 0.41-in LED displays for high visibility. It measures dc volts, ac volts, dc current, ac current and resistance. A special low-voltage circuit permits measuring resistance of transistor-shunted resistors. The unit has 100% overrange capability on four ranges. All readings have an automatically positioned decimal point. Basic dc accuracy is $\pm 0.5\%$ on the 1,000, 10.00 and 100.0 ranges.

CIRCLE NO. 303

Logic analyzer grabs 8 channels of data



Digital Broadcast Systems, Brentwood Lane, P.O. Box 381, Madison, AL 35758. (205) 837-2183. \$1595 w probe; stock to 60 days.

Model 80-M digital analyzer records and displays up to eight channels of digital signals on any conventional oscilloscope. The unit operates at speeds to 12 MHz. Variable threshold encompasses a wide range of logic families. Spike detection and word recognition are standard features. The memory function stores a 1024-bit record for each of the eight channels. When the record function is enabled, the 80-M triggers on a preselected word, a trace, or an external trigger source.

CIRCLE NO. 304

Instrument recorder stores 7 channels

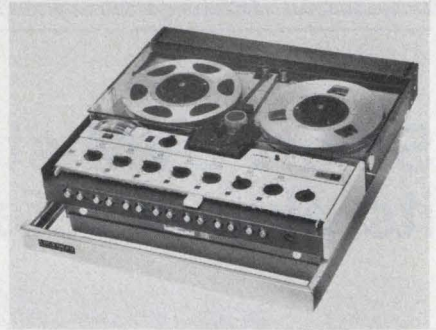

Lockheed Electronics, Plainfield, NJ 07061. (201) 757-1600. \$12,950.

This 7-track instrumentation recorder, STORE 7, is aimed at precision direct, FM or FM/direct recording. The unit provides seven channels for data in addition to one edge track for voice on a 1/2-in. tape and any thickness of tape down to triple-play. Intended for fixed or mobile use, the STORE 7 operates from 115/230 V ac or from an 11-to-32 V dc source. The unit accepts NAB reels of 8-in. diameter and can continuously record for 12 h on all tracks simultaneously.

CIRCLE NO. 305

Problem:

You want to talk with someone who can help you solve an enclosure design problem.

Solution:

Bud's 18 marketing groups have 97 sales engineers. Call us, and get the name of the man with the answers now.

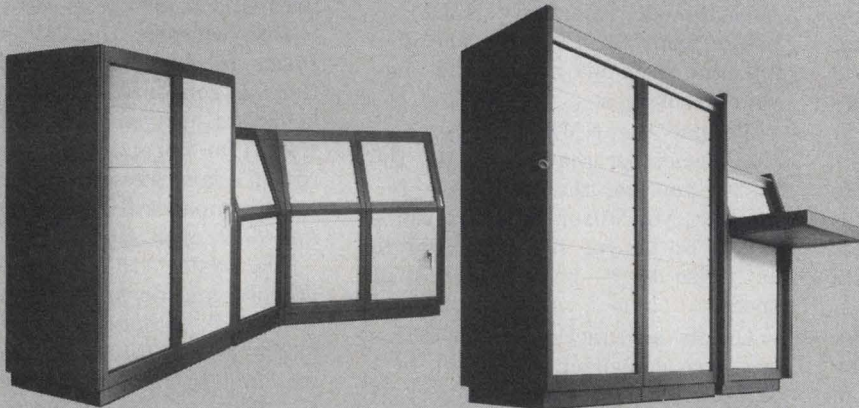

One reason he has the answers is that he can choose from Bud's nearly 3,000 cabinets, racks, enclosures and accessories any one of which will do a job — the right job for you. For example, Series 60 or Series 2000 racks or cabinets. **YOUR PROBLEM IS SOLVED!**

Call toll free:

(800) 321-1764; in Ohio, (800) 362-2265.

BUD

BUD RADIO, INC.
Willoughby, Ohio 44094

CIRCLE NUMBER 58

Need waveforms? Get three kinds for \$245



Krohn-Hite, Avon Industrial Park/
Bodwell St., Avon, MA 02322.
(617) 580-1660. \$245; stock.

Model 5800A function generator offers sine, square, and triangle waveforms over a range from 0.2 Hz to 2 MHz. Distortion is less than 0.3% throughout the audio range. The low-cost unit provides a frequency-control tuning range of 1000:1 from a single front-panel dial, without switching multiplier ranges. Convenient pushbuttons permit selection of three tuning multiplier ranges and the three waveforms. The 50-Ω output is adjustable from 5 mV pk-pk to 15 V pk-pk (open circuit) by an infinite-resolution vernier and a 40-dB pushbutton attenuator.

CIRCLE NO. 306

Low-cost scope offers triggered sweep, more

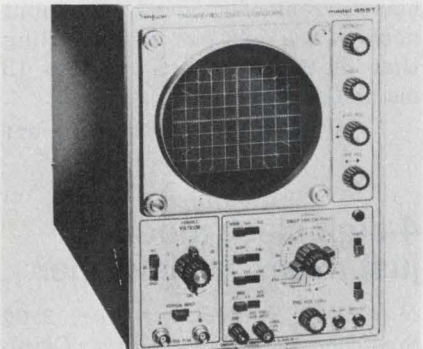

Simpson Electric Co., 853 Dundee
Ave., Elgin, IL 60120. (312) 697-
2260. \$395.

Among the many features of the 455T general-purpose scope are external triggering, internal (+ and -) and line triggering, and a TV sync separator. The sweep control has TVH, TVV, VITS and line-sync positions for rapid display of key television signals and a range of 19 sweep time bases from 0.5 μs/cm to 0.5 s/cm. Sensitivity is 10 mV/cm, and bandwidth is 12 MHz with smooth rolloff for usability into the 27-MHz CB band.

CIRCLE NO. 307

CHECK DIGITAL IC'S FASTER THAN A SCOPE, SAFER THAN A VOLTMETER

You're looking at the most convenient and efficient way developed to check digital IC's: CSC's Logic Monitor. It speeds digital design and testing by accurately and automatically displaying static and dynamic logic states of DTL, TTL, HTL and CMOS DIP IC's. All in a compact, self-contained 16-pin circuit-powered unit.

Use it to effortlessly trace signals through counters, shift registers, gating networks, flip-flops, decoders... even entire systems made up of mixed logic families. It's a great way to cut minutes, even hours all along the line from design through debugging.

Nothing could be simpler: just clip it over any DIP IC up to 16 pins, and the Logic Monitor does the rest. Precision plastic guides and unique flexible web insure positive connections between non-corrosive nickel-silver contacts and IC leads. Each contact connects to a single "bit" detector with high-intensity LED readout, activated when the applied voltage exceeds a fixed 2V threshold. Logic "1" (high voltage) turns LED on; Logic "0" (low voltage or open circuit) keeps LED off. A power-seeking gate network automatically locates supply leads and feeds them

to the Logic Monitor's internal circuitry.

Very clever. Very portable. Very effective. And very reasonable, at \$84.95* See the Logic Monitor at your CSC dealer, or write for our catalog and distributor list.



CONTINENTAL SPECIALTIES CORPORATION



EASY DOES IT

44 Kendall Street, Box 1942
New Haven, CT 06509 • 203-624-3103 TWX: 710-465-1227
West Coast office: Box 7809, San Francisco, CA
94119 • 415-421-8872 TWX: 910-372-7992
Canada: Len Finkler Ltd., Ontario

© 1976, Continental Specialties Corp.

*Manufacturer's suggested price. Prices and specifications subject to change without notice.

CIRCLE NUMBER 59

Wideband op amp settles in 85 ns to 0.1%

M. S. Kennedy, Pickard Dr., Syracuse, NY 13211. (315) 455-7077. \$125 (1 to 9); stock.

A high-power wideband amplifier, the Model 850, has a slewing rate of 1000 V/ μ s. The op amp has a FET differential input and a bandwidth of 100 MHz. Its settling time to 1% is 50 ns and is 85 ns to 0.1%. The amplifier can deliver 125 mA and operates over -55 to +125 C.

CIRCLE NO. 308

System expander adds 48 single-ended channels

Analogic, Audubon Rd., Wakefield, MA 01880. (617) 246-0300. \$200 (100-up); stock.

The MP6848 multiplexer expander increases the range of the company's MP6812 and MP6912 data-acquisition systems from 16 to 64 channels. Two versions of the expander are available—a low power, single supply CMOS version for high-level logic applications that draws 0.33 W, has a throughput rate of 27.5 kHz and can optionally run from ± 15 -V power supplies. The TTL version has outputs that can drive 10 TTL loads each at a throughput rate of 35 kHz and consumes 1 W. These specs are valid for use with the MP6812. To add an additional 48 channels to the MP6912, the MP6848 can provide throughput rates up to 100 kHz and requires 1.1 W for the CMOS version. All three versions of the MP6848 maintain an overall system accuracy of $\pm 0.025\%$ FSR at maximum throughput rates. Each expander contains a 48-channel multiplexer, an extension for the multiplexer address-counter register, a multiplexer address decoder and a break-before-make circuit that prevents shorting of a newly selected channel with the previously selected channel. The MP6848 is housed in a $2 \times 4.6 \times 0.375$ -in. insulated steel case (the same as the MP6812) that fits 0.5-in. card spacing.

CIRCLE NO. 309

Hybrid d/a converter cuts costs not corners

Hybrid Systems, 87 Second Ave., Burlington, MA 01803. (617) 272-1522. See text; stock to 4 wks.

In addition to its cost of only \$29 in unit quantities, the DAC349 12-bit d/a converter has fully calibrated output ranges of ± 5 , +10 and 0 to -10 V. The hybrid converter has a built-in reference, ladder and output op-amp. Its accuracy tempco is 30 ppm/ $^{\circ}$ C and linearity drift is 15 ppm/ $^{\circ}$ C. The converter has a settling time to 0.05% of 10 μ s and the output can drive a 10 mA load. The unit requires only 300 mW from ± 15 V supplies and is housed in a 24-pin DIP. Linearity error of the converter from -25 to +85 V is $\pm 1/2$ LSB and from -55 to +125 C is ± 1 LSB.

CIRCLE NO. 310

Focus correction circuit operates to 800 kHz

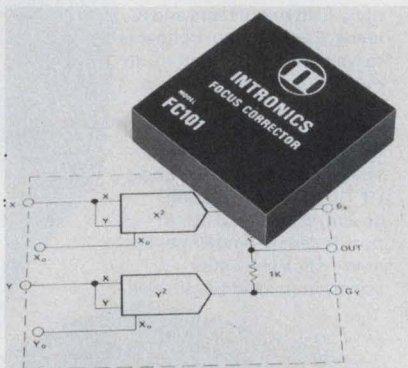

Intronics, 57 Chapel St., Newton, MA 02158. (617) 332-7350. \$70 (1 to 9); stock.

The FC101 focus correction module for CRTs can accurately correct errors in tubes which use either magnetic or electrostatic focusing. It is a companion to the company's C200 series of geometric "pincushion" correction modules. The module has a 800 kHz full-power output frequency with 1% full scale typical accuracy. A slew rate of 55 V/ μ s and a settling time of 1 μ s to 1% (for a 10-V step input) go along with an operating range of -25 to +85 C and a total error vs temperature of 0.06% FS/ $^{\circ}$ C. The module comes in a $1.5 \times 1.5 \times 0.4$ in. epoxy package.

CIRCLE NO. 320

Instrumentation amp drifts only 1 μ V/ $^{\circ}$ C

Burr-Brown, Box 11400, Tucson, AZ 85734. From \$13 to \$19.50 (100-up); stock to 4 wks.

The 3626 series of hybrid instrumentation amplifiers starts at only \$13 each in 100-unit quantities. The laser-trimmed amplifiers are housed in 14-pin DIPs. A unique feature of the 3626 family of amplifiers is its flat curve of input offset-voltage drift vs gain. Three versions are available: The premium 3626CP has a drift of $< 1 \mu$ V/ $^{\circ}$ C at G = 1000 and $< 2 \mu$ V/ $^{\circ}$ C at G = 5. The 3626BP a drift of $< 3 \mu$ V/ $^{\circ}$ C at G = 1000 and $< 4 \mu$ V/ $^{\circ}$ C at G = 5. The lowest-cost 3626AP has a drift of $< 6 \mu$ V/ $^{\circ}$ C at G = 1000 and $< 8 \mu$ V/ $^{\circ}$ C at G = 5. Both the BP and CP versions have maximum gain non-linearity of 0.01% at G = 5. Common-mode rejection, from dc to 60 Hz, with a 1-k Ω source unbalance is > 80 dB with gain = 10 to 1000. The AP version nonlinearity is 0.02% at G = 5 and the CMR is > 74 dB from G = 10 to 1000. Other specs, common to all versions, include a gain range of 5 to 1000; differential and common-mode input impedances of $5 \times 10^9 \Omega$ in parallel with 3 pF; an input bias current of ± 50 nA; an input noise of 2 μ V pk-pk; and a settling time of 0.02 ms at G = 5 to 12 ms at G = 1000.

CIRCLE NO. 321

4-digit clock module just needs transformer

National Semiconductor, 2900 Semiconductor Dr., Santa Clara, CA 95051. (408) 732-5000. From \$10 (100-up); stock.

A miniaturized digital clock circuit, the MA1002 has 0.5-in. high LED digits. The clock modules combine an LSI clock IC, four-digit LED display, a power supply (less transformer) and associated discrete components on a single PC board. Just a transformer and switches must be added. Timekeeping may be done from inputs of either 50 or 60 Hz, depending on the model selected and display formats of 12 or 24 hours are available.

CIRCLE NO. 322

NEW 3½ Digit Multimeter from B&K-PRECISION



B&K-PRECISION
MODEL 283—\$170

...you'll want it for its features
...but its the price that will sell you!

- High intensity LED display is easily read from at least 6 feet in the brightest room
- Measures AC and DC voltage, AC and DC current and resistance.
- 0.5% DC accuracy
- 100% overrange (1000 scale reads to 1999).
- Automatic polarity
- Automatic decimal point
- Flashing overrange indication on display
- Four voltage ranges to 1000V
- Four current ranges to 1000mA.
- Six resistance ranges to 10 meg.
- In-circuit resistance measurements at voltage levels below conduction threshold of semiconductors.
- Overload protection on all ranges

Complete new circuitry makes the Model 283 the most dependable and versatile 3½ digit multimeter you can buy. The extra-bright display allows you to use it where other units would cause reading problems. The selectable "low ohms" function permits accurate measurement of semiconductor shunted resistors.

An optional, internal battery pack (BP-83, \$50.00) provides 8 hours of continuous use on one overnight charging and charges when the Model 283 is in use on 115/230 VAC. Your B&K-PRECISION distributor has the Model 283 in stock and will be glad to demonstrate its features to you. Call him, or write for additional information.

B&K PRECISION
PRODUCTS OF DYNASCAN
6460 W. Cortland Avenue
Chicago, IL 60635 312/889-8870
In Canada: Atlas Electronics, Toronto

CIRCLE NUMBER 64

MODULES & SUBASSEMBLIES

Modular clock oscillator handles 10 TTL loads

Vectron Laboratories, 121 Water St., Norwalk, CT 06854. (203) 853-4433. From \$35 (50-up); stock to 60 days.

The CO-238T DIP-compatible clock oscillator can drive 10 TTL loads. Any frequency in the 3-to-20-MHz range is available. Each set frequency has a tuning adjustment for setting accuracy of $\pm 0.0001\%$. The oscillators operate from 5 V dc and have a stability of better than $\pm 0.0025\%$ over 0 to 70 C. A stability of $\pm 0.0003\%$ is optional. The low-profile module plugs directly into a 14-pin socket and measures only $0.5 \times 0.8 \times 0.35$ in.

CIRCLE NO. 323

Full MIL range converter handles 12-bit inputs

Teledyne Philbrick, Allied Dr. at Rte. 128, Dedham, MA 02026. (617) 329-1600. From \$200 (unit qty.); stock.

The 4058 series of 12-bit d/a converters has a nonlinearity of ± 0.5 LSB and an operating range of -55 to $+125$ C. Two versions of the converter are available: the 4058-83 comes with 100% screening to MIL-STD-883, Method 5004, Class B including internal and external visual, stabilization bake, constant acceleration, fine and gross leak, burn-in and temperature cycling. The 4058 is identical except that burn-in and temperature cycling are omitted. Model 4058's current settling time to within $\pm 0.01\%$ of final value for a full scale step is guaranteed to be less than 200 ns, or less than $2.5 \mu s$ for voltage settling. Operation over -55 to $+125$ C is possible since the units have a ± 10 ppm/ $^{\circ}$ C maximum full scale temperature coefficient. Zero stability is ± 1 ppm/ $^{\circ}$ C for current outputs and only ± 5 ppm/ $^{\circ}$ C for voltage ranges. Programmable full-scale outputs include ± 2 mA, $+4$ mA, ± 10 V, -10 V, ± 5 V, -5 V and ± 2.5 V. All units have internal references and are housed in 24-pin hermetically sealed DIPs.

CIRCLE NO. 324

32 character display contains all drive ckts

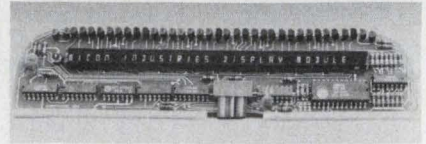

Micon Industries, 252 Oak St., Oakland, CA 94607. (415) 763-6033. \$5/digit.

The Model 932 alphanumeric display module contains 32 bright, 9-segment character positions, drive circuitry and storage register. The entire circuit is housed on an $8.2 \times 2 \times 0.5$ -in. PC board. All ASCII upper-case characters and symbols can be displayed. The display has a viewing angle of 90 degrees vertical or horizontal, and may be covered with a red glare-proof window. Code options include ASCII, Baudot and EBCDIC. The board terminates in a 16-pin connector. Backspace and character blanking are optional functions available for operator editing or correction.

CIRCLE NO. 325

S/d converter boasts ± 30 min accuracy

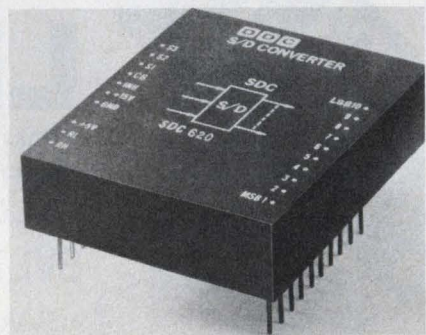

ILC Data Devices Corp., Airport International Plaza, Bohemia, NY 11716. (516) 567-5600. \$195; stock.

The SDC-620, a 10-bit tracking synchro-to-digital converter, is accurate to ± 30 min. The converter is transformer isolated and comes in 11.8 or 90 V, 400-Hz and 90-V, 50-to-400-Hz versions. It uses a ratiometric type II servo technique and is thus insensitive to voltage and frequency variations. Tracking within rated accuracy is possible at speeds of up to 100 rps for 400-Hz units and 25 rps for 50-to-400-Hz units. The $K_a = 40,000$ for 400-Hz models and 2000 for 50-to-400-Hz units.

CIRCLE NO. 326

IN WIRE-WRAPPING **ok** HAS THE LINE.....



OK MACHINE & TOOL CORPORATION

3455 Conner St., Bronx, N.Y. 10475 (212) 994-6600 / Telex 125091

CIRCLE NUMBER 65

Checkmated by high pushbutton switch costs?



These three new Centralab Pushbutton Switch products are real money savers, yet they offer the high-quality features of all Centralab switches. Contact your Centralab Distributor for details. Ask for a copy of Centralab's New Pushbutton Switch Catalog, Series No. 301.

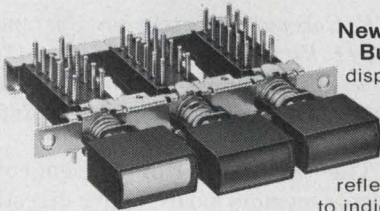

New Status Indicator Button. Adds visual display to non-lighted switches. The button, with a unique fluorescent display, uses reflected ambient light to indicate switch status. 6 display colors available.

Low Cost Lighted Switch uses T-1 1/4 wedge base lamp. Many lens and color options.

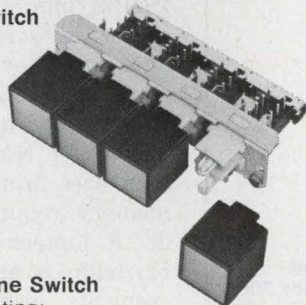

5 amp Pushbutton Line Switch is UL listed for TV-5 rating: 120V, 5A, 78A peak inrush current.

Check These Centralab Distributors For 3 New Ways To Cut Switch Costs.

CALIFORNIA

Kierulff Electronics, Inc.
Los Angeles
213/685-5511

Kierulff Electronics, Inc.
Palo Alto
415/968-6292

Kierulff Electronics, Inc.
San Diego
714/278-2112

COLORADO
Kierulff Electronics, Inc.
Denver
303/371-6500

FLORIDA
Hammond Electronics
Orlando
305/849-6060

INDIANA
Radio Distributing
Co., Inc.
South Bend
219/287-2911

MASSACHUSETTS
Sterling Electronics
Watertown
617/926-9720

MINNESOTA
Gopher Electronics Co.
St. Paul
612/645-0241

NEBRASKA

Radio Equipment Co.
Omaha
402/341-7700

NEW YORK
Electronic Equipment
Co., Inc.
Hempstead
516/538-5510

Peerless Radio Corp.
Lynbrook, L.I.
516/593-2121

Summit Distributors, Inc.
Buffalo
716/884-3450

NORTH CAROLINA
Kirkman Electronics, Inc.
Winston-Salem
919/724-0541

OHIO
ESCO Incorporated
Dayton
513/226-1133

Pioneer-Standard
Electronics, Inc.
Cleveland
216/587-3600

PENNSYLVANIA
Cam/RPC Industrial
Electronics
Pittsburgh
412/288-2600

Herbach & Rademan, Inc.
Philadelphia
215/426-1700

Pytronic Industries, Inc.
Montgomeryville
215/643-2850

TEXAS
Southwest Electronics Inc.
Stafford
713/494-6021

WASHINGTON
Almac/Stroum Electronics
Seattle
206/763-2300

Isostat Licensed

DISTRIBUTOR PRODUCTS



CENTRALAB
Electronics Division
GLOBE-UNION INC.

5757 NORTH GREEN BAY AVENUE
MILWAUKEE, WISCONSIN 53201

CIRCLE NUMBER 66

Be a Genius in your own time!



Join the hundreds who have already discovered the versatility of Repco's modular RF links.

How versatile? The overwhelming response to our Undiscovered Genius contest proves the true versatility of Repco's modular RF links. Prizes were awarded for these winning ideas:

- Hospital data system
- Bank teller alarm
- Remote drone fire fighter
- Cardiac rate alarm
- Mine roof failure alert
- Portable ticket vending system
- Silo inventory control
- Boat security system
- Remote timer/counter
- Porpoise communicator
- Radio controlled shark
- Remote corrosion monitoring

What can you do with RF links? While building a remote-control shark may be a little too zany for you, consider some of the innovative and commercially proven applications now utilizing Repco modular RF links:

- Air to ground communication
- Alarm systems
- Electric power line monitoring
- Fire nozzle pump operator
- Mine pollution monitoring
- Ocean monitoring buoy system
- Remote crane control
- Repeater link
- Seismic monitoring
- Small craft emergency beacon
- Traffic emergency assistance
- Water flow monitoring

Repco's modular RF links are designed for voice, low-speed digital, or tone operation. Frequencies available are 25-50 Mhz, 72-76 Mhz, 132-174 Mhz, and 450-470 Mhz ranges (66-88 Mhz for overseas usage). All units are built to stringent FCC & EIA specifications.

Be a Genius . . . design Repco's RF links into your system. Write or call for free specs brochure.

Repco

A subsidiary of Scope Inc

CIRCLE NUMBER 67

Special Products Department
1940 Lockwood Way, P.O. Box 7065
Orlando, FL 32804
(305) 843-8484 TWX 810-850-0120

DATA PROCESSING

3-megabit storage unit weighs only 5.5 lb

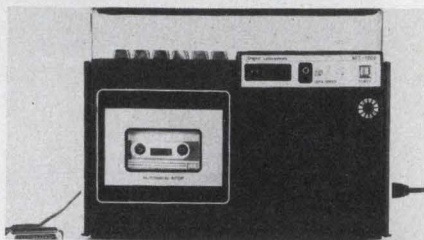

Digital Laboratories, 377 Putnam Ave., Cambridge, MA 02139. (617) 876-6220. \$75 (single qty.); 2 wks.

So small that it can be routinely carried in a briefcase or field service kit, the Model ACT-1200 stores 3 Mbits, yet weighs only 5.5 lb and has dimensions of 12.1 x 7.7 x 3.3 in. Designed primarily for field testing and program loading with small computers, the ACT-1200 plugs into any computer or terminal's standard serial asynchronous port. The unit can record and playback at standard rates up to 1200 baud using RS-232C interfacing. Most minicomputers can use existing paper tape oriented software. For example, the ACT-1200 can be used to record source programs following a PUNCH command and reload the data following a READ command. Similarly, the output of an assembler or compiler may be recorded for future loading via standard object loader programs.

CIRCLE NO. 327

Static IC memory fits into DEC PDP-8 chassis

WE Computer Extension Systems, 17311 El Camino Real, Suite 176, Houston, TX 77058. (713) 488-8830. WE-VM8E4: \$400; E8: \$650 (unit qty).

The WE-VM8E4 or E8 semiconductor memory boards plug directly into Digital Equipment Corp.'s PDP-8 Omnibus chassis. The boards contain either 4-k or 8-k words of memory. They are completely software compatible with the standard PDP-8 operating systems. The 1024 x 1 NMOS static RAM design uses minimal power. The 8-k memory requires 2.2 A at +5 V dc. A jumper matrix allows memory-address assignment in 4-k increments. An unconditional warranty is offered for one full year.

CIRCLE NO. 328

Lower cost computer emulates another

Datum, 1363 S. State College Blvd., Anaheim, CA 92806. (714) 533-6333. See text; 60 days.

The EI/16 Nucleus Package line of computer systems emulates General Automation's SPC-16 at a lower cost. The Nucleus Packages are made up of four system configurations and a variety of peripheral controllers in a single enclosure. They are designed to use RTOS, DBOS and data management software. The EI/16-RT Nucleus Package is designed for real-time, disc-based applications. The hardware includes the processor with 32-k of 16-bit memory, a controller for up to four cartridge discs, and serial I/O for a teletypewriter or CRT. This package is priced at \$13,950. The EI/16-DB Nucleus Package is an expanded version of the RT system with a controller for a line printer, card reader and card punch. The printer controller permits speeds of 300, 600 and 1200 line/min. Its price is \$16,350. The EI/16-D3 Nucleus Package consists of a computer with 32-k words of main memory and controllers for fixed or removable discs, line printer, card reader, card punch and up to four CRT terminals. Line speeds are program-selectable from 100 baud to 9600 baud. The price is \$18,350. The EI/16-D4 Nucleus Package is an augmented version of the D3 with 48-k of core, controllers for 25.6-Mbyte disc, line printer, card reader, card punch and four CRTs. The price is \$24,750.

CIRCLE NO. 329

Microcomputer connects to μ P-based systems

Interdata, Oceanport, NJ 07757. (201) 229-4040. \$868 (100-up).

The model 5/16, a single board computer, is compatible with the I/O busses of the 8080 and 6800 μ Ps. Another I/O bus connects to Interdata peripherals and is compatible with the manufacturer's processors and software. The board includes a full 16-bit processor with 16 general-purpose registers, 114 instructions, and 8-k bytes of NMOS dynamic random access memory.

CIRCLE NO. 330

SLIM-MOX

**NOW VICTOREEN
QUALITY COSTS LESS
THAN A DOLLAR.**

Victoreen announces **SLIM-MOX**, our new, thick-film, flat substrate resistor.

Compact in design, it carries with it all the quality and dependable performance you have come to expect from Victoreen.

SLIM-MOX, right now, is available from stock in a wide range of standard resistance values. More important, **SLIM-MOX** will deliver the same proven performance in high-voltage applications that you find in more expensive resistors with more bulk.

Specify **SLIM-MOX** in any standard resistance value and your unit cost will be less than one dollar in OEM quantities. Truly a major cost breakthrough for resistors designed for miniaturized

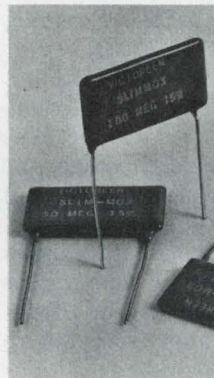

electronic networks and equipment, or other critical applications that demand stability and reliability.

Standard tolerance is $\pm 15\%$ for all standard resistance values which include 1, 2,

5, 10, 20, 50, 100, 200, 500, 1000, 2000, and 5000 megohm. All in stock. With a voltage coefficient of better than 5 ppm/volt, full-load drift typically less than 0.5% in 1000 hr at 70°C, and 250 ppm TCR or less to 5000 megohm, **SLIM-MOX** is a little, big performer. For less than a buck.

From a name you know you can count on. Victoreen.

**Victoreen Instrument Division,
Sheller-Globe Corporation,**



SHELLER-GLOBE CORPORATION

**10101
Woodland
Avenue,
Cleveland,
Ohio 44104**

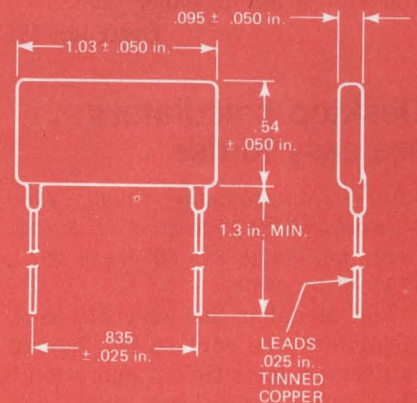

SLIM-MOX SPECIFICATIONS

Resistance Range	1M-5,000M
Power Rating @ 70°C	2W
Maximum Operating Volts (Applicable above critical resistance)	10,000V
Available Tolerance	15%
Critical Resistance	50M
Max. Service Temperature	150°C

CIRCLE NUMBER 68

DATA PROCESSING

21-slot card cage plugs into Data General CPUs

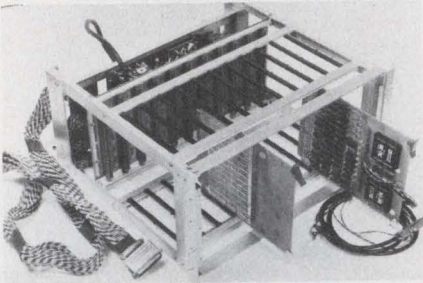

Data Engineering Associates, 6330 Alder St., Houston, TX 77081. (713) 665-8860. \$1350; stock to 90 days.

A card-cage assembly, supplied in kit form, connects to Data General's Nova or Eclipse computers. The basic kit consists of a card cage, a cable and cable-terminator assembly, wrapped-wire boards, a power supply, and wire-list aids. The card cage has 21 slots with motherboard and set of connectors. The chassis requires 18.75 x 19 in. of rack space. The two boards are for customer-designed wrapped-wire circuits. Each board will accommodate 56 ICs and has space for mounting special-purpose modules. The power supply provides 5 V at 12 A. The computerized wire-list aids include wire-list forms and a program on paper tape.

CIRCLE NO. 331

Desktop calculators are easy to use

Victor Comptometer Corp., 3900 N. Rockwell St., Chicago, IL 60618. (312) 539-8200. \$99.50 (type 204), \$159 (type 210).

The Medalist 204 and 210 desk calculators are said to be "human engineered for efficient operation." The units have large plus and minus keys that perform repeat addition and subtraction. A single key does percent, add-on and discount calculations. The 210 has two memories, change sign, square root and a five-position special-function switch; the 204 has one accumulating memory. The 12-column display on the 204 and the 14-column display on the 210 provide punctuation, a memory light and negative sign, error and overflow indication.

CIRCLE NO. 332

4800-baud modem has adaptive equalizer

AMBAC Industries, Inc., Tele-Dynamics Div., 525 Virginia Dr., Ft. Washington, PA 19034. (215) 643-3900. \$3250.

A Bell-208A compatible modem features an all-digital adaptive equalizer that minimizes errors produced on unconditioned telephone lines. The Model 7208A provides full-duplex or simplex transmission for point-to-point or multi-point polling applications at a 4800 bit/s rate. The 7208A has built-in on-line and off-line test capabilities with front-panel controls and diagnostic lights. The internal equalizer employs a mean-square algorithm which continually optimizes parameters without restarting the remote transmitter. No operator attention is required. The modem also has common-carrier and terminal loopback provisions.

CIRCLE NO. 333

Unit controls data from tape transports

Kennedy Co., 540 W. Woodbury Rd., Altadena, CA 91001. (213) 798-0953. \$1650. 45-60 days.

The Model 1629 half-duplex interface unit allows control between RS-232-C compatible terminals and buffered tape transports without requiring processing by a main-frame computer. The unit allows off-line key-to-tape or tape-to-tape data transfer via hardwires or telephone lines at rates from 110 to 19,200 baud.

The interface unit converts parallel data bytes from the tape to the correct RS-232-C serial standards. Thumbwheel switches accommodate either 5, 6, 7 or 8 bits per character. To match lines another thumbwheel switch selects rates from 110 to 19.2K bits/s in nine steps. ANSI compatible formatting, read-after-write and automatic error-tape correction are standard features. LED display clusters provide complete indication concerning communication status, errors, and operation conditions. The unit measures 17.13 x 3.41 x 11.94 in. Power requirements are either 115 V or 220 V at 48 to 62 Hz.

CIRCLE NO. 334

Mil-spec tape transport accesses data in 20 sec

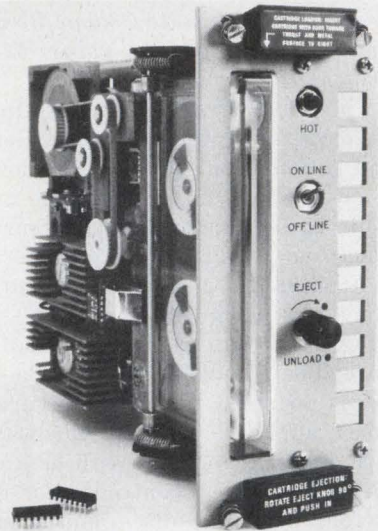

Qantex, 200 Terminal Dr., Plainview, NY 11803. (516) 681-8600. \$2175 (unit qty with electronics)

The Model 700, a militarized digital cartridge tape transport, accesses data on the tape in an average of 20 seconds. It uses the 3M DC300A data cartridge as the storage medium. Up to 23 M bits of data may be stored on one cartridge. The Model 700 records and reads at 6000 byte/s and has a 30 in. bidirectional tape speed. The transport measures 7 x 8.25 x 3.125 in., and is optionally available with the electronics on separate PC cards.

CIRCLE NO. 335

Floppy-disc unit fits on HP 9830A calculator

Infotek Systems, 733 E. Edna Pl., Covina, CA 91723. (213) 966-7431. \$3895; stock.

A floppy disc, Model FD-30, fits on top of the Hewlett-Packard 9830A scientific calculator. The disc unit emulates the 9830 cassette system so that no changes in existing software are required. The cassette-control commands and syntax of the 9830 are recognized by the FD-30, and all such programs operate without modification. The unit stores data on one floppy disc that would require five to seven cassettes. The discs provide 305-kbytes of user area. The FD-30 has a height of 4-in., and fits in place between the calculator and printer.

CIRCLE NO. 336

If you've got a complicated problem with EMI we've got a simple solution

Electromagnetic Interference. It shows up as static on radio and snow on TV. It can make computer terminals register input error. Make a pacemaker or an EKG malfunction. And interfere with sensitive navigation equipment.

Obviously, you've got to shield your equipment against EMI. You can use sheet metal. Or foil. Or a plating process. These are fine for small enclosures with flat surfaces. But when it comes to large cases and complex shapes, you need a better solution.

And here it is. Electrodag® coatings. We've engineered a whole range of them. To give you from 10-70 dB attenuation, from 1 MHz to 10 GHz. With varied physical properties that let you apply them to almost any material.

This means that you can build your enclosures out of light plastic, coat them with Electrodag, and still get perfect skintight shielding. Even on honeycomb structures and flexible parts made from foamed resins.

And you can forget about expensive techniques like plating, metallizing and vacuum deposition. With Electrodag, all you need is a spray gun, a simple dipping technique, or a paintbrush.

You can use these new coatings for everything from CB radios and EKG units to data terminals and microphones.

This is a new field, but we're the oldest company in it. With the greatest experience, the biggest R&D staff and the most EMI coatings. For technical advice on specific applications, write: Acheson Colloids Company, Electrical Products, Port Huron, Michigan 48060. Or call (313) 984-5581.

 **Acheson**
high technology coatings

CIRCLE NUMBER 73

© AC Co., 1976

INTEGRATED CIRCUITS

741-replacement op amp has 15 V/ μ s slew rate

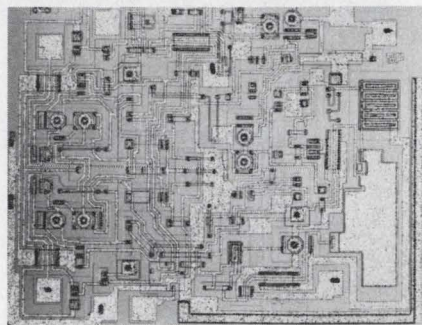

Signetics, 811 E. Arques Ave., Sunnyvale, CA 94086. (408) 739-7700. \$1.40 (100-up); stock.

The SE/NE 535 op amp offers a slewing rate of 15 V/ μ s and can be used as a direct replacement for 741-type amplifiers. The 535 op amps have internal compensation, offset voltages that are just 2 mV maximum and bias currents of only 60 nA.

CIRCLE NO. 337

High-voltage amplifier delivers up to ± 75 mA

Burr-Brown, International Airport Industrial Park, Tucson, AZ 85734. (602) 294-1431. From \$56 (100-up); stock to 4 wks.

The 3583 IC operational amplifier provides output voltage swings to ± 140 V at currents as high as ± 75 mA. A monolithic FET input stage gives the unit an input impedance of $10^{11} \Omega$ and a bias current of 20 pA. Laser trimming results in an input offset voltage of less than 3 mV at 25 C (and can be externally trimmed to zero) and a maximum input offset voltage drift of 25 μ V/ $^{\circ}$ C. CMR is a high 110 dB. The 3583 operates over a supply range of ± 50 to ± 150 V. Open-loop gain at rated load (dc) is typically 105 dB. Unity-gain bandwidth (small signal) is 5 MHz and full-power bandwidth is 60 kHz. The op amp slews at 30 V/ μ s. The unit has built-in input protection and automatic thermal shut-off to prevent amplifier damage. The 3583 comes in an eight-pin TO-3 package and is available in two versions. The 3583J has an operating range of 0 to 70 C and the 3583A a range of -25 to 85 C.

CIRCLE NO. 338

Analog switch arrays come in four versions

Motorola, 3501 Ed Bluestein Blvd., Austin, TX 78721. (512) 928-2600. From \$0.70 (100-up); stock.

An eight-channel analog multiplexer, a dual four-channel unit, a triple, two-channel unit and a quad bilateral switch have been added to Motorola's CMOS switch line. They are the MC14051, an 8PST switch; the MC14052, a 4PDT switch; the MC14053, a DP3T switch; and the MC14066, that has four SPST switches. All are controlled with a binary input. The switches have an ON/OFF output voltage ratio of typically 65 dB, a cross-talk between switches of 80 dB at 1 MHz for the MC14051, 2 and 3 and 50 dB at 8 MHz for the MC14066 and can operate at frequencies of up to 65 MHz when powered by a supply of 10 V. The total operating supply range is 3 to 18 V. The MC14051, 2 and 3 are available in 16-pin DIPs, and the MC14066 in a 14-pin DIP. Two temperature ranges are available: -55 to +125 C ("AL" suffix, ceramic package) and -40 to +85 C ("CL" and "CP" suffix in ceramic and plastic).

CIRCLE NO. 339

Analog-signal delay line has 32 different taps



Reticon, 910 Benicia Ave., Sunnyvale, CA 94086. (408) 738-4266. Under \$10 (OEM qty.); stock.

The TAD-32 tapped analog delay line has 32 equally spaced taps on an n-channel bucket-brigade circuit. Each tap is individually buffered, permitting variable loading of the taps. The output is a full-wave "box car" waveform, thus permitting direct summation of the desired tap weights without additional filtering. Tap-delay is linearly variable with sampling rates from 1 kHz to 5 MHz, with a dynamic range in excess of 80 dB. Several devices may be cascaded directly without interface electronics for applications requiring a large number of taps. The TAD-32 comes in a 40-pin DIP.

CIRCLE NO. 340



Short Story

EMC's New Short Contact for Short Leads

IC's jarring loose? EMC's brand new short contact grabs and holds IC leads even less than .10" long! We designed it into our patented Nurl-Loc® terminal to provide the precise insertion and withdrawal forces you need. And Nurl-Loc® gives you 5 times the gripping surface to prevent twist and spread the stress to eliminate warping. Short contacts are available now in EMC's Wire-Wrap® Panels . . . and in our full line of DIP and Transistor Sockets. Call Allan Klepper (401) 769-3800 for the longer story, or write Electronic Molding Corp., 96 Mill Street, Woonsocket, R.I. 02895.

Wire-Wrap® Gardner-Denver Co.

Interconnection Specialists

CIRCLE NUMBER 74



AMPERITE

THERMOSTATIC DELAY RELAYS

For **LOW COST, LONG LIFE, Maximum Stability**

Delays: 2 to 180 Sec.*

Hermetically sealed — not affected by altitude, moisture, or climate changes... **SPST only** — normally open or normally closed... Compensated for ambient temperature changes from -55° to $+80^{\circ}\text{C}$... **Rugged, explosion-proof, long-lived**... Standard radio octal and 9-pin miniatures.

Price, standard or min., under \$4.00 ea.

*Miniatures delays: 2 to 120 seconds.

PROBLEM? Send for Bulletin No. TR-81.

New! LONG DELAYS

240 & 300 Sec.

Same rugged construction, hermetic sealing and stability as the shorter Delay Relays described above... For delays beyond 300 seconds, these Relays may be used in series.

Price, under \$6.00 ea.

Write for Bulletin No. LD-73.



DIFFERENTIAL RELAYS

For automatic overload, over-voltage or under-voltage protection... Made only to specifications for 70V, 80V, 90V and 100V.

Price, under \$6.00 ea.

AMPERITE BALLAST REGULATORS

Automatically keeps current and voltage at a definite value. For AC or DC... **Hermetically sealed, rugged, vibration-resistant, compact, most inexpensive.**

Price, under \$3.00 ea.

Write for 4-p. Bulletin No. AB-51.

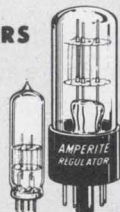

AMPERITE

600 PALISADE AVE., UNION CITY, N.J. 07087

Telephone: 201 UNion 4-9503

In Canada: Atlas Electronics, Ltd.,
50 Wingold Ave., Toronto 19

OUR COMPLETE PRODUCT LINE CAN BE FOUND
IN ELECTRONIC DESIGN'S GOLD BOOK.

CIRCLE NUMBER 75

INTEGRATED CIRCUITS

8-bit d/a converter has MIL-883 processing

Hybrid Systems, Crosby Dr., Bedford, MA 01730. (617) 275-1570. See text; stock to 4 wks.

An economically priced 8-bit d/a converter, the DAC334-8-M/B (or C), is available fully processed to MIL-STD-883 level B or C. It is designed for operation over the temperature range of -55 to $+125$ C. The unit is pin-for-pin equivalent to the MC1408/1508 and costs \$19.95 for the level B version and \$20.95 for level C. It comes packaged in a 16-pin hermetically sealed DIP. The current output settles in 300 ns and has a range of 0 to 2 or ± 1 mA depending upon pin interconnections and input coding.

CIRCLE NO. 341

16-k ROM claims access times of under 450 ns

American Microsystems, 3800 Homestead Rd., Santa Clara, CA 95051. (408) 246-0330. For plastic packages: \$14 (1000-up), plus mask charge of \$1000; 8 wks.

The S6831 (Series/A/B/C) 16-k MOS ROMs are organized as 2048×8 . They are made using a silicon-gate, depletion-load process, have access times of only 450 ns and consume only 150 mW. The S6831A is pin compatible with the Intel 2316A and 8316A. The B version is compatible with the Intel 2316B, 8316B and the Motorola 68317, and the C version with the Electronic Arrays 4600. The 450-ns access time is maintained, even with capacitive loads of up to 130-pF on the output. The S6831 series units are available in plastic or ceramic packages.

CIRCLE NO. 342

Filler

We learn from Tom Nawalinski of Hewlett-Packard that when Noah commanded his animals to multiply, two snakes refused on the grounds that they were adders. Bringing to bear his engineering ingenuity, Noah placed the snakes on a table he constructed from a small tree. "Even adders can multiply," he said, "on a log table."

Digital display driver provides 4-1/2 digits

EFICS, 85X 38041 Grenoble Cedex, France. 68 francs (500-up); stock.

Capable of driving 3-1/2 or 4-1/2 liquid crystal displays, the CDD contains its own up/down counter, latches, decoder and multiplexer. The p-channel MOS IC is housed in a 28-pin DIP and provides a maximum count of 20,000. A 10 to 30 V supply that delivers a typical current of 3 mA is required to power the circuit. The CDD can count at rates from 0 to 80 kHz and has an operating temperature range of -20 to $+85$ C.

CIRCLE NO. 343

Digital watch circuits have up to six functions

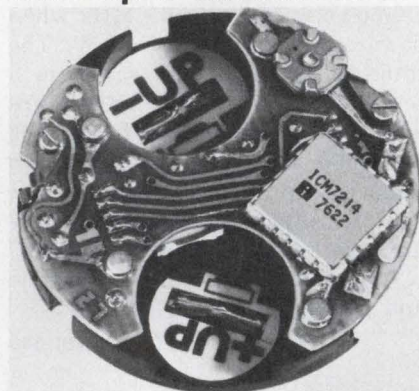

Intersil, 10900 N. Tantau Ave., Cupertino, CA 95014. (408) 996-5000. From \$8 (100-up); stock.

The ICM7214, a five-function time-keeping circuit, has alphanumeric capability. It provides readout of hours, minutes, day, date and seconds. It also features a perpetual calendar, which must be reset only once every four years. The ICM7214A is a six-function version which also provides a readout of the month. Both interface directly with existing nine-segment LED displays. The circuits operate with two spst switches. Antibounce circuitry on the switch inputs can handle up to 31 ms of switch bounce. The only external components required in addition to the display and the power source are a 32,768 Hz crystal, a trimming capacitor and two switches. The circuits require a current of $4 \mu\text{A}$, with the display off and have an output current drive of 6 mA per segment at a 25% duty cycle.

CIRCLE NO. 344

Gas-discharge driver ckt adjusts for each load



Signetics, 811 E. Arques Ave., Sunnyvale, CA 94086. (408) 739-7700. 100-up pricing: \$2.75 (584-9); \$2.50 (585-9); stock.

The NE584/585 gas-discharge display drivers have completely integrated, closed-loop current feedback systems for self-adjusting to accommodate changing load conditions. The NE584 cathode driver is current programmable and can drive up to nine segments. The NE585 anode driver can drive up to nine digits. Current capability is 5 mA per segment for the signal driver and 35 mA per digit for the digit driver. No capacitors or resistors are needed.

CIRCLE NO. 345

Peripheral support cks are TTL compatible

Fairchild Camera and Instrument Corp., 464 Ellis Street, Mountain View, CA 94042. (415) 962-3816. See text.

Peripheral drivers, dual line drivers and quad line receivers have been added to the company's line of TTL compatible support circuits. The 75470 peripheral drivers have an output current capability of 300 mA at 55 V and are pin-for-pin replacements for the 75450 and 75460 series units. Ac switching speeds are 45 ns. The 75112 dual line drivers can deliver 18 to 30 mA from each half and have no line transient effects during power-up or power down when inhibited. The quad line receiver, 75154, can meet the requirements of EIA standard RS-232-C. Normal operation is from a 5-V supply but a built-in option permits operation from a 12-V supply. Prices for the circuits start at \$0.81 for the 75470 family, \$1.88 for the 75112 family and \$2.48 for the 75154 series.

CIRCLE NO. 346

S/h amplifier acquires signals in only 4 μ s

Teledyne Philbrick, Allied Dr. at Rte. 128, Dedham, MA 02026. (617) 329-1600. \$14.75 (lge. qty.); stock.

The Model 4856 IC sample-and-hold amplifier operates in the inverting or noninverting mode with or without gain. Acquisition time,

to 0.1% of full scale, is typically 4 μ s with an external 0.001- μ F capacitor. Other specifications include a 50-ns aperture plus aperture delay time, a 5-V/ μ s slew rate and 0.005% nonlinearity. The 4856 has short circuit protection on the output and its offset voltages can be externally trimmed. It is housed in a 14-pin DIP.

CIRCLE NO. 347

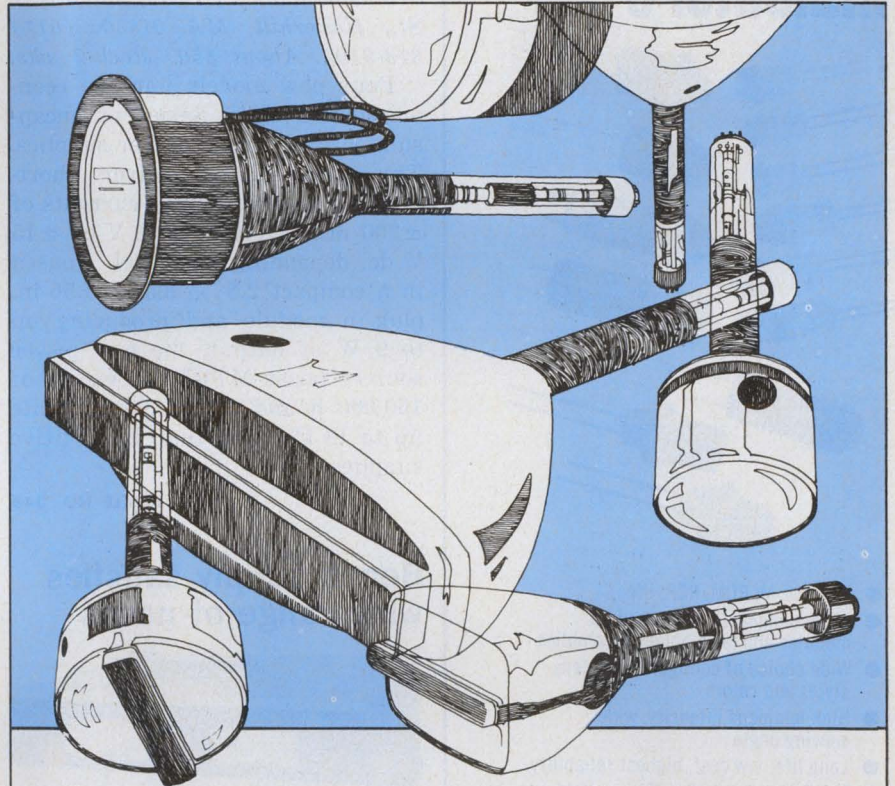

High Resolution CRT's For Optical Systems

Thomas Electronics, Inc., is currently producing a wide range of high resolution tubes for: Optical Character Recognition, Photo Recording, Hard Copy Printout and Photo Typesetting applications. Included in this range are optical quality non-browning glass and fibre optics strips faceplate CRT's in all sizes. All of these tubes can be supplied with special screen types for improved performance, in addition to the standard phosphor screens.

For high speed printing applications, Thomas has an electrostatic charge printing tube available that consists of a strip of very fine, closely spaced wires extending through the bulb faceplate.

Complete specifications and drawings are available for the above tube types upon request. Also, we invite you to send for our New Short Form Catalog describing our full complement of CRT's for varied applications.

THOMAS ELECTRONICS, INC.

100 RIVERVIEW DRIVE, WAYNE, N. J. 07470 / Telephone: 201-696-5200 / TWX: 710-988-5836 / Cable: TOMTRONICS

CIRCLE NUMBER 76

New Minelco MIN-Lites

LED Indicators

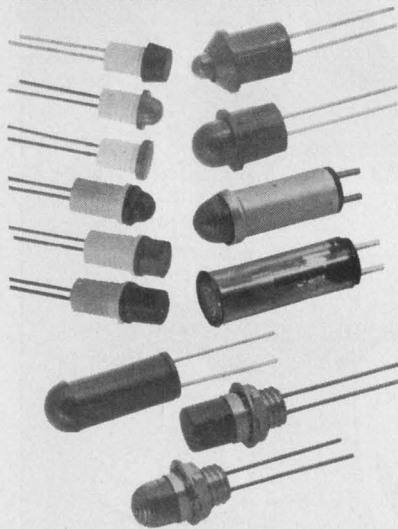

- MM, LM, M, RCM, RCP, UN
- Interchangeable with standard modules and lamp holder assemblies
- Wide choice of configurations, lens styles and colors
- High luminous intensity, wide viewing angle
- Long life, low cost, highest reliability
- Small size, low power, fast switching
- Available from stock, under \$1.00 ea. in quantity. Specials to suit

Sudden Service on Small Quantities!

PROTOTYPES

available on phone or letterhead request

MINELCO Div. General Time

135 South Main St., Thomaston, Conn. 06787

Phone 203-283-8261

A  TALLEY INDUSTRIES COMPANY

...from **Minelco**

CIRCLE NUMBER 77

POWER SOURCES

Economy modules deliver to ± 300 mA



Semiconductor Circuits, 306 River St., Haverhill, MA 01830. (617) 373-9104. About \$50; stock-2 wks.

Four new models join the economy-priced APS Series of encapsulated dual-output power supplies. The new entries deliver short-circuit-protected output currents of ± 300 mA at either ± 12 V or ± 15 V dc, depending on model. Housed in a compact $2.5 \times 3.5 \times 1.56$ -in. plug-in module and producing up to 9 W of output, the new power sources boast MTBFs in excess of 150,000 h and are said to operate up to 18 C cooler than competitive supplies.

CIRCLE NO. 348

Bench supply satisfies wide range of needs



Kepco, 131-38 Sanford Ave., Flushing, NY 11352. (212) 461-7000. \$475; stock.

Model MPS 620M provides the bench experimentalist with the three commonly used voltage/current combinations for IC circuits. The 5-V output is adjustable from 0 to 6 V, is rated 0 to 5 A at any voltage setting, and is operable without derating to 50 C. The ± 20 -V outputs are varied with a 10-turn control in a tracking mode and provide a 1-A output through the entire range (either dual 20 V or a single 0 to 40 V output).

CIRCLE NO. 349

50-W supply works at 75% efficiency

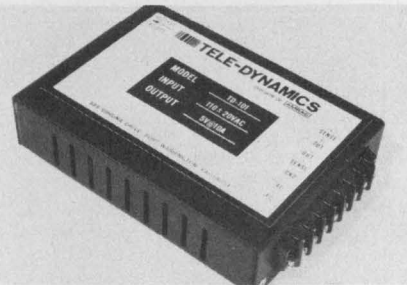

Tele-Dynamics, 525 Virginia Dr., Fort Washington, PA 19034. (215) 643-3900. \$240.

Model TD101 5-V 10-A regulated power supply produces a dc output of 50 W, yet measures only $6\text{-}1\frac{1}{2} \times 4\text{-}1\frac{1}{2} \times 1\text{-}1\frac{1}{2}$ in. and weighs 1.7 lb. Efficiency is 75% at full load. The TD101 operates with an ac input of 90 to 130 V, 47 to 450 Hz, and features remote sensing, current limiting, inherent short-circuit protection, and a built-in crowbar that trips at 6 V. Regulation is $\pm 0.1\%$, line and load.

CIRCLE NO. 350

Multiple-output supplies come in 24 models

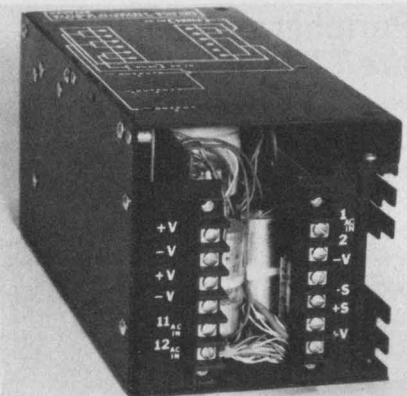

Modular Power Inc., 4818 Ronson St., San Diego, CA 92111. (714) 279-1641. From \$135; stock-4 wks.

A new line of power supplies is aimed at logic and linear applications. The TR Series consists of 24 models, available in single, dual and triple output, in three different case sizes with outputs ranging from 5 to 28 V dc and 2 to 50 A. Features include: dual input terminals for 115/230-V-ac operation, cooling fan on all models, full protection against short-circuit and overload conditions. Typical regulation is 0.01% line and 0.02% load. Ripple is 0.01% rms.

CIRCLE NO. 351

Finally! A low cost DC to 8MHz Up/Down Counter.

Ferranti Model ZN1040E features:

- 80mA per segment L.E.D. drive
- Multiplexed BCD and 7 segment outputs
- Cascadable
- Schmidt trigger input
- Switch-on reset
- Automatic zero suppression
- Single 5-V supply—TTL compatible



better by design



FERRANTI
semiconductors

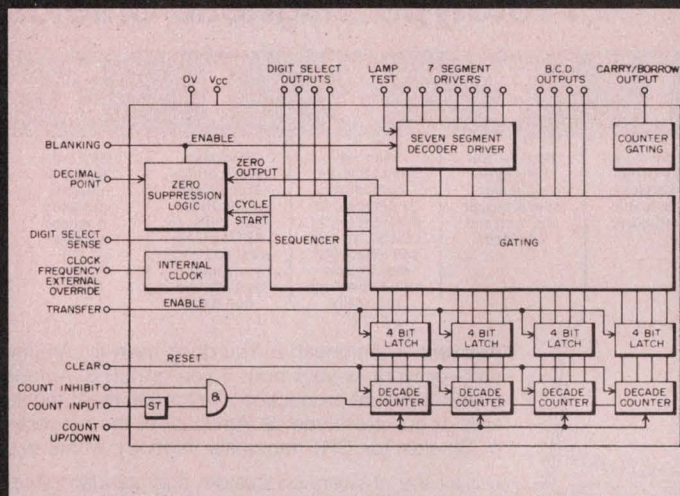

FOR COMPLETE SPECIFICATIONS, CONTACT: FERRANTI ELECTRIC, INC. / SEMICONDUCTOR PRODUCTS
EAST BETHPAGE ROAD, PLAINVIEW, NEW YORK 11803 PHONE: (516) 293-8383 / TWX: 510-224-6483

CIRCLE NUMBER 78

Price & Performance that can't be matched!

DigiTec's full-function Universal Counter/Timers and Frequency Counters supply extended frequency ranges at a ratio of price to performance that can't be matched.

Outstanding features include dual input channels with independent controls, high input sensitivity, oven controlled crystal, and full 9 digit LED display with autoranging.



50 MHz ... Universal Counter ...	8510A ...	\$725
150 MHz ... Frequency Counter ...	8720A ...	625
150 MHz ... Universal Counter ...	8520A ...	850
500 MHz ... Universal Counter ...	8530A ...	995
600 MHz ... Frequency Counter ...	8730A ...	795
1 GHz ... Frequency Counter ...	8740A ...	995
1 GHz ... Universal Counter ...	8540A ...	1295

DigiTec

**UNITED
SYSTEMS
CORPORATION**

918 Woodley Road, Dayton, Ohio 45403
(513) 254-6251, TWX (810) 459-1728

DigiTec: precision measurements to count on.

*These instruments available under
GSA contract GS-00S-27741.*

Mu 10. Quiz #2

Prototype Magnetic Shields

1	2	3	4	5	6
Who gives you 4-day prototype service—the fastest in the industry?	How do you determine optimum shield design and specs in advance?	Who will fabricate a number of prototypes, in different thicknesses, so you can determine exactly how much shielding you really need?	Who tests every prototype shield, using Helmholtz coils, to ASTM standards, and gives you guaranteed attenuation data?	Who's the leader in custom-designed magnetic shields?	What magnetic shield application is growing fastest?

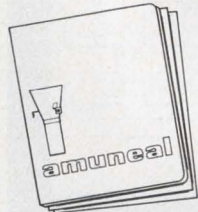

Answers: 1. Amuneal; 2. You don't have to, Amuneal will do it for you—or work to your print if you prefer; 3. Amuneal; 4. Amuneal guarantees that production shields will meet the same high standards of our prototype; 5. Amuneal is the biggest in the industry; 6. Shields for CRT terminals. Nobody wants wiggling displays.

For all the answers on custom and standard shields, send today for your free Magnetic Shield Source Book.

amuneal
MANUFACTURING CORP.

4737 Darrah St., Philadelphia, Pa. 19124, Telephone: 215-535-3000

CIRCLE NUMBER 80

PACKAGING & MATERIALS

Flexible cable assembly handles high rf power

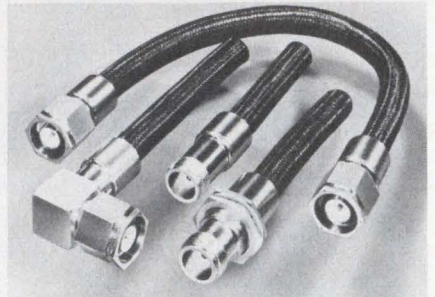

Omni Spectra, Inc., 21 Continental Blvd., Merrimack, NH 03054. (603) 424-4111. \$150 to \$300 (small qty); 2 to 3 wks.

The OSSC 300 series of flexible cable/connector assemblies carry up to 1000 W of CW rf power. Assemblies in this series have low losses, a low VSWR and low rf leakage and feature rugged construction. Cable assemblies are constructed of 1/2-in. OD high-power, flexible coaxial cable and the manufacturer's type SC coaxial connectors. Available connectors include right angle and straight plugs, and bulkhead and straight jacks. Power ratings, derated for maximum safe operation, are 1000 W, 3.5 GHz, 25 C at sea level, to 485 W, 9 GHz, 110 C at 60,000 ft. Cable retention force is 300 lb. Connectors are manufactured of stainless steel.

CIRCLE NO. 352

Look what just became faster and easier.

Not to mention less expensive.

Meet Great Jumpers™ and Great Daisy Jumpers™ from A P Products, the new fully-assembled and fully pre-tested flat cable/connector system that can cost about half as much as what you're using now.

Take your choice of the three most popular connectors, the five most popular flat cable widths, solid or stranded Electric Pink or rainbow cable, single ended, double ended or daisy chained. And Great Jumpers are directly-interchangeable replacements for the jumpers you're using now.

Our connectors are molded on. They provide both an integral cable strain relief and complete line-by-line probeability. And because they come to you factory assembled and tested, they're faster and easier to use.

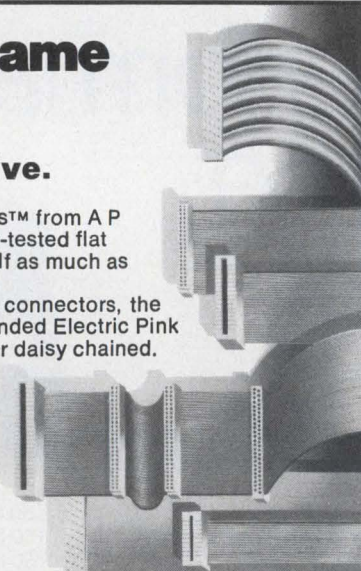

Connect with the A P rep nearest you.

(201) 546-3660	(219) 447-9623	(314) 434-6242	(512) 443-9687	(617) 272-8163
(203) 868-7748	(301) 484-5400	(315) 437-8343	(513) 433-0966	(713) 691-3961
(206) 822-8223	(303) 420-4646	(414) 421-2300	(602) 946-4437	(714) 560-6266
(214) 238-0408	(305) 894-3351	(415) 328-3232	(602) 949-8424	(714) 833-1802
(215) 923-5195	(312) 298-4830	(416) 638-1322	(609) 429-4013	(816) 765-2998
(216) 333-4120	(313) 356-2161	(503) 223-3374	(612) 922-7011	

Faster and easier is what we're all about.



AP PRODUCTS INCORPORATED

Box 110-F Painesville, OH 44077 (216) 354-2101 TWX: 810-425-2250

CIRCLE NUMBER 81

Machine cuts glass envelopes without wax

DKA, Inc., 14014 Northwest Passage, Marina Del Rey, CA 90291. (213) 823-5172.

The Waxless Cutter cuts glass cases for diodes, capacitors and reed switches without the wax potting and cleaning required by existing technology. The result is a cleaner, simpler operation that allows significant savings in labor, production and maintenance costs over current methods. The machine cuts both glass tube and cane, and eliminates hand operations associated with the wax potting process. The operator loads the hopper of the Waxless Cutter with loose glass tubes and removes the cut cases from the collector box.

CIRCLE NO. 353

Coax connector needs no special tools or solder

Bunker Ramo Corp., RF Div., 33 E. Franklin St., Danbury, CT 06810. (203) 743-9272.

The 83-58FCP coax connector installs onto RG-58 A/U cable without solder, special tools or adapters. To attach the connector, the user strips the coaxial cable and pushes the connector parts onto the center conductor and braid. The contact is squeezed at the tip to secure the center conductor. If you wish to reuse the connector, the contact can be soldered. No braid soldering, combing of cable braid, special crimping tools or adapters are needed.

CIRCLE NO. 354

Wire terminals fit wide range of mounting bolts

Thomas & Betts, 36 Butler St., Elizabeth, NJ 07207. (201) 354-4321. 16BA22: \$5.70 per 100 (500-up), 10BC14: \$7.80 per 100 (500-up).

Two wire terminals accommodate several different sizes of mounting studs. One, the 16BA22, handles #22 through #16 AWG wire and stud sizes #6, 8 and 10. The other, 10BC14, handles #14 through #10 AWG wire, and stud sizes 8, 10 and 1/4. The two types replace up to nine terminals formerly needed to cover the same job requirements. They are un-insulated, and have a locking fork design that permits them to be slipped on the stud or bolt with the ease of a forked terminal, with virtually the same security as a ring terminal.

CIRCLE NO. 355

Paper tape winder features gentle handling

Continuous Expression Processor, Inc., 12 Main St., Natick, MA 01760. (617) 235-2980. \$29.95.

A lightweight battery-powered paper-tape winder will not mar or otherwise tear tapes that may have snagged. The design features left or right-hand operation and lifetime lubrication. Tape threading and roll removal are simple. The winder uses two "C" type batteries and can wind tape rolls of up to 1-1/4 in. wide and 5 in. dia.

CIRCLE NO. 356

L-shaped socket enables vertical IC mounting

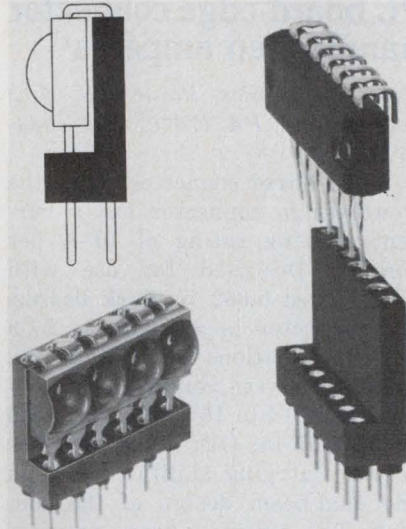

Electronic Molding Corp., 96 Mill St., Woonsocket, RI 02895. (401) 769-3800. 88¢ (100 up).

A socket is designed to save space in mounting LEDs and ICs on PC boards. The "L" socket requires one-third the mounting space of conventional LED sockets, and half the space of IC sockets. The socket comes with 12, 14 and 16 pins. DIP and LED forming tools are also available for the complete range of 0.300-in. center-line devices. Gold-plated, four-finger, contacts offer a firmer grip for more dependable lead connections, and closed-end terminals prevent solder wicking. The phenolic material will not soften during soldering operations.

CIRCLE NO. 431

Wrapped-wire board holds 22-pin DIPs

EECO, 1441 E. Chestnut Ave., Santa Ana, CA 92701. (714) 835-6000. \$100 (unit qty).

The model H-2964-01 wrapped-wire board holds up to 24 dual-inline 22-pin ICs. The unit is designed for 4-k RAMs. Four different voltages can be accommodated; V_{DD} , V_{CC} , V_{SS} , and V_{BB} . Posts are available for power connects and tabs are available for ground connections. The board comes with one tantalum and 12 ceramic capacitors. Extra capacitors may be added if needed. The board itself is made of flame-resistant glass epoxy with dimensions of 5.06 × 4.14 in.

CIRCLE NO. 432

FUJI 16K BYTES SYSTEM

PERFECTION!
FOR MICRO-PROCESSOR
RAM · PROM
MIXED MEMORY

FEATURES

- OPERATE AS RAM AND PROM (1K words increment)
- HIGH RELIABILITY
- LOW POWER CONSUMPTION
Single +5V Power Supply
- WIDE TEMPERATURE RANGE
0°C to +55°C
- NON-VOLATILE
- LOW COST

APPLICATIONS

- MAIN MEMORY FOR MICRO-PROCESSOR
- MINI DRUM MEMORY REPLACEMENT
- INVENTORY CONTROLLER
- PROCESS CONTROLLER
- NUMERIC CONTROLLER

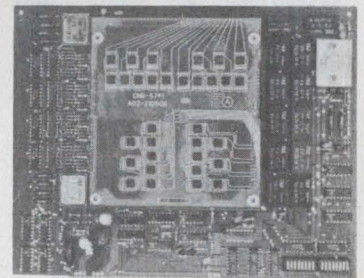

FUJI CMS2163 M-30 is a high-performance core memory system featuring versatility and non-volatility as internal main memory and mixed memory device for a micro-processor. Every memory address is changed by operating a compact toggle switch, part of which can be used as RAM and remainders can be utilized as PROM by means of a Read/Rewrite mode. Every address change can be selected by 1K-word each. This system provides much higher versatility and reliability even at lower operation cost in its overall function than any conventional RAM/PROM combination on a semiconductor memory. In addition to the following models, the standard products with 4 bits, 8 bits, or 18 bits are available. Also, we are always ready to accept quick delivery schedule on OEM systems for your special requirement.

MODEL NO.	CMS2163M-30	CMS2164M-10	
CAPACITY	16KW-8 B	16KW-9 B	
O W L D S	CYCLE TIME	3.0 μs	0.9 μs
	ACCESS TIME	1.0 μs	0.32 μs
POWER SUPPLY	+5V only	+5V, -12V	
DIMENSIONS (inch)	10"×8"×0.6"	15"×11"×0.5"	

FUJI ELECTROCHEMICAL CO., LTD.

Head Office
No. 36-11, 5-chome, Shinbashi, Minato-ku
Tokyo, Japan ☎03-434-1271
Los Angeles Office ☎213-323-1134
Düsseldorf Office ☎211-38811

CIRCLE NUMBER 82

Have you read Electronic Design's ACCURACY POLICY?



We have been printing it in every issue of *Electronic Design* for the past 24 years and adhering to it every business day of the year.

The accuracy policy of *Electronic Design* is:

- To make diligent efforts to ensure the accuracy of editorial matter.
- To publish prompt corrections whenever inaccuracies are brought to our attention. Corrections appear in "Across the Desk."
- To encourage our readers as responsible members of our business community to report to us misleading or fraudulent advertising.
- To refuse any advertisement deemed to be misleading or fraudulent.

Electronic Design

50 Essex Street, Rochelle Park, NJ 07662

PACKAGING & MATERIALS

PC board-edge connector handles ten amperes

Berg Electronics, Route 83S, New Cumberland, PA 17070. (717) 938-6711.

A PC board connector called the Power-Edge connector has a current-carrying rating of 10 A per contact. Designed for use with single-sided 0.062 in.-thick boards, the connector is available in 5, 9 and 15 positions with 0.156 in. spacing between contacts. The contacts take 14 to 16 AWG wire with up to 0.15-in. OD insulation. The current-carrying ability centers on the dual-beam design of the contact. The primary beam provides low insertion force with simultaneous positive pad-wiping action. When mated with the PC board, the secondary beam provides additional force and mechanical retention of the connector. Contacts are crimped to prestripped wire using a hand tool or bench press. They then snap into position in the connector housing.

CIRCLE NO. 357

Inexpensive enclosures made from extrusions

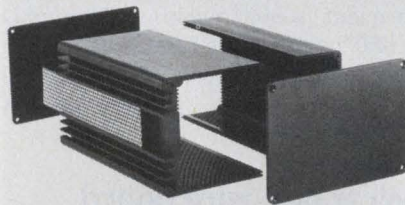

E-Tronics, 16774 Schoenborn St., Sepulveda, CA 91343. (213) 892-7279. See text.

Electronic housings assemble from aluminum extrusions that mate by tongue and groove. The extrusions come in 165 stock sizes. Assembled package sizes range from 2 x 2 x 4 in. to 4 x 8 x 12 in. The extrusions are slotted on the inside with 0.062 in. guides to accommodate circuit boards 3.775 in. wide. Plain or transistor mounting surfaces are finned for convection cooling and have a temperature coefficient of 0.08 C/W/ft. Prices start at \$2.75 for a complete enclosure.

CIRCLE NO. 358

Protective cases have polyfoam cushioning



Melmat, Inc., 2909 Oregon Ct., Torrance, CA 90503. (213) 320-3350. 6 x 4 x 2 in., \$2 (1-49); stock.

Kudl-Pak cases are made from either injection-molded polypropylene or thermoformed ABS, and come filled with convoluted polyurethane foam. The convolutions interlock when the case is closed, so various shaped parts are held securely in place, thus eliminating the custom interiors previously needed to hold products. A range of case sizes is offered, each capable of holding dozens of shapes. All units are reusable.

CIRCLE NO. 359

Fiber-optic cable used for data transmission

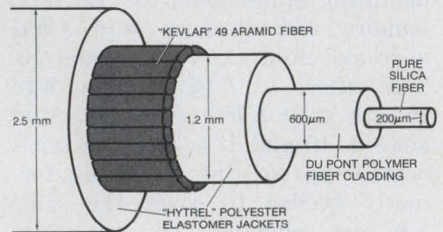

Du Pont Co., Plastic Products and Resins Dept., Wilmington, DE 19898. (302) 774-2291. \$5/m (50 m-up).

A fiber optics cable called PFX-S is intended for data transmission use. It is made with a pure-silica core and plastic jacket. The cable features attenuation of 80 dB/km at a transmitted-light wavelength of 800 nm. The large numerical aperture of light acceptance of the cable allows noncritical cable-to-cable splices and connection to LEDs with little transmission loss. The cable material is said to be extremely tough and will resist mechanical stresses better than other glass or silica fiber optics. PFX-S can be bent around a 3-mm radius without breaking. The PFX-S fiber optic material also resists radiation better than glass bundles.

CIRCLE NO. 360

NO TUNING REQUIRED ever!

Murata ceramic I.F. Filters for AM, FM, FM-Stereo, TV, CB.

Murata has a piezoelectric ceramic I.F. filter in 455 KHz, 10.7 MHz or 4.5 MHz frequency ranges that can provide the solid long-term performance demanded by today's sophisticated "entertainment" applications. I.F.'s, Discriminators, Traps, Series Resonators . . . there's a Murata unit that can meet your application requirements while providing that extra bit of performance that makes the difference. Write for technical details.

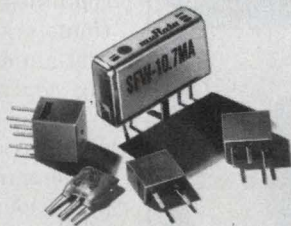

muRata

CORPORATION OF AMERICA

2 WESTCHESTER PLAZA, ELMSFORD, NEW YORK 10523
Phone: 914-592-9180 Telex: 13-7332

CIRCLE NUMBER 84

COST-CUTTING WESTON BREAKTHROUGH!

3/8" MULTITURN CERMET TRIMMER

FOR ONLY **99¢**

(1,000-Pc.
Price)

Same High Weston Quality
At A Real Savings In Price!



Weston has done it with the new #850! We took this widely used square multiturn trimmer, and by radically improving manufacturing techniques have been able to trim the price without sacrificing quality, performance or uniformity. It can give you an important new competitive edge.

WRITE FOR SPECS AND DETAILED
PRICE INFORMATION.

WESTON

Schlumberger

Weston Components
Archbald, Pa. 18403
Tel. (717) 876-1500
TWX 510 656-2902
Telex 83-7443

CIRCLE NUMBER 85

ELECTRONIC DESIGN 17, August 16, 1976

Schottky Barrier Rectifiers

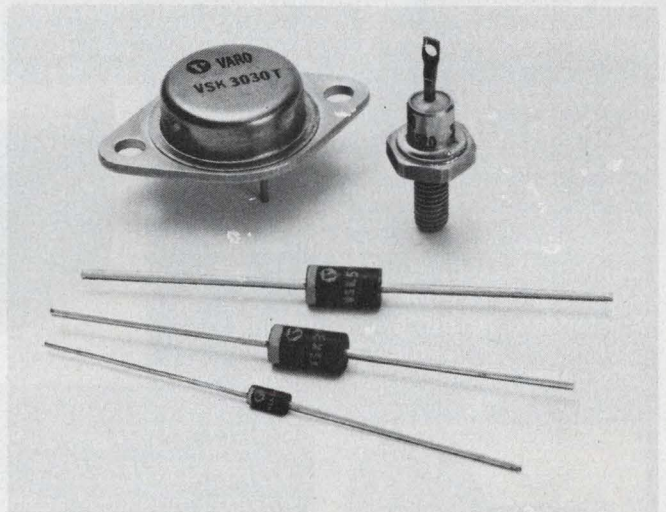

- Five series: 1A, 3A, 5A, 15A & 30A (I_o) with 20V, 30V and 40V (V_{RRM}).
- Extremely fast recovery (t_r), very low forward voltages (V_F), high reliability and low cost.
- VSK 120, 130 & 140-1A series in DO-41 packages. 550 mV (V_F). 40A peak $\frac{1}{2}$ cycle surge (I_{FSM}). 10 mA (I_R) at $T_c = 100^\circ\text{C}$.
- VSK 320, 330 & 340-3A series. Epoxy package, axial leads. 475 mV (V_F). 150A surge. 30 mA (I_R) at $T_c = 100^\circ\text{C}$.
- VSK 520, 530 & 540-5A series. Epoxy package, axial leads. 450 mV (V_F). 250A surge. 75 mA (I_R) at $T_c = 100^\circ\text{C}$.
- VSK 1520, 1530 & 1540-15A series in DO-4 metal stud cases. 600 mV (V_F). 300A surge. 75 mA (I_R) at $T_c = 100^\circ\text{C}$.
- VSK 3020T, 3030T & 3040T-30A series. Center-tapped, common cathode, 15A per leg in TO-3 package. 630 mV (V_F). 300A surge. 75 mA (I_R) at $T_c = 100^\circ\text{C}$. All series have junction operating temperature range of -65°C to $+150^\circ\text{C}$.

Call Mike Hawkins
214/272-4551
for more information



Design us in . . . we'll stay there
VARO SEMICONDUCTOR, INC.

P.O. BOX 676, 1000 N. SHILOH, GARLAND, TEX. 75040
(214) 272-4551 TWX 910-860-5178

EUROPEAN OFFICE: UK: VARO SEMICONDUCTOR INTERNATIONAL, INC.
Deepdene House, Bellegrave Road, Welling, Kent, England DA163PY, 01-304-6519/0

CIRCLE NUMBER 86

CLINTON PRESENTS THE SUPERTUBES

Clinton Electronics Corporation has for years been regarded as one of the world's leading manufacturers of Monochrome Cathode Ray Tubes in sizes from 3" to 23". These tubes are designed primarily for alpha-numeric data displays, medical electronics, video recording monitors and other applications requiring high resolution with minimum defocusing.

DATA DISPLAY SUPERTUBES . . .

are conventional rectangular tubes (3:4 aspect ratio) designed for a wide variety of information display applications. These tubes are available with deflection angles ranging from 55° to 114° and neck diameters from 20 mm to 37 mm. All standard JEDEC phosphors are available in addition to Clinton's own phosphors for unique applications.

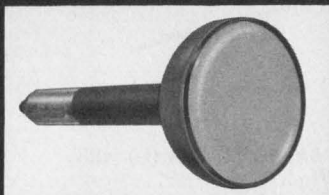
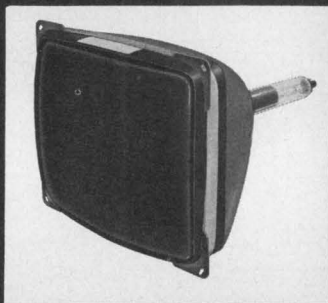

SPECIAL PURPOSE SUPERTUBES . . .

are used for unique applications such as flying spot scanners, hard copy printers, radar and projection systems to name just a few. Clinton can custom design a tube to meet your specific requirements.

LOW PROFILE SUPERTUBES . . .

are available where a combination of high performance and aesthetic appeal is of paramount consideration. We currently supply low profile tubes to companies such as Data Point, Hewlett-Packard, Teletype and Univac. Now we can supply you with similar tubes for your application.

See the supertubes in operation in the Clinton booth (#1107) at the National Computer Conference.

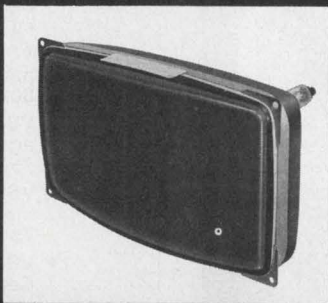

**CLINTON...
the ANSWER people
in CRT'S**



**CLINTON
ELECTRONICS
CORPORATION**

6701 Clinton Rd., Rockford, Ill. 61111 Phone 815-633-1444 Telex 257-484

CIRCLE NUMBER 87

COMPONENTS

Joy stick drives pots in slew-control system

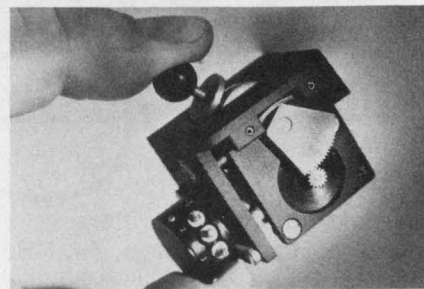

Beckman, 2500 Harbor Blvd., Fullerton, CA 92634. (714) 871-4848.

A joy-stick control assembly combines two single-turn potentiometers in a 1-1/2-in. square, cast-aluminum case. A self-centering control lever, moving through a square-pyramid envelope, meshes via gears with a two-gang and a single-gang potentiometer. One potentiometer may be at maximum travel at 29 degrees from center; the other can move from maximum at one end through zero to maximum at the other end. Originally engineered to slew a moving-map display of ground terrain in aircraft, the joy-stick control allowed horizontal, vertical or combined angular positioning. It is especially suited for application in electronic-game equipment.

CIRCLE NO. 361

Cooling fans deliver 16 cfm of air

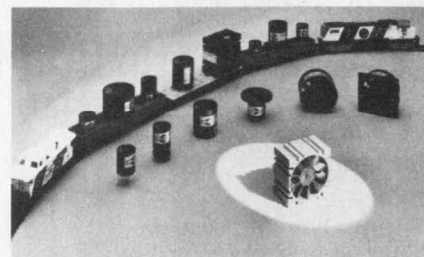

Micronel U.S., Box 271, Hudson, MA 01749. (617) 568-8542. \$22.80 (100 up); stock to 4 wks.

Cooling fans feature multivane impellers driven by high-efficiency dc or ac motors. Compact mechanical packages with carefully designed aerodynamic characteristics give good pressure/flow performance. Spotlight Model V571 has an output of 16 cfm in free air. Case size is 2.45 in.² Weight is 7 oz.

CIRCLE NO. 362

Transient protectors provide ns limiting

MCG Electronics, Inc., 279 Skidmore Rd., Deer Park, NY 11729. (516) 586-5125. \$8.53 to \$13.53 (100 up); 2 wks.

The SLP protectors were expressly designed to protect signal/data/telephone lines from transient overvoltages caused by lightning, heavy machinery, elevator motors, generators, etc. The unit interfaces between the signal line and the sensitive circuit (typically containing semiconductors) to provide a blend of nanosecond voltage limiting and brute-force protection. The SLP's recover automatically to standby when the need for protection has passed. Output clamping levels range from ± 5 to ± 200 V (selectable) for input voltage levels exceeding ± 20 kV (pulse, 10 μ s).

CIRCLE NO. 363

Small potentiometers feature metric sizes

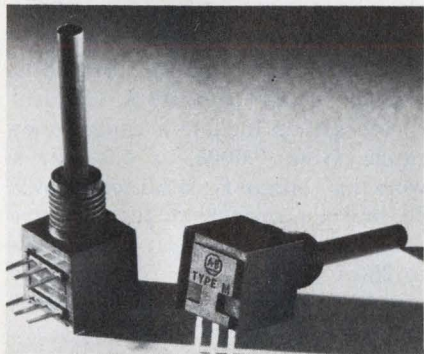

Allen-Bradley, 1201 S. Second St., Milwaukee, WI 52304. (414) 671-2000.

A completely metric panel potentiometer, the Mini-Metric Type M, has a 7-mm-long bushing and 3-mm-diameter shaft. This 10-mm-cube component is available with a switch and two resistor sections. A plastic case, shaft and bushing provide electrical isolation. The Type M is particularly suitable for handheld and other portable equipment. Resistances are standard IEC values—100, 220, 470 Ω to 1.0 M Ω . The resistance element is conductive plastic. Independent linearity has a maximum deviation of 5% in the range of 100 Ω to 100 k Ω . Power ratings are 0.1 W on the panel section and 0.05 W on the rear section at 40 C. Temperature range is -25 to 100 C.

CIRCLE NO. 364

MAGNETIC SHIELDING

- CO-NETIC (high permeability) Sheet and Foil
- NETIC (high saturation) Sheet and Foil
- CRT, Photomultiplier Tube and Transformer Shields
- Custom Shields — Prototype through Production
- Extensive Standard Tooling
- Engineering, Design and Test Facilities
- Quality Assurance—Certification to MIL Specs
- Broadest Shielding Line in the Industry —

SEND FOR OUR NEW CATALOG



MAGNETIC SHIELD DIV.



PERFECTION MICA CO.

740 N. Thomas Dr.
Bensenville, Ill. 60106
Ph. (312) 766-7800
TWX (910) 256-4815

CRT DISPLAY TERMINALS

50 Hz Design Assistance

Send Shield Print
For Prompt Quotation

CIRCLE NUMBER 88

VECTOR-PAK SYSTEM SOLVES PACKAGING PROBLEMS

- CAGES NOW AVAILABLE FULLY OR PARTIALLY ASSEMBLED.
- NEW EASY-TO-ORDER NUMBERING SYSTEM.
- BUILT IN ADJUSTABILITY AND FLEXIBILITY TO SOLVE YOUR PACKAGING PROBLEMS.

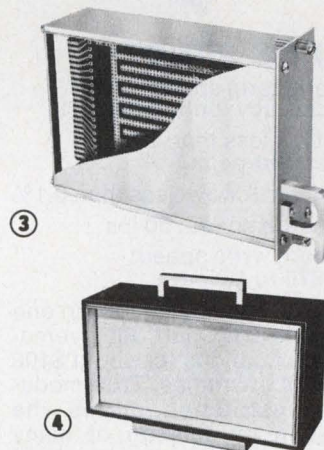
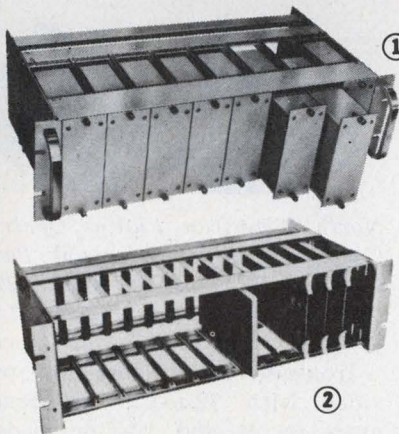

- ① Rack mountable cage and module systems available in 3 1/2", 5 1/4", 8 3/4" heights and 9", 12", 15" depths. Immediate availability — assembled or kit versions.
- ② Card Cages with plastic or aluminum guides located on .15", .25", or .3" multiples.
- ③ EFP cases with card slots, slide out sides — many sizes.
- ④ Multi-Mod Cases with card slots enclose circuitry for elegant instruments.

Also Available — Plug-In cards for microprocessors, ICs, etc. — many sizes and patterns.

Vector

Visit our WESCON/76 Booths 620-622

ELECTRONIC COMPANY, INC.
12460 Gladstone Ave., Sylmar, California 91342
Call Toll-Free 1-800-423-5659



32476

CIRCLE NUMBER 89

Amilon's cassette transports are compatible to more standards:

- *A.N.S.I.
- *E.C.M.A.
- *I.S.O.
- *N.A.B.

*Recognized under Component Program of Underwriters Laboratories.

Amilon pioneered U.S. made quality cassette tape transports with flexibility in mind.

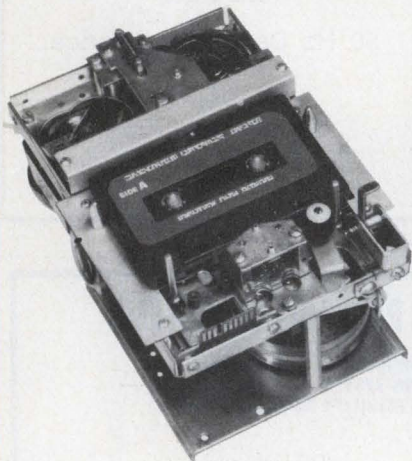

HERE'S PROOF:

- Long term speed accuracy: better than 1%
- Jitter: less than 1%, peak-to-peak
- Flutter & wow: less than 0.1%
- Search speed: 50 ips
- Read/write speed: 1.875 to 12 ips

Get all these advantages in one cassette transport with versatile applications for about \$100 in OEM quantities. True modular construction allows the addition or deletion of many options, tailoring the transport exactly for each application without the cost of unneeded features.

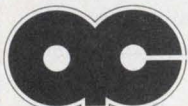

AMILON CORP.

49-12 30th Avenue Woodside, NY 11377
(212) 274-1794

CIRCLE NUMBER 90

COMPONENTS

Switches hold wires with push-in technique

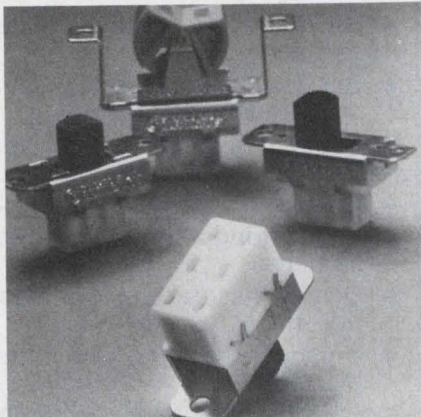

Stackpole Components Co., P.O. Box 14466, Raleigh, NC 27610. (919) 828-6201.

Push-in-lead slide and rocker switches (DPDT or SPDT) meet UL and CSA ratings of up to 6 A, 125 V ac. Lock clips inside a nylon base hold wires firmly in place. No soldering, special connectors, machines or fixtures are required. Wires are simply inserted into openings in the bases of the switches. Once inserted, they cannot be removed by hand.

CIRCLE NO. 365

Ironless-rotor motors come with 72-tooth tachs

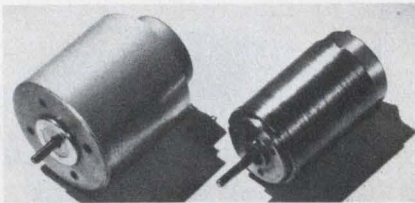

North American Philips Controls Corp., Cheshire Industrial Park, Cheshire, CT 06410. (203) 272-0301. \$17: 24 V, \$15.55: 12 V (500 up); prototypes from stock.

Ironless-rotor motors are provided with 72-tooth tachogenerators in 24 and 12-V-dc models. Power input is 4.35 and 3.6 W, respectively. The design eliminates the need for pre-established poles resulting in minimal cogging, smooth operation and low noise levels. A modified double-shaft version of the motor with a 26-mm rear-shaft extension is also available for use on encoders or similar dual-drive applications.

CIRCLE NO. 366

Film-Teflon capacitors come in two styles

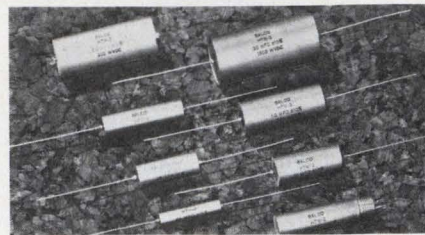

Custom Electronics, Inc., Browne St., Oneonta, NY 13820. (607) 432-3880.

New precision, film-Teflon capacitors are ultra-stable, low-loss, low-temperature-coefficient capacitors, suited for the high-insulation-resistance requirements at temperatures to 200 C (specials to 250 C). An extended-foil style offers low-dissipation factors and high circulating-current capabilities, which favor its selection for use in high-power resonant and pulse circuits. The metalized film style is self-healing in the event of voltage breakdown. Its more-uniform temperature coefficient and low volume per microfarad makes it ideal for resistor coefficient matching and for use in making small capacitors. Typical specifications include a capacitance range from 0.0005 to 4.0 μ F, a working voltage from 50 to 600 WV dc and an operating temperature range from -55 to 200 C (specials to 250 C) and a standard tolerance of 10% and precision tolerances to 1/4%.

CIRCLE NO. 367

Clutch/brake units mount easily

Inertia Dynamics, Inc., 12 Bridge St., Collinsville, CT 06022. (203) 693-0203. From \$12 (OEM qty).

These compact clutch brake packages provide easy mounting. The units simply slide on driven or driver shaft and are secured by set screws. The field magnet is restrained from rotating with a pin or torque-arm through an antirotation tab. Sizes range from 0.903-to-2.600-in. OD and provide torques from 2.5 to 80 lb-in. Units are available with bores from 3/16 to 5/8 in., four standard dc voltages—90, 28, 24, 12 V—and two coupling styles for in-line or parallel-shaft applications.

CIRCLE NO. 368

A SLIDE WITH PRIDE.

C&K's new Model 1101 subminiature SPDT slide switch has a proven internal mechanism be-

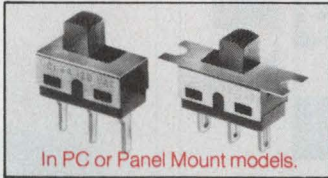

In PC or Panel Mount models.

cause it's the same one we've been using for years to build our famous toggle switches. We've retained all the toggle terminal and sealing options and added a spring-loaded teflon actuator. It's a powerful 6 amp (at 120 VAC) slide switch offering 40,000 actuations at full load. Because the actuator is only .200" high, the 1101 slide switch maintains a low profile but deep down it's a proud little son-of-a-toggle.

C&K Components, Inc. 103 Morse St., Watertown, Mass. 02172, U.S.A.
Tel: (617) 926-0800 Telex: 92-2546
TWX: 710-327-0460.

Free Engineering Sample on request.

See C&K at Wescon/76 Booth 928-930

CIRCLE NUMBER 91

DUAL OUTPUT

tracking open frame OEM power supplies from

FARATRON

cost less and run 50% cooler...

Model	Output VDC	Output Current Rating—Amps				Price Qty—100
		45°C	50°C	60°C	70°C	
OEM	±12	0.5	0.44	0.33	0.20	\$33
AD-1-152	±15	0.6	0.53	0.40	0.24	\$33
OEM	±12	1.0	0.86	0.66	0.40	\$39
AD-2-152	±15	1.2	1.06	0.77	0.48	\$39
OEM	±12	3.0	2.65	1.96	1.20	\$68
AD-3-152	±15	3.6	3.18	2.36	1.44	\$68

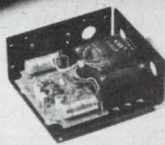

UL Recognized / IC Regulators / Auto Recovery Foldback / 3 Surface Mtg / Full Rating 47-440Hz / custom designs

Call or write for NEW DUAL OUTPUT SERIES CATALOG. Ask for Helpful Vic Plessner.

FARATRON

280 Green St., So. Hackensack, N.J. 07606
TWX 710-990-5022 Phone 201-488-1440

The COOLEST Power Supply People in the World!

CIRCLE NUMBER 92

ELECTRONIC DESIGN 17, August 16, 1976

New Hi-Temp Thermostat



...with European Acceptance

Ideal for a variety of high temperature applications! Elmwood's new snap-action RC thermostats include a glass-bonded mica (ceramo-plastic) base that allows set points to 550°F (290°C). The patented metal sleeve insert and rivet construction permit listings by European agencies as well as U.L. and C.S.A. The RC's are SPST, pre-set, tamperproof, and available with mountings, terminals and brackets to suit. Want more? Call or write Elmwood Sensors, Inc., 1659 Elmwood Ave., Cranston, R. I. 02907. Phone 401/781-6500. European Div., Elmwood Sensors Ltd., North Shields. Tyne and Wear, England.

ELMWOOD SENSORS

CIRCLE NUMBER 93

20 pages of design information on beryllium copper stampings...

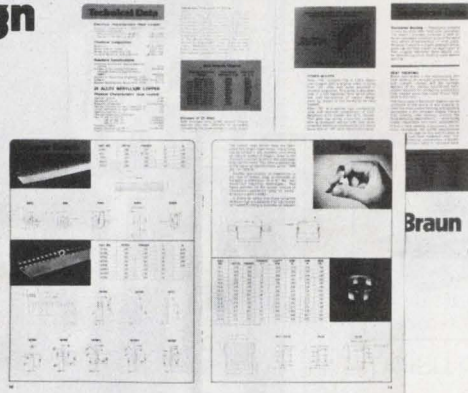

Free, in the Braun Catalog.

If you design, specify and use beryllium copper parts, the Braun catalog can put a lot of information at your fingertips. Braun's 25 years of experience in the art of producing beryllium copper products helped to fill this book with useful engineering data about precision stampings, contacts and springs in addition to intricate formed parts such as finger stock, rings and clips. Technical data includes: charts and tables on physical properties; information on tolerances; specification

prints on formed parts; data on heat treating, welding and soldering; recommendations for the use of other beryllium copper alloys.

BRAUN... for over 25 years, the name to say first when you say beryllium copper.



Just circle reader card number for your free copy or send request on your company letterhead.

TECH-ETCH, INC.
Plymouth Industrial Park
Plymouth, Mass. 02360
(617) 747-0300

Tech-Etch | Braun

BRAUN COMPANY, INC.
4200 31st Street North
St. Petersburg, Fla. 33714
(813) 526-9104

CIRCLE NUMBER 94

IMC FAN FACTS

IMC introduces fan for cooling sandwiched areas

IMC's new, high performance FULMAR fan features maximum efficiency for cooling high power density enclosures and rows of printed circuit board arrays. Unique design of this fan allows for convenience of "Side by Side" mountings for maximum airflow distribution and stable motor performance under low voltage (brown out conditions). Fulmar's low noise level is a natural for computer room use. Circle the "Bingo" for details! For immediate service please call Fred Taylor, Sales Manager at (603) 332-5300 or write.



4-3/4" diameter by 5-29/32"

FEATURES

- A compact 2" in depth
- Meets U.L. recognition requirements
- Automatic reset overload protector is standard
- Capacitor supplied with unit

50/60 HZ AIRMOVER



Our 25th Anniversary

IMC MAGNETICS CORP.

NEW HAMPSHIRE DIVISION

ROUTE 16B, ROCHESTER, NEW HAMPSHIRE 03867

CIRCLE NUMBER 95

MICROWAVES & LASERS

Resistive splitters span dc to 18 GHz

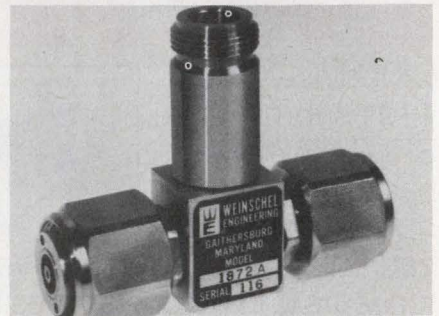

Weinschel Engineering, Gaithersburg, MD 20760. (301) 948-3434. \$425 to \$500; 30 days.

Resistive power splitters—Models 1870A through 1872A—can be used as part of a leveling loop or as a reference in a ratio system. The 50-Ω splitters span the range of dc to 18 GHz, and all have Type N input connectors. Outputs consist of Type N (1870A), APC-7 precision 7-mm (1871A) and WPC-7 precision 7-mm (1872A). VSWR is 1.07 maximum to 2 GHz and 1.15 maximum to 18 GHz. Maximum input power is 1 W average, 1 kW peak. Insertion loss (between input and either output) is 6 dB nominal, and outputs track to within 0.15 dB to 2 GHz, 0.20 dB to 8 GHz and 0.25 dB to 18 GHz.

CIRCLE NO. 369

Digital signals shift phase

Merrimac Industries, 41 Fairfield Pl., West Caldwell, NJ 07006. (201) 228-3890. \$595; 45 to 60 days.

Digitally controlled phase shifters can be used for applications through the hf-to-uhf frequency ranges. The PSD series of shifters varies the phases of rf signals in binary increments up to 360°. They are driven directly from TTL logic controls. Over-all phase-shifting accuracy is less than the least significant bit. Incremental accuracies of better than $\pm 0.2^\circ$ per bit are typical. A key member of this new family, the Model PSD-84-53-1, is an 8-bit unit that uses p-i-n diodes to switch precise lengths of cable in or out. The model has a 30-to-76-MHz frequency range, +10-dBm maximum input and 4- μ s switching time.

CIRCLE NO. 370

12.4-GHz mixer aims at high i-f uses

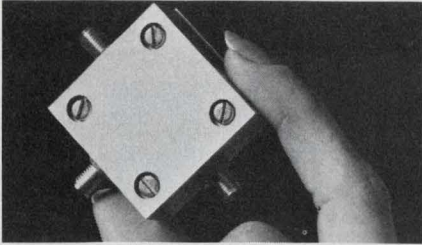

Vari-L Company, 3883 Monaco Pkwy., Denver, CO 80207. (303) 321-1511. \$350; stock-2 wks.

DBM-1200 is a 12.4-GHz doubly balanced mixer suitable for high-i-f-frequency applications. The mixer comes in a miniature, SMA-connector package and offers mutually overlapping R, L and i-f port frequency coverage. The R and L frequency coverage is from 0.5 to 12.4 GHz with the i-f port covering dc to 3.5 GHz. Typical conversion loss is 6.0 dB.

CIRCLE NO. 371

Lightweight filters seek space-comm use

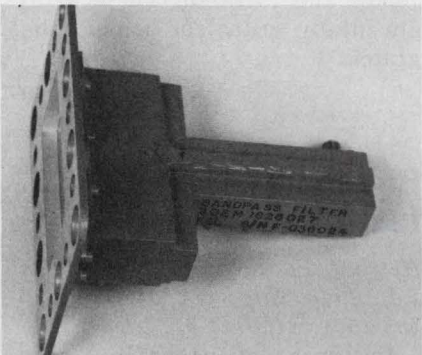

Frequency Engineering Laboratories, Farmingdale, NJ 07727. (201) 938-9221. \$875 to \$945 (5-9); 10 wks.

Bandpass filters directed toward space-communication uses operate in the 4 and 6-GHz bands. The units offer insertion losses of 0.2 dB over an equal-ripple bandwidth of 500 MHz, and pk-pk gain slope within the bandwidth of less than 1.0 dB. Designed to operate in 10⁻⁶-mm vacuum, the 5.75-oz 4-GHz unit (P/N 30EM1-826027) handles 50 W of incident power in-band, with SMA input and CPR 229 output. The 6-GHz version (P/N 50EM1826027) weighs 6.4 oz, and uses UG441/U input and SMA output.

CIRCLE NO. 372

Like peas in a pod...



all ball bearings may look alike, until you see what Chassis-Trak has done with them. Chassis-Trak ball bearing slides offer you . . . spacers that eliminate mounting problems by allowing no interference in the center of the slide . . . spacers that provide plenty of room to clear the mounting hardware . . . and standard mounting holes calibrated at 1" intervals that make special hole patterns unnecessary. Mounting couldn't be easier and the holes make the slides lighter in physical weight without sacrificing load carrying capacity. Chassis-Trak ball bearing slides move with ease because of smooth ball bearing action. This new construction allows faster delivery. Order Chassis-Trak for the best in Single Extention, Full Extention or Full Extention (over and under) ball bearing slides.

Accessories: Cabinet mounting hardware kit and lock-out devices.

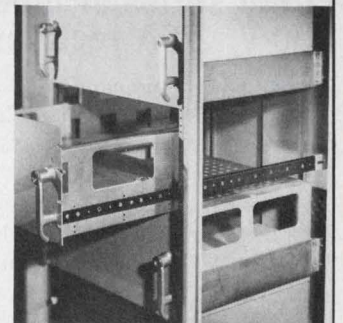
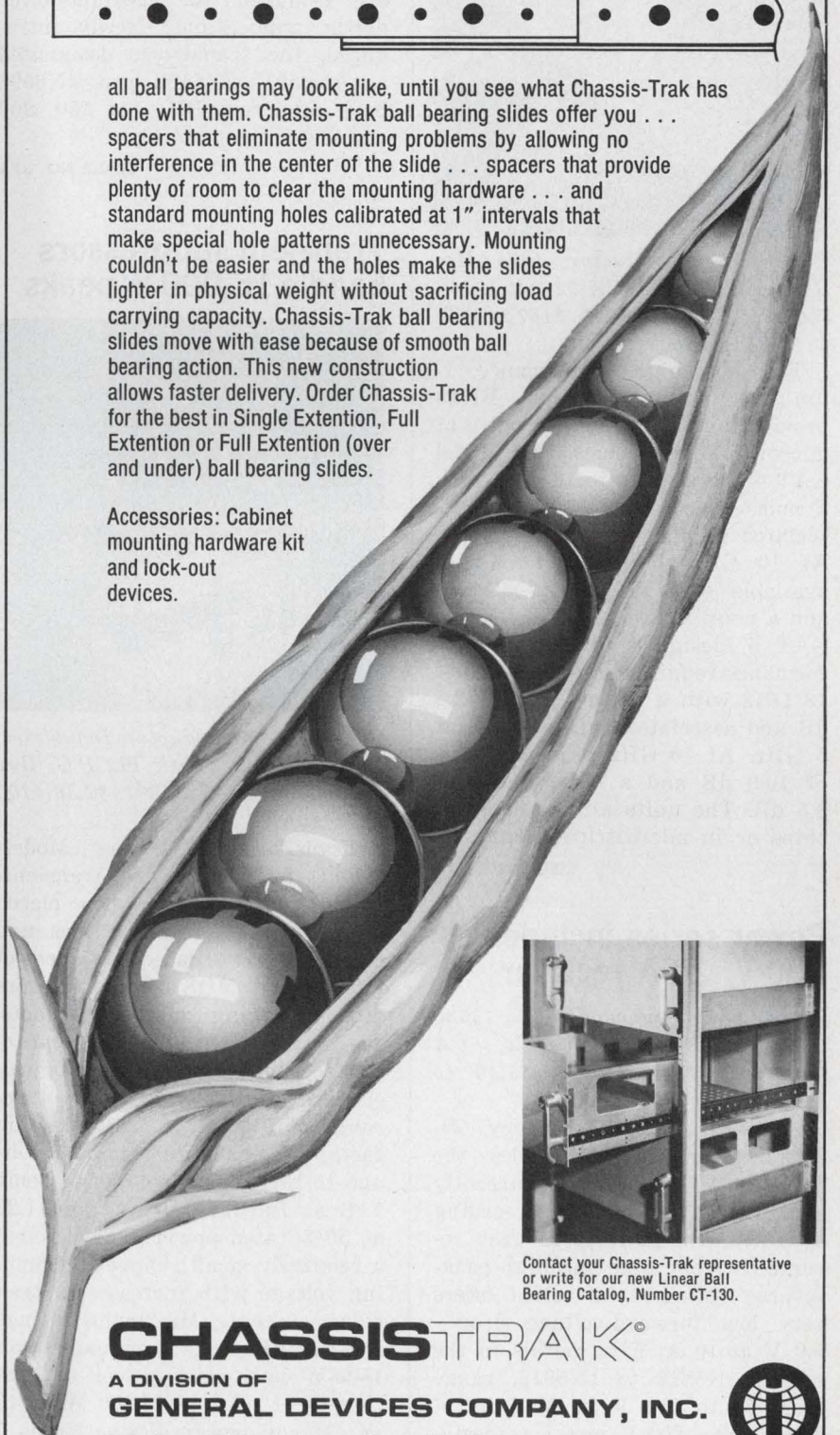

Contact your Chassis-Trak representative or write for our new Linear Ball Bearing Catalog, Number CT-130.

CHASSISTRAK[®]
A DIVISION OF
GENERAL DEVICES COMPANY, INC.

P.O. Box 19188, Indianapolis, Ind. 46219
(317) 897-7000 Telex: 27-2169 (GENDEVI CO IND)



CIRCLE NUMBER 96

DISCRETE SEMICONDUCTORS

GaAs FETs operate at microwave frequency

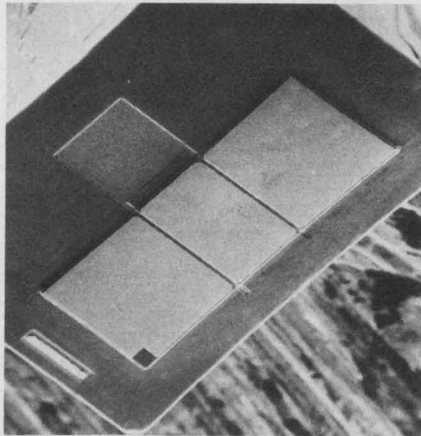

Plessey Semiconductor, 1674 McGaw Ave., Irvine, CA 92714. (714) 540-9945. \$116; GAT-3, \$167; GAT-4 (1-24); Stock.

Two new high performance, 1- μ m-gate gallium-arsenide FETs provide high gain and low noise at microwave frequencies. The Model GAT 4 operates up to 12 GHz with a noise figure of 1.8 dB and associated gain of 12 dB at 4 GHz. At 10 GHz, it has a maximum available gain (MAG) of 8.5 dB and a noise figure of 3.5 dB. Model GAT 5, designed for higher performance requirements, operates to 18 GHz with a noise figure of 2.5 dB and associated gain of 8 dB at 6 GHz. At 10 GHz it has a MAG of 10.3 dB and a noise figure of 3.5 dB. The units are available as chips or in microstrip packages.

CIRCLE NO. 373

Power series includes 200-V, 20-A rectifier

TRW Power Semiconductors, 14520 Aviation Blvd., Lawndale, CA 90260. (213) 679-4561. \$6.40 to \$13.20 (100-999); stock.

A series of high-efficiency, 20-A power rectifiers includes the only 200-V, 35-ns units currently available on the market, according to TRW. In addition to fast reverse-recovery time and high peak-inverse voltage, the series offers very low forward-voltage drop—0.9 V at 10 A. Five models in the series, 1N5812 to 1N5816, range from 50 to 150 V in 25-V increments. The 200-V model is designated SVD200-20.

CIRCLE NO. 374

High-voltage transistors dissipate 2 W

Motorola Semiconductor Products, Inc., P.O. Box 20294, Phoenix, AZ 85036. (602) 244-4556. \$0.58 to \$0.63 (100-999); stock.

Capable of dissipating 2 W at an ambient temperature of 25 C, these npn high-voltage Duowatt transistors in TO-202AC packages are designed for medium-power driver applications. Newly introduced, the transistors designated as 2N6591, 2N6592 and 2N6593 have minimum BV_{ceo} of 150, 200 and 250 V, respectively.

CIRCLE NO. 375

Transient suppressors handle 15,000-W peaks

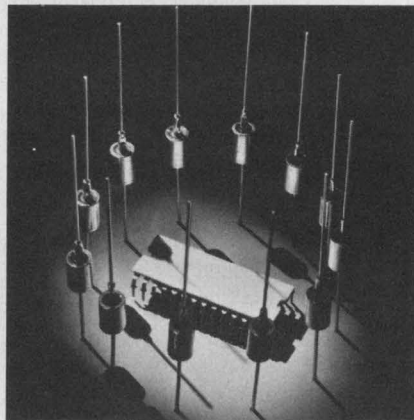

General Semiconductor Industries, Inc., 2001 W. Tenth Pl., P.O. Box 3078, Tempe, AZ 85281. \$2.36 (100 up); stock.

TransZorb μ P-series (Models MPTE 5 through 45) transient-voltage suppressors, when placed across V_{ss} , V_{dd} or V_{cc} lines and transient-prone data lines, protect bipolar and MOS microprocessors from damaging voltage transients. The devices have subnanosecond response times. Nine different models are available in the voltage range of 5 to 45 V. The clamping factor—the ratio of clamping voltage to breakdown voltage—is only 1.33 at full-rated power and 1.20 at 50% rated power. This assures a relatively small change in clamping voltage with increases in peak pulse current. Maximum ratings for the μ P-series suppressors are 1500-W peak-pulse power dissipation for 1 ms and 15,000 W at 10 μ s; steady power dissipation is 5 W at a duty cycle of 0.05%.

CIRCLE NO. 376

LED linear arrays pack 100 chips into 2 in.

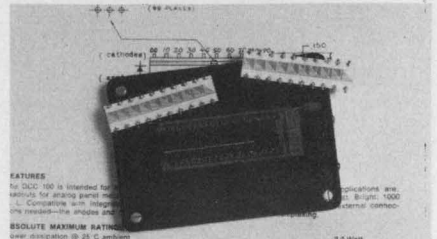

Digital Components Corp., 1111 E. Elizabeth Ave., Linden, NJ 07036. (201) 925-0200. \$46; red, \$51; green, \$56; yellow and IR (1-10); stock to 4 wks.

DCC's 100-LED linear arrays feature very dense packaging of individual LED chips and internal wiring that minimizes the number of external connections needed for multiplex operations. Outstanding features of the arrays include 100 LEDs on 0.020-in. centers; need for only 20 external connections; a low profile, only 0.125-in. thick; a low current requirement; compatibility with most standard ICs; end-to-end stackability to form arrays of 4, 6, 8, 10 or more inches long; availability in red, green, yellow and infrared. These arrays are ideally suited for bar and dial-graphs.

CIRCLE NO. 377

Bipolar transistor features low noise

Hewlett Packard, 1501 Page Mill Rd., Palo Alto, CA 94304. (415) 493-1501. \$150 (1-9); stock.

Designers of ultra-low-noise amplifiers will find this new microwave bipolar transistor suitable for 1 to 4 GHz. Designated the Model HXTR-6101, the new transistor has a specified noise figure of 2.7 dB, typical, at 4 GHz and 1.5 dB, typical, at 1.5 GHz. Typical gain is 9.0 dB at 4 GHz and 15 dB at 1.5 GHz. The transistor is a fully ion-implanted device with submicron emitter widths. A local oxidation process reduces pad parasitics to improve gain, and a self-aligning mask technique increases yield. The chip is packaged in the HPAC-70GT—a metal-ceramic hermetic package that meets the environmental requirements of MIL-S-19500 and the test requirements of MIL-STD-756/883.

CIRCLE NO. 378

WE'RE WARNING YOU...

... these new panel-type alarms for home, business and factory warning systems can't be ignored. Strident continuous, pulsing or continuous-plus-pulsing tone. Rated to 90 dbA at 2.7 kHz ... some models rated 85 dbA at 10 feet ... 6 to 16 vdc and 15 to 32 vdc ... drawing just 10 mA maximum current. Features 50mm diameter piezo crystal. Wire leads. Ask for your personal copy of our new catalog.

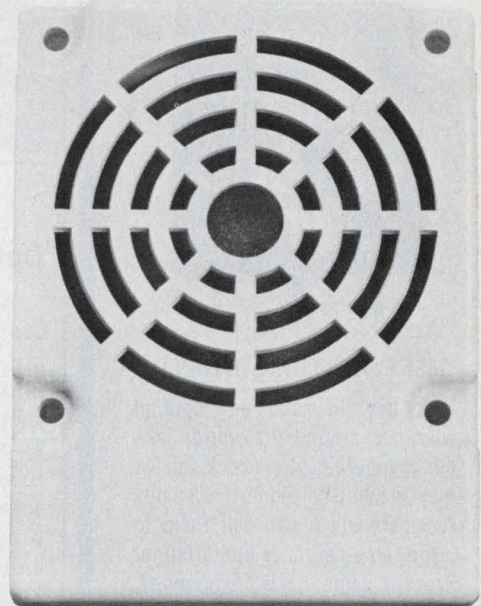

Series X-40 Panel Alarm

Actual Size

Where to buy an audio indicator for every need:



projects[®]
unlimited

3680 Wyse Road, Dayton, Ohio 45414
Tel. (513) 890-1918, TWX 810-450-2523

Selected distributorships available.

CALIFORNIA, COSTA MESA
MarVac Electronics

MASSACHUSETTS, SHARON
Adcour

MICHIGAN, FARMINGTON
CMP Distributor Co.

NEW YORK, ROCHESTER
Ossmann Components

OHIO, CLEVELAND
CMP Distributor Co.

OHIO, CINCINNATI
COLUMBUS
Hughes Peters, Inc.

TEXAS, DALLAS
K. A. Electronics

UTAH, SALT LAKE
Newark Electronics

WASHINGTON, SEATTLE
Frank Jackson & Associates

WISCONSIN, MILWAUKEE
Taylor Electric

ONTARIO, WILLOWDALE
Electro Sonic, Inc.

B. C., VANCOUVER
Deskin Sales Corp.

CIRCLE NUMBER 98

High performance you can really see.

Look to Motorola CRT modules for sharper, brighter displays.

Motorola's 12 and 15 inch CRT modules deliver! 80 sharp characters by 24 lines, with a 7x9 dot matrix display. Video response to 22MHz. Horizontal scan frequency up to 19KHz. TTL separate sync or composite video input. And all at a lower cost than you may now be paying for CRT's with lower performance.

Other screen sizes are 5, 9, 19 and 23 inches. All are optimized for data display applications. All are adaptable for U.S. or European operation. All circuitry is completely solid state. In fact, up to 99% of the module circuitry comes on easily removed printed circuit boards ... for quick and easy maintenance.

Readable. Economical. Versatile. Serviceable. Why not look us over? Send today for our free Design Kit with complete specs and application notes.

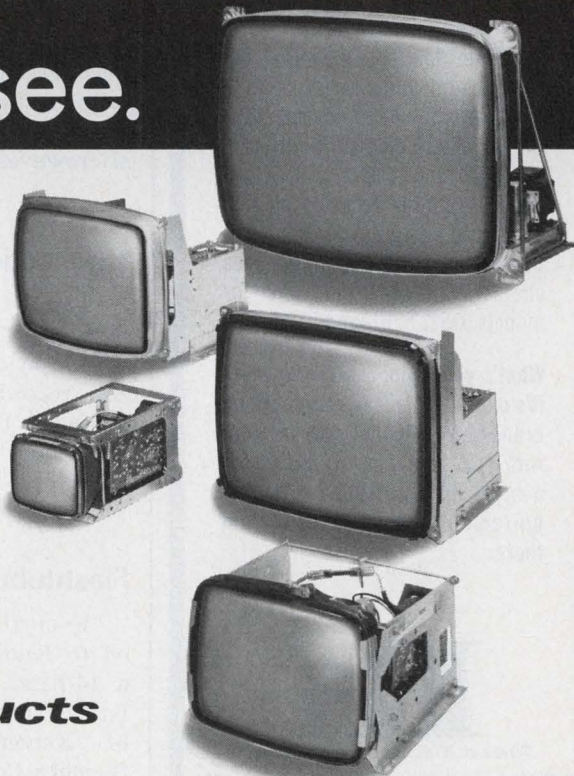

MOTOROLA Data Products

Domestic 455 East North Avenue
Carol Stream, Illinois 60187
312-690-1400 TWX: 910-252-4404

International Airport Center
4250 Veterans Memorial Hwy.
Holbrook, L.I., NY 11741 U.S.A.
516-588-4700 TWX: 510-228-1096

CIRCLE NUMBER 99

the state of the Art

TAKE A MONOLITHIC TO LUNCH

Every day, thousands of people, in countries around the world, take our monolithic filters to lunch, or maybe home to dinner (in paging receivers which can call them to a fire, an emergency operation, or a poker game). Size, ruggedness, and low cost are important in this application. Our standard 10.7 and 21.4 MHz monolithics offer all three. Many paging receivers operate in urban, dense signal areas, and there our VHF monolithic filters can simplify front-end design and reduce intermodulation. If you're thinking about paging, or any other production application of monolithic filters, call for PTI — the standard in monolithic crystal filters.

STRAIGHT STORY . . .

. . . about linear phase (constant group delay) monolithic filters. Three new four-pole models in our low-priced Comline® series offer a delay variation of 10 μ s. max. over the specified 3 dB. bandwidth (± 6 kHz.) for land mobile radio applications requiring data transmission or improved impulse response. Center frequency is 10.7 MHz. Spec sheet available. Just ask for models 5182, 5261, and 5262.

What's your application? Whether it's one of the above or something brand-new we'll be glad to work with you. Just give us a call, or a brief note outlining your requirements. We'll take it from there.



Piezo Technology Inc.

2400 Diversified Way Orlando, Florida 32804
305-425-1574

The Standard in monolithic crystal filters.

Application Notes

Optoelectronics

A 192-page "Optoelectronics Manual" includes seven sections on practical user-oriented information relating to emitters, detectors and couplers . . . theory, system design, reliability measurements, circuits, symbols and terms and specifications. Send \$3 plus applicable tax to GE Semiconductor, Electronics Park, Bldg. 7-49, Syracuse, NY 13201.

INQUIRE DIRECT

Gate turn-off SCR

An eight-page application note (No. U-71) explains the operation of the GTO-SCR and describes its advantages over previously available devices. Detailed applications are presented for dc circuit breakers, multivibrators, inverters and and ignition systems. Unitrode Corp., Watertown, MA

CIRCLE NO. 379

Magnetrons

Principles of operation, design considerations and applications of voltage tunable magnetrons are given in a 20-page guide. VTM Microwaves, Boulder, CO

CIRCLE NO. 380

Time-code data

"Time-Code Data Indexing Handbook" presents the theory on time-code data indexing on different recording mediums such as magnetic tape, video tape, camera film and oscillographs. Data-metrics, Wilmington, MA

CIRCLE NO. 381

Flashtube guide

"Everything You Always Wanted to Know About Flashtubes" is a 14-page guide to the characteristics, specifications and selection of Xenon gas-discharge tubes. Siemens Corp., Special Components Div., Iselin, NJ

CIRCLE NO. 382

Bulletin Board

Signetics has dropped the 1-24 quantity price from \$72 to \$26.50 for its 2650 general-purpose, 8-bit n-channel μ P. The 100-999 price is \$21.50.

CIRCLE NO. 383

RLC Electronics has announced major price reductions in its coaxial switch lines.

CIRCLE NO. 384

Spectral Dynamics has reduced the price of its Model SD360 FFT analyzer by \$9000 per unit.

CIRCLE NO. 385

Texas Instruments has introduced four prerecorded software libraries for the SR-52 programmable calculator.

CIRCLE NO. 386

Intel has introduced a program that allows low-cost MCS-40 microcomputer components to be used in hostile temperature environments as well as in the normal commercial temp range.

CIRCLE NO. 387

Rapidata has announced the release of PROBE graphics, a new service for preparing graphs on standard terminals, user plotters or plotting terminals and Rapidata's plotters.

CIRCLE NO. 388

Hewlett-Packard has introduced the HP-27—a 6-oz personal calculator that combines all of the most frequently used scientific, statistical and financial functions. It is priced at \$200.

CIRCLE NO. 389

Prices on Analog Devices' 16-channel AD7506 and eight-channel differential AD7507 monolithic CMOS analog multiplexers have been reduced by up to 46%.

CIRCLE NO. 390

Vendors Report

Annual and interim reports can provide much more than financial position information. They often include the first public disclosure of new products, new techniques and new directions of our vendors and customers. Further, they often contain superb analyses of segments of industry that a company serves.

Selected companies with recent reports are listed here with their main electronic products or services. For a copy, circle the indicated number.

CalComp. Printers and plotter/printers, disc memory systems, direct-access memory systems and automated tape library.

CIRCLE NO. 391

Astro Systems. Switches, synchro converters, synchro readouts, shaft encoders, laboratory standards, indicators, automatic drafting systems and plug-compatible memories.

CIRCLE NO. 392

National Semiconductor. Semiconductors, integrated circuits, consumer products, point-of-sale equipment, stand-alone terminals, polling subsystems and scanners.

CIRCLE NO. 393

VSI Corp. Specialized metal products.

CIRCLE NO. 394

Pentron Industries. Plastics, coils and electronic measuring instruments.

CIRCLE NO. 395

Beckman. Analytical and electronic instruments, precision electro-products and chemical products.

CIRCLE NO. 396

Computer Automation. Computers.

CIRCLE NO. 397

Tandy Corp. Consumer electronics, passive components, vacuum tubes and transistors.

CIRCLE NO. 398

Tektronix. Test and measuring equipment and information displays.

CIRCLE NO. 399

from Electronic Measurements . . .

SCR 1 ϕ & 3 ϕ DC Power Supplies

We are pleased to report that we now produce the industry's largest selection of SCR phase-controlled power supplies.

How did we do it?

Slowly.

We didn't acquire the largest selection without selling a lot of power supplies along the way. Our way, for 35 years, has been giving the user what he wants; and in a watts/dollar ratio that gives him no choice but E/M.

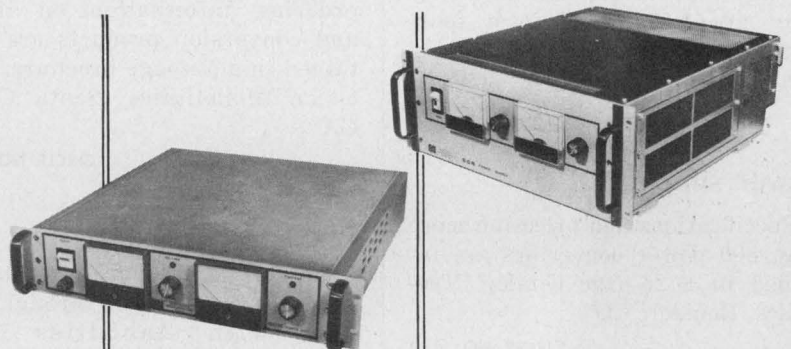

Type	SINGLE PHASE				THREE PHASE			
Watts	500	800	1600	2400	2500	5000	10 KW	To 60 KW
Volts	0 to 7.5 V up to 600 V DC							
Amperes	0 to 0.75 A up to 3000 A DC							
Height (in.)	3.50	3.50	5.25	7.00	7.00	8.75	12.25	To 4'
Price (\$)	450 to 500	575 to 650	800 to 895	1000 to 1100	1200 to 1600	1500 to 2300	2300 to 2900	To 9500

Over 100 standard models. Thousands of optional combinations.

To order, or for any technical information, call

TOLL FREE (800) 631-4298



ELECTRONIC MEASUREMENTS INC.

405 Essex Road, Neptune, N.J. 07753

Phone (New Jersey) 201-922-9300 (Toll free) 800-631-4298

Specialists in Power Conversion Equipment

CIRCLE NUMBER 101

New Literature

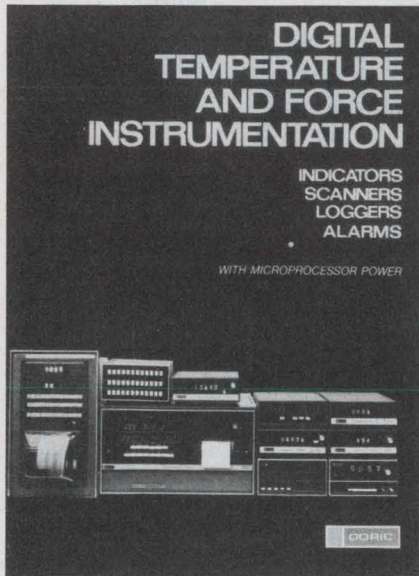

Digital instruments

Features of digital instruments for any type of physical measurement are highlighted in a four-page brochure. Doric Scientific, San Diego, CA

CIRCLE NO. 411

Power supplies

Specifications and prices on more than 800 power converters are included in a 26-page catalog. Tecnics, Boulder, CO

CIRCLE NO. 412

Epoxy systems

A four-page catalog presents one-part epoxy systems in a format designed for the buyer's convenience in selecting "mix" with the desired properties from up to 16 different systems. Emerson & Cuming, Canton, MA

CIRCLE NO. 413

Transient voltage protectors

A general description of miniature voltage surge arrestors, surge life data, environmental ratings, dimensions and specifications are included in a four-page catalog. C.P. Clare & Co., Chicago, IL

CIRCLE NO. 414

Rf, microwave amplifiers

Solid-state rf amplifiers from class-A medium power to class-A/B-or-C high power (1000-W) are described in a short-form catalog. The catalog covers more than 500 rf and microwave amps from 2 MHz to 4.2 GHz. Microwave Power Devices, Plainview, NY

CIRCLE NO. 415

Electronic packaging

A 128-page handbook describes electronic packaging and interconnect components. Stanford Applied Engineering, Santa Clara, CA

CIRCLE NO. 416

Aluminum knobs

Many different styles and sizes of aluminum knobs are shown in a six-page brochure. Kurz-Kasch, Wilmington, OH

CIRCLE NO. 417

Linear, conversion products

Drawings, specifications and ordering information on linear and conversion products are contained in a 12-page brochure. Precision Monolithics, Santa Clara, CA

CIRCLE NO. 418

Crystal oscillators

Crystal and clock oscillators ranging from 1 Hz through 400 MHz with stabilities from $\pm 0.01\%$ to 1×10^{-10} are covered in a brochure. Vectron Laboratories, Norwalk, CT

CIRCLE NO. 419

Miniature attenuators

Low-cost 11/16-in. rectangular attenuators are described in a brochure. TRW/IRC Potentiometers, St. Petersburg, FL

CIRCLE NO. 420

Disconnect hardware

Disconnect terminal boards, terminated lead assemblies, disconnect hardware and fuse clips and holders are featured in an eight-page catalog. Keystone Electronics, New York, NY

CIRCLE NO. 421

Switches

Miniature, subminiature and microminiature switches are highlighted in a 44-page catalog. C&K Components, Watertown, MA

CIRCLE NO. 422

Resistive components

Summary specifications and descriptions on resistive components are presented in a 20-page catalog. Bourns Trimpot Products Div., Riverside, CA

CIRCLE NO. 423

Sweeper system

Specifications, features and options for the Model 4310 A/K multiband sweeper system are presented in a 12-page catalog. Application data include block diagrams. Weinschel Engineering, Gaithersburg, MD

CIRCLE NO. 424

Integrated circuits

Specifications for a/d and d/a converters, instrumentation amps, s/h amps, multiplexers, references, FET-input and bipolar op amps and multiplier/dividers—all in IC form—are given in a 12-page brochure. Analog Devices, Norwood, MA

CIRCLE NO. 425

Fasteners

A revised 24-page catalog that gives complete engineering, application and purchasing information for hundreds of fasteners, is available. Nylock Div., Shelton, CT

CIRCLE NO. 426

μ C data book

A 260-page reference covers more than 100 microcomputers, 100 μ Ps and 1000 related memory and I/O devices manufactured throughout the world. Detailed specifications and operational characteristics of chips, cards and systems appear in 15 easy-to-compare technical sections. A one-year prepaid subscription (two complete editions) costs \$54.50 U.S. and \$56.80 international. D.A.T.A., Inc., 32 Lincoln Ave., Orange, NJ 07050.

INQUIRE DIRECT

UV SILICON PHOTOCELLS

LOW COST—HIGH QUALITY
200 to 1200 NM—UV TO VISIBLE TO IR
Low noise, wide range, stable, fast in a choice
of low level light detectors.

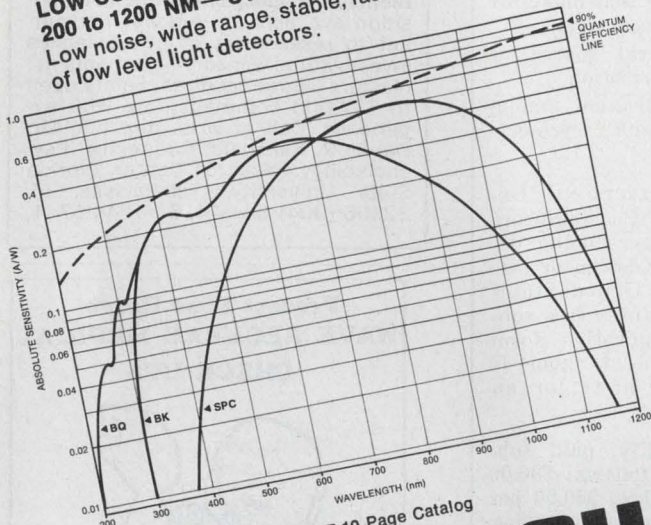

Call us for FREE 10 Page Catalog

HAMAMATSU

Hamamatsu Corporation • 120 Wood Avenue • Middlesex, New Jersey 08840
(201) 469-6640
International Offices In Major Countries of Europe and Asia.

CIRCLE NUMBER 103

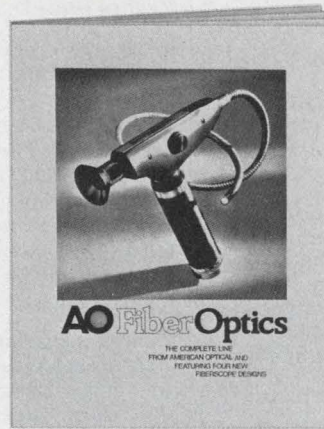

FREE Fiber Optics Catalog

Features the complete AO line of fiber optics products—from Inspection Fiberscopes and Light Guides to Illuminators, Image Conduits, Faceplates and Custom Components. Includes the four newest remote inspection fiberscopes now available.

Describes the principle, technology and techniques used to make flexible light and image transmissions a proven, practical fact. Write today for your FREE copy of the AO Fiber Optics catalog to American Optical Corporation, Fiber Optics Division, Southbridge, Mass. 01550.

AO
American Optical

CIRCLE NUMBER 104

new from Hayden!

“... well-organized, extremely well written ... highly recommended for practicing engineers...”
IEEE Transactions

DIGITAL SIGNAL ANALYSIS

Samuel D. Stearns

This is an ideal master handbook on today's signal processing procedures and systems, containing recent advances, new design material, and a comparison between continual and digital systems that's extremely helpful to newcomers to the field. Featuring a foreword by Richard Hamming, the book contains a review of linear analysis; sample-data systems; analog-to-digital and digital-to-analog conversion; the discrete Fourier transform and the fast Fourier transform algorithm; spectral computations; non-recursive and recursive digital systems; computer simulation of continual systems; analog and digital filter designs, and more. 288 pages

FORTRAN served up just right for the engineer...

FORTRAN FUNDAMENTALS

Jack Steingraber

You'll find this a fast and efficient guide to the fundamentals of FORTRAN. The main objective here, in fact, is to provide an abbreviated means of learning the language and of becoming familiar with language manuals — so it's just right for the engineer whose main interest may lie elsewhere. You'll find lots of sample problems along with complete solutions, although you're constantly encouraged to try various routines and analyze your own success or failure. The step-by-step format is perfect for self-study. 96 pages

HAYDEN BOOK COMPANY, INC.
50 Essex Street, Rochelle Park, New Jersey 07662

ELECTRONIC DESIGN 17, August 16, 1976

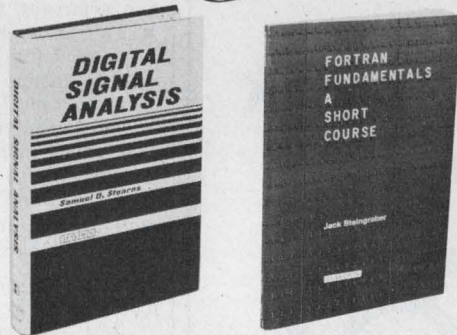

Order today—15-day examination!

Please send me the following book(s) to read and use FREE for 15 days. At the end of that time, I'll either send the amount indicated, plus postage and handling, or return the book(s) with no obligation.

- DIGITAL SIGNAL ANALYSIS, #5828-4, \$18.95
 FORTRAN FUNDAMENTALS, #5860-8, \$4.45

Name _____

Company/Institution _____

Address _____

City/State/Zip _____

SAVE MONEY! Payment Enclosed. Publisher will pay all shipping and handling charges. Same 15-day return privilege and full refund if not satisfied.

\$10.00 minimum for free exam orders. Because of higher billing and collection costs, we must ask for payment in full with any order for less than \$10.00. Books will be shipped postpaid. Same 15-day return privilege for full refund if not satisfied. 76-28

Electronic Design

ELECTRONIC DESIGN's function is:

- To aid progress in the electronics manufacturing industry by promoting good design.
- To give the electronic design engineer concepts and ideas that make his job easier and more productive.
- To provide a central source of timely electronics information.
- To promote communication among members of the electronics engineering community.

Want a subscription? ELECTRONIC DESIGN is sent free to qualified engineers and engineering managers doing design work, supervising design or setting standards in the United States and Western Europe. For a free subscription, use the application form bound in the magazine. If none is included, write to us direct for an application form.

If you do not qualify, paid subscription rates are as follows: \$30.00 per year (26 issues) U.S., \$40.00 per year (26 issues) all other countries. Single copies are \$2.00 U.S., \$3.00 all other countries. The Gold Book (27th issue) may be purchased for \$30.00 U.S. and \$40.00 all other countries.

If you change your address, send us an old mailing label and your new address; there is generally a postcard for this bound in the magazine. You will have to requalify to continue receiving ELECTRONIC DESIGN free.

The accuracy policy of ELECTRONIC DESIGN is:

- To make diligent efforts to ensure the accuracy of editorial matter.
- To publish prompt corrections whenever inaccuracies are brought to our attention. Corrections appear in "Across the Desk."
- To encourage our readers as responsible members of our business community to report to us misleading or fraudulent advertising.
- To refuse any advertisement deemed to be misleading or fraudulent.

Microfilm copies are available of complete volumes of ELECTRONIC DESIGN at \$19 per volume, beginning with Volume 1, 1952 through Volume 20. Reprints of individual articles may be obtained for \$3.00 each, prepaid (\$.50 for each additional copy of the same article) no matter how long the article. For further details and to place orders, contact the Customer Services Department, University Microfilms, 300 North Zeeb Road, Ann Arbor, Michigan 48106 telephone (313) 761-4700.

Want to contact us? If you have any comments or wish to submit a manuscript or article outline, address your correspondence to:

Editor
ELECTRONIC DESIGN
50 Essex Street
Rochelle Park, N.J. 07662

RENO, NEVADA

"DIGITAL FILTERS AND SIGNAL PROCESSING: THEORY, DESIGN, AND APPLICATIONS"

AN INTENSIVE SHORT COURSE

September 23, 24, 25, 1976

Holiday Inn, 6th Street, Reno, Nevada

Summary

This intensive short course is intended to provide an introduction or update on the subjects of digital filters and digital signal processing. Included are the following topics: sampled data theory, filter structure, stability concepts, discrete fast Fourier transforms, correlation methods, binary number systems, A/D and D/A conversion, analysis and synthesis techniques and practical design examples. Although the course presumes a Bachelors' degree, non degree engineers should find the course understandable and useful.

Lecturers: Dr. Sanjit Mitra (UC Davis); Dr. Stan White (Rockwell International); Dr. John Kleppe (Scientific Engineering Systems)

Cost: \$295 which includes course fee and a summary booklet of class notes.

How to enroll: Advanced enrollment required. Send payment/purchase order and request for hotel reservations or request for additional information to: Scientific Engineering Systems, Inc., 55 North Edison Way, P.O. Box 1171, Reno, Nevada 89504

(702) 322-7109 (7003)

CIRCLE NUMBER 106

KEEP

Electronic Design's

GOLD BOOK

HANDY

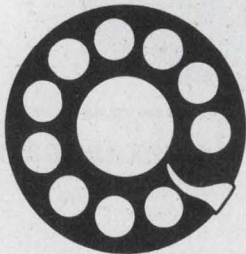

When You Call

Save time when you contact suppliers. Check their catalog pages first in *Electronic Design's* GOLD BOOK. Maybe the information you need is right at your fingertips.

classified ad

Biomedical Electronics Engineer position available as in-house consultant to researchers in Life Sciences investigating sensory mechanisms. Masters degree required. Salary open to \$17,000 commensurate with experience. Call or write direct to Dr. Daniel R. Kenshalo, Codirector, Psychobiology Research Center, Florida State University, Tallahassee, FL 32306 (904) 644-4416 or 644-5741.

Protect Your Heart HAVE REGULAR MEDICAL CHECK UPS



Give Heart Fund



Please Help Children Live

Research is our only weapon against childhood cancer.

St. Jude Children's Research Hospital, which is non-sectarian, is the largest childhood cancer research center in the world.

Please join in the fight against childhood cancer.

Send your special gift now.



**ST. JUDE
CHILDREN'S
RESEARCH
HOSPITAL**

Danny Thomas, Founder

Send contributions to:
MEMPHIS, TENN. 38101

This space donated by publication

Step-by-step coverage of
defense radar system
design . . .

INTRODUCTION TO DEFENSE RADAR SYSTEMS ENGINEERING

James N. Constant

This all-inclusive handbook covers virtually every facet of radar technology that must be mastered in order to design a complete defense radar system. In fact, it concludes with a *step-by-step procedure for specifying and designing a complete radar system for a given application*. Separate chapters cover target characteristics; radar detection; radar receivers; radar system error model; flight of a ballistic missile; ballistic reentry trajectories; trajectory prediction; radar data processing; reflector antennas; and array antennas. Order your 15-day examination copy today! #9194, 344 pages, cloth, illustrated, \$22.95



15-DAY FREE EXAMINATION!



Hayden Book Company, Inc.
50 Essex Street
Rochelle Park, N.J. 07662

- Please send me my copy of INTRODUCTION TO DEFENSE RADAR SYSTEMS ENGINEERING to read and use for 15 days. At the end of that time, I'll send a check or money order for \$22.95, plus postage and handling, or return the book and owe absolutely nothing.
- I want to save money! I have enclosed full amount. Publisher pays postage and handling. I get a complete 15-day money-back guarantee.

Name _____
Firm _____
Address _____
City/State/Zip _____

76-15

Electronic Design

Advertising Sales Staff

Tom W. Carr, Sales Director
Jean Bunfield, Sales Coordinator

Rochelle Park, NJ 07662

Robert W. Gascoigne
Daniel J. Rowland
Thomas P. Barth
50 Essex St.
(201) 843-0550
TWX: 710-990-5071

Philadelphia

Thomas P. Barth
(201) 843-0550

Boston 02178

Gene Pritchard
P.O. Box 379
Belmont, MA 02178
(617) 489-2340

Chicago 60611

Thomas P. Kavooras
Berry Conner, Jr.
200 East Ontario
(312) 337-0588

Cleveland

Thomas P. Kavooras
(312) 337-0588

Los Angeles 90045

Stanley I. Ehrenclou
Burt Underwood
8939 Sepulveda Blvd.
(213) 641-6544

Texas

Burt Underwood
(213) 641-6544

San Francisco

Robert A. Lukas
3579 Cambridge Lane
Mountain View, CA 94040
(415) 965-2636

London

Constance McKinley
50 Essex St.
Rochelle Park, N.J. 07662
Phone: (201) 843-0550

Amsterdam, Tokyo, Seoul

Sanders, W. J. M.
Raadhuisstraat 24
Graft-De Ryp, Holland
Phone: 02997-1303
Telegrams: Euradteam-Amsterdam

Haruki Hirayama

Electronic Media Service
5th Floor, Lila Bldg.,
4-9-8 Roppongi
Minato-ku, Tokyo, Japan
Phone: 402-4556
Cable: Electronicmedia, Tokyo

Mr. O-kyu Park, President

Dongbo Intl Corp.—
World Marketing
C.P.O. Box 4010
Seoul, Korea
Tel. 76-3910/3911
Cable: DONGBO SEOUL
Telex: EBKOREA K27286

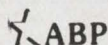

USC UPCC/REPC CONNECTORS

Draw Pull and Screwlocking. Built to MIL-C-55302 and Commercial Specifications Printed Circuit and Related Applications. REPC Connectors are Removable, Re-Entrancy, Crimp Contact Types.

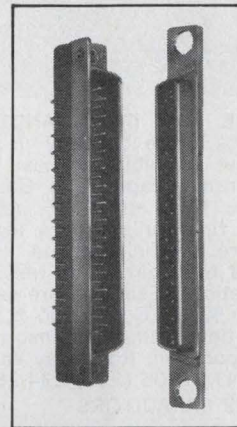

1 of over 20,000 Connector Types Manufactured. Send today for UPCC-REPC-A Series 32-page Catalog.

U.S. COMPONENTS, INC.

Leader in advanced
engineering design

1320 Zerega Avenue, Bronx, N.Y. 10462
(212) 824-1600 TWX 710-593-2141
Cable: COMPONENTS, NYK

CIRCLE NUMBER 108

PORTABLE DC RECORDER



Battery operated with internal charger. Compact, easily serviceable modular packaging. Accurate, reliable moving-iron galvanometer pen motor. Long-life, easily replaceable coaxial stylus. Trouble-free gear-reduced PM synchronous chart drive motor.

- tach-controlled chart speeds — 5 and 25 mm/sec.
- high frequency response — down 3db at 120Hz.
- input sensitivity selectable from 10 to 200 MV/mm.
- 10 operating hours before battery recharge.

In stock for immediate
delivery Model R1-5 DC
\$725.00 FOB Watertown,
Massachusetts.

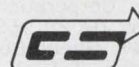

GENERAL SCANNING INC.
150 Coolidge Avenue
Watertown, MA. 02172
TEL: (617) 924-1010

CIRCLE NUMBER 109

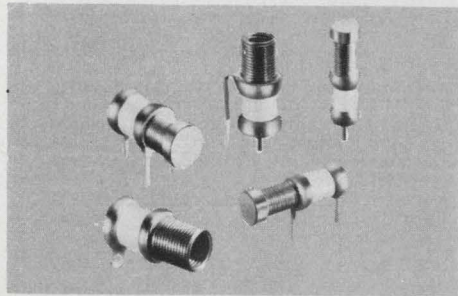

MINIATURE LOW INDUCTANCE CAPACITORS, 50% more capacity in the same size is now available in these Johanson extended range capacitors. Beautiful for microwave, VHF and UHF applications, they offer fine tuning, ultra high Q, low temperature coefficients and "sizes" for hybrid and microcircuit as well as standard applications. Featured are capacitance range .5 to 5.0 pf, $Q > 10,000 @ 100 \text{ MHz}$, and extra fine tuning. Johanson Manufacturing Corporation, Rockaway Valley Road, Boonton, NJ 07005 (201) 334-2676.

MINIATURE CAPACITORS

181

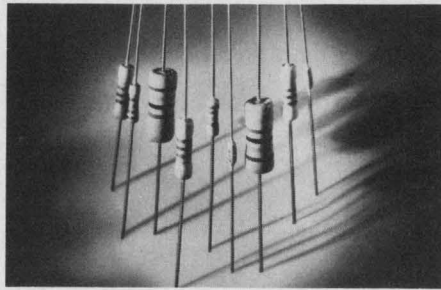

RCA FLAMEPROOF FILM RESISTORS. Design engineers prefer them because they won't flame or short under the most severe conditions. These resistors have a 2% tolerance, and are available in 1/4 watt, 1/2 watt, 1 watt, and 2 watt ratings. Resistance values range from 10 Ohms to 1.5 Megohms, depending on wattage rating. 475 film resistors to choose from. RCA Distributor & Special Products Division, Sales Promotion Services, Cherry Hill, N. J. 08101.

FILM RESISTORS

184

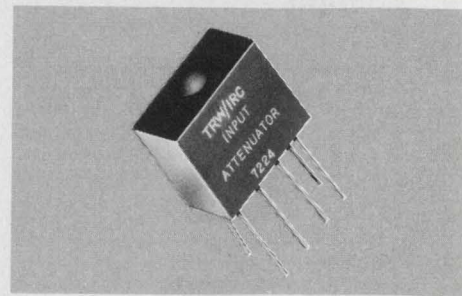

AR Ultra-Precision Resistor Networks from TRW provide maximum environmental protection. They feature lower effective cost, high density packaging, and all-welded construction. And, the AR Matched Resistor Sets provide ultra-precision performance at the lowest possible cost. TRW/IRC Resistors, an operation of TRW Electronic Components, 401 N. Broad St., Phila., Pa. 19108. (215) 922-8900.

AR MODULES

187

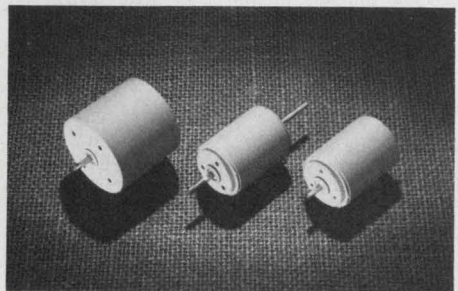

MINIATURE IRONLESS ROTOR DC MOTORS offer efficiencies to 80%, low inertia, rapid response and high starting torque. 24 and 12 VDC models available. Motor time constants are 17 and 23 MS respectively. Rotor torque is 100 and 50 gcm and starting torque 600 and 230 gcm, respectively. 12 VDC units can be ordered with either a single or extended double shaft. Tach versions also available. For reel and capstan drives, chart and pen drives, etc. North American Philips Controls Corp., Cheshire, Conn. 06410. (203) 272-0301.

IRONLESS ROTOR

182

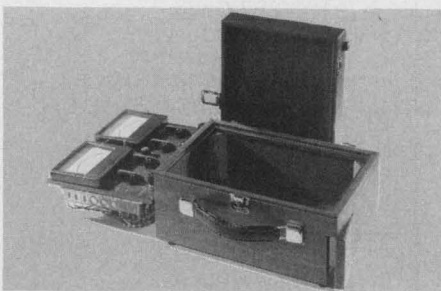

Custom made cases, cabinets and enclosures. Exceptionally rugged construction, laminated Formica-wood-Formica. Internally reinforced corners. Attractive wood grain or solid color exteriors. Superb workmanship, competitive prices, small or quantity lots. W. A. Miller Co., Inc., 306 Mingo Loop, Oquossoc, Maine 04964. Telephone: 207/864-3344.

CASES AND ENCLOSURES

185

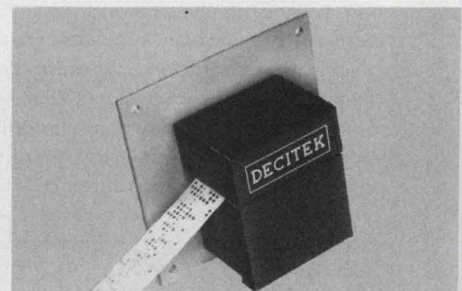

Low-cost tape reader is fast—up to 300 cps—and quality-built. Dual sprocket drive, a state-of-the-art fiber optic light source and photo transistor read head. Simplicity of design makes it easy to adapt to specific OEM requirements. Decitek, 250 Chandler Street, Worcester, MA 01602 (617) 798-8731

SAM® TAPE READER

186

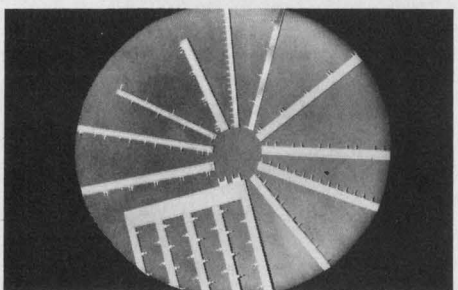

Mini/Bus® Evaluation Kit, \$25, in stock. Lets you try Rogers' low-cost, noise attenuating, high packaging density power distribution system for PC boards. Millions in use. Standard parts on 2 weeks delivery, or less! Customer parts 4 to 6 weeks delivery. Rogers Corporation, Chandler, AZ 85224. Phone (602) 963-4584. (EUROPE: Mektron NV, Ghent Belgium; JAPAN: Nippon Mektron, Tokyo)

MINI/BUS

183

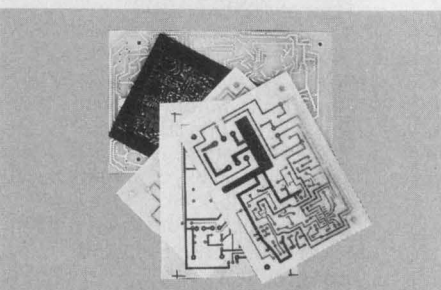

CUSTOM PC BOARDS AT LOW COST/FAST DELIVERY. No minimum order. Specialized service includes computer drilling, plated-through holes, tin or solder re-flow plating. Guaranteed delivery—3 days (single sided), 5 days (double), 1-24 pieces. All artwork services from schematic-to-proto available. Very competitive prices. WESTERN LABORATORIES, 110 South Rosemead Blvd., Pasadena, CA 91107 (213) 793-0148

CUSTOM PC BOARDS

186



HAND-HELD DIGITAL MULTIMETER FOR \$198. Provides 3½ digits at 0.1 percent accuracy. Autoranging and autopolarity. Measures up to 750 volts ac or dc and up to 20 megohms. For added temperature measurements up to 154°C, Mode 12T is available for only \$259. Logica Technical Services Corp., 71 West 23rd Street, New York, N. Y. 10010. Phone (212) 741-8340.

HAND HELD DIGITAL MULTIMETER

187

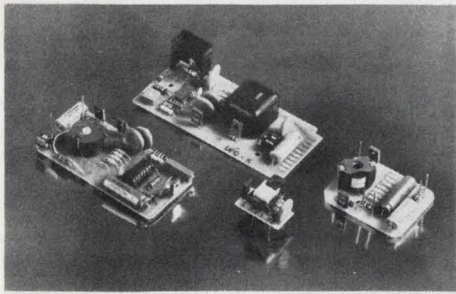

Activate gas discharge readouts! Custom designed and produced DC-to-DC power supplies to activate gas discharge displays, or for other applications. Regulation I/O options, packaging (encapsulated, aluminum shell or open frame), size and configuration, heat dissipation, mounting (PC board pins, edge connectors), etc., can be tailored to meet individual specifications. Price and delivery discussed after specifications are submitted. Endicott Coil Co., Inc., 31 Charlotte Street, Binghamton, N.Y. 13905 (607) 797-1263.

CUSTOM DESIGNED POWER SUPPLIES 190

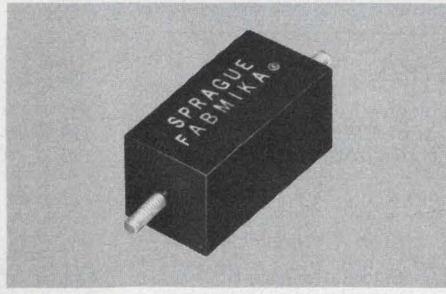

High-Voltage Epoxy/Fiberglass-Encased Type 305M Fabmika® Capacitors. Reconstituted mica dielectric, offering uniformity of performance and quality impractical with sheet mica. Impregnated with epoxy resin, forming solid capacitor section . . . no oil leak. Sprague Electric Co., 347 Marshall St., No. Adams, MA 01247. (413) 664-4411.

HIGH-VOLTAGE CAPACITORS 193

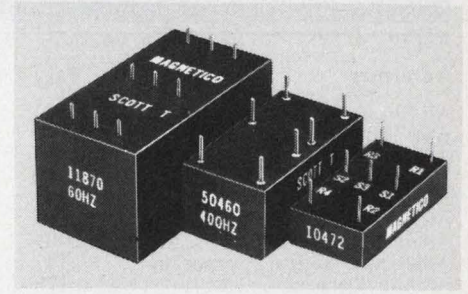

Scott T Transformer. 11870: 60HZ, 90v, L-L in. 1.1x2.1x1.1. 50460: 400 HZ, 90v, L-L in. 7/8x1-5/8x11/16. 50642: 400HZ, 11.8v, L-L in. 7/8x5/8-11/16. 10472: 400-HZ, 11.8v, L-L in. 3/4x1-1/2x3/8. All with 6v RMS sine & cosine output. MAGNETICO, INC., 182 Morris Ave., Holtsville, N.Y. 11742 516-654-1166.

TRANSFORMER 196

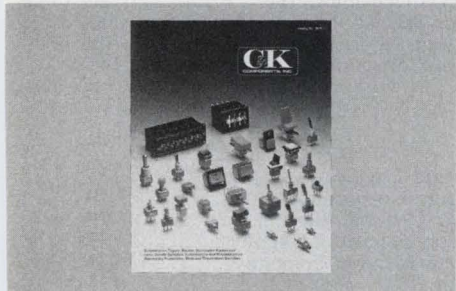

NEW 44-PAGE SWITCH CATALOG gives complete specs for subminiature toggle, rocker, illuminated rocker, lever handle, printed circuit mounting, snap-acting pushbutton, 6 amp alternate action and momentary pushbutton, subminiature and microminiature pushbutton, miniature power, slide, and thumbwheel switches. All switches are made in U.S.A. and most are available with U.L. listing. Free engineering switch samples on request. C&K Components, Inc., 103 Morse St., Waterown, MA 02172 (617) 926-0800

NEW 44-PAGE SWITCH CATALOG 191

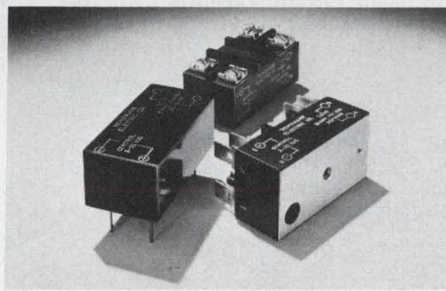

Fail-safe Heinemann solid-state relays combine dv/dt snubber, fusible link in the trigger circuit, and an oversized triac, all of which act to prevent catastrophic system failure should the triac fail to turn on. 5A and 10A ac output, load voltage from 25V ac to 270V ac. TTL and CMOS control compatible (3 to 32V dc input), choice of zero-voltage and non-zero-voltage switching. Solder-pin, quick-on, or screw terminals. Heinemann Electric Company, Brunswick Pike, Trenton, NJ 08602; phone (609) 882-4800.

SOLID-STATE RELAYS 194

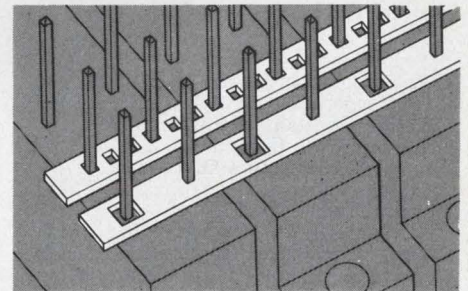

STRIP/BUS BY ROGERS. Low Cost Bussing Systems; easy installation, reliable solder joints; greater pin exposure. Write or call for details. Rogers Corporation, Rogers, CT 06263. Phone (203) 774-9605. (EUROPE: Mektron NV, Ghent, Belgium; Japan: Nippon Mektron, Tokyo)

STRIP/BUS 197

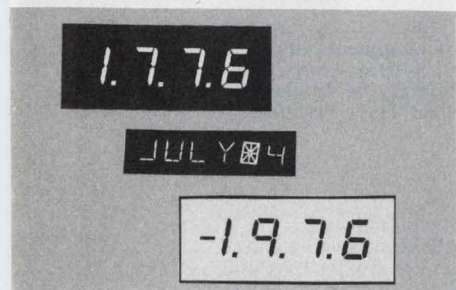

Liquid Crystal Displays — Standard 3 1/2 digit numerics for portable instrumentation, thru simple low power indicators, to custom fonts, 16 segment, alphanumerics and annunciators — Widest and most flexible information display applications — Special legends, language and configurations — May be coupled with UCE solar cells and battery for utility free operation for extended periods. Current drain less than 1 μ A/cm² of energized area! UCE, Inc., 20 No Main, Norwalk, CT 06854 (203) 838-7509

LOW POWER INDICATORS 192

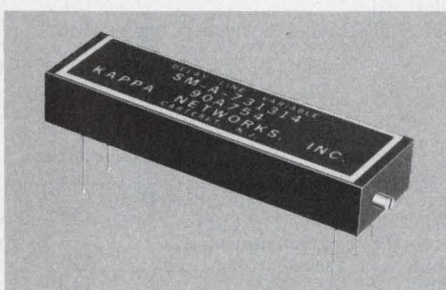

IMPROVED VARIABLE DELAY LINE *Crack-proof epoxy fiberglass case *Seamless construction *Two point terminal embedment *Assembled on internal P.C. Board *O-Ring seal *Bifurcated contacts *Delays to 300 nano sec. *Size: .35x .70x 2.25 or 4.00" length *Price: small quantity \$37.50 each *Send for spec. sheet Minitrim 101. KAPPA NETWORKS, INC., 165 Roosevelt Avenue, Carteret, NJ 07008. Call Toll-Free 800-631-5653. See our listing Gold Book Vol. 2, Page 414.

VARIABLE DELAY LINE 195

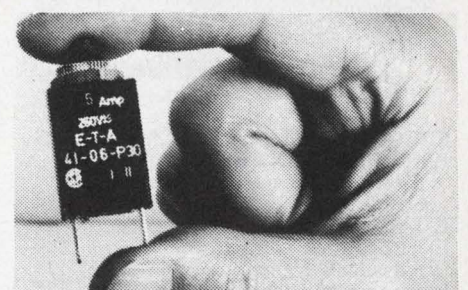

Overcurrent Protector, manual reset eliminates fuse replacement. Convenient panel mounting. 19 fractional ratings from 0.1 to 5 amp. Other models up to 400 amp. Trip-free and fool-proof, UL and CSA approved. High quality, low cost \$1.33 ea. in 1000 lots. E-T-A Products Co. of America, 7400 N. Croname Rd., Chicago, Ill. 60648. Tel: (312) 647-8303. Telex: 253780.

CIRCUIT BREAKER 198

Advertiser's Index

Advertiser	Page	Advertiser	Page	Advertiser	Page
AP Products Incorporated	122	Farotron	129	OK Machine & Tool Machine Corporation	111
AMP, Incorporated	41	Ferranti Electronics	121	Optron, Inc.	7
Abbott Transistor Laboratories, Inc.	6	Fuji Electrochemical Co., Ltd.	123		
Acheson Colloids Company	116			Philips Electronic Components and Materials	12, 13, *48A
Advanced Micro Devices	48B-C	GTE Automatic Electric	48A	Piezo Technology, Inc.	134
Alco Electronic Products, Inc.	115	GTE Sylvania, Miniature Lighting Products, Inc.	69	Plessey Semiconductor	81
Allen Bradley Co.	48D	Galileo Electro-Optics Corp.	53	Potter & Brumfield, Division of AMF, Incorporated	33
American Optical Corporation	137	General Electric Company	123	Projects Unlimited	133
Amilon Corp.	128	General Scanning, Inc.	139		
Amperite Co., Inc.	118	Gold Book, The	138, 143		
Amuneal Manufacturing Corp.	122	Gould, Inc., Instrument Systems Division	14		
Ansley Electronics Corp.	61				
				RCA Distributor & Special Products Division, Sales Promotion Services	140
B & K Products of Dynascan	110	Hamamatsu Corporation	137	RCA Electro Optics	99
BEI Electronics Inc.	109	Hayden Book Company, Inc.	*48D, 137, 139	RCA Solid State	Cover IV
Bourns, Inc., Trimpot Products Division	Cover II	Heinemann Electric Company	141	Raytheon Semiconductor	104
Bud Radio, Inc.	106	Hewlett-Packard	1, 11, 17, 31, 50, 79	Rental Electronics, Inc.	20
Burr-Brown Research Corporation	35			Repcor, Special Projects Department	112
				Rockwell International	109
				Rogers Corporation	40, 140, 141
C & K Components, Inc.	129, 141				
CTS Corporation	103	IMC Magnetics Corporation	130	Scientific Engineering Systems Inc.	138
CELCO (Constantine Engineering Laboratories Company)	47	ISE Electronics Corporation	101	Semtech Corporation	49
Centralab, Electronics Division of Globe-Union, Inc.	111	Intel Corporation	4, 5	Silicon General, Inc.	29
Chassis Truk, A Division of General Devices Company Inc.	131	Interdata, Inc.	94, 95	Simpson Electric Company	37
Clinton Electronics Corporation	126			Sprague Electric Company	55, 141
Constantine Engineering Laboratories Company (CELCO)	47	Johanson Manufacturing Corp.	140	Stahlin Bros., Inc.	115
Continental Specialties Corporation	107	Johnson Company, E.F.	10		
Control Products Division, Amerace Corporation	87			TRW, Electronic Components	140
Cutler-Hammer, Specialty Products Division	15			TRW Power Semiconductors	80
				Tech-Etch Inc.	130
				Teledyne Relays, A Teledyne Company	2
				Teledyne Semiconductor	58
Dale Electronics, Inc.	8, 9	Kappa Networks, Inc.	141	Thomas Electronics Inc.	119
Data General Corporation	27	Keithley Instruments, Inc.	70, 71	Triplett Corporation	97
Datatron, Inc.	56, 57	Kepeco, Inc.	44		
Decitek	140			UCE, Inc.	141
Dialight, A North American Philips Company	78			U. S. Components, Inc.	139
				United Systems Corporation, a Subsidiary of Monsanto	121
				Universal Data Systems	39
EECO	23			Varadyne Industries, Inc.	93
EMM Semi, A Division of Electronic Memories & Magnetics Corporation	24	3M Company	Cover III	Varo Semiconductor, Inc.	125
E-T-A Products Co. of America	141	Magneto, Inc.	141	Vector Electronics Co., Inc.	127
Electro Switch Corp.	109	Magnetic Shield Division, Perfection Mica Company	127	Victoreen Instrument Division, Shellar-Globe Corporation	113
Electronic Design	42, 43, 124	Micro Devices Division of Emerson Electric Co.	115		
Electronic Measurements, Inc.	135	Miller Co., Inc., W.A.	140		
Electronic Molding Corporation	117	Minelco Division, General Time	120		
Electronic Processors Incorporated	60	Mostek Corporation	25		
Elmwood Sensors, Inc.	129	Motorola Display Products	133		
Endicott Coil Co., Inc.	141	MuRata Corporation of America	125		
				Western Laboratories	140
				Weston Components	125
Fabri-Tek, Inc.	48				
Fairchild Semiconductor, A Division of Fairchild Camera and Instrument Corporation	88, 89	National Semiconductor Corporation	18, 19		
		North American Philips Controls Corp.	140		

*Advertisers in non-U.S. edition



HERE'S WHAT THEY'RE SAYING ABOUT THE GOLD BOOK

The GOLD BOOK is outperforming its nearest competitor 3 to 1 — and is providing \$75 in sales for every \$1 invested! Reports George A. O'Sullivan, President, Abacus Controls.

"We're switching to the GOLD BOOK this year!" Says Peter G. Wittenberg, Sales Manager, North Atlantic Industries.

"The GOLD BOOK just brought in two pending order for \$75,000!" Says James Zaros, Vice President Sales, Datel Systems, Inc.

"It's fantastic. We receive numerous calls and letters, both from the U.S.A. and all over the world, which we can readily ascribe to the GOLD BOOK!" Says Stephen J. Scorza, General Manager, Nobel Electronics, Inc.

"Our catalog in the GOLD BOOK paid for itself on the very first day!" Says Len Kornfeld, Executive Vice President, U.S. Box Crafts, Inc.

"I am a believer. We have attributed a number of inquiries and orders directly to our GOLD BOOK pages!" Says Alex M. Polner, Vice President, Power Tech, Inc.

**ELECTRONIC DESIGN'S GOLD BOOK IS WORKING
... IT'S WORKING FOR READERS ... AND IT'S
WORKING FOR ADVERTISERS, TOO.**

HAYDEN PUBLISHING COMPANY, INC.
50 Essex Street, Rochelle Park, N.J. 07662 • (201) 843-0550
WORLD LEADER IN ELECTRONICS PUBLISHING

Product Index

Information Retrieval Service. New Products, Evaluation Samples (ES), Design Aids (DA), Application Notes (AN), and New Literature (NL) in this issue are listed here with page and Information Retrieval numbers. Reader requests will be promptly processed by computer and mailed to the manufacturer within three days.

Category	Page	IRN	Category	Page	IRN	Category	Page	IRN
Components			Instrumentation			Packaging & Materials		
audio indicator	133	98	DMM	17		ball bearings	131	96
CRTs	126	87	DMM	71	242	cable assemblies, rf	122	352
capacitors	10	8	DMM	106	303	cable/connector system	III	253
capacitors, ceramic	93	50	DMM, 3-1/2 digit	110	64	circuit board	23	17
capacitors, electrolytic	55	281	DVM	105	301	coax connector	123	354
connectors	139	108	digital storage scope	14	11	connectors	41	28
control assembly	33	23	function gen	107	306	connectors	61	41
counter/timer	121	285	logic analyzer	106	304	contacts	117	74
delay relays	118	75	logic monitor	107	59	EMI coatings	116	73
encoders	109	62	logic state analyzers	79	44	enclosures	106	58
filters	134	100	oscilloscope	107	307	enclosures	115	69
filters, i-f	125	84	panel instruments	97	53	fiber optics catalog	137	104
lamps	69	42	panel meters	37	25	magnetic shielding	127	88
limit switches	7	6	portable dc recorders	139	109	magnetic shields	122	80
mechanical filters	109	63	rf links	112	67	metal stampings	130	94
motor/tach units	128	366	recorder	106	305	optical communication		
potentiometers	127	364	rental instruments	20	16	cable	53	36
pots, joystick	126	361	scope, 100-MHz	31	22	PC board connector	124	357
relay, rf	2	3	test systems	57	38	packaging	127	89
resistor networks	103	56	universal counters	50	35	terminal blocks	87	
resistors	9	7				winder, paper tape	123	356
resistors	113	68	Integrated Circuits			wire terminal	123	355
silicon photocells	137	103	amplifiers, s/h	119	347	wire-wrapping	111	65
switch	111	66	amplifier, high volt	116	338	Power Sources		
switch modules	16	13	circuits, support	119	346	bench supply	120	349
switch, slide	129	91	circuits, timekeeping	118	344	dc supplies	120	351
switches	115	70	converters, a/d	118	341	modular supplies	120	348
switches	128	365	delay line, analog	117	340	power supplies	6	5
switches, rotary	109	61	driver, display	118	343	power supplies	44	31
switches, slide	115	71	driver, gas display	119	345	power supplies	129	92
thermal cut-off	115	72	HiNIL	58	39	power supplies	135	101
thermostat	129	93	memory, read-only	118	342	switcher	120	350
transient protectors	127	363	op amp	116	337			
trimmers, cermet	125	85	switches, analog	117	339	new literature		
yokes	47	32				aluminum knobs	136	417
Data Processing			Microprocessor Design			crystal oscillators	136	419
calculators, desktop	114	332	computer, single-board	5	4	digital instruments	136	411
card cage, computer	114	331	d/a converter cards	54	506	disconnect hardware	136	421
cassette transports	128	90	development system, μ C	52	504	electronic packaging	136	416
computing calculator	11	9	microcomputer card	52	503	epoxy systems	136	413
data modems	39	26	simulator, EPROM	54	505	fasteners	136	426
floppy-disc unit	114	336	μ P analyzer	51	502	integrated circuits	136	425
memory, solid state	112	328	8080A μ P	51	501	linear conversion		
microcomputer	113	330				products	136	418
minicomputer	113	329	Microwaves & Lasers			miniature attenuators	136	420
minicomputers	95	52	filters	131	372	power supplies	136	412
modem, adaptive	114	333	mixer	131	371	rf, microwave		
tape interface	114	334	phase shifter	130	370	amplifiers	136	415
tape storage unit	112	327	splitters	130	369	resistive components	136	423
tape transport, digital	114	335				sweeper system	136	424
Discrete Semiconductors			Modules & Subassemblies			switches	136	422
electro-optics	99	291	amp, instrumentation	108	321	transient voltage		
FETs, microwave	132	373	amplifier, wideband	108	308	protectors	136	414
indicators, LED	120	77	clock, digital	108	322	application notes		
LED linear array	132	377	converter, d/a	108	310	flashtube guide	134	382
LEDs	78	43	converter, d/a	110	324	gate-turn-off SCR	134	379
optically coupled isolators	1	2	converter, s/d	110	326	magnetrons	134	380
power transistors	IV	254	corrector, focus	108	320	time-code data	134	381
rectifiers, power	132	374	display, alphanumeric	110	325			
transient suppressors	132	376	expander, system	108	309			
transistors, HV	132	375	oscillator, clock	110	323			
transistors, μ W	132	378						

Design with the complete flat cable/connector system.



trimming the cable after assembly.

Connector units provide positive alignment with precisely spaced conductors in 3M's flat, flexible PVC cable. The connector contacts strip through the insulation, capture the conductor, and provide a gas-tight pressure connection.

Assembly-cost savings are built in when you design a package with "Scotchflex" flat cable and connectors. But more important, 3M Company offers you the full reliability of a one-source system: cable *plus* connectors *plus* the inexpensive assembly aids that crimp the connections quickly and securely (with no special operator training required).

The fast, simple "Scotchflex" assembly sequence makes as many as 50 simultaneous multiple connections in seconds, without stripping, soldering or

With cable, connectors and assembly tools from one design and manufacturing source, you have added assurance the connection will be made surely, with no shorts or "opens."

And "Scotchflex" now offers you more design freedom than ever. From stock you can choose shielded and non-shielded 24-30 AWG cable with 10 to 50 conductors, and an ever-increasing variety of more than

The 3M DELTA pin and socket connector.

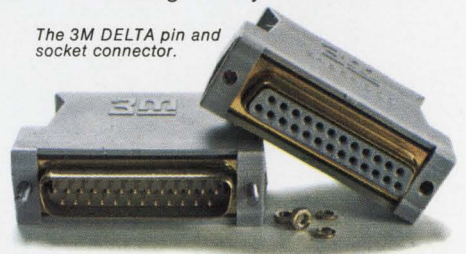

100 connectors to interface with standard DIP sockets, wrap posts on standard grid patterns, printed circuit boards, or headers for de-pluggable applications. 3M's DELTA "D" type pin and socket connectors are now also available. For full information, write Dept. EAH-1, 3M Center, St. Paul, MN 55101.

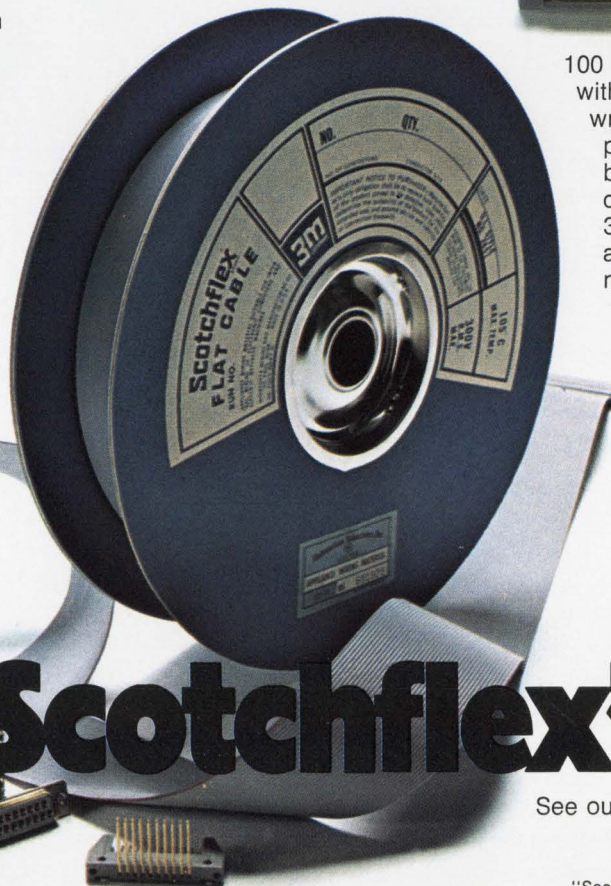

3M
COMPANY

3M's "Scotchflex" line.

See our catalog in EEM—Page 1056.

CIRCLE NUMBER 253

"Scotchflex" is a registered trademark of 3M Co.

RCA power transistors: More Value per Penny.

Socket for socket, penny for penny, RCA direct replacement types give you all these reliability extras:

- Thermal Cycling Characterization, to help you predict in-service reliability.



- Real Time Thermal Process Control, to help insure that every transistor you get has the reliability you expect.
- Safe Operating Area Characterization, so you can determine performance under virtually any operating condition.
- Clip Lead Construction, for extreme ruggedness.
- Steel Headers, for even greater reliability.

RCA replacements for TIP and DTS types

TIP 29	RCA 29	TIP 31	RCA 31	TIP 41	RCA 41	DTS 410	RCA 410
TIP 29A	RCA 29A	TIP 31A	RCA 31A	TIP 41A	RCA 41A	DTS 411	RCA 411
TIP 29B	RCA 29B	TIP 31B	RCA 31B	TIP 41B	RCA 41B	DTS 413	RCA 413
TIP 29C	RCA 29C	TIP 31C	RCA 31C	TIP 41C	RCA 41C	DTS 423	RCA 423
						DTS 431	RCA 431
TIP 30	RCA 30	TIP 32	RCA 32	TIP 42	RCA 42		
TIP 30A	RCA 30A	TIP 32A	RCA 32A	TIP 42A	RCA 42A		
TIP 30B	RCA 30B	TIP 32B	RCA 32B	TIP 42B	RCA 42B		
TIP 30C	RCA 30C	TIP 32C	RCA 32C	TIP 42C	RCA 42C		

More Value per Penny in over 500 types.

RCA has a broad line of power transistors — the table shows only our replacements for TIP and DTS types. And all are known for quality, performance and manufacturing innovations. Choose from high speed switching types. High voltage types. Rugged commodity types.

Hometaxial and epitaxial constructions. In both hermetic and plastic packages. All have the RCA reliability extras. All give you More Value per Penny.

Your guide to More Value per Penny in RCA power transistors.

Get the RCA Transistor Interchangeability Guide. You'll see hundreds

more replacements. All with More Value per Penny.

Your RCA Solid State distributor has these Interchangeability Guides now. Or write RCA Solid State, Box 3200, Somerville, N J 08876; Ste. Anne de Bellevue H9X 3L3, Canada; Sunbury-on-Thames, U.K.; Fuji Bldg., Tokyo, Japan.

RCA. Powerhouse in Transistors