

# Electronic Design<sup>®</sup> 15

VOL. 25 NO.

FOR ENGINEERS AND ENGINEERING MANAGERS

JULY 19, 1977

**Fiber-optic systems** for digital and analog communications are here. Data rates of 140 Mbits and 300-MHz FM carriers have now been achieved in multimode

systems of LEDs, lasers, optical fibers and photosensors. Some new optical driving and switching elements promise bandwidths as high as 100 GHz. See p. 26.

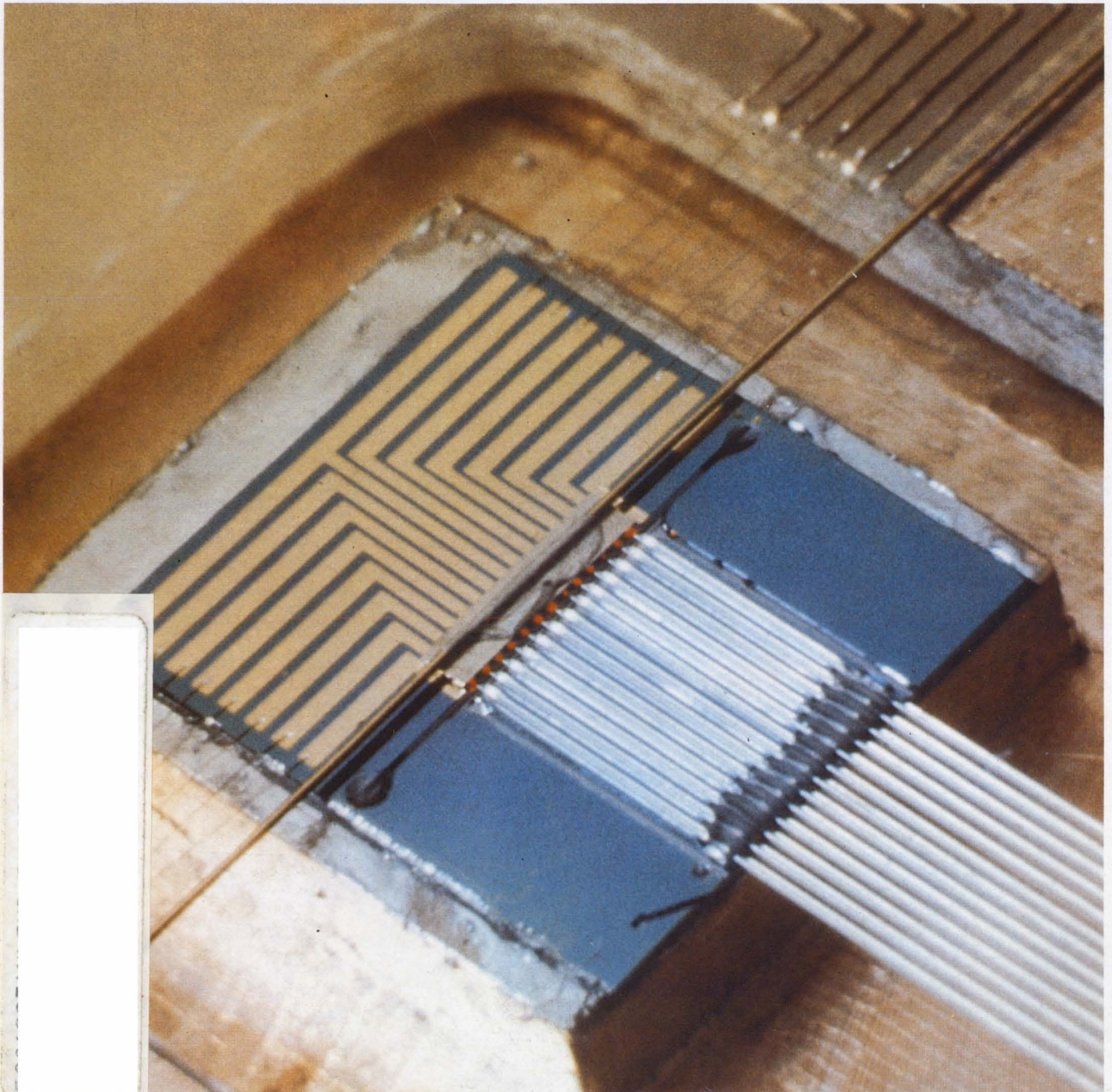

# The First Modular Precision Pot...

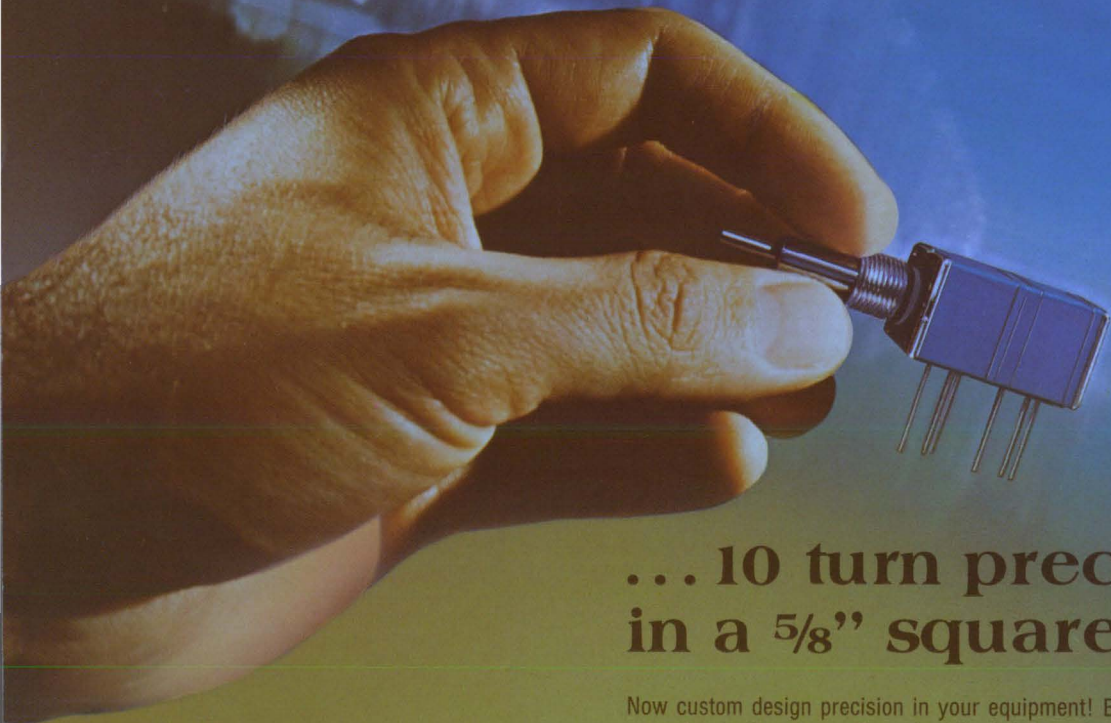

... 10 turn precision,  
in a  $\frac{5}{8}$ " square package.

Now custom design precision in your equipment! Bourns modular line of 10-turn wire-wound potentiometers offers virtually infinite selection of standard options, with specs that are unequaled in any other line of modular controls, potentiometers and switches.

**SMALL SIZE**—The  $\frac{5}{8}$ " square design saves up to 35% of panel space compared to standard circular models. Position them closer or in an area simply not possible before now.

**LOW ASSEMBLY COSTS**—Easy and economical mounting on P.C. boards. Only Bourns offers a choice of P.C. pins or solder lugs!

**MANY OPTIONS**—Single shafts of  $\frac{1}{8}$ " or  $\frac{1}{4}$ " diameter are each available in 3 standard lengths, or choose dual concentric shaft options - all with plain or locking bushings. Specify to your application and gang up to two modules.

You'll find these smaller modular precision pots offer the same electrical specs as the larger circular types - such as independent linearity of only  $\pm 0.25\%$ .

**"FEEL-APPEAL"**—As with Bourns other styles of controls and switches, this precision line offers the same smooth, consistent feel. The low rotational torque is still only .3 to 2.0 oz. inch!

**CALL TODAY**—for complete information on this versatile off-the-shelf, modular constructed potentiometer. Find out how to custom design precision in your equipment at standard cost and leadtime.

**MODULAR PRECISION... BEAUTIFUL!**

TRIMPOT PRODUCTS DIVISION, BOURNS, INC., 1200 Columbia Avenue, Riverside, CA 92507, Telephone 714 781-5122—TWX 910 332-1252.

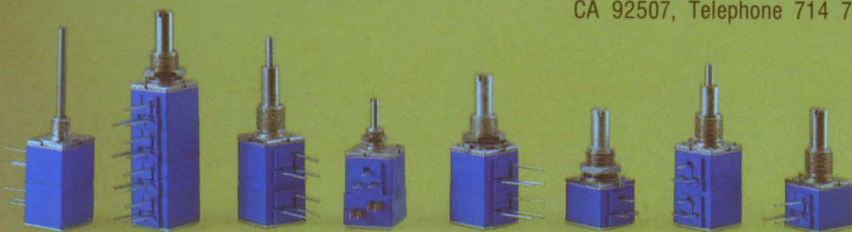

International Marketing Offices: European Headquarters — Switzerland 042/23 22 42 • Belgium 02/218 2005 • France 01/2039633 • Germany 0711/24 29 36 • Italy 02/32 56 88 • Netherlands 70/87 44 00 • United Kingdom 01/572 6531 • Norway 2/71 18 72 • Sweden 764/20 110 • Japan 075/921 9111 • Australia 02/55-0411 03/95-9566 • Israel 77 71 15/6/7

**For Immediate Application — Circle 130**  
**or for Future Application — Circle 230**

# SURPRISE!



## Our New Display Can Say A Lot For You

Our new HDSP-2000 Alphanumeric Display can spell it out for you in bright, crisp characters. The full 5x7 dot matrix can display ASCII or custom character sets including lower case and symbols.

Compact and complete with on-board electronics, the HDSP-2000 dramatically reduces display system size and complexity. Each 12 pin DIP contains 4 characters with row drivers and storage. End stackable and easy to interface, they're ideal for "smart" instruments, medical systems or business terminals, military applications, and almost any mobile, portable or hand-held device.

They're in stock today at HP's franchised distributors. In the U.S. contact Hall-Mark, Schweber, Wilshire or the Wyle Distribution Group (Liberty/Elmar) for immediate delivery. In Canada, contact Zentronics, Ltd.

**HEWLETT**  **PACKARD**

Sales and service from 172 offices in 65 countries.  
1507 Page Mill Road, Palo Alto, California 94304

# MIL-SSR UPDATE

## Ready for military service: Our new AC power SSR.

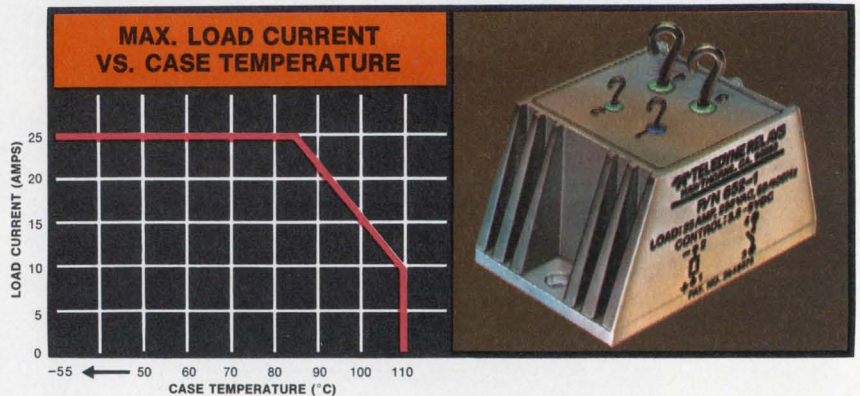

Commercial relays are no match for severe military or aerospace environments. But there's no doubt about our new 652 Series. Designed expressly for military and aerospace applications, this new AC SSR is packaged in a rugged, hermetically sealed aluminum case with the internal circuit assembly encapsulated to resist shock and vibration. What's more, all circuit components are military grade including the inverse parallel SCRs that provide reliable output switching — up to 25 Amps — over the frequency range of 45-440Hz.

Other features include logic compatible input drive

circuitry, optical isolation, and zero voltage turn-on to reduce EMI.

To top it all off, our 652 Series is designed to meet MIL-R-28750 and all categories of MIL-STD-704A, with an operating ambient temperature range of  $-55^{\circ}\text{C}$  to  $+110^{\circ}\text{C}$ .

For complete specification data, contact your nearest Teledyne Relays sales office listed in EEM, Gold Book and Electronics Buyers' Guide. You'll find we have the experience, products, and technical support to meet all your SSR needs — including a quick reaction capability to design SSRs specifically for your application.

### TELEDYNE'S MILITARY SSRs

- A. P/N 683-1 DC SSR  
DIP package, with output rated at 600mA/50VDC
- B. P/N JM640-1 Bi-polar SSR  
Mil P/N M28750/5. TO-5 package, with bi-polar (AC/DC) output rated at 60mA/40V
- C. P/N JM643-1 DC SSR  
Mil P/N M28750/6. TO-5 package, with output rated at 300mA/40VDC
- D. P/N JM643-2 DC SSR  
Mil P/N M28750/7. TO-5 package, with output rated at 100mA/250VDC
- E. 652 Series AC Power SSR  
Output rated at 25A/250VRMS

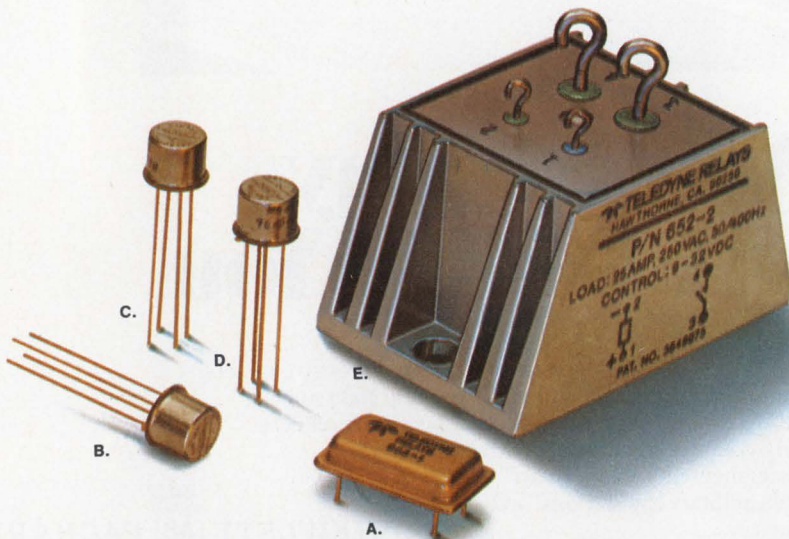

## TELEDYNE RELAYS

3155 West El Segundo Boulevard, Hawthorne, California 90250  
Telephone (213) 973-4545

CIRCLE NUMBER 3

---

## NEWS

- 21 **News Scope**  
26 **There aren't many fiber-optics systems around, yet**—but watch out for the explosion—A special report.  
34 **Software called the key** to future  $\mu$ P designs.  
43 **Washington Report**

---

## TECHNOLOGY

- 56 **Don't trade off analog-switch specs.** VMOS transistors economically combine current capacity and speed with low resistance, high isolation and more.  
64 **Simplify your next microcomputer** by designing it with an all-in-one processor. Units in the MCS-48 series put everything but the crystal on one chip.  
78 **Bypass filters extend** to the GHz range when solid-tantalum capacitors are used. A graphical method predicts filter performance for "real" capacitors.  
88 **Solve phase-angle averaging riddles.** Simple digital phase detection, coupled with resolution into orthogonal components, removes the ambiguities.  
94 **Eduard Pannenberg of Philips** speaks on measuring engineers.  
100 **Ideas for Design:**  
Electronic regulator for car alternators switches on/off rapidly to maintain 14 V.  
An electronic dice game built with only analog circuits.  
Locate interrupts for  $\mu$ P peripherals quickly without the need for polling.  
Recognize upper-case letters only with a simple two-gate circuit.  
111 **International Technology**

---

## PRODUCTS

- 115 **Micro/Mini Computing:** Floppy-disc drives come in compact packages.  
120 ICs & Semiconductors  
126 Components  
129 Data Processing  
134 Modules & Subassemblies  
138 Packaging & Materials  
142 Instrumentation  
145 Power Sources  
146 Microwaves & Lasers

---

## DEPARTMENTS

- 51 **Editorial:** The professionals  
7 Across the Desk  
147 Vendors Report  
148 Application Notes  
148 Bulletin Board  
150 New Literature  
158 Advertisers' Index  
160 Product Index  
160 Information Retrieval Card

**Cover:** A multichannel array of double-heterostructure lasers for fiber-optic communications, by IBM, is thermoelectrically cooled. Laser connections are at left, fiber lightguides exit at right.

# The 2900 Family: Two years later.

1975. Advanced Micro Devices introduces the world's best 4-bit microprocessor slice, the Am2901, along with a few support circuits.

1977. It's a whole new family. Now there's an Am2901A just like the Am2901, only better. Now there are 18 support circuits, two or three second sources and all the software you'd ever want. The 2900 family has become the family of the future. Here's why:

## **The first family.**

The Am2900 family is the first group of products designed specifically for microprogrammed machines. Microprogramming is rapidly becoming the most popular way to design medium- and high-performance systems, to reduce development time, make changes easily, and conveniently add new features.

## **Less weight, less size.**

With the Am2900 family, it's not uncommon for entire boards to be eliminated. You'll shrink system size and weight, increase

overall reliability and reduce manufacturing costs.

## **Time goes by, price goes down.**

In July 1975, we told you we'd reduce the cost of the Am2901 by 30% per year. We've done it twice. Once in April 1976 and once in March 1977. The Am2900 family gets less and less expensive all the time.

## **We're so popular, we're the industry standard.**

The Am2900 family is the most widely used Bipolar LSI family in:

- **Minicomputers:** For emulators, high-performance CPU's and add-ons by eight out of the top ten U.S. manufacturers.
- **High-performance controllers:** For discs, tapes, floppy discs and universal controllers.
- **Communications:** For PBX systems, central exchanges, multiplexers and modems.
- **Military:** For radar processors, display systems and the Navy's new standard avionic computer, the AN/AYK-14.

## The Family:

CPU Slice (ALU and general registers)	Am2901A, 2902, 2903*, 2904*
Microprogram Control Units	Am2909, 2910*, 2911
Branch and Instruction Control for Microprogram Sequencers	Am29803, 29811
LSI Bus Interface Devices	Am2905, 2906, 2907, 2915A, 2916A, 2917A
Priority Interrupt Control	Am2913, 2914
Main Program Control	Am2930*, 2931*, 2932*
New More Powerful MSI functions	Am2918, 2919, 2920, 2921, 2922

\*In Development

## Plus:

Schottky and low-power Schottky MSI, MOS static and dynamic RAM's and all the devices you need to build your high-performance microcomputer.

## We don't sell and run.

Advanced Micro Devices offers learning aids to help speed up designs and keep your engineers up-to-date on the very latest microprogramming techniques. Learning aids and application materials like these perennial favorites:

- A 16-Bit Microprogrammed Computer
- The Am2900K1 Learning and Evaluation Kit
- The Microprogramming Handbook

- A High Performance Microprogrammed Disc Controller

In development:

- Vertically Microprogrammed State Machines
- An emulation of the Am9080A/8224/8228 using the Am2900 family

## And two terrific design aids:

### AMDASM

Our powerful, easy-to-use microprogram assembler offering software support through the worldwide INFONET time-sharing division of Computer Science Corporation. (It supports user-defined mnemonics for producing microinstructions up to 128 bits wide, and includes formatting and default features as well as tape generation for PROM programmers. If you've got the other guy's MDS system, ask for AMDASM/80. It comes on a floppy disk and runs under their operating system.)

### AMDS

Beginning this fall, we'll be offering hardware support with the Advanced Microprogram Development System. (It's the first prototyping system especially designed for microprogramming systems.) It'll help speed up construction of prototype systems and generation and de-bug of microcode. Resident AMDASM, of course!

## The Am2900 family.

It's today's product family for tomorrow's high-performance machines. Am2900. Remember that number. You're going to be hearing it a lot.

# Advanced Micro Devices

Bipolar LSI. N-channel, silicon gate MOS. Low-power Schottky. Multiple technologies. One product: excellence.



CIRCLE NUMBER 17

**New  
Lower  
Prices**

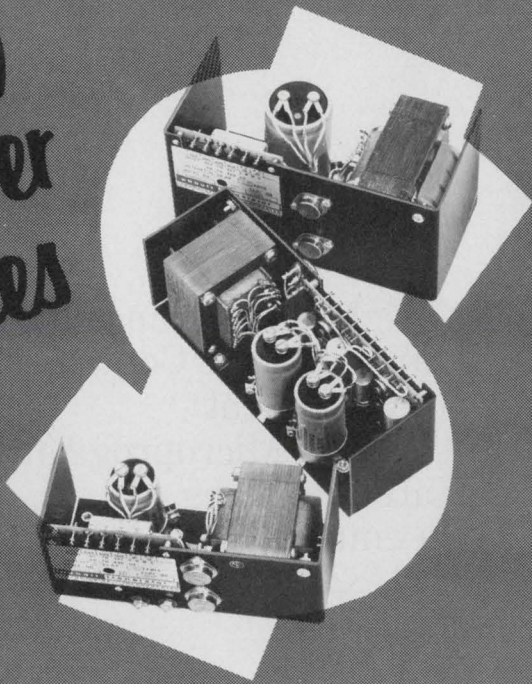

## Start Getting Your Money\$worth Out of Power Modules





Now, you can really start getting your moneysworth out of power modules with Abbott's new LOW COST series. Designed to give you 100,000 hours of trouble-free operation (that's 11½ years), these reliable units meet the needs of OEM engineers. Their purchase price is about \$7 per year of service. The model LC series feature:

- 47-420 Hz Input Frequency
- 0.1% Regulation
- +60°C. Ambient Operation
- Single and Dual Outputs
- 1 Day Stock Delivery

These units provide more quality per dollar compared to similar items on the market. See table below for prices on some of our LC models. Many other LC models are listed in our catalog.

If analyzing the many similar power supplies on the market is confusing; if you are concerned about the long-term reliability of those units, then decide on an Abbott power supply for your system. Your best buy in OEM power modules is ABBOTT.

Abbott also manufactures 3,000 other models of power supplies with output voltages from 5 to 740 VDC and with output currents from 2 milliamps to 20 amps. They are all listed with prices in the new Abbott Catalog with various inputs:

60  to DC  
 400  to DC  
 28 VDC to DC  
 28 VDC to 400   
 12-38 VDC to 60 

5V @ 6 Amps	5V @ 10 Amps	12V @ 10 Amps	15V @ 4 Amps	28V @ 1 Amp	±12V @ 1.2 Amps	±15V @ 4 Amps
LC5T6	LC5T10	LC12T10	LC15T4	LC28T1	LLC12T1.2	LLC15T4
\$62	\$73	\$99	\$73	\$62	\$87	\$119.00

Please see pages 1054-1056 Volume 1 of your 1975-76 EEM (ELECTRONIC ENGINEERS MASTER Catalog) or pages 612-613 and 620 Volume 2 of your 1975-76 GOLD BOOK for complete information on Abbott Modules.

Send for our new 60 page FREE catalog.

**abbott transistor**

INDUSTRIAL PRODUCTS DIVISION

general offices

eastern office

5176 W. Jefferson Blvd./Los Angeles 90016  
(213) 930-1040 Telex: 69-1398

1224 Anderson Ave./Fort Lee, N.J. 07024  
(201) 224-6900 Telex: 13-5332

CIRCLE NUMBER 4

### Sr. Vice President, Publisher

Peter Coley

### Editors

Editorial Offices  
50 Essex St.  
Rochelle Park, NJ 07662  
(201) 843-0550  
TWX: 710-990-5071  
(HAYDENPUB ROPK)  
Cable: Haydenpubs Rochellepark

Editor-in-Chief George Rostky

### Managing Editors:

Ralph Dobriner  
Michael Elphick

### Senior Associate Editor

Stanley Runyon

### Associate Editors:

Sid Adlerstein  
Dave Bursky  
Morris Grossman  
Dennis Kernoski  
Andy Santoni  
Max Schindler

### Contributing Editors:

Peter N. Budzilovich, Jules H. Gilder,  
John Kessler, Nathan Sussman

### Editorial Field Offices

#### East

Jim McDermott, Eastern Editor  
P.O. Box 272  
Easthampton, MA 01027  
(413) 527-3632

#### West

Dick Hackmeister, Western Editor  
8939 S. Sepulveda Blvd., Suite 414  
Los Angeles, CA 90045  
(213) 641-6544  
TWX: 1-910-328-7240

Dave Barnes, Western Editor  
465 S. Mathilda, Suite 302  
Sunnyvale, CA 94086  
(408) 736-6667

### Editorial Production

Marjorie A. Duffy, Production Editor  
James Keane, Copy Editor

### Art

Art Director, William Kelly  
Richard Luce, Anthony J. Fischetto

### Production

Manager, Dollie S. Viebig  
Helen De Polo, Nancy Hurey

### Circulation

Director, Barbara Freundlich

### Information Retrieval

Paula Greenleaf

### Advertising Promotion

Susan G. Apolant

### Reprints

Maxine Correal



# Across the desk

## Everyone overcommits

What a great editorial in the April 12 issue of *ELECTRONIC DESIGN* (ED No. 8, p. 87). We had a case very much like "The Test"—all I had to do was change the name and the products, and the match was virtually one-to-one. One other aspect to this problem is that we oftentimes have engineers who, on their own, make all these overcommitments.

Overcommitting people's time and ability, I think, is a far greater cause of problems, particularly in the smaller companies, than anything else. Obviously, management's time is overcommitted, particularly with the new 9-to-5 do-nothings in government figuring out all sorts of inspections and forms and criteria for us to meet. In turn, I see management overcommitting their field-sales force, the field-sales force overcommitting production to deliveries that are almost impossible, and production overcommitting engineering to complete the products before they are really completed.

Engineering must fit into this picture someplace, so they very frequently overcommit management to more different programs than can possibly be carried into production with the financial resources available to the company.

*J. Reid Anderson*

Information Terminals Corp.  
323 Soquel Way  
Sunnyvale, CA 94086

## Stanford isn't Standard

In our Focus on Miniature Switches (ED No. 6, March 15, 1977), we identified some switches on page 71 as being manufactured by Standard Applied Engineering. That was wrong. The company's name is Stanford Applied Engineering—of Santa Clara, CA. As is customary in such cases, we blame everything on the printer. Sorry.

## Random Thoughts

I read all your editorials. They get better and better. We use them to train our new boss. My personal favorite was "Teaching the Horse Not to Eat."—*Name withheld, Dallas, TX.* (Editorial: Oct 11, 1976).

Your editorials on the more sophisticated management techniques and company policy have particular significance for me since I just joined a small company in danger of being overmanaged.—*Name Withheld, Morristown, NJ.*

## Misplaced Caption Dept.



Microfiche retrieval systems have been around for years, but most fiche are still retrieved by hand.

Sorry. That's John Hoppner's "Portrait of the Artist," which hangs in the National Gallery of Ireland in Dublin.

*(continued on page 10)*

Electronic Design welcomes the opinions of its readers on the issues raised in the magazine's editorial columns. Address letters to Managing Editor, Electronic Design, 50 Essex St., Rochelle Park, NJ 07662. Try to keep letters under 200 words. Letters must be signed. Names will be withheld upon request.



## DIP ISOLATORS DIP ISOLATORS DIP ISOLATORS ISOLATORS

*OPTRON's complete line of optically coupled plastic DIP isolators offers immediate availability of standard devices for almost every application ... plus competitive pricing, high reliability and excellent customer service.*

*Check these features and choose the device best suited for your application.*



### GENERAL PURPOSE

A full selection of DIP isolators with transistor and darlington outputs to match all popular industry standards. Current transfer ratios range from 2.0% to 500%.

### HIGH VOLTAGE

For applications requiring an interface with high voltage circuits, select the OPI 6000 DIP isolator with a 300 volt output transistor.



### AC OPERATION

The OPI 2500 DIP isolator features two input LED's operating in inverse parallel and is ideal for applications where the LED is driven from an AC line.

### CUSTOM SELECTION

If your application demands "something a little different," OPTRON specializes in DIP isolators to meet special customer requirements.



*For reliability data and technical specifications on OPTRON's complete line of plastic DIP isolators, contact your nearest OPTRON sales representative or the factory direct.*



## OPTRON, INC.

1201 Tappan Circle  
Carrollton, Texas 75006, U.S.A.  
TWX-910-860-5958  
214/242-6571

# Intel delivers Intellec® There's no shorter route

Intellec® is Intel's Microcomputer Development System that delivers in-depth support. And, in-depth support gets your microcomputer based products to market faster and easier.

Intellec is the only system that supports the entire line of Intel microcomputers. It's the only system with ICE In-Circuit

Emulation for the 8080, 8085, 8048 and Series 3000 microcomputers. And Intellec is the only development system with a resident high level language for microcomputer system programming.

We call that language PL/M. It has become the most widely used language for microcomputer programming and can cut months off your software devel-



# in-depth support. from design to production.

opment cycle. And, because PL/M is resident in the Intellec system, you put an end to timeshare computer charges. You just can't get that kind of power and efficiency from any other system.

We've made Intellec easy to use. You communicate with the system in simple English-like statements. You can write application programs in small, manageable modules and link them together with other programs from the diskette library for loading into your microcomputer's PROM or EPROM memory.

To simplify hardware/software integration and system debugging, Intel's unique ICE modules give you a "diagnostic window" into the operation of your system. The ICE software system is the only one that lets you control, monitor and analyze all microcomputer functions using symbolic references for addresses



and data. And the new ICE-85™ provides expanded in-system emulation capability, extending the window to your entire microcomputer system.

You can count on Intel for in-depth support in other areas, too. Like user application assistance, complete documentation, training programs and design seminars worldwide, and a users' software library with over 275 programs and growing.

That kind of in-depth support is the reason more designers are using more Intel microcomputers and Intellec development systems than all others combined.

To find out how Intellec can get you on the road to faster and easier microcomputer development, contact your nearest Intel distributor or sales representative. For a local demonstration or a copy of the Intellec brochure, use the reader service card or contact us directly. Intel Corporation, 3065 Bowers Avenue, Santa Clara, California 95051. Telephone (408) 246-7501.

## intel® delivers.

CIRCLE NO. 6 FOR TECHNICAL INFORMATION

CIRCLE NO. 7 FOR TECHNICAL INFORMATION AND A DEMONSTRATION

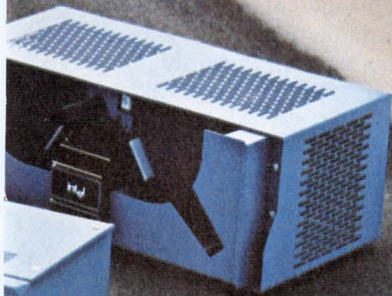

from *Electronic Measurements* . . .

# 10 to 60 KW DC Power Supplies

Time was when high power DC power supplies were available on a custom basis only.

No more, though.

Now, for the first time, you can get high power 3Ø SCR DC in a standard product.



E/M's EMHP series of standardized modular assemblies are custom-packaged for your specific industrial and scientific applications, and give you:

- Greatly reduced costs
- Greatly reduced delivery time
- Greatly increased efficiency
- Greatly increased performance

Model	Voltage (V)	Current (A)	Voltage Ripple (V rms)	Current Ripple (A rms)	Typical Price*
<b>SERIES 15 (20 KW max., 19" panel, 26½" package)</b>					
EMHP10-1000	0-10	0-1000	0.10	10	\$3700
EMHP20-750	0-20	0-750	0.15	5.7	
EMHP40-400	0-40	0-400	0.25	2.5	
EMHP80-250	0-80	0-250	0.50	1.6	
EMHP150-130	0-150	0-130	0.75	0.7	
EMHP600-30	0-600	0-30	3.00	0.2	
<b>SERIES 25 (30 KW max., 24" panel, 32" package)</b>					
EMHP10-1500	0-10	0-1500	0.1	15	\$4700
EMHP20-1000	0-20	0-1000	0.15	7.5	
EMHP40-600	0-40	0-600	0.25	3.8	
EMHP80-375	0-80	0-375	0.5	2.4	
EMHP150-200	0-150	0-200	0.75	1.0	
EMHP600-50	0-600	0-50	3.0	0.3	
<b>SERIES 40 (60 KW max., 24" panel, 47½" package)</b>					
EMHP10-3000	0-10	0-3000	0.10	30	\$8500
EMHP20-1500	0-20	0-1500	0.15	12	
EMHP40-900	0-40	0-900	0.25	6	
EMHP80-600	0-80	0-600	0.50	4	
EMHP150-350	0-150	0-350	0.75	2	
EMHP600-100	0-600	0-100	3.00	0.5	

\*Each application is priced at time of order. Please consult factory for complete details.

Any other combination of ratings to 3000 amps and 600 volts is available within the power rating of each series.

To order, or for any technical information, call

**TOLL FREE (800) 631-4298**



**ELECTRONIC MEASUREMENTS INC.**

405 Essex Road, Neptune, N.J. 07753

Phone (New Jersey) 201-922-9300 (Toll free) 800-631-4298

Specialists in Power Conversion Equipment

CIRCLE NUMBER 8

## Across the desk

(continued from page 7)

### OOPS!

In our description of Figaro Engineering's semiconductor gas sensor (ED No. 1, Jan. 4, 1977, p. 162) we wrote, incorrectly, that it was the first UL-approved gas sensor. That wasn't quite correct. What is correct is that the Figaro sensor is used in the Craft-Alarm, which is the first UL-approved detector of natural or propane gas.

### Never too young



When you consider the rapid pace of electronic developments these days, you have to conclude that it's never too soon to get a head start. Reader Glenn Baumgartner supports this view with this photo of his daughter, Joy, when she was three, and probably *Electronic Design's* youngest and certainly the prettiest reader. The photo was taken by Glenn's wife, Betty, who joins Glenn in assuring us that it was completely spontaneous and in no way staged.

### Edsel Murphy strikes again

Murphy's Law III-2; "Any error that can creep in, will." In our FOCUS on flat, flexible cable (ED No. 9, April 26, 1977, p. 67), the address of Ansley Electronics was given as Doylestown, PA. This is doubly regrettable, because Ansley's name is now T&B/Ansley, a subsidiary of Thomas & Betts, and the address is 3208 Humboldt St., Los Angeles, CA 90031 (213) 223-2331.

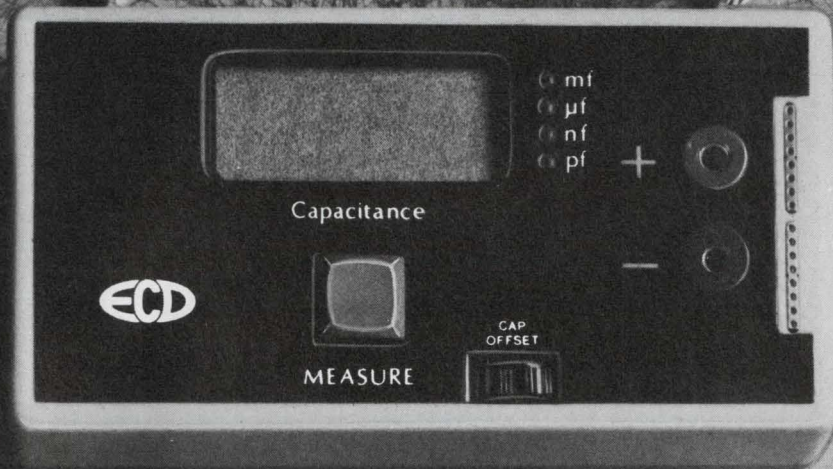

## My shirt, yes...my C-Meter, no.

Test the kind of guy who'll give you the shirt off his back: ask him for his C-Meter.<sup>®</sup>

He knows that his C-Meter gives him a definite edge. It exposes an obvious efficiency: capacitors are easier to measure than resistors.

No more twiddling and nulling. No need for expensive, tight-tolerance capacitors or tweak pots. With its pushbutton speed, high accuracy (0.1%), small size

and versatility (0.1 pf to 0.2 farads), the C-Meter makes you a more productive engineer.

You owe it to yourself to try one on. It'll cost no more than a fine suit: stocked locally at only **\$289.00.**

ECD CORP.  
196 Broadway, Cambridge  
Mass. 02139 (617) 661-4400



CIRCLE NUMBER 9

SALES OFFICES: AL, Huntsville (205) 533-5896; AZ, Scottsdale (602) 947-7841; CA, Costa Mesa (714) 540-7160; CA, Sunnyvale (408) 733-8690; CO, Denver (303) 750-1222; FL, Winter Haven (813) 294-5815; GA, Chamblee (404) 457-7117; IL, Elk Grove Vill (312) 593-0282; IN, Indianapolis (317) 293-9827; MD, Silver Spring (301) 622-4200; MA, Burlington (617) 273-0198; MN, Minneapolis (612) 781-1611; MO, Kansas City (816) 358-7272; NJ, Camden (215) 925-8711; NM, Albuquerque (505) 299-7658; NY, Great Neck (516) 482-3500; (212) 895-7177; Syracuse (315) 446-0220; NC, Raleigh (919) 787-5818; OH, Centerville (513) 433-8171; TX, Houston (713) 688-9971; TX, Richardson (214) 231-2573.

# We don't have

# bad breadth.

We have terrific breadth.

We're leaders in the entire spectrum of semiconductor technology: from simple transistors to the most complex large scale integrated circuits.

Our data books, chock full of specs, charts, graphs, tables, test circuits and waveforms, design and applications information are evidence of that tremendous breadth of line.

These books are available, for a price.

As, strangely enough, are the products they describe.

National Semiconductor  
Marketing Services Dept. M.S. 520  
2900 Semiconductor Drive  
Santa Clara, CA 95051

ED 7-19

Gentlemen:

Please send me the volumes of the National Semiconductor Data Bookshelf that I have selected below. I have enclosed a check or money order for the total amount of the order, made payable to National Semiconductor Corp.

_____ copies @ \$4, Audio Handbook (177 pages) . . . . .	Total \$ _____
_____ copies @ \$3, CMOS Data Book (256 pages) . . . . .	Total \$ _____
_____ copies @ \$4, Interface Data Book (464 pages) . . . . .	Total \$ _____
_____ copies @ \$4, Linear Applications, Vol. I (432 pages) . . . . .	Total \$ _____
_____ copies @ \$4, Linear Applications, Vol. II (256 pages) . . . . .	Total \$ _____
_____ copies @ \$4, Linear Data Book (968 pages) . . . . .	Total \$ _____
_____ copies @ \$3, Memory Data Book (544 pages) . . . . .	Total \$ _____
_____ copies @ \$4, MOS/LSI Data Book (720 pages) . . . . .	Total \$ _____
_____ copies @ \$5, PACE Microprocessor Systems Design Guide (80 pgs) . . . . .	Total \$ _____
_____ copies @ \$3, PACE Microprocessor Technical Description (96 pgs) . . . . .	Total \$ _____
_____ copies @ \$5, SC/MP Microprocessor Applications Handbook (160 pgs) . . . . .	Total \$ _____
_____ copies @ \$3, SC/MP Microprocessor Technical Description (65 pgs) . . . . .	Total \$ _____
_____ copies @ \$3, Special Function Data Book (308 pages) . . . . .	Total \$ _____
_____ copies @ \$3, Transducer Data Book (160 pages) . . . . .	Total \$ _____
_____ copies @ \$3, Transistor Data Book (288 pages) . . . . .	Total \$ _____
_____ copies @ \$4, TTL Data Book (592 pages) . . . . .	Total \$ _____
_____ copies @ \$3, Voltage Regulator Handbook (128 pages) . . . . .	Total \$ _____
	Subtotal \$ _____
	California Residents Add 6% Sales Tax \$ _____
	Grand Total \$ _____

Name \_\_\_\_\_ Title \_\_\_\_\_  
Company \_\_\_\_\_  
Address \_\_\_\_\_  
City \_\_\_\_\_ State \_\_\_\_\_ Zip \_\_\_\_\_

 **National Semiconductor**

# IF YOU THINK FIBER OPTICS IS A THING OF THE FUTURE, IT'S TIME YOU SAW THE LIGHT.

Some people think fiber optics is still a few years away.

But then some people still haven't heard about us. We're Galileo Electro-Optics Corporation.

And we've got the world's broadest line of optical communication cable.

It's called Galite.<sup>®</sup>

And it gives you the kind of choice in strength, propagation efficiency, thermal compatibility, chemical resistance, weight – and cost – to make all the incredible advantages of fiber optics practical for your application right now.

And just look at those advantages.

Optical fiber can handle over 10,000 times more information than copper wire, in the same amount of space.

Optical fiber can handle amounts of information copper wire can't even touch – a 30 volume Britannica, transmitted in a tenth of a second.

Optical fiber is virtually immune to electromagnetic interference, cross talk, short-circuit loading, and fire.

Optical fiber can resist temperatures up to 1000°C.

Within the Galite line, Galite 3000, for use up to 1100 feet, covers the broadest range of applications. With its wide light acceptance angle, it's the most efficient cable for LEDs, the most practical light source available.

We also offer, with varying light acceptance angles, Galite 1000, for use up to 150 feet. Galite 2000, for up to 250 feet. Galite 4000, for up to 3300 feet. Galite 5000, for beyond 3300 feet. Plus soon-to-be-introduced Galite 6000 and 7000, for even greater distances and wider bandwidths.

The reason we can offer so much is simply that we've had a head start. We've pioneered in glass fiber optic products since 1959 and are now the world's largest manufacturer, with over 2 trillion feet shipped.

We also have the country's most integrated production facility where we do everything from formulating the glass to making complete systems including light sources, detectors, and connectors. So we can keep reliability up. And costs down.

Why not call, write, or circle the reader service number for our new information package, "Fiber Optics Now."

It will bring a whole lot of solutions to light. Galileo Electro-Optics Corp., Galileo Park, Sturbridge, MA 01518, 617-347-9191.

CURRENT APPLICATIONS FOR GALITE<sup>®</sup> CABLES

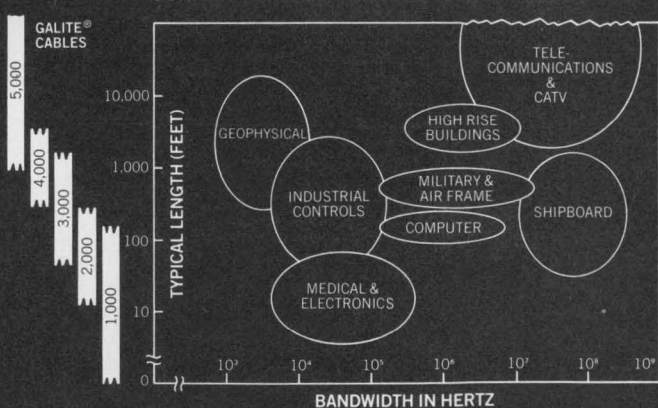

**Galileo Electro-Optics Corp.**

**THE FIRST COMPANY TO BRING FIBER OPTICS OUT OF THE LAB AND INTO PRODUCTION.**



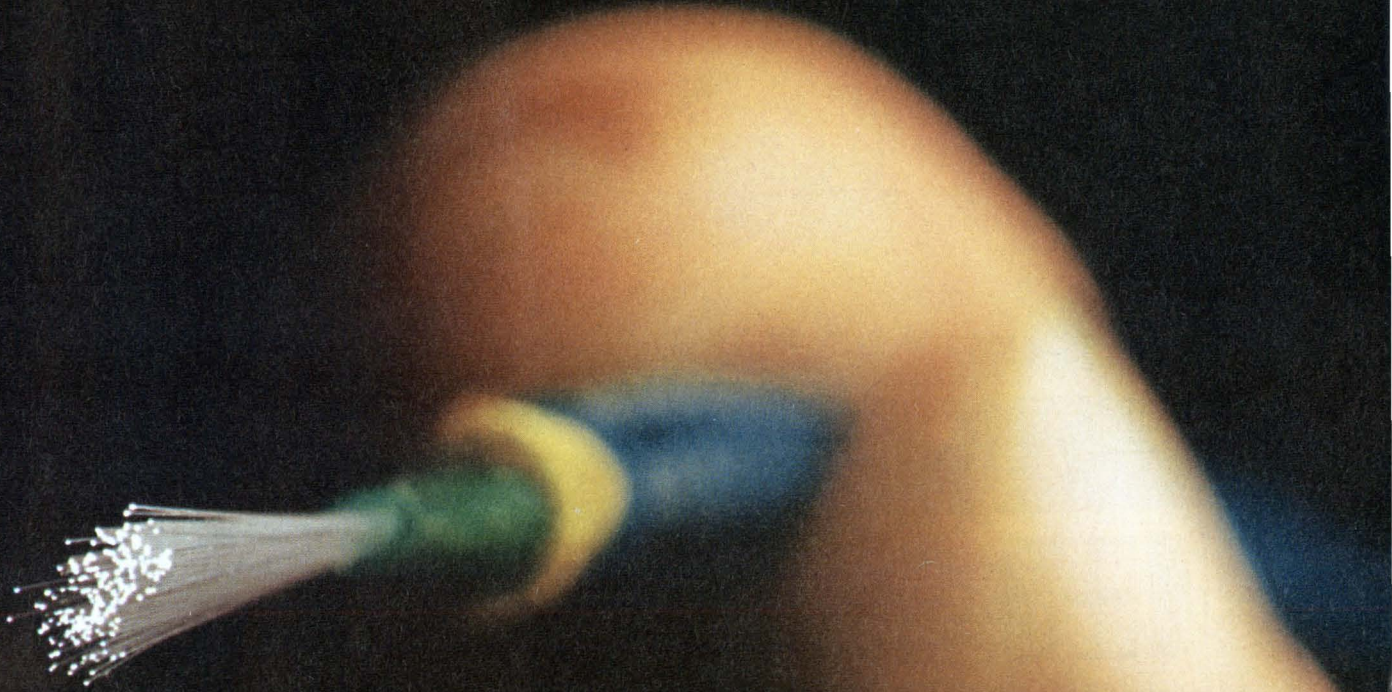

# A digital F.R.A. with an exciting new feature.

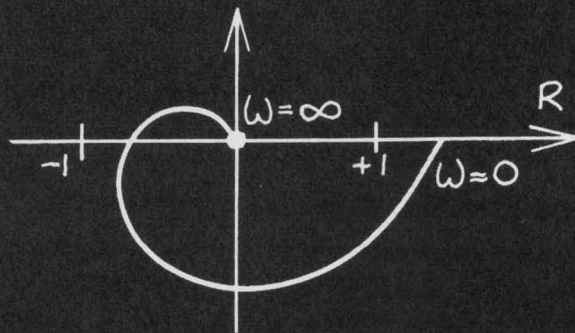

## Simplicity.

EMI has taken the complexity out of digital F.R.A. operation. In fact, our SM2001A is so simple that, in effect, all the operating instructions are on the front panel, reducing test time from minutes to seconds.

But don't think that simplicity means a sacrifice in performance. The SM2001A has complete harmonic analysis capability, so it's a frequency response analyzer in the fullest sense. Innovative digital techniques ensure high stability, resolution and accuracy. And a range of custom-built accessories provides unique flexibility.

Accessories include facilities for frequency

extension, two-channel operation, plotter and computer interfaces. There are also modulator/demodulator and reference synchronizer units.

Frequency range is 0.00001 Hz to 999 Hz (up to 999 kHz with frequency extension).

The price is easy, too. The SM2001A costs far less than competitive equipment.

Contact EMI for complete information.

EMI Technology Inc., Instrumentation Division,  
55 Kenosia Avenue, Danbury, CT 06810 (203) 744-3500,  
TWX: 710-456-3068



EMI Technology Inc., Instrumentation Division.  
A member of the EMI Group. International leaders in music, electronics and leisure.

CIRCLE NUMBER 11

1.

# Enhancement. Great Ideas for Design ...from Analogic

THE BETTMANN ARCHIVE, INC.

## Unique! A True Logarithmic A/D Converter

Dynamic Range  
≥ 1,000,000:1



The patent's still pending, so we're sure you've never seen this before: a 15-bit A/D converter whose binary-coded output is the *logarithm* of  $V_{ref}/V_{in}$ ; a converter that produces the log function directly, and has the dynamic range of a 20 to 24 bit linear converter!

It takes a bit of mental re-orientation to appreciate what this breakthrough means (and there's a lot to appreciate in the AN8020L) but here's just one aspect: con-

sider an application in which you want to digitize signals as big as 10 Volts, and as small as 10 mV, but always with a *minimum resolution of 0.1%*. In other words, you want to be able to detect a  $10\mu V$  change in the 10 millivolts, yet accommodate and digitize signals as large as 10 Volts. You've got four choices. . .

- a **20-bit linear converter** . . . virtually impossible, even with very expensive ultra-stable low-noise components. This route stops short at about 16 bits, for reasonable speed, cost and stability.
- a **floating-point, programmable-gain setup**, in which, for example, a 14-bit converter is fed from a programmable-gain amplifier whose gain is digitally settable from 1 to  $2^6$ , in binary-proportioned steps. You'll run out of gas at 19 or 20 bits. (One major problem is hysteresis: code overlap at the gain-changing points.)
- a **"companding" approach**, in which the slope and offset of the transfer function of an A/D converter are changed at pre-selected points in the range (e.g.,  $\frac{1}{2}$  scale,  $\frac{1}{4}$  scale,  $\frac{1}{8}$  scale.) This is only an approximation to the desired constant resolution, and again, accuracy, speed, and stability will fall short of your needs.
- a **true logarithmic A/D converter**, which (by *definition*) will give you constant resolution over its entire rated range. You *could* attempt to realize this function by first performing an *analog* conversion (linear to log), but the best accuracy and stability

you could hope for from that approach is of the order of  $\pm 1\%$ . But the all-digital approach—our Model AN8020L—will do the job easily. The Model AN8020L will provide a theoretical RMS quantum error of 0.015% of reading, over a full  $4\frac{1}{2}$  decades of input amplitude. Noise is low, stability is high, settling is reasonably fast, and log conformity is excellent . . . but you've got to study this unique product closely, to see how it opens new design doors for you.

Latch on to a brand-new technique! Write for this complete theoretical exposition on log A/D conversion.



Circle inquiry number 101.

ANALOGIC CORPORATION / AUDUBON ROAD / WAKEFIELD / MASSACHUSETTS 01880 / (617) 246-0300

## Meet the "First Family"... of Mini/Micro Front Ends (Best Performance and Best Value)

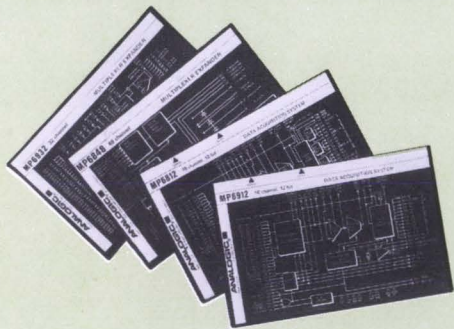

If you're applying a microcomputer or a minicomputer to the acquisition and processing of analog data, and if 12-bit accuracy is your ballpark, then your thoughts must inevitably turn to one of the self-contained multichannel "front ends" that are currently available from some five or six manufacturers.

Architecturally speaking, they are all about the same: a MUX, a buffer, a sample-and-hold, an A/D converter (buffered, usually), and some timing and control logic.

**But that's where the similarity ends.** When we invented this kind of module (yes, we were the first, by a couple of years in fact!) we set up standards for its flexibility and performance that have never been equalled. Meanwhile, we've been cutting costs (by higher production volume), adding new designs, and generally refining the package. For example...

Our microprocessor design (MP6812) gives you relative *and* absolute accuracies better than 0.025%, at a full 30 kHz throughput. And it makes those accuracies *meaningful* with T.C.'s of 3 to 15 ppm/°C. Tri-state output drivers for ease of interfacing. Ultra-flexible: pin-selectable output codes (3), output formats (3), input ranges (4), and input configurations (3).

Our minicomputer design (MP6912) is even more impressive. 100 kHz throughput, even lower T.C.'s, 3-Sigma noise <0.01% FSR. Even *greater* flexibility: *four* output codes, *eight* input ranges. Pin-selectable choice of single-ended or differential input.

And now there's an *especially* low-priced 75 kHz version of the MP6912 that gives you premium performance for lots less than the me-too imitations.

And all of these first-family designs are packaged in an EMI/RFI-shielded metal case, low-profile, only 3"x4.6"x0.375". They run exceptionally cool (e.g., the MP6812 dissipates <1.5 Watts, has <8°C rise) and this, combined with the low inherent T.C., provides truly remarkable stability. After a rigorous 96-hour burn-in, computer-programmed testing checks these designs at *every* code, on *every* range (about a *million* measurements!) and reports results in a printout shipped with each unit!

Finally, we sell compatible MUX expanders that let you extend the basic 16-channel capacity up to as high as 256 channels.

One word more: we've not only built *more* of these front ends than anyone else,

but we've helped *more* users to apply them to *more* different applications than anyone else. Need a helping hand? Just call (617) 246-0300, and ask for our "A.I.D.E." group.

**Get full data—Find out how to travel First Class, with the First Family, at coach prices.**

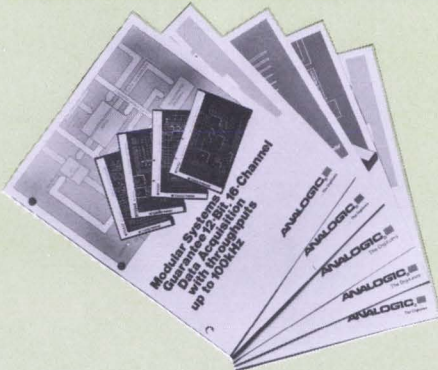

Circle inquiry number 102.

**How To Get The Most For Your \$39.  
(Not Just a DPM—a DPI)**



We've been telling you for years about the difference between digital panel *meters* (theirs) and digital panel *instruments* (ours), but the distinction has never been clearer than now, when you're being offered big-chip DPM's at a 100's price between \$69.00 and \$39.00. Some of those designs involve so much corner-cutting, it's a wonder they don't use a spherical case!

At Analogic, we cut prices (not corners) by taking advantage of the world's largest panel-digital volume. Our \$39.00 big-chip design makes no compromises. It's a real DPI—an *instrument*—with all of the interface features you need to make *meaningful, accurate, stable, dependable* measurements under realistic, non-ideal circuit conditions. After all, you're not building these things into a vacuum. You've got to fight all the old enemies: time and temperature drift, line-voltage sensitivity, bias-current errors, CMV, etc.

Despite its lowest-ever price, our new 3½-digit (*not* 3-digit), 2,000-count (*not* 1000) Model AN2570 has *everything* you need. For example, at the input: *bipolar* differential input, 1000-megohm input resistance, very high CMRR, very low bias current, ratiometric operation, and an optimized input filter for high NMR, with input protection up to ±300V.

Stability? The AN2570's autozeroed to ±1μV/°C, has a range T.C. of 35ppm/°C

(all the way from -10°C to +65°C, by the way!) and a code-center uncertainty of only 20μV RMS (ever see anyone else even *rate* that on a DPM?). So when we say ±0.05% accuracy, we *mean* it.

How does this hit you? The CMV is a cool 1400 Volts DC or peak AC from analog ground to power line. (While we're talking about *cool*, let's mention that the internal temperature rise is so low that the MTBF is over 100,000 hours, and our warranty is 24 months.)

But that's not all. DIN/NEMA case, universal powering (logic or worldwide-compatible line or 8 to 28V battery) *and* the highest reliability standards you've ever seen for a DPM or DPI.

**Get all the facts on how far \$39 will go.**

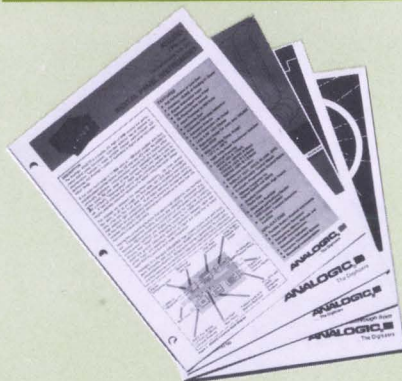

Circle inquiry number 103.

**It's a bird ... It's a plane  
It's SUPERDAC—  
A True 16-Bit Design  
Called "BSOTA."**

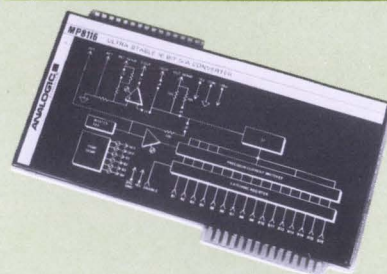

Why "BSOTA"? Because the first customer for this fantastically linear, incredibly stable 16-bit D/A Converter asked us for "the Best-State-Of-The-Art design—BSOTA." It may be an awkward acronym, but the MP816 is as successful a design as we've ever done.

Now that hundreds of these SuperDACs are solving tough D/A problems in dozens of fields, from biochemistry to communications, we think everyone ought to know what they can do...

First of all, 16 bits: that means the LSB is just 16 PPM of full scale. In that rarified atmosphere, 10μsec current-mode settling time is *real speed*. But that's just for openers.

How about relative accuracy (linearity) of 0.15 bit? Differential linearity of 0.12 bit? And for the clincher, T.C. of range and offset, less than 1 ppm/°C!

Get this theory/applications brochure on the ultimate in DAC design.

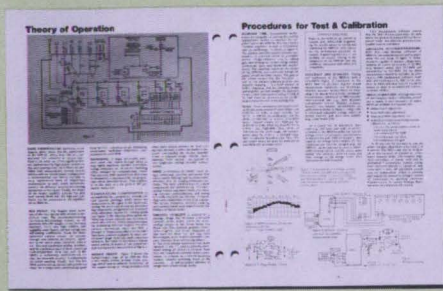

Circle inquiry number 104.

## Now — 2nd Generation Industrial Digitals... Designs That Anticipate all your needs



About a year ago, we introduced the most advanced digital process indicators ever offered to the industrial-measurement field—accurate, stable, sophisticated DPI's, compatible with thermocouples, load cells, process-variable transmitters, etc. They were *great* designs—and we've just obsoleted every one of them... as well as everybody else's industrial digitals.

We've made no fewer than *eleven* major design improvements, and now "Measurometer" has about as much competition as "Rolls Royce." (The prices are still Pontiac-to-Olds however.)

These digitals are *total* solutions to the very real problem of optimizing DPI performance in *industrial* environments. For example...

**Isolation?** They float up to 1400V off power ground. **Noise?** Built-in filters reject line spikes and broadband noise, differential inputs reject ground-loop interference, and all-metal cases shield out EMI/RFI. **Power-Line Quality?** Regulated power supplies let you ignore it. **Dust, dirt, contaminants, humidity?** These are sealed units, designed to *take it*. **Shock & Vibration?** These things are *tested* harder than you'll use them!

We're running out of room, but...

- Two full-scale ranges: 0 to ±1999 (PI 2400 Series) 0 to ±3999 (PI 4400 Series)... plus optional "dummy zeroes."
- Big, bright, glare-free displays, (LED or Plasma) for maximum readability... near, far, or off at an angle.
- Comprehensive test procedures ensure long-term reliability, sustained high performance. Burn-in, 96 Hours minimum.

There are 8 Measurometer families (Thermocouple, RTD, Wide-Range Thermocouple, Current-Loop, Voltage-mode, True-RMS, AC Line Voltage, and Microvolt Receiver—for load cells, strain gages, pressure cells, etc.). And *hundreds* of models. **A solution to just about every process-readout problem.**

Get the full Measurometer story.



Circle inquiry number 105.

## In 14-16 Bit Country... Where Every Bit Counts... The 8000's Hold The Line

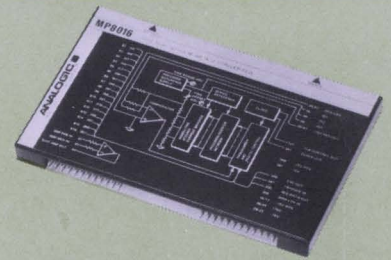

What do you do when most of the world can't afford to pay for the ultimate performance in an A/D converter... but can't settle for less? You design your head off, and come up with a new breed: the *very nearly* ultimate, for a *very nearly* modest price.

It's the MP 8000 series: 14 to 16 bit successive-approximation A/D converters that come within a gnat's eyebrow of the best you can buy (we make *those*, too), and cost 50% less.

Here's a little chart that tells you why the 8000's have been seiling as fast as we can make them:

	Binary Bits	Conversion Time	Relative Accuracy	Diff. Linearity
MP8014	14	10μsec	±006%FSR	±001%FSR
MP8015	15	15μsec	±003%FSR	±001%FSR
MP8016	16	30μsec	±002%FSR	±001%FSR
	Range T.C. (of Reading)	Offset T.C. (of FSR)	Diff. Linearity T.C. (of FSR)	
MP8014	±6ppm/°C	±1.5ppm/°C	±1ppm/°C	
MP8015	±6ppm/°C	±1.5ppm/°C	±1ppm/°C	
MP8016	±6ppm/°C	±1.5ppm/°C	±1ppm/°C	

The 8000's are fully buffered (input and output)... have adjustable conversion times (0.6 to 2.5 μsec/bit)... provide pin-programmable ranging, code selection, formatting, and short-cycling... NBS-traceable, guaranteed accuracy specs—and check the chart for those T.C.'s!

And, when you get to OEM quantities, these remarkable converters are **within the reach of any system sophisticated enough to require them.**

**ANALOGIC CORPORATION / AUDUBON ROAD / WAKEFIELD / MASSACHUSETTS 01880 / (617) 246-0300**

# For Immediate Action... Use This Card Today!

If card has already been used, circle the inquiry number indicated on this publication's reader service card.

FIRST CLASS  
Permit No.336  
Wakefield, Mass.

## BUSINESS REPLY MAIL

No Postage Stamp Necessary If Mailed in the United States

Postage Will Be Paid By

**ANALOGIC** CORPORATION

AUDUBON ROAD  
WAKEFIELD / MASSACHUSETTS 01880

Get the full specs,  
and see how we've held the line  
on price/performance.

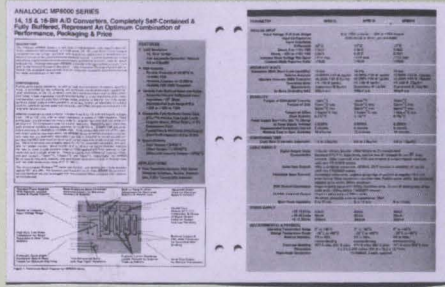

Circle inquiry number 106.

Now—A DPI for Your  
Portable, Power-Poor,  
Space-Pinched Packages  
... Only 49 Bucks



Turn back to page 2, and read the harsh words about the other guys' single-chip DPM's. Now let's talk about the newest "mini" in our OEM-built-in line of DPI's.

The AN2575 is a premium-grade,  $\pm 3\frac{1}{2}$ -digit, logic-powered DPI that offers all the performance, interface features, and versatility of the AN2570, in a metal case that's only  $\frac{1}{4}$  the size and weight. It operates from a 5V DC supply, and if the standard 160 mA current drain isn't low enough for you, we've got a 70mA option. The dimensions are perfect for  $\frac{1}{4}$ -DIN packaging, the case is very attractively styled, and you can buy it *without* a case, and save \$8 more (100's).

This is a tough little design, too . . . really *built* for portable service. Premium components, in a *solid* mechanical package. We shake it, shock it, burn it in, retest it, and slap a 24-month warranty on it.

For battery-powered equipment, airborne and marine systems, biomedical and geophysical instrumentation, and anywhere that size, weight, and power are at a premium, the AN2575 can't be beaten.

Free ... maxi-data on mini DPI's.

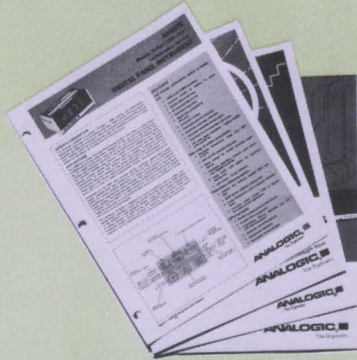

Circle inquiry number 107.

How About a 16-Bit A/D  
Converter for Under \$200?

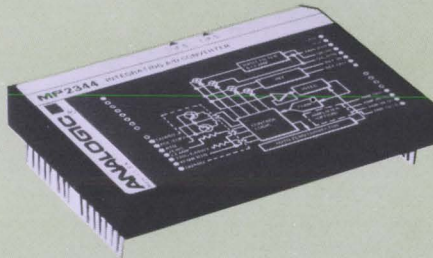

No kidding—we do it  
with DSI

If you thought that couldn't be done, you will be surprised to learn that we've been doing it (better and better) for over 7 years. Yes, we've built thousands of good, high-quality 16-bit A/D converters for users all over the world, and they sell for under \$200, in modest quantities. (We'll sell you *one* for only \$210.)

What's the secret? Dual-Slope Integration. That's all there is to it—you just trade away speed (picking up tons of extra noise rejection, by the way) and you can have superb accuracy, linearity, and stability, at full 16-bit resolution, for very few bucks. Our MP2344, shown above, is providing  $4\frac{1}{2}$ -decimal-digit-plus-sign performance (16 binary bits, including sign) in industrial and scientific instruments, control systems, data recorders, etc.—anywhere, in short, where 10 to 60 readings/second is fast enough.

Have you been neglecting the integrating A/D converter? Have you buried it in your subconscious as a "DPM technique"? Let us disabuse you of that prejudice . . . and save you a ton, on some present or near-future project.

Get the latest facts on the oldest  
precision A/D technology: DSI.



Circle inquiry number 108.

**ANALOGIC CORPORATION / AUDUBON ROAD / WAKEFIELD / MASSACHUSETTS 01880 / (617) 246-0300**

For Full Details on one or more of our products, please fill out the coupon and mail.

- SEND DATA SHEET/CATALOG  
 HAVE SALESMAN CALL FOR DEMONSTRATION

101    102    103    104    105    106    107    108

NAME \_\_\_\_\_ TITLE \_\_\_\_\_  
COMPANY \_\_\_\_\_ TEL. \_\_\_\_\_ EXT. \_\_\_\_\_  
ADDRESS \_\_\_\_\_  
CITY \_\_\_\_\_ STATE \_\_\_\_\_ ZIP \_\_\_\_\_

**ANALOGIC** 

...The Digitizers  
ED1

**For  
Immediate  
Action . . .  
Use This Card  
Today!**

If card has already been used, circle the inquiry number indicated on this publication's reader service card.



# Who helps TV get its act together?



Scenes from TV programs do not imply  
an endorsement of EECO products.

Blame it on us. We helped to make today's pre-recorded TV programming possible. We developed a video time code and sophisticated magnetic video tape editing equipment which changed the entire art of editing. And which won a special Citation during the EMMY awards in 1972.

So, almost every time you turn on your TV set, EECO enters your home. We're telling you now because we thought it's time you knew we do more than make thumbwheel switches, tape readers, and packaging hardware.

EECO is part of your life.

## EECO

1441 East Chestnut Avenue, Santa Ana, California 92701 Phone 714/835-6000

CIRCLE NUMBER 12

Now AMP's most versatile  
interconnection system  
is even more so.

We've added a  
whole family  
of pin  
headers.





Top performance in a tiny space. AMPMODU posts, receptacles and headers make your packaging designs as tight as necessary.

We've also made it easier to place pins on a board. Forget about positioning pins one at a time. Forget costly front-end insertion equipment. Because AMP engineering ability shows up in our recently introduced AMPMODU pin headers.

Pins are fully protected. Headers are polarized and have self-retention locking latches. Headers fit everywhere on a board, including board center.

Ten basic header styles offer several thousand possible variations. You can approach mass termination with AMPMODU headers. Up to 80 positions.

These headers now complement the AMPMODU interconnection system, which features dual cantilever spring beams in the receptacle, five basic contact types and board to board or board to wire versatility. The forgiving nature of the receptacle design also ensures a uniform, positive electrical contact with the mating posts, everytime.

At AMP our application, service and sales engineers are located throughout the world, and are ready to help you with prototyping as well as providing a complete after-sale service.

For more facts about AMPMODU headers, write or call Customer Service. (717) 564-0100. AMP Incorporated, Harrisburg, PA 17105.

AMP has a better way.

**AMP**  
INCORPORATED

CIRCLE NUMBER 13

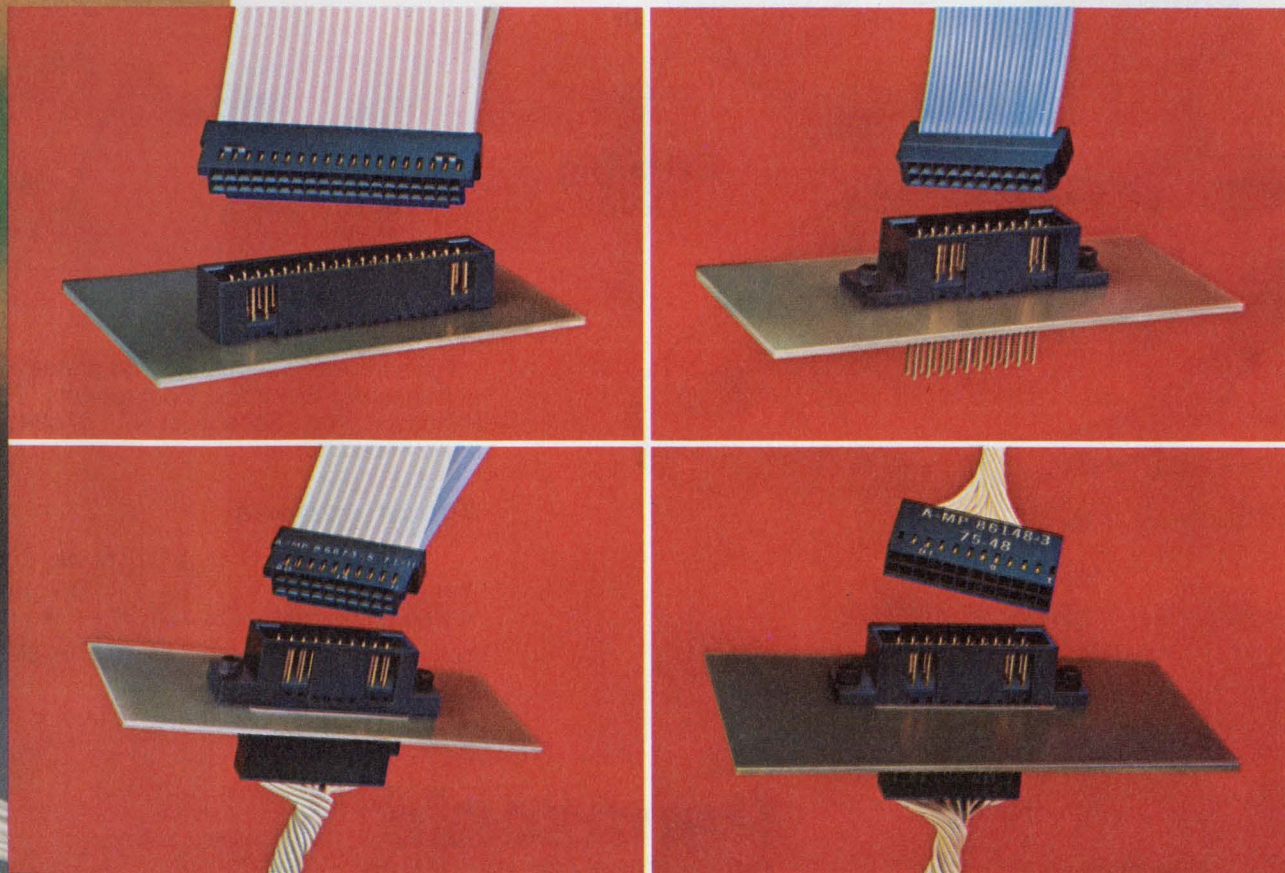

# The Panasonic Plus: you get more power transistor than you pay for.

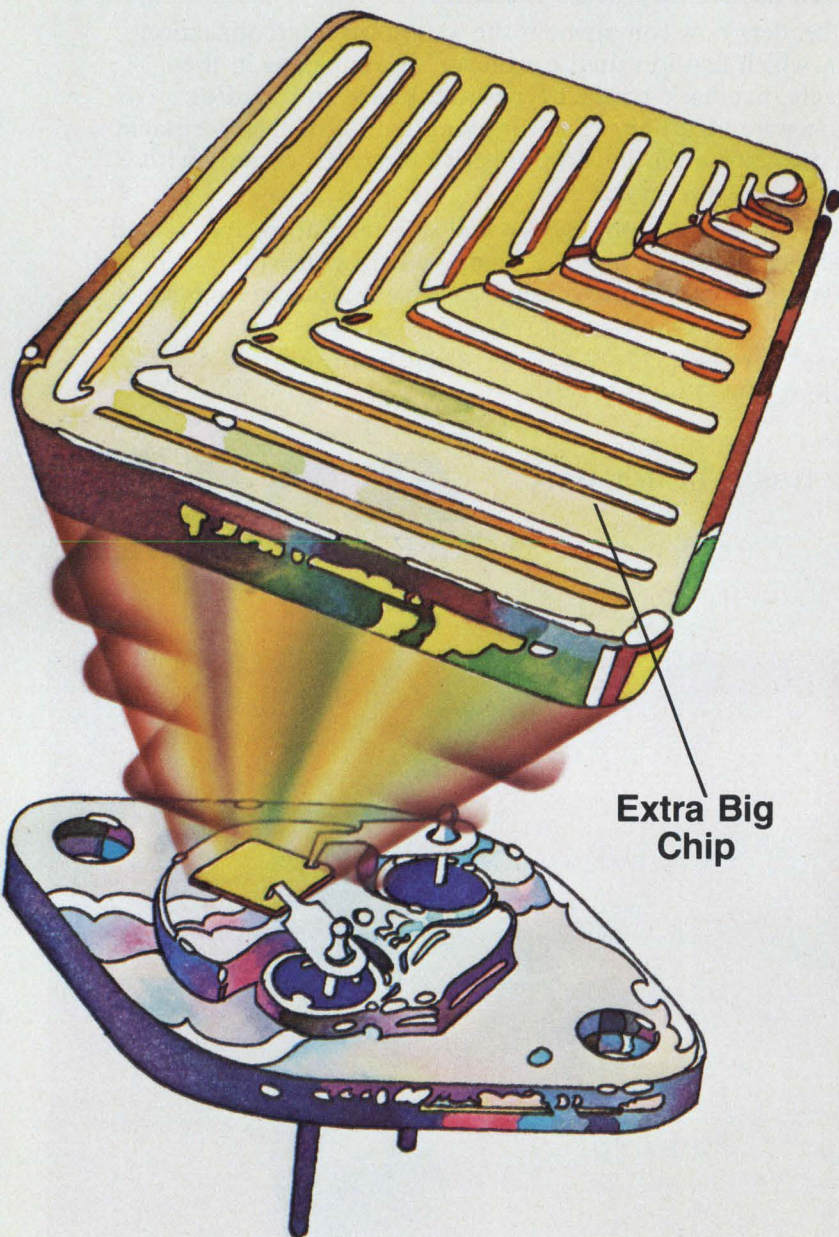

Extra Big Chip

One look at the extra big chip in any Panasonic power transistor makes it obvious—not all transistors are created equal.

Because of our extra big chip and proprietary construction we could rate these devices higher, but we don't. They're always conservatively rated. Which, along with our rigid QC system, is why we have such a low rejection rate.

That's part of the Panasonic Plus...one reason to switch to our power transistors. There's also competitive pricing and broad range.

Many of our power transistors are matched to 2N numbers, and are available in standard TO plastic or metal packages, in a complete range of power, voltage and current ratings. And we also offer a line of small signal transistors, Hall Effect devices, and 4-bit microprocessors. All at prices that are highly competitive with those of other makers of quality semiconductor devices.

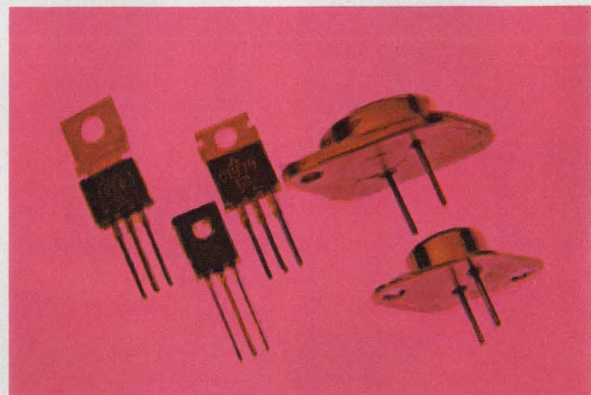

For complete information and prices, write to Panasonic Electronic Components, One Panasonic Way, Secaucus, N.J. 07094; or call (201) 348-7269.

## Specifications

	TO-3	TO-66	TO-126	TO-202 TO-220
V <sub>ceo</sub> (V)	80-©1500V	40->300V	18-300V	20-300V
I <sub>c</sub> (A)	100m->6A	100m-2.5A	50m-1.5A	100m-4A

Also available: TO-92 and other semiconductor packages

**Panasonic**<sup>®</sup>  
just slightly ahead of our time

## New technologies needed to increase IC density

Better ways to image, etch and dope silicon wafers must become commercially feasible to increase integrated-circuit densities and decrease costs, according to two industry executives.

The densest circuits now in development—65-kbit RAMs with line widths of 2.5 microns—represent a limit to present imaging techniques, says Brian Dale of GTE Laboratories in Waltham, MA, "since at these dimensions we are beginning to approach the wavelength of light, and diffraction effects prevent higher resolution."

Dean Toombs, engineering director of the Semiconductor group and assistant vice-president at Texas Instruments Inc. in Dallas, agrees that optical photolithographic methods will have to be replaced for advances in semiconductor densities to continue for more than the next five to seven years.

"Electron-beam lithography appears to be a viable alternative," says Toombs, though a great deal of engineering remains to make the technique commercially acceptable. Explains Dale, "Present electron beam equipment is very expensive—approximately \$1-million each—and has a throughput of only a few silicon wafers per hour."

These problems should be overcome and, within the next five years, direct electron-beam imaging should be applied on certain classes of devices, says Toombs. These products will not be small or medium-scale ICs, or even large-scale chips, but rather a new class of very-large-scale or grand-scale integrated (GSI) circuits.

"Since it has been proven that there are no fundamental limitations in reaching 1-micron line widths, it is reasonable to suppose that the practical problems will be resolved," and that historic growth trends will continue, says Dale in a paper prepared for the Armed Forces Communications and Electronics Association technical seminar in Washington, DC, last month.

According to Toombs, interviewed in Dallas, optical methods can attain 1.25 to 1.5-micron line widths, but such fine lines require that each mask be placed within 0.25 microns for proper registration between levels. "Electron-beam imaging can achieve the image size," and can overcome the registration problem because it is a "full-electronic technology," without manual positioning, according to Toombs.

The processes needed for selectively adding or removing material from silicon slices will change from present wet-etch methods to so-called dry processing in which an rf plasma containing gaseous carriers is held in contact with the slice, Toombs adds. This technique produces sharper lines because there is less undercutting of masked areas, he explains.

Techniques for doping will change, too, says Toombs. He notes that already taking place is a shift away from thermal diffusion toward ion implantation, which permits shallower areas with more precise control over dimensions.

### 16-k RAM makers play speed leapfrog

Even as the first 16-k dynamic RAMs begin to hit stride on some production lines, suppliers of these high-density memories are trying to jump ahead of one another to produce devices with even shorter access times.

A 120-ns dynamic 16-k from Mostek Corp., whose 150-ns 4116 is already the fastest available, will be out later this month—the 4116-1. And other 16-k RAMs are expected to be unveiled by Intel and Texas Instruments, among others, which will be improving the speed of their present devices.

The 4116-1's 20% speed improvement stems largely from cutting speed-robbing capacitance by shrinking the elements on the chip, says Derrell Coker, applications manager in the memory-

products department at the Carrollton, TX, manufacturer. The resulting chip size is not only smaller than the 4116's—22,000 sq. mil to 27,700—but is even smaller than Mostek's 4-k RAMs were in 1973 or 1974.

Meanwhile, an improved version of TI's 4070 16-k will be in production the third quarter of this year, a spokesman says, and its access time will be 150 to 200 ns. However, the company isn't ready to give details.

Intel, too, though working on an upgrade, isn't ready to give out details, says William Regitz, manager of product engineering at the Santa Clara, CA, firm. Nevertheless, the company, whose 2116 was the first 16-k RAM, expects its 2116 upgrade to offer better performance than Mostek's 4116.

Mostek's faster 16-k RAM will cost about the same as present parts, says Coker, and the price of the older design will drop. When the new price sheets are written, the present \$45 lower limit for 100 quantities will have fallen by a few dollars.

### Music played, recorded by electronic pianist

The first electronic player piano replaces the familiar piano rolls with magnetic tape recorded with digital data. The Pianocorder selects the grouping and sequence in which the keys are played by decoding the data, and also controls how hard solenoids are actuated to drive the string hammers. Standard Philips magnetic-tape cassettes can be used both to play recorded songs and to record, for example, a student's piano lesson, and play it back.

Developed by Superscope, Chatsworth, CA, the basic Pianocorder system will come either as a kit to be installed on any upright or spinet piano, or as a "Vorsetzer" unit that can be rolled up to a piano keyboard. Padded fingers extend from the latter unit to press the keys.

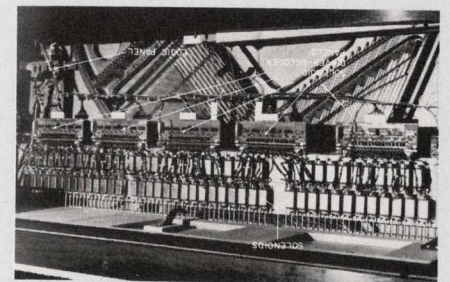

**Pianocorder system** installed in an upright piano.

To minimize drop-outs and ensure maximum data reliability in either the playback or recording mode, the cassette runs at 3-3/4 in. per second—twice the normal speed—and at bit rates greater than 4-kbits/s.

To make original studio recordings, an 8080  $\mu$ P-controlled system samples each key as it is depressed. Separate transducers on each key monitor key displacement, actuation speed and the pressure on each struck key. This parallel information is then digitized and multiplexed into serial format.

In playback, a logic panel delivers this information to five driver-decoder PC panels via a bus system. The Pianocorder system records and monitors 32 levels of intensity with which a key is hit, and decodes this information to drive the solenoids with a variable pulse width at full voltage. The wider the pulse the louder the struck note sounds.

To record on the home system, the sound intensity can be monitored by a microphone. The sound level from the microphone is applied to an arithmetic circuit that samples, at any instant, the sound volume, and the number of keys depressed. This sampling is converted, using an algorithm, into various sounds that mimic those of the original piece.

Volume production of the Pianocorder is slated to begin next January. The kit is expected to retail between \$1250 and \$1500, while the Vorsetzer unit is expected to sell for \$1500 to \$2000. With either the Pianocorder or Vorsetzer units, a prerecorded library of 100 45-min. cassettes will be furnished, many of them containing recordings of piano-roll classics from a 15,000-roll collection of Joseph S. Tushinsky, Supercope's president.

## Display tells how far to drive—or walk

You're tooling happily along an open stretch of desert highway. Suddenly, you notice that your gas indicator hovers around Empty. As panic sets in, you wonder whether you will make it to that gas station 10 miles away.

This problem has been "solved" with an optional miles-to-empty display, which will be available on Ford Motor Co.'s 1978 Continental Mark V. An LSI calculator provides an estimate of how many miles can be driven before running out of gas, and also tells you how many miles per gallon you're getting.

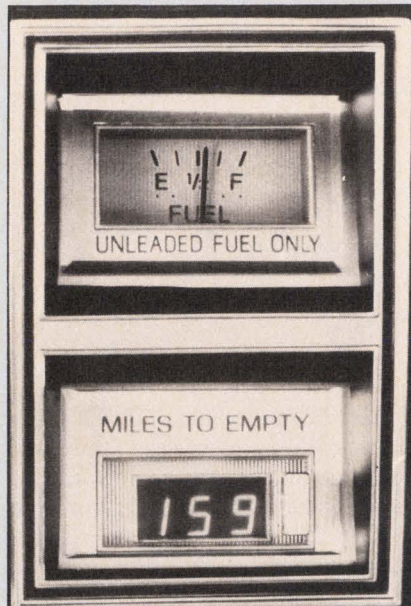

Driver obtains a miles-to-empty estimate by pushing the button at the right of the display.

The three-digit gas-discharge display on the dashboard reads out the computed number of miles remaining.

"Electronics would also permit us to calculate and display 'miles per gallon' reading for the driver," says Lawrence A. Lopez, advanced instrumentation and display engineering manager for Ford's Electrical and Electronics Division. "But we decided 'miles-to-empty' is what really counts."

The primary system component is a large-scale integrated logic circuit that contains approximately 3600 transistors. This custom-PMOS digital processor (from AMI, Santa Clara, CA) receives information from two transducers, one in the fuel tank to convert fuel level to dc voltage and the other linked to the transmission to translate vehicle speed to pulse rate.

From these two inputs, the electronic processor calculates distance traveled, fuel used, and miles per gallon. It then multiplies the miles per gallon by the fuel level to obtain the miles-to-empty estimate, which is transmitted to the digital display. A conventional analog fuel gauge is also provided.

"The miles-to-empty estimate is based on how the car is being driven, and the electronic processor makes its calculation in cycles, each lasting slightly more than a minute," says Lopez. "During each brief period, the processor compares the fuel-usage rate with that of the previous period. If it has changed, the miles-to-empty estimate is updated. Otherwise, the esti-

mate decreases one mile for each mile driven."

However, these changes are made in small increments over a period of several minutes, to avoid severe fluctuations that otherwise would be displayed during rapidly changing driving conditions, such as going from highway to city driving, hill climbing or rapid acceleration or deceleration.

The digital display in the instrument cluster is slightly larger than a matchbook. The entire miles-to-empty module is approximately 5 x 4 x 2.5 in., including the neon display, power supply, VCO analog-to-digital converter, signal processor and decoder.

The driver obtains a miles-to-empty reading simply by pushing the display button. The bright-orange figures normally remain lighted for several seconds, however, when the miles-to-empty number drops below 50, the display lights up and remains on.

## Chip power reduced by CAD programs

Over 20% of the power in current logic-chip circuitry layouts can be saved by using two new computer-aided design programs. One tells how to construct chip devices, such as transistors, in the most power-efficient manner. The other shows where to position these devices on the chip to reduce power even more.

The programs, developed by IBM at its Watson Research Center in Yorktown Heights, NY, use a System/370 Model 168 computer to design power-efficient placement of logic gates and their operating speed. Both programs can be applied to LSI chips by using insulated-gate field-effect transistors.

Two older programs, also developed to produce power-efficient designs, are used with the new programs.

First, one of the older programs is employed to determine where the devices should be placed on a chip, while minimizing total wire length needed to connect them. The other one then assigns wires to specific routes.

At this point, one of the new programs optimizes gate-switching times with an eye toward minimizing power. The second program then repositions some of the logic gates to cut chip power even more.

For a hypothetical chip with 1000 logic gates, the four programs can produce a power-optimized layout in 10 minutes on the System/370 Model 168.

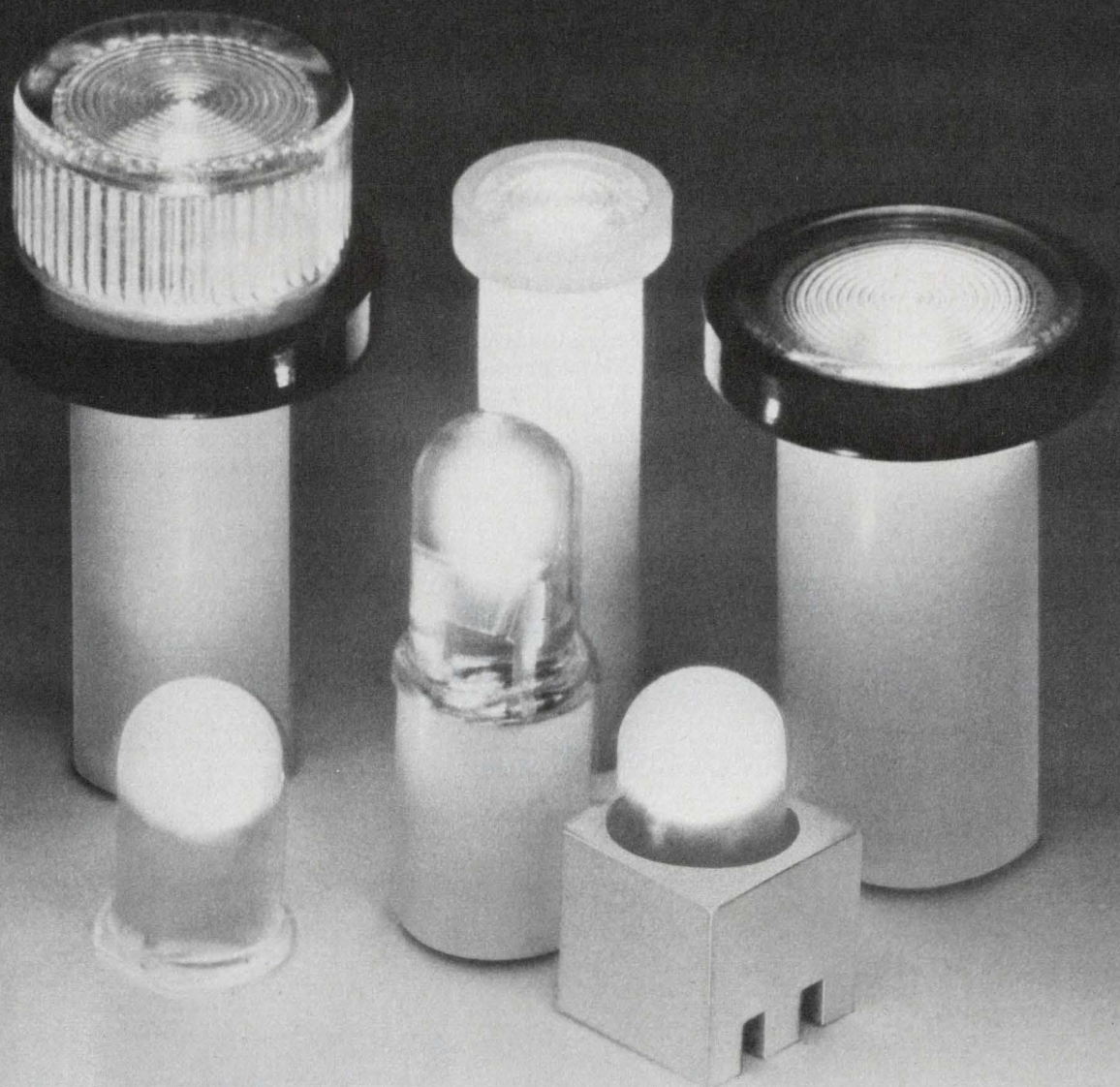

# The end of the incandescents.

The end of the incandescents is in sight. Our Brite-Lite® LED lamps outlast them by an average of 10X. When the incandescents were all you could get, there was no choice. Now, you've got Brite-Lites. The brightest ideas in LED lamps, yet.

Brite-Lites offer proven solid-state reliability with an average life of more than 100,000 hours and minimal power requirements. Brite-Lites are available in red, green, and amber. In your choice of current/voltage combinations with current limiting resistors from 1.6 to 20 volts—10 to 30 milliamps. In a wide range of packages from convenient snap-ins to space-saving T<sup>2</sup> Lites.

With all of their limitations, incandescents are much less practical than LED lamps. Now is the time to brighten up your next panel or printed circuit board project with Brite-Lites. The brightest LED lamps in the business. Our fast delivery won't hold you up either. All you have to do is call or write, today. Join the thousands who've seen why the end of the incandescents is just the beginning for Brite-Lites by Data Display Products.

**The brightest LED lamps in the business.**

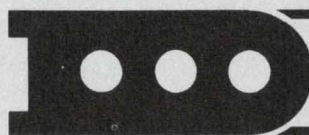

**DATA  
DISPLAY  
PRODUCTS**

303 NORTH OAK STREET, INGLEWOOD, CA 90301 (213) 677-6166

**Look at data in different ways.**

The 7D01F lets you choose from five display modes: maps; state tables in hexadecimal, binary, or octal code; or timing diagrams. How often have you encountered a problem you knew you could spot just by scanning overall program flow? How often have you wished you could compare state tables in the hexadecimal code you work with as well as the binary code your microprocessor knows? How often have you wanted to switch from a state table display to its corresponding timing diagram? The 7D01F can help at each step of this troubleshooting procedure.

You've designed, debugged, and loaded your system software. Now you need several powerful capabilities to ensure trouble-free execution on the prototype: the ability to look at data in different ways . . . to compare known good data with new data quickly and easily . . . to analyze both system and peripheral-interface timing.

The TEKTRONIX 7D01F Logic Analyzer offers you all those capabilities in a single instrument.

# Troubleshooting a microprocessor-based system is easier...

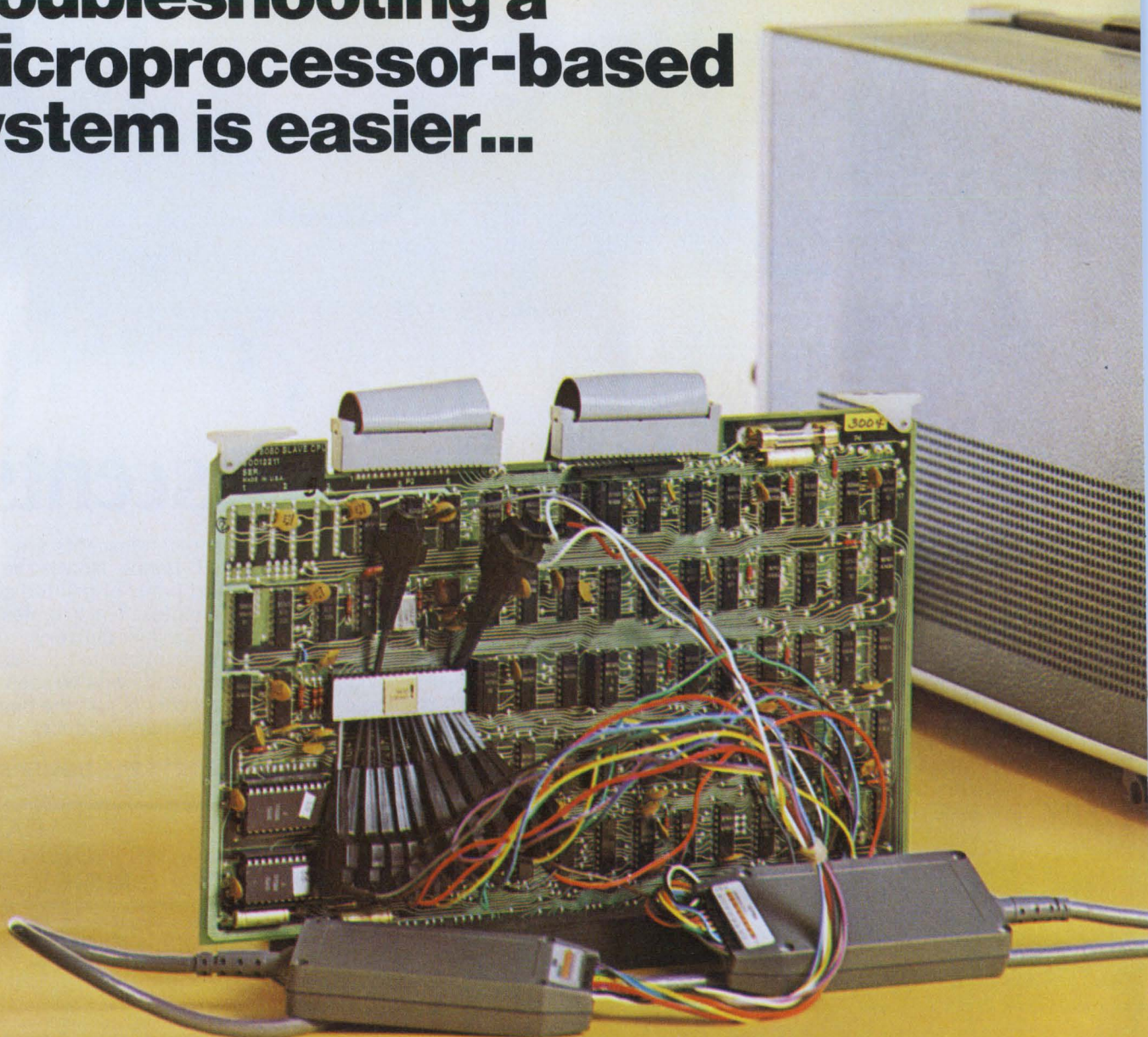

**Compare known good data with new data.**

The 7D01F features two comparison modes which facilitate in-depth software/hardware debugging. The EXCLUSIVE-OR and RESET-IF modes speed up what would otherwise be a very tedious process: checking the program flow chart against what falls out when the program is run.

For an EXCLUSIVE-OR comparison, simply verify known good data, store it in reference memory; acquire new data, and select a table comparison mode. The reference table and the compared table (which may be in hex, octal, or binary) will be displayed side by side, and the differences between the two will be highlighted for ready identification.

Use RESET-IF to track down an intermittent fault. In this mode the 7D01F can automatically acquire and compare up to 4096 bits of new data to 4096 bits of reference data. Data is continually reacquired until a mismatch occurs. If there is a mismatch, the instrument holds the display, highlights the differences, and displays the number of resets that occurred. This frees the operator from continually monitoring for wandering programs, intermittent loops, or ragged-edge timing problems.

**Analyze system and interface timing.**

The 7D01F offers synchronous data acquisition at speeds up to 50 MHz. But it is sometimes necessary to view microprocessor operation with increased timing resolution, as well as to locate timing discrepancies in the system's interface with the outside world. You may, for example, need to asynchronously examine data coming into the I/O port before you can determine whether incorrect information is coming from the I/O port itself or the hardware on the other side. The 7D01F offers asynchronous data acquisition at sample intervals of up to 100 MHz.

# ...with the Tektronix 7D01F Logic Analyzer.

All these unique features are available only in the TEKTRONIX Logic Analyzer. To find out more about how the 7D01F can simplify your work with microprocessor-based systems, just call your local Tektronix Field Engineer. He'll demonstrate the 7D01F in your application, and acquaint you with its many other features, including 16-channel word recognition, 1M $\Omega$ /5 pf logic probes, 16-channel data acquisition, 4k formattable memory, and 7000-Series mainframe compatibility.

You should also send for our newest application note, describing in detail how a 7D01F can be used with microprocessor-based systems. Write Tektronix, Inc., P.O. Box 500, Beaverton, Oregon 97077. In Europe, write Tektronix Limited, P.O. Box 36, St. Peter Port, Guernsey, Channel Islands.



# Tektronix<sup>®</sup>

COMMITTED TO EXCELLENCE

FOR TECHNICAL DATA CIRCLE 124  
FOR DEMONSTRATION CIRCLE 125

## Fiber-optics systems are few, but watch out for the explosion

The potential superiority of fiber-optics systems over comparable wire and coaxial-cable communication systems has been recognized for some time. First-generation hardware is verifying this potential by providing excellent performance in operational systems both in the U.S. and abroad. But as yet the number of systems is still relatively small. Compared to their coaxial and twisted-wire counterparts, these fiber-optics systems enjoy many performance advantages, including

- Immunity to strong electrical or magnetic noise fields.
- Dielectric isolation between transmitter and receiver, ranging from a few feet to hundreds of feet.
- Cables not only much smaller and lighter but also with much greater bandwidths.
- Lower loss than coaxial systems.
- Bandwidths of hundreds of Mbit/s with present systems and hundreds of Gbit/s for future systems.
- Negligible crosstalk between fiber-transmission elements.
- Secure data transmission.
- Ultimately lower cost than either coaxial or twisted-wire systems.

### Problems inhibit spread

But one problem inhibiting the spread of fiber-optics technology is the high cost of present system components. Another negative factor is the lack of standard parts specifically tailored to the requirements of these systems. These parts include LEDs, photodiodes (PDs), connectors and bundle and cable terminations.

A third retarding factor is that designers who have worked for years with familiar solid-state technology are reluctant to adopt the new, special technological approach of these electro-optical elements and systems.

---

**Jim McDermott**  
Eastern Editor



**Fiber-optics cable for a 5.6-mile telephone system** in California is pulled through an underground conduit. The 1.544-Mbit/s system, developed by General Telephone and Electronics, uses cables by General Cable Corp.

Even so, recent marketing studies predict a \$100-million fiber-optics technology in communications, computers, business data systems, industrial-process control, instrumentation and consumer applications by the early 1980s. Furthermore, a survey of more than 40 industry experts indicates that this figure may be reached much earlier.

The reason is this: Nearly every fiber-optics manufacturer is investing in the development of new fibers and cables. Says one major supplier: "We know the demand is coming and we want to be ready when it arrives."

Connector manufacturers are funding the design and production of new connector types, while the LED and photodiode manufacturers are developing components tailored for fiber-optics systems. What's more, this full-scale attack on the problems inhibiting the development and production of low-cost, high-production fiber-optics components and systems is gaining momentum.

### Starter kits offered

For example, an effort is growing to supply designers with low-cost fiber-



optics kits. Texas Instruments is now introducing 10-ft links of 40-mil-dia plastic-fiber bundles, at \$175 each, for prototype development. A 790-nm infrared (IR) LED especially developed for this link is aligned with the fiber bundle on one end; a p-i-n photodiode is aligned on the other. Both are epoxied in place. Once quantity production starts, however, the link will cost less than \$10.

The 10-ft link is designed for a typical 20-MHz bandwidth; with 50-mA LED current, it produces a minimum of 10- $\mu$ A output at the PD.

Like TI, Amphenol is spending money to get designers involved in fiber optics and, of course, to buy connectors. The company is now stocking FO cables from all of the manufacturers and is offering them in terminated assemblies in whatever prototype lengths the customer wants. This move is intended to bypass the \$200-to-\$500 minimum orders required by fiber suppliers and to make these elements available to a broad group of designers and researchers whose budgets are limited.

Amphenol is also preparing to market, by summer's end, a line of 1-MHz analog and digital data links consisting of a transmitter, a receiver, 50 ft of cable and all the necessary electrical and fiber-optics connectors. Price will be under \$200.

A "starter kit" is also being offered by Radiation Devices. Its \$55 "Link in a Wink" comes with two LEDs. One operates at 635 nm in the visible for plastic fibers; the other radiates at 940 nm in the invisible IR for glass. Rise and fall times of both LEDs are less than 100 ns.

The LEDs' radiation is piped through a 2-m length of multimode fiber cable with optically polished ends. End-terminal hardware is designed to accept LEDs or PDs in the TO-46 cans and T-1 3/4 plastic packages that are supplied with the kit or may be purchased as standard items.

### Systems simply assembled

For the engineer still unwilling to design fiber-optics systems, a growing number of suppliers are providing a variety of complete transmitter-cable receiver systems that require only electrical input and output data-signal connections and power.

One example is Quadri Corp.'s Opticable data link. Its 1.15 x 2.15 x 0.35-in. plastic-encapsulated transmitter and receiver modules can fit into 0.5-

in. PC-card centers and mate with 14-pin DIP sockets. Inputs and outputs are TTL-compatible. Data rates are 0.25 MHz for 100-ft fiber cables and 2.5 MHz for 10-ft links, which terminate directly in special connectors. Prices start at \$300 for a 10-ft system.

A line of plastic-housed LED driver modules and photodiode preamplifier modules for PC-board mounting is being marketed by Radiation Devices. Operation to 7.5 MHz is available, as well as TTL-compatible fiber-optic re-

tems with 300 Mbit data rates, at \$2000 to \$3000 per transmitter-receiver pair.

The 1-Mbit receiver-transmitter pair costs \$370 and the 5-Mbit pair \$620. The 30-Mbit combination goes for \$1400. All these prices include the optical cable.

A digital-terminal fiber-optic receiver and transmitter is available that can handle data rates from 100 kbits/s to 20 Mbit/s over a link of several kilometers. It's ITT Electro-Optical Products and costs \$2250 to \$2350,

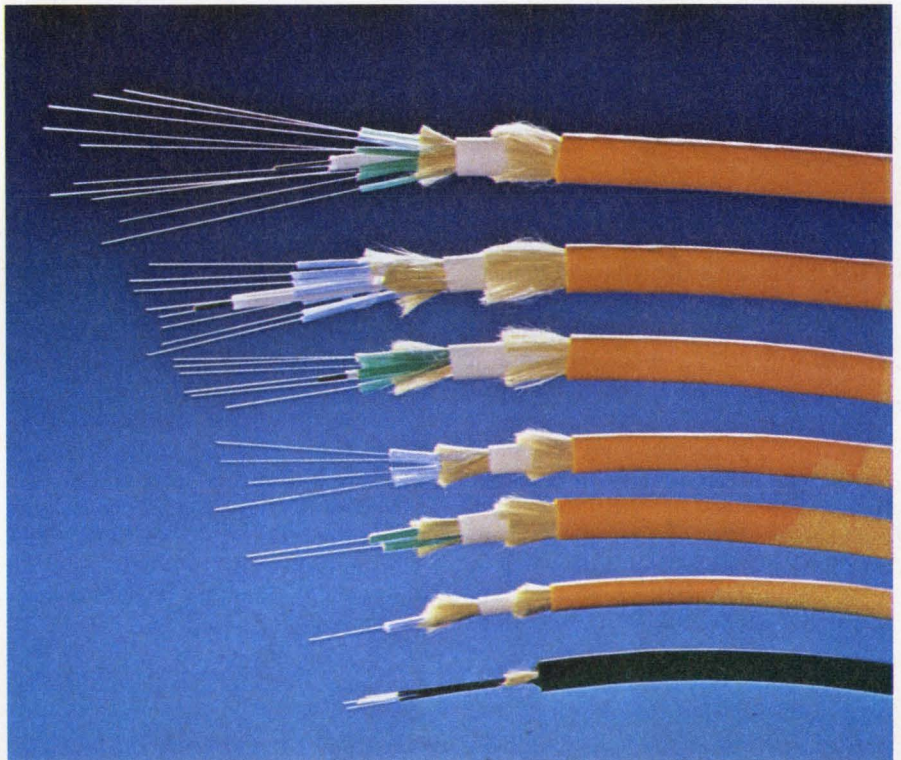

**Multimode, fiber-optics transmission cables**, like these from Corning, lead the trend away from large bundles to smaller bundles and single fibers.

ceivers with one end of the link terminating in a PC-mounted, shielded module. Response ranges from dc to 5 Mbits/s data rate.

TTL-compatible receiver-transmitter pairs and links are provided to specification by Spectronics (see photo). Typical links operate up to 10 Mbit/s and range from \$150 to \$1000, depending on a variety of requirements.

Three new TTL-compatible transmitter-receiver pairs, to be used with optical-cable systems, have data rates of 1, 5 and 30 Mbits/s. Marketed by Corning, the 1 and 5 Mbits/s models are products of Sיעor, a West German company jointly held by Corning and Siemens. The 30-Mbits/s model is made by the Plessey Co., England.

Harris is currently delivering sys-

depending upon connector type and system sensitivity. The cable and power supplies are additional.

A 10-Mbits/s transmitter-receiver pair suitable for 1-km links is being produced by Valtec at \$500 per set. A 1-km fiber cable for the set costs \$200.

### Aligning fibers a problem

Assembling a fiber-optic link from scratch leads to a big problem: aligning the fiber or fiber bundle to capture the maximum radiation from standard LED packages on one end, and to project the maximum radiation onto the PD's sensitive area on the other.

To overcome this problem, several suppliers have developed devices and device pairs with special LED-to-fiber interfaces. A TTL-compatible optical

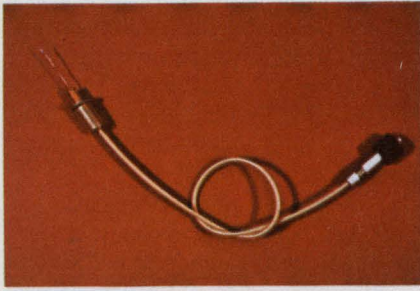

A 660-nm LED is mated with a section of DuPont single-channel plastic fiber-optics cable in this pigtail assembly by Aborn Electronics.

transmitting module from TI, the TIED472, contains a high-intensity, 910-nm GaAs LED for driving glass bundles.

An integrated current-drive circuit is included in the module's aluminum housing, which supports a mechanical termination for a fiber-bundle connector. An optical link can be formed by combining 472, a fiber cable, and a TIED452 avalanche diode housed in a receiving module that has an identical connector.

Another device designed to make fabricating a link an assembly rather than a laboratory job is RCA's C30133 high-speed LED for fiber-optics communications. The 820-nm device is in a stud-mounted package with a 5-in. length of DuPont PFX-S120R fiber cable extending through the top of the package. In 1 to 9 units, the C30133 is \$225, and \$175 for 100-up quantities.

The PFX-S120R is a pure 200- $\mu$ m silica-glass fiber clad with a 600- $\mu$ m plastic polymer. Its relatively large physical diameter and numerical aperture provide efficient coupling even with inexpensive connectors. The silica core is centered within the tough, hard cladding, to which the connector can be clamped directly.

The C30133 is suitable for pulsed or continuous operation. Typical radiant power output at the pigtail end is 500  $\mu$ W pulsed at 50 ns and 1 A and 150  $\mu$ W continuous at 200 mA. Rise time is 3 ns and frequency response is 150 MHz.

#### Fiber mates with LED

The 30133 may be connected to an external PFX fiber link by using either AMP's 530530-5 connector kit or Amphenol's 905-119-5022 PFX-S120R connector.

In addition, a special RCA line of silicon-avalanche PDs can mate with single fibers or small bundles whose



A typical point-to-point fiber-optics data link, by Spectronics, is TTL-compatible and operates with up to 10-Mbits/s data rates.

diameters range from 10 to 100 mil. Announced just recently, these devices—the C30903, 4, 5 and 6—are mounted in a modified three-lead, TO-8 package that incorporates a threaded structure extending from the top of the can. This structure supports light pipes that carry radiation from the LED chip to the top of the threaded portion mating with the fiber cable. The PD light pipes have diameters of 10, 20, 50 and 100 mil to accommodate various size bundles. Rise and fall times are typically 2 ns. Another PD series—the C30909, 10 and 11—is packaged in a modified 12-lead TO-8 can containing integrated preamplifiers, and light pipes of 10 and 20 mil. Rise and fall times range from 7 to 16 ns. Responsivity at 850 nm with a 50- $\Omega$  load is  $3.5 \times 10^5$  V/W. Responsivity of the PDs by themselves ranges from 40 to 65 A/W.

#### LEDs for plastic fibers

For plastic fiber-optics cables, which have a minimum attenuation of 400 to 500 dB/km in the 650 to 670-nm band, a LED-photodiode pair—the ALX-100 and APX-100—is provided by Aborn Electronics. Housed in plastic pack-

ages, both the ALX-100 and APX-100 have 9-1/2-in. pigtailed and mate with the same cable. Both use a standard AMP connector.

The PFX-P140R cable is suitable for 150 to 200-ft links with the Aborn devices. The ALX-100, which is a gallium-arsenide-phosphide device, has a peak output at 660 nm and an output of 25  $\mu$ W at 50 mA. Rise and fall times are close to 10 ns. The ALX-100 is \$20 in 1-to-10 quantities and \$10 for 100 and up.

The APX-100 photosensors are diffused planar units that can be operated as a photodiode or a phototransistor. Diode-connection responsivity is 0.2 A/W with rise and fall times of 150 ns. Phototransistor responsivity is 50 A/W, but the response speed is slower.

Meanwhile, to boost the radiant-power output of LEDs, most manufacturers have concentrated on improving chip technology. But Spectronics has chosen, instead, to raise the useful output through unique mechanical and optical design of a TO-45 LED package that concentrates the radiation on the end of the mating fiber or bundle. In addition, precise, repeatable, positioning of the LED chip makes Spectronics' package suitable for standardization. Dip-solderable, it is the first LED pack-



Fiber-optic connectors, like this 24-channel device by ITT Cannon, are MIL-standard hardware designed to accept optical fibers, LEDs and photodiodes.



# Introducing the hungry ECLIPSE.

Data General's new ECLIPSE S/130 computer has a bigger appetite for work than any other mid-range mini. And enough speed and versatility to wolf down any kind of data you have to dish out.

The hungry ECLIPSE computer is built around the same powerful architecture as our super high-speed ECLIPSE S/230. Added to that is a host of special features that make the hungry ECLIPSE unique. Like our fast micro-coded floating point and efficient character string instruction sets. And our second-generation WCS general-purpose user microprogramming ability that results in unmatched throughput in demanding applications. To top it off it also includes AOS, our amazing new heuristic multi-programming advanced operating system, and of course the full range of Data General's economi-

cal big-computer peripherals, software and worldwide support.

Now, you don't have to skimp along with an undernourished mini that's too limited for your work. Or splurge on one that's too fat just to get the performance you need. Just order an ECLIPSE S/130 computer. It will make your work load a lot leaner. Want more food for thought? Send for our brochure.

- Send your S/130 brochure.  
 Send your S/130 brochure and have your sales representative call.

Mail to: Data General, Westboro, MA 01581

Name \_\_\_\_\_

Title \_\_\_\_\_

Company \_\_\_\_\_

Address \_\_\_\_\_ Tel. \_\_\_\_\_

City \_\_\_\_\_ State \_\_\_\_\_ Zip \_\_\_\_\_

ECLIPSE is a registered trademark of Data General Corporation.

© Data General Corporation, 1977

ED 7/19

 **Data General**  
 It's smart business.

Data General, Westboro, MA 01581, (617) 366-8911. Data General (Canada) Ltd., Ontario.  
 Data General Europe, 15 Rue Le Sueur, Paris 75116, France. Data General Australia, Melbourne (03) 82-1361.

## Need more information?

The manufacturers listed below have been selected because they supply components that are specifically tailored for fiber-optics communications systems. For additional details, circle the appropriate number on the Reader Service Card. For vendors of LEDs, photodiodes and connectors for general applications consult **ELECTRONIC DESIGN's GOLD BOOK**.

Suppliers	LEDs, lasers	Photodiodes	Fibers and Cables	Connectors	F.O. Systems	F.O. Kits	Circle No.
Aborn Electronics, 1928C Old Middlefield Rd., Mountain View, CA 94043. (415) 327-7424.	•	•					451
AMP Inc., Box 3608, Harrisburg, PA 17105. (717) 564-0100.				•		•	452
Amphenol/Bunker Ramo Corp., 33 E. Franklin Ave., Danbury, CT 06810. (203) 743-9272.				•			453
Bell Northern Research Ltd., P.O. Box 3511, Station C, Ottawa, Canada K17 4H7. (613) 596-2210.	•				•		454
Burdny Corp., Richards Ave., Norwalk, CT 06856. (203) 838-4444.				•			455
Centronic, 1101 Bristol Rd., Mountainside, NJ 07092. (201) 233-7200.	•	•			•	•	456
Corning Telecommunications Prods. Div., Corning, NY 14830. (607) (607) 974-8812.			•		•		457
Devar, Inc., 706 Bostwick Ave., Bridgeport, CT 06605. (203) 368-6751.		•					458
The Deutsch Co., Municipal Airport, Banning, CA 92220. (714) 849-7844.				•			459
E.I. DuPont De Nemours & Co., Wilmington, DE 19898. (302) 774-7850.			•				460
Fiber Optic Cable Corp., P.O. Box 1492, Framingham, MA 01701. (617) 875-5530.			•				461
Galileo Electro Optics Corp., Galileo Park, Sturbridge, MA 01518. (617) 347-9191.			•				462
General Cable Corp., 500 W. Putnam Ave., Greenwich, CT 06830. (203) 661-0100.			•				463
International Audio Visual Inc., 15818 Arminta St., Van Nuys, CA 91406. (213) 784-4400.	•						464
ITT Cannon Electric, 666 Dyer Rd., Santa Ana, CA 92702. (715) 557-4700.				•	•		465
ITT Electro-Optical Prods. Div., 7635 Plantation Rd., Roanoke, VA 24019. (703) 563-0371.	•		•		•		466
Laser Diode Laboratories Inc., 205 Forrest St., Metuchen, NJ 08840. (201) 549-7700.	•	•					467
Meret Inc., 1815 24th St., Santa Monica, CA 90404. (213) 828-7496.					•		468
Poly-Optics Inc., 1815 E. Carnegie, Santa Ana, CA 92705. (714) 546-2250.			•				469
Quadri Corp., 1725 W. 17th St., Tempe, AZ 85282. (802) 894-2151.					•		470
Radiation Devices, P.O. Box 8450, Baltimore, MD 21234. (301) 628-2240.				•	•		471
Rank Precision Industries, 411 E. Jarvis Ave., Des Plaines, IL 60018. (312) 297-7720.			•				472
RCA Electro Optics Div., New Holland Ave., Lancaster, PA 17604. (717) 397-7661.	•	•					473
Spectronics Inc., 830 E. Arapaho Rd., Richardson, TX 75080. (214) 234-4271.	•	•			•		474
Texas Instruments, P.O. Box 5012, Dallas, TX 75222. (314) 238-2011.	•	•				•	475
Times Fiber Communications, 550 Research Parkway, Meriden, CT 06450. (203) 634-2171.					•		476
Valtec Corp., 99 Hartwell St., West Boylston, MA 01583. (617) 835-6082.			•		•		477

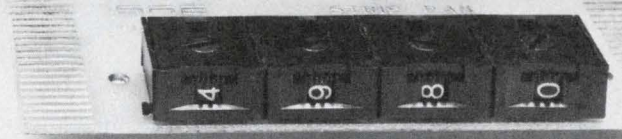
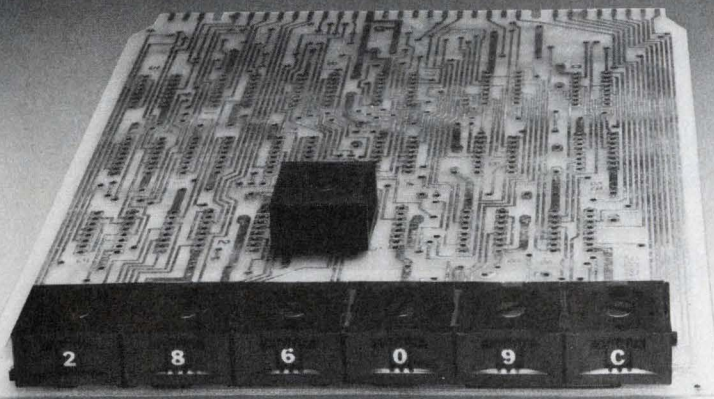

# SNAPPY LITTLE NUMBERS

Save time and money with SAE Strip-Pak™ rotary PCB switches. These snappy little numbers come in a wide range of output codes, and are the most reliable PC board rotary switches you can buy.

The unique modular design of Strip-Pak switches lets you snap them together in strings. You can even mix output codes within the same gang. And Strip-Pak switches can be placed individually, too, either horizontally or vertically, any place on a board.

Additional versatility is provided by a choice of three operating methods: by thumb pressure, with a screwdriver, or with an optional snap-in knob.

SAE Strip-Pak switches are every bit as tough as they are versatile. We use a beryllium copper detent spring instead of plastic teeth or gears, for an operating lifetime of 500,000 detents. And that's a snappy *big* number.

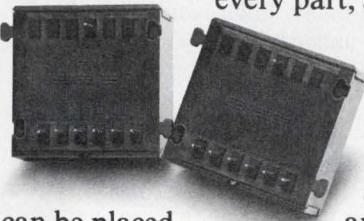

More reliability comes from total in-house manufacture. SAE makes every part, inspects every part, and controls every detail of assembly.

We use tighter tolerances and we demand more precise registration of code discs and contacts. Every switch is a work of art.

Preformed, heat-treated terminals are made from 30 percent thicker stock, and the glass filled polyester housing resists both moisture and solvents. The terminals are completely sealed so you can wavesolder without flux wicking.

SAE makes a complete selection of switches, including large thumbwheels, programmable Bit™ switches and Strip-Pak switches. Write or call us and ask for a catalog.

We're Stanford Applied Engineering,  
340 Martin Avenue, Santa Clara, California  
95050. 408/243-9200.



The OEM Connection

CIRCLE NUMBER 19

age to be hermetically sealed.

The SPX 2231 has a 20 to 30-ns rise time and a 907-nm radiant power output of 2 to 3 mW at 100-mA bias.

In the Spectronics SPX 2478 detector package, which is mounted in a TO-46 can, an optical condensing cone is incorporated between the window and the chip to redirect the radiance from the fiber onto the sensitive area of the chip. Responsivity with this package is 0.5 A/W at 900 nm.

Spectronics' SPX 2231 and SPX 2478 sell for \$40 each in 1-to-9 quantities and \$12 for 1000-up.

### LED performance improving

At the same time, the refinement of LED-chip technology and driving circuitry is raising power outputs and pushing bandwidths above 300 MHz—more than adequate for hundreds of short-link applications. Improvements have already been reported that indicate LED technology will approach the Gbit region.

As a matter of fact, semiconductor lasers for fiber-optics applications—which are easy to drive—have higher outputs and much greater bandwidth capability than LEDs. But widespread use of lasers in operational systems will lag substantially behind LED-system refinements. For one thing, adequate laser life has not been demonstrated in typical working environments. An increase in power output decreases device life.

Moreover, the power output of these lasers is highly temperature-sensitive. A 1-C increase in diode temperature causes about a 5% decrease in radiated power.

However, the laser problems are well defined and researchers both in private industry and under military contracts are confident that the 100-Gbit second-generation systems are, at the most, only a few years away.

Optical integrated-circuit systems, which have even greater bandwidth and switching potential, are in the research stage, but will not be practical for 10 to 15 years, according to researchers.

### On the verge

Right now, however, fiber optics has come to the brink of a new-technology explosion. One reason is that fibers have been developed with losses low

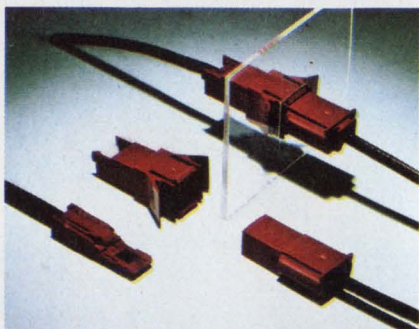

**A new dual-channel fiber-optics connector** by AMP is suitable for either bulkhead or PC-board mounting.

enough to make long systems practical.

The first 20-dB/km fiber was produced in 1970 by Corning and improvements have continued until today. Fibers with 10 to less than 6 dB are readily available from a number of sources. Commercial fibers with as low as 3 dB/km have been announced by some vendors. And losses less than 0.5 dB/km have been reported in the lab.

Also, as fiber continues to be improved, its price steadily drops. And as production and competition increase, the price will keep dropping. Last year alone, fibers dropped in cost by 50%, points out John Williams, manager of fiber-optics systems for Harris—and the price is expected to decrease another 25% this year.

What's more, the cost of low-loss, graded-index, high-bandwidth fibers will be under \$.25/m by next year, says Valtec's marketing manager, Rich Curny. And plastic-clad silica, which is rapidly becoming the workhorse of short-range systems, will cost even less because of its increasing use.

### Moving forward with change

In general, optical fibers are moving fast. A year ago, 45-mil bundles—an offshoot of the Navy's R&D programs—were the most in demand. Each of

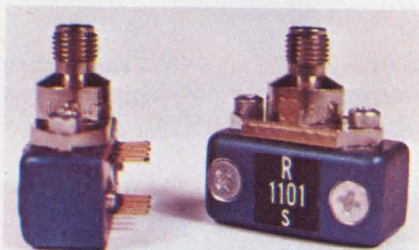

**Optical transmitters and receivers** are packaged in PC-board-mounted MoDel Superdip devices by Meret.

the 45-mil cables contained some 200 glass fibers, which gave the cable inherent strength, but added to the cost.

To reduce fiber costs, emphasis in both design and production has shifted from the 45-mil bundle to cables with bundles holding 7 to 19 fibers, such as those supplied by Corning, Galileo, ITT and Valtec, among others.

A variety of low-cost single and multipin connectors are available from a number of sources for the bundles. Strength for these cables is provided by plastic jacketing and Kevlar plastic strength members.

What's more, a transition has begun from bundle to single-fiber technology in the form of large, plastic-clad-silica single-fiber cables, like DuPont's PFX-S1200R and Valtec's PC-10. They are big enough to be used with bundle connectors. However, small single fibers aren't used generally yet because only special costly connectors are available for them. But this may change because Harris, which has been producing high-performance single-systems for the Defense Dept., has recently redesigned its single-fiber connector and is negotiating to license a connector organization to make and sell them.

Amphenol is introducing a new single-fiber connector and will start production this month. Target price is under \$20 in small quantities. Allen Kasiewicz, general products manager, says that the connector interface losses will lie between 1.5 and 2 dB in the IR range for the initial versions.

Another connector innovation, a high-density package connector, is used to terminate fiber-optics ribbon cable. Developed by ITT Cannon, the connector is designed to terminate large plastic fibers with medium-loss characteristics varying from 15 to 40 mils in diameter.

The Cannon connector houses LEDs or PDs in TO-packages and mates with PC-board-electronics drive and amplifier circuits. Designed for mass termination of the fiber-optics lines, the ribbon cable is severed by a guillotine-like tool and terminated.

AMP's latest fiber-optics connector is a dual-channel bulkhead and PC-board connector for single-plastic and bundle-glass fibers. The maximum splice loss is 3 dB with DuPont's PFX-P240R fiber. Unlike other fiber-optics connectors, it can align fibers of different diameters and join single plastic fibers to a glass bundle. ■■

Protection that adds value. . .

# Let your imagination run wild!

We did.

And today we offer you the world's most versatile line of OEM circuit protectors, so you can. . .

- Protect any kind of equipment against shorts, overcurrent, overvoltage, undervoltage—singly or in combination.
- Get precise, temperature-stable protection in *any* rating from 0.010 to 225 amp, with complete freedom from nuisance tripping and in-rush problems.
- Boost your product's reliability reputation by eliminating fuses and unnecessary service calls.
- Spruce up any front panel with even our lowest-cost breaker (rocker, pushbutton, and two styles of toggle handle), and let it double as the on/off switch.
- Protect air conditioning and heating equipment with a UL-listed 480/600-V protector that's more compact than many 240-V protectors, and costs about the same.
- Simplify switching and control schemes with our auxiliary switch, relay-trip, Du-Con™, and other special-function internal circuits.

These are just some of the ways our products can add value to your products. You can dig deeper by requesting your free Protector Selector—a handy reference chart loaded with specs, capabilities, and even dimension drawings on twelve top-selling protector lines. Get it from your nearby Heinemann representative (listed in EEM) or Heinemann Electric Company, Trenton, NJ 08602. (609) 882-4800.

**another reason Heinemann is No. 1 in OEM circuit protection.**



## HEINEMANN

**We keep you out of trouble.**

Factories in Trenton, Montreal, Dusseldorf, Johannesburg, and Melbourne.

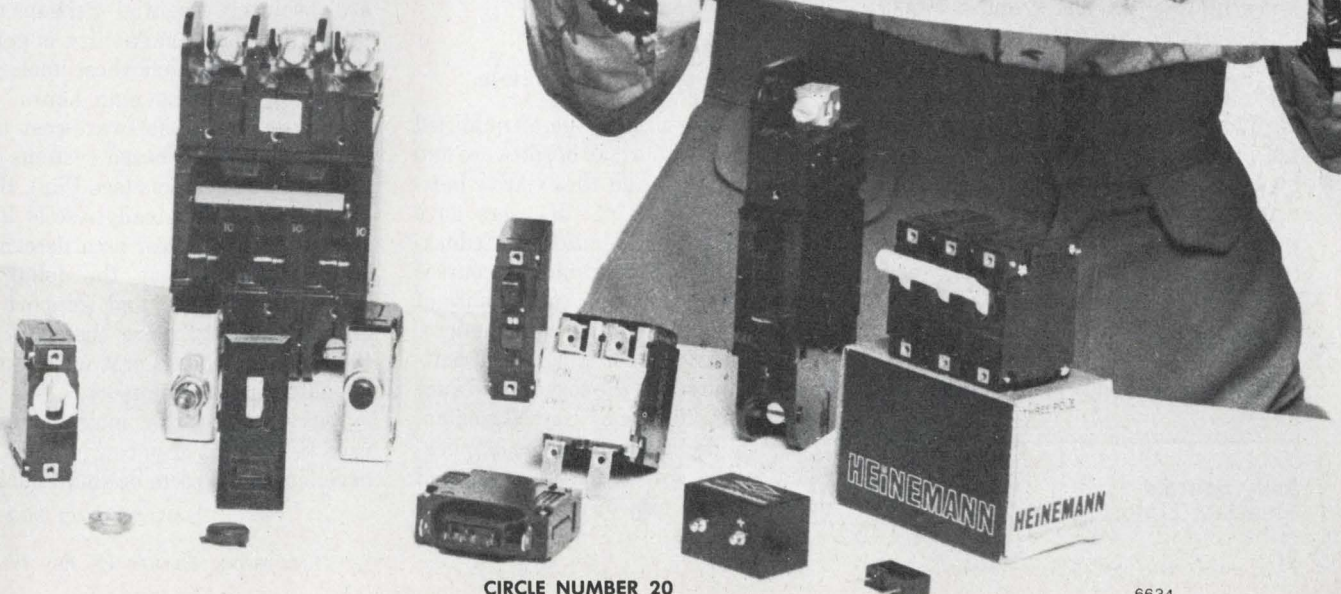

# Software called the key to future $\mu$ P designs

Major design changes in microprocessor-based systems will take place in software, not in hardware, engineers were told at the National Computer Conference in Dallas last month. The most significant trend will be away from assembly-level languages and toward higher-level languages that are easier to use.

"By 1980, most of the low-to-medium-volume applications will be programmed in high-level languages," says David Guzeman, president of Iasis Inc., Sunnyvale, CA, speaking at the NCC panel on the impact of microcomputers in the 1980s. Adds Don Pezzolo, manager of product development at Cognition Inc., Mountain View, CA: "This radical change in the language character of the microprocessor will be necessary if microcomputing is to grow as fast as projected."

But at this point, software is extremely expensive. According to Timothy Barry, an engineering consultant in Mountain View, "Conventional wisdom says that debugged, documented, and delivered microcomputer programs cost around \$5 per byte. Specialized, optimized or otherwise tricky programs can easily cost double that. So it can cost around \$80,000 or more to fill a 16-k memory with a program. Since the memory costs under \$1000, that's around an 80/1 program-cost ratio, and it will surely go up."

Programming is not as simple as hardware design since in most cases the program is written and debugged by designers more familiar with hardware, says Guzeman. The vast majority of this programming takes place at the assembly-language level, and higher level languages and software debugging tools are notably lacking.

So even as hardware costs have decreased tremendously, notes Guzeman,

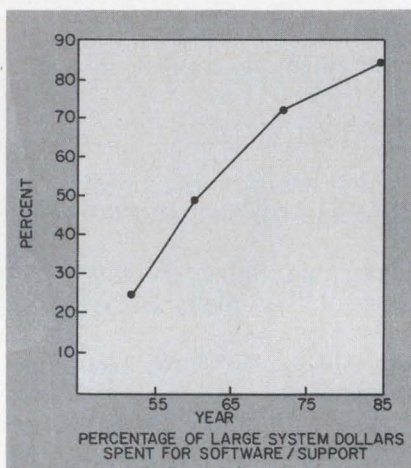

**Most of the money goes to software** in large-computer systems, a situation now faced in microprocessor systems, too.

software costs have not come down at all. What's more, "Experienced microcomputer programmers are in high demand, and the gap between supply and demand will widen."

"Probably the worst person you could find for a microcomputer project is a large-system veteran with 10 years of experience," adds Barry. "What is really needed are real-time programmers with a good feel for machine operation."

## Engineers need design help

Along with a shortage of qualified programmers, the lack of software and debugging tools and the relative inexperience of many of the users have created a heavy demand for educational material, programming courses and training systems. And because of the dramatic drop in the cost of microprocessor hardware, "the cost of software far outstrips the cost of hardware for most applications." Says Guzeman, "Only in the largest-volume applications is the software cost amortized over enough units to make it a small

fraction of the hardware costs."

"Micros may be cheap to buy, but they are no bargain to program," says Barry. "In programming terms, microcomputers are probably the most expensive computers running."

A major reason for the high cost of programming microcomputers is the architecture employed in CPU chips. Unlike large-scale and minicomputers, microcomputers are limited in the number of input and output lines they may have by the small size of their packages. Lines must therefore be omitted or multiplexed with other lines, which complicates the programming problem. Barry explains, "the architectures are all quite restrictive in terms of word size, instruction set, and execution speed. This is no problem once users adjust to the restrictions, but there is an initial tendency to overestimate the available capabilities."

What's more, microprocessor manufacturers rarely provide sufficient software support for their devices. Even the expensive and complex development tools available from microprocessor vendors are inadequate for the task. "This situation has improved, but there is still a long way to go," Barry notes. "Rapid source entry, editing, and sophisticated debugging tools are absolutely essential. Perhaps more important than availability is getting users to realize that these tools save money by lowering man hours."

Comparing the software-cost trend in microprocessor-based systems with that of large systems (see Fig.), Barry notes that in the steady rise of large-system software cost as a percentage of total system cost, the dollar bite going to software and support has already risen to more than 70%. By 1985, 85% of system cost will be going for software and support.

Barry believes that microprocessors used in systems applications such as a development system or small business

*(continued on page 38)*



# DP Dialogue

Notes and observations from IBM that may prove of interest to the engineering community.

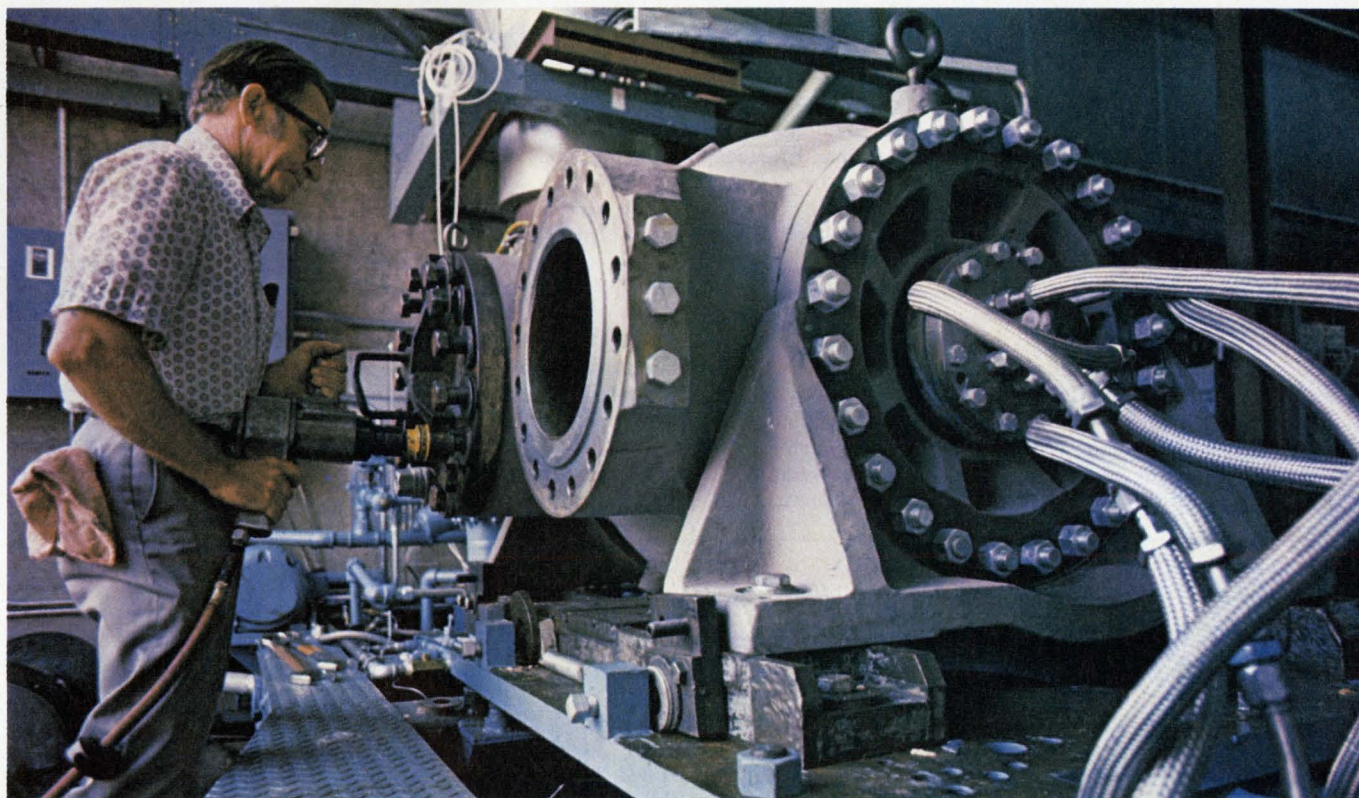

*Gas turbine-driven compressors must be custom-configured for each application. Engineers at Solar use an IBM computer interactively to find optimum specifications in minutes.*

## Solar Finds Best Pipeline Design with TSO

"When a customer asks us to recommend a compressor, one of our engineers enters the details at a terminal, and the computer immediately selects several suitable configurations. A computer-driven plotter then draws performance curves for each one, so the customer can compare them graphically."

Douglas McKerrow, manager of systems analysis for the Solar Group of International Harvester at San Diego, is describing Solar's use of Time Sharing Option (TSO). This IBM facility allows engineers to interact directly with the company's System/370 Model 158, operating their application programs through six visual display terminals.

Among other products, Solar makes turbine compressor systems which propel natural gas through cross-country pipelines. Each system is individually configured to meet customer needs. Tak-

ing into account all possible variations in components, Solar can build an eight-stage system in as many as 9,000 different configurations.

"Before we used TSO and interactive computing," McKerrow continues, "we applied a customer's specifications manually to formulas and sets of tables—and came back to him several days later with one configuration for his job. Now we give him a choice."

Solar's interactive facility goes far beyond that. The company can find the best design for an entire gas pipeline of which their compressor systems will be a part.

A customer describes in detail what the pipeline is intended to do. Then an engineer at a terminal interacts with the computer to reach an optimum solution. A pipeline is complex, with a vast range of possible tradeoffs. For example, the

pipe diameter and the spacing between compressors affects the pressure rise at each compressor. Finding the best balance between these two factors is just one such tradeoff.

"Only a few years ago," McKerrow explains, "it took pipeline designers eight or nine months to achieve a satisfactory result. With interactive computing, we can specify a better engineered, more economical pipeline in two or three weeks."

"Moreover, we're constantly improving the quality of our work with interactive computing. Today, we use six times the data we used two years ago, which makes possible even greater precision in our recommendations."

"We have built a powerful selling tool using interactive computing—one which helps our customers use Solar products better."

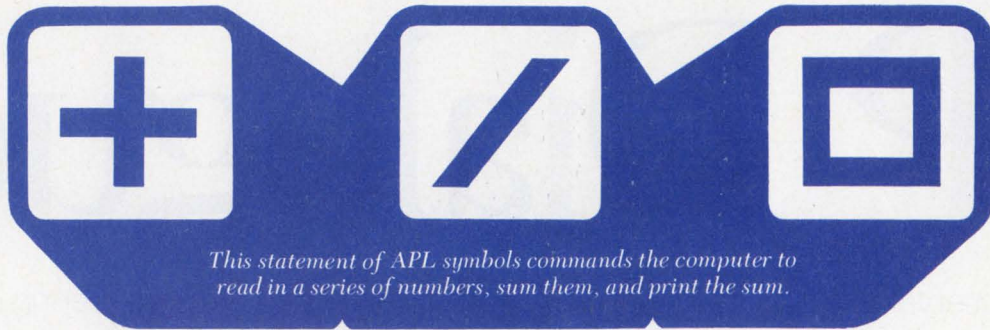

*This statement of APL symbols commands the computer to read in a series of numbers, sum them, and print the sum.*

## APL: A Flexible Problem-solver for Engineers

With APL, an interactive language from IBM, engineers can interact directly with the computer, entering a problem at a terminal and receiving prompt results. APL suits very small calculations—including those “one-time” solutions usually approached manually—as well as large computations such as heat transfer and structural analysis.

Engineers using APL have experienced major gains in productivity; applications have often been developed in one third or less the time required by conventional methods, and at corresponding savings in cost.

The user expresses his problem in familiar language, interacting creatively with the computer in the search for a solution. Tentative results can be presented graphically at an alphanumeric terminal, for quick evaluation, using facilities within APL for generating curves and charts.

The language uses standard mathematical notation in a concise form, capable of specifying extensive procedures in brief statements. For example, consider some vector arithmetic. If A, B and C are each a sequence of numbers (a vector) of 50 elements, which has previously been

entered, then typing:

$$D \leftarrow 1.125 \times A + B + C$$

at the terminal causes the computer to add the three vectors together element by element, multiply each element of the sum vector by 1.125, and assign the resulting 50-element vector to D.

An APL user can be given controlled access to any data in the system, including APL and non-APL files. The language can readily be added to any System/370. It is quickly learned, becoming productive almost immediately. Economically priced, APL can pay for itself many times in faster and better engineering solutions.

## ATMS Gets Specifications Out Faster for Ferguson

“ATMS saves us at least half the man-hours we would otherwise need to produce 150 pages a day of construction specifications,” says Robert C. Lord, Sr.

Lord manages the specification-writing department of the H.K. Ferguson Company, Cleveland, where he uses IBM’s Advanced Text Management System (ATMS), which helps users prepare many kinds of business and technical documents.

One of the 20 largest industrial plant

*Before building a process plant, H.K. Ferguson Company fabricates a detailed model such as this one of a chlor-alkali plant. Such models facilitate planning the piping layout and serve as a guide during construction.*



construction companies in the U.S., Ferguson specializes in building plants for heavy manufacturing, chemical and food processing companies.

“Each process plant we build requires massive documentation to spell out materials and methods for fabricating buildings, piping, wiring and so forth,” Lord says. “A project will typically involve 75 to 100 separate specifications, averaging 10 to 15 pages each.”

“We keep the entire text of each spec-

ification in ATMS,” Lord notes. “To enter revisions, the writer works at an online IBM terminal, using the ATMS editing facilities. Our System/370 Model 125 automatically takes care of any necessary renumbering of paragraphs and pages, and then prints out the entire revised specification at a high-speed printer. We don’t need to key in and proofread any parts of the text which were not altered. Since we average three or four revisions of each specification, this means major manhour savings.”

“We store generalized master specifications in ATMS which include alternative wording covering most requirements,” explains Robert V. Toensing, manager of computer facilities. “The specification writer marks up copy by hand, crossing out inapplicable wording, adding material and entering variable data for the specific project. Then a clerk enters these notations at the terminal; ATMS applies them to the stored master text and generates printed text.”

“This process is very rapid,” Lord adds. “We produce 150 pages a day at a terminal during a normal eight-hour day.”

“And the use of a master specification gives us automatic quality control, since the writers select existing wording rather than write from scratch.”

“ATMS has meant great strides in both the quality and productivity of specification writing at Ferguson.”

# Computer Guides Oil Exploration Teams To Pay Dirt

Drilling for oil is expensive. It can cost \$60,000 a day to keep an offshore drilling platform in operation. Once a rig is in place and drilling has started, the crew needs guidance fast. Should they continue? Should they drill straight down or deflect the hole? What is the next move?

At Amoco Production Company Research, scientists and engineers use interactive computing on an IBM System/370 Model 158, under the Virtual Machine/Conversational Monitor System (VM/CMS) for better insights into oil exploration. Well logging and seismic analysis are two exploratory tools in which the computer plays an important part.

Well logs are vital to evaluate what is found in a drill hole, to determine its value or where to drill next based on that hole. "Without well logs, we just have a hole in the ground. With them, we gather vital data about the rocks, fluids, and geological conditions found in that well-bore," says Michael Waller, vice president, research and director of the Amoco Research Center, Tulsa, Oklahoma.

Sensors measure earth composition—density, gamma ray intensity, porosity, resistivity, and water saturation—and readings are logged at the surface.

Correlation analysis of these variables can then describe the nature of the subsurface geology and the presence of hydrocarbons.

"With so many variables," Waller explains, "there are an enormous number of correlations we could plot. That's why we developed Inlan—Interactive Log Analysis. It permits a geologist working interactively at a computer terminal to explore possibilities and zero in on the most promising."

The computer is also used in the exploration process before drilling begins. Seismic excitation—a shock wave from an explosive charge or a mechanical



*It has been difficult to clarify visually the irregular contours of subsurface geology. Here Amoco scientists examine a three-dimensional model created on multiple sheets of clear acetate.*

"thumper"—is applied to the earth. Reflections from the interfaces between underground geological formations are detected by an array of sensors distributed over the exploration site.

Converting these readings into accurate three-dimensional maps of the subsurface configuration is a complex task. Amoco scientists use interactive techniques and build successive computer models of the geological layers as they expect them to be. They also calculate the sonic reflection path and compare it to the field recording, thus working toward a convergence of the field data with their idea of structure shape.

James G. Steward, manager of com-

puting research, directs a professional group which studies the application of the computer to oil production, conducts program development, and supports the interactive computing environment which gives scientists at the center direct access to computing power through terminals.

"With 300 people authorized to use the terminals," Steward says, "we now average over 400 'log-ons' a day. As many as 70 people may be online simultaneously. The beauty of the Conversational Monitor System for us is that our people communicate with the system in the terms of their science, not in computer talk. People find that they can often develop computer programs or test scientific ideas in a few minutes with interactive computing. It might have taken a week with conventional approaches—or would not have been possible at all."

*DP Dialogue is designed to provide you with useful information about data processing applications, concepts and techniques. For more information about IBM products or services, contact your local IBM branch office, or write Editor, DP Dialogue, IBM Data Processing Division, White Plains, N.Y. 10604.*

## Software Products from IBM

Three products available from IBM fill important needs for engineers and scientists:

**1. General Purpose Simulation System V (GPSS V)** Models any physical or logical system which can be represented as a series of discrete stages, processing points or transaction nodes.

**2. Continuous System Modeling Program III (CSMP III)** Models a continuous process expressed in the form of either an analog block diagram or a system of ordinary differential equations.

**3. Graphic Analysis of Three-Dimensional Data (GATD)** Graphically represents and analyzes three-dimensional data.

For more information on these products, contact your local IBM branch office or write to the Editor of DP Dialogue at the address on the right.

# IBM®

Data Processing Division

computer will follow the same curves, though at a slightly steeper slope due to lower basic hardware costs. In high-volume products such as calculators and video games, however, programming costs are incurred only once, and are therefore a lower percentage of the total cost and the number of units produced increases.

### Approach follows volume

According to Barry, the approach taken by a microprocessor-system designer will depend on the expected volume for the final product, and will be divided into four areas: low to medium-volume industrial applications, high-volume industrial applications, small business systems, and personal computing.

In low to medium-volume industrial applications, development will be handled by the more sophisticated microcomputers and my minicomputers emulating the relatively simple microprocessors likely to be incorporated in control and measurement applications. "The main emphasis will be on high-speed product turnaround and lowest development cost consistent with system requirements," Barry foresees. "In these applications, hardware costs are usually overshadowed by development cost."

In these applications, software will be written in high-level languages whenever possible, says Barry, who foresees a trend toward modular systems that combine predesigned hardware and associated software blocks into systems. "While possibly less hardware and software-efficient than conventional design techniques, this approach will speed the design cycle and cut development costs, thereby making it cost-effective for low-volume custom products," says Barry.

High-volume industrial applications share some features with lower-volume needs, but have some special properties. "Where the low-volume applications emphasize fast turnaround and low development costs, the high-volume applications place low product cost above all else. This means the use of single-chip processors and the absolute minimum of external memory and logic."

High-volume products will incorporate custom designs for both hardware and software, Barry predicts, adding:

"The programming will almost surely be done in assembly language, optimized as much as possible."

Small-business systems are emerging as a distinct software market area, and by the 1980s, should be a significant factor in the over-all software business, Barry predicts. The specifics of the hardware unimportant to the typical small-business-system user, Barry notes, but the typical 8-bit microprocessor, with its small data words, limited address space, and relatively primitive instruction set, has a disadvantage compared with mini-computers in data-processing applications. The software packages needed by

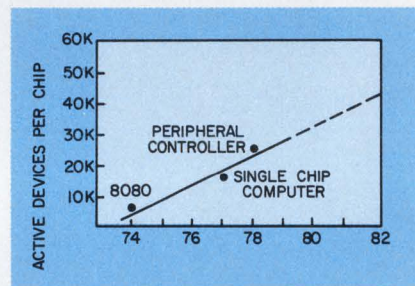

**High circuit complexity in chips** like peripheral controllers means that there's room for growth in  $\mu$ P chips—perhaps to include high-level languages and more memory space.

small-business users will require significant investment by the hardware and software supplier, and mini-computer manufacturers that have already made this investment will have the advantage, Barry observes.

### Consumers need software help

While the fourth application area, personal computing, "has spawned a large number of small companies producing a wide variety of computers and accessories," writing software, says Barry, "is still too formidable for a public that has trouble fine-tuning a color TV set." The percentage of users who will actually program their home computers will be extremely small, and will remain that way until major breakthroughs in programming languages make programming much simpler. "Any 'home computer' will be a black box with canned software interacting with the user via prompts and responses," says Barry.

The problems with microprocessor software are not insurmountable, says Iasis' Guzman. "The semiconductor

industry has the ability to impact software costs in the same way it impacted hardware costs. They need only address themselves to the matter." There are signs that this addressing has begun.

"At least one manufacturer has introduced a single-chip floating-point arithmetic package that plugs into the system bus," notes Guzman. And since this chip replaces 500 to 1000 software instructions, this represents "a tremendous boost in the right direction."

At the same time, Guzman adds, "cheaper memories remove the cost impact of higher-level language programming in terms of inefficient memory usage."

According to Cognition's Pezzolo, "Software efforts will no longer stress memory efficiency but rather high-level languages even for simple tasks." The major effort will be to place more and more capability in silicon circuits in the continuing effort to simplify the software job and therefore restrain the ever increasing cost of software.

Compared with some of the available peripheral chips, today's microprocessors have low circuit densities, Pezzolo points out (see Fig.) adding: "The technology exists for microprocessors to become more complex. This effort will primarily be directed at higher-level language capability since this feature will further simplify the software task. By 1980, we should see the introduction of a microprocessor circuit that will execute a high-level language directly."

Just as semiconductor technology has been the driving force behind the rapid advances in microcomputing hardware, the pool of engineers with the ability to program microcomputers will be the driving force behind rapidly expanding the applications base for microcomputers, according to Pezzolo. "A high-level language is essential if this engineering pool is to grow," he adds.

Says Guzman: "For the first time in the history of the digital IC industry, price reductions and increased circuit complexity are not going to expand the market at anywhere near the rate that has occurred in the past for the small and medium-volume applications that make up the large part of the market, the software has become the most costly item, and reductions in hardware costs no longer have the same impact on over-all systems costs that they once did. More significant software breakthroughs are needed if the systems cost is to be reduced appreciably." ■■

# *ii*ncredibly versati*ii*le

You know about the cost/quality bind. So do a lot of other people.

That's why *iii* recommends and sells Rubycon capacitors. They're hard to beat for dependability and long-life in a competitively-priced capacitor.

And they're ideally suited for a wide variety of products. So you're probably using our Rubycon capacitors already . . . in that calculator on your desk, the CB in your car, the video game you gave the kids . . . and dozens of other places.

Write or call Jim Ambrose for samples and literature. And let's talk about using Rubycon capacitors in your own products.



Rubycon Capacitors. An *iii* exclusive.



*ii*nquiries *ii*nvited



2244 South Western, Chicago, IL 60608, (312) 847-6363

# Incredible performance... at unbelievable prices!

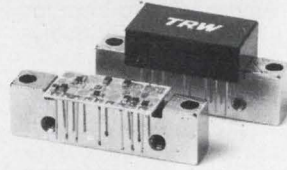

**TRW hybrids shatter the price/performance barrier for RF output power, linearity and dynamic range!**

You'll have to see it to believe it! And we're ready to show you proof. Take a look at some of our typical applications. Look at the gain quoted for each.

Then take a look at the price. Now, in your production units, you can get the performance you'd only expect from precision laboratory gear.

## TRANSMITTER DRIVERS:

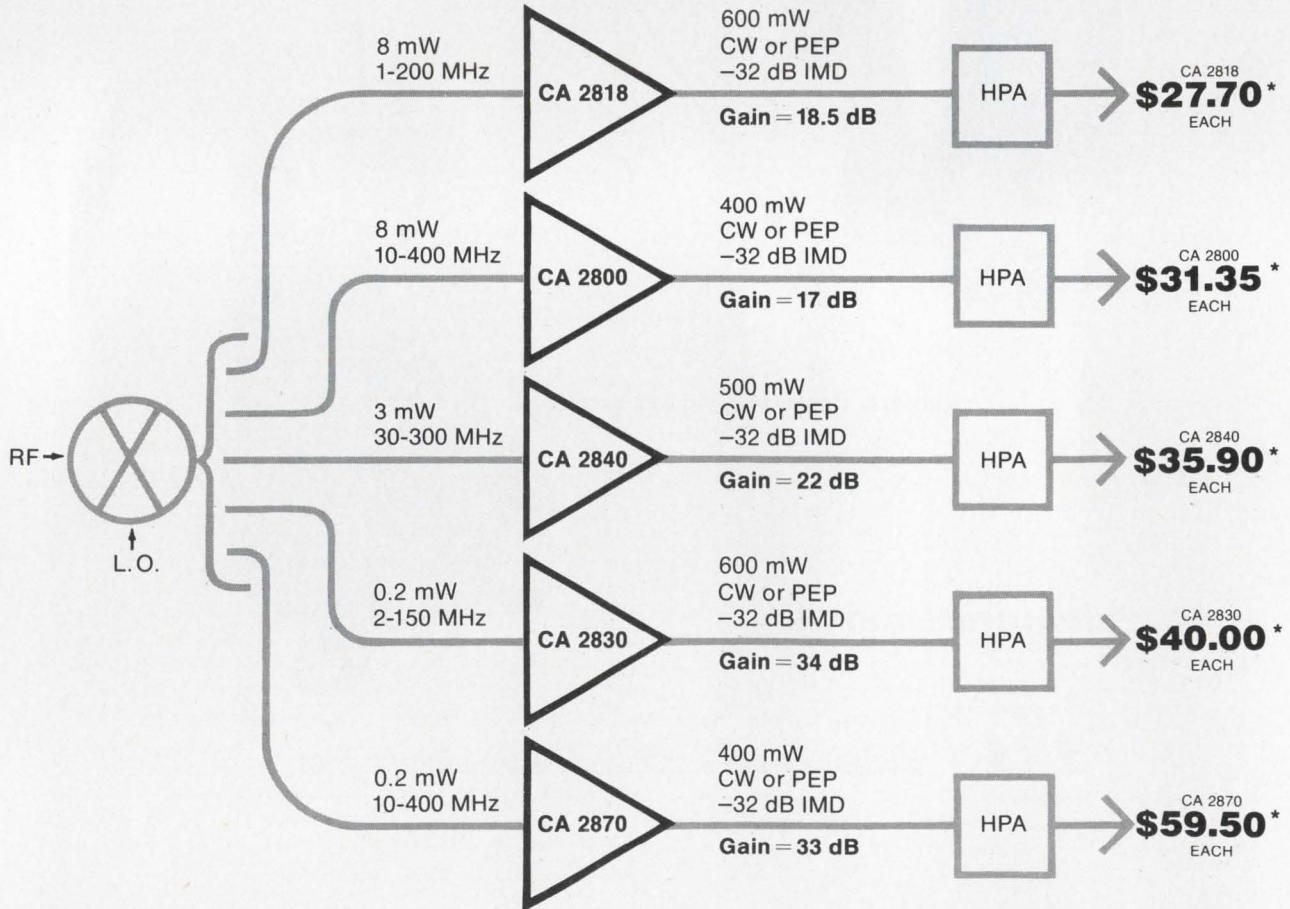

## RECEIVER APPLICATIONS:

40 MHz to 100 MHz IF amplifier.

### STANDARD IF

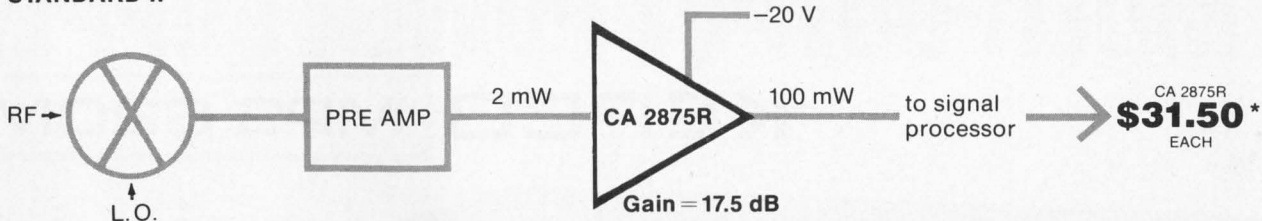

### HIGH PERFORMANCE IF

**Input**  
70 ±20 MHz  
NF = 3 dB  
Z<sub>in</sub> = 75Ω  
Ret. Loss = 26 dB

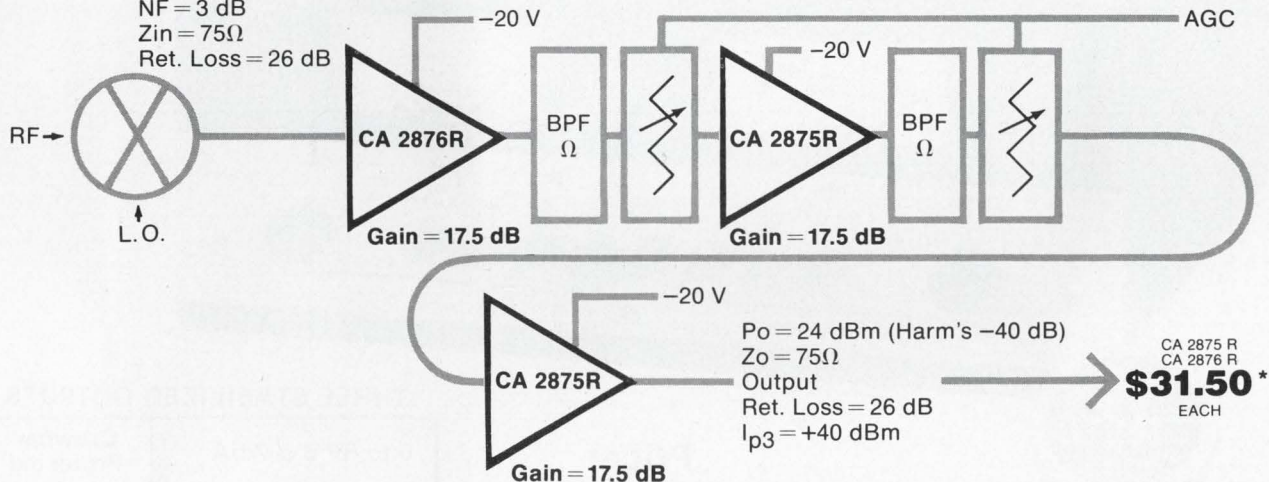

## INSTRUMENTATION APPLICATIONS:

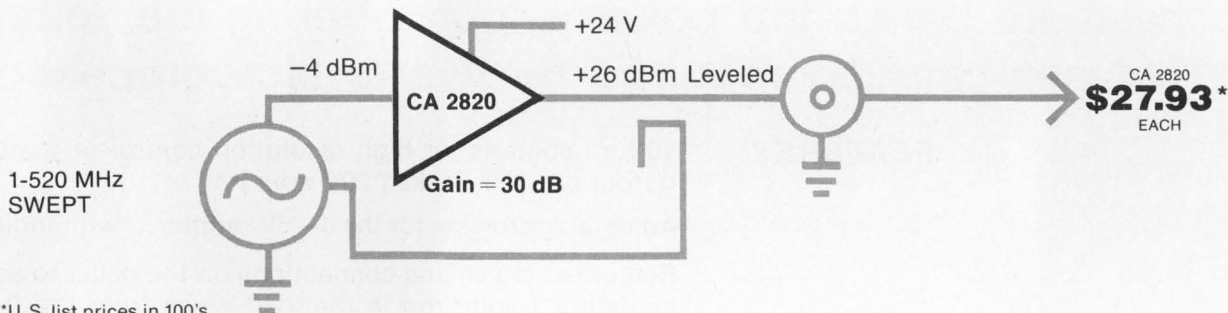

\*U.S. list prices in 100's

These applications are only the beginning. TRW RF linear hybrids can revolutionize design after design...with incredible performance at unbelievable prices. Let us prove it. To get complete data sheets, send us the coupon.

To find out how you can get a free sample and test fixture, call Dan Brayton at (213) 679-4561.

**TRW RF SEMICONDUCTORS**  
ANOTHER PRODUCT OF A COMPANY CALLED TRW

### TRW RF Semiconductors

An Electronic Components Division of TRW, Inc.  
14520 Aviation Boulevard, Lawndale, California 90260

- Please send me your new RF linear catalog.  
 Please have an applications engineer contact me.

(Phone) \_\_\_\_\_

Name \_\_\_\_\_

Position \_\_\_\_\_

Company Name \_\_\_\_\_

Address \_\_\_\_\_

City \_\_\_\_\_ State \_\_\_\_\_ Zip \_\_\_\_\_

introducing:

# A MULTI-OUTPUT POWER SUPPLY

## KEPCO MPS 620M



Price:  
**\$475.00**

### THREE STABILIZED OUTPUTS

0 to 6V d-c @ 5A	Crowbar Protected
0 to +20V d-c @ 1A 0 to -20V d-c @ 1A	Tracking

a convenient bench top power supply offering the voltage/  
current combination required for IC's & microprocessors

- FEATURES:**
- 10-turn controls for high resolution control of the 0—6V output and the tracked 20V outputs.
  - Adjustable crowbar for the 0—6V output ... with indicator.
  - Remote error sensing connections on the panel to accommodate a 1 volt drop in the load wires from the 0—6V output.
  - Full range adjustment of voltages and rectangular current limits (not a "slot" supply, no "foldback" current limiting, and no derating to an ambient of +50°C).
  - All three outputs available simultaneously and at full rating.
  - Convection cooled.
  - Two large recessed meters with switch, to monitor voltage and current.
  - Rack mountable in a 5¼" rack space (¾ width).

**KEPCO**® For complete specifications, write Dept. AZF-05

KEPCO, INC. • 131-38 SANFORD AVENUE • FLUSHING, N.Y. 11352 U.S.A. • (212) 461-7000 • TWX #710-582-2631 • Cable: KEPCOPOWER NEWYORK

CIRCLE NUMBER 23



# Washington report

---

## Navy still favors Seafarer, balks at laser sat

The Navy insists that its Seafarer ELF communications system is the only feasible way to maintain contact with submerged submarines, despite Congressional pressure to investigate spaceborne blue-green lasers as an alternative.

The laser approach represents too great a technical risk according to Navy Capt. Daniel E. Donovan, Seafarer program coordinator, at the recent Armed Forces Communications and Electronics Association conference in Washington. It will not be ready by the mid-1980s to support the Trident submarine, he said, and may cost more in the long run than Seafarer.

The House Appropriations Committee denied the entire \$23.7-million Navy request for Seafarer, but the House and Senate Armed Services committees in joint conference authorized \$20.1-million—plus another \$5-million for laser experiments, which the Navy didn't request.

The Navy wants to install Seafarer on Michigan's Upper Peninsula because the hard-rock strata there will increase the effective radiated power of the 75-Hz signals. The ground conductivity there is  $8.4 \times 10^{-4}$  Mhos/m vs  $149 \times 10^{-4}$  Mhos/m for an alternate site in Nevada and  $417 \times 10^{-4}$  Mhos/m for another proposed site in New Mexico. As a result, the Nevada site would have only 26% of the performance of the Michigan site and the New Mexico site only 10%.

## British to share in new Army radio production

By the end of this year, the Army Electronics Command expects to select at least two design contractors for a new field-army VHF radio, the Single Channel Ground and Airborne Radio System, and British industry is virtually assured of a share of the production phase. SINCGARS-V is estimated to cost \$450-million in current dollars (before inflation).

Racal-Tacticom, a British firm that recently updated and consolidated the British Army's tactical field radios with its Clansman VHF manpack series, is the prime contractor on one proposal team; RCA Government Communications Systems is its subcontractor. Another British firm, Marconi Space and Defense Systems, is the subcontractor on a Cincinnati Electronics team. A third British firm, Plessey Ltd., is expected to join one of the other two bidders, ITT Avionics Div. or GTE/Sylvania, as a subcontractor.

Currently, the U.S. Army uses 20-year-old technology. Since radios such as the PRC-77 achieved good reliability in Vietnam, typically 750 hours mean time between failure (MTBF), there has been no compulsion to upgrade them. However, the U.S. Army has become interested in VHF radios because of the increasingly sophisticated-electronic-countermeasure (ECM) environment in Europe, which will require more antijam capability in tactical communications.

Originally, the design competition, which is expected to last through 1980, had been limited to U.S. firms. But the British complained that this violated the Pentagon's policy of establishing a "two-way street" in weapons sales, and

successfully opened the competition to other NATO countries.

All competing designs will be demonstrated under simulated battlefield conditions during the first six months of 1981, with production due to begin in 1982. About 165,000 units are projected from 1982 to 1992.

## **Air Force to improve comsat antijam security**

A single-channel transponder has been added by the Air Force to its new series of Defense Satellite Communications System (DSCS III) satellites to improve their resistance to enemy jamming.

The transponder will receive data at UHF and SHF frequencies from flying military command posts such as the ED-135 and E-4, and relay the data to strategic bombers such as the B-52 and FB-111 via a UHF downlink. It uses secure digital-signal processing and digitally controlled frequency synthesizers demonstrated in the experimental LES 8 and 9 Air Force satellites developed by the Lincoln Laboratory of MIT.

## **Mm-wave airborne data transfer demonstrated**

The Navy has successfully proven that a hand-held millimeter-wave transceiver can transfer computer data between two P-3C Orion antisubmarine warfare (ASW) patrol aircraft in flight. In the two prototype transceivers used—from the Norden Div. of United Technologies Corp.—a single varactor-tuned Gunn oscillator is both the transmit source and receiver local oscillator.

In addition, the Norden equipment, which is also being evaluated by the Army for possible battlefield use in Europe, weighs 5 lb (including lithium batteries for 20 hours of operation) and can provide either a 4-MHz full duplex voice channel or a 5-MHz half-duplex, high-speed data channel. An integrated microwave front-end package contains most of the microwave componentry, including a low-noise Schottky diode-balance mixer.

In the test, one P-3C simulated an aircraft returning from an ASW mission and the other, an aircraft going out on station. As the aircraft came within 8 miles of each other, the returning aircraft dumped all the data in its computers to update the computers of the aircraft beginning its mission.

**Capital Capsules:** The Energy Research and Development Administration (ERDA) is asking for industry proposals on **advanced optical pumps to drive visible wavelength lasers**, which will be used in a laser-fusion power experiment. The pumps would use rare gases to generate vacuum-UV radiation for confinement. ERDA plans to award several one-year contracts worth \$400,000 to \$500,000 each, and proposals were due July 15 at ERDA's Laser Fusion Div....The Air Force plans to issue requests for proposals toward the end of this year on a new **data link to receive surveillance information from reconnaissance aircraft and drones**. Known as the tactical Reconnaissance Data Link, the program is being directed by the Aeronautical Systems Div., Dayton, OH....**The Navy is budgeting \$52-million over the next two years to begin a top-secret project known as Pilot Fish (Program Element 63525N)**, which (sources believe) is a transmitter that will be placed on the ocean floor to give directions to submarines....Another top-secret Navy project—due to begin next year—is an ocean-surveillance satellite nicknamed Clipper Bow (PE 63763N), which involves a **spaceborne radar for targeting enemy ships**. The satellites are due to be launched in 1983 and 1984.

# Only one 100 MHz portable STORES a 100 MHz single-shot waveform

Almost storing isn't enough. If you want to capture and retain glitches in a data system, pulsed rf sinewaves in a radar system, or any other non-repetitive phenomena at 100 MHz, you need a scope that stores pulses at very fast speeds. That's a tough job for all portable storage scopes except the TEKTRONIX 466.

With 3000 div/ $\mu$ s (1350 cm/ $\mu$ s) stored writing rate, the 466 is the only 100 MHz portable that stores pulses at its full bandwidth and deflection. And this makes it a valuable test instrument to carry in the field.

The 466 is not only fast, it's versatile. To study fast-rise, high-speed or single-shot waveforms, use the fast-mesh transfer mode. Or if you need to study sharp, non-flickering displays of slow-moving or low-rep-rate signals, use variable persistence storage.

In either mode, a SAVE feature will retain the signal for extended periods of time.

To add even more speed and accuracy to storage measurements made with the 466, the DM44 with a built-in digital multimeter is now available as a factory-installed option. The DM44 also adds differential time measurement capabilities to the 466.

Take the lab-type performance of the 466 into the field for on-site testing. It weighs less than 30 pounds. And when line power isn't available or when you want to isolate the 466 from

noisy or intermittent power sources, use the snap-on 1106 Dc Battery Pack. (Option 07 required.)

For more information or a demonstration of the 466, contact a Tektronix Field Engineer near you. Or write Tektronix, Inc., P.O. Box 500, Beaverton, OR 97007. In Europe write Tektronix Limited, P.O. Box 36, St. Peter Port, Guernsey, Channel Islands.

**Tektronix**<sup>®</sup>  
COMMITTED TO EXCELLENCE

For technical data circle #24

For demonstration circle #25

A 100 MHz single-shot waveform before there was a portable that could store at its full 100 MHz bandwidth.

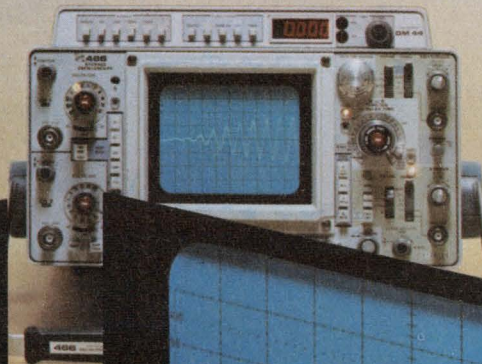

A 100 MHz single-shot waveform captured with the TEKTRONIX 466 Portable Storage Oscilloscope.

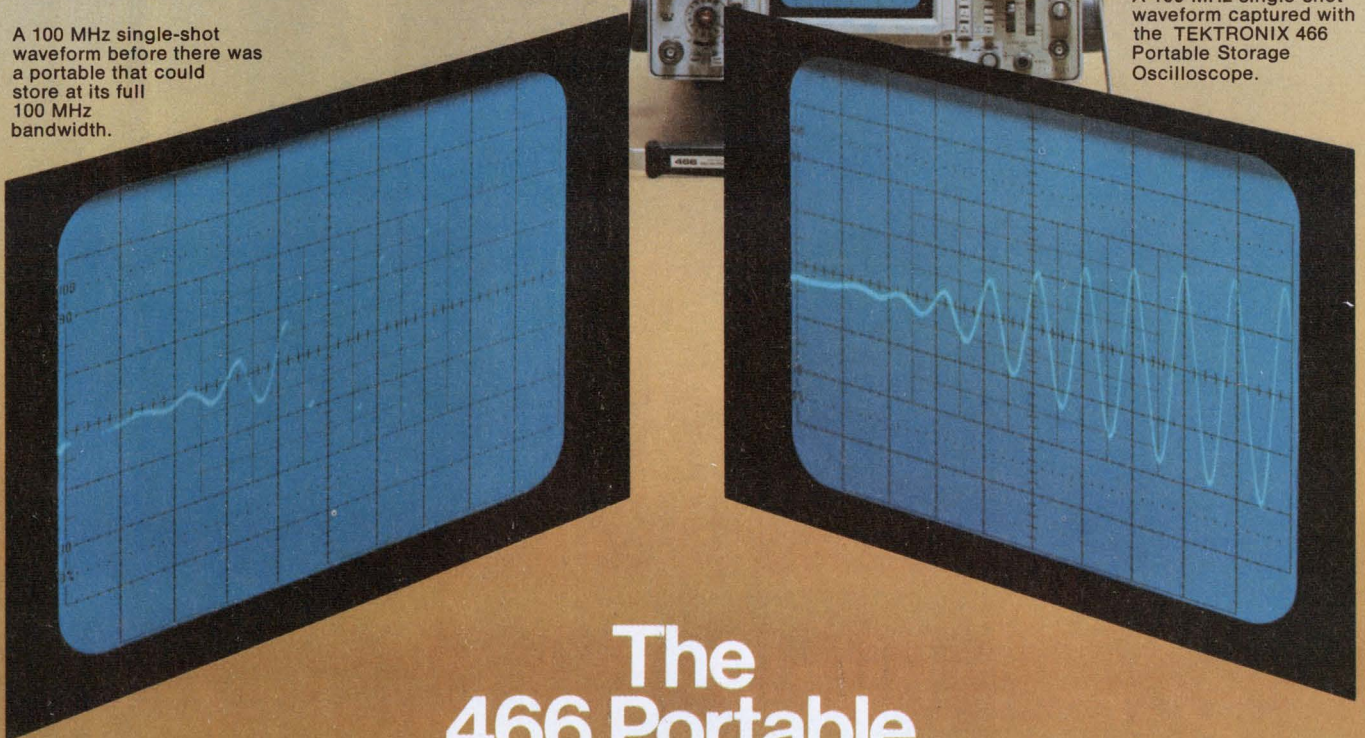

## The 466 Portable from Tektronix

**NOW DELIVERING**

# The 1602A

## A lot more computer in a smaller package

We've taken our proven and powerful 1602 (AN/UYK-19) and doubled the internal memory to 64K, developed a single microprogrammed CPU module, included space for seven I/O interface boards and two RAM/ROM slots, and value-engineered the whole package into a single 19½ inch ATR chassis. In the process we trimmed off weight and added a combined Floating Point/Built-in Test (BITE) capability . . . plus a number of other options.

End result—You get a microprogrammed military processor with a 150 to 250 nanosecond microcycle time that's most economical in terms of size, weight and memory requirements. And it's absolutely compatible with your previously developed 1602 software.

What we didn't reduce is our extensive set of software, our quick delivery and our world-wide service.



## That's Why We're #1 in Mil-Spec Computer Systems

**ROLM**

MIL-SPEC  
Computers

4900 Old Ironsides Drive, Santa Clara, CA 95050. (408) 988-2900. TWX 910-338-7350.

In Europe: 645 Hanau, Muehlstrasse 19, Germany, 06181 15011, TWX 418-4170.

CIRCLE NUMBER 26

# Need a 2-digit BCD DAC?

Our DAC-20 is the world's first monolithic 2-digit BCD-coded DAC. Gives you very high speed performance (85nsec settling, typ.) with very low power consumption (37mW), terrific nonlinearity ( $\pm 1/4$ LSB Max. over temp.)—all for very low cost.

It's simple to use. Provides a universal logic interface for TTL, CMOS, ECL, or any other logic. Full noise immunity is provided by high swing adjustable threshold logic inputs. And dual complementary current outputs with  $-10V$  to  $+18V$  compliance give you a voltage output with only a resistive termination. No speed-limiting output op amp needed.

Just ask . . . Applications for our DAC-20 series range from audio attenuators and analog meters to modems and micro-processors. We'll be glad to send you a data sheet full of these and other application ideas

using the DAC-20 in such things as reference amplifiers, logic threshold controls, and multiplying circuits with bipolar or pulsed references. Just circle the reader service number for a copy. And if you would like a free sample DAC-20, write us on your letterhead and tell us what application you're thinking about. We'll be glad to help you get going. Write DAC-20 at the address below. Thank you.



Precision Monolithics, Inc.,  
1500 Space Park Drive,  
Santa Clara, CA 95050  
(408) 246-9222. TWX 910-  
338-0528.

CIRCLE NUMBER 27

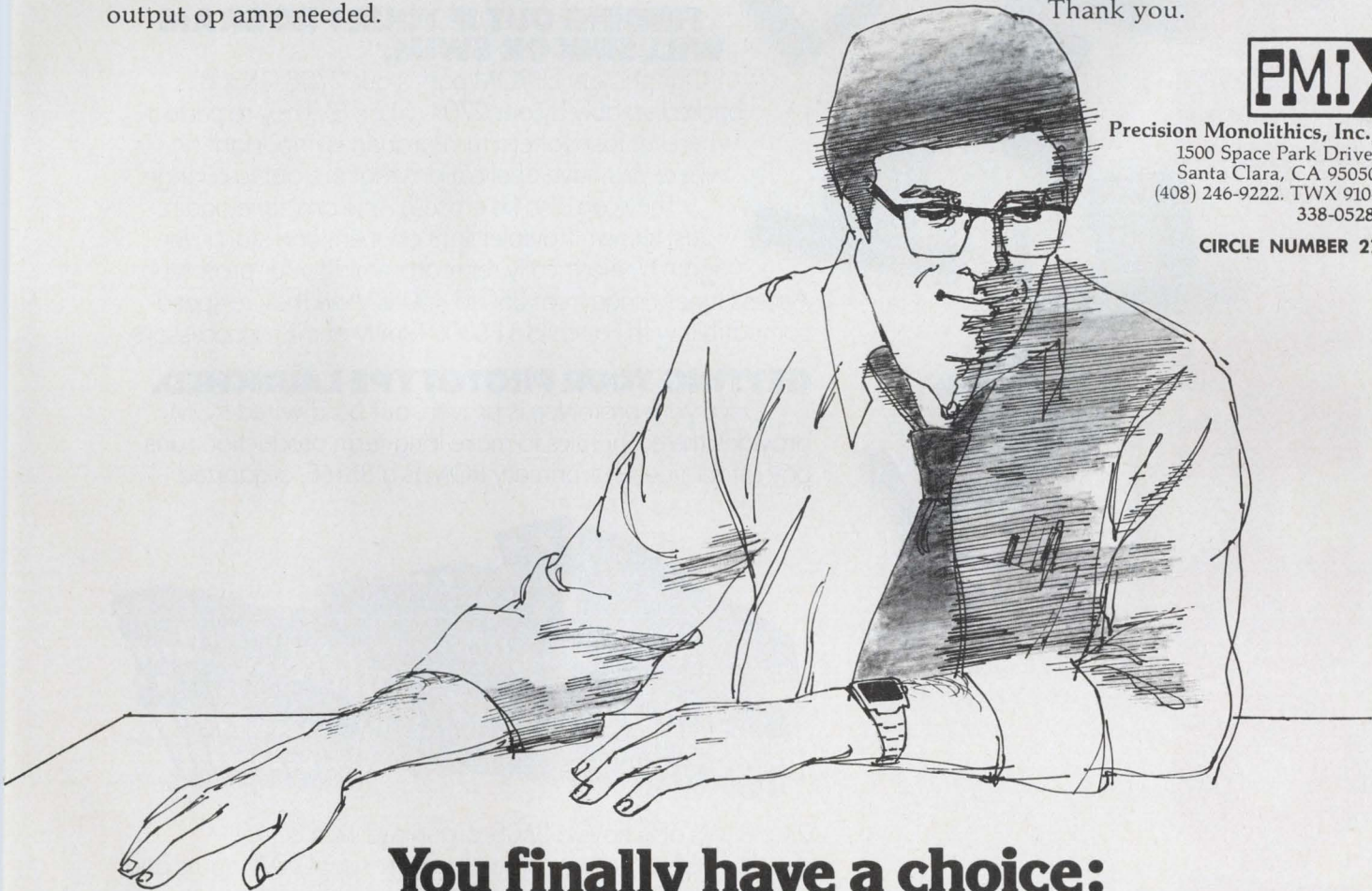

**You finally have a choice:**

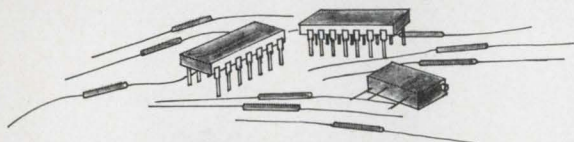

**Make**

**Buy**

# MOS MEMORY

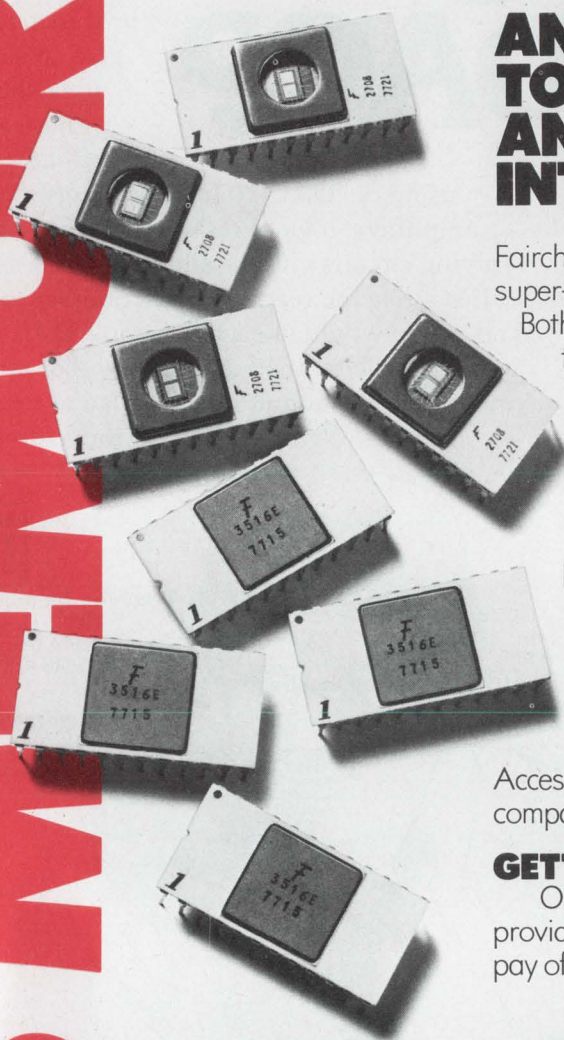

## ANNOUNCING AN EPROM TO TEST THE WATER AND A ROM TO PLUNGE INTO PRODUCTION.

Fairchild is making a splash in the Memory market with a super-flexible EPROM and a super-economical 16K ROM. Both compatible with each other. So now you can get fast turn-around on your prototypes and economy on your high volume production runs all from one source. And a leading Memory source at that.

### FINDING OUT IF YOUR PROGRAM WILL SINK OR SWIM.

Our primary EPROM part is our 2708 (1K x 8), backed up ably by our 2704 (512 x 8). They're perfect wherever fast pattern turn-around is important or where you have applications that are apt to change.

They can also be erased. Time and time again.

Just shine ultraviolet light on them and start over again by electrically reprogramming your prototype.

Access times range from 350 to 450ns. And they're speed-compatible with Fairchild's F6800 family of microprocessors.

### GETTING YOUR PROTOTYPE LAUNCHED.

Once your prototype is proven, our hard wired ROM provides the economics to make long-term production runs pay off for you. Our primary ROM is a 3516E, organized

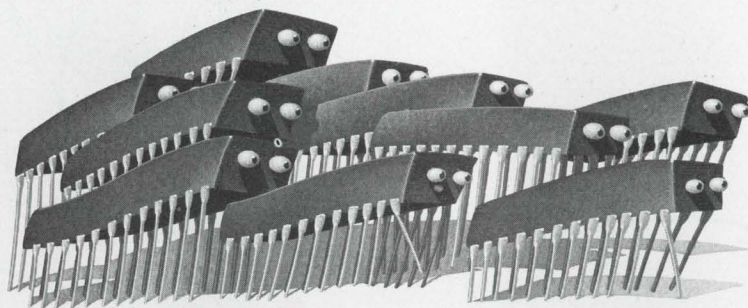

2K x 8. We also have a 3508, organized 1K x 8.

Our 3516E features a 5-volt power supply. All inputs and outputs are TTL-compatible. It also features microprocessor-

compatible access times, 3-state outputs and completely static operation.

Not to mention three programmable chip select inputs, fully decoded-on chip address decoders and inputs protected against static charge.

### **WE'LL KEEP YOUR PRODUCT ABOVE WATER.**

Fairchild is a proven name in the memory business. With a large and distinguished family of MOS products. A full understanding that the ROM business is a service business. And a track record for hassle-free initial cycle programming and speedy delivery of prototypes.

We are equipped to accept data in half a dozen different formats: Card decks. Mag tape. 733 TTY Cassette. HP 2644 Cartridge. Paper tape. Or Coded ROMs or EPROMs. And turn them all into 3516E ROMs ready for shipment.

We've also just completed another new domestic production plant. It's devoted 100% to MOS and it's already turning out devices. So when we promise delivery in 2-4 weeks, we can deliver on that promise.

### **YOU'D HAVE TO BE ALL WET TO IGNORE SUCH A DEAL.**

Then, as if pinpoint performance and timely turn-around aren't enough, our ROMs and EPROMs are priced so competitively it hardly pays to buy anyone else's.

So if you'd like to jump right in with an order, or simply learn more about our line, write or call your Fairchild sales office, distributor or representative today. Or use the direct line at the bottom of this ad to call our Memory experts direct.

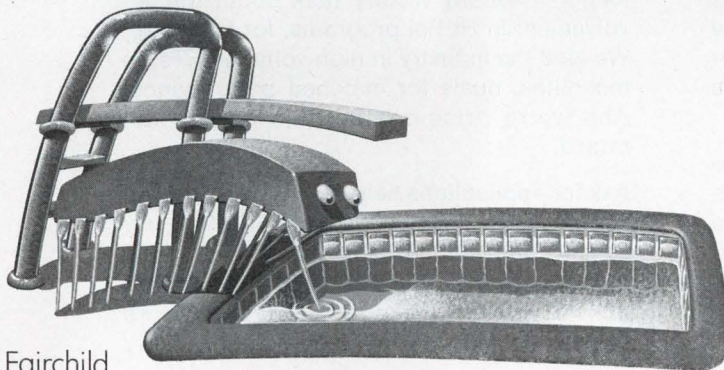

Fairchild  
Camera and Instrument Corporation, 464 Ellis St., Mountain  
View, Calif. 94042. Tel: (415) 962-3941. TWX: 910-373-1227.

**FAIRCHILD**  
**CALL US ON IT.**  
**(415) 962-3941**

# GET FETs

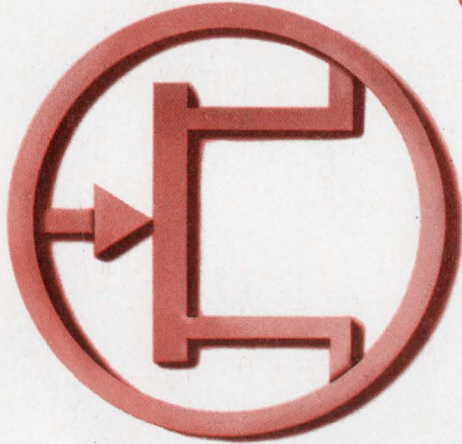

**FOR  
RF,  
AUDIO,  
VIDEO,  
MIXERS,  
SIGNAL SWITCHING,  
CURRENT SOURCES,  
HIGH VOLTAGE**

**Dial (415) 968-9241 for samples or design help**

It's that simple. Just ask for Walter Wong. He'll be glad to help you decide which of our broad FET line will meet your need and how to use it best. Or drop him a line on your company letterhead. He'll send your sample by return mail.

**FETs for all applications.** Whatever you're designing—if it's a function FETs can handle—you can be sure we'll have a FET with the precise characteristics to meet your need. You can be sure, too, that the performance of production orders will be consistent with the samples you test.

**Profit by our experience.** We've been making

FETs longer than anyone else. We have a longer reliability history (ask about our involvement in Hi Rel programs, for instance). We lead the industry in high voltage FETs; in monolithic duals for matched performance. And we're price-competitive across the board.

**Ask for applications help.** If you'd like design assistance in the best use of FETs for your specific application, just ask. If your need is more general, our FET Application Data Book is just off the press. It, too, is yours for the asking. So dial our number today and ask.

 **TELEDYNE SEMICONDUCTOR**

1300 Terra Bella Avenue, Mountain View, California 94043 Tel: (415) 968-9241 TWX: 910-379-6494 Telex: 34-8416

SALES OFFICES:

DOMESTIC: Salem, N.H. (603) 893-9551; Stony Brook, N.Y. (516) 751-5640; Des Plaines, IL (312) 299-6196; Los Angeles, CA (213) 826-6639; Mountain View, CA (415) 968-9241 • INTERNATIONAL: Hounslow, Middlesex, England (44) 01-897-2503; Tiengen, West Germany 7741-5066; Kowloon, Hong Kong 3-240122; Tokyo, Japan 03-405-5738.



## The professionals

Whenever we discuss professionalism, we always talk of the medical establishment—and with good cause. Nowhere is there more zealous protection of a membership's economic interests.

We see this in the controversy over laetrile (Vitamin B<sub>17</sub>), an apricot-pit extract that may have already helped thousands of cancer patients. Many report that it relieves their suffering, so they can live out their days in some comfort and dignity.

But the guardians of the medical profession—the Food and Drug Administration, the American Medical Association and the cancer-research organizations—resist laetrile with a passion. Though it's accepted in 26 countries, they have succeeded in getting federal bans against its use, manufacture and interstate shipment. So a patient in Indiana (one of the few states where laetrile is now legal) can be imprisoned for bringing it across state lines from Mexico, a prime source.

Even in the states that have legalized laetrile's use, the FDA has mounted vigorous action to prevent cancer patients from getting the vitamin. It has already conducted two raids against what it calls "laetrile profiteers" and confiscated 50 tons of apricot pits.

The main arguments against laetrile are that tests on mice have not proved the vitamin effective, and there's a grave risk that if people think it can help, they might not see their doctors. As I understand it, this means that mice have not reported a reduction in pain, and one mustn't permit a reduction in income for members of the club.

The outcry against laetrile comes from the professional successors to those who allowed thousands to suffer and die of beriberi, pellagra, scurvy and rickets rather than endorse foods containing thiamin (B<sub>1</sub>), riboflavin and niacin (B<sub>2</sub> and B<sub>3</sub>), ascorbic acid (C) and vitamin D, which had already been shown to prevent or cure those dread diseases.

If we were professionals like them, we would have stopped the integrated circuit. We would have said: "We tested ICs and they're no good. If people are allowed to buy them, they won't come to us for their circuit designs. Let's make it illegal to use ICs or transport them across state lines."

Do we want *that* kind of professionalism?

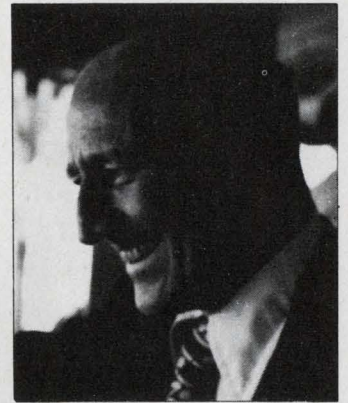

A handwritten signature in dark ink that reads "George Rostky". The signature is fluid and cursive, written in a professional style.

GEORGE ROSTKY  
Editor-in-Chief

# **Sure we make mistakes. The difference is we find them before our customers do.**

No component is more expensive than the one you've bought and can't use.

At MICRO SWITCH, we know people can make mistakes. But we also know people can find them. So even though our production people take a great deal of pride in their work, we still back them up. With our Quality Assurance Program.

Quality assurance engineers do not become involved just during production. A quality assurance engineer is actually a part of every design team working with the product from concept through final design and manufacturing.

Inspectors use everything from simple hand-held ring gauges to ultra-sophisticated electronic equipment. But the objective is the same. To see that every MICRO SWITCH product is everything our designers intended it to be.

To insure that nothing slips through, we're constantly running spot checks after assembly. (That is, if it's not an item where every unit is inspected.)



In other words, our people feel that quality is everybody's responsibility, not just our inspectors'. And the results speak for themselves.

You see, when you buy a MICRO SWITCH product, you're buying more than a component. You're buying a company. A company with

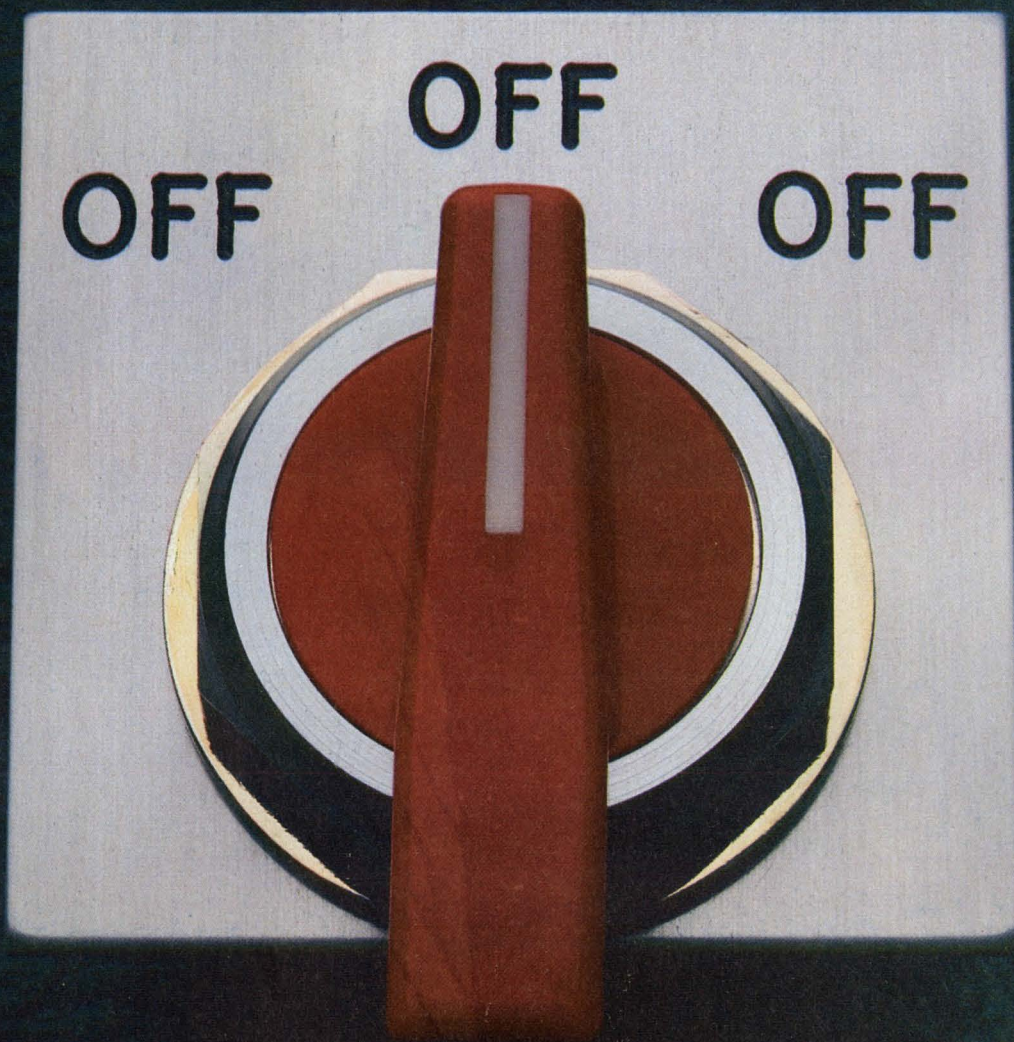

capabilities to help solve your problems. Whether through research and development. Innovation. Availability. Reliability. Or Quality Assurance.

MICRO SWITCH. Consider what it would cost to have anything less.

For more information, write for our Quality Assurance booklet.

MICRO SWITCH, Freeport, Illinois 61032. Or call 815/235-6600.

MICRO SWITCH products are available worldwide through Honeywell International.

**MICRO SWITCH**  
**Can you afford anything less?**

# VACTEC brings you BLUE

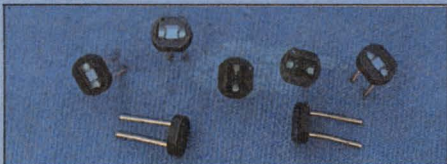

Unlike our little Japanese friend, photodetectors have always been insensitive to blue. Until now.

Vactec's latest development is a new Blue Enhanced Silicon (BES) photodiode with exceptionally low dark current for efficient response in the blue region (200 - 400 nm). Made in Missouri, U.S.A., it performs equally well in an expensive Japanese SLR camera or in an American-made colorimetric analyzer as well. And you'll like the price, which could be as big a breakthrough as blue sensitivity. Vactec also introduces a new line of PIN photodiodes that operate at high voltages, low noise levels, and fast rise times, with about half the blue sensitivity of the BES photodiode. For larger areas, Vactec offers a complete range of Blue Enhanced Silicon photovoltaic cells up to 1 1/8" diameter.

Vactec now supplies the broadest line of photodetectors in the industry, including:

- silicon solar cells
- hi-speed/low-leakage silicon cells
- NPN phototransistors
- NPN photodarlington
- CdS & CdSe photoconductors
- CMOS & bi-polar custom ICs
- opto-couplers
  - a) LED/photoconductor
  - b) LED/phototransistor or darlington
  - c) lamp/photoconductor
- selenium photovoltaic cells

Call or write today:

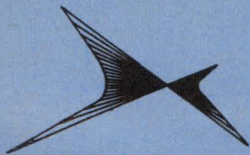

**Vactec, Inc.**  
2423 Northline Industrial Blvd.  
Maryland Heights, Mo. 63043  
(314) 872-8300

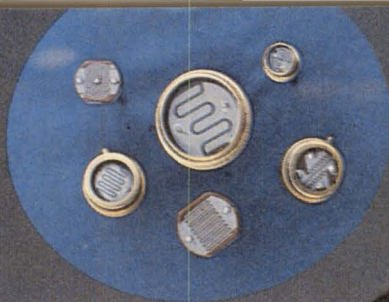

# BEST COST/PERFORMANCE

## resin-coated SOLID-TANTALUM

# CAPACITORS

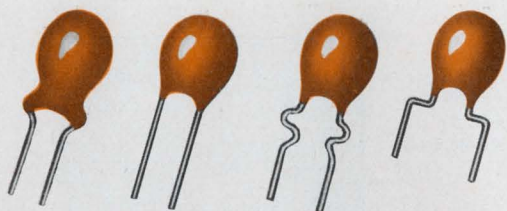

## New Sprague Type 199D Capacitors Give You the Most for Your Money

**LOWEST COST, YET IMPROVED PERFORMANCE.** Prices competitive with any other capacitors of this type, domestic or offshore. Max. impedance in ohms @ 10 kHz guaranteed for every capacitor. Lower d-c leakage currents, lower dissipation factor.

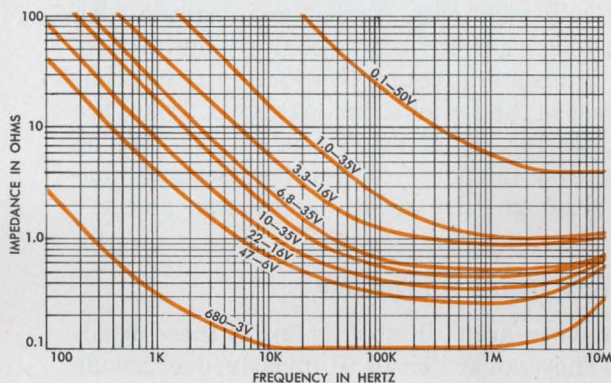

### Plus these additional advantages . . .

#### **SUPERIOR EPOXY ENCAPSULANT**

Flame-retardant, moisture-resistant resin will not crack or chip under temperature extremes.

#### **CHOICE OF LEAD CONFIGURATIONS**

Straight (2 configurations), hockeystick, or lock-in crimp with .100", .200", .250" lead spacing.

#### **STANDARD TOLERANCES: $\pm 20\%$ , $\pm 10\%$**

$\pm 5\%$  available on special order.

#### **PROVEN CAPACITOR TECHNOLOGY**

From the pioneer in solid-electrolyte tantalum capacitors.

#### **RAPID DELIVERY**

Up to 999 pieces off-the-shelf from Sprague Industrial Distributors. Larger quantities 4 to 8 weeks ARO.

For price and availability information call your Sprague district office or sales representative. For complete technical data, write for Engineering Bulletin 3547B to: Technical Literature Service, Sprague Electric Company, 347 Marshall Street, North Adams, Mass. 01247.

**THE BROAD-LINE PRODUCER OF ELECTRONIC PARTS**

CIRCLE NUMBER 33



## Don't trade off analog-switch specs.

VMOS transistors economically combine current capacity and speed with low resistance, high isolation and more.

For analog switches, Vertical-MOS (VMOS) transistors give you a nearly ideal combination of characteristics—without the tradeoffs required by the more conventional components. These devices are now available from two American suppliers: Siliconix and its licensee, Semtech.

Unlike the commonly used n-channel JFETs, VMOS chips that handle more than a few hundred milliamps are also small enough for economical production. Smaller chips lead to lower inherent capacitances. Moreover, the basic VMOS structure provides lower ON resistance.

Some analog switches use relays, bipolar transistors and even triacs. Although electromechanical relays offer the lowest ON resistance initially, their ON resistance will vary with current and degrade with use. Also, relays suffer from mechanical limitations.

Bipolar transistors require base-drive current that causes offset in the switched analog signal. Triacs are only suitable for switching raw power; for analog switching, they introduce too much offset and non-linearity although they easily handle high power.

### VMOS offers high performance

VMOS devices aren't limited by any of these disadvantages. They can switch 10 W, linearly, over a wide dynamic range. In addition, VMOS input impedance is very high, and only input voltage (no current) turns the transistors OFF or ON. And since the drain-to-source channel is purely resistive while ON, you get low distortion.

VMOS transistors in analog switches offer several more advantages, including

- 1.8- $\Omega$  ON resistance, which results in low insertion loss in low-impedance systems.
- 1.5-A dc-current capability—paralleling three VMOS devices increases this capability to 4.5 A and unlike other devices, paralleled VMOS do not require power-wasting ballast resistors.
- 2-A pk current, which makes VMOS super for driving capacitive lines and quickly charging and discharging capacitors in high-speed a/d converters,

Walt Heinzer, Applications Engineer, Siliconix, 2201 Laurelwood Rd., Santa Clara, CA 95054

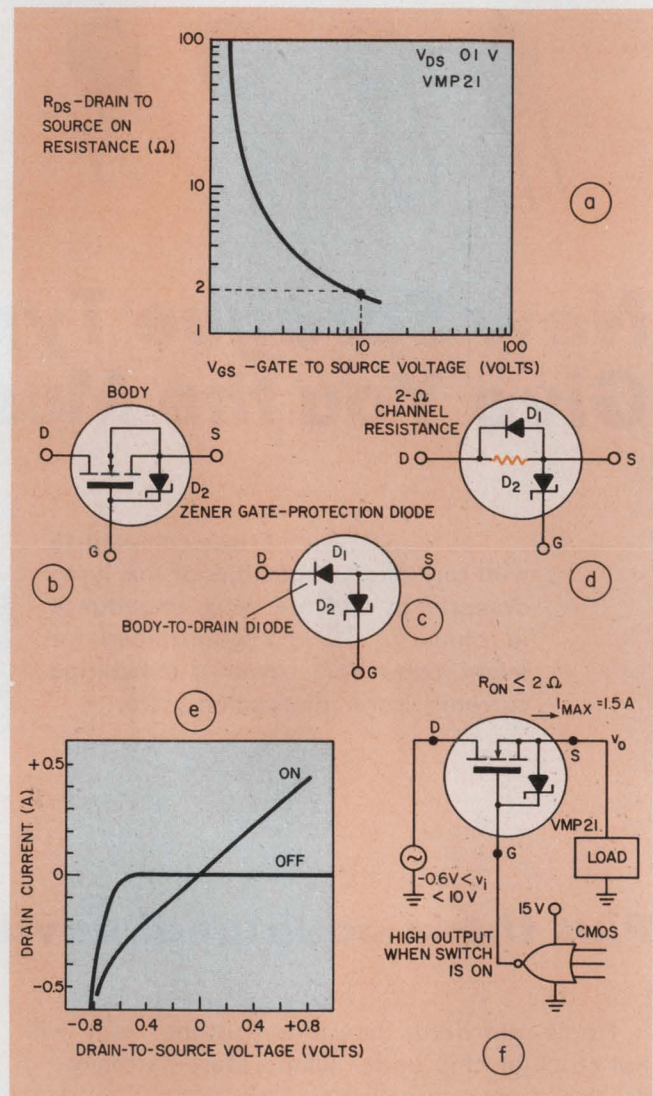

1. The VMP21 switches from OFF to ON with a 2- $\Omega$  drain-to-source resistance, when its gate-to-source potential swings from 0 to +10 V. The device turns OFF at about 1 V (a). Some VMOS transistors (b) carry an on-board zener diode that protects the gate-to-source junction. A VMOS transistor is equivalent to two diodes in the OFF state (c), when the gate-to-source voltage is less than the threshold value. The equivalent diode,  $D_1$ , is shunted by 2  $\Omega$  when the VMOS device is ON (d), with the gate-to-source potential at +10 V. The small-signal drain-to-source voltage-vs-current characteristic (e) is essentially determined by the body-to-drain diode. The input is restricted to positive voltages in the single-VMOS analog gate (f).

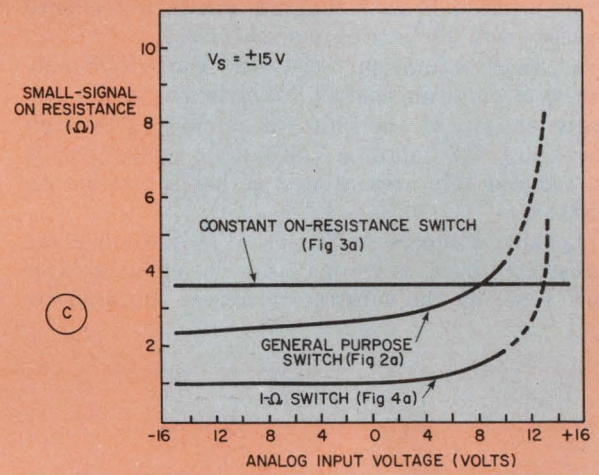
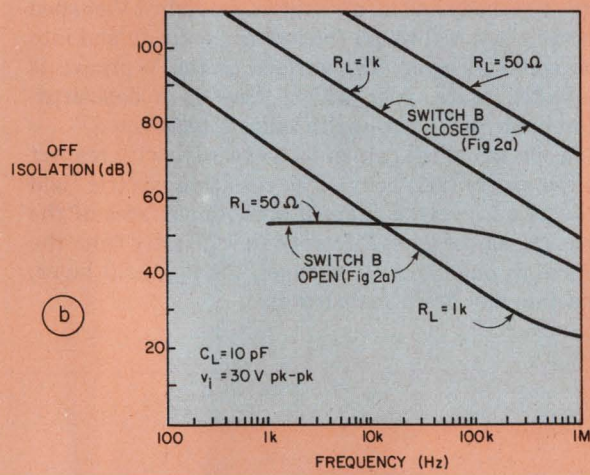
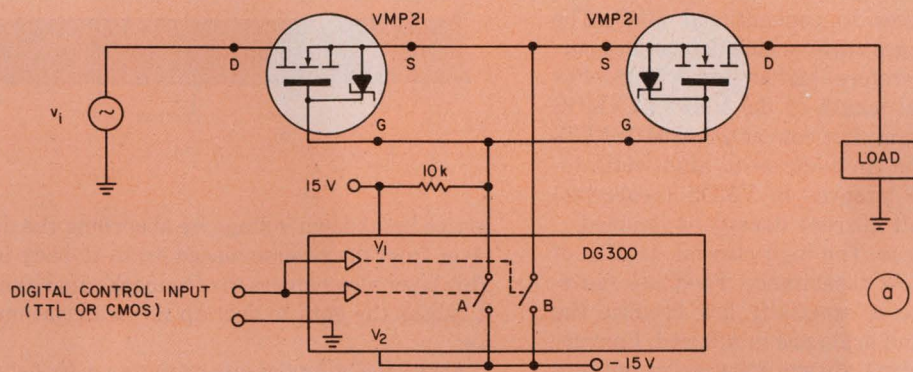

**2. ON resistance is doubled in the two-VMOS switch (a),** but inputs of both polarities are handled without losing isolation. The DG300 analog gate (b) raises the circuit's isolation by 30 dB. Decreasing load resistance also im-

proves isolation. With the gate drive referenced to a fixed voltage (c), the ON resistance varies undesirably with the input, and generates distortion, especially with low-impedance loads like speakers and transmission lines.

sample and hold circuits, and integrators.

- 60-dB isolation at 10 MHz and 500-nA dc leakage in the OFF state.
- Enhancement-mode operation with a 0.8 to 2.0-V threshold, which gives VMOS direct compatibility with CMOS and TTL. And the logic gates aren't loaded by the VMOS.
- Linear ON resistance, which results in low total-harmonic and intermodulation distortion.

What's more, all these capabilities come in a TO-39 package.

Examine the output characteristics of a low-resistance VMOS device like the Siliconix VMP21. A look at the transfer characteristic in Fig. 1a reveals that

varying the gate-to-source voltage from 0 to +10 V switches the VMP21 from OFF to ON—with a 2- $\Omega$  ON resistance. From the curve you can see that the device turns OFF well before zero volts, which eases interfacing with logic.

In the VMP21 schematic in Fig. 1b, note that the body and source are internally connected. Fig. 1c and 1d, respectively, show simplified models of the VMP21's OFF and ON states. Diode  $D_1$  is the body-to-drain pn junction. When the VMP21 is OFF, its drain-current-vs-drain-to-source-voltage characteristic (Fig. 1e) is essentially the curve for  $D_1$ .

The breakdown for  $D_1$  is 35 V, and the diode exhibits forward conduction for drain-to-source potential as

## What's different about VMOS?

In so-called vertical-MOS (VMOS) devices, current flows perpendicularly to the chip plane, rather than parallel to it as in conventional MOS transistors. The structure that leads to this direction of electron motion gives VMOS the following advantages over conventional MOS technology:

- Higher current density. VMOS-channel length is determined by diffusion depths, which can be more precisely controlled than the mask spacings that define channel lengths in conventional MOS. The channel-width-to-length ratio, which determines current density, is therefore higher for VMOS. For example, the channel length of the VMP2 (a VMOS device) is about 1.5  $\mu\text{m}$ , but conventional MOSFETs need more than 5  $\mu\text{m}$ . In addition to high width-to-length ratios, the V grooves in VMOS create two channels—as a result current density is doubled.

- Lower capacitance. The high current density of VMOS leads to its low capacitance. Feedback (gate-to-drain) capacitance is especially low because the overlap of the gate and drain are minimized. Conventional MOSFET designs always have extra gate-to-drain overlap in case the gate mask isn't aligned exactly with the source-to-drain mask.

- Lower saturation resistance. The VMOS substrate is the drain contact. So metalizing drain contacts on top of the chip (as in MOSFETs) isn't necessary. The improved VMOS drain contact results in reduced chip area as well as low saturation resistance.

Looking at a cross-section of a VMOS channel, the substrate (drain) is n+ material. The epitaxial layer (n- type) on the substrate increases the drain-to-

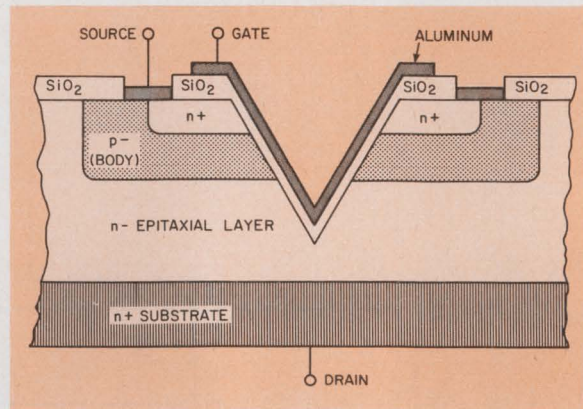

source breakdown voltage by absorbing the depletion layer from the reverse-biased drain-to-body junction. This layer also reduces the feedback capacitance since it causes the gate to overlap n- material instead of n+.

Above the epitaxial layer are two diffused regions: a p- type body and an n+ source. An etched V-shaped groove extends through the source and body and into the epitaxial layer. The surface of the V groove is deposited oxide, over which there is a deposited-aluminum gate. The entire chip is passivated.

In operation, the gate must be positive with respect to the source (and body). The resulting electric field induces an n- type channel on both surfaces of the body facing the gate. Electrons flow directly from the source through the n- channel, the epitaxial layer, and into the drain (substrate).

low as -0.6 V. This diode therefore constrains the analog voltage, which a simple switch (one VMOS transistor) can handle, to between -0.6 and +35 V.

When the VMP21 is ON, a 2- $\Omega$  resistance is in parallel with D<sub>1</sub>. Maximum continuous current in either direction is 1.5 A, even though the diode is forward-biased for currents over 0.5 A.

### One VMOS device makes an analog gate

VMOS characteristics are put to good use in the analog switch of Fig. 1f. In the ON state, the gate of the VMP21 is positive with respect to the source. In the OFF state, the gate-to-source voltage is zero. The 1.5-A capability and the 2- $\Omega$  ON resistance of the VMOS transistor can be fully exploited in this circuit. The input signal, however, is restricted to positive voltages and must always be greater than the output voltage. Otherwise, OFF isolation is impaired.

Both ON and OFF switching takes 200 ns; charge

feed-through during the ON-to-OFF transition is 80 pC with a 50- $\Omega$  load. Charge transfer is, of course, especially important in sample and hold systems. For example, 80 pC into 0.01  $\mu\text{F}$  causes an offset of 8 mV.

### In series, they switch both polarities

To increase the switch's dynamic range, connect two VMP21s in series (Fig. 2a). In the ON state, both halves of the DG300 analog switch are open, so the gates of both VMP21s are pulled to +15 V through the 10-k $\Omega$  resistor. The ON resistance of this analog switch is twice as high as the drain-to-source resistance of a single VMP21. The maximum current that this two-transistor switch can handle is the same as that for a single-transistor switch (1.5 A).

The switch is turned OFF by shorting the gates to the negative supply, thereby reducing the gate-to-source voltage to less than the threshold of 0.8 V. The second section of the DG300 adds 30 dB OFF isolation



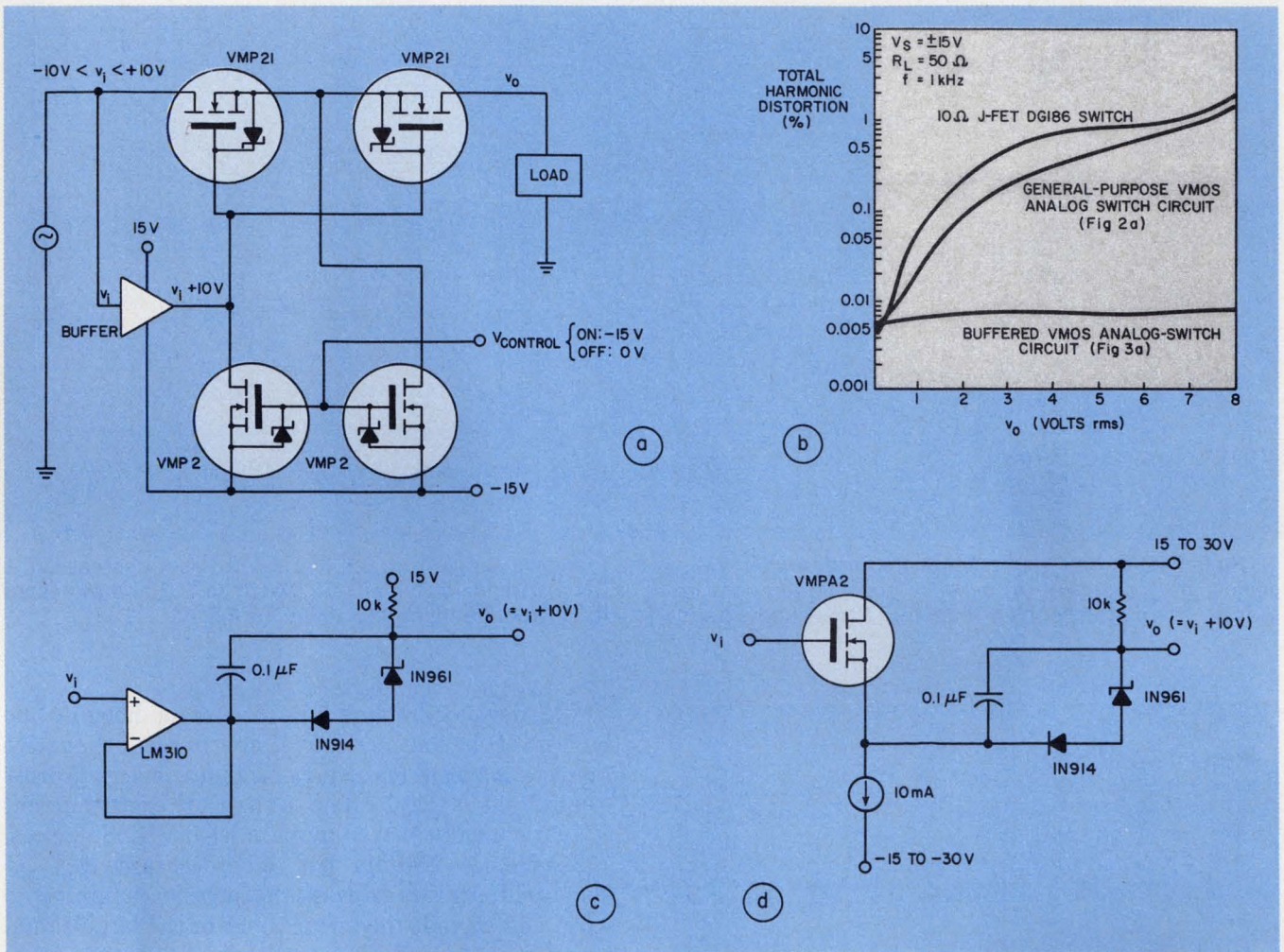

**3. Bootstrapping the gate and input cuts distortion** by holding the ON resistance constant (a). The buffered bootstrap circuit (a) distorts less than either a JFET or a nonbootstrapped VMOS analog switch (b). A general-

purpose buffer (c) using the LM310 op amp is suitable for low-speed switches, but when you need a fast analog switch, use the VMPA2 buffer (d). In addition to speed, this buffer gives you increased isolation.

by shunting the signal-leakage path (through both sources) to the negative supply. OFF-isolation curves (Fig. 2b) show that the DG300 raises the circuit's isolation and that decreasing the load resistance increases isolation.

Since the two transistors are back-to-back, one body-to-drain diode is always reverse-biased. This eliminates the OFF-state problem caused by forward-biasing the diode.

Since the bidirectional switch's gate drive is referenced to a fixed supply, its ON resistance varies with the input analog voltage (Fig. 2c). This variation introduces distortion when you're driving low-impedance loads such as speakers or transmission lines. For constant ON resistance, use the circuit in Fig. 3a.

**Bootstrapping adds linearity**

In the ON state, a bootstrap voltage that tracks the input drives the gates of the VMP21s. This bootstrap-

ping keeps the VMOS's gate-to-source voltage constant and independent of the input signal. So, changes in the input-signal level do not modulate the ON resistance of the switch.

The buffer circuit reduces the computed total harmonic distortion from 1.5% to 0.005%, for 8-V rms at 1 kHz into  $50\Omega$  (Fig. 3b). The popular  $10\Omega$  DG-186 JFET analog switch generates a higher total harmonic distortion of about 2%.

The two buffer circuits shown in Figs. 3c and 3d isolate the input signal and employ a zener diode to provide a fixed gate-to-source voltage. The general-purpose buffer of Fig. 3c has a flat frequency response of up to 300 kHz and accepts inputs ranging between  $\pm 15V$ . The buffer of Fig. 3d, a VMPA2 source follower, has its frequency response extended to 50 MHz and, when operated from  $\pm 30V$  supplies, increases the signal range to  $\pm 30V$ .

The VMPA2 does not have an on-board zener diode like the VMP2 and VMP21 transistors. At the expense

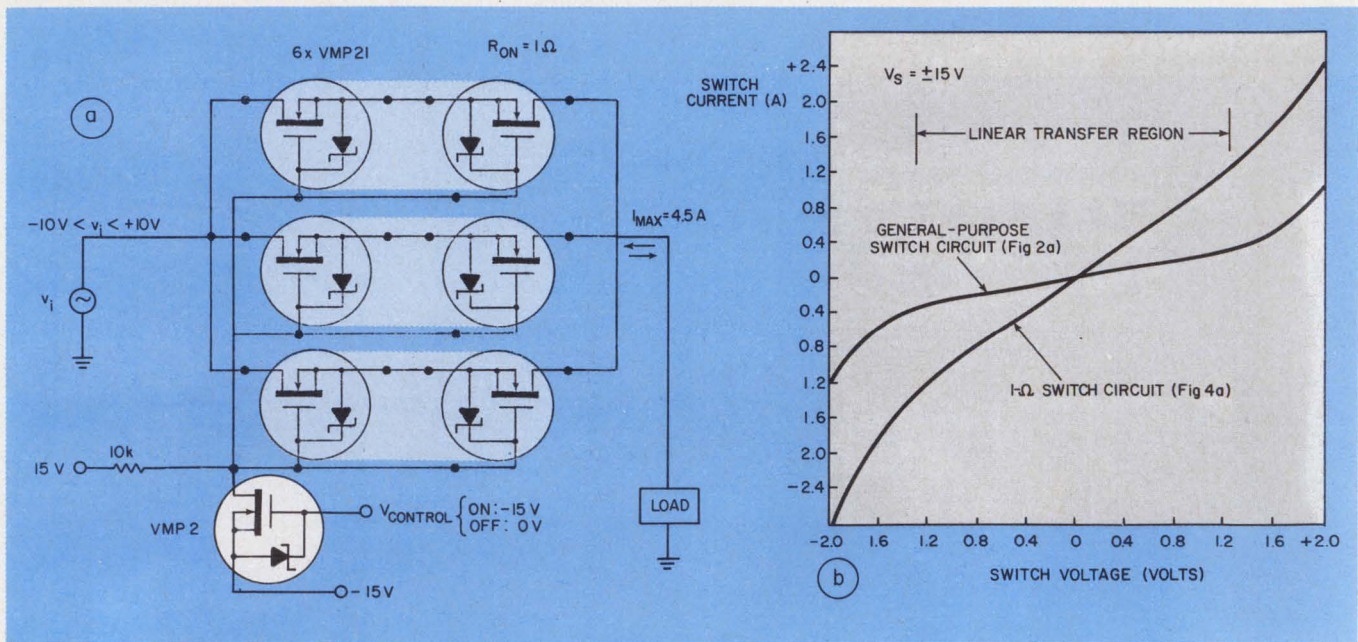

**4. No ballast or balance resistors are needed** when VMOS devices are paralleled (a) because negative tempcos immunize them from current hogging. Paralleling extends

the linear range from 0.3 to 1.2 A (b) as it decreases the ON resistance of the analog switch to 1  $\Omega$  and increases its current-handling capability to 4.5 A.

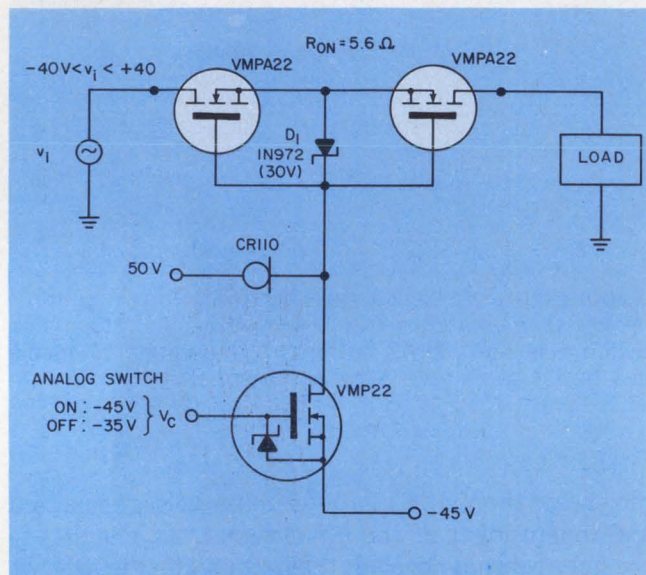

**5. You pay for 90-V breakdown in the VMPA22** with 2.8- $\Omega$  ON resistance, which allows swings of  $\pm 40$  V. The zener diode limits the gate-to-source potentials to 30 V.

of the diode's protection, the VMPA2 gains lower capacitance from gate-to-source and reduced dc "see through" from driver to signal path. Bootstrapping the switch's gate circuits with a buffer permits the switch to operate with low distortion even as the signal amplitude comes close to the positive supply voltage.

#### VMOS devices para. , without padding

Paralleling devices lowers the total ON resistance. For example, three paralleled legs, each with two VMP21s in series, make a 1- $\Omega$  switch (Fig. 4a). Because

VMOS devices are immune to current hogging, no ballast or balance resistors are needed. Negative tempcos, a VMOS feature, cause these devices to draw less current as they heat up. As a result, excess current is automatically shared by paralleled VMOS devices.

Paralleling VMP21s not only decreases ON resistance, but also increases the current capability to 4.5 A and extends the linear range of the large-signal transfer characteristic from 0.3 to 1.2 A (Fig. 4b).

The voltage range of the basic analog switch can also be increased. Simply use a higher-breakdown VMOS unit (Fig. 5). The VMPA22s have a 90-V breakdown, which allows up to  $\pm 40$  V of voltage-swing capability. However, these higher-voltage devices do carry a penalty—the ON resistance is higher: 2.8  $\Omega$  vs 1.2  $\Omega$  for the VMP21. Zener diode  $D_1$  limits the gate-to-source potential to 30 V, and thereby prevents a possible gate-oxide rupture. Diode CR110 limits the current from the +50-V gate-bias supply.

The high-power rf switch shown in Fig. 6a performs very well up to 50 MHz—with turn-ON and turn-OFF times of 50 ns. At 10 MHz, isolation is 60 dB with a 20-V pk-pk input signal. Insertion loss is only 1 dB with a 50- $\Omega$  load (Fig. 6b). The gain-vs-input-power curve in Fig. 6c shows that the rf analog switch using VMPA2s can put 1 W into a 50- $\Omega$  load at 14 MHz. The two-tone, third-order, intermodulation-product curves show a 42-dB intercept point with 1 dB of gain compression at 25-dBm input power.

Turn-ON time of the switch (Fig. 6d) is determined by the passive pull-up resistor combined with the capacitance at the gates of the VMPA2s. The negative turn-OFF transient is caused by charge-coupling to the output through the output capacitance of the VMPA2. ■

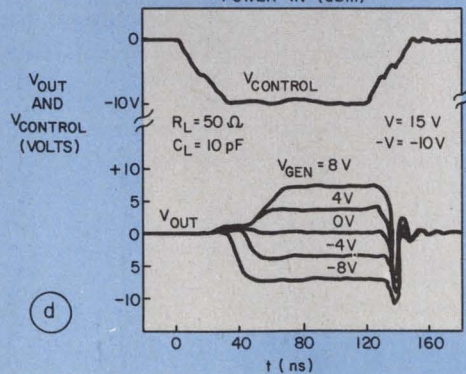
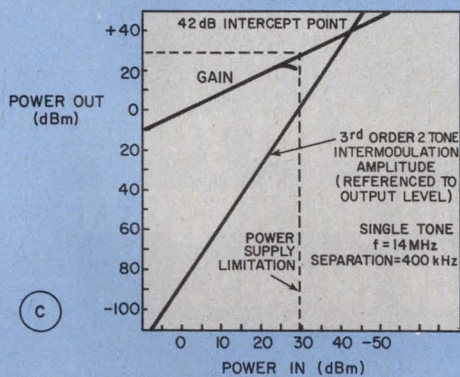
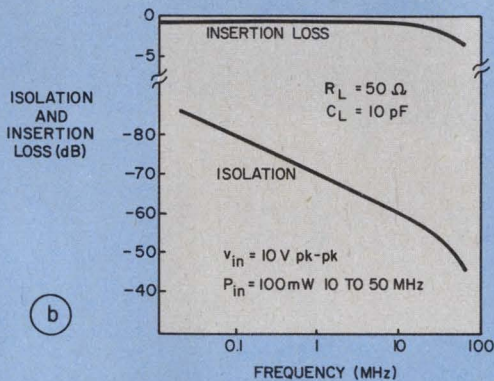
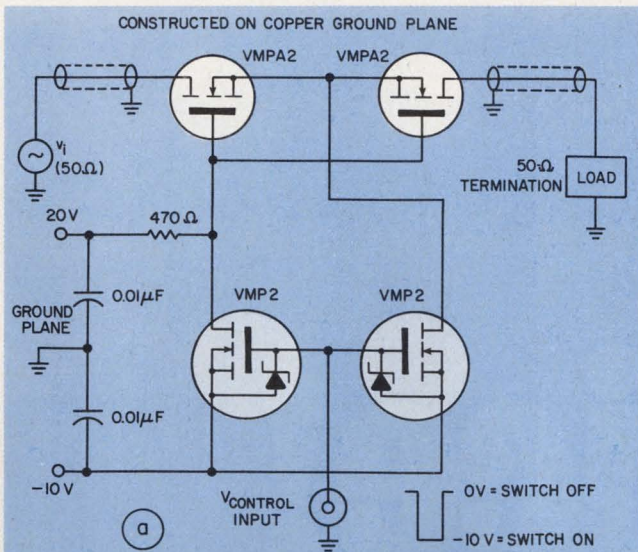

6. The VMPA2 switches high power at rf (a). At 10 MHz, a 20-V pk-pk signal is attenuated by 60 dB and the insertion loss is only 1 dB into 50  $\Omega$  and 10 pF (b). Third-order intermodulation distortion is given by the 42-dB intercept point, and 1-dB gain compression occurs at 25-dBm input for 14 MHz (c). The negative turn-OFF transient (d) is caused by charge-coupling to the output through the output capacitance of the VMPA2.

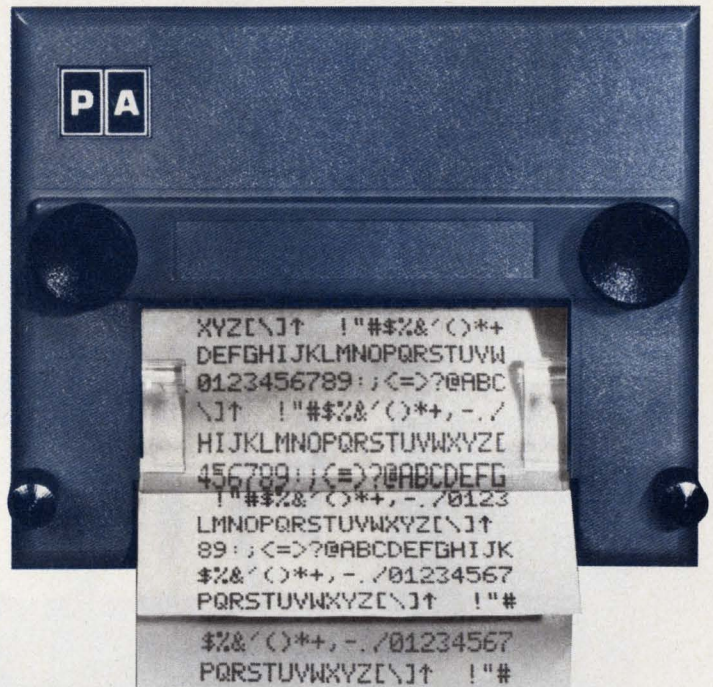

## Name one other printer this small that prints multiple copies using standard paper

Don't even bother trying; only our DMPT-3 Miniature Alphanumeric Printer puts it all together like this. Granted, our 20-column workhorse is the industry's smallest alphanumeric impact printer. Granted, it packs the versatility of both "first line up" text and "first line down" print formats. Even so, that's just the beginning for the DMPT-3.

The truth is, you not only get multiple-copy capabilities, but you can use ordinary adding machine rolls instead of the special paper thermal printers require. You not only get a full alphanumeric capability, but enhanced characters and high 120 cps speeds as well. You'll graduate from messy ribbons to a drop-in ink platen with a 75,000-line life. And you can move up to microprocessor compatibility by putting our programmable control option between the DMPT-3 and the outside world. You get it all, but only in the DMPT-3.

For more details, call or write today.

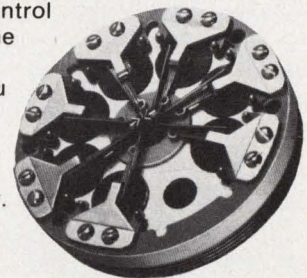

**PRACTICAL  
AUTOMATION, INC.**

Trap Falls Road  
Shelton, Connecticut 06484  
Tel.: (203) 929-5381

CIRCLE NUMBER 34



# Choice!

## New Dale MSP Networks let you match profile, power and package to meet your resistance needs.

Dale's new MSP single-in-line networks are the shape of things to come in resistance. Rugged. Machine insertable. And available in your choice of profiles: .350" with up to .3 watts per resistor or .195" (.19 watts) to meet critical board spacing requirements. Both are molded for extra protection. Both give you the kind of quality assurance we developed for Dale's SDM—the first network to meet MIL-R-83401. Sample the MSP now. It's available fast in quantity from stock... and it's only part of Dale's complete line of SIP and DIP networks.

Contact your Dale Representative or phone 402-371-0080

DALE ELECTRONICS, INC.  
Box 74, Norfolk, Nebraska 68701  
In Canada: Dale Electronics Canada Ltd.  
In Europe: Dale Electronics GmbH,  
8 Munchen 60, Falkweg 51, West Germany  
A subsidiary of The Lionel Corporation.

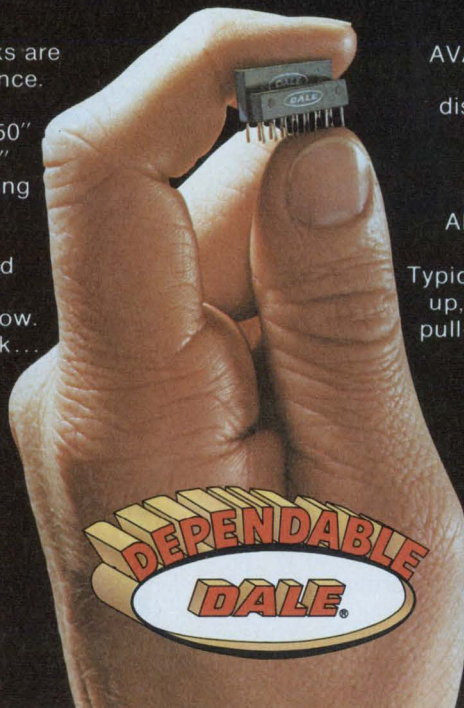

AVAILABLE FAST: .350" model (MSPXXXC) available in 1 week from factory or from distributor stock. 6, 8 or 10 pin models (-01 circuit) in 49 standard values. Consult factory for fast delivery times on other configurations and schematics.

APPLICATIONS: Standard circuit (-01) has 5, 7 or 9 resistors with 1 pin common. Typical applications include "wired OR" pull-up, power gate pull-up, MOS/ROM pull-up/pull-down, open collector pull-up, TTL input pull-down, TTL unused gate pull-up.

SPECIFICATIONS: *Power:* .350" model=.3 watts max. per resistor; .195" model=.19 watts max. per resistor. *Resistance:* 33Ω to 1 Meg. standard. *Tolerance:* ±2% standard. T.C. ±100 PPM/°C. *T.C. Tracking:* 50 PPM/°C. *Operating Temperature:* -55°C to +125°C.

CIRCLE NUMBER 35

FROM THE WORLD'S LARGEST SWITCHER MANUFACTURER . . .

# NEW *Tiny-MITE* Open-Frame Switchers

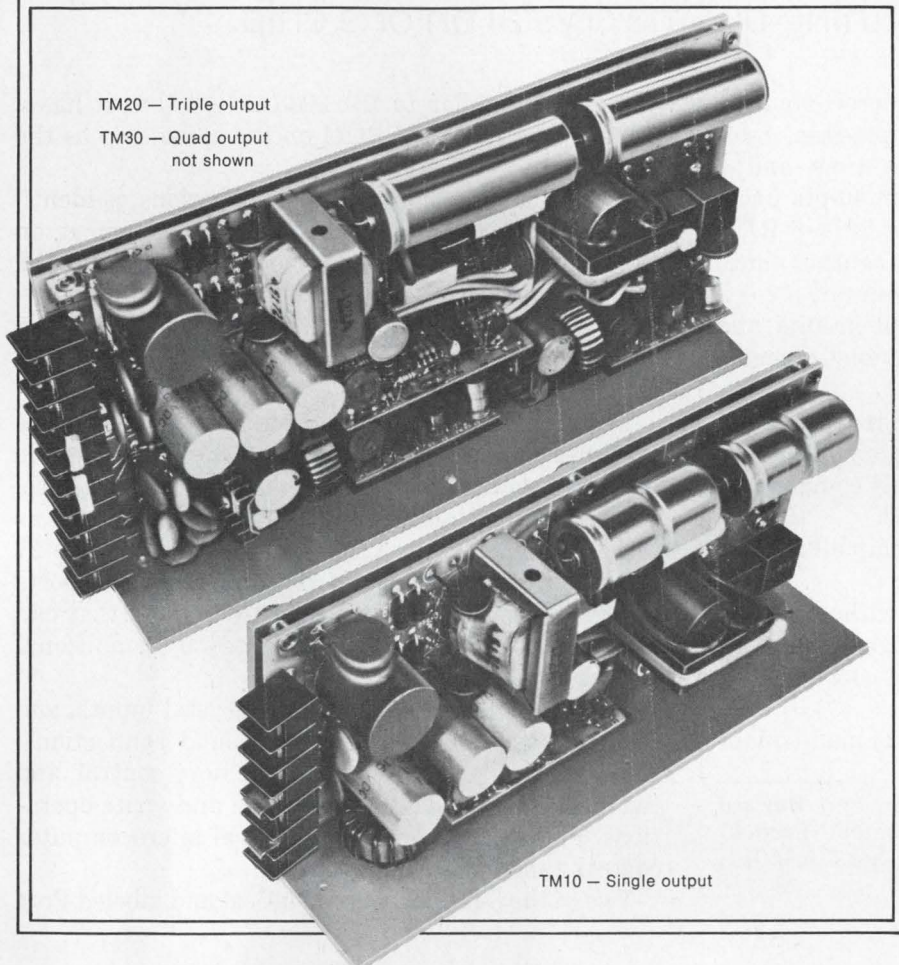

TM20 — Triple output

TM30 — Quad output  
not shown

TM10 — Single output

## Single- and multiple-output switchers for OEM computers and terminal systems.

### Power density of 1w/in.<sup>3</sup>

With LH's Tiny-MITE switchers you get power density of 1 watt/in.<sup>3</sup> in small, open-frame packages offering up to 75-percent efficiency — at a price much lower than switchers usually sell for.

The single-output TM10 packs 100 watts in a package that's only 9.5 in. L x 4.0 in. W x 2.5 in. H and weighs only 3 lbs. The triple-output TM20 produces 150 watts in a package that's 12.0 in. L x 5.0 in. W x 2.8 in. H and weighs less than 4 lbs. The TM30 produces 150 watts in a package that is 13.0 in. L x 6.0 in. W x 2.8 in. H and weighs less than 4½ lbs.

### Single, triple and quad outputs

TM10's single-output voltage is 5 volts adjustable  $\pm 5$  percent at 100 watts; other outputs are available including 12, 15, 18, 24, and 28 volts standard. The TM20's primary output is 5 volts adjustable  $\pm 5$  percent at 20 amperes with second and third outputs in any of the following combinations: 5 volts at 5 amps, 12 volts at 5 amps, 15 volts at 5 amps, 18 volts at 3 amps, 24 volts at 2 amps, or 28 volts at 2 amps. The TM30 quad allows an additional output of 5, 12 or 15 volts at 1.5 amps. (Combined power outputs may not exceed 150 watts.)

### More power, less space

TM10, TM20, and TM30 are perfect choices for OEM computer and terminal system applications. Why? Because the new Tiny-MITE switchers were specifically designed for high volume, low cost production and to pack more power in less space. This high power density is especially important when circuit redesign demands more power and there is no more space in your package.

Technology used in the new TM Series was developed by LH and has been proven in over 30,000 switchers now in the field. And to further assure reliability, every LH switcher is tested and burned-in before shipment.

### Advanced circuitry = versatile specs

- Wide input variation standard — 92-130 VAC and 180-260 VAC, 47-450 Hz.
- 50 mv or 1% peak-to-peak ripple and noise on output.
- 0.4% line regulation over entire input range.
- 0.4% load regulation from no load to full load.
- Power failure signal and remote on/off control standard.
- Response time of 200  $\mu$ sec to 1% after 25% load change at 5 amps/ $\mu$ sec.
- 0°C to 50°C operating temperature range in natural convection. Derated to 50% load at 70°C.
- Designed to meet UL 478.
- 1-cycle ride-through (16 msecs) before power fail is signaled.
- Fold-back current limit on outputs.
- Overvoltage protection standard (on main output) — factory-set at 125%  $\pm 5$ %.
- Remote sense (main output only) compensating for load cable loss up to 250 mv.
- — and a whole lot more.

Call or write today to learn how LH's Tiny-MITE Series will fit your needs.



LH RESEARCH, INC., 1821 Langley Avenue, Irvine, CA 92714 (714) 546-5279 • TWX 910-595-2540

CIRCLE NUMBER 36

## Simplify your next microcomputer

by designing it with an all-in-one processor. Units in the MCS-48 series put everything but the crystal on one chip.

The MCS-48 family of single-chip microcomputers can perform as well as many multiple-chip, 8-bit processors because of a 2.5- $\mu$ s cycle time and a repertoire of 96 instructions. Housed in 40-pin packages, the MCS-48 processors contain a 64  $\times$  8 RAM data memory, 27 programmable input/output lines, an 8-bit programmable timer/event counter, a clock oscillator and driver, reset and interrupt circuits, and either 0 or 1-k  $\times$  8 bits of ROM or ultraviolet-erasable PROM.

A variety of expansion circuits provides the family members with additional I/O or memory (Table 1). What's more, all standard MCS-80 family components (for 8080A and 8085  $\mu$ Ps) can be used.

The three versions of the processor chip all require just a 5-V supply to operate (Fig. 1):

- The 8035, a central-processor without ROM circuit, must be used with external program memory—it is intended for systems requiring more than 1 kword of program memory.
- The 8748, intended for prototyping or small quan-

tity use, is similar to the 8035 except that it has a 1-k  $\times$  8 ultraviolet EPROM on the same chip as the processor.

- The 8048, for high-volume applications, is identical to the 8748 except that the 1-k  $\times$  8 memory on the chip is mask-programmable ROM instead of UV erasable PROM.

### Do control as well as arithmetic

Designed as efficient controllers as well as arithmetic processors, the MCS-48 chips have a wide variety of branch and table-look-up instructions. Also, you can set and reset individual I/O lines as well as test individual bits within the accumulator. The 27 I/O lines of the processor are grouped as three ports of eight lines plus three special test inputs that can alter the program flow when tested by conditional jump instructions.

Two other lines are used as the crystal inputs, and two are needed for power and ground connections. Another two figure in program-memory control, and two more in external-memory read and write operations. Five lines perform the general microcomputer control functions.

Two of the 8-bit ports are identical and labeled Port

**Larry Goss**, Product Marketing Engineer, and **Howard Raphael** (now with National Semiconductor), Product Manager, Intel, 3065 Bowers Ave., Santa Clara, CA 95051.

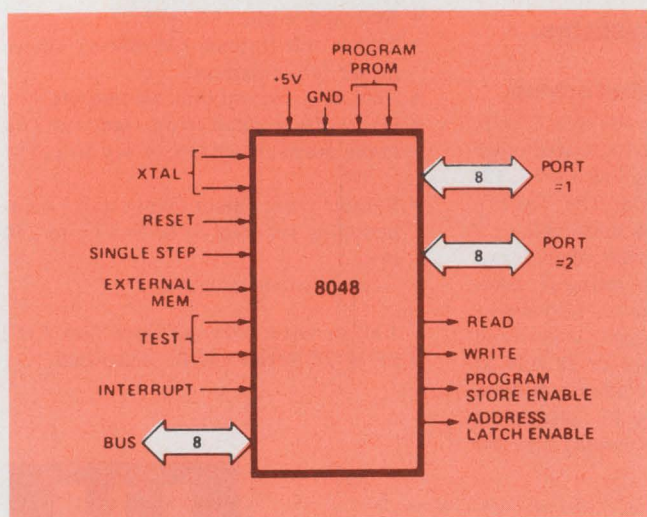

1. The MCS-48 family of processors provides three 8-bit ports, three test inputs and various other control lines as well as 1024 words of ROM/PROM in a 40-pin DIP.

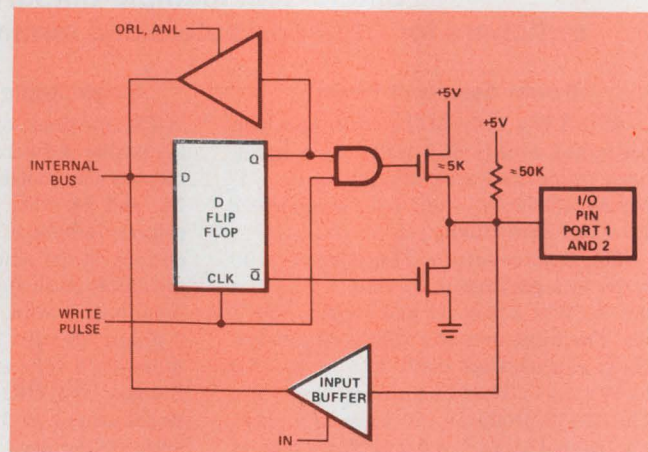

2. The quasi-bidirectional structure of each line on Ports 1 and 2 lets each pin act as either an input or an output. Each line is continually pulled to a 1 so that it can supply the source current to a TTL gate, yet can also easily be pulled to a 0 by a gate or internal command.

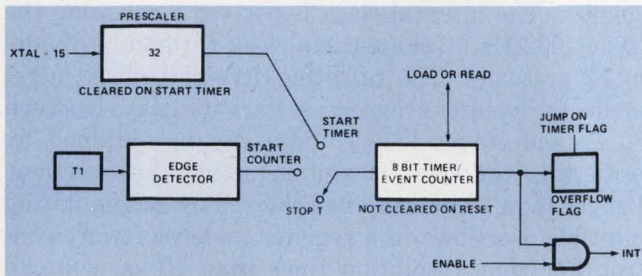

3. By switching the internal 8-bit timer/counter to either the clock source or to an input pin, timing periods as short as 7.5  $\mu$ s can be measured.

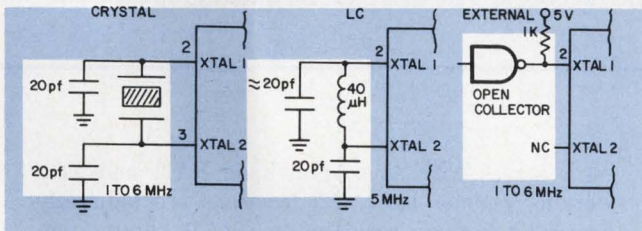

4. Timing signals for the MCS-48 series can come from one of three sources: an external crystal, an external inductor, or a TTL clock source (from left to right).

1 and Port 2. Data written to these ports are statically latched and remain unchanged until rewritten. Inputs are TTL-compatible, and outputs can drive one standard TTL load.

The lines of both ports are quasi-bidirectional because a special output structure permits each line to serve as an input, output or both, even though the outputs are statically latched (Fig. 2). Each line is pulled continuously up to the 5-V supply through a high impedance; it can supply the source current needed for a TTL "1," yet it can be pulled to "0" by a standard gate.

To provide fast switching times in a low-to-high transition, a relatively low-impedance device is switched into the circuit momentarily whenever a 1 is written to the line. When a 0 is written, the low-impedance device overcomes the light pull-up and provides TTL current-sinking capability. Since the pull-down transistor is a low-impedance device, a 1 must first be written to any line that is to be used as an input. The system reset initializes all lines to the high-impedance 1 state.

Table 1. MCS-48 family components

Part	Description	100 qty. price
8035	Microcomputer without ROM	\$ 13.55
8048	Microcomputer with 1-k ROM	*
8748	Microcomputer with 1-k UV PROM	175.00
8155	Data memory and I/O expander	14.00
8243	I/O expander	5.00
8355	2-k ROM and I/O expander	*
8755-8	2-k UV PROM and I/O expander	125.00
8212	8-bit I/O port	2.90
8255A	Programmable peripheral interface	7.40
8205	1-of-8 binary decoder	2.80
8214	Priority-interrupt controller	4.65
8216	Bidirectional bus driver	2.75
8226	Bidirectional bus driver (inverting)	2.75
8253	Programmable interval timer	17.55
8259	Programmable interrupt controller	17.20
8279	Programmable keyboard/display interface	14.10

\*Consult factory (100-piece minimum order).

The other 8-bit port, called Bus, is a true bidirectional port with associated input and output strobes. If the bidirectional feature isn't needed, Bus can serve as either a statically latched output port or nonlatched input port. In its bidirectional mode, Bus, along with the read and write output pins, can emulate an 8080A or 8085 microprocessor bus.

Able to handle interrupts, the processors are diverted from their normal operation by a low level applied to the interrupt input. The interrupt is level-triggered and active-low to permit wire-OR connections from several interrupt sources. Every machine cycle, the interrupt line gets sampled. Once detected the interrupt causes a jump to subroutine at location 3 in program memory as soon as all cycles in the current instruction are completed.

Since only one level of interrupt is available, once an interrupt is detected, all further interrupt requests are ignored until the execution of a return instruction re-enables the interrupt-input logic. This sequence also holds true for an internal interrupt generated by the built-in timer/counter. If an internal and external

interrupt are input simultaneously, the external source will be recognized first. Also, if needed, a second external interrupt can be created by enabling the timer/counter interrupt, loading  $FF_{16}$  in the counter (one less than terminal count), and enabling the event-counter mode. A high-to-low transition on the counter-input pin will then cause an interrupt to vector to location 7. The interrupt inputs may be enabled or disabled under program control, and are disabled by the system reset. They remain disabled until enabled by your program.

### Timing/counting is easy to do

The built-in counter can tally external events and generate accurate time delays without burdening the processor. In both modes the counter operation is the same—the only difference is the source of the input signal (Fig. 3).

In the counter mode, the 8-bit binary counter can be preset and read by means of processor instructions, which transfer the contents of the accumulator to the counter or vice versa. Execution of a Start counter instruction connects an input pin to the counter-edge

detector and the event counter to the edge detector's output. Subsequent high-to-low transitions on the input pin will cause the counter to increment at a maximum rate of once every three instruction cycles (every  $7.5 \mu\text{s}$  when a 6-MHz crystal is used). However, there is no minimum input frequency since the edge detector will adjust the transition time for proper triggering.

When executed, a Start timer command connects an internal clock to the counter input and enables the counter. The internal clock is derived by passing the basic 400-kHz machine-cycle clock through a divide-by-32 prescaler. The resulting 12.4-kHz clock increments the counter every  $80 \mu\text{s}$ . Various delays between  $80 \mu\text{s}$  and 20 ms (256 counts) can be obtained by presetting the counter and detecting the overflow. Longer than 20 ms may be achieved by accumulating multiple overflows in a register under software control. For time resolution finer than  $80 \mu\text{s}$ , you can apply an external clock to the external counter input and operate the counter in the event-counter mode.

Timing generation (Fig. 4) for the MCS-48 family is completely self-contained except for crystal or an LC network. An external-frequency source can be

## MCS-48 processor architecture

The MCS-48 family of microcomputer circuits consists of three processor chips, each with the same architecture but with different ROM options. If the  $1\text{-k} \times 8$  resident ROM or UV EPROM are removed from the 8048 and 8748, all that's left is the bare processor architecture of the 8035. Almost every subfunction of the MCS-48 processors is connected to a master 8-bit internal bus, buffered and fed to the outside world via one of the 8-bit I/O ports.

All three processors have two software-controllable I/O ports, another 8-bit port used as the main data bus, an 8-bit arithmetic-and-logic unit, an 8-bit timer/counter, a  $64 \times 8$ -RAM register bank and an 8-bit accumulator. Several internal decoding blocks handle all the control and timing, conditional branch decisions, and instruction decoding. Outputs of Ports 1 and 2 are statically latched but inputs are not. Either port, however, can be configured to allow inputs on specific pins by first writing "1" out to the pin.

Eight data-bus lines form a static port and can be used as a true, synchronous, bidirectional port. When instructions involving the port are executed, a corresponding Read or Write pulse is generated, which indicates that data on the bus are valid only during the pulse time. All three basic I/O ports can be expanded via a 4-bit expander bus and 8243 expanders using half of Port 2. Each expander circuit consists of four 4-bit ports, which are addressed as Ports 4 to 7. These ports have their own AND and OR instructions, as well as Move instructions for data.

The 64-word-deep register file included in the proc-

essor serves both as a scratchpad RAM and as a working register bank. All locations are indirectly accessible through either of two RAM pointer registers that reside at locations 0 and 1 of the file. Also, the first eight registers of the file are designated as working registers and can be addressed directly by several instructions. Since these working registers are easily addressable, they are used to store frequently accessed intermediate results or used as loop counters.

If necessary, a second set of registers in locations 24 to 31 can be used as an alternate bank of working registers. With a bank-switching instruction RAM, locations 24 to 31 are directly addressable as the working registers, and locations 0 to 7 are temporarily out of the picture. If locations 24 to 31 are not used as working registers, they still appear as RAM.

When the second bank is used as working registers, locations 24 and 25 act as a second set of RAM pointer registers. Locations 8 to 23 act either as an eight-level stack or a  $16 \times 8$  user RAM. And, the last 32 locations are all allocated as user RAM workspace.

Whether the program memory is on board or external, three locations are reserved for special operations. Location 0, is used to store an instruction to be executed when the reset line is pulsed. Location 3 holds the external interrupt vector, and location 7 the counter/timer interrupt vector. Thus, the first instruction to be executed is stored in location 0, the first word of an external interrupt routine in location 3 and the first word of a timer/counter interrupt routine in location 7.



added, if necessary. The on-board oscillator is a high-gain, series-resonant circuit with a frequency range of 1 to 6 MHz. When timing accuracy isn't critical, an inductor can be used to set the clock frequency. However, the inductor should be used only for frequencies as high as 4 to 6 MHz.

The 8048 alone has a power-down operating mode. Extra circuitry on the chip allows power to be removed from all circuits except the RAM array inside the processor. In the power-down mode, the contents of the data RAM can be maintained with only 10 to 15% of the normal operating power requirement. In normal operation, both the  $V_{DD}$  and  $V_{CC}$  are kept at 5 V, while in the standby mode the  $V_{CC}$  pin is grounded and  $V_{DD}$  is kept at 5 V. If a reset signal is applied to the reset pin, any access to the internal RAM is inhibited to prevent any accidental data alterations.

Power-down operations progress in four steps:

1. User-defined circuitry must detect imminent power-supply failure early enough to permit the 8048 to save all the data before supply levels fall.
2. This circuitry must also supply a signal to interrupt the processor and vector it to a power-fail service routine.

3. A power-fail routine saves all important data and machine status in the internal RAM array and initiates the transfer of a back-up supply to the  $V_{DD}$  pin (if available). Also, it should indicate to external circuits that the transfer is complete.

4. A reset signal is applied to guarantee that stored data won't be altered as the supply level falls below minimum levels. Reset must be held low until  $V_{CC}$  is at ground.

Other circuitry on all the processor chips helps you test and debug systems using the MCS-48 chips. A single-step control built into the processors permits one instruction to be executed at a time, regardless of whether the instruction requires one or two cycles. After the instruction is completed, the processor halts, with the address of the next instruction to be fetched available on the eight Bus lines and the lower four bits of Port 2. While the processor is stopped, the I/O information on the Bus port and the lower four bits of Port 2 are, of course, not available. However, the leading edge of the ALE signal I/O can be used to latch information.

Applying 5 V to the external-access pin (EA) of the 8048 or 8748 lets you effectively disable the internal

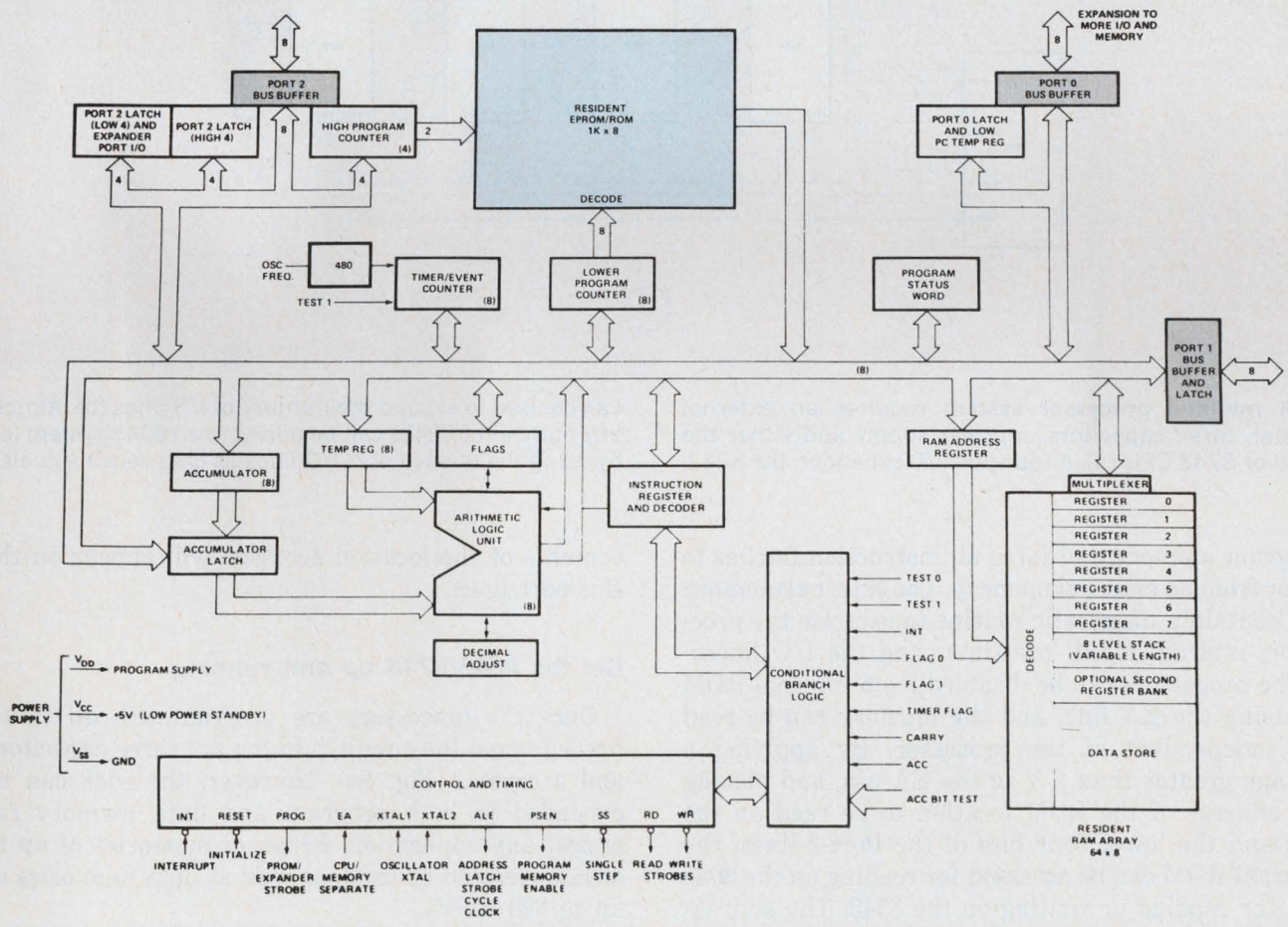

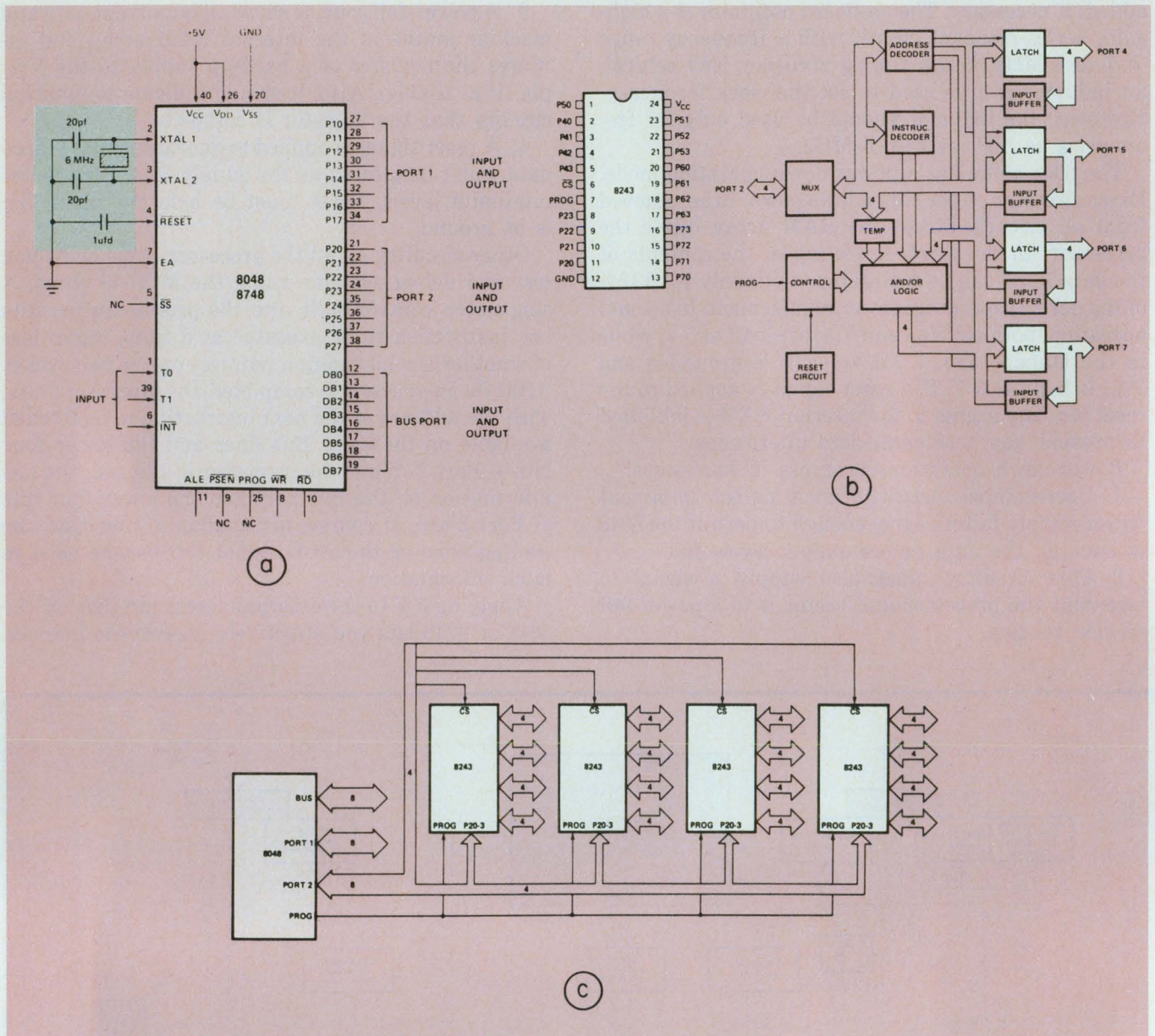

5. A minimal processor system requires an external crystal, three capacitors, a power supply and either the 8048 or 8748 CPU (a). A four-port I/O expander, the 8243,

can be used to expand the number of I/O lines (b). Almost any number of 8243s can be added to an 8048 system (c), by using the unused port I/O lines as chip-select signals.

program memory and force all instruction fetches to occur from an external memory. The external memory can contain a diagnostic routine to exercise the processor, internal RAM, the timer and the I/O lines.

The processors can be disabled from internal ROM by using the EA line, and the memory can be read out independent of the processor. By applying a voltage greater than 5 V to the EA pin, and placing the address of the ROM location to be read on the Bus and the lower four bits of the Port-2 lines, the internal ROM can be accessed for reading on the 8048 and for reading or writing on the 8748. The address on the ports is latched by a low-to-high transition on the reset line and by keeping the reset line high the

contents of the location accessed will appear on the Bus-port lines.

### Get the 8048/8748 up and running

Once the processors are programmed, all that's needed to get the circuit running are three capacitors and a crystal (Fig. 5a). However, the 8048 can be expanded in both program and data memory for almost any application. Program memories of up to 4096 words can be used, as well as data memories of up to 320 words.

Expansion can be accomplished in two ways:  
1. Expander I/O—a special I/O expansion circuit,

the 8243 (Fig. 5b), provides for the addition of four 4-bit I/O ports and sacrifices only the lower four bits of Port 2. Several 8243s may be added to the 4-bit bus by using a chip-select structure (Fig. 5c).

2. Standard 8080 bus—one port of the 8048 is like the 8-bit bidirectional bus of the 8080A or 8085 microprocessor, so numerous standard memory and I/O circuits can be used.

Program-memory expansion starts with location 1024 or greater. For all instruction fetches at locations higher than 1024, the processor outputs the contents of its 12-bit program counter onto the eight Bus lines and the lower half of Port 2. After the address is output, the address-latch-enable (ALE) line of the processor will go high to indicate the address is valid. The address can be externally latched by 8212 latches

that are controlled by the falling edge of the ALE signal (Fig. 6a). The program-store-enable (PSEN) line indicates that an external-instruction fetch is in progress and enables the external memory device. Meanwhile, the Bus reverts to the input mode, and the processor accepts its 8-bit contents as an instruction word.

Data memory can be expanded by using the 8080A bus compatibility of the MCS-48 processors (Fig. 6b). All address and data information must be transferred over the 8-bit Bus port. A read or write cycle takes four steps:

1. The contents of internal pointer register  $R_0$  or  $R_1$  are loaded onto the Bus port.

2. The ALE line goes high to indicate the address is valid. (The trailing edge of the ALE signal can be used to latch the address.)

3. A read ( $\overline{RD}$ ) or write ( $\overline{WR}$ ) pulse on the corresponding output pin of the processor indicates the type of data memory access in progress. Output data are valid at the trailing edge of the  $\overline{WR}$  signal and input data at the trailing edge of the  $\overline{RD}$  signal.

4. Data are transferred over the 8-bit bus.

External data memory is accessed with its own two-cycle move instructions—MOVX A, @R, and MOVX @R, A—which transfer eight bits of data between the accumulator and the external memory location being addressed by the contents of one of the internal-RAM

6. **Expanding the 8048's ROM** is as simple as adding the 8355 or 8755 (a). Each 8355 provides  $2\text{ k} \times 8$  of storage and 16 I/O lines. RAM can also be expanded (b) by using the Bus port of the 8048 just like the 8080A's data bus.

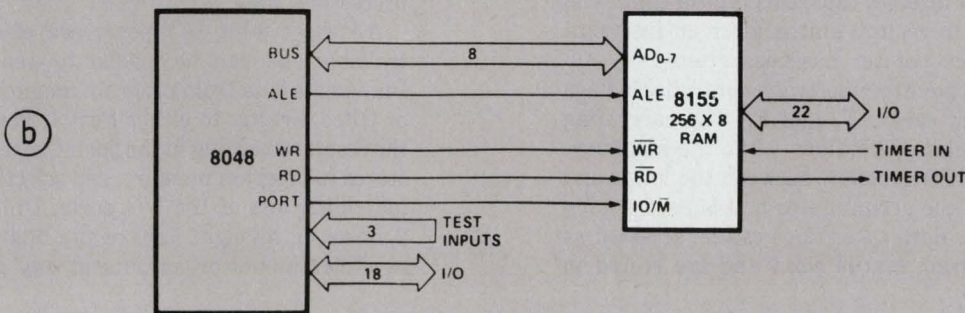
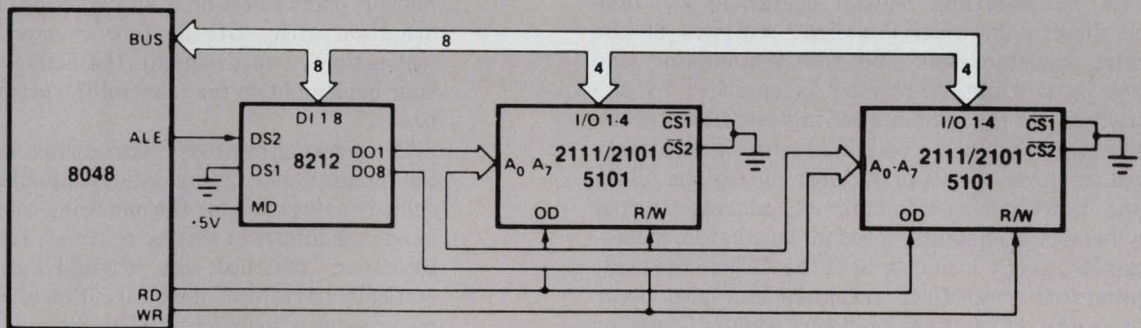
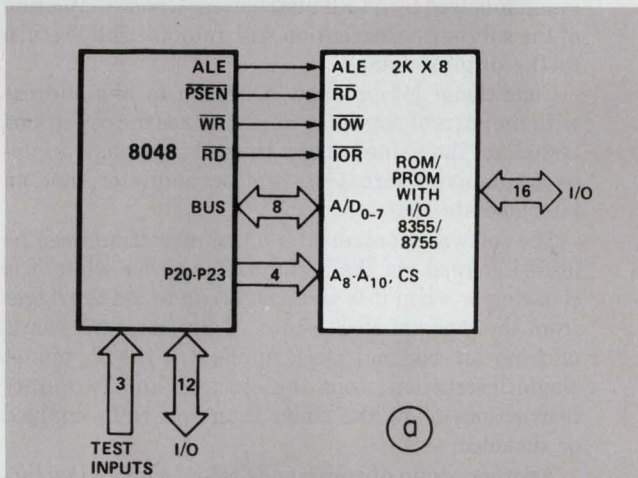

## Instruction set for the MCS-48 family

The instruction set of the MCS-48 family contains 96 commands that require either one or two bytes, although about 70% of the instructions require only one byte. Execution takes either one or two cycles (2.5, or 5  $\mu$ s when using a 6 MHz crystal); over 50% of all instructions execute in a single cycle. Double-cycle instructions include all immediate commands and all I/O operations. The MCS-48 circuits can efficiently handle both binary and BCD arithmetic operations as well as single-bit operations required in control applications. Special instructions have also been included to simplify loop counters, table look-up routines and N-way branches.

Instructions can be divided into seven groups as shown in the accompanying instruction summary. The accumulator (AC) commands are the most numerous, with 25 to choose from. Immediate data, data from the main memory or data from the working registers can be added with or without the carry to the AC. The same data can also be ANDed, ORed or Exclusive-ORed to the AC. Data can be shifted to or from the AC, working registers or data memory and, in a single operation, can be swapped between the AC and any register or memory location. For BCD arithmetic the lower four bits (nibble) of the AC can be swapped for the lower nibble of any internal RAM location. This instruction, XCHD A, @R, along with another command, SWAP A, that swaps the upper and lower nibbles of the AC, makes it simple to perform operations on 4-bit numbers.

Data transfers and register operations can take place directly between the eight registers of the working register bank and the accumulator (the source or destination register is specified by the instruction), or the remaining 56 internal registers can be addressed as data memory indirectly via an address stored in either the  $R_0$  or  $R_1$  working register. Both  $R_0$  and  $R_1$  are also used to indirectly address external data memory. Constants stored in the program memory can be directly loaded to both the AC and the eight working registers. Data transfers can also occur between the AC and the on-board counter/timer or between the AC and program status word. When writes are done to the program-status word, the machine status is altered; thus, this type of command is a handy way to restore status after an interrupt or after the stack pointer has been altered.

The processors have four software controllable flags—carry, auxiliary-carry,  $F_0$  and  $F_1$ . The carry flag indicates accumulator overflow, while the auxiliary-carry indicates BCD overflow between the lower and upper nibbles in the accumulator and is used during a decimal adjust. Both these flags can be accessed as part of the program status word and are stored in

the stack during subroutines. Flags  $F_0$  and  $F_1$  are general-purpose and can be cleared, complemented and tested by conditional jump instructions. However,  $F_0$  can be accessed through the program-status word and stored in the stack along with the carry flags.

Both conditional and unconditional jump commands are available. Unconditional jumps require 2 bytes and permit jumps anywhere in the first 2048 words of program memory. To get to locations 2048 and 4095, a Bank-select instruction must be executed, then the jump command. A subroutine in the opposite bank can be accessed by a Select-memory-bank command followed by a Call instruction. Upon completion of the subroutine, execution will automatically return to the original bank.

Conditional jumps allow a branch to any address with the current page (256 words). Since the conditions tested are the values at the time of a jump, a Jump-on-accumulator-zero tests the accumulator, not an intermediate flag.

The software-controlled 8-bit counter/timer can be loaded or read via the accumulator either while it is counting or when it is stopped. It can be set to trigger from the internal clock source, from external events or from an external clock applied to the  $T_1$  pin. A single instruction stops the counter, and two other instructions allow the timer interrupt to be enabled or disabled.

Another group of commands called control instructions provides interrupt-enable or disable operations, memory-bank selection, a special clock enable and no-operation cycle. Of the four memory-bank select instructions, two designate the active working register bank and two that control the program-memory banks.

The working register's bank-switch commands let the programmer immediately substitute a second eight-register bank for the one being used—especially handy for interrupt service routines. However, if the banks are switched, the original bank will automatically be restored upon execution of a Return-and-restore-status instruction. The Internal-clock-enable instruction enables an internal clock, which outputs the crystal frequency divided by three on one of the processor's pins.

All three 8-bit I/O ports are also software-controllable and can be loaded to and from the AC. Immediate data from program memory can be ANDed or ORed directly to either Port 1, Port 2 or Bus with the result remaining in the port. Consequently, masks, stored in program memory, can selectively set or reset individual bits of the I/O ports. Unlike Ports 1 and 2, however, all eight lines of the Bus must be treated as either inputs or outputs at any given time.

Mnemonic	Description
<b>Accumulator instructions</b>	
ADD A, R	Add register to A
ADD A, @R	Add data memory to A
ADD A, #data	Add immediate to A
ADDC A, R	Add register with carry
ADDC A, @R	Add data memory with carry
ADDC A, #data	Add immediate with carry
ANL A, R	AND register to A
ANL A, @R	AND data memory to A
ANL A, #data	AND immediate to A
ORL A, R	OR register to A
ORL A, @R	OR data memory to A
ORL A, #data	OR immediate to A
XRL A, R	Exclusive-OR register to A
XRL A, @R	Exclusive-OR data memory to A
XRL A, #data	Exclusive-OR immediate to A
INC A	Increment A
DEC A	Decrement A
CLR A	Clear A
CPL A	Complement A
DA A	Decimal adjust A
SWAP A	Swap nibbles of A
RL A	Rotate A left
RLC A	Rotate A left through carry
RR A	Rotate A right
RRC A	Rotate A right through carry
<b>Data move and register instructions</b>	
MOV A, R	Move register to A
MOV A, @R	Move data memory to A
MOV A, #data	Move immediate to A
MOV R, A	Move A to register
MOV @R, A	Move A to data memory
MOV R, #data	Move immediate to register
MOV @R, #data	Move immediate to data memory
MOV A, PSW	Move PSW to A
MOV PSW, A	Move A to PSW
XCH A, R	Exchange A and register
XCHA, @R	Exchange A and data memory
XCHD A, @R	Exchange nibble of A and register
MOVX A, @R	Move external data memory to A
MOVX @R, A	Move A to external data memory
MOVP A, @A	Move to A from current page
MOVP3 A, @A	Move to A from page 3
INC R	Increment register
INC @R	Increment data memory
DEC R	Decrement register
<b>Flag instructions</b>	
CLR C	Clear carry
CPL C	Complement carry
CLR F0	Clear flag 0
CPL F0	Complement flag 0

CLR F1	Clear flag 1
CPL F1	Complement flag 1
<b>Branch and subroutine instructions</b>	
JMP addr	Jump unconditional
JMPP @A	Jump indirect
DJNZ R, addr	Decrement register and skip
JC addr	Jump on carry = 1
JNC addr	Jump on carry = 0
J Z addr	Jump on A zero
JNZ addr	Jump on A not zero
JT0 addr	Jump on T0 = 1
JNT0 addr	Jump on T0 = 0
JT1 addr	Jump on T1 = 1
JNT 1 addr	Jump on T1 = 0
JF0 addr	Jump on F0 = 1
JF1 addr	Jump on F1 = 1
JTF addr	Jump on timer flag
JNI addr	Jump on INT = 0
JBb addr	Jump on accumulator bit
CALL	Jump to subroutine
RET	Return
RETR	Return and restore status
<b>Timer/counter instructions</b>	
MOV A, T	Read timer/counter
MOV T, A	Load timer/counter
STRT T	Start timer
STRT CNT	Start counter
STOP TCNT	Stop timer/counter
EN TCNTI	Enable timer/counter interrupt
DIS TCNTI	Disable timer/counter interrupt
<b>Control instructions</b>	
EN I	Enable external interrupt
DIS I	Disable external interrupt
SEL RB0	Select register bank 0
SEL RB1	Select register bank 1
SEL MB0	Select memory bank 0
SEL MB1	Select memory bank 1
ENTO CLK	Enable clock output on T0
NOP	No operation
<b>Input/output instructions</b>	
IN A, P	Input port to A
OUTL P, A	Output A to port
ANL P, #data	AND immediate to port
ORL P, #data	OR immediate to port
INS A, BUS	Input BUS to A
OUTL BUS, A	Output A to BUS
ANL BUS, #data	AND immediate to BUS
ORL BUS, #data	OR immediate to BUS
MOVD A, P	Input expander port to A
MOVD P, A	Output A to expander port
ANLD P, A	AND A to expander port
ORLD P, A	OR A to expander port

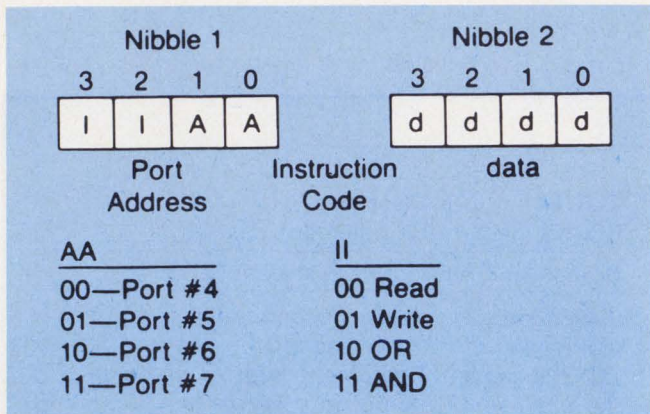

7. To use the I/O expanders, communication must take place in 4-bit words over the lower four lines of Port 2, with timing provided by an output pulse from the PROG pin of the processor. Each transfer consists of two 4-bit words, the first containing the operation code and port address, the second the four bits of data.

pointer registers,  $R_0$  or  $R_1$ . Thus, 256 locations can be addressed in addition to the 64 locations in the processor. Additional pages may be added by using some of the I/O lines of the processors to switch memory banks.

I/O expansion works similarly, using the 8243 four port expanders. Each of the ports can transfer data to the accumulator, accept data from the accumulator, AND data in the accumulator to data in the port, or OR data from the accumulator to the port. All communication between the processor and the 8243s occurs over the lower four bits of Port 2, with timing provided by an output pulse on the PROG pin of the processor. Each data transfer consists of two 4-bit nibbles, the first containing the operation code and port address and the second containing the actual four bits of data (Fig. 7). A low-to-high transition of the PROG line indicates that the address is present, while

a high-to-low transition indicates that data are present.

Now that the MCS-48 family of components is no longer a mystery, examine the actual development cycle and design tools for the processor and systems.

### Starting the development cycle

Of course, in any development cycle, the first step is to define the final product and construct a flow chart of product operation.

The next step is to define the hardware necessary to do the job. I/O capability must be defined in terms of the number of inputs, the number of outputs, the number of bidirectional lines, the need for latched or nonlatched lines, the output-drive capability and the input impedance.

Probably the hardest parameter to define initially is the amount of program memory needed to store the applications program. Many special functions such as serial-communications routines or keyboard/display interfaces can be put into software; however, they can place a severe load on the processor and tie it up when data must be processed. When speed is important, use peripheral circuits to do the specialized tasks.

Once the system function and hardware have been defined, you can start writing the final program code for the application. At this point, you can take one of two paths with Intel development tools (Table 2). One system, called the Prompt-48, is a bench-top development system that includes one 8748 and one 8035 and costs less than \$1800. It supports machine-language programming and has provisions for programming the 8748 version from a built-in RAM. The other system, a version of the Intellec microcomputer development system, supports both machine and assembly-level languages and can cost from \$4000 to \$15,000, depending on options.

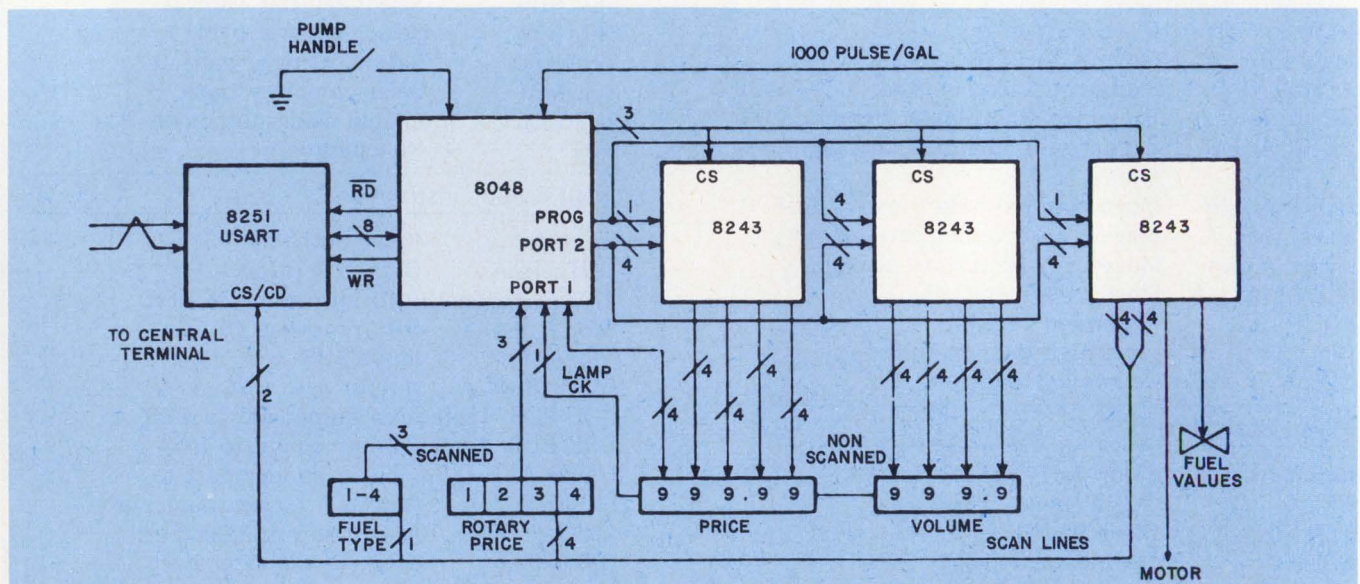

8. An all-electronic gas pump can be built with an 8048 processor and three expander circuits. The pump not only

displays price per gallon, total and volume, but also communicates with a central terminal.

In one of the Prompt-48's front-panel sockets is an 8748 processor that executes program steps and controls circuitry to provide debug functions such as single-step and breakpoints. A monitor program is also stored in ROM, and an EPROM programmer as well as a hexadecimal keyboard and display are included. The Prompt's front panel has two sockets—one for programming the 8748 and one for testing a programmed unit controlled by a monitor program.

To apply the Prompt-48, you must

- Load an application program into the unit's RAM via the hex keyboard or external terminal (TTY and RS-232 interfaces are provided).

- Execute and debug the code in RAM via an 8035 in the execution socket.

- Insert a blank 8748 into the programming socket of the Prompt and copy the program from RAM into the processor.

- Transfer the 8748 to the execution socket where the program can be executed in real time.

The monitor in the Prompt permits you to single-step the processor, examine or modify all internal registers and data memory, or run and then stop the processor at predetermined breakpoints. A multiple single-step feature is also available—you can step the processor through its program and dump all internal register contents to RAM for future display and analysis.

The Intellec system permits even more flexibility for software and hardware development. The base system consists of a processor based on the 8080A and such optional units as a PROM programmer, a high-speed paper-tape reader, a disc-operating system and a CRT terminal.

An ASM-48 macroassembler to support the MCS-48's development can be loaded via the disc-operating system. An in-circuit emulation capability with the ICE-48 option will be available later in the year. Macroassembler and text editor programs enable you to write and edit the programs in assembly language and then generate the machine code necessary for programming the processor.

The assembler for the MCS-48 family performs such duties as

- Evaluation of expressions: Arithmetic expressions and multiple symbols are permitted in the operand portion of instructions. For instance, the MCS-48 assembler permits `ADD A, #ALFA*BETA/2`, where ALFA and BETA are two previously defined symbols. At assembly time, the expression will be evaluated and the resulting number treated as immediate data and designated the second byte of an ADD immediate instruction.

- Conditional assembly: This allows you to select only certain portions of the assembly-language source program for conversion into machine code. Thus, various debug routines can be included during program development.

- Macros: Multiple assembly-language statements can be represented by a single higher-level command.

**Table 2. MCS-48 programming support**

Model	Description
Prompt-48 base cost: \$1750	Benchtop stand-alone programming system
Intellec base cost: \$3950	8080A-based microcomputer system consisting of 16 kwords of RAM (expandable to 64 k), 2 k of ROM (expandable) and software and hardware interfaces for TTYs, CRTs, line printers, paper-tape readers or punches, and PROM programmer, as well as a resident macroassembler and text editor.
Options include:	PROM programmer, in-circuit emulator, dual floppy-disc drive, DMA channel controller and other input/output interface modules.

Thus, a shorthand representation of often used routines can be employed to reduce programming time. For example, the 8048 doesn't have a subtract routine. But the 8048 can subtract by performing three instructions—`CPL A ADD A, REG CPL A`—in sequence, which subtract a register's contents from the accumulator and leave the result in the accumulator. By defining this sequence with the label SUB and an operand that can be any register from  $R_0$  to  $R_7$ , the programmer merely has to write `SUB R7`, and the assembler will automatically insert the instructions.

A typical application for the MCS-48 family microcomputers is a gasoline-pump controller, as shown in Fig. 8. In this system, an 8048 in each pump measures the flow of gasoline, corrects flow measurements, computes the corresponding price and drives digital displays for both price and volume. All pumps are connected by a serial-digital communications channel to a controlling console in the station operator's booth.

### Design an 8048 operating system

For this application, three 8243 I/O lines must be added to drive the latched displays and control the miscellaneous pump functions such as fuel valves and pump motors. The I/O lines of the 8048 help scan the manual switches that are set to indicate the type of fuel and the price per gallon. A switch in the pump handle can be used to generate a start signal for the pump. This signal is fed to one of the 8048's test inputs where it is continually tested by a conditional jump instruction.

Fuel is measured by an impeller in the fuel line that generates a string of pulses at a rate proportional to the flow rate. These pulses are accumulated in the event counter of the 8048 and the total is used to calculate the final cost of the gas. The serial data link can be built using the 8251 programmable communication interface so that data can be sent and received over two-wires. ■■

# DUAL COIL CIRCUIT BREAKER

reacts to both  
voltage and current.

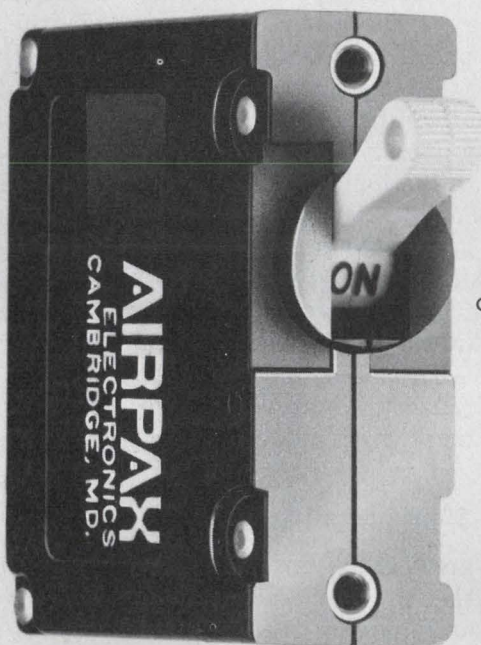

**Smaller, Lighter, Less Expensive.** The Airpax Dual Coil Circuit Breaker is a single pole magnetic circuit protector that reacts like a two pole breaker but is smaller, lighter, and less expensive.

**Wide Variety of Applications.** In addition to conventional circuit protection, the Airpax Dual Coil Circuit Breaker can be used in conjunction with a temperature transducer to protect heat-sensitive equipment such as power supplies. By connecting a sensing device to the voltage coil, it can be used in interlock circuits or can react to pressure, flow, weight, or fluid level.

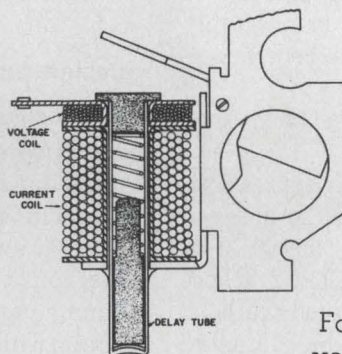

**Current Coil Ratings.** The current coil ratings are from 0.050 to 30 amperes at 65V dc or 250V ac maximum, 60 or 400 Hz. (Other models to 100 amperes.)

For more detailed information, call your local Airpax representative or contact Airpax Electronics, Cambridge Division, Cambridge, Md. 21613. Phone (301) 228-4600. Telex: 8-7715.

TWX: 865-9655. Other factories in Europe and Japan. European Sales Headquarters: Airpax S.A.R.L., 3 Rue de la Haise, 78370 Plaisir, France.

# AIRPAX™

**THE PRO IN PROTECTION**



The system  
builder's sensible  
display.

Everything  
you need and  
not one piece  
more.

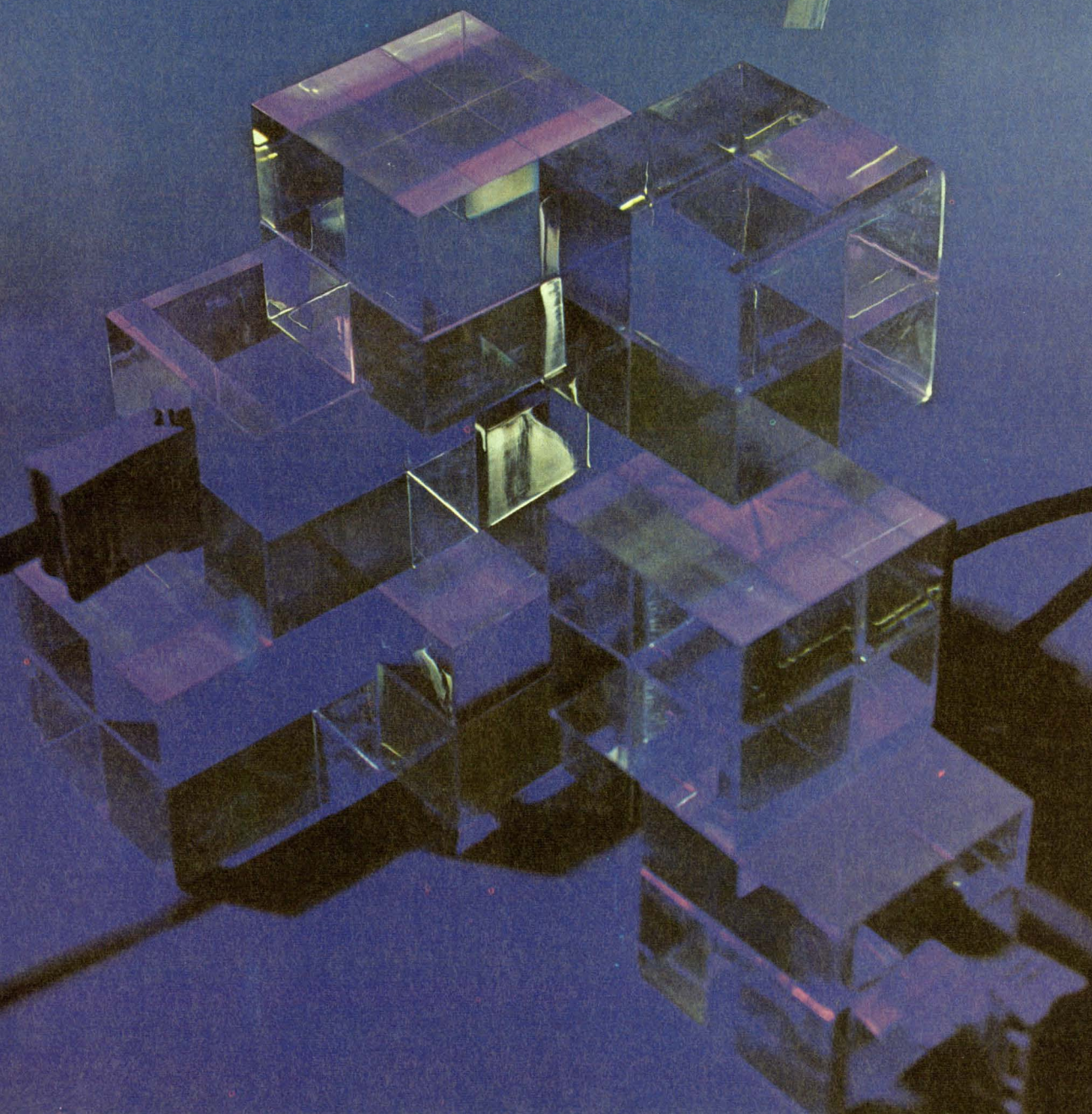

# We've combined refresh with storage in a new modular graphics display.

## You build from there.

### **Suddenly state-of-the-art display technology comes built for the OEM.**

Tektronix' new GMA display modules let you integrate into your system our most impressive display capabilities ever. Including refresh and storage graphics in one tube. Complete character and vector generators. Big 19" screen and fine resolution.

It's exactly what you need, because you can specify exactly what you want. Order CRT and power supply only, or select from a range of performance and packaging options in our extensive product line.

You can integrate other products from our graphics family, like hard copy modules. Or talk to us about other special product configurations, like our 11" storage-only components.

### **No other package lets you pick such comprehensive graphic display capability at anywhere near the price.**

It figures, because Tektronix has been the worldwide low-cost graphics leader for years. No matter what unique and unusual systems you're working with, we can help with manufacturing flexibility, engineering assistance, and a passion for excellence.

Get capability you can build with. From a supplier you can work with. Get your Tektronix OEM Sales Engineer on the phone today. Or write us for more information.

Tektronix, Inc.  
Information Display Group  
OEM Components  
P.O. Box 500  
Beaverton, OR 97077



CIRCLE NUMBER 38

**Tektronix**  
OEM components:  
the perfect fit.

**Tektronix**  
COMMITTED TO EXCELLENCE

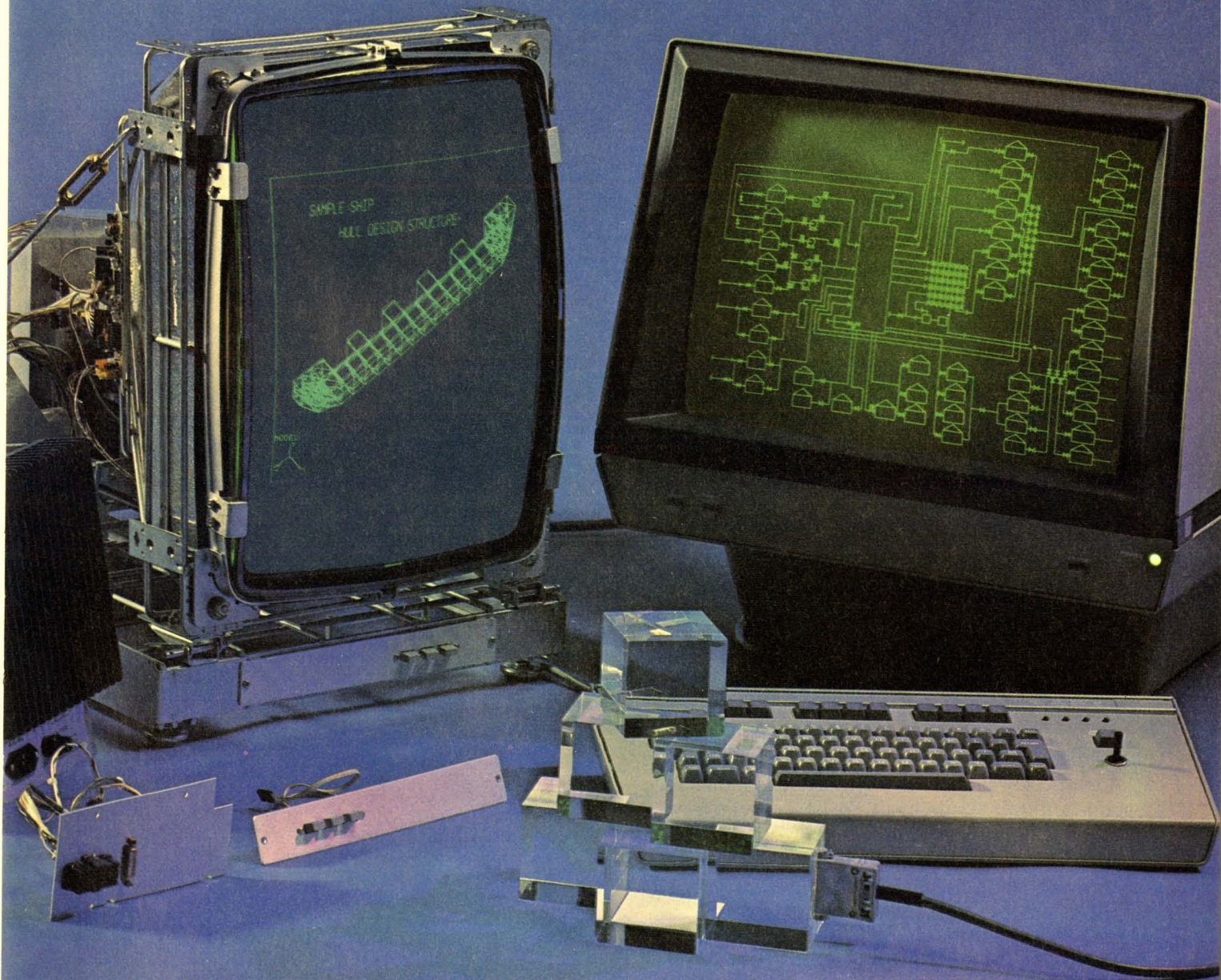

## Bypass filters extend to the GHz range when solid-tantalum capacitors are used. A graphical design method predicts filter performance for "real" capacitors.

Solid-tantalum capacitors make excellent bypass filters: They have low internal inductance and resistance, and thus don't resonate until well beyond 1 GHz (Fig. 1).

But even the superior performance of solid-tan-

the performance and lead-length correction curves (Figs. 4 and 6) are specific for practical solid-tantalum units.

Solid-tantalum capacitors can handle 5 to 100 V dc, have excellent stability, a wide temperature range, very small CV per volume, and come in a wide range of capacitances.<sup>2</sup> The curves include sizes from 0.01 to 220  $\mu\text{F}$ . However, most solid-tantalums are polarized, so they can literally explode if connected to an ac power line (though two back-to-back units with their negative terminals connected can handle ac). And unless protected, they won't survive the MIL-

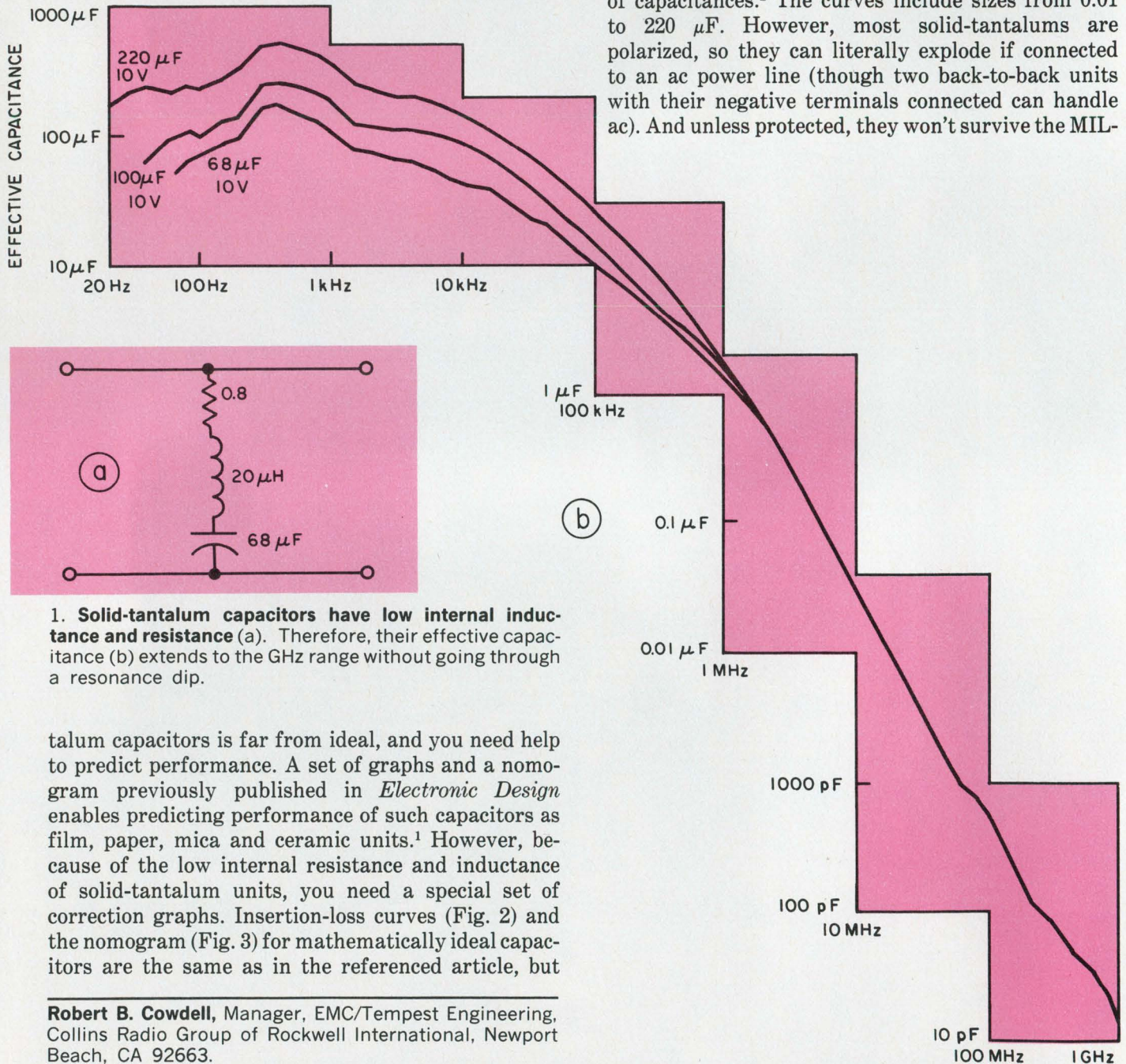

1. Solid-tantalum capacitors have low internal inductance and resistance (a). Therefore, their effective capacitance (b) extends to the GHz range without going through a resonance dip.

talum capacitors is far from ideal, and you need help to predict performance. A set of graphs and a nomogram previously published in *Electronic Design* enables predicting performance of such capacitors as film, paper, mica and ceramic units.<sup>1</sup> However, because of the low internal resistance and inductance of solid-tantalum units, you need a special set of correction graphs. Insertion-loss curves (Fig. 2) and the nomogram (Fig. 3) for mathematically ideal capacitors are the same as in the referenced article, but

**Robert B. Cowdell**, Manager, EMC/Tempest Engineering, Collins Radio Group of Rockwell International, Newport Beach, CA 92663.

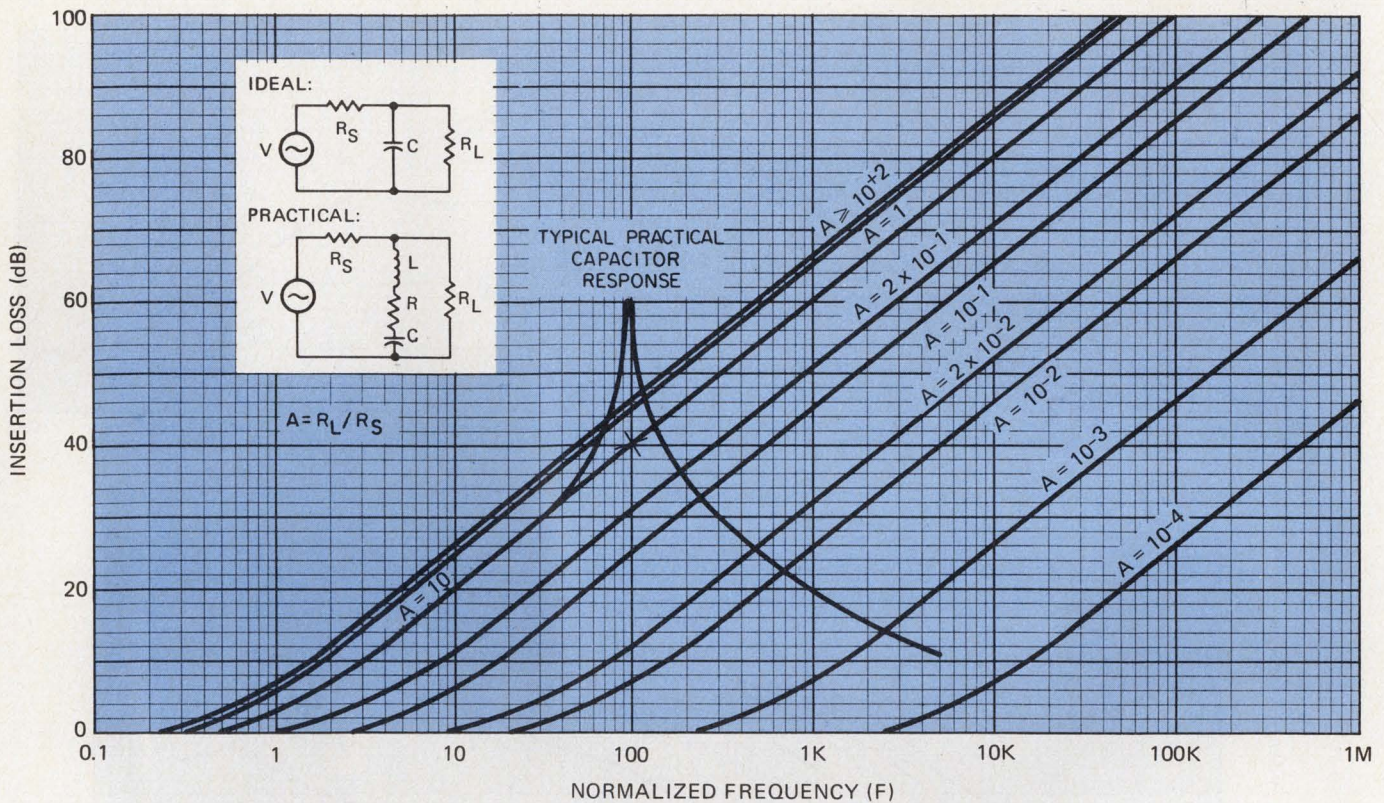

2. Curves of the insertion loss of an ideal bypass filter, for normalized frequency,  $F$ , and mismatch ratio,  $A$ , show a continually rising loss as frequency increases. A real

filter with a practical capacitor approximates such curves at low frequencies, but drops off to lower insertion loss at high-frequency values.

STD-704A transient-surge test on dc—which still leaves a vast area of use in low-voltage-dc bypass filtering such as in power-supply leads.

### Filtering with solid tantalums

To apply the graphs to solid tantalums, first let's examine a common bypass-filter circuit condition—a 50- $\Omega$  source resistance,  $R_s$ , and matching 50- $\Omega$  load,  $R_L$  (Fig. 2). The mismatch ratio is

$$A = R_L/R_s \quad (1)$$

$$= 1.$$

Suppose the design target is a 40-dB reduction of noise at 17 kHz. For an ideal capacitor, calculations are easy, but the normalized graph (Fig. 2) and nomogram (Fig. 3) make the procedure even easier. Fig. 2 is a plot of a family of curves of insertion loss (I.L.) versus normalized frequency ( $F$ ) for different mismatch ratios from  $A \geq 10^2$  to  $A = 10^{-4}$ , where

$$I.L. = 10 \text{ Log } \{ 1 + F^2 [ 4A^2 / (1 + A)^2 ] \}. \quad (2)$$

And Fig. 3 is a nomograph of

$$f_0 = 1/\pi R_s C, \quad (3)$$

where the cutoff frequency,  $f_0$ , is the frequency at which the filter's I.L. = 3 dB when  $A=1$ .

From Fig. 2, you can quickly get the required normalized frequency,  $F = 100$ , where Curve  $A = 1$

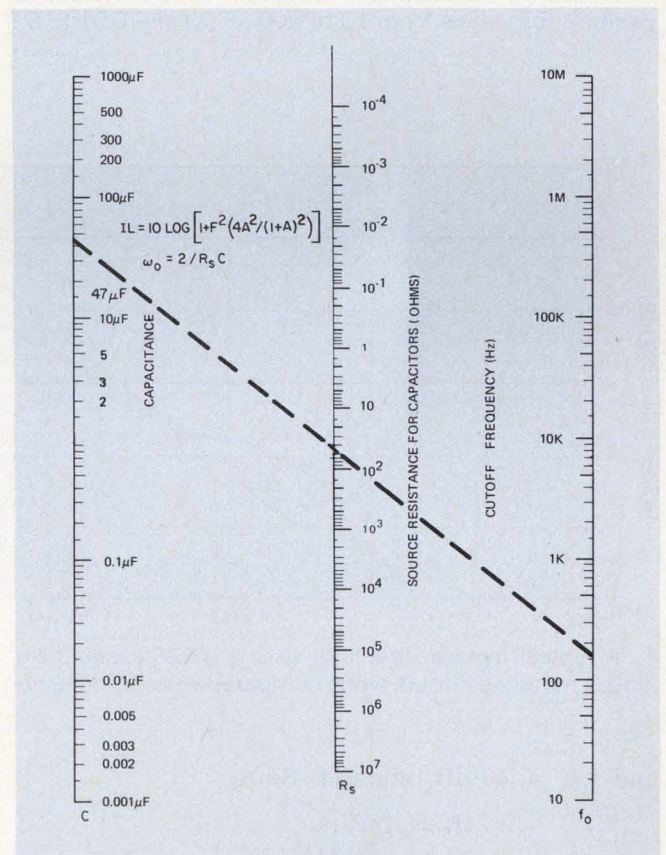

3. A nomogram of an idealized bypass filter simplifies determination of capacitance,  $C$ , given source resistance,  $R_s$ , and cutoff frequency,  $f_0$ .

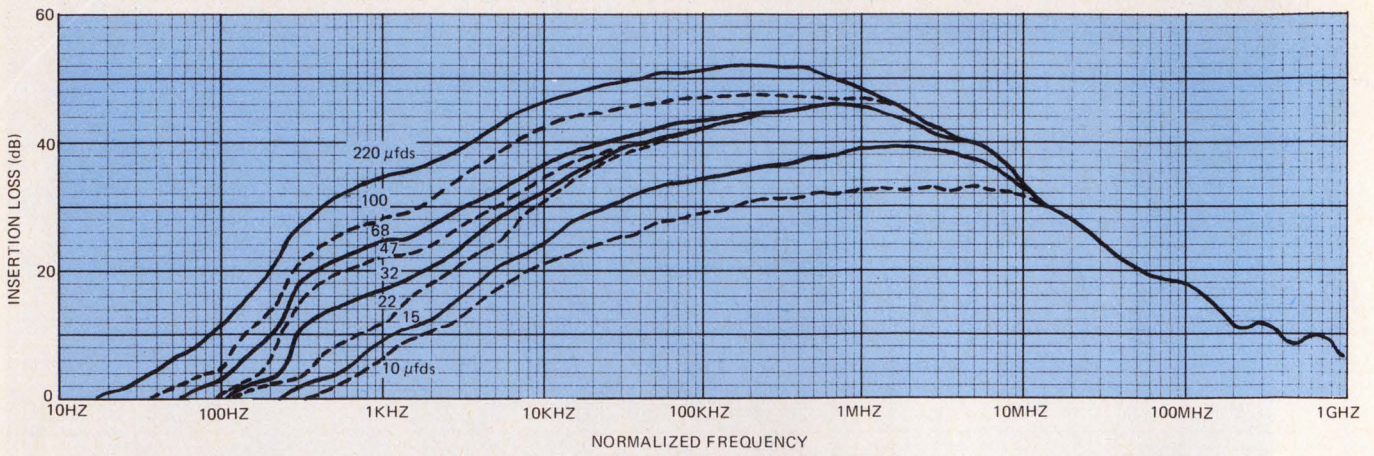

(a)

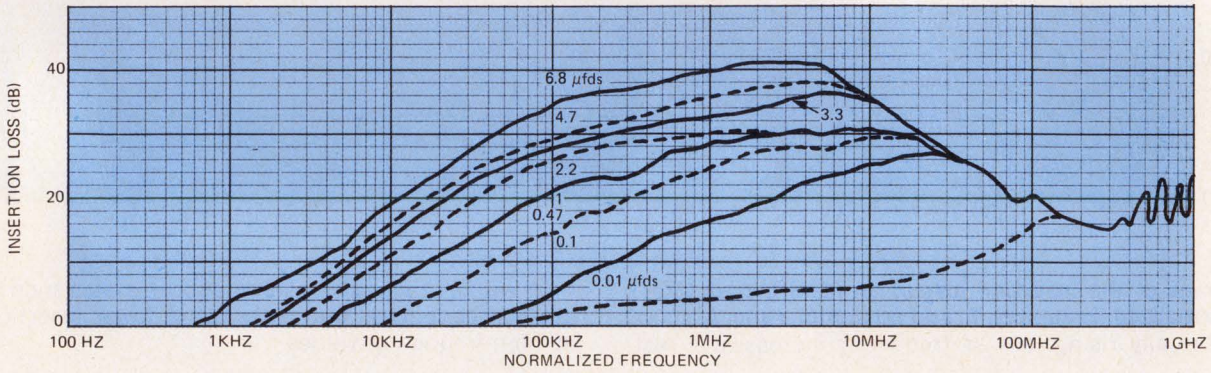

(b)

4. Measured insertion-loss curves for solid-tantalum capacitors for values from 10 to 200  $\mu\text{F}$  (a) and 0.01 to 6.8

$\mu\text{F}$  (b) at  $A = 1$  ( $R_S = R_L = 50 \Omega$ ) provide corrections for actual performance when used with the ideal curves.

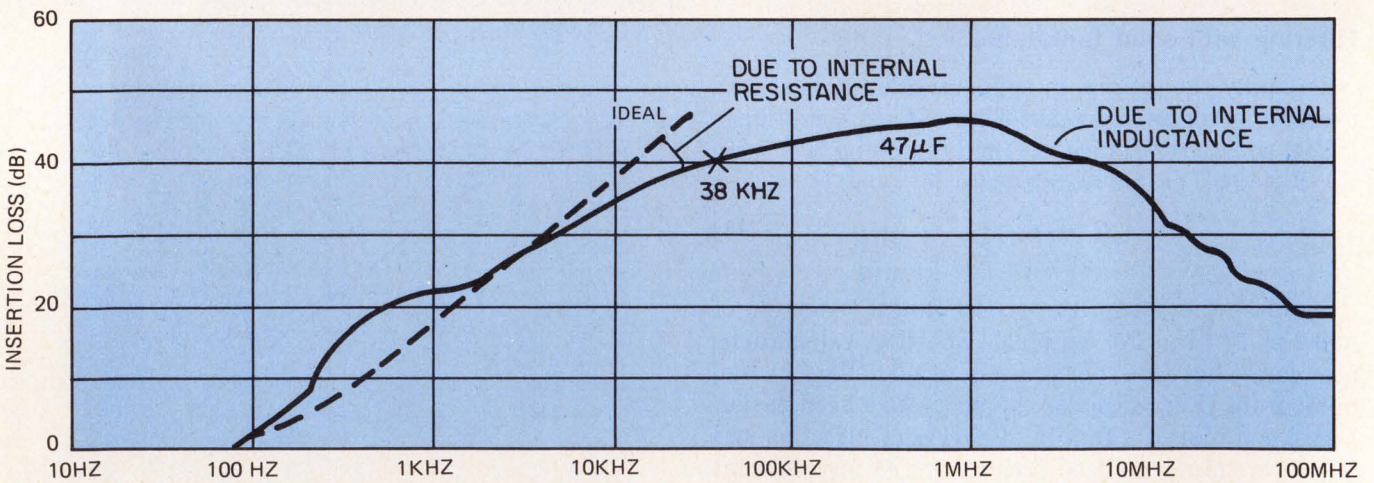

5. A typical bypass filter that uses a 47- $\mu\text{F}$  capacitor in a 50- $\Omega$  matched circuit, when compared with the behavior

of an ideal circuit, shows an increasingly wide divergence at high frequencies beyond about 20 kHz.

and I.L. = 40 dB intersect. Since

$$\begin{aligned} f_0 &= f/F \\ &= 17 \text{ kHz}/100 \\ &= 170 \text{ Hz}, \end{aligned} \quad (4)$$

from the nomogram (Fig. 3) you get  $C = 47 \mu\text{F}$  (the

closest standard capacitor size) by drawing a straight line between  $f_0 = 170 \text{ Hz}$  and  $R_S = 50 \Omega$ .

Figs. 4a and 4b are measured plots of I.L. for solid-tantalum capacitors from 0.01 to 220  $\mu\text{F}$  at  $R_S = R_L = 50 \Omega$  ( $A = 1$ ). To determine the discrepancy between the actual and theoretical insertion losses,

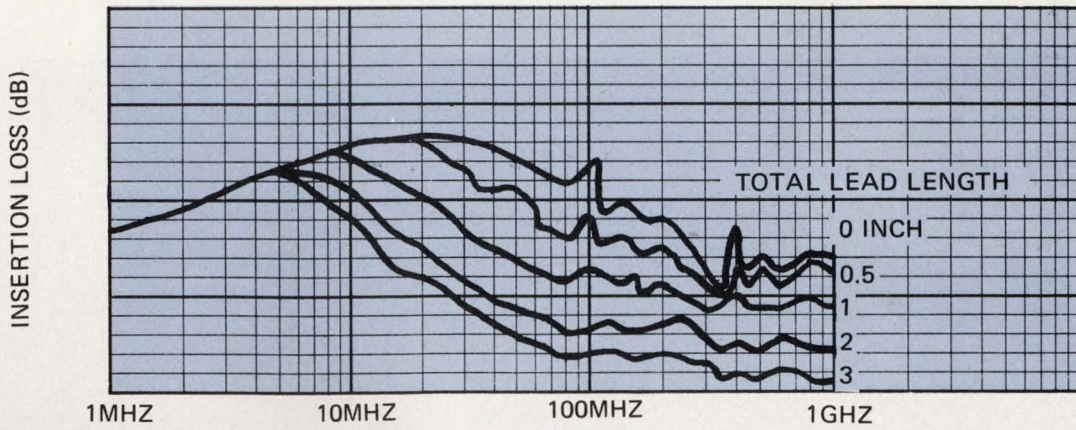

(a)

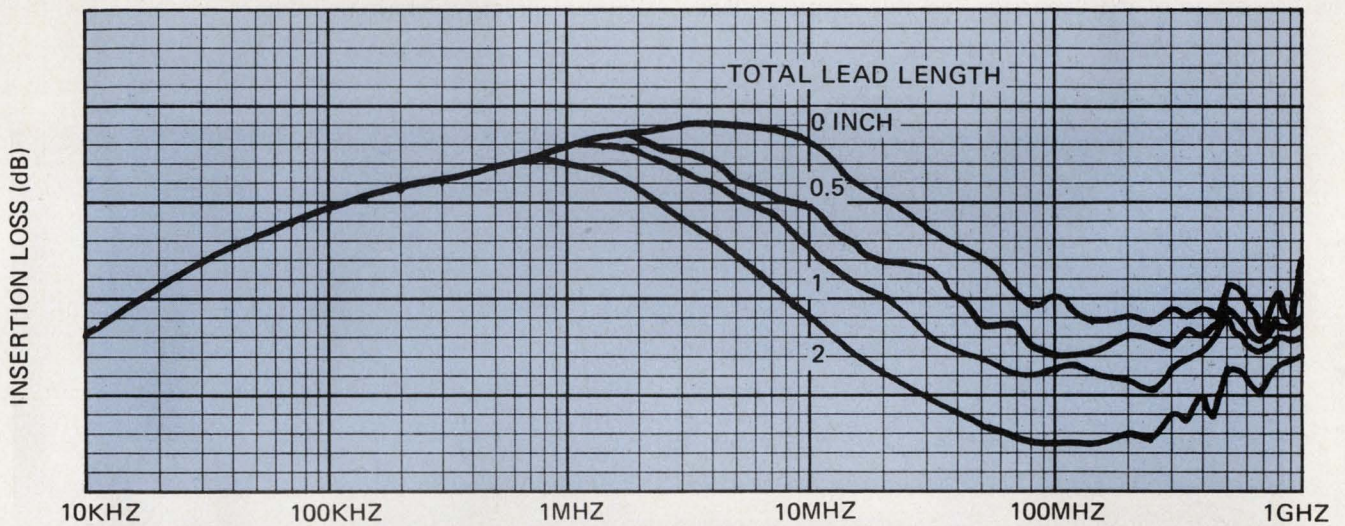

(b)

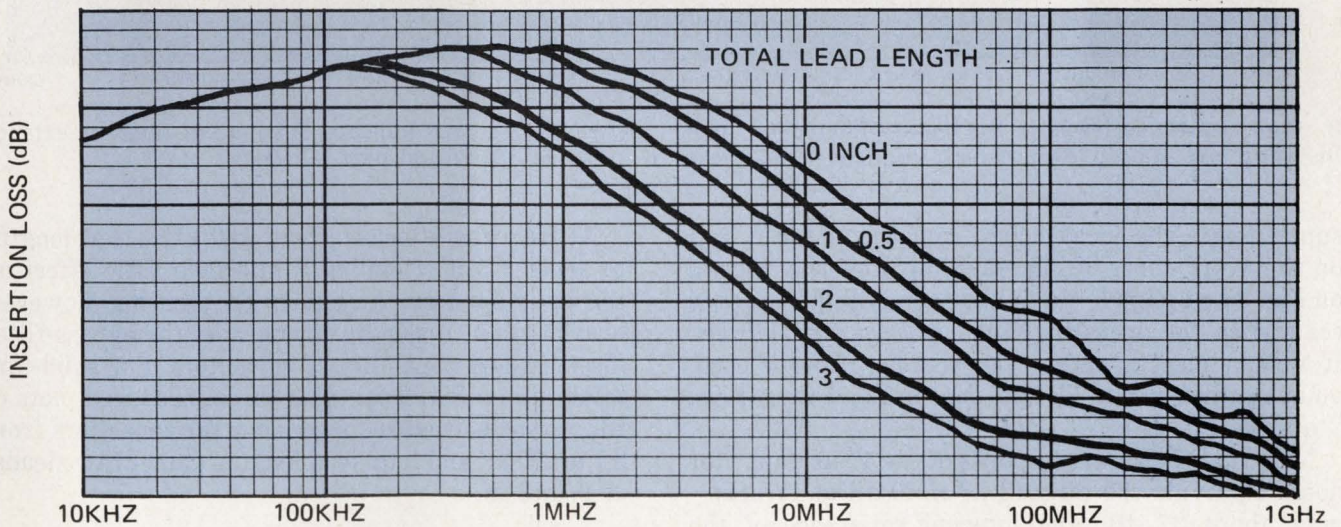

(c)

6. Lead length strongly affects the high-frequency performance of capacitors in bypass filters. These curves

provide corrections for lead length for 0.1-to-2.2- $\mu\text{F}$  (a), 3.3-to-15- $\mu\text{F}$  (b) and 22-to-220- $\mu\text{F}$  (c) capacitors.

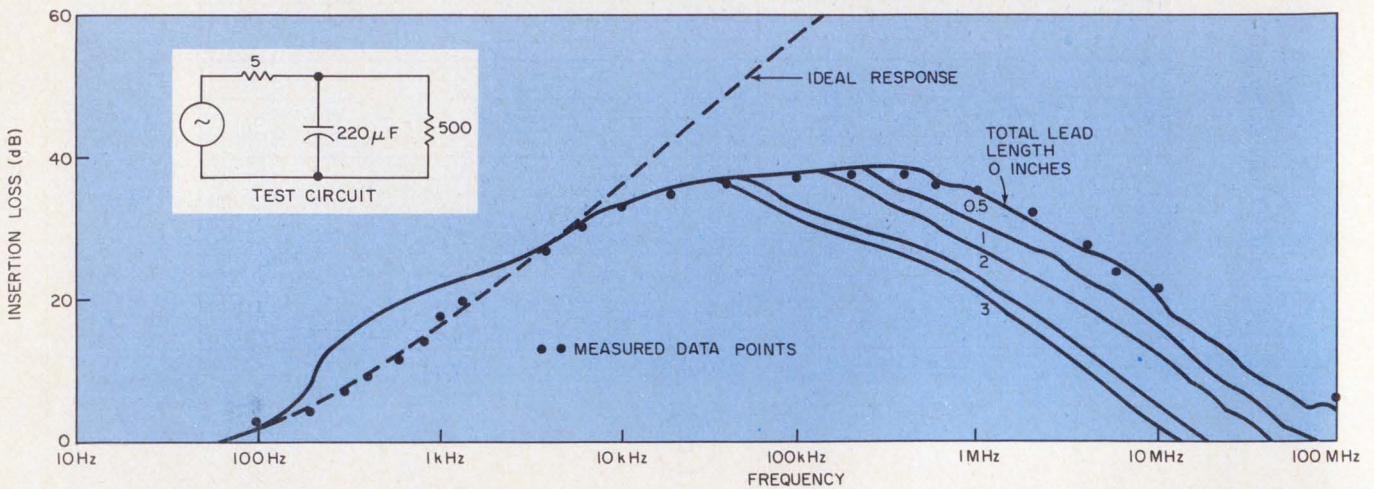

7. A practical filter design must take into account both the properties of the capacitor and the effects of lead

length. Note the close agreement between the measured and graphically determined data.

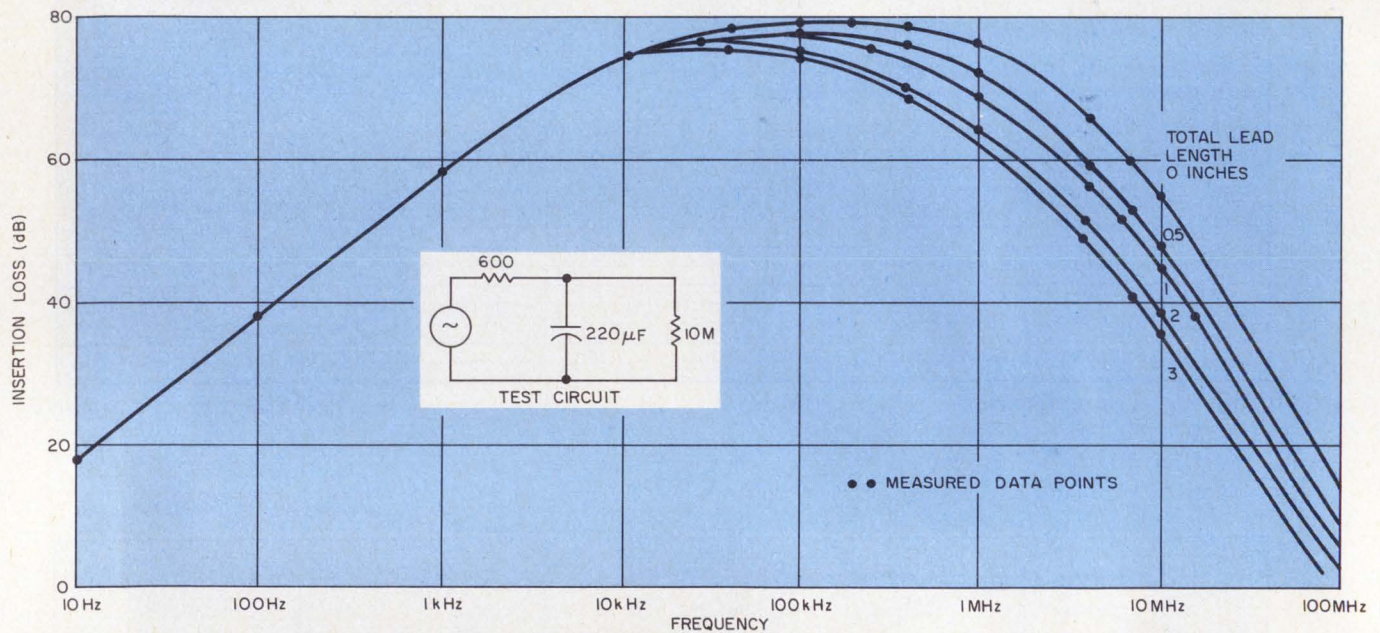

8. High resistance levels in the bypass filter allow high insertion loss at both low and high frequencies, as these

measured curves indicate. Substantial filtering extends down to 10 Hz and past 10 MHz.

superimpose the ideal curve from Fig. 2 for  $A = 1$  on the 47- $\mu\text{F}$  curve of Fig. 4a. Simply overlay Fig. 4a on Fig. 2 and align  $F = 1$  on the normalized-frequency scale with the operating frequency scale at 170 Hz. If a clean sheet of seven-cycle semilog paper is used, you can trace curves like the ones in Fig. 5 from Figs. 2 and 4a.

Note that the actual response of the 47- $\mu\text{F}$  capacitor doesn't provide the target I.L. of 40 dB at 17 kHz—only about 37 dB. The internal resistance of the capacitor accounts for most of this discrepancy. But a larger capacitor—perhaps 100  $\mu\text{F}$ —could provide even more than the targeted 40 dB. Also note that so far no corrections have been made for capacitor lead length.

At frequencies below about 100 kHz, lead lengths to about 1.5 in. (totaling 3 in.) have little effect on the insertion loss. At higher frequencies, however, lead length increasingly downgrades the bypass-filter insertion-loss capability of capacitors. For solid-tantalum units, Fig. 6 contains three measured plots of I.L. versus normalized frequency for capacitors from 0.1 to 200  $\mu\text{F}$  and total lead lengths (sum of two leads) of 0 to 3 in.

#### Correct for lead length

Since curves in Fig. 4 are for zero, or very short (less than 0.2-in. total) lead length, use Fig. 6 to correct



for practical lead lengths. To apply Fig. 6, let's use another example, only this time work with a mismatched design—a 5- $\Omega$  source resistance,  $R_S$ , and 500- $\Omega$  load,  $R_L$ . And as before, seek a target I.L. of 40 dB, but now at 15 kHz and out to, say, 1 MHz.

As you might expect, the practical response you will come up with won't quite meet this 40-dB target, although the ideal capacitor will appear to make it.

Solving the example takes seven steps:

1. Compute  $A = R_L/R_S = 500/5 = 10^2$ .
2. On Fig. 2, find  $F = 48$  at I.L. = 40 dB.
3. Compute  $f_0 = f/F = 15 \text{ kHz}/48 = 312.5 \text{ Hz}$ .
4. On Fig. 4a, find  $C = 220 \mu\text{F}$  (the closest standard size above the determined value) with  $R_S = 5 \Omega$  and  $f_0 = 312.5 \text{ Hz}$ .
5. On a blank sheet of translucent seven-cycle semilog graph paper, draw frequency and insertion-loss scales like the ones on Fig. 4a and trace the ideal curve,  $A = 10^2$ , with  $F = 1$  shifted horizontally to align with  $f_0 = 312.5 \text{ Hz}$ .

6. Overlay the translucent semilog sheet with the ideal curve from Step 5 onto Fig. 4a, and with the horizontal scales aligned, vertically shift the overlaid sheet upward until the low-frequency end of the ideal curve falls into the measured 220- $\mu\text{F}$  curve. Trace the 220- $\mu\text{F}$  I.L. curve onto the overlaid sheet.

(Now you have corrected the Fig. 4a curve—measured in a matched 50- $\Omega$  condition,  $A = 1$ —for the mismatch of this example,  $A = 10^2$ .)

7. Align the sheet from Step 6 over the appropriate lead-length correction curve (Fig. 6a) with the 10-kHz horizontal axes of both graphs coincident, and move the overlaid sheet vertically until the real I.L. curve from Step 6 falls into the lead-length correction curves. Trace the correction curves on the overlaid sheet.

The I.L. curve you now have includes the effects of both mismatch and lead length, and shows the difference between an ideal and real-capacitor bypass filter (Fig. 7).

As anticipated, the real I.L. doesn't quite reach the target of 40 dB at 15 kHz that an ideal capacitor would—the I.L. attained is only about 35 dB. And depending on the lead lengths, the I.L. varies from about 35 dB at 1 MHz with an impractical zero lead length to about 21 dB for a 3-in. total lead length. To get more insertion loss, you can use two filter sections in parallel.

Fig. 8 shows measurements of the effect of a high-resistance source and load, which makes  $f_0$  very low. Such high impedances move Fig. 4 to the right of  $F=1$  in Step 5, and in Step 6, into a high I.L. region, so that the single capacitor becomes an excellent bypass filter. ■■

#### References

1. Cowdell, R.B., "Bypass and Feedthrough Filters," *Electronic Design*, Aug. 16, 1975, pp. 62-67.
2. Epanand, D. and Liddane, K., "Selecting Capacitors Properly," *Electronic Design*, June 21, 1977, pp. 66-71.

DESIGNING FILTERS? SAMPLING SIGNALS?  
ENHANCING S/N? ANALYZING WAVEFORMS?  
ANALYZING BROADBAND NOISE?  
MAKING POWER SPECTRAL DENSITY MEASUREMENTS?  
OPTIMIZING PHASE-LOCKED-LOOP PERFORMANCE?  
STUDYING AM/FM NOISE?

## NOW—Get More Spectrum Analyzer for Less Money

- Easiest to Use
- Unique Features
- Highest Performance in Its Class!



- **Easiest to Use** — Human-engineered panel/control organization simplifies setup, regardless of mode or range. Alpha-numeric on-screen data display is *always* direct reading.
- **Greatest Versatility** — more than any other in its class, including dual and difference spectra, 3 kinds of averaging, 3 transient-capture modes, ultra-flexible cursor/sideband/harmonic readouts — *hundreds* of measurement combinations!
- **Highest Performance** — best sensitivity, dynamic range, S/N ratio, linearity, and accuracy in its class!
- **NEW! All-digital Range Translation ("Frequency ZOOM")** — magnifies resolution up to 128 times — resolves 2 Hz at 100 KHz ... 0.2 Hz at 10 KHz ... and an incredible 0.4 millihertz at 20 Hz!

Before you choose a spectrum analyzer for your work, check out our Model FFT 512/S — the most advanced real-time spectrum analyzer in the 0 to 100 KHz analysis range. Despite its superiority, its base price is only \$8,900 (U.S.), and its options are also modestly priced. To prove to you that it can solve virtually *any* problem you might encounter, and to show you how remarkably easy it is to use, we'll send you the most comprehensive technical brochure ever produced for such an instrument — 20 pages of step-by-step, result-by-result description of each of its 33 modes of operation — **PLUS a \$6.00 handbook of spectrum analysis theory and applications ... free.**

#### FREE \$6.00 TEXTBOOK ON SPECTRUM ANALYSIS!

36 pages, complete and authoritative! Limited offer — until Sept. 30th. Check inquiry number, or call: Joe Flink, Rockland Systems Corporation, 230 W. Nyack Road, W. Nyack, N.Y. 10994. TEL: (914) 623-6666. TWX: 710-575-2631



ADVANCED SIGNAL TECHNOLOGY  
**ROCKLAND**  
SYNTHESIS • PROCESSING • ANALYSIS

Our Second Decade of Leadership

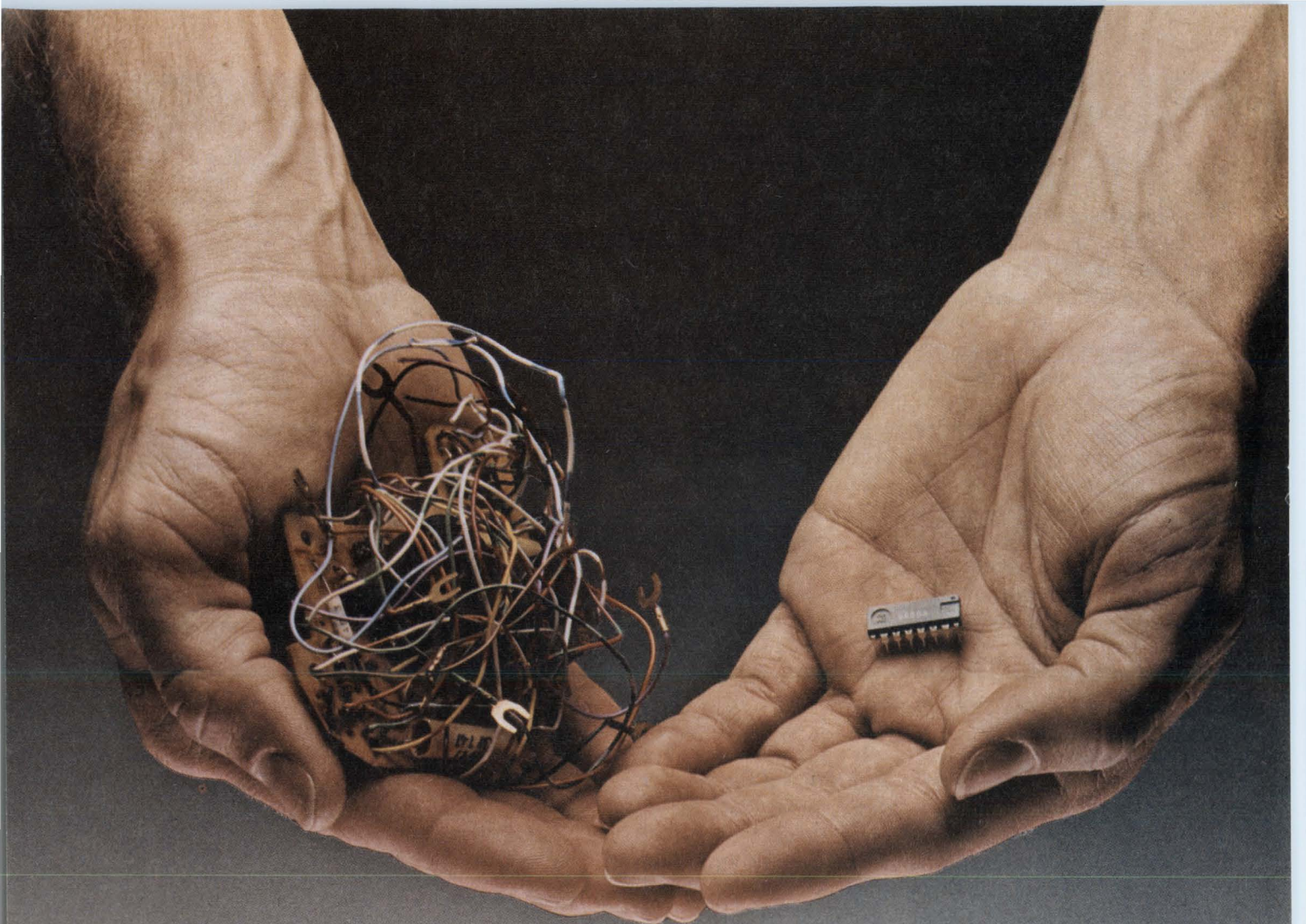

## Which tone generator rings your bell?

On the one hand, you have 21 wires, 2 coils and a PC board with 13 discrete components.

On the other hand, you have our S2559 Digital Tone Generator. It does everything the old generator did. But it's cheaper, easier to install and much more reliable.

This is the first in a series of off-the-shelf MOS telecommunications products from AMI. They're all designed to make phone systems simpler and less expensive.

This DTMF generator, for example, is the cleanest part on the market. And neatly replaces other generators on a pin-for-pin basis. You need fewer external components to hook it up. (The mute and transmitter drivers are right on board.) And, once it is working, you get a cleaner signal. Harmonic distortion is very low (typically 2%) and a 3.58 MHz color-burst crystal reference gives you high accuracy at low cost.

Being a CMOS circuit, it uses very

little power. And its wide operating voltage (anywhere from 3.5 to 13V) comes right off the tip and ring lines.

If you like the sound of these features, call your nearest AMI sales office for complete information.

Or give us a ring at (408) 246-0330 and ask for the Communications Marketing Department. American Microsystems, Inc., 3800 Homestead Road, Santa Clara CA 95051.

**AMI**<sup>®</sup>  
AMERICAN MICROSYSTEMS, INC.

CIRCLE NUMBER 44

# Introducing the SMALLEST BROADBAND MIXERS in the world - 40kHz - 2GHz



Act now to improve your system designs, increase your packaging density, and lower your costs... specify MiniCircuits' new microminiature TFM series. These tiny units, the smallest off-the-shelf Double-Balanced Mixers available today, cover the 40 kHz - 2 GHz range and offer isolation greater than 45 dB and conversion loss of 6 dB. Each unit carries with it a 1-year guarantee by MCL. Upgrade your new system designs with the TFM, rapidly becoming the new industry standard for high performance at lowest cost.

Model No.	Frequency Range, MHz			Conversion Loss, dB			Isolation, dB						Quantity	Price							
	LO	RF	IF	One Octave From Band Edge			Lower Band Edge to one Decade Higher			Mid-Range					Upper Band Edge to Octave Lower						
				Typ	Max	Typ	Min	Typ	Min	Typ	Min	Typ			Min	Typ	Min				
TFM-2	1-1000	1-1000	DC-1000	6.0	7.5	7.0	8.5	50	45	45	40	40	25	35	25	30	25	25	20	6-49	\$11.95
TFM-3	0.4-400	0.4-400	DC-400	5.3	7.0	6.0	8.0	60	50	55	40	50	35	45	30	35	25	35	25	5-49	\$19.95
TFM-4	5-1250	5-1250	DC-1250	6.0	7.5	7.5	8.5	50	45	45	40	40	30	35	25	30	25	25	20	5-49	\$19.95
TFM-11	1-2000	1-2000	5-600	7.0	8.5	7.5	9.0	50	45	45	40	40	35	25	27	20	25	20	25	1-24	\$39.95
TFM-12	800-1250	800-1250	50-90	—	—	6.0	7.5	35	25	30	20	35	25	30	20	35	25	30	20	1-24	\$39.95

Signal: 1 dB compression level +1 dBm. Impedance, all ports 50 ohms. Total input power 50 mW. Total input current peak 40 mA. Operating and storage temperature -55°C to +100°C. Pin temperature 510°F (10 sec).

Simple mounting options offer optimum circuit layout.

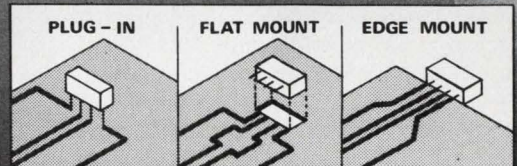

Use the TFM series to solve your tight space problems. Take advantage of the mounting versatility—plug it upright on a PC board or mount it sideways as a flatpack.

## WE'VE GROWN

Customer acceptance of our products has been so overwhelming, we've been forced to move to larger facilities — THANKS.

**International Representatives:** □ **AFRICA:** Aftra (PTY) Ltd, P.O. Box 9813, Johannesburg 2000, S. Africa □ **AUSTRALIA:** General Electronic Services, 89 Alexander Street, New South Wales, Australia 2065 □ **ENGLAND:** Dale Electronics, Dale House, Wharf Road, Frintley Green, Camberley Surrey □ **EASTERN CANADA:** B D Hummel, 2224 Maynard Avenue, Utica, NY 13502 (315) 7367821 □ **FRANCE:** S.C.I.E. - D.I.M.E.S. 31 Rue George - Sand 81120 Palaiseau, France □ **GERMANY, AUSTRIA, SWITZERLAND:** Industrial Electronics GMBH 6000 Frankfurt/Main Klüberstrasse 14 West Germany □ **INDIA:** Gaekwar Enterprise, Kama Mahal, M.L. Dananukar Marg, Bombay 400 026, India □ **ISRAEL:** Vectronics, Ltd., 69 Gordon Street, Tel-Aviv, Israel □ **NETHERLANDS, BELGIUM, LUXEMBOURG:** Coimex Veldweg II, Hattem, Holland □ **NORWAY:** Datamatik AS, Ostensjoveien 62, Oslo 6, Norway □ **SINGAPORE & MALAYSIA:** Electronics Trading Co. (PTE) Ltd., 87 Bukit Timah Road, Singapore 9, Malay Peninsula □ **SWEDEN:** Integrated Elektronik AB, Box 43, S-18251, Djursholm, Sweden.

**U.S. Distributors:** □ **NORTHERN CALIFORNIA:** Cain-White Co., Foothill Office Center, 105 Fremont Avenue, Los Altos, CA 94022 (415) 948-6533 □ **SOUTHERN CALIFORNIA, ARIZONA:** Crown Electronics, 11440 Collins Street, No. Hollywood, CA 91601 (213) 877-3550.

World's largest manufacturer of Double-Balanced Mixers

# Mini-Circuits

MINI-CIRCUITS LABORATORY A Division of Scientific Components Corp.

OUR NEW ADDRESS AND PHONE NO. IS:

2625 EAST 14th STREET  
BROOKLYN, NEW YORK 11235  
(212) 769-0200

DOMESTIC TLX 125460 • INTERNATIONAL TELEX 620156

# The Ansley "D" Connector...

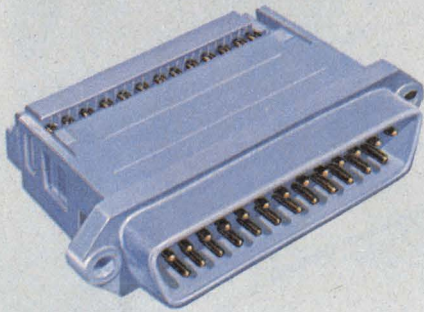

Our new series of male and female "D" connectors offer you a cost effective external mass termination cable and connector system second to none. Its uniqueness begins with a one-piece "D" connector package that meets industry standards for size, pin spacing, and contact reliability. With no loose parts to match up, positive cable-to-contact alignment is assured. Conductors are mass terminated in seconds with our standard BLUE MACS™ hand or bench tools. The results? Faster installation, higher reliability.

Contact pins are spaced on .0545" centers — a perfect fit for any standard inter-cabinet "D" type connector application. Our new "D" connectors are designed to mate with standard .050" pitch flat cable as well as our new, improved jacketed cable — the only flexible flat cable engineered specifically for out-of-cabinet use.

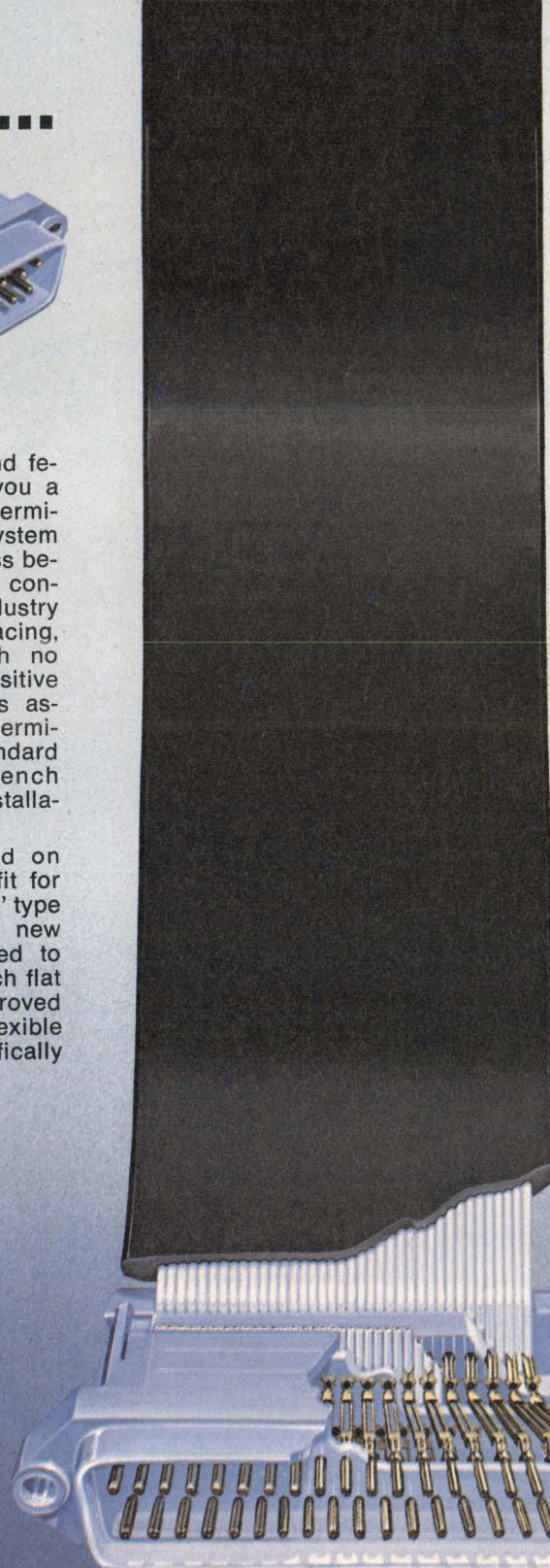
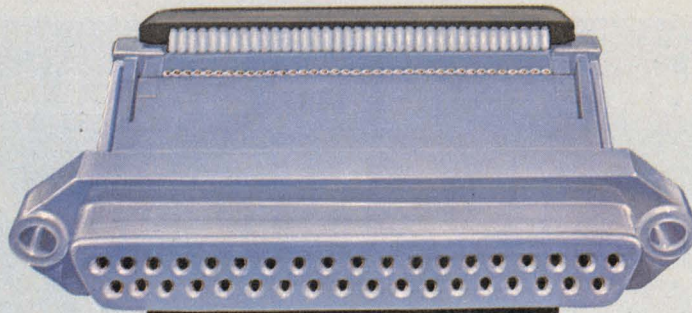

# a new meaning to cost effectiveness.



The Ansley BLUE MACS™ jacketed cable is U.L. listed for external interconnection of electronic equipment. Electrically, it outperforms standard jacketed twisted pairs in typical I/O applications. And there's no special zipper lock tubing required — reducing the need for an extra cable accessory. Installation is faster, easier. And like all Ansley connectors, you can daisy chain our "D" types anywhere in the cable — along with our DIP socket, card edge, or pc board connectors.

Cable alignment and high contact reliability is assured — because both cable and connector are grooved for absolute alignment. Our patented TULIP™ 4-point insulation-displacing contacts are permanently fixed and sealed-in to provide a reliable, gas-tight, corrosion-free mass termination.

For the full reliability/cost effectiveness story and technical data, call or write:

**T&B / Ansley**

The mass termination company.

**T&B/Ansley Corporation • Subsidiary  
of Thomas & Betts Corporation**  
3208 Humboldt St. • Los Angeles, CA  
90031 • Tel. (213) 223-2331 •  
TWX 910-321-3938

**Available through authorized  
Ansley distributors**

In Canada: T&B/Ansley, Ltd.  
700 Thomas Ave.,  
Industrial Park  
Iberville, P.Q.

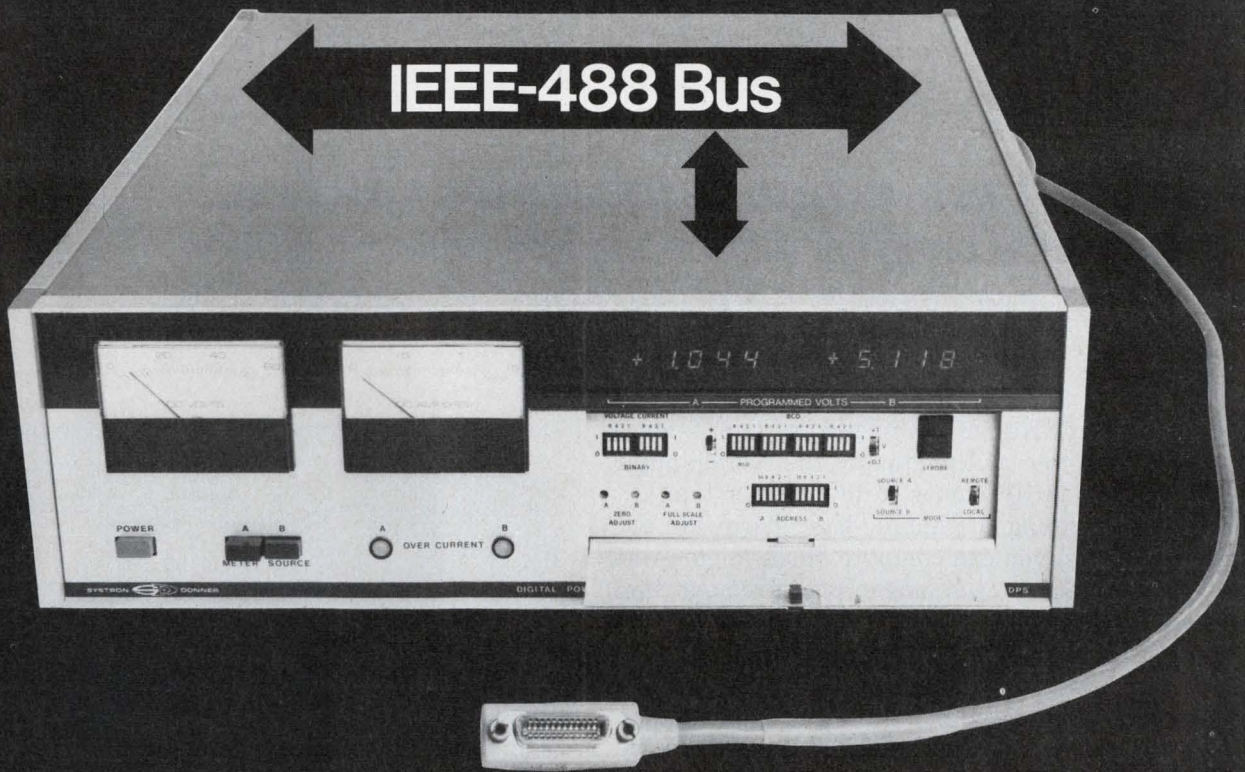

## BUS IN, POWER OUT

S-D's Dual Channel Power Supply: the first supply designed for IEEE-488 bus applications.

- Two independent, bipolar power sources
- All analog functions bus controlled
- Programmable overvoltage and current limits
- Memory register displays

The industry's best dual channel power supply now includes the IEEE bus interface as **standard equipment!** With a single address, you can program **two** 50 volt, 1 amp bipolar supplies; set the voltages; limit the currents; assign trip points, and reverse polarities. (For faster systems, a BCD parallel bus version is available.)

Behind the hinged front panel of Model DPSD-50 sits a complete local control center. These local-mode switches provide a fast and easy way to set the address, step through a program sequence, or verify calibration.

Key specifications: resolution, 1 mV; basic accuracy, 1 mV; stability, 300  $\mu$ V.

Instead of buying **two** expensive power supplies, you can now do the job with **one** DPSD-50 (\$3,000 in U.S., slightly higher outside U.S.). For more details, contact Scientific Devices or Systron-Donner at 10 Systron Drive, Concord, CA 94518. Phone (415) 676-5000.

SYSTRON  DONNER

CIRCLE NUMBER 42

## Solve phase-angle averaging riddles.

Simple digital phase detection, coupled with resolution into orthogonal components, removes the ambiguities.

You can't just take the arithmetic average of phase angles. For example, arithmetically, the average angle between  $350^\circ$  and  $10^\circ$  comes to  $180^\circ$  rather than  $0^\circ$ . But when designing arithmetic-logic hardware for phase averaging, you can compute phase-angle averages by separating each angle measurement into orthogonal components. You average these components and combine the averages for a single-angle result. Of course, a greater-than  $180^\circ$  spread in the original phase readings exceeds the Nyquist sampling limit, so a true average can't be guaranteed for such spreads.

To illustrate the orthogonal-component method, let's average the phase angle between two sine waves of the same frequency. First, square up both tones and apply them to an Exclusive-OR gate. The pulse-width output of the EX-OR gate is proportional to the phase angle between the two tones. The gate delivers zero output when the tones are exactly in-phase, maximum-width output when the tones are exactly out-of-phase, and the output pulse width varies linearly for angles between  $0$  and  $180^\circ$ .

### Phase output folds at $180^\circ$

For phase angles exceeding  $180^\circ$ , the output folds back on itself. That is, the output pulse width decreases with increasing angles from  $180^\circ$  to  $360^\circ$ . Therefore, the EX-OR phase detector contains an ambiguity. To resolve this ambiguity, operate a second EX-OR phase detector with one tone as is but with the second—a reference tone—phase-shifted by  $90^\circ$ . In this way, one phase detector delivers its maximum-width output when the other produces its mid-range output. Thus, the phase angle is derived linearly—from pulse width—in one detector, and the ambiguity is resolved digitally—from above or below midpoint—in the other.

Since phase measurement is a two-point process, you can easily incorporate phase averaging into the detection circuitry. Average by integrating the out-

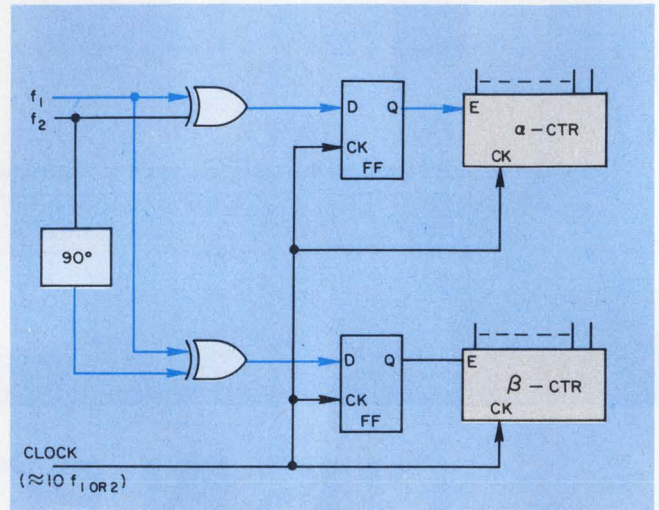

1. Squared tones,  $90^\circ$  apart, gate the clock into dedicated counters in the digital quadrature-phase detector.

puts of the EX-OR phase detectors. Let the EX-ORs gate  $\alpha$  and  $\beta$  counters as shown in Fig. 1.

Make the clock frequency for the  $\alpha$  and  $\beta$  counters at least 10-times higher than the signal-tone frequency. The period of integration, or averaging, must be short enough so that the counters don't overflow. So, run continuously a third counter that stops the clock to read out the  $\alpha$  and  $\beta$  counts and resets the counters. At the end of each integration period, compute the true-angle number from the  $\alpha$  and  $\beta$  counts.

This quadrature-type phase detection has a triangular transfer function (Fig. 2). To avoid confusion with circular trigonometry, call the quadrature components  $\alpha$  and  $\beta$  rather than the perhaps more familiar "in-phase" and "quadrature."

The straight line,  $\theta$ , depicts, in binary, the phase angle in percent of full circle vs phase angle. The number follows the angle up to the 50% point. Here, it is reflected and returns linearly to zero. The  $\alpha$  number follows the same sawtooth pattern but begins at half-count (quarter angle).

The bit following the integer point is the sign of the counter-output span referred to the 50% point. It is the most significant bit (MSB) of the counters. The diagram shows only four bits. Actually, accurate

J.D. Fogarty, Professional Engineer, 5130 Rondel Pl., Columbia, MD 21044.

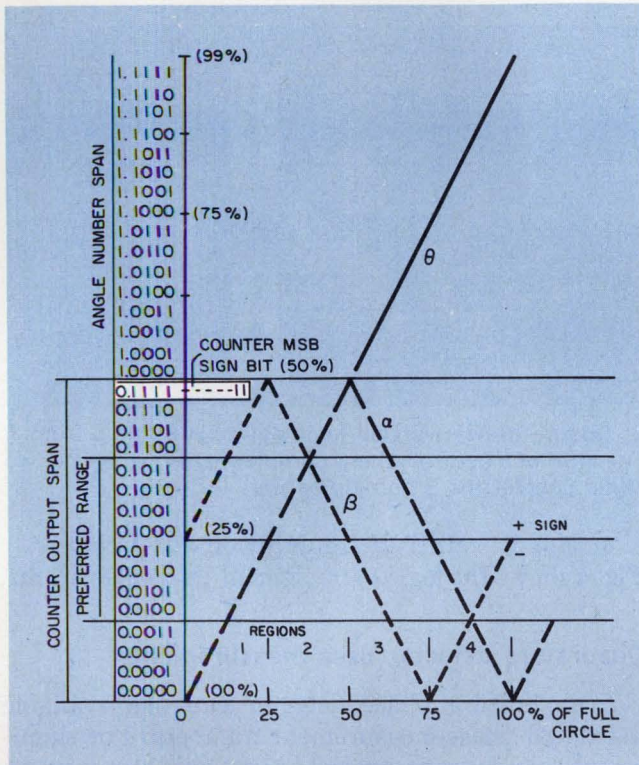

**2. The transfer function is triangular** for the phase detector. The two 90°-components are therefore dubbed  $\alpha$  and  $\beta$ , rather than in-phase and quadrature, to avoid confusion with circular-trigonometry terms.

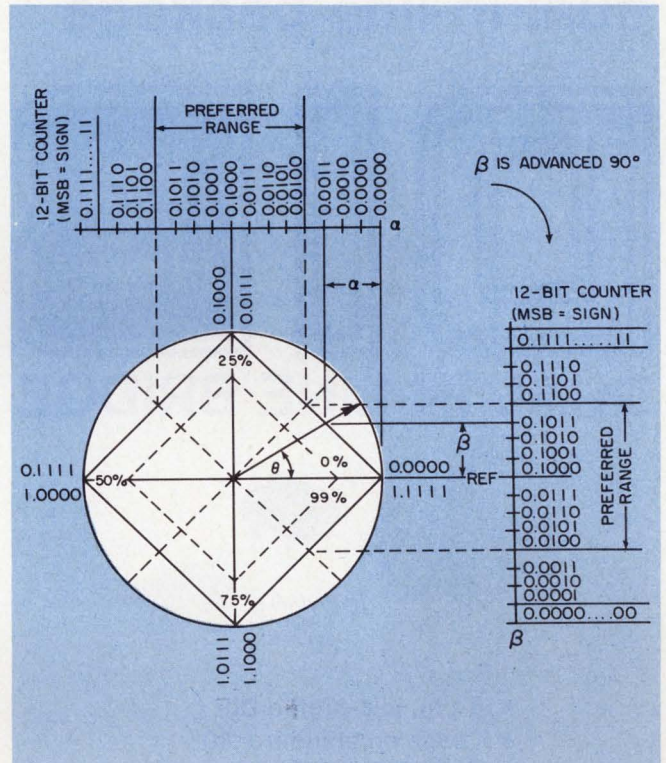

**3. Phase noise shrinks the phase detector's range.** The counters can't maintain a zero count or rise to the maximum count when processing noisy signals. Accuracy in noise is highest in the Preferred range.

integration requires 12-bit counters, even though the final answer carries only eight bits.

### Each converter has ranges

The preferred range in Fig. 2 is expanded in Fig. 3, which shows the  $\alpha$  and  $\beta$  counter-output ranges as projections in quadrature from both the phase-angle circle and the counter-value square. Both the  $\alpha$  and  $\beta$  counters represent the phase. But, although each by itself is ambiguous beyond 180°, together they uniquely define the phase angle.

Detector accuracy, in noise, is highest when both counters are used only over their mid-ranges. Phase noise on the signals shrinks the range of each counter.

With noisy signals, the counters can neither stay on zero count nor rise to maximum count.

Since the counters operate with quadrature reference signals, at least one counter should always be near mid-range—i.e., between 1/4 and 3/4 of full scale. In the circuit, therefore, monitor the counter for mid-range—if one and only one of the two MSBs is ONE. When  $\alpha$  is in mid-range, the algorithm, for the angle,  $\theta$ , is:

$$\begin{aligned} \theta &= \alpha \text{ if the MSB of } \beta \text{ is ONE.} \\ \theta &= \bar{\alpha} \text{ if the MSB of } \beta \text{ is ZERO.} \end{aligned}$$

When  $\alpha$  is out of its mid-range, determine the angle using  $\beta$ . This algorithm is:

$$\begin{aligned} \theta &= \beta \text{ (with MSB inverted) if the MSB of } \alpha \text{ is ZERO.} \\ \theta &= \bar{\beta} \text{ (with MSB reinverted, i.e., MSB is} \end{aligned}$$

# 19¢<sup>\*</sup> ea.

## An integrated bridge rectifier in a miniature dual in-line package

# DIB

## DUAL IN-LINE BRIDGE

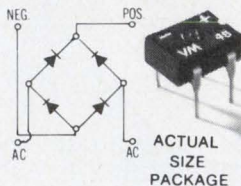

- 4-pin, low-profile DIP
- Leads on standard .10" (2,54 mm) grid
- Compatible with automatic testing, handling and inserting
- 1 Amp at 40°C ( $I_o$ )
- 25V to 1000V ( $V_{RRM}$ )
- 25A Peak One-Half Cycle Surge ( $I_{FSM}$ )
- Two devices will fit into standard 14-pin DIP socket
- Moisture resistant epoxy package
- Call Lee Miller 214/272-4551, Ext. 206 for more information.

\* 100V; 100,000 qty.

Design us in . . . we'll stay there

**VARO SEMICONDUCTOR, INC.**

P.O. BOX 676, 1000 N. SHILOH, GARLAND, TEX. 75040  
(214) 272-4551 TWX 910-860-5178

EUROPEAN OFFICE: UK: VARO SEMICONDUCTOR INTERNATIONAL, INC.  
Deepdene House, Bellegrave Road, Welling, Kent, England DA163PY, 01-304-6519/0

CIRCLE NUMBER 43

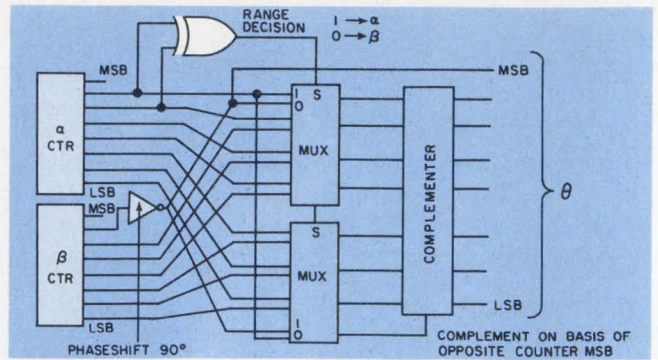

4. One counter is always within its mid-range, because the  $\alpha$  and  $\beta$  signals are 90° apart. A range-decision gate in the angle-decision logic selects the data set.

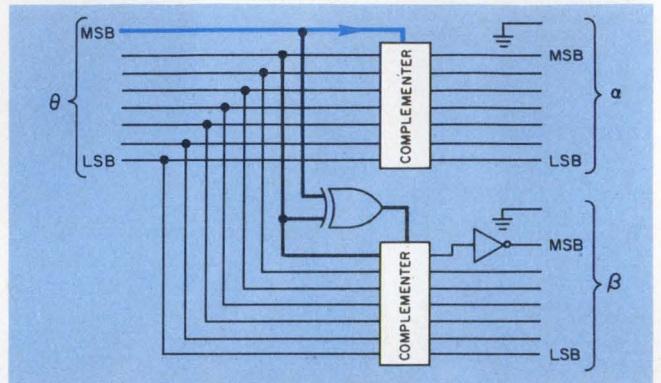

5. Quadrature-conversion logic develops  $\alpha$  and  $\beta$  from  $\theta$ . The MSB of  $\theta$  controls the  $\alpha$  complementer, while  $\theta$ 's two MSBs control the  $\beta$  complementer.

*always  $\beta$  - MSB) if the MSB of  $\alpha$  is ONE.*  
Fig. 4 shows the logic to implement these algorithms.

### Quadrature detector uses measurements

A quadrature phase detector can use available individual phase-measurement numbers. For example, you can average strobed-output numbers from an n-bit shaft encoder. First, convert the encoder's binary-angle number into  $(n - 1)$ -bit quadrature components. Next, average these components. Finally, reconvert the results into the binary-angle answer. The algorithm for such a quadrature conversion is  $\alpha$  comes from  $\theta$ , if the MSB is ZERO.

$\alpha$  comes from  $\bar{\theta}$ , if the MSB is ONE.

The  $\alpha$  value never exceeds  $n - 1$  bits and the MSB is always ZERO.

$\beta$  comes from  $\theta$ , if the MSB EX-ORed with the second MSB is ZERO.

$\beta$  comes from  $\bar{\theta}$ , if the MSB EX-ORed with the second MSB is ONE.

For  $\beta$ , the second MSB must be inverted, so the MSB is always ZERO.

Fig. 5 shows the quadrature-conversion logic that develops  $\alpha$  and  $\beta$  from  $\theta$ .

Once  $\alpha$  and  $\beta$  are developed, integrate them with adder-accumulator logic. Then, for the final answer, scale the accumulator outputs and apply them to the angle-converter logic of Fig. 4. ■■



# Coming through...

with a vital part in product design

It's what's up front that counts. That's why it pays off to involve Belden in the early stages of a project.

We know the codes, specs and electrical/environmental parameters your faced with. We've come through with answers to some extraordinary new applications.

As much as any component, wire, cable and cord, can make a critical difference in your product's performance. And your costs. By drawing on thousands of high-quality standards—and a wealth of custom engineering knowhow—we can tailor an answer to fit your needs. Exactly.

We can even help you cope with the economics of wire processing, assembly and installation. Our problem solving experience ranges from innovative

packaging to total manufacturing analysis.

Whether you need cord sets, special harnesses, shielded cable construction, flat cable—or help putting it all together, involve a Belden Wire Specialist. He'll come through with everything we've got. For answers right now, phone:

317-966-6661 Electronic Division or mark 400 on reader service card.

312-986-1600 Electrical Division or mark 401 on reader service card.

312-887-1800 Transportation Division or mark 402 on reader service card.

Or write Belden Corporation, 2000 S. Batavia Ave., Geneva, IL 60134

## BELDEN



**Coming through...**  
with new ideas for moving electrical energy

# WE'LL BET YOU \$400 THAT WE CAN SAVE YOU A HEAP OF TROUBLE.



## IF YOUR DESIGN USES HE-NE LASERS, WE'RE CALLING YOUR HAND.

We ain't bluffin' neither. Mean every word. We bet that a complete Coherent He-Ne laser package — or any part of it — can beat what you're now using. Exceptin', of course, if it happens to be Coherent already.

What are we out to prove? Simple. We want to show you how much worry, time and money Coherent He-Ne laser products can save you.

We save you worry because Coherent's a name you can trust — as sure as sunrise. Our lasers are tough critters — wrapped in aluminum. That's a mite harder than their glass tubes.

We save you time because you can buy all the components you need from one source. You don't have to run all over tarnation looking for optics and modulators.

Best optics? That's plain to see — none better than Coherent's Tropel optics. And our modulators are tough — just like a hotel steak. You just can't beat a Coherent system.

We save you money because we cost less than the other critters. Buy our He-Ne laser, optics, and modulator package and you get a discount. Those other critters can't offer you a package

discount — 'cause they don't have a package.



If we haven't stampeded you by now — and you're still hankering for a showdown — send that coupon over yonder. We'll send you back a letter written up all nice and proper. Tell us when and where you want this showdown to take place. At such time, we will prove to your satisfaction that: we can offer you a bigger and better product line than the other buzzards; our prices match or beat the competition's laser, optics and modulators. If you win, we'll give you a \$400 He-Ne System. If we win, you win again, 'cause we'll save you time, money and decisions. That simple. So see ya soon, pardner.

### LAY YOUR CARDS ON THE TABLE.

You can be designing whatever you please but it must include a He-Ne laser. Just fill out this coupon — we'll get back to you as quick as a jackrabbit.

Send to: Coherent Showdown  
3210 Porter Drive, Palo Alto, CA 94304

Name \_\_\_\_\_  
Position \_\_\_\_\_  
Company \_\_\_\_\_  
Address \_\_\_\_\_  
City/State/Zip \_\_\_\_\_



**COHERENT**  
LASER DIVISION  
3210 Porter Drive  
Palo Alto, CA 94304

THIS OFFER VOID WHERE PROHIBITED BY LAW AND SUBJECT TO TERMINATION WITHOUT NOTICE



# Simple, inexpensive ways to eliminate RF noise and high-frequency transients.

## Ferrite beads and wide band chokes from the Cube

If you need an inexpensive, effective means of eliminating RF noise and high-frequency transients from a circuit without power loss at low frequencies, call on the Cube.

### The problem:

Adjacent supply leads and circuit conductors offer convenient paths for the transfer of RF energy from one circuit to another. Capacitive decoupling, and/or series inductance to minimize the problem is seldom completely successful.

### The solution:

By simply stringing ferrite shielding beads on a supply lead or circuit conductor, you get excellent high-frequency isolation without a loss of DC or low-frequency power. You can even use the beads with small ceramic capacitors in attenuation circuits to provide additional rejection because of the self-resonant frequency of the capacitor. And Ferroxcube wide-band chokes offer even better performance.

### The conclusion: Call on the Cube

Our shielding beads and wide-band chokes are made of medium-permeability ferrite in a variety of material grades and sizes. They can save you design time, "real estate," and money. More important, they can eliminate RF noise. Complete specifications and design information is included in the new Ferroxcube Linear Ferrite Catalog. For a free copy write or call:



**FERROXCUBE**  
A North American Philips Company

Division of Amperex Electronics Corporation, Saugerties, N.Y. 12477 (914) 246-2811



**Eduard Pannenberg of Philips  
Speaks on  
Measuring Engineers**

Hiring people is difficult. It's particularly difficult to hire engineers, and almost as difficult, shortly after they're hired, to measure their performance.

A person's track record can help, of course. But it's not an infallible guide to his potential. If, for example, a man has a long record of achievement in, say, integrated-circuit development, one might assume it's safe to hire him to develop ICs. But if his achievements were in linear ICs and you want him to work on MOS memories, he might be inadequate.

Even if his expertise is directly in your field, he might not work out for you. The corporate structure or the working atmosphere where he was formerly employed might have been more conducive to his progress than the environment you can provide. The reverse is true, too. A man who didn't do well in another place might flourish in your atmosphere.

### **The first step in judging engineers is learning to judge the judges.**

My personal opinion is that the judgment of university professors, who often advise us when we are recruiting, is very largely poor. The professors tend to be bad judges. Yet we value their judgments because they tend to be consistent. So we must judge the judges. Over a period of years a particular professor might have provided recommendations on many engineers now working for us. Now we know how strong or weak those engineers turned out to be. So we now have a measure, not only of the engineers, but also of the professors who judged them.

Further, when a man applies for an engineering position, he is interviewed by perhaps half a dozen people. All of them must turn in a brief report on their impressions of the individual. These reports, like those of the professors, are kept by the people in the personnel department.

Years later we can look back at records, not only of the new engineers, but also of the professors and the older engineers who judged them. In this way we get to know a lot about the batting average of the interviewers and professors. If we find that a particular interviewer or professor has proven right in a large percentage of his impressions, we'll pay particularly close attention to his evaluations today.

### **In a sense, it's like evaluating a stock broker. If almost everything your broker recommends turns sour, it might be wise to consider buying the stocks that he urges you to sell.**

There's something else to worry about when you are hiring in a country where it's socially or legally difficult or impossible to discharge a man if he doesn't

work out. I'm not talking about the man who turns out to be a complete dud, but rather, about the man who, after a while, shows that he'll never be a particularly creative engineer.

In some countries there's no problem. The man is let go as soon as his boss realizes that a mistake was made in hiring him. In some countries there's no problem if the discovery is made early, but there are tremendous difficulties if you discover a man's inadequacy only after he's been with you five years.

So it's wise to look for abilities apart from engineering skills. Build in the possibility that, if the man should fail in his engineering role, he might, by character, disposition, temperament and facility of readjustment, be capable of moving to something else. You have to judge the man's possible value to the company aside from his value as an engineer in a particular job.

If a man doesn't work out in engineering, you would want to be able to move him into a position that's better suited to his talents. You might find, for example, that a fellow who is too weak as a design engineer might prove valuable as a production supervisor, or quality-control man. Or he might be equipped to make important contributions in your marketing department.

### **It's possible, too, that the fellow who might be a poor design engineer might prove to be a fine research engineer. And here the judgment of professors is rather good.**

Research, the kind we do in our central research organization, is not much different from academic research. The subject may be different but the method is largely the same. Good engineering talent, the kind professors are well equipped to judge, is valuable in research. But engineering talent alone is not enough in commercial-product engineering, where additional talents are important.

At a university, by and large, an individual is charged with individual jobs and is judged on the basis of individual efforts. But when he comes into industry he is usually expected to work in teams. And he may need some management talent as well.

It's relatively easy to find a good researcher. If a man was a good researcher in school, he'll probably be a good researcher in an industrial research organization.

If you get a qualified engineer from a technical university, he has been taught technology. He has probably learned a lot about circuit design. But he has not learned product design. He has not learned how to design a product that can be manufactured economically and sold competitively.

Even today it's almost impossible to teach product

## Who is Eduard Pannenberg?

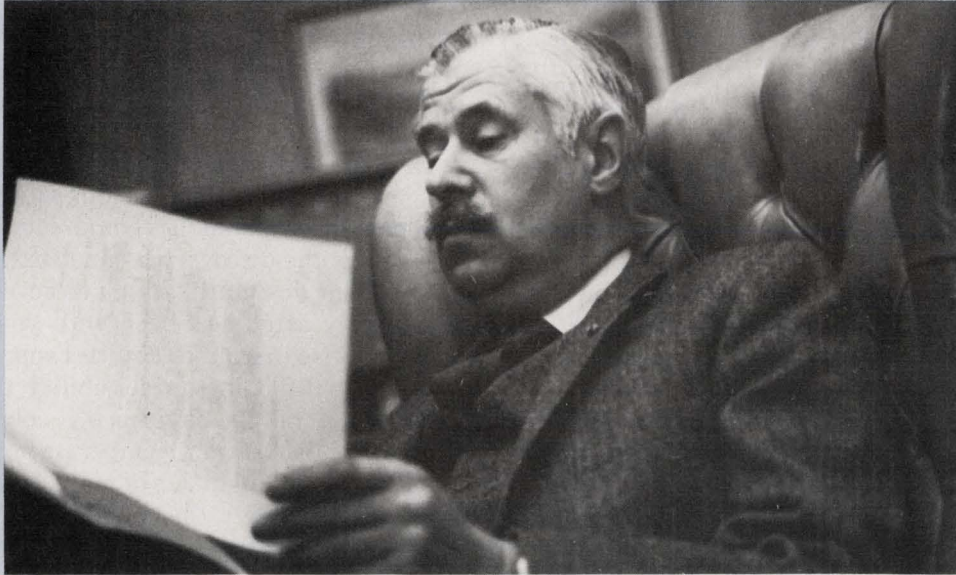

For three years during the German occupation he studied applied physics at Delft Technical University while he was active in the underground student movement. Then he interrupted his education and worked his way illegally through Belgium, France and Spain, arriving in England in early 1945, and joined the Free Dutch Brigade of the British Army.

Directly after the war, Eduard Pannenberg returned to his studies in Holland, married Louise "Louky" Stutterheim and joined the Philips Central Research Laboratories. He had promised himself that he would get his doctorate before he was 30 and, in 1952, he won that race by a week.

By this time he was working at the Philips headquarters in Eindhoven as assistant to the senior technical vice-president. In 1955 he was sent to Aachen to create an extension of the Central Research Laboratories and, for eight years, headed that lab and one

in Hamburg, regularly commuting almost 500 kilometers between them.

It was during this period that he learned an invaluable lesson, which he freely passes on: "When you find that transportation isn't working to your schedule, don't sit around airports, worrying. Just go home. The world will continue turning."

He returned to Eindhoven in 1963 to head the Central Research Lab, then, in 1969, was named a member of the 11-member Board of Management of Philips, a corporation that, in 1976, enjoyed worldwide revenues exceeding \$12,000 million. In addition to serving on the Board, Pannenberg now has line responsibility for Philips' worldwide corporate research and product development.

In his spare time, he plays the German flute in a chamber-music group. The Pannenburgs have three married children.

design with formal courses. We find that the best way to train a young engineer in product design is to place him under the daily guidance of an experienced product-design engineer. Then, after five years or so, we hope we can come back and discover that he has learned it. It's a master-and-apprentice situation.

Not only do we not know good formal ways to train product designers, we don't even know good ways to guess if a man is likely to become a good product designer. And I don't think these psycho-technical tests are of much value.

I recall the case of a brilliant colleague of mine who took one of those tests many years ago and heard nothing for several weeks. He was really worried about it. One part of the test included a Rorschach and he had described what he saw as: "Two ink stains, symmetrical." Later, when he heard no response to his application, he worried: "Could I have spelled

'symmetrical' with an 'i' instead of a 'y'?"

Fortunately, our engineering director recognized that this man had great talent and hired him. But the personnel director thought he was a dud. This shows once again that it's awfully hard to evaluate candidates for engineering positions. I know that I am poor at it.

So the answer to the problem of being certain that you're hiring good engineers is that there is no answer.

It's essential to make early and systematic evaluations of your people. Years later it becomes much more difficult and expensive to correct an error. Typically you hire a fellow and find that he's not a monster and he's not a genius. He just functions. So you forget to look at him. Then, after five years, you find that he's just coasting; he's not producing. It's unfortunately very easy to fall into a pattern of letting things go.

This is a particular problem in a large company, where an engineer's immediate superior does not look upon himself as an employer. He sees himself, merely, as a caretaker. So he must be taught that it's part of his responsibility to be an employer.

**The lower-level engineering manager doesn't want to be bothered with all the nonsense about whether an engineer comes in on time or parks his car in the right place. He simply wants to get engineering moving smoothly. He wants to work.**

That's commendable. But it's not enough in an organization where people have to work together. When an engineer's immediate manager has such a lack of concern for anything except the immediate engineering job, how can we expect him to evaluate his people carefully at salary-review time? We can't.

Determining salaries is, in any case, a subjective matter. So it's best to remove the decision from a man's immediate boss to eliminate bias due to particular friendship or hostility.

The best approach we've found to this problem is to place the decision two levels above the victim. A small number of people—generally two to half a dozen—is involved. Let's take an engineer, Harry, who has a boss, John, whose boss is Peter. Well, the decision on Harry's salary is handled at Peter's level.

Peter meets with his peers and several of them are likely to know Harry. This group evaluates several people, so a large degree of fairness derives from the fact that they are evaluating Harry relative to others at his level.

The next question is how to handle the salary of Harry's counterpart, Jack, who works in a country 2000 or 3000 miles away. I feel that the answer here is that all social and employment conditions should be handled exclusively on a national basis.

Take a large organization like Philips. Here in Eindhoven we have some 1500 engineers, so there are lots of bosses making decisions. But they can't really know what might be a fair salary in, say, New Jersey or Buenos Aires. We help our managers all over the world with information provided by our personnel department and a traveling salary committee. But we don't try to force local decisions.

Our traveling committee, which is heavily involved in setting salary scales, analyzes past history, looks for anomalies and offers guidelines for *average* salary advances.

This helps level out the gross inequities that might result from the fact that salary decisions must be made by human beings with human frailties, with one man being particularly generous while another is parsimonious.

We're pleased with the progress we've made in evaluating engineers. But we suspect we have much yet to learn. We are far from perfect. We suspect that everybody is. ■■

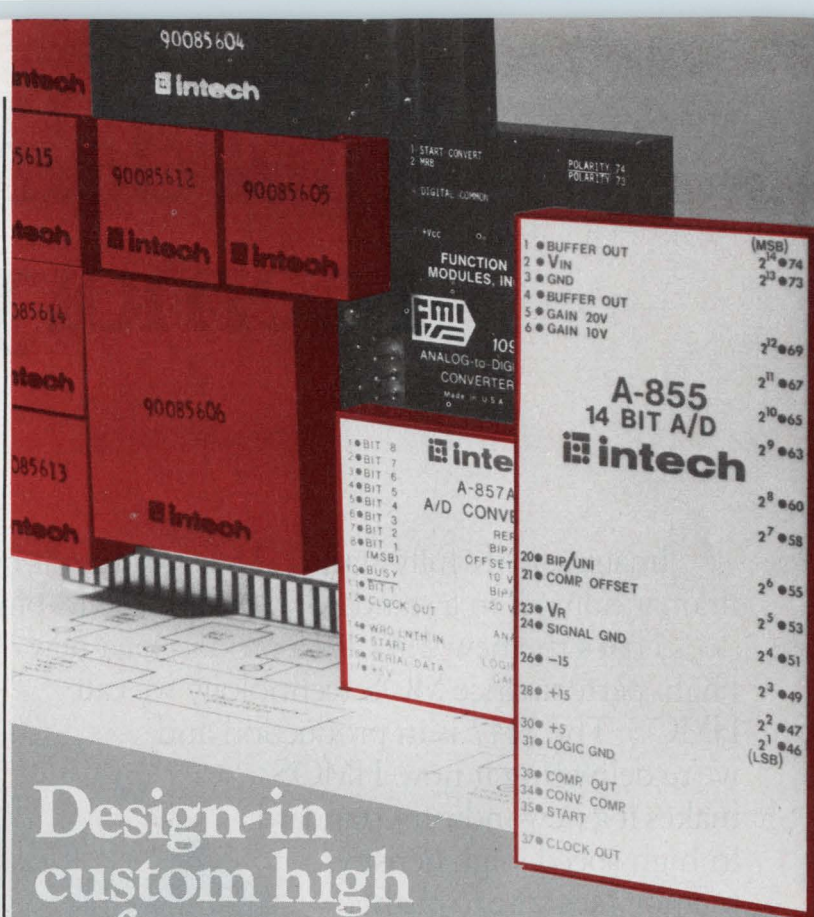

## Design-in custom high performance at standard low prices with Intech A/Ds.

Whether you're looking for high resolution and/or high speed for commercial or military applications, there's a broad line of A/D "cost performers" that you should, and can, take a look at today. For example:

**109** The versatile \$99.00 naked A/D with 16-bit or 5½-digit resolution offers OEM flexibility in output configuration.

**A-855-14** A 14-bit A/D with a conversion time of 30µs, gain t.c. of ±7 ppm/C at a new low price of \$375.00. A popular converter for medium to high speed computer-controlled data acquisition systems.

**A-856-16** A 16-bit performer at less than 10µs, with sample and hold, is a veteran unit for high speed data acquisition systems, with large numbers of low level data points.

**A-858-16** Our newest A/D offers 16-bit performance at 40µs and includes buffered input and byte-segmented tri-state outputs, all for \$425.00. Options include uni/bipolar inputs/outputs, Samples and Holds (settling times: 2µs to 10µs) and more.

The above listing is just a small sample of what Intech/FMI A/Ds can do to fit your design needs. We don't stop there either. There's a wide choice of high speed 8 and 12-bit A/Ds, also. Plus, Intech gives you design assistance and sample modules for testing that are available as fast as you ask. All units are tested through all parameters before delivery, burned-in, and guaranteed to be at spec or better.

Circle the reader service number below, or, call or write today, for more information on the Intech/FMI complete line of A/D converters.



**intech/function modules**

282 Brokaw Road, Santa Clara, California 95050  
Phone (408) 244-0500 TWX: 910-338-0254

# Intel delivers the 2147. memory technology

Imagine a 4K fully static RAM that runs at bipolar speed yet cuts power consumption dramatically, all in a standard 300-mil wide 18-pin DIP.

That's the new 2147. It's a product of a new High-performance MOS technology we call HMOS. The 2147 is in production and we're delivering it now. HMOS makes it a new industry standard in high speed, high density memory. It's sure to change the way you design high performance memory systems.

In fact, the larger the cache, main or add-on memory your design needs, the lower the power consumption per bit with the 2147. A unique new power-down mode makes that power reduction possible. When the 2147 is deselected it stands by at a typical power dissipation of 50 mW — less than 15 microwatts per bit. So you can achieve major savings in cooling and power supplies, in systems large or small.

Access times range from 55 to 70 ns maximum with identical cycle times. Typical operating power dissipation is 500 mW, with

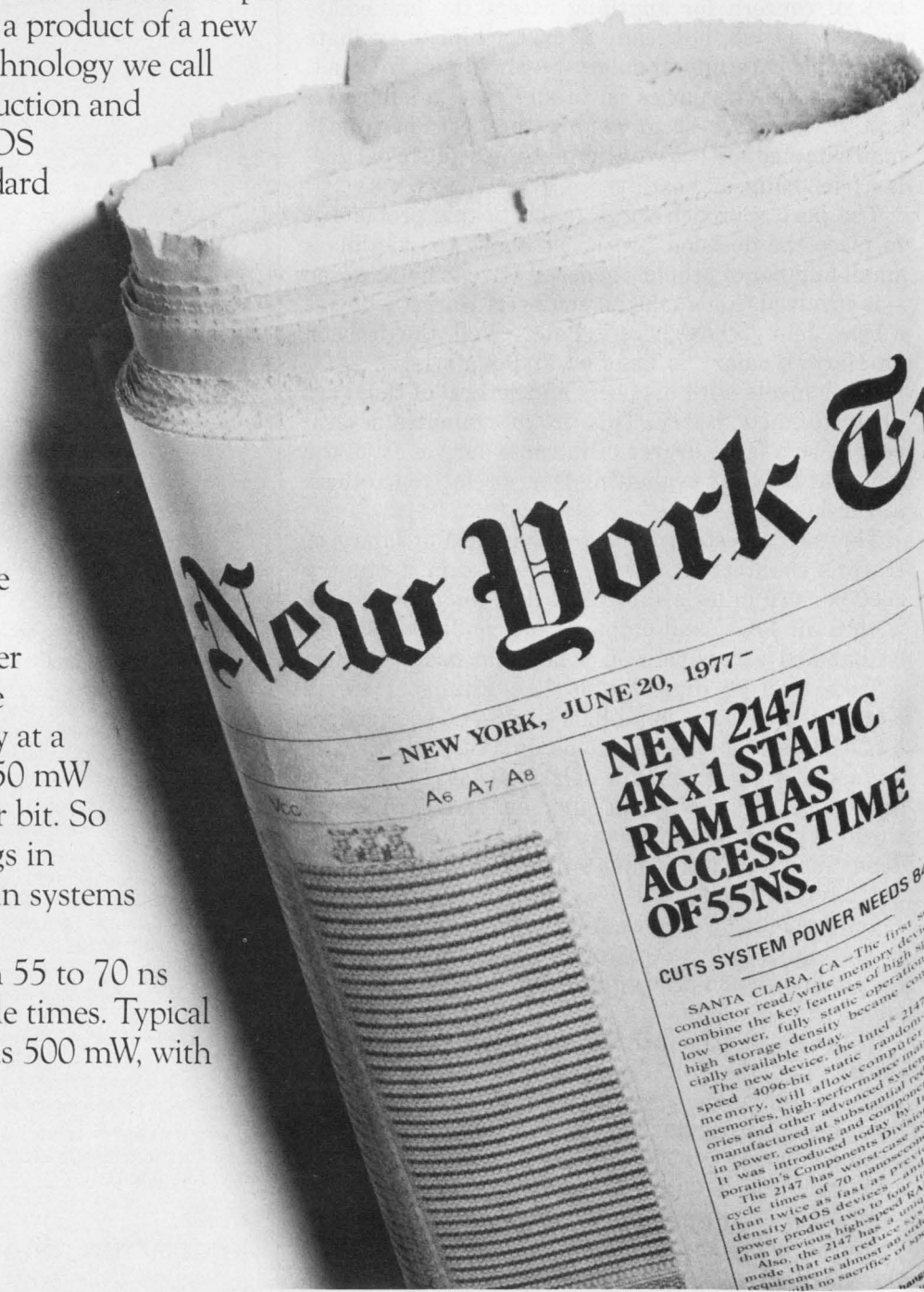



# It's HMOS, the new that scoops bipolar.

worst case specs not much higher.

Throughput is always high because the 2147 can respond to select inputs as fast as to address inputs. HMOS eliminates the power-up delays of conventional power-down techniques.

On top of this the 2147 is fully static, eliminating the complications of conventional high density RAMs, such as clocking, address set-up or hold times. The 2147 operates on a single +5V supply and is directly TTL compatible. It uses the industry standard pin-out for 4K x 1 static RAMs. The chip itself measures only 158 mils square.

Now Intel has an expanded family of HMOS 1K and 4K high performance static RAMs: the recently introduced 2115A/2125A and now the 2147. Check 2115A/2125A and 2147 performance specs at right.

Order 2147's, 2115A's and 2125A's from your local Intel distributor. Contact: Almac/Strom, Component Specialties, Cramer, Hamilton/Avnet, Harvey Electronics, Industrial Components, Pioneer, Sheridan, L.A. Varah, Wyle Liberty/Elmar or Zentronics.

For more information write: Intel Corporation, 3065 Bowers Avenue, Santa Clara, California 95051. In Europe: Intel International Corp. S.A., Rue du Moulin à Papier, 51-Boite 1, B-1160, Brussels, Belgium. Telex 24814. In Japan: Intel Japan Corp., Flower Hill-Shinmachi East Bldg. 1-23-9, Shinmachi, Setagaya-Ku, Tokyo 154.

**intel® delivers.**

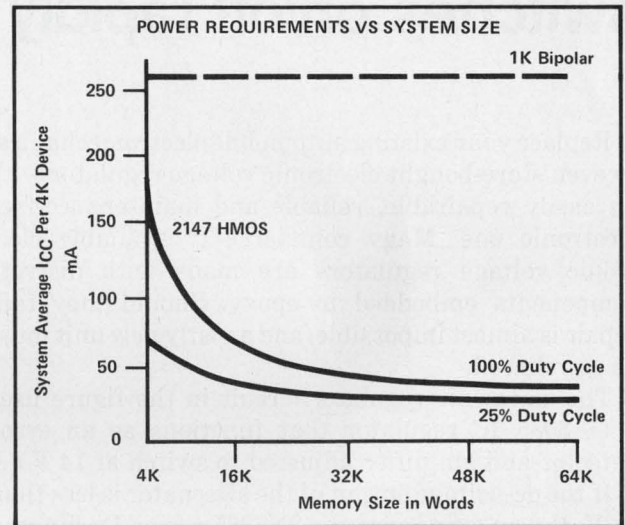

	Density	Current (mA)				Access Time(ns)
		Active		Standby		
		Typ.	Max.	Typ.	Max.	
2147	4K	100	160	10	20	70
2147-3	4K	120	180	15	30	55
2115A/25A	1K	100	125	N/A		45
2115AL/25AL	1K	60	75	N/A		45

## Electronic regulator for car alternators switches on/off rapidly to maintain 14 V

Replace your existing automobile electromechanical or even store-bought electronic voltage regulator with an easily repairable, reliable and maintenance-free electronic one. Many commercially available electronic voltage regulators are made with discrete components embedded in epoxy. Should they fail, repair is almost impossible, and a costly new unit must be purchased.

The electronic regulator circuit in the figure uses a CA3085 IC regulator that functions as an error detector and amplifier adjusted to switch at 14 V dc.

If the dc-voltage output of the alternator is less than 14 V, the op amp turns the 2N6385 power-Darlington transistor on and drives it into saturation. Current in the alternator-field winding rises to its maximum and the alternator output voltage increases.

If the output voltage of the alternator rises above 14 V, the 2N6385 cuts the field current off, which

reduces the generated voltage abruptly.

Continuous switching, at a frequency determined mainly by the field-coil inductance and response of the alternator, maintains a constant average 14-V-dc output. Time delay between the input of the CA3085 and the collector of the 2N6385 is only about 10  $\mu$ s, so the regulator electronics contributes little to determining the switching rate.

With a temperature coefficient of 500 ppm/ $^{\circ}$ C for voltage dividers  $R_1$  and  $R_2$ —a conservative value—the circuit has a  $\pm 10$ -mV resolution over a  $-50$  to  $100$ -C range. Temperature variations of  $R_3$ ,  $R_4$  and the 2N6385 do not affect the circuit's performance.

*A. I. Ozkaymak, Technical Supervisor, The New Brunswick Electric Power Commission, Power System Development Div., 527 King St., Fredericton, N.B., Canada.*

CIRCLE NO. 311

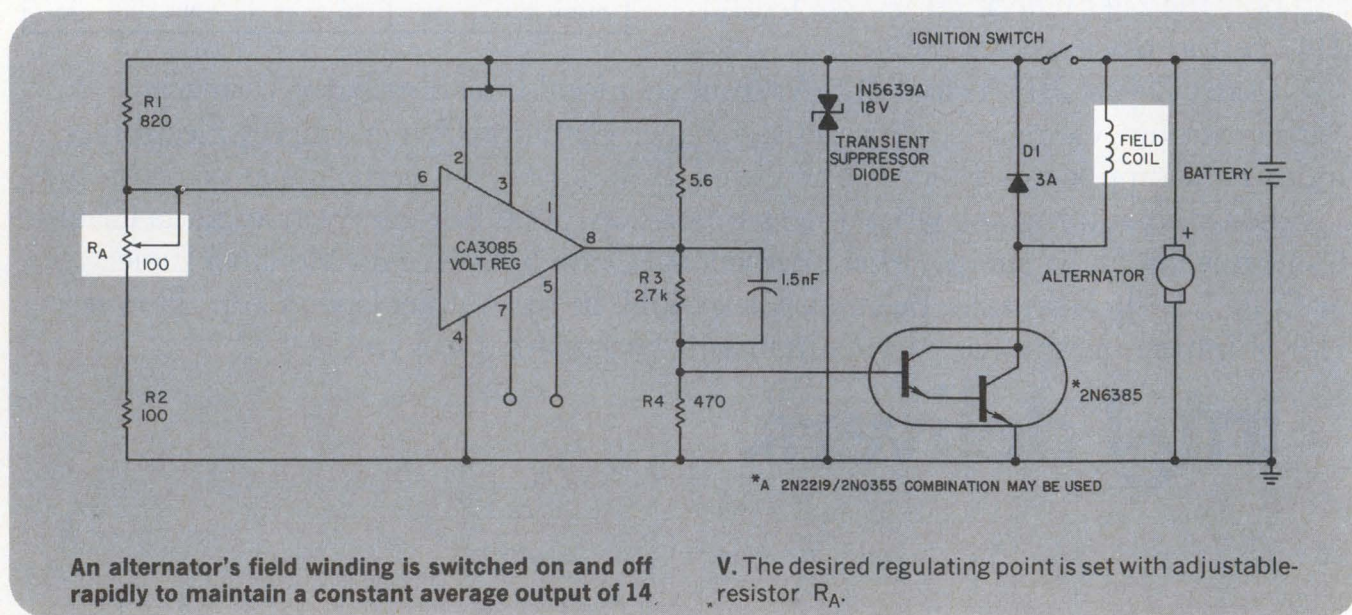

**Triplett  
310 mini-VOM's  
fit your hand  
and your  
wallet...**

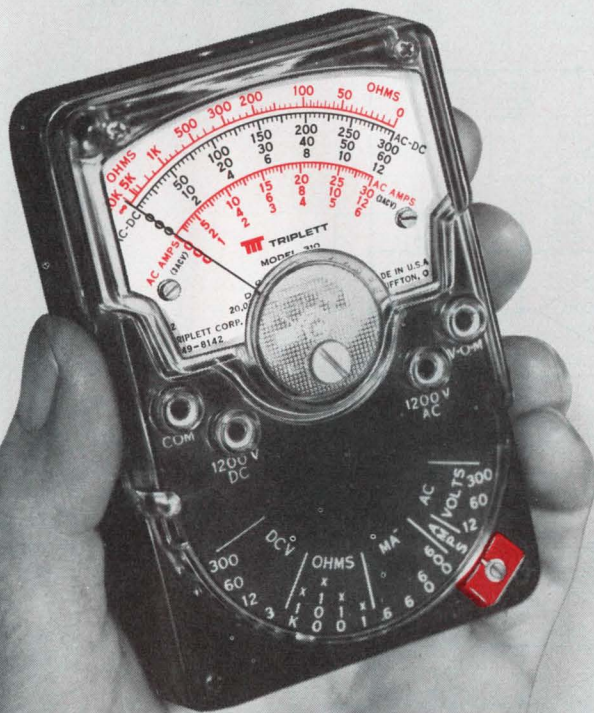
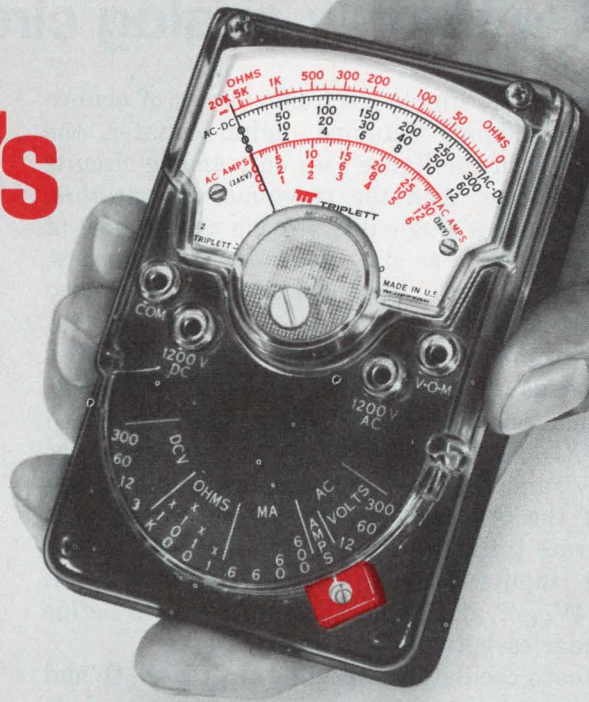

**only \$53**

The high quality Triplett 310 is a little all-in-one VOM. This made in the U.S.A. VOM gets around a lot for half fare. It packs most of the features you'd expect to find only on a meter twice the size and price. It fits in your shirt-pocket easily. The small size and its versatility is a boon to field servicemen as well as circuit designers, technicians, electrical maintenance engineers, and the price is right for vocational and hobbyist use.

A newly designed high impact, drop resistant case makes it practically indestructible . . . 20K ohms/volt DC and 5K ohms/volt AC ranges provide plenty of sensitivity for most applications . . . and, there's diode overload protection with a fused R X 1 ohm range. The single range selector switch is a real time saver for reading 0 - 1200 DC or AC volts, 0 - 20 megohms, and 0 - 600 micro-amps or 0 - 600 milliamps at 250 millivolts.

Comes complete with 42" leads, alligator clips, batteries and instruction manual. Accessories triple the versatility of a 310. Adding the Model 10 clamp-on ammeter allows you to measure AC currents easily with one hand.

Visit your local distributor or Mod Center and shake hands with a real bargain.



**TRIPLETT**  
BLUFFTON, OHIO 45817

**Triplett. The easy readers**

Circle Number 50 for information  
Circle Number 51 for free demonstration

# An electronic dice game built with only analog circuits

Although most simple electronic games of chance employ a randomly actuated digital counter, the circuit shown in the figure uses only analog circuits to simulate dice. And the two-quad comparators, which represent a single die, provide a good deal of mileage: they serve as state detectors, LED drivers, latches and decoders. Two such circuits are needed for a pair of dice.

The electronic die can be in any of six states. The state depends on the level of a sawtooth voltage,  $V_{IN}$ , which is detected by the comparators  $CO_1$  through  $CO_5$ . The sawtooth signal varies between zero and  $6V_{CC}/7$  and is applied to the common noninverting inputs of the comparators to scan the circuit at a uniform rate through the six states. The comparator inverting inputs are biased at  $V_{CC}/7$ ,  $2V_{CC}/7$ ,  $3V_{CC}/7$ ,  $4V_{CC}/7$  and  $5V_{CC}/7$ , respectively, to define the boundaries between states.

A sawtooth oscillator, consisting of  $CO_6$ ,  $Q_1$ ,  $Q_2$  and  $Q_3$  and associated components, turns on when  $S_2$  is pressed. When  $V_{IN}$  reaches  $6V_{CC}/7$ , comparator  $CO_6$  initiates a retrace via  $Q_2$  by discharging  $C_1$  through  $Q_3$ . Positive feedback through  $C_2$  assures that

$V_{IN}$  bottoms out at approximately zero volts.

When  $S_2$  is released,  $Q_1$  turns off and the circuit remains latched in its last state because of feedback resistors  $R_9$  through  $R_{13}$ . For maximum noise margin, bias-resistors  $R_8$  and  $R_{14}$  center the steady-state voltage between the boundary voltages of the states.

Seven LEDs arranged in the spot locations of a die serve as the circuit's output. LEDs "B," "C" and "D" turn off two at a time, every other time a boundary is crossed. And LED "A" is controlled by  $CO_7$ , which is wired as a threshold-logic element. The LED coding scheme is easy to figure out.

To assure that the outcomes of "throwing" two (or more) dice are uncorrelated, the frequencies of the sawtooth oscillators in the individual die circuits should be incommensurate. This can be ensured by deliberately using different values of  $C_1$  in the die circuits, and not depending on circuit tolerances to affect the change.

*Leonard M. Smithline, 13 Hunter Lane, Ithaca, NY 14850.*

CIRCLE NO. 312

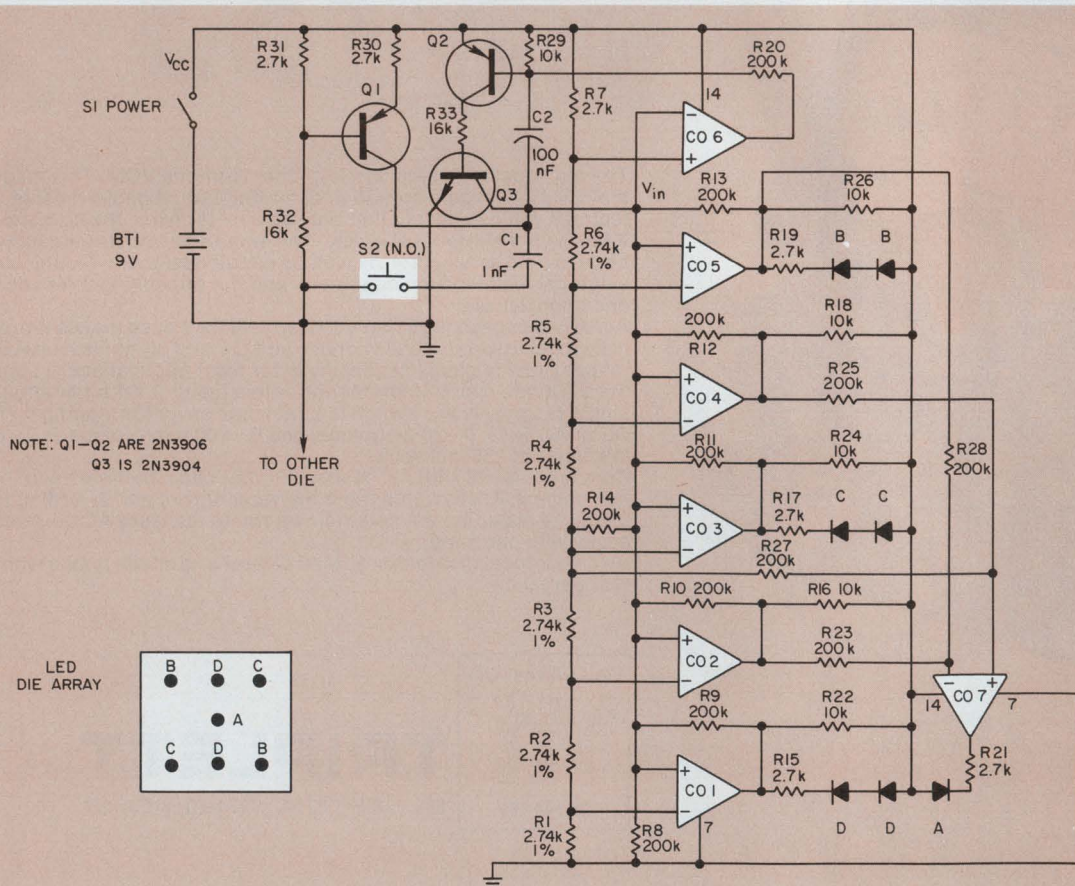

An analog circuit and LED display for an electronic dice game uses two quad comparators as state detectors, latches, decoders and LED drivers. Two

such unsynchronized circuits are needed to represent a pair of dice, and both may be actuated with a common switch,  $S_2$ .

# Datel's Low Power, Digital Cassette Transport

**MODEL ICT-WZ**



- Simple, reliable capstan stepping motor drive
- Ultra-low power (700 milliwatts while writing, microwatts in stand-by)
- CMOS electronics are ideal for +12VDC battery-powered portable instruments.
- Optional battery-power 16-channel A/D Converter input
- Very high data capacity: 1.8 megabits, 220K bytes or 120,000 A/D samples

COVERED BY GSA CONTRACT

You'll find complete specifications on this product and more than 300 data conversion circuits and systems in Gold Book.

Just check Gold Book's Volume 3. That's Datel's complete Engineering Product Handbook, in its own separate volume. More than 290 pages of D/A & A/D Converters, Multiplexers, Sample-Holds, Op Amps, Power Supplies, Digital Panel Meters, and Printers, Digital Panel Instruments, Data Loggers, Digital Cassette Recorders, and Data Acquisition Systems. Each fully detailed on individual data sheets.

And it's available to you in Gold Book.

**D DATEL**  
**SYSTEMS, INC.**

1020 Turnpike St., Canton, MA 02021  
Phone: (617) 828-8000



See Electronic Design's  
1977-78 "GOLD BOOK" — Vol. 3 page 281

• Santa Ana, CA (714) 835-2751, (L.A. Exchange) (213) 933-7256 • Sunnyvale, CA (408) 733-2424 • Gaithersburg, MD (301) 840-9490

## Ideas for design

# Locate interrupts for $\mu$ P peripherals quickly without the need for polling

Since most  $\mu$ Ps have only a single interrupt input, to service many interrupts on a random real-time basis, all peripherals with interrupt capability must be wire-ORed to this single input. As a result, the CPU must interrogate each peripheral separately through a polling sequence to determine which one requires service. Not only can this task be time-consuming, but it may even cause some data to be lost—especially if the requesting peripheral is near the end of the poll sequence.

The technique outlined in Figs. 1 and 2 can locate the requesting peripheral quickly at a cost of some additional but inexpensive hardware. And, the tech-

nique can be expanded to any number of inputs.

When a peripheral requires service, its interrupt-request line goes LOW and activates the CPU-interrupt input through an eight-input NAND gate (Fig. 1). Also, the input of the corresponding three-state inverter (one-of-eight inverters, or less) goes LOW. When the CPU recognizes the interrupt, it performs an interrupt-service routine. (Fig. 2).

The first of the activated three-state inverters is then enabled to allow the data bus to load into an accumulator. Each inverter group appears as a memory location to the CPU. If there is more than one group (byte) of interrupts, each is "quick tested" for zero.

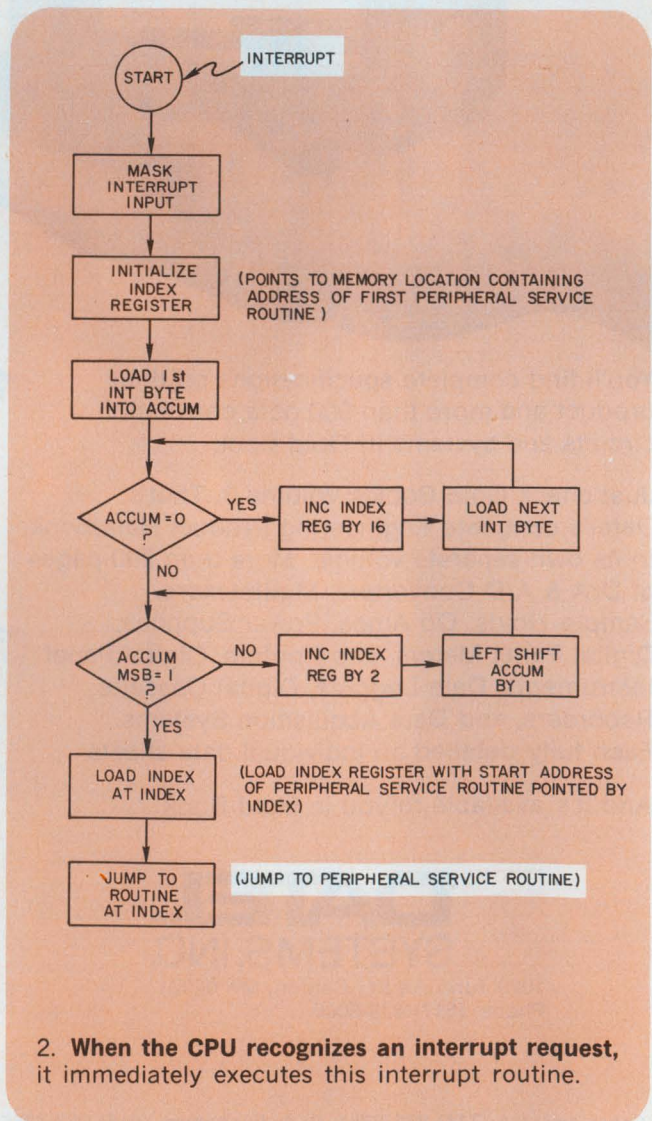
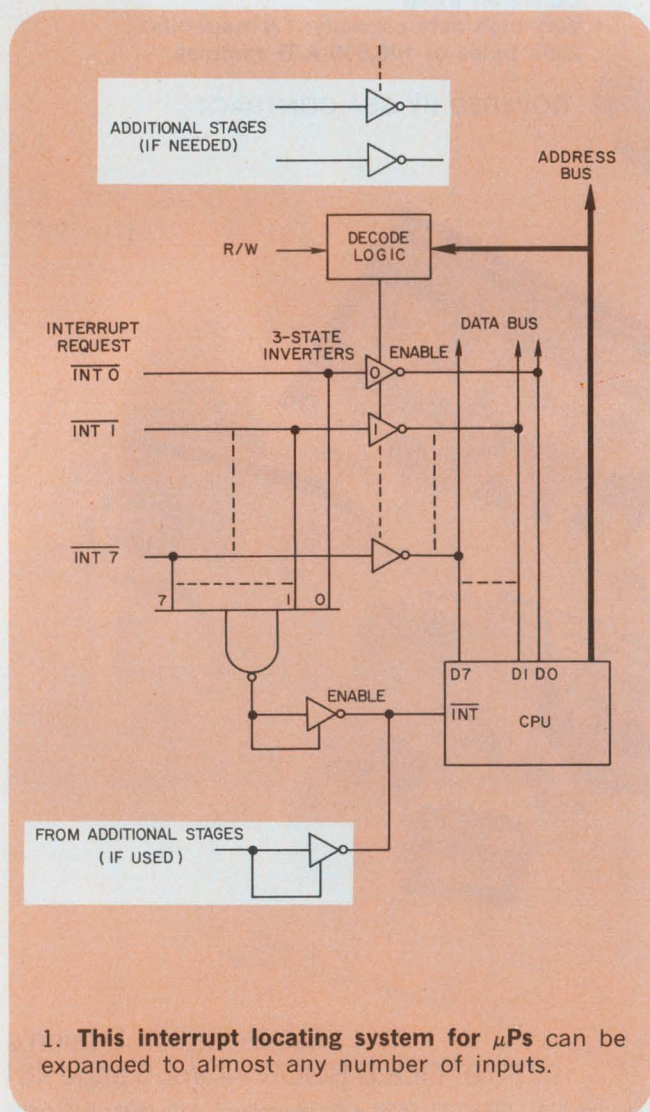

# Datel's Low Cost, Digital Panel Printer

## MODEL DPP-7

- Thermal 7-Segment Printhead uses no ink, hammers, or printwheels.
- Panel-mounting, featherweight 2.3 lb. (1,1 kg)
- 6-Digit and polarity sign formats available with optional hexadecimal.
- AC line power or +5, +12 or +28 VDC
- Includes all BCD TTL full parallel electronics plus input storage register for multiplexed bussing.
- Selectable positive/negative true data and controls logic coding.

COVERED BY GSA CONTRACT

You'll find complete specifications on this product and more than 300 data conversion circuits and systems in Gold Book.

Just check Gold Book's Volume 3. That's Datel's complete Engineering Product Handbook, in its own separate volume. More than 290 pages of D/A & A/D Converters, Multiplexers, Sample-Holds, Op Amps, Power Supplies, Digital Panel Meters, and Printers, Digital Panel Instruments, Data Loggers, Digital Cassette Recorders, and Data Acquisition Systems. Each fully detailed on individual data sheets.

And it's available to you in Gold Book.

 **DATEL**  
SYSTEMS, INC.

1020 Turnpike St., Canton, MA 02021  
Phone: (617) 828-8000

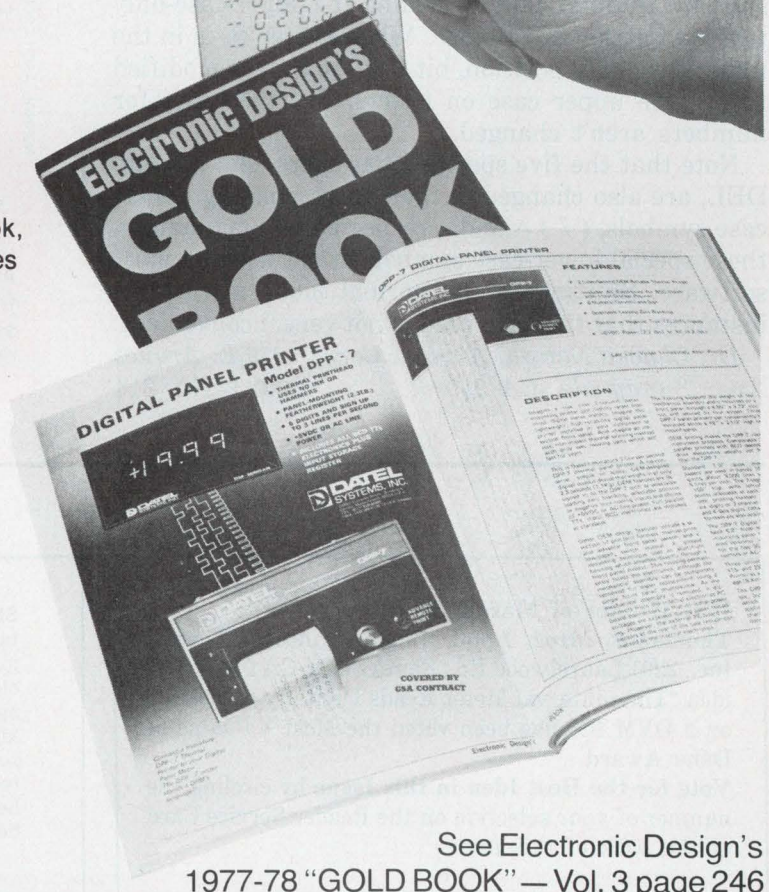

See Electronic Design's  
1977-78 "GOLD BOOK" — Vol. 3 page 246

• Santa Ana, CA (714) 835-2751, (L.A. Exchange) (213) 933-7256 • Sunnyvale, CA (408) 733-2424 • Gaithersburg, MD (301) 840-9490

Subsequent bytes are loaded until the interrupt is found.

When the data of the inverter group containing the interrupt enter the CPU, a bit is set in the accumulator corresponding to the interrupt. The service routine then ripples through the accumulator, incrementing a pointer, or index register, each time a bit is tested. The pointer is incremented by two, because the start address of each peripheral service routine has a low-order and high-order byte.

Once the interrupt bit is found, the pointer register locates the start address of that particular peripheral's service routine. This address is then loaded and used for a jump instruction. The first action of each peripheral service routine should clear the peripheral's interrupt request.

Simultaneous interrupts can be accommodated by

this technique. If two or more interrupts occur together, the first is serviced, but the interrupt input to the CPU remains low. Thus, when the interrupt line is unmasked, the CPU immediately restarts the service routine. If some of the peripherals require priority, their interrupt requests should be included in the first byte(s) to be examined by the CPU.

A 40-pin Motorola MC6820 peripheral interface adapter (PIA) can easily implement a 16-interrupt system. The PIA has two 8-bit I/O registers, plus decoding to access these registers. Though specifically designed for use with 6800  $\mu$ P systems, the PIA also is compatible with most of the other  $\mu$ Ps.

*Michael S. Rogers, PE, Member of the Tech Staff,  
Sandia Laboratories, Albuquerque, NM 87115.*

CIRCLE NO. 313

## Recognize upper-case letters only with a simple two-gate circuit

Very often you need an "upper-case-letters-only" feature for a terminal with an upper and lower case input. Many computer programs, especially for  $\mu$ Ps, use only upper-case letters. Numbers, therefore, require you to use the shift key—frequently.

The simple circuit in the figure avoids having to shift by automatically providing the upper-case-only feature for the ASCII code. When switch  $S_1$  is in the upper-case-only position, bit 6 of the code is modified to provide upper case on letters. But the codes for numbers aren't changed.

Note that the five special "characters," { | } ~ and DEL, are also changed to their corresponding upper-case symbols, ( / ) ^ and -, respectively. Fortunately, these special lower-case symbols aren't used by most software. Shifting to the normal mode in the few instances that they are used is not very inconvenient.

*Dr. Chacko Neroth, Amdahl Corp., 1250 E. Arques Ave., Sunnyvale, CA 94086.*

CIRCLE NO. 314

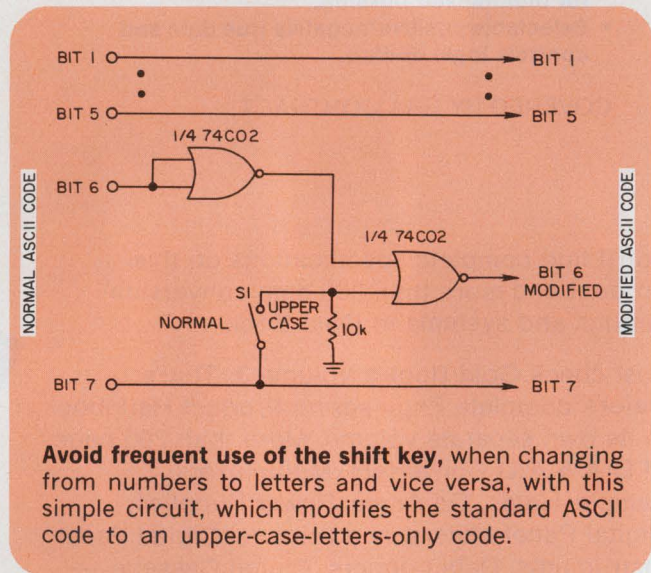

**Avoid frequent use of the shift key**, when changing from numbers to letters and vice versa, with this simple circuit, which modifies the standard ASCII code to an upper-case-letters-only code.

### IFD Winner of March 15, 1977

**Thomas J. Mroz**, Applications Engineer, Siliconix, Inc., 2201 Laurelwood Rd., Santa Clara, CA 95054. His idea "Time-interval Meter Reads Digitally to 99.9 ms on a DVM IC" has been voted the Most Valuable of Issue Award.

**Vote for the Best Idea in this Issue** by circling the number of your selection on the Reader Service Card at the back of this issue.

**SEND US YOUR IDEAS FOR DESIGN.** You may win a grand total of \$1050 (cash)! Here's how. Submit your IFD describing a new or important circuit or design technique, the clever use of a new component or test equipment, packaging tips, cost-saving ideas to our Ideas for Design editor. Ideas can only be considered for publication if they are submitted exclusively to ELECTRONIC DESIGN. You will receive \$20 for each published idea, \$30 more if it is voted best of issue by our readers. The best-of-issue winners become eligible for the Idea of the Year award of \$1000.



# Datel's Hybrid A/D's-D/A's New Low Prices, Stock Delivery

**MODELS ADC-HX, ADC-HZ, DAC-HZ**

## ADC-HZ12BGC

12 Bits Resolution  
8  $\mu$ sec. Conv. Time  
20 ppm/ $^{\circ}$ C Gain Tempco  
32 Pin Glass DIP

**\$119\*** (1-24)  
**\$77.50\*** (100's)

## ADC-HX12BGC

12 Bits Resolution  
20  $\mu$ sec. Conv. Time  
20 ppm/ $^{\circ}$ C Gain Tempco  
32 Pin Glass DIP

**\$82.50\*** (1-24)  
**\$45.00\*** (100's)

## DAC-HZ12BGC

12 Bits Resolution  
3  $\mu$ sec. Setting Time  
20 ppm/ $^{\circ}$ C Gain Tempco  
24 Pin Glass DIP

**\$39.00\*** (1-24)  
**\$25.00\*** (100's)

### COVERED BY GSA CONTRACT

You'll find complete specifications on this product and more than 300 data conversion circuits and systems in Gold Book.

Just check Gold Book's Volume 3. That's Datel's complete Engineering Product Handbook, in its own separate volume. More than 290 pages of D/A & A/D Converters, Multiplexers, Sample-Holds, Op Amps, Power Supplies, Digital Panel Meters, and Printers, Digital Panel Instruments, Data Loggers, Digital Cassette Recorders, and Data Acquisition Systems. Each fully detailed on individual data sheets.

And it's available to you in Gold Book.

\*U.S.A. Domestic Price Only



1020 Turnpike St., Canton, MA 02021  
Phone: (617) 828-8000



See Electronic Design's  
1977-78 "GOLD BOOK" Vol. 3 page 38

• Santa Ana, CA (714) 835-2751, (L.A. Exchange) (213) 933-7256 • Sunnyvale, CA (408) 733-2424 • Gaithersburg, MD (301) 840-9490

# Need a 3½ digit DPM?

Build your own LED or LCD panel meter and tailor it to fit your system.

No external active components.  
Only 7 passive components needed  
for an operating DPM.

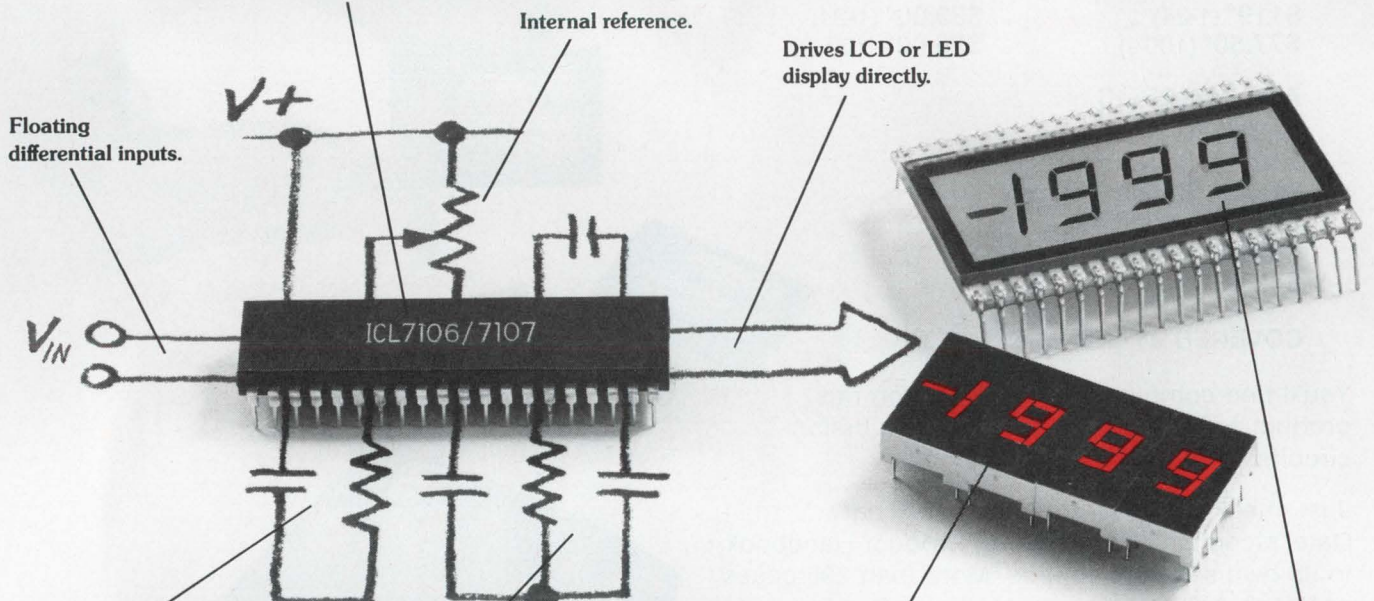

Built-in clock.

Precision auto-zero/  
auto-polarity circuitry.

\*

Part	5000+	Price
ICL7107		\$5.95
LED displays		3.00
Capacitors		.58
Resistors		.12
Potentiometer		.60
PC board		1.00
Misc.		.75
<b>Total parts cost</b>		<b>\$12.00</b>

Prices FOB Calif.

Part	5000+	Price
ICL7106		\$6.50
LCD display		6.50
Capacitors		.58
Resistors		.12
Potentiometer		.60
PC board		1.00
Misc.		.75
<b>Total parts cost</b>		<b>\$16.05</b>

Prices FOB Calif.

**Intersil stocking distributors:** Advent Electronics, Inc., (Indianapolis); Arrow Electronics; Century Electronics; Elmar/Liberty Electronics; Harvey (Upper N.Y.); Intermark (San Fran.); Kierulff Electronics (Mass.); R.A.E. Ind. Elect. Ltd. (Van. B.C.); RESCO (Raleigh, N.C.); Schweber Electronics; Sheridan Assoc.; Diplomat (Fla., N.J.); Weatherford; Zentronics (Canada).

# Put it all together for as little as \$12.\*

## Intersil's new single chip 3½-digit 7106 and 7107 A/D converters for LCD or LED displays.

Meet the latest in A/D converters: Intersil's 7106, the first single-chip CMOS A/D for driving LCD displays—including backplane—directly.

And the 7107, first single-chip CMOS A/D for driving instrument-size LED displays directly without buffering.

Each provides parallel seven segment outputs, ideal for DVMs, DPMs and anywhere modern digital displays are needed.

Both new devices provide cost advantages over multi-chip designs, because they require no additional active components. Both have internal reference and clock, and both are CMOS so you get low noise (12 to 15  $\mu$ V) comparable with the finest bipolar devices, and low power (10mW max. @ 10V). A few more features:

- $\pm 1$ -count accuracy over the entire  $\pm 2000$ -count range.
- Guaranteed to read Zero for 0 Volts input.
- Provides true polarity at Zero count for precise null detection.
- Differential input from 200mV to 2.000V full scale.

Get additional technical information, including detailed data sheet and application notes, from Intersil, 10710 North Tantau Ave., Cupertino, CA 95014.

## Build a working DPM in ½ hour with these complete evaluation kits.

Test these new parts for yourself with Intersil's low-cost prototyping kits, complete with A/D converter and LCD display (for the 7106) or LED display (for the 7107). Kits provide all materials, including PC board, for a functioning panel meter. Available from Intersil stocking distributors.

Kit No. ICL7106EV/KIT (LCD)

Kit No. ICL7107EV/KIT (LED)

CIRCLE NUMBER 55



**Intersil sales offices:** Boston (617)861-6220; Chicago (312)986-5303; Dallas (214)387-0539; Dayton (513)278-4837; Denver (303)750-7004; Los Angeles (213)532-3544; Ft. Lauderdale (305) 772-4122; Minneapolis (612)925-1844; New York (201)567-5585; San Francisco Bay Area (408) 996-5000.

# INTERSIL

# WE'RE LOOKING FOR LEAKS IN THE BOTTOM OF THE SEA.

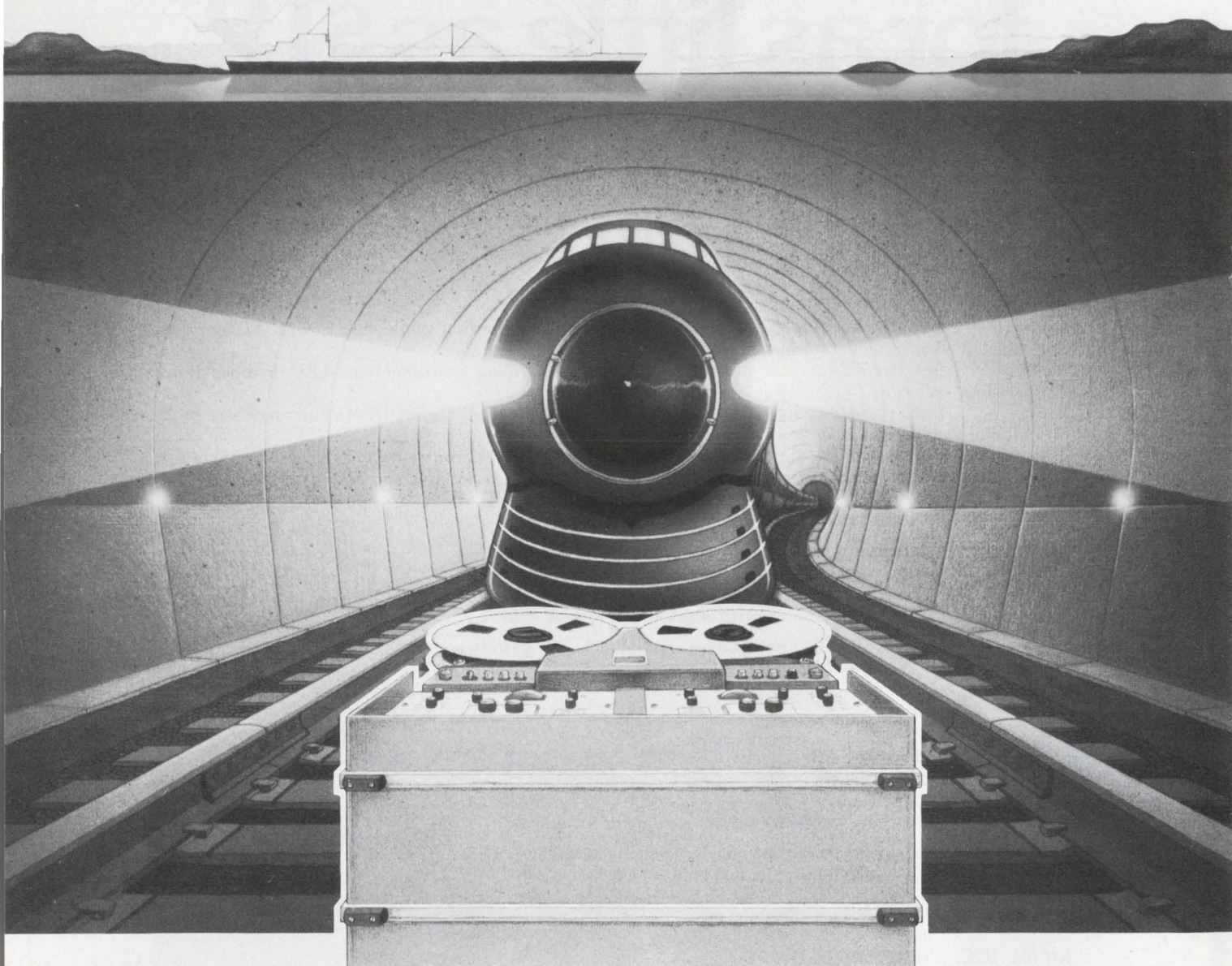

Almost 800 feet below the sea, crews are digging a 33-mile-long railroad tunnel to connect the Japanese islands of Honshu and Hokkaido. At that depth the water exerts tremendous pressure. So engineers continually probe the tunnel walls with ultrasound and rely on a Honeywell 5600 tape system to accurately record the echo-return signals. This critical data is then analyzed to pinpoint weak spots that could quickly become catastrophic leaks.

When you're responsible for one of the most

ambitious engineering projects ever attempted, you don't take chances. You choose a proven recorder like the 5600 that gives you up to 28 channels of exceptionally clean data, wideband or intermediateband.

If you need a tape system that can go just about anywhere, check our 5600 Series. For detailed information about these and other Honeywell instrumentation recorders, write or call: Darrell Petersen, Honeywell Test Instruments Division, Box 5227, Denver, CO 80217. (303) 771-4700.

## WE'LL SHOW YOU A BETTER WAY.

### Honeywell

CIRCLE NUMBER 56

## Waveguide uses laser for microwave power

An infrared-laser-controlled antenna intended for applications in the 30 to 40-GHz range may lead the way to practical real-time microwave holography. Taking the form of a dielectric waveguide made from monocrystalline intrinsic silicon, the antenna itself cannot radiate microwave power. It is designed to be physically and geometrically homogeneous in the direction of propagation. But a gallium arsenide laser beam focused on the waveguide induces local heterogeneities into the guide by generating electron-hole pairs. Some microwave power is radiated by this disturbance of the waveguide's symmetry; the residual power is reflected or transmitted in the guide.

The laser beam, whose diameter is 0.1 mm, is produced in 50-ns pulses. The relative intensity of the laser pulse (a), the radiated microwave signal (b), and the transmitted microwave power (c) are shown in the figure. The radiated microwave signal, while generated with negligible delay, lasts considerably longer than the laser pulse.

The waveguide was produced at the Institut für Hochfrequenztechnik in Erlangen, West Germany. It is com-

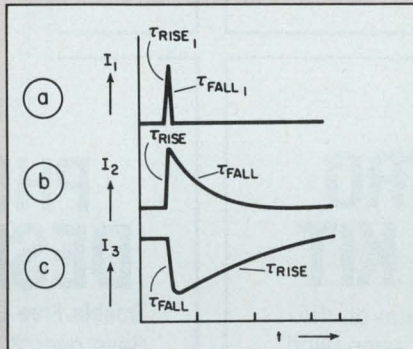

posed of eight 40-mm-long slabs of silicon, with a conductivity of  $2.5 \times 10^{-4}$  Siemens/cm. The 904-nm laser radiation penetrates the silicon as deeply as  $35 \mu\text{m}$ , and the lifetime of the carriers is about 2  $\mu\text{s}$ .

Radiation efficiency is determined principally by the magnitude of induced conductivity. Radiation efficiencies of about 50% can be achieved.

A microwave field can be scanned swiftly because the laser beam can be moved along the length of the waveguide at high speed. Moreover, a linear antenna array can be created by generating several heterogeneities simultaneously.

## LCDs driven directly with charge-coupled FET

An experimental driver for liquid-crystal displays uses a modified charge-coupled-device structure to drive LCDs directly. Called a CCFET and fabricated at the Mullard Research Labs in Redhill, England, it consists of a CCD with a FET charge detector integrated into the structure at each bit position. Each FET provides non-destructive sensing and can provide up to a 40-V swing across high-impedance loads.

During clocking periods, information is read into the CCD in the conventional manner. During the display period, the impedance of each FET depends on the charge present under the gate electrode, which is also the CCD phase-2 ( $\phi_2$ ) electrode.

When an LCD element is connected in series with a FET, the voltage drop across the LCD cell varies with the size of the corresponding charge packet in the CCD.

## 'Ear' may lessen severe hearing loss

Severe nerve deafness, which can't be helped significantly by conventional hearing aids, may one day be relieved by an electronic ear being developed at the University of Melbourne, Australia. A socket and cable have been developed that can connect an implanted module to hearing nerves. The cable, a bundle of 10 insulated electrodes, is only three times as thick as a human hair.

An external transducer converts sound into an electric signal that is transmitted to a module implanted in the ear. The module then converts the signal into 10 different frequencies, which are relayed to 10 small electrodes. The electrodes stimulate the hearing nerves.

By converting sounds into 10 frequencies of varying amplitudes, the artificial ear will make human speech intelligible, according to Professor Graeme Clark, leader of the research team. The quality will be poor, but with training the user will be able to take part in conversations.

For the Mullard Labs experiments, a two-phase CCD was fabricated and ion-implanted on a  $3.3\text{-}\mu\text{m}$ -thick n-on-p epitaxial layer. It was then connected to an external LCD cell operating in the reflection mode. The transparent conducting layer on the front of the LCD cell was tin-oxide-coated glass. Aluminum pads on the rear served as addressable electrodes. With a  $10\text{-}\mu\text{m}$ -thick liquid crystal layer and 40 V across the electrodes, the current density was  $5\text{-}\mu\text{A}/\text{cm}^2$ .

Without a charge packet, the maximum negative voltage of  $\phi_2$  is sufficient to deplete the epitaxial layer during the display period. This holds the FET off and keeps the corresponding LCD element dark. When there is a charge packet under a  $\phi_2$  electrode, the FET is turned on, and the LCD element is brightened. With typical charge packets of 1 to  $2 \times 10^{11}$  charges/ $\text{cm}^2$ , the display can be driven with a FET saturation current as low as 50  $\mu\text{A}$ .

**Integrated  
Photomatrix  
Incorporated**

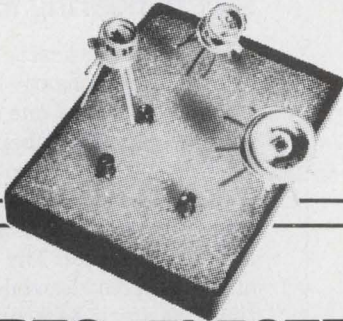

## OPTO-ELECTRO DESIGNERS KIT

Save over \$18.00 on these unique state-of-the-art opto electronic devices and a 147 page hand book of circuit and device design data with over 100 schematics and block diagrams.

### ●KIT CONTENTS●

DEVICE	DESCRIPTION	UNIT PRICE
PS 12	Light-activated switch with Schmitt Trigger and buffer amp	\$ 3.00
IPL 13	Light-Intensity-to-pulse frequency converter	\$ 6.75
IPL 15	Light-activated switch with trigger, Bipolar buffer, adj. threshold control	\$ 3.50
IPL 16	LINEAR ANALOG Photodetector, high-speed, adj. gain buffer op-amp (ultra-low-noise, high sensitivity eliminates pickup problems!)	\$50.00
IPL 17	Light Activated switch with trigger, buffer, threshold/hysteresis control, plus independent strobe and analog outputs	\$ 6.00
IPL 33	Linear silicon photodiode with 0.03" square detector element	\$ 2.90

**TOTAL UNIT PRICE\*** \$72.15  
**LIGHT SENSE HANDBOOK** 6.00  
**TOTAL VALUE** \$78.15  
**KIT PRICE** 60.00  
**YOU SAVE** \$18.15



The handbook is packed with new design ideas, ways to improve your control systems, instruments, etc. If you wish, you may purchase the handbook separately—

CIRCLE NUMBER 57

# CENTRONIC ELECTRO OPTICS

**High Performance Detectors**  
Spectral Response of Silicon Diffused Photodiodes

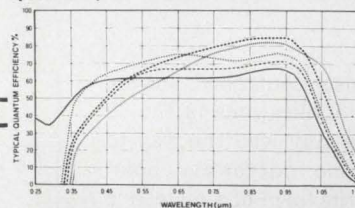

## PHOTO-DIODE DESIGNERS KIT

**Trouble Free Light Measurement-The Right Choice**

Save over \$27.00 on this selection of the most widely used silicon photodiodes covering a broad spectral range with high responsivity.

### ●KIT CONTENTS●

DEVICE	DESCRIPTION	UNIT PRICE
OSD1-3	1 mm <sup>2</sup> area high responsivity photodiode in TO18 can optimised at 0.9μ wavelength	\$ 7.50
OSD5-3	5 mm <sup>2</sup> area responsivity photodiode in TO 5 can optimised at 0.9μ wavelength	\$22.00
OSD5-0	5 mm <sup>2</sup> area general purpose photodiode in TO 5 can optimised for visible wavelengths	\$15.00
OSD50-0	50 mm <sup>2</sup> area general purpose photodiode in TO 8 can optimised for visible wavelengths	\$31.25
OSD5-5PV	5 mm <sup>2</sup> area general purpose photodiode in TO 5 can for low cost photovoltaic applications	\$12.10
OSI5-K	5 mm <sup>2</sup> high responsivity photodiode and low noise hybrid amplifier in TO 5 can for optimum signal/noise measurements	\$35.00

**TOTAL UNIT PRICE\*** \$122.85  
**KIT PRICE** 95.00  
**YOU SAVE** \$27.85

\*Note: These are quantity 1-9 prices  
In OEM quantities, prices drop sharply



**SEND FOR  
YOUR FREE  
SHORT FORM  
CATALOG**

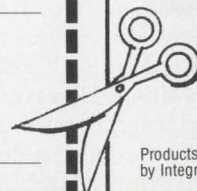

Products Distributed  
by Integrated Photomatrix Inc.

CIRCLE NUMBER 58

## IPI / CENTRONIC

201-233-7200

1101 Bristol Rd, Mountainside, N.J. 07092

Please send:

IPI Optoelectronic Designer Kit \$60.00 check enclosed

CENTRONIC Designer Kit \$95.00 check enclosed

Bill my company against Purchase Order # \_\_\_\_\_  
for  IPI Kit  CENTRONIC Kit

Send \_\_\_\_\_ copies of HANDBOOK ONLY @ \$6.00 each  
Check or purchase order enclosed.

Send FREE Centronic Short Form Catalog

Name \_\_\_\_\_

Company \_\_\_\_\_

Address \_\_\_\_\_

City, State, Zip \_\_\_\_\_

Here are two ways to measure  
ceramic capacitor reliability

40

## Major Hi-Rel Programs

You'll find our ceramic capacitors functioning in some of the toughest environments known to man. Here are just a few of the programs. Space: Surveyor, Mercury, Gemini, Apollo (Command Module, LEM, PLSS). Defense: Minuteman II and III, F-14, F-15 and F-16, Polaris and Poseidon, Sparrow, Hawk and Maverick, F-111 and the B-1 bomber.



15

## Years of Hi-Rel Experience

Founded in 1960 to supply ceramic capacitors for Hi-Rel programs, we were a technology leader almost from the start. We were the first to develop precious metal alloy electrode systems; the first to automate chip production to meet a proven failure rate level of .001% per 1000 hours; the first to perfect the use of base metals in electrodes. Latest — the totally redundant fail-safe feed-thru capacitor.

Unlike many companies, we do not have separate chip lines for Hi-Rel military and commercial MonoKap products. You get the same high quality in both. And, you can buy MonoKaps right off our distributor's shelves.



**CENTRALAB/USCC**

Electronics • GLOBE-UNION INC.

4561 Colorado Blvd., Los Angeles, CA 90039 (213) 240-4880

CERAMIC CAPACITORS • FILTERS • THICK FILM CIRCUITS • SWITCHES  
TOUCH SWITCHES • POTENTIOMETERS • TRIMMER RESISTORS

See our complete catalog in EEM: Pages 317 to 335; and Gold Book Pages 103 to 121; or contact us directly

CIRCLE NUMBER 59

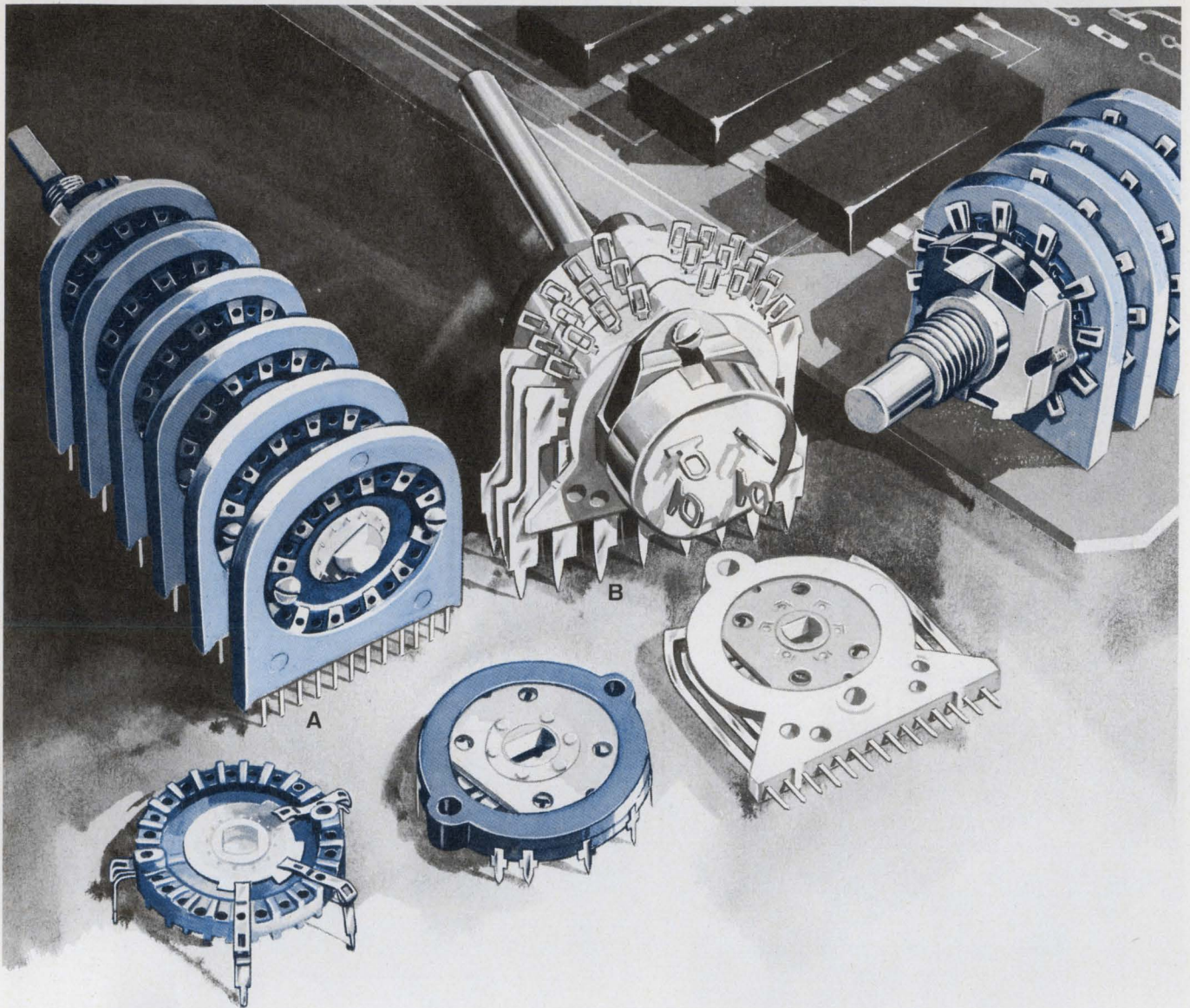

## Handle most PC needs with rugged, compact CTS rotary switches.

Specify CTS and satisfy nearly every printed circuit switch mounting requirement. Cut production time, too. And at lower cost than with conventional wiring.

**Choose from thousands** of variations of shorting, nonshorting or mixed circuitry; plus a wide selection of index assemblies and wafer constructions for either perpendicular or parallel PCB mounting. Available in combination with AC power switches and variable resistors. You get a one-source supply for the complete switch package.

**Two popular choices** include the new CTS Series 223 parallel mount style (view A) measuring only  $1\frac{1}{16}$ " wide by  $1\frac{3}{8}$ " above the PC board permitting 12 PC terminals on .100" centers; up to 1-pole, 11-position circuitry. An optional 13th PC or solder lug terminal

gives a full 12-position switching capacity. Shown at (B) above is the CTS Series 227 rotary selector switch, which provides years of virtual problem-free performance in all kinds of applications. Parallel mount ...single or multiple wafer constructions...compact  $1\frac{1}{16}$ " wide by  $1\frac{1}{32}$ " above PC board. One and two wafer designs are also available with shaft axis perpendicular to board. Ask about our NEW 14-terminal 1-pole, 12-position or 2-pole, 6-position PC switches, too.

**Made to your exact specifications** CTS switches assure proven reliability, design flexibility and MIL quality. Call your CTS representative or write **CTS Corporation**, 905 N. West Blvd., Elkhart, IN 46514. Phone: (219) 293-7511.

**CTS CORPORATION**  
ELKHART, INDIANA



CIRCLE NUMBER 60



# New products

## Floppy-disc drives come in compact packages

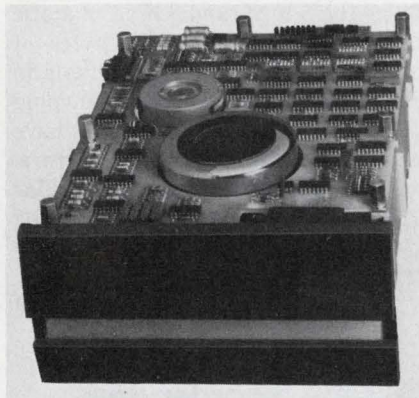

MFE Corp., Keewaydin Dr., Salem, NH 03079. Jim Bartley (603) 893-1921. P & A: See text.

With its special head-positioning system, the Mayflower series of IBM-compatible floppy-disc drives can be housed in packages whose volume— $8.7 \times 4.35 \times 12$  in.—is about 30% less than competing double-sided drives. The Heli-band head positioning system used in MFE's double-density drives (Model 700 or 750) translates  $3.6^\circ$  of rotary stepper motion to one track of travel.

Either a center-mounted brushless dc spindle-drive motor (Models 750 and 751) or a corner-mounted ac motor

(Models 700 and 701) is available. Models 750 and 700 are soft-sectored drives and the 751 and 701 are hard-sectored.

Basic drive features include a data-transfer rate of 250 kbit/s, a packing density of 6800 bit/in., a track-to-track travel time of 3 ms, and 77 tracks on a side at 48 tracks/in. The head-carriage mechanism uses dual ceramic read/write heads and ceramic load pads, which permit a head life of more than  $4 \times 10^7$  wear revolutions.

Standard options include activity lights, drive-select switches, and circuits for write-fault reset, radial ready, radial-index selection, separated data and separated clocks.

The drives require 56 W during normal operation, but two power-down modes are possible: A total power-down except for status electronics reduces consumption to 6 W; a partial power-down that reduces power to the stepper motor cuts over-all consumption to 12 W.

The two ac-powered drives cost \$725 each, and the dc-powered drives are \$25 more. All units are available in 4 weeks.

CIRCLE NO. 301

## Basic for control runs on Naked Milli

Computer Automation, 18651 Von Karman, Irvine, CA 92713. (714) 833-8830. \$400; stock.

Controller Basic extends the features of Basic into the real-time (process-controlled) environment. Requiring only 12 kwords of memory in a Naked Milli 3/05 computer, Controller Basic provides a full range of arithmetic and trigonometric functions, multidimensional arrays, matrices, string and relational functions. It is executed under the computer's real time executive program, allowing data, commands and status information to be transferred to and from input/output devices not commonly associated with the use of Basic. And, Controller Basic accepts and services randomly timed interrupts.

CIRCLE NO. 304

## 6800 software does math or cross assembly

Sci Pro, 2600 W. 2nd Ave., Denver, CO 80219. Dr. Franz Huber (303) 934-0824. From \$120 to \$450; stock.

A floating point package, the FPP/6800 and a cross assembler with floating point pseudo operations are available for 6800 microprocessors. The basic floating point package performs basic arithmetic operations and ASCII input and output conversions. An extended package performs square root, exponential, logarithm, arctangent and trigonometric functions as well as floating-point comparisons. Three versions with 4, 5, 7 and 10 digits can be selected to suit applications. Addition and subtraction time are 500, 600 or 700  $\mu$ s depending upon the number of digits, and multiply and divide times are approximately 1100, 1300 and 1500  $\mu$ s. The packages are available on NS5204 and 2708 PROMs. Custom formats and licensing for sources are available. The cross assembler is written in Fortran IV and may be adapted to any computer with a minimum word length of 16 bits. The assembler accepts 6800 assembly code with additional features for forming floating point constants. For users of Data General computers, a cross assembler that is ready to run using the RDOS or DOS operating systems is also available.

CIRCLE NO. 305

## Eurocards for SC/MP $\mu$ P hold CPU, RAM & PROM

National Semiconductor, 2900 Semiconductor Dr., Santa Clara, CA 95051. Bob Pecotich, (408) 737-5000. From \$125 (unit qty); 15 days.

CPU and memory application cards with Eurocard size and bus configuration speed design of SC/MP-based systems. The family consists of the ISP-8C/100(E) 8-bit SC/MP CPU card; the ISP-8C/004(E), a  $4 \text{ k} \times 8$  RAM card and the ISP-8C/004 B or P (E), a  $4 \text{ k} \times 8$  ROM/PROM card. All measure  $160 \times 100$  mm and have dual 32-pin connectors on 2.54 mm centers.

CIRCLE NO. 302

## System analyzer helps debug 6800 systems

Telcon Industries, Inc., 5701 N.W. 31st Ave., Fort Lauderdale, FL 33309. (305) 971-2250. \$995; stock.

The 6800 System Analyzer is designed to operate with any 6800 series microprocessor. The unit features individual hexadecimal address and data displays, thumbwheel selectable address, loop count, and cycle delay for use in both breakpoint and halt modes. Special features include single step, which allows the debugging of software by manually stepping through the program, and breakpoints.

CIRCLE NO. 303

## MICRO/MINI COMPUTING

### Microcomputer system includes Basic

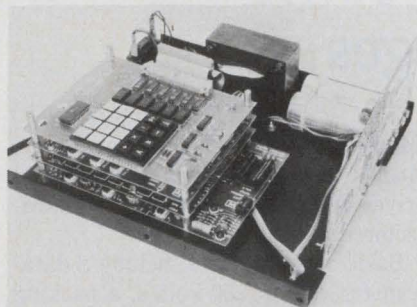

*Martin Research, 3336 Commercial Ave., Northbrook, IL 60062. Kerry Berland (312) 498-5060. \$895; stock.*

Built on 5.5 x 7-in. circuit boards, the Mike 8, a Z80 based microcomputer comes with 4 kwords of RAM and a 1-k monitor program in PROM. The system, also known as the Model 882, has a CPU board, and a console board which has a calculator-type keyboard and six LED digits. The Monitor allows the user to enter and execute programs via the console, and offers debug features including RAM test, single-stepping, and setting traps. Also included is a PROM programmer, so the user can permanently store his programs in a blank 2708 PROM (included). An ultraviolet lamp, for erasing PROMs, is also supplied along with a power supply and manual.

CIRCLE NO. 306

### Line by line assembler fits in 4 k of memory

*National Semiconductor, 2900 Semiconductor Dr., Santa Clara, CA 95051. Hashmukh Patel (408) 737-5173. \$300; stock.*

A line by line resident assembler firmware kit, known as SUPAK (ISP-8F/111), is designed for use with the SC/MP low-cost development system. Contained in eight PROM/ROMs, the assembler can be plugged into a blank ROM/PROM card (ISP-8C/004B) and then inserted into the system. SUPAK is a 4-kbyte package that consists of three programs: a line by line assembler, a paper-tape line editor and a PROM tape punch program. The line by line assembler accepts a program in limited assembly language from a keyboard or paper reader, and then assembles it directly into RAM.

CIRCLE NO. 307

### 8-k static memory board accesses in only 250 ns

*Seals Electronics, P.O. Box 11651, Knoxville, TN 37919. Bruce Seals (615) 693-8655. From \$269 (kit): stock.*

Available with access times of 500 or 250 ns the 8 K SC and 8 K SC-Z static RAM boards provide 8192 bytes of storage. Both boards are available in kit form or assembled and can plug directly into microcomputers that have the Altair, originated bus structure. The memory boards use the popular 21L02 RAM and can retain data when powered by a 1.5 to 4-V standby battery.

CIRCLE NO. 308

### Cassette recorder does formatting and writing

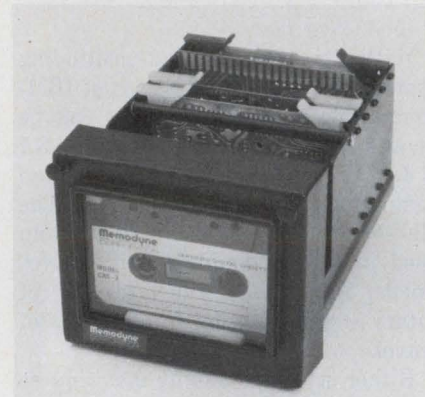

*Memodyne Corp., 385 Elliot St., Newton Upper Falls, MA 02164. Kevin Corbett (617) 527-6600. \$995; 4 to 6 wks.*

Both ANSI and ECMA-34 compatible, the 819-34 digital cassette recorder consists of an incremental digital transport and a card cage housing a write step card, a formatter card and an I/O card with cyclic redundancy check generator. Other cards such as an a/d converter and a 16-channel multiplexer may also be added. The standby power requirement is only 20  $\mu$ W and while recording, the unit requires 500 mW. A parallel input of up to 32 bits, a data rate of 50 bits/s and a formatted capacity of  $10^6$  bits are possible. The recorder measures 4.5 x 4 x 7 in. and weighs 3 lb. Since the 819-34 formats as well as writes the data, the cassette may be read on any ECMA-34 compatible reader, minicomputer or terminal.

CIRCLE NO. 309



### SBC 80 users, take note.

**Shugart Mini-Floppy Controller, IFC-M, \$795.** Super-intelligent, performs all file handling operations. User sends and receives arbitrary length byte strings to or from IFC-M, which stores them in standard 128-byte IBM-compatible sectors for 78K byte data storage. Entire disc may be scanned for any masked byte string. Standard RS232C interface with optional parallel 8-bit I/O interface. SBC 80 bus used only for voltages. Stand-alone operation—for interfacing to CRT or TTY for offline data entry and printout.

**A/D Converter, AD3212, \$495.** 12-bit resolution. 32 single-ended or 16 differential input channels, jumper selectable. Programmable gain amplifier (1, 2, 4, 8, 10, 50, 100 and user-definable). Jumper selectable memory or I/O mapping. Program Controlled, Status Controlled, Interrupt Controlled and Externally Triggered operating modes. Very low power consumption.

**Floating Point Unit, FPU, \$595.** Powerful math repertoire... + - x  $\div$ ; trig (inverse and hyperbolic)—polar/rect/polar conversion; logs and power (natural, common, x-power-y); ASCII floating point format ( $10^{\pm 99}$  to 12-digit accuracy); mean and standard deviation; and conversion constants. Called from user Assembly language as subroutine or used with console in conversational mode with high-level language interpreter. Includes driver and interpreter PROMs.

Send this coupon or your P.O. now to:

**CYBERNETIC MICRO SYSTEMS**  
2460 Embarcadero Way,  
Palo Alto, Calif. 94303  
(415) 321-0410

- Tell me more about the IFC-M Mini-Floppy Controller.
- Tell me more about the AD3212 A/D Converter.
- Tell me more about the FPU Floating Point Unit.
- Call me immediately at \_\_\_\_\_

NAME \_\_\_\_\_

ORGANIZATION \_\_\_\_\_

ADDRESS \_\_\_\_\_

CITY \_\_\_\_\_ STATE \_\_\_\_\_

ZIP \_\_\_\_\_ PHONE \_\_\_\_\_

CIRCLE NUMBER 61

# Introducing Robert Bosch Mini-Giants

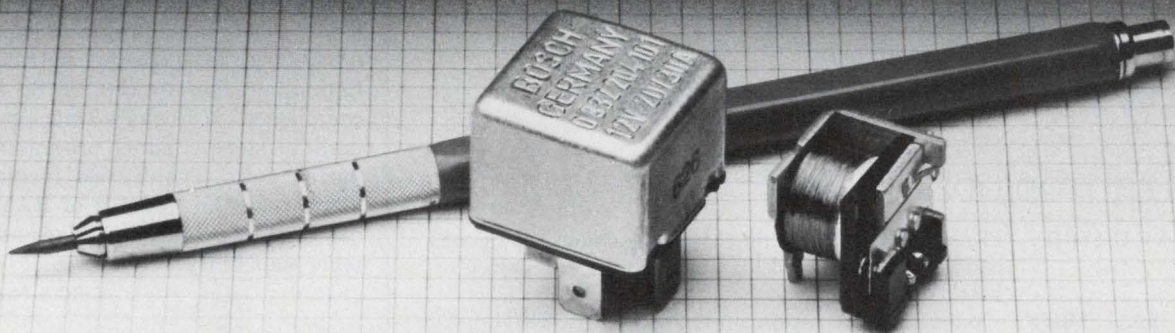

## 30-amp relays with a quarter-million cycles: smallest for the price

We invite you to compare the high technology advantages of Bosch Mini-Giants to the relays you're now using. We're confident you'll find Mini-Giants hard to beat on all the important criteria.

**Versatility.** Bosch has engineered the Mini-Giants to be at home in any 12- or 24-volt application—remote controls, generators, automotive systems, construction machinery, marine applications, agricultural equipment, hospitals, storage systems and more.

The same Mini-Giant that can switch the low current of an alarm can also control the high 30-amp load of a heating system.

**Size.** Bosch technologists have designed a PC board type relay that is 1" x .8" x .7" or just over half (.56) a cubic inch. The plug-in type (not including the plug prongs) is 1" x 1" x .8", still less than a cubic inch.

**Capacity.** Bosch plug-in Mini-Giants cover the entire power range up to 30 amps, with a peak current capacity of 60 amps. Even the standard 15-amp PC type is available in a 30-amp version on special order.

With one group of relays covering such a range of applications, you can cut down substantially on part numbers and simplify your stocking operations.

**Reliability.** All Mini-Giants are good for a minimum of 250,000 cycles at the rated current. This compares with 100,000 cycles in many comparable relays from other manufacturers.

And Bosch uses the finest materials for long life (at least 10 million cycles at no load). For example, we build the leaf springs of our plug-in relays from high-grade silver and bronze.

**Cost.** Bosch Mini-Giants give you all these benefits combined at

a surprisingly low price. You really should compare.

**For more information.** Fill out the coupon below and we will contact you to discuss your specific needs and answer your questions. Or call (312) 865-5200 and ask about relays. Either way, do it now.

Robert Bosch Corporation,  
Department O/ESL  
2800 South 25th Avenue,  
Broadview, Illinois 60153

Name \_\_\_\_\_

Address \_\_\_\_\_

City, State, ZIP \_\_\_\_\_

Telephone \_\_\_\_\_

ED/7/77

**MINI-GIANTS**  
ROBERT BOSCH

# Spanning The Spectrum

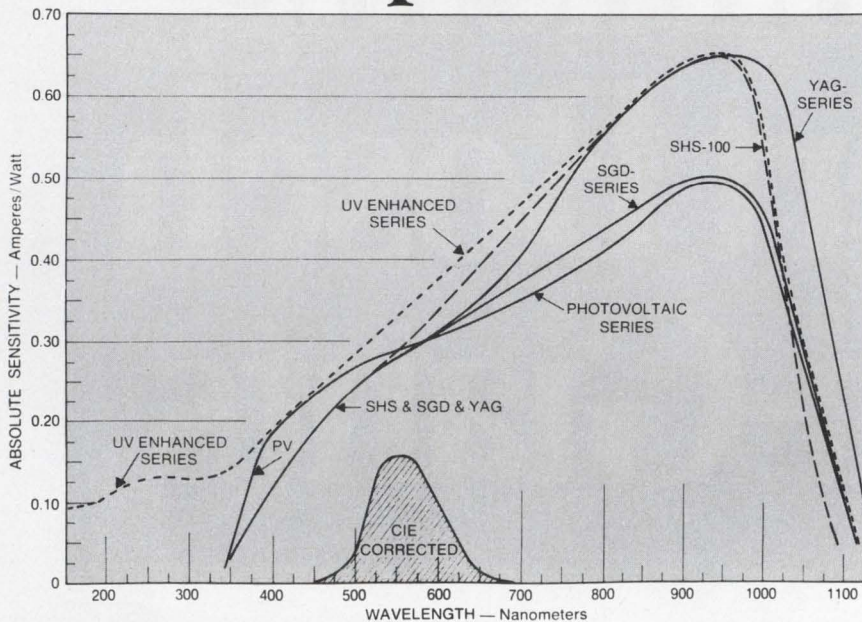

## With EG&G Photodiodes.

### SILICON PHOTODIODES

- SGD SERIES** Planar diffused (PIN) with guard ring to provide low noise, nanosecond speed, and high Q.E. (70%) with proven reliability.
- YAG SERIES** Optimized pulse quantum efficiency (pulse FWHM=20 nsec) at 1.06  $\mu\text{m}$  of greater than 40% with low noise. Ideal detectors for Neodymium/YAG laser systems.
- SHS-100** 5 nsec rise and fall times, low noise, and a Q.E. over 87% at 0.92  $\mu\text{m}$ . The perfect detector for GaAs LEDs.
- FND-100** Optimized responsivity (0.65A/W) at 0.904  $\mu\text{m}$  for fiber optics. Rise time < 1 nsec.

### PHOTOVOLTAIC SILICON

- PV SERIES** Planar diffused silicon detectors operating at a noise current of  $10^{-14}$  Amps/Hz<sup>1/2</sup> for active areas of 5.1 mm<sup>2</sup> to 314 mm<sup>2</sup>. Peak responsivity is greater than 0.47 Amps/Watt.
- UV SERIES** Planar diffused photodiodes which outperform Schottky devices as UV detectors. Absolute responsivity (min.) = 110 mA/Watt over the spectral range of 0.2 to 0.3  $\mu\text{m}$ . NEP =  $3 \times 10^{-13}$  Watts/Hz<sup>1/2</sup> at 0.2  $\mu\text{m}$ .

### OP-AMP/PHOTODIODES

- HAV-1000** PV-100 Photovoltaic photodiode and low noise op-amp in TO-5. NEP at 0.92  $\mu\text{m}$   $\leq 2.5 \times 10^{-14}$  Watts/Hz<sup>1/2</sup>.
- HUV-1000** UV-100 Photodiode and low noise op-amp in TO-5. NEP at 0.2  $\mu\text{m}$   $\leq 3 \times 10^{-13}$  Watts/Hz<sup>1/2</sup>.
- HUV-2000** UV-215 Photodiode and low noise op-amp in modified DIP. NEP <  $6 \times 10^{-13}$  Watts/Hz<sup>1/2</sup>.
- HUV-4000** UV-444 Photodiode and low noise op-amp in modified DIP. NEP <  $9 \times 10^{-13}$  Watts/Hz<sup>1/2</sup>.

For complete catalog contact Ed Danahy at EG&G, Inc., Electro-Optics Division, 35 Congress St., Salem, Mass. 01970. Tel (617) 745-3200. On the West Coast call Eamon Murphy at (213) 484-8780.



### MICRO/MINI COMPUTING

## Controller for IEEE-488 mates with SBC-80 $\mu\text{Cs}$

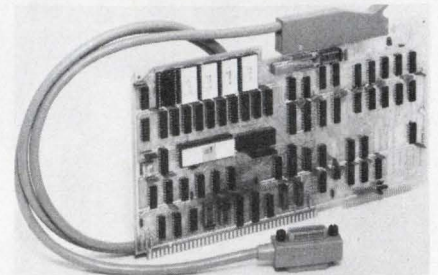

Zia Tech, 10762 La Roda Dr., Cupertino, CA 95014. Tom Gilbert (408) 996-7082. \$950 (unit qty.); stock.

The ZT 80, a self-contained intelligent controller, enables a system designer to interface IEEE-488 bus-compatible instruments and peripheral devices to the Intel SBC-80 single-board computer series. Operating as a controller, the ZT 80 fits in one SBC 80 card slot and is programmed using a set of high-level channel instructions. Communication to the ZT 80 is accomplished via a 1 shared memory area used to store channel programs and buffer data. The ZT 80 includes 4 kbytes of ROM and 1 k of RAM and has complete controller talker and listener capability.

CIRCLE NO. 310

## Number cruncher chip handles scientific math

National Semiconductor, 2900 Semiconductor Dr., Santa Clara, CA 95051. Orville Baker (408) 737-5000. \$12 (100 qty.); stock.

Performing complex number processing operations, the MM57109 is a pre-programmed microcontroller that combines scientific-calculator functions, test and branch capability, internal number storage and input/output functions on the same chip. The number cruncher can accept a series of BCD digits with a single input instruction, an asynchronous digit input, or a single bit input. Programming is done in a language similar to calculator keyboard level language. The internal data word of the device is like a calculator's, containing 12 digits, each digit consisting of four bits. When the MM57109 is used as a stand-alone processor, it receives its instructions from an external source (PROM) and program counter in six-bit form (six bit op code). It is TTL compatible and can operate from a +5 and -4-V supply.

CIRCLE NO. 320

# Arrow-M R Relays

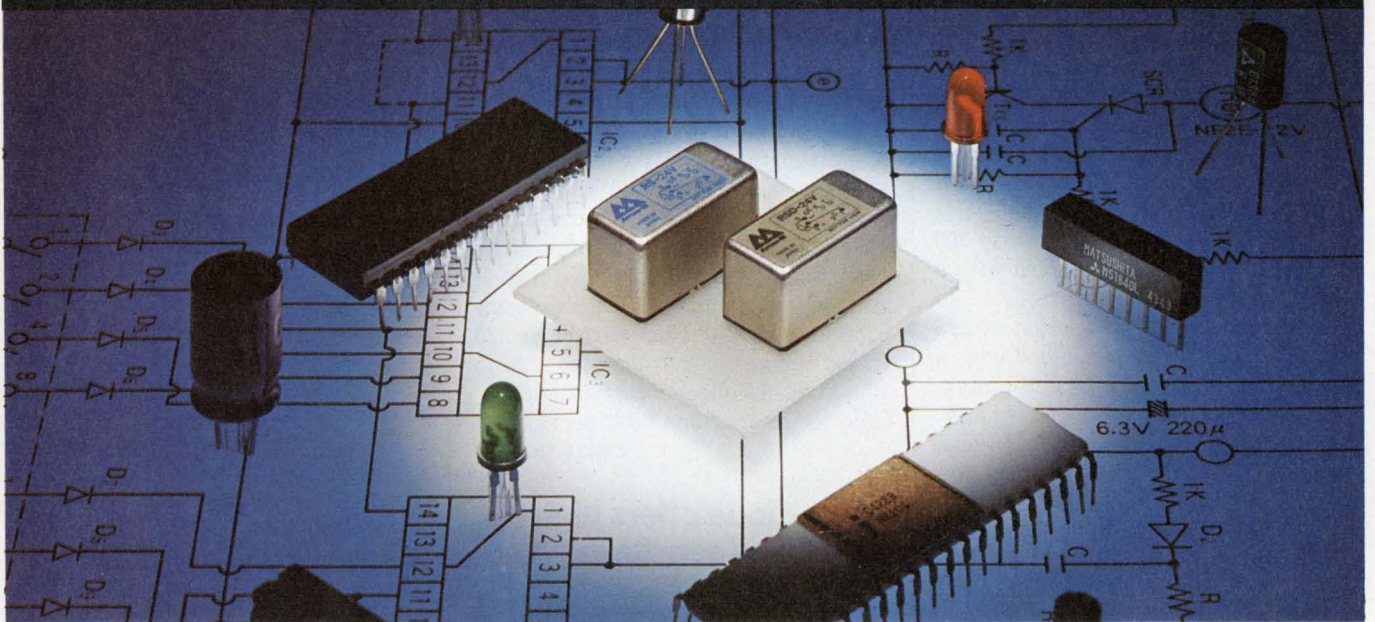

The many advantages and unique capabilities of Arrow-M's R Relays are far too extensive to be covered here. Therefore, we'd like to whet your creative appetite with a few outstanding facts:

1. Arrow-M R Relays are available in 1 Form C contacts which can carry a high current capacity of 1 Ampere 20 watts, and are capable of resisting welding at higher inrush currents. The dry circuit type which can switch current as low-level as 100uA is available in addition to the power type.

2. *High Speed:* Arrow-M R Relays can be operated at 500 cycles/sec.

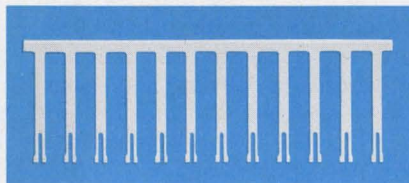
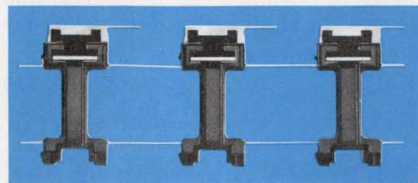

3. Greater reliability and lower cost, due to simultaneous automatic fabrication of coil bobbin, contact and terminal.

4. In addition to the standard there are 1 coil and 2 coil latching types, which are useful for logic circuit design as a memory component.

5. Not only can they be automatically wave soldered on PC boards with a high density of electronic parts, but they are simple to clean with most degreasers and detergents without affecting maximum contact reliability.

6. *High Sensitivity:* Minimum operating power: Single Side Stable 80 mw/Bistable 40 mw

7. *Longer Life:* Mechanical: More than  $10^9$  operations.  
Electrical: More than  $10^6$  operations.  
(1A 20vdc, 0.3A 110vac)

## The tiny power memory reed

Relays for Advanced Technology



Member of Matsushita Group

Hungry for more information?  
For exact specifications  
on all of our relays,  
write or call your  
nearest Arrow-M office.

**Arrow-M Corporation**  
250 Sheffield Street  
Mountainside, NJ 07092  
(201) 232-4260

*Mid-Western Office:*  
600 E. Higgins Rd.  
Elk Grove Village, Ill. 60007  
(312) 593-8535

*Western Office:*  
22010 So. Wilmington Ave.  
Suites 300 & 301  
Carson, Calif. 90745  
(213) 775-3512

## High-speed divider needs only 225 mW

Plessey Semiconductors, 1674 McGaw Ave., Irvine, CA 92714. Dennis Chant (714) 540-9945. \$6.20 (100 qty); stock.

The SP8720 and SP8725 are ECL 10,000-compatible frequency synthesizer dividers. They can both be programmed to divide by 3 or by 4 with sine wave inputs from 40 to 300 MHz or with square waves from dc to 300 MHz. The SP8720 is ac-coupled with a typical propagation delay of 4 ns and a maximum power dissipation of 225 mW. The SP8725 is dc-coupled with a propagation delay of 3 ns and a maximum power dissipation of 250 mW. Both devices are available in 16-lead ceramic DIPs for the temperature range of -55 to +125 C (A version), 0 to +70 C (B version), and -40 to +85 C (M version).

CIRCLE NO. 321

## 20-W audio amplifier comes in 11-pin package

Nucleonic Products Co., P.O. Box 1454, Canoga Park, CA 91304. Les Kilpatrick (213) 887-1010. \$3.75 (1-99 qty); 4-6 wks.

Model ESM 532C audio amplifier delivers 20 W peak sine power from an 11-pin single-in-line package. At full power and working into a 4- $\Omega$  load, the harmonic distortion is less than 1%; at 10 W the distortion drops to less than 0.1%. Frequency range is from 15 Hz to 30 kHz. The unit has differential inputs. A bootstrap shutdown circuit on the chip diverts excess current to ground when the junction temperature exceeds 100 C.

CIRCLE NO. 322

## Power Darlington packs their own dampers

Motorola, P.O. Box 20912, Phoenix, AZ 85036. Bob Haver (602) 244-6461. \$3.50 (100-999 qty); stock.

A built-in monolithic diode takes the place of the conventional discrete damper in the MJ10011 power Darlington transistor. A nominal gain of 40 at a collector current of 5 A makes the unit's base drive requirement only 200 mA. Further specifications include a typical breakdown voltage of 1400 V and a saturation voltage of less than 2 V at 4 A. TO-3 package.

CIRCLE NO. 323

## Power transistors come in complementary pairs

International Rectifier, 233 Kansas St., El Segundo, CA 90245. (213) 322-3331. \$2.80 (for 2N5883 in 100 qty) and \$3.05 (for 2N5886 in 100 qty); stock.

The 2N5883 (pnp)/2N5885 (npn) pair and the 2N5884 (pnp)/2N5886 (npn) pair power transistors are rated for 50-A peak collector current. The collector-to-emitter and emitter-to-base voltages for each pair are 60 V and 80 V, respectively. All units feature a rise time of 0.7  $\mu$ s, with storage time of 1.0  $\mu$ s, and a fall time of 0.8  $\mu$ s. Saturation voltage for all units is 4 V at a collector current of 25 A and base current of 6.25 A. Dc current gain ranges from 20 to 100, at 10-A collector current and 4-V collector-to-emitter. TO-3 package.

CIRCLE NO. 324

## Photodiode offers high speed and sensitivity

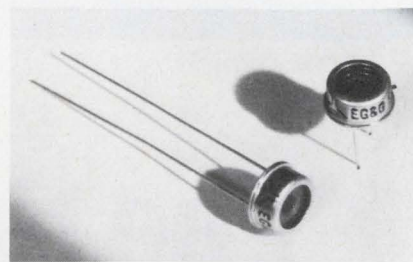

EG & G, Inc., 35 Congress St., Salem, MA 01970. Edward Danahy (617) 745-3200. \$40 (1-9 qty); stock.

Model FND-100 silicon photodiode has a rise time of less than 1 ns and a responsivity greater than 0.65 ampere/watt at 904 nm. The unit has an active area of 5.1 mm<sup>2</sup> and comes in a TO-5 package.

CIRCLE NO. 325

## Zeners stand up to 200-V PIV

Sarkes Tarzian, Inc., 415 N. College Ave., Bloomington, IN 47401. (812) 332-1435. \$1.08 to \$1.32 (1000 qty).

The 3BZ series of zener diodes offer peak-inverse-voltage ratings from 5.6 V at 250 mA to 200 V at 3.7 mA. Maximum power dissipation for all units is 3 W. Standard voltage tolerance is 10%, with 5% and 20% tolerances available. Dynamic impedance ranges from 1 to 45  $\Omega$  for the low-voltage types to 55 to 750  $\Omega$  for the 56 to 200-V types. Each diode measures 0.374-in. long by 0.196-in. dia with 1.25-in. leads.

CIRCLE NO. 326

## P-i-n diodes offer low series resistance

Hewlett-Packard, 1501 Page Mill Rd., Palo Alto, CA 94304. (415) 493-1501. \$16 (1-9), \$12 (10-99); stock.

The HPND-4050 p-i-n diode has a series resistance of only 1.3  $\Omega$  typical (1.7  $\Omega$  max) at 10 mA forward current. Specifications include a typical reverse recovery time of 2 ns, capacitance of 0.15 pF max, and minimum breakdown voltage of 30 V. Glass backfilling allows a lead pull of 4 g.

CIRCLE NO. 327

## Digital dialing circuit accepts keyboard entry

Siliconix, 2201 Laurelwood Ave., Santa Clara, CA 95054. Norm Wheelock (408) 246-8000. 100 qty. prices: \$10.18 (320), \$13.57 (321); stock.

Able to operate with an inexpensive 3.58-MHz crystal, the DF 320 loop-disconnect dialer accepts keyboard switch closures and delivers dial pulse trains out. A 2.5 to 5-V supply can be used to power the CMOS device but power drain is very low—just 3- $\mu$ W standby and 600  $\mu$ W during operation. The DF 320 has circuits for power-on reset, keyboard debounce, storage of a 20-digit number, repeat of last number and selectable mark/space ratios, pulsing speeds and interdigit pauses. The circuit is available in two versions, a 28-pin model (the DF 321) with extra lines to permit loading a number into the circuit from a digital source, and an 18-pin unit (the DF 320) for keyboard-only entry.

CIRCLE NO. 328

## CMOS PLL operates at frequencies to 10.24 MHz

Energy Electronic Products, 6060 Manchester Ave., Los Angeles, CA 90045. Tom Nixon (213) 670-7880. \$5.20 (100 qty); stock.

The MN6040, a silicon-gate CMOS phase-locked loop, consists of a reference signal counter, programmable preset counter for frequency dividing and phase detector. Operating at frequencies as high as 10.24 MHz, the PLL uses binary code as the preset counter input and has a maximum operating frequency of the programmable counter of 2.55 MHz. Housed in a 16-pin DIP, the PLL requires 4.7 to 5.8 V at 5 mA.

CIRCLE NO. 329

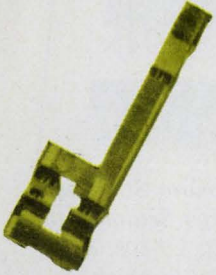
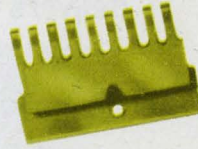

# FLAT SPRINGS

from Instrument Specialties  
cut your product's cost  
and improve performance!



Beryllium copper springs from Instrument Specialties can cut your installed costs several ways. I/S springs are more uniform, speeding assembly, because we heat-treat them *after* forming, in special fixtures. They can be delivered on strips, saving time at incoming inspection. They can be detached singly, without burrs, along precise score lines, eliminating tangling. Or, the strips can be designed for automatic assembly, virtually eliminating hand work.

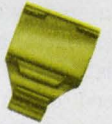

What's more, Instrument Specialties springs improve your product's performance... ensure longer life... and protect *your* reputation—because they're precision-made of beryllium copper, with its inherently superior endurance life, conductivity and reliability.

We can stamp them with proprietary dies made and held exclusively for you, or, in some cases, adapt our standard tools. Or, photo-etch them, when short runs make expensive tools uneconomical.



Our catalog gives you complete information. It's free for the asking. Write today to Dept. ED-83.



**INSTRUMENT SPECIALTIES CO., INC.**

Little Falls, New Jersey 07424

telephone: 201-256-3500 twx: 710-988-5732

*Specialists in beryllium copper since 1938*

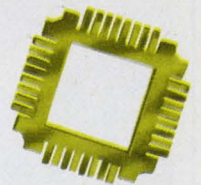

### FET analog gate turns on fast

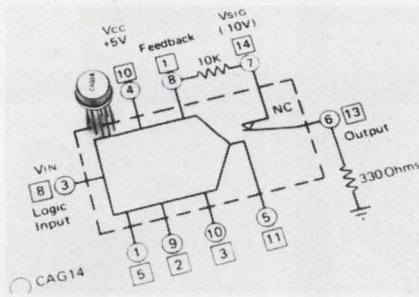

Teledyne Crystalonics, 147 Sherman St., Cambridge, MA 02140. Gregory Kizik (617) 491-1670. \$42 (1-49 qty), \$35 (50-99 qty); stock.

With a turn-on time of 20 ns, the CAG14 FET analog gate is said to be five times faster than comparable monolithic analog switches. The unit is an spst switch and driver circuit, and features a voltage-constant on-resistance of 35  $\Omega$  (typical) and guaranteed operation over the entire MIL temp range.

CIRCLE NO. 330

### Power audio amplifier delivers up to 5.5 W

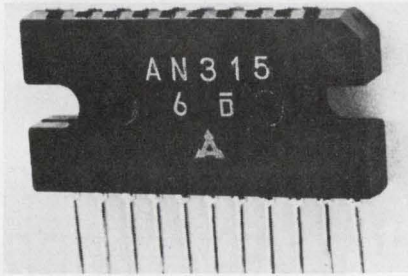

Energy Electronic Products, 6060 Manchester Ave., Los Angeles, CA 90045. Tom Nixon (213) 670-7880. \$2.50 (100 qty); stock.

Housed in an 11-pin single in-line package, the AN315 audio power amplifier delivers 5.5 W. The unit consists of a differential pre-amplifier, a drive amplifier, a ripple filter, an automatic operating point stabilizer and a quasi-complementary power amplifier circuit. Features of the AN315 include a 53-dB closed-loop gain and overload and short-circuit protection. The amplifier has a THD of 1.5%, maximum and a noise voltage of 4.5 mV, max.

CIRCLE NO. 331

### Chips drive large fluorescent displays

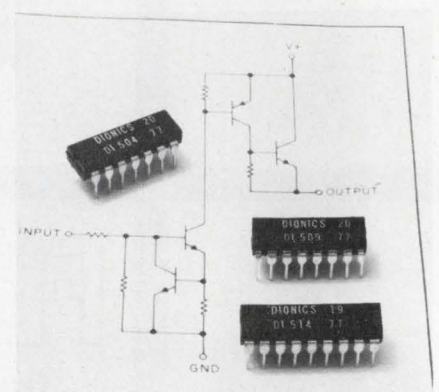

Dionics Inc., 65 Rushmore St., Westbury, NY 11590. George Seaton (516) 997-7474. DI-504, \$0.93; DI-509, \$1.10; DI-514, \$1.22 (10,000 qty); stock.

Vacuum-fluorescent displays requiring 35-V supplies can be driven directly by the DI-504/509/514 series level-shifted drivers. Both the shift level and output of each model are 50 V. Output drivers saturate at 1.5 V and 10 mA (typical). Inputs are MOS or TTL-compatible. The DI-504, 509 and 514 come in 4, 6 and 8-line versions, respectively.

CIRCLE NO. 332

## KEYBOARD SWITCHES for INSTRUMENT PANELS

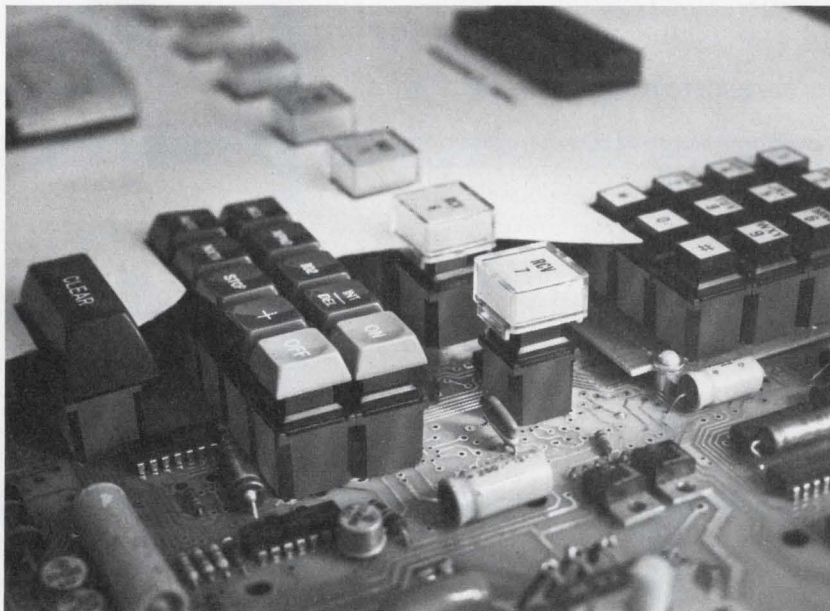

Now is the time to stop hand wiring to expensive panel-mounted switches.

Mechanical Enterprises' keyswitches are available at about *half-the-cost*. And, they are *self-supporting* on the PC board without the need for metal sub-plates.

Our switches feature —

- Sealed contacts or inexpensive gold bar mechanical contacts
- 3/4" or 5/8" spacing, or stand-alone
- Selection of legending systems including doubleshot keytops
- Lighted models in three lens styles, all relampable from front
- Single or double pole, NO or NC
- Momentary or alternate action
- Wave solderable
- 20 million cycle life at TTL loads with guaranteed low bounce

Please phone for a free sample with keytop.



**Mechanical Enterprises, Inc.**

8000 Forbes Place Springfield, Virginia 22151 (703) 321-8282 TWX 710-832-0942

Germany - NEUMULLER GMBH, MUNICH / U.K. - TEKDATA Ltd., STOKE-ON-TRENT / France - TEKELEC AIRTRONIC, SEVRES / Switzerland - DIMOS, AG ZURICH



# LOOK:

1. Characterize phase lock loops.
2. Generate digital phase modulation.
3. Program signals 10kHz to 2600MHz.

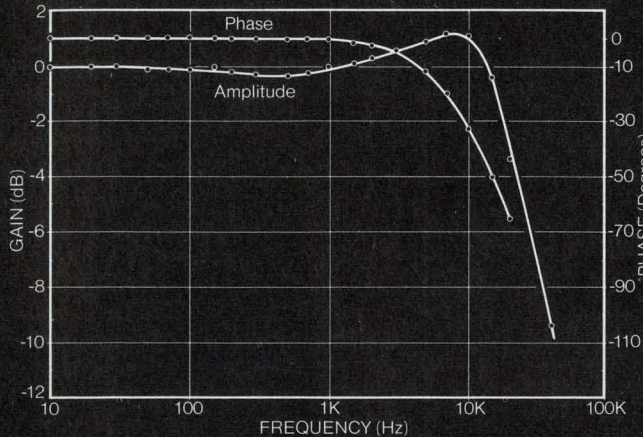

1. A complete Bode Plot of a phase lock loop can be generated with 8660C phase modulation capability.

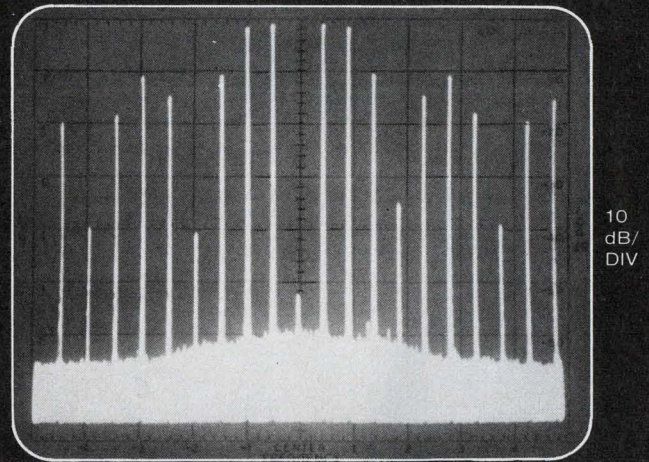

2. A QPSK phase modulation signal is shown with 1 MHz clock rate and 50 dB carrier null.



3. 8660C Synthesized Signal Generator under 9825A Desk Top Computer Control provides fully programmed signals from 10 kHz to 2600 MHz with AM, FM, phase or pulse modulation.

Look how the HP 8660 Synthesized Signal Generator makes a lot of things easy. Its phase modulated signals allow you to test a wide variety of phase lock loops in their closed loop, operating condition. And low frequency drift gives good results even with narrow band PLL's. We've discussed it in detail in our Application Note 164-3.

You can use the HP-86634-35 Modulation Sections with their analog phase capability to generate discrete phase states for binary and quadra-phase shift keyed (BPSK & QPSK) signals. Such signals will prove valuable for applications such as communications receiver testing, military secure links and time domain multiple access satellites. Our Application Note 164-4 tells how to build the simple interface circuit.

You can also use it as a programmable signal simulator. Application Notes 164-1 and

164-2 show how to program the 8660A/C for automatic test systems or signal simulation.

The versatile 8660A/C Synthesized Signal Generator and its family of three RF output plug-ins (10 kHz to 2600 MHz) and 5 modulation plug-ins (AM, FM,  $\phi$ M, and pulse modulation) are made even more valuable with the information in these application notes:

- AN 164-1 BCD Programming
- AN 164-2 Calculator Programming
- AN 164-3 Phase Lock Loop Testing
- AN 164-4 Digital Phase Modulation

Circle the appropriate bingo number, or contact your nearby HP field sales office.



1507 Page Mill Road, Palo Alto, California 94304

For assistance call: Washington (301) 948-6370, Chicago (312) 255-9800, Atlanta (404) 955-1500, Los Angeles (213) 877-1282

Circle 117 For AN 164-1

Circle 118 For AN 164-2

Circle 119 For AN 164-3

Circle 120 For AN 164-4

04706

# First in the Industry! LEDs with PHOTOCONDUCTORS in DIP OPTO-ISOLATORS

- For linear and logic functions
  - High immunity to noise and transients
  - 250V PAC output
  - 1500 PAC isolation
  - A-C input units utilize 2 LEDs in inverse parallel
- Call (914) 664-6602



**CLAIREX ELECTRONICS**  
A Division of Clairex Corporation

CIRCLE NUMBER 68

## NEW! INSTANT FREQUENCY DIFFERENCE!



**Tracor Model 527A measures frequency difference instantly, precisely. For precisely \$3,150.**

Front-panel meter reads directly to parts per 10<sup>11</sup>. Allows adjustment of two oscillators to the same frequency, adjustment to a specific offset, determination of offset — all instantly. Plus both short-term and long-term stability analysis. Internal oscilloscope extends precision to 1 x 10<sup>-12</sup>. Reference and signal frequencies need not be the same. Write or call for full technical and application information.

**Tracor** Industrial Instruments

6500 Tracor Lane • Austin, Texas 78721 • AC 512/926-2800

CIRCLE NUMBER 69

## ICs & SEMICONDUCTORS

### LSI CMOS chip drives LCD

*Hughes, 500 Superior Ave., Newport Beach, CA 92663. (714) 548-0671. \$8 (1000 qty); 30 days.*

The HMUX0190 is a CMOS large-scale integrated circuit for converting multiplexed BCD information into signals suitable for driving a liquid crystal display. The unit can be applied in any system using a parallel-drive LCD with four-digit multiplexed BCD input. The package is a 40-pin plastic DIP.

CIRCLE NO. 333

### Power transistor series gets 35 additions

*Motorola, P.O. Box 20912, Phoenix, AZ 85036. Lothar Stern (602) 244-0900. 100 to 999 prices: from \$0.36 to \$1.30; stock.*

Thirty-five power transistors with medium-power, low-frequency characteristics have been added to the company's line. Included are Darlington and standard complementary transistors with current ratings of up to 15 A and voltage breakdown ratings as high as 400 V. All devices come in TO-220 packages and are second-source components for TI and RCA transistors. Prices in 100 to 999 quantities are claimed to be at least 10% below those for equivalent competitors units.

CIRCLE NO. 334

### Analog chip improves a/d converter

*Siliconix, Inc., 2201 Laurelwood Rd., Santa Clara, CA 95054. Jim Graham (408) 246-8006. Prices (100 qty): \$6.15 for LD111A, \$5.29 for LD110, and \$11.44 for the set; stock.*

The LD111A is a second-generation analog processor IC designed to replace the LD111 chip of the LD110/LD111 analog-to-digital converter set. The LD111A retains the automatic zeroing, automatic polarity sensing and the 100-M $\Omega$  input impedance of its predecessor. Further specifications include a 10- $\mu$ V sensitivity, typical nonlinearity of less than 0.02%, differential inputs, and sampling rates to 40 samples per second. The PMOS-bipolar-fabricated unit comes in a 16-pin plastic DIP rated for 0 to 70-C operation.

CIRCLE NO. 335

# 8080 Core

## non-volatile • high reliability

Dataram introduces the industry's widest range of byte-designed single-board core systems for 8080 and other byte-oriented applications.

And when Dataram says "byte," we mean true byte systems — with 1K to 32K bytes, 8 to 10 bits/byte, not 16 or 18 bits/word systems that simulate byte systems.

What that means to you is less power and fewer components...and that means more for less. More reliability and more performance with smaller size...and lower product costs.

8080 Core. For people who think small.

Find out more about 8080 Core today. Return this coupon at once, or call us at 609-799-0071.

SYSTEM	CAPACITY	CYCLE/ACCESS	DIMENSIONS	VOLTAGES	TYPICAL POWER	COMPATIBILITY
DR-180	4K x 8 8K x 8	750/250 ns 750/250 ns	9.2" x 6.3" (233.4 mm x 160 mm)	+5V, +12V	30 Watts	8080 Microprocessor
DR-121	1K x 10 2K x 8 2K x 10	900/350 ns 900/350 ns 900/350 ns	11.7" x 11.5" (297 mm x 292 mm)	+5V, -12V	25 Watts	Cambridge Memories' 1K x 9 Unicore
DR-104	4K x 9 8K x 9 16K x 9 32K x 9	750/350 ns 750/350 ns 750/300 ns 800/300 ns	13.5" x 8.3" (343 mm x 211 mm)	+5V, -12V	32 Watts	National Semiconductors' MOSRAM 104

In addition to standard systems, Dataram offers impressive custom design capabilities.

I'd like to learn more about 8080 Core.

Please send information

Please have a salesman contact me

Please have a technical type call me.

Name \_\_\_\_\_

Title \_\_\_\_\_ Phone \_\_\_\_\_

Company \_\_\_\_\_

Address \_\_\_\_\_

City \_\_\_\_\_ State \_\_\_\_\_ Zip \_\_\_\_\_

Please send me information about BULK CORE:  
256K byte memory system on a single board

Please send me information about mini-memories for  
minicomputers



PRINCETON-HIGHTSTOWN ROAD  
CRANBURY, NEW JERSEY 08512  
TEL: 609-799-0071 TWX: 510-685-2542

CIRCLE NUMBER 70

# CUT SYSTEM COSTS WITH HUMPHREY'S COMPLETE LINE OF LOW COST GYROS



## FOR PRECISE GUIDANCE AND CONTROL OF EXPENDABLE DRONES, OR SOPHISTICATED RPV'S

Humphrey's fully qualified line of gyros lets you select the right model to meet your exact mission requirements. Production models are available with AC or DC motors, and potentiometer pickoffs for a wide variety of autopilot systems. They're in production for major short, medium and long range flight programs. The Humphrey line includes:

- Spring driven - instant start gyros.
- Spring driven - motor sustained gyros.
- Vertical and directional gyros - magnetic north seekers.
- Rate gyros.
- Custom designed gyros for specific applications.

For full information write: Humphrey, Inc., 9212 Balboa Ave., Dept. ED 777 San Diego, California 92123. Phone (714) 565-6631

### WRITE FOR GYROSCOPE SELECTION GUIDES . . .

with specifications and dimensional drawings on Humphrey's standard line of gyros.



**Humphrey Inc.**  
SAN DIEGO • WICHITA • PHILADELPHIA

CIRCLE NUMBER 71

## COMPONENTS

### Precision potentiometer functions nonlinearly

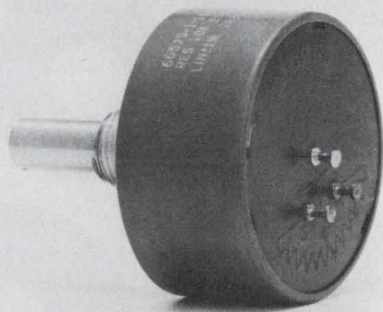

Bourns, Inc., 1200 Columbia Ave., Riverside, CA 92507. R. L. White (714) 781-5140. \$6 (OEM qty.); stock to 8 wks.

A low-cost precision potentiometer, Model 6657, is offered with a full line of single-turn nonlinear functions. The linear version has an independent linearity of 1%. And, the pot can be ordered with sine, cosine, sine-cosine, log and empirical functions. The pot has a 1-5/16-in. dia, a bushing mounting, conductive-plastic element and mold-in terminals. Other specifications include a resistance range of 1 to 100 k $\Omega$ , a power rating of 1.5 W at 70 C and a life of 10-million revolutions.

CIRCLE NO. 336

### Small slide control offers variety of tapers

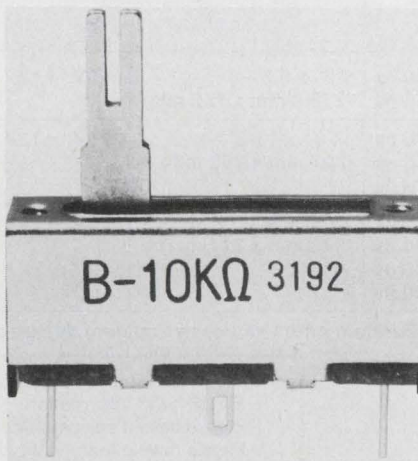

Impact Electrical Products, Inc., 7 Westchester Plaza, Elmsford, NY 10523. Harry Hooper (914) 592-2880. \$0.40 (1000 qty); stock.

This miniature slide potentiometer is 1.18 (L)  $\times$  0.33 (W)  $\times$  0.47 (H) in., with a stroke of 0.59 in. The unit is available in log, linear, reverse-log, 10% log, and 5% log tapers.

CIRCLE NO. 337

### Rf switch comes in TO-5 package



Summit Engineering, 2311 S. Seventh Ave., P.O. Box 1906, Bozeman, MT 59715. (406) 587-0636. \$60; stock to 30 days.

The Model 541 rf switch is a sub-miniature spst current-controlled attenuator housed in a TO-5 can. Designed for switching and pulse modulation to 500 MHz in a 50- $\Omega$  system, the unit's typical midrange specifications include loss of 2.5 dB, on-off ratio of 40 dB and switching-signal isolation of 25 dB.

CIRCLE NO. 338

### Tiny DIP switches fill only half a socket

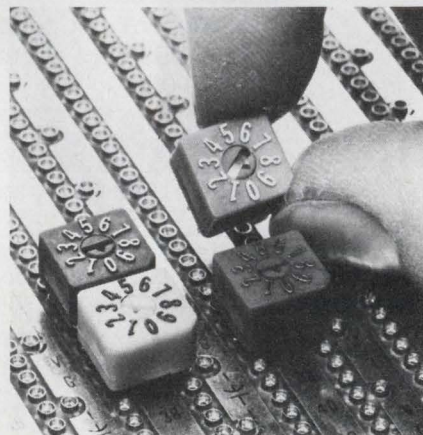

EECO, 1441 E. Chestnut Ave., Santa Ana, CA 92701. D. Henriksen (714) 835-6000. Under \$1.00 (10,000 qty.).

Color codes allow easy recognition of Micro-DIP switch output codes. Red for BCD 1-2-4-8, orange for BCD complement only, green for 2-pole 0, 1 repeating and blue for 1-pole 0 to 4 repeating. The switches occupy only half of a 14-pin DIP socket, or they can be directly mounted and connected by hand or flow soldering. Only 0.4  $\times$  0.38  $\times$  0.225 in., the 0-to-9 positions are screwdriver set.

CIRCLE NO. 339

# Now you can get 3 different types of solid-state relays from P&B.

## That's P&B solid-statesmanship.

Specify P&B solid-state relays for wide choice, top performance, fast delivery. Three designs—103 ratings and voltages—now available from your local distributor. Get P&B experience—nearly two decades of designing solid-state devices.

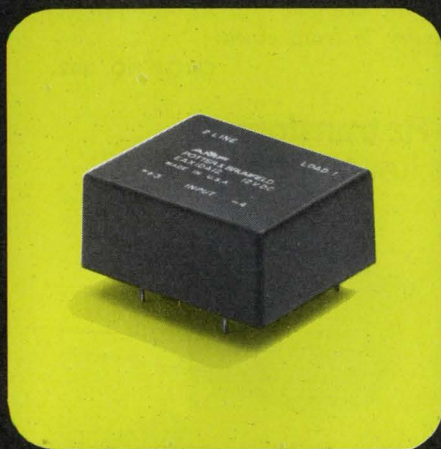

### **New EAX Series. Solid-state 1.2 ampere AC relay. Transformer coupled. Zero current turn-off.**

Low cost, solid-state relays that can be driven directly by logic circuitry (TTL, MOS, HTL, and others). For switching solenoids, fractional hp motors, heating elements, contactors and small lamp loads.

Thyristor switch controlled and isolated by a pulse transformer circuit. Terminals for printed circuit board mounting (0.1" grid).

Expected life of over 100 million operations. Temp. range: storage, -40°C to +85°C. Operating ambient, -10°C to +55°C.

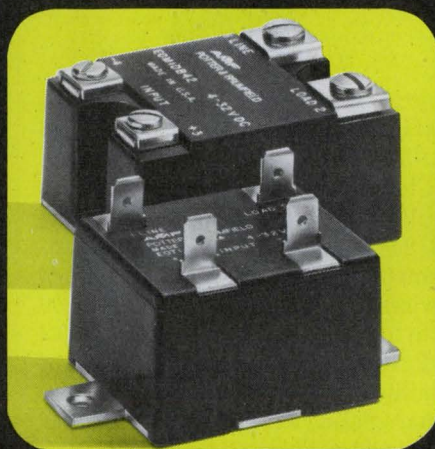

### **EOM/EOT Series. 0.1 to 20 amperes. All solid-state opto-coupled AC relays.**

Medium power, 120/240 VAC 50/60 Hz switches. Controlled and isolated by opto-electronic coupler. For use as ON/OFF switch for loads through 20 amperes. EMI and RFI are greatly reduced due to zero voltage turn-on and zero current turn-off.

An ideal component for interfacing between the logic output of TTL, HTL, or MOS circuitry and such AC loads as solenoids, motors, lamps and transformers.

Expected life greater than 100 million operations. Temp. range: storage, -40°C to +85°C. Operating ambient, -10°C to +55°C.

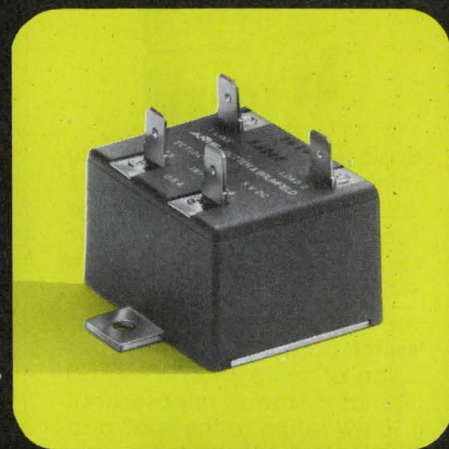

### **ECT Series. Solid-state Hybrid relay. Reed triggered triac. 0.1 to 32 amperes.**

Medium power, 120/240 VAC 50/60Hz solid-state switches controlled and isolated by a reed relay, packaged for direct chassis mounting. Intended for switching AC loads such as solenoids, motors, lamps and transformers through 32 amperes. AC and DC actuation available.

Advantages: long life, high inrush switching capacity and input/output isolation provided by the reed relay.

Expected life greater than 10 million operations. Operating ambient, -10°C to +55°C.

Standard models have .250" quick-connect terminals. .187" and .205" also available.

Ideal applications for P&B solid-state relays include process controls, instrumentation, life support equipment, alarm devices, machine tools, vending machines, dryers, photocopiers, lighting and traffic controls.

See your P&B representative or authorized P&B distributor for specifications on his 103 off-the-shelf solid-state and hybrid relays. Or, write Potter & Brumfield Division AMF Incorporated, 200 Richland Creek Drive, Princeton, Indiana 47671. 812/386-1000.

AMF  
Potter & Brumfield

# Potter & Brumfield

## an investment in capitol buys rugged switch design and long, trouble-free life

For Example!  
Our Extremely Dependable, Multiple-Position Push Button Strip Switches

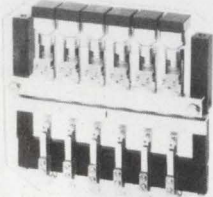

Basic frames are anodized aluminum. Plungers are 5/32" square brass with a nylon actuator molded on them. Hence, they will not bend or warp.

Mechanical linking of all switch positions prevents operation of more than one position at a time. A released button will return to the "up" position before the next button can be actuated. These switches can be illuminated either by an external circuit or directly from the switch. Lamps do not travel when positions are engaged, eliminating shock to the bulb.

Capitol switches are tested with 2 to 3 million operations to assure life-long, trouble-free performance.

Our 28-page catalog will give you all the "specs" on CAPITOL's entire line of quality switches.

**CAPITOL SWITCHES** are rated at 3 Amps, 110 Volts AC, non-inductive.



CAPITOL manufactures a complete, high-quality line of push button and lever switches — illuminated if desired — standard and custom designs to fit your every need.

# CAPITOL

The Capitol Machine and Switch Co.  
87 Newtown Road, Danbury, Conn. 06810  
Phone: 203-744-3300

## COMPONENTS

### Precision multiturn pots are modular

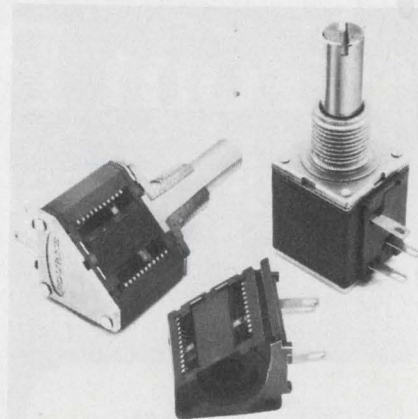

Bourns, Inc., 1200 Columbia Ave., Riverside, CA 92507. Rene L. White (714) 781-5140. \$3.94 (1000 qty); 10 days.

Close panel spacing and design versatility are made possible by Model 83/84 modular precision potentiometers. These wirewound multiturn devices offer a resistance range of 200  $\Omega$  to 100 k $\Omega$ , linearity of  $\pm 0.25\%$ , 0.3 to 2 oz-in. torque and rotational life of 1 million shaft revolutions. The 5/8-in. square package comes with PC pins or with solder lugs.

CIRCLE NO. 340

### Slide potentiometers alternative to rotaries

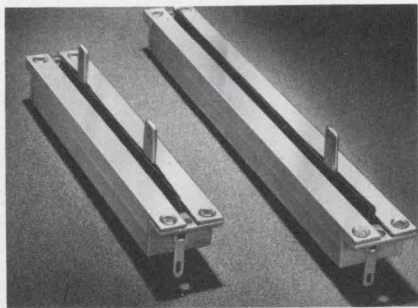

Waters Mfg., Longfellow Center, Wayland, MA 01778. R. A. Waters (617) 358-2777. \$10: MM-4, \$12: MM-6 (100 qty).

Industrial linear-motion slide potentiometers with conductive-plastic elements, series MM-4 and MM-6, provide equipment designers with a linearity of 1% and standard and resistance values of 1000, 5000, and 10,000  $\Omega$ . The pots are also available with dual independent wipers. Some specifications include stroke lengths of 2.6 and 4.12 in., resistance values of 1, 5 and 10 k $\Omega$   $\pm 20\%$  and a life of 250,000 cycles min.

CIRCLE NO. 341

### Thick-film resistors handle up to 40 kV

Pyrofilm Corp., 60 S. Jefferson Rd., Whippany, NJ 07981. Jim Cook (201) 887-8100. See text.

Voltage ratings of up to 40 kV are available in the PVC series of thick-film resistors. The units are axial-leaded with resistances from 10 k $\Omega$  to 1000 M $\Omega$  and a tempo of  $\pm 100$  ppm/C. The maximum power rating is 5.25 W at 70 C. Sizes range from 1/4  $\times$  0.105 in. dia. (for the 10 k $\Omega$  to 50 M $\Omega$  resistors) to 4  $\times$  0.3 in. (for the 50 k $\Omega$  to 100 M $\Omega$  unit). Prices (100 qty) are from \$0.85 for the 100 k $\Omega$  to 1 M $\Omega$  range to \$3.67 for the 500 k to 1000 M range. Delivery is from stock.

CIRCLE NO. 342

### 60-Hz transformer sits low on board

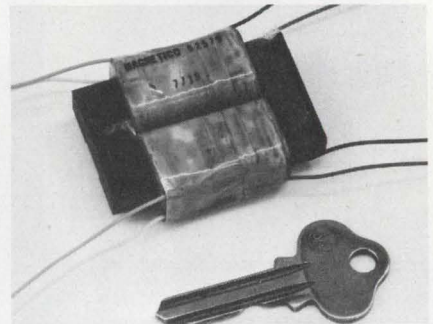

Magnetics, Inc., 182 Morris Ave., Holtsville, NY 11742. T. Sullivan (516) 654-1166. \$6.80 (1000 qty); 6 wks.

Designed for a 5-V-dc supply, the type-52593 60-Hz transformer is only 1-7/8  $\times$  1-1/2  $\times$  1/2 in. high. The unit has a 115-V input and a 7-V output at 0.1 A. Leads and mounting holes are provided. 208, 230, and 440-V primaries are available as options.

CIRCLE NO. 343

### Relays snub false firings

Electronic Instrument & Speciality Corp., 42 Pleasant St., Stoneham, MA 02180. John Beigel (617) 438-5300. \$13-\$15 (100 qty); 3-5 wks.

This line of opto-isolated ac solid state relays features snubber networks that eliminate false firings. Specifications for the 24 models include zero-voltage turn-on; 3, 6, 10 and 25-A current rating, and switching voltages of 120 and 240-V rms. Transient protection, dV/dt, in the off state at 25 C is 400 V/ $\mu$ s minimum. Inputs are TTL/MOS compatible.

CIRCLE NO. 344

## DATA PROCESSING

### Rugged mini crams full Mbyte into standard box

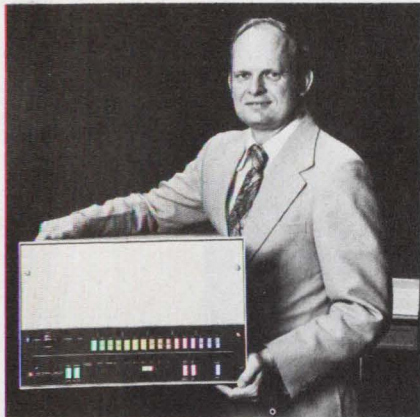

Hewlett-Packard, 1501 Page Mill Rd., Palo Alto, CA 94304. (415) 493-1501. \$59,800; August, 77.

If your environment is too noisy or too dusty for disc storage, the 21MX can provide an answer. A 12-1/4-in.-high mainframe contains the whole mini, including up to 1 Mbyte of storage. And, with an optional extender, the 21MX can handle additional memory (at about 5¢/byte) to a total of 1.8 Mbytes. The secret: a high-density memory module with 128 kbytes of error-correcting storage. It works in any 21MX computer that has a dynamic mapping system—without any changes to existing software. The fault-control feature improves MTBF tenfold, to about 7000 hours. If the modules are used with the fast E-series, their cycle time is 630 ns.

CIRCLE NO. 345

### Versatile terminal has software support

Mini-Computer Systems, Inc., 2259 Via Burton, Anaheim, CA 92806. (714) 870-7660. \$1225 (100 qty).

The MIDAS II video display terminal provides high versatility at a low cost. The microprocessor-based terminal has eight selectable data transmission rates from 110 to 19,200 baud, a display format of 24 lines by 80 characters on a 12-in. screen, and a 128-character repertoire. Other features include RS-232C or current-loop compatibility, a remote, solid-state keyboard and the availability of wide-ranging modular software. The terminal is also available on a 12-month rental plan at \$85/month including on-site maintenance.

CIRCLE NO. 346

### Expand mini memory by up to 128 kwords

Dataram Corp., Princeton-Hightstown Rd., Cranbury, NJ 08512. John F. Gilligan (609) 799-0071. \$3475 (unit qty); 8 wks.

The DR-114 is a single board 32 k × 18 core-memory system for main memory expansion of DEC's popular

PDP-11 series. It is available in either 16 k × 18 or 32 k × 18 configurations, and is plug-compatible with DEC's MM11-D and MM11-DP boards. If no slots are vacant in the host PDP-11, a frame is available which can hold four DR-114 systems, providing a maximum capacity of 128 k × 18. DR-114 cycle time is 900 ns, and access time is 350 ns.

CIRCLE NO. 347

## After you look at the specs, look how long they're guaranteed.

The accuracy specs for the Dana 5100 5½ digit multimeter are guaranteed for a full year. Not 90 days. Not 6 months. That means you only have to calibrate it once a year.

All other multimeters have to be calibrated an average of three times a year. At about \$75 a pop. Which makes their \$995 units a lot more expensive to own than the Dana 5100 at \$1145\*

Instead of sitting in the shop for six weeks over the course of the year, the Dana 5100 will stay right where you are. Measuring AC, DC, Ohms and frequency (yes, frequency too) with very high accuracy. Just like the specs say. For a year at a time.

When you look at it that way, one thing becomes obvious. The cost of owning a multimeter is a lot more important than the price.

Write Dana Laboratories, Inc., 2401 Campus Drive, Irvine, CA 92715 for all the specs. And take a good look. With specs that good, you'll be glad you only have to give it up once a year.

**DANA**®

Others measure by us.

\*U.S. domestic prices.



**Dana 5100.**  
Ask for a free demonstration before you consider anything less.

For Product Demonstration Circle 74

For Literature Only Circle 73



## **THE GOLD BOOK PUTS IT ALL TOGETHER... IT'S THE FINEST DIRECTORY IN THE FIELD**

Mr. Robert T. Dudley is president of ELECTROL, INC., York, Pennsylvania, manufacturer of adjustable speed drive controllers, "Command Lock" SCR controls and "Command-Tach" digital readout controls. His directory? *Electronic Design's* GOLD BOOK.

**"I think the GOLD BOOK is the finest directory in the field. We use it constantly. We've had especially good results from the Trade Names section. The GOLD BOOK gives an excellent feel for the sources available for each particular product. It's a vast well of information for electronics engineers and designers. The GOLD BOOK does a better job of putting directory information together than anyone in the industry."**

The GOLD BOOK is working for advertisers because it's working for 95,000 engineers, engineering managers and specifiers — like Mr. Dudley — throughout the U.S. and overseas. Is your company represented in its pages?

**IF IT'S ELECTRONIC...IT'S IN THE GOLD BOOK!**



## DATA PROCESSING

### Disc-drive controllers provide second source

*Bytronix, 2751 E. Chapman Ave., Fullerton, CA 92631. (714) 871-8763. \$2600 (unit qty); 6 wks.*

The Model B234 two-disc controller works with Data General computers and requires one slot of the computer chassis. It is software and media-compatible with the DG 4234 disc system, and controls up to four drives. The Model B446 controller can replace the Digital Computer Controls 116446 controller board in existing systems; it controls one or two drives. Both are compatible with Diablo Series 40 disc drives with up to 10 Mbytes of storage capacity.

CIRCLE NO. 348

### Low-cost acoustic modem is tough, will travel

*Datec, Inc., P.O. Box 839, Chapel Hill, NC 27514. Bill Jefferson (919) 967-5605. \$310.*

The Model 30 acoustic modem withstands a 4-ft drop, and 0 to 50 C (32 to 122 F) temperatures. It is Bell-System 103/113 compatible, full or half-duplex, and provides 300 bit/s over conventional dial telephones. A carrier detector measures received base-band signal-to-noise ratio, and operates independently of received signal amplitude, down to -55 dBm. The modem can be wall-mounted, and easily snaps loose for portability.

CIRCLE NO. 349

### Minifloppy drive includes software

*Realistic Controls Corp., 3530 Warrensville Center Rd., Cleveland, OH 44122. Ronald Larsen (216) 751-3158. \$1220 (see text); stock.*

The Z//25 Fortran IV-Minifloppy includes a Shugart SA400 drive, cables and cabinet, an interface module, operating system with file management, text editor, FORT//80 (a Fortran IV subset for the 8080) and documentation. The unit operates with any standard S-100 bus system having 20 k of RAM. System software is provided on a Shugart SA105 Minidiskette. The Fortran IV-Minifloppy is also available as a kit at \$1095.

CIRCLE NO. 350

### Video generator flashes messages on TV screen

*Thalner Electronic Laboratories, Inc., 7235 Jackson Rd., Ann Arbor, MI 48103. James Jackson (313) 761-4506. \$695 (unit qty); stock to 2 wks.*

The Model VM-516 video message generator superimposes up to 16 lines of 16 alphanumeric characters on any

conventional video signal. Nonvolatile field-replaceable message modules are factory programmed to user specifications. Any portion of the information may be programmed to flash. Character height, width, intensity and message position on the TV picture are adjustable. The VM-516 measures 1.7 × 8.0 × 10.3 in. Rack mount adaptors are available.

CIRCLE NO. 356

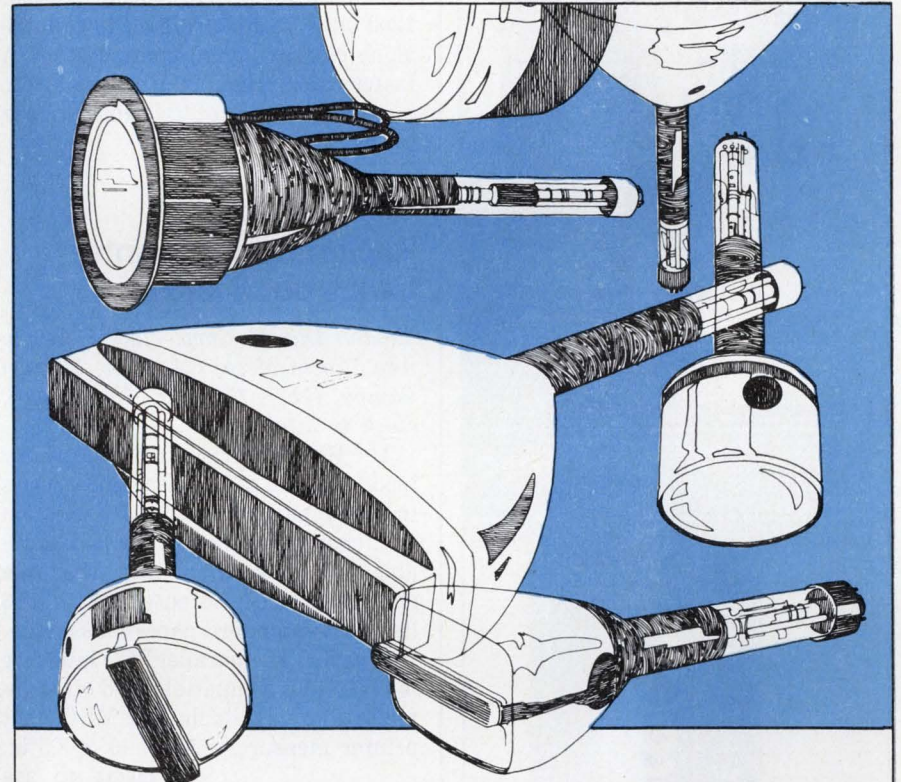

### High Resolution CRT's For Optical Systems

Thomas Electronics, Inc., is currently producing a wide range of high resolution tubes for: Optical Character Recognition, Photo Recording, Hard Copy Printout and Photo Typesetting applications. Included in this range are optical quality non-browning glass and fibre optics strips faceplate CRT's in all sizes. All of these tubes can be supplied with special screen types for improved performance, in addition to the standard phosphor screens.

For high speed printing applications, Thomas has an electrostatic charge printing tube available that consists of a strip of very fine, closely spaced wires extending through the bulb faceplate.

*Complete specifications and drawings are available for the above tube types upon request. Also, we invite you to send for our New Short Form Catalog describing our full complement of CRT's for varied applications.*

# THOMAS ELECTRONICS, INC.

100 RIVERVIEW DRIVE, WAYNE, N. J. 07470 / Telephone: 201-696-5200 / TWX: 710-988-5836 / Cable: TOMTRONICS

CIRCLE NUMBER 75

**spill-  
proof  
power**

**for  
every  
stand-by  
emer-  
gency  
need**



**Our batteries are truly Carefree. They won't spill, never require maintenance, built with dual covers and they're completely rechargeable. We've got practically all sizes, but if you need a unique configuration that isn't on our shelf, we can probably build it for you. Call us. We're prompt and we're Carefree.**

**EAGLE EP PICHER**  
SINCE 1843

**EAGLE-PICHER INDUSTRIES, INC.**  
Commercial Products Department ED  
P.O. Box 130, Seneca, Mo. 64865  
Telephone (417) 776-2258

CIRCLE NUMBER 76

## DATA PROCESSING

### Modem features modest cost

*General DataComm Industries Inc., 131 Danbury Rd., Wilton, CT 06897. E. S. Tworkowski (203) 762-0711. \$671 (1-7); 4 wks.*

The 1200 EP modem operates half-duplex over two-wire, or full duplex over four-wire leased lines, either point-to-point or multipoint. The modem functions asynchronously up to 1200 bit/s and synchronously at 600 or 1200 bit/s, and is available in a stand-alone or rack-mount configuration. A faster model, the 2400 EP, costs \$1072.

CIRCLE NO. 357

### Rack-mounted printer bangs out 3 lines/s

*Master Digital Corp., 1308-F Logan Ave., Costa Mesa, CA 92626. Michael Campo (714) 751-8271. From \$665; stock to 4 wks.*

The MDC300R rack-mounted printer incorporates a Precisa 388 Series impact-type print head with a selection of 12 characters. The printers are available with 16 or 21 columns. The large characters are printed at a rate of 3 lines/s on standard paper rolls or fan-fold paper. The parallel BCD interface is DTL/TTL compatible, and other interfaces are available. The MDC 300R printer measures 8.72 x 19 x 8.5 in.

CIRCLE NO. 358

### Need billions of bytes? Just add a few discs

*Telefile Computer Products, 17131 Daimler St., Irvine, CA 92714. Hal E. Eden (714) 557-6660. See text.*

Low-cost, mass-storage facility for HP 3000 computers can add up to 1.2 billion bytes of on-line random-access disc storage to each HP 3000 selector channel port. As an added benefit, the disc drives take advantage of the high packing density and simplified electronics of the new 3330 disc technology. A single drive and Matchmaker controller cost \$30,000 and each additional 300-Mbyte drive costs \$18,000.

CIRCLE NO. 359

### Plotter interface used with new terminal

*Houston Instrument, One Houston Sq., Austin, TX 78753. Rod Schaffner (512) 837-2820. \$2595; 6 wks.*

The Model BTC-7/734, originally designed as an interface between the CDC 734 and the Complot digital plotters, can be used with Control Data's Cyber 18-5 remote batch terminal to provide automatic, inexpensive plotting of graphs, charts and drawings. Completely automatic plotting is done at plotter speeds up to 4.5 in/s.

CIRCLE NO. 360

### 'Smart' controller is compact, yet versatile



*Allen-Bradley, 1201 S. Second St., Milwaukee, WI 53204. (414) 671-2000. From \$3350; Oct., 1977.*

A  $\mu$ P-based programmable controller, the PLC-2 with up to 256 inputs or outputs, is compatible with the Series 1774 PLC controllers. PLC-2 uses the same powerful instruction set, but is designed for applications that do not require the extensive memory or I/O capabilities of PLC. A lightweight LED display program panel allows programming, editing and trouble-shooting. The basic PLC-2 processor contains one module each for control, interface and memory.

CIRCLE NO. 361

### Program reduces Total overhead

*Varian Data Machines, 2722 Michelson Dr., P.O. Box C-19504, Irvine, CA 92713. (714) 833-2400. \$9500.*

Varian enhances its Total Data Base Management system with Total-C, a multitasking program that improves multi-user capabilities. Its major feature is the separation of Total from the user's program; for multi-users, Total-C reduces the memory overhead by up to 5000 words per user. Current Total users can upgrade their system for \$1400.

CIRCLE NO. 362

# Need custom LSI? That's easy. Call NITRON: (408) 255-7550.

When you need custom LSI, you need Nitron. For years, we've been meeting hard-nosed designers' demands for industrial, commercial and military LSI applications with just what they need: definition, design assists, and unequalled manufacturing capabilities for MNOS, n and p channel MOS, CMOS, and Ion-implant custom products that are the best in the business.

#### Stability: it's an advantage

Sized right to give you the flexibility and attention of a high-quality custom house, Nitron has the added advantage of the resources and stability of McDonnell Douglas behind it. And the production versatility of a standard products supplier.

#### Your one-stop source

Services? Everything from design assistance through manufacturing to packaging. Response? Design cycle times of 20 weeks are not uncommon with us. Special capabilities? A few of immediate

interest to you might be our own in-house mask making facility (utilizing chrome masking, by the way), application of ADS computer aided design to generate masks, and a new cell technology which brings the densities of Nitron's ADS circuits to within 13% of that of expensive, handcrafted layouts.

#### Custom or off-the-shelf

Name your needs: non-volatile memories (NVMs); mask-programmable ROMs; frequency synthesizers; communications circuits; or something that's never been done before. Tell us. We can work with you on the design if you wish, translate it into a manufactured and packaged product, or you may even discover that it's already on our shelf. Whatever the problem, we're here to help you solve it. Quickly, efficiently, happily. If you want more information, fill out the coupon below and send it to us, or call Nitron Custom Marketing at (408) 255-7550.

**NITRON**   
A DIVISION OF MCDONNELL DOUGLAS

MAIL TO: Nitron Custom Marketing  
10420 Bubb Road, Cupertino, CA 95014

#### SEND ME THE FACTS!

I'm interested in (check boxes):

- |  |                               |
|--|-------------------------------|
| <input type="checkbox"/> Capabilities Brochure | <input type="checkbox"/> MNOS |
| <input type="checkbox"/> NMOS                  | <input type="checkbox"/> CMOS |
| <input type="checkbox"/> PMOS                  |                               |

#### DATA SHEETS

- |   |   |
|---|---|
| <input type="checkbox"/> Non volatile memories (NVMs) | <input type="checkbox"/> Frequency synthesizers |
| <input type="checkbox"/> Data Communications          | <input type="checkbox"/> ROMs                   |
| <input type="checkbox"/> Telecommunications           |   |

SEND TO:

name & title

company

address

city

state

zip

ED-7

EQUAL OPPORTUNITY IN PROFESSIONAL CAREERS. SEND RESUME: BOX 14526, ST. LOUIS, MO. 63178

MILITARY APPLICATIONS

# AD CONVERTERS

by

## MSK

Accuracy

Speed

Size

Repairability

Military

Temp. Range  
-55°C to +125°C

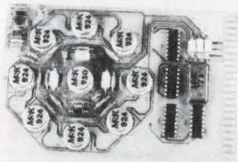

- 4 Bit/50 nSec; Low Cost
- Ideal for Radar Scan Converters
- Holds Absolute Accuracy Over Temperatures
- Tracks a 10 MHz Analog Input

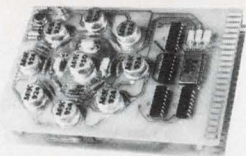

- 9 Bit/200 nSec.
- < 2 Bit Drift Over Temperature
- Insensitive to Clock Frequency

For Further Information Call or Write  
**M.S. Kennedy Corp.**  
 Pickard Drive, Syracuse, New York 13211  
 Tel. 315-455-7077

CIRCLE NUMBER 78

## MODULES & SUBASSEMBLIES

### Instrumentation amp eases gain switching

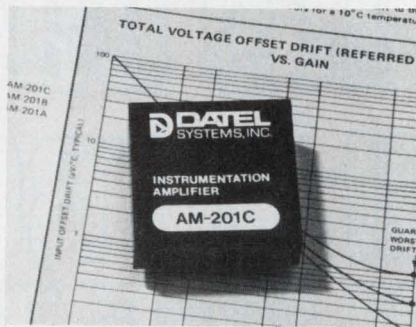

Datel Systems, 1020 Turnpike St., Canton, MA 02021. E. Murphy (617) 828-8000. \$89 (1-9 qty.); stock to 4 wks.

Unlike some instrumentation amps, with a constant term in the gain equation, the AM-201C is suited for gain-switching because its gain is simply an inverse function of the gain resistor. The 1.5 x 1.5 x 0.375 in. unit also boasts a voltage-offset drift of 0.25  $\mu\text{V}/^\circ\text{C}$  at a gain of 1000. At this gain level, the common-mode rejection is 114 dB with a 1-k $\Omega$  source unbalance. Other key specifications include an input bias current of 25 nA with a drift of 20 pA/ $^\circ\text{C}$ . This low drift permits operation with balanced source impedances of up to 40 k $\Omega$ . Additional features include: a bandwidth of 45 kHz at 1000 gain and 180 kHz at 100 gain; an output settling time, to 0.01%, of 20  $\mu\text{s}$ ; and  $\pm 10\text{-V}$  at 5-mA output capability.

CIRCLE NO. 363

### Shaft encoder built for rough use

Kessler-Ellis Products, Atlantic Highlands, NJ 07716. (201) 291-0550. \$180; 2 wks.

Featuring 0.25-in. thick walls and a sealed ball-bearing shaft assembly, Model-70B encoders meet the requirements of Nema-12 (dust-tight) Nema-4 (water-tight) or Nema-3 (weather-proof). An internal, flexible, shaft coupling protects precise encoder elements from extreme axial and radial shaft loading. Options include bi-directional output, a reference pulse and dual-channel output. The 3 x 3 x 6 in. unit outputs 5 or 12 V, sinking up to 20 mA.

CIRCLE NO. 364

### Stable unit converts voltage to frequency

Dynamic Measurements, 6 Lowell Ave., Winchester, MA 01890. (800) 225-1151. \$65 to \$95 (1 qty); stock to 2 wks.

Featuring maximums for 100-kHz linearity of 0.005%, monthly gain drift of 100 ppm, and gain tempo of 5 ppm/ $^\circ\text{C}$ , the 8116 v/f-converter family warms-up to  $\pm 0.005\%$  in 5 s. Available options include -55 to +125-C operating range, expanded scaling ranges, 20-V differential-input range, five-sided RFI/EMI shielding, ratiometric operation, sign outputs and FET inputs. Before final testing all units are burned-in for 24 h.

CIRCLE NO. 365

### Mechanical display steps 30 times/s



ENM Chicago, 5342 Northwest Highway, Chicago, IL 60630. G. Glynn (312) 775-8400. \$82.80 (1 qty.); stock.

Model-5210, a six-digit plug-in pre-selection counter, electromechanically records and displays 30 pulses/s. The topmost of the counter's two scales shows the limit set by depressing pushbuttons for each of the six digits. The bottom scale shows the tally. When the tally reaches the preset-limit number, a switch is activated for control. Both scales have a pushbutton reset. Models are available, with or without a face frame, for 12-V dc, 24-V dc, 24-V at 60-Hz, and 110-V at 60-Hz operation. A unit draws 5 W.

CIRCLE NO. 366

CIRCLE NUMBER 79 ►



# UNIVERSAL'S NEWEST MODEM

For two-wire, full-duplex operation at 1200 BPS, Universal Data Systems proudly announces the Model 12-12, the newest addition to the UDS family of data modems. The unit operates synchronously or asynchronously over unconditioned dial-up or private telephone lines.

Terminal interface discipline with the 12-12 is identical to that commonly used for 103/113 modems. Using experience-proved phase shift modulation techniques, the UDS-12-12 transmits at 1200 BPS or any integral sub-multiple rate, without restrapping or adjustments.

The 12-12 is insensitive to word length, and it includes integral provision for automatic remote and local loopback testing. Delivery: 45 days ARO. For technical details contact UDS today.

**\$600 Single Unit Price.**



# universal data systems

member of  
IDCMA

4900 Bradford Drive • Huntsville, Alabama 35805 • Telephone (205) 837-8100 • TWX 810-726-2100

Created by Hall & McKenzie Advertising, Winter Park, Florida

## MODULES & SUBASSEMBLIES

### Capacitor modules save space

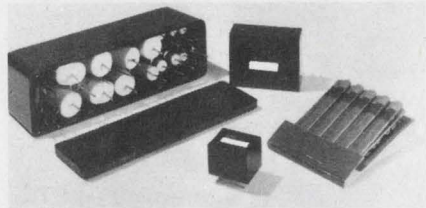

TRW Capacitors, 301 West O St., Ogallala, NE 69153. (308) 284-3611. See text.

The TRW capacitor module series can replace bulky discrete capacitors in most circuit configurations. A typical module takes only 4-1/2 in.<sup>2</sup> of board space and has 18 wound-film capacitors from 0.001 to 2.71  $\mu$ F at voltage ratings of 50 to 200 V dc. The dissipation factor is less than 1%. The devices are embedded in polyurethane and have tolerances of  $\pm$ 1%. Prices range from \$4 to \$20 depending on specifications and design configurations. Delivery is 4-8 wks.

CIRCLE NO. 367

### Thermocouple scanner mates ten to converter

San Diego Instrument Laboratory, 7969 Engineer Rd., San Diego, CA 92111. N. Looper (714) 292-0646. \$499 (11 qty); stock.

A thermocouple acquisition module on a card, the SL102, contains everything needed to go from ten thermocouples directly into an a/d converter. The unit accepts signals from grounded, ungrounded, or mixed thermocouples; it then references, scans, amplifies, filters, and controls the selected signal. A zero stabilizer provides zero referencing for both the amplifier and the on-board reference junction. Other standard features include a low-thermal reed scanner, an active 60-Hz filter, a filter-settling timer, and a multiplexer for the analog output. Wire types J, K, T, E, R, S, and B are standard. The control logic is configured for bus operation with  $\mu$ Ps and is DTL/TTL/CMOS compatible without buffering.

CIRCLE NO. 368

### Amplifier modules span broad vhf or hf ranges

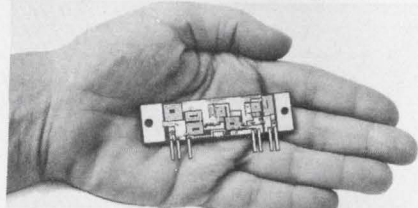

Amperex Electronic, Hicksville, NY 11802. M. Burden (516) 931-6200. \$44.50 (10-99 qty); stock to 90 days.

Internal matching networks allow the BGY32 and BGY36 amplifier modules to operate from 68 to 88 MHz and 148 to 174 MHz, respectively. Operating from a 12.5-V supply, each module boosts 150-mW drive power to an 18-W output. The input and output impedances are matched to 50  $\Omega$  with no instability into a VSWR of up to 3:1, for all phase angles. Both units suffer no damage with VSWRs of 50:1, through all phase angles, at heat-sink temperatures up to 70 C.

CIRCLE NO. 369

### BI-DIRECTIONAL CODE SWITCH

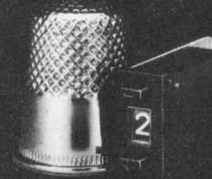

PICO SERIES

The industry's smallest BI-DIRECTIONAL CODE switch. Less than 0.6" in height, with large easy to read numerals and mating accessories. Ideal for hand-held instruments subject to field abuse. Heavy gold plating on wiping contacts affords a low contact resistance.

Call (617) 685-4371 today for your "dummy" switch, prices, specifications and catalog.

CIRCLE NUMBER 80

### ECONOMY SLIDE SWITCH

SLS-121M-RA

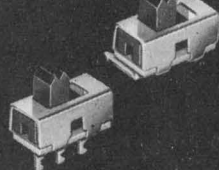

SLS-121M

Compact slide switches for wired or PC applications. A variety of types available in 1 and 2 poles and up to 4 positions. Contacts and terminals are silver plated for improved conductivity and easy soldering. Available with or without mounting tabs.

Write or call (617) 685-4371 for more detailed information on these and other ALCO switches.

Write or call (617) 685-4371 for more detailed information on these and other ALCO switches.

**ALCO** ELECTRONIC PRODUCTS, INC.  
1551 OSGOOD STREET, NORTH ANDOVER, MA 01845 U.S.A.  
Tel: (617) 685-4371 TWX: 710-342-0552

A SUBSIDIARY OF AUGAT INC.

CIRCLE NUMBER 81

### How Ugly™ Can You Get?

Plenty. Elxon will show you standard dc supplies that will tickle your pocketbook. And fulfill your requirements, 90% of the time.

Underneath their harsh exterior is a body that's met every test. Overload. Hi-temp. The worst-case line conditions that an Ugly™ is likely to ever get.

With the Ugliers you've got your pick. 16 voltages. Multi currents. Varied inputs. Shapes and sizes for every requirement.

You've got custom capabilities, too. Our "Ugly" Computer designs while it cost estimates, within 30 minutes, from start to "quote."

For modular dc supplies look to the Ugliers, where the beauty's not just skin deep.

©Elpac Electronics, Inc.

**HE Elxon Power Systems** 3131 S. Standard Avenue,  
Santa Ana, California 92705 (714) 979-4440 TWX 910-595-1513

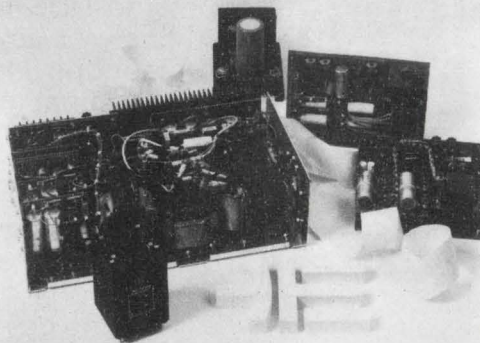

Get Ugly™ At Our National and Regional Distributors.

Get Ugly™ Nationally at: Cramer, Newark. Get Ugly™ Regionally at: MIL-COMM, Los Angeles, Ca., GPL Electronics, UTRONICS, KA Electronic Sales, TRANSDUCTION, LTD., SHAP Electronics, TECHNICO, CLASSIC Components, HAMMOND Electronics, ACK Radio Supply Company, GARDEN STATE Industrial Electronics.

CIRCLE NUMBER 82

ELECTRONIC DESIGN 15, July 19, 1977

## F/v converter slashes voltage ripple

*D-B-Developments, 7709 Kilbourne Rd., Rome, NY 13440. D. Manzolini (315) 339-1265. From \$31.50 (100 qty); stock.*

The 22-Series f/v converters offer essentially zero voltage ripple without sacrificing speed of response. The error due to the residual ripple is less than one part in 16 bits. Basically an analog converter, the devices have no quantization errors to limit small changes in frequency (and the quantity that it represents). Also the device is monotonic. These converters are especially fast, for example, the Model 22AL-10k can be used as a 1070-Hz-to-1270-Hz FSK detector (with a comparator) to 600 baud.

CIRCLE NO. 370

## Modules correct flat-faced CRT distortion

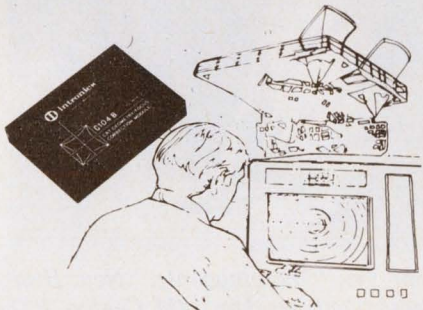

*Intronics, 57 Chapel St., Newton, MA 02158. R. Beede (617) 332-7350. See text; 4 wks.*

C104/C104B modules correct for geometric (pin-cushion) and focus distortion in flat-and-semiflat-faced magnetically deflected CRTs. The units produce corrected output functions for horizontal and vertical deflections plus dynamic focus. They connect between the horizontal and vertical inputs of a CRT's deflection amplifiers. Models are available for deflection angles up to 90°. External adjustments provide for horizontal and vertical size and correction magnitude, and horizontal and vertical keystone and curvature symmetry. Both modules feature bandwidths of 10 MHz, slew rates of 400 V/ $\mu$ s, settling times (to 0.1%) of 400 ns and typical accuracies of 0.2% of full scale. The C104 is a voltage-output device with an output impedance of 50  $\Omega$  and sells for \$395 (1-9 qty) while the C104B is a current-output unit and sells for \$275. The voltage-output modules are 3.5 x 2.5 x 1 in. The B-version is 3.5 x 2.5 x 0.62 in.

CIRCLE NO. 371

## Modules fire SCRs over full phase range

*Hazelton Scientific, Box 163, Hazel Park, MI 48030. D. Nelson (313) 255-0630. \$43.00; stock.*

The Royal family of SCR-gate drives controls the phase of SCRs in all single and three-phase circuits. The modules feature smooth full-range phase control, a hard-firing gate pulse, and half-cycle response. The drives provide re-

liable operation under adverse power-line conditions and close phase-angle balance between phases and between half cycles in each phase. All units have a built-in dc supply for control, or an external dc supply can be used. Models are available for firing SCRs in 1, 2, 3, 6, and 12-phase circuits and for line-voltage ranges from 10 to 3000 V ac and line-frequency ranges from 20 to 5000 Hz. Models for firing triacs, ignitrons, and thyratrons also are available.

CIRCLE NO. 372

## CABINETS WITH FLAIR



**Elegant Designs** for marketing power...  
**Rugged Construction** for practical packaging...  
**Many Models and Sizes** for space requirements...  
**Accessories** for completion of enclosure needs...  
(panels, fans, blowers, slides, outlet strips, shelves, drawers, chassis, hardware, etc.)

You can rely on Premier for quality, good delivery, and surprisingly low prices.

write for complete catalog and prices



**PREMIER METAL PRODUCTS CO.**

381 CANAL PLACE, BRONX, N.Y. 10451 (212) 993-9200

# ALONE AGAIN

in low cost 1-watt  
Zener Diodes

# SCHAUER

"Z" SERIES  
ZENERS

DO-41 epoxy  
molded case

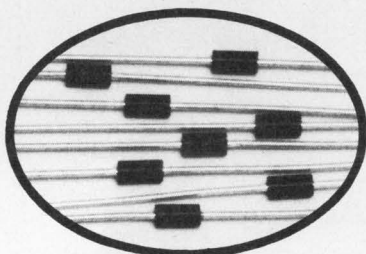

**ANY VOLTAGE**  
2.6 to 34.0

**ANY TOLERANCE**

1% 2% 5% 10%

**At Any Test Current**

**Compare These Prices  
On 1% Tolerance Diodes**

Quantity	Price each
1-99	91¢
100-499	83¢
500-999	77¢
1000 up	73¢

**LARGE STOCK  
GOOD DELIVERIES**

Send for complete rating data  
and other tolerance prices.

Semiconductor Division

**SCHAUER**  
MANUFACTURING CORP.

4511 Alpine Ave., Cincinnati, OH 45242  
Telephone 513-791-3030 Telex 21-4576

CIRCLE NUMBER 84

## PACKAGING & MATERIALS

### Line of test sockets handles 300-C temp

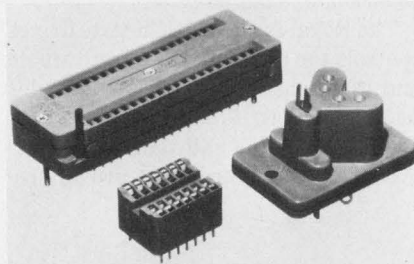

*Textool Products, Inc., 1410 W. Pioneer Dr., Irving, TX 75061. (214) 259-2676. Stock.*

A line of 300-C test sockets in a wide range of models is immediately available. The line includes zero-insertion pressure sockets and sockets for TO-5 packages, flatpacks and DIPs, power devices, axial-lead packages and miscellaneous hybrid devices. The sockets are available with nickel-boron plated BeNi contacts for extended use at the elevated temperatures.

CIRCLE NO. 373

### Modular connector parts easy to assemble

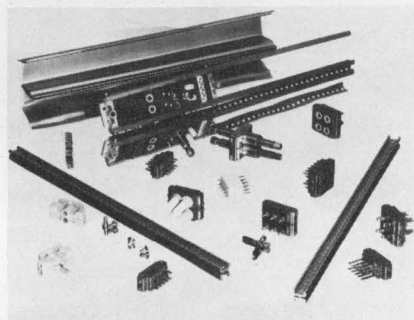

*Souriau/IEE, 7740 Lemona Ave., Van Nuys, CA 91405. (213) 787-0311. From \$0.18 per mated line (500 qty); 4 to 6 wks.*

The 8140 modular connector system enables quick assembly of connectors with a very wide range of different pin layouts from modular components. Contacts for soldering, crimping, taper-pin inserting, coaxial attaching and wire-wrapping are available. The only limitation on the size of the connector is the resulting insertion or extraction force of the connector. Where there are a large number of pins, a screw type extractor can be built into the center of the connector. Contact sizes 22 through 12, as well as coaxial and high-voltage contacts are available. All plastic components are of UL 94V-O approved materials.

CIRCLE NO. 374

### Label dispenser speeds cable marking

*T&B/Thomas & Betts, 36 Butler St., Elizabeth, NJ 07207. (201) 354-4321.*

Conveniently handle and store a variety of markers in a neat, accessible arrangement of alphanumeric markers in roll form. The WT-610M roll dispenser holds up to 15 marker rolls. Random lengths can be selected without restrictions and waste is reduced because the operator removes only the length needed. Handling loose cards is eliminated.

CIRCLE NO. 375

### Tag your product to avoid counterfeiting



*3M Co., "Microtaggants," New Business Ventures Div., 3M Center, P.O. Box 33600, St. Paul, MN 55133. (612) 733-1186.*

Products now can be "fingerprinted" for positive identification, even when labels, logos, serial numbers and other conventional identifiers can't be used or are easily removable or alterable. Identification can be made with 3M brand Microtaggant particles—tiny, multilayered particles that can be incorporated in trace quantities into explosives, paints, plastics, or almost any other solid or semisolid material. In solid-state devices, the particles can be used for protection against counterfeiting. The particles can provide more than 500,000 layer combinations, each representing a specific color code. Particles can be attracted to a magnet for easy isolation, and their top layers can be made fluorescent for identification in the dark with portable ultraviolet light (black light) equipment. In addition, fast, on-site readout is possible without the use of special analytical equipment. Color codes can be "read" under a low-power (40X to 100X) microscope.

CIRCLE NO. 376



The new L-1003 tri-color cartridge light offers red-green-amber light through a clear lens. Three permanently wired incandescent lamps provide 5 volt operation and each lamp has a 40,000 hour life. The L-1003 is available with either gold finished wire-wrap pins, or color coded wire leads.

**TEC, Incorporated, 2727 N. Fairview Avenue  
Tucson, Arizona, USA 85705.**

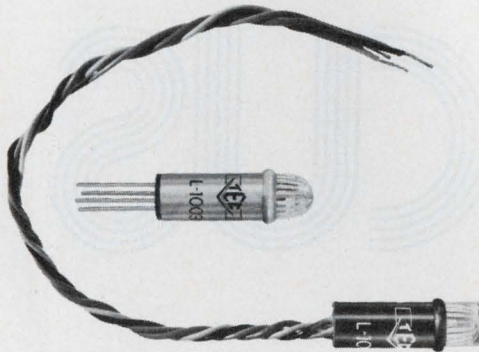

**CIRCLE NUMBER 85**

## goes anywhere

### Battery servo recorder: Get yours in 72 hours

Here's the most versatile, portable, self-contained servo recorder you can buy for field use in studies, monitoring, maintenance—any application including those remote from power lines. This compact battery Miniservo® sets up quick: switch-select spans of 1, 5, 10, 50, 100 and 500 mVDC and 1, 5, 10, 50, and 100 VDC. Zero settable to anyplace on the 100 mm Z-fold chart. 8 chart speeds from 6 cm/hr to 20 cm/min. Throwaway ink/pen cartridge for smooth, dependable writing. Simple adapter for AC operation and battery charging. Order Stock No. S22243-1A. Or request Bulletin F613 from Esterline Angus Instrument Corporation, P.O. Box 24000, Indianapolis, IN 46224. Tel: 317-244-7611.

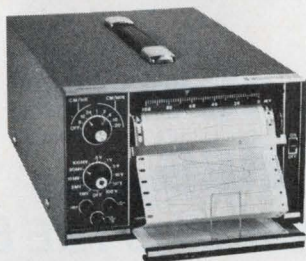

**Miniservo® Self-contained Recorder**

**CIRCLE NUMBER 86**

ELECTRONIC DESIGN 15, July 19, 1977

**Get embedded**

DIGITAL EQUIPMENT CORP. DATA GENERAL CORP.

# PDP-11 & NOVA

**USERS . . . GET THE BEST  
TAPE AND DISC CONTROLLERS**

- Available for virtually all tape and disc drives.
- (Tape) Mix PE and NRZ formats, 7 or 9 track, 8 drives.
- (Disc) Front load, top load or 10-high, up to 100 megabyte.
- DEC and DG software compatible.

**SEND FOR COMPLETE INFORMATION**

**western peripherals™**

(714) 991-8700 • TWX: 910-591-1687 • Cable: WESPER  
1100 Claudina Place, Anaheim, CA 92805

**CIRCLE NUMBER 87**

## FLAT CABLE CONNECTORS

Auto-Swage low cost, precision fit square connector pins provide smooth mating in female connectors without scoring, scaling or shiving. Connector lead-in angles in both flat and diagonal planes can be uniformly blended together. Round pins and connectors with wrap tips or mating tips are available. High speed production with in-house gold plating is our specialty. Write for free samples, or, send drawings and prototypes for a fast accurate quotation.

**auto-swage**  
PRODUCTS, INC.

726 River Road, Shelton, CT 06484 Tel. (203) 929-1401

**CIRCLE NUMBER 88**

# COMING IN



## POWER SUPPLIES

The 8th in *Electronic Design's* 1977 series of award-winning FOCUS reports is scheduled for the September 27 issue. The Topic: Multiple-output DC Power Supplies.

There is growing interest in power supplies that deliver more than one voltage. These units have all the problems of ordinary power supplies, plus special ones of their own. The report will help engineer-readers avoid pitfalls in specification, application and use. It will look at questions like:

- *Why should you select one supplier over another?*
- *What special features do companies offer in their products?*
- *How do they obtain these features?*
- *What specs are deceptive, ambiguous or omitted?*
- *Where is confusion most apt to occur?*
- *How do you select a power supply most appropriate to your needs?*

As usual, the FOCUS will dig beneath the surface to tell it like it is.

Don't miss this report, it's one you will want to read and keep.

## FOCUS ON MULTIPLE-OUTPUT DC POWER SUPPLIES

**ANOTHER REASON ELECTRONIC DESIGN IS THE BEST  
READ ELECTRONICS PUBLICATION IN THE WORLD.**

## PACKAGING & MATERIALS

### Low-profile sink saves PC real estate

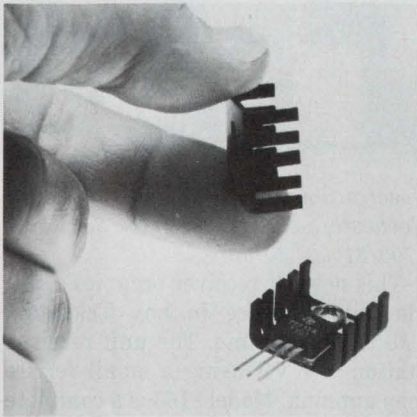

Thermalloy, Inc., Dept. M., 2021 W. Valley View Lane, Dallas, TX 75234. (214) 350-6734. \$0.045 (5000 qty); stock.

Low-profile, low-cost heat sinks for plastic power devices, the 6073, are designed to cool SCRs and transistors in TO-220, Motorola Case 90 and Case 77 packages. For Case 90 applications, the heat sink can be mounted either above or below the device. Typical thermal resistance is 21 C/W in natural convection. The heat sink is only 0.375-in. tall, for use on PC boards mounted on 0.5-in. centers.

CIRCLE NO. 377

### Package seals itself, resists moisture



The Crowell Corp., Newport, DE 19804. (302) 998-0557.

Cro-Nel, a cohesive-coated lamination of Kraft paper and Du Pont Microfoam, seals to itself to form a padded, lightweight, dust-free, moisture-resistant package. Available in standard diameter rolls for automatic equipment and in sheets for manual packaging, Cro-Nel can be ordered in four weights of paper/liner board and in several thicknesses of Microfoam, a closed-cell cushioning material. Cro-Nel also is available reinforced with glass fiber for additional strength.

CIRCLE NO. 378

### Connectors designed for mass terminating

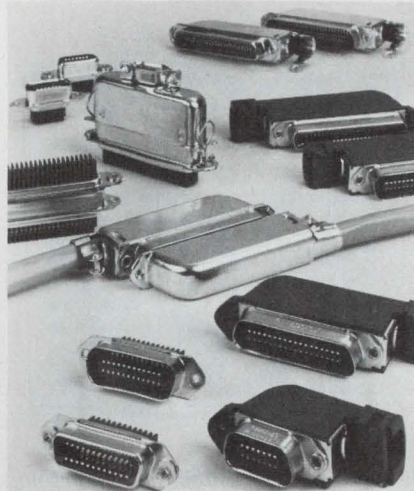

Amphenol North America Div., Bunker Ramo Corp., 900 Commerce Dr., Oak Brook, IL 60521. Fred Fitzpatrick (312) 986-3788. From \$4.30 per mated pair (1000 qty); stock, 2 to 3 wks.

An insulation-piercing solderless mass-termination system, designated the Amphenol 157 Series Micro-Pierce, is an addition to the Amphenol 57 Series solder line. Cables can be terminated in the field to exact lengths without waste, without danger of solder splash or bridging, and at a fast speed. Terminating a 25-pair cable with a specially designed field tool takes less than 4 min under normal conditions. And terminated wires can be easily removed and replaced. Connectors are offered in 14, 24, 36, 50 and 64-contact configurations and in a choice of three mounting styles—rack and panel, cable to panel and cable to cable. All 24 and 26-gauge solid-conductor wires, with PVC, irradiated PVC or cotton-lacquer insulation, can be terminated.

CIRCLE NO. 379

### Epoxy-glass boards have four power buses

Midgard Electronics, 26 Walnut St., Watertown, MA 02172. (617) 924-9053. \$17.15 (1-6).

The UMB, an epoxy-glass circuit board, has 1380 plated-through holes in a two-sided foil pattern. Four power-distribution buses and continuous 0.1-in. pad spacing allow almost any combination of part arrangement. The power-distribution buses provide short interconnect distances to IC positions. A reverse-foil pattern minimizes characteristic impedance.

CIRCLE NO. 380

**You made us  
Number One  
in standard  
enclosures.**

**Now,  
we'd like to  
make you  
something  
"special!"**

Bud enclosures repeatedly score number one in brand preference studies. Why? Because you know what we're doing! That's why you've made us Number One. But what about special enclosures? No one comes close. Here's why.

**You have options.** We can build your special enclosure by modifying one of our 2700 standard enclosures. And by using existing dies and tooling, you save money!

However, if your enclosure design calls for more than modifying a standard, we'll help you design it, then build it.

Hundreds of firms have asked us to build special enclosures during the past 50 years. And why not! They know we're the Number One designer and manufacturer of enclosures. Standards. And specials.

**You've got our number!** Dial it now, toll free, if you want to talk about special enclosures. (800) 321-1764; in Ohio, (800) 362-2265.

**An extra  
"special" offer!  
Win a trip to the  
next Super Bowl!**

Circle Bud's number on the reader service card and we'll mail you a brochure on our special fabrication service and an entry form for our Super Bowl Sweepstakes!

**BUD**

BUD INDUSTRIES, INC.  
4605 East 355th Street  
Willoughby, Ohio 44094

BUD WEST, INC.  
3838 North 36th Avenue  
Phoenix, Arizona 85019

CIRCLE NUMBER 89

## Data logger works unattended



Datel, 1020 Turnpike St., Canton, MA 02021. (617) 828-8000. Starts at \$2995; 4-6 wks.

A "naked" version of the company's DL-2 data logger provides the same performance specifications except for the environmental housing, the connectors and battery power source. And the "naked" DL-2 costs \$1000 less. The data logger 2 makes a complete scan of all selected analog input channels at preset intervals of 1 s to 30 h. With each scan, the day of the year, hours, minutes, and seconds are automatically encoded on the tape cassette. A full scan of all 64 inputs takes about 11 s.

CIRCLE NO. 381

## Probe converts meter to thermometer

Fluke, P.O. Box 43210, Mountlake Terrace, WA 98043. (800) 426-0361. See text.

Model 80T-150 universal temperature probe converts any high-impedance ( $\geq 1\text{-M}\Omega$  input) dc voltmeter to a thermometer. The unit measures in either Fahrenheit or Celsius, with a temperature range of  $-50$  to  $+150$  C ( $-58$  to  $+302$  F). Voltage standoff capability is 350 V dc or peak ac between sensor and output low. Sensitivity is 1 mV/ $^{\circ}$ C or  $^{\circ}$ F, accuracy is  $\pm 2$  C ( $-25$  to  $+125$  C), including 0.25% meter error. Settling time is 8 s to within  $1^{\circ}$  after 100-degree step.

CIRCLE NO. 382

## Waveform recorder offers $\Delta t$ , $\Delta V$ analysis

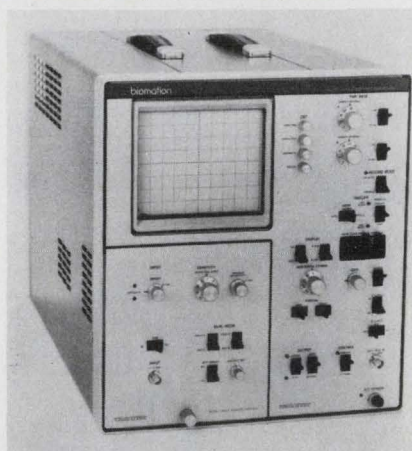

Biomation, 10411 Bubb Rd., Cupertino, CA 95014. (408) 255-9500. \$8400; 60 days.

Model 820 waveform recorder includes its own CRT display with graphic analysis capability. Included are two settable cursors with delta-voltage and delta-time readout on two stored signals. The 820's 8-bit a/d digitizes at 20 MHz max, providing an amplitude resolution of 0.4% and time resolution of 50 ns. The converted input signals are stored in a 2048-word semiconductor memory. A dual memory mode records and stores one signal in half the memory, a subsequent signal in the second half for comparison on the CRT.

CIRCLE NO. 383

## 50-MHz data generator memorizes 2048 bits

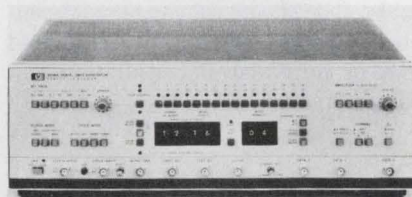

Hewlett-Packard, 1501 Page Mill Rd., Palo Alto, CA 94304. (415) 493-1501. \$3475.

Model 8018A 50-MHz data generator is directly compatible with CMOS, TTL, and ECL and features a 2048-bit memory configurable in almost any way. Further, the unit can produce addressed pseudorandom binary sequences more than a million bits long. Memory contents and data format are remotely programmable via optional HP Interface Bus, and a card reader is offered for convenient pattern loading.

CIRCLE NO. 384

## Receiver plugs into TM-500 mainframe

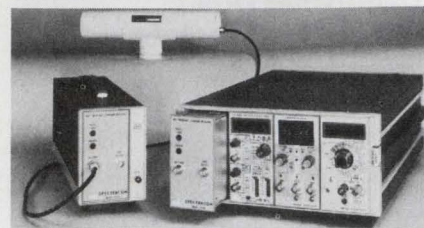

Spectracom Corp., 1667 Penfield Rd., Rochester, NY 14625. (716) 381-4827. \$700/\$1000; 30 days.

This new vlf receiver occupies a single plug-in space in any Tektronix TM-500 mainframe. The unit receives station WWVB using a small ferrite loop antenna. Model 8163 is a complete receiver/comparator, with meter ranges of 10 and 50  $\mu$ s relative phase difference, enabling calibration resolution of a few parts in  $10^{11}$ . Model 8162 contains the same receiver, but operates only as a phase locked signal source without the comparator. Either unit can serve as the clock oscillator for an adjacent Tektronix frequency counter. Operation in this mode provides a continuously traceable frequency counter phase locked to WWVB.

CIRCLE NO. 385

## Miniature unit displays 4 traces on 1-trace scope



Digital Broadcast Systems, 4306 Governors Dr., Huntsville, AL 35805. (205) 837-2183. \$149.95 w/battery and ac adaptor.

The 45-B hand-held instrument lets you simultaneously display four channels of digital logic waveforms on a conventional, single-trace scope. Battery and ac operation make the 45-B at home on the bench or in the field. The 45-B can be used with TTL, DTL, RTL, and CMOS, without having to set threshold. Only two knobs control the waveform amplitude and the multiplexed display rate. Once these are set, the scope time-base control operates normally.

CIRCLE NO. 386

# Grand Closing.

**Heyco Nylon Hole Plugs for low cost entrance closures.**

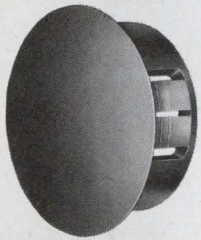

Easy fingertip assembly—for holes 3/16 to 2 inches in diameter. By far the quickest way to close holes.

### FREE SAMPLE PACK

Send for a free sample pack of Heyco Hole Plugs and a catalog of the complete Heyco line today.

### HEYMAN MANUFACTURING COMPANY

KENILWORTH, NEW JERSEY 07033      WAUKESHA, WISCONSIN 53186  
(201) 245-2345 • TWX: 710-996-5986      (414) 542-7155 • TWX: 910-265-3668

Call Toll-Free (800) 558-0917 except from Wisconsin.  
If calling from Wisconsin use (800) 242-0985



CIRCLE NUMBER 90

# Instant Modulation



## Just Plug-in and Read...

The low cost AM/FM Modulation Meter **mi 2304** Tunes... Levels... Automatically... and Presents the Read-out Within 2 Seconds! Ideal for Mobile Radio Production and Maintenance. Covers All Bands Thru 960 MHz.

**mi MARCONI INSTRUMENTS**

100 STONEHURST COURT, NORTHVALE, NEW JERSEY 07647  
TELEPHONE: 201/767-7250 • TWX: 710-991-9752

CIRCLE NUMBER 92

## The \$60 OEM freebie.



We build the finest control meters in the business. And we'll prove it. Contact us and we'll arrange to send you an Airpax meter scaled to your specifications. No charge.

Try the meter. If you decide to buy it, you'll find we're priced about 25% under competition. Or, return the meter and no harm done.

Offer good for OEM's with at least a 100-units-per-year potential. After all, we don't give freebies to just anybody.

**AIRPAX™**

EXS  
1977

CIRCLE NUMBER 91

ELECTRONIC DESIGN 15, July 19, 1977

## WHO NEEDS \$1.2 BILLION IN ELECTRONIC COMPONENTS?

Britain does. And the U.S. Department of Commerce wants to help you sell your products to this rapidly escalating market.

Come and exhibit at ELECTRONIC COMPONENTS 77 at the London Trade Center, November 7-11, 1977. Our 1975 London show featured the products of 63 U.S. manufacturers—and resulted in \$1 million in floor sales alone.

Plan now to zero in on this lucrative market. We'll help you in a host of ways. For starters, our valuable executive summary of the British market is yours for the asking.

Find out more. Send the coupon today. Or call Robert Connan, (202) 377-3465

U.S. Department of Commerce  
Rm. 4217, Attn: Robert Connan  
Washington, D.C. 20230

Please send my executive summary, and more information on ELECTRONIC COMPONENTS 77.

Name \_\_\_\_\_ Title \_\_\_\_\_

Firm \_\_\_\_\_

Address \_\_\_\_\_

City/State \_\_\_\_\_ Zip \_\_\_\_\_

CIRCLE NUMBER 93

# strip chart recorders

- OEM MODULES
- LOW PROFILE
- PACKAGED UNITS
- PORTABLE DC

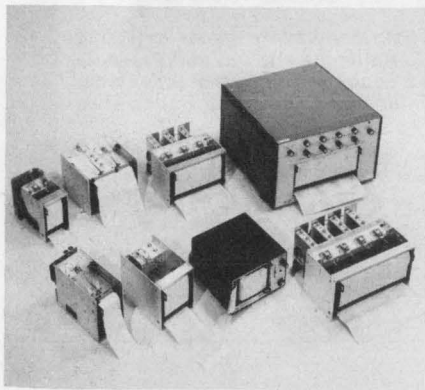

General Scannings thermal writing Strip Chart Recorders are available in a wide range of configurations and performance characteristics to meet virtually every recorder need. You can select open-loop, velocity feedback or closed-loop operation; continuous roll or fan-feed paper; one to eight channels in channel widths of 20, 40, 50, 80 or 100mm; a variety of chart speeds; and either AC or DC operation.

Recorders can be furnished as modules for use by OEM's or fully packaged.



For complete details, circle readers' service number or write today for our full line Strip Chart Recorder Catalog.



**GENERAL SCANNING INC.**  
150 Coolidge Avenue  
Watertown, MA. 02172  
TEL: (617) 924-1010

CIRCLE NUMBER 94

## INSTRUMENTATION

### Scope measures $\Delta T$ with 0.002% accuracy

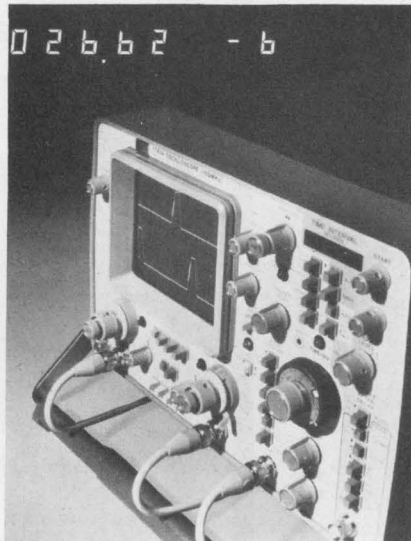

Hewlett-Packard, 1501 Page Mill Rd., Palo Alto, CA 94304. (415) 493-1501. 1743A, \$3300; 1715A, \$3000.

Two new oscilloscopes emphasize time-interval ( $\Delta T$ ) measurements with high accuracy and resolution. The 100-MHz 1743A incorporates a 5-digit time-interval-averaging counter (with 100-MHz crystal reference) which resolves intervals to 100 ps. Accuracy is 0.002%  $\pm 1$  count. The second unit—the 200-MHz 1715A—measures time intervals with a system of two intensified markers (Delta-Time method). The time difference between two selected points on a waveform (or waveforms) can be read directly on an optional built-in  $3\frac{1}{2}$ -digit DMM.

CIRCLE NO. 387

### Unit adds 16 bits to logic-analyzer repertory

Paratronics, Inc., 150 Tait Ave., Los Gatos, CA 95030. (408) 354-7766. \$295, assembled; \$229, kit; stock-2 wks.

Model 10 Trigger/Expander is a 16-bit add-on unit that mates with the company's 8-bit Model 100A to form an integrated, 24-bit logic analyzer. Besides expanding the triggering capability from 8 to 24 bits, the Model 10 permits an  $8 \times 16$  truth-table display of a microprocessor's data byte and the upper and lower address bytes—without moving the data input probes. Both the 100A and the 10 operate directly with all popular logic families, and both are available in kit or assembled form.

CIRCLE NO. 388

### 100-MHz counter sells for \$140

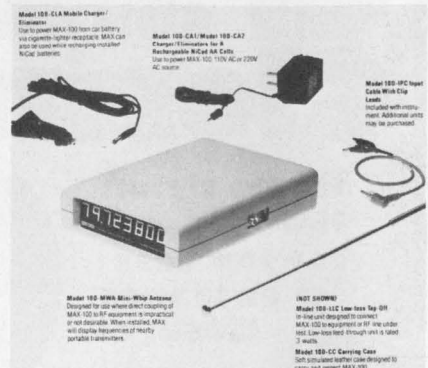

Continental Specialties, 44 Kendall St., P.O. Box 1942, New Haven, CT 06509. (202) 624-3013. \$139.95 (suggested retail); stock.

MAX-100 solid-state frequency counter reads from 20 Hz to a guaranteed 100 MHz. A clip-lead or other input cable, or a mini-whip antenna, is simply plugged in, and the unit turned on. MAX-100 automatically gives direct readings on its 8-digit, 0.6-in. LED display. Readout is updated once a second, and overflow signals (above 100 MHz) are automatically indicated by flashing the most significant (left-hand) display digit. Sensitivity is 30 mV to 50 MHz.

CIRCLE NO. 389

### Microwave analyzer stresses convenience

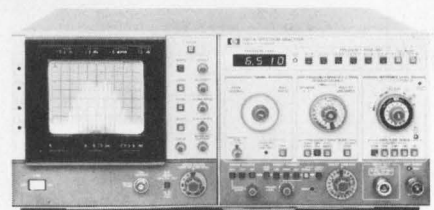

Hewlett-Packard, 1501 Page Mill Rd., Palo Alto, CA 94304. (415) 493-1501. \$17,850.

The 8565A microwave spectrum analyzer covers 10 MHz to 22 GHz (extendable to 40 GHz) and provides fully calibrated performance, with internal preselection, to enable unambiguous measurements over a wide dynamic range (30 to  $-72$  dBm at 22 GHz,  $-110$  dBm to 1.8 GHz). Features include LED readouts around the CRT to indicate control settings and operating conditions, plus coupling of controls to reduce most measurements to a simple three-knob sequence.

CIRCLE NO. 390

# Introducing the intelligent LED display.

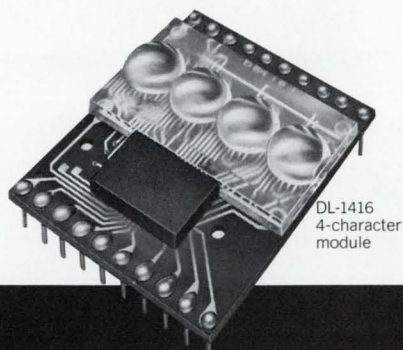

DL-1416  
4-character  
module

I I N T E R F A C E J U S T L I K E A R A M

Photograph of display actual size

## Alphanumeric at the lowest cost ever.

This newest Litronix Alphanumeric display has built-in ASCII decoder, multiplexer, memory and LED drivers. That means it needs only the inputs you'd feed a RAM. Operates directly off a microprocessor bus. Creates all 64 ASCII characters 0.16" high — shown in actual size above.

No alphanumeric display has ever been so simple to use. Actuated entirely by TTL logic levels. Needs only a +5v supply.

And it's by far the most economical way to create alphanumeric displays as long as 80 characters. Because you don't need to supply all that built-in circuitry externally.

The DL-1416 4-character modules can be butted end-to-end to make displays of any length with equal spacing between all characters.

### I'm in favor of intelligence. Tell me more.

For DL-1416 data phone (408) 257-7910 or send coupon.

NAME  TITLE

ORGANIZATION

ADDRESS

ZIP  PHONE

Mail to Litronix, Dept. D, 19000 Homestead Road,  
Cupertino, CA 95014. Phone (408) 257-7910.

# litronix

# TRW's MAR™ ultra stable resistors. Performance plus.

Our ultra-precision MAR resistors match the performance of precision wirewound, *plus* they give the inherent advantages of TRW metal film.

Like smaller size, better frequency response, higher resistance values and lower cost.

And MAR's are not "selected" from a lower grade process. The entire facility was *designed* to yield *only* high accuracy devices.

And it *DOES*:



## MAR axial lead family

Tolerances to  $\pm 0.01\%$ . TC's  $\pm 5$  to 25 ppm/ $^{\circ}\text{C}$ . Where speed and precision count, the MAR does it all. In a dimensionally clean, axial lead molded package.

With the non-measurable noise, low voltage coefficient, load stability, resistance/size ratio and *reliability* of our metal film process.

*Plus* MAR matched sets and packaged networks have tolerance and TC matching to  $\pm 0.005\%$  and 1 ppm/ $^{\circ}\text{C}$ .

## Specifications

IRC Type	Resistance Range* (Ohms)	Temperature Coefficients -20 $^{\circ}\text{C}$ to +85 $^{\circ}\text{C}$ ( $\pm$ ppm/ $^{\circ}\text{C}$ )	Tolerances ( $\pm\%$ )	Power Rating** @ 85 $^{\circ}\text{C}$ (Watts)	Voltage Ratings (Volts)
MAR3	20 - 100K	T10 = 15	1.00, 0.50, 0.25,	$\frac{1}{2}$	200
MAR5	20 - 250K	T13 = 10	0.10, 0.05, 0.02,	$\frac{1}{4}$	250
MAR6	20 - 500K	T16 = 5	0.01	$\frac{1}{8}$	300
MAR7	20 - 1 Meg			$\frac{1}{4}$	500

\*Wider ranges available, contact factory.

\*\*Higher power ratings available. Contact factory.

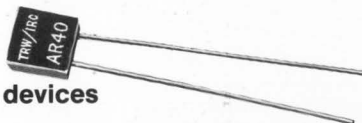

## AR40 radial lead devices

This plug in configuration offers absolute accuracy and documented reliability. TC's to  $\pm 2$ ppm/ $^{\circ}\text{C}$ , tolerances to  $\pm 0.01\%$  are standard.

*Plus*, AR40 uses only .03 in.<sup>2</sup> PCB area including lead attachment, and has the same mechanically rugged terminations used on all MAR resistors.

## Specifications

TCR Class.	Standard Temp. Coeff. ( $^{\circ}\text{C}$ )	Resistance Range* (Ohms)	Standard Tolerance ( $\pm\%$ )	Wattage 85 $^{\circ}\text{C}$
T-18	2 ppm 0 to 60 $^{\circ}\text{C}$ 5 ppm -55 to 125 $^{\circ}\text{C}$	20 to 100K	.01, .02, .05, .10,	.3 watts
T-16	5ppm 0 to 60 $^{\circ}\text{C}$ 10 ppm -55 to 125 $^{\circ}\text{C}$		.25, .50, 1.00	

\*Wider ranges available, contact factory.

## AR90 high range resistors

Designed for applications where you need values up to 10 Meg Ohms—such as precision voltage dividers, input attenuators.

*Plus*, despite its high resistance range, the AR90 has standard TC's to  $\pm 5$ ppm/ $^{\circ}\text{C}$  and tolerances to  $\pm 0.05\%$ . And it is a *real* space saver.

## Specifications

IRC Type	Resistance Range* (ohms)	Temperature Coefficients -20 $^{\circ}\text{C}$ to +85 $^{\circ}\text{C}$ ( $\pm$ PPM/ $^{\circ}\text{C}$ )	Tolerances	Power Rating	Voltage Rating
AR90	1M - 10M	T10 = 5 T13 = 10 T16 = 15	1.0, 0.5, 0.25, 0.1, 0.05	.5W	1000

\*Wider ranges available. Contact factory.

## Need prototypes fast?

TRW has on stream another *big plus*—a short order production line (in addition to our regular facility) designed to give you quick delivery on bread board quantities. Delivery to satisfy your needs, typically 2-3 weeks.

For more information on ultra-precision resistors, contact TRW/IRC Burlington. TRW/IRC Resistors, an Electronic Components Division of TRW, Inc., 2850 Mt. Pleasant St., Burlington, Iowa 52601. (319) 754-8491.

**TRW** IRC RESISTORS  
CIRCLE NUMBER 126



## POWER SOURCES

### On-board supplies put dc power in the rack

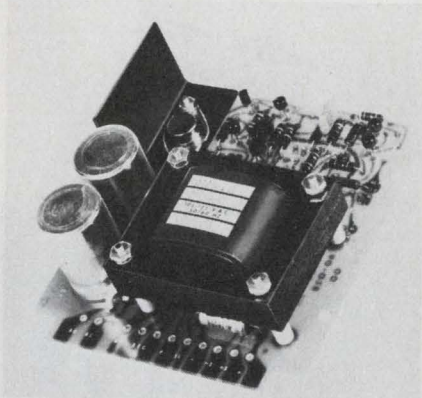

ACDC Electronics, 401 Jones Rd., Oceanside, CA 92054. B. Humphries (714) 757-1880. From \$29 (99 qty); stock.

The CD Series of regulated supplies is mounted on 4.5-in.<sup>2</sup> PC boards and provides outputs ranging from 5 V at 1.5 A to 30 V at 0.42 A. In addition to 11 single-voltage outputs, dual  $\pm 12$  V at 0.42 A and  $\pm 15$  V at 0.37 A outputs are available. No-load to full-load regulation is 0.1% +5 mV and line regulation is  $\pm 0.1\%$   $\pm 5$  mV for a 10% input change. These supplies mate with standard PC card-edge connectors; barrier-strip terminals are optional. All units are foldback protected against short circuits; crowbar over-voltage protection is optional.

CIRCLE NO. 391

### Switchers work with several power inputs

Abbott Transistor Laboratories, 5200 W. Jefferson Blvd., Los Angeles, CA 90016. \$310 (unit qty); stock to 10 wks.

The DA-50 series of three switching-regulated power modules work with inputs of 115 V ac  $\pm 10\%$ , single phase or three-phase Wye, or 230 V ac  $\pm 10\%$ , single phase or three-phase Delta. Outputs are either 5,  $\pm 12$  or  $\pm 15$  V dc and total power is 50 W with efficiency up to 80%. The units pass full power at ambients of 55 C but 50% derating is needed at 71 C. Line and load regulation is 0.5% and pk-pk ripple is 100 mV. Standard features include over-voltage protection, short-circuit protection, overtemperature shutdown and remote error sensing. The supplies come in a 5.5  $\times$  9.4  $\times$  2-in. case.

CIRCLE NO. 392

### Transformers filter your kVA input lines

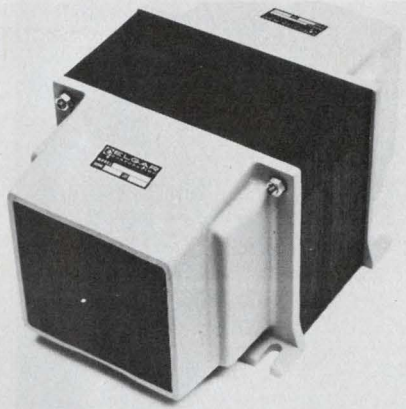

Elgar, 8225 Mercury Court, San Diego, CA 92111. J. Reed (714) 565-1155. From \$290; stock.

High-Isolation Transformers, available in ratings from 1 kVA, protect equipment from noisy power lines. The devices reduce by 125 dB both common-mode and transverse-mode transients caused by common-mode noise. The units are connectable for 120 and 240-V input or output and can act as a combination stepdown transformer and noise isolator. All models operate from either 50 or 60 Hz. These transformers have been used in the company's line-conditioning products.

CIRCLE NO. 393

### Tiny supply runs cool

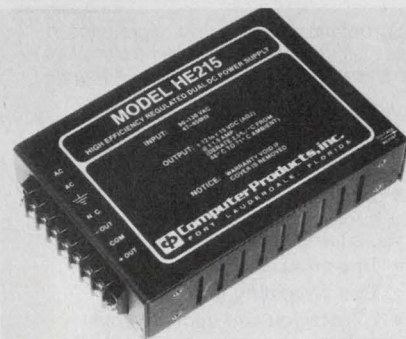

Computer Products, 1400 N.W. 70th St., Box 23849, Fort Lauderdale, FL 33307. Royal Orton (305) 974-5500. \$195; stock to 45 days.

At full load, the HE215 dual-output power supply gives 75% efficiency with less than 0.5 mV rms ripple and noise. The  $\pm 12$ -V to  $\pm 15$ -V unit measures 6.5  $\times$  4.5  $\times$  1.5 in., and weighs only 1.7 lb. Further specifications include  $\pm 0.1\%$  maximum load regulation and 0.01%/°C tempco (typical). Input requirement is 90 to 130 V ac at 47 to 450 Hz.

CIRCLE NO. 394

# RF power

We've made the most of it...  
You can, too!!

All wrapped up in a neat little package, our Model 510L is an ultra-wideband RF power amplifier whose wide range of frequency coverage and power output provide the user with the ultimate in flexibility and versatility in a laboratory instrument. Easily mated with any signal generator, this completely solid state unit amplifies AM, FM, SSB, TV, pulse and other complex modulations with a minimum of distortion.

Constant forward power is continuously available regardless of the output load impedance match making the 510L ideal for driving highly reactive loads.

Unconditional stability and instantaneous fail-safe provisions in the unit provide absolute protection from damage due to transients and overloads.

This outstanding unit covers the frequency range of 1.7 to 500 MHz with a linear power output of more than 9.5 watts and there is no tuning.

For further information or a demonstration, contact ENI, 3000 Winton Road South, Rochester, New York 14623. Call 716-473-6900 or TELEX 97-8283 E N I ROC

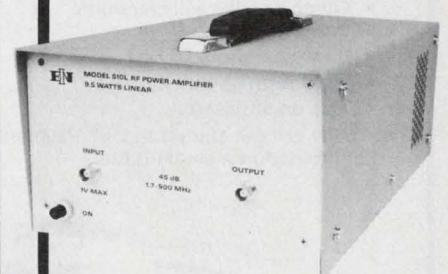

# ENI

SEE ELECTRONIC DESIGN'S GOLD BOOK FOR COMPLETE PURCHASING INFORMATION

The world's leader  
in solid state power amplifiers

CIRCLE NUMBER 95

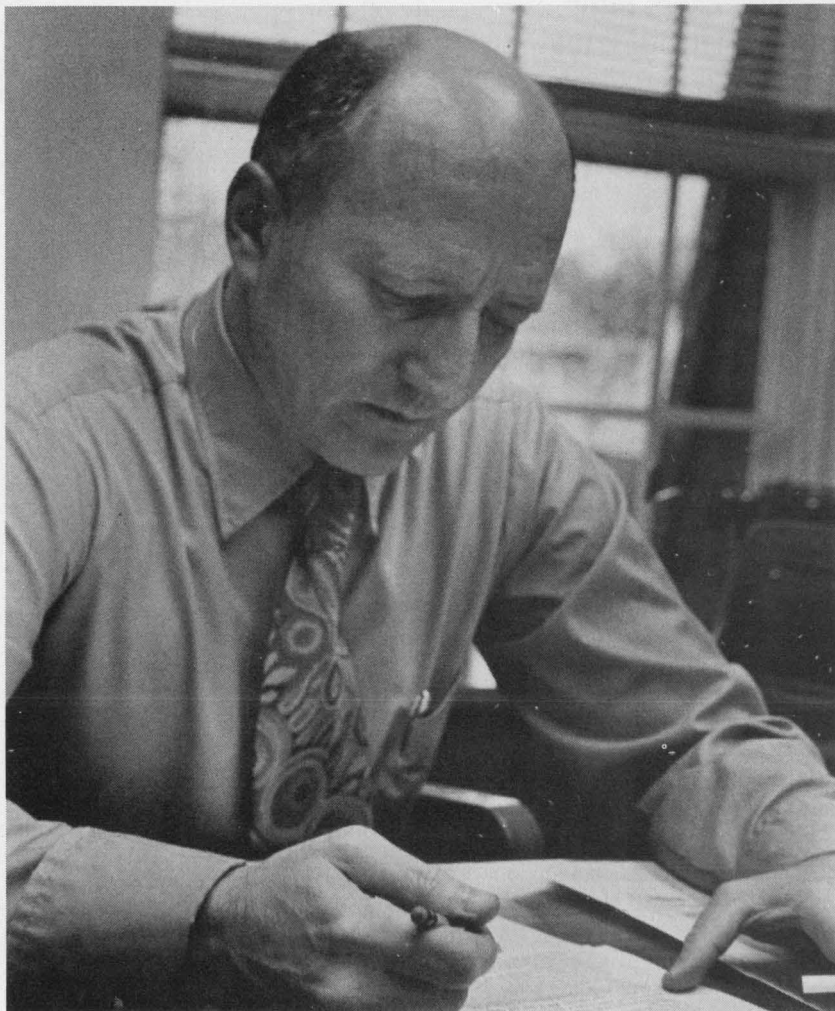

George Rostky, Editor-in-Chief, *Electronic Design*

## Electronic Design WANTS YOU

If you have solved a tricky or unusual design problem... if you have experience in a special area that will aid the design process... if you have simplified a circuit or developed a practical design aid *why not share it with your fellow engineer-readers of Electronic Design?*

Each man has his own motivation for writing an article. Here are just a few:

- To help other engineers do their jobs better.
- To help build your company's image.
- To raise your professional status and speed your advancement.
- To increase your own knowledge.

To encourage authors to submit material to us, and to make it easier, we've prepared a special AUTHOR'S GUIDE that's yours for the asking. Contents include:

- Why write?
- Why write for *Electronic Design*?
- Which articles will *Electronic Design* accept?
- How long should it be?
- What form should it take?
- Tips on structure.
- Tips on writing.
- Tips on getting it done.
- 7 Tests you can apply to your article.
- What happens to your article?
- Where to send it.

Why not get started today? Payment can range as high as \$200 for an article contributed in a single issue.

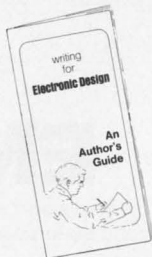

**FOR FREE**  
**Electronic Design**  
**AUTHOR'S GUIDE**  
**CIRCLE NUMBER 300**

## MICROWAVES & LASERS

### YIG-tuned oscillator spans 8 to 18 GHz

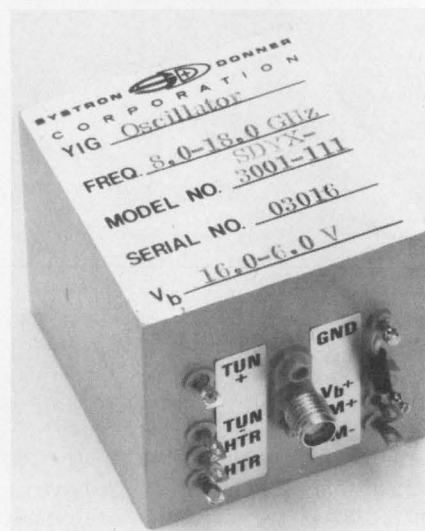

Systron-Donner, Advanced Component Div., 735 Palomar Ave., Sunnyvale, CA 94086. (408) 735-9660. \$1530; 6 wks.

The Model SDYX-3001-111 is a YIG-tuned Gunn-diode oscillator that covers the full Ku band with a minimum power output of 10 mW. (Higher power options are available.) Maximum power variation over the band is 16-dB peak-to-peak.

CIRCLE NO. 395

### Coaxial sliding load matches 2 to 26.5 GHz



Hewlett-Packard, 1501 Page Mill Rd., Palo Alto, CA 94304. (415) 493-1501. \$720; 4 wks.

The new APC-3.5 connector permits use of 3.5-mm coaxial lines above 18 GHz, and the Model 911C sliding load provides more accurate measurements from 2 to 26.5 GHz. The 911C features interchangeable fittings so that either male or female connectors may be checked. The movable terminating element has 5.5-cm travel, and its reflection coefficient is 0.035 max. To this, the male connector adds 0.02, and the female 0.02 + 0.001 F.

CIRCLE NO. 396

# Vendors report

Annual and interim reports can provide much more than financial position information. They often include the first public disclosure of new products, new techniques and new directions of our vendors and customers. Further, they often contain superb analyses of segments of industry that a company serves.

Selected companies with recent reports are listed here with their main electronic products or services. For a copy, circle the indicated number.

**Eastman Kodak.** Photographic films, papers, chemicals and equipment.  
CIRCLE NO. 397

**Dynascan.** Test equipment, remote radio controls and CB radios.  
CIRCLE NO. 398

**Philip A. Hunt Chemical Corp.** Chemicals for imaging processes.  
CIRCLE NO. 399

**Laser Link.** Industrial electronic components.  
CIRCLE NO. 403

**SCI Systems.** Government programs, automation systems and commercial products.  
CIRCLE NO. 404

**P.R. Mallory & Co.** Batteries and battery systems; timing devices and motors; electrical and electronic components, and metallurgical products.  
CIRCLE NO. 405

**G.D. Searle & Co.** Health care products and services.  
CIRCLE NO. 406

**Cray Research.** Computers.  
CIRCLE NO. 407

**Hoffman Electronics.** Airborne navigation systems; military and civilian communications systems, and multimedia education systems and equipment.  
CIRCLE NO. 408

**Hazeltine.** Electronic display systems; electronic identification and communications; computer-terminal equipment; sonobuoys; color analysis and previewer systems, and antennas.  
CIRCLE NO. 409

**The Foxboro Co.** Instruments and systems for process management and control.  
CIRCLE NO. 410

**Arthur D. Little.** Engineering consultants.  
CIRCLE NO. 411

**Nashua Corp.** Image-forming, adhe-

sive and magnetic-recording materials.  
CIRCLE NO. 412

**Teradyne.** IC test systems; PC-board, backplanes and subassemblies test systems; telephone-subscriber lines test systems, and connectors.  
CIRCLE NO. 413

**Technicon.** Automated instruments and systems for the analysis of blood and serum; automated medical information systems.  
CIRCLE NO. 414

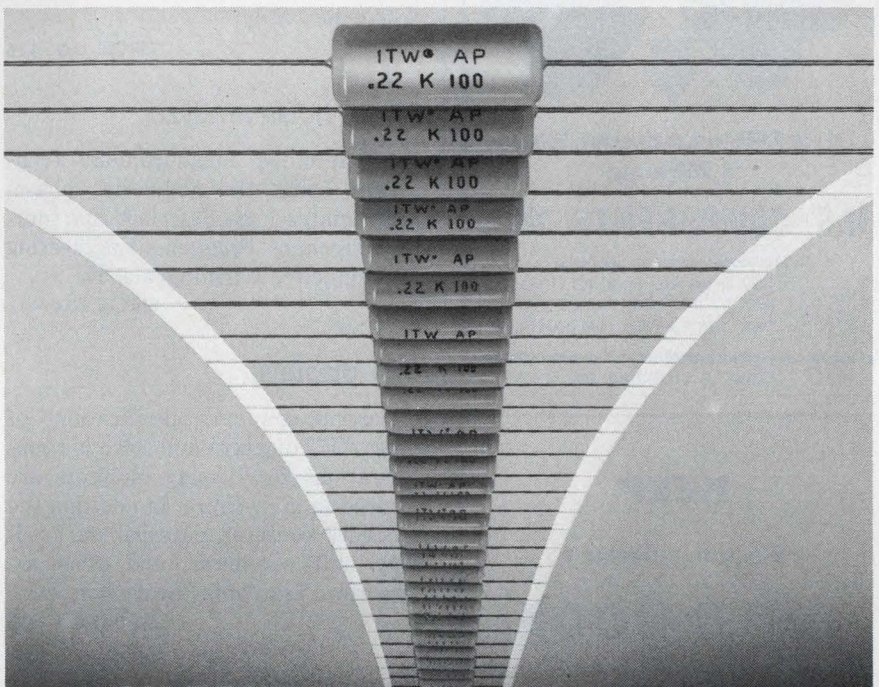

## AX-PAK™ Metalized Capacitors automatically lower your in-place costs

- Automatically insertable for lower in-place cost.
- Metalized polyester film construction . . . volumetrically efficient and self-clearing.
- Conformally-coated . . . flame retardant and puncture resistant.
- Round design for high stability.
- .047 to 10mfd. and 100 and 200 VDC.
- Off-the-shelf delivery on popular values.
- Economical.
- Available through your local distributors.

Request full details and catalog.



**PAKTRON**

A DIVISION OF ILLINOIS TOOL WORKS INC.  
900 Follin Lane, S.E., Vienna, Virginia 22180  
Phone: (703) 281-2810 TWX 710-833-0682

In Europe—ITW Electronics, Franz Pruller Str. 15, 8000 Munich 80 West Germany  
Telephone—089/483021/22 Telex 910 322 1130

The Innovative Electronic Components Group of ITW . . . PAKTRON and EMCON  
© Illinois Tool Works Inc. 1977

# USC REMI CONNECTOR SERIES

100% fail-safe performance! Never disconnect until you want to disconnect.

Confines mechanical stress between metallic elements!

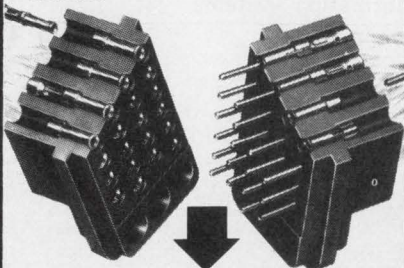

1 of over 2,000 types of connectors. Send today for REMI catalog!

**U.S. COMPONENTS, INC.**

Leader in advanced engineering and design

1320 Zerega Ave., Bronx, N.Y. 10462

(212) 824-1600 • TWX: 710-593-2141

Telex: 1-2411 • Cable: COMPONENTS, NYK



CIRCLE NUMBER 97

## KEEP

Electronic Design's

# GOLD BOOK

## HANDY

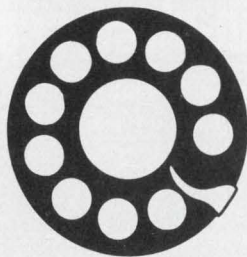

## When You Call

Save time when you contact suppliers. Check their catalog pages first in *Electronic Design's* GOLD BOOK. Maybe the information you need is right at your fingertips.

## Application notes

### Digital testing

Modeling and simulation for digital testing is the subject of a 48-page application note. Hewlett-Packard, Palo Alto, CA

CIRCLE NO. 415

### D/a, a/d reliability

Reliability predictions for over 75 data-conversion products are shown in a four-page brochure. Micro Networks, Worcester, MA

CIRCLE NO. 416

### Phase-noise analyzer

Phase-noise measurement techniques using the 800-Series phase-noise analyzer are described in a four-page brochure. Frequency Engineering Laboratories, Farmingdale, NJ

CIRCLE NO. 417

### CRT displays

Descriptions and specifications of seven CRT displays and selection considerations for display monitors are covered in a brochure. In addition the brochure contains material on hard-copy units, cameras, and other accessories. Tektronix, Beaverton, OR

CIRCLE NO. 418

### Thermal protection, motors

Various means by which a motor can be prevented from operating at excessive temperatures are discussed and compared in *Motorgram*. Bodine Electric, Chicago, IL

CIRCLE NO. 419

### Flat springs

"Set and Relaxation in Flat Springs" contains graphs, charts and a comparison table of the most-common spring materials. Instrument Specialties, Little Falls, NJ

CIRCLE NO. 420

### Capacitors

"The Secret Life of Capacitors" covers the capacitor's hidden flaws. ECD Corp., Cambridge, MA

CIRCLE NO. 421

## Bulletin board

**Precision Monolithics' ultra-low off-set-voltage op-amp, the OP-07DJ,** competes with Analog Devices' AD510J. Priced at \$5.75 (100-999), substantial high-quantity discounts are available.

CIRCLE NO. 422

**National Semiconductor** has reduced prices on all standard **resistor networks** by an average of 50%.

CIRCLE NO. 423

**Texas Instruments' dual differential comparator, the LM2903,** is a second-source for the National Semiconductor device with the same designation.

CIRCLE NO. 424

**Deltron** has reduced prices an average of 4% on almost half its **open-frame power supplies**. All units are guaranteed for 48-hour shipment.

CIRCLE NO. 425

**SGS-ATES** is **second-sourcing Fairchild's F8 microprocessor system and low-power Schottky family**.

CIRCLE NO. 426

**Bendix Corp.'s Electrical Components Div.** has increased prices averaging 8% on its **standard (MIL-C-5015) and miniature (Pygmy) electrical connector lines**.

CIRCLE NO. 427

Prices have been reduced over 40% on the **8X300 microprocessor** from **Signetics**.

CIRCLE NO. 428

**High-speed semiconductor-memory options for Hewlett-Packard's 21MX E-Series small computers** increase the throughput capacity of systems using them by as much as 30%.

CIRCLE NO. 429

**Solid State Scientific** has added two **CMOS Schmitt trigger ICs** to its 4000 series. The SCL4093B is a quad two-input NAND Schmitt trigger and is a replacement for RCA's CD4093. The SCL4584B is a hex Schmitt trigger inverter, and is an exact replacement for Motorola's MC14584B.

CIRCLE NO. 430

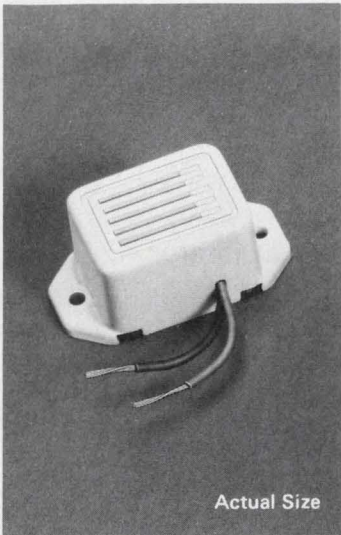

Actual Size

Series AI-120 Audio Indicator

# WE'RE WARNING YOU...™

... if economy is your buzz word for today, this newly developed series AI-120 mini audio indicator can put new horizons within your reach. This tiny unit, encased in sturdy, white plastic, is our answer to industry's quest for a small buzzer which is low in cost but high in dependability. It sounds off at 80 dbA with a tone you can't ignore! Mode is from 1.5 to 30 vdc. Low current drain prolongs battery life. Compacted to .61" (15.6 mm) x .65" (16.6 mm) x 1.3" (33.2 mm) for real versatility. Excellent for pocket paging sets, timers, test apparatus, terminals, telephones, various alarms and warning devices. For catalog and a demonstration, give us a buzz.

**Where to buy** an audio indicator for every need:



projects<sup>®</sup>  
unlimited

3680 Wyse Road, Dayton, Ohio 45414  
Tel. (513) 890-1918, TWX 810-450-2523  
*Distributors throughout the world.*

**CALIFORNIA, COSTA MESA**  
MarVac Electronics

**CALIFORNIA, SUNNYVALE**  
Pyramid Electronics

**COLORADO, DENVER**  
Waco Electronics Inc.

**MASSACHUSETTS, SHARON**  
Adcour

**MICHIGAN, FARMINGTON**  
CMP Distributor Co.

**MISSOURI, ST. LOUIS**  
Olive Industrial Elec.

**NEW JERSEY, WAYNE**  
Gordon/Horne, Inc.

**NEW YORK, ROCHESTER**  
Osmann Component Sales

**OHIO, CINCINNATI**  
Hughes Peters Inc.

**OHIO, CLEVELAND**  
CMP Distributor Co.

**OHIO, COLUMBUS**  
Hughes Peters Inc.

**OHIO, DAYTON**  
NASCO

**TEXAS, DALLAS**  
GARLAND

**K. A. Electronics**  
WASHINGTON, SEATTLE

Frank Jackson & Associates

**WISCONSIN, MILWAUKEE**  
Taylor Electric Co.

**B. C., VANCOUVER**  
Deskin Sales Corp.

**ONTARIO, TORONTO**  
Deskin Sales Corp.

**ONTARIO, WILLOWDALE**  
Electro Sonic, Inc.

**QUEBEC, MONTREAL**  
Deskin Sales Corp.

CIRCLE NUMBER 109



## AMPERITE

### Thermostatic DELAY RELAYS

Delays: 2 to 180 Sec.\*

*Featuring*

**LOW COST**

**LONG LIFE**

**MAXIMUM**

**STABILITY**

\*MINIATURES Delays:  
2 to 120 seconds.

Hermetically sealed — not affected by altitude, moisture, or climate changes... **SPST only** — normally open or closed...  
Compensated for ambient temperature changes from -55° to +80° C... **Rugged, explosion-proof, long-lived**... Standard radio octal and 9-pin miniatures.

**AMPERITE**

**BALLAST REGULATORS**

Automatically keeps current at a definite value. For AC or DC ... Hermetically sealed, rugged vibration-resistant, compact, most inexpensive.

Price, under \$3.00 ea.

Write for Bulletins TR-81, LD-73 and AB-51



Price, standard or min., under \$4.00 each.

**PROBLEM?** Send for **BULLETIN No. TR-81**

Also available:  
**LONG DELAYS** — 240 and 300 Seconds.  
**DIFFERENTIAL RELAYS** to specs.

# AMPERITE

600 PALISADE AVE.,  
UNION CITY, N.J. 07087

Telephone: 201 UNion 4-9503

Canada: Atlas Electronics, Ltd., 50 Wingold Ave., Toronto M6B 1P7

CIRCLE NUMBER 110

ELECTRONIC DESIGN 15, July 19, 1977

## PROBLEM SOLVER

### For Electronics Manufacturers

# FOAMEDGE

## Vinyl Encased Polyurethane Foam

Consider this product as a solution to some of your problems. It comes in diameters from 3/16" to 3", cut to any length.

**Suggested uses include:**

Dust Seals

Light Seals

Vibration Dampener

Airflow Stoppage

Shock Absorption

Sound Seals

Heat Insulation

Perhaps you have your own special need for FOAMEDGE. It is tough and durable, very soft, conforms to shape of irregular surfaces and has lowest K factor of any insulation.

*Write For Information and Samples*



## TELEDYNE MONO-THANE

1460 Industrial Parkway, Akron, Ohio 44310

Phone: 216/633-6100

CIRCLE NUMBER 111

149

# New literature

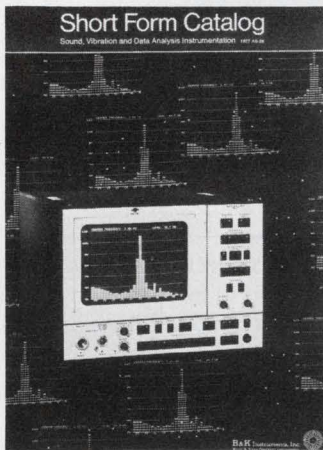

## Instrumentation

Precision transducers and instrumentation for sensing, measuring and analyzing sound and vibration are described in a 36-page catalog. B & K Instruments, Cleveland, OH

CIRCLE NO. 431

## Rf transistors and hybrids

Package-design diagrams and a frequency index for microwave vhf, uhf, linear and mobile-radio products can be found in a 16-page guide. TRW RF Semiconductors, Lawndale, CA

CIRCLE NO. 432

## Power supplies

Dc power supplies and related devices are described in a 32-page catalog. The catalog lists specifications and prices. Standard Power, Santa Ana, CA

CIRCLE NO. 433

## Connectors

Connectors for mass termination are featured in a four-page data sheet. AMP, Harrisburg, PA

CIRCLE NO. 434

## Spectrum analyzer

Descriptions, functions and features of a narrowband, real-time spectrum analyzer are given in a 20-page brochure. Rockland Systems, West Nyack, NY

CIRCLE NO. 435

## Thermistor housing

Thousands of different thermistor sensor assemblies, custom designed for use in air, liquid and solids, as well as a broad variety of standard units are depicted in a 26-page manual. Fenwal Electronics, Framingham, MA

CIRCLE NO. 436

## Metallized ceramics

Applications and descriptions of metallized ceramics are shown in a four-page brochure. Tekform, Anaheim, CA

CIRCLE NO. 437

## Calculators

Several informative articles are contained in a 30-page publication that combines a complete catalog of HP pocket and personal calculators and accessories in an easy-to-read magazine format. Hewlett-Packard, Palo Alto, CA

CIRCLE NO. 438

## Cermet trimming pots

A 56-page catalog of cermet trimming potentiometers contains specifications, drawings and photos of six military and 16 general-purpose models and panel-mounting adapters. Beckman Instruments, Helipot Div., Fullerton, CA

CIRCLE NO. 439

## Terminations

In addition to complete specifications for 152 different terminal blocks, a 196-page publication contains individual sections on special terminals, accessories, marking tags, and product approvals around the world. Weidmuller Terminations, Richmond, VA

CIRCLE NO. 440

## Optoelectronics

Photographs, outline drawings, and specifications of National's red, yellow and green LED lamps; large-area, (0.3, 0.5 and 0.7-in. high) multidigit, numeric displays; small, calculator-type numeric arrays; and watch-display dies are contained in a 12-page catalog. National Semiconductor, Santa Clara, CA

CIRCLE NO. 441

## Switches

Data on switches are presented in a 76-page catalog in an easy-to-follow manner, using dimensional diagrams, photographs and charts. CW Industries, Warminster, PA

CIRCLE NO. 442

## Voltage calibrator

Functional description, features, electrical and mechanical specifications, and price and ordering information on the Model DVC-8500, a digital voltage calibrator, are included in a six-page data sheet. Datel Systems, Canton, MA

CIRCLE NO. 443



## Waveguide mixers

Features, applications, specifications, photos and prices for the WM series of waveguide mixers and mixer preamps are contained in a four-page bulletin. RHG Electronics Laboratory, Deer Park, NY

CIRCLE NO. 444

## Power transistors

Glass-passivated, triple-diffused power transistors and Darlington's are featured in a six-page brochure. International Rectifier, Semiconductor Div., El Segundo, CA

CIRCLE NO. 445

## Automatic test equipment

Five major sections of the 54-page ATE catalog are: IC test equipment; transistor and diode test equipment; subassembly test equipment; laser-trimming equipment, and connector products. Letterhead requests only. Teradyne, 183 Essex St., Boston, MA 02111.

INQUIRE DIRECT

## PCB Mounted ROTARY SWITCHES

INTERSWITCH GRS rotary switches are designed for parallel or perpendicular mounting to PCB's. You may choose from a wide variety of output codes; up to 24 positions; shorting or non-shorting contacts.

Write or call for complete information and name of your local distributor.



ONE OF THE PURDY GROUP OF COMPANIES

770 Airport Boulevard  
Burlingame, CA 94010  
(415) 347-8217 • TWX 910-374-2353

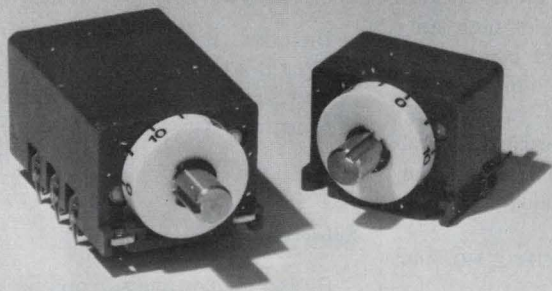

CIRCLE NUMBER 112

## New! Model 640 Low Cost\* Loader Reads 350 Characters per Second

All solid state photo-electronic components.  
Reads all standard 5,6,7 or 8 level tapes.  
Smooth, quiet, AC drive.

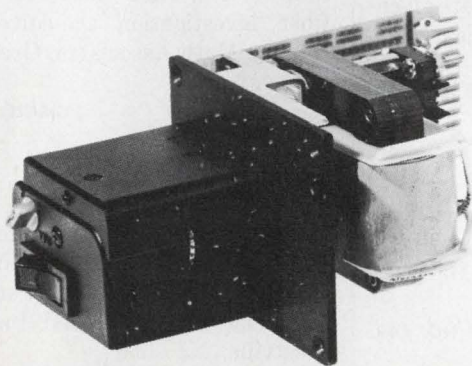

Provides reliable, high speed data entry. Data amplifiers and "character ready" output available for CMOS or TTL interfaces. Fanfold box available.

The Model 640 is the newest addition to the Addmaster line of quality paper tape equipment.

\*Only \$166-189! (1-49 units; substantial quantity discounts available.)

Addmaster Corporation, 416 Junipero Serra Drive, San Gabriel, California 91776. Telephone: (213) 285 1121.

CIRCLE NUMBER 113

ELECTRONIC DESIGN 15, July 19, 1977

## New! Research Kits for special soldering problems.

Now, 3 Kits available to help you test special joining or sealing techniques. Join unusual materials. Prevent gold leaching. Make glass-to-metal joints, etc. Each Kit comes with 10 or more solders, plus accessories.

"Microelectronics" Solder Kit(s) @ \$95 ..... \$ \_\_\_\_\_  
 "General Purpose" Solder Kit(s) @ \$95 ..... \$ \_\_\_\_\_  
 "Special Joining" Solder Kit(s) @ \$95 ..... \$ \_\_\_\_\_  
 Save \$35 and order all three for \$250 ..... \$ \_\_\_\_\_  
 Check enclosed \_\_\_\_\_ Money Order enclosed \_\_\_\_\_ TOTAL \$ \_\_\_\_\_  
 Bill my firm on Purchase Order # \_\_\_\_\_

Name \_\_\_\_\_ Title \_\_\_\_\_  
 Firm \_\_\_\_\_  
 Address \_\_\_\_\_  
 City \_\_\_\_\_ State \_\_\_\_\_ Zip \_\_\_\_\_  
 Telephone \_\_\_\_\_ Signature \_\_\_\_\_

Send for your new Research  
Solder Kit today!

THE INDIUM CORPORATION OF AMERICA  
P.O. BOX 269 • UTICA, NY 13503



CIRCLE NUMBER 114

## COST - CUTTING WESTON BREAKTHROUGH!

### 3/8" MULTITURN CERMET TRIMMER

FOR ONLY **99¢** (1,000-Pc. Price)

Same High Weston Quality  
At A Real Savings In Price!



Weston has done it with the new #850! We took this widely used square multiturn trimmer, and by radically improving manufacturing techniques have been able to trim the price without sacrificing quality, performance or uniformity. It can give you an important new competitive edge.

WRITE FOR SPECS AND DETAILED  
PRICE INFORMATION.

SANGAMO WESTON  
**Schlumberger**

WESTON COMPONENTS & CONTROLS  
A Division of Sangamo Weston, Inc.  
Archbald, Pa. 18403  
Tel. (717) 876-1500  
TWX 510 656-2902  
Telex 83-1873

CIRCLE NUMBER 115

# Sabor presents the **NEW** **SONY** Instrumentation Cassette Recorder

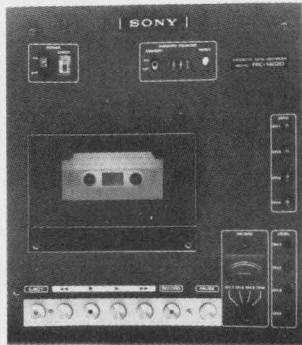

The new Sony FRC-1402 D provides 4 FM data channels with a frequency response of DC to 625 Hz. S/N ratio has been increased to 50 dB! Remote control is available.

Price \$2,250

12597 Crenshaw Blvd.  
Hawthorne, CA 90250  
(213) 644-8689

**Sabor corporation**

CIRCLE NUMBER 98

## **SOC FUSES** meet World-wide standards



UL CSA SEMKO CB(CEE) MITI

- QUICK ACTING
- MEDIUM TIME DELAY
- TIME DELAY (slow-blow)

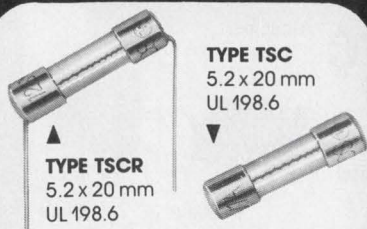

Only SOC 5.2 x 20 mm fuses are UL listed.  
FILE NO. E39265 (for both)

Many other Fuses, Fuse holders  
and Fuse blocks are available —  
approved by UL, CSA and MITI

**SANO**  
INDUSTRIAL CORPORATION

35-D Orville Dr., Bohemia, N.Y. 11716  
TEL: (516) 567-5556 TWX: 510-228-7701

© 1977

CIRCLE NUMBER 99

## NEW LITERATURE



### A/d, d/a converters

A 16-page a/d and d/a-conversion-modules brochure discusses such subjects as error sources in converters, converter terminology, dynamic parameters of amplifiers, multiplexer and s/h parameters, resistance and induction of connections, CMR, and much, much more. Analogic, Wakefield, MA

CIRCLE NO. 446

### 250-MHz counter

Applications, specifications and accessories for a portable 250-MHz counter are given in a six-page brochure. Data Precision, Wakefield, MA

CIRCLE NO. 447

### Computing modules

The specifications of modules for analog-function computation are given in a four-page catalog. Intronics, Newton, MA

CIRCLE NO. 448

### Computer systems

A 124-page booklet includes nearly all published data sheets about HP 21 MX-based computer systems. Hewlett-Packard, Palo Alto, CA

CIRCLE NO. 449

### Quartz crystals

Two new guides cover the use of quartz crystals. A 4-page cross-reference guide for monitor crystals shows the proper crystal by alphabetical make and model. The second is a 40-page directory on crystals for the 40-channel Citizen Band. Crystek Crystals, Fort Myers, FL

CIRCLE NO. 450

### Elastomer gaskets

Design and performance data, part descriptions and numbers, and ordering instructions for standard EMI/RFI conductive-elastomer gaskets are contained in a 28-page catalog. Chomerics, Woburn, MA

CIRCLE NO. 490

### IC accessories

Descriptive data about IC-interconnection packaging devices and accessories are contained in a 16-page catalog. AMP, Harrisburg, PA

CIRCLE NO. 491

### DIP relays

Included in a 16-page DIP-relay catalog is a two-page chart which gives characteristics of the entire line. Magnecraft Electric, Chicago, IL

CIRCLE NO. 492

### Microwave products

Rf and microwave silicon planar npn epitaxial transistors, amplifiers and oscillators are described in a 82-page catalog. Avantek, Santa Clara, CA

CIRCLE NO. 493

### Optical fibers

Data on optical fibers, fiber cables, optical-fiber laboratory accessories, fiber connectors, related optics and filters, source/detector systems, sources, and R&D needs for optical-fiber investigation are given in a catalog. Math Associates, Great Neck, NY

CIRCLE NO. 494

### Multiple outlet strips

Fully illustrated, a 24-page catalog gives descriptions and specifications covering 240 multiple-outlet strips and 15 carriers on wheels. SGL Industries, Westville, NJ

CIRCLE NO. 495

### Solid-state keyboards

Sealed solid-state keyboards are reviewed in a 12-page catalog. The illustrated brochure includes mounting dimensions, photographs, electrical data and code and character assignments. Micro Switch, Freeport, IL

CIRCLE NO. 496



# YOU WERE HIRED FOR YOUR BRAINS, NOT YOUR BODY.

It's not as silly as it sounds. Because many bright engineers and technicians are still spending their time soldering, desoldering and resoldering. Instead of designing.

Which is pretty silly, considering the waste of talent. Especially when there's a better alternative.

With CSC Proto-Board® solderless breadboards, assembling a circuit is practically as fast as designing one. No special jumpers or patch cords required—all types of components—from complex microprocessors to resistors, capacitors and LED's—connect and interconnect as simply as pushing in a lead... or short lengths of #22-30 solid hookup wire. And circuit changes are done with the same

plug-out, plug-in ease. All thanks to rugged, nickel-silver contacts and CSC's superior use-tested design.

Proto-Board breadboards are available in a variety of sizes, from 630 to 3060 solderless tie-points (six to thirty-two 14-pin DIP capacity), at prices from \$15.95\* (kit) to \$79.95. And if you'd like built-in regulated supplies, they're available too, in models priced at \$75 and \$120.

Before you start your next project, put down your soldering iron and call 203-624-3103 (East Coast) or 415-421-8872 (West Coast)

for full specifications and ordering information. Once you do,

you'll find yourself soldering less... and more than likely, earning more.

MODEL	NO. OF TIE-POINTS	14-PIN DIP CAPACITY	MFR'S SUGGEST LIST *	OTHER FEATURES
PB-6	630	6	\$15.95	Kit—10-minute assembly
PB-100	760	10	19.95	Kit—with larger capacity
PB-101	940	10	29.95	8 distribution buses, higher capacity
PB-102	1240	12	39.95	Large capacity, moderate price
PB-103	2250	24	59.95	Even larger capacity: only 2.7¢ per tie-point
PB-104	3060	32	79.95	Largest capacity: lowest price per tie-point
PB-203	2250	24	75.00	Built-in 1% regulated 5V, 1A low-ripple power supply
PB-203A	2250	24	120.00	As above plus separate 1/2-amp +15V and -15V internally adjustable regulated outputs

\*Manufacturer's suggested list  
Prices and specifications subject to change without notice.

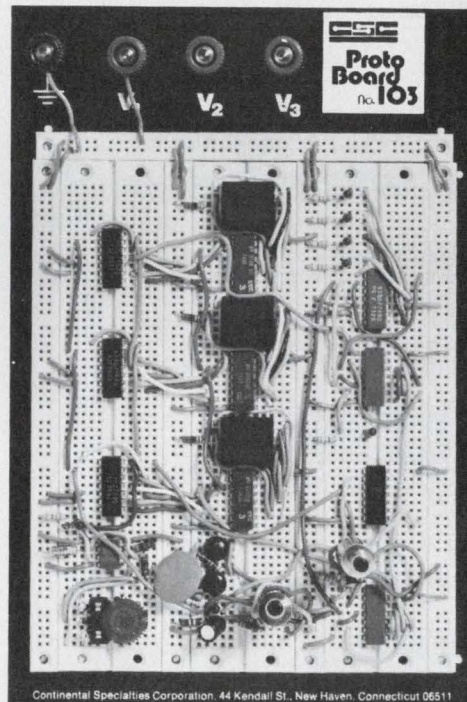

Continental Specialties Corporation, 44 Kendall St., New Haven, Connecticut 06511

CONTINENTAL SPECIALTIES CORPORATION



44 Kendall Street

Box 1942 New Haven CT 06509

203-624-3103 TWX 710-465-1227

West Coast office Box 7809 San Francisco, CA

94119 • 415-421-8872 TWX 910-372-7992

© 1976, Continental Specialties Corporation

CIRCLE NUMBER 116

# UNIVERSAL



FOR DIGITAL  
MEASUREMENT  
OF FREQUENCY,  
RATIO OR PERIOD

# PANEL COUNTER

VERSATILITY . . . is designed into this new Model 6130 digital panel counter. It's fully programmable into seven operating modes: Frequency (9999.9 Hz to 999.99 KHz), frequency ratio, period, period average, time interval, accumulate, and stop watch.

Features of the 6130 include sixteen selectable time base periods from 1 $\mu$ s to 1 hour, five bright 13 mm LED digits, opto-isolated or TTL inputs and a DIN standard case.

When you add it all up it's your best buy in a panel counter at \$250.00.

Ask for a demonstration.

FOR IMMEDIATE RESPONSE:

Newport Labs / 630 East Young Street  
Santa Ana, California 92705  
Phone (714) 540-4914  
In Europe-Tele Amsterdam 20-452052



CIRCLE NUMBER 121

## Electronic Design

ELECTRONIC DESIGN's function is:

- To aid progress in the electronics manufacturing industry by promoting good design.
- To give the electronic design engineer concepts and ideas that make his job easier and more productive.
- To provide a central source of timely electronics information.
- To promote communication among members of the electronics engineering community.

**Want a subscription?** ELECTRONIC DESIGN is sent free to qualified engineers and engineering managers doing design work, supervising design or setting standards in the United States and Western Europe. For a free subscription, use the application form bound in the magazine. If none is included, write to us direct for an application form.

If you do not qualify, paid subscription rates are as follows: \$30.00 per year (26 issues) U.S./Canada/Mexico, \$40.00 per year (26 issues) all other countries. Single copies are \$2.50 U.S. and all other countries. The Gold Book (27th issue) may be purchased for \$30.00 U.S./Canada/Mexico, and \$40.00 all other countries.

**If you change your address,** send us an old mailing label and your new address; there is generally a postcard for this in the magazine. You will have to requalify to continue receiving ELECTRONIC DESIGN free.

**The accuracy policy** of ELECTRONIC DESIGN is:

- To make diligent efforts to ensure the accuracy of editorial matter.
- To publish prompt corrections whenever inaccuracies are brought to our attention. Corrections appear in "Across the Desk."
- To encourage our readers as responsible members of our business community to report to us misleading or fraudulent advertising.
- To refuse any advertisement deemed to be misleading or fraudulent.

Individual article reprints and microfilm copies of complete annual volumes are available. Reprints cost \$6.00 each, prepaid (\$.50 for each additional copy of the same article), no matter how long the article. Microfilmed volumes cost \$23 for 1976 (Vol. 24); \$30 for 1973-75 (Vols. 21-23), varied prices for 1952-72 (Vols. 1-20). Prices may change. For further details and to place orders, contact Customer Services Dept. University Microfilms, 300 N. Zeeb Rd., Ann Arbor, MI 48106. (313) 761-4700.

**Want to contact us?** If you have any comments or wish to submit a manuscript or article outline, address your correspondence to:

Editor  
ELECTRONIC DESIGN  
50 Essex St.  
Rochelle Park, NJ 07662

ELECTRONIC DESIGN 15, July 19, 1977

## Now! Recorder modules with 2 year warranties

For medical and industrial applications . . . DC to 140 Hz . . . meet AHA specs . . . choose from low profile, extended view and wide chart AC or DC operated recorders . . . alphanumeric printing option . . . 1 through 8 channels . . . ceramic stylus with two year guarantee offered . . . custom requirements easily met. Send for new catalog.

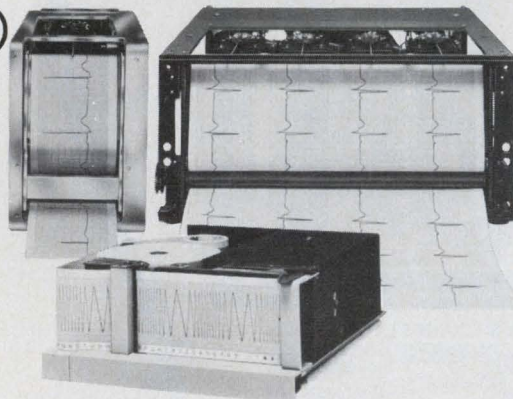

**gulton**®

Measurement & Control Systems Division  
Gulton Industries Inc., East Greenwich, Rhode Island 02818  
401-884-6800 • TWX 710-387-1500

CIRCLE NUMBER 122

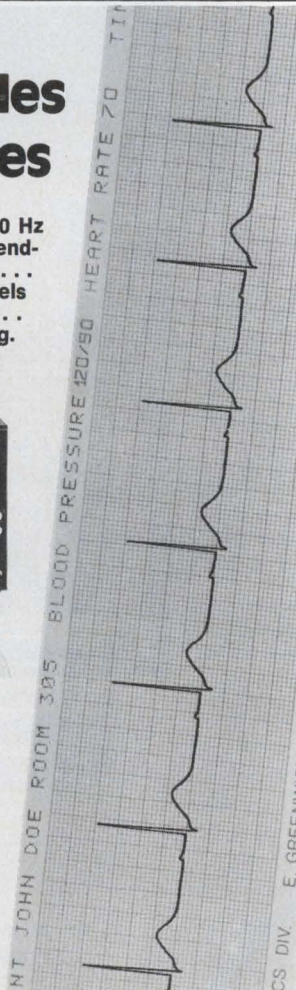

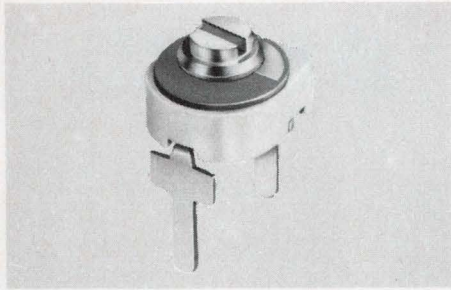

**MINIATURE CERAMIC TRIMMER CAPACITORS** 9371 series of ceramic trimmer capacitors are compact, economical and rugged. They are 50% smaller than other trimmers of this type yet provide high capacitance values. Available in 4 capacitance ranges, 1.5 to 4, 3.0 to 10, 3.5 to 18 and 5.0 to 25 pf with Q's > 300 at 10 MHz. They have an overall diameter of .225" with .215" above board height. JOHANSON MANUFACTURING CORPORATION, Rockaway Valley Road, Boonton, N.J. 07005 201-334-2676

TRIMMER CAPACITORS

181

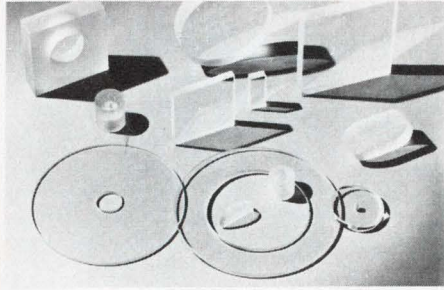

**FREE 32 PAGE CATALOG. WINDOWS - PLATES - DISCS - OPTICS.** Fused quartz, optical glasses, pyrex Ultra-low expansion materials, highly resistant to thermal shock. High UV and IR transmission. Chemically inert to most corrosive materials. Stocking center for lenses, prisms and laser accessories. Complete fabricating facilities. ESCO PRODUCTS, 181 Oak Ridge Rd., Oak Ridge, N.J. 07438. (201) 697-3700

LENSE, PRISM CATALOG

184

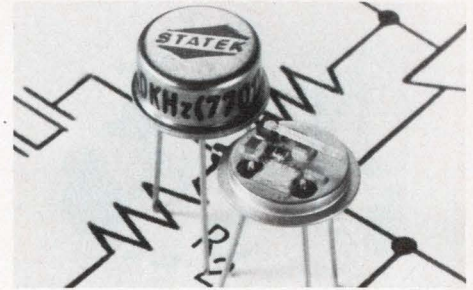

**CMOS Crystal Oscillators in Low profile TO-5.** Frequency range is 10 kHz to 300 kHz (divided outputs to 1 kHz, low as one cycle per month available). Low milli-amp current consumption. Accuracy  $\pm 0.01\%$ . Shock 1000 g. Hybrid thick and thin film chip and wire design is rugged and ideally suited for portable equipment. Details in Gold Book & EEM \* STATEK CORP \* 512 N. Main, Orange, Ca. 92668 \* (714) 639-7810 \* Telex 67-8394.

CRYSTAL OSCILLATOR

187

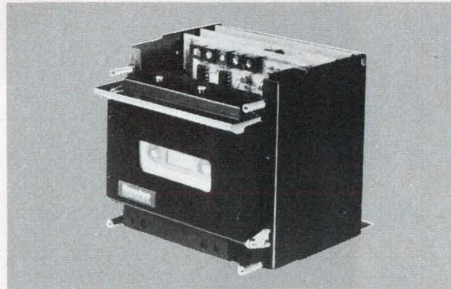

**HIGH SPEED RECORDER FOR MICRO-PROCESSORS** Model 764 has a patented constant speed tape drive using only 2 moving parts. No capstans, tachometers or clock tracks are necessary. Records up to 32,000 bits per second. Searches at 100 inches per second. Can store up to 5 megabits per 300 foot cassette. ANSI/ECMA compatible. Priced under \$500.00/OEM quantities. MEMODYNE CORPORATION, 385 Elliot Street, Newton Upper Falls, MA 02164. Telephone (617) 527-6600.

MICROPROCESSOR RECORDER

182

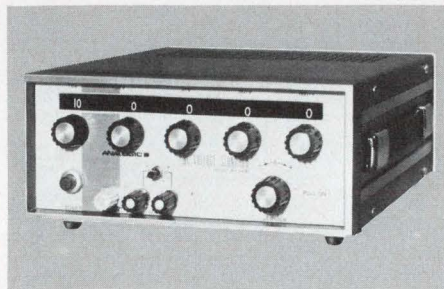

**PORTABLE SECONDARY DC VOLTAGE STANDARD - ONLY \$695** The AN3100 provides a range from  $\mu$ Volts to volts with 7 decade resolution • Five dialable, digital decades of DC Voltage - two simultaneous ranges: 0-11.1110 Volts with 100  $\mu$ V resolution, and 0-111.110 mV with 1  $\mu$ V resolution • Absolute accuracy of 50 ppm of Reading • Noise < 0.001% of reading +50  $\mu$ V • NBS Traceability • Analogic, Audubon Rd., Wakefield, MA 01880

SECONDARY DC VOLTAGE STANDARD 185

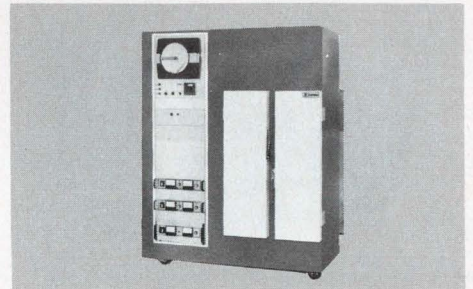

**CRITERIA IV, BURN-IN SYSTEM** for IC's, RAMs, UP's etc. performs dynamic or static screening up to 200°C, is now available for in-house burn-in use. The high temperature dynamic capability is provided by means of a "Exsert Connection" (extending the socket board through the oven wall) and connecting to externally mounted driver cards. For a brochure and a proposal to help you set up an in-house lab, contact Bob Burton, Reliability, Inc., P.O. Box 37409, Houston, Texas 77036. (713) 666-3261

SEMICONDUCTOR BURN-IN SYSTEM 188

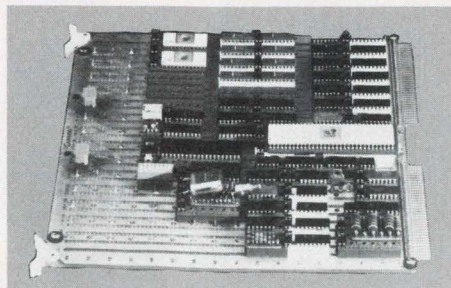

**Evaluation Board for TMS-9900 Chip.** Cambion has a complete Evaluation Board package for Texas Instruments' TMS-9900 chip. Included are components and a microcomputer kit monitor and design documentation listing. The board saves design, interconnection and evaluation time. It can accommodate any circuit change and may be used for applications as well as evaluation. For more information write: Cambridge Thermionic Corporation, 445 Concord Ave., Cambridge, MA 02138. Phone: 617-491-5400.

CAMBION

183

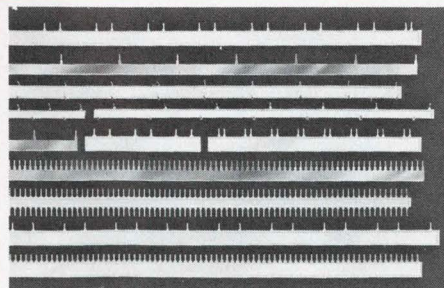

**MINI/BUS® BY ROGERS**, low-cost, low-inductance, high capacitance printed circuit board bus bars for noise reducing voltage distribution, are available in a variety of ready-to-ship designs. Prototype kits are also available from stock. Call or write Mini/Bus product specialist for a complete list. Rogers Corporation, Chandler, AZ 85224. Phone: (602) 963-4584. (EUROPE: Mektron NV, Gent, Belgium; JAPAN: Nippon Mektron, Tokyo.)

BUS BARS

186

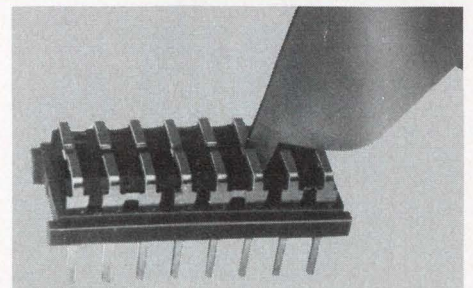

**DIP PROGRAM HEADER (8 - 14 - 16 PIN)** Program within the header itself! Available pre-programmed to your program or you program them with Aries Program Header Tool or needle nose pliers . . . simply by removing interconnection sections between adjacent or opposing pins. Low profile can be marked to identify program. Layout sheets to indicate programming are available. ARIES ELECTRONICS, INC., P.O. Box 231, Frenchtown, N.J. 08825. Telephone (201) 996-4096, TWX 510-235-3391.

DIP PROGRAM HEADER

189

# quick ads

New and current products  
for the electronic designer  
presented by their manufacturers.



**MAGNETIC SHIELDING** Take advantage of Eagle's 23-year background in shield design and production. Custom and standard models. Full service includes design, engineering, fabrication, heat treating, finishing, testing. Also wide selection of sheet and foil so you can form your own shields. For helpful design and cost data, request Bulletin E-77. Eagle Magnetic Co., Inc., Box 24283, Indianapolis, IN 46224, 317-297-1030.

MAGNETIC SHIELDING

190

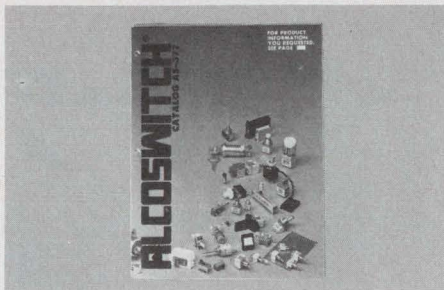

**NEW 1977 ALCOSWITCH CATALOG now available.** Full 76-pages illustrate over 1,400 miniature switches for the electronics industry. Every conceivable type is shown including toggles, rockers, push-buttons, slides, DIPS, rotary etc. with emphasis on switches for PC applications and many with gold plated contacts. Each listing includes specs, in quantity prices. Immediate delivery for nearly all switches. Copy is free, plus nationwide distributor list and field offices. ALCO ELECTRONIC PRODUCTS, INC. No. Andover MA 01845

MINIATURE SWITCH CATALOG

193

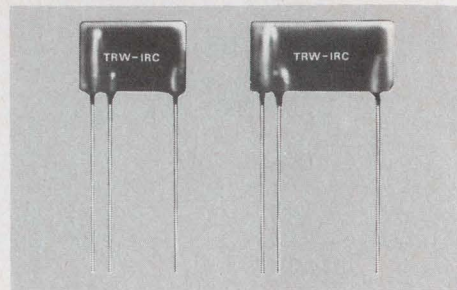

**Thick-Film High Voltage Dividers** are the latest line of high-voltage resistors from TRW. Each device consists of a high-voltage thick-film resistor circuit deposited on a high alumina ceramic substrate. The circuit can be encapsulated in a high-temperature epoxy coating with printed circuit leads or it can be made as a substrate for customer assembly into an integral high-voltage function. Available in various sizes and configurations. TRW/IRC Resistors, 401 N. Broad St., Phila, Pa. 19108. (215) 922-8900.

HIGH VOLTAGE RESISTORS

196

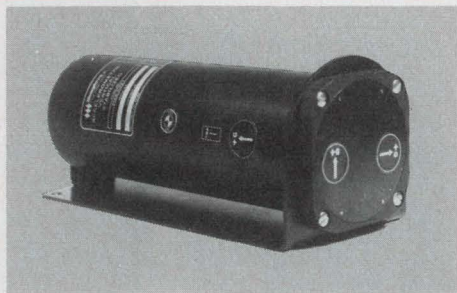

**GYRO STABILIZED, 3-AXIS ACCELEROMETER** for precise acceleration measurements free from the disturbing element of earth's gravity vector. Model SA09 has accelerometers on inner gimbal of a vertical gyro which is maintained with a verticality within  $\pm 0.2^\circ$  of local gravity. Wirewound potentiometers provide continuous pitch and roll outputs. Angular freedom of  $\pm 85^\circ$  pitch and  $360^\circ$  continuous roll. 3.13" x 10.0" long, 3.5 pounds. AC/DC. Humphrey, Inc., 9212 Balboa Ave., San Diego, CA 92123. (714) 565-6631

3-AXIS ACCELEROMETER

191

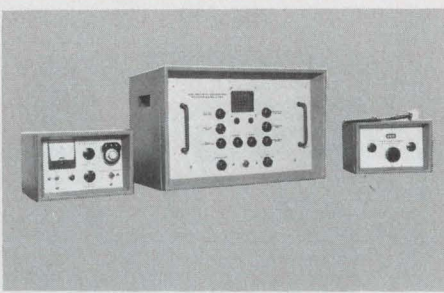

**NMR GAUSSMETER.** Model G-502 has a range of 300 to 85,500 gauss and resolution better than 15 milligauss. Provides accurate and rapid measurements of constant or slowly changing magnetic fields, measuring both average value of field and distribution of field over sample volume. Also used to monitor multi-magnet systems, calibrate fluxmeters and align magnet systems. Write: Walker Scientific Inc., Rockdale St., Worcester, MA 01606.

NMR GAUSSMETER

194

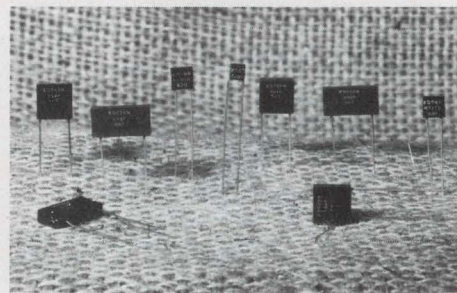

**HIGH VOLTAGE CERAMIC CAPACITORS, MULTI-LAYER OR LOW CORONA — MULTI-LAYER CAPACITORS** from 10 pf to .33 mfd, with working voltages from 500 to 5,000 VDC, temperature range,  $-55$  to  $125^\circ\text{C}$ . **LOW CORONA CAPACITORS** from 10 pf to .01 mfd — working voltages from 1,000 to 20,000 VDC, temp range of  $-55$  to  $125^\circ\text{C}$  — Corona less than 10 picocoulombs at rated voltage — Request catalog, write Mike Day, KD Components, 3016 S. Orange Ave., Santa Ana, CA 92707, (714) 545-7108.

HV CERAMIC CAPACITORS

197

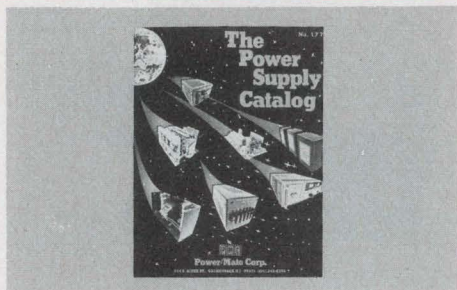

**Free New '77 catalog** contains over 34,500 quality power supplies from the world's largest manufacturer, Power/Mate Corp. Power Supplies for every application including submodulars, open frame, variorated, encapsulated, laboratory & system. All units UL approved and meet most military and commercial specs for industrial and computer uses. Power/Mate Corp., 514 S. River St., Hackensack, NJ 07601 (201) 343-6294

POWER SUPPLIES

192

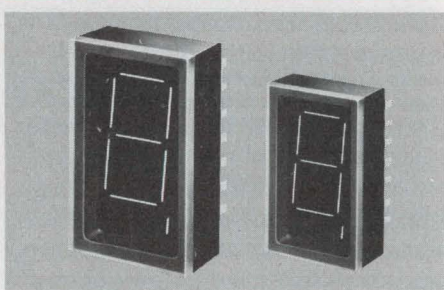

**INCANDESCENT FLATPACK DIGITAL DISPLAYS** IEE-AURORA gives a choice of .472" or .614" high, segment tungsten filament character, with decimal point. Features slim profile, low power (15mA per segment at 5VDC) sharp contrast and excellent  $120^\circ$  viewing angle easily readable in direct sunlight. Operating range is  $-55^\circ$  to  $+70^\circ\text{C}$  — avg. life exp. 100,000 hrs. — standard 14-pin DIP package design, standard TTL driver/decoder compatible. Immed. delivery. IEE, 7740 Lemona Ave., Van Nuys, CA 91405 (213) 787-0311.

FLATPACK DISPLAYS

195

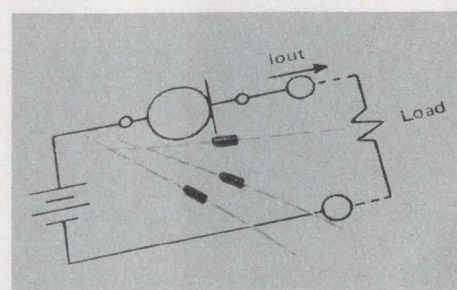

**JAN APPROVED CURRENT REGULATOR DIODES** The 1N5283-1N5314 series of FET current regulator diodes features constant current from 3V to 100V in 10% increments from 0.22mA to 4.7mA. Hermetic DO-7 ideal for systems requiring tight packaging/minimum parts counts. Applications include stable reference currents for TC zeners, high stability biasing for oscillators. JAN, \$6.25; JAN-TX, \$10.10; JAN-TX-V, \$10.60 per 100. Tele-dyne Crystalonics, 147 Sherman St., Cambridge, MA 02140 (617) 491-1670.

JAN CURRENT REG. DIODES

198

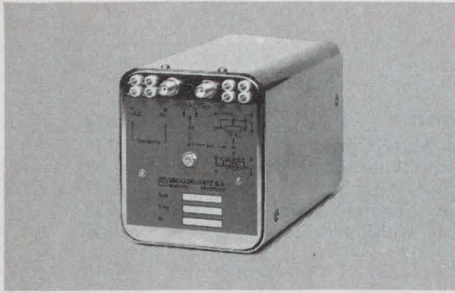

**HIGH STABILITY CRYSTAL OSCILLATOR**  
The Model B-5400 crystal oscillator is the best oscillator commercially available for close in phase noise and overall performance. The voltage controlled adjustment permits phase lock operation. The Model B-5400 is ideal for narrow band communications systems, atomic standards, navigation systems, and precision timing devices. Frequency and Time Systems, Inc., 182 Conant Street, Danvers, MA 01923 (617) 777-1255 Telex: 94-0518

CRYSTAL OSCILLATOR

199

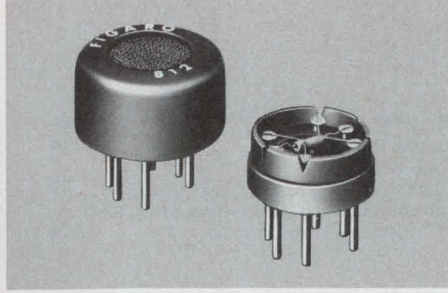

**FIGARO GAS SENSOR TGS** is a gas sensitive semiconductor. When combustible gas is absorbed on the sensor surface, a marked decrease of electrical resistance occurs. Major features of the sensor include high sensitivity, long term reliability and low cost. The applications are: GAS-LEAK ALARM, AUTOMATIC FAN CONTROL, FIRE ALARM, ALCOHOL DETECTOR, etc. Figaro Engineering Inc., North America Office-3303 Harbor Boulevard, Suite D-8, Costa Mesa, Calif. 92626 Tel: (714) 751-4103 Telex: 678396

GAS SENSOR

202



**NEW PRODUCT - OVER 5000 DPM MODELS??** Yes, the series A300 from IMC actually is available in over 5000 COMBINATIONS.  $\pm 3\frac{1}{2}$  DIGIT, AUTO ZERO, BIPOLAR, any LED COLOR, 10uV to 1000V input, buffered MUX BCD, parallel BCD, AUTO RANGE, DIFFERENTIAL, OHMS, RMS, °C, digital comparator, I-E receiver, Peak and Hold, Integrator, Analog Multiplexers, TRISTATE BCD . . . 150 hour burn-in and fully guaranteed for 2 years, available worldwide. IMC, 4016 E. Tennessee St., Tucson, AZ 85714 (602) 748-7900  
5000 DPM'S - SERIES A300

200

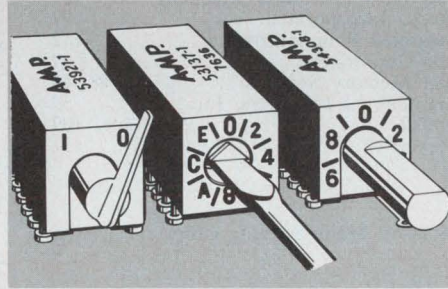

**Triple-threat DIP Printed Circuit Board Switches** from AMP can be switched three ways and provide three different functions. Switch them by screw-driver, lever or extended D shaft actuator. Functions include binary coded hexadecimal and decimal, with complements, and two position 4PDT. For more information, call Customer Service at (212) 564-0100. Or write AMP Incorporated, Harrisburg, PA 17105.

DIP PC BOARD SWITCHES

203



**New medium-scale, multi-use computer system from Harris.** Powerful VULCAN Virtual Memory Operating System supports more than 50 terminals simultaneously. Greater I/O throughput. MOS Memory with error correction. Powerful micro processor based CPU. Operates with ANSI 74 COBOL, FORGO, SNOBOL, FORTRAN, RPG II, extended BASIC. Handles multi-stream batch processing, multi-concurrent RJE's (host and remote). Harris Computer Systems, 1200 Gateway Dr., Ft. Lauderdale, Fl. 33309 (305) 974-1700.  
COMPUTER SYSTEMS

201

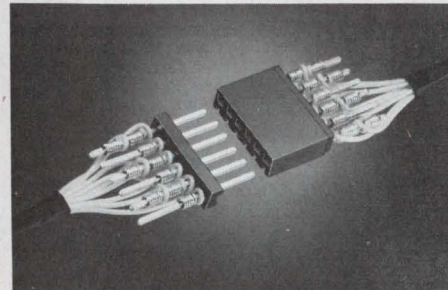

**NEW MINIATURE "HAPPY-WRAPPER" CONNECTORS.** Rugged .045" square pins married to sturdy female contacts to withstand high production wrapping torque. Permit flying lead connections via hand wrap terminations to both male and female elements. Pins available with .156" or .200" centers. Take 8 inch-ozs of torque without distortion. Contacts rated 2.5 amps, 250 VAC. Methode Electronics Corporation, 1700 Hicks Road, Rolling Meadows, IL 60008. (312) 392-3500.  
HIGH PRODUCTION "HAPPY WRAPPERS" CONNECTORS

204

# Electronic Design

## Advertising Sales Staff

Tom W. Carr, Sales Director  
Robert M. Lepore,  
Sales Coordinator

## Rochelle Park, NJ 07662

Robert W. Gascoigne  
Thomas P. Barth  
Stan Tessler  
50 Essex St.  
(201) 843-0550  
TWX: 710-990-5071  
(HAYDENPUB ROPK)

## Philadelphia

Thomas P. Barth  
(201) 843-0550

## Boston 02178

Gene Pritchard  
P.O. Box 379  
Belmont, MA 02178  
(617) 489-2340

## Chicago 60611

Thomas P. Kavooras  
Berry Conner, Jr.  
200 East Ontario  
(312) 337-0588

## Cleveland

Thomas P. Kavooras  
(312) 337-0588

## Los Angeles 90045

Stanley I. Ehrenclou  
Burt Underwood  
8939 Sepulveda Blvd.  
(213) 641-6544

## Texas

Burt Underwood  
(213) 641-6544

## San Francisco

Robert A. Lukas  
3579 Cambridge Lane  
Mountain View, CA 94040  
(415) 965-2636

## England

Constance McKinley  
50 Essex St.  
Rochelle Park, N.J. 07662  
Phone: (201) 843-0550

## Europe

Sanders, W. J. M.  
Raadhuisstraat 24  
Graft-De Ryp, Holland  
Phone: 02997-1303  
Telegrams: Euradteam-Amsterdam  
Telex: 13039-SIPAS

## G. Nebut

Promotion Presse Internationale  
7 ter Cour des Petites Ecuries  
75010 Paris, France  
Telephone: 5231917, 1918, 1919

## Dieter Wollenberg

Erikastrasse 8  
D-8011 Baldham/Muenchen  
Germany  
Telephone: 0 8106/4541

## Tokyo

Haruki Hirayama  
EMS, Inc.  
5th Floor, Lila Bldg.,  
4-9-8 Roppongi  
Minato-ku, Tokyo, Japan  
Phone: 402-4556  
Cable: EMSINCPERIOD, Tokyo

★ABP

BPA



# The New 1977-1978 **GOLD BOOK** Has Just Been Published

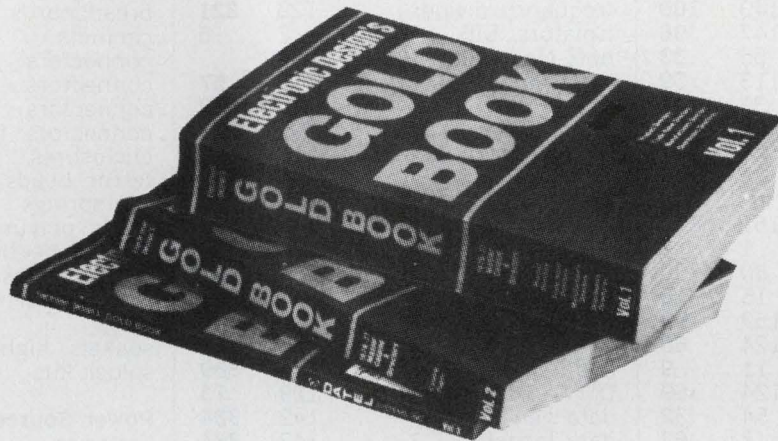

## And Completely Outdates Last Year's Edition

If you are currently a subscriber on **ELECTRONIC DESIGN's** qualified circulation file, you need do nothing. You will receive your new **GOLD BOOK** automatically. If you wish additional copies for other members of your company, you may order them now using the convenient coupon form below.

If you are not currently an **ELECTRONIC DESIGN** subscriber on our controlled circulation list, you may order your own multi-section set of the new **GOLD BOOK** by completing the form below. Shipment will be made promptly on receipt of your payment or company purchase order.

**HERE IS WHAT YOU AND YOUR COMPANY  
WILL FIND IN THE UPDATED 1977-78**

### **GOLD BOOK**

- **Three sections** containing 2,496 pages of information to quickly locate products used by the electronics industry.
- **A Product Directory** with 5,434 product categories.
- **A Trade Name Directory** of 9,814 listings.
- **A Manufacturers' Directory** listing 8,057 companies in the electronics industry.
- **Two Distributors' Directories** with 2,050 distributors listed.
- **A Giant Compendium of Manufacturers' Data Pages** with specifications.

### MAIL TODAY WITH PURCHASE ORDER

Electronic Design's GOLD BOOK 449R  
Hayden Publishing Co., Inc.  
P.O. Box 13803, Philadelphia, Pa. 19101 U.S.A.

Here is our purchase order for \_\_\_\_\_ sets of the 1977-1978 GOLD BOOK at \$30.00 per set—for U.S., Canada and Mexico.  
(All other countries: \$40.00 per set)

Check enclosed for \$\_\_\_\_\_.  Bill us.

Name (Print) \_\_\_\_\_

Title \_\_\_\_\_

Company \_\_\_\_\_

Address \_\_\_\_\_

City/Province \_\_\_\_\_

State/Country \_\_\_\_\_

Zip or Postal Code No. \_\_\_\_\_

**QUANTITIES ARE LIMITED. PLACE ORDER TODAY!**

# Product index

**Information Retrieval Service.** New Products, Evaluation Samples (ES), Design Aids (DA), Application Notes (AN), and New Literature (NL) in this issue are listed here with page and Reader Service numbers. Reader requests will be promptly processed by computer and mailed to the manufacturer within three days.

Category	Page	RSN	Category	Page	RSN	Category	Page	RSN
<b>Components</b>			driver, LCD			124 <b>333</b>		
audio indicator	149	<b>109</b>	frequency divider	120	<b>321</b>	<b>Packaging &amp; Materials</b>		
capacitors	147	<b>96</b>	isolators, DIP	7	<b>5</b>	breadboards	125	<b>70</b>
capacitors	55	<b>33</b>	opto-electro			cabinets	137	<b>83</b>
capacitors, ceramic	113	<b>59</b>	designers kit	112	<b>57</b>	connectors	III	<b>231</b>
capacitors, Rubycon	39	<b>21</b>	PLL, CMOS	120	<b>329</b>	connectors	141	<b>379</b>
cartridge light	139	<b>85</b>	photodiode			connectors	148	<b>97</b>
circuit breakers	74	<b>37</b>	designers kit	112	<b>58</b>	connectors, flat cable	139	<b>88</b>
circuit protectors	33	<b>20</b>	photodiodes	120	<b>325</b>	enclosures	141	<b>89</b>
components,			switch, FET	122	<b>330</b>	ferrite beads	93	<b>46</b>
photoelectronic	151	<b>113</b>	transistors, power	120	<b>323</b>	flat springs	121	<b>65</b>
display, alphanumeric	1	<b>2</b>	transistors, power	124	<b>334</b>	foam, polyurethane	149	<b>111</b>
FETs	50	<b>30</b>	$\mu$ P slice, 4-bit	5	<b>17</b>	interconnection sys.	19	<b>13</b>
fiber optics	15	<b>10</b>	<b>Instrumentation</b>			label dispenser	138	<b>375</b>
fuses	152	<b>99</b>	analyzer, freq response	16	<b>11</b>	labeling particles	138	<b>376</b>
LEDs	124	<b>68</b>	counter	144	<b>389</b>	plugs	143	<b>90</b>
meter	11	<b>9</b>	DMM, 5-1/2-digit	129	<b>73</b>	sockets, high-temp	138	<b>373</b>
meter	124	<b>69</b>	data generator	142	<b>384</b>	solder kits	151	<b>114</b>
photodetectors	54	<b>32</b>	data logger	142	<b>381</b>	<b>Power Sources</b>		
photodiodes	118	<b>63</b>	gyros	126	<b>71</b>	batteries	132	<b>76</b>
potentiometer	126	<b>336</b>	instrumentation			power supplies	10	<b>8</b>
potentiometers	II	<b>130</b>	recorders	110	<b>56</b>	power supplies, dc	145	<b>391</b>
potentiometers	128	<b>340</b>	logic analyzer	25	<b>124</b>	power supply	42	<b>23</b>
power transistors	20	<b>14</b>	oscilloscopes	144	<b>387</b>	power supply, dc	145	<b>392</b>
relays, solid-state	127	<b>72</b>	panel counter	154	<b>121</b>	transformer, isolator	145	<b>393</b>
relays, 30-A	117	<b>62</b>	recorder, servo	139	<b>86</b>	<b>new literature</b>		
resistors	128	<b>342</b>	recorder, waveform	142	<b>383</b>	a/d, d/a converters	152	<b>446</b>
switch	53	<b>31</b>	recorders, strip-chart	144	<b>94</b>	calculators	150	<b>438</b>
switch, bidirection code	136	<b>80</b>	signal generator	98	<b>117</b>	cermet trimming pots	150	<b>439</b>
switch, slide	136	<b>81</b>	spectrum analyzer	83	<b>39</b>	computer systems	152	<b>449</b>
switches, DIP	126	<b>339</b>	spectrum analyzer	144	<b>390</b>	computing modules	152	<b>448</b>
switches, keyboard	122	<b>66</b>	storage scopes	45	<b>24</b>	connectors	150	<b>434</b>
switchers, open-frame	63	<b>36</b>	temperature probe	142	<b>382</b>	DIP relays	152	<b>492</b>
switches, PCB	31	<b>19</b>	tone generator	84	<b>44</b>	elastomer gaskets	152	<b>490</b>
switches, rotary	114	<b>60</b>	VLF receiver	142	<b>385</b>	IC accessories	152	<b>491</b>
switches, rotary	151	<b>112</b>	VOMs	101	<b>50</b>	instrumentation	150	<b>431</b>
transformers	128	<b>343</b>	video editing equipment	17	<b>12</b>	metallized ceramics	150	<b>437</b>
trimmer, cermet	151	<b>115</b>	<b>Micro/Mini Computing</b>			microwave products	152	<b>493</b>
zeners	138	<b>84</b>	assembler, line			multiple outlet strips	152	<b>495</b>
<b>Data Processing</b>			by line	116	<b>307</b>	optical fibers	152	<b>494</b>
computer	29	<b>18</b>	cruncher, number	118	<b>320</b>	optoelectronics	150	<b>441</b>
controller, process	132	<b>361</b>	drive, floppy-disc	115	<b>301</b>	power supplies	150	<b>433</b>
controllers,			Eurocards, SC/MP	115	<b>302</b>	power transistors	150	<b>445</b>
tape and disc	139	<b>87</b>	recorder, cassette	116	<b>309</b>	quartz crystals	152	<b>450</b>
data-base system	132	<b>362</b>	recorder, cassette	152	<b>98</b>	rf Xistors, hybrids	150	<b>432</b>
data modems	135	<b>79</b>	software, Basic	115	<b>304</b>	solid-state keyboards	152	<b>496</b>
mass storage	132	<b>359</b>	$\mu$ C development system	9	<b>6</b>	spectrum analyzer	150	<b>435</b>
memory, core	129	<b>347</b>	8080 core	99	<b>49</b>	switches	150	<b>442</b>
minicomputer	129	<b>345</b>	<b>Modules &amp; Subassemblies</b>			terminations	150	<b>440</b>
modem	132	<b>357</b>	amp, instrumentation	134	<b>363</b>	thermistor housing	150	<b>436</b>
modem, acoustic	131	<b>349</b>	controls, SCR	137	<b>372</b>	voltage calibrator	150	<b>443</b>
plotter controller	132	<b>360</b>	converter, v/f	134	<b>365</b>	waveguide mixers	150	<b>444</b>
printer	132	<b>358</b>	converters, a/d	97	<b>47</b>	250-MHz counter	152	<b>447</b>
printer, alphanumeric	61	<b>34</b>	converters, a/d	134	<b>78</b>	<b>application notes</b>		
<b>ICs &amp; Semiconductors</b>			correctors, CRT	137	<b>371</b>	CRT displays	148	<b>418</b>
amplifier, power	120	<b>322</b>	encoder, shaft	134	<b>364</b>	capacitors	148	<b>421</b>
COS/MOS	IV	<b>246</b>	module, capacitors	136	<b>367</b>	d/a, a/d reliability	148	<b>416</b>
converter, a/d	124	<b>335</b>	power amplifiers	145	<b>95</b>	digital testing	148	<b>415</b>
DAC, BCD-coded	47	<b>27</b>	power modules	6	<b>4</b>	flat springs	148	<b>420</b>
Darlington	120	<b>323</b>	recorder modules	154	<b>122</b>	motors	148	<b>419</b>
dialer, digital	120	<b>328</b>	relay, solid-state	2	<b>3</b>	phase-noise analyzer	148	<b>417</b>
diodes, p-i-n	120	<b>327</b>						
diodes, zener	120	<b>326</b>						



# Light heavyweights: Amphenol<sup>®</sup> fiber-optic connectors.

**State-of-the-art is our strong point.**

Right now, you can get Amphenol precision fiber-optic connectors for all popular bundle cables. They're simple, easy-to-assemble, and easy-to-use. Also available: optical launchers for source-to-fiber and detector-to-fiber interfacing in panel, bulkhead, or p.c. mount configurations; optical cable splices; multipin connectors; and complete cable assemblies. And new, advanced designs are coming.

**Put our muscle to work for you.** Take advantage of our in-depth know-how in fiber-optic interconnections. Our advanced development lab. And our complete manufacturing capability.

Call (203) 743-9272.  
Or write: Amphenol  
North America Division,  
Bunker Ramo Corporation,  
RF Operations/Fiber  
Optic Marketing, Dept. C77D,  
33 East Franklin Street,  
Danbury, Connecticut 06810.



CIRCLE NUMBER 231

The right idea  
at the  
right time.

**AMPHENOL<sup>®</sup>** **BUNKER RAMO<sup>®</sup>**

In high-voltage CMOS designs...

# To B or to UB? RCA COS/MOS helps with the answer.

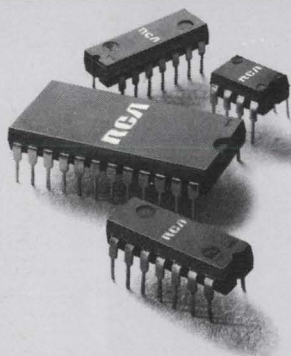

Not all B-Series CMOS is buffered — that's why there's a UB suffix. RCA experience shows that certain designs call for a buffered gate, but in others, unbuffered is better. Only the designer is in a position to decide.

That's why we offer you both. To JEDEC specs. With COS/MOS you don't have to worry about non-interchangeability of "B" devices in applications where speed, noise immunity, output impedance and linear gain-bandwidth characteristics are critical. As the table shows, you can select the COS/MOS option that does what you want in the environment to be faced — without having to add components or compromise on system performance.

Get the RCA B-Series Product Guide from your Solid State distributor. Or RCA.

## Which COS/MOS option is best for your design?

Requirement/environment	Buffered	Unbuffered
High speed		x
Ultra-low frequency		x
High freq., moderate gain, linear amplification		x
High-noise environment, low-speed system	x	
Constant output impedance	x	
Low freq., high gain, linear amplification	x	

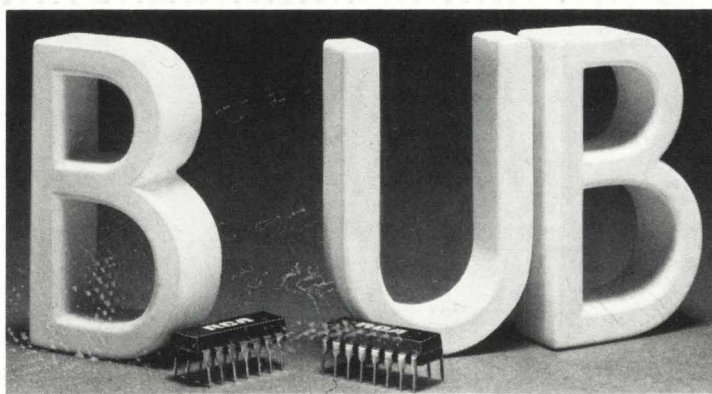

### Buffered B      Unbuffered B

CD4000B	CD4000UB
CD4001B	CD4001UB
CD4002B	CD4002UB
CD4011B	CD4011UB
CD4012B	CD4012UB
CD4023B	CD4023UB
CD4025B	CD4025UB

Write: RCA Solid State, Box 3200, Somerville, NJ 08876; Sunbury-on-Thames, Middlesex TW16 7HW, England; Ste-Anne-de-Bellevue, Quebec, Canada; Fuji Bldg., Tokyo, Japan.

**RCA COS/MOS experience is working for you.**