

Electronic Design 20

VOL. 25 NO.

FOR ENGINEERS AND ENGINEERING MANAGERS

SEPT. 27, 1977

Multi-output or separate supplies:

Which direction is your proper route? Though the guideposts of size, cost and efficiency point to the multiple-output road, beware!

Interacting outputs may bar the way. Secondary outputs having shaky regulation and dissipation specs can derail your system. To map your course, see p. 58.



A New Dial Design...

... beautiful
from any angle.

Any way you look at it, there's beauty and reliability at a low cost in our new Model H-1400 turns-counting dial. From the smooth, high impact tapered plastic design . . . to the big, bold legible numbers . . . this dial will add to the aesthetics of any control panel. But, with beauty being only skin deep, we've put durable long-lasting metal inside where it counts — including the gears and set-screw thread insert. And, the price is just as attractive — only \$4.26* in production quantities!

Send today for complete technical data and discover a beautiful new angle in turns-counting dials — from Bourns, naturally! Direct or through your local distributor.

TRIMPOT PRODUCTS DIVISION, BOURNS, INC. 1200 Columbia Ave.,
Riverside, CA 92507 Phone: 714 781-5123. TWX: 910 332-1252

*Domestic U.S.A. price only, H1411, without brake.



International Marketing Offices: European Headquarters — Switzerland 042/23 22 42 • Belgium 02/218 2005 • France 01/2039633 • Germany 0711/24 29 36 • Italy 02/32 56 88 • Netherlands 70/87 44 00 • United Kingdom 01/572 6531 • Norway 2/71 18 72 • Sweden 764/20 110 • Japan 075/921 9111 • Australia 02/55-0411 03/95-9566 • Israel 77 71 15/6/7

For Immediate Application — Circle 130
or for Future Application — Circle 230

The sweep signal generator world has a new leader to look up to. Model 2002 sweeps from 1 to 2500 MHz in four bands. Or it can sweep the entire range using the band stacking option. It has more flexibility than any broadband sweeper

we've made, along with +13 dBm output, ± 0.5 dB flatness, 0.005% marker accuracy, and $\pm 1\%$ display linearity. Look at the Model 2002 from any angle and you'll become a follower. Send us \$2700 and you'll become an

owner. Circle our reader service number for details. WAVETEK Indiana Incorporated, P.O. Box 190, Beech Grove, Indiana 46107. Telephone (317) 783-3221. TWX 810-341-3226.

WAVETEK[®]
CIRCLE NUMBER 2

The new 2002 will sweep you off your feet.

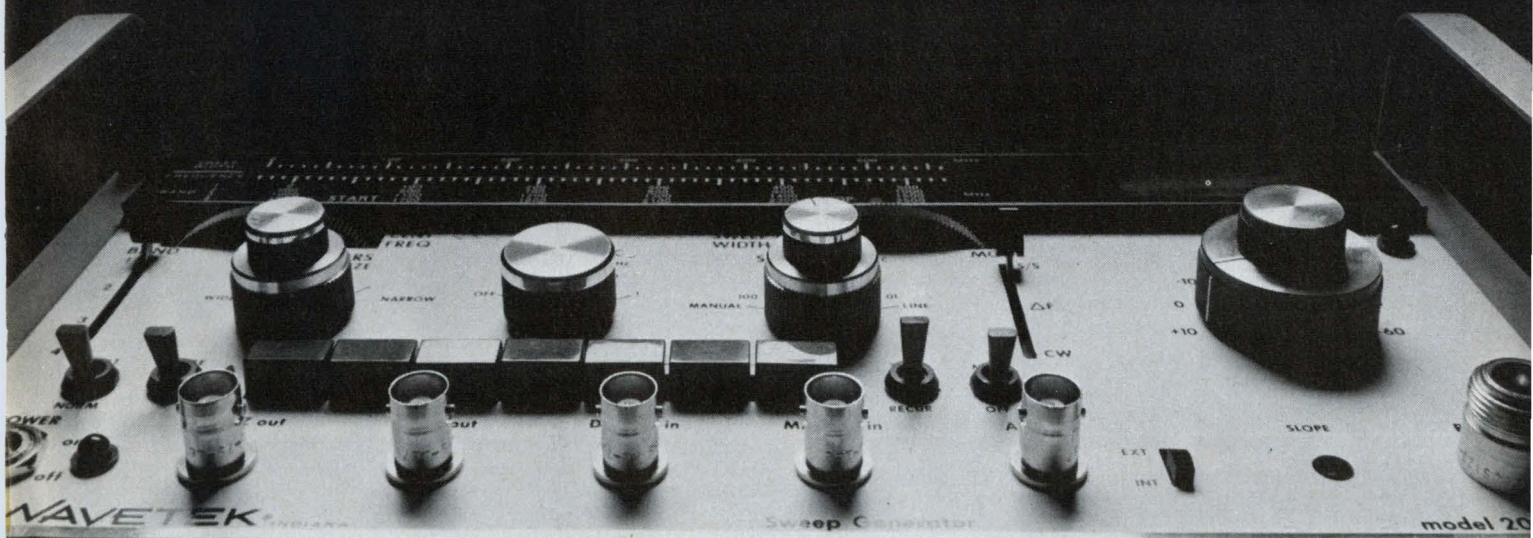

The most significant price breakthrough in DOUBLE-BALANCED MIXERS!

...from Mini-Circuits of course!

\$2.95

500 pieces

\$3.95 (10-49)



Model SBL-1

Model SBL-1, metal case, non hermetic-seal

Frequency Range, MHz

LO 1-500 RF 1-500 IF DC 500

Conversion Loss, dB	Typ.	Max.
One Octave from Band Edge	5.5	7.5
Total Range	6.5	8.5

Isolation, dB	Typ.	Min.
Lower Band Edge to LO-RF	50	35
One Decade Higher LO-IF	45	30
Mid Range LO-RF	45	30
LO-IF	40	25
Upper Band Edge to LO-RF	35	25
One Octave Lower LO-IF	30	20

Signal, 1dB Compression Level	+1dBm
Impedance, All Ports	50 ohms
Electronic Attenuation Min (20mA)	3dB

Lower Band Edge to LO-RF	Typ.	Min.
One Decade Higher LO-IF	45	30
Mid Range LO-RF	45	30
LO-IF	40	25
Upper Band Edge to LO-RF	35	25
One Octave Lower LO-IF	30	20

Lower Band Edge to LO-RF	Typ.	Min.
One Decade Higher LO-IF	45	30
Mid Range LO-RF	45	30
LO-IF	40	25
Upper Band Edge to LO-RF	35	25
One Octave Lower LO-IF	30	20

Lower Band Edge to LO-RF	Typ.	Min.
One Decade Higher LO-IF	45	30
Mid Range LO-RF	45	30
LO-IF	40	25
Upper Band Edge to LO-RF	35	25
One Octave Lower LO-IF	30	20

Lower Band Edge to LO-RF	Typ.	Min.
One Decade Higher LO-IF	45	30
Mid Range LO-RF	45	30
LO-IF	40	25
Upper Band Edge to LO-RF	35	25
One Octave Lower LO-IF	30	20

Lower Band Edge to LO-RF	Typ.	Min.
One Decade Higher LO-IF	45	30
Mid Range LO-RF	45	30
LO-IF	40	25
Upper Band Edge to LO-RF	35	25
One Octave Lower LO-IF	30	20

Lower Band Edge to LO-RF	Typ.	Min.
One Decade Higher LO-IF	45	30
Mid Range LO-RF	45	30
LO-IF	40	25
Upper Band Edge to LO-RF	35	25
One Octave Lower LO-IF	30	20

Lower Band Edge to LO-RF	Typ.	Min.
One Decade Higher LO-IF	45	30
Mid Range LO-RF	45	30
LO-IF	40	25
Upper Band Edge to LO-RF	35	25
One Octave Lower LO-IF	30	20

Lower Band Edge to LO-RF	Typ.	Min.
One Decade Higher LO-IF	45	30
Mid Range LO-RF	45	30
LO-IF	40	25
Upper Band Edge to LO-RF	35	25
One Octave Lower LO-IF	30	20

Lower Band Edge to LO-RF	Typ.	Min.
One Decade Higher LO-IF	45	30
Mid Range LO-RF	45	30
LO-IF	40	25
Upper Band Edge to LO-RF	35	25
One Octave Lower LO-IF	30	20

Lower Band Edge to LO-RF	Typ.	Min.
One Decade Higher LO-IF	45	30
Mid Range LO-RF	45	30
LO-IF	40	25
Upper Band Edge to LO-RF	35	25
One Octave Lower LO-IF	30	20

For demanding industrial and commercial applications, where low-cost and high-performance are critical; model SBL-1 will fill your need.

Don't let the low price mislead you. As the world's number one manufacturer of double-balanced mixers, Mini Circuits' has accumulated extensive experience in high-volume production and testing, a key factor in achieving a successful low cost/high performance line of products.

The tough SBL-1 covers the broad frequency range of 1-500 MHz with 6 dB conversion loss and isolation greater than 40 dB. Only well-matched, hot-carrier diodes and ruggedly constructed transmission-line transformers are used. Internally, every component is bonded to the header for excellent protection against shock, vibration and acceleration.

Here are some of the steps taken to ensure quality: Every SBL-1 is RF tested two times, every solder connection is 100 per cent inspected under a high power microscope, all transformer leads are double-wrapped, and all components are rated for more than + 85 °C operation. Of course, our one-year guarantee applies to these units.

World's largest manufacturer of Double-Balanced Mixers

Mini-Circuits
MINI-CIRCUITS LABORATORY

A Division of Scientific Components Corp.

2625 East 14th Street Brooklyn, New York 11235 (212) 769-0200
Domestic and International Telex 125460 International Telex 620156

OUR NEW ADDRESS AND PHONE NO. IS:

WE'VE GROWN

Customer acceptance of our products has been so overwhelming, we've been forced to move to larger facilities — THANKS.

International Representatives: AFRICA: Afitra (PTY) Ltd. P.O. Box 9813, Johannesburg 2000, S. Africa. AUSTRALIA: General Electronic Services, 99 Alexander Street, New South Wales, Australia 2065. ENGLAND: Dale Electronics, Dale House, Wharf Road, Frimley Green, Camberley Surrey. EASTERN CANADA: B.D. Hummel, 2224 Maynard Avenue, Utica, NY 13502 (315) 736-7821. FRANCE: S.C.I.E. - D.I.M.E.S. 31 Rue George - Sand 91120 Palaiseau, France. GERMANY, AUSTRIA, SWITZERLAND, DENMARK: Industrial Electronics GMBH 6000 Frankfurt/Main Klüberstrasse 14 West Germany. INDIA: Gaekwar Enterprise, Kama Mahal, M.L. Dananukar Marg, Bombay 400 026, India. ISRAEL: Vectronics, Ltd., 69 Gordon Street, Tel-Aviv.

Israel. NETHERLANDS, BELGIUM, LUXEMBOURG: Coimex Veldweg 11, Hättem, Holland. NORWAY: Datamatik AS, Ostensjoveien 62, Oslo 6, Norway. SINGAPORE & MALAYSIA: Electronics Trading Co. (PTE) Ltd., 87 Bukit Timah Road, Singapore 9, Malay-Peninsula. SWEDEN: Integerad Elektronik AB, Box 43, S-18251, Djursholm, Sweden.

U.S. Distributors: NORTHERN CALIFORNIA: Cain-White Co., Foothill Office Center, 105 Fremont Avenue, Los Altos, CA 94022 (415) 948-6533. SOUTHERN CALIFORNIA, ARIZONA: Crown Electronics, 11440 Collins Street, No. Hollywood, CA 91601 (213) 877-3550.

NEWS

- 23 **NewsScope**
- 28 **Faster modems and terminal equipment** are helping to spur data communications.
- 32 **The latest talking and Braille calculators** are serving the blind, but for a high price.
- 45 **Washington Report**

TECHNOLOGY

- 58 **FOCUS on multiple-output dc supplies:** Benefits like smaller total packages and lower costs can be offset by problems with output interactions. Total power, regulation and noise should be examined closely.
- 70 **SCR-bridge currents can be complex.** To avoid pitfalls in specifying components use curves based on actual waveforms rather than on theoretical data.
- 76 **Consider polypropylene capacitors:** Low ESRs, correspondingly low DFs and high stability make them better than electrolytics in switching power supplies.
- 84 **Need a high-voltage resistor?** Metal-oxide films offer a variety of styles with tight TCs and excellent stability at values of up to 10 GΩ.
- 90 **Determine wire size with nomograms.** With these two charts you can easily select the right-size wire for system voltage-drop and current requirements.
- 96 **Class E can boost the efficiency** of rf power amplifiers, and keep transistors cool and reliable. You'll save dc power, weight, and money too.
- 106 **Ideas for Design:**
Transformer completely isolates contact without a floating power source. Simple circuit blanks the leading zeros for single-chip DVM/DPM a/d converters.
Wideband vertically mounted microstrip transformer uses little PC-board area. Provide a carriage-return delay for typewriter data terminals with hardware.
- 112 **International Technology**

PRODUCTS

- 115 **Modules & Subassemblies:** Two-speed s/d converter yields 20 bits from a single module.
- | | | | |
|-----|----------------------|-----|-----------------------|
| 118 | Micro/Mini Computing | 136 | Packaging & Materials |
| 122 | ICs & Semiconductors | 142 | Instrumentation |
| 128 | Components | 146 | Power Sources |
| 132 | Data Processing | | |

DEPARTMENTS

- | | | | |
|-----|--------------------------------|-----|----------------------------|
| 55 | Editorial: Don't listen | 160 | Advertisers' Index |
| 7 | Across the Desk | 162 | Product Index |
| 148 | Application Notes | 162 | Information Retrieval Card |
| 149 | New Literature | | |
| 150 | Vendors Report | | |

Cover: Photo by Marty Sauber, courtesy of Lambda Electronics Corp.

ELECTRONIC DESIGN is published biweekly except 3 issues in July by Hayden Publishing Company, Inc., 50 Essex St., Rochelle Park, NJ 07662. James S. Mulholland Jr., President. Printed at Brown Printing Co., Waseca, MN Controlled circulation postage paid at Waseca, MN and New York, NY, postage pending Rochelle Park, NJ. Copyright© 1977. Hayden Publishing Company, Inc. All rights reserved. POSTMASTER: Please send form 3579 to ELECTRONIC DESIGN, P.O. Box 13803, Philadelphia, PA 19101.

VICTOREEN WRAPS HIGH VOLTAGE PERFORMANCE IN SLIM-MOX PACKAGES.

Victoreen's SLIM-MOX is the small, flat substrate, high voltage resistor that saves you space with no sacrifice in performance.

That's because small size is only one of many SLIM-MOX features.

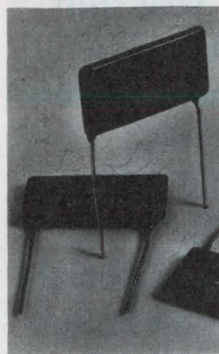

Designed into your high voltage circuits, SLIM-MOX will deliver better long term stability. You will appreciate its small temperature co-

efficients over a wide temperature range.

Switch to SLIM-MOX, the rugged and highly stable resistor now available in an expanded resistance range — 1 to 5,000 M. Tolerances to 1%.

Standard values are available from stock. And at any value, Victoreen quality is a built-in SLIM-MOX virtue. Find out for yourself by using SLIM-MOX wherever you need to save space in high voltage circuitry. Wherever stability and reliability are key performance characteristics.

Victoreen Instrument Division,
Sheller-Globe Corporation,



SHELLER-GLOBE CORPORATION

10101
Woodland
Avenue,
Cleveland,
Ohio 44104

RESISTOR SPECIFICATIONS			
Model	SLIM-MOX 204	SLIM-MOX 208	SLIM-MOX 308
Resistance Range	1M- 5,000M	2M- 5,000M	5M- 5,000M
Critical Resistance	50M	56.25M	64.8M
Power Rating at 70° C	2W	4W	5W
Maximum ² Operating Volts	10,000V	15,000V	18,000V
Available Tolerance	1% 5% 15%	1% 5% 15%	1% 5% 15%
Max. Surface Temp.	150°C	150°C	150°C

²Applicable above critical resistance

MAXIMUM DIMENSIONS (inches)			
Model	204	208	308
A	1.08	2.08	2.08
B	.59	.59	.89
C	.145	.145	.145
D	.860	1.885	1.885

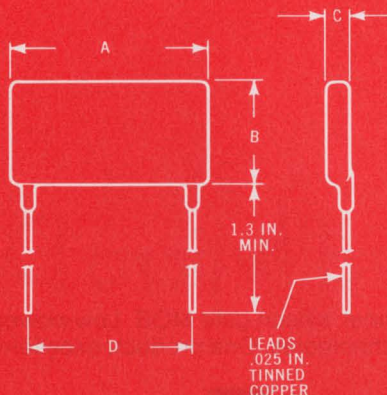

Sr. Vice President, Publisher
Peter Coley

Editors

Editorial Offices
50 Essex St.
Rochelle Park, NJ 07662
(201) 843-0550
TWX: 710-990-5071
(HAYDENPUB ROPK)
Cable: Haydenpubs Rochellepark

Editor-in-Chief George Rostky

Managing Editors:
Ralph Dobriner
Michael Elphick

Senior Associate Editor
Stanley Runyon

Associate Editors:
Sid Adlerstein
Dave Bursky
Morris Grossman
Gene Heftman
Andy Santoni
Max Schindler

Contributing Editors:

Peter N. Budzilovich, Jules H. Gilder,
John Kessler, Nathan Sussman

Editorial Field Offices

East

Jim McDermott, Eastern Editor
P.O. Box 272
Easthampton, MA 01027
(413) 527-3632

West

Dick Hackmeister, Western Editor
8939 S. Sepulveda Blvd., Suite 414
Los Angeles, CA 90045
(213) 641-6544
TWX: 1-910-328-7240
Dave Barnes, Western Editor
465 S. Mathilda, Suite 302
Sunnyvale, CA 94086
(408) 736-6667

Editorial Production

Marjorie A. Duffy, Production Editor
James Keane, Copy Editor

Art

Art Director, William Kelly
Richard Luce, Anthony J. Fischetto

Production

Manager, Dollie S. Viebig
Helen De Polo, Nancy Hurey

Circulation

Director, Barbara Freundlich

Information Retrieval

Paula Greenleaf

Advertising Promotion

Judith Nappo

Reprints

Maxine Correal

Across the desk

Differing outlooks

As a rule, I enjoy your "Challenges to the Engineer Who Manages." However, the article by and about Dave Methvin (ED No. 11, May 24, 1977, p. 206) was most unenjoyable. The picture I am left with is that this man believes that making money is not only the most important thing but the only thing an engineer should be concerned with. Methvin says, "We want to let them (the engineers) make mistakes," as if the object of engineering is a quick, dirty and cheap product while the object in life is to make a buck at any sacrifice.

W. Thomas Adams

11608 Broad Oak
Austin, TX 78759

The opinions Dave Methvin expressed in the May 24 issue of ELECTRONIC DESIGN reveal his position as clearly as did the 10 months I spent working for him at Computer Automation. Another man might have soft-pedaled the less than humanistic attitudes that he believes are necessary to "...help the company become as profitable as he can..." But Dave Methvin soft-pedals nothing.

I left Computer Automation after less than a year because I resented the lack of concern for human values that resulted from Dave Methvin's philosophy. When the president of a company reacts to a sign on an engineer's desk by thinking, "Dammit, I'll kill that guy," he reveals the level at which he relates to his employees.

At the time I left Dave Methvin's employ, I considered his policy toward engineers exploitive. I believed that the

unpleasant environment he had created would lead the company to failure. I guess I was wrong. Business is booming. But then, maybe there's a kind of failure that doesn't show up on a profit-and-loss statement.

Bill Berger

Member of Technical Staff

Rockwell International
Anaheim, CA 92803

Regarding Dave Methvin's evaluations of engineering: Simpler systems are easier to understand and should be more reliable. However, given the ratio of software cost and performance to hardware cost and performance, no engineer should be unconscious of the end-user requirements, if at all possible. As a software professional who also dabbles in hardware, I believe that the point about leaving out \$5.00 worth of parts is that when done in the right places it makes a machine more useful. Not only that, but architecturally sound, basic conveniences can save thousands of man (people) hours of just plain misery.

Michael J. Viehman

1323 Locust
San Diego, CA 92106

Can't find the error

R.W. Ulrickson's "Real-Time Systems Often Use Interrupts" (ED No. 10, May 10, 1977, p. 80) describes a checksum algorithm that uses modulo 2^n summation of the n-bit data words. But if carries are ignored, a double-bit error

(continued on page 8)

Electronic Design welcomes the opinions of its readers on the issues raised in the magazine's editorial columns. Address letters to Managing Editor, Electronic Design, 50 Essex St., Rochelle Park, NJ 07662. Try to keep letters under 200 words. Letters must be signed. Names will be withheld upon request.

BIG POWER SUPPLIES



IN LITTLE PACKAGES

**AC-DC and DC-DC
miniaturized power converters
that deliver 3.9 watts
per cubic inch.**

- AC inputs: 115-220 VAC, 47-500 Hz.
- DC inputs: 12, 28, 48, 115 & 150 VDC.
- 1 to 6 isolated and regulated DC outputs from 4.2 to 300 VDC.
- Line and load regulation to 0.1%.
- Up to 800 watts per output.
- Efficiencies to 85%.
- Design-As-You-Order construction from standard sub-modules . . . over 1200 possible configurations.
- Completed converters provided in tested and encapsulated, conduction cooled packages in just days.

See for yourself how we've packed the power and performance in . . . request our actual size "little black box" punch out kit and catalog today!

Call us collect . . . ask for Jim Dunn.



ARNOLD MAGNETICS CORPORATION

11520 W. Jefferson Blvd.
Culver City, Ca. 90230 • (213) 870-7014

CIRCLE NUMBER 5

Across the desk

(continued from page 7)

in which two most-significant zeros are changed to ones results in an undetectable error. By summing modulo 2^n-1 (adding carries end-around), more unidirectional errors can be detected. If end-around carries are used, an 8-bit checksum on a 255-byte data record detects $100-2 \times 10^{-73}\%$ of all multiple unidirectional errors, but only 86.4% if carries are ignored.

Most processors have convenient instructions for adding the carry bit to the usual modulo 2^n sum. With end-around carry, a word of all zeros changed to all ones or vice versa is not detectable. But this type of error is not very likely to occur.

Alan M. Usas

Member of Technical Staff

Bell Laboratories
600 Mountain Ave.
Murray Hill, NJ 07974

Mr. Ulrickson replies:

The checksum example is intended to show the beginning programmer one method of error detection. Mr. Usas' comment is appreciated—it could have significant value to the more advanced reader.

The real story

Regarding your article on instrument safety standards, (ED No. 9, April 26, 1977, p. 42): Do you really believe that manufacturers—of their own volition—went to Underwriters' Laboratories and asked them to create a standard? Why would established manufacturers of well accepted instruments look for trouble and be willing to pay large sums of money to boot?

I have a different version of how UL 1244 came into being. Our tiny company started late in 1969. In 1970 we contacted UL to determine if a standard existed that would be applicable to test instruments, both ac and battery-operated. No such standard existed—but UL suggested we still submit our instruments for testing and listing.

Inasmuch as no appropriate standard existed for UL to test to, we abstained. I feel that UL realized that a fantastically lucrative source of income was sitting under its nose and therefore started action to generate a

standard to bring in that income.

The financial impact of UL 1244 will be enormous. The many hundreds of manufacturers of test instruments generate many thousands of models. Each model will require testing and the enormous cost to the manufacturers will have to be passed on to the customers. The inflationary spiral will continue and the end result will probably be that many small businesses disappear.

Merrill Callum
President

Bio-Design, Inc.
65 Tosca Drive
Stoughton, MA 02072

Misplaced Caption Dept.



Of course! $E=IR$. I knew it would come back to me if I concentrated long enough.

Sorry. That's Rembrandt Van Rijn's "Faust in His Study," which hangs in the University of Kansas Museum in Lawrence, KS.

Editorial prompts parable

Your editorial, "The Test" (ED No. 8, Apr. 12, 1977), reminds me vaguely of the situation at the Eastern Test Range and of the government service-contract situation. It prompted me to write this parable:

The Contract

John Q. was too busy to paint his own car so he gave Sam (your uncle) \$300 to take care of it. Sam advertised for bids and got estimates of \$150, \$175, \$200, \$10 and \$15. Lest he be accused

of ignoring technical merits, he awarded the job to Charlie's Paint Shop, which at \$15, was not the lowest bidder.

Painter Jack was agitated when Charlie told him to take no more than an hour on John's car. Charlie explained that it was a \$15 level-of-effort as he handed him the roller and the \$1.97 gallon of paint. Jack scurried around the car, painting as carefully and professionally as he could in the time allotted. He hated the results and so did Charlie.

"Your performance just hasn't measured up lately, Jack. I'm afraid there won't be any merit increase this year," Charlie roared, while he was thinking of his profit on the job. Now that he had established Jack's incompetence, he could cut down those irritating requests for a raise.

John Q. was unhappy, too. How could anyone do such a lousy job for \$300? Sam wasn't kicking, though. He had \$285, along with thoughts of trying the \$10 job next time.

Frank R. Leslie

150 Norwood Ave.
Satellite Beach, FL 32937

Switch maker was left out

I have just read your article "Focus on Miniature Switches" (ED No. 6, March 15, 1977, p. 66). I think you did a splendid job in the editorial as well as the illustrations. But you left us out of your report.

The rocker switches on p. 69 are similar to those we manufacture; therefore it would be appreciated if you could mention our name.

Larry Lewis
President

Arcoelectric Corp.
P.O. Box 348
11120 Chandler Blvd.
North Hollywood, CA 91603

Circle No. 318

Misplaced Letter Dept.

The following letter was found by Warren Collier of Tektronix near the podium following a recent meeting of the local computer society. He asked us to publish it as a public service:

Dear Mom,

Just got a job with "Little Giant," a foot-held calculator company. I'll be in

(continued on page 20)

hp MEASUREMENT COMPUTATION NEWS

product advances from Hewlett-Packard

SEPTEMBER 1977

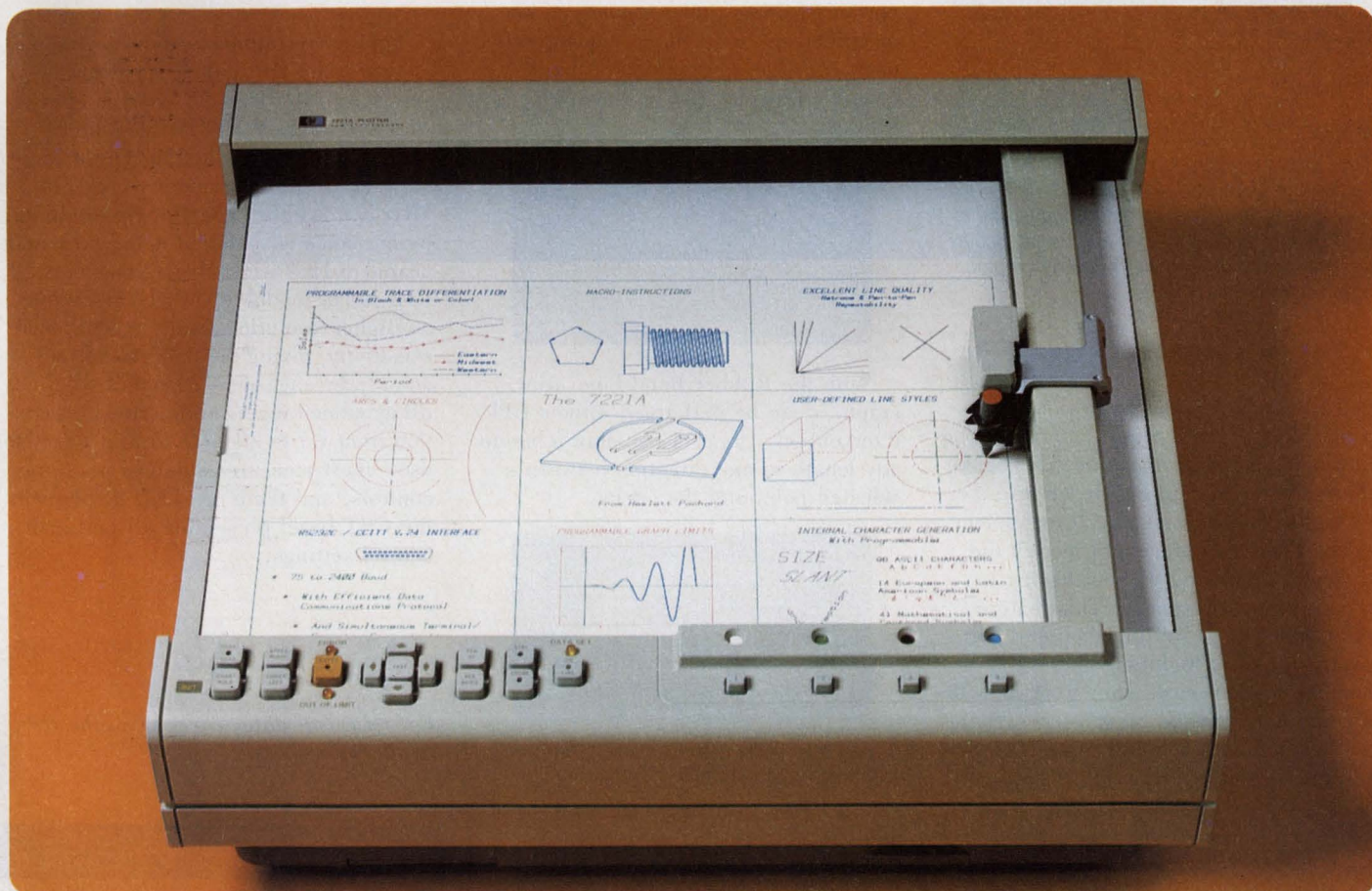

Multicolor plots are especially useful in engineering modeling, plots of more than one measurement, manufacturing production control, numerical control verification, and in wide areas of mathematics, physics, and chemistry.

New buffered plotter presents data in 4 colors, remotely

This new, programmable, microprocessor-based 7221A Graphic Plotter from Hewlett-Packard produces low cost, multicolor and high quality graphic plots from remote processing facilities.

Convenient and flexible operation of the terminal plotter is achieved through high-level commands designed to reduce the cost of data communications.

A built-in buffer allows the 7221A to store approximately 1150 eight-bit data bytes and can be expanded to 3080 bytes as an option. This saves time share computer and transmission costs since the computer no longer has to wait for the plotter to execute instructions. Portions of

the buffer storage can also be reallocated to store up to 64 user-defined macro-instructions. These can be frequently used shapes, such as a logo-type, and can be invoked at any time by a single command.

Six resident character sets, including three European and Latin American sets, and miscellaneous mathematical and centered symbols with program control of
(continued on third page)

IN THIS ISSUE

First SOS μ P product • Extensive triggering in new logic analyzer • Interactive graphics terminal

New graphics terminal has interactive alphanumeric capabilities, too

Spectrum analysis with 100 or 300 Hz resolution with new option

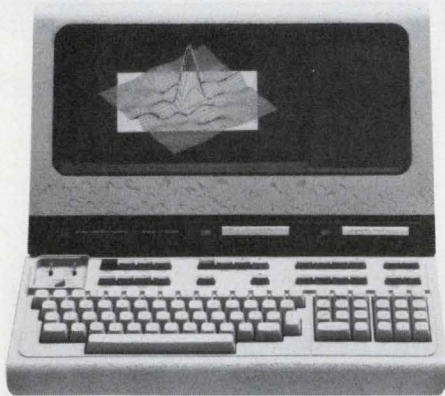

The latest in microprocessor and raster scan technology are combined in Hewlett-Packard's new 2648A Graphics Terminal to produce a high performance, low-cost and bright display terminal that aids the user in many graphic application areas.

Easy-to-use and flexible, the 2648A allows the user to explore new concepts and try out new ideas in two or three dimensional picture representations. The terminal's many advanced features make these representations easy to achieve. For example: the display-refresh technology enables users to erase and modify the display selectively, without having to redraw the entire image. This feature minimizes user's waiting time and CPU overhead, while reducing communications costs when working with a computer network.

Raster scan technology gives the terminal a continually bright display that is easy to read even in well lit work areas.

Not only can the terminal generate sophisticated graphics, it also has those characteristics of HP's data entry and communications terminals that make programming so much easier. And, dual mini cartridges provide mass storage capability.

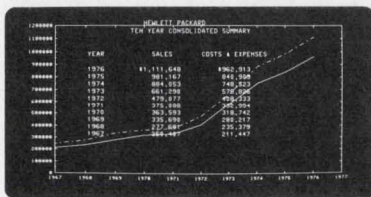

Even with little or no programming knowledge, you can Auto-Plot tabular data automatically. Enter your data parameters on the keyboard; a single keystroke plots the data instantly.

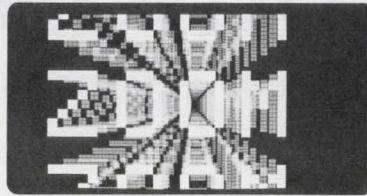

Hardware Zoom and Pan allows any portion of the graphics memory to be magnified up to 16 times. Concurrently, users may pan any portion of the magnified display not in the viewing window.

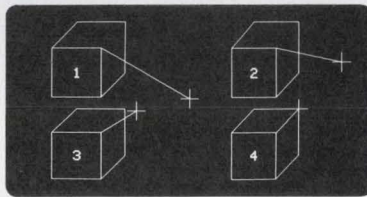

With the Rubber Band Line, trial graphics can be performed without CPU intervention. The user can draw a line to any length in any direction between a selected point and the cursor.

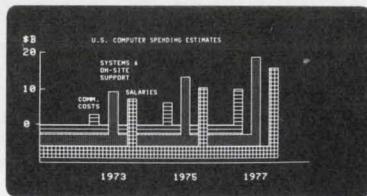

Added visual dimension to graphics is achieved through Rectangular Area Shading which enhances the shading of parts and assemblies, and facilitates differentiation of similar bar graphs.

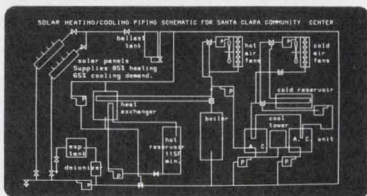

Graphic Text Composition allows the user to select a character size, direction and slant within the graphics memory. This can be especially useful for labeling axes and adding notes or comments to the picture before it is committed to a hard copy device.

For more details, check G on the HP Reply Card.

For high resolution in microwave signal analysis, the HP 8565A Spectrum Analyzer (10 MHz—22 GHz) is offered with 100 Hz and 300 Hz resolution bandwidths as a new option. These are in addition to the instrument's 1 kHz to 3 MHz bandwidths. The 100 Hz resolution performance is specified to 8.5 GHz and usable to 12.9 GHz. Measurements at 22 GHz can be made with 300 Hz resolution.

Higher resolution results in 10 dB more sensitivity, giving the 8565A analyzer an amplitude range of -120 to +30 dBm, 70 dB dynamic range, and internal preselection from 1.7 to 22 GHz. And it's easy to use—most measurements use just three controls, and there are LED displays in the CRT bezel presenting all pertinent control settings.

For technical data, check O on the HP Reply Card.

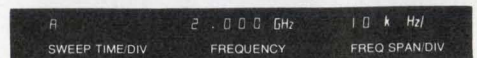
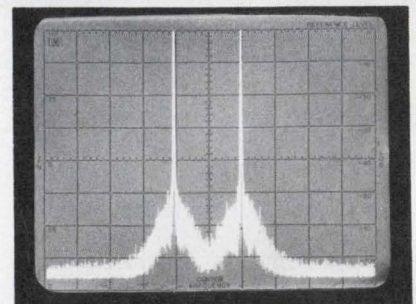

The HP 8565A spectrum analyzer's stability and low noise sidebands ensure full use of 100 Hz resolution, as shown in this two-tone intermodulation test.

New financial calculator evaluates and prints investment alternatives

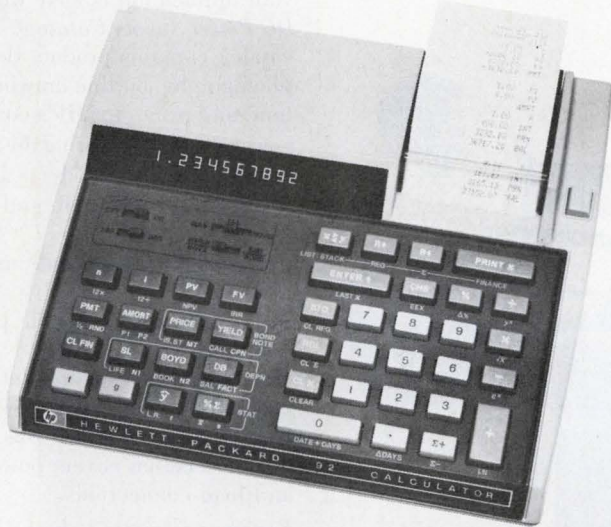

Whether you're printing amortization and depreciation schedules, or listing all the cash flows in an Internal Rate of Return problem, the HP-92 Investor gives you that indispensable hard copy for instant analysis or later perusal.

The new Hewlett-Packard HP-92 is a briefcase-sized, financial calculator, — with printer and display. It offers time savings with its preprogrammed functions for institutional investors, financial consultants, and other professionals examining investment alternatives.

The HP-92 Investor solves problems involving time and money. Compound interest. Annuities. Balloons. Internal rate of return for 30 uneven cash flows. Net present value. Bonds and notes. Three kinds of depreciation.

The printer on the HP-92 gives you the answers quickly and quietly—with descriptive labels.

The HP-92 will fit into a standard briefcase and can operate from the rechargeable batteries inside its case. Instant financial analyses are available whether you're at your desk, in a boardroom, even traveling across the country.

The HP-92 Investor solves complicated "real world" problems: time and money calculations; discounted cash flow analysis; percent functions; amortization and depreciation schedules; bonds and notes computation; and statistical functions.

For more details, check B on the HP Reply Card.

New remote terminal plotter *(continued from first page)*

size, slant and direction, combine to provide flexibility and application throughout the world.

Automatic selection of any four colored pens, through program command or front panel control, permits multi-color plotting which proves extremely useful in applications where traces are hard to distinguish or interpret.

Over forty different instructions, including automatic pen selectability, are built in to simplify programming and increase communications efficiency. Point digitizing, labeling, character sizing, programmable graph limits, rotation, and single command arc and circle plotting are

some of the standard instructions.

PLOT/21 user level software support is available for a number of systems and timeshare services. Interface is RS-232C/CCITT V.24 asynchronous serial ASCII, with eight switch selectable baud rates from 75 to 2400 baud.

Excellent line quality and repeatability is retained at all 36 pen speeds, from 1 to 36 cm/s. This results in precise, easy-to-read graphic plots suitable for reports and presentations as well as your more mundane data and graphic needs.

To see more examples of four-color plots, check M on the HP Reply Card.

GHz pulser system for advanced digital design meets your growing needs

Hewlett-Packard's new 8080 system produces precision 300 ps pulses with repetition rates from dc to 1000 MHz. This flexible system is also a digital data generator, producing 16, 32, or 64-bit serial words at up to 300 megabit rates. The 8080 gives you the stimulus capabilities you need for multi-hundred megahertz research and development—in integrated circuits and digital system development, telecommunications research, and fiber optic design.

The system is modular; you choose just the functions you need from a range of pulse and word generating modules. Should testing requirements change, you can easily expand or reconfigure your system to keep it tailored to your application.

Starting simply, for example, with a repetition rate generator and output amplifier, you have a GHz clocking source for subnanosecond logic systems. 300 ps transition times, ECL pulse levels, external triggering, and synchronous gating guarantee high performance and wide applicability. Later a delay generator/frequency divider and a second output amplifier can be added.

For details on this versatile new stimulus system, check Non on the HP Reply Card.

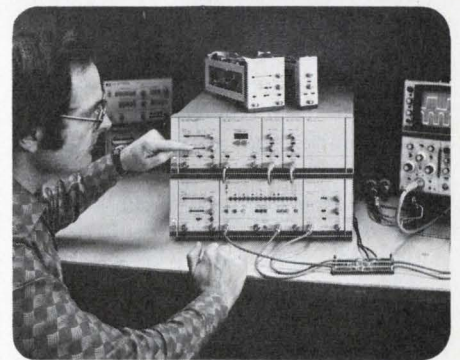

The HP 8080 series is a powerful new 1 GHz pulse and word generator system for subnanosecond rise-time applications. Because of modular capability, you can configure a pulse stimulus system to exactly match your high frequency testing requirements.

"Smart" instrument/computer interface uses HP's new SOS microprocessor

New complete DC power supply catalog from HP

Choosing the right power supply for your application is easy with HP's new *DC Power Supply Catalog*. This 128-page catalog contains product descriptions, photographs, outline drawings, specification, and prices for HP's complete line of power supplies covering the range from 10 watts to 11 kW. Products include:

- General-purpose lab and system power supplies
- Precision voltage and current sources
- Digitally programmable power sources

Included is a section detailing several methods to control DC power supplies using the HP Interface Bus. In addition, another section covers power supply ac and load connections.

For your free copy, check Q on the HP Reply Card.

HP reduces prices on 2 popular counters

HP's highly popular lower priced counters are now more affordable than ever before with a recent 20% price reduction. The counters are the 8-digit 225 MHz Model 5382A and the 9-digit 520 MHz Model 5383A. Their benefits include:

- Direct counting and direct readout to 1 Hz in 1 sec makes it easy to monitor or adjust frequencies to a precise value much faster than by analog techniques or with a low frequency counter and prescaler.
- High sensitivity (25 to 50 mV)
- Stable time base (aging rate <0.3 ppm/mo.) TCXO optional.
- Three position input attenuator
- Rugged metal case, with rack mounting hardware optional
- In the 5383A, input is fused and switchable (50Ω/1 MΩ).

For more details, check K on the HP Reply Card.

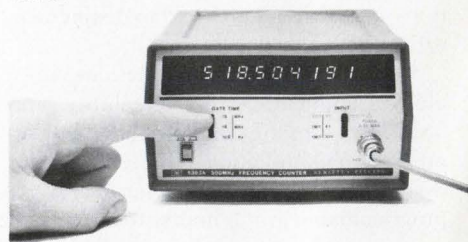

In laboratory testing...



In industrial automation...

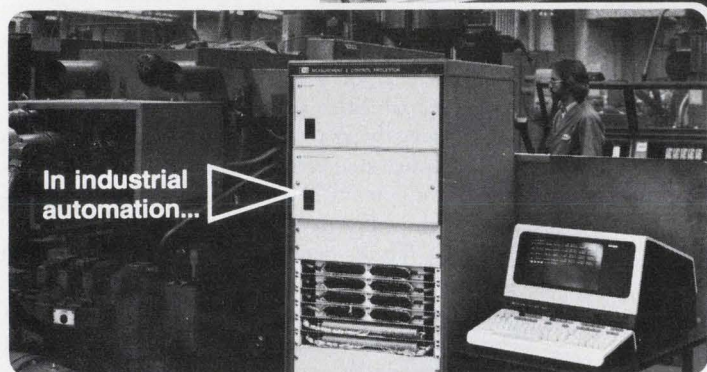

HP-IB

New intelligent analog/digital subsystem simplifies product test, monitoring, and control.

Incorporating HP's new silicon-on-sapphire LSI technology, this microprocessor-based analog/digital subsystem is designed to simplify product testing and real-time monitoring and control. Powerful commands are sent to the HP 2240A with simple FORTRAN, BASIC, or HPL programming statements. It performs measurement and control tasks that your computer previously had to handle, freeing it for other uses and reducing program timing constraints.

The HP 2240A in conjunction with the HP Interface Bus (HP-IB) simplifies task communications and programming. It decouples automation tasks from the computer through its microprocessor intelligence: timing, scanning, event synchronizing, formatting, and interrupt tasks can now be delegated to the HP 2240. And an advanced level of self testing allows you to speed your installation and lower your service costs.

The 16-bit silicon-on-sapphire (SOS) microprocessor, tailored for controller applications, operates at the high speed required for real-time applications, and consumes just half the power of comparable systems. This built-in intelligence, and an industry-standard interface (HP-IB), let you implement measurement and

control solutions in three easy steps:

- **Connect to the computer of your choice.** The HP 2240 operates with any HP-IB compatible computer. With the HP 2240, the HP 1000 and 21MX series computers and HP 9800 series desk-top computers become powerful tools for the acquisition of data and the control of physical and electrical processes.
- **Connect to your measurement and control application.** The HP 2240 accepts both analog/digital inputs and outputs, and several interrupt-driven inputs. Simplify interfacing with industrial sensors common in real-time processes.
- **Give simplified instructions to the HP 2240.** The powerful command set of the HP 2240 is easy to use. When you delegate real-time tasks from the computer, the HP 2240 holds the task instructions in memory and executes them in sequence without further computer interaction—freeing the computer for other operations.

For more information on building your own laboratory data acquisition system, check F on the HP Reply Card.

New 70 dB step attenuators for equipment designs to 26.5 GHz

Two new coaxial step attenuators are available for designers of equipment and systems requiring 26.5 GHz operation.

Both models offer 70 dB range in 10 dB steps. Model 33321D is manual and model 33321K is electrically-actuated. The attenuators use the new APC-3.5 connector to achieve operation dc-26.5 GHz, mode-free, and with high repeatability. (Typically 0.05 dB after 1 million steps.) Typical accuracy is 4% of dB reading at 26.5 GHz where SWR is <2.2.

For equipment designs, the small size will be appreciated. Both models fit a 168 x 52 x 43 mm envelope (6.6 x 2.1 x 1.7

inches). For the programmable version, the 24V, 3 watt solenoids are automatically disconnected after a 20 ms switching time. The manual version uses a cam-actuated design that exhibits a low torque action with a particularly smooth "feel", ideal for front panel use on quality instrumentation.

For additional information, check H on the HP Reply Card.

HP 33321D/K attenuators provide 0—70 dB in 10 dB steps to 26.5 GHz.



New systems ROM gives communication capability to 9825A desktop computer



HP-IB

The new System Programming ROM for the HP 9825A desktop computer enhances its capabilities. Among the capabilities provided by the 98224A ROM are the following:

- Read from a busy input buffer.
- Operate the 9825A via a remote keyboard.
- Simplified access to the R4 registers on the 98036A Interface.
- Dynamically store and modify program lines while a program is running.
- Use the 9825A keyboard as an external peripheral using interrupt.

The 98224A ROM will be useful in the following applications:

Terminal Emulation—allows the 9825A to go on-line to a large computer which supports asynchronous data communication.

High Speed Data Logging—in conjunction with the 9885M Flexible Disk Drive, it is possible to log continuous, periodic

data at rates in excess of 1K bytes/sec. **Redefinition of 9825A Keyboard**—using the keyboard interrupt routines, the keyboard can be treated as an external device with each key being redefined. **Operation of the 9825A in a Remote Environment**—control the 9825A from a remote keyboard, useful if the 9825A is located in a hostile environment.

The 98224A and the Asynchronous Terminal Emulator software package (09825-10040) allows the 9825A to act as terminal to the HP 3000 or other computers that support timesharing via an asynchronous, full duplex line.

For more information, check P on the HP Reply Card.

HP quartz oscillators are available for "do-it-yourself" needs

This family of three, high performance quartz oscillators helps you optimally meet your needs for precise frequency in instrumentation, communication and navigation systems...electrically and physically. The 10544 A/B/C family offers:

AGING RATE is a low 5×10^{-10} /day in all models. These are aged under computer surveillance and are never shipped until that rate is met. So you don't need to age them for months and recalibrate frequently.

SPECTRAL PURITY is excellent, so you can multiply the frequency into the microwave region. Signal to phase noise ratio exceeds 150 dB (for 1 kHz offset) and short term stability is 1×10^{-10} (1 sec. avg. time).

RUGGEDNESS All models are built to withstand field use, and environmental performance is fully specified. One model has shock mount provisions, too.

CONNECTORS Models are available with pc board or feed through connectors.

RELIABILITY We produce these oscillators in large quantity both for systems users and for HP's most accurate electronic counters and frequency synthesizers so we have the large data base necessary for accurate reliability figures. And, they're built to HP's high quality standards, of course.

For more details, check C on the HP Reply Card.

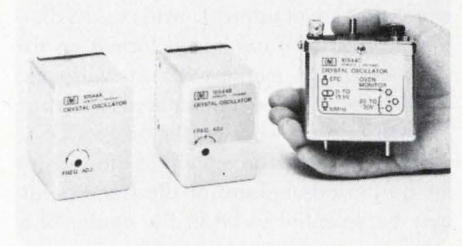

Compactness (72 x 52 x 62 mm), ruggedness, and high performance are key features in this quartz oscillator family.

New logic analyzer traces nested loops to 7 levels with state sequences and 'menu' control



The new HP 1610A logic state analyzer is designed to efficiently test digital systems ranging from the simplest logic circuits to microprocessors and computers. Keystroke retrievable testing and display programs offer such test formats as numerical trace listing, data magnitude versus time graphs, and a comparison between current and stored measurements.

The new HP 1610A logic analyzer offers the most extensive triggering available in a logic state analyzer. New measurement capabilities include a greatly expanded trace specification with up to seven levels of sequential state conditions (state values with multiple occurrences); seven choices of trace qualification; and a state count or time interval which can be acquired and displayed in either absolute or relative modes.

With the easy-to-operate 1610A keyboard, the user can trace events in as many as 32 channels at rates up to 10 MHz, selecting only the particular occurrences, coincidences, or logical sequences that are of interest, with results displayed in a well organized format on the CRT screen. A memory 32 bits wide and 64 bits deep can be commanded to capture everything that went on for 63 clock-periods after the trace point of interest, or for 63 periods before; or the trace point may be selected to be in the center of a trace.

A new "menu" concept allows you to select measurement parameters as they are displayed on the screen. Press a key,

and the screen presents one of two specification menus: a **format specification**, which defines the relationship between the input channels and the display, or a **trace specification** which defines the conditions under which the test data will be captured.

With state sequences, you can directly locate branched, looped or nested forms (or sections) of state flow. Since you can specify each state condition to "occur" up to 65,536 times, you can locate the nth pass of a loop, beginning at a given state.

Not only can the instrument trace and display logic states, it can also measure absolute or relative time intervals between events, it can count events, it has a graph mode for an overview of all 64 words in memory and produces documentation.

For hard copy records, the 1610A is compatible with HP 9866 thermal printers.

For additional information, check D on the HP Reply Card.

Signature analysis proves effective in HP service programs. Possibly yours too!

The HP 5004A Signature Analyzer detects and displays the unique digital "signatures" associated with data nodes in digital products. By comparing actual signatures to correct ones as shown in the appropriate product manual, a technician can backtrace to a faulty node in a malfunctioning product.

By designing Signature Analysis into appropriate new Hewlett-Packard products, we can provide troubleshooting procedures for component-level repair, without dependence on expensive board exchange programs. The results:

- Decreased costs of ownership for end-users.
- Reduced warranty and service support costs.
- Increased confidence in field repair results.

Can Signature Analysis yield these benefits in *your* service operation? HP and over 50 other companies are finding that the answer is "Yes". Some of the digital products currently benefiting from the technique are:

- Computers and peripherals
- Instrumentation
- Communication/navigation equipment
- Industrial and process controls

To learn how signature analysis can make your service operation more efficient, send for the 5004A literature package which includes Application Note 222, *A Designer's Guide to Signature Analysis*. Check J on the HP Reply Card.



Many of HP's new μ P-based instruments and data products utilize the Signature Analysis technique for economical component-level troubleshooting in production and service.

HEWLETT-PACKARD COMPONENT NEWS

First subminiature LED lamps with built-in resistors

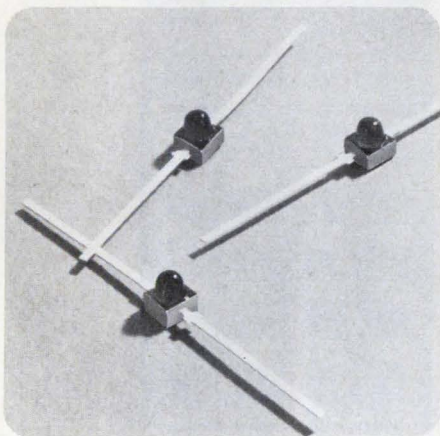

Because of low current requirements and low size, these lamps will be widely used as gate status indicators with DTL, TTL and low power Schottky TTL gates. Manufacturers will also find them an excellent choice as indicator lamps in cameras and portable electronic equipment.

HP offers the first subminiature light-emitting diode lamps with built-in current limiting resistors.

The red 5-volt HLMP-6600/6620 lamps have a current limiting resistor chip built-in with the LED chip, eliminating the need for an external resistor and giving the digital designer a compact package with which to work.

In addition, the lamps contain a reverse protection diode which allows the user to operate the lamp from a 5-volt source without additional biasing components. The diode offers advantages to designers whose circuits may encounter reverse transients and to customers who drive lamps in the pull-up mode.

The lamps may be mounted on .100 inch centers. The nominal forward current for the HLMP-6600 is 10 milliamperes at 5 volts and provides typically 2.4 millicandelas of axial luminous intensity.

Broadband mixer features low loss, high isolation

The new HMXR-5001 is designed for low conversion loss and high isolation across the full 2 to 12.4 GHz RF/LO band, while retaining a wideband IF of 0.01 to 1.0 GHz. Conversion loss is typically 7.5 dB from 1-8 GHz and 8.5 dB from 8-12.4 GHz. LO to RF isolation is typically 30 dB. With only a slight sacrifice in performance the HMXR-5001 can be used up to 18 GHz.

The HMXR-5001 contains hermetically packaged Schottky beam lead quads instead of the chip diodes used in most microwave mixers. For applications where high reliability testing is required, the user can order mixers with screened Schottky diodes. The mixer also uses small semi-rigid cables for transmission lines instead of the stripline configurations found in other mixers.

The combination of sealed diode packages and semi-rigid transmission lines confines the high frequency signal within these components for improved isolation. In addition, this combination allows the use of an epoxy foam to fill the mixer package void and greatly increase mechanical ruggedness.

For more details, check I on the HP Reply Card.



New double balanced mixer is intended for frequency conversion use in electronic surveillance systems, instrumentation and test bench set-ups.

HP lowers price on alphanumeric displays

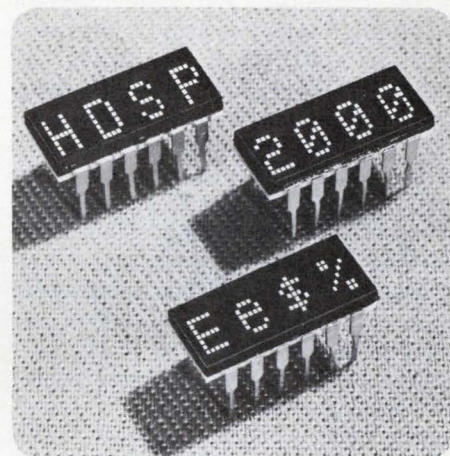

Display the full ASCII character set, upper and lower-case letters, punctuation, mathematical symbols, and numerals with displays now available at reduced prices.

HDSP-2000 alphanumeric, solid-state displays have been decreased in price up to 30%.

The HDSP-2000 is a compact, 5x7 dot matrix display with on-board electronics. By including shift registers and constant-current drivers within the display package, the user can reduce external parts count for a typical 32-character system by a factor of 36 to 1. These low-voltage displays are TTL or CMOS compatible and are readily microprocessor controlled.

Because of their small package size (3.8 mm) and on-board circuitry, HDSP displays are used in applications including interactive point-of-sale devices, hand-held devices, compact mobile communication sets, 'smart' microprocessor-based systems, medical instruments, and portable terminals.

These displays are available immediately through HP's franchised distributors.

For more technical information, check E on the HP Reply Card.

Two new scientific programmables that won't forget. One prints; one doesn't

Both the new HP-19C and HP-29C handheld calculators have Continuous Memory capability so the programs you store are saved, ready for use, until you clear or overwrite them.

As a result, you can program frequently-needed calculations once, and then perform them as often as necessary—hour after hour, day after day—without the bother or lost time caused by reentering your program.

The Continuous Memory not only retains programs, it also retains the data stored in 16 of the 30 addressable registers plus the display register.

You can merge up to four keystrokes in each of the 98 program steps. Thus you can typically store programs of 175 keystrokes or more for those complex calculation problems you face daily.

The high-powered HP-19C and HP-29C easily handle today's sophisticated calculations with advanced programming features including:

- Branching
- Three levels of subroutines
- 8 Conditional tests
- Indirect addressing
- Relative addressing
- Indirect control of data register operations
- Decrement or increment for looping
- Pause function
- Ten labels for programs and subroutines
- And, editing is fast and easy. You can

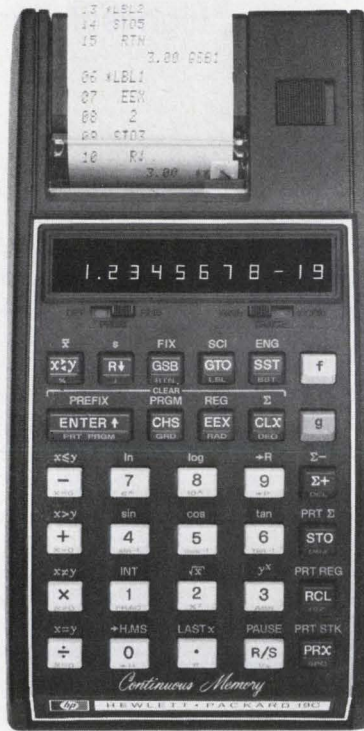

step through your program a step at a time verifying the listing. Operations can be inserted or deleted and all subsequent steps are automatically "bumped" down or moved upward.

With the HP-19C you have the additional advantage of a quiet thermal printer

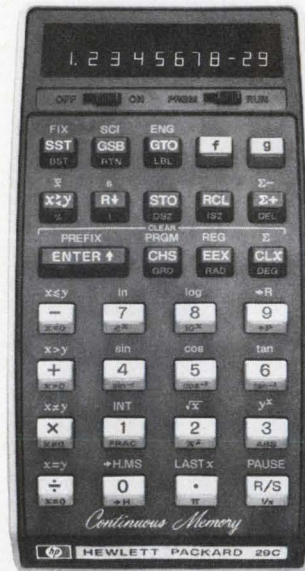

On or off, your programs and data are always ready for instant reuse in two new advanced programmable calculators.

to help you with your editing. You can list your programs or trace executing programs and easily check them for mistakes.

For more information, check A on the HP Reply Card.

East-4 Choke Cherry Road, Rockville, MD 20850,
Ph. (301) 948-6370.
South-P.O. Box 10505, Atlanta, GA 30348,
Ph. (404) 434-4000.
Midwest-5201 Tollview Dr., Rolling Meadows, IL 60008,
Ph. (312) 255-9800.
West-3939 Lankershim Blvd, North Hollywood, CA
91604, Ph. (213) 877-1282.
Europe-Central Mailing Depot., P.O. Box 529,
Amstelveen-1134, Netherlands,
Ph. (020) 47 20 21
Japan-Yokogawa-Hewlett-Packard Ltd., Ohashi
Bldg., 1-59-1 Yoyogi, Shibuya-ku,
Tokyo 151, Ph. 03-370-2281/92.



hp MEASUREMENT COMPUTATION news
product advances from Hewlett-Packard

September/October 1977

New product information from
HEWLETT-PACKARD

Editor: Iona M. Smith

Editorial Offices:
1507 Page Mill Road
Palo Alto, California, 94304 U.S.A.

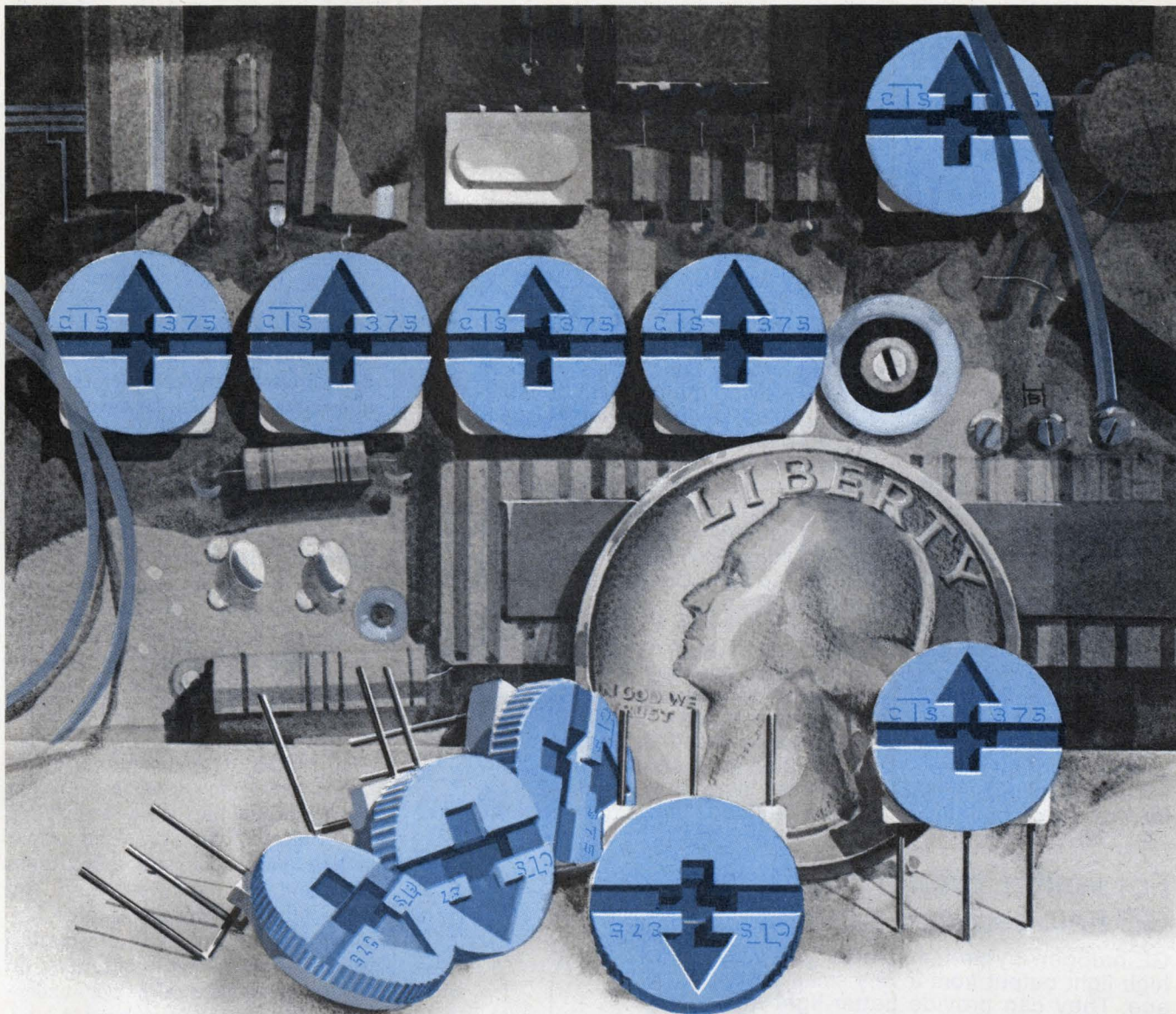

CTS mini cermet trimmers... low in price, high in performance.

Fantastic! Small $\frac{3}{8}$ " dia. (10mm), great performance and CTS reliability are only three reasons you should use our NEW series 375 single turn cermet trimmers. The low 25¢ price tag is still another.

CTS 375's, in six popular terminal styles, feature a low ± 100 ppm/ $^{\circ}$ C standard temperature coefficient—throughout the resistance range. Power rating, 1 watt at 40° C; $\frac{1}{2}$ watt at

70° C. CRV of 2%. Settability of .03%.

And the serrated adjustment knob doubles as a dust cover to protect the element from dirt, oil and other contaminants. It's a lot for so little. But you expect that from a company that's put millions into electronics for industry. For complete information, write **CTS OF WEST LIBERTY, INC.**, 6800 County Road 189, West Liberty, Ohio 43357 or phone (513) 465-3030.

CTS CORPORATION
ELKHART, INDIANA



A world leader in cermet and variable resistor technology.

CIRCLE NUMBER 6

GE miniature lamps offer you gigantic design advantages.

With 11 new wedge base GE lamps, you have more choices than ever.

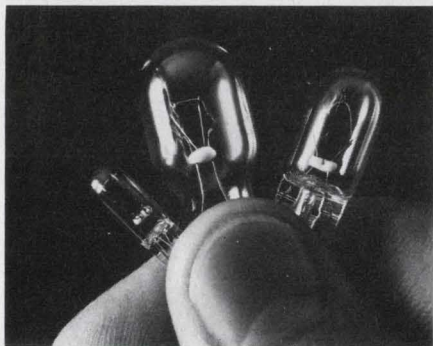

Enjoy new design freedom with this expanded line of GE all-glass wedge base lamps. And keep enjoying the inherent benefits of the line: savings in weight, space, time and costs. GE now offers more than 30 wedge base lamps in three sizes: miniature lamps T-3¼ (10 mm diam.) and T-5 (15 mm diam.); subminiature lamp T-1¼ (6 mm diam.). Voltages range from 2.5 V to 28 V. Candlepower from 0.03 to 21 cd.

Use GE wedge base lamps with confidence for indicator, marker and general illumination applications, especially where space is at a premium. You may enjoy lower systems cost than with metal-based lamps and LED's. They're easy to insert and remove; have no soldered connections to corrode or break; and the filament is always oriented the same in relation to the base.

To start saving with GE wedge base lamps now, send for the latest bulletin on GE's expanded line. Order #3-5259R2. It's free.

For whiter, brighter light use GE halogen-cycle lamps.

GE halogen-cycle lamps offer you very high light output from a very small package. They can provide better light efficiency because the bulb doesn't blacken and because of accurate filament placement. Many have uniform bulb tops (no tip).

You get a whiter light than from comparable incandescent lamps because of higher color temperature operation. And they maintain their high initial output level for virtually the life of the lamp.

Because of their lower electrical power requirements, you also save on operating costs vs. comparable incandescent lamps. Some halogen lamps have long design life for low maintenance costs, too.

You can use GE halogen-cycle lamps with confidence when your design needs call for a lot of light in restricted space. For greatly expanded information on GE halogen-cycle lamps, send for your free copy of the new GE bulletin #3-5257-R.

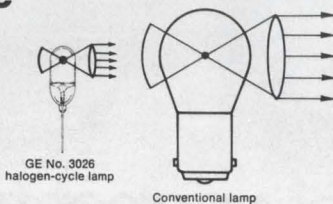

How to order lamp samples and important new free catalogs.

For catalogs and information on how to get lamp samples, call your local GE Miniature Lamp Products Representative or write: General Electric, Miniature Lamp Products Department #3382, Nela Park, Cleveland, Ohio 44112.

GENERAL  ELECTRIC

CIRCLE NUMBER 7

Across the desk

(continued from page 8)

the multiplication division. I wanted a spot in the division division, but they would have had to subtract from the addition division and add to the subtraction division, clear the memory group and get to the root of the multiplication problem.

There was some opportunity for equal work, but I'm not an exponent of changing signs. They've thought about integrating the divisions, but there are some negative factors. To go into the trig division, I'd have to lease an apartment and get a cosiner—but there I go, off on a tangent again!

If I don't try to program this thing, I'll probably become another deviant in the stats division. But enough of this hyperbole! If you can't register here, things will stack up against you. Just the other day, Al Gebraic was bracketed by a Polish fellow, and things reversed in a hurry, I noted. As I recall, a degree is no longer the only way to gain entry here. Some people just radiate.

Of course, if you can convert to metric units, you'll probably be on display most of the time, and won't end up in storage. I do worry about my job getting routine (or even subroutine), but how else do you pass the hours/minutes/seconds? Another factorial determinant of my progression will be whether I get a "theory X" or "theory Y" manager, although I understand they can be interchanged by a single stroke in a key situation.

I'm going to square off against the powers that be, even if I have to fight to the "last X."

Well, I have to "go to" it now, so guess I'll run. I've tried to sum things up as well as I can before I log in on the job. Don't twiddle your digits, and be sure to keep your batteries charged, because you're the MOS.

One last thing: Don't be LED astray by someone who gasps at you. Drinking those liquids could crystalize things in a hurry!

Love,
Junior

We left them out

The "Focus on Semiconductor RAMs" (ED No. 17, Aug 16, 1977, p. 56) inadvertently omitted Rockwell International, Anaheim, CA, as a manufacturer of such devices. For more information

Circle No. 319

Overprotection can affect a CMOS switch for life.

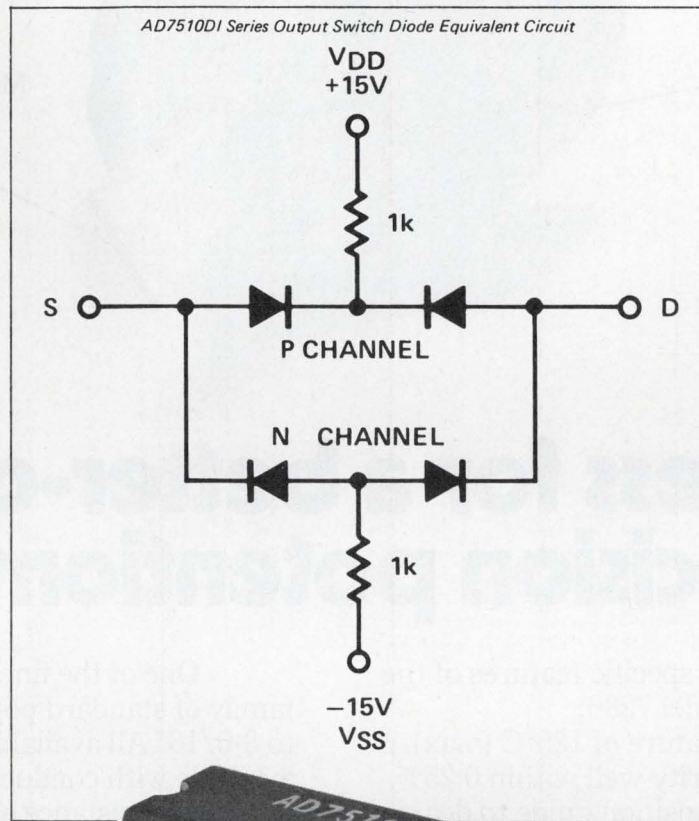

But not Analog Devices' AD7510 family of DI CMOS analog switches. They belong to a whole new generation. With positive overvoltage protection, but without any inhibition on performance.

We accomplished it through a unique design, utilizing "on-chip" resistors in series with the power supply. It provides as much as $\pm 25V$ overvoltage protection. But the resistors only switch in when an overvoltage condition occurs. So normal performance never suffers. And you get both the main assets of an analog switch: a low "ON" resistance of 75Ω and a low leakage current of $400pA$.

The equivalent circuit of the output switch element shows that, indeed, the $1k\Omega$ limiting resistors are in series with the back-gates of the P- and N-channel output devices — not in series with the signal path between the S and D terminals.

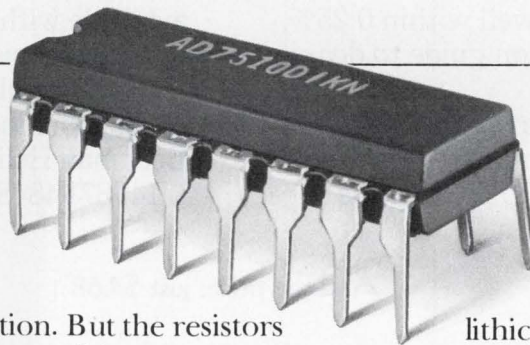

This design, combined with our dielectrically-isolated CMOS fabrication process, prevents

latch-up. And allows TTL/CMOS direct interfacing.

We also included two other measures of security. Silicon nitride passivation to ensure long term stability and monolithic construction for reliability.

Now when it comes to protecting

CMOS switches so they can survive in the real world, Analog Devices knows best. Write for our 8-page technical bulletin on the entire family of DI CMOS protected analog switches, to Analog Devices, the real company in precision measurement and control.

 **ANALOG
DEVICES**

The real CMOS switch company

Analog Devices, Inc., Box 280, Norwood, Massachusetts 02062. East Coast: (617) 329-4700, Midwest: (312) 894-3300, West Coast: (213) 595-1783, Texas: (214) 231-5094. Belgium: 03 3827 07, Denmark: 97 95 99, England: 01/94 10466, France: 686-7760, Germany: 089/53 03 19, Japan: 03/26 36 826, Holland: 076-879251, Switzerland: 022/319704 and representatives around the world.

CIRCLE NUMBER 8

All-plastic case guards
against shorts.

Welded terminations for
superior resistance stability.

Cemented front and rear
casing guards against
solder flux.

Metal slotted shaft and
metal bushing.

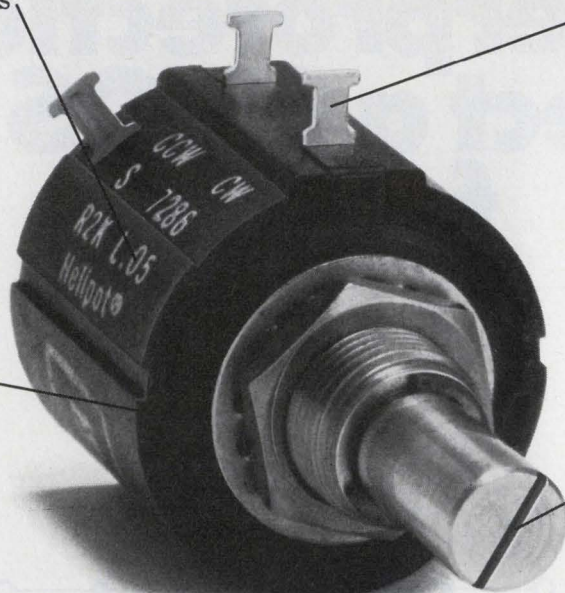

The Beckman 7/8" 10-Turn
Model 7286

Pay less for a better-quality precision potentiometer.

Look at more of the specific features of the
100%-inspected Model 7286:

- Operating temperature of 125°C (max).
- Independent linearity well within 0.25%.
- Separate contact position guide to decrease coil wear.
- Power rating: 2 watts at 70°C.
- Resistance range: 11 standard wirewound versions from 100 ohms to 100K ohms.
- Excellent setting stability.

One of the fine Beckman Helipot®
family of standard pots, in sizes from 7/8"
to 3-5/16". All available in wirewound; many
available with conductive plastic, cermet,
or hybrid resistance elements.

Available for delivery now. To order,
or for more information, call your nearest
Beckman Helipot distributor, or call
(714) 871-4848, Extension 1776.

And the price: just \$4.68*



BECKMAN®

*In the 100-piece quantity.

With rf power alerts, control begins at home

A two-step, radio-frequency transmission system not only totals the power used by home owners during peak, high-rate periods, but also warns them, both audibly and visibly, to cut back. What's more, the system can prevent high-demand water heaters and air conditioners from drawing excessive power from a power utility by disconnecting them via commands from a central station.

The load-management system, which alerts and warns by means of a small receiver-indicator plugged into any convenient wall outlet, is being installed in 3150 homes near Augusta, GA, by the Georgia Power Co. It was developed to reduce the need for additional generating capacity to take care of peak-period load demands.

Designed by Scientific Atlanta for Georgia Power—the system transmits eight bits of monitoring and control information from a central Message Generator Unit over a radius of 25 miles via a 154.4365-MHz FM transmitter. Receivers are located on power-distribution poles, one to each transformer feeding a group of homes.

Each receiver converts the 154-MHz control signals to 200 kHz, 8-bit power-line carrier signals, which are sent on a given transformer's secondary circuit. These signals are picked up in the home by the plug-in alert warning unit and by switching units connected to water heaters and air conditioners.

The Scientific Atlanta 8-bit control code uses five bits for the address field to address up to 32 receivers. The other three bits control electric-meter switching, customer alarms, and shedding high-consumption devices.

These three control bits help the home owner in several ways. For example, a low/high-rate meter controlled by Georgia Power identifies how much power is being used by water heaters, air conditioners, and other high-demand appliances during peak periods.

Five minutes before an established

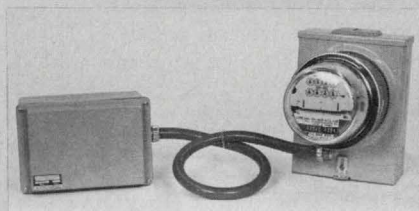

A combination radio receiver/carrier-current transmitter, connected to a standard power meter, warns consumers when they are using too much electrical power.

peak period begins, a command is sent to light an amber light on the customer's wall-outlet alarm unit. This gives him time to shut down his appliances.

When the peak period begins, another command switches the meter register to a second dial that registers a premium-use rate. The alarm box emits a 5-second "beep-beep" like that of auto safety-belt warning systems, while lighting a red indicator. At the end of the peak period, a new command switches the meter register back to the low rate, sounds the 5-second alarm, and turns a green light on.

Other bit combinations are set up to connect or disconnect water heaters and air conditioners, which for now are the only high-energy appliances controlled in the Georgia experiment. Spare control functions are set aside for applications such as space-heater control and for disaster alerts, like calling out volunteer firemen.

Currently, 150 homes are connected to the Scientific Atlanta, with the rest to be linked by the end of this year. Scientific Atlanta is also providing equipment for a Southern California Edison Co. installation serving 12,000 homes in the Los Angeles area. But this system is only capable of load-managing some 22,900 water heaters and air conditioners, since high low-rate meter switching is not included.

Clipped pin protects software from prying eyes

Software written for a microprocessor can be kept secret by storing a small part of the program in the ROM of a single-chip microcomputer, then disabling the ROM's external access pin.

An 8080, for example, can defer some part of its program to an 8048, which can execute the program instructions without making the instructions themselves available to the outside, says Bruce Van Natta, manager of product planning at Imsai Manufacturing Corp., San Leandro, CA. Imsai, which makes small computers for personal and small-business applications, plans to use the technique to provide software to its customers without imposing a software license agreement on them.

Users often ignore license agreements anyway and copy software, notes Seymour I. Rubinstein, Imsai's director of marketing. A supplier cannot simply raise prices to the few who pay for software, or no one will buy it at all, he maintains. "We have to charge a fair price for software, but we have to make back our investment, too," says Rubinstein.

Software protection can also be useful in a microprocessor-based product to keep competitors from copying design techniques.

While the external-access pin of a microcomputer could simply be cut off, inventive users would still be able to attach a wire to the nub that is left, says Van Natta. A better alternative is to purchase a microcomputer with its pin unconnected internally—once the ROM program has been debugged and proven.

Peripheral distributes computer power with cable

A power-distributing peripheral will eliminate the need for installing hard conduit to bring power to each element in a computer installation. Currently, each system element needs to be hard-wired into its own box. Each box has to be fused, and all the peripherals' pipe and conduit wire has to be installed by a union tradesman.

With the power-distributing peripheral introduced by Data Processing Power of Los Angeles, all that is needed is a flexible cable to bring power to wherever it is needed—and anyone can

connect it up.

"An average computer system grows and gets moved around every five years," observes Heinz Zweipfennig, vice president of operations. "A computer power center will eliminate the expense of having to install hard conduit everytime."

Through the power-distribution peripheral, the mainframe and all its peripherals are connected into a single electrical box, like a toaster. Should the system take on more memory, printers, and tape and disc drives, a single flexible cable will bring power to each new unit. Each cable is protected against overload, and all are grounded at a single point.

As an energy-saving option, the computer can command the distributing unit to power-down any peripheral not being used.

To compensate for IR drop along the cable lengths, a voltage-trimming transformer provides taps in 2.5% steps—four steps up and two steps down. These are useful to prepare the system for power "brownouts"—brief voltage reductions of 7 to 10%.

A small operator's panel holds input and output voltmeters, overload alarms and phase-loss flags.

All the elements of the distribution system are UL-approved. The new peripheral is available for system power demands from 15 kVA to more than 125 kVA. Prices vary with individual requirements, but a median 75-kVA unit costs \$12,000.

Heat pipe may replace heat sink in power semis

Bulky heat sinks now required by high-power semiconductors may soon become obsolete. Thanks to a new cooling method, transcalent (heat-transfer) semis from RCA's Solid State Div., Lancaster, PA, are 75% smaller and more than 85% lighter than hockey-puck and stud-mounted semiconductors using heat sinks.

This cooling technique stems from work done by RCA for the U.S. Army Mobility Equipment Research Command. Instead of a sink, the transcalent semis have an integral heat pipe that is bonded directly to the silicon chip. The pipe contains a capillary tube filled with a heat-transfer liquid.

When the transcalent semi chip is being cooled, the liquid is brought into contact with the surface of the silicon and evaporated. The vapors then rise

in the heat pipe and, as they move away from the heat source, start to condense on the walls of the pipe. The condensed liquid is then returned via the capillary tube to the surface of the semiconductor chip, where the process repeats itself.

The heat pipe extends from the surface of the semiconductor through the case. Circular fins mounted on the external part of the heat pipe help increase heat radiation. It is capable of dissipating as much as 500 W and cooling can be either with air or liquid.

This cooling method is available in three RCA devices: a 250-A, 1200-V diode, a 400-A thyristor and a 100-A transistor.

Changing tests as you go improves ATE throughput

The time it takes to test integrated circuits can be cut by more than an order of magnitude by using the computer built into an automatic test system to decide which tests in a sequence are really necessary, and dropping less-productive tests.

In addition, instead of an operator interrupting a test procedure and leaving the system idle for a long time to examine the test results for a sample lot, the computer can quickly determine which set of tests will catch most device failures in the least time. Testing continues almost immediately.

In one instance, test time was cut from 6.63 seconds/device to 0.29 seconds/device, according to Nate Phillips, principal programmer in diagnostic engineering at Digital Equipment Corp., Maynard, MA. Phillips will describe the technique at the Semiconductor Test Symposium in Cherry Hill, NJ, Oct. 25 to 27.

A sequence for testing a bit-slice microprocessor may have as many as 319 tests, says Phillips. On a randomly selected sample of 461 devices, 32 failed one or more of these tests. The 32 bad devices failed a total of 71 different tests.

But many of the bad devices failed the same two or more tests. With the test system's computer optimizing the test program, nine tests were identified as enough to have uncovered all of the bad devices.

On the remaining 525 devices in the lot, only those nine tests were performed. Of the 525, 31 failed and 494 passed. In the lot of 494 so-called good parts, four were found to be defective

when the complete set of 319 tests was run.

The number of devices selected for the sample lot is chosen to achieve a given acceptable quality level, says Phillips. First, all tests are run on the sample. Then the automatic test system is ready to test the remaining integrated circuits. "There's a large set of tests, and I'm looking for the tests that will pick up the most failures in the least time," says Phillips.

Some tests don't prove anything, or take too long, he adds.

The greatest reduction in total test time is achieved when the devices are being fed to the test system by an automatic handler, says Phillips. But even when inserting and removing devices by hand, total test time can be cut from as much as 10 seconds/devices to less than four seconds/device.

Devices that have the shortest time in the test socket are generally simple circuits that are already handled by automatic loaders, Phillips points out. Manually inserted and removed chips are often complex parts for which the test itself is relatively long. In either case, cutting the time each device is in the socket can increase the throughput of the tester.

California may get its very own satellite

California will pick NASA's brain to see if space technology can be applied to that state's requirements for communications, navigation, resource management and earthquake prediction. The result could be a state-owned and operated satellite.

The liaison gets rolling this month when former astronaut Russell Schweickart, who, for 10 days in 1969 piloted the Apollo 9 lunar module, begins a year's assignment as Governor Jerry Brown's Special Advisor for Science and Technology.

"We will be looking across the board at space technology for California use," says Schweickart. "It could apply to energy requirements, air-quality management, or educational TV, among other things."

A satellite for California is still a long way off. "We need to take a long, hard look and do a lot of experimental work first," cautions Schweickart. "But if a California satellite makes sense in terms of the over-all needs of the state, we would move aggressively in that direction."

DP Dialogue

Notes and observations from IBM that may prove of interest to the engineering community.



This welder at Ingalls Shipbuilding, has access to an IBM computer to verify that his construction drawings are up to date. Workers and engineers throughout the huge shipyard access a wide range of computer applications through nearby terminals.

Computer Helps Shipbuilders Communicate at Ingalls

In the sprawling 800 acres of one of the largest shipyards in the United States, a welder about to start on a critical assembly may be a mile from the engineering offices. To verify that he is working from the latest drawing, he has access to a nearby computer terminal where he can receive a prompt response from an online System/370 Model 158.

Says Richard Shields, manager of technical and engineering applications for Ingalls Shipbuilding division of Litton Industries in Pascagoula, Mississippi: "The system can help our skilled workers become much more productive."

Litton provides direct access to the computer by means of Time Sharing Option (TSO). This IBM subsystem enables workers in many phases of the shipbuilding process to activate an application through simple terminal procedures.

During the design phase, naval architects and engineers can observe progress and interact directly with the computer to make corrections as they work.

During manufacturing, the computer produces a tape which guides a numerically controlled flame cutter in turning out pieces of flat steel plate. It also helps design the bending templates or fixtures on which the plates are

formed into curved sections of hull.

"We make wide use of numerical control," Shields says, "and through TSO we have a quick and accurate way to define required parts. The parts programmer enters data at a terminal and the computer error-checks it, line by line. Parts programs run correctly the first time, and plate cutters and welders can get revised tapes earlier.

"TSO brings the responsiveness of interactive computing to design and manufacturing. It helps get vital data from the engineers out to the production workers where it's needed, when it's needed."

Computer Model Throws Light on Solar Energy

Converting the sun's radiant energy directly into electricity could contribute significantly to the world's supply of energy. But the associated technical problems are complicated enormously by the fact that the sun's direct radiation is not the only important energy source.

A very significant portion of the energy of the sun is reduced in strength before it can reach the surface of the earth. This visible and invisible light is absorbed and scattered by the atmosphere — its water droplets, dust particles and gases — and the scattered radiation arrives at a solar cell along a nearly infinite number of indirect paths.

At the surface of the earth, explains Dr. J. V. Dave of the IBM Scientific Center in Palo Alto, California, such indirect radiation can range as high as 40 percent of the total energy on sunny days, and 100 percent on mildly overcast days. A system utilizing all available radiation, he points out, can lead to a more efficient harvesting of solar energy under average conditions as encountered at various feasible locations.

Using the computer, Dr. Dave is experimenting with a solar energy model to get a better picture of the total radiation energy arriving at the earth's surface.

"We live at the bottom of a very complex atmospheric soup," he notes, "a mixture of gases, water droplets and suspended particles. The effect of each of



these is different for each wavelength of solar radiation. And the geographical location of the solar cell panel, its altitude and orientation, time of day, season, weather and natural as well as man-made air pollution exert an influence.

"To help estimate the energy output that can be expected from a proposed solar energy system design, we hope to construct a computer model of the diffuse solar radiation in the atmosphere. At present we have completed an experimental model with one simplification: it considers only one orientation of the solar cell—aimed directly overhead, at the zenith. It uses a simplified but realistic representation of the atmosphere.

"By varying the time of day, atmospheric makeup, and other parameters, we have solved the radiative transfer equation for our atmospheric models for several thousands of data points. Taking our simplifying assumption about the orientation of the solar cell into account, these results indicate that the diffuse radiation plays a very significant role in determining the performance of a terrestrial solar cell.

We are now planning for the radiation modeling for an arbitrarily oriented solar cell which requires several million data points."

Important amounts of solar energy reach the earth's surface indirectly, after dispersion in the atmosphere.

Keeping Projects on Target with the Computer

As experienced project managers know, it is one thing to plan—and another to carry out—a big multi-faceted project, such as the development of a space vehicle or the construction of a major new process plant.

Riding herd on an ongoing program means coping with the unexpected: technical problems, loss of key people, tasks which overrun the budgeted money or time.

It is vital to catch such problems early. But even so, many times it is impossible to work out intuitively a solution that keeps everything on track. There are too many variables: precedence relationships, time, cost, and manpower calculations.

IBM offers two computer programs, either of which can be an important aid to project managers: Project Management System IV (PMS IV) and Project Analysis and Control System (PROJACS).

Far beyond the precedence and "i-j" (point-to-point) diagrams which it can generate, each program incorporates proven tools for managing a project in its totality—helping optimize resource allocations and calculating detailed work schedules on the basis of user-supplied constraints. And each assists in continuously monitoring progress against the schedule, budget, and resource requirements.

Each program produces a basic set of

reports, in formats whose usefulness has been proven in hundreds of actual projects. These can be used intact, or they can easily be modified to meet unique reporting needs. Accurate, detailed and timely, the reports reveal incipient problems before they become crises.

Both PMS IV and PROJACS suit a wide variety of engineering and other projects—development of an information or programming system, for example, or installation of a manufacturing facility. The manager of any large-scale phased project, facing a constant stream of difficult problems, will find either IBM program to be a powerful aid in marshaling the decision-making information he needs.

A Cracking Good Sample Tracker

"The online system helps meet our goal of moving all samples through the lab within three to eight days. Manually, it took as long as 20 to 30 days. And we respond promptly to 1,500 phone inquiries a month, retrieving test data on the screen of a terminal while the caller is on the line."

John Brent is manager of the Analytical Control Laboratory in the Davison Chemical Division of W. R. Grace & Company. The computer system he is describing tracks 50,000 samples — over 350,000 analytical determinations—each year. All told, over a six-year period, Brent projects tangible savings attributable to the system of \$100,000.

The laboratory, part of the division's Curtis Bay Works, serves Davison's petroleum refinery customers, who need periodic analyses of catalysts from their cracking units. It also helps perform quality control for chemical production at Davison and supports research activities within the division.

As each sample arrives, a description of tests to be performed is entered through a terminal into the division's IBM System/370 Model 135, 10 miles away in downtown Baltimore.

After a test is completed, results are keyed into a terminal and the computer adds them to the record. The program automatically detects test values outside the expected range and notifies the analyst through the terminal display.

Brent adds: "With the data in the computer, it was simple to program regular reports of the status of work in the laboratory. We get a list of incompleting samples every morning, a breakdown of the lab workload, tables of analysis standards, and a list of samples which have been in the laboratory more than three days.

"Since we installed the system our volume of work in the lab has increased by 24 percent, with no increase in staff."

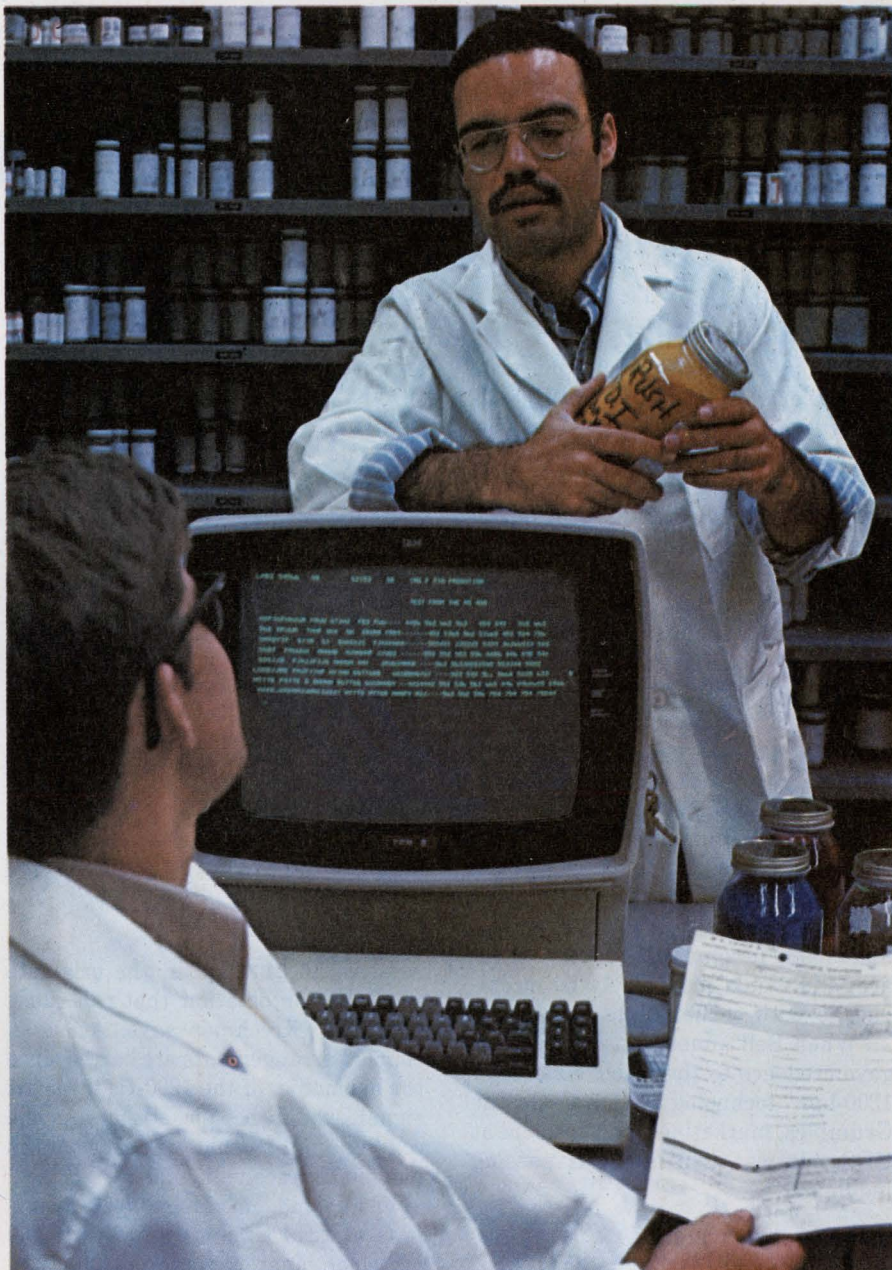

Analysts at Davison Chemical's Analytical Control Laboratory enter a list of the tests to be performed through a terminal in the sample room.

IBM Software Products

These program products are implemented in the user-oriented APL programming language. Each is designed to be operated interactively, through a terminal.

1. APL Statistical Library A set of routines for performing functions widely used in statistical analysis and linear programming.

2. APL General Purpose Simulation System (APL GPSS) Models any

system comprising a series of discrete stages or transaction nodes.

3. GRAPHPAK Generates linear or logarithmic data plots, and fits curves to defined data. A descriptive geometry component scales, translates and displays a projection of three-dimensional objects.

For more information on these Software Products, contact your local IBM branch or write: Editor of DP Dialogue at the address on the right.

DP Dialogue is designed to provide you with useful information about data processing applications, concepts and techniques. For more information about IBM products or services, contact your local IBM branch office, or write Editor, DP Dialogue, IBM Data Processing Division, White Plains, New York 10604.

IBM[®]

Data Processing Division

Faster modems and terminals spur data communications at 1200 bps

Full-duplex digital-communication rates over standard two-wire lines is quadrupling from 300 to 1200 bps. Now that the Bell System's 1200-bps modem, the 212A, is available for lease, manufacturers of modems and terminals are convinced 1200-bps communications will eventually replace 300 bps as the standard.

Before Bell, such firms as Universal Data Systems of Huntsville, AL, and Vadac Corp. of Mt. View, CA had gone ahead and introduced 1200-bps, full-duplex, two-wire modems, but sales were relatively slow. For one thing, the units were incompatible, so users of one couldn't communicate with users of the other. Not only that, but users felt that whatever method Bell used for achieving 1200-bps data rates would most likely become the industry standard, and would most likely be incompatible with earlier units.

"When Bell announced the 212A, it gave credence to the whole concept of 1200-bps technology," says George Grumbles, marketing vice-president at UDS. "It was like the gods passing judgment."

Stirring controversy

But Bell's introduction is not without controversy. Vadac is battling to keep states from writing tariffs that would allow Bell to market the 212A, according to Ken Krechmer, Vadac's national sales manager. So far, few states have permitted commercial use of the 212A, though Bob Hamer, product and services marketing manager at Bell in Morristown, NJ, says tariff applications have been submitted in 22 states and accepted in more than half of these.

The 212A transmits at 1200 Hz and



With the 212A modem Bell has anointed the concept of 1200-bps data communications. Users are helped in making the switch from 300 bps since lower-speed circuitry is also included in the unit.

receives at 2400 Hz in the originate mode—a combination that can cause problems, Krechmer says. Acoustic-coupled arrangements are barred since the harmonics of the 1200-Hz transmit signal would be picked up by the coupler and would appear to the modem as receive signals.

Vadac's modem, Model 3400, transmits at 2250 Hz and receives at 1150 Hz, a combination chosen to eliminate the harmonic problem. "Users have shown a preference for acoustic coupling at 300 bps," says Krechmer, "and it's reasonable to conclude they'll want acoustic coupling at 1200 bps." Vadac has signed an agreement with Anderson Jacobson Inc., San Jose, CA, to develop jointly an acoustically coupled modem. Introduction is expected early next year.

Bell's response is that since 300-bps modems operate at 1200 and 2400 Hz, its 1200-bps modem should operate in the same manner. Bell has tested its technique at 1200 bps and found no problem.

Krechmer also claims that the higher frequency chosen by Bell is

more prone to noise problems. The modulation technique in the 212A that puts digital data on telephone lines is sensitive to phase distortion, which gets worse at higher frequencies. The difference in signal-to-noise ratio between transmissions at 2250 Hz and 2400 Hz is about 3 to 5 dB, he says.

In fact, the higher frequency chosen by Bell may cause the modulation technique to be rejected by the CCITT, an international data-communications standards organization. Telephone lines outside the U.S., which often roll off in frequency response at levels lower than the U.S. standard 3-dB point of 3300 Hz, may not be able to handle the 400 to 600-Hz deviation above 2400 Hz required by the Bell modem.

But, Bell has tested for this problem as well and is satisfied the 212A can operate reliably over common telephone lines. The modulation technique used in the 212A has been submitted to the CCITT, says Hamer, who is confident that the standard will be adopted. "We have reason to believe that frequency is not going to be a factor," he says.

Tying to Bell's lines

However, the 212A's high frequency may require additional tweaking of transmission lines in the U.S., says Krechmer. While it may be relatively simple for a Bell-installed modem, he continues, this tweaking may be difficult or inconvenient for a user-installed modem purchased from an independent source like Vadac.

Hamer responds that Bell System Practices, the handbooks by which telephone installers operate, require that a line meet stringent standards regardless of the maker of the modem. An installer is expected to check out a line and bring it up to par no matter which modem—Bell's or a competitor's—is to

"Light-up" your customers

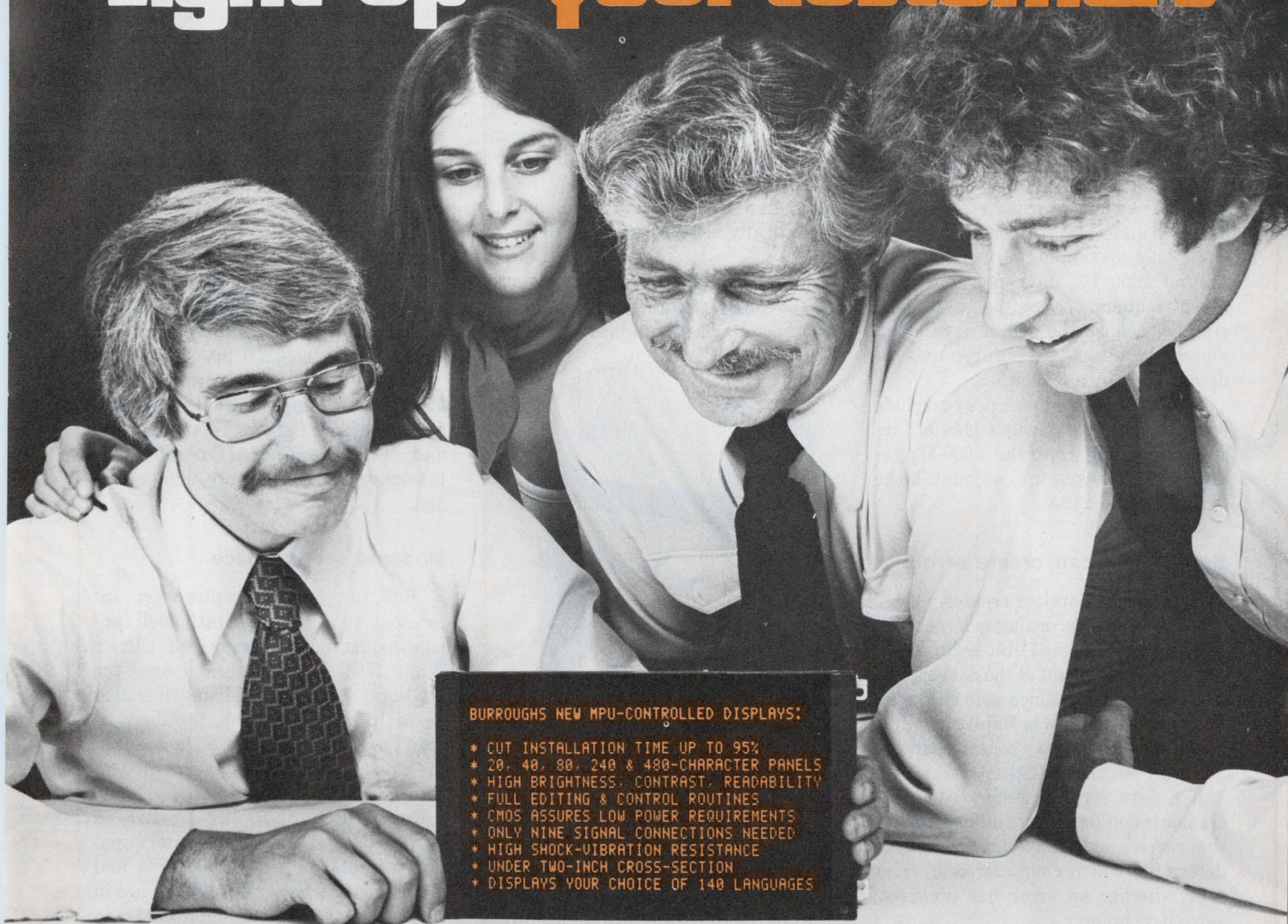

BURROUGHS NEW MPU-CONTROLLED DISPLAYS:

- * CUT INSTALLATION TIME UP TO 95%
- * 20, 40, 80, 240 & 480-CHARACTER PANELS
- * HIGH BRIGHTNESS, CONTRAST, READABILITY
- * FULL EDITING & CONTROL ROUTINES
- * CMOS ASSURES LOW POWER REQUIREMENTS
- * ONLY NINE SIGNAL CONNECTIONS NEEDED
- * HIGH SHOCK-VIBRATION RESISTANCE
- * UNDER TWO-INCH CROSS-SECTION
- * DISPLAYS YOUR CHOICE OF 140 LANGUAGES

...with Burroughs new microprocessor-controlled thin display systems!

Burroughs announces a major advance in its popular line of SELF-SCAN® gas plasma displays: *microprocessor-control and memory!* This means big savings plus the greatest operating and packaging flexibility ever in the flat panel display of alphanumeric information.

Your engineers will "light-up", too, as they discover operating advantages unmatched by any display. The new SELF-SCAN II displays are bright, crisp, easy-to-read. And, with Burroughs' unique new simplified control circuitry, the display panel — complete with electronics — is less than 2" thin for easy installation in compact designs.

The display's built-in microprocessor memory and control eliminate the need for you to design, develop and build circuitry to effect display operation. Just feed in appropriate 8-bit signals for the characters and control commands and you're in operation. Large system manufacturers save 95% of the engineering and development time formerly required and small system producers can now use displays since "design-in" cost is no longer a significant factor.

Adapting the Burroughs displays to your needs is as easy as a change in software. Their operation can be tailored for any product and changed for others with different display requirements.

The display subsystem operates off an 8-bit bi-directional buss or a TTL buss. Data can be entered at rates up to 1 MHz. and, with the addition of a keyboard and communication interface, it becomes a low-cost, compact data terminal!

The system's edit and control routine allows insertion, deletion and blinking of letters or lines, increasing or decreasing brightness, right-to-left data entry, etc.

Light up your customers and your engineers. And lighten your costs with Burroughs SELF-SCAN II microprocessor-controlled displays. For a copy of our SELF-SCAN Subsystems Brochure, write Burroughs Corporation, Electronic Components Division, P.O. Box 1226, Plainfield, New Jersey 07061 or call (201) 757-5000. Overseas, contact Burroughs ECD International, Buckingham House, The Broadway, Stanmore, Middlesex, England.

You can **see** the difference

Burroughs



DISTRIBUTED BY HAMILTON AVNET AND CRAMER ELECTRONICS

be tied in.

There are other potential problems, says Krechmer. For one, the Bell modem may violate existing FCC tariffs, which require that no more than 3 dB more energy ever be transmitted at 2600 Hz than is transmitted at any other frequency. The 2600-Hz frequency is used by the phone company for a disconnect signal to clear a line when the calling party hangs up.

This 3-dB limit may be exceeded, says Krechmer, because the randomized patterns transmitted by the 212A may contain high concentrations around 2600 Hz. Low power at any given frequency cannot be guaranteed simply because the signal is random; where the peaks will occur cannot be determined in advance.

The 212A's randomizer *does* preclude exceeding tariff levels, Hamer responds, adding that the 2600-Hz requirement is taken into account in the design of the 212A.

Scrambling can create errors

But this randomizer creates yet another problem, according to Krechmer. Within the modem, 17-bit segments of data are grabbed out of the data stream to be treated. But, since each character of transmitted data is 10 bits long, the segment selected may contain parts of as many as three characters.

If a data error is generated in the transmission line after randomization, the receive end may not be able to determine which character is in error—or whether an error has occurred, says Krechmer.

With a 17-bit scrambler, an error in a single bit can cause three characters to be printed as error messages—ampersands or some other flag. The text may become so garbled that it is unreadable. With a standard character-by-character randomizer, rarely are two consecutive characters printed as error flags. So a message containing an error is much more likely to be readable, even if some interpretation is required.

Hamer agrees that the 212A's 17-bit scrambler can create a reading problem, but argues that other possible sources of data-transmission errors are eliminated. "It's a design tradeoff," he says, adding that, on balance, the 17-bit scrambler is a desirable feature.

Bell adds versatility

Another feature of the Model 212A, also called the Dataphone 300/1200

data set, is an asynchronous 300-bps interface. Since the protocol for the low-speed mode of the modem is compatible with earlier Bell 300-bps models, the 100-Series Bell data sets, the 212A can be incorporated into existing data networks, which can be upgraded to the higher rate.

Speed selection at the originating Dataphone 300/1200 data set is controlled by a switch on the face of the unit. In the answering mode, the set recognizes the incoming signal and automatically selects the compatible bit rate.

Like the 100 Series, there are over 600,000 modems in use that operate at 300 bps, UDS's Grumbles points out.



Because high-speed keyboard send and receive terminals like DEC's LS-120 may become the industry standard in a couple of years, slower-speed terminals, like this identical-looking LA-36 DECwriter II, may be consigned to such speed-insensitive applications as home computing.

He expects that at least 20% of these units "and probably more like 50%" will be switched to 1200-bps units. Adding in a 15% growth rate in modes points to a substantial market, he notes.

Higher cost is justified

In fact, 1200 bps may become the dominant rate within two or three years, says Paul Preo, OEM marketing manager at Digital Equipment Corp.'s Components Group in Marlborough, MA. In high-volume markets for printing terminals, such as time-shared computer systems, line charges become an important part of system-operating costs.

Users will be willing to spend the extra \$800 or so a 1200-bps terminal costs over a 300-bps terminal, he predicts. The slower machines will still find niches where high-speed data transmission is less important, as in home-computer systems.

At Data General Corp, in Westboro, MA, senior marketing specialist Martyn Cooper agrees that 1200-bps communications "is going to take off, driven by the availability of low-cost 1200-bps networks, peripherals, and modems." And when the market does take off, "DG will be there with a terminal," Cooper promises.

A handful of peripheral suppliers already markets terminals that can communicate at 1200 bps.

Two of the earliest entrants in the 1200-bps terminal market, Intertech Data Systems Corp of Charlotte, NC, and MI-Squared Corp of Columbus, OH introduced products more than a year ago.

Modems set the pace

"But not many people were interested in 1200 bps until Bell announced its modem," says DEC's Preo. While DEC had foreseen a need for 1200-bps terminals and had included on in its product plant, the demand didn't materialize until Bell introduced the 212A, he says, for "as the modem goes, so goes the terminal."

Now DEC has the LS-120, a keyboard/send-and-receive terminal that accepts data at 120 char/s and prints at 180/char/s. The difference in rates, along with a 1024-char buffer to store data during carriage returns and line feeds, helps keep the printer ready at all times. "Housekeeping" chores don't halt communications.

The LS-120 uses the print head and mechanism from DEC's LA-180 print-only terminal, along with the keyboard and housing from DEC's LA-36 DEC writer II 300-bps KSR terminal. New microprocessor-based controller boards incorporate an RS232 interface and as many as five protocols for compatibility with a variety of communications networks.

Even as the data-transmission rate increases four times, the actual throughput of the data networks will only about double, says UDS's Grumbles, because the higher speed affects only how long data are on the wire. The amount of time a network is idle and the amount of time taken for dial-up to enter the network will not change. ■■

New: The First Monolithic D/A Converter System.

No one else can give you an 8-bit DAC with all peripheral functions on-chip. It's truly microprocessor-compatible and costs \$6.95!

Single-chip D/A converter circuits have been around a long time. But so have the design problems that go along with them when interfacing with microprocessors—selection of op amps, voltage reference, latches and the various other active components you've had to add to use them.

Now, for the first time, you can simplify your system design by using the Signetics 5018 Monolithic D/A Converter System. It combines, on a single chip, the converter circuit and all the required peripheral functions—a voltage reference, input latches, and an output amplifier. It costs, in quantities of 100 and up, only \$6.95. That's one reason why it saves you money.

Reduce Parts Count and Assembly Costs. The 5018 is a system simplifier and cost reducer. You can forget about the costs associated with all those extra parts. Material control is simpler. Incoming test and inspection costs go down. Component handling and assembly expenses can be reduced as much as 75 percent.

SIGNETICS D/A CONVERTERS

5018—Monolithic D/A Converter System
5007/5008—8-Bit, High Speed, Multiplying DAC ($\pm 0.19\%$)
5009—8-Bit, High Speed, Multiplying DAC ($\pm 0.1\%$)
MC 1408—8-Bit, Multiplying D/A Converter

Ideal Architecture for Computer-Based Systems.

The 5018 has built-in latches and extremely low input loading (1/100 TTL load per line). These features make it a good choice for multiple-peripheral, bus-oriented microprocessor or computer-

based systems. The low input loading lets you drive many converters from a single bus. The latches then permit the bus to service several peripherals at its maximum throughput rate.

Temperature stability is an added plus. The reference voltage can be adjusted for correct full-scale value with minimal temperature effects.

Temperature-related inaccuracies are also minimized because the precision, low-temperature coefficient resistors are on the chip.

Other Signetics DACs.

The 5018 is our newest D/A conversion product. The coupon below will help you learn more about it. If you'd like other data sheets on our other D/A converters listed below, be sure to check the appropriate boxes or call your nearest Signetics distributor.

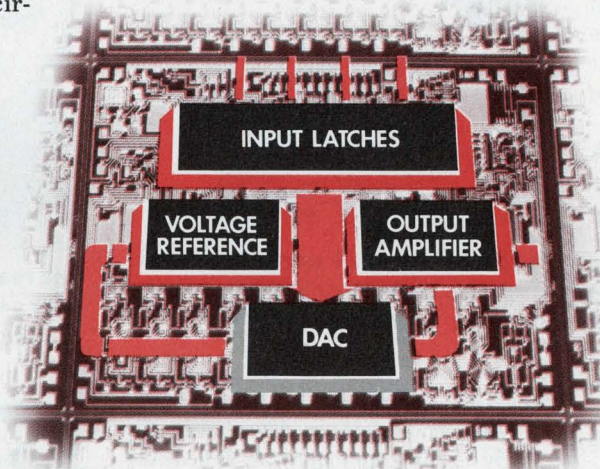

Signetics

a subsidiary of U.S. Philips Corporation

Signetics Corporation
811 East Arques Avenue
Sunnyvale, California 94086
Telephone 408/739-7700

To: Signetics Information Services, 811 E. Arques Ave.
P.O. Box 9052, MS 27, Sunnyvale, CA 94086

Please send me information on the 5018 DAC System

I'm also interested in these other D/A conversion products:

5007/5008 5009 MC1408

I have an urgent requirement. Please have a D/A conversion specialist phone me at once: () _____ X _____

Name _____ Title _____

Company _____ Division _____

Address _____ MS _____

City _____ State _____ ZIP _____

ED927

Talking and Braille calculators serve the blind—for a high price

Developing calculators for the blind is more than a matter of presenting the keyed-in information and calculated answers in a form that does not have to be read visually. Calculators that talk and calculators that produce Braille outputs—tactile or on tape—are being developed to fill that need. But one major problem is to interface calculator-display signals with audio or Braille-output systems at a reasonable price. Current calculator prices range from a few hundred to over a thousand dollars. Incorporating microprocessors into these systems promises to substantially reduce costs—but in future designs.

Another problem is that developers of calculators for the blind are separated into two camps—those who believe in talking calculators, and those who are convinced that a Braille-tape readout is the optimum design. While one or the other may be better for a given application, neither is the best solution for all applications.

Survey gets results

A principal contributor to talking-calculator technology is Telesensory Systems, Inc., Palo Alto, with its \$395 Speech Plus Hand-held, standard four-function calculator (see photo). The Speech Plus, which has a 24-“word” vocabulary, incorporates features rated high in a predevelopment survey of 180 blind persons throughout this country.

One big problem with most Braille systems, the survey revealed, is that there is no way to verify that the correct data have been entered. For this reason, the number or other key functions such as plus, minus, and times are pronounced by the Telesensory unit whenever the appropriate



A vocabulary of 24 words is designed into this talking calculator for the blind by Telesensory Systems.

keys are depressed.

Another preference revealed in the study is for a keyboard arranged like that of a Touch-Tone telephone, rather than the standard calculator arrangement. The Speech Plus unit incorporates the telephone format.

The Speech-Plus calculator has a three-chip architecture (see block diagram). A calculator chip drives a visual LED display and sends speech-command signals to a speech synthesizer. The synthesizer uses two custom LSI circuits, one of which is a 16-k MOS ROM. The other is a dedicated Texas Instruments microcontroller that, upon command by the calculator chip, fetches control data from the ROM.

Sound is produced from the ROM data. Speech sounds are made up of digital bits that each make up an increment of an audio analog signal. The control chip converts the digital information into the audio signal via an on-chip d/a converter.

Calculator language can be changed simply by replacing the ROM. Both German and Arabic vocabularies are now available from newer ROMs.

A student model of the Speech-Plus is being developed by the American Printing House for the Blind, Louisville, KY. Whereas Speech-Plus gives all answers with decimal points, the Printing House model does not. It also operates at a one-third slower speech



The readouts of a Monroe 1920 calculator are deciphered by a μ P to control a 35-word vocabulary in this Wespro talking-calculator system.

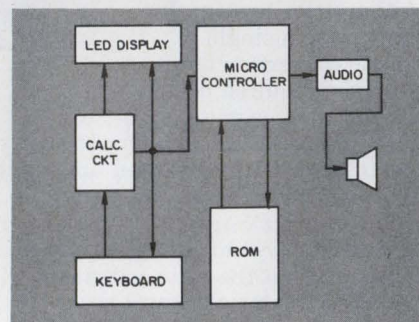

The speech synthesizer of the Telesensory calculator uses a custom microcontroller that converts the output of a special ROM to voice signals.

rate so that the user may make Braille notes if desired.

Speech board is available

The speech board of the Speech-Plus calculator has been made available for \$95 to designers working on calculators for the blind. A more recent “Standard Vocabulary” board (\$179) with 64 words, including volts, amps, dc, ac, and numbers up to 999,999, is also available. In October, a 64-word ASCII character set will be available for the same price.

A standard Monroe 1920 scientific calculator has been interfaced with the Telesensory-calculator speech board to produce a vocabulary of 35 words and

Jim McDermott
Eastern Editor

“When he says it’s 5 volts, it’s 5 volts”

Son of Ref-01! The instant success of our Instant-On 10V monolithic Ref-01 made it only logical that we'd do a 5V version to serve designers who are working with 5V systems. Instantly-on, the Ref-02 replaces all those noisy, dirty, power guzzling zener references, with *essentially zero warm-up time*.

And like the 10V Ref-01, it is referenced to the bandgap energy of the silicon substrate itself.

So if you need low drift reference circuits for your low TC instruments (like 3ppm/°C), the Ref-02 will provide a stable 5V reference, *adjustable by 6%* with minimal effect on temperature stability. Price? \$1.90 (100's). Delivery? From stock. Application notes? You bet. Circle the reader number or write SON OF REF at address below.

YOU NOISY
POWER GUZZLING
ZENER REFERENCES
ARE OUT
OF THE
GAME!



Precision Monolithics, Inc.
1500 Space Park Drive
Santa Clara, CA 95050
(408) 246-9222
TWX: 910 338 0528
Cable MONO.

CIRCLE NUMBER 13

word-beep or word-buzz sound combinations. The Monroe 1920 has over 25 scientific functions, 10 memories and scientific notation.

Produced by consultant Larry Waldron, who heads Wespro Industries, 442 Kasson Rd., Syracuse, NY, the calculator provides a voice output for each keypress and reads the output display after each calculation, or on demand.

Developed for Tim Cranmer, director of the Division of Special and Technical Services of the Kentucky State Bureau for the Blind in Frankfort, KY, the Wespro unit is now being used at Kentucky's state universities. It sells for \$920. A statistical talking-calculator version is available using the Monroe 1930.

"What I've done is hang a speech-bus outboard of the Monroe machine," says Waldron. "The machine is a typical calculator because it has multiplexed digital readouts. The strobes for the display also multiplex the keyboard entries.

"I used a MOS Technology 6502 to monitor all of the lines coming out of the machine because this microprocessor is low-cost and simple to use. It's the intelligence that deciphers the keyboard entries and readouts. The 6502 interfaces directly with the TSI speech board which uses a 6-bit code."

The interface system uses MOS Technology's 6530 interface chip, plus two 1702 PROMs, Waldron notes. "This



Keys are categorized into three groups for two-hand operation in this Master Specialties voice-output calculator.

combination simplifies the system design by giving me hardware features in software." For example, Waldron had trouble with noise on the interconnection cable between the calculator and his adapter. So he polled the lines with software and waited until the lines settled down and were valid.

To tell the blind user that the calculator is on though not in use, Waldron put in software to count keyboard scans. When a defined number of scans have been counted without any key activity, the calculator gives a "beep" that is in the speech-board vocabulary. This costs nothing in hardware—just some 15 or 20 bytes of software, according to Waldron. "The whole program takes up the two 1702 PROMs, or a total of 512 bytes of ROM."

HP calculator talks

Also developed for Cranmer is a telephone system that interfaces the

powerful Hewlett-Packard 9825A calculator with the Telesensory calculator speech board. Operated by blind women, the system is used to store the telephone numbers of staff and faculty at the University of Kentucky and at the University of Louisville.

The HP calculator is connected to the talking board through the IEEE 488 Interface Bus, according to designer Deane Blazie, vice president of Maryland Computer Services, Belair, MD.

"We buy the interface card from HP and we design from the end of that terminator to the voice board," says Blazie. "We've found that we can store 10,000 names on tape and get an average access time from the HP machine of from 6 to 10 seconds. The principal problem was getting a program to efficiently retrieve the names at random."

There is another problem. "We're currently marketing these systems for \$8500 per 10,000 names," says Blazie. "We're considering redesigning a whole system based on a microprocessor and thus getting the cost way down. We're taking a serious look at the MOS Technology 6502 and the Z-80 microprocessor."

Calculator has lifelike voice

Another talking calculator generates a more lifelike voice than that produced by the Telesensory unit—the ARC 9500 Audio Response calculator by Master Specialties Co., Costa Mesa, CA.

"We try to duplicate a complete waveform," says Ali Malekzadeh, project manager of electronic products and designer of the \$565 calculator. The Telesensory system pieces together an audio waveform.

"We know there are a lot of redundancies in our system that make our processor more complex," Malekzadeh goes on. "But the object was to come up with a system that could use 'off-the shelf CMOS' rather than special custom chips." Another goal was to incorporate the most-wanted features in audio machines as determined by a Master Specialties survey of blind people—and at a low cost.

The more redundant technique was chosen because in addition to producing a more human-sounding voice, it is easy to implement and low-cost.

The ARC 9500's keyboard design differs from the Speech Plus's. For one thing, it is engineered for multifinger entry—more like a desk-top machine, Malekzadeh points out.

The vocabulary, however, contains

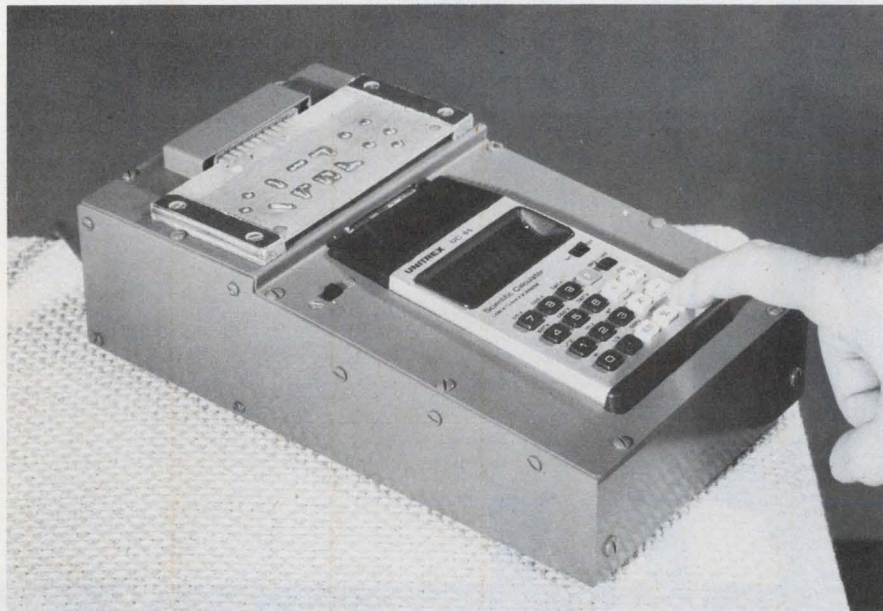

Stationary, tactile Braille readouts are part of a special PC board on this low-cost calculator designed at the National Research Council of Canada. Tones generated by touching the PC elements indicate the digits in the display, a decimal point, or overflow.

VACTEC Photodetectors

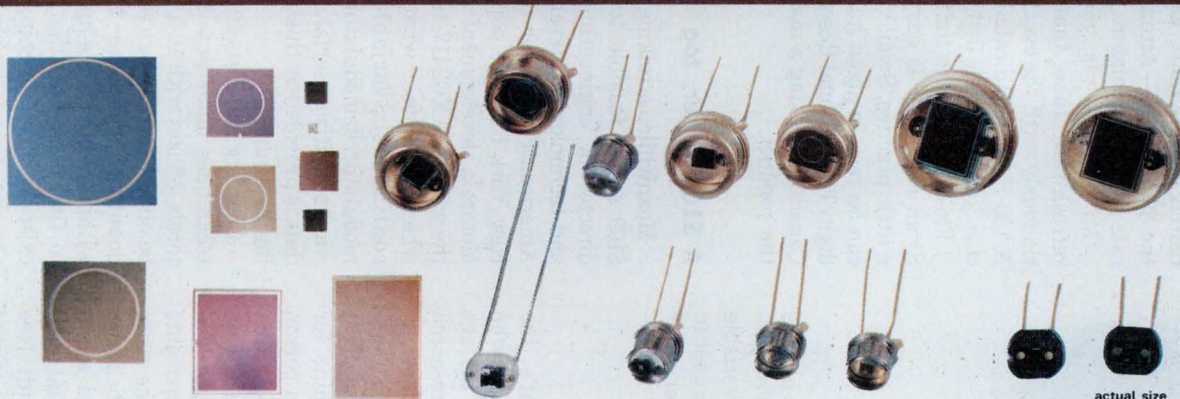

Chips approx. 1.6 x actual size

actual size

Dumb looking little chips for silicon are tough to advertise. They don't look like much, but they do remarkable things, if you can use microamperes of light current (at 100 f.c.) vs. picoamperes of dark current for a million-to-one signal-to-noise ratio. Linearity and stability are super with a surprising response to visible and blue light (400 nm). These BES (blue enhanced silicon) photodiodes are available in a variety of ceramic or metal hermetic packages so that you needn't be expert at handling these insignificant looking chips.

Even though our devices are as good as we say and reasonably priced, so what is different? Our dedication to this industry is remarkable for a small company. We have technology normally found at only the giants of the semi-conductor industry. At this one facility in Maryland Heights, Missouri, we not only make photodiodes and phototransistors but custom LSI light actuated CMOS IC's for the new Kodak cameras. Even more remarkably, we not only process these chips in entirety, we design the circuits. When you can do such processes as silicon gate CMOS, and epitaxy for bipolar, you learn a lot about silicon chemistry that necessarily spills over to the production of photodiodes and phototransistors. Coupling this with our photometric expertise gained through seventeen years of experience makes an unbeatable combination. We even assemble our own special purpose computers for testing both IC's, transistors, and diodes as well as making many of our own parts handlers to feed the parts into position for automatic testing with a calibrated light source. We don't just brag about "planar" processing, we do all types of silicon processing. This high level of silicon technology plus our exclusive dedication to photodetection must inevitably make our phototransistors and photodiodes a little better than the rest.

So that our CDS, selenium, silicon solar cell, and coupler departments won't feel left out, we make the best of those devices also. It's just that they have had their share of our advertising dollars in the past.

Talk to us but better yet, visit us and we think you'll not only be impressed but amazed. We'd like to work closely with your applications people, and making custom photodevices of any kind is no big deal for us at Vactec.

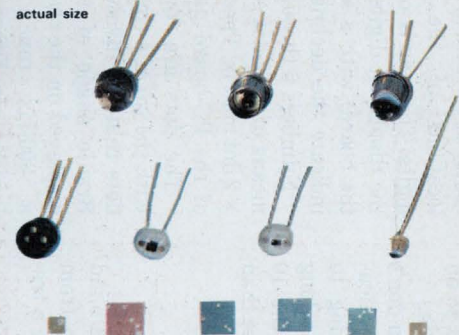

actual size

Chips approx. 3 x actual size

Almost equally as dull looking are the phototransistor and photodarlington. Since they don't look much different than the others, why buy ours? One reason is that we test what we specify. Not only are the wafers one hundred per cent probed, but once the devices are packaged (in equally insignificant looking packages), we one hundred per cent sort for light-current characteristics, dark current (leakage), and breakdown.

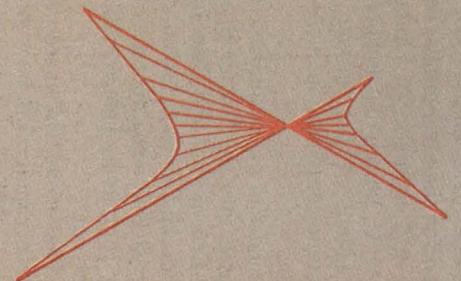

VACTEC, INC.

CIRCLE NUMBER 14

Write today for catalogs and more information: 2423 Northline Industrial Blvd., Maryland Heights, Mo. 63043 • (314) 872-8300

only 16 words. A vocal readout is provided for the digits entered and displayed and for the plus, minus, times, divide-by and equals keys. Functions such as $1/x$, x^2 , square root and percent give a readout of the answer, but without audio confirmation of the key depression.

Three modes of operation have been incorporated into the Master Specialties unit: Learn, Fast and Calc. In the Learn mode, the key is locked out after each entry so that a beginner may hear one entry completely before making a sequential one.

In the Fast mode, the operator can make entries rapidly. But he won't get any audio verification of the digits, only the operational functions, such as times, divided by and equals.

In the Calc mode, the machine operates like a standard calculator. An audio output is possible only by pressing a repeat key.

In any of the modes the operator can verify what's in the display by pressing a repeat button.

Finger thinking

Unfortunately, some blind individuals can easily lose track of figures when doing complex problems on a talking calculator. Indeed, how effectively a blind person uses a talking calculator greatly depends on how that person thinks. While some can think better aurally, others can think better "visually" or—with their fingers—in Braille.

For the tactile thinkers, hard-copy output from a Braille calculator is a better answer, according to Tom Benham, a blind engineer who heads Science for the Blind Products, Bala-Cynwyd, PA. Benham has integrated a Kingspoint-44 scientific calculator into an \$895 system that prints the answer in Braille on $\frac{1}{2}$ -in. paper tape. Two newer machines will be available shortly.

"We've had no problems with the Braille printer," he says. "But we've learned that signals feeding the displays of calculators must be cleaned up before they can be used to operate such a printer. We take an existing system and wire it into a calculator and bring out the seven-segment signals. We feed these signals into a ROM that's been programmed to convert them to four-dot Braille printouts."

Because of slow printer speed, however, the Braille signals are clocked at a much slower rate than the calculator signals. The Braille dots are made

during a 0-to-32 string of counts. Counts 0, 1 and 2 make one set of dots, 7, 8 and 9 moves the paper, and so on in a fairly complicated sequence.

Even legally blind people who don't read Braille can use his Braille calculator, Benham insists. "Learning to read the full Braille system is a long process. But learning to read the 10 digits shouldn't take anyone more than a half-hour."

Cost must come down

But no matter which method a blind person uses to get information from calculators, he still must hurdle a tre-



A Braille readout is provided on this calculator by the American Foundation for the Blind. It has a variable speed control that enables the user to read as slowly as one digit every four seconds. It sells for \$425.

mendous barrier—cost. That's the opinion of Jim Swail, an engineer who has been without sight since the age of four. According to Swail, a research engineer in the medical engineering section of the National Research Council of Canada in Ottawa, the least expensive four-function machine for the blind costs \$375. A sighted person can buy an equivalent for under \$10.

Hoping to narrow this price gap, Swail has developed a calculator system that uses off-the-shelf components and has no moving parts. The price should be around \$100, Swail believes.

A combination of touch and sound is employed to produce the digital readout. In Swail's prototype unit (see photo), a Unitrex calculator is mated with his readout system, a PC Braille board at the top of the instrument.

Two horizontal rows of Braille numbers, extending from the left to the center of the board, represent the eight locations of the calculator-display digits. The matrix of dots used to read the displayed digits is at the right of the board, with a single dot below to indicate the decimal point.

Numbers 0 through 9 are formed by means of four-dot combinations in a 2×2 dot matrix. These dots are also part of the PC-board pattern.

The dots are touched sequentially with the tip of a finger. But only those dots that are involved in forming the Braille shape of the number being displayed on the read-out will activate a 300-Hz tone in an on-board loudspeaker. Other dots remain silent when touched.

To read an answer, one finger is placed on the digit position to be read while another explores the readout matrix for the dots that will produce the 300-Hz tone—actually the refresh rate of the calculator.

An overflow is indicated by a refresh-rate tone that sounds continuously until the overflow is cleared. A 100-Hz tone indicates that the function key has been depressed.

Field trials have indicated that the Swail calculator is easy to use. With a little practice, Swail says, an answer can be read in about half a second per digit. The National Research Council of Canada is seeking a manufacturer for the product.

A \$100 talker, too

Meanwhile, a talking calculator for \$100 seems feasible to Doug Maure, director of engineering for research and technological development at the American Foundation for the Blind in New York City. He points to a recent Motorola development that may lead the way—the XC3417 and XC3418 ICs, which comprise what is called a continuously-variable-slope delta modulator/demodulator. A low-cost way to digitize a serial stream of voice data is provided by this system, according to Maure.

Coupling low-cost efficient digitizing techniques made possible by the Motorola devices with 16-k ROMs that can be obtained for about \$6 in reasonable quantities puts the \$100 price tag within range, Maure insists. "We need to find somebody that can adapt an existing calculator chip, or even modify the chip to get the outputs necessary to directly feed or address a ROM that would in turn address the Motorola

Designing switching regulators?

Here comes help

more

NEW GAPPED, FERRITE COMPONENTS

are designed, specified and tested for storage inductor applications in switching regulators. They're easier to use, smaller, more economical and improve regulator performance significantly.

NEW DESIGN DATA makes it easier to use our expanding line of **SWITCHING REGULATOR-RATED™** ferrites. Nomographs relate guaranteed energy storage, temperature rise and inductance for each component to help you select the smallest inductor that meets your design requirements.

DESIGN ASSISTANCE is yours for the asking from Application Engineering—(201) 826-5100, Indiana General, Ferrite Products, Keasbey, NJ 08832. We'll help you improve power supply performance and keep you informed of all new developments in switching regulator ferrite technology.

Indiana General Ferrite Products

a division of Electronic Memories & Magnetics Corp.

Keasbey NJ 08832 • (201) 826-5100

CIRCLE NUMBER 15

giga-trim capacitors for microcircuit designers

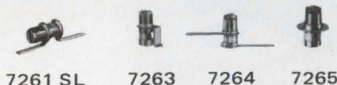
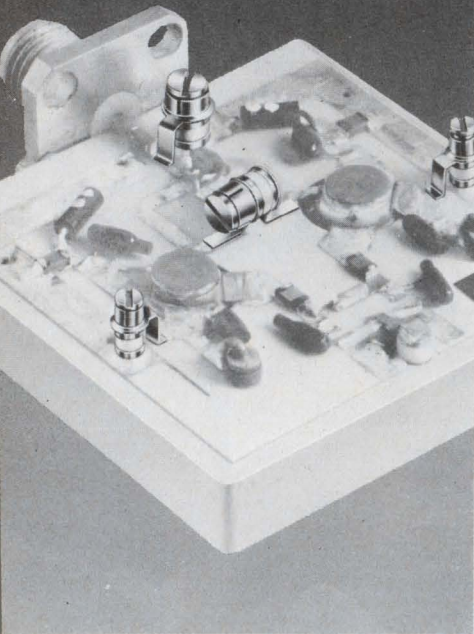

Giga-Trim® (gigahertz-trimmers) are tiny variable capacitors which provide a beautifully straight forward technique to fine tune RF hybrid circuits and MIC's into proper behavior. They replace time consuming cut-and-try adjustment techniques and trimming by interchange of fixed capacitors.

Applications include impedance matching of GHz transistor circuits, series or shunt "gap-trimming" of microstrips, external tweaking of cavities, and fine tuning of crystal oscillators.

Johanson

MANUFACTURING CORPORATION

BOONTON, NEW JERSEY 07005

201 / 334-2676

CIRCLE NUMBER 16



A system that allows a blind person to work as a long-distance operator is the outgrowth of a calculator for the blind designed at MIT. Information from 82 switchboard keys is fed to a Motorola 6800, which converts it to 12-character Braille messages at this Little Rock, Arkansas, installation.

devices."

The Foundation, which was started by Helen Keller, is not a commercial organization, Maure explains. "We try to interest commercial organizations in developing products of this sort. If no one else can supply a product, we will develop it."

Indeed, two Braille calculators have already been produced and marketed by the Foundation. One is a \$325 five-function device with an eight-digit visual display and a single-digit Braille display that can be used to sample the calculator's eight digit positions at varying speeds. A similar scientific unit sells for \$425 (see photo).

Another Foundation objective is a microprocessor-based voice system, with several interchangeable custom I/O chips and ROMs that could be plugged into it. These chips and ROMs would permit the voice system to be used with calculators, electronic thermometers and clocks, and a variety of other such devices.

Efforts to design calculators for the blind are not confined to the U.S. and Canada. A variety of talking and Braille calculators are also being produced in West Germany, Switzerland, Sweden and France. Descriptions of these machines as well as the addresses of several of their suppliers can be found in "The International Guide to Aids and Appliances for Blind and Visually Impaired Persons," available

for \$3 from the American Foundation for the Blind, 15 W. 16th Street, New York, NY 10011. This publication also describes calculators for the blind available in the U.S. as well as many other kinds of aids.

A discussion of technical problems involved in interfacing calculators with Braille devices is found in "Powerful Calculators for the Blind," ED No. 5, Mar 1, 1977, p. 54. ■■

For more information

Readers interested in pursuing the ideas and concepts discussed in this article may wish to contact the key organizations mentioned.

American Foundation for the Blind (see address in text). Douglas Maure (212) 924-0420.

Bureau for the Blind, State Office Building Annex, Frankfort, KY 40601. T.V. Cranmer (502) 564-4754.

M.I.T. Rehabilitation Engineering Center, 77 Massachusetts Ave., Cambridge, MA 02139. George P. Dalrymple (617) 253-5331.

National Research Council of Canada, Div. of Electrical Engineering, Ottawa, Canada KLA OR8. James Swail (613) 993-2482.

Science for the Blind Products, P.O. Box 120, Bala-Cynwyd, PA 19004. Thomas Benham (215) 664-9429.

MOTOROLA OMNIBUS



Rollin' along the routes to right design

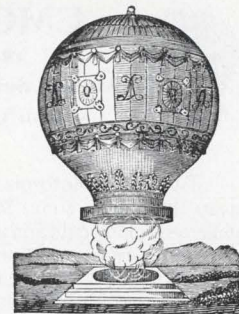

Raise your SOA with

1500 V horizontal deflection MJ12005

The story's simple—25 times more SOA than the BU208. Correct. 25 Times more. At 400 V, the new MJ12005 offers 20 amps of SOA, 50 μ s single pulse. The BU208 provides just 0.8 amps.

Where Darlingtons aren't needed, the new unit's ideal. And besides super SOA, you get higher gain, too—all the way out to 5 at 8 A.

The MJ12005 is triple-diffused to attain its high-voltage rating and photo-glass-passivated at collector-base junction for reliability and stability. Operating and storage junction temperature is spec'd from -65°C to $+150^{\circ}\text{C}$.

Price is only \$3.50, 100-up, or about 35% less than the '208.

Super SOA. Super gain. Super price. From the SuperPower, of course. Motorola.

E

Do it at any frequency

Motorola RF does it better!

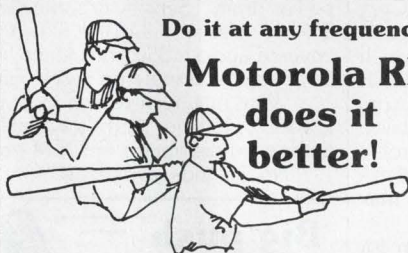

More 900 MHz stuff . . .

Rugged radio message here.

Characterized at 870 MHz for the 806-907 FM mobile band, the new MRF840/842 units are 100% tested for load mismatch stress at all phase angles with 20:1 VSWR at 16 V supply and 50% RF overdrive.

We publish that on the data sheet! Not just infer it in private.

Min power gain specs for the 12.5 V units range from 6.5 dB for the 1 W MRF838 common-emitter studless and 838A stud unit to 8 dB for the 20 W CQ-packaged MRF842 . . . pretty super for this frequency. Both the MRF840 and 842 are internally matched for broadband operation.

Here's the lineup:

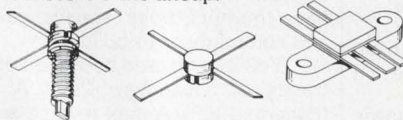

A

Speaking of Linear Price/Performance . . .

Here's the only transistor spec'd for 100 to 500 MHz with mounting ease and increased P_D through emitter-grounding.

The MRF525 TO-39 offers impressive specs for linear aircraft radio/instruments and cable communications. Third order intercept is +35 dB, minimizing those nasty IMD problems in AM and multi-channel.

It's fully characterized for S parameters at 13.6 and 26 V, 10-100 mA, has

min gain of 13 dB and max noise figure of just 4 dB at 225-400 MHz, 26 V.

If you can go \$2.30 each for a hundred or more, contact your authorized distributor. If not, dicker with your OEM man for larger quantity savings. A bargain either way. B

Now back to rugged VHF

Here's a bunch of splendid 28 V devices complementing a UHF lineup we intro'd a while back, the MRF321-327.

Gold-reliable and thermally-engineered using IR scan techniques for guaranteed ruggedness at 30:1 VSWR, all phase angles, the new MRF314-317s have super wide-band characteristics and are ideal for hi-rel designs. They employ SOE and Controlled Q* technology, offering up to 10 dB min G_{PE} at 150 MHz.

You get stud and studless in 0.380 SOE and 0.5 CQ. P_{out} ranges from 30 to 100 W.

Input impedances remain consistent through programmed, computer-controlled wire bonding. You'll surely use them in MIL radio, class A, AB, B and C for AM, FM or FSK application. They're good as gold.

C

HF RF at LF \$\$ = TO-220

There's a lot of RF in TO-220 around. But none with the low lists of ours—prices approaching that of our also-new but well-accepted LF TO-220. Take the new MRF476. At \$1.09, 500-up. A comparable ceramic SOE stud would run about \$8.50.

Whattaya get for that? The same performance for SSB and CB others offer at higher prices. The 12.5-V '476, for instance, provides 3 W PEP, 15 dB min G_{PE} and 40% SSB efficiency at 30 MHz. IMD is typically -35.

The '475 muscles out 12 W at 13.6 V, 10 dB min G_{PE} and 50% efficiency (CW) at 30 MHz. IMD is -30 min. It's just \$2.30.

Plus we offer gold-plated headers, gold-tin pre-forms for die-attach and high-volume production taken for granted by everyone using plastic devices. Now it's your turn. D

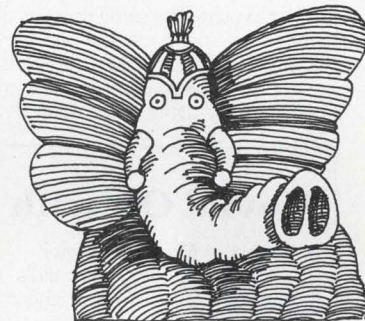

Bigger and Bigger static ROMs.

This one's 32K.

The MCM68332 is a 32K static ROM with 4096-word by 8-bit organization that makes it prime for high-density fixed memory applications like microprogramming in MPU-based systems. It's a second source for TMS4732 and MK32000.

All inputs and outputs are TTL-compatible. Inputs are directly driven by TTL without external pull-up resistors, and outputs drive TTL without external resistors. Outputs are three-state.

Silicon gate NMOS technology gives this large ROM excellent speed. Max access time is 450 ns, and min cycle time the same. Active P_D is 450 mW (typ). It operates with a single 5 V supply.

Pin-compatibility with MCM2708, MCM65308 and MCM68316E is another important feature of the MCM6832, available in both plastic and ceramic 24-pin. F



CMOS ICs reduce smoke detector costs, simplify circuitry.

Two new Motorola CMOS ICs clear away the fog of some 30-odd components while reducing costs and improving reliability in battery-operated ionization chamber smoke detectors. Because the units are designed for use with less expensive 9-volt alkaline batteries, the consumer nets additional savings in operating costs.

It's the combination of economical circuitry, battery operation, and ease of wire-free installation that's generating the consumer popularity of this type detector.

The MC14462P incorporates an on-board FET for direct operation with the ion chamber, whereas with the MC14461P the FET is separate. Another key feature of the MC14462 is the active guard on the input, which achieves vast reductions in circuit and package leakage currents. Both units provide the choice of operating in the low battery warning circuit in either the static-test or pulse-test mode. On-off pulsing of the horn and protection from pulse-caused transients are exclusive features.

Additional system cost-savings in the smoke detector are realized because both use minimal external capacitance and require a low value of timing capacitance. The circuits also feature on-chip predrivers, voltage reference, and voltage regulator.

Large volume supplies of these smoke detector ICs are assured. They're produced with low-power linear and digital CMOS on the chip using the same process and lines on which we produce the industry's largest volume of CMOS gates, flip-flops, and MSI.

Call us and compare the cost savings obtained by using our smoke detector ICs.

G

Sleuthing around for cost-saving?



Try L14H1/MRD160 Photo Detectors

Plastic is what they're packaged in and tight places are where these new miniature photo transistors go.

Sensitive throughout the visible and near IR spectral range, the TO-92 and Mini-T* units are ideal for punched card and tape reading, pattern/character recognition, industrial inspection, processing and control, sorters, switching and logic circuits, shaft encoders or any design requiring radiation sensitivity, stable characteristics and high-density mounting. (Whew!)

Easiest to understand is price—just 33¢ for the L14H1 and 50¢ for the MRD160. And that's in published quantities.

The L14H family has a range of sensitivity and voltage for your exact needs. You have a choice of either 30 or 60 V min C_{EO} and either 0.5 or 2.0 mA collector light current. Dark current is just 100 nA, max. It makes a great companion to the MLED92 IR emitter and, of course, derives from Motorola's "billions-made" TO-92 capability.

The MRD160 complements Motorola's MLED60/90 IREDs. It specs out at 0.20 mA light current sensitivity and 0.10 μ A max dark current. C_{EO} is 40 V.

Both offer Annular† passivation for reliability and stability.

Both offer the solution to cost problems. Try 'em and you'll like 'em. H

†Annular is a patented Motorola process.

Big IF for FM Scanners

Big is right. Not in size, for this little linear gem's in standard 16-pin plastic DIP.

What we're talking about in the MC3357 is just about the whole bag of functions needed for the IF stage in FM scanners. To wit: oscillator, mixer, limiting amp, quadrature discriminator, active filter, squelch, scan control and mute switch. Not many externals to add here.

This Mr. Complete uses a dual conversion system including second crystal oscillator circuit with demodulator for max signal to noise ratio.

You can convert the input frequency (i.e., 10.7 MHz) down to 455 kHz where, after external bandpass filtering, most of the amplification is done. Audio is recovered using the quadrature and absence of input signal is indicated by presence of noise above desired frequency. "Noise band" is monitored by the filter and detector and the squelch trigger indicates presence of noise (or tone) by an output which can control scanning. Plus, an internal switch is operated which can be used to mute audio.

At 6 V_{CC} , squelch-on draws a measly 3 mA typ. (others run high as 10 to 20) for low power drain. Sensitivity's excellent—input limiting voltage: (-3 dB) = 5.0 μ V typ. Recovered audio is 350 mVrms typ, mute off is 0.5 V max and mute on is 5 V min.

What may turn you on most is the low, low \$1.75, 100-up. And it's available through authorized distributor or OEM order.

No ifs, ands, or buts. K

Big push on Small SCR nets 600 V technology

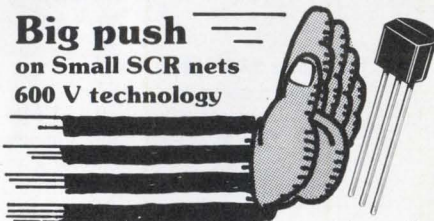

All of the people have some of the stuff—none of the people have all the stuff... except Motorola... leader in 0.5 A to 40 A thyristors. We're talking about the capital and the equipment to do what we've done—come up with the one and only 600 V TO-92 SCR in the industry.

Right. The good ol' MCR100 TO-92 SCR is rated to 600 V, something nobody else but we plastic SCR pioneers seem to have the nuts, bolts, screws, gears, bucks and commitment to build.

You'll be pleased because it offers all the traditional advantages: 200 μ A max gate triggering, 100 μ A max reverse and forward blocking, 5 mA max holding current, etc. Not to mention glass passivation that (at last count) has provided second-to-none reliability in TO-220 SCRs of 43 million cycles of 30°C to 125°C T_J power cycling with just 15 failures!

Use it for bigger jobs in line-power applications like relay and lamp drivers, small motor controls, gate drives for larger thyristors, sensing and detection circuits. And have your P.A. check our pricing. He'll find it's the most aggressive since the beads-for-Manhattan deal... and less than half TO-18s and TO-5s! L

Movin' On with M10800

Motorola in Mountain View?

Could be, for Fairchild's announced intentions of second-sourcing the M10800 prove what we've been telling you all along... the M10800 high-performance processor family will be the standard for next generation, performance-oriented systems.

Motorola and Fairchild. Partners in progress. What more can you ask?

Well, how about our MC10802 timing function for starters. Fast starters. Currently being sampled, the part is designed to provide timing signals for a processor in one LSI circuit. It contains logic to generate 4 clock pulses, simplify system start and stop commands and provide some diagnostic capability. It is not restricted to use in '10800 systems, but can simplify timing requirements in any MECL 10K designs because (how could you forget!?) it's fully compatible with the industry standard 10K family!

Other new sample members are the MC10804 and '10805 bidirectional transceivers that interface MECL logic levels with T²L logic levels. Data can be transferred in either direction—MECL to T²L or T²L to MECL—and an optional gated latch is also provided.



The '10804 is a 4-bit version in 16-pin CERDIP and the '10805 is a 5-bit device in a 20-pin CERDIP.

For MOS memory freaks, the MC10805 is designed to interface MECL systems to MOS main memories. And if you haven't been able to remember all our Fast Freddie's on the MECL track, one more time—

MC10800	4-Bit ALU -30°C to +85°C
MC10800M	4-Bit ALU -55°C T_A to +150°C T_J
MC10801	Microprogram Control
MC10802	4-Phase Timing
MC10803	Memory Interface
MC10804	4-Bit Bidirectional Translator w/Latch
MC10805	5-Bit Bidirectional Translator w/Latch
MC10806	32 x 9 Dual Access Stack
MC10807	5-Bit MECL Transceiver w/Latch
MC10808	16-Bit Programmable Shifter

Keep on movin' with MECL. J

**Motorola PowerBase
Silicon Power Breaks**

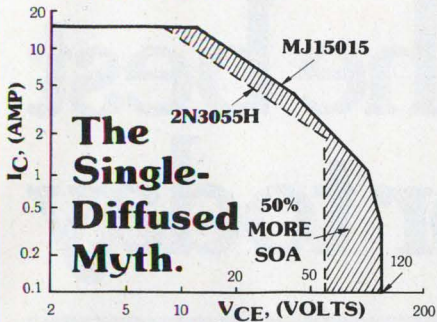

Everybody thinks single-diffused is always better. Everybody thinks single-diffused dice make for increased SOA curves. Everybody's wrong.

Motorola's new PowerBase* is a high-energy breakthrough in power transistor technology and here's what it does:

1. Provides rugged SOA previously obtained only with conventional single-diffused.
2. Allows economy previously possible only with conventional EpiBase* products.
3. Closely approximates f_T characteristics of single-diffused transistors (there's hardly any difference).
4. Offers complementary structures eliminating the single-diffused, single-polarity bugaboo.

Take a look at the curve and you'll find 50% more SOA capability with our '15015 than a single-diffused 2N3055H.

We use a patented process on our optimized PowerBase die to achieve superior SOA with greatly improved uniformity and reproducibility over S.D. By improving device thermal efficiency so significantly less silicon is required, we offer you lower cost. Simple, right?

What it all comes down to is if you're using a single-diffused RCA 2N3055H, you can obtain 50% more SOA for 19% less bucks with the MJ15015! If you're using a 2N3443 unit you get 10% more SOA for 49% less \$\$\$. And so on, according to latest available pricing.

Flawless performance at far less cost! Make your own comparisons today. Your authorized distributor's got off-the-shelf units. Coupon response brings you new PowerBase product data sheets.

Motorola PowerBase is a hit and that ain't no myth. **M**

*Trademark of Motorola Inc.

**RAMs multiply
like rabbits**

MCM2114 4K static RAM

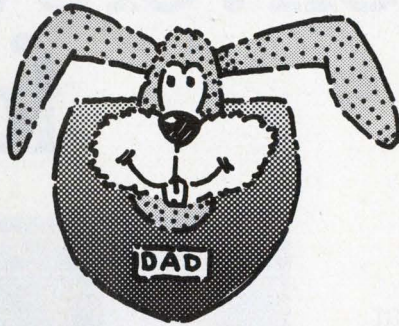

Static operation means no clocks and no refreshing required for Motorola's new MCM2114, a 1024-word by 4-bit organized silicon-gate plug-in equivalent for the Intel NMOS RAM.

It's fast, with access time as low as 200 ns and cycle times to match. Power dissipation is typically a low 400 mW, and the 2114 operates from a single 5 V power supply. It's directly compatible with TTL and DTL, and has three-state outputs. **N**

MCM4116 makes the 16K RAM derby a real race.

Those hard to get 16K RAMs will be a lot easier to find now that Motorola has introduced the MCM4116. It's in the industry standard 16-pin package and compatible with common automated test and insertion equipment. It's an easy upgrade from 16-pin 4Ks, and is pin-compatible with other 16Ks now on the RAM market.

Three different speed options are available with access times from 200 ns to 300 ns. All inputs are TTL-compatible as are the three-state outputs. **P**

New source for the 4096 dynamic 4K.

Maybe you've noticed. Availability of the 4096-type 4K has tightened up. Well, we're loosening things up again with the MCM4096. It's compatible with the other popular 4K standards like the 2104, MK4096, and MCM6604A.

**Eight-Bit Latches
added to CMOS B Series**

The new MC14099B and MC14599B are the first in a series of 8-bit addressable latches being added to Motorola's industry-leading standard CMOS line. These latches are designed to meet JEDEC B-Series specifications. They are excellent in demultiplexing and serial-to-parallel conversion applications, but they have yet another claim to fame. Use MC14599B or MC14099B to provide outputs for our unique new MC14500B single-bit processor called the Industrial Control Unit.

The MC14099B is an alternate source part for the CD4099B. The MC14099B and the MC14599B are similar, with but one significant difference. The MC14599B has a bi-directional input port, which allows data to be placed in a latch, then retrieved through the single port or from the 8 parallel outputs. It's in 18-pin plastic and ceramic packages, and the MC14099B uses 16-pin packages. The two extra pins in the MC14599B are assigned to Chip Enable and Write/Read.

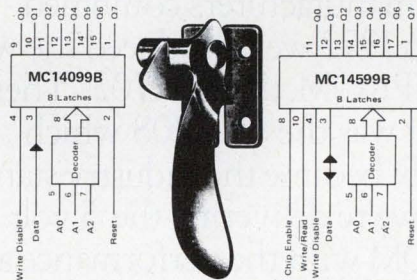

Three additional 8-bit latches are being prepared for introduction. The MC14598B is similar to the MC14099B, but its outputs are three-state, with the capability to drive a bus line and sink one TTL load or four LSTTL loads over temperature. The MC14597B differs from the MC14598B by virtue of an on-board counter at the input, rather than direct address. The third future 8-bit latch is the MC14094B, alternate sourcing the CD4094B. It also has three-state output, with a drive capability of one LSTTL load. The MC14094B has a shift register input contrasted to the decoder input of the MC14598B or the counter input for the MC14597B. Pricing, 100-up, for the introduced parts is \$2.21 for the MC14099B and \$2.81 for the MC14599B. **R**

All Aboard! Motorola Omnibus • Rollin' along the routes to right design.



Please Check Only Items You're Interested In:

- | | | |
|--|---|---|
| A <input type="checkbox"/> 900 MHz RF | F <input type="checkbox"/> MCM68332 ROM | L <input type="checkbox"/> 600 V Plastic SCR |
| B <input type="checkbox"/> MRF525 RF | G <input type="checkbox"/> Smoke Detector IC | M <input type="checkbox"/> PowerBase |
| C <input type="checkbox"/> VHF MRF314-317 | H <input type="checkbox"/> Photodetectors | N <input type="checkbox"/> 4K Static RAM |
| D <input type="checkbox"/> TO-220 RF | J <input type="checkbox"/> M10800 MPU | P <input type="checkbox"/> 16K RAM |
| E <input type="checkbox"/> MJ12005 Power | K <input type="checkbox"/> Linear IF | R <input type="checkbox"/> 8-bit latches |

For complete product itineraries, fill in and send to: Motorola Semiconductor Products Inc., P.O. Box 20912, Phoenix, Arizona 85036

Please have salesman call () _____

Name _____ Title _____

Company _____ Address _____

City _____ State _____ Zip _____

Intel delivers the best for today

Industry standards, volume support and cost efficiency are what you've learned to expect from Intel, the company that invented EPROMs and delivers more of them than all other manufacturers combined.

In 1972 we introduced the world's first EPROM, the 2K 1702. Then in 1975 it was the 8K 2708 which quickly became the industry standard. Now we're delivering the 5 volt 2716 EPROM with the performance and economic advantages it takes to be the industry standard 16K EPROM—for today's system upgrades from 8K to 16K and for tomorrow's systems designed with 5 volt microprocessors.

For economy, the 2716 offers a die size 20% smaller than any other 16K EPROM and a price-volume learning curve that will descend even more rapidly than our 1702 and 2708 EPROMs. And the 2716 is the only 16K EPROM with a pin for pin interchangeable 16K ROM, the 2316E.

For performance, the 2716 consumes a maximum of 525 mW in the read mode. That's 50% less power than our 2708 and 25% less than any other 16K EPROM. Intel's unique power-down feature reduces the standby current to 25mA maximum, a 75% savings over active power. And at 450ns there's no penalty in access time.

Programming the 2716 is simpler and twice as fast as any other 16K EPROM. Single-pulse, single-location

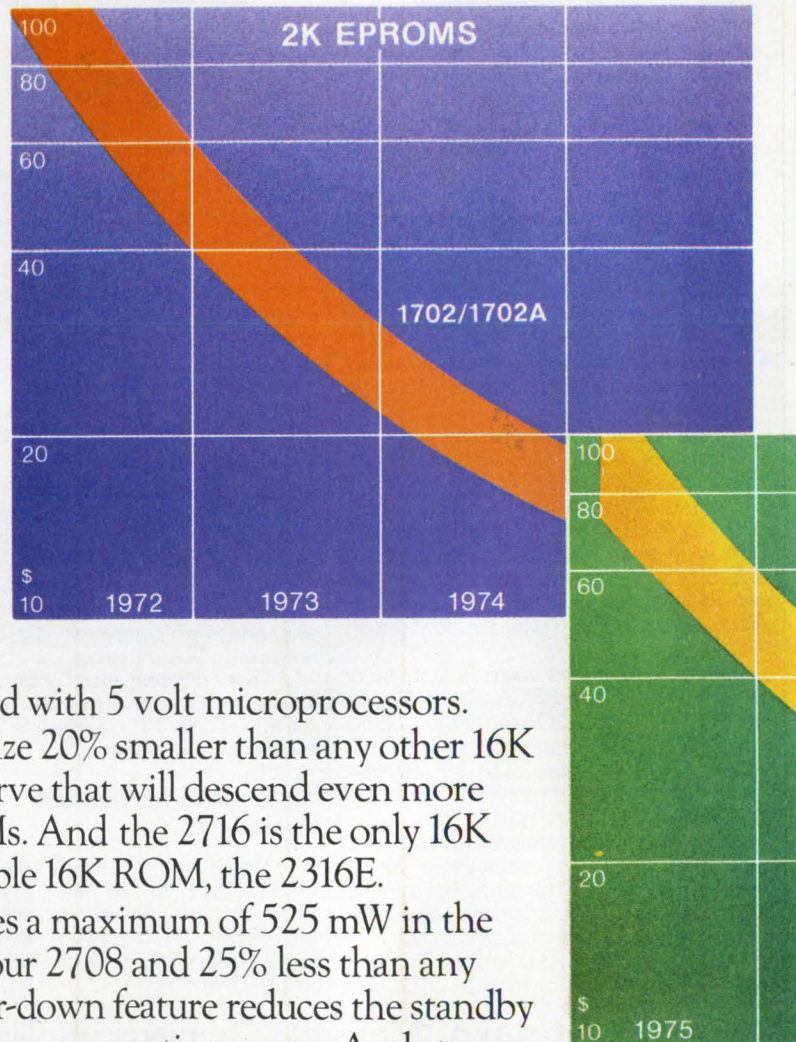

PART NUMBER	SIZE	POWER SUPPLY	MAXIMUM CURRENT		ACCESS TIME (MAX)	COMPATIBLE ROM
			ACTIVE	STANDBY		
1702A	256 x 8	+5V -9V	65 mA	65 mA	1 μ s	1302
2708	1K x 8	+5V -5V +12V	10 mA 45 mA 65 mA	10 mA 45 mA 65 mA	450 ns	2308
2758	1K x 8	+5V only	100 mA	25 mA	450 ns	2316E
2716	2K x 8	+5V only	100 mA	25 mA	450 ns	2316E



8K and 16K EPROMs and tomorrow.

programming and TTL-levels allow programming on-board, even in the field. Use the Intel Universal PROM Programmer or any other commercially available programmer to program any 2716 word location, either individually, sequentially or randomly.

Intel's 2716, along with the compatible 2316E ROM, is your best choice for upgrading from 8K to 16K.

For new designs using 5 volt microprocessors, the 2716 and new 5 volt 2758 8K EPROM are the obvious choices.

The 2758 is the lowest power 8K EPROM available. Use it for small systems where 1K bytes is all you need, or for 1K byte modularity. The 2758 has all the cost savings and performance benefits of the 2716. And since the 2758 and 2716 are completely interchangeable, future upgrading from 8K to 16K in 5 volt systems is simplified.

Go with Intel industry standard EPROMs because they give you maximum value in today's system upgrades to 16K and in tomorrow's 5 volt designs. Order the 2716, 2758 and compatible 2316E ROM from your Intel distributor.

For technical information and a copy of "The new 16K EPROM" article reprint (AR-42) write Intel Corporation, 3065 Bowers Avenue, Santa Clara, California 95051. In Europe contact Intel International Brussels, Belgium. Telex 24814. In Japan contact Intel Japan, K. K. Tokyo Telex, 28426.

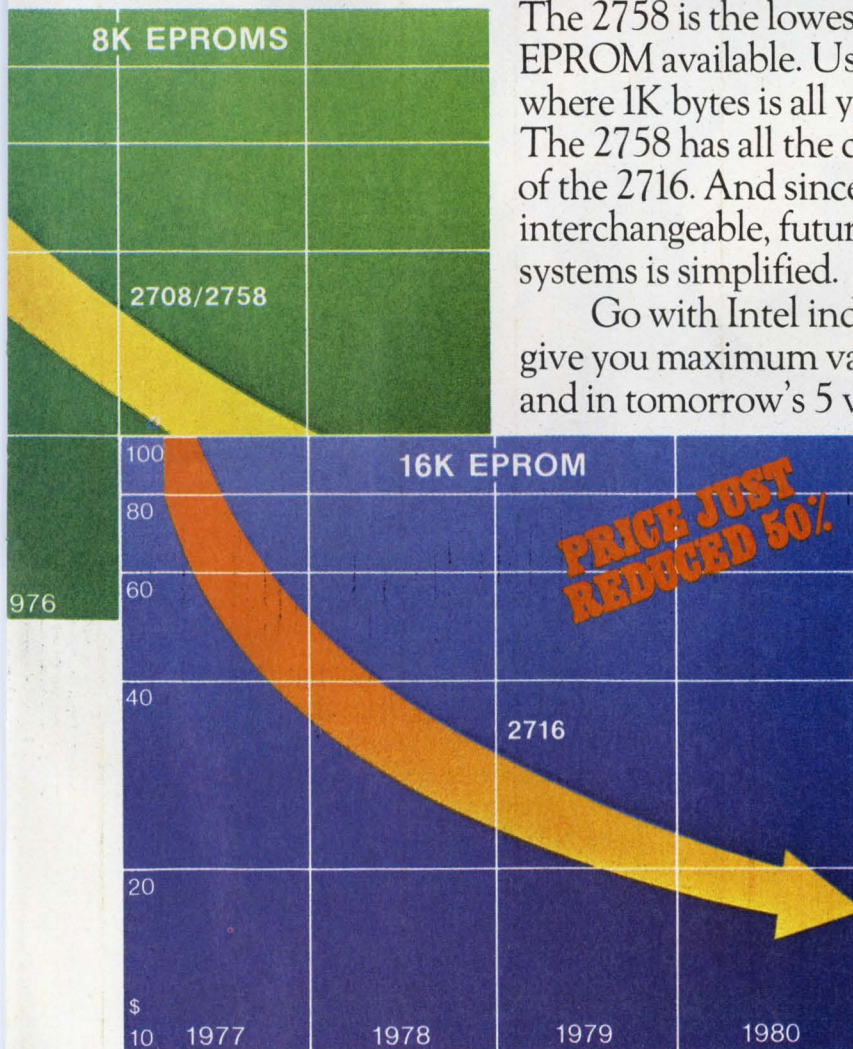

intel® delivers.

No other conformal coating can make this statement.



Dow Corning 3140 RTV silicone coating is the only conformal coating that has UL recognition to 180 C and also meets the requirements of Mil Spec MIL-I-45608. But, there's more.

Dow Corning 3140 silicone coating stands up to the toughest environments. It is a one-part coating that is non-corrosive to copper and other sensitive materials. Its high tear strength allows you to use it anywhere you need good shock insulation. Dielectric properties are excellent. 3140 really performs when the heat is on. As we said, it's UL-listed to 180 C.

Dow Corning 3140 is fast and easy to apply or repair. You can brush, dip, flow coat or spray it on at room temperature. It goes on clear, so you can easily identify coated components. It can be handled in 24 hours or less, and a little goes a long way.

If you have an application that requires proven durability, toughness and resistance to heat and corrosion, you just can't afford less.

Decide for yourself. Write for literature and a how-to-apply brochure to Dow Corning Corporation, Dept. A7-512, Midland, Michigan 48640.

DOW CORNING

DOW CORNING

Washington report

MLS competition planned this fall in Buenos Aires

The two microwave landing systems vying to be the international standard may be tested side-by-side this fall in Buenos Aires. The Argentine government, which is hosting a communications conference (Oct. 31 to Nov. 4) sponsored by the Organization of American States, has offered to test both the U.S. time-reference-scanning-beam system specified by the Federal Aviation Administration and the British doppler system at Aeroparque Airport during the meeting. If some questions remain unresolved, the Federal Aviation Administration will conduct field tests of its system at the Brussels Airport, the site of previous computer-model tests of the competing systems and actual field tests of the British system.

While initial British reaction to the Argentine offer was cool, the FAA accepted immediately. Members of the House Science and Technology subcommittee on transportation have warned the agency in writing that they will not support the time-reference, scanning-beam approach unless it demonstrates its superiority over the doppler system in side-by-side tests. The subcommittee members question the validity of the computer-model predictions at Brussels, which indicated the U.S. system is superior.

The International Civil Aviation Organization has repeatedly postponed selecting one of the MLSs to be the global standard, and is already a year overdue. The decision is now set for next year.

250-kW solar-cell array to power Arkansas college

A solar-cell array with a peak output of 250 kilowatts, the largest photovoltaic system yet approved, is due to start operating in mid-1979 at a classroom building to be constructed at Mississippi County Community College, Blytheville, AR. Previously, the largest planned photovoltaic system was a 60-kW flat-plate unit for a Navy base.

In the 250-kW array, roof and ground-mounted solar collectors will concentrate sunlight onto thin wafers of silicon crystals, which will convert the sunlight directly into electricity. Using optical concentrators is expected to result in systems costs of \$2 per peak watt of capacity—a tenfold reduction from current flat-plate arrays, according to Dr. Henry H. Marvin, director of ERDA's Division of Solar Energy.

The Energy Research and Development Administration is putting up \$6.3-million for the array, and Mississippi County residents are funding the building through a \$2.5-million bond issue.

RPVs may spot targets for missiles

The Navy is planning to develop a ship-recoverable, remotely piloted vehicle to provide long-distance targeting information for its Harpoon antiship missile, its version of the Army's laser-guided Copperhead artillery round, and its Tomahawk cruise missile.

One of two competitors, Lockheed Missiles & Space Co. and Teledyne Ryan Aeronautical Div., is expected to be awarded a six-month contract by Oct. 1 to demonstrate that RPVs can be operated safely from ships. Actual tests at sea are due to begin next February near San Diego.

Lockheed is bidding its Aquila battlefield-surveillance drone, developed under contract for the Army. Ryan is offering its ship tactical airborne (STAR) RPV, developed for the Navy. Both weigh less than 200 lb and can be recovered with nets.

If the tests are successful, the Navy plans to seek proposals from industry for an 18-month development program for a recoverable over-the-horizon RPV. If the tests fail, the Navy may be forced to choose a more expensive alternative—expendable RPVs.

Whichever design wins, reconnaissance will be investigated as another possible function.

NBS seeking industry aid in IC-mask studies

The National Bureau of Standards hopes to select 10 organizations by mid-October to participate in tests aimed at better defining line widths of integrated circuit photomasks in the 1 to 10-micrometer range.

Companies participating in the program will be asked to test the NBS standard, which preliminary tests indicate can achieve calibrations accurate to within 0.1 μm by using chromium etched on glass. Line-width-measurement variations of 0.25 μm or more commonly occur, according to NBS, because microscopes, measurement eyepieces, observers and operating conditions differ from test to test.

Two trained operators from each participating firm will be assigned to the project. The participants must also provide microscopes operating in bright-field transmitted light and equipped with a filter for green light (560 nm). The microscopes should also have an objective with a numerical aperture of at least 0.6 and a condenser with a numerical aperture about two-thirds of the objective's.

The program is being directed by John M. Jenke of the NBS Washington office and is being supported partially by the Defense Advanced Research Projects Agency.

New uses for AWACS antennas being examined

Applying sidelobe-suppression techniques developed for Airborne Warning and Control System (AWACS) aircraft to ground-based tactical radar is being studied by Westinghouse Electric Corp.

The study, funded at \$2.8-million by the Air Force's Home Air Development Center, examines using an ultra-low sidelobe antenna from AWACS to reduce vulnerability to enemy jamming. With the AWACS antenna, this reduction is reportedly three orders of magnitude over antennas without sidelobe suppression.

Westinghouse currently is under contract to the Air Force to deliver 49 of its AN/TPS-43E three-dimensional tactical-surveillance radars as part of the 487L system. The firm is also supplying long-range two-dimensional surveillance radars with height finders to an undisclosed foreign country.

Capital Capsules: **Laser-guided bombs are 200 times more accurate than manually released bombs**, according to the Air Force's Armament Development and Test Center, which is conducting a series of tests at its Eglin range in Florida and which has ordered production of Texas Instruments laser-guidance kits to continue. The tests involve 30 launches of 2000-lb MK-84 bombs and 10 launches of 500-lb MK-82 bombs, all equipped with the standard TI kit. The bombs were dropped from F-4C aircraft...**Vought Corp. has begun installing the Martin Marietta Pave Penny laser-target-designation system** on 350 Air Force A-7D attack aircraft. The aircraft-modification costs are estimated at \$15-million...**A low-cost detector of ozone is needed in aircraft cabins**, according to the Federal Aviation Administration, because ozone can cause respiratory problems. But none exists despite their wide use in scientific applications.



POW!!
THE LASER AGE IS HERE!
INTRODUCING

BI-FET II™

If you've been reading our ads (and shame on you if you haven't) you know that just a few months ago we told you how "the early bird catches the worm" and "practice makes perfect."

Our point was that our extra years in the BI-FET business have given us the experience to be able to develop better BI-FET products than the Johnny-come-lately's.

That should be abundantly evident now.

OP AMP REVAMP

Introducing National's unique (and besides that, nobody else has got it) new laser trimmed op amps, BI-FET II. A technology so advanced

it puts the original BI-FET in the rumble-seat along with racoon coats.

Laser trimming reduces amplifier offset voltage dramatically. To as low as 0.5 mV. Which means you don't need an external offset zeroing potentiometer anymore.

Or so many components.

Or so much money. (BI-FET II costs less than ordinary op amp plus potentiometer and extra assembly time.)

Or so much worry about reliability.

Other tidbits too good to keep to ourselves include 30 pA typical input current, the lowest noise in the industry, slew rate of 12V/us, and band width of 5 MHz.

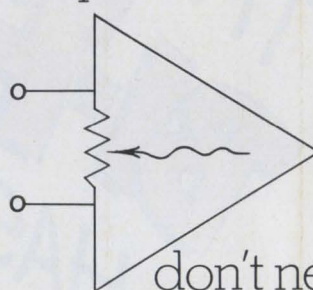

BUCK ROGERS WOULD BE PLEASED

He had his ray gun. We have our laser.

The trimming is done with a krypton pumped, Q switched YAG laser.

This advanced technology process results not only in better performance but also permits NSC to provide the best specs/dollar available anywhere.

THE SUPERSTAR OF OP AMPS

The top
of the line of

BI-FET II is a pair of op amps with really remarkable specs. LFT356H (\$12.00) features an offset voltage (max) of only 1 mV. And

LFT356AH (\$15.00) takes that even a step further. 0.5 mV.

Those are the lowest offset voltage devices you can buy. Need more

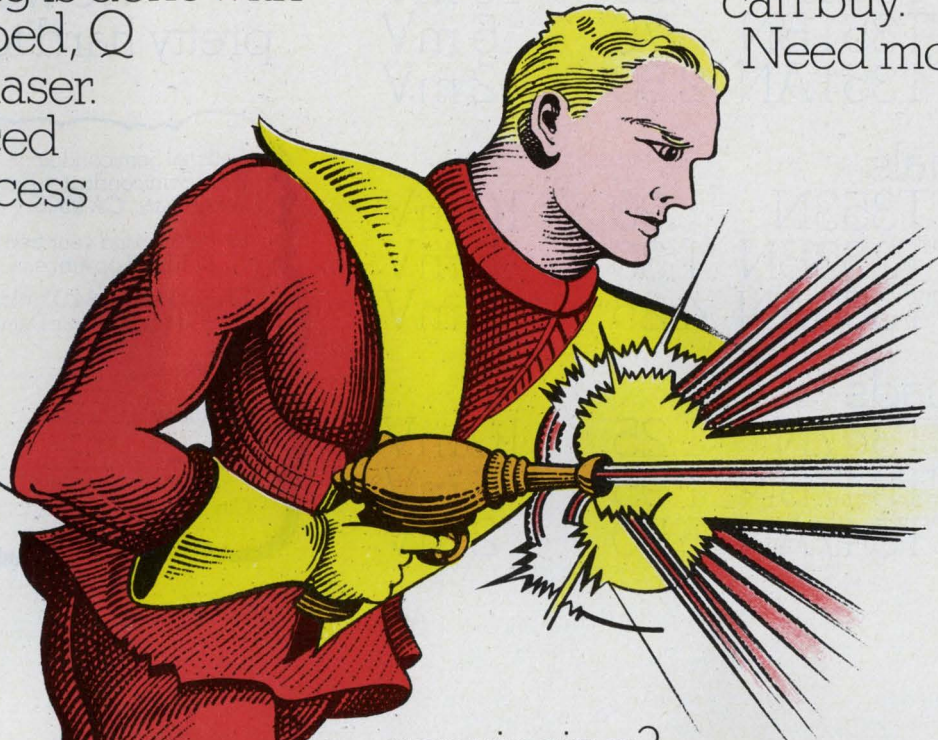

convincing?

Offset voltage drift, only 5 $\mu\text{V}/^\circ\text{C}$ guaranteed maximum.

Noise, just 12 $\text{nV}/\sqrt{\text{Hz}}$. And these Cadillacs of op amps also feature a special output stage which enables them to drive high capacitance loads directly. Which makes LFT356 even better than before. Even better than bipolar.

You just can't get performance like that at prices like that anywhere else in the universe. Ditto the balance of our line.

MORE GREAT BI-FET II STUFF

Singles	Price	Offset Voltage (max)
LFT351N	.39 (!)	10 mV
LFT351BN	.75	5 mV
LFT351AN	2.50	2 mV

Duals		
LFT353N	.90	10 mV
LFT353BN	1.30	5 mV
LFT353AN	4.25	2 mV

Quads		
LFT347N	1.25	10 mV
LFT347BN	1.95	5 mV
LFT347AN	6.50	2 mV

DO YOU GET THE IMPRESSION THAT NATIONAL LEADS IN LINEAR?

We would find that
pretty hard to argue with.

National Semiconductor
2900 Semiconductor Drive
Santa Clara, CA 95051

- Please send your free brochure about laser trimmed BI-FET II op amps.
- Enclosed is \$4.00; please send your fact-packed 968-page Linear Data Book.

Name _____ Title _____

Company _____

Address _____

City _____ State _____ Zip _____

 **National Semiconductor**
The Linear Leader

TRW's MAR™ ultra stable resistors. Performance plus.

Our ultra-precision MAR resistors match the performance of precision wirewound, *plus* they give the inherent advantages of TRW metal film.

Like smaller size, better frequency response, higher resistance values and lower cost.

And MAR's are not "selected" from a lower grade process. The entire facility was *designed* to yield *only* high accuracy devices.

And it *DOES*:



MAR axial lead family

Tolerances to $\pm 0.01\%$. TC's ± 5 to 25 ppm/ $^{\circ}\text{C}$. Where speed and precision count, the MAR does it all. In a dimensionally clean, axial lead molded package.

With the non-measurable noise, low voltage coefficient, load stability, resistance/size ratio and *reliability* of our metal film process.

Plus MAR matched sets and packaged networks have tolerance and TC matching to $\pm 0.005\%$ and 1 ppm/ $^{\circ}\text{C}$.

Specifications

IRC Type	Resistance Range* (Ohms)	Temperature Coefficients -20 $^{\circ}\text{C}$ to +85 $^{\circ}\text{C}$ (\pm ppm/ $^{\circ}\text{C}$)	Tolerances ($\pm\%$)	Power Rating** @ 85 $^{\circ}\text{C}$ (Watts)	Voltage Ratings (Volts)
MAR3	20 - 100K	T10 = 15	1.00, 0.50, 0.25,	$\frac{1}{2}$	200
MAR5	20 - 250K	T13 = 10	0.10, 0.05, 0.02,	$\frac{1}{4}$	250
MAR6	20 - 500K	T16 = 5	0.01	$\frac{1}{8}$	300
MAR7	20 - 1 Meg			$\frac{1}{4}$	500

*Wider ranges available, contact factory.

**Higher power ratings available. Contact factory.

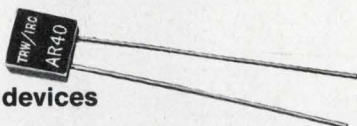

AR40 radial lead devices

This plug in configuration offers absolute accuracy and documented reliability. TC's to ± 2 ppm/ $^{\circ}\text{C}$, tolerances to $\pm 0.01\%$ are standard.

Plus, AR40 uses only .03 in.² PCB area including lead attachment, and has the same mechanically rugged terminations used on all MAR resistors.

Specifications

TCR Class.	Standard Temp. Coeff. ($^{\circ}\text{C}$)	Resistance Range* (Ohms)	Standard Tolerance ($\pm\%$)	Wattage 85 $^{\circ}\text{C}$
T-18	2 ppm 0 to 60 $^{\circ}\text{C}$ 5 ppm -55 to 125 $^{\circ}\text{C}$	20 to 100K	.01, .02, .05, .10,	.3 watts
T-16	5 ppm 0 to 60 $^{\circ}\text{C}$ 10 ppm -55 to 125 $^{\circ}\text{C}$		1.00	

*Wider ranges available, contact factory.

AR90 high range resistors

Designed for applications where you need values up to 10 Meg Ohms—such as precision voltage dividers, input attenuators.

Plus, despite its high resistance range, the AR90 has standard TC's to ± 5 ppm/ $^{\circ}\text{C}$ and tolerances to $\pm 0.05\%$. And it is a *real* space saver.

Specifications

IRC Type	Resistance Range* (ohms)	Temperature Coefficients -20 $^{\circ}\text{C}$ to +85 $^{\circ}\text{C}$ (\pm PPM/ $^{\circ}\text{C}$)	Tolerances	Power Rating	Voltage Rating
AR90	1M - 10M	T10 = 5 T13 = 10 T16 = 15	1.0, 0.5, 0.25, 0.1, 0.05	.5W	1000

*Wider ranges available. Contact factory.

Need prototypes fast?

TRW has on stream another *big plus*—a short order production line (in addition to our regular facility) designed to give you quick delivery on bread board quantities. Delivery to satisfy your needs, typically 2-3 weeks.

For more information on ultra-precision resistors, contact TRW/IRC Burlington. TRW/IRC Resistors, an Electronic Components Division of TRW, Inc., 2850 Mt. Pleasant St., Burlington, Iowa 52601. (319) 754-8491.

TRW IRC RESISTORS

CIRCLE NUMBER 20

Adtech Power Supplies cost about the same as the others.

But they're guaranteed for 6 years, while 1 to 2 years is typical.

Here's why.

OVER 50,000 HOUR MTBF / U.L. RECOGNIZED AS NOTED.

UNIVERSAL INPUT: 115/230 Vac $\pm 10\%$, 47-440 Hz
No derating for operation at 50 Hz.

AUTOMATIC FOLDBACK CURRENT LIMITING AND SHORT CIRCUIT PROTECTION.

IC IS ZENER PROTECTED AGAINST OVERVOLTAGE

CHASSIS DESIGN PROVIDES UP TO 40% MORE HEAT TRANSFER AREA THAN OTHER MAKES.

INSULATED SHAFT POTENTIOMETERS . . . (No Humdingers!) prevent shorting during adjustment.

ELECTROSTATICALLY SHIELDED TRANSFORMERS reduce noise better than 4 to 1.

Transformers are larger than on other makes . . . for added reliability.

COMPUTER GRADE CAPACITORS rated for 10-year life.

ALL TRANSISTORS AND IC's ARE HERMETICALLY SEALED (No Plastic types)

INTEGRATED CIRCUIT REGULATION AND INTEGRATED DARLINGTON TO-3 OUTPUT STAGE simplify circuitry . . . increase reliability.

3 Day Delivery . . . 6 Year Guarantee!

Single Output Microcomputer Power Supplies.

REQUEST BULLETIN APS-277



DIMENSIONS: 4"x2.75"x4.87"

15 TO 24 WATT "RED BARON" SERIES. *U.L. Recognized (File No. E58512)

MODEL NUMBER	RATING		REGULATION		RIPPLE (PK/PK)	OVP MODEL SUFFIX	PRICES-ALL MODELS		
	Vdc	Amps	Line	Load			QTY	POWER SUPPLY	OVP UNIT
APS 5-3*	5	3	±0.05%	±0.1%	3mV	OV1-53	1-4	34.00	7.00
APS 5-2.5	5	2.5	±0.05%	±0.1%	3mV	OV1-53	5-9	33.15	6.90
APS 15-1.6*	15	1.6	±0.05%	±0.1%	3mV	OV1-122	10-24	32.20	6.70
APS 15-1.5*	15	1.5	±0.05%	±0.1%	3mV	OV1-152	25-49	30.70	6.40
APS 20-1	20	1.0	±0.05%	±0.1%	5mV	OV1-201	50-99	29.20	6.05
APS 24-1*	24	1.0	±0.05%	±0.1%	5mV	OV1-241	100-249	27.00	5.70
APS 28-0.8*	28	0.8	±0.05%	±0.1%	5mV	OV1-281	250-499	25.20	5.25

30 TO 60 WATT "GREEN HORNET" SERIES. †U.L. Recognized (File No. E58512)

MODEL NUMBER	RATING		REGULATION		OVP MODEL SUFFIX	POWER SUPPLY PRICES			
	Vdc	Amps	Line	Load		QTY	APS 48-1	ALL OTHERS	OVP PRICES
APS 6-6*	5	6.0	±0.05%	±0.1%	OV2-56	1-4	68.00	55.00	15.00
APS 6-5*	5	5.0	±0.05%	±0.1%	OV2-55	5-9	66.70	53.65	14.85
APS 12-4*	12	4.0	±0.05%	±0.1%	OV2-124	10-24	64.75	52.10	14.40
APS 15-3*	15	3.0	±0.05%	±0.1%	OV2-153	25-49	61.75	49.65	13.75
APS 20-2.4*	20	2.4	±0.05%	±0.1%	OV2-203	50-99	58.75	47.25	13.05
APS 24-2.2*	24	2.2	±0.05%	±0.1%	OV2-245	100-249	55.15	44.35	12.25
APS 28-2*	28	2.0	±0.05%	±0.1%	OV2-284	250-499	50.75	42.00	11.30
APS 48-1*	48	1.0	±0.05%	±0.1%	OV2-481	500-999	49.60	40.00	11.05

* RIPPLE: (PK/PK) 5mV. All others 3mV.

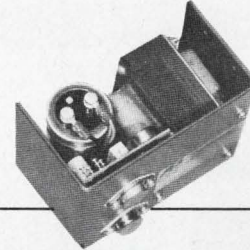

DIMENSIONS: 5.62"x3.40"x4.87"

50 TO 120 WATT "BLACK BEAUTY" SERIES. *U.L. Recognized (File No. E58512)

MODEL NUMBER	RATING		OVP MODEL SUFFIX	POWER SUPPLY PRICES				OVP PRICES	
	Vdc	Amps		QTY.	APS 5-9	APS 5-12	APS 5-18		ALL OTHERS
APS 5-9	5	9	OV2-510	1-4	71.00	85.00	108.00	75.20	15.00
APS 5-10*	5	10	OV2-510	5-9	68.75	82.95	104.50	73.40	14.85
APS 5-12	5	12	OV2-518	10-24	66.74	80.55	101.45	71.30	14.40
APS 5-18	5	18	OV2-518	25-49	63.90	76.80	96.70	67.95	13.75
APS 12-7*	12	7	OV2-127	50-99	61.05	73.00	91.95	64.60	13.05
APS 15-6*	15	6	OV2-156	100-249	57.30	68.55	86.35	60.65	12.25
APS 24-5*	24	5	OV2-245	250-499	52.75	65.00	79.45	55.80	11.30
APS 28-4*	28	4	OV2-284	500-999	51.60	57.90	77.70	54.60	11.05

REGULATION: LINE ±0.05% Load ±0.1% RIPPLE (PK/PK): 3mV on 5, 12, 15V models. 5mV on 24, 28V.

DIMENSIONS: 9"x3.65"x4.87"
APS 5-18 DIMENSIONS: 14"x3.65"x4.87"

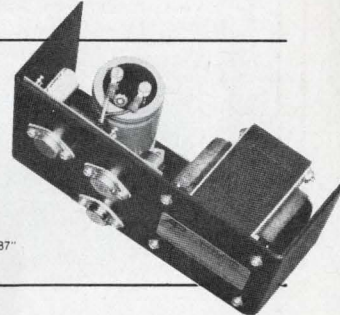

125 TO 250 WATT "BLUE MAX" SERIES.

MODEL NUMBER	RATING		REGULATION		OVP MODEL SUFFIX	POWER SUPPLY PRICES				OVP PRICES
	Vdc	Amps	Line	Load		QTY	APS 5-30	ALL OTHERS		
APS 5-25	5	25	±0.05%	±0.01%	OV3-525	1-4	163.00	158.00	25.00	
APS 5-30	5	30	±0.05%	±0.01%	OV3-530	5-9	159.25	154.40	24.50	
APS 6-22	6	22	±0.05%	±0.01%	OV3-622	10-24	154.65	149.95	24.25	
APS 12-17	12	17	±0.05%	±0.01%	OV3-1217	25-49	147.45	142.95	23.15	
APS 15-15	15	15	±0.05%	±0.01%	OV3-1515	50-99	140.20	135.90	22.00	
APS 20-11	20	11	±0.05%	±0.01%	OV3-2011	100-249	131.65	127.60	20.65	
APS 24-10	24	10	±0.05%	±0.01%	OV3-2410	250-499	121.10	117.40	19.00	
APS 28-9	28	9	±0.05%	±0.01%	OV3-289	500-999	118.50	114.85	18.60	

RIPPLE (PK/PK): 3mV on 5, 6, 12, 15V models. 5mV on 20, 24, 28V models.

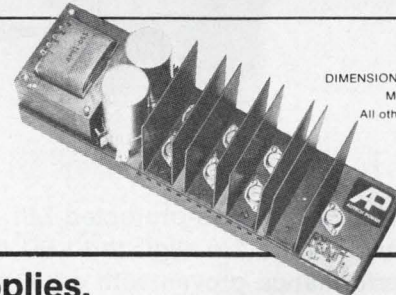

DIMENSIONS: 16.72"x4.87"x6.60"
Max. APS 5-30 only
All others 16.72"x4.87"x5.75"

New Multiple Output Microprocessor Power Supplies.

DUAL OUTPUT MICROPROCESSOR SERIES U.L. Recognized (File No. E58512)

MODEL NUMBER	RATING		QUANTITY PRICES						
	Vdc	Amps	1-4	5-9	10-24	25-49	50-99	100-249	250-499
DAPS 5.8	±5	0.8	43.00	41.95	40.70	39.80	38.00	36.80	33.00
DAPS 9-12.5	±9-12	0.5	43.00	41.95	40.70	39.80	38.00	35.80	33.00
DAPS 12-7.5	±12	0.75	43.00	41.95	40.70	39.80	38.00	35.80	33.00
DAPS 15-6.0	±15	0.06	43.00	41.95	40.70	39.80	38.00	35.80	33.00
DAPS 5112.5	±5	1.0	43.00	41.95	40.70	39.80	38.00	35.80	33.00
DAPS 12-1.5	±12	1.5	59.00	57.60	55.90	53.30	50.65	47.60	43.80
DAPS 15-1.3	±15	1.3	59.00	57.60	55.90	53.30	50.65	47.60	43.80
DAPS 53121.5	±5	3.0	59.00	57.60	55.90	53.30	50.65	47.60	43.80

REGULATION: ±0.05% Line. ±0.1% Load. RIPPLE (PK/PK) 3mV.

DIMENSIONS: (Small unit) 4"x2.75"x4.87" (Large Unit) 7"x3.40"x4.87"

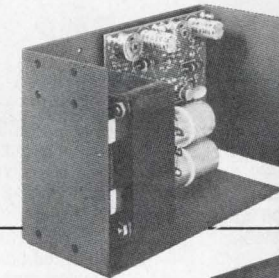

REQUEST BULLETIN DAPS - 976

TRIPLE OUTPUT "TAPS" MICROPROCESSOR/GENERAL PURPOSE SERIES

MODEL NUMBER	RATING		QUANTITY PRICES						
	Vdc	Amps	1-4	5-9	10-24	25-49	50-99	100-249	250-499
TAPS 1	5V	4.0	94.15	91.85	89.20	85.05	80.85	75.90	71.00
TAPS 2	±9-12*	0.5	107.00	104.60	101.60	96.85	92.10	89.00	87.50
TAPS 3	±9-12*	1.0	137.00	134.00	129.80	127.80	125.00	123.75	113.85
TAPS 4	±9-12*	1.5	163.00	159.00	154.45	151.50	149.00	148.00	147.00

* Also available with +12-15V output. Specify if desired. REGULATION: ±0.1% Line, ±0.1% Load. RIPPLE (PK/PK): 5mV

REQUEST BULLETIN TAPS - 377

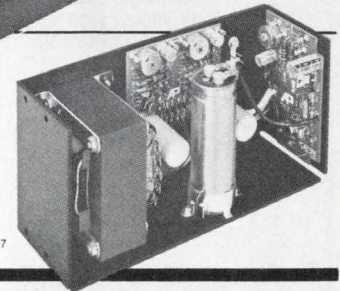

DIMENSIONS: 8.62"x3.65"x4.87" to 15"x4.5"x4.87"

CALL OUR ENGINEERING SALES OFFICE IN YOUR AREA FOR APPLICATION ASSISTANCE

Arizona, Phoenix (602) 946-9860
 California, Long Beach (213) 426-7375
 San Francisco (408) 733-6690
 Colorado, Denver (303) 773-2830
 Connecticut, Meriden (203) 237-9232
 Hawaii, Honolulu (808) 941-1574
 Illinois, Chicago (312) 298-4830
 Kansas, Kansas City (913) 381-0004
 Wichita (316) 264-2662
 Massachusetts, Boston (617) 245-0250

Michigan, Detroit (313) 576-4705
 Minnesota, Minneapolis (612) 854-4270
 Missouri, St. Louis (314) 569-1220
 New Mexico, Albuquerque (505) 294-8408
 Las Cruces (505) 524-0126
 New York, Albany (518) 456-6667
 Buffalo (716) 632-7880
 New York (516) 487-3966
 Rochester (716) 482-3000

New York, Syracuse (315) 637-9383
 North Carolina, Winston-Salem (919) 725-6196
 Ohio, Dayton (513) 434-8808
 Pennsylvania, Philadelphia (215) 825-9515
 Pittsburgh (412) 961-0414
 Texas, Dallas (214) 387-2489
 Houston (713) 665-0991
 Washington D.C., (202) 363-9417
 Wisconsin, Milwaukee (414) 421-2300

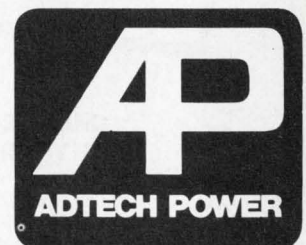

Canada: Montreal (514) 363-5120, Ottawa (613) 745-0541, Toronto (416) 787-0991, Winnipeg (204) 338-5050, Vancouver (614) 748-2392
 In Europe: SOPHIA, Wholly Owned Subsidiary of Adtech Power, 46 BD. Roger Salengro, 78200 Mantes La Ville, France. Tel: 4775301+

Adtech Power Inc., 1621 South Sinclair Street, Anaheim, California 92806, Telephone: (714) 634-9211

CIRCLE NUMBER 21

The Simpson DIGITAL MULTIMETER FAMILY KEEPS GROWING!

Here's our latest addition
For \$130



New Compact Portable Model 461
Complete with nickel-cadmium batteries, AC charger/adaptor, test leads and instruction manual

- 8 FULL HOURS continuous battery operation . . . a full day's work without interruption
- 0.25% DC V accuracy
- Large bright 0.3" LED display
- Automatic zero and polarity
- 100 μ V, 0.1 Ω , 100 nA sensitivity
- 26 pushbutton selected ranges
- High energy fuse safely contained in case
- Folding bench stand
- Only 2 x 5.6 x 4.6"; 1 1/2 lb.

ALL SIMPSON DMM'S HAVE

- Reliable overload-protected LSI circuitry
- Easy-to-read 3 1/2 digit red LED displays with automatic polarity
- Performance proven with a 200-hour burn-in, backed up by a one-year guarantee
- Complete line of accessories is available

For \$210

Popular Priced Model 464A

- 0.1% DC V accuracy
- 28 pushbutton ranges including 10A AC/DC
- Bright 0.43" LEDs, automatic zero
- High-impact case with tilt-view adjustable handle
- For AC line operation. Optional AC/rechargeable version available for \$247



For \$285

Deluxe 460-3A

- 0.1% DC V accuracy, custom MOS/LSI circuitry
- 32 ranges including low power resistance ranges and 10A AC/DC current
- Bright 0.43" LEDs, automatic ZERO
- Calibrated auxiliary analog meter
- For AC line operation. Optional AC/rechargeable version available for \$322



For \$295

Autoranging Model 465A

- Automatically selects and displays the proper measuring range
- High 0.1% DC V accuracy, custom MOS/LSI circuitry, 0.43" LEDs
- Measures DC voltage to 1000 V, AC voltage to 600 V, resistance to 20 megohms, low power ohms ranges AC/DC current to 10A
- AC line operation. Optional AC/rechargeable version available for \$332



For \$257

Digital VOM — the 360-2

- AC line and rechargeable operation standard
- 0.25% DC V accuracy exclusive MOS/LSI circuitry, automatic zero
- 29 ranges including low power resistance
- Calibrated zero center analog meter
- Recorder output



KATY INDUSTRIES



INDUSTRIAL
EQUIPMENT
GROUP

CHOOSE THE ONE THAT'S BEST FOR YOU
AT YOUR LOCAL ELECTRONICS DISTRIBUTOR

Simpson
INSTRUMENTS THAT STAY ACCURATE

SIMPSON ELECTRIC COMPANY

853 Dundee Avenue, Elgin, Illinois 60120
(312) 697-2260 • Cable SIMELCO • Telex 72-2416

Don't listen

Recovering from a case of terminal marriage, a friend of mine summarized the main lesson he learned during the period he calls his sentence: "Don't listen."

He's an entertaining guy, so I assumed his principal object was to amuse me. Then I realized he wasn't kidding. Or, at least, not entirely. Later, as I munched on his words, I realized that they may have carried more wisdom than mirth. I saw that, while many problems in bad marriages stem from inadequate listening, many come from too much. And that's true in business and engineering, too.

In fact, listening too much might be the greater danger. All of us are so much aware of the danger of listening too little—of missing something important that might be said in a business discussion or that might be posed in an engineering problem, that we concentrate on hearing everything. We want to be sure we miss no crucial details. If our customer says he wants a crackle-finish front panel, we want to be certain not to miss that requirement. So we listen very distinctly. That can sometimes hurt.

It's often far more valuable to know what the customer really wanted than to know what he said. Perhaps he wanted a no-glare front panel, or one that wouldn't show fingerprints. Or maybe, when a customer said he wanted MOS circuitry, he really meant that he wanted low power consumption. And maybe we can get that by other means.

Or maybe one of our engineers spends a lot of time bitching about his colleagues or his technicians while he's really trying to let us know how valuable he is.

So it might be wise to listen with greater discrimination. It might be valuable to learn when our brains should tell our ears: "This is important; listen very carefully," and when they should say: "This is nonsense," or "This isn't the point. Don't listen."

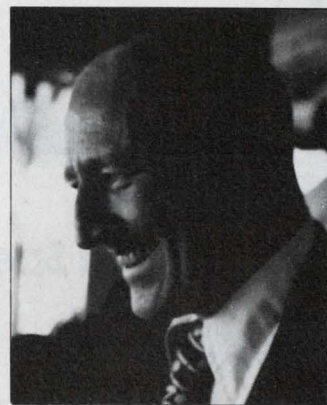

A handwritten signature in dark ink that reads "George Rostky". The signature is fluid and cursive, with a long, sweeping underline that extends to the right.

GEORGE ROSTKY
Editor-in-Chief

Now the selection, availability, price, and performance you want in Open Frame Power Supplies

- Fifty-five models; single and dual outputs.
- Seven industry-standard sizes.
- In stock.
- Full performance over a wide 100-125 or 200-250 VAC input range.

- More power per package size.
- Full rated current with 50 Hz input.
- True remote sense capabilities.
- Fully adjustable current limit.
- Overload and shortcircuit protection.
- UL recognized, standard 478.

More power conversion products: Our Power House line includes a wide selection of encapsulated and ferroresonant power supplies as well as programmable solid state loads for testing. Write for our free master catalog.

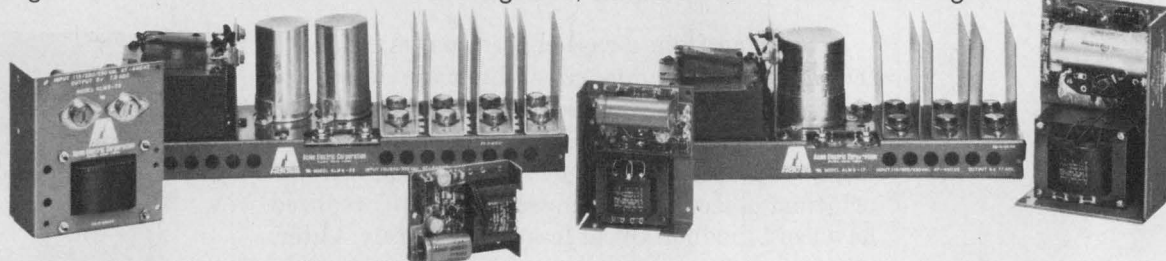

Common Specifications:

AC Input: 100-125 or 200-250 VAC, 47-440 Hz.

Ripple and Noise: 1.5 mV RMS, 5 mV P to P.

Transient Response: 50 μ sec.

Regulation — Line or Load: 0.1%.

Operating Temperature: 0°-60°C.

Cooling: Convection.

Stability: \pm 0.2%.

ALM Single Output Units:

A Series

Price: \$27

Nominal Output Voltage	Current Rating @ 40°C.	Model No.
2	1.5	ALM 2-1.5
5	1.5	ALM 5-1.5
6	1.3	ALM 6-1.3
12	0.7	ALM 12-0.7
15	0.7	ALM 15-0.7
20	0.5	ALM 20-0.5
24	0.5	ALM 24-0.5

Overvoltage Protector — OVM-1 \$8.00
Overall dimensions: 3.03 x 3.78 x 1.28.

D Series

Price: \$72

Nominal Output Voltage	Current Rating @ 40°C.	Model No.
2	11.0	ALM 2-11
5	11.0	ALM 5-11
6	10.0	ALM 6-10
12	6.0	ALM 12-6
15	5.0	ALM 15-5
20	4.0	ALM 20-4
24	3.8	ALM 24-3.8

Overvoltage Protector — OVM-2 \$16.00
Overall dimensions: 4.90 x 7.03 x 2.78

F Series

Price: \$106

Nominal Output Voltage	Current Rating @ 40°C.	Model No.
2	20.0	ALM 2-20.0
5	20.0	ALM 5-20.0
6	17.0	ALM 6-17.0
12	13.0	ALM 12-13.0
15	10.7	ALM 15-10.7
20	9.0	ALM 20-9.0
24	8.2	ALM 24-8.2

Overvoltage Protector — OVM-2 \$16.00
Overall dimensions: 4.88 x 4.88 x 13.75

B Series

Price: \$31

Nominal Output Voltage	Current Rating @ 40°C.	Model No.
2	4.0	ALM 2-4.0
5	4.0	ALM 5-4.0
6	3.3	ALM 6-3.3
12	2.0	ALM 12-2.0
15	1.7	ALM 15-1.7
20	1.4	ALM 20-1.4
24	1.3	ALM 24-1.3

Overvoltage Protector — OVM-1 \$8.00
Overall dimensions: 4.00 x 4.87 x 1.76

E Series

Price: \$88

Nominal Output Voltage	Current Rating @ 40°C.	Model No.
2	15.0	ALM 2-15.0
5	15.0	ALM 5-15.0
6	12.5	ALM 6-12.5
12	8.8	ALM 12-8.8
15	8.0	ALM 15-8.0
20	7.0	ALM 20-7.0
24	6.5	ALM 24-6.5

Overvoltage Protector — OVM-2 \$16.00
Overall dimensions: 4.87 x 9.00 x 2.75

G Series

Price: \$128

Nominal Output Voltage	Current Rating @ 40°C.	Model No.
2	25.0	ALM 2-25.0
5	25.0	ALM 5-25.0
6	23.0	ALM 6-23.0
12	16.0	ALM 12-16.0
15	14.0	ALM 15-14.0
20	11.5	ALM 20-11.5
24	10.5	ALM 24-10.5

Overvoltage Protector — OVM-2 \$16.00
Overall dimensions: 4.88 x 4.88 x 16.75

C Series

Price: \$54

Nominal Output Voltage	Current Rating @ 40°C.	Model No.
2	7.5	ALM 2-7.5
5	7.5	ALM 5-7.5
6	6.5	ALM 6-6.5
12	4.0	ALM 12-4.0
15	3.5	ALM 15-3.5
20	3.2	ALM 20-3.2
24	3.0	ALM 24-3.0

Overvoltage Protector — OVM-1 \$8.00
Overall dimensions: 4.87 x 5.62 x 2.50

ALM Dual Output Units:

Adjust Range	Current Rating @ 40°C.	Model No.	Series	Price
12-15	0.55	ALM 15D-0.55	B	\$ 45.00
12-15	1.10	ALM 15D-1.1	C	55.00
12-15	2.20	ALM 15D-2.2	D	68.00
12-15	3.30	ALM 15D-3.3	E	91.00
12-15	4.40	ALM 15D-4.4	F	114.00
12-15	8.00	ALM 15D-8.0	G	136.00

Overvoltage Protector — Two OVM-1 \$8.00 Each.



Phone (716) 968-2400 TELEX 91-6451 TWX 510-245-2700

Acme Electric Corporation

Cuba, N.Y. 14727

CIRCLE NUMBER 141

The Symbol Says It All.



The Power House symbol that appears on Acme Electric standard power supplies identifies a product made by the largest independent manufacturer exclusively in the power conversion business... the company with more than \$30 million in sales last year.

It also stands for a wide selection — one of the widest in the industry. For consistent performance. Competitive prices. On-time delivery. Honest specifications.

And, it stands for professionalism. Professionalism in every phase: pre-sale and post-sale backup, large inventory, nationwide distribution, fully supportive engineering, manufacturing capabilities second to none in the industry.

Power House. The signature of the professional power people. Reflecting the meticulous craftsmanship that has earned us a leadership position for 60 years. And assuring you extra value every time you buy a product bearing the Power House symbol.



Acme Electric Corporation
Cuba, N.Y. 14727

CIRCLE NUMBER 142

ELECTRONIC DESIGN 20, September 27, 1977

Now an easy, precise, convenient way to load and test

DC power supplies and regulators.

Programmable Solid State Loads

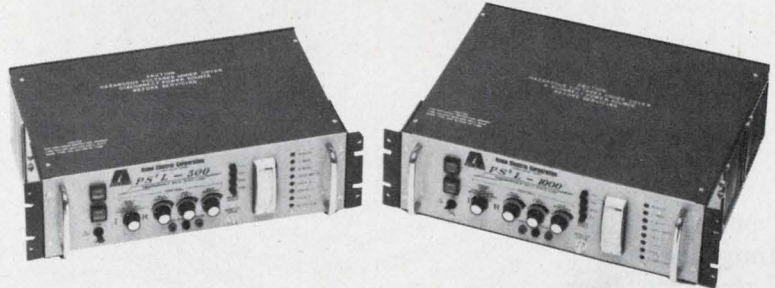

- Designed to fulfill a wide range of DC test applications requiring constant current, constant resistance, or both.
- Provides 0.02 ohm to 2K ohm adjustment in constant resistance mode.
- In the constant current mode, the PS²L may be used to load test DC regulators and power supplies, or act as a constant current discharge to battery and capacitor banks.
- Programmable with any number of waveforms for calculating or verifying power supply specifications, such as load regulation, transient response and output impedance.
- May be used with a DC power source to make an adjustable constant - current supply.
- Available in 500 and 1000 watt models.
- Bench top/rack mount adaptable.

Performance Characteristics

	PS ² L-500	PS ² L-1000
Maximum Loading Power @ 25°C	500 Watts	1000 Watts
Maximum Loading Voltage	60 VDC	60 VDC
Maximum Loading Current	55 ADC	110 ADC
Minimum Loading Voltage	2 VDC	2 VDC
Constant Resistance Range (Typ.)	.036Ω-2000Ω	.018Ω-2000Ω
Program Input Impedance (Typ.)	50 K	50 K
Programming Input Volt (Typ.)	.5V/10 Amp load	1V/10 Amp load
Current Monitor Output (Typ.)	-100mV/Amp load	-50mV/Amp load
Square Wave Response (Typ.)	80 μsec for 50 Amp step	120 μsec for 100 Amp step
Regulation (constant current, constant resistance)	1%	1%
Overvoltage Crowbar Point (adjustable)	70-78 VDC	70-78 VDC
Operating Ambient	0°-55°C.	0°-55°C.
Input Voltage Requirements	115/230VAC±10%	115/230VAC±10%
Input Frequency Range	47-63 Hz	47-63 Hz
Maximum Input Current	1 Amp	1 Amp
Price	\$630	\$725

Write for our master catalog, which includes open frame, encapsulated, and ferroresonant power supplies.

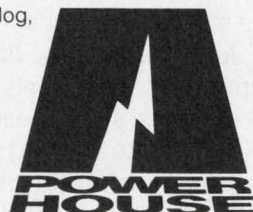

Phone (716) 968-2400 TELEX 91-6451 TWX 510-245-2700

Acme Electric Corporation

Cuba, N.Y. 14727

CIRCLE NUMBER 143

on Multiple- output dc supplies

DCUS

An obscure Eskimo legend says that the Bear god was so touched by an offering of octopus eyes that he bellowed: "Cost and size aside, the more outputs in a power supply the more difficulty you'll have specifying it." You question the validity of this report? Then why hasn't a single power-supply manufacturer received complaints from above the Arctic Circle?

In the more temperate areas of the world, too, multiple-output power supplies are often a mixed blessing. Attractive primarily because of low cost and small size, they can carry the penalty of interacting outputs. This interaction often affects a supply's power-output capability, regulation (or *stabilization* for the purists), ripple and noise.

For example, one manufacturer specifies regulation of 0.1% for his three-output module. Further probing uncovers the limitation that this figure refers to the ± 12 -V outputs only. The 5-V output (with 0.5% regulation) isn't quite that tight. "But it's only meant to be a supply for logic," is the company's response. And of course, that's all it will be once you've learned its unpublicized limitations.

In any supply, power is basic

The most basic quantity in any power supply is, of course, the amount of power that it supplies. But, in multiple-output supplies, the power drawn from one output often affects the power that other outputs can supply. Surprisingly, even so fundamental a parameter is often spec'd unclearly in multi-output supplies. Many data sheets boast of high voltage and current combinations for each output. But the supply can't deliver these voltages and currents simultaneously. The better specing practice is to quote the outputs in terms of voltage and associated maximum currents for each output and immediately follow these with



All combinations of output voltage are available in the multiple-output dc supplies from Acopian. To order you specify the catalog-listed outputs that you want and then add their prices for the total cost.

the restriction on the total power. Some spec sheets bury this total-power disclaimer away from the power data for each output. But you'll find out when you plug the supply into your current-thirsty loads.

Supplies also fall short of current for reasons other than misleading specs. Often, last-minute additions to the system overburden the supply. Suddenly, questions arise about paralleling. Can an overdrained

Sid Adlerstein
Associate Editor

output be paralleled at all? If yes, is the output's quality (regulation, drift, noise, etc.) affected? Will the output still be protected against short circuits, over-voltage etc.? And finally, is any auxiliary circuitry needed? If your power-supply requirements can change down the development stream, look into paralleling and what it entails.

Often only the regulators are paralleled. For example, in data-acquisition systems, the logic commonly uses 5-V dc power while the analog circuits take either ± 12 or ± 15 -V dc. Hard decisions as to the sources of this power can plague the system designer. Should all the power come from a single multiple-output unit? Or are separate on-board regulators the right answer? Separate regulators for each board prevent the distribution of noise and drift from one board to another. Separate regulators can be controlled from a single zener where tracking is required. On the other hand, on-board regulators occupy valuable board space and generate heat—right at the analog circuitry—just where it can do the most harm. Some data-acquisition packages solve the problem by including dc supplies within the package.

Input power quality can be decisive

One problem that you must solve for yourself stems from the quality of your input power. Present-day power lines are subject to disturbances and, of course, even outages. Most of these disturbances occur as:

- Voltage spikes
- Oscillatory decaying
- Undervoltages and
- Overvoltages.

Fortunately, both line-voltage spikes and oscillations usually last for less than a full cycle of the ac input. They therefore show up on the output briefly, if at all, as noise.

It's usually another matter with line undervoltages and overvoltages. Frequently, they last longer than a cycle of the input. And the three most often used dc-output regulators—linears, switchers and ferromagnetics—all have unique limitations vis-a-vis input-line variations.

Disturbances resulting in low-line conditions are a serious matter for linear series-pass regulators. Many linears hold to their regulation specs only for inputs between $\pm 10\%$ of nominal. Additionally, most linears can supply full-power output in the face of no more than a 1-cycle input outage.

Switchers usually do much better. Some can ride through an input outage of as long as five cycles at full-power output. Most switchers, though, claim the capability of supplying full-power output over only a two-cycle maximum outage.

Overvoltages, also, are handled more easily by switchers than by linears. Short-duration overvoltages, especially when high, can cause a regulator's output-crowbar circuit (if there is one) to shut down the supply completely. Most switchers, of course use squelch-type rather than crowbar circuits for over-

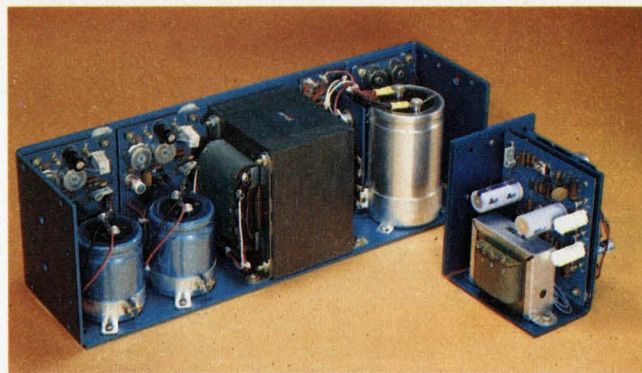

Open framers that deliver isolated triple outputs are features of the SPS family from Standard Power. Sizes range from the 30T which develops 5-V at 2-A plus two 12-to-15-V outputs at 250 mA each, to the 250T which develops its 5-V at 12 A plus two auxiliary 12-V outputs at current levels of 3.5 A each.

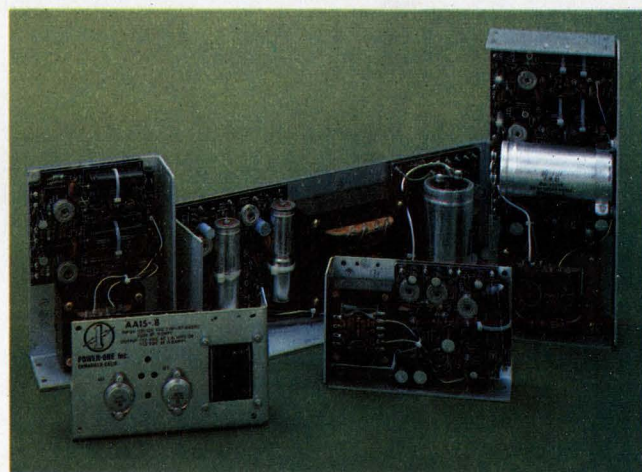

Just one jumper gives you a negative 5-V output from any multiple-output supply by Power One. The company manufactures only open-frame supplies and tests each unit both before and after burn-in.

voltage protection. But don't be complacent, for systems that demand full-time supplies, check how the vague "overvoltage protection" claimed on the spec sheet is implemented.

Long-duration overvoltages are easily handled by most switchers. They simply adjust the pulse width, duty cycle or amplitude as required. But long-duration overvoltages are another matter with supplies using series-pass regulators. Higher input voltages mean higher power dissipation by the series element. At full load this can mean trouble for the regulator.

Beware of regulators' common input

In particular, you've got the seeds of destruction planted in a multiple outputter in which a low-current, low-voltage-output regulator shares the unregulated dc that feeds a higher-current, higher-voltage regulator.

This design saves a transformer-secondary tap, rectifiers and possibly a filter capacitor. But, the

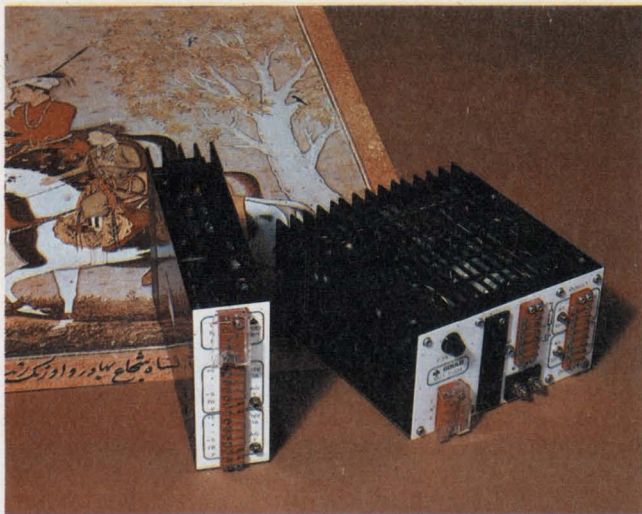

Meeting international standards for switching supplies is the forte at Gould Advance Ltd. The three-output MGT5-20 meets VDE 087 for RFI and VDE 0804 for isolation and insulation. UL478, CEE15 and BS3535 are also met.

voltage across the low-voltage regulator is greater than optimum—even at nominal input-line voltage. So when the line voltage goes high and there is a full load on the low-voltage supply together with no load on the other outputs, the low-voltage regulator faces being overpowered.

Fortunately, many series regulators have built-in thermal shut-down mechanisms. But at best, this means that the dc power goes off. In supplies without thermal protection, however, reliability suffers. Excessive heat shortens component life. At worst, a series-pass transistor shorts out, sending a higher voltage than you bargained for throughout your system. To avoid this potential disaster either ensure that the circuitry can handle possible overvoltages or buy overvoltage protection in a linear regulated supply.

But if input-line-voltage disturbances are your problem, they are best handled by ferromagnetic regulators. Because these supplies deliver regulated power via a saturated-magnetic element, most line-voltage variations have little or no effect on the output.

When the line frequency changes, ferromagnetics perform poorly. Their output voltages drop drastically when the line frequency departs from nominal. Almost any kind of regulator outperforms the ferromagnetic type in the face of line-frequency changes. And these changes do occur—almost every day.

Power utilities do try to stabilize their frequencies. But utility power is generated from rotating equipment. So moment-to-moment frequency does vary, albeit slightly. Paradoxically, the largest frequency shifts come about because the utilities deliberately change their frequencies. To compensate for a day's short-term fluctuations utilities change their frequencies—usually at midnight. These late-night changes are the power company's way of ensuring they generate a precise number of cycles in each day. In this way such equipment as clocks are automatically

adjusted. So if you want your system to run around the clock, ferromagnetic regulation is out.

Inrushes can wipe out switchers

In switchers watch out for inrush currents. Though almost every modern switcher claims to have inrush-current protection, most use only a simple thermistor to slow the surge of current through the input rectifiers and into the input filter capacitor (usually a large one). The thermistor works well enough when the supply is turned on from standing cold.

But in these days of overburdened and irregular input-line service, thermistor protection leaves the door open in a very important case. That is where the supply has been on for a long time so that the thermistor is warm but the input line is low. If the line rises suddenly to or even past nominal, the thermistor is useless and the surge is unimpeded. So if you do choose a switcher, look into just how the inrush current is limited. You'll never find out how inrush is limited from the spec sheet. Here's an example of when a \$3 phone call can get you thousands of dollars in power-supply-consulting help.

And while you've got your switcher expert on the phone, find out what is the ripple factor of the input-rectifier capacitor under your load conditions. Then ask for the failure data for this capacitor at that ripple load and your temperature level. No, you're not being a pest—these are high-voltage capacitors and they don't fail quietly—they explode.

Output-voltage variations due to line changes occur in every power supply. The defining specification, that for regulation against line voltage, usually spells out clearly its line-voltage-and-frequency limits. But you rarely get the data for other than one set of load conditions. Even the National Electrical Manufacturers Association (NEMA) requires only that all other conditions be at nominal.

Line and load can interact

In multiple-output supplies the separation and implied independence of line-and-load-regulation limits can be particularly misleading. Supplies with several outputs often use a common transformer for cost effectiveness, size and weight reduction and, sometimes, increased efficiency. Thus load changes, on any one output, appear as line changes to all other outputs. Most multiple-output supplies are specified only for static regulation as NEMA requires. The actual regulation and, of course, the efficiency, may therefore vary unexpectedly with the real loads and lines that the supply experiences in your system.

Almost everyone knows of the line-like effect that any one of the multiple outputs in a linear regulator has on its companion outputs. And most engineers know why, also. As more current passes to any output, the voltage drops increase in the fixed resistances: the input transformer and rectifiers. To the series-pass

regulator it appears as though the input-line voltage has dropped.

In switchers, secondary outputs (those with less power capability than the principal output) are frequently taken from the same pulse-width-modulated transformer as is the heavy-power output.

This leads to the almost weird interaction between fully loaded secondary outputs and an unloaded primary output at the high-input-line condition. The primary output controls the regulator and calls for a minimum pulse width. This is the minimum-output-power condition. So, as the secondary outputs then call for more power, dropout occurs. The secondary outputs fail even if individual series or small switch-regulators are used on these secondary outputs.

To avoid these secondary-output-dropouts, some supplies require a minimum load on the primary output. This keeps the inverter running always, but at the expense of true efficiency.

Other load interactions, though not as hair-raising



All three outputs are adjustable and isolated in Model 62312D, Hewlett-Packard's series-regulated μ C supply. One rail spans 4.75 to 5.25 V at 3 A. Two provide from 4.75 V at 380 mA to 12.6 V at 600 mA.

as the secondary-output dropout, nevertheless can cause grief.

Heavy currents need isolation

When filter or dc-return lines are shared by more than one output, look out for heavy currents. High currents, going through the return's resistance at low frequencies and its inductance at radio frequencies or at pulse edges, can crosstalk your system into a noisy bedlam.

In particular, be careful with the isolated 24-to-28-V outputs that some "microprocessor supplies" offer for electromechanical control devices such as relays

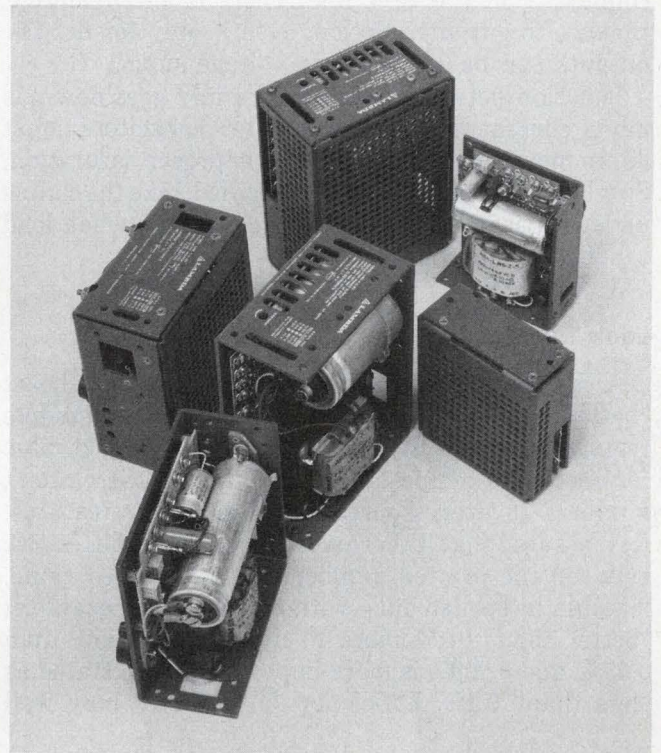

Heat sinks or blowers aren't needed with the convection-cooled LN linear-regulated power supplies from Lambda. The series, which includes dual outputters, features mounting in any of three axes, from three surfaces.

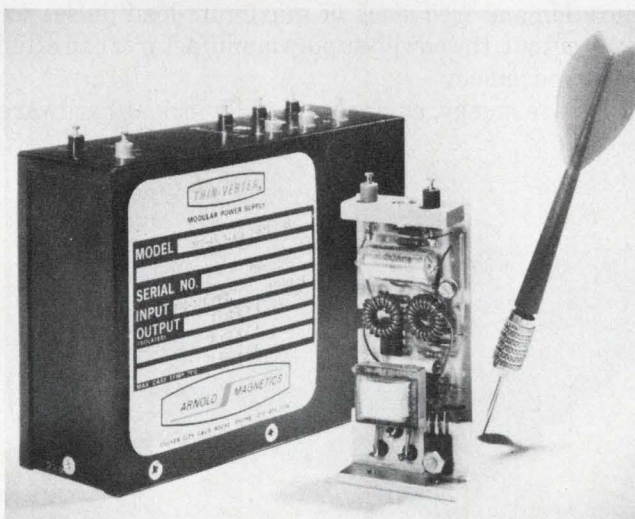

Supplies are divided into driving and regulator modules at Arnold Magnetics. Drivers use ac or dc inputs while three types of regulators are available: linear, switchers and the extremely reliable magnetic-amp type.

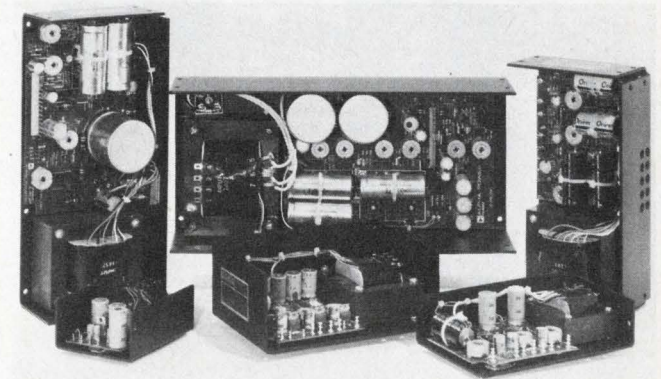

Repairable construction is a feature of the open-frame multiple-output dc supplies from Alpha Power. For easy replacement, power semiconductors are mounted on a PC board rather than through the frame.

and motors. Even if you do keep these outputs isolated, expect some crosscoupling between them.

The isolation between outputs is rarely specified—probably because isolation is layout sensitive and also because EMI testing is, at best, cumbersome and expensive.

Some units do have dc isolation spec'd between their outputs. This is better, of course, than nothing at all—but not much better. Not too much system sense went into the internally generated noise specification that ranges up to an adequate 20-MHz bandwidth, and is followed by an output impedance specified up to only 100 kHz and isolation called out just for dc.

Your system won't care much whether the spikes on the ± 15 -V lines are internally generated noise or coupled from the 24-V line. There is an advantage, though, to output isolation, even if only for dc. The outputs can be stacked into voltage sums.

Isolation between outputs generally goes down as more current is delivered. Filter capacitors must dump more ripple and inductors approach saturation. So when you do find isolation specified, take the claims under advisement until you find out at what load conditions they apply.

Look for numbers

Also, don't be too impressed by specs that boast "better than" a specified number for parameters like regulation or stability and "less than" a specified value for specs like tempco. It's not as though there aren't numbers to express precisely these super features. Rest assured that if there were a significant difference between the printed number and the implied value, it would be spelled out—with precision. For example: "better than" 0.1% more likely means 0.095% than 0.05%, and 0.099% is more impressive when stated as "less than" 0.1%. Efficiency "up to" 80% may well

mean that if you buy a switcher with 28-V and 5-V outputs you can get 80% efficient operation at nominal line and full load (resistive, of course) on the 28-V output if the 5-V output is unloaded. If you draw any 5-V current, watch the efficiency drop.

That is, watch it drop—if you can. When measuring efficiency, remember that ferromagnetics and switchers do wonderful things to the input-line current waveshape, so your efficiency measurement had better be made with true-rms equipment.

You don't have to make exotic measurements to specify whether or not outputs may be allowed to track each other. If your system can abide this special kind of interaction, you're in luck—the manufacturer can save the reference circuit (at least a temperature-compensated zener and a resistor) for one of the regulators, and pass the savings on to you. That's right, tracking outputs should reduce the cost of the supply.

Of course there are other ways that you can reduce the cost of your power supply. One is to specify regulation only on those outputs that warrant close control. Partially regulated supplies are less expensive, more reliable and more efficient than those boasting full regulation of each output. Also make sure you specify which changes the regulated outputs must be steadied against. Regulation against line-voltage changes alone costs less than against both line and load changes. A semi-regulated supply should be considered when total regulation requirements are of the order of 10%. For control this coarse, supplies with only preregulation are often the prudent choice.

Pay for only what you need

Take advantage of the unique loading characteristics of your system. Some outputs are never used at the same time as others and the maximum current is seldom drawn on a continuous basis but is most often required as pulses. Armed with data for the duration and frequency of maximum-load pulses for each output, the power-supply manufacturer can often save you money.

To save money, engineers usually look at hardware

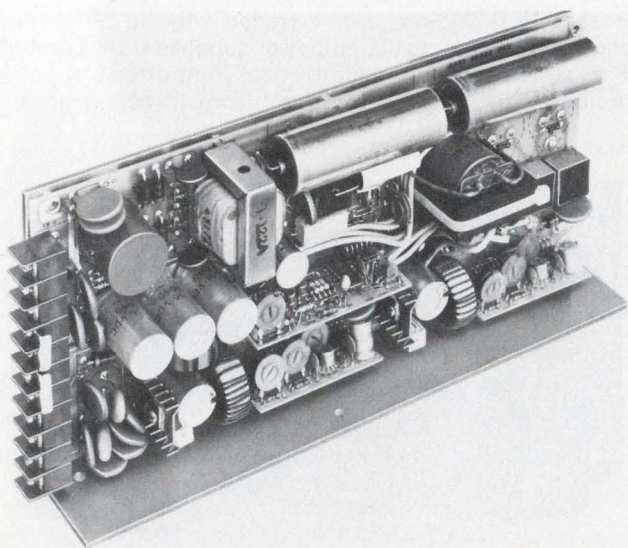

You get a power density of 1-W per cubic inch with the Model TM20 from LH Research. The switcher's three outputs combined deliver 150-W max. A power-failure signal comes after a 1-cycle ride-through.

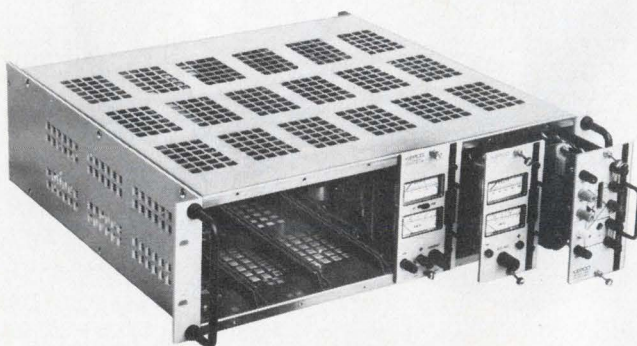

Six modules slide into the 19-inch rack of the PCX system by Kepco. The modules include RMT switching-mode supplies which use three, independent, secondary, pulse-width modulators—one for each of the outputs.

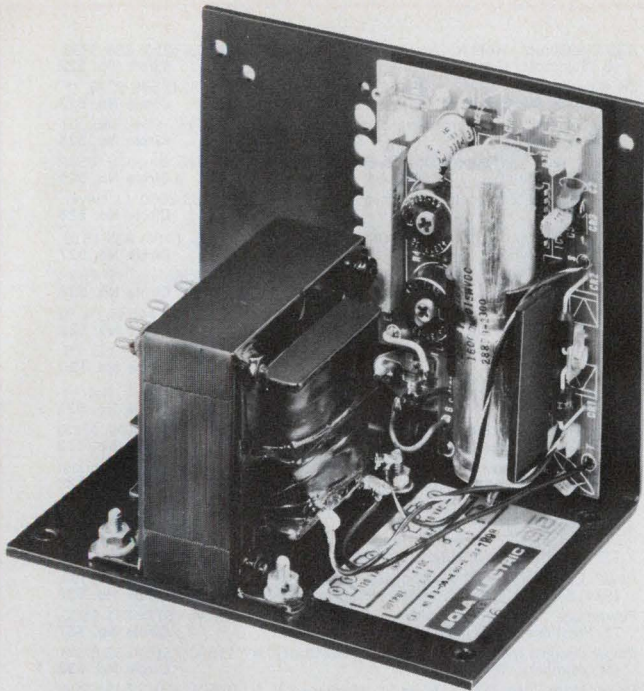

28 models provide 15 to 120 W of series-regulated dc power in the OEM family of open-frame supplies from Sola Electric. Dual-output versions deliver either ± 12 V or ± 15 -V. Triples have ± 5 -V also.

rather than power cost. And this is so even though a 1000-W series-regulated supply can, in a year, consume hundreds of dollars more in power than a switcher does. Equipment manufacturers aren't being drawn to the power-miserly switchers to save power because the customer pays the electric bill.

Up to now, the power-drain advantage of switchers has been important only where there have been severe energy or heat restraints. Switchers have been heavily used in military, aircraft and remote location uses.

The major advantage, to date, that comes from efficiency is that less heat is generated. System cooling is therefore easier and reliability improves.

To enhance reliability even further, it's wise to avoid specifying variable outputs. Potentiometers are notoriously failure prone and variable outputs aren't as efficient as are their fixed counterparts. Also even though compactness is a virtue that is currently in vogue for power supplies, don't overdo a good thing. The more squeezing you force on the manufacturer, the worse is your chance for a good thermal design,



An on-board module can power μ P's, a/d's and op amps. The MP series of encapsulated triple outputters from Semiconductor Circuits deliver dual racking outputs of ± 7 V, ± 12 V or ± 15 V plus a 5-V output for logic.

with air channels passing around every dissipating element. Remember the supply itself generates heat—lots of it. Even at 75% efficiency, 25% of the input power is dissipated by the supply itself.

And this heat gets us right back to the specs. The maximum current that each output can deliver is, of course, limited by the temperature. But to what temperature does the spec refer? That of free-air with the supply on? If not, how much does the supply itself heat the ambient? The following example shows why some spec sheets want to ignore self-heating problems.

Consider a 100-W supply that causes a 30-C ambient-air-temperature rise. Suppose further that the specs call for derating to 70% at 50-C ambient. Apparently, this kind of 100-watter cannot deliver 100 W if it is turned on. The full-power rating at 20 C seems to apply only while the supply is off.

Another sometimes crucial spec, notable by its absence from most multiple-output-supply data sheets, is that for output sequencing. For circuit protection it is often crucial that power-supply voltages come up (and also go down) in a specified sequence. Before you undergo the expense of designing your own sequencing circuitry consult the manufacturer. He may have already overcome what seems to be your unique problem. ■■

Need more information?

For further information on multiple-output dc supplies, readers may consult the manufacturers listed here by circling the appropriate numbers on the reader service card. More vendors and information may be found in **ELECTRONIC DESIGN's GOLD BOOK**.

Abbott Transistor Laboratories, 5200 W. Jefferson Blvd., Los Angeles, CA 90016. (213) 936-8185. (J. Bell, Sales Dir.) **Circle No. 465**
 Acme Electric Corp., 205 Water St., Cuba, NY 14727. (716) 968-2400. (D. Swift, Prod. Mgr.) **Circle No. 466**

Acopian Corp., 131 Loomis St., Easton, PA 18042. (215) 258-5441. (T. Skopal, Sales Mgr.) **Circle No. 467**
 Adtech Power Inc., 1621 S. Sinclair, Anaheim, CA 92806. (714) 634-9211. (K. Nelson, Sales) **Circle No. 468**
 Aiken Industries Inc., Keltec Florida Div., P.O. Box 1348, Fort Walton Beach, FL 32548. (904) 651-1210. (A. Coronis, Eng. Mgr.) **Circle No. 469**
 Almond Instrument Co., Inc., 1223 E. Edna Pl., Covina, CA 91724. (213) 967-4151. (R. Ardia, VP Mktg.) **Circle No. 470**
 Alpha Power Inc., 9020 Eton Ave., Canoga Park, CA 91304. (213) 998-9873. (T. Ingman, Pres.) **Circle No. 471**
 Ambac Industries Inc., Tele Dynamics Div., 525 Virginia Dr., Fort Washington, PA 19034. (215) 643-3900. (W. Talbert, Sales Mgr.) **Circle No. 472**
 AMP Inc., Capatron Div., 1595 S. Mt. Joy St., Elizabethtown, PA 17022. (717) 367-1105. (B. Grebe, Eng. Mgr.) **Circle No. 473**

(continued on page 64)

(continued from page 63)

- Analog Devices Inc., P.O. Box 280, Norwood, MA 02062. (617) 329-4700. (J. Maxwell, Prod. Mkt. Specialist) **Circle No. 474**
- Analogic Corp., 1 Audubon Rd., Wakefield, MA 01880. (617) 246-0300. (B. Gordon, Chmn.) **Circle No. 475**
- Arnold Magnetics, 11520 W. Jefferson, Culver City, CA 90230. (213) 870-7014. (L. Arnold, Dir. Mktg.) **Circle No. 476**
- Behlman Engineering, 427 N. Nopal St., P.O. Box 4518, Santa Barbara, CA 93103. (805) 963-9019. (J. Behlman, Sales Mgr.) **Circle No. 477**
- Benrus, Technipower, Benrus Ctr., Ridgefield, CT 06877. (203) 431-1300. (L. Sanders, Mktg. Svcs.) **Circle No. 478**
- Bertan Associates Inc., 180 Miller Pl., Hicksville, NY 11801. (516) 433-3110. (L. Bertan, Pres.) **Circle No. 479**
- B H Industries, 5784 Venice Blvd., Los Angeles, CA 90019. (213) 937-4763. (R. Quiring, Pres.) **Circle No. 480**
- Bikor Corp., 1228 253 St., Harbor City, CA 90710. (213) 325-2820. (R. Pizer, Pres.) **Circle No. 481**
- Boschert, 38 Santa Trinita, Sunnyvale, CA 94086. (408) 732-2440. (D. Snyder) **Circle No. 482**
- Buchbinder Corp., Elasco Div., 6 Northwood Rd., Bloomfield, CT 06002. (203) 242-0708. (S. Buchbinder, Pres.) **Circle No. 483**
- Burr-Brown Research Corp., 6730 S. Tucson Blvd., Tucson, AZ 85734. (602) 294-1431. (G. Tobey, Mktg. Mgr.) **Circle No. 484**
- Calex Mfg. Co., Inc., 3305 Vincent Rd., Pleasant Hill, CA 94523. (415) 932-3911. (R. Kreps, Sales Mgr.) **Circle No. 485**
- California D.C., 2348 Towsgate Rd., Westlake Village, CA 91361. (213) 991-1168. (J. Burens) **Circle No. 486**
- Christie Electric Corp., 3410 W. 67, Los Angeles, CA 90043. (213) 750-1151. (F. Benjamin, VP Mktg.) **Circle No. 487**
- Computer Power Inc., 42 Park Ave., Madison, NJ 07940. (201) 377-4003. (R. Love, Pres.) **Circle No. 488**
- Computer Products, 1400 N.W. 70th St., Fort Lauderdale, FL 33307. (305) 974-5500. (W. Ford, Sales Mgr.) **Circle No. 489**
- Continental Specialties Corp., P.O. Box 1942, New Haven, CT 06509. (203) 624-3103. (S. Halpern, Sales Mgr.) **Circle No. 490**
- Control Data, Magnetic Components Div., 7801 Computer Ave., Minneapolis, MN 55436. (612) 830-5800. (J. Daly) **Circle No. 491**
- CPS Inc., 722 E. Evelyn Ave., Sunnyvale, CA 94086. (408) 738-0530. (J. Gwiner) **Circle No. 492**
- Data Translation Inc., 109 Concord St., Framingham, MA 01701. (617) 655-5300. (F. Molinari, Pres.) **Circle No. 493**
- Datel Systems Inc., 1020 Turnpike St., Canton, MA 02021. (617) 828-8000. (E. Zuch) **Circle No. 494**
- Del Electronics Corp., 250 E. Sandford, Mount Vernon, NY 10550. (914) 699-2000. (W. Young, VP Mktg.) **Circle No. 495**
- Deltron Inc., Wissahickon Ave., North Wales, PA 19454. (215) 699-9261. (A. Anton, Adv. Mgr.) **Circle No. 496**
- Dracon Industries, 9541 Mason Ave., Chatsworth, CA 91311. (213) 882-8595. (A. Polzer, Sales Mgr.) **Circle No. 497**
- Dressen-Barnes Electronics Corp., 2695 E. Foothill Blvd., Pasadena, CA 91107. (213) 795-7731. (D. Walden, Power Con. Mgr.) **Circle No. 498**
- Dynage Inc., Power Supply Gp., 1331 Blue Hills Ave., Bloomfield, CT 06002. (203) 243-0315. (J. Pfingsten, Sales Mgr.) **Circle No. 499**
- Electronic Measurements Inc., 405 Essex Rd., Neptune, NJ 07753. (201) 922-9300. (C. Applegate, Sales Mgr.) **Circle No. 500**
- Electrostatics Inc., 7718 Clairemont Mesa Blvd., San Diego, CA 92111. (714) 279-1414. (R. McCartney, Sales Mgr.) **Circle No. 501**
- Elxon Power Systems, Elpac Electronics Div., 3131 S. Standard Ave., Santa Ana, CA 92705. (714) 979-4440. (E. Blackman, VP.) **Circle No. 502**
- Emerson Electric Co., ACDC Electronics Co. Inc., 401 Jones Rd., Oceanside, CA 92054. (714) 757-1880. (R. Hecton, Adv. Mgr.) **Circle No. 503**
- Endicott Coil Co., 24 Charlotte St., Binghamton, NY 13905. (607) 797-1263. (R. Beebe, Sales Mgr.) **Circle No. 504**
- EPSCO Inc., 920 Westwood Ave., Addison, IL 60101. (312) 543-0410. (P. Amerena) **Circle No. 505**
- ERA Transpac Corp., 311A E. Park St., Dept. 1201, Moonachie, NJ 07074. (201) 641-3650. (J. Grieg, VP) **Circle No. 506**
- Etatech Inc., 187-M W. Orangethorpe Ave., Placentia, CA 92670. (714) 996-0981. (J. Grant, Pres.) **Circle No. 507**
- Faratron Corp., 280 Green St., South Hackensack, NJ 07606. (201) 488-1440. (V. Plessner) **Circle No. 508**
- Ferranti Ltd., Hollinwood, Lancashire OL97JS, England. 061-681-2000. (C. Hill, Adv. Mgr.) **Circle No. 509**
- Ferrotron Electronics Co., 683 Broadway, New York, NY 10012. (212) 254-5810. (H. King, Sales Mgr.) **Circle No. 510**
- General Resistance Inc., Instruments Div., 75 Haven Ave., Mount Vernon, NY 10553. (914) 699-8010. (J. Jamieson, VP Mktg.) **Circle No. 511**
- Glassman High Voltage Co., 124 W. Main St., High Bridge, NJ 08829. (201) 735-8800. (S. Glassman) **Circle No. 512**
- Gould Inc., Power Supply Div., 4601 N. Arden Dr., El Monte, CA 91371. (213) 442-7755. (J. Antrim) **Circle No. 513**
- Hades Mfg. Corp., 151A Verdi St., Farmingdale, NY 11735. (516) 249-4244. (E. Brand, VP Mktg.) **Circle No. 514**
- Hewlett-Packard, Green Pond Rd., Rockaway, NJ 07866. (G. Green, Mkt. Comm. Mgr.) **Circle No. 515**
- Hipotronics Inc., Route 22, P.O. Box A, Brewster, NY 10509. (914) 279-8091. (W. Boyer, Sales Mgr.) **Circle No. 516**
- ILC Data Device Corp., 105 Wilbur Pl., Bohemia, NY 11716. (516) 567-5600. (J. Sheahan, Sales Mgr.) **Circle No. 517**
- Instant Instruments Inc., 306 River St., Haverhill, MA 01830. (617) 373-9260. (J. Bonfiglio, Sales Mgr.) **Circle No. 518**
- Intech/Function Modules Inc., 282 Brokau Rd., Santa Clara, CA 95050. (408) 244-0500. (P. Pinter, Prod. Mktg. Mgr.) **Circle No. 519**
- Integrated Circuits Inc., 13256 Northrup Way-18, Bellevue, WA 98005. (206) 747-8556. (C. Duke, Mktg. Mgr.) **Circle No. 520**
- Intronics Inc., 57 Chapel St., Newton, MA 02158. (617) 332-7350. (R. Sakakeeny, Sales Mgr.) **Circle No. 521**
- Kepco Inc., 131-38 Sanford Ave., Flushing, NY 11352. (212) 461-7000. (P. Birman, Adv. Mgr.) **Circle No. 522**
- KGS Electronics, 2029 N. Lincoln Ave., Pasadena, CA 91103. (213) 798-0786. (G. Sugimoto, Gen. Mgr.) **Circle No. 523**
- LH Research Inc., 1821 Langley Ave., Irvine, CA 92714. (714) 546-5279. (F. Nusslock, Mktg. Mgr.) **Circle No. 524**
- Magneto Inc., 182 Morris Ave., Holtsville, NY 11742. (516) 654-1166. (H. Eicher, Pres.) **Circle No. 525**
- Measurement Technology Ltd., 26-30 John St., Luton LU2JE, England. 0582 33945. (I. Hutcheon, VP Mktg.) **Circle No. 526**
- Moxon Inc., 2222 Michelson Dr., Irvine, CA 92715. (714) 833-2000. (J. Heyer, VP Mktg.) **Circle No. 527**
- NH Research Inc., 1510 S. Lyon St., Santa Ana, CA 92705. (714) 835-1616. (V. Shaker, VP) **Circle No. 528**
- NJE, P.O. Box 50, Dayton, NJ 08810. (201) 329-4611. (R. Kulvin, VP Eng.) **Circle No. 529**
- North Electric Co., Electronics Div., P.O. Box 688, Galion, OH 44833. (419) 468-8100. (R. Neumann, Prod. Mgr. Pwr. Equip.) **Circle No. 530**
- Optical Electronics Inc., Box 11140, Tucson, AZ 85734. (602) 624-8358. (R. Gerdes, Pres.) **Circle No. 531**
- Philips Inds., Electronics Components and Materials Div., Eindhoven, Netherlands. (M. Hull) **Circle No. 532**
- Pioneer Magnetics Inc., 1745 Berkeley St., Santa Monica, CA 90404. (213) 829-3305. (F. Heath, Prod. Mgr.) **Circle No. 533**
- Plessey Co. Ltd., Aerospace Electrical Components, Abbey Werke, Titchfield Fareham Hampshire, England. 032-944-3031. **Circle No. 534**
- Polystron Devices Inc., P.O. Box 398, Paterson, NJ 07524. (201) 365-0401. (D. Metzger, Pres.) **Circle No. 535**
- Power Concepts Co., Power Systems Div., Rte. 81 Exit 68, Hallstead, PA 18822. (717) 879-2114. (D. Kriebel, VP Mktg.) **Circle No. 536**
- Power Conversion Inc., 70 MacQuesten Pkwy S., Mount Vernon, NY 10550. (914) 699-7333. (S. Chodosh, VP Mktg.) **Circle No. 537**
- Powercube Corp., 214 A Calvary St., Waltham, MA 02154. (617) 891-1830. (J. Prestidge, Sales Mgr.) **Circle No. 538**
- Power Designs Inc., 1700 Shames Dr., Westbury, NY 11590. (516) 333-6200. (M. Zaimberg, Dir. Eng.) **Circle No. 539**
- Power Mate Corp., 514 S. River St., Hackensack, NJ 07601. (201) 343-6294. (M. Brown, App. Engr.) **Circle No. 540**
- Power-One Inc., 531 Dawson Dr., Camarillo, CA 93010. (805) 484-2806. (S. Cole, VP Mktg.) **Circle No. 541**
- Power Pac Inc., 18 Marshall St. S., Norwalk, CT 06854. (203) 866-4484. (C. Mittel, Pres.) **Circle No. 542**
- Powertec Inc., 9168 Desoto Ave., Chatsworth, CA 91311. (213) 882-0004. (B. MacClanahan) **Circle No. 543**
- Reliability Inc., 5325 Glenmont, Houston, TX 77036. (713) 666-3261. (B. Miller, Sales Mgr.) **Circle No. 544**
- RO Associates Inc., 3705 Haven Ave., Menlo Park, CA 94025. (415) 322-5321. (R. Okada, VP Mktg.) **Circle No. 545**
- Rohde & Schwarz, Muehldorfstrasse, Munich, West Germany. 4989 41291. (D. Bardehle, Sales Mgr.) **Circle No. 546**
- Semiconductor Circuits Inc., 306 River St., Haverhill, MA 01830. (617) 373-9104. (F. Frontiero, Prod. Mgr.) **Circle No. 547**
- Shindengem Electric Mfg. Co. Ltd., New-Ohtemachi Bldg. 2-1 2-Chome Ohtemachi C hiyoda-Ku, Tokyo, Japan. (03) 794431. (J. Hagiwara, Sales Mgr.) **Circle No. 548**
- Siemens Corp., Communications Equipment Div., 186 Wood Ave. S., Iselin, NJ 08830. (201) 494-1000. (F. Cosmen, Adv. Mgr.) **Circle No. 549**
- Signal Laboratories Inc., 202 N. State College Blvd., Orange, CA 92668. (714) 634-1533. (P. Beaudoin, Sales Mgr.) **Circle No. 550**
- Sodilec, 7 Ave. Louise/Neuilly, Plaisance 93360. France. 927-3807. (J. Haas) **Circle No. 551**
- Sola Electric Div., 1717 Busse Rd., Elk Grove Village, IL 60007. (312) 439-2800. (D. Kemp, Electron Prod. Mgr.) **Circle No. 552**
- Solid State Electronics, 15321 Rayen St., Sepulveda, CA 91343. (213) 894-2271. (E. Politi, Pres.) **Circle No. 553**
- Sorensen Co., 676 Island Pond Rd., Manchester, NH 03103. (603) 668-4500. (C. Dougherty, Customer Relations Mgr.) **Circle No. 554**
- Spacetic Inc., Crosby Dr., Bedford, MA 01730. (617) 275-1710. (B. Hurwitch, Group leader) **Circle No. 555**
- Spellman High Voltage Electronics, 7 Fairchild Ave., Plainview, NY 11803. (516) 822-2130. (A. Civin, VP Mktg.) **Circle No. 556**
- Standard Power Inc., 1400 S. Village Way, Santa Ana, CA 92705. (714) 558-8512. (C. Goldworth, VP Mktg.) **Circle No. 557**
- Stevens-Arnold Inc., 7 Elkins St., S Boston, MA 02127. (617) 268-1170. (J. Karon, VP Eng.) **Circle No. 558**
- Systron-Donner Corp., 1 Systron Dr., Concord, CA 94518. (415) 676-5000. (D. Barnes, Prod. Mgr., Power Supplies) **Circle No. 559**
- Technetics Inc., 1625 Range St., Boulder, CO 80302. (303) 442-3837. (M. Pogue, Pres.) **Circle No. 560**
- Teledyne Philbrick, Allied Dr., Rte. 128, Dedham, MA 02026. (617) 329-1600. (J. Slomski, Sales Mgr.) **Circle No. 561**
- Todd Products Corp., 123 Milbar Blvd., Farmingdale, NY 11735. (516) 293-3440. (R. Savold, Sales Mgr.) **Circle No. 562**
- Tracor Inc., Industrial Inst. Time/Frequency, 6500 Tracor Lane, Bldg. 8, Austin, TX 78721. (512) 926-2800. (H. Thomas, Sales Mgr.) **Circle No. 563**
- Transistor Devices Inc., 85 Horsehill Rd., Cedar Knolls, NJ 07297. (201) 267-1900. (J. Gilson, VP Sales) **Circle No. 564**
- Trio Laboratories Inc., 80 Dupont St., Plainview, NY 11803. (516) 681-0400. (P. Bauer, VP Mktg.) **Circle No. 565**
- Valor Instruments Inc., 1122 G. Llewellyn Ave., Torrance, CA 90501. (213) 320-5471. (N. Regnier, VP Mktg.) **Circle No. 566**
- Vecco Instruments Inc., Lambda Electronics, 515 Broad Hollow Rd., Melville, NY 11746. (516) 694-4200. (I. Gutman, Mkt. Svcs. Mgr.) **Circle No. 567**
- Venus Scientific Inc., 399 Smith St., Farmingdale, NY 11735. (516) 293-4100. (T. Krilovich, Sales Mgr.) **Circle No. 568**
- Wall Industries Inc., 175 Middlesex Tpke., Bedford, MA 01730. (617) 275-0700. (J. McCann, Pres.) **Circle No. 569**
- Wilmore Electronics Co., Inc., P.O. Box 2973 W. Durham Station, Durham, NC 27705. (919) 489-3318. (J. Harris, Sales Mgr.) **Circle No. 570**
- Xentek Inc., 1550 Linda Vista Dr., San Marcos, CA 92069. (714) 744-3346. (L. Kester, Sales Mgr.) **Circle No. 570**

Take a chance on a power supply and win an airline trip.

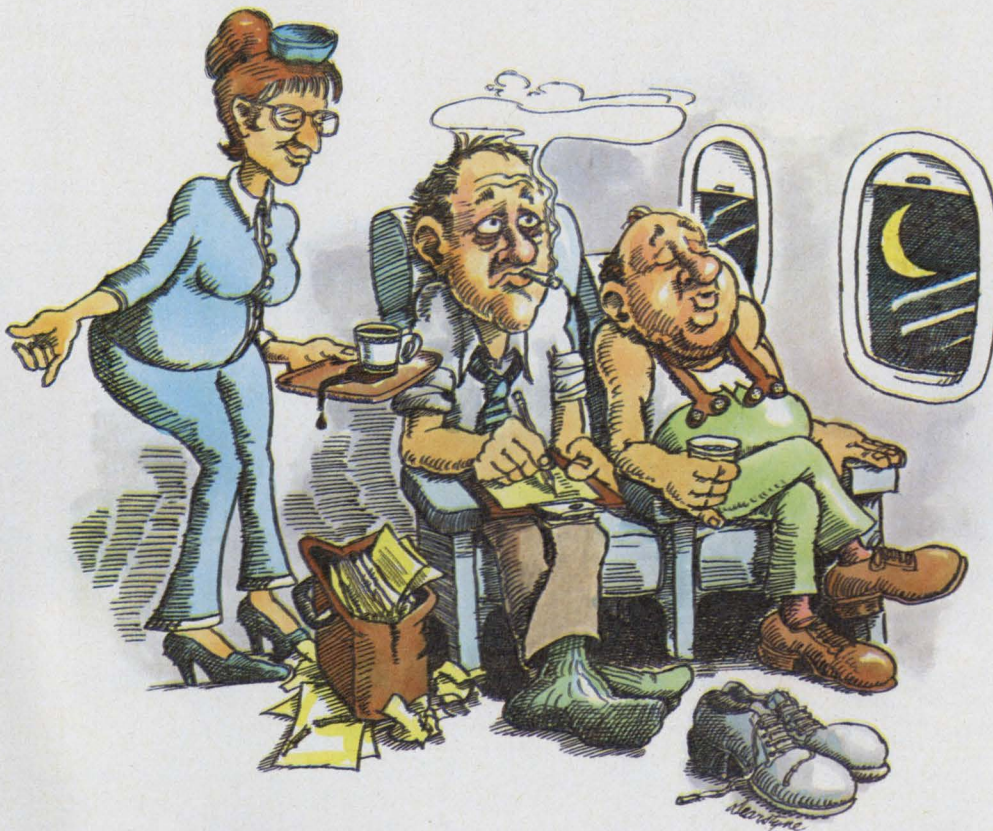

Red Eye Flights to Customer Sites

A chancy power supply's bottom-line cost doesn't show up on a price list. It shows up in increased emergency service calls, total aggravation, and catastrophic downtime costs to the customer. Our Switching Regulated Power Supplies - the Dependables - can minimize such worries.

Time-Proven Winners: the Dependables

For over 19 years, the Dependables have proved their reliability in OEM digital applications where superior line and dynamic load regulation are needed. And their low RFI/EMI and low output ripple (less than 3 mV peak-to-peak at line frequencies) make them ideal for sensitive analog applications.

Brownoutproof: These Days, a Must

The Dependables can supply their specified regulated outputs **at full load** over input variations from 92 to 138 or 184 to 250 VAC. And they'll keep it up for several minutes even if the input drops to 70 or 140 VAC. If AC fails completely, the supplies will hold up for at least 30 mSec., allowing orderly shutdown or shift to optional DC back-up. **Catalog DP-77** gives details on our single output supplies and brownoutproof features.

DC to DC Units Too

DC input versions, using 48, 120 or 220 VDC as standard input voltages, are available. We can also provide units that operate from both AC and DC sources allowing easy transfer to battery back-up for UPS applications. Ask for **Data Sheet PM-27** for our DC/DC Converter specifications.

Supplies to Fit Your Application

A complete family of standard models provide output voltages from 2 to 48 VDC with output power up to 2000 watts. Single and four-channel multiple outputs with options such as logic inhibit, power-fail signal, remote margin check or programming, and sequencing allow tailoring the supplies to your needs. **Data Sheet PM-26** gives details on the multiple units.

To find out how the Dependables can keep your system on the air and your maintenance people out of it, call or write Pioneer Magnetics, Department A, today.



**Pioneer
Magnetics**

1745 Berkeley Street • Santa Monica, CA 90404
Telephone (213) 829-6751 • TWX 910-343-6249



Series 481

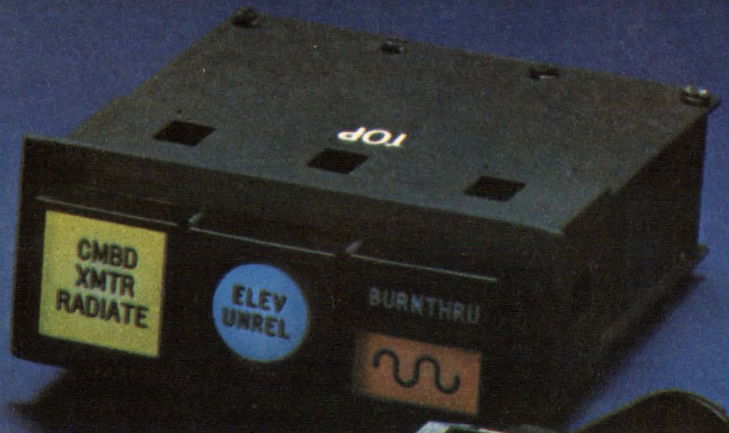

Series 800

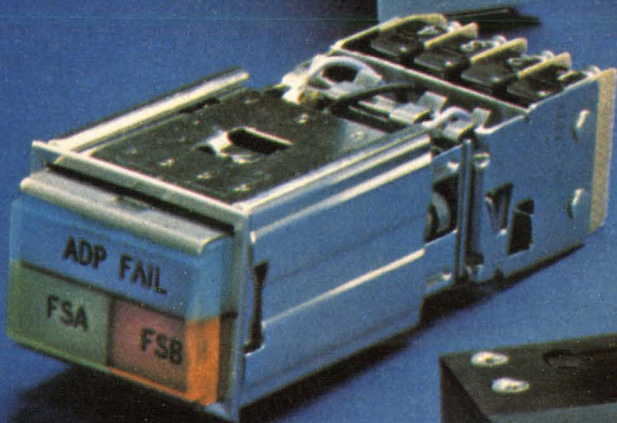

Series 10



Series 600



Series 925



Series 90

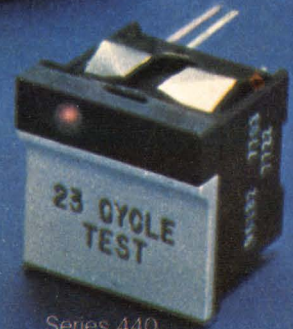

Series 440

Series 10, Circle No. 131 Series 600, Circle No. 135
 Series 90, Circle No. 132 Series 800, Circle No. 136
 Series 440, Circle No. 133 Series 925, Circle No. 137
 Series 481, Circle No. 134

Modern electronics demands switches of all types. Switches capable of withstanding the most rugged working conditions. And giving reliable service that continues throughout the life of the systems they serve.

The same electronic technology demands displays that speak to you clearly. Conveying vital information without confusing the issue.

MSC manufactures a wide range of switches and displays that meet the many applications of today's technology. All have unique characteristics which help to make your system just that little bit more easy to operate and comprehend.

Small wonder that MSC switches and displays are an everyday word in avionics, military and shipboard applications. And in computers, telephone panels and hundreds of other uses which have a daily influence on your life.

Take a look at the variety:

Series 10

This rugged, versatile four lamp pushbutton switch has become the standard of the industry with many diverse applications in control panels for fields and power

ships, oil generating plants, just to name a few. This switch has UL approval, is QPL (MIL-S-22885/9/10) listed and features positive indexing and front panel re-lamping without tools. RFI protection, solid state switching, and "high shock" modifications are available as options.

Series 90—This two lamp pushbutton switch is cased in stainless steel and is resistant to most environmental extremes. A favorite of designers everywhere because of its overall versatility and the wide variety of terminations available for low cost assembly. Standard features include: UL approval, QPL (MIL-S-22885/58), relamping and legend change from front panel without tools, and a wide choice of switch actions.

Series 440—This switch series provides the electronic designer with a microprocessor compatible, touch activated solid state switch. The 440 switch becomes part of the electronic circuitry without the need for interface. Because it is a capacity transducer, the reliability of the switch equals that of any transistor. The compact design eliminates the need for deep panel clearance. The touch face incorporates an optional LED as a visual activation indicator.

Series 481—A true solid state electronic "thumbwheel" switch with the same design advantages as the Series 440. Incorporating two series 440 switching functions with an encoder/decoder/driver IC which makes an all solid state lighted thumbwheel switch with true BCD output. The seven segment LED display occupies the center section of the switch plate. The bottom plate advances the count and the top plate resets the switch to zero.

Series 600—The Series 600 computer-grade switch is the most versatile switch in its class; unmatched performance is provided by the

performance is providing action contact design unavailable in any other line of low-cost, computer-grade lighted pushbutton switches. Available in many different mounting configurations, sizes, styles and colors, the 600 also offers a wide choice of switch actions.

Series 800—Ideal for matrix mount applications, this four lamp pushbutton switch is available in two display face sizes. A standard 3/4" square and a 3/4" by 1" provide the flexibility needed in panel design. Standard features include positive indexing and front panel relamping without tools. Optional solid state models and electrical interlock holding coils are available. The 800-H has received MIL-S-22885/74/80 approval.

Series 925—Designed to meet MIL-R-28803, the 925 offers sunlight readability, required for avionic displays and other control panels used in high ambient light conditions. Utilizing fiber optics, this compact unit can be ordered with 7 or 16-segment displays. Other sizes and character configurations are also available. All MSC fiber optic displays are re-lampable and replaceable from the panel front.

Switch on to MSC today by circling the numbers of the products in which you're interested on the enclosed reader card.



MSC

Worth Switching To
Master Specialties Company, 1640 Monrovia,
Costa Mesa, CA 92627, Telephone 714/642-2427

The power you need is the power you get.

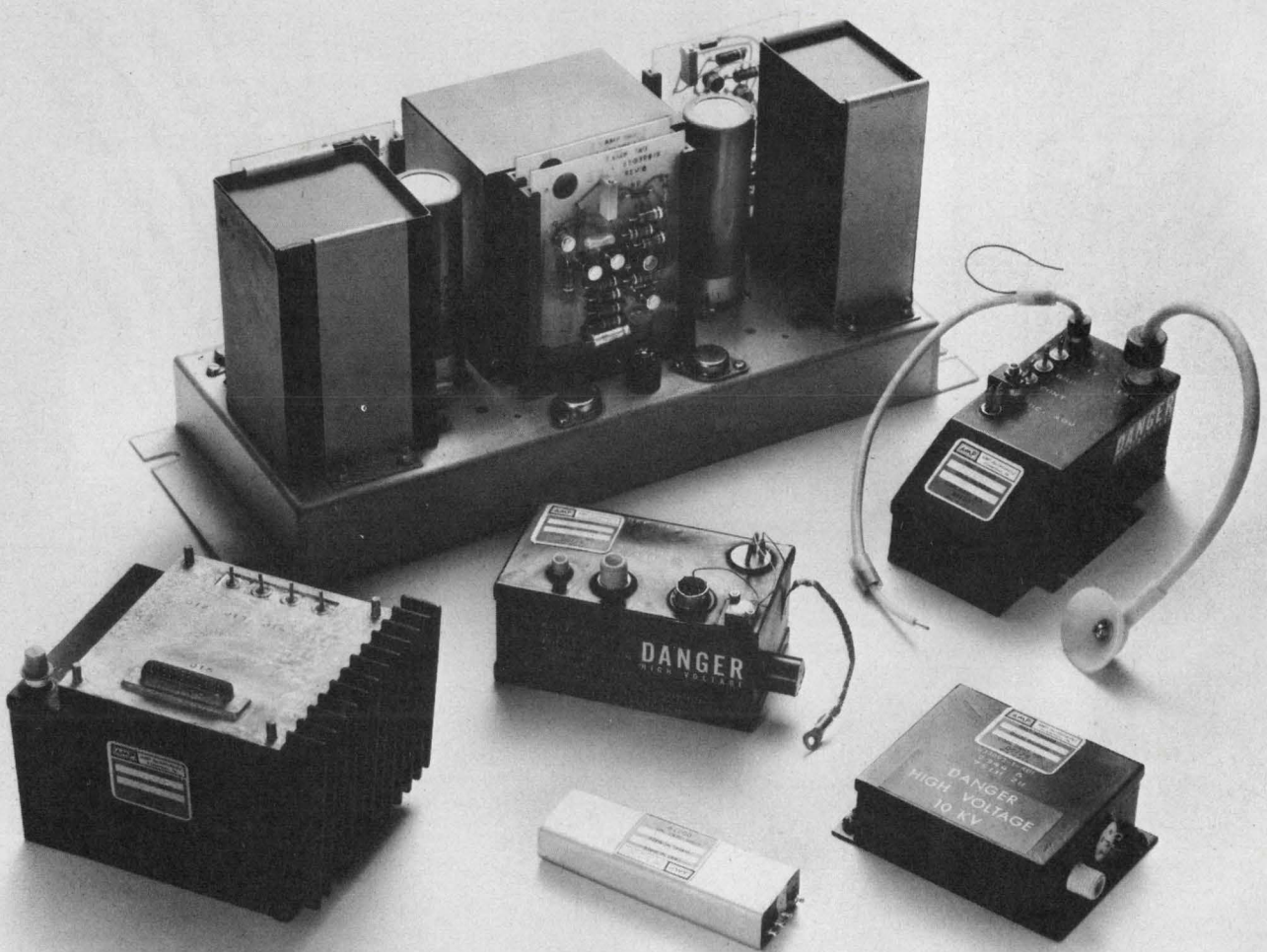

From AMP—the power supply that's a perfect match to the system, any electronic system. We're the specialists.

The power behind multicolor CRT displays, for instance, with a big family of 1 through 18-KV fast-switching supplies. Ones that change output voltage levels in millionths of a second, and do it with long-life dependability in environmental extremes.

Whatever your application, military or commercial—no matter how demanding the complexity, performance and miniature size requirements—we'll fit a power supply to your need. With over 1000 existing designs—up to 60 KV and 2 KW—your power supply could be "on the shelf." Or we'll quickly tailor one for you.

And we also engineer some very unusual low-voltage supplies, as well as multiple output types combining both low and high voltages. All feature our unique oil/gas dielectric for high reliability and long life.

Send for our free Power Supply Specifying Guide. AMP Incorporated, Capatron Division, Elizabethtown, PA 17022. (717) 367-1105.

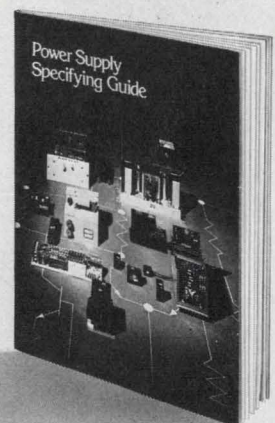

AMP INCORPORATED

CIRCLE NUMBER 28

Our New Dual-Polarity Voltage Regulator replaces two singles for less than a buck.

Replacing 78M and 79M regulators, this new IC gives you positive and negative regulation at 32% lower cost.

How many times have you reached for two single-polarity regulators, and wished that the functions of both were handled by a single, low-cost IC?

Wish no more. Signetics dual-polarity voltage regulators are here. And each new model is designed to replace both 78M and 79M devices at a 32% savings.

They cost only 99¢ each in hundred quantity. But low price isn't the only reason to choose our dual-polarity regulators for your next design. They also reduce capacitor costs and increase design flexibility.

Compare Capacitor Costs. Almost always, a voltage regulator requires input/output capacitors because it is remotely located from the power supply filter. With the 78M/79M approach, two fixed-composition capacitors (0.1µf and 0.33µf) and two electrolytics (1.0µf and 2.0µf) must be used. But because of a unique design, our dual-polarity ICs use only low-cost, fixed-composition capacitors (0.1µf). Even when components are purchased in large quantity, the dual-polarity approach can save more than 40¢ per regulator in capacitor costs alone, when compared to the 78M/79M requirements.

Enhance Design Flexibility. Check the chart below to select from the five fixed-voltage models now available. Continuously adjustable, each model can be balanced/unbalanced simply by using shunt resistors. This feature enhances design flexibility during development or small production runs. Internally current-limited, our dual-polarity regulators are also fully protected against thermal overload. And they come in a choice of packages: either a commercial-grade plastic DIP—or a TO-99 specified over the full military temperature range.

Now's the time to start designing in the Signetics dual-polarity regulators for future cost savings and reduced parts count. And if you're designing a single-polarity power supply, don't forget that we also have a complete line of 3- and 4-terminal, single-polarity regulators. To get complete technical information and a quick response to your specific needs, complete and mail the coupon below.

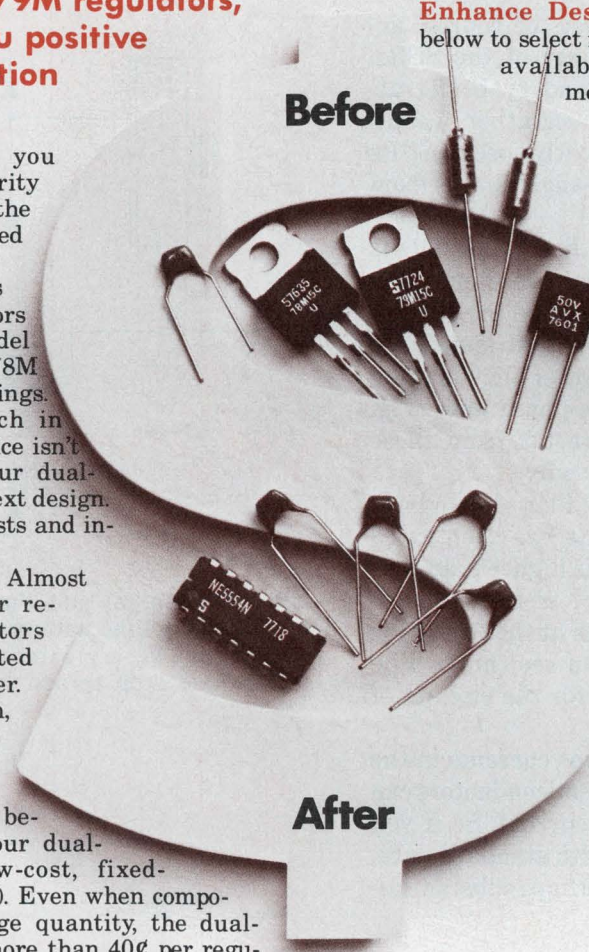

Signetics

a subsidiary of U.S. Philips Corporation

Signetics Corporation
811 East Arques Avenue
Sunnyvale, California 94086
Telephone 408/739-7700

Model	Voltages*
SE/NE5551	±5.0
SE/NE5552	±6.0
SE/NE5553	±12.0
SE/NE5554	±15.0
SE/NE5555	+5/-12

I_{out}: 300 mA with heat sinking.
Regulation: 1% Line; 0.5% Load.
Input Voltage: Up to ±32V.
SE: TO-99, **NE:** Plastic DIP

*Continuously adjustable with shunt resistors.

To: Signetics Information Services, 811 E. Arques Ave.
P.O. Box 9052, MS 27, Sunnyvale, CA 94086

Please send data sheet and application note for:

Dual-Polarity Regulators

Single-Polarity Regulators

Name _____ Title _____

Company _____ Division _____

Address _____ MS _____

City _____ State _____ Zip _____

My need is immediate. Please have your local sales representative provide me with a free sample.

Phone () _____ ED927

SCR-bridge currents can be complex.

To avoid pitfalls in specifying components use curves based on actual waveforms rather than on simpler theoretical data.

In SCR power bridges, you must, of course, accurately determine the power ratings of the SCRs, diodes and even the transformer secondary. Underrating can lead to failures while overrating wastes money. But, often, you can't confidently specify SCRs by using the families of conduction-angle curves from the data sheets.

These curves do show maximum dissipation versus average forward current but they are based on either square or half-sine waves of current. And the current in many actual power bridges isn't that simple. In battery chargers, particularly, whether they operate from single-phase (Fig. 1a) or three-phase lines (Fig. 1b), actual current waveshapes are far from those shown on data sheets—and here's why.

In the typical power bridges of Figs. 1a and 1b, current flows after one of the SCRs has been gated ON only if the transformer voltage is higher than that of the battery plus the forward drop of the semiconductors. So, current flow is zero both at the beginning and end of each half cycle. You can see this in Fig. 2, which shows typical waveforms for the circuits of Fig. 1.

With the waveshapes of Fig. 2, rms currents in the transformer secondary and bridge semiconductors can climb to five times the average dc current. So if you were to determine power ratings with standard data, the ratings would be inaccurate—perhaps substantially enough to lower reliability.

Zero-in with the curves

To determine accurately the power dissipated (P_{AVG}) in each bridge semiconductor, use the curves in Figs. 3 and 4 with the following formula:

$$P_{AVG} = V_0 I_{FAVG} + m I_{FRMS}^2 \quad (1)$$

where V_0 and m are defined from the SCR characteristic for V_F versus I_F , as shown in Fig. 6. The average dc current through the SCRs and diodes is I_{FAVG} and the rms current is I_{FRMS} . Use the curves in 3a and 4a for single-phase-input circuits and those in 3b and 4b for three-phase inputs.

Values of V_0 and m can be determined from the data sheets by selecting values of I_F in the power

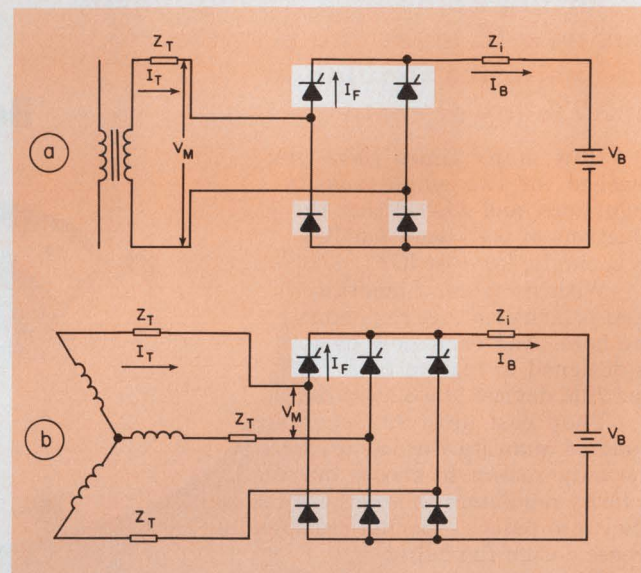

1. Single-phase (a) and three-phase (b) SCR-controlled bridges charge the battery when the transformer-secondary voltage V_M is greater than the battery voltage plus the forward drop across the semiconductors.

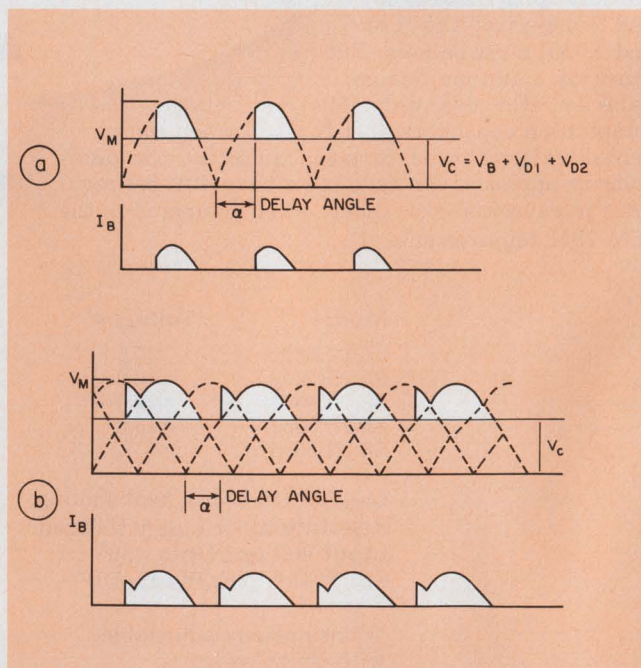

2. Actual power-bridge currents have complex waveshapes in the single-phase (a) and three-phase (b) battery charger circuits shown in Fig. 1.

bridge's operating range, noting the corresponding values of V_F and computing m :

$$m = \frac{V_{F2} - V_{F1}}{I_{F2} - I_{F1}}$$

V_0 is the value on the y axis where the slope, m , of the extrapolated V/I characteristic intercepts the y axis.

For the battery-charger circuits of Fig. 1, you can determine I_{FRMS} from the appropriate curves of Fig. 3. These curves show I_{FRMS}/I_{FAVG} versus the SCR's firing-delay angle for various battery voltages. Note that I_{FAVG} equals half of I_B for single-phase circuits and one third of I_B for three-phase circuits. The battery voltages aren't shown explicitly. Rather, they're implicit in the ratio

$$V_C = V_B + V_{D1} + V_{D2} \quad (2)$$

V_C/V_M , where

The factors that make-up V_C are:

V_B = battery voltage,

V_{D1} = forward drop across the SCR and

V_{D2} = forward drop across the diode. The divisor,

V_M = peak transformer-secondary voltage.

Don't use external inductors

The only impedances in the circuits are Z_T , the transformer impedance, and Z_i , the impedance of the battery plus the charger's leads to the battery. In general, external inductors aren't used because they are both costly and cumbersome. You can get all the impedance you need from the leakage inductance of the transformer.

If you don't know the firing angle of the SCRs, check the curves in Fig. 4, which show the ratios of average charging current, I_B , to peak output current, I_M , versus firing angles for various V_C/V_M ratios. Using the firing angle, you can also find the transformer-secondary rms current from I_T/I_B on the appropriate curves in Fig. 5.

With the values for V_0 , m , I_{FAVG} and I_{FRMS} , use Eq. 1 to compute the power dissipated in the semiconductors. Then, from the data-sheet value of thermal impedance, determine the case temperatures of the SCRs.

Build a battery charger

To see how the procedure works, determine the power dissipation of the SCRs and the transformer-secondary rms current for a single-phase power-bridge circuit like that in Fig. 1a. For representative values, assume that the bridge delivers 100 A into a 40-V battery, and that the following conditions apply:

- $Z_T = 0.02 \Omega$.
- $Z_i = 0.005 \Omega$.
- $V_M = 70.7 \text{ V}$.
- $V_B = 40 \text{ V}$.
- $V_D = 1 \text{ V}$.
- $V_F = 2 \text{ V}$.

Then using Eq. 2,

$$V_C = 43 \text{ V},$$

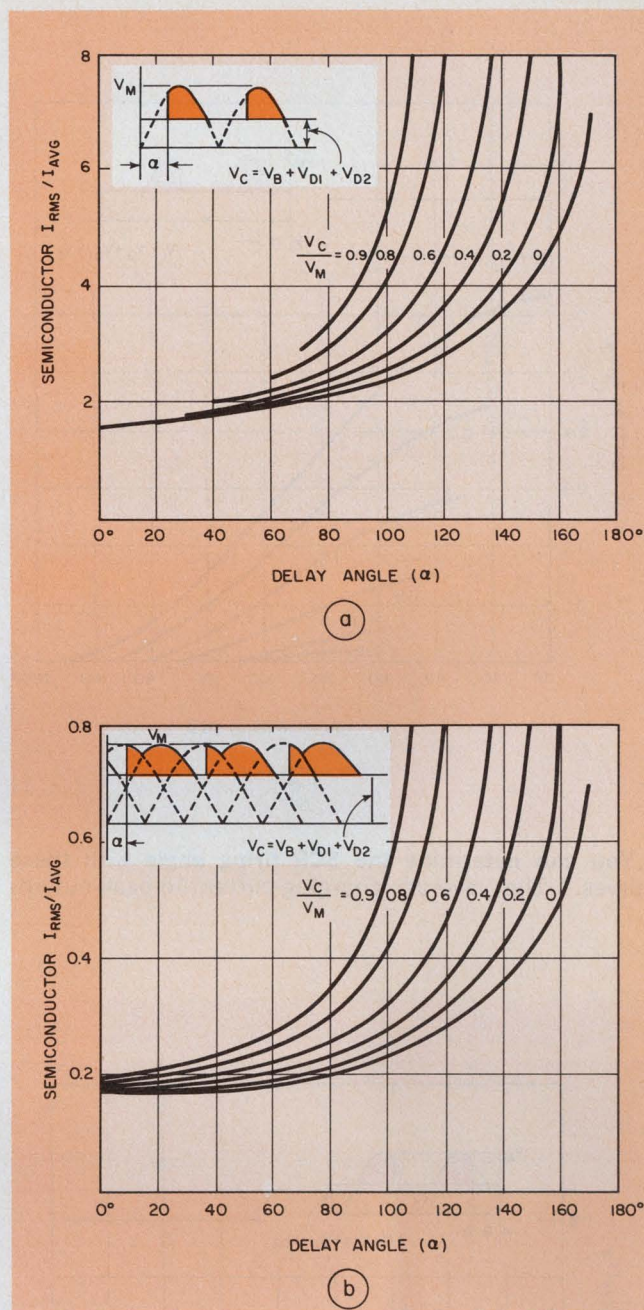

3.A family of curves defines the rms current through the power-bridge semiconductors for single-phase (a) and three-phase (b) circuits. These battery-voltage curves show the ratios of I_{RMS} to I_{FAVG} versus the firing angles. so that,

$$\begin{aligned} \frac{V_C}{V_M} &= \frac{43}{70.7} \\ &= 0.608, \end{aligned}$$

which puts you very near the 0.6 curve in Fig. 4a. Note that

$$Z_T + Z_i = 0.025 \Omega.$$

Next, determine the peak transformer-secondary current, I_M .

$$\begin{aligned} I_M &\approx \frac{V_M - V_C}{Z_T + Z_i} \\ &= \frac{27.7}{0.025} \\ &= 1108 \text{ A}. \end{aligned}$$

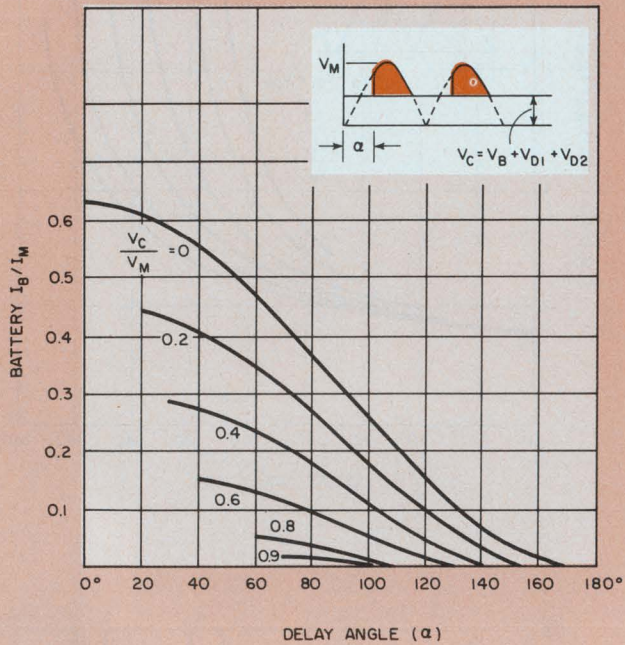

(a)

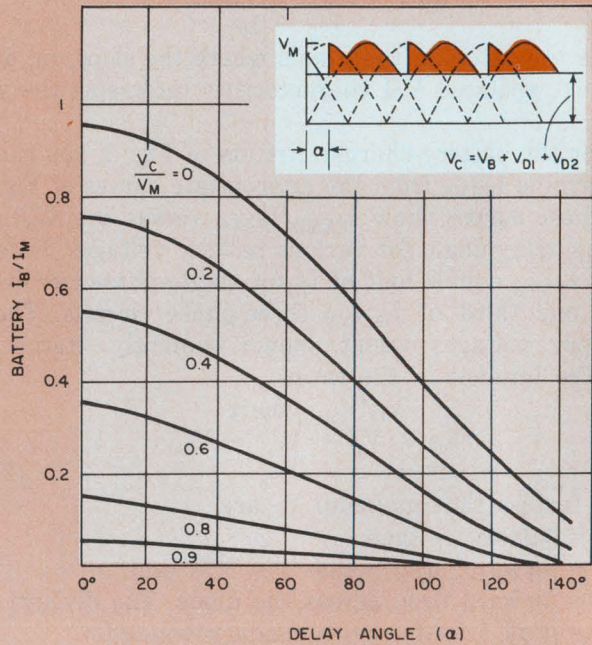

(b)

4. You can determine the SCR firing angle with these curves. The average-charging-current-to-peak-output-

current ratio versus the firing angle for various V_C/V_M ratios is shown for single-phase (a) and three-phase (b).

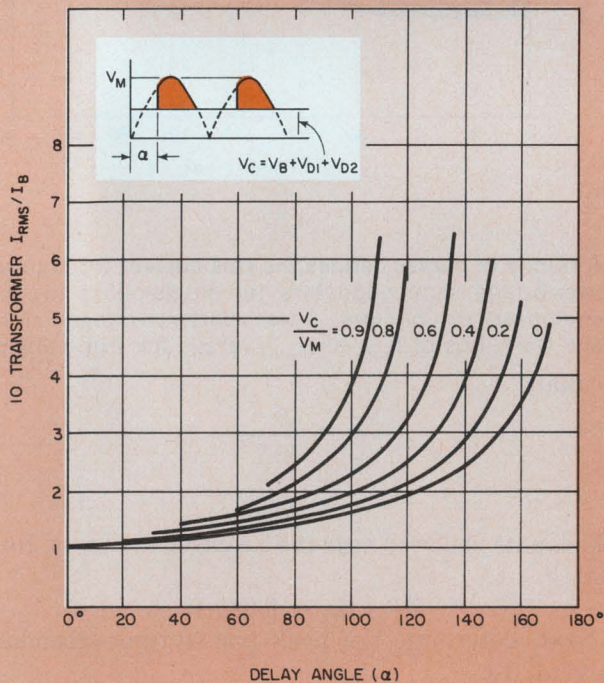

(a)

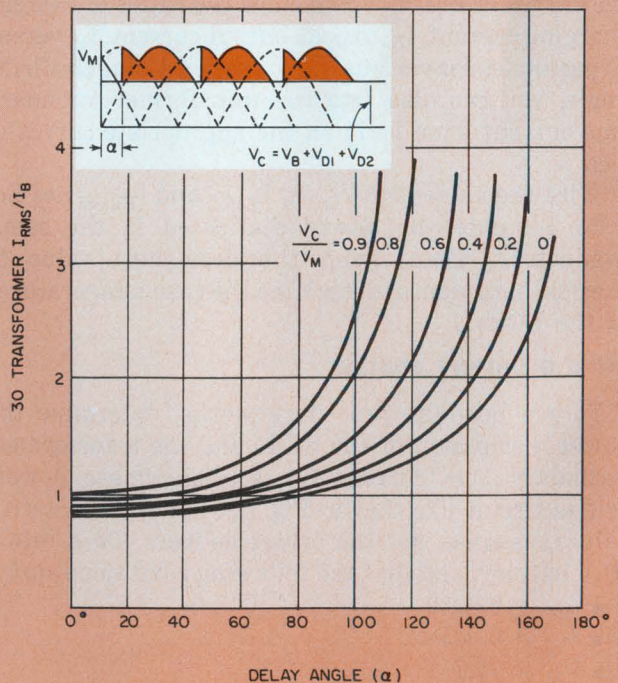

(b)

5. Once the firing angle is determined, you can find the rms current in the transformer secondary from the ratio

of transformer-secondary current to battery-charging current for single-phase (a) and three-phase bridges (b).

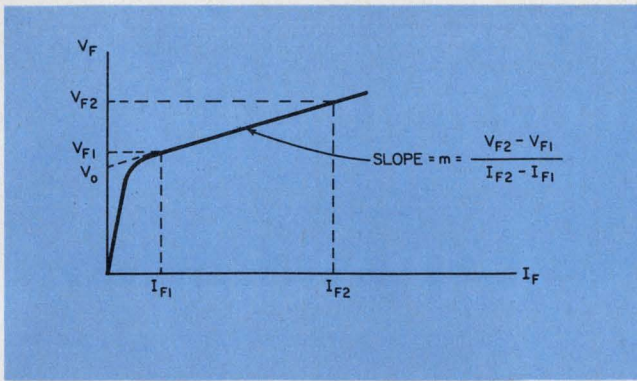

6. V_0 is the value on the y axis where a curve with the slope m intersects, when extrapolated.

Furthermore, note that

$$I_B = 100 \text{ A.}$$

So the ratio of

$$\begin{aligned} \frac{I_B}{I_M} &= \frac{100}{1108} \\ &= 0.0903. \end{aligned}$$

Therefore, from the curves of Fig. 4a, the delay angle, α , is 80° . On the curves of Fig. 3a for $\alpha = 80^\circ$ and $V_C/V_M = 0.608$,

$$\frac{I_{FRMS}}{I_{FAVG}} = 2.6.$$

$$I_{FAVG}$$

In a single-phase circuit

$$I_{FAVG} = I_B / 2.$$

So $I_{FRMS} = 2.6 \times 50$

$$= 130 \text{ A through the SCRs.}$$

Typical V_F values from the data sheet are on the order of

$$V_{F2} = 1.1 \text{ V, at } I_{F2} = 20 \text{ A,}$$

$$V_{F1} = 2.6 \text{ V, at } I_{F1} = 1000 \text{ A, and}$$

$$V_0 = 1 \text{ V.}$$

The value of m can then be calculated from

$$\begin{aligned} m &= \frac{V_{F2} - V_{F1}}{I_{F2} - I_{F1}} \\ &= \frac{2.6 - 1.1}{1000 - 20} \\ &= 1.53 \times 10^{-3}. \end{aligned}$$

The SCR dissipation can then be found:

$$\begin{aligned} P &= V_0 I_{FAVG} + m I_{FRMS}^2 \\ &= 1 \times 50 + 1.53 \times 10^{-3} \times (130)^2 \\ &= 75 \text{ W.} \end{aligned}$$

From the curves of Fig. 5a, $\frac{I_{RMS}}{I_B}$ for the transformer

is 1.8 for an α of 80° and

$$\frac{V_C}{V_M} = 0.608.$$

The transformer secondary current is found by

$$\begin{aligned} I_{RMS} &= 1.8(100) \\ &= 180 \text{ A.} \end{aligned}$$

Use the same process to determine the power rating of the diodes as you use for the SCRs. Be careful to check semiconductor power dissipation and transformer rms current at the different charging currents and battery voltages that may come up. ■■

A CAMBION® Double "QQ" Product Line

Socketing IC's?



Trust CAMBION for three good reasons.

Engineers more and more are putting IC's in separate sockets. What's the reason? There are three.

First, reliability. True pin positioning and precisely formed contacts are required for hand or automatic wire-wrapping.

Second, serviceability. Replacement and servicing of IC's is quick. Equipment downtime is minimal.

Third, protection. A DIP should not be subjected to the elevated temperatures of pin soldering. Or, if wrapped, needs a positive, long-life connection.

Those are the reasons for socketing. The reasons for trusting CAMBION?

First, quality. Each CAMBION socket has controlled body design and materials, finest contact plating, excellent retention, true durability.

Second, quantity. In either wrappable or solderable types, in variety and body design, CAMBION has 6, 8, 14, 16, 18, 22, 24, 28, 36 and 40 pin sockets available in whatever quantity you require. We sell millions annually.

Third, reliability. So far, customer rejects have been less than .1 of 1% (our QC man says that's infinitesimal).

So take CAMBION Double "QQ" approach to socketing and order the quality you want—in any quantity. We've a catalog full of them so you can make your own selection. Cambridge Thermionic Corporation, 445 Concord Avenue, Cambridge, Massachusetts 02138. Phone: 617-491-5400. In Los Angeles, 2733 Pacific Coast Highway, Torrance, CA 90505. Phone: 213-326-7822.

Standardize on

CAMBION®

The Guaranteed Electronic Components

CIRCLE NUMBER 30

Must you always obtain new application tooling when you develop a new design?

Not always. You can use AMP Multimate.

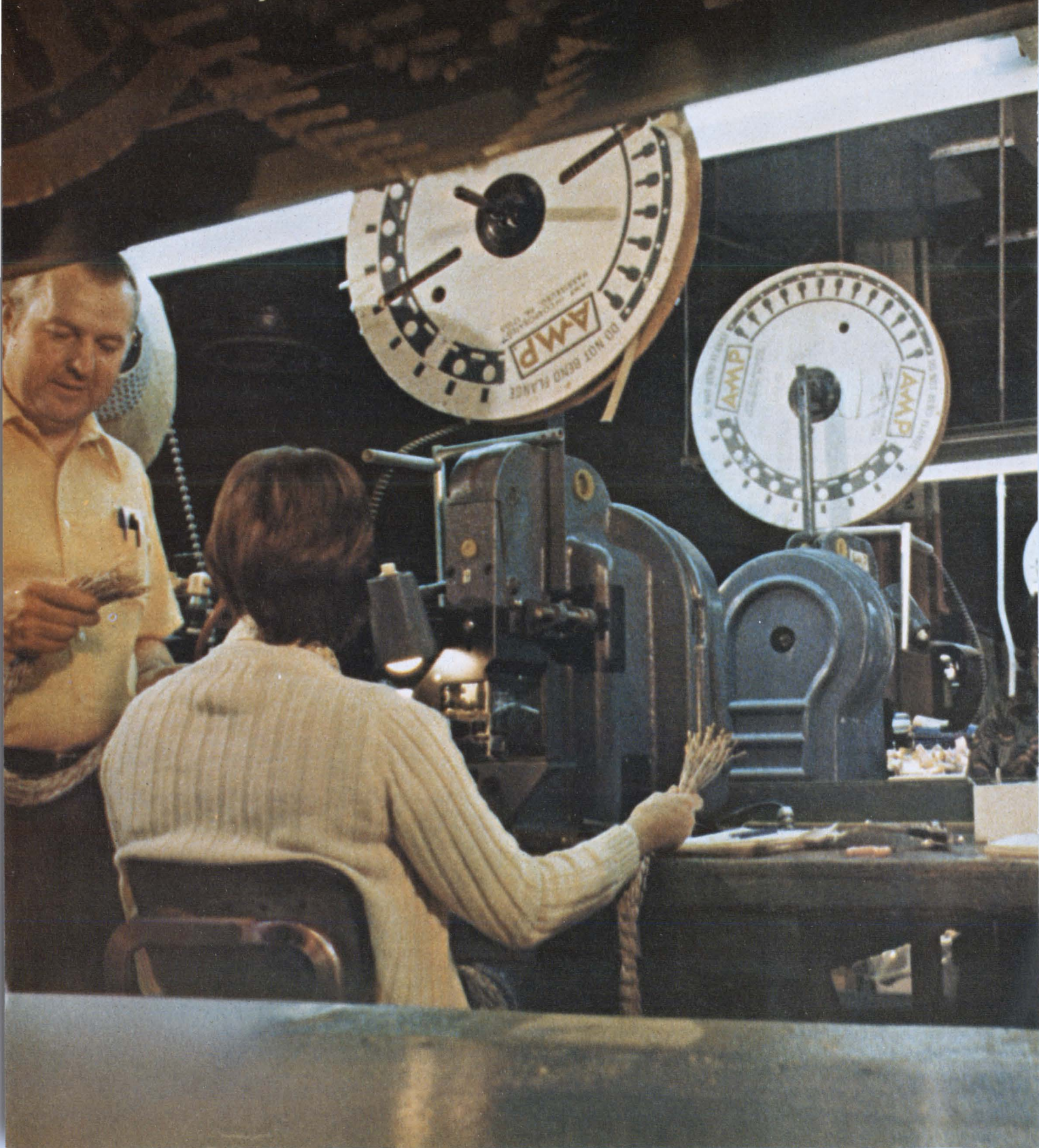

You asked for a way to produce new I/O cable or internal harness designs without always having to obtain new connector application tooling.

AMP answers with the Multimate concept.

For example.

A choice of three, size 16 contacts. A screw machine contact, and 1 or 2-piece precision formed contacts. All interchangeable and intermateable plus AMP Subminiature Coaxial contacts fit in the same cavities when needed.

Then specify AMP Connector housings from many proven styles and sizes.

The rugged, economical Circular Plastic Connector, or those versatile M Series connectors widely used for commercial and military applications; or the AMP MI Connectors, designed to international standards. Additionally there is a cast shell rack and panel range as well as metal-shelled modular connectors.

If you have AMP application tooling for the Multimate contacts, you can produce these connector assemblies. And that can save inventory and allows for larger piece part volume purchases. Further savings can be made in the field because fewer service tools are needed.

Here at AMP, answering your problems is our business.

So when you work with Multimate, you can expect the kind of service and backup for which AMP is famous.

We have district sales offices around the country; they are there for one purpose only. To serve you.

With Multimate, you not only get real contact-connector flexibility, you have AMP behind your design innovations.

For information on Multimate, write or call AMP Incorporated, Harrisburg, PA 17105. (717) 564-0100.

AMP has a better way.

SEE US AT
INTERNEPCON, BRIGHTON

AMP
INCORPORATED
CIRCLE NUMBER 31

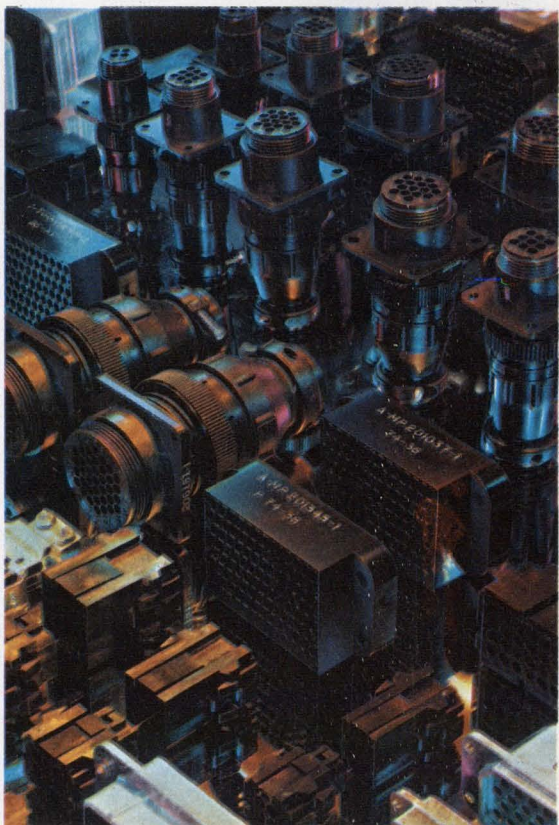
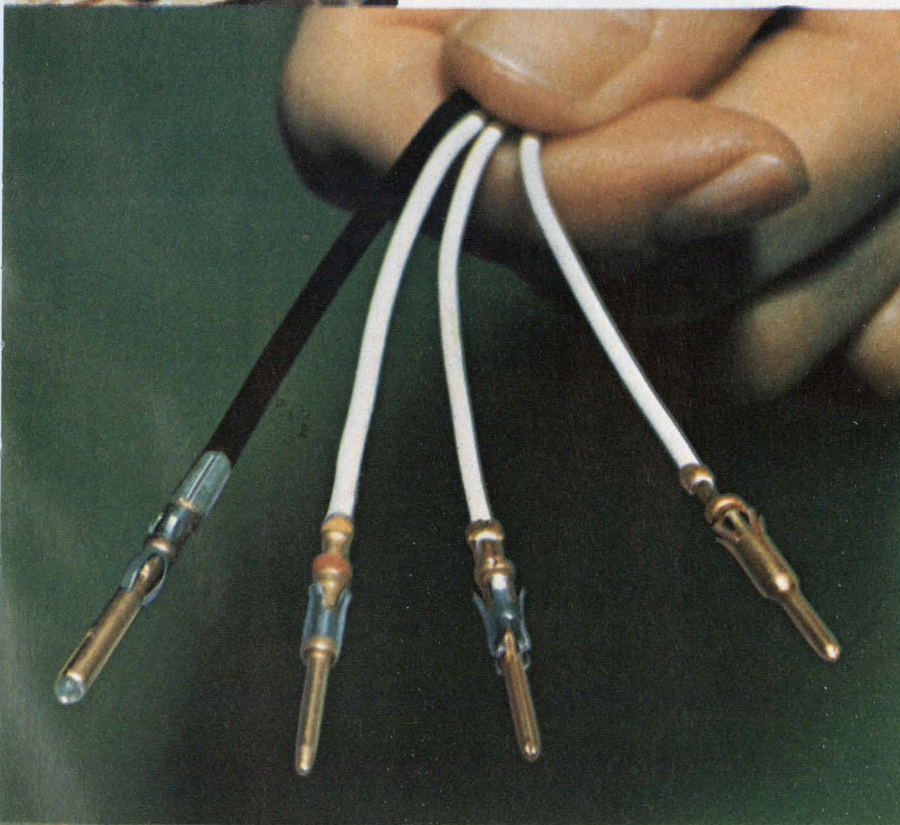
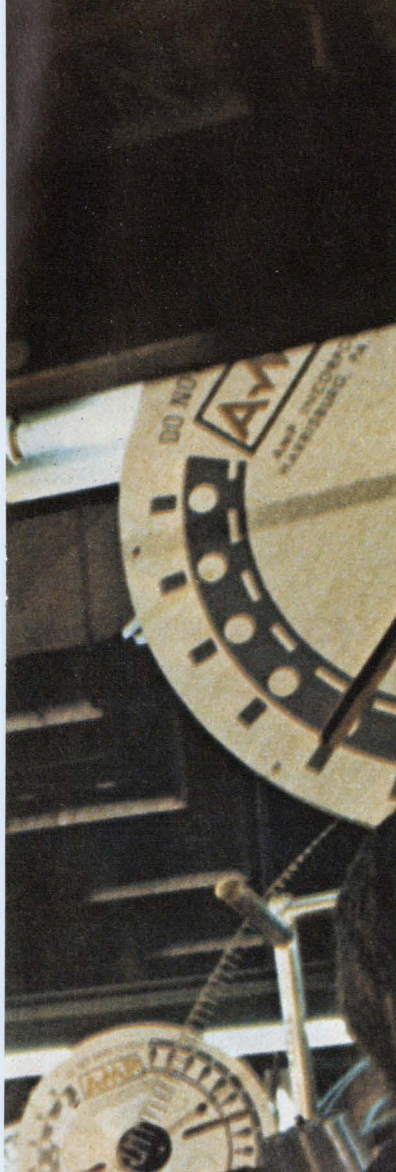

Consider polypropylene capacitors:

Low ESRs, correspondingly low DFs and high stability make them better than electrolytics in switching power supplies.

New plastic capacitor dielectrics, notably polypropylenes, provide significantly greater efficiencies and reliability than electrolytics, especially at the frequencies used in switching power supplies (20 to 60 kHz). And the high efficiency of polypropylene dielectric capacitors allows you to use lower rated-capacitance values than with electrolytic dielectrics. The effective-capacitance values of polypropylene units are higher than in electrolytics of the same rated value, when measured at high frequencies. Furthermore, polypropylenes have the very low equivalent-series-resistance (ESR) values needed in filter circuits.

Though plastic dielectric capacitors generally have a low dissipation factor (DF), even here, polypropylene capacitors are among the lowest—better than polysulfone, polycarbonate, polyester and even polystyrene units.

A real capacitor is a complex component

Dissipation factor (DF) is related to ESR by the following equation:

$$DF = \frac{ESR}{X_c} \times 100\%$$

where X_c is the capacitive reactance,

$$X_c = \frac{1}{2\pi fC}$$

at frequency f .

A real capacitor (Fig. 1a) has, in addition to its capacitance (C) and ESR, an equivalent series inductance (ESL). Consequently, a real capacitor's impedance (Z) is found by

$$Z = \sqrt{(ESR)^2 + \left[X_c - 2\pi f(ESL) \right]^2}$$

As a result, a capacitor's impedance experiences a series-resonant dip when the inductive and capacitive reactances become equal at the equivalent circuit's resonance frequency (Fig. 1b).

The minimum impedance at resonance is the ESR, which is far lower for polypropylene—1 to 10 m Ω —

Ted Vonkampen, Chief Engineer, and **Paul Reeves**, Field Applications Engineer, TRW Capacitors, 301 West O St., Ogallala, NE 69153.

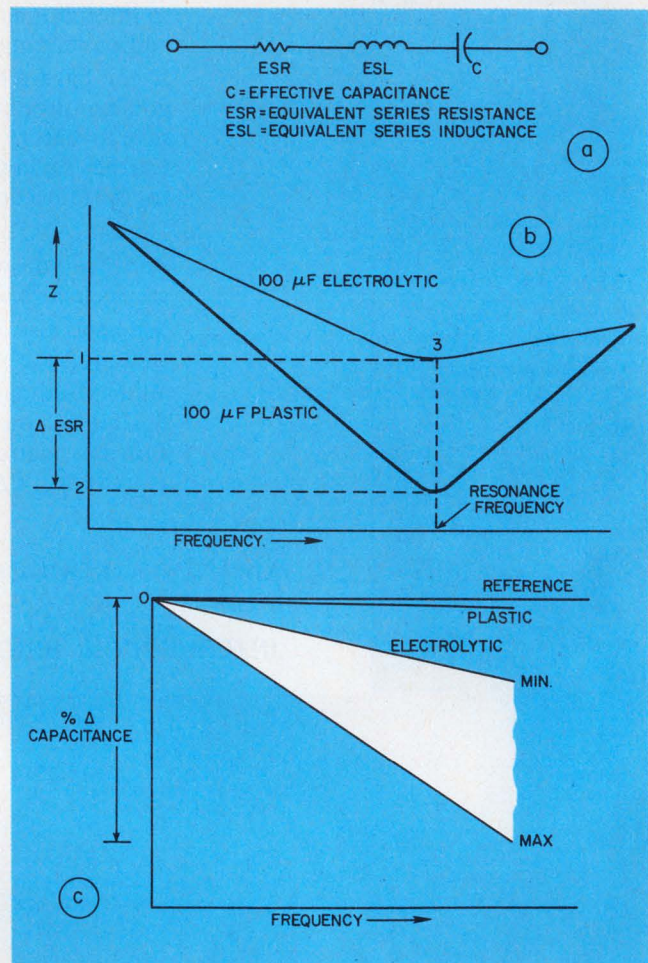

1. The equivalent circuit of a real capacitor (a) behaves as a series-resonant circuit whose lowest impedance, at resonance, is the capacitor's equivalent series resistance (b). Furthermore, the effective capacitance of a real capacitor is not a constant, but tends to fall off at high-frequencies (c).

than for typical medium-grade electrolytic units, whose ESR is usually measured in hundreds of milliohms (Fig. 2). And although the ESL of both capacitor types is about the same, the effective capacitance of polypropylene units remains almost constant as frequency increases (Fig. 1c). In electrolytics, effective capacitance decreases rapidly with increasing frequency—as much as 80% at switching-power-supply frequencies. This is the main reason lower-valued polypropylene units can be used in filtering applica-

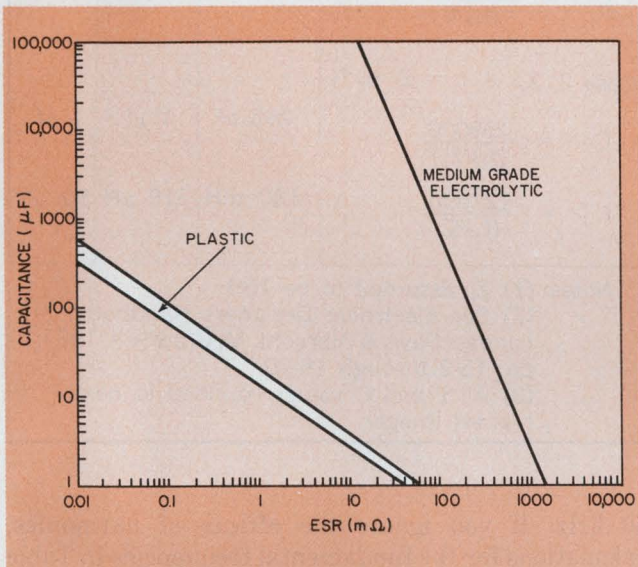

2. The equivalent series resistance (ESR) of polypropylene capacitors is substantially lower than that of electrolytic units of the same capacitance values.

tions for power supplies.

Furthermore, the ESR in electrolytics increases by more than 100% at -40°C over the value at 25°C , but by only 5 to 10% in polypropylene capacitors. For low-temperature applications, this stability is another reason you can use lower-valued polypropylene units than when using electrolytics.

Often overlooked is the current-carrying rating of capacitors. Most electrolytics are limited to under 1 A rms, though some large electrolytics over $100\ \mu\text{F}$ can handle almost 2.5 A. So several electrolytics often must be operated in parallel, just to handle the ripple current. Polypropylene capacitors, however, are rated to carry up to 9 A of ripple current.

Even by weight, polypropylenes win out over electrolytics: Polypropylene capacitors typically weigh between 16 and $20\ \text{g/in}^3$; electrolytics typically weigh about $26\ \text{g/in}^3$. And because electrolytics contain pastes or even fluids, leaks can contaminate the circuit. But polypropylene capacitors are bone dry.

Low-pass filters are used in both the output and

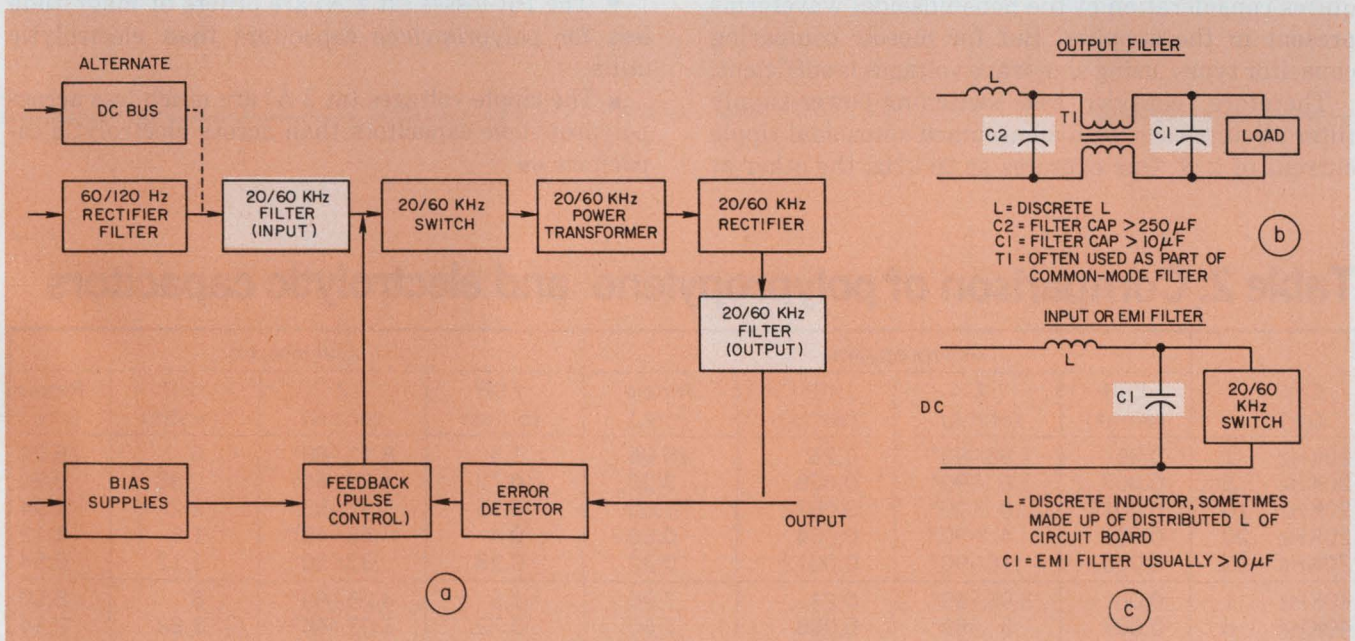

3. A typical switching power supply has low-pass filters at both its output and input (a). Typical simplified filter circuits for the output (b) and the input (c) both depend

upon high-quality capacitors for effective filtering. Polypropylene units can do a better job than the electrolytic types usually used.

input of switching power supplies (Fig. 2a). In an output filter (Fig. 3b), because the filter capacitor C_2 must be large to reduce ripple, C_2 is often an electrolytic capacitor with a capacitance greater than 250 μF . But with usually no sacrifice in ripple suppression, you can replace the electrolytic with a 20-to-40- μF polypropylene capacitor.

Polypropylenes replace electrolytics

Not only that, but in an input filter like the one in Fig. 3c, a 2-to-5- μF polypropylene unit will outperform the usual 10- μF electrolytic, and sometimes even a 100- μF electrolytic capacitor, C_1 . Although polypropylenes are somewhat larger in size than the electrolytics they would replace, the higher efficiency and reliability are often worth the space.

Selecting the L and C values in filters is not an exact science. You must usually supplement theoretical calculations with trial-and-test methods. Of prime importance in getting results as close as possible to that provided by theoretical calculations, lead length to the capacitors should be as short as possible. Table 1 demonstrates how the theoretical values of L and C are influenced by the operating frequencies. The values shown are minimum for a load impedance of 10 Ω and very short lead lengths.

High load impedances generally allow low L and C values. In any event, good design practice calls for greater than the minimum theoretical values. Since the main design aim of such filters is minimum ripple voltage across the filter capacitor, the lower the capacitor's impedance—the larger the capacitor and the shorter the leads—the better the filter.

Table 2 compares the ripple-reduction capabilities of polypropylenes and electrolytics. A rigorous analysis of switching-power-supply filter circuits requires consideration of the nonsinusoidal waveforms present in the supplies. But for merely comparing capacitor types, using sine-wave voltages is sufficient.

Therefore, consider two switching-power-supply filter circuits each with an assumed sinusoidal ripple current of 2 A. One operates at 20 kHz, the other at

Table 1. Low-pass filter L and C as a function of cut-off frequency

	Frequency		
	60Hz	20kHz	50kHz
Case 1: $X_c < = \frac{Z_L}{5}$			
$C > = \frac{296000}{(f_1)(Z_L)}$	494 μF	2 μF	1 μF
$L > = \frac{127000}{(f_1)^2 C}$	70 mH	159 μH	50 μH
Case 2: $X_c < < = Z_L @ f_1$			
$C > = \frac{159000}{(f_1)(Z_L)}$	265 μF	1 μF	1 μF
$L > = \frac{127000}{(f_1)^2 C}$	130 mH	318 μH	50 μH
Notes: (1) Z_L assumed to be 10 Ω (2) See Electronic Designers Handbook, Landee, Davis & Albrecht, McGraw Hill, 1957, pp. 15-2 through 15-20. (3) All L and C values rounded to next highest integer.			

40 kHz. If you ignore the effects of harmonics, calculations for the fundamental frequencies in Table 2 show that:

- The impedance in polypropylenes is substantially lower than in electrolytics. But more important, the polypropylenes' impedance phase angles remain almost constant at -90° because of very low ESR values.

- The I^2R losses (at 2 A) are orders of magnitude less for polypropylene capacitors than electrolytic units.

- The ripple voltages (at 2 A) are much less across polypropylene capacitors than across electrolytic capacitors. ■■

Table 2. Comparison of polypropylene and electrolytic capacitors

Cap (μF)	Polypropylene				Electrolytic			
	ESR (ohms)	Z (ohms)	I^2R (watts)	Ripple (mv.)	ESR (ohms)	Z (ohms)	I^2R (watts)	Ripple (mv.)
20KHz 1	0.06	7.98/-90°	0.24	15.96	1.5	8.12/-80°	6	16.24
20KHz 5	0.007	1.6 /-90°	0.028	3.20	0.72	1.75/-66°	2.88	3.50
20KHz 10	0.0018	.8 /-90°	0.0072	1.60	0.55	.97/-55°	2.2	1.94
20KHz 20	0.001	.4 /-90°	0.004	0.80	0.4	.56/-45°	1.6	1.12
20KHz 50	0.0003	.16/-90°	0.0012	0.32	0.28	.32/-30°	1.12	0.64
40KHz 1	0.06	3.98/-89°	0.24	7.96	1.5	4.25/-69°	6	8.50
40KHz 5	0.007	.8 /-89°	0.028	1.60	0.72	1.07/-48°	2.88	2.14
40KHz 10	0.0018	.39/-90°	0.0072	0.78	0.55	.68/-36°	2.2	1.36
40KHz 20	0.001	.19/-90°	0.004	0.38	0.44	.44/-26°	1.6	0.88
40KHz 50	0.0003	.07/-90°	0.0012	0.14	0.28	.29/-14°	1.12	0.58

BEST COST/PERFORMANCE

resin-coated SOLID-TANTALUM

CAPACITORS

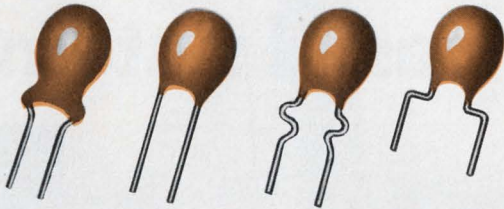

New Sprague Type 199D Capacitors Give You the Most for Your Money

LOWEST COST, YET IMPROVED PERFORMANCE. Prices competitive with any other capacitors of this type, domestic or offshore. Max. impedance in ohms @ 10 kHz guaranteed for every capacitor. Lower d-c leakage currents, lower dissipation factor.

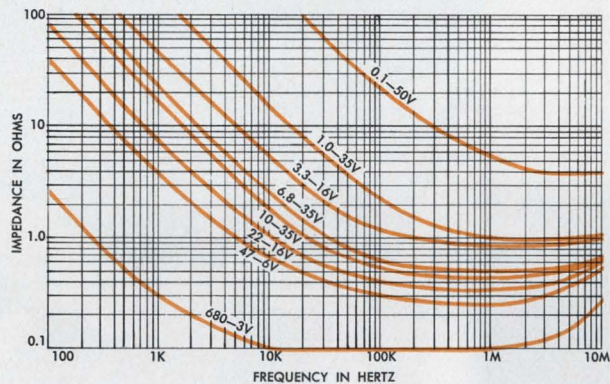

Plus these additional advantages . . .

SUPERIOR EPOXY ENCAPSULANT

Flame-retardant, moisture-resistant resin will not crack or chip under temperature extremes.

CHOICE OF LEAD CONFIGURATIONS

Straight (2 configurations), hockeystick, or lock-in crimp with .100", .200", .250" lead spacing.

STANDARD TOLERANCES: $\pm 20\%$, $\pm 10\%$

$\pm 5\%$ available on special order.

PROVEN CAPACITOR TECHNOLOGY

From the pioneer in solid-electrolyte tantalum capacitors.

RAPID DELIVERY

Up to 999 pieces off-the-shelf from Sprague Industrial Distributors. Larger quantities 4 to 8 weeks ARO.

For price and availability information call your Sprague district office or sales representative. For complete technical data, write for Engineering Bulletin 3547B to: Technical Literature Service, Sprague Electric Company, 347 Marshall Street, North Adams, Mass. 01247.

THE BROAD-LINE PRODUCER OF ELECTRONIC PARTS

CIRCLE NUMBER 32





SMP 80-2 DC Power Supply

When you have to engineer for microprocessor-based systems



The new SMP Series DC power supplies from STANDARD POWER, INC., are just the ticket you need for those tough microprocessor-based system applications. And there are several reasons.

First, it interfaces directly with the power requirements of virtually all microprocessor ICs. No expensive custom design work is needed.

Too, you can get four independent and isolated outputs. You can power logic, memory and displays, for example, from one simple power source.

For extra flexibility, SMP gives you 115/230 V ac universal input. And we've designed in all the little extras for top per-

formance: well regulated, overvoltage protection, highest quality components and low ripple.

The SMP 80-2 also features temperature compensated circuitry. So if the temperature goes up, your output stays right on track.

But most importantly, it embodies a reliable design proven in more than 10,000 units now in use.

For specs, price schedule, and product arrival times, telephone your Wyle Distributor at the phone numbers listed below. Don't forget to ask for the new Standard Power 32-page power supply catalog.

WYLE DISTRIBUTION GROUP

ELMAR ELECTRONICS

- MTN. VIEW, CA (415) 961-3611
- DENVER, CO (303) 287-9611



LIBERTY ELECTRONICS

- EL SEGUNDO, CA (213) 322-8100
- PHOENIX, AZ (602) 257-1272
- SAN DIEGO, CA (714) 565-9171
- SEATTLE, WA (206) 763-8200

"We stock STANDARD POWER SUPPLIES by the carload"

CIRCLE NUMBER 33

A "Special" reminder.

We don't stock this one.

We put it together to demonstrate Cutler-Hammer's unique capability to produce custom—and even proprietary—switch "specials" to satisfy virtually any end-product requirement.

We offer "specials". . . toggle, rocker, paddle, rotary, slide, key, lever-lock or pushbutton. Both illuminated and non-illuminated.

. . . ac or ac/dc. For one-hole, flush, sub-panel, snap-in or nest mounting. In all sizes. With special circuits that can be ampere or horsepower rated . . . or both.

. . . with screw, spade, pc, solder lug, wire wrap, wire lead and integrated wire terminations.

For "special" assistance on commercial, industrial and MIL-Spec applications, call your Cutler-Hammer sales office or distributor.

And for the many "non-specials" we *do* stock—write Milwaukee for your copy of our new 144-page catalog.

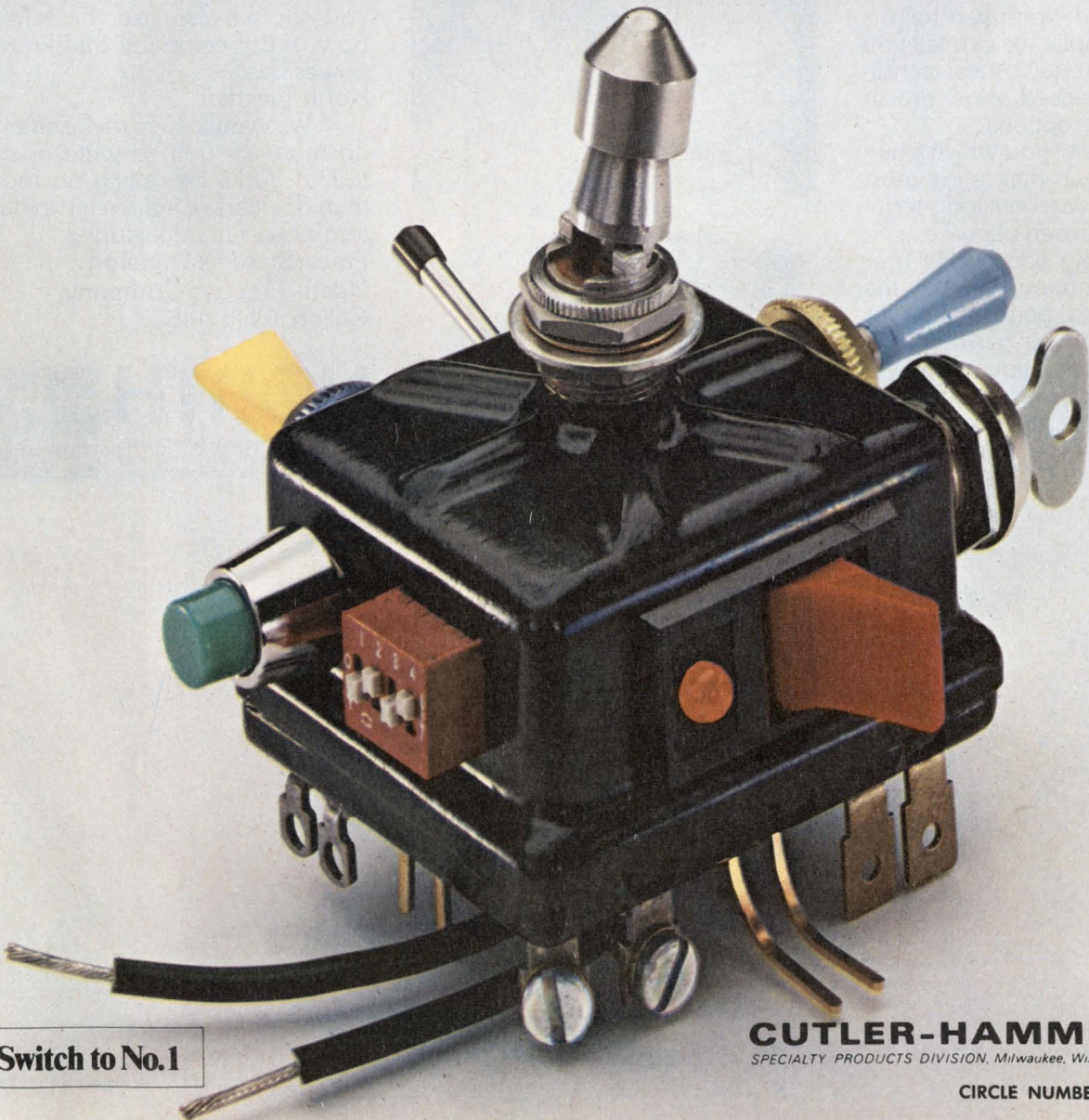

 Switch to No. 1

CUTLER-HAMMER
SPECIALTY PRODUCTS DIVISION, Milwaukee, Wis. 53201



CIRCLE NUMBER 34

NORTH INVITES HARD NOSED QUESTIONS ON YOUR POWER PROBLEMS.

The pressure is on to find sensible answers to serious power questions. And North can help.

For example, we can tell you all about today's most technically advanced, most practical power options.

Or, we can show you which power approach makes the most sense for you on a long-term, energy conservation basis.

Or, we can help you decide how your company can get the best power performance for the least power-per-unit cost.

The point is, if you use power in your products such as computers, business machines, solid-state

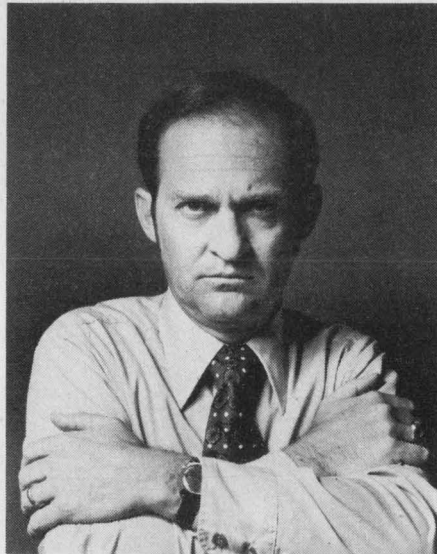

switching, high-speed printing or communications linkage, then you should also use the know-how of the company that knows power best—
North Electric!

We want to help make energy do more for you, so write or call today! You'll be calling on more than 35 years of leadership in custom power manufacturing.
PowerSystems Division
North Electric Company
Galion, Ohio 44833

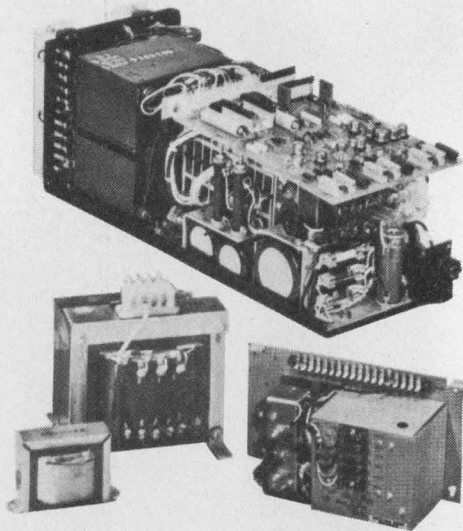

NORTH 
PowerSystems Division
North Electric Company
A United Telecom Company

**CALL FOR ANSWERS.
CALL FOR ACTION.
(419) 468-8285**

TP-39

**Now, a new generation
of semiconductor-grade
molding compounds.**



Dow Corning 631 molding The advantages of silicone. The advantages of epoxy. And something more.

At first it might appear pretentious to announce a new generation of semiconductor-grade molding compounds. "New generation" implies a product so outstanding, so totally unique, that it overshadows all existing technology. But that is precisely what we have developed. We've taken the best advantages of silicone. The best advantages of epoxy. And put them together in one very unique product. Dow Corning® 631 silicone/epoxy molding compound.

What this new generation of molding compound means to you is that now you have the best advantages of silicone and epoxy in one product specifically designed for integrated circuit applications. And it means something more. It means that now every other molding compound is second best.

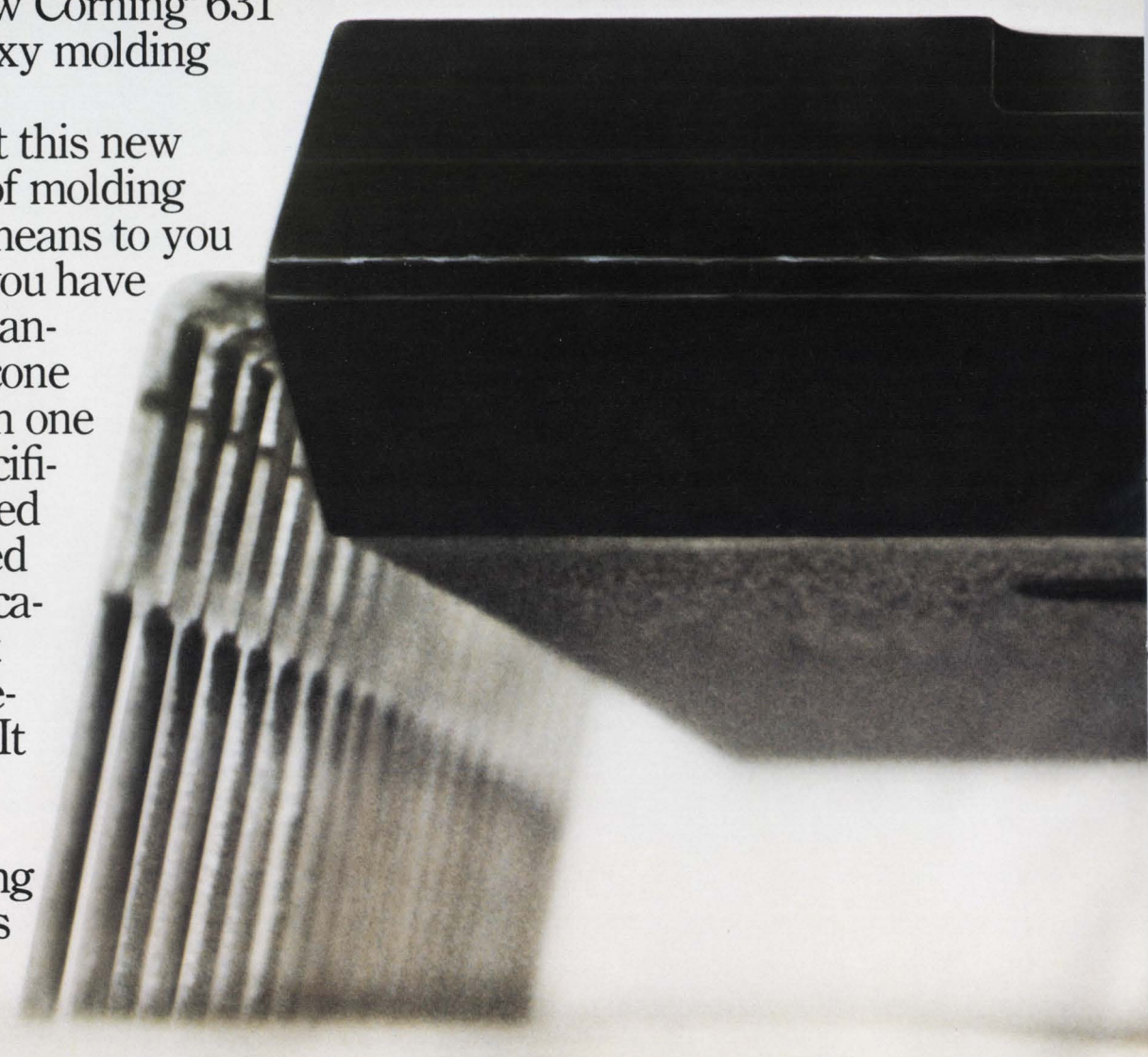

compound.

Dow Corning 631. Better than silicone.

Dow Corning 631 silicone/epoxy molding compound represents a breakthrough

in a very real sense. It's the only molding compound that combines the compatibility and ease of molding of silicone compounds with the salt atmosphere resistance of epoxy compounds. The graph at right proves our point. After 600 hours' exposure to corrosive salt atmosphere, none of the devices that were molded in Dow Corning 631 silicone/epoxy compound failed. That's a major advantage over ordinary silicone molding compounds.

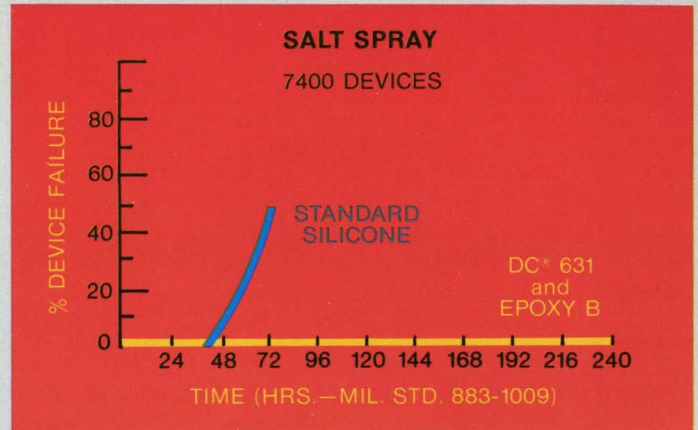

Dow Corning 631. Better than epoxy. Dow Corning 631's advantages over silicone are only half the story. It's also the only molding compound that combines the high strength and strong lead seal of epoxy with the

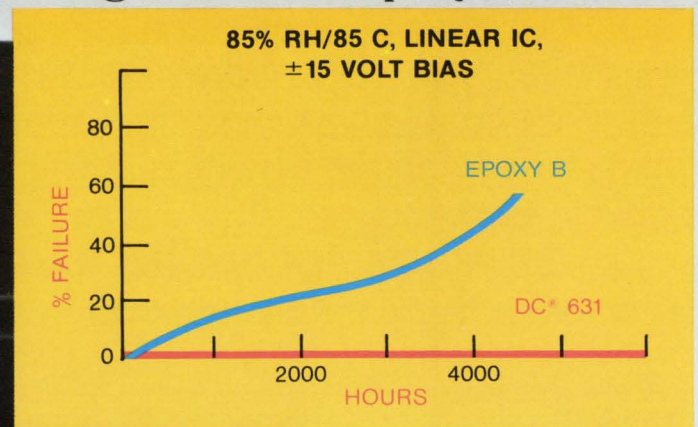

outstanding moisture resistance of silicone. The autoclave resistance of Dow Corning 631 is very nearly as high as that of an all-silicone molding compound. And look what happened on 85°C/85% R.H.-bias testing.

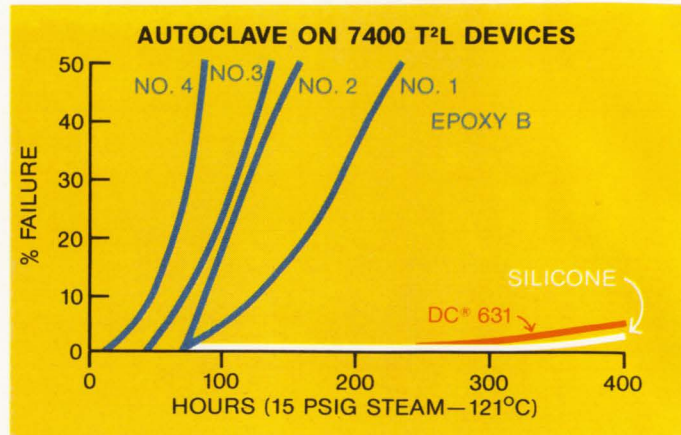
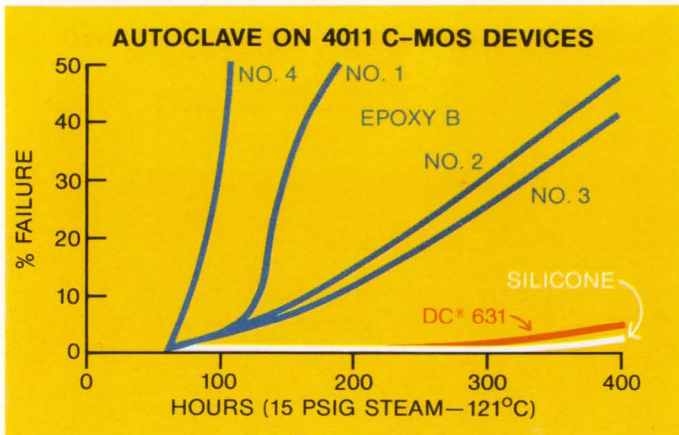

Dow Corning 631. Unmatched design flexibility. Dow Corning 631 silicone/epoxy molding compound gives you the compatibility, the moisture resistance and the unmatched ease of molding of silicone compounds. It gives you excellent 85/85-bias protection. It gives you the high strength, the strong lead seal, and the superb salt spray resistance of epoxy compounds. And it gives you all those advantages in one product. You can solve a problem with Dow Corning 631 that you wouldn't even approach with conventional molding compounds.

You have our word on how good Dow Corning 631 is. But we don't want you to just take our word for it. We want you to see for yourself. For samples and more information, write Dow Corning Corporation, Box 1767, Midland, Michigan 48640. Or, for immediate attention, call (517) 496-4682.

**Dow Corning 631 silicone/epoxy molding compound.
Now everything else is second best.**

Hong Kong

Dow Corning Asia, Ltd.
P&O Building, 9th Floor
21 Des Voeux Road C
Ph. 5-258035/7

Toronto

6747 Campobello Road
Mississauga, Ontario L5N 2M1
416/826-9700

Brussels

Dow Corning International, Ltd.
Chaussee de la Hulpe, 177
1170 Brussels, Belgium
Ph. 02/673.80.60

Munich

Dow Corning GmbH
8 Munchen 50
Pelkovenstrasse 152
Ph. 89/14861

France

Dow Corning SarL
140 Avenue Paul Doumer
92500-Rueil Malmaison, France
Ph. 1/977.0040

São Paulo

Dow Corning do Brazil Ltda.
Caixa Postal 4102-01000
São Paulo, Brazil
Ph. 52-2572, 52-8672

Mexico City

Dow Corning de Mexico, S.A.deC.V.
Paseo de las Palmas 751, Piso 5
Mexico 10, D.F., Mexico
Ph. 905 5 40 31 10

DOW CORNING



The Cube widens the gap...

In Power-Ferrite EC cores for switching power supply chokes

Now available from Ferroxcube are standardized gapped EC cores in four sizes: 35, 41, 52 and 70 mm. The gap lengths have been optimized to prevent saturation of the core due to a high DC field while simultaneously providing maximum impedance to the AC ripple current.

For worst case DC bias, two gapped cores should be used. Under less stringent conditions, one gapped and one ungapped core in combination may be used. The chart below shows the DC ampere-turns which can be supported for both 2-gapped and gapped/ungapped combinations that will not decrease incremental permeability more than 10%.

EC Core	2 Gapped Cores	1 Gapped + 1 Ungapped Core
35 mm	325 AT	200 AT
41 mm	370 AT	220 AT
52 mm	540 AT	330 AT
70 mm	860 AT	570 AT

For complete specifications on gapped EC cores, bobbins and hardware, call on The Cube.



FERROXCUBE Division of Amperex Electronic Corporation,
Saugerties, New York 12477 (914) 246-2811
A North American Philips Company

Call
on the
cube

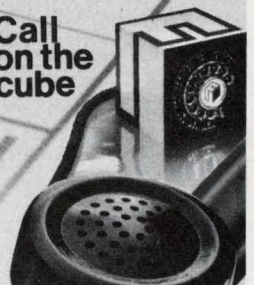

Need a high-voltage resistor? Metal-oxide films offer a variety of styles with tight TCs and excellent stability at values of up to 10 G Ω .

When you're designing equipment for operation at 1 kV and above, it's important to be selective about resistors.

Carbon composition, wirewound and metal-film resistors all come in high-voltage styles, but the films offer some advantages over the others. Voltage gradients in carbon composition types can produce resistance changes at high potentials. And at high resistance values, wirewounds become physically too large. Metal-film resistors come in three styles—carbon-film, metal-alloy and metal-oxide, and you must know how to select the correct type for your application.

Most parameters for resistor operation in low-voltage circuits apply to resistor operation at high voltages. Such specs as power rating, temperature coefficient of resistance (TCR), and stability (% ΔR) don't change. At high voltages, however, you've got to be more aware of parameters like voltage breakdown and voltage coefficient of resistance (VCR).

Selecting the proper resistor is important, but also consider the circuit layout and temperatures at which it will operate. Part spacing, cooling and insulating materials become more significant at high voltages.

Familiar types, different specs

Each type of film resistor is suitable for specific applications—metal oxide for high stability requirements, carbon-film for general purpose use, and metal-alloy for some high stability and general purpose requirements. Use high-stability types in voltage dividers or meter multipliers, and general purpose for noncritical functions like current limiting or bleeder resistors.

Carbon-films are the workhorses of the high-voltage resistors (see Fig. 1). They offer the highest resistance values at the highest breakdown voltages: as much as 10¹² Ω at up to 125 kV. They come in ¼ to 100-W power ratings with an initial resistance tolerance as low as 1%. In addition, they come in the widest variety of styles. The film is applied to the substrate in a helical fashion, providing a conducting path of long effective length and reducing the voltage gradient from turn to turn. This construction technique is what gives the carbon-film resistors their very high voltage

breakdown properties.

Metal-alloy resistors are made from a microcrystalline film that is improved by forming a passivated film over it. As the specs in Fig. 1 show, this process gives metal-alloy resistors greater stability and higher operating temperatures than carbon resistors. However, metal-alloy types are manufactured in lower power ratings than carbon types and come in fewer styles.

Metal-oxides are the elite of the metal-film resistors. Look at the specifications available: 50-ppm TCR, 30-kV breakdown voltage, high resistance range and outstanding ΔR . Sometimes called glaze films, they are cermetts formed of metal powders and glass. They are similar to the metal-alloys, in that they are small parts with about the same power-handling capabilities.

Play it cool

Selecting a film resistor from a spec sheet, begins naturally, with knowing the operating conditions imposed by your circuit. The voltage and power dissipation are established by your resistance value, and the drift specs such as TCR, VCR and stability are dictated by system requirements. You also know whether the application is general-purpose or high-stability. But how do you use the ratings found on most data sheets?

Power rating is the maximum wattage that can be continuously dissipated by a resistor at a specified ambient temperature, with the hot-spot temperature—the ambient plus the rise temperature caused by self-heating—not exceeding a stated maximum. When applying the power-rating spec to your circuit, keep the following points in mind.

- Resistors can be operated in ambient temperatures higher than specified, if the power dissipation is less than the rated maximum.

- Resistors can dissipate higher wattages than rated, if both the ambient temperature and the voltage rating aren't exceeded.

- Resistors can be operated at higher power levels if forced air or coolants are used. Carbon films are full load rated to operate at 25 C, but metal-alloy and oxide films are rated much higher (Fig. 2). At 25 C these latter two types can operate at 200% of rated load. Fig. 3 shows you how to determine the rise temperature as a function of the resistors load. Note

William Mulligan, Manager, Quality Assurance, American Components Inc., 8th Ave. at Harry St., Conshohocken, PA 19428.

High voltage resistors

Type	Resistance Range (Ω)	Tol. (%)	Power Range (W)	Voltage Range (kV)	Temp. Coeff. Range (ppm/ $^{\circ}$ C)	Volt. Coeff. Range (ppm/V)	Oper. Temp. ($^{\circ}$ C) max	Time Stability (1000 h) (% Δ R)
Carbon Film	10K-1M	1-20	$\frac{1}{4}$ -100	1-125	-500 to -1000	0.1 to 5	120	2 to 5
	1M-1G	1-20	$\frac{1}{4}$ -100	1-125	-1000 to -4000	0.1 to 15	120	2 to 10
	1G-1007	2-20	$\frac{1}{4}$ -100	1-125	-2000 to -7000	0.2 to 50	120	5 to 10
Metal Alloy	1K-100K	1-10	$\frac{1}{2}$ -5	3.5-15	-200 to -350	0.1 to 1	225-350	1
	100K-100M	1-10	$\frac{1}{2}$ -5	3.5-15	-350 to -2500	0.1 to 5	225-350	1 to 2
	100M-1G	2-10	$\frac{1}{2}$ -5	3.5-15	-2500 to -4000	0.5 to 10	225-350	2 to 5
Metal Oxide	1K-1M	$\frac{1}{2}$ -5	$\frac{1}{4}$ -6	1.5-30	± 50 to ± 200	0.1 to 3	225	0.1 to 1
	1M-100M	$\frac{1}{2}$ -5	$\frac{1}{4}$ -6	1.5-30	± 50 to ± 200	0.5 to 5	225	0.5 to 2
	100M-10G	$\frac{1}{2}$ -10	$\frac{1}{4}$ -6	1.5-30	± 50 to ± 600	1 to 50	225	1 to 5

1. The characteristics of high-voltage film resistors cover wide resistance, power and voltage ranges. Carbon types

have the best all-around capability, but metal-alloys and oxides are needed for critical applications.

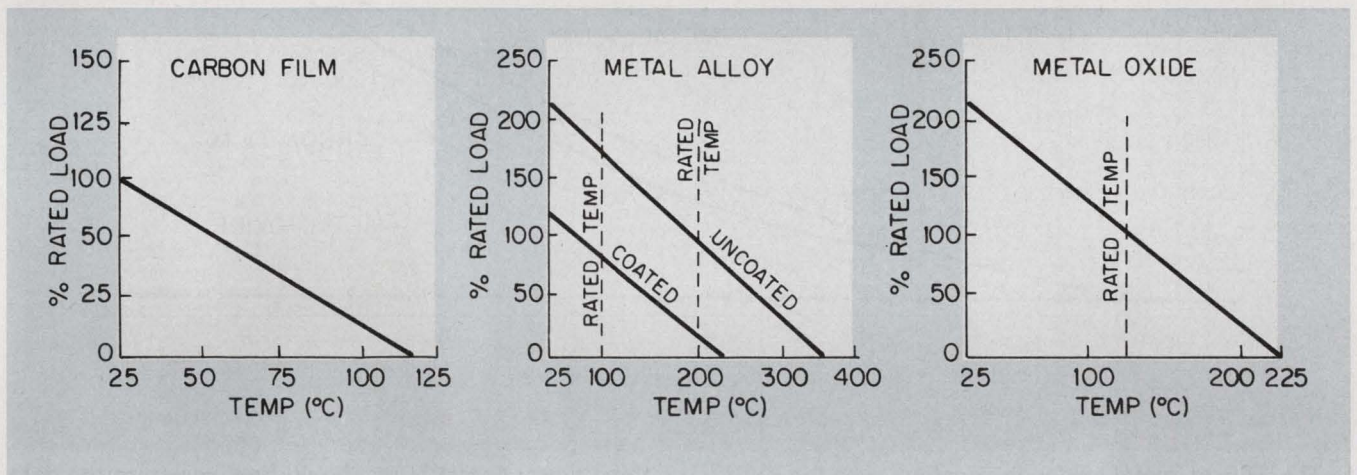

2. Temperature derating may be unnecessary for some metal-films since they handle 100% of rated load at

ambient temperatures in excess of 100 C. Carbon-films, however are full load rated at 25 C.

that the derating and temperature-rise curves relate to free-air operation. Encapsulation, or operation of components in coolants, nullifies the curves.

C, but are available to ± 50 ppm, over the entire resistance range.

Voltage capability is the safe voltage limit that the resistor can withstand across its terminals. It should not be exceeded, no matter what the combination of wattage and heat. If you've taken the precaution of derating the power by 50%, you should have no problems. Assigning strict voltage derating rules is difficult because of the various ways in which breakdown occurs. Also, the size and configuration of the resistor must be considered.

Voltage coefficient of resistance (VCR) is a change in resistance caused by a change in voltage. It's a property of the resistor film, caused by high-voltage stress across conductive particles seeking shorter paths. Construction and size of the resistor are critical,—the longer the element for a given voltage, the lower the gradient per unit size and the lower the resistance change per volt. VCR increases with increasing values of resistance, and is typically 0.1 ppm/V for low value resistors, but around 20 to 30 ppm for the highest values.

Temperature coefficient of resistance (TCR) represents the change in resistance per $^{\circ}$ C. Fig. 4 is a comparison curve showing how the three types of film resistors rate. Generally, TCR is a function of resistance and element length in carbon and metal-alloy types. Metal-oxide resistors, however, are offered with typical TCRs of ± 200 ppm over a range of -55 to $+150$

Stability is a resistor's ability to maintain its initial resistance over extended periods of time when subjected to various environmental conditions and electrical stresses. As expected, metal-oxide resistors are the most stable, with metal-alloy types not far behind.

To sum up the electrical characteristics of metal-

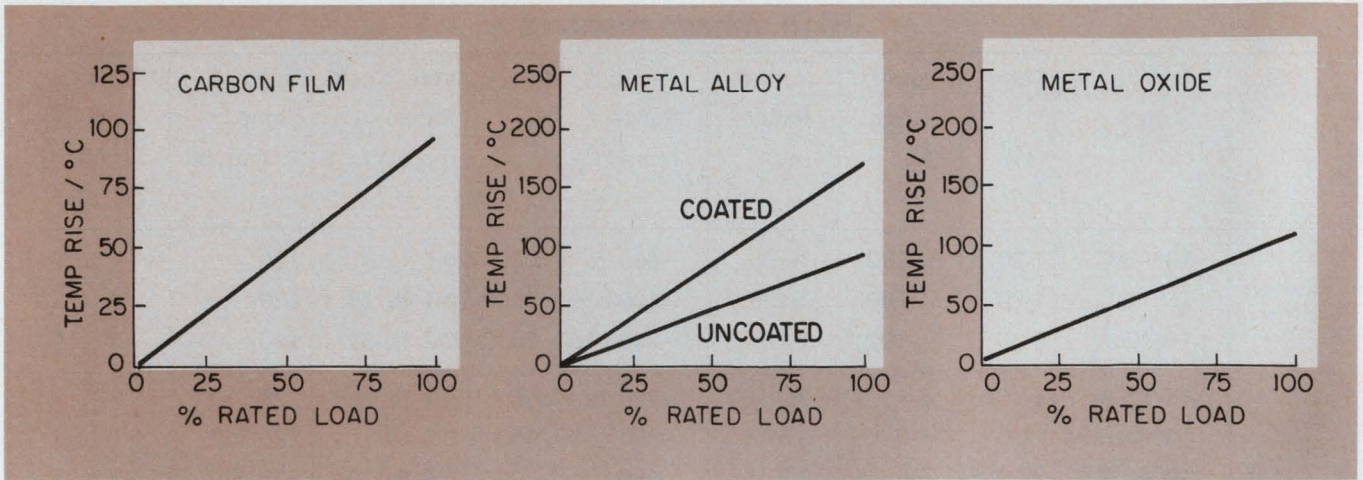

3. Rise plus ambient gives the hot-spot temperature. Temperature rise curves show an approximately linear

relationship for the three resistor types. Metal-alloy types offer the highest over-all temperature capability.

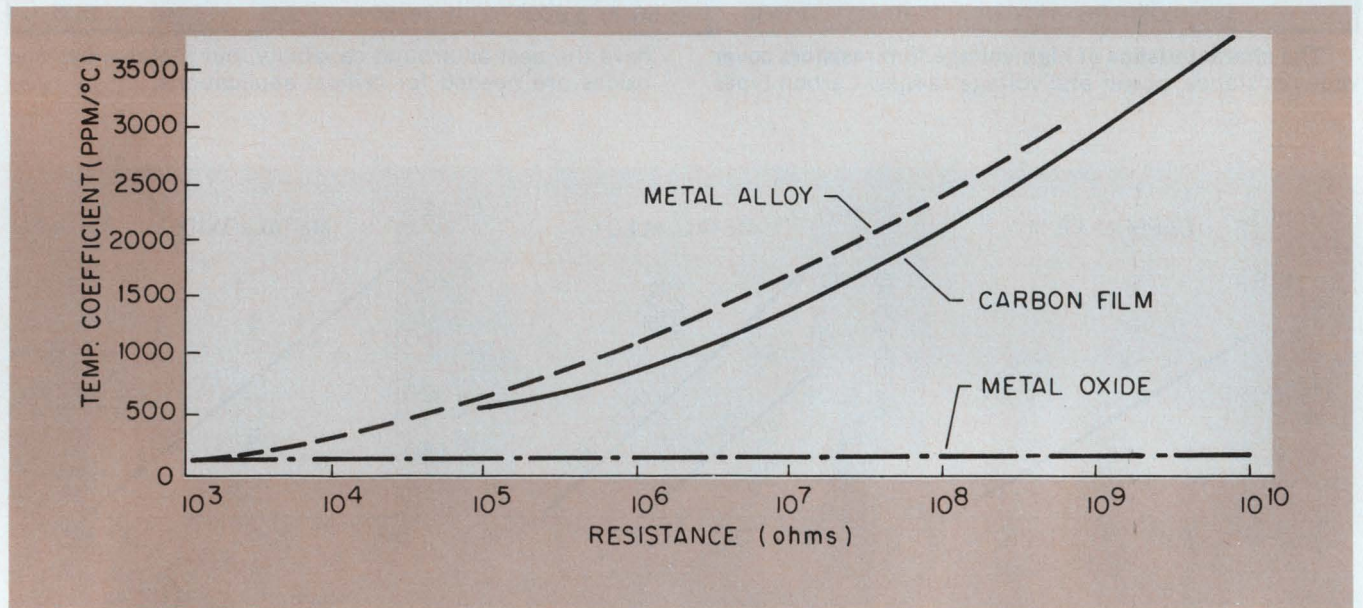

4. The TCR of metal-oxides is constant over the entire resistance range. Use this curve only for comparing the

three types. Actual TCRs should be taken from the data sheet for the specific part that you choose.

Table 1. Film-resistor selection guide

Carbon-film	Metal-alloy	Metal-oxide
<p>Advantages</p> <ul style="list-style-type: none"> ■ Highest power capability ■ Highest voltage capability ■ Highest resistance capability ■ Wide resistance range ■ Most styles and terminations 	<p>Advantages</p> <ul style="list-style-type: none"> ■ Highest Operating temperature ■ Good load stability ■ Low VCR 	<p>Advantages</p> <ul style="list-style-type: none"> ■ Best load stability ■ Best resistance tolerance ■ Lowest TCR ■ High operating temperature ■ Wide resistance range
<p>Disadvantages</p> <ul style="list-style-type: none"> Low operating temperature High TCR Poorest load stability 	<p>Disadvantages</p> <ul style="list-style-type: none"> Lowest power capability Lowest voltage capability 	<p>Disadvantages</p> <ul style="list-style-type: none"> Low power capability Low voltage capability

film resistors, Table 1 shows the strong points and weaknesses of each type. But no matter which type you select, it can fail at high voltages because of the special conditions encountered in this environment.

Failures can be avoided

In high-voltage designs, you must provide adequate space between components, run heat-dissipating elements as cool as possible, and choose insulating materials that meet the voltage and temperature requirements of your system.

One of the most likely causes of premature failure of high-voltage circuits is corona breakdown. No matter how well a resistor is insulated, it has an electrostatic field around it. A corona is an electrical discharge that breaks down the field. If air cannot move freely in an electrostatic field, corona can occur.

A prolonged corona can deteriorate even the best insulation, and cause voltage breakdown. A high-voltage breakdown between a resistor and another part of the system will create hot spots on the resistor, which will eventually avalanche and lead to thermal failure.

To prevent corona breakdown, keep the air flowing. Induced air flow from fans or blowers may be necessary. Also, avoid sharp ground points or screws which attract corona discharges. In systems where potentials will be greater than 20 kV, you can use void-free fillings of gas, oil, or solid dielectric to decrease the

possibility of voltage breakdown in the space around the components.

To assure uniform convection cooling, you should mount resistors horizontally, with at least one inch of free air space surrounding them. This will prevent hot-spots from being formed by radiated self-heating. Be careful about inserting high dielectric material between voltage gradient points, such as resistor to case. While it will increase the breakdown capability, air circulation may be blocked, allowing temperatures to rise on the components. Insulation, if not selected properly, can be detrimental, since it may concentrate potentials in an otherwise distributed system.

When choosing insulation, keep in mind that your choice greatly depends upon the temperature, humidity and voltage environment that the circuit operates in. Many insulators that are good at room temperature develop leakage at high temperature. Of the plastics, for example, avoid Bakelite, which absorbs moisture and has fairly low dielectric strength (about 300 V/mil at 25 C). Instead, choose Teflon, which absorbs virtually no moisture and has a dielectric strength of about 1000 V/mil at 25 C.

Finally, keep your system clean. Dust can be attracted to the resistor surfaces by high potentials. Should the dust become baked on from either self-heating or high temperatures, it can absorb moisture and cause leakage which will lead to voltage breakdown. Clean up your parts and leakage paths with a cloth dipped in alcohol. ■

Photomultiplier Power Supplies

- Low Cost
- High Reliability
- MTBF 75,000 Hrs
- Short circuit Reverse Polarity Protected
- Input/Output floating

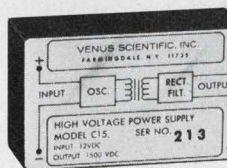

Model C15

Model K15

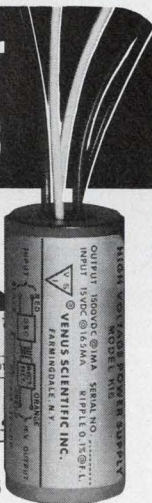

Cathode Ray Tube Power Supplies

- Military Reliability at commercial cost
- PC connector & Turret terminals = plug in capability
- MTBF 30,000 Hr
- Fully encapsulated silicon circuitry
- Electrostatically shielded

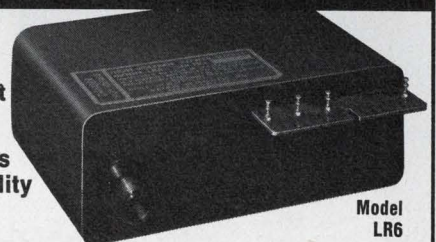

Model LR6

Model	Input	Output		Ripple P-P	Regulation	10 Pc. Price
		V	i			
K15	3-15VDC	300 to 1500VDC	1 ma	<0.15% FL	Output Prop. to Input	\$139
K30	3-15VDC	600 to 3000VDC	500 ua	<0.5% FL	Output Prop. to Input	\$149
C15	5-12VDC	500 to 1500VDC	1 ma	<0.5% FL	Output Prop. to Input	\$ 62
C30	5-12VDC	1000 to 3000VDC	500 ua	<.33% FL	Output Prop. to Input	\$ 63
LR2N	24-32VDC	0 to -2000VDC	5 ma	300 MVFL	Load .005%/ma Line .007%/V	\$144

Model	Input	Output		Ripple P-P	Regulation	10 Pc. Price
		V	i			
LR6	24-32VDC	500 to 6 KVDC	500 ua	15 volts	<5 volts	\$115
LR15	24-32VDC	500 to 15KVDC +750 focus -150 cutoff	300 ua	.075%	.03%	\$125
LR20	24-32VDC	500 to 20KVDC +850 focus -150 cutoff	150 ua	.05%	.03%	\$131
LU15	3-15VDC	3KV to 15KVDC +725 focus -150 cutoff	300 ua	.25%	Output Prop. to Input	\$ 86

Over 40 standard models / Off the shelf delivery



VENUS SCIENTIFIC INC. 399 Smith Street, Farmingdale, N. Y. 11735

Telephone (516) 293-4100 - TWX 510-224-6492

CIRCLE NUMBER 37

How does our broad line of discrete semiconductors fit your growing line of switching power supplies?



IOR
FAST RECOVERY RECTIFIERS
 8 SERIES
 6-12 Amps
 50-1000 Volts

IOR
RECTIFIERS
 28 SERIES
 1-40 Amps
 50-1000 Volts

IOR
ZENERS
 26 SERIES
 250mW-50W
 2.4-280 Volts

IOR
TEMP. COMP. VOLTAGE REFERENCES
 16 SERIES
 250mW-1.6W
 5.9-49.6 Volts

IOR
POWER SCHÖTTKYS
 6 SERIES
 20-50 Amps
 10-50 Volts
 150°C Junction Temp

IOR
SCR's
 22 SERIES
 4-70 Amps (RMS)
 15-1200 Volts

IOR
INVERTER SCR's.
 4 SERIES
 35 Amps (RMS)
 20-400 Volts

IOR
POWER TRANSISTORS
 34 High Gain Types
 1-10 AMPS
 15 Fast Switching Types
 5-15 AMPS

IOR
HIGH VOLTAGE POWER DARLINGTONS
 25 High Gain Types
 10-20 AMPS
 9 Fast Switching Types
 10-20 AMPS

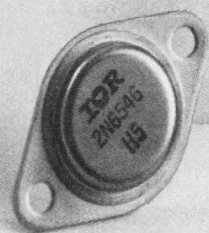

Beautifully.

When you're breaking new ground in switching power supplies you need a vendor who can solve most of your problems.

In discrete semiconductors, only a broad-line supplier like International Rectifier can help you in so many ways. Both in design and later in production.

Design Tradeoffs. Like your own circuits, each of our discrete semiconductors has its own limitations as well as advantages. If a part number you've previously specified doesn't seem to do the job, we can probably suggest one that will. We can also select standard devices with the special parameters you need, or start fresh with a new design.

If you need a capability trade-off between different types of discrettes, no one has more knowledge to assist you with than IR.

Applications Assistance. We know it takes more than data sheets and application notes to keep your design and production running smoothly. No matter what your questions, if it has to do with discrete semiconductors we can help. And we do help. Our application engineers will come when you call.

High, and consistent quality. For 28 years we have been specializing in discrete semiconductors. They have earned a reputation for consistently high quality, ruggedness, dependability, and good performance. Our manufacturing, test and QC procedures are sound, and painstakingly adhered to.

One source. We can save you design time. We can keep your production running smoothly. We can deliver the kind of performance that will help increase your sales.

For information, just give us a call. At the factory (213) 322-3331, at our 30 local sales offices, or at any of our nationwide distributors. Write to International Rectifier, 233 Kansas Street, El Segundo, CA 90245.

Mail this Coupon for Design Data today !

Please send information on the devices checked to:

- Power Transistors
- High Voltage Power Darlingtons
- Power Schottkys
- SCR's
- Inverter SCR's
- Rectifiers
- Fast Recovery Rectifiers
- Zeners
- Temp. Comp. Voltage References
- Diode Bridges
- Semiconductor Fuses
- Semiconductor Heat Exchangers

Name _____

Title _____ Phone _____

Company _____

Address _____

City _____

State/Zip _____



SEMICONDUCTOR HEAT EXCHANGERS

12 Types
readily available.



SEMICONDUCTOR FUSES

130 and 250 Volts
5-800 AMPS (RMS)

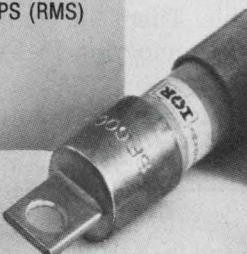

DIODE BRIDGES

1.8 to 25 Amps
50-1000 Volts

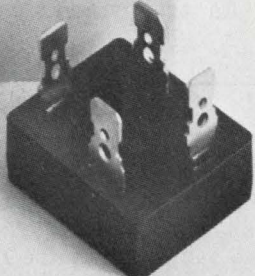

International Rectifier

... the innovative semiconductor people



Determine wire size with nomograms.

With these two charts you can easily select the right-size wire for system voltage-drop and current requirements.

Determining wire size involves two major considerations: current density and voltage drop. Obviously a wire must carry its current without overheating. Less apparent, perhaps, but nonetheless crucial is the limitation on the voltage drop in a wire.

Use the nomograms

For quick and accurate wire selection use the nomograms in Fig. 1. Select the safe wire size from Fig. 1a and limit the voltage drop with Fig. 1b. Using these graphs is easier than going back and forth with wire-data tables and equations. The results you get with the nomograms are as accurate as with calculations.

Use the nomogram in Fig. 1a as follows:

- To determine the wire size, lay a straightedge from the required current through the cross-hatched area and read the corresponding wire size.

- To find how much current a wire size can carry, do the reverse. Lay the straightedge from the wire size through the cross-hatching.

Current levels found by running the straightedge below the cross-hatched region would make the wire too hot. Wire sizes found by running the straightedge above the cross-hatching are safe but costly.

Use the nomogram in Fig. 1b as follows:

- Draw a line through the two known values that are on the same side of the reference line (voltage drop and current or wire gauge and length). Mark the point where this line intersects the reference.

- Connect the intersection point and the other known value with another line.

- Extend the line if necessary and read the desired value on the unknown item's scale. Cross check that the wire size and current from Fig. 1a fall within acceptable limits on Fig. 1b.

Usually, line losses are held to under 10% of the applied voltage. This 10% loss must include the voltage drop on the return line. In a 10-ft cable, for example, you have 20 ft of wire on which the voltage will drop.

The nomograms can be applied effectively to branched wires (busses) also. However, when only a

single ground line is used, remember that it must carry the currents from all the supplies.

Nomograms apply to combinations also

When using the nomograms for cables and busses in which wires are connected in parallel, these three facts are often helpful:

- Current divides equally among wires whose gauges and lengths are the same.

- Voltage drops equally with distance along each wire.

- Voltage drop reduces as more wires are added to the bus or cable. The voltage drop for a cable containing equal-size wires reduces to the voltage drop for one wire divided by the number of wires.

As an example of how to use the nomograms, let's find the proper wire size for a 5-V TTL-logic system that draws 5 A and is 5 ft from its power supply. TTL logic requires a minimum of 4.5 V at the circuits. We therefore can afford a 500-mV-maximum drop on the line. In Fig. 2a (line a) the nomogram indicates that 5 A requires AWG-16 wire. From Fig. 2b (lines b and c) the voltage drop on 10 ft of AWG-16 wire is 210 mV—well within our 500-mV limitation.

With more information you can use the nomogram differently. As an example let's find the correct wire size for the same 5-V TTL system as before, except that this time it's 15 ft from the power supply. Since we already know that AWG-16 wire will carry the required 5 A, we start with AWG-16 wire in Fig. 2b (lines d and e). The 620-mV drop is too great. So we try the next-heavier wire size, AWG 14. From Fig. 2b (lines g and h) the drop on 30 ft of AWG-14 wire is 380 mV, which is acceptable. Then, for completeness, do a quick check on the nomogram in Fig. 2a (line f).

As they stand, the nomograms are pointed to

1. Select the safe wire size (a) and limit voltage drop (b). For the wire size lay a straightedge from the current, through the cross-hatching, to the wire size. For the voltage drop, draw a line through two known values on the same side of the reference. Connect this line's intersection of the reference to the other value and read.

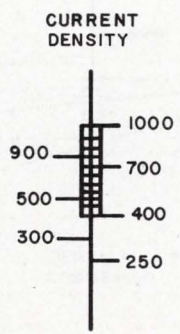
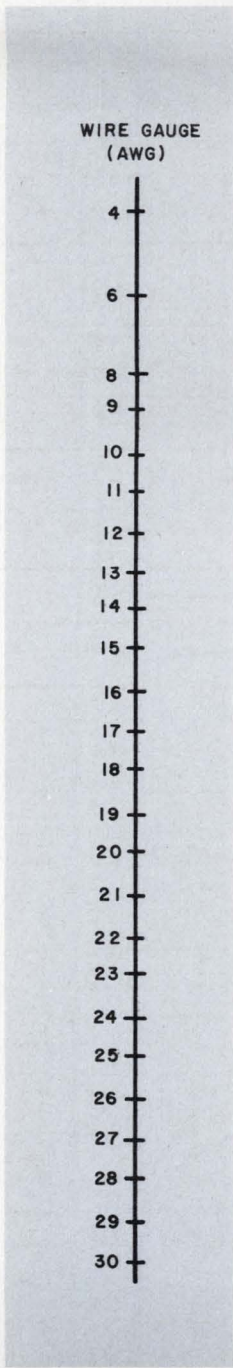

(a)

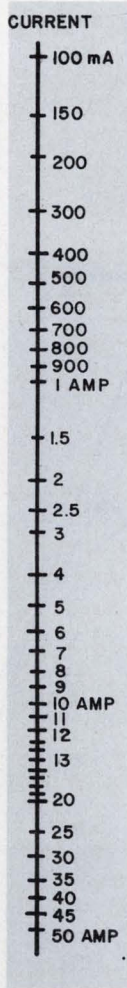
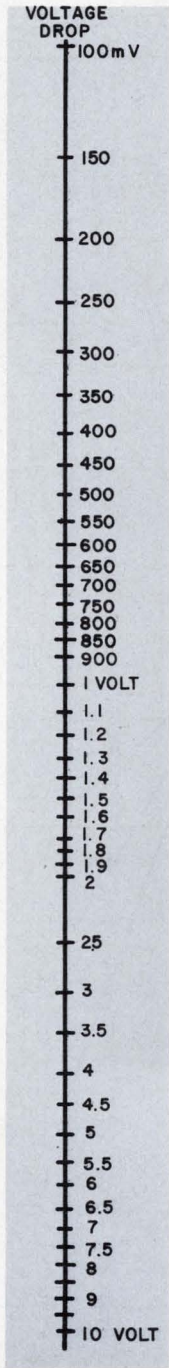
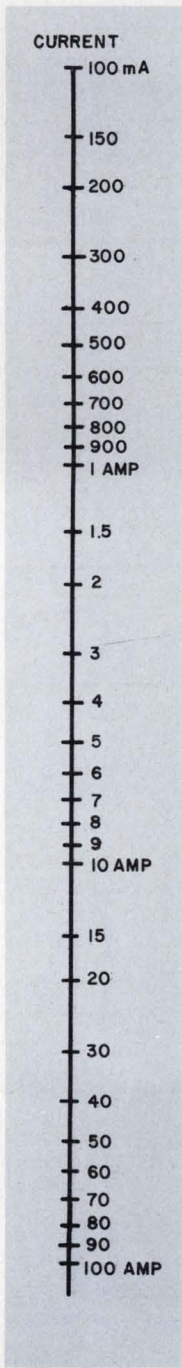

REFERENCE LINE

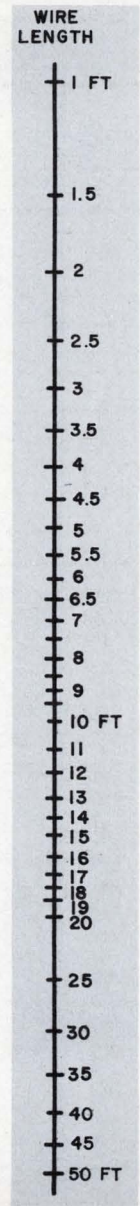
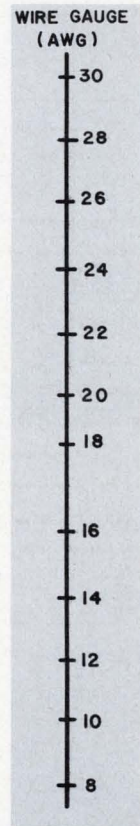

(b)

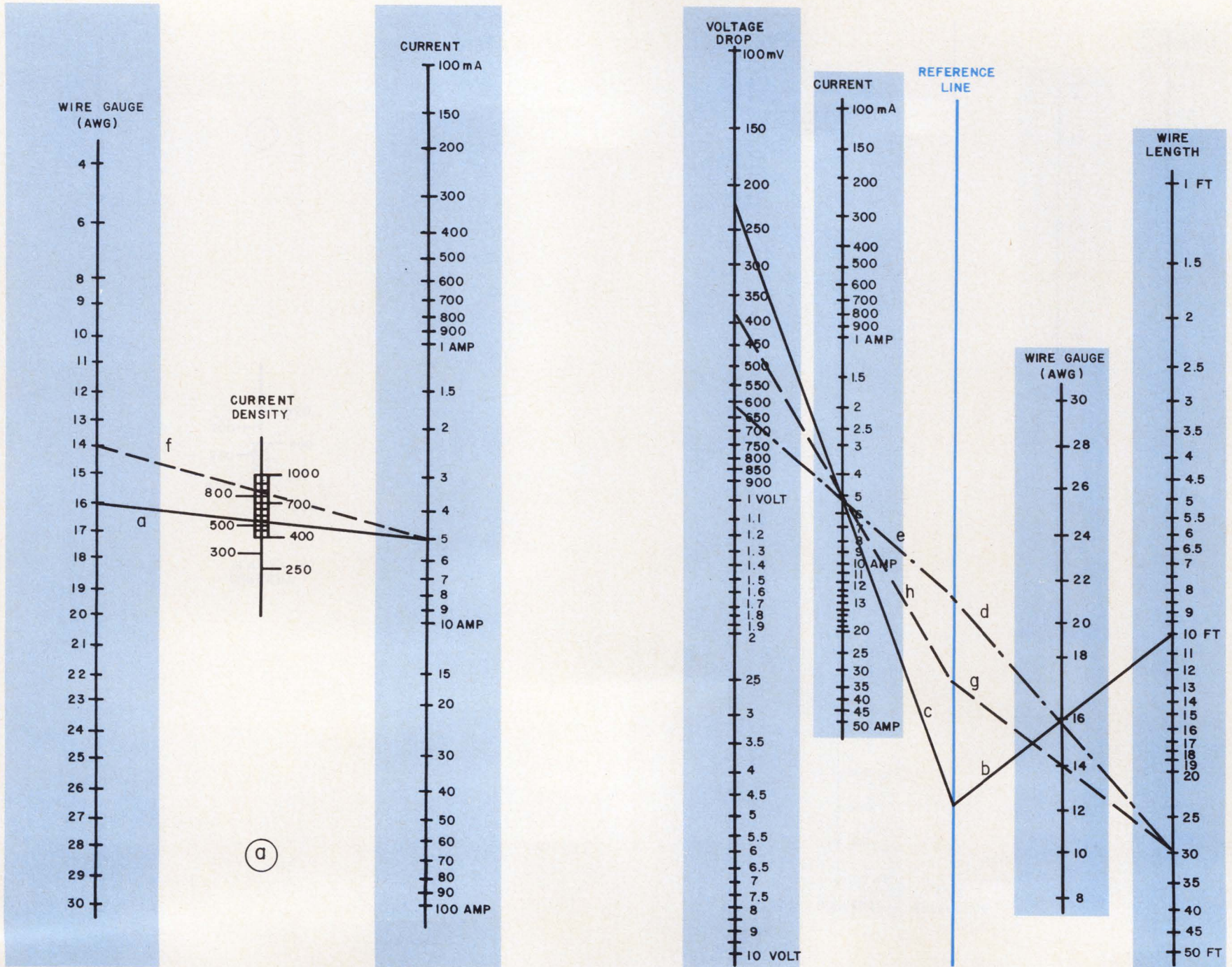

2. Nomogram (a) indicates 5 A requires AWG-16 wire (line a). From (b) 10 ft of AWG-16 wire drops 200 mV (lines b, c).

Some wire facts untangled

Wire, in electronic use, is usually round. The cross-sectional area of round wire in circular mils equals the square of its diameter in mils (one mil equals 0.001 in.).

A one-foot length of wire with a one-circular-mil cross section is called a mil-foot wire. Wire resistivity is expressed in Ω per mil-foot. At 20 C the resistivity of copper wire is 10.4- Ω per mil-foot and that for aluminum is 17- Ω per mil-foot.

The resistance of a length of wire is

$$R = \frac{\rho l}{d^2}$$

where: R = Ω
 ρ = resistivity in Ω /mil-ft
 l = length in ft
 d = diameter in mils.

Wire tables are often used for resistance and diameter data. In the absence of a table, the following is a widely used rule of thumb:

- American Wire Gauge (AWG) 10 wire has a cross section of 10-k circular mils and a resistance of 1 Ω per 1000 ft.
- As the AWG number increases by three, the wire's cross section halves and its resistance doubles. For example: AWG 13 has a 5-k circular-mil cross section and a 2- Ω per 1000-ft resistance; AWG 7 has a 20-k circular-mil cross-sectional area and a 0.5- Ω per 1000-ft resistance.

Another design criterion limits the number of circular mils per ampere to between 400 and 1000, with 700 widely used to meet the -55 to +125-C military requirement. Where requirements aren't so stringent, circular-mils-per-ampere can be reduced to 400 for general use in multi-wire bundles and to 250 for single wires in free air.

systems which must meet the full -55 to +125-C military-temperature requirements. Over that span, the variation in resistance from the 20-C-nominal value is approximately $\pm 30\%$. In order to minimize voltage drops and current-induced temperature rises, the current densities on which the nomograms are based may be more conservative than in other charts.

The nomogram in Fig. 1b is based on 20-C-nominal-resistance values. Be mindful that resistance varies with temperature according to

$$R_t = R_0 (1 + \alpha t)$$

where R_t = resistance at temperature t , in $^{\circ}\text{C}$,
 R_0 = resistance at 0°C ,
 α = resistance tempco.
 = 0.00393 for Copper

This implies a 0.4% change in resistance for every $^{\circ}\text{C}$ change. For every 25°C change, the resistance changes *directly* by 10%. Therefore the values for voltage drop in the nomogram of Fig. 1b change directly by 10% for each 25°C change. ■■

INTRODUCING

"PEP" MOBILE UNINTERRUPTIBLE POWER SUPPLIES NEW from

**CML
MACARR**

Power Support Equipment

STEADY-CLEAN UNINTERRUPTIBLE POWER FOR SOPHISTICATED ELECTRONIC EQUIPMENT

CML-Macarr presents the "PEP" system—designed to provide regulated power to monitoring devices, data processing and evaluation systems or other sophisticated electronic equipment and to protect this equipment from circuit fluctuations caused by voltage changes, overloaded lines, frequency shifts and from power failure. All of which can cause instruments to act erratically, produce erroneous records and monitor inaccurately.

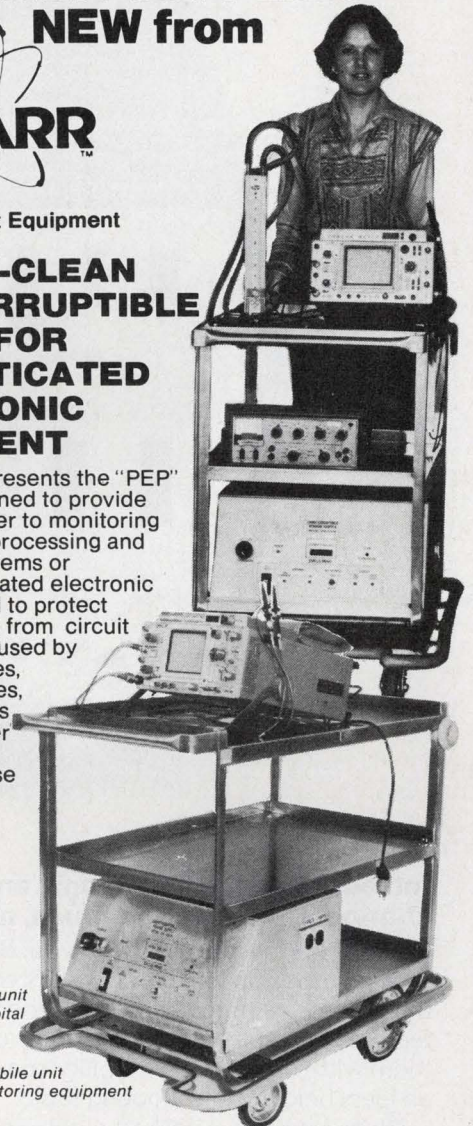

TOP "PEP" mobile unit
in use in hospital

BOTTOM "PEP" mobile unit
with monitoring equipment

AVAILABLE IN STANDARD 115V 50HZ MODELS COMPLETE WITH STAINLESS STEEL CART

Model	Output VA	Amps	Dimensions	Wgt
UPS-100H	100	0.87	5¼ × 19" × 20"	70 lbs.
UPS-250H	250	2.17	5¼ × 19" × 20"	95 lbs.
UPS-250H	500	4.34	5¼ × 19" × 20"	120 lbs.

Also available in 220V 60Hz. models with outputs as high as 1000VA.

Send today for complete specifications.



A Product Line Of
MARINE ELECTRIC RAILWAY PRODUCTS DIVISION

166 NATIONAL RD., EDISON, NJ 08817
Telephone No. 201-287-2810 • TWX 710-998-0560

More

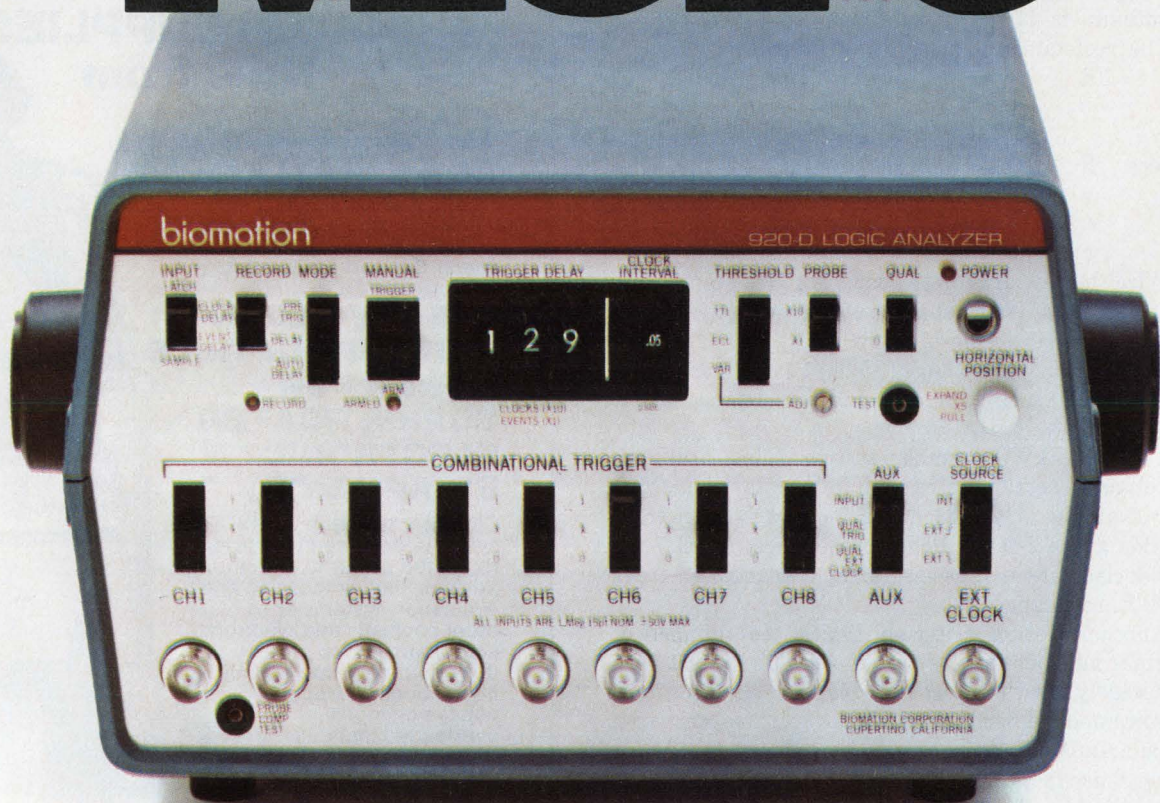

Introducing the 920-D logic analyzer. Nine channels, 20 MHz and much, much more.

Don't let the low price mislead you. Biomatic's new 920-D stands up to logic analyzers costing twice, even three times as much. It includes the functional features design engineers ask for most. And combines them with 9½ pound portability, making the 920-D an ideal field troubleshooting tool.

Nine channels — not just eight — give you added capability for more applications. Use the extra channel for recording data, or to mark a trigger location. And select between trigger or clock qualifier. Attach the optional Biomatics 10-TC probe pod and you can select up to a 19-bit combinational trigger word.

The 920-D enables you to set a precise interval between the actual trigger and the start of recording, using either clock periods or number of trigger events. Or the pre-trigger recording mode can be selected to capture data from before the actual trigger. The logic threshold level is selectable — TTL, ECL

or variable. And you can record at rates from DC to 20 MHz.

Captured data, at 256 bits per channel, can then be displayed on any single channel scope or CRT display in timing diagram format.

Compare the 920-D with other logic analyzers, for both price and performance. Then ask yourself if you can afford to settle for less.

Don't let the 920-D's many features and high

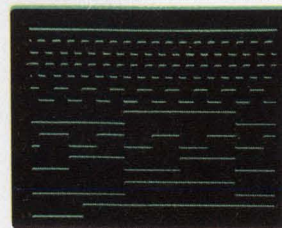

performance mislead you. It's priced less — far less — than any comparable logic analyzer.

In fact, the 920-D's \$1295* price tag makes it practical to put its extensive capabilities to work

wherever you design, debug or troubleshoot TTL logic.

The 920-D is a cost-effective first logic analyzer for most applications. Years of experience providing

Less

\$1295.00

**BIOMATION 920-D
LOGIC ANALYZER**

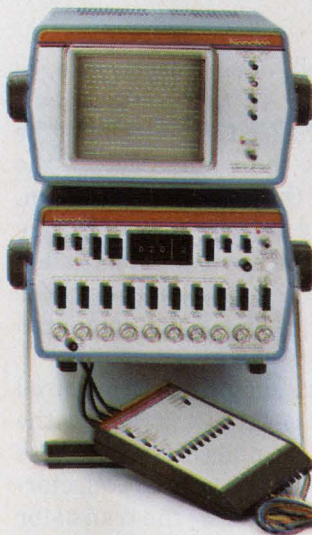

thousands of engineers and technicians with the industry's leading family of logic analyzers has helped us design the 920-D with proven real-world features you can put to good use.

Low price makes the 920-D a great choice for your second... or third or fourth logic analyzer. You won't need

to stand in line or share your company's only

logic analyzer when you have a 920-D of your own.

We built the 920-D for lightweight portability. It weighs in at under 10 pounds and connects to

the nearest oscilloscope or CRT. That makes the 920-D the newest tool for field service.

Biomatik has led the way in logic analyzer developments. Today there are seven Biomatik analyzers, offering from 8 to 16 channels, 10 to 200 MHz capture rate, memory lengths from 256 bits to 2048 bits per channel and operating in both time and data domains.

What more can we tell you? Plenty. Ask for the 920-D product sheet. Or give us a call to arrange a demonstration. Ask for Ed Jacklitch (408) 255-9500. Or write Biomatik, 10411 Bubb Road, Cupertino, CA 95014.

biomatik

*U.S. price only

Class E can boost the efficiency

of rf power amplifiers, and keep transistors cool and reliable. You'll save dc power, weight, and money too.

Class E rf power amplifiers¹ not only offer efficiencies of 80 to 97%, but they are also reproducible, relatively insensitive to component tolerances (including transistor characteristics) and can be designed for predictable results. Equipment using Class E amplifiers costs less to design and manufacture, is smaller, lighter and more reliable, and uses less power than conventional gear. Where space, weight and power are at a premium, or where reliability at high temperatures is important, Class E power stages are your best choice. The active devices can be bipolar or field-effect transistors, vacuum tubes, or electron-bombarded semiconductors.

While amplifiers of Class A, B and C are basically analog circuits, Class E (and D) stages are essentially switching circuits. As a result, Class E amplifiers are not very sensitive to transistor characteristics, and less power is dissipated in the transistor. Switching-mode power supplies are widely accepted, and broadcast transmitters with Class D output stages are being sold by RCA, Harris, and others.

But above 2 MHz Class E amplifiers quickly leave Class Ds behind. The latter run into trouble, because it is hard to generate fast-switching square-waves across the inevitable circuit capacitances and to keep the power dissipation low when switching times aren't small compared to the rf period. Push-pull Class D circuits are especially vulnerable. This is because simultaneous conduction in the two transistors can easily destroy them.

In a class by itself

The Class E amplifier is designed to avoid Class D limitations, without sacrificing its advantages, by imposing the following criteria:

- The active device(s) must be either non-conducting (an open switch) or conducting with as little voltage drop as possible (a closed switch).
- The switch must not serve as the discharge path for capacitor C_1 because the dissipation of the stored energy wastes power, and places high second-breakdown stresses on the switch. Instead, the energy in

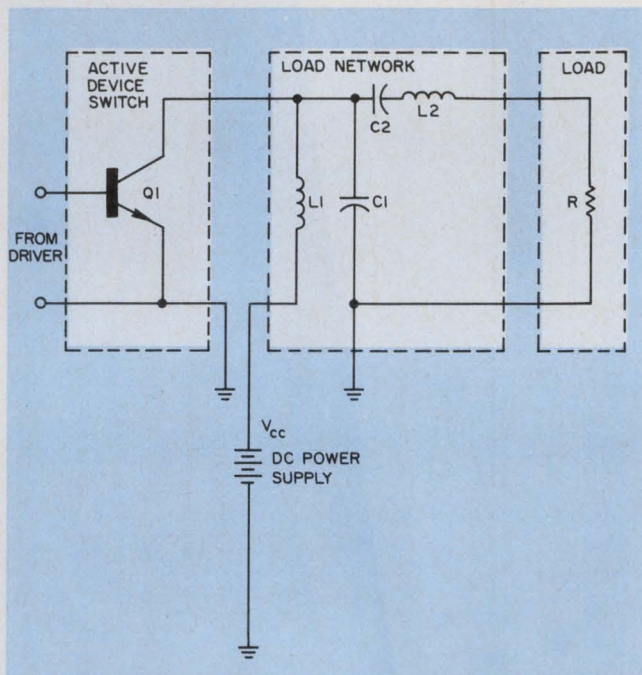

1. The basic Class-E circuit closely resembles a conventional rf power stage. But, in this mode of operation, the transistor acts only as a switch.

the capacitance is transferred, during each cycle, to the load, and so becomes part of the useful circuit output. To accomplish this, the load network must be designed in such a way that the voltage across the switch returns to zero before the switch is turned on.

- The voltage rise across the switch at turn-off time must be delayed until the switch current has fallen essentially to zero to yield low dissipation even if the active device's turn-off time is not short compared with the rf period.

- At turn-on time, the switch should not be required to build up current rapidly. A step function in the transistor's collector current is undesirable because a transistor will "unsaturate" if the required collector-current rate of rise exceeds the rate that the transistor can sustain with the applied base drive. The result is increased power dissipation.

In the basic Class E circuit of Fig. 1, R is the rf load, and Q₁ is the rf power transistor operated as a switch with a duty ratio, D, of about 50%. The rf choke, L₁, supplies dc current, but serves no other

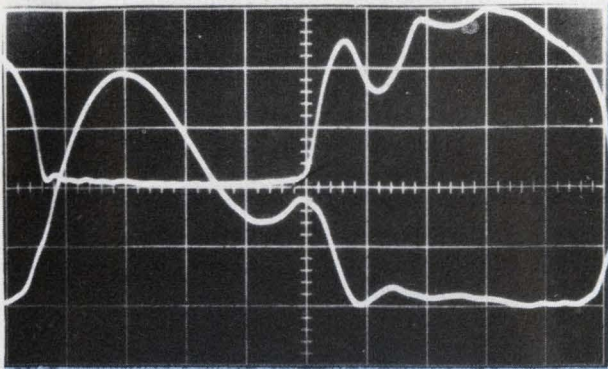

(a)

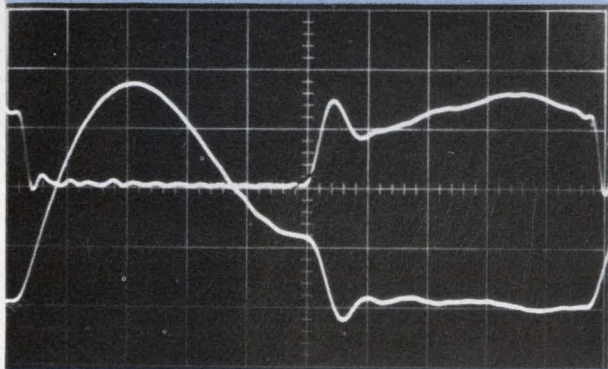

(b)

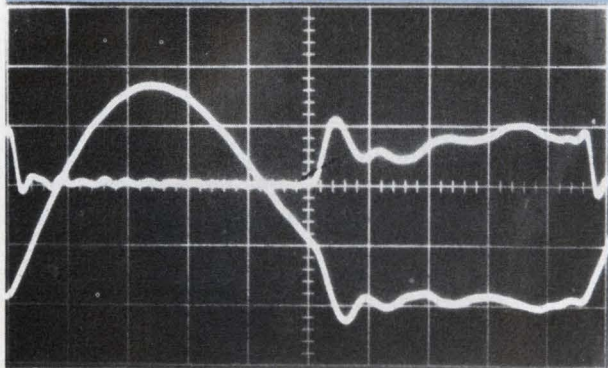

(c)

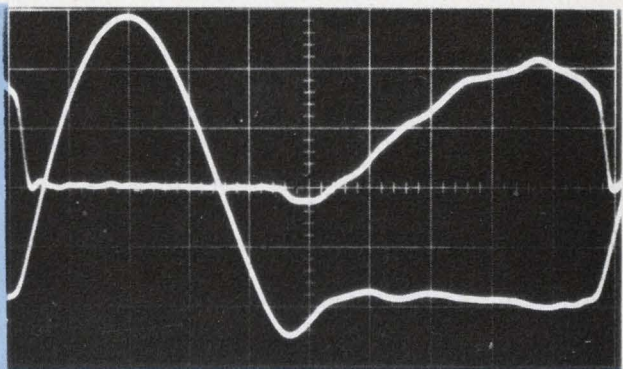

(d)

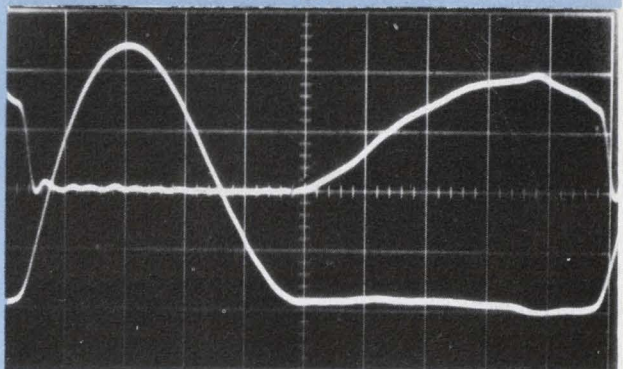

(e)

2. The waveforms of I_C (upper trace) and V_{CE} (lower trace) are good diagnostics for Class-E amplifiers. Incorrect circuit elements can cause positive voltage at turn-on time, with zero-slope occurring too early (a), at the right time (b), or too late (c). Or they can cause a negative voltage at turn-on (d). Simultaneous zero-voltage, and zero-slope at turn-on leads to the best operation (e).

function in the circuit's operation. The capacitor, C_1 provides a voltage delay during switch turn-off, while a nearly sinusoidal output current flows in $C_2-L_2=R$. This current flows in Q_1 during that part of the rf cycle when Q_1 is "on", and through C_1 during the remainder of the cycle.

The values of the four circuit elements C_1 , C_2 , L_2 , and R are dimensioned to deliver the specified rf power, provide zero V_{CE} when the transistor turns on, and shape a collector current that starts at zero and increases with a moderate, well-defined rate of rise.

The collector current at turn-on is proportional to the prevailing value of dV_{CE}/dt . So, by making this

derivative zero at turn-on time, the voltage drop on the transistor remains small, even if the switching time isn't small relative to the rf period.

Choosing Q_L involves the usual tradeoffs among operating bandwidth, harmonic output and power losses in the parasitic series resistances of L_2 and C_2 . No separate load reactance is shown—the reactance (if any) is absorbed into C_2 and L_2 .

Design equations that work

To build the Class E circuit of Fig. 1, you have to calculate the component values. In the following

design equations, R includes the load and the equivalent series resistance of C_2 and L_2 , while C_1 includes the collector-base capacitance of the transistor, the shunt capacitance of L_1 , and stray capacitances. The duty ratio is 50%. You can choose a value for Q_L , but make sure it's larger than 1.8.

If the exact transistor parameters aren't available, use approximations. The collector-emitter breakdown voltage BV_{CEV} should be measured at a V_{BE} of -1 V. It is usually close to BV_{CBO} . The saturated collector-emitter voltage, $V_{CE(sat)}$, is typically around 3 V.

Find the circuit parameters as follows:

$$V_{CC} < (BV_{CEV} + 2.562 V_{CE(sat)})/3.562.$$

$$R = 0.5768 (V_{CC} - V_{CE(sat)})^2/P_{out}.$$

$$L_2 = Q_L R/(2\pi f).$$

$$C_1 = [1/(2\pi f) 5.447R][1 + 0.81 Q_L/(Q_L^2 + 4.0)]$$

$$C_2 = [1/(2\pi f)^2 L_2][1 + 1.110/(Q_L - 1.7879)].$$

Then find the collector efficiency:

$$\eta = \frac{1 - \frac{2(\pi A)^2}{3} - \frac{V_{CE(sat)}}{V_{CC}} \left[1 + A - \frac{2(\pi A)^2}{3} \right]}{1 - (\pi A)^2/3}$$

where $A = (1 + 0.82/Q_L) t_F$, and t_F is the total collector current fall time, assuming a linear ramp. Furthermore,

$$I_{dc} = P_{out}/\eta V_{CC}.$$

$$I_{C(pk)} = I_{dc} [1 + 1.862(1 - 1/2Q_L)].$$

$$V_{CE(pk)} = 3.562 V_{CC} - 2.562 V_{CE(sat)}.$$

Although taken from a previous article¹, these equations incorporate results of a more exact analysis used. For circuit topologies superior to that of Fig. 1, constants 3.562 and 2.562 are replaced by lower values, which lead to higher efficiency.

When you construct the Class E circuit from the calculated components, look at the current and voltage waveforms on a scope (Fig. 2). Their appearance tells you whether the circuit works properly, or some components have wrong values.

See for yourself

If you have no experience with Class E amplifiers, you may want to check their operation with the test circuit in Fig. 3. It lets you observe the voltage and current waveforms, and vary the circuit parameters while watching the effects. Try transistors of different type numbers and from different vendors, and observe how little difference the substitution makes.

The test circuit operates at high enough frequency and power level to be meaningful for an rf application. Yet frequency and power are low enough for you to construct the test circuit easily and economically. You are able to observe the circuit's detailed operation, and replace transistors easily to test their interchangeability.

Input-drive requirements are low enough to operate the circuit from standard lab equipment, and circuit components are easily variable by about $\pm 30\%$ so that you can observe the effects of circuit variation. The circuit of Fig. 3 operates at 10.5 MHz. It uses a TO-5

The trouble with Class-C amplifiers

The state of the art for conventional Class-C (or B) transistor rf power amplifiers is exactly that—an art.

Commonly used design equations^{1, 2, 3} provide only a rough approximation. The final design is accomplished empirically by varying the circuit components and the input drive until the results are satisfactory.

Published articles and application notes don't specify which component should be varied in which direction by how much to achieve improved performance. Even in a design that works well, transistors from a second-source vendor likely will require a different circuit adjustment to obtain proper performance. In fact, later lots of transistors from the same manufacturer may also require circuit adjustments.

As an alternative design approach, the equipment manufacturer can match the input and output circuit to the transistor vendor's published data, and leave it up to him to supply the proper devices. While this approach simplifies the design task, the resulting circuit can use only that particular transistor type from that particular manufacturer.

Class-C collector efficiency is typically 65 to 70%, i. e. the power dissipation in the transistor(s) is typically as much as 43 to 54% of the rf power output. Consequently, large heat sinks are needed to prevent overheating and failures.

Class-C amplifiers contain many hidden costs stemming from the expense of adjustable components, the delay of adapting a design to new vendors (or lots) of transistors, the production delays when acceptable transistors are not available and extensive warranty-service.

Why should rf power amplifiers be so unpredictable? Primarily because the usual design procedure makes invalid assumptions. It assumes that the transistor acts as a current source which delivers truncated-sine current pulses into the input terminals of a load network.

Those pulses are supposed to have a prescribed magnitude and conduction angle. But in reality, the magnitude and conduction angle may differ greatly from the assumed values. Worse yet, the transistor may act as a current source during only part of the "on" time but almost as a short-circuit across the load network input during the remainder of the "on" time, when the transistor saturates. How much of the time the transistor saturates depends on the input drive, the load network and secondary transistor parameters, which aren't specified on the data sheets.

No wonder the performance of Class C amplifiers is so hard to control.

References

1. Hejhall, R., "Systemizing rf Power Amplifier Design," *Application Note AN-282A*, Motorola Semiconductor Products, Inc., Phoenix, AZ, June, 1972.
2. Leuthauser, C. and Maximow, B., "16 and 25-Watt Broadband Power Amplifiers Using RCA-2N5918, 2N5919, and TA 7706 Uhf/Microwave Power Transistors," *Application Note AN4421*, RCA Solid State Division, Somerville, NJ, October, 1970.
3. Minton, R., "Semiconductor High-frequency Power-amplifier Design," *Publication ST-3230*, RCA Electronic Components and Devices, Somerville, NJ., August, 1966.

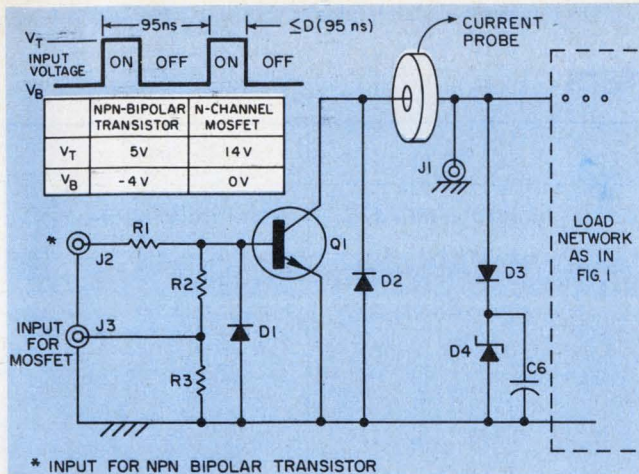

Parts list for $f = 10.5 \text{ MHz}$, $P_{\text{out}} = 6 \text{ W}$, $V_{CC} = 18 \text{ V}$

Component

Q1:	Npn bipolar transistor with $C_{ob} = 16$ to 50 pF at 18 V , e.g. 2N2631, 2N3262, RCA 40581, National Semiconductor NCBS35, Motorola MRF8004; or N-channel MOSFET, e.g. Siliconix VMP22. Use press-on heat dissipator, e.g. Thermalloy 2227B, 2228B or equiv.	C1:	7 to 60 pF compression mica trimmer (e.g. Arco 404), in parallel with 10 pF
L1:	$20 \mu\text{H}$ min, 0.2Ω max, e.g. J.W. Miller 5240 ($40 \mu\text{H}$, 0.082Ω dc)	C2:	4 to 40 pF (e.g. Arco 403), in parallel with 150 pF mica or NPO ceramic
L2 (for $Q_L=5$):	$1.96 \mu\text{H}$, $Q \cong 250$, e.g. (for 2% rf power loss at 10.5 MHz): 10.8 turns, AWG #16 magnet wire, at 13.1 turns/in., on a low-loss 7/8 in. dia. coil form.	Load resistor R:	25Ω (two $50\text{-}\Omega$ rf loads in parallel, each rated $\geq 6 \text{ W}$)
		R1:	$39 \Omega \pm 5\%$, $1/2 \text{ W}$, carbon composition
		R2:	For bipolar transistor: $100 \Omega \pm 10\%$, $1/8 \text{ W}$ carbon composition.
		R3:	$50 \Omega \pm 5\%$, 2 W , if a pulse generator drives a MOSFET. Otherwise J3 and R3 can be omitted
		D1:	1N4448 (1N914B)
		D2:	1N4448 (1N914B)
		D3:	1N4448 (1N914B)
		D4:	1-W Zener, $BV < (BV_{CEV} \text{ or } BV_{DSS})$
		C6:	1000 pF min rf bypass, working voltage $\geq 100 \text{ V}$
		J1:	Coaxial jack for oscilloscope probe tip, e.g. Tektronix 131-0258-00
		J2, J3:	BNC female chassis connectors
		Current probe:	Tektronix, Inc. P6022 or CT-2; Design Automation Inc. RF1-500 or equivalent
		Press-on transistor heat dissipator:	Thermalloy 2227B, 2228B or equivalent

3. A 10.5-MHz test circuit is convenient to explore the capabilities of Class-E amplifier stages.

transistor plugged into a socket, and has a $25\text{-}\Omega$ rf dummy load rated for at least twice the expected output power.

For simplicity, no impedance-matching network is inserted between the amplifier and the load. But there is an optional harmonic-suppression filter. The amplifier delivers about 6 W at $V_{CC} = 18 \text{ V}$, which keeps $V_{CE(pk)}$ below 65 V . This voltage is suitable for many representative transistors; some of the types cited in the parts list of Fig. 3, however, have a BV_{CEV} of 100 V or more, which permits operation at $V_{CC} = 27 \text{ V}$, and doubles the output power. (A parts list for a 3-W version is available upon request.)

MOSFET and bipolar transistors can be used interchangeably in the test circuit—a feat you better not try with a conventional rf power amplifier.

You can observe the effect of varying the load resistance by replacing the fixed dummy load with a suitable rheostat (e.g. Allen-Bradley Type J). To

avoid excessive power dissipation in the rheostat, keep V_{CC} low.

Get your input right

The input drive required of the test amplifier is low enough to use most laboratory pulse generators as a signal source. This way you can observe circuit operation while varying the switch's duty ratio (by varying the pulse width), the turn-off switching speed (by varying the pulse-baseline voltage, V_B), and the turn-on switching speed and transistor saturation (by varying the pulse-top voltage, V_T).

To maintain a constant pulse-top voltage, some pulse generators may require that you readjust the pulse amplitude after any base-line change. The duty ratio you have to set on the generator depends on the transistor type you use, because of the differences in storage time. To obtain about a 50% switch ratio, an

Table 1. Comparison of rf transmitters

	Class E	Class C	Class C
Transistor	Motorola MRF472	Motorola MRF472	Motorola MPS-U31
Power output (W)	5.0 (20)	4.0	≥3.5
V _{CC} (V)	13.5 (27)	12.5	13.6
Collector efficiency η (%)	85 (86)	65	70
$P_{diss}/P_{out} = 1/\eta - 1$	0.18 (0.16)	0.54	0.43
Second harmonic (dBc)	67 min	Not given	37
Third harmonic (dBc)	67 min	Not given	55
Number of stages	3	1	3
Rf power input (mW)	10	200 typ	Not given
Harmonic-suppression filter included?	Yes	No*	Yes

*Due to parasitic losses, filter reduces the efficiency by several percent.

Table 2. Comparison of power amplifiers

	Class E		Class C
Transistor (Made by CTC)	A25-28		A25-28
	Sample 1	Sample 2	
Power output (W)	27	28	25
Frequency (MHz)	54	54	80*
Collector efficiency η (%)	87	92	65
$P_{diss}/P_{out} = 1/\eta - 1$	0.15	0.09	0.54
Power gain (dB)	Not avail.	12	9.99 typ at 80 MHz 13.1 typ at 54 MHz
Harmonic-suppression filter included?	Yes	Yes	No**

* According to the manufacturer, efficiency at 54 MHz is approximately the same.

** Due to parasitic losses; filter reduces the efficiency by several percent.

NOTE: The Class E circuit is protected by U.S. Patent 3,919,656. Licenses for experimental use are available at no charge from Design Automation, Inc.

rf bipolar transistor requires a setting of about 30%, while a "core driver" bipolar transistor needs around a 45% duty ratio on the input drive.

For an rf power MOSFET, set the drive signal to around 50%.

Note that most of the input signal power is dissipated in R₁ or R₃, not in the transistor. So, while this input circuit is convenient for evaluating the Class E amplifier, you shouldn't use it for a real-life radio transmitter.

In any laboratory test circuit, transistors are likely to be damaged by accidental overloads. The evaluation circuit of Fig. 3 therefore includes several protective components: R₂ and R₃ prevent a bipolar transistor from being left in the open-base condition if the signal

source is disconnected. Diode D₁ prevents excessive reverse base-emitter or gate-source voltage, while D₂ keeps the transistor from being forced into the active-inverted mode. And D₃, D₄ and C₆ prevent excessive peaks in V_{CE} or V_{DS}. Choose the breakdown voltage of D₄ lower than BV_{CEV} or BV_{DSS} of transistor Q₁. A press-on heat dissipator (e.g. Thermalloy 2227B or 2228B) gives your transistor some extra margin.

Start the countdown

Before you turn your evaluation amplifier on, set the input-signal source to the desired voltage waveform, using a 50-Ω dummy load in place of the circuit. Compare your signal with that shown in Fig.

3. Input pulses of 9 V peak-to-peak with a zero-volt baseline won't give the same operation as 9-V pulses mounted on the specified baseline of -4 V, because in the first case you don't provide any turnoff drive for the transistor.

When you have the correct input signal, connect the source to the amplifier input with V_{CC} set at zero volts. Now gradually increase V_{CC} while observing the input and V_{CE} waveforms. Adjust the signal source if necessary. Once you know that the equipment is set up correctly, V_{CC} can be simply switched on and off. Avoid power supplies with large voltage overshoots at turn-on or turn-off, because they can damage many components simultaneously.

To simulate real-life operation, you may want to insert a harmonic filter between L_2 and R of Fig. 3. Use the usual filter construction techniques to avoid inductive coupling among the three circuit loops (C_1/Q_1)- C_2 - $L_2=C_3$, C_3 -(L_4/C_4)- C_5 - L_5 and L_5 - C_5 - R (Fig. 4). Such spurious coupling can feed the harmonics into the load, bypassing the filter.

This harmonic filter does not provide any impedance transformation, and so permits you to insert or remove it with little effect other than harmonic suppression. In both traps (L_4 - C_4 and L_5 - C_5), either the capacitor or the inductor can be made adjustable.

Install fixed components as close to the nominal values as convenient ($\pm 2\%$, if possible) and trim the associated adjustable components for nulls at 21 MHz (L_5 - C_5) and 31.5 MHz (L_4 - C_4). The components C_3 , L_4 , L_5 and C_5 should have high Q (e.g., ≥ 200) at 10.5 MHz, to assure low filter loss at the fundamental frequency. The loaded Q of the filter in Fig. 4 is 5.0. Small deviations from the correct values of L_4 , C_3 or C_5 cause approximately double those deviations (in percent) in the value of R , as seen from C_2 - L_2 . If the filter is built properly, all harmonics will be more than 67 dB below the carrier.

Watch the nitty-gritty

When you build the evaluation circuit, use a transistor socket that provides low lead inductances (e.g., the Robinson-Nugent LP5173). Minimize the area (hence the inductance) of the circuit loop formed by Q_1 and C_1 . Build the circuit above a ground plane. Provide a spacing between L_2 (also L_4 , if used) and the ground plane of at least half the inductor's diameter.

The junction of C_2 and L_2 is a high-voltage high-impedance node. Avoid stray capacitance to ground at that node, and keep your fingers away from it otherwise you may get an rf burn. The terminal of C_2 connected to the adjustment screw should be away from inductor L_2 . The adjustment-screw terminal of C_1 should be the grounded terminal. (Contact Design Automation for ready-made Class E demonstrator circuits similar to that of Fig. 3, but with additional features. They are self-contained except for dc power supplies and load.)

Table 3. Harmonic current components

Harmonic order	Harmonic amplitude *
1	1.00
2	$0.51/Q_L$
3	$0.080/Q_L$
4	$0.037/Q_L$
5	$0.016/Q_L$
6	$0.010/Q_L$
7	$0.0059/Q_L$
8	$0.0041/Q_L$
9	$0.0028/Q_L$
10	$0.0021/Q_L$

*The listed relative amplitudes occur in L_2 , and apply for $Q_L \geq 3$

Once you have your test circuit working, you can compare its performance with that of other amplifiers. Such a comparison cannot, however, be made on a theoretical basis, because often Class C and B amplifiers don't operate as predictably as their Class E cousins. You must resort instead to an experimental comparison between data measured on a "representative" Class C amplifier and on a comparable Class E amplifier, using the same transistor.

Table 1 compares the published data for 27-MHz citizens' band transmitters using Motorola's MPS-U31² and MRF472³ as output transistors with the measured performance of a comparable Class E transmitter. For the latter, 11 different output-transistor types from seven different manufacturers were tried. There was little or no performance change. Table 2

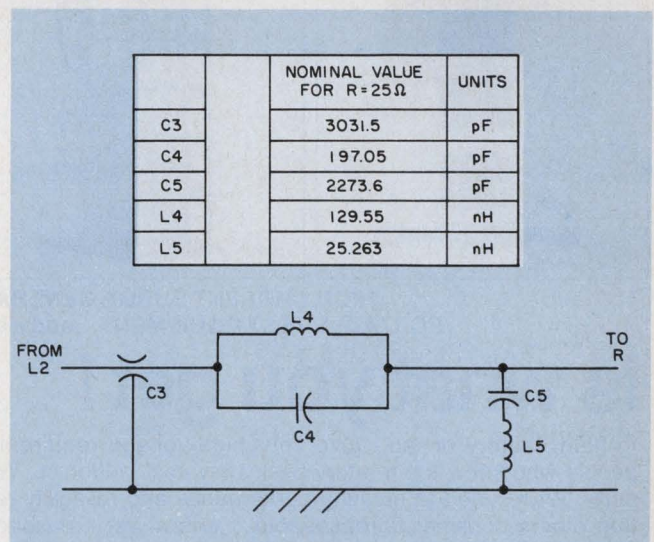

4. This harmonic filter can be inserted between L_2 and R of Fig. 1. It does not affect the match at f_0 .

compares data taken from a 25 to 54-MHz Class E transmitter with the "typical performance" from the transistor manufacturer's data sheet.

In addition to collector efficiency, the tables give the ratio of dissipated to rf power, which is a better measure for high-efficiency circuit performance than collector efficiency. For instance, the improvement in collector efficiency from 87 to 92% corresponds to a drop in the power ratio from 0.15 to 0.09—a factor of 1.7. For the Class C amplifier, the power ratio is 0.54, which is six times higher than that of the better Class E amplifier (sample 2). This can reduce the transistor's junction temperature by as much as 80C, and the failure rate by a factor of about 20.

Like all amplifiers, Class E amplifiers may require load impedance transformation, load tuning and harmonic filtering, and conventional techniques can be used. Table 3 gives the harmonic output⁴ of the Class E circuit in Fig. 1.

Watch those gremlins

Take care to avoid "invisible" emitter-base reverse breakdown⁵ which may cause transistor unreliability and broadband noise in the rf output in all but Class A amplifiers. Spurious oscillation at frequencies either higher or lower than the operating frequency is another potential problem, although Class E (and D) amplifiers are less vulnerable to high-frequency

oscillation than are Class B and C amplifiers. (No high-frequency oscillations have been observed in Class E amplifiers so far.)

However, low-frequency oscillations occur in Class B or C transistor amplifiers, from several different causes, and can also occur in Class E amplifiers. You can eliminate them by attacking the root cause(s), such as insufficient resistive loading of a base bias inductor. None of these measures reduces efficiency or power gain significantly, nor will they substantially increase product cost.

Depending on the individual circuit designs, a Class E output stage may have a few dB less power gain than a conventional Class C stage with the same transistor. If neither the signal source nor the driver chain can be modified to yield a few more dB, you may need one additional low-level amplifier stage to make up for the gain deficit. ■■

References

1. Sokal, N.O. and Sokal, A.D., "Class E—A New Class of High-efficiency Tuned Single-ended Switching Power Amplifiers," *IEEE Journal of Solid-State Circuits*, June, 1975, pp. 168-176.
2. Young, G., "A Class D Citizen's Band Transmitter Using Low-cost Plastic Transistors," *Application Note AN-596*, Motorola Semiconductor Products, Inc., Phoenix, AZ, August, 1975 (Note: "Class D" here refers to a frequency allocation).
3. *MRF 472 Data Sheet ADI-351*, Motorola Semiconductor Products, Inc., Phoenix, AZ, February, 1976.
4. Sokal, N.O. and Raab, F.H., "Harmonic Output of Class-E rf Power Amplifiers and Load Coupling Network Design," *IEEE Journal of Solid-State Circuits*, February, 1977, pp. 86-88.
5. Sokal, N.O., "Unseen Emitter-base Breakdown in rf Power Amplifiers—A Possible Hazard," *IEEE Journal of Solid-State Circuits*, June, 1977, pp. 319-322.

What you need...

...in DC INSULATION TESTERS
(1 KV to 2500 KV)

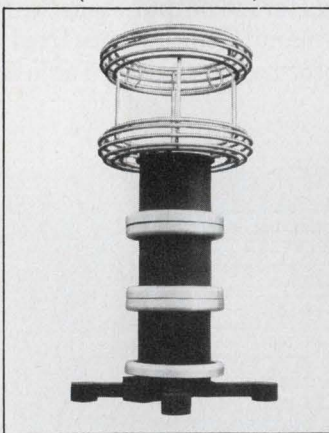

...in IMPULSE GENERATORS
(up to 2000 KV)

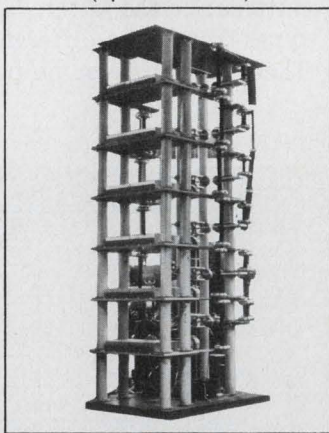

...in AC INSULATION TEST SETS
(up to 500 KV)



...in AC/DC and IMPULSE DIVIDERS
(up to 2500 KV)



...HIGH CURRENT SURGE GENERATORS...HIGH VOLTAGE TERMINATIONS...
PORTABLE TEST EQUIPMENT...and a broad range of other high-voltage equipment...

is what you get!

In field, factory or lab...give your high-voltage requirements to the people who know the territory best: Universal Voltronics. We're HV experts. We're used to meeting performance and reliability requirements that others consider unreasonable... and at very reasonable cost. If you're tired of making round pegs fit square holes, you'll like our kind of application assistance too. So bring your problem to UVC... where what you need is what you get!

Call or write for data or technical assistance.



**UNIVERSAL
VOLTRONICS
CORP**

27 Radio Circle Drive, Mt. Kisco, N.Y. 10549
(914) 241-1300

CIRCLE NUMBER 42

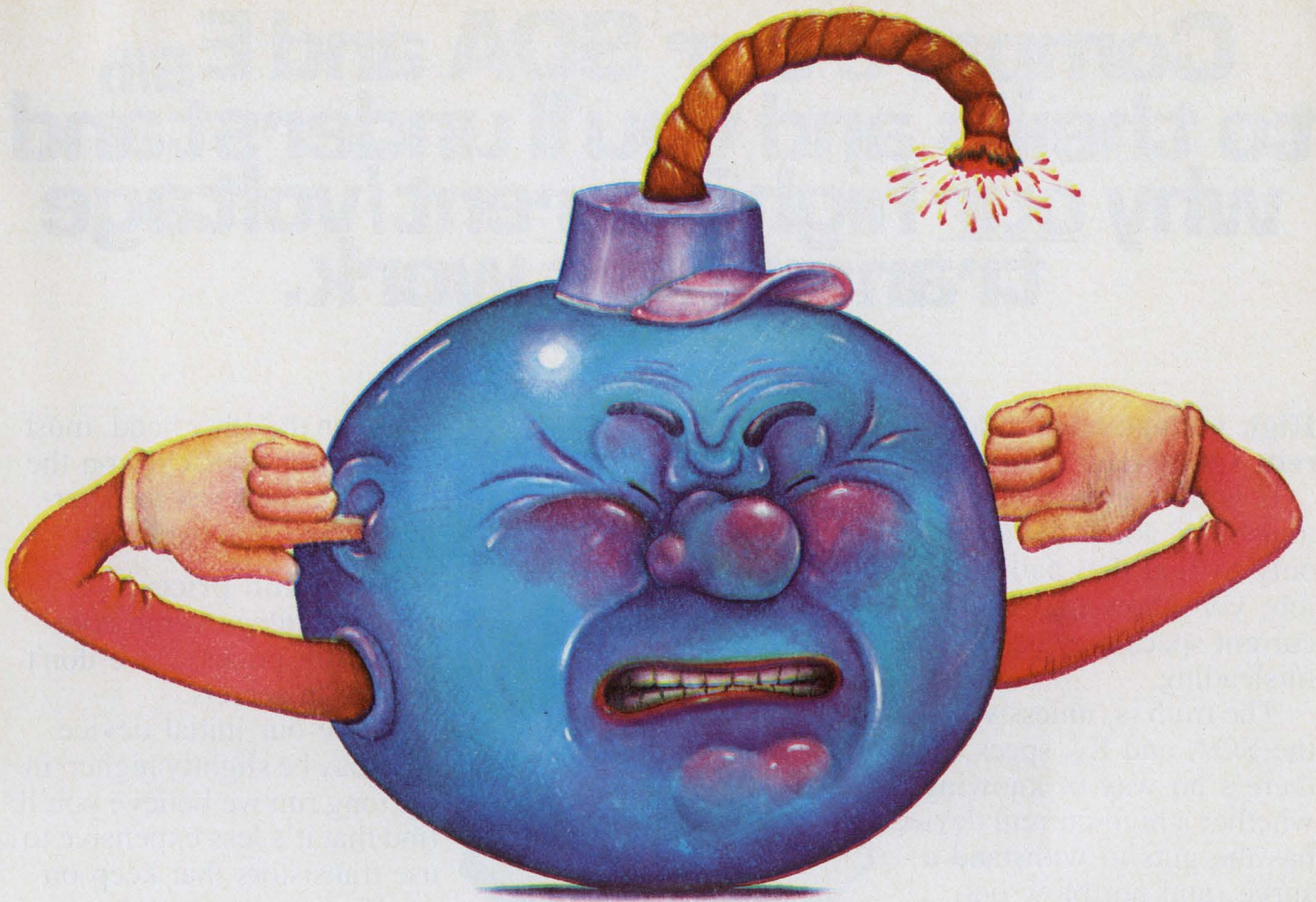

acdc explodes a myth!

We've got a mighty short fuse when it comes to the myth about ACDC not being competitive in low-cost open-frame power supplies. And while myths usually aren't worth the powder to blow 'em up, we've taken aim at this one.

We have exploded our production facilities to become one of the industry's largest and most modern - with production lines capable of turning out thousands of open-frame power supplies of the highest quality, yet at much lower cost.

Our inventory is bursting with more than 80 models. Microprocessor power supplies for the popular 8080A, single output power supplies ranging from 2V at 3 amps to 24V at 10 amps plus dual and triple output models. All ready for immediate delivery.

And not one of 'em is a dud. We're so sure that we unconditionally guarantee each unit, even if re-sold as part of your OEM package.

Use the coupon to tell us what types of power supplies you need, the quantities you require, *and the prices you'd like to pay*. Fire it off to us right away, and by return salvo we'll tell you how quickly we can get them into your arsenal.

If you don't have a requirement yet, but would like full specs on our low-cost power supplies, just circle the reader service number.

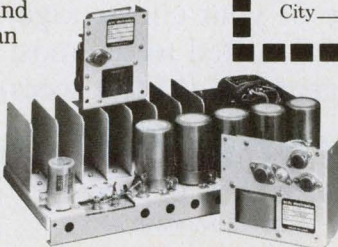

 HIMSON

DO IT YOURSELF POWER SUPPLY PRICING

I'd like to help you explode your myth. Listed below are the details of the linear power supplies we'd like to have in our arsenal.

Description	Overvoltage Protection		Quantity	Price I'd Like to Pay
	Yes	No		
1. _____ V@ _____ Amps	()	()	_____	_____
2. _____ V@ _____ Amps	()	()	_____	_____
3. _____ V@ _____ Amps	()	()	_____	_____

Special features, number of outputs, etc. _____

Name _____ Title _____

Company _____

Street _____

City _____ State _____ Zip _____

acdc electronics

401 Jones Road, Oceanside, California 92054, (714) 757-1880

CIRCLE NUMBER 43

Compare our SOA and $E_{S/b}$ to theirs and you'll understand why our high current/voltage transistors work.

High voltage and high current specs aren't enough.

If you've ever specified transistors above 50 amps, only to find they fail on the job, you know how high-current specs may actually be misleading.

The truth is, unless you see the SOA and $E_{S/b}$ specs, there's no way of knowing whether a high-current device has the guts to withstand a surge, and not blow out.

That's why we publish both our Safe Operating Area and $E_{S/b}$ specs.

We want you to see precisely the kind of super-ruggedness you can expect from PowerTech—and only PowerTech—high-current transistors. Compare our $E_{S/b}$ ratings, from 1.5 to 6 joules, against the millijoules or unpublished ratings of other high-voltage/current devices.

Copper makes the difference.

We use extra-heavy copper-metalizing on our bigger, beefier chip—thereby assuring maximum thermal

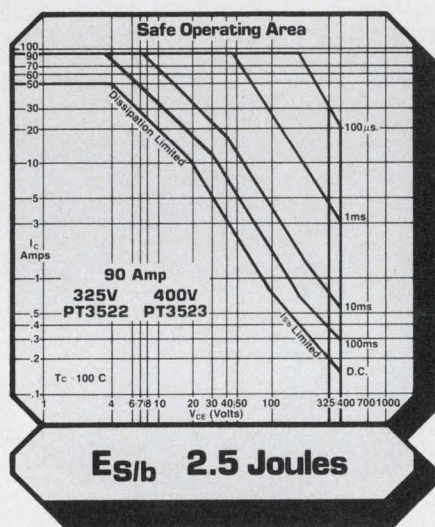

and electrical conductivity and yielding the highest resistance to second breakdown with the lowest $V_{CE(sat)}$. Their smaller chips use thin aluminum-metalizing with fragile, current-limiting wires (ours have solid copper posts).

Which would you rather have your circuit depend on? And we don't stop there. To guarantee rapid delivery, we pre-mount our chip on an integral moly-copper heat sink so we can categorize and pre-test the module at high currents to insure maximum reliability prior to mounting in the package of your choice (again 100% tested to the most stringent MIL/AERO specs).

They, on the other hand, must first mount their chip on the package, then test to determine if it's shippable.

Delivery and prices.

Our catalogs come complete with prices...we don't believe in secrets.

While our initial device cost may be slightly higher, in the long run we believe you'll find that it's less expensive to use transistors that keep on working.

We rely on direct factory-to-customer contact to ensure 100% responsiveness, backed up by the flexibility of chips already built, pre-tested and ready for whatever electrical/packaging requirements you may have.

But see for yourself: call for further information and applications assistance: Sales Engineering, PowerTech, Inc., 0-02 Fair Lawn Avenue, Fair Lawn, New Jersey 07410; Tel. (201) 791-5050.

TYPICAL PRODUCTS			
I_c	V_{CE}	$E_{S/b}$	Part No.
1200A	80V	6.0J	MT-5007
400A	120V	6.0J	PT-9503
150A	200V	1.5J	PT-4500
90A	400V	2.5J	PT-3523
40A	600V	2.5J	PT-3526

JAN-TX Types Also Available
Guaranteed SOA

PowerTech, Inc.

"BIG IDEAS IN BIG POWER"

CIRCLE NUMBER 44

The double-sided floppy from number 1

**Double storage capacity.
Double media selection.
Double access speed.**

Double your storage power with SA 850/851

Store twice as much data as a single-sided, double density drive, four times that of an IBM single-sided single density disk. Reach that data more than twice as fast with two heads and track-to-track access time of 3 ms. Choose from a wider selection of media—single or double-sided, single or double density, sector or hard sector formats. **Capacity.** The SA 850/851

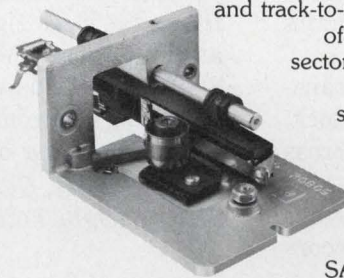

gives you twice as much storage capacity as a single-sided, double density drive. Yet it requires no more cabinet space. One drive packs up to 1600 kbytes unformatted, or 1200 kbytes formatted.

Double density gives you 1600 kbytes—compatible and equivalent to the newly announced IBM S/34 two-sided drive. The Shugart

SA 850/851 is available now and this drive accepts

FM and double density MFM or M²FM encoding.

Speed. Data access is faster, too. Just 3 ms track-to-track.

Average seek time, including settling, is 91 ms.

That's 71 ms faster than IBM's two-sided floppy.

Remember lead screw actuators? Now you can forget them.

The key to faster access is the new Shugart Fasflex™ metal band actuator which provides faster access time with positive, low friction head movement. This more efficient actuator requires less than half the power used by standard lead screw actuators.

Compatibility. Media compatible. SA 850/851 drives read and write data on any industry standard single-sided, single or double density diskette, two-sided IBM Diskette 2, 2D or equivalent. Drive Compatible.

Upgrading from your existing SA 800/801 is easy. The SA 850/851 is identical in size, outline and electrical interface. Rack mounting? You've got it with the "skinny"

SA 850R/851R version. Two units mount side-by-side in a 19-inch RETMA rack.

Even more reliable. Data integrity and system reliability begin with Shugart's own read/write head—the same glass bonded ferrite/barium titanate head proven in more than 100,000 installations.

Drive mechanical integrity rests on the same industry accepted die cast aluminum chassis technology used in all Shugart Drives. This rock solid recording platform is not a place to cut costs. Shugart keeps data safe, too. Write protect circuitry and a new I/O controlled programmable door lock

for better data security are standard. **First.** Shugart has a habit of being first.

First with an IBM-compatible drive. First with double density drives. First with the minifloppy®. And now first to deliver a double-sided drive.

Two out of three OEM's specify Shugart. They get more experience, more technology, more support. **See both sides now.** See how Shugart

double-sided floppy drives can give your system bigger, more accessible storage in the same space.

Then listen closely to the OEM price. Doubling storage capacity was never more affordable.

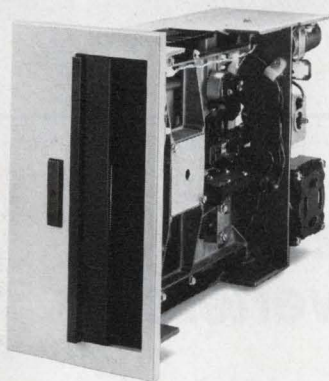
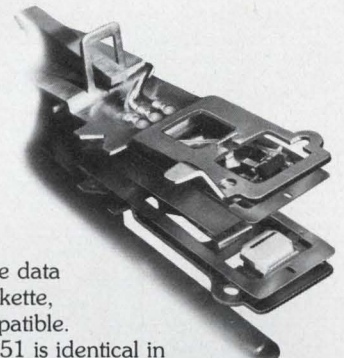

1 *The Leader
In Low Cost
Disk Storage*

Shugart Associates

415 Oakmead Parkway, Sunnyvale, California 94086

Telephone: (408) 733-0100

West Coast Sales/Service: Telephone: (408) 252-6860

East Coast Sales/Service: Telephone: (617) 890-0808

Europe Sales/Service: 3, Place Gustave Eiffel, Silic 311

94588 Rungis, France Telephone: (1) 686-00-85

™Fasflex actuator trademark of Shugart Associates.

Ideas for design

Transformer completely isolates contact without a floating power source

A miniature audio transformer can act as a contact isolator without the extra isolated power supply (Fig. 1a) that is usually required by LED optical isolators (Fig. 1b).

With the contact open, the secondary of the transformer presents a high impedance to a 10-kHz clock. Consequently, most of the 10-kHz signal drops across the secondary.

When the contact closes, it shorts the transformer primary. The low impedance reflects into the sec-

ondary, and most of the 10-kHz clock drops across the $C_1C_2R_1D_1$ filter network. The network rectifies and filters the clock signal, which raises the voltage level at pin 2 of the LM311 voltage comparator above pin 3. The LM311 output (pin 7) then rises close to V_{CC} . Reversing the connections to pins 2 and 3 provides a negative-going output.

Joe Orender, General Manufacturing Co., P.O. Box 5123, Wichita Falls, TX 76307.

CIRCLE No. 311

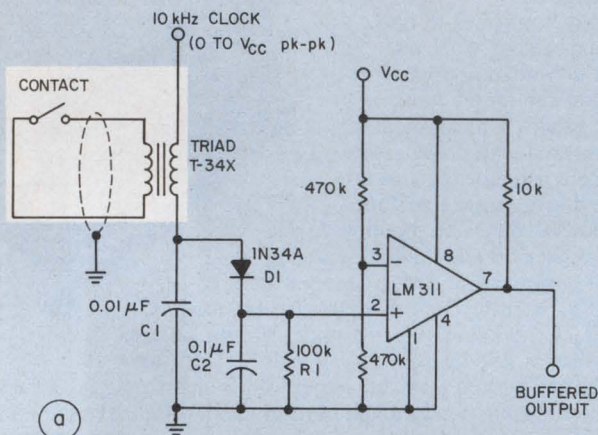

A transformer-coupled contact buffer (a) can isolate a contact completely without the separate, isolated

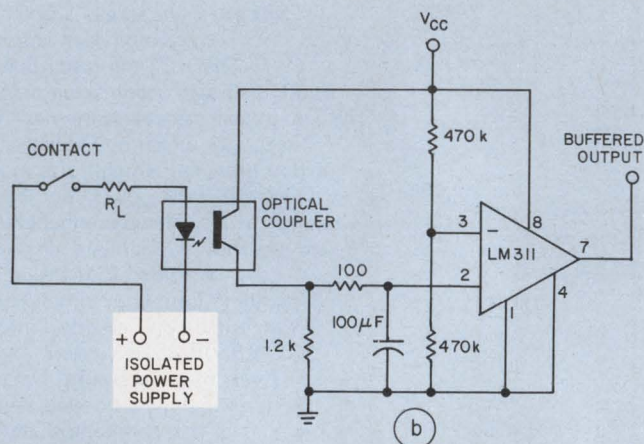

power source required by the conventional optically coupled isolator circuit (b).

Simple circuit blanks the leading zeros for single-chip DVM/DPM a/d converters

Several 3 and 3½-digit single-chip a/d converters, like the MC 14433, are available for DVM/DPM applications. But without leading-zero blanking, you have to put up with zeros ahead of the first nonzero digit. The simple circuit in the figure can blank leading

zeros for DVM/DPM applications, and in addition, flash the display for overrange conditions. The parts cost approximately \$1.20.

The MC 14433 scans the display from most-to-least-significant digit, and the display is blanked when the

Inductor sizes shrink to meet new uses.

The space age has brought with it an expanding need for shrinking of inductor sizes to satisfy such applications as electronic watches, the new lightweight telephone headsets, and a host of other modern devices.

Cambion's line of inductive products covers the range from standard ceramic, tunable coils to completely electromagnetically and electrostatically shielded units for regular or printed circuit applications to the new ultra-miniaturized space age indicators measuring only .075" by .170" max. They literally "fit" anywhere. What's your application?

We've got a catalog full of them. You can get one today by writing: Cambridge Thermionic Corporation, 445 Concord Avenue, Cambridge, Ma. 02138. In Los Angeles, 2733 Pacific Coast Highway, Torrance, CA 90505.

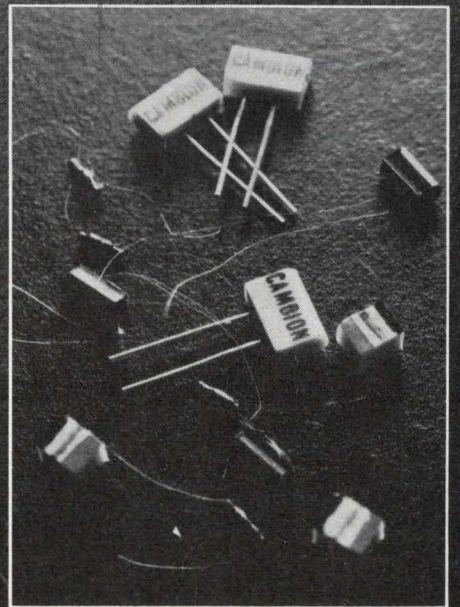

Standardize on

CAMBION[®]

The Guaranteed Electronic Components

CIRCLE NUMBER 46

Ideas for design

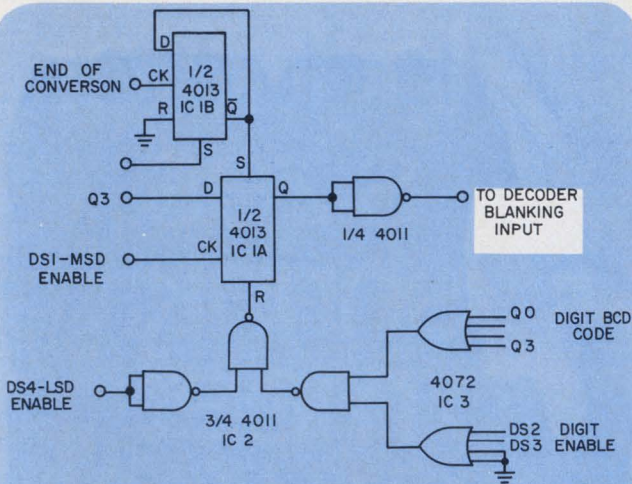

The blanking of leading zeros isn't provided in many of the latest a/d converters. Until manufacturers provide the blanking function in their converter chips, this simple circuit can do the job for you.

most-significant digit is a zero. If the most-significant digit is not a zero, the display is immediately unblanked for all $3\frac{1}{2}$ digits. Blanking for a zero MSD results when the leading edge of the DS1 digit-select pulse clocks the Q output of IC_{1A} HIGH.

If the second and third digits are also zero, the display is left in the blanked state. The BCD codes for these digits are detected by IC₃. If one of the codes is nonzero, IC_{1A} resets and unblanks the display. Otherwise, only the least-significant-digit enable, DS₄, unblanks the display.

On an overrange, the display flashes at the conversion rate because IC_{1B} toggles the set input of IC_{1A}. Since both the set and reset inputs of IC_{1A} may be ONE simultaneously, the Q output of IC_{1A} must be used for the blanking signal. And as IC_{1B} toggles, regardless of the state of the IC_{1A} reset, the display flashes.

Paul Kranz, Dyttron Inc., 241 Crescent St., Waltham, MA 02154. CIRCLE NO. 312

Wideband vertically mounted microstrip transformer uses little PC-board area

Here's a vertically mounted sub-board with a printed-microstrip transformer you can use where PC-board area is limited. The transformer is highly efficient. Loss is less than 0.2 dB over more than an octave of bandwidth. The impedance transformation is 4:1. Transformer line length for the mid-frequency point is approximately $1/8$ of a wavelength. You get best results, if Z_0 of the transformer is at the geometric mean of the input and output impedances (see figure).

The practical impedance-transformation range depends greatly on the dielectric constant and thickness of both mother and vertical-transformer boards. Impedance Z_0 can extend from approximately 7 to 120 Ω . What's more the frequency range is 100 to 1500 MHz—in some cases even higher.

Microstrip on $1/32$ -in., glass-Teflon laminate ($\epsilon_r = 2.5$), dimensioned as in the figure, produces a 50-to-12.5- Ω transformation from 450 to 1150 MHz at the 0.2-dB loss points.

Bibliography

Sevick, J., "Broadband Matching Transformers Can Handle Many Kilowatts," *Electronics*, Nov. 25, 1976.

Donald G. Owen, State Electricity Commission of Victoria, Melbourne, Australia. CIRCLE NO. 313

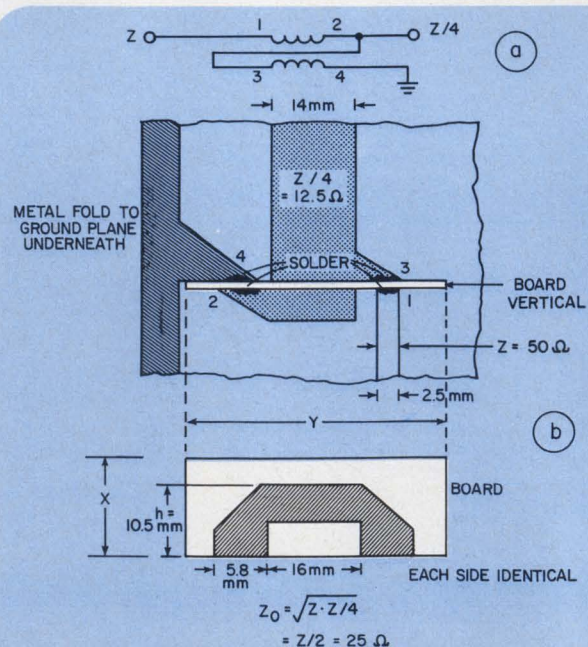

NOTE: DIMENSIONS X & Y ARE SLIGHTLY LARGER THAN COPPER PATTERN

A microstrip transmission-line transformer schematic (a) is implemented on a vertically mounted board (b). The transformer can handle a wide band of frequencies.

Who put long-track stability into a ceramic trimmer no larger than this?



CENTRALAB!

Centralab, a leading producer of ceramic-based trimmer resistors, now offers the long-track stability of full-size trimmers with a resistor element measuring .750" in a unit only .475" x .640" . . . and with terminals which meet IEC requirements of 0.100" spacing.

We call it "Series R".

Despite its miniature size, this new trimmer provides set-stability of 0.2% total voltage, thanks to its long-track resistor element which permits 300° mechanical and 260° electrical rotation.

In addition to big-trimmer stability, the new Series R retains all the most-wanted quality features of the Centralab Series S. See the cutaway view and listing of features at right.

Shown above are prices for both series of Centralab trimmer resistors.

For full specifications and complete pricing for the Series R, talk to your Centralab Technical Representative, or call (915) 779-3961.

PRICING (1,000 lot quantities)

	Series S Vert. Mount	Series S Horiz. Mount	Series R
CERBON™	.17	.19	.20
CERMET	.26	.28	.29

*Products you need
from people who care.*



CENTRALAB
Electronics Division
GLOBE-UNION INC.
7158 MERCHANT AVENUE
EL PASO, TEXAS 79915

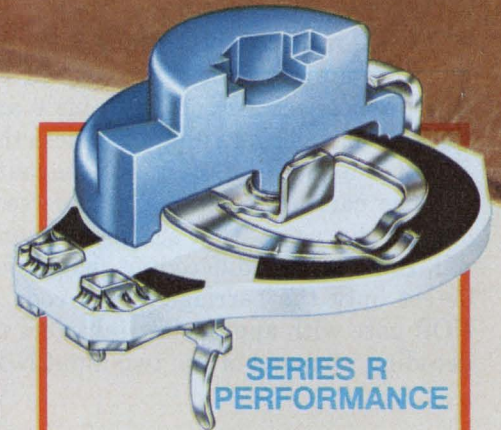

SERIES R PERFORMANCE

Set-stability, Adjustability, Low Noise

- Long-track resistor element.
- Dual tine contacts.
- Mechanical ruggedness.

Reliability

- Ceramic substrate.
- Rigid soldered terminals with hold-in option.
- "Fluxgard" environmental protection.

Flexibility

- CERBON and cermet resistor systems.
- 1-1/4 watts cermet, 3/4 watts CERBON.
- Hex hole/screwdriver and screwdriver/finger adjust knobs.

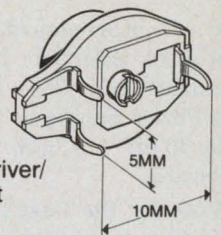

Provide a carriage-return delay for typewriter data terminals with hardware

Most typewriter terminals require more time for a carriage return than to type a character. This extra time is often provided by software, with several null characters programmed after a carriage return. But the simple circuit shown in Fig. 1a provides the needed additional delay for ASCII-code systems, *without* any software modifications. Frequently, software changes are very difficult to make, especially if the program is in a ROM.

Fig. 1b shows typical connections between a processor and a universal asynchronous receiver/transmitter, before the carriage-return delay is introduced. The negative-going edge of an XMIT signal gates a character into the UART and starts transmission. The positive-going edge of a DONE signal indicates that a character has been transmitted. If the polarities of the existing signals are different from those shown in Fig. 1b, inverters must be introduced into the circuit of Fig. 1a to reverse them.

The RC time constant of the 74121 one-shot should be chosen to provide the required carriage-return delay. On all characters with bit 6 and bit 7 LOW, the one-shot triggers and introduces the delay. In the ASCII code, these bits define all the control characters.

Since carriage return and line feed are the only control characters that are usually sent to the terminal, this simplified decoding should be sufficient. To detect only the carriage-return code, a seven-input NOR gate with appropriate inverters can be used for decoding,¹ instead of the two-input NOR gate shown.

Reference

1. Stetson, R. J., "Select a Character/Function Decoder," *Electronic Design*, July 5, 1977, pp. 80-83.

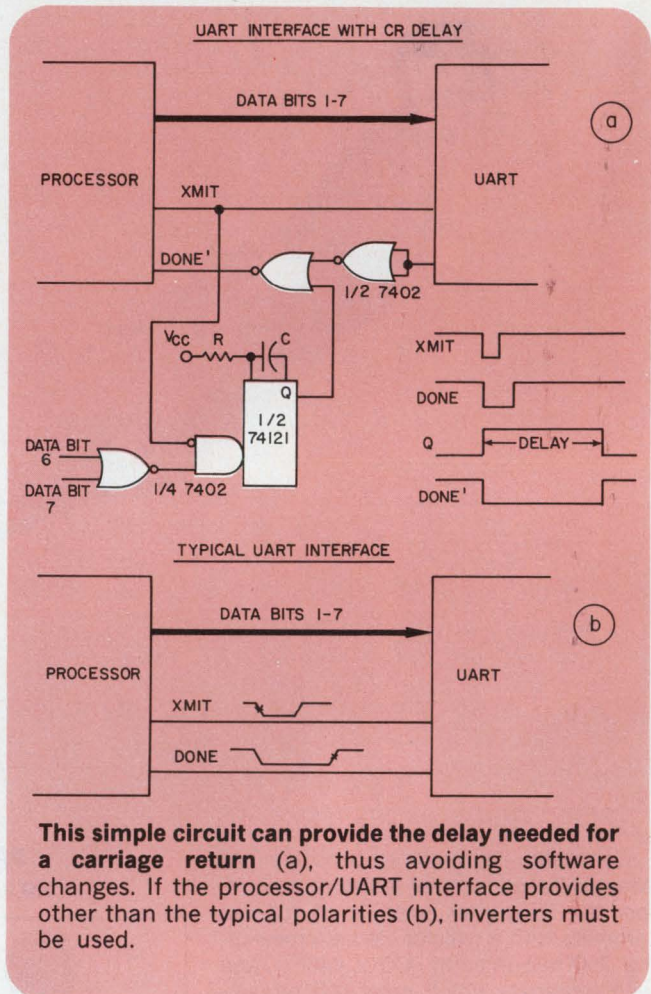

Dr. Chacko C. Neroth, Manager, Diagnostics Development, Amdahl Corp., 2350 E. Arques Ave., P.O. Box 5070, Sunnyvale, CA 94086. CIRCLE NO. 314

IFD Winner of May 24, 1977

B. L. Kortegaard, University of California, Los Alamos Scientific Laboratory, P.O. Box 1663, Los Alamos, NM 87544. His idea "Control the ac Input to a Power Supply and Reduce Load and Line Effects by 40 dB" has been voted the Most Valuable of Issue Award.

Vote for the Best Idea in this issue by circling the number for your selection on the Reader Service Card at the back of this issue.

SEND US YOUR IDEAS FOR DESIGN. You may win a grand total of \$1050 (cash)! Here's how. Submit your IFD describing a new or important circuit or design technique, the clever use of a new component or test equipment, packaging tips, cost-saving ideas to our Ideas for Design editor. Ideas can only be considered for publication if they are submitted exclusively to ELECTRONIC DESIGN. You will receive \$20 for each published idea, \$30 more if it is voted best of issue by our readers. The best-of-issue winners become eligible for the Idea of the Year award of \$1000.

Who offers more pushbutton switch options to meet your design needs? . . .



CENTRALAB!

Why restrict your switching designs to a few limited options? Come to Centralab . . . The pushbutton switch manufacturer that offers you true design flexibility.

Shown above are 18 of the most popular options available. They're described at the right. Included are epoxy sealed terminals with built-in standoffs at no additional cost. And more programming capabilities using lockout options than any other supplier. With a wide choice of lighted and non-lighted buttons.

There's one feature of Centralab pushbutton switches that's not an option. It's *Centralab Service*. It comes with every switch. Proof? We'll send you samples with your choice of options in one week . . . Production quantities in six.

For a complete catalog of Centralab pushbutton switches, options and prices, talk to your Centralab Technical Representative, or call (515) 955-8534.

Products you need from people who care.



CENTRALAB

Electronics Division
GLOBE-UNION INC.

P.O. BOX 858
FORT DODGE, IOWA 50501

Key to Picture Above

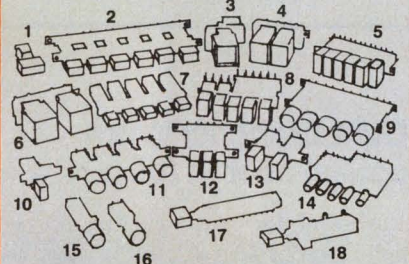

- | | |
|---|---------------------------------------|
| 1. Dust seal cover. | 9. Master-on lockout. |
| 2. Interlocking lockout. | 10. Selective pin cutting. |
| 3. Lighted TV-5 line switch. | 11. Momentary actuation. |
| 4. 17.5 mm lighted switch with flat and concave lenses. | 12. Momentary lockout. |
| 5. Panel offset bracket. | 13. Push-push and momentary assembly. |
| 6. 20 mm lighted switch with recessed lenses. | 14. Override cam release function. |
| 7. Diallyl phthalate insulation. | 15. Epoxy seal. |
| 8. 10 mm gold terminals. | 16. Rear coupler. |
| | 17. Terminals with built-in standoff. |
| | 18. 2 amp. line switch. |

VIII, new I²L concept, eliminates yield losses

A logic combines conventional I²L concepts with V-groove techniques to eliminate a critical requirement in the fabrication of conventional I²L—the need to align two closely spaced p-type diffusions. This new process, known as VIII, was developed at the National Chiao Tung University in Taiwan.

Like other V-groove processes, VIII begins with type 100-oriented silicon in the starting material. Two diffusions are made to form p-type and n+ regions, resulting in the structure shown in the figure.

The n+ regions isolate adjacent unit cells and also act as multicollector elements of the vertical npn transistors. Unlike I²L, the VIII unit cell has just one p-type region—which eliminates a major contribution to yield losses. The p region has a large surface area, which is required for the subsequent vertical etching indicated by the broken lines in the figure. The V-

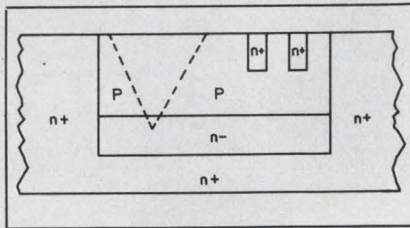

groove is produced by controlled etching, as with conventional VMOS.

The VIII technique retains the high circuit density and low speedpower advantages of I²L. But the current gains of the vertical npn, and the lateral npn transistors, are somewhat higher in the VIII structure. The base of the lateral pnp transistor lies at the bottom of the V-groove. If a slow etching rate (10 $\mu\text{m}/\text{h}$) is used, the base width can be controlled to within 0.1 μm . The production yield of VIII is expected to be much greater than that of I²L.

Light branched from optical fiber in foil

A novel, low-cost structure conveys light from a source optical fiber into optical-fiber branches feeding off the main fiber. A light-sensitive plastic foil is used whose thickness, 0.1 mm, is close to the diameter of the fibers. Indeed, any desired structure can be etched into this foil by photolithographic processes, according to development researchers at Siemens in West Germany.

The new technique will be useful in an optical-fiber communication network where optical energy must be branched off the main optical waveguide. In the waveguide-branch structure, the two ends of the cut fibers meet with a slight offset. The light escaping at this interface enters the foil and is

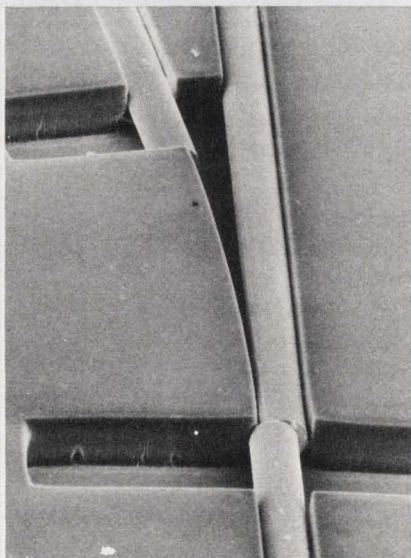

Scanning electron micrograph shows a branch structure for coupling light out of a glass fiber.

Selenium ions used in FET, Impatt implants

Selenium ions have proven much more effective and easier to use than conventional sulfur or silicon ions in the ion-implantation of microwave gallium-arsenide FETs and Impatts.

For example, selenium ions (Se^+) can be easily selected by mass-analysis techniques, unlike the lighter sulfur (S^+) or silicon (Si^+) ions. As a result, highly pure Se^+ ion beams can be produced relatively simply, according to researchers at the University of Surrey, Guildford, England.

Generating pure beams of S^+ or Si^+ ions is difficult because the most abundant isotopes of these elements have the same mass as commonly occurring oxygen (O_2^+) and nitrogen (N_2^+) ions.

Because selenium ions are much heavier than the conventional ions, their implanted profile is not as susceptible to broadening because of ion diffusion during annealing. This difference, is particularly crucial to the fabrication of low-noise microwave FETs: The active layers of these devices must have accurately controlled carrier concentrations at depths down to about 1 μm .

However, because selenium ions are heavier, a greater accelerating voltage is required to penetrate them to a specified depth. To overcome this problem, the Guildford group used doubly charged selenium ions at 500 kV—which gives the same result, theoretically, as implanting 1-MeV S^+ ions that can be penetrated to 0.35 μm .

guided along the foil's curvature to a branching fiber. The amount of optical power coupled out depends on the magnitude of the offset at the ends of the main waveguide at the interface.

The light-guiding structure in the foil and the guiding channels for the fibers can be produced in a single, simple operation. At the same time, this fabrication fulfills stringent dimension tolerances required to align the fiber ends accurately—approximately $\pm 3 \mu\text{m}$.

Single Diffused Power

Rugged reliability. Superior performance. That's what you'll get with Solitron's single diffused NPN silicon power transistors. They're ideal for power supplies, audio power stages, series and shunt regulators, inverters. . . for any tough linear application.

These transistors feature low sat voltages, high DC current gain, high power dissipation and excellent SOA's. Each one is 100% power pulse tested and highly resistant to secondary breakdown. And, all are low priced and available for immediate shipment.

Dial 800-327-8462 for a toll-free telephone call and further information. Or contact your local Solitron distributor.

SINGLE DIFFUSED POWER TRANSISTOR SELECTION GUIDE

TYPE	V _{CEO} Volts	h _{FE} Min/Max	I _C Amps	V _{CE} (V)	I _S /B ₀ I _C (A)	Pulse (sec)	Power Watts	Case Style
SDT 31303	200	10/50	2.0	200	1.25	1.0	250	TO-3
SDT 31305	250	10/50	2.0	250	1.0	1.0	250	TO-3
SDT 31307	300	10/50	2.0	250	1.0	1.0	250	TO-3
SDT 49302	50	10/40	60.0	50	6.0	1.0	300	TO-3 1)
SDT 49304	70	10/40	40.0	70	4.3	1.0	300	TO-3 1)
2N 6259	150	15/60	8.0	100	2.5	1.0	250	TO-3
2N 6258	80	20/60	15.0	80	3.1	1.0	250	TO-3
2N 3773	140	15/60	8.0	100	1.5	1.0	150	TO-3
2N 3772 2)	60	15/60	10.0	60	2.5	1.0	150	TO-3
2N 3771 2)	40	15/60	15.0	40	3.75	1.0	150	TO-3
2N 6254	80	20/70	5.0	80	1.87	1.0	150	TO-3
2N 3055H 2) 3)	60	20/70	4.0	60	1.95	1.0	117	TO-3
SDT 3055	60	20/70	4.0	40	2.92	1.0	117	TO-3
2N 6100	70	20/80	5.0	70	1.07	1.0	75	TO-220
2N 6098	60	20/70	4.0	60	1.25	1.0	75	TO-220
2N 5496	70	20/100	3.5	70	0.714	1.0	50	TO-220
2N 5298	60	20/80	1.5	60	0.60	1.0	36	TO-220
2N 3441	140	25/100	0.5	120	0.208	1.0	25	TO-66
2N 3054	55	25/100	0.5	55	0.45	1.0	25	TO-66

1) Copper core leads 2) Also Available as JAN, JANTX 3) Suffix "H" denotes full SOA at max. V_{CEO} rating of 60V

Solitron
DEVICES, INC.

1177 BLUE HERON BLVD. • RIVIERA BEACH, FLORIDA 33404
(305) 848-4311/TWX: (510) 952-7610/TELEX: 51-3435

From the House of Power

Boschert is the new leader in low cost, OEM Switching Power Supplies

—in fact we're price-competitive with linears!

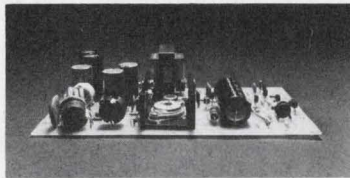

For example: our 50 watt has 4 outputs, weighs only 14 oz. and costs less than \$100. —just right for microprocessors.*

Our standard switchers produce 50 to 300 watts with 4 to 6 outputs, and protection against short circuit, reverse-polarity and over-voltage is built in.

Our state-of-the-art experience with the F-14 and four satellite programs coupled with volume production for corporations like Diablo and Qume insures high quality at low cost.

So, if you're in the middle of designing a printer, display, data storage or microprocessor system and you want to save not only heat, weight and space but dollars, then call us collect for the name of the Boschert Sales Engineer nearest you.

We're the new leader.

boschert

384 Santa Trinita Ave. ■ Sunnyvale, CA 94086 ■ 408 732-2440

**in quantities of 100 or more.*

New products

Two-speed s/d converter yields 20 bits from 1 box

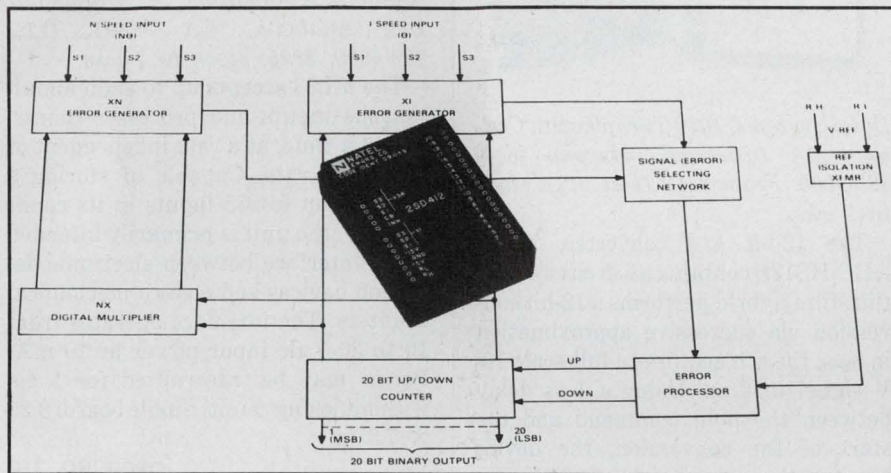

Natel Engineering Co. Inc., 8954 Mason Ave., Canoga Park, CA 91306. (213) 882-9620. P&A: See text.

The first two-speed synchro-to-digital converter in a single encapsulated module is Natel's 2SD412. It produces a 20-bit output word at TTL levels and consumes only 3.5 W from +5-V and +15-V supplies; a low-power version uses a mere 2 W.

Fixed fine-to-coarse shaft ratios of 36:1, 72:1 and even higher are available. Non-binary ratios are standard, while noninteger ratios can be accommodated. The standard package is $2.625 \times 3.625 \times 0.82$ in.

The 2SD412 is a continuous tracker, whose resolution cycle takes 3 μ s. Its transformer-isolated reference input is 26 V, or 115 V rms at 400 Hz. And it maintains 0.001° accuracy on the coarse-shaft position at up to 15 rpm.

Normal temp range is 0 to 70 C—optionally, -55 to 105 C. Other options include a synchro resolver input and high reliability to MIL-STD-883. In unit quantities, the 2SD412 costs \$1195; delivery takes 6 to 8 weeks ARO.

Analog Devices, Norwood, MA, can also supply two-speed s/d conversion, but only in a two-package system. Its TSDC-1608 converts binary-shaft ratios from 8:1 to 64:1. The set takes three power supplies (± 15 V, +5 V), costs \$915 and is available from stock. It yields a 19-bit output word.

To accommodate nonbinary ratios, Analog offers TSL-1612 three-module sets for 36:1, 18:1 and 9:1 geared shafts. This set costs \$990, yields 19 bits and is available from stock. A more recent set, the TSL-1729, is wire-programmable for any integral shaft ratio from 1:1 to 63:1. At \$1140, it is the only other system to provide 20 bits of shaft position data.

Two-speed s/d conversion is also available from ILC Data Device Corp., Bohemia, NY. Its SDC-36 is a two-module set that generates a 16-bit output word. The SDC-36 costs \$1225, but can track the coarse shaft at higher speeds than the Natel unit—up to 60 rpm.

Two control transformers and a data processor make up ILC's other conversion scheme, the HSDC-360. This set of three modules costs \$960, can be delivered in 30 days ARO and yields 16 bits of shaft-position data. By the end of this year, ILC expects to have the HSDC-360 integrated into a single module. ILC also offers the TSC-360 module, which combines the digital outputs of two separate converters, and provides 19 bits of data. It costs \$265, needs just +5 V and is available within 4 weeks ARO.

Natel
Analog Devices
ILC Data Device

CIRCLE NO. 301
CIRCLE NO. 302
CIRCLE NO. 303

Terminate DIP delays criss-cross or in-line

Pulse Engineering, P.O. Box 12235, San Diego, CA 92112. J. Kerr (714) 279-5900. Stock.

Fifteen models, featuring either in-line or criss-cross termination, comprise the 21100 series of 14-pin-DIP delay lines. Total delays span 10 to 500 ns. The impedance level is 100 Ω and rise-times range from 2.4 to 100 ns. Resistance of 1 Ω at dc for the 10-ns delay line scales to 17 Ω for the 500-ns delay line. Delay tempo is 120 ppm/°C from -55 to +125 C. Package projects above seating by 0.25 in.

CIRCLE NO. 304

Small multiplier zips in all 4 quadrants



SGR Corp., Neponset Valley Industrial Park, P.O. Box 391, Canton, MA 02021. (617) 828-7773. From \$39 (1-9 qty).

In only 0.5 in³, Series SGR-400 hybrid 4-quadrant multipliers have a transconductance multiplying element, a stable reference, an output amplifier that is internally trimmed for zero feedthrough output and gain trim. The units multiply in four quadrants with a transfer function of XY/10. Multiplying errors of 1%, 0.5%, 0.25%, and 0.1% at 25 C include the effects of offset voltage, feedthrough, scale factors, and nonlinearity in all four quadrants. Key specs include: small-signal bandwidth of 1 MHz, full-power bandwidth of 750 kHz and slew rate of 45 V/ μ s. The output can swing ± 10 V at 5 mA, and is fully protected against short circuits to ground or supply voltage. Inputs are protected against overvoltage transients.

CIRCLE NO. 305

Instrumentation amp hardly drifts

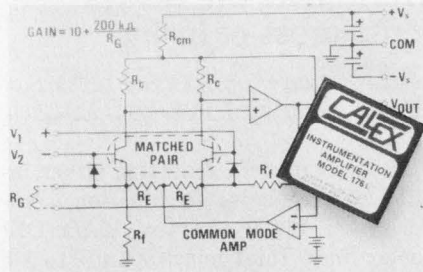

Calex Mfg. Inc., 3305 Vincent Rd., Pleasant Hill, CA 94523. R. Kreps (415) 932-3911. \$59 (1-9 qty); stock.

The 176L differential-input instrumentation amplifier features $\pm 0.25\text{-}\mu\text{V}$ drift. Other features include: common-mode rejection of 120 dB, gain adjustable from 10 to 1000, gain linearity of $\pm 0.005\%$, gain accuracy of $\pm 0.2\%$, input impedance of 10 M Ω , input common-mode potential of $\pm 6\text{ V}$, input noise referred to input of $0.01\text{ }\mu\text{V}$ to 10 Hz and $1\text{ }\mu\text{Vrms}$ to 10 kHz, output of $\pm 10\text{ V}$ at 5 mA, input protection of $\pm 20\text{ V}$. $1.5 \times 1.5 \times 0.5\text{ in.}$

CIRCLE NO. 306

Wide range rf amp has low distortion

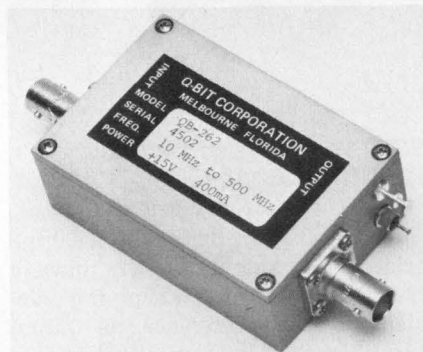

Q-Bit Corp., P.O. Box 2208, Melbourne, FL 32901. (305) 727-1838. \$290; stock to 30 days.

The QB262 rf amp boasts a 60-dBm min second-order intercept and less than 1.5:1 in/out VSWR over the 10 to 500-MHz range. This push-pull amplifier is intended for use as an ultra-linear LO driver for high-level mixers, or as a gain block in a distribution system. Optimums for mixer performance and hybrid-splitter isolation are realized when these devices are interfaced with the amp. Gain: 28 dB $\pm 1/2\text{ dB}$; bias: 15 V at 400 mA.

CIRCLE NO. 307

Converter samples and holds input

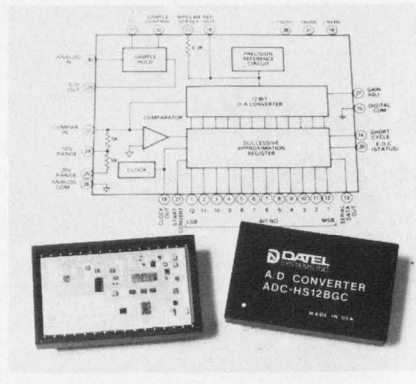

Datel Systems, 1020 Turnpike St., Canton, MA 02021. E. Murphy (617) 828-8000. From \$149 (1-24 qty); stock to 4 wks.

The 12-bit a/d converter, model ADC-HS12B contains a s/h circuit. The thin-film hybrid performs a 12-bit conversion via successive approximation in 8 μs ; the s/h acquires a full-scale 10-V signal in 6 μs . Using a 1- μs delay between the hold command and the start of the conversion, the device boasts a throughput rate of 66 kHz for full-scale-input changes; for smaller input changes or for track-and-convert applications the throughput rate can reach 100 kHz. Aperture time for the s/h is 50 μs . In addition the device features five programmable input voltage ranges: 0 to +5 V, 0 to +10 V, $\pm 2.5\text{ V}$, $\pm 5\text{ V}$, and $\pm 10\text{ V}$. Output coding is complementary binary or complementary offset binary with both parallel and serial outputs available. The gain tempco is $\pm 20\text{ ppm}/^\circ\text{C}$ max. An external 1000-pF holding capacitor is required for the s/h.

CIRCLE NO. 308

Sample and hold unit grabs fast spikes

Optical Electronics, P.O. Box 11140, Tucson, AZ 85734. P. Suozzi (602) 624-8358. \$100 (3-9 qty); stock.

The Model 5021 s/h operates at video frequencies. The device can hold fast transient pulses. Features of the analog-memory device include a max aperture-uncertainty time of 300 ps and a max total-aperture-delay time of 3 ns. Max acquisition time is 1 μs with an external 100-pF memory capacitor and with the same size capacitor the tracking-mode bandwidth ranges from dc to 10 MHz. The unit operates from -55 to $+85\text{ C}$. $1.8 \times 1.2 \times 0.6\text{ in.}$

CIRCLE NO. 309

Counter interface accepts eight inputs

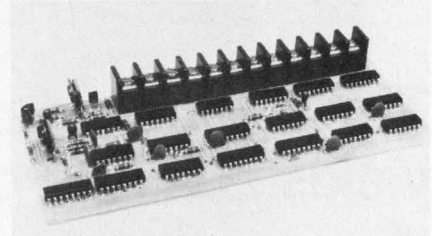

Anaheim Automation, 922 Orangefair Ln., Anaheim, CA 92801. (714) 992-6990. \$125; stock to 4 wks.

The ML33 accepts up to eight simultaneous inputs and processes counts, one at a time, at a rate independent of the input rate. Capable of storing a burst of up to 255 inputs in its count register, the unit is primarily intended as an interface between electronic detection devices and electro-mechanical counters. The interface operates from 10 to 30-V dc input power at 10 mA. Power may be interrupted for 1 ms without losing count. Single board: $3.25 \times 7.5\text{ in.}$

CIRCLE NO. 310

Analog CCD delay lines process audio or video

Reticon, 910 Benicia Ave., Sunnyvale, CA 94086. (408) RET-ICON. From \$16; stock.

For analog signals in the audio range, the R5101 provides 2,000 stages of delay and an on-chip driver. When used at sampling rates from 1 kHz to 1 MHz the CCD's dynamic range is 80 dB with max distortion of 1%. The R5102 and R5103 devices contain 455 and 910 stages of delay respectively and are intended for video signals requiring up to 16-MHz sampling rates. For use with television, the 910-stage device stores a complete TV line when sampled at 14.3 MHz (four times the color subcarrier). Storage time or delay depends on the sampling frequency. All three units exhibit a 70-dB signal-to-noise ratio and are packaged in standard 16-lead DIPs. Modules are available. They contain all required peripheral circuitry such as clock generators, drivers and video or audio amps.

CIRCLE NO. 320

Filler

Time is a device whose purpose is to prevent everything from happening all at once.

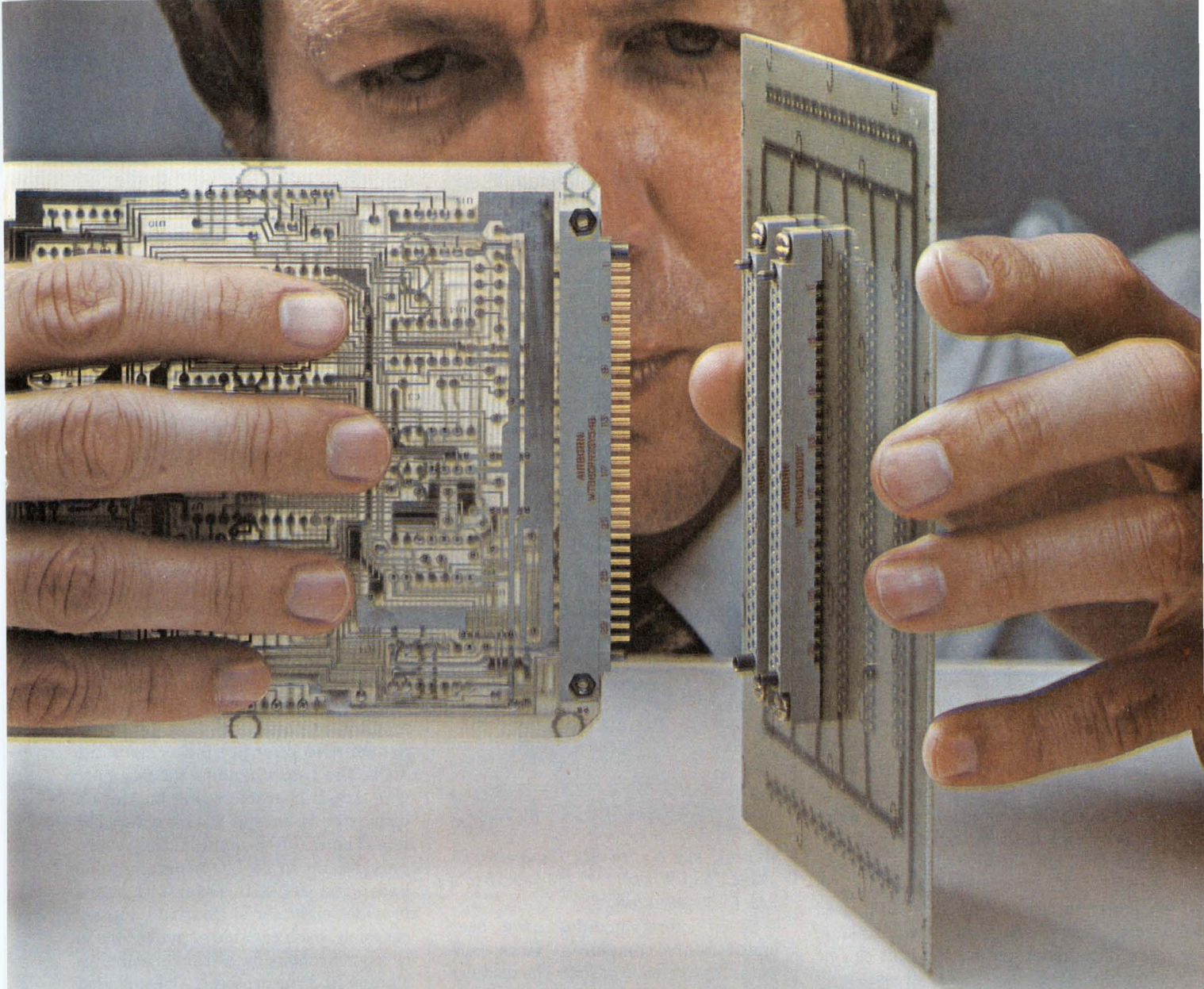

We don't build a connector for everybody.

We build everybody a connector.

More often than not, your problem can't be solved with a substandard connector.

That's why our first concern is quality. You present us with a problem and we're flexible enough to give you back an approved connector that's designed or modified for your application.

We make connectors for PC card to chassis or mother board connections. We make connectors for PC board input-output, cable to panel and cable to chassis connections. We make connectors for inter-

equipment connections like cable to panel, cable to cable and drawer to cabinet. And we make every component that goes into them.

It simply comes down to this. You either use a connector that's been stamped out on an assembly line or a connector that's carefully and completely built specifically for your job.

That decision is easy. And that's why we're in the connector business.

If you want the best, call AirBorn.

AirBorn, Inc.

4321 AirBorn Dr., Addison, Texas 75001, 214/233-2000

MICRO/MINI COMPUTING

Speed math processing with slave math unit

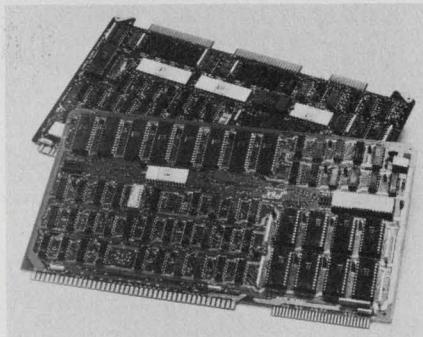

Intel, 3065 Bowers Ave., Santa Clara, CA 95051. Rob Walker (408) 246-7501. \$595 (unit qty); stock.

The SBC 310 high-speed mathematics unit does 32-bit floating point arithmetic, 16 and 32-bit fixed-point integer arithmetic, compare and test operations relative to zero or to floating point constants, and float-to-fix or fix-to-float conversions. The programs operate at almost 10 times the speed of 8080 software and are stored in the unit's microprogram memory. Operating as a concurrent processor, the math unit lets SBC 80 computers continue executing their main programs while it processes arithmetic data in parallel. The SBC 80 Multibus allows as many as 16 SBC 80 computers to share a single math unit. The SBC 310 is used with memory-mapped I/O addressing. So data generated by the unit can be manipulated like data accessed in memory. Also, the unit can operate in interrupt driven or polled modes, like the I/O ports on SBC 80 computer boards.

CIRCLE NO. 321

Single-board μ C has large memory

Control Logic, 9 Tech Circle, Natick, MA 01760. Hiram French (617) 655-1170. \$500; stock.

CCS-1143 contains, on a single PC board, an 8-bit microprocessor (Z80), 1-k \times 8 RAM, sockets for up to 16-k bytes of EPROM (2708), a serial interface for either 20-mA current loop or EIA RS-232-C serial devices, 2-MHz clock and CPU support hardware and logic for I/O. The memory-mapped and bussed I/O structure of the CCS-1143 permits the user to employ the many memory reference instructions of the Z80 when executing I/O operations.

CIRCLE NO. 322

Paper tape reader handles 300 characters/second

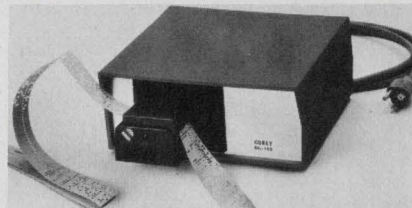

Corey Engineering, 2119 Earnshaw Dr., Placentia, CA 92670. (714) 993-5661. \$595 (unit qty); stock.

The DG150, a high-speed paper-tape reader, can input 300 characters/second. It comes complete with power supplies, interface, and interconnecting cable for the Data General computer family. Housed in a 3 \times 8.5 \times 7-in. cabinet the reader requires 115 V ac at 0.5 A.

CIRCLE NO. 323

Support modules for μ P system give many options

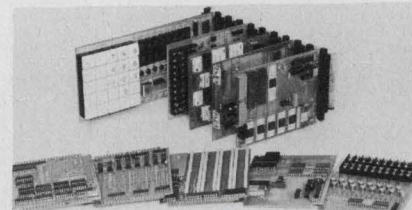

Wintek, 902 N. 9th St., Lafayette, IN 47904. Paul Wintz (317) 742-6802. From \$69 to \$1499; stock

Seven more modules have been added to the company's Wince computer family (6800 based). The modules are on 4.5 \times 6.5 in. printed-circuit cards with standard 44-pin connectors. Included are a driver/sensor module (with up to 16 electronic switches for 28 V at 250 mA and/or 8 optically isolated inputs); an analog interface module (has an 8, 10, or 12-bit a/d converter, 16-channel multiplexer, and 8-bit d/a converter); a cassette interface for loading and dumping data on an audio cassette at 300 baud (Kansas City Standard) or 2400 baud; a CMOS RAM/battery module (has up to 2 kbytes of RAM with automatic battery backup for nonvolatile data storage); a console module (has up to 25 key switches and 16 7-segment LED displays for data entry and display; an option is a real time clock); a floppy-disc interface module (for the ICOM/Perlec drive); and a telephone tone transmit/receive module (interfaces to the telephone system and allows automatic dialing and answering as well as data transfer).

CIRCLE NO. 324

Support boards for Z80 μ C provide display & I/O

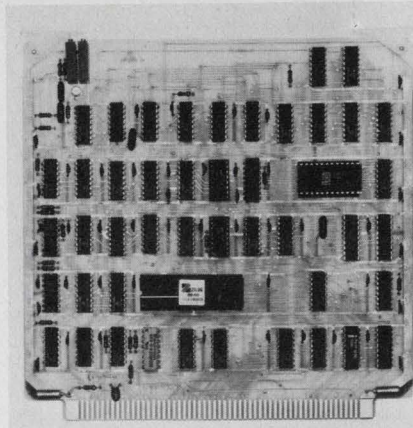

Zilog, 10460 Bubb Rd., Cupertino, CA 95014. Dave West (408) 446-4666. \$475 (VDB), \$350 (IOB), \$375 (SIP); 30 days.

A video display board, an input/output board, and a serial I/O board have been added to the MCB family of Z80 microcomputer boards. The Z80-VDB video display board interfaces the CPU board directly to TTL horizontal, vertical and video drives of a standard TV monitor. Containing 256 bytes of dynamic RAM for line buffering to the MCB, the board handles the 64 upper case ASCII characters and provides a display of 24 lines at 80 characters per line. The Z80-IOB input/output board provides up to 64 I/O programmable lines. The Z80-SIB serial I/O board provides eight serial (four full duplex) channels, each capable of synchronous or asynchronous data transmission including Bi-Sync protocol. Also included are two onboard Z80-CTC programmable timers.

CIRCLE NO. 325

Floppy disc controller handles up to 8 drives

Processor Applications, 2801 E. Valley View Ave., West Covina, CA 91792. Daniel Nesin (213) 965-8865.

The μ Pal FDC1016, a floppy-disc controller, handles up to eight discs under DMA. The S-100 microcomputer bus compatible card handles IBM 3740 and other formats and has error detection features. When used with the optional DFM80 software package, the user need only know the name of the file, the operation to be performed and the actual disc or drive where the file resides. The software package also includes a monitor, debugger and bootstrap programs.

CIRCLE NO. 326

MULTIPLE OUTPUT POWER SUPPLIES

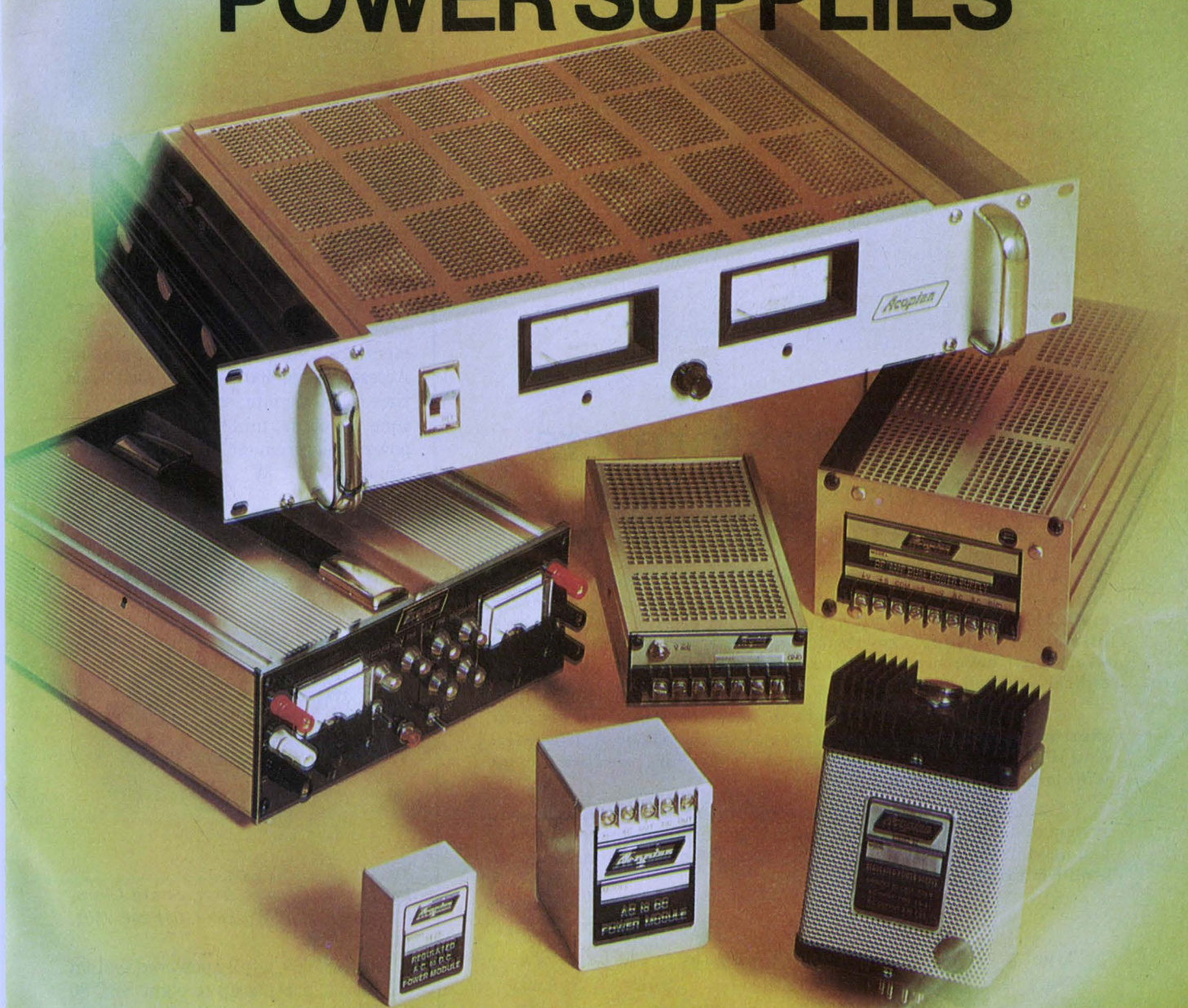

Single, dual, and triple output supplies having output ratings from 1 to 28 volts; from 30 ma to 60 amps. A choice of performance levels, with regulation ranging from $\pm 0.005\%$ to $\pm 0.5\%$. Many provide dual and triple isolated outputs, matched or dissimilar, in both standard and user-selectable combinations. Others have balanced, tracking outputs.

The variety of shape factors and the mounting versatility of these supplies provide easy answers to mechanical layout problems. Miniaturized models are available for either PCB mounting or, with screw terminals, for chassis mounting. Narrow profile units fit into thin

spaces. Metered benchtop supplies are handy sources of power for experimental circuitry. Plug-in modules mount in seconds.

Ask for a copy of our full color, 28-page brochure. It contains complete specifications, outline drawings, prices, and — just as important — it also details our guarantee to ship within 3 days after receiving your order.



Corp., Easton, Pa. 18042 • Tel: (215) 258-5441



Triad Transformers

Dependable Control For A Better Control Circuit

If you're designing a new control circuit — or upgrading an old one — specify Triad control transformers. Triad gives you a choice of 6, 12, 24 and 48 volt secondaries for series or parallel operation; dual primaries, and open construction with U-bracket or mounting straps. All have been proven rugged and reliable in hundreds of critical applications.

Your Triad distributor already has them in stock for your short-run needs so you won't have to wait for them to be built to order. And if he doesn't have enough for your longer runs, we back him up with large bulk quantities at our plant.

If you're designing magnetic components of any type into your system or device, you'll probably find just the transformer or inductor you need in the Triad catalog. So see your Triad distributor today, or send for a copy.

Type No.	Primary	Secondary		VA Rating
		Parallel	Series	
F-105Z		6V @ 2A	12V @ 1A	12
F-106Z	115V/230V	6V @ 4A	12V @ 2A	24
F-107Z	50/ 60 CPS	12V @ 4A	24V @ 2A	48
F-108U	on all	12V @ 8A	24V @ 4A	96
F-109U		12V @ 16A	24V @ 8A	192
F-211Z		24V @ .5A	48V @ .25A	12
F-212Z		24V @ 1.0A	48V @ .50A	24
F-213Z		24V @ 2.0A	48V @ 1.0A	48
F-214U		24V @ 4.0A	48V @ 2.0A	96
F-215U		24V @ 8.0A	48V @ 4.0A	192



Litton TRIAD-UTRAD
Distributor Services
305 North Briant Street, Huntington, Indiana 46750

CIRCLE NUMBER 53

MICRO/MINI COMPUTING

Dynamic memory board holds up to 32 kwords

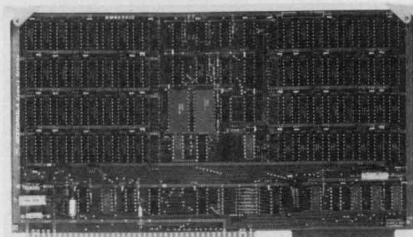

Motorola Semiconductor, 3501 Ed Bluestein Blvd., Austin, TX 78721. (512) 928-2600. \$1135 (unit qty); 2 wks.

The MMS80810, a 32 kword \times 8 bit system, is pin compatible with the SBC 80/10 family of single board computers. Address select changes are easily made by using the on-board jumper wires. For smaller memory requirements 16-k versions are also available. Access time is 400 ns, max, read cycle time is 760 ns, min, and the write cycle time is 760 ns, min. Maximum active power requirement is 13.6 W and standby is 9.1 W.

CIRCLE NO. 327

Chassis for SBC 80 boards includes supply

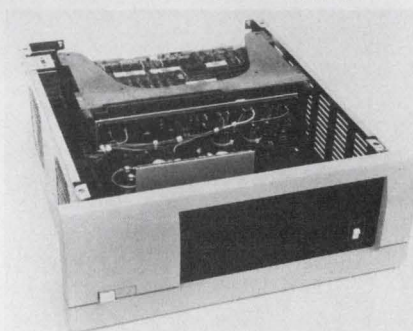

Intel, 3065 Bowers Ave., Santa Clara, CA 95051. Rob Walker (408) 246-7501. \$1350; stock.

The SBC 660, a fully powered system 80 chassis, accepts up to eight SBC 80 boards. Systems can be constructed by simply plugging boards into the unit's card cage. The boards may be SBC 80/10 or SBC 80/20 family products. The chassis, which has an attractive pop-off front panel, can be used as a table top unit for stand alone applications or mounted in a standard 19-in. rack. Inside is a heavy duty power supply with regulated +12, +5, -5 and -12 V dc outputs, and remote sensing of the +5 V regulation. Moreover, the supply includes ac power failure sensing that can be used to initiate a user-written power-fail routine.

CIRCLE NO. 328

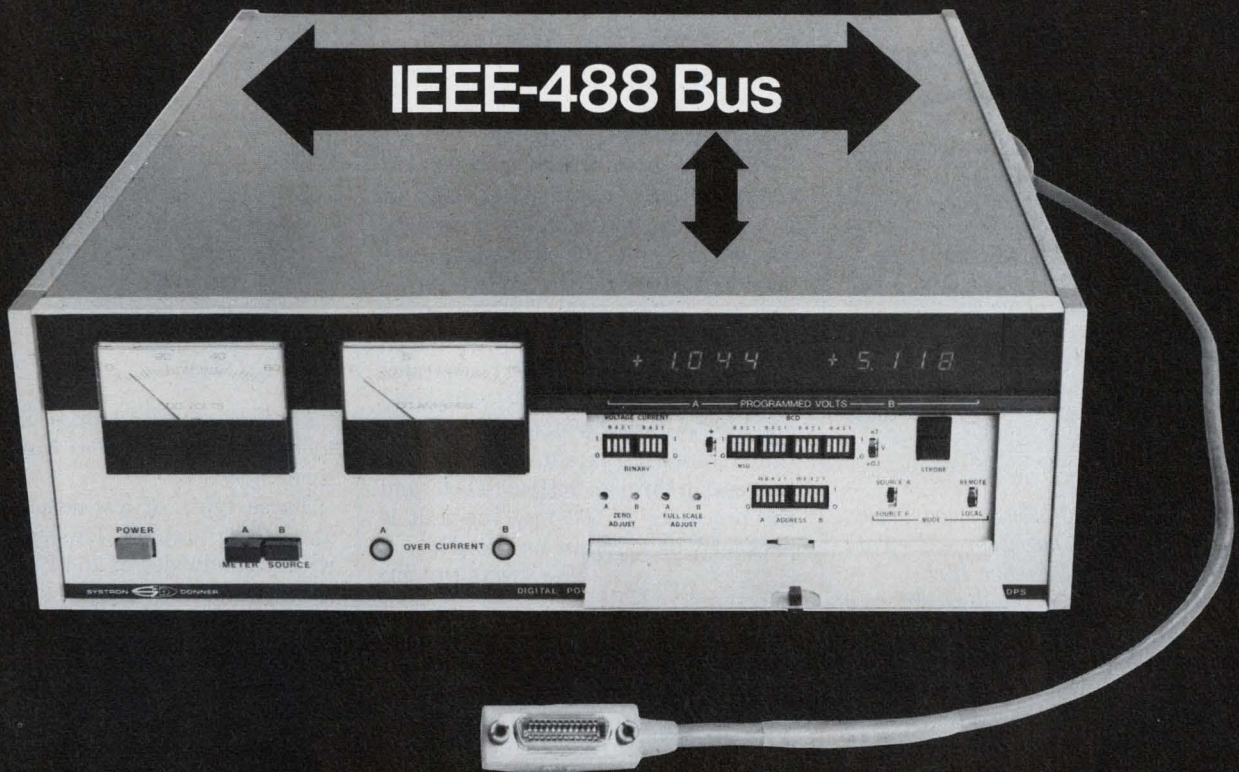

BUS IN, POWER OUT

S-D's Dual Channel Power Supply: the first supply designed for IEEE-488 bus applications.

- Two independent, bipolar power sources
- All analog functions bus controlled
- Programmable overvoltage and current limits
- Memory register displays

The industry's best dual channel power supply now includes the IEEE bus interface as **standard equipment!** With a single address, you can program **two** 50 volt, 1 amp bipolar supplies; set the voltages; limit the currents; assign trip points, and reverse polarities. (For faster systems, a BCD parallel bus version is available.)

Behind the hinged front panel of Model DPSD-50 sits a complete local control center. These local-mode switches provide a fast and easy way to set the address, step through a program sequence, or verify calibration.

Key specifications: resolution, 1 mV; basic accuracy, 1 mV; stability, 300 μ V.

Instead of buying **two** expensive power supplies, you can now do the job with **one** DPSD-50 (\$3,000 in U.S., slightly higher outside U.S.). For more details, contact Scientific Devices or Systron-Donner at 10 Systron Drive, Concord, CA 94518. Phone (415) 676-5000.

SYSTRON  DONNER

Linear breadboard IC has MOSFETs, npn & pnps

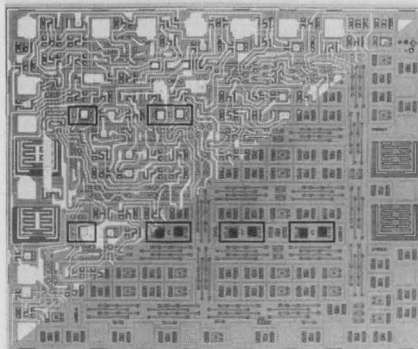

Interdesign, 1255 Reamwood Ave., Sunnyvale, CA 94086. George Stephan (408) 734-8666. P&A: See text.

Containing both field-effects and bipolar transistors, Monochips E and F permit mixed-device IC designs. P-channel, high threshold enhancement mode devices together with npn and pnp transistors are designed for linear applications. Monochip E measures 70 × 70 mils and contains 200 components and up to 18 pins. Monochip F contains 460 components, including 10 MOSFET's and four high-current npn transistors. The chip measures 90 × 110 mils and can accommodate up to 24 pins. The entire tooling for a custom Monochip costs \$2800 and it takes four weeks to deliver prototypes.

CIRCLE NO. 329

Switched PROMs have OC or three-state outputs

Raytheon, 350 Ellis St., Mountain View, CA 94040. Dan Andersen (415) 968-9211. From \$4.25 (100-qty); stock.

Both the 256 × 4 and the 512 × 4 switched PROMs are available in either open-collector or three-state configurations. These PROMs include built-in power switching circuitry to reduce power consumption. The 29612 and 29613 SPROMs have access times of 60 ns and 75 ns for the commercial and military versions, respectively. V_{CC} tolerance of 5% for the commercial version and 10% for the military is available. The actual power savings for the two devices is 90% for the open collector versions and 75% for the three-state versions. Because the chip select inputs activate the power switch, their access times are 10 ns longer than the respective address access times.

CIRCLE NO. 330

Convert data while the processor calculates

Texas Instruments, P. O. Box 5012, Dallas, TX 75222. Dale Pippenger (214) 238-3527. \$3.90 (100-qty); stock.

Microprocessors similar to the TMS1000 series can use the TL505 a/d converter as an input device. This unit is a unipolar auto-zeroing dual-slope converter, with the dual-slope conversion performed as a software routine by the processor. A single 7 to 15 V dc supply can power the IC which features three-digit (0.1%) accuracy, on-chip reference voltage, auto-zero and high impedance MOS inputs. Total time required to execute a 3-digit BCD conversion through both the TL505 and the processor is 500 ms. The unit is packaged in a 14-pin plastic DIP.

CIRCLE NO. 331

Use octal registers in processor interface

Advanced Micro Devices, 901 Thompson Pl., Sunnyvale, CA 94086. E. Sopkin (408) 732-2400. \$2.04 (plastic in 100-qty); stock.

An eight-bit D-type register with three-state outputs is used with fixed instruction set microprocessors as well as the microprogrammable four-bit slice type. The Am54/74LS374 features a buffered common clock and buffered three-state control. An improved version, the Am25LS374, offers better noise margin and higher fan-out. The registers are available in 20-pin packages, either molded plastic or ceramic dual-in-line, as well as a flat-pack version. Use of low-power Schottky construction results in typical clock-to-output delay of 20 ns.

CIRCLE NO. 332

LSI multiplies in 100 ns with 1-W power input

Monolithic Memories, 1165 E. Arques Ave., Sunnyvale, CA 94086. Ray Gouldsberry (408) 739-3535. \$64/100; stock.

The MMI67558, a 40-pin bipolar LSI device, is an 8 × 8 multiplier for use in digital signal processing. It can multiply two 8-bit unsigned or signed 2's-complement numbers and generate the 16-bit unsigned or signed product. The device uses a single +5 V power supply and features three-state outputs for pipelined operations.

CIRCLE NO. 333

Dual IC preamplifiers have low noise to 75 kHz

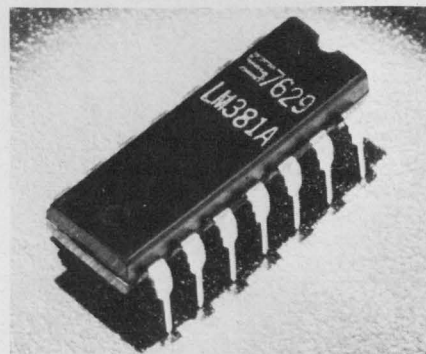

Signetics, 811 E. Arques Ave., Sunnyvale, CA 94086. (408) 739-7700. See text; stock.

Three types of low-noise dual preamplifiers amplify low-level signals with a bandwidth of 75 kHz. Common characteristics are 2-V output swing and operation from a single 9 to 40-V power supply. The LM381/LM381A provides 120-dB supply rejection, 60-dB channel separation, 112-dB open-loop gain, and 0.5- μ V total input noise. It comes in a 14-lead DIP. The LM382 is the same except the open-loop gain is 100 dB and total input noise is 0.8 μ V. A resistor matrix is provided in the LM382 to select closed-loop gain and frequency response—such as flat-band, NAB or RIAA equalization. The LM387 is similar, with 104-dB open-loop gain and is available in a 8-lead package. Prices per 100 units are \$1.50/LM381, \$2.40/LM381A, \$1.15/LM382 and 95¢/LM387.

CIRCLE NO. 334

Ease processor burden with memory interface

Motorola, P.O. Box 20912, Phoenix, AZ 85036. Jerry Tonn (602) 962-2515. \$40 (100-qty); stock.

A memory interface circuit, the MC10803 containing its own ALU, can relieve the main processor of numerous tasks. The device can interface between a processor subsystem such as the MC10800 4-bit slice and either main memory or peripherals. On-board logic and registers generate memory addresses and route incoming or outgoing data. The ALU performs arithmetic, logic and shift operations on seven possible operands. A total of 13 basic ALU functions and 17 data-transfer operations are possible. Housed in a 48-pin quad-in-line package, the unit is compatible with all devices in the MECL-10,000 series.

CIRCLE NO. 335

Fast delivery of power supplies is no problem for Power/Mate.

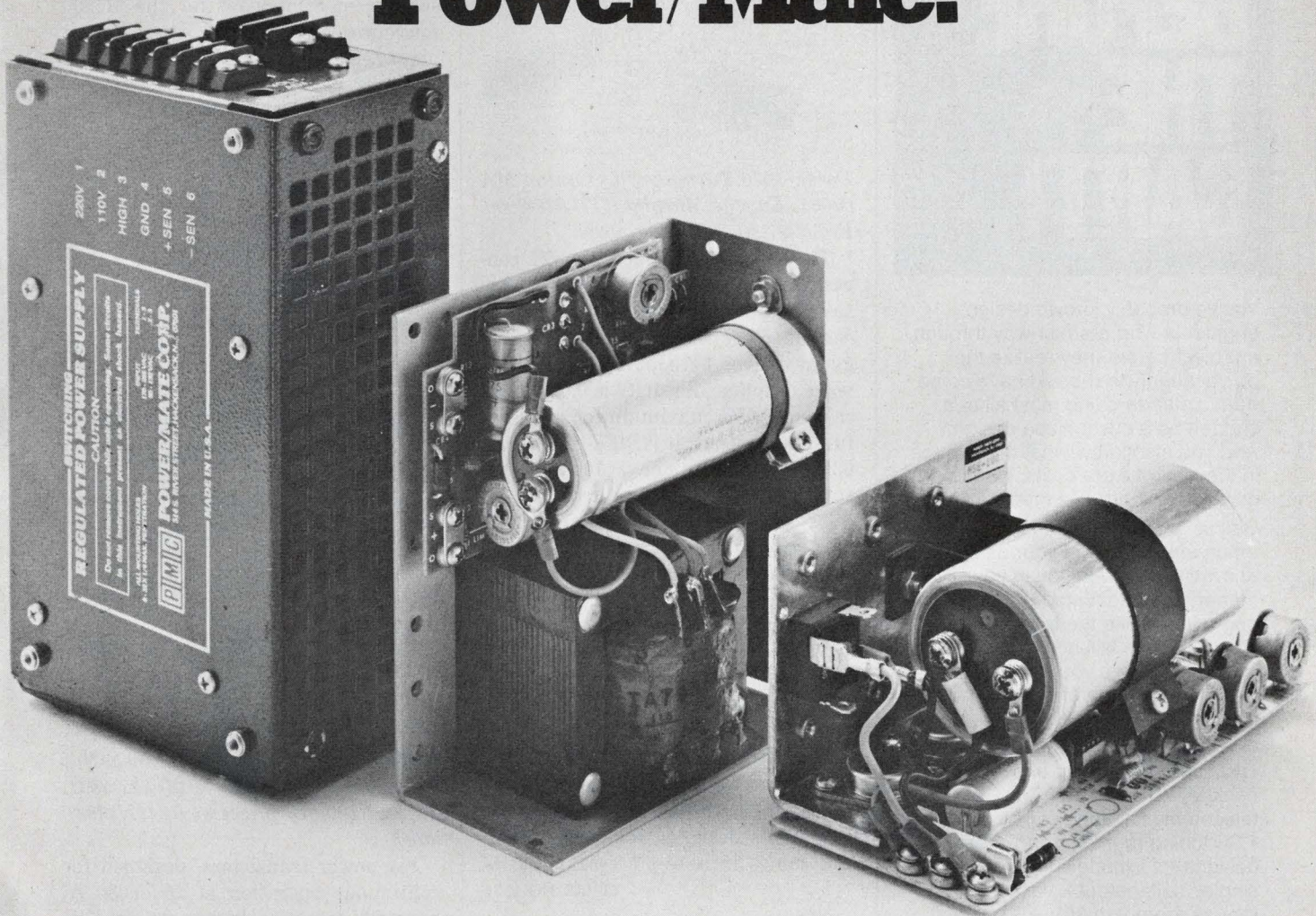

If you need open frames, sub-modules, switchers and other power supplies now, call Power/Mate.

90% of all catalog items are ready to be shipped to you today.

Power/Mate's East and West Coast plants are fully stocked with reliable open frame, sub-modular and switching power supplies ready for immediate delivery.

But our in-depth stock isn't the only thing

that has kept us the leader in the field of power supplies.

Our in-the-field representatives, factory trained applications engineers, telephone salespeople and complete repair facilities make us a company that's just as dependable when it comes to service.

We'll make sure you get the power supply you need when you need it. Because keeping you ahead of your competition keeps us ahead of ours.

For more information call us or write:



POWER/MATE CORP.

514 S. River St./Hackensack, New Jersey 07601/(201) 343-6294/TWX (710) 990-5023
17942 Skypark Circle/Irvine, California 92714/(714) 957-1606/TWX (910) 595-1766

The world's largest supplier of quality power supplies.

KEEP THE HORSE BEFORE THE CART!

You've probably known design engineers who are half-way through a project before they realize the power supply that could have come from a standard line must all of a sudden be a customized design. And you also know what that means in the way of extra costs. It's the old cart before the horse theory.

Call us when you are in the embryonic stages of your design and we'll work with you in your primary important stages. And not only will you like the fact that our standard lines will both fit your supply and keep you in budget... you'll like the idea of our already field-tested dependability.

Our power supplies are available for OEM computer, point of sale, EDP, bank telling and telecommunications use:

- Switching regulator and linear designs • 11 models — single/multi-output • Voltage ranges, from 2 to 30V • 50 current levels from .01 to 225 amps • Overcurrent/overvoltage protection • Filtering to meet world-wide EMI requirements • Designed and built to UL, CSA and European safety requirements.

Dependability. That's a word we define as quality and reliability. It's also what design engineers define as our reputation!



NCR POWER SYSTEMS DIVISION

formerly Scott Electronics
584 S. Lake Emma Road, P.O. Box 898
Lake Mary, Florida 32746
Telephone (305) 323-9250

CIRCLE NUMBER 56

ICs & SEMICONDUCTORS

V/f-f/v converter operates up to 100 kHz

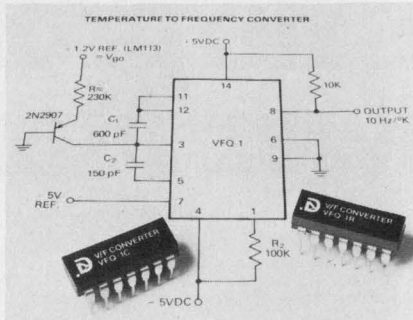

Datel, 1020 Turnpike St., Canton MA 02021. Eugene Murphy (617) 828-8000. From \$7.50 (1 to 24); stock.

The VFQ-1, a monolithic v/f converter, has a 10 kHz to 100-kHz full scale output frequency. The device uses combined CMOS and bipolar technology to deliver both pulse and square-wave outputs. Linearity is 0.01% typical and 0.05% maximum for a 10-kHz full scale output; it is 0.1% typical and 0.25% maximum for a 100-kHz full scale output. The gain temperature coefficient is typically 25 ppm/°C. Normal operation requires three external resistors, two external capacitors, and a reference. The VFQ-1 can be operated as either a v/f or f/v converter by external pin connection. The input current range is 0 to +10 μ A with a 500% overrange capability. Power requirement is ± 4 to ± 7.5 V at 4 mA. There are two versions available: the VFQ-1C is designed for 0 to 70-C operation and comes in a 14-pin plastic DIP; the VFQ-1R is designed for -25 to +85-C and comes in a 14-pin ceramic DIP.

CIRCLE NO. 336

Long delay is obtained by one-chip BBD

Panasonic, 1 Panasonic Way, Secaucus, NJ 07094. Bill Bottari (201) 348-7276.

A long-delay bucket brigade device (BBD) can delay an audio signal with near-zero insertion loss. Model MN-3005 is a 4096-stage unit which can electronically delay an audio signal for up to 205 ms. It can be used for improved reverberation and echo effects in electronic musical instruments, and for variable or fixed analog signal delays, analog shift registers and time compression or voice scrambling in communication systems.

CIRCLE NO. 337

Programmable timer joins microprocessor family

Motorola IC Div., 3501 Ed Bluestein Blvd., Austin, TX 78721. Irwin Carroll (512) 928-2600. MC6840L: \$16 (100-qty); MC6840P: \$13 (100-qty); stock.

Variable system time intervals are provided by the MC6840 programmable timer. The IC is intended as a subsystem component for the M6800 microprocessor family. Three 16-bit binary counters with corresponding control registers and a status register are contained in the 28-pin DIP. The counters are under software control and can be used to cause system interrupts and/or generate output signals. Applications include frequency measurement, event counting, square wave generation and pulse-width modulation. The units are available in either a plastic or ceramic package.

CIRCLE NO. 338

Power transistors handle up to 30 A, continuous

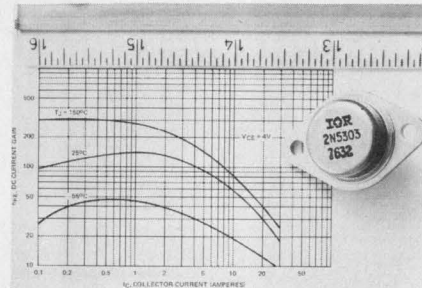

International Rectifier, 233 Kansas St., El Segundo, CA 90245. (213) 322-3331. Typical 100-qty prices \$4.05 (2N4398); stock.

Six power transistors, designed for continuous operation at 20 or 30 A, have fall times as low as 0.6 μ s. The transistors include both npn and pnp types with voltage ratings (both collector-to-emitter and collector-to-base) of 40, 60 and 80 V. Both the 2N4398 and 2N5301 npn devices have a 40-V rating, the 2N4399 (pnp) and 2N5302 (nnp) handle 60 V, and the 2N5745 (pnp) and 2N5303 (nnp) can withstand 80 V. The 40 and 60 V units have a continuous rating of 30 A, while the 80-V units handle 20 A. Collector-to-emitter saturation voltages for the transistors are as low as 0.75 V at an I_C of 10 A. Dc current gain for all units is a minimum of 5 at the full-rated current. All units come in TO-3 cases and offer a junction operating range of -65 to +200 C. Maximum dissipation at 25 C is 200 W.

CIRCLE NO. 339

COMPARE THE TOP-RATED 4½-DIGIT DMMs.

Put these three 4½-digit multimeters side-by-side and you'll want the Keithley 172.

The 172 gives you superior accuracy, resolution and convenience with no compromise—at a competitive price.

If you want more evidence, send for our detailed "Comparative Guide to 4½-digit DMMs"

The Keithley 172 rates best—not on every factor, but on most.

If you want hands-on proof, put our 172 side-by-side with the Fluke 8600A, HP 3465A, or any other 4½-digit DMM. The Keithley will stand alone.

Check the chart below or make your own comparison, you'll pick the Keithley 172.

Fluke 8600A



HP 3465A



Keithley 172



	Fluke 8600A	HP 3465A	Keithley 172
Functions & Ranging:			
dcV	Auto/Manual	Manual	Auto/Manual
acV	Auto/Manual	Manual	Auto/Manual
dcA	Manual	Manual	Manual
acA	Manual	Manual	Auto/Manual
ohms	Auto/Manual	Manual	Auto/Manual
Basic Accuracy (dc volts @ 25°C ambient)	± 0.02% reading + 1 digit	± 0.02% reading + 1 digit	± 0.01% reading + 1 digit
Full Range Display (Counts)	19999	19999	29999
HI/LO Ohms	No	No	Yes
Ohms Configuration	2 terminals	2 terminals	2 or 4 terminals
Lighted Function Indicator	No	No	Yes
Price	\$549	\$510	\$525

Comparison based on manufacturers' published specifications. Prices are domestic U.S. for ac line-operated instruments.

It's easy to make your own comparison. Use coupon. Or call (216) 248-0400.

KEITHLEY INSTRUMENTS, 28775 Aurora Road, Cleveland, Ohio 44139.
In Europe: D-8000 München 70, Heighhofstrasse 5, West Germany, (089) 7144065.

- Send specs on the Keithley 172. I'll make my own comparison.
- Send "Comparative Guide to 4½-digit DMMs." I need more proof.
- Bring in a Keithley 172 so I can make a side-by-side comparison.



Name _____ Title _____
Company _____
Address _____
City _____ State _____ Zip _____
Phone _____

KEITHLEY
The measurement engineers.

CIRCLE NUMBER 57

ICs & SEMICONDUCTORS

10-A npn/pnp transistors have ratings to 150 W

International Rectifier, 233 Kansas St., El Segundo, CA 90245. (213) 322-3331. \$2.25 to \$4.15 (100 qty); stock

Complementary npn (2N5758-60) and pnp (2N6226-28) power transistors are rated for 10-A peak collector current and power dissipation of 150 W. V_{CE} ratings range from 100 to 140 V. Maximum dc current gain ranges from 60 for the 2N5760 and 2N6228 to 100 for the 2N5758 and 2N6226. Maximum junction temperature is 200 C for all units with a maximum thermal resistance, junction to case, of 1.7 C/W.

CIRCLE NO. 340

Low noise amp delivers 10 V rms into 600 Ω

Signetics, 811 E. Arques Ave., Sunnyvale, CA 94086. Jim Wyland (408) 739-7700. From \$1.50 (100-qty); stock.

A low-noise general-purpose op amp, the SE/NE5534, can drive 10 V (rms) into 600 Ω directly. It features a small-signal bandwidth of 10 MHz and power bandwidth of 200 kHz. Noise voltage is 4 nV/ $\sqrt{\text{Hz}}$ and the slew rate is 13 V/ μs . In addition to the standard 5534, an improved version, the 5534A, offers an input bias current of 800 nA, maximum, an offset current of 200 nA, maximum, and a noise voltage of 4.5 nV/ $\sqrt{\text{Hz}}$, maximum, at 1 kHz. The 5534 is internally compensated for gain equal to, or higher than, +3. Basic specifications of the 5534 include: a dc voltage gain of 100,000; an ac voltage gain of 6000 at 10 kHz; and a supply voltage range of ± 3 to ± 20 V. 8-pin DIP.

CIRCLE NO. 341

Microwave transistor operates up to 4 GHz

Aertech, 825 Stewart Dr., Sunnyvale, CA 94086. (408) 732-0880. \$17 (1 to 9); stock.

ABT7101 is an npn silicon-bipolar microwave transistor for low-noise and general purpose small-signal applications up to 4 GHz. The transistor is in a 100-mil hermetic stripline package. It is also available in chip form as the ABT7100. Typical noise-figure is 3.6 dB at 2 GHz and 1.9 dB at 1 GHz.

CIRCLE NO. 342

FET input op amps offer low power and low noise

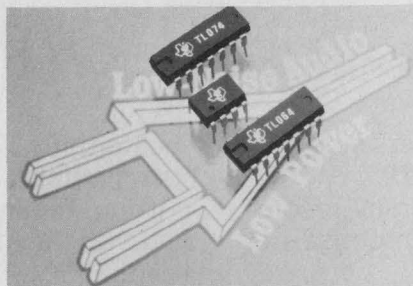

Texas Instruments, P.O. Box 5012, Dallas, TX 75222. Dale Pippenger (214) 238-2011. From \$0.47 (100-qty); stock.

Two series of bipolar/FET op amps, the TL061 series with three low-power op amps and the TL071 series with four low-noise audio op amps, add seven more models to the company's existing TL081 line of BIFET op amps. At 25 C, op amps in the TL061 low-power group require only 0.2 mA maximum supply current for each amplifier yet provide a 3.5 V/ μs slew rate. They have the same pin-outs as TL071 and TL081 op amps, as well as being functionally equivalent. And the TL061 units can be programmed for power control by connecting pin 8 to the supply voltage. Units in the TL071 series feature harmonic distortion of 0.01%, typically, and a noise of only 18 nV/ $\sqrt{\text{Hz}}$. Maximum supply current per amplifier for TL071 is 2.5 mA and the slew rate is 13 V/ μs . Types TL061 and TL071 are compensated single op amps with offset control; types TL062 and TL072 are compensated dual op amps without offset control; types TL064 and TL074 are compensated quadruple op amps with LM324 type pin-outs and the TL075 is a compensated quadruple op amp with an RC 4136 type pin-out.

CIRCLE NO. 343

Transistor series work from 70 MHz to 1 GHz

California Eastern Laboratories, One Edwards Court, Burlingame, CA 94010. (415) 342-7744. From \$0.50 (1000-qty); stock.

The NE734 series of transistors provides 70-MHz tuned-noise figures of less than 1.5 dB at 2.5 V and 0.5 mA with associated gains of 16 dB and higher. Units in the series can operate from 70 MHz to 1 GHz at bias currents from 0.5 to 20 mA. Transistors are available in T0-92, mini-mold and hermetic metal-ceramic stripline packages or as bare chips.

CIRCLE NO. 344

Call your nearest ISC sales representative.

ALABAMA: Huntsville
W. A. Brown Inst. Inc. 205/539-4411
ARIZONA: Phoenix
Thorson Co. 602/956-5300
CALIFORNIA: Goleta
Thorson Co. 805/964-8751
CALIFORNIA: Los Angeles
Thorson Co. 213/476-1241
CALIFORNIA: Mountain View
Thorson Co. 415/964-9300
CALIFORNIA: San Diego
Thorson Co. 714/298-8385
CALIFORNIA: Tustin
Thorson Co. 714/544-5121
COLORADO: Denver
Thorson Co. 303/759-0809
FLORIDA: Ft. Lauderdale
W. A. Brown Inst. Inc. 305/776-4800
FLORIDA: Melbourne
W. A. Brown Inst. Inc. 305/723-0766
FLORIDA: Orlando
W. A. Brown Inst. Inc. 305/425-5505
FLORIDA: Valparaiso
W. A. Brown Inst. Inc. 904/678-7932
GEORGIA: Atlanta
W. A. Brown Inst. Inc. 404/939-1674
ILLINOIS: Arlington Hts.
Future Systems 312/640-6091
LOUISIANA: Gretna
W. A. Brown Inst. Inc. 504/366-5766
MARYLAND: Bethesda
Bartlett Assoc. 301/656-3061
MASSACHUSETTS: Framingham
Bartlett Assoc. 617/879-7530
MICHIGAN: Madison Hts.
WKM Associates 313/588-2300
NEW MEXICO: Albuquerque
Thorson Co. 505/265-5655
NEW YORK: White Plains
Bartlett Assoc. 914/949-6476
NORTH CAROLINA: Durham
W. A. Brown Inst. Inc. 919/682-2383
OHIO: Cleveland
WKM Associates 216/267-0445
OKLAHOMA: Norman
Data Marketing Assoc. 405/364-8320
PENNSYLVANIA: Pittsburgh
WKM Associates 412/892-2953
PENNSYLVANIA: Wayne
Bartlett Assoc. 215/688-7325
SOUTH CAROLINA: Columbia
W. A. Brown Inst. Inc. 803/798-3297
TENNESSEE: Knoxville
McCain Elec. Equip. 615/584-8411
TEXAS: Austin
Data Marketing Assoc. 512/451-5174
TEXAS: Dallas
Data Marketing Assoc. 214/661-0300
TEXAS: Houston
Data Marketing Assoc. 713/780-2511
TEXAS: San Antonio
Data Marketing Assoc. 512/828-0937
WASHINGTON: Bellevue
Thorson Co. 206/455-9180
AUSTRALIA: Mt. Waverly, Victoria
Anderson Digital Elec. 03-543-2077
CANADA: Montreal
Cantec Rep. 514/620-3121
CANADA: Ottawa
Cantec Rep. 613/225-0363
CANADA: Toronto
Cantec Rep. 416/624-9696
EUROPE: England
Techex, Ltd. 0202-293-115
EUROPE: France
Peritex 749-40-37
EUROPE: Switzerland
Interstest, AG 031-224481
JAPAN: Tokyo
Munzing International 586-2701



Intelligent Systems Corp.

\$995



Unretouched
photograph
of screen

Get the jump on your competition without outspending your competition.

We're Intelligent Systems Corporation, and we've just lowered the price of our Intecolor 8001 to \$995. So now you can upgrade the terminals in the systems you're marketing to color at black and white prices.

The fact is that the Intecolor 8001 has the best price-performance ratio of any intelligent data entry terminal on the market—color or black and white. And that can really add some punch to your sales story. So can color, not because it looks better, but because it

communicates better than black and white.

And if you're marketing your systems by promoting the stand-alone capabilities of your terminals, we've got a list of options that'll give you just about any degree of sophistication you want. Including disk storage devices, bi-directional desk-top line printers and a brand new 2708/2716 PROM programmer.

Contact the ISC rep nearest you. We guarantee delivery of your Intecolor 8001 evaluation unit for \$995 (cash-with-order) within 30 days or your money back. Or if you've seen

the Intecolor 8001 in action and you're already sold on the price and performance, we'll give you the same \$995 price for orders of 100 units or more. Get the jump on your competition without outspending your competition. Get the Intecolor 8001.



Intelligent Systems Corp.

5965 Peachtree Corners East
Norcross, Georgia 30071
Telephone 404-449-5961 TWX: 810-766-1581

Two weeks delivery on portable multichannel recorders

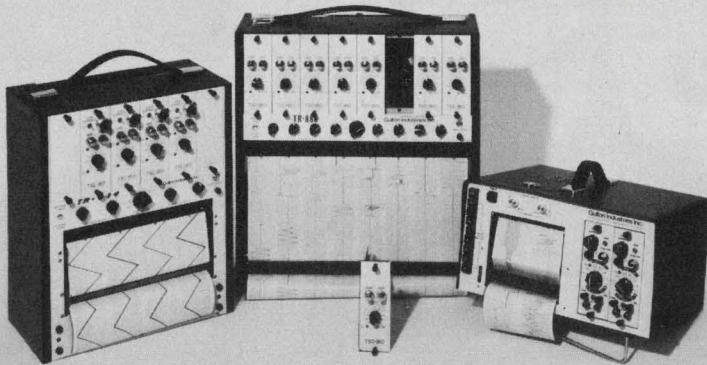

On any Gulton 2, 4, 6 or 8 channel portable with standard signal conditioners. Gulton portables are the lightest, smallest and most versatile medium frequency oscillographic recorders available. A wide range of quick-change plug-in signal conditioners permit recording of volts, amps, temperature, EKG, strain, ac to dc, log to dc, etc. Write or call for 12 page portables catalog.

gulton®

Measurement & Control Systems Division
Gulton Industries Inc., East Greenwich, Rhode Island 02818
401-884-6800 • TWX 710-387-1500

CIRCLE NUMBER 59

ION IMPLANTED Tuning Diodes 2 to 500 pF

Design in Implion® hyperabrupt and abrupt tuning diodes which offer superior capacitance swings, reproducibility and reliability. Tailored for octave or linear tuning in communications and test equipment.

Send for our catalog including selection guide and electrical characteristics as well as information on PIN diodes and low avalanche zener diodes or call 617-273-1730.

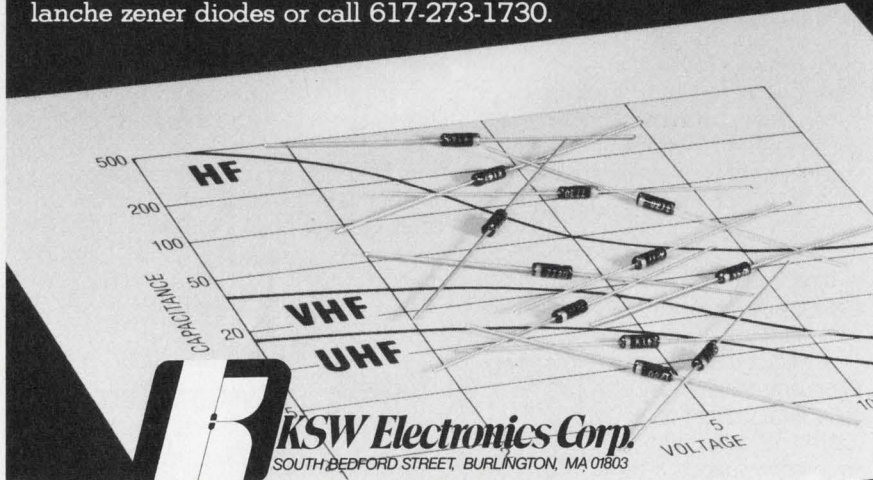

KSW Electronics Corp.
SOUTH BEDFORD STREET, BURLINGTON, MA 01803

CIRCLE NUMBER 60

COMPONENTS

Indicator lights offer wide variety of lenses

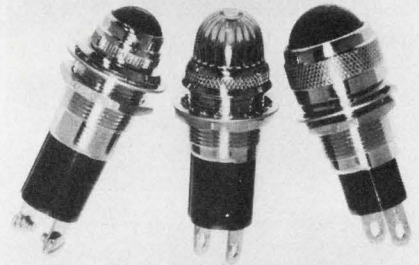

Dialight, 203 Harrison Pl., Brooklyn, NY 11237. (212) 497-7600. \$0.87 to \$2.00 (1000-qty); stock.

Indicator lights with five different lens styles are offered with a variety of lens-finish options. Lenses may have stovepipe, dome, convex, flat or cylindrical shapes. Finish options are transparent, translucent, internally fluted, back frosted and matte back. The lights use incandescent lamps and operate over the voltage range from 2 to 120-V, ac or dc. Lens colors available are red, green, blue, amber, light yellow and either translucent white or clear colorless, depending upon the lens finish. Lens caps made of high-temperature plastic are available for units using lamps of 2-W or greater.

CIRCLE NO. 345

Self-amplification used in pressure transducer

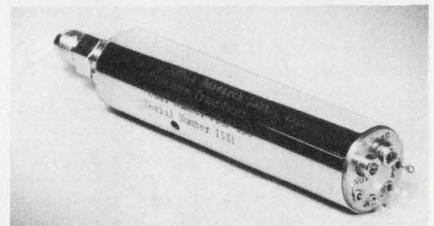

Columbia Research Labs, McDade Blvd. and Bullens Lane, Woodlyn, PA 19094. William Mansfield (215) 532-9464. \$55 (1000-qty); stock-4 wks.

Signal conditioning electronics is not required to operate PDC-series self-amplifying pressure transducers. Output voltage from the units is proportional to the pressure in ranges from 0.01 to 10⁵ lb/in.² Incorporated into the transducers are 2 pots—a span pot to normalize sensitivity and a null pot to give a minimum signal under all conditions. The units require only an external LVDT used as a sensing element for operation.

CIRCLE NO. 346

ELECTRONIC DESIGN 20, September 27, 1977

The IC Switching Regulator that has everything!

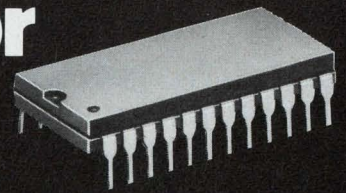

The Ferranti Model ZN1066E Pulse Width Modulator for use in: Switching Regulated Power Supplies, Motor Speed Controllers, DC/DC Converters and much more.

Features:

- High Efficiency
- 0-100% duty cycle control
- Zero overlap of external output transistors guaranteed
- Single ended or complimentary output drive
- Up to 120 mA output drive
- Output frequency adjustable to 500 KHz
- On-chip amplifiers for voltage and current control

- Short circuit protected
- 2.6 V stable reference, ± 50 PPM/ $^{\circ}$ C
- Soft start capability
- Inhibit and synchronizing inputs
- Major circuit functions externally accessible

better by design



FERRANTI
semiconductors

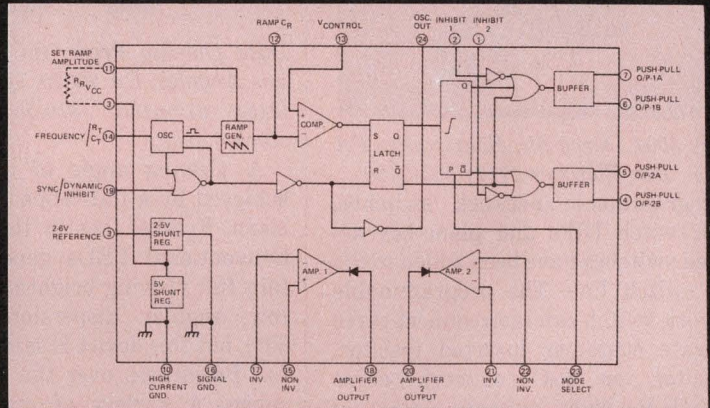

FOR COMPLETE SPECIFICATIONS, CONTACT: FERRANTI ELECTRIC, INC. / SEMICONDUCTOR PRODUCTS EAST BETHPAGE ROAD, PLAINVIEW, NEW YORK 11803 PHONE: (516) 293-8383 / TWX: 510-224-6483

CIRCLE NUMBER 61

All new TD Series power supplies

Reliable enough for microprocessors.
Economical enough for general purpose use.

- 45 different models; 5 to 250 volts.
- Single, dual, and triple outputs.
- 115 or 230 VAC input; 50 or 60 Hz.
- Regulation: 0.05% line; 0.1% load.
- Remote voltage sensing (most models).
- Automatic foldback current limiting.

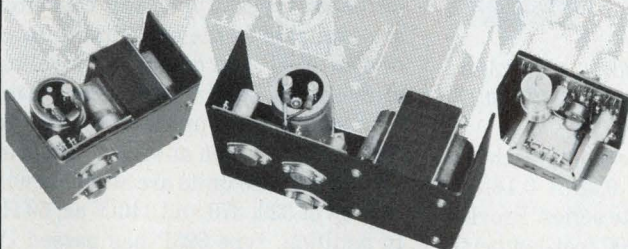

Ambac † **Tele-Dynamics**

Write or call for facts and specs.

Tele-Dynamics Division
Ambac Industries Inc.
525 Virginia Drive
Fort Washington, Pa. 19034
215-643-3900

CIRCLE NUMBER 62

ELECTRONIC DESIGN 20, September 27, 1977

Buzzzzz. (Write for new catalog.)



Solid state electronic MICRO-BUZZER from CITIZEN: High reliability, competitively priced with immediate delivery.

A complete range: **SMB** 1.5, 6, 12, 24, VDC
RMB 3, 6, 12, 24, VDC
IMB (Intermittent) 6, 12, VDC

CITIZEN

CITIZEN AMERICA CORPORATION
1710 - 22nd St.
Santa Monica,
CA 90404

Toll Free (800) 421-6516
In Calif. (213) 829-3541
TWX: (910) 343-6450

Name _____
Company _____
Address _____
City _____ State _____
Zip _____ Phone _____

CIRCLE NUMBER 63

DIP switch line gets three new models

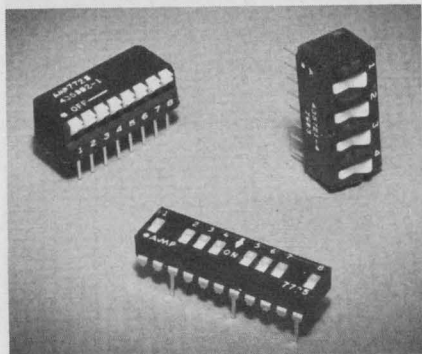

AMP, 3901 Derry St., Harrisburg, PA 17105. Jim Pletcher (717) 564-0100.

Programmable network switches, LED/switch DIPs and piano-key actuated switches have been added to the DIP switch line. The programmable network switch can interconnect three separate customer inserted resistor, capacitor or R-C network chips through its eight switches. Inserting programmed time delays or impedance levels in digital circuits is an application for the device. LED switches consist of one to six sets of SPST switches with associated GaAsP LEDs in a single DIP. Each switch and LED is electrically independent. Both snap-action and momentary-contact versions are available.

CIRCLE NO. 347

Solid-state transducer is option oriented

Bourns, 6135 Magnolia Ave., Riverside, CA 92506. (714) 781-5182.

Options available on the model-2900 solid state pressure transducer allow the user to design the unit to his individual requirements. Standard-price choices include: Ac or dc power inputs, zero balances of ± 1 , ± 2 , or ± 4 -mV, span of ± 5 or ± 10 -mV and temperature-coefficient accuracy of ± 1 , ± 2 or $\pm 4\%$. In addition, 3 different electrical connections and a number of process connections are offered. The units register pressures referenced to either absolute (PSIA), gage (PSIG) or sealed (PSIS) pressure. A solid-state sensor and a four-element piezoresistive silicon semiconductor bridge make up the working portion of the transducer.

CIRCLE NO. 348

Wide-angle viewing with Fresnel-lens LED

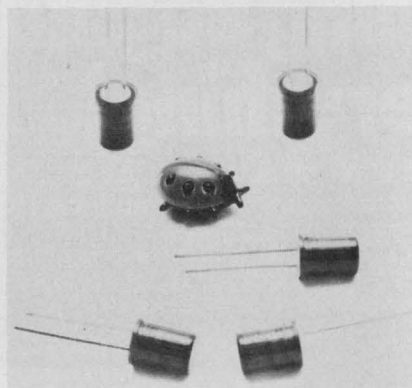

Data Display Prod., P.O. Box 91072, Los Angeles, CA 90009. Qamar Lodhie (213) 677-6166. \$10.56 (1000-qty); stock-6 wks.

A viewing angle of over 180° is achieved by a flat-topped, cylindrical, lexan, Fresnel lens in the Ledy Bug. Conventional LEDs generally maintain full viewing brightness over narrow angular dispersions (typically 30°), but this device is said to maintain full brightness over the much larger range. A variety of mounting configurations are available—panel mounting clips, bushings or sockets. The unit can also be soldered directly to PC boards with a flat at the base of the lens designated as the cathode. Dimensions of the lens are 0.28×0.203 in. dia.

CIRCLE NO. 349

Incandescent display uses limited space



Readouts, Inc., P.O. Box 149, Del Mar, CA 92014. Jack McKim (714) 755-2641. \$4.05 (1000-qty); stock.

An incandescent readout, with an over-all size of $0.5 \times 0.38 \times 0.14$ in., is designated the Petite series. Providing a brightness of 4000 foot-lamberts at 4 V, each segment of the 7-segment device draws 15 mA. Life expectancy for the units is 100,000 hrs. The display itself measures only 0.31×0.2 in. and is designed for good viewing in high ambient-light conditions.

CIRCLE NO. 350

Fuseholder, switch, light in single package

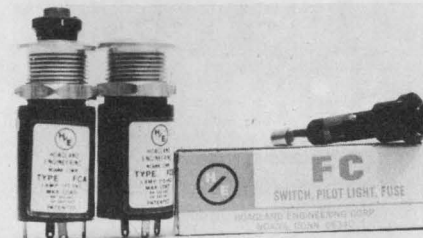

Hoagland Engineering, P.O. Box 177, Noank, CT 06340. (203) 536-4027.

One panel-mounted device combines the functions of fuseholder, switch and pilot light. The UL listed device, type FC, comes in styles with voltage ratings from 6 to 230-V, ac and dc. Two basic types are available—one has 2 isolated circuits for contacts and pilot light and the other has a dual circuit for contacts and light. Both types have the fuse circuit in series with the main contacts. Mounting sizes include $\frac{1}{2}$ and $\frac{3}{4}$ in. holes, with various ferrules and mounting nuts. Type 3AG standard instrument fuses, or any $\frac{1}{4}$ -in. dia. \times 1.25-in. long fuse can be used.

CIRCLE NO. 356

Low-loss ac capacitors replace oil/paper types

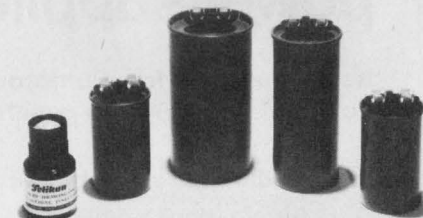

Sprague Electric, 347 Marshall St., North Adams, MA 01247. (413) 664-4411.

Low-loss metallized-polypropylene ac capacitors are designed to replace oil/paper types. Type 315P capacitors are available in the capacitance range of 4 to 60 μ F and operate at a voltage of 300-V ac, 60 Hz. A biodegradable liquid fill is used in the type 325P for corona suppression at higher operating voltages. These units are supplied with ratings of 330, 370 and 440-V ac, 60 Hz. In addition, type 325P has passed UL tests and has been granted component recognition under File E13806. Both units feature an internal pressure interrupter to disconnect the capacitor element should excessive pressure develop inside the case.

CIRCLE NO. 357

ELECTRONIC DESIGN 20, September 27, 1977

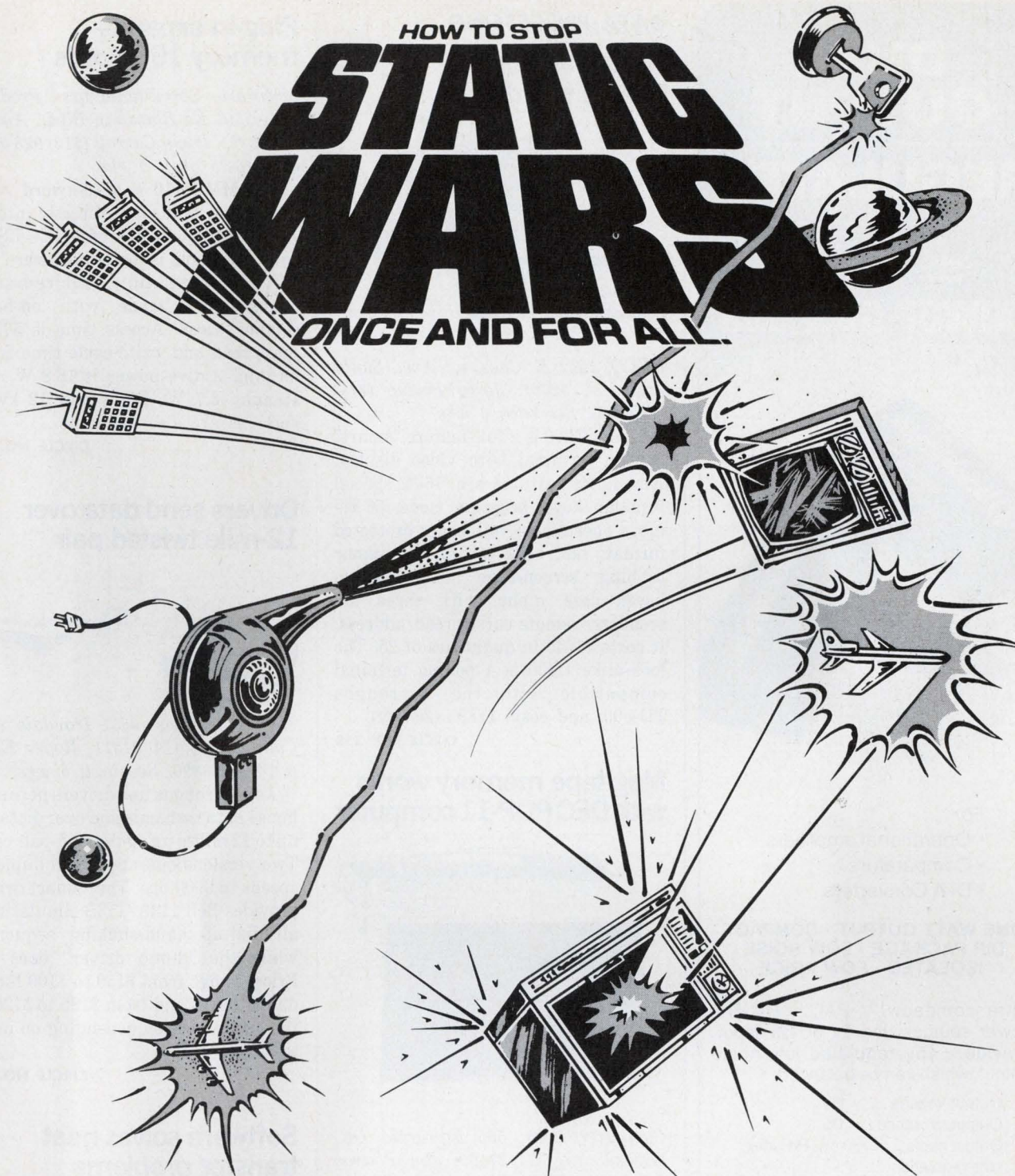

Electromagnetic interference. The hair dryer zaps the TV with it. The auto ignition zaps the ambulance radio. And the CB radio zaps the stereo. Why, we ask, must these senseless Static Wars go on and on forever?

We at Acheson ask you to join together in lasting peace. Now, the easiest way to handle the problem of housings emitting or admitting EMI is to use protective coatings. And the most practical, cost-effective EMI protective coating is Electrodag® (From 1 MHz to 10 GHz it provides a protective shield from 25dB all the way to 70+ dB).

Foil, plating, and vacuum metalizing may be suitable for small, flat surfaces. But when it comes to complex shapes

or large parts, Electrodag EMI shielding is the most practical solution. It doesn't require sending parts out for plating, metalizing, and so forth, because lightweight, easy-to-apply Electrodag can be sprayed right in the shop.

The result is a glove of skintight protection no matter how big the part, no matter how complex the shape.

If you have an EMI problem, we'd like to discuss it with you. Then we can all unite together under the protective Electrodag shield and finally silence the skies of our planet ...now and for all time.

Call or write Acheson Colloids Company, Electrical Products, Port Huron, Michigan 48060. 313-984-5581.

DUAL OUTPUT REGULATED

± 15v DC power sources

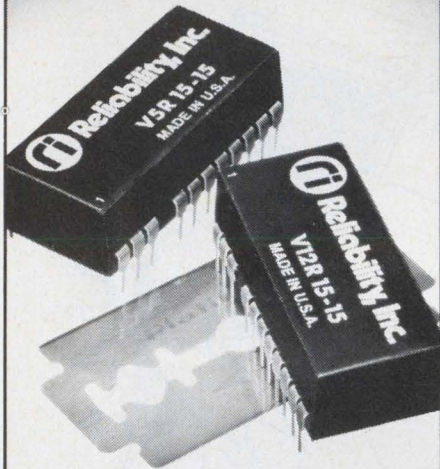

For...

- Operational amplifiers
- Comparators
- D-A Converters

**ONE WATT OUTPUT • COMPACT
DIP PACKAGE • LOW NOISE
ISOLATED • LOW PRICE**

Ultra compact "V-PAC" *DC-DC power sources use 5v or 12v input, provide ±15v regulated low noise output, which can be balanced.

Output Voltage ___ ± 15v
 Output tolerance ___ ± 5%
 Output ripple ___ 30 mv, P-P max.
 Line regulation ___ .3%
 Load regulation ___ .3%
 Operating temp ___ 0° to 70°C
 Isolation ___ 10 MΩ @ 50v
 Price ___ \$20.20 (100 pcs)



Reliability, Inc.

5325 Glenmont/Houston, Texas 77036
 713-666-3261/TWX: 910-881-1739

International: Reliability Nederland, B. V.
 Summerhill, Nenagh, Co. Tipperary, Ireland

*Trademark, Reliability, Inc.
 Price subject to change without notice

CIRCLE NUMBER 65

DATA PROCESSING

Editing terminals handle text data



EECO, 1441 E. Chestnut Ave., Santa Ana, CA 92701. Jerry Pisano (714) 835-6000. See text; 6 wks.

Model D300 is a full-feature "smart" editing terminal with video display. Among its features are: 16-32 special function keys; program mode; 56 remote operations; roll/page; protected format; tab, back tab and columnar tabbing; screen-edge mode display; lower case alpha with three descenders; remote cursor read/address. It costs \$1645 in quantities of 25. The look-alike D400 is a polling terminal compatible with the Burroughs TD-800, and costs \$1895 (25 qty).

CIRCLE NO. 358

Mag-tape memory works with DEC PDP-11 computer

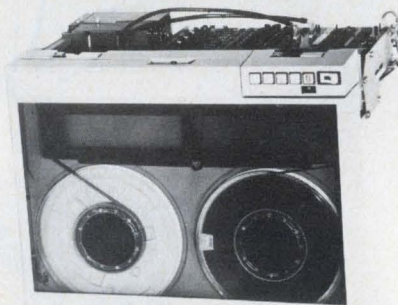

Computer Labs, 505 Edwardia Dr., Greensboro, NC 27409. Jim Poitras (919) 292-6427. \$8350; 4 to 6 wks.

Incorporating a 75-in/s magnetic tape transport, the T9000 Magnetic Tape Memory System permits complete PDP-11 system integration without any software changes. The 9-track PDP-11-compatible controller is available in either an 800-bits/in NRZI version, or one using both NRZI and 1600-bits/in. phase-encoded formats. It runs RSX-11, RT-11 and DOS unaltered, and is also TM11/TU10 compatible. The T9000 has the same device starting address as the DEC unit, assuring an error-free boot.

CIRCLE NO. 359

Plug-in expands memory 16 kwords

Motorola Semiconductors Products Inc., 3501 Ed Bluestein Blvd., Austin, TX 78721. Irwin Carroll (512) 928-2600. \$865 (6-25 qty); 2 wks.

The MMS1110 is a 16-kword × 16-bit system that plugs directly into the H9270 backplane slot of a DEC LSI-11 computer and is both hardware and software-compatible. Address-select changes are made with on-board jumper wires. Access time is 575 ns max, read and write cycle time is 750 ns min. Active power is 16.8 W max, standby 6.7 W. Eight and 12 kword versions are also available.

CIRCLE NO. 360

Drivers send data over 12-mile twisted pair



Micom Systems, 9551 Irondale Ave., Chatsworth, CA 91311. Roger Evans (213) 882-6890. See text; 6 wks.

Asynchronous line drivers permit in-house data transmission over distances up to 12 miles, using twisted-pair cable. Two versions operate in full duplex at speeds to 9600 bps: The "smart driver" provides Bell 113A/113B simulation of all dial-up hand-shaking sequences, while the "dumb driver" does not. Prices range from \$150 to \$100 for the dumb driver and from \$185 to \$120 for the smart version, depending on quantity.

CIRCLE NO. 361

Software solves heat transfer problems

Technical Consultants, 7701 Normandale Rd., Minneapolis, MN 55435. Richard Sampson (612) 835-2388.

Software, called Thermal, provides solutions to more than 600 of the most frequently encountered heat transfer problems. Thermal covers conduction, natural convection, radiation, boiling, condensation and combined modes. All tasks in a thermal analysis are automatically carried out. A typical program provides unit conversions, thermal property values, calculations and a report of the analysis.

CIRCLE NO. 362

Your New Microprocessor Power Supply will need to be custom designed...Right?

But it takes a long time to design and build a Power Supply for Microprocessors... and it costs a lot of money...Right?

Right.

Wrong. At KELTEC FLORIDA we build high efficiency multiple-output power supplies to outlast and out-perform "off-the-shelf" units.

We've developed a proven series of power supplies ideal for microprocessor applications that can be easily tailored to your individual specs. Quickly...no lengthy development phase, at a great savings to you.

Plus, you're offered a choice of input voltages, output current levels, and packaging configurations.



CHOOSE THE SPECS. YOU NEED:

INPUTS AVAILABLE	OUTPUT CURRENTS AVAILABLE
115 VAC 47-400 Hz	+ 5 VDC @ 2 to 10A
230 VAC 47-400 Hz	- 5 VDC @ 0.5 to 3A
24, 36 or 48 VDC	+ 12 or + 15 VDC @ 0.5 to 2A
115 VAC w/Battery Backup	- 12 or - 15 VDC @ 0.5 to 2A

CONSTRUCTION: Fully Enclosed, Open Frame, or PC Mount (depending on output power).

EMI/RFI: Input and Output filtering custom designed as required.

REGULATION: Typical specs. are 0.5% or 1% for + 5 VDC; and 2% or 3% for - 5, + 12(15), and - 12(15) outputs; line, load, and temp.

RIPPLE & NOISE: 1% P-P

EFFICIENCY: 65-75% depending on input and output power chosen.

Aiken Industries
Keltec Florida Division

P. O. Drawer 1348
Fort Walton Beach, Florida 32548
(904) 651-1210 • TWX 510-730-7775

If you don't see what you need... specify it your way. Very powerful reasons for making the power supply for your next microprocessor application one of KELTEC FLORIDA's rugged, powerful, dependable and versatile units.

The right power supply for your needs.

Call Larry Thompson — the right man to help you with your needs.

DATA PROCESSING

Graphic information digitized automatically

Broomall Ind., 700 Abbott Dr., Broomall, PA 19008. Richard Stover (215) 328-1040.

Four progressively larger Scan-Graphics systems automatically scan, process, store and display graphic material 12 x 18 in. (optionally up to 54 x 76 in.) Documents can be edited, updated and modified. Output can consist of points, lines, intersections, polygons, area and centroids of polygons, line-width data and black area fill-in. Some of the systems operate independently of a mainframe computer, thus saving expensive data processing time.

CIRCLE NO. 363

Board joins computer to video monitor

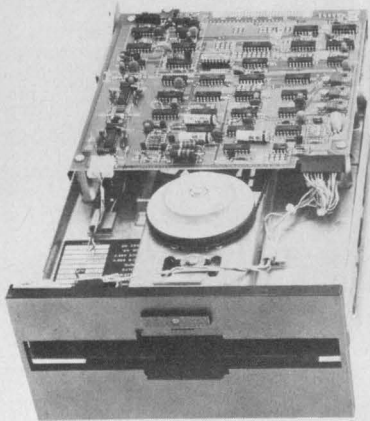

Computer Technology, 6043 Lawton Ave., Oakland, CA 94618. (415) 451-7145. \$495 (25-49).

The Viuram-L11/16 is an alphanumeric video interface that connects a Digital Equipment Corp. LSI-11 microcomputer to a standard video monitor. The Viuram appears to the computer as 1024 words of memory, each corresponding to a character position on the display. The board provides a display of 16 lines, each with 64 characters using a 7 x 12 dot matrix. Display characters include the 96-character USASCII set plus 32 special symbols, with positive or reverse video. A jumper option adds a blinking or half-bright mode by limiting the display to the 64-character ASCII set. The Viuram occupies half slot in the LSI-11 backplane and connects to the video monitor via a coaxial cable.

CIRCLE NO. 364

Floppy discs can be loaded automatically

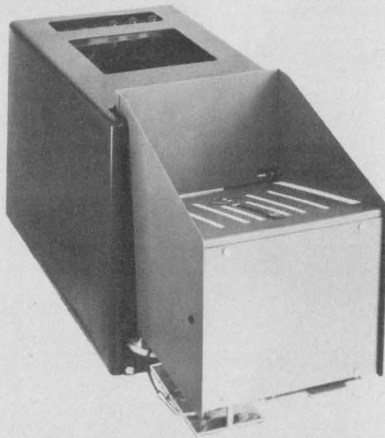

General Systems International Inc., 1440 Allec St., Anaheim, CA 92805. (714) 956-7183. \$3500, 60 days.

The Model H155 autoloader permits processing of up to 30 diskettes without operator assistance. Data can be transferred from cards, cassettes or tape to sequential diskettes, or data can be handled when more than one diskette is required to store information. Cycle time to load and unload the drive is less than 1 sec., and the H155 can separate accepted and rejected diskettes into two self-contained bins.

CIRCLE NO. 365

50-megabyte disc drive has removable cartridge



Fujitsu America, 2945 Oakmead Village Ct., Santa Clara, CA 95051. Saburo Adachi (408) 735-0735. See text.

In the M2201 front-loading disc drive, all of the data (up to 50 Mbytes unformatted, 40 Mbytes, formatted) are contained on two discs within the cartridge. The removable disc contains four times as much data as other single-disc methods, and no internal, nonremovable media are required. A linear actuator provides fast access times of 6 ms track to track, and 30 ms average. Deliveries are scheduled for 1978. Price in 100-quantities will be \$3900 for the drive, \$215 for the cartridge.

CIRCLE NO. 366

Record 1600-kbytes on ferrite recording head

Tandon Magnetics, 20731 Prairie St., Chatsworth, CA 91311. Gerald Lembas (213) 998-8877. \$50 (OEM-qty); 30 days.

An IBM-compatible, double-sided ferrite recording head, Series 200, is used with floppy-disc drives. The head meets the requirements of double density recording, providing up to 1600-kbytes of unformatted storage on a single diskette. Recording on both sides of the head provides an advantage to the system operator since the need to flip a diskette is eliminated. It also allows increased data storage capacity and minimizes the investment in diskettes. The heads are available either unmounted or mounted and aligned in a users cartridge. They feature tunnel erase and have the same electrical characteristics as industry-standard single-sided heads.

CIRCLE NO. 367

Smart cards communicate with computers

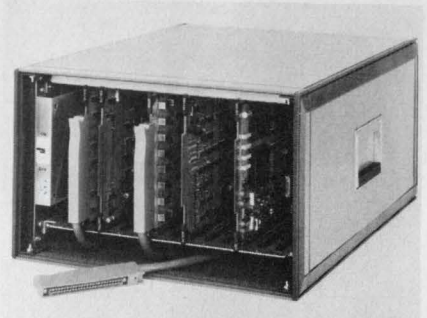

Computer Data Systems, 186-58 Homestead, Morrison, CO 80465. Mike Casey (303) 697-8014. \$4000-\$9000; 8 wks.

Building blocks comprising the 53A ASCII Party Line System consist of programmable "smart" PC cards, housed in a mainframe, that communicate with calculators, computers and microprocessors via preformatted ASCII characters. The cards use the decimal notations and standard formats expected by the user's application programs and appear to the user's system as either a high-speed teletype or an IEEE-488 bus instrument. Card functions include IEEE-488 compatibility, digital data coupling, analog measurement and stimulus, switches and scanners, resistance programming, and clocks.

CIRCLE NO. 368

A-B quality trimmers for the same price as "B" trimmers.

Accept nothing less than Allen-Bradley quality in trimmers, especially when it doesn't cost you any more. The real decision is whether to use our Type 90 or Type D. Both are cermet, single-turn with a choice of top, side or through-the-board adjustment.

We have what you need; our distributors have it when your need is now. Ask for Publication 5242 (Type 90) and 5240 (Type D).

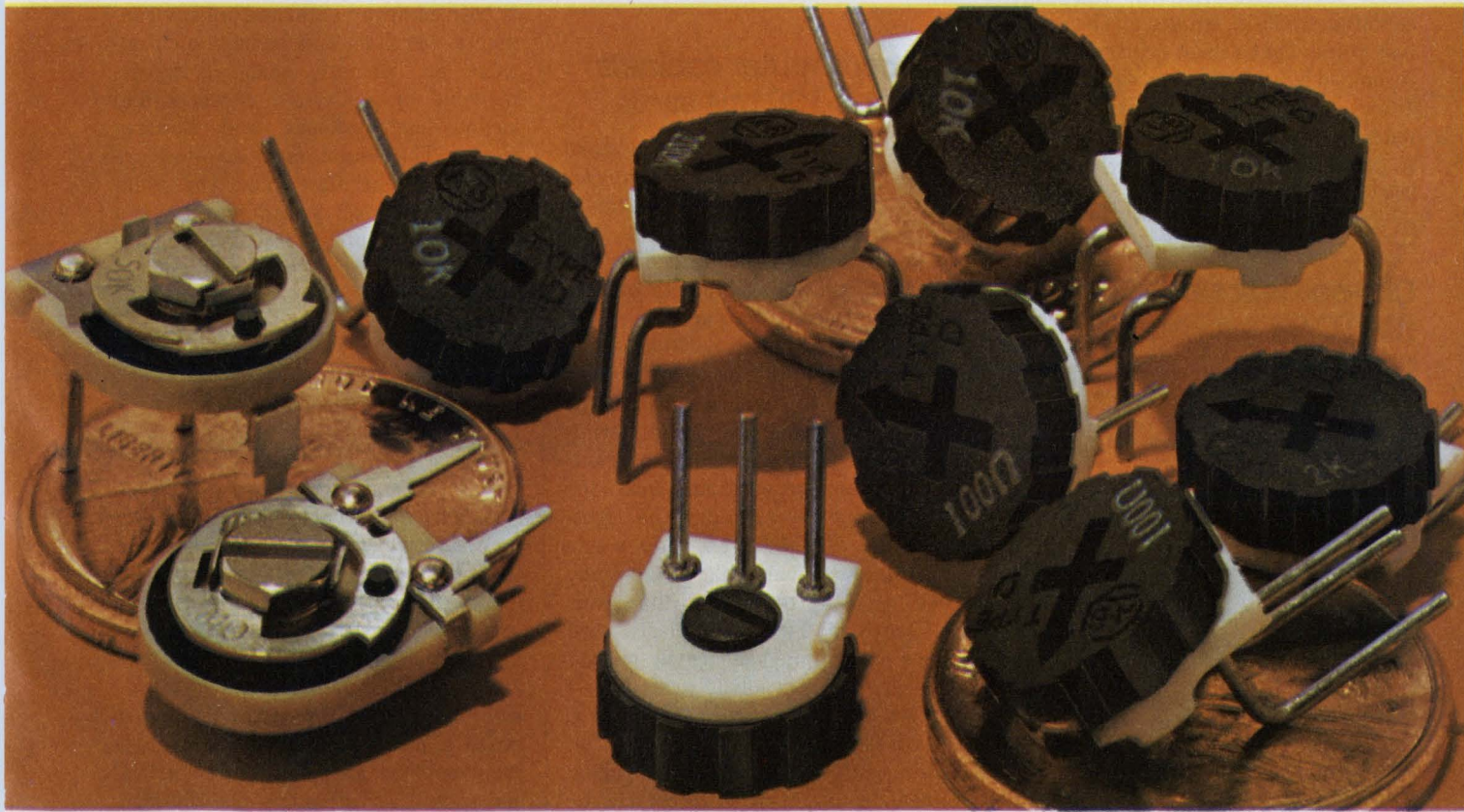
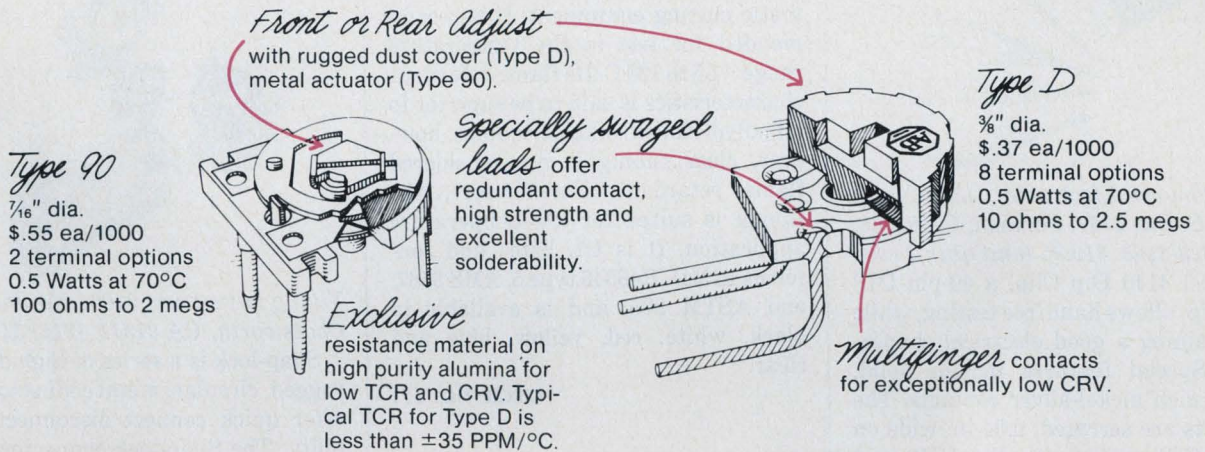

Quality in the best tradition.



ALLEN-BRADLEY
Milwaukee, Wisconsin 53204

CIRCLE NUMBER 67

PACKAGING & MATERIALS

40-pin DIP test clip eases LSI testing

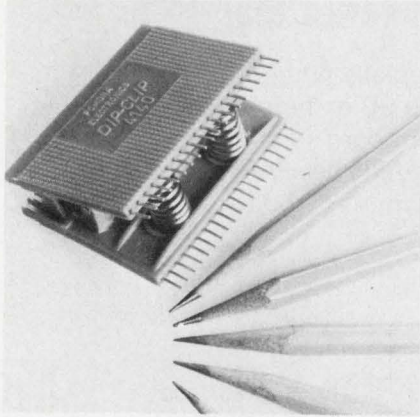

ITT Pomona Electronics, 1500 Ninth St., P.O. Box 2767, Pomona, CA 91766. (714) 623-3463. \$19.95 (unit qty); 2 wks.

Model 4140 Dip Clip, a 40-pin DIP test clip, allows handfree testing, while maintaining a good electrical connection. Special features include solid, nontarnish nickel-silver contacts. The contacts are serrated, 0.04-in. wide on those that mate with the DIP, and serrated, 0.025-in. square on the upper test points that accept mini test clips. A molded barrier between each contact allows connecting to live boards without danger of accidental shorting. A glass-filled nylon body withstands 240 C at 40% RH. The clip also can serve as a DIP-removal tool.

CIRCLE NO. 369

Clip-on heat sink fits TO-92 packages

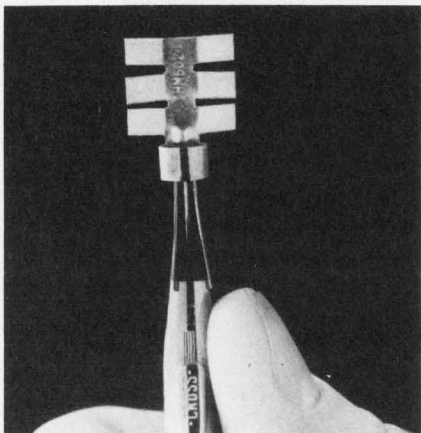

Thermalloy, Inc., 2021 W. Valley View Lane, Dallas, TX 95234. (214) 243-4321. \$0.02 (1000 qty); stock.

Clip-on heat sinks for TO-92 devices, Model 6024, mounts without hardware or adhesives. Thermal resistance in natural convection is 58°C/W. The sink weighs only 0.60 g and is made from solid phosphor-bronze.

CIRCLE NO. 370

Tubing shrinks 50% at 100 C

Cole Flex Corp., 91 Cabot St., West Babylon, NY 11704. (516) 249-6150. Typically \$22.33/100 ft; stock.

A heat-shrinkable tubing line, STL 221, recovers to a predetermined smaller 50% diameter when heat over 100 C is applied. The irradiated, very flexible polyolefin product is supplied on 24-in. corrugated reels. The tubing is suitable for processing through automatic cutting equipment. It is recommended for use in the temperature range -55 to 135 C. Its flame-retardant characteristics is said to be superior to all polyolefin shrinkable tubings; however, clear tubing is not considered flame retardant. Furthermore, the tubing is suited for low-temperature application. It is UL listed and conforms to MIL R46846 type 5, AMS 3587, and ASTM 876, and is available in black, white, red, yellow, blue and clear.

CIRCLE NO. 371

Microcomputer cabinets accept S-100 bus cards

Vector Electronic Co., 12460 Gladstone Ave., Sylmar, CA 91342. Floyd Hill (213) 365-9661. \$128.30 (VP1), \$134.30 (VP2); stock.

Two enclosures, the Vector-Pak VP1 and VP2, allow designers to quickly and inexpensively package their own microcomputers using S-100 bus-compatible cards. Both cases are designed to house 5.31 x 10-in. boards with up to 100 card-edge input/output terminations. The VP2 uses the Imsai front-to-back card orientation with the power supply space along the right-hand side. The VP1 has side-to-side card placement with the power supply location in the rear, as in the Altair configuration. Two dozen plastic card guides are supplied separately so that the user may position 12 cards in any location and with any board spacing. The cases have space for 21 cards on 0.75-in. centers. Adjustable slots allow convenient mounting of receptacles or a motherboard. No cutting or drilling is required for card mounting. Both cases measure 17.85 x 9.01 x 17.1 in. and weigh 15 lb. Optional accessories include a pre-punched rear panel with ten holes for 25-pin "D" type connectors and a power-supply mounting plate.

CIRCLE NO. 372

Quick connect/disconnect offered by circular unit

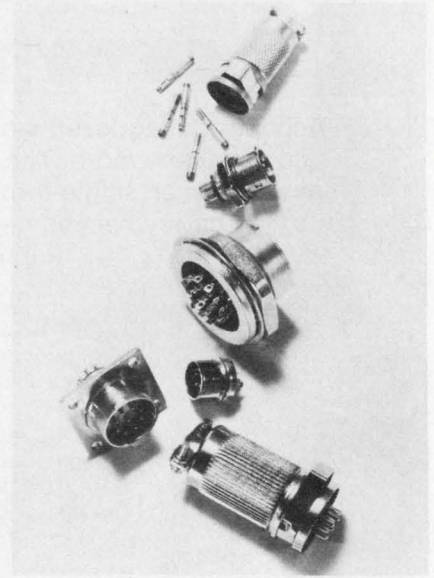

Viking Industries, 21001 Nordhoff St., Chatsworth, CA 91311. (213) 341-4330.

Snap-lock is a series of high density, rugged, circular, metal connectors that offer quick connect/disconnect capability. The Snap-lock connectors come in both environmental and nonenvironmental versions and include such options as hermetic seals, crimp-removable or solder-pot contacts and various-length hoods and plotting sleeves. The insulators in Snap-lock are of diallyl phthalate, and the gold-plated copper-alloy contacts have a current rating of 7-1/2 A. They operate over a temperature range of -67 to +250 F.

CIRCLE NO. 373

No electricity needed for selective solder stripper

Oxy Metal Industries Corp., 75 River Rd., Nutley, NJ 07110. (201) 667-5200.

A selective stripper is now available that can strip tin, lead, and tin-lead alloys from copper and steel without using electric current. Known as Sel-Rex Oxytron Solderstrip 661, it operates at room temperature and is specifically designed for printed circuit board applications where microfinish requirements must be met on the finger tabs after stripping the tin-lead deposit. It is also ideally suited for stripping solder from integrated circuits, transistors, diodes, and other electronic components. The solution is capable of removing 7.5 to 12.5 microns of solder per minute without attacking the underlying copper substrate of PC boards.

CIRCLE NO. 374

Datel's A/D-D/A I/O Peripheral Boards for the NOVA Minicomputers

MODEL ST-NOVA

- ▶ Slides directly into Data General's NOVA Series Minicomputers
- ▶ Includes 64 Single-ended or 32 Differential A/D Channels plus 4 D/A Channels on one board
- ▶ Expandable up to 256 Channels
- ▶ Powerful paper tape diagnostic software included!
- ▶ DMA, interrupt or program control
- ▶ Prices from \$1445

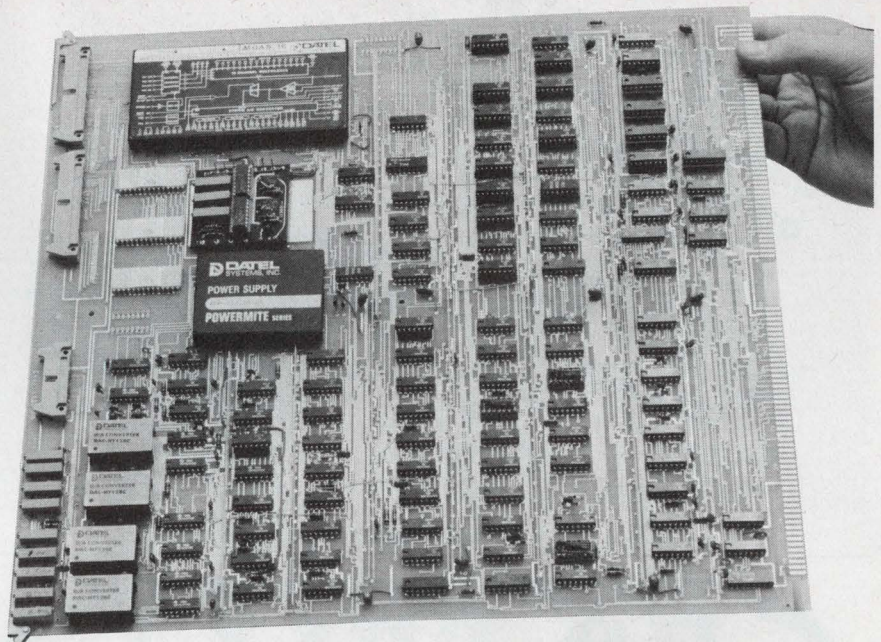

You'll find more specifications on this product and more than 300 data conversion circuits and systems in Gold Book.

Just check Gold Book's Volume 3. That's Datel's complete Engineering Product Handbook, in its own separate volume. More than 290 pages of D/A & A/D Converters, Multiplexers, Sample-Holds, Op Amps, Power Supplies, Digital Panel Meters and Printers, Digital Panel Instruments, Data Loggers, Digital Cassette Recorders, and Data Acquisition Systems. Each fully detailed on individual data sheets. And it's available to you in Gold Book.

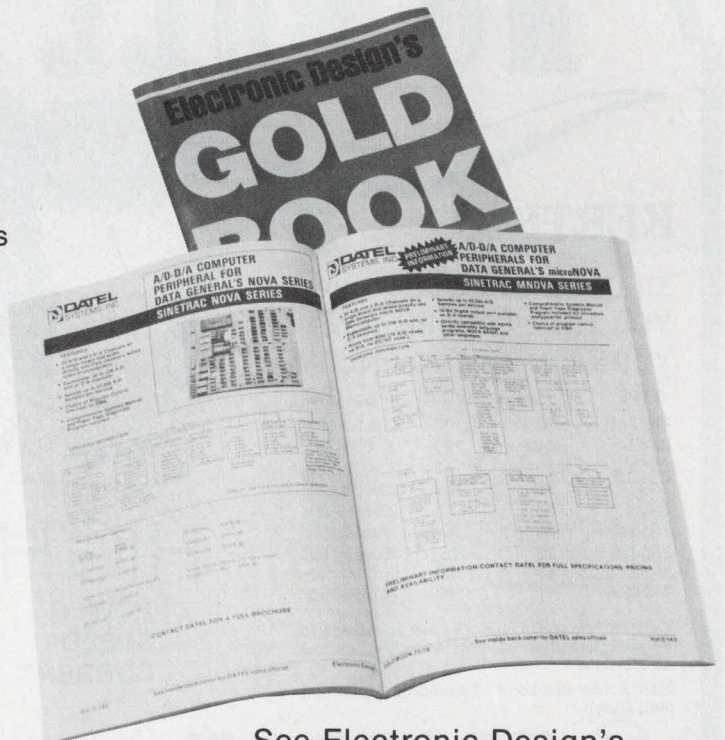

DTEL
SYSTEMS, INC.

1020 Turnpike St., Canton, MA 02021
Phone: (617) 828-8000

See Electronic Design's
1977-78 "Gold Book"-Vol. 3, page 142

Santa Ana, CA (714) 835-2751, (L.A.) (213) 933-7256 • Sunnyvale, CA (408) 733-2424 • Gaithersburg, MD (301) 840-9490 • Houston, TX (713) 932-1130
OVERSEAS: DTEL (UK) LTD—TEL: ANDOVER (0264) 51055 • DTEL SYSTEMS SARL 620-06-74 • DATELEK SYSTEMS GmbH (089) 78-40-45

CIRCLE NUMBER 68



Solderable Heat Sinks

Eliminate costly hand work on your production line.

You can now mount your plastic power devices to Thermalloy solderable heat sinks before board insertion, then solder in place on your automated equipment. Solderable heat sinks save hand labor, improve thermal performance, and protect semiconductor leads. Available for most plastic power packages.

Number one in Semiconductor Accessories



Thermalloy, Inc.
 Post Office Box 34829
 2021 West Valley View Lane
 Dallas, TX 75234 • (214) 243-4321

Free sample and all products catalog with your response

CIRCLE NUMBER 69

NO BULL!

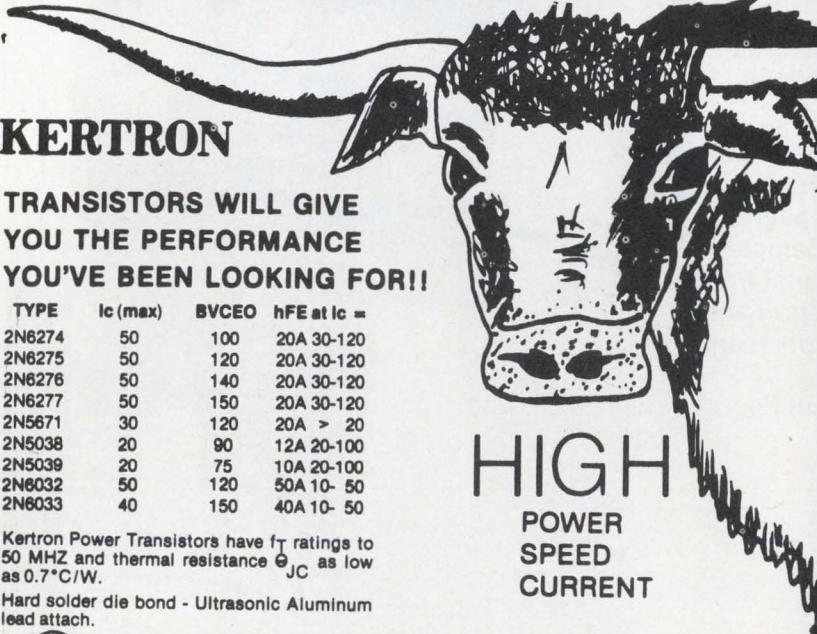

KERTRON

TRANSISTORS WILL GIVE YOU THE PERFORMANCE YOU'VE BEEN LOOKING FOR!!

TYPE	Ic (max)	BVCEO	hFE at Ic =
2N6274	50	100	20A 30-120
2N6275	50	120	20A 30-120
2N6276	50	140	20A 30-120
2N6277	50	150	20A 30-120
2N5671	30	120	20A > 20
2N5038	20	90	12A 20-100
2N5039	20	75	10A 20-100
2N6032	50	120	50A 10- 50
2N6033	40	150	40A 10- 50

Kertron Power Transistors have f_T ratings to 50 MHz and thermal resistance θ_{JC} as low as $0.7^\circ\text{C}/\text{W}$.

Hard solder die bond - Ultrasonic Aluminum lead attach.

HIGH

**POWER
SPEED
CURRENT**



KERTRON INCORPORATED

7516 Central Industrial Dr. Riviera Beach, Fla. 33404 U.S.A.
 Tel. 305/848-9606 TWX 510/952-7611

CIRCLE NUMBER 70

PACKAGING & MATERIALS

Shield plastic housings with metal-spray coat

TAFI Metallisation Inc., Dow Rd., Bow (Concord), NH 03301. (603) 224-9585. See text.

Reduce or eliminate EMI in circuits enclosed in plastic housings with a wire-arc thermal-spraying technique. The method lays down a metal coating even on temperature-sensitive substrates, without heating or warping. The coating is more durable than tapes, pigmented sprays or foils, according to TFA. A specially designed arc-spray pistol feeds two electrically isolated wires. An electric current melts their ends and the molten metal is blown off as fine particles by an air-atomizing jet. A dense, well-bonded coating forms on the plastic part. The hand-held pistol can lay down 48 lb/hr of zinc. One pass can deposit a metal coating from 0.002 to 0.007-in. thick at a cost of less than \$1/ft².

CIRCLE NO. 375

Military ceramic packages commercially available

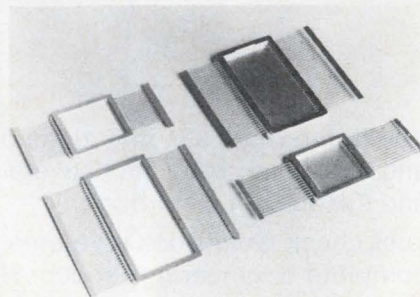

3M Co., P.O. Box 33600, St. Paul, MN 55133. (612) 733-9214.

Commercial manufacturers may now order certain multilayer ceramic hybrid packages which were formerly available only to key military avionics programs. The four basic packages available were formerly available only to programs such as the F-14 and F-15 aircraft and the Tow Cobra missile system. Package parameters include lead counts of 16, 30, 38 and 74. The 16 and 30-lead packages accommodate a 0.75 in. square substrate; the 38 and 74-lead packages accommodate substrates measuring 0.75 by 1.75 in. Lead spacings are on 0.05- or 0.1-in. centerlines.

CIRCLE NO. 376

Datel's A/D-D/A I/O Peripheral Boards for the DEC PDP-11 Minicomputers

MODEL ST-PDP

- ▶ Slides directly into DEC's PDP-11 Minicomputer housing
- ▶ Includes 64 Single-ended or 32 Differential A/D Channels plus 2 D/A Channels on one BB11 Connector Block
- ▶ Expandable up to 768 single-ended or 384 Differential Channels.
- ▶ Powerful paper tape diagnostic software included!
- ▶ DMA, Interrupt or Program Control
- ▶ Prices from \$795.00

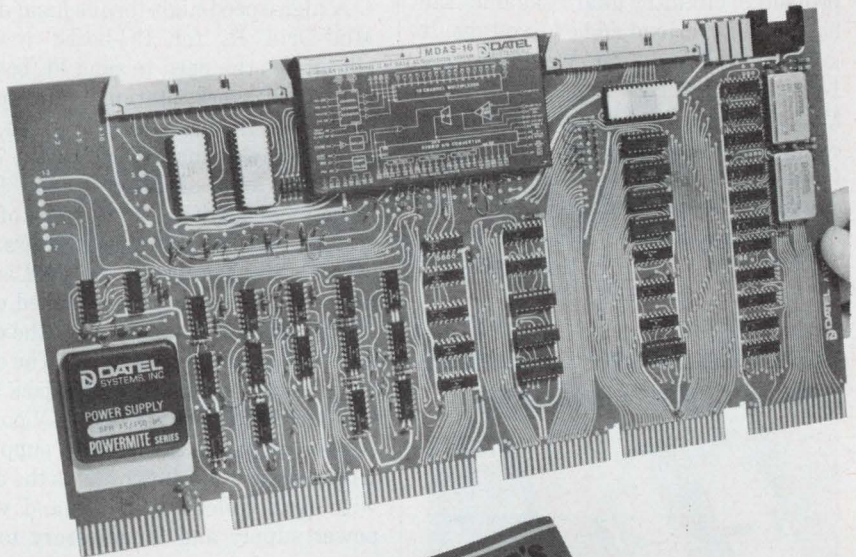

You'll find more specifications on this product and more than 300 data conversion circuits and systems in Gold Book.

Just check Gold Book's Volume 3. That's Datel's complete Engineering Product Handbook, in its own separate volume. More than 290 pages of D/A & A/D Converters, Multiplexers, Sample-Holds, Op Amps, Power Supplies, Digital Panel Meters and Printers, Digital Panel Instruments, Data Loggers, Digital Cassette Recorders, and Data Acquisition Systems. Each fully detailed on individual data sheets. And it's available to you in Gold Book.

D **DATEL**
SYSTEMS, INC.

1020 Turnpike St., Canton, MA 02021
Phone: (617) 828-8000

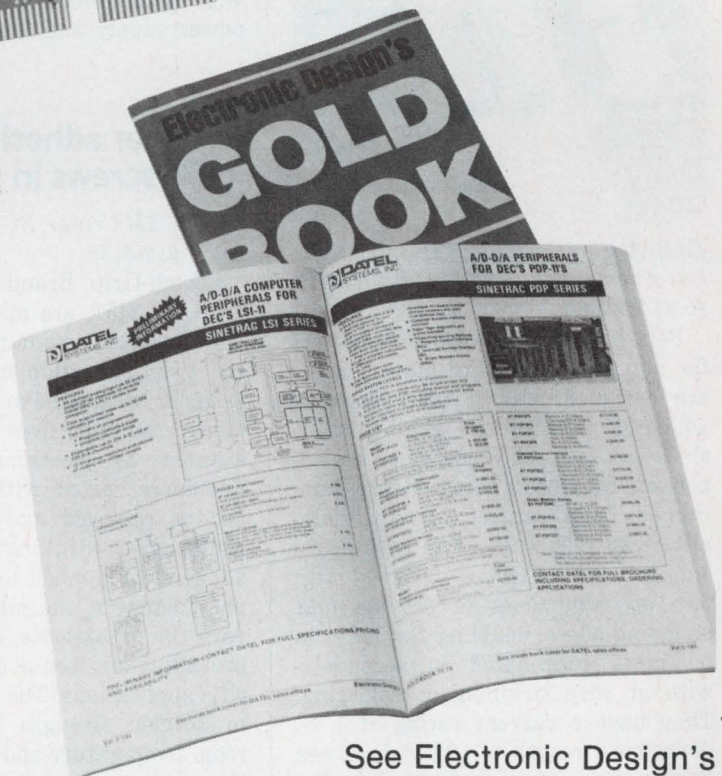

See Electronic Design's
1977-78 "Gold Book"-Vol. 3, page 145

Santa Ana, CA (714) 835-2751, (L.A.) (213) 933-7256 • Sunnyvale, CA (408) 733-2424 • Gaithersburg, MD (301) 840-9490 • Houston, TX (713) 932-1130
OVERSEAS: DATEL (UK) LTD—TEL: ANDOVER (0264) 51055 • DATEL SYSTEMS SARL 620-06-74 • DATELEK SYSTEMS GmbH (089) 78-40-45

CIRCLE NUMBER 71

Dc converter provides regulated output up to 4 A

KGS Electronics, Inc., 2029 N. Lincoln Ave., Pasadena, CA 91103. (213) 798-0786. \$350; unit qty.

A pulse width-modulated dc-to-dc line stabilizer can convert an unregulated 20-to-36-V-dc input to a regulated +28-V-dc output, and up to 4.0 A. Known as the LS-120 it is designed for installation in aircraft and vehicles which requires regulated 28-V-dc inputs to power instruments. Built-in protective circuitry guards against the hazards of overload and overvoltage. It is both small and light. Weighing only 1-1/2 lbs., it is 2.25 x 2.25 x 5.75 in. long. The converter will operate in an environmental temperature range from -55 to +71C. It is factory set to deliver an output voltage of +28 V dc but may be adjusted ± 2 V dc.

CIRCLE NO. 377

Polarized connectors make more contacts available

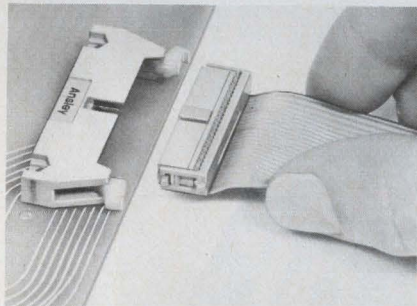

T&B/Ansley Corp., 3208 Humboldt St., Los Angeles, CA 90031. (213) 321-3938. \$0.85/contact.

Polarized female socket connectors for mating to standard male headers are designed with a polarizing tab which permits full use of all contacts since separate polarizing plugs are not needed. They use a patented beryllium copper Tulip contact for maximum electrical reliability. The cylindrical shaped wire contact is designed with two opposing slots to provide four stripping edges, enabling flat cable to be mass terminated in seconds - without wire stripping or soldering. They have a current rating of 1 A, dielectric strength of 500 V dc at sea level, a maximum temperature rating of 105C, and are available in 10 to 60 contact versions.

CIRCLE NO. 378

Miniature hand drill speeds PC-board rework

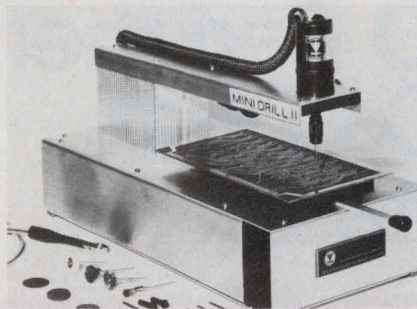

Micro Electronic Systems Inc., 8 Kevin Dr., Danbury, CT 06810. (203) 746-2525. \$199.50: Standard, \$235.50: Super Model (unit qty); 30 days.

A high-speed high-torque hand drill, Mini-Drill II, for PC-board rework eliminates the need to send PC boards to special work stations for repair, change or rework. Its drill stand, including power supply, occupies a 7-1/2-by-15-in. area of bench space. Two basic models with a wide-range of accessory tools come in versatile kits. An outstanding feature of the drill is its deep throat of 8 in. And a coiled cord on the drill allows removal of the drill from the stand for bench use. The cord come with a standard 1/4-in. jack and the unit operates from any 12-V power supply or from the supply supplied with the kit. Each kit contains the drill with four collets, a drill stand with power supply and 30 accessory tools.

CIRCLE NO. 379

Fastener adhesive locks screws in place

3M Co., 3M Center, St. Paul, MN 55101. (313) 646-5458.

Scotch-Grip Brand fastener adhesives, XC2451, are microencapsulated adhesives that remain dormant until the twisting action of installing the fastener breaks the microcapsules and starts the adhesive cure. High resistance to loosening is achieved. Fasteners coated with this adhesive can be removed and reused several times. By controlling the amount of adhesive preapplied to threaded parts and fasteners, the manufacturer can vary the break-loose, break-away and prevailing-out torque required for specific applications. The adhesive begins to develop strength immediately at room temperature and achieves 90% of the ultimate strength in 72 hr. At 160 F, the adhesive cures completely in 60 min on a 3/8-in., 16 x 1-1/4-in. screw.

CIRCLE NO. 380

Connector holding kit available for all types

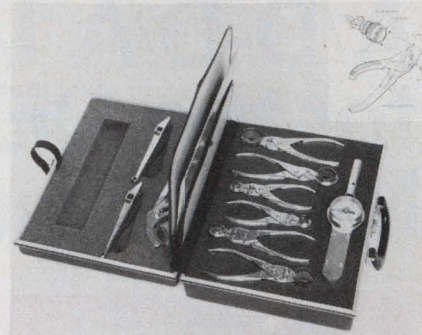

Glenair Inc., 1211 Air Way, Glendale, CA 91201. (213) 247-6000. \$369 (unit qty).

The TG-80 holder kit protects connectors, contact terminations and rear-hardware during assembly and installation. Available for all connector series, the kit includes six universal holding devices for circular, bayonet-coupled and thread-coupled connector plugs. The design is not affected by alternate key or keyway locations. The kit also includes a handy slip-proof strap wrench and soft-jawed pliers.

CIRCLE NO. 381

Soldering pistol eliminates the need for a third hand

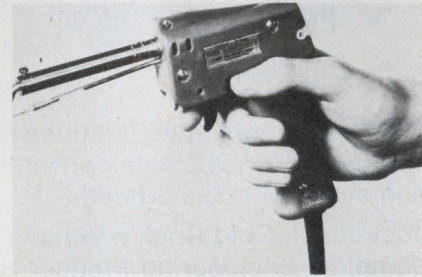

Kager International, Suite 710, 1180 S. Beverly Dr., Los Angeles, CA 90035. (213) 879-1575. See text.

The need for three hands is eliminated with the Kager KL 3000 single handed soldering pistol. Solder is incorporated in the pistol and by simply squeezing the trigger, it is fed to the heated soldering tip. The precise amount of solder required for a particular joint may be selected by simply turning a knob. Cold soldering spots are almost completely eliminated because the object being soldered or the copper lamination surrounding it is heated prior to the application of the solder. The KL 3000 is available with power inputs of 20 to 60 W. A large choice of solder tip designs is also available. 20 and 40 W units cost \$38 while the 60 W pistol is \$45.

CIRCLE NO. 382

Datel's A/D-D/A I/O Peripheral Boards for the M6800 Microcomputers

MODEL ST-6800

- ▶ Slides directly into Motorola's M6800 EXORciser Microcomputer
- ▶ Includes 32 Single-ended or 16 Differential A/D Channels plus 2 D/A Channels on one board
- ▶ Expandable up to 128 A/D and/or D/A Channels
- ▶ Powerful paper tape diagnostic software included!
- ▶ Comprehensive systems manual included!
- ▶ Prices from \$335

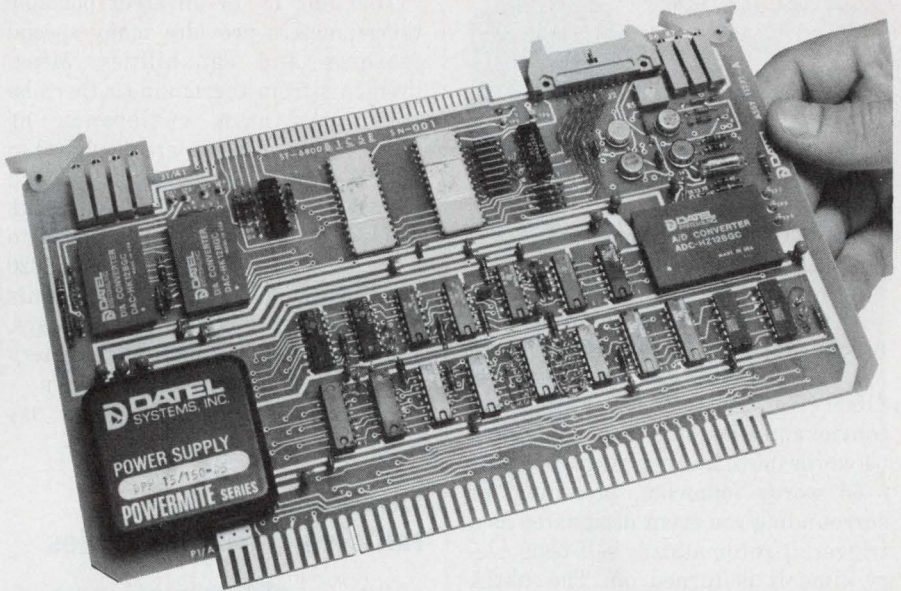

You'll find more specifications on this product and more than 300 data conversion circuits and systems in Gold Book.

Just check Gold Book's Volume 3. That's Datel's complete Engineering Product Handbook, in its own separate volume. More than 290 pages of D/A & A/D Converters, Multiplexers, Sample-Holds, Op Amps, Power Supplies, Digital Panel Meters and Printers, Digital Panel Instruments, Data Loggers, Digital Cassette Recorders, and Data Acquisition Systems. Each fully detailed on individual data sheets. And it's available to you in Gold Book.

 **DATEL**
SYSTEMS, INC.
1020 Turnpike St., Canton, MA 02021
Phone: (617) 828-8000



See Electronic Design's
1977-78 "Gold Book"-Vol. 3, page 146

Santa Ana, CA (714) 835-2751, (L.A.) (213) 933-7256 • Sunnyvale, CA (408) 733-2424 • Gaithersburg, MD (301) 840-9490 • Houston, TX (713) 932-1130
OVERSEAS: DATEL (UK) LTD—TEL: ANDOVER (0264) 51055 • DATEL SYSTEMS SARL 620-06-74 • DATELEK SYSTEMS GmbH (089) 78-40-45

CIRCLE NUMBER 72

INSTRUMENTATION

Low-cost logic analyzer offers IEEE-bus option



Hewlett-Packard, 1501 Page Mill Rd., Palo Alto, CA 94304. (415) 493-1501. \$1800; 4-6 weeks.

Model 1602A logic-state analyzer weighs only 10 lb, is no larger than an average-size briefcase and costs only \$1800. Yet, with F8 microprocessor control and a memory 16-bits wide and 64-words deep, it can capture 64 events—63 words following, preceding, or surrounding the event designated as a trigger; it automatically self-tests every time it is turned on. The 1602A interacts with the user, through its keyboard, pointing the way through every operation. An important feature is optional programmability via the HP Interface Bus (IEEE Standard 488-1975).

CIRCLE NO. 383

Frequency counter kits cover to 1 GHz

Heath Co., Dept. 350-25, Benton Harbor, MI 49022. (616) 982-3417. IM-4110, \$189.95; IM-4120, \$329.95; IM-4130, \$529.95.

Three new frequency-counter kits, the IM-4110, IM-4120 and IM-4130, cover 5 Hz to 110 MHz, 5 Hz to 250 MHz and 5 Hz to 1 GHz, respectively. A red, eight-digit LED indicates the counted frequency. A switchable attenuator on the 110-MHz input divides the input signal by 1, 10 or 100. The time-base switch selects the gate time and the resolution of the display. The 4120 and 4130 time bases are controlled by a TCXO with a temperature stability of ± 1 ppm and an aging rate of < 5 ppm/yr.

CIRCLE NO. 384

Digital thermometers use LEDs or LCDs



United Systems Corp., 918 Woodley Rd., Dayton, OH 45403. (513) 254-6251. \$395 to \$510; available Sept. 1.

This line of 13 different portable thermometers provides many special features and capabilities. Measurements from thermoliner thermistors, platinum resistance or thermocouple sensors are displayed in $^{\circ}\text{C}$, $^{\circ}\text{F}$, or in some models both C and F by switch selection. The 5900 Series resolves to 1 C or F; the Model 5800 to 0.1 C and F, and Models 5810 and 5820 to 0.01 C and F, respectively. The units come with either LCD or LED displays. An internal or external in-line battery charger is standard on all models.

CIRCLE NO. 385

Dual-channel FET handles cross properties

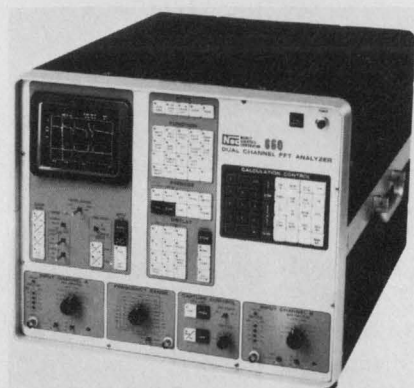

Nicolet Scientific, 245 Livingston St., Northvale, NJ 07647. (201) 767-7100. Starts at \$25,000; 60-90 days.

Model 660 dual channel FFT analyzer seeks the source of unwanted vibration or noise. The microprocessor-based unit is said to be the first complete cross-property unit offering time, frequency and probability functions in a single portable package. Non-repeatable setup of the analyzer is avoided by the storage of nine separate patterns of panel settings for instant recall by number, even if the power has been removed. Specs include 400 resolution elements (800 elements for single-channel operation).

CIRCLE NO. 386

Prescaler stretches counter range to 600 MHz



Sencore Inc., 3200 Sencore Dr., Sioux Falls, SD 57107. (605) 339-0100. \$125.

Model PR47600 uhf frequency prescaler extends the range of any 60-MHz frequency counter to 600 MHz. The prescaler quickly connects between the test lead and a frequency counter and divides the input frequency by 10, so the actual readout is multiplied by 10 to obtain the measured frequency. The PR47 is equipped with a BNC connector cable to adapt directly to the 1-M Ω input jack on any frequency counter. Transmitters may be tuned up to 2.5 times the FCC standards in the uhf range as the PR47 does not change the accuracy of the counter. However, a 1 part per million counter must be used to meet these FCC specs.

CIRCLE NO. 387

Microprocessor DVMs do 16 calculations

Solartron, Victoria Rd., Farnborough, Hants, England. Tel. 44433 Telex 85245.

Microprocessor digital voltmeters process their measurements to display a host of results. Built-in are eight programs that give access to 16 different calculations. A ninth program puts all measurement and processing under time control. Both the 7055, with 5½ digits, and the 7065, with 6½ digits, are 1- μV instruments with variable scale length and a maximum speed of 330 readings per second. Scaling factors, statistical analysis, time, temperature in deg C,—these and many more are controlled from a front-panel keyboard interacting with the display.

CIRCLE NO. 388

If you want really efficient ferrite materials, come to us.

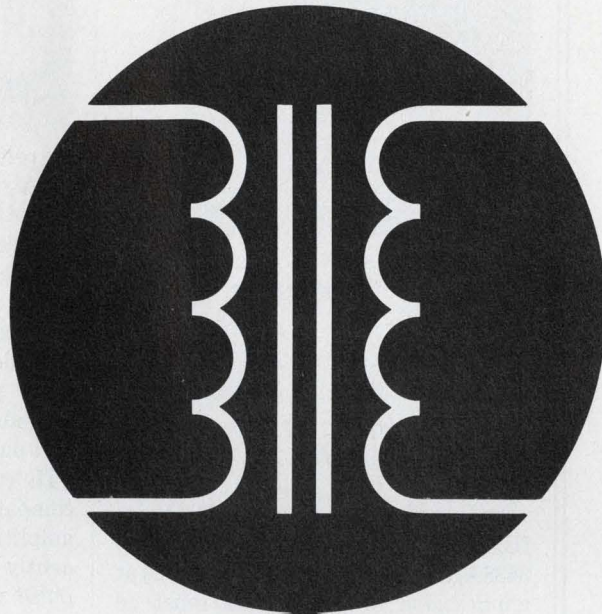

● **H7C1 material**

This high-power material has a higher saturation flux density ($B_s = 5050$) than the H7A material. Very little heat is generated even when used in higher magnetic fields. It's ideal for switching power supplies.

● **H7A material**

Although it has a high saturation flux density ($B_s = 4600$ at 15 Oe), this material also features a relatively high permeability ($\mu_i = 4500$). It's ideal for cores in transformers used in high magnetic fields.

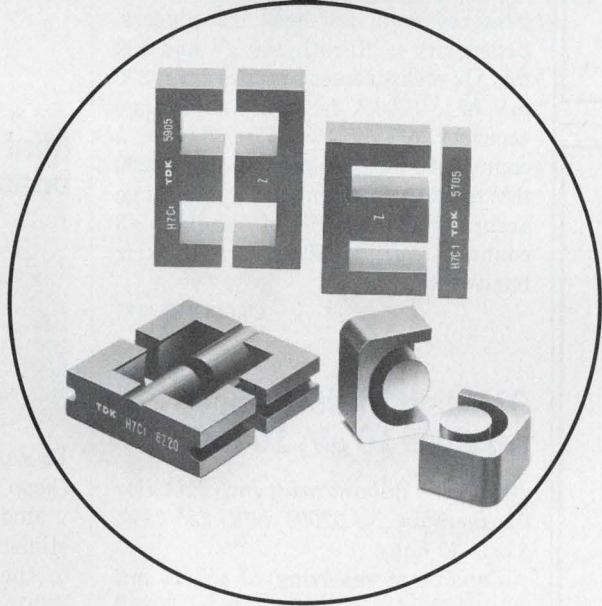

● **H5A material**

This material features low loss up to several hundred kilohertz and a high permeability ($\mu_i = 3300$). The loss coefficient ($\tan \delta / \mu_i$) is 2.5 Max (10 kHz). The material is ideal for hybrid coils and many other types of transformers.

If you want to improve the performance and efficiency of your products, you start with effective transformer design and you probably take a good look around for the best materials, right?

You don't have to look very far, though. We at TDK, specialists in ferrites, have a whole host of materials with superb flux density and low loss characteristics designed especially for transformers.

Our products are the result of original development on raw materials. If you want to improve the design of your transformers, contact us. You'll find we've got just what you want.

Representative in U.S.A. & Canada for telecommunication and industrial use ferrites

MH&W INTERNATIONAL CORP.

14 Leighton Place, Mahwah, New Jersey 07430 U.S.A.

Phone: (201) 891-8800 Telex: 134 484

MH&W INTERNATIONAL (CANADA) LTD.

81 Kelfield Str., Rexdale, Ont. M9W 5A3 CANADA

Phone: 416-245-3606 Telex: 06-965656 TWX: 610-492-2352



TDK ELECTRONICS CO., LTD.

14-6, Uchikanda 2-chome, Chiyoda-ku, Tokyo 101, Japan

If You Have A Question About Your Subscription...

Our circulation records are kept at our fulfillment house — and not in our office. So we are not always able to give you specific answers about the status of your subscription over the phone.

If you ever do have a question, comment, change of address, etc., please drop us a note explaining the problem and be sure to include a mailing label from a recent issue. If you do that you'll save long distance phone calls and help us immensely to solve your problem. We promise to get an answer to you within 5 working days.

Write to:

ELECTRONIC DESIGN
Box 13803
Philadelphia, Pa. 19101
Attn: Circulation Dept.

KEEP

Electronic Design's

GOLD BOOK HANDY

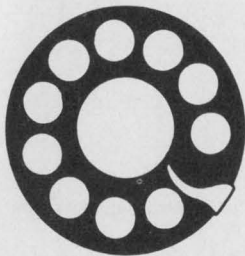

When You Call

Save time when you contact suppliers. Check their catalog pages first in *Electronic Design's* GOLD BOOK. Maybe the information you need is right at your fingertips.

INSTRUMENTATION

DMM talks on IEEE bus, doesn't cost a bundle



Hewlett-Packard, 1501 Page Mill Rd., Palo Alto, CA 94304. (415) 493-1501. \$875; stock.

Designed to be a talk-only DMM for IEEE-488 (HP-IB) systems, the Model 3438A, 3½-digit multimeter is aimed at applications in which data must be gathered from low-level transducers. Sensitivity is 10 mΩ, 100 μV and 100 nA. Dc measurement ranges from 200 mV fs to 1200 V fs, with a mid-range accuracy of ±(0.1% of reading + 1 count). Ac measurement range is 200 mV to 1200 V rms fs with a mid-range accuracy of ±(0.3% of reading + 3 counts) over a 30-Hz to 100-kHz bandwidth.

CIRCLE NO. 391

3½-digit multimeter resolves 10 μV, 10 mΩ

Ballantine Laboratories Inc., P.O. Box 97, Boonton, NJ 07005. (201) 335-0900. \$295. 30 days.

Capable of resolving 10 μV, 10 mΩ or 10 nA, the 3½-digit Model 3028B multimeter provides rms response for waveforms that have up to 10% distortion and crest factors of 1.2 to 1.6. Frequency range is 15 Hz to 110 kHz.

The DMM is protected up to 1200 V on voltage ranges and 285 V (dc plus rms ac) on any ohms range.

In the LO-Ω mode, less than 200 mV is applied for checking in-circuit resistances without turning on semiconductor junctions. In the HI-Ω mode, less than 2 V is applied for semiconductor resistance and quality checks. Measuring current is always limited to less than 1 mA.

CIRCLE NO. 390

Low-cost pulser varies width and delay



Wavetek, 9045 Balboa Ave., San Diego, CA 92123. (714) 279-2200. \$545; 45 days.

Model 802 50-MHz pulse generator, features variable pulse width and delay over the 5-Hz-to-50-MHz operating range. Continuous, triggered, gated and external-width operation are selectable with single, double or complement pulse outputs. Simultaneously available outputs include a ±10-V variable output, a fixed TTL output, a fixed TTL complement output and a TTL compatible sync output. The variable amplitude output features independently adjustable upper and lower pulse voltage levels.

CIRCLE NO. 389

Mini DMM-counter-scope boasts dual-trace

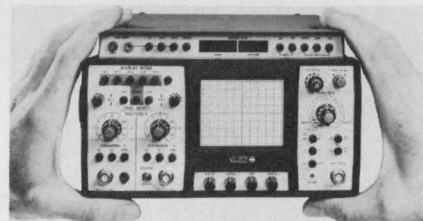

Vu-data Corp., 7170 Convoy Ct., San Diego, CA 92111. (714) 279-6572. \$1895.

Model PS935/975 DMM-Counter-Miniscope is the dual-trace companion to the company's single-trace Model PS915/975. Bandwidth has been increased to 35 MHz from 20 MHz, vertical sensitivity has been doubled from 10 mV/div to 5 mV/div, sweep resolution has been increased from 20 ns/div to 10 ns/div, and the scope trigger range extends from dc to 50 MHz instead of from dc to 20 MHz. Furthermore, the counter frequency range has been extended from 20 MHz to 50 MHz. Other improvements include an increase in CRT acceleration voltage from 2 kV to 5 kV, and an increase in CRT display area from 6 × 10, ¼-in. divisions to 8 × 10, ¼-in. divisions.

CIRCLE NO. 392

**FINALLY... a complete up to date
Printed Circuit Handbook!**

Specifically written for
Engineers, P.C. Designers
and Quality Control,
with 325 pages, and 300
pictures and illustrations
for easy understanding.



This large durable 8" x 10½" hardbound book covers raw materials, design criteria, Q.C. surveys, inspection, how to mfr. boards and much more. It tells the whole printed circuit story, eliminating guesswork and 'hand-me-down' techniques for higher reliability in today's processes.

Price: 1-3 books, \$39.50 ea.; 4-10 books, \$37.00 ea.; over 10 books, \$34.00 ea. (add \$2.50 for C.O.D.).

Make check payable to "Printed Circuit Technology"

printed circuit technology P.O. Box 334
(617) 272-0938 Burlington, Mass. 01803

CIRCLE NUMBER 75

**WALL'S FULL LINE
OF POWER SUPPLIES**



Wall offers a full line of highly reliable, low cost, AC/DC and DC/DC modular power supplies. More than 150 different models to choose from. Input voltages from 5VDC to 28VDC and 105VAC to 252VAC. Output voltages from 5VDC to 3000VDC. All Wall power supplies feature rugged construction, compact size, 40 hour "burn in" and 100% testing of all components. Full year service warranty. Here is the low cost, problem free "answer" to your power supply requirements.

Call or send for free catalog and prices.

WALL Industries Inc.
175 Middlesex Tpk.
Bedford, Mass. 01730
(617) 275-0708

CIRCLE NUMBER 76

ELECTRONIC DESIGN 20, September 27, 1977

FUJI

**HIGH RELIABILITY
NONVOLATILE**

LARGE CAPACITY CORE MEMORY

APPLICATIONS:

- Terminal device
- Industrial control device
- Large capacity internal memory
- Large capacity auxiliary memory
- Block transfer RAM
- Disk, drum replacement
- Intelligent terminals

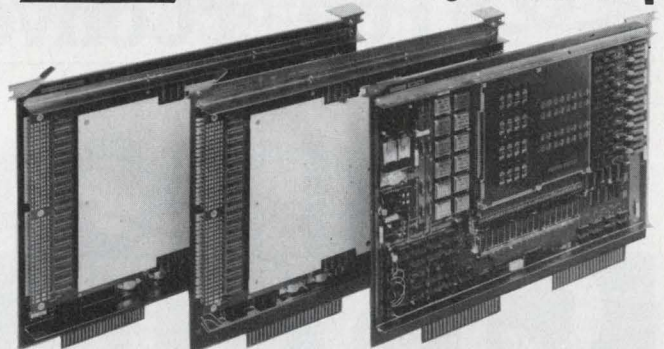

**PLUG COMPATIBLE
128K (BYTES)
64K (1CARD)**

Model	Capacity	Cycle time	Access time
CMS2651(HS)	65K words, 18 bits	1.8 μs	0.8 μs
CMS2651(LS)		3.0 μs	0.8 μs
CMS2804QD(HS)	32K words, 18 bits	750ns	300ns
CMS2804QD(MS)		850ns	350ns
CMS2804QD(LS)		1.4 μs	400ns

FUJI ELECTROCHEMICAL CO., LTD.

HEAD OFFICE 5-36-11, Shinbashi, Minato-ku, Tokyo 105, Japan
TEL: 03-434-1271
U.S.A. OFFICE TEL: 213-323-1134
EUROPE OFFICE TEL: 211-38811
HONG KONG OFFICE TEL: 3-691382

CIRCLE NUMBER 77

Memory Power

Eternacell® 10 year lithium primary battery for semiconductor memories

Don't risk memory failure. Eternacell® high reliability, lithium primary batteries are the ideal standby power source for all types of volatile memory applications. The reasons:

- Steady voltage (2.9 volts per cell) at low continuous current
- Shelf life of up to 10 years
- Highest energy per unit weight and volume
- No recharging
- Hermetically sealed
- Designed for pc board mounting

For complete information and pricing write:
Power Conversion, Inc.,
70 MacQuesten
Parkway South,
Mt. Vernon, N.Y. 10550.
Or call (914) 699-7333

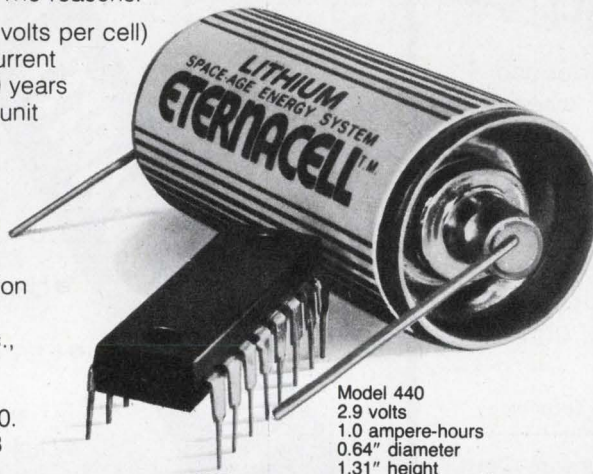

Model 440
2.9 volts
1.0 ampere-hours
0.64" diameter
1.31" height

Power Conversion

CIRCLE NUMBER 78

CRITICAL CRYSTALS

come from M-tron

M Tron specializes in providing quality crystals and design assistance with maximum economy. Complete facilities for production of AT Cut crystals for commercial and military applications from 800 KHz to 200 MHz. Computer-aided design program speeds sample delivery for all types of precision, industrial and commercial applications.

Phone 800-843-6842 or write

M-tron INDUSTRIES, INC.

Box 630, Yankton, South Dakota 57078 A Div. of Lynch Corp.

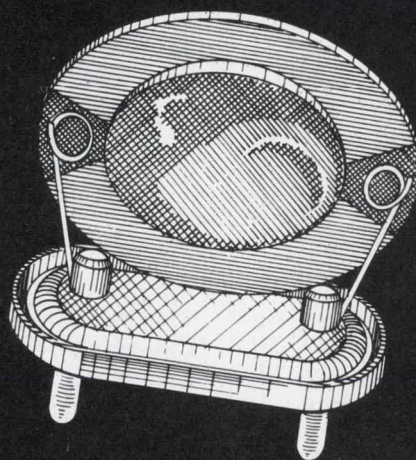

CIRCLE NUMBER 79

POWER SOURCES

Open framers supply μ P system voltages

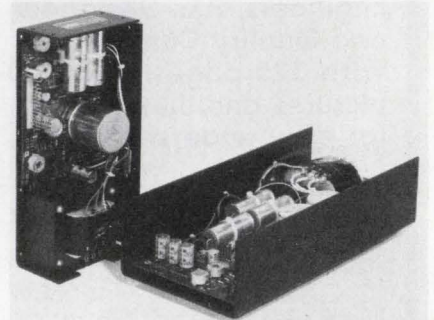

Alpha Power, 20536 Plummer St., Chatsworth, CA 91311. A. Long (213) 998-9873. From \$119; stock to 2 wks.

Two supplies each provide the four most common voltage levels for μ P systems: +5 V at 8.A, -5 V at 500 mA, +12 V at 1.7 A and -12 V at 1 A for the Model 2PMP; +5 V at 15 A, -5 V at 1 A, +12 V at 3.4 A and -12 V at 1.7 A for the more powerful Model 2QMP. All outputs of both open-frame supplies are current-foldback and over-voltage protected. All outputs except the -5 V, are adjustable and regulated to $\pm 0.15\%$ for either line or load changes, with max ripple of 10 mV pk-pk. The -5-V outputs for each device stay within a $\pm 3\%$ total-tolerance band including line and load regulation and ripple which is 25-mV pk-pk max. Input power: 115/230 V $\pm 10\%$, 47 to 63 Hz. 3-1/8 \times 4-7/8 \times 11 and 3-3/4 \times 6-1/4 \times 13-1/2 in.

CIRCLE NO. 393

Converter branches to 4 isolated dc outputs

Burr-Brown, International Airport Industrial Park, P.O. Box 11400, Tucson, AZ 85734. D. Haynes (602) 294-1431. \$28 (100-249 qty).

Supply a 10 to 18-V input to one Model 710 isolated dc/dc converter module and you get four dual isolated outputs at the same voltage as the input. Key specifications of power module include: continuous isolation rating of 850-V pk (100% tested at 3110-V pk); isolation impedance of $10^{10}\Omega$ in parallel with 8 pF, leakage current (240 V at 60 Hz) of 1 μ A; and total output current of 76 mA, divided among the four channels. Operates from 25 to +85 C. 2 \times 2 \times 0.4 in.

CIRCLE NO. 394

Wall adapter goes with multi-output converter

Scientific Programming, 1499 Bayshore Hwy., Burlingame, CA 94010. (415) 493-2199. \$39.95 to \$69.00; stock to 4 wk.

The Micro-Supply family consists of ac adapters combined with regulated dc/dc converters. The adapter is a wall-plug unit compatible with all SPI converters. Nine types of converters are available with dual or triple outputs. A typical unit supplies +5 V at 250 mA, +12 V at 100 mA and -5 V at 100 mA. The converter is 2.2 x 3.2 x 0.5 in., and the plug-in unit is 2 x 2 x 1.8 in.

CIRCLE NO. 395

Switching supply works from 41 to 52 V dc

Abbott Transistor Lab., 5200 W. Jefferson Blvd., Los Angeles, CA 90016. Andrew Hilbert (213) 936-8185. \$325; stock to 10 wk.

The DC100 series of switching-regulated power modules are designed for computer and computer peripheral applications. Input power is 41 to 52 Vdc. Three units are available with outputs of 5 Vdc, ±12 Vdc and ±15 Vdc with total power of 100 W at ambient temperature of 55 C. Line and load regulation is less than 0.5% and ripple is less than 100 mV pk-pk. Measured efficiency is 80% and size is 5.5 x 10.5 x 2.5 in. Other series in this line include 50 and 150-W units and 1φ and 3φ input units at 50, 100 and 200 W.

CIRCLE NO. 396

Switching power supply drives non-linear loads

Kepeco, 131 Sanford Ave., Flushing, NY 11352. Paul Birman (212) 461-7000. \$259; stock.

RMK Series "B" supplies come in five models: 5 V at 36 A, 9 V at 20 A, 12 V at 16.6 A, 15 V at 13.3 A and 24 V at 8.5 A. Operating temperature range is 0 to 71 C. The units feature a rectangular current-limit circuit, which avoids lockout problems when operated in series or parallel. Also, they can drive such non-linear loads as motors and incandescent lamps without the need for "starter" circuits. They use "logic-off" overvoltage protection is another feature. Switching speed is 25 kHz with a typical efficiency of 75%. Size is 3-9/32 (H) X 5-1/8 (W) X 8-3/4 (D).

CIRCLE NO. 397

High-voltage supplies are well protected

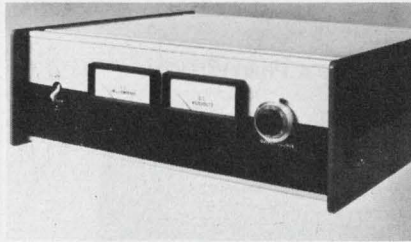

Glassman High Voltage Co., 124 W. Main St., High Bridge, NJ 08829. S. Glassman (201) 735-8800.

The CG Series of regulated high-voltage power supplies comprises 24 models in six ratings, from 0 to 10 kV at 15 mA to 0 to 50 kV at 2.5 mA. Each supply is available in either positive or negative polarity, in bench or rack-mounting cabinets. Unique oscillator-rectifier circuitry provides inherent protection against failure to restart after overload, damage from overload, shorts and transient spikes. Efficiency is typically better than 80% at full load. Ripple is 0.1% rms. Typical recovery time from a 50% transient load is 2 ms. Regulation, both line and load, is ±0.05% over the full range of input voltage and output current. Options include 220-V or 100-V inputs, a focus tap for CRT applications, parallel operation of two supplies, deluxe bench cabinet, with or without tilt stand.

CIRCLE NO. 398

High-voltage output varies with dc input

Emco High Voltage Co., 2444 Old Middlefield Way, Mountain View, CA 94043. B Doherty (415) 969-3056. \$49.75 (1-9 qty); 3 days.

Operating from dc inputs of 5 to 15 V, series E10 thru E30 dc/dc converters produce output voltages from 1 to 3 kV, with the output proportional to the input. The modules contain inaudible 20-kHz circuitry, RFI filtering via a three-section input filter, and short-circuit protection. Additional features include floating input and output, plus or minus output, 0.5% pk-pk output ripple and 3500-V isolation. All models can be provided with center tap for dual polarity. With MTBF in excess of 100,000 h at rated output, supplies operate from -10 to +60 C and are fully encapsulated. Mounting: four PC pins; 30 x 2.5 x 1.5 x 0.812 in.

CIRCLE NO. 399

Quad Output Power Sources...

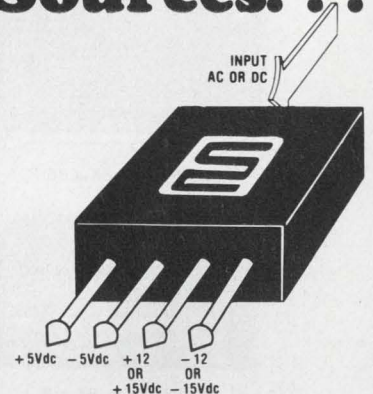

QUADRUPLE YOUR DESIGN POWER DENSITY!!

Now... Up to FOUR dc outputs from a compact, cool-running package... AC/DC and DC/DC models for powering μP's, A/D/A's, DAS's and op amps.

Take Your Choice...

- ☐ **OUTPUTS...**
±5, ±12, ±15V
... To 25 Watts
- ☐ **INPUTS...**
AC
105-125Vac
210-250Vac (K2 Option)
50-440Hz (All Models)
- ☐ **DC**
4.5-90V
INPUT RANGE UP TO 4:1
Over/under voltage protection available
- ☐ **PERFORMANCE...**
Reg. to 0.15%
- ☐ **RELIABILITY...**
MTBF's > 100,000Hrs.
- ☐ **PRICE...***
From \$133.00 (unit)
*LIBERAL OEM DISCOUNTS

To get complete data and our NEW 1977 Catalog, **circle the number below**. Your No. 1 SOURCE is ready to serve you.



SEMICONDUCTOR CIRCUITS, INC.
POWER SOURCES DIVISION

306 RIVER ST., HAVERHILL, MA 01830
TEL. (617) 373-9104, TWX. 710-347-0269

CIRCLE NUMBER 80

MICROPROCESSOR CORE MEMORIES

FOR THE LSI-11, 8080, 6800, IMP-16P

- NON-VOLATILE.
- PIN-TO-PIN COMPATIBILITY.
- POWER MONITORING FOR DATA PROTECTION.

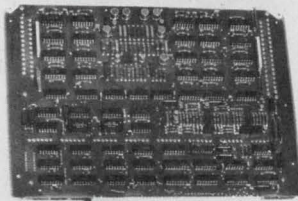

MM-16P 8K x 16

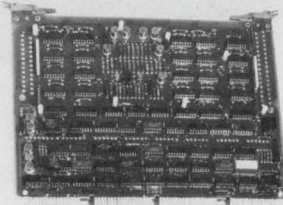

MM-1103 8K x 16

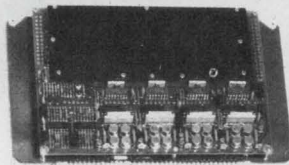

MM-6800 8K x 8

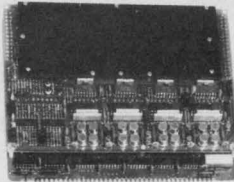

MM-8080 8K x 8

MM-1103 —Plugs directly to DEC LSI-11 and PDP 11-03 computer.
MM-8080 —Plugs directly to Intel's MCS 8 and MCS 80 Microcomputer.
MM-8080A—Plugs directly to Intel's MDS 800 and SBC 80/10 Microcomputer.
MM-6800 —Plugs directly to Motorola's EXORciser and compatible with the Evaluation Modules.
MM-16P —Plugs directly to National's IMP-16P Microcomputer.

**micro
memory
inc**

9438 Irondale Ave., Chatsworth, California
Tel: (213) 998-0070

CIRCLE NUMBER 81

Application notes

Power-supply interface

"HP-IB/Power Supply Interface Guide," a 28-page booklet, describes several alternative methods to control dc power supplies with 0 to 600-V and 20-W to 11-kW ratings. Hewlett-Packard, Palo Alto, CA

CIRCLE NO. 403

Exponential oscillator

"Exponential Digitally Controlled Oscillator Using DAC-76" describes an oscillator with a 8159:1 frequency range covering 2.5 Hz to 20 kHz. A schematic, parts list, timing diagram and table of frequency response accompany the detailed theory of operation. Precision Monolithics, Santa Clara, CA

CIRCLE NO. 404

Component/network testing

An applications note discusses several techniques for detecting and analyzing process changes for networks and components during the manufacturing cycle. Examples of these testing techniques are defined and illustrated with data derived from the GenRad 2230 component/network test system. GenRad, Concord, MA

CIRCLE NO. 405

Switching transistors

Some up to date insights into the failure mechanisms associated with high-speed switching transistors are presented in a 10-page report. Measures to counteract failures in power systems are included. General Semiconductor Industries, Tempe, AZ

CIRCLE NO. 406

Power supplies

"Power Supply Specifying Guide," 16 pages, includes sections on: the make-or-buy decision; whether or not you need a custom or a standard package; how to specify high-voltage power supplies, using oil as a high-voltage insulator, and packaging high-voltage circuits. AMP Capatron Div., Elizabethtown, PA

CIRCLE NO. 407

MAGNETIC SHIELDING

MATERIAL

- CO-NETIC AA Alloy
High Permeability
.002" to .100" thick

EXCLUSIVE

Perfection Annealed — No further anneal required if severe forming is avoided.

- NETIC S3-6 Alloy — High Saturation Induction.
.004" to .095" thick
- Immediate Shipment from Stock



MAGNETIC SHIELD DIV.



PERFECTION MICA CO.
740 North Thomas Drive
Bensenville, Ill. 60106, USA
Phone 312 / 766-7800
TWX 910-256-4815

SEND FOR NEW MG-4
Material, Application
and Fabrication Guide.

*Complimentary Foil
Samples Included.*

CIRCLE NUMBER 82

New literature

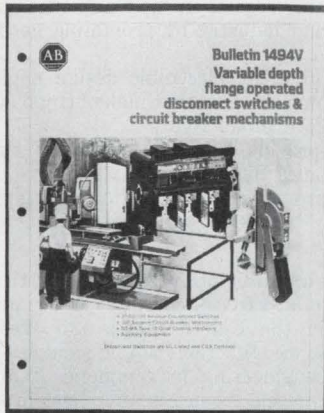

Switches, circuit breakers

Variable depth, flange-operated disconnect switches and circuit-breaker operating mechanisms are described in an eight-page brochure. Allen-Bradley, Milwaukee, WI

CIRCLE NO. 408

Precision motors

Big Inch miniature precision motors are described in a 12-page catalog. Torque curves, dimension and weight data, typical drive circuits and temperature information are included. Haydon Switch and Instrument, Waterbury, CT

CIRCLE NO. 409

The Bi-FET Story

An 82-page booklet offers an unabashed, undisguised, competitive swing against Bi-FET op amps from National, TI, AMD and RCA. The booklet includes advertisements from these manufacturers, with annotation added, and annotated articles from the trade press. Precision Monolithics, Santa Clara, CA

CIRCLE NO. 410

CMOS databook

A 556-page handbook provides data on CMOS ICs, including technical specifications, applications, charts and diagrams. To purchase the handbook, send \$3 (CA residents include 6% sales tax) to Marketing Services Dept., National Semiconductor, 2900 Semiconductor Dr., Santa Clara, CA 95051.

INQUIRE DIRECT

Control systems

A compact reference guide describes industrial machine and process-control components and systems, ranging from general-purpose control relays to on-line μ P-based controller systems. Eagle Signal Div., Davenport, IA

CIRCLE NO. 411

Data processing

How hardware and software are organized to provide nonstop, failure-immune computer processing is explained in a 12-page brochure. Tandem Computers, Cupertino, CA

CIRCLE NO. 412

Soft ferrites

Properties and frequency characteristics of Ceramag materials are described in a four-page folder. An easy-to-read material chart shows magnetic characteristics and composition for each Ceramag material. Stackpole Carbon, St. Marys, PA

CIRCLE NO. 413

Connector assembly

A connector-assembly machine designed to prepare insulated wire to varying lengths, crimp a terminal to one end of these wires, and assemble the terminated wire to a connector housing in a predetermined circuit arrangement at 3600 wires per hour is described in a four-page bulletin. Molex, Lisle, IL

CIRCLE NO. 414

Line driver, receiver

"The Line Driver and Line Receiver Data Book for Design Engineers," 206 pages, covers over 70 types. Schematics, function tables and electrical and switching characteristics are given. Texas Instruments, Dallas, TX

CIRCLE NO. 415

Memory newsletter

A quarterly newsletter is designed to keep the company's 1100 installations and the 360/370 IBM-compatible marketplace informed of new developments. The Computer Products Div. of EMM, Hawthorne, CA

CIRCLE NO. 416

NEVER AGAIN?

If it can happen in New York it can happen anywhere.

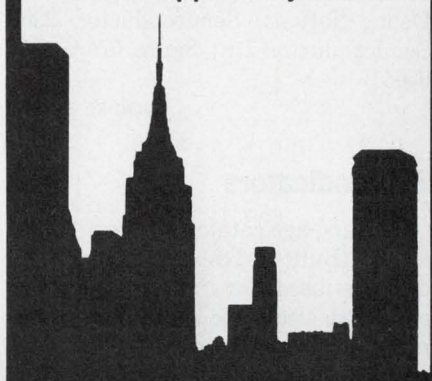

POWERLESS!!

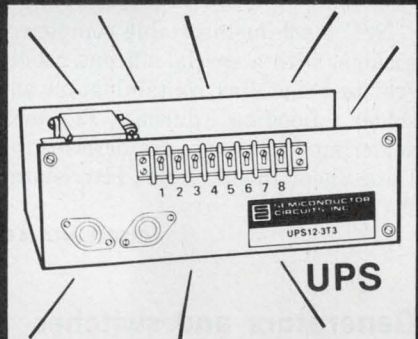

Protect your Memory and Systems against Blackout with one of S.C.I.'s UNINTERRUPTIBLE POWER SUPPLY SYSTEMS . . . or design your own system using S.C.I. modules.

UPS SERIES priced from: \$155.00 to \$225.00 (unit price)

PERFORMANCE!

- Reliable Float Charge Battery Backup Systems
- Regulated Single & Multi Outputs
- 36 Standard High Performance, High Efficiency Models

The Memory Savers from the No. 1 Source. Want the Facts Fast? Call Frank Frontiero



SEMICONDUCTOR CIRCUITS, INC.
POWER SOURCES DIVISION

306 RIVER ST., HAVERHILL, MA 01830
TEL. (617) 373-9104, TWX. 710 347 0269

CIRCLE NUMBER 83

Large-scale MOS ICs

Descriptions, specifications and applications for all large-scale MOS IC products are contained in a 714-page book. The book may be ordered by sending a check for \$4 (CA residents add 6% sales tax) to Marketing Services Dept., National Semiconductor, 2900 Semiconductor Dr., Santa Clara, CA 95051.

INQUIRE DIRECT

BITE indicators

A four-page catalog covers a line of BITE (Built-in-Test-Equipment) indicators used for fault isolation in electrical/electronic circuits and components. North American Philips Controls, Cheshire, CT

CIRCLE NO. 417

Sockets

N/C machine-insertable component sockets, with a special silicone rubber seal to avoid flux contamination and solder flooding during PC-board soldering operations, are described in Data Sheet 76-407. AMP, Harrisburg, PA

CIRCLE NO. 418

Generators and switches

Two technical catalogs feature 5 to 150-kW generators and automatic transfer switches. Pavid Manufacturing, Westbury, NY

CIRCLE NO. 419

Vibratory tables

A 12-page brochure details and illustrates a complete line of vibratory tables for settling parts, chemicals, pellets and powders in drums, bulk boxes, cartons and tote bins. Cleveland Vibrator, Cleveland, OH

CIRCLE NO. 420

Energy measurer

Complete specifications are available on an automatic energy monitor that measures electrical-energy consumption within specified time frames. Franklin Electric, Sunnyvale, CA

CIRCLE NO. 421

Vendors report

Annual and interim reports can provide much more than financial position information. They often include the first public disclosure of new products, new techniques and new directions of our vendors and customers. Further, they often contain superb analyses of segments of industry that a company serves.

Selected companies with recent reports are listed here with their main electronic products or services. For a copy, circle the indicated number.

Nuclear Data, Inc. Laboratory computer systems, PC boards for peripherals, business machines and communications systems.

CIRCLE NO. 422

LM Ericsson Telephone Co. Public and private telephone exchanges; transmission equipment; cable, wire, and line equipment.

CIRCLE NO. 423

Wavetek. Programmable signal sources; function generators, sweep generators, audio response units and signal generators.

CIRCLE NO. 424

Analog Devices. Signal conditioning, computer interface, instruments and systems, modular assemblies and semiconductor ICs.

CIRCLE NO. 425

NEC (Nippon Electric Co.) Telecommunications, computers, electron devices and consumer electronics products.

CIRCLE NO. 426

Texas Instruments. Semiconductors; semiconductor memories; microprocessors; calculators; geophysical data collection and processing and government electronics.

CIRCLE NO. 427

McGraw-Edison. Power systems; fuses; electronic test equipment; components, motors and gearmotors; solenoids and timers, and temperature sensing and monitoring devices.

CIRCLE NO. 428

Electronic Design

ELECTRONIC DESIGN's function is:

- To aid progress in the electronics manufacturing industry by promoting good design.
- To give the electronic design engineer concepts and ideas that make his job easier and more productive.
- To provide a central source of timely electronics information.
- To promote communication among members of the electronics engineering community.

Want a subscription? ELECTRONIC DESIGN is circulated free of charge to those individuals in the United States and Western Europe who function in design and development engineering in companies that incorporate electronics in their end product and government or military agencies involved in electronics activities. For a free subscription, use the application form bound in the magazine or write for an application form.

If you do not qualify, paid subscription rates are as follows: \$30.00 per year (26 issues) U.S./Canada/Mexico, \$40.00 per year (26 issues) all other countries. Single copies are \$2.50 U.S. and all other countries. The Gold Book (27th issue) may be purchased for \$30.00 U.S./Canada/Mexico, and \$40.00 all other countries.

If you change your address, send us an old mailing label and your new address; there is generally a postcard for this in the magazine. You will have to requalify to continue receiving ELECTRONIC DESIGN free.

The accuracy policy of ELECTRONIC DESIGN is:

- To make diligent efforts to ensure the accuracy of editorial matter.
- To publish prompt corrections whenever inaccuracies are brought to our attention. Corrections appear in "Across the Desk."
- To encourage our readers as responsible members of our business community to report to us misleading or fraudulent advertising.
- To refuse any advertisement deemed to be misleading or fraudulent.

Individual article reprints and microfilm copies of complete annual volumes are available. Reprints cost \$6.00 each, prepaid (\$5.00 for each additional copy of the same article), no matter how long the article. Microfilmed volumes cost \$23 for 1976 (Vol. 24); \$30 for 1973-75 (Vols. 21-23), varied prices for 1952-72 (Vols. 1-20). Prices may change. For further details and to place orders, contact Customer Services Dept. University Microfilms, 300 N. Zeeb Rd., Ann Arbor, MI 48106. (313) 761-4700.

Want to contact us? If you have any comments or wish to submit a manuscript or article outline, address your correspondence to:

Editor
ELECTRONIC DESIGN
50 Essex St.
Rochelle Park, NJ 07662

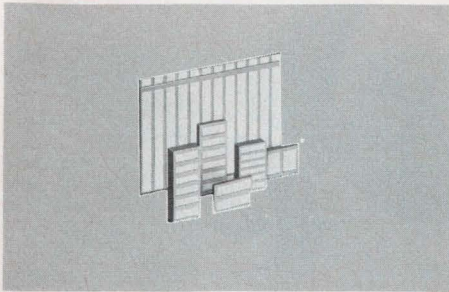

MULTIPLE CAPACITOR ARRAYS are single-plate multiple capacitance elements and serve as replacements of individually bonded chips in hybrid circuits. They are perfect for multiple circuit coupling, filtering, by-pass and high voltage meter multiplier circuits. They are easy to install and provide savings over the assembly of individual capacitors. Multiple capacitor arrays available in a variety of dielectric characteristics to meet specific requirements. JOHANSON DIELECTRICS, INC., Bx 6456, Burbank, Ca. 91510 213-848-4465.

CAPACITOR ARRAYS 181

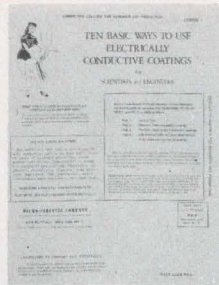

Why not try SILVER?

FREE facts

Just Ohm's Law and common sense

Solve some of your toughest production and research problems with our highly conductive silver paints and glues. Just Ohm's Law and common sense. Thousands of users. Proven dependable for 26 years. Make wires, rf shields. Dependable contacts on plastic, skin, iron. Detect cracks, count, change pc boards and pots. Simplify, shrink, put one component on another. **FREE 8-page crash course** in saving with silver. Circle number below. Micro-Circuits, R1 Box 518, New Buffalo, Mi. 49117.

SILVER PAINT 184

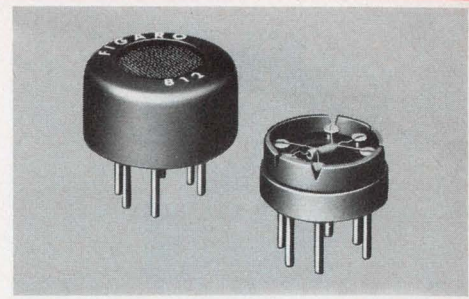

FIGARO GAS SENSOR TGS is a gas sensitive semiconductor. When combustible gas is absorbed on the sensor surface, a marked decrease of electrical resistance occurs. Major features of the sensor include high sensitivity, long term reliability and low cost. The applications are: GAS-LEAK ALARM, AUTOMATIC FAN CONTROL, FIRE ALARM, ALCOHOL DETECTOR, etc. Figaro Engineering Inc., North America Office-3303 Harbor Boulevard, Suite D-8, Costa Mesa, Calif. 92626 Tel: (714) 751-4103 Telex: 678396

GAS SENSOR 187

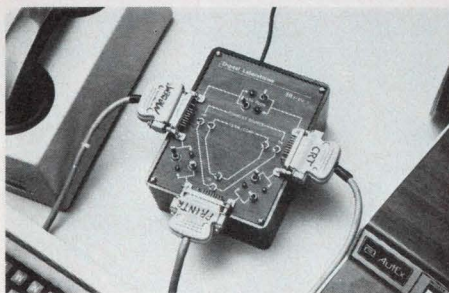

UNIVERSAL JUNCTION UNIT . . . for three devices, RS232C or current loop.

. . . Six switches provide all 63 interconnects that are possible between three I-O devices. LED's indicate data flow. . . . Designed to provide circuit compatibility and easy data routing between different manufacturer's devices. . . . \$350 (1-4) from DIGITAL LABORATORIES, 600 Pleasant St., Watertown, MA 02172 (617) 924-1680

3 PORT RS232 & 20 MA LOOP 182

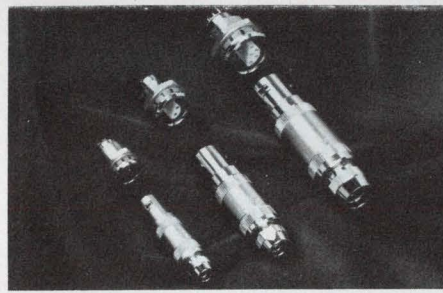

LEMO CONNECTORS are perfect for front panel applications. Superb design and craftsmanship complement any front panel design. The Quick Lock mechanism allows easy connection & disconnection. Panel space is saved because finger clearance is required on only two sides. The all metal shell is rugged and an effective strain relief grips the cable securely. Coax & multipin types from 2-18 pins are available from stock. Lemo U.S.A. Inc., 2015 2nd St., Berkeley, Ca 94710. Tel: 415/548-1966, Tx 335-393.

CONNECTORS 185

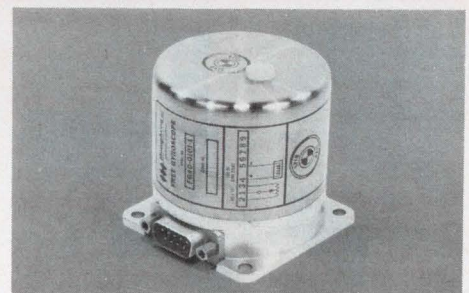

SPRING-DRIVEN GYRO FG40-0100 SERIES for missile applications. Rugged, 2 1/4" diameter, eight-ounce gyro fully qualified to MIL specs and GSA scheduled, contract No. GS-OOS. Solenoid activated, potentiometer on outer gimbal, manual caging, remote electrical uncaging, 100 MS runup time, full rotation, electrical range 357°, resolution 0.25°. Commonality of critical parts ensures low cost and fast delivery. Humphrey, Inc., 9212 Balboa Ave., San Diego, California 92123. Phone (714) 565-6631.

SPRING DRIVEN MISSILE GYRO 188

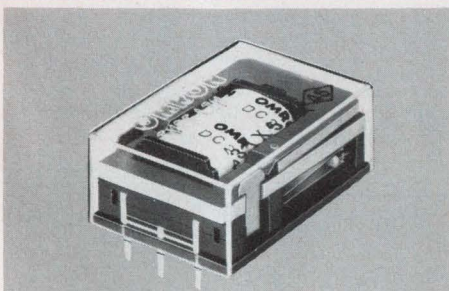

OMRON LOW PROFILE DRY CIRCUIT RELAY Reduces contact resistance for stringent low-voltage/low-current circuits, switches up to 3A at 24 VDC. Offers DPDT or 4PDT format, packaged to fit PCBs on 1/2" centers. High reliability, with 100 million mechanical operations (min.) with bifurcated cross bar contacts. Plastic covers can be sealed for wave soldering, with air or nitrogen filling. OMRON ELECTRONICS, INC., 233 South Wacker Drive, Chicago, Ill. 60606 Phone (312) 876-0800.

LZN LOW PROFILE RELAY 183

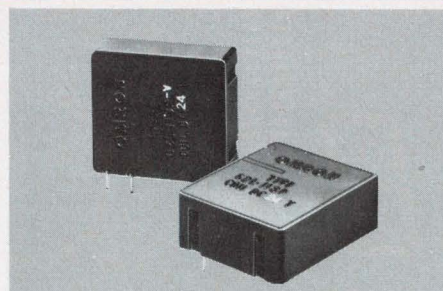

OMRON LOW-PROFILE POWER RELAY Takes the bulk out of power switching up to 8A at 24 VDC. Mounts flat for PCBs on 1/2" centers, or upright to save board area (1.22" x 0.413"). Extra long life of 200 million mechanical operations (min.). Available in DC3 to DC48 coil voltages. Dielectric strength exceeds 2500 VAC. Meets UL, CSA and VDE requirements. OMRON ELECTRONICS, INC. 233 South Wacker Drive, Chicago, Ill. 60606. Phone (312) 876-0800

G2L LOW PROFILE POWER RELAY 186

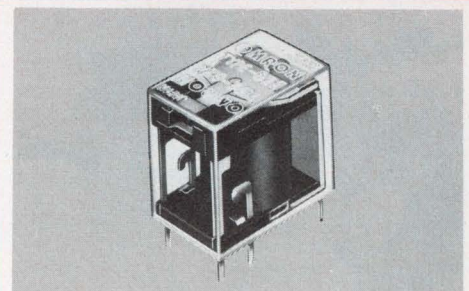

OMRON HIGH-POWER SUGAR CUBE RELAY Highest power for its size. Built to resist flux wicking. Switches up to 3A at 24 VDC, occupies less than 0.3 cubic inch. Reliable silver-palladium cross bar contacts. Saves space in portable battery instruments, radio gear, security devices, phone networks, etc. Long life of 5 million mechanical operations. Available in DC6-DC24 coil voltages. PCB pins match 0.100" grid. OMRON ELECTRONICS INC., 233 South Wacker Drive, Chicago, Ill. 60606. Phone (312) 876-0800.

G2K SUGAR CUBE RELAY 189

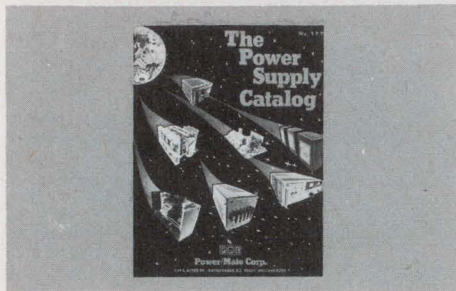

Free New '77 catalog contains over 34,500 quality power supplies from the world's largest manufacturer, Power/Mate Corp. Power Supplies for every application including submodulars, open frame, variorated, encapsulated, laboratory & system. All units UL approved and meet most military and commercial specs for industrial and computer uses. Power/Mate Corp., 514 S. River St., Hackensack, NJ 07601 (201) 343-6294

POWER SUPPLIES

190

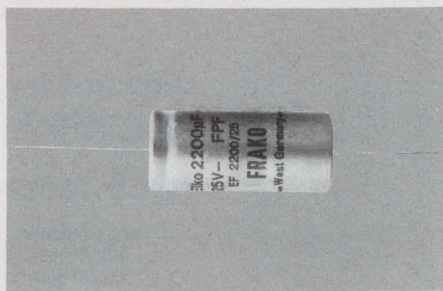

ALUMINIUM ELECTROLYTIC CAPACITORS by FRAKO of West Germany offer superior Performance/Space/Cost relationships. Now, improved specs for ESR, working leakage current and permissible ripple current make them better than ever! Ask for a NEW FRAKO Brochure. We'll include our latest stock list covering a wide range of axial and radial FRAKO 'Lytics. From TRADELINE, Inc., 1 World Trade Center, Suite 1829, NY, NY 10048. (212) 938-0930

ELECTROLYTIC CAPACITORS

193

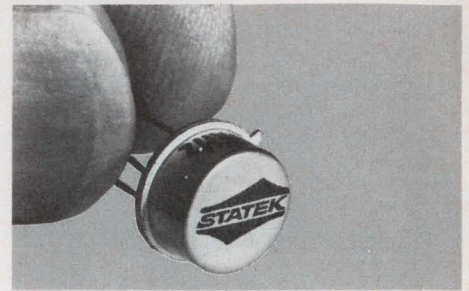

LOW COST QUARTZ CRYSTALS Use Statek 10 to 300 kHz quartz crystals in TO-5s . . . they eliminate count down for oscillators, filters, tone generators, timers . . . They're rugged, accurate & resistant to high vibration and shock. Prices low as \$1.70 ea. in 1000 qty. Send your written application & we'll send you a sample. Call or write for literature. Details in Gold Book and EEM * STATEK CORP. * 512 N. Main, Orange, Ca. 92668 * (714) 639-7810 * Telex 67-8394

QUARTZ CRYSTALS

196

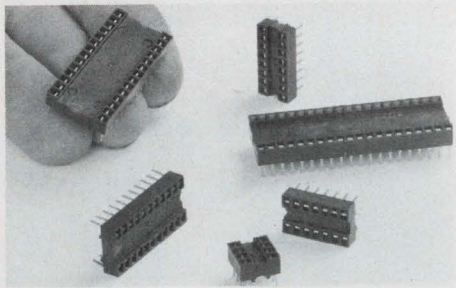

METHODE IC SOCKETS are end and side stackable for ultra-high density packaging. Sizes for all standard DIP packages are available on .300", .400" and .600" centers. Anti-wicking contact design with stand-off makes soldering and clean-up easy. Large ramped lead-in for simple assembly and field repairs. Insulators are glass filled nylon and contacts are tin-plated brass. Methode Manufacturing Corp. 1700 Hicks Road, Rolling Meadows, IL 60008, (312) 392-3500.

IC SOCKETS

191

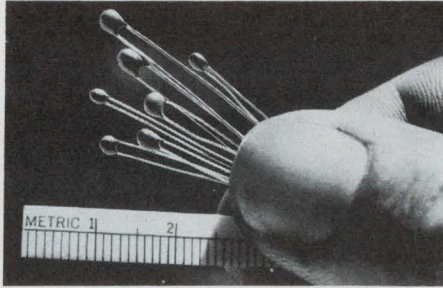

THERMISTORS with leads and coating are highly reliable low cost components in small dimensions more compatible with modern circuit design. R @ 25°C 100Ω to 1 meg Ω ±10% to ±1%. CURVE MATCHED INTERCHANGEABLES to ±.25°C. POINT MATCHED INTERCHANGEABLES to ±.2°C. Call or write for HP97 or TI SR52 THERMISTOR LINEARIZATION PROGRAM. WESTERN THERMISTOR CORPORATION, 403 Via El Centro, Ocean-side, CA 92054- (714) 433-4484.

THERMISTOR

194

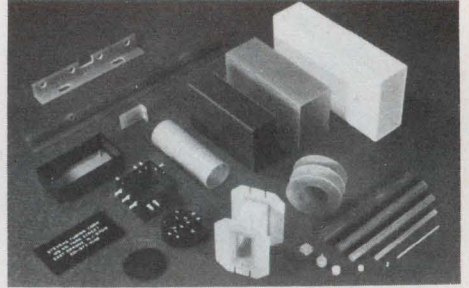

EPOXY INSULATORS From open stock tooling, thousands of custom shapes of glass laminated epoxy 155°C insulators are now available. Basic tubing line yields coil bobbins, potting forms, structural angles and channels, rods, and coil winding forms. Material meets MIL-C-9084 and MIL-R-9300 and has excellent shock resistance, electrical and mechanical values. Data available from Stevens Tubing, 128 N. Park St., East Orange, N.J. 07019, 201-672-2140.

STEVENS TUBING

197

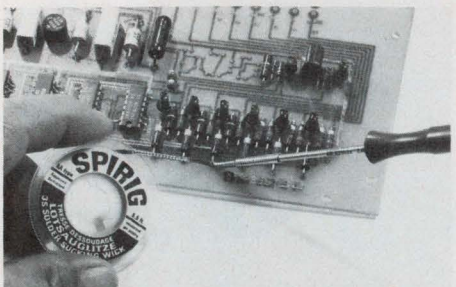

3S-WICK® De-solder Braid. Spirig produces the vacuumized (pat. pend.) solder removal wick in unequalled technology to meet any standards worldwide. 3S-Wicks unique three dimension combination solves all electronics desoldering problems. 3S-Wick pat. pend. Spirig also produces pencil soldering irons. Dealers and distributor inquiries welcomed. USA: Spirig-Signalarm, PO Box 3128, Springfield, Mass. 01101, (413) 788-0224 Internat: Spirig, PO Box 160, CH-8640 Rapperswil, Switzerland TX 75400

3S-WICK DE-SOLDER BRAID

192

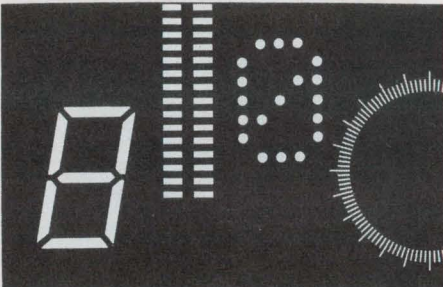

Power converters for gas discharge displays DC-to-DC power supplies convert low DC line voltages of 5, 9, 12 or 15 volts to nominal 200 or 250 volt DC levels required to activate gas discharge displays (multi-segment, matrix or bar graph). Ideal for battery powered applications. Ask about custom designs and cost-efficient models for high-volume users. For PC board mounting. ENDICOTT COIL CO., INC., 31 Charlotte Street, Binghamton, N. Y. 13905 (607) 797-1263.

DC-to-DC CONVERTER

195



SEIKO's MECHANICAL FILTERS FOR NAVIGATION SYSTEMS • Compact & Reliable. • Frequencies: 10.2kHz, 11.333kHz, 13.6-kHz, 100kHz *Other frequencies are also available 300Hz to 100kHz • Oscillators are also available. • Applications: Omega receiver, Loren C receiver, Decca receiver *For more detailed information, please contact to: SEIKO INSTRUMENTS, INC., 2990 West Lomita Blvd., Torrance, Ca. 90505 Tel. (213) 530-3400 Telex: 25-910-347-7307

MECHANICAL FILTERS

198

Electronic Design

Advertising Sales Staff

Susan G. Apolant
Sales Coordinator

Rochelle Park, NJ 07662

Robert W. Gascoigne
Thomas P. Barth
Stan Tessler
Constance McKinley
50 Essex St.
(201) 843-0550
TWX: 710-990-5071
(HAYDENPUB ROPK)

Philadelphia

Thomas P. Barth
(201) 843-0550

Boston 02178

Gene Pritchard
P.O. Box 379
Belmont, MA 02178
(617) 489-2340

Chicago 60611

Thomas P. Kavooras
Berry Conner, Jr.
200 East Ontario
(312) 337-0588

Cleveland

Thomas P. Kavooras
(312) 337-0588

Los Angeles 90045

Stanley I. Ehrenclou
Burt Underwood
8939 Sepulveda Blvd.
(213) 641-6544

Texas

Burt Underwood
(213) 641-6544

San Francisco

Robert A. Lukas
465 S. Mathilda, Suite 302
Sunnyvale, CA 94086
(408) 736-6667

England

Constance McKinley
50 Essex St.
Rochelle Park, N.J. 07662
Phone: (201) 843-0550

Europe

Sanders, W. J. M.
Raadhuisstraat 24
Graft-De Ryp, Holland
Phone: 02997-1303
Telegrams: Euradteam-Amsterdam
Telex: 13039-SIPAS

G. Nebut

Promotion Presse Internationale
7 ter Cour des Petites Ecuries
75010 Paris, France
Telephone: 5231917, 1918, 1919

Dieter Wollenberg

Erikastrasse 8
D-8011 Baldham/Muenchen
Germany
Telephone: 0 8106/4541

Tokyo

Haruki Hirayama
EMS, Inc.
5th Floor, Lila Bldg.,
4-9-8 Roppongi
Minato-ku, Tokyo, Japan
Phone: 402-4556
Cable: EMSINCPERIOD, Tokyo

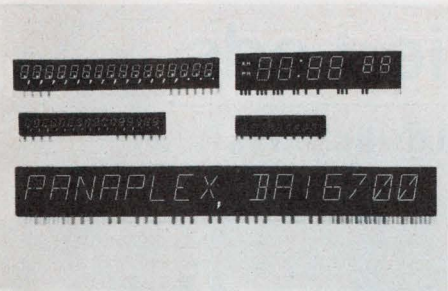

IN-STOCK AT VERY ATTRACTIVE PRICES
Ready now for off-the-shelf delivery are several popular Burroughs Panaplex displays. These gas plasma panels provide exceptional readability in low or high ambient light plus uniform brightness and high/shock vibration resistance. Applications range from instruments to cash registers to pin-ball machines. Circle reader service number below for additional information. Or call Hamilton/Avnet or Cramer Electronics.

GAS PLASMA PANELS

199

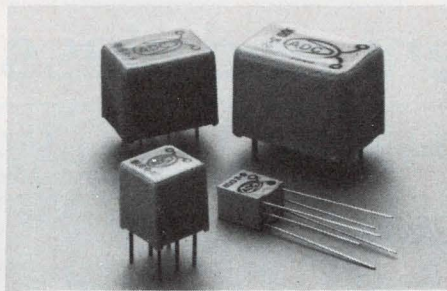

LADY BUG AUDIO TRANSFORMERS give you the reliability you'd expect from military transformers, at a commercial price. 46 different electrical configurations. Power ratings from 50mw to 2 watts. Operating frequencies from 100Hz to 100KHz. 4 case sizes (smallest: 1/3 cubic inch). ADC Products, 4900 W. 78th, Minneapolis, MN 55435. (612) 835-6800.

AUDIO TRANSFORMERS

202

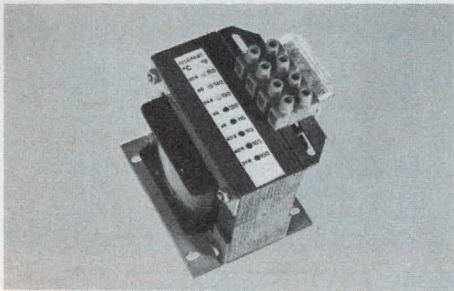

CELSIPOINT® temperature recording dots and strips do indicate by irreversible colour change (white→black) that a specific rated temperature was exceeded in the past of a component, equipment or any other item. Ideal for control of guarantee claims against overheating damages. Range from 100° F in 10° steps to 500°F. Accuracy ±1%. Distributors required. Spirig-Signalarm, PO Box 3128, Springfield, Mass. 01101, (413) 788-0224. Internat: Spirig PO Box 160, CH8640 Rapperswil, Switzerland Tx 75400

TEMPERATURE INDICATORS

200

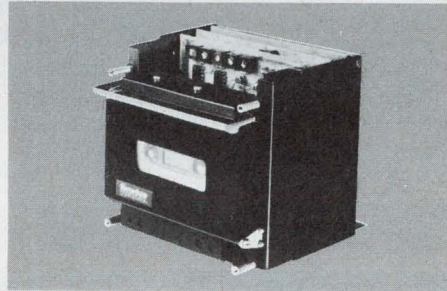

HIGH SPEED RECORDER FOR MICRO-PROCESSORS Model 764 has a patented constant speed tape drive using only 2 moving parts. No capstans, tachometers or clock tracks are necessary. Records up to 32,000 bits per second. Searches at 100 inches per second. Can store up to 5 megabits per 300 foot cassette. ANSI/ECMA compatible. Priced under \$500.00/OEM quantities. MEMODYNE CORPORATION, 385 Elliot Street, Newton Upper Falls, MA 02164. Telephone (617) 527-6600.

MICROPROCESSOR RECORDER

203

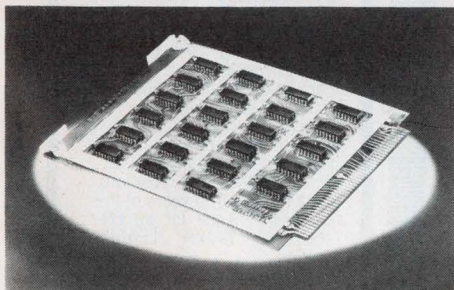

T2L Power Distribution—Noise attenuation and highest packaging density for P.C. boards with T2L logic are yours with Mini/Bus®, the Rogers way to eliminate the cost of multilayer boards by off-board power distribution. Rogers Corporation, Chandler, AZ 85224. Phone (602) 963-4584. (EUROPE: Mektron NV, Ghent, Belgium; JAPAN: Nippon Mektron, Tokyo)

PC POWER DISTRIBUTION

201

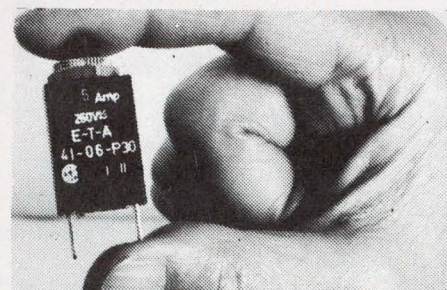

Overcurrent Protector, manual reset eliminates fuse replacement. Convenient panel mounting. 19 fractional ratings from 0.1 to 5 amp. Other models up to 400 amp. Trip-free and fool-proof, UL and CSA approved. High quality, low cost \$1.39 ea. in 1000 lots. E-T-A Products Co. of America, 7400 N. Croname Rd., Chicago, Ill. 60648. Tel: (312) 647-8303. Telex: 253780.

CIRCUIT BREAKER

204



Electronic Design

recruitment and classified ads

PLACE YOUR AD AT ONLY \$45 PER COLUMN INCH IN

Electronic Design

— GET A REPEAT AD FREE!

With our 2 for 1 plan, your net cost in *Electronic Design* is only \$22.50 per column inch, lowest among all the national newspapers and electronics media. You get a total of 165,402 exposures to OEM engineers and engineering managers (not counting 10,600 more among general or corporate managers) at only 27¢ per thousand! You can't beat the price. You can't beat the coverage and you can't beat the quality.

YOU REACH ENGINEERS WITH TITLES LIKE THESE:

- Chief Engineer • Development Engineer • Design Engineer • Project Engineer • Electronic Engineer • Engineer-Supervisor • Section Leader • Staff Engineer • Systems Engineer • Test Engineer • Standards Engineer • Master Engineer

Electronic Design RECRUITMENT ADVERTISING RATES

15% commission to recognized agencies supplying offset film negatives. 2% 10 days, net 30 days. Four column make-up. Column width 1-3/4" x 10".

SPACE	DIMENSIONS		COST
	Wide	Deep	
One column inch	1-3/4" x 1"		\$45.
2 col. in.	1-3/4" x 2"		\$90.
1/16 page (1/4 col.)	1-3/4" x 2-1/2"		\$112.
1/8 page (1/2 col.)	1-3/4" x 5"		\$225.
1/4 page (1 col.)	1-3/4" x 10" Vert.		\$450.
	3-1/2" x 5" Hor.		
1/2 page (2 cols.)	3-1/2" x 10" Vert.		\$900.
	7" x 5" Hor.		
3/4 page (3 cols.)	5-1/4" x 10"		\$1350.
1 page	7" x 10"		\$1800.

NOTE: EACH RECRUITMENT AD YOU PLACE WILL BE REPEATED FREE OF CHARGE!

LATE CLOSING DATES

Electronic Design is mailed every two weeks. Because of its timeliness, personnel recruitment advertising closes only two weeks before each issue's mailing date.

1977 Mailing Date	Recruitment Closing Date	Issue Date on Cover
Sept. 9	Aug. 26	Sept. 27
Sept. 23	Sept. 9	Oct. 11
Oct. 7	Sept. 23	Oct. 25
Oct. 21	Oct. 7	Nov. 8
Nov. 4	Oct. 21	Nov. 22
Nov. 18	Nov. 4	Dec. 6
Dec. 2	Nov. 18	Dec. 20



HOW TO PLACE YOUR AD CALL THE RECRUITMENT HOT LINE 201-843-0550

Camera-ready film (right reading negatives, emulsion side down) or camera-ready mechanicals must be received by deadline. Or, if you wish us to set your ad (typesetting is free) simply pick up the phone and call our RECRUITMENT HOT LINE — (201) 843-0550. Ask for:

Constance McKinley
RECRUITMENT ADVERTISING MANAGER
ELECTRONIC DESIGN

50 Essex Street, Rochelle Park, New Jersey 07662

DESIGN ENGINEERS

SALARY RANGE: 18,000 -

Several current openings in digital telecommunications. M.S.E. preferred. 3+ years' experience in digital logic and circuit design in areas of modems, multiplexes & digital communication systems required. Send resume in confidence to:

DATABIT INCORPORATED

50 DAVIDS DRIVE, HAUPPAUGE, NY 11787
An Equal Opportunity Employer M/F

SWITCHING POWER SUPPLIES

Outstanding opportunity for Senior Electrical Engineer to work in Magnetic Circuits, pot cores, solenoids and switching power supplies for high speed mechanisms in Matrix Printer development. To 23K.

BRUCKS PERSONNEL CORPORATION
2541 Monroe Ave., Rochester, NY 14618
(716) 442-5400

DISCRETE ANALOG DESIGN

Growth oriented implantable medical devices company is planning a new generation of products. Team management organization. Outstanding opportunity.

Credentials: BSEE + 3—10 years experience in discrete analog circuit design involving low power and low frequency applications and good personal qualities.

Please call or write Gene Trusky CEC

DUNHILL
PENN CENTER
Pgh., Pa. 15235
(412) 241-8383

Manager Electronic Technology

Are you ready to lead one of the most advanced operations in the telecommunications industry?

If you are, Stromberg-Carlson will offer you the chance to direct a highly skilled engineering team involved in applying the latest semiconductor, power and related electronic technologies to innovative, new telecommunications systems.

As our Manager of Electronic Technology you'll make visible contributions to an important part of our System CENTURY® — a family of digital switching products meeting the exploding demand for state-of-the-art telecommunications systems.

Position requires BSEE or MSEE and 3-5 years experience in analog or digital circuit design. You should also have in-depth knowledge of such areas as microprocessor selection — both evaluation and application, solid-state component characteristics and selection; and analog to digital conversion circuit design.

We offer commensurate salary and excellent benefits. Location is in Rochester, N.Y., an area noted for its broad variety of cultural, recreational and educational attractions. Send resume, including salary history, to: Mr. Steve Peters, Stromberg-Carlson, 100 Carlson Road, Rochester, N.Y. 14603.

Stromberg-Carlson

A SUBSIDIARY OF GENERAL DYNAMICS CORPORATION

An equal opportunity employer m/f
U.S. Citizenship or permanent visa required.



ENGINEERS

Needed for FEE-PAID positions THROUGHOUT THE U.S. Over 1,000 client companies. Send resume and salary history or request confidential application today.

ATOMIC PERSONNEL, INC.
Suite D-2, 1518 Walnut St. Phila., Pa. 19102
Empl. Agcy. - All Technical Fields - Est. 1959

DIGITAL PRODUCT DEVELOPMENT

Exciting organization involved with advanced automotive electronic products and state of the art technology. Energetic professional atmosphere. Team management style.

Work encompasses electronic product design and development involving digital and microprocessor technology.

Credentials: BSEE + 2-5 years of digital product development experience for several DEVELOPMENT ENGINEERING positions and a BSEE + 6-10 years of the above experience for an ENGINEERING GROUP LEADER position.

Please call or write Gene Trusky CEC

DUNHILL
PENN CENTER
Pgh., Pa. 15235 (412) 241-8383

2 RECRUITMENT ADS
FOR
THE PRICE OF 1



Advanced Software Design

**Talk With Us About The Career Challenges
In Telecommunications**

CALL TOLL FREE

(800) 323-1966

In Illinois (800) 942-0491

Today thru Friday, from 8 am to 5 pm cst

Telecommunications is one of the most rapidly growing segments of the software frontier. We have major projects underway now . . . forerunners of our long-term commitment to significantly advancing the state-of-the-art. We're working from definition and design through development and implementation in areas such as CAD, Data Base Systems, Simulation, Fault Recovery, Diagnostics and many areas of software design in an on-line, real-time environment.

SOFTWARE DESIGN

We're looking for an indepth background in the development of systems software and a minimum of 3 years' experience in structured design, testing and documentation of programs running on large data base, multi-file systems in real-time. Familiarity with HIPO design documentation, TSO usage and software simulation techniques as well as PL1, Fortran and assembler languages for the 8080 and PDP 11 programming is also important.

DATA BASE DESIGN

This position requires a minimum of 5 years' experience in the planning development, design and implementation of data base software, including data base management systems administration. Your primary responsibilities will be the development of data base system for a large on-going project including the implementation, support and administration of systems.

COMPUTER AIDED DESIGN

We are looking for an extensive background in the design of CAD/CAM systems and the development of Interactive access by the users of CAD/CAM functions. Required is 5-10 years' experience in both hardware and software aspects; DA systems operations, and design, and systems engineering. Your initial responsibilities will include evaluation of existing systems, and working with a project team in the Architectural Planning of a major new system.

MINI-COMPUTER PROGRAMMERS

We have specific assignments available on project development teams responsible for the design implementation of various telecommunication processing systems utilizing mini-computers as the processing element. Responsibilities will include the development of software programs for real-time operating systems as well as unique hardware elements incorporated into the systems.

If you have in-depth expertise in one or more of these areas, a BS, MS or PhD in Electrical Engineering, Computer Science, Math or other appropriate engineering discipline and have an interest in moving forward with one of the challenging new frontiers in computer technology, talk with us.

**If unable to call, please send your resume to:
Manager of Technical Employment, Dept. 471A6**

**GTE AUTOMATIC
ELECTRIC LABORATORIES**

400 N. Wolf Road
Northlake, Illinois 60164

An Equal Opportunity Employer M/F

MODCOMP[®]

HARDWARE DEVELOPMENT CAREER OPPORTUNITIES

We are seeking experienced professionals to join us and be a part of our rapid expansion in the booming mini-computer industry. There's never been a better time to consider the outstanding career opportunities with MODCOMP and the good life in sunny Ft. Lauderdale, Florida.

MANAGER, COMPUTER DEVELOPMENT

We are seeking an aggressive thinker to lead the entire computer design activity in an environment providing rapid advancement. Immediate responsibilities include, system conceptual design of all new processors and memory systems, technical management and guidance of a team of senior and junior computer designers and significant contribution to definition and development of a new distributed intelligence network system.

COMPUTER DEVELOPMENT ENGINEER

To explore new concepts in mini and midi-computer architectures and develop for the marketplace. This is an opportunity to participate in the specification design of multiprocessor networks. Requires design experience.

We offer highly competitive salaries, substantial fringe benefits, challenge and the opportunity to move out in front of the pack with a leader. If you are interested in finding out more about the exciting career openings with MODCOMP, please send your resume including salary history, or call (800) 327-8997.

Mr. Robert M. Coyner

MODULAR COMPUTER SYSTEMS, INC.

1650 West McNab Road
Ft. Lauderdale, Florida 33309
An Equal Opportunity Employer M/F

MODCOMP[®]

ELECTRICAL ENGINEERS

with

Arnold Research Organization, Inc., contractor operator of the Arnold Engineering Development Center, located in Middle Tennessee.

Electronic Instrumentation Engineer

Solve engineering problems involved with the performance testing of precision measuring equipment. Develop procedures and techniques for routine servicing and calibration of instruments, particularly in the areas of acceleration/vibration and dynamic pressure. Design and implement digital control circuitry for automation of laboratory processes. Requires BSEE with an interest in physics and up to five years of experience. Fortran programming ability is desirable.

Electrical Design Engineer

Electrical design for power distribution, process control, communication, building services and lighting systems typical of heavy industrial plants. Requires BSEE and 1-3 years experience.

Please send resume including salary history or request application by contacting:

R. F. Shanks

ARO, Inc.

Arnold Air Force Station, TN 37389

(615) 455-2611, extension 529

An Equal Opportunity Employer

Electronic Design

BRINGS YOU THE HIGHEST
NUMBER OF QUALIFIED OEM
ENGINEERS AND ENGINEERING
MANAGERS ANYWHERE
... AT THE LOWEST COST
ANYWHERE!

JOIN THE WORLD OF DBA IN FLORIDA

DIGITAL IMAGE PROCESSING

- *systems analysis and software development experience
- *PDP-11 programming knowledge

ANALYTICAL PHOTOGRAMMETRY

- *FORTRAN IV or V and stereoplotter
- *PDP-11 assembly language

ANALYST/PROGRAMMERS

- *Department of Defense message switching systems experience
- *FORTRAN background desirable

ENGINEERS

- *digital systems and logic design experience

IN ARIZONA

ANALYST/PROGRAMMERS

- *PDP-11 assembly language
- *FORTRAN IV experience

The world of DBA offers daily technical challenge and year round summer living. Science and sunshine are available in either Florida or Arizona. DBA offers competitive salaries and benefits plus relocation to attractive southern climates.

To schedule an interview in your area call collect or write Brad Jones, Personnel Director.

U.S. Citizenship Required

(305) 727-0660



DBA SYSTEMS, INC.

P.O. Drawer 550
Melbourne, Florida 32901

Equal Opportunity Employer M/F/H

Technological Leadership for 3 Decades!

Ampex, headquartered on the San Francisco Peninsula, is the company that "invented" the magnetic recording industry.

The technology pioneered by Ampex over three decades has affected many aspects of our modern lifestyles, and has established Ampex as a leader in magnetic recording. Our continued effort in developing new technology has always been the key to our leadership. Right now our Advanced Technology, Data Products and Audio-Video Systems Divisions are embarking on several new programs. To insure the success of these programs we are seeking innovative graduate engineers with experience in the fields listed below.

Opportunities like this don't happen very often. But they're happening at Ampex now.

Advanced Technology Division

- electron beam and optical recording
- magnetic recording
- tape or film handling
- servos
- high-bit rate digital circuit design
- optics
- signal analysis
- pattern recognition
- high frequency circuit
- communications theory

Data Products Division

- circuit/systems design of very high-bit rate systems

- disk read/write systems and equalizing systems for tape recorders
- codes for magnetic recording
- precision servo systems for both linear positioners and rotating systems
- mechanical design of high precision systems in disk recorders and in longitudinal, helical and transverse scan tape recorders

Audio-Video Systems Division

- analog videotape signal systems
- digital video signal processing
- servo systems
- videotape editing
- professional audio recorders
- head technology
- TV cameras

If you think you have something valuable to offer in any of these or closely related areas, and if you would like to join some of America's most talented engineers, please send your resume or a letter outlining your qualifications to: Ampex Corporation, ATTN: Corporate Staffing Manager, Building 2, 2655 Bay Road, Redwood City, CA 94063. Or you can send us this coupon and we'll get back to you. We are an equal opportunity employer m/f.

**Manager Corporate Staffing
AMPEX Corporation
Building 2, 2655 Bay Road
Redwood City, CA 94063**

Dept. 9

Name _____
Address _____
City, State, Zip _____
Phone _____

Occupation _____
Years of Experience _____
Employer _____



**SPECIAL
2
RECRUITMENT
ADS**

**FOR THE
PRICE OF**

1

Double the coverage . . .
double the effectiveness
of every ad
you place!

**Electronic
Design**

BRINGS YOU
THE HIGHEST
NUMBER OF
QUALIFIED EOEM
ENGINEERS AND
ENGINEERING
MANAGERS
ANYWHERE
. . . AT THE
LOWEST COST
ANYWHERE!

**Senior Design
Engineer**

SIGNAL CONDITIONING

Senior Design Engineer-- become involved with a new, but well-established second generation state-of-the-art product. And work for a growing company with plenty of resources to ensure success: Analog Devices.

Our performance in the area of signal conditioning and analog to digital interface has us growing at the annual rate of 25%. This is an opportunity to join a growing team in an environment offering challenge and personal recognition.

This second generation -- micro-processor based measurement and control system has created an opportunity for an exceptional individual in the design of low level signal conditioning circuits for data acquisition and control systems. This position requires a strong background in conditioning low level signals in a digital systems environment. Direct experience with thermocouple amplification and compensation circuits a must. Experience with circuit techniques for galvanic isolation of signals desired.

Qualified applicants should forward a resume, with salary history, to Mr. Ed D. O'Brien, Analog Devices, Inc., Route 1 Industrial Park, Norwood, MA 02062, or call him collect at (617) 329-4700. All inquiries will be acknowledged.



An Equal Opportunity/Affirmative Action Employer M/F.

Constance McKinley
RECRUITMENT ADVERTISING MANAGER
ELECTRONIC DESIGN
50 Essex Street, Rochelle Park, New Jersey 07662
(201) 843-0550

I'm interested in placing recruitment
advertising in *Electronic Design*

Issue _____ Size of ad _____
 My copy is enclosed I need more information
 Name _____
 Title _____
 Company _____
 Address _____
 City _____ State _____ Zip _____
 Telephone _____

**R&D
ENGINEERS**

MICRO/MINI/COMPUTER

Computer Memory	\$18-28K
Minicomp Arch	\$26-31K
Minicomp CPU	\$19-28K
Minicomp Progmg	\$18-30K
Intel 8080 or M6800	\$18-30K
Non Impact Printers	\$18-25K
ASSEMBLER/FORTRAN	\$16-26K
Microprocessor Apps	\$20-26K
Microprogramming	\$20-26K
A&D Circuit Design	\$20-27K
TV Receiver Design	\$20-26K

Partial List
Openings in 35 States

Call toll free 1-800-821 2270 X605
(IN MO. 1-800-892-7655) or send resume

RALPH STEVENSON, Partner



JIM KING

438 GULF LIFE TOWER
JACKSONVILLE, FLA 32207

COMMUNICATIONS

ENGR MGR	\$35K
Security Syst	
SOFTWARE SYST ENGR	\$28K
PDP 11 -- online systems	
PROG-TELECOMM	\$24K
Real time protocols, BTAM, assembler	
FIELD ENGRS-Iran	\$33K pkg
Installation telecomm system	
PROJECT MGR	to \$32K
Computer based switching syst	
MFG ENGR G MGR	\$30K
Hi volume PC assembly	
MODEM ENGRS	to \$30K
Telecommunications system	
SYSTEM ENGR	\$25K
Digital store & forward	
DESIGN ENGR	\$25K
M-processor interfaces/software	
INSTRUCTORS	\$23K
Teach maint on comm systems	
INSTRUMENTATION ENGRS	to \$30K
Analog/digital process control	
DESIGN ENGR	to \$26K
Layout control systems	
Include salary/geographic limits	
All Positions Fee Paid	
MOGUL CONSULTANTS, Inc.	
380 N. Bway Jericho, N.Y. 11753	
(516) 822-4363	

KEEP

Electronic Design's
GOLD BOOK
HANDY

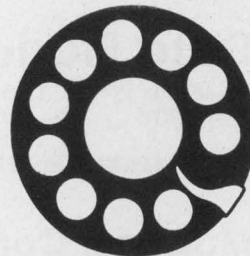

**When
You Call**

Save time when you contact suppliers. Check their catalog pages first in *Electronic Design's* GOLD BOOK. Maybe the information you need is right at your fingertips.

Engineers... are you pigeonholed?

We won't keep you pigeonholed in the same old assignment, year after year. After all, variety is the spice of a life's work. And we have a commitment to it. We make our living selling variety: command and control systems, complete air defense systems, radar systems, sonar systems, computer systems and much more. We're part of a company of 36,000 people, active in more than 550 major product areas in 80 technologies. Plenty of room for developing interests, plenty of room for growth.

Our Systems Division engineers enjoy technical diversity because of our program variety, and growth opportunities that we're steadily expanding. They benefit from the technically oriented management which put us on our strong growth curve. And they enjoy a good professional environment, where many of our people wear 10, 15, and 20 year service pins.

Any more good news? Well, yes. We're hiring now.
For quick action, reach for your phone instead of your resume... call Richard Navarro collect (714) 871-4080, Ext. 2136 between 8 A.M. and 4 P.M. Monday through Friday. Or send your resume to: Professional Employment—Ground Systems Group C, 1901 W. Malvern, Fullerton, CA 92634.

U.S. citizenship required • Equal opportunity M/F/HC employer

HUGHES

HUGHES AIRCRAFT COMPANY

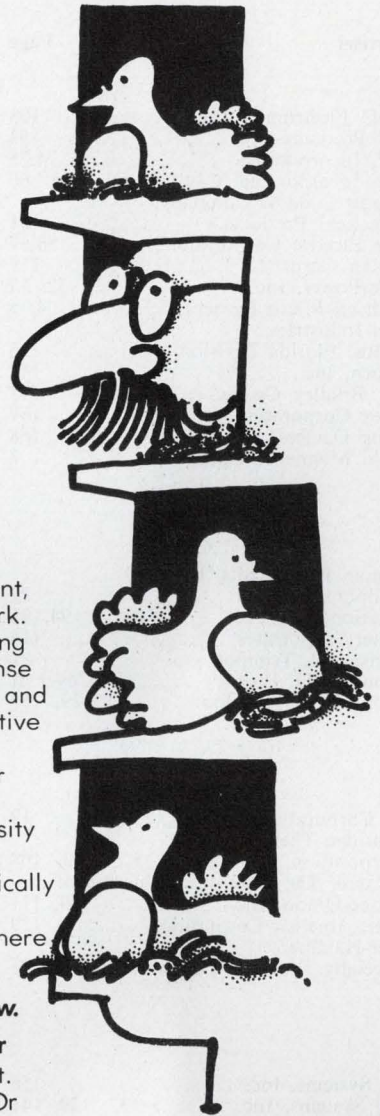

Communications System Engineers. Must understand hardware/software interaction, signal processing, spread spectrum.

Senior Systems Engineers. Tactical, strategic system application of radar, sonar communications, electro-optical software, data processing and command and control technologies.

Communication Analysts. Lead/direct application of systems theory, applied math, estimation, probability to communication system problems.

Data Processing and Software Analysts. System level data processing architecture analysis, design, performance evaluation for multisensor systems.

Display System Engineers. Long term opportunity to lead display product definition/selection for military C&C Systems.

Radar Systems Engineers. Lead/direct radar system conceptual design/analysis. Integration of radar, weapon, command and control systems.

Senior Air Defense Engineers. BSEE, Math or Physics, project management experience in real-time hardware software systems.

Hardware System Engineers. Large scale data processing, peripheral, display systems design, specification, integration checkout.

Systems Analysts. Systems Theory, applied math background. Variety of problems requiring modern analysis techniques.

The New 1977-1978 **GOLD BOOK** Has Just Been Published

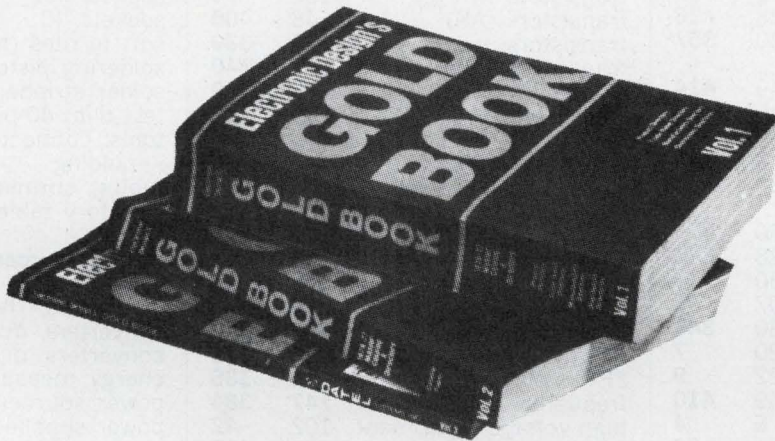

And Completely Outdates Last Year's Edition

If you are currently a subscriber on **ELECTRONIC DESIGN's** qualified circulation file, you need do nothing. You will receive your new **GOLD BOOK** automatically. If you wish additional copies for other members of your company, you may order them now using the convenient coupon form below.

If you are not currently an **ELECTRONIC DESIGN** subscriber on our controlled circulation list, you may order your own multi-section set of the new **GOLD BOOK** by completing the form below. Shipment will be made promptly on receipt of your payment or company purchase order.

**HERE IS WHAT YOU AND YOUR COMPANY
WILL FIND IN THE UPDATED 1977-78**

GOLD BOOK

- **Three sections** containing 2,496 pages of information to quickly locate products used by the electronics industry.
- **A Product Directory** with 5,434 product categories.
- **A Trade Name Directory** of 9,814 listings.
- **A Manufacturers' Directory** listing 8,057 companies in the electronics industry.
- **Two Distributors' Directories** with 2,050 distributors listed.
- **A Giant Compendium of Manufacturers' Data Pages** with specifications.

MAIL TODAY WITH PURCHASE ORDER

Electronic Design's **GOLD BOOK** 449R
Hayden Publishing Co., Inc.
P.O. Box 13803, Philadelphia, Pa. 19101 U.S.A.

Here is our purchase order for _____ sets of the 1977-1978 **GOLD BOOK** at \$30.00 per set—for U.S., Canada and Mexico.
(All other countries: \$40.00 per set)

Check enclosed for \$_____. Bill us.

Name (Print) _____

Title _____

Company _____

Address _____

City/Province _____

State/Country _____

Zip or Postal Code No. _____

QUANTITIES ARE LIMITED. PLACE ORDER TODAY!

Product index

Information Retrieval Service. New Products, Evaluation Samples (ES), Design Aids (DA), Application Notes (AN), and New Literature (NL) in this issue are listed here with page and Reader Service numbers. Reader requests will be promptly processed by computer and mailed to the manufacturer within three days.

Category	Page	RSN	Category	Page	RSN	Category	Page	RSN
Components			transistor, wideband			shielding, spray-on		
capacitor	79	32	transistors	126	344	sockets (NL)	138	375
capacitors	38	16	transistors (AN)	138	70	sockets, IC	150	418
capacitors, ac	130	357	transistors, power	148	406	soft ferrites (NL)	73	30
connector assembly (NL)	149	414	transistors, power	124	339	soldering pistol	149	413
crystals	146	79	voltage regulators	126	340	solder stripper	140	382
DIP switches	130	347	zener reference	69	29	test clip, 40-pin	136	374
display, incandescent	130	350	Instrumentation			tools, connector-	136	369
fuseholder	130	356	component/network			holding	140	381
generators, switches (NL)	150	419	testing	148	405	tubing, shrinkable	136	371
indicator lights	128	345	DMM	144	391	vibratory tables (NL)	150	420
indicators (NL)	150	417	DMM-counter-scope	144	392	Power Sources		
inductors	107	46	DMM, 4½ digit	125	57	batteries	146	78
LEDs	130	349	DMMs	54	23	converters, HV dc/dc	147	399
lamps, miniature	20	7	DVM	142	388	converters, dc/dc	147	395
potentiometers	22	9	energy measurer (NL)	150	421	converters, dc/dc	146	394
precision motors	149	410	FFT analyzer	142	386	energy measurer (NL)	150	421
resistors	6	4	frequency counters	142	384	power sources	147	80
resistors	51	20	high-voltage equipment	102	42	power supplies	7	5
switches	81	34	indicators (NL)	150	417	power supplies	65	25
switches (NL)	149	408	multimeter, digital	144	390	power supplies	82	35
transducer	130	348	prescaler	142	387	power supplies	87	37
transducer, pressure	128	346	pulse gen	144	389	power supplies	103	43
transformers	120	53	recorders	128	59	power supplies	114	50
transformers	III	231	signal generator	1	1	power supplies	119	52
trimmers	19	6	thermometers	142	385	power supplies	121	54
Data Processing			Micro/Mini Computing			power supplies	129	62
core memories	148	81	board, memory	120	327	power supplies	133	66
data-entry terminal	127	58	boards, microcomputer	118	325	power supplies (AN)	148	407
data processing (NL)	149	412	chassis, SBC 80	120	328	power supply	124	56
disc drive	134	366	controller, disc	118	326	power supply	146	393
floppy-disc	105	45	data processing (NL)	149	412	power supply, HV	147	398
graphic digitizer	134	363	microcomputer	118	322	power-supply interface (AN)	148	403
interface cards	134	368	modules, support	118	324	regulators, switching	37	15
interface, computer	134	364	reader paper-tape	118	323	supplies, switching	147	397
line driver	132	361	subsystem, math	118	321	supply, switching	147	396
loader, floppy-disc	134	365	Modules & Subassemblies			transistors, power	104	44
memory board	132	360	amp, rf	116	307	UPS	149	83
memory newsletter (NL)	149	416	amp, instrumentation	116	306	new literature		
recording head	134	367	CCD, analog delay	116	320	connector assembly	149	414
software	132	362	control systems (NL)	149	411	control systems	149	411
tape memory	132	359	converter, a/d	116	308	data processing	149	412
terminals, editing	132	358	converter, s/d	115	301	energy measurer	150	421
ICs & Semiconductors			delay lines, DIP	115	304	generators and switches	150	419
amplifier, low noise	126	341	interface, counter	116	304	indicators	150	417
BBD, 4096-stage	124	337	multiplier	115	305	line driver, receiver	149	415
converter, a/d	122	331	s/h module	116	309	memory newsletter	149	416
converter, v/f/v	124	336	Packaging & Materials			sockets	150	418
converters, d/a	31	12	adhesive, screw-locking	140	380	soft ferrites	149	413
EPRoMs	43	18	cabinet, microcomputer	136	372	switches	149	408
ICs	122	332	conformal coating	44	19	vibratory tales	150	420
line driver, receiver (NL)	149	415	connectors	75	31	application notes		
memories, interface	122	335	connectors	117	51	component/network		
monochips	122	329	connectors	136	373	testing	148	405
multiplier, digital	122	333	connectors	140	378	oscillator	148	404
op amps, FET	126	343	connectors	140	377	power supplies	148	407
oscillator (AN)	148	404	converters, dc/dc	140	379	power-supply interface	148	403
PROMs, switched	122	330	drill, PC-board	140	379	transistors	148	406
power transistors	113	49	handbook, PC	145	75			
preamps, dual	122	334	heat sink, clip-on	136	370			
timer, programmable	124	338	heat sinks	138	69			
transistor, rf	126	342	magnetic shielding	148	82			
			packages, ceramic	138	376			

Announcing Split/Tran[®]— high isolation at prices lower than standard PC board transformers.

Split bobbin design makes the difference

• 2500V RMS HIPOT • NON-CONCENTRIC WINDINGS New from Signal—miniature PC board transformers with high isolation (2500V RMS HIPOT standard) and low capacitive coupling. All this and lower than standard transformer prices, too. Split/Tran is available with single 115V or dual 115/230V primaries. Secondary windings are split, so they can be series or parallel connected. Like all our other transformers and chokes, Split/Tran is always ready for Pronto delivery. Write or call: Signal Transformer Co., Inc., 500 Bayview Ave., Inwood, N.Y. 11696; Tel. (516) 239-7200.

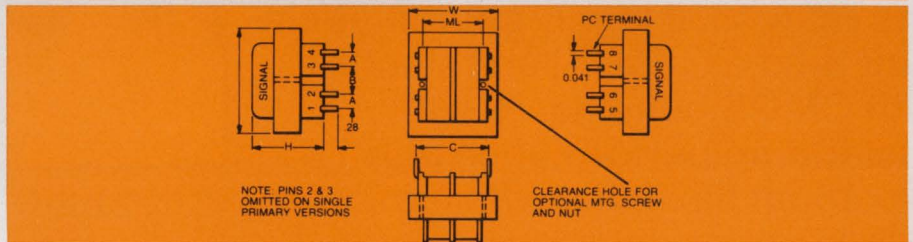
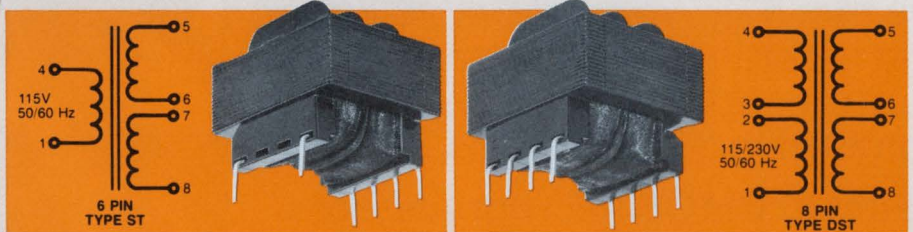
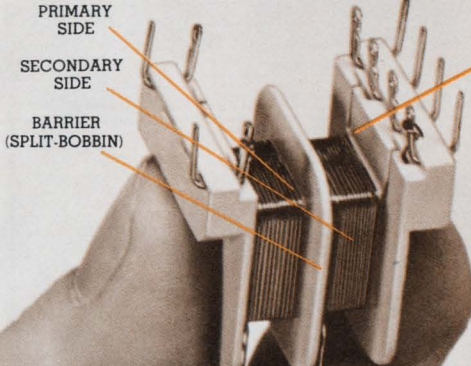

Size	VA	L	W	H	ML	A	B	C	Optional Mtg. Screw & Nut*	Lbs.
3	2.4	1 ³ / ₈	1 ¹ / ₈	1 ³ / ₁₆	1 ¹⁵ / ₁₆	.250	.250	1.200	None	0.25
4	6	1 ⁵ / ₈	1 ⁵ / ₁₆	1 ⁵ / ₁₆	1 ¹ / ₁₆	.250	.350	1.280	4-40 x 1 ³ / ₈ Nylon	0.44
5	12	1 ⁷ / ₈	1 ⁹ / ₁₆	1 ⁷ / ₁₆	1 ¹ / ₄	.300	.400	1.410	4-40 x 1 ³ / ₈ Nylon	0.70
6	20	2 ¹ / ₄	1 ⁷ / ₈	1 ⁷ / ₁₆	1 ¹ / ₂	.300	.400	1.600	4-40 x 1 ³ / ₈ Nylon	0.80

*Available from Signal: Part No. ST-MS (Screw) & Part No. ST-MN (Nut).

PART NUMBER*		SECONDARY RMS RATING		PART NUMBER*		SECONDARY RMS RATING	
Single 115V 6 Pin	Dual 115/230V 8 Pin	Series	Parallel	Single 115V 6 Pin	Dual 115/230V 8 Pin	Series	Parallel
ST 3-10	DST 3-10	10V C.T. @ 0.25A	5V @ 0.5A	ST 3-28	DST 3-28	28V C.T. @ 0.085A	14V @ 0.17A
ST 4-10	DST 4-10	10V C.T. @ 0.6A	5V @ 1.2A	ST 4-28	DST 4-28	28V C.T. @ 0.2A	14V @ 0.4A
ST 5-10	DST 5-10	10V C.T. @ 1.2A	5V @ 2.4A	ST 5-28	DST 5-28	28V C.T. @ 0.42A	14V @ 0.84A
ST 6-10	DST 6-10	10V C.T. @ 2A	5V @ 4A	ST 6-28	DST 6-28	28V C.T. @ 0.7A	14V @ 1.4A
ST 3-12	DST 3-12	12.6V C.T. @ 0.2A	6.3V @ 0.4A	ST 3-36	DST 3-36	36V C.T. @ 0.065A	18V @ 0.13A
ST 4-12	DST 4-12	12.6V C.T. @ 0.5A	6.3V @ 1.0A	ST 4-36	DST 4-36	36V C.T. @ 0.17A	18V @ 0.34A
ST 5-12	DST 5-12	12.6V C.T. @ 1.0A	6.3V @ 2.0A	ST 5-36	DST 5-36	36V C.T. @ 0.35A	18V @ 0.7A
ST 6-12	DST 6-12	12.6V C.T. @ 1.6A	6.3V @ 3.2A	ST 6-36	DST 6-36	36V C.T. @ 0.55A	18V @ 1.1A
ST 3-16	DST 3-16	16V C.T. @ 0.15A	8V @ 0.3A	ST 3-48	DST 3-48	48V C.T. @ 0.05A	24V @ 0.1A
ST 4-16	DST 4-16	16V C.T. @ 0.4A	8V @ 0.8A	ST 4-48	DST 4-48	48V C.T. @ 0.125A	24V @ 0.25A
ST 5-16	DST 5-16	16V C.T. @ 0.8A	8V @ 1.6A	ST 5-48	DST 5-48	48V C.T. @ 0.25A	24V @ 0.5A
ST 6-16	DST 6-16	16V C.T. @ 1.25A	8V @ 2.5A	ST 6-48	DST 6-48	48V C.T. @ 0.4A	24V @ 0.8A
ST 3-20	DST 3-20	20V C.T. @ 0.12A	10V @ 0.24A	ST 3-56	DST 3-56	56V C.T. @ 0.045A	28V @ 0.09A
ST 4-20	DST 4-20	20V C.T. @ 0.3A	10V @ 0.6A	ST 4-56	DST 4-56	56V C.T. @ 0.11A	28V @ 0.22A
ST 5-20	DST 5-20	20V C.T. @ 0.6A	10V @ 1.2A	ST 5-56	DST 5-56	56V C.T. @ 0.22A	28V @ 0.44A
ST 6-20	DST 6-20	20V C.T. @ 1A	10V @ 2A	ST 6-56	DST 6-56	56V C.T. @ 0.35A	28V @ 0.7A
ST 3-24	DST 3-24	24V C.T. @ 0.1A	12V @ 0.2A	ST 3-120	DST 3-120	120V C.T. @ 0.02A	60V @ 0.04A
ST 4-24	DST 4-24	24V C.T. @ 0.25A	12V @ 0.5A	ST 4-120	DST 4-120	120V C.T. @ 0.05A	60V @ 0.1A
ST 5-24	DST 5-24	24V C.T. @ 0.5A	12V @ 1.0A	ST 5-120	DST 5-120	120V C.T. @ 0.1A	60V @ 0.2A
ST 6-24	DST 6-24	24V C.T. @ 0.8A	12V @ 1.6A	ST 6-120	DST 6-120	120V C.T. @ 0.16A	60V @ 0.32A

*Explanation of Part Number: Series—ST; Size 4; Series Secondary Volts—36

Special variations will be quoted and shipped promptly.

NET PRICES (1-4 pcs.)

signal
TRANSFORMER

ALL	ALL		
ST-3	\$4.90	DST-3	\$5.80
ST-4	5.00	DST-4	5.90
ST-5	5.50	DST-5	6.50
ST-6	6.90	DST-6	7.90

RCA first in CMOS.

First in total product experience.

- **First in A-Series.** RCA created the industry standard 4000A-Series and has led the way ever since.

- **First in B-Series.** RCA introduced the first high-voltage CMOS circuit and is setting new standards for performance in circuits which conform to JEDEC specs.

- **First in CMOS microprocessors.** The RCA 1800 family combines elegant 8-bit COSMAC architecture with CMOS benefits. Result: outstanding performance plus maximum flexibility with minimum parts count.

- **First in High Reliability.** RCA is the first and only manufacturer to achieve Part I approval and plans to soon announce parts with unprecedented radiation hardness.

- **First in SOS memories.** RCA has the widest experience in the design and manufacture of silicon on sapphire circuits and is first in LSI.

- **200,000,000th unit this year.** RCA COS/MOS production capacity has doubled in the last six months to meet demand. At this rate, the 200,000,000th COS/MOS unit manufactured by RCA since we invented it will be shipped in 1977.

To fill your needs in CMOS, call your RCA Solid State distributor. Or contact RCA Solid State headquarters in Somerville, NJ; Sunbury-on-Thames, Middlesex, England; Quickborn 2085, W. Germany; Ste.-Anne-de-Bellevue, Quebec, Canada; Sao Paulo, Brazil; Tokyo, Japan.

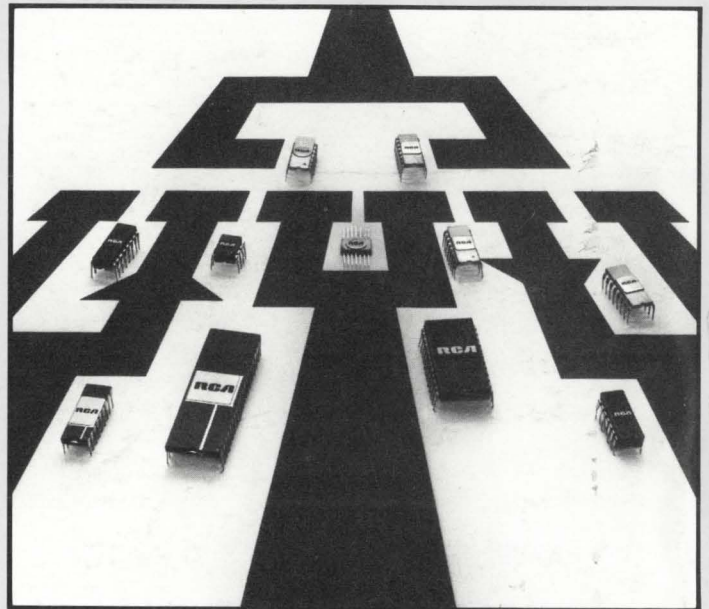

When you say CMOS, say RCA first.

RCA