

**INTERFACE IC EMBRACES ALL ETHERNETS  
SPECIAL REPORT: PLDS AND FPGAS**

FOR ENGINEERS AND ENGINEERING MANAGERS — WORLDWIDE

# **ELECTRONIC DESIGN**

A PENTON PUBLICATION U.S. \$5.00

MARCH 14, 1991



**SCSI CHIP SET  
TURNS DISK  
ARRAY INTO A  
VIRTUAL DRIVE**

**•SPECIAL SECTION: DESIGNING FOR PC SYSTEMS**



# THIS IS A BIG TIME GAL.<sup>®</sup>



Time is finally on your side. Our new **GAL20RA10-15**, with ten individually programmable clocks and a 15ns propagation delay, offers the world's fastest performance. A combination that delivers the ultimate in design flexibility and speed, all in a 24-pin E<sup>2</sup>CMOS<sup>®</sup> GAL device.

For example, design engineers can independently clock, reset and preset each of ten output logic macrocells. These individually programmable clocks enable asynchronous designs, taking your system performance to even higher levels.

If your design is ready for the big time, call **1-800-FASTGAL**, and ask for dept. 203. We'll send you free samples and a data-book describing our entire line of high speed E<sup>2</sup>CMOS GAL devices. Fast.



5555 Northeast Moore Court • Hillsboro, Oregon 97124

**Leader in E<sup>2</sup>CMOS PLDs.<sup>™</sup>**



# We've put CMOS on display.

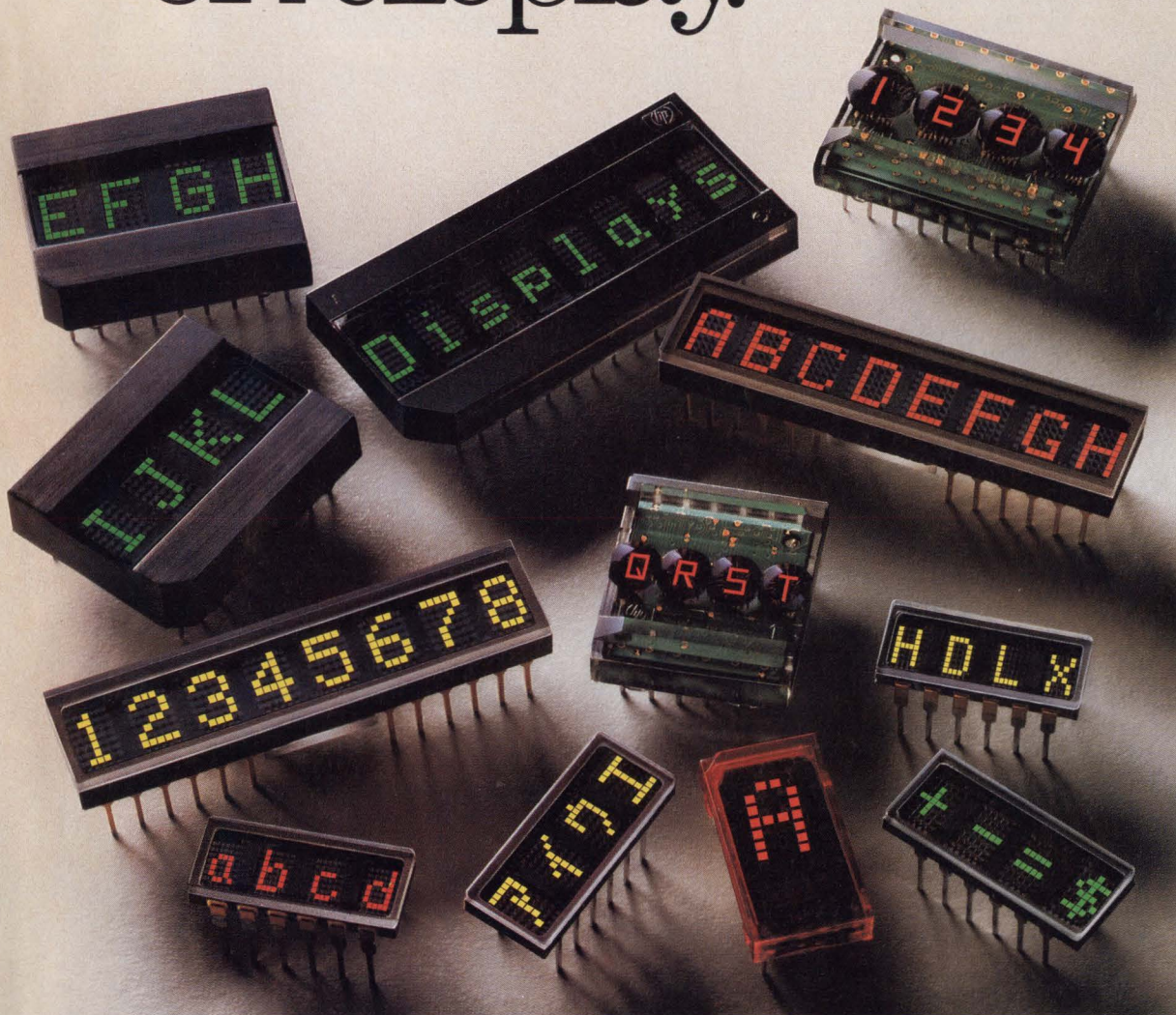

If you're looking for the right LED display solution, take a look at HP. We've got a full line of low-power, easy-to-use alphanumeric CMOS displays.

All featuring an integrated on-board CMOS IC. And all designed to provide you with a better way to meet your display requirements.

Take our eight-character 5 x 7 smart alphanumeric display, for example. It's the industry's only customizable display. With up to 16 user-defin-

able characters and the capability to generate foreign characters, special symbols and logos.

Or choose from four-character 5 x 7 CMOS displays in all four LED colors.

Smart 16-segment displays with built-in RAM, ASCII decoder and LED drive circuitry. Which also come in a drop-in 5 x 7 dot-matrix upgrade.

And single-character red hexadecimal displays with a 4 x 7 dot-matrix display.

Best of all, they're from HP. So you're always assured of HP's commitment to excellence in service, support and reliability.

For a free brochure describing our full line of CMOS display solutions, call **1-800-752-0900 ext. 233H**. And see how easy it is to shine.

**There is a better way.**

 **HEWLETT  
PACKARD**

CG08902



# Extraordinary disc drives require extraordinary parts.



Seagate and the Seagate logo are registered trademarks of Seagate Technology, Inc.  
© 1991, Seagate Technology, Inc.



Today's disc drives are smaller in size and larger in capacity than ever before due to advances in component technology. By

designing and manufacturing most of the components ourselves — a concept called vertical integration — we can control the technology, cost, availability and quality of these critical parts.

Technically speaking, no one builds more advanced thin-film discs and recording heads than Seagate. These core technologies help us put 3 gigabytes of storage in a box the size of a toaster. And because we design our own components, we can bring our new products to market faster.

Of course, a key consideration in building our own parts is the cost. By controlling the manufacturing process down to the component level, we can have a significant impact on the cost of our finished products. The

end-result is a better value for the customer without sacrificing quality or performance.

In terms of availability, it's important to know that Seagate shipped over 7 million disc drives last year alone. With volumes like these, building our own components helps us avoid the parts shortages that often plague other disc drive manufacturers.

Most importantly, vertical integration allows us to maximize the quality of every component we produce. With the industry's most advanced equipment and testing techniques, we consistently turn out components and finished products that are beyond reproach.

Obviously, it takes an extraordinary capital investment to pursue this strategy. But the disc drive companies who control their critical component production will be better able to control their own destinies, as well as those of their customers.

For more information on our complete line of high-performance disc storage products, contact your authorized Seagate distributor. Or call Seagate at 800-468-DISC, or 408-438-6550.



 **Seagate**

The first name in disc drives  
CIRCLE 146



# ELECTRONIC DESIGN

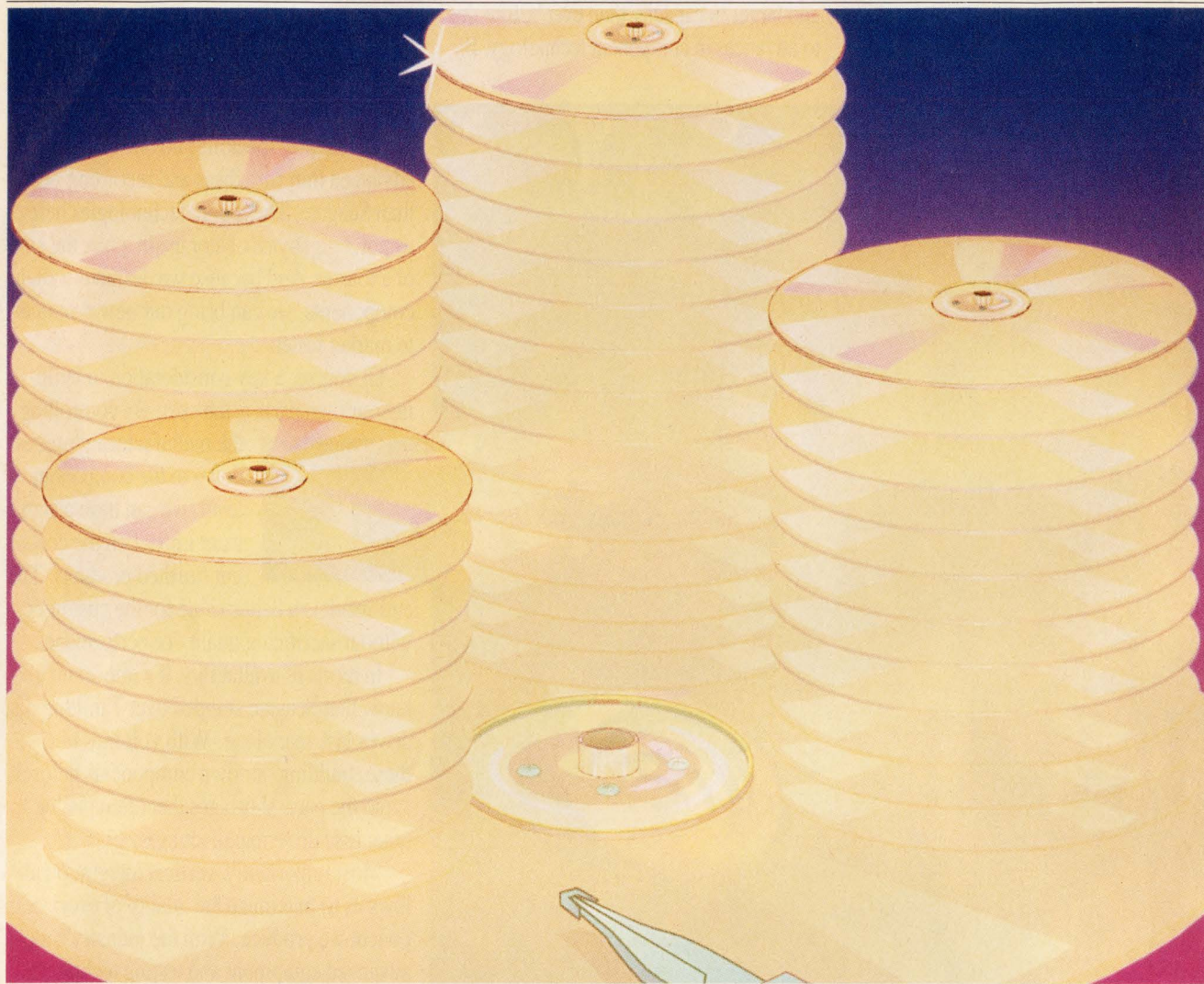

**COVER FEATURE** **35 BUILD SCSI RAID SYSTEMS TO BOOST DATA AVAILABILITY**

Two chip-set options let designers readily implement small or large storage using redundant arrays of inexpensive disks.

**ELECTRONIC DESIGN REPORT** **45 HIGH-DENSITY PROGRAMMABLE LOGIC TAKES ON GATE ARRAYS**

As density, speed, and flexibility improve, field-programmable chips start to replace masked gate arrays.

**DESIGN APPLICATIONS** **59 UPGRADE A 68030-BASED SYSTEM WITH A CLEVER CACHE DESIGN**

Build a cache daughterboard that plugs into the existing processor socket to exploit the processor's synchronous mode.

**PRODUCT INNOVATIONS** **101 REPEATER INTERFACE IC TAKES ON ETHERNET MEDIA**

Robust executive and control functions simplify network-management tasks for future Ethernet LANs.

**105 SCOPES OFFER DIGITAL POWER IN A COZY SETTING**

A pair of digital storage oscilloscopes try to make designers forsake the comfort of their familiar analog instruments.



## 14 EDITORIAL

### 18 TECHNOLOGY BRIEFING

Improve power factor or lose Europe

### 23 TECHNOLOGY NEWSLETTER

- Software tackles RF designs up to 3 GHz
- Technology database aids system designers
- Software deal aims for common environment
- IBM strengthens its support for ISDN
- Service group judges system performance
- Graphical software does EMI modeling
- Box connects up to 16 hardware emulators
- Largest biCMOS arrays pack 150,000 gates

### 29 TECHNOLOGY ADVANCES

- U.S.-Japan developments enhance DRAM performance and packaging

## PC DESIGN SPECIAL EDITORIAL SECTION

### 69 PC Design Newsletter

### 71 PC Design Editorial Feature

Simple upgrade lets 80386 systems use i486

### 81 PC Design Products

### 85 IDEAS FOR DESIGN

- Model thermistor with Spice
- Increase dc-dc converter power
- Frequency divider is programmable

### 91 QUICK LOOK

- Perspectives on Time-to-Market: Creating project models
- Universal frequency counter-timer teams up with Windows 3.0
- Free software to help you find out if you qualify for a small-business loan
- Demand for RISC chips propels market for 32-bit microprocessors
- What engineering investors need to know about futures funds

### 97 PEASE PORRIDGE

What's all this statistical stuff, anyhow?

### NEW PRODUCTS

**109 Computer-Aided Engineering**  
Spreadsheet-like VHDL tool alleviates programming hassles

### 117 Communications

### 118 Instruments

### 127 INDEX OF ADVERTISERS

### 129 READER SERVICE CARD

## COMING NEXT ISSUE

- Special Report: Fax modem chips
- Design Team Issues: Architectural models are key to system-level design
- First details on new workstation graphics ICs
- PIPS: Power, Packaging, Interconnections, Switches & Relays
- Suppress EMI/RFI from the ground up
- How to recognize a good conductor crimp
- Manufacturer listing for interconnections
- Special products section
- PLUS:  
Ideas for Design  
Pease Porridge  
Technology Advances

ELECTRONIC DESIGN (USPS 172-080; ISSN 0013-4872) is published semi monthly by Penton Publishing Inc., 1100 Superior Ave., Cleveland, OH 44114-2543. Paid rates for a one year subscription are as follows: \$75 U.S., \$140 Canada, \$230 International. Second-class postage paid at Cleveland, OH, and additional mailing offices. Editorial and advertising addresses: ELECTRONIC DESIGN, 611 Route #46 West, Hasbrouck Heights, NJ 07604. Telephone (201) 393-6060. Facsimile (201) 393-0204.

Printed in U.S.A. Title registered in U.S. Patent Office. Copyright © 1991 by Penton Publishing Inc. All rights reserved. The contents of this publication may not be reproduced in whole or in part without the consent of the copyright owner.

Permission is granted to users registered with the Copyright Clearance Center Inc. (CCC) to photocopy any article, with the exception of those for which separate copyright ownership is indicated on the first page of the article, provided that a base fee of \$1 per copy of the article plus \$.50 per page is paid directly to the CCC, 27 Congress St., Salem, MA 01970 (Code No. 0013-4872/91 \$1.00 + .50). Copying done for other than personal or internal reference use without the express permission of Penton Publishing, Inc. is prohibited. Requests for special permission or bulk orders should be addressed to the editor.

For subscriber change of address and subscription inquiries, call (216) 696-7000.

POSTMASTER: Please send change of address to ELECTRONIC DESIGN, Penton Publishing Inc., 1100 Superior Ave., Cleveland, OH 44114-2543.



Certificate of Merit  
Winner, 1988  
Jesse H. Neal Editorial  
Achievement Awards

Cover: Tony Vitolo



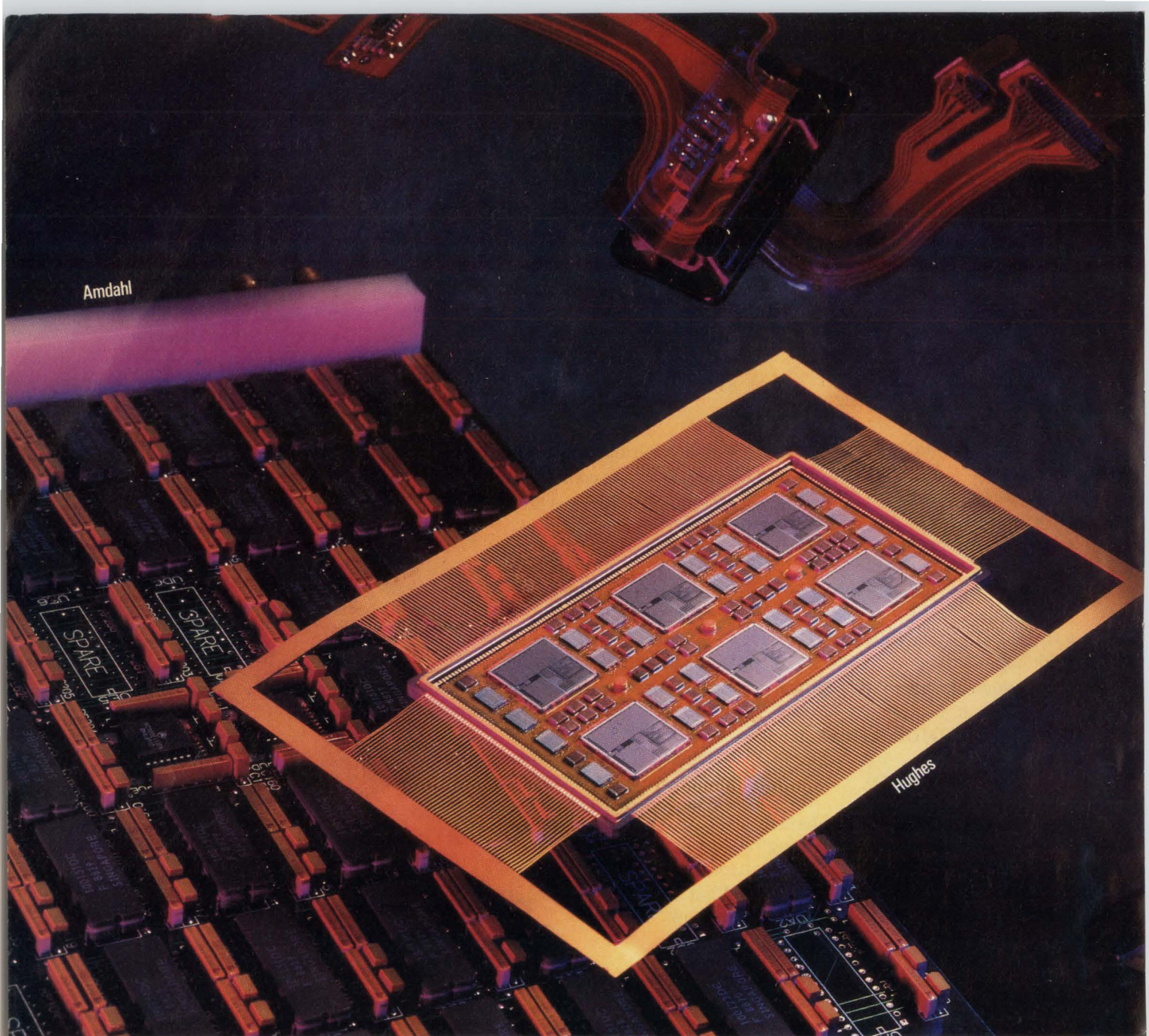

## THE LEADERS IN PCB DESIGN WE SUPPLY

You're looking at some truly outstanding examples of advanced systems technology. PCB, hybrid, MCM. From some of the most prominent players in the electronics industry.

In each case, Mentor Graphics design tools helped leverage these complex board technologies into successful products:

A ten-layer ECL board from Amdahl with 1257 components and 1659 nets,

each with a length or impedance constraint.

A board from Tektronix combining very high-speed digital and low-noise analog circuitry.

A PCB from NovAtel using chip-on-board (COB) technology for dramatic space savings.

A flexible circuit board from a major hard disk manufacturer with complex curved geometries.

A multi-chip module (MCM) from Hughes with 82 devices and 3300 interconnects on a 96x45 mm (3.8" x 1.8") silicon substrate.

A Mil-Std multi-layer ceramic module from Unisys that packs 57 chips and 2834 pins into a 6"x6" space less than .6" thick.

Each of these designs required superior engineering combined with superb tool technology. Precisely the kind of partnership



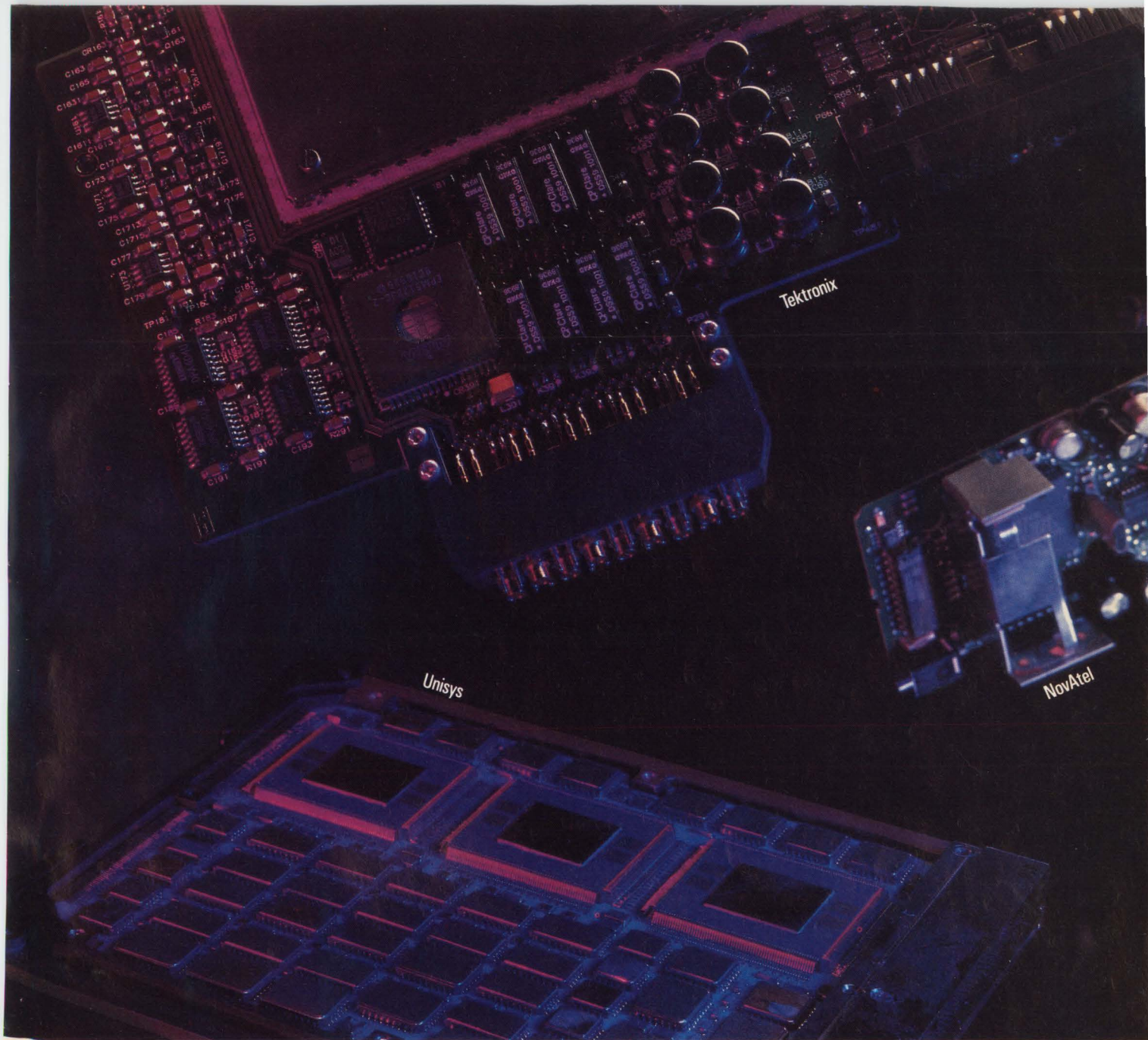

# SIGN SUPPLY THE TALENT. THE TOOLS.

you get with Mentor Graphics, the leader in design automation. We offer tools that span the entire bandwidth of electronics systems technology, from PCB to hybrid to MCM.

Our Advanced Dynamic Editor, which brings new dimensions of productivity to manual routing operations. Our high-performance autorouter. And our special support for high-speed circuitry.

But tools are only half the story.

Mentor Graphics Consulting and Support Services round out our partnership with you and help ensure your success. The best in customer and engineering support. Integration services that smooth the transition of our tools into your environment. Plus the Mentor Graphics Falcon Framework™ can bind all your design automation tools into a productive whole, regardless of their source.

So for more information, phone 1-800-547-3000 or 1-503-685-8000 (Dept. 102). If you've got the talent, we've got the tools.

 **Mentor  
Graphics**<sup>®</sup>  
Changing The Way The World Designs. Together.



# SCSI INSTRUMENTS



ANCOT's SCSI instruments are powerful, easier to use, and cost less. Proven in use worldwide, Ancot's portable equipment travels from bench to field and back again without ever slowing down. They are time and labor saving instruments, for design, manufacturing, repairing, and inspection applications.

Call today for product data sheets, demo disc, or to make arrangements for a free evaluation unit in your facility.

**ANCOT**  
CORPORATION

**[415] 322-5322**

fax: (415) 322-0455  
115 Constitution Drive  
Menlo Park, CA 94025

CIRCLE 132

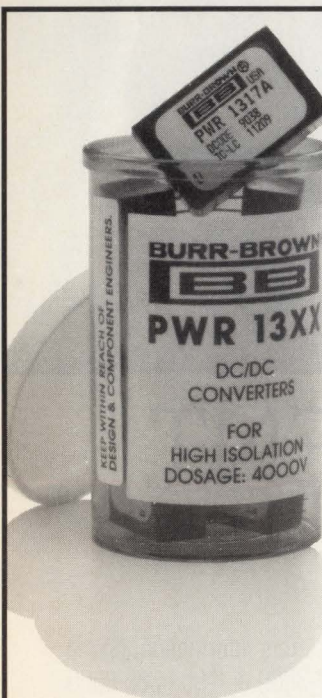

## For The Health Of Your Monitoring Systems, Burr-Brown Prescribes PWR13XX.

### The DIP DC/DC Converter For Ultra High Isolation: 4000V.

Medical grade isolation is yours with a dose of 1.5 watts of unregulated output power from the PWR13XX. Its dual-in-line package uses only 1 inch<sup>2</sup> of PC Board space and comes in low prices that are easy to swallow.

Use as needed for applications where system integrity and reliability are critical. No external parts required.

Contact your salesperson for quick delivery.

**\$ 21**  
**OEM**

**BURR-BROWN®**

**BB**

Your Partner in Quality

CALL 1-800-548-6132 ext. 532

Fax 1-602-741-3895

Write P.O. Box 11400 - Tucson, Arizona 85734

CIRCLE 100

**8** E L E C T R O N I C D E S I G N

MARCH 14, 1991

# ELECTRONIC DESIGN

**Editor-in-Chief:** Stephen E. Scrupski

**Executive Editor:** Roger Allan

**Managing Editor:** Bob Milne

**Senior Editors:** Frank Goodenough,  
Milt Leonard, John Novellino

**Technology Editors:**

*Analog & Power:* Frank Goodenough

*Communications & Industrial:*

Milt Leonard (San Jose)

*Components & Packaging:* David Maliniak

*Computer-Aided Engineering:*

Lisa Maliniak

*Computer Systems:* Richard Nass

*Semiconductors:* Dave Bursky (San Jose)

*Test & Measurement:* John Novellino

**News Editor:** Sherrie Van Tyle

**New Products Editor:** Susan Nordyk

**Field Bureaus:**

*West Coast Executive Editor:*

Dave Bursky (San Jose)

*Boston:* Lawrence Curran

*Dallas:* Jon Campbell

*Frankfurt:* John Gosch

*London:* Peter Fletcher

**Chief Copy Editor:** Roger Engelke, Jr.

**Contributing Editors:**

Ron Kmetovicz, Robert A. Pease

**Editorial Production Manager:**

Lisa Iarkowski

**Editorial Support Supervisor:** Mary James

**Editorial Assistant:** Ann Kunzweiler

**Editorial Secretary:** Bradie Guerrero

**Editorial Offices:** (201) 393-6272

**Advertising Production:**

(201) 393-6093 or FAX (201) 393-0410

**Production Manager:** Michael McCabe

*Production Assistants:*

Donna Marie Bright, Lucrezia Hlavaty,

Eileen Slavinsky

**Circulation Manager:** Robert Clark

**Promotion Manager:** Clifford Meth

**Reprints:** Helen Ryan 1-800-835-7746

**Group Art Director:** Peter K. Jeziorski

**Computer Systems Administrator:**

Anne Gilio Turtoro

**Published by Penton Publishing**

**Vice President-Editorial:** Perry Pascarella

**Group Editorial Director:** Leland Teschler

**Publisher:** Paul C. Mazzacano



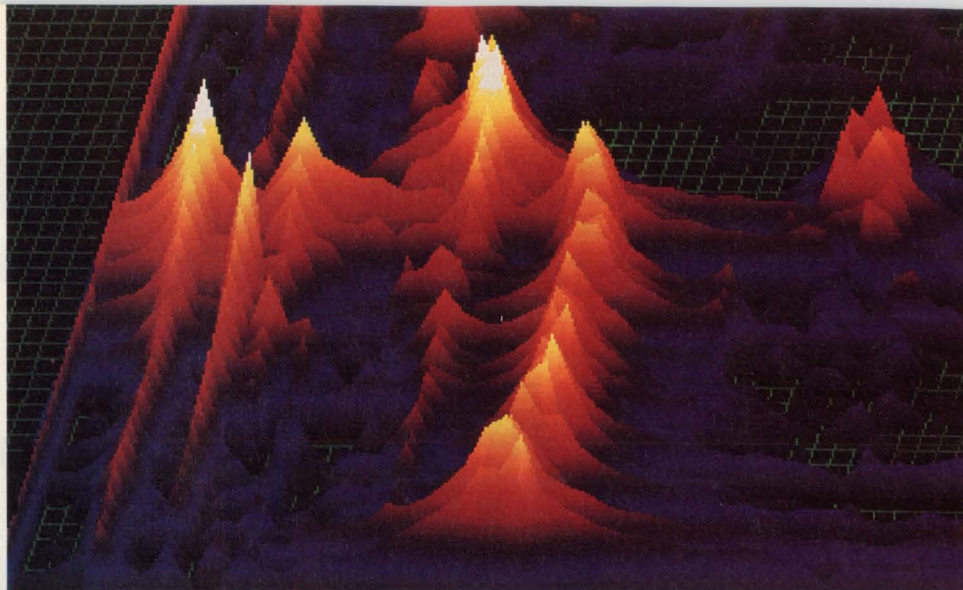

## IS IT C#, JENNY'S FIRST WORD, OR A TURBINE ABOUT TO EXPLODE?



MacDSP can acquire, analyze and display signals so quickly you can actually see the harmonic variations of a flute as it plays, recognize speech, or spot dangerous signals before it's too late.

With an advanced 50 MHz floating-point digital signal processor and modular data acquisition on a single card, MacDSP's design bypasses CPU traffic jams and lets the Macintosh do what it does best: graphics.

MacDSP hardware can be configured with a variety of processor speeds to meet your specs and budget, memory capacities large enough for speech analysis or image processing, and acquisition options to handle anything from robotic control to electronic music to ultrasonic vibration.

MacDSP Signal Analysis software turns your Macintosh into a signal processing instrument with real-time displays which surpass ordinary oscilloscopes and spectrum analyzers. We offer an array processing library of common DSP and mathematical functions to speed up your existing programs, and AT&T's optimized C compiler for more advanced applications.

Contact us for a free demo disk. Spectral Innovations, Inc.,  
4633 Old Ironsides Dr., Ste.450, Santa Clara, CA 95054.  
Phone: (408) 727-1314. FAX: (408) 727-1423.





# Because Speed We'll Stop



**MACH**

**Fastest High Density  
CMOS PLDs  
At 15ns**



**PALCE16V8H-10**

**Fast Universal  
CMOS PLD Family  
At 10ns**



**PAL16L8-5**

**Fast Bipolar  
PLD Family  
At 5ns**



# Is Everything, At Nothing.

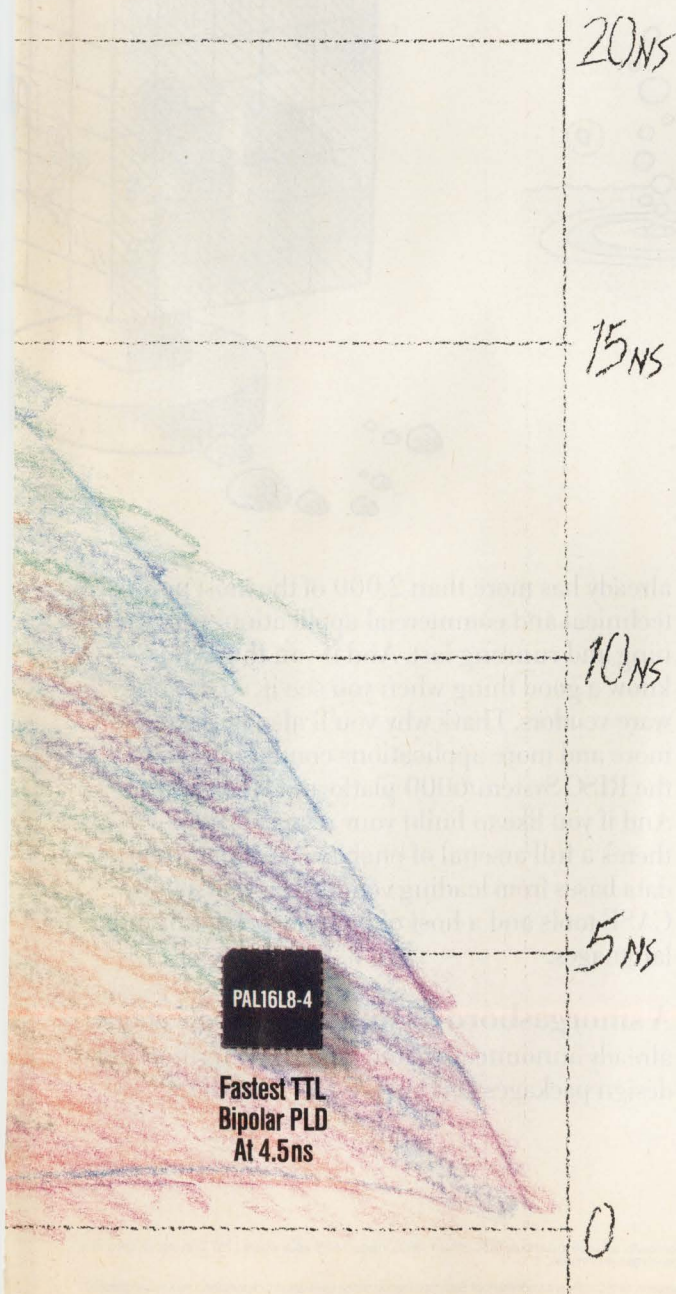

## Whatever kind of PLD you need, the fastest comes from AMD.

We'd love it if all our work amounted to "zero." As in zero delay. And we're not far off.

Not surprising—because AMD invented the PAL® device. That's why we know programmables better. And offer you the most choices of the best devices.

Say you want speed, but can't sacrifice density. Don't. Use our new MACH™ products (Macro Array CMOS High-density) that give you up to 3600 gates and 15ns performance. They're two to three times faster than the competition and cost 40% less.

For more speed, along with low power consumption, try our new 10- and 15-nanosecond CMOS PLDs. Use our 16V8-10s and 20V8-10s anywhere you'd use a GAL® device. Or choose the ever-popular AMD-invented 22V10, at 15ns.

Faster still are our seventh generation bipolar PAL devices. Complete families of 16L8-5s, 20L8-5s, and the 22V10-10s. And for real speed freaks, we're now shipping a 4.5ns bipolar PAL device—the world's fastest TTL programmable logic.

Along with all this speed, we're providing equally fast delivery. In quantity. In fact, we deliver more programmable logic devices than all our competitors combined.

For details, call AMD now at **1-800-222-9323**. And let nothing stand between you and your need for speed.



## Advanced Micro Devices

901 Thompson Place, P.O. Box 3453, Sunnyvale, CA 94088 © 1991 Advanced Micro Devices, Inc.  
MACH is a trademark and PAL is a registered trademark of Advanced Micro Devices.  
GAL is a registered trademark of Lattice Semiconductor.



# The IBM RISC System/ The power you've been seeking

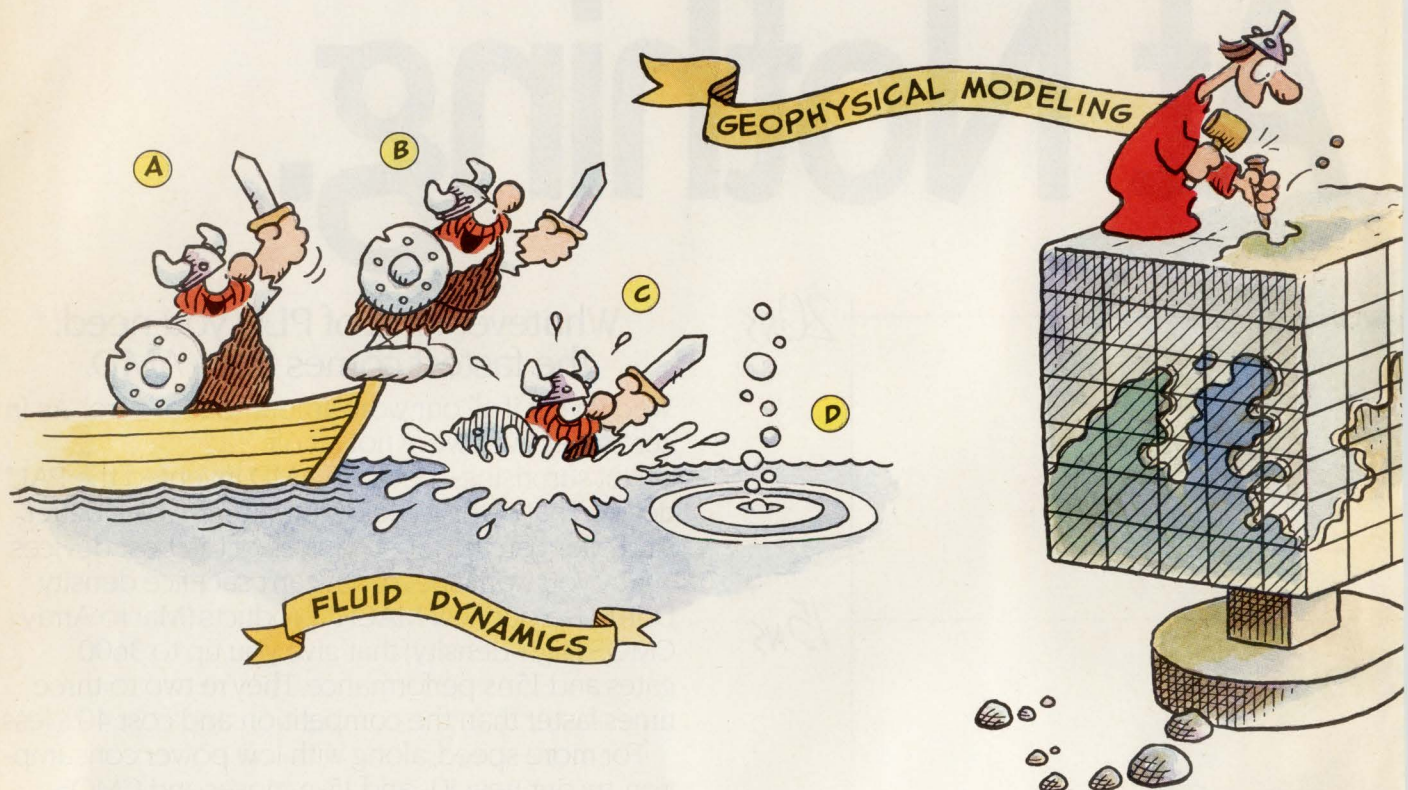

It's a never-ending quest for power seekers. You're always looking for ways to run your favorite applications faster. Well, search no more. The RISC System/6000™ family of POWERstations and POWERservers gives you power that soars as high as 23 MFLOPS and 56 MIPS.

	MFLOPS	MIPS	SPECmark™
POWERstation 320	7.4	29.5	22.4
DECstation 5000-200	3.7	24.2	18.5

**When it comes to porting, your ship has come in.** Of course, all the speed in the world wouldn't mean much without the applications you need. So the RISC System/6000 family

already has more than 2,000 of the most popular technical and commercial applications up, running and running fast. And if you think you know a good thing when you see it, so do software vendors. That's why you'll also be seeing more and more applications coming on board the RISC System/6000 platform all the time. And if you like to build your own solutions, there's a full arsenal of enablers and relational data bases from leading vendors, as well as CASE tools and a host of popular programming languages.

**A smorgasbord of solutions.** Applications already announced include the IBM engineering design packages CADAM™, CAEDS™, CBDS™,

MFLOPS are the results of the double-precision, all FORTRAN Linpack test 100x100 array suite. The Dhrystone Version 11 test results are used to compute RISC System/6000 Integer MIPS value where 1,757 Dhrystones/second is 1 MIPS (Vax 11/780). SPECmark is a geometric mean of ten benchmark tests. All performance data are based on published benchmark information.

IBM is a registered trademark, and RISC System/6000 and CAEDS are trademarks of International Business Machines Corporation. SPECmark is a trademark of Standard Performance Evaluation Corporation. UNIX is a registered trademark of UNIX System Laboratories, Inc. CADAM is a trademark of CADAM INC. CATIA is a trademark of Dassault Systemes. CBDS is a trademark of Bell Northern Research Corporation. DECstation is a trademark of Digital Equipment Corporation. HAGAR THE HORRIBLE Character(s) © 1990 King Features Syndicate, Inc. © IBM Corp. 1991. All rights reserved.







# LCD Proto Kit

Everything you need to start your LCD application .... create complex screens in just a few hours!

240 x 64 pixel Supertwist LCD mounts directly onto CYB003 prototyping board.

Kit provides serial interface to IBM PC for quick prototyping. Board also supports displays up to 240 x 128 pixels.

Interface to 6 soft keys or 4 x 4 key matrix.

Dial 0-25k ohms for LCD contrast.

\* The CY325 LCD Windows Controller provides parallel or serial high-level control of Instrument-size LCDs. Up to 256 built-in windows support window-relative text, bargraphs, waveforms, and plots. Text and graphics are maintained in separate planes, facilitating special effects. Complete User Manual included.

Wirewrap area for custom circuitry or back-light.

RJ 11 serial jack for Rx/D, Tx/D, CTS, and GND, plus 2 spares.

5 Pin Power DIN.

Alternate Power Connector.

Add your own 8051 CPU for stand alone operation.

## Kit also includes:

Power supply provides +5v and Gnd for board, -12v for LCD, and +12v spare.

Sample routines in 8051 Assembler and QuickBasic.

LCD Paint™ for creating your own graphics images.

4-wire RJ11 style cable with DB25F connector for your IBM PC.

Demo routines preprogrammed into 8751 for immediate gratification.

**\$495 - Kit**  
Popular LCD Starter Kit.



(\$595 pre-assembled & tested)

\*The CY325 40-pin CMOS LCD Controller IC is available from stock @ \$75/singles, \$20/1000s (Surface mount also avail in qty.)

**CyberneticMicroSystems**

Box 3000 • San Gregorio CA 94074  
Tel: 415-726-3000 • Fax: 415-726-3003

# EDITORIAL



## THE ELECTRONIC ROLE IN WAR

Up to now, we've hesitated to mention the Persian Gulf War in this column because of a time lag between the time this column must be written to meet our deadline and the time it appears on readers' desks. In this intervening period, rapidly changing events may render our comments, when they appear in print, inappropriate, or worse, insensitive to a negative turn of events in the war. However, while writing this column, the situation seems close to being resolved, with little doubt about the outcome. In the hope that peace will soon arrive, and within the bounds of the caveat cited above, we offer a comment on the technological aspects of the episode.

The prime-time TV showcase for the U.S. arsenal of sophisticated, electronically controlled weapons will be etched in our memories. For those who have built careers on designing electronic equipment to solve a customer's problem, there should be little surprise about their performance. After all, these devices, properly designed, simply follow the laws of physics, just as much as a bomb falling from a plane follows the basic physical law of gravity. But even knowing this, we still marvel at just how well those systems work, combining optics, radar, computer, and propulsion technologies.

Having proven the performance of this breed of intelligent weapons, what's next for the defense electronics industry? These weapons, with their demonstrated effectiveness, could undoubtedly be improved by incorporating the latest technology. We certainly hope that this is the last time they're used, but that should not stop us from improving the accuracy and reliability of the next generation, just in case we need them again.

While we're at it, let's also hope that the Department of Defense and defense-industry management will institute corresponding improvements in program administration to cut waste and inefficiency. This may not be easy to do, but it's as important as the swiftness and accuracy of the weapons themselves.

Stephen E. Scrupski  
Editor-in-Chief





# PRECISION TTL-CONTROLLED ATTENUATORS

up to 35dB  
10 to 1000MHz  
only **\$5995**

TOAT-R512		TOAT-124		TOAT-3610		TOAT-51020	
Accuracy (dB)	(+/-dB)	Accuracy (dB)	(+/-dB)	Accuracy (dB)	(+/-dB)	Accuracy (dB)	(+/-dB)
<b>0.5</b>	<b>0.12</b>	<b>1.0</b>	<b>0.2</b>	<b>3.0</b>	<b>0.3</b>	<b>5.0</b>	<b>0.3</b>
<b>1.0</b>	<b>0.2</b>	<b>2.0</b>	<b>0.2</b>	<b>6.0</b>	<b>0.3</b>	<b>10.0</b>	<b>0.3</b>
1.5	0.32	3.0	0.4	9.0	0.6	15.0	0.6
<b>2.0</b>	<b>0.2</b>	<b>4.0</b>	<b>0.3</b>	<b>10.0</b>	<b>0.3</b>	<b>20.0</b>	<b>0.4</b>
2.5	0.32	5.0	0.5	13.0	0.6	25.0	0.7
3.0	0.4	6.0	0.5	16.0	0.6	30.0	0.7
3.5	0.52	7.0	0.7	19.0	0.9	35.0	1.0

**bold faced values are individual elements in the units**

Now...precision TTL-controlled attenuators accurate over 10 to 1000MHz and -55 to +100 °C. Four models are available in the new TOAT-series, each with 3 discrete attenuators switchable to provide 7 discrete and accurate attenuation levels (see chart). Cascade all four models for up to 64.5dB control in 0.5dB steps. Custom values available on request. The 50-ohm TOAT-series performs with 6µsec switching speed and can handle power levels up to 0dBm. Units are housed in a rugged hermetically-sealed TO-8 package to withstand the shock, vibration, and temperature stresses of MIL-STD-883. Connector versions are available. Take advantage of the \$59.95 (1-9 qty) price breakthrough to stimulate new applications as you implement present designs and plan future systems.



finding new ways...  
setting higher standards

**Mini-Circuits**

CIRCLE 148

WE ACCEPT AMERICAN EXPRESS

P.O. Box 350166, Brooklyn, New York 11235-0003 (718) 934-4500 Fax (718) 332-4661 Domestic and International Telexes: 6852844 or 620156



# What's you

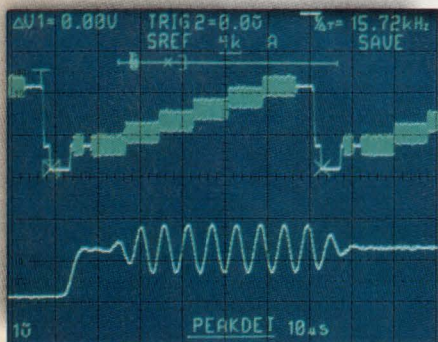

Analyzing TV and complex video signals?

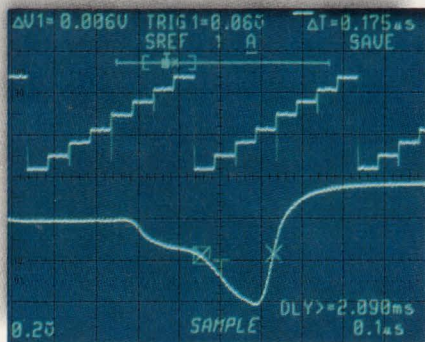

Uncovering elusive glitches?

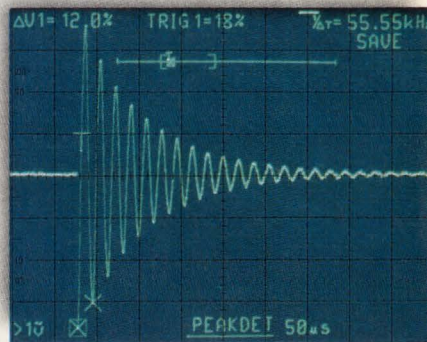

Capturing single-shot events?

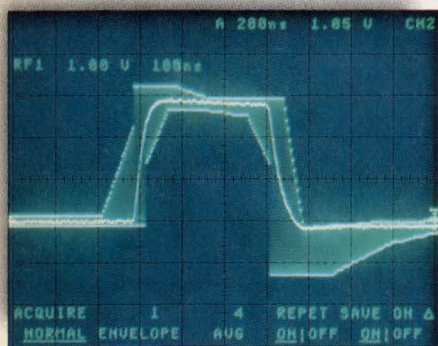

Testing telecommunications signals?



Finding aberrations buried within a signal?

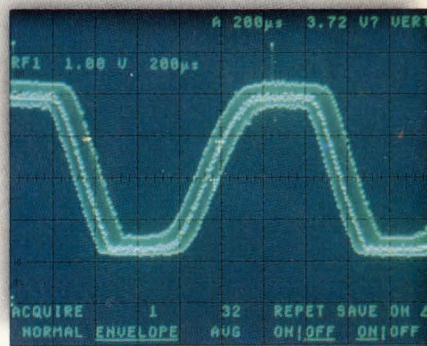

Automatic PASS/FAIL testing?

**You can't depend on banner specs alone to solve problems like these.**

Whether you're trying to measure waveform parameters or analyze long data streams, identify infrequent events or track down glitches as narrow as 2 ns — there's all the difference between the depth of Tek troubleshooting and the trade-offs in other DSOs that compromise your results.

Spec for spec, feature for feature, no other company offers the credentials Tek does to

effectively match DSO performance to your application needs. Whatever your criteria, you'll find a perfect solution in our line of problem-solving portable DSOs, from 10 to 500 MS/s.

**Select the features to support your application.** Tek DSOs offer a diverse set of capabilities including peak detect to uncover elusive glitches. Fast update rate for live signal display. Combined analog/digital operation for real-time verification of your



# r problem?

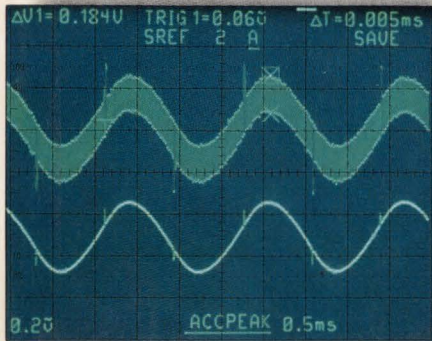

Characterizing signal noise?

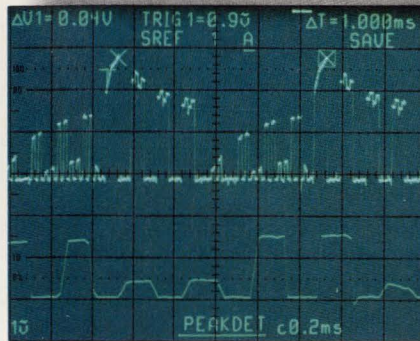

Capturing and analyzing long data streams?

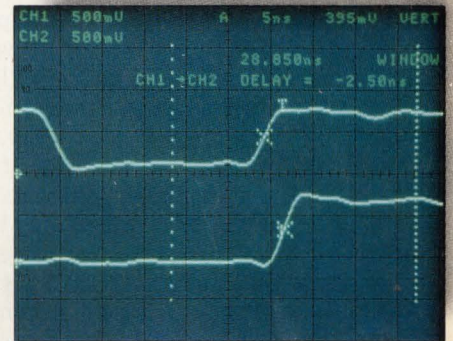

Measuring timing relationship between signals?

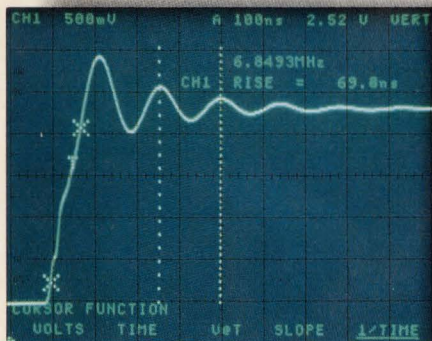

Performing complex measurements automatically?

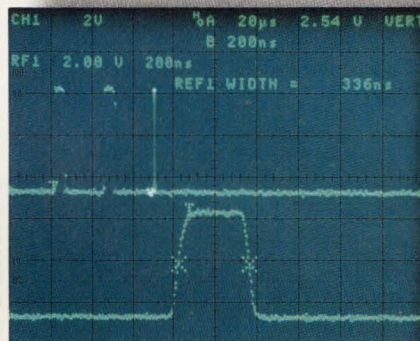

Expanding glitches for close analysis?

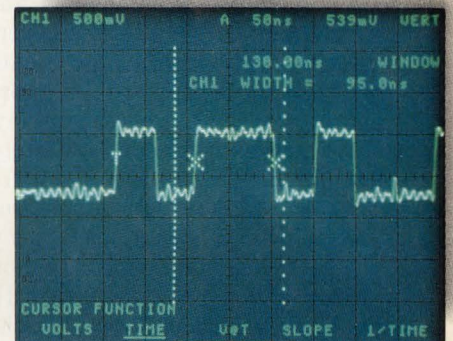

Windowing in on signal details?

signal. Or Save on Delta to automatically verify that all parts of your signal fall within prescribed limits. Best of all, Tek's line of 100 MS/s digitizing scopes start at just \$3995.

To find out which Tek scope is right for you, contact your Tek representative, return the card or call Tek direct. We can answer your questions and show you a scope that doesn't just look good on paper. It makes your toughest troubleshooting challenges routine.

## 1-800-426-2200

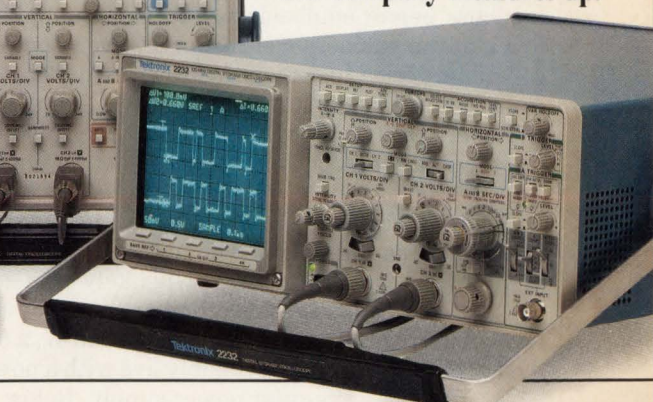
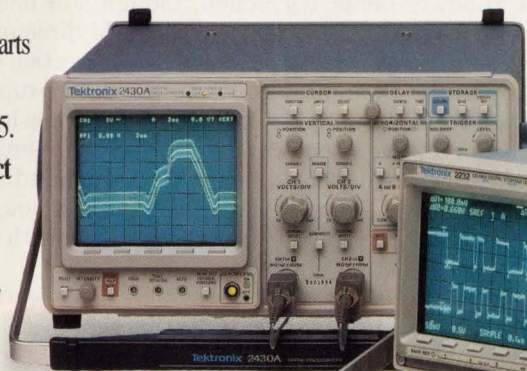

One company measures up.

**Tektronix**  
COMMITTED TO EXCELLENCE



## IMPROVE POWER FACTOR OR LOSE EUROPE

**B**uilding power-factor correction into switching power supplies has become a fact of life for a number of reasons. For one, it alleviates the problems caused in electrical-distribution networks when the supplies' filter capacitors draw current in short pulses. It also keeps current out of the neutral line in balanced-load systems.

But for those who keep an eye on such things, as all power-supply manufacturers must (and as users should), power-factor correction can also keep products from running afoul of some prickly regulatory requirements. One requirement, which now exists only in an advisory capacity in Europe, may, upon its widespread adoption, fundamentally change the way power-supply makers and users look at the need for power-factor correction.

Though intended originally for household electronic equipment at power levels above 200 W, the requirement in question, IEC 555-2, allows a maximum third-harmonic current of 2.3 A with decreasing limits for higher-order harmonics. These limits will become even more stringent when a new revision (77A) is accepted. In this proposal, the standard applies to all equipment with line currents up to 16 A—there's no minimum. It also gives a relative as well as a reduced absolute limit for each current harmonic. The third-harmonic limit will now be set at 3.6 mA/W or 1.08 A absolute, with similarly decreasing limits for the higher orders.

The implications of the specification are already becoming clear. It's anticipated that these limits will be enforced extensively in Europe within the next year or two. Austria has begun invoking the standard and Germany is preparing to do so. Moreover, it's likely that the United States will soon begin to take these limits seriously. The effect of enforcement is to effectively ban the sale of any equipment that does not comply. Major systems manufacturers, who must be looking at least two years ahead in terms of their component specifications, should pay attention. If they want to get their products into the European marketplace, they'll be compelled to specify higher power factors and lower harmonic-current levels in their next-generation power supplies. The alternative, which is to specify a compliant and a non-compliant supply, is likely to be too costly for most OEMs.

There are some caveats to power-factor correction, though. For one, it makes the supply's design more complex. According to Lou Pechi, director of marketing at Power-One Inc., Camarillo, Calif., power-factor correction can increase design difficulty by up to a magnitude. When the power-supply business began emphasizing switching supplies instead of linear designs, much of the business went from captive to non-captive. Many power-supply consumers tried to design their own switchers in-house, but it required specialized design skills that were in short supply. Instead, many users bought switchers from OEM vendors. The same trend is likely to continue with the new generation of power-factor-corrected supplies.

On the one hand, Pechi agrees that enforcing the IEC 555-2 specification, on a virtual worldwide basis, is inevitable. But on the other, he noted, the IEC 555-2 specification doesn't demand a 0.99 power factor in all cases. For a 2000-W supply, in which harmonics will likely exceed the specification, the upper limits of correction are a necessity. As output levels decrease, however, the level of correction can fall as well. At 750 W, a 0.8 power factor is adequate. And at 500 W, users can probably live with a power factor of 0.6, which is the power factor of a regular power supply. Below 250 W, its not needed at all, because the harmonic content isn't there. The bottom line is that before specifying a power-factor-corrected supply for a given application, users have to dust off their Fourier textbooks and determine if it's needed at all.



DAVID MALINIAK  
COMPONENTS & PACKAGING

### The best address for Siemens Semiconductors:

- (A) **Wien**  
Tel. (02 22) 71711-56 61
- (AUS) **Melbourne, Vic. 3121**  
Tel. (03) 4 20 71 11
- (B) **Bruxelles**  
Tel. (02) 5 36-2111
- (BR) **São Paulo-SP**  
Tel. (011) 8 33-22 11
- (CDN) **Mississauga L5T 1P2**  
Tel. (416) 5 64-19 95
- (CH) **Zürich**  
Tel. (01) 4 95-3111
- (D) **Berlin 10**  
Tel. (030) 39 93-0  
**Düsseldorf 1**  
Tel. (0211) 3 99-0  
**Frankfurt 1**  
Tel. (069) 7 97-0  
**Hamburg 1**  
Tel. (040) 28 89-0  
**Hannover 81**  
Tel. (0511) 8 77-0  
**München 80**  
Tel. (089) 92 21-43 91/4138  
**Nürnberg 1**  
Tel. (0911) 6 54-0  
**Stuttgart 1**  
Tel. (0711) 20 76-0
- (DK) **Ballerup**  
Tel. (44) 7 744 77
- (E) **Madrid**  
Tel. (01) 5 55 40 62
- (F) **Paris**  
Tel. (1) 49 22-38 10
- (GB) **Sunbury on Thames**  
Tel. (0932) 75 26 15
- (GR) **Amaroussio/Athen**  
Tel. (01) 68 64-111
- (HK) **Hongkong**  
Tel. 5-833 02 22
- (I) **Milano**  
Tel. (02) 67 66-42 41
- (IND) **Bombay 400018**  
Tel. 4 93 87 86
- (IRL) **Dublin**  
Tel. (01) 30 28 55
- (J) **Tokyo 100**  
Tel. (03) 2 01-24 01
- (N) **Oslo 5**  
Tel. (02) 63 30 00
- (NL) **Den Haag**  
Tel. (070) 3 33 33 33
- (P) **Alfragide**  
Tel. (01) 4 18 33 11
- (RA) **Buenos Aires**  
Tel. (01) 30 04 11
- (RC) **Taipei**  
Tel. (02) 5 23 47 00
- (ROK) **Seoul**  
Tel. (02) 2 75-61 11
- (S) **Kista**  
Tel. (08) 7 03 35 00
- (SF) **Helsinki**  
Tel. (9) 05 10 51
- (SBP) **Singapore 0513**  
Tel. 7 76 00 44
- (TR) **Istanbul**  
Tel. (01) 1 51 09 00
- (USA) **Iselin**  
Tel. (201) 9 06-43 00 (Discrete)  
**Santa Clara**  
Tel. (408) 9 80-45 00 (ICs)  
**Cupertino**  
Tel. (408) 7 25-79 10 (Opto)
- (ZA) **Johannesburg**  
Tel. (011) 4 07-41 11



# SIEMENS

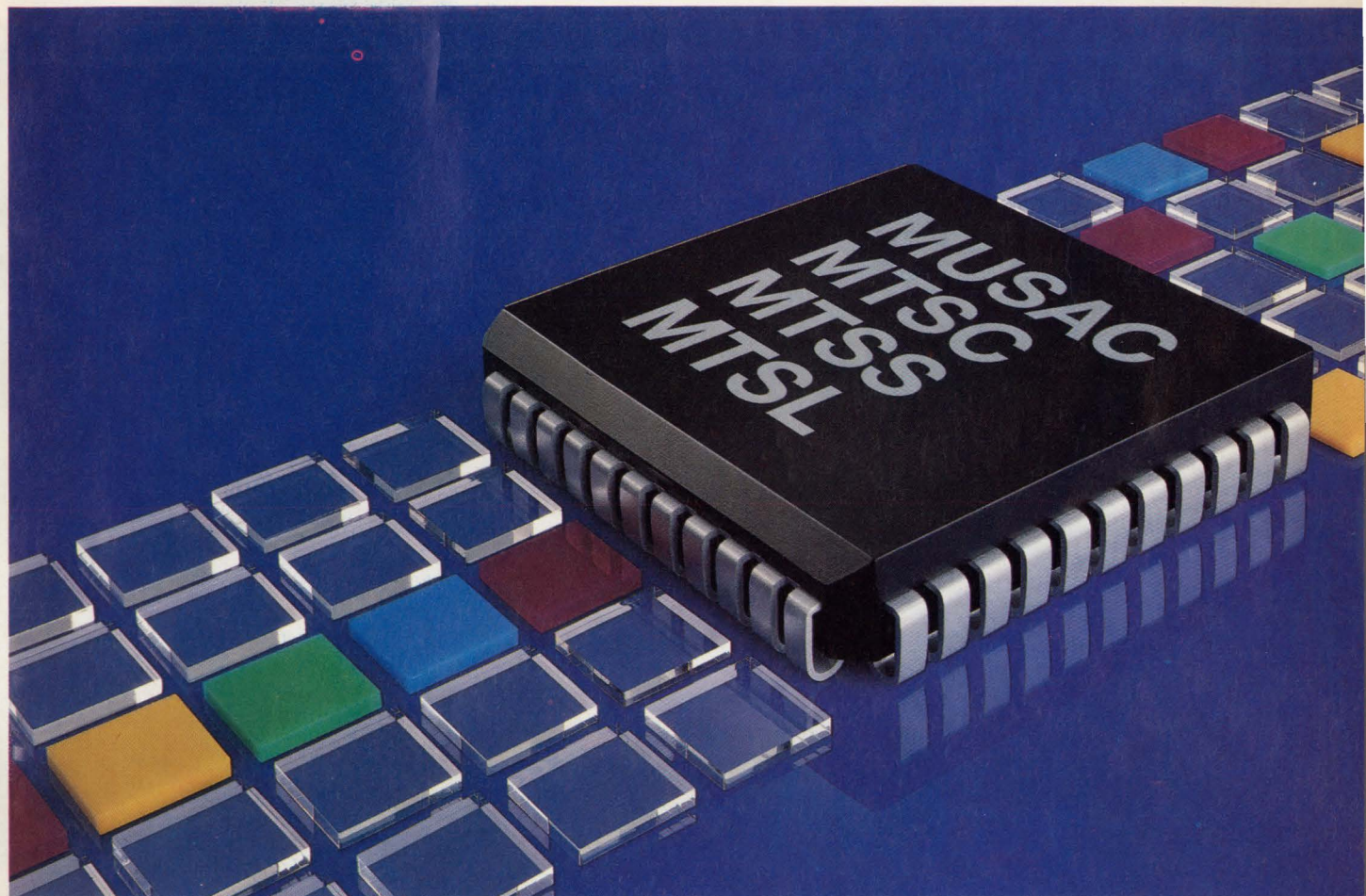

## Switchcraft as witchcraft.

If the issue is digital switching and conferencing, the solution is utmost flexibility in capability, capacity and unsurpassed economy. Switchcraft is wanted as witchcraft.

Siemens Semiconductors offers the most economical answer to any conceivable application in the field: Our complete family of switching network devices satisfies even the most rigorous switching demands.

Take our MTSC (Memory Time Switch CMOS) PEB 2045 with a switching capability of 512 incoming PCM channels to 256 outgoing PCM channels. It has the perfect size to build very economical medium sized switches. The design of a non-blocking switch for 512 PCM channels is possible with a simple parallel configuration of a second MTSC.

If you need a non-blocking switch for up to 256 channels, we offer a smaller version of the MTSC, the MTSS (Memory Time Switch Small) PEB 2046. And the MTSL (Memory Time Switch Large) PEB 2047, the largest in our family, is capable of switching 1024 PCM channels in a single device.

Siemens also supplies the best solution for conferencing. Our MUSAC (Multipoint Switching and Conferencing Unit) PEB 2245 performs the complete switching functions of the MTSC, and offers a signal processor for handling up to 64 conferencing channels in any combination. The input and output channels can also be attenuated individually to achieve best transmission quality.

Pin compatible devices as well as wideband switching capabilities allows simplicity in hardware and software design. To allow for more flexibility, the PCM data rate can be 2, 4 or 8 MBit/s – configurable also for mixed use. No matter what size you need, is it not time to switch over?

For details, call (800) 456-9229, or write Siemens Components, Inc., 2191 Laurelwood Road, Santa Clara, CA 95054-1514. Ask for literature package M12A005.

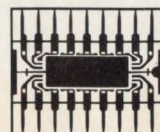

**Siemens  
Practical Solutions  
By Design**

CIRCLE 152

M12A005



# FILTERS





# dc to 3GHz from \$1145

## lowpass, highpass, bandpass, narrowband IF

- less than 1dB insertion loss • greater than 40dB stopband rejection
- 5-section, 30dB/octave rolloff • VSWR less than 1.7 (typ) • meets MIL-STD-202 tests
- rugged hermetically-sealed pin models • BNC, Type N; SMA available
- surface-mount • over 100 off-the-shelf models • immediate delivery



### low pass dc to 1200MHz

MODEL NO.	PASSBAND, MHz (loss <1dB)		fco, MHz (loss 3db)	STOP BAND, MHz (loss >20dB) (loss >40dB)			VSWR		PRICE \$ Qty. (1-9)
	Min.	Max.		Min.	Max.	Min.	pass-band typ.	stop-band typ.	
PLP-10.7	DC-11		14	19	24	200	1.7	18	11.45
PLP-21.4	DC-22		24.5	32	41	200	1.7	18	11.45
PLP-30	DC-32		35	47	61	200	1.7	18	11.45
PLP-50	DC-48		55	70	90	200	1.7	18	11.45
PLP-70	DC-60		67	90	117	300	1.7	18	11.45
PLP-100	DC-98		108	146	189	400	1.7	18	11.45
PLP-150	DC-140		155	210	300	600	1.7	18	11.45
PLP-200	DC-190		210	290	390	800	1.7	18	11.45
PLP-250	DC-225		250	320	400	1200	1.7	18	11.45
PLP-300	DC-270		297	410	550	1200	1.7	18	11.45
PLP-450	DC-400		440	580	750	1800	1.7	18	11.45
PLP-550	DC-520		570	750	920	2000	1.7	18	11.45
PLP-600	DC-580		640	840	1120	2000	1.7	18	11.45
PLP-750	DC-700		770	1000	1300	2000	1.7	18	11.45
PLP-800	DC-720		800	1080	1400	2000	1.7	18	11.45
PLP-850	DC-780		850	1100	1400	2000	1.7	18	11.45
PLP-1000	DC-900		990	1340	1750	2000	1.7	18	11.45
PLP-1200	DC-1000		1200	1620	2100	2500	1.7	18	11.45

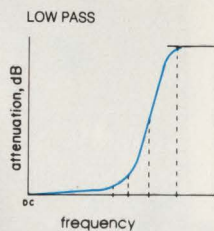

### high pass dc to 2500MHz

MODEL NO.	PASSBAND, MHz (loss <1dB)		fco, MHz (loss 3db)	STOP BAND, MHz (loss >20dB) (loss >40dB)		VSWR		PRICE \$ Qty. (1-9)
	Min.	Max.		Min.	Max.	pass-band typ.	stop-band typ.	
PHP-50	41	200	37	26	20	1.5	17	14.95
PHP-100	90	400	82	55	40	1.5	17	14.95
PHP-150	133	600	120	95	70	1.8	17	14.95
PHP-175	160	800	140	105	70	1.5	17	14.95
PHP-200	185	800	164	116	90	1.6	17	14.95
PHP-250	225	1200	205	150	100	1.3	17	14.95
PHP-300	290	1200	245	190	145	1.7	17	14.95
PHP-400	395	1600	360	290	210	1.7	17	14.95
PHP-500	500	1600	454	365	280	1.9	17	14.95
PHP-600	600	1600	545	440	350	2.0	17	14.95
PHP-700	700	1800	640	520	400	1.6	17	14.95
PHP-800	780	2000	710	570	445	2.1	17	14.95
PHP-900	910	2100	820	660	520	1.8	17	14.95
PHP-1000	1000	2200	900	720	550	1.9	17	14.95

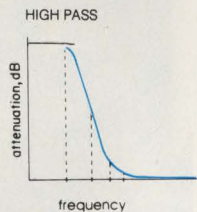

### bandpass 20 to 70MHz

MODEL NO.	CENTER FREQ. MHz F0	PASS BAND, MHz (loss <1dB)			STOP BAND, MHz (loss > 10 dB) (loss > 20 dB)				VSWR 1.3:1 typ. total band MHz	PRICE \$ Qty. (1-9)
		Max. F1	Min. F2	Max. F3	Min. F4	Max. F5	Max. F6			
PIF-21.4	21.4	18	25	4.9	85	1.3	150	DC-220	14.95	
PIF-30	30	25	35	7	120	1.9	210	DC-330	14.95	
PIF-40	42	35	49	10	168	2.6	300	DC-400	14.95	
PIF-50	50	41	58	11.5	200	3.1	350	DC-440	14.95	
PIF-60	60	50	70	14	240	3.8	400	DC-500	14.95	
PIF-70	70	58	82	16	280	4.4	490	DC-550	14.95	

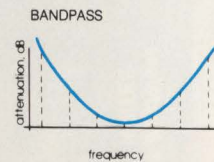

### narrowband IF

MODEL NO.	CENTER FREQ. MHz F0	PASS BAND, MHz I.L. 1.5dB max. F1-F2	STOP BAND, MHz I.L. > 20dB		STOP BAND, MHz I.L. > 35dB		PASS-BAND VSWR Max.	PRICE \$ Qty. (1-9)
			F5	F6	F7	F8-F9		
PBP-10.7	10.7	9.5-11.5	7.5	15	0.6	50-1000	1.7	18.95
PBP-21.4	21.4	19.2-23.6	15.5	29	3.0	80-1000	1.7	18.95
PBP-30	30.0	27.0-33.0	22	40	3.2	99-1000	1.7	18.95
PBP-60	60.0	55.0-67.0	44	79	4.6	190-1000	1.7	18.95
PBP-70	70.0	63.0-77.0	51	94	6	193-1000	1.7	18.95

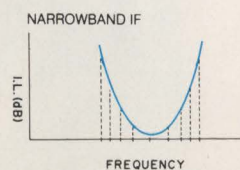

**Mini-Circuits**

P.O. BOX 350166, Brooklyn, New York 11235-0003 (718) 934-4500 FAX (718) 332-4661 TELEX 6852844 or 620156 WE ACCEPT AMERICAN EXPRESS



Ask  
about our 488.2  
Upgrade Program

### PC/XT/AT

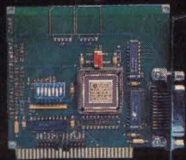

CIRCLE 155

- Industry Standard
- 7210/9914 Compatible

### PC AT



CIRCLE 156

- The New Industry Standard
- 16-bit speed

### Sun SPARCstation SBUS



CIRCLE 157

### DECstation TURBOchannel

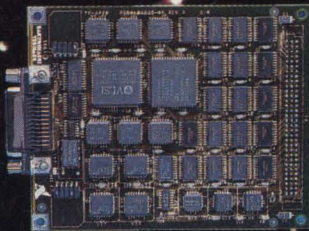

CIRCLE 158

### Macintosh NuBus

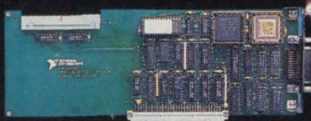

CIRCLE 159

**Continuing  
Unchallenged  
Leadership**



**NATIONAL  
INSTRUMENTS®**  
*The Software is the Instrument®*



# NAT4882 The Only Way to Reach Full 488.2 Compatibility

### VXI Embedded Controllers

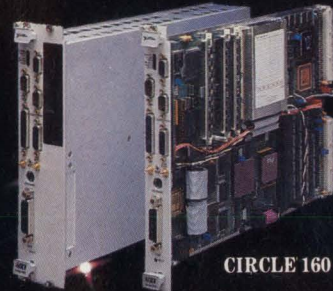

CIRCLE 160

### IBM PS/2 and RISC System/6000



CIRCLE 161

### Macintosh SE/30

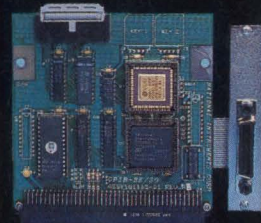

CIRCLE 162

Call for a **FREE** Catalog  
(512) 794-0100  
(800) IEEE-488 (U.S. and Canada)

6504 Bridge Point Parkway  
Austin, TX 78730

IEEE-488.2

Turbo488

1 Mbyte/sec  
READS

1 Mbyte/sec  
WRITES



## SOFTWARE TACKLES RF DESIGNS UP TO 3 GHz

By combining a harmonic-balance simulator and advanced graphics capabilities, a software package for RF engineers promises to drastically trim circuit development time. The simulator portion, from EEsof Inc., Westlake Village, Calif., lets designers analyze, tune, and optimize many linear and nonlinear RF circuits operating at frequencies of 3 GHz and below. As with lower-frequency software, such as Spice, the jOMEGA harmonic-balance program offers frequency- and time-domain simulation to analyze and optimize waveform characteristics. It also provides frequency response for such circuits as amplifiers, mixers, and oscillators, as well as for interface and signal-distribution networks. The harmonic-balance algorithms work with a full range of RF models (lossy and dispersive transmission lines, for example) developed for frequency-domain simulators. Nonlinear tuning and optimization capabilities quickly find the best conditions for amplifier outputs, mixer-conversion losses, and oscillator output-spectral purity. Other features include schematic entry, multi-window simulation controls, engineering documentation, and an optional module for RF board-design layout and floor planning. With that option, users can view circuit layout while simulating a design. Circuit parasitics and potential layout problems can thus be eliminated earlier in the design stage. The jOMEGA software runs on popular OS/2 and Unix platforms. It's starting price is \$24,500. Contact Thomas Reeder, (818) 991-7530. *DB*

## TECHNOLOGY DATABASE AIDS SYSTEM DESIGNERS

The first in a series of technology databases helps system designers approach their job from an international, market, and application-driven perspective. The Integrated Circuit Technology Database from Cypress Information Resources, Los Gatos, Calif., quickly gives designers about 100,000 IC offerings of over 350 IC companies for 500-plus applications. The application-structured database provides product selection and analysis with functional operation, electrical specifications, and product features for various VLSI chips. For example, a designer can enter in an application, such as data compression, and immediately retrieve a diverse selection of ICs. Or research and development, market, and vendor information, such as agreements, customer base, facilities, and sales could be examined. Addresses, fax numbers, and 800 numbers are listed for each company as well. The IC Technology Database, which costs \$295, includes diskettes, a printed version of "The IC Product & Market Guide," and an instruction manual. For more information, call (408) 354-4887. *LM*

## SOFTWARE DEAL AIMS FOR COMMON ENVIRONMENT

Hewlett-Packard Co., Palo Alto, Calif., and Sun Microsystems Inc., Mountain View, Calif., have inked a joint software development agreement to remove many application-interoperability barriers on different Unix workstation platforms. As a result, users will be able to seamlessly integrate data objects—text, graphics, and a spreadsheet block, for example—from systems made by different vendors on one or more networks. HP and Sun are targeting a common software environment to be made available through licensing. Initially, they've jointly defined an object-management specification—the object-management facility—and just proposed it as a common standard to the Object Management Group, a 108-member organization. The proposed standard employs object-management technology from HP and distributed computing technologies from both companies. In the next stage, both firms will work with standards bodies to promote interoperability of the HP network computing system and Sun's open network computing standards at the working protocol level. The ultimate objective is a common distributed application environment for Unix and other operating systems. Sunsoft Inc., Sun's new software subsidiary, will do the development work with HP. Contact Robert Frankenberg of HP at (408) 447-0905 and Edward Zander of SunSoft at (415) 336-6543. *DB*

## IBM STRENGTHENS ITS SUPPORT FOR ISDN

Following up on its 7820 terminal adapter for the Integrated Services Digital Network (ISDN), IBM Corp., White Plains, N. Y., deepened its ISDN market involvement with several additional products and services for its PS/2 workstations. The company's new ISDN Interface Coprocessor/2 Model 2 adapter card attaches to the ISDN Basic Rate Interface. The card, teamed with supporting IBM software, transmits full-duplex data at 64 kbits/s over each of the two information (B) channels, controlled by the 16-kbit/s control (D) channel. This processing speed is over six times faster than 9600-bit/s modems currently used with PS/2s. Up to four cards can be installed in a PS/2 workstation for ISDN connection to similarly equipped IBM systems using either the 7820 terminal adapter or the new 3174 ISDN Basic Rate Interface adapter. Four ports on the 3174 support up to eight



# How to get customs witho

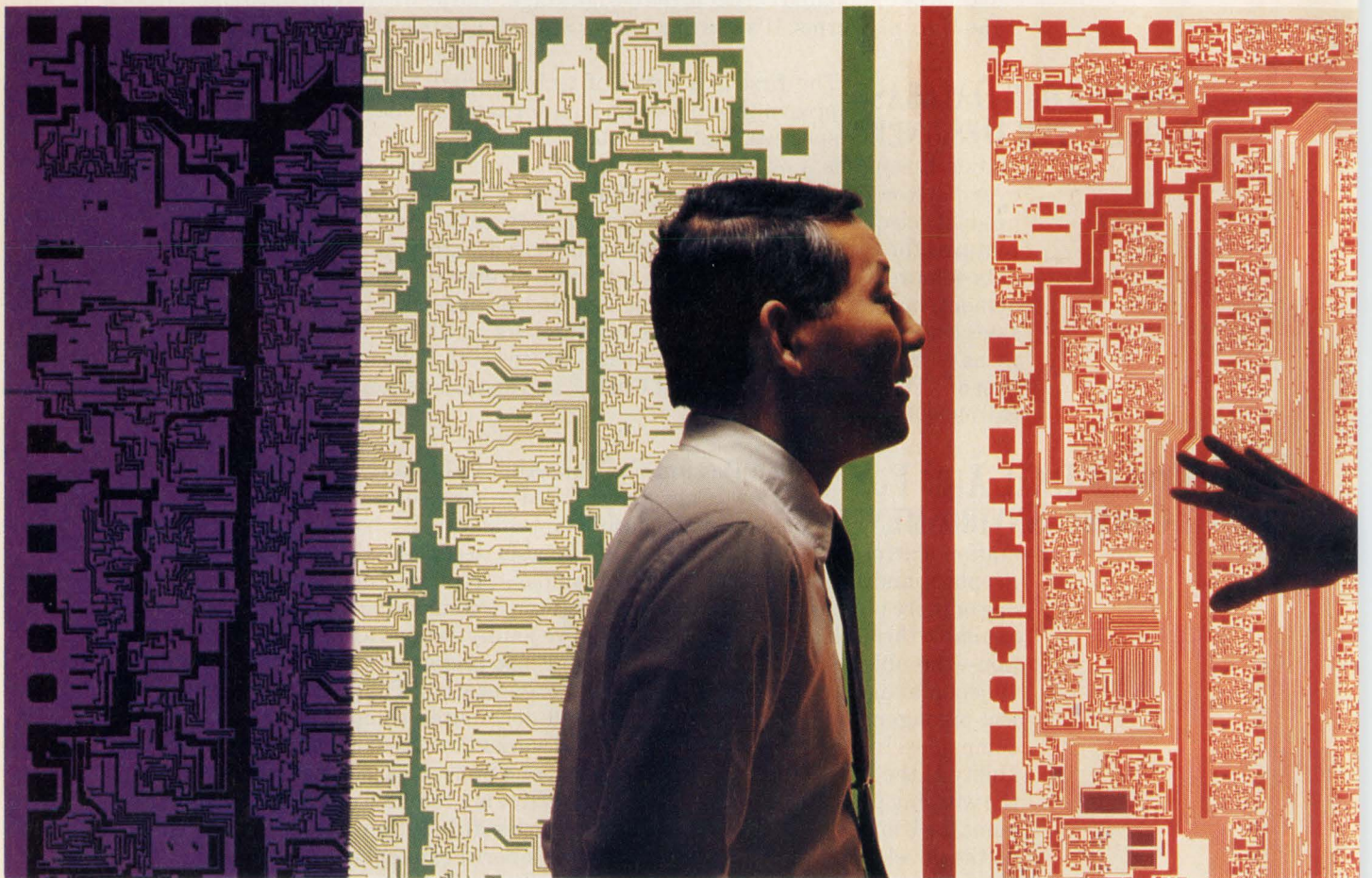

## Custom IC Solutions

Need a custom IC? You'll bypass the usual red tape by working with an experienced custom IC partner like Silicon Systems.

Our 20 years of experience developing ICs for mass storage, communications and automotive applications means we can move quickly from your inspiration to a

working custom prototype in no time.

And speed your custom IC into volume production.

In our MSICs™ (Mixed-Signal Integrated Circuits) world we combine high-performance analog and digital circuitry on a single chip and allow you to take full advantage of our state-of-the-art design systems. From there we will optimize the performance and integration of your design in CMOS, Bipolar or BiCMOS



# et through out any delays.

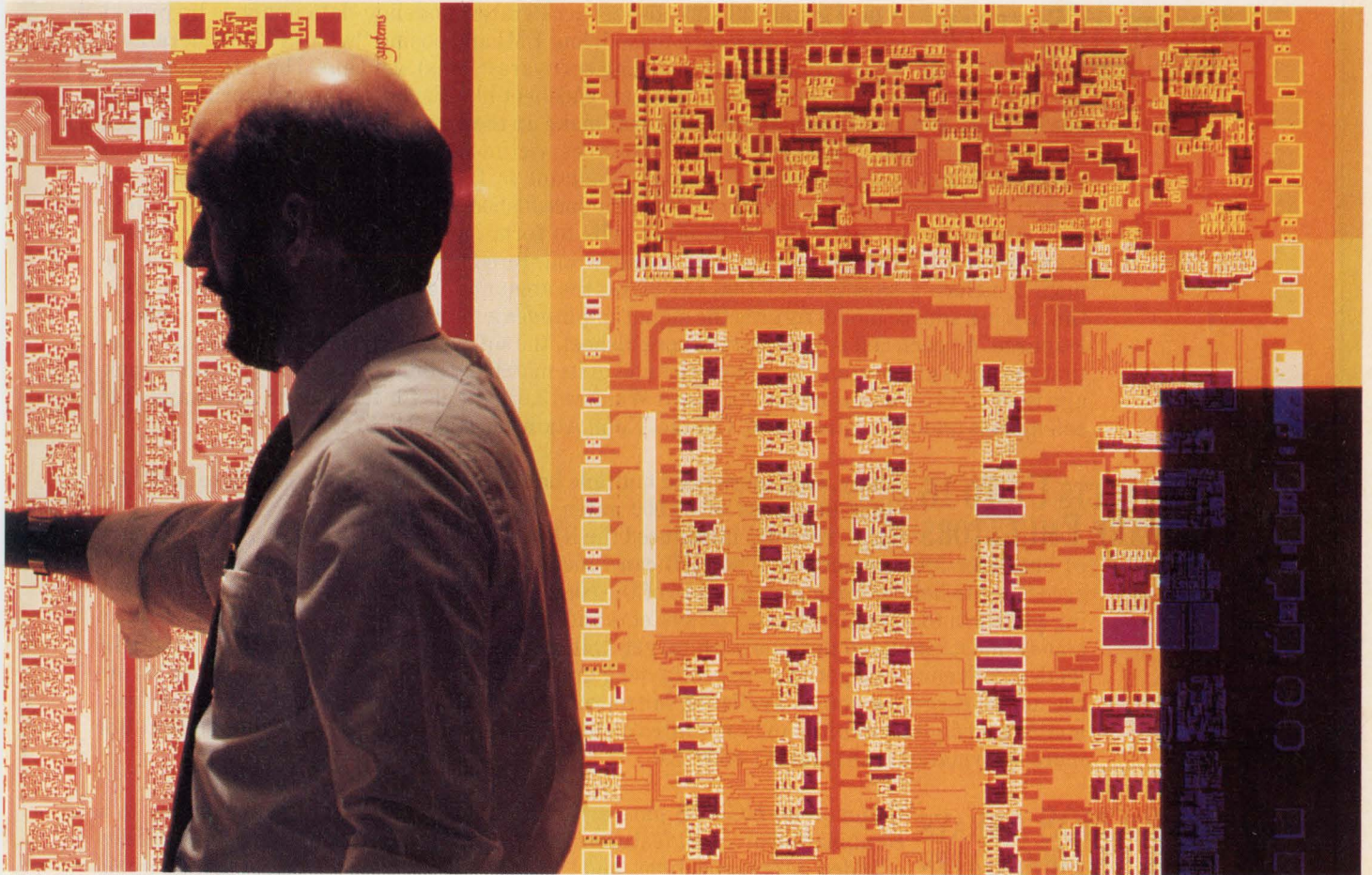

process technologies.

Enough said? Move to the front of the line and discuss your custom design requirements with a Silicon Systems representative. Or call us for literature package CUST-1.

Silicon Systems, Inc.,

14351 Myford Road, Tustin, CA 92680

Ph 1-800-624-8999, ext.151 Fax (714) 669-8814

European Hdq. U.K. Ph (44) 79-881-2331 Fax (44) 79-881-2117

Circle 111 for Product Info  
Circle 112 for Career Info

*silicon systems*<sup>®</sup>  
A TDK Group Company



remote PS/2 ISDN workstations with no contention. Through dial-up connections, workstations equipped with these products will be able to access IBM applications and systems on the company's Information Network. Initially, network connections will be available in Boulder, Chicago, Dallas, Houston, Philadelphia, St. Louis, and Tampa. *ML*

**SERVICE GROUP JUDGES SYSTEM PERFORMANCE** A service called Performance Design and Debug (PDD) is now available to designers of complex electronic and computer-based systems. Typical users of PDD, from CAE Plus Inc., Austin, Texas, are electrical and computer engineers who evaluate system performance prior to implementing a new design or debugging performance problems in existing systems. CAE Plus uses validated and parameterized architectural models along with client-supplied data to identify performance attributes and bottlenecks. PDD features customized architectural models, model validation, analysis of simulation results, and architecture design recommendations. For more information, call (512) 338-0165. *LM*

**GRAPHICAL SOFTWARE DOES EMI MODELING** A new graphical spreadsheet accelerates modeling-data analysis by providing a visual approach to modeling EMI and posing "what-if" considerations. The graphical EMI modeling software (Gems), developed by Atkinson Engineering, Warrenton, Va., gives designers a spreadsheet-like display that can describe the various sources, victims, and coupling paths that make up the overall EMI situation. Every interconnection and interrelation between the sources, victims, and coupling paths can then be visualized. Graphics window displays supply amplitude vs. frequency plots for input, model, and output for any cell in the spreadsheet. With the spreadsheet concept, each cell (item model) can be a simple model that's tied with other cells to form more complex models. Libraries of standard or configurable models can be created and stored for future reuse. Some examples of models include a crosstalk cell that calculates the amount of crosstalk from a culprit to a victim, while a source model figures the signal amplitudes and frequencies generated at a specific source. As each cell is added to the spreadsheet, the software checks the cell type to ensure that the input and output characteristics and units match the connecting cells. The Gems package runs on PC systems under Microsoft Windows 3.0 and sells for \$2950, with a package of 10 cell models adding another \$950. Contact Kenn Atkinson, (703) 347-5716. *DB*

**BOX CONNECTS UP TO 16 HARDWARE EMULATORS** Today, engineers need multiple hardware emulators that validate ASIC designs in excess of 50,000 gates. Quickturn Systems Inc., Mountain View, Calif., recently introduced the RPM Interconnect Box (RIB) to ease the task of emulator interconnection. The RIB can function either as a connector and breadboard accessory to help interconnect up to 16 of the company's RPM emulators or as a breadboarding platform to assemble prototype systems and to interconnect to an RPM emulator. It can also connect emulated designs with target systems. As a breadboarding platform, the RIB lends a convenient target-system prototyping area for connection to an RPM emulator before the actual target system is available. Microprocessors, peripherals, RAM, and user-defined analog and digital circuits can be mounted on the RIB. The RIB is available now for \$2950. For more information, call (415) 967-3300. *LM*

**LARGEST BiCMOS ARRAYS PACK 150,000 GATES** Commercial biCMOS gate arrays have now hit 150,000 gates thanks to a combination of small features, three levels of metal, a half level of localized silicided interconnections, and an epitaxial-based biCMOS process. This chip is the largest in a family of seven from Texas Instruments Inc., Dallas. The abundant levels of interconnection allow array utilization to approach 75% in most applications. The sea-of-gates architecture is akin to the one reported at several previous conferences, with just a few minor adjustments. Compilers are available to custom-define memory blocks, data paths, and other functions. Unloaded gate delays are typically about 150 ps, while on-chip RAM blocks achieve 3-ns access times. TI will allow large customers to define a user-specific version that has RAM, ROM, or data-path sections prediffused into base silicon. Core logic on the biCMOS arrays (without the I/O buffers) consumes only about 10% more power than logic on a pure-CMOS array. From 80 to 320 signal pins are available, depending on the array. Package pin counts range from 100 to 240 leads when housing an array in a metal quad-sided flat package, and up to 409 pins for a pin-grid-array package. Contact Tom Sprunger at (214) 997-3156. *DB*



A NEW CONCEPT

# DC-DC CONVERTER

## MILITARY GRADE

### FEATURES

- Designed and Built for Reliability
- Rugged:
  - Low Internal Temperatures
  - Low Component Count
  - Withstands 5000g
  - Welded Hermetic Package
  - Remote Shutdown and Sense
- 28V to 5V, Single Output
- Full Output Power for  $T_c = -55^\circ\text{C}$  to  $125^\circ\text{C}$  (No Derating)
- Wide Continuous Supply Range 16 to 50 volts
- High Power Density  $20\text{W}/\text{in}^3$

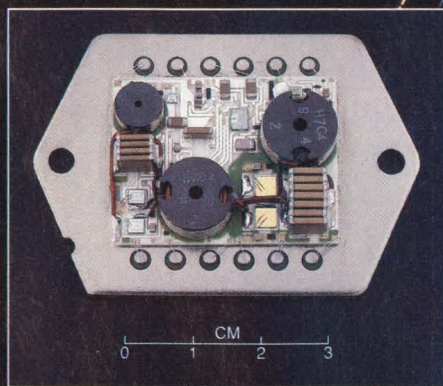

PATENT PENDING

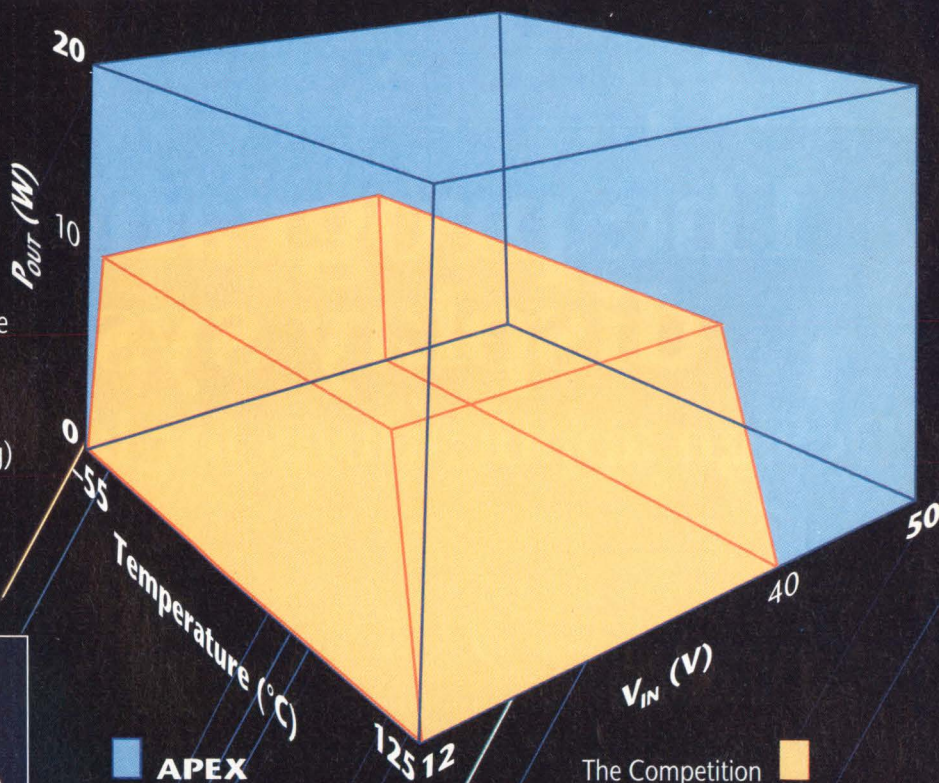

### APPLICATIONS

- 28 volt 704D Designs
- Digital Circuit Power Supply
- Isolated Instrumentation
- Parallel Redundant Operation
- High Current, Low Voltage Analog Circuits

**APEX...RELIABILITY BY DESIGN**

To Place An Order Call  
**602-742-8601**

For Applications Assistance Call  
**1-800-421-1865**

**APEX**<sup>®</sup>  
**μtech**  
DEDICATED TO EXCELLENCE

**APEX**  
**MICROTECHNOLOGY**  
**CORPORATION**



To receive your copy of our High Performance Amplifier Handbook please call toll free  
**1-800-448-1025**



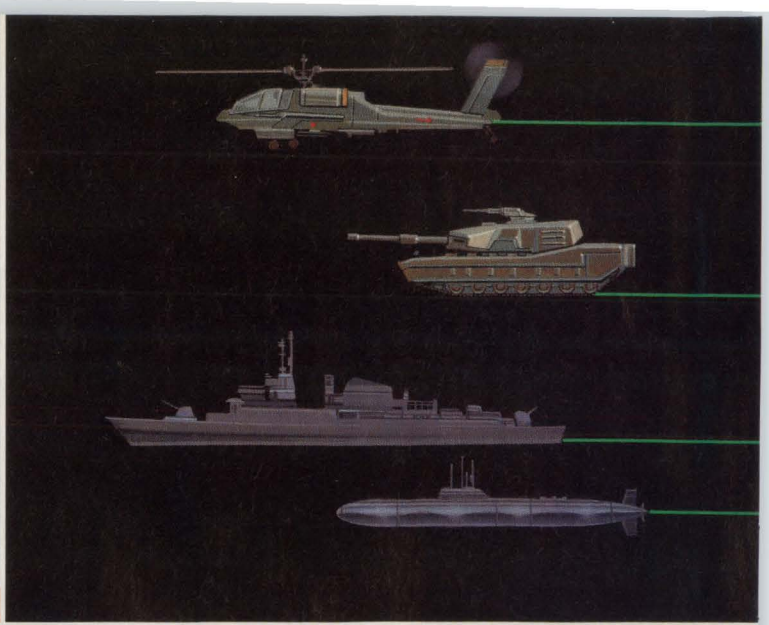

# The programmable display system: Design applications for land, sea or air.

Vivisun Series 2000, now the leading programmable display pushbutton system, interfaces the operator with the host computer. The user-friendly LED dot-matrix displays can display any graphics or alpha-numerics and are available in green, red or amber. They can efficiently guide the operator through any complex sequence with no errors and no wasted time.

They also simplify operator training as well as control panel design. One Vivisun Series 2000

programmable display system can do the work of 50 or more dedicated switches. In short, Vivisun Series 2000 gives the design engineer more control over the design.

Contact us today.



## **AEROSPACE OPTICS INC.**

3201 Sandy Lane, Fort Worth, Texas 76112  
(817) 451-1141 • Telex 75-8461 • Fax (817) 654-3405

*Vivisun Series 2000  
programmable displays. The intelligent  
communications system.*

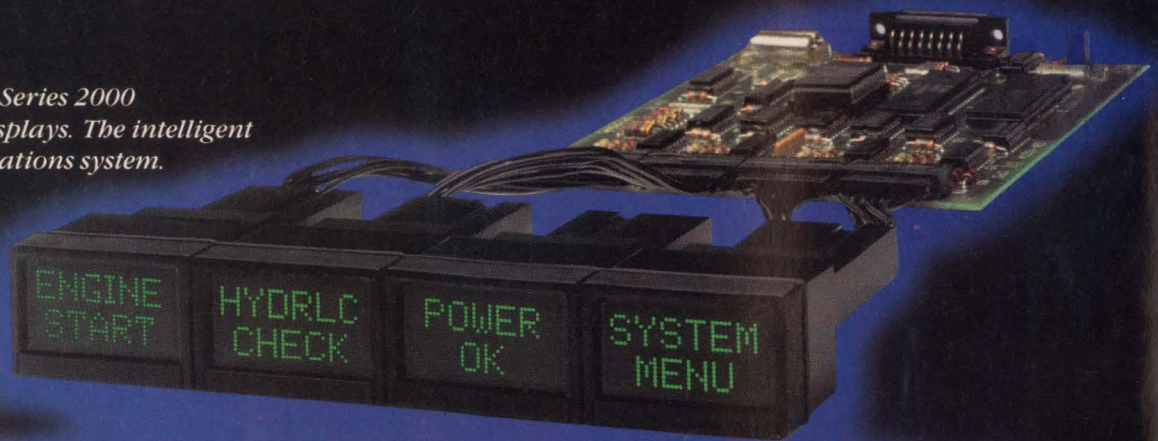

SERIES

# VIVISUN 2000™



## U.S.-JAPAN DEVELOPMENTS ENHANCE DRAM PERFORMANCE AND PACKAGING

A pair of joint U.S. and Japanese developments promise to improve dynamic-RAM density and performance, as well as revolutionize the way chip design is approached. In one development, a new field-shield-capacitor cell structure improves the densities and speeds of DRAMs, and simplifies their structures. In another development, a packaging technique called lead-on-chip with center bond (LOCCB) allows DRAM designers to put more silicon in the same package size. It also minimizes on-chip noise and improves DRAM lead electrical uniformity.

As dynamic RAMs increase in density, fabricating their storage cells gets more and more complex, with designers being forced to either stack layers above the substrate or create trench structures in the substrate. A novel coaxial memory cell, created inside a trench, now promises to simplify the fabrication processes compared to other trench or stacked structures previously described by other companies. The cell was developed jointly by a small U.S.-based design consulting firm, United Memories Ltd., Colorado Springs, Colo., and NMB Semiconductor Ltd., Chiba, Japan.

Designers at United Memories in 1988 took a field-shield coaxial capacitor structure and implemented DRAM storage cells that provide sufficient capacitance for use in 4-, 16-, and possibly 64-Mbit-generation DRAMs.

First prototypes of the structures for a 4-Mbit chip yield access times of 50 ns with a chip that fits in a 300-mil DIP.

The field-shield structure incorporates a polysilicon field-shield layer in the isolation or field-oxide region of the memory cell (see the *United Memories/NMB figure*). By holding the field-shield region over the p-well implants in the substrate at ground potential, n-channel parasitic devices can be shut off. The field-shield sections over n-well regions are kept at the supply level to shut off p-channel parasitic field devices.

Because the gates of both parasitic transistor types are actively held off, the devices' threshold voltages can be set for about 2 V. Standard devices made with local-oxide-isolation schemes require a 10-V isolation capability, which means larger spacings between devices. The lower voltage enables the field-shield devices to be closer because isolation distances don't have to be as large.

The field shield also precludes a field implant, simplifying the manufacturing flow.

Although the memory cell might be loosely classified as a "stacked-in-trench" type structure, the field shield goes into the trench before the cell electrode. That shields the cell electrode and reduces cell leakage. The combined structure is known as a buried-electrode shielded-trench (Best) cell.

Only two masking steps are required to build the Best capacitor, compared with the three to five masks typically needed for stacked capacitors. Moreover, only two etch steps are needed (one is a trench-formation etch). By comparison, a stacked-capacitor structure requires three to five etch steps (but no trench etch).

Because the field shield goes into the trench before the cell electrode and is separated from the substrate by a grown oxide, the trench's sidewalls and bottom serve as isolation areas. Consequently,

there's no need to dope the sidewalls of the trench, as might be required in a typical trench process.

The counter-electrode of the DRAM cell capacitor serves as the field shield. This shield encloses the cell's capacitor electrode, preventing any cell-to-cell or cell-to-substrate coupling. That reduces any pattern sensitivity of the memory array. Furthermore, because the cell's capacitor electrode is shielded from the substrate by the field shield, trenches can be located adjacent to the wordline transistor without affecting the wordline-transistor characteristics.

A high resistivity p-type substrate and shallow p well help fabricate n-channel transistors with low-body effects and low source/drain-to-substrate capacitance.

The low-body effect lets more of the charge reach the memory cell during a write operation. That eliminates the need to boost or bootstrap the wordline, simplifying memory circuit design and reducing chip operating power.

One key issue during coaxial-cell fabrication is the need for a highly selective polysilicon etching process, so that the polysilicon can be removed without affecting the oxide layer. An etch ratio of about 15:1 is needed, and that ratio can be achieved on a repeatable basis with today's processing equipment.

In a related area of DRAM development, wide-ranging implications can be seen with the recent packaging innovations from Texas Instruments, Dallas, and Hitachi America Ltd., Brisbane, Calif., in

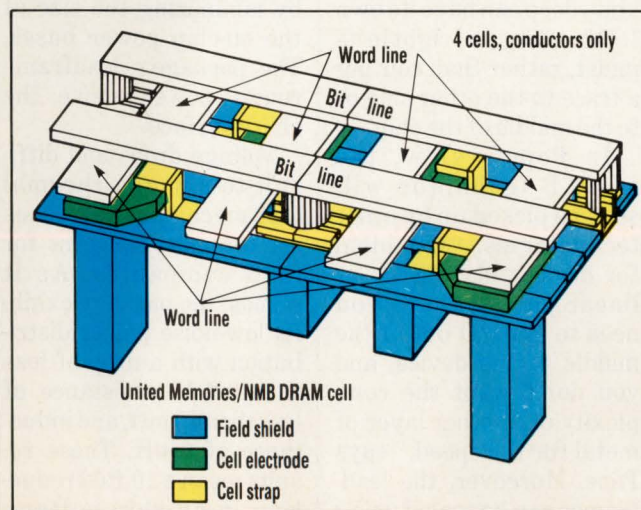



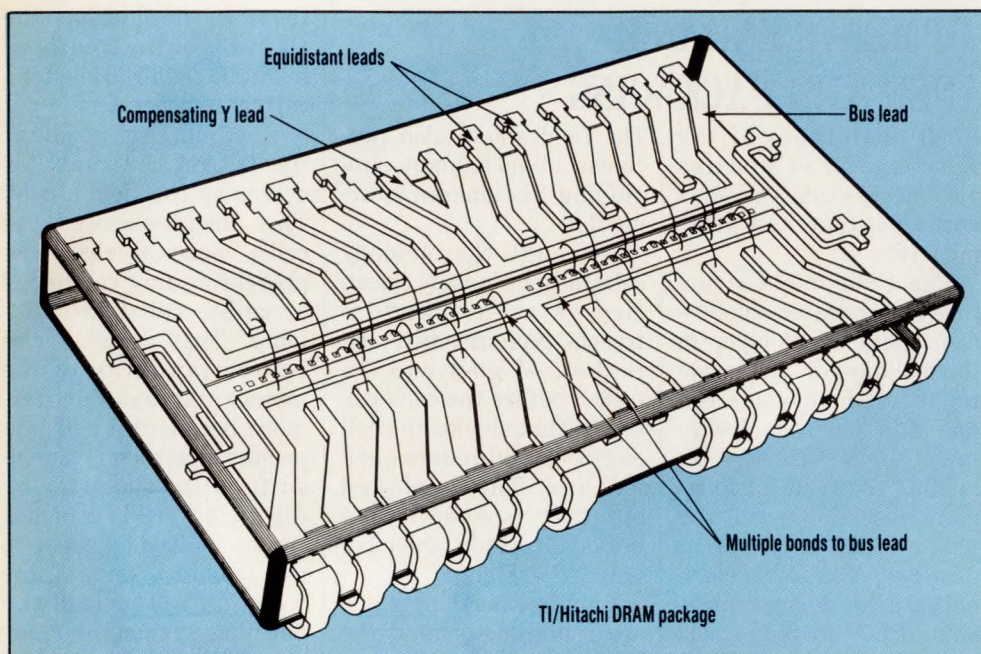

their forthcoming 16-Mbit DRAM. The new package involves bond pads running in parallel rows down the chip's center rather than around its edges. The chip is then wire-bonded to a leadframe that extends over the top of the chip.

For a 16-Mbit DRAM, the effect is to create a very stable ground with multiple bonds to the chip. But the leadframe technique carries great promise for future memories, plus other technologies involving large die and high speeds, such as ASICs and linear ICs. It also may change the way designers approach chip design and layout: Traditional approaches, with bond pads around the chip's perimeter and a third layer of metal for grounds, may be passe.

According to Ken Pope, manager of product marketing for Hitachi America, the LOCCB packaging technology will shine brightest when it's applied to memory devices handling such wide words as by-16 and by-18 parts. The

multiple outputs required by such chips can benefit greatly from the stable ground offered by the LOCCB technique.

In addition, the technique allows bond pads to be placed where it's most convenient for the design's sake and not for bonding machines. It also saves the complexity and expense of a third or fourth layer of metal to achieve the highest possible speed. In a high-speed static RAM, for example, a block of memory cells that's perhaps 512-kbits deep can have its own I/O bonding pad right in its midst, rather than routing a trace to the other side or to the middle of the chip.

In Pope's view, the LOCCB technique will soon be picked up by other technologies. "It's ideal for devices like ASICs or linear parts, where you need to get I/O out of the middle of the device, and you don't want the complexity of another layer of metal for the speed," says Pope. Moreover, the leadframes can be tooled using

standard CAD tools for ICs with irregular structures.

The packaging technique is the first result to be disclosed from the total 16-Mbit DRAM development project the two companies launched in December, 1988. The memory's plastic SOJ package houses chips as large as 330 by 660 mils, conforms to JEDEC standards of 400 by 725 mils, and has dual-power ( $V_{CC}$ ) and ground ( $V_{SS}$ ) pins. The lead-on-chip package also offers a very area-efficient chip design by minimizing the size of the on-chip power buses. The package's leadframe routes power above the chip's surface.

Voltage drops and difficult-to-manage thermal and mechanical stresses are foremost concerns for both companies. As it stands, the package exhibits low-noise power distribution with a drop of less than 0.2 V, resistance of less than 10 m $\Omega$ , and inductance of 6 nH. These results mean a 10-fold reduction in on-chip voltage

spikes compared with conventional plastic SOJ packages, which have 20-m $\Omega$  resistances and 10-to-20-nH inductances in the on-chip power buses.

At the heart of the LOCCB design is its balanced-capacitance leadframe that maintains uniform input-pin capacitance. All internal leads are equidistant from each other. A passive Y lead in the middle of the leadframe, and on either side, minimizes differences in pin-to-pin capacitance (see the TI/Hitachi figure).

Two metal bus lines run parallel above the full length of the chip. One links the dual  $V_{SS}$  pins located at the ends of the package, while the other links the corner dual  $V_{CC}$  pins on the other side of the chip. As a result, multiple bonds exist from the power and ground pins to the circuit. With dual pins for each bus, resistance is slashed to under 10 m $\Omega$ , effective inductance to about 6 nH, and electrical noise to less than 0.2 V.

Later iterations of the 16-Mbit DRAM will involve smaller die, and the leadframe will shrink accordingly. But rather than going to fewer pins, which would take the part out of JEDEC standards, the developers may widen some traces to improve speed as they work toward wide-word memories. Another advantage of the LOCCB technique is that because the bond pads aren't on the chip's periphery, designers gain some space on the die for circuitry. That means more than one generation of die could be squeezed into a same-size package.

DAVE BURSKY and  
DAVID MALINIAC



# Count On IDT

## The R3001 RISController™: The Embedded Processing Solution

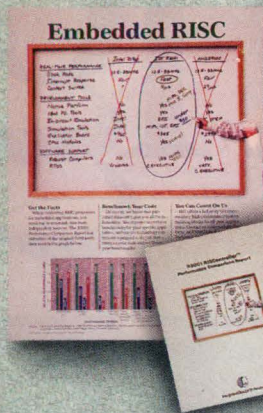

The R3001 is the first derivative of the R3000 processor designed specifically for embedded control applications. Compared to the Intel 960 and AMD 29K processors, the R3001 is the most cost-effective solution for these applications—we have the data to prove it! Call and ask for **KIT CODE 0091A** to get an **R3001 Performance Comparison Report**.

## BiCEMOS™ ECL SRAMs: Technology for the '90s

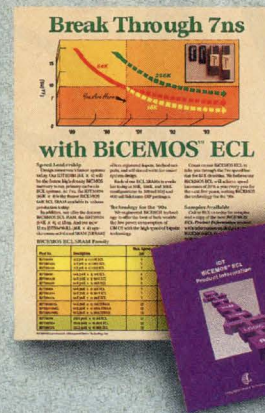

Design the fastest systems with IDT's BiCEMOS ECL family. At 7ns, the IDT10494 is the fastest BiCEMOS 64K ECL SRAM in production. 256K and synchronous self-timed SRAMs are also available in 10K/100K/101K configurations. Call and ask for **KIT CODE 0091B** to get a copy of the **BiCEMOS ECL Product Information** booklet.

## FCT-T Logic: Fastest Speed/ Lowest Ground Bounce



IDT's FCT-T Logic Family is the fastest logic family available and has the lowest ground bounce—up to 40% less than previous FCT devices! The FCT-T family provides direct TTL logic compatibility and is available in FCT, FCT-AT, and FCT-CT speeds. Call today for **KIT CODE 0091C** and get a copy of the **High-Speed CMOS Logic Design Guide**.

## The SyncFIFO™ Family: Double Your FIFO Performance



SyncFIFOs offer leading-edge performance that is 50% faster than other FIFOs. The synchronous architecture is easy to implement and reduces chip count 9-to-1. SyncFIFOs have 18-bit buses and are ideal for 32-bit systems. Ask for **KIT CODE 0091D** to get **AN-60: Designing with the IDT SyncFIFO™**.

## IDT Subsystem Modules: Building Blocks for the '90s



IDT offers a complete line of board-level subsystem products, including cache memory, shared-port memory, writable control store, RISC CPU, high integration modules, and custom designs for specific applications. Call today for **KIT CODE 0091E** and receive technical data and a **free IDT puzzle!**

## 12ns Cache Tag SRAMs: Wait No Longer



IDT's cache tag SRAMs have the features you want to design in: single-pin block reset, totem-pole match output, 4K and 8K depths, industry standard pinouts, and an on-board comparator to simplify design. Call and ask for **KIT CODE 0091F** to get **free samples** of the IDT6178 cache tag.

RISController, BiCEMOS, and SyncFIFO are trademarks of Integrated Device Technology, Inc. The IDT logo is a registered trademark of Integrated Device Technology, Inc.

Contact us today to receive data sheets and other design information on IDT's products.

**(800) 345-7015**  
**FAX: 408-492-8454**

3236 Scott Boulevard, P.O. Box 58015, Santa Clara, CA 95052-8015

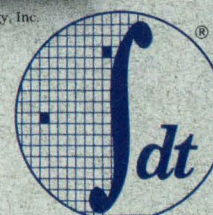

When cost-effective performance counts

**Integrated Device Technology, Inc.**



# Making

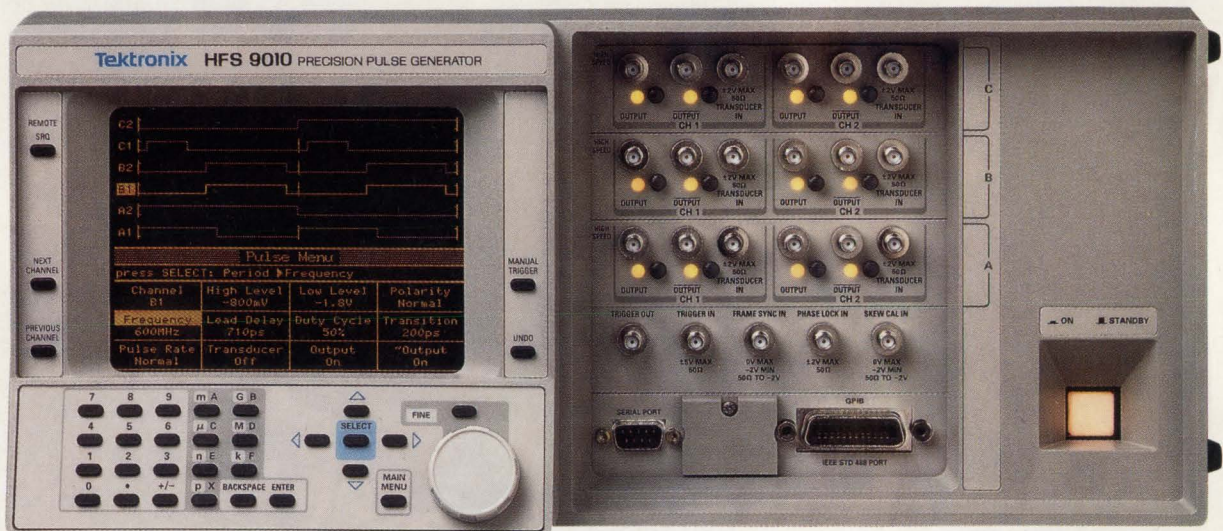

You're looking at the biggest news in signal sources in years: two new families of pulse generators from Tektronix.

You can already see one reason why Tek's new pulse generators are stirring up so much interest: their what-you-see-is-what-you-get user interface vastly simplifies your life.

Now you can stop piecing the big picture together from one-line LEDs, blinking error lights and trial-and-error iteration. Tek's new scope-like display lets you set up and modify a whole set of parameters at once, with a true representation of your pulses

and instant, visual feedback.

**You name your application and logic technology: Tek has a signal source to match.** For the first time, you can choose channel capacities from one to six channels, or rep rates from 50 MHz to a remarkable 600 MHz. Choose tools designed for logic, fast logic, or *mixed* technologies. Vary transition times from 200 ps to 10 ms. Test complex timing relationships with ease.

Add to all this our popular pulse generator plug-ins from Tek TM500/



# Waves.

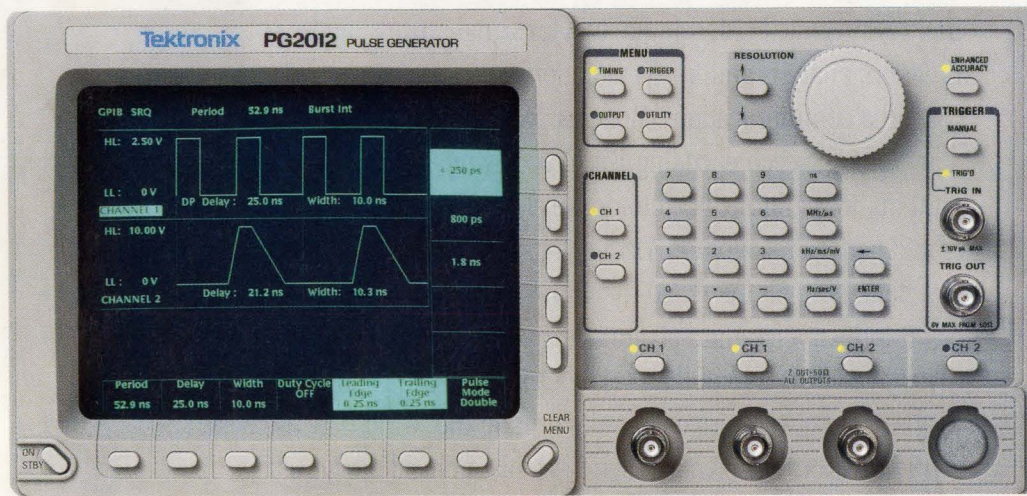

5000 modular instrumentation, and you can see why we're making waves!

Easier to use, more precise and more expandable, Tek's new pulse generators are doing for signal sources what DSOs have done for measurements.

Contact your Tek sales office for a demonstration, or call for more information.

1-800-426-2200

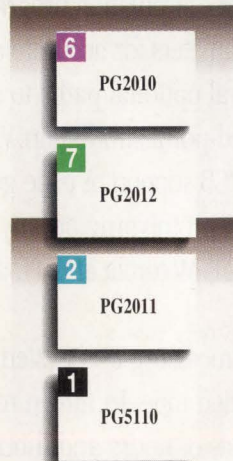

MODULES & ASSEMBLIES



COMPONENTS

FAST LOGIC  
( $<7$ ns transitions)  
ECL, ECLinPS,  
Sony ECL, GaAs

LOGIC  
( $\geq 7$ ns transitions)  
TTL, CMOS

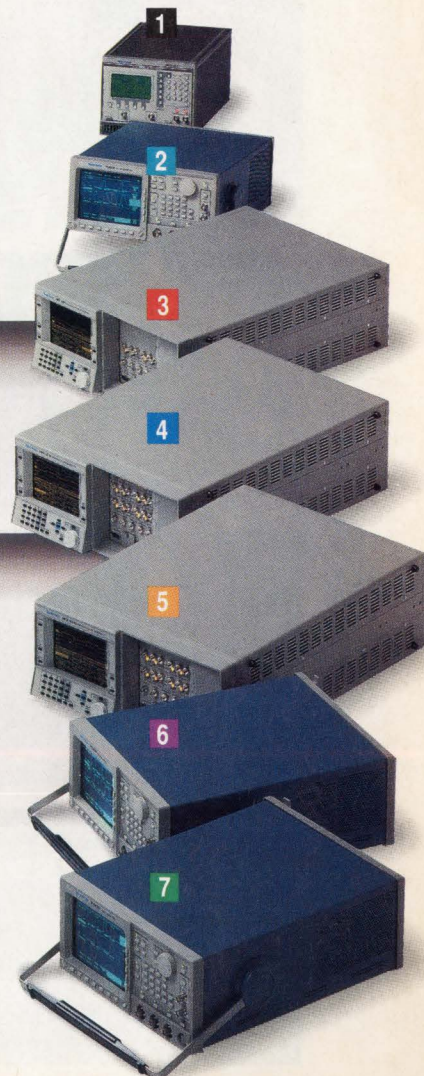

One company measures up.

**Tektronix**  
COMMITTED TO EXCELLENCE

CIRCLE 137



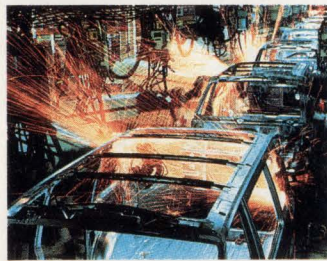
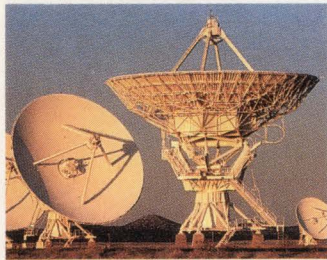
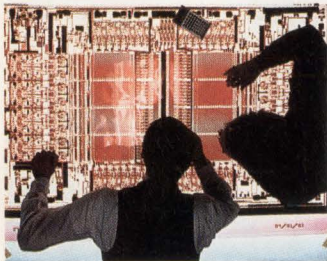

# WHO NEEDS THE SIGNAL PROCESSING WORKSYSTEM?

Anyone involved in DSP and communications design can benefit from the Signal Processing WorkSystem.<sup>®</sup> Because SPW<sup>™</sup> is the only complete, integrated CAE software tool for signal processing design, simulation, analysis and implementation.

Satellite communications. Modems. Mobile radios. Cellular phones. Radar. Sonar. Speech encoding. Voice processing. Image processing. Digital audio. Multimedia. Automotive electronics. Robotics. Neural nets and pattern recognition. Data compression. HDTV. Biomedical instrumentation. All these and much more can be designed using SPW on industry-standard platforms from Sun, DEC and HP/Apollo.

That's why over 200 of the world's leading telecommunications, aerospace and electronics companies around the world now use SPW.

With SPW you first create a high-level, hierarchical design using its extensive libraries of DSP and communications function blocks, as well as your own custom blocks. SPW then automatically converts your design into an error-free simulation program that can accept real-world signals and parameters for accurate design analysis.

SPW also provides several optional paths to implementation, including bit-accurate fixed-point simulation, VHDL generation, logic synthesis and other ASIC/PCB support. A code generation system produces generic-C for fast prototyping on any DSP platform, links SPW to DSP chips from AT&T, Motorola and TI, and supports boards from leading vendors.

To preview the Signal Processing WorkSystem, call (415) 574-5800 for a free video demonstration tape. In fifteen minutes, you'll see how SPW can save hundreds of hours and thousands of dollars in DSP design.

**COMDISCO<sup>®</sup>**  
**SYSTEMS, INC**

919 East Hillsdale Blvd., Foster City, CA 94404 (415) 574-5800



TWO CHIP-SET OPTIONS LET DESIGNERS READILY IMPLEMENT SMALL OR LARGE STORAGE USING REDUNDANT ARRAYS OF INEXPENSIVE DISKS.

# BUILD SCSI RAID SYSTEMS TO BOOST DATA AVAILABILITY

DAVE BURSKY

**N**ow that CPU throughput rates and new system buses (the extended ISA, IBM's Micro Channel) have faster data-transfer rates than standard mass-storage subsystems, designers are being forced to reexamine the subsystems to eliminate I/O bottlenecks. Implementing fast and wide options of the ANSI SCSI-2 standard can push data rates to 40 Mbytes/s. But single disk drives can't sustain such data rates.

One solution, an offshoot of research at many universities, is using redundant arrays of inexpensive disks, better known as Raid architectures, for the storage subsystem. When combined with fast- and wide-SCSI controllers, Raid systems offer higher I/O throughputs to keep up with fast processors. Data is also better protected against drive failures, large "virtual" disk drives can effectively be created, and the redundant drive array's cost more than offsets the potential cost of losing mission-critical data.

The biggest problem with implementing a Raid subsystem is the design and programming of the storage controller that manages the array of drives. Seizing both sides of that design challenge, NCR has come up with a two-pronged solution. The first is the industry's first commercial chip sets for building small and large Raid systems that can be configured for Raid levels 0, 1, 3, and 5. Except for a few rare cases, those four levels will satisfy any system design requirement.

As part of those chip sets, the first 16-bit wide and fast-SCSI 2 controller (the 53C916) and a bus extender (the 53C932) allow building 32-bit wide- and fast-SCSI channels. At 10

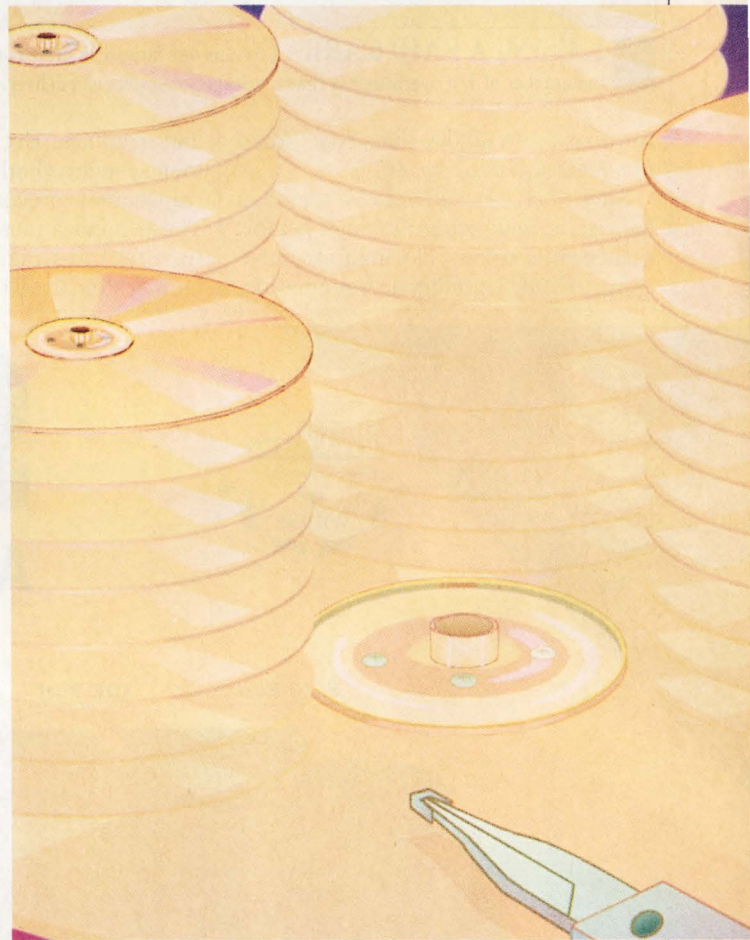

MHz and with 32-bit words, the SCSI channel has four times the throughput of the fiberoptic I/O channels used on mainframes. And it runs ten times the speed of desktop system I/O transfers.

The second half of the solution is a control program that runs on an Intel 68020 controller that implements Raid levels 0, 1, 3, and 5. Such a program has well over 125,000 lines of code. A program for just one Raid level might



# RAID STORAGE CONTROLLER

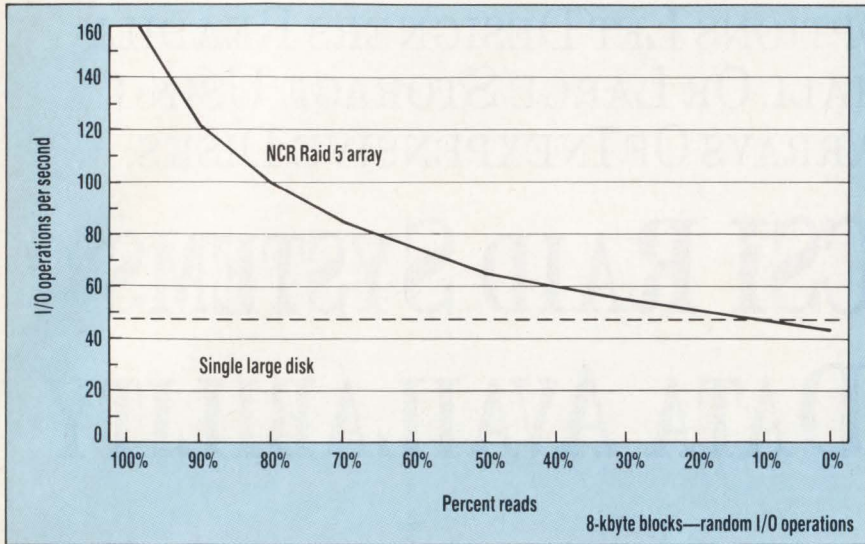

**1. USING A RAID 5 ARRAY** versus one large disk drive could more than double the number of I/O operations/s that a storage subsystem can deliver.

require about 40,000 lines (see "Raid levels explained," p. 40).

Such SCSI-2-based Raid systems can address a wide range of high-performance applications, like imaging, modeling, artificial intelligence, simulation,

and graphics. Even business requirements, such as high-throughput on-line transaction processing, can benefit. These applications require very high transfer rates, high data integrity, and high system availability—at low cost.

The number of I/O operations per second is a good measure of drive subsystem performance, says Al Loftus, NCR's director of logic products. For a single drive, a system might typically achieve close to 50 I/O operations/s (assuming 8 kbytes per I/O transfer). With a Raid subsystem, however, more than twice that can easily be achieved with a SCSI-2-based Raid system due to the various parallel operations that take place inside the array (Fig. 1). Furthermore, he continues, depending on such factors as hardware cost, its performance, and data availability, a different level of Raid architecture might be appropriate to better match the system applications. Other more detailed factors include the logical-block size used by the system, and the read to write ratios for data in the files. Different factors may influence the choice of Raid level (see the table).

There are two separate chip approaches that NCR offers. The first, for small arrays, consists of two new chips: the 53C916 wide-SCSI-2 controller with a 16-bit interface and 20-

Inquire about price reductions on DTI's Single Board Computers.



# STILL..MORE

## About The DTI 25/33MHz '486'

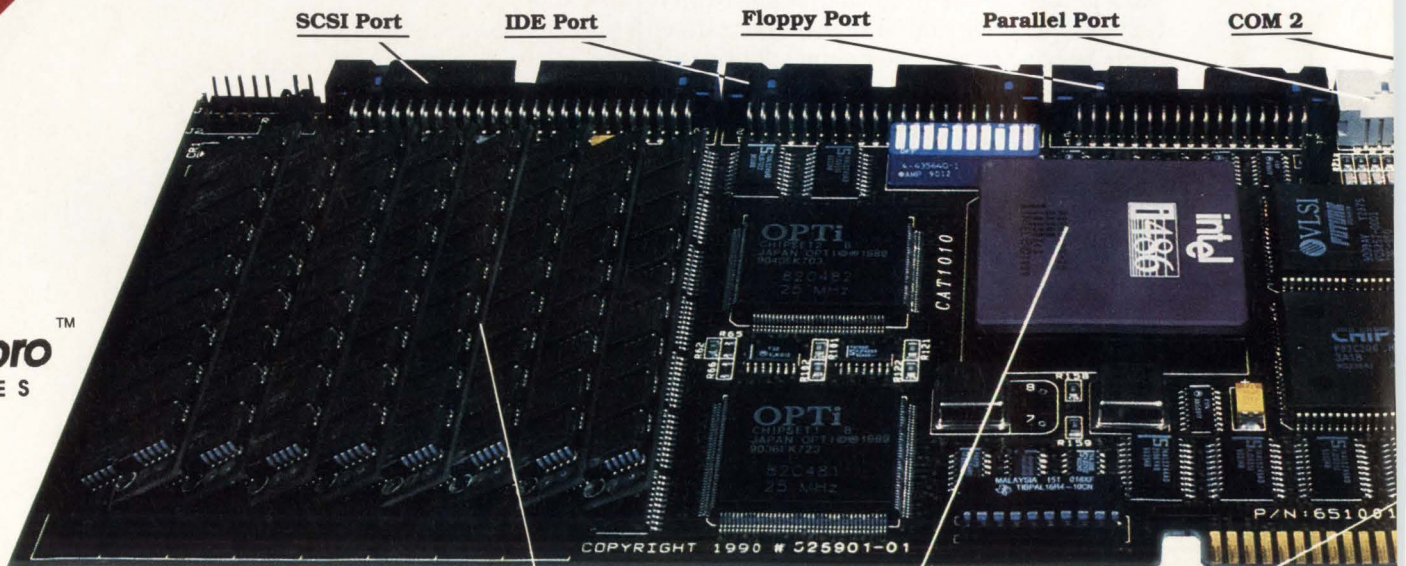

SCSI Port

IDE Port

Floppy Port

Parallel Port

COM 2

Slotpro™ SERIES

Up to 32M RAM On-board

High Performance Intel 80486 33MHz

Industry Standard Custom BIOS

Product names are trademarks or registered trademarks of their respective companies. 386 & 486 are trademarks of Intel Corp. Slotpro is a trademark of Diversified Technology



# RAID STORAGE CONTROLLER

Mbyte/s data-transfer capability, and the 53C920 SCSI data-path manager. Several standard SCSI controllers (such as the 53C96) and other readily available components are also included. The combination will enable designers to build single-board controllers that can control a small array of five SCSI devices and transfer data to the host system (Fig. 2). Data transfers can be done either over another SCSI port, or through a system bus connector for an IBM PC or compatible. The PC or compatible can have an AT bus (also referred to as ISA or industry-standard adapter bus), or a Micro Channel Adapter (MCA) bus. Also possible are an extended ISA bus or an Apple-compatible NuBus interface.

For larger drive-array systems, the second approach employs five more custom-developed chips that supplement the 53C916. The expanded configuration handles arrays up to 90 drives. One of the extra chips is the 53C932, a

## RAID SELECTION CRITERIA PRIORITIZATION

Cost	Performance	Data availability	Optimum raid level
—	—	X	Raid 1
—	X	—	Raid 0
—	X	—	Raid 1
X	—	—	Raid 0
X	—	X	Raid 3/5
X	X	—	Raid 0
X	X	X	Raid 3/5

SCSI bus extender that adds the second 16-bit half of a full 32-bit interface and ties into the 53C916. It makes the 916/932 combination act as a 32-bit SCSI controller.

The four other chips designed by NCR handle all other hardware control and logic functions. The first is the 53C921, a data multiplexer and converter chip that transfers and directs data between an 8-, 16-, or 32-bit DMA bus and four 16-bit buffer buses, each with byte parity. Each bus also has a 4-word FIFO register to buffer the data transfers and lessen rate dependence

during asynchronous transfers. The chip also includes cyclic-redundancy generation and checking to increase the integrity of the data paths. The chip would control the front-end host data for level 1, 3, and 5 Raid systems.

The 53C922 manages array data activity, supplying the DMA and buffer control for the 53C921. This chip supports host reads and writes from or to a buffer, target reads and writes from or to a buffer, direct reads and writes that bypass the buffer, as well as processor reads and writes. Transfer rates of up to 40 Mbytes/s can be handled in the Raid 3 configuration. The chip also supports levels 1 and 5. On-chip logic can manage an off-chip buffer of up to 4 Mbytes, and also performs concurrent, interleaved DMA, and DMA linking operations.

Providing the basic control functions to implement the Raid subsystem, the 53C923 is designed to supply the bus

# REAL FACTS!

## Single Board Computer

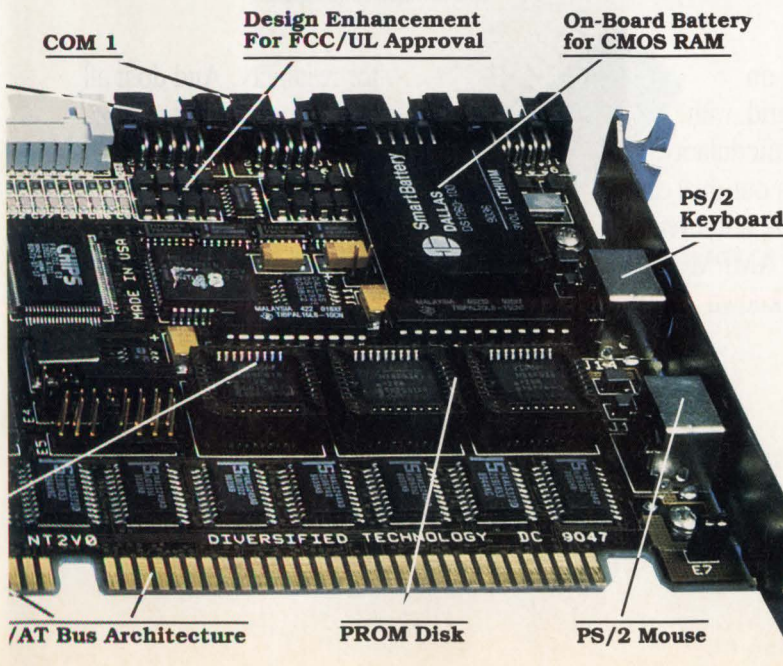

COMPARE FUNCTION	DTI CAT1010 486	Competitor 1 486	Competitor 2 486
25, 33MHz CPU- Shipping Now!	✓		25MHz Only 7-8 Wks Del.
Up to 32M RAM Onboard	✓		
Noise Reduction Circuitry For FCC Class B	✓		
PS/2 Mouse Support	✓		
PS/2 Keyboard Support	✓		
On-Board Battery Real Time Clock	✓		✓
Bi-directional PS/2 Printer Port	✓		
2 Serial Ports - Up to 115K Baud	✓		
Future Domain SCSI	✓		
IDE Interface	✓		
Floppy Interface	✓		
Up to 512Kb User PROM Disk	✓		
Double Sided Surface Mount Technology	✓		
Manufactured In-House(U.S.A.)	✓		
Landmark V1.14 Speed at 25MHz	114.1		84
Landmark V1.14 Speed at 33MHz	150.9		

NOT AVAILABLE

Call us toll free for orders and information.

**1-800-443-2667**

**Diversified Technology**  
An Ergon Co.

U.S.A. - (601) 856-4121 Fax (601) 856-2888  
Outside U.S.A. - (201) 891-8718 Fax (201) 891-9629

CIRCLE 96



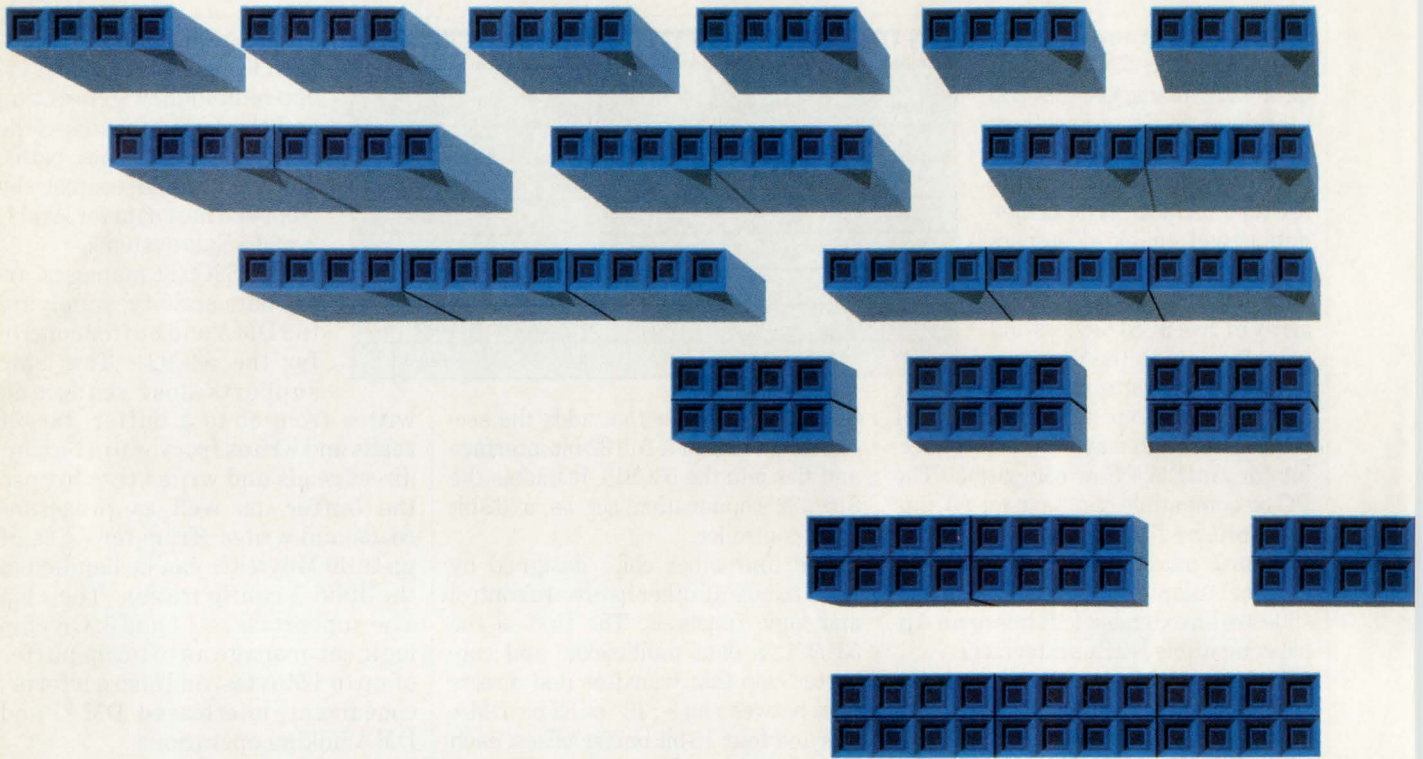

# Enough

Design freedom speaks for itself.

Our mass-terminating AMPMODU MTE connectors stack up neatly, side-to-side or end-to-end. Take your message

*Dual-beam contacts are over-stress-protected, and feature post stops to protect wire on wrap type posts.*

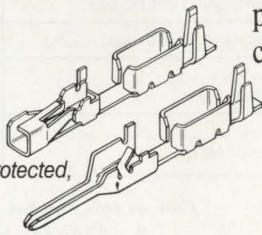

anywhere on a 0.100" grid, with complete modularity. Do it with our dual cantilever beam, anti-overstress protected AMPMODU contacts, known worldwide



*Carrier strips key contacts to tooling, pre-loaded assemblies speed mass termination.*

for reliability. And do it all with just two contact sizes—30-26 AWG and 26-22 AWG.

Choose vertical or right-angle headers. Shrouded or unshrouded.

Choose polarized or latching receptacles. Or our unique ribbed receptacles that stack (side-to-side, end-to-end) into single- and double-



RAID STORAGE CONTROLLER

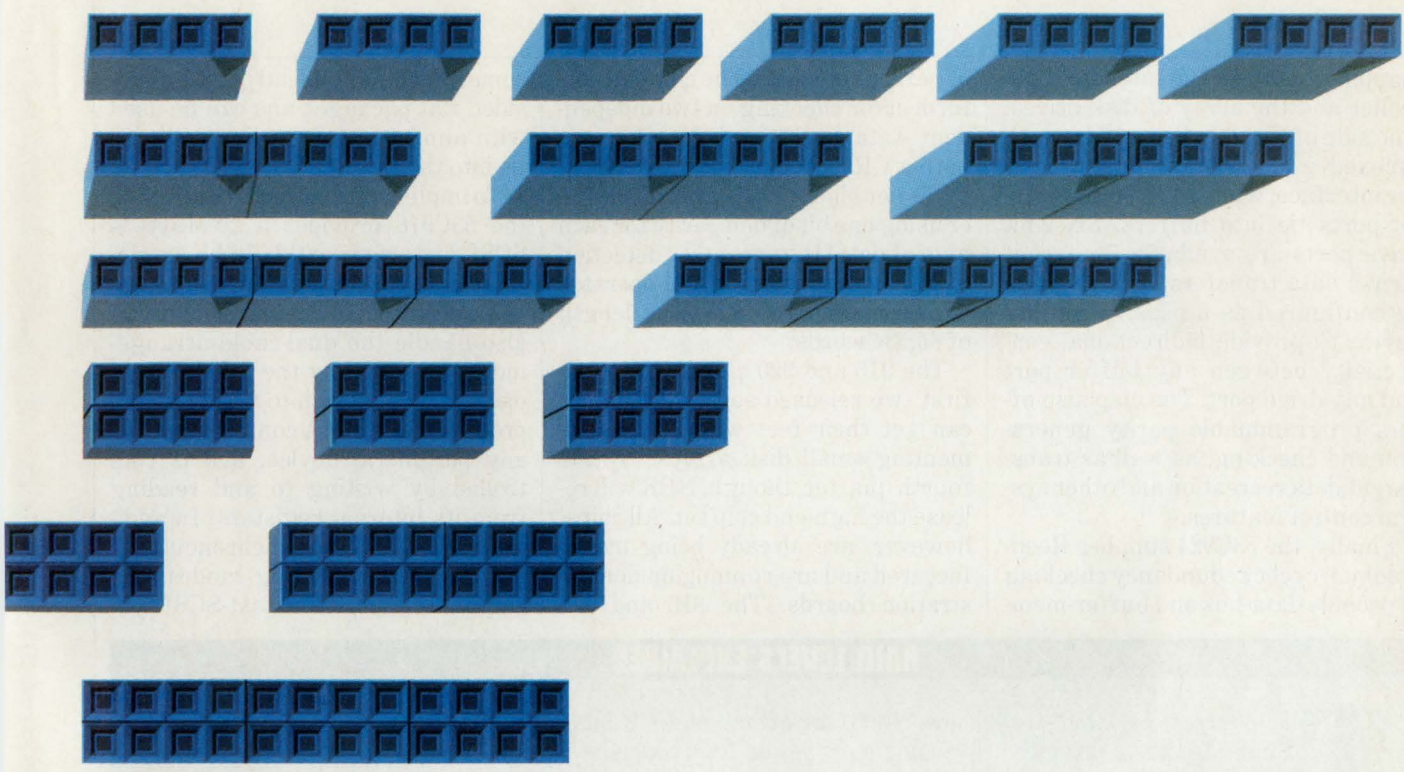

said.

row coupling shrouds.

Round out the options with pin-contact receptacles for wire-to-wire and panel-mount applications.

We haven't neglected production needs, either. Pre-loaded contact assemblies are keyed to locate accurately in tooling for fast, simple mass termination. And

as you'd expect from AMP, tooling is available for hand, semiautomatic and automatic termination, to meet any level of production you need.

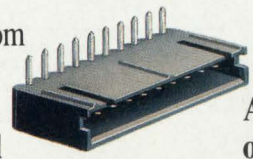

Speak out for design freedom. Call 1-800-522-6752 and ask the AMP Information Center for more on modular AMPMODU MTE connectors. AMP Incorporated, Harrisburg, PA 17105-3608.

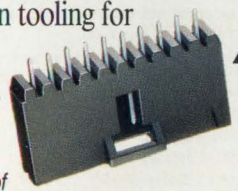

Selection of shrouded headers strengthens modular flexibility.

**AMP** Interconnecting ideas



# RAID STORAGE CONTROLLER

mapping between the interface controller and the array of disk drives. One side of the chip has a 16-bit multiplexed address/data host-processor interface, while four additional 9-bit ports tie into buffers. Six 9-bit drive ports are available for target (drive) data transfers. The chip can be configured as a passive routing device to provide bidirectional connectivity between any buffer port and any drive port. The chip also offers programmable parity generation and checking, as well as transparent data recreation and other system control features.

Finally, the 53C924 supplies Reed-Solomon cyclic redundancy checking to provide data-bus and buffer-mem-

ory error detection. The chip can perform error checking on two independent data paths and functions as both a CRC checker with two check bytes per block and as a parity checker using one bit of odd parity for each byte of data. It guarantees detection of any one-word error and operates with a maximum data-block length of 65,534 words.

The 916 and 920 chips will be the first two released so that designers can get their feet wet with implementing small disk arrays. By the fourth quarter, though, NCR will release the high-end chip set. All chips, however, are already being manufactured and are running on demonstration boards. The 916 and 920

come in 84- and 160-lead plastic quad-sided flat packages and can be used with almost any SCSI controller to tie into the five SCSI drives.

To implement the small disk array, the 53C916 provides a 20-Mbyte/s SCSI-2 interface with a 16-bit single-cable data path to maximize the data-transfer rate. However, the chip can also handle the dual-cable arrangements specified by the SCSI-2 standard. The chip ties into a local microprocessor and DMA control logic like any peripheral device, and is controlled by writing to and reading from its internal registers. In addition to supporting asynchronous and synchronous operating modes, the chip also supports the fast-SCSI syn-

## RAID LEVELS EXPLAINED

The concept of Raid—redundant arrays of inexpensive disks—evolved from university research into schemes to improve disk-drive data I/O transfer rates, storage capacity, and drive-subsystem reliability (uptime). Raid basically refers to an architecture that safeguards data. If a disk fails, data can be reconstructed, because data is striped across several disks. An extra disk drive is typically used in the Raid approaches, either to serve as a dedicated parity drive or to hold part of the striped data.

Redundant arrays offer very high data-availability ratings, because even if one drive fails, data can be accessed transparently to that failure. The arrays are also high in performance since multiple spindles can access data concurrently. And, the arrays can be very cost effective because multiple low-cost drives are used rather than the highest-density single-spindle drive. There are six basic Raid architectures, referred to as levels 0 through 5, that designers can use. Each aims at different performance and cost requirements.

Raid levels 2 and 4 are rarely implemented because the other schemes either perform better or

are more cost effective. NCR has a simple primer on Raid concepts, "What Are Disk Arrays?," publi-

cation number ST-2116-73, that's available at no cost. For a copy, **CIRCLE 514**

Raid level	Title	Description
0	Data striping without parity (DSA)	Data is striped by system block size. <ul style="list-style-type: none"> <li>• Drive spindles may be synchronized, but it's not required.</li> <li>• Independent data paths go to the drives.</li> <li>• The number of drives is scalable.</li> <li>• The number of drive groups is scalable.</li> </ul>
1	Mirrored disk array (MDA)	Each block of data is duplicated on the mirror drive. <ul style="list-style-type: none"> <li>• Drive spindles may be synchronized, but aren't required.</li> <li>• Independent data paths go to the drives.</li> <li>• The number of drives isn't scalable.</li> <li>• The number of groups is scalable.</li> </ul>
2	Hamming code for error correction	Bit-interleaved data is transferred across a group of disks, and then enough check disks are added to supply single-error correction and double-error detection. (similar to DRAM ECC approaches). <ul style="list-style-type: none"> <li>• Drive spindles may be synchronized, but aren't required.</li> <li>• Independent data paths go to the drives.</li> <li>• The number of drives isn't scalable.</li> <li>• The number of groups is scalable.</li> </ul>
3	Parallel disk array (PDA)	An array of disk drives transferring data in parallel with one redundant drive that functions as a parity check disk. Together they work as one large virtual drive. <ul style="list-style-type: none"> <li>• Parity is the Exclusive-OR of data on drives 1, 2, 3, and 4.</li> <li>• Drive spindles are synchronized.</li> <li>• Parallel data paths are supplied to each drive.</li> <li>• The number of data drives is expandable.</li> </ul>
4	Independent disk array (IDA)	An array with the ability to read and write in individual drives within the array, but all data drives use a common parity drive. <ul style="list-style-type: none"> <li>• Data is striped by system block size.</li> <li>• Parity is the Exclusive-OR of data across all drives.</li> <li>• Drive spindles may be synchronized, but it's not required.</li> <li>• Independent data paths go to each disk drive.</li> <li>• Both the number of drives and the number of drive groups are scalable.</li> </ul>
5	Independent disk array (IDA)	An array of drives with the ability to read and write data and parity across all disks. No dedicated parity drive exists. <ul style="list-style-type: none"> <li>• Data is striped by system block size.</li> <li>• Parity is the Exclusive-OR of data across all drives.</li> <li>• Drive spindles may be synchronized, but it's not required.</li> <li>• Independent data paths go to each drive.</li> <li>• Both the number of drives and the number of drive groups are scalable.</li> </ul>



# RAID STORAGE CONTROLLER

chronous option of SCSI-2, as well as both 8- and 16-bit cabling schemes. In addition, the 916 responds to the advanced commands included in the SCSI-2 standard, such as the multiple-byte command queuing and extended-message transfers.

On-chip logic also ties directly into the 932, the bus extender chip used in the large array configuration that expands the bus interface to 32 bits. Two data buses on the SCSI-2 chip—an 8-bit microprocessor interface and a 16-bit DMA channel bus—enable the chip to keep both ports simultaneously active to maximize data throughput. The dual ports also eliminate the need for off-chip bus-steering logic to route data between the microprocessor, the DMA channel, and the SCSI chip.

Complete with its own 1-kword by 32-bit ROM and 256-byte RAM, the on-chip controller that performs the command interpretation is a powerful state machine that the rest of the chip puts to work. An on-chip 24-bit transfer counter and the appropriate SCSI and DMA handshake signals handle large DMA transfers with minimal microprocessor intervention. The processor is only interrupted either when it detects a bus condition that requires servicing or when a programmable sequence or command sequence is completed. The chip has two degrees of user programmability—the command level and the instruction-sequence level.

At the command level, single commands are handled after they're written to the internal command register. The more-complex sequence level has the chip executing a sequence of commands that were previously downloaded. Downloading can be done by writing to the chip's sequence-execution-instruction-address register. This level of programming reduces bus overhead and protocol interrupt handling.

To handle all of the data move-

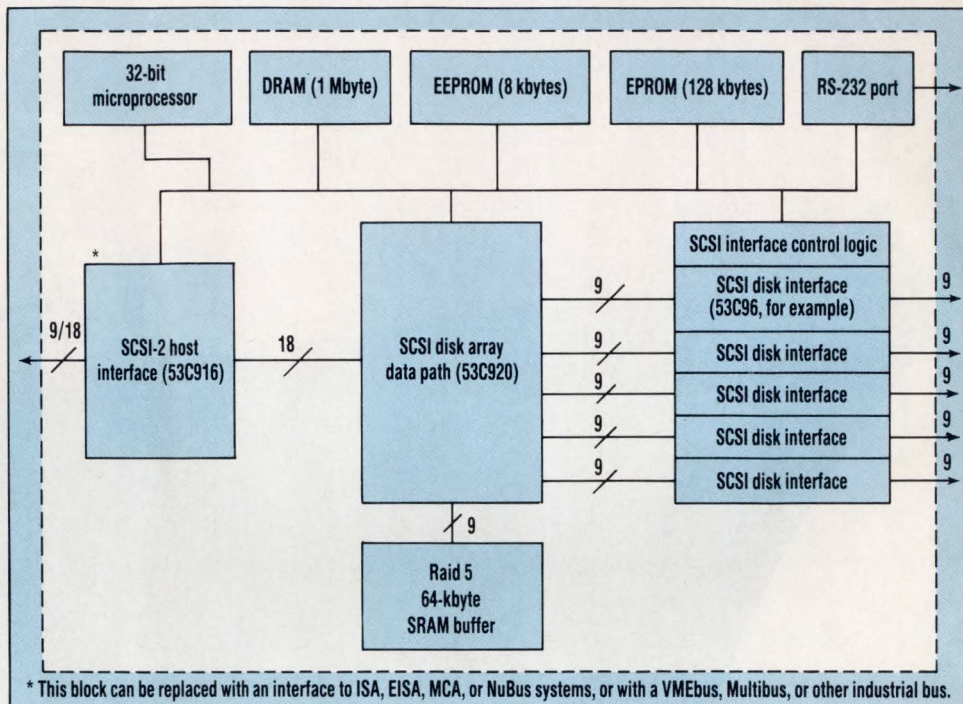

**2. TWO CHIPS**, the NCR 53C916 and 920, make building small Raid subsystems a more manageable task. With a CPU, RAM, control memory, SCSI ports, and a temporary data buffer, the chips reduce the additional logic needed. The controller can then reside on a board of less than 80 in.<sup>2</sup>

ment between the multiple disk drives that make up the small Raid subsystem, the 53C920 does all data routing, data multiplexing/demultiplexing, and parity generation/checking. The chip also contains all of the logic required to handle data transfers between the DMA data bus of the host-side SCSI chip, the DMA data buses of the five other SCSI chips that connect to the disk drives, and an external buffer memory used for temporary storage. Each operation of the 920 is supervised and controlled by a local microprocessor that executes the control programs that instruct it how to implement any of the Raid levels.

One application that spurred the 920's and the 916's development was a 68020-based single-board array controller—the ADP-92. The board manages one rank of up to five disk drives and has an RS-232 serial port for local communication and diagnostics. Each drive is controlled by one of five 53C96 byte-wide SCSI controllers.

The board implements Raid 0, 1, 3, or 5 levels and provides a SCSI-2 10-

Mbyte/s 8-bit interface, or a 20-Mbyte/s 16-bit interface, to the host system. Furthermore, an expanded version of the board can control multiple ranks of drives, each operating at a different Raid level. The ADP-92 disk-array controller board is sold by the company's Wichita, Kans.-based division for about \$2500. That's about the same price as the previously introduced EISA-based integrated-drive-array controllers. □

## PRICE AND AVAILABILITY

The first two chips to be released, the 16-bit 53C916 SCSI-2 controller and the 53C920 data-path manager, will sell for \$93 and \$89, respectively, both in 1000-unit quantities. Samples of both chips are available immediately. The five additional chips for the large Raid arrays won't have set prices until late second quarter when samples are to be released.

NCR Corp., 1635 Aero Plaza Dr., Colorado Springs, CO 80916; Walt Krysiak, (719) 596-5612. CIRCLE 511

HOW VALUABLE?	CIRCLE
HIGHLY	529
MODERATELY	530
SLIGHTLY	531



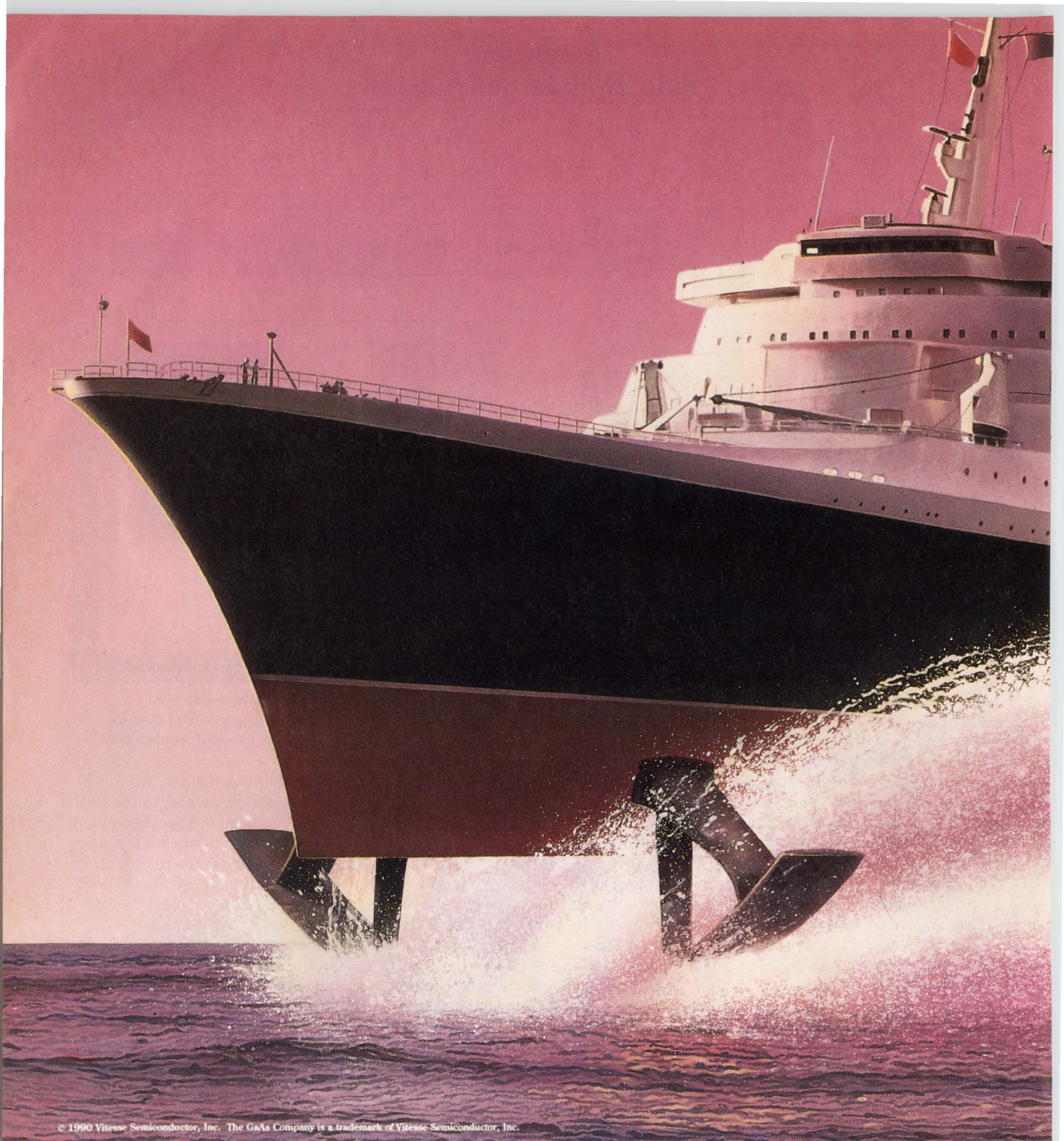

© 1990 Vitesse Semiconductor, Inc. The GaAs Company is a trademark of Vitesse Semiconductor, Inc.

## **ONE MILLION TRANSISTORS AND**

We're talking better than the best ECL performance at a fraction of the power. And for high frequency designs, Vitesse GaAs chips are lower power than BiCMOS.

Our prices won't sink your budget either—our GaAs chips can give you better performance for your dollar than BiCMOS.

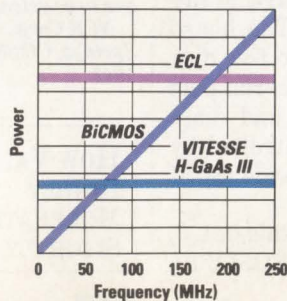





**THE SIZE OF BiCMOS.  
ONLY FASTER.**

**THE BLINDING SPEED OF GaAs.**

For more information on our ASIC and standard products with integration levels up to 350K gates, call Vitesse at (805) 388-7455. And leave the competition in your wake.

FX Arrays	Raw Gates	Usable Gates	Availability
FX100K	102,000	Up To 70,000	Now
FX200K	195,000	Up To 137,000	Now
FX350K	353,000	Up To 177,000	Summer 1991

**VITESSE**  
The GaAs Company.™



**NEW**  
**ABEL-4**  
 with SmartPart™  
 intelligent device selection



# Knock-your-socks-off PLD software on a shoestring budget.

Who says you can't afford the world's best PLD development tools? Data I/O's industry-standard design software and programming solutions are more powerful—and more affordable—than ever before. So now the best tools on the market are also the best value.

**NEW ABEL™-4** marks a major milestone in PLD software. The leader in device support, ABEL-4 automatically identifies which PLDs match your design needs with new SmartPart™ intelligent device selection. New optional device fitters automatically assign pins and

configure macrocells for complex device architectures. And an all-new user interface speeds the entire PLD design process.

A major new version of the leading schematic capture software, **NEW FutureNet®-5**, redefines "ease-of-use" with pop-up menus, extensive dialog boxes and a fast symbol browsing feature.

To make designing for testability practical, choose **NEW PLDgrade™**. This inexpensive fault grading software helps you optimize your design for testability before production.

And the affordable **NEW 2900 Programming System** brings the cost of high-performance programming down to earth. Its innovative technology makes programming any PLD—even surface-mount devices—fast and easy.

CALL TODAY for your **FREE tutorial** on designing with PLDs—a \$12.95 value.



**1-800-247-5700**

The Personal Silicon Experts

**DATA I/O**  
 Corporation

**Data I/O Corporation** 10525 Willows Road N.E., P.O. Box 97046, Redmond, WA 98073-9746, U.S.A. (206) 881-6444/1-800-247-5700  
**Data I/O Canada** 6725 Airport Road, Suite 302, Mississauga, Ontario L4V 1V2 (416) 678-0761  
**Data I/O Europe** World Trade Center, Strawinskylaan 633, 1077 XX Amsterdam, The Netherlands + 31 (0)20-6622866/Telex 16616 DATIO NL  
**Data I/O Instrument Electronic Systems Vertriebs GmbH** Lochhamer Schlag 5A, 8032 Graefelfing, W. Germany, + 49 (0)89-858580  
**Data I/O Japan** Sumitoseimei Higashishinbashi Bldg., 8F, 2-1-7, Higashi-Shinbashi, Minato-Ku, Tokyo 105, Japan  
 (03) 432-6991/Telex 2522685 DATAIO J

©1990 Data I/O Corporation



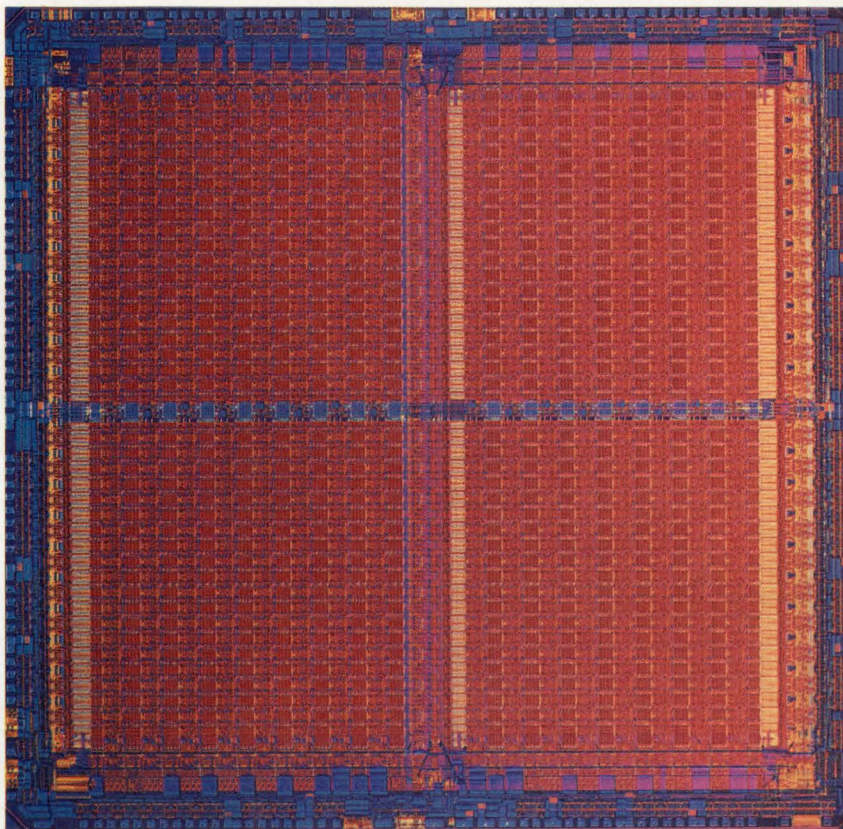

ACTEL CORP.

# HIGH-DENSITY PROGRAMMABLE LOGIC TAKES ON GATE ARRAYS

**I**n the 15-plus years since the first field-programmable logic devices (PLDs) were introduced, densities have crept up from tens of gates to several thousand per chip. The flexibility of programmable logic chips has also increased. Today's large field-programmable chips now vie with low-end (sub-10,000-gate) mask-programmable gate arrays by offering designers the ability to almost instantly create a functional proto-

type of their desired circuit. result, losses caused by parasitic elements are cut down, translating into lower power consumption.

One particularly difficult issue involves defining exactly what an FPGA is. No standard definition exists, but several points can be used as guidelines. First, the circuit should allow multiple levels of logic to be interconnected through programmable-interconnection elements without using an I/O pin. Second, it should have a defined propagation delay through each level. And third, it

**DAVE BURSKY**

**AS DENSITY, SPEED, AND FLEXIBILITY IMPROVE, FIELD-PROGRAMMABLE CHIPS START TO REPLACE MASKED GATE ARRAYS.**

type of their desired circuit.

Although the per-unit cost of a large field-programmable gate array (FPGA) is higher than that of a mass-produced gate array, the non-recurring-engineering costs can be much lower. This makes the FPGA attractive for small to moderate production runs. However, to achieve true gate-array replacement capability, FPGAs face several challenges. These include reducing on-chip signal-propagation delays, improving circuit implementation flexibility, and increasing the gate count—all without significantly increasing power consumption.

Though not an easy task, the challenges are being met with innovative programmable architectures that reduce the delays while offering more flexible interconnections. Help also comes from finer-line processes—smaller device features reduce the gate delays. That increases the maximum operating speed and allows more gates per chip. Reduced device sizes also enables transistors to be positioned closer together. As a re-



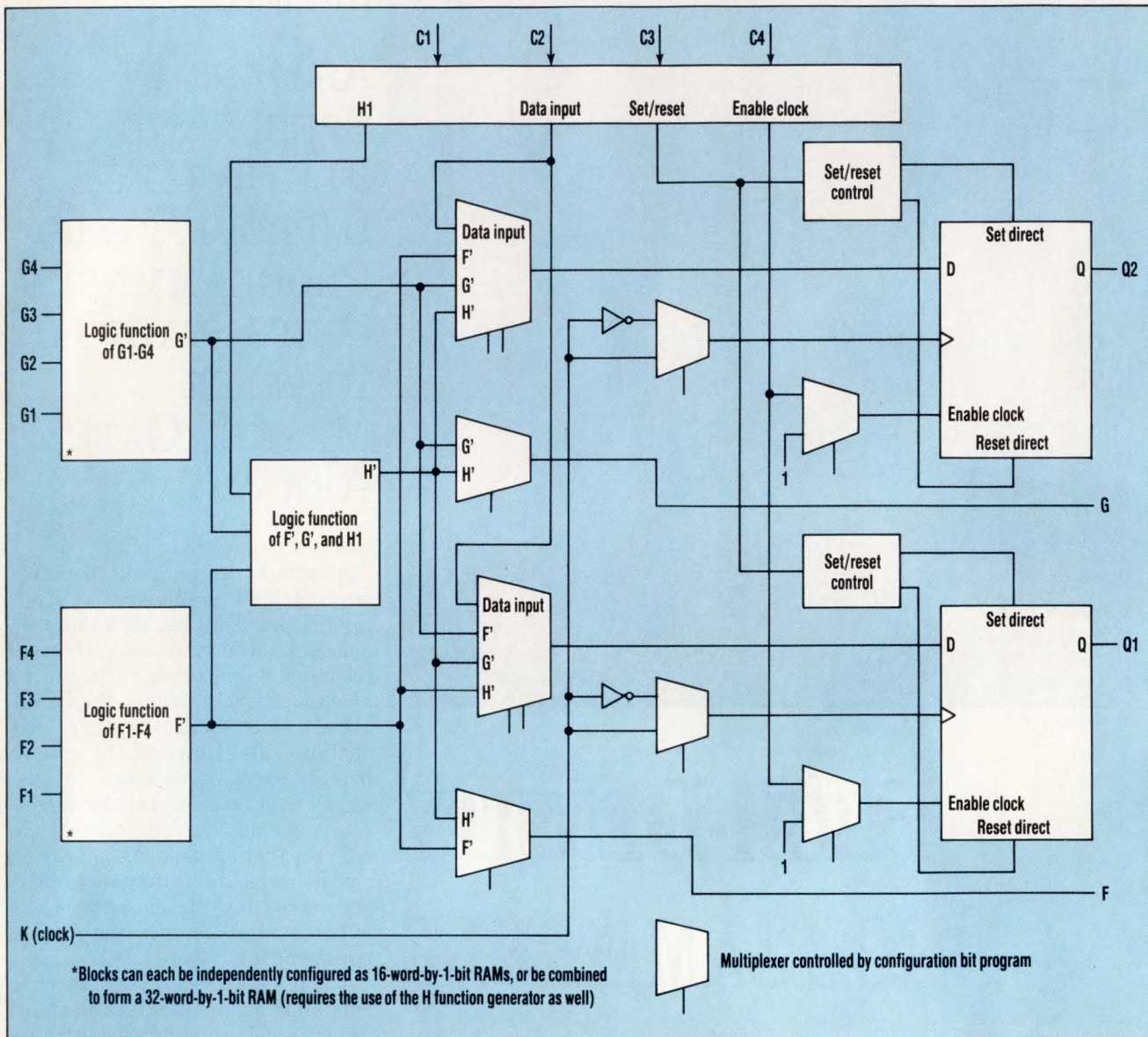

**1. MORE INPUTS ARE AVAILABLE** on the enhanced configurable logic block of Xilinx's XC4000 series of programmable arrays than on the CLBs of Xilinx's previous family. The series includes dedicated carry logic to improve arithmetic operations.

should have a reasonably large number of available equivalent gates (over 1500 gates is a well-accepted rating that moves a chip's classification from a PAL device or a simple PLD to an FPGA).

A noticeable FPGA trend is the virtual complete shift away from bipolar technology as densities increase. Advanced CMOS processes with submicron features now dominate the high-density programmable-device arena. The FPGA field is also dominated by California-based startup companies—firms less than

six years old, with most not even owning their own processing facilities. But that won't stop engineers from adopting FPGAs. Presently, only about 8% of engineers using programmable logic currently employ FPGA-complexity devices. However, a recently released ASIC study by Electronic Trend Publications, Saratoga, Calif., projects that FPGAs will account for 25% of all programmable-logic sales by 1993.

The more programmable devices resemble a gate array, the more designers must depend on good software

tools. These tools must hide chip architectures from system designers and allow them to work at the macrocell level. Only the desired functions from the cell library would need to be chosen. In addition, as more of the system is built from FPGAs, simulation models and delay-extraction tools will be increasingly counted on to verify system operation and performance prior to hardware implementation (see "Software tools are crucial," p. 48).

None of the early large PLD manufacturers could develop the innovative circuits needed to stay at the



forefront of density. Texas Instruments, for example, licensed both the Altera and Actel field-programmable logic structures to gain a foothold in the complex PLD market. TI also has rights to use the Actel technology in other product areas not yet disclosed. Intel also licensed some of the Altera devices, but has recently focused attention on more application-focused programmable devices aimed at specific system problems.

To some extent, Advanced Micro Devices also bought its way into the market by first acquiring Monolithic Memories Inc. MMI, the original patent holder for PAL devices, had also invested in and licensed the Xilinx RAM-based logic-cell-array (LCA) programmable architecture. Although AMD is still an investor in Xilinx, it has refocused its strategy by phasing out sales of the LCA devices while developing proprietary mid-range-complexity chips based on EEPROM elements—the Mach family.

Until this month, National Semiconductor has been a player only in low-complexity and high-speed PLDs. However, this week, National unveiled a mid-range family based on a multiple-array programmable logic (MAPL) architecture. The family is also based on EEPROM configuration cells and will compete with the Mach family as well as PLDs from Cypress Semiconductor, Exel, Philips-Signetics, and Plus Logic. It will also vie with the lower-complexity family members from Actel, Altera, and Xilinx.

The fuse-programming technique for PLDs has moved from the metal-link-style fuse to RAM, EPROM, EEPROM, and even antifuse-type control cells for all of the CMOS logic chips. In the case of RAM, EPROM, and EEPROM cells, chips using them can be erased and rewritten to reconfigure the chip in the prototype system or even once the end equipment is fielded (RAM and EEPROM-based units predominantly).

So far, Xilinx and Plessey, a newcomer to the market, are the only companies using configurable logic based on static-RAM storage cells that hold array configuration data. Xilinx, though, has lined up AT&T

Microelectronics and Seiko-Epson as alternate sources for its XC2000, XC3000, and recently released XC4000 families. The arrays find many applications, whether as a prototyping aid due to their in-system reprogrammability and internal observability, or as a production device for low-to-medium-volume end products (several hundred to tens-of-thousands of units per year).

The Xilinx families are popular because they can implement significant blocks of logic, and because their in-system reconfigurability enables one chip to perform multiple functions or have its logic updated. An informal survey of computer-board makers at this year's Buscon revealed that many manufacturers use one or more Xilinx arrays on their production-version boards. The chips are used to implement secondary bus controllers and specialized interface logic.

Xilinx recently released its third generation, the XC4000 series, which will offer better flexibility, more features, and higher performance. Improved flexibility comes from additional routing resources and an enhanced logic-cell architecture that allows more functions in each cell. Also, the RAM configuration cells can be used as standard memory cells. The inefficient implementation of registers and small blocks of RAM was a major complaint with the XC2000 and XC3000 families. Members in the 3000 family offer complexities from 2000 up to 9000 gates and 64 to 82 I/O lines, depending on the package.

With improvements in array connectivity and the use of a submicron process (instead of the 1.2- $\mu$ m process that manufactured the previous families), the XC4000 series can offer higher operating speeds—as much as 33% over the XC3000 family. The smaller features also enable designers to pack more equivalent gates on a chip; XC4000 devices range in complexity from 2000 to 20,000 gates per chip. The first XC4000 devices to be sampled range from 5000 to 10,000 gates.

External system clock speeds with the 4000 series can run as high as 60

to 70 MHz. Internal logic functions also operate faster. For some simple functions, such as a 16-bit multiplexer, a 16-bit synchronous counter, and an 8- or 9-bit parity generator/checker, the XC4000 family requires 20 ns with 8 configurable logic blocks (CLBs), 20 ns and 5 CLBs, and 5 ns with one CLB, respectively. In comparison, the XC3000 arrays require 35 ns and 14 CLBs, 28 ns and 7 CLBs, and 14 ns and 2 CLBs, respectively.

The basic CLB on the chip has been restructured to add more inputs (9 vs. 5 in the XC3000 series), as well as to include carry logic to improve circuit performance for adders and other ALU operations (*Fig. 1*). With the enhanced block, wide and fast decoders can also be created thanks to some dedicated decoding logic added to the matrix. Furthermore, the 4000-series architecture permits the 16 configuration-bit storage locations in each CLB to be used as RAM. At the same time, the combinatorial function generators can perform a different, perhaps unrelated job. Depending on the total array size, blocks of RAM ranging in size from 2 to 28 kbytes can be formed.

Unlike the CLB programming level of the Xilinx arrays, Plessey's electrically reconfigurable array (ERA) offers a much finer level of granularity. In the ERA, the basic programmable element is a NAND gate, similar to the basic element in a mask-programmed gate array. Such a fine level of granularity is both a blessing and a curse to the designer. It's great if custom logic down to that level must be implemented. But for more standard logic, it depends heavily on a comprehensive macrocell library of more complex logic functions to eliminate repetitive design tasks.

The gate-level granularity is also somewhat slow. Because each level of gating incurs a fixed propagation delay, designers must minimize the number of levels. With more complex logic cells, some of the gate levels are already precombined in the macrofunction to improve circuit performance. Thus, the longer propagation delays in finer-granularity circuits may limit the frequency to a level below that of some of the ma-



## SOFTWARE TOOLS ARE CRUCIAL

**F**or the complex field-programmable gate array to be on a par with the masked gate array when designing, then the tools that capture and verify the design must be as good as those tools used for masked arrays. Such tool improvements are starting to emerge as programmable chip makers feel they must hide the actual array architecture.

Submerging chip architectures is actually a result of increased chip complexity. Increased internal logic, which gives programmable arrays their flexibility, makes it harder and harder for system designers to really understand the intimate details of every array family. Consequently, by submerging the architecture's details into the tools, the software supplier lets users concentrate on their design rather than the low-level implementation. However, that puts a strong onus on the tools to offer the most advanced features and capabilities to maximize the use of the unique architectures of each array.

Most silicon suppliers first offered their tools on PC-type platforms, because initial architectures weren't very complex and the horsepower of 80286- and 80386-based PCs could handle the placement and routing. However, as complexities increased, the PC no longer had processing overhead to spare. As a result, the more powerful desktop workstations have become a prime target for the new FPGA design tools.

For the designer to verify system operation, the tools will have to analyze how best to fit a design into the available logic, and perhaps perform logic reduction and optimization, post-placement delay extraction, and back-annotation of the propagation delay figures. Some of the tools are even starting to link into logic-synthesis software, so that portions of the desired circuit can be derived

from a logic description, rather than from a schematic.

In addition to software tools offered by the FPGA vendors, simulation models for many chips are available from Logic Automation Inc., Beaverton, Ore. Full design suites of tools, such as the Amadeus PLD package, are available from Cadence Design Systems Inc., San Jose, Calif.; other tools come from Mentor Corp., Beaverton, Ore. With the Cadence Amadeus PLD package, engineers can create a design with schematics, or hardware-description languages. They can also use Boolean, truth-table, or state-machine syntax descriptions in Abel 4.0, the popular PLD design language from Data I/O Corp., Redmond, Wash. The design-entry portion of the software is linked with Cadence's Improvisor, a design-synthesis tool that allows designers to explore implementation alternatives early in the design cycle.

With simulation models available, designers not only evaluate the operation of a chip, but of an entire board or system. The cost of an FGPA—\$20 to \$30 on the low end and close to \$200 on the high end—is much lower than that of the engineering and mask charges for a gate array. But no one wants to go through several iterations of a design, throwing away a few hundred dollars each time. Simulation can avoid the iterations, as well as possibly catch design inconsistencies in the rest of the system.

One unique option that Logic Automation has for its models is a windowing capability that allows designers to "look" inside the registers of an FPGA during simulation. Breakpoints can be set on particular data patterns, execution can be single-stepped, and register values altered—all to quickly identify and correct design problems. The windows feature is especially helpful with ICs that have many buried registers.

crocell-based chips. Depending on the number of speed-critical paths within the chip, the finer-grained circuits may not be fast enough.

The Actel ACT-1 and ACT-2 families of one-time programmable arrays, which compete for some of the same applications, may offer an even higher degree of configurability than the Xilinx products. However, configurability comes at the expense of reprogrammability. The reason is they employ one-time programmable antifuse elements that form small, short-circuit paths to configure the chip. One major benefit of the antifuse technology is its "hardness" to radiation, which makes the arrays promising candidates for many military and satellite systems.

Initially fabricated with a 2- $\mu$ m process, the ACT-1 arrays offer the equivalent of 1200 and 2000 gates (for the A1010 and A1020, respectively). However, designers at Actel feel that the technology is on the early edges of the scaling curve, with plenty of room for feature reduction. The newly released ACT-2 family illustrates that point by trimming the features to 1.2  $\mu$ m and upping the gate count to 2500, 4000, or 8000 on the A1225, 1240, and 1280, respectively. The largest chip, the A1280, comes in a 176-lead pin-grid array. In small quantities, it sells for \$440 each. Such a high pin count is essential for the chips to be used in many of the latest digital systems.

The gate-array-like architecture of the ACT-2 series makes it possible for the chips to implement large macros easily and achieve moderate performance levels. A 16-bit loadable binary counter can run at 40 MHz, a 16-bit binary adder requires 20 ns, and a 32-bit version needs 30 ns. Those numbers are worst-case specifications over temperature and voltage variations. The chips still use rather large feature sizes, compared with the submicron-process features of some EEPROM- and EPROM-based programmable logic devices. Actel, though, is confident that chips performing 50 to 150% faster than today's will be possible, as feature sizes drop to 0.8  $\mu$ m.

Competing with the RAM and anti-



## HIGH-DENSITY PLDs

fuse arrays are the UV EPROM-based programmable logic chips that are part of the Altera Max and EP families and in part, alternate-sourced by Cypress, Intel, and TI.

The Max 5000 series architecture consists of multiple programmable logic blocks on one chip that can be tied to each other through both local and global programmable connections. Each logic-array block (LAB) consists of a macrocell array containing 16 macrocells, an expander prod-

uct-term array, and an I/O control block (Fig. 2). Each macrocell, in turn, consists of a programmable logic array and an independently configurable register that can be set as a D, T, J-K, or S-R flip-flop, a flow-through latch, or bypassed for purely combinatorial operation. Each LAB has one system clock input.

That architecture differs markedly from the Actel and Xilinx approaches, and somewhat resembles a chip built from multiple, indepen-

dent PAL devices. The largest Max-family member is the recently released EPM5192, which packs 12 LABs and comes in either a 100- or 84-lead package. However, designers at Altera also noted the need for a high-pin-count chip without as much logic. Along came the EPM5130, which packs only 8 LABs but comes in a 128-lead package. The 5192 has about 7500 gates, while the smallest member, the 5016, contains the equivalent of about 600 gates. Counters formed on the arrays have a top speed of about 40 MHz on the 5192, and 100 MHz on the 5016.

Of course, one problem when evaluating the chips in real systems is that loading conditions are rarely perfect, and direct signal paths don't justify employing a complex device. If other elements, such as using the expander terms, are considered, system performance will degrade by as much as 50%. These performance changes might be avoided if designers are totally familiar with an architecture, or have some software tools that can avoid such situations automatically (see "Sidestepping architectural curves," p. 53).

Designers at Altera are working on a second-generation Max family that will offer complexities of up to about 20,000 gates and pin counts of up to 208 pins. Although full details won't be available for a while, some preliminary data is included in the company's 1991 product catalog.

Licensed alternate sources for both the Max and older EP logic families—Cypress, Intel and Texas Instruments—offer exact replacement devices. Both Cypress and Intel, however, also developed proprietary programmable chips based on UV-EPROM technology. The CY7C3xx family from Cypress focuses on various aspects of bus interfacing and is architecturally more like PAL-type devices than FPGAs. Intel's most recent devices are also relatively low-complexity chips, but they run fast and aim at applications in which power is a key issue: They consume about one-tenth the power of most equivalent-complexity devices.

One relative newcomer to the EPROM-based logic market, Plus

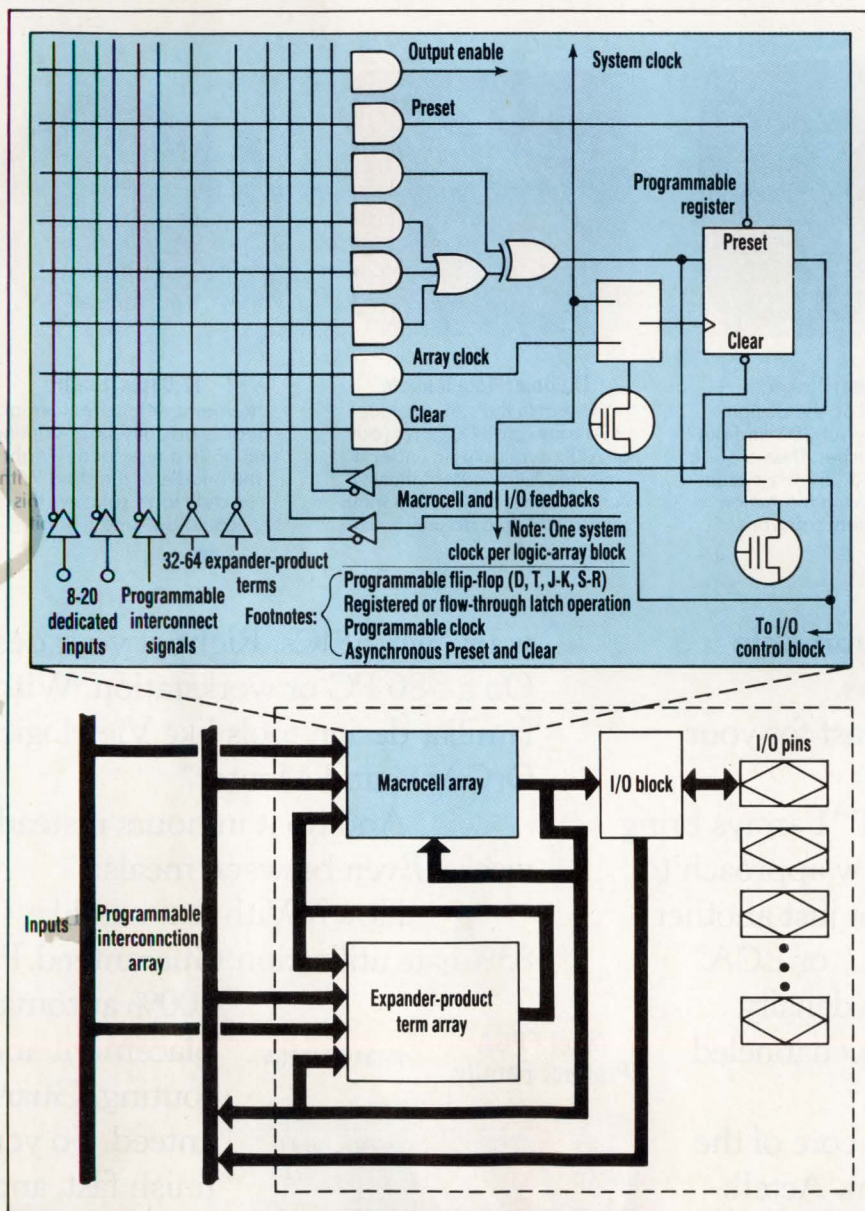

**2. EACH OF THE MAX 5000** series chips from Altera has 1 to 12 logic-array blocks. Each block in turn contains 16 programmable macrocells. Altera connects the LABs with both local and global routing. The local routing makes it possible for the localized functions to be routed without going through the main interconnection matrix.



# Be Brilliant At In Production

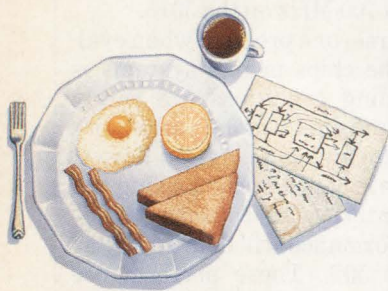

## 7:05 am: Breakfast

Suddenly, between bites, the answer to that new system design jumps right into your brain. But how to make it work in silicon? Use an Actel field programmable gate array!

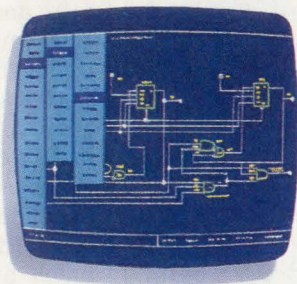

## 8:50 am: Design

You warm up the design program on your 386 and put in the final touches. Then a quick rule check and 25 MHz system simulation with the Action Logic System software.



## 11:00 am: Place & Route

You watch the system place and route all 1700 gates (out of 2000 available) in under 40 minutes. 100% automatically! A final timing check. Then think of something to do until lunch.

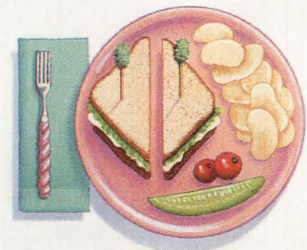

## 12:00 pm: Lunch

Remember lunch? Normal people actually *stop working* and have a nice meal — right in the middle of the day! With Actel's logic solution, this could become a habit.

## Actel Field Programmable Gate Array Systems.

They're a feast for your imagination.

Actel's ACT™ 1 arrays bring you a completely new approach to logic integration. Not just another brand of EPLD, PAL® or LCA™ chips. But true, high density, desktop configurable, channeled gate arrays.

They're the core of the Action Logic System, Actel's comprehensive design and production solution for creating

your own ASICs. Right at your desk. On a 386 PC or workstation. With familiar design tools like Viewlogic™, OrCAD™, and Mentor™.

And do it in hours instead of weeks. Even between meals.

How? With features like 85% gate utilization. Guaranteed. Plus

100% automatic placement and routing. Guaranteed. So you finish fast, and never get stuck doing the most

Actel FPGA Product Family		1010A	1020A
Equivalent Gate Array	PLD/LCA	1200	2000
Equivalent Gates		3000	6000
User I/O		57	69
System Clock (MHz)		20-40	20-40
Availability		NOW	NOW
Technology (micron)		1.2	1.2



# Breakfast And n By Dinner.

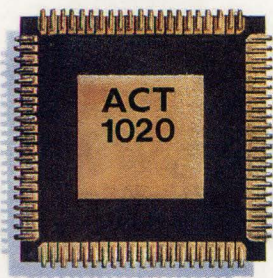

#### 1:15 pm: Program

You load the Activator™ programming module with a 2000-gate ACT 1020 chip and hit "configure." Take a very quick coffee break while your design becomes a reality.

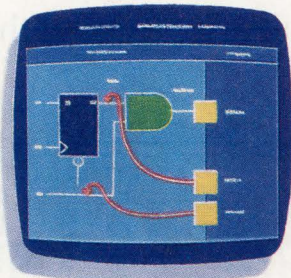

#### 1:25 pm: Test

You do a complete, real-time performance check, with built-in test circuits that provide 100% observability of all on-chip functions. *Without* generating any test vectors.

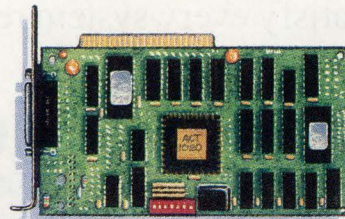

#### 4:00 pm: Production

Your pride and joy is designed, created, tested, and off to the boys in Production. And you're finished way ahead of schedule! Better think of something to do until 5:00.

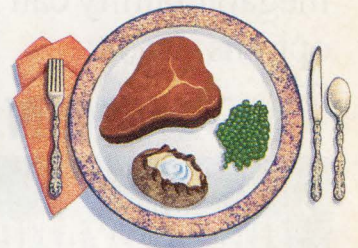

#### 6:00 pm: Dinner

Remember dinner? Normal people actually *go home* and eat with their families. On your way, start thinking about how Actel's logic solution can help you be brilliant tomorrow.

tedious part of the job by hand.

Design verification is quick and easy with our Actionprobe™ diagnostic tools, for 100% observability of internal logic signals. Guaranteed. So you don't have to give up testability for convenience.

In fact, the only thing you'll give up is the NRE you pay with full masked arrays. You can get started with an entry level Action Logic System for under \$5000. Guaranteed.

And Actel FPGAs are even 883 mil-spec compliant.

You can be brilliant right now

with 1200- and 2000-gate devices, and a whole new family of 8000-, 4000- and 2500-gate parts are on the way. Call 1-800-227-1817, ext 60 today for a free demo disk and full details about the Action Logic System.

It could make your whole day.



## Risk-Free Logic Integration

You loved ACT 1. Now catch ACT 2. Phone 1-800-227-1817, ext 62 to reserve a place at the Actel FPGA Technology Seminar coming soon to your area.

© 1990 Actel Corporation, 955 E. Arques Ave., Sunnyvale, CA 94086. ACT, Action Logic, Activator, and Actionprobe are trademarks of Actel Corporation. All other products or brand names mentioned are trademarks or registered trademarks of their respective holders.



# THE MEGABIT E<sup>2</sup> WITH OPTIONS

Now you can choose the exact megabit E<sup>2</sup>PROM to meet your system needs. You don't have to design around your suppliers' shortcomings ever again. Our new megabit family can satisfy every system requirement. Call it the megabit E<sup>2</sup> with options. Look:

## OPTION 1

### ORGANIZATIONS

- 128K by 8  
AT28C010
- 64K by 16  
AT28C1024

## OPTION 2

### PACKAGES

- DIP
- LCC
- Flatpack
- TAB

## OPTION 3

### ENVIRONMENTS

- Industrial
- Commercial
- Military
- Space

No matter what options you need, our megabit E<sup>2</sup>PROMs run as fast as 120 nano-seconds, have 300 microamp standby\* power, up to 100,000 write cycle endurance, individual byte programmability and on-chip error detection and correction. And, as with everything we make, they are available processed to MIL STD 883C.

So, if you want the megabit E<sup>2</sup>PROM designed for your system, in volume now, call Atmel.



*The people who make the difference.*

CIRCLE 134

ATMEL CORPORATION  
2125 O'Neil Drive  
San Jose, CA 95131

Tel. 1-800-292-8635  
Tel. (408) 441-0311  
FAX (408) 436-4200



## SIDESTEPPING ARCHITECTURAL CURVES

The once simple architecture of programmable logic devices has been radically transformed over the past few years into a wide range of complex-architecture variations. Such complex-device families as Altera Corp.'s Max family or similar chips increase the logic capacity to gate-array proportions. But always tagging along are numerous unusual traits or peculiarities that designers must know about to unleash a device's full performance.

Unfortunately, with such a proliferation of devices on the market, it's become more difficult for designers to understand the details of device architectures—especially those with obscure but important features. As a result, advanced fitter software is emerging as an aid designers can use to take advantage of obscure or little-exploited features.

The more common peculiarities found in the three broad device-architecture categories relate to partitioning, expansion of terms, and product-term steering. A number of available and popular devices can personify these traits.

One of those three device categories, a partitioned architecture, consists of one large logic array that's divided into multiple programmable sub-arrays. Those sub-arrays resemble smaller PLDs, and are interconnected through local and global buses. Altera's EP1800, for instance, has four quadrants, and each quadrant has eight local and four global macrocells. Local macrocells feed back only into their own quadrant. Global macrocells, though, have feedback paths onto a global bus, and thus into other quadrants. However, their pin feedback is global while their register feedback is local.

Global feedback, in a limited amount, forces the designer or the fitter software to partition logic between quadrants wisely to

maximize the utility of the global paths. If a design is incorrectly partitioned and has too much communication between quadrants, the global feedback will be exhausted and the logic won't fit.

Another aspect to watch carefully with the EP1800 is the source of global feedback—it's not the macrocell's registered output, but rather its pin output. Because the pin is fed by a three-statable buffer, the feedback won't work as expected unless the buffer's three-state control is permanently enabled.

A third peculiarity of the EP1800 is its clocking. Usually, a macrocell's flip-flop can be clocked by either a synchronous, quadrant-wide clock, or if necessary, by a gated product term. However, if a product term is needed to control the macrocell's output enable, only the synchronous clock is available; term clocking is no longer an option.

Macrocells in Altera's MAX devices, such as the EPM5128, are a good example of using expander terms. Each macrocell has a limited number of product terms available. If they're inadequate in a particular instance, the expander capabilities can increase the number of available terms. But the expansion bus is effectively fed by NAND gates, which implies that the incoming terms must be transformed to maintain their functionality before being used. This may involve more than complementing the logic. An entire, second reduction pass may be necessary to best utilize the expansion capability.

In addition, the EPM5128's expansion bus is shared between macrocells, which means that shared product terms are the best candidates for expansion. Placing singly used terms on the bus is a waste of silicon resources.

Product-term steering, the last of the three categories, shows up in devices like Atmel's 2500 and Intel's 5AC312. There are two ver-

sions of steering: term joining and term sharing. The AT2500 exemplifies joining. Each macrocell has 12 product terms available to it. In the simplest configuration, four feed the combinatorial output, four feed one buried register, and four feed a second buried register. However, if required, the combinatorial output can "grab" some or all of the 12 terms to extend its capabilities.

The peculiarity is that the buried registers can still be used, even if the combinatorial output has accessed extra terms, as long as the register's equation is a subset of the combinatorial equation. If not, the register is wasted.

Product term sharing is similar to joining. In this case, however, increasing the number of product term inputs to a macrocell is done by having the macrocell borrow logic from its neighbors. An example is Intel's 5AC312, which packs three adjacent macrocells, each containing two groups of four product terms.

The uniqueness or peculiarity is that each macrocell (A, B, or C) can either give up a group of four product terms or borrow a group from each adjacent macrocell. For example, say A and C each needs 12 product terms for their equations. Each then takes a set of four terms from B, leaving B unusable because it has no more product terms.

One thread runs through all of these peculiarities: If not properly understood and accounted for, the devices that employ them can't be utilized efficiently. The penalties are wasted effort, wasted silicon, and wasted board space. The onus is on the designer, or a smart piece of software, to understand the oddities and make the proper trade-offs that result in efficient utilization.

*This information is provided by Steve Kaufer, project engineering manager at Data I/O Corp., Redmond, Wash.*



# IMAGINE WHAT A CMO COULD DO TO YO

Now you can really stick it to 'em. And you can be sure they'll get the point. Because our two new MAX® parts will make your next design



unbeatable. And get it to market faster.



Introducing Altera's 100-pin EPM5130 and 7500-gate EPM5192. Both packed with I/O and logic unheard of in a CMOS EPLD.



In fact, they're your best programmable alternative to gate arrays yet. Because

MAX delivers high logic density and superior 50 MHz *in-system* speed. All thanks to our innovative MAX architecture.

Even design is faster. That's because our new MAX+PLUS® II software takes full advantage of the enhanced memory management and multi-tasking capabilities of Windows™ 3.0.

MAX+PLUS II can also automatically partition large logic designs into a set of EPLDs. In minutes. So you can deliver your finished design while





# S EPLD WITH 100 PINS UR COMPETITION.

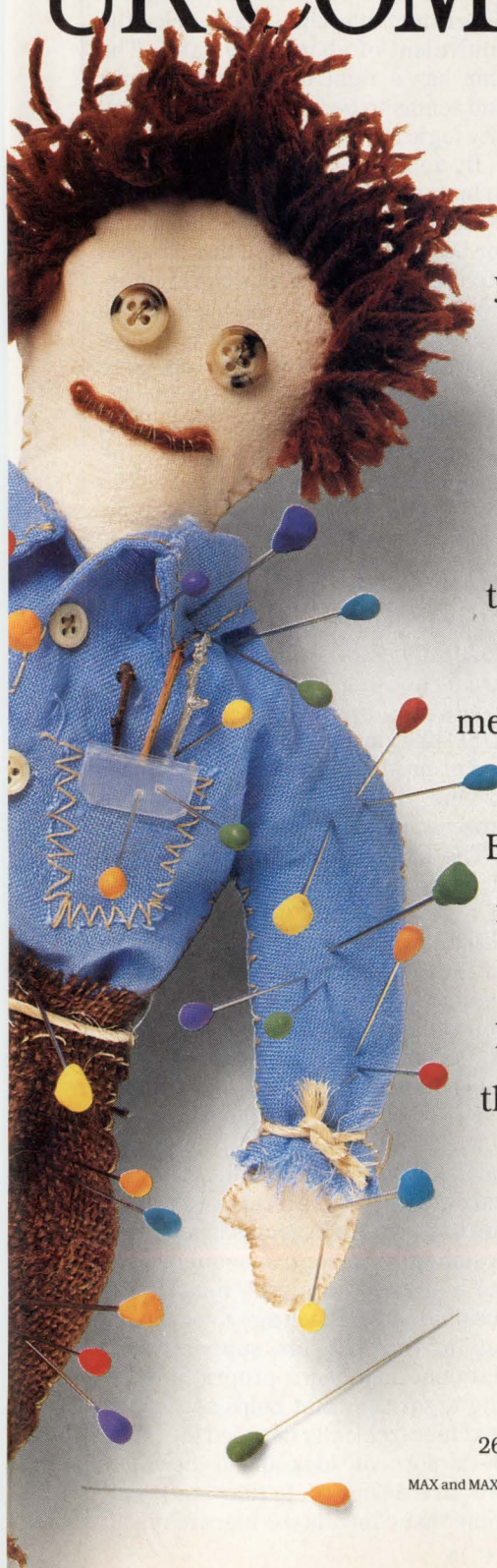

your competition's stuck manually partitioning his schematics.

You can even choose from a wide variety of erasable windowed and OTP packages. Including pin grid array, quad flat pack and PLCC package options. Which makes them perfect for full production or gate array prototyping.

Of course, the EPM5130 and EPM5192 are just two members of the modular MAX family. Devices range from 20 to 100 pins, 16 to 192 macrocells. In fact, there's an EPLD for every logic design task. Because we make the industry's broadest line of CMOS PLDs.

So if you're looking for devices with high density, high I/O and high speed, talk to the people who invented the EPLD. Call Altera today at (408) 984-2800.

We'll help you keep your competition pinned down.

# ALTERA

2610 Orchard Pkwy. San Jose, CA 95134-2020/(408) 984-2800/Fax: (408) 248-6924

MAX and MAX + PLUS are registered trademarks of Altera Corporation. Windows is a trademark of Microsoft Corporation. © 1991, Altera Corporation.



Logic, has developed a family of three programmable arrays in its FPGA2000 series with equivalent complexities of 2000, 4000, and 8000 gates in packages with 40 to 144 leads. Based on a 1.5- $\mu$ m CMOS process, the chips' architecture is very similar to that employed by Altera—function blocks containing the programmable logic cells surround a universal interconnection matrix. However, unlike the Altera parts, the I/O cells come in two parts—the first section is associated with each function block, and the second portion is part of a common I/O pool on either side of the interconnection matrix that the function blocks tie into. Currently, only the mid-density chip is in production, but the smaller family member will be available next quarter and the largest should be sampled near the end of the year.

In addition to the general-purpose logic chips, Plus Logic has come up with a special array version with an on-board 1152-bit configurable register, the FPSL5110. The company plans to officially release the chip next quarter. The register contains 32 words of storage, each word 36-bits wide. The configuration logic allows the register to be set up as ei-

ther a dual-port RAM or a FIFO register (uni- or bidirectional).

Unique among the programmable logic chips, this data buffer chip will contain the equivalent of the 2000-gate FPGA2000 in addition to the register. It's about the same complexity as the forthcoming RAM-based Xilinx XC4005, but occupies about 1/4 the chip area. Operating at 40 MHz, the chip can be set to work as a rate buffer between systems operating at dissimilar speeds, or as a mailbox conveying control information between two systems.

Moving its bipolar programmable macro logic architecture into CMOS EPROM technology, Philips-Signetics will soon release the PML2552, a 68-lead chip with 29 dedicated inputs and 24 I/O lines. Internal flip-flops can toggle at 50 MHz while the internal NAND logic paths have a propagation delay of 12 ns/level.

Employing a folded-NAND structure, the array permits 100% connectivity, eliminating routing restrictions. In addition, the chip contains 52 dedicated flip-flops—16 input D-types, 20 internal J-Ks, and 16 output D-types. Multiple, dedicated clock inputs enable the circuit to be partitioned into multiple subcircuits that

can operate independent of each other. To improve the multilevel logic capability, 96 NAND foldback gates are included on the chip.

Atmel is also pushing up the density of its EPROM-based logic with a programmable chip that packs the equivalent of about 2500 gates. The chip has a relatively low pin count and seems to be targeted at mid-density logic replacement.

By applying EEPROM technology to high-density programmable logic, designers at National Semiconductor have come up with a novel paged architecture that allows the logic array to maintain its best speed across a wide range of densities. Chips range from the first 28-pin 1000-gate ICs released this month, to the 68-lead, 4000-gate chips slated for 1992. The paged architecture allows the arrays to run at system speeds of 45 to 50 MHz (with feedback) without submicron processing. The first arrays employ 1.4- $\mu$ m design rules.

The MAPL architecture is optimized for state-machine applications. It banks on the fact that the circuit doesn't require all logic elements at the same time. That allows RISC-like design approaches to the use of product terms. Only a subset of the product terms must be powered on at any one time.

The 128 product terms in the first chips are broken down into 8 pages of 16 terms each. Full interconnectivity allows any input to be routed to any output through any programmable array—with the same propagation delay, regardless of the path. The consistent delay makes overall chip performance more predictable.

The hierarchical scheme creates a new critical path. Unlike a logic signal delay path in other chips, the critical path is the time it takes to power-on and power-off various levels. Programming the control sequence for the hierarchy would be next to impossible for the average user. So, as part of the software support tools, National included a proprietary fitting algorithm that helps set up the next hierarchically decoded logic level—a sort of look-ahead decoder. Bits are assigned to the state machine that controls the hierarchy and

### MANUFACTURERS OF HIGH-DENSITY FIELD-PROGRAMMABLE LOGIC

<b>Actel Corp.</b> Sunnyvale, Calif. (408) 739-1010 <b>CIRCLE 301</b>	<b>Exel Microelectronics Inc.</b> San Jose, Calif. (408) 432-0500 <b>CIRCLE 307</b>	(408) 991-2000 <b>CIRCLE 312</b>
<b>Advanced Micro Devices Inc.</b> Sunnyvale, Calif. (408) 732-2400 <b>CIRCLE 302</b>	<b>Intel Corp.</b> Folsom, Calif. (916) 351-2746 <b>CIRCLE 308</b>	<b>Plessey Semiconductors Corp.</b> Scotts Valley, Calif. (408) 438-2900 <b>CIRCLE 313</b>
<b>Altera Corp.</b> San Jose, Calif. (408) 984-2800 <b>CIRCLE 303</b>	<b>International CMOS Technology Inc.</b> San Jose, Calif. (408) 434-0678 <b>CIRCLE 309</b>	<b>Plus Logic Inc.</b> San Jose, Calif. (408) 293-7587 <b>CIRCLE 314</b>
<b>Atmel Corp.</b> San Jose, Calif. (408) 436-4267 <b>CIRCLE 304</b>	<b>Lattice Semiconductor Corp.</b> Beaverton, Ore. (503) 681-0118 <b>CIRCLE 310</b>	<b>Quicklogic Corp.</b> (formerly Peer Research) Santa Clara, Calif. (408) 987-2000 <b>CIRCLE 315</b>
<b>Crosspoint Solutions Inc.</b> San Jose, Calif. (408) 988-1584 <b>CIRCLE 305</b>	<b>National Semiconductor Corp.</b> Santa Clara, Calif. (408) 721-5341 <b>CIRCLE 311</b>	<b>Texas Instruments Inc.</b> Dallas, Texas (214) 995-2011 <b>CIRCLE 316</b>
<b>Cypress Semiconductor Corp.</b> San Jose, Calif. (408) 943-2600 <b>CIRCLE 306</b>	<b>Philips-Signetics Corp.</b> Sunnyvale, Calif.	<b>Xilinx</b> San Jose, Calif. (408) 559-7778 <b>CIRCLE 317</b>

This is intended to be a guide rather than a definitive list.



## HIGH-DENSITY PLDs

act as decoding tags to determine the level that's activated.

The first series of chips in the MAPL family—the MAPL128 and 144—will be targeted at synchronous state-machine applications. They come in 28- and 44-lead packages, respectively. Both D and J-K flip-flops are included as part of the hardware resources, minimizing the need for software transformations or additional product terms to implement such flip-flops.

Going head-to-head with National's new family, the Mach series from Advanced Micro Devices claims to merge the best of PLDs with the best of FPGAs. The first family of Mach chips, the Mach 110 series, aims at general-purpose logic-replacement applications; the 210 series, which packs embedded flip-flops, is more suitable for state-machine applications (ELECTRONIC DESIGN, March 8, 1990, p. 105). The chips have internal 15-ns propagation delays and can handle system clocks at rates of up to 50 MHz.

The first members of each series are now available. The larger 84-pin Mach 130 and 230 are slated for release next quarter; the mid-size 68-pin Mach 120 and 220 are scheduled for third-quarter release. AMD has also developed a mask-programmable replacement for the Mach chips that allows a customer to move to a lower cost for production. The company estimates that quantities of as few as 15,000 units would permit them to use a masked version.

Both Lattice Semiconductor and International CMOS Technology also have EEPROM-based programmable logic chips with the GAL6001 and the PEEL family, respectively. But their largest available chips only marginally fall into the large PLD area, and are equivalent to about 1200 gates. New things are afoot at Lattice that push densities up into the FPGA area, but the company is keeping mum until later this year. □

**HOW VALUABLE?**

HIGHLY  
MODERATELY  
SLIGHTLY

**CIRCLE**

526  
527  
528

# Join Best Western's Gold Crown Club...

and the rewards can be yours.



Best Western's Gold Crown Club—  
it's easier than ever to earn points\*  
redeemable for valuable awards at  
nearly 1900 Best Western locations in the U.S., Canada, Mexico and  
the Caribbean.

Just look at the values! Here's what you can earn:

- Room nights at Best Westerns in the U.S., Canada, Mexico and the Caribbean
- U.S. Savings Bonds (gift certificates for non-U.S. residents)
- General Rent-A-Car Certificates • Gourmet Dining Certificates

Start earning points today. There's no cost to join!  
Make your Gold Crown Club membership a  
necessary part of your travel plans.



Each Best Western is independently owned and operated.

Here's my application. Please enroll me in your Gold Crown Club today, at no cost to me.

Name \_\_\_\_\_  
Company \_\_\_\_\_ Phone \_\_\_\_\_ Ext. \_\_\_\_\_  
Please mail to my \_\_\_\_\_ Home \_\_\_\_\_ Business address \_\_\_\_\_  
Address \_\_\_\_\_ City \_\_\_\_\_  
State / Province \_\_\_\_\_ Zip / Postal Code \_\_\_\_\_ Country \_\_\_\_\_

Mail to: Best Western International, Inc. Gold Crown Club  
P.O. Box 3858, Holliston, MA 01746

\*Gold Crown Club Points are awarded for rooms purchased at the regular rate. Points will not be awarded for discounted room rates.

**CIRCLE 1**



# SOFTWARE CONFIGURABLE BOARD MAKES DATA ACQUISITION EASY



*"With our 'Hands-Off' DT2831 board series for the PC AT, all set up and calibration is automatic via software."*

—Fred Molinari, President

## Total software control—No pots! No jumpers!

- Configuration of all board functions
- Self-calibration
- Gain and offset correction
- Independent selection of gains, sampling rates, DMA channels, and interrupts

## Up to 250kHz gap-free data transfer

## Simultaneous A/D, D/A

## Up to 256 input channels with expansion panel

## Two 16-bit counter/timers (AM9513)

## Eight lines of digital I/O

## Maximum noise immunity with shielded connector and analog modules

## FREE software

- Drivers and subroutine library
- C, Pascal, BASIC and FORTRAN support

## Application software available

- GLOBAL LAB™ Data Acquisition
- Leading software packages including LABTECH NOTEBOOK

Quantity pricing available; All prices U.S. list.

## FAST 5 day delivery

Call for FREE Catalog

**(508) 481-3700**

In Canada, call (800) 268-0427

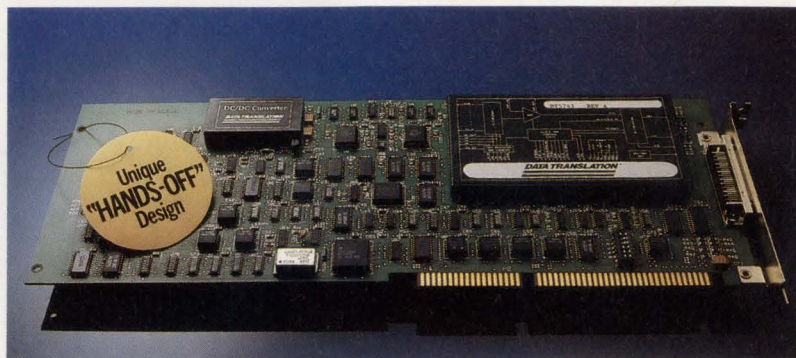

## HIGH PERFORMANCE FEATURES

	DT2831	DT2835	DT2831-G	DT2836	DT2837
<b>ANALOG INPUTS</b>					
Channels	16	16	16	16	16
Resolution (bits)	12	12	12	16	16
Sampling Rate	50kHz	50kHz	250kHz	30kHz	30kHz
Gain	1,2,4,8	1,10,100,500	1,2,4,8	1,2,4,8	1,10,100,500
<b>ANALOG OUTPUTS</b>					
Channels	2	2	2	2	2
Resolution (bits)	12	12	12	16	16
Throughput	130kHz	130kHz	130kHz	100kHz	100kHz
<b>PRICE</b>					
	\$1,750	\$1,850	\$2,450	\$2,735	\$2,795

# DATA TRANSLATION®

**World Headquarters:** Data Translation, Inc., 100 Locke Drive, Marlboro, MA 01752-1192 USA, (508) 481-3700, Fax (508) 481-8620, Tlx 951646

**United Kingdom Headquarters:** Data Translation Ltd., The Mulberry Business Park, Wokingham, Berkshire RG11 2QJ, U.K., (734) 793838, Fax (734) 776670, Tlx 94011914

**Germany Headquarters:** Data Translation GmbH, Stuttgarter Strasse 66, 7120 Bietigheim-Bissingen, Germany 7142-54025, Fax 7142-64042

**International Sales Offices:** Australia (2) 699-8300; Belgium (2) 466-8199; Brazil (1) 240-0598; Canada (416) 625-1907; China (1) 513-7766 x1222; Denmark 2 274511; Finland (0) 3511800; France (1) 69077802; Greece (1) 361-4300; Hong Kong (5) 448963; India (22) 23-1040; Israel 52-545685; Italy (2) 824701; Japan (3) 502-5550, (3) 5379-1971; Korea (2) 718-9521; Netherlands (70) 399-6360; New Zealand (9) 415-8362; Norway (2) 53 12 50; Poland (22) 580701; Portugal 1-7934834; Singapore 338-1300; South Africa (12) 803-7680; Spain (1) 555-8112; Sweden (8) 761 78 20; Switzerland (1) 723-1410; Taiwan (2) 3039836

GLOBAL LAB is a trademark and Data Translation is a registered trademark of Data Translation, Inc. All other trademarks and registered trademarks are the property of their respective holders.



# EASILY UPGRADE A 68030-BASED SYSTEM WITH A CLEVER CACHE DESIGN

BUILD A CACHE DAUGHTERBOARD THAT PLUGS INTO THE EXISTING PROCESSOR SOCKET TO EXPLOIT THE PROCESSOR'S SYNCHRONOUS MODE.

**C**ompanies spend lots of time and resources creating a microprocessor-based product. By the time the product is ready for the market, however, the industry has already introduced a faster or more advanced processor. Selling yesterday's technology is difficult, yet it's not profitable to sacrifice the existing system and develop another product that uses the updated technology. The ideal solution is to bring the updated technology to the existing system without major changes.

For instance, a 68030-based system that uses dynamic RAM (DRAM) runs at 3 clock cycles/access in the asynchronous mode. The system doesn't take advantage of the processor's synchronous operation, which runs at 2 clock cycles/access at 33 MHz. Adding cache memory to the existing system would convert a large number of the slow DRAM accesses to fast accesses in the cache static RAM (SRAM). A high ratio of SRAM accesses to DRAM accesses indicates better performance.

A cache can be built on a daughterboard that plugs into the system's existing processor socket. That way, designers can upgrade an outdated microprocessor-based system without changing its architecture. The cache system is a small subsystem that uses fast SRAM and cache technology. With that technology, the processor can run at its maximum speed. The cost of developing this small, add-in daughterboard is minimal compared to the cost and the time it takes to rebuild another system. This cache system can upgrade an application's speed up to 30%.

The operation of cache is based on the principle of program locality. Programs usually access the same memory blocks repeatedly. In addition, they spend much time executing instructions in a loop. DRAM is used for main memory and SRAM for the cache. Accesses to SRAM are fast and don't need wait states. When the program reads data or instructions from the slower DRAM memory, the processor writes the surrounding block of data into the cache. Subsequently, the next access to the same information comes from the cache memory with no wait states.

There are drawbacks, however. The data that the microprocessor needs may not always be in the cache memory. When the program attempts to find data in the cache, the system will indicate if the desired data is stored there. This is done with

**NAGI MEKHIEL**

Ryerson Polytechnical Institute, 350 Victoria St., Toronto, Ontario, Canada M5B 2K3; (416) 979-5000.



# CACHE MEMORY DESIGN

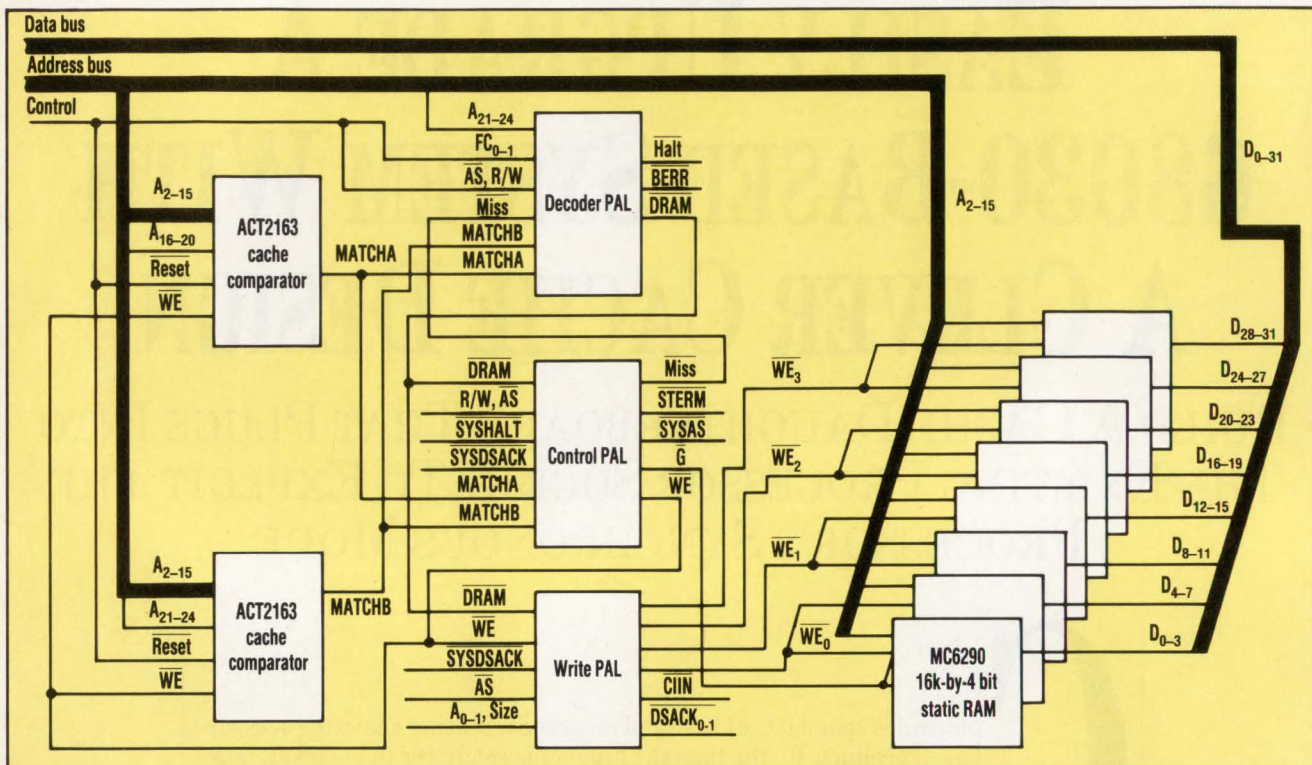

1. THE CACHE SYSTEM is made up of eight Motorola SRAM chips, three PAL devices, and two Texas Instruments tag comparators.

the cache tag comparator, which compares the current address being accessed by the processor to the addresses of data stored in SRAM and determines if they match.

A cache hit occurs when a match is found. In that case, the memory location needed by the program is already in the cache (SRAM), so the cache can give the required information to the processor without delay. A cache miss occurs when there's no match, and the processor has to fetch data from the main memory (DRAM) and update the cache.

## A TRICKY TASK

Designing the add-in cache system is tricky because it can't alter the existing system, but instead must work around it. This cache has unique features that optimize the overall system performance. For example, the design interleaves DRAM and SRAM accesses. Interleaving memory accesses reduces the penalty of a cache miss. In addition, the cache controller hides the dynamic RAM refresh in static RAM and peripheral accesses.

The daughterboard uses a simple direct-mapped cache that's made from 64 kbytes of fast static memory. Direct-mapped design offers simplicity and uses the least amount of tag memory. The main memory (DRAM on the system board) is divided into logical pages. Each page of DRAM is the same size as the cache.

The total number of the DRAM pages is calculated by dividing the DRAM size by the size of the SRAM. In this 68030-based system, 8 Mbytes of DRAM and 64 kbytes of SRAM exist. The number of pages is  $8000 \div 64 = 128$  pages.

Each page is directly mapped to the 64-kbyte SRAM space. A page consists of 16k 4-byte lines. The address space  $A_{2-15}$  covers the 16k lines needed for each page.

Tag memory, which is the fast SRAM part of the tag comparator, stores the tag of each line. The tag is the page number that's unique for each line. In this system, the tag takes a value of 0 to 127 for the total of 128 pages. When the processor stores any information into the

SRAM, the cache controller stores the line tag into the tag memory. The tag memory is 16k by 7 bits, and is mapped directly into the SRAM space  $A_{2-15}$ . Seven bits are needed to store 128 tags.

When the processor starts an access, the tag comparator reads the stored tag data for this location. It compares the tag data with the current accessed address ( $A_{16-22}$ ) and indicates a hit if they match. Address lines  $A_{16-22}$  select one page of the 128 pages.

The cache is made up of eight 15-ns, 16k-by-4-bit Motorola MC6290 SRAM chips (Fig. 1). Each page is organized as 16k 32-bit words. Address signals  $A_{0-1}$  are used to decode 4 bytes of the cache line, while  $A_{2-15}$  create the 16k words of address space.

This design uses two Texas Instruments ACT2163 16k-by-5-bit, 20-ns tag comparators. Address lines  $A_{2-15}$  are connected to both of the tag comparators and the SRAM address bus. Also,  $A_{16-20}$  and  $A_{21-24}$  are connected to the data inputs of the two cache tag comparators to store the page



# CACHE MEMORY DESIGN

number.

MATCHA and MATCHB are the output signals of the tag comparators. These signals go high on a compare cycle if the current processor address  $A_{2-24}$  matches a previously stored tag. Address tags are stored each time the processor writes to the cache.

The DRAM controller used in the existing system supports three modes. A standard DRAM page-mode access requires a precharge time delay before the controller accesses a new row and column. This access takes 7 clock cycles at 33 MHz and is the slowest mode. Fast page mode is used if the controller accesses a new column in the same row. This is the fastest access, taking only 3 clock cycles. Interleaving mode is used when the controller finds an access in a different row and that row is precharged. It takes only 5 clock cycles/access in this mode.

## DIFFERENT MODES

The old non-cache system runs at an average speed of about 5 cycles/access with the DRAM memory. The three different modes that the controller uses with the DRAM in the old system will average 5 clock cycles/access. This average access time is calculated as  $(3 + 5 + 7) \div 3 = 5$ , assuming that each mode has an equal chance to occur.

In the new system, when the cache controller misses, the processor has to get the information from the DRAM main memory. On a cache miss, the cache controller adds two more clock cycles to the DRAM access because it enters the retry mode of the 68030. The retry mode is used because the 68030 samples the Synchronous Termination signal  $\overline{STERM}$  before a valid result of the miss or hit signal. The total average access time in a miss is  $5 + 2 = 7$  clock cycles/access.

With a cache hit, the system can run at 2 clock cycles/access. This design gives an average hit/miss ratio of about 85%. The average read access time becomes  $(2 \times 0.85) + (7 \times 0.15) = 2.75$  clock cycles/access assuming 85% SRAM accesses and 15% DRAM accesses.

The cache controller uses the write-through method in which the controller writes every time to the DRAM and to SRAM. This technique minimizes the memory write time. The average write time, 5 clock cycles/access, is the same as for the DRAM access because the retry operation isn't needed.

Overall read and write speed for the new system can be calculated from the read accesses and the write accesses. It averages about  $(2.75 + 5) \div 2 = 3.875$  clock cycles/access. The percentage performance increase over the non-cache system is  $5 \div 3.875 = 29\%$ .

The upgraded system board is the old system with the 68030 unplugged from its socket (*Fig. 2*). The cache daughterboard includes the static RAM, a control block containing the cache controller that arbitrates between the old system resources and the cache system memory, and the 68030 microprocessor. A 169-pin connector links the old system to the daughterboard through the existing processor socket.

The address bus, which is the 68030 address bus ( $A_{0-24}$ ), is shared by the processor, the cache system,

and the old system. The data bus is the 68030 data bus ( $D_{0-31}$ ) and is also shared by the processor, cache system, and the old system. The control bus consists of 68030 control signals that are shared by both the cache board and the system board. Those signals are Clock, Reset, Read/Write (R/W), and the dynamic bus-sizing signals.

The Start Access signal is the Address Strobe ( $\overline{AS}$ ) signal from the 68030 microprocessor that indicates a valid access.  $\overline{AS}$  indicates a valid address on the bus, and is connected to the cache controller to indicate a start of an access.

## A CACHE HIT

Cache Ready is an output of the tag comparator that indicates a cache hit if the information can be retrieved from the SRAM. The Cache Enable signal is an output of the cache controller to enable the SRAM so that the processor can get the information from it.

The cache controller drives the System Enable signal active if the processor needs information from the old system that has the DRAM and the peripherals. System Enable

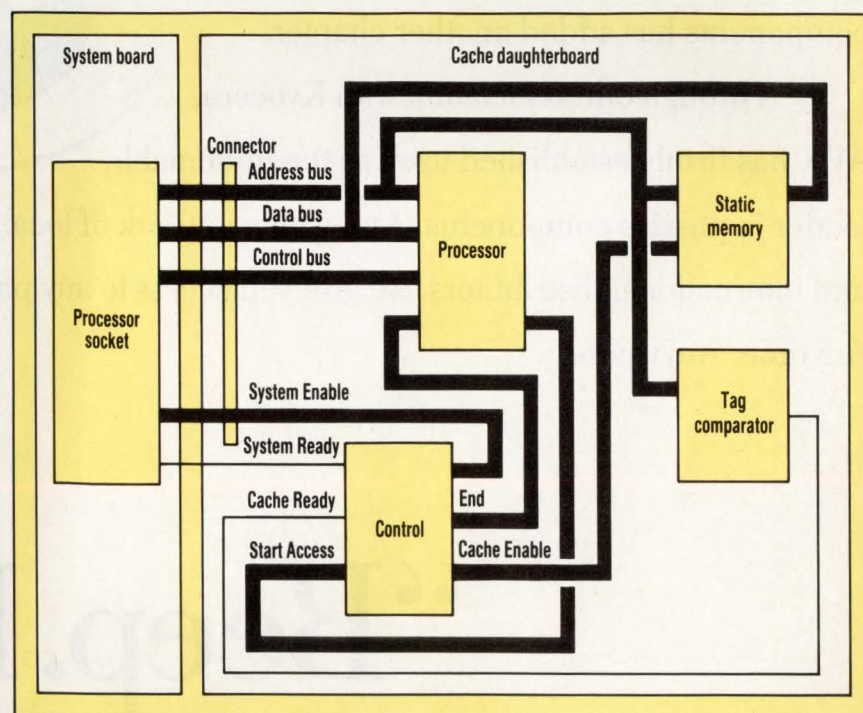

**2. AN EXISTING SYSTEM** is upgraded by plugging a cache daughterboard into the system's microprocessor socket. The processor is relocated to the daughterboard.



# AVX would like to about their expanded product line.

Feedback has been tremendous. Since we added clock oscillators, piezo devices, resonators and trimmer potentiometers to an already extensive line of capacitors, AVX has people everywhere talking. Because the company that wrote the book on passive components has added another chapter.

Through our association with Kyocera, AVX has firmly established itself as the undeniable leader in passive components. And with a network of local, national and international distributors, we give you access to any part you need. Anytime. Anywhere.



## “Beep. Buzz. Ri



# make a little noise

Ours is an industry where thinking globally is not just the key to victory, but to survival. That's why we've created distribution capabilities that offer solutions. No matter where you are. Or what you need. Plus the firm commitment to world-class quality, service, technology and manufacturing you've always come to expect. From the company that always makes sound decisions. AVX.

For more information about the AVX/Kyocera product line, contact AVX Corporation today by calling (803) 448-9411, or fax us at (803) 448-1943. Write to:

AVX Corporation, 17th Avenue South,  
P.O. Box 867,  
Myrtle Beach,  
SC 29577.

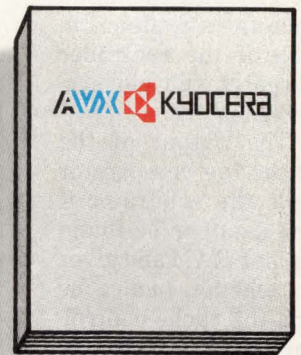

**AVX** CORPORATION  
A KYOCERA GROUP COMPANY

CIRCLE 116

ng. Tick. Hum.”



# CACHE MEMORY DESIGN

is the Address Strobe signal to the old system. Called  $\overline{\text{SYSAS}}$ , it starts accesses on the old board.

System Ready is used on the old system board for the bus cycle termination signal  $\overline{\text{DSACK}}_{0-1}$ . On the cache board, it's called  $\overline{\text{SYDSACK}}$  and tells the controller that the information is ready from the system board. The controller generates  $\overline{\text{STERM}}$  and  $\overline{\text{DSACK}}_{0-1}$  synchronous and asynchronous termination signals to end the processor access.

The cache controller has a special arbitrator that allows the 68030 to choose between the added system's SRAM memory and the old system's DRAM or peripherals. The arbitrator monitors the processor's Start Access signal ( $\overline{\text{AS}}$ ), Clock, and the address. It then generates a Cache Enable signal if the controller accesses the cache and generates System Enable if the controller accesses the old system memory.

The output of the cache tag comparator tells the arbitrator if the data can be found in the SRAM and gives a cache hit. In a cache hit, the cache controller ends the access by generating  $\overline{\text{STERM}}$  to the 68030.

In a cache miss or a peripheral access, the arbitrator generates another start signal for the system board called  $\overline{\text{SYSAS}}$ . This signal is connected to the system board's  $\overline{\text{AS}}$  signal in the interface socket. The system board sees  $\overline{\text{SYSAS}}$  as a Start Address strobe from the processor, and responds to it with the asynchronous ter-

mination signal  $\overline{\text{SYDSACK}}$  when data is ready from the DRAM or a peripheral device.

The cache controller regenerates  $\overline{\text{STERM}}$  after receiving  $\overline{\text{SYDSACK}}$  on a DRAM access. It passes the  $\overline{\text{SYDSACK}}$  signal directly to the processor as the  $\overline{\text{DSACK}}$  signal on a peripheral access.

The 68030 processor supports synchronous bus cycles that are terminated with the Synchronous Termination

signal  $\overline{\text{STERM}}$ . These cycles are for 32-bit ports and take a minimum of two clock cycles. The bus cycle is synchronous if:

- Data Transfer Acknowledge ( $\overline{\text{DSACK}}$ ) is not asserted.
- The port size is 32 bits.
- Synchronous-input setup and hold time for  $\overline{\text{STERM}}$  is met.

Synchronous mode is used to run

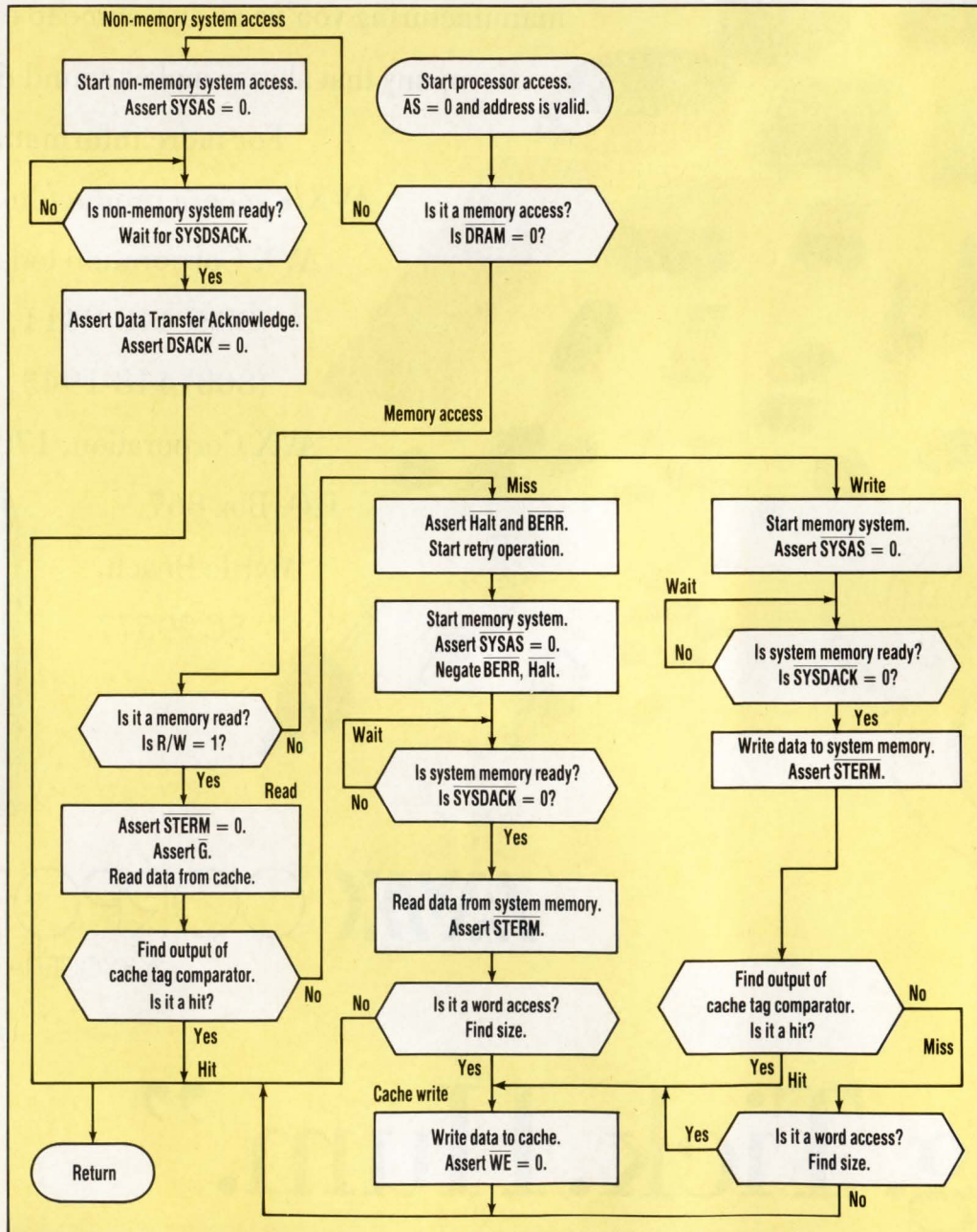

**3. THE DIFFERENT PATHS** taken by the cache-based system for memory and non-memory accesses are shown in a flow chart.



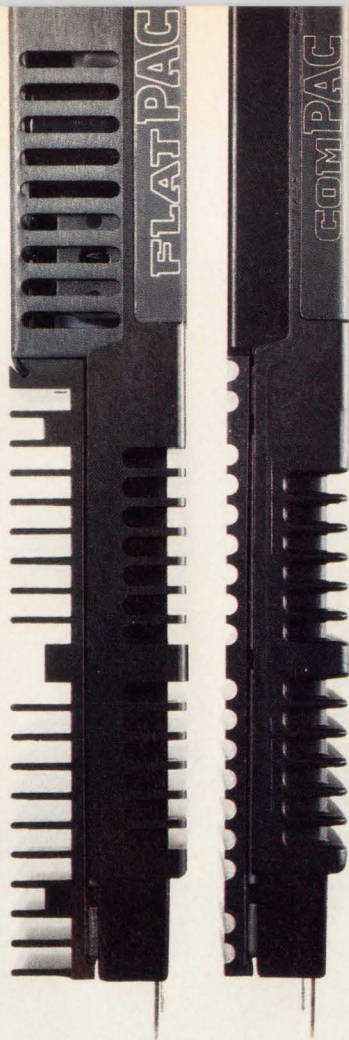

# Up To 600 Watts Per Inch

Our expanding family of compact, configurable, power systems combine the flexibility of a custom supply with the availability of standard catalog products . . . in low profile, compact packages that let you pack the most power into the least amount of space. And they meet the specialized input voltage, noise and transient requirements of major worldwide markets. Think of them as a universal solution for most of your system power requirements . . . AC or DC input . . . in computer, telecom or vehicular applications . . . up to 600 Watts.

FlatPAC™ is the industry benchmark for power density in off-line applications. And now, ComPAC™ sets the standard for DC input supplies . . . in a package less than one inch tall! Both offer unprecedented flexibility in configuration along with instant availability . . . in a fraction of the space required by conventional switchers. Just define your requirements . . . we utilize our high frequency, high power-density converters to quickly configure a FlatPAC or ComPAC specific to your needs.

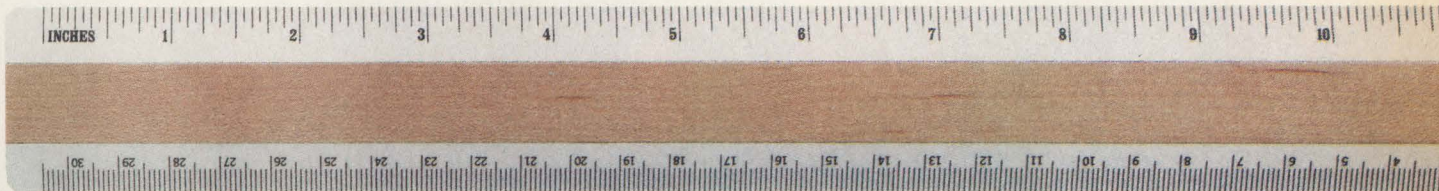

You benefit from the proven field performance, high efficiency and inherently high reliability of our component-level power converters, without sacrificing any of the features you need: off-line inputs for worldwide application; nominal DC inputs from 24 to 300 VDC; surge limiting; safety agency recognition; EMI/RFI to FCC/VDE, British Telecom, Bellcore or MIL-STD-461; totally isolated and trimmable outputs; AC OK and DC OK status signals . . . and more.

You don't have to choose between costly and risky custom development or bulky catalog supplies. Call us to discuss FlatPAC and ComPAC . . . the new standards that make customs obsolete.

Does your power supply measure up?  
Call **VICOR EXPRESS** for a free ruler  
at **1-800-735-6200** or **508-470-2900** at ext. 265

FlatPAC™ AC Input		ComPAC™ DC Input
110/220 VAC	<b>Voltage Inputs</b>	24, 28, 48, 270, 300 VDC
1, 2, or 3	<b>Number of Outputs</b>	1, 2, or 3
2 to 95 VDC	<b>Output Voltages</b>	2 to 95 VDC
Up to 600 Watts	<b>Output Power</b>	Up to 600 Watts
1.37"	<b>Height</b>	1"
FCC Part 15, Class A VDE 0871, Class A IEEE Std 587-1980	<b>Applicable Specifications</b>	Bellcore (24/48 V) British Telecom (24/48 V) FCC/VDE, Class A (300 V) MIL-STD-461 C (28/270 V) MIL-STD-704A



Component Solutions For Your Power System  
23 Frontage Road, Andover, MA 01810

Common Stock Traded on NASDAQ under "VICR"



# From Outer Space to Your Place,





# We're Your Best Defense.

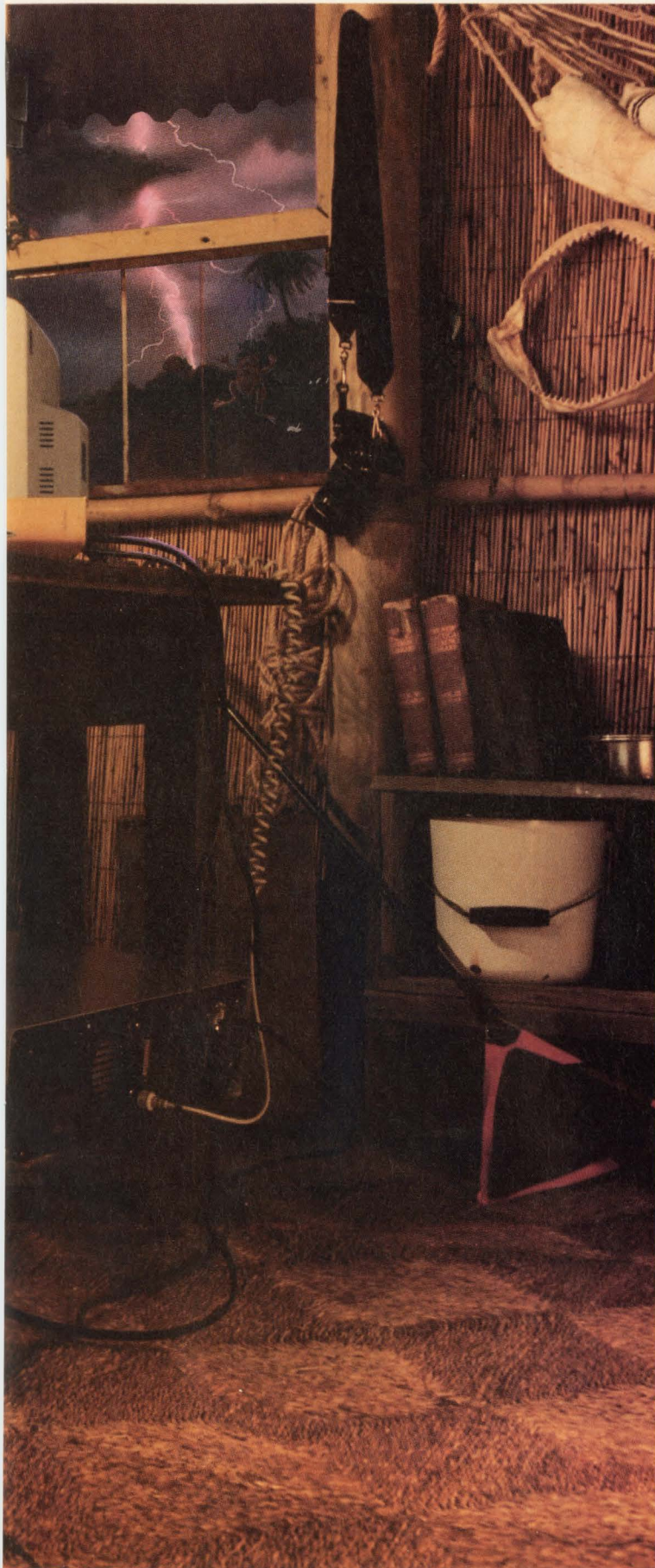

By putting our military experience to work in high-volume, low-cost applications, we're giving new meaning to the term *National Defense*. Our Power Supply Supervisory Chips are a good example.

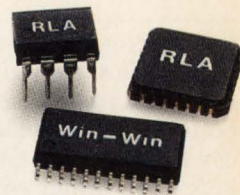

These Raytheon Linear Arrays (RLAs) act as a computer's early warning system. They monitor internal voltage levels to 0.3% accuracy—and signal a shut down before power surges can fry the system.

It's "Defense Technology" with a peaceful purpose. And it's helping take computers into places they've never been.

Our RLAs have business benefits, too. If you can't decide between a custom or semicustom device, don't. Our *Win-Win* program lets you get to market quickly with a semicustom array, then shift to full custom as sales increase.

*Win-Win* is fast, flexible, and makes good business sense because it eliminates the risk of getting into a full custom array before you're really ready.

Raytheon is committed to analog technology. From our design kits and engineering support to our fab and plastic assembly facility. We have the experience it takes to help you develop creative, cost effective solutions.

Find out how. Call 1-800-722-7074 for our new analog brochure.

Raytheon Company, Semiconductor Division.  
350 Ellis St. Mountain View, CA 94039.

CIRCLE 150

**Raytheon**

Where quality starts with fundamentals



# CACHE MEMORY DESIGN

the processor at two cycles in the SRAM. To avoid wait states, the system must assert the  $\overline{\text{STERM}}$  signal before the rising edge of the second clock cycle. Data must be valid 0 ns before the falling edge of the second clock so that the processor latches valid data. The cache controller asserts the Synchronous Termination ( $\overline{\text{STERM}}$ ) signal early and doesn't wait for Address Strobe ( $\overline{\text{AS}}$ ).

Asynchronous operation is used for data transfer to peripherals on the main system board. The system uses  $\overline{\text{AS}}$ ,  $\overline{\text{DS}}$ , and  $\overline{\text{DSACK}}$  to control data transfers.

$\overline{\text{AS}}$  signals the start of a bus cycle, and  $\overline{\text{DS}}$  is used as a condition for valid data on a write operation. Decoding the 68030 size output signals and  $A_{0-1}$  provides strobes that select the active portion of data bus. The peripheral then responds by placing the requested data on the correct portion of the data bus and asserting the  $\overline{\text{DSACK}}$  signals to terminate the cycle.

## RETRY OPERATION

On a cache miss, the cache controller forces a retry operation to prevent the processor from latching bad data. The system asserts  $\overline{\text{STERM}}$  and doesn't wait for the output of the tag comparator to become valid, avoiding a wait state.

The cache controller asserts  $\overline{\text{BERR}}$  and  $\overline{\text{Halt}}$  during a bus cycle so that the processor enters the retry sequence. The processor samples the  $\overline{\text{BERR}}$  and  $\overline{\text{Halt}}$  signals on the falling edge of the second clock cycle. It also terminates the bus cycle and places the control signals in their inactive states. The processor retries the previous access when  $\overline{\text{BERR}}$  and  $\overline{\text{Halt}}$  are negated.

The decoder PAL device asserts  $\overline{\text{DRAM}}$  if the accesses are to the memory (Fig. 3). The PAL equation to generate the memory decode signal is:

$$\overline{\text{DRAM}} = \overline{A_{24}} * \overline{A_{23}}$$

If  $\overline{\text{DRAM}}$  is false, the access is to non-memory devices. On the start of processor access, the control PAL device monitors  $\overline{\text{AS}}$  and  $\overline{\text{DRAM}}$ . It asserts  $\overline{\text{SYSAS}}$  if the access is to the

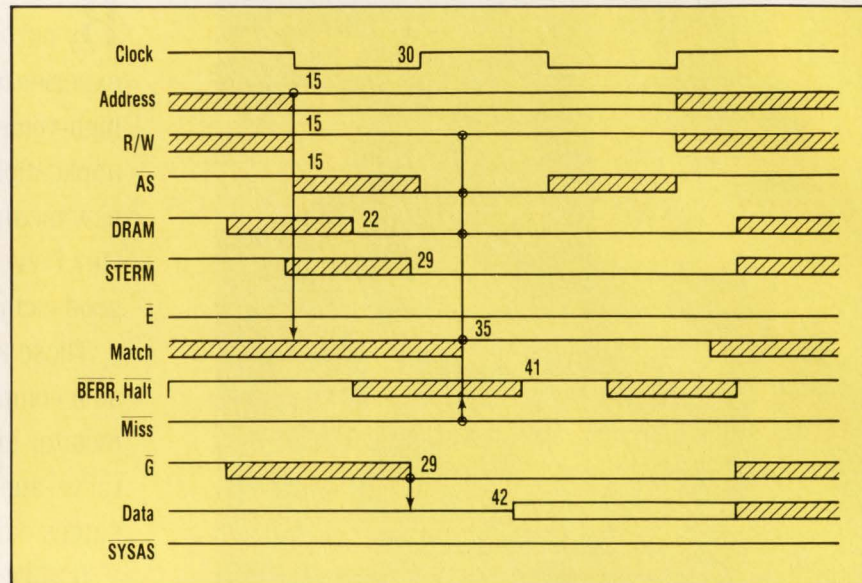

**4. A CACHE HIT** occurs when the  $\overline{\text{Miss}}$  signal is false. The processor can read data located in the SRAM when the  $\overline{\text{G}}$  signal is asserted.

non-memory devices. The PAL equation is:

$$\overline{\text{SYSAS}} = \overline{\text{DRAM}} * \overline{\text{AS}}$$

$\overline{\text{SYSAS}}$  is the Start Access signal, previously  $\overline{\text{AS}}$  in the old system. Assertion of  $\overline{\text{SYSAS}}$  causes the system to start the non-memory access.

The write PAL device then waits for  $\overline{\text{SYSDSACK}}$ , which comes from the old system when it has valid data. The PAL device asserts the  $\overline{\text{DSACK}}$  signals to end the processor cycle. The PAL equation is:

$$\overline{\text{DSACK}} = \overline{\text{DRAM}} * \overline{\text{SYSDSACK}}$$

The control PAL device asserts  $\overline{\text{STERM}}$  when the processor starts a memory read.  $\overline{\text{STERM}}$  comes early enough to be sampled by the processor's second clock rising edge for a synchronous access with zero wait states. The PAL device examines the results of the tag comparator's output and generates  $\overline{\text{Miss}}$  if it's false. It also asserts a read enable signal called  $\overline{\text{G}}$  to the SRAM. The PAL equations are:

$$\overline{\text{STERM}} = \overline{\text{DRAM}} * \overline{\text{R/W}} * \overline{\text{Miss}}$$

$$\overline{\text{G}} = \overline{\text{DRAM}} * \overline{\text{AS}} * \overline{\text{Miss}}$$

$\overline{\text{DRAM}}$  is generated by the address, and is valid at: time = address valid time + PAL delay = 15 + 7 = 22

ns (Fig. 4).  $\overline{\text{DRAM}}$  and  $\overline{\text{R/W}}$  generate the  $\overline{\text{STERM}}$  signal, which is valid at: time =  $\overline{\text{DRAM}}$  valid time + PAL delay = 22 + 7 = 29 ns. The microprocessor samples  $\overline{\text{STERM}}$  at the rising edge of  $S_2$  at 30 ns for zero-wait-state access.

During an SRAM or DRAM read cycle, the cache controller asserts  $\overline{\text{STERM}}$  and  $\overline{\text{G}}$ . It then generates a  $\overline{\text{Miss}}$  state signal if  $\overline{\text{MATCHA}}$ ,  $\overline{\text{MATCHB}}$ , or both are false. The  $\overline{\text{Miss}}$  state is generated from a PAL register clocked by the falling edge of the clock.

The decoder PAL device examines  $\overline{\text{MATCHA}}$  and  $\overline{\text{MATCHB}}$ , and asserts  $\overline{\text{BERR}}$  and  $\overline{\text{Halt}}$  if a miss occurs. The processor samples  $\overline{\text{BERR}}$ ,  $\overline{\text{Halt}}$  on the falling edge of the second clock, and enters the retry operation. It stays idle for two cycles.  $\overline{\text{Miss}}$  becomes active and negates  $\overline{\text{BERR}}$  and  $\overline{\text{Halt}}$ , therefore the retry time is minimum.

$\overline{\text{SYSAS}}$  is asserted by the control PAL device as soon as  $\overline{\text{Miss}}$  is generated. It doesn't wait for the processor to finish the retry mode.  $\overline{\text{SYSAS}}$  starts the DRAM access from the system memory, thereby interleaving it with the cache accesses. The PAL equations are:

$$\overline{\text{Miss}} = \overline{\text{DRAM}} * \overline{\text{AS}} * \overline{\text{R/W}} *$$



# MEGA MEMORY.

SONY HIGH-DENSITY SRAMS				
MODEL	CONFIG.	SPEED (ns)	PACKAGING	DATA RETENTION
CXK581000P*	128K x 8	100/120	DIP 600 mil	L, LL
CXK581000M*	128K x 8	100/120	SOP 525 mil	L, LL
CXK58100TM*	128K x 8	100/120	TSOP	L, LL
CXK58100YM*	128K x 8	100/120	TSOP (reverse)	L, LL
CXK581001P	128K x 8	70/85	DIP 600 mil	L
CXK581001M	128K x 8	70/85	SOP 525 mil	L
CXK581020SP	128K x 8	35/45/55	SDIP 400 mil	
CXK581020J	128K x 8	35/45/55	SOJ 400 mil	

\*Extended temperature range available. L = Low power. LL = Low, low power.

# MEGA COMMITMENT.



As you can see, Sony's more committed than ever to meeting your high-density SRAM needs. Just consider the enhancements we've made in a few short months: TSOP and TSOP-reverse packaging. Low data retention current. And extended temperature range.

All based on our unique 0.8-micron CMOS technology, and available in 32-pin DIP and surface-mount plastic packages.

Then consider our ever-increasing production capabilities. We've just added yet another SRAM facility in Japan. And acquired a large AMD facility in San Antonio, Texas.

So you can really count on us in a crunch. Need more proof we're serious about your each and every SRAM need? Call us. We've got more breakthroughs on the way. Well over 100 SRAM products spanning the performance spectrum. And the desire to meet—or exceed—your toughest performance spec.

Sony high-density SRAMS are shipping now, complete with competitive pricing. So call (714) 229-4190 today. Or write Sony Corporation Of America, Component Products Company, 10833 Valley View St., Cypress, CA 90630, Attention: Semiconductor sales. FAX (714) 229-4285.

**SONY**®



# CACHE MEMORY DESIGN

$$\frac{(\overline{\text{MATCHA}} * \overline{\text{MATCHB}})}$$

$$\text{Halt} = \overline{\text{BERR}} = \overline{\text{DRAM}} * \overline{\text{AS}} * \frac{\overline{\text{R/W}} * (\overline{\text{MATCHA}} * \overline{\text{MATCHB}})}{\text{Miss}}$$

$$\text{SYSAS} = \overline{\text{DRAM}} * \text{Miss}$$

The old system asserts  $\overline{\text{SYSDSACK}}$  when it completes the DRAM access. The control PAL device waits until  $\overline{\text{SYSDSACK}}$  comes before asserting  $\overline{\text{STERM}}$  to end the access. The PAL equation is:

$$\overline{\text{STERM}} = \overline{\text{DRAM}} * \text{Miss} * \overline{\text{SYSDSACK}}$$

Byte read or write from the SRAM is possible because the cache controller writes the data that comes from the system DRAM to the SRAM if it's a word. The PAL equation is:

$$\overline{\text{WE}} = \text{Miss} * (\overline{\text{A}_0} * \overline{\text{A}_1} * \overline{\text{Size}_0} * \overline{\text{Size}_1})$$

The rising edge of  $\overline{\text{Miss}}$  makes  $\overline{\text{WE}}$  go from low to high and writes the data into the SRAM.

$\overline{\text{MATCHA}}$ ,  $\overline{\text{MATCHB}}$  comes from the address tag comparators, and is valid at: time = address valid + access time = 15 + 20 = 35 ns (Fig. 5).  $\overline{\text{BERR}}$ ,  $\overline{\text{Halt}}$  comes from  $\overline{\text{MATCHA}}$ ,  $\overline{\text{MATCHB}}$ ,  $\overline{\text{DRAM}}$ ,  $\overline{\text{R/W}}$ , and  $\overline{\text{AS}}$  at: time = match valid + PAL delay = 35 + 7 = 42 ns. The processor samples  $\overline{\text{BERR}}$ ,  $\overline{\text{Halt}}$  at the falling edge of  $S_2$ , which occurs at 45 ns.

Miss is generated from the clock's falling edge and  $\overline{\text{AS}}$  at: time = falling edge of  $S_2$  + PAL delay = 45 + 7 = 52.  $\overline{\text{BERR}}$ ,  $\overline{\text{Halt}}$  becomes false from  $\overline{\text{Miss}}$  at: time =  $\overline{\text{Miss}}$  valid + PAL delay = 52 + 7 = 59. The processor samples  $\overline{\text{BERR}}$ ,  $\overline{\text{Halt}}$  by the falling edge of the clock at 75 ns. In addition,  $\overline{\text{SYSAS}}$  is generated by  $\overline{\text{Miss}}$  at: time =  $\overline{\text{Miss}}$  valid + PAL delay = 52 + 7 = 59 ns.  $\overline{\text{SYSDSACK}}$  comes from the system DRAM controller before the clock's falling edge.

The cache system supports byte access from the SRAM to increase

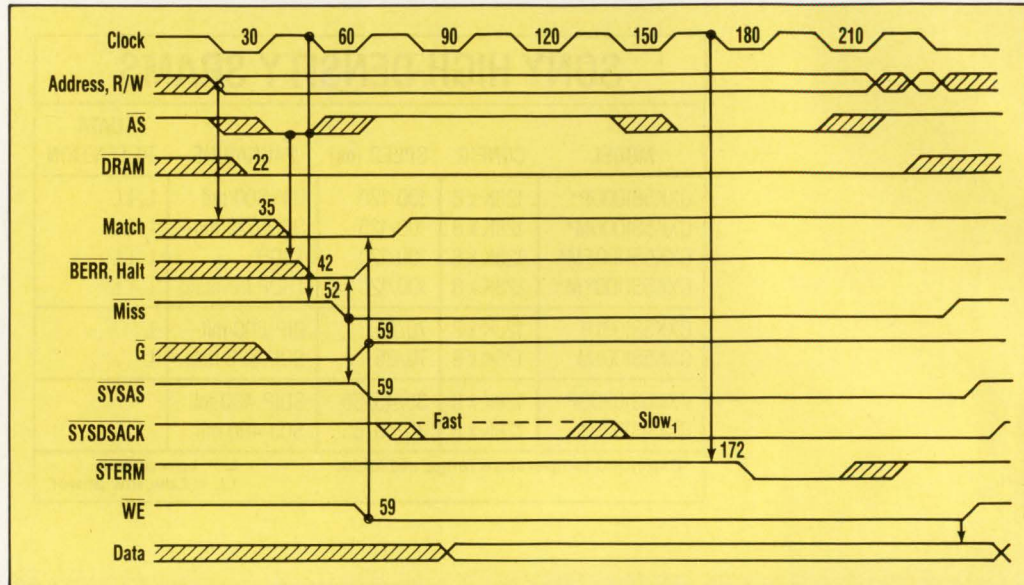

**5. IF THE TAG COMPARATORS don't find a match, a cache miss occurs;  $\overline{\text{BERR}}$ ,  $\overline{\text{Halt}}$  is asserted; and the processor reads data from the main memory.**

system performance. To support the byte read from the cache memory, the controller uses byte writes to the static RAM in a write access with a hit. In a memory write with a miss, the cache controller writes the data to the SRAM if it's a word access. The PAL equations for a write operation are:

$$\text{SYSAS} = \overline{\text{DRAM}} * (\overline{\text{R/W}}) * \overline{\text{AS}} * \overline{\text{SYSHALT}}$$

$$\overline{\text{STERM}} = \overline{\text{DRAM}} * (\overline{\text{R/W}}) * \overline{\text{AS}} * \overline{\text{SYSDSACK}}$$

$$\overline{\text{WE}} = \overline{\text{DRAM}} * (\overline{\text{R/W}}) * \overline{\text{AS}} * \frac{(\overline{\text{MATCHA}} * \overline{\text{MATCHB}}) + \overline{\text{DRAM}} * (\overline{\text{R/W}}) * \overline{\text{AS}} * (\overline{\text{A}_0} * \overline{\text{A}_1} * \overline{\text{Size}_0} * \overline{\text{Size}_1})}{\text{Size}_0 * \text{Size}_1}$$

On a write to memory, the control PAL asserts  $\overline{\text{SYSAS}}$  to start the DRAM access. Control PAL waits for the  $\overline{\text{SYSDSACK}}$  (DRAM is ready) signal, then it asserts  $\overline{\text{STERM}}$  to finish the cycle. The control PAL generates the  $\overline{\text{WE}}$  signal to do byte write to the SRAM if the accesses are a write with a hit. In a write with a miss, the controller asserts  $\overline{\text{WE}}$  to do only word write if  $(\overline{\text{A}_0} * \overline{\text{A}_1} * \overline{\text{Size}_0} * \overline{\text{Size}_1})$  is true.

$\overline{\text{SYSDSACK}}$  generates  $\overline{\text{STERM}}$  on DRAM accesses and when  $\overline{\text{STERM}} = \overline{\text{SYSDSACK}}$  valid + PAL delay = 45 + 7 = 52 ns. The processor samples  $\overline{\text{STERM}}$  at the clock's rising

edge at 60 ns.

The cache controller improves the system refresh time by hiding the refresh in memory or peripheral accesses. The old system uses the  $\overline{\text{Halt}}$  signal to refresh the DRAM. With the new design, the cache controller can monitor  $\overline{\text{SYSHALT}}$  (the old  $\overline{\text{Halt}}$  that goes to the processor socket in the old system board) and doesn't assert a  $\overline{\text{Halt}}$  signal to the processor. The controller, instead of halting SRAM or peripheral accesses, allows them to continue.

The cache controller uses the  $\overline{\text{SYSAS}}$  and  $\overline{\text{SYSHALT}}$  signals to stretch a system DRAM access if the refresh is occurring during a memory access. If a refresh has already started, the controller delays the start of a system DRAM access until the refresh is finished. □

*Nagi Mekhiel, a professor in the Electrical Engineering Dept. at Ryerson Polytechnical Institute in Toronto, has a BSEE from the University of Assiut, Egypt, and an MSEE from the University of Toronto.*

HOW VALUABLE?	CIRCLE
HIGHLY	541
MODERATELY	542
SLIGHTLY	543





Your business is safe with us.  
Especially when it's really rolling.



Whatever business you're in, we're ready to roll in just about any size, capacity or factory formatted disk you need. And if business is really moving, look into our 4 megabyte diskette — it's ready for your new system whenever you are.

That's why more business protects important information on 3M brand diskettes and data cartridges than any other brand in the world.

Call 1-800-888-1889 ext.3 to find out more.



Innovation working for you™

Diskettes require a compatible drive. ©3M 1991.

**3M** |   
Worldwide Sponsor 1992 Olympic Games  
36USC380

CIRCLE 2



# When Time Is Money ... Tektronix QuickCustom™ ASICs

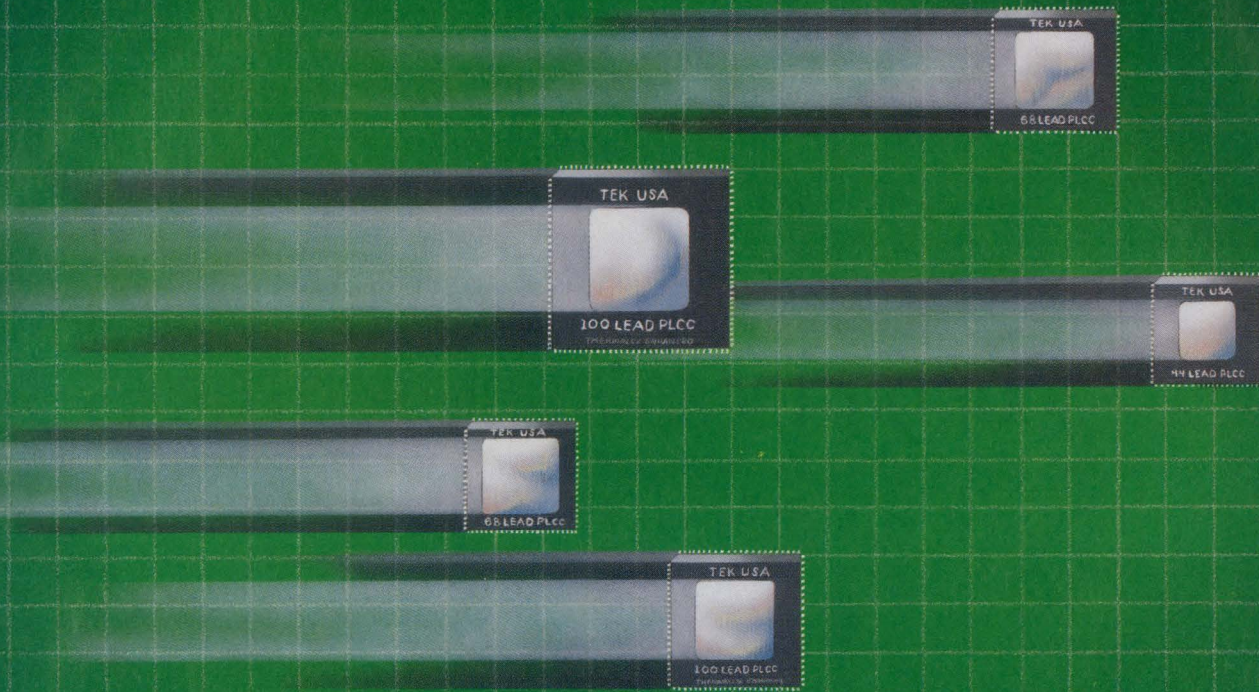

Tektronix' QuickCustom ASICs make it easy for you to create your own analog designs fast. And error free.

Our high speed QuickCustom family of bipolar products, together with Tek's QuickCustom design system, help ensure that your design works right the first time, reducing development time and cutting costs.

◆ Tektronix QuickChips™ help you move from concept to finished product with minimum design and fabrication time. ◆ For even higher performance and greater flexibility, the Tektronix QuickTile™ design method offers standard building blocks for fast implementation of analog and mixed signal functions.

◆ And finally for optimum performance and functionality, Tektronix' Full Custom design method is also available.

All three QuickCustom products

provide convenient access to our high performance bipolar process ( $f_T = 8.5$  GHz and  $V_{CE0} \geq 8$  V) with Schottky diodes, JFETs, NiCr resistors, and PNPs. Typical applications include high speed data converters, L-Band amplifiers and mixers, and low noise transducer amplifiers. Our advanced QuickCustom design system, which includes complete CAD tools, thorough characterization of all devices, and support, allows even the first time user to successfully complete the design.

When time and performance are critical, choose QuickCustom from Tektronix.

Your quickest solution.

For more information, please circle our reader number, or call 1-800-835-9433, extension 1CO.

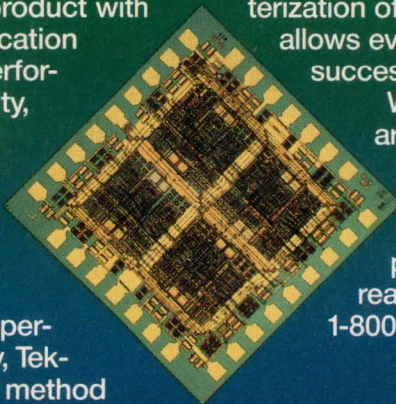

**Tektronix**  
COMMITTED TO EXCELLENCE

CIRCLE 119



# Designing For

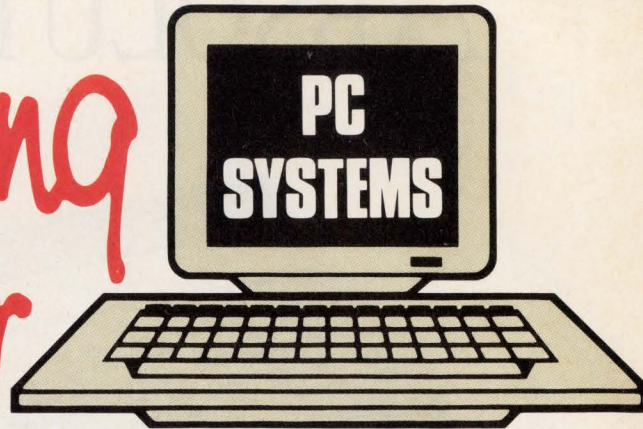

*This is the second installment of a new section in Electronic Design focusing on the design of PC systems. The section will appear regularly throughout 1991.*

## CHIP SET RUNS 486 CPUs FROM 20 TO 50 MHz

OPTI INC., SANTA CLARA, Calif. has started sampling a motherboard chip set for AT-based systems that can support 80486 personal-computer architectures running at clock speeds from 20 to 50 MHz. The 486WB chip set also incorporates write-back cache-control logic to improve the processor efficiency over standard write-through cache implementations. By placing all of the speed-critical memory data paths in the 82C491 (the first of the two chips in the chip set), designers at the company could simplify the memory subsystem on the motherboard. DRAMs with access times from 80 to 120 ns could be used without impacting cache performance. Caches from 64 to 512 kbytes can be implemented, and cache burst cycles of 2-1-1-1 and 3-1-1-1 are supported for 33- and 50-MHz system clocks, respectively. This subsystem enables the CPU to achieve about a 10% performance improvement over write-through approaches. The second chip, the 82C492, handles the bus interface and CPU control and clocking. It requires just a single-phase 50-MHz input, which should also satisfy FCC certification requirements. The 33- and 50-MHz versions are immediately available for \$80 and \$110, respectively, in 10,000-set lots. Contact Raj Jaswa (408) 980-6511. **CIRCLE 532**

## INNOVATIVE DESIGNS DEBUTED AT MAC EXPO

A PLETHORA OF APPLE Macintosh support and expansion products could be seen in almost every aisle at the recently held Mac Expo in San Francisco, Calif. A six-processor Macintosh-based system developed by Pacific Data Systems, Arieta, Calif., delivers the power of six Macintosh systems in one desk-side cabinet. The system employs a proprietary CPU-sharing multiplexed design that gives the power user multiprocessing capabilities that permit multiple complex tasks to execute concurrently. Integrating six processors in one system improves system efficiency because all six share the same

peripherals. Contact Alex Nury, (818) 899-6077.

.....For Macintosh users that need the utmost in data-transfer rates from their mass-storage systems, a disk array storage subsystem developed by MicroNet Technology Inc., Irvine, Calif. pushes the sustained transfer rate to 4.4 Mbytes/s. The array uses a 16-bit SCSI-2 interface and proprietary control software that takes advantage of the SCSI-2 commands to deal with small- and large-block accesses. An overlapping seek algorithm is also used to achieve effective seek times as fast as 5.7 ms. The \$19,995 Raven SBT-2500NPR contains a pair of 1.25-Gbyte drives and dual, SCSI-2 host adapters. Contact Suzanne Kimball, (714) 837-6033.

.....Using an offshoot of the solid-state still-image camera developed by several Japanese companies, Dycam Inc., Chatsworth, Calif., has created a still-image "point-and-shoot" camera that feeds data directly to the Macintosh or a PC. The Dycam model 1 captures and stores up to 32 gray-scale photographs with a resolution of 376-by-240 pixels and 256 shades of gray. Like electronic cameras, just one button needs to be pressed to capture an image—exposure setting, flash, and focus are all controlled automatically. Captured images are transferred to the computer over the serial communications port. Contact Mark Vonarx, (818) 988-7951.

.....A 68040-based NuBus card extends the useful life of older Macintosh II systems by accelerating computations on Macintosh II computers. The card, from Radius Inc., San Jose, Calif., will come in 25- and 33-MHz versions and operates transparently to all Macintosh programs. The card will speed integer and floating-point operations, and will also be integral component to Radius' high-performance color display subsystems. Contact Steve Holtzman, (408) 434-1010.

.....For Macintosh, PC, or workstation users that really need data in a hurry, Atto Technology Inc., Amherst, N.Y., unveiled a solid-state disk subsystem that trims the access time to just 50  $\mu$ s, potentially improving system performance by up to 10-fold over mechanical disk drives. The SiliconDisk Plus employs an 8-bit SCSI interface to the host system and can sustain a 5-Mbyte/s data-transfer rate. The base system has 32 memory slots—each can hold 1- or 4-Mbyte SIMMs for a total capacity of 128 Mbytes. Contact Tim Klein at (716) 688-4259. A slightly slower solid-state drive with the same capacity was also released by Newer Technology, Wichita, Kans. Its access time is just 0.5 ms, about 10 times that of the Atto drive. Contact Newer at (316) 685-4904.



# ABSOLUTE VALUE.



High performance LCR meters from SRS.  
0.05% accuracy, 100 kHz frequency.  
Absolutely lowest price.

**Value. It means getting your money's worth.**

For passive component measurement, the new standards in value are the SR720/715 LCR meters from SRS. Meters that offer significant advantages in performance and price. Performance like .05% basic accuracy, 100 kHz test frequency, and fast measurement rates up to 20 per second. Features like a built in Kelvin fixture, averaging, binning and limits, stored setups, and quick calibration. With the standard RS232 and optional GPIB and Handler interfaces, the SR720/715 solves your incoming inspection and automated test needs. All for a price well below what you'd expect.

The SR720/SR715. Absolute values in a complex world. Call **(408)744-9040** today for more information about the SRS advantage.

---

**SR720**

---

**\$2295**

- 0.05% basic accuracy
- 100 Hz to 100 kHz measurement frequency
- Two 5 digit displays for simultaneous readout of major and minor parameters.
- Auto, R+Q, L+Q, C+D, C+R, Series and Parallel measurement modes
- 100 mV to 1.0 V test signals
- Internal and External Bias
- Binning and Limits for production testing and component inspection.
- RS232 interface
- GPIB and Handler interface (optional)

---

**SR715**

---

**\$1495**

- Same as SR720 except:
- 0.2% basic accuracy
  - 100 Hz to 10 kHz measurement frequency
- 

**STANFORD RESEARCH SYSTEMS**

1290 D Reamwood Avenue, Sunnyvale, CA 94089 TEL (408)744-9040 FAX 4087449049 TLX 706891 SRS UD



# Simple upgrade lets 80386 systems use i486

*Adding a few PLDs and some simple logic enables an i486 CPU to boost system throughput.*

BY BRIAN DELLACROCE

VLSI Technology Inc., 8375 South River Pkwy., M/S 260, Tempe, AZ 85284; (602) 752-6394, FAX 602-752-6000.

A performance boost of up to 290% for systems currently using the full 32-bit 80386DX microprocessor from Intel Corp. is now possible by substituting the more powerful i486 processor. However, rather than redesign the entire system motherboard to use a new chip set and go through the component requalification process, existing i386-based systems can be modified with the addition of about seven active components to accept the i486 processor and run in the non-burst mode. The cost of the modification is about \$30, not counting the cost of the new CPU.

Benchmark performance comparisons between a 33-MHz 80386DX-based system using an 80387 coprocessor and a converted i486-based system are shown in Table 1. The performance increases come from several architectural improvements that were incorporated in the i486: specifically, the internal, high-speed cache memory and the on-board floating-point unit (FPU). The processor's instruction set was also optimized for speed. However, the built-in 8-kbyte cache has the most impact on performance.

The one feature that the i386 system modification can't incorporate—burst-mode transfers—enables the i486 to achieve significantly higher bus throughput rates than the 80386DX's pipelined method. However, using the burst mode would require significant changes to the memory subsystem. When substituting an i486 for an 80386DX in a system originally designed for an 80386DX, there are a number of hardware issues and incompatibilities that the processor interface must resolve (Fig. 1).

The first area, clock generation and phasing, is fairly straightforward. The i486 requires a clock that's half the frequency of the clock supplied to the 80386DX. Many systems already have an internal clock with that frequency. However, in these systems (e.g. chip sets), this lower frequency (internal) clock signal may not be available to drive the i486's clock input. The clock also may be disabled when the system is in reset. However, the i486 must be supplied with an active clock during reset. Consequently, the interface circuitry may have to divide the master 80386DX clock frequency in half to generate the i486's clock.

In addition, the logic must ensure that the i486's clock is generated in phase with the system's (internal) clock. There are two approaches that can be used. First, the system's clock can be synchronized to be in phase with the clock supplied to the i486. Second, the clock supplied to the i486 can be synchronized to the system's clock.

The first approach is recommended if the system clock's

phase can be predetermined or predicted. If it can't, then the second approach must be taken. But it isn't as desirable due to the delay required to meet the i486's specification of clock-period stability. Rephasing the i486's clock implies modifying the period during one clock cycle. To meet the i486's clock-stability specification, a 1- $\mu$ s delay is required before allowing the i486 to come out of the reset state after the clock is rephased. By using the first approach, the clocks can be synchronized without this delay penalty.

Dealing with the Byte Enable signal control requires

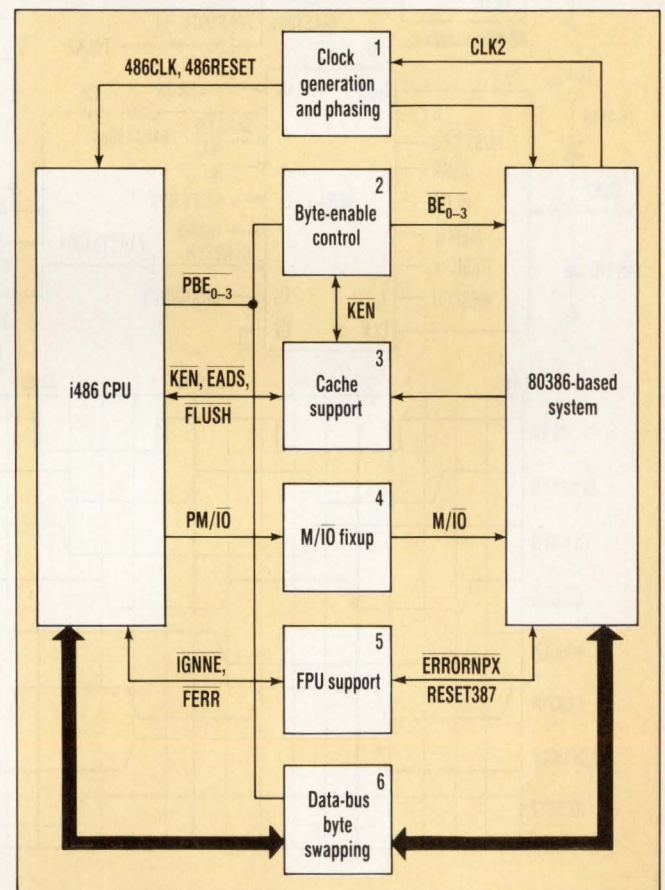

1. To replace an 80386DX processor with an 80486 without redesigning the entire system, an adapter can be built to handle the six areas in which the two CPUs are incompatible.



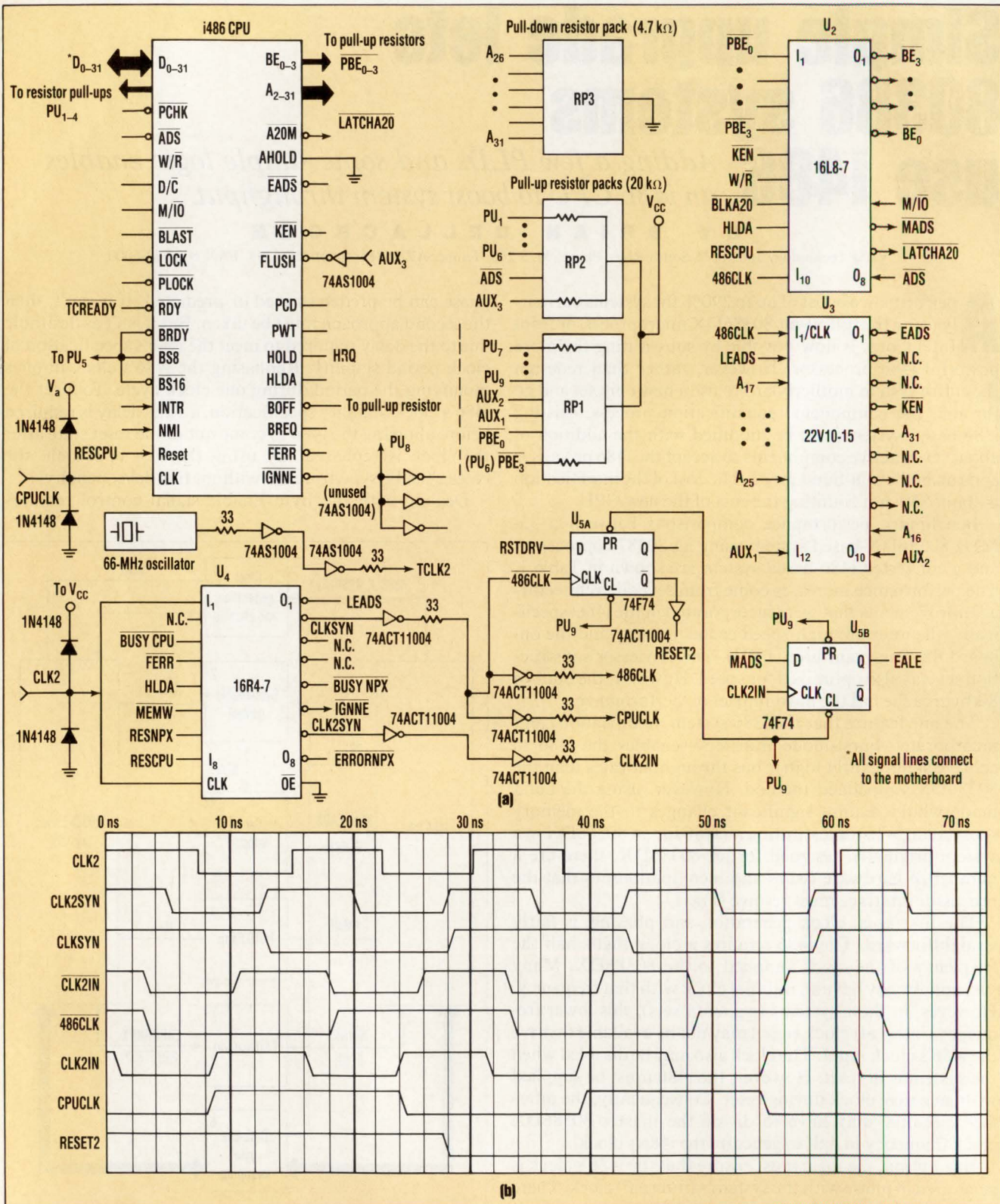

2. The logic needed to build an adapter that converts an 80386DX system to work with an 80486 microprocessor consists of seven small logic chips plus the CPU and a few discrete components (a). The adapter must deal with such issues as synchronizing the CPU to the system clock (U<sub>4</sub>, U<sub>5A</sub>, U<sub>7A-B</sub>, and U<sub>8</sub>), ensuring correct operation of the cache (U<sub>3</sub>), and controlling the byte-enable lines (U<sub>2</sub>). The typical clock waveforms and reset input to the Topcat VL82C330 controller illustrates that timing is critical in the path that generates RESET2 (b).



monitoring the internal state execution of the processor. When an i486 issues the first address of a cache line fill, it may not assert all four Byte Enable signals. This occurs when the internal execution unit requests only 8 or 16 bits of information. Byte enables are asserted at the same time the address is driven, but the cache unit can only determine if an address is cacheable after it samples the Cache Enable input (**KEN**).

Because the cache line is four 32-bit (double) words, the i486 expects valid data on all 32 data lines for cacheable regions, even though it didn't drive all four Byte Enable lines active. The system must supply 32 bits of valid data so that invalid data isn't cached. If the address is cacheable, the interface must ensure that all four Byte Enable lines are asserted to the system.

The modified interface must define non-cacheable memory areas (for example, video, expanded memory, etc.) and drive the i486's **KEN** input accordingly. In addition, cacheability information should be supplied to the part of the interface that must overcome the byte-enable issue. Cacheability mapping can be accommodated by using either of two possible methods to decode the address lines and generate the **KEN** signal. In the first scheme, a programmable logic chip can be used, or alternatively, a fast static

RAM can be added. The PLD has the advantage of simplicity and low cost, while the SRAM offers more flexibility for programmers to define the cacheability map. However, the implementation is more complex and costs more as well.

Cache support also requires that the cache invalidation signal be generated (**EADS**). During non-CPU (e.g. DMA) transfers to main memory, the i486 must snoop the address bus and invalidate cache lines. Therefore, addresses must be driven to the i486 during non-CPU transfers. Some 80386DX-based systems may not have this ability because the address bus for an 80386DX is defined as output only. Furthermore, all 32 address lines must be driven during non-CPU cycles. Because very few systems use the full available 32-bit address space, some of the upper address lines may not be driven during non-CPU cycles. The cache-flush mechanism can also prevent a stale cache condition caused by non-CPU writes. The snooping method will perform better because the entire cache need not be invalidated during DMA cycles.

Another signal that needs some help is the Memory/ Input-Output (**M/IO**) cycle select line. The i486 issues an **M/IO** as a low during Halt/Special bus cycles. Conversely, the 80386DX issues **M/IO** as a high during these cycles. If the system uses **M/IO** to decode Halt/Special cycles, the interface must detect the Halt/Special cycle and invert the **M/IO** signal as it appears to the system.

Some signal tricks also have to be played with the 80386 lines that connect to the FPU. In an 80386DX/80387 system, a hardware reset of the FPU can be performed when it handles exceptions during various computations. However, because the FPU of the i486 is internal and lacks a separate reset line, floating point exceptions must be handled in a slightly different manner. The Ignore Numeric Error (**IGNNE**) input to the i486 is designed to allow its FPU to recover from an exception. The FPU will freeze upon the next FPU instruction after an error if **IGNNE** is inactive. By driving this input active, FPU control instructions can be executed to handle and clear the exception.

One other signal area where the i486 differs is its ability to perform data-bus byte swapping. An 80386DX requires that data read from a 16-bit device be supplied on the lower half of the 32-bit data bus (bits 0-15). The i486 requires that the data ap-

```

;THIS PLD GENERATES CLKSYN AND CLK2SYN FROM CLK2. CLKSYN IS CLK2 DIVIDED BY
;TWO AND DE-SKEWED TO MATCH CLK2SYN WHICH IS A BUFFERED VERSION OF CLK2.
;SKEW BETWEEN CLKSYN AND CLK2SYN IS LESS THAN 1NS AND IS SIMPLY THE INTERNAL
;SKEW BETWEEN SIMILIAR NON-REGISTERED PATHS. NOTE, PHASE SYNCHRONIZATION OF
;CLKSYN TO CLK2SYN IS NOT NECESSARY SINCE SYNCHRONIZING THE CHIPSET
;TO THE PROCESSOR IS ACCOMPLISHED BY CONTROLLING RESET TO THE '330.
;THIS PLD ALSO GENERATES IGNNE ___ TO THE 486 AND ERRORNPX ___ TO THE CHIPSET.

CHIP U4 PAL16R4
:1      2      3      4      5      6      7      8      9      10
CLK2   CLK2A   BUSYCPU  NC     FERR   HLDA   MEMW   RESNPX  RESCPU  GND
:11     12     13     14     15     16     17     18     19     20
OE     ERRORNPX  CLK2SYN  IGNNE  BUSYNPX  FERR1  CLK2BY2  CLKSYN  /LEADS  VCC

EQUATIONS
CLK2BY2 := /CLK2BY2                ; EQUALIZE INTERNAL DELAY BETWEEN
; CLK2SYN AND CLKSYN FOR MINIMUM POSSIBLE SKEW.
/CLKSYN = /CLK2A * /CLK2BY2        ; LATCH ON NOT CLK2A FOR VERY LITTLE SKEW IN
+ CLK2A * /CLKSYN                  ; RELATION TO CLK2SYN.
+ /CLK2BY2 * /CLKSYN

CLK2SYN = /CLK2A                    ; ONE PROP DELAY TO DESKEW.

ERRORNPX ___ = BUSYNPX ___          ; WHEN A NUMERIC ERROR OCCURS -FERR GOES
; ACTIVE THIS CAUSES U3 TO ACTIVATE THE
; ERRORNPX ___.

IGNNE ___ := FERR1 ___ + FERR ___ + /BUSYNPX ___
+ /ERRORNPX ___ + /BUSYCPU ___      ; THE INTERRUPT SERVICE ROUTINE IS THEN
; EXPECTED TO CLEAR THE INTERRUPT BY
; WRITING TO PORT F0H. AT THIS POINT
; THE -IGNNE SIGNAL IS DRIVEN LOW BY
; THIS PAL
; THUS CAUSING THE PROCESSOR TO IGNORE
; NON-CONTROL FLOATING POINT
; INSTRUCTIONS. -IGNNE IS DEACTIVATED
; WHEN -FERR GOES HI IN RESPONSE TO
; SOFTWARE CLEARING THE NUMERIC ERROR.

FERR1 ___ := FERR ___

BUSYNPX ___ := FERR ___ + /FERR1 ___ + RESNPX

LEADS ___ = /MEMW ___ * HLDA        ; FORM LONG INVALIDATION SIGNAL ON ANY
; MEMORY WRITE WHEN IN HOLD. THEN GO
; ELSEWHERE AND SHORTEN TO 1 CLOCK LONG
    
```

3. The logic equations to configure U<sub>4</sub> are relatively simple. The PLD generates the CLKSYN and CLK2SYN signals from the CLK2 signal.



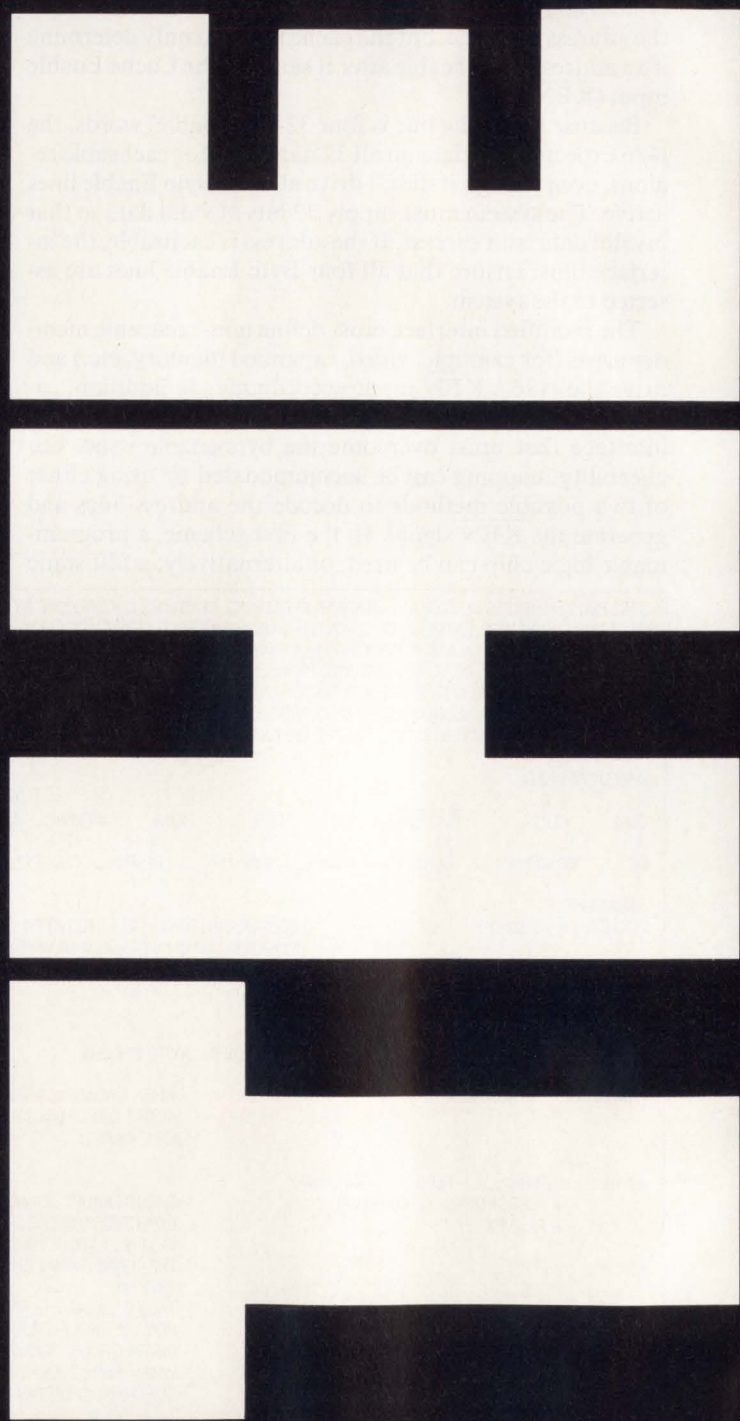
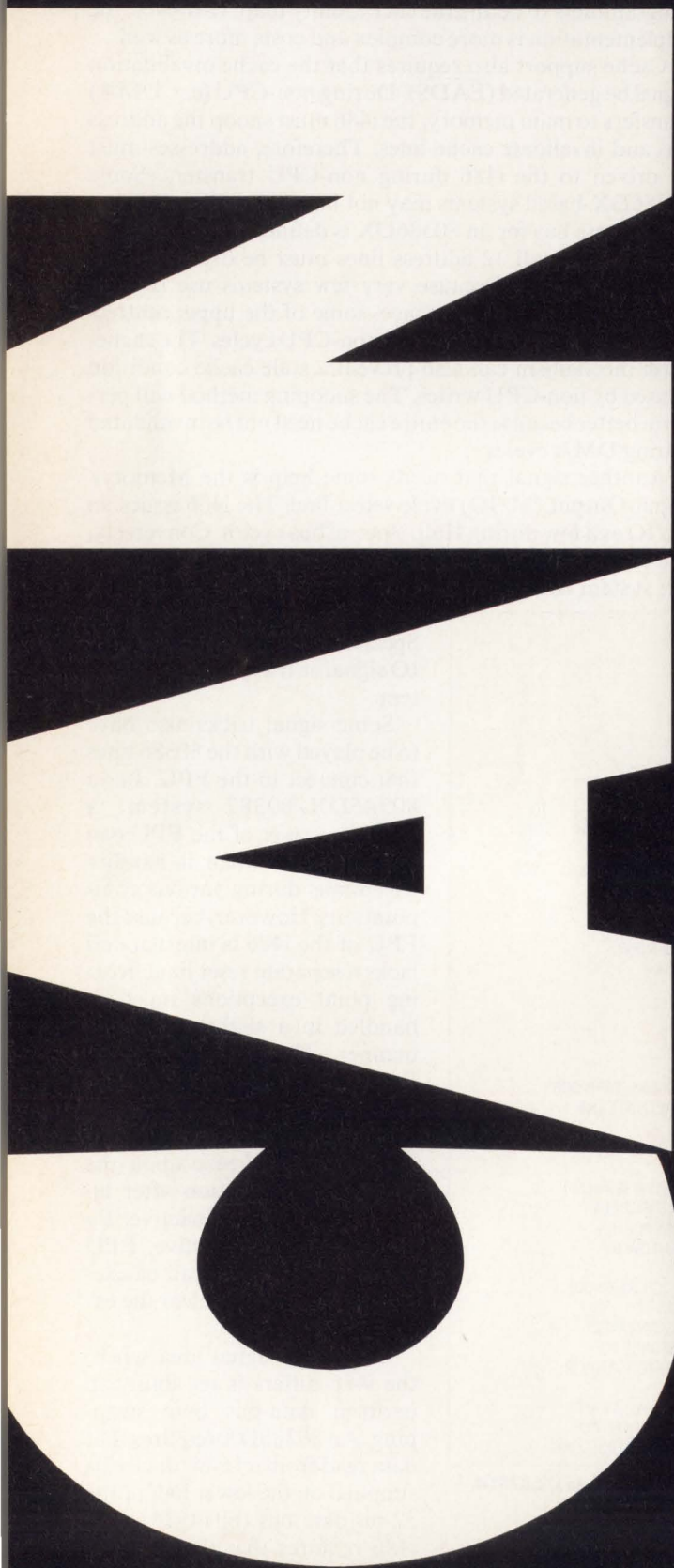



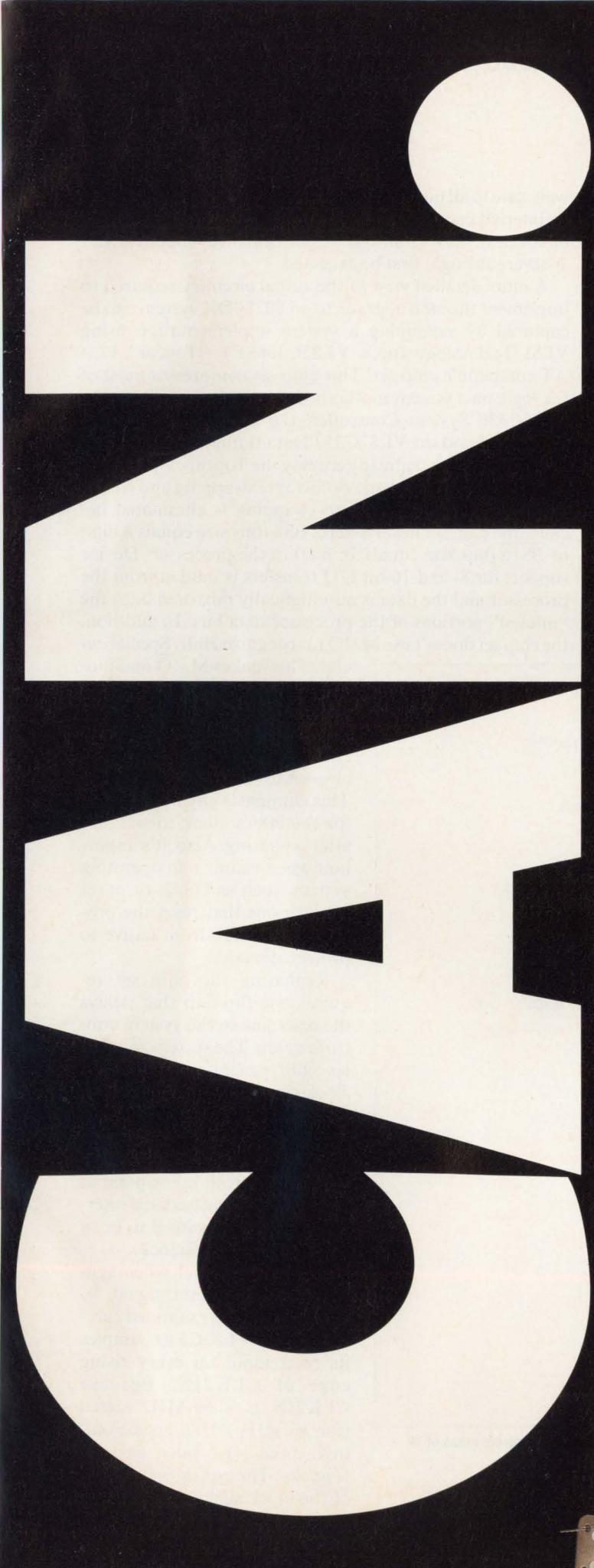

Too many oscillator "cans" can litter your board or trash a design altogether.

But no more.

Now, just a single frequency generator from Avasem can replace up to 20 crystals and crystal oscillators. So you can free-up needed board space, reduce power, and drastically lower component costs.



AV9127 Motherboard Frequency Generator. Actual size.

Speeds of up to 110 MHz make our family of frequency generators perfect for motherboards and video graphics. And with power-down features, they're also ideal for laptops.

Our expertise in analog ASICs allows us to quickly customize a frequency generator for just about any application.

So for more information and a free sample, call us toll free now at 1-800-3AVASEM or 408-297-1201. Or write to Avasem, 1271 Parkmoor Ave., San Jose, CA 95126.

And can the can for good.

# AVASEM

CIRCLE 123





pear on the data lines as indicated by the Byte Enable lines. For example, consider a 16-bit (word) read cycle of byte addresses 2 and 3 from a 16-bit device. Either processor will assert Byte Enables 2 and 3 (making them true) when issuing the address. However, the 80386DX will expect the data to appear on data lines 0-15 while ignoring data on lines 16-31. The i486 expects the data to appear on data lines 16-31 and will ignore data lines 0-15. A similar mechanism applies for accesses to 8-bit devices. This can present difficulties in systems that don't "mirror" the data on the unused lines of the processor data bus.

In most systems, timing constraints on the M/I $\bar{O}$  and the Byte Enable signals are the critical factors in obtaining the highest performance from an i486 conversion. Because of delays imposed in manipulating these signals, a one-clock-cycle delay may have to be injected at the beginning of each bus cycle. In other words, the Address Strobe (ADS) signal may have to be delayed by one full processor clock to have more time available. In this manner, the bus cycles can be pipelined to the system, starting the system cycle one clock after the i486 cycle. This is undesirable because it adds one

wait state to all bus cycles. But, since the i486 operates from its internal cache most of the time (which doesn't require bus cycles), the overall system performance reduction isn't as severe as might first be expected.

A more detailed view of the actual circuitry required to implement the i486 upgrade to an 80386DX system can be captured by examining a system implementation using VLSI Technology Inc.'s VL82C386SET "Topcat" PC/AT-compatible chip set. This chip set compresses most of the logic on a system motherboard to just three chips: the VL82C330 System Controller, the VL82C331 ISA Bus Controller, and the VL82C332 Data Buffer.

For systems that already employ the Topcat chip set, two of the six interfacing issues—the byte swapping and M/I $\bar{O}$  issues—are eliminated. Byte swapping is eliminated because the chip set never asserts BS8 (bus size equals 8 bits) or BS16 (bus size equals 16 bits) to the processor. Device support for 8- and 16-bit I/O transfers is hidden from the processor and the data is automatically mirrored onto the "unused" portions of the processor data bus. In addition, the chip set doesn't use M/I $\bar{O}$  to recognize Halt/Special cycles. This makes M/I $\bar{O}$  manipulation unnecessary.

As mentioned, the best method for handling the clock synchronization issue is phasing the chip set to the processor's clock. This eliminates any need to wait for the i486's clock to stabilize after rephasing. Also, it's important when running an operating system, such as OS/2, or other applications that reset the processor to switch from native to protected mode.

Rephasing the chip set requires one flip-flop that delays the reset line to the system controller chip. The system controller chip generates an internal clock signal that's the same frequency as the i486's clock. Because the system controller generates the reset signal to the i486, by controlling the point at which reset is released, the internal clock is guaranteed to be in phase with the i486 clock.

Timing is critical when synchronizing the reset signal, so timing should be examined carefully. The VL82C330 samples its reset input on every rising edge of CLK2IN. Because CLK2IN is a 66-MHz signal (for 33-MHz 80386 operation), high-speed logic must be used (Fig. 2a). The typical waveforms of the clock signals required by

```

; THIS PLD GENERATES THE FOLLOWING SIGNALS
; KEN ___ - CACHE ENABLE IS DECODED FROM ADDRESS A16-A31
; CURRENTLY THE FOLLOWING AREAS OF MEMORY WILL NOT BE CACHED.
; 000A 0000 - 000B FFFF ; VIDEO RAM
; 000C 0000 - 000C FFFF ; VIDEO BIOS (OPTIONAL VIA THE 330 CHIP'S EXT CTRL 1 OUTPUT)
; EXT CTRL1 = 1, VIDEO BIOS CACHEING ON
; EXT CTRL1 = 0, VIDEO BIOS CACHEING OFF
; 000D 0000 - 000D FFFF ; EMS
; 000E 0000 - 000F FFFF ; BIOS -(OPTIONAL VIA THE 330 CHIP'S EXT CTRL 2 OUTPUT)
; EXT CTRL2 = 1, BIOS CACHEING ON
; EXT CTRL2 = 0, BIOS CACHEING OFF
; 8000 0000 - FFFF FFFF ; POWER ON RESET
; EADS ___ - A SHORTENED (1 CLK WIDE) ADDRESS INVALIDATION SIGNAL GENERATED DURING MEMORY
; WRITES DURING HOLD.
;
; CHIP U3 PAL22V10
;PIN1 2 3 4 5 6 7 8 9 10 11 12
;CLK LEADS ___ A17 A18 A19 A20 A21 A22 A23 A24 A25 GND
; 13 14 15 16 17 18 19 20 21 22 23 24
;AUX1 AUX2 A16 NC NC NC A31 KEN ___ SLEADS ___ DSLEADS ___ /EADS ___ VCC

EQUATIONS
KEN ___ = /A16 * /A17 * A18 * A19 * /A20 ; CXXXX VIDEO BIOS
          * /A21 * /A22 * /A23 * /A24 * /A25 * /AUX1 ; bios
          + A16 * /A17 * A18 * A19 * /A20 ; DXXXX EMS
          * /A21 * /A22 * /A23 * /A24 * /A25
          + /A16 * A17 * /A18 * A19 * /A20 ; AXXXX VIDEO
          * /A21 * /A22 * /A23 * /A24 * /A25 ; buffers
          + A16 * A17 * A18 * A19 * /A20 ; BXXXX VIDEO
          * /A21 * /A22 * /A23 * /A24 * /A25 ; buffers
          + /A16 * A17 * A18 * A19 * /A20 ; EXXXX BIOS
          * /A21 * /A22 * /A23 * /A24 * /A25 * /AUX2
          + A16 * A17 * A18 * A19 * /A20 ; FXXXX BIOS
          * /A21 * /A22 * /A23 * /A24 * /A25 * /AUX2
          + A31 ; POWER ON RESET

SLEADS ___ := LEADS ___ ; SYNC IT
DSLEADS ___ := SLEADS ___ ; DELAY IT
EADS ___ := /SLEADS ___ * DSLEADS ___ ; OUTPUT SHORT (1 CLK LONG) EADS ___
    
```

4. To control the cache, the configuration equations for PLD U<sub>3</sub> allow up to 16 non-cacheable areas of 32 kbytes each to be mapped in the cache.



the i486 adapter show that the in-phase operation of the chip set depends on the recognition of RESET2 as low at the third rising edge of CLK2IN (Fig. 2b). Care must be taken to avoid the possible race condition that can arise between the second rising edge of CLK2IN and RESET2.

When the 486CLK is used as the clock input to U<sub>5A</sub> (half of a 74F74 dual flip-flop), it imposes a minimum propagation delay requirement on the combination of U<sub>5A</sub> and U<sub>6A</sub> (a 74ACT11004 inverter). The RSTDRV signal must not propagate through the combination of U<sub>5A</sub> and U<sub>6A</sub> in less than 6 ns.

If it does, RESET2 might appear low at the VL82C330 on the wrong edge of CLK2IN. Proper operation is guaranteed by the circuits as shown. There is a temptation, however, to replace the U<sub>5A</sub>-U<sub>6A</sub> combination with one ACT74 flip-flop. An ACT74 will, however, violate the 6-ns minimum propagation delay requirement, and the VL82C330 may then sample its reset line as low on the wrong edge of CLK2IN.

If, for other reasons, the ACT74 flip-flop must be used, it must be clocked with CLKSYN instead of 486CLK. Out-of-phase operation between the CPU and chip set can be easily identified by observing the CPU's READY input and Address Strobe (ADS) output. There will be no significant (< 10 ns) overlap time when both signals are low if the CPU and chip set are operating in phase. Critical timing exists in virtually every path found in this interface, therefore device substitutions should not be made without careful timing analysis.

Because the i486 and the chip set operate off different clock signals (the i486 clock is half the frequency of the chip set clock), the skew between these two signals must be minimized—that's the job of PLD U<sub>4</sub>. A number of equations are used to configure the PLD, a 16R4-7 (Fig. 3). The 16R4 generates CLKSYN and CLK2SYN with typically less than 1 ns of skew. The clocks are buffered, inverted twice by four inverters from U<sub>6</sub> to avoid duty cycle distortion, and converted to CMOS levels for the chip set.

The clock stability requirement precludes using the turbo-mode clock switching function that's supported by the chip set. Switching between turbo and non-turbo modes dynamically switches the clock frequency and will cause the i486 to crash. In most applications, however, the slower, non-turbo mode isn't used. As a result, little is lost by not having the option of slowing down the CPU.

Floating-point error handling is also controlled by U<sub>4</sub>.

```

; THIS PLD GENERATES THE SYSTEM BYTE ENABLES, IT ALSO LATCHES
; BLKA20 DURING HOLD.
; ALL BYTE ENABLES ARE FORCED ACTIVE ON MEMORY READ CYCLES FROM A CACHEABLE
; AREA. THIS IS TO PREVENT CACHING INVALID DATA.

CHIP U2 PAL16L8
;1      2      3      4      5      6      7      8      9      10
PBE0 ___ PBE1 ___ PBE2 ___ PBE3 ___ KEN ___ WR      BLKA20 ___ HLDA      RESCPU      GND
;11     12     13     14     15     16     17     18     19     20
486CLK  ADS ___ LATCHA20 ___ MADS ___      PMIO      BE0 ___ BE1 ___ BE2 ___ BE3 ___ VCC

EQUATIONS
/BE0 ___ = /PBE0 ___ ; FORCE BYTE ENABLES LOW IF
+ PMIO * /WR * /KEN ___ ; MEMORY READ.
; DO NOT FORCE FOR UNCACHEABLE
; AREA.

/BE1 ___ = /PBE1 ___
+ PMIO * /WR * /KEN ___

/BE2 ___ = /PBE2 ___
+ PMIO * /WR * /KEN ___

/BE3 ___ = /PBE3 ___
+ PMIO * /WR * /KEN ___

BE0 ___ .TRST = /HLDA * /RESCPU ; GET OFF THE LINE DURING HOLD
BE1 ___ .TRST = /HLDA * /RESCPU ; OR RESET.
BE2 ___ .TRST = /HLDA * /RESCPU
BE3 ___ .TRST = /HLDA * /RESCPU

LATCHA20 ___ = /HLDA * BLKA20 ___ ; LATCH BLKA20 SIGNAL ON HLDA SINCE
+ HLDA * LATCHA20 ___ ; CHIPSET WILL DEASSERT IT DURING HOLD.
+ BLKA20 * LATCHA20 ___

MADS ___ = ADS ___ + 486CLK
    
```

5. The set-up equations for PLD U<sub>2</sub> (which handles the byte-enable control) let the chip generate the proper system Byte Enable signals and latch the BLKA20 line during Hold.

When a numeric error occurs, the i486 asserts  $\overline{FERR}$ . That signal causes U<sub>3</sub> to activate the signal ERRORNPX, which in turn causes an interrupt number 13 to be generated by the VL82C330. The interrupt service routine clears the interrupt by writing to port F0 (h). This causes U<sub>4</sub> to drive the  $\overline{IGNNE}$  signal active (low). Now the processor ignores non-control floating-point instructions until  $\overline{FERR}$  goes high in response to software clearing the numeric error (for example, executing a FINIT instruction).

To support the cache, the simpler implementation employing a PLD will be used. A 22V10 (U<sub>3</sub>) was selected and it monitors the address bus and generates the  $\overline{KEN}$  signal. The 22V10 proved to be the best choice because it has the necessary input width and speed. With the accompanying configuration equations, the circuit can create up to 16 non-cacheable areas of 32-kbytes each (Fig. 4).

The address invalidation signal (EADS) is generated when a memory write occurs during a processor hold state, such as a DMA write. Fortunately, this method works because the chip set drives the address back to the processor. Since the processor suspends internal operation during invalidation cycles, the EADS signal is shortened to one clock cycle, improving CPU performance. Address lines A<sub>26-31</sub> are pulled down during non-CPU cycles because they're not driven by the chip set. Passive or active pull-down can be used on these lines. Passive pull-downs are adequate for most applications because the i486 will only drive these address lines high when it's fetching its reset



**TABLE 1: COMPARISON OF 80386DX VS. 80486 THROUGHPUT**

Benchmark	80386	80486	Increase
Landmark 1.14	38	149	292%
Norton S1	33.2	50.7	53%
QAplus Dhrystones	6500	22,700	249%

Note: Comparison is based on i486 and 80386 33-MHz systems using Topcat chip set. Norton SI is heavily biased toward write operations and therefore shows the lowest performance improvement.

vector. After vectoring to the BIOS boot code, the i486 will drive these lines low.

In addition, resetting the processor causes the cache to be flushed and disabled. Therefore, active pull-downs should be used if the processor drives any of these upper address lines when the cache is enabled. If the system uses a Weitek coprocessor, the i486 will drive A<sub>31</sub> high when performing coprocessor cycles. If the next cycle is a DMA write cycle, the passive pull-downs may not be able to bleed off the voltage stored in board capacitance quickly enough. Active pull-downs that are enabled during DMA write cycles would ensure that the correct address is invalidated.

Lastly, a 16L8 PLD (U<sub>2</sub>) can be used to resolve the byte-enable control problem. This PLD forces all Byte Enable lines low during memory read cycles that are to cacheable areas. Performance would be degraded if all memory reads, including those to noncacheable areas, were forced to be 32-bit reads. The Byte Enable outputs of this PLD are three-stated during hold and reset cycles to prevent bus contention. A number of equations are required (Fig. 5).

A timing analysis of the critical path for byte-enable timing shows that the byte-enable timing specifications are sat-

isfied for the VL82C330. Byte Enables are sampled by the VL82C330 halfway through the T2 phase, and a 4-ns setup time is required. The setup time permits 1.5 cycles (T1 plus half of T2) or a total of 45 ns for the decoding. Allowing 16 ns for the i486's delay for address and Byte Enables, 15 ns for  $\overline{\text{KEN}}$  generation, 7.5 ns for the byte-enable PLD propagation delay, 4 ns for VL82C330 setup time, and 2 ns of CPUCLK to CLK2IN skew leaves a byte-enable timing margin of 0.5 ns, worst case.

However, worst-case byte-enable timing to the VL82C331 results in a negative timing margin if the i486's  $\overline{\text{ADS}}$  signal drives the VL82C331's  $\overline{\text{EALE}}$  pin. The delay information can be derived from the following calculations:

$$\begin{aligned}
 &+30.0 \text{ ns ADS falling edge to ADS rising edge} \\
 &-13.0 \text{ ns worst case address and Byte Enable lines valid (16-3)} \\
 &-15.0 \text{ ns } \overline{\text{KEN}} \text{ generation/PLD propagation delay} \\
 &-7.5 \text{ ns Byte-enable fixup PLD propagation delay} \\
 &-4.0 \text{ ns VL82C331 setup time} \\
 &-2.0 \text{ ns CPUCLK to CLK2IN skew} \\
 &= -11.5 \text{ ns Byte-enable timing margin to VL82C331.}
 \end{aligned}$$

The difficulty with this initial proposal is that  $\overline{\text{ADS}}$  may return to the high state as soon as 3 ns after the start of the T2 state. In the worst case, the address and Byte Enable lines may not be valid until 16 ns after the start of T1.

So, instead of a worst-case analysis, a "common parts" analysis should be used. One useful assumption is that the maximum time difference between  $\overline{\text{ADS}}$  low and address valid is 6.5 ns (1/2 the maximum difference of 16 ns - 3 ns). However, even with this method, the adapter is still 5 ns shy of meeting specification.

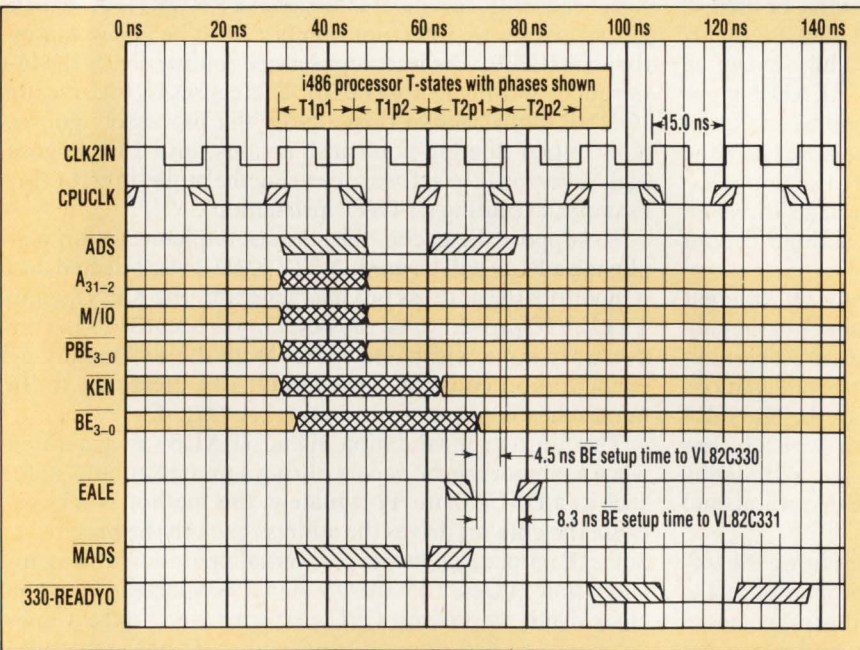

6. Signal timing requirements for the Byte Enable control lines require that the  $\overline{\text{EALE}}$  signal be synthesized from the  $\overline{\text{ADS}}$  and 486CLK signals. The  $\overline{\text{EALE}}$  signal delays the point at which the VL82C331 samples the Byte Enable signals, ensuring that the setup time specification is satisfied.

The solution is to generate an  $\overline{\text{EALE}}$  signal whose rising edge is guaranteed to occur near the middle of the T2 state (Fig. 6). That can be done by clocking "ORed"  $\overline{\text{ADS}}$  and 486CLK through a flip-flop. The clock for the flip-flop is the CLK2IN signal. Stepping through the worst-case timing numbers for the generated  $\overline{\text{EALE}}$  signal appears as:

$$\begin{aligned}
 &+30.0 \text{ ns T1 state, width} \\
 &+15.0 \text{ ns 1/2 of T2 state} \\
 &+3.8 \text{ ns Minimum low-to-high propagation delay of 74F74} \\
 &-16.0 \text{ ns Maximum i486 address-valid delay} \\
 &-15.0 \text{ ns } \overline{\text{KEN}} \text{ generation PLD propagation delay} \\
 &-7.5 \text{ ns Byte-enable fixup-PLD delay} \\
 &-2.0 \text{ ns CPUCLK to CLK2IN skew} \\
 &= +8.3 \text{ ns available } \overline{\text{BE}} \text{ setup time} \\
 &-4.0 \text{ ns VL82C331 setup time} \\
 &= +4.3 \text{ ns Byte-enable timing margin}
 \end{aligned}$$



# NETWORKING SOLUTIONS

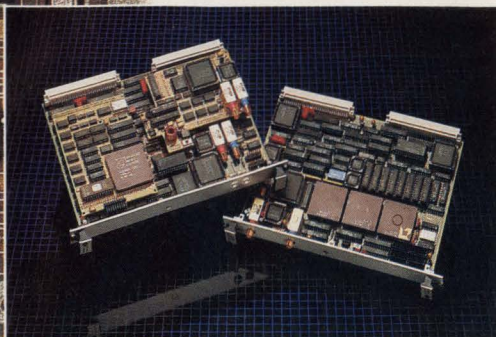

V/FDDI 4211 Peregrine  
V/FDDI 3211 Falcon

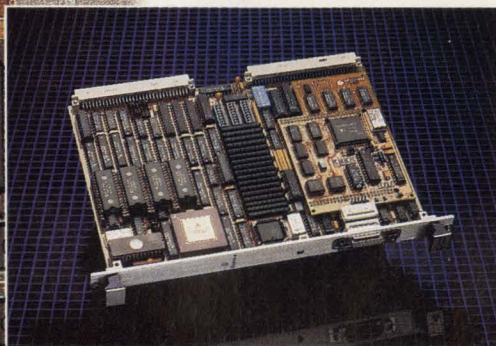

V/Token-Ring 4212 Owl

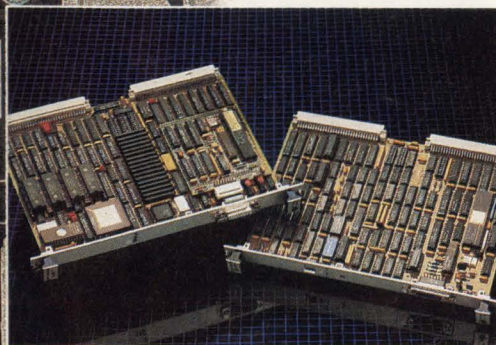

V/Ethernet 4207 Eagle  
V/Ethernet 3207 Hawk

## FDDI, TOKEN-RING AND ETHERNET COMMUNICATIONS

The need to network has never been greater. Diverse processing platforms, distributed architectures, client-server, departmental and workgroup environments all contribute to increased demands on the network. System and network designers need a proven source of technology solutions for the wide range of networking and communication application problems they face. Interphase delivers those solutions.

## FDDI, TOKEN-RING AND ETHERNET SOLUTIONS

Interphase has long led the industry in high-performance VMEbus peripheral controllers, and that same leadership is now evident in networking node controllers. Interphase has FDDI, Token-Ring and Ethernet solutions for virtually any VMEbus system application challenge.

## PROVEN FDDI SPEED AND INTELLIGENCE

Interphase's FDDI 100 Mb/s offerings are a logical choice for the industry. The V/FDDI 3211 Falcon received *UnixWorld* magazine's Product of the Year designation and was the industry's first 6U VMEbus FDDI solution. Interphase's newest FDDI product is the V/FDDI 4211 Peregrine, a RISC-based high-performance node controller capable of link level operation or on-board protocol processing. The Peregrine provides single or dual attach configurations, with SMT (Station Management Software) running on-board, all in one 6U VME slot.

## TOKEN-RING RESULTS

The V/Token-Ring 4212 Owl is an ultrafast Token-Ring node controller based on the partitioned architecture of Interphase's proven Eagle class of controllers. The Owl facilitates connectivity of UNIX<sup>®</sup> systems, workstations, supercomputers or any other VMEbus system into an IBM<sup>®</sup> environment using IEEE 802.5 Token-Ring. This multiple processor design provides an elegant queued interface to the system supporting IEEE 802.2 LLC, and a flexible 4 or 16 Mbit interface to the Token-Ring network.

## ETHERNET CHOICES

Interphase also offers two Ethernet design options. The V/Ethernet 4207 Eagle 32-bit protocol platform is the high-performance standard for the industry, and offers on-board TCP/IP support. The V/Ethernet 3207 Hawk is designed specifically for cost-sensitive VMEbus applications.

## GET YOUR NET WORKING NOW

No matter what your networking need – FDDI, Token-Ring or Ethernet – Interphase is ready to provide the solution. For more information call today:

(214) 919-9000



**INTERPHASE**  
CORPORATION

OPEN SYSTEMS CONTROLLERS™

Disk • Tape • Networking

13800 Senlac • Dallas, Texas 75234 • (214) 919-9000 • FAX: (214) 919-9200 • NASDAQ-NMS:INPH

Interphase International  
Astral House, Granville Way • Bicester, Oxon OX6 0JT • (01144) 869-321222 • FAX: (01144) 869-247720

© 1990 Interphase Corporation. Interphase is a registered trademark of Interphase Corporation. Open Systems Controllers is a trademark of Interphase Corporation. Specifications subject to change without notice. UNIX is a registered trademark of AT&T in the United States and other countries. IBM is a registered trademark of International Business Machines.



## MICRO SYSTEM Technologies 91

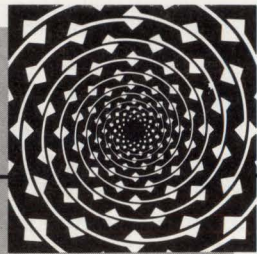

2nd International Conference and Exhibition on Micro Electro, Opto, Mechanical Systems and Components

- Micro System Technologies
- Micro Electronics
- Micro Sensing
- Micro Optics
- Micro Mechanics

Concurrent International Conference under the Chairmanship of Dipl.-Ing. R. Krahn, VDI/VDE-TZ IT GmbH and Prof. Dr.-Ing. H. Reichl, Techn. University Berlin

Highlights 91:

- Micro System Applications in Automotive Engineering
- Medical Equipments
- Environmental Engineering

Sponsor: ◆ IEEE Institute of Electrical and Electronics Engineers

With the support of the Senat of Berlin, Department of Economics



## ICC Berlin

October 29 – November 1, '91

Informations:

MESAGO USA Corp.  
376 Boylston Street  
Boston, MA 02116, USA  
Tel. 001 (617) 536 8677  
Fax 001 (617) 536 8682

Organizer:

AMK Berlin  
Ausstellungs-Messe-  
Kongreß GmbH  
MESAGO Exhibition &  
Conference Group

## ■ RUN 80486 WITH 80386 CHIP SET ■

**TABLE 2: SIGNAL CONNECTIONS FROM ADAPTER TO 80386 HOST**

Adapter side	Host system side
A <sub>2-31</sub>	VL82C330 A <sub>2-26</sub> , A <sub>29</sub> , A <sub>31</sub>
	VL82C331 A <sub>2-25</sub>
D <sub>0-31</sub>	VL82C332 D <sub>0-31</sub>
ADS	VL82C330 pin 27
W/R	VL82C330 pin 24
D/C	VL82C330 pin 25
M/I/O	VL82C330 pin 26
BE <sub>3</sub>	VL82C330 pin 20
	VL82C331 pin 69
BE <sub>2</sub>	VL82C330 pin 21
	VL82C331 pin 70
BE <sub>2</sub>	VL82C330 pin 22
	VL82C331 pin 71
BE <sub>0</sub>	VL82C330 pin 23
	VL82C331 pin 72
EALE	VL82C331 pin 83
TCLK2	VL82C330 pin 44
CLK2	VL82C330 pin 32
CLK2IN	VL82C330 pin 30
RSTDRV	VL82C331 pin 122
RESET2	VL82C330 pin 111
RESCPU	VL82C330 pin 36
RESNPX	VL82C330 pin 41
TCReady	VL82C330 pin 34
INTR	VL82C331 pin 75
NMI	VL82C331 pin 76
MEMW	VL82C331 pin 35
ERRORNPX	VL82C330 pin 43
HRQ	VL82C330 pin 40
HLDA	VL82C330 pin 28
AUX <sub>1</sub>	VL82C330 pin 41
AUX <sub>2</sub>	VL82C330 pin 50
AUX <sub>3</sub>	VL82C330 pin 49
BLKA20	VL82C330 pin 94
BUSYNPX	VL82C330 pin 42
BUSYCPU	VL82C330 pin 38

to VL82C331

In an actual 80386DX system, there will be more connections between the i486 adapter than those discussed. Of course, all of the address and data lines must be connected, as well as many other signal lines to tie all of the logic together. Table 2 shows the mapping of signals from the Topcat chip set to the i486 adapter. Signals on the system side may have many connections to devices within the system, and aren't necessarily connected only to the adapter.

*Brian Dellacroce, systems engineer for the Personal Computer Products Division of VLSI Technology Inc., holds a BSEE from Arizona State University, Tempe.*

### HOW VALUABLE?

HIGHLY  
MODERATELY  
SLIGHTLY

CIRCLE 523  
CIRCLE 524  
CIRCLE 525



## PC DESIGN PRODUCTS

### ▼ RAISE DISK PERFORMANCE USING FEWER CHIPS

As hard disk drives become smaller and more intelligent, designers look for ways to reduce space and power demand while increasing performance. Two SCSI (Small Computer Systems Interface) disk controllers from Cirrus Logic Inc., the CL-SH370 and the CL-SH351, do just that.

In one chip, the SH370 contains most of the hardware that's needed to build a complete SCSI Winchester disk-drive controller subsystem. It's suitable for the 3-1/2- and 2-1/2-in. drives incorporated into the smaller footprint workstations and laptop and notebook PCs.

The SH370 automates many functions that would usually require a local microprocessor. For this reason, designers can eliminate one of the two local embedded processors that typically were needed to control a disk drive, as well as the circuitry needed to execute the functions. In addition, the chip supports zone-recording formats and a proprietary split data-field capability that increases the areal density of data on the drive's media. This nearly doubles the drive's capacity without changing the media or head technology. To compensate for the inherently higher error rates created by higher densities, the IC incorporates the company's proprietary Reed-Solomon on-the-fly error-correction technology.



The SH351 controller is a socket- and firmware-compatible upgrade of the company's SH350 controller. With a 10-Mbyte/s synchronous SCSI-2 transfer rate and a 32-MHz disk-transfer rate, the SH351 implements the "fast" data transfer of the SCSI-2 standard. It's intended for such applications as workstations and minicomputers.

The SH351 includes support for embedded servo designs and zone-recording formats. It's speed-matching capabilities permit up to 15-byte synchronous transfer offsets and 13 programmable transfer periods.

Both disk controllers are housed in 100-lead quad flat packs. Both are available now in sample quantities, with production starting in the second quarter. The SH370 goes for \$22 in quantities of 100. The SH351 costs \$20 in similar quantities.

**Cirrus Logic Inc.**  
1463 Centre Pointe Dr.  
Milpitas, CA 95035  
(408) 945-8300

► CIRCLE 336

### ▼ MOUSE LOSES ITS CORD

With the introduction of Logitech's cordless mouse, the MouseMan Cordless Radio Mouse, users are no longer restricted by the constraints of corded input devices. Eight adjustable channel settings on the re-

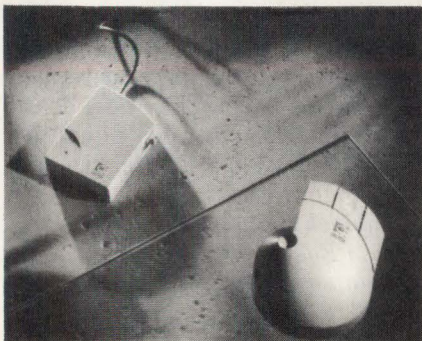

ceiver enable the mouse to be operated simultaneously by multiple users working within the device's 6-ft. range, with no interference from other units. The MouseMan doesn't require direct line-of-sight communication with its receiver, which can be positioned anywhere within the transmission range. It also features standby and sleep modes to prolong the one-year (or so) battery life. The mouse's resolution is 400 dots/in. The cordless MouseMan, which is fully compatible with Microsoft Windows 3.0, costs \$199.

**Logitech Inc.**  
6505 Kaiser Dr.  
Fremont, CA 94555  
(415) 795-8500

► CIRCLE 337

## TIMING DIAGRAMS

- ✓ Hard to Draw
- ✓ Tough to Modify
- ✓ Painful to Analyze
- ✓ Required for Reliable Designs

Relax,  
now there's

## TIMING DESIGNER™

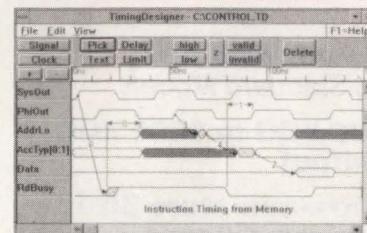

### The Timing Diagram Drawing and Analysis Software that ...

- Lets you create and modify timing diagrams in minutes instead of hours.
- Automatically performs worst case timing analysis.
- Instantly highlights timing violations.
- Generates standardized timing documentation.

*TimingDesigner™ will help you develop better designs more quickly!*

*Pick up the phone now and call for more information.*

**206 • 869-4227**



**CHRONOLOGY**

2849 152nd Ave. NE / Redmond, WA 98052  
FAX: (206) 869-4229



# High Voltage DC-DC Converters



ACTUAL  
SIZE

**.5" x .5" x .4" Ht.  
1000 VDC Output**

- **New Series AV—**  
56 Standard Models
- **100 VDC to 1000 VDC**  
Output
- **Ultra-miniature Size**  
Weight: 4 Grams  
0.1 Cubic Inch Volume
- **Standard Input Voltages**  
5, 12, 24 and 28 Volts DC
- **Operating Temperature**  
Standard: -25°C to +70°C  
Optional: -55°C to +85°C
- **MIL-STD-883**  
Screening Available
- **Isolated: Input to Output**  
up to 1500 VDC

PICO also manufactures over 800 regulated and isolated DC-DC Converters and AC-DC Power Supplies and over 2500 standard ultra-miniature Transformers and Inductors.

Delivery—  
stock to  
one week

SEE EEM,  
THOMAS REGISTER  
OR SEND DIRECT FOR  
FREE PICO CATALOG

**PICO**  
**Electronics, Inc.**

453 N. MacQuesten Pkwy. Mt. Vernon, N.Y. 10552

Call Toll Free **800-431-1064**

IN NEW YORK CALL **914-699-5514**

## PC DESIGN PRODUCTS

### ▼ 18-BIT COLOR SCANNER DISPLAYS 262,144 COLORS

PC and Macintosh users can now scan in 18-bit-color or gray-scale images. The M-6000CG boasts an 18-bit/pixel display resulting in 262,144 colors. The scanner also supplies 400-dot/in. gray-scale resolution for text



or line-art applications. Bundled software includes a high-end color paint-imaging package as well as optical-character recognition. Available now, the PC version costs \$695, while the Macintosh version sells for \$795.

**Marstek Inc.**  
17795-F Skypark Cir.  
Irvine, CA 92714  
(714) 833-7740

► CIRCLE 338

### ▼ PRINTER FITS UNDER NOTEBOOK PC

As more and more laptops are being sold, users need printers with a similar footprint. Enter the LT-20 dot-matrix printer. It's designed to fit under a notebook-style laptop with its flat-sheet feed design. The low-profile printer measures 14.6 by 11.3 by 2 in. and weighs 5.9 lbs. It comes with a 50-sheet cassette tray. Powered by a rechargeable NiCd battery, the LT-20 printer can print 100 pages on one 10-hour charge. A car-battery adapter and a font ROM with eight fonts are also available. The printer's MTBF is rated at 4000 hours, excluding the printhead, which is rated at 50 million characters. The LT-20 sells for \$499.

**Seikosha**  
10 Industrial Ave.  
Mahwah, NJ 07430  
(201) 327-7227

► CIRCLE 339

### ▼ INPUT DEVICE MIGRATES TO KEYBOARD

With all of the new Windows 3.0 applications being developed, users find that an input device, such as a mouse or a trackball, is a necessity. The MouseBoard puts an alternate input device right on the keyboard, so an external pointer isn't needed. Positioned where the directional keys would sit on typical AT-style keyboards, the MousePanel does the job of a mouse and directional keys. Hitting a "mouse" key switches between the mouse and the directional keys. Cursor movements are controlled by gliding movements on the panel. The keyboard also comes with a software driver and a paint application. It works with IBM PC/XT/AT, PS/2, and compatible computers. It's also compatible with all Microsoft protocols. Click-type keys are available on request.

**Cherry Electrical Products Corp.**  
3600 Sunset Ave.  
Waukegan, IL 60087  
(708) 662-9200

► CIRCLE 340

### ▼ CONNECT MIL HARDWARE TO PCs

Designed to connect Navy tactical data systems to personal computers, the Eagle interface board fits right into a vacant slot in a PC. With the board, military-systems integrators can develop, monitor, simulate, and test military software systems without the lengthy lead times and high prices of military hardware. The board can even be installed in a laptop computer for field applications. The Eagle is fully compliant with MIL-STD-1397, types B and C. It features full-duplex 32-bit I/O support. The board features MS-DOS resident drivers and it interfaces to high-level languages. Eight software-selectable data rates range from 1.2 to 25.6  $\mu$ s per transfer. The board contains a built-in test feature for self-diagnosis. Up to 32 Eagle boards can reside in a system. The Eagle board is priced at \$4050 with large-quantity discounts available. Delivery is from stock to four weeks.

**Sabtech Industries Inc.,**  
5411 East La Palma Ave.  
Anaheim, CA 92807  
(714) 970-5311

► CIRCLE 341



## PC DESIGN PRODUCTS

### ▼ 3.5-IN. DAT DRIVE HOLDS 5 GBYTES

The Model 3600 DAT (digital-audio-tape) drive holds 5 Gbytes of data in a 3.5-in. form factor. The drive features a sustained transfer rate of 520 kbytes/s. The high capacity is achieved by combining hardware-based data compression with long-



length tapes. Another feature of the drive is its high reliability—60,000 hours. This is done by reducing the chip count and using just one board. The 3600 uses a vertical hub assembly that assures a reliable cassette engagement and disengagement. The drive costs under \$1400 in OEM quantities and is available now.

**WangDAT Inc.,**  
151 Kalmus Dr., K-3  
Costa Mesa, CA 92626  
(714) 241-9613

► CIRCLE 342

### ▼ LOCATE AND DIAGNOSE A PC'S HARDWARE PROBLEMS

By using QAPlus/fe-tech, advanced PC end users or field technicians can test all of their major hardware components, including floppy and fixed disks and I/O ports. The software

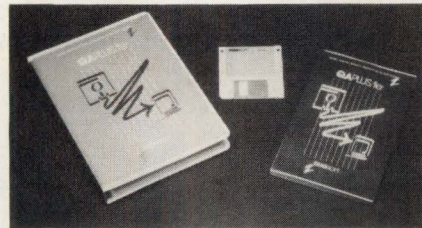

quickly locates and diagnoses any problems. QAPlus/fe-tech can be used with IBM PC/XT/AT, PS/2, and compatible computers. It contains interactive testing capabilities that let users evaluate a computer's keyboard, mouse, joystick, or audio speaker. The software can also diagnose faulty RAM chips. QAPlus/fe-tech is priced at \$499.95.

**DiagSoft Inc.**  
5615 Scotts Valley Dr., Suite 140  
Scotts Valley, CA 95066  
(408) 438-8247

► CIRCLE 343

## Megatel PC+i

High Reliability, Performance & Low Profile IBM PC/XT® Compatible Single Board Microcomputer Power Consumption Under 2 Watts

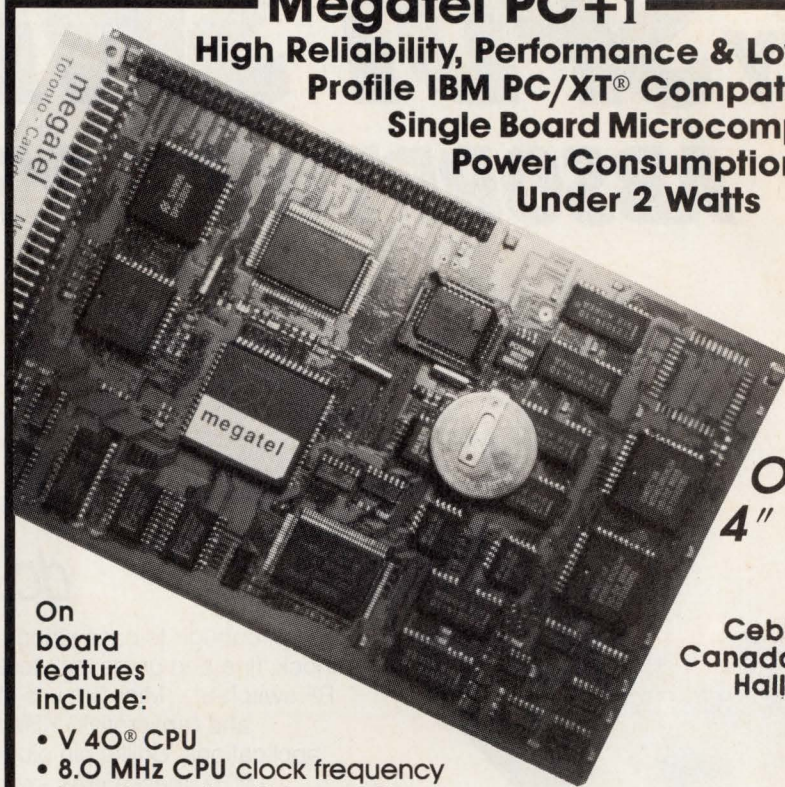

Only  
4" x 6"

Cebit' 91  
Canada Stand  
Hall Six

On board features include:

- V 40® CPU
- 8.0 MHz CPU clock frequency
- Requires only +5V operation
- Will boot PC, MS and DR DOS™
- Yamaha PCDC6366 CMOS Video Color LCD Controller
- NCR 5380 SCSI Hard Disk Controller
- Western Digital 37C65 CMOS Disk Controller (1.44 M Support)
- 704k Byte User DRAM. 32k-256k Byte BIOS Flash EPROM
- 2 IBM compatible RS-232 Serial Ports. 1 V40® Serial Port
- On-board voltage converter for Serial ± voltages
- 8087 Math Co-Processor socket
- Less than 2 Watt Power Consumption

The PC+i is Megatel's second generation single board computer which boasts a complete IBM PC® compatible CPU plus on-board peripheral controllers, networking capability and low power consumption.

**FOR INTERNATIONAL INQUIRIES, CALL US AT A NUMBER BELOW:**

AUSTRALIA - 3 568 0988

ITALY - 331 77 0016

GERMANY - 6074 98031

DENMARK - 44 44 04 88

NORWAY - 9 86 99 70

GREAT BRITAIN - 959 71011

FINLAND - 0757 1711

SWEDEN - 40 97 10 90

AUSTRIA - 222 587 6475

NETHERLANDS - 8385 41301

FRANCE - 149 65 2550

SINGAPORE - 338 1300

### Megatel Comp. Corp.

125 Wendell Ave.  
Weston, Ontario M9N 3K9  
TEL: (416) 245-2953  
FAX: (416) 245-6505

For U.S. Distribution contact:

DENSITRON CORPORATION  
2540 West 237th St.  
Torrance, CA 90505  
TEL: (213) 530-3530 FAX: (213) 534-8419

IBM, IBM PC/XT are registered trademarks of IBM Corp. as is V40 of NEC Corp. DR DOS is a trademark of Digital Research Corp. MS DOS is a trademark of Microsoft Corp.

# megatel

CIRCLE 124



# TINY SPDT SWITCHES

## ABSORPTIVE... REFLECTIVE

dc to 4.6 GHz from \$32<sup>95</sup><sub>(10-24)</sub>

Tough enough to pass stringent MIL-STD-883 vibration, shock, thermal shock, fine and gross leak tests... useable to 6GHz... smaller than most RF switches... Mini-Circuits' hermetically-sealed (reflective) KSW-2-46 and (absorptive) KSWA-2-46 offer a new, unexplored horizon of applications. Unlike pin diode switches that become ineffective below 1MHz, these GaAs switches can operate down to dc with control voltage as low as -5V, at a blinding 2ns switching speed.

Despite its extremely tiny size, only 0.185 by 0.185 by 0.06 in., these switches provide 50dB isolation (considerably higher than many larger units) and insertion loss of only 1dB. The absorptive model KSWA-2-46 exhibits a typical VSWR of 1.5 in its "OFF" state over the entire frequency range. These surface-mount units can be soldered to pc boards using conventional assembly techniques. The KSW-2-46, priced at only \$32.95, and the KSWA-2-46, at \$48.95, are the latest examples of components from Mini-Circuits with unbeatable price/performance.

Connector versions, packaged in a 1.25 x 1.25 x 0.75 in. metal case, contain five SMA connectors, including one at each control port to maintain 3ns switching speed.

**Switch fast... to Mini-Circuits' GaAs switches.**

### SPECIFICATIONS

Pin Model	<b>KSW-2-46</b>	<b>KSWA-2-46</b>
Connector Version	<b>ZFSW-2-46</b>	<b>ZFSWA-2-46</b>
FREQ. RANGE	dc-4.6 GHz	dc-4.6 GHz
INSERT. LOSS (db)	typ max	typ max
dc-200MHz	0.9 1.1	0.8 1.1
200-1000MHz	1.0 1.3	0.9 1.3
1-4.6GHz	1.3 1.7	1.5 2.6
ISOLATION (dB)	typ min	typ min
dc-200MHz	60 50	60 50
200-1000MHz	45 40	50 40
1-4.6GHz	30 23	30 25
VSWR (typ)	ON 1.3:1 OFF —	1.3 1.4
SW. SPEED (nsec)		
rise or fall time	2(typ)	3(typ)
MAX RF INPUT (bBm)		
up to 500MHz	+17	+17
above 500MHz	+27	+27
CONTROL VOLT.	-8V on, OV off	-8V on, OV off
OPER/STOR TEMP.	-55° to +125°C	-55° to +125°C
PRICE (10-24)	<b>\$32.95</b> <b>\$69.95</b>	<b>\$48.95</b> <b>\$79.95</b>

finding new ways...  
setting higher standards

**Mini-Circuits**

A Division of Scientific Components Corporation

P.O. Box 350166, Brooklyn, New York 11235-0003 (718) 934-4500

Fax (718) 332-4661 Domestic and International Telexes: 6852844 or 620156

WE ACCEPT AMERICAN EXPRESS

CIRCLE 149

C 117 REV. G



**CIRCLE**  
**521 MODEL THERMISTOR WITH SPICE**

JIM HAGERMAN  
5137 Camino Playa Malago,  
San Diego, CA 92124; (619) 931-5012.

**W**ith this Spice subcircuit, a typical resistive component can be replaced by a two-terminal thermistor in Spice simulations (Fig. 1). Most Spice-based simulators permit a temperature-dependent model of a resistor. However, the model is limited to a second-order polynomial that may not result in an accurate model of the actual component's characteristic, especially over a wide temperature range. To overcome this problem, the subcircuit uses the high-order polynomial description of the nonlinear voltage-controlled current source. In this way, any polynomi-

al (of nth degree) that describes the thermistor's resistance as a function of temperature can be applied directly in Spice. There are several known methods for generating these polynomials, and numerous easy-to-use software packages can simplify this task.

The model's accuracy is mostly limited by the accuracy of the polynomial. Using TableCurve 2.0 from AISN Software, Grants Pass, Ore., two polynomials were generated to model the data listed for a Dale Electronics negative-temperature coefficient (NTC) curve #1 from 0 to 100°C. The results for the two polynomials indicate good correlation with the expected data (Figs. 2a and 2b). □

Reference:  
Tuinenga, Paul, *Spice, A Guide to Circuit Simulation and Analysis Using PSpice*. Englewood Cliffs, NJ: Prentice-Hall, 1988.

```
* NTC.SUB    Jim Hagerman 7/5/90
*
* This is a model of a 10k Ohm thermistor with characteristics of a Dale Electronics NTC
* curve #1.
* The nominal value of resistance at 25C is Rref.
*
* The characteristics R(T) is used for Gout. Note that if Celsius is used TNOM is set to
* zero.

.options tnom=0
.subckt ntc 1 2
Eout 1 3 poly(2) (5,0) (4,0) 0 0 0 1.0
Vsense 3 2 dc 0.0
Fout 0 4 Vsense 1.0
Rref 4 0 10k
Gout 0 5 poly(1) 6 0 3.266
+          -0.16633619
+          0.0046450693
+          -8.6856965e-5
+          1.017213e-6
+          -3.8668603e-9
+          -8.8615615e-11
+          1.678045e-12
+          -1.3013017e-14
+          4.8617031e-17
+          -6.8866237e-20
Ro 5 0 1.0
Itemp 0 6 dc 1.0
Rt 6 0 Rtemp 0.001
.model Rtemp res(r=1 tc1=1000)
.ends ntc
```

**1. THIS SPICE SUBCIRCUIT** serves as a model of a 10-kΩ thermistor. When simulating with Spice, the model can be used in place of a normal resistive component.

**VOTE!**

Read all the Ideas for Design in this issue, select your favorite, and circle the appropriate number on the Reader Service Card. The winner receives a \$150 Best-of-Issue award and becomes eligible for a \$1,500 Idea-of-the-Year award.

T	Resistance (kΩ)		
	Expected	Spice	
		n = 5	n = 10
0	32.66	32.63	32.66
10	19.90	19.98	19.90
20	12.49	12.45	12.49
25	10.00	9.949	10.00
30	8.058	8.025	8.058
40	5.326	5.360	5.326
50	3.602	3.652	3.602
60	2.488	2.488	2.488
70	1.751	1.701	1.751
80	1.256	1.229	1.256
90	0.9164	0.9751	0.9164
100	0.6792	0.6597	0.6793

(a)

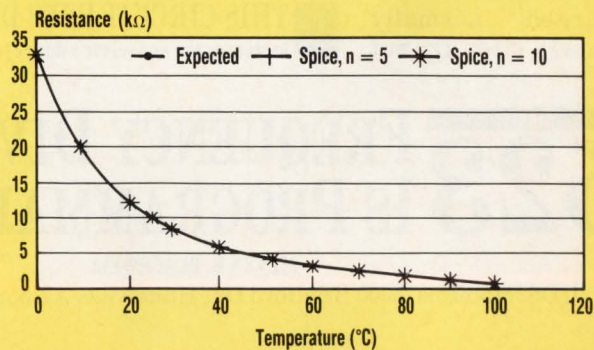

(b)

**2. ACTUAL SPICE SIMULATION** results for two different values of n are compared with the expected values (a). A plot of the same data illustrates the model's resistance-temperature curve (b).



# CIRCLE 522 INCREASE DC-DC CONVERTER POWER

CARL SPEAROW

Sundstrand Corp., 4747 Harrison Ave., Rockford, IL 61125; (815) 394-3263.

The MAX630 dc-dc converter, which has a fixed 50% duty cycle, achieves regulation by skipping cycles as necessary. This is fine for voltage-doubling applications, but for large step-up ratios, the inductor dumps its energy very quickly and the converter idles for the remainder of the cycle. As a result of this action, output power becomes less than optimal.

This 3- to 15-V converter circuit sidesteps that problem (see the figure). The oscillator circuitry has been modified to increase the duty cycle to 80%.

The  $C_X$  pin on the MAX630 is a bidirectional current source that's intended to charge and discharge a capacitor to produce a 50% duty cycle. Here, capacitor  $C_1$  is charged normally through diode  $D_1$ , but

the capacitor is discharged in one-fourth the time through transistor  $Q_1$  and resistor  $R_1$ .

The resulting output power rating depends on the tolerances of the component chosen and the input volt-

age range. But in any case, it's about 1.6 times that of the standard circuit. □

## IFD WINNER

IFD Winner for November 8, 1990

**James Wong**, Analog Devices, Precision Monolithic Div., 1500 Space Park Dr., P.O. Box 58020, Santa Clara, CA 95052; (408) 727-9222. His idea: "Add Programmable Gain, Attenuation."

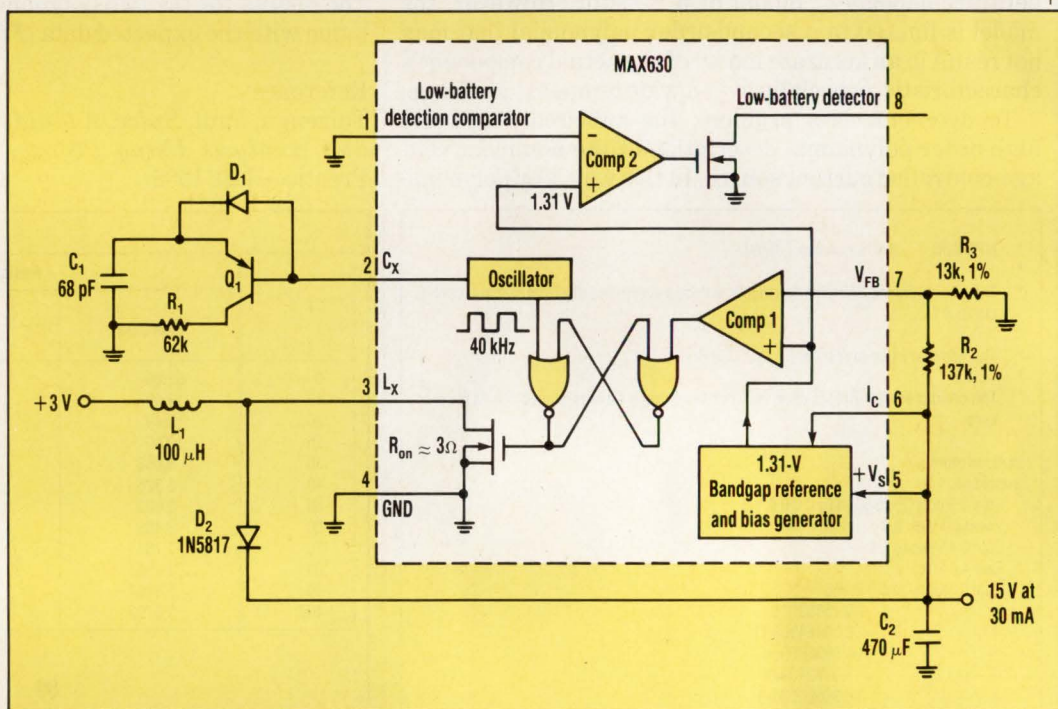

**THIS CIRCUIT USES DUTY-CYCLE CONTROL** to increase the dc-dc converter power.  $Q_1$  increases the converter's duty cycle by speeding up  $C_1$ 's discharge by a factor of four.

# CIRCLE 523 FREQUENCY DIVIDER IS PROGRAMMABLE

STEVEN R. BLACKWELL

UDS/Motorola, 5000 Bradford Dr., Huntsville, AL 35805; (205) 430-8112.

Frequency-divider circuits are used in a wide variety of devices, and programmable frequency dividers are often required so that these devices can operate in multiple modes. This circuit offers a simple, inexpensive divider that can be programmed to divide by

any integer from 2 to 65 (Fig. 1). It employs a variable-length shift register (4557), a D-type flip-flop (1/2 74HC74), and an inverter (1/6 74HC14). The circuit is self-starting, so it doesn't need an external reset and doesn't have any undefined "hang-up" states, unlike many other

divider circuits. This is critical in the design of timers that can't be easily monitored and controlled from a processor.

The circuit's operation is illustrated by its timing diagram. The flip-flop's input is connected to the output of the 4557, so the flip-flop simply latches the output of the shift register. The clock phase is inverted between the two devices, enabling their outputs to change on opposite clock edges. The flip-flop's output is fed back into the 4557's reset input. The 4557's serial input is tied high, so each clock pulse shifts another "1"



# Our quad high-side driver is the perfect switch for your intelligent environment.

Offering four independent 1A switches.

The LMD18400, the industry's first and only quad high-side switch, truly has a mind of its own.

Our intelligent solution has four independent power switches, each with a separate ON/OFF control. They're capable of driving 1A continuous and 3A peak loads. Together, they have a rating of 6A peak.

Our quad design achieves a higher level of integration and saves you a valuable chunk of real estate.

What's more, it drives every possible load: resistive, capacitive, and inductive. Making it the ideal design for automotive and far-reaching industrial applications.

Communicating with 11 diagnostic checks.

With a built-in serial interface, the LMD18400 provides extensive diagnostic data to a  $\mu\text{C}$  or  $\mu\text{P}$ , including switch status readback, output-load fault conditions, and thermal and overvoltage shut-down status.

Which results in bidirectional, real-time communications that can prevent blowouts, minimize downtime, and maximize your system performance.

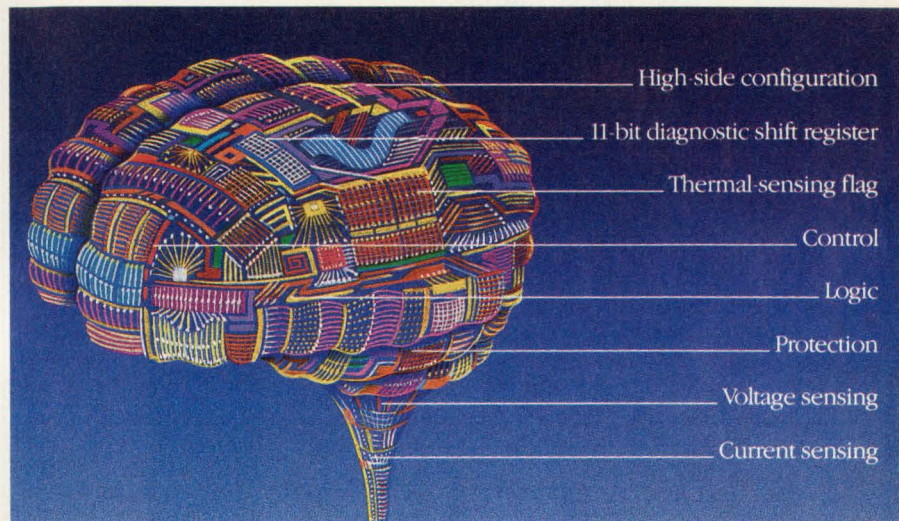

Providing unparalleled protection.

By integrating CMOS, DMOS, and bipolar on the same chip, we're able to deliver an optimized, mixed analog + digital technology for power, control, and protection.

action. And should the temperature reach  $170^\circ$ , the device automatically shuts down. A critical feature that can make your design less susceptible to damage.

It also means voltage and current sensors, which prevent burnout with an instantaneous power limit of 15W. And due to its high-side configuration, an accidental short wouldn't ground the battery.

Make the intelligent switch.

For your LMD18400 design kit, call or write us today.

And get an inside look at the brains behind the brawn.

1-800-NAT-SEMI, Ext. 107  
National Semiconductor Corp.  
P.O. Box 7643  
Mt. Prospect, IL 60056-7643

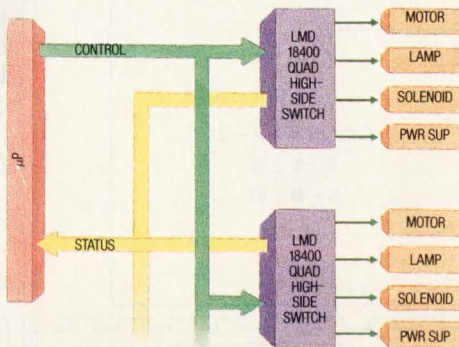

Parallel operation of LMD18400s

Fail-safe protection. Which means a two-stage thermal warning system that sends a distress flag to the host system at  $145^\circ$ , giving you ample time to take corrective



# IDEAS FOR DESIGN

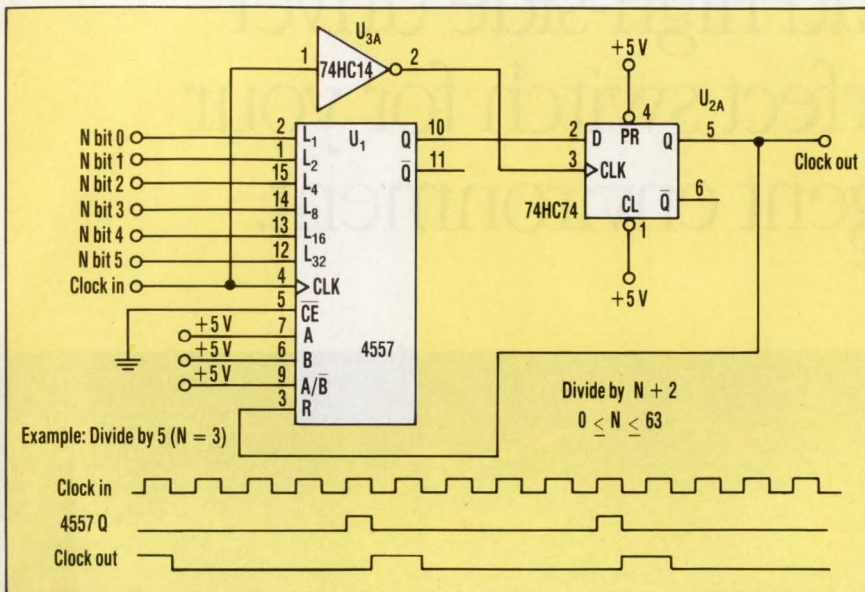

**1. THIS SIMPLE, INEXPENSIVE FREQUENCY DIVIDER** circuit can be programmed to divide by any integer from 2 to 65. The actual frequency division equals  $N + 2$ , where  $N$  is from 0 to 63. When  $N = 3$ , as shown in the timing diagram, the circuit divides by 5.

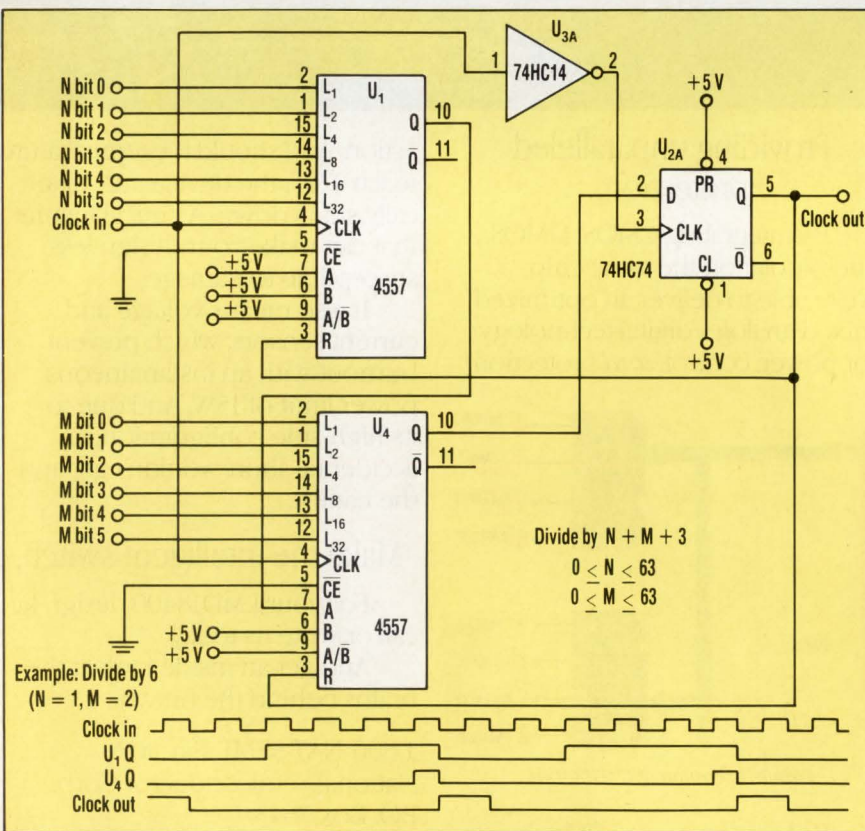

**2. BY ADDING A SECOND SHIFT REGISTER**, the range of programmability can be extended. The first shift register's output is fed into the input of the second. In essence, the two parts act as a single shift register with a length of  $(N + 1) + (M + 1)$ . The timing diagram shows a division by 6.

into the 4557.  $N + 1$  cycles after the reset pulse is removed, the first 1 will propagate to the shift register's output. The 1 is latched into the flip-flop on the clock's next falling edge and then fed back to the 4557 reset pin, causing the shift register's contents to be set to 0.

The reset is removed when a 0 is clocked into the flip-flop on the next falling clock edge, restarting the process. No external reset is required to start the divider. This is because a 1 will propagate to the shift register's output within the first  $N + 1$  clock cycles to supply the first reset pulse, regardless of the 4557's power-up state.

The length-control inputs ( $N$ ) of the 4557 set the divide ratio. The shift register will have a length of  $N + 1$ , where  $N$  can be set to any integer from 0 to 63. One clock cycle is taken for the reset pulse, so the total divide count is  $N + 2$ .

Some applications require a symmetrical output clock. An extra flip-flop can be added at the output to perform a divide by 2, producing a symmetric output.

The divider circuit's range of programmability can be easily extended by increasing the shift register's effective length. This is done by adding one or more 4557s (Fig. 2). The output of the first shift register ( $U_1$ ) is fed into the serial input of the second shift register ( $U_4$ ), whose output drives the flip-flop. The 4557s' clock inputs are tied together, as are the reset inputs. As a result, the two chips act as one shift register of length  $(N + 1) + (M + 1)$ . The circuit's divide count is now  $(N + 1) + (M + 1) + 1$ , or simply  $N + M + 3$ , offering a divide range of 3 to 129. This technique can be extended to any number of shift registers, with each register adding  $N + 1$  to the divide count. □

## Send in Your Ideas for Design

Address your Ideas-for-Design submissions to Richard Nass, Ideas-for-Design Editor, Electronic Design, 611 Route 46 West, Hasbrouck Heights, NJ 07604.



# Complete Family Of High Performance D/A Converters

Burr-Brown offers one of the industry's most complete line of high performance digital-to-analog converters. High quality and reliability are assured by our 35+ years of microcircuit design and manufacturing experience. Key features include:

- wide selection of 12-bit, 16-bit, and 18-bit resolution DACs with many performance options
- $\mu$ processor-compatible DACs with double-buffered latches
- zero-chip interface DACs for digital signal processing and digital audio applications
- low cost, low power, CMOS DACs
- variety of package options

## New Family Members

### Complete 12-Bit DAC813

- $\pm 1/2$ LSB linearity error
- $\mu$ processor interface
- 270mW max power dissipation
- compact 0.3" wide DIP, SOIC
- from \$11.90\*

### Dual 12-Bit CMOS DAC7800/01/02

- 8-bit, 12-bit, serial port interface
- single +5V supply
- 4 quadrant multiplying
- 0.3" wide DIP, SOIC
- From \$12.35\*

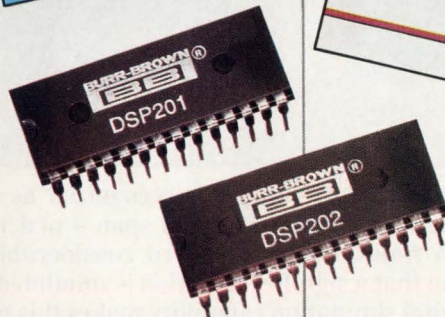
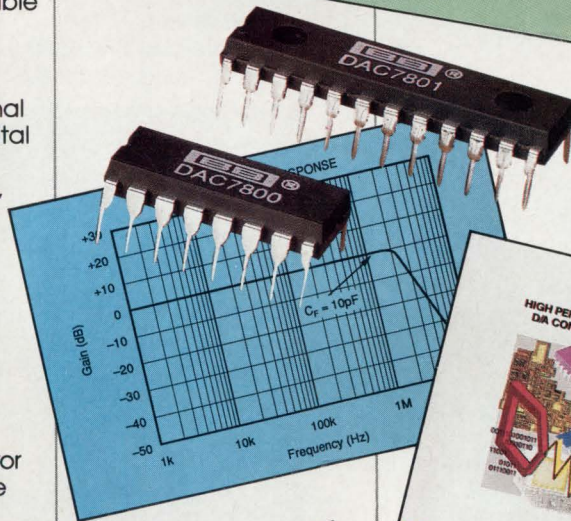
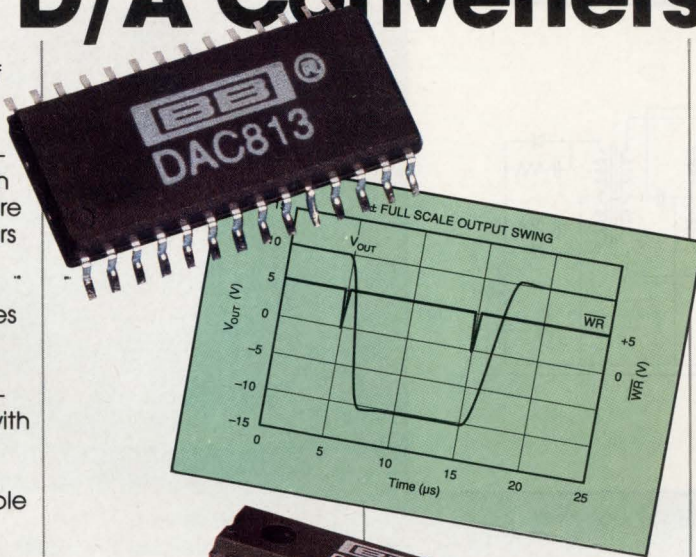

### Single/Dual 18-bit DSP201/202

- zero-chip interface to most popular DSP ICs
- 500kHz update rate
- 90dB Signal-to-Noise +Distortion
- -92dB THD
- from \$24.95\*

### Low Power, 12-Bit DAC667

- drop-in AD667 replacement
- 390mW max power dissipation
- fast 60ns digital interface
- $\pm 10$ V out on  $\pm 12$ V to  $\pm 15$ V supplies
- From \$11.90\*

## Free Selection Guide

Our new *High Performance D/A Converters* guide contains key product specs, performance diagrams, applications information and examples of our newest D/A converters. Ask your Burr-Brown sales representative for a copy, or call **1-800-548-6132** for immediate assistance.

Burr-Brown Corp.  
P.O. Box 11400  
Tucson, Az 85734  
\*U.S. OEM prices, in 100s.

**BURR-BROWN®**  
**BB**





## The Standard for Circuit Simulation Switch-Mode Power Supply Design

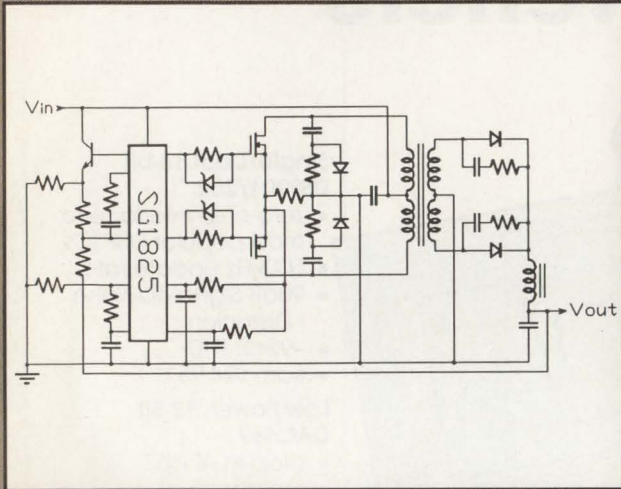

Current mode power supply schematic.

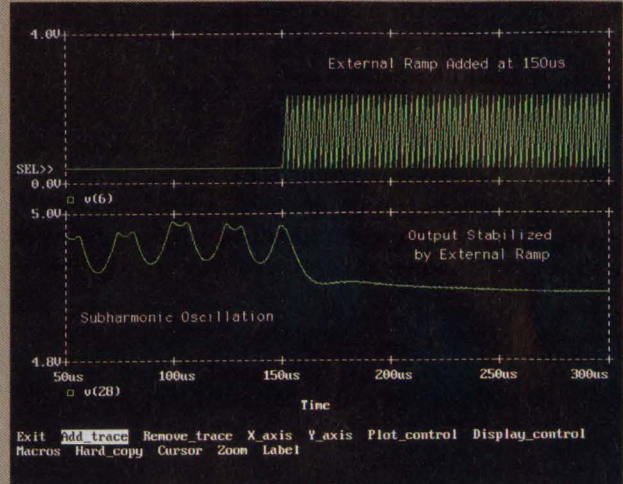

Power supply simulated using mixed analog/digital simulation. Plot shows subharmonic oscillation being suppressed by external ramp.

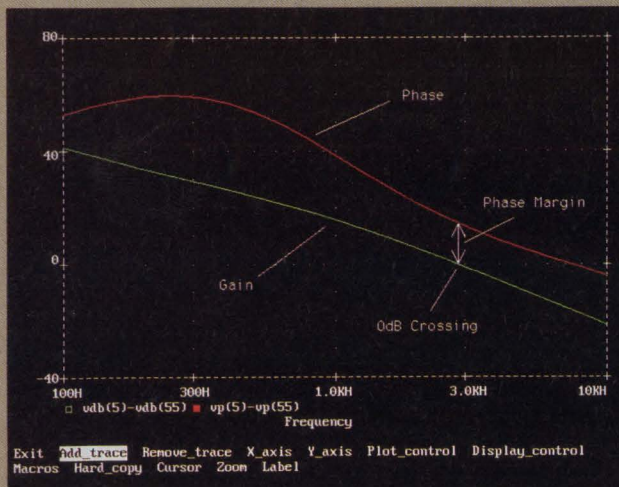

Simulation using the Vorperian switch model to examine the stability of a power supply.

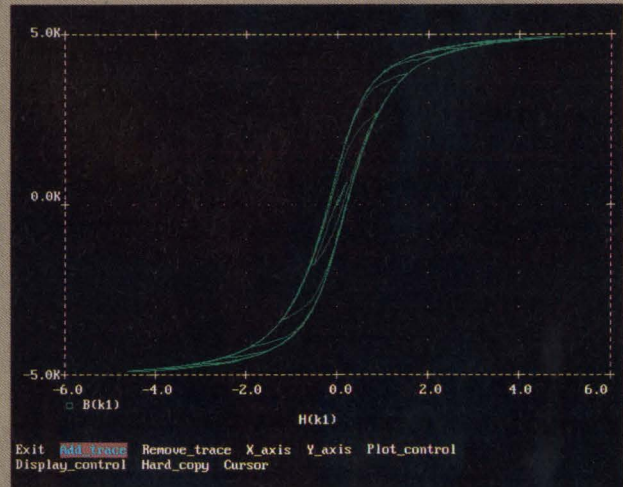

Hysteresis curve of transformer.

A cycle by cycle simulation of switch-mode power supplies is recognized as a difficult simulation task for SPICE-based simulators, which must cope with timings that can span 4 orders of magnitude. This problem invariably results in very long simulation times, but is improved considerably by MicroSim's approach of building the controller macromodel chips so that a significant section is simulated in the digital domain. PSpice's behavioral modeling and mixed analog/digital simulation capability makes this possible.

PSpice is available on the IBM-PC (running DOS or OS/2); Macintosh II; Sun 3, Sun 4, and SPARCstation; DECstation 2100, 3100, and 5000; and the VAX/VMS families. In addition to the PWM macromodels, the PSpice library contains over 3,500 analog and 1,500 digital parts which can be used in a variety of applications. Our technical staff has over 150 years of combined experience in CAD/CAE, and our software is supported by the engineers who wrote it.

For further information about the PSpice family of products, call us at (714) 770-3022, or toll free at (800) 245-3022. Find out for yourself why PSpice has become the standard for circuit simulation.

20 Fairbanks • Irvine, CA 92718 USA • FAX (714) 455-0554



# ELECTRONIC DESIGN QUICK LOOK

EDITED BY SHERRIE VAN TYLE

## MARKET FACTS

**F**ueled by brisk demand for RISC chips in workstations, sales of 32-bit microprocessors should amount to \$1.37 billion this year, a 10% increase over last year's revenues. This prediction comes from Market Intelligence Research Corp.

Nonetheless, the overall growth rate for 32-bit processors is tapering off, according to the Mountain View, Calif., market researcher.

Next year should see just a 3% increase over 1991. Compare that with 1988's revenue increase of 169% over 1987. The compound annual growth rate from 1989 to 1996 is expected to be 3.8%.

The 32-bit processor market is made up of CISC and RISC processors, with the latter showing faster growth. In 1989, revenues for CISC microprocessors amounted to \$1.06 billion compared with \$60.3 million for 32-bit RISC processors. By 1993, sales in the 32-bit CISC arena will inch up to \$1.07 billion vs. \$349.5 million for 32-bit RISC processors.

From the performance standpoint, the speed of RISC processors is increasing sharply, from today's 12 MIPS standard to at least 100 MIPS by 1995. Another trend is merging CISC and RISC architectures. Multiprocessing also is enabling vendors to pack more system punch while still relying on standard microprocessors.

As for software, the Unix operating system holds the lead for 32-bit processors, with C as a programming language. Underlying this trend is a growing emphasis on portability and compatibility among systems.

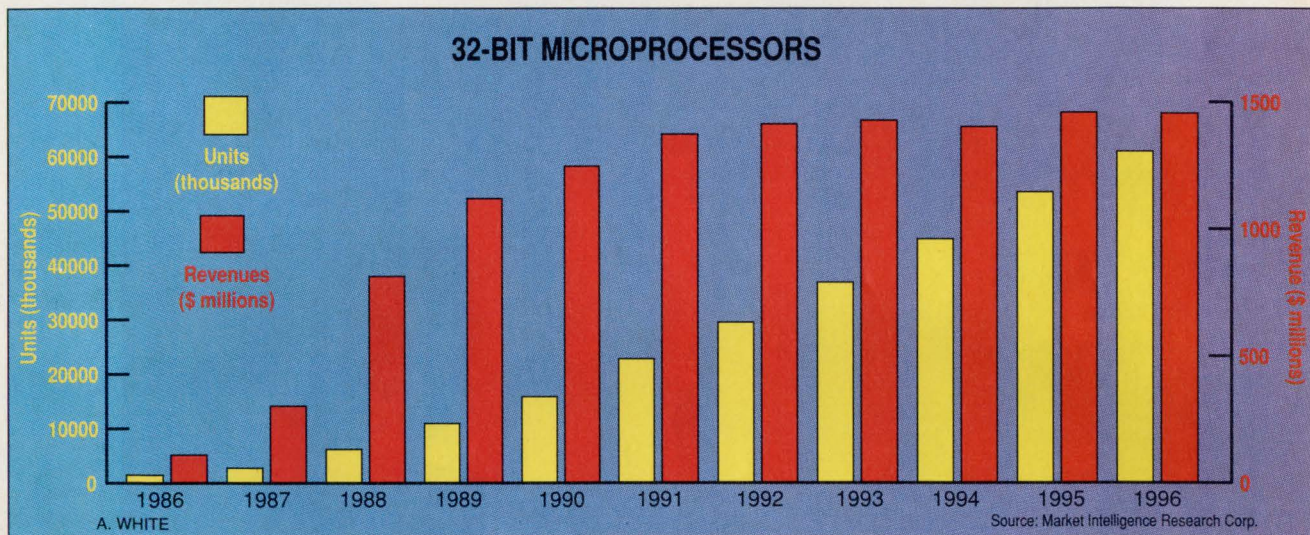

## OFFERS YOU CAN'T REFUSE

**E**ntrepreneurs take note: Free software can help you find out if you qualify for a business loan. First Step Review, developed by the National Business Association and the U. S. Small Business Administration, gives an orientation to the SBA guaranteed-loan program. The program asks for information about the applicant seeking the loan, which it evaluates and scores. A score of 70 or above suggests that the applicant has a good chance to receive a loan. With the program, an applicant can do "what-if" analyses to see how the application can be improved. Results include an approximate monthly payment at various interest rates.

Contact the National Business Association, First Step Review Program, P. O. Box 870728, Dallas, TX 75287; (800) 456-0440.

**P**ersonal computers drop in value—by up to one-third—the moment they're plugged in. One way around this is to buy used PCs. A brochure, "How to Buy or Sell in the Used Computer Marketplace," is free from the National Comput-

er Exchange, New York, N. Y. The brochure describes the quickest, most convenient way to buy or sell Macintoshes, 386s, 286s, XTs, PS/2s, portables, laptops, Apple II, and laser printers.

For more information, contact NACOMEX, 118 East 25th St., New York, NY 10010; (212) 614-0700; fax (212) 777-1290.

**T**he Cosmic Software Catalog lists abstracts of 1200 scientific programs made available under NASA's Technical Utilization Program. The abstracts explain the program's capabilities and note the programming language, machine requirements, size, and price of the source code and supporting documentation. The printed and microfiche catalogs contain a keyword index; the disk versions have a search menu. Source code is usually included, and educational discounts may apply. The catalog sells for \$25 in print or in microfiche; a DOS disk is \$30; the international version costs \$60. For further information, contact the Cosmic catalog order department at (404) 542-3265; fax (404) 542-4807.



# Motorola's In Real



© 1990 Motorola, Inc. Motorola Computer Group is a member of Motorola's General Systems Sector. VMEExec is a trademark of Motorola, Inc. All other product or brand names mentioned are trademarks or registered trademarks of their respective holders.





# -Time, Big-Time.

**O**ne glance at the full array of options Motorola offers in real-time, and you'll see why it's become the developer's platform of choice. For both target and host environments, no other single vendor has anything like it.

One reason is our long-time experience with real-time technology, beginning with our pioneering work back in 1980. Another is the broad spectrum of our product line, which includes ICs, boards, systems, and software. In short, Motorola has everything you need to build real-time applications ranging from simulation to industrial automation to imaging and more.

Yet another reason to choose Motorola is our unending commitment to open standards. Our real-time platform gives you standards-based choices at various levels of integration. The centerpiece of this non-proprietary approach is VMEexec™, our wide-open, totally integrated development environment. VMEexec allows you to use standard UNIX® interfaces to write a single set of application code, and then reuse it for other projects. Better still, you can combine any software product that conforms to these standards. VMEexec includes a high-performance real-time executive, a strong run-time connection to UNIX-based systems, flexible and efficient real-time I/O and file systems, as well as powerful development and debug capabilities. And because VMEexec is integrated with the hardware, you can begin

software development even before the hardware is available.

If you're thinking about real-time, you should be thinking about time to market, and that's all the more reason to think Motorola. Especially when you consider that we can help speed product integration by serving as a single source for boards, software and systems. Add to that the industry's best applications expertise and design support, ranging from small embedded control systems to multi-processor simulation. Then factor in Six Sigma quality control. And remember that Motorola gives you the industry's only true migration path from

**CISC  
RISC**



Right now, Motorola real-time systems are hard at work in critical applications worldwide.

CISC to RISC in both the development and run-time environments.

Give us a call today at 1-800-624-8999, ext. 230, and put the real-time resources of Motorola on your side. We think you'll find the benefits are very big, and very real.

## We Do Real-Time Full-Time.

**A**t Motorola, we've dedicated an entire division solely to real-time development systems. Our real-time system architecture begins at the micro-processor level in either CISC or RISC, and

extends all the way to the end-user. Today, you can use VMEexec to port UNIX applications to an SVID-compliant (and soon, POSIX-compliant) real-time environment, and vice versa. And they can be used for run-time capabilities as well

as for development. Several human interfaces are available for UNIX, including Motif, X.11 and DeltaWINDOWS™. As for networking, Motorola supports all popular protocols, including TCP/IP, NFS, SNA, OSI, and X.400. We also offer database and CASE tools, and you can work in C, LISP, FORTRAN, ADA, BASIC, COBOL, and PASCAL. Put it all together, and you will discover only one company gives you the full story on real-time, and that's Motorola.

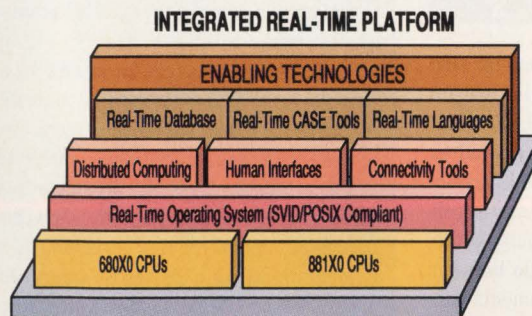

**MOTOROLA**  
Computer Group



## BEST SELLERS

**Which technical books are the most popular in Silicon Valley?**

### ELECTRONICS:

1. *Noise Reduction Techniques in Electronic Systems*, 2nd ed. by Henry W. Ott. Wiley, 1988. **\$47.95.**
2. *Microchip Fabrication*, 2nd ed. by Peter Van Zant. McGraw-Hill, 1990. **\$49.50.**
3. *Art of Electronics*, 2nd ed. by Paul Horowitz and Winfield Hill. Cambridge University Press, 1989. **\$49.50.**
4. *C Language Algorithms for Digital Signal Processing*. Paul M. Embree and Bruce Kimble. Prentice-Hall, 1991. **\$50.**
5. *Principles of Electronic Packaging*. Donald P. Seraphim, Ronald Lasky, and Che-Yu Li. McGraw-Hill, 1989. **\$56.95.**

### COMPUTER SCIENCE:

1. *Object-oriented Design with Applications* by Grady Booch. Addison Wesley, 1990. **\$37.25.**
2. *Programming Windows*, 2nd ed. by Charles Petzold. Microsoft Press, 1990. **\$29.95.**
3. *Postscript Language Reference Manual*, 2nd ed. Adobe Systems Inc. Addison-Wesley, 1990. **\$28.95.**
4. *Computer Architecture: A Quantitative Approach* by John Hennessy and David Patterson. Morgan Kaufman, 1990. **\$54.95.**
5. *Introduction to Algorithms* by Thomas H. Cormen, Charles E. Leiserson, and Ronald L. Rivest. McGraw-Hill, 1990. **\$49.95.**

This list is compiled for *Electronic Design* by Stacey's Bookstore, 219 University Ave., Palo Alto, CA 94301; phone (415) 326-0681; fax (415) 326-0693.

## HOT PC PRODUCTS

**A** universal frequency counter-timer fits on a 9-in. add-in card for PCs. It uses Windows 3.0 as a control panel and display window. The PC-10 counter timer from Optoelectronics measures, captures, and analyzes discrete and average frequency readings, pulse width, time interval, period, and the ratio between two frequencies. The unit's assignments window controls input and reference signal conditions like gain, prescaler, input impedance, polarity, hysteresis, interval, and ratio. List price is \$335. Contact Optoelectronics, 5821 N.E. 14th Ave., Fort Lauderdale, FL 33334; (800) 327-5912 or (305) 771-2050.

## DID YOU KNOW?

... that high-tech products that come to market six months late but on budget will earn 33% less profit over five years. In contrast, products that come out on time yet 50% over budget diminish profits by a scant 4%.

McKinsey & Co.

## K M E T ' S K O R N E R

### ...Perspectives on Time-to-Market

**BY RON KMETOVICZ**

President, Time to Market Associates Inc.  
Cupertino, Calif.; (408) 446-4458; fax (408) 253-6085



**I** struggled with the creation of project models over about 10 years. I tried an assortment of techniques based on a variety of project-management software tools. A major advance, which had nothing to do with the tools I used, materialized in 1985. At that time, I was managing Hewlett-Packard's program to develop the 8770A Arbitrary Waveform Synthesizer. It was a development effort that was taking place in locations scattered across the western United States.

I knew that a model of the entire development effort was absolutely essential for us to achieve our development goals within this distributed, concurrent engineering environment. Armed with an Apple Macintosh 512k loaded with MacProject, I set out singlehandedly to create the model. It took me about two weeks to build an activity network that contained 200 elements. I was working in a paperless environment, going from brain to MacProject. Placing the first 30 or so tasks was easy and fun.

After that, the creation, placement, arrangement, and connection of the remaining 170 elements became quite a chore. With the creation of each task, I had to estimate its duration, assign resources, and establish predecessor and successor relationships. I gave my best effort at doing this for all 200 elements. With data entry complete, I ran a printout from the Imagewriter. A few hours and a few rolls of Scotch tape later, a new layer of wallpaper was decorating my office wall. Of course, seeing the network model in this form for the first time made it necessary to go back and make a few adjustments. When I felt that I had reached the point of diminishing returns, I stopped creating the model and took it out for a reality test.

The model was given to every individual that I had in the resource listing for critical analysis, comment, and revision. I explained to each person why the network looked the way it did. These people explained to me why I was wrong and what I should do about it. It was either get humble or disappear—I chose humility. Then I methodically updated the entire model in about a week, based on the feedback supplied by the project participants. Where things did not look right, I asked responsible people to help me or I called them on the phone to make them a part of the decision process. Trace elements of a shared planning process began to appear.

This revision went out for review by all participants. I took this baseline version of the plan to functional and general management, which fully committed all the resources identified in the plan to execute the project. I now had a model of reality for myself and the entire 8770A new product-development team.

For me, doing the 8770A project with a network model completely eliminated the possibility of ever doing another project without one. It's an essential element in the characterization of the new product development process. However, creating this model taught me a number of valuable lessons for improvement when building a model for my next project/program. And I began to form a clear idea of how to help others model and plan their work.

*Ron Kmetovicz will lead a Time to Market seminar entitled "Speeding New Ideas to the Marketplace" at Santa Clara University's Executive Development Center, to be held April 25, 1991. For more information call Elmer Luthman, center director, (408) 554-4521; fax (408) 554-4571.*



## TIPS ON INVESTING

**F**utures funds offer engineering investors a way to diversify their portfolios and participate in the world market. Consider typical questions investors might ask:

**Q.** What is a futures fund?

A futures fund is a way to participate in a wide variety of financial commodity markets. Such funds offer potential for substantial gain without taking on many of the significant risks often associated with speculative commodity trading.

**Q.** How are futures funds structured and what do they invest in?

They are structured as limited partnerships where your losses and liability are limited to the amount you actually invest. The funds often invest in traditional commodity markets such as agricultural products and precious metals and energy (for example, crude oil, gasoline, and heating oil). Trading in these markets often allows you to participate in trends that can run counter-cyclical to a declining stock market. This diversification can be beneficial for the traditional portfolio.

Futures funds also invest in the worldwide financial markets such as foreign currencies (the yen and the deutsche mark, for example), international interest-rate instruments, and stock-market indexes.

**Q.** Who should invest?

Futures transactions often involve substantial risk and aren't suitable for every engineering investor. If you've built a solid portfolio of investments to meet your basic financial needs and can put some risk capital to work, you might consider the futures markets and the limited partnership structure of a futures fund.

**Q.** Who manages the trading in a futures fund?

As the limited partnership structure of a futures fund limits the risk of trading in commodities, the use of a professional commodity trading adviser (CTA) to manage the money may enhance the potential for returns.

Successful commodity trading requires a full-time commitment to these fast-moving markets. The CTA analyzes markets, develops sophisticated trading strategies, invests the funds assets, monitors positions, and determines when to take a profit or limit a loss.

**Q.** What is the minimum investment?

For most funds, you may invest as little as \$5,000. For retirement plan accounts—IRA and Keogh plans—you may invest as little as \$2,000. A portion of the assets also earn interest, an important source of income that helps defray management fees, which are generally 3% to 4% of net assets. In addition, incentive fees are paid to the CTA when the fund makes money. These fees generally range from 10% to 20% of profits for most public funds. Commissions range from 8 to 10% of the fund's trading assets. When considering a futures investment, note that rate of return is usually quoted after these fees and expenses are deducted.

To see if a futures fund is appropriate for your overall portfolio, talk it over with your financial consultant.



*Henry Wiesel is a financial consultant with Shearson Lehman Bros, 1040 Broad St., Shrewsbury, NJ 07702; (800) 631-2221, (800) 221-0073 in N.J. Wiesel invites questions and comments from readers.*

## MICROPROCESSOR SURVEY

### WHAT OTHER ICs DO YOU USE IN YOUR MICROPROCESSOR-BASED SYSTEM?

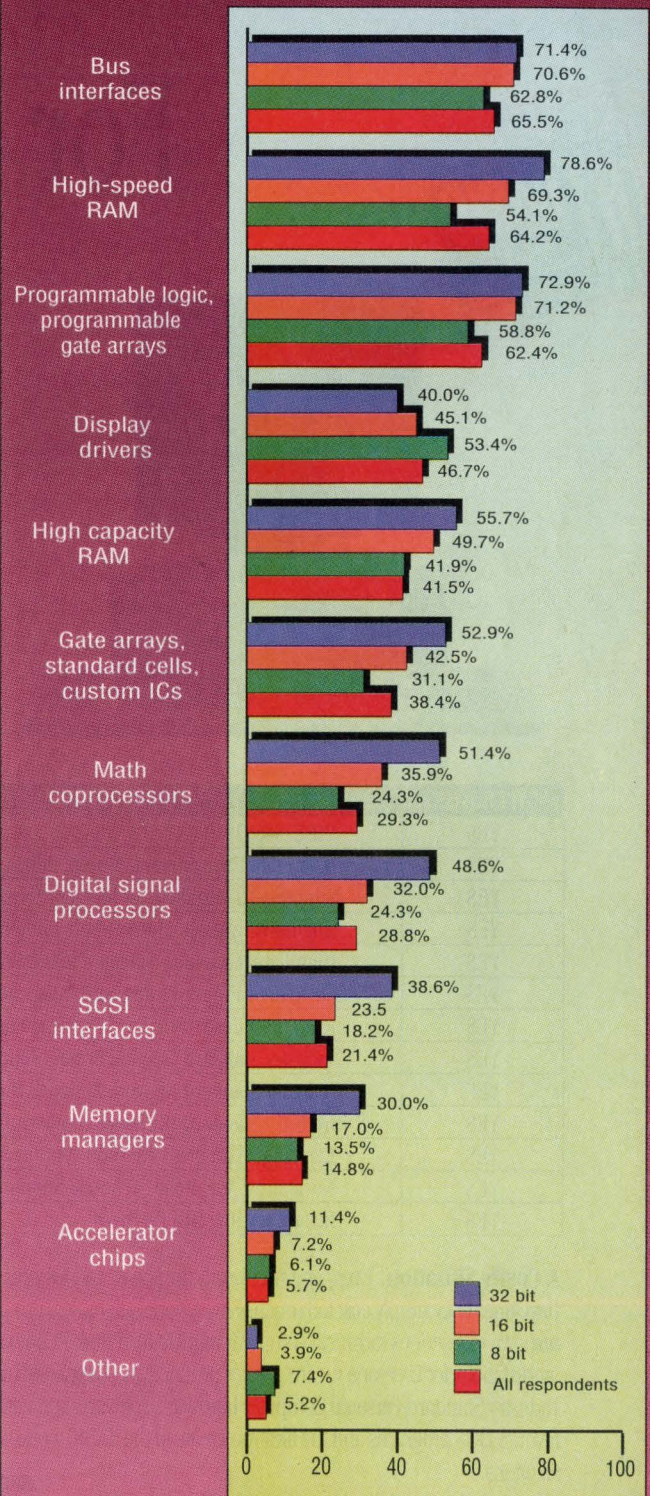

Source: a survey of Electronic Design readers conducted by the Adams Co., Palo Alto, Calif.



# All the features of HP BASIC, and more. For less.



HTBasic	BASIC FEATURES:	HP BASIC
YES	IEEE-488 GPIB (HP-IB), RS-232 Instrument Control	YES
YES	Integrated Environment: Mouse, Editor, Debugger, Calculator	YES
YES	Supports 16 Megabytes of Memory (breaks DOS 640K barrier)	YES
YES	Engineering Math: Matrix Math, Complex Numbers	YES
YES	High Level Graphics: Screen, Plotter, Printer	YES
YES	Structured Programming with Independent Subprograms	YES
YES	Runs on Industry Standard Personal Computers	NO*
YES	Industry Standard Graphic Printer Support: Epson, IBM, lasers, etc.	NO
YES	Industry Standard Network Support: Novell, IBM, Microsoft, NFS, etc.	NO
YES	Industry Standard IEEE-488 Support: National Instruments, Iotech, etc.	NO
YES	Exchange data files with Industry Standard PC applications	NO*
YES	No-charge Telephone Technical Support	NO
YES	Instant on-line HELP system	NO

**A Costly Situation.** Every engineer needs the power and features of a "Rocky Mountain" BASIC workstation, but not everyone can have one. They simply cost too much. Fewer workstations, less productivity. **The Best Way.** TransEra HTBasic software provides the *only* way for serious technical computer users to turn their PC into a workstation without having to add costly hardware. Powerful workstations for everyone means greater productivity. **Extraordinary Versatility.** In addition, TransEra HTBasic works with the Industry Standard Personal Computer hardware, software, and networks. It even allows you to easily exchange data between your favorite DOS programs and the files you create in the BASIC workstation environment. All at a fraction of the cost of other solutions.

More compatibility. More versatility. More possibilities.  
Less expense. Less hassle.

To find out more, call 1-801-224-6550.

**TransEra**  
Engineering Excellence for 15 Years™

CIRCLE 98

\* Without the addition of a costly 68000 co-processor. © Copyright 1990 TransEra Corporation. All rights reserved. HP, HP BASIC, and HPIB are registered trademarks of Hewlett-Packard Co.





# WHAT'S ALL THIS STATISTICAL STUFF, ANYHOW?

I've always been a fan of Mark Twain and his writing. He had a rather good perception of the American people, and many topics that he wrote about are fascinating to this day. One of my favorite quotes of Twain is: "There are three kinds of lies: there are 'lies,' there are *damned lies*, and there are *STATISTICS*...."

One thing that doesn't help me a darned bit is "statistics," at least in the sense that most mathematicians and engineers use them. I find most statistical analyses worse than useless. But I *do* like to use charts and graphs. I took some data of diodes'  $V_F$  versus  $I_F$  recently. The data was a little suspicious when I wrote down the numbers, but after I plotted the



**BOB PEASE**  
OBTAINED A  
BSEE FROM MIT  
IN 1961 AND IS  
STAFF SCIENTIST  
AT NATIONAL  
SEMICONDUCTOR  
CORP.,  
SANTA CLARA,  
CALIF.

data, I *knew* there was something wrong. Then I just went back and took more data until I understood what the error was, ac current noise that was being pumped out of the inputs of the digital voltmeter, crashing into the diode, and causing rectification. If data arises from a well-behaved phenomenon and conforms to a nice Gaussian distribution, then I don't care if people use their statistical analyses—it may not do a *lot* of harm. (Personally I think it does harm, because when

you use the computer and rely on it like a crutch, you get used to believing it and trusting it without thinking....) However, when the data gets screwy, classical statistical analysis is worse than useless.

For example, one time a test engineer came to me with a big formal report. Of course, it didn't help that it arrived at 1:04 P.M. for a Production Release Meeting that was supposed to start at 1:00 P.M. But this was not just any hand-screwed report. It was handsome, neat, and computerized; it looked professional and compelling. The test engineer quoted many statistical items to show that his test system and statistical software were great (even if the ICs weren't). Finally he turned to the last page and explained that, according to the statistics, the ICs' outputs were completely incompetent and way out of spec. Thus, the part could not be released.

In fact, he observed, the median output of the output was 9 V, which was pretty absurd for the logical output of an LM1525-type switching regulator, which could only go to the Low level of 0.2 V or the High level of 18.4 V. How could the outputs have a median level of 9 V?

How do you get an R-S flip-flop to hang up at an output level half-way between the rails? Unlikely.... Then he pointed out some other statistics—the 3 sigma values of the output were +30 V and -8 V. Now, that's pretty bizarre for a circuit that only has a +20-V supply and ground, (and it isn't running as a switching regulator, it's just sitting there at dc). The meeting broke up before I could find the facts and protest, so that product

wasn't released on schedule.

It turns out, of course, that the tester was running falsely. So while the outputs were all supposed to be *set* to +18.4 V, they were actually in a random state. Half of the time the outputs might be at 18.4 V and half of the time at 0.2 V. If you feed this data into a statistical program, it might indeed tell you that a lot of the outputs would be at +9 V, and some of the outputs might be at -8 V, assuming that the data came from a Gaussian distribution. But if you *look* at the data and *think*, it's obvious that the data came from a ridiculous situation. Rather than ramming the data into a statistical format, the engineer should have checked his tester.

Unfortunately, this engineer had so much confidence in his statistical program that he spent a whole week preparing the Beautiful Report. Did he inform the design engineer that there were some problems? No. Did he check his data, check the tester? No. He just kept his computer cranking along, because he knew the computer analysis was the most important thing.

We finally fixed the tester and got the product out a little late, but obviously I wasn't a fan of that test engineer (nor his statistics) as long as he was at our company. And that's just one of a number of examples I trot out when anybody tries to use statistics that are inappropriate.

I do like to use scatter plots in two dimensions to help me look for trends, and to look for "sports" that run against the trend. I don't look at lots of data on good parts or good runs, but I study the *heck* out of bad parts and bad runs. And when I work with other test engineers who have computer programs that facilitate these plots, I support and encourage those guys to use those programs, and to *look at* their data, and to *think* about those data. I support anything that facilitates thinking.

A couple years ago, I was approached by an engineer who was trying to use one of our good voltage references with a typical characteristic of about 20 ppm per 1000 hours long-term stability at +125°C. He



## PEASE PORRIDGE

was using it around room temperature, and was furious because he expected it to drift about 0.1 ppm per 1000 hours at room temp, and it was a *lot* worse than that. He asked why our reference was no good. I pointed out that amplifiers' drifts and references' drifts do *not* keep improving

by a factor of 2 every time you cool them off another 11 degrees more.

I'm not sure who led him to believe that, but in general, modern electronic components aren't greatly improved by cooling or the absence of heating. In fact, those of us who remember the old vacuum-tube days

remember that a good scope or voltmeter usually worked better if you kept it running nice and warm all the time, because all of the resistors and components stayed dry and never got moist under humid conditions. I won't say that the electrolytic capacitors might not have liked being a little cooler. But the mindless effort to improve the reliability by keeping components as cool as possible has been overdone. I'm sure you can blame much of that foolishness on MIL-HBDBK-217 and all its versions. In some businesses, you have to conform to -217, no matter how silly it is, but in the industrial and instrument business, we don't really have to follow its every silly quirk and whim.

One guy who argues strenuously about -217 is Charles Leonard of Boeing, and you may well enjoy his writing (Leonard, Charles, "Is reliability prediction methodology for the birds?," *PowerConversion and Intelligent Motion*, November 1988, p. 4). So if something is drifting a little and you think you can make a big improvement by adding a fan and knocking its temperature down from +75 to +55°C, I caution you that you'll probably be disappointed because there usually isn't a lot of improvement to be had. It's conceivable that if you have a bad thermal pattern causing lots of gradients and convection, you can cut down that kind of thermal problem. In general, though, there's not much to be gained unless parts are getting up near their maximum rated temperature or above +100°C. Even plastic parts can be pretty reliable at +100°C. I know the ones I'm familiar with are.

(This column is an excerpt from the soon-to-be-published book I have written entitled "Troubleshooting Analog Circuits." This endeavor will be published by Butterworths in April 1991.)

All for now. / Comments invited! /  
RAP / Robert A. Pease / Engineer

ADDRESS:  
Mail Stop C2500A  
National Semiconductor  
P.O. Box 58090  
Santa Clara, CA 95052-8090

## Good Sines & Bad Signs

Looking for a low-noise, fast-switching signal source?

### Good Sines

Whether it's automatic test equipment, satellite uplinks, EW communications or imaging systems, **Programmed Test Sources** has a frequency synthesizer to fit your needs. GE MRI units, Teradyne Testers, Varian Spectrometers . . . all use **PTS** synthesizers.

### Bad Signs \$\$\$

And while other manufacturers have big dollar signs, **PTS** synthesizers start as low as \$1,950.

**PTS** manufactures a complete line of precision synthesizers covering the 100 KHz to 1 GHz frequency range with switching times as fast as  $1\mu$  second for our **direct digital** models. And plenty of other options as well, like resolution down to .1 hertz (millihertz available as special order), GPIB and digital phase rotation.

Just as important, along with every **PTS** synthesizer comes our "absolutely everything covered" **2-year warranty**. At the end of two years comes our flat \$350 service charge for any repair up to the year 2001! **PTS** has a commitment to quality you won't find anywhere else.

Find out how **PTS** synthesizers used the world over can help you in for your application today. Call for our complete catalog, or to talk to an applications engineer.

Call (508) 486-3008 Fax (508) 486-4495

# PTS

PROGRAMMED TEST SOURCES, Inc.  
9 Beaver Brook Road, P.O. Box 517, Littleton, MA 01460

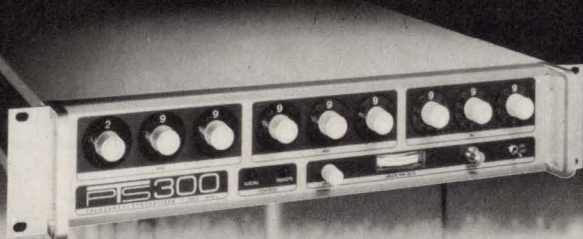

CIRCLE 127



INTERNATIONAL  
DESIGN ENGINEERING  
&  
ASIC EXPOSITION

*idea*

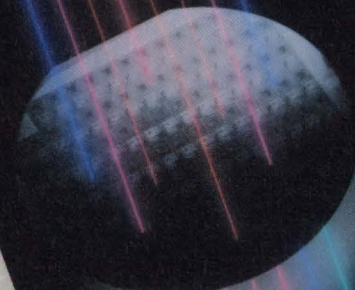

NINETYONE

complimentary  
EXHIBIT  
PASS

April 2 · 3 · 4, 1991

SAN JOSE  
CONVENTION CENTER

**Free**

**Exhibits,**

**Interactive  
Theater,**

**Product  
Showcases**

**and Panels.**

**15% Pre-Registration Discount**

**50 Technical and  
Management Training  
Sessions and Seminars.**

**ASiC**

Sponsored by ASiC Technology & News  
480 San Antonio Road, Suite 245  
Mountain View, CA 94040  
1.415.949.2742

**The year's most important event ...**

**for  
ASIC & EDA users.**

**Explore and analyze ...**

**every major  
ASIC & EDA company.**

**Learn and interact ...**

**with the industry's  
most experienced users.**

**Today's ...**

**issues and solutions.**

**Keynote ...**

**Scott McNealy**  
CEO, Sun Microsystems

**Register Now !**

**1-800-848-IDEA**

1 · 8 0 0 · 8 4 8 · 4 3 3 2



From OC-3 to OC-12...

# Regenerate your SONET signals with our PLL clock and data recovery IC.



**\*\$710**  
\*10,000 quantity

If you are designing a fiber optic receiver subsystem for applications requiring data rates from 100 to 625 Mbit/s NRZ, you should find out more about our PLL-based 16G041-H clock and data regenerator. It's a three terminal (data in, clock and data out) device in a compact 1.25 inch x 1.25 inch flatpack package.

The 16G041-H synchronizes an internal VCO directly to an incoming data stream and simultaneously retimes and regenerates the data, unlike SAW filter clock recovery circuits which first filter the clock signal from incoming data and then retime it. Moreover, the 16G041-H

generates a clock output in the absence of incoming data. The SAW filter does not.

To find out more about our PLL clock and data recovery circuit as well as the other members of our complete high speed fiber optic communications chip family including 16x16 crosspoint switch, limiting amplifier, transimpedance amplifiers, laser diode driver, LED driver, MUX and DEMUX, call us today.

United States and Canada (805) 499-0610, FAX (805) 499-2751

Europe GIGA, +45 4343 1588, FAX +45 4343 5967

Japan Nippon Imex, (81) 3-321-4415, FAX (81) 3-325-0021

Korea Sam Jin Hi-Tech, (82) 2-722-2179, FAX (82) 2-734-0085

**GBL** GigaBit Logic



# REPEATER INTERFACE IC TAKES ON ETHERNET MEDIA

ROBUST  
EXECUTIVE  
AND CONTROL  
FUNCTIONS  
SIMPLIFY  
NETWORK-  
MANAGEMENT  
TASKS FOR  
FUTURE  
ETHERNET  
LANs.

MILT LEONARD

**W**ith proven adaptability to changing user needs, the IEEE 802.3 Ethernet topology is positioned to become the local-area network (LAN) of choice for larger and more complex networks of the future. Adding to Ethernet's popularity is the various data-carrying media it can support, a trend that will stretch into the 1990s. Anticipating such a trend, National Semiconductor Corp. has developed a repeater interface designed for multimedia Ethernet LANs.

The DP83950 repeater interface controller (RIC) is designed to totally manage multimedia Ethernet LANs with diversified equipment and lengthy cable runs, and to detect and correct error transmissions. These LANs, which will require repeaters, hubs, bridges, and gateways, will link PCs, workstations, and specialized servers over a wide range of Ethernet configurations.

One configuration may be an older thick Ethernet cable interconnected with a thin Ethernet type to support a cluster of computers and peripherals. Another could be a low-cost, unshielded twisted-pair cable with a 10-Mbit/s data rate, running from the thick coaxial cable to a cluster of similar machines. Future networks that will be interconnected to the Fiber Distributed Data Interface (FDDI) can also exploit the DP83950's capabilities. The FDDI is a 100-Mbit/s fiber-optic data highway for next-generation computers working in a distributed processing environment.

The RIC, a multiport repeater, regenerates incoming signals. A repeater permits a network to be con-

structed using a mix of media—thick coax, thin coax, and twisted-pair cabling. When equipped with an interface to a CPU, network-management hardware, and error-display devices on a circuit board, the repeater becomes the core of a hub. The hub protects the network from malfunctioning segments.

According to National Semiconductor, the RIC is the industry's only networking IC that integrates 10Base-T transceivers, a transceiver interface, a Manchester encoder/decoder, a system interface, and digital logic on one mixed-signal chip (*see the figure*). The device has 13 ports that connect to network segments. Functions replicated in all ports include a port-status register, port-partitioning logic, and a port-state machine. Automatic signal-polarity detection and correction capabilities are also incorporated.

A port-state machine controls the transmission of repeated data and jam signals over the attached segment. It also decides whether or not a port will be the source of data or collision information to be repeated over the network. Twelve ports (2 through 13) also have a user-configurable transceiver interface that connects an on-chip 10Base-T transceiver to twisted-pair cabling, or bypasses the transceiver for an external transceiver. The Port-1 interface is dedicated to connecting to transceiver boxes and cables that are attached-unit-interface (AUI) compatible. These AUI interfaces consist of four-pair shielded wires.

The repeater core logic, which holds 30% of the chip's logic circuitry, contains a main state machine. This control-center oversees operations shared by all ports: a phase-



# MULTIPORT REPEATER CONTROLLER

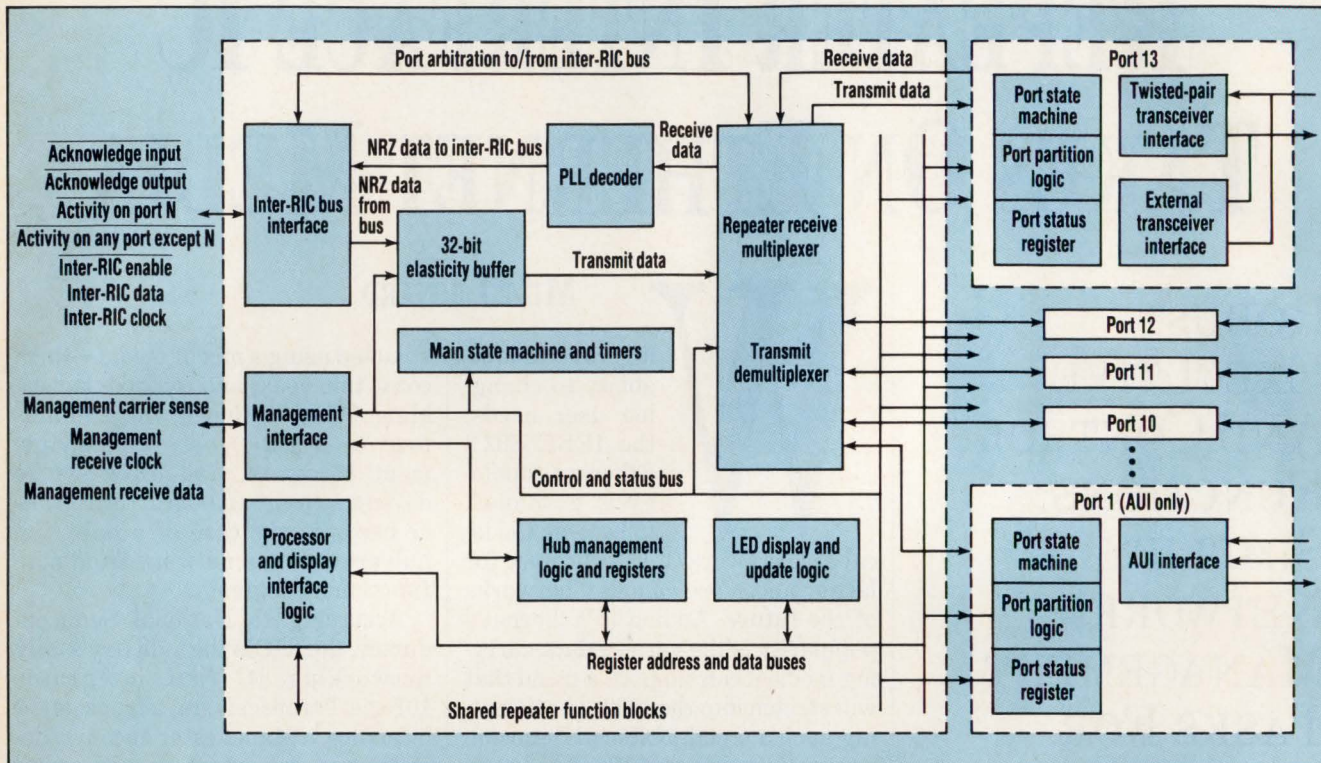

**THE DP83950 REPEATER INTERFACE CONTROLLER** contains all functions to support the IEEE 802.3 10Base-T standard for managed and non-managed Ethernet hubs. The chip includes interfaces for a system microprocessor, as well as the company's Sonic network interface controller for advanced network-management functions. This combination supplies the managed objects for the simple network-management protocol (SNMP), as well as the Open Systems Interconnection (OSI) network-management protocols.

locked loop for decoding, a 32-bit elasticity buffer for temporary storage of data-field bits, and receive and transmit multiplexers.

Many network applications are expected to be in "dumb" or standalone repeater modules. Here, the RIC serves only as a signal regenerator for point-to-point connections between nodes on the star topology of 10Base-T. For more complex connections, the device can be combined with a microprocessor and logic circuits to perform network-management and control functions. Data transfer between the RIC and processor occurs over an octal bidirectional bus. A number of RIC registers contain information that indicates the status of the hub-management functions, chip configuration, and port status. An arbiter schedules and controls processor accesses and ensures that correct information is written into display latches.

A repeater module can contain from three to eight RICs and support

up to 256 external ports. When multiple RICs are cascaded in a hub, they communicate through an inter-RIC bus to share data packets and collision status while still operating as individual logical repeaters. One RIC failure won't affect the rest of the network. Repeater systems usually include visual displays that indicate network activity and the status of specific repeater operations. The RIC's display-update function block accommodates various indicators and merely requires external SSI devices to drive the indicators—usually LEDs. Over 60 LEDs associated with 12 ports can be used to indicate general repeater status and individual port status.

Future network controllers will not only supply basic management and control functions, but will also be used in hubs that collect, analyze, and display status and error conditions of the network segments to which they're attached. Ideally, the system would store the combined

data-packet and status field of specific ports in system memory to be examined by hub-management software. The RIC does this with a dedicated hub-management interface, which is similar to the inter-RIC bus. That bus enables data packets to be recovered from the receiving RIC. The target recipient in this case is a network interface controller, such as National's DP83932 Sonic IC.

The DP83950 RIC is fabricated with a 1.5- $\mu$ m CMOS process. The repeater IC dissipates 1.5 W. □

## PRICE AND AVAILABILITY

Packaged in a 160-lead pin grid array, the DP83950 RIC is available now for \$145 each in sample quantities of up to 100 units.

National Semiconductor Corp., 2900 Semiconductor Dr., P.O. Box 58090, Santa Clara, CA 95052-8090; Tushar Kothari, (408) 721-7020. CIRCLE 513

HOW VALUABLE?	CIRCLE
HIGHLY	535
MODERATELY	536
SLIGHTLY	537



# GRAPHIC MEMORY

A full spectrum of choices.

Device	Organization	Speed (ns)	Package	Micron Part #	Availability	Applications							
						VGA	8514	Super VGA	TIGA-340™	XGA	MAC®	Work-station	Multi-media
1 Meg DRAM	x4*	70 - 100	DIP, ZIP, SOJ	MT4C4256	Now	■		■					
	x16*	80 - 100	ZIP, SOJ	MT4C1664/65/70	Now	■	■	■		■			
4 Meg DRAM	x16*	60 - 100	SOJ, TSOP	MT4C16256/7	Samp. Q4 '91; Prod. 1H '92		■	■		■			
256K VRAM	x4	100 - 120	DIP, ZIP	MT42C4064	Now	■	■	■	■		■	■	
1 Meg VRAM	x4	80 - 120	ZIP, SOJ	MT42C4255/6	4255 Now; 4256 Q4 '91		■	■	■	■	■	■	■
	x8	80 - 120	ZIP, SOJ	MT42C8127/8	8127 Now; 8128 Q4 '91		■	■	■	■	■	■	■
2 Meg VRAM	x8	70 - 100	SOJ	MT42C8256	Samp. Q4 '91; Prod. 1H '92			■	■	■	■	■	■
1 Meg Triple-Port DRAM	x4	80 - 120	SOJ	MT43C4257/8	Now							■	■
	x8	80 - 120	PLCC	MT43C8128/9	Now							■	■

\*Also in low power versions.

© Micron Technology, Inc. 1991

**MICRON**  
TECHNOLOGY, INC.

2805 E. Columbia Rd., Boise, ID 83706 (208) 368-3800

CIRCLE 129



# Never stop at our counter again.



When you're a member of Hertz #1 Club Gold<sup>®</sup>, there's no stopping at counters, no paperwork, nothing to slow you down. At 28 major airports, "Gold" is the fastest, easiest way ever to rent. It's another way #1 has more going for you.

Hertz rents Fords and other fine cars.

**Hertz**  
**AMERICA'S WHEELS™**

® REG. U.S. PAT. OFF © HERTZ SYSTEM INC. 1990.

CIRCLE 4



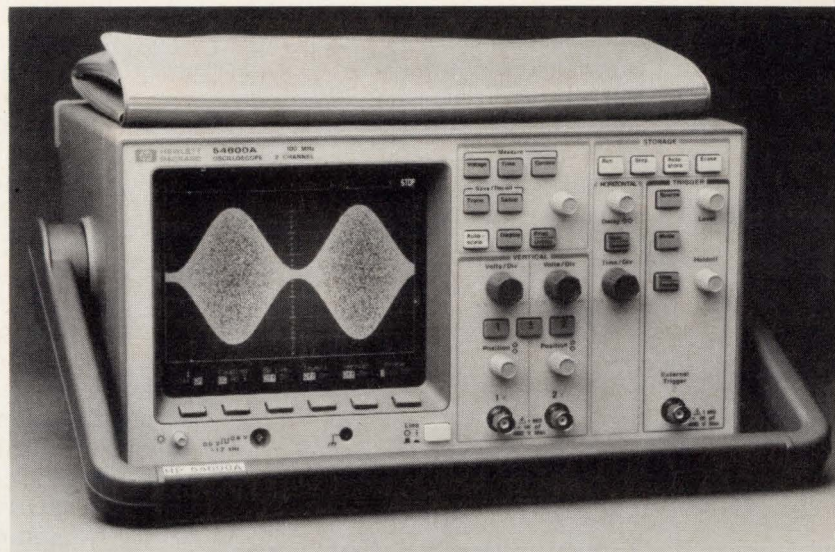

1. THE HP 54600A USER INTERFACE is designed to look and feel like that of an analog oscilloscope in order to appeal to engineers reluctant to make the move to a digital scope.

A PAIR OF DIGITAL STORAGE OSCILLOSCOPES TRY TO MAKE DESIGNERS FORSAKE THE COMFORT OF THEIR FAMILIAR ANALOG INSTRUMENTS.

## SCOPES OFFER DIGITAL POWER IN A COZY SETTING

JOHN NOVELLINO

**A**s popular as digital oscilloscopes have become, many engineers are still leery about making the switch from their trusted analog instruments. Some don't like the menu-driven interfaces usually found on digital scopes. Another complaint is that some digital scope displays lack a "live" feel—that is, they have a slow update rate. Price can also be an inhibiting factor.

Two portable digital scopes from Hewlett-Packard, the HP 54600A and HP 54601A, take direct aim at the analog holdouts. The goal is to convince analog-scope users that they can exploit the numerous features offered by digital instruments without losing the analog look and feel. The scopes fit into the heart of the general-purpose market, with 100-MHz bandwidths in 2-channel (54600A) and 4-channel (54601A) versions. Furthermore, prices are quite attractive. For a few hundred dollars more than comparable analog scopes, users can enjoy the automated features of digital storage instruments.

HP heavily emphasized user feedback in the design of the two scopes, espe-



## DIGITAL OSCILLOSCOPES

cially the interface and display update rate. "In extensive focus group testing," says Dennis Weller, R&D section manager at HP's Colorado Springs Div. "we asked users why people don't buy digital scopes." Some users disliked the interface on earlier HP digital scopes, which in-

cluded one knob whose function was controlled by keystrokes. So the 54600-series front panel looks very similar to that of an analog scope (see the figure). Dedicated knobs adjust primary control functions: vertical sensitivity and position, time base, horizontal delay, trigger level, and

hold-off. Buttons control storage, measurement, and utility functions.

A weakness of early HP digital scopes was the display update rate. Previous units could process and display 20,000 to 100,000 data points/s. But because the 54600-series breaks up the processing tasks among three processors, the new scopes improve that by an order of magnitude, reaching 1 million points/s.

The acquisition and display processing are done by custom devices, leaving the system CPU free to perform its own tasks. The acquisition processor, which is built in HP's proprietary CMOS process, contains 200,000 transistors. The IC creates waveform records from the digitizer data. The display processor, a gate array that uses a commercially available process, transforms the waveform records into the pixel display.

The scopes have a 20-Msample/s sampling rate with an 8-bit vertical resolution and peak-detection capability. The vertical sensitivity range is 2mV to 5 V/div. Edge, line, and TV triggering are offered.

The advantages of digital technology are evident in the scopes' ability to perform 12 automatic measurements on frequency, time, and voltage. In addition, dual cursors help users make manual time and voltage measurements. An autoscale function sets up the scope with one keystroke. Two trace memories hold a total of 2 ksamples. The units are fully programmable through optional GPIB or RS-232 interfaces. These interfaces, as well as an optional parallel interface, can also be used to supply a plotter or printer. □

### PRICE AND AVAILABILITY

The 2-channel HP 54600A costs \$2395, and the 4-channel HP 54601A goes for \$2895. The GPIB and RS-232 interface modules are \$425 each, and the parallel interface costs \$275. All are available 4 weeks from receipt of an order.

Hewlett-Packard Co., Colorado Springs Div., P.O. Box 2197, Colorado Springs, CO 80901-2197; (800) 752-0900. CIRCLE 512



UTMC designed every aspect of the UTE-R to be rad-hard — from process to package to cell library. In contrast, most other companies merely screen commercial ICs for the necessary rad-tolerance. Our UTE-R, with 20K or 50K usable gates, is guaranteed functional up to  $10^7$  rads total dose. And, like all UTMC rad-hard circuits, the UTE-R is backed by RAD-SPEC<sup>sm</sup>, your guarantee that we deliver DOD-specified rad-hard levels — from kilo-rad tactical to mega-rad strategic. Call today for details.

1575 Garden of the Gods Rd. Colorado Springs, CO 80907

1-800-MIL-UTMC



DEDICATED TO MILITARY AND AEROSPACE

CIRCLE 89

HOW VALUABLE?	CIRCLE
HIGHLY	538
MODERATELY	539
SLIGHTLY	540





Picture your flat panel display using Cirrus Logic controller chips. They actually add colors to your display capabilities for more realistic shading.

The same panel looks flat without our enhanced VGA capabilities. And it will lose face faster without our optimized power management system.

# How To Avoid Losing Face On Your Color LCD Display.

Face it. The first thing everybody notices about your newest laptop is the display quality. Is it bright? Are the images clear and well modeled? Are the colors vivid?

With Cirrus Logic LCD VGA controllers, your answer is yes. Which is why we're the leading supplier of display controller chips in the laptop and notebook market.

For life-like 3-dimensional imaging, Cirrus Logic color LCD controllers offer technology leadership for your color products. With direct support for the latest active-matrix color LCD panels. Our controller chips do more than support your panel's color capabilities — they enhance it with full VGA color support and a fuller color palette. To give you color so good it competes with CRT quality.

Our monochrome solutions give you displays that *PC Magazine* called "the stars of our VGA color-mapping tests"\* with up to 64 shades of gray. And with a lower dot clock rate, your power consumption

is lower than other solutions for longer battery operation.

Cirrus Logic LCD controllers are fully compatible with the popular PC video standards and will work with LCD, plasma, or electroluminescent displays.

Simplify your design job. A higher level of integration gives you all this in the smallest form factor available. We also supply software and hardware design notes and full design support. You get the results you want quickly and easily.

Design a more competitive product. One that looks better — and makes you look better. That lasts longer on a battery. Use the display solutions from a proven technology leader in laptop and motherboard VGA: LCD controller chips from Cirrus Logic.

Get the picture. Get more information on LCD controllers.

Call 1-800-952-6300, ask for dept. LL34

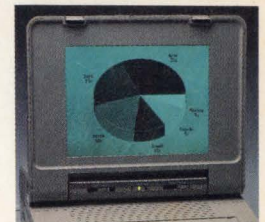
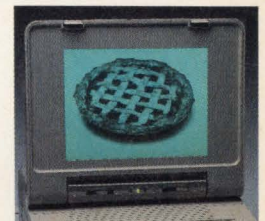

Cirrus Logic monochrome LCD controllers will also make everything from realistic scanned images to business charts look tastier.

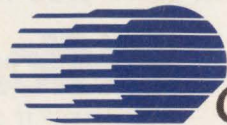
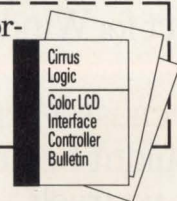

CIRRUS LOGIC

C L O S I N G T H E G A P

©1991 Cirrus Logic, Inc., 3100 West Warren Avenue, Fremont, CA 94538 (415) 623-8300; Japan: 462-76-0601; Singapore: 65-3532122; Taiwan: 2-718-4533; West Germany: 81-52-2030/6203  
Cirrus Logic and the Cirrus Logic logo are trademarks of Cirrus Logic, Inc. All other trademarks are registered to their respective companies. \* PC Magazine, March 13, 1990, p. 204.



# We're giving away our management secrets.

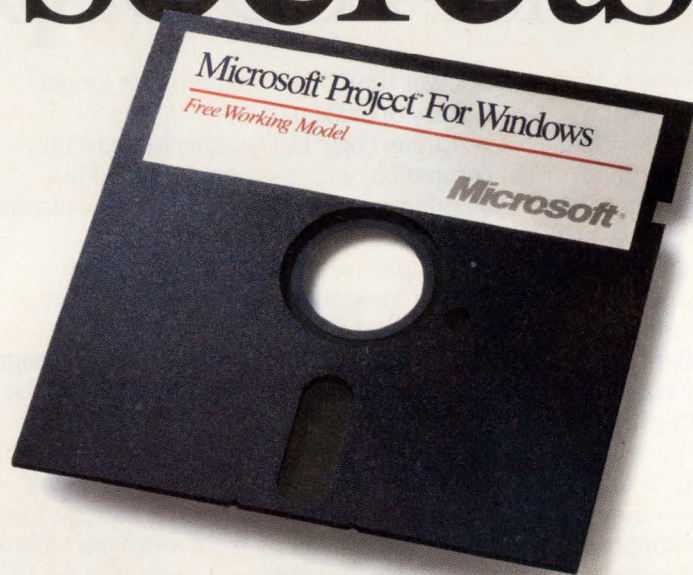

More project managers are using Microsoft® Project for Windows™ than any other package.

Probably because Microsoft Project for Windows wouldn't be any different if you'd planned it yourself.

Work with data easily. Create customized filters, tables, even output.

Manipulate PERT and Gantt charts by clicking and dragging.

See for yourself. Just give us a call at (800) 541-1261, Dept. P96, and we'll send you a free working model.

**Microsoft**  
Making it all make sense

Offer good until June 30, 1991 or while supplies last. The first working model is free; additional models are \$9.95 plus applicable sales tax. Offer good only in the 50 United States. In the U.S., call (800) 541-1261, Dept. P96. For information only: In Canada, call (416) 568-3503; outside the U.S. and Canada, call (206) 936-8661. © 1991 Microsoft Corporation. All rights reserved. Microsoft and the Microsoft logo are registered trademarks and Windows and Making it all make sense are trademarks of Microsoft Corporation.



# SPREADSHEET-LIKE VHDL TOOL ALLEVIATES PROGRAMMING HASSLES

LISA MALINIAK

Engineers who want to design with VHDL but don't want to tangle with the programming process can find relief with the Hum design system from Lewis Systems Inc. The Hum design system is constructed from modules that are invoked from the initial menu. Users can switch back and forth between modules during the design process.

The Humtable is a spreadsheet-like table used to create VHDL models. The first and second columns in the Humtable are the control and object columns. Words in the control column (such as when, and, if) determine whether or not the identifiers in the object column (such as clk, S0) are control objects or assignment objects. Identifiers or operators in the remainder of the columns define conditions that produce a result assigned to the identifier in the object column. Events are "read" down each column. For example, when the clock falls, set S0 low.

Humtables are created almost the same way and in the same sequence in which they're conceived in the engineer's mind. Two different engineers often develop different Humtables for the same process, yet the resulting VHDL models are compatible. Also, Humtables are well-suited to segmenting the design into individual logical processes, such as memory read, reset, and instruction execution functions.

A nice feature of the system is that once an identifier is used, it's placed in a pop-up table and never has to be typed in again. Users move the mouse to the desired box in the table and select proper identifiers.

Users may enter logic equations in the Humtable. These equations may be of any complexity and may overrun the width of the entry space. In addition, other Humtables can be called from the one in use. This is equivalent to invoking a procedure or function in VHDL.

A new design begins in the Hum-

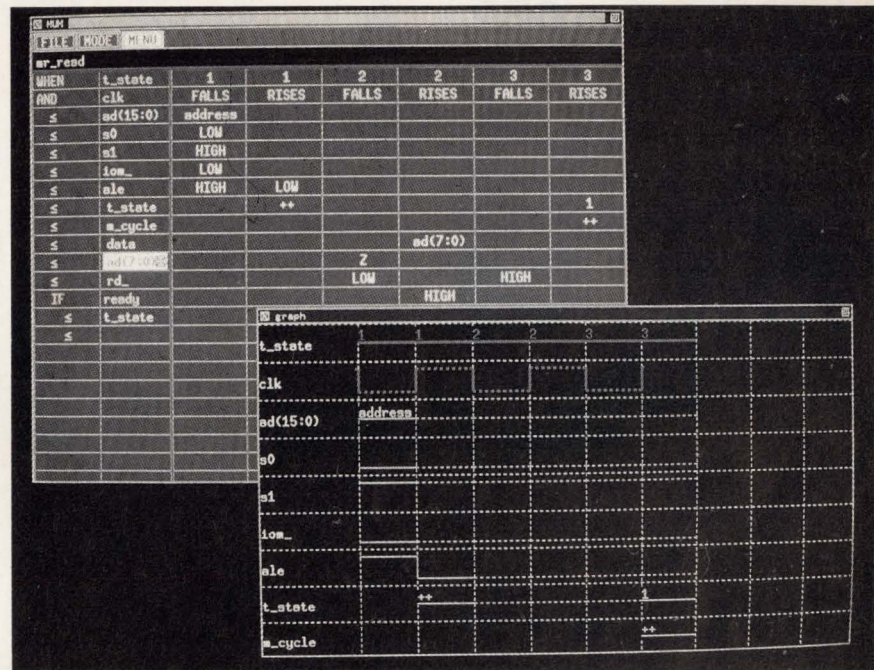

pins module—a table that designers use to identify the I/O pins of the design. Once entered in the table, they're placed in the pop-up menu and are available for use in Humtable development.

The Humsym and Humgraph modules furnish visual feedback of the design process occurring in the Humtable. Humgraphs are symbolic representations of the process, close to those shown in data books. Each time an event is entered into a Humtable, it's immediately reflected in a corresponding Humgraph (see the photo).

Humtables are expanded into a native Hum language called Humbase. Humbase is less elegant than VHDL, and doesn't require much more programming ability than the Humtable. It's made available to users in case they want to add to or modify the design at this level.

Engineers can generate large numbers of vectors for their design with the Humstim module (it will not be available with the first release of the product). Engineers use the Humtime module (also not available with the first release) to supply com-

plex input-pin-to-output-pin timing values for the design. Timing can be implemented in the first-release Hum product by selecting the timing option while a Humtable is active. Timing values are then entered in the active space in the table, which in turn are entered directly into the VHDL code.

A Humcode module, to be available in the second quarter, will enable users to define the format modes for an instruction set. Users will be able to define instructions in a shorthand form that will expand into the Humtables automatically.

Additional Hum modules include a debug module, a color-selector module, a symbolic simulator, and a user-setup module. All Hum modules except the Humtime, Humcode, and Humstim modules are available now. The other three modules will ship in the second quarter of this year. The software, which costs \$24,000, runs on Sun workstations. It will eventually run on HP/Apollo and Vax workstations.

Lewis Systems Inc., 1915 Peters Rd., Suite 113, Irving, TX 75061; (214) 438-3189. **CIRCLE 319**



# PICO POWER transformers & inductors

**PLUG-IN SURFACE MOUNT AXIAL INDUCTORS TOROIDAL INSULATED LEADS**

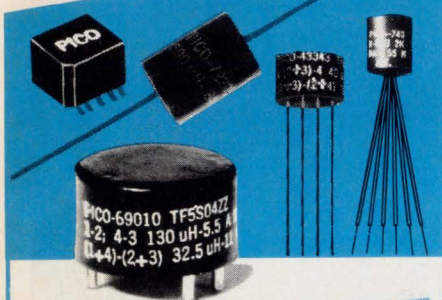

## TRANSFORMERS

QPL standards available MIL-T-27/96-01; 97-01 and 02; 103-1 thru 16; 172-1 thru 50; 277-01; 290-01; 357-1 thru 114; 358-1 thru 123; 359-1 thru 147.

- Audio Transformers ranging in size from 1/4" x 1/4" to 3/4" x 1 3/16". 20 Hz to 250 KHz. Up to 3 watts.
- Pulse Transformers .05μSEC to 100μSEC miniaturized construction.
- Ultra-miniature DC-DC Converter Transformers. 40 watts.
- Miniaturized Switchmode Inverter Transformers. 60 watts.
- 400 Hz Power Transformers. Primary voltages of 115V or 26V. Plug-in construction. Ultra-miniature
- Microphone/Transducer Audio Input.
- MIL-STD-1553 Interface Multiplex Data BUS Pulse Transformers.

## POWER INDUCTORS

QPL standards available MIL-T-27/356-1 thru 63

- Temperature range - 55°C + 130°C
- All units are magnetically shielded
- Inductance values to 20mH with DC currents to 23 amps
- Split windings

**PICO Electronics, Inc.**  
453 N. MacQuesten Pkwy. Mt. Vernon, N.Y. 10552

Call Toll Free **800-431-1064**  
IN NEW YORK CALL **914-699-5514**  
FAX **914-699-5565**

See EEM or THOMAS REGISTER or send direct for FREE PICO Catalog

CIRCLE 110

## NEW PRODUCTS

COMPUTER-AIDED ENGINEERING

## PROGRAMMABLE-LOGIC TOOLS RUN UNDER WINDOWS 3.0

Altera's Max+Plus II software is the first logic design system operating under Microsoft Windows 3.0. Max+Plus II is a CAE system offering hierarchical schematic capture and HDL logic entry, logic synthesis, and timing simulation for the company's Classic and Max erasable programmable-logic devices (EPLDs). A 5000-gate design is typically compiled in 10 minutes or less.

By using the enhanced memory-management capabilities of Windows 3.0, Max+Plus II can automatically partition very large logic designs into a set of EPLDs. Designers can identify critical timing paths in the source design. Then the software automatically synthesizes the design and fits it into multiple EPLDs. The software also performs multichip simulation to verify the total design. And because Max+Plus II supports EDIF net lists, workstation-based designers can use their existing design-entry and veri-

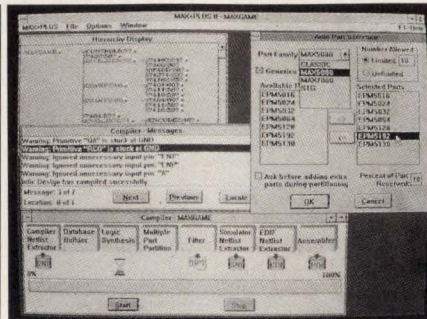

fication tools with the tool's EPLD logic synthesis.

Max+Plus II, which will ship in April, costs \$9995. The software supports all Altera general-purpose EPLDs, including the recently announced Max 7000 family that extends to 20,000 gates.

Altera Corp., 2610 Orchard Pkwy., San Jose, CA 95134-2020; (408) 984-2800. **CIRCLE 320**

■ LISA MALINIAK

## PC SOFTWARE CHECKS TIMING FOR DIGITAL CIRCUITS

Electronic engineers can use the TimingDesigner software to specify, modify, and check timing requirements for digital circuits. TimingDesigner is a front-end design tool that automates the creation and analysis of timing diagrams.

Waveforms, clocks, gate and path

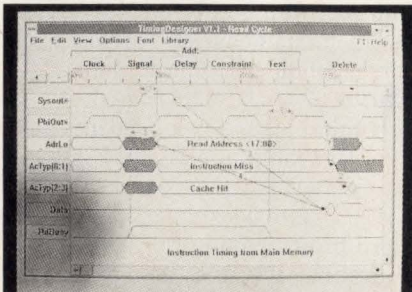

delays, setup and hold times, text annotations, and timing-parameter tables are entered with point and click mouse operations. To draw timing diagrams, designers use a mouse to place edges on the diagram model and to select between high and low signal states or valid or invalid bus states. Clock signals are generated automatically by entering period, duty cycle, duration, phase,

and jitter into a dialog box.

Designers select delays from a separate library window. Each part has a minimum and maximum delay. The minimum and maximum values can be entered directly or computed from formulas based on user-defined variables such as temperature or voltage. Text can be placed anywhere on the diagram in several sizes and fonts.

As a timing diagram is modified, TimingDesigner automatically maintains the timing relationships specified between waveform edges. The software then performs timing analysis that gets updated dynamically as the diagram is modified. It displays the earliest and latest time that every edge can occur, computes the available margins for all timing limits, and highlights timing-limit violations in red and valid conditions in green.

TimingDesigner, which is shipping now, costs \$1495. It runs under Windows 3.0, and requires an IBM PC or compatible with 1 Mbyte of memory, an EGA monitor, a hard disk, and a mouse.

Chronology Corp., 2849 152nd Ave. NE, Redmond, WA 98052-5516; (206) 869-4227. **CIRCLE 321**

■ LISA MALINIAK



# Sampling ADCs With Zero Power Dissipation\* Plus 100% Tested Dynamic Performance.

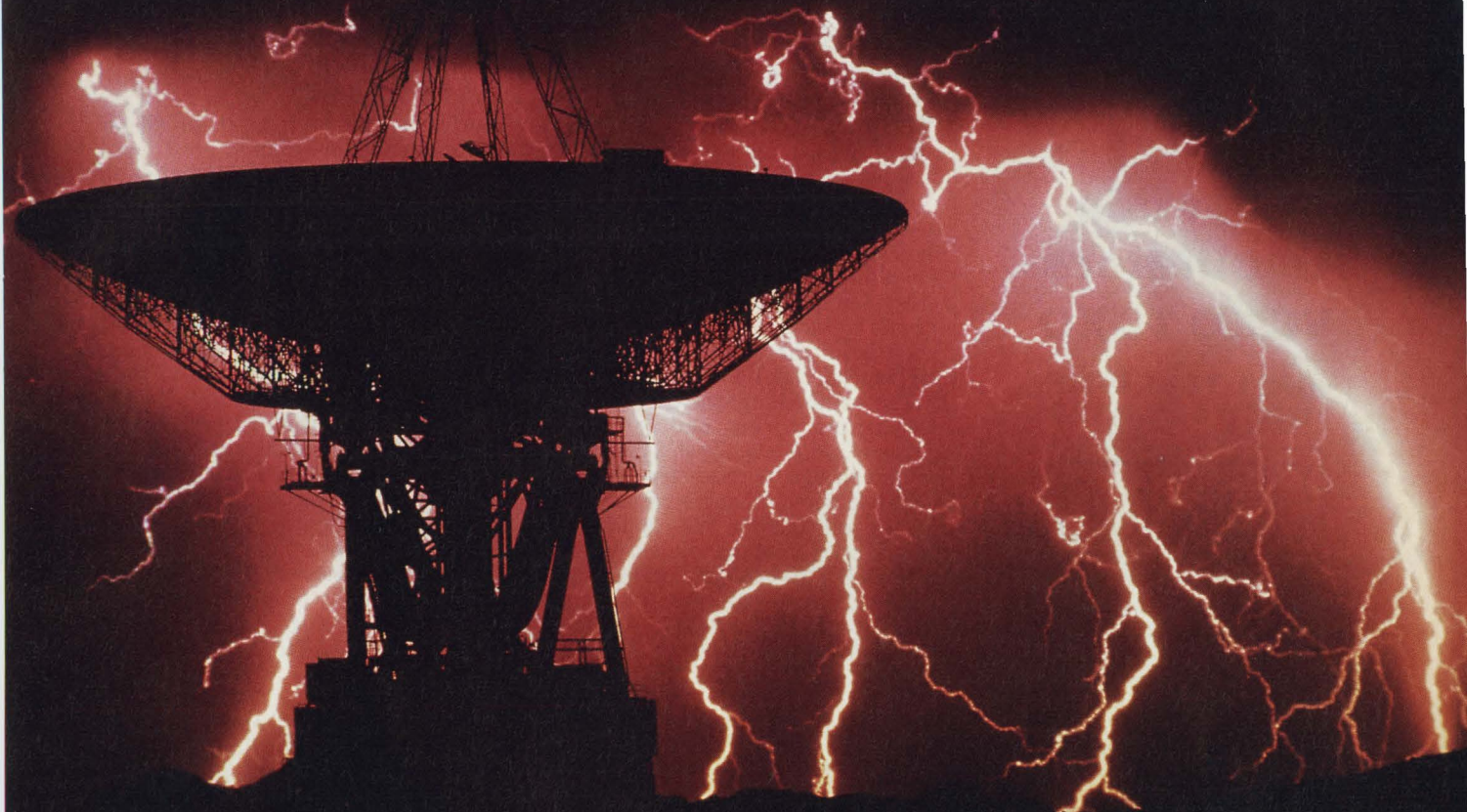

*Anybody* can guarantee the dynamic performance of a Sampling ADC. Like most other ADC suppliers, Sipex understands what dynamic performance means to the final image, and ultimate success of your system. That's why we run all-codes and full dynamic production testing on 100% of our Sampling ADCs — to give you guaranteed dc and SNR, THD and SINAD ac dynamic performance.

But, Sipex's 100% tested performance comes with one very important difference — *the lowest power dissipation in the industry.*

\*While we can't give you these high performance SADCs with *no* power dissipation, one look at "their" power dissipation specs will show you ours are almost zero by com-

parison. Think what that will mean to system reliability.

Of course, the high-level of integration, with single-package ADC, Sample-and-Hold and reference gets you an easier design-in, and less pc board space.

When you're ready to design your next medical imaging, radar or other high performance system with the lowest-power SADCs available, let us know. We'll get you a data sheet and application note on either of these two high performance Sampling ADCs, and a unit to evaluate.

Which will get you convinced. 100%.

**Sipex**  
Corporation

SIGNAL PROCESSING EXCELLENCE Sipex Corporation • 22 Linnell Circle • Billerica, MA 01821 • 1-800-272-1772 • (508) 667-8700

**12-BIT/10MHZ (SP9560)**  
(25°C at Nyquist)  
• 72dB Spurious-Free Range  
• 70dB SNR  
• 64dB SINAD  
• 3.0 Watts



**16-Bit/1MHz (SP9490)**  
(25°C @ 1MHz Sampling Rate)  
• 90dB Spurious-Free Range  
• 87dB SNR  
• 85dB SINAD  
• 2.7 Watts



40 years  
of quality  
crystals

**Crystals  
Oscillators  
VCXO TCXO**

**CALL TOLL FREE  
1-800 426-9825**



**INTERNATIONAL CRYSTAL  
MANUFACTURING CO., INC.**

P.O. Box 26330, Oklahoma City, OK 73126

CIRCLE 117

## INTERFACE CONTROL BOARD

Delta Technologies Interface Control Board (ICB) gives you the ability to incorporate a IEEE-488 interface into your custom instrumentation at a low cost. The ICB offers all the interface circuitry as well as support software needed to build a custom interface with full IEEE-488 compatibility. DTBUG, a resident monitor program in firmware, provides a method for complete integration of your custom circuitry while your custom firmware is being developed in a parallel effort.

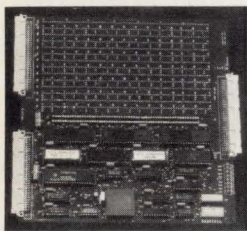

- 10 MHz 80188  $\mu$ P / 3 Timers / 2 DMA Channels
- 8K RAM & 8K ROM with DTBUG Monitor Firmware
- 32K RAM & 32K ROM for Custom Firmware
- IEEE-488 Interface Circuitry
- 72 Programmable Digital I/O lines
- 2-96 Pin DIN Connectors with 6U Eurocard Spacing
- 1-96 Pin DIN Expansion Connector
- Custom Circuitry Prototyping Area
- All  $\mu$ P Signals available on Distribution Bus
- C Source Code for Custom Firmware Development

**Delta Technologies**  
978 Salem Street,  
Aurora, Colorado, 80011  
(719) 594-6159

CIRCLE 93

## NEW PRODUCTS

COMPUTER-AIDED ENGINEERING

## REVAMPED PC-BOARD DESIGN SYSTEM RUNS ON SUN WORKSTATIONS

**V**ersion 2.1 of the Crystal pc-board design system features an engineering change system, a 3D spacing checker, and a Gerber data viewer and editor. In addition, users can now run the tool set on Sun Microsystems' Sparcstation as well as Apollo workstations. The Crystal software is for the design and routing of high-speed, high-density pc boards.

The engineering-change system incorporates wiring and component changes automatically in a completely routed design without rerouting unmodified wires. Changes are added using the transmission-line, coupling, and length rules from the original design.

With the 3D spacing checker, users can verify routed Gerber data against spacing and clearance rules to ensure there aren't any violations. Spacing

checks can be performed on all pc-board layers at one time.

Users can view any combination of Gerber layers on a color display with the Gerber viewer and editor. The Gerber viewer can pan and zoom any area of the printed-circuit-board surface, and also measures feature sizes and clearance with a built-in ruler. With the editor, users can move and change the size of Gerber segments to solve clearance problems.

The Crystal Version 2.1 pc-board design system is available now on Apollo and Sun workstations. Pricing starts at \$50,000, depending on configuration and platform. Delivery is four weeks after receipt of order.

*Shared Resources Inc., 3047 Orchard Pkwy., San Jose, CA 95134; (408) 434-0444. CIRCLE 322*  
■ LISA MALINIAK

## FAULT SIMULATOR NOW HAS TEST PLANNING

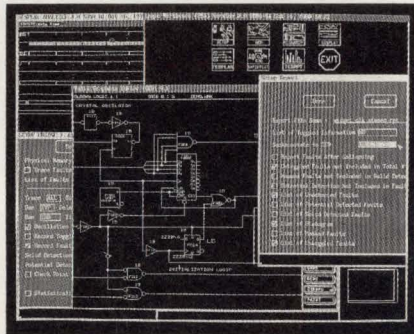

Test planning is among the many new features Valid Logic has added to the newest version of the RapidTest fault simulator. Specific test-planning features include: hierarchical fault selection for partitioning designs into blocks for test-vector creation; an automatic fault-collapsing algorithm to eliminate redundant faults; and a test-plan control function to define and automate the sequencing of multiple, hierarchical simulation runs. RapidTest 3.0 also offers schematic back-annotation, board-level simulation, and full integration with the company's Logic Workbench digital simulation environment. Operating under Logic Workbench, RapidTest 3.0 shares the same user interface, libraries, analysis tools, and database as Valid's RapidSim logic simulator. Pricing for RapidTest 3.0 with the Logic Workbench starts at

\$24,000. The starting price when sold separately is \$17,000. RapidTest runs on DEC, IBM, and Sun workstations.

*Valid Logic Systems Inc., 2820 Orchard Pkwy., San Jose, CA 95134; (408) 432-9400. CIRCLE 323*

## CAE TOOL CATERS TO SEQUENTIAL LOGIC

State/view is a graphical editor tailored for designing sequential circuits. It combines the advantages of graphical editing with the flexibility of high-level languages, closing the gap between hand-drawn diagrams and the sometimes complex syntax of logic compilers. Designers use State/view to draw diagrams interactively on the screen and then convert them to input files for various logic compilers. These design files can be used to synthesize PLDs, FPGAs, or gate arrays. Both Mealy and Moore machines can be defined at either circuit level or in flexible abstract terms. State/view creates concise documentation of the design and also ensures that flow diagrams and the compiler's input file are always congruent. The first release of the tool will produce design files for LOG/ic from Isdata and Data I/O's Abel. VHDL files will be supported in the future. State/view runs on all PCs with EGA or VGA graphics. It will be available in the first quarter for \$945.

*Isdata Inc., 800 Airport Rd., Monterey, CA 93940; (408) 373-7359. CIRCLE 324*



# MAGNESIUM. THE LIGHTWEIGHT SOLUTION FOR TOUGH DESIGN PROBLEMS.

## SOLUTIONS ARE OUR STRENGTH

When challenging design problems weigh you down — ask Kaiser about using magnesium extrusions to lighten the load. Magnesium's unique properties perform exceptionally well for many applications in every industry. Kaiser's turnkey design, engineering, processing and fabrication expertise ensure you of the best solution to meet your specifications.

## MAGNESIUM VS. OTHER MATERIALS

Magnesium is the lightest structural metal available, about one fourth the weight of steel and two-thirds that of aluminum. It has an unusually high strength-to-weight ratio for replacement of these materials as well as plastics. You can specify thinner extrusions that are more cost-effective and easier to handle, machine and weld. Magnesium also has a low friction coefficient. Its non-fretting tenacious oxide makes it corrosion resistant without anodizing so it's perfect for applications where cleanliness is vital. Its vibration absorbing, non-magnetic and thermal dissipation properties make it ideal for electronic applications.

## THE RIGHT EXTRUSION FOR THE JOB

One of the nation's leading specialists in magnesium processing and fabrication, Kaiser offers a variety of sizes and shapes — including rod, bar, tube and custom extrusions. We offer experienced design and engineering assistance to get your project from the drawing board to the product line. For more information, call Kaiser today at 1-800-688-1461.

Kaiser Aluminum Specialty Products  
P.O. Box 470170 • 7311 East 41st Street  
Tulsa, Oklahoma 74147  
Phone: 918/627-0100 • FAX 918/663-3795

**KAISER ALUMINUM**  
**SPECIALTY PRODUCTS**

A division of Kaiser Aluminum & Chemical Corporation

CIRCLE 114

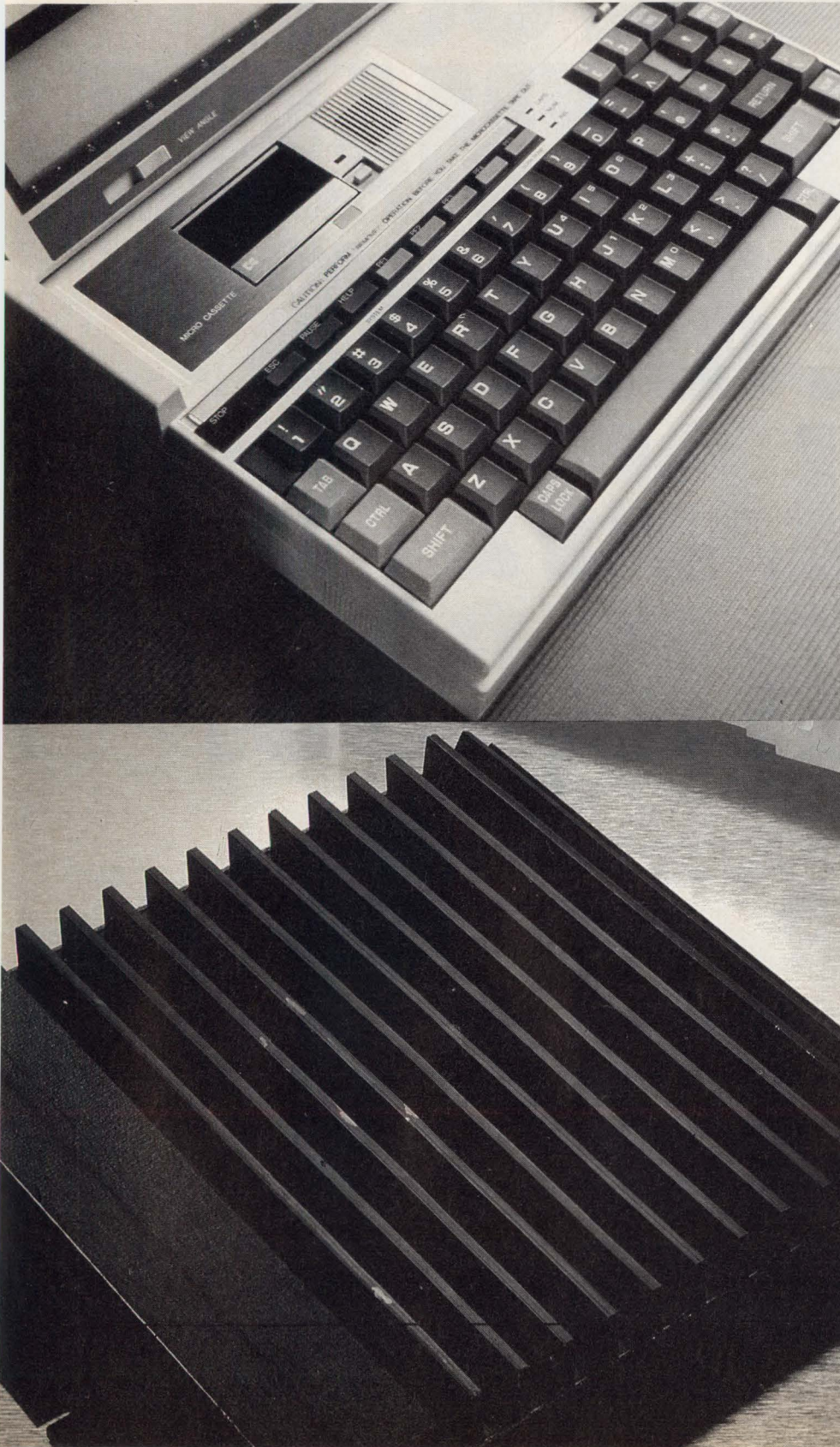



# NEED A REASON TO USE OUR PROGRAMMABLE GATE ARRAYS? WE'LL GIVE YOU OVER 10,000.

Tens of thousands of designs have proven Xilinx Field Programmable Gate Arrays to be the ideal logic device. In fact, there are over four million of our FPGAs in use around the world today.

Some are commanding satellite earth station receivers. Others are controlling optical disk drives.

Still others are controlling graphics for workstations, PCs and Local Area Networks.

With toggle rates of up to 100 MHz and densities up to 9,000 gates (with faster speeds

and higher gate densities to come), Xilinx Field Programmable Gate Arrays can meet the specs for your most ambitious designs.

In a fraction of the time.

And at a fraction of the cost of anything else available in the industry today.

Turnaround time on design revs is measured in hours, not months.

Non-recurring engineering charges are non-existent.

Our new Automated Design Implementation and Design Manager software give

you the easiest-to-use user interface in the industry. And they run on PCs and the most popular engineering workstations.

Just call, 1-800-255-7778 or if you're working in California, call 408-559-7778. And we'll send you a free copy of the FPGA fact book. It's an objective look at the key reasons why FPGAs should be in your next design.



**XILINX**  
The Programmable  
Gate Array Company.™



## NEW PRODUCTS

COMPUTER-AIDED ENGINEERING

### IEEE-488



Control any IEEE-488 (HP-IB, GP-IB) device with our cards, cables, and software for the PC/AT/386, EISA, MicroChannel, and NuBus.

### LOGIC-DESIGN SOFTWARE USES EXTENDED MEMORY

The second version of the Bool logic-synthesis tool uses up to 16 Mbytes of extended memory in AT-class PCs. Bool is a general tool for synthesizing two-level logic from a behavioral description, and is aimed at ASIC and PLD designs. A compiler reads a behavioral description of a digital circuit written in a C-like language, then minimizes, simulates, and prints it out in various formats. Version 2 includes improvements in the syntax, minimizer, simulator, and output formatting. Among the new features are: support for multistage logic by including such variable types as flip-flops and nodes, an improved behavioral model, an event-driven simulator, and an enhanced built-in library. The Bool software runs on PCs and Sun workstations. Bool Version 2 is shipping now for \$1100. A scaled-down version that can't use extended memory is available for \$590.

*Cornell Design Tools, 761 Cornell Dr., Santa Clara, CA 95051; (408) 984-0777. CIRCLE 325*

### LOGIC COMPILER MIXES FOUR ALGORITHMS

A Macintosh-based logic compiler for programmable devices uses four different reduction algorithms, depending on the circuit's complexity and desired compilation speed. The MacCUPL compiler uses the Quine-McCluskey reduction algorithm to guarantee minimum logic gates; Espresso, Presto, and Quick algorithms are used for faster compilation times. It runs under the Mac operating system and complies with all Apple user-interface guidelines. Device simulations are displayed

in either waveform or tabular form. With assertion-level tracking, users can define arbitrary logic levels according to the levels they want to come out of the target devices. After inputting a design, users declare pins active high or active low, and MacCUPL automatically changes signal definitions throughout the design. The compiler supports PLDs, PALs, PROMs, EPROMs, EEPROMs, FPLAs, and other programmable devices. MacCUPL is shipping now for \$1895.

*Logical Devices Inc., 1201 N.W. 65th Pl., Ft. Lauderdale, FL 33309; (305) 974-0967. CIRCLE 326*

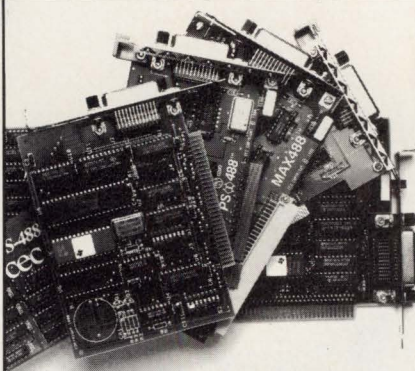

You get fast hardware and software support for all the popular languages. A software library and time saving utilities are included that make instrument control easier than ever before. Ask about our no risk guarantee.

### ANALOG LIBRARY GROWS BY MORE THAN 40%

By adding 1025 new analog components models and symbols, the size of Mentor Graphics' AccuParts library has increased by more than 40%. The library now has 3454 models. Parts categories range from transistors and diodes to complex analog ICs. Also included in the new library are over 500 macromodels for such complex components as operational amplifiers. In addition, many model templates now incorporate more dc, ac, and transient effects. AccuParts models and symbols are qualified by Mentor and are integrated with the company's schematic-capture tools and AccuSim analog simulator. AccuSim can interactively simulate thousands of analog circuit elements. The updated AccuParts library, which is available now, is useful for

simulating analog systems in the aerospace, communications, automotive, and other industries. Pricing ranges from \$6000 to \$22,000 for a one-year subscription.

*Mentor Graphics Corp., 8500 S.W. Creekside Pl., Beaverton, OR 97005-7191; (503) 626-7000. CIRCLE 327*

### ANALOG EDITOR LINKS SCHEMATICS AND LAYOUT

The Analog Artist Layout Editor is an interactive editor from Cadence Design Systems for the physical layout of analog and mixed-signal ICs. Because the tool tightly links schematic design and physical layout, users needn't learn two separate sets of commands for schematic and layout representation. The editor has both layout-editing and layout-checking functions. It has polygon editing capabilities that allow users to cut polygon shapes, merge two or more polygons into one, and convert paths to polygons. In addition, users can interactively select one device in the schematic and place a corresponding layout device in the layout. The editor is available as an option to the company's Analog Artist Design System. It can also be purchased as an upgrade to existing Cadence layout editor installations. Analog Artist Layout Editor runs on most Unix platforms, and is shipping now for \$25,000 per seat.

*Cadence Design Systems Inc., 555 River Oaks Pkwy., San Jose, CA 95134; (408) 943-1234. CIRCLE 328*



Free:  
Informative  
catalog 800-234-4232  
Applications help (617) 273-1818

**cec**

Capital Equipment Corp.  
Burlington, MA. 01803

CIRCLE 118



# Introducing The New CADSTAR...

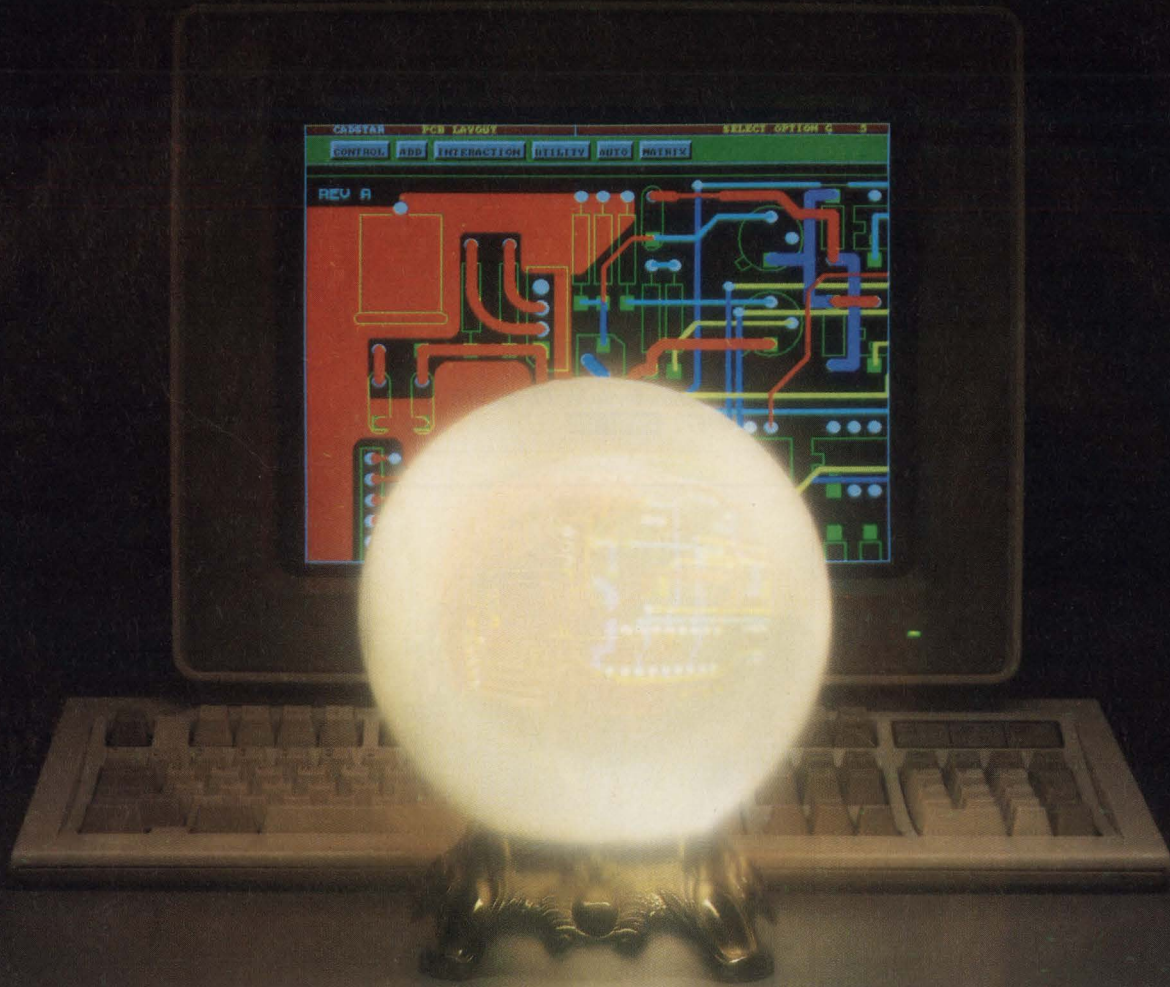

## IT ALMOST READS YOUR MIND.

CADSTAR's revolutionary new user interface almost reads your mind, anticipating your next move and intelligently defaulting to the most likely action. For example, if you pick a part, CADSTAR lets you move it without selecting an action from a menu. If you pick a connection, you can manually route it instantly.

CADSTAR's new Motif style graphical interface has clear, logical menus integrated across all functions. The best part is, you'll rarely need to use those menus! Imagine software so smart, it knows what you want to do next. CADSTAR is easy to learn, and it drastically reduces keystrokes, saving you hours.

### The Power Remains

CADSTAR remains the most powerful design software you can

run on a PC. Unique features like comprehensive, automatic/interactive routines for placement, gate and pin swapping, and routing give you remarkable design flexibility. Racal-Redac continues to enhance the design technology used by thousands of engineers worldwide. CADSTAR includes:

- Integrated Schematic Capture, PCB Layout, Autorouting, Manufacturing Outputs
- 5,000 part library
- Double sided SMDs
- Curved tracks & copper, teardrop pads
- Copper maximization
- Blind & buried vias
- Toll Free hotline support

CADSTAR works with Racal-Redac's 386 Advanced Router, the

most powerful PC based router available. It features 32 bit, gridless, shove aside, rip up and retry technology for 100% routing completion.

### Is There A CADSTAR In Your Future?

Call or write for your free CADSTAR demo disk and brochure. See for yourself how powerful, and easy to use, new CADSTAR really is. Call (508) 692-4900.

# CADSTAR™

## RACAL-REDAC

Racal-Redac, Inc.  
238 Littleton Road  
Westford, MA 01886-9984, USA  
Phone: (508) 692-4900  
Fax: (508) 692-4725



## CHIP SET MIXES VIDEO AND GRAPHICS ON MONITORS

**T**wo chips from Philips Components-Signetics enable video and computer-painted images to be combined on computer monitor screens. The SAA7191 digital decoder converts digitized NTSC, PAL, or SECAM signals into the square-pixel luminance and chrominance (Y, U, V) signals required for desktop video. The conversion to square pixels allows image manipulation without distortion, and produces hard-copy prints that precisely match the on-screen video and graphics.

The SAA7191 accepts either composite or S-VHS inputs. Its output chroma and luminance values are compatible with CCIR 601 specifications, also known as D1 in the U.S. The SAA7192 color-space converter accepts YUV signals from the SAA7191, interpolates samples, and digitally converts the YUV signals to the 24-bit RGB data format required for driving desktop color displays. The chip also performs inverse gamma correction using an on-chip lookup table. The RGB output can be manipulated as computer graphics, or converted into analog red, green, and blue.

Both devices operate on 5 V and are packaged in 68-pin plastic leaded chip carriers. Prices for quantities of 100 to 1000 pieces are \$34.30 for the SAA7191 and \$22.81 for the SAA7192. Production volumes are scheduled for the first quarter of 1991.

*Philips Components-Signetics, 811 E. Arques Ave., Sunnyvale, CA 94088-3409; Steve Solari, (408) 991-4577* **CIRCLE 329**

■ MILT LEONARD

## 32-BIT DSP CORE FEATURES SMALL SIZE

The ST18932 32-bit DSP core has the industry's smallest core die size. Designed for cellular telephones, it's based on SGS's ST18 DSP architecture. Built in 1.2- $\mu$ m CMOS, it's compatible with SGS's CMOS standard cells. A combination of the DSP core, the digital cell library and the module generators for RAM, ROM and PLAs allows complete DSP systems to be imple-

mented in customer-specific form. The chip's 32-bit ALU operates on real or complex numbers. Its parallel architecture allows it to read two independent operands, perform a multiplication and an ALU operation, write a result back to memory, modify three address pointers, and perform an I/O operation, all within one machine cycle of 77 ns. The ST18932 is supported by a complete set of hardware and software tools for system development. Available now, a customer-specific chip, including the 32-bit DSP core, will cost around \$20 in large quantities.

*SGS-Thomson Microelectronics Inc., 1-20014 Agrate Brianza, Italy; (0039) 39-6555-597.* **CIRCLE 330**

## GROUP LISTENING-IN IC COMBINES NEW FEATURES

A "group listening-in" IC for analog telephone sets now incorporates supply circuits. Unlike other ICs, the TEA1805 maintains its high audio quality even at low line currents.

The bipolar IC works in line-powered

telephone sets that have a loudspeaker in the base as well as the handset, enabling a group of people to listen to a telephone conversation at the same time. It offers excellent acoustical performance by suppressing feedback, or howling, and by ensuring that the received speech signal isn't influenced by outgoing speech.

The 1085 also provides call-progress monitoring of pulse or dual-tone multiple-frequency (DTMF) tones. It incorporates a loudspeaker amplifier with fixed 35-dB gain, a dynamic limiter, and mute circuitry. It can develop more than 40 mW into a 50- $\Omega$  speaker in a bridge-tied-load configuration.

The IC draws up to 120 mA of current and provides a stabilized 3.6-V supply for peripheral ICs. Its minimum input current is 4 mA. The TEA1805 device is available in a 24-lead plastic SOT-101B DIL package or surface-mount SO-24 minipack. Samples are now available. Price is about \$4 each in 100-unit lots.

*Philips Components, P.O. Box 218, NL-5600 MD Eindhoven, the Netherlands; (0031) 40-724173.* **CIRCLE 331**

## MORE IN THE SERIES OF DESIGN ADVANTAGES

# LOGIC

### THE SHORTEST CONNECTION BETWEEN IDEA AND SILICON!

#### Design Advantage #2

#### DESIGN VERIFICATION

Functional Design Verifier provides a waveform simulator that allows you to interactively confirm the behavior of the design *before* deciding on device or technology to be used.

#### Design Advantage #9

#### VHDL SYNTHESIS

Our optional VHDL Synthesis tool not only allows you to combine your behavioral *and* hardware descriptions, but also gives you *automatic state assignment and state reduction!*

Contact ISDATA 1-800-777-1202 for complete details on these and other design advantages of LOG/iC.

*Design tools that take your functional descriptions for optimal implementation into semicustom ASICs from PLDs to Gate Arrays.*

**ISDATA**  
INCORPORATED

800 AIRPORT RD.  
MONTEREY, CA  
93940  
408 373-7359

CIRCLE 108



## TESTER, DEVELOPMENT SOFTWARE HANDLE TOUGHEST PC BOARDS

**T**he Advance, a functional ATE workstation, combines with the Spectrum functional test and diagnostics software system to tackle test and diagnostic problems on high-performance pc boards.

The Advance aims specifically at boards with one or more microprocessors, mixed-signal technology, custom devices, and fine-pitch surface-mounted components. The system employs a workstation form-factor ideally suited to the distributed test needs of a parallel or cell-level manufacturing process. This architecture makes it possible for quick and economical distribution, and addition, of tester resources to handle rapidly changing market and product needs.

The Spectrum software offers a development environment that speeds test programming, from simple pass-fail functional tests to complete fault-isolation packages. A built-in test executive, called the Spectrum TestExec, provides a sophisticated framework for organizing test programs and eliminates large segments of application programming. Furthermore, with Spectrum, the functional test and diagnostics program are the same. Spectrum's primary diagnostic tool, its fault dictionary, goes beyond the conven-

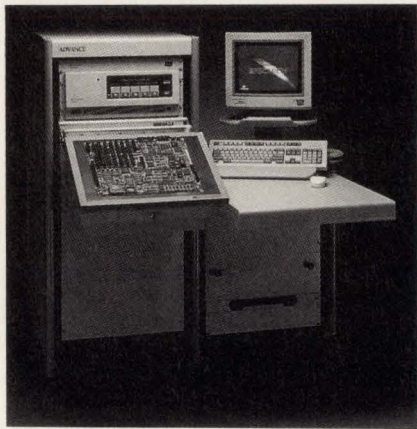

tional driver/sensor-based dictionary to include a wide range of data, including microprocessor emulation, high-speed measurement, and analog results.

Prices for the Advance depend on configuration and start at approximately \$100,000. First shipments are scheduled for March. The Spectrum software costs \$9500 for a complete development version and \$1500 for a runtime version. Shipments are scheduled for April.

*Summation Inc., 11335 NE 122nd Way, Kirkland, WA 98034; (206) 823-8688. CIRCLE 332*  
**■ JOHN NOVELLINO**

## DEBUG TOOLS FOR 4-BIT CPUs RUN WITH WINDOWS

**O**ne major complaint from designers working with 4-bit microcontrollers are primitive and unwieldy development tools. The Simplehost software debugging tool for NEC Electronic's 17000 family of 4-bit controllers will change that thanks to its ability to run under the Microsoft Windows shell. The Simplehost software deals only with source code, automatically assembling the code for the designer. This eliminates a tedious step in the design process.

A novel patch feature of the Simplehost software debugging tool allows the debugger to transfer only changed lines of code to a target system when the designer makes a change in the program. As a result, the time required to test program fixes is reduced drastically because the entire program needn't be recompiled.

Also part of the Simplehost software package is a programmable pulse generator that acts as a pattern generator, permitting the designer to create signal patterns graphically. With the ability to call multiple windows onto the PC-hosted screen, a designer can execute a software program while viewing the trace file. The designer can then highlight a particular instruction in the code file and see the same instruction highlighted automatically in the trace file.

Another feature is Simplehost's ability to let the engineer set up break conditions up to four levels deep. A RAM coverage feature enables the programmer to identify whether he has written to or read from any RAM location at any given time.

A ROM coverage function of the Simplehost software debugging tool helps identify how many times each instruction is executed.

The Simplehost software runs on any PC platform using Windows 3.0 and is employed with the IE-17K hardware emulator. Prices for the emulator and software combination start at \$4000. Users already owning an IE-17K emulator can get the Simplehost software at no charge.

*NEC Electronics Inc., 401 Ellis St., Mountain View, CA 94039; Mahmoud Etemadi, (415) 960-6000. CIRCLE 335*  
**■ DAVE BURSKEY**

## ACQUISITION SYSTEM DISPLAYS IN REAL TIME

Version 5.3 of the AT/MCA CODAS (computer-based oscillograph and data-acquisition system) software-hardware package has been enhanced with a third real-time display mode, a variety of frequency-domain analysis tools, and a built-in statistics program. In addition, version 3.1 of the Advanced CODAS waveform analysis program has been upgraded with an arithmetic operations module and other analysis features. The AT/MCA package is a real-time waveform-acquisition, display, and analysis system for IBM PC/AT or MicroChannel computers. The Advanced CODAS software speeds analysis and reduction of waveform data acquired with the AT/MCA CODAS system. AT/MCA CODAS 5.3 costs \$2790, and Advanced CODAS 3.1 goes for \$595. Upgrades to current

owners are free. Delivery of both is within 2 weeks.

*Dataq Instruments Inc., 825 Sweitzer Ave., Akron, OH 44311; (216) 434-4284. CIRCLE 345*

## ASSEMBLY CONVERTS 28-PIN DIP PLUG TO PLCC

Emulators designed for 28-pin DIP devices can be converted to work with PROMs in 28-pin PLCC packages using the SOCON 28DIP6/PLCC converter. The assembly consists of a pc board with a female production-style DIP socket on top. The board is mounted on a PLCC plug with 50-mil-space, gold-plated round contact pins. The pins are wired one-to-one. The 28DIP6/PLCC costs \$165 each; quantity discounts are available. Delivery is stock to 5 days after receipt of an order.

*EDI Corp., P.O. Box 366, Patterson, CA 95363; (209) 892-3270. CIRCLE 333*



# CAE Technology Report

March 1991  
Vol. 3, No. 3

## Silicon Breadboards Arrive

Silicon vendors got together with a leading CAE house and scored in a big way. They created silicon breadboarding that allows interactive simulation of multiple field programmable gate arrays (FPGAs), as if they were one piece of silicon. The user can display, next to each other, cells from different FPGAs and observe in real-time how a change in one cell affects operations of cells in other FPGA packages. This new technological advancement allows the user to break any design into multiple FPGAs and test them as one entity. This way, designers don't have to wait for the newest and biggest FPGAs; instead, they can design with the most economical and well established FPGA parts. Contact Actel at (800-227-1817) and XILINX at (408-879-5199) about FPGAs. For Silicon Breadboarding (SUSIE 6.0), contact ALDEC (805-499-6867). **CIRCLE 102**

## OrCAD™ Users Benefit Again

Users of the popular OrCAD schematic capture program got a major support from SUSIE 6.0 which simulates their designs with 10 picosecond accuracy. OrCAD users can now directly interact with their designs as if they were real hardware breadboards. For example, they can toggle switches, move jumpers, replace ICs, change JEDEC fuse maps and hex files, modify layout delays, etc., all in real-time. The designers can also modify their designs and test vectors while they simulate. Since there are no compilations and the simulator behaves like a real hardware breadboard, it is easy to learn and use. The SUSIE simulator is finding broad applications, primarily among PLD and FPGA designers who urgently need such an interactive tool. SUSIE 6.0 sells from stock. **CIRCLE 103.**



## Mentor™ Designs - Run In Real-Time!

Mentor users can now verify their designs in real-time thanks to a new EDIF interface to SUSIE which is the industry's most popular logic simulator. SUSIE runs on 386/486 PC platforms and simulates designs in excess of 200,000 gates, with 10 picosecond accuracy. SUSIE comes equipped with a software accelerator, milestones, and an automatic design errors locator. The user can modify design and test vectors while he or she simulates, and working with SUSIE is much like working with real hardware. SUSIE frees Mentor workstations to handle more designs and costs only \$9,995, including Mentor interface. **CIRCLE 104.**

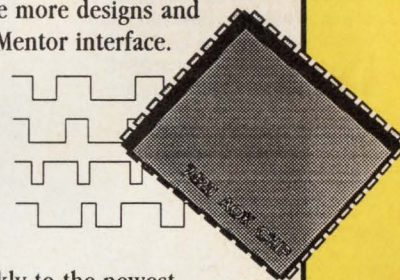

## Free Upgrade to VHDL Libraries

To help customers move quickly to the newest industry standard, SUSIE 6.0, ALDEC is upgrading all SUSIE installations at a straight price differential. The libraries are upgraded to the new VHDL standard at no cost. The new SUSIE has many improvements like a DOS extender, milestones, graphical test vector editor, software accelerator, powerful breakpoint editor and many other features that make it the most popular engineering tool.

SUSIE is resold or recommended by over 15 OEMs worldwide, including CADAM™, Racal-Redac™, Accel™, Omation™, CAD Software™, etc. It looks like everybody's betting on SUSIE these days. **CIRCLE 105.**

## How To Shop For A Good Simulator

There are many benchmarks and comparison sheets that pit one simulator against another. However, newest benchmarks stress speed, real-time operation and test automation. Clearly, the most important trend is interactive, real-time simulation that allows the user to interact with the design and test vectors while simulating. This allows for the kind of interaction that designers used to have with a real hardware breadboard. The latest enhancements in speed is selective simulation which allows instant manual selection of design sections for simulation. This may speed simulation over 100 times. The latest in automation is "milestones" which allows instant resimulation of past cycles with new design and test vector changes. Simulators have considerably progressed during the last year, and if you're looking for a good buy, make sure that your simulator operates in **real-time** and comes equipped with **selective simulation** and **milestone functions**. Don't waste today's budget on yesterday's batch-style technology.

\* SUSIE is a trademark of ALDEC Co., Inc. Newbury Park, California, USA . TEL: (805) 499-6867 FAX: (805) 498-7945 Actel, Xilinx, OrCAD, CADAM, Racal-Redac, Omation, CAD Software and Mentor are trademarks of their respective holders.



# MEGABIT MEMORIES

## As Big As Your Imagination

The first time your designs start having density or space problems, we should be talking. Whether you need a few megabits of SRAM in a 32-pin DIP, or 64-Megabits of Flash PROM in a 2" x 2" flatpack, we can help.

Our newest models, for example, are a series of 4-Megabit (512Kx8) CMOS SRAMs in a rugged 1.6" x 0.6" ceramic 32-pin DIP with JEDEC standard pinouts. They offer read access times from 45nSec to 120nSec, and three temperature ranges. They also feature a typical operating current of just 37mA, and data retention with voltages as low as 2.0 volts. Data retention current at 25°C is typically 10ua. Just right for

those low-power battery-backed applications. As with all our products, Screening and burn in to Military standards are available options. White is certified to MIL-STD-1772.

If 4-Megabit isn't enough, we have a new 34-pin 8-Megabit Flash PROM module that measures just 1.93" x 1.14". At 0.41 in<sup>2</sup>, it's probably the smallest package available holding that much non-volatile memory. Organized as 1 Megabyte x 8, its eight pages of one megabits each can be erased a page at a time without affecting the other pages. Access time is 150nSec. Programming typically takes just 10uSec/byte and 2

seconds/page. Chip erase also takes 2 seconds/page. We also have a 2" x 2" 64-Megabit Flash PROM flatpack in test now, and still larger capacities to follow.

We have all the building blocks for your tiny systems, the memory and density for your terabit

dreams, and the products to help you anywhere in between. If it's only a 2-Megabit SRAM or EEPROM in a miniature package, or a shoebox-size supercomputer array, we have the technology and the expertise to respond. Your imagination or ours, we'll make it happen.

### White Technology, Inc.

A wholly owned subsidiary of Bowmar Instrument Corporation  
4246 E. Wood St. • Phoenix, Arizona 85040  
(602) 437-1520 • FAX 602-437-9120

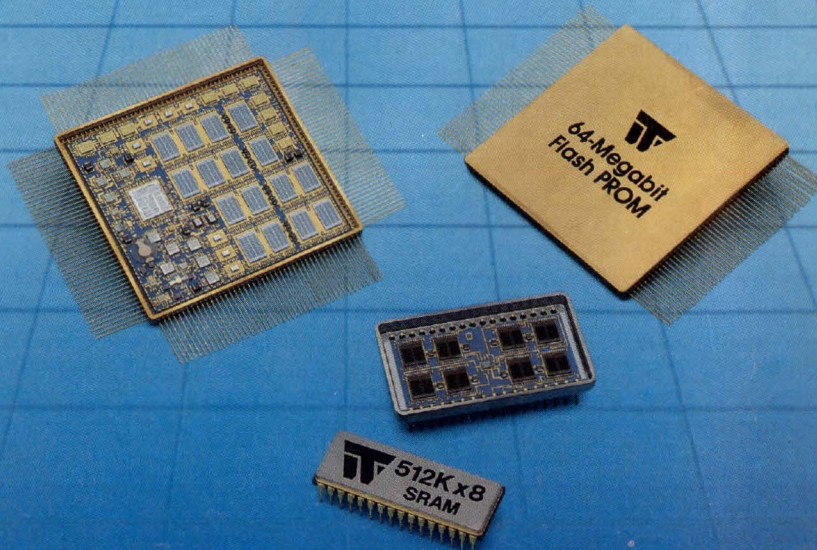
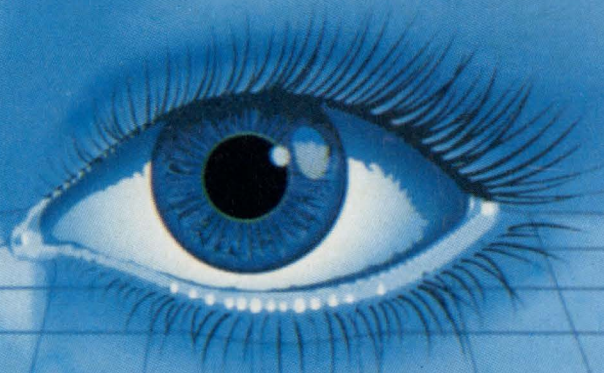

CERTIFIED AND  
QUALIFIED TO  
MIL-STD-1772





# ELECTRONIC DESIGN

## DIRECT CONNECTION ADS

New Products/Services Presented By The Manufacturer.  
To Advertise, Call JEANIE GRIFFIN At 201/393-6080

WORLD'S SMALLEST  
**SMT** QUARTZ CRYSTALS and CLOCK OSCILLATORS

708-806-1485

- 10kHz-32MHz
- ceramic & metal packages
- hermetically-sealed
- hi-temp mounting
- tape & reel
- thru-hole versions
- shock resistant

**MICRO CRYSTAL**  
702 N. Algonquin Rd.  
Arlington Heights, IL 60005

FREE CATALOG

**MICRO CRYSTAL** CIRCLE 254

☆☆☆☆  
"The Best 8051 Emulator"

**NEW**  
30 MHz REAL-TIME



5 ft. cable

**8051** SEE EEM 90/91 PAGES D 1320-1323

PC based emulators for the 8051 family

8031, 8032, 8051, 8052, 80C152/154/321/451/452/51FA/51GB/515/517/535/537/552/562/552/851, 80532, 83C451/552/652/751/752/851, 8344, 87C451/552/751/752, 8751, 8752, DS5000 + CMOS ... more.

- PC plug-in boards or RS-232 box.
- Up to 30 MHz real-time emulation.
- Full Source-level Debugger w/complete C-variable support.
- 48 bit wide, 16K deep trace, with "source line trace".
- "Bond-out" pods for 8051, 83C552, 83C451, 83C652, 83C751, 80C515/80C517, 83C752.

Prices: 32K Emulator 8031 \$1790; 4K Trace \$1495\*

**CALL OR WRITE FOR FREE DEMO DISK!**  
Ask about our demo VIDEO

**NOHOU** CORPORATION (408) 866-1820

51 E. Campbell Avenue  
Campbell, CA 95008  
FAX (408) 378-7869

\*US only

SEE US AT ELCTRO BOOTH 2244 CIRCLE 255

**Analog Circuit Simulation**  
Completely Integrated CAE from \$95

From Schematic Entry through SPICE Simulation to Post Processing

IsSPICE \$95, the complete SPICE program, runs on all PC's.

IsSPICE/386 \$386, The fastest PC based SPICE program available. Has virtually no circuit size limitations.

SPICENET \$295, a schematic editor for any SPICE simulator. Generates a complete SPICE netlist.

INTUSCOPE \$250, a graphics post processor that performs all the functions of a digital oscilloscope.

PRESPICE \$200, extensive model libraries, Monte Carlo analysis, and parameter sweeping.

Please Write or Call  
P.O. Box 6607 (213) 833-0710  
San Pedro, CA 30 Day Money Back Guarantee  
90734-6607

**intusoft**

INTUSOFT CIRCLE 284

**NEW.**

**MATRIX SYSTEMS**

CATALOG ON MATRIX SWITCHING MODULES

Over 50 data sheets arranged in a convenient spiral binder provides descriptions, photos, specifications and interconnections on broadband reed relay and solid state switching modules, matrices & systems. Audio, video and RF inputs are compatible with RS-232, RS-422, IEEE-488, 16 bit parallel, and the new VXI bus.

**MATRIX SYSTEMS CORPORATION**  
5177 North Douglas Fir Road, Calabasas, CA 91302  
Phone: 818-992-6776 Fax: 818-992-8521

**MATRIX SYSTEMS** CIRCLE 257

**EPROM PROGRAMMER**  
FOR THE PC \$139.95



2 foot cable  
40 pin ZIF

- 2716 to 4 Meg
- Programs 2764A in 10 seconds
- 16/32 bit split programming
- Menu driven software
- No personality modules required
- Adapter for 8748, 49, 51, 52, 55, TMS 7742, 27210, 57C1024, and memory cards
- 1 year warranty • 10 day money back guarantee
- Made in the U.S.A.

MasterCard  
VISA

For more information, call (916) 924-8037  
EMPDEMO.EXE available BBS (916) 972-8042

**NEEDHAM'S ELECTRONICS**  
4539 Orange Grove Ave. • Sacramento, CA 95841  
(Monday - Friday 8:00 a.m. - 5:00 p.m. PST)

**NEEDHAM'S ELECTRONICS** CIRCLE 258

**CHIPS SAFE™**

For Safely Storing, Organizing, Archiving and Transporting Your IC Components



Our handsome, Crushproof, Dust-Tight, Snap-fastened IC Storage albums with ESD protection are the perfect solution for physically and electrically protecting your library of IC MASTERS, MODS, REVS and samples. In stock for immediate delivery.

Product	Model	Size	Chip Capacity (DIP)	Features	Prices (1-4)
ChipSafe™	100	7" x 10"	528 264 76 56	Maximum IC storage	\$ 16.95
ChipStore™	200	7" x 10"	264 132 38 28	Combination IC & diskette storage	\$ 16.95
			5 5 1/4" diskettes		
ChipCarry™	300	5" x 6"	120 70 19 12	Briefcase size IC storage	\$ 12.95
ChipPocket™	400	3" x 4"	55 26 7 5	Shirt pocket size	\$ 6.95

**iTOI** ENTERPRISES P.O. Box 59, Newton Highlands, MA 02161  
TEL: (617) 332-1010

**ITOI ENTERPRISES** CIRCLE 259



**"Tango gives us more than just great CAE/CAD tools."**

"We love using every one of the programs in the Tango design suite. But owning Tango tools means more than getting high performance and quality output at an affordable price. It also means getting that extra measure of value with ACCEL's excellent service and support."

With each Tango design tool for schematic entry and PCB and PLD design, you'll get: thorough documentation; friendly customer service; affordable updates; reliable technical support; BBS; user newsletter; and a 30-day guarantee.

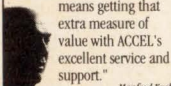

**Tango**

See for yourself. Call today for information or a free evaluation package.

**800 488-0680**

619 554-1000 • FAX: 619 554-1019

ACCEL Technologies, Inc.  
6825 Flanders Drive • San Diego, CA • 92121 • USA  
Contact us for the representative nearest you.

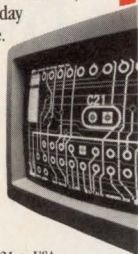

ACCEL TECHNOLOGIES

CIRCLE 260

**NEW, POWERFUL, UNIVERSAL**

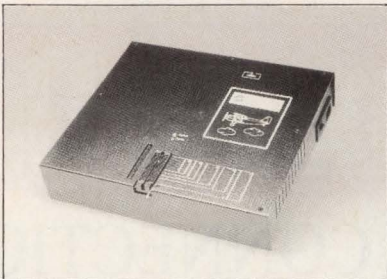

PILOT-U40 is our second generation 40-pin universal programmer, following the very successful and popular Sailor-PAL line of programmers. Programs PALs, GALs, PROMs, E/PROMs, micros, AMD MACH-110, etc, etc. 28-pin and 32-pin versions also available. Industrial quality. \$1,095 to \$2,495. Satisfaction guaranteed.

408-243-7000, 800-627-2456, Fax 408-736-2503



**ADVIN SYSTEMS INC.**

1050-L E. Duane Ave., Sunnyvale, CA 94086

ADVIN SYSTEMS

CIRCLE 261

**FREE FOR ALL**

Free for all who call Omation - a PC board layout demo disk! Try SCHEMA PCB for FREE and optimize designs for boards as large as 32" x 32", 30 layers, right on your PC. Call Omation for your FREE demo disk today!



**1-800-553-9119**

OMATION

CIRCLE 280

**Little Giant™  
New! Tiny Giant™  
C Programmable Controllers**

We have miniature controllers with parallel I/O, solenoid drivers, A/D and D/A converters, clock, watchdog, LCD interface, RS485 serial, built-in power supply and much more! Use them to control anything. Our \$195 interactive Dynamic C™ development system makes software development easy. These units have high performance and serious software support. We also have design-your-own-board core modules as low as \$59.

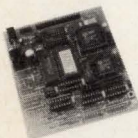

**\$159**

(Tiny Giant Digital, qty. 1)

**Z-World Engineering**

1340 Covell Blvd., Davis, CA 95616 USA  
**(916) 753-3722**

Regular Fax: (916) 753-5141

Automatic Fax: **(916) 753-0618**

(Call from your fax, hear computer voice, use touchtone dial to request desired data sheets.)

Z-WORLD ENGINEERING

CIRCLE 278

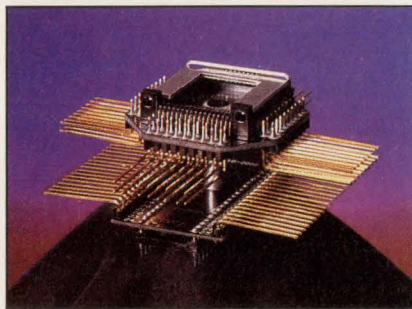

**Quick, Fast Socket Conversion**

- Convert-A-Socket™ makes it a snap to convert a production socket to a test socket and vice-versa.
- Complete line of male/female sockets for LCC, PLCC, PGA, PQFP, and DIP circuits.
- A must if you're inserting circuits repeatedly in low insertion force sockets.
- Quick turnaround on custom engineering services, if needed. For a free catalog, contact:

Emulation Technology, Inc.  
2344 Walsh Ave. Santa Clara, CA 95051  
Phone: 408-982-0660 FAX: 408-982-0664



EMULATION TECHNOLOGY

CIRCLE 264

**The New Standard in Circuit Simulation for Workstations, PCs, and Macintoshes**

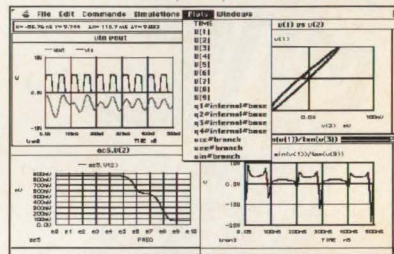

Enjoy the power and flexibility of the next generation of SPICE!

- Interactive simulation, integrated real-time graphics, and...
- Advanced Temperature Analysis
  - Noise & Distortion Analysis
  - Transfer Functions
  - Sensitivity Analysis
  - Short-Channel MOS Models
  - Advanced GaAs Models
  - User-Definable Device Equations
  - Automatic Branch Currents
  - Symbolic Function Libraries
  - Extensive Device Libraries

Enjoy the full power of a complete workstation-quality analog CAE environment, now available at your fingertips. Edit, simulate, and plot, all without ever leaving the program. With TurboSPICE™ for workstations or DOS, SPICEWindows™ for Windows 3.0, or MacSPICE Professional™ for the Macintosh you will have:

- Real-Time Simulation Ability - So you can see your results as they happen
- The ability to stop a simulation, instantly change the circuit and rerun
- Unlimited Levels of Mouse-Based Zooming and Value Display
- Transparent Interface to Schematic Capture
- Multiple Plot Windows - Unlimited simultaneous simulations on screen
- Built-in Mathematical Functions
- Desktop Publishing Quality Graphics
- The best SPICE available at any price

DEUTSCH RESEARCH

761 De Soto Drive • Palo Alto, CA 94303 • (415) 327-8677 • FAX (415) 327-0925

DEUTSCH RESEARCH

CIRCLE 283

**Design PLDs with ABEL-PLD, now just \$495.\***

FREE ABEL-PLD start-up kit!

- 150 PLD architectures supported (over 4000 devices)
- Uses ABEL™ Hardware Description Language (ABEL-HDL™)
- Intelligent synthesis and optimization
- Upgradable to full-featured ABEL

**1-800-247-5700**

\*U.S. list price only. Limited-time offer.

**DATA I/O Corporation**

DATA I/O CORP.

CIRCLE 267

**Program PLDs and memories with the low-cost 212.**



Now supports the 27C4001, 87C51 and 22CV10!

- Supports more than 450 CMOS devices
- Memory cards for easy updates
- Extensive editing capabilities
- Compatible with JEDEC standard programming files

Call for your FREE 212 15-day trial!

**1-800-247-5700**

**DATA I/O Corporation**

DATA I/O CORP.

CIRCLE 268

**YOUR AD HERE**

Here's all you have to do:

- Send a B/W or 4C glossy photo.
- Include 13 lines of copy. (37 characters per line)
- Write a headline of 32 characters or less.

**We do all the rest. No production charges.**

We also accept camera-ready art. Ad size 2 3/16" wide X 3" deep.

CIRCLE 269



# YOUR AD HERE

Here's all you have to do:

- Send a B/W or 4C glossy photo.
- Include 13 lines of copy. (37 characters per line)
- Write a headline of 32 characters or less.

**We do all the rest. No production charges.**

We also accept camera-ready art. Ad size 2<sup>3</sup>/<sub>16</sub>" wide X 3" deep.

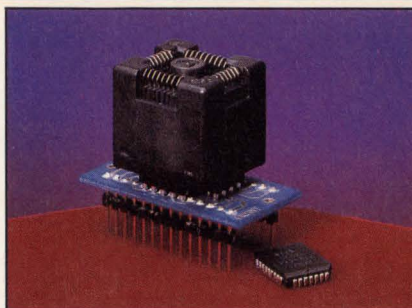

## PAL/PROM Programmer Adapters

- Any EPROM programmer designed for DIPs can be converted to accept LCC, PLCC, and SOIC sockets in seconds!
- To program, just insert an Adapt-A-Socket™ between the programmer's DIP socket and the circuit to be programmed.
- Designed to fit all types of EPROM programmers, including Data I/O 120/121A, Stag, Logical Devices, etc.
- Quick turnaround on custom engineering services, if needed. For a free catalog, contact:

Emulation Technology, Inc.  
2344 Walsh Ave. Santa Clara, CA 95051  
Phone: 408-982-0660 FAX: 408-982-0664  
EMULATION TECHNOLOGY



CIRCLE 271



**LOW COST INTERFACE CARDS FOR PC/XT/AT**

### RS-485/422 Card [PC485] \$95/125

- Serial Async. Communication up to 4000ft; 2 or 4 wires; NS16450 UART;
- COM-1-4; Max. Baud Rate 56KB. High speed version (256KB) - \$165.
- Dual drivers/receivers; Handles 64 devices; Compatible with most comm S/W.
- DB9 or phonejack. Sample programs included. Optional sourcecode - \$150

### Dual-Port RS-485/422 [PCL743] \$175

- Two independent channels/UARTs; 2 or 4 wire operation. Max. Baud 56KB.
- Dipswitch configurable as COM-4 (IRQ2-7). On board terminator resistor.

### IEEE-488 Card [PC488A/C] \$145/445

- Includes DOS Device Driver and sample Communication program in BASIC.
- Additional sample programs in C, Pascal & Assembly - \$50.
- Selectable IRQ (1-6). DMA channel 1 or 2. Up to four boards per computer.
- Compatible with most IEEE-488 Software packages for IBM-PC.
- I/O Addresses and Control registers compatible with XT, GFB-PC/IA
- PC488C card version with Built-In Bus Analyzer hardware and software

### Stepper Motor Card [PCL838] \$395

- Capable of independent and simultaneous control of up to 3 stepper motors.
- Programmable speed from 1 to 10,000 rpm. Steps per command 1 to 65535.
- DIP switch selectable I/O port base address and wait state. 24 bit TTL I/O port
- Crystal based timing; All control signals opto-isolated.

### 144 Bit Digital I/O [PCL722] \$345

- 144 lines (24 bits x 6 ports) of TTL compatible digital I/O. Output buffers sink 24mA, source 15mA. Interrupt handling capability. Opto-22 module compatible. MC / VISA / AMEX Call today for datasheets!



**B&C MICROSYSTEMS INC.**  
750 N. Pastoria Ave., Sunnyvale, CA 94086 USA  
TEL: (408) 730-5511 FAX: (408) 730-5521

B&C MICROSYSTEMS

CIRCLE 272

# RELIABILITY PREDICTION SOFTWARE

## ARE YOUR PRODUCTS RELIABLE?

The RelCalc 2 Software Package predicts the reliability of your system using the part stress procedure of MIL-HDBK-217E, and runs on the IBM PC and full compatibles. Say goodbye to tedious, time consuming, and error prone manual methods! RelCalc 2 is very easy to use, and features menu windows, library functions, global editing for what-if? trials, and clear report formats. Try our Demo Package for \$25.

T-CUBED SYSTEMS, 31220 La Baya Drive # 110, Westlake Village, CA 91362. (818) 991-0057 • FAX: (818) 991-1281

T-CUBED SYSTEMS

CIRCLE 270

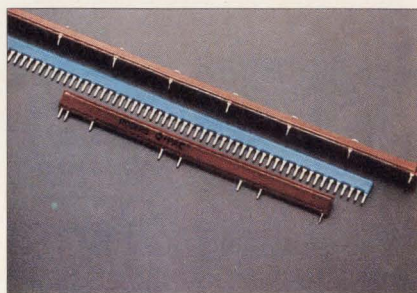

## SAVE SPACE WITH Q/PAC® COMPONENTS

- Provide built-in capacitance
- Eliminate decoupling capacitance
- 4-layer board quietness, 2-layer economy
- Vertical or horizontal mounting

Send for Rogers Q/PAC® Application Bulletin

Rogers Corp., 2400 S. Roosevelt St.  
Tempe, AZ 85282 602/967-0624

ROGERS CORP.

CIRCLE 274

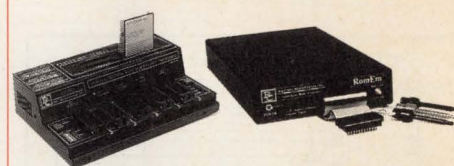

## RS232 EE/EPROM, MICRO & MEMORY CARD PROGRAMMER \$345/495

- Programs EE/EProms, Flash EProms, ZPRams, Intel Micros, Memory Cards.
- Stand-Alone Mode for EE/EProms and Memory Card Duplication / Verify.
- All 24/28/32 pin EE/EProms to 8 MBits (upgradeable to 32 Megabits).
- Micros: 8741/A, 2/A, 4, 8, 9, 51, C51, C51FA/B, 52, 53, 55, C521, C541, 9761.
- Accepts dedicated modules: Memory Card Programming Module (Seiko/Epson) - \$145, Eraser/Timer Module - \$50, Gang Module (4 sockets) - \$145. Simultaneously duplicates up to 5 devices in stand-alone mode (with Gang).
- Can be operated with any computer containing an RS-232 serial port.
- User friendly Menu-Driven Interface Program for IBM-PC or compatible.
- Full 1 year warranty. Customer support via voice line, fax or dedicated BBS.

## INTELLIGENT ROM EMULATOR \$395

- Emulates 2716 through 27512 EProms with a single unit. Access time 120ns.
- Connects to the standard parallel printer port via a standard printer cable.
- User friendly software. Command set includes: Load(data), Write(data), Display(memory), Type(of EProm), Edit(memory), Fill(memory), Calculator, Reset(target system), Activate(debugging feature), Monitor(selected feature).
- Address Compare with Halt output, Address Snapshot, Trigger input.
- Fast data loading via parallel printer port (64k bytes in less than 10 sec).
- Cascadeable up to 8 units. Includes target cable with Trigger/Reset/Halt clips.
- CMOS (stand-alone) model with rechargeable NiCad battery backup: \$495



**B&C MICROSYSTEMS INC.**  
750 N. Pastoria Ave., Sunnyvale, CA 94086 USA  
TEL: (408) 730-5511 FAX: (408) 730-5521

B&C MICROSYSTEMS

CIRCLE 275

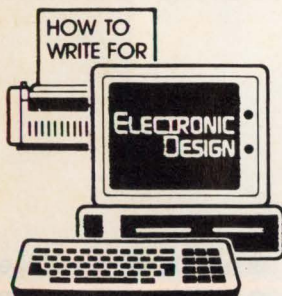

## ELECTRONIC DESIGN AUTHOR'S GUIDE

Thinking of writing a technical article for publication in Electronic Design? This 12-page brochure contains just about everything you need to know about the process: submitting the outline, tips on writing the manuscript, preparing the artwork, and more.

**ELECTRONIC DESIGN**  
611 Route #46 West  
Hasbrouck Heights, NJ 07604

ELECTRONIC DESIGN

CIRCLE 276

## AUTOSCOPE, INC. MODEL 180B



### 180 MHz PULSE GENERATOR

- MAIN OUT:** -0.5Vp-p to +5Vp-p into 50Ω or 10Vp-p max. into open (within -5V to +5V range); Two transition time settings (1.3ns or 2ns typ.); Normal or Complement mode; Less than 5% aberrations at 5Vp-p into 50Ω.
- PERIOD:** <5.5ns to >1s in 9 ranges or EXT clock and MANUAL or = 2 times oscillator period when in OSC = 2 mode.
- DELTA:** <2.5ns to >1s in 9 ranges or SYNC = MAIN; Delay setting error indicator.
- WIDTH:** <2.5ns to >1s in 9 ranges or = oscillator period when in OSC = 2 mode; Width setting error indicator.
- MODE:** Single pulse or Double pulse; NORMAL, GATE or BURST (External or manual triggered pulse burst with burst-length controlled by Delay section).
- OTHER:** Power 120Vac/50-60Hz; 75W Size 8"wx4"hx9"; Weight 8lb.
- SUM IN:** Digital OR with Main; 50Ω input; 0.7V threshold; <1V input sensitivity.
- PRICE:** \$1680; delivery is 8 weeks after receiving order.

897 Independence Ave. #4D, Mtn. View, CA 94043. Tel (415) 691-0618

AUTOSCOPE

CIRCLE 277

Telecom Solutions from Teltone

# Telecom IC Data Book

The reference for telecom design engineers. Includes:

- DTMF and call progress tone receivers and transmitters
- MF trunk receivers and transmitters
- DC signaling devices
- Key system/PBX enhancements
- Test and demonstration equipment
- Telecom signaling application notes

**1-800-426-3926**

Or: 206-487-1515 Fax: 206-487-2288



**INNOVATING SOLUTIONS**  
In Telecom Interface Components

Teltone Corporation, 22121-20th Avenue SE, Bothell, WA 98021  
TEL TONE CIRCLE 263



**NEED ENGINEERING SUPPORT?**

Let GNOSTECH help develop your next hardware or software product. We are an engineering consulting firm specializing in custom electronics, software, design and development. Customers include both the government and Fortune 500 companies with world wide distribution. Our experience includes: Data Acquisition and Analysis, Real Time Simulation and Process Control. Our specialty is customer satisfaction. Call or write for more info:



**Gnostech Inc.**  
650 Louis Drive, Suite 190  
Warminster, PA 18974  
(215)443-8660

GNOSTECH CIRCLE 279

**AT BUS DESIGN**

At last, here is the **timing book** for the XT and AT Bus. Detailed text, tables and diagrams tell you what each signal line is for, what it does and when it does it. All the information is compatible with the IEEE P996 Specification for the ISA (AT) Bus. In addition, the 8 and 16 bit parts of the EISA Bus are included. **AT Bus Design**, by Ed Solari, has over 200 pages, with more than 100 figures and tables. Handy 7" x 9" format, soft cover, \$69.95.

**FREE** We'll include a free copy of the pocket-sized **XT-AT Handbook** by Chissoer and Foster with each AT Bus Design book if you tell us where you saw this ad. Of course, this \$9.95 value is also available by itself. Or buy five or more for only \$5.00 each.

VISA 800-462-1042 MasterCard  
619-271-9526

**Annabooks**  
12145 Alta Carmel Ct., Suite 250  
San Diego, CA 92128 FAX 619-592-0061  
Money-back guarantee

ANNABOOKS CIRCLE 262

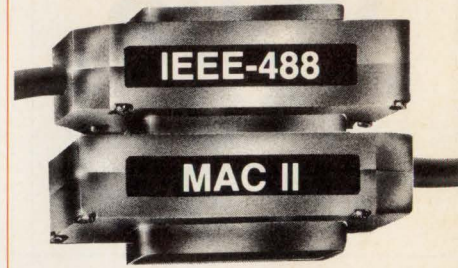

**'488 CONTROL FOR YOUR MACINTOSH II**

- Control any instrument in minutes.
- Supports BASIC, Pascal, C and Hypertalk.
- HyperCard utilities included.
- Software library. Risk free guarantee.

**cec** Capital Equipment Corp.  
Burlington, MA. 01803

**Informative catalog 800-234-4232**  
**Applications help (617) 273-1818**

CAPITAL EQUIPMENT CIRCLE 281

**CUT DESIGN TIME IN HALF!**

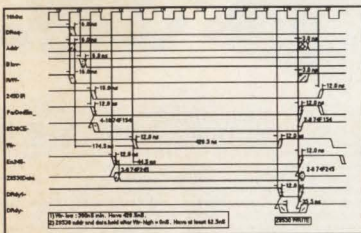

dV/dt® Timing Diagram Accelerator

**POWERFUL FEATURES INCLUDE:**

- "What-if" analysis
- Calculation of critical edge timing
- Display and verification of IC timing requirements
- And many more features...all for **ONLY \$695!!**

"I use dV/dt quite a bit. It's a terrific product that saves me weeks of design time!" Tony Radice, General Instrument

**CALL FOR A FREE EVALUATION PACKAGE**

Phone 619-457-4545 Fax 619-457-1168  
Doctor Design • 5415 Oberlin Drive • San Diego • CA • 92121

DR. DESIGN CIRCLE 282



**FREE!**  
**120**  
**Page**  
**Catalog**  
-----  
**"Optics**  
**for**  
**Industry"**

**ROLYN OPTICS** supplies all types of "Off-the-Shelf" optical components. Lenses, prisms, mirrors, irises, microscope objectives & eyepieces plus hundreds of others. All from stock. Rolyne also supplies custom products & coatings in prototype or production quantities. Write or call for our free 120 page catalog describing products & listing off-the-shelf prices. **ROLYN OPTICS CO.**, 706 Arrowgrand Circle, Covina, CA 91722, (818) 915-5707 & (818) 915-5717. TELEX: 67-0380. FAX: (818) 915-1379.

ROLYN OPTICS CIRCLE 265

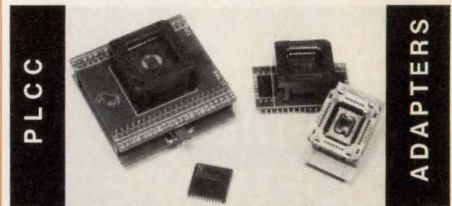

Program PLCC devices on your DIP programmer. The PLCC sockets are live-bug auto-eject style providing positive alignment and push-in/pop-out mechanism. **Accepts NEW CERQUAD erasable package!**  
AMD MACH-110 & 210 ..... PA-MACH-210 ..... \$115.  
28 DIP to 44 PLCC..... **new!!**  
20 pin PALS ..... PA20-20D ..... \$90.  
20 DIP to 20 PLCC (dead bug loading) **new!!**  
2764 thru 27512, 27C011 ..... PA28-32 ..... \$90.  
28 DIP to 32 PLCC..... **new!!**  
27010 thru 27080 ..... PA32-32 ..... \$90.  
32 DIP to 32 PLCC..... **new!!**  
27202-3, 27210-27280, 87C75PF. PA280-44 ..... \$115.  
40 DIP to 44 PLCC..... **new!!**

**CALL or FAX for full device list!**

**CALL (315) 478-0722 FAX (315) 475-8460**

Logical Systems Corporation  
P.O. Box 6184, Syracuse NY 13217 USA

LOGICAL SYSTEMS CIRCLE 256

**ELECTRONIC DESIGN**

**DIRECT CONNECTION ADS**

**1991 SCHEDULE**

Issue Date:	Ad Close	Issue Date:	Ad Close	Issue Date:	Ad Close	Issue Date:	Ad Close
Jan. 10	Dec. 14	April 11	March 15	July 11	June 14	Oct. 10	Sept. 13
Jan. 31	Jan. 4	April 25	March 29	July 25	June 28	Oct. 24	Sept. 27
Feb. 14	Jan. 18	May 9	April 12	August 8	July 12	Nov. 7	Oct. 11
Feb. 28	Feb. 1	May 23	April 26	August 22	July 26	Nov. 21	Oct. 25
March 14	Feb. 15	June 13	May 17	Sept. 12	Aug. 16	Dec. 5	Nov. 8
March 28	March 1	June 27	May 31	Sept. 26	Aug. 30	Dec. 19	Nov. 20

To Advertise, Call JEANIE GRIFFIN At 201/393-6080



# CUSTOMIZING YOUR WAVEFORM ANALYSIS DOESN'T TAKE A PC.

## IT JUST TAKES A LITTLE TACT.™

The company that gave you the first digital oscilloscope, the longest memory, best resolution and greatest storage capacity has gone a giant step further toward the perfect scope. All you need is a Nicolet 400 Series DSO - and TACT.™

TACT software elevates Nicolet's 400 Series DSO into the first application-specific oscilloscope. It gives you the power to say and do the right thing at the right time - to enhance the productivity of your test capabilities.

### No computer needed.

Other scopes give you waveforms. Nicolet gives you answers. Forget the PC. You don't need one. Program directly on the scope using a built-in, full-screen editor and 101-key PC-type keyboard. Creating your own custom

programs, calculations and plots has never been this fast...this simple. Time savings are dramatic as TACT's LEARN mode writes and remembers most of your programs for you. Automatically.

Perform complex data reductions. Print a complete analysis. Plot trends from previous tests. And automate pass/fail decisions. They're no problem. You just need TACT.



### BASIC language - SUPERIOR performance.

A built-in BASIC language with easy access to on-screen prompts and menus puts even more power in your hands. All scope functions, conditional testing, variable storage, custom printer and plotter output capabilities are just a touch away. With TACT, put waveforms in; get reliable answers out.

To simplify your testing you need two things. Nicolet...and a little TACT. Call Nicolet toll free 1-800-356-3090 for further information.

*Nicolet Test Instruments Division*

5225 Verona Road, Madison, WI USA 53711-4495, Tel. 608-273-5008  
Toll free in U.S. 1-800-356-3090. In Canada, call 1-800-387-3385.

**Nicolet**  
INSTRUMENTS OF DISCOVERY



# After years of putting your electronics in our cabinets, you can now look at our cabinets electronically



**N**ow you can get the Equipto Electronics catalog on a free floppy diskette. It includes all the modular electronic cabinets and computer furniture featured in our 304-page print version. And it runs on any IBM® compatible PC.

That makes it easier than ever to use Equipto Electronics as a design resource. With the help of on-screen prompts you can, in effect, design your enclosure from thousands of options. You can even select enclosures especially engineered to provide maximum shielding effectiveness in meeting EMI/RFI, FCC, Military, TEMPEST and EMP requirements. Then, just print out the data and Fax it to us. We'll respond with your quote, usually within 48 hours.

Of course, all the extra services that Equipto customers count on—including customer service reps, engineering consultation or Express Line 5-Day Shipping—are readily available to computer catalog users. In fact, about the only thing that has changed about the Equipto Electronics catalog is that now you can thumb through it electronically.

It all adds up to commitment. A commitment by Equipto Electronics Corporation to provide the combination of quality products and quality service that helps you create the right enclosure for your project.

**For your FREE copy of the Equipto Electronics diskette catalog—phone, FAX or write us today.**

**Equipto Electronics Corporation**  
351 Woodlawn Avenue  
Aurora, Illinois 60506-9988  
Phone (708) 897-4691  
Fax (708) 897-5314

© Equipto Electronics Corporation, 1989

See our catalog pages C-1040 through C-1052  
eem/electronic engineers master

*Committed to Excellence Since 1960*

**EQUIPTO**  
Electronics Corporation®



# INDEX OF ADVERTISERS

<b>A</b>		
ACCEL Technologies .....	122	
Actel .....	50-51	
Advanced Micro Devices .....	10-11	
Avasem .....	74-75	
Advin Systems .....	122	
Aerospace Optics .....	28	
Aldac .....	119	
Altera .....	54-55	
AMP .....	38-39	
Ancot .....	8	
Annabooks .....	122	
Apex Microtechnology .....	27	
ASIC Technology .....	99	
Atmel .....	52	
Autoscope .....	123	
AVX .....	62-63	
<b>B</b>		
B&C Microsystems .....	123	
Best Western .....	57	
Burr Brown .....	8, 89	
<b>C</b>		
Capital Equipment Corp. ....	115, 124	
Cirrus Logic .....	107	
Comdisco .....	34	
Crynology .....	81	
Cybernetic Micro Systems .....	14	
Cypress Semiconductor .....	Cover IV	
<b>D</b>		
Data I/O .....	44, 122	
Data Translation .....	58	
Delta Technology .....	112	
Deutsch Research .....	124	
Diversified Technology .....	36-37	
Dr. Design .....	124	
<b>E</b>		
Emulation Technology .....	122, 123	
Equipto Electronics .....	126	
<b>G</b>		
GigaBit Logic .....	100	
Gnostech Inc. ....	124	
<b>H</b>		
Hertz .....	104	
Hewlett-Packard Co. ....	1	
<b>I</b>		
IBM .....	12-13	
Integrated Device Technology Inc. ....	31	
International Crystal Mfg. ....	112	
Interphase .....	79	
Intusoft .....	124	
Isdata .....	117	
IPOI Enterprises .....	121	
<b>K</b>		
Kaiser Aluminum .....	113	
<b>L</b>		
Lambda Electronics .....	57A-1	
Lattice Semiconductor .....	Cover II	
Logical Systems .....	121	
Loughborough Sound .....	106**	
<b>M</b>		
Matrix .....	121	
Megatel Computer .....	83	
<b>Mentor Graphics</b> .....		6-7
<b>Mesago Messe &amp; Kongress GmbH</b> .....		80
<b>MicroCrystal</b> .....		121
<b>Micon Technology</b> .....		103
<b>MicroSim</b> .....		90
<b>Microsoft</b> .....		108
<b>Mini-Circuits Laboratory, a Div. of Scientific Components Corp.</b> .....		15, 20-21, 84, Cover III
<b>Motorola Computer Group</b> .....		92-93
<b>N</b>		
<b>National Golf</b> .....		128
<b>National Instruments</b> .....		22
<b>National Semiconductor</b> .....		87
<b>Needham's Electronics</b> .....		121
<b>Nicolet</b> .....		125*
<b>Nohau</b> .....		121
<b>O</b>		
<b>Omaton</b> .....		124
<b>P</b>		
<b>Pacific Hybrid</b> .....		127*
<b>Philips Test &amp; Measurement</b> .....		65**, 125**
<b>Pico Electronics, Inc.</b> .....		82, 110
<b>Program Test Sources</b> .....		98
<b>R</b>		
<b>Raytheon</b> .....		64B-C
<b>Recal-Redac</b> .....		116
<b>Rogers Corp.</b> .....		123
<b>Rolyn Optics</b> .....		122
<b>S</b>		
<b>Seagate Technology</b> .....		2-3
<b>Siemens AG</b> .....		18-19
<b>Silicon Systems</b> .....		24-25
<b>Sipex</b> .....		111
<b>Sony</b> .....		65
<b>Spectral Innovations</b> .....		9
<b>Stanford Research Systems</b> .....		70
<b>T</b>		
<b>T-Cubed Systems</b> .....		123
<b>Tech Express</b> .....		128
<b>Tektronix</b> .....		16-17, 32-33, 68
<b>Teltone</b> .....		122
<b>3M</b> .....		67
<b>TransEra</b> .....		96
<b>U</b>		
<b>UTMC</b> .....		106*, 127**
<b>V</b>		
<b>Vicor</b> .....		64A
<b>Vitesse Semiconductor</b> .....		42-43
<b>W</b>		
<b>White Technology</b> .....		120
<b>X</b>		
<b>Xilinx</b> .....		114
<b>Z</b>		
<b>Z-World Engineering</b> .....		123

\* Domestic Advertiser Only \*\* International Advertiser Only

## CLASSIFIEDS

### COMPUTER SOFTWARE

DRAW SCHEMATICS WITH THE POWER OF

# ELECSYM 1.0

IN 1/10 THE TIME

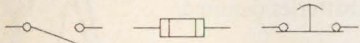

BLOCK LIBRARY FOR AutoCAD  
OVER 75 ELECTRICAL SYMBOLS  
DXF FORMATS AVAILABLE  
\$195.00 PLUS SHIPPING



**NORTH COAST**  
DYNAMIC SYSTEMS

CALL (216) 234-8833 FAX (216) 234-3313

**FAX YOUR ORDER!**  
To Advertise in  
Penton Classifieds,

**FAX: (216) 696-1267**

### EMPLOYMENT OPPORTUNITIES

**ELECTRONIC-ELECTRICAL ENGINEERS. Nationwide Design/Project/QC/Mfg., Power, Software/Systems, Controls, Circuits, Equipment, Test, Communications, etc. Contact: John Longberry, Longberry Employment, 913 Main Place, P.O. Box 471, Niles, OH 44446. (216) 652-5871.**

### BUSINESS SERVICES

### HARDWARE AND SOFTWARE DEVELOPMENT SERVICES

- We specialize in developing microprocessor/FPGA based products/systems and embedded software development.
- Analog, video, RF, and digital circuit design facilities.
- We can help with part of your project or handle the entire project.
- Full Microprocessor Development Systems, i<sup>2</sup>C, CAD/CAM, and PCB layout system.
- Bus development for Multibus, VME, PC, MCA, LAN and STD.

**ACT Applied Computer Techniques, Inc.**  
Tel. (407) 851-2525 Incorporated 1978

# Looking into a multichip module? Read between the lines and you'll get it.

Small wonder! Multichip modules deliver faster, denser, more reliable performance.

Smaller vias, .005 dia., with .003 trace and space widths and buried resistors add up to increased densities.

Faster processing lowers cost by 5 to 10 times over polymer multichip modules.

Each tape layer saves processing steps and cuts leadtimes.

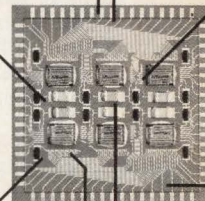

Vias are laser-drilled to control size reduction, increase density and improve reliability.

Lamination assures coverage control, improves trace resistance and reduces crosstalk.

Improved physical and electrical properties provide a dielectric constant approaching a K of 4.

Pacific Hybrid is ready now to put multichip modules to work for you fast. Just call!

10575 SW Cascade Blvd. Portland, OR 97223  
(503) 684-5657 FAX (503) 620-8051  
**1-800-622-5574**

 **PACIFIC HYBRID**  
MICROELECTRONICS  
**We do small miracles.™**  
Copyright © 1991 Pacific Hybrid Microelectronics



**NEW!...THE MOST POWERFUL...MOST ACCURATE CLUB IN GOLF!**

**The CONTROLLER® HITS 30-50 YARDS LONGER, AUTOMATICALLY CORRECTS HOOKS AND SLICES ...MUST CUT STROKES — OR MONEY BACK!**

Put your #3, #4 and #5 woods in the cellar. Tests show our new Controller driving iron can out hit all three by 30 to 50 yards.

And that's only half the story. The Controller automatically corrects hooks and slices! The club is so powerful, so accurate, we unconditionally guarantee it will cut 5 to 10 strokes off your score — or you owe us nothing! In fact, to prove it we'll send you one risk-free.

Test it against your #3 wood. If it doesn't give you 30 more yards (if you are a fairly good golfer), send the club back for a refund.

But it will give you 30 more yards! In fact, the Controller is so powerful many golfers use it off the tee, especially on narrow fairways.

Here is the Controller's exact distance advantage as compiled by some low-80's golfers.

CONTROLLER® .....	220 yards
#3 Wood .....	190 yards
#4 Wood .....	180 yards
#5 Wood .....	170 yards

Now test the Controller's accuracy against your 3-iron. Purposely hit a shot off the *toe* of each club and watch what happens. Your 3-iron will *hook* the ball violently—the Controller will keep it down the middle! The same is true with *heel* shots. Your 3-iron will *slice* the ball violently—the Controller will automatically keep it on course!

**THE GREATEST STROKE-CUTTER IN GOLF**

These scientific breakthroughs make the Controller driving iron the most powerful strokecutter in golf. We believe the club will transform the game. First of all, it *obsoletes fairway woods!* The Controller not only hits 30 to 50 yards farther than fairway woods, it automatically corrects hooks and slices! Here's how it works.

**AUTOMATIC ACCURACY**

The Controller has an *invisible curve* across its hitting surface—a curve that's going to revolutionize your game. *No other iron has it!* Hit a shot off the Controller's sweet spot and it will go straight, as it would with an ordinary iron. But even pros hit off the heel and toe.

Now, here is the Controller's genius...here is why you could cut as many as 10 strokes off your score. Hit the ball off the Controller's heel or toe and its invisible curve will automatically impart a corrective spin to what would otherwise be a disastrous hook or slice. The ball will actually fade or draw back on course! It's an incredible sight and you can prove it to yourself with only a few test shots. **THIS IS THE MOST IMPORTANT GOLFING BREAKTHROUGH IN GENERATIONS. ALONG WITH THE CONTROLLER'S EXTRA 30-50 YARDS, YOU SHOULD EASILY CUT 5-10 STROKES OFF YOUR GAME!**

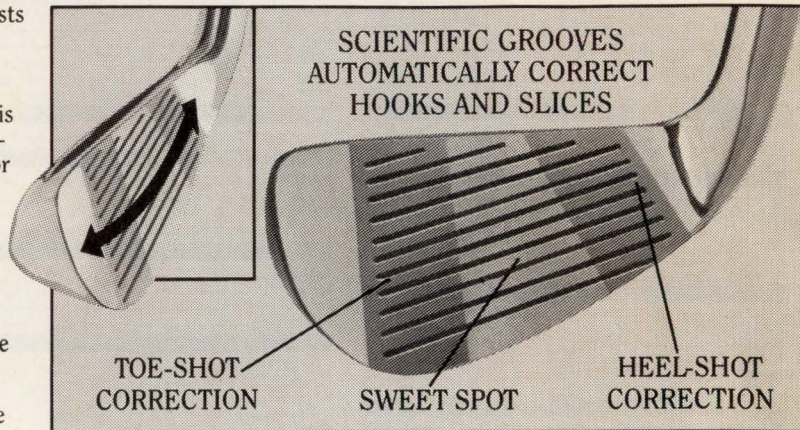

Here are more reasons why the Controller driving iron is going to give you the best golf of your life...

- it gives you the power of a driver with the control of an iron...
- its sleek, smooth head swoops through grass more cleanly than a wood...
- its 17° loft gets your shot up faster than a #3 wood...
- its smaller head size (versus a wood) boosts clubhead speed...
- its boron-graphite shaft model adds even more clubhead speed...
- it lets you carry more wedges and putters without exceeding the 14-club limit (by eliminating your #3, #4 and #5 wood)...

The Controller is new and supply is limited. You must act now and remember, you are completely protected. If the Controller doesn't cut 5-10 strokes off your score, you may return it (undamaged, of course) for a prompt refund of its price.

**FREE!**

...just for trying the Controller! Keep your new power pin-high with a \$15.00 Rangefinder! It's yours to keep FREE! even if you return the Controller for a refund. **NOW YOU CAN RANGE YOUR NEW DISTANCE LIKE AN ARTILLERY OFFICER.** No batteries required. Clips to belt.



**HOW TO ORDER**

Send your name, address and check (or credit card number and expiration date) to the NATIONAL GOLF CENTER (Dept. DR-50), 500 So. Broad St., Meriden, CT 06450. Or call 203-238-2712 (8-8 PM, M-F). The steel-shaft CONTROLLER costs only \$59.00; the boron-graphite model costs \$89.00. Add \$4.00 for shipping. CT and NY must add sales tax. Specify regular or stiff flex, no P.O. boxes, all deliveries are UPS. A refund is guaranteed if a club is returned undamaged within 30 days. Clubs are also available in ladies size, steel or graphite, same prices.

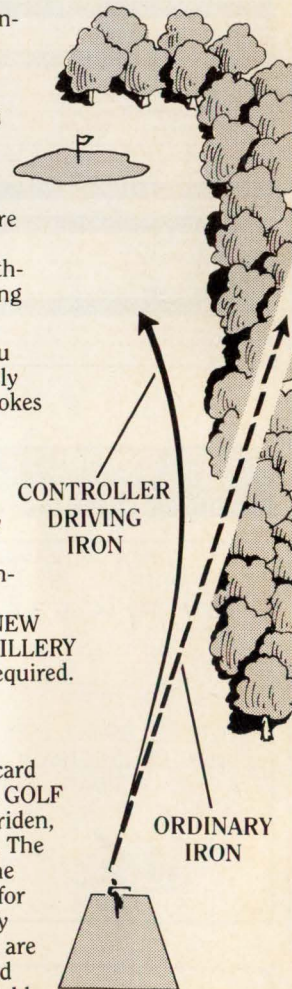

**THE CONTROLLER HITS LONGER AND STRAIGHTER THAN ANY OTHER CLUB IN GOLF. IF IT DOESN'T CUT 5-10 STROKES, YOU OWE US NOTHING! ACT NOW!**



# incredible!

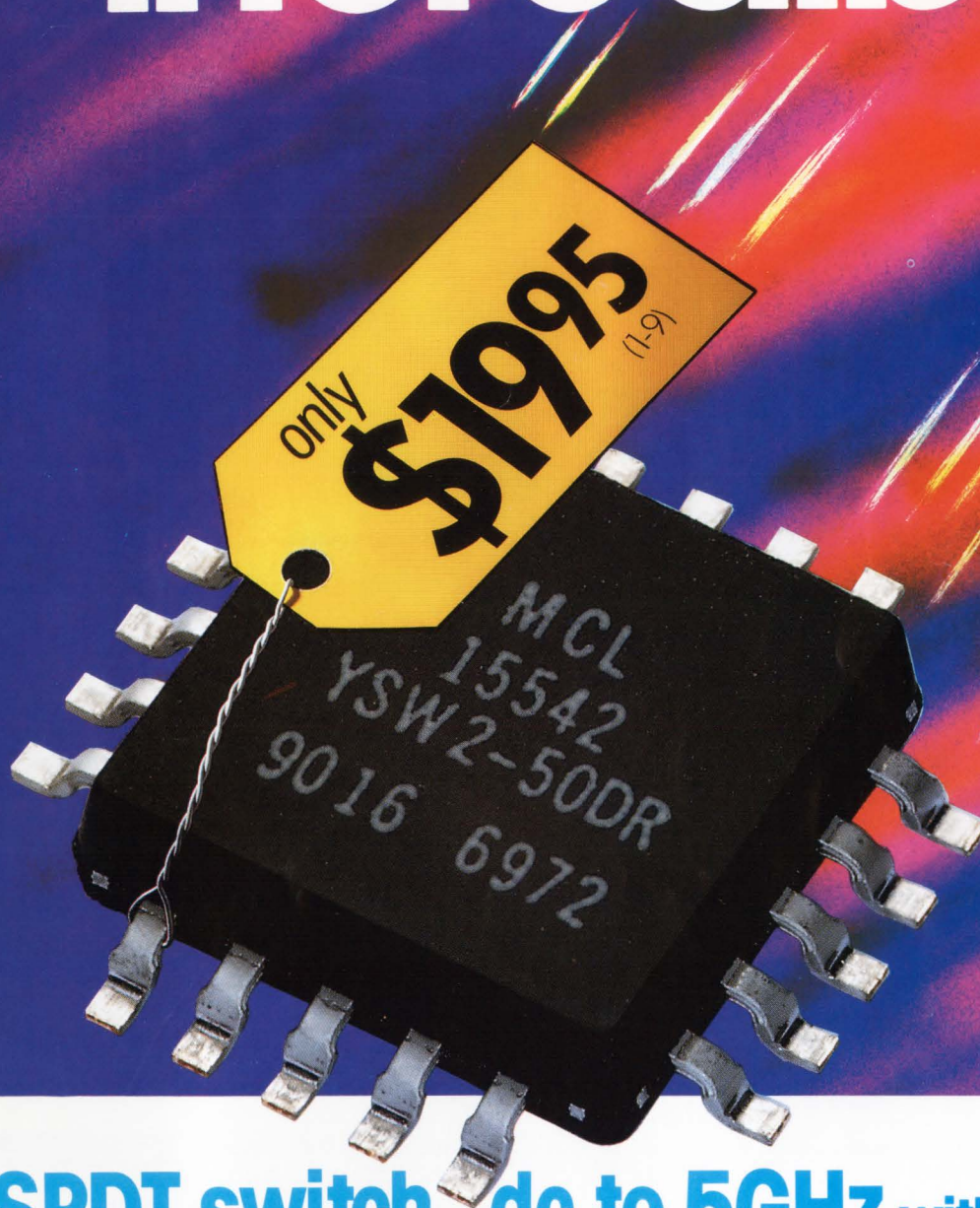

## SPDT switch dc to 5GHz with built-in driver

Truly incredible... a superfast 3nsec GaAs SPDT reflective switch with a built-in driver for only \$19.95. So why bother designing and building a driver interface to further complicate your subsystem and take added space when you can specify Mini-Circuits' YSW-2-50DR?

Check the outstanding performance specs of the rugged device, housed in a tiny plastic case, over a  $-55^{\circ}$  to  $+85^{\circ}$  C span. Unit-to-unit repeatability for insertion loss is 3-sigma guaranteed, which means less than 15 of a 10,000-unit production run will come close to the spec limit. Available for immediate delivery in tape-and-reel format for automatic placement equipment.

### SPECIFICATIONS YSW-2-50DR

	dc- 500MHz	500- 2000MHz	2000- 5000MHz
Insertion loss, typ (dB)	0.9	1.3	1.4
Isolation, typ(dB)*	50	40	28
1dB compression, typ (dBm @ in port)	20	20	24
RF input, max dBm (no damage)	22	22	26
VSWR (on), typ	_____	1.4	_____
Video breakthrough to RF, typ (mV p-p)	_____	30	_____
Rise/Fall time, typ (nsec)	_____	3.0	_____



\*typ isolation at 5MHz is 80dB and decreases 5dB/octave from 5-1000 MHz

finding new ways ...  
setting higher standards



## Mini-Circuits

WE ACCEPT AMERICAN EXPRESS

P.O. Box 350166, Brooklyn, New York 11235-0003 (718) 934-4500 Fax (718) 332-4661 Tele

CIRCLE 153



DAVE -  
NICE DESIGN. I WRITE  
DOWN SOME PARTS  
THAT'LL MAKE IT A  
REALITY. - J  
P.S. KEEP YOUR DAY JOB!

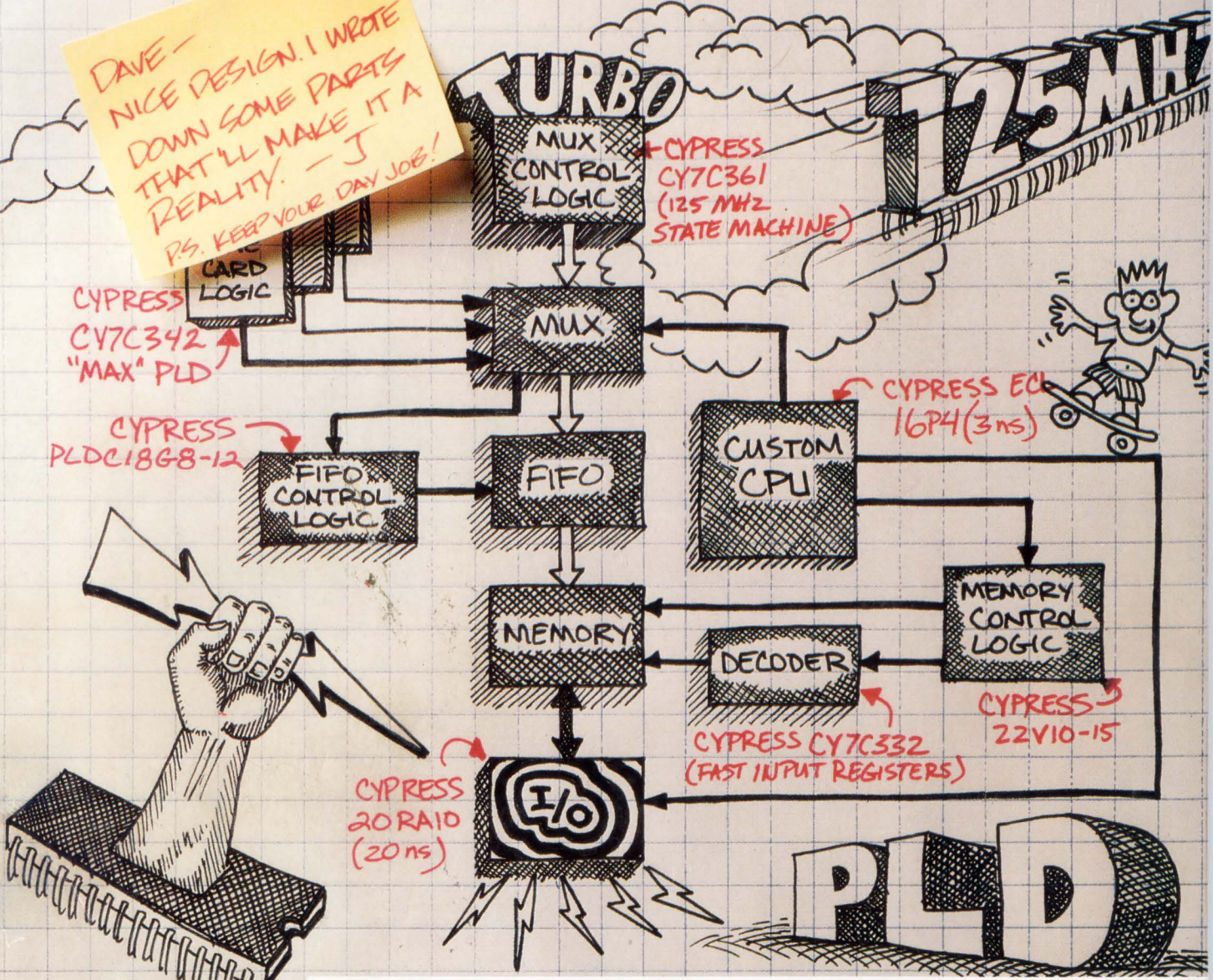

## No matter where you're going, or how fast, we have the right PLD.

**High Density Family:** If you need density up to the level of small gate arrays, coupled with high performance and quick development times, our MAX™ family fills the bill. You get parts that can replace up to 50 TTL parts, or up to 15 PLDs, with performance to 50 MHz. Very flexible, very well supported.

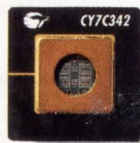

**Functionally Specialized Family:** We've created new architectures tailored to key functions, to give you maximum performance. For example, for state machine functions, our CY7C361 employs an innovative 'split-plane' architecture to cut feedback loop delay and enable 125 MHz performance.



**Standard Enhanced Family:** If you like the 'classics' but want state-of-the-art performance, you'll find plenty of solutions in our Standard Enhanced Family. Consider our CMOS 18G8 Universal PAL at 12 ns. Or our CMOS 22V10 at 15 ns. Or our 20RA10 at 20 ns. Our ECL 16P4 (10E302) at 3 ns. To name a very fast few.

\*1-800-387-7599 In Canada. (32)2-672-2220 In Europe.  
©1990 Cypress Semiconductor, 3901 North First Street,  
San Jose, CA 95134. Phone: (408)943-2666, Telex 821032  
CYPRESS SNJUD, TWX 910-997-0753. Trademarks:  
MAX - Altera Corporation.

Call for your free  
Data Book. Hotline:  
1-800-952-6300.\*  
Ask for Dept. C3J.

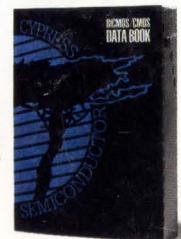

CYPRESS  
SEMICONDUCTOR