

electronics

A McGraw-Hill Publication 75 Cents

FIBER OPTICS

*Versatile tool
with electronic
applications, p 37*

Also in this issue:

- *Extending
Tunnel Diode
Frequency, p 43*
- *Magnetometer
for Space
Applications, p 48*

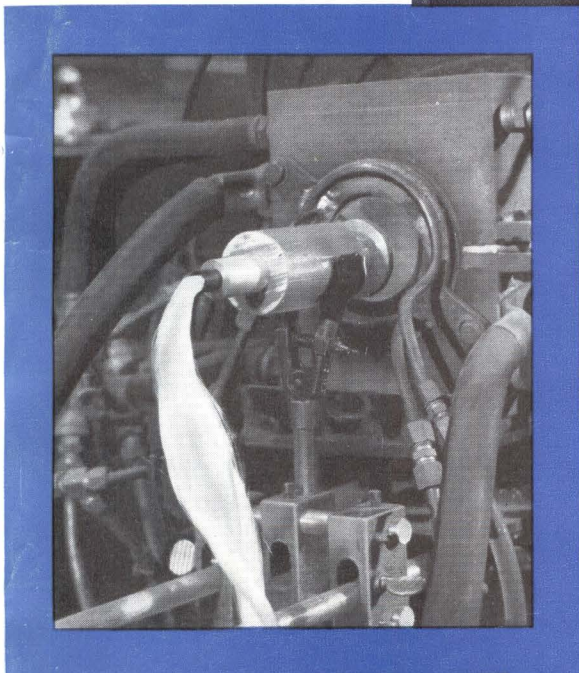
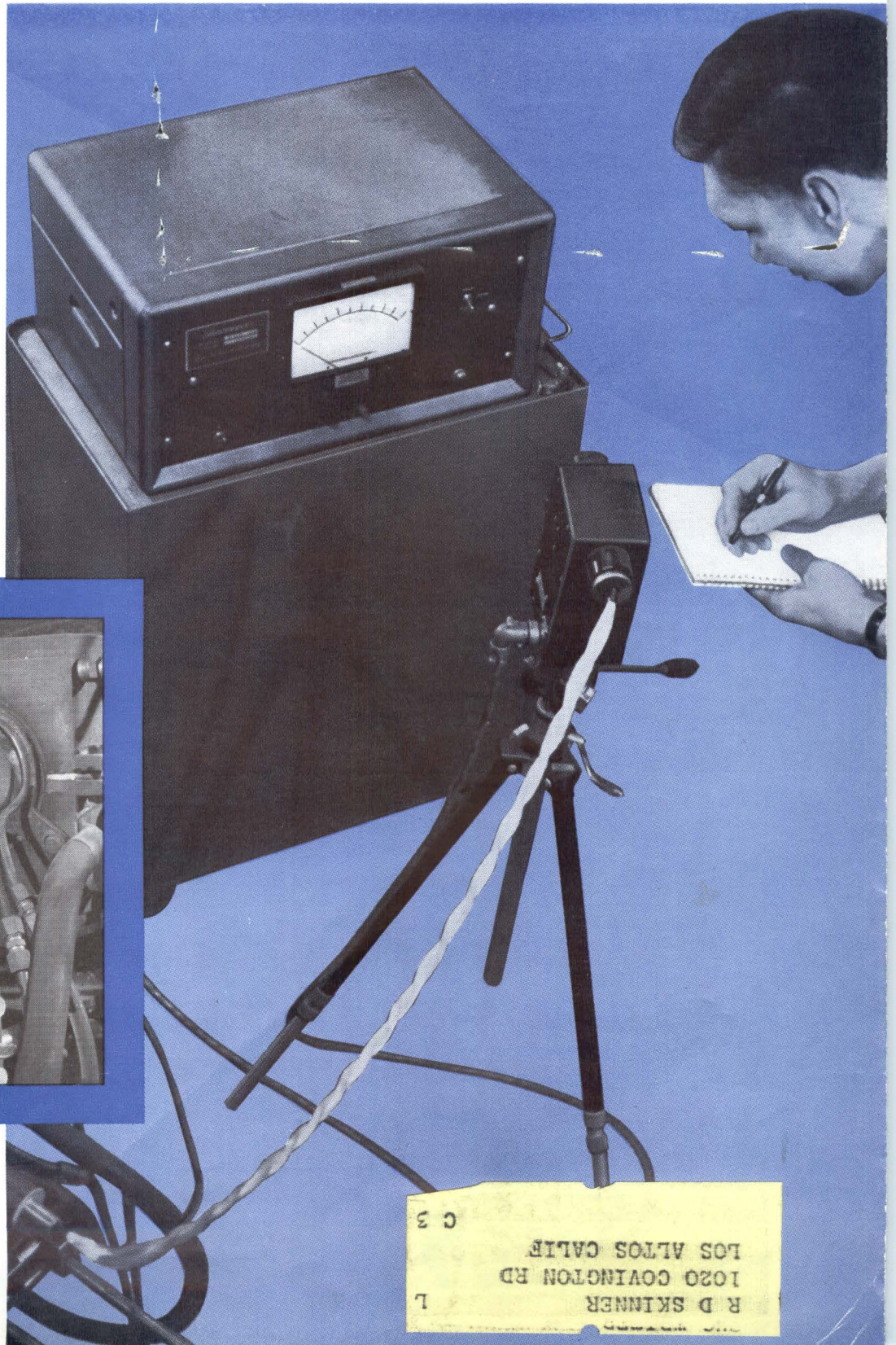

*Pyrometer using
fiber optics for
remote reading*

3 C
LOS ALAMOS CALIF
1020 GOVINGTON RD
R D SKINNER
L

you need from hp

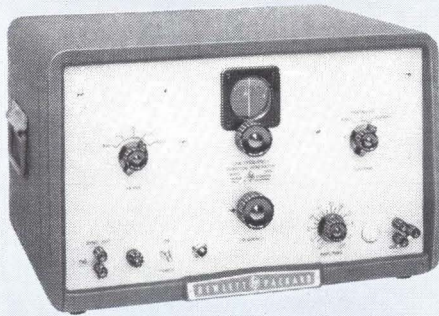

hp 202A Function Generator, 0.008 to 1,200 cps.

Source of transient-free sine, square and triangular waves, frequency continuously variable through 5 bands for electrically simulating mechanical, physi-

cal, medical phenomena. Stability within 1%, distortion less than 1% up to 100 cps. Sine, square or triangular waves selectable by front panel switch. Output 28 mw or 30 v p-p/4,000 ohms. **hp 202A** (cabinet), \$550.00; **hp 202AR** (rack mount), \$535.00.

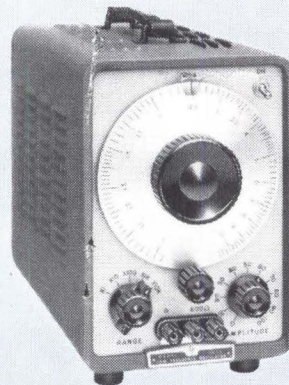

hp 202C Low Frequency Oscillator, 1 cps to 100 KC.

Especially convenient for measurements in the subsonic, audio and ultrasonic regions such as vibration, electro-cardiograph, electro-encephalograph. Distortion less than 0.5%, hum voltage less than 0.1%, short recovery time. Output 10 v/600 ohms. **hp 202C** (cabinet), \$300.00; **hp 202CR** (rack mount), \$305.00.

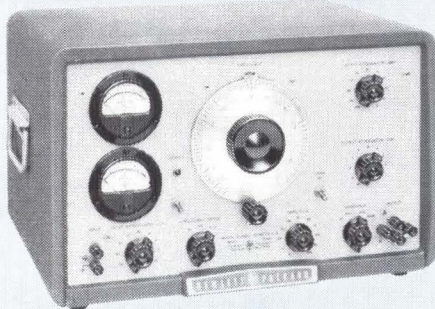

hp 205AG Audio Signal Generator, 20 cps to 20 KC.

Six basic instruments combined in one for high power audio tests, gain measurements. Two voltmeters measure input and output of the device under test.

Output 5 watts, adjustable. Output impedance selected by front panel switch. **hp 205AG** (cabinet), \$600.00; **hp 205AGR** (rack mount), \$585.00.

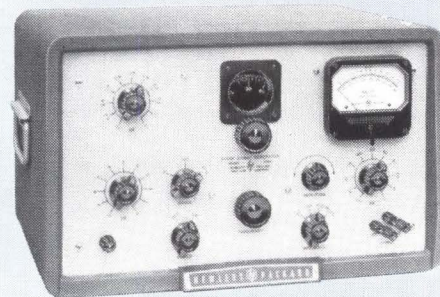

hp 206A Low Distortion Audio Signal Generator, 20 cps to 20 KC.

Distortion less than 0.1% makes the **hp 206A** ideal for use in testing of FM broadcasting units

and high fidelity audio systems. Metered output, variable in 0.1 db steps, +15 dbm into 50, 150, 600 ohms. **hp 206A** (cabinet) \$900.00; **hp 206AR** (rack mount), \$885.00.

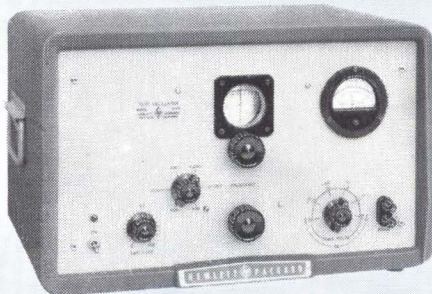

hp 650A Test Oscillator, 10 cps to 10 MC.

Metered output flat within 1 db full range. Voltage range is 0.00003 to 3 v. 600 ohm impedance, voltage divider furnished

for 6 ohm impedance. Distortion less than 1% to 100 KC. **hp 650A** (cabinet), \$550.00; **hp 650AR** (rack mount), \$535.00.



HEWLETT-PACKARD COMPANY

1501 Page Mill Road, Palo Alto, California. Area Code 415, DA 6-7000
Sales and Service representatives in all principal United States areas; Europe, Hewlett-Packard S.A., Rue du Vieux Billard No. 1, Geneva; Canada, Hewlett-Packard (Canada) Ltd., 8270 Mayrand Street, Montreal.

Get the exact test signal

Hewlett-Packard pioneered and developed the resistance-capacity oscillator, available today in these versatile instruments.



A feature of the R-C oscillator circuit is its automatically varied negative feedback which provides low distortion, excellent frequency response and amplitude stability. R-C oscillators are extremely simple to operate and, because of their high stability and wide frequency range, require no tedious resetting or adjustment during operation. They are light-

weight, portable, compact in size. Dependable operation is assured by clean, simple circuitry and painstaking construction from quality components.

Hewlett-Packard's years of experience in design and development of oscillators, plus continuous improvement of components and manufacturing techniques, assure you of the most dependable, rugged, useful oscillators available today.

204B Portable Oscillator, 5 cps to 500 KC.

Use it on the bench, carry it anywhere. This solid state portable oscillator offers battery or optional ac operation, is small and lightweight, gives you highly stable signals from 5 cps to 500 KC. Internal heat is small, warmup drift is negligible. Output is fully floating, isolated from both power line ground and chassis. The 204B will drive balanced and unbalanced loads and loads referenced either above or below ground.

 204B maintains excellent frequency stability even with rapidly changing loads. Frequency stability over the entire 5 cps to 500 KC range is better than $\pm 0.03\%/^{\circ}\text{C}$ from 0° to 55°C . Output is flat within $\pm 3\%$ at all settings of dial and range switch. Distortion less than 1%, hum and noise less than 0.05%. Output 10 mw (2.5 v rms) into 600 ohms; 5 v rms open circuit.  204B, with batteries, \$275.00. AC operation optional, \$25.00 extra.

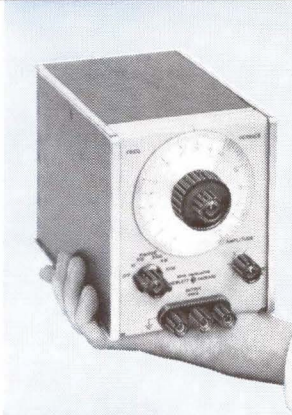

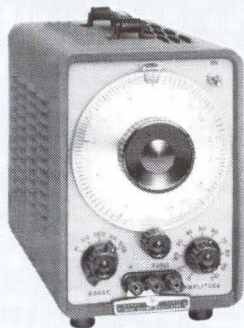
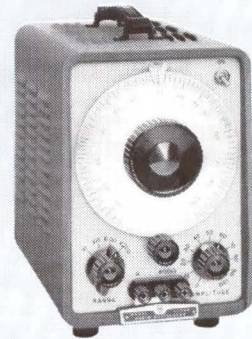

200AB Audio Oscillator, 20 cps to 40 KC.

Ideal for amplifier testing, modulating signal generators, testing transmitter modulator response. Covers its range in four overlapping bands. Simple operation, just three controls. No zero setting required. High stability, with accurate tuning circuits. Output 1 watt (24.5 v) into a 600 ohm load.  200AB (cabinet), \$165.00;  200ABR (rack mount) \$170.00.





200CD Wide Range Oscillator, 5 cps to 600 KC.

Subsonic to radio frequencies covered in five overlapping decade bands. Used for testing servo and vibration systems, medical and geophysical equipment, audio amplifiers, video frequency circuits, etc. 85 dial divisions for reading convenience. Distortion rating less than 0.5% below 500 KC. Output 160 mw (10 v/600 ohms); 20 v open circuit.  200CD (cabinet), \$195.00;  200CDR (rack mount), \$200.00.



201C Audio Oscillator, 20 cps to 20 KC.

Especially designed for testing amplifiers, speakers, cross-over networks, this high power oscillator offers an output of 3 watts or 42.5 v into 600 ohms over its full frequency range. Response is 1 db full range. Attenuator adjusts output 0 to 40 db in 10 db steps, provides either low impedance or constant 600 ohm impedance.  201C (cabinet), \$250.00;  201CR (rack mount), \$255.00.

time

after time

after time

accurate test signals

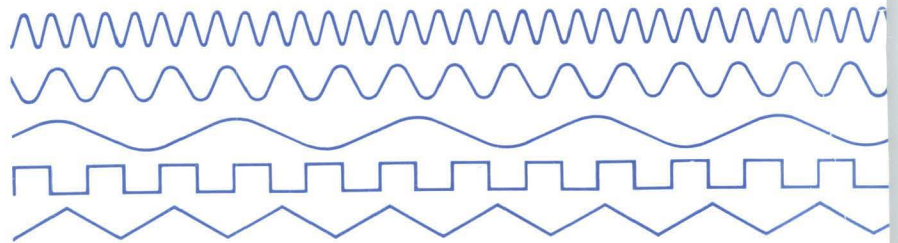

0.008 cps to 10 MC!

***Get
what you need
from***



Turn the page

electronics

A McGraw-Hill Publication 75 Cents



W. W. MacDONALD, Editor

J. M. CARROLL, Managing Editor
 SENIOR EDITORS: Samuel Weber, George W. Sideris. SENIOR ASSOCIATE EDITORS: William E. Bushor, Michael F. Wolff. ASSOCIATE EDITORS: Michael F. Tomaino, Sylvester P. Carter, William P. O'Brien, John F. Mason, Thomas Emma, Sy Vogel, Leslie Solomon, George J. Flynn, Laurence D. Shergalis. ASSISTANT EDITORS: Nilo Lindgren, Stanley Froud, Stephen B. Gray, Roy J. Bruun, George V. Novotny, Leon H. Dulberger. REGIONAL EDITORS: Harold C. Hood (Pacific Coast, Los Angeles), Thomas Maguire (New England, Boston), Cletus M. Wiley (Midwest, Chicago). ART DIRECTOR: Harry Phillips; Howard R. Berry. PRODUCTION EDITOR: John C. Wright, Jr. EDITORIAL ASSISTANTS: Gloria J. Meurer, Bernice Duffy, Lorraine Rossi, Virginia T. Bastian, Lynn Emery, Bette H. Snyder, Rosemary Abbruzese, Judy Haskins, Ann Mella. FOREIGN NEWS BUREAU: Director, John Wilhelm, Alyne Elias. LONDON—John Shinn, Derek Barlow, Nicholas Landon. Bonn—Peter Forbath, Silke McQueen. Paris—Robert Farrell, Arthur Erikson. Milan—Gene DiRaimondo. Mexico City—Bruce Bendow. Rio de Janeiro—Leslie Warren. Moscow—Stewart Ramsey. Tokyo—Richard Halloran, Charles Cohen, John Yamaguchi.

JAMES GIRDWOOD, Publisher

FLEXIBLE GLASS bundle transmits thermal radiation to automatic two-color pyrometer. The system, built by Armour Research Foundation for measuring temperatures of rocket nose cones during reentry, *will use fiber optic bundles to monitor outer skin of missile, send signals on uneven heating to correct reentry attitude.* See p 37

COVER

NAECON Shows Gains in Molecular Circuits. Computers are now being built with integrated circuits. The list of circuits made as one unit continues to grow. *IRE president predicts a billion-dollar molecular circuits market in the 1970's*

18

MILLIMETER-WAVE DEVICES. Reports at National Aerospace Electronics Conference indicate that millimeter-wave devices have not only passed the feasibility stage but that they are getting ahead of applications. *Among the laser papers: setup to modulate and demodulate laser beam*

19

NAVY'S RDT&E BUDGET FOR 1963 Totals \$1,474 Billion. To meet the threat of enemy submarines carrying long-range missiles, Navy is stepping up antisubmarine warfare R&D. *Here is a fact-packed summary of projects that will generate military electronics developments during the next few years*

26

GERMAN ELECTRONICS Industry Spotty. Though the experts said it would be a major growth industry, output is dropping. One reason is growing competition from U.S. and British imports. *German manufacturers hope industrial electronics will perk up sales*

28

THERMOPLASTIC RECORDING Tapes Radar Data. Direct recording from video signals promises high-density, high-resolution technique. *Analog and wideband recording methods are being worked on*

30

FIBER OPTICS for Electronic Engineers. The wedding of electronic and optical techniques has produced many important and versatile system developments. Fiber optics now promises to widen the scope of electro-optical applications. *This new technique is attractive in data processing, display devices, image handling, and lasers.*

By G. V. Novotny 37

EXTENDING TUNNEL DIODE OPERATING FREQUENCY.

By proper matching of the microwave impedance of the external circuit to the negative impedance of an S-band tunnel diode, successful operation was achieved at X-band. *The method can extend use of commercially available diodes into the millimeter wave region.* By K. Ishii and C. C. Hoffins, Marquette University

43

VOLTAGE-VARIABLE BANDWIDTH FILTER. Two-tube circuit has voltage-controlled, continuously-variable bandwidth between 200 Kc and 15 Mc centered at 30 Mc, introduces near-zero insertion loss. *Device extends range of a military radar system by varying the bandwidth as a function of signal strength.*

By R. B. Hirsch, RHG Electronics Laboratory 46

Published weekly, with Electronics Buyers' Guide and Reference issue, as part of the subscription, by McGraw-Hill Publishing Company, Inc. Founder: James H. McGraw (1860-1948).

Indexed Annually in Buyers' Guide and Reference issue.

Title ® registered U.S. Patent Office; © Copyright 1962 by McGraw-Hill Publishing Co., Inc. All rights reserved, including the right to reproduce the contents of this publication, in whole or in part.

Executive, editorial, circulation and advertising offices McGraw-Hill Building, 330 West 42nd Street, New York 36, N. Y. Telephone Longacre 4-3000. Teletype TWX N.Y. 1-1636. Cable McGrawhill, N. Y. PRINTED IN ALBANY, N. Y.; second class postage paid at Albany, N. Y.

OFFICERS OF THE PUBLICATIONS DIVISION: Nelson L. Bond, President; Shelton Fisher, Wallace F. Traendly, Senior Vice Presidents; John R. Callahan, Vice President and Editorial Director; Joseph H. Allen, Vice President and Director of Advertising Sales; A. R. Venezian, Vice President and Circulation Coordinator; Daniel F. Crowley, Vice President and Controller.

OFFICERS OF THE CORPORATION: Donald C. McGraw, President; Hugh J. Kelly, Harry L. Waddell, Executive Vice Presidents; L. Keith Goodrich, Executive Vice President and Treasurer; John J. Cooke, Vice President and Secretary.

Subscriptions are solicited only from those actively engaged in the field of the publication. Position and company connection must be indicated on orders. Subscription rates: United States and Possessions, \$6.00 one year; \$9.00 two years; \$12.00 three years. Canada, \$10.00 one year. All other countries \$20.00 one year. Single Copies, United States and Possessions and Canada 75¢. Single copies all other countries \$1.50.

THE PUBLISHER, UPON WRITTEN REQUEST FROM ANY SUBSCRIBER TO OUR NEW YORK OFFICE, AGREES TO REFUND THAT PART OF THE SUBSCRIPTION PRICE APPLYING TO COPIES NOT YET MAILED.

Subscribers: Please address all correspondence, change of address notices, subscription orders or complaints to Fulfillment Manager, Electronics, at above address. Change of address notices should provide old as well as new address, including postal zone number if any. If possible, attach address label from recent issue. Allow one month for change to become effective.

Postmaster: Please send Form 3579 to Fulfillment Manager, Electronics, 330 West 42nd Street, New York 36, New York.



Audited Paid Circulation

CONTENTS continued

TRANSISTOR Q-MULTIPLIER and Oscillator. Simple circuit uses only one inductor to achieve high Q multiplication. It is relatively independent of transistor parameters, thus stability depends only on tank circuit elements. *High-Q filters can be designed with ordinary coils.*
By J. R. Woodbury, Stanford Research Institute 53

FLUX-GATE MAGNETOMETER Uses Toroidal Core. For space experiments a magnetometer must be highly sensitive, small and light, consume little power. This new circuit uses an ordinary toroidal core with switching transistors to meet this requirement. *Device overcomes undesirable "memory effects" of conventional circuits.* By W. A. Geyger, Naval Ordnance Laboratory 48

DEPARTMENTS

Crosstalk. <i>Spreading Confusion</i>	3
Comment. <i>All-Channel Tv Receiver. The Earadio</i>	4
Electronics Newsletter. <i>EIA Convention</i>	7
Washington Outlook. <i>Tariff Bill Gets Escape Clause. Renegotiation Act Staying Put</i>	12
Meetings Ahead. <i>Space Phenomena and Measurements Symposium</i>	32
Research and Development. <i>Optics Generates Multidimensional Functions</i>	60
Components and Materials. <i>Avalanche Breakdown of Silicon Rectifiers. Extending Range of Controlled Rectifiers</i>	68
Production Techniques. <i>Welding School Improves Circuit Reliability</i>	78
New Products Design and Application. <i>Clock-Compensated Oscillator</i>	88
Literature of the Week	104
Books. <i>Electromagnetics. Radio Electronics Transmission Fundamentals</i>	106
People and Plants. <i>Space-General Consolidates in El Monte</i>	108
Index to Advertisers	119
Publisher's Page. <i>The Dangerous Years</i>	122

CROSSTALK

SPREADING CONFUSION. Part of the basic training of every engineer of any caliber is blowing fuses. He should be proficient in fuse-blowing by the time he is 14 or 15.

Next in his training, the young engineer is confronted with the ridiculous contradictions of transmission lines. They permit themselves to be joined with large chunks of metal, under the guise of supporting brackets maybe, but definitely without any undue protest or blown fuses. It is a grave source of doubt to the young engineer and he can't always be mollified by explanations about nodes and antinodes and analogies with vibrating strings.

Later, the would-be engineer comes across waveguidery. This sorts the men from the boys. He emerges from this contact determined to be a dentist, or he will plod on, come what may, to the bitter end.

And now, the witchcraft is compounded. Not only can you pump electricity down pipes, but visible light, that former touchstone of scientific incorruptibility, has fallen too. No longer is the shortest distance between points A and B the path that a beam of light would travel between them: the weakening of fundamental principles has spread. Now light will go around corners, travel in circles and perform just about any convolution that fiber optics demands of it. This upsetting of optical first principles would have Issac Newton working nights rewriting *Optiks*.

George Novotny, an *ELECTRONICS'* editor with a taste for the fallen-from-grace story, has penetrated the Frankensteinian laboratories and has come up with a six-page revelation. Among the other facts that he tells us in this issue about the degradation of visible light is that a tube of fiber optics can have individual fibers so small that waveguide-like transmission ensues instead of continual reflection from the fiber walls. This means that you could pull out the core of the individual fibers, leaving just about nothing, and the performance of the whole pipe is improved.

As if trying to grasp all the consequences of the wave-versus-corpuseular theories wasn't enough!

In fact, the unusual behavior of light in a pipe even puzzled the discoverer (in 1870), the British physicist, John Tyndall. Shining light into a tank of water, he saw the light carried by a thin

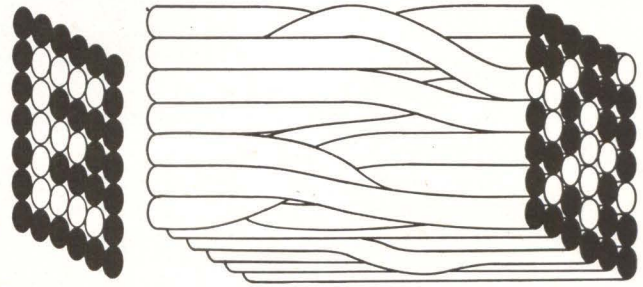

stream issuing from a hole in the side of the tank. It was then thought that this was a way of making light travel in curves, instead of straight lines. Today we know better. While the pipe may be curved, the light—so far at least—still travels in straight lines, bouncing down the inside of the pipe.

Once understood, light pipes caught on. But it was a long time before the more complex possibilities of fiber optics took hold, although a patent for a "bundle of light pipes" was granted in 1930.

The illustration above is rated an early example of fiber optics trickery, dating all the way back to 1953. The principle of scrambling letters by mixing up the fiber bundle was used then in a secret message coder devised for the Dutch navy.

In the actual coder, thousands of fine fibers convert the message into a random scattering of dots. The scrambled message can be read by simply reversing the bundle, but a spy would need to know the alphabet and type used and perform a random analysis on a computer.

Today, our military plan to use fiber optics to couple the stages of night-warfare image intensifiers so sensitive that individual photons can be seen striking the screen. In medicine, thin fiber probes take color movies of patients' viscera. Video processing, data display, scanning, image concentration or expansion are among the many other important uses now emerging.

These applications depend upon using a bundle of many fibers to manipulate light. For the future, fiber optics experts see the field going far beyond flexible fiber bundles, opening possibilities for optical computers, fiber lasers and long-distance communications at optical frequencies using fibers as waveguides.

When that day comes, our young friend—the embryo engineer—will really have something to ponder over.

New Bridge Design For Safe, Accurate, Easy Measurement of Capacitors

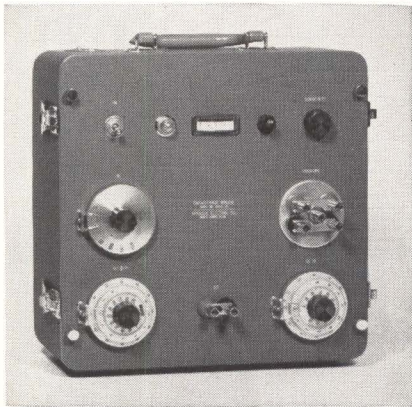

The Sprague Model 1W1 Capacitance Bridge introduces a new concept in bridge design. Built by capacitor engineers for capacitor users, it incorporates the best features of bridges used for many years in Sprague laboratories and production facilities.

Special Features For Greater Accuracy

The internal generator of the 1W1 Bridge is a line-driven frequency converter, and detection is obtained from an internal tuned transistor amplifier-null detector, whose sensitivity increases as the balance point is approached. It has provision for 2-terminal, 3-terminal, and 4-terminal capacitance measurements, which are essential for accurate measurement... $\pm 1\%$ of reading $+ 10\mu\mu\text{F}$... of medium, low, and high capacitance values, respectively.

No Damage to Capacitors

The model 1W1 Capacitance Bridge will not cause degradation or failure in electrolytic or low-voltage ceramic capacitors during test, as is the case in many conventional bridges and test circuits. The 120 cycle A-C voltage, applied to capacitors under test from a built-in source, never exceeds 0.5 volt! It is usually unnecessary to apply d-c polarizing voltage to electrolytic capacitors because of this safe, low voltage.

Complete Specifications Available

For complete technical data on this precision instrument, write for Engineering Bulletin 90,010 to Technical Literature Section, Sprague Electric Company, 35 Marshall Street, North Adams, Massachusetts.

COMMENT

Lasers and Peace

In the *Comment* column of May 18 (p 4), Clarence Stephans of the Newark College of Engineering prefaced his advertisement for a series of engineering seminars with the remark that recent articles on lasers have played up their death-ray possibilities, and have neglected to mention the applications of lasers in manufacturing.

If Mr. Stephans is referring to the *ELECTRONICS* series on lasers [p 39, Oct. 27; p 40, Nov. 3; p 81, Nov. 10; p 54, Nov. 24], then he didn't read it as closely as I did. Checking it again just now, I find only two references to the laser as a death ray, both of them in the Nov. 10 issue, a total of four sentences, in the middle of two dozen pages on the use of lasers in land and space communication, medical applications, space exploration, computer memories, and basic optical research.

Mr. Stephans takes to task "recent articles in business periodicals" because they fail to mention laser "effectiveness to industry for metal removal." I believe that the only connection so far of the laser with metal removal has been to drill microscopic holes in razor blades, as a demonstration. What is so effective about a punctured razor blade?

R. L. SMITH

New York, New York

Our thanks to reader Smith for setting the record straight regarding military versus other uses of lasers. We've also reported that high-intensity optical beams have a future, too, in metalworking (p 21, March 2, and p 8, March 23, for example), for cutting, welding and other operations requiring clean, high-intensity heat. Those punctured razor blades merely indicate possibilities.

All-Channel TV Receiver

Regarding the Federal Communications Commission's all-channel television receiver legislation: it may not be too late to also consider some modern engineering refinements—at very long last—such as the following:

(1) Shielding against local r-f

from other services than tv.

(2) High-pass filtering integral with vhf and uhf inputs.

These two items should do much to reduce the mental anguish caused by tv interference, and further educational tv—should they be applied to all receiving equipment offered to the public.

If placed on the drawing-board in time, these two very simple sound engineering practices could be applied for pennies.

DAVID H. ATKINS

Los Angeles, California

The Earadio

Your comment on the letter by R. A. Purifoy in the April 20 issue (*Comment*, p 4) told him that his idea for a locket-sized electronic music box is not yet possible, according to the present state of the art of miniaturization.

This is undoubtedly true; aside from the electronics involved, it would take a long piece of recording tape to play a musical number at a speed that would allow decent reproduction. And making the device cartridge-loading, as Mr. Purifoy suggests, would increase the size.

Why not take advantage of present hardware and techniques and make a radio receiver to fit in the ear? I recently saw an advertisement for a hearing aid that would fit in the ear, so why not a radio?

Despite your deploring the fact that many of today's young people keep an ear glued to a transistor radio, nothing will keep them from it, not even a law like the French regulation you mentioned, which forbids playing a radio in the street or subway.

The teenage market is a vast one, and an inexpensive "earadio" could be worth a fortune to the manufacturer who gets there first.

K. MORI

New York, New York

Earadio or electronic music-box locket, it still amounts to mass hypnotism, and puts the listener in such a trance that he is barely sure of where he is.

Life must surely be difficult for a teenager if he can't go for a walk without having to resort to an earfulsome radio to escape from it all, into the dream world of "ooh-baby, c'mon 'n twist!"



TUNG-SOL PRESS-FIT DIODES RATED TO 30 AMPS

NEW RELIABILITY/ECONOMY IN SILICON RECTIFIERS

Now it is possible to have the advantages of the most reliable stud-mounted diodes with the convenience and economy of press-fit assembly.

COMPACT, SMALL SIZE, INTERCHANGEABLE. Available in both polarities; one heat sink can carry more than one diode. Easily installed with hand tools or automatic machinery. Eliminate the need for mounting hardware.

RELIABILITY. Tung-Sol 30 amp press-fit silicon rectifiers are available as types 1N3659-1N3665, with ratings and characteristics as indicated below. The only press-fit diodes with welded cases and ceramic-to-metal seals to minimize leakage and resist thermal shock. Environmental testing through thousands of operational thermal cycles verifies stability of characteristics. Also available are lower current rectifiers in the same construction, types 1N3491-1N3495.

Electrically these units are the equivalent of the best available stud mounted diodes with comparable ratings. Write for complete technical information. Tung-Sol Electric Inc., Newark 4, N. J. TWK: NK193

	1N3659	1N3660	1N3661	1N3662	1N3663	1N3664	1N3665	Unit
Transient Peak Reverse Voltage.....	100	200	350	450	600	700	800	V
Repetitive Peak Reverse Voltage.....	50	100	200	300	400	500	600	V
Max. Rectified Output Current @ 100°C. case.....	30	30	30	30	30	30	30	A
@ 150°C. case.....	25	25	25	25	25	25	25	A
Max. Peak one-cycle Surge Current 60 cps..	400	400	400	400	400	400	400	A
Max. Full Load Reverse Current, Full Cycle average, 150°C. case.	5.0	4.5	4.0	3.5	3.0	2.5	2.0	mA
Max. Operating Temperature Range.....	-65°C. to + 175°C.							

INTEGRATED CIRCUITS.

Tung-Sol supplies modular rectifier assemblies which embody the many practical features of the press-fit diodes. Typical is the single phase bridge assembly shown; from a package measuring only 1 1/4" x 3 1/4" x 3 1/2", outputs to 55 amperes are possible.

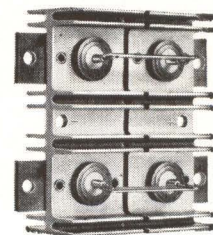

 **TUNG-SOL®**

SALES OFFICES: ATLANTA, GA.; COLUMBUS, OHIO; CULVER CITY, CALIF.; DALLAS, TEXAS; DENVER, COLO.; DETROIT, MICH.; IRVINGTON, N. J.; MELROSE PARK, ILL.; NEWARK, N. J.; SEATTLE, WASH. CANADA: TORONTO, ONT.

to simplify your communications work—Sierra's wide

variety of **FREQUENCY SELECTIVE VOLTMETERS**

—wave analyzers available for
off-the-shelf delivery*

- Continuous tuning, 3 to 620 KC
- Variable selectivity, ± 250 cps and ± 2500 cps
- Flat AC voltmeter, 1 to 620 KC
- Frequency accuracy, 1 KC
- Measuring accuracy, 1 db
- 100 KC built-in crystal calibrator

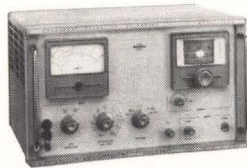

General purpose Model 125B
Price: \$895.00

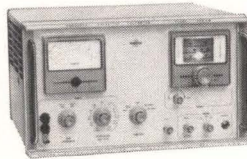

Carrier reinsertion Model 125B-CR
Permits aurally monitoring ssb suppressed carrier
Price: \$995.00

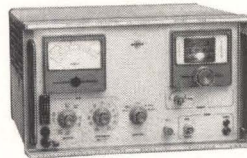

Carrier rack fast patch Model 125B-Y
Front-panel connector for use with Western Electric Type O and N carrier
Price: \$955.00

PLUS



High-frequency Model 126A
Frequency range: 5-1620 KC in two bands
Dual selectivity: 250 cps and 2500 cps
Frequency accuracy: ± 2 KC, 100 KC to 1620 KC
Measuring accuracy: ± 1.5 db
Provides for carrier reinsertion
Special feature: Optional 50 megohm probe for wave analysis
Price: \$1,195.00



Solid State Model 127 A-Y
Special feature: Solid state with rechargeable battery pack. Carrier rack fast patch for use with Western Electric Type O and N carrier
Frequency range: 2 KC to 350 KC
Selectivity: 250 cps
Frequency accuracy: ± 1 KC
Measuring accuracy: ± 1 db
Size: $7\frac{1}{2}$ " x $7\frac{1}{2}$ " x $12\frac{1}{2}$ ", 16 lbs., including batteries
Price: \$945.00 with battery pack. Rechargeable batteries and charger optional at extra cost

Prices f.o.b. factory. Data subject to change without notice.

SIERRA ELECTRONIC CORPORATION
DIVISION OF PHILCO • SUBSIDIARY OF *Ford Motor Company*
7896 Bohannon Drive • Davenport 6-2060 (Area Code 415) • Menlo Park, California

*Subject to prior sale

7896

ELECTRONICS NEWSLETTER

At EIA: Failure and Truce for Semiconductors

CHICAGO—H. M. Evans, chairman of the Electronic Industries Association's credit committee, told EIA's 38th annual convention last week that failures in the industry have reached a 28-year high. In the year ending April 30, 56 manufacturers and 38 distributors closed shop.

Evans mostly blamed inadequate management. Most new components manufacturers, particularly in solid state, he said, were launched by engineers who may not have sufficient business and sales experience. Component firms led the list of failing manufacturers.

Industry sources at the meeting generally thought that the shakeout in solid state would continue apace and that failures would remain high in 1962.

However, while increasing use of distributors may cause local price cutting, the feeling was that transistor and diode prices have finally "bottomed out." One sales executive said the only radical price drops would be in new components such as integrated circuits.

George W. Keown, EIA tube and semiconductor division chairman, blamed 1961 sales decreases in those components on increasing cost-consciousness by government and industrial purchasers. In 1960-1961, transistor unit sales rose from 128 million to 191 million, but volume dropped from \$301 million to \$300 million.

West Sees Nine Percent Sales Gain During 1962

LOS ANGELES—Latest Western Electronic Manufacturers Association survey projects 1962 sales for the 11 western states at \$3.3 billion, a gain of nine percent over 1961 and one-fourth estimated national sales.

Predictions for 1962 by area are: greater Los Angeles, \$1.8 billion; northern California, \$730 million; San Diego and Arizona, each \$185 million; Pacific northwest, \$175 million, and the rest of the west, \$147 million.

Western electronics employment is expected to rise 17,000 to 230,000. William Miller, WEMA presi-

dent, said this is a 40 percent increase in three years. The number of graduate engineers has risen from 17,500 in 1957 to 38,500 today. Southern California has 60 percent of total employes, 137,000.

Horne Succeeds Davis As President of EIA

CHICAGO—Charles F. Horne, president of General Dynamics' Pomona and Electronics division and a GD senior vice president, was elected to succeed L. Berkley Davis, of General Electric, as EIA president. A retired rear admiral, Horne served as a communications and electronics officer.

Parametric Oscillation at Optical Frequencies Seen

THEORETICAL calculations made by a group at MIT under C. F. Townes indicate that parametric oscillation at optical frequencies can be achieved.

Electromagnetic radiation at half-frequency will appear if a non-

linearly polarizable material is driven at an optical frequency. If gain is sufficient to sustain oscillation, the subharmonic component's power approaches that of the fundamental. If a high-power, far-infrared laser pumps the material, output in the near-infrared region is substantial.

Such a laser is now under construction, say MIT scientists, for further experiments in nonlinear effects at optical frequencies.

Hydrofoil Subchaser Gets Special Computer, Radar

COMPUTING and attack-plotting system for the Navy's hydrofoil subchaser has been delivered by General Precision's Librascope division. The system will show the crew where the craft is, where the target is and at what point the craft should launch its torpedoes. It can also automatically track a target.

The subchaser, being built by Boeing, will go more than 40 knots when raised on its hydrofoils. Sonar bearings to a submarine will be taken when the craft is down in the water.

Raytheon last week announced it has received a contract to develop the subchaser's radar system. It will use a bright display and image storage to provide the history of a target track. A similar Raytheon scope presentation is being used by the Coast Guard in an experimental harbor navigation system (ELECTRONICS, p 76 and cover, May 18).

Highways in the Sky For Sound Waves, Too

ATMOSPHERIC physicist with the Army Missile Support Agency told the Acoustical Society of America meeting in New York last week that sonic waveguides exist at altitudes to 30 miles and between 30 and 80 miles.

Abnormally high temperatures tremendously increase speed and duration of sound in the ducts, according to Marvin Diamond. Sound travels swiftly eastward in winter, westward in summer, bends toward earth at different points, depending

Two Bills Move Up

WASHINGTON—The Senate Commerce Committee last week approved two bills previously passed by the House of Representatives (p 12, May 11):

One is the all-channel tv receivers law which would require tv sets to receive 70 uhf as well as the vhf channels. The other is the act providing for establishment of a satellite communications system

on the time of the year.

Diamond thinks it possible to establish recording stations to detect and analyze sound coming from great distances. The ducts were discovered by rocket probes. It was recently reported that r-f ducts also exist in the atmosphere (p 8, May 11).

Navy Sets Up Navigation Satellite Ground Units

NAVY has established a group to operate its navigation satellite system. The unit, to be headquartered at Point Mugu, Calif., will have a computer center, a satellite tracking station, and will maintain ground and satellite equipment. Tracking stations will also be located at Minneapolis, Winter Harbor, Me., and Wahiawa, Hawaii.

British Showing Their Microminiature Circuits

LONDON—Among the new and experimental products to be displayed this week at the International Instruments, Electronics and Automation Exhibition were:

Thin-film deposited circuits under development for the Ministry of Aviation; 15-stage shift register with 34 transistors, 90 diodes, 162 resistors and 64 capacitors, in a matchbox-size assembly, by Mulard; experimental solid circuits and integrated tunnel diode memory elements, by Standard Telephones and Cables; dice-sized, six-transistor recording modules for rockets, by McMichael Radio; 10-pound, battery-operated tv camera, by EMI Electronics.

Four-Sensor Detector Sorts Seven Weathers

RAIN, DRIZZLE, hail, sleet, snow, freezing rain or freezing drizzle are identified and measured with a four-sensor weather detector system developed by Thompson Ramo Wooldridge. The kind of precipitation is indicated by the output from all sensors and from temperature and other data.

In one sensor, light reflection from particles is focused on a

photodiode, indicating reflectivity of particles and how often they are falling. In another sensor, the change in a tuning fork's frequency indicates ice accumulation.

An array of piezoelectric crystals in an impact sensor tells how big the particles are. The fourth sensor also uses crystals, arranged to detect how much a particle bounces.

Sporadic-E Experiment Goes Up on Schedule

LANGMUIR PROBE experiment to measure daytime sporadic-E (p 18, May 25) was launched as scheduled last Friday. The probe, designed by Geophysics Corporation of America, was among a payload of 213 pounds on an Aerobee rocket fired from NASA's Wallops Station, Va. Three Goddard Space Flight Center Experiments were also carried. The rocket went up 152 miles.

Hope to Get 10-Year Life in Space Radio

SYLVANIA has received a \$380,000 Air Force contract to develop a feasibility model of a communications set for second-generation satellites and spacecraft. The company indicated it could build a system able to operate continuously for 10 or more years.

The model will contain a solid-state multichannel transmitter and receiver. Narrow-beam phased-array antennas will be used for communications signal acquisition and tracking, to prevent mechanical movements causing satellite tumbling and to guard against hostile interception of transmissions.

Lear Stockholders Vote For Merger with Siegler

LEAR, INC., shareholders last week approved the merger of Lear and the Siegler Corp. Siegler stockholders were to vote yesterday. Their merger would give the new company, Lear-Siegler, Inc., annual sales of more than \$200 million. The company would be headquartered in Los Angeles. Plants are located in seven states, West Germany and Switzerland.

In Brief . . .

FEDERAL AVIATION AGENCY has begun awarding research contracts for a supersonic transport plane. Among \$2.66 million in initial contracts announced last week was \$111,250 to Cornell Aeronautical Lab to study feasibility of self-adaptive control systems.

ENGINEERS JOINT COUNCIL is issuing a report, "The Nation's Engineering Research Needs, 1965-1985," based on a two-year study.

CONTRACTORS for the Navy's radio station in Australia (p 7, May 25) will be Deco Electronics, Continental Electronics Mfg. Co. and Holmes and Narver.

GREECE is getting a 500-mile, 17-hop microwave radio net. It will be installed by Standard Telephones and Cables, London, for about \$3 million.

TWO COMPANIES announced purchases of components firms. P. R. Mallory is buying Tyco Semiconductor Co. Sprague Electric has acquired Sky-Borne Electronics.

ADVANCED TECHNOLOGY LABS will design and produce infrared horizon scanners for Gemini, the two-man spacecraft.

LIMITED WAR electronic command and control system requirements will be studied by Martin under a \$225,000 contract.

SYSTEMS CONTRACTS include one for a Titan II missile procedures trainer, to ACF, and one for \$1 million of communications-identification-navigation systems for F-105 fighter-bombers, to Collins Radio.

NASA has awarded Documentation Inc. a \$1.2 million contract to provide a space and aeronautical sciences information center serving NASA and its contractors. The edp center will be in Bethesda, Md.

MARCONI, of England, will supply the Norwegian Air Force with a two microwave radar links for \$1.4 million.

New From Sprague!

ECDC[®] Type XT-300 LOGIC TRANSISTOR



TO-18 CASE

"NON-UNIVERSAL" SWITCH!

- Specifically designed to meet your challenging ultra-high-speed needs for "next generation" computers!
- No need to compromise on any key parameters!
- Combines the best of diffused collector and electro-chemical technology in one superlative logic device!

Compare the XT-300 with Present-day Selected "Bests"...

CHARACTERISTICS	2N779A	2N964	XT-300
$BV_{CES} @ I_C = 100 \mu A$	15 V min.	15 V min.	25 V min.
$BV_{CEO} @ I_C = 1 mA$	12 V min.	6 V min.	12 V min.
$I_{CBO} @ V_{CB} = 6V$	3 μA max.	3 μA max.	3 μA max.
$h_{FE} @ I_C = 50 mA, V_{CE} = 1V$	40 min.	40 min.	40 min.
$V_{CE} (SAT) @ I_C = 50 mA, I_B = 5 mA$.18 V min.	.35 V min.	.18 V min.
$V_{BE} @ I_C = 50 mA, I_B = 5 mA$.6 V max.	.75 V max.	.6 V max.
$f_T @ I_C = 20 mA, V_{CE} = 1V$	200 mc min.	300 mc min.	300 mc min.
$t (on) @ I_C = 10 mA, R_L = 300 \text{ ohms}$ $I_{B1} = 1 mA, V_{BE} (off) = 1.25 V$	60 nsec max.	50 nsec max.	50 nsec max.
$t (off) @ I_C = 10 mA, R_L = 300 \text{ ohms}$ $I_{B1} = 1 mA, I_{B2} = .25 mA$	120 nsec max.	85 nsec max.	85 nsec max.

For complete information, write Product Marketing Section, Transistor Division, Sprague Electric Company, Concord, New Hampshire.

SPRAGUE COMPONENTS

TRANSISTORS
CAPACITORS
MAGNETIC COMPONENTS
RESISTORS
MICROCIRCUITS

INTERFERENCE FILTERS
PULSE TRANSFORMERS
PIEZOELECTRIC CERAMICS
PULSE-FORMING NETWORKS
TOROIDAL INDUCTORS

HIGH TEMPERATURE MAGNET WIRE
CERAMIC-BASE PRINTED NETWORKS
PACKAGED COMPONENT ASSEMBLIES
FUNCTIONAL DIGITAL CIRCUITS
ELECTRIC WAVE FILTERS



'Sprague' and 'Q' are registered trademarks of the Sprague Electric Co.

There's
power a'plenty
in **THE
EMPIRE
UPSTATE**

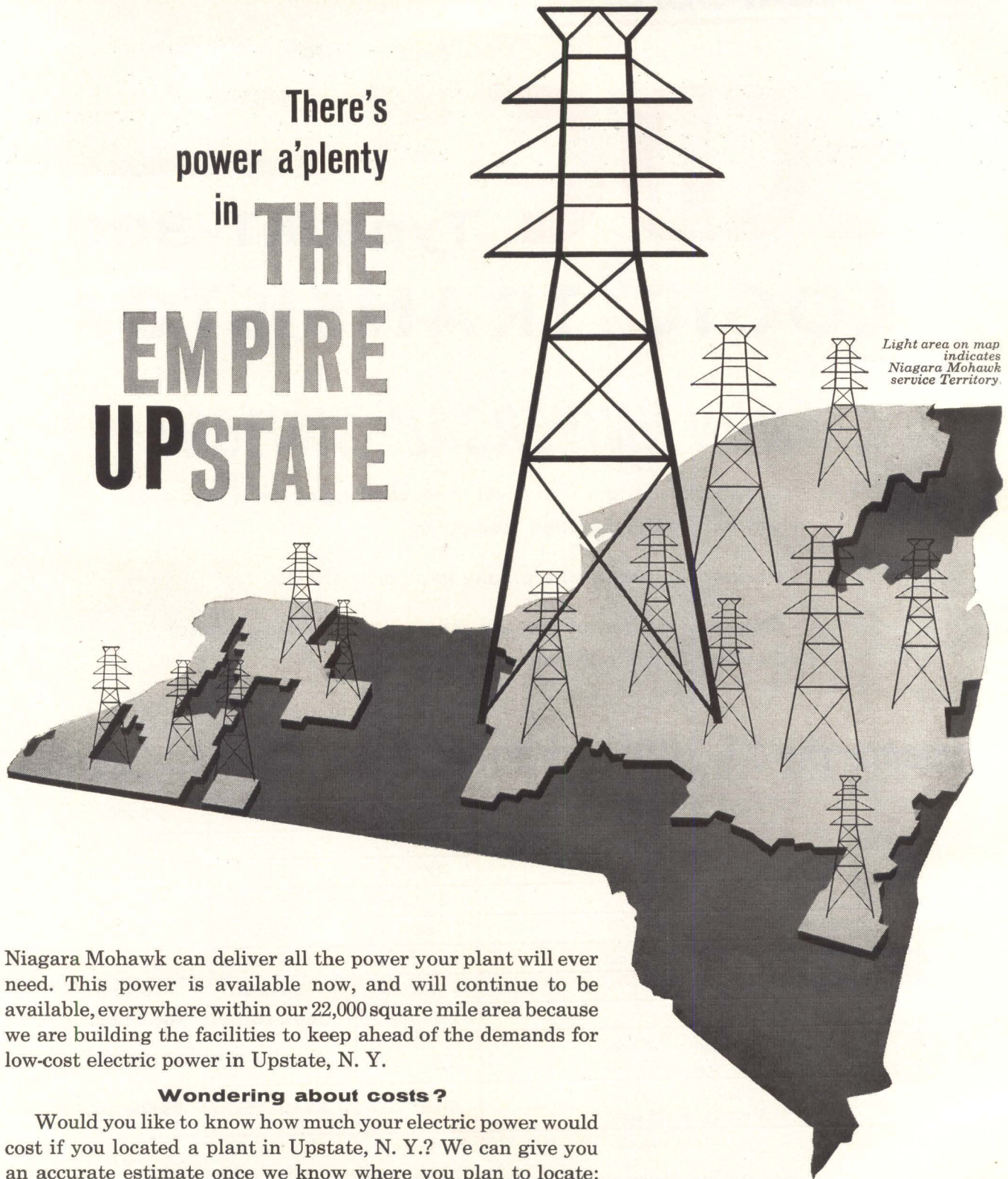

Light area on map
indicates
Niagara Mohawk
service Territory.

Niagara Mohawk can deliver all the power your plant will ever need. This power is available now, and will continue to be available, everywhere within our 22,000 square mile area because we are building the facilities to keep ahead of the demands for low-cost electric power in Upstate, N. Y.

Wondering about costs?

Would you like to know how much your electric power would cost if you located a plant in Upstate, N. Y.? We can give you an accurate estimate once we know where you plan to locate; whether you will furnish all facilities to take delivery and at what voltage; your probable maximum demand in KW; your probable power factor; your probable monthly consumption in KWH.

We'll compute the bill without cost or obligation and in complete confidence. Just write or phone Richard F. Torrey, Director of Area Development, Niagara Mohawk Power Corporation Dept. E-6, 300 Erie Blvd. West, Syracuse 2, N. Y... Phone GRanite 4-1511 (Area Code 315).

Your one best source of information
about the **EMPIRE UP STATE**

NIAGARA



MOHAWK

INVESTOR OWNED • TAXPAYING

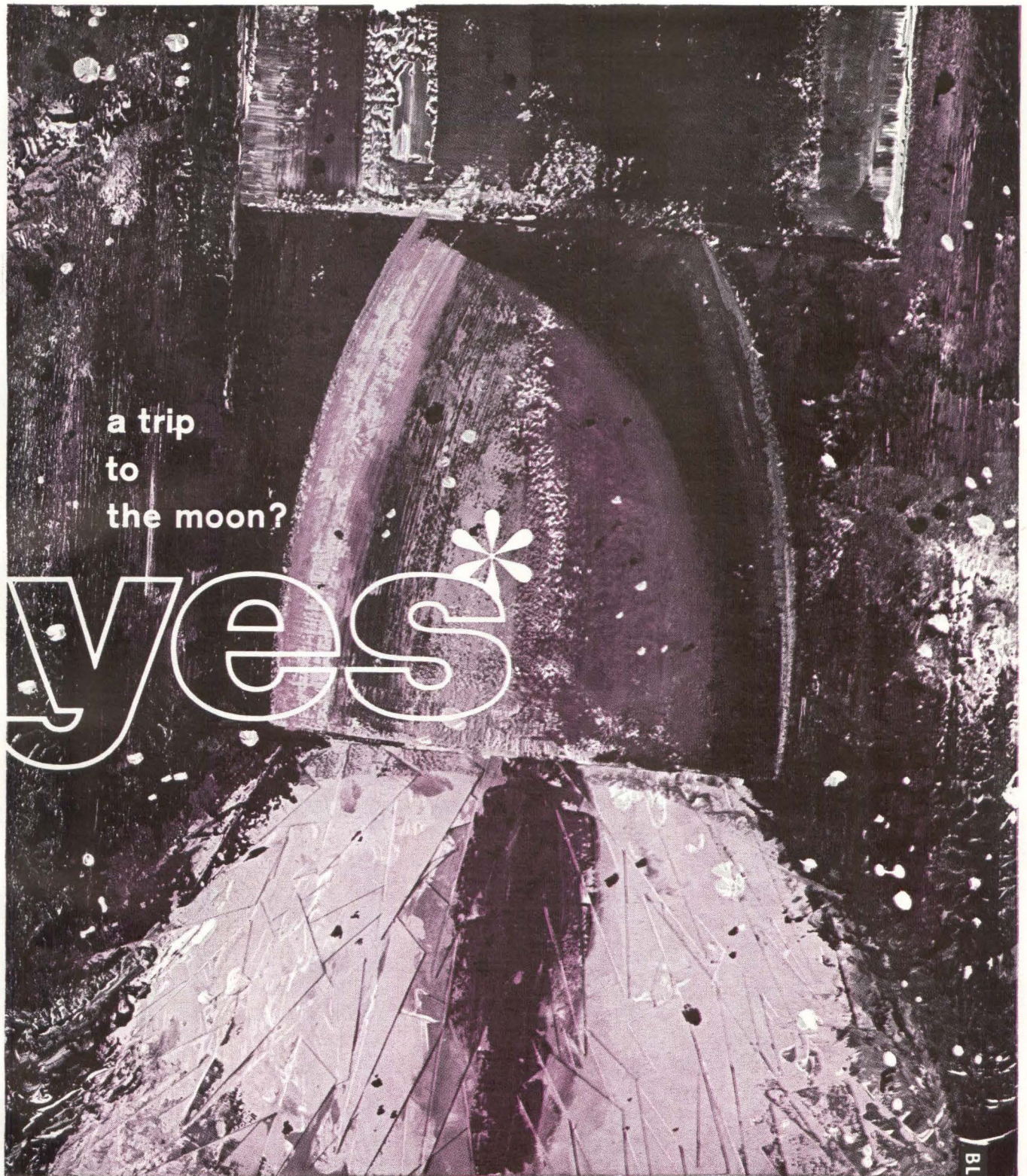

a trip
to
the moon?

yes

BLISS

Gamewell made a Master Pot with these characteristics: resistance, 31,500 ohms (nominal); total angle, 359.5°; resolution, .000055 (or approximately 1 minute of arc); linearity, $\pm .01^\circ$ zero based; cam corrected; O.D., 8"; thickness, 2"; shaft, 1/4"; alignment boss, 1" x 1/16"; and an anodized aluminum finish. This extremely accurate precision potentiometer demonstrates our ability to manufacture pots to meet the most demanding specifications — such as might be necessary on a trip to the moon. Write and tell us about your *special* pot problems. Chances are they can be solved by Gamewell's YES service — ***your engineered specials** service.



THE GAMEWELL COMPANY, ELECTRONICS DIVISION, 1617 CHESTNUT ST., NEWTON UPPER FALLS 64, MASS. A SUBSIDIARY OF E. W. BLISS COMPANY

WASHINGTON OUTLOOK

TARIFF BILL GETS ESCAPE CLAUSE

HOUSE WAYS AND MEANS COMMITTEE put an escape clause into the trade expansion bill before passing it last week. The President would no longer be the sole judge of whether a company or an industry gets tariff protection. As the bill goes to the House floor, the President would receive a recommendation from the Tariff Commission. If he rejected the recommendation, Congress could override him by a two-thirds vote. Companies would have to show real damage from imports to an entire operation, not just one product.

The language giving the President power to negotiate tariff cuts of 50 to 100 percent for products on the "zero list" was left practically intact. However, the committee deleted reliance on standard international trade classifications to list these products (world trade controlled 80 percent by the U.S. and European Common Market) and there is no written-in method of determining them. Companies would have more time to find out what products may face 100 percent tariff cuts in deals with the EEC.

CENTAUR SNAGS ADVENT

DEPARTMENT OF DEFENSE is expected to decide within a few weeks whether to make changes in Project Advent, Army's communications satellite system. The Centaur liquid-hydrogen-fueled rocket that was supposed to put Advent into orbit next year is almost two years behind schedule. Advent's weight may be cut so it can be launched by an Atlas-Agena-B combination, able to loft 600 to 700 pounds into synchronous orbit. Advent's exact weight is classified, but it has pyramided to over 1,000 pounds. Pentagon technical personnel say advanced electronics could scale it down. Another alternative is to wait a couple of years for the Air Force's Titan III booster.

EXCESS PROFITS STAY PUT

RENEGOTIATION ACT RENEWAL for four years is shaping up as a cut-and-dried matter. The House Ways and Means Committee has given industry five weeks to submit written comments on the administration's recommendation to extend the law. There are no plans now for hearings. The law, expiring June 30, provides for government recovery of "excessive profits" on defense contracts.

Industry has asked that incentive contract profits be exempted or granted special consideration. New Pentagon procurement policies will favor such contracts to boost contractor performance.

Some defense officials privately support an amendment on incentive profits, but the administration has officially rejected the idea, and it has little if any congressional support.

LIMIT RESEARCH REFUNDS

PRESIDENT KENNEDY asked House and Senate leaders to reverse a restriction on overhead or indirect costs reimbursable to universities under government research grants. A 15-percent restriction is in the House-passed Defense Appropriations Act and in pending appropriations for AEC, NASA and National Science Foundation. If the House won't go along Senate pressure for a more liberal policy is expected to peg the restriction at about 20 percent. Universities and administration science advisors say the restriction would force university subsidy of government basic research.

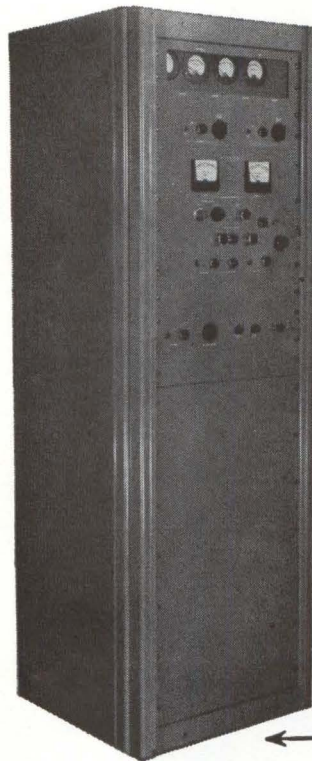

← Model 15101, TWT Supply, \$9,925

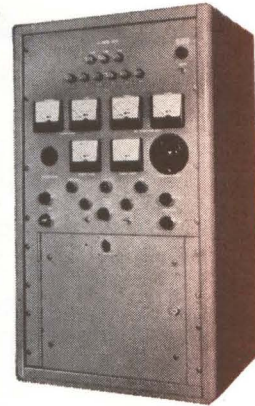

Model 11020, Soft Tube Modulator, \$5,560

Now! These features—in STANDARD UNITS! Modulators! TWT Supply!

- Widest pulse width ranges available
- Complete coverage, including MW tubes
- Extensive use of solid-state devices
- Variable repetition rate and pulse width
- Built-in meters and viewing connectors for all principle parameters
- Regulation $\pm \frac{1}{2}\%$
- Built-in, floating grid pulse modulation
- Built-in vac-ion pump supply
- Built-in, floating DC filament supply

Check these specs for yourself:

MODULATORS

Model Number	Peak Power Output	Pulse Width (μsec)	Maximum Duty Cycle	Pulse Freq. (pps)	Drop $\%/\mu\text{sec}$	Rise Time (μsec)	Price
10003	-4.5KV at 2A	0.25 to 2.2	0.002	200-4000	1%	0.1	\$2,450
10004	-4.5KV at 4A	0.25 to 5.0	0.001	100-2500	2%	0.1	\$2,925
10005	-9KV at 4A	0.25 to 5.0	0.001	100-2500	1%	0.1	\$3,850
10010	-16KV at 16A	0.25 to 5.0	0.001	100-2500	2%	0.1	\$5,875
11020	-18KV at 20A	0.5, 1.0 & 2.0	0.001	200-2000	5%	0.1	\$5,560
11040	-33KV at 33A	0.5, 1.0 & 2.0	0.001	200-2000	5%	0.1	\$9,650

TWT SUPPLY

DC Output: -2 to -12 KV DC at 75 ma.
Regulation: 0.5% max. for 95 to 135 V line variation, 0.5% max. from no load to full load.
Grid Pulse: 0 to 600 V peak, 0.25 to 2.5 microseconds pulse width, 0.1 microsecond max. rise time. Internal repetition rate generator variable from 400 to 4000 pps, or by external trigger input. Maximum duty cycle 0.005.
D.C. Bias: 0 to 250 V at 15 ma.
D.C. Filament: 0 to 10 V at 5 A.

Call your local rep or write us for complete data sheets. Ask, too, for our free catalog of over 600 microwave instruments and components. Address: Dept. E-1-18.

the
narda
 microwave corporation



Plainview, L. I., New York
 Area Code 516 GE 3-9000

NEW SILICON TRANSISTORS FROM DELCO RADIO



ACTUAL SIZE

Silicon power transistors in a TO-37 package

Delco's unique new family of silicon NPN power transistors combines the benefits of miniaturization (TO-37) and light weight with the ability to withstand continuous junction temperatures of up to 175°C while operating at these absolute maximum ratings: collector diode voltage V_{cb} 100 volts; emitter diode voltage V_{eb} , 4 volts; collector current, 1 amp.; base current, .2 amp. This entire 2N2340 family is particularly useful where moderate power handling capa-

bilities are required in a miniature package. The units have just two mounting holes and may be mounted with leads up, down or sideways on either side of the heat sink. Available in either single or matched units, they're characterized by low saturation voltage and high switching speeds. The transistors in this family are especially well suited for military or industrial applications in regulated power supplies, square wave oscillators, servo amplifiers and core driver circuitry. For complete engineering data, or applications assistance, write or call our nearest Sales Office or your nearest Delco Radio Semiconductor Distributor.

Number	IC Max.	V_{cbo}	V_{ceo}	Sat. V @ IC Max.	Gain Min.—Max. @ IC	f_{ae} @ 250 ma IC (typical)
2N2340	1A	50V	40V	4V @ .75A	10—40 @ .75A	900 kc
2N2341	1A	50V	40V	4V @ .75A	40—100 @ .75A	550 kc
2N2342	1A	100V	60V	3V @ .75A	10—40 @ .75A	900 kc
2N2343	1A	100V	40V	2.5V @ .75A	40—100 @ .75A	550 kc

Thermal resistance of 8°C/watt max. Typical Alpha cutoff of 15 Mc

Rise Time of .2 μ seconds—.75A, I_B = 40 ma (V_{ce} = 12V), Fall Time of .5 μ seconds (I_C = 0 V_{eb} = 2v R_{eb} = 37 Ω)

Union, New Jersey
324 Chestnut Street
Murdock 7-3770
AREA CODE 201

Detroit, Michigan
57 Harper Avenue
TRinity 3-6560
AREA CODE 313

Santa Monica, California
726 Santa Monica Blvd.
Upton 0-8807
AREA CODE 213

Syracuse, New York
1054 James Street
GRanite 2-2668
AREA CODE 315

Chicago, Illinois
5750 West 51st Street
PORTsmouth 7-3500
AREA CODE 312

General Sales Office: 700 E. Firmin, Kokomo, Indiana, GLadstone 2-8211—Ext. 500 • AREA CODE 317 • Division of General Motors

DELCO
DEPENDABILITY
RADIO
RELIABILITY

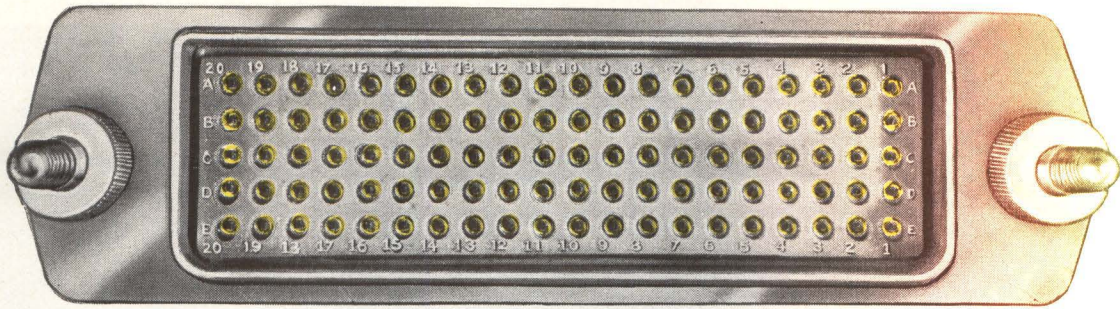

A connectorful of reliability... not one drop of solder!

Twelve minutes crimping time to assemble this 100-circuit AMPin-cert Series "A" Pin and Socket Connector! And no solder pot haze or hot iron smoke will hide the fact that time savings is only one advantage of this crimp, snap-in type connector. An AMP Automatic tool will turn out 800 to 1000 of these connections per hour with no chance of hit or miss reliability. Every connection is identical—crimped that way with precision controlled pressures that make a homogeneous mass of wire and terminal. Every connection is corrosion and vibration resistant. Each has tensile strength almost equal to that of the wire itself. All are safely recessed in the block. And there are other features:

- configurations of 50 or 100 positions
- glass-filled Diallyl Phthalate inserts
- cadmium plated aluminum shells
- alpha-numerically coded inserts, front and back
- plating of .0005" gold over nickel
- wire size range #22-20, #26-24
- complete hardware
- sealed for (35 PSI)
- unsealed for less critical applications

What an AMP Automatic Tool and AMPin-cert Contacts can do to a solder assembly line makes interesting reading in both product performance and profit. AMP has the facts and figures to prove it! Get them today! Complete information will be sent on request.

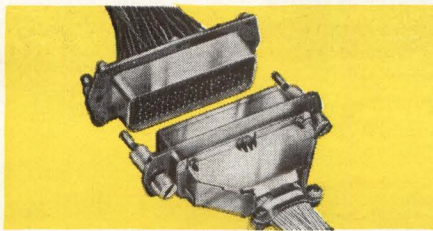

AMP INCORPORATED

Harrisburg, Pennsylvania

AMP products and engineering assistance are available through subsidiary companies in: Australia • Canada • England • France • Holland • Italy • Japan • Mexico • West Germany

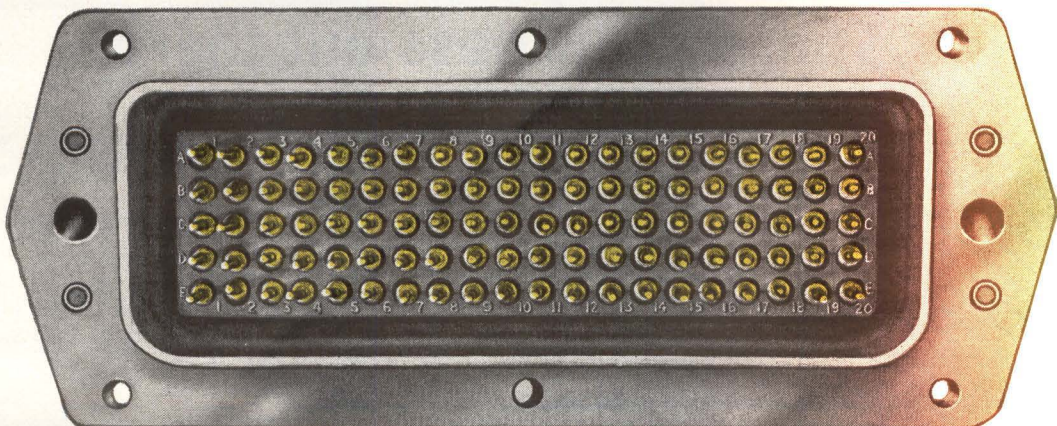

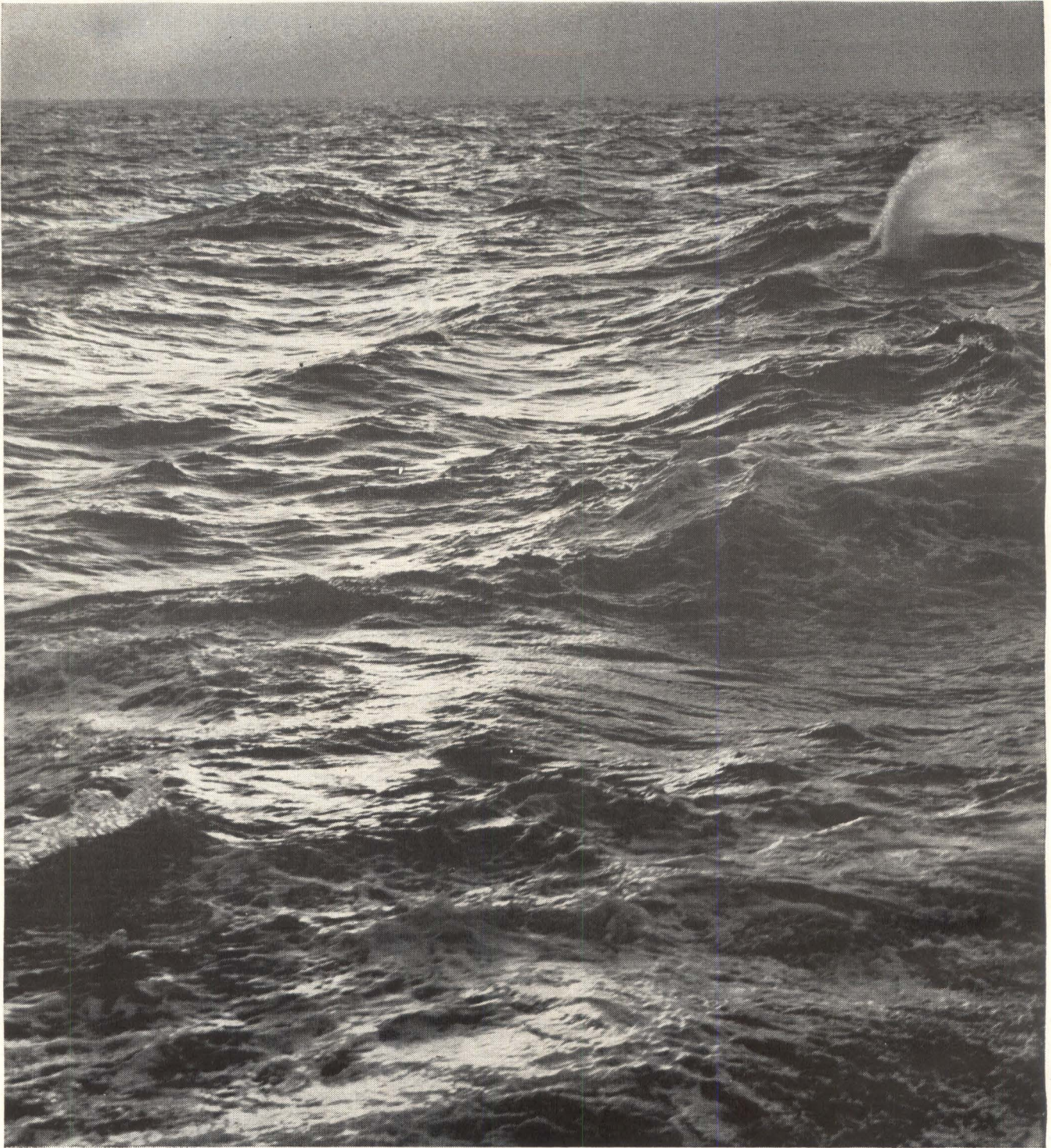

There's business out there.

You're looking at more than a horizon. It's a future, yours and America's. Out there is Europe and Latin America and Asia and Africa. But in 1960, of all U. S. manufacturers, less than 5% saw these foreign shores for what they are worth: a 19-billion-dollar export market, a vast source of foreign trade.

Move in for your share. Build your business and help keep America growing. Extra production creates more jobs, helps balance the outflow of gold, and wins new friends abroad with U. S.-made products.

Even if you've never sold overseas, you have a rare op-

portunity to start—now. Your U. S. Department of Commerce will help with counsel by experts on what, where and how to sell—with data on credits, payments and financing. A package of invaluable know-how is yours for the asking.

Now's the time to discover the many ways in which your business can grow. In the lucrative export markets. In new U. S. markets. In developing new products. In attracting new industry to your community. Just write or phone the U. S. Department of Commerce Office of Field Services in your city, or Washington 25, D. C. They are ready to help you grow with America!



NOW'S THE TIME TO GET GROWING IN A GROWING AMERICA!

NEW BR-5 RELAY COMPLEMENTS OTHER BABCOCK SERIES

The new BR-5 is smallest of the precision relays that Babcock manufactures. Despite its small size, it features the same rugged dependability and operating versatility that distinguish all Babcock products.

Most airborne, undersea or ground support requirements can be satisfied by Babcock's standard line of relays, while other requirements are met by special variations. The following relay series show typical performance characteristics of Babcock's standard product line.

BR-5 MICRO/MICROMINIATURE DRY CIRCUIT TO 1 AMP SERIES

Contact Rating: 1 amp res. @ 32V DC, .050 Ω max. • **Contact Arrangement:** SPDT • **Vibration:** 30g, 40 to 3000 cps; 0.4" DA, 10-40 cps • **Shock:** 125g, 11 millisecond. • **Life:** 100,000 operations min. @ 1 amp, 125°C. • **Military Specification:** meets MIL-R-5757D.

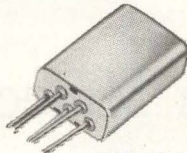

BR-5 SERIES

BR-7 SUBMINIATURE DRY CIRCUIT TO POWER SWITCHING SERIES

Contact Rating: 2, 5 and 10 amp res. @ 28V DC or 110V AC, 400 cps • **Contact Arrangement:** SPDT, DPDT • **Min. Pull-in Power:** 80 mw/pole, derated to 50 mw • **Header Styles:** plug-in terminals, solder hooks, 3" printed circuit leads.

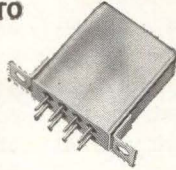

BR-7 SERIES

BR-8 MICROMINIATURE CRYSTAL CAN SERIES

Contact Rating: 2 amp res. @ 32V DC or 115V AC, 400 cps; 1 amp inductive @ 32V DC • **Contact Arrangement:** SPDT or DPDT • **Dry Circuit:** 1 μ a @ 1 mv, 100 Ω max. contact resistance • **Size:** .360" x .790" x .870" high (current sensitive, 1.190" high).

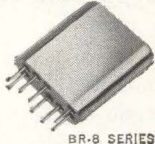

BR-8 SERIES

BR-9 SUBMINIATURE MAGNETIC LATCHING SERIES

Contact Rating: 5 and 10 amp res. @ 28V DC or 110V AC, 400 cps • **Contact Arrangement:** DPDT • **Header Styles:** 10 pin or 8 pin polarized • **Holding Coils:** separate or series operation.

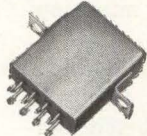

BR-9 SERIES

BR-12 MICROMINIATURE ULTRASENSITIVE SERIES

Relay Types: standard, high sensitivity, max. sensitivity and centepede "lie down" printed circuit versions • **Contact Rating:** 2 and 3 amp res. @ 32V DC or 115V AC, 400 cps; 1 amp inductive @ 32V DC (max. sensitivity unit) 2 amp res. @ 28V DC • **Contact Arrangement:** SPDT or DPDT • **Coil Power** (max. sensitivity unit): 25 mw SPDT, 40 mw DPDT.

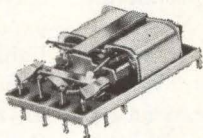

BR-12 SERIES
BR-12P SHOWN

BR-14 SUBMINIATURE FOUR POLE, DOUBLE THROW SERIES

Contact Rating: (@ 28V DC or 115V, 400 cps): 10 amp res., 3.5 amp inductive; 7.5 amp res., 2.5 amp inductive; 5 amp res., 2 amp inductive • **Contact Arrangement:** 4PDT (4 form C) • **Size:** 1.000" x 1.075" x 1.300" • **Weight:** 3.0 oz. max.

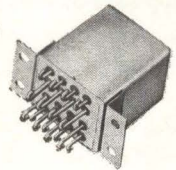

BR-14 SERIES

big enough

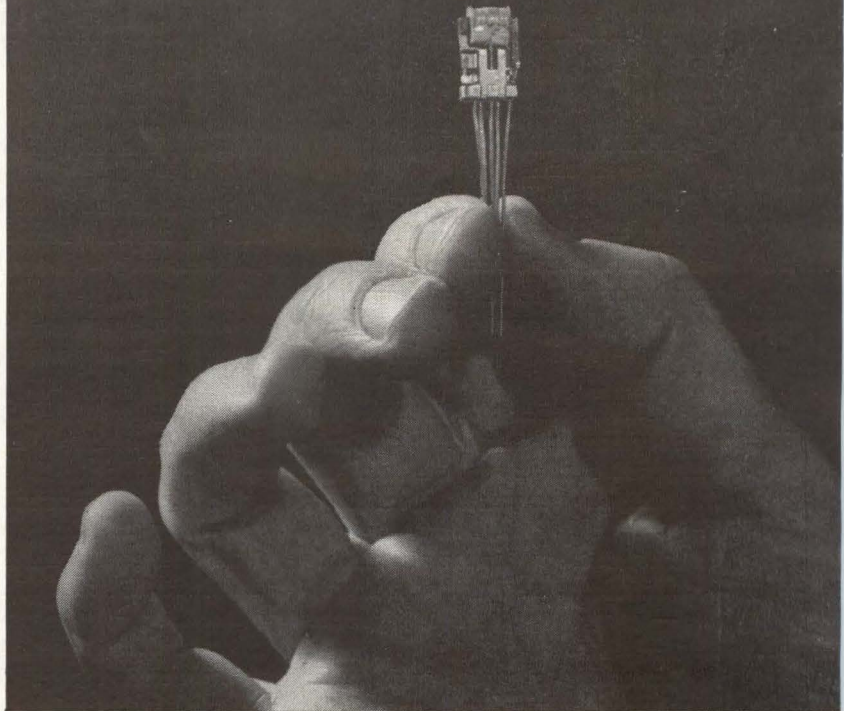

Dry circuit to 1 amp switching in a rugged 1/10th oz. hermetically sealed relay

Babcock's dependable new BR-5 SPDT relay easily handles any load to 1 full amp, at 32V DC. The transistor can-sized package is only as large as it needs to be, measuring 0.2" x 0.4" x 0.6". A special magnetic circuit is responsible for its high sensitivity, generally a limiting factor in relay miniaturization. Exceptionally rugged, the BR-5 is built to withstand 125g shock and 30g vibration at 3000 cps. Selective utilization of materials enables -65°C to +125°C operation, ideal for missile and space probe environments. Available in various mounting styles with printed circuit leads. Interested designers should contact their Babcock representative or write direct for Bulletin BR 617.

Babcock Relays

A Division of Babcock Electronics Corporation
1645 Babcock Avenue, Costa Mesa, Calif.

CIRCLE 17 ON READER SERVICE CARD

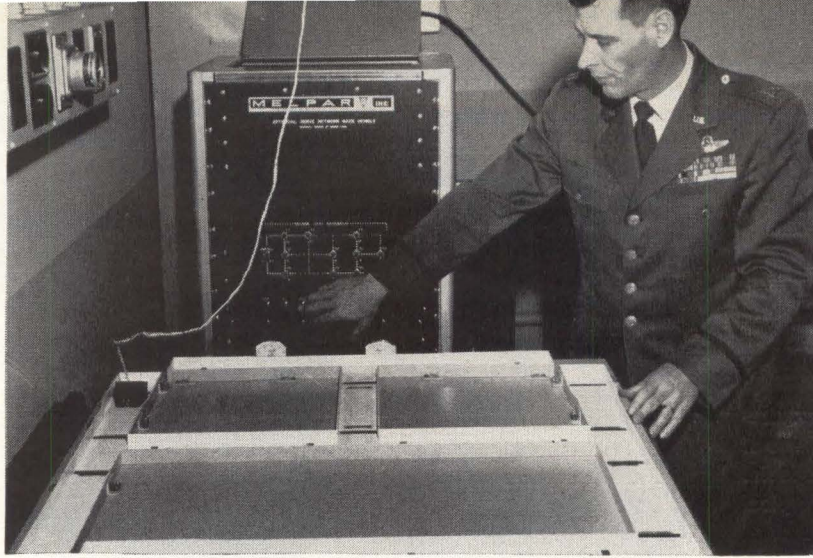

Air Force demonstrates Arton learning network developed by Melpar

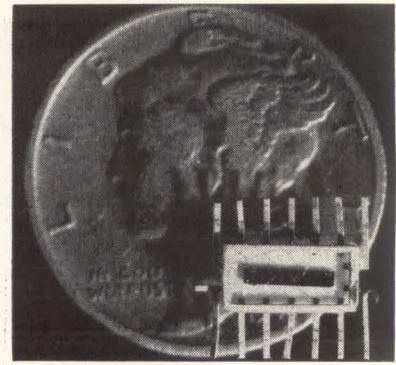

Quarter-inch is the widest dimension of molecular amplifier reported by Autonetics, division of North American Aviation

NAECON Shows Gains in Molecular Circuits

By CLETUS M. WILEY
Midwest Editor

DAYTON—During the next 10 years, molecular electronics will spark a revolution in electronics comparable to that caused by transistors during the last decade, Patrick Haggerty, IRE president, told National Aerospace Electronics Conference.

He predicted that integrated circuits will account for \$1 billion of a \$20 billion electronics market by the 1970's. Suppliers must prepare to meet these needs, many already existing, because they will be satisfied—by new companies, if necessary—he indicated.

Conference reports made clear that progress in molecular and integrated circuits has reached the point where they may be used to build entire systems.

A molecular computer assembled in half the man hours required for its conventional component equivalent was demonstrated by H. Cragon, of Texas Instruments. Molecular flip-flops helped reduce memory size to seven cubic inches and power dissipation to 15 w.

Martin-Denver announced availability of a production digital computer using Fairchild Semiconductor's Micrologic integrated circuits. The computer was designed for missile launch control and remote electronic systems checkout.

William DeBoice, of Autonetics,

announced development of a molecular differential amplifier which bypasses the need for transformers and capacitors. Texas Instruments is developing a silicon block version of the prototype.

A molecular high-frequency oscillator mixer that can be adapted for biomedical implantations was discussed by P. R. Amlinger, of Westinghouse Electric. A fundamental crystal used in a Pierce-type oscillator circuit eliminated need for frequency-stabilizing capacitors in the 27-Mc oscillator. The mixer operates at 0.5 to 10 Mc.

Another Westinghouse development, a diode transistor AND gate fabricated in a monolithic semiconductor functional block, was reported by J. Zubek. Characteristics can be designed for reproducible batch processing, he said. Near uniform temperatures makes it unnecessary to compensate for voltage drops across diodes and transistors.

J. Payton, Litton Systems, described a nondestructive, random-access, tunnel-diode memory switching in 1 to 50 nsec and highly immune to radiation. Speed was increased by eliminating a requirement for timing pulses. Nondestructive read eliminated the write-back or restore cycle and clear-write cycle time was reduced by having word clearing simultaneous with write-in. The usual requirement for buffer register and associ-

ated delays was removed by a direct-coupled read amplifier.

Higher packing density of optical components helped reduce the size of a bulk storage memory discussed by D. H. Blauvelt and W. W. Lee, of Bendix. Information is stored as clear or opaque areas in a glass cylinder drum. Fiber optics and a photodetector handle readout.

Among bionics reports was one by a psychologist, Mildred Mitchell, on a laminar adaptive device made of semiconductor, insulating, photoemissive and storage materials, being developed for the Air Force Aeronautical Systems Division. Controlling component and circuit formation by reward and punishment techniques will permit autonomous adaptation and problem solving, she said. The approach is expected to cut size and improve reliability of learning equipment.

E. B. Carne, of Melpar, discussed an Arton maze runner delivered to the Air Force (ELECTRONICS, p 39, Feb. 9). It has 10 decision elements, learns a trial course in a half hour. Complex problems require eight to 10 trials for solution.

A coding system that presents an image in terms of basic areas or blocks improves channel compression, said Richard Schaphorst, of Philco. A 10-to-1 reduction in time bandwidth is expected from equipment designed for a data link with a bandwidth of 10 Kc.

100-Gc Devices Now Ready for Systems

By MICHAEL F. WOLFF
Senior Associate Editor

DAYTON—Two high-interest regions of the frequency spectrum—the millimetric and the visible—came under scrutiny at the National Aerospace Electronics Conference.

Summarizing the millimeter wave session, J. F. Hull, of Litton Industries, said devices are past the feasibility stage and ahead of applications. He asked that more attention be paid to applications because of the importance of millimeter waves in such areas as secure communications and anti-jam radar.

A progress report on linear beam tubes was given by M. R. Currie, of Hughes Research Labs. He thought these tubes would be dominant at millimeter wavelengths.

Systems applications to 100 Gc can be satisfied now by backward-wave oscillators in the 10 to 20-watt, c-w, range with 5 to 10 percent efficiencies, and forward-wave amplifiers and oscillators producing tens of watts with efficiencies of 25 to 30 percent. Currie predicted 200 to 400-watt, c-w, at 5 mm in the near future and said tens of watts should be possible at 1 mm.

Currie described a class of solid-beam interaction structures based on arrays of quarter-wave resonant bars that could be used in either forward or backward-wave tubes or extended-interaction klystrons. Primary emphasis was on fabrication feasibility rather than optimum electrical performance.

Structures described included a modified easitron circuit useful in

bwos, a second easitron modification for forward-wave oscillators, a combination of the two structures known as the interdigital line suitable for forward-wave amplifiers, and the Millman or vane-line structure which has been employed in bwos. For low-voltage space harmonic operation these structures exhibit typical tuning ranges of less than 10 percent, less than 4 percent, greater than 10 percent, and 15 percent, respectively.

Prospects for the Ubitron as a high-power millimeter-wave amplifier were discussed by R. M. Phillips, of GE. The Ubitron is a traveling-wave amplifier based on the interaction between a magnetically undulated electron beam and the TE_{01} waveguide mode. Phillips said 1 Mw had been obtained at 6 percent efficiency from a 14 to 20-Gc model. Magnetic circuits are being developed to scale the Ubitron to millimeter wavelengths where it is expected to have peak-power capabilities similar to that of a 1-cm traveling-wave tube.

H. R. Johnson described bwo, traveling-wave amplifier and electrically tunable filter work presently underway at Watkins-Johnson. He reported obtaining 100 Kw peak and 100 w average power from a bwo at 100 Gc.

Results of a one-year-old program to develop transverse-wave tubes for the millimeter region were discussed by J. Feinstein, of SFD Laboratories. He said 3 to 5 w had been obtained from a bwo tuned over 65 to 72 Gc and that this

type of tube could be highly efficient.

Generating millimeter waves by extending traveling-wave tube techniques was reported on by G. R. White, of Sperry Electronic Tube division. He said a two-tube amplifier chain to give 50 Kw peak power output, and a traveling-wave tube mixer were being developed for 5.5 mm. These components could be used in a space radar transmitter.

Laser Sessions

Two sessions on lasers heard several workers agree that materials were still the major problem in laser research. Little optimism was expressed for one potential solution to materials problems—the use of liquids.

Few doping ions fluoresce in solution and quantum efficiencies may not be high, T. H. Maiman, of Quantatron, said. He thought that the number of liquids that would work would be restricted. D. S. Bayley reported that a number of liquids were being investigated at General Precision without, so far, any lasing observed. Plans are to try to observe fluorescence in some liquid compound of neodymium.

A. E. Siegman, of Stanford University, reported what he believed to be the first direct modulation and demodulation of light at microwave frequencies. With the system illustrated, he obtained 100-percent amplitude modulation at 2.8 Gc, with a 5-Mc bandwidth.

Siegman felt the best modulation techniques were those performed outside the laser. Particularly promising seem to be traveling-wave systems with KDP (potassium dihydrogen phosphate) or other crystals distributed along various types of slow-wave circuits. He predicted bandwidths of a few gigacycles with modulating powers of 100 watts or less would be obtained soon. Other modulation methods meriting attention include Faraday rotation in garnets or thin magnetic films, and changing the absorption of a semiconductor outside its absorption edge by injecting free electrons.

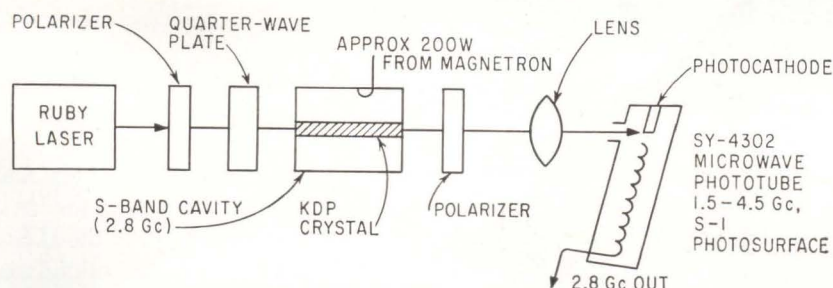

Stanford University experiment for 2.8-Gc modulation and demodulation of laser beam

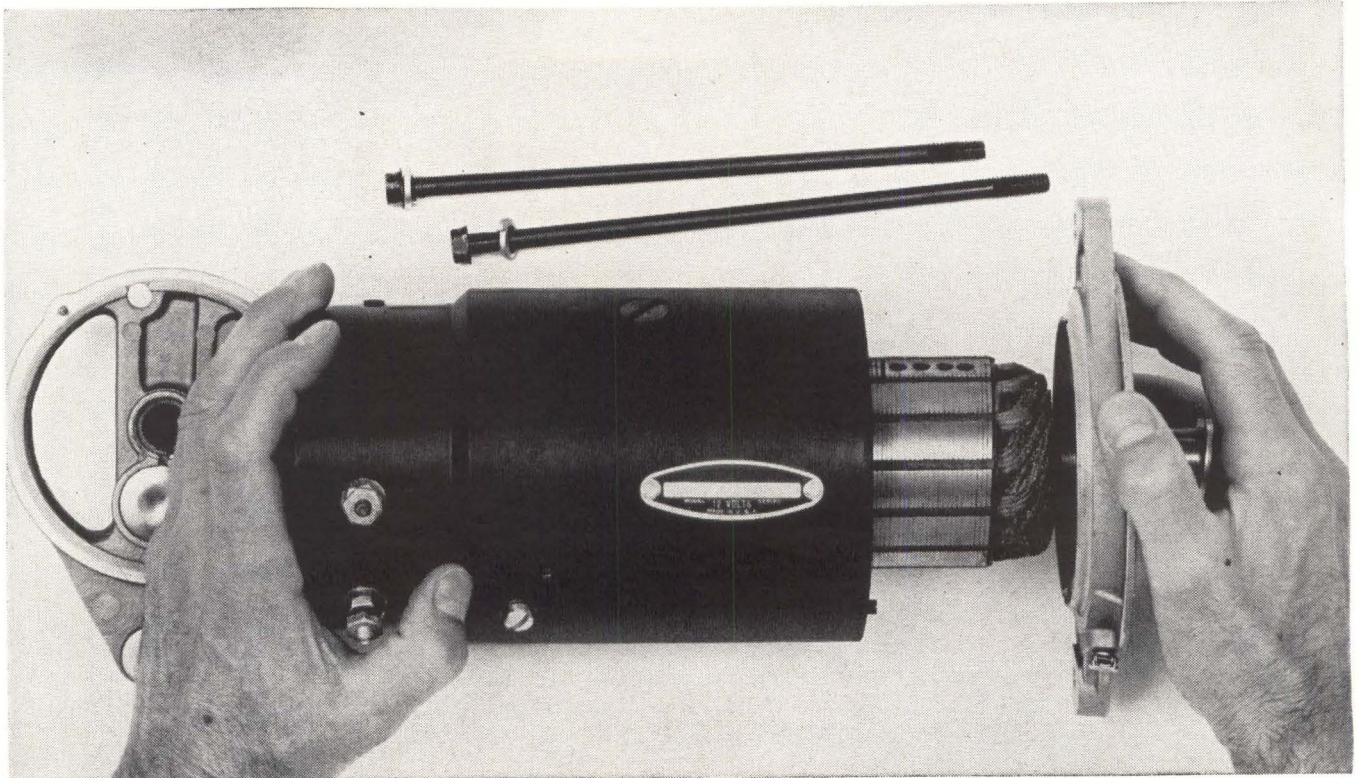

ASSEMBLE IT TODAY SELL IT TOMORROW ANYWHERE IN THE U.S.A WITH



Swift shipment of parts from where they are to where you need them is sure . . . when you specify "via Air Express." It's the only air shipping service with priority on the 36 scheduled U.S. Airlines. The cost is far less than you think. 10 lbs. travel 1,000 miles for only \$5.06. Door-to-door service is assured, anywhere in the U.S., Puerto Rico and Canada with 13,000 REA Express trucks providing pick-up and delivery. You can eliminate costly warehousing and delays, simply by specifying Air Express for all your in-bound and out-bound shipments. **CALL YOUR LOCAL REA EXPRESS OFFICE FOR AIR EXPRESS SERVICE**

PROTECTION

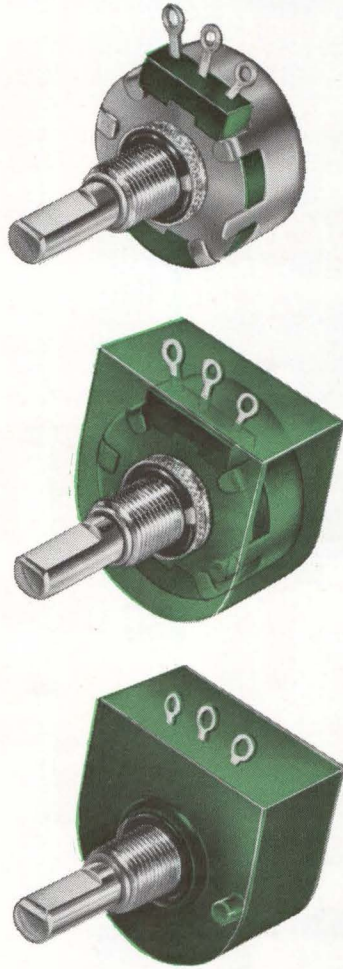

FOR INCREASED RELIABILITY

Seal out troubles. Clarostat exclusive PotPot encapsulation is the most advanced technique in the industry. Wide choice of processes including optimum protection, pre-seals, and varying degrees of moisture and dust protection. PotPot protection is available on virtually all Clarostat potentiometers, plus custom potting of assemblies or other components.

EXCLUSIVE
CLAROSTAT
POT POT

WRITE FOR DATA...

CLAROSTAT

CLAROSTAT MFG. CO., INC. DOVER, NEW HAMPSHIRE



Type 661

SIMPLIFY YOUR PULSE-SAMPLING MEASUREMENTS

with this NEW
Tektronix
Dual-Trace
Oscilloscope

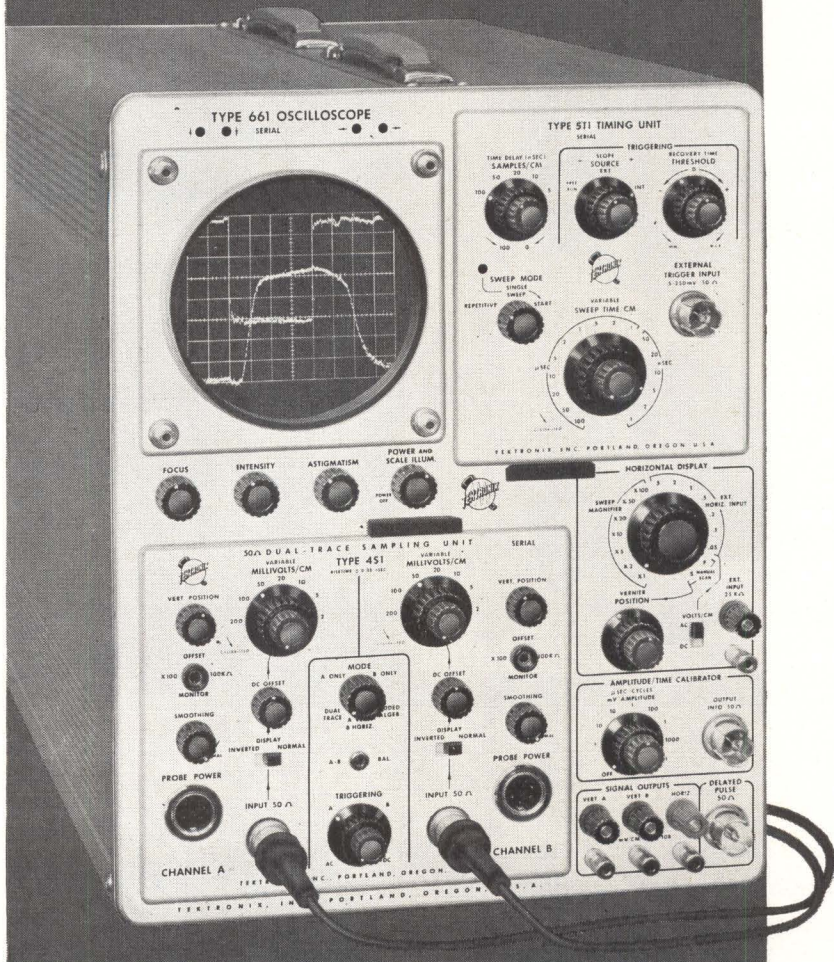

Here's what you can do:

- ... Trigger internally—observe the leading edges of both A and B traces. Matched internal delay lines in both channels assure accurate time comparisons.
- ... Measure pulse risetimes with 0.35 nanosecond response in both channels. Time-measurement range extends to 1 millisecond.
- ... Display repetitive signals on 16 calibrated equivalent sweep rates from 1 nsec/cm to 100 μ sec/cm, accurate within 3%. Magnifier provides sweep expansion from 2 to 100 times . . . time per dot remains the same for digital readout.
- ... Change the probes' signal source without affecting the dot transient response.
- ... Reduce time jitter and amplitude noise, if needed, on the more sensitive vertical ranges and faster sweep rates by means of a smoothing control.
- ... Measure millivolt signals in the presence of a substantial dc component by means of a dc-offset voltage monitorable at the front panel.
- ... Calibrate with amplitude signals available from the front panel. Calibrate with timing signals traceable to National Bureau of Standards.
- ... Show lissajous patterns in addition to single and dual-trace displays and signals added algebraically.
- ... Drive X-Y plotters or similar readout accessories.
- ... Drive external equipment, with fast delayed-pulse output.
- ... Add plug-in units as they come along.

Here's how you do it:

- 1 Plug in the power cord and signal source,
- 2 Set the controls on the vertical and timing plug-in units,
- 3 Take the measurements.

In one compact laboratory oscilloscope you have a complete pulse sampling system with risetime of 0.35 nanosecond. Using the 50 Ω inputs, or the Tektronix passive probe or cathode-follower probe designed for use with the instrument, you can meet most of the general-purpose-measurement demands in repetitive-signal applications.

Type 661 Oscilloscope (without plug-ins) \$1150
 Type 451 50 Ω Dual-Trace Sampling Unit \$1430
 Type 511 Timing Unit \$ 750
 Probes:

Type P6026 Passive Probe \$ 140
 Type P6032 Cathode-Follower Probe. . \$ 160

U.S. Sales Prices, f.o.b. Beaverton, Oregon

For complete information — please call your Tektronix Field Engineer.

Tektronix, Inc. P. O. BOX 500 • BEAVERTON, OREGON / Mitchell 4-0161 • TWX—BEAV 311 • Cable: TEKTRONIX

TEKTRONIX FIELD OFFICES: Albuquerque, N. Mex. • Atlanta, Ga. • Baltimore (Towson) Md. • Boston (Lexington) Mass. • Buffalo, N.Y. • Chicago (Park Ridge) Ill. • Cleveland, Ohio • Dallas, Texas • Dayton, Ohio • Denver, Colo. • Detroit (Lathrup Village) Mich. • Endicott (Endwell) N.Y. • Greensboro, N.C. • Houston, Texas • Indianapolis, Ind. • Kansas City (Mission) Kan. • Los Angeles, Calif. Area (East Los Angeles Encino • Pasadena • West Los Angeles) • Minneapolis, Minn. • New York City Area (Albertson, L.I., N.Y. • Stamford, Conn. • Union, N.J.) • Orlando, Fla. • Philadelphia, Pa. • Phoenix (Scottsdale) Ariz. • Portland, Ore. • Poughkeepsie, N.Y. • San Diego, Calif. • San Francisco, Calif. Area (Lafayette • Palo Alto) • Seattle, Wash. • Syracuse, N.Y. • Washington, D.C. (Annandale, Va.).

TEKTRONIX CANADA LTD: Montreal, Quebec • Toronto (Willowdale) Ontario.

ENGINEERING REPRESENTATIVES: Kentron Hawaii Ltd., Honolulu, Hawaii. Tektronix is represented in twenty-five overseas countries by qualified engineering organizations. European and African countries, the countries of Lebanon and Turkey, please contact TEKTRONIX INTERNATIONAL A.G., Terrassenweg 1A, Zug, Switzerland, for the name of your local engineering representative. Other Overseas areas, please write or cable directly to Tektronix, Inc., International Marketing Department, P. O. Box 500, Beaverton, Oregon, U.S.A. Cable: TEKTRONIX.

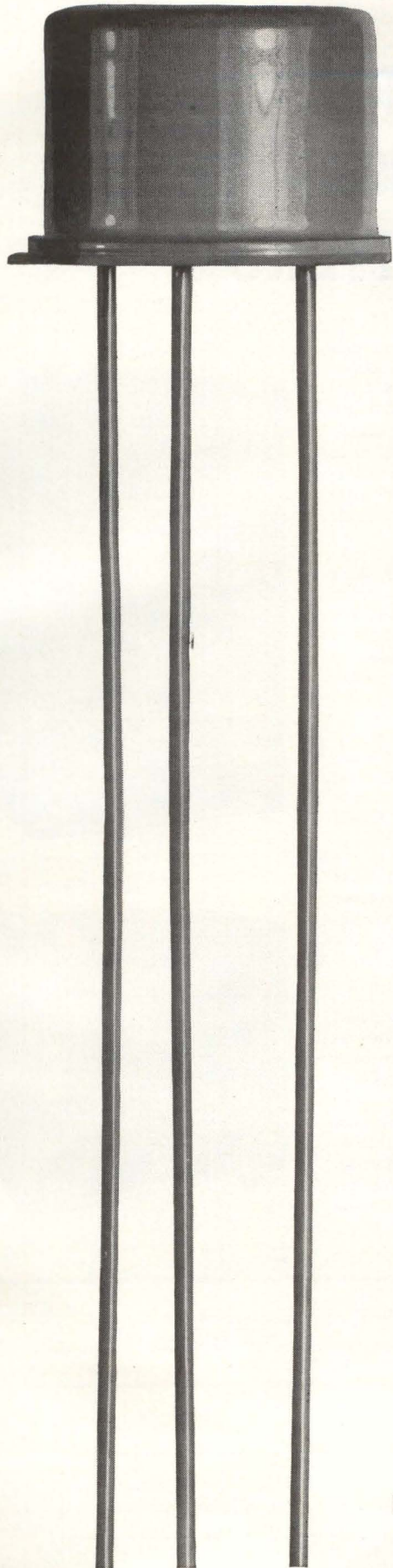

15 NEW TYPES FROM BENDIX



MEDIUM POWER TRANSISTORS

The new, wider line of Bendix® Medium Power Transistors offers more advantages for audio frequency and switching applications, such as audio amplifiers, audio oscillators, power switches, servo controls, relay drivers. Among these many advantages: more linear current gain characteristics and lower distortion output, high voltage rating, high current gain, low saturation resistance, long life, and stable operation. Bendix Medium Power Transistors offer a maximum of reliability and versatility at low cost. Each transistor is 'Dynamically Tested,' an exclusive Bendix quality control process to assure uniformity and maximum reliability. For data on the complete line of Bendix Power Transistors and Power Rectifiers, write us in Holmdel, N. J.

Type Number	MAXIMUM RATINGS				CURRENT GAIN	
	V _{CES} Vdc	I _C mAdc	P _C mW	T _J °C	h _{FE} @	I _C mAdc
2N331	30	200	200	100	20	5
2N398,A	105	200	500	100	20	5
2N464-2N467	15-40	100	150	100	14-90	1
2N650-52,A	45	500	200	100	30&45&80	10
2N1008,A,B*	20-60	300	400	100	40-150	10
2N1009	40	300	400	100	40-150	10
2N1176,A,B	15-60	300	300	100	20	10
2N1287,A	35	300	300	100	40&60	10

*2N1008B also available per MIL-S-19500/196 (SigC)

Bendix Semiconductor Division



Main Office: South St., Holmdel, N.J.—Ph: SH 7-5400 • New England Office: 114 Waltham, Lexington, Mass.—Ph: VO 2-7650 • Detroit Office: 12950 W. 8 Mile Rd., Detroit 37, Mich.—Ph: JO 6-1420 • Midwest Office: 1915 N. Harlem Ave., Chicago, Ill.—Ph: 637-6929 • West Coast Office: 117 E. Providencia Ave., Burbank, Calif.—Ph: VI 9-3961 • Canadian Affiliate: Computing Devices of Canada, Ltd., P.O. Box 508, Ottawa 4, Ont. • Export Office: Bendix International, 205 E. 42nd Street, New York 17, N.Y. Stocking Distributors: Contact nearest sales office for name of local distributor.

AEROCOM PRESENTS VHF AM TRANSMITTERS and RECEIVERS

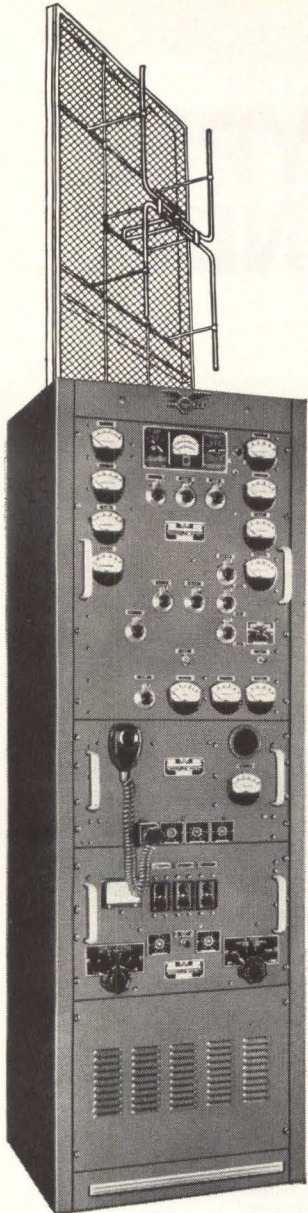

AEROCOM communications equipment is designed with both performance and reliability in mind, and is produced by experienced personnel using high-quality materials. The following features are found in all three transmitters: Single crystal controlled frequency (plus an additional frequency $\frac{1}{2}\%$ away from main frequency): stability $\pm .003\%$ or $\pm .001\%$ over temperature range of 0°C to $+55^\circ\text{C}$, any humidity up to 95%; audio system incorporates high level plate modulation, with compression; forced ventilation with air filter is employed. Welded steel cabinets.

◀ **Model 10V1-A**—1000 Watts output—Successfully being used in Troposcatter service for communications with aircraft beyond the optical horizon. Frequency range 118-153 mc. Can be completely remote controlled by using AEROCOM's remote control equipment. All tuning from front panel by means of dials. Power requirements 210-250 V 50/60 cycles, single phase.

Model VH-200—200 Watts output in range 118-132 mc. Excellent for both point-to-point and ground-to-air communications. Press-to-talk and audio input may be remoted using single pair of telephone lines. Power requirements 105-120V 50/60 cycles. Also available for use above 132 mc; output drops gradually to 150 watts at 165 mc. →

Model VH-50—50 Watts output. Frequency range 118-153 mc. Outstanding low power transmitter for ground-to-air service. With remote control provisions; main power control with front panel switch. Convection cooling for press-to-talk service—otherwise forced air cooling. Power requirements 115/230 V 50/60 cycles. →

◀ **Model 85** VHF Receiver. A high performance, low noise, single channel crystal controlled, single conversion VHF receiver. Stability normally $\pm .001\%$ (with oven crystal $\pm .0005\%$) over temperature range 0°C to $+55^\circ\text{C}$. Sensitivity $\frac{1}{2}$ microvolt or better for 1 watt output with 6 db signal to noise ratio. Standard selectivity bandwidth 30 kc; other widths available. Spurious response down 90 db. Frequency range 118-154 mc. Power requirements either 115 V or 230 V 50/60 cycles. Made for standard rack panel mounting.

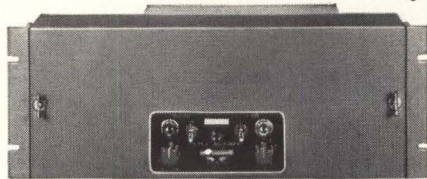
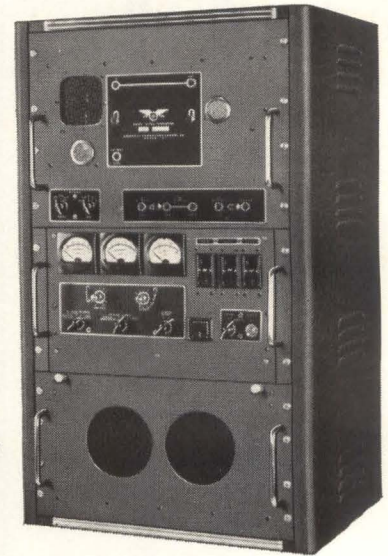

As in all AEROCOM products, the quality and workmanship of this VHF equipment is of the highest. All components are conservatively rated. Replacements parts are always available for all AEROCOM equipment.

*Complete
technical data available
on request*

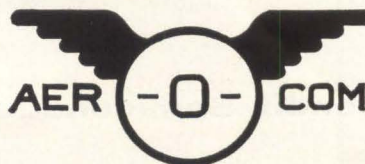

FCC Type Accepted
for Aviation Service

3090 S. W. 37th Avenue — Miami 33, Florida



*APPROX. PRICE OF COMPETITIVE DEVICES

NEW
GENERAL ELECTRIC
CERAMIC TUBES
REDUCE
MICROWAVE
COMPONENT COSTS
DOWN TO
\$16.00
OR LESS

Detailed value-analysis chart shows how cost, size, and performance advantages can be yours. Clip coupon, or circle reader service number, for free copy.

Why pay as much as \$1500 for a microwave device if a \$16 G-E ceramic tube will do the job? In many UHF applications up to 10 KMC (power amplifiers, oscillators, or frequency multipliers) high-gain, low-noise ceramic tubes can often replace TWT's, klystrons, magnetrons or pencil tubes and provide better over-all performance. Oftentimes, ceramic tubes can effect component cost reductions of 5 or 10 to 1, and reductions of 50 to 1 are possible.

Value analysis will show you that G-E ceramic tubes can mean even greater over-all savings. Most common reasons: simplified system design, fewer components, reduced power requirements, and elimination of cooling equipment. Microminiature ceramic tubes increase system resistance to radiation, provide extreme high-temperature tolerance (400°C., max.), and are **up to 40 times smaller and 20 times lighter than many other UHF devices.**

Most G-E ceramic tubes are on approved MIL-spec lists and are available "off-the-shelf" from your local G-E receiving tube sales representative. Send, today, for your free value-analysis chart which lists all the cost, size, and performance advantages that can be yours with G-E ceramic tubes.

G-E TIPS (Technical Information and Product Service)
 General Electric Receiving Tube Dept.
 Room 1718
 Owensboro, Kentucky

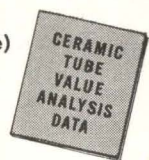

Name _____ Title _____

Company _____ Address _____

City _____ Zone _____ State _____

Progress Is Our Most Important Product

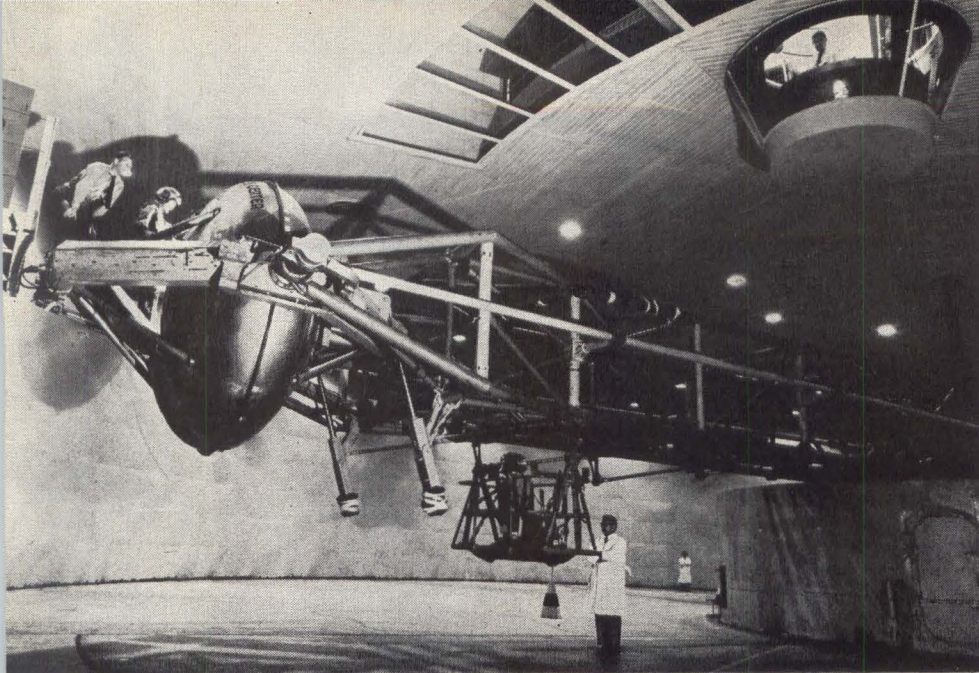

Giant centrifuge at Naval Air Development Center is used to check out pilots and instruments for space flight

By JOHN F. MASON
Associate Editor

WITHIN A FEW DAYS, the Navy's appropriations request for research, development, test and evaluation (RDT&E) in fiscal year 1963 will go to the Senate floor. The House has approved \$1,474 million, about $\frac{1}{2}$ million less than Navy wanted. Major programs are:

Antisubmarine Warfare — At \$291 million, this is one of the biggest programs. Since there is no air defense against submarine-launched missiles, defense is concentrated on getting the subs before missiles are launched.

Extensive effort will be placed on shipborne detection/deception and countermeasures. Sonar R&D will be aimed at reducing size, weight and power requirements while increasing detection range. The Navy says the powerful new SQS-26 sonar promises the longest range yet obtained in shipborne active sonar. Range of helicopter sonar and Lofar sonobuoys has also been improved. Sonars now going into ships and subs have 10 times the range of five years ago.

Projects Trident and Artemis will be stepped up. Trident will survey large ocean areas with active and passive sonar and fixed and mobile detection systems to locate submarines beyond their maximum missile-launching range. Artemis,

applied research in long-range submarine detection, will include sea trials of signal-processing components in 1963.

Sensitive, airborne infrared equipment will be developed. Experimental infrared gear has detected submerged submarines at night, hours after passage. The passage of submerged submarines has also been detected in restricted waters by active barriers of transducers. A barrier set is being bought this year for operational testing.

A precision graphic recorder (Aspect) for destroyers and helicopters will tell whether the target located is a submarine or fish. Lofar target classifiers and more sensitive magnetic airborne detection (Mad) gear are being developed.

ASW Weapons—The House provided an extra \$7 million to overcome difficulties in the Mark 46 torpedo. The components worked, but the assembled torpedo didn't. A lightweight torpedo for aircraft and destroyers, it will use long-range sonar for target searching and homing. Work will begin this year on an asw torpedo with higher speed, longer acquisition and greater depth capability.

Other continuing developments include a wire-guided torpedo, the EX-10, and mines more sensitive to targets and more resistant to countermeasures. The Mark 57 mine development is a project that

1963 RDT&E SPENDING

Type of Activity	Amount (\$1,000,000)	%
Basic research	77.7	5
Applied research	146	10
Development of weapons equipment and components	847	57
Test and evaluation	335	23
Program-wide management and support items not distributed elsewhere	68	5
Total	1,473.7	100

Navy Steps

will be completed.

The Navy is also going ahead with Asroc, Subroc and Dash. Asroc, a ship-launched rocket, delivers a mine or sonar-homing torpedo. Subroc, a submarine-launched rocket-torpedo, is slated for test-firing in December. Dash is a torpedo or nuclear depth charge carried by a drone helicopter controlled from a destroyer.

Missiles—Although Navy is reducing R&D on Polaris in 1963, it will continue developing the A-3 version with a 2,500-nm range.

Typhon, the newest surface-launched missile, is to be used on a nuclear-powered, guided-missile frigate, also in the 1963 budget. Typhon is being developed in long-range and medium-range versions.

Tower near Bermuda is relay point for hydrophones

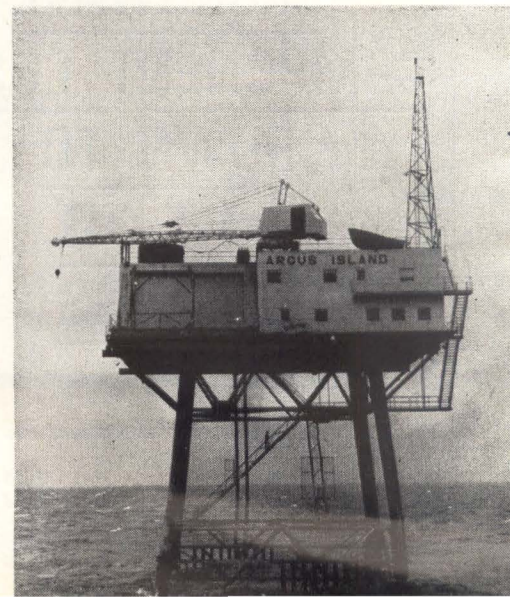

WHERE NAVY SPENDS RDT&E MONEY

Fiscal Year	1961	1962	1963
	(\$1,000,000)		
Department of Defense facilities.	527	535	588
Other government agencies.	6	8	17
Industrial facilities.	719	779	793
Educational and nonprofit organizations.	78	75	72
Total obligations.	1,330	1,398	1,470

RDT&E ON ASW IN 1962 AND 1963

Fiscal Year	1962	1963
	(\$1,000,000)	
Detection, classification and localization (65 projects)	88.4	119.4
Weapons, ordnance, and fire control (28 projects)	59.6	63.8
Vehicle and propulsion equipment (35 projects)	48.2	58
Collateral, support, and related (24 projects)	35	41.8
Total 152 projects.	231.2	286

Up Antisubmarine Warfare R&D

IN ITS \$1,474 RDT&E BUDGET FOR 1963

Designed to cope with enemy threats in 1970, it will attack large numbers of targets. The system will use phased-array radar.

Both Typhons will fit into Terrier and Tartar launchers, so ships now carrying those missiles can be backfitted later with Typhon. Navy also wants to improve Terrier, Tartar and Talos shipboard surface-to-air missiles.

RDT&E funds for the air-launched Bullpup are being reduced since it is entering the procurement phase. Technical and operational evaluation of Shrike is slated to begin by July, 1963.

Conventional and Limited War Equipment—Non-nuclear weapons will be modernized and research will start on new weapons.

Developments for the Marine Corps include a man-packed communications jammer, man-transportable mortar locator, Lightweight surveillance radar, lightweight command, tactical and logistics control radios, more reliable ground-to-air radio.

The Marine Tactical Data System (Mtds) will evaluate air situations. Tactical operations centers with digital computers will receive and process radar and IFF information and direct action against enemy aircraft. Long-range, lightweight early-warning and height-finding radar are under development.

Aircraft and Related Equipment—Navy is participating in tri-service development of vertical-takeoff-

and-landing planes, the TFX supersonic, all-weather, missile-carrying interceptor and the VAX, to provide close support to troops. TFX's missile control system will use high-power airborne intercept radar.

To improve asw aircraft capability, detection and classification data display and communications equipment is needed.

Communications and Command—R&D is underway on communications systems for future command ships. Operations control centers using advanced data processing and display equipment are also being developed. Future systems must cope with limited wars.

Pacific Missile Range—Navy wants \$113.3 million for instrumentation of downrange sites and ships, training support, and tests of Navy, Air Force and Army missiles and satellites.

Astronautics—Navy's interests are in navigation, space surveillance, geodesy and communications.

Project Transit, a doppler navigation satellite system, will provide worldwide ship navigation in 1963. A four-satellite prototype system will be established. Six launches are planned for 1963.

Ship equipment is being developed and evaluated for operational use. Ground tracking, computer and control network are required.

Spasur, the operational space surveillance network, will be ex-

Island of aircraft carrier *Enterprise*. Four rows of horizontal bars are part of ship's radar

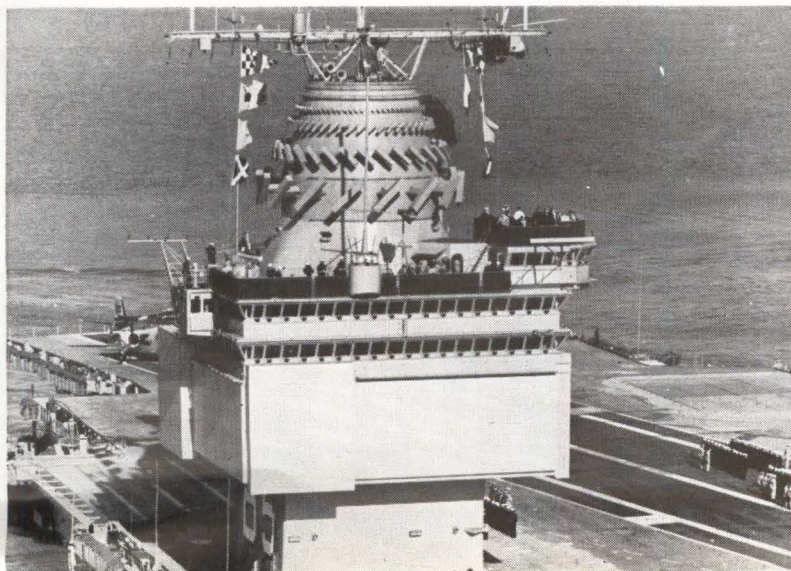

tended to monitor satellites and low and high altitudes and to improve satellite prediction accuracy.

Oceanography—Navy will spend \$38 million (out of \$124 total government funds) on research, much of it aimed at applications in undersea and antisubmarine warfare. Studies include surface waves, ice physics and sea floor. To predict sonar conditions, an antisubmarine warfare environmental prediction system (Asweps) will be developed.

Navy hopes to use infrared-equipped satellites to determine surface water temperatures and thereby currents. Satellites may also receive data from sonobouy-type sensors and provide information on surface weather.

Electronic Sciences—Work includes fundamental principles of devices and circuits, elf and vlf research, non-acoustic submarine detection and communications, thermoelectricity, countermeasures, solid-state power supplies and millimeter waves.

Radar surveillance programs include Projects Madre and Teepee. Madre is a Navy-Air Force program for over-the-horizon detection of missiles and aircraft. Teepee is to detect missile launches. Emphasis in 1963 will be on optimizing multihop backscatter techniques and developing specialized equipment. A two-hop technique has detected at 4,000 miles.

Basic Research—A \$77.7 million request has been made for work in biological, physical and mathematical sciences, nuclear physics and physical acoustics.

Programwide Management and Support—Funds will support the Atlantic Undersea Test and Evaluation Center at Andros Island, in the Bahamas. Radar, underwater and optical tracking, telemetry, microwave and communications, computing and data processing equipment will be bought. The range will be fully operational in fiscal year 1964.

ASW Director—As part of its antisubmarine warfare program, the post of Director of ASW Warfare has been created and two auxiliary groups have been formed. The ASW Systems Analysis Group will be concerned with specific research efforts and the Chief of Naval Operations ASW Study Group, long-range plans.



Huge fairgrounds at Hannover cover 9.5 million square feet

German Electronics Spotty

BONN — The German Industries Fair at Hannover last month confirmed that the German electronics industry today presents a confusing picture.

Two years ago, experts predicted it would be a major growth industry. This seemed apparent in 1960 when German electronics output hit \$825 million—seven percent of Free World production.

But overcapacity in some sections—particularly entertainment electronics—and rapidly increasing competition from British and U. S. firms have had a major impact. Output dipped sharply to \$750 million in 1961 and may drop off even further this year.

Electronics exports increased by about \$200,000 in 1961, to \$339 million. Against this, imports rose from \$27 million to \$108 million.

American firms are beginning to show a major interest in the European market, buying into European firms or establishing license agreements. As competitors, U. S. firms are seen to have the advantages of a long start, government help for development and cheaper materials. The high cost of labor in the U. S. is of little import in such a capital-intensive industry as electronics.

Radio and tv sets are still the German industry's bread and butter. With components and allied equipment, this accounts for almost half of total output. But tv sales dropped from 2.28 million sets in

1960 to 1.82 million in 1961. The forecast for 1962 is less than 1.7 million set sales.

Transistor radios are still best sellers, but indications are that competition from Japan and Hong Kong will be increasingly severe.

Manufacturers seem to have made up their minds that their future lies in industrial electronics. The potential market for telecommunications equipment looks enormous, but to date German demand offers little encouragement to manufacturers.

Prospects are bright for inexpensive electronic business machines. Successful prototypes of electronic telephone exchanges have been developed and pushbutton

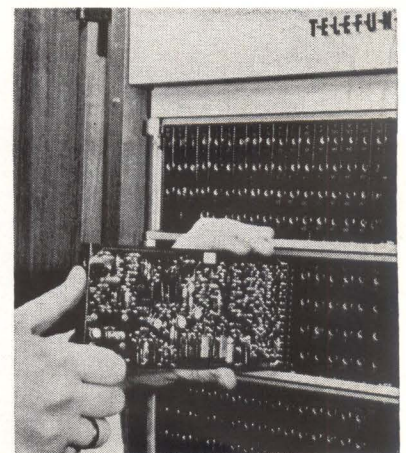

Telefunken computer uses interchangeable printed circuit boards

phone sets are on the market.

In 10 years, major German post offices will be equipped with automatic letter sorters, patterned after one at Darmstadt. The federal Post Office has its first electronic money order accounting system.

Prominent among 230 foreign exhibitors of electronic and electrical equipment were Minneapolis-Honeywell, Budd, Beckman Instruments and Texas Instruments.

Among the German firms, Telefunken unveiled its TR4 general-purpose digital computer. The central computing unit operates with parallel word transmission and has a parallel computer unit for 48 bits. Instruction, binary floating-point notations, binary and decimal fixed point numbers and alphanumeric characters are employed internally. Clock frequency is 2 Mc.

There are two permanent memories, each of 4,096 52-bit words. One is expandable to 24,576 words. Access time is 1 msec. Up to 64 auxiliary units may be connected to eight input and output channels.

All-Transistor Telephone Switchboard Weighs 500 Lb

CHICAGO—Kellogg Division of ITT Corp. unveiled an all-transistor, 500-pound telephone switching system at the Navy League convention here. Up to 30 trunks and 200 extension lines can be accommodated.

Kellogg designed the system primarily for military and government applications where light weight, minimal maintenance, and mobility are important factors. The equipment can be airlifted.

The company also sees some commercial applications, because of its size. Power consumption is 250 to 600 watts, depending on the number of branch telephones served. It uses 60-cps power; batteries may be used in emergencies.

Heart of the switching system is a scanner using a three-stage cascaded array, permitting a firm register seizure time of 30 μ sec. The system features modular construction. A minimum of 48 extensions can be handled economically, but additional lines can be added in increments of four by plugging in modules.

MARC Time Division Multiplex

alarm, remote control, and data transmission systems

MARC systems automatically monitor the status of any number of remote points, and transmit on/off control, alarm, or data information to a central station over any communication link — physical pair, carrier, radio, VHF, or microwave.

MARC CODER AND DECODER UNITS DESIGNED FOR STANDARD RACK MOUNTING

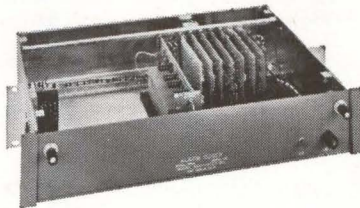

The MARC Coder continuously generates serial time coded signals in accordance with the input signals monitored. Each pulse in the serial code train is weighted short or long, in appropriate sequential order, according to the condition of the input information to be transmitted. Information sent in this time-sharing mode is called time division multiplex (TDM).

Marc TDM signals can be transmitted, much like teletype, over DC physical pairs, or voice frequency tone channels, to modulate carrier, wire, or microwave links. Marc can also be used to key the baseband of a VHF or microwave transmitter directly. Speed of transmission of control information is adjusted to system requirements, within the communication link bandwidth.

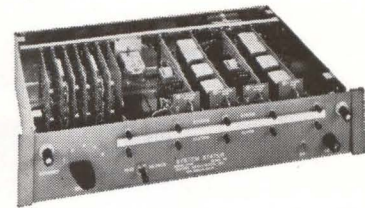

The MARC Decoder is synchronized with the coder by means of a synchronizing pulse at the end of each serial pulse train. By use of logic circuitry, the system affords extremely high immunity to noise and spurious signals, virtually excluding improper control function selection.

The information output of the decoder is the presence or absence of a voltage, corresponding to the information received from the coder. This voltage can be used to operate inductive loads, such as relays, or resistive loads, such as indicator lamps.

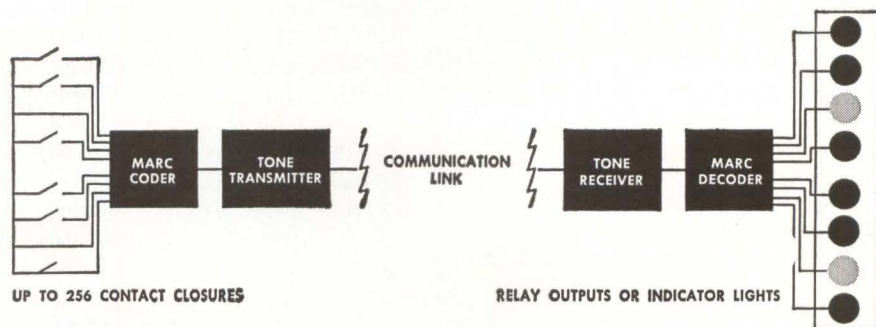

MARC equipment is all-solid-state, providing extremely reliable operation with virtually no maintenance. Modular components — code-notched printed circuit cards — can be combined in many different configurations to meet the operating requirements of virtually any application. Systems can be simple or highly sophisticated, depending upon the mode of operation, reliability parameters, and time available for transmission. For details, write:



MOORE ASSOCIATES INC.

893 American Street, San Carlos, California

FILMISTOR®

METAL FILM RESISTORS
OFFER 5 TEMP. COEFFICIENTS
TO MEET ALL CIRCUIT
REQUIREMENTS

RUGGED END-CAP
CONSTRUCTION
FOR LONG TERM
STABILITY

EXCEPTIONAL
RESISTANCE TO
MOISTURE AND
MECHANICAL DAMAGE

SURPASS MIL-R-10509
PERFORMANCE
REQUIREMENTS

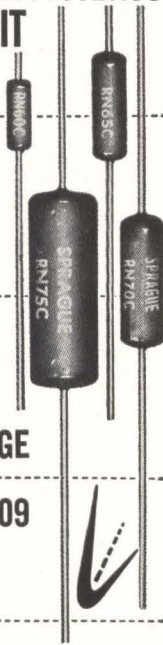

Providing close accuracy, reliability and stability with low controlled temperature coefficients, these molded case metal-film resistors outperform precision wirewound and carbon film resistors. Prime characteristics include minimum inherent noise level, negligible voltage coefficient of resistance and excellent long-time stability under rated load as well as under severe conditions of humidity.

Close tracking of resistance values of 2 or more resistors over a wide temperature range is another key performance characteristic of molded-case Filmistor Metal Film Resistors. This is especially important where they are used to make highly accurate ratio dividers.

Filmistor Resistors, in $\frac{1}{8}$, $\frac{1}{4}$, $\frac{1}{2}$ and 1 watt ratings, surpass stringent performance requirements of MIL-R-10509D, Characteristics C and E.

Write for Engineering Bulletin No. 7025 to: Technical Literature Section, Sprague Electric Co., 35 Marshall Street, North Adams, Mass.

For application engineering assistance, write: Resistor Div., Sprague Electric Co. Nashua, New Hampshire



'Sprague' and '®' are registered trademarks of the Sprague Electric Co.

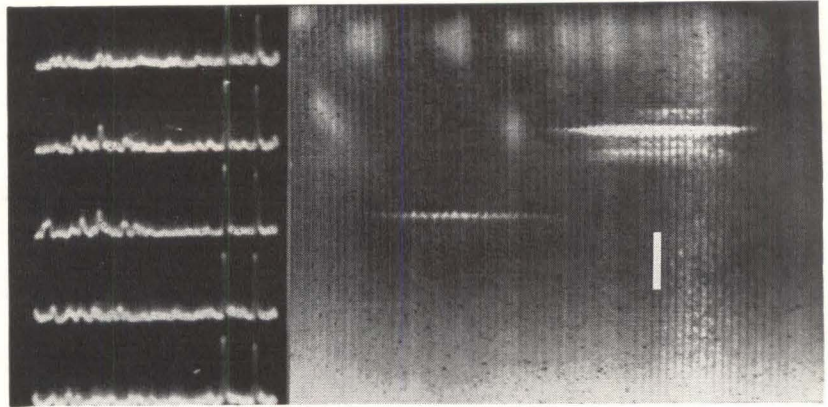

GE says that data in the white rectangle on the thermoplastic recording (right) is equivalent to that on the erofilm photo (left)

Thermoplastic Tape Records Radar Data

THERMOPLASTIC recording of radar video information may point the way to improvements in radar test evaluation, GE announced recently. The technique was used experimentally during tests of a new airborne radar at the company's Light Military Electronics department.

GE said that resolution and recording density were considerably higher than can be obtained by conventional oscilloscope and high-speed camera recording. An average hour of fly-bys required 45 feet of thermoplastic tape. When the thermoplastic recording was projected, pulse-to-pulse echo intensity was clearly visible, GE said.

In thermoplastic recording, video output is fed to an electron gun that places a charge pattern on the tape. The tape is converted in the recorder by heating, converting the charge image into a groove image. Groove depth is proportional to signal strength.

The equipment used has recorded frequencies up to 10 Mc. The re-

corded data is viewed with a movie projector modified by the addition of Schlieren bars. Clear areas of the tape are seen as dark and grooved areas as light. Illumination varies with groove depth.

GE says it is also working on thermoplastic recording for latent image photography, random access digital storage, recording composite radar, infrared and tv analog signals, and wide-band signals from reconnaissance equipment.

Convert Voice to Digits For Speech Recognition

AUTOMATIC SPEECH recognition program in RCA's Surface Communications division has reportedly achieved recognition accuracy as high as 85 percent. Objective of the program is to convert speech to digital form with an order of magnitude reduction in bandwidth, for teletypewriter transmission.

Speech is analyzed, encoded in binary form and recorded for input to an RCA 501 computer. The 501 picks out and recognizes vowels spoken in isolated monosyllables consisting of an initial consonant, a vowel and final consonant. Vowel location is automatic and no adjustment is made for individual talkers. Problems of error source, accuracy improvement and consonant recognition are under attack.

Work is sponsored by the Air Force. When perfected, speech recognition can foster language translators, phonetic typewriters and voice-controlled machines.

Micro Tv Set



Sony's eight-pound, five-inch, transistor tv (p 7, April 27)

REDUCE CAPACITOR COSTS

80%

WITH CENTRALAB Q-KAPS POLYSTYRENE CAPACITORS

EXCEPTIONALLY LONG LIFE AND PROVEN RELIABILITY

The polystyrene film dielectric of these new Centralab capacitors permits their use as direct replacements for micas and Mylars... in any application within their capacity limits and operating temperature range... yet their price is fantastically low. Fast delivery is available on all standard EIA (RETMA) values from 20 pf to .01 mf, 500 VDCW, 1500 VDCT, $\pm 5\%$ or $\pm 10\%$ tolerance. Other capacity values, tolerances ($\pm 2.5\%$, $\pm 20\%$), and voltages (125 VDCW, 375 VDCT) can be supplied on special order.

CAPACITANCE DRIFT: 0.3% or less after temperature cycling of +25, -10, +85, +25°C.

INSULATION RESISTANCE: 5000 Meg/mf or 500,000 Meg, whichever is greater, at 100 VDC, +25°C, 80% R.H.

"Q" FACTOR: Over 2000 at 1 mc, 25°C.

OPERATING TEMPERATURE RANGE: -10°C to +85°C.

For detailed information and complete specifications on these new Centralab "Q"-Kaps, write for Bulletin EP1034R3.

Immediate delivery, from stock, of all EIA values, 5% tolerance, is available through Centralab Industrial Distributors.

The logo for Centralab, featuring the word "Centralab" in a white serif font on a dark blue rectangular background. A small diamond-shaped logo with the letters "CRL" is positioned below the "a" in "Centralab".

D-6223

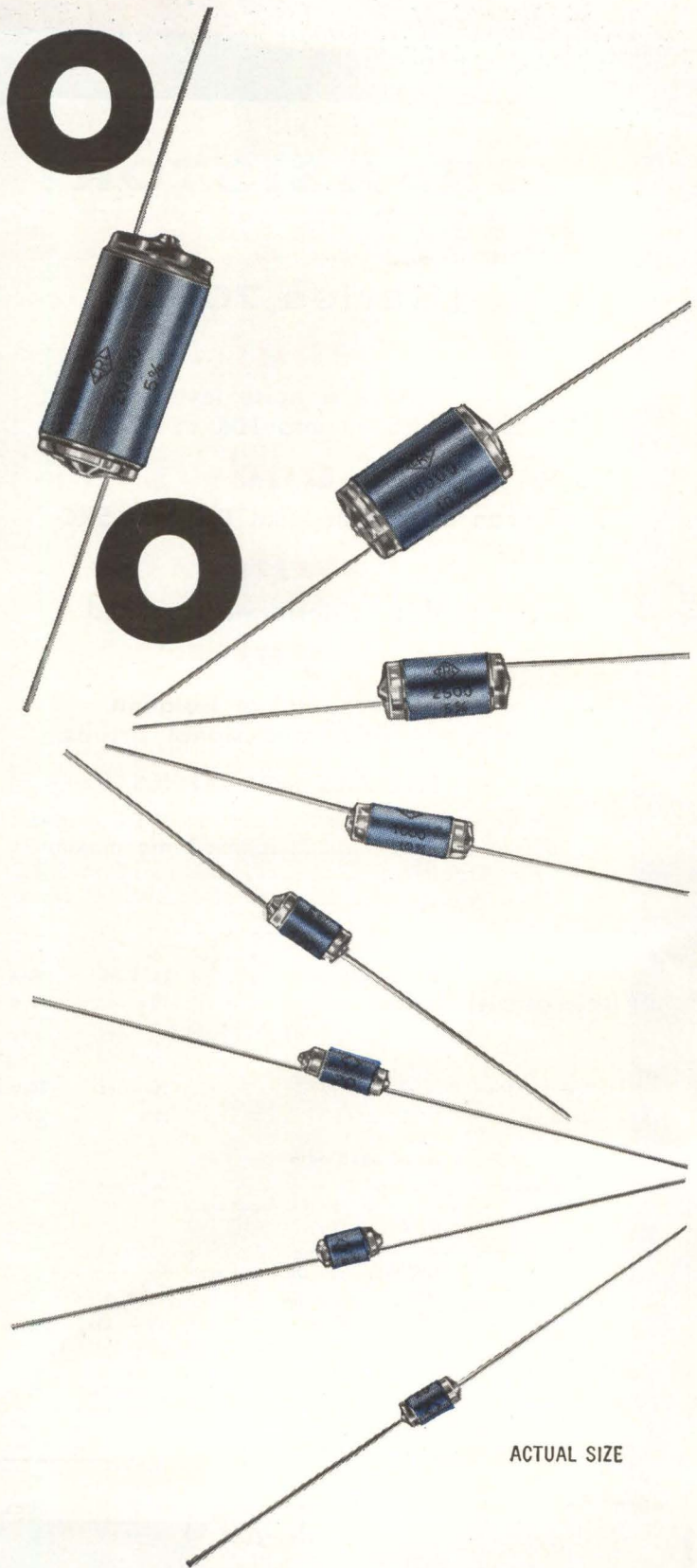

ACTUAL SIZE

THE ELECTRONICS DIVISION OF GLOBE-UNION INC.

• 914F EAST KEEFE AVENUE

• MILWAUKEE 1, WISCONSIN

June 1, 1962

CIRCLE 31 ON READER SERVICE CARD

31



TRANSISTOR CHOPPERS

(Series 7000)

that
have a noise level
of only 35 uv into 10K at 400 CPS
and
can be driven from DC thru 5KC
with
no drive transformer required
yet
provide complete isolation
between drive and signal circuits.

TYPE 7005 SPDT RATINGS

Signal Input Voltage ± 15 V DC or peak
Signal Current 1 ma maximum
Drive Frequency 0 to 5 KC
Drive Voltage 6 to 10 V RMS sq. wave

SPECIFICATIONS (AT 25° C)

PARAMETER	CONDITIONS	TYPICAL	MAX.
Turn On Time	0 to 1KC 1.5V DC input sig. 10K load 50 KC bandwidth	10 μ sec.	20 μ sec.
Turn Off Time	as above	20 μ sec.	30 μ sec.
Linearity	6V DC drive 10K load 50 KC bandwidth	.5%	1.5%
On Resistance	10K load 10 mv to 15V DC input sig. 6V DC drive	50 ohms	
Off Resistance	No drive voltage 10K load 0.1V DC input sig.	1000 meg.	
Drive Input Imp.	6V DC input to drive	1200 ohms	
Noise	6V 400 CPS sq. wv. drive 10K load on pins 3, 4, & 5 20 CPS to 1.5KC bandwidth	35 μ v RMS	70 μ v RMS
Offset (between pins 3-4 and 3-5)	6V 400 CPS sq. wv. drive 100 ohms input 10K ohms output 20 CPS to 1.5KC bandwidth	50 μ v RMS	70 μ v RMS

Volume is only
1 cubic inch.

CC34

PHONE
228-4600



TWX CAMB
MD 545-U

CAMBRIDGE DIVISION INCORPORATED CAMBRIDGE, MARYLAND

MEETINGS AHEAD

NUCLEAR CONGRESS & EXHIBIT, Engineers Joint Council; Statler Hilton Hotel, New York City, June 4-7.

RADAR ANNUAL SYMPOSIUM, University of Michigan; at the University, Ann Arbor, Mich., June 6-8.

MOLECULAR BEAMS CONFERENCE, Brookhaven National Laboratory; Upton, N. Y., June 11-13.

ARMED FORCES COMMUNICATIONS AND ELECTRONICS CONVENTION AND SHOW; Sheraton Park and Shoreham Hotels, Washington, D. C., June 12-14.

AEROSPACE TRANSPORTATION CONFERENCE, AIEE; Denver-Hilton Hotel, Denver, Colo., June 17-22.

BROADCAST & TELEVISION RECEIVERS CONFERENCE, IRE; O'Hare Inn, Chicago, Ill., June 18-19.

MILITARY ELECTRONICS 6TH NATIONAL CONVENTION, IRE-PGMIL; Shoreham Hotel, Washington, D. C., June 25-27.

ELECTROMAGNETIC THEORY & ANTENNAS SYMPOSIUM, Tech. Univ. of Denmark, et al; Copenhagen, June 25-30.

COMPUTER AND DATA PROCESSING SYMPOSIUM, Denver Research Institute; Elkhorn Lodge, Estes Park, Colo., June 27-28.

AUTOMATIC CONTROL JOINT CONFERENCE, IRE-PGAC, AIEE, ISA, ASME, AICHE; NY Univ, New York City, June 27-29.

RADIO PROPAGATION COURSE, National Bureau of Standards and University of Colorado; NBS Boulder Laboratories, Boulder, Colo., June 16-Aug. 3.

LUNAR MISSIONS MEETING, American Rocket Society; Pick-Carter and Statler-Hilton Hotels, Cleveland, Ohio, July 17-19.

MEDICINE & BIOLOGY DATA ACQUISITION AND PROCESSING, IRE-PGBME, AIEE, ISA; Strong Memorial Hosp., Rochester, N. Y., July 18-19.

INTERNATIONAL SOUND FAIR, Institute of High Fidelity Manufacturers, Magnetic Recording Industry Assoc., et al; Cobo Hall, Detroit, July 25-29.

INDUSTRIAL RESEARCH CONFERENCE, Columbia University; Arden House, Harriman, N. Y., Aug. 5.

WESTERN ELECTRONICS SHOW AND CONFERENCE, WEMA, IRE; Los Angeles, Calif., Aug. 21-24.

ADVANCE REPORT

SPACE PHENOMENA & MEASUREMENT SYMPOSIUM, IRE-PGNS; Statler-Hilton Hotel, Detroit, Oct. 15-18. July 1 is the deadline for submitting 300-500 word summary and 35-word abstract to: M. Ihnat, Avco Corp., 201 Lowell St., Wilmington, Mass. Topical areas include, but are not limited to, the following: fundamental and applied research on space environment; recent advances on nucleonic instruments and controls; space and laboratory diagnostics.

MOTOROLA ZENER DIODES

characterized at 3 critical points

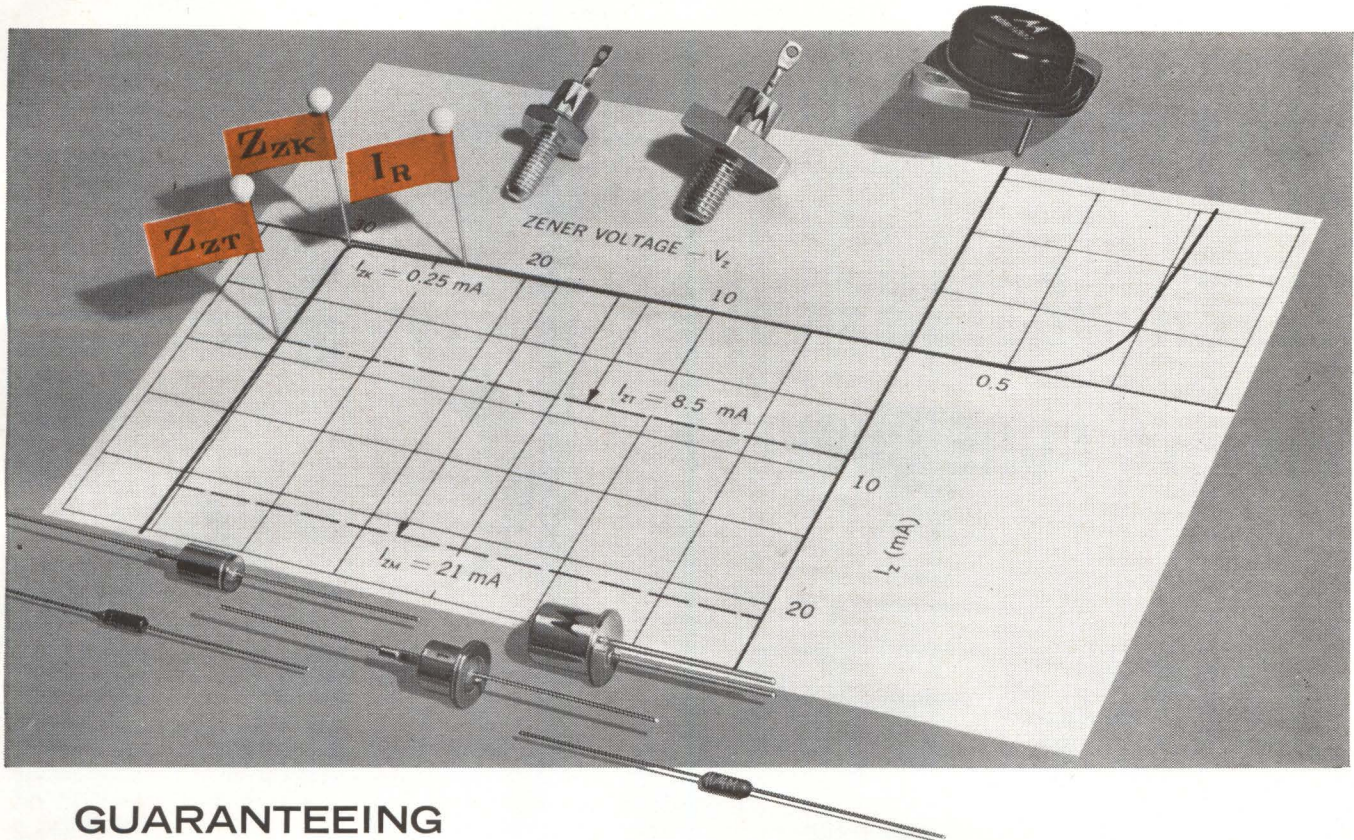

GUARANTEEING

- Meaningful, reverse leakage spec (I_R)
- Clearly defined, zener knee region (Z_{zk})
- Low dynamic impedance (Z_{zt})

All Motorola zener diodes are tested at 80% of the minimum zener voltage . . . giving you a much more meaningful reverse current leakage specification than you get with those devices having leakage specified at lower percentages of the zener voltage.

Also . . . Motorola zener diodes are unique in that the point of measurement for specified leakage is the same for each power rating from $\frac{1}{4}W$ through 50W . . . and for all voltages . . . rather than the customary and confusing practice of using test points farther away from the zener knee for the lower voltages.

Meaningful reverse leakage current data tells you the precise current drain in the region below breakdown . . . helps to clearly define the critical zener knee region . . . gives you a good indication of cleanliness of junctions.

In addition . . . all Motorola zener diodes are characterized for you by two guaranteed maximum impedances . . . (1) at the practical $\frac{1}{4}$ power operating point (Z_{zt}) . . . (2) at the zener

knee (Z_{zk}). These two points help define the zener knee region, and prove that it does not soften past the I_R test point, but continues sharp beyond Z_{zk} . . . giving you assurance of stability of the zener voltage with current changes.

For the industry's finest, best-characterized zener diodes, specify Motorola. More than 2,000 different types . . . most complete, most meaningful specifications . . . highest-reliability industrial and military devices.

MOTOROLA ZENER DIODES

WATTS	VOLTS	WATTS	VOLTS
$\frac{1}{4}$	2.4 to 200	1.5	6.8 to 200
400 mW	3.3 to 200	10	6.8 to 200
$\frac{3}{4}$	6.8 to 200	50 (TO-3)	6.8 to 200
1	6.8 to 200	50 (Stud)	6.8 to 200

- REVERSE POLARITY 10 & 50W UNITS
- MATCHED SETS
- TEMPERATURE COMPENSATED TYPES 6.2V - 8.4V - 9.0V - 9.3V - 11.7V
- SPECIALS

WORLD'S LARGEST SUPPLIER OF ZENER DIODES



MOTOROLA
Semiconductor Products Inc.

A SUBSIDIARY OF MOTOROLA, INC.

1963

5005 EAST McDOWELL ROAD • PHOENIX 8, ARIZONA

FOR MORE INFORMATION CONTACT your local Motorola Distributor or District Office, or call or write: Motorola Semiconductor Products Inc., Technical Information Center, 5005 East McDowell Road, Phoenix 8, Arizona.



MOTOROLA ZENER DIODE-RECTIFIER APPLICATIONS HANDBOOK

This 185-page engineering reference booklet is invaluable to zener/rectifier users. Available for only \$2 from your local Motorola Semiconductor distributor.

FILTER DESIGNERS! WANT TC CORE CURVES?

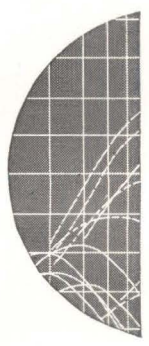
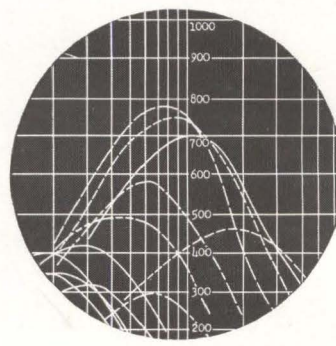
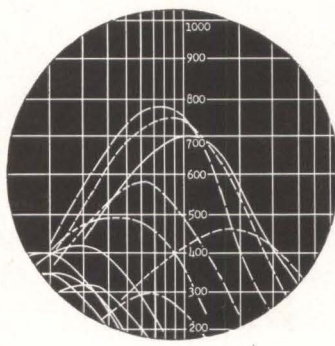
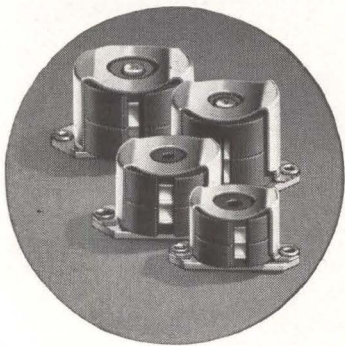

Q VS FREQUENCY

Magnetism is our business . . . so we now offer you another industry first: Complete test standards, specifications and performance curves in the International Series of temperature-compensated FERRAMIC® cup core assemblies. Designed for filter applications requiring a low and linear temperature coefficient with high Q factors, these cup cores are far superior to old-style toroid-shape cores. This detailed test data and specifications are typical of the technical leadership and application assistance we offer you. Our ferrite core experience, specialized manufacturing facilities, highly skilled engineering and production personnel can help you build more reliability into your products. ■ **Phone or write** Indiana General—Electronics Division, Keasbey, New Jersey, for our new engineering data file on our TC cores.

INDIANA GENERAL

 FERRITES	 MEMORY PRODUCTS	 PERMANENT MAGNETS	 MINIATURE MOTORS	 MEMORY PRODUCTS
--------------------------------------------------------------------------------------------------------	---------------------------------------------------------------------------------------------------------------	------------------------------------------------------------------------------------------------------------------	------------------------------------------------------------------------------------------------------------------	-----------------------------------------------------------------------------------------------------------------

BELL LABORATORIES' NEW CONNECTOR STREAMLINES CABLE SPLICING



Telephone craftsman uses special pneumatic tool to flatten connector onto insulated wires. Metal tangs pierce insulation and produce a splice that is equivalent to a soldered joint.

Along the cable routes of the Bell System, wires are spliced at a rate of 250,000,000 a year. Conventionally, connections are made by "skinning" the insulation, twisting the bare wires together, and slipping on an insulating sleeve. Now, with a new connector initiated at Bell Telephone Laboratories, (diagram at lower right) splices can be made faster, yet are even more reliable.

The craftsman slips the two wire ends—with insulation intact—into the connector, then flattens the connector with a pneumatic tool. Springy phosphor bronze tangs inside the connector bite through the insulation to contact the copper wire. The stable, low-resistance splice established is maintained for many years, even under conditions of high humidity, corrosive atmospheres and vibration.

Ultrasensitive measuring techniques devised by our engineers demonstrate that the new connector provides the equivalent of a soldered connection,

even with voltages as low as 25 millionths of a volt.

Working with our manufacturing partners at Western Electric, our engineers developed this connector into a design capable of being mass-produced at low cost. It is being introduced in the Bell System.

NEW WIRE CONNECTOR HAS THREE PARTS:

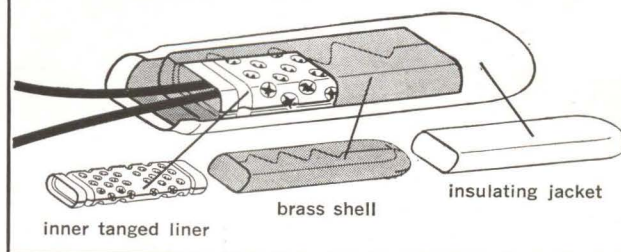

BELL TELEPHONE LABORATORIES

World center of communications research and development

COST CUTTING CERAMICS FOR TRANSISTOR CIRCUITRY

RMC Magnacaps®

SPECIFICATIONS

3 VOLT MAGNACAP

Capacitance μ f. 1 Kc., .05 vrms max. @ 25° C.	Tolerance %	Dissipation Factor (% Max.) 1 Kc., .05 vrms max. @ 25° C.	Insulation Resistance Min. @ 100% Rated DC Voltage $R = E/I$	Diameter Max. (Inches)	Thickness Max. (Inches)	Lead Spacing $\pm .035"$
.05	+80 -20	3%	60,000 ohms	.265	.156	.250
.10	+80 -20	3%	30,000 ohms	.265	.156	.250
.22	+80 -20	3%	13,600 ohms	.310	.156	.250
.47	+80 -20	3%	6,270 ohms	.425	.156	.250
1.0	+80 -20	3%	3,000 ohms	.615	.156	.375
2.2	+80 -20	3%	1,360 ohms	.880	.156	.375

12 VOLT MAGNACAP

Capacitance μ f. 1 Kc., .05 vrms max. @ 25° C.	Tolerance %	Dissipation Factor (% Max.) 1 Kc., .05 vrms max. @ 25° C.	Insulation Resistance Min. @ 100% Rated DC Voltage $R = E/I$	Diameter Max. (Inches)	Thickness Max. (Inches)	Lead Spacing $\pm .035"$
.05	+80 -20	7%	800,000 ohms	.310	.156	.250
.10	+80 -20	7%	400,000 ohms	.380	.156	.250
.22	+80 -20	7%	180,000 ohms	.575	.156	.375
.47	+80 -20	7%	85,000 ohms	.800	.156	.375
1.0	+80 -20	7%	40,000 ohms	1.045	.156	.375

25 VOLT MAGNACAP

Capacitance μ f. 1 Kc., .05 vrms max. @ 25° C.	Tolerance %	Dissipation Factor (% Max.) 1 Kc., .05 vrms max. @ 25° C.	Insulation Resistance Min. @ 100% Rated DC Voltage $R = E/I$	Diameter Max. (Inches)	Thickness Max. (Inches)	Lead Spacing $\pm .035"$
.02	+80 -20	7%	10 megohms	.380	.156	.250
.05	+80 -20	7%	10 megohms	.520	.156	.375
.10	+80 -20	7%	10 megohms	.695	.156	.375

For applications requiring capacitors with ultra high values and low power factors specify RMC MAGNACAPS. These new units combine the miniature size, reliability and lower costs always associated with ceramic capacitors. Write today on your letterhead for additional information on MAGNACAPS.

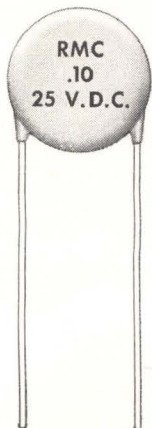
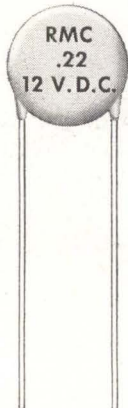

DISCAP
CERAMIC
CAPACITORS

RADIO MATERIALS COMPANY
A DIVISION OF P. R. MALLORY & CO., INC.
GENERAL OFFICE: 4242 W. Bryn Mawr Ave., Chicago 46, Ill.
Two RMC Plants Devoted Exclusively to Ceramic Capacitors
FACTORIES AT CHICAGO, ILL. AND ATTICA, IND.

FIBER OPTICS

FOR ELECTRONICS ENGINEERS

A recently developed optical technique is finding a variety of applications in data processing and display, image handling, lasers and other fields.

Here is an account of the present state of the art

By **GEORGE V. NOVOTNY**
Assistant Editor

Loose bundle of optical fibers, made by American Optical Co, conducts light from candle flame and releases it in lower right corner

FIBER OPTICS is the technique of transmitting light through long, thin fibers of glass, plastic or other transparent material. A properly aligned bundle of such fibers can shift a complete image, element by element, from place to place.

At present, use of fiber optics is limited by high initial cost, but this is often justified by special advantages. Fiber optics can channel and guide light, often much more efficiently than lenses can. It can transfer an image over a short or a long distance, while a lens system is limited by its focal length. The increased efficiency results in greater sensitivity and simpler photographic techniques.

Fiber-optic bundles can be made flexible, as in probes and fiberscopes, or can be fused into solid blocks of glass, such as in cathode-ray-tube faceplates. Glass fibers, singly or in various forms, are commercially available to below 10 microns diameter; there is no upper limit.

Light propagates through an optical fiber by a series of reflections from wall to wall; therefore only those rays are propagated that enter the end of the fiber at a small enough angle to cause total reflec-



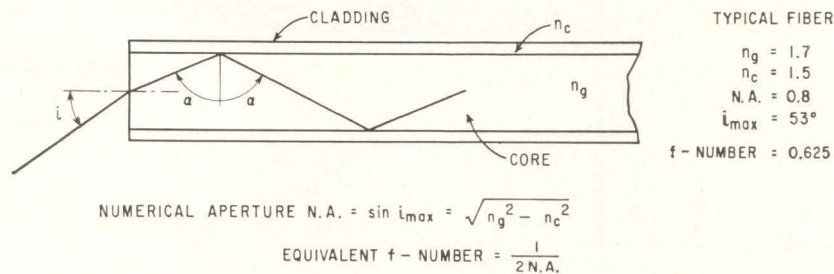

FIG. 1—Maximum angle i_{max} at which a fiber accepts light depends on the indices of refraction of fiber and cladding. Typical values shown at right

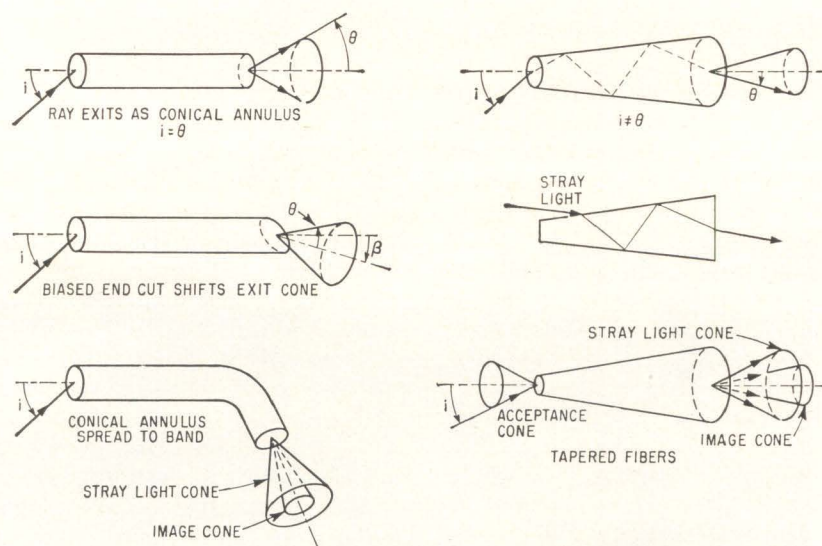

FIG. 2—Behavior of light rays in different fibers. A more complex analysis applies to rays that do not enter through center of face (skew rays)

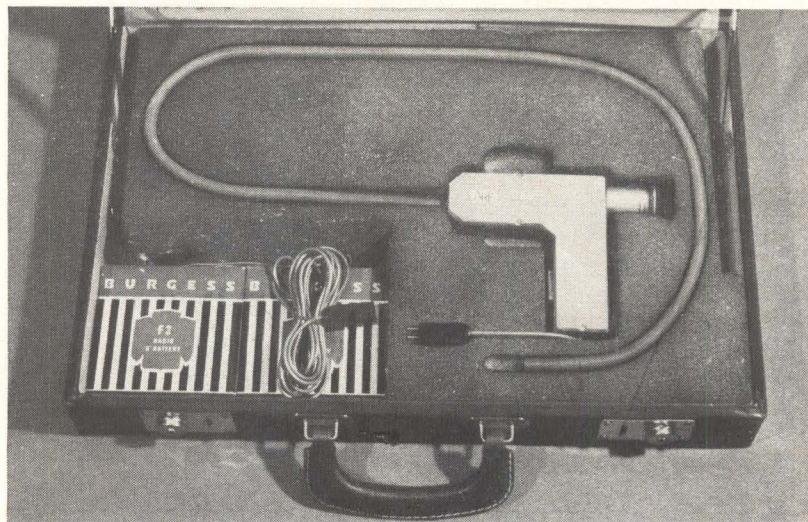

FIG. 3—Flexible fiberscope made by Armour Research Foundation for use by Sandia's Livermore Laboratory in missile applications

tion from the walls (see Fig. 1). For lossless reflection, the walls must be smooth and clean. A ray in a 50-micron fiber undergoes about 4,000 reflections a foot.

When two glass fibers come within about half a wavelength of each other, some light leaks from one to the other. If the fibers are small and closely packed, they touch over an appreciable area, and leakage, or "crosstalk", becomes a serious problem. Such a bundle would degrade the transmitted image by loss of contrast.

For this reason, fibers are usually insulated from each other by a thin jacket of transparent material whose index of refraction is lower than that of the fibers. This cladding, usually glass, both reduces crosstalk and protects the smooth reflecting walls. Cladding must be at least a wavelength, or 0.5 micron, thick.

An additional thin layer of dark absorbing coating is sometimes added over cladding, to further increase contrast and absorb scatter light. This is called E.M.C., extramural cladding, or E.M.A., extramural absorption.

The maximum angle (i_{max}) at which a clad fiber in air accepts light for transmission is determined by the indices of refraction of core and cladding material, n_g and n_c , respectively, and is

$$i_{max} = \text{arc sin } \sqrt{n_g^2 - n_c^2}$$

The expression $(n_g^2 - n_c^2)^{1/2}$ is the nominal numerical aperture, N.A., of the fiber, and is a measure of its efficiency: the light-gathering power is proportional to $(\text{N.A.})^2$. Effective nominal apertures are somewhat lower. Typical values are 0.5 to 0.97. Quantity N.A. is related to equivalent photographic lens speed by the relation

$$\text{N.A.} = \frac{1}{2 (\text{f-number})}$$

where the f-number is the ratio of focal length to effective diameter of the lens.

Cladding reduces N.A., since its index of refraction exceeds that of air ($n_o = 1$); also it introduces a dead area into the bundle cross-section.

A fiber optic bundle will not, in

general, transmit an image unless it occurs right on its input face or very close to it. This may be a physical image, such as a drawing, or an optically focused real image (as distinct from a virtual image, such as seen in a telescope eyepiece). Without a focusing system, a bundle will not "see" an image any distance away.

If all fibers of a bundle are aligned in substantially the same relative position at both ends, the bundle is coherent, and will transmit an image. If the fibers are scrambled, the bundle becomes incoherent, and will act as a light pipe, or in special cases as an optical encoder. Bundles can be tapered (each fiber then has a taper) to enlarge or reduce an image or to concentrate or diffuse a light source; the bundle faces may be ground and polished flat or curved, according to the application. Figure 2 shows the behavior of light rays in some differently shaped fibers.

Some light is always lost in transmission through a fiber bundle. Almost all the loss is due to absorption in the glass, not to the reflections from the walls. A typical fiber-optic crt faceplate $\frac{1}{2}$ -inch thick delivers 90 percent of the received light, and a flexible bundle 7 feet long loses about half its input light.

The resolving power of a fiber bundle depends on the fiber diameter, fiber separation, cladding thickness. Generally, definition can be expressed as

$$W = \frac{1}{2D} \text{ lines/unit length}$$

where D is the fiber diameter. Using dynamic scanning (vibrating the bundle in the plane of the image) this can be increased to about $1.22/D$ lines per unit length, as the vibrating fibers cover the area that in a stationary bundle would be taken up by cladding and dead space.

Only the fibers in an image bundle transmit useful light; the overall efficiency is reduced by the amount of cladding and spaces between fibers. This depends on the geometrical arrangement of the fibers. The reduction factor ranges from 70 to 92 percent.

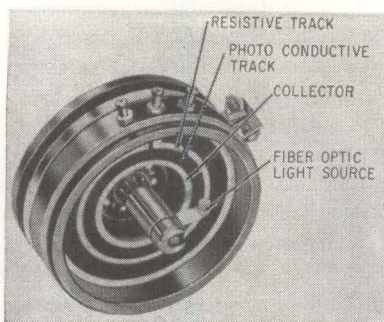

FIG. 4—Duncan Betapot potentiometer uses glass fiber to direct light onto photoconductive track, to make contact between resistive and collector rings

To make a glass fiber, a glass cylinder say 1 inch in diameter and 12 inches long is carefully ground and polished, then tightly fitted with a tube of the cladding glass. The two are fused by r-f heating and then drawn out to the desired diameter.

Fiberscopes are probably the best known application of fiber optics. They consist of clad fibers, loose except at the ends where they are aligned, potted and ground. The entire bundle is protected by an outside sheath. Lubrication between fibers is often used to improve flexibility. Fiberscopes can be bent to a radius of the order of one inch. Typical resolution is 20 to 50 lines/mm.

A representative fiberscope, shown in Fig. 3, has 2,000 fibers, each 0.002 in. in diameter, is three feet long, has overall diameter of $\frac{3}{8}$ inch. Lenses at both ends focus images; the inner fibers transmit the image while the outer fibers carry light to the object being viewed.

Similar probes are made for medical purposes: viewing the interior of body cavities, such as the duodenum or the heart. A uretoscope made by American Cystoscope Makers has an outside diameter of $3\frac{1}{2}$ mm, contains 50,000 lubricated fibers. Probes are also used for viewing the inside of missile tanks, engines or other cavities and carrying the image from an inaccessible, vibrating or dangerous location directly to television cameras or eyepieces. One single fiber can carry one bit of information, such as the presence or absence of light or color

(fire warning in aircraft). Unaligned flexible bundles provide remote illumination (American Optical's intracardiac illuminator).

An unaligned fiber optic bundle used in a remote pyrometer for missile applications, fabricated by Armour Research Foundation, is illustrated on the cover.

An unusual electronic use of a single optical fiber is the contactless Duncan Betapot potentiometer, shown in Fig. 4. A rotating arm with a light-conducting optical fiber focuses light on a photoconductive track, which then closes the circuit between concentric resistive and collector tracks. This affords a noise-free, frictionless pickoff with infinite resolution and absence of track wear.

Cathode-ray-tube faceplates made of fiber-optic mosaics have a number of advantages in exacting display applications. Since the phosphor is applied directly to the inside face of the fibers, parallax is eliminated, and a brighter-than-normal focused image is available on the outside face of the tube. The image is brighter than normal because the fibers gather light rays that in ordinary glass would be scattered through 180 degrees.

Such an image can be photographed by contact-print methods, eliminating lenses and shutters, saving space and set-up time. Image flattening is often incorporated in the fiber optic faceplate, thus reducing distortion (see Fig. 5). Good resolution is available: a 3-inch diameter faceplate made by Mosaic Fabrications has 625 million fibers (a conventional television image can be resolved by 250,000 elements).

In photographing an oscilloscope trace, the most powerful lens usually available is an $f/2.8$. The equivalent numerical aperture of an $f/2.8$ lens working at 1:1 magnification is 0.09, therefore the light gathering power of a fiber-optic faceplate with an N.A. of 0.9 is $0.9^2/0.09^2$ or 100 times greater. Other factors may reduce this advantage somewhat.

Thus a fiber-optic faceplate has available a greatly increased amount of light or radiation energy. If this extra light is not all needed, several circuit improve-

ments can be made: faster scanning rate, reduced final anode potential, lower scanning power, less screen burning and freedom from X-radiation, lower operating beam current, lower drive voltage, sharper focus, possibly even electrostatic instead of electromagnetic focusing.

Comparable advantages result from applying fiber optics to other image-handling tubes (see Fig. 6). Fiber-optic-faced vidicons respond to as little as 0.5 footcandle illumination on the tube face. For high resolution, vidicon faceplates use fibers as small as 0.0006 in. For more sensitive requirements, a fiber-optic image orthicon (RCA) can operate with as little as 0.02 footcandle on the tube face, and in special applications at much lower levels.

Manufacture of image orthicons with fiber-optic faceplates presents special problems because of chemical interaction between the photocathode and the fiber glass; also special sealing techniques had to be developed because of unusual expansion characteristics of the non-homogenous fiber-optic faceplate.

A related use is in image-handling systems such as image intensifiers, where fiber-optic bundles are used as coupling between stages, again saving space and improving quality over lens systems. A pos-

sible two-stage image intensifier is shown in Fig. 7A. In such applications, extramural absorption coating is usually applied to preserve contrast of the faint images. A similar application is image intensification in X-rays to cut down exposure time.

A direct outgrowth of fiber optic faceplates are electrical mosaics, which consist of a glass matrix with metal wires running from one face to the other. The wire center-to-center spacing is 0.001 to 0.004 in., with wire diameters a tenth to half the space. They are used as cathode-ray-tube faceplates for direct electrostatic readout. This has been done successfully by A. B. Dick Co.

The resolution of a simple electrical mosaic is limited by capacitive coupling. An improvement is the chemically etched "intagliated" electrical mosaic, shown in Fig. 7B, which has low interelectrode capacitance and high writing-area efficiency.

A suitably designed fiber optic bundle can take an image in one form and convert it into a more convenient form, for recording, readout or other processing. A scan converter, illustrated in Fig. 8A, converts the rectangular image on a crt into a long thin image. If a photographic film is placed against

the thin end of the converter, it can be moved continuously to record all information shown on the tube. This process increases the effective resolution of the image, and simplifies the recording or transmission of the image.

Such a system can be used with a high-speed, high-resolution facsimile transmitter. For instance, in transmitting a 20-in. wide detailed drawing using a flying-spot scanner with a 3-in. long scanning line, the smallest element size that could be resolved is about 0.02 in. in diameter. If a fiber-optic transformer bundle with 20,000 fibers of 0.001-in. diameter is used, an element size of at least 0.002 in. in diameter can be resolved.

Another image shape converter, shown in Fig. 8B, converts a circular trace to a straight line. Such a converter has been also used in reverse for a rotary-scanning spectroscopy. Other possibilities are radial converters (radar and sonar), spiral converters (radar).

Image dissection with fiber optics can be used in flying-spot scanners, as shown in Fig. 9A. Fiber-optic coupling here is much more efficient than a lens system, and thus more light is transmitted with greater accuracy. This shows up in the system as an improvement in the signal-to-noise ratio of the

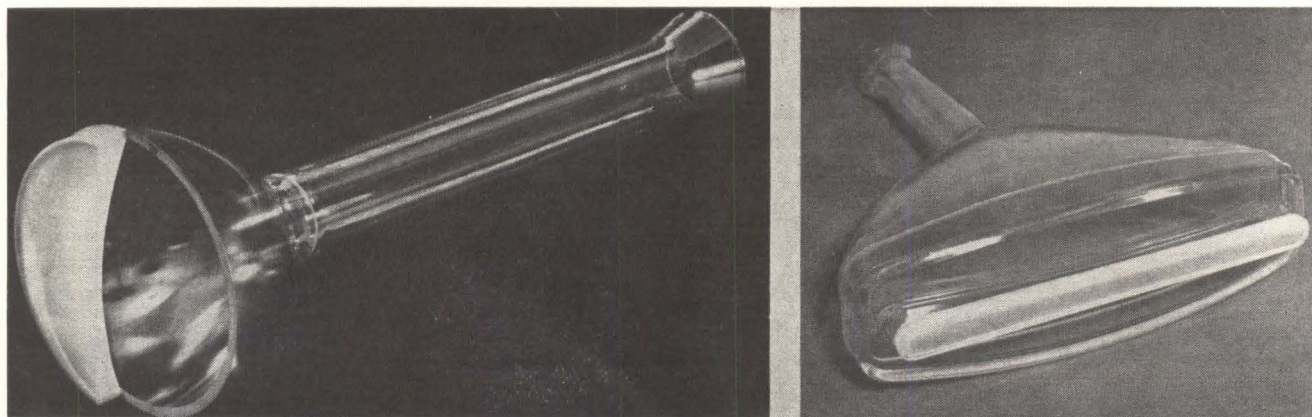

FIG. 5—Cathode-Ray-tube with image-flattening fiber optic faceplate, Mosaic Fabrications, (left); faceplate for full-page readout, with $\frac{3}{8}$ by $8\frac{1}{2}$ -inch fiber-optic strip by American Optical, (right)

FREE REPRINT

Single copy of this article available free by simply checking the READER SERVICE CARD

order of 25, and a consequent reduction in error rate, or a possible increase in scanning speed. Such scanners are also applicable in computers with optical memories.

A fiber-optic scanner using a revolving lens, developed by Gulton Industries, is shown in Fig. 9B. Here the crt image is transformed into a circle of fibers, and the rotating lens focuses each fiber successively onto a phototube.

Coding of secret messages is a classical application of fiber optics. A fiber bundle is aligned at both ends, then scrambled in the middle, potted and cut. The resulting halves serve as encoders or decoders: a scrambled message appears as a random scattering of black dots. The problem, of course, is how to make the scrambler reproducible in quantity. A device marketed by RCA for use by banks for coding clients' signatures is shown in Fig. 10.

At present, fiber optics is expensive, most of the cost being due to custom fabrication and precision labor. A 5-inch crt faceplate costs roughly \$1,200; a 5-mm square flexible fiberscope four feet long costs \$1,050. Incoherent and low-definition devices are cheaper, while image transformers and other custom items are considerably more expensive. Prices can be expected to



FIG. 6—Video tubes using fiber-optic faceplates, from top to bottom, cathode-ray tube, two image orthicons and a vidicon, all by RCA

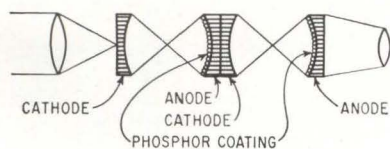

(A)

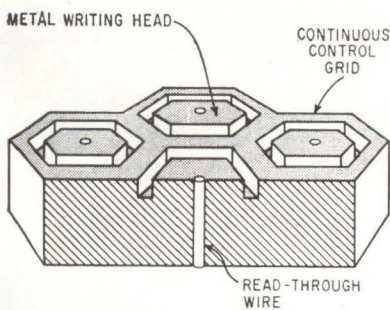

(B)

FIG. 7—Image intensifier, (A), uses fiber optic coupling between stages; an electrical mosaic such as used in an electrostatic readout c.r. tube, (B)

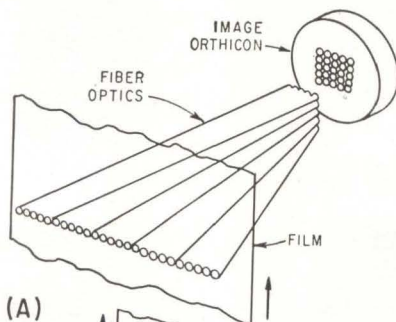

(A)

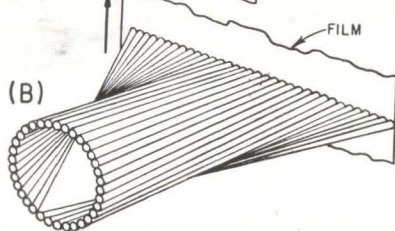

(B)

FIG. 8—Image converters transform information into more convenient form: raster to line, (A), circular-to-line, (B)—both can also operate in reverse

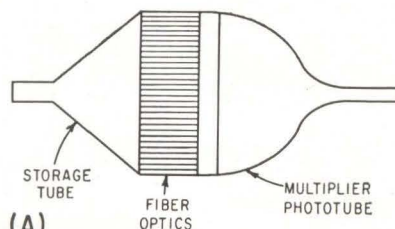

(A)

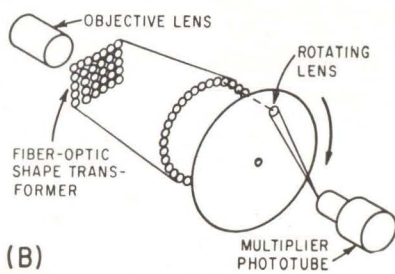

(B)

FIG. 9—Fiber-optic flying-spot scanner, (A), can be used for reading optical memory in computer. Revolving-lens fiber optic scanner, (B) produces sequential scanning

drop as mass production and some degree of standardization are introduced.

Optical fibers are generally made for the visible spectrum, and their response falls off at both the ultraviolet and infrared ends. Recent researches have extended the range.

At the ultraviolet end, glass fibers transmit down to 3,300 angstroms, but 4,000 is the present practical limit. Quartz fibers operate to 2,000 angstroms but are difficult to clad.

In the infrared region, practical limit is 10 to 12 microns. Arsenic trisulfide glass is used for special infrared fibers, with experiments up to 25 microns in progress. At this end, the path length of the ray between reflections approaches half its wavelength and absorption results.

As the glass fibers are made thinner and their diameters become comparable to the wavelength of light, optical geometrical analysis no longer applies, and the fibers behave as dielectric waveguides, exhibiting waveguide transmission modes (see Fig. 10). It is then possible to calculate the waveguide modes that can be established and deduce the conditions for their excitation.

By its ability to sustain a relatively small number of modes with

extremely low loss factor, the glass fiber fulfills one of the important conditions necessary to produce a laser action. Optical fibers, therefore, may find their most important application in the future not as simple light pipes but as conductors for ultrahigh-frequency radiation.

A single optical fiber replaces the ruby crystal in the laser; rather than acting as a resonator with both ends silvered, it is left "open" and acts as a traveling-wave oscillator or amplifier. Light travels in one direction throughout the length of the fiber, interacting with virtually all the atoms in its path, and emerging with high energy density. Fiber lasers have two main advantages:

By controlling the indices of refraction of the core and cladding materials, the modes of the laser can be varied, corresponding to different waveguide modes. This is not possible with crystal lasers.

Laser action by glass fibers is at much lower power levels than other existing laser schemes. Energy spikes from the fiber are much shorter than with a crystal; of the order of 0.5 microsecond compared to about 5 microseconds. A number of fiber lasers can be operated from one single low-power flash tube. The first fiber laser was built by E. Snitzer of American Op-

tical Co. in Southbridge, Mass.

Laser fibers are commercially available (Mosaic Fabrications) in diameters from 0.5 to 8 mils; they are made of glass doped with neodymium, which produces the characteristic wavelength of 1.06 microns, and are about 30 inches long. The smaller fibers, 2 mils and below, can be wrapped around the laser flash tube. A subject of current research is the use of fiber lasers in computers, and for amplification of complete images.

Thanks are due to the following for their help in preparation of this article: Robert J. Potter, IBM; J. W. Hicks, Mosaic Fabrications, L. J. Krolak, RCA; L. E. Curtiss, American Cystoscope Makers; E. Snitzer and R. Kazarian, American Optical Co., N. S. Kapany, Optics Technology Inc.

SELECTED BIBLIOGRAPHY

J. W. Hicks and Paul Kiritsy, *Fiber Optics Handbook*, 1961, Mosaic Fabrications, Southbridge, Mass.
 R. J. Potter, *Transmission Properties of Optical Fibers*, *Jour Opt Soc Am*, **51**, No 10, p 1079, Oct 1961
 E. Snitzer and H. Osterberg, *Observed Dielectric Waveguide Modes in the Visible Spectrum*, *Jour Opt Soc Am*, **51**, No 5, p 499, May 1961
 N. H. Kapany, *Electro-Optical Systems Using Fiber Optics*, *Optica Acta*, **7**, No 3, p 201, July 1960
 W. B. Karkow, A. M. Baker, *Fiber Optics, Report I—Technical Discussion, Characteristics, Applications*, Chicago Aerial Industries, Barrington, Ill.
 L. J. Krolak, W. P. Siegmund and R. G. Neuhauser, *Fiber Optics—A New Tool in Electronics*, *SMPTE*, **69**, No 10, p 705, Oct 1960

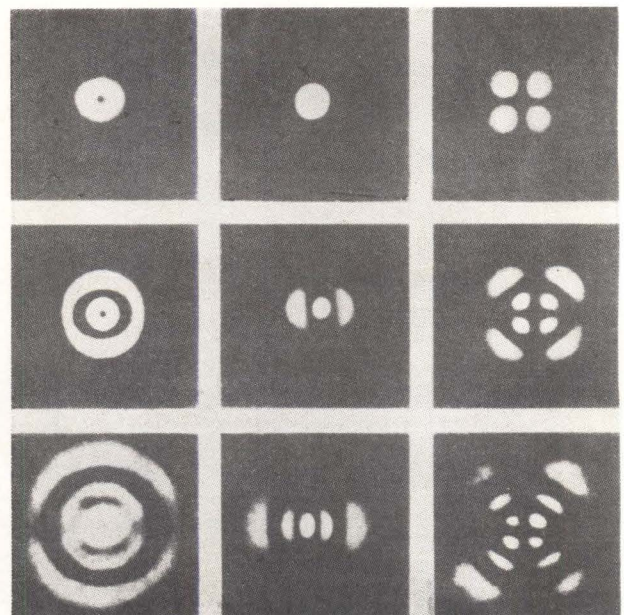
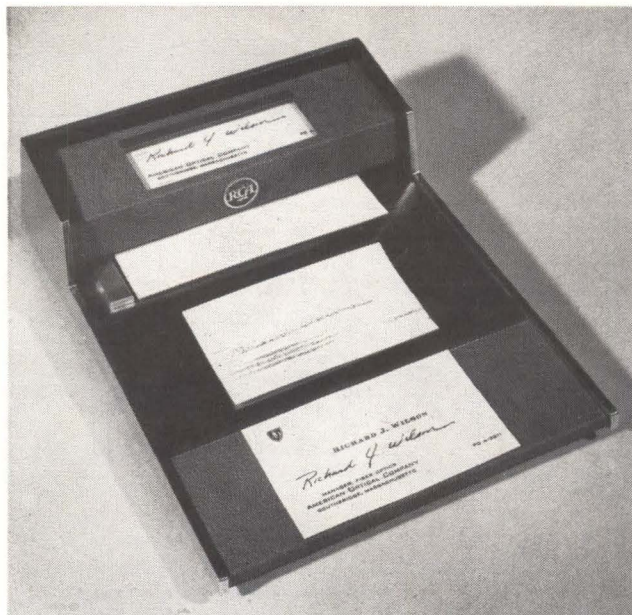
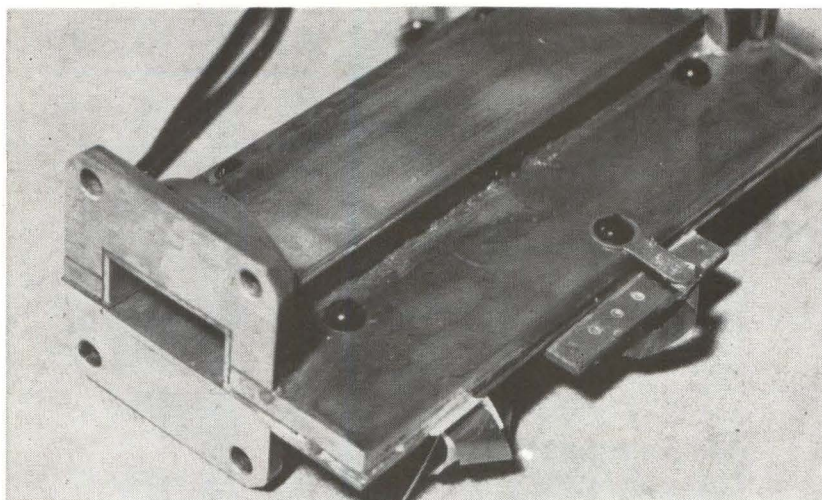

FIG. 10—Signa-Guard optical decoder, for signature protection in banks, uses fiber optic scrambler, (left); a thin fiber shows waveguide power transmission modes, (right)



Microwave tunnel diode mount. The diode is mounted underneath

EXTENDING Tunnel Diode Operating Frequency

*Using a special waveguide transformer and mounting,
top operating frequency of a tunnel diode can be raised to 100 Gc*

By KORYU ISHII
CORDELL C. HOFFINS

Department of Electrical Engineering,
Marquette University, Milwaukee, Wis.

ALTHOUGH TUNNEL (ESAKI) diodes are now commercially available only for frequencies up to X-band (8,200-12,400 Mc), it is possible to operate ordinary tunnel diodes at frequencies as high as 100 Gc.¹ Tunnel diodes are generally economical in comparison with thermionic devices, but this is not always true at microwave or higher frequencies; the price of microwave tunnel diodes rises rapidly with the operating frequency. For example, the X-band tunnel diode is 25 times more expensive than the audio-frequency tunnel diode and 5 times more expensive than the S-band (2,600-3,950 Mc) one. Thus, it is economical to use a low-frequency tunnel diode at the higher frequencies.

Given a tunnel diode mounted in a microwave circuit, the only physically adjustable parameter in the microwave circuit is the circuit it-

self. The microwave circuit must be designed so that the microwave impedance of the circuit matches the negative impedance of the tunnel diode at a desired operating frequency. A 1N3219A S-band tunnel diode was used in a microwave circuit designed to operate with this diode in the X-band.

A schematic diagram of the experimental system is shown in Fig. 1. The 1N3219A S-band tunnel diode (strip-line type package) was mounted in a specially designed X-band waveguide transformer. The waveguide transformer section was d-c insulated from the remainder of the X-band waveguide circuit to provide biasing and oscilloscope display. The tunnel diode was biased by either the variable d-c bias supply or sweep bias supply. The d-c bias voltage was read by a millivoltmeter and the volt-ampere characteristic of the tunnel diode displayed on the oscilloscope. Connecting flange A to B in Fig. 1, the microwave output of the tunnel diode was detected by an RWT microwave superheterodyne re-

ceiver and displayed on the output meter and oscilloscope, the E-H tuner was used for impedance matching and the isolator was used for stabilizing the circuit.

Frequency of oscillation was determined by the cavity wavemeter, waveguide shorting plunger and RWT receiver (a wide-range multiband receiver 2-75 Gc). The tunnel diode output power was compared with the output of a 2K25 reflex klystron test oscillator for the output power measurement. This method was used because the output power of the tunnel diode was too small for accurate measurement by a conventional power meter. Connecting flange B to C and waveguide switch 1 to 2 in Fig. 1, the reflex klystron output was fed to the receiver. The TPX-27PB/77A attenuator was adjusted to produce the same output meter reading on the receiver as the tunnel diode output. From the attenuator reading and the power measured at the waveguide switch by the bolometer and the power meter, the output power of the tunnel di-

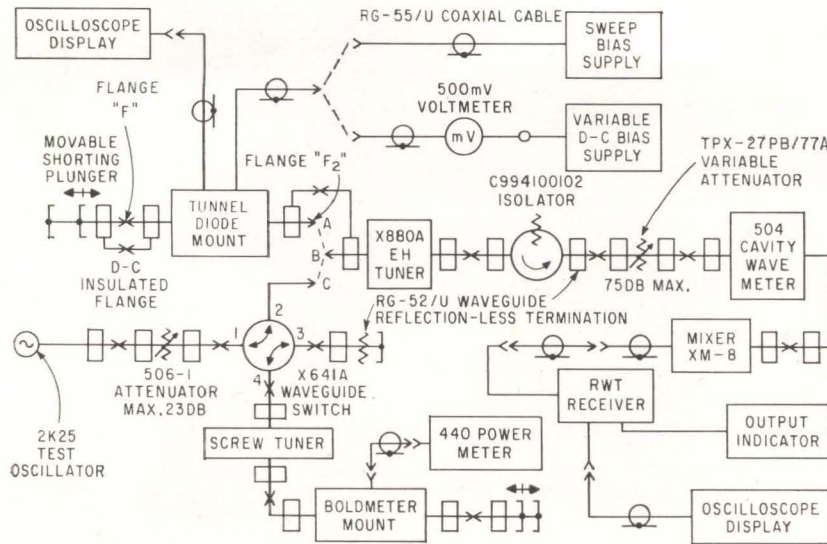

FIG. 1—Schematic diagram of the test circuit used to extend tunnel-diode operating frequency

ode was determined by calculation.

A sketch of the tunnel diode mount used in this experiment is shown in Fig. 2. The mount was designed for 8.5 Gc. It uses the tapered waveguide section for impedance transformation and a quarter wavelength line r-f bypass on one side of the guide and a three quarter line r-f bypass on the other side of the guide plus a resistive film network one half wavelength from the inside of the guide for the tunnel diode characteristic display. The two sections of the waveguide are insulated with polystyrene, and clamped with nylon bolts. The entire waveguide is insulated from the remainder of the microwave circuit by a dielectric spacer between the end flanges. The diode is mounted using a spring-loaded pressure contact and can be positioned at any point along the cross-section of the waveguide. This mounting allows the diode to be placed at the optimum position within the guide where input impedance to the mount provides a proper load to the diode for maximum power output.

Two film resistor strips were employed to suppress low-frequency parasitic oscillations and to display the diode volt-ampere characteristic for monitoring. Both film resistors were separated by a brass strip as shown in Fig. 2. Bias voltage was applied between the upper part of the waveguide and the brass strip. The bias voltage appeared between

the upper and lower sections of the split waveguide and was applied to the horizontal axis of the scope. The voltage appearing across the 18-ohm resistance strip, which is proportional to the diode current, was applied to the vertical axis of the oscilloscope.

The design absorbs the junction capacitance of the diode into the distributed-parameter capacitance of the mount, thereby rendering it ineffective and enabling the diode to operate beyond its self-resonant frequency, determined by its series inductance and junction capacitance. Assuming both ends of the waveguide mount are matched, the load impedance presented to the tunnel diode was calculated using

a modification of the method proposed by Tanaka.²

$$Z_i = \frac{1}{2} \left[\frac{T^2}{1 + T^2} + j \frac{T}{1 + T^2} \right] \frac{b_o}{b} \cdot \frac{\lambda_g}{\lambda_o} \quad (1)$$

λ_o is the operating free space wavelength, (meter)

λ_g is the operating waveguide wavelength, (meter)

b is the height of the rectangular waveguide, (10.2×10^{-3} meter)

b_o is the height of the tapered waveguide at the narrowest portion, (1×10^{-3} meter)

$$T \equiv \frac{2a}{\lambda_g} \tan \frac{\pi x_o}{a} \quad (2)$$

a is the width of the rectangular waveguide (22.9×10^{-3} meter) and x_o is the mounting position of the diode, that is the transverse distance from the waveguide wall to the center of the diode. The load impedance Z_i was calculated using a digital computer for the frequency range 8.5 Gc to 9.6 Gc for various mounting positions x_o . The magnitude and phase angle of the load impedance is shown in Fig. 3. These computed results indicate that the load impedance of this type of waveguide mount is suitable for matching to the tunnel diode impedance.

Before a signal can be detected using a receiver, the presence of microwave oscillations of the tunnel diode is evidenced by noting the shape of the volt-ampere characteristic displayed on the oscilloscope. When there is no oscillation, the V-I curve is smooth as shown by the top pattern in Fig. 4. When the

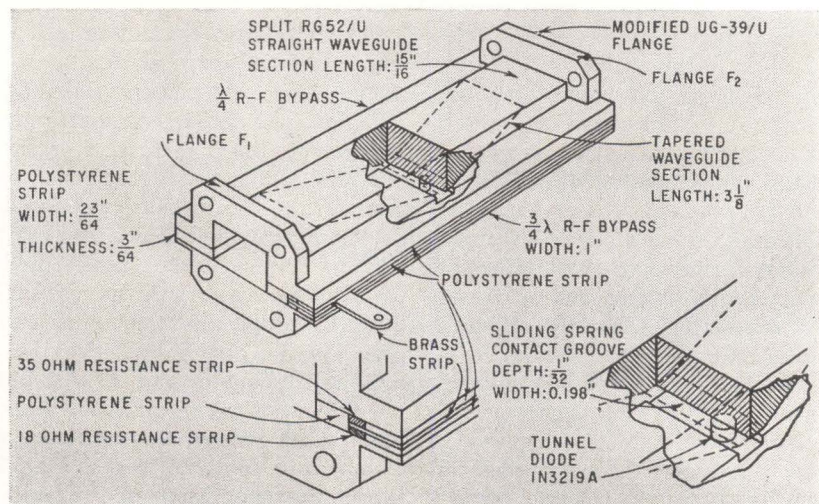

FIG. 2—Waveguide mount for the tunnel diode; the position of the diode can be adjusted continuously to find optimum input impedance

diode oscillates with adjustment of the microwave circuit, a step appears in the negative resistance portion of the V - I curve as shown by the middle pattern in Fig. 4. With strong oscillation, the step is more emphasized as shown by the bottom pattern in Fig. 4. It appears that this method of detection is more reliable than the use of a superheterodyne receiver at the extremely small signals encountered.

Once the presence of oscillation is observed from the oscilloscope display of the volt-ampere curve, the microwave superheterodyne receiver can detect the microwave output of the tunnel diode. The frequency of oscillation was checked with the cavity wavemeter and by measuring the waveguide wavelength using the shorting plunger. The three different ways of checking the S-band tunnel diode frequency agreed, indicating that the diode was indeed oscillating in the X-band. The frequency was very stable both for mismatching and for long time operation.

Factors determining the microwave tunnel diode oscillator performance were the shorting plunger, mounting position of the diode, bias voltage, dielectric block tuner and end flange insulation. The waveguide shorting plunger terminating one end of the tunnel diode mount has a certain effect on the tunnel diode performance. The plunger setting had a marked effect on the output power due to impedance matching. The output frequency deviation due to the shorting plunger was 8 Mc, which was small. When the output power was optimally adjusted, the shorting plunger had little control on frequency.

Theoretical analysis indicated that the load impedance to the tunnel diode varied as a function of the diode mounting position, as shown in Fig. 3. Thus, there is an optimum mounting position for a given diode. Although the experimental results indicate that $\frac{1}{3}$ of the waveguide width from the $\lambda/4$ r-f bypass wall is the optimum mounting position, the results might not be conclusive due to an uncontrollable contact resistance between the diode package and the waveguide. This experiment indicated that it may be advisable to

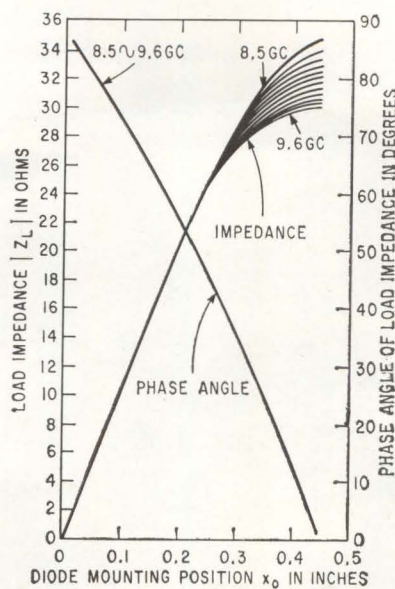
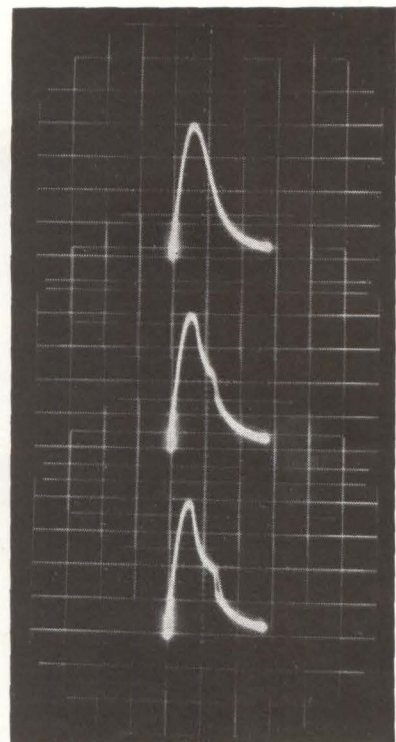

FIG. 3—Load impedance of the tunnel diode, and phase angle, against mounting position

FIG. 4—Tunnel-diode voltage-current curve; no oscillation (top), weak (center), strong oscillation (bottom)



silver-plate the contact surfaces to reduce the contact resistance. The operating frequency varied as much as 1.5 Gc with changes in the contact condition.

The bias supply voltage had significant influence on the output power and frequency. The experimental results indicate that the frequency can be varied over a range of approximately 60 Mc by adjusting the bias supply voltage. There exists an optimum bias supply voltage for maximum output at a given load impedance. Also the output power changed considerably with the bias voltage. To avoid this output power change during voltage tuning, the following experiment was performed. A dielectric block of 12 mm \times 10.5 mm \times 16 mm made of Plexiglass was mounted on the $\lambda/4$ r-f bypass so that the dielectric block could slide along the r-f bypass. The dielectric block was capable of changing the frequency over a range of 25 Mc with an output power change of less than 1 db with the bias voltage fixed for maximum power output.

The thickness of the insulation between the end flanges F_1 and F_2 in Fig. 1 had a considerable effect on the power output and the frequency of oscillation. The dielectric (polystyrene) spacer at flange

F_1 had to be at least $\frac{1}{16}$ inch thick to obtain a high power output. Power output varied from -37.5 dbm to -25 dbm by using spacings of 0.004 inch to $\frac{1}{16}$ inch respectively. Negligible effect on frequency was noted. The spacing at flange F_2 had a large effect on frequency, but a negligible effect on output power. A frequency change of 1,710 Mc from 7,300 Mc to 9,010 Mc was observed by changing the spacing from 0.004 inch to 0.001 inch respectively.

The microwave tunnel-diode oscillator exhibited good frequency stability over a wide range of load mismatch. The 1N3219A S-band tunnel diode operated in the X-band producing a maximum frequency of 9.5 Gc with a maximum power output of -15 dbm. The diode was voltage tunable, the voltage tuning range being 40 Mc at 7.4 Gc which is comparable to or better than that of reflex klystrons.

The authors thank the Marquette University Computing Center for the use of the IBM 1620 digital computer. The authors also thank J. E. Billo, J. A. Stefancin and S. Krupnik, Jr., for their assistance.

REFERENCES

- (1) C. A. Burrus "Millimeter wave Esaki diode oscillators," Proc. IRE (Correspondence), 48, p 2024, Dec. 1960.
- (2) S. Tanaka, "A Broadband Coaxial to Waveguide Junction," J Inst Elec Com Engr, Japan; 37, p 172, March 1954.

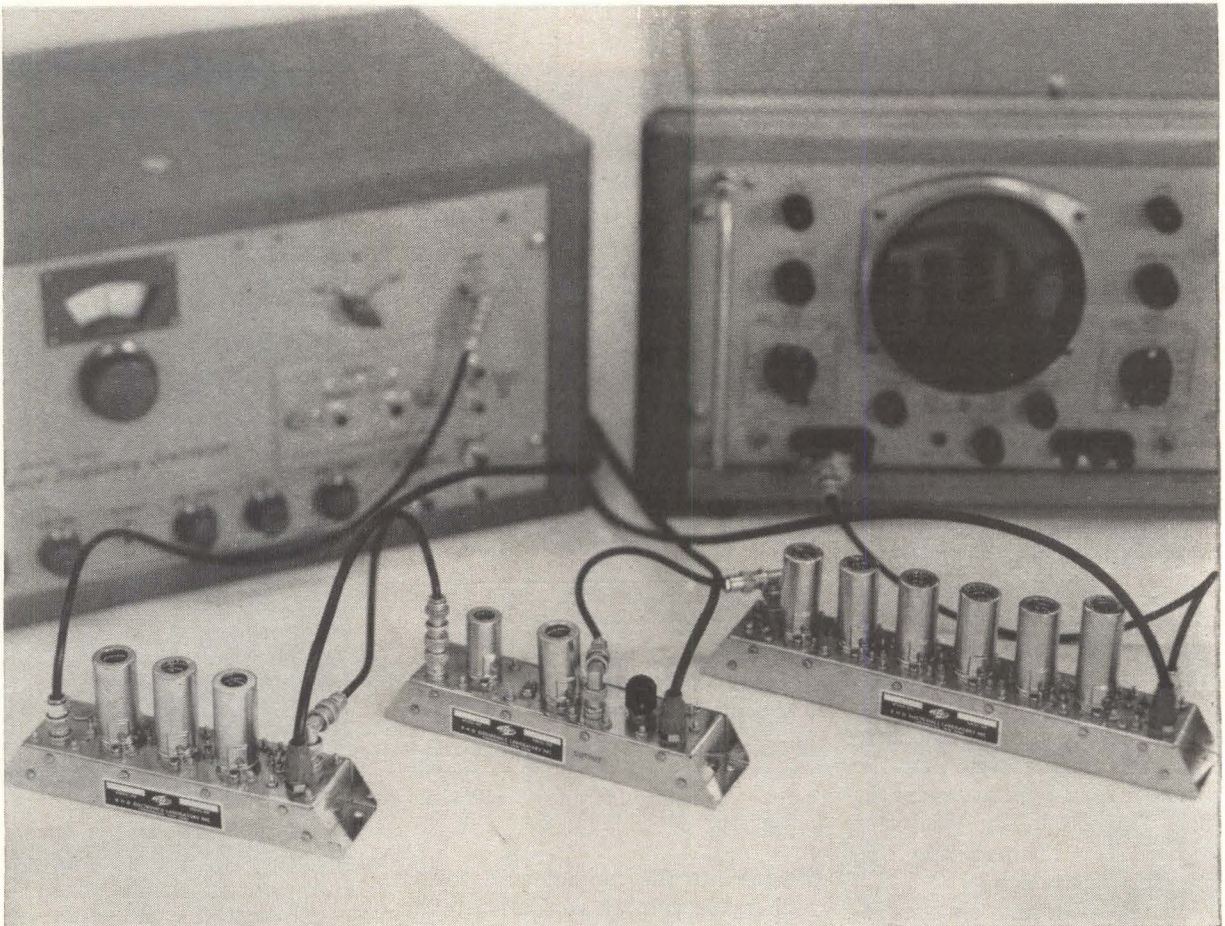

Variable bandwidth filter can be used to make bandwidth a function of signal level

Voltage-Variable Bandwidth Filter

Two-tube circuit has voltage controlled, continuously variable bandwidth between 200 Kc and 15 Mc at 30-Mc center frequency with nominal insertion loss of zero db

By RONALD HIRSCH, President, RHG Electronics Laboratory, Inc., Farmingdale, L. I., New York

DURING a military program to provide a search radar system with added flexibility and extended useful range, the requirement for several preamplifiers was presented. The existing system had a typical front end consisting of an X-band mixer and a 30-Mc low-noise preamplifier with 10-Mc bandwidth. To achieve a greater search range, the bandwidth of the system had to be narrowed since noise power is directly proportional to bandwidth.

The first thought was to provide a series of filters covering the range of bandwidths and a number of coaxial relays to choose the filter. However, this was a cumbersome technique, offered only a series of steps of bandwidth, and was mechanical. The following characteristics were deemed optimum; bandwidth should be variable from 500 Kc to 15 Mc; adjustment should be continuous, not steps; insertion loss should be 0 db nominal at all set-

tings; control should be accomplished by a voltage or current of low power drain; the device should be all electronic, with no moving parts and should be of reasonable size and easy to install.

The circuit of Fig. 1A shows that variable bandwidth is achieved through control of bias on a grounded-grid stage. Power gain of the pentode stage is $Gm_1^2 R_1 R_L$ while power gain of the triode is $Gm_2 R_o$. However, $R_L = (r_p +$

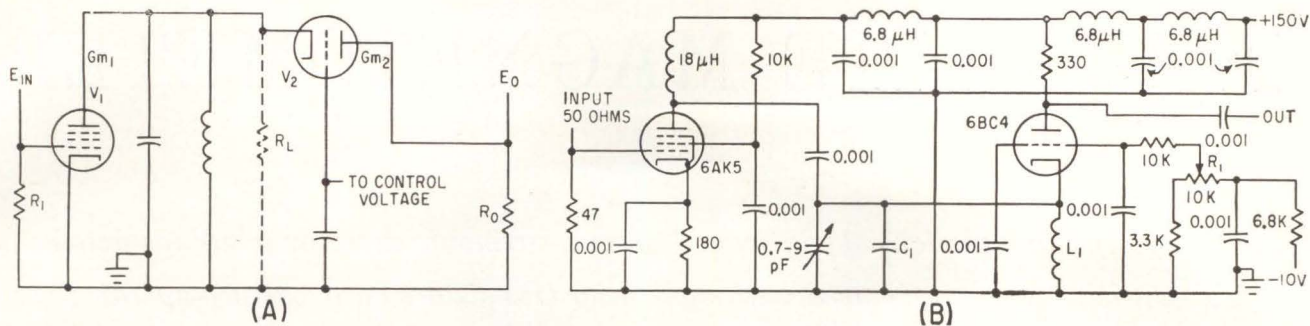

FIG. 1—Basic circuit of variable bandwidth filter (A) and final circuit (B)

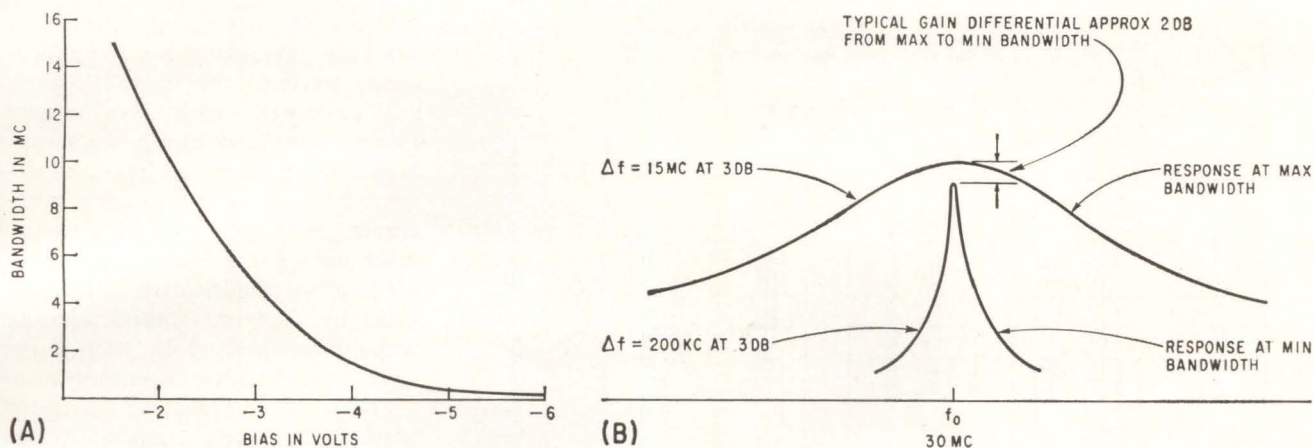

FIG. 2—Bandwidth against applied bias in a typical performance (A) with bandpass response (B)

R_o/μ in parallel with the coil interstage losses. Neglecting the interstage losses and assuming that R_o is small compared to r_p , then $R_L = r_p/\mu = 1/Gm_2$. The gain of the pentode stage is then $Gm_1^2 R_1 (1/Gm_2)$ and the overall gain then becomes $Gm_1^2 R_1 R_o$. However, the interstage bandwidth is $1/2\pi C R_L$ and since $2\pi C$ is constant, the bandwidth varies directly as the Gm of the triode.

As tube loading approaches circuit loss loading, a slight reduction in overall gain occurs. The interstage tank circuit uses high-Q components, and allows narrow bandwidths to be achieved.

The two important factors in the design of the unit in Fig. 1B are the available Q in the interstage, and the input impedance at the cathode of the grounded-grid stage at its normal operating point. For the 6BC4, $1/Gm \cong 100$ ohms is the resistive load at widest bandwidth (heaviest damping) presented by the tube; using $\Delta f = 1/2\pi RC$ and $C = 1/2\pi R \Delta f$ with $\Delta f = 15$ Mc and $R = 100$ ohms, $C \cong 105$ pf. Thus to achieve a maximum band-

width of 15 Mc when the 6BC4 is operating in the normal current region, a total shunt capacitance of 105 pf must be provided.

Allowing about 15 pf for tube capacitance, a padding capacitance of 90 pf must be used. In the actual circuit, an 82-pf mica and a 1-9 pf glass trimmer supplied this amount.

To minimize the effects of coil loading, coil Q must be kept as high as possible. At 30 Mc, to resonate with 105 pf, a coil of about 0.28 μ h is required. This coil may be achieved by winding 5 turns of No. 12 wire on a $\frac{1}{2}$ -inch form. To insure the best Q, silver wire should be used.

Measurements of Q indicate that it is well over 350, and will have little effect on the circuit.

If a standard slug-tuned coil were used, the available Q would have been less than half this amount.

Referring to Fig. 1B note that a 330-ohm resistor is used in the plate of the 6BC4. This is a d-c return as the load resistor of 50 ohms, which is used externally, will control the impedance level. Should the

saturation capability be too low for an application, this impedance level may be raised by an r-f transformer.

Figure 2A shows a plot of bandwidth against applied bias. This curve can be shaped to any particular curve desired through the use of large cathode resistors, plate resistors, and networks preceding the bias input to the grounded-grid stage.

Figure 2B is a presentation of bandpass response at maximum and minimum settings of R_1 .

There are many applications where this instrument will offer advantages.

Several of these are: laboratory studies of noise and related phenomena where system bandwidths (and, therefore, noise bandwidths) must be optimized; panoramic receivers, to achieve variable resolution; radar receivers, where the stc voltages or agc voltage may be used to improve s/n ratios by narrowing bandwidths; and evaluation of optimum fixed bandwidths in systems by substituting a variable device in prototype system.

FLUX-GATE MAGNETOMETER

Toroidal core with semicircularly wound second-harmonic detector windings acts as a field-sensitive element, is used with switching transistors in a battery-operated flux-gate magnetometer of small size, light weight and minimum power requirements

By WILLIAM A. GEYGER
U. S. Naval Ordnance Laboratory,
Silver Spring, Md.

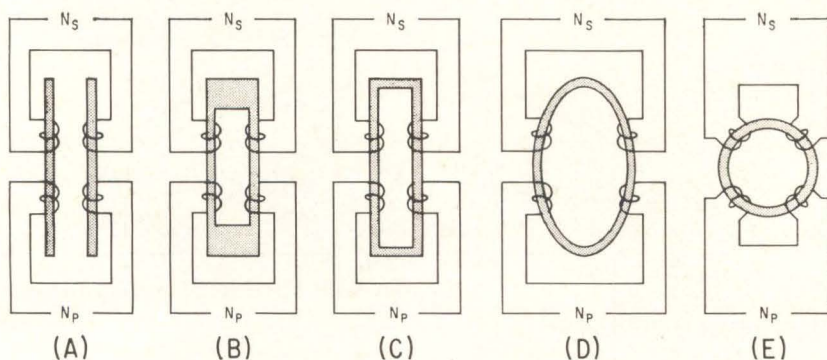

FIG. 1—Various core configurations illustrate the evolution of the ring-core flux-gate magnetometer

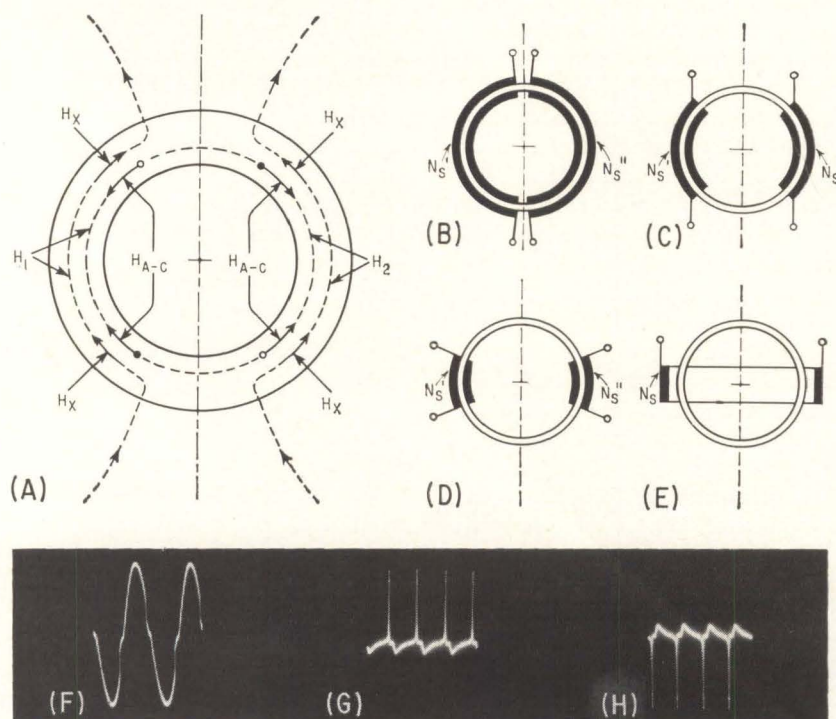

FIG. 2—Fundamental principle (A) of the ring-core flux-gate element; various windings arrangements with winding angles of 180 deg (B), 90 deg (C) and 45 deg (D), plus the single-winding type (E); waveforms characterizing the operation: exciting current (F), phase-reversible output voltage (G and H)

IN VIEW OF increasing interest in flux-gate magnetometers applications, particularly in earth-satellite equipment with solar-battery supply, recent research work has produced an improved flux-gate element with minimized magnetizing-current requirements. This development uses a toroidal core without air-gap as the field-sensitive element by applying special winding techniques, preferably semi-circularly wound and differentially connected second-harmonic detector windings.¹ Other important aspects are various advantageous circuit configurations and a novel method for providing the a-c excitation of a ring-core flux-gate element from a switching-transistor magnetic-coupled multivibrator so that the oscillation frequency is solely determined by the parameters of the ring core and its excitation windings.² Since, in this arrangement, the core flux is swinging between saturation levels, and because all parts of the ring core operate in the saturation region, memory effects are eliminated.

The field-sensitive elements of conventional forms of second-harmonic flux-gate magnetometers³ consist of two parallel nickel-iron alloy strips or scrolls, Fig. 1A, with series-aiding a-c excitation (primary) windings N_p and series-opposing detector (secondary) windings N_s . In such straight-core structures with a large air gap (open magnetic circuit), the effective permeability (μ_{eff}) is a function of the core geometry as well as of the permeability of the magnetic material itself.⁴ To obtain a high sensitivity of these flux-gate elements (a high value of μ_{eff}), the longitudinal dimension of the straight cores is generally great in

USES TOROIDAL CORE

proportion to the transverse dimension.

In the modified flux-gate construction of Fig. 1B, a closed magnetic circuit has been provided to reduce the magnetizing current requirements. This construction, however, has the serious disadvantage that, although the magnetic material near the rectangular core window may be driven well into saturation, large portions of the core do not operate in the saturation region. Thus, undesirable memory effects, due to remanence after applying a large external field, may be produced in this type of single-core flux-gate element.

This undesirable property of the core configuration of Fig. 1B can be eliminated by applying a rectangular core, Fig. 1C, having substantially the same cross-sectional area around the core window. Figures 1D and 1E show that either an elliptical or toroidal core may be used equally well, provided that the effective permeability μ_{eff} has a sufficiently high value. The ring-core structure of Fig. 1E provides the important advantage that commercially available, either tape-wound or laminated (washer-type), cores can be used without any change, by varying the arrangement of the windings.

The results of investigations with toroidal cores of various sizes and different core materials have shown that the effective permeability μ_{eff} of such a ring-core flux-gate element is a function of i-d/o-d ratio and mean diameter of the core, as well as of the permeability of the magnetic material. For example, when using Supermalloy 2-mil tape cores (i-d/o-d ratio is in the range from 0.85 to 0.98; mean diameter is 0.5 to 1.5 in., or less) with semicircularly wound and differentially connected second-harmonic detector windings, a sensitivity of 1,000 microamperes per oersted or 1 volt per oersted can be achieved.

Besides the possibility of employing such commercially available

toroidal cores, application of ring-core flux-gate elements has these advantages:

(1) Relatively high excitation frequencies, above 10,000 cps, may be used by taking full advantage of the favorable magnetic properties of $\frac{1}{8}$ -mil or $\frac{1}{4}$ -mil tapes (considerably reduced eddy-current losses and skin effect), preferably wound in the usual way on small, ceramic bobbins. Such ultrathin tapes, however, can not be used successfully for the conventional straight forms of flux-gate elements, Fig. 1A.

(2) The size of ring-core flux-gate elements may be correspondingly reduced (mean diameter = 0.5 in., or less) to permit point measurements on small areas of inhomogeneous fields.

(3) Because a closed magnetic circuit is provided in the ring-core structure, the magnetizing-current requirements are reduced to the minimum.

(4) Since all parts of the ring core, acting as a flux-gate, operate in the saturation region, memory effects, due to remanence after applying a large external field, are eliminated.

(5) Because the two active parts of the flux gate; that is, the two semicircular portions of the ring core, belong to the same core, the matching of the magnetic characteristics of these parts is greatly facilitated.

(6) Distortion of the magnetic field in the vicinity of a ring-core flux gate is inherently independent of its angular position. This contrasts with the properties of straight-core flux gates, Fig. 1A, and other core configurations, Fig. 1B to Fig. 1D, where the field-distorting effect depends upon the angular position of the flux gate.

(7) The symmetrical core structure of a ring-core flux-gate element, Fig. 1E, makes it possible to apply, for special purposes, several second-harmonic detector windings having different angular displacements with respect to the

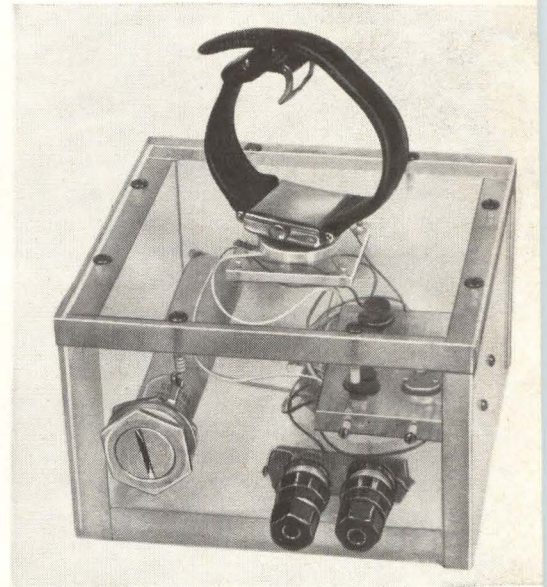

Demonstration magnetometer with $\frac{1}{2}$ -inch flux gate and polarity-sensitive demodulator uses 6.75 v, detects movements of ferromagnetic parts of watch

direction of the external field. Application of such multiple detector windings on a common core permits, for example, removing the cosine-law directivity and providing an omnidirectional magnetometer having a nearly circular directional characteristic, for coverage in all directions in a horizontal or vertical plane.

Although the ring-core structure and the conventional flux-gate structure with two parallel straight-core elements are different, their operating principle is the same. Figure 2A shows that the semicircular portions of the toroidal core are influenced alternately, by the sum of difference of H_{A-C} and the external steady field H_x to be measured during both half-cycles of the exciting a-c magnetomotive force H_{A-C} for example, the earth's field. Thus, the total magnetomotive force in these semicircle portions will be $H_1 = H_{A-C} + H_x$, and $H_2 = H_{A-C} - H_x$. The magnetomotive forces, H_1 and H_2 , give rise to corresponding fluxes, $\phi_1 = \phi_{A-C} + \phi_{SH}$, and $\phi_2 = \phi_{A-C} - \phi_{SH}$. The first component, ϕ_{A-C} , is common to both semicircle portions of the core and varies with the excitation fre-

quency. The second (even-harmonic) component, ϕ_{SH} , exists because of H_x combined with H_{A-c} . The corresponding phase-reversible second-harmonic output voltage, produced across the detector windings, is a measure of the external field influencing the toroidal core which acts as a flux gate.

The semicircle portions of the ring core, Fig. 2A, operate like two separate cores, corresponding to the two parallel strips or scrolls, Fig. 1A, for second-harmonic flux components. These flux components can be utilized by second-harmonic detector windings, which are associated with the semicircle portions of the core. These windings are uniformly distributed along the semicircular portions of the core (winding angle = 180 degrees), as shown in Fig. 2B, but smaller winding angles, Fig. 2C and 2D, or a single, diametrically wound detector winding, Fig. 2E, may be applied equally well.

In a given magnetic field, the second-harmonic output voltage varies from a maximum (when the axis of the ring-core element indicated in Fig. 2B to 2E and the field are parallel) to zero when they are perpendicular (cosine-law directivity). Thus, the symmetry axis of the ring core must be aligned with the field being investigated to insure measurement of the total field. Three orthogonal flux-gate elements of this type may be employed in the usual way, in combination with various kinds of second-harmonic or total-even-harmonic detector systems.

The oscillograms of Fig. 2F to 2H show waveforms of the exciting current (400 cps) and of the phase-reversible even-harmonic output voltage (800 cps) corresponding to a Supermalloy washertype core which consists of three 6-mil laminations (inside diameter = 1.125 in., outside diameter = 1.500 in.). This output voltage may be measured in the usual way by a phase-sensitive detector system; for example, a polarity-sensitive demodulator operating with a center-zero-scale, d'Arsonval-type, indicating or recording, instrument.

Second-harmonic flux-gate magnetometer circuits may be subdivided into two main groups:

(1) Transformer-type circuits with several winding units which

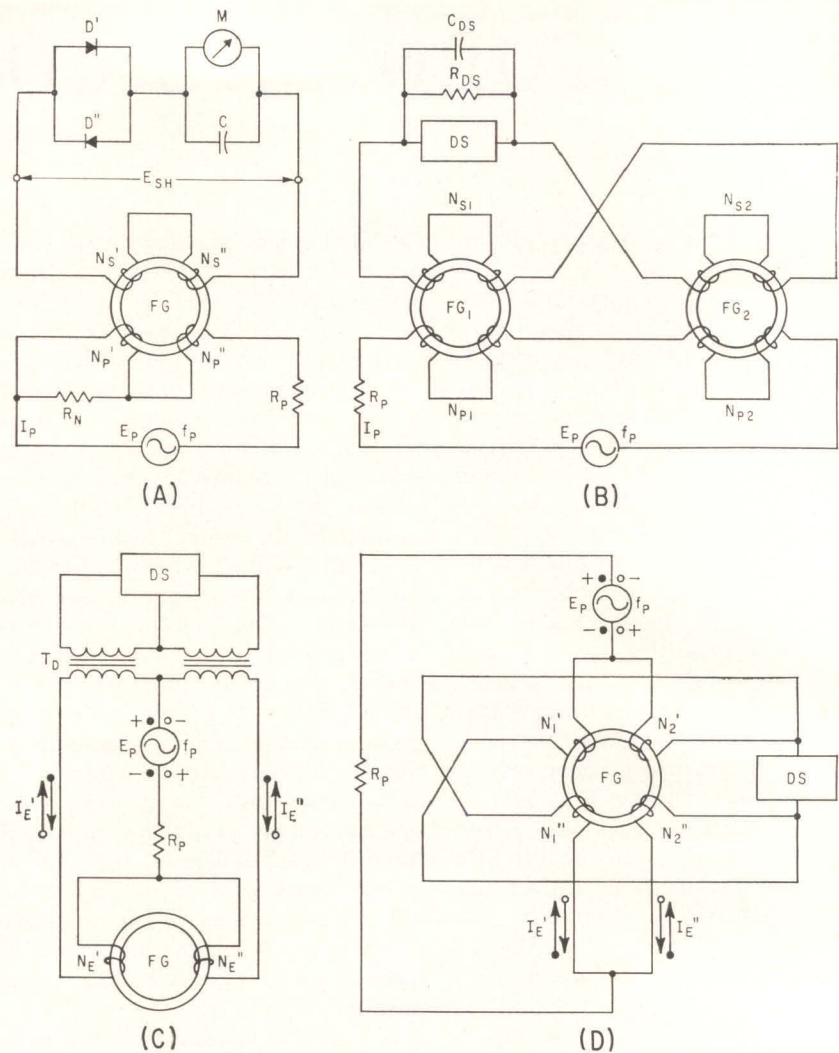

FIG. 3—Transformer circuits: magnetometer (A) with a single flux gate; gradiometer (B) with two equally rated flux gates. Autoconnected magnetometer circuits: differential (C) with two windings and center-tapped output transformer; bridge (D) with four equally rated windings

are isolated from each other and are used separately as a-c excitation windings and second-harmonic detector (pickoff) windings.

(2) Bridge and differential circuits with autoconnected winding units acting simultaneously as a-c excitation windings and second-harmonic detector windings.

The choice of circuit configuration may be influenced by the properties of the even-harmonic detector system. Such systems may be classified as:

(a) Second-harmonic detector systems, in which the second-harmonic component of output voltage is selected by filtering and used to control a tuned vacuum-tube or transistor a-c amplifier having a phase-sensitive rectifier (demodulator) in its output circuit.

(b) Even-harmonic detector sys-

tems, in which the peak height of the even-harmonic output-voltage waveform, Fig. 2G and 2H, is measured after a-c amplification by a polarity-sensitive peak rectifier acting as a demodulator.

(c) Even-harmonic detector systems without a-c amplifier, in which the even-harmonic output voltage is measured directly by a polarity-sensitive demodulator, as widely used with even-harmonic-type magnetic modulators (static d-c to a-c signal converters.)

Figure 3A shows a transformer-type ringcore magnetometer circuit with a simple polarity-reversible demodulator⁵ consisting of a parallel-rectifier combination $D'D''$, and a reservoir capacitor C with d'Arsonval-type, center-zero-scale microammeter M . Because operation of this form of demodulator

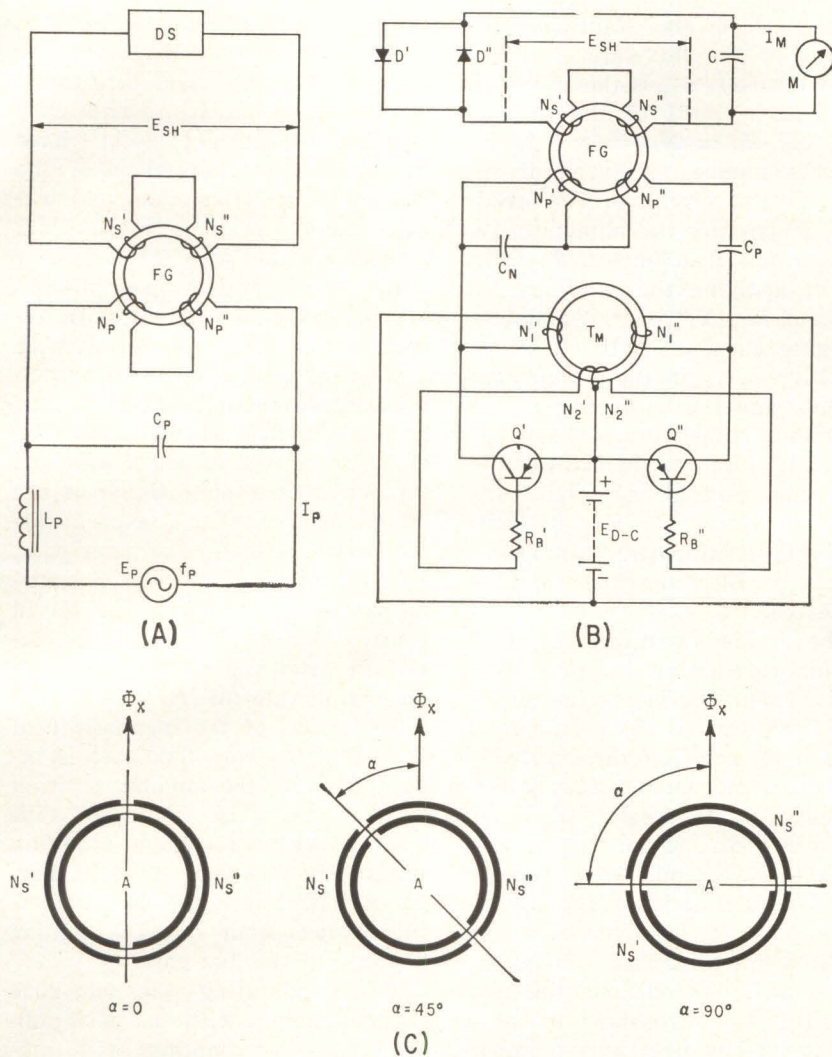

FIG. 4—A-c excitation: ferroresonant circuit (A); switching-transistor magnetic-coupled multivibrator (B). Angular positions (C) element with semicircularly wound second-harmonic detector windings

is governed by the level to which the second-harmonic output-voltage pulses are adjusted, it is necessary to fulfill these conditions:

(1) The slope of the voltage-current characteristic of the diodes D' , D'' must change rapidly near the origin. Copper-oxide rectifier elements have proven to be suitable, but germanium diodes may be used equally well.

(2) Performance of such a polarity-sensitive demodulator circuit may be improved (higher sensitivity of the magnetometer) by introducing asymmetry between the two windings on the semicircle portions of the core. In the arrangement of Fig. 3A, selection of the winding unit (N_p' or N_p'') and determination of the optimum value of the shunt resistor R_N (about 10,000 to 30,000 ohms) are made empirically.

In the gradiometer circuit, Fig. 3B, with two equally rated ring-core flux-gate elements, FG_1 and FG_2 , the primary windings, N_{p1} and N_{p2} , are series-aiding connected, while the secondary windings, N_{s1} and N_{s2} , are series-opposing connected. The second-harmonic output voltage across the detector system DS is linearly proportional to the difference between the field intensities influencing the flux gates, FG_1 and FG_2 . Figure 3B also shows that the sensitivity of the gradiometer and that of other ring-core flux-gate magnetometer circuits may be increased by connecting across the second-harmonic output terminals a capacitor C_{DS} which tunes the output circuit to the second harmonic and provides a positive-feedback effect. As indicated in Fig. 3B, it is advisable to

add a shunt resistor R_{DS} to this tuning network to prevent instability of the detector system.

In the differential circuit of Fig. 3C, the two portions of the center-tapped transformer winding are primary windings, and the secondary winding of the differential transformer T_D (in this example with center tap) may be matched with the input resistance of the detector system DS ; for example, a vacuum-tube or transistor amplifier. The a-c supply with current-limiting resistor R_p is connected with the a-c excitation windings N_E' , N_E'' so that an alternating magnetomotive force, H_{A-c} , is produced in the core, Fig. 2A.

Figure 3D shows a bridge circuit, the four branches of which consist of the toroidal winding units N_1' , N_1'' and N_2' , N_2'' . These four equally rated winding units are associated with the two semicircle portions of the core so that the second-harmonic output voltage appearing across the detector system DS is proportional to the difference of currents I_E' and I_E'' .

To eliminate memory effects, the primary requirement to be met by the a-c excitation source is that it deliver sufficient power to drive the core material well into saturation. A small 400-cycle generator is often a desirable way for feeding such circuits. This includes application of a ferroresonant constant-voltage transformer to obtain stability of operation.

Figure 4A illustrates use of the ring-core flux-gate element as the saturating reactor of a parallel-connected ferroresonant circuit. The linear reactor L_p with a Molybdenum-Permalloy powder core is a current-limiting impedance. Constant average value of the excitation voltage across the primary windings N_p' , N_p'' and minimum of the supply current I_p can be obtained by selecting the proper rating of capacitor C_p .

Another method for providing the a-c excitation is preferred where small size, light weight and power drain not exceeding 20 to 50 milliwatts are of prime importance. This method consists in combining the ring-core flux-gate element with a switching-transistor magnetic-coupled multivibrator so that the oscillation frequency is determined by the parameters of the ring core

and its excitation windings. Since the core is swinging between saturation levels, and because all parts of the ring core operate in the saturation region, memory effects are eliminated.

In Fig. 4B, the excitation windings N_p' , N_p'' of the ring-core flux gate FG are supplied from a miniature common-emitter multivibrator operating as a static d-c to a-c power converter with 70 to 80 percent efficiency. This prototype design contains:

(1) The flux-gate element, FG , with a tape-wound Supermalloy core having 26 wraps of 2-mil tape (tape width = 0.125 in.) and an inside diameter of 1.375 in. or 1.750 in., respectively ($N_p' = N_p'' = N_s' = N_s'' = 800$ turns of No. 34 wire).

(2) A transformer, T_M , with (unsaturated) Supermalloy 2-mil tape core (i-d = 1.00 in., o-d = 1.25 in., tape width = 0.25 in.), primary windings ($N_1' = N_1'' = 800$ turns of No. 32 wire, and feedback windings ($N_2' = N_2'' = 400$ turns of No. 32 wire).

(3) Two *pn*p switching transistors, Q' and Q'' , type 2N43A.

(4) Two bias resistors, $R_B' = R_B'' = 4,000$ ohms.

(5) Blocking capacitor, $C_p = 2$ microfarads, which prevents direct current from flowing through the a-c excitation windings N_p' , N_p'' of the flux-gate element.

(6) The d-c power supply (6-volt battery).

(7) A polarity-sensitive even-harmonic detector system, corresponding to the arrangement of Fig. 3A.

(8) A shunt capacitor, $C_N = 0.1$ microfarad, which provides high sensitivity of the magnetometer by introducing asymmetry between the windings, N_p' and N_p'' , on the semicircle portions of the core.

There are many other such multivibrators in which the electrodes of the two switching transistors are connected in different ways with the primary windings N_1' , N_1'' and feedback windings N_2' , N_2'' of the transformer T_M . In the preferred arrangement of Fig. 4B, the oscillation frequency of the multivibrator circuit is determined by the parameters of FG and is given by

$$f_o = \frac{E_{D-C}}{4 B_s A_{FG} N_p} \times 10^5$$

where E_{D-C} is the d-c supply voltage

(volts,) B_s is the saturation-flux density of the flux-gate core material (gauss), A_{FG} is the cross-sectional area (cm^2) of the toroidal core and $N_p = N_p' = N_p''$ is the effective number of turns of the multivibrator circuit of Fig. 4B.

It is possible to eliminate the unsaturated transformer T_M , Fig. 4B, by applying the windings N_1' , N_1'' and N_2' , N_2'' on the ring-core flux-gate element itself. However, any asymmetry in the circuit components and the characteristics of switching transistors, Q' and Q'' , will introduce an undesirable d-c flux component in the core. Thus, the arrangement of Fig. 4B with separate unsaturated transformer T_M and d-c blocking capacitor C_p is preferred.

The cosine-law directivity of a toroidal core acting as a field-sensitive element in the magnetometer circuit of Fig. 4B has been demonstrated by rotating the core, Fig. 4C, in a homogenous magnetic field produced by Helmholtz coils. The respective directional characteristic; that is, the microammeter current I_M as a function of the angular deviation α of the symmetry axis A from the direction of the external field ϕ_x , indicates the relationship: $I_M = \text{constant} \times \cos \alpha$. The cosine-law directivity is important in direction-finding systems (Permalloy compass). In using the ring-core flux gate for direction finding, the position for minimum rather than maximum response will be used because the percentage of change of response with small change in core position is much greater in near zero output; that is, around the zero position of the pointer of the microammeter M in the arrangement of Fig. 4B.

The symmetrical core structure of this type of flux gate makes it also possible to apply several second-harmonic detector windings having different angular displacements with respect to the direction of the external field ϕ_x . Using a single toroidal core having three groups of detector windings and bridge-type, full-wave rectifiers with series-connected d-c terminals, an omnidirectional flux-gate magnetometer was developed for coverage in all directions in a horizontal or vertical plane. It was possible to remove the cosine-law directivity of ring-core flux-gate elements with

a single group of detector windings and to provide a magnetometer with nearly circular directional characteristic. Measurements with rotating Helmholtz coils have shown that the deviations of the characteristic from the ideal circular characteristic are about ± 2 percent.

In a given angular position (α) of the flux-gate element with respect to the field ϕ_x , preferably with $\alpha = 0$, the second-harmonic output, for example, the microammeter current I_M , in Fig. 4B, is a function of the actual magnitude of ϕ_x which represents the input signal of the magnetometer. Thus, experimentally determined characteristics, $I_M = f(H_x)$, may be termed input-output characteristics. This is in contrast to the directional characteristics showing $I_M = f(\alpha)$, with a constant value of H_x .

Distortion of the magnetic field near the ring-core flux gate is independent of the angular position of the core. This contrasts with the properties of straight-core flux gates, Fig. 1A, and those of Fig. 1B to 1D, where the field-distorting effect depends upon the angular position of the flux gate.

When operating the ring-core magnetometer with a push-pull-type magnetic amplifier with infinite internal gain, the d-c flux in the core is balanced by an opposing d-c flux (self-balancing flux-gate magnetometer).⁶ The output current of the magnetic amplifier is varied by an infinitesimal d-c flux increment in the semicircle portions of the ring core; and the external magnetic field to be investigated; for example, the earth's field near this core, remains undisturbed. In a modified arrangement acting as a gradiometer,⁶ a similar balance method may be applied for measurement of inhomogeneity of magnetic fields.

REFERENCES

- (1) W. A. Geyger, The Ring-Core Magnetometer, A New Type of Second-Harmonic Flux-Gate Magnetometer, AIEE Transactions 81, Pt. I, p 65, Mar. 1962.
- (2) W. A. Geyger, Frequency Control of Magnetic Multivibrators, Electronics, 32, No. 30, p 54, July 1959.
- (3) W. A. Geyger, "Magnetic-Amplifier Circuits," McGraw-Hill Book Company, Inc., New York, N. Y., second edition, 1957, p 271, (Survey and Bibliography).
- (4) E. P. Felch, V. E. Legg, and F. G. Merrill, Magnetic Modulators, Electronics, 25, No. 2, p 113, Feb. 1952.
- (5) P. D. Atkinson and A. V. Hemingway, An Even-Harmonic Magnetic Amplifier, Electronic Engineering (London), 26, No. 321, p 482, Nov. 1954.
- (6) W. A. Geyger, Self-Balancing Flux-Gate Magnetometers, AIEE Transactions, 77, Pt. I, p 213, May 1958.

SIMPLE TRANSISTOR Q-Multiplier or Oscillator

Insensitive to temperature drift of transistor parameters,

this circuit uses only one coil to achieve high Q multiplication

By JAMES R.
WOODBURY

Stanford Research Institute,
Menlo Park, California

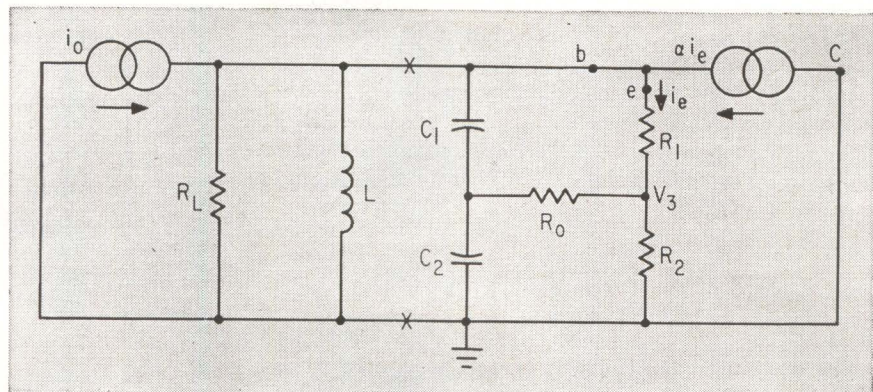

FIG. 1—Equivalent circuit of the Q-multiplier or oscillator configuration

A USEFUL ACTIVE Q-multiplier network, often overlooked by filter or oscillator designers, is shown in Fig. 1. Using stages of this type, filters requiring high Q's can be built with ordinary coils. However, the circuit is often not considered because it is assumed that a Q multiplier, especially one using a germanium transistor as the active element, is too sensitive to temperature variations to be practical. But with proper design the circuit Q can be made insensitive to drift in the parameters of the active element.

The active element in Fig. 1 is represented by the three-terminal constant-current generator, $a i_e$. If the element represents a transistor, the emitter, base, and collector will correspond to points e , b and c ; and $a < 1$. If the active element is a vacuum tube pentode, e , b and c would correspond to cathode, grid, and plate; and $a = 1$. The effect of a finite emitter resistor, r_e (or vacuum tube transconductance, g_m) is included in resistor R_1 . The frequency response of the transistor can be inserted by using the usual R-C approximation

$$\frac{1}{\beta} = 1 - \alpha = \frac{1}{\beta_0} + \frac{p}{\omega_t}$$

where p is the frequency variable ($j\omega$ for steady state sinusoids). The collector-to-base (or plate-to-grid) capacitance may affect the tank circuit center frequency slightly, but otherwise it can be neglected.

Resistance R_L includes the equivalent shunt conductance of the coil. The output can be taken either at V_3 (in which case R_2 includes the load resistance as well as the emitter, or cathode, biasing resistor); or the output can be taken, usually with some loss, from a resistor in series with the collector (or plate).

The nodal equations for the circuit looking to the right of XX determine the input admittance at this point as

$$Y_1 = C_s[ap + (b - ae) + \Delta] \quad \text{where}$$

$$\Delta = \frac{ae^2 - eb + c}{p + e}, \quad a = 1 + \frac{R_p}{\omega_t R_1} \left(\frac{1}{R_2 C_s} + \frac{1}{R_0 C_1} \right)$$

$$b = R_p \left[\frac{1}{R_0 R_2 C_2} + \frac{1}{\beta_0 R_1} \left(\frac{1}{R_2 C_s} + \frac{1}{R_0 C_1} \right) + \frac{1}{\omega_t R_0 R_1 R_2 C_1 C_2} \right]$$

$$c = \frac{R_p}{\beta_o R_o R_1 R_2 C_1 C_2}, \quad e = \frac{1}{(R_o + R_{p1})(C_1 + C_2)}$$

$$\frac{1}{R_p} = \frac{1}{R_o} + \frac{1}{R_1} + \frac{1}{R_2}, \quad \frac{1}{R_{p1}} = \frac{1}{R_1} + \frac{1}{R_2}, \quad \text{and}$$

$$\frac{1}{C_s} = \frac{1}{C_1} + \frac{1}{C_2}.$$

The Δ term in most cases is negligible and will be dropped.

Including the generator and inductor, the circuit therefore becomes a simple shunt RLC. The total shunt conductance is: $G_T = C_s (b - ae) + 1/R_L$. This can be made negative, in which case the circuit will be an oscillator, or slightly positive, in which case the Q can be multiplied by any desired factor, depending on the stability requirements. Circuit resonant frequency is $\omega_o = 1/\sqrt{LC_s}$, and the Q is: $Q = 1/G_T \omega_o L = \omega_o C_s / G_T$. The Q multiplication is $M = Q/Q_L = 1/G_T R_L$. ($Q_L = R_L / \omega_o L$.)

Typically R_1 is made as small as possible ($R_1 = r_e$ or $1/g_m$), and R_2 is made as large as possible ($R_2 \geq (n+1)R_o$, where $C_1 = nC_2$). For frequencies where the $1/\omega_i$ terms are small the following condition is obtained for R_o :

$$R_o = \frac{nR_L}{(n+1)^2 \left(1 - \frac{1}{M}\right)}$$

The primary variations in Q will be due to variations in G_T . By differentiating the expression for G_T an expression can be obtained for the percentage change in G_T as a function of the percentage change in β_o , r_e , and R_L . Assuming that the parameters of the generator, coil, and the value of Q multiplication desired (M) are given, and assuming $R_1 = r_e \ll R_o$, $n \geq 1$, $R_2 \geq (n+1)R_o$, and

$$\omega_i \gg \frac{4\omega_o}{Q_L}$$

the following expression results:

$$\frac{k_g}{M} = \left[\frac{R_L}{R_2} + \frac{n+1}{n} \left(1 - \frac{1}{M}\right) \right] \left[k_r \left(\frac{r_e}{R_L} \right) (n+1) \left(1 - \frac{1}{M}\right) - \frac{k_\beta}{\beta_o} \right] - k_L$$

where k_g , k_r , k_β , and k_L are the percentage changes in G_T , r_e , β_o , and R_L . This expression shows that k_g is minimum when β_o is large, r_e is small, $n \approx 1$, and $R_2 \geq R_L/2$ for large M .

The equations will hold for a vacuum tube where $r_e = 1/g_m$ and $1/\beta = 0$. Of course, $g_m \gg 1/R_o$ for the approximations to hold.

A practical design procedure is as follows: a suitable coil is selected. The value of R_L and the value of M necessary to give the desired Q are computed from the coil Q . ($1/M$ should be slightly negative for stable oscillator applications). A value of $n = 1$ is generally used, so that $C_1 = C_2 = 2C_s$. Then R_o becomes $R_L/4 (1 - 1/M)$. (This value of R_o will usually be 5 to 10 percent high due to the approximations.)

The maximum value of R_2 is usually limited by the emitter current required, and it often must be less than $R_L/2$. The emitter current should be large, since it must be much greater than the peak signal emitter current; and also since r_e , which should be small, is inversely proportional to emitter current.

A typical circuit is shown in Fig. 2. Applying the stability equation to the circuit

$$k_g = 12.8[2.5k_r - 10k_\beta]10^{-3} - 6k_L$$

A change of 30 deg C in junction temperature will produce a change of about 10 percent in r_e . The change in G_T due to this change in r_e is only $k_g = 0.32$ percent. A 10 percent change in β_o would give $k_\beta = -1.28$ percent. However, a change in R_L of only 1 percent would produce a change in G_T , or the circuit Q , of -6 percent.

Therefore, this circuit is relatively independent of the transistor parameters, so that the only major stability problem becomes that of finding tank circuit elements with stable Q 's.

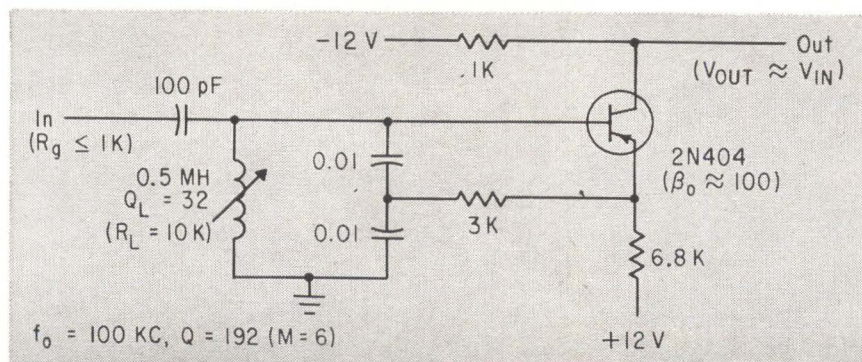
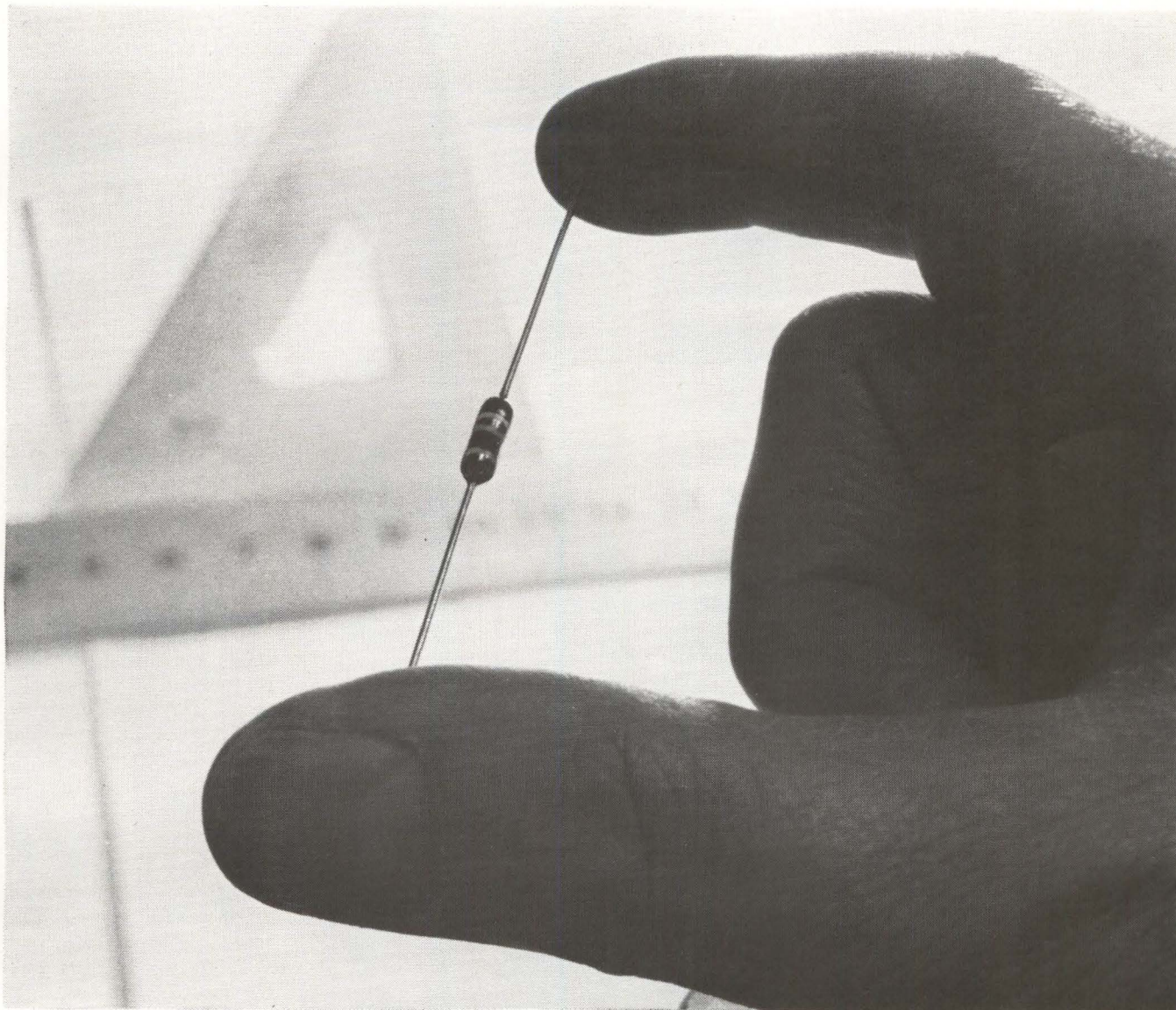

FIG. 2—Typical practical Q -multiplier circuit using a transistor as the active element



Why more good circuits start with Corning C resistors

First, you get performance within precision parameters from general purpose C-style resistors.

Second, C resistors let you plan a circuit within *known* limits of total resistance change from nominal—as little as 5%. Our new Corning Design Tolerances, based on extended load-life tests, give you that assurance.

Third, you get this predictably high performance at low

cost. C resistors are priced competitively with composition types.

C resistors give you these design advantages uniformly because we control the composition of their materials, and the way those materials bond together, in a continuous process.

C resistors that meet MIL-R-22684 are available from your Corning distributor in four sizes and values.

Get data sheets, test reports, and a brochure, "The Story Behind the Corning C Resistor," by writing Corning Glass Works, 539 High Street, Bradford, Pa.

Type	Wattage	Resistance (ohms)		Nominal Dimensions	Design Tolerance Full power, 70°C.
		min.	max.		
C07, Mil Style RL07	¼	51	150K	.250" x .090"	5% plus purchase tolerance
C20, Mil Style RL20	½	51	150K	.375" x .138"	
C32, Mil Style RL32	1	51	470K	.562" x .190"	
C42S, Mil Style RL42	2	10	1.3 meg	.688" x .318"	

CORNING

Electronic Components

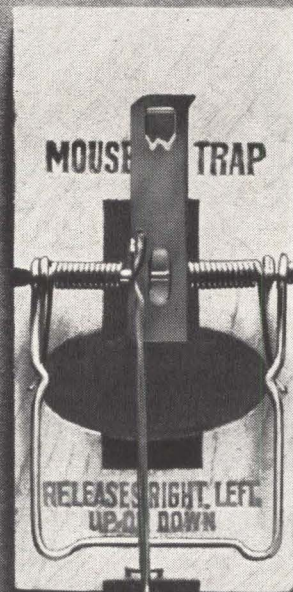

9 billion dollars to build a better one.

We're living in a needing, buying, growing America—a time for new and improved products and services—the creation of new jobs. More than ever, a businessman with an idea, with the urge for something better will move ahead with our expanding economy.

But after the idea, what follows can be a costly period of research and development. Not necessarily—if you use the immense 9-billion-dollar fund of research and patent information that's available at your U.S. Department of Commerce. Think of the saving—in time and money.

For example: there are reports on extensive research by your Government in new products and processes. A trans-

lation of data on inventions and discoveries abroad—information on over 3 million patents—a fortune in patents owned by your Government. All this is yours—for your use and your benefit.

Take advantage of the many ways in which your business can grow. In developing new products and services. In the lucrative foreign markets. In new U.S. markets. In attracting new industry to your local community. Just phone or write the U.S. Department of Commerce Office of Field Services in your city, or Washington 25, D.C. Your U.S. Department of Commerce is always ready to help you grow with America!



NOW'S THE TIME TO GET GROWING IN A GROWING AMERICA!

Of interest to engineers and scientists

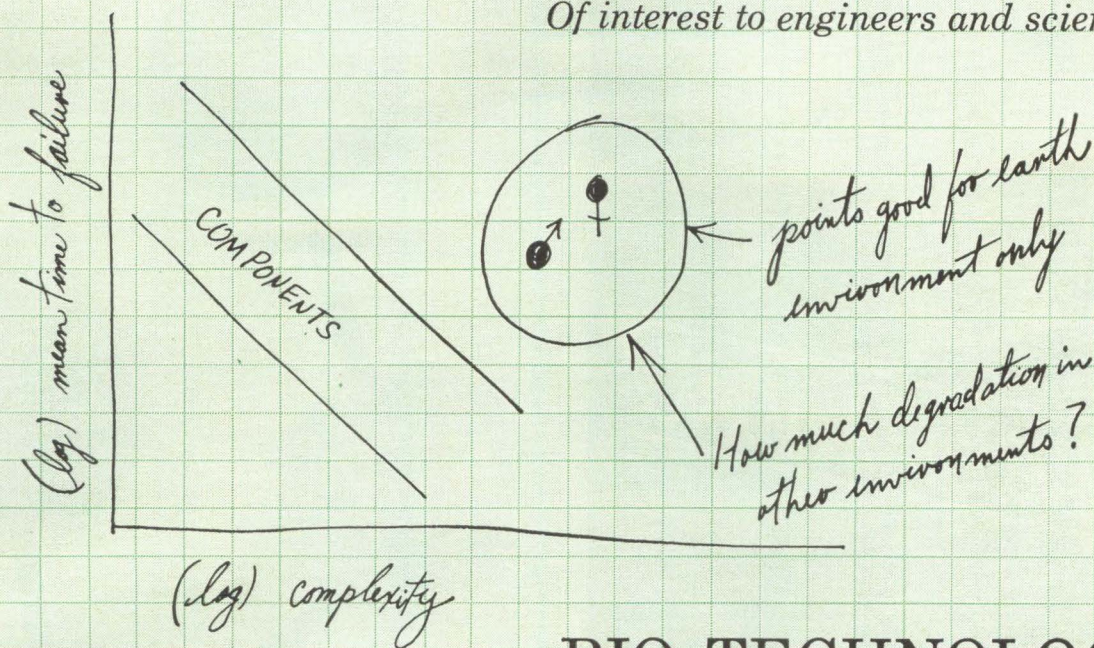

BIO-TECHNOLOGY

...one of more than 500 R&D programs under way at Douglas

This Douglas program is studying areas related to man-machine and biological systems as:

- Psycho-physiological monitoring techniques for determining biological stability in normal and exotic ecological systems;
- Cybernetic and bionic principles for application to personnel subsystem support;
- Techniques for producing artificial environments and evaluating their biological effects;
- Learning and teaching machines, remote handling systems, and display and control techniques to support space operations.

Bio-technological devices will be constructed related to experimentation in the above fields. A considerable amount of work has already been accomplished on ecological problems associated with advanced space systems.

Of career interest to engineers and scientists

To further aerospace research and development, Douglas is investing millions of dollars to pro-

vide an environment most conducive to scientific and engineering achievement.

Present modern facilities will soon be augmented by an extensive new research-development-test complex. Included will be an advanced \$3 million space chamber.

If you are seeking stimulating scientific or engineering assignments and full support in carrying them out — plus a wide range of outstanding opportunities for career advancement — we invite you to contact Douglas. Send us your resume or fill out and mail the coupon. You will receive specific information on openings in your field at Douglas within 15 days.

Mr. F. V. Edmonds
Missiles and Space Systems Division
Douglas Aircraft Company
3000 Ocean Park Boulevard
Santa Monica, California

Please send me full information on professional opportunities in my field at Douglas.

Name _____
Engineering or scientific field _____
Address _____
City _____ State _____

DOUGLAS

Missile and Space Systems Division

An equal opportunity employer

LARGE CAPACITY
SUPER-CLEAN
ENVIRONMENT



White Bench

Designed to provide the ultimate clean room facility. One piece basic structure eliminates cracks and crevices. Unique floating film outer wall permits operator access to all parts of the interior. Completely pressurized system assures no infiltration of contaminants. Extra large filters and pre-filters extend filter life. Up to eight workers can use a single standard size "White Bench" or a single worker can spread out and build a complex structure or do large size operations without removing his hands from the parts.

Matthews RESEARCH INC.
4306 WHEELER AVE. ALEXANDRIA, VIRGINIA
TELEPHONE: 549-0087

CIRCLE 200 ON READER SERVICE CARD

FREE 576-PAGE
**PIC CONSOLIDATED
CATALOG #30**

Completely illustrated,
with detailed drawings,
specifications and prices.

Lists over 25,000
**PRECISION INSTRUMENT PARTS
and ASSOCIATED COMPONENTS**

Available From STOCK!



GEARS • SHAFTS • COLLARS • CLUTCHES •
BEARINGS • COUPLINGS • DIFFERENTIALS
• SPEED REDUCERS and many other Pre-
cision Engineered Parts & Components.

Send for
your **FREE**
copy
today.

PIC DESIGN CORP.

Subsidiary of **BENRUS WATCH COMPANY, Inc.**

477 Atlantic Ave., East Rockaway, L.I., N.Y.

58 CIRCLE 58 ON READER SERVICE CARD

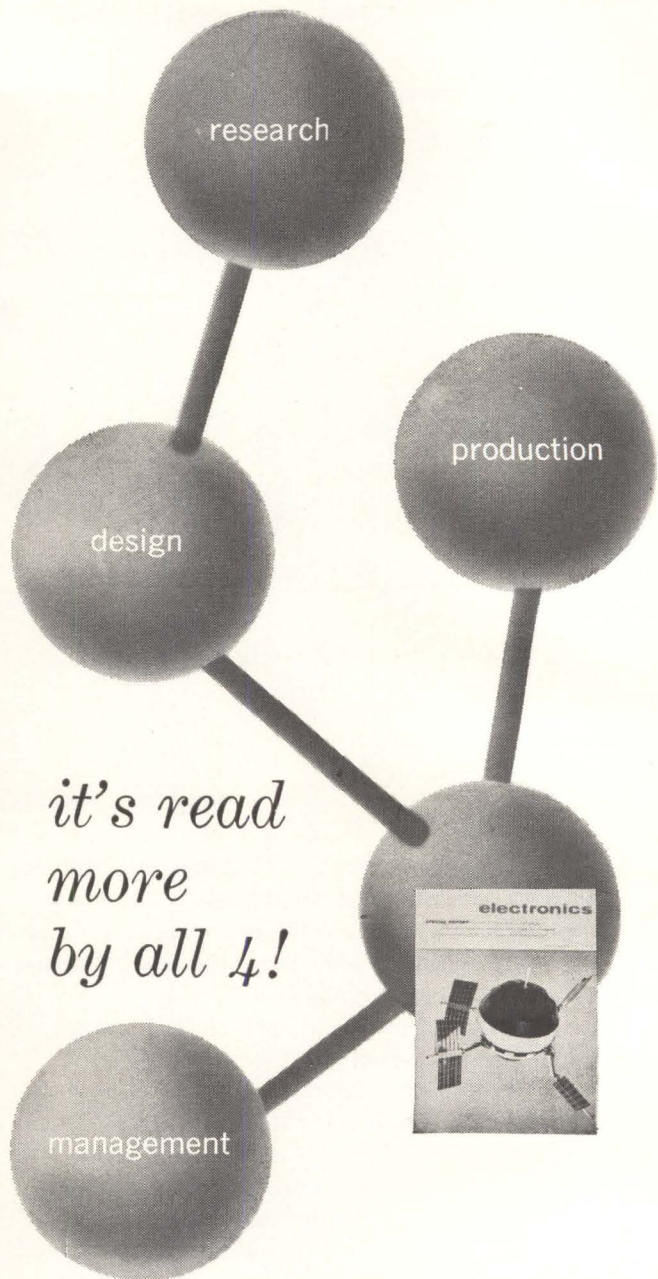

electronics is specially edited to keep you informed about the entire industry. With special issues on Electronic Markets, Modern Microwaves, Search and Probe Systems, and other reports you'll want to file and keep

subscribe today to **electronics**

Every Friday, **electronics** gives you the latest engineering developments and technically interpreted market trends. So don't wait till everyone on the routing slip has read it. Subscribe now and read **electronics** first. Mail the reader service card (postpaid) to **electronics**, the magazine that helps you to know and to grow! Rates: three years for \$12, one year for \$6; Canadian, one year for \$10; foreign, one year for \$20. Annual **electronics** BUYERS' GUIDE included with every subscription.

CIRCLE 59 ON READER SERVICE CARD →

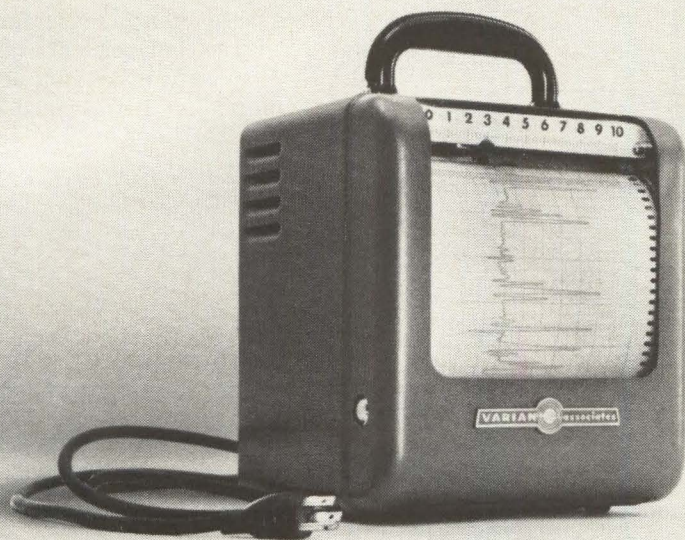

It's just like buying a custom-built recorder!

With so many standard options from which to choose, it takes a bit of extra effort to buy a Varian G-11A recorder. But most of our customers don't seem to mind at all. After all, where else could they buy a compact, reliable potentiometer recorder custom-built to their exact specifications at such a reasonable price?

Here are just a few of the many options which the G-11A offers: you have a choice of input circuits for measuring voltage, current or temperature; a choice of one, two or four chart speeds from $\frac{1}{8}$ "/hr up to 60"/min; a choice of voltage spans from 10mv to 100v — temperature spans from -200°C to $+1500^{\circ}\text{C}$; a choice of reference voltage — mercury cell or zener diode; and a choice of many other options including

ink or inkless writing, event markers, zero center scale, field span adjust, and rack mounting.

Best of all, no matter which options you select for your G-11A, you still have a light-weight, reliable recorder with 1% limit of error and a pen speed of 1 second full scale.

Wouldn't you like to have your next recorder custom-built? For complete information on prices and all available options, see your Varian Recorder Representative or write the INSTRUMENT DIVISION.

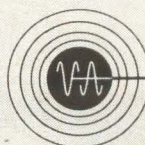

VARIAN associates

PALO ALTO 1, CALIFORNIA

Optics Generates Multidimensional Functions

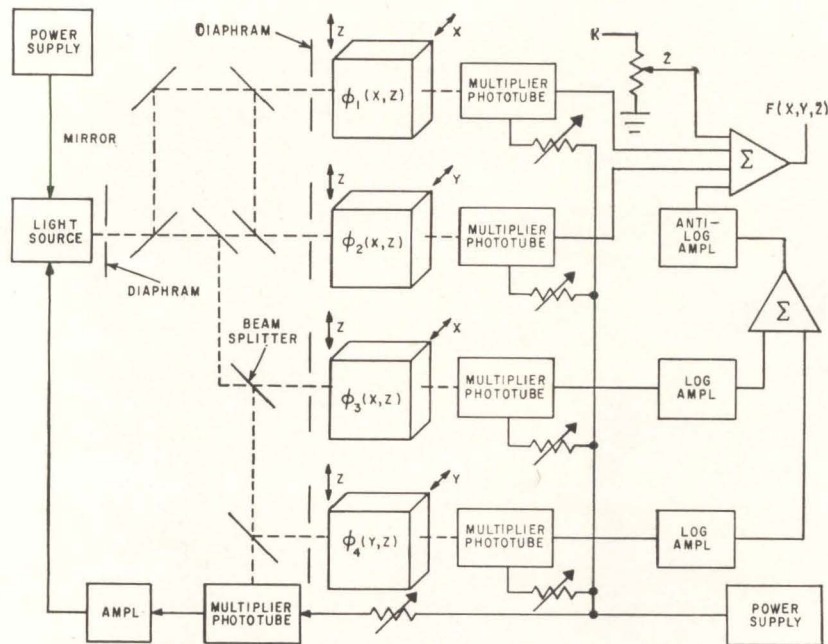

FIG. 1—Functions of three independent variables are generated by driving plastic blocks with servos to the instantaneous values of the variables

By WILBUR H. DAY
 Link Div., General Precision, Inc.,
 Binghamton, New York

FUNCTIONS dependent on several variables can be generated simply and accurately using optical techniques. These multidimensional functions are inherent in the increasingly complex problems considered for solution by computers. However, conventional methods for generating them require large numbers of operational amplifiers in analog computers or large storage space in digital computers.

The three-independent variable generator in Fig. 1 provides a more economical method for generating such functions. A regulated light source with such optical components as diaphragms, mirrors and beam splitters provide stabilized light beams as generator inputs.

Data required to generate a multidimensional function, one of three variables X , Y and Z , for example, is stored in four plastic blocks as $\phi_1(X,Z)$, $\phi_2(Y,Z)$, $\phi_3(X,Z)$ and $\phi_4(Y,Z)$. The blocks are driven by servos to the instantaneous values

of the independent variables X , Y and Z . The attenuated light beams are then converted by multiplier phototubes into d-c signals. The signals are fed through appropriate circuits using log, antilog and summing amplifiers and converted into a form that satisfies the equation:

$$F(X,Y,Z) = K + \phi_1(X,Z) + \phi_2(Y,Z) + [\phi_3(X,Z)][\phi_4(Y,Z)] \quad (1)$$

If greater accuracy is required than that attainable with one set of product functions, overall errors can be reduced to almost any specified tolerance by adding components to include additional product pairs. The requirements of a function generator using two sets of product pairs is shown in Fig. 2. It solves an equation of the form:

$$F(X,Y,Z) = K + \phi_1(X,Z) + \phi_2(Y,Z) + [\phi_3(X,Z)][\phi_4(Y,Z)] + [\phi_5(X,Z)][\phi_6(Y,Z)] \quad (2)$$

The mathematical formulation¹ was intended for implementation in mechanical computers for fire-control systems and generally limited to generation of functions of only two independent variables.

However, the mathematics is applicable to analog computation in general.

A function of two variables (Fig. 3) can be approximated using the least squares method¹ by the equation:

$$F(X,Y) = K + f_1(X) + f_2(Y) + f_3(X) + f_4(Y) + f_5(X)f_6(Y) + \dots \quad (3)$$

Well-behaved continuous functions of three independent variables X , Y and Z can be reduced to a set of functions of two variables¹ as follows:

$$F(X,Y,Z_1) = K_{z1} + f_{1z1}(X) + f_{2z1}(Y) + f_{3z1}(X)f_{4z1}(Y) + \dots$$

$$F(X,Y,Z_2) = K_{z2} + f_{1z2}(X) + f_{2z2}(Y) + f_{3z2}(X)f_{4z2}(Y) + \dots$$

$$F(X,Y,Z_n) = K_{zn} + f_{1zn}(X) + f_{2zn}(Y) + f_{3zn}(X)f_{4zn}(Y) + \dots$$

This matrix of functions can be combined to define $\phi_1(X,Z)$, $\phi_2(Y,Z)$, $\phi_3(X,Z)$ and $\phi_4(Y,Z)$. The set of functions are:

$$\begin{aligned} f_{1z1}(X), f_{1z2}(X), \dots \\ f_{1zn}(X) \text{ defines } G_1(X,Z) \\ f_{2z1}(Y), f_{2z2}(Y), \dots \\ f_{2zn}(Y) \text{ defines } G_2(Y,Z) \\ f_{3z1}(X), f_{3z2}(X), \dots \\ f_{3zn}(X) \text{ defines } G_3(X,Z) \\ f_{4z1}(Y), f_{4z2}(Y), \dots \\ f_{4zn}(Y) \text{ defines } G_4(Y,Z) \end{aligned}$$

where $G(\)$ is a function of two variables.

The final functions used to define the data stored in the plastic blocks are derived by taking the values of the natural logs of $G_m(X,Z)$, $G_n(Y,Z)$ for all X_i , Y_j and Z_k , where $m = 1, 3, 5 \dots$, $n = 2, 4, 6 \dots$ and i, j and k are discrete values of the variables over the ranges of interest.

Studies indicate that analogs can be generated of original multidimensional functions within 2 to 3 percent with the number of product terms restricted to one pair. By adding a second pair, the total error can be reduced as much as half that for a single-pair generator. This total is composed of 0.5 to 1 percent from mathematical approximations, 0.5 percent from physical inaccuracies in plastic block fabrication, 0.25 to 0.5 percent from electro-optical components (power supplies,

VERSATILE



You can play practically any instrumentation tune you want on the versatile **Mincom CM-100 Magnetic Tape Recorder/Reproducer**. Seven or fourteen tracks, 1 or 1.2 mc at 120 ips—with the rugged reliability possible only with Mincom's longitudinal recording on fixed heads. Analog recording/reproducing, or simultaneous post- and predetection capabilities in FM/FM modulation, PCM, PCM/FM and virtually all other FM-type carrier systems. CM-100 is mechanically simple: Mincom's exclusive DC tape transport provides dynamic braking, plus instant push-button choice of six speeds with no belt changes. With its system flexibility, its minimum down time and maintenance, the CM-100 can be the answer to your instrumentation requirements for years to come. Write today for specifications.

Mincom Division **3M**
COMPANY
Los Angeles 25, California • Washington 4, D.C.

who cares about audio transistors today?

As a cost conscious, quality-hungry designer of audio equipment you know that for nearly a decade—despite spectacular advances in other design areas—little has changed with audio transistors. You know because your design possibilities and the quality of your end products have been severely limited by the absence of improved audio types.

Yes, you care! And because you care, Amperex cares.

Indeed, Amperex cared enough to develop an entirely new process, the Uniform Low Frequency Technique, for manufacturing quality audio frequency transistors. The advantages of this technique—measured in terms of beta linearity and exceptional uniformity without a corresponding increase in price—could scarcely be more impressive.

To take but one example from among the first five U.L.T. types available in production quantities: The 2N2431, a PNP medium power transistor designed for Class A and B audio output stages, is capable of up to 2 watts power output per pair. It is available in a TO-1 case, as are all five U.L.T. transistors. The exceptional linearity of its beta is dramatically shown in the curve reproduced at right where beta remains substantially constant up to the maximum rated current of 500 ma. Further, the 2N2431 offers high gain with a beta of 50 to 180, 550 mw maximum dissipation and a collector-to-emitter breakdown voltage of 32 volts.

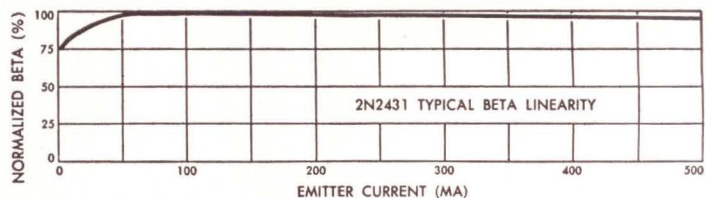

Here, then, are five great new transistors—as economical as they are excellent—to open new doors for you in the design of • Portable Radios • AM-FM Receivers • Car Radio Audio Drivers • Audio applications in communications systems • Slow-speed switching in computer applications.

ULT Transistor Type No.	Case	Application	Breakdown Voltages	Beta	Peak Current	Collector Dissipation
2N2428 PNP	To-1	Preamps, drivers and low wattage output devices	-32 volts	80-160	100 ma	165 mw
2N2429 PNP	To-1	Preamps, drivers and low wattage output devices	-32 volts	130-300	100 ma	165 mw
2N2430 NPN	To-1	Preamps, drivers and low wattage output devices	-15 volts	65-190	100 ma	165 mw
AC127/132 NPN PNP	To-1	Matched pair, NPN-PNP for 200 mw output stage using complementary-symmetry circuits.	15 volts	65-190	100 ma	165 mw
2N2431 PNP	To-1	Class A & B audio output stages up to 2 watts.	-32 volts	50-180	500 ma	550 mw

Write for complete data on the U.L.T. types that will make the big difference in your particular audio frequency application. Amperex Electronic Corporation, 230 Duffy Avenue, Hicksville, L. I., N. Y.

IN CANADA: PHILIPS ELECTRON DEVICES LTD., 116 VANDERHOOF AVENUE, TORONTO 16, ONTARIO



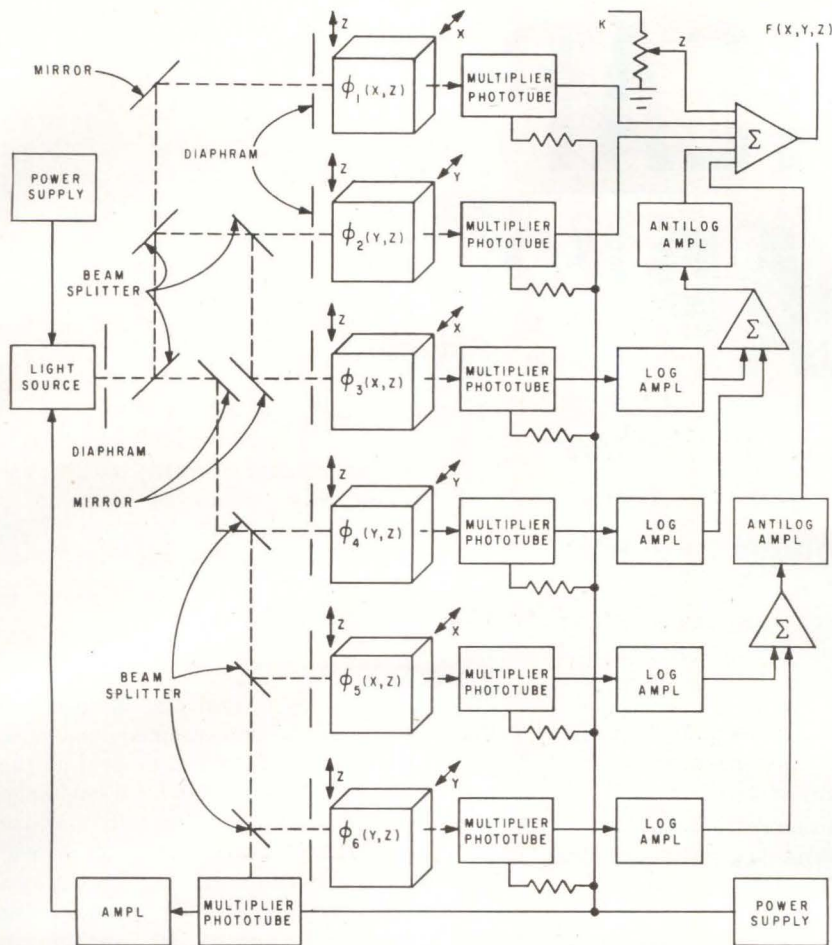

FIG. 2—Using double instead of single product pairs reduces errors

finite beam width, beam refraction, residual noise), 0.5 percent from electromechanical sources and 0.5 to 1 percent from miscellaneous sources. Errors of this magnitude in the case of empirical data are often well within the degree of original certainty.

REFERENCE

(1) Eugene W. Pike and Thomas R. Silverberg, Designing Mechanical Computers, Machine, Design, p 131, July 1952.

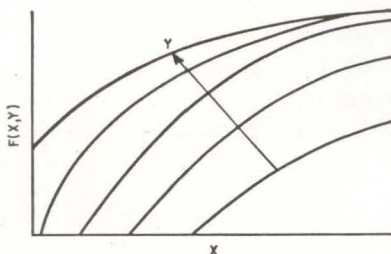

FIG. 3—Functions of two variables are found by least squares method

Simplified Technique Classifies Patterns

PATTERNS can be classified rapidly and without elaborate equipment. The logic for a relatively simple method of pattern classification has been designed called the paraprogram pattern classifier. The system can be constructed using present technology. The system was reported by the Computer and Mathematical Sciences Laboratory, AFRL.

Most approaches to pattern rec-

ognition require sophisticated computer programs and circuits. Letters and numbers are often catalogued by their loops, angles, open ends or other characteristics. However, a simpler approach is possible.

Several operations are performed on each letter. It is first placed into one of two major classes and then into its subclass. By continuing through successive subclasses, the range of possible classifications is

who carries Amperex ULT audio transistors ?

The ULT line is now available from these and other leading industrial electronic distributors

CALIFORNIA

R. V. WEATHERFORD COMPANY
Glendale 1, Calif.
BRILL SEMICONDUCTOR CORP.
Oakland 6, Calif.
ELMAR ELECTRONICS INC.
Oakland 7, Calif.

COLORADO

INTERSTATE RADIO & SUPPLY
Denver 4, Colorado

CONNECTICUT

CRAMER ELECTRONICS, INC., Hamden, Conn.

DISTRICT OF COLUMBIA

ELECTRONIC WHOLESALERS, INC.
Washington 1, D. C.

FLORIDA

THUROW ELECTRONICS, INC.
Cocoa, Fla. • Jacksonville, Fla. • Miami, Fla.
Orlando, Fla. • Pensacola, Fla. • Tampa, Fla.

ILLINOIS

NEWARK ELECTRONICS CORP.
Chicago, Ill.

INDIANA

RADIO DISTRIBUTING COMPANY
Indianapolis 6, Indiana

MASSACHUSETTS

RADIO SHACK CORP., Boston, Mass.

MICHIGAN

RADIO SPECIALTIES COMPANY
Detroit, Michigan

MISSOURI

INTERSTATE INDUSTRIAL ELECTRONICS
St. Louis 32, Missouri
BURSTEIN-APPLEBEE COMPANY
Kansas City, Missouri

NEW YORK

MILO ELECTRONICS, New York, N. Y.
ROME ELECTRONICS, Rome, N. Y.

OHIO

UNITED RADIO, INC., Cincinnati, Ohio

OKLAHOMA

OIL CAPITOL INDUSTRIAL ELECTRONIC
DISTRIBUTORS, Tulsa, Oklahoma

OREGON

UNITED RADIO SUPPLY, INC.
Portland 9, Oregon

PENNSYLVANIA

RADIO ELECTRIC SERVICE CO.
Philadelphia, Pa.

TEXAS

ADLETA COMPANY
Dallas 1, Texas • Fort Worth, Texas
BUSACKER ELECTRONIC EQUIPMENT CO., INC.
Houston 19, Texas

WASHINGTON

ROBERT E. PRIEBEE COMPANY
Seattle 1, Washington



HOW CHEAP IS "CHEAP"?

"Why should we buy from you when we can get the 'same thing' from other suppliers at a lower price?"

In selecting a supplier of lacing tape (or any component), price and compliance with specifications are not the only criteria. But too often, manufacturers ignore the other factors involved and consequently lose money.

For example, in a \$15,000 piece of equipment there may be only 15 cents worth of Gudebrod lacing tape. It costs \$75 to work this tape. It may be possible to buy the same amount of tape from other suppliers for 2 or 3 cents less . . . it "will meet the specs" according to these suppliers. But one of our customers recently pointed out why he still specifies only Gudebrod lacing tape in such cases.

"We tried buying some cheaper tape that 'met the specs.' Within a few months our production was off by 50% . . . boy, did the production people really scream about that tape. And our labor costs doubled . . . our costing people really flipped!

"Another thing, why should we risk the possible loss of thousands of dollars when the original material cost difference is only a few cents. Once you put cheaper tape on and something goes wrong after the equipment is finished . . . you've had it. No, thank you! We learned our lesson! We buy Gudebrod lacing tape!"

Whether your firm uses one spool of lacing tape or thousands, there are four advantages in specifying Gudebrod for all your lacing requirements:

1. *Gudebrod lacing tape guarantees increased production!*
2. *Gudebrod lacing tape guarantees reduced labor costs!*
3. *Gudebrod lacing tape guarantees minimal maintenance after installation!*
4. *Gudebrod guarantees quality!* On every spool is a lot number and seal which guarantees that all Gudebrod lacing tape is produced under strict quality control. Our standards are more exacting than those required for compliance with Mil-T.

Our Technical Products Data Book explains in detail the complete line of Gudebrod lacing tapes for both civilian and military use. For your copy write to Mr. F. W. Krupp, Vice President, Electronics Division

GUDEBROD BROS. SILK CO., INC.

Electronics Division
225 West 34th Street
New York 1, New York

Executive Offices
12 South 12th Street
Philadelphia 7, Pa.

narrowed until the letter is identified. As many as eight subdivisions may be needed.

The classifier consists of an array of identical cells each of which can exist in its original zero state or in the one state. The cells are connected so that a change from the zero to the one state can be propagated across the array from the right, from the left, from the top downward or from the bottom up.

A two-dimensional pattern can also be projected on the array by illumination. As the change of state is propagated inward toward the illuminated cells, the illuminated cells prevent further propagation. The illuminated pattern thus forms an outline of cells that remain in the zero state.

Readout of Array

After propagating changes of state in a programmed sequence, the array is tested to determine the number of cells that have remained in the zero state. The cells that are not changed to the one state depend on the illuminated pattern and on the sequence of propagating changes of state. If propagation were only from the left and from the top, the cells remaining in the zero state would usually be quite different from those remaining if propagation had been from the right and from the bottom.

By propagating commands in the proper sequence, the classifier can also derive a new pattern from the original pattern that is also capable of blocking propagation. Making tests on the new pattern can provide the basis for further classification of the original pattern.

Superconducting Magnet Does Not Require Wire

TECHNIQUE for increasing the strength of magnetic fields is simpler and less expensive than existing methods. Magnetic fields up to 15,000 oersteds have been produced using the new method, and fields of 20,000 to 25,000 oersteds are attainable. Theoretically, fields exceeding 100,000 oersteds seem possible.

The new technique was described at the Spring Meeting of the Amer-

MORE OPERATING FEATURES THAN ANY OTHER MEDIUM FREQUENCY RECORDER

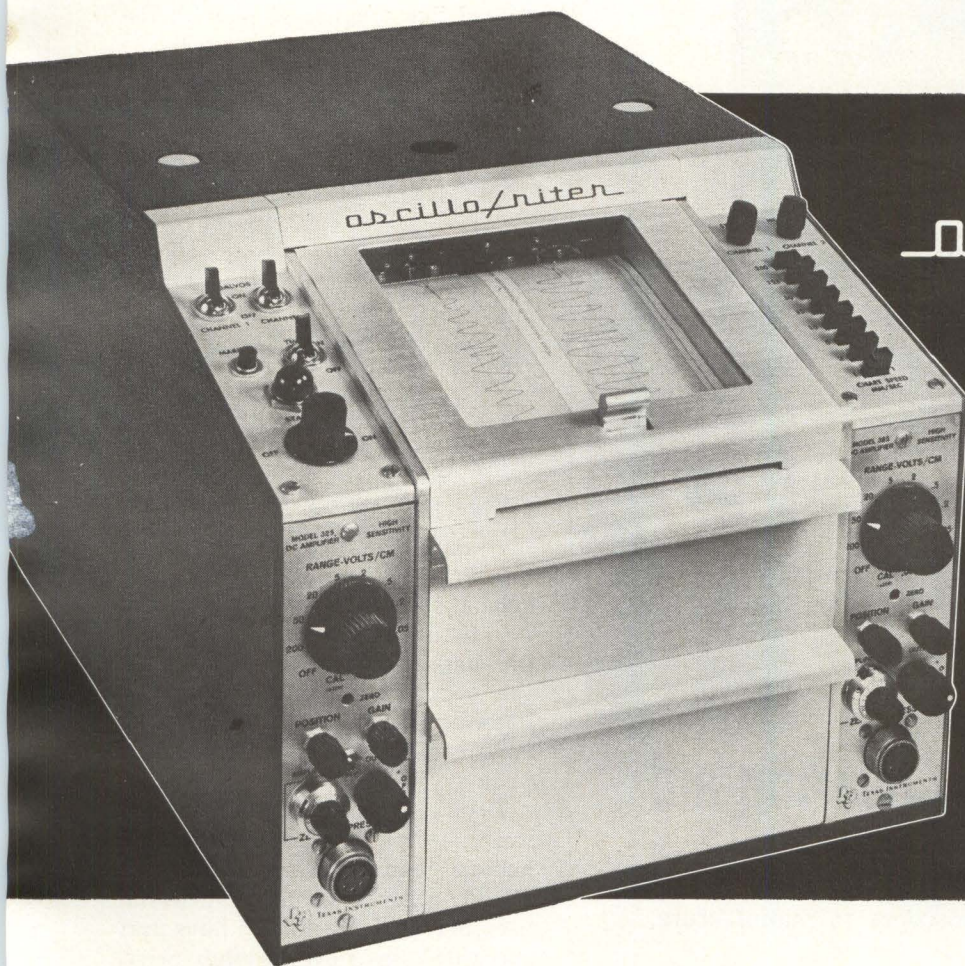

oscillo/riter*

MEDIUM FREQUENCY RECORDER

Here is the instrument that combines *all* the features found in other medium frequency recorders plus some TI exclusives. The *oscillo/riter* offers highest sensitivity, widest selection of ranges and chart speeds, rectilinear recording in either heat or ink, transistorized electronics, interchangeable plug-in amplifiers, and the convenience of Z-fold chart paper.

Broad Frequency Response. Flat to 200 cps within 1 db, 10 mm peak to peak with ink writing system.

High Sensitivity. Sensitivity range with high-gain amplifier is 0.5 mv/mm to 200 V/cm in 10 steps.

Push-Button Chart Speeds. Eight push buttons select 1, 2, 5, 10, 25, 50, 125, and 250 mm/sec.

Plug-In Amplifiers. Interchangeable amplifiers offer complete flexibility to economically handle more recording jobs. All electronics are fully transistorized for long-term reliability and convenience of no warm-up time.

Z-Fold Chart Paper. Provides random access to minutes, hours or days of recorded data by simply flipping pages of the chart as you would pages of a book. Roll chart paper optional.

Compare feature for feature, and you'll choose the *oscillo/riter* from industry's most complete line of strip chart recorders . . . made by Texas Instruments.

WRITE FOR COMPLETE INFORMATION

*A trademark of Texas Instruments Incorporated



TEXAS INSTRUMENTS

INCORPORATED
3609 BUFFALO SPEEDWAY
P. O. BOX 66027 HOUSTON 6, TEXAS

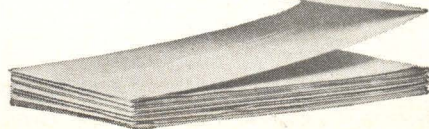

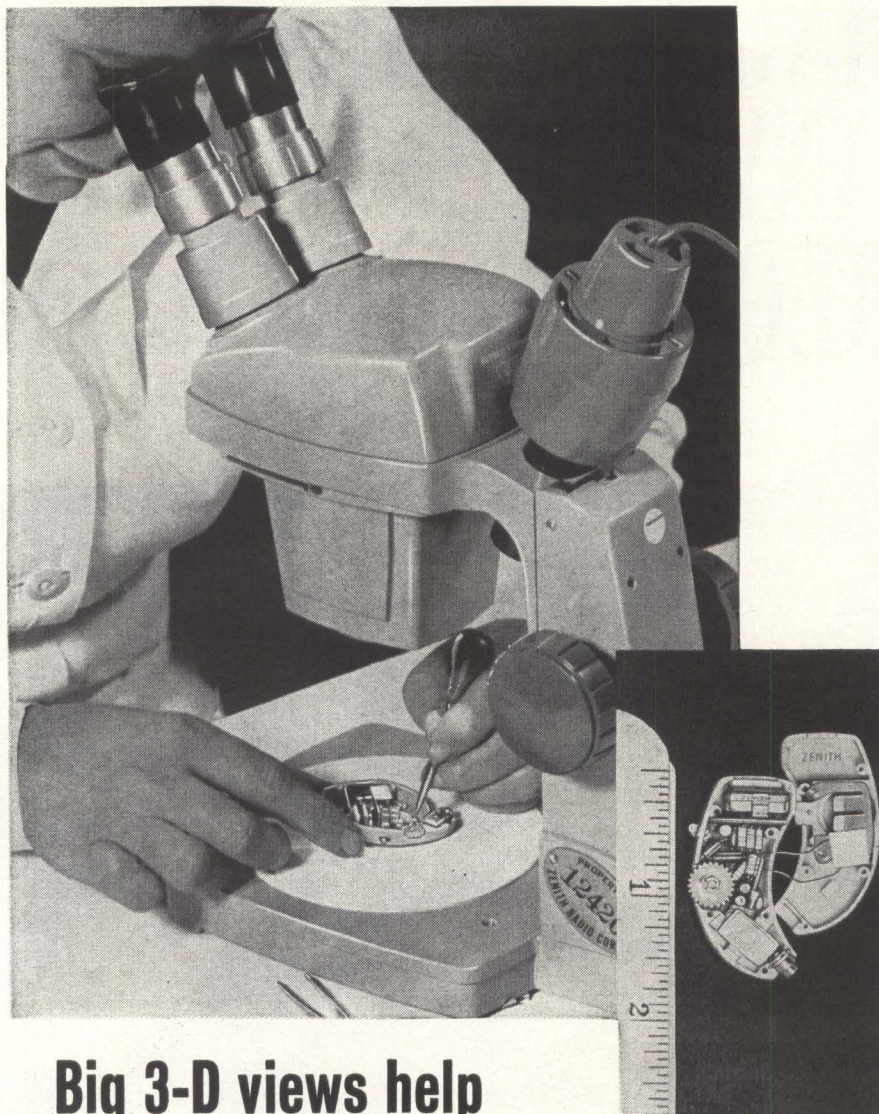

Big 3-D views help Zenith assemble tiny hearing aid

Zenith's new "Signet" hearing aid packs wider response and greater gain than before into a package so tiny that it takes Bausch & Lomb StereoZoom® Microscopes to manufacture, assemble and inspect it.

Zenith chose StereoZoom Microscopes for vivid views of tiny parts, magnified in natural 3-D . . . for all-day viewing without eye fatigue . . . for 7 inches of unobstructed working distance for hands and tools.

Put B&L StereoZoom Microscopes to work on *your* precision operations. Choose from the most complete line of industrial microscopes, including zoom models for scanning or critical study throughout the entire range of 3.5× to 120×!

BAUSCH & LOMB 

**BAUSCH & LOMB
INCORPORATED**
61430 Bausch Street
Rochester 2, N. Y.

- Schedule a demonstration at my convenience.
 Send StereoZoom Catalog D-15.

NAME

COMPANY

ADDRESS

CITY ZONE STATE

ican Physical Society in a paper by P. S. Swarz, General Electric Research Laboratory, and co-authored by C. H. Rosner. (See Electronics, p 8, April 27.)

Resistance of superconductors to the penetration of magnetic fields into their interiors is the basis for the new method. A magnetic field is established inside a hollow cylinder of superconducting material, as shown in the figure. The cross section of the hole in the cylinder is shaped like a figure eight with the loops joined by a narrow neck.

When the magnetic field has been established inside the hollow cylin-

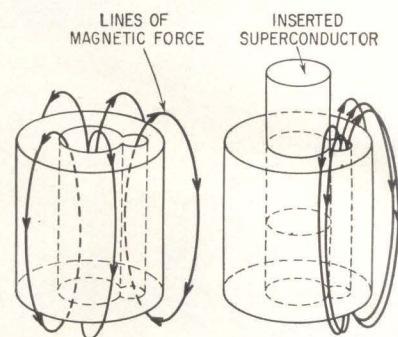

Magnetic lines of force are distributed evenly until superconductive material is inserted

der, a superconductor is inserted into the larger hole, filling it. Since the magnetic flux cannot penetrate the superconductor, the magnetic lines are forced into the smaller hole, creating a concentrated field in it.

Devices built at the laboratory were normally operated near liquid helium temperature (4.2 degrees K). The superconducting material used is Nb₃Sn, which Bell Labs first succeeded in forming into wire. This wire wound into a coil can function as a superconducting solenoid producing strong magnetic fields. Research on such solenoids is being conducted at several laboratories using this wire and alloys of niobium and zirconium. Unlike most superconductors, these materials remain superconductive in strong magnetic fields.

The main advantage of the technique announced by General Electric is that the superconducting material is used in bulk form. The solenoid-type design requires superconducting wire, which is difficult to fabricate. Therefore, the cost and complexity of the GE device is greatly reduced.

NEW!

ANSCO SUPERAY H-D

Ultra-High Definition X-ray Film...

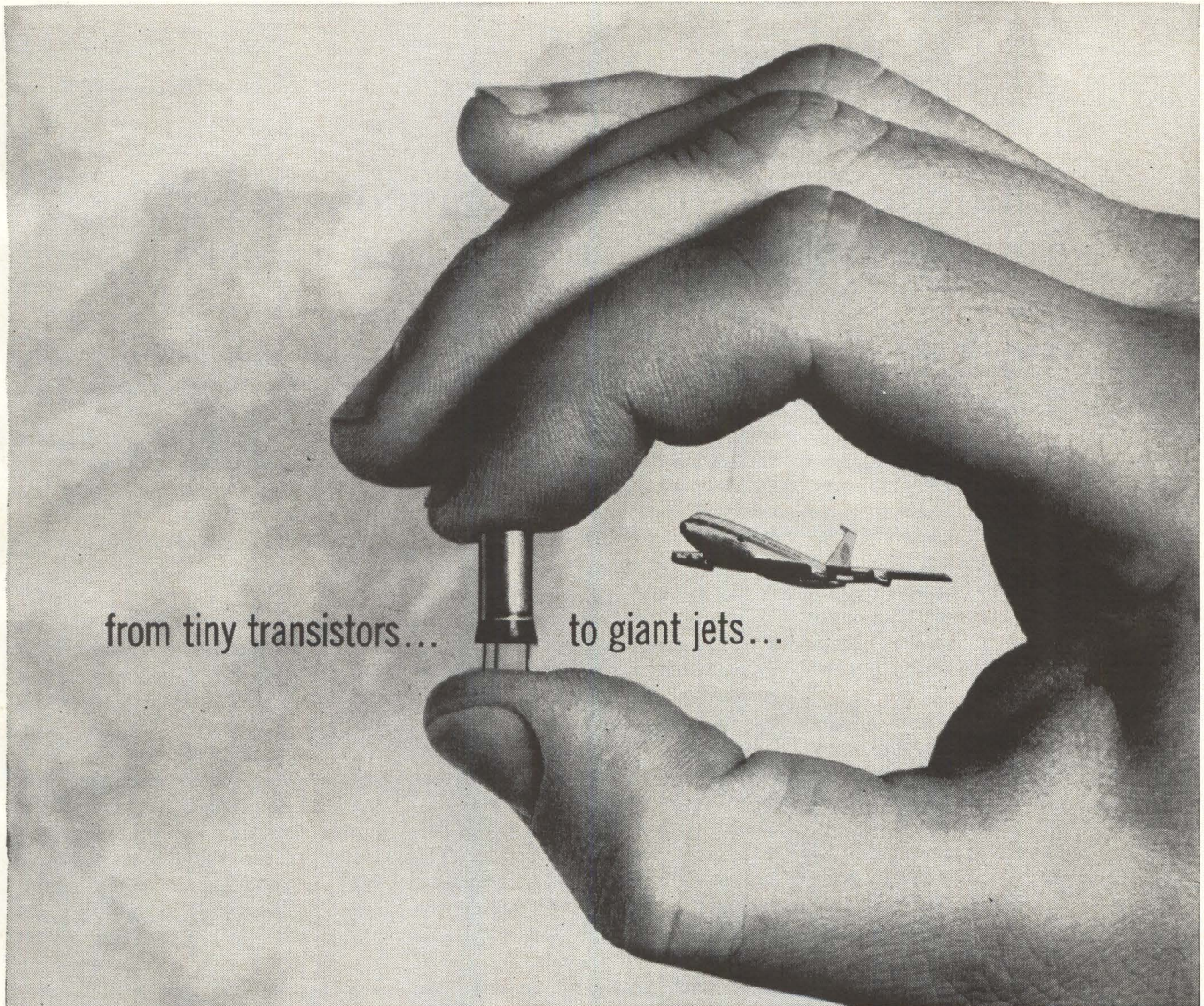

from tiny transistors... to giant jets...

Be "Anscosure"...

With the first American X-ray film for ultra-high definition radiography! If you require critical definition of correspondingly minute defects, be "Anscosure" with this new film. The extremely fine grain characteristics of Superay® H-D film provide the ultimate in image sharpness and maintain high definition throughout the entire 65-250 KVP range.

For radiography—it's Anscosure best by definition.

Anscosure—America's first manufacturer of photographic materials... since 1842.

June 1, 1962

Anscosure <small>Binghamton, N. Y.</small>
X-RAY FILM
CHEMICALS
SERVICE

CIRCLE 67 ON READER SERVICE CARD 67

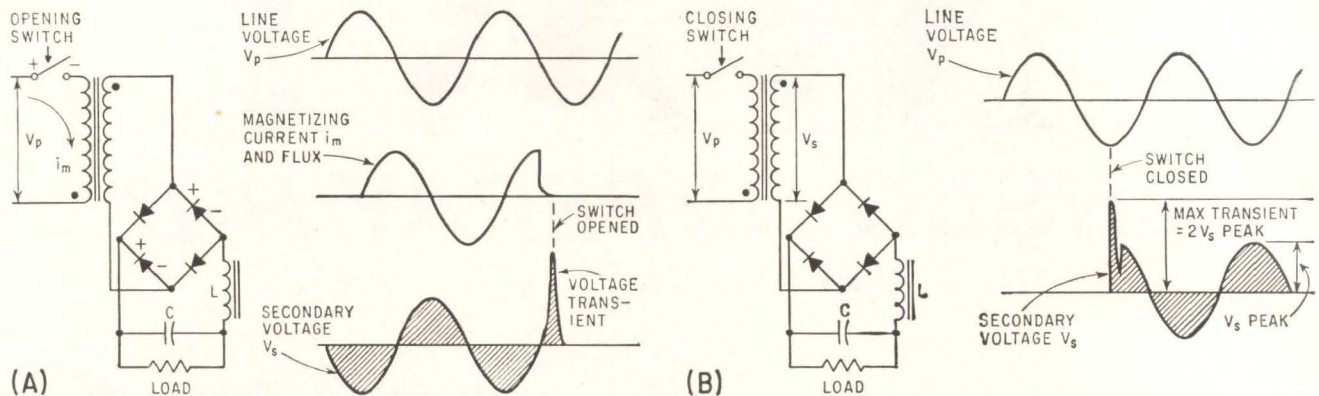

Transient voltage due to interruption of transformer magnetizing current (A), and transient voltage caused by energizing transformer primary (B)

Avalanche Breakdown of Silicon Rectifiers

FAILURES PREVENTED BY PROPER DESIGN TECHNIQUES

By S. P. FAIRCHILD JR,
Electronics Engineer
Federal Aviation Agency,
Tallahassee, Florida

NEW DESIGN TECHNIQUES and protective devices, properly employed, can eliminate many silicon rectifier failures caused by severe environmental stresses. Unforeseen failures in the field can be prevented by understanding voltage transients involved in the avalanche breakdown mechanism, and designing the system accordingly.

Current flow through a silicon diode in the forward direction may greatly exceed normal currents for small durations. Most small diodes are able to handle 10 times this rating as a 60 cps recurrent peak amperage and about 50 times this amount up to about 5 milliseconds¹.

On the other hand, when a silicon diode is overvoltaged in the reverse direction beyond its piv rating, the device is usually destroyed in microseconds by avalanche breakdown. This characteristic of the silicon diode causes excessive power supply failures in the field.

A silicon diode is usually overvoltaged by transients in the reverse direction by switching transients, and by power line overvoltage and transients caused by

thunderstorm activity.

When a transformer is energized by being switched on, a transient oscillation may be set up in the secondary. If the primary is energized at the peak of the supply voltage, the transient may approach twice the normal piv in the secondary, if little or no damping is provided in the circuit² (see diagram).

Opening the primary circuit of a transformer interrupts the transformer magnetizing circuit. The sudden collapse of this current and the magnetic flux which is proportional to the magnetic current couples a high voltage transient into the secondary, unless a discharge path is provided in the primary or secondary circuits. The amplitude of this type of transient depends on the instant during the a-c cycle at which the circuit is opened. Highest transients occur if the switch opens at or near the point where the primary voltage swings through zero².

Power line transients can be generated in four ways:

Switching transients, mentioned previously are caused by power going off and coming back on.

Transients are also caused by direct lightning strokes to nearby power lines.

Transients can be caused by in-

duced voltages into the line by lightning not actually striking the line.

Surges and transients are caused by reflected waves and surges of the power company equipment trying to adjust to the load after momentary power interruption.

Worst Offender

As a destroyer of silicon diode rectifiers, thunderstorm activity is by far the worst offender. In a great majority of cases, silicon diode failure occurs while a thunderstorm is in progress.

In addition to the lightning protection equipment used by the power company, a lightning protector of the thyrite magne-valve type is installed in many equipment buildings. If a lightning arrester with a 175-v rating is installed at the site, the question arises whether this would offer sufficient protection for electronic equipment installed nearby. This rating of 175-v does not mean that all voltages over 175-v to ground are eliminated. Once a lightning arrester breaks down, its internal resistance falls to a very low value around one ohm. The voltage generated by several hundred or several thousand amperes flowing through one ohm means however

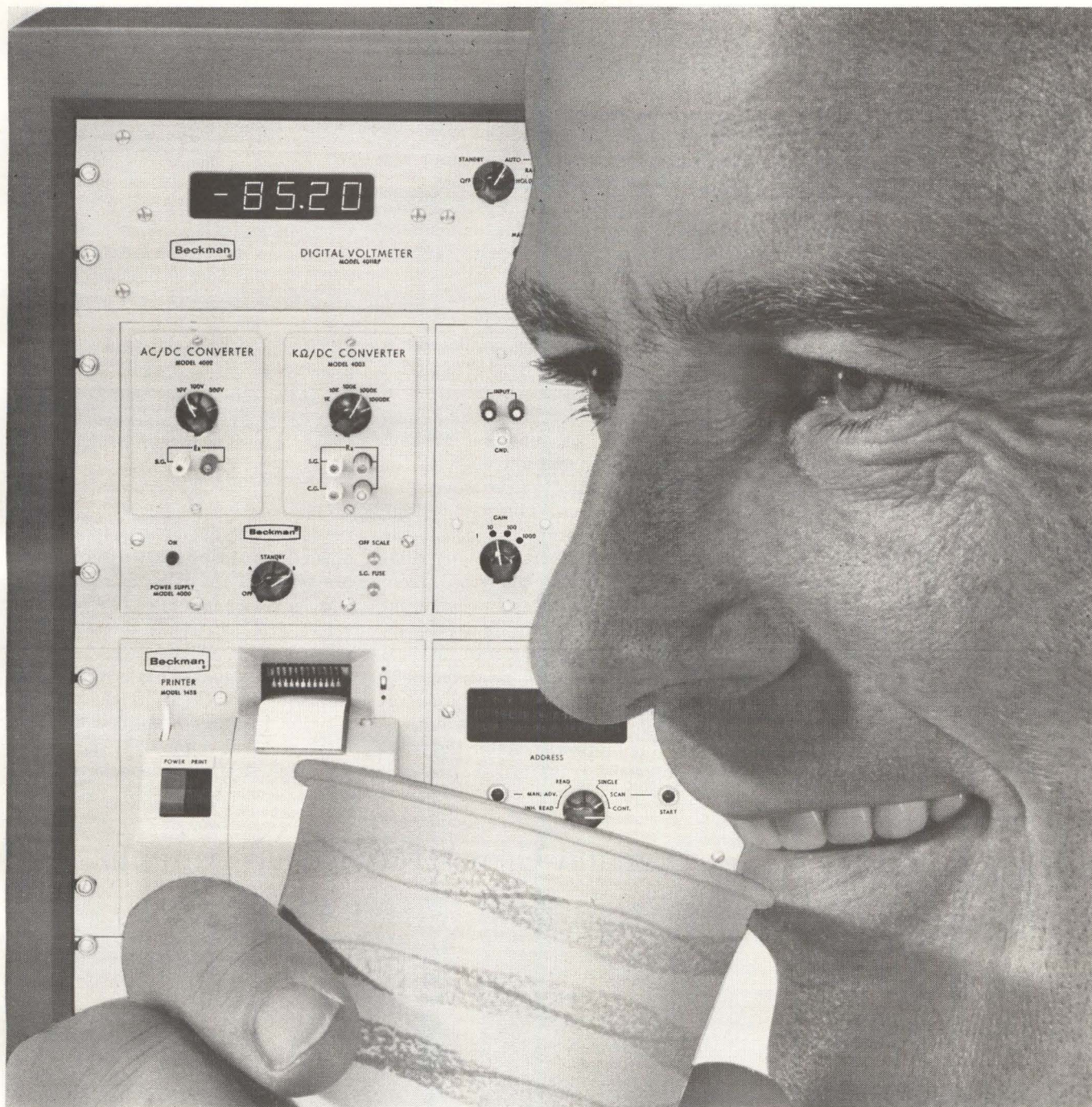

HOW TO LOG VOLTAGE AND RESISTANCE ON A COFFEE BREAK

Put yourself in his place. You can program your Beckman® digital multimeter system to continuously measure and record a variety of AC voltages, K ohms, and DC voltages. You'll have a 29-point DC scanner, a DC preamplifier, a KΩ/DC converter, and an AC/DC converter. Your four-digit 0.01% DVM will have the advantages of in-line, in-plane readout. This is all recorded in two colors with a Beckman solid-state, 7- to 12-digit printer.

You'll like the price. About \$5775 for the complete system shown. (Other DVM systems as low as \$2200.) The modular design of these instruments allows any system configuration or field expansion without custom costs. Complete details are found in 4011 System Technical Product Bulletin—yours for the asking.

Beckman® INSTRUMENTS, INC.
BERKELEY DIVISION
Richmond, California

SWEENEY MODEL SWE-1125
STATIC METER

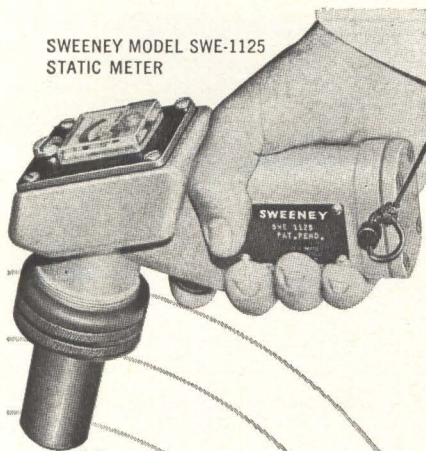

If your target is the detection of **STATIC ELECTRICITY** that exists between improperly grounded or bonded objects, your answer is the

SWEENEY

MODEL SWE-1125

**STATIC
METER**

WRITE FOR AMMUNITION!

**B. K. SWEENEY MFG. CO.
DENVER 16, COLO.**

that instantaneous voltage levels can rise tremendously. The 175-v rating is the extinguishing voltage at which the arrester disconnects when the peak of the overvoltage is past. This prevents the arrester from being a short to ground for the normal power line voltage. Silicon rectifiers fail at sites with lightning arresters and one cannot depend on these devices to prevent failures.

Thunderstorm Transients

A direct lightning strike on a power line acts as a d-c voltage with a steep wavefront even after a lightning arrester has broken down and diverts current to ground. This d-c wavefront travels with the velocity of light over the power distribution system. This d-c voltage causes saturation of the iron in the supply transformers and distribution transformers connected from line to ground, thereby changing the transformer from its previously high surge impedance of several thousand ohms to a relatively low resistance (approaching the d-c resistance of the primary winding) from line to ground. After the transition, each transformer presents

a low resistance drainage path in parallel with that of the arrester, thereby diverting a large portion of the long duration stroke current away from the arrester. Urban systems with multi-grounded neutral will result in less severe long duration discharge duty on arresters, because the high density of relatively large transformers connected from line to ground will divert more of the long duration current away from the arrester. Conversely, rural systems having lower density of relatively small transformers divert less current away from the arrester.³ This means that lightning transients are more severe and of longer duration in rural areas.

Voltage Transients

One solution to increase piv ratings is to put two or more rectifiers in series. But this creates additional problems. If the reverse resistance and leakage currents of diodes in series are not equal, then the inverse voltage across each rectifier will not be equal. This is solved by shunting each diode with a fixed resistor forming a voltage divider network that equalizes back resistances. A similar capacitive volt-

Demand Grows for Special Antennas

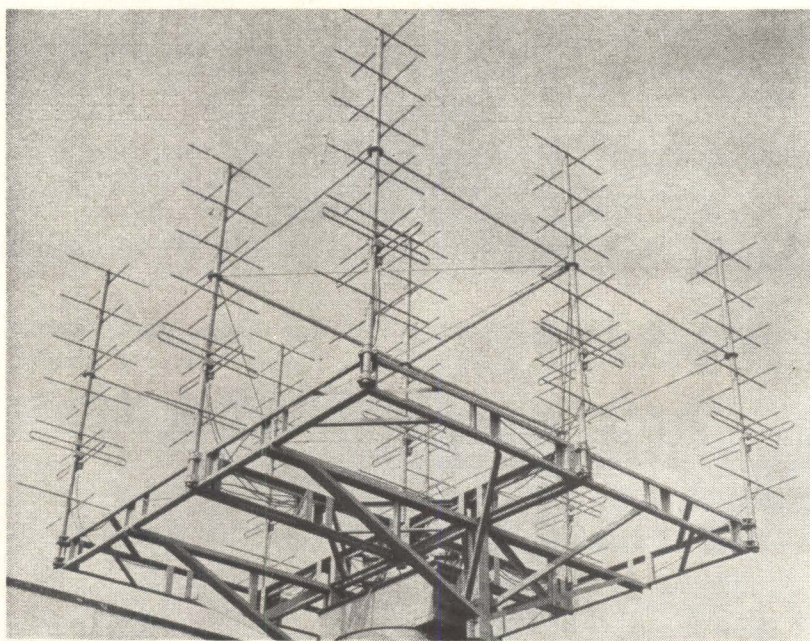

Array of Yagi antennas, used for down range data acquisition and tracking applications in satellite programs, exemplifies creative antennas design required for space programs. Structure above incorporates remote-controlled hydraulically-actuated, azimuth-elevation mount and support tower. Controls select horizontal or vertical linear polarization, as well as right-hand or left-hand sense circular polarization. (Taco, of Sherburne, N. Y.)



From Avco... traffic cop for today's crowded skyways

It delivers up to 120 landings per hour, even under instrument conditions . . . handles 24 aircraft in the terminal area at a time . . . provides continuous surveillance of every plane in its 90-mile control radius.

It's Avco's Air Traffic Control Central—the AN/GSN-11—developed by Avco's Electronics and Ordnance Division. The GSN-11 is designed to make more efficient use of limited air space at busy terminals—increase landing safety. It automatically guides a plane's pilot from point of identification to landing position. It computes air speed and capability, wind direction, and all other arriving traffic—then selects the simplest, most economical flight path to a safe landing.

Now on test at the National Aviation Flight Experimental Center near Atlantic City, the GSN-11 is being tried out with planes ranging from high-speed jet interceptors to slow single-engine types. Upon completion of these tests by the USAF and the FAA, Avco will be able to offer the most advanced air traffic control equipment in existence today.

For complete information on Avco's Air Traffic Control Central, write: Director of Marketing, Electronics and Ordnance Division, Avco Corp., Cincinnati 41, Ohio.

UNUSUAL CAREER OPPORTUNITIES FOR QUALIFIED SCIENTISTS AND ENGINEERS . . . REGARDLESS OF RACE, CREED, COLOR OR NATIONAL ORIGIN . . . WRITE AVCO/ELECTRONICS & ORDNANCE TODAY.

Avco // **ELECTRONICS AND
ORDNANCE DIVISION**

CIRCLE 71 ON READER SERVICE CARD



Avco's computer-directed Air Traffic Control Central, AN/GSN-11

Itek

Crystal Filters do Wonderful Things



A toast to Itek for a wonderful thing . . . Itek Crystal Filter 968B, with a near-Gaussian attenuation characteristic makes possible a 10,000 channel receiver! In antenna circuits, this 5 MC Filter optimizes pulse response, minimizes overshoot, and eliminates adjacent channel interference.

Perhaps you don't need a Gaussian crystal filter. But could you use the ingenuity that built one? Could Itek technical leadership help you?

Of course, the world's largest and most complete selection of stock filters is available, too. Choose from more than 3,000 Itek-Hermes designs.

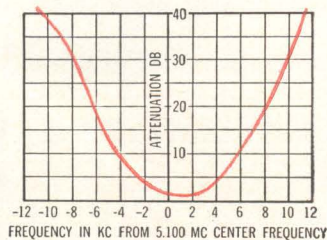

Write for free Brochure "WEESKACFAACP" or, *What Every Engineer Should Know About Crystal Filters At A Cocktail Party. You'll enjoy it.*

Itek Electro-Products Company

75 CAMBRIDGE PARKWAY, CAMBRIDGE 42, MASS. A DIVISION OF

Itek

age divider equalizes transients.¹ Thyrite resistors, or spark gaps across transformer secondaries can also be used.

Eliminating Transients

Several interesting devices have been developed recently to combat the avalanche problem. Silicon rectifiers with piv ratings to 10,000 volts and even higher are now available. A device to eliminate transients in the power supply is the selenium transient suppressor. This is a "back to back zener" type device that draws negligible current below rated recurrent peak voltage. However, as the voltage rises above this point, as would be the case in a transient condition, the diode current increases rapidly and dissipates the transient energy. They are marketed under such names as General Electric's Thyrector and Sarkes Tarzian's Klip-volt lines.

Recently General Electric announced their Controlled Avalanche rectifier. Carefully controlled non-destructive internal avalanche breakdown across the entire junction area protects the junction surface and eliminates destructive local surface heating that permanently destroys the conventional rectifier. Thus a great deal of avalanche breakdown protection is a "built in" feature of this rectifier.

The help and assistance of the Rectifier Components Department of General Electric and of the Sarkes Tarzian Company in the preparation of this article is gratefully acknowledged.

REFERENCES

- (1) Kampf, H. A., *Electronics*, Oct. 2, 1959.
- (2) General Electric Company, *Silicon Controlled Rectifier Manual*, Second Edition.
- (3) Towne, H. M., *Lightning Protection of Distribution Equipment and Circuits*, paper presented at Southwestern Distribution Power Conf., Austin, Texas, Oct. 20, 1953. Published by General Electric.

Extending Range of Controlled Rectifiers

A NEW TECHNIQUE developed by Transitron Electronic Corporation increases the usefulness of silicon controlled rectifiers over a wider temperature range and provides more desirable firing characteristics. This process is now used in

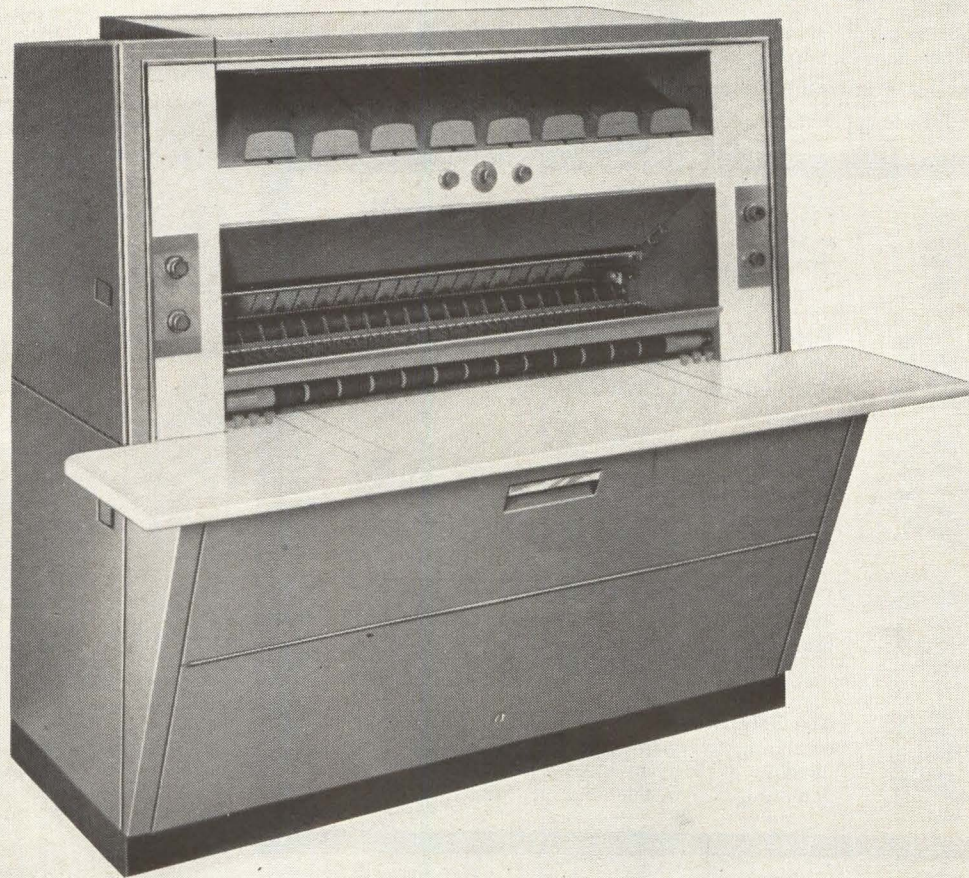

Why a machine that develops whiteprints from the back?

Simple. In the first place, the new Ozalid Printmaster® 900 develops dual-sided materials in one pass! . . . But, also important, single-coated papers are developed through the back of the base stock, as well as from the front, insuring prints with no under-developed images to fade or discolor. And, with the exclusive Ozalid sleeveless developer section, the 900 develops plastic-coated papers without sticking. Print speeds to 75 fpm, hi-intensity 100 or 150 wpi lamp, balanced cooling and simplified speed control give you unmatched reproduction versatility.

The most machine for the money on the market! Get all these extras at no extra cost—instant reversing switch, automatic exhaust timer, enclosed roll holders, automatic feed safety device, lamp intensity switch, instant-start variable speed control, remote ammonia supply attachments. Send coupon for full details.

OZALID
WE REPEAT
OZALID

Division of General Aniline & Film Corporation

In Canada: Hughes-Owens Co., Ltd., Montreal.

OZALID, Dept. 185
Johnson City, N.Y.
Send complete details on the new
Printmaster 900.

NAME _____
FIRM _____
ADDRESS _____
CITY _____ ZONE _____ STATE _____

WHEN COST IS A FACTOR AND RELIABILITY COUNTS... ITT KELLOGG INDUSTRIAL RELAYS

Backed by 60 years of telephone and industrial experience . . . to give you premium performance at production-line prices.

• Sensitive • Durable • Miniaturized models

For a variety of hard-use applications.

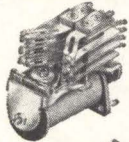

TYPE L Miniaturized, extremely versatile. Up to 220 volts DC operating current. 1 to 2 milliseconds operating speed.

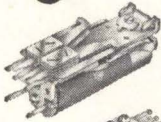

TYPE AK Highly sensitive. Can operate on as little as .002 amps. Fast open-close for maximum number of circuits.

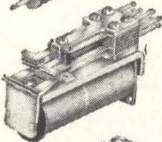

TYPE "4000" General purpose. Very long life, extreme reliability. Over 100 coils available, for varied circuit needs.

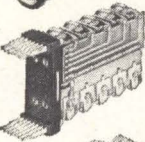

DUO-QUINTET Designed for application as a memory device. Can also be used in binary or binary decimal storage.

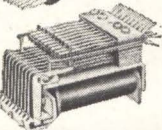

MAGNETIC IMPULSE COUNTER For switching or control where information is supplied in a series of electrical impulses, as in computer design, telemetering, etc.

These are only a few of the relays that ITT Kellogg has for virtually every industrial use . . . from the simplest to the most sophisticated. Types for "memory" devices, binary data storage, magnetic impulse counters, multiple-circuit operation, hazardous atmospheres, special requirements. Miniaturized models are particularly adaptable to use in computer systems, two-way radio, and automation devices.

got a problem?

ITT Kellogg will engineer relays for the special, exacting needs of the modern systems and controls designer. You'll find ITT Kellogg relays . . . or other components . . . reliable, durable, efficient . . . yet moderately priced. They are built to exacting, high-performance standards developed by more than 60 years of design and manufacturing experience for the telephone industry. Write or call for a specialist to discuss your needs. Whatever your problem, Kellogg has the experts to help you. No obligation.

other industrial systems components

ITT Kellogg designs and manufactures a broad range of other electronic and electro-mechanical components . . . such as translation matrices, magnetic data-storage drums, transistorized circuit modules for digital systems, telephone-type hardware of all kinds.



For more information, contact your nearest representative today.

KELLOGG

A Division of
International Telephone & Telegraph Corporation
Industrial Sales Department
6650 South Cicero Avenue, Chicago 38, Illinois

REPRESENTATIVES:

Penwarden/Dalvey Associates
14547 Titus Street
Van Nuys, California

Robert W. Gray
572 Washington Street
Wellesley 81, Massachusetts

T. H. Ellis Sales Co., Inc.
7711 State Line Road
Kansas City 14, Missouri

Albert A. Jacobs
3913 N. 35th Street
Milwaukee 16, Wisconsin

Berndt & Klein Associates
6322 N. Milwaukee Ave.
Chicago, Illinois

47 DeForest Street
Watertown, Connecticut

H. Markowitz
511 Montana Street
P. O. Box 191
El Paso, Texas

Land-C-Air Sales Co.
76 Main Street
Tuckahoe, New York

the production of the firm's silicon controlled rectifiers.

David H. Navon, Director of Transitron's Research and Development, points out that while silicon transistors can operate safely at temperatures of 150 C and higher, and the current gain in general becomes greater as the temperature rises, some silicon controlled rectifiers can fail at temperatures not much in excess of 150 C.

Above this temperature the rectifier no longer maintains its high impedance and switches automatically to a low impedance state at some elevated temperature.

It is desirable to stabilize the sili-

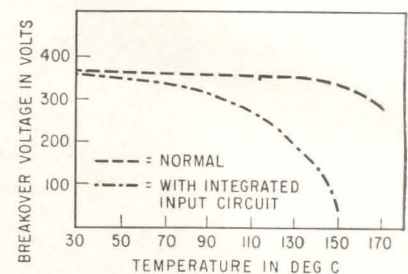

FIG. 1—Controlled rectifier break-over voltage vs temperature

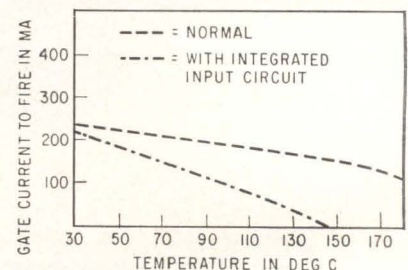

FIG. 2—Controlled rectifier gate current to fire vs temperature

con controlled rectifier so that its blocking voltage is maintained at higher temperatures. Also, it is convenient to have the gate current necessary to fire the rectifier essentially constant and independent of temperature.

To accomplish this, an appropriate input circuit has been integrated into the device. Figure 1 shows the rectifier blocking voltage and Fig. 2 the gate firing current as a function of temperature in a normal controlled rectifier. Also included is the data for a similar rectifier that incorporates the integrated input circuit. The integrated device is useful over a much wider temperature range and has significantly more desirable firing characteristics.



Mindpower and Manpower...
shaping the future in **ELECTRONIC COMMAND SYSTEMS**

ENGINEERS: Creative mind-power is being applied today by the men of Motorola to such vital aerospace programs as the NASA/JPL Mariner planetary probes... the Mercury manned orbital space vehicles...and the Navy's DASH drone anti-submarine helicopter. Advanced instrumentation is also being developed for more than 20 major U.S. missiles. ✎ If you are interested in shaping the future with Motorola on these and other programs, we can offer immediate opportunities to both system and equipment design engineers. Write us today describing in complete detail your experience in the following areas:

Systems Design • operational and functional mission analysis, optimum time-bandwidth utilization, redundant system organization for reliability, phased arrays, digital and voice communications, and A-J secure communications.

Equipment Design • solid state receivers, transmitters and transponders, distributed parameter microwave equipment, digital Modems, controls and displays, low-level switching circuits, and digital data processing circuitry.

Familiarity with State-of-the-Art • spread spectrum techniques, visual spectrum intelligence transmission, statistical theory of communication, integrated circuit applications, multiple logic element techniques, organization of digital data handling systems, correlation and phase-lock techniques, and coding and modulation.

We are particularly interested in the programs on which your experience was obtained, and the extent of your technical responsibility. Please address this information to our Manager of Engineering for immediate and confidential attention.

*An equal
opportunity
employer*



MOTOROLA

Military Electronics Division Headquarters
8201 E. McDowell Road • Scottsdale, Arizona
MILITARY PLANTS LOCATED IN CHICAGO, ILLINOIS;
SCOTTSDALE, ARIZONA; RIVERSIDE, CALIFORNIA.

Lepel

High Frequency INDUCTION HEATING EQUIPMENT

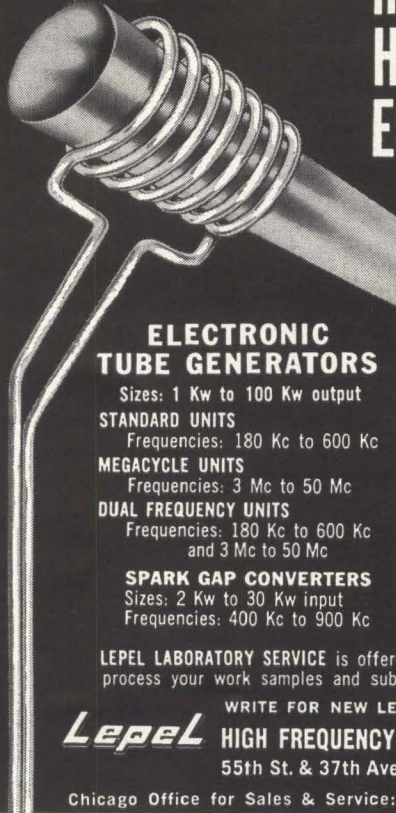

for

- BRAZING
- SOLDERING
- HARDENING
- ANNEALING
- MELTING
- BOMBARDING
- ZONE REFINING
- CRYSTAL GROWING
- PLASMA TORCH

ELECTRONIC TUBE GENERATORS

Sizes: 1 Kw to 100 Kw output
STANDARD UNITS

Frequencies: 180 Kc to 600 Kc
MEGACYCLE UNITS

Frequencies: 3 Mc to 50 Mc

DUAL FREQUENCY UNITS
Frequencies: 180 Kc to 600 Kc
and 3 Mc to 50 Mc

SPARK GAP CONVERTERS

Sizes: 2 Kw to 30 Kw input
Frequencies: 400 Kc to 900 Kc

LEPEL LABORATORY SERVICE is offered without charge, to process your work samples and submit recommendations.

WRITE FOR NEW LEPEL CATALOG

Lepel HIGH FREQUENCY LABORATORIES, Inc.

55th St. & 37th Ave., Woodside 77, N. Y. C.

Chicago Office for Sales & Service: 6246 W. NORTH AVE.

CIRCLE 201 ON READER SERVICE CARD

NEW

- Low cost
 - High Speed,
SPDT
 - Broadband
 - High isolation
- SOLID STATE SWITCH**



The 50 nanosecond maximum switching time and superior reliability of this new broadband (0.1 to 600 MC) coax switch are achieved by solid state circuitry. Isolation is better than 70 db. And its semiconductor design reduces not only switching lags inherent in electromechanical devices, but power drive consumption, too. What's more, it weighs only 4½ ounces and measures ¾" x 1¾" x 3¾", yet offers high performance switching.

This new Sanders switch operates equally well in both directions... can be used to switch a single input into either of two outputs, or to switch either of two inputs into a single output.

These features offer new solutions to a wide variety of switching problems, including: in multiplexing, feeding a time-shared antenna or feeding one receiver from many time-shared sources; in signal suppression of unwanted signals such as T-R devices in a receiver; in pulse modulation, as a broadband pulse modulator; in steering, to direct VHF signals for different system modes of operation.

COST — a low \$87, 100 — up; \$92, 25 — 99; \$97, 1 — 24.

DELIVERY — From stock

SEND COUPON FOR COMPLETE DETAILS

Sanders Associates, Inc.
Microwave Department, Nashua, New Hampshire
Please send complete performance data and other information on Model 201 switch.

Name.....
Company.....
Street.....
City..... Zone..... State.....



76 CIRCLE 76 ON READER SERVICE CARD

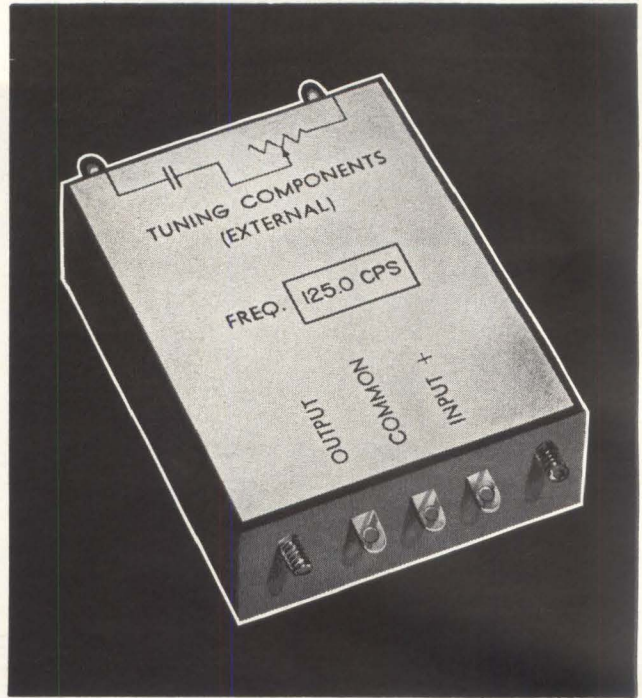

NEED A FREQUENCY?

FREQUENCY SOURCES

RANGE: 10 cps to 10 kcs

WHY LET SOMEONE ELSE DISCOVER ALLEN TYPE C OSCILLATORS?

(and someone does discover these unique transistorized frequency generators for another new application almost every day.)

Allen Type C Oscillators provide THREE IMPORTANT ADVANTAGES:

- Surprisingly LOW COST
- Uniform pre-tested QUALITY
- "Same-week" delivery for your specified frequency

The efficient mass-production of high quality frequency sources, indispensable to the success of Allen electronic organs, now contributes to the great flexibility of Type C Oscillator production.

You are invited to investigate this unusual component. Write Dept. 2305 for illustrated technical data.

COMPONENTS DIVISION

Allen

ORGAN COMPANY, INC.

MACUNGIE, PA., PHONE 965-9801

CIRCLE 215 ON READER SERVICE CARD

electronics

DC to 5000 cycles
over an amplitude
of 4" peak to peak

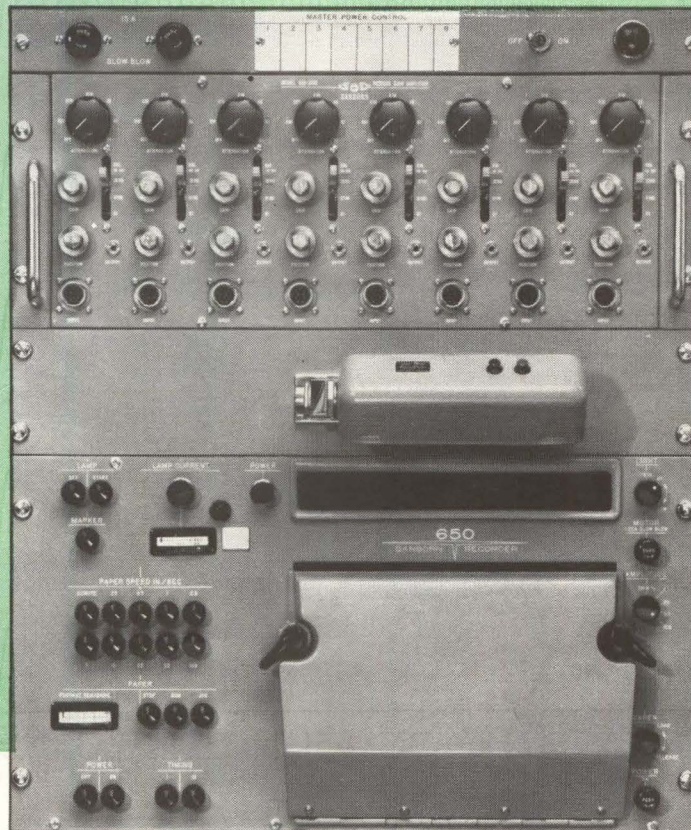

NEW SANBORN "650" SYSTEM

OFFERS DIRECT READOUT, 8 TO 24 CHANNELS, ALL SOLID STATE CIRCUITS, FOR RACK MOUNTING OR INDIVIDUAL CASES.

SENSITIVITY 20 mv input gives 8" deflection; 12 attenuator steps to X5000, smooth gain control.

INPUT RESISTANCE 100,000 ohms all ranges, floating and guarded; DC source resistance must be kept below 1000 ohms on mv ranges only.

COMMON MODE PERFORMANCE Rejection at least 140 db at DC, tolerance to ± 500 volts, max.

GAIN STABILITY Better than 1% to 50° C. and for line voltage variation from 103 to 127 volts.

LINEARITY 1½% of full scale (8 in.)

NOISE 0.02" peak-to-peak, max.

MONITOR OUTPUT On front panel; provides $\pm 1v$ full scale across 100,000 ohm load

POWER REQUIREMENTS 103-127 volts, 60 cycle AC, 625 watts



Here's the *one* system that lets you record inputs from DC to 5 KC within 3 db at 4" peak-to-peak amplitudes, without changing galvanometers. The "650" system consists of an 8-channel medium gain, general purpose amplifier unit driving a high speed, high resolution optical oscillographic recorder. It can be easily built into your system, packaged in a mobile cabinet or housed in individual cases. The single-chassis, 7" high amplifier module has 8 separate channels, *complete from floating and guarded inputs to galvanometer outputs*; each channel comprises a front end modulator and input transformer, carrier amplifier, demodulator, filter and driver amplifier. Power Supply and Master Oscillator Power Amplifier are built-in. All amplifier elements are plug-in transistorized units for easy servicing.

Immediately readable recordings are made on 8" wide daylight-loading ultra-violet-sensitive charts which require no chemical development. Features of the 12¼" high recorder unit include 9 electrically controlled chart speeds from ¼" to 100"/sec; calibrated monitoring screen; automatic trace identification and timing lines at 0.01 or 0.1 sec. intervals; amplitude lines spaced 0.1" apart which can be blanked from ¼, ½, ¾ or all of chart. Recorder is available with an 8-, 16- or 24-channel galvanometer block which is then equipped with the number of galvanometer elements desired by the customer. Either the Recorder or Amplifier are also available as individual units for use with other equipment.

Contact your Sanborn Sales-Engineering Representative for complete specifications and applications engineering assistance. Offices throughout the U. S., Canada and foreign countries.

SANBORN COMPANY
INDUSTRIAL DIVISION
175 Wyman St., Waltham 54, Massachusetts

CIRCLE 77 ON READER SERVICE CARD

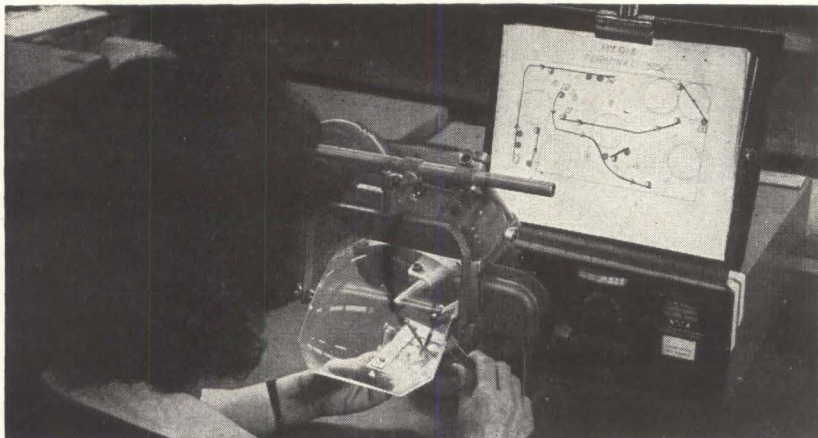

Qualification examination at end of course consists of welding components and wires to complete a typical electronic module

In 20-hour course, welders and inspectors learn principles of welding and how to make uniform, reliable welds

Welding School Improves Circuit Reliability

By STEPHEN W. MAHON
Westinghouse Air Arm Div.,
Friendship Airport,
Baltimore, Maryland

ADVANTAGES of formal training for production workers in welding electronic circuits appear to be well worth the cost and effort involved. The major result is better workmanship and thus increased reliability. Cost savings in production have not yet been thoroughly evaluated but are known to be occurring, primarily as a result of reduction in rework and inspection and from greater uniformity in workmanship.

To obtain maximum results from a formal training course, certain conditions should be met. A classroom within the plant with conditions similar to actual working conditions is desirable since it does not create a false image of the job as it will be performed on the production line. In-plant training also allows adequate control over the program and the equipment used.

The instructor should be selected for three qualities: ability to do the work to high standards, ability to teach, and ability to motivate and lead the trainees. Production fore-

men often make good instructors but in this case the instructor was selected from the engineering group that worked out the production problems of introducing resistance welding to the plant.

Group training is preferable to work-station training since it makes the best use of the instructor's time and focuses the trainee's attention on the training, rather than serving as a make-work operation during what would otherwise be non-productive time. Work-station training during non-productive time can often be costly because of the amount of rework required.

When a regular course in training is set up, it is good practice to let the trainees attend it without interruption, rather than attempt to fit in the training when it is convenient.

Course Organization

It was possible to meet all the above conditions in the welding course set up here recently. The course itself is organized as shown in Table I. Twenty hours of classroom work is provided, with no distinction being made between trainees on the basis of prior cir-

cuit welding experience. A training department representative makes the introductory remarks, explaining course objectives and impressing trainees with the need for introducing new tools and methods, management support of the program and the need for reliable circuits.

Developing Skills

The rest of the course is devoted to giving the student a thorough grounding in welding techniques and in developing his skill to the maximum. Individual guidance and shop practice is the largest block of time (14 hr.) in the program,

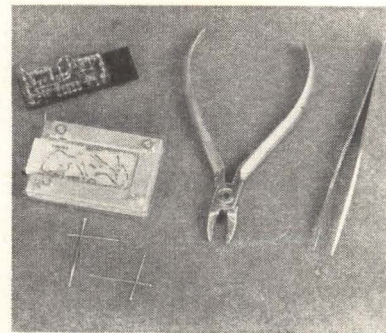

Welded module, fixture, and simple tools

Capacitors of MYLAR[®] often cost no more than paper—sometimes cost less

AT LOW PRICES

This graph is an analysis of capacitor prices using capacitance range versus typical unit costs as ordinates. The graph was plotted by using average capacitor prices of a variety of representative capacitor manufacturers.

Analysis of this graph demonstrates that for a wide range of capacitance values, from approximately .001 to 1 mfd., capacitors using "Mylar" polyester film are lower in cost than paper capacitors. In addition, capacitors of "Mylar" are comparable in price to paper units throughout the entire capacitance range. In fact, for the sizes and voltage ratings found in typical electronic gear, the average price for a group of capacitors of "Mylar" would be little different than comparable paper types.

Improved size and weight factors, circuit and packaging simplification often brings the total performance cost below other types of capacitors.

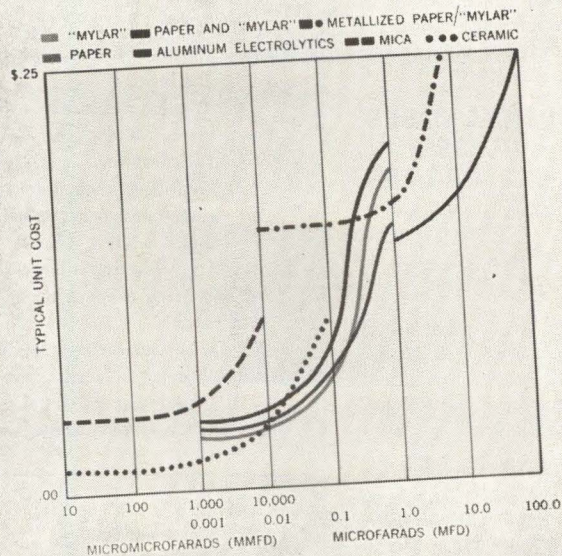

**As shown
by an analysis of industry prices**

A recent industry survey made by Du Pont showed that most design engineers did not consider capacitors of "Mylar"* in the same low price range as paper. Yet a study of manufacturers' average prices, as reported in our capacitor booklet, points out THAT OVER A RANGE OF SIMILAR CAPACITANCES AND RATINGS—UNITS MADE WITH "MYLAR" COMPARE CLOSELY IN PRICE WITH THOSE OF PAPER.

This means, at no greater cost, you get the extra

reliability of "Mylar"—superior dielectric strength, moisture resistance, and thermal stability over a wide range of temperatures. And you can design more compact components with the reduced capacitor size permitted by "Mylar".

Write for this industry study and price chart. Evaluate the full advantages and properties of "Mylar" before specifying your choice of capacitors. Du Pont Co., Film Dept., Wilmington 98, Del.

*"Mylar" is Du Pont's registered trademark for its polyester film.



BETTER THINGS FOR BETTER LIVING... THROUGH CHEMISTRY

June 1, 1962

only DU PONT makes

MYLAR[®]
POLYESTER FILM

CIRCLE 79 ON READER SERVICE CARD 79



ADVANCED FLASH TECHNOLOGY

for

- Flash-induced chemical catalysis
- High-speed photography of chemical and process reaction
- Motion studies, shock-wave photos
- Cloud chamber physics
- Deep-sea photography
- U.V. printing and time-marking
- Satellite beacon systems

EG&G's leadership in flash technology is solidly based on original contributions to the state of the art which have produced more than 40 patents for tubes, circuits and strobe systems.

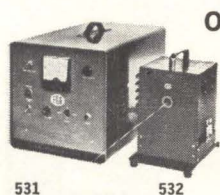

OPTICAL MASER (LASER) LIGHT PUMPS

400 ws. system
\$1190

1280 ws. system
\$3345

Model 531 Output: 400 ws. (1050 mfd at 900 v.) Input: 115 v. 60 cycle a.c. Price \$795. **Model 532** Flash Head with 2 Model 100 tubes: \$395. System will drive ruby rods with 400 ws. threshold. System price: \$1190.

Model 522 Two unit 1280 ws. system provides up to 4 kv. into 80 mfd. or 160 mfd. Triggered externally or from front panel. Drives Model 511, 512, 513 Flash Heads with 4 to 10 Model 100 tubes. Accommodates crystals 2" long up to 1/2" dia. Input: 110 v. or 220 v. 60 cycle ac. Price \$3345 (complete system with 4 tubes).

Note: Power supplies, capacitor banks, flash heads, pulse transformers are all available as separate items.

XENON FLASH TUBES

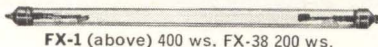

FX-1 (above) 400 ws. FX-38 200 ws.



FX-42 (above) 3" arc, 600 ws.
FX-45 6" arc, 2000 ws.

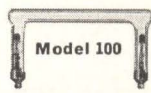

Model 100

FX-31 (above) 5 ws. flat-topped for optimum optical characteristics.

Further information on request on above products and on Hydrogen Thyratrons and Diodes, Triggered Spark Gaps, Transformers, Oceanographic Instruments, Radiation Detection Devices, other Flash Tubes, Flash Machines, Stroboscopes, etc.



161M BROOKLINE AVENUE, BOSTON 15, MASS.

TABLE I—WELDING SCHOOL PROGRAM

I Introduction (0.5 hours): purpose and objectives of the welding school program.

II Orientation and indoctrination (0.5 hrs.): School rules, good housekeeping and safety, new machines and accessory tools and equipment.

III Introduction to resistance welding miniature modules (2 hrs.):

A. Reasons for welding: elimination of flux, closer packing of components, less danger of contamination through encapsulation, less heat damage, more positive control.

B. Components and leads: recognition of components and leads, precautions in handling, precautions in assembly.

C. Welding machines: principles of operation, power, pressure, electrodes, importance of machine settings.

D. Weld schedules and certification of machine: explanation of procedures and forms.

E. Weldability of materials.

F. Electrodes: effect of electrode materials, effect of electrode shape, cleaning and dressing electrodes, electrode alignment.

IV Individual guidance and shop practice (14 hrs.):

A. Welding cross wire joints: component leads (Alloy 42, Kovar, Dumet), nickel ribbon interconnections.

B. Pull-test.

C. Welding dummy modules: circuit sketch, positioning nickel ribbon with respect to leads, sequence of operations on both sides of dummy module, visual inspection.

D. Welding complete module: introduction to circuit sketch (weld settings for diodes, resistors, transistors, terminals), visual inspection of complete module.

V Pre-test review (1 hr.): machine characteristics, misalignment of leads while welding, cleaning electrodes, trimming leads and nickel ribbon, placing nickel ribbon with respect to mylar, welding on correct side of lead, review of defects and causes.

VI Qualification examination (2 hr.): welding complete module in accordance with sketch of circuit.

VII Inspection of work: review and grading of welded module by product reliability department, including visual inspection and electrical test.

and excellence is strived for throughout; welding speed will develop later when the trainee puts his knowledge to use on the production line.

The qualification examination given at the end of the course consists of welding 9 resistors, 6 diodes, 3 transistors, jumper wires, pins and terminals for a total of eighty welds. The allotted two hours is more than enough time to make the welds and is made long deliberately to encourage excellence and to discourage hasty and slipshod work.

Test modules are graded by the Product Reliability Department on the basis given in Table II; each of the 80 welds is graded on each of the eight points listed. A score of 90 percent is needed to pass the course and a certificate of course completion is awarded each successful student.

Of the first 26 employees taking the course, 21 passed the examination on the first try. Of the five who failed, four repeated the com-

plete 20-hour course and passed it. Test scores of those passing the course averaged 96.7 percent, indicating that the program is effective in meeting the training goals.

Training costs, including direct labor costs of the trainees, training materials, and instructor's time, averaged about \$80 per student for

TABLE II—GRADING SYSTEM FOR WELDED MODULES

- A. Length of component lead above ribbon
- B. Length of ribbon tail beyond the terminal
- C. Spacing between ribbons or ribbons and terminals
- D. Spacing between ribbon and film
- E. Deviation of ribbon from film outline
- F. Centralization weld on lead
- G. Overall module thickness
- H. Other flaws

(Inadequate workmanship in categories A, B, and F gets 2 demerits; in C, D, E, G, and H, one demerit.)

RS = Economical Power Conversion

Sarkes Tarzian hermetically sealed medium and heavy current rectifiers combine efficient operation with low cost. A wide choice of ratings and circuitry fit power supply applications from air space to electrochemistry. Tarzian literature is available to show you the products—Tarzian engineering assistance is ready to apply them to economical solutions to your power conversion problems—at no cost. Write or call us now.

FOR HEAVY CURRENT APPLICATIONS...

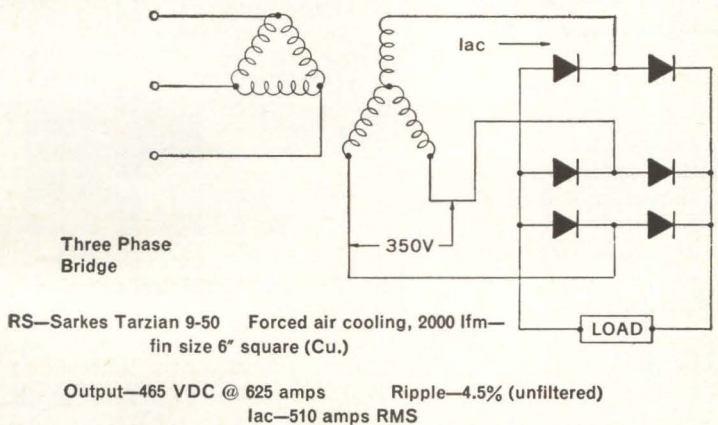
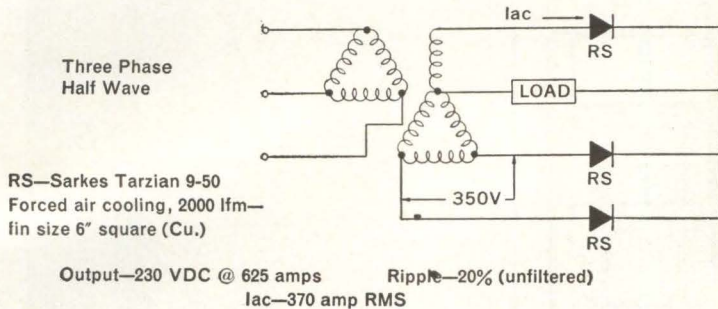

FOR VERY HEAVY CURRENT APPLICATIONS...

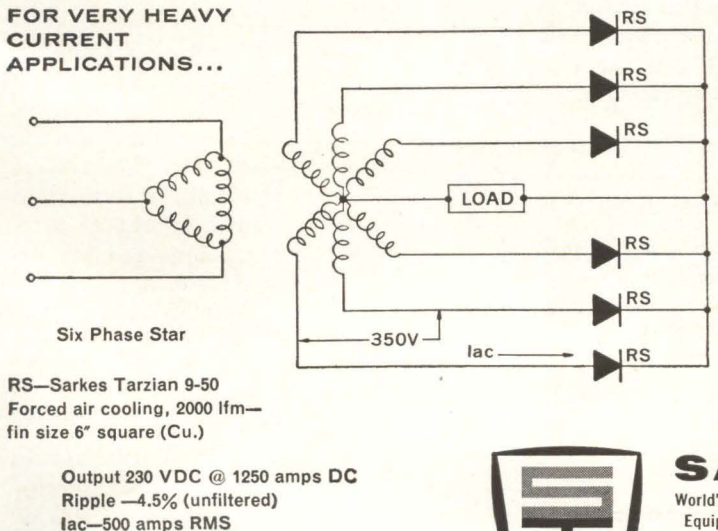

FOR MEDIUM CURRENT APPLICATIONS...

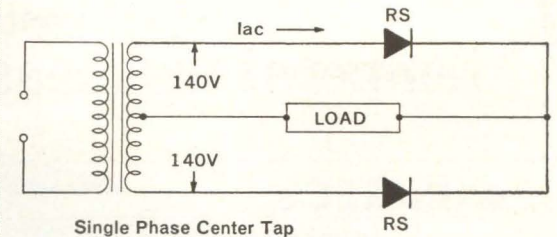

RS—Sarkes Tarzian 40H3
Convection cooling—fin size 3" square (Al.)

Output—125 VDC @ 12 amp DC
Ripple—52% (unfiltered)
lac—9.5 amp RMS

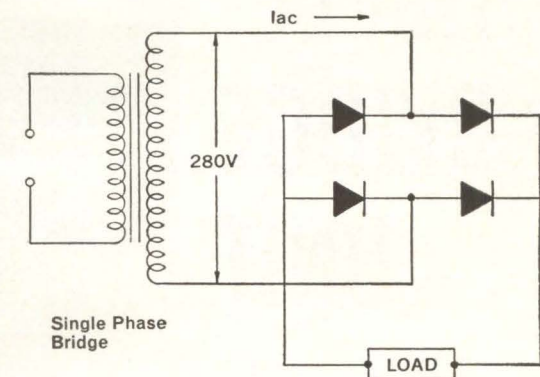

RS—Sarkes Tarzian 2-40
Convection cooling—fin size 4" square (Al. or Cu.)

Output—250 VDC @ 25 amp DC
Ripple—52% (unfiltered)
lac—28 amp RMS

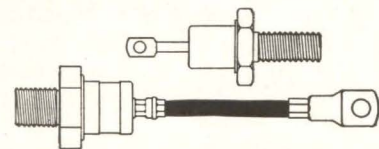

Some Typical Sarkes Tarzian Hermetically Sealed Rectifiers

Type	Max. Peak Volts	Max. DC Amps*
Type H3 - 6 Amp Series		
20H3	200	6
40H3	400	6
60H3	600	6
Type 2 - 12 Amp Series		
2 - 20	200	12
2 - 40	400	12
2 - 60	600	12
Type 9 - 250 Amp Series		
9 - 20	200	250
9 - 40	400	250
9 - 60	600	250

Positive or negative base polarity available in all types
*with adequate cooling fins



SARKES TARZIAN, INC.

World's Leading Manufacturers of TV and FM Tuners • Closed Circuit TV Systems • Broadcast Equipment • Air Trimmers • FM Radios • Magnetic Recording Tape • Semiconductor Devices

SEMICONDUCTOR DIVISION • BLOOMINGTON, INDIANA

Suppress lead wire error in resistance temperature measurement

with REC's

NEW

TRIPLE BRIDGE UNIT

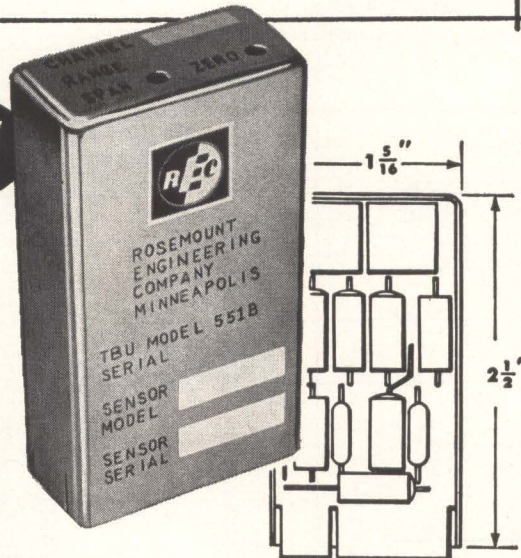

The new Rosemount Triple-Bridge Unit suppresses the effects of variable unknown lead resistance better than any previous method used in variable resistance temperature measurement. Lead variation can introduce substantial errors, particularly where leads are unequal or lead resistance is unknown. The Rosemount TBU shows vastly better suppression of these errors than conventional 3-wire and 4-wire bridge circuits.

Check these advantages of this newly developed variation of the basic Wheatstone bridge:

- Suppresses large lead resistance changes (up to 5 ohms)
- Suppresses variable lead resistances both at null and when unbalanced
- Suppresses unequal lead resistances
- Can trim out calibration differences
- Multiple temperature ranges available at standardized output
- Standardized 10 mv. D.C. output to match existing equipment
- Complete selection of auxiliary equipment

The TBU is a precision-made, plug-in unit permitting convenient change of full-scale temperature and capable of correcting known calibration errors of the temperature probe used. A basic 10-channel Triple-Bridge Unit is offered, with sockets and inter-connecting wiring for 10 sensors and 10 plug-in TBU's, thus providing 10 temperature ranges for each sensor.

WRITE FOR BULLETIN 86012. It gives specification detail and a mathematical analysis of the increased accuracy possible with the Triple-Bridge Unit as compared with conventional 3-wire and 4-wire bridges.



**ROSEMOUNT
ENGINEERING
COMPANY**

4900 West 78th Street, Minneapolis 24, Minnesota

SPECIALISTS IN TEMPERATURE AND PRESSURE MEASUREMENTS

the first group trained. These costs are expected to be offset by savings realized in 1962 from reductions in repair work and inspection time, due to the uniformity of connections. It is believed by all concerned that basic production training has a vital bearing on reliability.

Drafting Technique Shows Both Sides of PC Boards

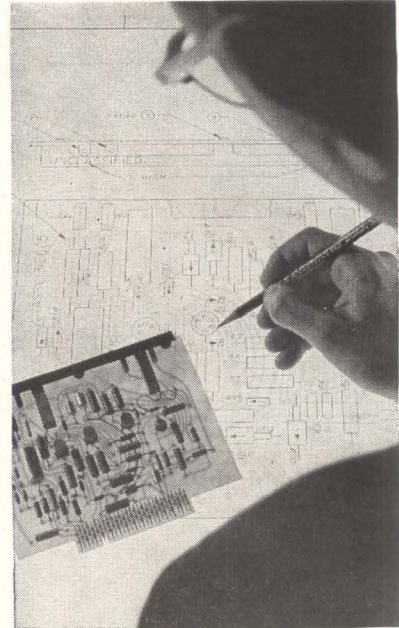

Faded-out circuit pattern plus component layout simulates actual pc board

A DRAFTING TECHNIQUE that shows both sides of an etched circuit board has been developed by Hughes Aircraft Co. communications division at Culver City, Calif.

Dual visibility is achieved photographically by printing a bold outline of the component side of the circuit board over a faded outline of the back, or solder side. Thus the complete circuit, with the location of all the components in relation to the solder points, is visible at a glance. The technique reduces error in circuit layout and has reduced design drawing costs by 50 percent. Microfilmed copies of the drawings meet the strictest military specifications.

First a master drawing of 4 to 1 scale is made of only the etched side of the board. This is photographically reduced to make negatives of machine and assembly drawings. Two negatives of the master are

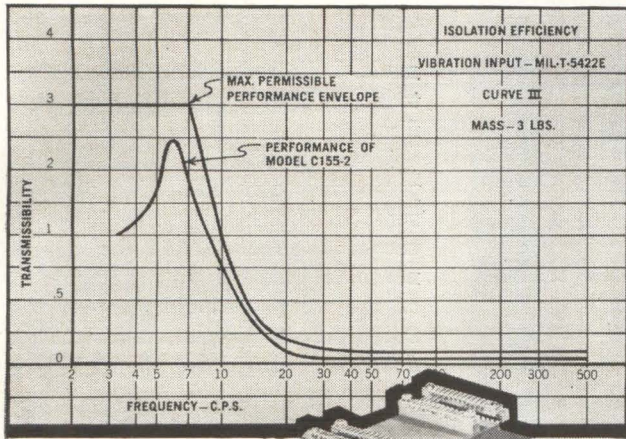

ACHIEVE
* **90%**
ISOLATION

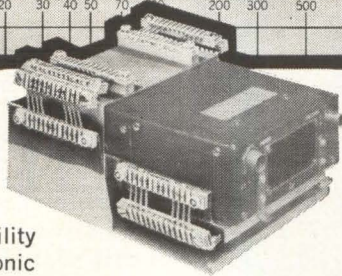

with maximum transmissibility of less than 3, on electronic equipment subjected to the vibration of a helicopter environment exceeding MIL-T-5422E (ASG) requirements.

*Listed in the VSMF microfilm catalog file.

For information on how we can solve your particular vibration problem write to Dept. BL-32

AEROFLEX LABORATORIES

INCORPORATED

48-25 36TH STREET • LONG ISLAND CITY 1, N. Y.

CIRCLE 204 ON READER SERVICE CARD



How to grow a beard...

Sit back and wait for your copy on that routing list. Okay if you like beards. Otherwise, look in this issue for the Reader Service Card. Fill in the "for subscriptions" section. Mail. Only 7½ cents a week.

electronics

A McGraw-Hill Publication, 330 West 42nd St., N. Y. 36

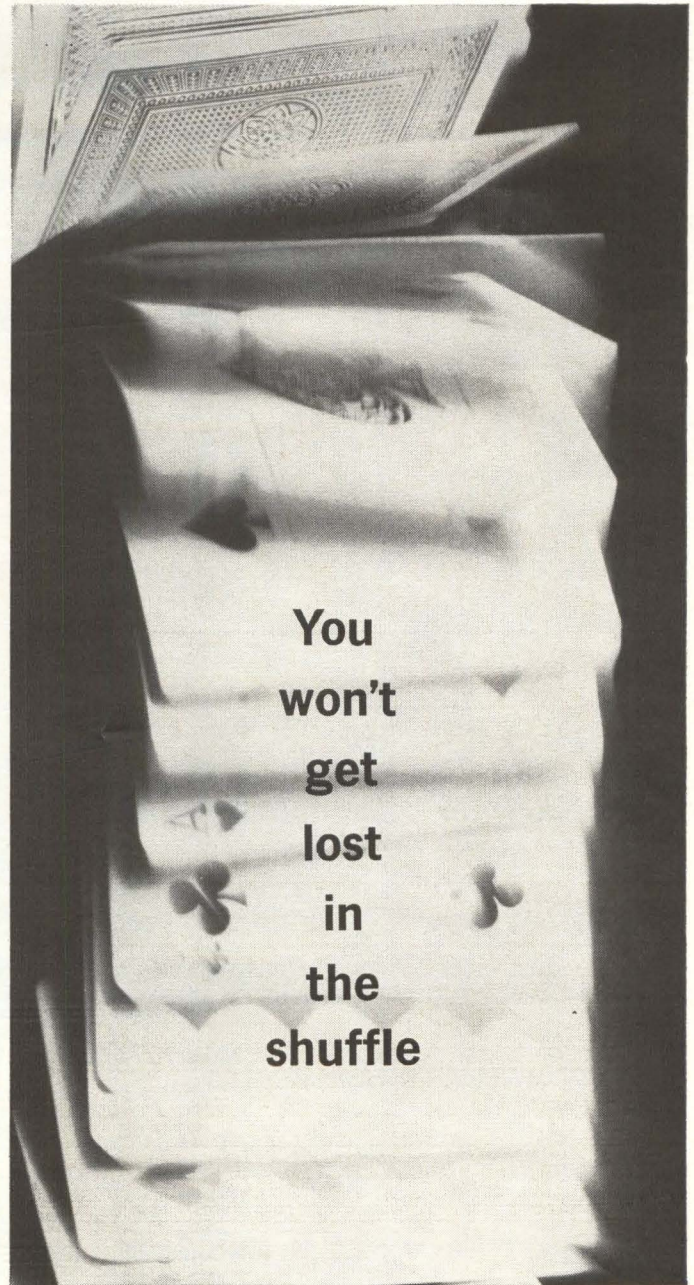

**You
won't
get
lost
in
the
shuffle**

at Eimac.

As a development engineer at Eimac you follow each project through from start to finish. You are consulted on customer requirements and applications. You conduct feasibility studies and have complete device development responsibility. You deal directly with engineering management — no complicated chains of command. You're an individual, recognized for your achievements. And at your command are three specialized tube development labs and model shops, each one concentrating on a specific area: high power microwave, microwave and power grid. If you are interested and have relative experience, we'd like to tell you more. No resume necessary. Just write to: Mr. C. F. Gieseler, Department B, Eitel-McCullough, Inc., San Carlos, Calif. An equal opportunity employer.



DATAPULSE 200 DATA GENERATOR

*is a general purpose
digital test instrument*

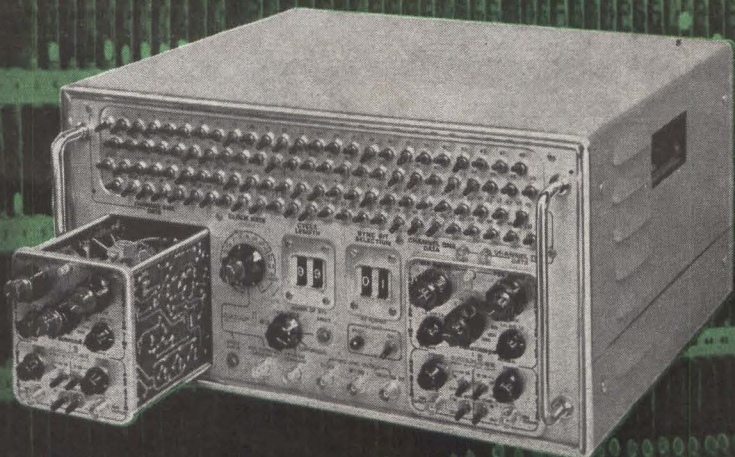

*The 200 Data Generator is a source of simulated
serial data, serial words, or pulse programs.
Output is fully controllable as to clock rate, word
or frame length, data content,
data format, and output signal characteristics.*

Photo of core memory courtesy of Ampex Corporation

DATA CHANNELS AND CYCLE LENGTH 1 to 100 serial bits single channel or 1 to 50 serial bits two channels.

CLOCK RATES Variable 2cps to 2mc, external clock, or push button clock.

DATA RECYCLE Continuous recycling or single cycle on command.

SYNC OUTPUTS Clock sync, bit no. one sync, or selected bit sync.

DATA OUTPUT Selectable 1/0 coding within the data cycle for each channel.

PROVISION FOR TWO OUTPUT UNITS IS MADE FOR PRESENTATION OF CHANNELS ONE AND TWO DATA.

P 901 output unit provides simultaneous pos. and neg. pulse outputs with variable fast rise and fall times.

P 902 output unit provides a variable DC level pulse output or a modulated carrier output.

Write for more detailed information.

Additional Datapulse products

104 PULSE GENERATOR

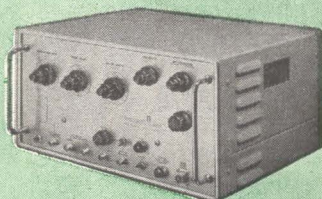

Repetition rate to 10mc
±40v into 50 ohms output
Pulse width from 20 nanosec. to 500µ sec.
Delay from 50 nanosec. to 10 millisecc.

DATAPULSE

INCORPORATED

509 HINDRY AVE. INGLEWOOD 1, CALIFORNIA

Data Systems • Pulse Instrumentation

ORchard 1-7713

ORegon 8-3983

made, both reduced to 2 to 1 scale to fit on D-size sensitized drawing film.

Dual visibility is achieved by projecting the etched circuit on sensitized film and fading it out by use of a screen. Then the components are inked in and the boldness of the component outline over the faded circuit presents a distinctive drawing, providing marked contrast between the two sides.

The same technique can be employed to show circuits on a double-sided etched board. The circuit on the near side is shown bold and the reverse side is faded out.

Differences in line density readily distinguish the component, circuit near-side, and circuit far-side in the double-sided etched board.

Simple Forms Aid Cable Making

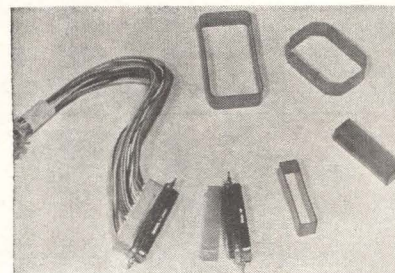

A SPACE PROBLEM in an airborne monitoring unit was solved at Lockheed Electronics Co. by using specially molded cable connector potting forms of glass epoxy made by Stevens Tubing Corp., East Orange, N. J.

Standard cable connector forms were too large and restricted the direction of wire take off. A special shorter form was designed to snap fit over the connector receptacle. The form was then filled with RTV Silastic compound, encapsulating the wire connections.

The resulting cable assembly—with its high resistance to moisture, temperature, and shock—was more economical than conventional connector components.

Inexpensive potting forms are made by cutting short pieces from lengths of glass laminated epoxy or silicone tubing, molded with tight tolerances to snap fit over the connector receptacle.

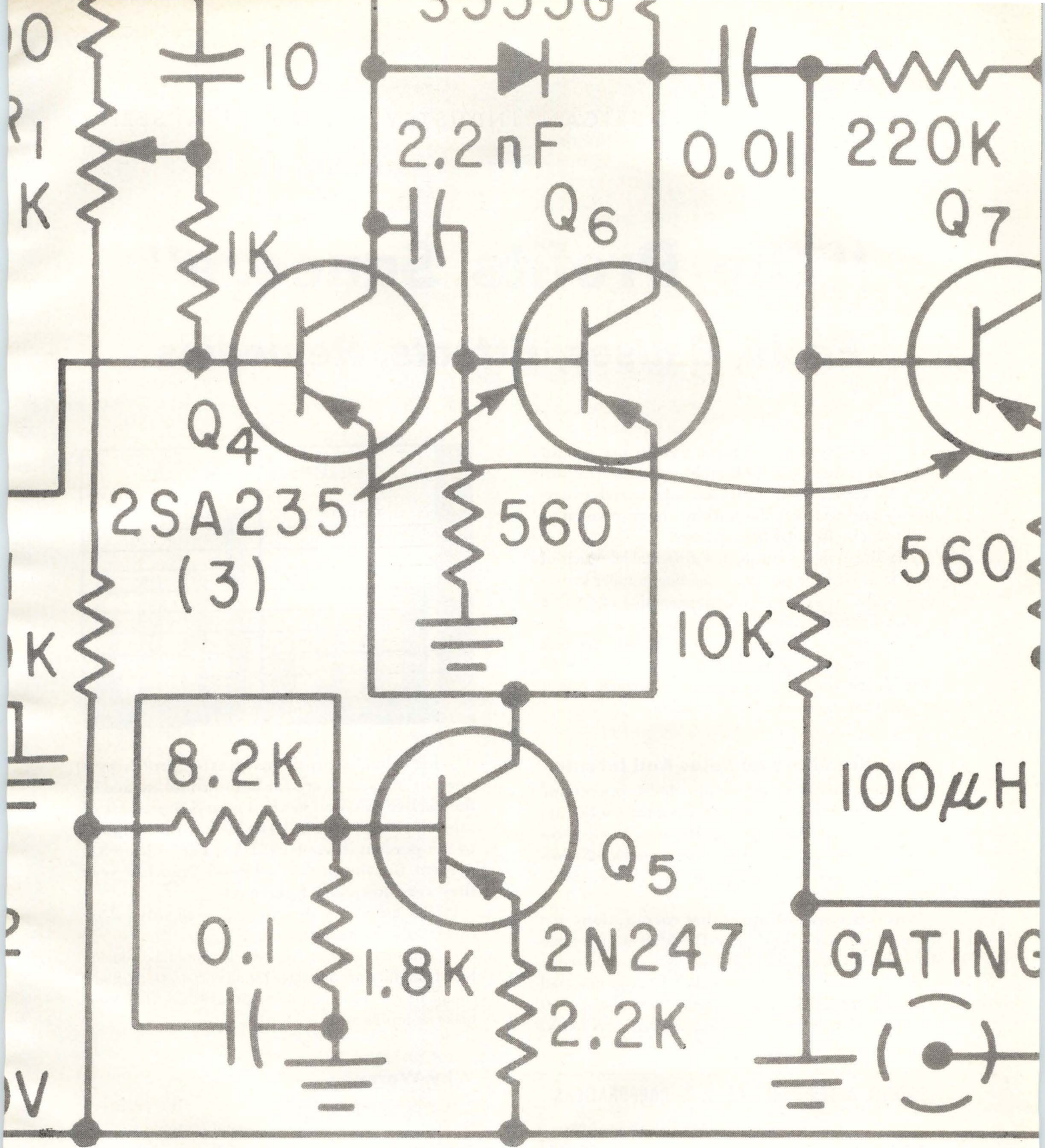

They don't read **electronics** ... they study it!

“The Profits Squeeze”

Facts, Causes, Effects, Remedies

U. S. business is in a bind. Profits are caught between rising costs and stable prices. And unless the pressures are substantially eased, everyone — and not just the nation’s businessmen — will soon be hurt by the squeeze.

The situation is critical, but correctable. Much of what is needed is more understanding, a fuller knowledge of the facts, and a wider appreciation of the role profits play in the American economy.

This statement is designed to contribute to this end. It shows what has happened to profits since World War II. It looks at events behind the change. And it suggests routes out of the predicament.

A Smaller Share Of Sales And Income

Among the most important developments of the present business recovery is the rise in corporate profits. Edging slightly above the 1960 level, after-tax profits last year rose to \$23 billion. They are likely to push on to a new high this year.

But this does not mean that corporations are doing unusually well. Far from it. As the table below shows, profits for 1961 were less than those for 1959 and 1956. They just equalled 1955 profits, and were only a hair’s breadth above the earnings of 1950 when the economy was 45% smaller than it is today.

PROFITS AFTER TAXES OF U. S. CORPORATIONS

Year	Billion Dollars	Year	Billion Dollars
1946	\$13.4	1954	\$16.8
1947	18.2	1955	23.0
1948	20.5	1956	23.5
1949	16.0	1957	22.3
1950	22.8	1958	18.8
1951	19.7	1959	23.7
1952	17.2	1960	22.7
1953	18.1	1961 estimate	23.0

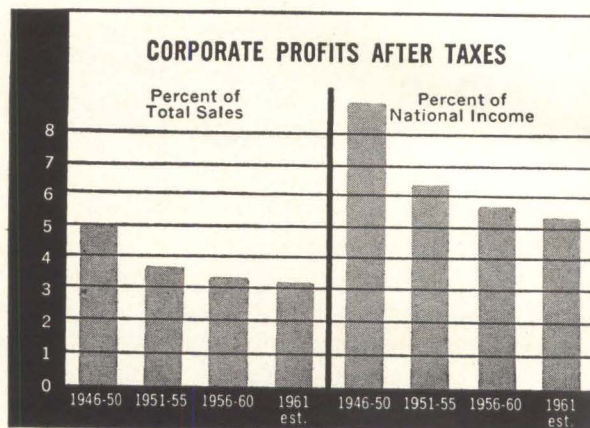

What’s more, profit margins — profits as a percent of sales — are far below those earned in the earlier postwar years. From 5.0 percent of sales during the years 1946-50, profits dropped to 3.6 percent during 1951-55. They slid to 3.2 percent for the period 1956-60. And last year they were down to 3.1 percent.

Profits are also a shrinking share of national income, as the chart above shows.

In considering these figures, it should be remembered that they are averages for all corporations. Some companies make more than the average, and some make no profits at all.

Why Worry?

If only a few companies were making low profits or showing losses, there would be scant reason for public concern. But when business firms generally begin showing a poor profit record, it becomes the proper concern of everyone — stockholders, managers, workers, government officials and consumers. This is because profits perform three indispensable jobs in the American economy:

First, profits provide economic motive power. They induce businessmen to research new products and new techniques of production. They encourage

risk-takers to put their savings into economic activity that is useful to the entire community.

Second, retained profits are the single most important source of growth capital. As President Kennedy said in his Economic Report to Congress, "While we move toward full and sustained use of today's productive capacity, we must expand our potential for tomorrow."

Third, the quest for profits directs labor and other resources to the jobs people want done. They tell management whether it is doing a good job or a bad job, and channel resources into the production of the things consumers want.

If profit margins continue dwindling at the present rate, these jobs can't be done efficiently. Businessmen will provide fewer new goods and services for consumers. Investors won't buy the new plants and equipment that mean more employment opportunities and better working conditions for labor. And some companies will lose their zeal for shifting their efforts in accord with consumer preferences.

Behind The Decline

While profit margins have been falling, the corporate compensation of employees has taken a growing share of both corporate sales and national income. The following table shows what has been happening here.

CORPORATE COMPENSATION OF EMPLOYEES

Year	Percent of Total Sales	Percent of National Income
1946-50	23.5	40.1
1951-55	24.3	42.4
1956-60	24.4	43.8
1961 estimate	25.0	43.5

But generally confronted by increasingly competitive conditions, both at home and abroad, companies have usually been unable to pass along a bigger wage and salary bill to their consumers in the form of higher prices, even if they wanted to. In the early years after World War II it was often possible to pass along higher costs by marking up prices, but in these days of general abundance intense competition for sales makes this difficult. Hence the squeeze of profits between rising costs and relatively stable prices.

High federal taxes also intensify the profit squeeze. Except for the profits of very small companies, the federal government still takes 52 percent of business profit. This is the same giant slice that was taken before tougher competition made profit dollars so much harder to acquire.

What Can Be Done?

There is no disposition here to deprecate the desirability of high wages. Nor is there any lack of appreciation that the federal government must have very large revenues if it is to perform its role in the 60's properly.

But it is important to realize that excessive wage hikes and excessive taxes can be self-defeating. They can lead to reduced wages and reduced tax revenues if they squeeze profits to the point where these cannot play their vitally necessary role in the economy. Before this happens both labor and government should take time out to ponder the long-run effects of today's actions.

There is an ancient and honorable phrase which says that "the laborer is worthy of his hire." Labor leaders, as they sit around the negotiating tables this year, should remember that profit makers, no less than they, are likewise worthy of their hire.

In considering new tax legislation, it's up to Congress to keep constantly in mind that a prosperous business community is absolutely essential to the defense of freedom, to the maintenance of high employment, even to the revenues that pay Congressional salaries. The present tax load works against having this prosperous kind of business community.

Of course, business too has an obligation to keep profits from falling to an ineffective remnant. One of the best ways it can discharge this obligation is by continuing its research efforts, by developing new products and new cost-cutting ways to make them as well as their present products and services.

The prevailing profits squeeze is a matter of vital concern to every American. We all have a stake in seeing that steps are taken — in the offices of business management, in halls of Congress where tax laws are made and revised, and at the bargaining tables where agreements on wage rates are made — to see that this squeeze is relaxed.

This message was prepared by my staff associates as part of our company-wide effort to report on major new developments in American business and industry. Permission is freely extended to newspapers, groups or individuals to quote or reprint all or part of the text.

Donald McGraw

PRESIDENT

McGRAW-HILL PUBLISHING COMPANY

DESIGN AND APPLICATION

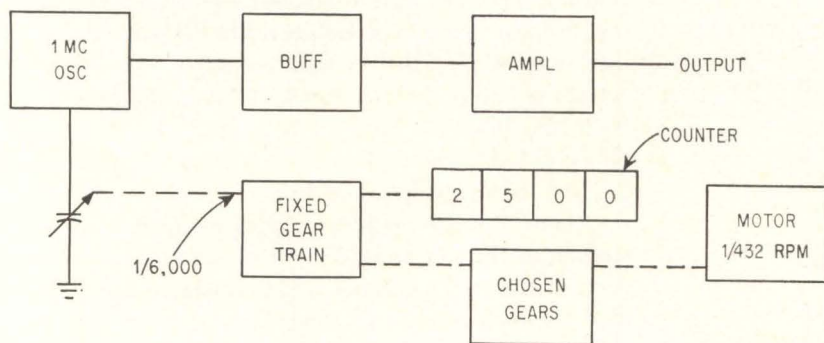

Clock Compensated Oscillator

1 MC WITH STABILITY OF 1 PART IN 10^8

RECENTLY announced by Manson Laboratories Inc., 375 Fairfield Ave., Stamford, Conn., is the model RD 144A-010 clock-driven transistorized oscillator that generates a 1 Mc signal adjustable within 4 cps, having a drift rate less than 1 part in 10^8 per week after initial aging period. The tuning capacitor of the oven-controlled crystal oscillator is connected (see sketch) through a gear train having a fixed reduction of 1/6,000, and a set of chosen gears to a motor having 1/432 rpm. The chosen gears are selected after an examination of the crystal aging characteristics and a proper set

are picked. As the clock motor and fixed gear train operate, the tuning capacitor is varied at 5.5×10^{-4} revolutions per day or 0.2 degree. The tuning capacitor has a travel range of 150 degrees and can vary frequency by 3 cps. A change of 0.2 degree per day equals frequency change of 4 parts in 10^9 per day (assuming chosen gear ratio of 1:1). As the unit operates, a front-panel digital counter indicates the amount of compensating capacitance remaining. No other adjustment is required for a minimum period of one year.

CIRCLE 301 ON READER SERVICE CARD

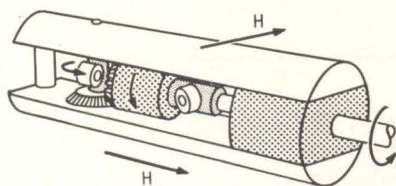

Axial Field Gaussmeter

FOR THREE DIMENSIONS

MANUFACTURED by Rawson Electrical Instrument Co., Inc., 110 Potter St., Cambridge 42, Mass., is the type 729 gaussmeter capable of measuring a magnetic field in three dimensions. Having a probe diameter of $\frac{1}{8}$ in. and a length of ap-

proximately 20 inches, ranges are 0.4, 1.2, 4, 12, 40 and 120 kilogauss. Accuracy is 1-percent of full scale. The device has a second coil (see sketch) rotating at right angles to usual coil and sensitive only to fields along the axis. The two coils are matched in sensitivity and either can be used with the indicating meter. A field in any direction can be measured by combining the measurements of the two coils. Using the transverse coil, the transverse field is located in direction by rotating the probe on its axis until a maximum reading is obtained. An arrow on the case indicates direction and the meter indi-

cates intensity. Switching to the axial coil then gives a reading showing component of field along axis. Rotation of probe around axis does not vary reading of axial coil. Vector sum can be computed to give total field. All three mutually-perpendicular components can be measured separately if preferred. Measurements can be made of magnetic fields of solenoids, focussing coils and magnets for ion or electron beams.

CIRCLE 302 ON READER SERVICE CARD

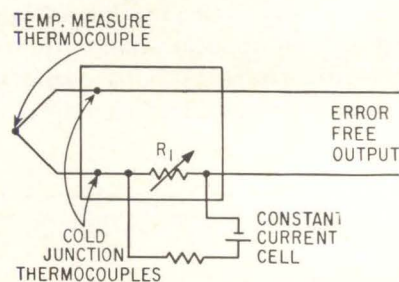

Thermocouple Reference

PASSIVE SELF POWERED

ANNOUNCED by Consolidated Ohmic Devices, Inc., New Hyde Park, New York, is the model EZT205 self-powered passive state thermocouple reference junction with ± 0.5 degree accuracy. The 25 gram weight device contains its own power source and can be supplied between -200 F and $+500$ F reference temperature. It may be used with chromel/alumel, copper/constantin and iron/constantin thermocouples as well as other thermocouple metals. Multiple installations may be achieved with infinite inter-channel resolution. Cold junction compensation (see sketch) is achieved by introducing an emf equal and opposite to the error emf produced by the cold junction thermocouples. Zero error is achieved by producing an emf across R_1 whose reciprocal equality to the cold junction thermocouple

HIGH PURITY METALS AND ELECTRONIC MATERIALS

METALS AND ALLOYS

ALUMINUM	ANTIMONY
ARSENIC	BISMUTH
CADMIUM	GOLD
INDIUM	LEAD
SILVER	TIN
	ZINC

High purity alloys are made from these metals to customer specifications.

STANDARD FORMS

INGOTS	SHEET
BAR	SHOT
RODS	POWDER
RIBBON	WIRE

PREFORMS

Preforms are available in a range of sizes and shapes such as discs, dots, washers, squares and spheres. Enquiries are invited on our alloy preforms.

COMPOUND SEMICONDUCTORS INDIUM ANTIMONIDE

Available as crystals, wafers, circles, rings and other shapes made to precise tolerances.

CHEMICALS SALTS SOLUTIONS

COMINCO PRODUCTS INC.

Electronic Materials Department
933 West Third Avenue
Spokane, Washington
Ph. RI 7-7103 TWX: SP 311

emf is maintained over an expanded temperature range. Exacting selection and temperature compensation of the constant-current source as well as unique alloy combinations for R_1 permits near perfect compensation for a wide variety of thermocouples. The resultant output voltage of the system is exactly equal to that generated by the thermocouple measurement junction.

CIRCLE 303 ON READER SERVICE CARD

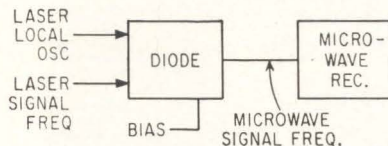

Photomixer Diode

DEMODULATES LASERS

MANUFACTURED by Philco Corporation, Church Road, Lansdale, Pa., the L-4500 silicon planar epitaxial diode is used to detect difference frequency between two closely-spaced optical laser frequencies. It provides high quantum efficiency and operates with bandwidths up to 5 Gc. In detecting wideband transmission from a laser, the mixing process is analogous to conventional superheterodynes. Unlike conventional crystal mixers, this device need not respond electrically to either a signal or a local oscillator frequency, merely to the difference frequency. At 7,000 A, quantum efficiency is estimated to be typically 85 percent. It is packaged in a coaxial microwave housing similar to conventional K-band mixer crystals. Direct coupling to a 50-ohm line is provided as the unit is also mounted in a BNC UG88/U coupler.

CIRCLE 304 ON READER SERVICE CARD

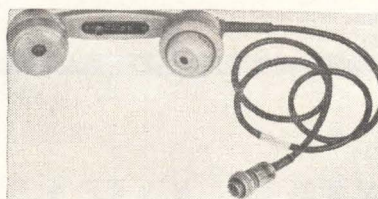

Heavy Duty Handset FOR MILITARY USE

ROANWELL CORP., 180 Varick St.,
New York 14, N. Y. Model RH-169

(38) heavy duty, naval/military communications handset, is designed to operate with a high level of intelligibility in high ambient noise level areas. The microphone effectively cancels unwanted sound by directing ambient noise to sound chambers on both sides of the diaphragm. Recommended load is 30 ohms. Frequency range is 300 cps to 5,000 cps and sensitivity is 35 db ref: 1 mv at 1,000 cps with sound pressure of 28 dynes/cm² applied.

CIRCLE 305 ON READER SERVICE CARD

Tetrode

PULSE MODULATOR

CALVERT ELECTRONICS, INC., 220 E. 23rd St., New York 10, N. Y. The 4PR60WB/C1149 pulse modulator tetrode features a reinforced grid/cathode structure that gives it extra reliability and long life characteristics under conditions of extreme vibration and mechanical stress.

CIRCLE 306 ON READER SERVICE CARD

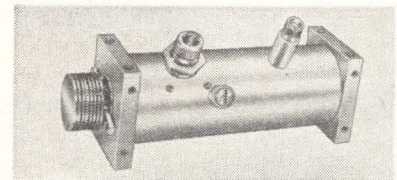

Pulse Oscillator

HIGH POWER

TRAK MICROWAVE CORP., Tampa, Fla. Type 2971 pulse oscillator has these typical characteristics: frequency, 1600 Mc; peak power, 5 Kw nominal; duty cycle, 0.0033 max; weight 12 oz and size 2.0 in. in diameter by 6 in. long. Required operating voltages and currents: peak cathode voltage 3,500 (negative), peak plate current 5 amp max, heater voltage 6.3 v a-c or d-c and heater current 1.3 amp.

CIRCLE 307 ON READER SERVICE CARD

Audio Oscillator

BARKER & WILLIAMSON, Bristol, Pa. Model 210 provides a sine wave signal from 10 cps to 100 Kc; output level within ± 1 db when working into 600 ohms (reference 5 Kc); power output, variable to above 150

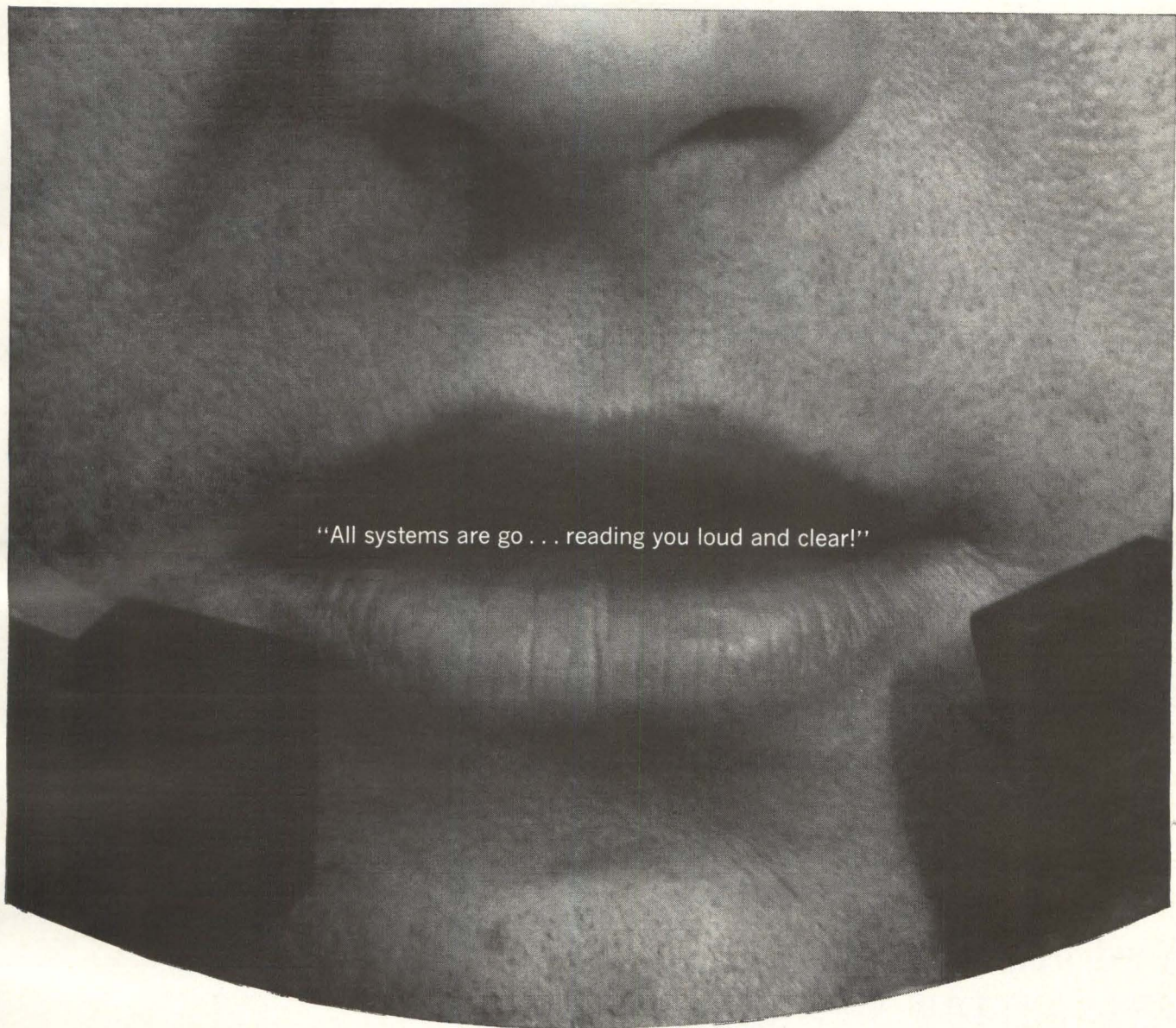

"All systems are go . . . reading you loud and clear!"

Your Project: America's Voice from Space

Your Company: Collins, whose equipment transmitted the voices of Alan Shepherd, Gus Grissom, and John Glenn, from space. Collins designs, develops, and produces systems essential to every phase of manned space capsules. Prelaunch . . . launch . . . flight . . . re-entry . . . recovery. Collins is the link between earth and space in both human and electrical language.

Your Opportunity: Collins is working on a variety of long-range space projects which provide openings for qualified E.E.'s, M.E.'s, mathematicians, and physicists for development of space communication systems. Specialists are required with design experience in HF, VHF and UHF equipment, digital communications, spacecraft antennas, television, radar, modulation techniques, tracking and ranging, information theory, and ground systems. If you are interested in the challenge of a career with Collins, contact L. R. Nuss, Collins Radio Company, Cedar Rapids, Iowa.

an equal opportunity employer





Now! from Weldmatic— PUSHBUTTON WELDING

DEMAND ANY OF 6 PRECISE PRESET HEATS
AT THE PUSH OF A BUTTON.

With a Weldmatic Model 1059B-1068 you can get a variety of precisely repeatable heat settings with push-button ease and speed. It's the positive way to increase production efficiency, minimize operator decision and error, cut rejects and waste.

Highest accuracy, too. Weldmatic Model 1059B Power Supply (voltage regulated) has a dual energy range of 45 and 9 watt-seconds. Model 1068 Weld Energy Selector mounts on top, plugs directly in, and becomes an integral part of the power supply. Operator selects one of five available weld energy settings (a sixth is obtained by depressing M Button for return to power supply) in either of the two ranges, as predetermined by the weld schedule. Button illuminates to indicate activated heat setting. Concealed heat adjustment panel (shown at left) minimizes inadvertent setting changes. Can be used with one or two welding heads. Ask your Weldmatic representative or write to the Weldmatic Division/Unitek, 950 Royal Oaks Drive, Monrovia, California.



WELDMATIC DIVISION / UNITEK

mw; hum and noise, -70 db at 5 v output; distortion, less than 0.2 percent at 5 v output from 50 to 20,000 cps.

CIRCLE 308 ON READER SERVICE CARD

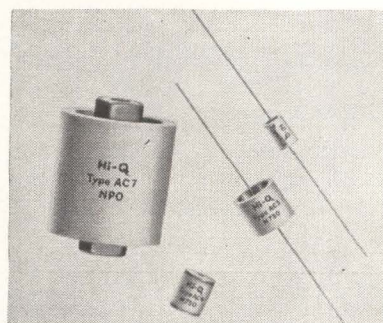

Ceramic Capacitors

FOR H-F SERVICE

HI-Q DIV., Aerovox Corp., Olean, N. Y. Aerocup small, light weight, ceramic capacitors are useful in such applications as transmitters, ultrasonic equipment, electronic welding machines, ovens and induction heating devices. Values range from 2 to 1,000 μmf , depending on type, with standard tolerances as low as ± 5 percent. Capacitors also have a low power factor—ranging from 0.05 percent to 0.1 percent, max.

CIRCLE 309 ON READER SERVICE CARD

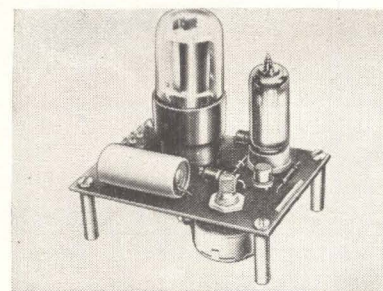

Power Supply Modules

SMALL SIZE, LOW COST

PRODUCTION ELECTRONICS INC., 525 Lehigh Ave., Union, N. J. Model DCV-121 is designed to provide regulated d-c output from unregulated d-c input. Entire circuit is on a p-c board provided with threaded standoffs for mounting. The ACV-121 uses the same regulating circuit as the DCV-121 and has its own built-in power transformer, rectifier and filter to provide operation directly from the a-c power line. An auxiliary a-c output of 6.3 v at 2.0 amp is provided. Both units have

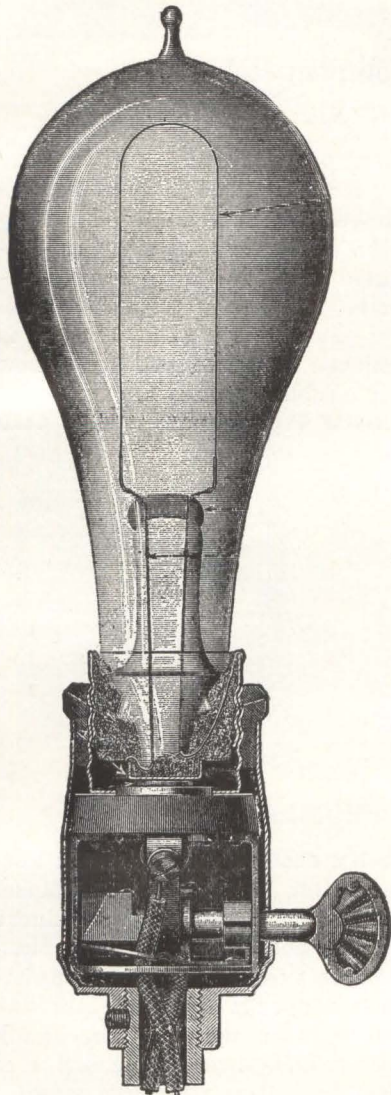

**Is it ancient history
by the time you see
electronics?**

Get the facts while they're new. Don't wait for **electronics** on a route slip. Look in this issue for the Reader Service Card. Fill out and mail the "for subscriptions" section. Only 7½ cents a week.

electronics

A McGraw-Hill Publication, 330 West 42nd St., N. Y. 36

June 1, 1962



Employment opportunities with

PAN AM at Cape Canaveral

Scientific Advisory Staff
Advanced Planning
Range Instrumentation
Planning & Systems
Design
Program Management
Operations
Facilities Planning
Facilities Engineering

Pan American, as prime contractor to the U.S. Air Force, has fulfilled the responsibility for planning, engineering, operating and maintaining Cape Canaveral and the Atlantic Missile Range since 1953.

Pan American scientists and engineers have participated intimately in all stages of the national programs since early V-2 tests through Project Mercury's series of manned space flights.

With Pan American, technically respected people have freedom to choose career positions with unlimited opportunities for professional development.

In addition to normal company benefits, Pan Am offers the unique advantage of a 90% world-wide air-travel discount.

You are invited to send your resume in confidence to David H. Bruner, Personnel Manager, Guided Missiles Range Division, Pan American World Airways, Inc., P.O. Box 4336, Patrick Air Force Base, Florida.

An Equal Opportunity Employer.



GUIDED MISSILES RANGE DIVISION

CAPE CANAVERAL, FLORIDA

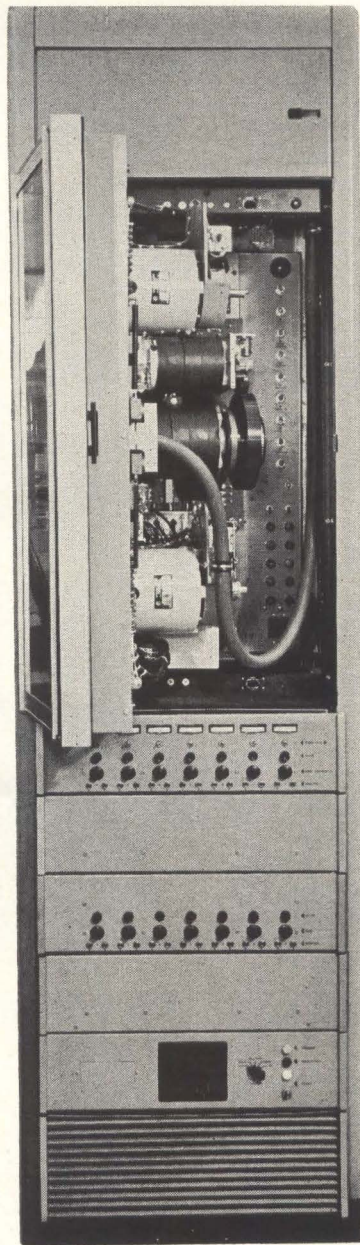

Look in on 7 channels of

Inside this new, 7-channel, VR-3600 Magnetic Tape Recorder/Reproducer by CEC is circuitry that meets the toughest of specs—and simultaneously records predetected and postdetected data. A completely integrated system, its skew is under $\pm 0.30 \mu\text{sec}$; intermodulation distortion, under 0.75%; flutter, less than 0.10% at 120 ips. And a 1.0 μsec . phase response on the low pass channels permits faithful reproduction of transient information. It has 4 predetection and 3 postdetection channels and 3 operating speeds (30 to 120 ips.) The VR-3600 is packaged in this single cabinet, thanks to compact styling and use of solid-state electronics—plug-in record and reproduce amplifiers with printed circuit epoxy boards. Tape transport and electronics are placed to insure maximum operator efficiency. »»

typical regulation of 0.02 percent for both line and load variation.

CIRCLE 310 ON READER SERVICE CARD

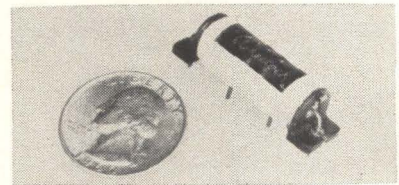

Compact Relay

GENERAL PURPOSE

WHELOCK SIGNALS, INC., Long Branch, N. J., offers a long life, 4 pdt relay. Contacts conservatively rated at 15 amp, 115 v a-c are separated by molded Melmac arc barriers for increased switching reliability. Fast, one plane wiring is achieved through the use of new crimp-solder terminals.

CIRCLE 311 ON READER SERVICE CARD

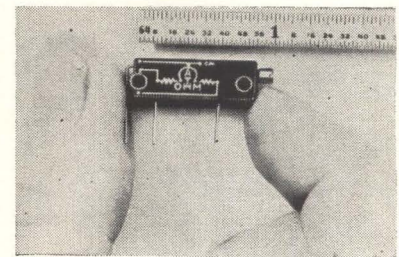

Trimmer Pot

RECTILINEAR

ATOHM ELECTRONICS, 7648 San Fernando Rd., Sun Valley, Calif. Model 225 is a mil-quality, rectilinear trimmer pot with p-c lugs and measuring less than 1 in. overall. Resistance range is 10 ohms through 100,000 ohms with ± 5 percent tolerance, and power rating is 2 w at 70 C. Operating temperature range is -65 C to $+200 \text{ C}$. End resistance is 0.25 percent or 1 ohm, whichever is greater. Case is sealed against humidity.

CIRCLE 312 ON READER SERVICE CARD

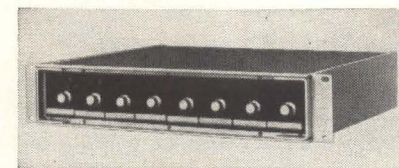

Amplifier

FOR GALVANOMETERS

VIDAR CORP., 2296 Mora Drive, Mountain View, Calif. A high-level

d-c amplifier, model 410, is designed to drive galvanometers and other low impedance loads requiring high current output. Input impedance is greater than 1 megohm; output impedance, less than 1 ohm. Output is ± 10 v at ± 100 ma. Gain is continuously adjustable from 1 to 20, plus four calibrated settings. Response is flat within ± 2 percent, d-c to 10 Kc.

CIRCLE 313 ON READER SERVICE CARD

Down Converter

INTERNATIONAL MICROWAVE CORP., 1 Seneca Place, Greenwich, Conn. Microwave down converters, operating in the 2 to 12 Gc range, measure 8 cu in., include a transistor i-f preamplifier with 34 db gain and 100 Mc bandwidth.

CIRCLE 314 ON READER SERVICE CARD



TR Tube

100 KW PEAK POWER

METCOM INC., Salem, Mass. The MST-38 is a crystal protector TR tube for use in high pressure systems. It has a peak power of 100 Kw; has a frequency range of 2,625-2,925 Mc, and can be used in systems pressurized up to 50 psig.

CIRCLE 315 ON READER SERVICE CARD

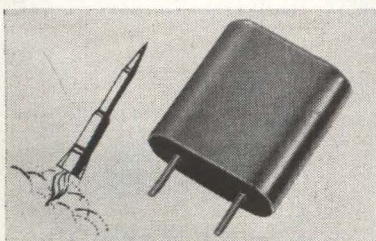

Crystals

HIGH VIBRATION

MONITOR PRODUCTS CO., INC., 815 Fremont Ave., South Pasadena, Calif., announces the MC-V series in frequency ranges from 4 Kc to 100 Mc. Vibration is 30 g at 20 to 3,000 cps. Shock is 100 g. Frequency tolerance over temperature

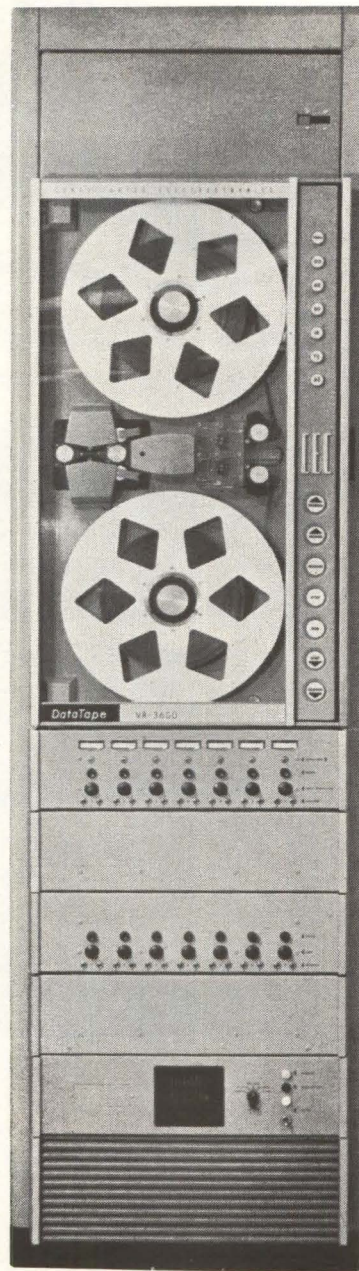

pre/post detection telemetry

Mode and speed selector controls are back-lighted and clearly marked ... and you can load and unload reels standing up. ■ Designed with an eye on telemetry ground stations (tracking stations included), VR-3600 is right at home in a laboratory type environment. ■ Want more information—besides this ... and that on the left hand page? Your CEC sales and service office will be glad to furnish it. Just call. Or, write for Bulletin CEC 3600-X6.

CEC

Data Recorders Division

CONSOLIDATED ELECTRODYNAMICS
PASADENA, CALIFORNIA • A SUBSIDIARY OF BELL & HOWELL

CIRCLE 95 ON READER SERVICE CARD

95

BALLANTINE VOLTMETER

model
305A

Price \$415.

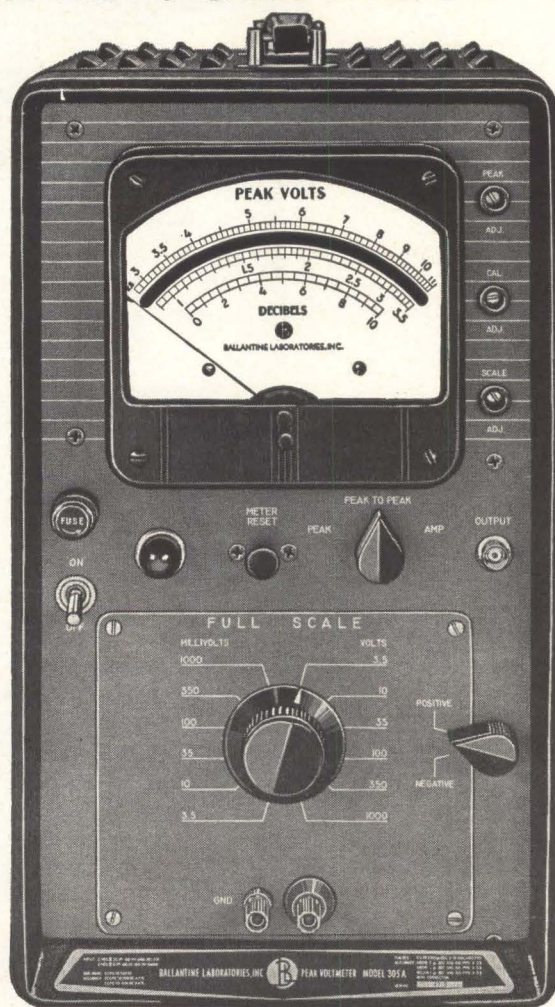

**MEASURES
PEAK**

**OR PEAK-TO-PEAK PULSES
AS SHORT AS 0.5 μ s**

**... at pulse rates as low as 5 pps ... voltages
of 1 mV to 1000 V**

Also measures **COMPLEX WAVEFORMS** having fundamental of 5 cps to 500 kc with harmonics to 2 Mc.

ACCURACY is 2% to 5% OF INDICATED VOLTAGE, depending upon waveform and frequency.

SCALE is the usual Ballantine log-voltage and linear db, individually hand-calibrated for optimum precision.

INPUT IMPEDANCE is 2 meg, shunted by 10 pF to 25 pF.

Write for brochure giving many more details

— Since 1932 —

B **BALLANTINE LABORATORIES INC.**

Boonton, New Jersey

CHECK WITH BALLANTINE FIRST FOR LABORATORY AC VACUUM TUBE VOLTMETERS, REGARDLESS OF YOUR REQUIREMENTS FOR AMPLITUDE, FREQUENCY, OR WAVEFORM. WE HAVE A LARGE LINE, WITH ADDITIONS EACH YEAR. ALSO AC/DC AND DC/AC INVERTERS, CALIBRATORS, CALIBRATED WIDE BAND AF AMPLIFIER, DIRECT-READING CAPACITANCE METER, OTHER ACCESSORIES. ASK ABOUT OUR LABORATORY VOLTAGE STANDARDS TO 1,000 MC.

range of -55°C to $+105^{\circ}\text{C}$ to ± 0.003 percent depending on frequency. Frequency tolerance under vibration is not more than 5 parts per million. Prices from \$9 to \$55 each in small quantities.

CIRCLE 316 ON READER SERVICE CARD

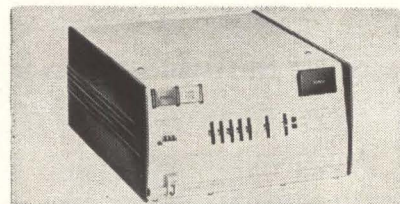

Tape Punch

SEMIAUTOMATIC

JONATHAN ELECTRONICS CORP., 1151 E. Ash St., Fullerton, Calif. Although a single-column punch, model J-3000 performs the functions of more expensive block punch units through the use of a system of panel thumbwheel switches which position a set of memory cams. These cams program the punching logic to the correct hole pattern for each block of data, while returning the panel switches to the zero position. Unit has a standard capacity of 117 bits per block.

CIRCLE 317 ON READER SERVICE CARD

Industrial Laminate

GENERAL ELECTRIC CO., Coshocton, O. Low-cost warm-to-hot punching grade of Textolite industrial laminate, grade 11602, is available. The paper base phenolic laminate is a NEMA grade XP and is rated Class A for insulation purposes.

CIRCLE 318 ON READER SERVICE CARD

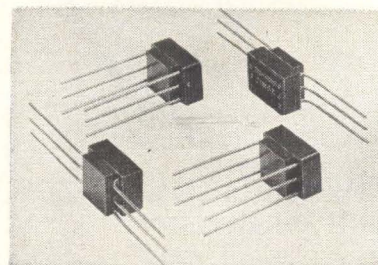

Pulse Transformers

MINIATURIZED

TECHNITROL INC., 1952 E. Allegheny Ave., Philadelphia 34, Pa. Genie pulse transformers have a rectang-

ular shape, 0.650 by 0.425 by 0.350 in., which results in a minimum waste of space between components. Even when a transformer is mounted flush against a p-c board, the leads are exposed on both sides of the board for convenient testing. The exposed leads also permit solder flux to be easily flushed away. Lead clearance eliminates the need for tight tolerances on hole spacing.

CIRCLE 319 ON READER SERVICE CARD

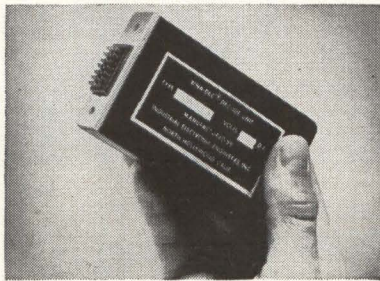

Decode Unit

ELECTROMECHANICAL

INDUSTRIAL ELECTRONIC ENGINEERS, INC., 5528 Vineland Ave., N. Hollywood, Calif. Low-cost electromechanical decoder can be driven directly by transistor circuitry. Requiring only 40 mw per bit with a 4 w set pulse, the Bina-Dec decoder will accept any 4-bit code. The 50-w output contact capacity can be used without amplification to drive readouts, indicator tubes, printers, key punches and other equipment requiring decimal output.

CIRCLE 320 ON READER SERVICE CARD

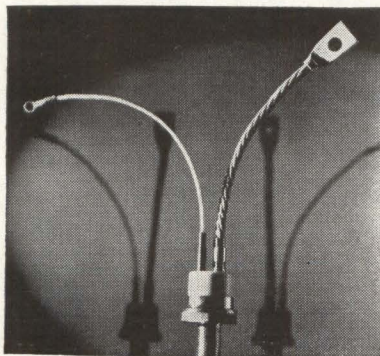

Four-Layer PNP SCR

70-AMPERE

WESTINGHOUSE SEMICONDUCTOR DIV., Youngwood, Pa., offers a 70-amp Rock-Top Trinistor controlled-rectifier line with forward blocking voltage to 400 v and prv to 480 v. The scr features a turnoff time of 10 to

APPLICATION ENGINEERING NOTE FROM ALADDIN ELECTRONICS

Blocking oscillator circuits

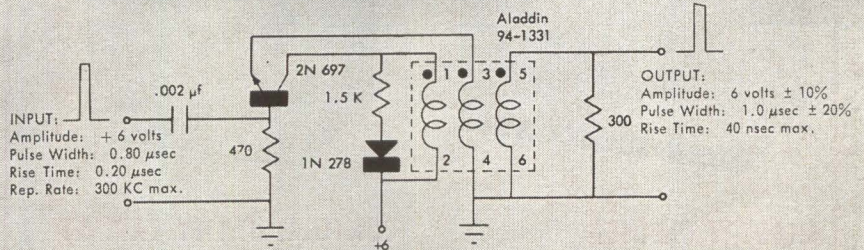

for 40 nanoseconds rise time

Shown above is a common base transistor blocking oscillator using the popular 2N697 transistor. This circuit offers a rise time of 40 nanoseconds maximum as well as a duty cycle of 30%.

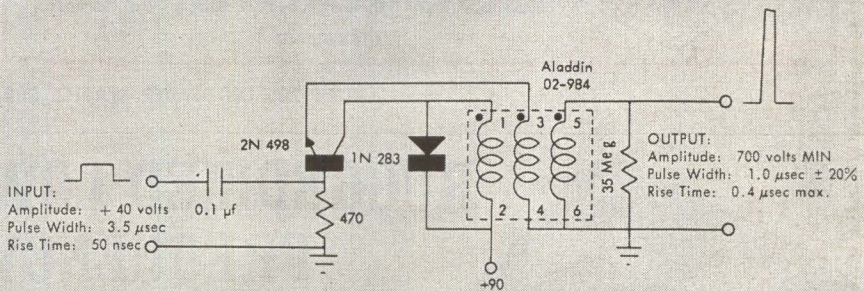

for 700 volt amplitude

A look at the output characteristics of the circuit above indicates it will produce a one microsecond wide pulse with an amplitude of at least 700 volts. Ideal for circuits where high voltage is needed and the current drain is low—e.g., igniting a thyatron.

Using other transistors or transformers in the circuits shown above, it is possible to get many combinations of performance characteristics. For information to assist you in the design of circuits involving pulse transformers, wide band coupling transformers or inductors, write for your free copy of our "Product Directory!"

Write Department 2-E

Aladdin[®]
electronics
"Where the Magic of Magnetics is a Science"
A Division of Aladdin Industries, Inc., Nashville 10, Tennessee

VALUE ENGINEERED

BUD ELECTRONIC CABINETS

YOUR BEST BUY

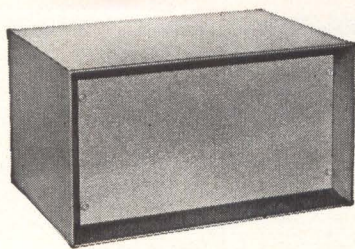

SHADOW CABINET

Both front and rear panels as well as bottom may be removed for installation or servicing purposes. Unusually attractive appearance is created by recessing the front panel as well as by beveling the front. The recessed front panel prevents accidental movement of controls attached to it. The two piece body is made of 18 gauge steel and the panels of 16 gauge steel. Four sizes available. Finished in light gray hammertone.

See these and other Bud Housings at your local Authorized Bud Distributor. Inspect them for engineering and fabrication features that save you money. Catalog available upon request.



BUD RADIO, INC.

CLEVELAND 3, OHIO

CIRCLE 205 ON READER SERVICE CARD

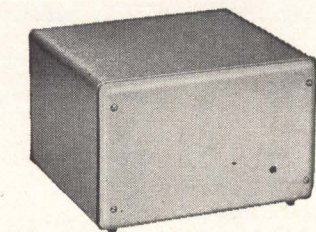

CONTOUR UTILITY CABINET

A very practical housing with symmetry and strength. The rounded contour corners as well as the flanged panels combine to preserve the eye-catching design. All parts are fabricated from 20 gauge steel to provide strength and rigidity. Both front and rear panels are removable. Six sizes available. The body is finished in smooth dark gray enamel and the panels in light gray enamel.

20 μ sec. Turn-on time is 0.6 to 3.0 μ sec and max d-c current is 110 amp. Typical applications include high-power inverters, light dimmers, motor control, magnetic amplifier replacement, ignitron firing, frequency changers and d-c power regulators.

CIRCLE 321 ON READER SERVICE CARD

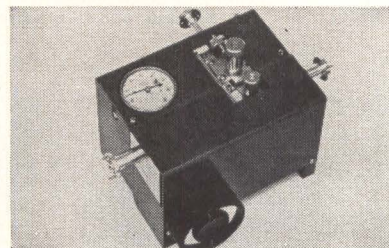

Calorimeters

USED AT 26-140 GC

TRG, INC., 400 Border St., East Boston, Mass. Line of calorimeters, useful over the entire 26 to 140 Gc band, have a power range of 10^{-4} to 0.5 w, and a vswr of 1.3 max. Stabilization time is 10 sec, accuracy is 5 percent (5 to 500 mv), water flow rate is approximately 2 cc per min, and power is supplied by internal batteries. Units provide rapid, accurate and relatively inexpensive measurement of millimeter power.

CIRCLE 322 ON READER SERVICE CARD

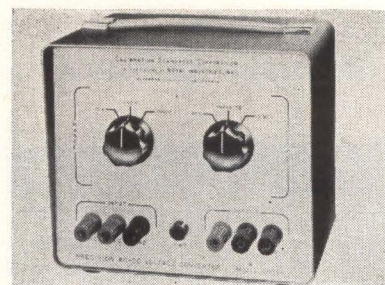

A-C/D-C Converter

SOLID STATE, LOW COST

CALIBRATION STANDARDS CORP., 1031 Westminster Ave., Alhambra, Calif. Designed to extend the operation of existing d-c precision and digital voltmeters to have a-c measuring capabilities, the model C-100A is also used in electronic systems where an a-c signal must be converted to d-c prior to control, computing or measuring. Instruments feature a frequency range of 30 cps to 10 Kc with accuracy of 0.15 percent. Voltage ranges, 0.5 to



RUGGEDIZED LOW FREQUENCY CRYSTALS

1 kc
to
250 kc

Bliley BH9 Series offers choice of standard Mil Specs. and low resistance/ruggedized types. Bulletin 501 provides complete specifications.

Bliley ... if you buy quality

BLILEY ELECTRIC COMPANY / ERIE, PENNSYLVANIA

100 CIRCLE 100 ON READER SERVICE CARD

electronics



DON'T HUNT!

for connectors or components

Even with a bloodhound you can't beat the ease of POWELL'S catalog 62 when looking for the exact connector or component you need.

POWELL'S catalog 62 is the only catalog to have **BENDIX PYGMY** and **WINCHESTER ELECTRONICS, INC.** connectors completely listed, illustrated and priced.

POWELL'S catalog 62 also contains design and dimensional data, as well as prices, of **DAGE - MICRODOT - ELCO - RAYTHEON - SEAELECTRO** - and 13 other major component manufacturers.

Powell Electronics, Inc., an authorized stocking distributor for the 20 manufacturers in catalog 62, offers this unique reference manual as evidence of our stock and our effort toward ever improving service.

Write today for your FREE copy

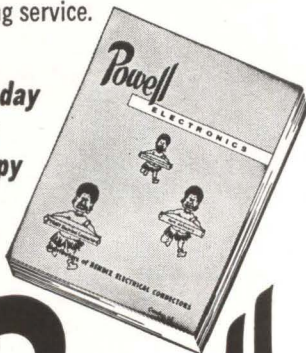

Powell

ELECTRONICS
INCORPORATED
P.O. BOX 8765 • PHILADELPHIA 1 • PA.
Saratoga 4-1900 • TWX PH45

CIRCLE 210 ON READER SERVICE CARD

June 1, 1962

10, 10 to 100 and 100 to 1,000 v a-c. Voltage linearity is better than 0.02 percent typical; frequency linearity, better than 0.05 percent typical.
CIRCLE 323 ON READER SERVICE CARD

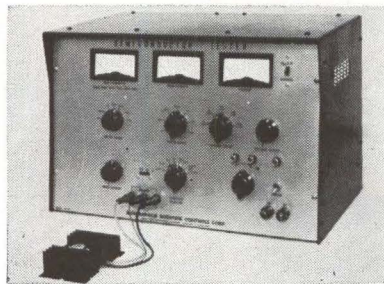

Semiconductor Tester VERSATILE UNIT

MINNEAPOLIS SCIENTIFIC CONTROLS CORP., 9330 James Ave. S., Minneapolis 20, Minn. Model ST101 tests d-c characteristics of transistors, diodes and rectifiers. It features 25 amp current capability and simplicity of operation. Used for either production or laboratory testing, the unit's output power range is up to 150 w. Three meters are mounted in the face plate and give readings for base current, main current and voltage.

CIRCLE 324 ON READER SERVICE CARD

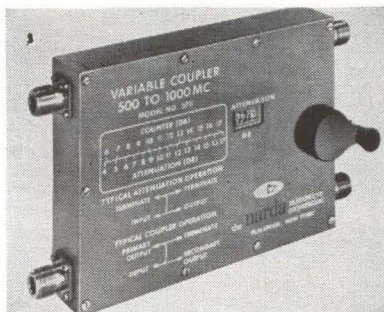

Digital Attenuator PRECISION UNIT

NARDA MICROWAVE CORP., Plainview, L. I., N. Y. Model 3711 coaxial coupler-attenuator features an accurate digital counter. The high power unit exhibits an extremely low vswr (1.1 above 15 db) and covers the octave frequency range from 500 to 1,000 Mc. For any setting above 20 db, relative accuracy is 0.1 db within any 10 db range and 0.3 db max up to 70 db range. Absolute accuracy is 1 db anywhere in the attenuation or frequency range.

CIRCLE 325 ON READER SERVICE CARD

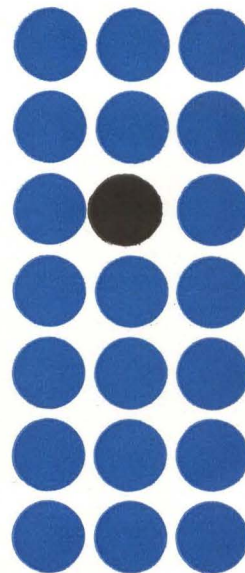

SEMI- CONDUCTOR TESTER

Accurately tests diodes, rectifiers and transistors



- Measures Beta, I_{CBO} , I_{EBO} , I_{CEO} , I_{CES} and I_{ECS} as well as all bias voltages and currents of transistors, diodes, and rectifiers.
- Base current, collector and leakage voltages are all continuously variable.
- Panel designations show proper terminal connections to semi-conductor.
- Self contained power supplies.
- A three-position test switch automatically provides the proper voltage and current polarities and illuminates polarity "Reminder" indicator.

POWER RANGE... microwatts to 150 watts
CURRENT RANGE... microamps to 25 amps
UNIT PRICE... \$745
For prompt information and detailed specifications... call or write

**MINNEAPOLIS
SCIENTIFIC
CONTROLS**

9330 James Ave. S. • Minneapolis 20, Minn. • TU 8-4671

CIRCLE 101 ON READER SERVICE CARD 101

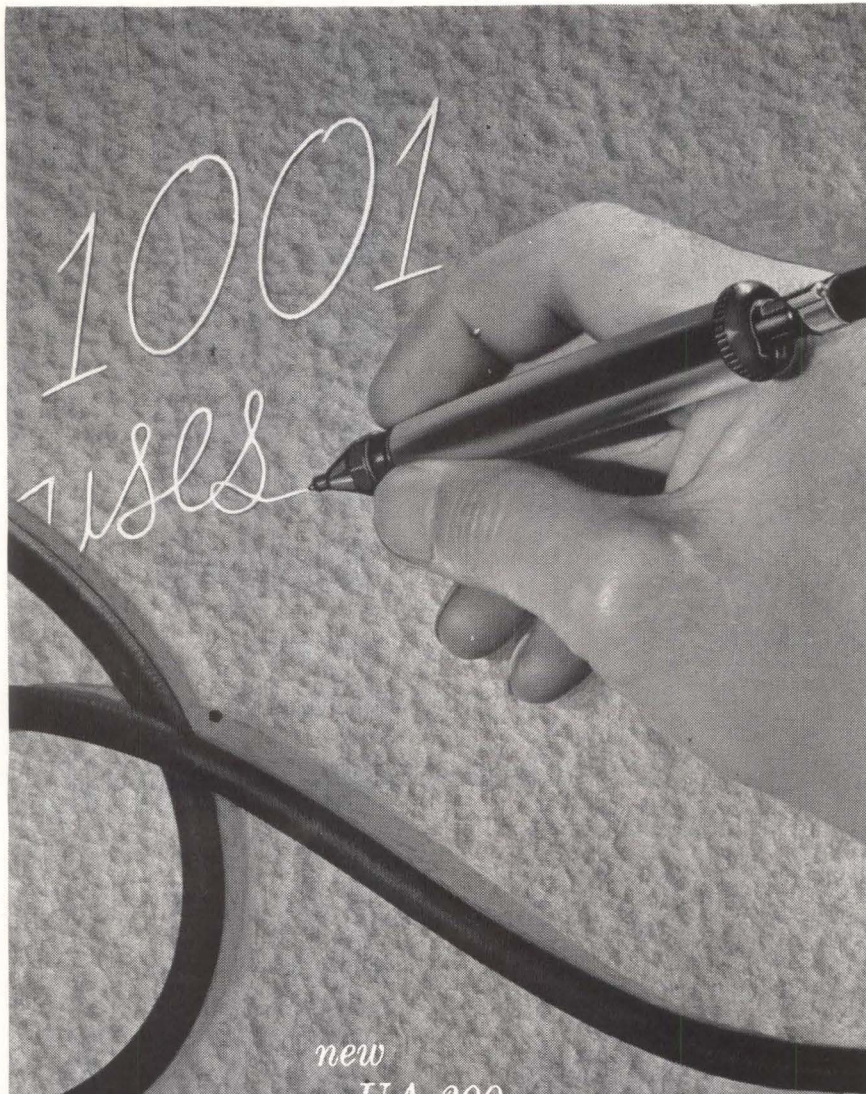

new
UA-300
power writer

UTICA

Just as the name implies, the UA-300 Power Writer is a power writing tool. It's a pencil styled, air-activated tool for inscribing, coding, labeling or marking all types of materials such as hard and soft metals, plastics, ceramics and glass. Almost vibrationless, the tool produces readable marks down to $\frac{1}{32}$ ". It operates on a line pressure of 40 to 100 psi. No valves or regulators needed. Each unit is equipped with an 8 ft. air hose. Anyone who can handle a piece of chalk or pencil can write on metal or other hard surfaces with this new tool. Write for price and complete information.

UTICA DROP FORGE & TOOL DIVISION • KELSEY-HAYES COMPANY, UTICA 4, NEW YORK

PRODUCT BRIEFS

WELDING MACHINE 6,000 F torch flame. Henes Mfg. Co., 1336 N. 21st Ave., Phoenix, Ariz. (326)

ASYMPTOTIC CALORIMETER 10 mv full scale output. Hy-Cal Engineering, 12105 Los Nietos Road, Santa Fe Springs, Calif. (327)

SOLID-STATE DIGITAL CLOCK features flexibility. Ransom Research Div., Wyle Laboratories, San Pedro, Calif. (328)

TAPE RECORDER BRAKE in one complete assembly. Magnasync Corp., 5546 Satsuma Ave., N. Hollywood, Calif. (329)

CLUTCH-POTENTIOMETER size 9, low cost. FAE Instrument Corp., 16 Norden Lane, Huntington Sta., N. Y. (330)

LASER POWER SOURCE and energy storage bank. Electro Powerpacs, Inc., 5 Hadley St., Cambridge 40, Mass. (331)

FREQUENCY-PHASE LOCK CONTROL SYSTEM with 100 percent accuracy. Sequential Electronic Systems, Inc., 66 Saw Mill River Road, Elmsford, N. Y. (332)

A-M RECEIVER 2.0 to 30.0 Mc range. Advanced Communications, Inc., 7225 Alabama Ave., Canoga Park, Calif. (333)

DECADE INDUCTOR direct digital readout. Arnold Magnetics Corp., 6050 W. Jefferson Blvd., Los Angeles, Calif. (334)

VARACTOR MOUNT high heat dissipation. Microwave Associates, Inc., Burlington, Mass. (335)

DIGITAL FREQUENCY METER 300 Kc. Racal Electronics Ltd., Bracknell, Berkshire, England. (336)

RELAYS dry reed contacts. Hathaway Instruments, Inc., 5800 E. Jewell Ave., Denver, Col. (337)

FIELD EFFECT TRANSISTOR diffused silicon. Amelco, Inc., 341 Moffett Blvd., Mtn. View, Calif. (338)

COMPUTER SUPPLY multiple output. Atlas Controls, Inc., 9 Erie Drive, Natick, Mass. (339)

HALL EFFECT MULTIPLIER single unit priced at \$50. Helipot Div. of Beck-

new

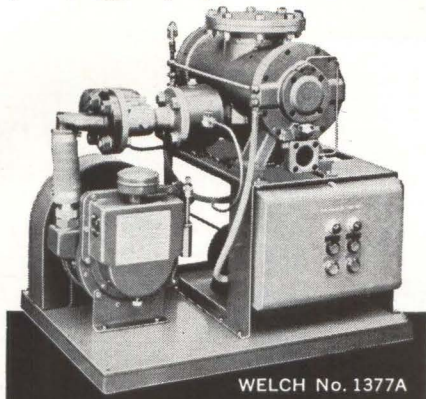

WELCH No. 1377A

Ultra High Vacuum Pumping System

140 Liters per Second Ultimate Vacuum
 1×10^{-9} mm Hg (Torr)

**WITH CONSTANT SPEED
OVER WIDE PRESSURE RANGE**

The new Welch 1377A Turbo-Molecular Pumping System produces an ultimate vacuum of 1×10^{-9} mm Hg (Torr) and better; constant speed of 140 liters per second, over a range of 1×10^{-2} to 1×10^{-8} mm Hg (Torr).

The clean, *vapor-free* Turbo-Molecular Pump is combined with the well known Welch Duo-Seal 1397 two-stage mechanical pump, providing a completely assembled and tested pumping system, ready for use.

Advance design of the Turbo-Molecular Pump permits the use of an air slit ten times the size of previous designs and greatly reduces risk of damage by impact, heat expansion and dirt particles.

TYPICAL USES:

- Evacuation of power tubes and X-ray tubes.
- Solid state research.
- Semi conductor production.
- Thin film metallizing.
- Purification of metals.
- Optic coating.

The Welch 1377A is particularly useful in processes involving separation of materials or isotopes with different molecular weights, as in particle acceleration work.

Send for Bulletin 1377A
TODAY!



SINCE 1880 THE WELCH SCIENTIFIC COMPANY
foremost manufacturers of scientific equipment
1507N. Sedgwick Street, Chicago 10, Illinois

CIRCLE 206 ON READER SERVICE CARD

June 1, 1962

man Instruments, Inc., 2500 Harbor Blvd., Fullerton, Calif. (340)

GALVANOMETER AMPLIFIER solid state. Vidar Corp., 2296 Mora Drive, Mtn. View, Calif. (341)

SEQUENCE TIMER battery powered. Geodyne Corp., 180 Bear Hill Road, Waltham 54, Mass. (342)

FAULT-RECORDING SYSTEM automatic. Western Electrodynamics, P.O. Box 98, Colorado Springs, Colo. (343)

PRECISION POTENTIOMETER low-priced Micropot. Borg Equipment Div., Amphenol-Borg Electronics Corp., Janesville, Wis. (344)

COMPACTRON TUBES 12-pin. Tung-Sol Electric Inc., 1 Summer Ave., Newark 4, N. J. (345)

EVENT RECORDING SYSTEM 120-channel. Sanborn Co., 175 Wyman St., Waltham 54, Mass. (346)

TRANSFORMERS used at 300 cps to 30 Mc. Aladdin Electronics, Nashville 10, Tenn. (347)

SILICON RADIATION DETECTORS for alpha particle detection. Ferranti Electric Inc., Industrial Park No. 1, Plainview, L. I., N. Y. (348)

CLIMATE CONTROL CABINET compact unit. Dexon Inc., 3517 Raleigh, Minneapolis 16, Minn. (349)

THERMISTOR PROBE fast acting. Fenwal Electronics, 63 Fountain St., Framingham, Mass. (350)

INDUCTORS subminiature. Vanguard Electronics Co., 3384 Motor Ave., Los Angeles 34, Calif. (351)

NPN CHOPPER TRANSISTORS silicon planar/epitaxial. Advanced Micro Electronics, 99 Bald Hill Road, Cranston 10, R. I. (352)

SIGNAL GENERATOR transistorized. Consolidated Cybernetics Controls, P. O. Box 67, Station H. Montreal 25, P. Q., Canada. (353)

1-MC OSCILLATOR high stability. Hewlett-Packard Co., 1501 Page Mill Road, Palo Alto, Calif. (354)

POT PRESSURE TRANSDUCER carbon-film resistive element. Computer Instruments Corp., 92 Madison Ave., Hempstead, N. Y. (355)

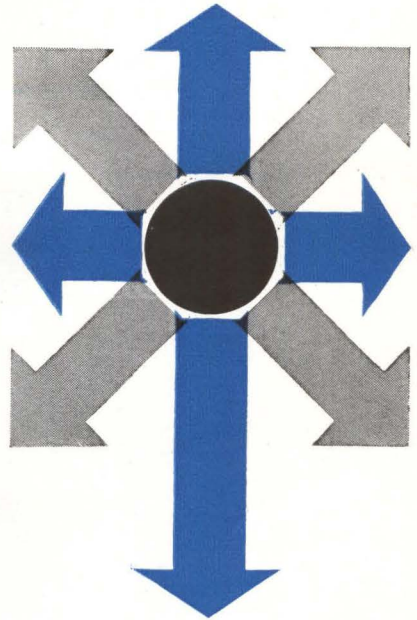

NEW BROAD BAND HF MULTI- COUPLER

Isolates and amplifies up to 8 selectable signal outputs in a frequency range from .04 to 40 mcs from one antenna



This solid state multi-coupler was designed for use in high frequency direction-finding or communications systems and in video distribution application where it is desired to operate two or more receivers from a single antenna. Amplification is 18 ± 2 db with a noise figure of less than 6 db. Distortion is minimized through use of linear transistorized circuitry design. Unit price \$675.

For prompt information and quantity prices, call or write



**MINNEAPOLIS
SCIENTIFIC
CONTROLS**

9330 James Ave. S. • Minneapolis 20, Minn. • TU 8-4671

CIRCLE 103 ON READER SERVICE CARD

103

Literature of the Week

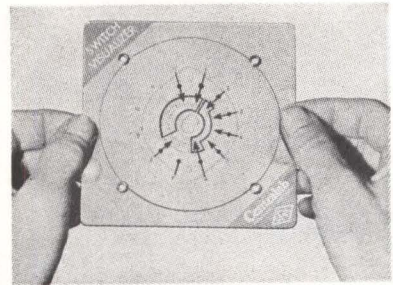

SWITCHES Centralab, 900 E. Keefe Ave., Milwaukee 1, Wisconsin. A 43 page catalog and reference bulletin covers rotary, slide and lever switches. Available via a card in this catalog is a switch visualizer made of translucent plastic (see photo) which represents a 12-position rotary switch section. The plastic can be drawn on and erased repeatedly. The main square card represents the stator while the rotor can be revolved to simulate actual switch action. Using the rotor and stator connections for the switch in question, the visualizer readily and conveniently finalizes switch section design before referring to and filling in the switch specification sheet. A series of switch specification sheets are also available. These sheets, used in conjunction with the switch visualizer, list and illustrate design parameters of switch type under consideration and can be used as master drawings. (356)

AEROSPACE GROUND EQUIPMENT Arma Div., American Bosch Arma Corp., Garden City, N. Y., has issued a brochure describing its capabilities in development and production of aerospace ground equipment. (357)

MEMORY SYSTEMS Indiana General Corp., Electronics Div., Keasbey, N. J., has published a 6-page "Applications Guide to Magnetic Core Memory Systems." (358)

MAGNETIC AMPLIFIERS Military & Computer Electronics Corp., 900 N.E. 13th St., Ft. Lauderdale, Fla., offers a data sheet kit on its Ultra-mag harmonic type solid state magnetic amplifiers. (359)

POLYESTER-FILM CAPACITORS Sprague Electric Co., 35 Marshall

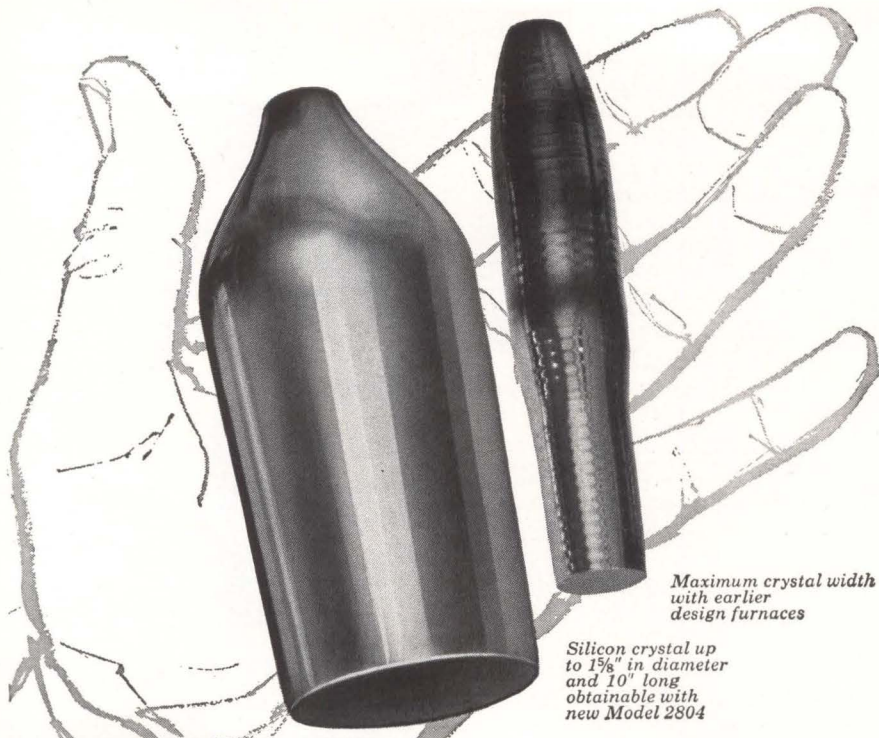

Maximum crystal width
with earlier
design furnaces

Silicon crystal up
to 1 1/2" in diameter
and 10' long
obtainable with
new Model 2804



100%

**PRODUCTION
INCREASE**

with the new NRC CRYSTAL GROWING FURNACE

The new NRC Model 2804 is a "Czochralski method" crystal furnace primarily designed for making single crystal ingots of silicon for semiconductor devices. However, it is easily adaptable for use with germanium and intermetallic compounds with reliability and consistently high quality.

Because the Czochralski method of growing single crystals is a critical process, it needs quality equipment with proven mechanical, thermodynamic and control features. Only from NRC can you buy a quality crystal growing unit with a proven record for high production and more profit. Buy the NRC Model 2804 with complete assurance that you can increase your production rate 100% and own the best equipment of its type available today.

UNIQUE FEATURES OF THE MODEL 2804

- Proven design for performance and reliability
- Inert gas or vacuum operation
- Precise temperature control
- Versatility of use
- Vibrationless mechanical motion-control
- Greater productivity and higher efficiency

Write today for a data sheet on the NRC Model 2804 Crystal Growing Furnace.



A Subsidiary of National Research Corp.

160 Charlemont Street, Dept. 4F
Newton 61, Massachusetts

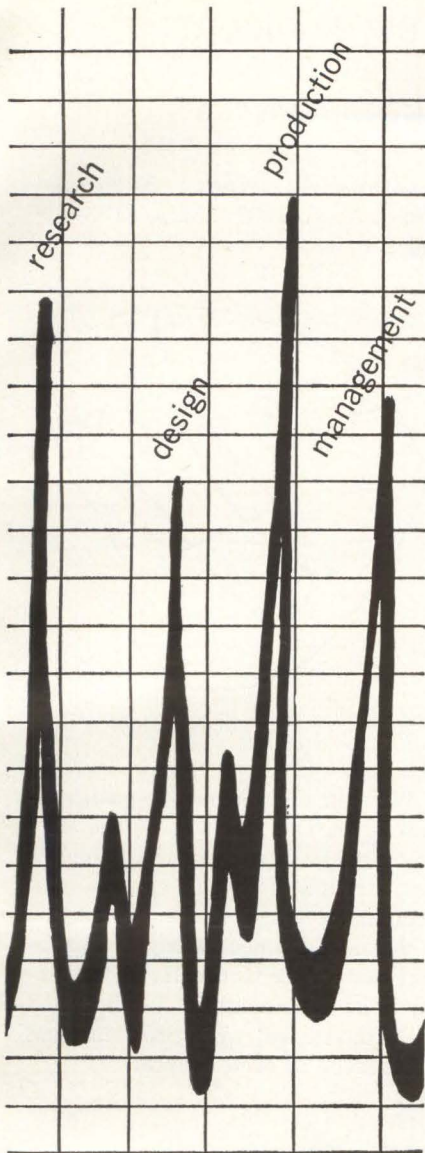

IT'S READ MORE BY ALL 4!

electronics magazine interprets electronics for electronics men every week. The latest components, economic trends, military applications. Technical data you'll want to file and keep. Get the facts first with a personal subscription (don't be low man on a routing slip). Mail the reader service card (postpaid) to **electronics**, the magazine that helps you to know and to grow! Rates: three years for \$12, one year for \$6; Canadian, one year for \$10; foreign, one year for \$20. Annual **electronics** BUYERS' GUIDE included with every subscription.

subscribe today to
electronics

June 1, 1962

St., North Adams, Mass. Technical paper No. 62-11 reports results of an evaluation program on wrapped-type PETP polyester-film capacitors. Available upon letterhead request.

ELECTRON-BEAM WELDING W. S. Romark and Co., Inc., 18233 S. Miles Parkway, Cleveland 28, O. Technical manual describes the electron-beam welding process and its application for joining miniature components. (360)

SEMICONDUCTORS General Instrument Corp., 65 Gouverneur St., Newark 4, N. J. Bulletin SR3099 covers silicon and germanium transistors and diodes, silicon Zener diodes and nanocircuits. (361)

MICROWAVE BULLETIN Empire Devices, Inc., Amsterdam, N. Y. Bulletin discusses five categories of microwave equipment. (362)

TIME INTERVAL COUNTER Eldorado Electronics, 2821 Tenth St., Berkeley 10, Calif. Bulletin describes the 108 series solid state 10 nsec time interval counter. (363)

L-F OSCILLATORS Accutronics, Inc., 12 South Island, Batavia, Ill., has produced a 4-page brochure entitled "How To Specify Low Frequency Oscillators." (364)

THIN FILM TECHNOLOGY Metavac, Inc., 45-68 162nd St., Flushing 58, N. Y. A 10-page catalog describes high vacuum thin film technology products for the microwave, electronics, optical and infrared industries. (365)

HAND WINDER Geo. Stevens Mfg. Co., Inc., Pulaski Road at Peterson, Chicago 46, Ill. Catalog page describes a heavy duty hand winder with 2 speed torque ranges. (366)

DIGITAL COMPARATOR Kearfott Div., General Precision, Inc., Little Falls, N. J. Reference sheet C05 9152 illustrates and describes a digital comparator. (367)

SPECTRUM ANALYZER Panoramic Electronics Inc., 520 S. Fulton Ave., Mt. Vernon, N. Y. Six-page folder describes the SPA-10 spectrum analyzer for signals in the 10 Mc through 43 Gc range. (368)

SOLDERS AND PAINT Joseph Waldman & Sons, 137 Coit St., Irvington 11, N. J., offers a bulletin on the use of epoxy silver solders and conductive coatings. (369)

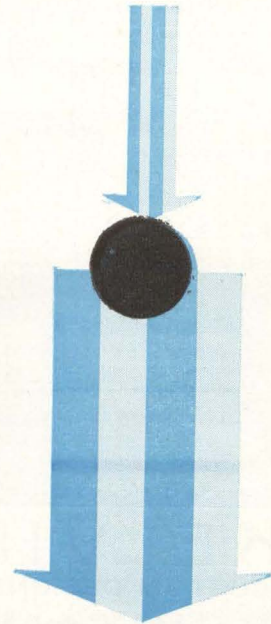

NEW WIDE BAND HF AMPLIFIER

Gives a 20 db gain in a frequency range of .05 to 50 mcs with less than 6 db noise figure



This miniaturized solid state HF amplifier was designed for use in control, navigation, communication, and video systems where minimum size, weight and power consumption are of primary importance.

MODEL BBA-1 SPECIFICATIONS
Size..... 2 3/4" x 1 3/4" x 1 1/8"
Power requirements..... 24 v d-c, 30 ma
Output voltage..... 1 volt pk
Input Z..... nominally 75 ohms
Output Z..... nominally 75 ohms
Unit price..... \$105

For prompt information and quantity prices on various models available, call or write

**MINNEAPOLIS
SCIENTIFIC
CONTROLS**

9330 James Ave. S. • Minneapolis 20, Minn. • TU 8-4671

THE PERFECT PACKAGE

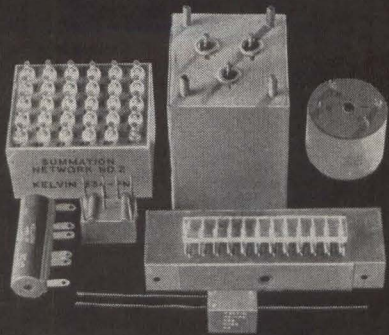

FOR HIGH PERFORMANCE APPLICATIONS

KELVIN CUSTOM DESIGNED RESISTANCE NETWORKS

Our experienced engineers will answer your application inquiries accurately and promptly. Send specifications or requirements to:

PRESENT APPLICATIONS:

VOLTAGE DIVIDERS	REFERENCE OR RATIO STANDARDS
COMPUTER APPLICATIONS	LADDER TYPE CONVERTERS
SUMMING NETWORKS	MISSILE CHECKOUT SYSTEMS
DIGITAL TO ANALOG CONVERSION	

Kelvin has specialized for years in the custom design and production of resistance networks to suit individual customer requirements.

Recognized, high quality Kelvin precision wire-wound resistors are used to obtain the ultimate in high accuracy and stability. Units perform in airborne and missile environments involving altitude, shock, vibration, humidity and wide temperature ranges. Networks are packaged in hermetically sealed cases or encapsulated in epoxy resin to meet exact mechanical specifications.

Electrical Characteristics Available:

- Nominal resistance tolerances to $\pm .005\%$.
- Resistance ratio tolerances as close as $.002\%$.
- Long term resistance stability of $\pm .002\%$ per year.
- Low reactances to provide rise times as low as 50 nanoseconds.
- Temperature coefficients of resistors track as close as 1PPM/ $^{\circ}\text{C}$ from -55°C to $+125^{\circ}\text{C}$.

Representatives in principal cities



KELVIN ELECTRIC COMPANY

5907 Noble Ave., Van Nuys, Calif., TRiangle 3-3430
New York: Yonkers, 916 McLean Ave., BEverly 7-2500

CIRCLE 207 ON READER SERVICE CARD

NEW BOOKS

Electromagnetics

By ROBERT M. WHITMER

Prentice-Hall, Inc., Englewood Cliffs., N. J., 1962, 357 p, \$13. Second Edition.

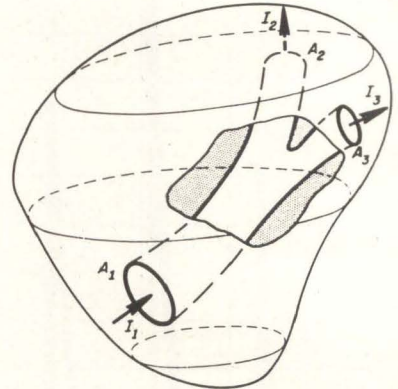

A surface enclosing the junction of three conductors

Written on a senior-to-postgraduate level, this text covers the electromagnetic theory from Coulomb's law through Maxwell's equations to circular waveguides. Vector analysis is developed concurrently with subject matter up to the Hertzian vector. The treatment is detailed and well illustrated, with problems and references in each chapter.

Radio-Electronic Transmission Fundamentals

By B. WHITFIELD GRIFFITH, JR.

McGraw-Hill Book Company, Inc., New York, 1962, 612 p, \$10.75.

A guide and reference book on the generation and handling of high-power electrical energy at radio frequencies, this work has four major parts—Electrical networks, transmission lines, radio antennas and radio transmitters. Some knowledge of radio is presupposed; the mathematics is basic and ample problems are included.—G.V.N.

Inertial Guidance.

Edited by GEORGE R. PITMAN, JR.

John Wiley & Sons, Inc., New York, 1962, 481 p, \$18.50.

Each detailed chapter is written by a different author, selected as

Good parts work best!

Write for our catalogue

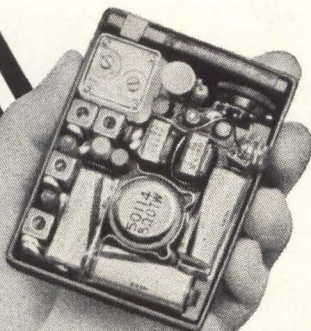

Intermediate Frequency Transformer IFT



POLYVARICON Variable Capacitor



The high standards of MITSUMI electronic components are insured by a fully-automated assembly system, and double-checked by rigid quality controls. Mitsumi Electric Company is Japan's largest manufacturer of components for radio, television and communications equipment.

MITSUMI PARTS

MITSUMI ELECTRIC CO., LTD.

Komae, Kitatama, Tokyo



an authority in his field. The book has three parts: principal inertial sensing instruments and components of a modern inertial guidance system; the problems of designing and mechanizing inertial guidance systems for aircraft and ships; and finally, inertial guidance systems for rocket propelled vehicles and space navigation. An interesting chapter is devoted to error analysis and performance optimization.—G.V.N.

Square-Loop Ferrite Circuitry: Storage and Logic Techniques

By C. J. QUARTLY

Iliffe Books Ltd., London, 1962, 166 p., \$6.

Here is a fine introduction to the use of magnetic cores in computers and other digital equipment, with an absolute minimum of mathematics and a large number of well-arranged and informative illustrations, in the usual clear and concise Iliffe style.

Starting with the history and properties of square-loop materials, the book describes various systems in detail. Later chapters go into nondestructive readout, storage circuits, logic circuits, multi-aperture logic elements and counting circuits with more than two flux levels.—S.B.G.

Principles of Electronic Warfare

By R. J. SCHLESINGER, K. ABBEY, R. W. EHRHORN, K. J. FRIEDENTHAL and S. H. LOGUE

Prentice-Hall, Inc., Englewood Cliffs, N. J., 213 p., \$8.

In discussing electronic countermeasures (ECM) and their role in electronic warfare, the authors provide broad and useful—though brief—surveys of many areas involving ECM. Among these are radar, recovery of signal information in the presence of noise, and antennas. ECM problems that are described are largely on radar and aerospace warfare; communications aspects are not discussed in detail and surface and subsurface warfare are implied rather than described.—S.V.

NEW WATTMETER-LOAD FOR RF OUTPUT TO 150 WATTS

The new BIRD Model 6150 TERMALINE RF Wattmeter is a termination type absorption instrument having selectable dual power ranges of 0-30/0-150 watts. Power values are read directly throughout the frequency range of 30-500 mc. The instrument is portable, simple to operate, and requires no calibration or auxiliary power.

Specifications: BIRD Model 6150

Power scales:	0-30 and 0-150 watts
Impedance:	50 ohms nominal
Frequency Range:	30-500 mc
VSWR:	1.1 maximum
Accuracy:	± 5% of full scale
Input Connector:	Female N
Weight:	8 pounds
Size:	3 ¹ / ₁₆ " x 6 ³ / ₈ " x 12"
Price:	\$225.00 F.O.B. Factory

other models available

BIRD Model 611 (power scales 0-15 and 0-60 watts) and Model 612 (power scales 0-20 and 0-80 watts). Price, either model: \$175.00. Model 61 with two compatible power scales as low as one watt and up to 80 watts. Price: \$220.00. Frequency range of any model may be extended. Prices on request. Contact BIRD for further information on these instruments and other BIRD products.

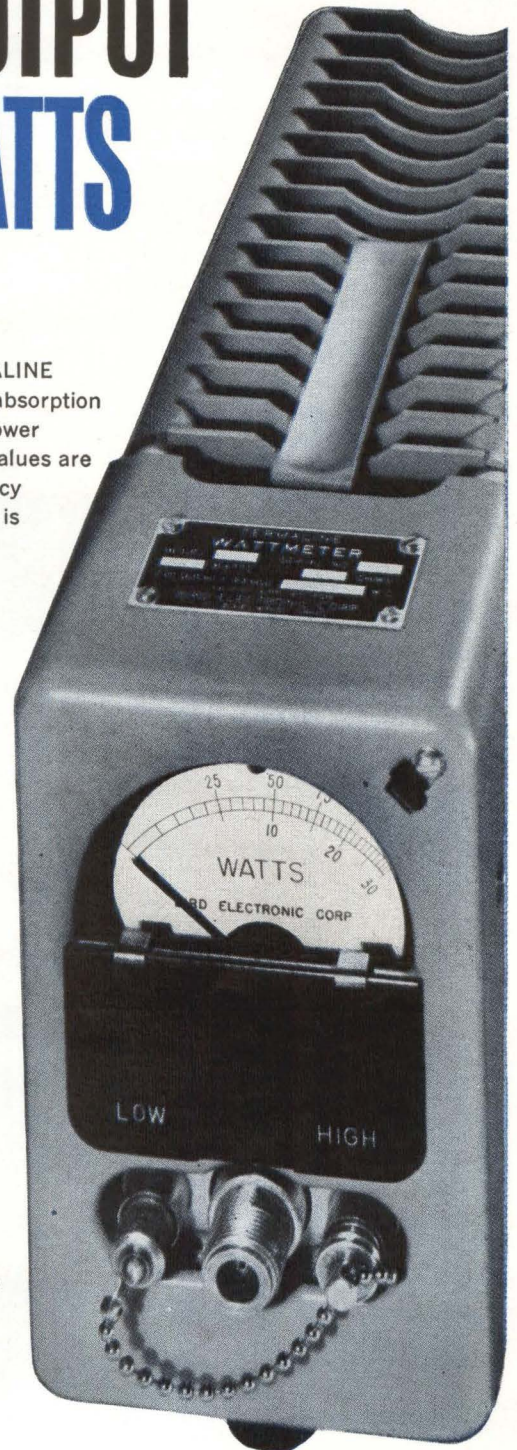

BIRD Model 6150
TERMALINE RF Wattmeter



BIRD

ELECTRONIC CORPORATION
30303 Aurora Rd., Cleveland 39 (Solon), Ohio
CHurchill 8-1200 TWX CGN FS 679
Western Representative:
VAN GROOS COMPANY, Woodland Hills, Calif.

Space-General Consolidates in El Monte

SPACE-GENERAL CORPORATION, Aerojet-General's subsidiary engaged in the design, development and assembly of complete space and missile systems and subsystems, has consolidated administration and engineering functions of its Azusa and Glendale, Calif., plants in a new 167,000-sq-ft, two-story facility in El Monte. Construction was supervised by the company's AETRON division.

The new building is the first of three to be completed on a thirty-acre tract. A systems evaluation facility is now being erected and beside it the foundation for a cafeteria is underway. When completed in July, the three buildings will incorporate 250,000 square feet for a total cost of about \$6 million.

As a major subsidiary of Aerojet-General, Space-General was organized in June, 1961, with about 700 employees and a multimillion dollar business base to provide capabilities in advanced electronics,

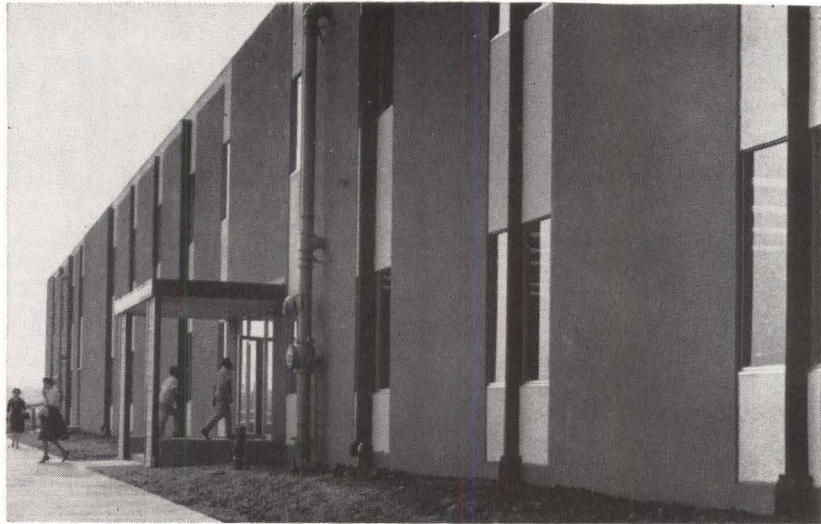

nucleonics, communications, spacecraft, payloads and data processing systems.

Programs now underway at Space-General include Ablestar upper stage used in the Transit/Courier satellite series, Aerobee and Astrobee research rockets, scien-

tific satellites, attitude control systems, rocket sleds, instrumentation for Ranger and Surveyor lunar spacecraft, subsurface communications, advanced deep space telemetry systems, ICBM terminal guidance, compact moonmobiles and satellite search and rescue systems.

Prepare Telecommunications for Apollo

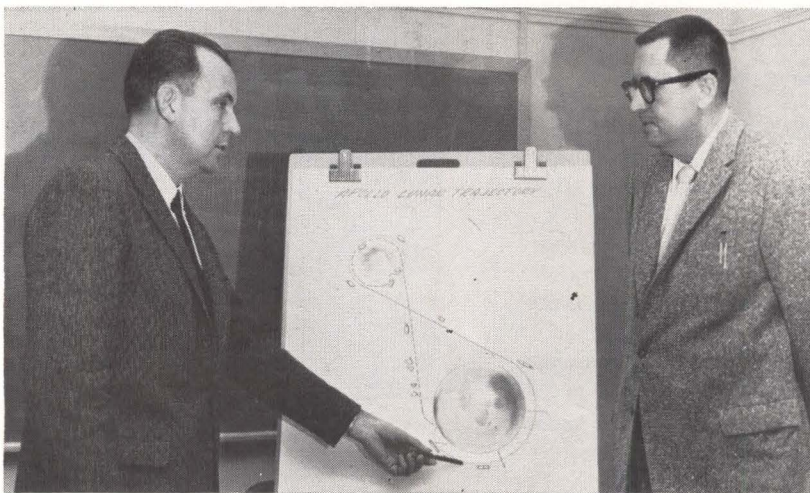

Dallas, Texas—Development of the telecommunication system for the Apollo spacecraft gets underway at Collins Radio Co. under the direction of Dr. Simeon E. Watson, left. He is discussing one of the many problems involved in the project with Stephen E. Hamilton of the North American Aviation Space and Information Systems division. Hamilton is serving as liaison between Collins and North American, prime contractor for NASA. Collins previously designed and built the communication system for the Mercury space program

Elect Barreca Admiral President

VINCENT BARRECA, executive vice president of Admiral Corp., Chicago, Ill., has been elected president, succeeding Ross D. Siragusa, who had held the post since establishing the company 28 years ago. Siragusa continues as chief executive officer and chairman of the board of directors.

Arwood Opens Sixth Casting Plant

ARWOOD CORP., New York City, recently opened its sixth investment casting plant in Cleveland, O. The 45,000-sq ft plant is a fully-integrated foundry with its own tool and die making facilities.

Among its features are electronically-controlled melting furnaces, one with a melting capacity of 1,500 lb; precise environmental

Presenting Bourns Trimpot® Model 3300 — NUMBER 20—NEW PRODUCT SERIES

The Only Potentiometer with All These Features:

- (1) Smaller-than-transistor size—just 5/16" dia. x 3/16".
- (2) Resistance from 50Ω to 20K.
- (3) Full compliance to MIL Specs for cycling humidity, sand, dust, salt spray, fungus (meets MIL-STD-202, MIL-E-5272).
- (4) Positive end stops.
- (5) Precious-metal contacts.
- (6) Sealed lightweight plastic case (no shorts to the board).
- (7) Industry-standard pin arrangement.
- (8) Exclusive Silverweld® multi-wire termination (virtually inde-

structible under thermal or mechanical stress).

The single-turn, 0.5 watt Model 3300 is as tough as it is tiny. It stands up to 175°C heat, 30G vibration and 100G shock. Its quality is checked by 100% inspection and double-checked by the rigid Bourns Reliability Assurance Program. In every unit, the performance you specify is the performance you get.

Production quantities available immediately with either printed circuit pins or solder lugs and bushing mount. Write for complete data.

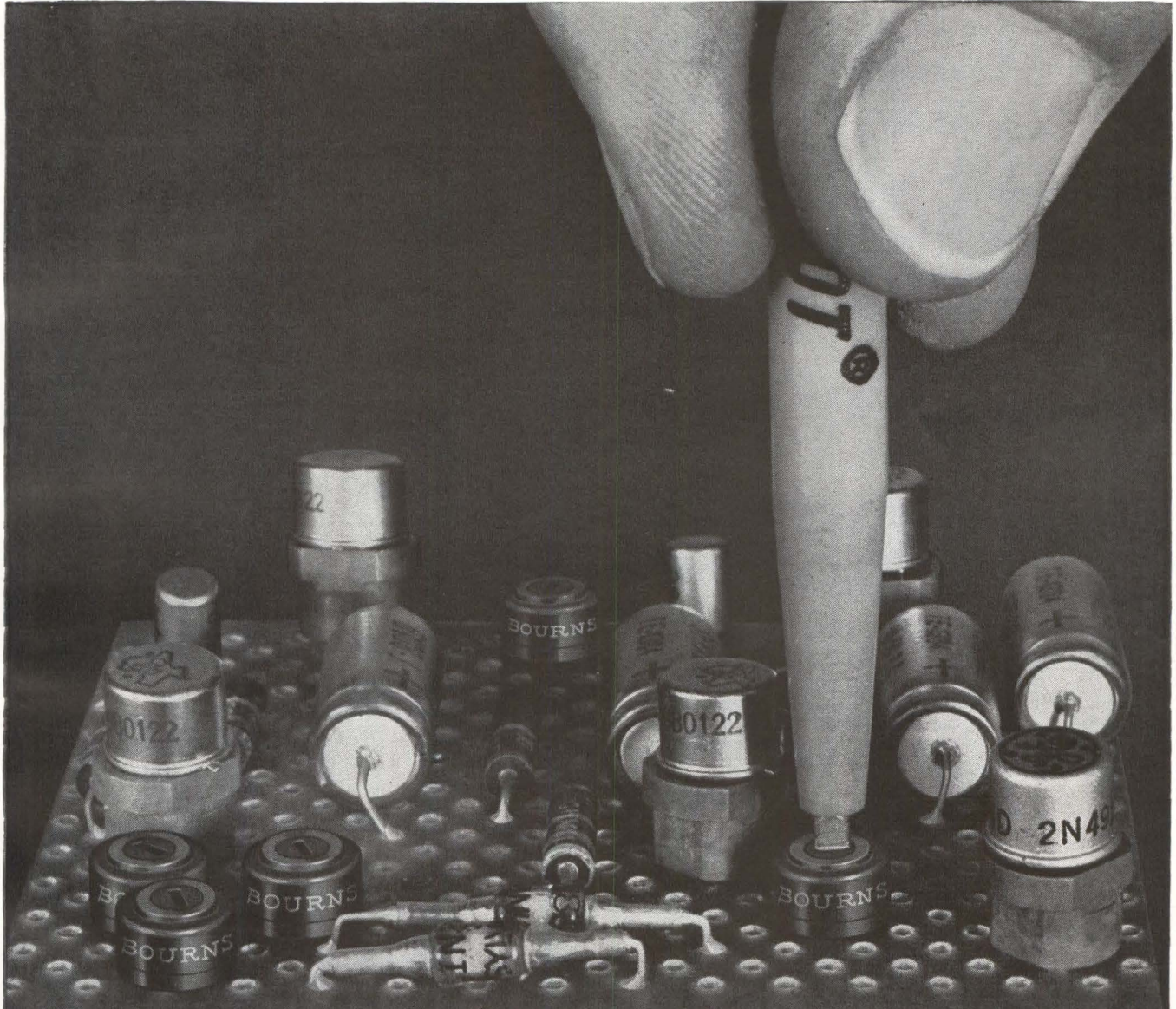

BOURNS

BOURNS, INC., TRIMPOT DIVISION
6135 MAGNOLIA AVE., RIVERSIDE, CALIF.
PHONE: OVERLAND 4-1700 • TWX: RZ 9222
CABLE: BOURNSINC.

Manufacturer: Trimpot® potentiometers; transducers for position, pressure, acceleration. Plants: Riverside, California; Ames, Iowa; and Toronto, Canada

JAPAN ELECTRONICS SHOW '62

Gala Exhibition of the Latest Achievement of Japan's Electronics Industry
The First Annual Show



From Sept. 20 to 29
At International Trade
Fair Grounds
Harumi, Tokyo



Scope of Exhibition

Exhibit Halls17,700 m2
Number of Booth...520
Number of Exhibits
.....Approx. 30,000 units
Exhibitors
.....416 Manufacturers

Exhibits

Radio & TV sets, Tape-recorders, Stereophonic and other Audio Equipment
Radio Communications and Associated Equipment
Electronic Computers and other Allied Electronics Apparatus
Electronics-applied Medical & Industrial Equipment
Industrial Measuring Apparatus and Instruments
Electron Tubes and Semi-conductor Devices
Electronic Components

This form entitles you to full and free information on the forthcoming ELECTRONICS SHOW. Fill and mail it to:

Electronic Industries Association of Japan
TOKYO SHOKOKAIGISHO (Tokyo Chamber of Commerce & Industry) Bldg., No. 14, 3-chome, Chiyoda-ku, Tokyo

Your Name: _____ Organization: _____

Address: _____

Full particulars will be forwarded to you no matter where you are located.

control; and a straight-line production set-up which eliminates unnecessary delays.

William I. Matthes, company president, said that almost \$700,000 has been spent in equipping the plant, and additional planned expenditures will bring the total to about \$1 million in the near future.



Arthur Bruno Joins
Audio Devices

AUDIO DEVICES, INC., New York, manufacturer of magnetic tapes, has appointed Arthur J. Bruno manager of research and engineering. Bruno assumes his duties at the company's newly opened research and engineering building in Glenbrook, Conn.

Before joining Audio Devices, Bruno was technical manager of the Johns-Manville Corp., Dutch Brand Division in Chicago, Ill.



Name G. W. Harrison
Allegany President

G. WILLIAM HARRISON has been named president of Allegany Instrument Co., a division of Textron Electronics, Inc. He had been vice president and general manager since 1960.

Allegany Instrument, with headquarters in Cumberland, Md., manufactures precision electronic measuring devices, pressure trans-

ducers, load cells and thrust measuring systems.



Faflick Moves Up At Sylvania

APPOINTMENT of Carl E. Faflick as director of the advanced systems planning organization of Sylvania Electronic Systems in Waltham, Mass., is announced. He was formerly senior staff specialist-systems for the division.

PM Electronics Changes Name

PM ELECTRONICS, INC., San Diego, Calif., has changed its name to California Instruments Corp.

The name change follows an earlier announcement that PM has expanded its product line to include automatic oscilloscopes and analog voltage comparators, as well as its established line of d-c instrumentation amplifiers for both ground support and missileborne applications.



Sola Names McGuire Senior V-P and G-M

JOHN V. MCGUIRE has been named senior vice president and general manager of Sola Electric Co., Elk Grove Village, Ill. He joins the company after extensive experience

FOR PROJECT MERCURY THE TERMINAL COMMUNICATION EQUIPMENT IS ROANWELL

-Because high intelligibility between sender and receiver is a necessity in space communications.

Since 1948 Roanwell has manufactured and supplied high quality **Headsets, Handsets, and Noise-Cancelling Microphones** for use in aircraft, submarines, with ship-to-shore single sideband systems, sonar and doppler radar, and underwater mine detectors. Roanwell terminal communication equipment is used in most of the missile and space programs such as Project Mercury, X15, the Atlas, Minuteman, Saturn, Jupiter, Pershing and Redstone.

Roanwell's high reputation in this field comes from specialized technical "know-how," manufacturing integrity and product adaptability that permits us to meet our customers' most rigid specifications. For reliable terminal communication equipment, contact Roanwell. Write for catalog E-6.

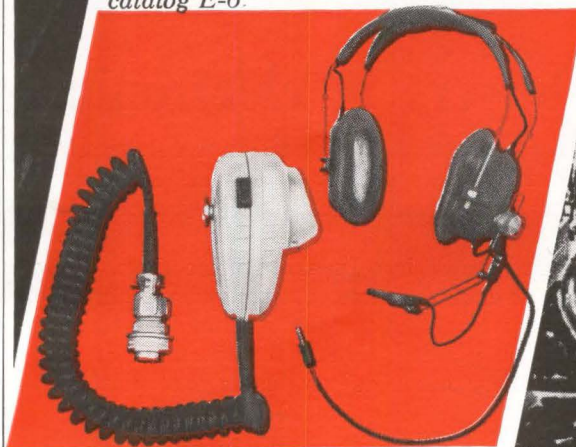

Prime authority in electro-acoustic devices
ROANWELL CORPORATION

ROANWELL BUILDING
180 Varick Street, New York 14, N. Y.
212 YUkon 9-1090 TWX NY1-478



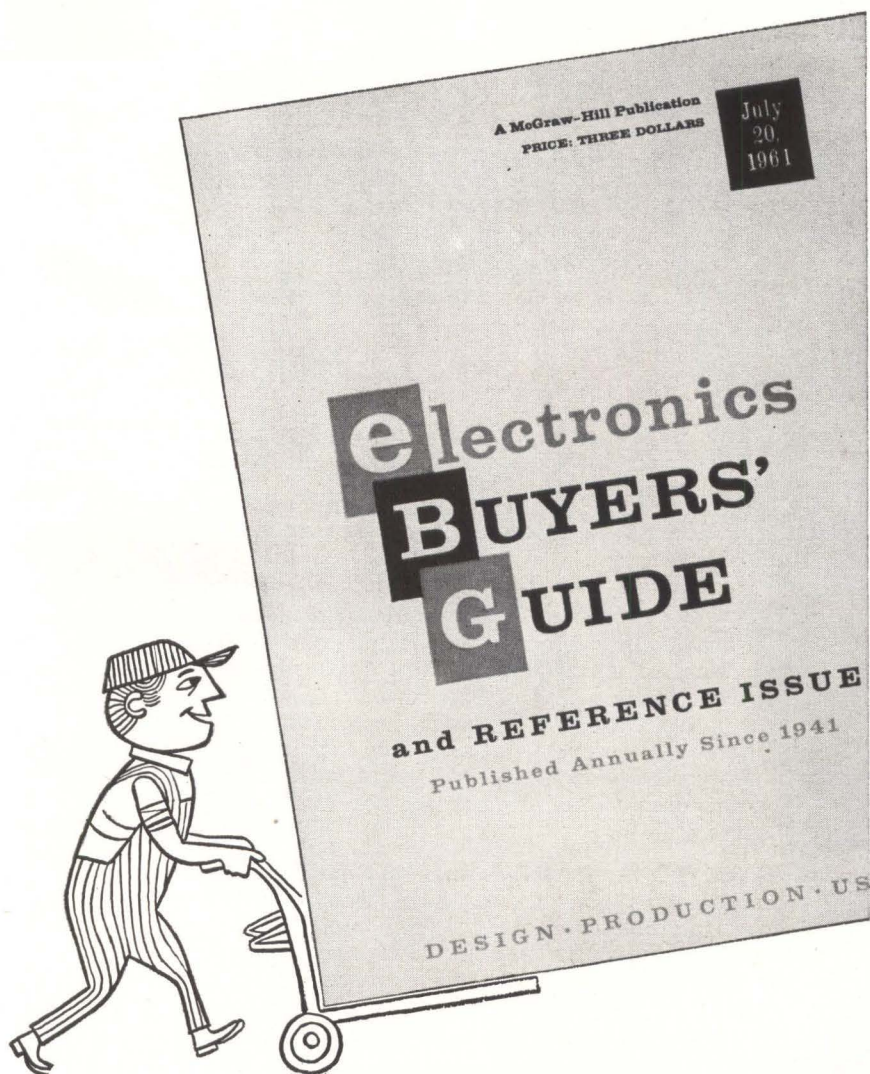

Big book for buyers in electronics

... and for sellers, too. Whether you want to buy or sell in the electronics industry, chances are that information in **electronics Buyers' Guide** and Reference Issue will help you do it better, more easily, more efficiently, or more profitably.

EBG puts key facts at your fingertips, by: Indexing more than 4,700 manufacturers; Listing all up-to-date products, components, materials, services; Giving you company statistics, such as dollar volume of business, number of employees, number of engineers; Giving you the name of the actual man in each company to call for prices, delivery dates, specifications, etc.

Complete information like this puts EBG away ahead in the electronic catalog league. It pays you to know and use the EBG.

electronics BUYERS' GUIDE and Reference Issue



The Basic Buying Guide in Electronics since 1941

with the Allis-Chalmers Mfg. Co., most recently as general manager of that company's Pittsburgh, Pa., plant.

Kazan Accepts New Position

BENJAMIN KAZAN has joined the staff of Electro-Optical Systems, Inc., Pasadena, Calif., as chief scientist of the Solid State division. He will be responsible for solid state research and development programs in thin film techniques and light-imaging and amplifying devices.

Prior to joining EOS, Kazan was head of the solid state display group of the Hughes Research Laboratories.



Van Slyck Assumes New Zenith Post

WILLIAM S. VAN SLYCK has been appointed to the new position of assistant director of Zenith Radio Corporation's Government and Special Products division in Chicago, Ill.

He was formerly chief electrical engineer for Zenith's Military division.

Shockley Announces R&D Appointments

ADOLF GOETZBERGER and Robert Tamblin have been given new duties in the R&D section of Cleveite/Shockley Transistor in Palo Alto, Calif.

Goetzberger, a member of the senior research staff for three years, is appointed manager of R&D.

Tamblin, controller of the organ-

ization, takes on the additional work of R&D administrator.

Raytheon Appoints Sidney Topol

RAYTHEON COMPANY recently appointed Sidney Topol general manager of Raytheon (Europe) A.G., a wholly-owned subsidiary located in Zug, Switzerland. He will have management and supervisory responsibilities for all companies in which Raytheon (Europe) A.G. has a controlling interest.

Topol joined Raytheon in 1949. He was named director of planning for Europe in 1959.

PEOPLE IN BRIEF

George J. Mozek is promoted to chief application engineer for National Transistor Mfg., Inc. **Alan F. Stevens** leaves Telecomputing Services, Inc., to join the Systems Div. of Electro-Mechanical Research, Inc., as a senior engineer. **Robert Moffat** and **William A. Hriszko** advance to executive v-p and v-p of manufacturing and engineering, respectively, at Webecor, Inc. Raytheon elevates **Frank F. Oddi** to managing director of A. C. Cossor, Ltd., its London subsidiary. **Chandler L. Goldthwaite** moves up at Sanders Associates, Inc., to operation mgr. of its new New Hampshire facility. **Walter L. Schlenker** of GE named a project mgr. in its internal automation operation. ITT ups **Mortimer Rogoff** to v-p, program planning and development, for its Federal Laboratories. **G. O. Haglund**, former General Mills exec, elected v-p of Vitro Corp. of America. **William Turner**, previously with Lionel Corp., appointed mgr. for research at Dynamic Electronics Div., Capehart Corp. **Robert O. Case, Jr.**, ex-North American Aviation now director of research for Tamar Electronics, Inc., and its four divisions. Promotions at Entron, Inc.: **James L. Lahey**, to president and chief executive officer; **Henry M. Diambra**, to chairman of the board; **W. C. Godsey, Jr.**, to head of the executive committee. **Arthur H. Schweitzer**, g-m of the Jet Div. of TRW Inc., elected a v-p of the company.

SUPERFLUOUS

The zero adjuster is superfluous on Honeywell sealed, ruggedized meters, even though it is required by specification. The reason is that these Honeywell meters are designed and manufactured to pass qualification tests and regular monthly production acceptance tests without any zero adjustment. ■ It takes an excellent meter to pass all of the tests, one after another, without "fixing" the meter after each test segment by resetting the pointer to zero. Try it and see for yourself. ■ Ask your present supplier if he will certify that his products have been qualified and are regularly tested in this manner. If his answer doesn't satisfy you, our answer will. Write to Honeywell, Precision Meter Division, Manchester, N.H.

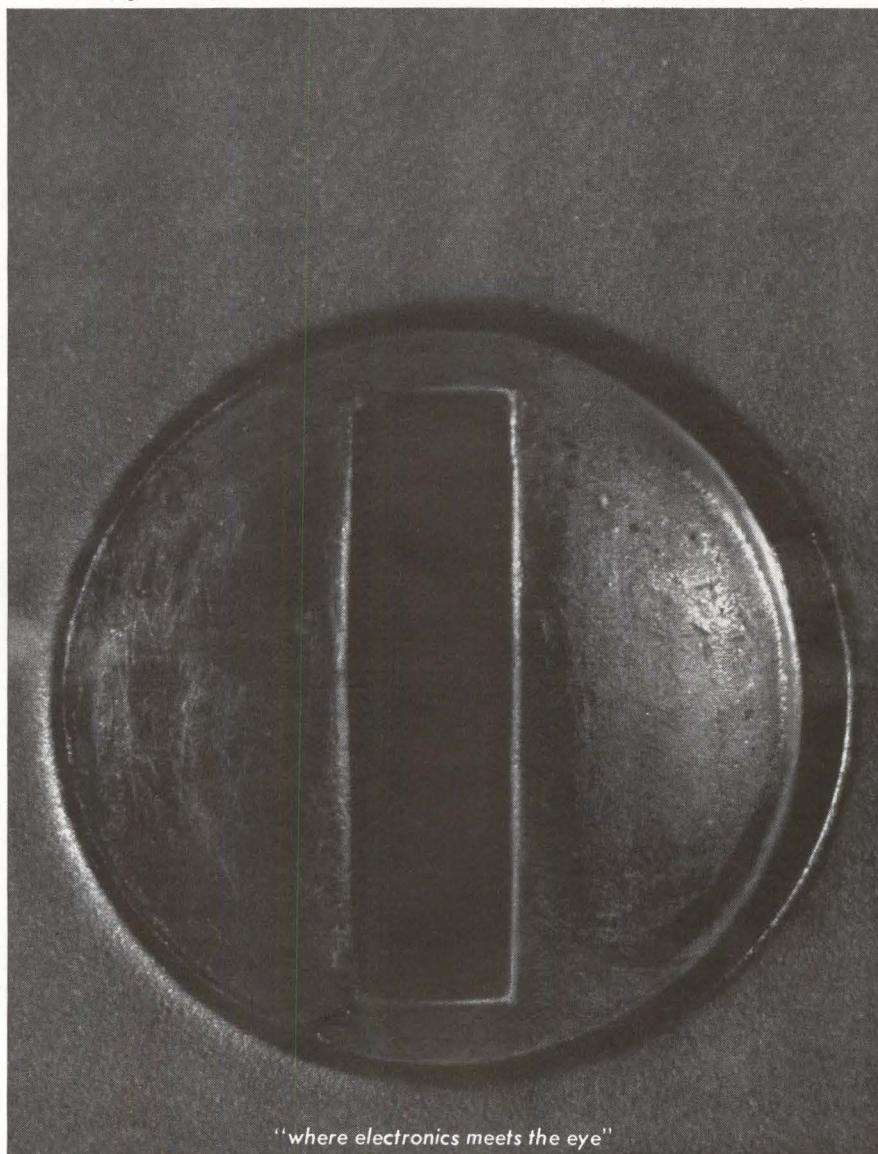

"where electronics meets the eye"

Honeywell



Precision Meters

electronics

WEEKLY QUALIFICATION FORM FOR POSITIONS AVAILABLE

ATTENTION: ENGINEERS, SCIENTISTS, PHYSICISTS

This Qualification Form is designed to help you advance in the electronics industry. It is unique and compact. Designed with the assistance of professional personnel management, it isolates specific experience in electronics and deals only in essential background information.

The advertisers listed here are seeking professional experience. Fill in the Qualification Form below.

STRICTLY CONFIDENTIAL

Your Qualification form will be handled as "Strictly Confidential" by ELECTRONICS. Our processing system is such that your form will be forwarded within 24 hours to the proper executives in the companies you select. You will be contacted at your home by the interested companies.

WHAT TO DO

1. Review the positions in the advertisements.
2. Select those for which you qualify.
3. Notice the key numbers.
4. Circle the corresponding key number below the Qualification Form.
5. Fill out the form completely. *Please print clearly.*
6. Mail to: D. Hawksby, Classified Advertising Div., ELECTRONICS, Box 12, New York 36, N. Y. (No charge, of course).

COMPANY	SEE PAGE	KEY #
BRISTOL COMPANY Waterbury, Connecticut	94°	1
COLLINS RADIO COMPANY Dallas, Texas	91	2
DOUGLAS AIRCRAFT CO. Missile and Space Systems Div. Santa Monica, California	85	3
E. I. DU PONT DE NEMOURS & CO., INC. Wilmington, Delaware	116	4
EITEL-McCULLOUGH INC. San Carlos, California	83	5
HAMILTON WATCH CO. Metals & Electronics Div. Lancaster, Pennsylvania	93°	6
INTERNATIONAL BUSINESS MACHINES CORP. New York, New York	115	7
INTERNATIONAL BUSINESS MACHINES CORP. Space Guidance Center Owego, New York	91°	8
LAWRENCE RADIATION LABORATORY Livermore, California	93°	9
MARTIN COMPANY Orlando, Division Orlando, California	116	10
MICROWAVE SERVICES INTERNATIONAL, INC. Denville, New Jersey	118	11
NATIONAL AERONAUTICS AND SPACE ADMINISTRATION Washington, D. C.	117	12
NATIONAL CASH REGISTER CO. Dayton, Ohio	116, 118	13
NORTHROP CORP. Norair Div. Hawthorne, California	81*	14
NORTHROP CORP. Space Laboratories Hawthorne, California	83°	15
PAN AMERICAN WORLD AIRWAYS INC. Guided Missiles Range Division Patrick AFB, Florida	93	16

CONTINUED ON PAGE 118

(cut here)

(cut here)

electronics WEEKLY QUALIFICATION FORM FOR POSITIONS AVAILABLE

Personal Background

NAME

HOME ADDRESS

CITY ZONE STATE

HOME TELEPHONE

Education

PROFESSIONAL DEGREE(S)

MAJOR(S)

UNIVERSITY

DATE(S)

FIELDS OF EXPERIENCE (Please Check)

6162

- | | | |
|----------------------------------------------|----------------------------------------------|---------------------------------------|
| <input type="checkbox"/> Aerospace | <input type="checkbox"/> Fire Control | <input type="checkbox"/> Radar |
| <input type="checkbox"/> Antennas | <input type="checkbox"/> Human Factors | <input type="checkbox"/> Radio—TV |
| <input type="checkbox"/> ASW | <input type="checkbox"/> Infrared | <input type="checkbox"/> Simulators |
| <input type="checkbox"/> Circuits | <input type="checkbox"/> Instrumentation | <input type="checkbox"/> Solid State |
| <input type="checkbox"/> Communications | <input type="checkbox"/> Medicine | <input type="checkbox"/> Telemetry |
| <input type="checkbox"/> Components | <input type="checkbox"/> Microwave | <input type="checkbox"/> Transformers |
| <input type="checkbox"/> Computers | <input type="checkbox"/> Navigation | <input type="checkbox"/> Other |
| <input type="checkbox"/> ECM | <input type="checkbox"/> Operations Research | <input type="checkbox"/> |
| <input type="checkbox"/> Electron Tubes | <input type="checkbox"/> Optics | <input type="checkbox"/> |
| <input type="checkbox"/> Engineering Writing | <input type="checkbox"/> Packaging | <input type="checkbox"/> |

CATEGORY OF SPECIALIZATION

Please indicate number of months
experience on proper lines.

	Technical Experience (Months)	Supervisory Experience (Months)
RESEARCH (pure, fundamental, basic)
RESEARCH (Applied)
SYSTEMS (New Concepts)
DEVELOPMENT (Model)
DESIGN (Product)
MANUFACTURING (Product)
FIELD (Service)
SALES (Proposals & Products)

CIRCLE KEY NUMBERS OF ABOVE COMPANIES' POSITIONS THAT INTEREST YOU

1 2 3 4 5 6 7 8 9 10 11 12 13 14 15 16 17 18 19 20 21 22 23 24 25

IBM asks basic questions in information retrieval

What is known?

FUEL CELLS

by Herman A. Liebhafsky **Making valence electrons do work before they're captured by oxygen is the most direct way to convert chemical into electrical energy. But effective cells seem years away**

IN BRIEF: Like the ordinary battery, the fuel cell is a low-voltage source of dc; unlike the battery, the fuel cell does not store energy but merely converts it. Ideally, it has most of the advantages of the battery—compactness, no moving parts, soundlessness; has a disadvantage in its need for accessory fuel supply and oxide removal apparatus; and has a number of unique virtues—steady output without recharging, long life, and operation on air and conventional fuels. It can use these latter more efficiently than conventional generators because, unlike them, it converts the energy of fuel oxidation directly into electricity. The theory is simple; valence electrons of a conventional fuel are forced to do work en route to the oxidation product. But practice is bedeviled by technical demands that are difficult to meet one at a time, let alone all at once. Still, after a century of failure to develop a practical fuel cell, recent work has led to a handful of devices that work well enough to merit attention.—T. M.

■ Since the Second World War, and largely because of military and space needs for new energy sources, there has been a tremendous expansion of fuel-cell research here and

there valence electrons can be made to do useful work before they come to rest in the oxidation products—if they are caught in flight, so to speak—chemical energy can be converted directly into electrical energy, and the intermediate conversion to heat disappears.

How it works

A fuel cell, like any other electrochemical cell, contains two electrodes (the anode and the cathode). These are joined externally by a metallic circuit through which the valence electrons from the fuel flow, and internally by a conducting medium (the electrolyte) through which ions flow to complete the circuit.

In the hydrogen fuel cell of Fig. 3, these component parts are labeled, and the substances involved in the reaction at each electrode are indicated. These are the electrode reactions:

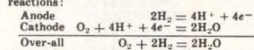

Note that the over-all reaction, which is the equation for combustion of hydrogen, has in it no charged species. But the electrode reactions involve two charged species, the hydrogen ion H^+ (here written without its water of hydration) and the electron e^- . The electron works

S+T30 FUEL CELLS BY HERMAN A. LIEBHAFSKY

FOR YEARS, SUCH FAMILIAR ELECTROCHEMICAL CELLS AS DANIEL CELLS, DRY CELLS, AND STORAGE BATTERIES HAVE BEEN DIRECTLY CONVERTING INTO ELECTRICITY THE FREE ENERGY OF OXIDATION OR IN THE CHEMIST'S BROAD SENSE OF OXIDATION AS THE ADDING OF OXYGEN OR ANY OTHER ELECTRO-NEGATIVE ATOM OR GROUP.

THE SUBSTANCES THAT ORDINARY BATTERIES CONSUME AT THEIR ANODES ARE THE ANODES THEMSELVES, WHICH ARE EXPENSIVE METALS SUCH AS ZINC, MAGNESIUM, OR LEAD, OR EVEN SODIUM — CERTAINLY NOT THE INEXPENSIVE FOSSIL FUELS THAT FUEL CELLS ARE INTENDED TO CONSUME, SUCH AS COAL AND HYDROCARBONS, AND SUBSTANCES EASILY DERIVED FROM THEM, LIKE HYDROGEN, CARBON MONOXIDE, AND THE SIMPLER ALCOHOLS.

THE ACTUAL EFFICIENCY OF A FUEL CELL IS NECESSARILY LESS THAN THE IDEAL, BECAUSE THE ACTUAL ELECTROMOTIVE FORCE IS ALWAYS LESS THAN THE IDEAL DUE TO IRREVERSIBLE CHANGES IN THE ACTIVATION-ENERGY BARRIERS TO HIGH ELECTRODE ACTIVITY, THE INTERNAL RESISTANCE OF THE ELECTROLYTE TO IONIC MOBILITY, AND LOCAL CHANGES IN THE ELECTROLYTE'S CONCENTRATION AND COMPOSITION.

IN 1842, GROVE SAID OF HIS HYDROGEN-OXYGEN CELLS, "AS THE CHEMICAL OR CATALYTIC ACTION...COULD ONLY BE SUPPOSED TO TAKE PLACE...AT THE LINE OR WATERMARK WHERE THE LIQUID, GAS AND PLATINA (PLATINUM) MET, THE CHIEF DIFFICULTY WAS TO OBTAIN ANYTHING LIKE A NOTABLE SURFACE OF ACTION.

IN SEPTEMBER, K. SCHWABE OF THE INSTITUTE FOR ELEKTROCHEMIE AND PHYSIKALISCHE CHEMIE OF THE TECHNISCHE HOCHSCHULE IN DRESDEN ANNOUNCED THAT PREPARATORY GAMMA, AND EVEN BETTER, BETA, IRRADIATION OF ELECTRODE SURFACES INCREASED THEIR ACTIVITY.

This 4000-word article appeared in the January, 1962, issue of International Science and Technology. To abstract the article, a document analyst would read it, define its purpose, and summarize its essential points.

Each year in the physical and life sciences, some 50,000 technical journals will be published throughout the world. 100,000 research reports and 60,000 technical books will also be written. Somewhere in this mass of knowledge may be information you need. To tell what is known—and where to find it—IBM is investigating systems for the dissemination, storage, and retrieval of information.

To create an advanced information retrieval system, labels must be found for *all* useful information in documents. With conventional library indexing, it is difficult to make allowance for new kinds of knowledge. However, computers let us use more versatile methods of indexing. In one of these, the KWIC INDEX (Key Word In Context), a computer selects significant terms in the titles of documents, then prints them out as index entries.

Once indexed, characteristics of documents' contents can be used to notify people of their existence. The Selective Dissemination of Information system at IBM stores profiles describing individuals' interests. A new document's key words are matched against key words in a person's profile. If there is sufficient correlation, he is informed of the document. Profile matching can also be used to retrieve

This abstract was prepared by an IBM computer. The text was first coded in machine language. The computer then counted key words, and printed out sentences having the greatest statistical significance.

information by storing documents and feeding keyword queries through the system.

At present it is relatively difficult to get text into machine-readable form. However, the development of high-speed optical character readers, automatic language translators, and improved methods of capturing linguistic information at the source may make it possible to introduce information directly into retrieval systems. Once harvested, vast quantities of information will present storage problems. IBM is investigating random-access photostorage systems capable of storing millions of documents and retrieving them in seconds. Out of systems like these may come total information centers which will acquaint scientists and businessmen with all the information needed in their work.

If you have been searching for an opportunity to make important contributions in information retrieval, component engineering, optics, space systems, or any of the other fields in which IBM scientists and engineers are finding answers to basic questions, please contact us. IBM is an Equal Opportunity Employer. Write to: Manager of Professional Employment, IBM Corporation, Department 554S1, 590 Madison Avenue, New York 22, New York.



REG. U.S. PAT. OFF.

Offers a Career Opportunity in

SOLID STATE PHYSICS

A professional opening exists for a Solid State Physicist in the Engineering Service Division of Du Pont's central Engineering Department. This division's objectives are to anticipate the Company's technological needs and apply advanced engineering and scientific knowledge to improve existing and future Du Pont processes. Consultation and services are provided on problems in research, development, manufacturing, and sales.

The Solid State Physicist will provide consultation to various plants and laboratories on behavior of semi-conductor, non-conductor, and magnetic materials. He will conceive, develop, and apply special devices to measure and control such properties. He will conceive applications of such materials in the electronics industry and other fields. He will design and apply special purpose semi-conductor and magnetic amplifier circuits to process measurement and control. Location: Louviers Building, Wilmington, Delaware.

Write in confidence to Mr. W. M. Redd
Engineering Department

E. I. du Pont de Nemours and Company
INCORPORATED

Wilmington 98, Delaware

An Equal Opportunity Employer

Communications

Engineers and Scientists

Investigate wide-ranging growth opportunities with the Martin Company in Orlando, Florida! Projects are now under way on seven missile, electronic and communication systems prime contracts, plus extensive research and development programs. Senior level openings exist on advanced programs and in project engineering for conceptual communications systems engineering and communication equipment design. Experience in one or more of the following areas is desirable:

- Digital Pulse Communications
- Wide Band RF/IF Amplifiers
- Air-Ground Communications Systems
- Probability Theory
- Pulsed Power RF Amplifiers
- Information Theory
- Troposcatter System Design and Analysis

Work with the team who developed Pershing, Bullpup, GAM-83, Lacrosse, Racep, Missile Master and BIRDIE. Investigate these opportunities by sending your resume, in confidence, to Mr. P. A. Miller, Martin Company, Orlando Division, Sec. 419, Orlando, Florida. (An equal opportunity employer.)

MARTIN
ORLANDO
A Division of Martin Marietta



ADVANCED
DEVELOPMENT

INTEGRATED
ELECTRONICS

A new program has started in the development of Integrated Circuits for computers and business machines. Circuits both in thin films and in semiconductor blocks will be designed, made, and evaluated. Novel circuits, applications, and processes will be sought. This program will provide growth opportunities along technical or managerial lines for imaginative experienced individuals. Backgrounds are desired in thin films, semiconductors, or logic design. Specific openings comprise:

● **SOLID STATE PHYSICS**

To design and confirm integrated circuit structures

● **ELECTRONICS**

To design and evaluate integrated circuits

● **LOGIC**

To specify and evaluate integrated circuits in logical applications

● **PROCESS**

To establish and improve processes in thin film and semiconductor technology such as evaporation, diffusion, contacting, surface treatment, epitaxy, etc.

In addition to unexcelled facilities and opportunities, NCR offers many unusual and unexpected benefits both in living and working climate. Purposeful effort, long range planning, and good management backed with 78 years of systems experience underlie the stimulating program of research and development now emerging at NCR. To be considered for what may be your ground floor opportunity, write to:

T. F. Wade, Technical Placement,
The National Cash Register Company,
Main & K Streets, Dayton 9,
Ohio

An Equal Opportunity Employer

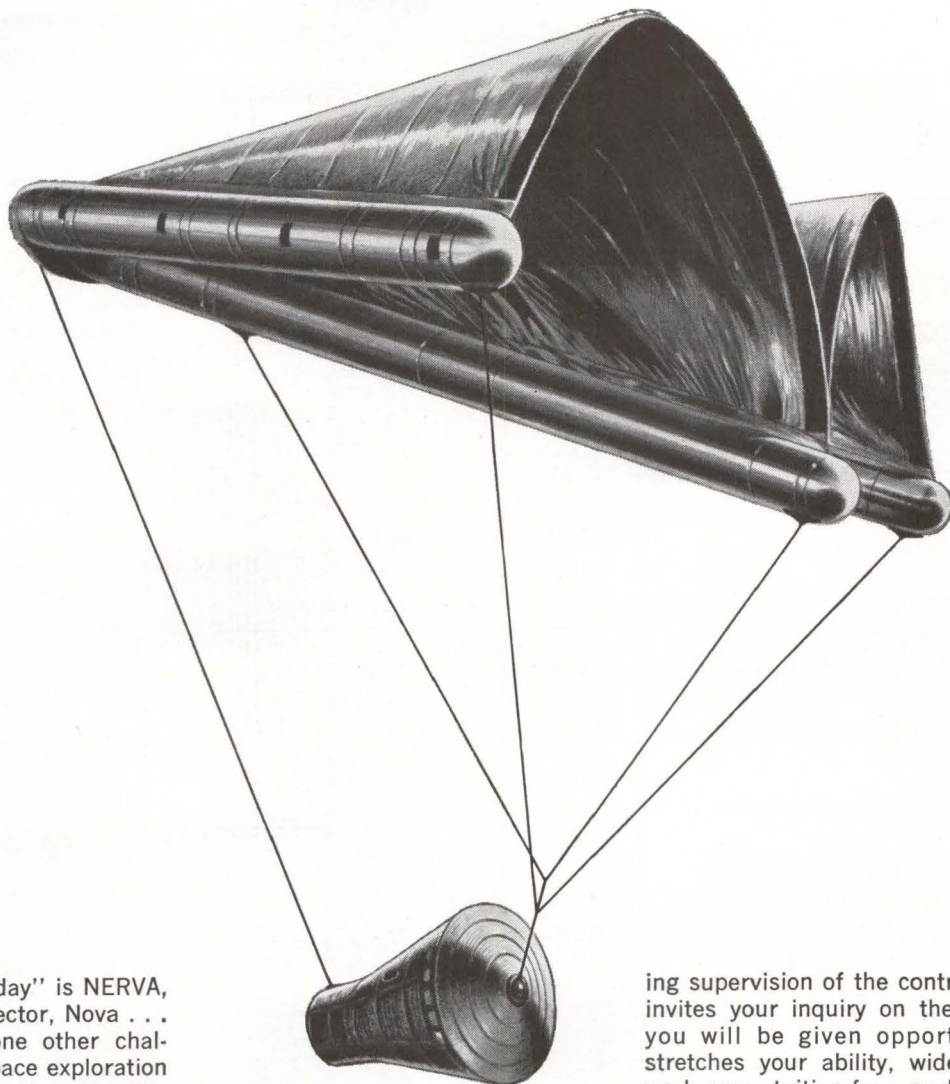

For the NASA man, "today" is NERVA, Apollo, Surveyor, Prospector, Nova . . . and a thousand and one other challenges. The future of space exploration is primarily in the hands, the mind, the ingenuity of NASA men and women.

NASA is the focal point for the assault on space. Here are unmatched facilities—the tools, the associates, the atmosphere a man needs for unfettered creativity. NASA is downstage center, and the scientist or engineer who works under this exacting spotlight finds the opportunity, the fulfillment, the security and respect that so many of us so eagerly pursue.

NASA is for the man who wants to be "in at the beginning."

NASA scientists and engineers work in many diversified fields. Included are: Fluid and Flight Mechanics, Energy and Power Systems, Materials and Structures, Space Sciences, Measurement and Control Systems, Data Systems, Experimental Facilities and Techniques, Life Sciences and Systems, and Program and Project Management, includ-

AT NASA, YOU'LL WORK ON THE PROJECTS OF 1970 . . . TODAY



ing supervision of the contracts. NASA invites your inquiry on the basis that you will be given opportunity that stretches your ability, wide choice of work area, tuition-free graduate study, if desired, while on full pay. You may direct your inquiry to any of the following NASA centers:

NASA Launch Operations Center, Cocoa Beach, Florida; NASA Manned Spacecraft Center, Houston, Texas; NASA Goddard Space Flight Center, Greenbelt, Maryland; NASA Marshall Space Flight Center, Huntsville, Alabama; NASA Ames Research Center, Mountain View, California; NASA Flight Research Center, Edwards, California; NASA Langley Research Center, Hampton, Virginia; NASA Wallops Station, Wallops Island, Virginia; NASA Lewis Research Center, Cleveland, Ohio, or NASA Headquarters, Washington 25, D. C.

All qualified applicants will receive consideration for employment without regard to race, creed or color, or national origin. Positions are filled in accordance with Aero-Space Technology Announcement 252-B.

NATIONAL AERONAUTICS AND SPACE ADMINISTRATION



RESEARCH

SOLID STATE PHYSICS

New programs in semi conductor and thin films research have created ground floor opportunity for qualified and vigorous research scientists in NCR's expanding research and development effort. Our interest is not temporary; rather it is an element of the stable long range viewpoint that has led to 78 years of leadership in the field of business equipment and systems. Perhaps you qualify to become a part of this respected organization.

Openings in our Physical Research Department include:

Ph.D in physics, with at least five years experience in semi conductor component research and development, a theoretical understanding of semi conductor (silicon and germanium) physics, research and development experience in the semi conductor device fabrication techniques such as diffusion, alloying, masking, etching, and in particular be familiar with the epitaxial formation of multilayer semi conductor structures.

Assignment involves technical leadership for a program in molecular electronics which will first be concerned with the investigation and exploitation of the epitaxial technique to determine its limitation and capabilities as related to the fabrication of functional semi conductor structures.

Ph.D in physical chemistry with three years of experience in the areas of electro-chemistry, preferably as applied to the formation of thin magnetic films. He should be familiar with the process of electro-deposition as related to magnetic materials and alloys, and have considerable understanding of magnetic theory, processes of crystal nucleation and growth as they are related to the formation of metallic electro-deposited films. It is also desirable to have technical familiarity with x-ray and electron diffraction examination and analysis methods, so that these skills may be brought to bear on the problem of the relationships of film composition and crystalline structure to the magnetic characteristics of electro-deposited films.

Ph.D in physical chemistry, with approximately 5 years experience and theoretical understanding of the problems of materials preparation, structural and compositional analysis and interpretation, and methods of materials evaluation. Particular emphasis should include solid state materials, such as semi conductors, magnetic materials, superconductors, and dielectrics.

To investigate these and other openings, write to:

Technical Placement
The National Cash Register Company
Main and K Streets
Dayton 9, Ohio

An Equal Opportunity Employer

SCIENTISTS/ENGINEERS

Career opportunities in:

- DESIGN
- RESEARCH
- DEVELOPMENT
- SALES
- MARKETING
- APPLICATION

Submit resume in confidence to:

- Alan Glou Technical/Scientific
- Sid Hopper Sales/Marketing

Specialists in the personalized placement of Electronic Engineers and Scientists, on a national basis, who have a BS or advanced degree. Client companies assume fee and relocation costs.



PROFESSIONAL PLACEMENT CENTER
1277 MAIN ST. WALTHAM, MASS.

PHYSICIST

Nationally prominent firm located in midtown Manhattan seeks the services of a physicist to work in the broad areas of electronics and the basic sciences as they apply to Aerospace Technology.

Minimum requirements:

- BS in Physics (EE's considered)
- 5 years or more general experience preferably oriented toward solid state electronics
- U. S. citizenship
- Willingness to do invited traveling

Interested physicists should send complete resume including salary requirements to:

P-9005, Electronics
Class. Adv. Div., P.O. Box 12, N.Y. 36, N.Y.

An equal opportunity employer

COMMUNICATIONS APPLICATION ENGINEER

Analysis of advanced electronic communication systems including radio, carrier, telephone, microwave: Must have design and marketing experience with commercial and military users.



EE degree, 5 yrs. exp. min.
Send Resume to:
Microwave Services International Inc.
Consulting Engineers
Route 46 Denville, N. J.

POSITION VACANT

Electronic Engineers—We have immediate openings for competent engineers to develop electronic devices and to design electronic circuits for analytical instruments. Bachelors or Masters degree with experience in vacuum tube and solid state technology required. These are unusual growth opportunities with a dynamic and rapidly expanding organization. Please send resume with references and salary requirements to: Mr. James R. Badger, F & M Scientific Corp., Starr Road and Route 41, Avondale, Pennsylvania.

POSITION WANTED

Sold successful small manufacturing business. Familiar with all phases manufacturing from idea stage through production and marketing. Engineering and management background. Particularly qualified, but not limited to, electro-mechanical devices, air drives, automation of small machine tools and product packaging. Age 34. Minimum salary \$10,000 to \$12,000. All replies confidential. PW-9045, Electronics, Classified Adv. Div., 255 California St., San Francisco 11, Calif.

PROFESSIONAL SERVICES

GIBBS & HILL, Inc.

Consulting Engineers

- Systems Engineering
- Operations Research • Development
- Field Studies • Design • Procurement
- Power • Transportation • Communications
- Water Supply • Waste Treatment

393 Seventh Avenue New York 1, N. Y.

electronics

WEEKLY QUALIFICATIONS FORM FOR POSITIONS AVAILABLE

(Continued from page 114)

PHILCO TECHREP DIVISION SUB. OF FORD MOTOR CO. Philadelphia, Pennsylvania	94*	17
RAYTHEON CO. Missile & Space Div. Bedford, Massachusetts	92*	18
REPUBLIC AVIATION CORPORATION Farmingdale, L.I., New York	92*	19
SCOPE PROFESSIONAL PLACEMENT CENTER Waltham, Massachusetts	118	20
SPERRY GYROSCOPE COMPANY Div. of Sperry Rand Corp. Great Neck, L.I., New York	93*	21
P-8932	94*	22
P-9005	118	23

* These advertisements appeared in the 5/25/62 issue.

SEARCHLIGHT SECTION

(Classified Advertising)

BUSINESS OPPORTUNITIES
EQUIPMENT - USED or RESALE

OUR BUSINESS IS CUTTING



Manufacturers of small electrical or mechanical units, however intricate, with high labor content will find our cost-cutting services interesting.

Our complete overseas facilities in Japan, Hong Kong, etc., provide unlimited services by skilled workers, under trained supervision, for the manufacture of complete units or sub-assemblies to your most rigid specifications. All transactions held in strictest confidence.

Submit sample or blueprint for firm quotation. Get the facts about our cost-cutting services — save dollars and build profits!

OVER 25 YEARS EXPERIENCE IN ELECTRONICS

INTERCONTINENTAL INDUSTRIES, INC.
555 W. Adams Street Chicago 6, Illinois
Established 1938

CIRCLE 460 ON READER SERVICE CARD FOR RESEARCH — DEVELOPMENT & EXPERIMENTAL WORK

Over 10,000 different electronic parts: waveguide, radar components and parts, test sets, pulsers, antennas, pulse xmfrs, magnetrons, IF and pulse amplifiers, dynamotors, 400 cycle xmfrs, 584 ant. pedestals, etc.
PRICES AT A FRACTION OF ORIGINAL COST!
COMMUNICATIONS EQUIP CO.
343 CANAL ST., N. Y. 13, W.O. 6-4045
CHAS. ROSEN (Formerly at 131 Liberty St.)

CIRCLE 461 ON READER SERVICE CARD

INDEX TO ADVERTISERS



Audited Paid Circulation

• AMP Incorporated 15	• Hewlett-Packard
Aerocom 24	Company Inside Front Cover
Aeroflex Laboratories Inc. 83	Honeywell
Air Express 20	Precision Meter Division..... 113
• Airpax Electronics, Inc. 32	
Aladdin Electronics 99	
Allen Organ Co., Inc. 76	
• Amperex Electronic Corp. 62, 63	
Anso 67	
Avco Electronics & Ordnance Div. 71	
	• Indiana General Corp. 34
	International Telephone and Telegraph
	Corp., Kellogg Division 74
	Itek Electro-Products Co. 72
Babcock Relays, Inc. 17	
• Ballantine Laboratories, Inc. 96	
Bausch & Lomb, Inc. 66	
• Beckman Instruments, Inc.	
Berkeley Division 69	Kelvin Electric Co. 106
Bell Telephone Laboratories..... 35	• Kintel, A division of Cohu Electronics
Bendix Corporation	Inc. 3rd Cover
Semiconductor Division 23	
• Bird Electronic Corporation 107	
• Biiley Electric Co. 100	
Bourns Inc. 109	
• Bud Radio Inc. 100	
	• Lepel High Frequency Laboratories,
	Inc. 76
• Centralab, The Electronics	
Div. of Globe-Union Inc. 31	Matthews Research Inc. 58
• Clarostat Mfg. Co., Inc. 21	Minneapolis Scientific Controls 101, 103, 105
Collins Radio Co. 91	Minnesota Mining & Mfg. Co.
Cominco Products Inc. 90	Mincom Division 61
Consolidated Electrodynamics Corp. 94, 95	• Mitsumi Electric Co., Ltd. 106
Corning Electronic Components..... 55	Moore Associates Inc. 29
	Motorola Semiconductor Products Inc. 33
	Motorola Military Electronics Div. 75
Datapulse Inc. 84	
Delco Radio 14	
Douglas Aircraft Co.	
Missiles & Space Systems Div. 57	NRC Equipment Co. 104
duPont de Nemours & Co., Inc. E. L. 79	Narda Microwave Corporation..... 13
	Niagara Mohawk Power Corp. 10
• Edgerton, Gernsmaus & Grier Inc. 80	
• Eitel-McCullough, Inc. 83	
Electronic Industries Association of	
Japan 110	
• Electronic Instruments Co., Inc.	
(EICO) 119	Ozalid, A Div. of General Aniline &
• Empire Devices, Inc. 89	Film Corp. 73
Gamewell Co., The 11	
General Electric Co.	
Receiving Tube Dept. 25	• See advertisement in the July 20, 1961 issue
• Gudebrod Bros. Silk Co., Inc. 64	of Electronics Buyers' Guide for complete line of
	products or services.



PUTS THE BEST IN CREATIVE ELECTRONICS INTO YOUR HANDS



Send for
FREE
Catalog

28 pages of professional electronic equipment in kit and wired form - for Lab . . . Line . . . Home

EICO, 3300 N. Blvd., L.I.C. 1, N. Y. E-6A
 Send free 32-page catalog & dealer's name.
 Send new 36-page Guidebook to WI-FI for which I enclose 25¢ for postage & handling.

Name _____
Address _____
City _____ Zone _____ State _____

EICO® 3300 N. Blvd., L.I.C. 1, N. Y.
Export Dept., Roburn Agencies
431 Greenwich St., N. Y. 13, N. Y.

CIRCLE 208 ON READER SERVICE CARD



Operational guidance for buyers

That's what your 1961 **electronics Buyers' Guide** and Reference Issue gives you . . . this year more than ever before.

Your EBG is bigger and better this year than ever . . . and more helpful than ever . . . with more new exclusive features than ever. Keep it close at hand, you'll find it's useful day in and day out.

**electronics
BUYERS' GUIDE
and Reference Issue**

The Basic Buying Guide
in Electronics *since 1941*

*first
choice of
all 4*

research

design

production

management

Because the BUYERS' GUIDE satisfies the buying and specifying needs of all four segments of the industry! Gives more information in less space. Easier to use. Only the BUYERS' GUIDE has been screened for usefulness over a 20 year period . . . comes to you compact, complete and accurate.

gives more to all 4!

**electronics
BUYERS' GUIDE
and REFERENCE ISSUE**

Pan American World Airways.....	93
Pic Design Corp.	58
Powell Electronics Inc.	101

PROFESSIONAL SERVICES	118
-----------------------------	-----

• Radio Corporation of America... 4th Cover	
Radio Materials Co.....	36
Roanwell Corp.	111
Rosemount Engineering Co.....	82

• Sanborn Company	77
• Sanders Associates, Inc.	76
Sarkes Tarzian Inc.	81
• Sierra Electronic Corp.	6
Sprague Electric Co.	4, 9, 30
Sweeney Mfg. Co., B. K.....	70

Tektronix, Inc.	22
Texas Instruments Incorporated.....	65
• Tung-Sol Electric, Inc.	5

• Utica Drop Forge & Tool Division, Kelsey-Hayes Co.	102
--------------------------------------------------------------	-----

Varian Associates	59
-------------------------	----

Welch Scientific Co., The.....	103
Weldmatic Division/Unitek	92

CLASSIFIED ADVERTISING
F. J. Eberle, Business Mgr.

EMPLOYMENT OPPORTUNITIES..	115-118
SPECIAL SERVICES	118
EQUIPMENT (Used or Surplus New) For Sale	118

INDEX TO CLASSIFIED ADVERTISERS

• Communications Equipment Co.....	118
du Pont de Nemours & Co., Inc., E. I.	116
Intercontinental Industries Inc.	118
International Business Machines Corp.	115
Martin Co., Orlando Division.....	116
Microwave Services International Inc.	118
National Aeronautics and Space Ad- ministration	117
National Cash Register Co.....	116, 118
Scope Professional Placement Center..	118

• See advertisement in the July 20, 1961 issue of Electronics Buyers' Guide for complete line of products or services.

This Index and our Reader Service Numbers are published as a service. Every precaution is taken to make them accurate, but ELECTRONICS assumes no responsibilities for errors or omissions.

electronics



Audit Bureau
of Circulations



Associated Business
Publications

Audited Paid Circulation

JAMES T. HAUPTLI

Advertising Sales Manager

R. S. QUINT:
Assistant Publisher Buyers'
Guide and Business Manager
FRED STEWART:
Promotion Manager
B. ANELLO:
Market Services Manager

RICHARD J. TOMLINSON:
Production Manager
GEORGE E. POMEROY:
Classified Manager
HUGH J. QUINN:
Circulation Manager

ADVERTISING REPRESENTATIVES

NEW YORK (36):
Donald H. Miller, Henry M. Shaw,
George F. Werner
500 Fifth Avenue, LO-4-3000
(area code 212)

BOSTON (16):
William S. Hodgkinson, Donald R. Furth
McGraw-Hill Building, Copley Square,
Congress 2-1160 (area code 617)

PHILADELPHIA (3):
Warren H. Gardner, William J. Boyle
6 Penn Center Plaza, LOcust 8-4330
(area code 215)

CHICAGO (11):
Harvey W. Wernecke, Robert M. Denmead
645 North Michigan Avenue, Mohawk 4-5800
(area code 312)

CLEVELAND (13):
Paul T. Fegley
55 Public Square, Superior 1-7000
(area code 216)

SAN FRANCISCO (11):
R. C. Alcorn
255 California Street, Douglas 2-4600
(area code 415)

LOS ANGELES (17):
Peter S. Carberry, Ashley P. Hartman
1125 W. 6th St., Huntley 2-5450
(area code 213)

DENVER (2):
J. W. Patten
Tower Bldg., 1700 Broadway,
Alpine 5-2981 (area code 303)

ATLANTA (9):
Michael H. Miller, Robert C. Johnson
1375 Peachtree St. N.E., Trinity 5-0523
(area code 404)

HOUSTON (25):
Joseph C. Page, Jr.
Prudential Bldg., Holcomb Blvd.,
Jackson 6-1281 (area code 713)

DALLAS (1):
Frank Le Beau
The Vaughn Bldg., 1712 Commerce St.
Riverside 7-9721 (area code 214)

LONDON W1:
Dennis McDonald
34 Dover St.

FRANKFURT/Main:
Matthée Herfurth
85 Westendstrasse

GENEVA:
Michael R. Zeynel
2 Place du Port

"Headquarters for Business Information"

McGraw-Hill Technical and Business Publications

American Machinist/Metal-
working Manufacturing
Aviation Week and Space
Technology
Business Week
Chemical Engineering
Chemical Week
Coal Age
Construction Methods and
Equipment
Construction Daily
Control Engineering
Electrical Construction
and Maintenance
Electrical Merchandising Week
Electrical Newsletter
Electrical West

Electrical Wholesaling
Electrical World
Electronics
Engineering Digest
Engineering and Mining Journal
E & MJ Metal and Mineral
Markets
Engineering News-Record
Factory
Fleet Owner
Industrial Distribution
National Petroleum News
Nucleonics
Nucleonics Week
Platt's Oilgram News
Platt's Oilgram Price Service
Power

Product Engineering
Purchasing Week
Science Week
Textile World

Overseas only:
Automobile International
(English, Spanish)
Ingenieria Internacional
Construccion (Spanish)
International Management
(English, Spanish)
Portuguese editions
Metalworking Production
(Great Britain)

Available by subscription only — to qualified persons actively engaged in the field of the publication. For subscription rates and information describing the editorial coverage of any of the above publications, write to: *Subscription Manager, Circulation Department, McGraw-Hill Publishing Company, 330 West 42nd Street, New York 36, N. Y.*

electronics fills you in on every phase of the electronics industry each week featuring engineering and technical data every issue. Latest economic trends, technically interpreted, to help you make sound plans. Facts you'll want to file and keep. Subscribe now. Mail the reader service card (postpaid) to **electronics**, the magazine that helps you to know and to grow! Rates: three years for \$12, one year for \$6; Canadian, one year for \$10; foreign, one year for \$20. Annual **electronics** BUYERS' GUIDE included with every subscription.

it's read
more by
all 4!

RESEARCH

DESIGN

PRODUCTION

MANAGEMENT

SUBSCRIBE TODAY TO
electronics!

The Dangerous Years



BETWEEN World War II and the Korean conflict, before missiles came of age, the electronics industry was reverting to peacetime products and customers. In that period the inefficient went to the wall and the company with the right combination went to the top. And the right combination was, in more than one case, ability to predict what was needed, to produce it with quality and at a price. Sounds simple. What we call diversification today was known then as turning out a new product.

But the years since Korea have gone quickly, until today the Federal government is the direct customer for more than half our electronic goods and services, the indirect but identifiable stimulator of a far larger total. The government does business with our industry much as though it were a gigantic job shop. As a result, has the requirement for ingenuity "gone by the boards"? New-product ingenuity is an ingenuity which does not exist per se in a corporate body. It costs time, and money, to generate and maintain. In short, ability to diversify quickly, being neither understood nor accepted by the government as a prerequisite of doing business, is a luxury which large prime contractors can't afford. These are dangerous years.

We were no little shocked to learn that a telegram was sent to the President early this year requesting rescheduling of the F-105D airplane. Assuming that the F-110 is more suitable for the Nation's defense, it is hardly logical that the F-105D should be reconsidered on the basis that its abandonment would cause a labor problem of major proportion in one location. And it was on this basis the request was made.

Geographic concentrations of military suppliers, while desirable and logical on some counts, create the possibility of temporary but near disastrous unemployment, the costs of which

can be astronomic to local, State and Federal government.

Is there an obligation of government to maintain employment through contract assignments to specific corporations, the major portion of whose volume is in government contract work? What is the obligation of such corporations to shareholders and employees to diversify in consumer and industrial goods, or to perform research and development work which will reasonably assure a continuing flow of government contract work on the merit of proposals?

Are there not, on the part of the government, two obligations? First, to insure sufficient profit on production contracts to permit the corporation to fund reasonable R & D from profit dollars? Second, since 75 percent of all R & D is government-funded, to look favorably on assignment of R & D work to producer corporations, as opposed to strictly R & D firms, with particular reference to "non-profit" research organizations?

The corporation bears a parallel obligation to spend more profit dollars more sensibly in properly-directed R & D, particularly product-oriented and product-producing programs, so that diversification may be accomplished. The major airframe corporations are now in the business of manufacturing electronic apparatus and systems. These firms grew large, not in the electronics industry but in their own aircraft industry, as creators and producers of products, many of them entirely proprietary. It is neither economical nor proper that these same companies, having entered the electronics industry, should fail to develop new proprietary electronic products. Realistic R & D programs could not help but alleviate the feast-or-famine of government contract work, could not help but contribute to more stable employment.

James Gidwood

PUBLISHER

Why settle for too little or pay for too much in a digital voltmeter?

...now you can get
exactly what you need at a
sensible price from KIN TEL

These eight KIN TEL instruments, plus off-the-shelf accessories, meet every known requirement for digital voltmeters. This means you no longer have to over- or under-buy. You just select the one instrument that delivers the exact degree and combination of speed, accuracy, stability, adaptability, range, and reliability your particular applications call for.

Militarized Digital Voltmeter (Model 412). Rugged, programmable, differential input. Auto ranging, displays polarity. Measures AC and \pm DC potentials between 0.001 and 999.9 volts. Accuracy is 0.01% (of reading) ± 1 digit for DC, 0.1% of full scale for AC. Designed to MIL-E-4158A. Ideal for use in automatic systems. Price, in quantities of five or more: \$10,000.

DC Digital Voltmeter (Model 864A). New! High speed, solid state, programmable, modular construction. Measures 0.000 to ± 999.9 volts to 0.05% accuracy within approximately 0.02 second – within 0.005 second when programmed to any single range scale. Bidirectionally follows inputs changing as fast as 10 volts per second on the low range, 100 volts per second on the 100-volt range, or 1000 volts per second on the high range. Has electrical outputs for BCD, BCD excess-3, or 10-line parallel signals which are accessories. Price: From \$3180.

AC/DC Digital Voltmeter/Ratiometer (Model 551). New! First to bring you 5 readings-per-second speed with mercury-wetted relays. Full 5-digit, measures DC from 0.0000 to ± 999.99 volts to an absolute accuracy within 0.01% of the reading, ± 1 digit; AC from 30 to 10,000 cps between 0.0000 and 999.99 volts to an accuracy within 0.1% of the reading or 0.05% of full scale, whichever is greater. Adaptable without modification to fit a variety of data-logging systems. Ideal for laboratory use. Accessories include projection readout, BCD mercury-relay output, 10-line mercury-relay output, and AC converter. Price (without optional visual readout) for the basic 5-digit instrument with buffer register and auto/manual/command range: \$4150.

DC Digital Voltmeter and Ratiometer (Model 507D). Measures voltages between ± 100 microvolts and ± 1000 volts, ratios between $\pm 0.0001:1$ and $\pm 999.9:1$ with 0.01% (of reading) ± 1 digit accuracy. Accessories permit AC/DC and AC/AC ratio measurements. Stepping switches guaranteed for 2 years. Price: \$3835.

DC Digital Voltmeter (Model 501B). Four-digit, fifth-digit over-ranging. Measures positive or negative DC between 100 microvolts and 1000 volts, with 0.01% (of reading) ± 1 digit accuracy. Automatic or programmable range; auto polarity. Combines the useful accuracy of a 5-digit voltmeter with the stability, reliability, and price advantage of a 4-digit voltmeter. Stepping switches guaranteed for 2 years. Price: \$2995.

DC Digital Voltmeter (Model 501BZ). Similar to Model 501B (see above). Circuit is automatically and continually calibrated against a Zener diode reference source instead of against an unsaturated mercury-cadmium standard cell. For submarine and other special environment applications. Price: \$3160.

AC/DC Digital Voltmeter (Model 502B). Gives you AC accuracy within 0.1% of reading; over-ranging on both AC and DC; automatic ranging and remote (programmable) control. Measures DC between ± 100 microvolts and ± 1000 volts, AC from 30 cps to 10 kc between 1 millivolt and 1000 volts. Five-digit readout. Stepping switches guaranteed for 2 years. Price: \$4245.

AC/DC Digital Voltmeter (Model 502BZ). Similar to the Model 502B (see above). Circuit is automatically and continually calibrated against a Zener diode reference source instead of against an unsaturated mercury-cadmium standard cell. Price: \$4410.

Write for detailed literature or a demonstration of any of these exceptional instruments. Representatives in all major cities. All prices FOB, San Diego, Calif. 50 cps/220 volt operation at additional cost.

5725 Kearny Villa Road
San Diego 12, California
Phone 277-6700
(Area Code 714)

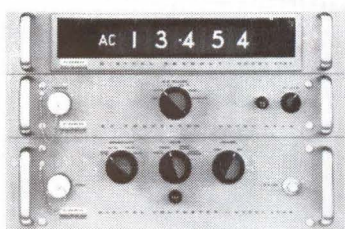
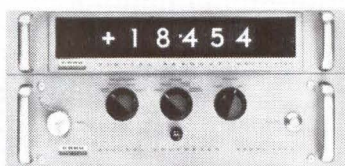
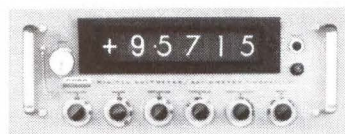
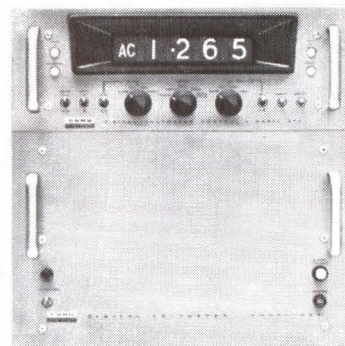

CIRCLE 203 ON READER SERVICE CARD

RESEARCH SATELLITE DIGITAL VOLTMETER ELECTROMETER
 VIDEO TAPE RECORDER JET ENGINE FUEL SHUT-OFF CONTROL
 SWITCH VIDEO AMPLIFIER AIRBORNE BEACON TRANSPONDER
 TURBO-PROP ENGINE VIBRATION ANALYZER 60 MC IF AMPLI-
 FIER JET/RECIPROCATING ENGINE VIBRATION ANALYZER 54 MC IF
 GAIN-CONTROLLED RADAR RADAR RANGE TRANSDUCER OSCILLA-
 TOR SONOBUOYS 30 MC AMPLIFIER WEATHER
 RADAR RECEIVER OSCILLATOR IF VOLTAGE CONTROL SAFETY
 BEACON TRANSPONDER SONAR SYSTEMS TUNERS
 HIGH-IMPEDANCE CATHODE FOLLOWER IN VIDEO AMPLIFIER IF STRIP
 IN AVQ WEATHER RADAR VIDEO PRE-AMPLIFIER CAMERAS
 RADAR AIR TRAFFIC CONTROLLER DISCRIMINA-
 TOR FILTER SCINTILLATION COUNTER FREQUENCY MULTIPLIER
 PULSE AMPLIFIER IN FAA UHF TRANSMITTER DOPPLER RADAR
 SYSTEMS CASCADE RF AMPLIFIER INPUT CATHODE
 FOLLOWER IN OSCILLOSCOPES MISSILE LAUNCH LOCATORS

THE NUVISTORIZATION EXPLOSION!

Almost daily, it seems, equipment manufacturers come up with new applications for the amazing RCA nuvistor tube. Small wonder! This radically new type of electron tube packs unexcelled performance capabilities into a package of extremely small size and light weight. Witness these nuvistor advantages to designers and manufacturers:

- Low heater drain • Very high transconductance at low plate current and voltage • Exceptional mechanical ruggedness from all ceramic-and-metal construction
- Exceptional uniformity of characteristics from tube to tube • Operation at full ratings at any altitude
- Dependable performance in fields of strong nuclear radiation • Extremely low interelectrode leakage • Low reverse grid current • High sensitivity and stability
- Low noise figure.

Keeping pace with an expanding number of applications, RCA brings you an expanding line of nuvistors.

Commercially available types now include:

- RCA-7586** General-purpose industrial medium- μ triode
- RCA-7587** General-purpose industrial sharp-cutoff tetrode
- RCA-7895** Industrial high- μ triode ($\mu=64j$)
- RCA-6CW4** TV and FM tuner high- μ triode
- RCA-2CW4** TV and FM tuner high- μ triode
- RCA-6DS4** TV and FM tuner high- μ triode with semiremote-cutoff characteristic

PLUS TWO NEW TYPES . . .

- RCA-8056** medium- μ triode for use with low-voltage power supplies in industrial and military applications. Excellent for small-signal amplifier applications up to 350 Mc.
- RCA-8058** double-ended, high- μ triode, for use in cathode-drive amplifier service up to 1200 Mc in a variety of applications.

Nuvistorization has been the answer to many critical circuit design problems; it may well be the answer to yours. For additional information, write to Commercial Engineering, RCA Electron Tube Division, Section F-19-DE-1, Harrison, N.J.



The Most Trusted Name in Electronics

RCA ELECTRON TUBE DIVISION—FIELD OFFICES
 EAST: 744 Broad Street, Newark 2, New Jersey,
 Humboldt 5-3900 • MIDWEST: Suite 1154, Merchandise
 Mart Plaza, Chicago 54, Illinois, Whitehall 4-2900
 WEST: 6801 E. Washington Blvd., Los Angeles 22,
 Calif., Raymond 3-8361 • 1838 El Camino Real, Bur-
 lington, Calif., Oxford 7-1620