

electronics

PHOTOTRANSISTOR TACHOMETER

*Measures missile
spin, p 33*

USING TRANSISTORS ABOVE CUTOFF

*Details of parametric
conversion, p 46*

Giant antenna at Goldstone, Calif. looks at Venus through interference from sun. New feed system makes it possible, p 36

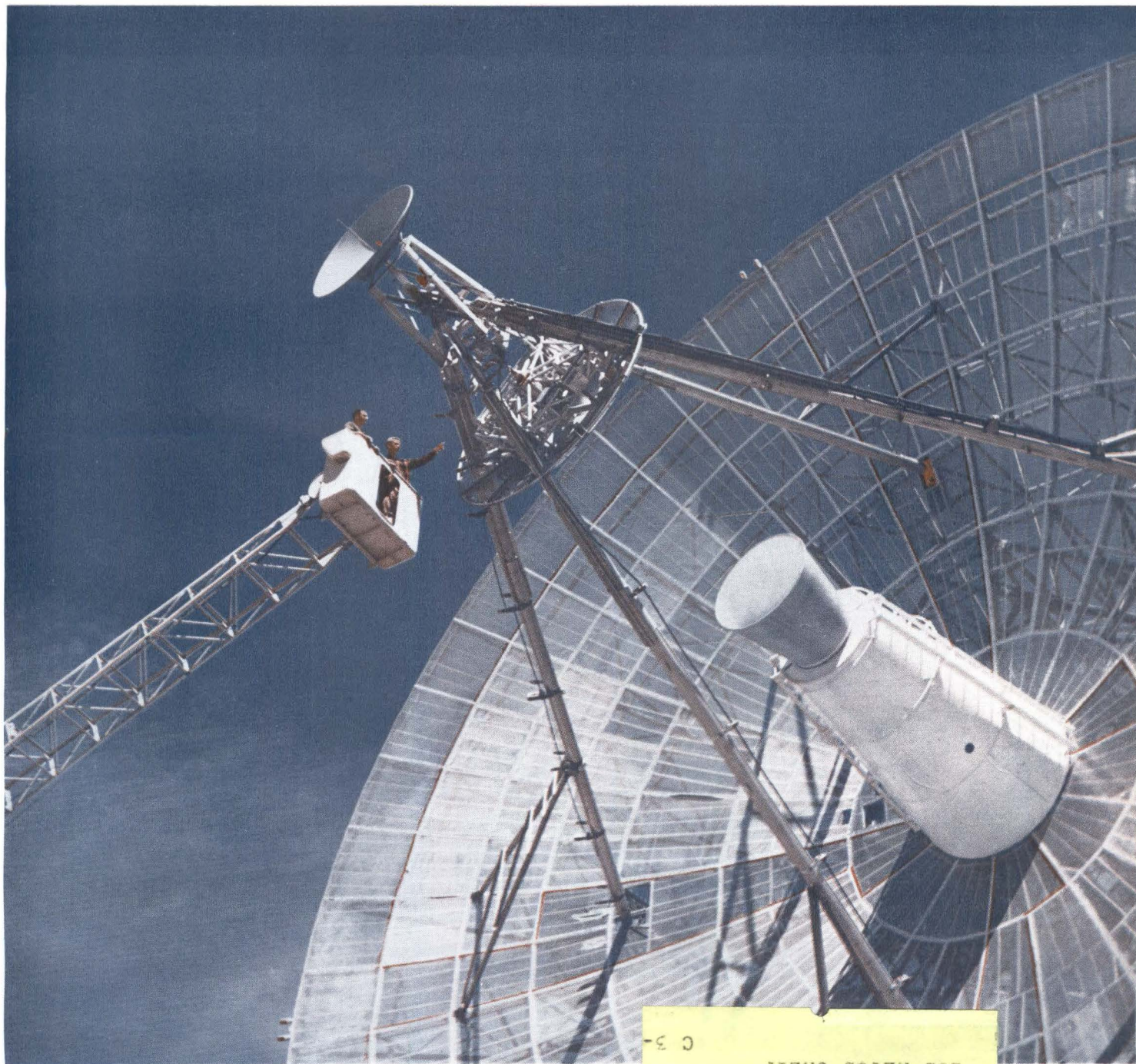

C 3-
LOS ALTOS CALIF
1020 GOVINGTON RD
R D SKINNER
L



SPECIAL CUSTOM BUILT POWER

TRANSFORMERS & REACTORS

New designs for both military and commercial types custom built to YOUR specifications for transistor and tube applications.

Exceptional quality and reliability is provided in all UTC designs. Over 30 years of engineering knowledge and experience backed by complete environmental testing and life testing facilities assure the highest standard in the industry. Full analysis and evaluation of materials are conducted in UTC's Material and Chemical Laboratories. Rigid quality control measures coordinated with exhaustive statistical findings and latest production procedures results in the industry's highest degree of reliability. Range covered in Power Transformers is from milliwatts to 100 KVA.

SOME TYPICAL APPLICATIONS:

- Current Limiting
- Filament
- Isolation
- Plate
- Transistor Inverter
- Transistor Supply

**SPECIAL
CUSTOM BUILT
IRON CORE
COMPONENTS
FOR
EVERY PHASE
OF THE
ELECTRONICS
ART** →



Write for catalog of over 1,000 STOCK ITEMS with UTC High Reliability IMMEDIATELY AVAILABLE from your local distributor.

**POWER TRANSFORMERS • AUDIO TRANSFORMERS
REACTORS • PULSE TRANSFORMERS • ELECTRIC
WAVE FILTERS • LUMPED CONSTANT DELAY LINES
HIGH Q COILS • MAGNETIC AMPLIFIERS
SATURABLE REACTORS • REFERENCE UNITS**

UNITED TRANSFORMER CORP.

150 VARICK STREET, NEW YORK 13, N. Y.

PACIFIC MFG. DIVISION: 3630 EASTHAM DRIVE, CULVER CITY, CALIF.

EXPORT DIVISION: 13 EAST 40th STREET, NEW YORK 16, N. Y.

CABLES: "ARLAB"

CIRCLE 900 INSIDE FRONT COVER

electronics

A McGraw-Hill Publication 75 Cents



W. W. MacDONALD, Editor

J. M. CARROLL, Managing Editor
 SENIOR EDITORS: Samuel Weber, George W. Sideris. SENIOR ASSOCIATE EDITORS: William E. Bushor, Michael F. Wolff. ASSOCIATE EDITORS: Michael F. Tomaino, Sylvester P. Carter, William P. O'Brien, John F. Mason, Thomas Emma, Sy Vogel, Leslie Solomon, George J. Flynn, Laurence D. Shergalis. ASSISTANT EDITORS: Nilo Lindgren, Stanley Froud, Stephen B. Gray, Roy J. Bruun, George V. Novatny, Leon H. Dulberger. REGIONAL EDITORS: Harold C. Hood (Pacific Coast, Los Angeles), Thomas Maguire (New England, Boston), Cletus M. Wiley (Midwest, Chicago). ART DIRECTOR: Harry Phillips; Howard R. Berry. PRODUCTION EDITOR: John C. Wright, Jr. EDITORIAL ASSISTANTS: Gloria J. Meurer, Bernice Duffy, Lorraine Rossi, Virginia T. Bastian, Lynn Emery, Bette H. Snyder, Rosemary Abbruzese, Judy Haskins, Ann Mella. FOREIGN NEWS BUREAU: Director, John Wilhelm, Alyne Elias. LONDON—John Shinn, Derek Barlow, Nicholas Landon. Bonn—Peter Forbath, Silke McQueen. Paris—Robert Farrell, Arthur Erikson. Milan—Marc A. Messina. Mexico City—Bruce Bendow. Rio de Janeiro—Leslie Warren. Moscow—Stewart Ramsey. Tokyo—Richard Halloran, Charles Cohen, John Yamaguchi.

JAMES GIRDWOOD, Publisher

INSPECTING CASSEGRAINIAN FEED SYSTEM on the 85-foot paraboloidal space tracking antenna at Goldstone, Calif. *Two-reflector system permits mounting feedhorn, maser, follow-on amplifier and instrumentation on surface of paraboloid not at its focus. See p 36* COVER

JAPAN RANKS SECOND In World Electronics Production. Estimated 1962 output is \$1,622 million. *Industrial electronics products are overtaking consumer products as the number-one moneymakers* 18

PENTAGON RESHAPING Procurement Policy. Defense Department officials ask electronics firms to help solve their problems. *The military isn't happy with some of its own practices, either* 19

DYNA-SOAR'S SHF COMMUNICATIONS System Is Being Designed to Pierce Reentry Blackout. Here's a close look at how voice and data systems will work. *This is a pioneering effort to solve one of the major space problems* 24

NEW RADIOTELESCOPES Share Receivers. Feed horns for 85-foot and 33-foot antennas are interchangeable. *Sensitivity is improved by asymmetrical cycle for ferrite switch* 26

TRANSISTORS Make Piano Portable. Piano can operate on batteries. *Players can use earphones for private listening* 28

DIGITAL TV Proposed for Apollo. Random-noise coding technique would suppress spurious contours. *Scan conversion needs work* 28

NEW PHOTOTRANSISTOR TACHOMETER Measures Missile Spin. Instrument consists of light source, perforated wheel and phototransistor. *It is used in wind-tunnel instrumentation and has performed better than other types of tachometers.*
 By C. F. Miller, Jr., U. S. Naval Ordnance Laboratory 33

UNIQUE FEED SYSTEM Improves Space Antenna. The two-reflector Cassegrainian antenna provides many operational advantages for space tracking antennas but ground spillover reduces performance. *A simple beamshaping technique reduces spillover and also improves aperture efficiency.*
 By P. D. Potter, Jet Propulsion Laboratory 36

STABLE FREQUENCY SYNTHESIZER Replaces Sideband Converter. Produces output in increments of 1 Kc over a range of 2 Mc to 30 Mc with tolerance dependent on that of controlling standard. *It replaces local oscillator in first conversion stage of dual-conversion single-sideband receiver.*
 By J. E. MacDowell, Airtronics 41

Contents continued

Published weekly, with Electronics Buyers' Guide and Reference issue, as part of the subscription, by McGraw-Hill Publishing Company, Inc. Founder: James H. McGraw (1860-1948).

Indexed Annually in Buyers' Guide and Reference issue.

Title ® registered U.S. Patent Office; © copyright 1962 by McGraw-Hill Publishing Co., Inc. All rights reserved, including the right to reproduce the contents of this publication, in whole or in part.

Executive, editorial, circulation and advertising offices McGraw-Hill Building, 330 West 42nd Street, New York 36, N. Y. Telephone Longacre 4-3000. Teletype TWX N.Y. 1-1636. Cable McGrawhill, N. Y. PRINTED IN ALBANY, N. Y.; second class postage paid at Albany, N. Y.

OFFICERS OF THE PUBLICATIONS DIVISION: Nelson L. Bond, President; Shelton Fisher, Wallace F. Traendly, Senior Vice Presidents; John R. Callahan, Vice President and Editorial Director; Joseph H. Allen, Vice President and Director of Advertising Sales; A. R. Venezian, Vice President and Circulation Coordinator; Daniel F. Crowley, Vice President and Controller.

OFFICERS OF THE CORPORATION: Donald C. McGraw, President; Hugh J. Kelly, Harry L. Waddell, Executive Vice Presidents; L. Keith Goodrich, Executive Vice President and Treasurer; John J. Cooke, Vice President and Secretary.

Subscriptions are solicited only from those actively engaged in the field of the publication. Position and company connection must be indicated on orders. Subscription rates: United States and Possessions, \$6.00 one year; \$9.00 two years; \$12.00 three years. Canada, \$10.00 one year. All other countries \$20.00 one year. Single Copies, United States and Possessions and Canada 75¢. Single copies all other countries \$1.50.

THE PUBLISHER, UPON WRITTEN REQUEST FROM ANY SUBSCRIBER TO OUR NEW YORK OFFICE, AGREES TO REFUND THAT PART OF THE SUBSCRIPTION PRICE APPLYING TO COPIES NOT YET MAILED.

Subscribers: Please address all correspondence, change of address notices, subscription orders or complaints to Fulfillment Manager, Electronics, at above address. Change of address notices should provide old as well as new address, including postal zone number if any. If possible, attach address label from recent issue. Allow one month for change to become effective.

Postmaster: Please send Form 3579 to Fulfillment Manager, Electronics, 330 West 42nd Street, New York 36, New York.



Audited Paid Circulation

CONTENTS continued

SENDING WEATHER-RADAR DISPLAYS Over Teletypewriter Circuits. Storage tube holds complete azimuth scan for digitizing by Nipkow scanning drum. *Output is punched on paper tape for data transmission or computer analysis.*
By W. Fischer and H. Hironaka, Rabinow Engineering 44

PUSHING TRANSISTORS ABOVE THEIR FREQUENCY LIMITS With Parametric Conversion. This is an extension of the Vodicka-Zuleeg technique (ELECTRONICS, p 56, Aug. 26, 1960) for operating transistors above frequency cutoff. Mathematical rationale is given in terms of parametric conversion. *Circuits achieve substantial gain and low-noise operation up to 5,000 Mc using commercially available transistors.*
By U. L. Rohde 46

SIMULATED BACKSCATTER PULSES Check Ionospheric Sounder Displays. Radar-like transmitter-receivers are used to determine propagation conditions in the ionosphere. This instrument simulates the long and short pulse returns characteristic of these systems. *It is used in designing display units for ionospheric sounders.*
By K. Perry, University of Queensland 50

DEPARTMENTS

Crosstalk. *Equal Partner or Baby Brother? Automated Information* 3

Comment. *Electronic Anesthesia* 4

Electronics Newsletter. *All-Channel Tv Bill Passes* 7

Washington Outlook. *House Passes Bill to Reduce Negotiated Contracts. NATO Research* 12

Meetings Ahead 30

Research and Development. *New Transducer Provides Greater Sensitivity* 52

Components and Materials. *Analysis of Cooling Methods* 56

Production Techniques. *Micro Labels for Micro Components* 60

New Products Design and Application. *Spectrum Signature Adapter* 64

Literature of the Week 71

People and Plants. *RCA to Lease New Midwest Facility* 72

Index to Advertisers 79

Equal Partner or Baby Brother?

A BILL PASSED by the House of Representatives would empower the Federal Communications Commission to require that all television receivers manufactured and shipped from one state to another receive uhf as well as vhf. A similar bill passed the Senate last week.

Some commentators feel that this is a good thing for tv, for the electronics industry and for the public . . . more tv stations will be on the air, more transmitters and receivers will be sold, and uhf spectrum space now lying fallow will be put to work in the public interest.

While the aims are commendable and it may be that some day all tv should be uhf, it seems to us that the time has come to take a close look at the means. What is involved here is not a matter of whether or not America needs uhf television but whether it should be force-fed. Since its evolution as one of the most vital factors in the U. S. economy, our industry has done a pretty good job when Government has said, "We need this. Can you make it?" Now, we are being told . . . "We need this and you have to make it or else!"

Whether or not uhf is really needed is still an open question, but the implications of this legislation, "You have to make it," we find contrary to relationships that have historically existed between industry and Government. If legislation like this can pass, we may very well ask ourselves what comes next. One industry spokesman, also against the measure, asks quite reasonably about the possibility of stimulating the growth of f-m broadcasting by ordering that all radio receivers hereafter be designed to handle f-m as well as a-m.

Looking over other areas of the U. S. economy, might the electronics industry be faced one day with the ghastly condition that prevails in agriculture? How many of our semiconductor manufacturers would enjoy being ordered not to produce for a few months a year so as to maintain parity price levels on transistors and diodes?

Some of these points might appear extreme, but none-the-less we feel there is a very real danger when any segment of our economy stops being an equal partner with Government and declines to the level of being a kid brother who has to fetch and carry when orders come from Washington.

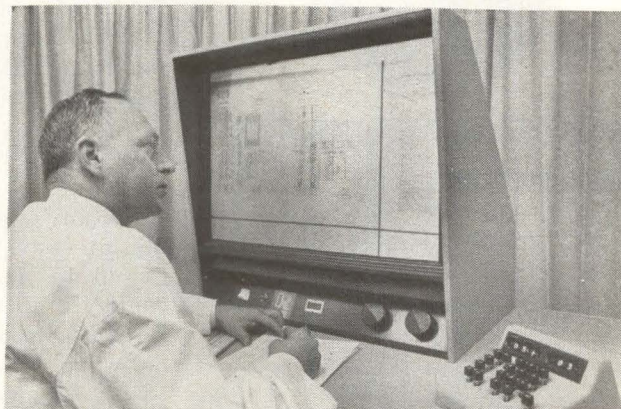

AUTOMATED INFORMATION. Next week, we publish a special report on information storage and retrieval, one of the most rapidly burgeoning fields in the industry. The report will of course summarize hardware and system design, developments and concepts.

In addition, the report will look into some of the technological and semantic roadblocks that designers and users run up against. For example, back when large-scale, all-electronic computers were new, they spurred the idea of systems that could rapidly extract related bits of randomly-stored information.

This early concept of information retrieval still endures. However, it is based on a determination of what the machine can do, not what the machine should do. That is like finding questions to fit ready answers. It slights the more fundamental problem of seeking questions, then developing the machine.

Computers are dandy for hunting up references and computermen have often proposed and sold reference-hunting systems. These are fine if that is what the customer really needs. But sometimes a computer can turn out more references in a minute than the customer can winnow in a week. Growing realization of this difficulty has led to development of a number of systems that store select actual documents (like Information for Industry's, photo).

Another concept being discarded is that information retrieval is concerned only with written information. Guy H. Doshier, manager of the technical information center in Motorola's Military Electronics division, says information retrieval systems really are invented to improve person-to-person technical communications. Motorola-Phoenix assembles technical dossiers on each of its engineers and enters them into the main retrieval system. Sometimes the only source for vital information is a human memory.

Trends like these are what make information retrieval developments of interest not only to specialists in the field, but to all engineers.

VERY NARROW

10kc*

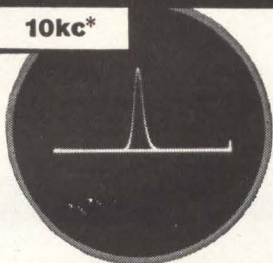

TO VERY WIDE

400mc**

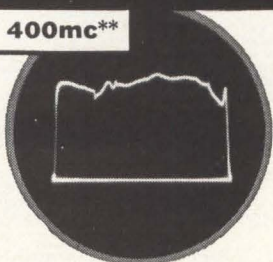

SWEEP WIDTHS
...all in one instrument

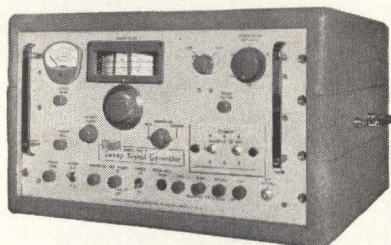

NEW JERROLD® 900B
SWEEP SIGNAL
GENERATOR

The new Jerrold 900B is the last word in versatility and precision, the ultimate instrument for all your IF, VHF, and UHF sweep requirements. Bench space requirements and test set-up time are drastically cut because so much is already built in:

- Built-in crystal-controlled harmonic markers at 1, 10, and 100mc intervals.
- Built-in variable-gain dc or ac-coupled 'scope preamplifier with 200X maximum gain.
- Built-in precision attenuator from zero to 50db in 10db steps.

Generating sweeps with center frequencies ranging from 500kc to 1200mc, the 900B offers unusual stability with sweep widths as narrow as 10kc and as wide as 400mc. Write for complete technical data.

\$1,980.00 f.o.b. Philadelphia

*Typical communication receiver IF (selectivity approx. 6 kc).

**Frequency response of typical wide-band distributed amplifier (4-216 mc).

JERROLD® ELECTRONICS CORPORATION
Industrial Products Division, Dept. ITE-145
The Jerrold Building, Philadelphia 32, Pa.
Jerrold Electronics (Canada) Ltd., Toronto
Export Representative: Roche International, N.Y. 16, N.Y.

COMMENT

Electronic Anesthesia

I am doing some research into electronic anesthesia of meat animals, via audiofrequency waves, for humane slaughter purposes.

I would appreciate your indicating to me any material you may have on this subject.

JERRY ROSEN

New York, New York

For any other readers with similar interests, the closest we have gotten to animal anesthesia recently is an article by Harry P. Dale, *Electronic Fishing With Underwater Pulses* (p 31, Jan. 23, 1959), on electro-narcosis of fish with pulsed d-c.

The University of Mississippi Medical Center has an electro-narcosis project, according to Part III of our *Medical Electronics* series (p 54, Feb. 24, 1961), in which a 700-cps oscillator current is passed through the patient's brain, causing anesthesia deep enough for a demonstrated abdominal surgery operation.

Back to 1933

Please send us a photostat of the two-part article, *A Study of Litz Wire Coils*, by David Grimes and W. S. Burden, (p 303, Nov., and p 342, Dec., 1933) and any other articles you have published on Litz wire.

PETER J. OTTOWITZ

New England

Electrical Works, Inc.
Lisbon, New Hampshire

Among the many requests we get for copies of articles, there are several each month that go back to the thirties, back to articles that cover some of the first published information in many fields of electronics, and which are still of value and assistance after three decades.

Sweep Circuits

I enjoyed the article, *Sweep Circuits Using Two Three-Terminal Active Elements*, by Mr. A. S. Kislovsky (p 54, Mar. 23). I noticed one error that should be corrected.

Mr. Kislovsky gives the "run-down time" as $t_1 = (R_c + R)C$ [which is referenced to L. Strauss, *Wave Generation and Shaping*, McGraw-Hill Book Co., 1960, Eq. 7-19]. This was given in Professor Strauss' book incorrectly. Equation 7-18 in the book is correct, but the erroneous assumption is made that the "initial jump" is insignificant. Unless the initial jump term is included, $e_2(t)$ in the equation that appears between 7-18 and 7-19 will appear to start at some value greater than E_{bb} . If the initial jump term is left in the equation, $e_2(t)$ starts at E_{bb} as it should, and the solution of the equation for $e_2 = 0$ gives $t_1 = RC$.

Using the values given in Mr. Kislovsky's article gives a small error, but as the value R is reduced, the error will become progressively larger.

WILLIS A. FINCHUM

Utah State University
Logan, Utah

Prof. Strauss reports that the error in his Eq. 7-19 was inadvertently transcribed from an analysis of a slightly different circuit. Noted too late for the first printing, it has been corrected in the current second printing.

Wrong Caption

I was very pleased to see the photograph of this division's controlled atmosphere ballistics range on the cover of the May 25 issue of *ELECTRONICS*. My enthusiasm cooled somewhat upon looking at the caption, which identified the installation as being at the Avco-Everett Research Laboratory. It is, of course, located here in Wilmington, Mass., at the Research and Advanced Development Division.

I realize some confusion of these two organizations is bound to continue on the part of people outside Avco in spite of our identifying letterheads, ads, and separate locations. I pass this information along in the hope that this division and the Avco-Everett Research Laboratory will continue to have good coverage in *ELECTRONICS*, and wearing our proper labels.

J. R. MCLEOD

Avco Corporation
Wilmington, Mass.

Why engineers
are specifying **VK** Capacitors
for CK Capacitor requirements...

VITRAMON, INC. SUPPLIES
PROOF
OF PERFORMANCE
with every shipment

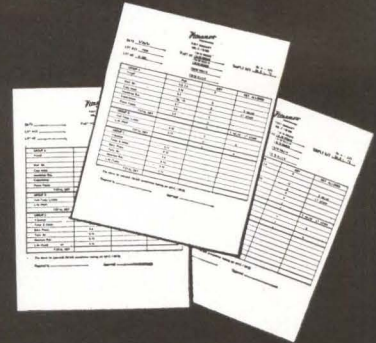

The "proof of performance" for all CK Capacitors ("VK" Capacitors purchased against MIL-C-11015/18 or /19) is enclosed with your order! Automatically and voluntarily, "Vitramon" supplies copies of Acceptance Testing Data — with every shipment.

And test results are impressive! Where absolute conformance to military specifications is essential, CK Capacitors adhere closely to requirements. In critical areas where specifications may be surpassed, CK Capacitors offer reliability "above and beyond." Here's how they measure up:

DISSIPATION FACTOR

MIL. REQUIREMENT	ACTUAL PERFORMANCE
2.5% for all values	1.5% for values thru 680 mmf.
	2.5% for values 820 thru 10,000 mmf.

TEMPERATURE COEFFICIENT

MIL. REQUIREMENT	ACTUAL PERFORMANCE
+30% -56% for all values	±10% for values thru 680 mmf.
	±15% for values 820 thru 10,000 mmf.

CK Capacitors are checked 100% for dissipation factor and capacitance, and to insure that the parts stay within tolerance, only 2/3 of the available capacitance band is used. Parts are checked for Insulation Resistance after being subjected to a seal test consisting of exposure in live steam for 2½ hours under 15 p.s.i. Parts are also gauged 100% for physical dimensions.

MIL PARTS
NOW IN STOCK!

VK Micro-miniature
CERAMIC CAPACITORS
Conforms with MIL-C-11015/18/19



VK 30
case size:
0.3" square
lead spacing:
0.2"



VK 20
case size:
0.2" square
lead spacing:
0.2"

- 10-10,000 mmf
- -55° C to 150° C
- 200 VDC rating

© VITRAMON, INC., 1962

June 22, 1962

Vitramon[®]
INCORPORATED
P.O. Box 544
Bridgeport 1, Connecticut

CIRCLE 5 ON READER SERVICE CARD 5

MEASURE FREQUENCY, 200 MC to 12.4 GC,

with COUNTER
ACCURACY!

Faster
More accurate
More useful
Microwave frequency
measurements

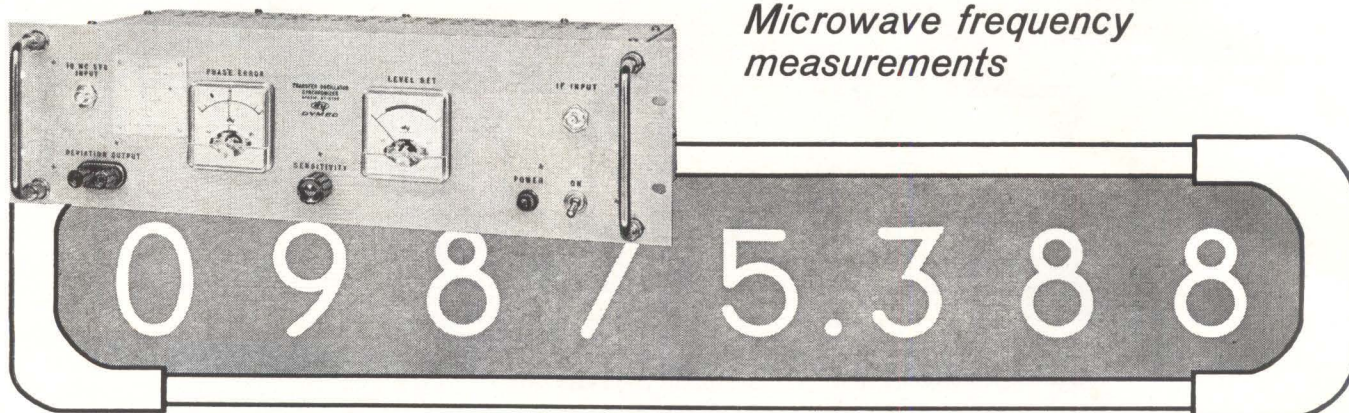

Introduce counter accuracy to your microwave frequency measurements with the unique Dymec Transfer Oscillator Synchronizer! Model DY-5796, used with a Hewlett-Packard Transfer Oscillator and an Φ Counter, permits high-accuracy automatic frequency measurements, even on varying signals, all the way to 12.4 GC.

With the Φ 540A/B Transfer Oscillator and Φ 524/525B Frequency Counter, the DY-5796 Synchronizer provides positive locking of the transfer oscillator to the signal frequency . . . thus giving you measurement accuracy equal to that of the counter time base. Higher accuracies can be achieved with an external frequency standard, such as the Φ Model 103A Quartz Oscillator, which provides short term stability better than 5 parts in 10^{10} . The Φ 524C and 525B Frequency Converter covers 100 to 220 MC, and the Φ 540A (with external Φ 934A Harmonic Mixer) or 540B (with the mixer built in) extends your measuring range to 12.4 GC.

By keeping the transfer oscillator and the signal frequency in permanent synchronization, the DY-5796 also permits long term measurements of low drift rates at microwave frequencies. FM deviations up to 0.2% of the carrier frequency can be measured with the addition of a VTVM and/or oscilloscope. Further, this instrument and the associated equipment greatly simplify determination of the harmonic number and microwave frequency.

The DY-5796 Synchronizer is available from Dymec for use with your present Φ Transfer Oscillator* and Counter—or you can use the Dymec 5854 Frequency Measuring System composed of the Synchronizer and the optimum related Φ equipment mounted in only 52½" of rack space.

SPECIFICATIONS

DY-5796 Transfer Oscillator Synchronizer

Frequency Range: 200 MC to 12.4 GC
Lock-on Range: $\pm 0.2\%$ of signal frequency, maximum*
Price: \$685.00

*With Modification Kit 9200-0028 for 540A/B Oscillator. \$65.00

DY-5854 Frequency Measuring System

Includes synchronizer, modified transfer oscillator, electronic counter with frequency converter, digital recorder with analog output, cabinet and interconnecting cables.

Frequency Range: 200 MC to 12.4 GC
Lock-on Range: $\pm 0.2\%$ of signal frequency, maximum
Accuracy: ± 1 count \pm stability
Stability: $3/10^8$ short term, $5/10^8$ per week with 524C/D internal time base. May be used with external frequency standard, e.g., Φ 103AR, for greater accuracy.

Registration: 9 places: first 2 on converter dial, next 7 on counter.

Printout: Full readout of counter printed on paper tape.

Analog Output: For Potentiometer Recorder: 0-100 mv. Minimum load resistance 0.5M. Calibrate control. For Galvanometer Recorder: 0-1 ma into 5000 ohms or less. Zero and calibrate controls.

FM Measurement: Deviations up to 0.2% of signal frequency at rates to 1 kc. Above 1 kc, max. deviation limit reduced at 20 db/decade to max. of 0.001% at 200 kc.

Price: \$6,405.00.

Data subject to change without notice.

Prices f.o.b. factory.

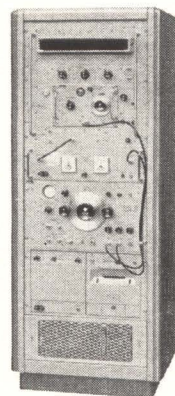

Write to your Dymec/Hewlett-Packard representative or contact us directly for complete information.

DYMEC
A division of HEWLETT-PACKARD COMPANY

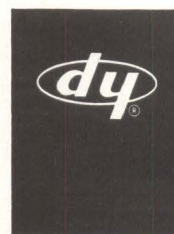

DEPT. E-10, 395 PAGE MILL ROAD, PALO ALTO, CALIFORNIA • DAVenport 6-1755 • Area Code 415

TWX-117-U

7204

ELECTRONICS NEWSLETTER

Senate Passes All-Channel Television Bill

WASHINGTON—The Senate passed by voice vote last Thursday the all-channel television receiver bill. The measure would give the Federal Communications Commission power to require that manufacturers shipping sets in interstate commerce make the sets to receive all uhf channels as well as vhf channels.

The House passed the bill last month (p 12, May 11). The bill was sent by the Senate back to the house for action on a minor amendment.

FCC had requested the bill to spur development and utilization of uhf television. Before the Senate voted, some Republican senators protested that it was an unwarranted extension of government control (see p 3, this week) and would boost the price of sets. A court test of the bill's constitutionality is anticipated.

Will Try to Get Power From Jet Engine Noise

ACOUSTIC energy converter for transforming the sound of jet aircraft engines into electric power will be built by U. S. Sonics Corp., Cambridge, Mass., under a \$50,000 Air Force contract for an experimental unit. The converter will use the piezoelectric principle. The company says that in their final form such converters could extend jet plane ranges by thousands of miles, since a third of a four-engine plane's fuel is used to produce electrical power.

Kerr Shutter Controls 50-Mw Pulsed Laser

ATTAINMENT of more than 50 Mw of optical power and pulse widths of 10 nsec is reported by Quantatron, Inc., a Santa Monica, Calif., company headed by T. H. Maiman. R. F. Wuerker, in charge of the development team, says a gigawatt of optical power will be obtained in the near future.

The ruby laser is controlled by a Kerr shutter within the laser resonator. The shutter inhibits oscillation while the ruby is pumped, then is opened in nanoseconds to

allow high-power oscillation.

The 10-nsec pulses with 3-nsec rise times are expected to allow laser ranging systems to attain range resolution accuracies of 20 inches "at all meaningful distances," the company said. High peak power is also expected to facilitate harmonic generation and further studies of materials and effects.

Telescope and Scanner To Detect Space Objects

BOSTON—Prototype optical surveillance system for Air Force's Space-track network (p 32, Nov. 24, 1961) will be built by RCA under a \$2.8-million contract awarded by Air Force's Electronic Systems Division.

Besides a powerful telescope, the prototype will employ photosensitive surfaces of image-orthicon tubes coupled with data correlation techniques for fast readout. Star background, moonlets and other natural objects will be nulled out electronically. Scanning and memory techniques will detect the motion of man-made space objects.

Although radar techniques can yield more information on satellites with close-to-earth orbits, optical systems will be relied on for detec-

Healthy Slice

WASHINGTON—Harold Brown, director of defense research and engineering, last week gave these estimates of electronics's share of military spending:

R&D, 30 to 40 percent

Hardware, slightly less.

Military budgets are now running about \$7 billion a year for R&D and \$17 billion for procurement

tion and tracking at extremely long ranges.

RCA also got a \$6-million contract from ESO for an air-transportable air-traffic control, navigation and communications system. Air Force may eventually have 14 systems at air bases around the world. Each will be housed in six vans, transportable in C-130A planes. System will include precision approach and search radar, vfr and ifr gear, tower vans, communications and Tacan.

Component Sales Rise to \$3.6 Billion During 1961

WASHINGTON—Shipments of electronic components in 1961 were valued at \$3.6 billion, an increase of nearly six percent over the preceding year, Business and Defense Services Administration reports. At the end of the year, unfilled orders for components were about eight percent higher than a year earlier.

Capacitor sales gained 18 percent to \$301 million, resistors increased by 16 percent to about \$286 million, connectors were up 13 percent to \$190 million, quartz crystals gained 30 percent to \$28 million, and complex components were up 38 percent to \$38 million. Relay sales declined two percent to \$182 million and transformers shipments were down slightly to \$181 million.

Sales of electron tubes remained virtually unchanged at \$860 million. A 13 percent increase in power and special purpose tubes was offset by declines in receiving tubes and relatively low picture tube output in early 1961.

Semiconductor shipments increased about four percent to \$565 million despite the sharp decline in prices of many transistor and diode items. New devices contributed substantially to the overall net gain.

Japanese Says They'll Hold Radio Price Level

TOKYO—Masaru Ibuka, president of Sony Corp. and chairman of Japan Electronics Instruments Export Association, said last week that there are no immediate plans to reduce prices of six-transistor radios imported to the U. S. The remark was

prompted by news received by the Japan External Trade Organization that U. S. importers are pressing the Japanese to cut prices to match the nearly 40 percent price cut on six-transistor radios by RCA and GE.

Ibuka said the price difference between Japanese and U. S. transistor radios and those now stands 10 percent more for the Japanese but is well covered by the accessories that Japanese manufacturers include. GE came down on retail prices for old models, not new ones, and that U. S. importers are trying to take advantage of this, he added.

An industry observer, said however, that the price-cutting offensive from the U. S. importers has hurt the industry so badly that most of the small firms have gone out of business. Major firms are also having a tough time, he said.

Tiros V Ready to Go as Tiros IV Loses Recorder

NASA LAUNCHED the fifth in the series of Tiros weather satellites Tuesday from Cape Canaveral. The satellite is similar in design to earlier Tiros satellites. Tiros V is to orbit at an altitude of about 350 nautical miles. Orbit inclination will be 58 degrees, so it will cover the northern ice regions, then the southern hemisphere and ice fields, then go north again in time for the hurricane season.

NASA also reported that the tape recorder for Tiros IV's second tv camera has malfunctioned, allowing it to transmit pictures only singly within the 1,500-mile range of U. S. command stations. Pictures suitable for global weather forecasting are no longer obtainable. Infrared data is still being received. NASA said the satellite has exceeded its design performance.

Incentive Contracting Extended to Servicing

NASA's Goddard Space Flight Center has issued what it believes to be the first incentive contract awarded by any agency for service work. The contract, a renewal of a Bendix Radio division contract to operate

and maintain Project Mercury tracking and communications stations and other facilities, provides for payments above a fixed fee if the company demonstrates superior performance. The contract is for some \$10 million and will run through 1963 and 1964.

Japanese Ready to Make Micropack Logic Circuits

TOKYO—Nippon Electric has stolen a lead on other semiconductor manufacturers here by announcing their silicon solid-state logic circuits in TO-5 transistor cases. Units are available on sample basis now, will be placed on sale this fall.

Circuits include seven types of six-diode AND and OR circuits; transistor NOR gates with six transistors connected in one group of six (all collectors common), two groups of three, and three groups of two; dctl gates, both OR and NOR, with load resistances formed on the same wafer as the transistors; Darlington-connected circuit with three horseshoe-shape concentric transistors on one wafer; and two-transistor units that may be used either as choppers or differential amplifiers.

Transportable Troposcatter System Has 460-Mile Range

PHILCO Communications Systems division will install a 24-channel, transportable, tropospheric-scatter system for voice and teletypewriter transmission over a 460-mile range in the Far East. The system, being developed for Signal Corps, has data handling capabilities in the 1.7-Gc to 2-Gc region.

A special f-m phase-lock receiver will receive signals to within 1 db of the effective receiver noise threshold and provides a telephone channel signal-to-noise ratio of 26 db and 45 db flat weighted at carrier input levels of -130 and -120 dbw, respectively.

Low-noise parametric devices and diversity techniques further extend receiver performance, Philco said. Antennas are 60-foot dishes. A dual f-m exciter drives 10-Kw power amplifiers.

In Brief . . .

ADMIRAL's chairman, Ross D. Siragusa, predicts 400,000 color tv sets will be sold this year and 750,000 next year—equivalent in dollar value to nearly 2 million black and white sets.

ZENITH reports that distributor orders for its consumer electronics products are 25 percent higher than last year, with stereo orders double and 1961 tv orders rising.

SPERRY RAND's Electronic Tube division is making a helium-neon laser with hard-glass tube and internal plane polarizers. Anticipated first use is in an electro-optical doppler radar system now in development.

MINUTEMAN missile launched from an underground silo at Cape Canaveral last week successfully flew 3,000 miles.

IBM PLANS to build a small (30 to 40 staff members) research laboratory in Japan.

RYAN AERONAUTICAL is licensing Compagnie Francaise Thomson-Houston to produce Ryan's doppler radar navigators in Europe.

MOTOROLA will install a transistor, battery-operated, microwave system 1,000 miles long in Texas, for Atlantic Pipeline Co. Longest hop will be 50.1 miles.

GPL DIVISION of General Precision has Army R&D contract to examine feasibility of optical correlation for automatically reducing photos to maps. GPL also has \$1.7 million in Air Force contracts for doppler radar test sets.

OTHER AIR FORCE contracts include \$3.8 million to Collins Radio for airborne equipment; \$3.1 million to Adler Electronics for transportable communications systems; \$2.2 million to Olympic Radio & Tv, for weather radar.

HAZELTINE's moving-target indicator radar receiver is being evaluated by Army for possible use with Nike Hercules.

SPRAGUE HYREL® ST CAPACITORS ACHIEVE MINUTEMAN GOAL OF ULTRA-HIGH-RELIABILITY!

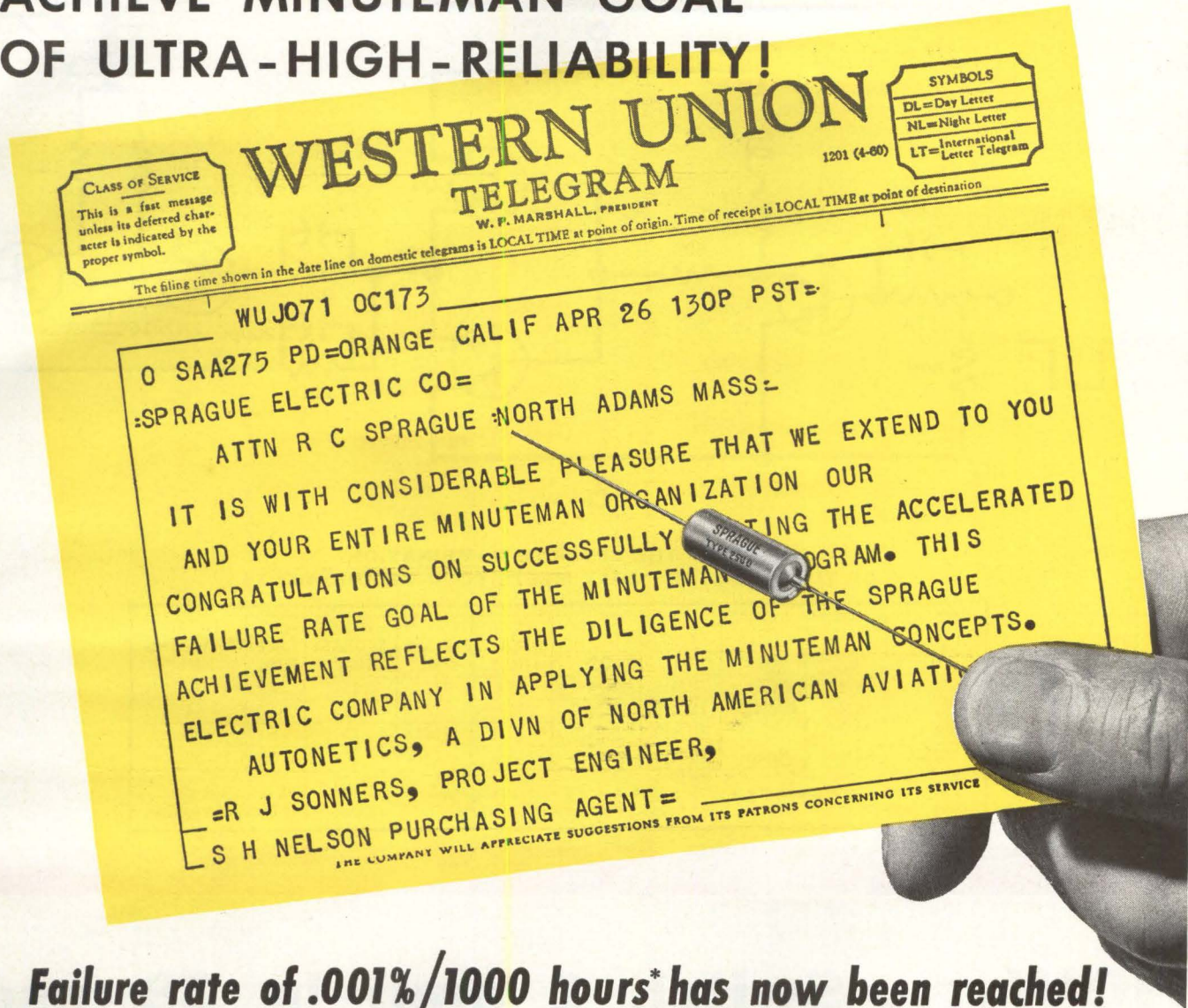

Failure rate of .001%/1000 hours* has now been reached!

• Following comprehensive life tests, Sprague HYREL ST Solid Tantalum Capacitors have now attained Minuteman's component development objective. Minuteman ultra-high-reliability demands quality 100 times greater than that of former "highly-reliable" capacitors. This standard allows only one failure in 200,000 units per 1000 hours of test under Minuteman use conditions.

• Behind this achievement is an unequalled test history of more than 130 million unit-hours. Backing this performance is Sprague's record of pioneering in highly reliable capacitors, which earned us the oppor-

tunity to participate in the Air Force's Minuteman Component Development Program at Autonetics, a division of North American Aviation, Inc.

• All of the special processes and quality control procedures that make HYREL ST Capacitors the most reliable in the world can now help you in your military electronic circuitry. A tantalum capacitor engineer will be glad to discuss the application of these capacitors to your missile and space projects. Write to Mr. C. G. Killen, Vice-president, Industrial and Military Sales, Sprague Electric Company, 35 Marshall Street, North Adams, Massachusetts.

*At 60% confidence level by accelerated qualification tests.

SPRAGUE COMPONENTS

CAPACITORS
TRANSISTORS
MAGNETIC COMPONENTS
RESISTORS
MICRO CIRCUITS

INTERFERENCE FILTERS
PULSE TRANSFORMERS
PIEZOELECTRIC CERAMICS
PULSE-FORMING NETWORKS
TOROIDAL INDUCTORS

HIGH TEMPERATURE MAGNET WIRE
CERAMIC-BASE PRINTED NETWORKS
PACKAGED COMPONENT ASSEMBLIES
FUNCTIONAL DIGITAL CIRCUITS
ELECTRIC WAVE FILTERS



'Sprague' and '®' are registered trademarks of the Sprague Electric Co.

**THIN FILM DRIVER CIRCUIT
SWITCHES 1 AMP IN 39 NSEC**

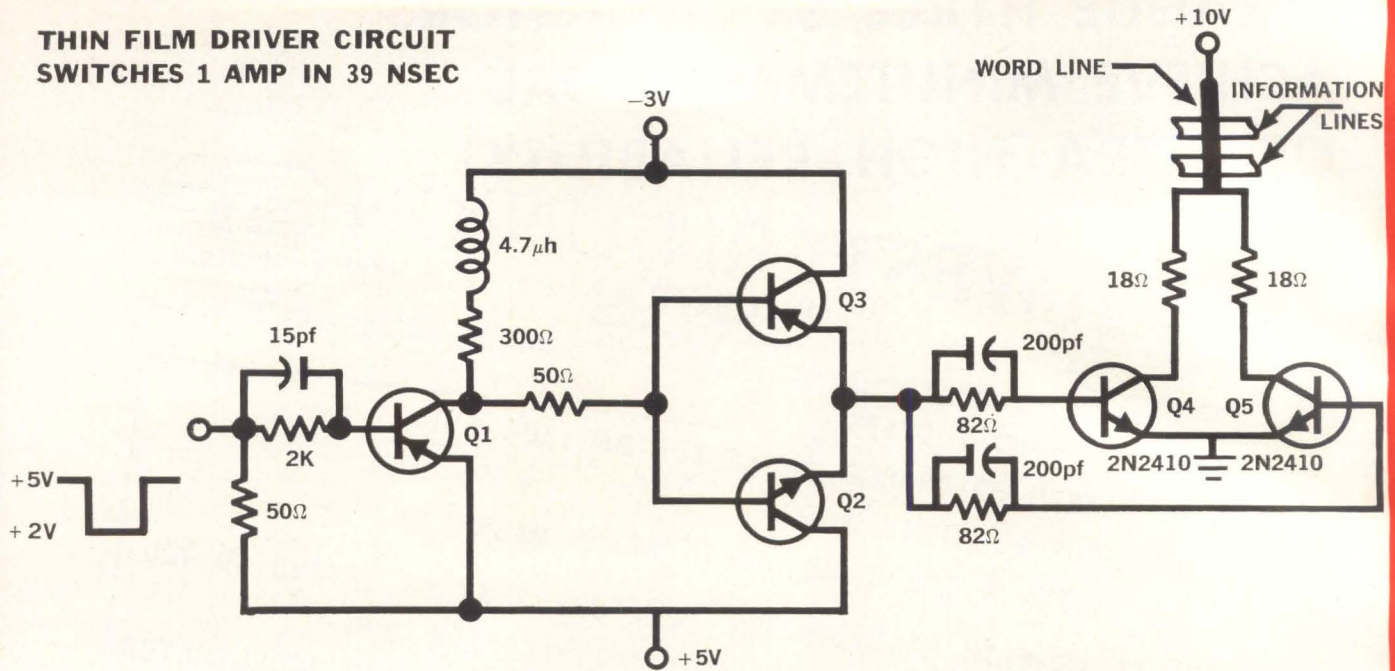

**SELECT THE OPTIMUM COMBINATION
OF TI TRANSISTORS THAT MEETS YOUR REQUIREMENTS**

Q1	Q2	Q3	Q4	Q5	DELAY TIME*	RISE TIME*	STORAGE TIME*	FALL TIME*	TOTAL SWITCHING TIME*
2N964	2N743	2N964	2N2410	2N2410	8	12	15	4	39
2N2411	2N743	2N2411	2N2410	2N2410	10	17	22	5	54
2N2412	2N743	2N2411	2N2410	2N2410	10	16	24	5	55
2N964	2N797	2N964	2N2410	2N2410	8	12	16	3	39

2N2410—NPN Silicon Epitaxial Planar 2N2412—PNP Silicon Epitaxial Planar 2N797—NPN Germanium Mesa
 2N2411—PNP Silicon Epitaxial Planar 2N743 —NPN Silicon Epitaxial Mesa 2N964—PNP Germanium Epitaxial

*All times in Nanoseconds

NOW.... Switch 1 amp in 39 nsec

Advanced Transistor Technology Means Faster Switching For Your Computer Memory Circuits

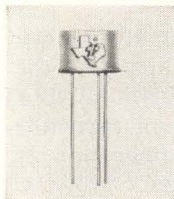

TO-5 CASE

Now... you can increase computer information handling capacity by designing TI's 2N2410 "Snowflake" transistors into your thin film driver circuitry. The ideal combination of high current and fast switching you need for advanced, high-speed computers can now be obtained with these NPN Silicon Epitaxial Planar transistors.

Your circuits will be capable of operating at higher frequencies with faster switching of higher current. You have the advantage of TI's epitaxial planar process combined with the new "Snowflake" geometry... available now!

The 2N2410 employs this six-pointed emitter geometry to provide the optimum ratio of emitter periphery to emitter area. When used as an amplifier, the TI 2N2410 provides flat dc beta from 10 ma to 500 ma for greater circuit stability and a reduction in compensating circuitry. High f_T (typically 300 mc) assures efficient operation in the VHF range.

As shown in the thin film driver circuit, two TI 2N2410 transistors will perform the same function as ten less-advanced transistors because of the high current switching capability of "Snowflake". Typically, the 2N2410 will switch 0.5 amp in 85 nanoseconds and 150 ma in 75 nanoseconds, under data sheet conditions. Guaranteed total switching times are 120 nanoseconds at 150 ma and 130 nanoseconds at 500 ma.

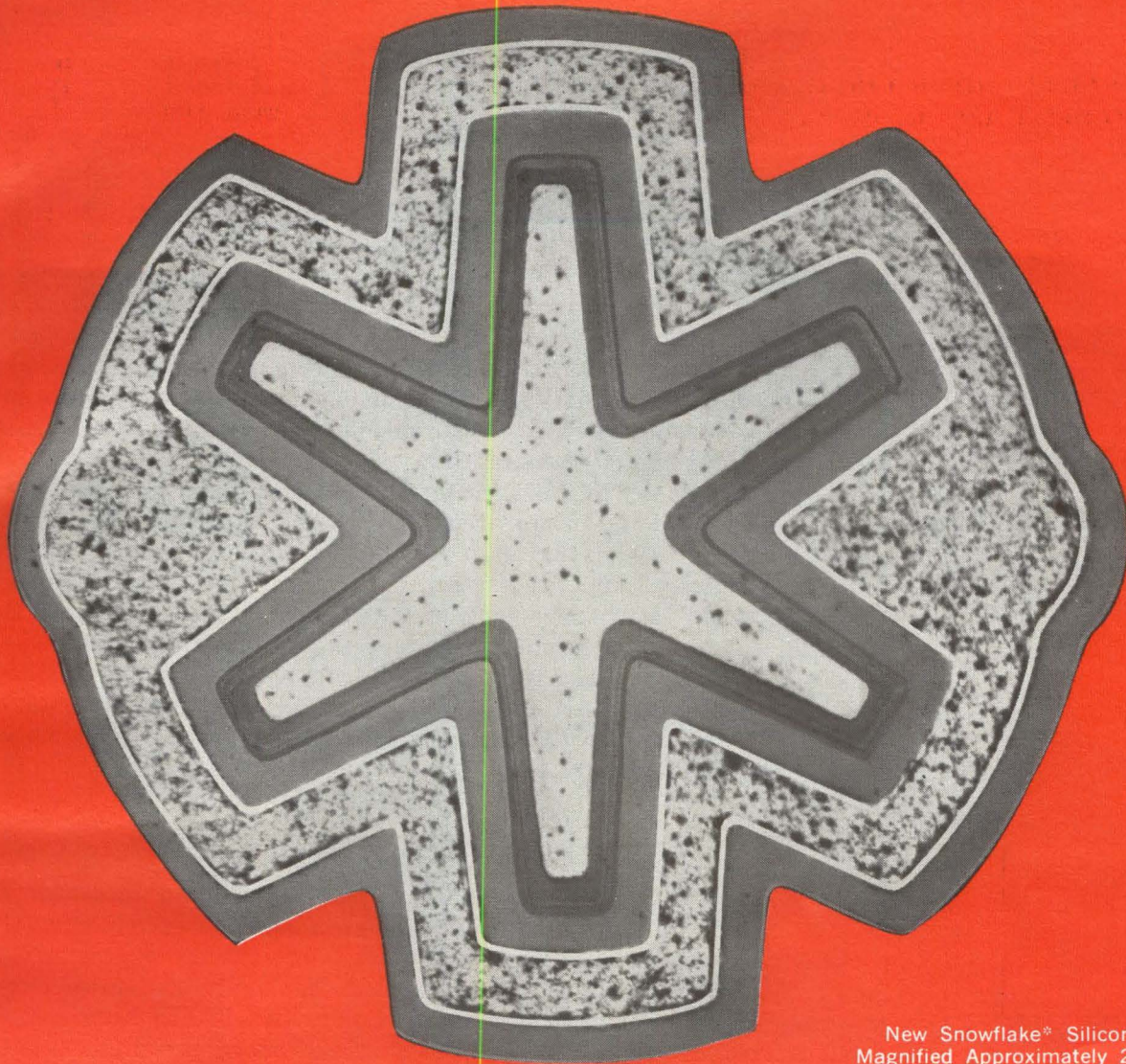

New Snowflake* Silicon Wafer
Magnified Approximately 270 Times

*Trademark of Texas Instruments

With New **SNOWFLAKE** TRANSISTORS

TI 2N2410 "SNOWFLAKE" SPECIFICATIONS

Plan your development and manufacturing schedules with full assurance that TI's volume production will meet your delivery requirements. Order now from your nearest TI Sales Office or Authorized TI Distributor!

Write today for your free copy of the new *TI Transistor Logic Circuit Design Handbook*, and complete data sheets on the TI transistors selected for your Thin Film Driver Circuits.

Parameter	Test Conditions	Min	Typ	Max
BV_{CBO}	$I_C = 100 \mu a, I_E = 0$	60 v		
h_{FE}	$V_{CE} = 10 v, I_C = 10 ma$	30	75	120
h_{FE}	$V_{CE} = 10 v, I_C = 150 ma$	30	75	120
h_{FE}	$V_{CE} = 10 v, I_C = 500 ma$	25	60	100
$V_{CE(sat)}$	$I_B = 15 ma, I_C = 150 ma$		0.35 v	0.45 v
$ h_{fe} $	$V_{CE} = 10 v, I_C = 50 ma, f = 100 mc$	2.0	3.0	
t_{on}	$I_C = 150 ma, I_{B(1)} = 15 ma,$ $I_{B(2)} = -15 ma$		35 nsec	65 nsec
t_{off}	$V_{BE(off)} = -2.75 v, R_L = 40 \Omega$		40 nsec	55 nsec
t_{on}	$I_C = 500 ma, I_{B(1)} = 50 ma,$ $I_{B(2)} = -50 ma$		40 nsec	65 nsec
t_{off}	$V_{BE(off)} = -3.50 v, R_L = 40 \Omega$		45 nsec	65 nsec

TRANSISTOR
PRODUCTS
DIVISION



TEXAS INSTRUMENTS
INCORPORATED
13500 N. CENTRAL EXPRESSWAY
P. O. BOX 5012 • DALLAS 22, TEXAS

#19196

CIRCLE 11 ON READER SERVICE CARD

WASHINGTON OUTLOOK

HOUSE ASKS FOR FEWER NEGOTIATED CONTRACTS

HOUSE HAS PASSED a bill aimed at increasing the volume of formal advertised bidding in military contracting and cutting the rate of negotiated procurement, and curbing excessive profits on inflated cost formulas in incentive-type contracts.

The bill would make it harder for the military to negotiate contracts, but most observers doubt that it will have an appreciable effect on how military awards are made. The Pentagon takes a dim view of the bill, argues that a more significant legal distinction should be drawn between competitive and noncompetitive procurement rather than between formal advertising and negotiated contracting.

Defense officials say technical factors make negotiations more feasible than advertised bidding in procurement of the more costly and complex military hardware, and that it would be more meaningful to foster negotiated contract competition rather than to insist on formal bidding.

The bill would also require contractors to certify the validity of cost estimates submitted in setting price targets for incentive contracts—something already required by Pentagon regulations. Congressional critics and the General Accounting Office have charged that many contractors have inflated cost estimates in incentive contracts, then have earned excessive profits by keeping actual costs below the targets set in the contract.

ONE SUCH CONTRACT HITS SNAG

REP. EARL WILSON (R., IND.) has stirred up a fuss over a pending Navy contract to Collins Radio for production of AN/PRC-41 portable uhf radio sets. The AN/PRC-41 was developed by Collins under a \$1-million R&D contract. Wilson learned that a \$1.3-million production contract was being negotiated for Collins, which had been designated a sole supply source on the grounds that "procurement by advertising and competitive bid will unduly delay procurement." On behalf of Arvin Industries, located in his district, Wilson stormed into the Navy department, obtained technical drawings and specifications for the radio set. Arvin then submitted a bid on the production order which, Wilson claims, is 34 percent lower than the price tentatively negotiated by Collins. The Navy has delayed the contract award to Collins to investigate the case.

U. S. BACKS OVERSEAS WEAPONS RESEARCH

DEFENSE DEPARTMENT is thinking about contributing funds to electronic firms in Great Britain and France for maser and laser research. The expenditures would be made under the Mutual Weapons Developments Program in which U.S. and NATO governments jointly sponsor R&D projects.

The U.S. has spent \$275 million on the program since 1954, allied governments equivalent amounts or more. Electronics now accounts for about 20 percent of the program. Among military electronics projects in which DOD has shared costs: work on image-intensifier tubes, infrared detectors and counter radar jammers (carcinotron tubes), in France; sonar and uhf transmitter-receivers, in Italy; Hasdic sonar and frequency-scanning radar, in Great Britain; and scatter and ionospheric communications systems, in The Netherlands.

The program provides for licensing U.S. firms to produce any equipment the Pentagon decides to buy. So far, no important production arrangements have been made in the electronics field, but several firms in this country are reportedly interested in the French carcinotrons.

RELIABLE products from RAYTHEON



NOW... LOW-COST TV RADAR WITH RAYTHEON CK7702 STORAGE TUBE

Ships with just a UHF TV receiver can now be guided by a televised around-the-clock radar presentation of New York harbor — thanks to the Coast Guard RATAN system and Raytheon's CK7702. Heart of the Radar and Television Aid to Navigation system, the dual-gun CK7702, converts radar to TV scan to provide a bright display featuring target trails for course and speed indications.

This is just one example of the many application possibilities of the CK7702. Characteristics such as simultaneous write and read, variable automatic prime, and magnetic deflection of both read and write beams

make possible the design of advanced systems with outstanding features. High, uniform resolution of 1200 TV lines per diameter at 50% modulation is assured through the use of magnetic focus with dynamic correction. And, the Raytheon CK7702 fully meets the requirements of FAA-R-1213b and is designated for use in many other military equipment specifications.

Unequaled capabilities for the development and production of storage and display tubes enable Raytheon to offer you a broad line of high quality standard types, as well as special tubes designed and produced to meet the requirements of your design.

For complete details please write:

Raytheon, Industrial Components Division, 55 Chapel Street, Newton 58, Massachusetts.

INDUSTRIAL COMPONENTS DIVISION

RAYTHEON

NEWTON 58, MASSACHUSETTS

Collins communications careers point

Every American voice from space — from the X-15 and Mercury — has been carried by Collins communications. Now, with the accent on reliability, Collins is readying extensive systems for the next and most ambitious U.S. space effort, NASA's Apollo manned lunar spacecraft. leadership in space communications, Collins requires specialists in HF, VHF, UHF equipment, digital communications, spacecraft antennas, TV, radar, modulation techniques, tracking and ranging, information theory, and ground systems. If interested in this challenge, write Mr. L. R. Nuss, Cedar Rapids, Iowa; Mr. C. P. Nelson, Dallas, Texas; Mr. E. Montano,

UP

carried by Collins communications systems for the next and To further extend this VHF, UHF equipment, digital communications, tracking and ranging, write Mr. L. R. Nuss, Cedar Rapids, Iowa; Mr. C. P. Nelson, Dallas, Texas; Mr. E. Montano, Newport Beach, California.



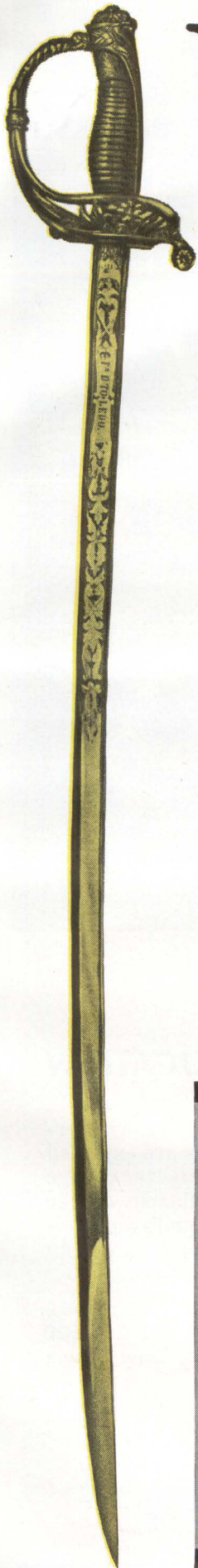

QUALITY

The famed Toledo blade or the AMPin-cert*
Blade Connector depends on quality built to last.



From precision crimped receptacle contacts to gold over nickel plating, the AMPin-cert Blade Connector offers feature after feature for maximum performance capabilities, long-lasting reliability and lowest applied costs. And the AMP-Blade* Connector doesn't split hairs when it comes to meeting and even exceeding the most stringent applicable requirements—military or commercial. Check this partial listing of features and compare.

FEATURES: ♦ Crimped contacts insure uniformity of connections.

- ♦ Gold over nickel plating assures lasting reliability.
- ♦ Encapsulated male tab member prevents misalignment of contacts.
Staked down male tab housing eliminates board warpage.
- ♦ Guide pins assure positive mating of connector halves.
- ♦ Raised barrier section and large contact cavities avoid moisture entrapment.
- ♦ Three large areas of contact between receptacle contact and male tab.
 - ♦ Built-in egg crate construction and crimp, snap-in receptacle contacts eliminate sleeving and soldering.
- ♦ Not pre-loaded . . . buy and use only the receptacle contacts you need.
 - ♦ Terminated by high speed crimping machines or hand tools.

For complete information on AMPin-cert blade-type printed circuit connectors, write today!

*Trademark of AMP INCORPORATED



Cross-Section View

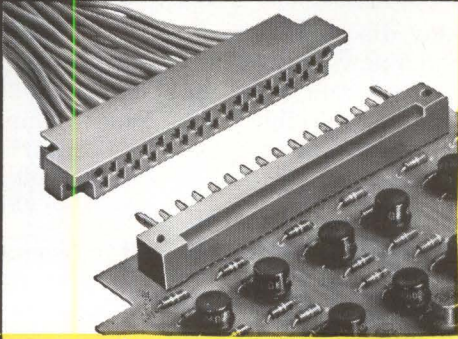

AMP
INCORPORATED
Harrisburg, Pennsylvania



AMP products and engineering assistance are available through subsidiary companies in: Australia • Canada • England • France • Holland • Italy • Japan • Mexico • West Germany

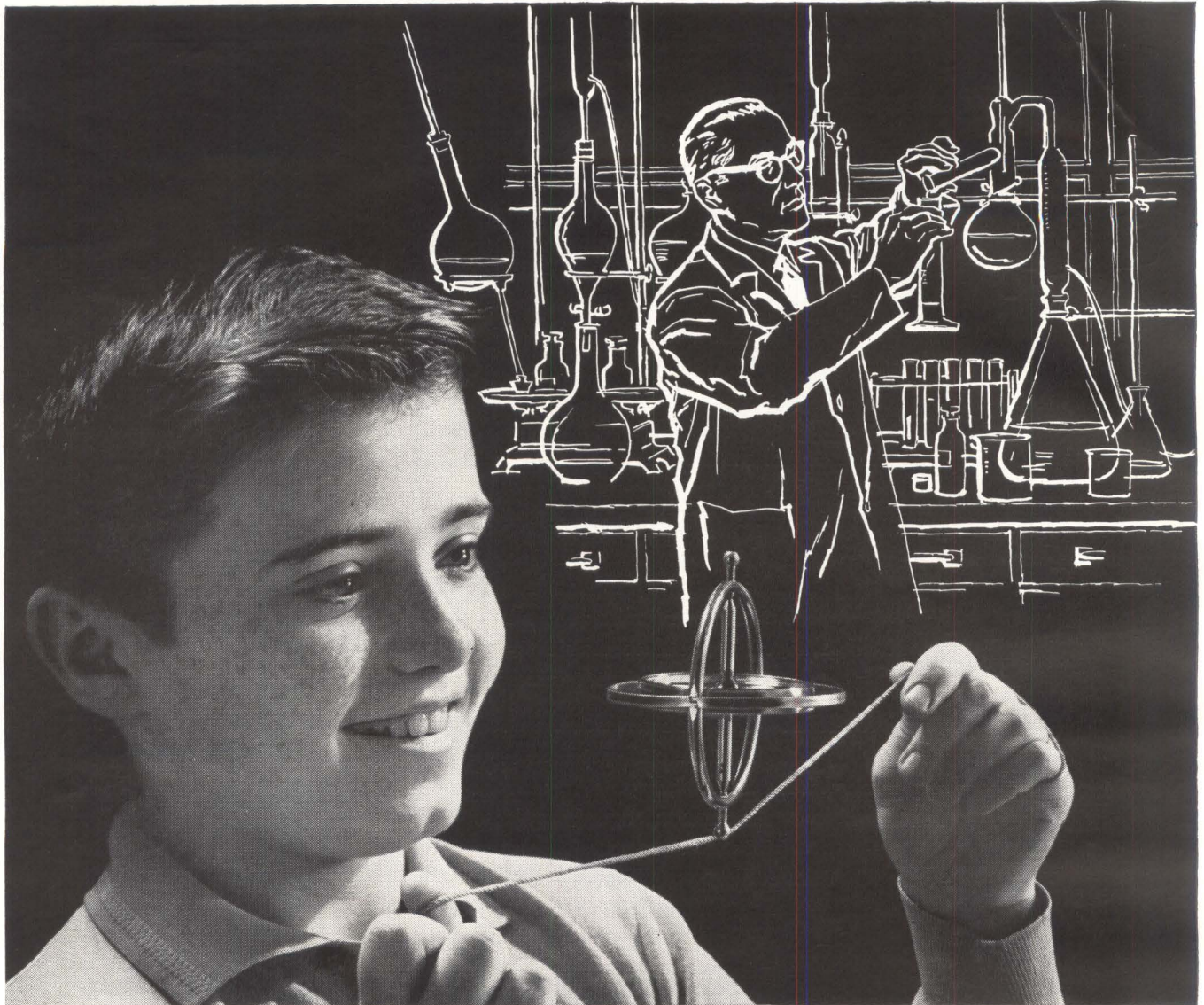

The Future of Your Business

MAY DEPEND UPON HIS EDUCATION

The young mind which today discovers an old principle may someday reveal a new one capable of revolutionizing your business and creating undreamed of growth. But this is possible only if he gets the finest education we can offer.

By the time today's youngsters are ready for college, business and industrial technology will be even more complicated and will require many more trained specialists. To fill this order we must provide our young people with the best possible college educations.

Unfortunately many colleges are already overcrowded. In ten years applications are expected to double. We will need more and better college classrooms and libraries, more efficient college laboratories, and additional top-quality professors. *You can help assure your own future by helping the college of your choice.*

If you want to know what the college crisis means to you, write for a free booklet, "OPEN WIDE THE COLLEGE DOOR," to Higher Education, Box 36, Times Square Station, New York 36, N.Y.



Published as a public service
in cooperation with The Advertising Council and
the Council for Financial Aid to Education



Of interest to engineers and scientists

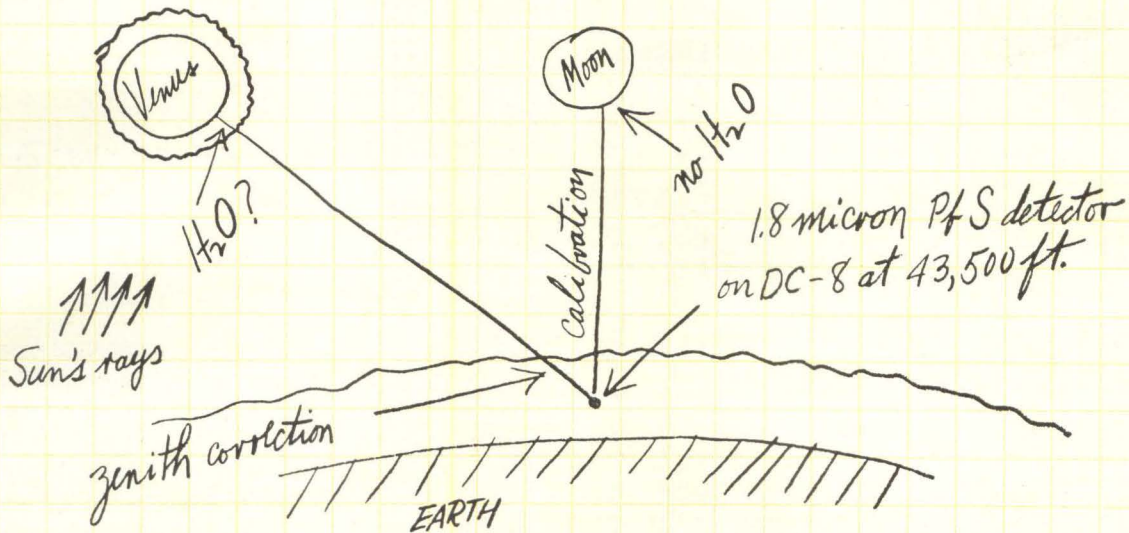

PLANETARY ENVIRONMENTS

...one of more than 500 R&D programs under way at Douglas

The purpose of this Douglas study is to gain a comprehensive insight into the atmospheric characteristics of Venus, Mars and Jupiter. This is to include a detailed knowledge of the following: composition, radiative equilibrium, vertical and horizontal distribution of radiative flux, pressure, temperature, density, and three-dimensional planetary circulation.

Utilizing the most recent observations and advanced theory, working models of these atmospheres are being constructed. New data are being sought through photographic astrometry, spectroscopy and photometry. Feasibility studies of new space instruments are being undertaken as one of many aspects of this investigation.

Of career interest to engineers and scientists

Because leadership in tomorrow's technology is a strong Douglas objective, the company is placing great emphasis on expanding its

research and development staff. This has opened outstanding opportunities to scientists and engineers in the multitude of areas related to aerospace, nucleonic and other fields.

An extensive new laboratory complex is being constructed to provide the most modern facilities to aid in R&D operations. If you are seeking a stimulating environment in which to further your career, contact Douglas.

Send us your resume or fill out and mail the coupon. Within 15 days from the receipt of your letter, we will send you specific information on opportunities in your field at Douglas.

Mr. F. V. Edmonds
Missile and Space Systems Division
Douglas Aircraft Company
3000 Ocean Park Boulevard
Santa Monica, California

F-3

Please send me full information on professional opportunities in my field at Douglas.

Name _____

Engineering or scientific field _____

Address _____

City _____ State _____

DOUGLAS

Missile and Space Systems Division

An equal opportunity employer

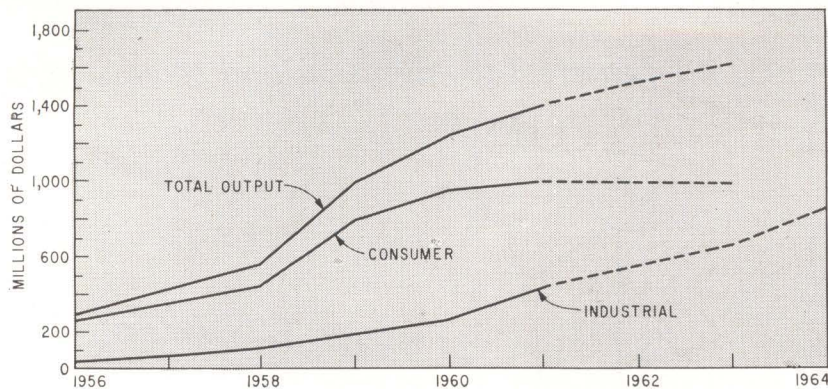

Industrial electronics output is fast overtaking consumer electronics

JAPANESE PRODUCTION OF ELECTRONIC EQUIPMENT AND COMPONENTS, 1960, 1961 AND 1962 (EST.)

	1960		1961		1962 (est)		1962/1961	
	Units (000)	\$ (mil-lions)	Units (000)	\$ (mil-lions)	Units (000)	\$ (mil-lions)	Units %	\$ %
Total electronics	1,204		1,413		1,622		+14.79	
Receivers	12,851	194.3	13,707	195.1	14,900	214.5	+ 8.7	+ 9.9
Tube type	1,772	25.1	1,513	18.5	1,400	17.5	- 7.5	- 5.3
Transistor	11,079	169.2	12,194	176.6	13,500	196.9	+10.7	+11.5
Tv receivers	3,578	396.1	4,609	489.4	4,500	481.9	- 2.3	- 1.63
Audio equipment	—	79.4	—	120.6	—	168.9	—	+40.1
Tape recorders	446	24.5	883	40.2	1,350	56.4	+52.8	+40.4
Radio-phono	493	25.7	696	39.9	1,100	63.9	+58.0	+60.1
Other audio	—	29.2	—	40.5	—	48.6	—	+20.0
Broadcasting	—	10.7	—	14.8	—	17.8	—	+20.3
Communication	—	27.9	—	35.0	—	41.9	—	+19.8
R-f equipment	—	12.5	—	16.5	—	19.7	—	+19.4
Electronic equipment	—	31.6	—	50.0	—	75.0	—	+49.9
Measuring	—	28.6	—	31.8	—	38.1	—	+19.6
Industrial	—	47.2	—	60.7	—	83.3	—	+37.3
Vacuum tubes (entertainment)	155,257	82.8	165,513	51.8	196,000	61.1	+18.4	+18.1
Cathode ray tubes	4,225	71.0	4,956	71.3	5,900	86.1	+19	+20.8
Other tubes	—	17.3	—	16.3	—	18.9	—	+15.6
Transistors	139,871	54.0	180,191	54.3	220,000	59.7	+22.1	+10.1
Diodes	44,990	7.4	62,915	8.8	80,000	10.8	+27.1	+16.8
Other semiconductors	21,527	10.0	29,278	15.4	—	18.3	—	+19.1
	206,388	71.4	272,385	78.5	—	88.8	—	+12.6
Resistors	709,040	19.9	1,009,077	26.0	1,300,000	31.4	+28.8	+20.6
Capacitors	940,959	44.0	1,269,967	56.4	1,650,000	69.4	+29.9	+23.1
Transformers	5,365	28.4	178,172	41.8	230,000	51.1	+29.1	+22.1
Speakers	19,906	16.3	32,811	24.1	42,000	31.1	+28.0	+28.9
Other components	—	22.9	—	33.4	—	43.1	—	+25.6

Source: Electronics Industries Association of Japan

Japan Now

Estimated 1962 output is \$1,622 million, as growth rate levels off

JAPAN'S ELECTRONICS equipment output in 1961 increased 17 percent over 1960 to a total of \$1,413 million in factory-door value. This equals 15 percent of U.S. electronics production, ranking Japan second among the world's electronics producers, according to information provided the Market Services Department of ELECTRONICS.

Output in 1962 is expected to reach \$1,622 million.

Nearly all of Japan's electronics products registered increases during the year. Transistor production increased 54 percent in 1961 to more than 180 million units, almost equal to U.S. transistor production. Other outstanding gains were made by tv receivers, tape recorders, capacitors, and loudspeakers (see table). Exports totaled \$459 million in 1961.

The Japanese are placing increasing emphasis on research and development. Several companies are building additional research laboratories.

Previously, the industries depended on government and university laboratories for much of the needed R & D.

Microminiature circuits, thermoelectricity, millimeter and other traveling-wave tubes, machines to translate from English typewritten material, voice operate typewriters, compact microwave equipment, and advanced types of scatter equipment are among promising development fields.

This trend toward increased research and development reflects the feeling that the Japanese electronics industry is now at a turning point. The 1959 total output increased 80 percent over that of 1958. The rate of increase dropped

Second in World Electronics Output

to 30 percent for 1960 and 27 percent for 1961. The growth rate is expected to stabilize at 10 to 15 percent a year by 1964.

During this growth period the

makeup of the industry is changing rapidly. Domestic appliances are now 77 percent of the total output and industrial equipment 23 percent. By 1964, anticipated output

of \$1,760 million should be equally divided between domestic and industrial products. The increase in industrial equipment parallels the world-wide trend.

Pentagon Reshaping Procurement Policy

WASHINGTON — Military electronic contractors were advised last week to compete for defense business only in areas in which they are technically qualified and to press only for projects "really important" to national security.

The advice came from Harold Brown, director of defense research and engineering, at the Armed Forces Communications and Electronics Association Convention.

If industry does this, Brown said, there would be fewer Pentagon reviews of what contractors are doing, faster decisions from procurement agencies, and wider authority for industrial management.

Brown complained that military contracting agencies are "abdicate responsibility" by failing to screen out R&D projects with less critical priority. The result, he said, has been the controversial trend toward centralized control by his office of what the military services and their contractors do.

Brown said that there are too many "marginally useful" projects.

Rear Adm. Herschel J. Goldberg, vice chief of naval materiel, spoke of the Defense Department's new emphasis on breaking out "subelements and major components" in weapon systems for competitive procurement. A long-range plan is being set up to push this, he said, which will involve "identification of the items susceptible to breakout and competitive procurement, acquisition and control of technical data, and actual purchase, on a

competitive basis, of the items broken out and properly described by adequate technical data."

The admiral listed "obstacles" to this plan: the lack of standard criteria in determining what is to be "broken out," the absence of clearly divided responsibilities between the military and industry as to "the extent of participation in breaking out the identified items," industry's "refusal to provide technical data for competitive procurement," and inadequate lead time for contracting officers to solicit competitive and negotiated prices.

Maj. Gen. Robert G. Ruegg, director of procurement and production for the Air Force Logistical Command at Dayton, Ohio, said the military has a "dilemma" in determining whether to award first production contracts to the original R&D contractor or whether to seek new sources by competition.

He said the question is being handled on a case-by-case basis and that there is a need for more advanced engineering planning and control before actual procurement begins. This would involve "clearly established quantities of early production after which competition will be introduced," early planning for tooling, spare parts, and aerospace ground equipment, and scheduled delivery of specifications and other data.

The general policy favors awarding initial production contracts, Ruegg said, to the R&D contractor when performance, reliability, and

productibility experience is particularly vital, when shorter production leadtimes can be assured, when critical parts depend on the prime contractors' design, and when continued product improvement militates for strongly coordinated design and production work.

On the other side, he said, solicitation of new production sources is conducted in cases such as these: when complexity of the item is not a factor, when proprietary rights can be easily acquired by the government, when there's a need to keep the R&D contractor "on his toes" in controlling overhead costs, when national policy calls for substantially increased output, when the development contractor lacks fully adequate financial, technical, and production resources, and when a fair price cannot be negotiated with the developer.

Fish Camera



Nippon Electric calls this gadget a fish camera. It's a transistor sonar set. Frequency is 200 Kc, maximum depth 200 feet, price in Tokyo \$110

DUROTHERM* Non-freezing Soldering Tips

PATENT PENDING



POSITIVELY CANNOT FREEZE OR STICK IN ANY IRON BECAUSE OF PROTECTIVE ANTI-CORROSIVE ALLOY!

AT LAST! MAXIMUM LIFE AND PERFORMANCE FROM BOTH ENDS OF COATED SOLDERING TIPS!

***Inserted Section**—Inserted portion of tip protected by long-wearing 100% scale-resistant DUROTHERM coating, bonded to base copper so securely that they become one integral part, to insure maximum heat transfer. Because there are no air spaces or looseness between coating and base copper, tip cannot become dented or out of round, or move or slide out of place. This means faster and more constant delivery of heat with no tip maintenance.

A—Heavy Iron Coating
C—Pretinned Section
D—Multi-coated and immunized

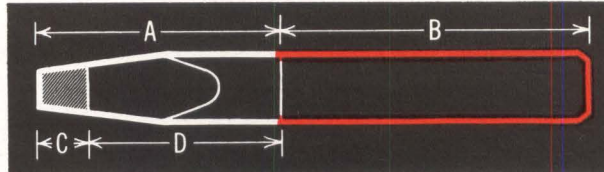

B—Scale-Resistant DUROTHERM COATING Bonded to base copper

***Exposed Section**—Factory pretinning by exclusive process insures best performance and minimum maintenance. Exposed section is also multi-coated for extra long wear. This multi-coating immunizes shank of tip from solder, thus preventing solder from creeping into tip hole and spilling on components.

***Resulting In—The longest wearing and best performing tip ever produced!**

***Both Features Exclusive Hexacon Developments**

HEXACON ELECTRIC COMPANY, 130 West Clay Ave., Roselle Park, N. J.

SERVING INDUSTRY FOR MORE THAN THIRTY YEARS—PIONEER DESIGNER OF INDUSTRIAL SOLDERING IRONS AND COATED TIPS

CIRCLE 200 ON READER SERVICE CARD

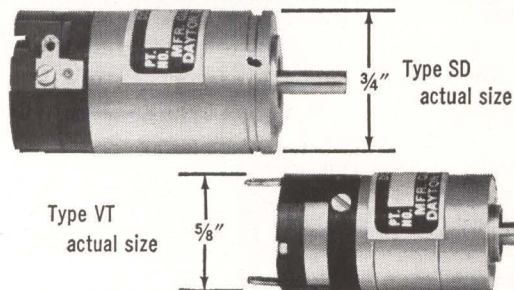

2 BRAND NEW D.C. MOTORS

yes, smaller!

We believe the new Globe SD and VT motors are the smallest and lightest permanent magnet precision d.c. motors available. Typical continuous duty output for these motors is 0.3 oz. in. and 0.25 oz. in. at 10,000 rpm. respectively. A variety of windings is offered to produce the characteristics required. Standard windings for 27 v.d.c. produce no-load speeds from 5,000 to 22,000 rpm; 3 to 50 volts standard, higher voltages available. Special units can include speed governors, gearheads, brakes, and radio noise filters. Unusual efficiency and output torque are obtained with high reliability, designed to meet MIL specs. Write for Bulletin VTD to Globe Industries, Inc., 1784 Stanley Avenue, Dayton 4, Ohio.

GLOBE

GLOBE INDUSTRIES, INC.

New! MINIATURE AXIAL FANS
with
up to 4 times greater cooling efficiency!

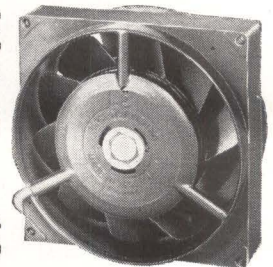

Characteristic	PAMOTOR Model 1000	Conventional Fan
Type of Motor	induction (capacitor-type squirrel cage)	shaded-pole
Housing	die cast warp-free Zymec	plastic
Output @ 60 cps (0 back pressure)	125 cfm	100 cfm
(.25" back pressure)	75 cfm	20 cfm
(.3" back pressure)	50 cfm	0
Output @ 50 cps (0 back pressure)	100 cfm	75 cfm
(.25" back pressure)	62.5 cfm	5 cfm
Operating Temp. Range	-55°C to +85°C	-18°C to +44°C

The PAMOTOR Model 1000 Miniature Fan is completely interchangeable with conventional units now in use (4 1/8" center-to-center mounting holes). But the similarity ends there.

check this comparison chart!

The Model 1000 Fan meets MIL-T-5422E, Class 2 Environmental specifications. Inside-outside rotating motor design gives flywheel effect, resulting in constant, quiet fan speed. Large surface sleeve bearings mean minimum maintenance, maximum reliability.

For complete specifications and name of nearest stocking distributor, write to:

PAMOTOR, Inc.

312 Seventh Street • San Francisco 3, Calif.



Mindpower and Manpower...
shaping the future in **ELECTRONIC COMMAND SYSTEMS**

ENGINEERS: Creative mind-power is being applied today by the men of Motorola to such vital aerospace programs as the NASA/JPL Mariner planetary probes... the Mercury manned orbital space vehicles...and the Navy's DASH drone anti-submarine helicopter. Advanced instrumentation is also being developed for more than 20 major U.S. missiles. ☒ If you are interested in shaping the future with Motorola on these and other programs, we can offer immediate opportunities to both system and equipment design engineers. Write us today describing in complete detail your experience in the following areas:

Systems Design • operational and functional mission analysis, optimum time-bandwidth utilization, redundant system organization for reliability, phased arrays, digital and voice communications, and A-J secure communications.

Equipment Design • solid state receivers, transmitters and transponders, distributed parameter microwave equipment, digital Modems, controls and displays, low-level switching circuits, and digital data processing circuitry.

Familiarity with State-of-the-Art • spread spectrum techniques, visual spectrum intelligence transmission, statistical theory of communication, integrated circuit applications, multiple logic element techniques, organization of digital data handling systems, correlation and phase-lock techniques, and coding and modulation.

We are particularly interested in the programs on which your experience was obtained, and the extent of your technical responsibility. Please address this information to our Manager of Engineering for immediate and confidential attention.

*An equal
opportunity
employer*



MOTOROLA

Military Electronics Division Headquarters
8201 E. McDowell Road • Scottsdale, Arizona
MILITARY PLANTS LOCATED IN CHICAGO, ILLINOIS;
SCOTTSDALE, ARIZONA; RIVERSIDE, CALIFORNIA.

□ Telstar orbits with FXR Products

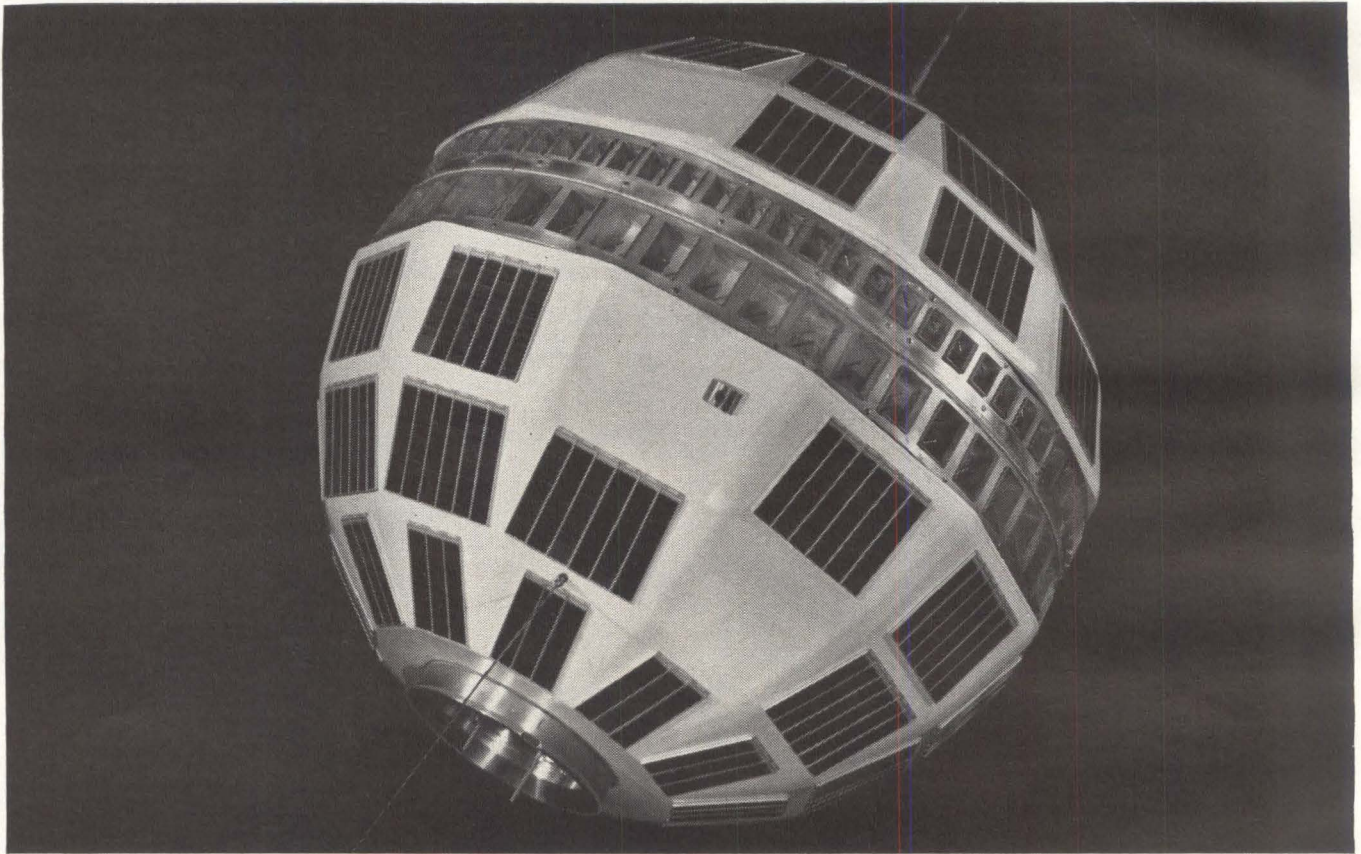

Model of Telstar experimental communications satellite. The dual row of slotted antennas can be seen around the equator of the sphere. Patches of solar cells on the shell convert sunlight into electricity to provide power.

Telstar orbits with FXR products

Project Telstar—the first privately financed space effort—is a Bell System communications experiment, carried out in cooperation with N.A.S.A. Telstar will test the use of broadband repeater satellites for overseas communications. The program will also check out tracking techniques and ground equipment. Intercontinental telephone and TV trials will be conducted. Telemetry data on radiation and numerous conditions in the space environment will be gathered, too.

The vehicle is a step toward continuous global communications with microwave radio.

When Telstar orbits the earth FXR products will go with it. ■

Antenna probes specially made for relay sphere

The waist of the relay satellite has a double row of antennas for transmitting and receiving microwave signals. The probes within the antenna slots—120 of them—were custom produced by FXR to Bell Telephone

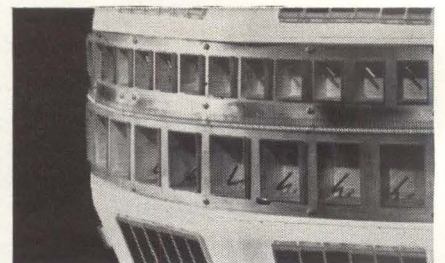

Section of satellite shows equatorial antenna slots. Upper row transmits, lower row receives microwave signals.

Laboratories design. They consist of long and short probes tooled from beryllium with Tellon insulators. ■

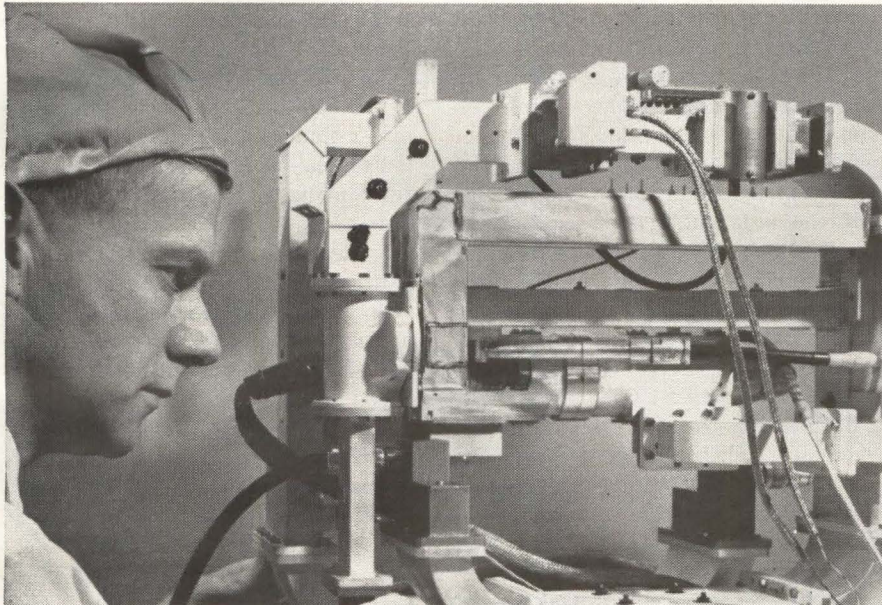

The waveguide "plumbing" is shown undergoing tests before final assembly of satellite. Microwaves are received, amplified, and transmitted back to the ground in Telstar.

FXR waveguides in satellite

FXR fabricated 13 of 20 waveguide-type pieces in the satellite. These waveguides—"straights" and "bends"—were precision fabricated of light-weight magnesium to exacting Bell Telephone Laboratories specifications. Some of the components are used to filter signals from the crowded spectrum. FXR is a major supplier of waveguides and waveguide components for systems application: custom or standards of aluminum, brass, copper, coin silver or magnesium.

Amphenol cable used at tracking station



Antenna at the Andover tracking station was erected this winter. Cable is shown being carried during construction.

At the giant Andover, Maine, tracking station, 37 lengths of Amphenol RG 11 A/U coaxial cable measuring a total of over 28 miles, connect the tracking horn with the control building. RG 11 A/U is a copper braid co-

axial cable with a non-contaminating jacket of polyvinyl chloride and polyethylene core. It's a standard FXR cable made to rigid specifications that meet or surpass military requirements.

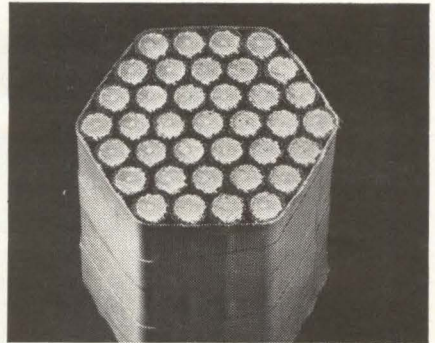

Cross-section of RG 11 A/U cable that connects antenna horn to transmitting equipment. Thirty-seven lengths—a total of 28 miles—of this standard FXR cable were used.

FXR is your single source of Amphenol cable and wire, microwave test equipment and subsystems, FXR waveguide switches, DK coaxial switches, Amphenol and ipc coaxial connectors. ■

The RF Products and Microwave Division Amphenol-Borg Electronics Corporation 33 East Franklin Street, Danbury, Connecticut.

FXR™

Dyna-Soar's SHF Communications System

By JOHN F. MASON

Associate Editor

THROUGHOUT the political storms that plagued the Dyna-Soar program for so long, the development of the communications and tracking subsystem (CTS) has continued without interruption. Results of this pioneering effort will not only benefit Dyna-Soar, but all future space vehicles that must communicate with the ground during reentry.

Present status of the work was recently described to ELECTRONICS by the Dyna-Soar Program Office responsible for the CTS, headed by C. K. Law, of RCA's Aerospace Communications and Control Div.

Major functions of the CTS (described in ELECTRONICS, p 24, July 21, 1961, as CADL, communications and data link, as it was formerly called) include: vehicle-to-surface transmission of pilot voice, flight safety data and scientific test data; surface-to-vehicle transmission of range safety and test-conductor voice commands; vehicle position data in spherical coordinates; and rescue communication between pilot and search craft.

Main emphasis in the current de-

velopment and fabrication program is on vehicle/surface transmissions during reentry. Reentry, considered to last from the time the glider's velocity becomes suborbital until it reaches the sonic region, may well prevail during most of the Dyna-Soar's flight. The only times Dyna-Soar will not be in reentry conditions are when it is in orbit and during landings.

"The net effect on a typical reentry body is that the vehicle appears to be surrounded by a copper bubble of electromagnetic energy at frequencies from vlf through much of the shf bands and occasionally extending through the extremely high frequency (30 to 300 gigacycles) ehf band," according to RCA's engineering systems leader for the CTS, L. B. Garrett. "The exact frequency span of the 'blacked-out-band' depends on the velocity, altitude, geometry, and configuration of the reentry body."

Garrett believes communications outages for Dyna-Soar Step I can be held to less than 1 percent if shf frequencies between 3 Gc and 30 Gc are used. No equipment exists in this region, Garrett says, but RCA is working on it.

Besides blackout, the expected

skin temperatures of 2,000 F near the shf antennas create a problem. "The selection of dielectrics and metals for the antennas and waveguides has required some compromise between optimum r-f performance and the need for good thermal isolation between the waveguides and equipment," Garrett says. "In addition to conduction losses on the order of 3 db, the noise emission from the heated conductors results in a 5-db increase in the vehicle receiver noise figure."

Vehicle weight restrictions require utilization of the surface portion of the communication link to provide part of the total radio-link gain necessary. Gain is needed to overcome the free-space and atmospheric losses caused by operation in the shf band—plus the losses induced by temperature effects.

"This has led to surface-antenna gains in excess of 40 db, state-of-the-art receiver preamplifiers, ground-transmitter power levels, and predetection bandwidth-reduction techniques. Penalties of high-gain antennas are resultant beamwidths on the order of one deg and the attendant effects on acquisition and tracking," Garrett said.

The airborne portion of the shf

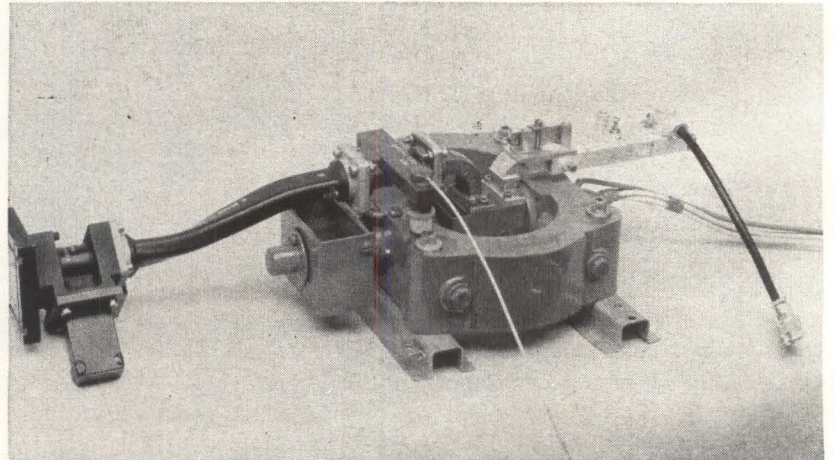
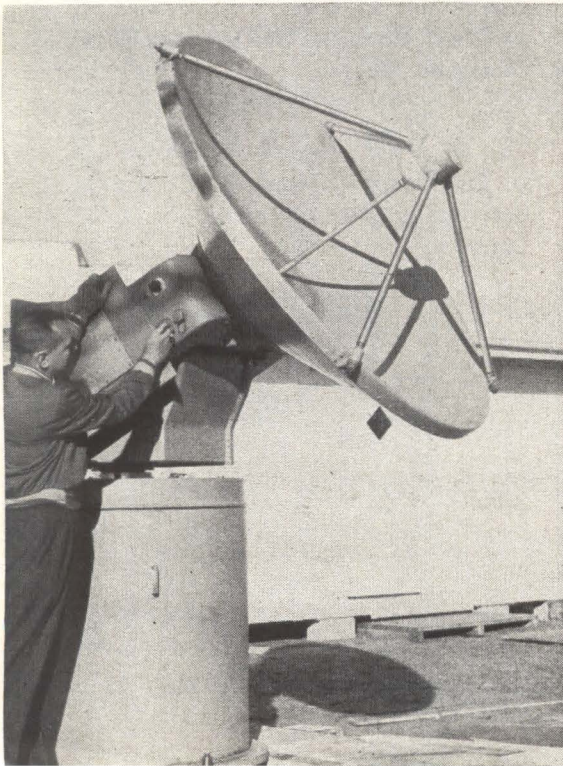

Shf transmitter output shows multiplier stage, klystron, flexible waveguide, circulator and r-f load

◀ *Antenna-pedestal for Dyna-Soar's shf communications system uses solid state, servo control system with short saturation recovery time. Drive motor windings couple directly to low-impedance-output power transistors*

Will Penetrate Reentry Blackout

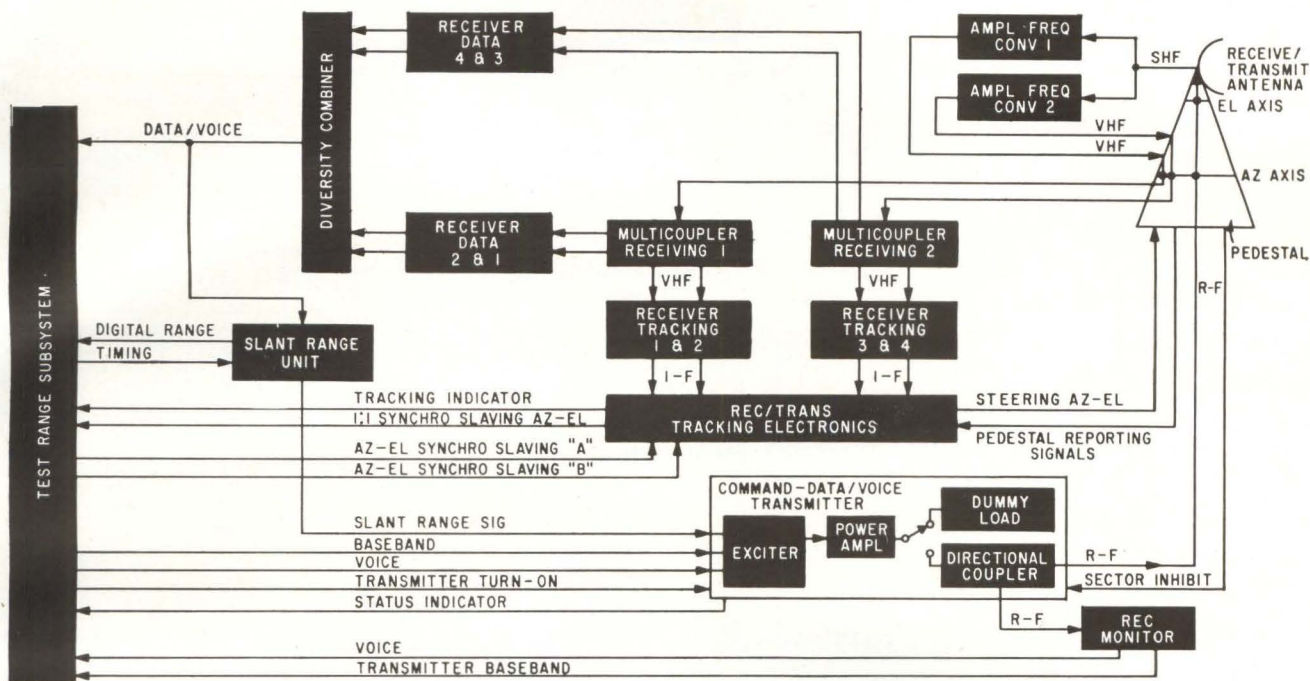

Surface equipment—three major functions are shown in the composite receive-transmit site: signal tracking, r-f conversion/demodulation and r-f transmission

vehicle-to-surface link (see illustration) consists of a pair of transmitters connected to a transmitter antenna multicoupler. Input gear consists of two receivers, converter decoders and a pilot's headset amplifier in the control panel. The pilot's voice is fed to the test instrumentation subsystem (TIS) where it modulates a subcarrier and is fed back to the transmitters.

The TIS gear, being built for Boeing by Electro-Mechanical Research, includes several hundred sensors for checking glider conditions, and signal conditioning and conversion equipment for both pcm and continuous analog data on f-m carriers. Multiplexing is performed by the conditioning and conversion equipment and fed to a single 400-Kc baseband to the transmitters where subcarriers are frequency modulated on the carrier.

The two transmitters are fixed tuned to different frequencies, within 40 Mc of each other, and use different antennas, as do the two shf receivers. The receivers differ from the transmitters in that they use no switching multicoupler. The airborne equipment illustration also shows the pilot's microphone and headset amplifier as well as

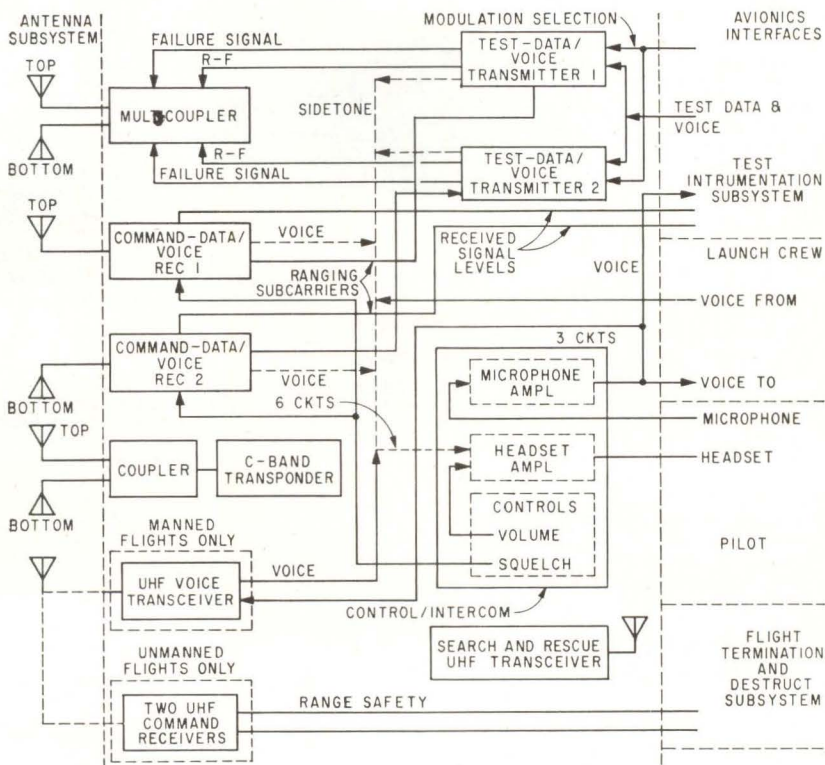

Airborne equipment—two transmitters and the microphone amplifier in the control panel are the airborne portion of the shf vehicle-to-surface link. Two receivers, converter decoders, and pilot's headset amplifier in the control panel are the surface-to-vehicle shf link

simplified controls.

The uhf command receiver/decoders will be used for range safety during unmanned flights and will be replaced by a uhf voice transceiver during orbital and landing phases of the manned flights. The blade antennas for uhf, similar to those used on the X-15, will be retracted during boost and reentry.

Ground site design (see surface equipment diagram) calls for transmitting and receiving facilities at the same site. The three major functions at each site are signal tracking, r-f conversion demodulation, and r-f transmission.

The antenna subsystem, designed and developed for RCA by Radiation, Inc., permits simultaneous reception and transmission of voice and technical data as well as target angular coordinates relative to the

ground station. Solid state circuits are used exclusively in the servo control system. The application of NOR logic facilitates the automatic selection of the highest priority operational modes.

As was described in *ELECTRONICS*, p 24, July 21, 1961, the solid reflector receives the transmitted signals, converts them to vhf and sends them to four vhf receivers at each site.

The tracking portion of the surface receiving gear makes use of the conical nutation performed by the antenna feed. Tracking error will rarely exceed 0.1 degree.

The Atlantic Missile Range will get several shf ground stations. One may be on a ship. Other shf tracking stations will be located on the Pacific Missile Range to monitor reentry into the atmosphere.

The last ground station will be at Edwards AFB, Calif., to aid final descent and landing.

RCA's first contract for the CTS ran for over nine months, ended the end of September, 1961, and amounted to \$3.5 million. A continuing contract began the following day, has not yet been definitized. It will probably include the rest of the program, through 1967 or 1968. Contract amount is estimated at \$40 million.

Radiation, Inc., RCA's main subcontractor, has been contracted for a little less than \$1½ million to date; total will probably hit \$5½ to \$6 million before work is finished. Sprague Electric, responsible for radio interference environment control, has received about \$100,000 from RCA to date and will receive an estimated \$150,000 more.



Single 70-ton counterweight balances 85-foot telescope in any position

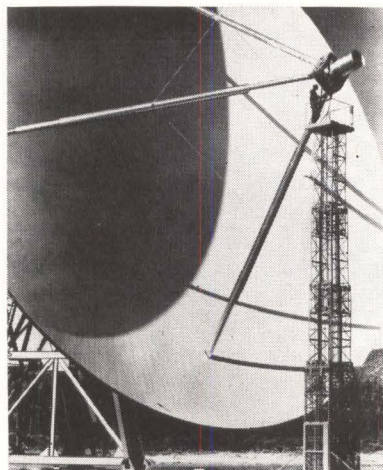

Technician uses portable elevator to adjust horn. The 6,000-square-foot reflector skin is aluminum

Two New Telescopes Share Receivers

UNIVERSITY OF CALIFORNIA'S new radio astronomy laboratory went into full operation this month. Located in Hat Creek Valley, Calif., near Lassen Volcanic National Park, the laboratory is equipped with 85-foot and 33-foot radiotelescopes.

The university considers the 85-foot telescope the most accurate yet constructed. Weighing 220 tons, it is designed to withstand winds of 100 mph. The concrete foundation

rests on a solid bed of lava.

Philco was prime contractor for the project and built the two telescopes under a \$270,000 contract. Office of Naval Research supplied \$1 million of the \$1.2 million total laboratory cost.

Initial research programs will be confined largely to studies of the distributions and motions of gases in the Milky Way. Information is expected to help indicate how stars are formed in the galaxy.

The telescopes use two 21-cm and one 3-cm receivers. A dual concentric feed horn, built by Jasik Laboratories, and a single feed horn are interchangeable on the telescopes. Either telescope can be used with a 21-cm and the 3-cm receivers.

One receiver is a modified Ewen-Dae radiometer that can cover the range of 1,000 Mc to 1,450 Mc in 10-Mc steps, or scan slowly over any 16-Mc portion. Major modification is an r-f ferrite switch built

by Melabs. The signal comparison switching cycle is asymmetrical, improving receiver sensitivity and stability. Sensitivity of only a few tenths of a degree Centigrade has been achieved, the university reports.

The other 21-cm receiver is similar in function, but was designed primarily for hydrogen line studies. One channel switches at 400 cps between the hydrogen line and an off-line comparison frequency and a second channel switches between the line and a comparison frequency on the other side of the line. This permits continuous observation of the line. The number of channels can be expanded to 100.

The 3-cm receiver, also supplied by Ewen-Dae, was modified by locating the first stage close to the feed horn. The wide acceptance band, 7,500-8,500 Mc, and recording response time of 80 seconds permits an antenna resolution of a few hundredths of a degree Centigrade.

Air Force Plans New Proposals for Advent

WASHINGTON—Although Air Force has been given the primary role in developing Advent (ELECTRONICS, p 7, June 22), the Army will retain responsibility for ground stations in the global satellite communications system project.

Air Force will work out a detailed development plan in the next month or so and call for new industry proposals. Initially, a 500 to 600-pound satellite will be developed for intermediate altitude orbits, using the Atlas-Agena-B booster. First flights are expected in 1964 with the system going operational later that year.

Later, larger satellites may be placed into 22,300-mile-high synchronous orbits by the Titan III booster now under development.

Consideration is being given to a system using 40 to 50 lightweight satellites in polar orbits. The Relay satellite being developed by RCA for NASA might provide the pattern.

Army's Advent costs total around \$170 million. GE, the prime contractor, got about \$70 million. Other contractors include Bendix and Philco.

DVST

Announcing
Machlett
Direct View
Storage
Tubes

ML-8130
ML-8139



Brightness:

Over 2000 foot lamberts — ML-8130
Over 1500 foot lamberts — ML-8139

Writing Speed — at full brightness:

Over one half million inches per second — ML-8130
Over 150,000 inches per second — ML-8139

Storage: Uniform Storage Characteristics

Resolution: To 80 written lines per inch at optimum brightness

Focus: — both tubes: Electrostatic

Deflection: ML-8130 — Electrostatic ML-8139 — Magnetic

USES

Airborne

Weather radar
Search Navigation
Terrain Avoidance

Shipboard

Sonar long-memory displays
Marine displays
Sonar devices displays

Ground

Slow-scan television
Storage instrumentation

Write today for complete data on these new Machlett Direct View Storage Tubes.



The Machlett Laboratories, Inc.



Springdale, Connecticut

An Affiliate of Raytheon Company

SPRAGUE PIEZO- ELECTRIC CERAMIC ELEMENTS



**ELEMENTS
FOR ALL
APPLICATIONS
AS WELL AS
COMPLETE**

**TRANSDUCER ASSEMBLIES
FOR MOST APPLICATIONS,
SUCH AS UNDERWATER
SOUND AND
VARIOUS ORDNANCE AND
MISSILE DEVICES.**



Sprague-developed mass production and quality-control techniques assure lowest possible cost consistent with utmost quality and reliability. Here too, complete fabrication facilities permit prompt production in a full, wide range of sizes and shapes.

Look to Sprague for today's most advanced ceramic elements—where continuing intensive research promises new material with many properties extended beyond present limits.



**YOUR INQUIRIES
ARE INVITED**

**WRITE FOR
LITERATURE**

SPRAGUE ELECTRIC COMPANY
35 Marshall Street, North Adams, Mass.

SPRAGUE®
THE MARK OF RELIABILITY



Accessories for group music instruction let teacher talk to and monitor pupils. One control console handles up to 24 instruments

Transistors Make Piano Portable

NEW YORK—Electronic piano employing steel reeds vibrating in a polarized electric field and transistor amplifiers was introduced last week by Wurlitzer.

The 64-note instrument can operate on a-c power or battery pack. It weighs 81 pounds and is portable—removable legs fit in the cover.

Swedish-steel reeds, less than four inches long, transmit vibrations to pickup plates. Plate outputs go to a nine-transistor amplifier using a balanced two-transistor output to drive a speaker.

Two varistors are used as modulators in a vibrato-control system. A tone color much like that of a vibraharp is obtained using the vibrato. Keyboard action is like a conventional piano's.

Players can use earphones when they want to play the piano without disturbing others.

Digital Tv Proposed For Apollo Project

BOSTON—Modified pcm techniques will apparently play a major role in digital image transmission from space. One of the first systems to leave the laboratory will be the coding method for Project Celestope (ELECTRONICS, p 22, Feb. 28). In the proposal stage is a digital television system to transmit to

earth live action pictures of the astronauts and the lunar surface during Project Apollo.

Raytheon is proposing a digital transmission technique and RCA is building a competitive analog system. Raytheon's would use a digitally deflected vidicon camera. To suppress spurious contours that have troubled previous pcm tv systems, a technique devised by L. G. Roberts, of MIT Lincoln Laboratory, will be used. A pseudo-random noise is added to video before quantizing at the transmitter and is subtracted from the decoded signal received.

Apollo tv system is to be able to transmit pictures from the spacecraft on commercial tv broadcasting networks. Scan conversion from the 15-frame-a-second, 250-line spacecraft standard to 30 frames, 525 lines with minimum quality loss is necessary. This is a challenging problem, said W. F. Schreiber, of MIT, during an AIEE conference.

The kinescope-camera tube method used by BBC to convert between British and continental standards would result in considerable loss of motion continuity if storage time is made long enough to suppress flicker. For the same reason, storage-tube scan converters used in radar-to-tv conversion are not suitable. Modifications of these methods are being explored.

We don't like CHOPPERS



OF COURSE, we prefer transistor choppers. Our Type 7000, with a noise level of less than 35 microvolts, is equal to the best you can get, and we will sell it to you with great pleasure.



However — LIFE? Our Type 300 (mechanical) chopper has pretty short life, somewhere over 10,000 hours. How far? Dunno. Our life tests are still running strong at 68,000 hours.



RELIABILITY? Let's give in. Solid state devices are more reliable (except at -65 C and 100 C) if you need over 68,000 hours. Solid state will take vibration and shock. (Mechanical choppers are limited to about 15 G vibration out to 2KC, and about 100 G shock.) Pretty poor. (We will be glad to sell you Type 7000, a very fine solid state chopper.)

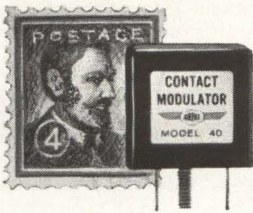

CIRCUIT NOISE? Our Models 36 and 46 have lower noise than any other choppers existing today, (0.6 μ v RMS across 100 ohms), and are TWO orders of magnitude less than the best solid state device.

And SIZE? There is no transistor chopper as small as our Model 40 with a volume of only 0.151 cubic inch. In fact, most are bigger than our enormous Type 300 which uses a 7 pin header and is a frightening 1 $\frac{3}{4}$ inch long.

$$\int_0^{\infty} Z$$

LOW and HIGH IMPEDANCE? Any mechanical chopper has lower closed and higher open circuit resistance than any solid state device.



And COST? Any mechanical chopper undersells any moderately good solid state chopper.



CANNON

engineering notes:

MICROPLUGS®

One of the objectives of microminiature circuit design is to reduce to a minimum the number of interconnections between circuit elements. Assembly of conventional microminiaturized components, using welded interconnections, has resulted in practical circuit module packing densities greater than 10^5 parts/ft³. Trends in thin film and functional block semiconductor work greatly reduce point-to-point interconnection and have resulted in packing densities which are the equivalent of 10^8 parts/ft³.

Microcircuit designers may ultimately reduce a room full of computer equipment to the size of a salt molecule on someone's napkin, but we believe that they will still have to afford the user of their equipment a series of modules which can be quickly connected and disconnected by human hands, without the use of specialized tools.

To provide a means of quick-disconnect capability for present and anticipated micromodule designs, we have perfected a Micropin® and Microsocket® concept. Standard pins now in production fit a .022 diameter socket bore and may be mounted on .050 centers. Micropin features are described in the line drawing below. It mates with a Microsocket which is simply a tube that can readily be incorporated into a wide variety of devices.

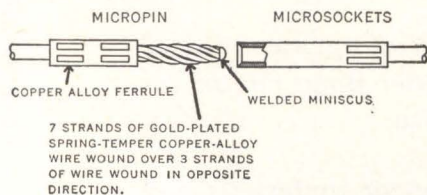

The Poly-Diode,† a computer gate component (produced by Delta Semiconductors) shows application of Micropins and Microsockets to a semiconductor functional block.

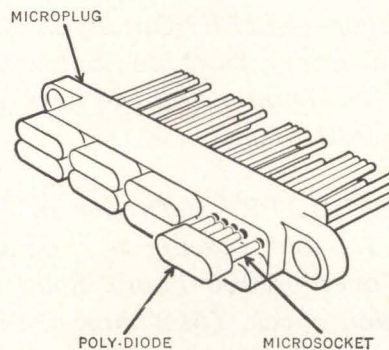

Nanopins,* currently under development, are for those who wish to incorporate a quick-disconnect capability into their modules on .025 centers. It is identically constructed to the Micropin, but is half its size.

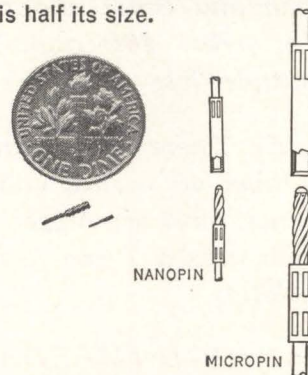

We have developed terminating techniques for Micropins and Nanopins which may also interest you. Write to our Microelectronics Department.

James H. Cannon
Vice President, Engineering

*CANNON TRADEMARK

†TRADEMARK OF DELTA SEMICONDUCTORS, INC.

Imaginative Engineering For The Space Era.

CANNON ELECTRIC COMPANY, 3208 Humboldt St., Los Angeles 31, Calif.



MEETINGS AHEAD

MILITARY ELECTRONICS 6TH NATIONAL CONVENTION IRE-PGMIL; Shoreham Hotel, Washington, D. C., June 25-27.

ELECTROMAGNETIC THEORY & ANTENNAS SYMPOSIUM, Tech. Univ. of Denmark, et al; Copenhagen, June 25-30.

COMPUTER & DATA PROCESSING SYMPOSIUM, Denver Research Instit.; Estes Park, Colo., June 27-29.

AUTOMATIC CONTROL JOINT CONFERENCE, IRE-PGAC, AIEE, ISA, ASME, AICHE; N. Y. Univ., New York City, June 27-29.

RADIO PROPAGATION COURSE, National Bureau of Standards and University of Colorado; NBS Boulder Laboratories, Boulder, Colo., July 16-Aug. 3.

RELIABILITY TRAINING CONFERENCE, IRE, ASQC; Princeton Inn, Princeton, N. J., July 9-13.

LUNAR MISSIONS MEETING, American Rocket Society; Pick-Carter and Statler-Hilton Hotels, Cleveland, Ohio, July 17-19.

MEDICINE & BIOLOGY DATA ACQUISITION AND PROCESSING, IRE-PGME, AIEE, ISA; Strong Memorial Hosp., Rochester, N. Y., July 18-19.

INTERNATIONAL SOUND FAIR, Institute of High Fidelity Manufacturers, Magnetic Recording Industry Assoc., et al; Cobo Hall, Detroit, July 25-29.

ENERGY CONVERSION PACIFIC CONFERENCE, AIEE; Fairmount Hotel, San Francisco, Calif., Aug. 13-16.

PRECISION ELECTRONIC MEASUREMENTS INTERNATIONAL CONFERENCE, IRE-PGI, NBS, AIEE; NBS Boulder Labs, Boulder, Colo., Aug. 14-16.

CRYOGENIC ENGINEERING CONFERENCE, University of California; at UCLA, Los Angeles, Calif., Aug. 14-16.

ELECTRONIC CIRCUIT PACKAGING SYMPOSIUM, U. of Colorado, et al; at U. of Colorado, Boulder, Colo.; Aug. 15-17.

AIRCRAFT & MISSILES JOINT WESTERN REGIONAL CONFERENCE, Amer. Soc. for Quality Control; Benjamin Franklin Hotel, Seattle, Wash., Aug. 16-18.

APPLICATIONS & RELIABILITY SYMPOSIUM, Precision Potentiometer Manufacturer's Assoc.; Statler-Hilton Hotel, Los Angeles, August 20.

WESTERN ELECTRONICS SHOW AND CONFERENCE, WEMA, IRE; Los Angeles, Calif., Aug. 21-24.

METALLURGY OF SEMICONDUCTOR MATERIALS CONFERENCE; the American Institute of Mining, et al; Ben Franklin Hotel, Philadelphia, Pa., Aug. 27-29.

BALLISTIC MISSILE & SPACE TECHNOLOGY SYMPOSIUM, U. S. Air Force and Aerospace Corp.; Statler Hilton Hotel, Los Angeles, Aug. 27-29.

MAINTAINABILITY OF ELECTRONIC EQUIPMENT, EIA Engineering Department and Department of Defense; U. of Colorado, Boulder, Colo., Aug. 28-30.

RF CANNON COAXIAL PLUGS FOR SPACE AGE APPLICATIONS

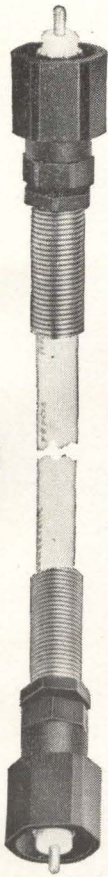

SUBMINIATURE TO SUPERSIZE...CANNON CAN SOLVE YOUR COAXIAL CONNECTOR PROBLEMS.

Cannon RF Coaxial Plugs—both subminiature and standard—meet the exacting demands of space age environments. Our newest line of subminiature RF plugs, the "Crimp-Imp"*, incorporates crimp assembly techniques for both the cable center conductor and the cable braid. These impedance-matched connectors have a VSWR not greater than 1.08:1 up to 2.0 KMC, a new level of achievement in subminiature RF connectors...also employ Cannon Micropin® and Micro-socket® contacts. For use with large RF cable, our lightweight

ALLT Series provides specially designed environmental plugs for continuous operation at 1000 watts CW over the range of 0.03-5.0 KMC from sea level to 70,000 feet altitude. An assembly of two ALLT plugs on 50 inches of cable exhibit a VSWR not greater than 1.2:1 over this same range. The Crimp-Imp and the ALLT are but two typical examples of Cannon's capabilities to design and produce RF connectors meeting the most demanding requirements of size and electrical characteristics. For information write to:

CRIMP-IMP VSWR CURVE

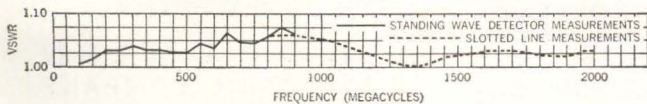

* TRADEMARK

CANNON ELECTRIC COMPANY, 3208 Humboldt Street, Los Angeles 31, Calif.

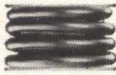

this 
is why
you need
never
derate
a Heinemann
circuit breaker

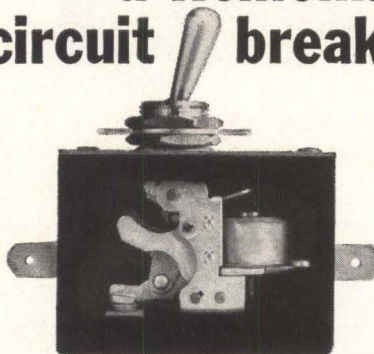

Most circuit breakers (and all fuses) depend on thermal effect for actuation. The Heinemann circuit breaker operates on magnetic flux. Its actuating element is a solenoid coil. It senses actual load current directly.

This makes a world of difference—particularly where higher ambient temperatures are involved.

Thermal devices, because they are heat-sensing, are necessarily heat-sensitive. The Heinemann circuit breaker, being magnetic, is not. Its current-carrying capacity and calibrated trip points will not vary with the ambient. If you spec a one-amp breaker, you can expect it to carry one amp continuously under any temperature conditions. And you can expect it to trip precisely as it should—always. There is no derating to consider.

You might find it well worth your while to look into the possibilities of the Heinemann breaker. We offer a rather wide variety of models ranging from subminiature on up. Most can be had in either single- or multi-pole configurations, with a choice of several inverse time delays or instantaneous response. The current range for the line extends from 0.010 to 200 amps, and we can give you any integral or fractional rating you might need anywhere between.

Bulletin 201, the Heinemann Engineering Guide, will give you full technical information. Write for a copy.

**HEINEMANN
ELECTRIC COMPANY
2600 BRUNSWICK PIKE
TRENTON 2, NEW JERSEY**

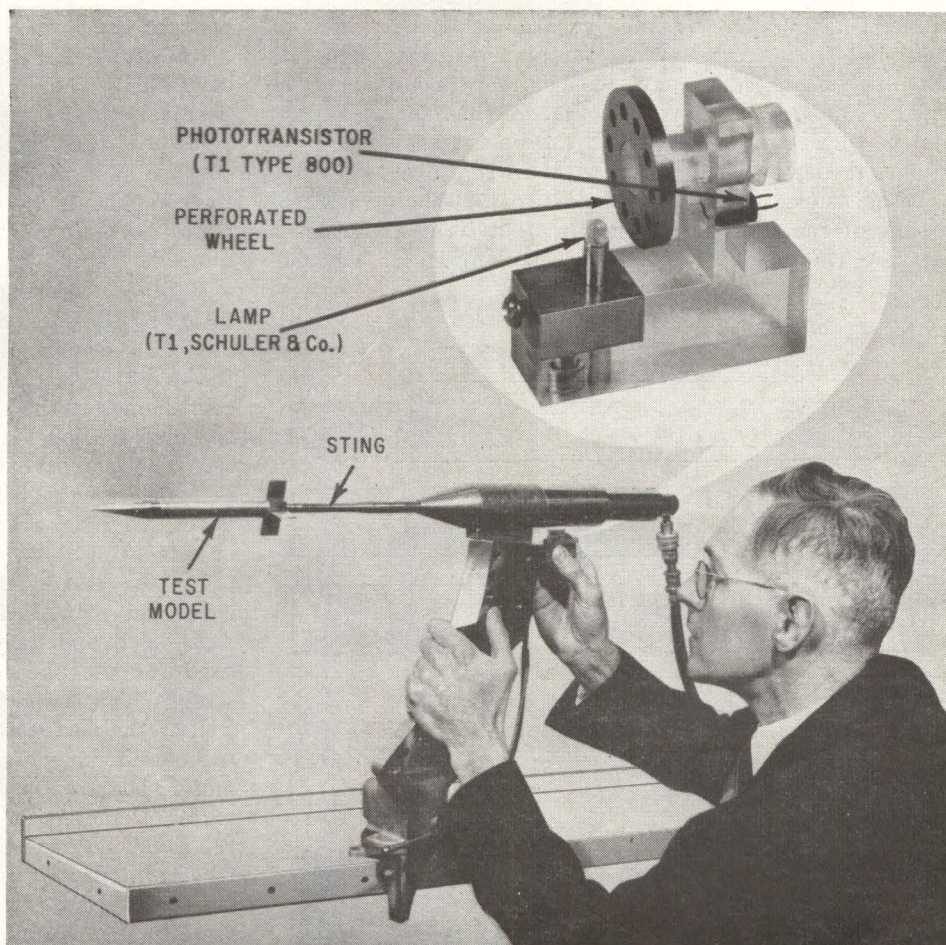

FIG. 1—Inset shows mockup of phototransistor tachometer. Author is inserting tachometer section that comprises lamp and phototransistor

New Phototransistor Tachometers Measure Missile Spin

They consist of a light source, light interrupter or reflector, and phototransistor. In one type, a perforated wheel rotating with a model being tested in a wind tunnel interrupts the light beam. Phototransistor tachometers have performed better than other types of tachometer

By CHARLES F. MILLER, Jr.* Naval Ordnance Laboratory,
White Oak, Silver Spring, Maryland

* Now with Goddard Space Flight Center, NASA.

SPIN RATES and roll damping coefficients obtained from wind-tunnel models are important parameters for predicting the behavior of missiles and rockets during flight. An accurate way of measuring these parameters has been developed, using phototransistor tachometers. A phototransistor tachometer is superior to other types of tachometers since it works over a greater range of frequencies and provides greater

signal strength at slower rotational speeds.

A typical phototransistor tachometer is made from three elements: light source, rotating perforated wheel, and phototransistor. The light source emits a beam that is interrupted by the rotating perforated wheel. As the wheel rotates with the wind-tunnel model whose spin rate is to be measured, the flashes per unit time of the interrupted light beam are counted by

the phototransistor. For example, ten perforations in the wheel give ten counts for every revolution of the model. Signal strength is maintained regardless of the spin rate. Other phototransistor tachometers have fixed mirrors mounted on the rotating model that reflect a light beam to the phototransistor.

The inset in Fig. 1 shows a display model of a phototransistor tachometer. The light source is an ophthalmoscope lamp, a 2.5-volt, 0.3-

ampere bulb. The light beam from the lamp to the phototransistor is interrupted by a rotating perforated wheel. The phototransistor is beneath the plastic shaft in the upright support of the shaft. It receives only the light through the perforations in the wheel as the wheel rotates. In this application, the small size and ease of mounting the components are significant. The phototransistor is an *npn* germanium device.

Figure 1 also shows the author inserting the portion of the tachometer that comprises the lamp and the phototransistor. This portion corresponds to the lower portion of the display model shown in the inset. The perforated wheel of the tachometer, which is not visible in the main photograph, is mounted on the sting. The sting also supports the test model. The power cord at the left is a shielded twin-axial lead, and an RG-58 cable is used for the phototransistor. The sting, which supports the model as well as the perforated wheel of the tachometer, is rotated by an air motor; the air line is visible at the right. A magnetic clutch connects the model shaft with the perforated wheel to the motor. The model, shaft and perforated wheel rotate from their own inertia after the magnetic clutch releases the air motor from the model. The fixed lamp and phototransistor indicate the rotational speed of the perforated wheel and the model during the time they coast.

Figure 2 shows the roll-damping test circuit of a wind-tunnel model. The signal from the phototransistor goes to the electronic tachometer, whose output is continuously recorded. The phototransistor tachometer's output also goes to a counter, which samples either the frequency or the period of the signal; for example, the counter may be set up so that it makes successive measurements of the number of pulses received from the phototransistor in a certain period of time (as the model's rotation slows down, the number of pulses received in each period decreases). At the end of each period, the counter sends a negative pulse to the time-of-sampling-of-period circuit.

This circuit (Fig. 3) consists of

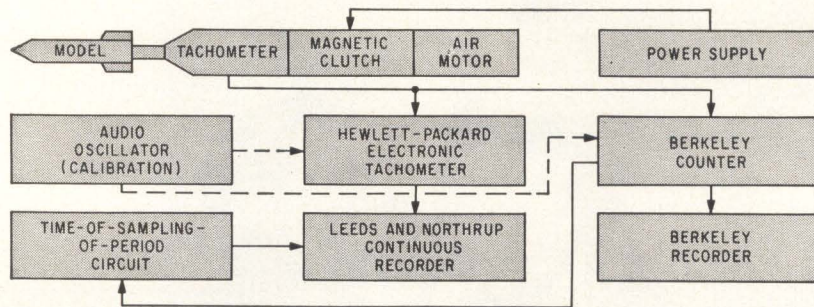
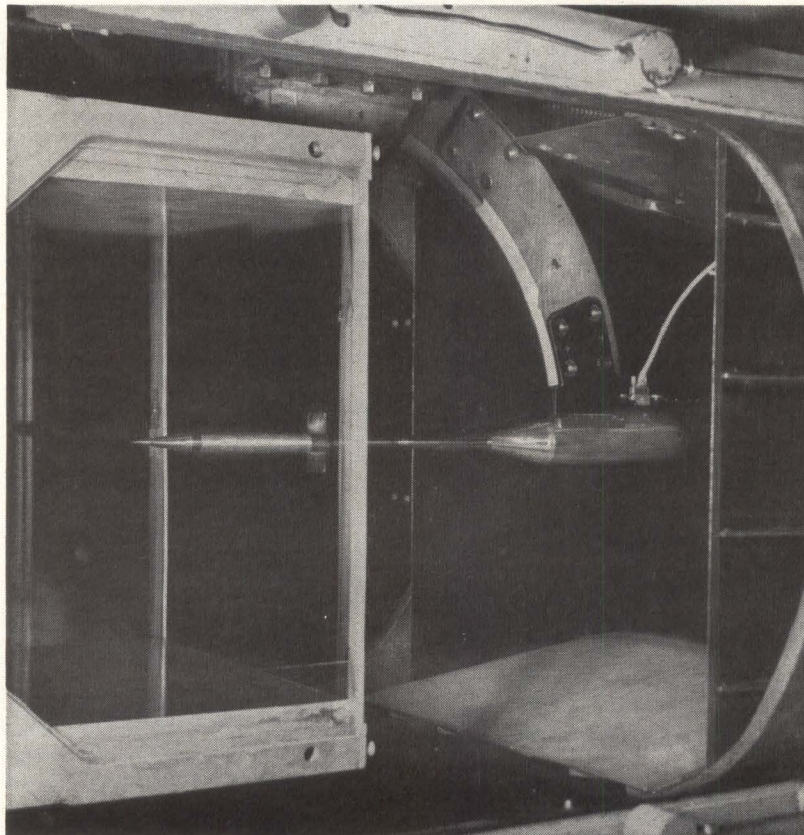

FIG. 2—Test setup for taking data on roll damping. Pulse-count data is fed to a computer (not shown), which calculates roll-damping coefficient



Test setup and model are shown inside a wind tunnel prior to testing

an amplifier and thyatron trigger. Its output pulse goes to a solenoid pen of the recorder, which indicates the time that a pulse-count sample is made. The pulse-count sample is printed by the counter. Thus, at regular time intervals, the output of the continuous recorder can be calibrated by comparing its level with the printed pulse count. Accuracy of the record depends on the calibration of the crystal oscillator in the counter.

The phototransistor was connected in series with a 180,000-ohm resistor and 20 volts d-c, and the signal taken across the phototransistor. Two volts light the lamp.

Mach numbers from subsonic to Mach 5, or five times the speed of sound, have been used in tests to determine the effect of spin on the aerodynamics of the model. Frequencies from two to 2,000 cps were recorded. With the older tachometer of the electromagnetic type, the minimum frequency was 6 cps and the signal strength was about 7 millivolts, making it necessary to use an amplifier for the signal. With the phototransistor tachometer, the signals were ten volts throughout the range of frequencies. Any vibration of the model affected the older type; no performance degradation due to vibration was noted when using phototransistor tachometers.

Figures 4A, 4B, and 4C show parts of models that are tested by mounting the tachometer within each model. Such models are used to determine the effect of Magnus forces on the behavior of spinning missiles and rockets during flight. (The slice of a golf ball is caused by the Magnus-force effect—as well as by the golfer.)

Figure 4A shows a finned tail of a model. On the inside periphery, there are ten flats machined in the shape of a ten-sided polygon. Each inside flat is polished and becomes a mirror for the tachometer that is inserted in the finned tail (Fig. 4B). The finned tail rotates and the lamp and phototransistor remain fixed. The light beam from the lamp strikes the inside reflecting-mirror flats, and is reflected to the phototransistor, whose leads are visible in the photo. The phototransistor counts successive reflected beams.

In the measuring setup shown in Fig. 4C, the light beam from the lamp is successively reflected from the faces of ten polished and plated internal gear teeth as the gear rotates. The internal gear is mounted to the rotating model and the lamp and transistor are fixed. The scales shown in Fig. 4 are in inches.

Some shells and explosives have an arming device that keeps the missile inert until a desired time.

One such device is armed when a small impeller spins a certain number of revolutions. The angular-reflection test setup shown in Fig. 4D determines the spin rate of this impeller. The phototransistor receives light pulses from the reflecting blades of the impeller. An external light source is used. The impeller rotates and the mount remains fixed. The flow field causes the impeller to rotate.

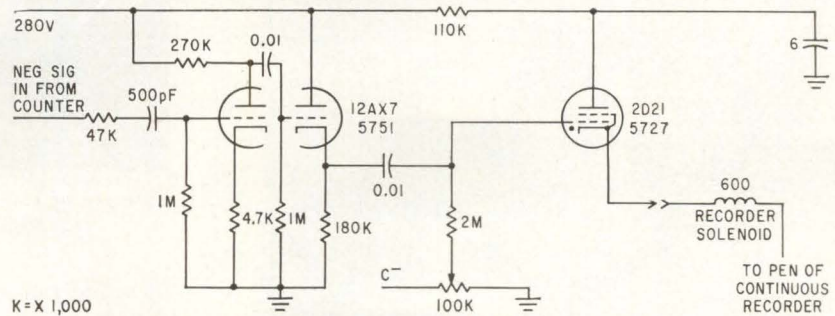

FIG. 3—Output of this time-of-sampling-of-period circuit goes to the continuous recorder shown in Fig. 2

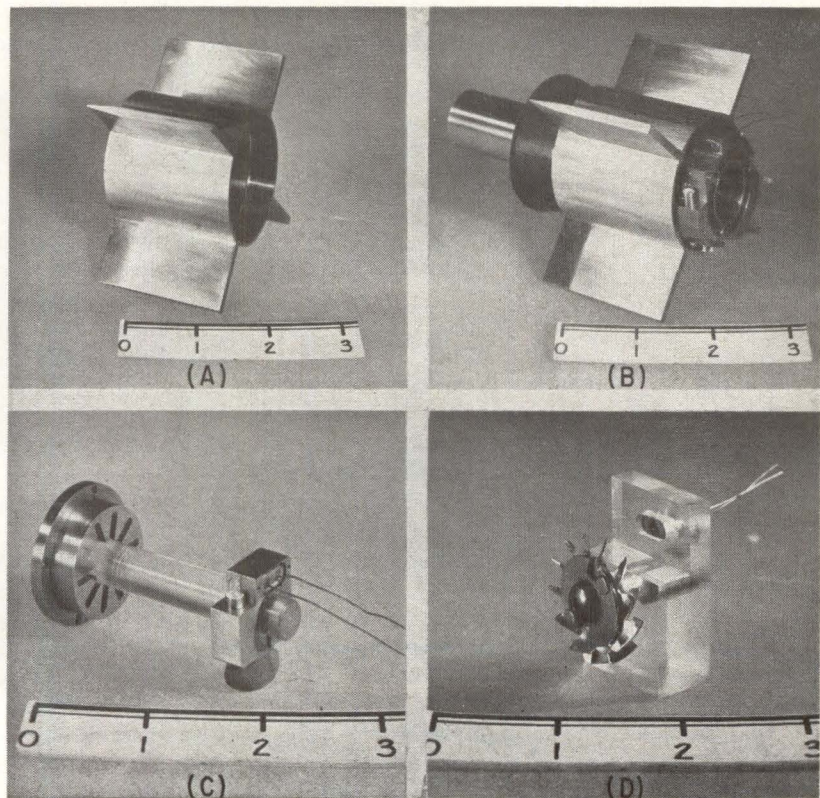
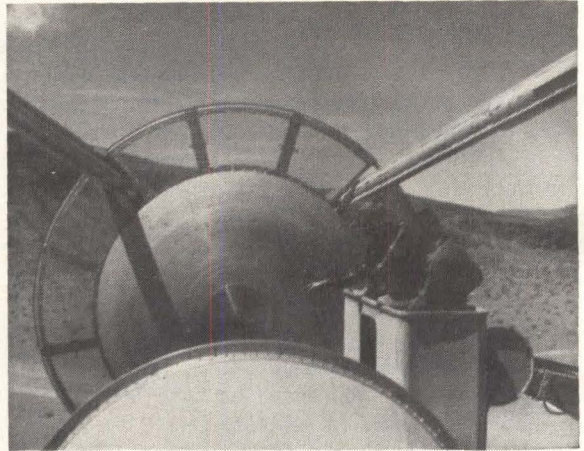

FIG. 4—Finned tail (A) has internal mirrors on inside surface that successively reflect light to tachometer (B). Phototransistor in (C) receives light pulses from reflecting faces of gear teeth. An angular reflection model is shown in (D)

UNIQUE FEED



Close-up of full scale modified subreflector

Complete full-scale modified Cassegrainian antenna system

A Cassegrainian or double-reflector antenna system offers many advantages but ground spillover lowers performance. The simple beamshaping modification described here reduces spillover by a factor of 2 and increases aperture efficiency

By P. D. POTTER

Jet Propulsion Laboratory,
California Institute of Technology,
Pasadena, Calif.

PARABOLOIDAL REFLECTORS for large-aperture ground-based antennas are widely used. This type of antenna appears unrivaled in low noise applications as a good compromise between performance and cost.

Design and construction of a large ground antenna is a difficult financial, structural and servomechanical task, and it is imperative that maximum r-f performance be achieved. Theoretically, achieving extremely high aperture efficiency (about 90 percent) with low spillover (about 1-2 percent) appears possible. For this application, the ordinary horn-type antenna is only a zero-order solution to the paraboloid feed problem. The antenna designer's difficulty in simultaneously obtaining uniform aperture illumination and low spillover is virtually unknown to the optical telescope designer. It is natural, therefore, to attempt optical design approaches to ground antennas which are extremely large compared to the operating wavelength. The two-reflector Cassegrainian

system is such an antenna. An attractive feature of this system is that the feedhorn, microwave circuits and receiving equipment are mounted near the surface of the paraboloid, rather than near its focus, thus providing operational advantages. Ready adaptability of air conditioning to a maser, follow-on amplifier and their instrumentation may be a significant factor in system performance, so that, practically, Cassegrainian feed may be desirable.

In performance, however, an optically designed system leaves much to be desired. Even for antennas a hundred wavelengths in diameter the spillover properties of the Cassegrainian feed system are not exceptionally good. A simple analysis is advanced that qualitatively predicts the performance of an unmodified Cassegrainian feed system in terms of its size in wavelengths. Based on this, a simple beamshaping device that drastically improves the spillover performance has been developed.¹ Experimental data are presented.

Generally, the important performance parameters associated with large ground-based paraboloids are aperture efficiency and noise temperature. Calculation of aperture efficiency of paraboloidal antenna

SYSTEM Improves Space Antennas

amounts to a calculation of the radiated axial far-field strength for a given power input. As pointed out by Silver², the result of such an axial field strength calculation is independent of whether the aperture field or the surface current method is used. The calculation is generally more expeditiously performed as an integration of a current on the reflector surface. Using this method, it can be shown³ that for a uniformly phased paraboloid illumination the aperture efficiency η is given by:

$$\eta = \frac{1}{4\pi^2} \cot^2 \left(\frac{\Psi}{2} \right) G_{of} \left| \int_0^{2\pi} \int_0^{\Psi} E_f(\psi, \xi) \tan \left(\frac{\psi}{2} \right) d\psi d\xi \right|^2 \quad (1)$$

where Ψ = aperture half angle; ξ, ψ = angular coordinates of a point on the reflector surface; G_{of} = feed system power gain; and $E_f(\psi, \xi)$ = normalized field system voltage radiation pattern.

The geometry used in Eq. 1 is shown in Fig. 1A. The maximum feed gain G_{of} and the radiation pattern $E_f(\psi, \xi)$ are readily measurable quantities for any feed system. In practice, $E_f(\psi, \xi)$ may be established by measuring radiation patterns as a function of ψ for two or more discrete values of ξ . In this case, Eq. 1 reduces to³

$$\eta \approx \cot^2 \left(\frac{\Psi}{2} \right) G_{of} \left| \frac{1}{N} \sum_{n=1}^{n=N} \int_0^{\Psi} E_f(\psi, \xi_n) \tan \left(\frac{\psi}{2} \right) d\psi \right|^2 \quad (2)$$

The error introduced by this sampling process in ξ is generally very small.³ It should be noted that Eq. 2 takes account of several significant factors which are generally neglected by the aperture integration method²; mismatch losses, dissipative feed losses and

cross-polarization losses are all included in the experimental determination of G_{of} and $E_f(\psi, \xi_n)$. A weighted graph paper may be constructed³ which permits simple but accurate graphical evaluation of Eq. 2.

Although the noise properties of antennas have only recently become a practical problem in communication systems, the subject of effective antenna noise temperature is an old one. The basic relationships were derived by Burgess⁴ twenty years ago. A good discussion of the effect, together with World War II experimental data on antenna temperature measurements, is available.⁵

The basic fundamentals of antenna noise theory may be easily developed. At r-f, the thermal noise generated by a matched load at T deg absolute (or Kelvin), is given by:

$$P = kT df \text{ watts} \quad (3)$$

where k is Boltzmann's constant of 1.3803×10^{-23} watt-sec/deg K and df is the effective noise bandwidth. If we had a perfectly matched antenna with no dissipative losses, we would similarly discover that it had a noise output P due to reception of thermal noise from its environment. This noise may be defined in terms of an effective antenna noise temperature T_a as follows:

$$T_a = P/k df \quad (4)$$

For an antenna with no dissipative or mismatch losses, effective antenna temperature is given in spherical coordinates by:⁵

$$T_a = \frac{1}{4\pi} \int_0^{2\pi} \int_0^{\pi} T(\theta, \phi) G(\theta, \phi) \sin \theta d\theta d\phi \quad (5)$$

where $T(\theta, \phi)$ = black-body temperature of the antenna's environment; and $G(\theta, \phi)$ = unnormalized antenna gain function.

Figure 1B illustrates the practical feed design problem. A large dish is shown pointing at zenith,

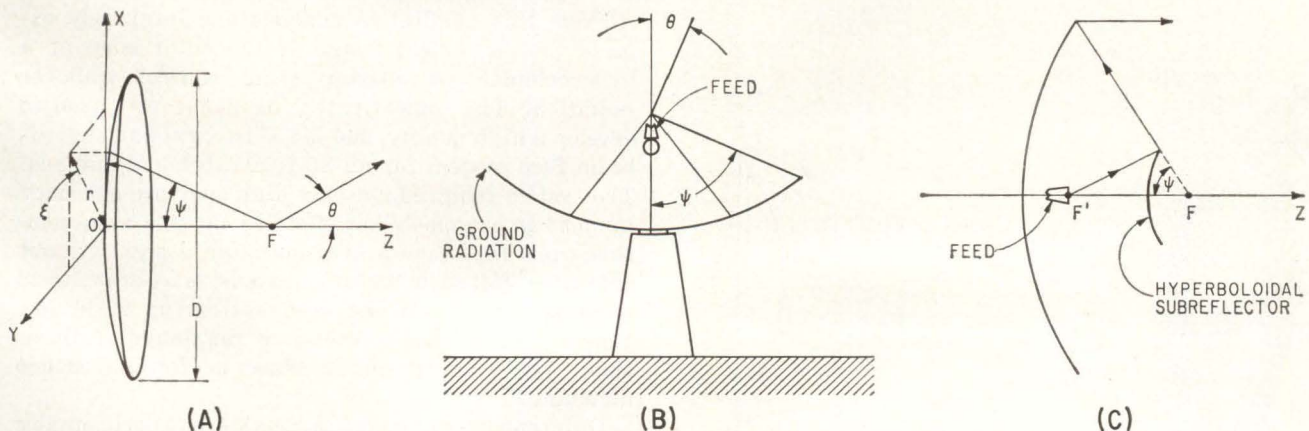

FIG. 1—Paraboloid geometry (A); parabola pointing to zenith (B); and basic geometry of the Cassegrainian antenna system (C)

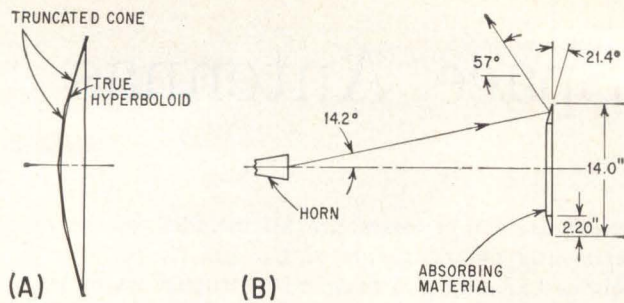

FIG. 2—Conical approximation (A); scatterer (B)

that is, at 90-deg elevation. To achieve high aperture efficiency a feed that strongly illuminates the outer region of the dish might be used. Unfortunately, owing to the necessarily finite rate of angular cutoff of the feed radiation, the feed also significantly illuminates the ground. In accordance with the reciprocity theorem, this means that the antenna is susceptible to ground thermal noise radiation. As an example, if the ground had an effective noise temperature of 250 deg K, and the feed had a spillover of 10 percent in the angular region between the paraboloidal reflector edge and the horizon, Eq. 5 indicates a noise contribution of 25 deg K—a serious effect on the performance of a low noise system. The effect of spillover on effective antenna temperature has been established experimentally.⁶ A high-performance feed system should possess low ground-directed spillover and high aperture efficiency.

The basic geometry of the Cassegrainian system⁷ can be seen in Fig. 1C. A hyperboloidal subreflector is interposed between the focal point of the reflector and the reflector surface. The hyperbola is chosen as the curve for the subreflector to achieve the desired constant path length and correct ray direction. Simple ray-tracing shows that, based on geometrical optics, the Cassegrainian system has no spillover. In practice, however, the subreflector is only moderately sized in terms of a wavelength and hence the geometrical optics approximation breaks down.

The effect of subreflector wavelength size on spillover and edge taper may be determined approximately from Fig. 2A which shows a hyperboloidal subreflector with a conical approximation. The latter

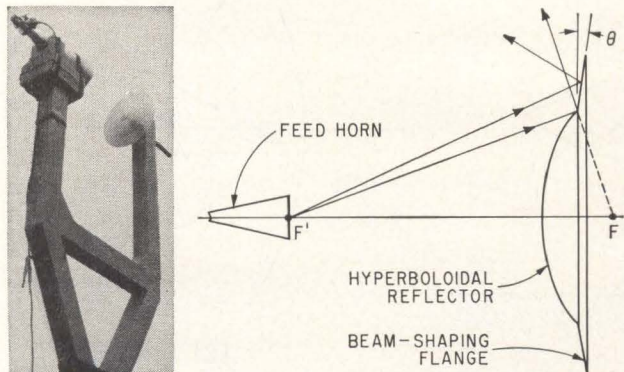

FIG. 4—Geometry of shaped-beam subreflector with photo of scale model feed system and mount

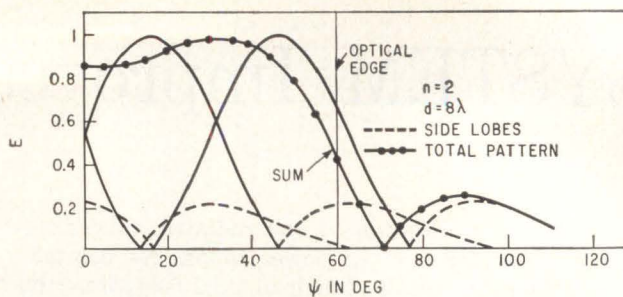

FIG. 3—Calculated synthesis of Cassegrainian pattern

is formed by approximating the hyperbola with a series of tangential straight-line segments. The resulting curve is then revolved about its axis of symmetry to generate the hypothetical subreflector surface. The scattering pattern of each conical ring may be added to derive the total subreflector scattering pattern. This technique is rigorous in the limit of zero ring width (that is, a true hyperboloid). However, the computational problem becomes difficult, and the solution yields little or no insight into the problem of modifying the surface to enhance performance.

Since each ring is uniformly illuminated, each ring scatters an approximately $\sin X/X$ type of radiation pattern, whose maximum will be in the direction indicated by geometric ray-tracing. To verify this experimentally, a conical ring was constructed (Fig. 2B) and its scattering pattern measured. The measured pattern showed that the peak radiation occurs almost exactly at the optically predicted angle of 57 deg. The half-power beamwidth predicted by the $\sin X/X$ pattern for a ring of this width is 28 deg, which is close to the measured value of 30 deg.

The largest-width ring usable in the hypothetical conical ring model of the hyperboloidal subreflector is that which introduces negligible pattern ripple when the individual ring-scattering patterns are added together. This point occurs when the scattering patterns overlap at roughly their 6-db points.

A sample calculation is shown (Fig. 3) for an 8-wavelength-diameter subreflector approximated by two cones, the central truncated cone being 4 wavelengths in diameter and the outer angular cone being 2 wavelengths wide on each side. The predicted pattern resembles the measured pattern (Fig. 2B).

From this qualitative analysis one intuitively expects that a conical flange at the outer edge of a hyperboloidal subreflector could control spillover radiation. The conical extension flange was used to develop a high quality, 960-Mc, Cassegrainian shaped-beam feed system for an 85-ft paraboloidal antenna. The system required not only high aperture efficiency but also an extremely low effective antenna noise temperature. To derive a near-optimum design without extensive full-scale testing, extensive $1/10$ -scale tests were performed on the feed system at 9,600 Mc. Figure 4 shows the geometry of the flange modification. The conical vertex plate is for impedance matching.⁸

Different flange configurations were experimentally evaluated. In all cases, the hyperboloid had a diameter of 9.6 in. (approximately 8 wavelengths) and

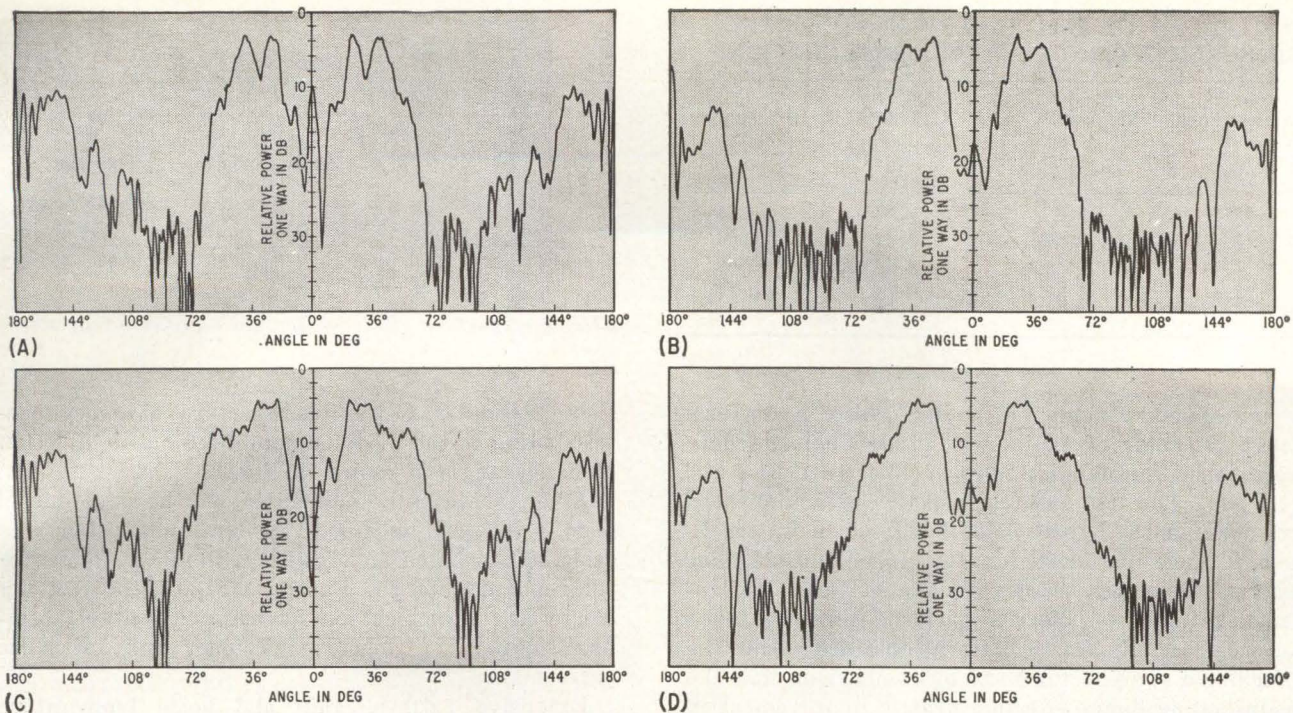

FIG. 5—Modified reflector patterns: E-plane pattern (A) and H-plane pattern (B) for $\theta = 15.4$ deg; and E-plane pattern (C) and H-plane pattern (D) for $\theta = 24.4$ degrees

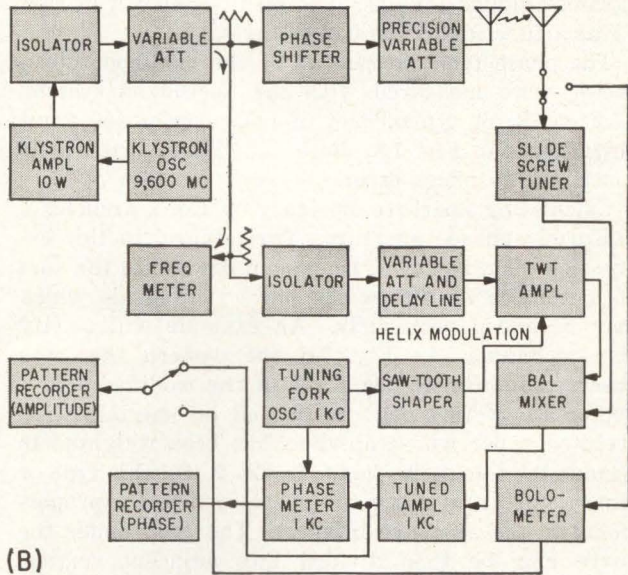
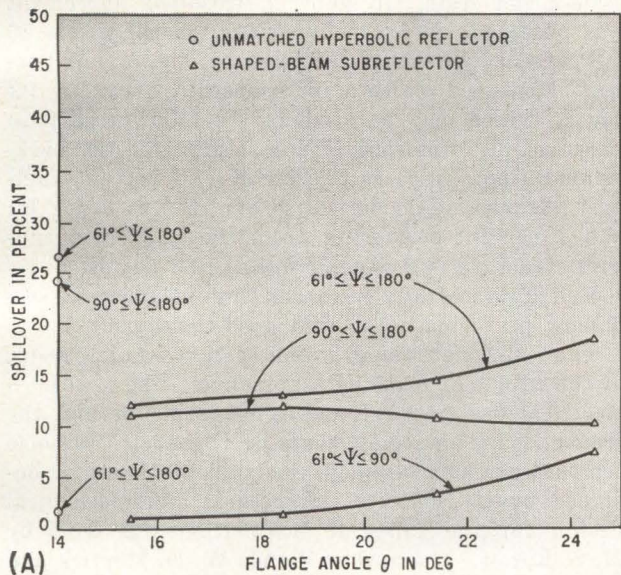

FIG. 6—Spillover plotted against flange angle (A), and Serrodyne phase measuring system (B)

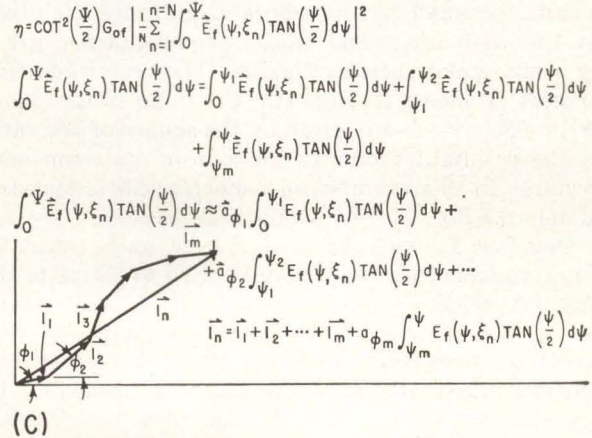
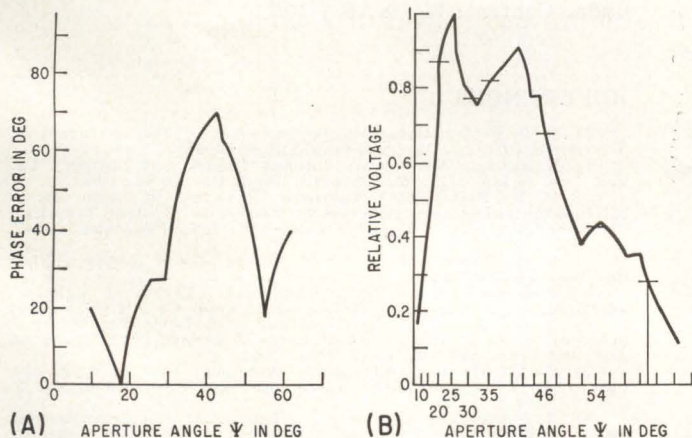

FIG. 7—Phase error plot, 45-deg plane, $\theta = 18.4$ degrees (A); aperture integration plot, 45-deg plane, $\theta = 18.4$ degrees (B); and vector integration diagram (C)

COMPARISON OF FEED SYSTEM CENTER GAIN MEASUREMENT AND PATTERN INTEGRATION

Flange angle deg	Measured gain db	Calculated directivity db	Discrepancy db
15.4	9.25	9.04	+0.21
18.4	8.47	8.51	-0.04
21.4	8.46	8.54	-0.08
24.4	8.89	8.72	+0.17

a half-aperture angle of 60 deg. Also, a uniform flange diameter of 14 in. was used. Complete data were taken for flange angles of 15.4, 18.4, 21.4 and 24.4 deg. The last case corresponds to a tangential extension of the hyperboloid. Figure 5 shows the E- and H-plane patterns for the 15.4- and 24.4-deg flanges. Diagonal (45-deg) plane patterns and diagonal plane cross-polarized patterns were also taken for each case. Radiation patterns obtained within the unmodified subreflector show by comparison that the beamshaping flange effects a drastic improvement in the spillover performance. The radiation patterns were graphically integrated to determine spillover in various angular regions. The result is shown in Fig. 6A as a function of the flange angle.

The phase front properties of the modified subreflector were measured with the Serrodyne system⁹ of Fig. 6B. A typical plot of measured phase front deviation is in Fig. 7A. Both flange and vertex plate contribute to phase error.

Calculating aperture efficiency by Eq. 2 assumes a uniformly phased aperture. The integral in this expression may, however, be broken down into the sum of a number of differently phased integrals which may be added vectorially. An example will clarify this technique. In Fig. 7B the pattern that was observed for the 45-deg plane of the modified subreflector ($\theta = 18.4$ deg) is plotted on specially constructed paper whose abscissa has been weighted to include the $\tan(\psi/2)$ factor in Eq. 2. On this type of paper³, the area under the curve is directly proportional to the aperture integral. The area under the curve may be then divided into adjacent vertical strips, each of which is reasonably constant in phase. The aperture may thus be represented as the sum of a series of small vectors whose magnitudes are given by the strip areas and whose arguments are given by a phase plot such as Fig. 7A. The vector addition process is shown in Fig. 7C. From Eq. 2 the phase error efficiency loss is given by the square of the ratio of the resultant vector to the sum of its component vectors. In this example, phase error loss is approximately 0.5 db.

One last factor—the feed system gain—must be determined before Eq. 2 may be used to estimate the aperture efficiency to be achieved with a feed system. In the feed system described here, two methods were used: the directivity was calculated by feed system pattern integration, and the gain was measured by the standard horn substitution method (see Table). It was concluded that use of the calculated directivity rather than the measured gain would yield more con-

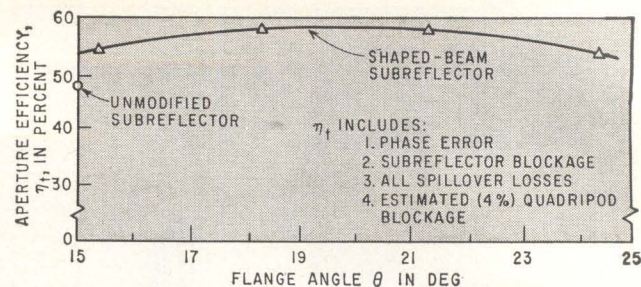

FIG. 8—Aperture efficiency plotted against flange angle

sistent results. Calculated aperture efficiency corresponding to the modified subreflector as a function of flange angle is shown in Fig. 8.

After successful completion of the scale-model tests, a full-scale modified Cassegrainian system was designed, installed and tested in the 85-ft Goldstone polar-mount antenna. Based on Fig. 8, the 18.4-deg flange angle was chosen as being a suitable compromise between aperture efficiency and low noise performance.

Extensive pattern, gain and noise temperature tests were performed on the installation to correlate full-scale performance to that predicted from the scale-model tests. In general, excellent agreement was observed. Measured aperture efficiency was 50 ± 8 percent, while that predicted by Fig. 8 is 58 percent. Measured zenith noise temperature was 9.5 ± 2 deg K, which may be predicted as follows: galactic background, atmospheric loss, extragalactic background (measured) is 3.5 deg K; 1.3 percent spillover (from scale-model tests, Fig. 6A) is 3 deg K; and 1 percent scattering from the quadripod support structure is 3 deg K; total is 9.5 deg K.

Full-scale pattern tests relating primary to secondary performance showed good agreement.

The full-scale Cassegrainian system was the result of the efforts of many JPL personnel. The feed horn electrical design was done by D. Schuster and the transmission line components by G. Levy. The noise temperature measurement instrumentation was designed by C. Stelzried. Structural and mechanical design for the full-scale installation was done by M. S. Katow. The author thanks W. D. Merrick and R. Stevens for their enthusiastic support.

The work reported here was sponsored by NASA under Contract No. NAS 7-100.

REFERENCES

- (1) P. D. Potter, Cassegrainian Subreflector Flange, Invention Report No. 30-92, JPL, Pasadena, Calif., Oct. 12, 1961.
- (2) S. Silver, "Microwave Antenna Theory and Design," 12, Rad Lab Series, MIT, McGraw-Hill Book Co., N.Y., 1949.
- (3) P. D. Potter, The Aperture Efficiency of Large Paraboloidal Antennas as a Function of Their Feed System Radiation Characteristics, Tech Report No. 32-149, JPL, Pasadena, Calif., Oct. 1961.
- (4) R. E. Burgess, Noise in Receiving Aerial Systems, Proc Phys Soc, London, 53, p 293, 1941.
- (5) J. L. Lawson and G. E. Uhlenbeck, "Threshold Signals," 24, Rad Lab Series, MIT, McGraw-Hill Book Co., N. Y., 1950.
- (6) D. Schuster, C. T. Stelzried and G. S. Levy, The Determination of Noise Temperatures of Large Antennas, IRE Trans on Ant. and Prop., AP-10, No. 3, May 1962.
- (7) P. W. Hannon, Microwave Antennas Derived from the Cassegrain Telescope, IRE Trans on Ant and Prop., AP-9, No. 2, p 140, March 1961.
- (8) P. Foldes and S. Komlos, "Theoretical and Experimental Study of Wide Band Paraboloid Antenna with Central Reflector Feed, RCA Rev. XXI, No. 1, p 94, March 1960.
- (9) R. C. Cumming, The Serrodyne Frequency Translator, Proc IRE, 45, p 175, Feb. 1957.

Stable Frequency Synthesizer Replaces Sideband Converter

Three oscillators allow frequency increments of 1 Kc from 2 to 30 Mc, replacing local-oscillator operation in a double-conversion receiver, with a long-term frequency stability of 1 part in 10^8

By JAMES E. MACDOWELL
Manager, Florida Division
Airtronics, Inc., Destin, Florida

FREQUENCY SYNTHESIZERS produce extremely stable frequencies over a wide range. Frequency tolerances are dependent only upon the tolerance of the controlling standard. The frequency increments of the synthesizer output can be made as low as one cycle over any desired range.

The synthesizer described here was designed to provide an output in increments of 1 Kc over a range of 2 to 30 Mc. Its purpose was to supplant the first conversion oscillator in a double-conversion radio receiver and, with associated circuits, provide a receiver whose overall stability was better than 1 part in 10^8 . The fixed frequency for the second conversion was also derived from the standard source. Since this unit was to be used in single-sideband operation, the beat-frequency oscillator source was synthesized from a stable 452-Kc oscillator.

The synthesizer consists of two units: the frequency standard, which here is a Lavoie LA-90, and the frequency controller.

The frequency controller (Fig. 1) consists of three oscillators, associated pulse-shaping circuits and means for locking these oscillators to the external frequency standard. The final output frequency is the result of heterodyne action. Oscillator 1 can be locked to a 100-Kc pulse from an external frequency standard in 100-Kc increments from 2 to 30 megacycles. Oscillator 2, is adjusted to a frequency 100 Kc above or below that of oscillator 1. Oscillator 3 can be locked to a

1-Kc pulse from an external frequency standard in 1-Kc increments from 100 to 200 Kc. The outputs from oscillators 1 and 2 are fed to a mixer, resulting in a heterodyned signal of between 100 and 200 Kc, which is coupled to a phase detector simultaneously with the signal from the 100-200 Kc oscillator. When the signals from both sources coincide in the phase detector, an output is derived. A d-c component of this signal locks oscillator 2 to the selected 1-Kc multiple within the selected 100-Kc interval.

As shown in Fig. 2, a 100-Kc pulse is supplied by the external standard and fed to a pulse-sharpener circuit composed of V_6 , V_6 and V_7 , which supplies an output pulse of 2-nsec duration. The pulse must be sharp so that usable harmonics up to 30 Mc can be generated. The output pulse is introduced to the grid of the first mixer or pulse detector. Also supplied to this first mixer is the output of oscil-

lator 1 (V_{10A} , and cathode follower V_{10B}) which is tunable from 2 to 30 Mc. Part of the tuned circuit of V_{10A} is a voltage-variable capacitance diode D_1 . When the harmonics of the 100-Kc pulse and the frequency of V_{10A} coincide, the additive voltage provides a change in d-c level at the plate of the first mixer, V_4 . This voltage biases D_1 , and thus locks the harmonic to the particular frequency setting of V_{10A} . A twin-T network, resonant at 100 Kc, in the feedback loop to D_1 isolates the frequency components from D_1 . The particular harmonic to which V_{10A} is locked is referred to as frequency f_1 .

The output of cathode follower V_{10B} provides a locked signal, f_1 to sinewave mixer V_8 . Oscillator 2, V_{9A} , and its associated cathode follower, V_{9B} , are adjusted to a frequency f_2 within 100 Kc above or below that of f_1 . It is usually adjusted to the nearest 10-Kc multiple of the desired f_2 . From cathode

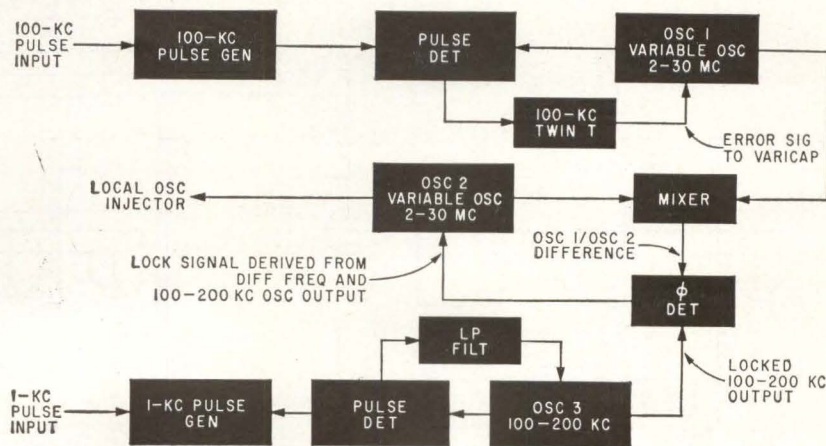

FIG. 1—Frequency controller. The 100-Kc pulse generator consists of a one-shot, trigger, blocking oscillator and ringing oscillator. Oscillator 2 is adjusted to 100 Kc from oscillator 1 frequency

difference between f_1 and f_2 (some frequency between 100 and 200 Kc), and the output of oscillator 3, also between 100 and 200 Kc. When the two signals coincide at a predetermined frequency, the phase detector provides a d-c bias for diode D_3 , a voltage-variable capacitance in the tuned circuit of oscillator 2. Thus, oscillator 2 can be locked to some 1-Kc increment between 100 and 200 Kc, and output frequency f_2 can be anywhere between 2 and 30 Mc at 1-Kc intervals. The stability of the entire system then depends upon the stability of the 100-Kc and 1-Kc pulses provided by the frequency standard.

Operation of this device is typified more fully by a setup to provide a first-conversion local-oscillator frequency for a National NC400 receiver. Figure 3B is a spectrum display of the frequencies required of the various oscillators.

In this procedure, the tuning dial of the NC400 serves as a frequency indicator with sufficient tracking accuracy. The speaker output of the receiver also assists in determining lock points. An oscilloscope provides visual indication of lock. Since this frequency controller was to be an inexpensive device, such features as individual vacuum tube voltmeters at mixer stages to indicate locking conditions were eliminated. Also, with this particular apparatus it was not envisioned that frequent changes of frequency would be required.

Assume received signal is 7.394 Mc. Operation will be on a lower band of the NC400, one having a 455-Kc i-f frequency. Thus, the local-oscillator injection signal (output from oscillator 2) is the carrier at 7.394 Mc plus the 455-Kc i-f, or 7.849 mc.

The idea is to arrange matters so that the heterodyned output of oscillators 1 and 2 are as close together as possible, and midband with respect to oscillator 3. This means that they should be in the vicinity of 150 Kc. The proper 100-Kc multiple must first be selected for oscillator 1. To do this, subtract 150 Kc from the desired signal: $7.849 - 0.150 = 7.699$ Mc. The nearest 100-Kc multiple is 7.7 Mc. With the bfo on, the receiver dial is adjusted to 7.7 Mc. Patching the output of oscillator 1 into the receiver front end, adjust oscil-

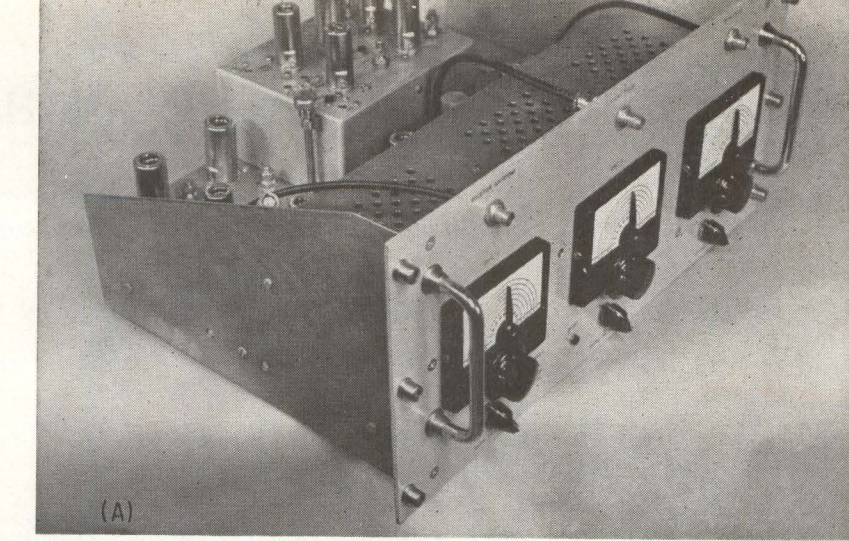

1. DESIRED SIGNAL	7.394 MC
2. +455 KC IF	0.455
3. LOCAL OSC SIG	7.849 MC
4. -150 KC	0.150
	7.699 MC
5. NEAREST 100-KC MULTIPLE	7.700 MC
6. OSC 1	7.700 MC
7. NEAREST 10-KC MULTIPLE BELOW LOCAL OSC SIG	7.840 MC
8. OSC 2	7.840 MC
9. DIFF FREQ (OSC 2-OSC 1)	0.140 MC
10. OSC 3 INCREMENT	0.009 MC

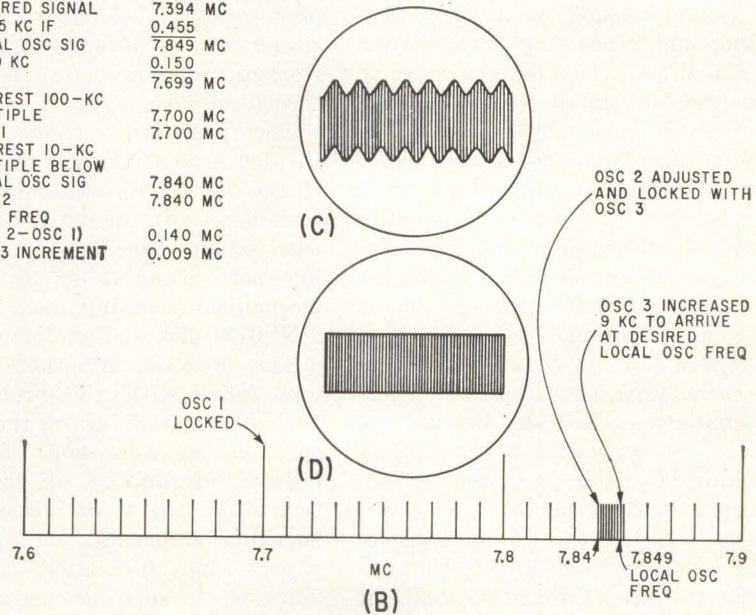

FIG. 3—Frequency control (A); spectrum display of required oscillator frequencies (B). Typical oscillator 1 lock patterns; approaching lock point (C); locked (D)

lator 1 to a lock with the 7.7-Mc harmonic. This is determined by the presence of an audible ringing note or by connecting the oscilloscope to J_1 , the mixer V_1 plate. Figures 3C and 3D are typical of what can be seen with the cross sweep at about 0.5 ms.

Oscillator 2 is set 149 Kc away from oscillator 1 (above). One could zero-beat oscillator 2 at 7.7 Mc, and count up with oscillator 3 to 149 Kc. However, since a 10-Kc pulse is available at the external standard, adjust oscillator 2 is adjusted to the nearest 10-Kc harmonic below 7.849 Mc. The receiver dial is reset to 7.84 Mc, and the 10-Kc pulses patched into the receiver input. With the bfo, the nearest 10 Kc can be noted, and the dial accurately adjusted to 7.84 Mc.

The 10 Kc is now removed, and oscillator 2 tuned to coincide with the same zero beat, thus being roughly adjusted to 7.84 Mc, but not locked. Two signals are now being fed into the phase detector, resulting in a heterodyne note of 140 Kc. With the oscilloscope connected to J_2 , oscillator 3 is adjusted to 140 Kc by noting the lock occurring when the heterodyne note and oscillator frequency coincide. The system loop is now adjusted and oscillator 2 locked to 7.84 Mc. Oscillator 3 has now captured oscillator 2, and it is possible to move oscillator 3 up in frequency 9 lock points, counting them on the scope, and ending up with oscillator 2 being locked to a heterodyne note of 149 Kc. The output of oscillator 2 is now 7.849 Kc, the desired signal.

Sending Weather Radar Displays

Storage tube holds a complete azimuth scan for digitizing by Nipkow scanning drum. Digital data is punched into paper tape for later computer analysis

By WILLIAM FISCHER
HENRY HIRONAKA
Rainbow Engineering Co., Inc.,
Rockville, Maryland

A PERIODIC PROBLEM in data handling and processing occurs when a visual picture or pattern must be analyzed or stored by digital computers. It is usually necessary for the pattern to be broken down into many small areas, called bits. Each bit is then handled as a separate unit of information and typically, it is necessary for the equipment to know the position of each bit as well as its content.

There are a number of approaches that are successful for performing such a task. One of the more obvious approaches is the projection of an image of the pattern onto a grid of photosensitive elements, each one of which senses the content of one bit. If the pattern is fixed, information can be fed from the photosensitive ele-

ments through electronic circuits to punched paper tape or magnetic tape for later input to a computer. If the pattern is constantly changing, information detected by the photosensitive elements can be stored in one of several types of storage registers before being recorded on tape.

The previous systems take a parallel look at the entire pattern. If the pattern is stationary, it is possible to scan the pattern serially, with either cathode-ray tube (flying-spot) scanning or by optical-mechanical scanning, such as with a Nipkow disk and photomultiplier.

The Federal Aviation Agency was faced with the problem of periodic digitalizing of the image on a weather radar scope. The digitalized information of the cloud formation was to be recorded, at periodic intervals, on punched paper tape for later computer analysis. In such an operation the pattern is constantly changing. The

area of the total pattern was to be broken down into a grid of 80 by 80 segments for a total of 6,400 bits. This can be done by selecting any particular full sweep of the radar, recording the pulses as they come off the radar line and storing this information in a 6,400-stage storage register. The register then feeds out its information at the rate required by paper tape punching equipment. One of the difficulties with such an approach is that it is expensive. The solution was to store as periodically required a full azimuth scan of the radar information on the face of a Memoscope, and then scan a projected image of the Memoscope pattern by a slowly revolving Nipkow drum and a single photomultiplier. The Nipkow drum is driven synchronously with the paper punch equipment so that the scanning holes in the Nipkow drum pass the discrete areas at the same rate as the punching rate of the paper tape punch equipment. In this manner, a highly accurate pattern converter can be made at a much lower cost than would be required to produce the same results by orthodox electronic storage methods.

The pattern to be examined for this particular problem is that of the cloud formations as seen by the weather radar. Actually, two simultaneous outputs were built into the system; one for later input to a computer for analysis of the cloud formations and their changes, and the other in ordinary teletypewriter RE code for transmission over teletype lines so that remote teletypewriters can reproduce the image by typed characters.

A simplified block diagram of the basic system is shown in Fig. 1. The radar information is constantly available to the Memoscope. The radar azimuth information is converted by sine-cosine potentiometers before it enters the Memo-

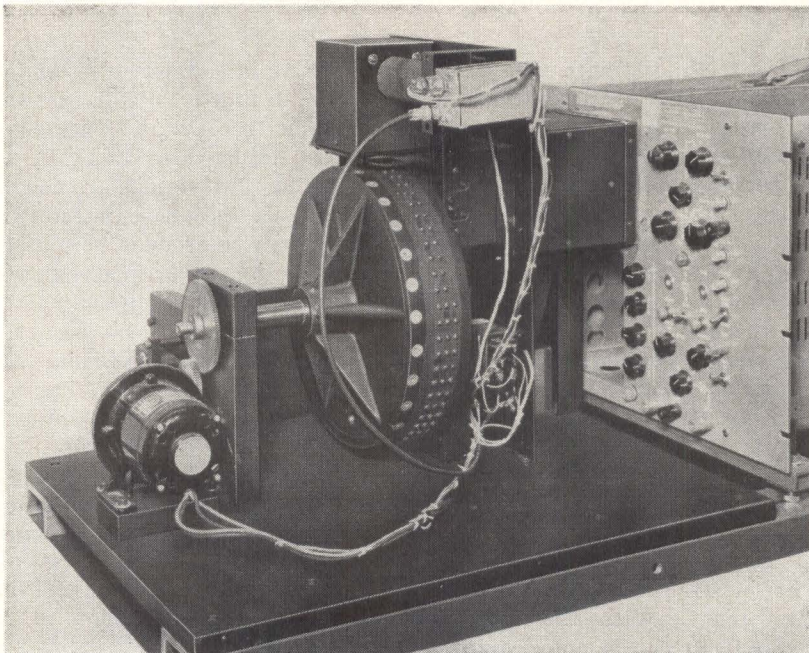

Scanner unit with cover removed

Over Teletypewriter Circuits

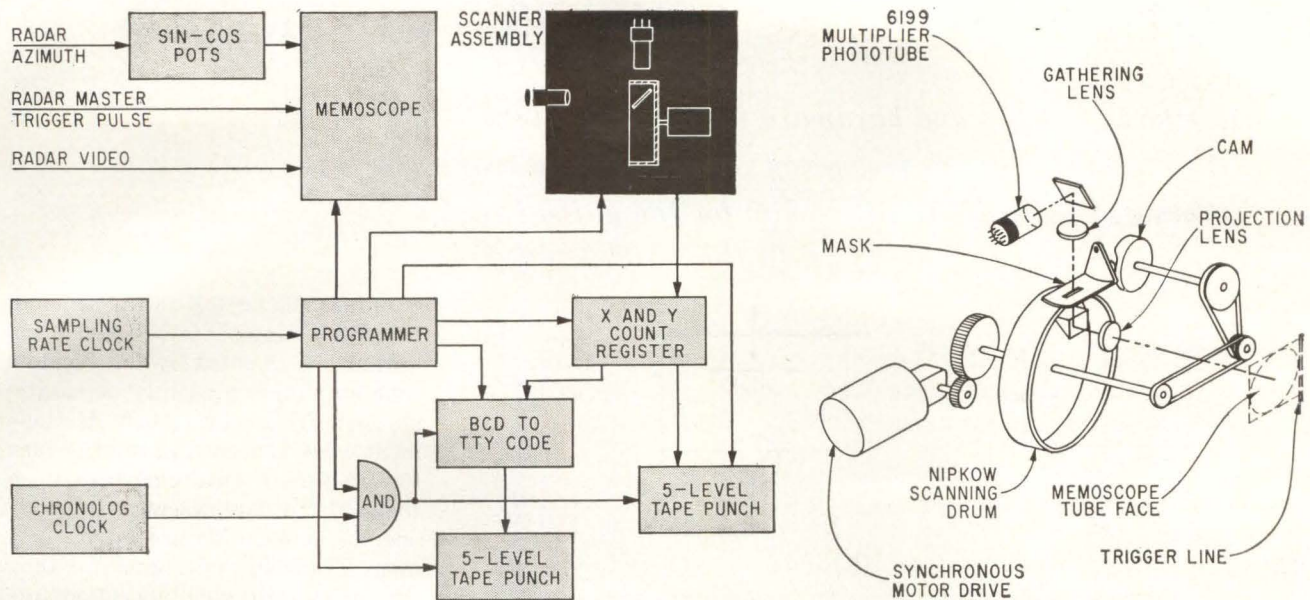

Block diagram of scanning system (left); optical and mechanical components of scanning system (right)

scope to enable the Memoscope to reproduce the radar polar sweep. (The Memoscope is normally an X-Y sweep device.) The Memoscope reproduces the radar information like any ppi. However, the Memoscope has the capability of retaining the video information and being erased at will.

A programmer controls the recording, retention and erasure of the Memoscope video information. The programmer is triggered by a sampling rate clock which is manually set so that samples are taken at intervals of from 5 minutes each to one hour each, with intermediate steps in multiples of 5 minutes. Once the Memoscope has recorded and retained one full azimuth scan; the programmer shuts off additional input from the radar line. The programmer then starts the Nipkow drum of the scanner assembly shown in simplified form in Fig. 2.

An optical system projects an image of the recorded Memoscope video information to the surface of a Nipkow scanning drum. The Nipkow drum carries a helical series of 80 holes and scans the projected image at such a rate that each hole passes 1/80th of the width of the image in 1/60th of a second. The light passing through

the scanning holes is directed to a photomultiplier. As each hole scans across an artificial trigger line near the Memoscope face, the X and Y count register is started. Every sixtieth of a second the light transmitted by a scanning hole is sampled and the information is encoded and recorded on two punched paper tapes.

The Memoscope image projected on the face of the scanning drum is a one-inch diameter circle. The pitch of the 81 scanning holes on the Nipkow scanning drum is therefore one inch. If these holes were placed around the drum to form less than one turn of a helix, the required drum diameter would be more than 27 inches. To allow the use of a smaller drum diameter, the holes are arranged to form a little less than three turns of a helix around the drum. With this setup, there is always more than one scanning hole at any given time passing information to the multiplier phototube. The mask optically gates only one of three turns of the helix. The cam controls the location of the mask, moving it across the top of the drum to follow the helix.

The scanning holes are 0.012 inch in diameter and are pre-punched in pieces of thin shim

stock, which are arranged in a helix around the outer surface of the scanning drum and each held by two button-head screws. Under the center of each piece of shim stock is a relatively large hole in the scanning drum shell.

The programmer is the heart of the system and controls most of the functions. Both tapes are five-level. One of the tapes records the scanned information of every other point in every third scanned line. The information is recorded in teletypewriter RE code in one of two coded combinations, either a space for no overcast, or an overcast symbol.

In addition, programmed information is inserted, such as the date and time information and line space information. This tape is used for transmission of the data to remote teletypewriters for reproduction as a typed image of the scanned information.

The other five-level tape is for input to a computer. On this tape the Y-coordinate of each line is recorded in binary-coded decimal form before each line scan and the X-coordinates are recorded only for those points in each line that have an overcast. In addition, date and time information is entered before each full azimuth scan.

Pushing Transistors Above

WITH PARAMETRIC CONVERSION OPERATION

Methods, circuits and hardware for operating transistors beyond their manufacturer's frequency rating. Several transistor types are evaluated in a variety of circuits for the uhf-shf region

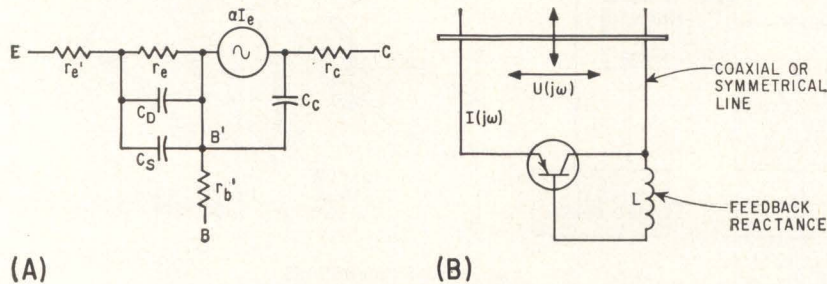

FIG. 1—Equivalent circuit of transistor when considered for high frequency use (A); conditions for operation of actual circuit (B) are based on this equivalent circuit

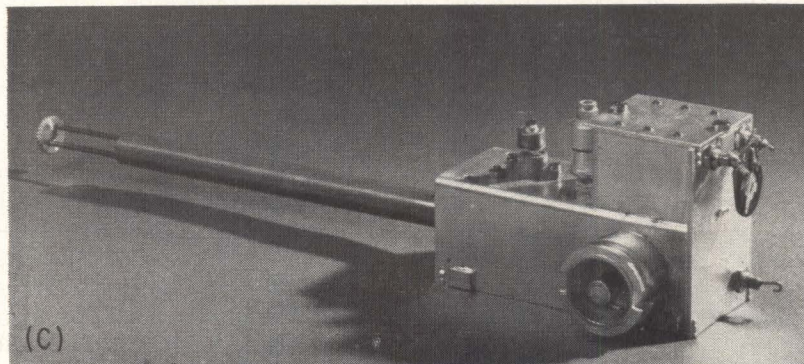
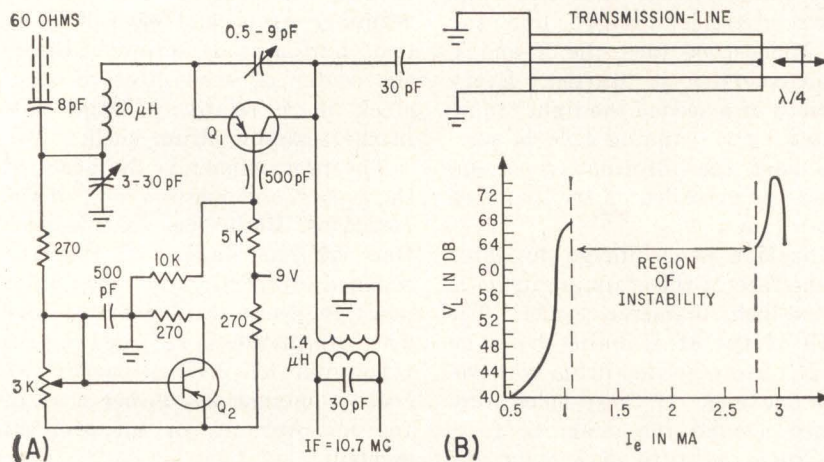

FIG. 2—Current-tuned uhf tuner (A) and its performance curves (B); illustration (C) shows hardware used. Table I gives performance for several transistors that were tested in the circuit

IF SIGNAL RECEPTION in the uhf/shf frequency range is to be freed from limitations imposed by the vacuum tube amplifiers presently necessary at that frequency, much development work is needed in semiconductor amplifiers that can take over the job. To date, vacuum tubes to operate at 5000 Mc are fairly common. Transistors designed for that frequency are virtually unobtainable.

In this article, the author describes a method of using a more-or-less ordinary transistor at a frequency considerably beyond the upper frequency limit at which it is rated by the manufacturer. Amplifier circuits and techniques are described, plus test figures for several transistor types. The results of the work might well have some application in the potentially enormous volume of future uhf television work.

The cut-off frequency of high-frequency transistors is mainly determined by the phase-shift of the transistor R-C input characteristics, Fig. 1A. The intrinsic base spreading resistance r_e' is the dominating factor in this relation: it gives the limit for the maximum oscillation frequency

$$f_{\max} = \sqrt{\frac{f_{\alpha}}{8\pi C r_e'}} \quad (1)$$

Where f_{α} is formed by the delay line consisting of the emitter diffusion capacitance, the barrier layer capacitance and the emitter diffusion resistance in Fig. 1A, where r_e' = emitter-spreading resistance, r_e = emitter-diffusion resistance ($26 \text{ mv} / I_e$ at 20 degrees), r_c = collector-spreading resistance, C_D = emitter diffusion capacitance, $(39(W^2/2D)I_e)$, where W = width of the base, D = diffusion constant of the holes in a pnp transistor, I_e

Their Frequency Limits

By ULRICH L. ROHDE, Consultant, Munich, West Germany

is the emitter current, C_s = barrier layer capacitance and C_c = collector capacitance.

For operation close to the $\beta = 1$ cut-off frequency, the transistor is considered to operate in the circuit of Fig. 1B. The current gain in grounded base is given by

$$\alpha = a_o / (1 + j\omega/\omega_\alpha) \quad (2)$$

Both emitter and collector are transformed to a coaxial line of tunable frequency. A suitable reactance transfers part of the collector a-c voltage to the base, producing a negative resistance between terminals E and C of magnitude Z . If we call the voltage at the two terminals $U(j\omega)$ and the high-frequency current through the transistor $I(j\omega)$, the inequality

$$|\text{Arg}[U(j\omega)/I(j\omega)]| \geq 90 \text{ degrees} \quad (3)$$

gives the phase for the oscillation condition; if this condition is achieved for high values of Q , Eq. (1) can be experimentally validated. Collector capacitance C_c is a pure reactance pC_c , parallel to $(1 - \alpha)$ giving

$$Z_{BC} = \frac{(1 - \alpha)}{pC_c} \quad (4)$$

or

$$\left| \text{Arg} \left(\frac{1 - \alpha}{pC_c} \right) \right| \geq 90 \text{ degrees} \quad (5)$$

One important conclusion can be drawn immediately from Eq. (4): since the argument of $(1 - \alpha)$ is always less than 90 degrees in magnitude, the argument of pC_c and the argument of $(1 - \alpha)$ should be of the same sign if it is desired to meet the inequality at all. For those frequencies in which the argument of $(1 - \alpha)$ is positive, the reactance from collector to base must be an inductive impedance; for those frequencies at which $\text{Arg}(1 - \alpha)$ is negative, a capacitance is required. Assume the collector capacitance and feedback reactance to form a resultant reactance X and the limit of $\text{Arg}(X)$ to be 90 degrees. Basing calculations on Fig. 1A

$$\text{Arg}(X)_{\max} = \arctan(1/4\omega\alpha C_c r_b' - \omega\alpha C_c r_b') \quad (6)$$

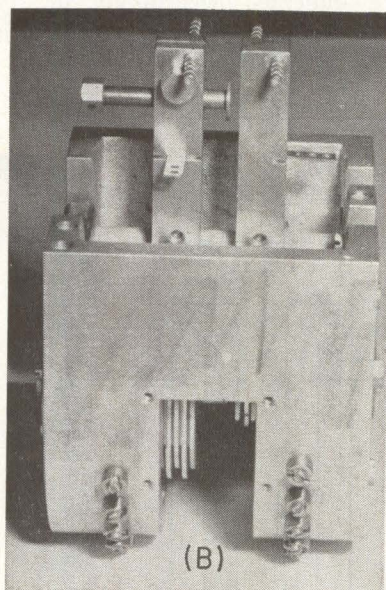
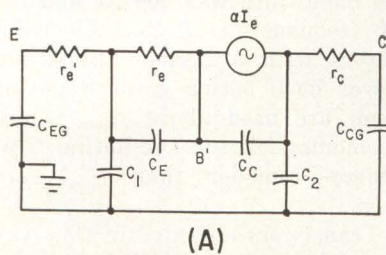

FIG. 3—Revised equivalent circuit for transistor operated beyond $\beta = 1$ cutoff frequency (A); high- Q cavity resonator for testing transistors to 5,000 Mc (B)

For $\text{Arg}(X)_{\max} = 90$ degrees, and by Eq. (2)

$$\text{Arg}(1 - \alpha) = 90 \text{ degrees} - \arctan(\omega/\omega_\alpha) \quad (7)$$

which can be formed into

$$0 \leq \arctan(1/4\omega C_c r_b' - \omega C_c r_b') - \arctan \omega/\omega_\alpha \quad (8)$$

$$\text{or } 1/4\omega C_c r_b' - \omega C_c r_b' \geq \omega/\omega_\alpha \quad (9)$$

Equation (9) can be written like Eq. (1) for $\omega\alpha C_c r_b' \ll 1$.

The input cut-off frequency is given by

$$f_o = 1/2\pi r_e C_B \quad (10)$$

where r_e is the resulting input resistance and C_B = total emitter capacitance.

The diffusion capacitance in the grounded-base circuit appears as an inductance that can be made to

cancel the barrier layer capacitance (using the convention that the phase-shift of voltage and current is counted as positive). If by this process C_B can be made equal to zero, f_o will reach infinity. In the following discussion this condition of operation will be called "current-tuned" since this special mode is achieved only for one special emitter current.

How this affects the behavior of the transistor was experimentally determined in a current-tuned uhf-tuner. Figure 2A shows the circuit, Fig. 2B the current-tuned condition and Fig. 2C illustrates the hardware.

The high-frequency transistor is used as a negative feedback oscillator in which the oscillating frequency (smaller than f_{\max}) is determined by the length of the co-axial line (or any other harmonic-operation resonant-circuit operated as a cavity resonator). The amount of feedback, and thereby the conversion, gain is controlled by the adjustable capacitor between emitter and collector. From feedback amplifier theory, the output impedance will be transferred by this capacitance to the input as a negative resistance with an inductive component.

To achieve this condition properly it has been found convenient to use a Rohde & Schwarz ZG-Diagraph Type ZDD, since this readily enables the input impedance to be set to the correct resistive value. It is also necessary to use an electronically regulated source which allows the voltage across the emitter and base to be set, yet keeps the emitter current constant.

The input impedance of the transistor can be considered as a varactor with a relatively high series resistor ($r_e' + r_e + r_c$). Since we are dealing with an oscillating feedback circuit, this series resistor appears negative and the input tuned circuit seems to have a high Q at both the input and the oscillating frequencies provided these only

differ by a small amount: for example, by the magnitude of the intermediate frequency. This applies also to harmonics of the oscillating frequency as will be demonstrated later.

Amplification is produced because, for a properly adjusted transistor, the input circuit appears to have a high Q at both frequencies. Therefore it is similar to any parametric amplifier that is periodically tuned within the needed bandwidth as the transistor impedance is varied from capacitive to inductive by the oscillating frequency (which varies C_d by modulating the emitter current). Since the intermediate

frequency also appears at the input the transistor can also be used to amplify the i-f frequency.

Table I gives practical examples for different frequencies and different transistors. In each case the bandwidth was 500 Kc and the i-f frequency 10.7 Mc. All transistors with a higher dissipation power have better gain. Some of them are used above f_{max} , where harmonics of the oscillating frequency (smaller than f_{max}) are used.

Transistors operated in this way are indicated accordingly in the Table. The values given in this table are excellent but may be fur-

ther improved. An interesting method uses the transistor as a transit-time diode far beyond normal cut-off frequency.

For operation beyond $\beta = 1$ cut-off frequency the transistor is used in a frequency band in which the reactance of C_c is enough to produce oscillation by internal feedback direct to the inner base point marked by B' in Fig. 3. In addition, all the spreading resistances must be very small. This condition is met only by epitaxial germanium or silicon mesas and micro-alloy diffused-base techniques. These spreading resistances should be about 2 ohms for the emitter and 0.5 ohms for the collector.

The transistor is now used as the revised equivalent circuit, Fig. 3. In this mode, no high-frequency current flows in the base lead; hence r_b^1 does not appear in the modified circuit and its related equations though all parasitic capacitances are given. As in the former method, a coaxial line is used. Extremely high values of Q are necessary to achieve proper results ($Q = 800$ to $1,000$). Returning to Eq. (3), since no external feedback is used, $\text{Arg}(pC_c) = -90$ degrees, hence $\text{Arg}(1 - \alpha)$ must be negative. Oscillation will be observed in all bands where this condition is met. We can assume the negative impedance Z as

$$Z_{EC} = \frac{(1 - \alpha)}{pC_c} \quad (11)$$

All the spreading resistors shall be expressed by R_v which gives Eq. (11) the form

$$Z_{EC} = R_v + \frac{(1 - \alpha)}{pC_c} \quad (12)$$

For a limiting case,³ the minority carrier lifetime (of a transistor base) is considered to be infinite; minority carriers are assumed to move across the base by pure drift, reaching the collector in time t . Now $\alpha = e^{-j\omega t}$. Hence, rewriting Eq. (11)

$$Z_{EC} = R_v + \frac{(1 - e^{-j\omega t})}{pC_c} \quad (13)$$

and

$$Z_{EC} = \frac{t}{C_c} \cdot \frac{\sin(\omega t/2)}{(\omega t/2)} \cdot e^{-i(\omega t/2)} + R_v \quad (14)$$

which is exactly the same as Eq.

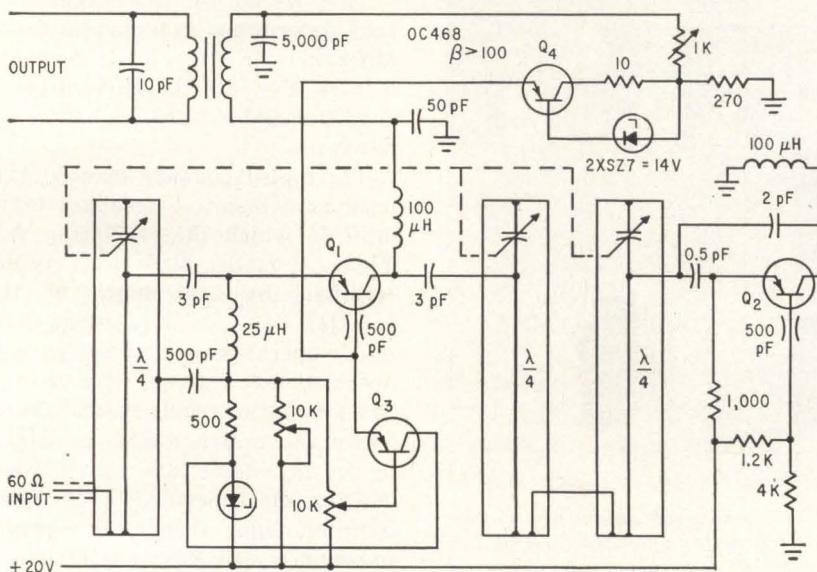

(A)

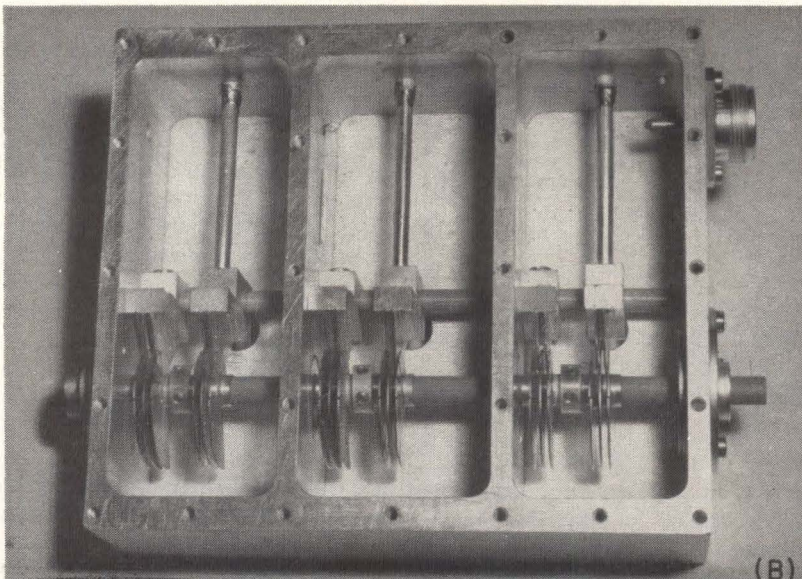

(B)

FIG. 4—Tuner uses epitaxial transistors to cover uhf/shf bands, operates up to 5,000 Mc (A); physical construction of the tuner (B). Table II gives test results

TABLE I—PERFORMANCE OF TRANSISTOR TYPES

Frequency in Mc	Transistor Q_1	Power Gain in Db	Noise Figure in Db
88-100	OC 615 (pnip)	88	3
88-100	AF 114	88	3.2
200 ^a	OC 615	83	3
400 ^a	OC 615	46	5
600 ^a	OC 615	25	8
600	AF 102	46	6
600	AFY 11	70	5
600 ^a	AF 122	47	7
600	AF 106	50	6
600 ^a	AF 129	30	8
1000	AF 106	48	7
1000	AFY 11	60	7
1000	OC 914	55	5.5
2000 ^a	OC 914	35	6
2000 ^a	2 N 709	45	5.5
2000 ^a	2 N 700	30	11

a) Transistors are operated above f_{max} where harmonics of operating frequency (below f_{max}) are used

(13). If we use Eq. (2) the final form of Eq. (13) becomes

$$Z_{EC} = R_v + \frac{1 - \frac{\alpha_o}{1 + j\omega/\omega_o}}{j\omega C_c} \quad (15)$$

In a numerical example the silicon epitaxial planar high-frequency transistor BSY21 is assumed to have an $f_{(\beta=1)}$ of 300 Mc and $C_c = 0.5$ pf. From Eq. (15) for about 1,000 Mc operation

$$Z_{EC} = R_v - (55 + j387) \text{ ohms}$$

Since R_v is of the order of 7 ohms, oscillation could be obtained. Figure 3B shows the mechanical construction of a high Q cavity resonator which could be used up to 5,000 Mc.

The noise-figure of the transistor as a transit-time diode is derived as follows. Measurements and calculations yield the expression

$$F = 1 + R_v \left[\frac{eI_e}{2KT} - \left| \frac{j\omega C_c}{1 - \frac{\alpha_o}{1 + j\omega/\omega_o}} \right| \right] \quad (16)$$

where $eI_e/2KT =$ noise conductance of emitter diode, $R_v =$ loss resistance of the circuit, and

$$\left| \frac{j\omega C_c}{1 - \frac{\alpha_o}{1 + j\omega/\omega_o}} \right| = \text{magnitude of the negative conductance}$$

An experimental transit-time diode uhf/shf tuner covering 400 Mc to 5,000 employing conventional and epitaxial transistors was built to verify the theoretical data; the tuner is shown in Fig. 4A. It was

TABLE II—OPERATION OF EXPERIMENTAL TUNER

Frequency in Mc	Transistors Q_1 and Q_2	Power Gain in Db	Noise Figure in Db
400	OC 914	45	2
400	AF 102	-32	2.3
400	AF 106	30	2.4
400	AF 122	30	2.6
1200	OC 914	40	2.5
1200	AF 102	27	3.5
1200	AF 106	25	3
1200	AF 122	22	3.5
2000	V 120	25	4
2000	T-2351	30	6
3000	2 N 709	18	5
3000	OC 914	20	4.6
3000	V 120	22	4.5
4000	OC 914	15	5
4000	V 120	8	9
5000	OC 914	11	5.8

first necessary to find those frequencies in which $\text{Arg}(1 - a)$ was negative. It is helpful that C_c is voltage dependent and can therefore be adjusted. Two electronically regulated sources are necessary to control the current tuned condition and the collector voltage. For this purpose the transistors TF 65 and OC 468 in connection with the zener diodes are used. Another transistor in the harmonic-generation mode is operated as a pump-oscillator, producing the mixing frequency as well as variation of both the emitter and collector voltage and capacitance. The source using the OC 468 now permits adjustment of C_c in a way that self-oscillation condition is nearly achieved. This produces a high Q for both the input circuit and the collector circuit. As in the earlier example, the circuits are periodically tuned within the needed bandwidth, since bandwidth and the power of the pump-oscillator are proportional. This method can be used as a nonreciprocal parametric amplifier for straightforward amplification (the pump-frequency being half the input frequency) and in the conversion mode for producing an i-f frequency.

In the experimental model, Fig. 4A, the i-f frequency was 36 Mc and the bandwidth 7 Mc; Fig. 4B is the physical realization of Fig. 4A schematic.

The transistor acts as a varactor diode in producing an i-f frequency

in the tuned circuit formed by the 3 pf capacitance and the i-f transformer. The selective microvoltmeter measures the amplification of the device. Table II gives numerical details of performance. The author thanks his colleague Miss J. Jarausch, as well as Dr. R uchardt of the development department of Siemens, Dr. Engbert of the semiconductor division of Telefunken and Mr. Dietrich of the development department of Intermetall, for their help. The firms Valvo (Philips) and Intermetall (Clevite) are also thanked for providing high-frequency transistors.

REFERENCES

- (1) J. F. Gibbons, An Analysis of the Modes of Operation of a Simple Transistor Oscillator, Proc IRE, **49**, p 1383, Sept. 1961.
- (2) U. L. Rohde, Parametric Amplification with Transistors, Wireless World, Oct. 1961.
- (3) W. Shockley, Negative resistance arising from transit-time in semiconductor diodes, Bell Sys Tech J, **33**, July 1954.

BIBLIOGRAPHY

- (1) V. W. Vodicka and R. Zuleeg, Transistor Operation beyond Cut-off Frequency, ELECTRONICS p 56, Aug. 26, 1960.
- (2) G. H. Heilmeyer, Millimeter Wave Generation by Parametric Methods, Proc IRE, **48**, No. 7, July 1960.
- (3) D. L. Hedderly, Parametric Amplification by Charge-Storage, Proc IRE, **49**, No. 5, May 1961.
- (4) R. Lowell and M. S. Kiss, Solid State Microwave Power-Source Using Harmonic Generation, Proc IRE, **48**, No. 7, July 1960.
- (5) J. Cho, Parametric Excited Resonator Using Junction Transistors, Proc IRE, **49**, No. 5, May 1961.
- (6) D. J. Hamilton, Maximum Avalanche Multiplication in pn-Junctions, Proc. IRE, **48**, No. 10, Oct. 1960.
- (7) R. L. Pritchard, Frequency Variation of Junction Transistor Parameters, Proc IRE, **42**, May 1954.
- (8) R. Hearn, R. J. Bennett and B. A. Wind, Some Types of Low Noise Amplifiers, Proc Brit IRE, **22**, No. 5, Nov. 1962.
- (9) U. L. Rohde, Der Transistor als parametrische Diode, Funkschau, **9**, May 1962.

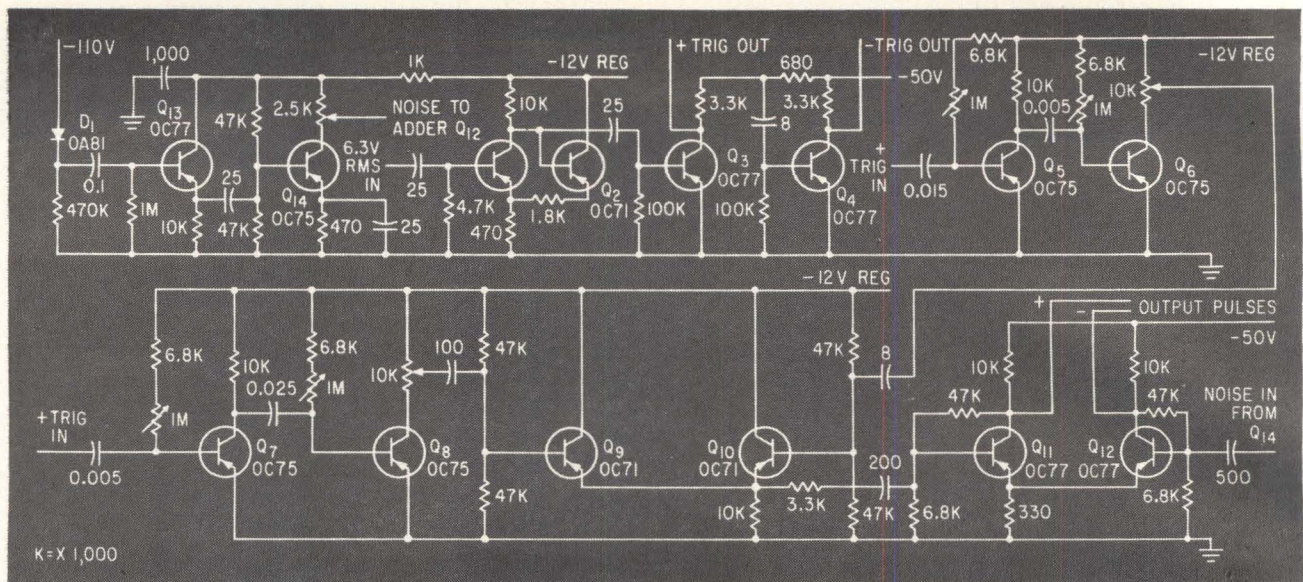

Output pulses of this circuit are long and short pulses of positive and negative polarities. Either pulse can be adjusted in duration and amplitude

Back-Scatter Simulator

CHECKS IONOSPHERIC SOUNDER DISPLAYS

Simulator duplicates the long and short pulse returns characteristic of an ionospheric sounding system Device has aided in designing such systems

By K. PERRY

Dept. of Physics,
University of Queensland,
St. Lucia, Brisbane, Australia

THIS SIMULATOR is used to check out the units that display pulse returns picked up by the receivers of back-scatter ionospheric sounders. The simulator can deliver a long pulse of large amplitude (simulating normal back scatter), a small-amplitude short pulse, (simulating, for example, field aligned echoes), and variable receiver noise. The small pulse can be moved in time through the large pulse, without causing addition of the pulses, and the noise that is added to the pulses fully simulates the output of a pulse receiver.

Since it is customary to trigger ionospheric sounders at the line frequency, the simulator is also line triggered; hence the prf is 50 cps. In the drawing, transistors Q_1 and Q_2 comprise a Schmitt trigger circuit driven by 6.3 v rms. Transistor Q_3 squares and amplifies the Schmitt trigger output, and Q_4 inverts the

output of Q_3 . This gives trigger edges of either polarity and of approximately 50-v amplitude.

Transistor Q_5 is the long-delay stage for Q_6 , the short-pulse generator. Stages Q_7 and Q_8 are the short delay and long-pulse generator, respectively. The long delay produced by Q_5 allows the short output pulse from Q_6 to be placed either before or after the long pulse from Q_8 . Both Q_6 and Q_8 have potentiometers as their collector loads, allowing the pulse outputs to be varied in amplitude. The long pulse can be made some 10 msec long.

Operation of the delay and pulse generator stages is identical. Consider the functioning of delay stage Q_5 . Since the base is returned to the -12 v line, transistor Q_5 is normally fully on and its collector is virtually at ground potential. When a positive-going square-wave trigger goes to the 0.015- μ f base-coupling capacitor, the capacitor charges, the positive edge turns off Q_5 , and its collector falls toward -12 volts. Transistor Q_5 stays off

for a period that depends on the base R-C product, generating a negative output pulse whose length may be varied by adjusting R_1 . The positive-going trailing edge of the delay-stage output triggers Q_6 .

Transistors Q_9 and Q_{10} comprise a common emitter follower and mixer that mixes the two pulses from generators Q_6 and Q_8 with negligible addition.

The output of the mixer goes to adder Q_{11} - Q_{12} , where noise is added to the pulses. This stage also amplifies the pulse level to 30 v peak-to-peak, of both polarities.

The noise generator consists of germanium diode D_1 , back-biased with about 110 volts. Transistor Q_{13} is an emitter follower feeding amplifier Q_{14} in a common-emitter configuration. The collector load of Q_{14} is a potentiometer that can be used to adjust the noise output.

The assistance of H. MacGregor is acknowledged.

REFERENCE

K. Perry, Simulator Tests Pulse and Phase-Path Receivers, *ELECTRONICS*, p67, Oct. 7, 1960.



Passivation inactivates the junction surface, greatly increasing reliability and stability. Getter and retaining ring are dispensed with.

**NO
GETTER... NO
RETAINING RING**

PASSIVATED 2N332A-338A's

General Electric's new passivated 2N332A thru 2N338A transistors exceed in reliability even the heretofore unsurpassed G-E 2N332 series, an industry standard. General Electric developed its new process for the MINUTEMAN RELIABILITY Program. The surface passivation technique inactivates the junction surface and dispenses with the need for getter and retaining ring.

4700 units now on MINUTEMAN life test at G.E. have operated for 1000 hours without a single failure. These units have already operated for 6,650,000 transistor hours @ 280 mw., and are still on test. This new passivated series may well comprise the most reliable silicon grown-junction triodes available today . . . and they are

in stock now at all General Electric Semiconductor distributors. Every "A" and MIL version of the 2N332A-338A series you purchase from now on will be this new, high-reliability passivated transistor type. *And at the same price as before.*

Your General Electric Semiconductor Products District Sales Manager can give you complete details. Or write Semiconductor Products Department, Section 16F131, General Electric Company, Electronics Park, Syracuse, New York. In Canada: Canadian General Electric Co., 189 Dufferin Street, Toronto, Ont. Export: International General Electric, 159 Madison Avenue, New York 16, N.Y.

AVAILABLE THROUGH YOUR GENERAL ELECTRIC SEMICONDUCTOR DISTRIBUTOR

GENERAL  ELECTRIC

New Transducer Provides Greater Sensitivity

By HARVEY H. HUNTER
Batelle Memorial Institute,
Columbus, Ohio

CAPACITANCE-TYPE transducer provides an output voltage directly proportional to mechanical motion. The pickup can be mounted separately from the instrument using a cable of any convenient length and cable capacitance does not affect operation.

Capacitance-type transducers are simple, rugged and inexpensive. However, if the pickup of a conventional transducer is mounted separately from the instrument, cable capacitance is often greater than pickup capacitance, limiting sensitivity and possibly introducing errors through changes in cable capacitance. If the cable is eliminated, at least part of the instrument must be mounted on the pickup.

The simple pickup for the new transducer is a variable capacitor in which capacitance is controlled by the parameter being measured. A constant-current r-f voltage

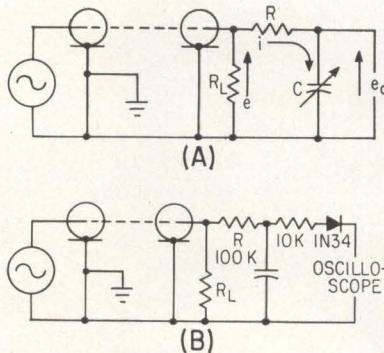

Simplified version (A) of capacitance transducer was instrumented (B) to measure machine-tool vibration

source is connected to the pickup so that voltage across the capacitor is inversely proportional to capacitance. The r-f voltage is sensed and used for measurement or control.

A simplified version of the system is shown in Fig. 1A. The transmission line is terminated in its characteristic impedance so that for practical purposes the voltage supplied to the pickup is independent

of line length. Transducer output voltage is $e_o = X_c i$, where e_o is output in volts, X_c is capacitive reactance in ohms and i is current in amperes through the pickup.

Current $i = e / (R^2 + X_c^2)^{1/2}$, where e is potential across the pickup in volts rms, and R is resistance of the pickup in ohms. Output voltage is thus $e_o = X_c e / (R^2 + X_c^2)^{1/2}$. Assuming negligible losses in the transmission line, potential $e = (WR_L)^{1/2}$, where W is generator output power in watts and R_L is transmission line characteristic impedance in ohms.

Output voltage is thus $e_o = X_c (WR_L)^{1/2} / (R^2 + X_c^2)^{1/2}$. When R is much greater than X_c , the equation may be approximated by $e_o \cong X_c (WR_L)^{1/2} / R$. Since $X_c = 1/2 \pi f C$, where f is frequency of applied potential in cps and C is capacitance in farads, $e_o = (WR_L)^{1/2} / 2 \pi f C R$.

For a parallel-plate capacitor where plate dimensions are large compared to plate spacing, $C = 8.8KA/d \times 10^{-14}$, where K is dielectric constant of insulator, A is plate area in cm^2 and d is plate spacing in cm. Output potential is then $e_o = 1.8 \times 10^{12} d (WR_L)^{1/2} / f R K A$.

Transducer output potential is thus directly proportional to displacement of the capacitor plates over the range where R is much greater than X_c . For example, if differential displacement d is 0.001 inch (2.5×10^{-3} cm), generator power output is 1 watt at 10 Mc, R_L is 52 ohms, capacitor dielectric is air with a dielectric constant of 1, capacitor plate area is 1 cm^2 and resistance R is 0.1 megohm, peak-to-peak transducer output is 32 millivolts.

Practical Application

An example of the practical use of the transducer is in an instrument to measure displacement of an ultrasonic machine tool vibrating at 20 Kc. One capacitor plate was formed by a small metal disk mounted on an insulator that in turn was mounted on a depth micrometer. The other plate was the

Helium-Neon Laser for Research

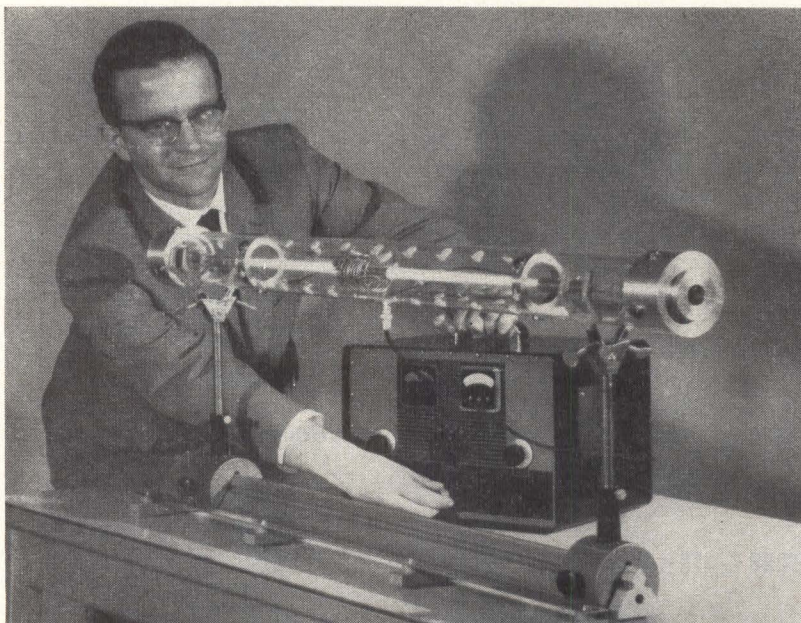

Output of 1.5 mw is provided from each end of helium-neon laser introduced by Raytheon and warranted for 1,000 hours continuous operation

- used in communication networks in 18 countries.
- oscillator cavities and TWT circuits available or 'tailored' to individual requirements.

H-wave Oscillators
Range 5.6 to 7.8 Gc/s

Klystrons

Coaxial Line Oscillators
Range 0.5 to 5 Gc/s

Backward Wave Oscillators
Range 4 to 40 Gc/s

Travelling Wave Tubes
Medium power and low noise tubes,
Range 2.5 to 7.5 Gc/s

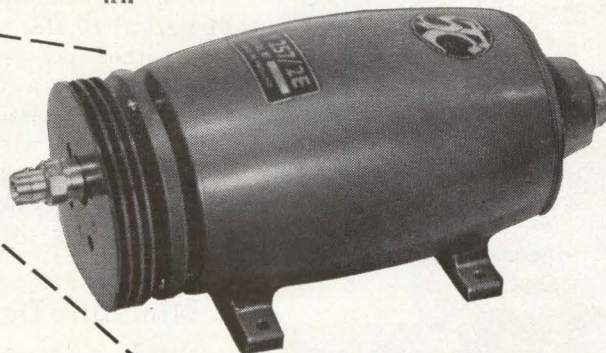
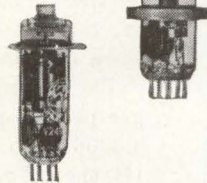
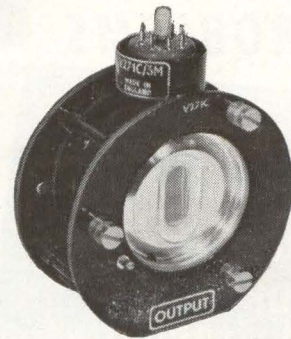

STC

MICROWAVE TUBES

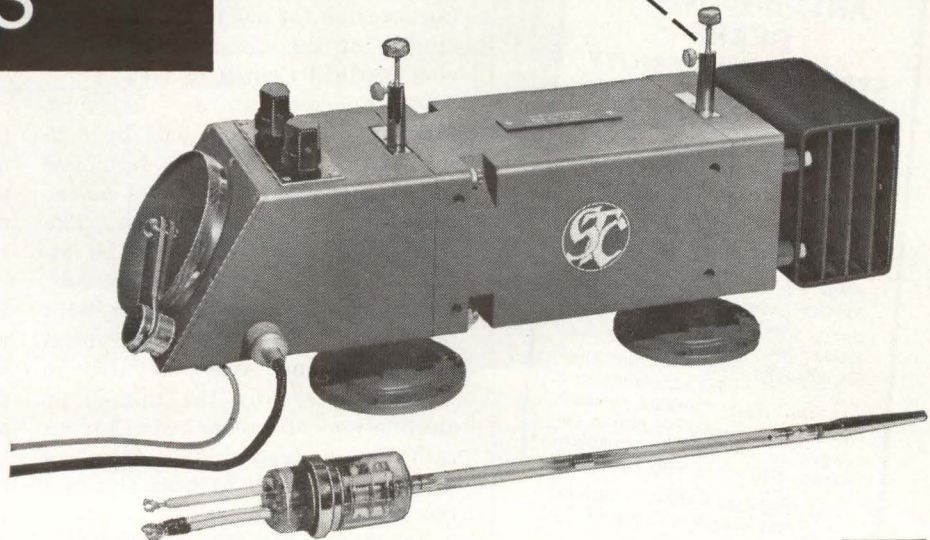

Send for brochure MS/113
"STC Microwave Tubes"



62/17MS

Standard Telephones and Cables Limited

VALVE DIVISION: FOOTSCRAY · SIDCUP · KENT · ENGLAND

USA enquiries for price and delivery to ITT Components Division, P.O. Box 412, Clifton, N.J.



TORQUE PROBLEMS?

IN APPCO GEARS YOU CAN SELECT, SPECIFY AND BE SURE OF EXACT TORQUE

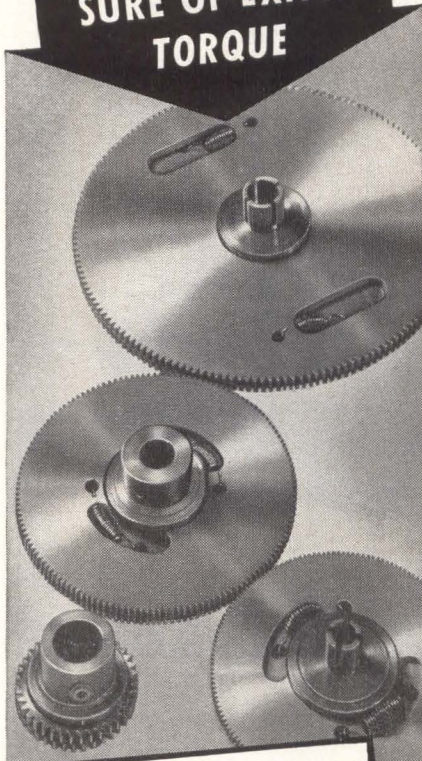

APPCO STOCK ANTI-BACKLASH GEARS CERTIFIED RELIABILITY

Now, get the most complete line of its type . . . certified precision to AGMA specifications . . . and your exact choice of torque. Get APPCO Gears. Choose from stock gears the various pre-determined tooth loadings for any specific gear requirement . . . custom gear design at stock gear prices.

APPCO precision anti-backlash gears available in AGMA Precision Classes 1 and 2 in 32, 48, 64, 72, 96 and 120 diametral pitches . . . in aluminum and stainless steel. Certified for reliability . . . sealed in plastic for protection. Write for complete details and catalog to . . .

ATLAS PRECISION PRODUCTS COMPANY
3801 Castor Ave., Phila. 24, Pa.

West Coast:
9596 Garden Grove Blvd.
Garden Grove, Calif.



face of the machine tool, which was electrically grounded.

Transducer output was fed to a crystal diode, which demodulated the signal, and the demodulated signal was supplied to an oscilloscope having a d-c amplifier. To calibrate the instrument, the insulated capacitor plate was placed in contact with the face of the machine tool, which was not vibrating. While the insulated plate was moved away from the face of the machine tool, the position indicated by the micrometer and the position of the trace on the oscilloscope were recorded.

The technique was used to measure peak-to-peak vibration of about 0.0006 inch. In the setup in Fig. 1B, the r-f generator supplied about 1 watt at 10 Mc.

Another potential use of this transducer is a vibration pickup. One capacitor plate could be seismically mounted with output voltage a function of displacement. Velocity or acceleration could be obtained by differentiating the output.

Miniature Detectors Will Study Tumor Cell Growth

MICROMINIATURE SYSTEM has been developed for monitoring tumor cell growth during treatment. The system consists of a Geiger counter tube and associated mobile readout and data-recording equipment.

The system was developed by Eon Corporation for use in experimental studies at the Columbia-Presbyterian Medical Center in New York. The microminiature detectors, ranging in size from 0.04 by 0.25 to 0.125 by 1 inch, were developed in response to a request by a cancer research team at the Center. The small radiation detectors can be implanted directly into blood vessels, body cavities or solid tissue with limited damage to tissue. Hospital research teams are thus able to monitor internally the uptake or elimination of compounds having radioisotope traces. The detectors are small enough to pass through the bore of a hypodermic needle.

The new counters are expected to provide a new tool in a number of areas of medical research, also including blood vessel flow rates and certain aspects of gastrointestinal, liver and kidney physiology.

It is hoped that by studying the changes in concentrations within tumors of molecules tagged by radioisotopes of deoxyribonucleic acid, changes in tumor growth induced by all forms of nonoperative tumor treatment can be more rapidly predicted. However, the project is only in its initial stages and representatives of both Eon and Columbia-Presbyterian stressed its experimental nature.

Measuring Light Flux And Light-Flux Ratios

LONDON—Total flux measurements of all forms of lamps are said to be made more easily and accurately using a 2-meter sphere and an associated photoelectric photometer. The system was designed by the National Physical Laboratory in collaboration with the makers of the unit, Metaducts Ltd.

The light alloy sphere is made in two halves hinged together to facilitate changing lamps. The rigid construction has a wide range of adjustments to ensure that the halves mate properly. It can be used for measurements with tubular fluorescent lamps up to 5 ft long. The sphere will be used to determine the accuracy attainable with sets of discharge lamps used as references.

The photometer will consist of a single-stage vacuum photocell used with a 5-digit voltmeter. Thus instant readout will be provided without potentiometer balancing.

The National Physical Laboratory has also established a time-ratio method of photometry that increases by several orders of magnitude the accuracy of comparing unequal light fluxes. The more powerful beam is attenuated by a repetitive shutter in which the open-to-shut time ratio is variable. By measuring this ratio using timing techniques, light transmission through the attenuator can be determined accurately. The attenuated and unattenuated beams in turn are allowed to fall on a detector. The time ratio of the shutter is varied until the effects of the two beams are equal and the ratio of the fluxes is indicated by the transmissivity of the shutter. Thus the detector is used as a null indicator and time is the only measured quantity.

Now!
High Power Level
from your present
signal generator —

10 Volts/50 Ohms
10 to 500 Mc

— with the new BRC Type 230-A
Signal Generator Power Amplifier

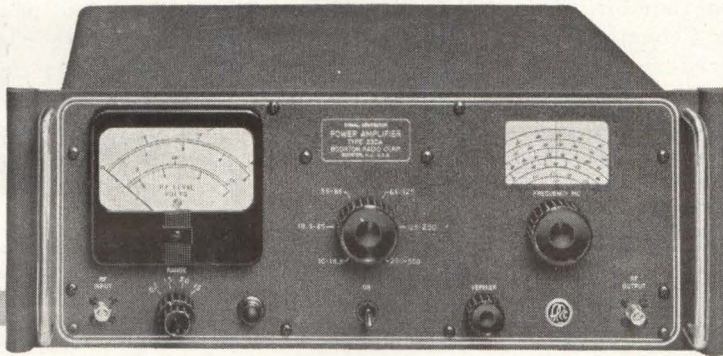

The new Signal Generator Power Amplifier Type 230-A is the ideal solution to your high RF power requirements including receiver testing, wattmeter calibration, antenna testing, filter and component testing, and attenuation measurements. The amplifier may be conveniently driven with any conventional signal generator and is designed to reproduce AM, FM, and pulse modulation characteristics of the driving generator with minimum distortion.

The new Signal Generator Power Amplifier Type 230-A employs three tuned, cascaded stages of grounded-grid amplification fed from a regulated power supply. An RF output voltmeter is also included and the unit is designed for either standard 19" rack or cabinet mounting.

RF RANGE
 10 to 500 MC

RF OUTPUT
 RANGE:
 0.1 to 15 volts*
 *Across external 50 ohm load

IMPEDANCE:
 50 ohms

RF INPUT
 RANGE:
 0.2 volts*, 10 to 250 MC
 0.32 volts*, 250 to 400 MC
 0.4 volts*, 400 to 500 MC
 *For 10 volt output

IMPEDANCE
 50 ohms

AM RANGE
 Reproduces modulation of driving signal generator 0 to 100% up to 5 volt max. carrier output

AM DISTORTION
 <10% added to modulation of driving signal generator

AM FIDELITY
 Equivalent base-band bandwidth >350 KC

FM RANGE
 Reproduces modulation of driving signal generator to adequately serve all presently established FM services

FM DISTORTION
 Negligible distortion added to modulation of driving signal generator

INCIDENTAL AM
 <10%* added to modulation of driving signal generator
 *At 150 KC FM deviation

PM RISE TIME
 <1 μsec

POWER REQUIREMENTS
 105-125/210-250 volts,
 50-60 cps

Price: \$875.00

F.O.B. Boonton, New Jersey

BOONTON RADIO CORPORATION

 A Subsidiary of Hewlett-Packard Company



P. O. BOX 390
 BOONTON, NEW JERSEY

Precision Electronic Instruments since 1934

TELEPHONE: OAKWOOD 7-6400 • TWX: BOONTON, NEW JERSEY 866 • CABLE ADDRESS: BOONRACO

An Analysis of Cooling Methods

FOR RELIABLE OPERATION OF COMPONENTS

By PAUL S. BIRMAN

Kepeco, Inc., Flushing, New York

MAJOR PROBLEM in the design of high-powered electronic equipment is disposal of excess heat generated within the equipment. The problem is acute in regulated heavy-duty power supplies where unwanted variations in power output are purposely converted to heat for removal. Small size, coupled with high power, requires efficient removal of heat.

No matter what the mechanism, heat generated within a closed container must be conducted to the surrounding atmosphere to avoid excessive temperature rise. This conducted heat must not interfere with the operation of sensitive components in the vicinity.

Forced-air blowers and large-area convection systems are the two cooling methods in common use today, excluding liquids. Choice between them is based upon consideration of size, power levels, thermal efficiency, system reliability and the proximity of other equipment. In the design of regulated power supplies above the 25-watt level, these factors swing sharply to forced-air cooling methods.

A convection radiator, since it works with a limited air flow, must transfer large amounts of heat to each unit-volume of air. The stabilization temperature, that temperature at which heat transfer equals heat input, is therefore necessarily high. A 40 deg C temperature rise is not uncommon. Forced-air cooling is by comparison much more efficient. By working with large volumes of air, the heat transfer per unit volume is made small and temperature rise can be held low.

Actual thermal measurements based upon 17 watts per dissipator show a "thermal resistance" of 2.5 deg C per watt for a typical convection radiator. This yields a 42.5 deg C temperature rise. A simple forced-air radiator, on the other hand, operating with as little as 50 CFM air flow, exhibits a "thermal resistance" of 0.8 deg C per watt for a rise of only 13.6 deg C.

The decrease in operating temperature afforded by forced-air cooling, greatly increases chances for safe, reliable operation of all components in the system. The convection radiator, moreover, can occupy up to 3-4 times the volume of the simpler forced-air radiator, especially since convection types

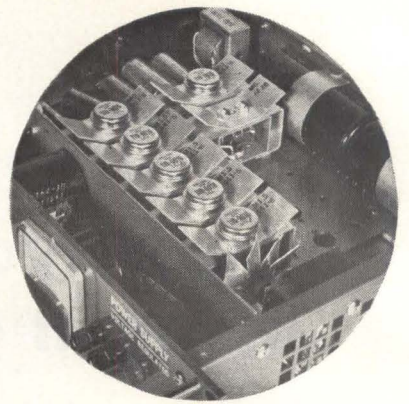

Close up of typical plug-in radiators in forced air stream. Use of forced air results in smaller size, reliability of components

cannot be placed closely together without increasing thermal resistance.

Modern air blowers are quiet, long lasting devices, designed with reliability factors that often exceed those of our own solid-state electronic technology. By reducing the number of electronic components needed to dissipate power at a specified temperature rise, blower cooling results in dramatic improvement in overall reliability.

Many other advantages also accrue to forced-air cooled equipment. Components can be more accessible, since heat dissipating elements such as power transistors need not be bolted into place on large fixed heat sinks.

An important advantage of the forced-air cooled system is the simplicity of its plug-in radiator, see photograph. Longer life is achieved in relatively non-heating compo-

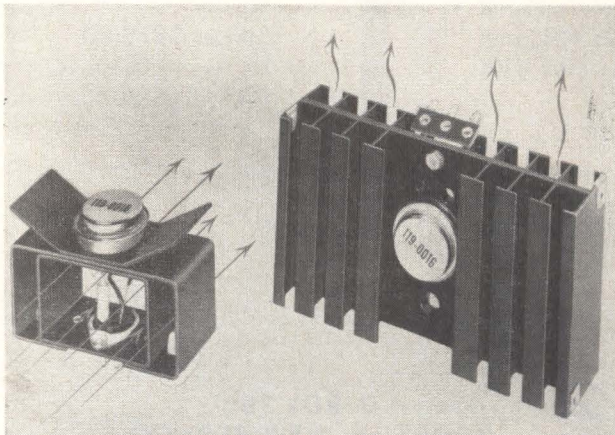

Forced air stream applies lateral circulation of air in heat sink at left. Heat sink at right illustrates a typical convection cooler

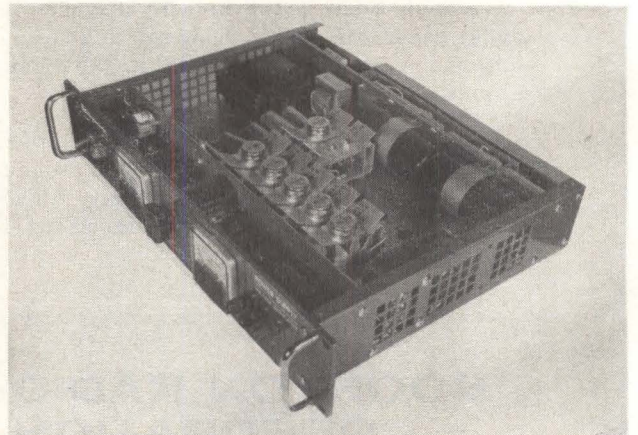

Power supply equipped with plug-in radiators illustrates open construction and shows efficient circulation attained in stacked racks

Q.

Who has the facts about getting four billion signals out of a rotary switch?

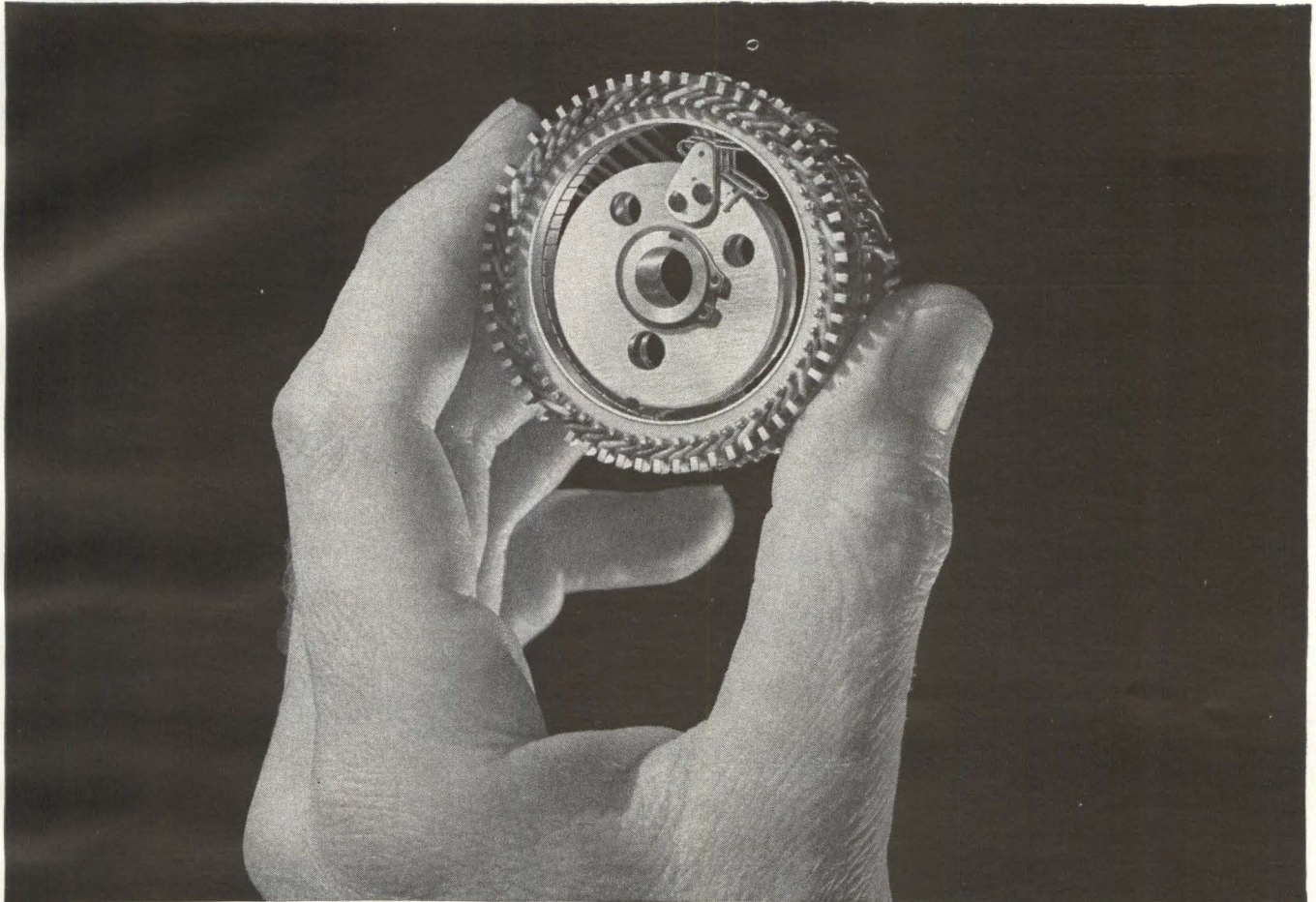

A.

The Engineers who create IDL* Commutating Switches

A talk with them will reveal interesting facts about a miniature IDL rotary switch created for an airborne radar guidance system. It has 60 signal channels . . . a scanning rate of 60 rps . . . a 350-hour life. Total. 4,536,000,000 signals during its service-free lifetime.

You'll also learn that IDL makes a complete line of standard commutating switches with a great record of success in PDM and PAM telemetering in Sub-Roc, Bomarc, Redstone and

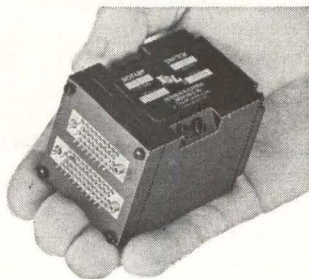

Pershing Flight Test Systems. These electro-mechanical switches operate at signal levels between 15 millivolts and 100 VDC . . . at scanning rates from 1 rpm to 60 rps . . . for periods in excess of 500 hours . . . without drop-out, noise, bounce or signal contamination.

What is your question? If it is in the area of remote viewing, aligning, testing, measuring or controlling, the answer may already be among the growing number of optical/electronic/mechanical components, instruments and systems engineered and produced by Kollmorgen and its subsidiaries.

Write for literature describing the combined capabilities and facilities of Kollmorgen, Instrument Development Laboratories and Inland Motor Corporation of Virginia.

*Products of INSTRUMENT DEVELOPMENT LABORATORIES.



KOLLMORGEN

KOLLMORGEN CORPORATION • NORTHAMPTON, MASSACHUSETTS

may already have the answer to your next question in optics or electromechanics.

TYPICAL 75-W POWER SUPPLY

Component Type	Failure Per Hour Contribution of Each Part Group
Capacitors.....	0.075×10^{-6}
Electrolytics.....	1.350×10^{-6}
Resistors.....	0.870×10^{-6}
Transistors.....	6.500×10^{-6}
Rectifiers.....	4.500×10^{-6}
Switches.....	0.140×10^{-6}
Relays.....	0.210×10^{-6}
Blowers.....	0.270×10^{-6}
Transformers.....	0.075×10^{-6}
Miscellaneous.....	5.150×10^{-6}

nents like electrolytic capacitors, since rapidly moving air reduces absorption of radiated heat from internal or external sources. Further, magnetic components last longer when they are cooled.

Lateral air circulation permits stacking of units in a typical equipment rack *without derating*. Because heat is not radiated upward, the topmost unit is as cool as the lowest. Sensitive equipment can be stacked above and below without concern. Even exhaust air from the power supply is useful, since it is at a relatively low temperature and can be used to prevent hot spots within the overall enclosure.

For a given power output from a regulated power supply, one of two procedures must be followed if forced-air cooling is to be eliminated in favor of natural convection. Either power dissipation per element must be decreased sharply to prevent a temperature increase in the face of higher thermal resistance, or the components must be allowed to operate at a higher temperature. The first method requires a larger number of components to handle the power, while the second alternative forces components to operate in an environment prejudicial to their reliability.

Choosing to avoid a temperature increase, the reliability of a 75 watt power supply can be calculated to determine the effect of added dissipating components. For simplicity, consider the series regulator only, concentrating on two elements: blowers and transistors. The method used is the RADC "ball-park" calculation (Rome Air Development Center, reliability notebook PB 161894).

Reliability can be expressed as $R = e^{-\lambda t}$ where R equals the probability of a component operating without failure for time t, and λ is the failure rate per unit time.

A reasonable estimate can be made of total equipment reliability by a simple summing of component failure rates, when λ is weighted to account for the relative occurrence of each component.

For calculation, an effective thermal resistance of 1 deg C per watt is used for the blower cooled system; for the convection cooled radiator, we use 2.5 deg C per watt. Settling upon 15 deg C as a safe, temperature rise, 5 transistors are needed to dissipate 75 watts with one blower. The transistors have an expected failure rate of 6.5×10^{-6} failures per hour and the blower has a failure rate of 5.5×10^{-6} . Using transistors as the base (N), and adjusting for occurrence: the blower contributes $\lambda/5$ or 1.1×10^{-6} failures per hour for a total equipment failure rate of 76×10^{-6} . This gives a mean time to failure of

$$\frac{10^6}{7.6 (N)} = 0.026 \times 10^6 \\ = 26,000 \text{ hours.}$$

If the blower is replaced by a convection-cooled system, additional power dissipating transistors must be added to avoid an increase in operating temperature. N increases to 12.5 while the contribution of the eliminated blower is zero. Mean time to failure is

$$\frac{10^6}{6.5 (N)} = 12,000 \text{ hours.}$$

Thus logically, chance of failure increases as a function of the number of individual components employed.

If all the other components that make up this power supply were added in, the loss in reliability would not be as large on a percentage basis, but here we do not consider the effect of temperature on capacitors, resistors, transformers, and the other components. An exact evaluation would be exceedingly complex.

The table above for a typical 75 watt power supply shows the relative contribution of various component types to the failure rate of a completed unit. Figures are weighted to include the relative number of each component per assembly.

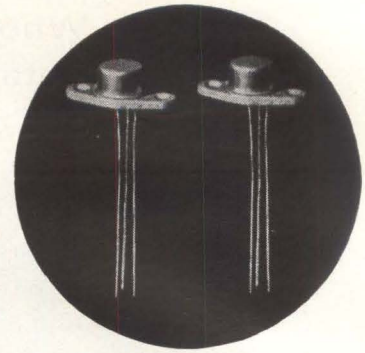

DELCO SEMICONDUCTORS NOW AVAILABLE AT THESE DISTRIBUTORS

EAST

- Philadelphia 23, Pa.**—Almo Industrial Electronics, Inc.
412 North 6th Street/WA 2-5918
- Pittsburgh 6, Pa.**—Radio Parts Company, Inc.
6401 Penn Avenue/EM 1-4600
- Newton, Mass.**—Greene-Shaw Distributing Co.
341 Watertown St./WO 9-8900
- New York 36, N. Y.**—Harvey Radio Co., Inc.
103 W. 43rd St./JU 2-6380
- Syracuse 11, N. Y.**—Harvey Electronics-Syracuse, Inc.
P.O. Box 185, Pickard Drive/GL 4-9282
- Baltimore, Md.**—Radio Electric Service
5 N. Howard St./LE 9-3835

SOUTH

- Birmingham 5, Ala.**—Forbes Distributing Co., Inc.
2610 Third Ave., S./AL 1-4104
- West Palm Beach, Fla.**—Goddard, Inc.
1309-11 North Dixie/TE 3-5701
- Richmond 20, Va.**—Meridian Electronics, Inc.
1001 W. Broad St./EL 5-2834

MIDWEST

- Detroit 3, Mich.**—Glendale Electronic Supply Co.
12530 Hamilton Ave./TU 3-1500
- Minneapolis 16, Minn.**—Admiral Distributors, Inc.
5305 Cedar Lake Road/LI 5-8811
- Indianapolis 25, Ind.**—Graham Electronics
122 S. Senate Ave./ME 4-8486
- Cleveland 14, Ohio**—Main Line Electronics Division
1260 E. 38th St./EX 1-4944
- Chicago 30, Ill.**—Merquip Electronics, Inc.
4939 N. Elston Ave./AV 2-5400
- Cincinnati 10, Ohio**—United Radio, Inc.
1308 Vine Street/MA 1-6530—CH 1-6530

WEST

- Dallas 1, Texas**—Adleta Company
1914 Cedar Springs/RI 1-3151
- Phoenix 20, Ariz.**—Astronics, Inc.
9310 N. Central Ave./944-1551
- Seattle 1, Wash.**—C & G Electronics
2221 Third Ave./MA 4-4355
- Houston 2, Texas**—Harrison Equipment Co., Inc.
1422 San Jacinto St./CA 4-9131
- Monrovia, Cal.**—Lynch Electronics, Inc.
1818 S. Myrtle Ave./EL 9-8261
- San Diego 1, Cal.**—Radio Parts Co.
2060 India St./BE 2-8951
- Los Angeles 15, Cal.**—Radio Products Sales, Inc.
1501 S. Hill St./RI 8-1271
- San Jose 13, Cal.**—Schad Electronic Supply, Inc.
499 S. Market St./CY 8-0511
- Denver, Colo.**—L. B. Walker Co.
300 Bryant/WE 5-2401

Ask for a complete catalog



CIRCLE 58 ON READER SERVICE CARD
electronics

ONE SIZE

(small . . . TO-37 package)

TWO KINDS

(PNP and NPN)



MANY APPLICATIONS

low leakage . . . faster switching speeds . . . high power handling . . . low price

GERMANIUM (1.5A) for DC amplifiers • voltage regulators • driver for power stage • driver for servo amplifiers • and many others

Number	V _{cb0} (Max.)	V _{ce0} (Max.)	Sat. V @ IC Max.	Gain Min.—Max. @ IC	f _{hfe} (typical)
2N1612	60V	40V	0.6V @ 0.5A	50/125 @ 0.1A	15 kc
2N1611	60V	40V	1.0V @ 0.5A	30/75 @ 0.1A	20 kc
2N1172	40V	30V	0.5V @ 0.5A	30/90 @ 0.1A	20 kc

Junction Temp. (Max.)—100°C • Thermal Resistance—10°C/W

Union, New Jersey
324 Chestnut Street

MURdock 7-3770 • AREA CODE 201

General Sales Office: 700 E. Firmin, Kokomo, Ind., GLadstone 2-8211—Ext. 500 • Area Code 517

Detroit, Michigan
57 Harper Avenue

TRinity 3-6560 • AREA CODE 313

Santa Monica, California
726 Santa Monica Blvd.

UPTon 0-8807 • AREA CODE 213

Max. Cont. Junct. Temp.—175°C • Thermal Resistance—8°C/W

SILICON (1A) for regulated power supplies • square wave oscillators • servo amplifiers • core driver circuitry • and many others

Number	V _{cb0}	V _{ce0}	Sat. V @ IC Max.	Gain Min.—Max. @ IC	f _{hfe} @ 250 ma IC (typical)
2N2340	50V	40V	4V @ .75A	10—40 @ .75A	900 kc
2N2341	50V	40V	4V @ .75A	40—100 @ .75A	550 kc
2N2342	100V	60V	3V @ .75A	10—40 @ .75A	900 kc
2N2343	100V	40V	2.5V @ .75A	40—100 @ .75A	550 kc

Syracuse, New York
1054 James Street

GRanite 2-2668 • AREA CODE 315

Chicago, Illinois
5151 N. Harlem Ave.

775-5411 • AREA CODE 312

Micro Labels for Micro Components

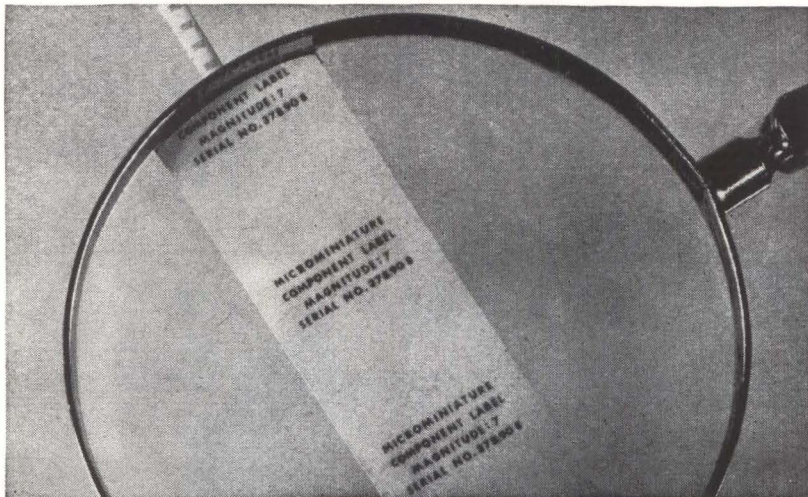

Demagnetized labels should be read with a magnifying glass with a power approximately the same as the magnitude of the label. Serially numbered labels with characters to 40th magnitude appear practical

By WILLIS CAIN

Engineering Practice Standards,
General Dynamics/Astronautics,
San Diego, Calif.

MICROMINIATURE LABELING is being classified by some suppliers as either naked-eye or demagnified. Naked-eye labeling is being used on those components, circuits, modules that are large enough to carry such lettering. Special high temperature and solvent-resistant inks are used, and the legend is either screen printed or stenciled on. The smallest printing generally offered for naked-eye reading is seldom less than 0.050 inches high.

Naked-eye identification is also applied to much smaller components, usually in the form of tags or labels affixed to the part. But here the identification must necessarily be larger than the component itself. Dot transistors, resistors and diodes for instance, are sometimes mounted in holes in cards that contain identifying data. But when the component is removed from the card, it can no longer be readily identified. Photolithographic reduction techniques, as used in printing currency, and requiring magnification to be read, are being used by American Tag

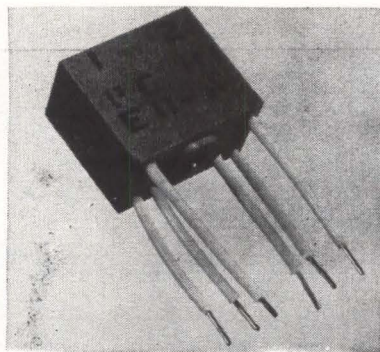

Limit on naked-eye lettering is characters about 0.05 inch high, which is approximately the size of 4-point type (This is a sample of 4-point type)

Co., Belleville, N. J. and the Latrix Co., Escondido, Calif., to make demagnified labels.

One of the photographs shows a de-magnified label applied to a microminiaturized diode that is 0.06 inch in diameter and 0.065 inch long. With components this small, naked-eye identification applied directly to the component would allow only limited color coding and one identifying character. Because of such limitations most microminiature components do not carry any identification. However, the label shown in the photograph includes a seven-digit part number and two

lines of additional information.

Serial numbering is seldom used on small electronic components because of lack of space. As a result, failure analysis and reliability investigations are handicapped. With microminiature labeling however, it is possible to provide both serial number and identifying information.

Mylar is being used as a base for the microminiature labels and the adhesives used have high temperature and solvent resistance. Exposure in air at up to 200 C failed to cause label deterioration. They show no tendency to wrinkle, darken, or otherwise become illegible, and the information bearing legend does not slip or separate from the mylar base. Solvent resistance tests with trichloroethylene, BUTOL, THF, caustic soda, live steam and salt spray failed to cause significant damage. Only certain oils appeared harmful.

An innovation of the microminiature labelers is the classification of label sizes. The Latrix size scale is based on the principle of astronomical star magnitudes: the larger magnitudes represent smaller label sizes. Thus magnitude denotes the degree of magnification, starting with 0.05 inch high characters as first magnitude. The letters on the miniature labels shown are only 0.0075 inches high, which is one-seventh the size of the 0.05 inch

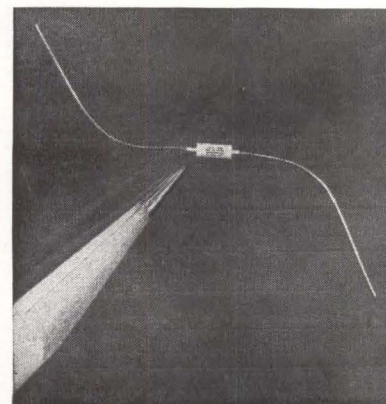

Labels use a Mylar base and do not deteriorate easily

AIRTRONICS

electronic products for the telephone industry...

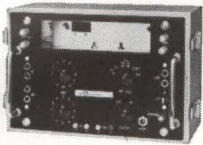

Portable Test Hybrid
Simplifies cable acceptance tests and return loss measurements.



Far End Terminating Set
Provides precision network termination during cable testing.



Pulse Meter
Furnishes a convenient method of measuring dial speed and percent make.

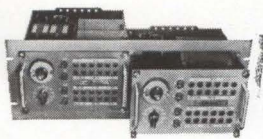

Program Equalizer
Corrects Attenuation Distortion easily, quickly. In use by many AM and FM Broadcast Stations.

PRECISION NETWORKS
WE 115 TYPE

BUILD OUT AND
TERMINATING SET

PROGRAM EQUALIZERS

TRANSMISSION
MEASURING SET

● FOR DETAILED SPECIFICATIONS AND PRICES, CONTACT YOUR NEAREST DISTRIBUTOR OR WRITE AIRTRONICS INTERNATIONAL CORPORATION — P.O. BOX 8429, FORT LAUDERDALE, FLORIDA.

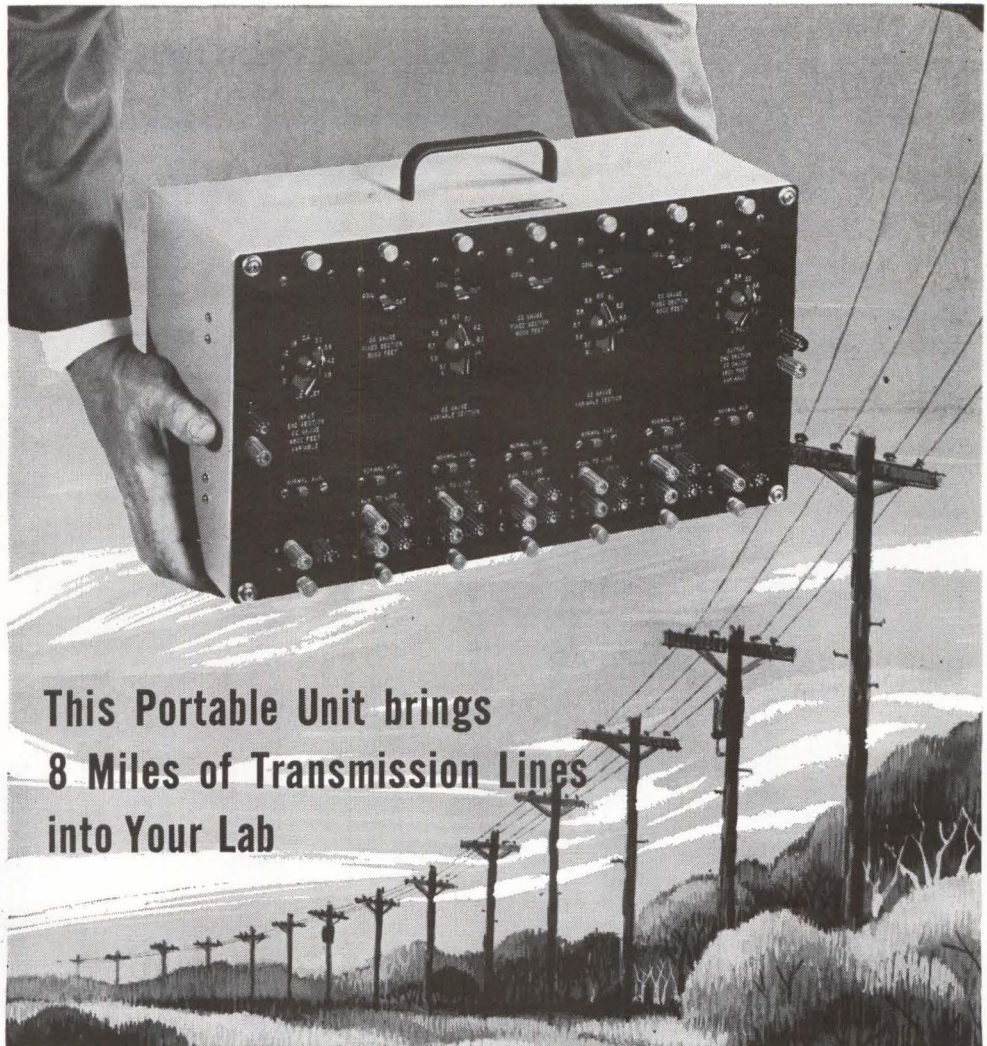

This Portable Unit brings
8 Miles of Transmission Lines
into Your Lab

Eliminates the Need for Leased Lines

Wherever you have a requirement for transmitting information, data, and intelligence this portable equipment will simulate transmission lines right in your lab.

The standard unit simulates 8 miles of transmission line, but it can be modified for any line length required. Plug-in modular construction. Seven plug-in modules each simulate 6,000 ft. of standard telephone cable with loading coil.

The Airtronics Artificial Line meets field engineering requirements. Some time-saving, money-saving laboratory uses are for testing data transmission (offers loaded or unloaded test facility); for testing amplifier operation over telephone lines (permits actual frequency response measurement to be observed over a simulated line); for checking system gain requirements for a pre-determined frequency range; for simulating complex values of AC impedance and DC resistance as incorporated in telemetry circuit transmission; for training purposes (used exclusively by every major telephone company).

The Airtronics Artificial Line is available in 19, 22, 24 and 26 gauge.

FOR FURTHER INFORMATION CONTACT:

AUTOMATIC SALES CORPORATION / A subsidiary of General Telephone & Electronics
or Write direct...



6900 WEST ROAD 84
FORT LAUDERDALE, FLA.
TELEPHONE LU 3-4541

U T I C A[®]

UTICA

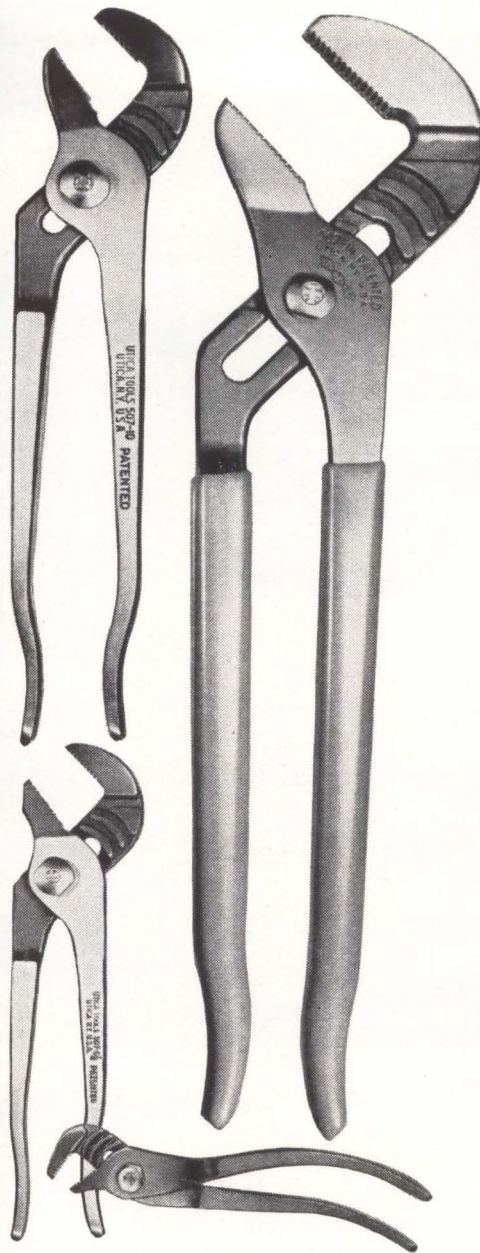

YES, WE DO HAVE YOUR SIZE

A giant 14" plier has now been added to Utica's famous "Rib-Joint" line. This powerful tool with parallel jaw opening of $2\frac{13}{16}$ ", completes Utica's full line of "Rib-Joints". All are available from stock. We serve our customers by carrying the widest assortment of pliers. All have been developed for specific uses. All are made to the high standards required by American industry. If you use pliers, ask to see our new catalog.

**Utica Tool Division,
Kelsey-Hayes Company, Utica 4, N. Y.**

tools the experts use!

letters on the module; therefore the label is characterized as seventh-magnitude.

Any type of magnifier may be used, but its power should be comparable to the magnitude rating of the label. For instance, fifth magnitude labels can be read comfortably with three to seven power magnification. If a higher powered magnifier is used, the field of vision is limited and focus is unsteady. The flashlight magnifier or the pocket comparator are more practical than hand-held glasses or jeweler's eye loupe's for magnitudes greater than eight.

Demagnified labeling appears practical to 40th magnitude, which uses characters 0.002 inch high.

Projector Aids PC Film Processing



Enlarged image of printed circuit film is easily inspected for tolerances and pin-hole flaws

A MODIFIED OVERHEAD projector is being used by General Electric Company's Heavy Military Electronics Department, Syracuse, N. Y., to facilitate inspection and punching of films for printed-circuit boards.

Using a standard overhead projector, the printed-circuit film is projected on a wall screen at ten times the size of the original drawing. A 0.1-inch grid pattern on

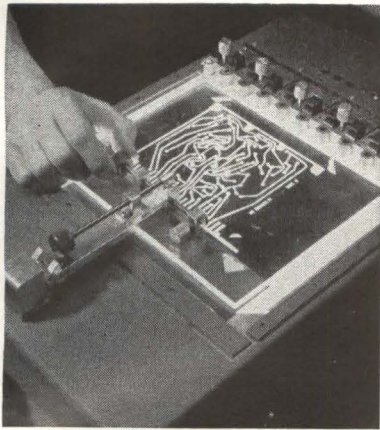

Grid pattern is mounted on plate covering projector light source. Both pc and grid pattern films expand at same rate to heat from projector lamp. Three-way aligning arm gives quick, precise adjustment

film is mounted on a plastic plate covering the projector light source, thus providing an accurate alignment pattern for checking the drawing. In operation, the tenth-grid pattern is displayed on the wall screen, then the printed-circuit film is placed over the light source grid plate. Component hole centers on the film are then carefully aligned to the intersections of the grid pattern. The inspector checks tolerances and notes photographic defects.

When alignment and inspection are completed, the film is secured in place and two indexing holes are punched. A series of punches, arranged at intervals of one inch, are available for this purpose. Indexing holes usually are punched on five-inch centers near the top edge of the film.

Minor photographic defects observed during projection are corrected after the indexing holes are punched. This includes covering pinholes in the film and removing specks from clear film areas.

Films accepted by the inspector are forwarded for fabrication and assembly. When films are rejected, the inspector's report is used for making corrections. The entire inspection and punching process is repeated after new photographic reproductions have been made.

Before the magnified projection system was installed, about 20 percent of all films processed had to be rejected for punching inaccuracies; practically no films are ruined with the enlargement technique.



NEMS-CLARKE® enters the winners' circle again!

Mercury Tracking Stations throughout the world are being refitted with the latest Nems-Clarke telemetry reception equipment in preparation for Gemini and Apollo tests. The gear being replaced was the best available when installed. It too is Nems-Clarke equipment. The state-of-the-art of telemetry reception has increased steadily to meet previously unheard-of reception requirements. Nems-Clarke products continue to set the standards.

The most advanced and versatile receiver yet designed is the new model 1455A. Plug-in IF/Demodulator Modules give bandwidth capabilities for PCM Telemetry from 10 KC to 1.5 MC.

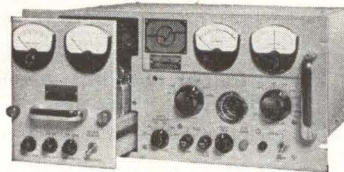

Write for Data Sheet 1455A
Vitro Electronics, 919 Jesup-Blair Dr.
Silver Spring, Maryland
A Division of Vitro Corp. of America

Vitro ELECTRONICS

SPECIFICATIONS

Circuitry Double conversion
Tuning Range 215-260 mc
Noise figure less than 8 db
IF Rejection 60 db
Dual IF Bw . . .30/50, 50/100, 150/300,
300/500, 750/1500
Single Bw 10 KC, also available
Shape Factor (6-60db) . . . as low as 2.5
Demodulators—AM envelope detector, Foster-Seeley FM discriminator, FM Phase—Lock Detector except on wide bandwidths.

DESIGN AND APPLICATION

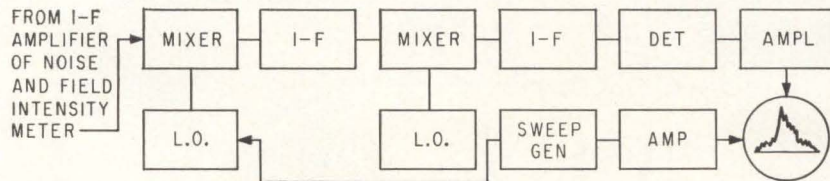

Spectrum Signature Adapter

Used with Noise and Field Intensity Meters

PRESENTLY available from Electro-Magnetic Measurements Co., 50 Baiting Place Rd., Farmingdale, L. I., N. Y., the spectrum signature adapter is a frequency display unit that can be used in conjunction with all conventional noise and field intensity meters as multiple input frequency tuning heads are available. Use of the adapter increases c-w sensitivity of the field intensity meter by 20 db or more. The unit also meets requirements of the Military Collection Plan for spectrum signatures. The sweep width is adjustable from zero to greater than the maximum i-f bandwidth of the noise and field intensity meter with which it is used. Ampli-

tude scales are linear, log (40 db) and power (square law). Dynamic range is 40 db screen display. In use, the field intensity meter will indicate signal level so no further amplitude calibration is required. The composite system uses both preselection and r-f amplification of the field intensity meter therefore is not susceptible to spurious signals or to overloading by off-band strong signals and frequency ambiguity is eliminated. Maximum sensitivity is attained because signal is amplified at r-f in receiver before mixing. No signal level calibration is required as field intensity meter provides this.

CIRCLE 301, READER SERVICE CARD

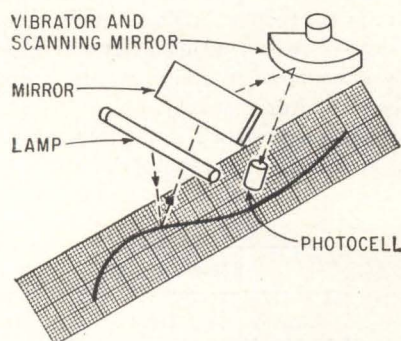

Recorder Line Follower

Regenerates Data

AVAILABLE from F. L. Moseley Co., 409 North Fair Oaks Ave., Pasadena, Cal., the type F-2 line follower optically follows recorded lines made with pencil or pigment-

type inks and rejects grid or other lines made with dye-type inks and can track curve slopes up to 80 degrees at paper speeds up to 15 inches per minute. The scanning and pickup unit replaces the recorder pen and the light beam scans the chart 0.2-in. on either side of center line and 0.08-in. along the center line. All signal variations within this area are averaged. An alarm circuit detects excess tracking error. The line follower can be used to linearize recorded data and will produce an output proportional to the prerecorded trace. For automatic reduction of high-frequency data, especially where the information is on photographs and a pair of cross hairs must be placed over the data point and X and Y coordi-

nates transcribed visually, the films are enlarged and placed on a recorder and the curve tracer placed in operation. Readout from the Y axis is taken from the follow potentiometer at any time, and an infinite number of samples can be taken. The pick-up assembly (see sketch) light source illuminates the paper and reflected light strikes an oscillating mirror which redirects the beam to the photocell. When the head is not directly over the trace an error signal is developed, amplified and applied to a positioning servo system. (302)

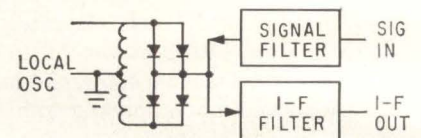

Balanced Mixers

Feature Broad Band

ANNOUNCED BY Anzac Electronics, Inc., 375 Fairfield Ave., Stamford, Conn., the KMC line of balanced mixers approximates an ideal switch opening and closing at i-f frequency. Signal and i-f connections are made to a common terminal through filters to separate the frequencies. Mixer is available with or without the filters. Without them, dimensions are $13/16 \times 9/16 \times 113/16$ in. Three types are presently available, octave bandwidth, $2\frac{1}{2}:1$ bandwidth and 100:1 bandwidth from 10 Mc to 1 Gc. Typical specifications are noise figure (with 1.5 db i-f amplifier) 6.5 db max, local oscillator rejection 30 db min, conversion loss 6 db max, signal input power 1.2 watts max, and uniform vswr of less than 2:1 across their passband. The circuit is a broadband, balanced center-tapped transformer and a half-wave diode switch (see sketch). Filters

Super Squaremu "79" is a new high-purity alloy of closely controlled composition, an exclusive development of Magnetic Metals. When used in Centricore tape-wound cores, it assures the magnetic amplifier designer the ultimate in core performance and consistent reproducibility of his designs.

Compared with conventional alloys of the same nominal composition, Super Squaremu "79" offers these advantages: ■ High flux density ■ Greater gain ■ Increased

linear range ■ Greater thermal stability ■ Improved uniformity of performance

Centricores made of Super Squaremu "79" deliver the same consistently high performance from core to core and lot to lot, as proved through production quantity runs. They're now available in a new hermetically sealed case, in all standard sizes and shapes. Write or call today for complete specifications. MAGNETIC METALS COMPANY, Hayes Avenue at 21st Street, Camden 1, N. J.

NEW HIGH PERFORMANCE ALLOY



*... makes Centricores®
the most uniform of all
tape-wound cores!*

transformer laminations • motor laminations • tape-wound cores • powdered molybdenum permalloy cores • electromagnetic shields

MMAGNETIC
MMETALS

Acoustical Components of Superior Quality

JAPAN PIEZO supplies 80% of Japan's crystal product requirements.

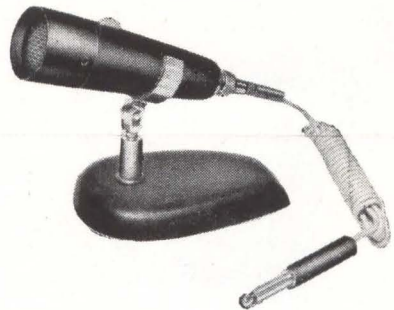
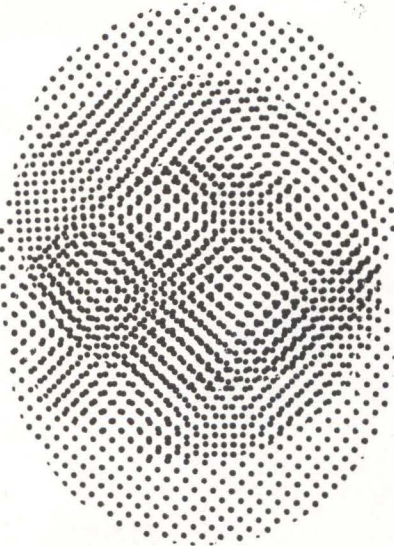

MICROPHONE

Crystal — X-29

At 20°C, 1 KC/s, Sensitivity is -58 ± 5 db. Impedance: 100 K Ω . Capacitance: 1,500 pF.

Write for detailed catalog on our complete line of acoustical products including pickups, cartridges, record players, phonograph motors and many associated products.



JAPAN PIEZO ELECTRIC CO., LTD.

Kami-renjaku, Mitaka, Tokyo, Japan

separate the signal and i-f signals. When diodes are in nonconducting signal input is shunted to ground through diode forward impedance in series with transformer leakage inductance, typically 2 nanohenries. When diodes are in nonconducting state, input signal is open circuited. Average input impedance is close to 50 ohms.

CIRCLE 303, READER SERVICE CARD

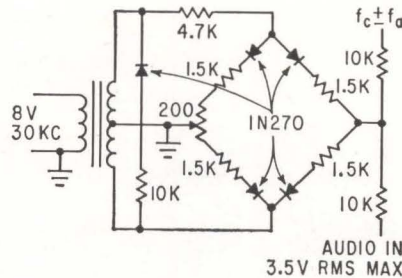

Wide-Band Transformer Covers 3 Kc to 22 Mc

MANUFACTURED by Spectran Electronics Corp., 146 Main St., Maynard, Mass., the S-005-95 transformer has a frequency response from 3 Kc to 22 Mc with amplitude variation less than ± 2 db. The principal design objective was not wide frequency response, but the best possible balance between the two halves of a center-tapped secondary. It is particularly suited for balanced modulator applications between 25 Kc and 1 Mc, or wherever precise phase splitting is desired at any frequency as long as the saturation voltage of 0.5 v/Kc/sec is not exceeded. Typical application in a Boynton-Scholt modulator is shown in the sketch. (304)

Power Amplifier Provides 10-W for Telemetry Use

TELEMET CORP., Amityville, L. I., N. Y. Model 1844A is a pressurized, 10-w power amplifier for telemetry use in the 215 to 260 Mc range. Bandwidth at the 1-db points to 0.3 Mc minimum. Input drive power is 2 w with an input impedance of 50 ohms. Temperature range is from -55 C to 100 C. Unit will survive a shock of 30 g and will meet all performance specs after a vibration of 10 g from 10 to 2,000 cps and

after an acceleration of 30 g. Meets all environmental requirements of MIL-E-5272A. (305)

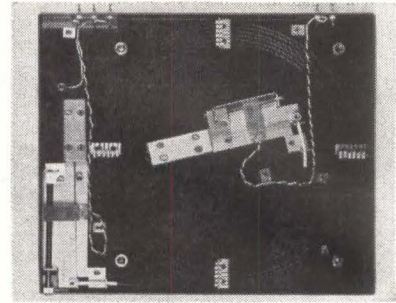

Magnetostrictive Line Has 1,000 μ sec Delay

SONIC MEMORY CORP., 494 Oak St., Copiague, N. Y. Model TD-2 has a maximum delay of 1,000 μ sec. Digit rate: 1 Mc in a return-to-zero mode; 2 Mc in a non-return-to-zero mode. Case size: $8\frac{1}{2}$ in. by 7 in. by $\frac{1}{2}$ in. Price: \$150 each. Availability: 3 weeks. (306)



Klystron Power Supply Offers Unitized Assembly

PRD ELECTRONICS, INC., 202 Tillary St., Brooklyn 1, N. Y. Model 815 contains three separately regulated voltage supplies: beam 200 to 2,200 v, 65 ma max; reflector 0 to 1,000 v; grid 0 to +150 v and 0 to -300 v and a 6.3 v a-c filament supply. Output frequency of the klystron remains constant under floating modulator system when switching from c-w to square wave and/or pulse modulation. Price of the unit is \$1,195. (307)

Clocked Counter Board

ELECTRONIC MODULES CORP., 1949 Greenspring Dr., Timonium, Md. Clocked counter board holds four

stages of flip-flops and the additional gating necessary to provide a four stage clocked counter useful in applications where the propagation delay of a ripple through counter is undesirable. (308)

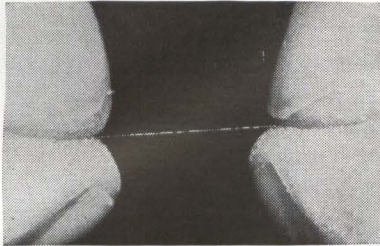

Microdiameter Wire Has Magnetic Properties

MAGNETIC SHIELD DIVISION, Perfection Mica Co., 1322 No. Elston Ave., Chicago 22, Ill., has developed a microdiameter wire drawn from high permeability Co-Netic AA alloy. Diameter is 5.0×10^{-4} in. (0.25 circular mil). The wire displays magnetic properties and is offered for experimental investigation as to applications. An experimental sample 200 ft long is available from stock for \$9. (309)

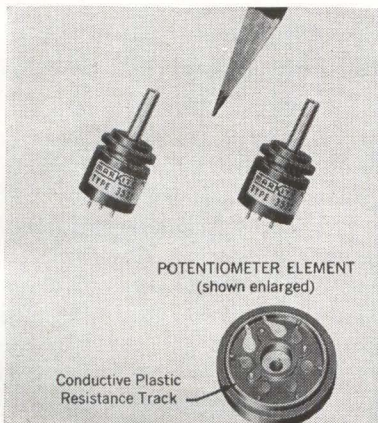

Conductive Plastic Pots Designed for Controls

MARKITE CORP., 155 Waverly Place, New York 14, N. Y., offers $\frac{1}{2}$ in. diameter conductive plastic precision rotary pots for controls and instrumentation. The resistance element is a sturdy one-piece unit embodying a solid raised track of conductive plastic, integrally co-molded, together with taps and terminals, to an insulator base of temperature-resistant mineral-filled plastic of matched coefficient of thermal ex-

when reliability is essential, yet you're cramped on costs . . .

ITT KELLOGG INDUSTRIAL COMPONENTS

. . . backed by 60 years of telephone experience . . . to give you premium performance at production-line prices

Take these components, for instance. They are only three examples of a broad line of electronic and electro-mechanical devices for hundreds of industrial and commercial applications where cost is a problem. ITT Kellogg components are reliable, versatile, durable . . . yet moderately priced. They are built to exacting high-performance standards developed by more than 60 years of design and manufacturing experience for the telephone industry.

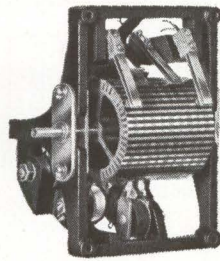

MAGNETIC DATA-STORAGE DRUM

For permanent storage of DC pulse data. Basic module storage drum has 250-bit capacity. Additional drums can be added. Useful for operations requiring repetitive information, such as vending automats, automatic message routing, card punching, numerical machine control, automatic programming, personnel locator, etc.

outstanding features:

- Low Cost
- No Amplification of Readout
- Repetitive, Non Destruct Readout
- Selective Write-in, Readout, and Erasure
- Variable Speed—up to 20 pulses per second
- 100 million cycle expectancy
- Adaptable to all pulse codings

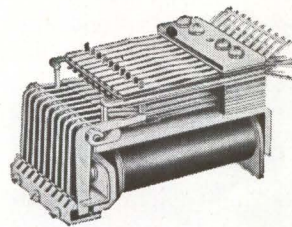

MAGNETIC IMPULSE COUNTER

For switching or control application where intelligence—to be registered or stored and then released—is supplied as a series of electrical pulses. In many applications, this unit can replace a chain of 10 or more relays. Useful in control systems, computer designs, telephone, microwave selective signalling and telemetering.

outstanding features:

- Simplified circuitry
- Compact design
- Impulse rate can exceed 20 per second
- No sliding contact or mechanical ratchet & dog arrangement
- Counting sequence controlled electromagnetically

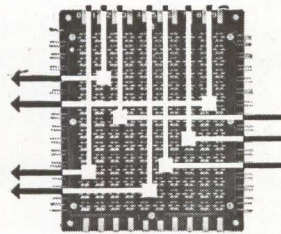

SYSTEMS TRANSLATION MATRIX

Exceptionally versatile, highly reliable . . . ideal for systems requiring translation or various diode matrices, such as in automated warehousing, central control of processing plant operations, etc.

outstanding features:

- Selenium disc rectifiers, mounted without soldering or wiring
- Easy to position
- Never needs adjustment
- High matrix capacity—300 discs
- Simple circuit rearrangement—merely reposition discs
- Compact, miniaturized design



for more information, contact your nearest representative, or write us today.

KELLOGG

A Division of

International Telephone & Telegraph Corporation

Industrial Sales Department • 6650 S. Cicero Ave. • Chicago 38, Ill.

REPRESENTATIVES:

Penwarden/Dailey Associates
14547 Titus Street
Van Nuys, California

Robert W. Gray
572 Washington Street
Wellesley 81, Massachusetts

T. H. Ellis Sales Co., Inc.
7711 State Line Road
Kansas City 14, Missouri

Albert A. Jacobs
3913 N. 35th Street
Milwaukee 16, Wisconsin

Berndt & Klein Associates
6322 N. Milwaukee Ave.
Chicago, Illinois

47 DeForest Street
Watertown, Connecticut

H. Markowitz
511 Montana Street
P. O. Box 191
El Paso, Texas

Land-C-Air Sales Co.
76 Main Street
Tuckahoe, New York

AROUND THE WORLD

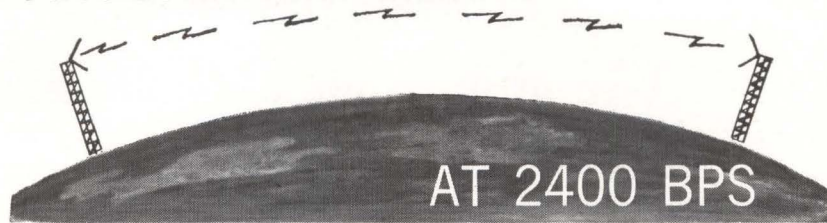

60 to 100 wpm H-F radio data channels literally circle the globe. These are teletype or TWX channels used by both military and commercial services.

The Rixon **DD Line** Serial-Parallel converter system (Sephath) provides reliable high-speed transmission of digital data over existing H-F radio links. Modern high-speed (1200-2400 BPS), real-time data processing signals cannot be accommodated over single channel H-F radio circuits because of the 3 to 4 milli-second multipath degradation of received signals. This obstacle can be overcome by using the **DD Line** Sepath to process serial data into parallel streams at data rates which are compatible with existing telegraph channels. Since multiple parallel channels are widely provided by existing multiplexing equipment, maximum use is made of existing facilities.

The **DD Line** of data communications equipment features modular design—if you wish to process your data faster and more accurately, contact Rixon for a demonstration of our data transmission equipment.

RIXON ELECTRONICS, INC.

2121 Industrial Parkway—Montgomery Industrial Park—Silver Spring, Maryland
Telephone: 622-2121

TWX: S Spg 213

CIRCLE 202 ON READER SERVICE CARD

Three basic escapements—verge, pin and lever, and the patented pallet-torsion wire—provide WHEATON with answers to any time or programming requirements. Environmental, size, reliability or price problems fall before WHEATON's know-how. Advancing the state of the art is our business.

Mechanical and Electro-Mechanical devices

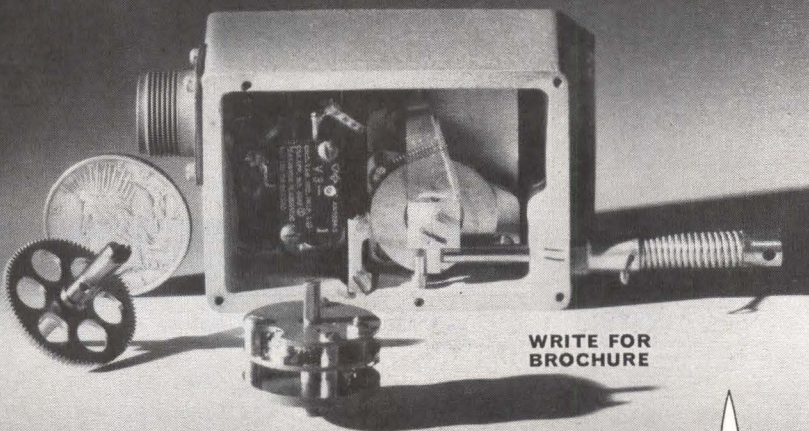

WHEATON Engineering Division
HURLETRON, INC.
320 Manchester Road, Wheaton, Illinois



pansion. Track can be provided with a wide range of electrical resistivities.

CIRCLE 310, READER SERVICE CARD

Filament Holders Insulated for H-V Use

TECHNI-TOOL, INC., 1216 Arch St., Philadelphia 7, Pa. Stainless steel filament holders for h-v applications are six inches long and have curved, serrated tips suited for bending and inserting fine diameter wires and component leads in miniaturized circuits. The durable Tec-Insulation maintains its physical and electrical characteristics at temperatures well above or below normal operating temperatures. (311)



Sweeping Oscillator Includes Frequency Marker

KAY ELECTRIC CO., 14 Maple Ave., Pine Brook, N. J. The Kilo Sweep 131-B bfo provides clean, stable waveshapes from 100 cps to 2 Mc. It provides excellent continuously variable wide sweeps to cover tape recorder applications and stable, narrow sweeps for filter alignment. Featuring fixed and variable pulse type markers, the Kilo Sweep is capable of a single wide sweep from 2 Mc down to 2 Kc, 200 Kc to 200 cps. (312)

UHF-VHF Coax Cable

PRODELIN INC., Hightstown, N. J., announces a 75-ohm version of Spir-O-foam coaxial cable for community and c-c tv services. Cable features include unlimited operating life, perfect r-f shielding, clearly-marked sheaths for easy length measurements and cable identification. (313)

PRODUCT BRIEFS

D-C/D-C CONVERTER militarized. Electronic Development Corp., 423 West Broadway, Boston, Mass. (314)

PATCH STRIP ASSEMBLIES designed to save space. Cambridge Thermionic Corp., 445 Concord Ave., Cambridge 38, Mass. (315)

LOGIC SYMBOL KIT for the design engineer. Computer Control Co., Inc., 983 Concord St., Framingham, Mass. (316)

REMOTE ANGLE INDICATOR for 360 deg readout. IMC Magnetics Corp., Western Div., 6058 Walker Ave., Maywood, Calif. (317)

MULTIPLE-DIVIDER features wide bandwidth. GPS Instrument Co., Inc., 180 Needham St., Newton 64, Mass. (318)

FREQUENCY CONVERTER for phase, gain measurement to 100 Mc. Ad-Yu Electronics Lab., Inc., 249 Terhune Av., Passaic, N. J. (319)

STANDARD COILS 33 types. Cambridge Thermionic Corp., 445 Concord Ave., Cambridge, Mass. (320)

SINGLE-IN-LINE CONNECTORS for coax cable and shielded wire. AMP Inc., Harrisburg, Pa. (321)

MOLDED INDUCTORS single or twin lead devices. Delevan Electronics Corp., 270 Quaker Road, East Aurora, N. Y. (322)

SOLDERING-IRON ATTACHMENT facilitates module removal. Control Logic, Inc., 11 Mercer Road, Natick, Mass. (323)

P-C CONNECTORS for $\frac{1}{8}$ in. board. Continental Connector Corp., 34-63 56th St., Woodside, N. Y. (324)

SOLAR SIMULATOR 3 in. diameter beam. The Te Co., 415 E. Montecito St., Santa Barbara, Calif. (325)

VHF FREQUENCY STANDARD light weight. Wayne Kerr Corp., 1633 Race St., Philadelphia, Pa. (326)

PRECISION DEPTH RECORDERS transistorized. Westrex Co., 540 W. 58th St., New York 19, N. Y. (327)

VHF A-M RECEIVER up to 5 channels. Cossor Communications Co. Ltd.,



HELIARC WELDED HERMETIC SEAL guards against thermostat failure

... when KLIXON® M1 Precision Thermostats are specified for hostile environments

A helium leak rate less than 1×10^{-9} cc/sec is just one of the benefits derived from the KLIXON M1's hermetic seal. This void-free welded seal also eliminates contact contamination due to trapped solder flux, and provides unequalled resistance to salt spray, sand, dust and humidity.

High resistance to other environmental extremes also contributes to KLIXON M1 reliability. Its dependable clean-breaking, snap-action KLIXON disc operates without contact chatter or bounce under vibration of 5-2000 cps at 20 G and shock and acceleration up to 60 G. Contact life of 100,000 cycles at 5 amp, 30 V-dc is another high-reliability feature.

Fully qualified under MIL-E-5272 and MIL-T-5574, KLIXON M1 Thermostats are now in use in many high-reliability aircraft and missile applications such as the Polaris, Saturn, Atlas Series and Sidewinder. Typical uses are for controlling temperatures or activating warning systems in radar and other electronic equipment, gyros, fuel pumps, servo-motors and heating blankets as well as air conditioning, photographic, telemetering, de-icing and other equipment.

Our fast-response custom packaging team will design and produce M1 Thermostat packages to fit your special requirements.

Write today for complete specifications.

KLIXON M1
PRECISION THERMOSTAT
(actual size)



METALS & CONTROLS INC.
5006 FOREST ST., ATTLEBORO, MASS.
A CORPORATE DIVISION OF
TEXAS INSTRUMENTS
INCORPORATED

**Jack
Penwell
can
show
you...**

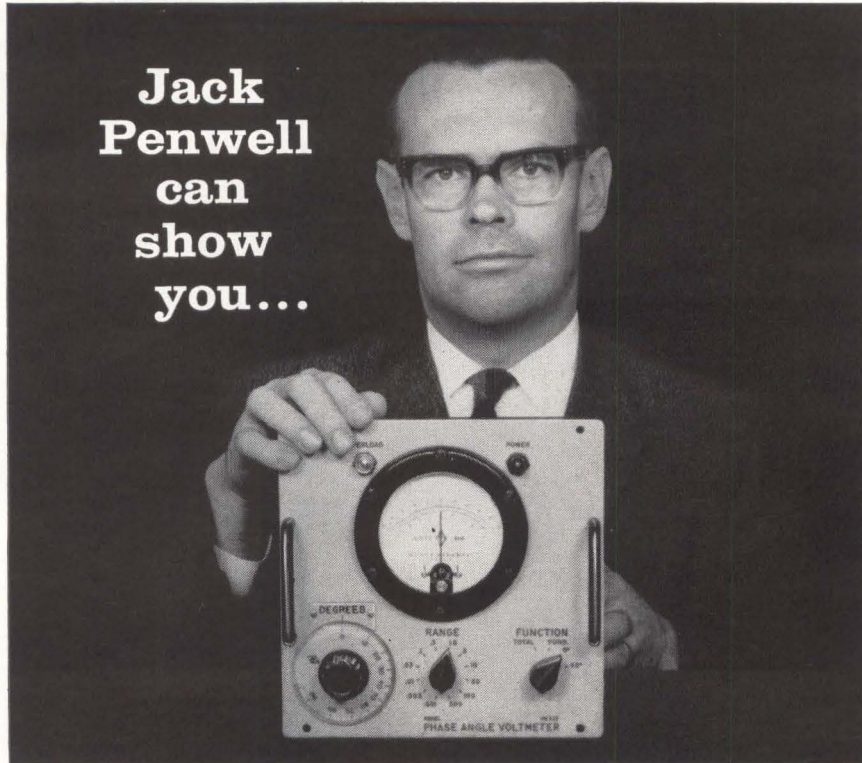

how to match a PAV to tough GSE specs

From its all solid state circuitry to its MIL-type hermetically sealed meter and plug-in amplifiers, every design feature of the Model VM-235 Phase Angle Voltmeter has been selected for rigorous service in Aerospace Ground Equipment.

Your North Atlantic man can quickly demonstrate how this rugged, miniaturized version of North Atlantic's famous PAV provides direct, accurate reading of phase angle, nulls, total, fundamental, quadrature and in-phase voltages—even under the roughest of military field conditions.

The VM-235's ability to meet tough system specs is demonstrated daily in operational and support equipment for USAF and Navy aircraft and missile programs. Its capabilities for complex measurements are shown in the abridged specifications below:

Voltage Range.....	1 mv to 300 v f.s., 12 ranges
Voltage Accuracy.....	±2% f.s.
Phase Accuracy.....	dial: ±1°; meter: ±3% of F.S. degrees
Signal Frequency.....	400 cps
Input Impedance.....	1 megohm
Reference Input.....	26 v or 115 v
Meter scale.....	3-0-3, 10-0-10 linear
Phase Angle Dial.....	2 scales, 90° (elec.) apart
Nulling Sensitivity.....	2 microvolts (phase sensitive)
Harmonic Rejection.....	55db (with filters)
Dimensions.....	8 ¹ / ₁₆ " h. x 8 ¹ / ₂ " w. x 6 ³ / ₁₆ " d.

North Atlantic's field engineering representative in your area has full data on the VM-235, as well as modified versions for specific systems requirements. For his name, call or write today, or request Bulletin VM-235.



NORTH ATLANTIC industries, inc.
TERMINAL DRIVE, PLAINVIEW, L. I., NEW YORK • Overbrook 1-8600

Honeypot Lane, Stanmore, Middlesex, England. (328)

FERRITE CORE MEMORIES for space vehicles. Electronic Memories, Inc., 9430 Bellanca Ave., Los Angeles 45, Calif. (329)

DIFFERENTIAL TRANSFORMER magnetically shielded. Automatic Timing & Controls, Inc., King of Prussia, Pa. (330)

MICROMINIATURE RELAY transistor-type case. Teledyne Precision, Inc., 3155 West El Segundo Blvd., Hawthorne, Calif. (331)

RATE GYRO built-in inverter. Humphrey, Inc., 2805 Canon St., San Diego 6, Calif. (332)

ANGLE POSITION SIMULATORS variety of sensors. Kearfott Div., General Precision, Inc., 1150 McBride Ave., Little Falls, N. J. (333)

STRAIN GAGE-PRESSURE TRANSDUCER 5-v output. Statham Instruments, Inc., 12401 W. Olympic Blvd., Los Angeles 64, Calif. (334)

TINY THERMOSTAT glass-sealed. Elmwood Sensors, Inc., 669 Elmwood Ave., Providence, R. I. (335)

PACKAGED FREQUENCY STANDARDS crystal controlled. Greenray Industries, Inc., 5281 E. Simpson Road, Mechanicsburg, Pa. (336)

VARIABLE SPEED DRIVE solid rotor. Fidelity Instrument Corp., 1000 E. Boundary Ave., York, Pa. (337)

ASBESTOS PAPER electrical grade. Johns-Manville, 22 E. 40th St., New York 16, N. Y. (338)

SUBMINIATURE SWITCH withstands 700 F temperature. Haydon Switch Inc., Waterbury 20, Conn. (339)

ADVANCED COMMAND RECEIVER with isolated ground system. Motorola Inc., 8201 E. McDowell Rd., Scottsdale, Ariz. (340)

EXCESS SOLDER REMOVER time saving. Macdonald & Co., 714 E. California St., Glendale 6, Calif. (341)

CLEANER KIT for miniature assemblies. Mini-Tool Technical Industries, Box 84, Highbridge Station, New York 52, N. Y. (342)

URETHANE RUBBER PRODUCTS custom-compounded. Lord Mfg. Co., Erie, Pa. (343)

Literature of the Week

MICROLOGIC BROCHURE Fairchild Semiconductor, 545 Whisman Road, Mountain View, Calif. A 12-page brochure describes the manufacture of a typical Micrologic element from silicon crystal growing through to final test. (344)

ELECTRIC MOTORS U. S. Industries, Inc., 6312 Hollister Ave., Goleta, Calif. Catalog 400 shows a broad range of electric motors in specification tables. (345)

WAVEGUIDE BENDS Microwave Development Laboratories, Inc., 15 Strathmore Road, Natick Industrial Centre, Natick, Mass. Catalog BE61 contains description and dimensional drawings for a wide line of waveguide bands. (346)

RESISTOR MODULES Trio Laboratories, Inc., Dupont St., Plainview, N. Y. Bulletin TL200-621 describes four new programmable resistor modules. Request copy on company letterhead.

MINIATURE FASTENERS Penn Engineering & Mfg. Corp., Doylestown, Pa. Bulletin covers type FE miniature self-locking, self-clinching fasteners. (347)

CONTROLLING EDP ENVIRONMENT The Austin Co., 3650 Mayfield Road, Cleveland 21, O. Controlling environment for electronic data processing facilities is the subject of an illustrated folder. Request copy on business letterhead.

MAGNETIC CIRCUITRY Sprague Electric Co., Marshall St., North Adams, Mass. A 24-page technical paper on "Magnetic Circuitry and Applications" is available on letterhead request.

PROGRAMMING SUPPORT Bendix Computer Division, 5630 Arbor Vitae St., Los Angeles 45, Calif. Four bulletins describe programming support for the G-20 computing system. (348)

ANGLE AND RATE MEASUREMENT Razdow Laboratories, Inc., 77 Twelfth Ave., Newark 3, N. J. Operation of the Micro Dynamic Angle and Rate Monitoring System (MIDARM) is explained in a 4-page folder. (349)

June 22, 1962

LAPP COOLING GIVES LONGER LIFE

TO HIGH-POWER TUBES



WATER-COOLED

Carrying cooling water which must undergo a change in potential is a job best handled by Lapp Porcelain Water Coils. These coils are completely vitrified, non-absorbent porcelain, white glazed inside and out, providing very low resistance to water flow and eliminating all possibility of contamination in the water. Assuring positive cooling and long tube life, a Lapp Porcelain Water Coil installation represents a permanent investment—a completely trouble-free cooling system.

AIR-COOLED

Use of Lapp standard-design tube supports facilitates circuit design, improves production economy, provides interchangeability and easy replacement. They are compact, efficient and attractive in appearance, with polished nickel-plated brass hardware permanently attached to the body. Equipment manufacturers will realize a triple service from these supports, for they support the tubes and act as an insulator, and channel air over the fins for maximum cooling of tubes.

WRITE for Bulletin 301 containing complete description and specification data. Lapp Insulator Co., Inc., 193 Sumner Street, LeRoy, New York.

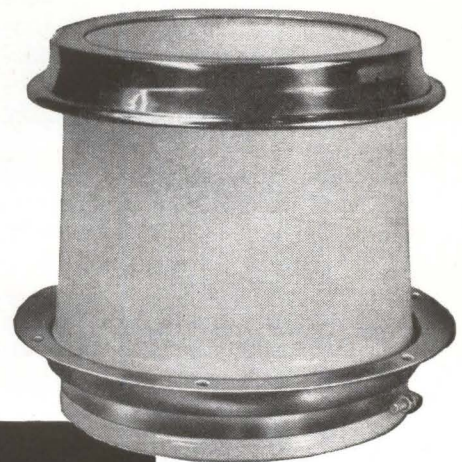

Lapp

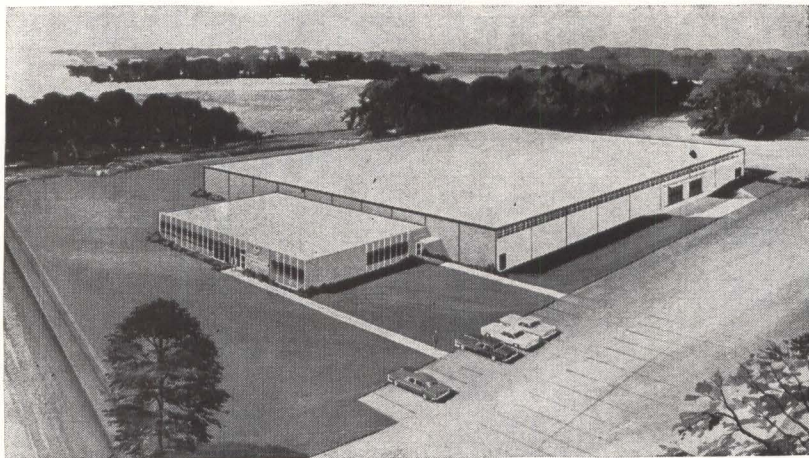

RCA To Lease New Midwest Facility

GROUND has been broken in Plymouth, Mich., a Detroit suburb, for a new 40,000-square-foot structure to house the RCA Industrial and Automation Products department, now located in Detroit. The combined factory and office building being erected for lease to RCA is to be completed by early fall.

C. H. Colledge, division vice president and general manager, RCA Broadcast and Communications Products division, which includes the department, said larger quarters are needed because of greater RCA participation in the inspection and gaging systems market and by sales potential for such equipment, particularly in the automotive and metal-working industries.

Norman R. Amberg, manager of the Detroit facility, pointed out that these industries are placing increased emphasis on product reliability, requiring closer tolerances. As this trend becomes more pronounced, he added, the metal-working industries can be expected to turn increasingly to electronic inspection of all critical components rather than random sampling.

Among its major projects, the RCA department has built for an automobile manufacturer an electronic system that automatically inspects, classifies and matches engine pistons and wrist pins for optimum fit.

Amberg said the enlarged Detroit facility also would produce other equipment such as the Ve-Det, an electronic vehicle detector system that controls traffic signals and counts passing vehicles. It also will manufacture electronic metal detectors and custom-built inspection and assembly machines.

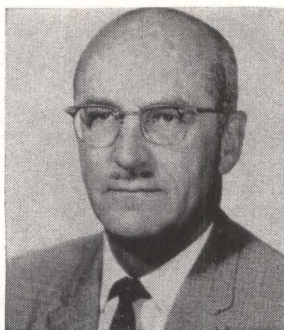

Stuhrman Advances At Bourns, Inc.

A. P. STUHRMAN, Trimpot division manager of Bourns, Inc., Riverside, Calif., has been appointed a corporate vice president of the company, according to Marlan E. Bourns, president.

"Stuhrman will continue to be responsible for engineering, manufacturing, and quality control of the Trimpot division, throughout Bourns, Inc. plants in Riverside, Calif., Ames, Iowa, and Toronto,

Canada; in addition to assuming the duties of a corporate officer", Bourns said.

Philips Plans Building Dublin Plant

PHILIPS ELECTRICAL INDUSTRIES has announced plans to build a \$2,800,000 plant north of Dublin, Ireland, to manufacture electronic components for export.

Construction, partly financed by a government grant, is scheduled to begin in September. Production is expected to begin about a year following.

Output of the facility will add some \$4½ million annually to Philips exports of electronic components, company says.



Arnold Takes New Sylvania Post

APPOINTMENT of Joseph B. Arnold as manager of the Minuteman program office at the Reconnaissance Systems Laboratories of Sylvania Electric Products Inc., Mountain View, Calif., has been announced.

Prior to this, Arnold was a member of the program office of a special Sylvania-Air Force project.

Telex, Inc., Names Two Executives

M. E. MORROW has been elected chairman of the board of Telex, Inc., Minneapolis, Minn., manufacturer of instruments and equipment for the electronics industry. He is the founder and chief executive of Midwestern Instruments, of Tulsa, Okla., a subsidiary of Telex.

William F. Wells has been ap-

...how to succeed by really trying

You are looking at the fourth largest industrial magazine*... only five years ago it was 7th **electronics**—paid for and read by electronics engineers in research, design, production, management

A McGRAW-HILL PUBLICATION   330 West 42nd Street, New York 36, New York

*in advertising pages: Industrial Marketing's famous annual survey of "Advertising Volume in Business Papers," in its January, 1962 issue, P. 148. Who's ahead? Oil & Gas Journal, Iron Age, Steel. Who's behind? At least 2000 other business papers...

2.24

electronics

January 3, 1962
A McGraw-Hill Publication - 75 Cents

Our Growing Markets

CONSUMER

FEDERAL

INDUSTRIAL

COMPONENTS



NOW'S THE TIME TO GET THE FACTS!

DAYTONA BEACH INDUSTRIAL AREAS

Only 30.6 miles to Project Nova Expansion at Cape Canaveral! Strategically situated

IN FLORIDA'S SPACE AGE "GOLDEN TRIANGLE"

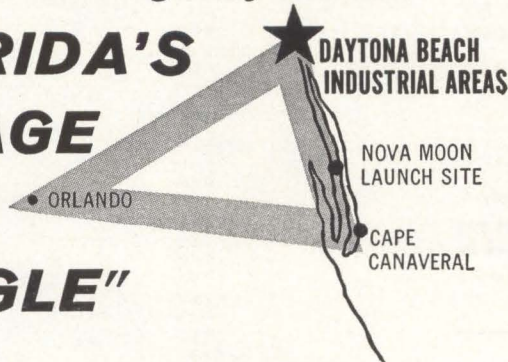

A red-carpet welcome awaits you in the Daytona Beach Industrial Areas! Look at the advantages of locating in this friendly METROPOLITAN AREA:

Ample Manpower—Skilled labor in abundance; favorable wage rates and living conditions.

No Labor Problems—Long record of harmonious management-labor relations. High productivity.

Mild Year-Round Climate—The best of Florida's climate keeps absenteeism at an absolute minimum.

Growing Room—Ample prime industrial sites at low cost; plenty of room for expansion. No crowding. Sensible zoning.

Warm Business Climate—Genuine community interest in industrial development. Full cooperation of local business and government.

Favorable Taxes—No local or state personal or corporate income taxes. No state ad valorem taxes on real or tangible property.

Top Markets—Florida's expanding \$10 billion-plus market... the surging Southeast... nearby Latin America.

Excellent Transportation—Modern highways, airlines, railroads, truck lines, busses, Intracoastal Waterway.

Ample Power, Water, Fuel—Limitless water resources. Electric power capacity to keep ahead of all future requirements. Plenty of natural gas, fuel oil.

THE DAYTONA BEACH AREA COMMITTEE OF 100 pledges its complete cooperation in helping you find a profitable site for plant relocation or branch operation. If financing is a problem, **lease-purchase financing is available.** Direct your inquiry to J. Saxton Lloyd, Chairman, who will hold all such inquiries in his personal file IN THE VERY STRICTEST CONFIDENCE.

DAYTONA BEACH INDUSTRIAL AREAS

Ormond Beach • Holly Hill • Daytona Beach • Daytona Beach Shores
South Daytona • Port Orange



Mr. J. Saxton Lloyd, Chairman
Committee of 100, Daytona Beach Industrial Areas
Dept. E-2, Daytona Beach, Florida
Please send detailed information on the Daytona Beach Industrial Areas.

NAME.....
TITLE.....
COMPANY NAME.....
ADDRESS.....
CITY.....ZONE.....STATE.....

pointed executive vice president of the company. He is also executive v-p for Midwestern Instruments.

Wye Moves Up At Philco Corp.

ROGER E. WYE has been named technical director, programs office at Western Development Laboratories of Philco Corp., Palo Alto, Calif.

Wye is a veteran of 11 years service with Philco, having joined WDL in 1957.

PEOPLE IN BRIEF

Clement G. Maloney promoted to v-p of government operations of Kollsman Instrument Corp. Ivan R. Saddler, ex-RCA, named exec v-p of Microelectron, Inc. Karle S. Packard advances to head of the reliability dept. at Airborne Instruments Lab. Richard M. Whitehorn, formerly with Varian Associates, now chief engineer of the RF Systems div. of Radiation at Stanford. David A. Kahn, previously with Cornell Aero-Lab, named systems associate by Melpar, Inc. Earl D. Gibson leaves ACF Industries Inc. to join Rixon Electronics Inc. as senior staff engineer. Lawrence J. Straw, from Hughes Aircraft to American Electronics, Inc., as a corporate v-p. George Rappaport, former Emerson v-p, elected president and chief exec officer of Warnecke Electron Tubes, Inc. Landis S. Gephart, ex-NASA, joins Lockheed Missiles & Space Co. as director of products assurance for space systems. Texas Instruments Incorporated senior v-p W. F. Joyce heads new TI function designated operations service & control. TI v-p H. J. Wissemann succeeds Joyce as head of the Apparatus div. He is succeeded as mgr. of the Apparatus div. by Ronald Keener. Harold McInnes, previously with Reed Rolled Thread Die Co., appointed operations v-p at Dresser-Electronics/SIE. Thomas F. Keating moves up to production control mgr. of the Electronics div., Baldwin-Lima-Hamilton. Henry Siegel, Computer Instruments Corp. exec, elected chairman of the board.

electronics

WEEKLY QUALIFICATION FORM FOR POSITIONS AVAILABLE

ATTENTION: ENGINEERS, SCIENTISTS, PHYSICISTS

This Qualification Form is designed to help you advance in the electronics industry. It is unique and compact. Designed with the assistance of professional personnel management, it isolates specific experience in electronics and deals only in essential background information.

The advertisers listed here are seeking professional experience. Fill in the Qualification Form below.

STRICTLY CONFIDENTIAL

Your Qualification form will be handled as "Strictly Confidential" by ELECTRONICS. Our processing system is such that your form will be forwarded within 24 hours to the proper executives in the companies you select. You will be contacted at your home by the interested companies.

WHAT TO DO

1. Review the positions in the advertisements.
2. Select those for which you qualify.
3. Notice the key numbers.
4. Circle the corresponding key number below the Qualification Form.
5. Fill out the form completely. Please print clearly.
6. Mail to: D. Hawksby, Classified Advertising Div., ELECTRONICS, Box 12, New York 36, N. Y. (No charge, of course).

COMPANY	SEE PAGE	KEY #
ATOMIC PERSONNEL INC. Philadelphia, Pennsylvania	77	1
COLLINS RADIO COMPANY Dallas, Texas	14	2
DELCO RADIO Div. of General Motors Corp. Kokomo, Indiana	24*	3
DOUGLAS AIRCRAFT CO. Missile and Space Systems Division Santa Monica, California	17	4
ESQUIRE PERSONNEL Chicago 4, Illinois	77	5
INTERNATIONAL BUSINESS MACHINES CORP. Space Guidance Center Owego, New York	77	6
MICROWAVE SERVICES INTERNATIONAL, INC. Denville, New Jersey	94*	7
PAN AMERICAN WORLD AIRWAYS INC. Guided Missiles Range Div. Patrick AFB, Florida	83*	8
RAYTHEON COMPANY Equipment Division Waltham, Massachusetts	59*	9
REPUBLIC AVIATION CORPORATION Farmingdale, L.I., New York	94*	10
SCOPE PROFESSIONAL PLACEMENT CENTER Waltham, Massachusetts	94*	11
SEARCH ASSOCIATES Philadelphia, Penna.	94*	12
SYLVANIA ELECTRONIC SYSTEMS • WEST Mountain View, California	76	13
P 8932	77	14

* These advertisements appeared in the 6/15/62 issue.

(cut here)

electronics WEEKLY QUALIFICATION FORM FOR POSITIONS AVAILABLE

(cut here)

(Please type or print clearly. Necessary for reproduction.)

Personal Background

Education

NAME
HOME ADDRESS
CITY ZONE STATE
HOME TELEPHONE

PROFESSIONAL DEGREE(S)
MAJOR(S)
UNIVERSITY
DATE(S)

FIELDS OF EXPERIENCE (Please Check)

62262

- | | | |
|--|--|---------------------------------------|
| <input type="checkbox"/> Aerospace | <input type="checkbox"/> Fire Control | <input type="checkbox"/> Radar |
| <input type="checkbox"/> Antennas | <input type="checkbox"/> Human Factors | <input type="checkbox"/> Radio-TV |
| <input type="checkbox"/> ASW | <input type="checkbox"/> Infrared | <input type="checkbox"/> Simulators |
| <input type="checkbox"/> Circuits | <input type="checkbox"/> Instrumentation | <input type="checkbox"/> Solid State |
| <input type="checkbox"/> Communications | <input type="checkbox"/> Medicine | <input type="checkbox"/> Telemetry |
| <input type="checkbox"/> Components | <input type="checkbox"/> Microwave | <input type="checkbox"/> Transformers |
| <input type="checkbox"/> Computers | <input type="checkbox"/> Navigation | <input type="checkbox"/> Other |
| <input type="checkbox"/> ECM | <input type="checkbox"/> Operations Research | <input type="checkbox"/> |
| <input type="checkbox"/> Electron Tubes | <input type="checkbox"/> Optics | <input type="checkbox"/> |
| <input type="checkbox"/> Engineering Writing | <input type="checkbox"/> Packaging | <input type="checkbox"/> |

CATEGORY OF SPECIALIZATION

Please indicate number of months experience on proper lines.

	Technical Experience (Months)	Supervisory Experience (Months)
RESEARCH (pure, fundamental, basic)
RESEARCH (Applied)
SYSTEMS (New Concepts)
DEVELOPMENT (Model)
DESIGN (Product)
MANUFACTURING (Product)
FIELD (Service)
SALES (Proposals & Products)

CIRCLE KEY NUMBERS OF ABOVE COMPANIES' POSITIONS THAT INTEREST YOU

1 2 3 4 5 6 7 8 9 10 11 12 13 14 15 16 17 18 19 20 21 22 23 24 25



**Stimulating career opportunities for Reconnaissance Systems Engineers
at Sylvania on the San Francisco Peninsula**

SYLVANIA ELECTRONIC SYSTEMS—WEST

offers a broad spectrum of challenging problems involved in Reconnaissance Systems Engineering including: Feasibility Studies, Operational Analysis, System Synthesis and Performance Analysis, Application and Development of Advanced Techniques, Specification of Constituent Subsystems, Human Factors Engineering and Operations Research. Typical areas in which openings currently exist include the following:

DATA ANALYSIS and SIGNAL PROCESSING. Carry out studies, the objectives of which are the design of new, or the refinement of existing data collection systems. Studies range from the analysis required to develop and define operating requirements compatible with economic and state-of-the-art considerations, through systems conceptual design in block diagram form and including specification of hardware design approach.

STATISTICAL ANALYSIS. Perform various statistical analyses at various levels of sophistication, set up mathematical models of stochastic processes. Fields of particular interest include experimental design, theory of queues, theory of mixtures, allocation of resources, search theory, and general operations research.

INTERCEPT AND DETECTION. Direct or perform reconnaissance systems operational and technical requirements studies; electronic signal environment studies; synthesis of electronic intercept systems from conception to hardware specification and system block diagram; analysis of system performance and of data related to telemetry, communications, radar and others. Direct or prepare reports and proposals and maintain technical contact with customer representatives.

ANTENNA AND PROPAGATION. Perform analyses of electromagnetic propagation aspects of reconnaissance and other systems; analyze direction finding problems and develop direction finding techniques; determine antenna requirements and configuration during synthesis of reconnaissance systems. Activities include report writing, and customer contacts.

These openings exist at all experience levels. Advanced degrees in EE, physics, or mathematics desirable.



*Complete information may be obtained by writing, in confidence to
Roger Harlan*

SYLVANIA ELECTRONIC SYSTEMS • WEST
P. O. Box 188 • Mountain View, California
An Equal Opportunity Employer

EMPLOYMENT OPPORTUNITIES



The advertisements in this section include all employment opportunities—executive, management, technical, selling, office, skilled, manual, etc. Look in the forward section of the magazine for additional Employment Opportunities advertising.

— RATES —

DISPLAYED: The advertising rate is \$40.17 per inch for all advertising appearing on other than a contract basis. Contract rates quoted on request.

An advertising inch is measured $\frac{3}{4}$ " vertically on a column—3 columns—30 inches to a page.

Subject to Agency Commission.

UNDISPLAYED: \$2.70 per line, minimum 3 lines. To figure advance payment count 5 average words as a line.

Box numbers—count as 1 line.

Discount of 10% if full payment is made in advance for 4 consecutive insertions.

Not subject to Agency Commission.

OVERSEAS OPPORTUNITIES EUROPEAN AREA

RADIO ENGINEERS

Minimum 5 years experience in standard and high-frequency broadcasting, emphasis on high power transmitters. Administrative experience desirable.

PROJECT ENGINEER

Electronics experience and BSEE required. Knowledge civil, hydraulics or other engineering helpful.

Travel and housing allowances given. Submit experience and earnings to

P-8932, Electronics

Class. Adv. Div., P.O. Box 12, N.Y. 36, N.Y.



E.E.'s

For professional, individualized fee-paid service write for confidential application.

A national employment agency for the Nuclear & Scientific Fields.

ATOMIC PERSONNEL, INC.

Suite 1207L, 1518 Walnut St., Phila. 2, Pa.

SECTION HEAD

To \$16,000 Per Year

Technical leadership and supervision of instruments section encompassing study, design and development of instrumentation systems, monitoring systems, displays, and calibration systems. 3 years of supervision required. Company assumes all expenses.

ESQUIRE PERSONNEL

202 South State St. Chicago 4, Illinois

POSITION VACANT

Communications Engineer — To supervise technical assistance to schools participating in the Midwest Program on Airborne Television Instruction. Desire graduate Electronic or Electrical Engineer with experience in UHF TV reception or UHF air-ground communications. Send resume and salary requirements to DeW. Schatzel, Director of Engineering, MPATI, Memorial Center, Purdue University, Lafayette, Indiana.



MANUFACTURERS' REPRESENTATIVES

IN THE ELECTRONIC INDUSTRY

SAMUEL K. MACDONALD, INC.

manufacturers representatives over 25 years
1531 SPRUCE STREET, PHILA. 2, PA.

Territory:
Pennsylvania • New Jersey
Delaware • Maryland
Virginia • West Virginia
District of Columbia

Other Offices:
Pittsburgh
Baltimore
Washington, D.C.

Peel back the sky

IBM Space Guidance Center

IBM engineers and scientists are helping to map the heavens by developing a digital data processor and memory for the NASA Orbiting Astronomical Observatory (OAO).

The memory, largest of its type for space application, will collect observations free of the earth's atmospheric distortion. As the vehicle orbits at 18,000 miles/hr., the data processor will tell the OAO's sensitive telescope where and when to look, check for occulted and malfunctioning star trackers, start and stop each experiment. Over 200,000 bits of information, stored in the satellite's random-access memory, can be telemetered to the ground in 7.5 seconds. In designing the memory and processor, a redundancy technique provided a system far more reliable than conventional designs.

Other projects include: guidance and control systems for manned aircraft, satellites, spacecraft, submarines, and other vehicles. Engineers and scientists are invited to inquire about openings in . . . reliability statistics; logic design; circuit design; programming; quality engineering; control systems engineering; solid-state physics (radiation effects studies); mechanical engineering (heat transfer/stress analysis). IBM is an Equal Opportunity Employer. Please write, outlining your background and interests: Fred Guth, Dept. 554S4, IBM Space Guidance Center, Owego, New York.

IBM

SEARCHLIGHT SECTION

(Classified Advertising)

BUSINESS OPPORTUNITIES

EQUIPMENT - USED or RESALE

DISPLAYED RATE

The advertising rate is \$27.25 per inch for all advertising appearing on other than a contract basis. Contract rates quoted on request. AN ADVERTISING INCH is measured $\frac{1}{8}$ inch vertically on one column, 3 columns—30 inches—to a page. EQUIPMENT WANTED or FOR SALE ADVERTISEMENTS acceptable only in Displayed Style.

UNDISPLAYED RATE

\$2.70 a line, minimum 3 lines. To figure advance payment count 5 average words as a line.

PROPOSALS, \$2.70 a line an insertion. BOX NUMBERS count as one line additional in undisplayed ads.

DISCOUNT OF 10% if full payment is made in advance for four consecutive insertions of undisplayed ads (not including proposals).

OUR BUSINESS IS CUTTING



Manufacturers of small electrical or mechanical units, however intricate, with high labor content will find our cost-cutting services interesting.

Our complete overseas facilities in Japan, Hong Kong, etc., provide unlimited services by skilled workers, under trained supervision, for the manufacture of complete units or sub-assemblies to your most rigid specifications. All transactions held in strictest confidence.

Submit sample or blueprint for firm quotation. Get the facts about our cost-cutting services — save dollars and build profits!

OVER 25 YEARS EXPERIENCE IN ELECTRONICS

INTERCONTINENTAL INDUSTRIES, INC.
555 W. Adams Street Chicago 6, Illinois
Established 1938

CIRCLE 460 ON READER SERVICE CARD FOR RESEARCH — DEVELOPMENT & EXPERIMENTAL WORK

Over 10,000 different electronic parts: waveguide, radar components and parts, test sets, pulsers, antennas, pulse xmfrs, magnetrons, IF and pulse amplifiers, dynamotors, 400 cycle xmfrs, 584 ant. pedestals, etc.

PRICES AT A FRACTION OF ORIGINAL COST!

COMMUNICATIONS EQUIP CO.

343 CANAL ST., N. Y. 13, WO 6-4045
CHAS. ROSEN (Formerly at 131 Liberty St.)

CIRCLE 461 ON READER SERVICE CARD

WEAK IN MATH?

Don't let inadequacy in mathematics hold you back. Now you can learn the basic math you must know to succeed as a technical man. Learn through Grantham Schools' unusual home study math course for technicians, engineers, and mechanics. Write for details today.

Write to : Dept. 2E.
GRANTHAM SCHOOLS, INC.
1505 N. Western Ave. Los Angeles 27, Calif.

CIRCLE 462 ON READER SERVICE CARD

LOOKING FOR USED/SURPLUS ELECTRONIC EQUIPMENT/COMPONENTS?

For an up-to-date listing of such equipment See Searchlight Section of June 8th.



How to grow a beard...

Sit back and wait for your copy on that routing list. Okay if you like beards. Otherwise, look in this issue for the Reader Service Card. Fill in the "for subscriptions" section. Mail. Only 7½ cents a week.

electronics A McGraw-Hill Publication, 330 West 42nd St., N. Y. 36

electronics

Editorial Opportunity

IT DOESN'T HAPPEN OFTEN, but **electronics**, "bible of the industry" and a McGraw-Hill publication, has an opening for an Assistant Editor.

Ideally, the man we are looking for and to whom a post on our New York staff could be a long-term challenge, would have an electrical engineering degree or technical equivalent, practical experience in our field and a demonstrated aptitude for editing, writing, reporting. He probably lives somewhere in the metropolitan area and therefore would have no relocation problem.

Write The Editor, **electronics**, 330 W. 42nd St., New York 36, stating experience, aspirations and past earnings. Mark the envelope "Confidential" and it will be kept that way.

INDEX TO ADVERTISERS



Audited Paid Circulation

• AMP Incorporated	15
• Airpax Electronics, Inc.	29
Airtronics International Corp.	61
Atlas Precision Products Co.	54
• Boonton Radio Corp.	55
Cannon Electric Co.	30, 31
• Collins Radio Co.	14
Daytona Beach Industrial Areas.....	74
Delco Radio	58, 59
Douglas Aircraft Co., Missile and Space Systems Div.	17
Dymec, A Division of Hewlett Packard Co.	6
• FXR, A Div. of Amphenol-Borg Electronics Corp.	22, 23
• Fairchild Semiconductor Corp.	3rd Cover
Ford Instrument Co., Div. of Sperry Rand Corp.	79
Garfield Co., Inc., Oliver	80
General Electric Co., Semiconductor Products Dept.	51
Globe Industries Inc.	20
Heinemann Electric Co.	32
Hexacon Electric Co.	20
International Telephone and Telegraph Corp., Kellogg Division.....	67
• Japan Piezo Electric Co., Ltd.	66
Jerrold Electronics Corp.	4
Kollmorgen Corp.	57
• Lapp Insulator Co., Inc.	71
• Machlett Laboratories, Inc.	27
Magnetic Metals Company.....	65
Motorola, Military Electronics Div....	21
• North Atlantic Industries, Inc.	70
Pamotor Inc.	20
• Radio Corporation of America	4th Cover
• Raytheon Company	13
• Rixon Electronics, Inc.	68

Sprague Electric Co.	9, 28
Standard Telephones and Cables Ltd..	53
Telrex Laboratories	80
• Texas Instruments Incorporated Metals & Controls Division	69
Texas Instruments Incorporated	10
Transistor Products Division	11
• United Transformer Corp.	2nd Cover
• Utica Tool Division, Kelsey-Hayes Co.	62
• Vitramon, Inc.	5
• Vitro Electronics	63
Wheaton Engineering Div., Hurlertron, Inc.	68

MANUFACTURERS' REPRESENTATIVES

MacDonald, Inc., Samuel K.	77
---------------------------------	----

CLASSIFIED ADVERTISING

F. J. Eberle, Business Mgr.	
EMPLOYMENT OPPORTUNITIES	76, 77
SPECIAL SERVICES	78
EDUCATIONAL	78
EQUIPMENT (Used or Surplus New) For Sale	78

INDEX TO CLASSIFIED ADVERTISERS

Atomic Personnel Inc.	77
• Communications Equipment Co.	78
Esquire Personnel	77
Grantham Schools Inc.	78
Intercontinental Industries Inc.	78
International Business Machines.....	77
Sylvania Electronics Systems • West..	76

• See advertisement in the July 20, 1961 issue of Electronics Buyers' Guide for complete line of products or services.

This Index and our Reader Service Numbers are published as a service. Every precaution is taken to make them accurate, but **ELECTRONICS** assumes no responsibilities for errors or omissions.

How to develop 0.01% accuracy

in a
size 23 resolver



First develop a size 23 resolver for naval fire control computers. Next develop one for the B-58's navigational system. Then combine the best features of both, add a couple of new ideas, and produce the Size 23, 0.01% Resolver. That's what Ford Instrument did. With the result that this new resolver has a maximum variation of transformation ratio (with input voltage from 0.3 to 6 volts) that is only 0.02% of 6 volts. Far as we know, this is the most accurate resolver made today. Most durable and trouble-free. Priced right, too. Conforms to Mil-E 5272A. Specify this resolver for application in analog computers, automatic control systems, and data transmission systems for coordinate conversion, precision phase shifting, and similar operations. Bulletin 23TR-61-1 gives full specifications. It's yours for the asking. Write:

2.2

FORD INSTRUMENT CO.
DIVISION OF SPERRY RAND CORPORATION
31-10 Thomson Ave., Long Island City 1, N.Y.

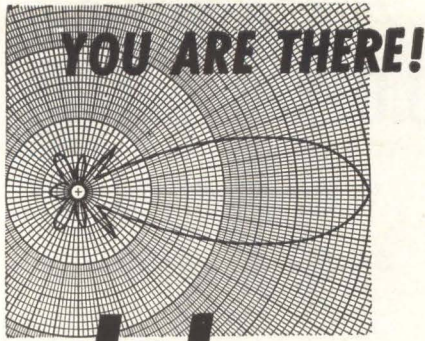

with **telrex**

"BEAMED-POWER" ANTENNAS

NOW MAILING! PL88 — technical data, pricing bulletin describing Advanced-design commercial and citizen-band base-station antennas and accessories. Includes Tower, Rotator, "Baluns," Mast and Transmission line data, plus nice-to-have-around "info." Request your copy, today; no obligation.

WORLD RENOWNED AND RESPECTED PERFORMANCE — 6 to 1500 MC.



ASBURY PARK 25, NEW JERSEY, U.S.A.
CIRCLE 203 ON READER SERVICE CARD

How to File a Card in ... 25 Places at Once

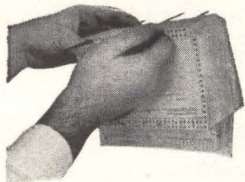

For the busy scientist, engineer, teacher, business man or student who has to keep basic information on file for use in a variety of categories, the Geniac PMU (Portable Memory Unit) is specifically designed.

Information retrieval systems for personal use or small card files (from 1000-10,000) with abstracts, original articles or information are usually cumbersome, expensive and out of the question for small budgets. But our PMU is a low cost information retrieval system that is as fast or faster than much more expensive units.

Low initial cost, only \$19.95 for the basic kit with two hundred cards, notcher, sorting rods, and coding instructions, **low maintenance** with new cards costing \$4.00 per 100 or \$30.00 per 1000, are combined with ready access to thousands of categories. No electrical vibrators or mechanical shakers are needed. No parts to go out of operation. Sorting is by rod and is remarkably rapid.

Sorting rates are conservatively 400 per minute and this is for simultaneous sorting of at least 25 categories, using extra rods.

Information is coded into the cards by notching prepunched holes around the edge of the card. The user need have no previous knowledge of coding and may choose as many categories as is necessary.

To use you prepare an abstract on the card or actually paste on small articles, microprints, etc. Once coded the card is filed at random and will automatically appear during sorts for the categories it contains. The possibilities of the PMU information retrieval system are unlimited and enable the small to medium size information file to compete in flexibility with extremely expensive electronic sorting devices. It serves as a useful adjunct to company integrated information systems.

The Geniac Portable Memory Unit and information retrieval system is a quality products design for long use. The basic PMU contains a notching hand punch, sorting rods, 200 cards and is only \$19.95. Add 60¢ postage and handling in the United States, \$1.60 abroad. In NYC add 3% City Sales Tax. Additional cards are \$4.00/100, \$30.00/1,000. Filing Cabinet \$8.00.

Send check or money order to Dept. E-62D or telephone OR-4-3720

OLIVER GARFIELD CO., INC.

17 St Marks Place New York 3, N. Y.

electronics



Audit Bureau
of Circulations

Associated Business
Publications

Audited Paid Circulation

JAMES T. HAUPTLI

Advertising Sales Manager

R. S. QUINT:
Assistant Publisher Buyers'
Guide and Business Manager
FRED STEWART:
Promotion Manager
B. ANELLO:
Market Services Manager

RICHARD J. TOMLINSON:
Production Manager
GEORGE E. POMEROY:
Classified Manager
HUGH J. QUINN:
Circulation Manager

ADVERTISING REPRESENTATIVES

NEW YORK (36):
Donald H. Miller, Henry M. Shaw,
George F. Werner
500 Fifth Avenue, LO-4-3000
(area code 212)

BOSTON (16):
William S. Hodgkinson, Donald R. Furth
McGraw-Hill Building, Copley Square,
Congress 2-1160 (area code 617)

PHILADELPHIA (3):
Warren H. Gardner, William J. Boyle
6 Penn Center Plaza, LOcust 8-4330
(area code 215)

CHICAGO (11):
Harvey W. Wernecke, Robert M. Denmead
645 North Michigan Avenue, Mohawk 4-5800
(area code 312)

CLEVELAND (13):
Paul T. Fegley
55 Public Square, Superior 1-7000
(area code 216)

SAN FRANCISCO (11):
R. C. Alcorn
255 California Street, Douglas 2-4600
(area code 415)

LOS ANGELES (17):
Peter S. Carberry, Ashley P. Hartman
1125 W. 6th St., Huntley 2-5450
(area code 213)

DENVER (2):
J. W. Patten
Tower Bldg., 1700 Broadway,
Alpine 5-2981 (area code 303)

ATLANTA (9):
Michael H. Miller, Robert C. Johnson
1375 Peachtree St. N.E., Trinity 5-0523
(area code 404)

HOUSTON (25):
Joseph C. Page, Jr.
Prudential Bldg., Holcomb Blvd.,
Riverside 8-1280 (area code 713)

DALLAS (1):
Frank Le Beau
The Vaughn Bldg., 1712 Commerce St.
Riverside 7-9721 (area code 214)

LONDON W1:
Edwin S. Murphy Jr.
34 Dover St.

FRANKFURT/Main:
Matthé Herfurth
85 Westendstrasse

GENEVA:
Michael R. Zeynel
2 Place du Port

"Headquarters for Business Information"

McGraw-Hill Technical and Business Publications

American Machinist/Metal-
working Manufacturing
Aviation Week and Space
Technology
Business Week
Chemical Engineering
Chemical Week
Coal Age
Construction Methods and
Equipment
Construction Daily
Control Engineering
Electrical Construction
and Maintenance
Electrical Merchandising Week
Electrical Newsletter
Electrical West

Electrical Wholesaling
Electrical World
Electronics
Engineering Digest
Engineering and Mining Journal
E & MJ Metal and Mineral
Markets
Engineering News-Record
Factory
Fleet Owner
Industrial Distribution
National Petroleum News
Nucleonics
Nucleonics Week
Platt's Oilgram News
Platt's Oilgram Price Service
Power

Product Engineering
Purchasing Week
Science Week
Textile World

Overseas only:
Automobile International
(English, Spanish)
Ingenieria Internacional
Construccion (Spanish)
International Management
(English, Spanish
Portuguese editions)
Metalworking Production
(Great Britain)

Available by subscription only — to qualified persons actively engaged in the field of the publication. For subscription rates and information describing the editorial coverage of any of the above publications, write to: *Subscription Manager, Circulation Department, McGraw-Hill Publishing Company, 330 West 42nd Street, New York 36, N. Y.*

DUAL TRANSISTORS

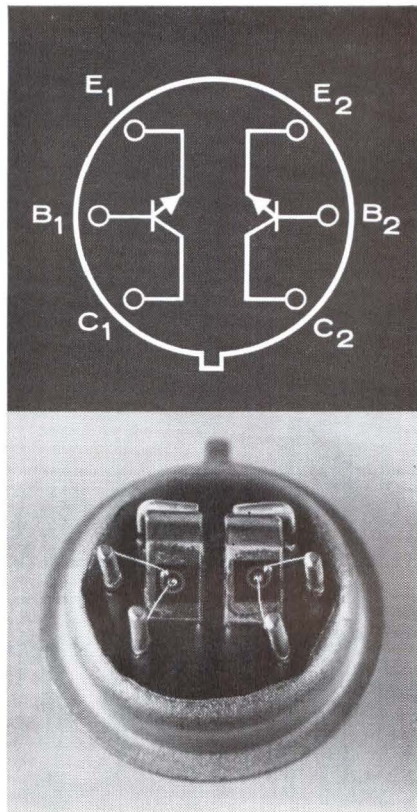

IN A SINGLE TO-5 PACKAGE

- All leads isolated
- Improved thermal tracking
- Less board space
- A wide range of Fairchild Silicon Planar or Silicon Planar Epitaxial transistors
- Fairchild Planar reliability

FAIRCHILD TRANSISTORS AVAILABLE IN DUALS

Similar Types	Dual	Similar Types	Dual	Similar Types	Dual
2N708	SP8300	2N916	SP8306	2N2297	SP8312
2N709	SP8301	2N995	SP8307	2N2368	SP8313
2N910	SP8302	2N1132	SP8308	2N2369	SP8314
2N911	SP8303	2N1613	SP8309		
2N914	SP8304	2N1711	SP8310		
2N915	SP8305	2N1893	SP8311		

MATCHED AMPLIFIER TYPES AVAILABLE

2N2060†	2N2223†	2N2223A†	SP8305A (2N915)*	SP8306A (2N916)*
---------	---------	----------	------------------	------------------

*Matched Beta within 10% at $I_c = 1$ mA, and $V_{CE} = 5$ V; $V_{BE1} - V_{BE2}$ (absolute values) ≤ 0.005 V.

†See data sheets for matching specifications.

**For complete information,
check your Fairchild Sales Representative.**

FAIRCHILD
SEMICONDUCTOR

545 WHISMAN ROAD, MOUNTAIN VIEW, CALIF. • YORKSHIRE 8-8161 • TWX: MN VW CAL 853
A DIVISION OF FAIRCHILD CAMERA AND INSTRUMENT CORPORATION

CIRCLE 901 INSIDE BACK COVER

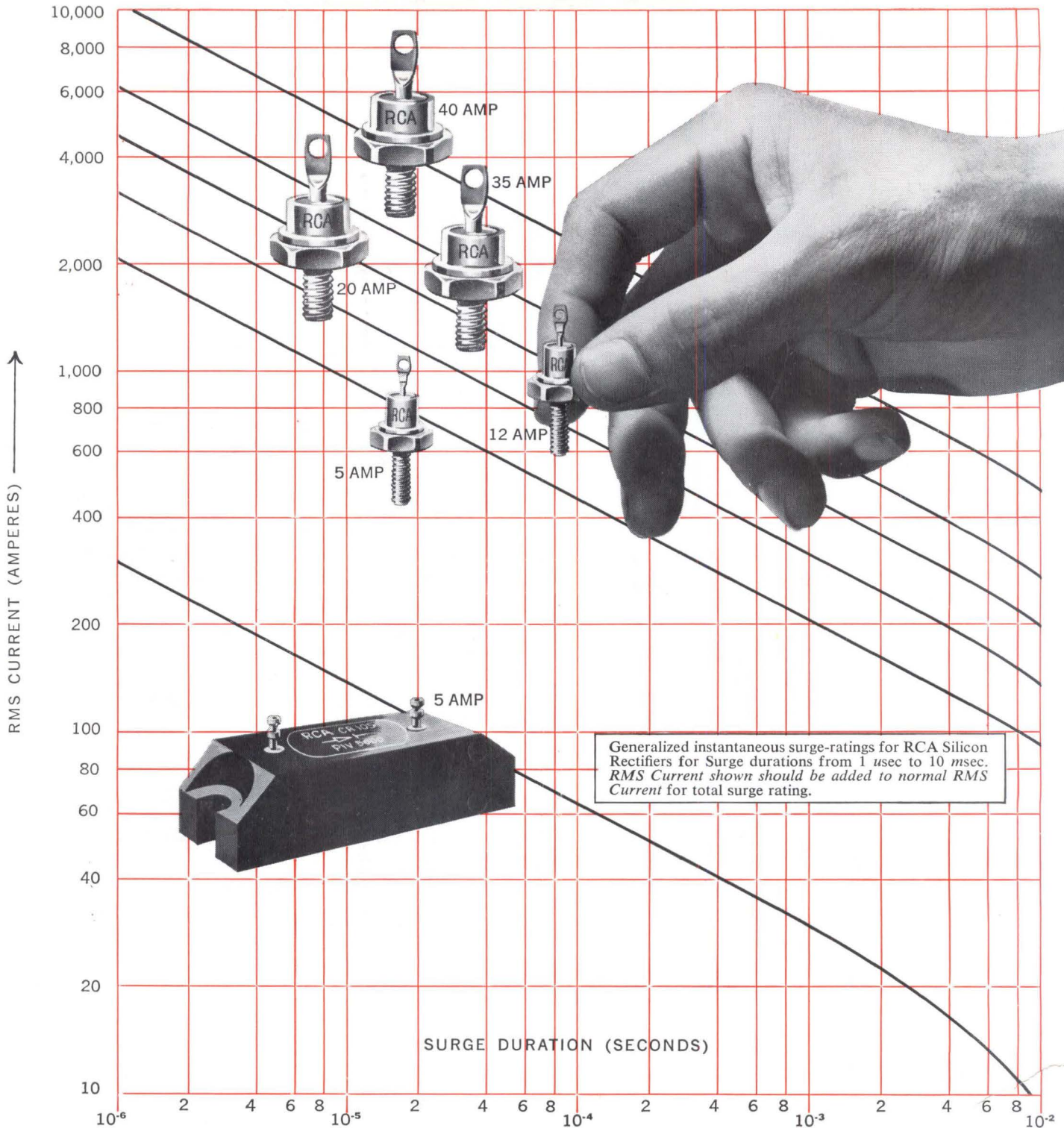

Here's New Assurance of Extra Performance... in Every RCA Silicon Rectifier You Specify

Now you can design rectifier circuits with much greater assurance with RCA Silicon Diffused-Junction Rectifiers, because you have *complete* surge information. Check the surge value for the conditions you must meet and you'll find the right RCA rectifier for the job.

RCA Silicon Rectifiers can withstand temporary current overloads hundreds of times higher than average current rating.

Here are some of the features of RCA Silicon Rectifiers that make this quality possible:

- Diffused Junction Process...extremely tight characteristics limits

- Each package designed to meet the stringent environmental and mechanical requirements of today's military and industrial power equipment
- Extra-high-strength zirconium-alloy mounting stud
- Unique internal heat sink assures union of pellet and contact to eliminate high-current hot spots
- Thermal fatigue cycling tests — the best

- assurance for long and dependable service
- Every unit is dynamically tested prior to shipment

Call your RCA Representative for complete information. For your copy of the RCA Application Note, SMA-4, write to RCA Semiconductor and Materials Division, Commercial Engineering, Section IN6-4, Somerville, N. J.

AVAILABLE THROUGH YOUR RCA DISTRIBUTOR



THE MOST TRUSTED NAME IN ELECTRONICS

CIRCLE 902 READERS SERVICE CARD