

electronics®

LASER VS MISSILES

*What problems
lie ahead? p 20*

ANALOG CONVERTERS

*Give nanosecond
resolution, p 55*

HIGHLY STABLE 400-CPS SOURCE

*Uses magnetic
multiplier, p 58*



SPECIAL Latest innovations in CONSUMER ELECTRONICS

R D SKINNER
1020 COVINGTON RD
LOS ALTOS CALIF
C 3
L

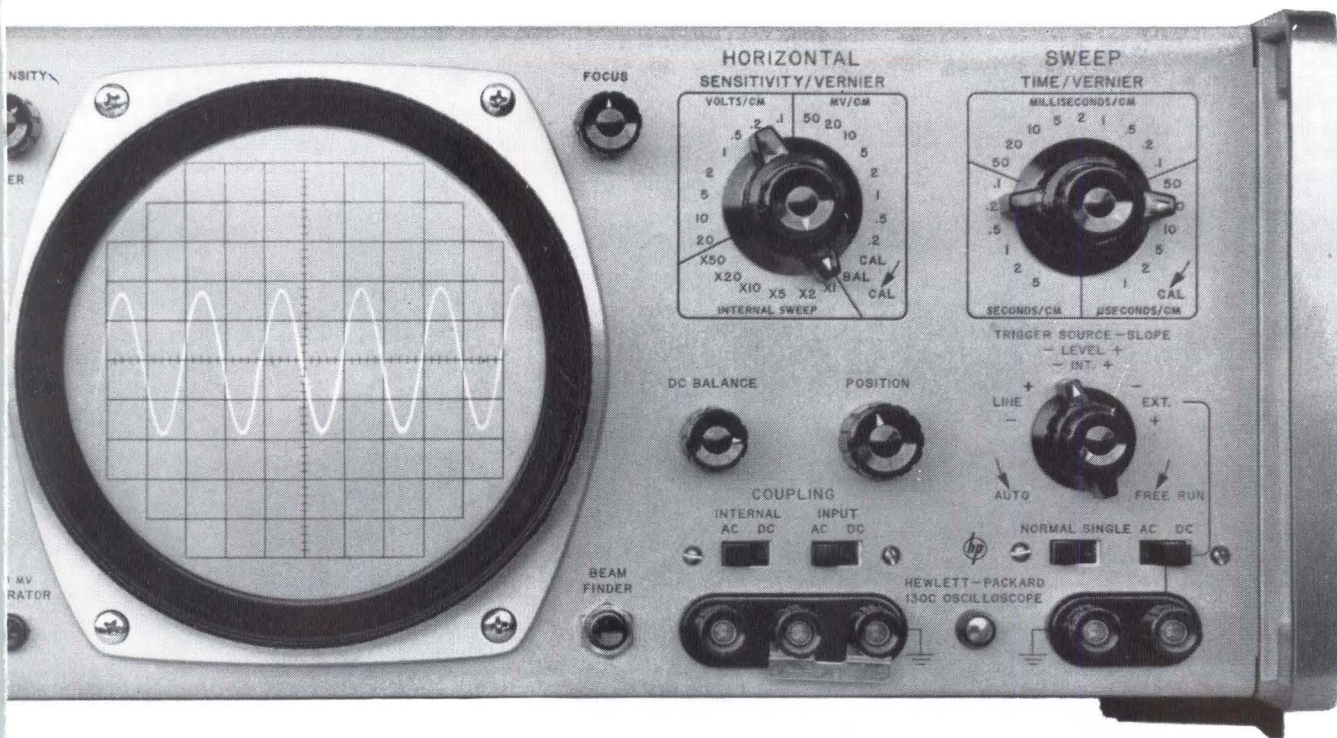

SPECIFICATIONS SWEEP GENERATOR

- Internal Sweep:** 21 ranges, 1 $\mu\text{sec/cm}$ to 5 sec/cm, accuracy within $\pm 3\%$. Vernier extends slowest sweep to at least 12.5 sec/cm
- Magnification:** X2, X5, X10, X20, X50, accuracy within $\pm 5\%$ of sweep rates not exceeding a maximum rate of 0.2 $\mu\text{sec/cm}$
- Automatic Triggering:** Base line displayed in the absence of input signal. Internal, 10 cps to 500 KC signal causing 0.5 cm or more vertical deflection; also from line voltage. External, 20 cps to 500 KC, < 0.5 v p-p. Trigger point and slope, zero crossing, positive or negative slope
- Trigger Point Selection:** From +10 volts to -10 volts, positive or negative slope of external signal or internally from any point of the vertical waveform presented on screen. Internal, 0.5 cm or more vertical deflection. External, dc or ac coupled 15 volts p-p or more
- Single Sweep:** Front panel switch

VERTICAL & HORIZONTAL AMPLIFIERS

- Bandwidth:** DC Coupled: dc to 500 KC
AC Coupled (at input): 10 cps to 500 KC
AC Coupled (in amplifiers for trace stabilization): 25 cps to 500 KC at 0.2 mv/cm sensitivity. Lower cut-off is reduced proportional to sensitivity down to 20 mv/cm where it is 0.25 cps
- Sensitivity:** 0.2 mv/cm to 20 v/cm. 16 ranges in 1, 2, 5, 10 sequence. Attenuator accuracy, $\pm 3\%$. Vernier extends minimum sensitivity to 50 v/cm
- Internal Calibrator:** Approximately 350 cps square wave, 5 mv $\pm 3\%$
- Input Impedance:** 1 megohm shunted by 45 pf, constant on all sensitivity ranges
- Balanced Input:** Available on all sensitivity ranges
- Phase Shift:** Within $\pm 1^\circ$ relative phase shift to 100 KC

GENERAL

- External Calibrator:** Approx. 350 cps, 500 mv $\pm 2\%$, front panel input
- Cathode Ray Tube:** 10 x 10 cm internal graticule type, P31 phosphor standard, P-2, P-7 and P-11 available, same cost
- Intensity Modulation:** Terminals on rear; +20 volt pulse blanks CRT at normal intensity
- Power:** 115/230 volts $\pm 10\%$. 50 to 1,000 cps approx. 90 watts
- Size:** 16 $\frac{3}{4}$ " wide, 7 $\frac{1}{2}$ " high, 16 $\frac{3}{8}$ " deep; brackets furnished for quick conversion to 7" x 19" rack mount. 32 lbs.
- Price:** \$695.00

Price f.o.b. factory. Data subject to change without notice.

**HEWLETT
PACKARD
COMPANY**

1501 Page Mill Road, Palo Alto, California, Area Code 415, DA 6-7000
Sales and service representatives in all principal areas; Europe,
Hewlett-Packard S.A., 54-54bis Route des Acacias, Geneva; Canada,
Hewlett-Packard (Canada) Ltd., 8270 Mayrand Street, Montreal



8008

CIRCLE 900 ON READER SERVICE CARD

200 $\mu\text{V}/\text{cm}$ sensitivity
500 KC bandwidth
Identical X & Y amplifiers
X2 to X50 magnification
No-parallax, no-glare CRT
Automatic triggering, beam finder
One instrument for rack and bench

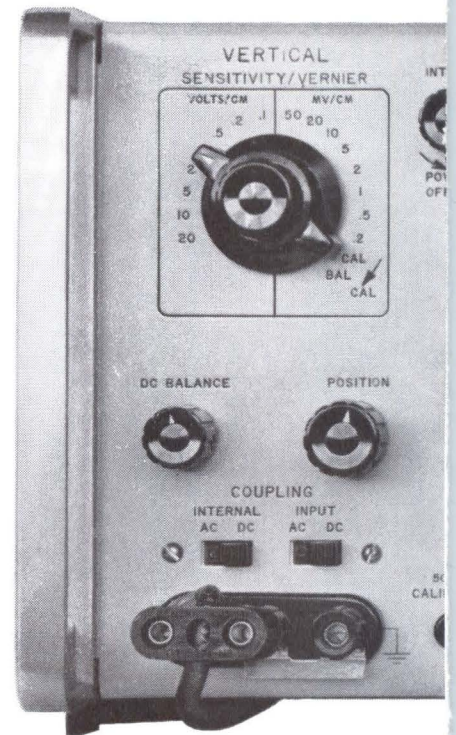

MEASURE

low-level signals directly
with the new hp
130C 500 KC Oscilloscope!

With the new  130C Oscilloscope you get a full 10 x 10 cm picture of low-level signals without external preamplification. The 130C is ideal for viewing output from low-level transducers, strain gauges, small signals in solid state devices, detected RF, medical, physical phenomena, phase shift, and X-Y plots.

Identical horizontal and vertical amplifiers have 200 $\mu\text{V}/\text{cm}$ sensitivity and 500 KC passbands, with balanced input for rejection of common mode signals. Near identical phase characteristics of the amplifiers (less than 1° up to 100 KC) permit highly accurate phase measurements.

Automatic, versatile sweep circuitry makes the 130C fast and easy for even inexperienced personnel to use. Automatic triggering eliminates complicated trigger adjustments. The push button beam finder brings the trace onto

the screen regardless of control settings. To further aid in locating the trace, a base line automatically appears on the CRT in the absence of an input signal. The automatic feature may be locked out, and a front panel control set to select trigger level and slope for special applications. A single sweep switch allows viewing of transients.

The 130C is equipped with the  internal graticule CRT that eliminates viewing and photographic parallax error. An etched safety glass faceplate cuts glare making the scope easy to read in high ambient light. Easy access modular construction allows both rack mounting and bench use.

The specifications tell the detailed story. Check them out... and then call your Hewlett-Packard representative for a demonstration on your own bench.

Measure Low-Level Signals Directly

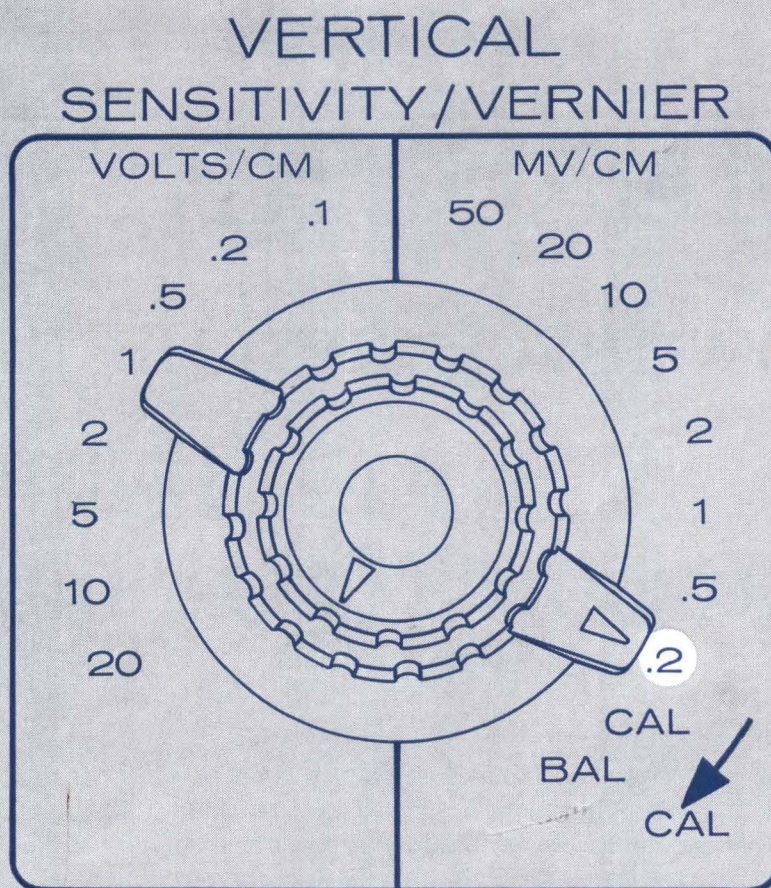

200 $\mu\text{v/cm}$ sensitivity... 500 KC

New *hp* 130C Oscilloscope



electronics

A McGraw-Hill Weekly 75 Cents

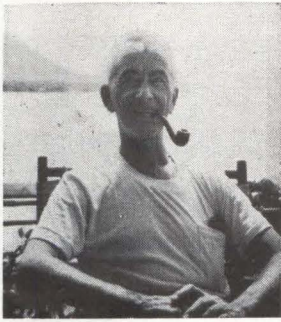

W. W. MacDONALD, Editor

J. M. CARROLL, Managing Editor

SENIOR EDITORS

Samuel Weber, George W. Sideris

SENIOR ASSOCIATE EDITORS

Michael F. Wolff, John F. Mason

ASSOCIATE EDITORS

Michael F. Tomaino, William P. O'Brien, Sy Vogel, Leslie Solomon, George J. Flynn, Laurence D. Shergalis, George V. Novotny, Leon H. Dulberger

ASSISTANT EDITORS

Stanley Froud, Stephen B. Gray, Roy J. Bruun, Barry A. Briskman, Dan Smith, Joel A. Strasser

REGIONAL EDITORS

Harold C. Hood (Pacific Coast, Los Angeles), Thomas Maguire (New England, Boston), Cletus M. Wiley (Midwest, Chicago)

ART DIRECTOR

Howard R. Berry

ASSISTANT ART DIRECTOR

John C. Wright, Jr

EDITORIAL ASSISTANTS

Lorraine Rossi, Virginia T. Bastian, Lynn Emery, Ann Mella, Lorraine Werner, Alice M. O'Brien, Sharon Parks, Patricia Mitchell, Claire Benell

FOREIGN NEWS BUREAU

DIRECTOR, John Wilhelm;
Alyne Elias, Charles Oberance

LONDON—John Shinn, Derek Barlow, Nicholas Landon

BONN—Bruce Bendow,
Richard Mikton, Silke McQueen

BRUSSELS—Peter Forbath

PARIS—Robert Farrell,
Arthur Erikson

MILAN—Marc A. Messina

MEXICO CITY—Wesley Perry, Jr

RIO DE JANEIRO—Leslie Warren

MOSCOW—Stewart Ramsey

TOKYO—Richard Halloran,
Charles Cohen, John Yamaguchi

CIRCULATION MANAGER

Hugh J. Quinn

W. W. GAREY, Publisher

BANK OF MIRRORS lining darkroom helps in final adjustment of RCA color television receiver. *Color tv will be a pace setter among new consumer products. See p 49* **COVER**

ANTI-ICBM LASERS: Can They Be Developed? Yes, say laser experts, but it will require the solution of many thorny engineering problems. *Solar-pumped systems operating in spacecraft are feasible* **20**

3-D BATTLEFIELD RADAR Uses V-Beam Antenna. Two feed horns produce vertical and slant beams. *This air defense radar for the Marines gives altitude, azimuth and range information directly* **24**

TWO MORE LASER ADVANCES. Nonlinear effects now make possible conversion of a laser beam to any frequency and light amplification. *Another team of physicists reports on a low-current technique for energizing superconducting magnets* **30**

MICROCIRCUITS GO ALOFT. Integrated circuits will soon be operational in Navy's airborne systems. *In June or July, they'll be introduced into airborne digital computers* **37**

TV TEST Uses Two Colors. Mexican system puts color picture tube in black-and-white set. *Inventor thinks a low-cost system like this will open up the Latin American market* **42**

JAPANESE EXPORTS Keep Climbing. Another gain of 16 percent in electronics exports is expected in 1963. *Production is also rising; an increase of 171 percent is planned by 1967* **45**

SPECIAL—CONSUMER ELECTRONICS: First of a Series. New home-entertainment developments include small-screen transistor tv sets, build-it-yourself electric organs, stereo tape recorders and f-m multiplex receivers. *This may be the first really big year for color tv.* By S. B. Gray **49**

ANALOG-TO-DIGITAL CONVERSION: New Method Provides Nanosecond Resolution. Parallel sampling at predetermined levels and time intervals requires a bank of eight circuits. *Sampling circuit outputs are fed to fast tunnel-diode switching circuits.* By A. A. Fleischer and E. Johnson, Edgerton, Germeshausen and Grier, Inc. **55**

MAGNETIC FREQUENCY SEPTUPLER Gives Stable Output Voltage. A master of magnetic-amplifier design tells how to run 400-cps equipment from a 60-cps line using only this static frequency multiplier. *Square-wave output voltage is stable against large variations in three-phase supply.* By W. A. Geyger, U. S. Naval Ordnance Lab **58**

Published weekly, with Electronics Buyers' Guide as part of the subscription, by McGraw-Hill Publishing Company, Inc. Founder: James H. McGraw (1860-1948).

Title ® registered U.S. Patent Office; © copyright 1963 by McGraw-Hill Publishing Co., Inc. All rights reserved, including the right to reproduce the contents of this publication, in whole or in part.

Executive, editorial, circulation and advertising offices: McGraw-Hill Building, 330 West 42nd Street, New York 36, N. Y. Telephone Longacre 4-3000. Teletype TWX N.Y. 212-640-4646. Cable McGrawhill, N. Y. PRINTED IN ALBANY, N. Y.; second class postage paid at Albany, N. Y.

OFFICERS OF THE PUBLICATIONS DIVISION: Shelton Fisher, President; Vice Presidents: Joseph H. Allen, Operations; John R. Callahan, Editorial; Ervin E. DeGraff, Circulation; Donald C. McGraw, Jr., Advertising Sales; Angelo R. Venezian, Marketing.

OFFICERS OF THE CORPORATION: Donald C. McGraw, President; Hugh J. Kelly, Harry L. Waddell, Executive Vice Presidents; L. Keith Goodrich, Executive Vice President and Treasurer; John J. Cooke, Vice President and Secretary.

Subscriptions are solicited only from those actively engaged in the field of the publication. Position and company connection must be indicated on orders. Subscription rates: United States and Possessions, \$6.00 one year, \$9.00 two years, \$12.00 three years. Canada: \$10.00 one year. All other countries \$20.00 one year. Single copies, United States and Possessions and Canada 75¢. Single copies all other countries \$1.50.

THE PUBLISHER, UPON WRITTEN REQUEST FROM ANY SUBSCRIBER TO OUR NEW YORK OFFICE AGREES TO REFUND THAT PART OF THE SUBSCRIPTION PRICE APPLYING TO COPIES NOT YET MAILED.

Subscribers: Please send change of address notices, subscription orders or complaints to Fulfillment Manager, Electronics, at the address below. Change of address notices should provide old as well as new address, including postal zone number if any. If possible, attach address label from recent issue. Allow one month for change to become effective.

Postmaster: Please send Form 3579 to Fulfillment Manager, Electronics, P. O. Box 430, Hightstown, New Jersey.



Audited Paid Circulation

CONTENTS continued

PULSE MODULATION Using Three New Approaches. These three different modulators can control high power traveling-wave tubes, some of which put out 10 Kw or more. *One modulator uses four-layer diodes, another diodes and transistors while the third uses vacuum tubes and semiconductors.* By E. H. Heckman, Westinghouse Electric 62

D-C LEVEL SHIFTER Affords High Precision, Reduces Output Impedance. The output signal appears at a lower impedance and shifted in d-c voltage level by a predetermined amount. *Zener diodes in balanced bridge circuits give high linearity and low drift.* By J. Willis, Southern Instruments, Ltd., England 65

DEPARTMENTS

| | |
|--|-----|
| Crosstalk. <i>Equal Pay for Women</i> | 3 |
| Comment. <i>Dynamic Null. Government Patent Policy</i> | 4 |
| Electronics Newsletter. <i>Space Command Post Sought by Air Force. ELECTRONICS Transmits Color Cover Photo by Facsimile and Relay Satellite</i> | 7 |
| Washington This Week. <i>Pentagon Changing Policy on Proprietary Data</i> | 12 |
| Meetings Ahead. <i>Canadian Electronics Conference. National Electronics Conference. North East Electronics Research and Engineering Meeting</i> | 46 |
| Research and Development. <i>Optical Computers Approach Reality</i> | 72 |
| Components and Materials. <i>Compatible Techniques for Integrated Circuits</i> | 82 |
| Production Techniques. <i>Notation Language Speeds Production Changes</i> | 92 |
| New Products. <i>Aging Correction Stabilizes Frequency</i> | 102 |
| Literature of the Week. | 120 |
| People and Plants. <i>H-P to Build \$2-Million Plant</i> | 122 |
| Index to Advertisers | 132 |

Equal Pay for Women

CONGRESS is again considering legislation to require employers to pay women wages equal to men if they do equal work. Whether HR 3861 or S 910 or some combination of the two is adopted is of great concern to the electronics industry. We depend heavily on women to staff our production lines.

Of course we favor equal pay for equal work, just as we oppose sin and defend motherhood. But does everything have to be written into law and draped with red tape? Laws that tell an employer how to treat his employees should be adopted only when flagrant and socially unacceptable abuses need correction, as was the case with child labor.

We defy any lawyer to draft a formula that will tell an employer when his male and female employees are of equal value to him. Men are men and women are women and the two sexes have different—different, not greater or lesser—abilities. That's not male chauvinism, that's biology.

There are jobs in the electronics industry that are usually done by women and rarely done by men. For example, some of the fine hand work required in semiconductor device assembly. This kind of work cannot be equated against work that requires broader technical experience and judgment.

There is no denying that the average woman is paid less than the average man in the electronics industry, but the average male employee is generally worth more, long term, to an employer than the average female employee. That is also a result of biology. Most men are committed to industry as a career, because of their role as breadwinners. Most women can and many frequently do exercise the option of becoming homemakers rather than factory employees.

It is the rare employer who has not invested substantial training costs in an employee. An employee most likely to stick with the company is a more valuable employee. Further, if an employee invests his or her own time and money in technical education that also makes the employee more valuable. Men frequently do this, women infrequently.

So much for the average.

In a minority are women who don't fit into the general pattern. We mean women who make a



career of industrial employment and who leap the biological barriers because of exceptional talent or ambition. These women are of greater value than the average male employee, should be paid accordingly, and usually are. The employer who cannot appreciate the worth of an exceptional woman is a dolt, but equal pay legislation won't correct his stupidity.

ELECTRONICS AND THE CONSUMER. If, like many electronics engineers, your contact with consumer electronics is now limited to adjusting your tv set or fiddling with a hi-fi, you'll be pleasantly surprised to find just how sophisticated consumer electronics is becoming.

The design of consumer products has kept up well with recent advances in electronics. In a three-part series on consumer electronics, beginning in this issue on p 49, Assistant Editor Gray reports, for instance, on a tiny hearing aid with an integrated amplifier circuit, a doppler security alarm the size of two table-model radio receivers, a microwave oven that heats in six seconds, and a model train control that uses silicon controlled rectifiers to separate the controlling r-f frequency from the a-c track voltage.

This week, the subject is entertainment, from tv receivers to f-m multiplex. Next week, we get into electroluminescence, silicon controlled rectifiers and their many applications, and auto ignition. In the third article, the topic is appliances and housewares, from thermoelectric cooling to an electronic telephone dialer. We think you'll be interested, not just as a consumer, but as an engineer.

TOUGH



... AS A TURTLE'S BACK

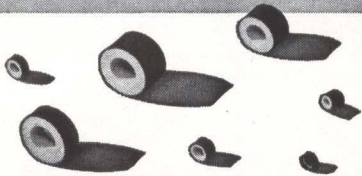

**ARMAG*-PROTECTED
DYNACOR®
BOBBIN CORES**

AT NO EXTRA COST!

Tough-as-tortoise-shell Armag armor is an exclusive Sprague development. It is a thin, non-metallic laminated jacket for bobbin cores that replaces the defects of nylon materials and polyester tape with very definite advantages—and, you pay no premium for Armag extra protection.

Tough Armag is suitable for use with normal encapsulation techniques on both ceramic and stainless steel bobbins. It withstands 180°C without deterioration—is completely compatible with poured potted compounds—has no abrasive effect on copper wire during winding—fabricates easily to close-tolerance dimensions—inner layer is compressible to assure tight fit on bobbin—does not shrink, age or discolor.

For complete data covering the wide range of Dynacor standard and custom Bobbin Cores, write for Engineering Bulletins to Technical Literature Service, Sprague Electric Company, 35 Marshall Street, North Adams, Mass.

TRADEMARK

SPRAGUE®

THE MARK OF RELIABILITY

4S-512-R1

COMMENT

Dynamic Null

In reference to the article, New Method for Measuring Equipment Performance (p 78, March 15), I do not believe that the method outlined by the author can be said to be a new one. An examination of p 280 of the 1962 Radio Amateur's Handbook will reveal that author Haynes has modified a well-known and widely used method which differs but little from the one discussed in the article.

RICHARD R. SLATER
Oklahoma State University
Stillwater, Oklahoma

Author Haynes replies:

I was unable to locate a 1962 Radio Amateur's Handbook, but did find a 1963 edition. The method therein described (pp 283-4) is, as Mr. Slater states, well known and probably adequate for checking out ham gear. It would be virtually useless, however, for evaluating instrumentation equipment. Even assuming the oscilloscope vertical and horizontal amplifiers to have identical (or negligible) distortion and phase shift, the measurement is limited by the resolution of the scope trace to about two percent. Using the Dynamic Null method, measurement of errors is limited only by the sensitivity of the vertical amplifier. Errors of 0.02 percent are easily measured in a 10-volt signal. This is the essence of a null form of measurement.

JOHN L. HAYNES
Redwood City, California

Government Patent Policy

I note with renewed frustration and alarm, under *Washington This Week* (p 12, March 29) that presidential adviser Jerome Wiesner, in a message to Congress, has struck a middle ground between NASA's and the Defense Department's policy relative to "who gets the patents."

Here, as in the past, the intellectual and creative rights of employed inventors are given not the slightest consideration, yet only they can create the innovations

which both the government and corporate contractors would claim. All the gold in Ft. Knox cannot create anything; neither can the great governmental or corporate show-place laboratories, or their project teams. Creativity, wherever one finds it, in science, in engineering, or in the arts, always has been and must still be the product of a single human mind. But present patent practices, and those now proposed, can only strangle its productivity for the very simple and obvious reason that no incentives or rewards exist for it.

The patent productivity in Europe and Russia, per million of population, exceeds our own by factors as high as ten or more. The obvious reason for this lies in their laws, even now being strengthened, which provide compulsory, realistic remuneration for employed inventors.

BENJAMIN F. MIESSNER
Miami Shores, Florida

Thermocouple Circuit Tester

In my *Research and Development* article, Tester Checks Out Thermocouple Circuits (p 102, March 15), two slight editor's revisions were made in the original which I feel should be corrected in the interest of complete clarity and accuracy.

In the first sentence, the tester is said to "check out thermocouple installations . . . without causing any temperature change on the thermocouple junction." The word "causing" loses the sense of the statement, which should read ". . . without applying any temperature change . . ."

The third sentence, as it appeared, states "The resistance, per 100 feet, of 28-gauge wire at 68 deg F varies from 6.489 ohms for copper to 266 ohms for Chromel-P." The inference here is that copper and Chromel-P are used together, which is not the case. The various combinations of wires used, and their resistance differences, should be expressed as "copper, 6.489 ohms and constantan, 184.0 ohms; iron, 37.63 ohms and constantan, 184.0 ohms; Chromel-P, 266 ohms and alumel, 110.8 ohms.

SIGMUND MEIERAN
Aero-Space Division
The Boeing Company
Seattle, Washington

SILICON FIELD EFFECT TRANSISTORS



2N2386



2N2794

These P-channel diffused silicon transistors embody all the desirable characteristics inherent in the field effect design—low input capacitance and high impedance. Use of an S-shaped gate configuration contributes to the exceptionally low capacitance ■ Tung-Sol's wide application experience with injection transistors and vacuum tubes—features of which are combined in the field effect transistor—is an important consideration for anyone seeking a competent source of this advanced semiconductor device ■ Write for complete technical information. Tung-Sol Electric Inc., Newark 4, N. J. TWX: 201-621-7977

TYPICAL ELECTRICAL CHARACTERISTICS (25°C)

| | TEST | SYMBOL | CONDITIONS | MIN. | TYP. | MAX. | UNIT |
|---------------|-------------------------|-----------|--|------|------|------|-----------|
| 2N2386 | Drain Current | I_{DSS} | $V_{DS} = -10V, V_{GS} = 0$ | | 3.0 | | mA |
| | Forward Transadmittance | Y_{FS} | $V_{DS} = -10V, V_{GS} = 0$ $f = 1Kc$ | 1000 | | 3000 | μmho |
| 2N2794 | Drain Current | I_{DSS} | $V_{DS} = -10V, V_{GS} = 0$ | 1.5 | | 5 | mA |
| | Forward Transadmittance | Y_{FS} | $V_{DS} = -10V, V_{GS} = 0$ $f = 1Kc$ | 1000 | | 3000 | μmho |



TUNG-SOL

FIRST SILICON POWER SUPPLY UNDER \$100

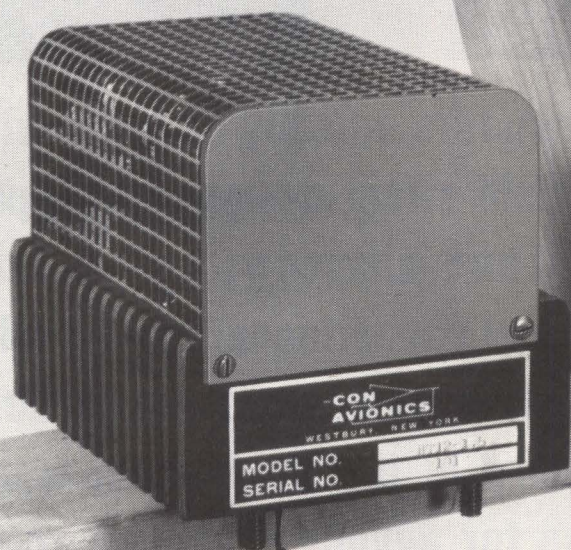

A Big New Price Step—35% Below Germanium Units

New Development. Here is a unique combination of low cost and high reliability. Featuring all silicon semiconductors throughout, these supplies are priced as much as 35% lower than comparable germanium supplies.

Designed to operate in ambient temperatures up to 50°C without an external heat sink, they may be used up to 75° with a comparatively small

external heat sink or with forced air. "Worst Case" Analysis designed, these supplies are capable of operating under the worst possible conditions with a "Mean Time Between Failure" that rivals many supplies costing two or three times as much.

For the full money-saving details on Con Avionics new HT Series Silicon Power Supplies, send for literature today.

SPECIFICATIONS

Regulation Accuracy ±0.5%
 Ripple 10 mv RMS Max.
 Max. Operating Ambient 75°C
 Automatic Short Circuit Protection.
 Models available from 6V @ 1.5A to 32 V @ 600 ma
 Dimensions 4½" H, 4¼" W, 5½" D

CONSOLIDATED AVIONICS CORPORATION

800 SHAMES DRIVE, WESTBURY, L. I., NEW YORK

CIRCLE 6 ON READER SERVICE CARD



SAC Head Wants Space Command Station

DALLAS — Renewed charges that the military's space program is floundering were made last week at the Manned Space Flight meeting here, cosponsored by NASA and the American Institute of Aeronautics and Astronautics.

Gen. Thomas S. Power, commander of the Strategic Air Command, warned that the nation's survival would be at stake if the U.S. is confronted with a "space Cuba." He said men should be trained to operate a deep-space command station.

Courtland D. Perkins, of Princeton's aeronautical engineering department, said the "rambling and largely unsupported" R&D program of the Air Force needs to be brought into focus. He urged support of the X-20 Dyna-Soar and Blue Gemini programs, with the possible addition of a manned military space station and dual-launch space plane system.

The military is "groping around for better state-of-the-art, better concepts, and better arguments" to develop military space missions in all fields except surveillance, Perkins charged.

Other officials warned that "go" decisions must be made now if systems and techniques are to be developed in time to land men on Mars during 1973-75. Mars will be in a favorable position then for interplanetary travel. It won't be again until 1984.

NASA reported that the arc jet, resistojet, contact ionization and electron bombardment ion engines are moving into engineering phases. Snap-10A, a 500-w nuclear system, has shown "some success" and is "expected to be integrated with the nuclear system this year, with flight tests within two years."

California Site Bounces Microwaves to England

THE MOON was the middle link last week in what is believed to be the

COLOR COVER PHOTO SENT BY RELAY

First successful satellite transmission of a full-color photograph by facsimile was accomplished April 25 by ELECTRONICS with the cooperation of NASA Headquarters, Goddard Space Flight Center, RCA Communications, Inc., RCA, ITT and American Cable & Radio.

The photograph will appear on our May 24 front cover. Three color separations, used for preparing the color printing plates, were transmitted via NASA's Relay satellite from Nutley, N. J., to the Goonhilly Downs station in England. Polaroid black-and-white photos of the experiment were also transmitted late in the same satellite pass.

An article in our May 24 issue will detail the color transmission technique employed.

At the same time, neighboring channels transmitted an electroencephalogram from Burden Neurological Institute, Bristol, England, to the Mayo Clinic for readout at Minneapolis, Minn.

longest direct microwave hook-up ever achieved—5,333 miles from Camp Parks, Pleasanton, Calif., to the Royal Aircraft Establishment at Farnborough, England. Camp Parks, point of origin for the X-band transmissions, is a MIT Lincoln Laboratory field site. Its cassegrainian antenna system, using a 60-foot paraboloidal reflector, was designed primarily for Project West Ford. Transmission was at the standard 60 wpm teletype rate. Special design features of the receiver combat smearing in the doppler shift and in relay.

How Do Missiles Affect Radiation?

CAPE CANAVERAL—The Air Force wants to find out if the presence of missiles affects the amount of radiation found at high altitudes. Under Project Hi-Tab, it will launch a large number of Aerobee rockets from Walker Cay in the Bahamas to get a thorough mapping of natural background radiation.

Launches will be made under all weather conditions. Flight altitudes will be about 135 miles. When this program is completed, similar

rockets will be fired in conjunction with missile launchings here to measure any differences in background radiation. This part of the project is known as Tabstone, for Target and Background Signal-To-Noise Experiment.

Japan Starting to Make 16-Inch Color Tv Sets

TOKYO—Japanese tv makers hope to popularize color tv by October, 1964—in time for the Olympics here. Unable to agree on a standard 16-inch color tube, the size they think is most likely to win wide acceptance, manufacturers will soon start production of 16-inch color sets using three different types of 3-gun shadow mask tubes.

The main differences between the tubes will be in deflection angle and size of front faceplate. First sets using these tubes are expected to go on sale around the end of August. EIA-Japan was unsuccessful in its attempts to persuade set makers to settle on a standard tube and now hopes that the customers will display a marked preference for one type, forcing the others to adopt it.

Space Tracker

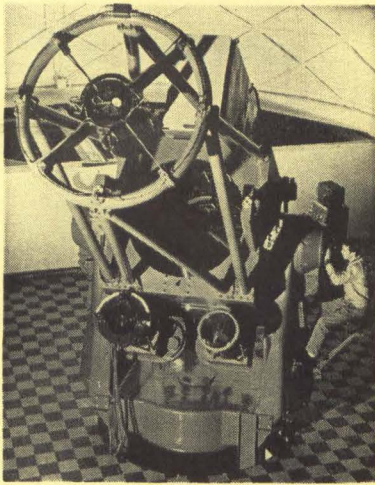

48-INCH spectrometric telescope built by MIT Lincoln Laboratory will probe the thermal, electrical and aerodynamic phenomena that occur when a space vehicle reenters the earth's atmosphere. Located at Arbuckle Neck, Va., the telescope can lock onto the faint tiny glow from a fast-moving target. The radiometer (right), measures light intensity in the near infrared region

nounced it will waive commodity taxes on transistor tv sets until March 31, 1966. This is expected to cut domestic prices about 10 percent. The resulting increase in production should mean an eventual cut in export prices too.

Long-Life Plasma Claimed by Russians

MOSCOW—The Kurchatov Atomic Energy Institute has produced a plasma with a period of retention of "hundredths of parts of a second," Pravda claims. A "magnetic field of an intricate geometric form" was used. The temperature was said to have been 40 million C and density approximately 10 billion particles per cc.

Reportedly, the installation was built on the principle that "one of the peculiarities of employing a magnetic system is that the power of the field increases on all sides from the sphere occupied by the plasma."

"Plasma occupying a volume of several dozen liters in a vacuum chamber does not reveal those ordinary types of instability which were

earlier considered irremovable," the newspaper said. Soviet scientists now hope to raise plasma temperature to 200 million degrees and increase density a thousand-fold, Pravda said.

A-Blast Detection Puzzle: Where's the Epicenter?

WASHINGTON—Epicenter location is still the bugaboo of scientists trying to identify nuclear tests by remote instrumentation. Locating the depth of a disturbance is little better than two years ago when instruments were "recording" explosions 1,200 feet underground as being as much as 30 miles in the air. Since most earthquakes occur 3 to 12 miles down, where nuclear tests are not feasible, epicenter location within a 1,000-yard tolerance is seen as a crucial factor to identifying tests.

DOD Aide Urges Use Of Microcircuits

DALLAS—The space industry should use microelectronic circuits wherever possible, James Bridges, director of electronics in the DOD's Office of Defense Research, said at the Manned Space Flight meeting here last week. He said that microcircuits offer the best hope for obtaining the reliability levels needed for manned space flights.

Tunnel Diode Used In Computer Memory

IBM HAS INSTALLED for study purposes a tunnel-diode memory unit in the Stretch computer at its Poughkeepsie development labs. Company says this is the first time such a unit has been used in an operating computer. One possible application is as a buffer.

In Stretch, the memory has a storage-retrieval cycle time of 600 nsec and has reached 200 nsec in tests—three times the speed required by any existing computer, IBM says. Capacity is 17 words of 74 bits each.

In Brief . . .

NATIONAL ACADEMY OF SCIENCE gave its backing last week to a proposal that would establish a National Academy of Engineering (p 3, Oct. 5, 1962).

NATIONAL BUREAU OF STANDARDS has obtained interference fringes over a 200-meter path using a laser light source. Work is now under way to stabilize the laser for interferometric calibrations of length-measuring devices.

TOP EXECUTIVES of the nation's space projects deserve higher salaries, says Charles W. Frick. He resigned from his \$20,000-a-year job as head of Project Apollo to return to private industry.

STOCKHOLDERS of Beck's, Inc. have been asked to approve the sale of the firm to Control Data Corp.

AIR REDUCTION CO. sees future uses in welding of light gauge metals and chemical synthesis for its new 9-w, c-w laser.

TOSHIBA will supply tv sets to Sears Roebuck for sale under Sears' trade names.

GE IS ADDING a new computer, the GE-235, to its medium-range line. Typical cost is \$475,000.

YOKOGAWA will form a joint venture company in Japan with Hewlett-Packard to produce instruments.

GOVERNMENT MARKET for simulation systems totaled \$250 million in fiscal year 1962, according to Smith, Winters, Mabuchi.

SOLION TETRODE produced by Self-Organizing Systems, Inc. is used as the analog memory element in a machine called Child (for Chemical Hybrid Intelligent Learning Device) being built by the Air Force.

PROPOSED MERGER of Baird-Atomic and Allied Research Associates, Inc. has been called off.

A TITAN II launched from an underground silo last week hit a target more than 4,000 miles away.

30 RCA 301 computers will be installed at 10 key sites of the Air Force Logistics Command to replace over 500 pieces of punched card equipment.

New from Sprague!

3cc IN A DECADE!

FOIL TANTALUM CAPACITORS for satellites and other high-vacuum environments are now available from Sprague Electric.

The new Type 142D and 143D hermetically-sealed Tantalex[®] Capacitors utilize a *true* glass-to-metal seal for these applications. *The seals on these new capacitors will not diffuse more than three cubic centimeters of helium in ten years**, enabling them to survive the extreme vacuums of outer space!

Type 142D and 143D Tantalex Capacitors are beyond the pilot production stage. They're available *now* in plain-foil or etched-foil, polarized or non-polarized construction, with voltage ratings up to 450 VDC.



If you have need for this premium product, write for further information (on your letterhead, please) to Tantalum Capacitor Section, Field Engineering Department, Sprague Electric Company, 35 Marshall Street, North Adams, Massachusetts.

*by mass spectrometer test at one atmosphere

SPRAGUE COMPONENTS

CAPACITORS

TRANSISTORS

MAGNETIC COMPONENTS

RESISTORS

MICROCIRCUITS

45C-103-63

INTERFERENCE FILTERS

PULSE TRANSFORMERS

PIEZOELECTRIC CERAMICS

PULSE-FORMING NETWORKS

TOROIDAL INDUCTORS

HIGH TEMPERATURE MAGNET WIRE

CERAMIC-BASE PRINTED NETWORKS

PACKAGED COMPONENT ASSEMBLIES

FUNCTIONAL DIGITAL CIRCUITS

ELECTRIC WAVE FILTERS

SPRAGUE[®]

THE MARK OF RELIABILITY

'Sprague' and '®' are registered trademarks of the Sprague Electric Co.



MANNED OR

Aircraft & missiles can now fly automatic, ground-

Terrain Following Radar now enables air-to-ground missiles, drones and aircraft to fly automatically at selected low altitudes permitting penetration below early warning radar. This new on-the-deck mission capability and many others can be added to all types of aircraft by the General Dynamics|Electronics Terrain Following Radar. The system, which detects all terrain obstacles and transmits continuous instructions to pilot or autopilot, is suitable for both military and commercial aircraft.

***THOROUGHLY TESTED** — More than 25,000 miles of actual low level flight tests and 200,000 miles of computer simulation have proven the system's capability and reliability. In one test an aircraft flew at 400 feet from San Diego, California, to Las Vegas, Nevada, over some of the roughest terrain in the United States without the pilot having touched the controls. Available now, the versatile General Dynamics|Elec-

tronics unit is suitable for manual or automatic blind flying at speeds from 100 knots to well in excess of Mach. 2.5.

COMPACT, LIGHTWEIGHT — The General Dynamics|Electronics Terrain Following Radar is the only thoroughly and successfully tested system compact enough to fit in any aircraft and is readily adaptable to air-to-ground missiles. The low-powered, lightweight system weighs only 40 lbs. and occupies $\frac{1}{2}$ cubic foot. The design is so simple that preflight calibration and alignment are not necessary.

APPLICATIONS — Besides adding all-weather, low-level mission capabilities, the system permits safe, automatic let down through cloud cover to non-instrumented air fields. It also protects aircraft flying through unfamiliar mountainous terrain in periods of poor visibility. During any ground-hugging flight the radar system frees the pilot to observe or operate navigation and other equipment.



UNMANNED

hugging missions with compact, proven radar*

RELIABILITY — As a result of simplicity of design the system is highly reliable and requires an absolute minimum of maintenance. This factor is enhanced because there is no scanning antenna and no requirement for a radar scope. For further information on Terrain Following Radar, write to Department D-21, General Dynamics Electronics — San Diego, P.O. Box 127, San Diego 12, California.

SPECIFICATIONS:

- FREQUENCY: Ku Band
- POWER IN: 1 amp, 28v d-c, 2 amps, 115v a-c, 400 cycles
- POWER OUT: 10 KW peak
- WEIGHT: 40 pounds
- CIRCUITRY: transistorized.

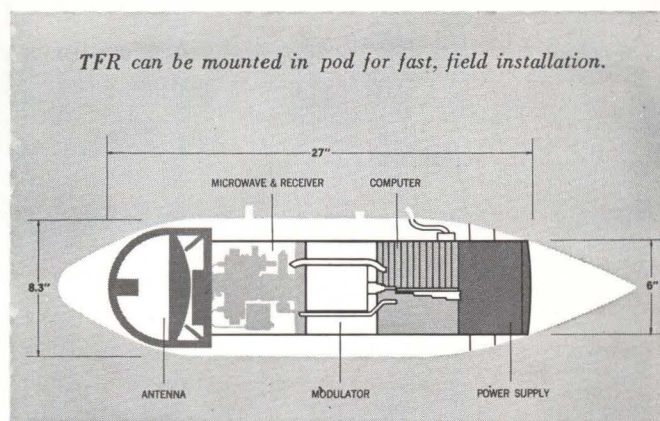

GENERAL DYNAMICS | ELECTRONICS **G D** **SAN DIEGO**
 CIRCLE 11 ON READER SERVICE CARD

WASHINGTON THIS WEEK

DOD PROPOSES CHANGES IN PROPRIETARY DATA POLICY

DEFENSE DEPARTMENT proposes wide-ranging changes in the Armed Services Procurement Regulations dealing with proprietary data—long a source of controversy. Industry complains of excessive military demands for contractors' trade secrets and inadequate protection of proprietary data from commercial competitors.

On May 7, industry representatives will discuss with Pentagon officials proposed changes that are both liberalized and more restrictive. On one hand, they would allow acquisition of unlimited proprietary data in formally advertised contracts. This would primarily involved follow-on production contracts for items developed at military expense and "broken out" for competitive bidding. EIA opposes this change.

On the other hand, DOD also proposed to broaden its recognition of proprietary data. Aim is to discourage so-called "reverse engineering" by protecting proprietary data "not readily disclosed by inspection or analysis." In effect, the change in definition expands the volume of protected proprietary data.

DCA PUSHES COMMUNICATION NETS—IN SPACE AND ON EARTH

DEFENSE COMMUNICATIONS AGENCY will award contracts soon for program definition of a military communications satellite system. The time goal to get an R&D system in orbit is two years following contract awards, roughly around 1965.

DCA has decided to proceed with a system based on present state of the art—several satellites at altitudes from 4,000 to 6,000 miles in polar orbit. Synchronous satellites were rejected for the first system because of the research still required and vulnerability to enemy jamming and interference.

DCA will also modernize and expand its world-wide communications facilities to provide automatic switching for voice, teletypewriter and data communications among overseas bases and between U.S. and foreign sites. Two networks are involved: Autovon, for voice, and Autodin, for data and teletypewriter communications. Both jobs will be under contract this fall and operational sometime in 1965.

MORE PLUGS OVERSEAS FOR ELECTRONICS

ELECTRONICS is getting new emphasis in Department of Commerce efforts to improve the overseas position of U.S. products. Officials are conferring with industry to identify possible areas of concentration. Trade center shows of advanced components are being planned for London and Frankfurt this winter. In light of European competition, advanced components are seen as the best initial area of emphasis. Also, the instrument and lab apparatus promotion now in Tokyo will go to England and Germany later.

SATELLITE CORPORATION GOES TO WORK

SENATE CONFIRMATION of the 14 board members of the new Communications Satellite Corporation frees the group to get on with the job of establishing a commercial satellite communications system. The next big step for the corporation is to issue stock to the public and communications carriers, probably within another year. Manpower requirements, R&D needs and anticipated use by carriers, which will determine amount of stock issued, are now being studied.



We produced the world's thinnest (.005 diam.) flux-core solder ... then somebody dropped it!

Less than twice the size of a human hair, this new Kester wire solder they're looking for is just .005" in overall diameter. Try to find that on a tweed carpet!

This new Kester solder has a hollow core filled with flux. To produce this takes ingenuity. It requires the most precise manufacturing standards to conform to the rigid specifications of the electronics industry. Can you

visualize using this .005" diam. Kester Solder in your manufacturing operation? Perhaps this is just what you need to solve your most difficult precision soldering problem. Kester will offer engineering assistance if you will state briefly your application situation. Write today.

KESTER SOLDER
KESTER SOLDER COMPANY

4202 Wrightwood Avenue, Chicago 39, Illinois • Newark 5, New Jersey • Anaheim, Calif. • Brantford, Ontario, Canada

Over 64 years manufacturing quality solders and fluxes

MORE THAN 100 KLEIN PLIERS

SPECIALLY DESIGNED FOR THE ELECTRONIC FIELD

Special skills are important in the wiring of today's sophisticated assemblies for electronic and telemetry systems. Klein has developed special pliers to assist in solving difficult assembly problems.

- For instance, there is a plier with a blade as hard as a file for cutting nickel ribbon wire (No. D230-4C).
- For instance, there is an oblique cutter, specially designed for printed circuits . . . it cuts and crimps the end to hold wire in place for soldering. (D 052-C).
- For instance, there is a needle nose plier with the tip bent to facilitate reaching into confined spaces. D 338-5½ C.

In all, there are over 100 different styles and sizes of pliers available from stock. Klein will be glad to discuss with you the development of a special tool to solve a particular problem you may be facing.

ASK YOUR SUPPLIER



The Klein Plier Catalog illustrating and describing the complete Klein line of pliers is available on request.

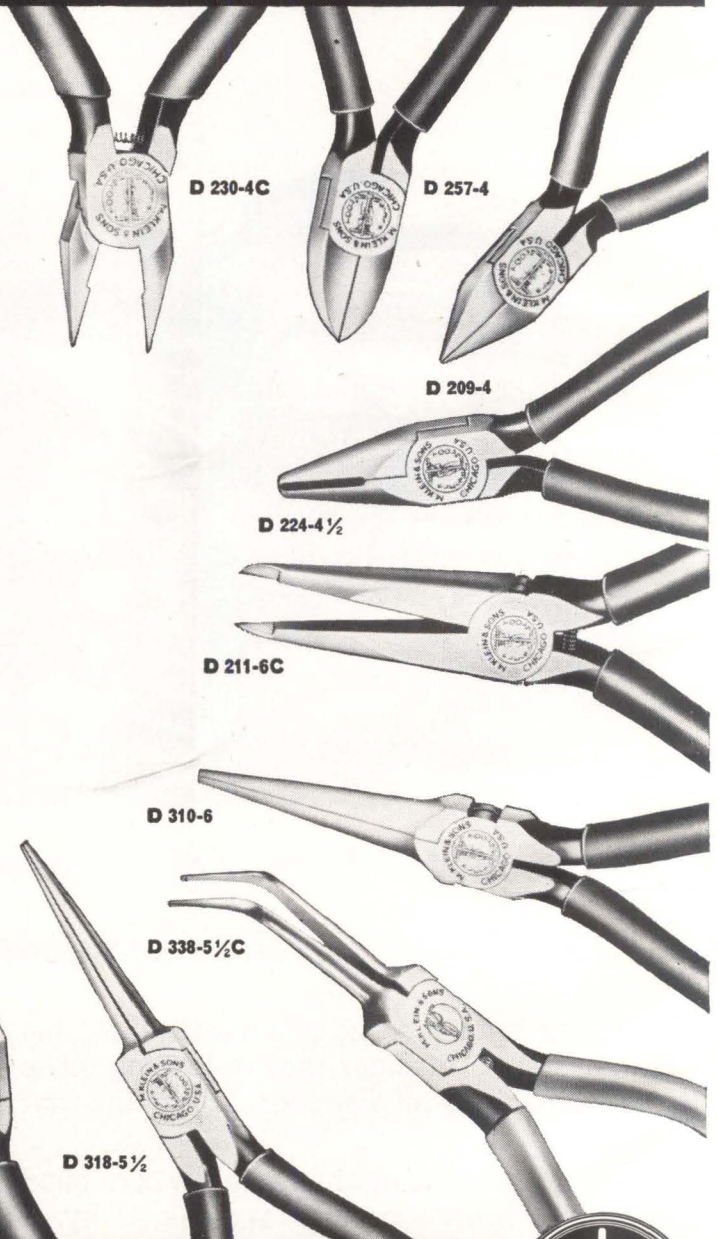

Mathias KLEIN & Sons
 Established 1857 **INCORPORATED**
 Chicago, Ill., U.S.A.
 7200 McCORMICK ROAD, CHICAGO 45, ILL.



"Ultra-Reliable" is a name that we have given, after 3½ years of evaluation studies, to both a new program and a new potentiometer. The program is unprecedented in its severity, thoroughness and single-mindedness; its one goal is reliability. The potentiometer is the first of its kind ever offered; its key advantage is statistically verified reliability.

Never before has a company reliability program been so comprehensively planned and implemented. Never before has a potentiometer undergone such relentless checking, sampling, screening and testing. Selected personnel produce the units, working with small, rigidly controlled lots in a separate production area.

Complete acceptance test results accompany every shipment of these potentiometers. Documentation of reliability as test verification progresses beyond 0.01% (failure rate per 1000 hrs. at 60% confidence level) is sent to each customer four times a year. If you want potentiometers that squarely meet the most

urgent demands of critical projects, you want Bourns Ultra-Reliable potentiometers. They're available off the shelf. Write for detailed technical data.

40-PAGE PROCUREMENT DOCUMENT AVAILABLE containing all you need to draft a specification for an Ultra-Reliable potentiometer. Just write or call, and your personal copy will be delivered by a Bourns field engineer.

TRIMPOT® ULTRA-RELIABLE POTENTIOMETER SPECIFICATIONS



ACTUAL SIZE

- Element: Wirewound
- Resistances: 100Ω to 20K
- Power Rating @ 70°C: 0.5 watt
- Max. Op. Temp.: 150°C
- Humidity: Meets MIL-STD-202, Method 106

THE BOURNS ULTRA-RELIABILITY CONCEPT

— a method now producing potentiometers with statistically verified reliability

MAX. FAILURE RATE: 0.01% PER 1000 HOURS (60% CONFIDENCE LEVEL)

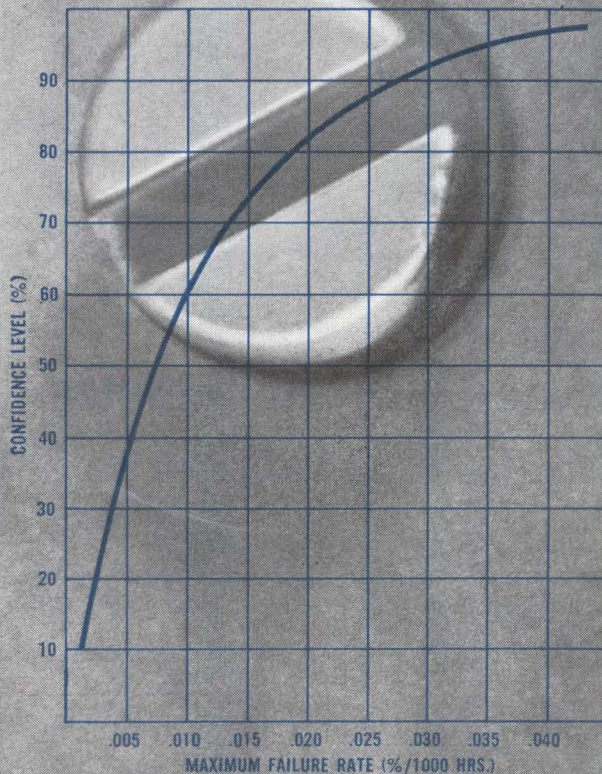

Curves are based on a constant failure rate (Poisson distribution)

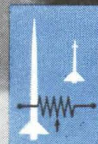

BOURNS

BOURNS, INC., TRIMPOT DIVISION
1200 COLUMBIA AVE., RIVERSIDE, CALIF.
PHONE 684-1700 · TWX: 714-682 9582
CABLE: BOURNSINC.

MANUFACTURER: TRIMPOT® SINGLE- AND MULTI-TURN POTENTIOMETERS, TRIMPOT RELAYS, PRECISION POTENTIOMETERS. PLANTS: RIVERSIDE, CALIF.; AMES, IOWA; TORONTO, CANADA

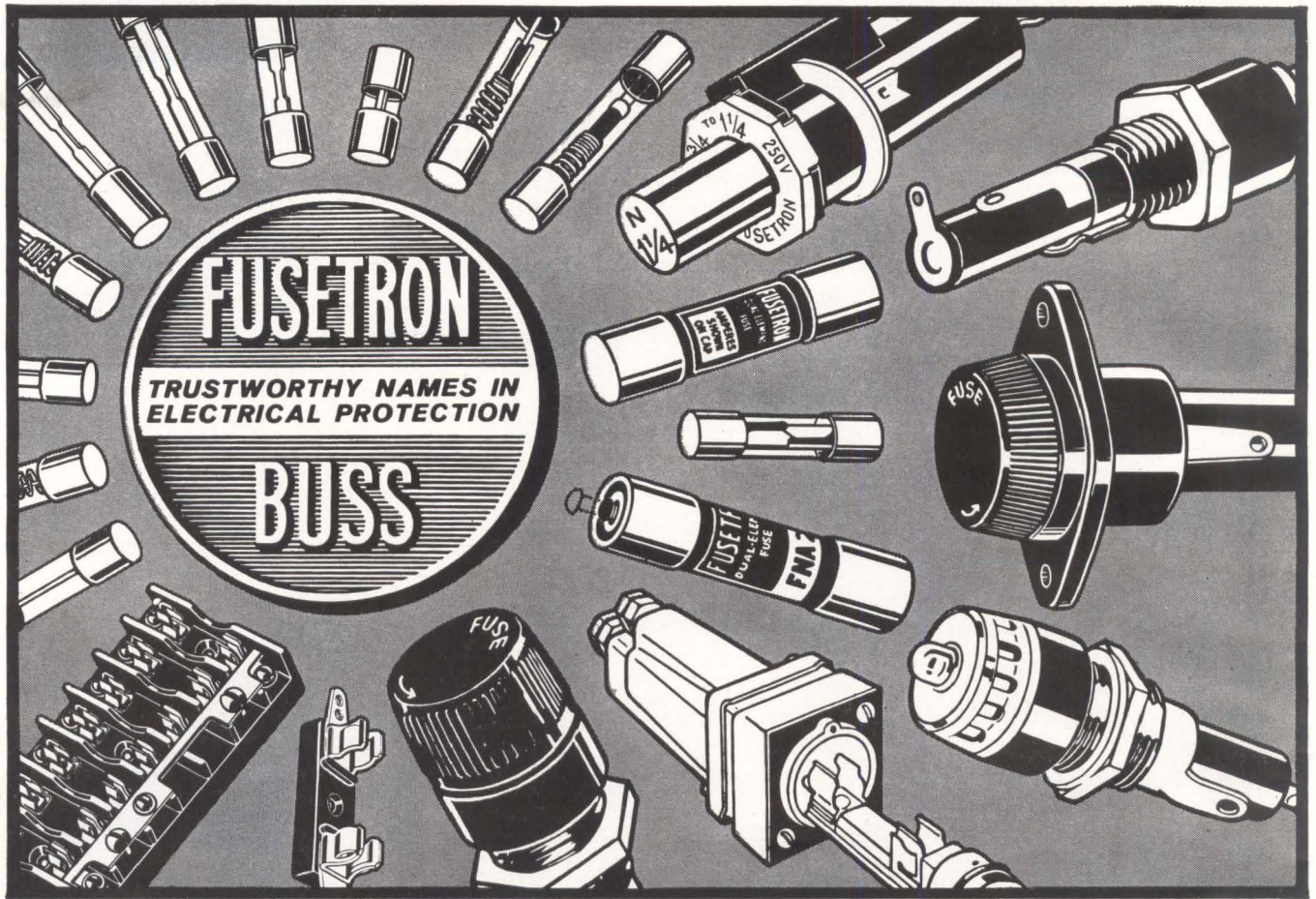

Save Time and Trouble by standardizing on BUSS Fuses—You'll find the right fuse every time...in the Complete BUSS Line!

By using BUSS as your source for fuses, you can quickly find the type and size fuse you need. The complete BUSS line of fuses includes: dual-element "slow-blowing", single-element "quick-acting", and signal or visual indicating types . . . in sizes from 1/500 amp. up—plus a companion line of fuse clips, blocks and holders.

BUSS Trademark Is Your Assurance Of Fuses Of Unquestioned High Quality

For almost half a century, millions upon millions of BUSS fuses have operated properly under all service conditions.

To make sure this high standard of dependability is maintained...BUSS fuses are tested in a sensitive

electronic device. Any fuse not correctly calibrated, properly constructed and right in all physical dimensions is automatically rejected.

Should You Have A Special Problem in Electrical Protection . . . BUSS fuse engineers are at your service—and in many cases can save you engineering time by helping you choose the right fuse for the job. Whenever possible, the fuse selected will be available in local wholesalers' stocks, so that your device can be serviced easily.

For more information on the complete line of BUSS and FUSETRON Small Dimension Fuses and Fuseholders, write for BUSS bulletin SFB.

BUSS

BUSSMANN MFG. DIVISION

MAKERS OF THE COMPLETE LINE OF FUSES OF UNQUESTIONED HIGH QUALITY

McGraw-Edison Co. • St. Louis 7, Mo.

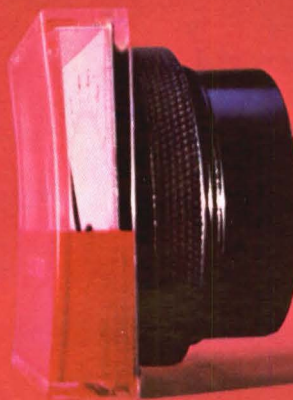
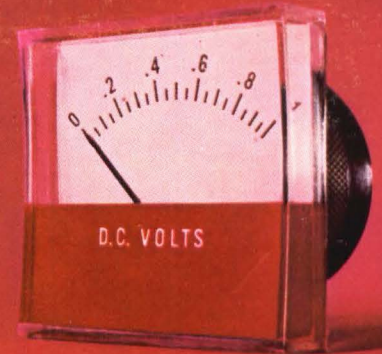
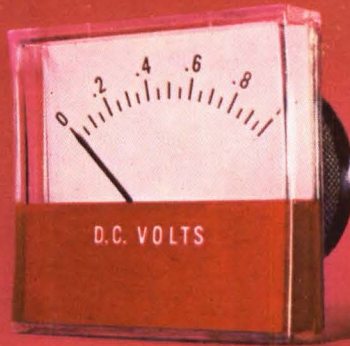
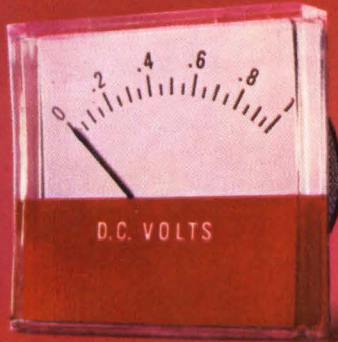
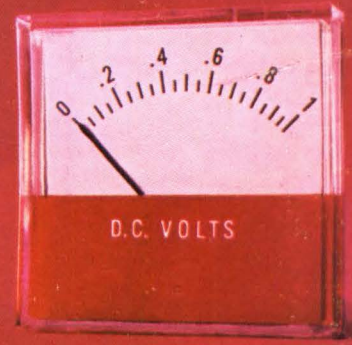
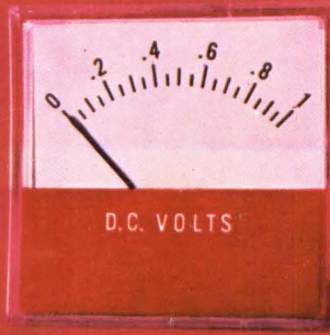
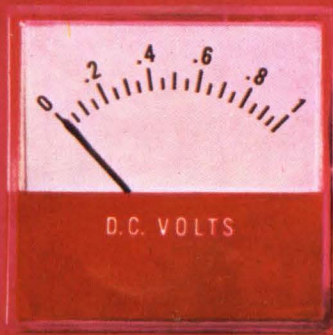

Look what Honeywell has done to modernize meters

The New Honeywell MS Line—3 sizes, all colors

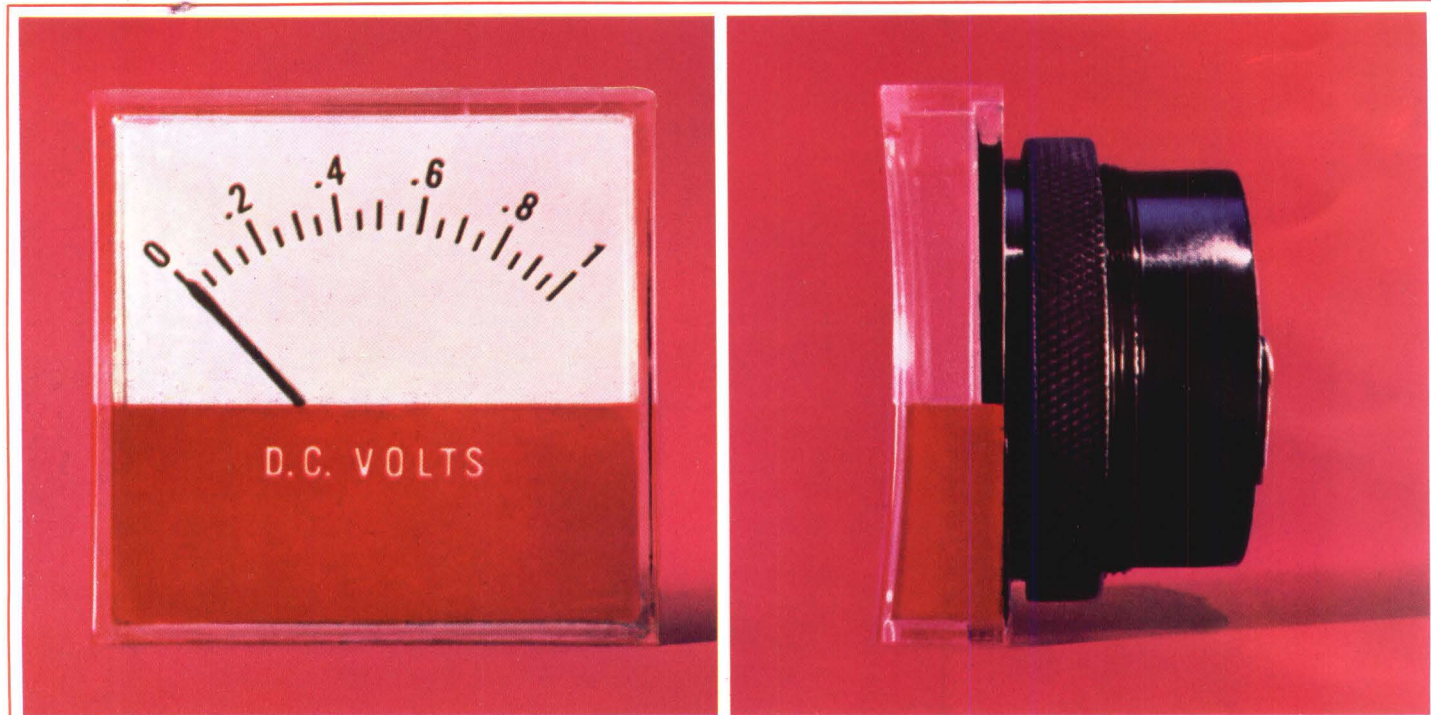

Contemporary design

Straight sides and square corners, plus color styling of the cover, give the "MS" Series a distinctive appearance. The clean, functional design blends with the square and rectangular shapes of modern electronic and process equipment.

Clear, uncluttered dial

All extraneous data has been removed from the dial face — the unit of measurement is hot-stamped on the inner surface of the cover.

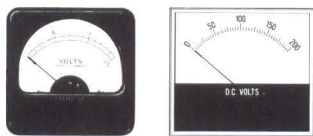

The scale numerals are above the scale to avoid covering by the pointer. This new "clean face" is a Honeywell exclusive.

Minimum glare and shadow

Concave face improves readout by minimizing shadows and glare. Whereas light is reflected over the entire area of a flat surface, a concave surface reduces the effect and localizes it to a much smaller area.

Full light reaches the dial through the sides and top as well as the front of the crystal-clear Plexiglas cover.

Longer scale length

Scale is as much as 50% longer than conventional meters of same size. For instance, the MS1 meter has greater scale length than some 2½-inch meters — a real saving in valuable panel space without sacrificing reading accuracy.

For complete information, write Honeywell, Precision Meter Division, Manchester, N. H. In Canada, Toronto 17, Ontario.

SPECIFICATIONS

Sizes and Types — MS1 (1½-inch), MS2 (2½-inch) and MS3 (3½-inch). DC meters in all sizes to measure volts, millivolts, milliamperes, amperes and microamperes. AC rectifier-type voltmeters in all sizes; AC iron-vane types in 2½-inch and 3½-inch sizes to measure milliamperes, amperes and volts. VU meters with buff dial, "A" or "B" scales in all sizes. Null indicator types available in 1½-inch and 2½-inch sizes.

Ranges — All standard ranges. Special ranges and customized dials also available on request.

Accuracy — ±2% of full scale for all DC ranges. For AC ranges, ±3% of full scale.

Mechanism — Model MS1 has self-shielded, core-magnet mechanism. MS2 and MS3 models require special calibration for use on steel panels.

Mounting — MS1—single-hole mounting. Gasket and mounting ring provided. MS2, MS3 — to ASA mounting dimensions.

Cover Dimensions — MS1 — 1.750" square; MS2 — 2.178" high x 3.140" wide; MS3 — 3.500" high x 4.100" wide.

Cover Colors — Normally furnished in onyx black. Available in 15 other standard colors. Any custom color to order.

"WHERE ELECTRONICS MEETS THE EYE"

Honeywell International: Sales and service offices in all principal cities of the world. Manufacturing in United States, United Kingdom, Canada, Netherlands, Germany, France and Japan.

Honeywell



Shown above are the
CORNING resistors which have failed
in more than 135,000,000 (MOSTLY
OVERSTRESSED) unit test hours.

We may have a failure any year now.

In the meantime, we have calculated statistical failure rates which may change your thinking about high-reliability resistors . . . whether you are working with MIL-R-22684 (NAVY), MIL-R-10509D or MIL-R-55182. The rates look like this:

Less than 0.0015%/1000 hours. CORNING has failure rate data based on continuous life testing for periods up to 50,000 hours; nearly six years. This test is for 1800 resistors that have been on continuous life test for

60,000,000 unit hours at powers up to 140% of rated. The confidence level is 60%.

Less than 0.0012%/1000 hours. This one is based on 75,000,000 unit hours at 250% of rated power and 25°C.

CORNING resistors live through high-stress reliability programs like these because of the inherent reliability of the tin oxide and glass that go into them. They demonstrate flat load-life characteristics for the same reason.

High-reliability CORNING resistors are available in general purpose C-style, precision RN-type, and hermetically sealed precision NF-type. A bulletin on CORNING "Resistor Reliability" is now available. Write for your copy.

**CORNING
ELECTRONICS**

A DIVISION OF CORNING GLASS WORKS
3901 ELECTRONICS DR., RALEIGH, N. C.

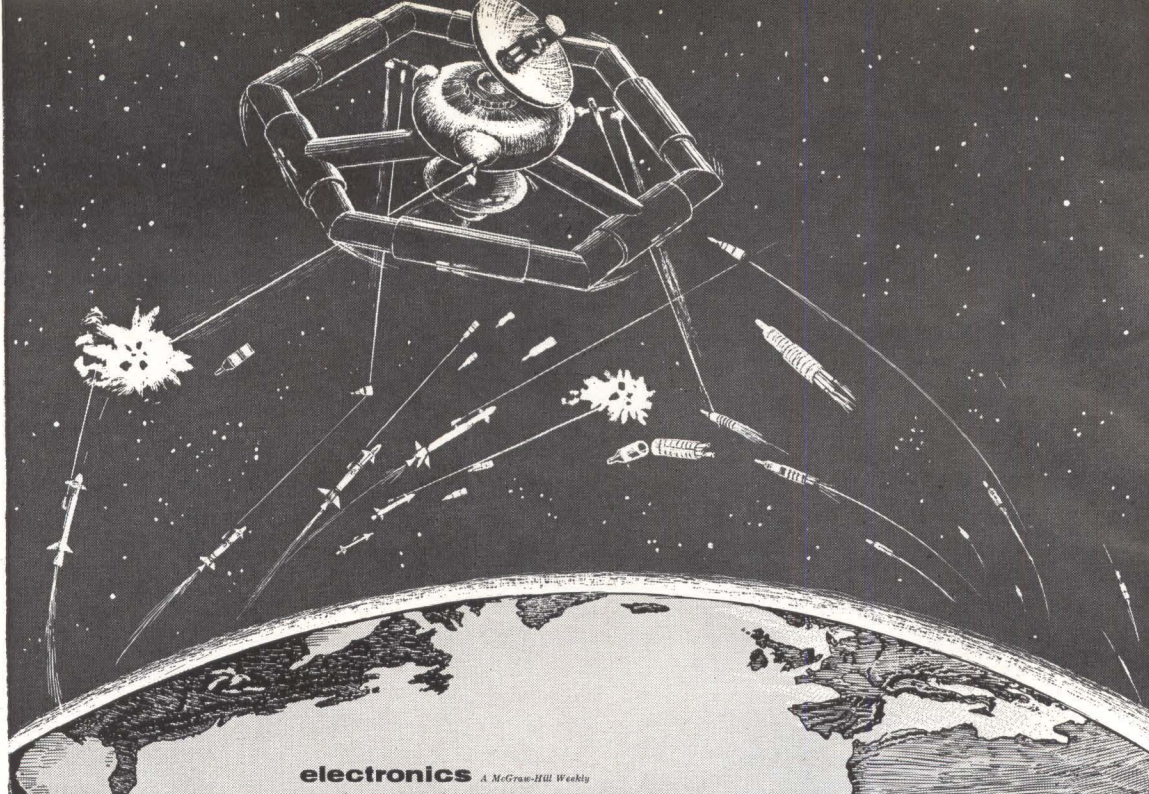

ORBITING SPACE station armed with radar controlled, sun pumped, laser radiation weapons may eventually provide ICBM protection. In areas not covered by space stations, laser carrying missiles can be launched and directed from earth against enemy ICBM's

Will Lasers Protect Our Cities Against ICBM's?

Laser experts find radiation weapon possible, but difficult

By LEON H. DULBERGER
Associate Editor

DEVELOPMENT OF a laser radiation weapon for use in anti-missile defense is possible, according to laser experts interviewed by ELECTRONICS. But they say that many thorny engineering problems must be surmounted to produce a working system. Materials research is one area requiring much investigation—both for laser operation and target damage knowledge.

DOD will only say that it is investigating the possibility of anti-ICBM lasers, along with other avenues of ICBM defense, in an orderly scientific fashion. Details are classified.

Scientists at Raytheon's Surface Radar and Navigation Operation are doing analysis and experimental work on a definition of laser weapon system design parameters. Raytheon acknowledges that the small beamwidth and possibility of high target-spot energy density suggest weapons possibilities. Raytheon has a commercial 350-joule ruby laser that can cut through $\frac{1}{8}$ -inch steel.

A Russian military publication has alluded to possible use of lasers for locating and destroying space vehicles. But while it mentioned U. S. work on this, it did not mention any Soviet efforts. Khrushchev,

however, has said he believes his scientists are ahead of the U. S. in general laser work. Last year, he showed a visiting American a steel ruler supposedly perforated by a laser beam.

Major Gen. D. F. Ostrander, Commander, Air Force Office of Aerospace Research, said this at a laser symposium: "As a professional military man, I am naturally excited about the practical applications of these revolutionary devices (lasers) in the fields of military communications, and possible disruption of matter by high energy density of radiation, and so on."

Laser beam attenuation studies are being made for Air Force at Ohio State University. A 50-foot chamber is fitted with reflectors to simulate approximately a 1-mile path. Propagation and attenuation of beams from various lasers is explored under varying atmospheric conditions. Effects of altitude and space are included. Air Force won't comment on specific goals for this research beyond saying it is designed to study the atmosphere in relation to laser beams.

WEAPONS POSSIBILITIES — Some of the possibilities, problems,

and progress are:

- One laser could attack many targets. Discrimination against decoys should be unnecessary since slewing speeds could be high and laser bursts should be readily repeatable. However, at present high-power lasers usually require four or five minutes between bursts to allow energy storage and cooling the laser.

- One possible ICBM-defense system is an orbiting space station equipped with detecting and tracking radar, and lasers pumped by direct sunlight. One big problem would be making the platform stable enough for accurate target tracking. Also the laser would have to focus on the target long enough to destroy it, implying an extremely fast slewing servo. Techniques to focus enough energy density on the target pose formidable problems.

- An interceptor rocket could be launched to areas not protected by space stations. Its laser weapon could be controlled from earth and chemical flash powders used to pump the laser.

- A space platform would not be needed to field-test laser weapons concepts. Testing could be done in the thin air on mountain peaks in clear weather. Helicopters with ceilings of 25,000 ft are available to supply test teams. Mountains in the continental U. S. reach heights of over 14,000 feet in the western portion of the nation and some exceed 6,000 feet in the east. Alaska has peaks to 20,000 feet.

- Countermeasures against laser radiation weapons might include laying smoke screens in beam's path to disperse and attenuate it. Or, the beam could be deflected by highly reflective surfaces on targets such as nuclear warheads. Reflection techniques now being researched to protect men and equipment against nuclear bomb blast temperatures up to 3,000 F may lead to protective devices against laser beams. However, any tarnishing on the surface of a polished reflector would soon be cumulative and destroy protective qualities finally allowing damage.

SOLAR PUMPING—Energy levels in the millions or even billions of joules will be required for anti-ICBM lasers. These high-energy, high-power lasers might be directly

pumped with sunlight. A large tracking reflector could gather solar energy and direct it through a mirror system to the laser material—whether it be crystal, gas, liquid, plastic or glass. Direct sun pumping would eliminate conversion to electricity and back again to light, to pump the laser.

Some of the work now being done in industry and at universities may lead to extremely high-power lasers. Nuclear Research Associates, Inc., of New York, is working on a laser intended to deliver 1 billion joules of energy from a laboratory-size generator. The firm has at least one Air Force contract for high-energy laser development. They plan to use unorthodox pumping and lasing techniques in a solid-state laser. While the exact quantum mechanical operation to be employed in such lasers is not easily spelled out scientists do not preclude their final development.

HOW DO LASERS BURN?—

Burning or destroying material with a laser beam at great range is a real problem. In space it is many times more difficult than in a lab. A study of the interaction between energy and materials is required.

One scientist believes that laser cutting action resembles a localized explosion. For example, if a 1-joule laser beam is focused on carbon paper, the laser only chars the paper when the pulse width is long. When a 1-microsecond pulse is employed, a distinct snap—caused by gases trying to escape—is heard as the beam strikes the carbon paper. In metal cutting, long pulse widths allow heat dissipation on the target surface, reducing cutting action. A rapid, high-peak-power pulse vaporizes part of the target surface in an explosive fashion.

Therefore, it may be possible to damage a reentry warhead by relying on the shock wave effect to extend the initial destructive effect.

Thin-film deposition technique work at the University of Rochester has posed this question about laser action in heating: Is material actually vaporized by a laser or does it come off as finely divided debris from a miniature explosion? Clearly, laser damage demands much research and even the concept of "radiation pressure" is suggested as the active effect.

THE POTTER MT-36

digital magnetic tape transport

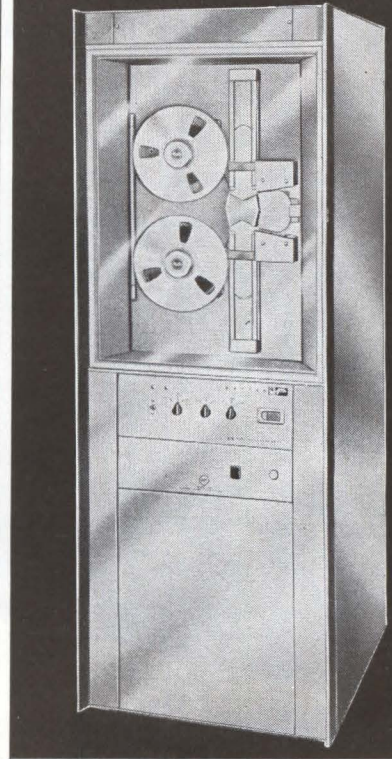

MT-36: THE MOST RELIABLE TRANSPORT in its price range

The Potter MT-36 Digital Magnetic Tape Transport offers maximum reliability for computer systems requiring an economical transport. The Potter MT-36 features:

- **NO PROGRAM RESTRICTIONS...** up to 200 commands per second at 36 ips.
- **SOLID STATE CIRCUITRY...** photo electric sensing minimizes the need for switches and relays.
- **VACUUM TROUGH GUIDES...** provide smooth tape stops.
- **IMPROVED PINCH-ROLLER CIRCUITS...** offer fast tape starts and stops.
- **EASE OF MAINTENANCE...** drive electronics and fully regulated power supply are mounted on individual plug-in boards.
- **RAPID TAPE THREADING...** Just 15 seconds for complete threading.
- **BUILT IN TAPE CLEANER...** vacuum on trough guide removes all loose oxide and dust.

For full information and specifications on the MT-36 Digital Magnetic Tape Transport, write today.



POTTER INSTRUMENT CO., INC.

TAPE TRANSPORT DIVISION

151 Sunnyside Boulevard • Plainview, New York

CIRCLE 22 ON READER SERVICE CARD →
CIRCLE 21 ON READER SERVICE CARD 21



WE USE BOTH ENDS OF THE PENCIL...

to solve advanced systems research problems



Out beyond the State-of-the-Art, original solutions to the formidable new problems of today's advanced electronic systems depend on the effective application of three important tools... the pencil, the eraser and man's brain. At Motorola, these factors have been successfully applied to the design and development of such major electronic systems as the NASA/Goddard Range & Range Rate Satellite Tracking System... the Air Force data acquisition and relaying system at the Edwards AFB high speed flight corridor... and the RADAS random access, discrete address system.

If you are interested in participating in these stimulating areas of systems research, write today describing your background and training in:

Applied Systems Research • conceptual design and equipment development, communications theory, coding theory, logic systems design, systems and analysis, and operations research as applied to both military and non-military systems.

Systems and Sub-Systems Design • antenna and microwave design, integrated circuit applications, stress analysis and heat transfer, digital and voice communications, command and control, telemetry and tracking systems design, data processing and display, ultrareliability design techniques, radar and guidance equipment.

We are particularly interested in programs on which this experience was obtained, and the extent of your technical responsibility. Address information to our Manager of Engineering at the location of your choice for immediate attention.

MOTOROLA
An equal opportunity employer



Military Electronics Division

CHICAGO 51, Illinois, 1450 N. Cicero Ave./SCOTTSDALE, Arizona, 8201 E. McDowell Rd./RIVERSIDE, California, 8330 Indiana Ave.

MARINES TO GET

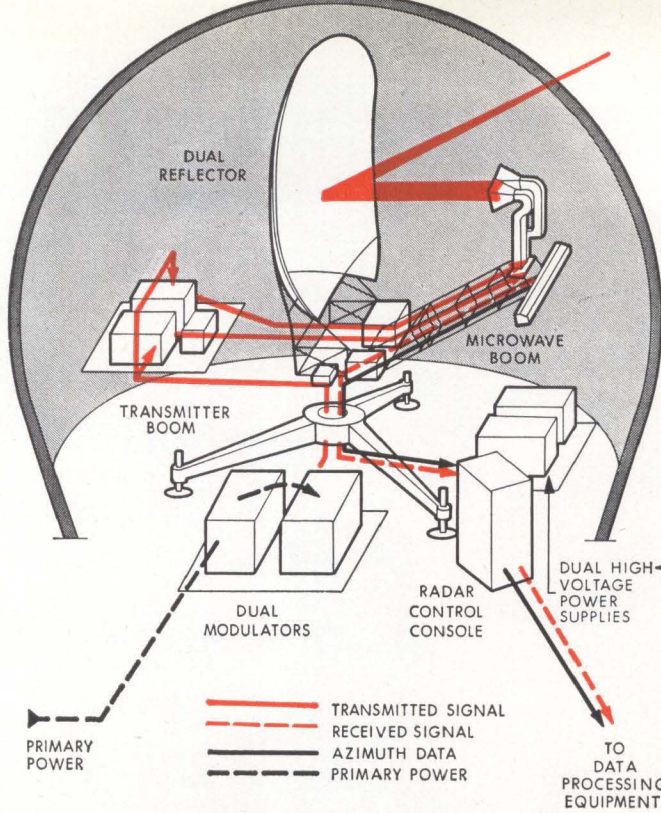

DUAL BEAM radar using single physical antenna. Sperry Gyroscope design will be produced in \$34-million-plus Navy contract

VERTICAL AND SLANT beams are combined through superimposition of each polarized reflector on a single backup structure (below)

Air defense radar gives altitude, azimuth, range information directly

SINGLE PHYSICAL antenna generates two sheet beams, oriented in space to form the required V configuration, in a new three-dimensional military air defense radar. The transportable equipment, designed by Sperry Gyroscope Co. begins operation with the U. S. Marine Corps this spring. The Corps will receive twenty systems —two every month.

A compact single physical antenna is achieved by superimposing two electrically separate antenna reflectors on a single backup structure. Tactical mobility is thus implemented. A plastic honeycomb sandwich supports the reflectors which are created of flat metallic strips to provide polarization.

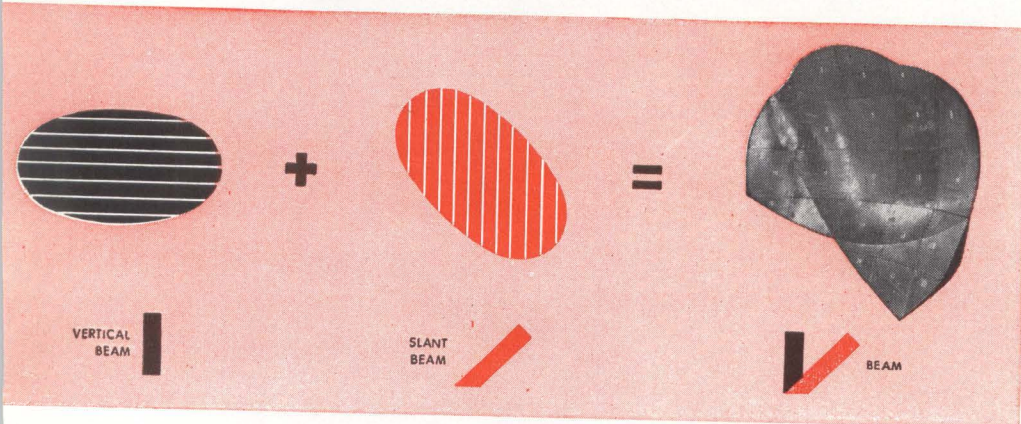

V-BEAM — Two independent microwave horns produce separate vertically oriented and slant oriented sheet beams which rotate as a unit and afford V-beam coverage. The vertical sheet beam, aided by the slant beam, searches. The slant, combined with the vertical beam, affords altitude information.

Solution of the V-beam geometry provides altitude information. The angle of rotation between the vertical and slant sheet echoes are measured electronically as an angle identified as the turn angle. Along with target range it is used to solve for target height. Dual modulators couple through high-voltage-pulse rings to dual transmitters mounted on the rotating antenna assembly, and then to the antenna reflector feed horns.

Targets are isolated by gating the receiver channels of the two beams. Measurement to vertical and slant beam centers provides turn-angle accuracy. Angular interval is measured by digitally counting pulses obtained with a magnetic pickoff which senses teeth on a ferromagnetic gear rotating with the antenna. A func-

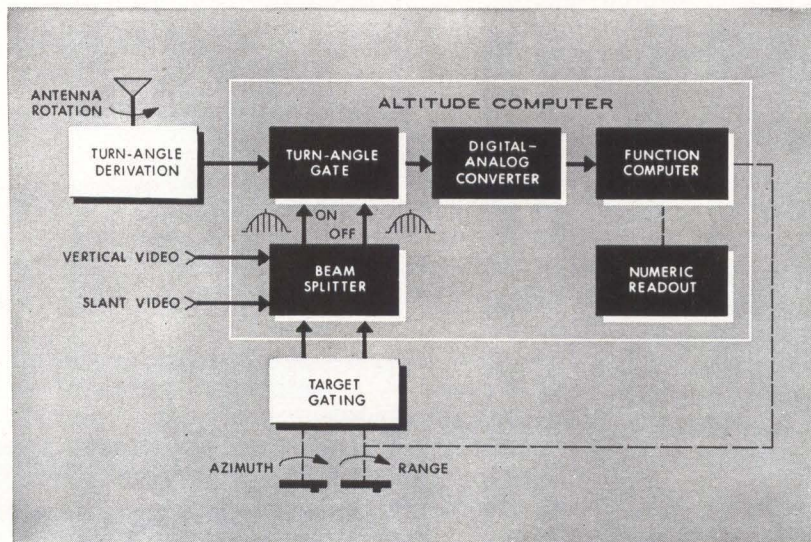

HEIGHT COMPUTER solves V-beam equation. PPI operator marks target's range and azimuth coordinates to orient acquisition gate

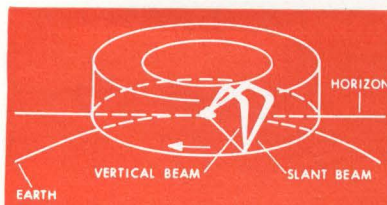

V-BEAM spatial coverage, and the geometry that is solved for altitude

3-D RADAR

tion-generator technique solves the height equation by approximating straight-line segments.

The height-finding operation may use height-smoothing equipment to improve output data through averaging a series of height readings and rejecting spurious signals.

COMPUTER—An automatic computer solves the V-beam equation and computes target heights after an operator manually selects the target. An automatic digital computer system may be added to provide 3-D coordinate data on all targets within the illumination and detection area.

The radar, designated AN/TPS-34 and developed by Sperry's Surface Armament division, is reportedly a quarter of the size of a two-radar installation. It can be transported by helicopter, cargo aircraft, truck and amphibious vehicle and be ready for operation in eight hours. An inflatable radome with dual walls eliminates entrance air locks and protects the antenna and equipment from weather. Possible application to air-traffic control and long-range 3-D air-route surveillance is envisioned. Additionally, 3-D air-corridor safety surveillance for missile test ranges is possible using the radar.

High-Resolution Scope Reported Easier to Work

CLEVELAND — Time-sharing digital oscilloscope was introduced by Fred Katzman, of Du Mont, at the Cleveland Electronics Conference last month. The cro has realizable resolution of over 1,000 lines and readout precision to half percent.

Improvements reduce training time, permit less skilled technicians to achieve optimum use of the instrument, Katzman said. One control allows operator to choose desired display, method of signal correction and time-base synchronization. A calibration marker system permits the scope to magnify reference calibration off screen.

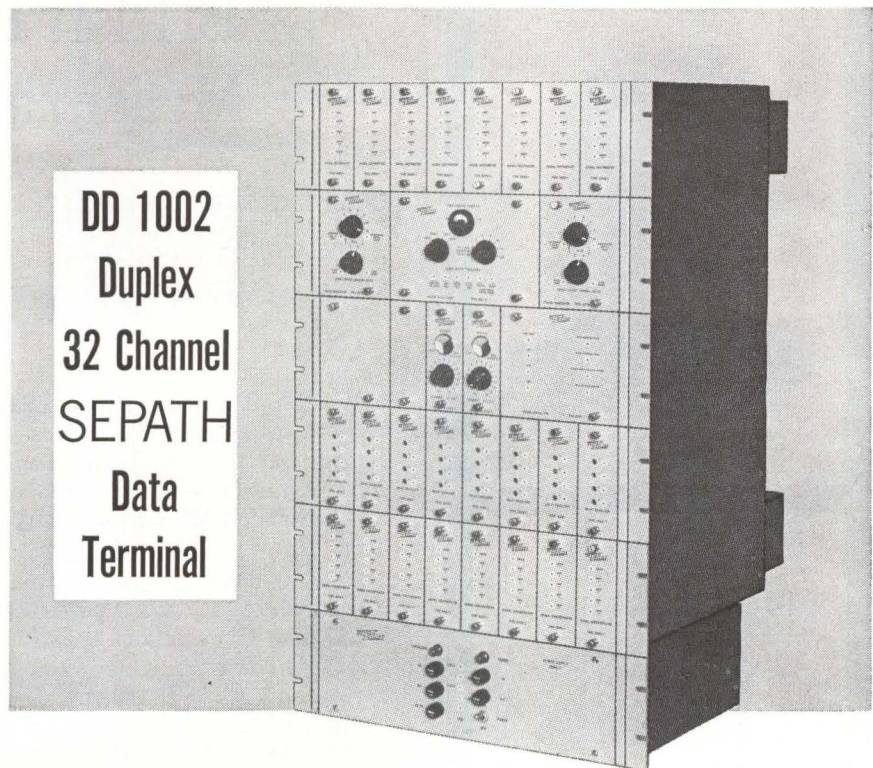

From the DD Line of data transmission equipment

“SEPATH”

Rixon DD 1002 SEPATH data terminals, operating in conjunction with existing frequency division multiplexing equipment, provide an excellent means for transmitting high-speed digital data via hf radio circuits. Serial binary data is converted into parallel low-speed data streams at the transmit terminal to permit propagation through multipath conditions. These are simultaneously transmitted on TTY channels. At the receive station, the parallel information is regenerated and reassembled into the original serial format.

Other systems available which use the SEPATH principle are the SEPATH/Teletype system [SEP 589-1(A)] for bulk encryption, and the DD 3005 30 Channel time division multiplexer for 60 and 100 wpm TTY signals. For further information, contact . . .

RIXON ELECTRONICS, INC.

2121 INDUSTRIAL PARKWAY—MONTGOMERY INDUSTRIAL PARK—SILVER SPRING, MARYLAND
TELEPHONE: 622-2121 TWX: 301 622-2292

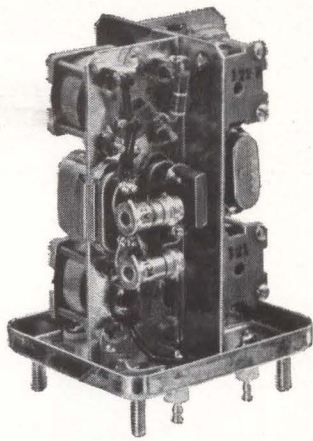

BULOVA PRECISION CRYSTAL FILTERS

Bulova experience with prototype and production quantities of precision filters guarantees maximum sensitivity, stability — in "isolating" any frequency. These examples indicate Bulova mastery of difficult problems in high performance filter engineering.

BAND PASS FILTERS — In a band of 30 filters, insertion loss variation between filters, and over the temperature range 25°C to 75°C, held to .3db between highest and lowest. Part #69-A-RP-13-2N (1 thru 30).

SINGLE SIDE BAND FILTERS — Band ripple held to $\pm 1/2$ db, both 1 and 3db points defined, over the temperature range 0°C to 85°C, and 300 to 3000 cps vibration at 30G level. Part #117B-FC-22-4WU.

DISCRIMINATOR — Center frequency held to within 10 cps, frequencies equally spaced from center, held to 5.4v peak $\pm 5\%$. Part #186C-TN-22A-WD. **BAND SUPPRESSION FILTERS** — 2kc wide band attenuated 60db, right next to it a pass band held flat to $\pm 1/4$ db for 150kc. Part #158-TF15-6R.

Contact Bulova engineering specialists to help you choose the right filters — when you have tough filtering problems, need additional information, or practical application assistance. Write Dept. 2702, Bulova Electronics, Woodside 77, N. Y.



INDUSTRIAL/DEFENSE GROUP

BULOVA

ELECTRONICS DIVISION

British Report Latest Measuring Techniques

One new instrument is a frequency meter that needs no sampling period

SOUTHAMPTON, ENGLAND— Several measuring techniques—including one for continually displaying frequencies—were introduced at a British IRE conference April 16 to 20.

The dynamic frequency meter, described by P. Wood, of Plessey, Ltd., gives a continuous 6-digit display of frequencies between 250 cps and 16 Kc without the normal sampling period.

The unknown frequency input is converted to a pulse train that is fed to the add input of a reversible counter. The subtract input is obtained from a binary rate multiplier comprising a binary scaler to which is applied a fixed-frequency pulse train. Scaler outputs are fed to gates controlled by the counter stages. Combined, the gate outputs give a pulse train whose mean rate equals the product of the fixed frequency and the contents of the counter. When the mean rates applied to the add and subtract inputs become equal, the number held by the counter represents the input frequency. Jitter is eliminated by a digital filter.

E. Harrison and P. F. Roach, of the United Kingdom Atomic Energy

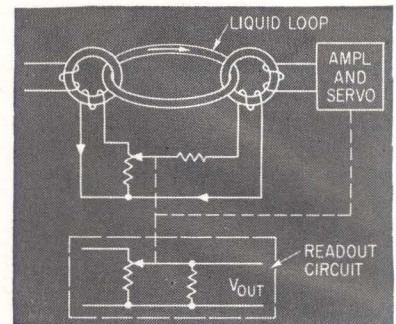

LIQUID conductivity is measured without electrodes by nulling transformer output

Authority, reported on a system that continuously measures conductivity of radioactive liquids without electrodes and with 1-percent accuracy. A liquid loop couples two toroidal transformers (see diagram). A second coupling induces an antiphase signal that is adjusted by a servo-driven series potentiometer to null the transformer output. At balance the potentiometer value is proportional to the liquid conductance.

A simple three-dimensional numerically controlled die-making machine has been designed by P. Burgess, of Wickman Ltd., and R. Duthia, of Parmeko Ltd. A magnetic tape programmer records movements of a zero pressure stylus over a model. Stylus position is determined by the onset of a spark discharge between the stylus and the model's conductive material.

What Happened to Project Bambi?

AIR FORCE project to intercept enemy ballistic missiles during their boost phase from a rocket-carrying satellite seems dead.

Testimony released last month from the Senate Armed Services Committee hearings during February quote Defense Secretary McNamara:

"(Bambi) was an Air Force project, but it was never developed with any effectiveness up to the

present time. We spent practically nothing on it. It has been a study project phase. We have not held it back for lack of expenditures, but we have not found a way to expend funds effectively on that project."

Clue to one of the major problems encountered was contained in another statement: "I think we found that the sky was bigger, perhaps, than we had anticipated."

TOM:

HERE'S THE LIST YOU WANTED OF SYSTEMS
NOW USING FAKTRON'S MR-330 & MR-700 CAPACITORS.
PARDON MY LOOSE DRAWINGS BUT I THOUGHT
THEY MIGHT AID RECOGNITION.

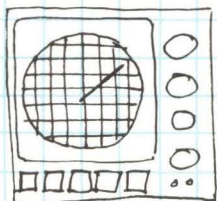

AIRPLANE NAVIGATIONAL
EQUIPMENT (DOPLAR)

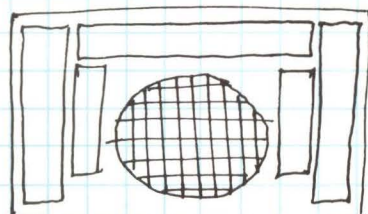

UNDERSEA DETECTION
EQUIPMENT (SONAR)

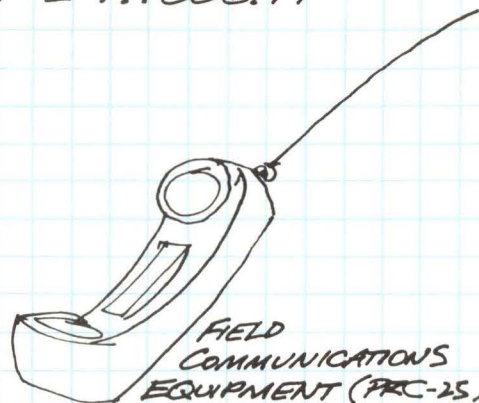

FIELD
COMMUNICATIONS
EQUIPMENT (PRC-25)

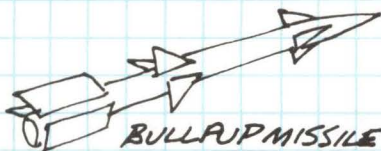

BULLET MISSILE



MISSILE FUZE

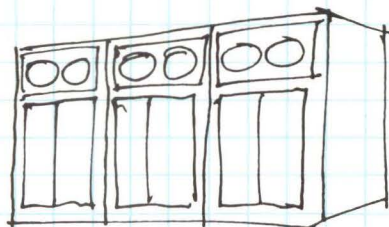

COMPUTERS

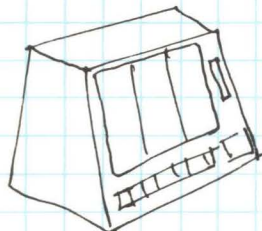

ELECTRONIC TEACHING
EQUIPMENT

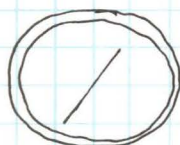

TACHOMETERS

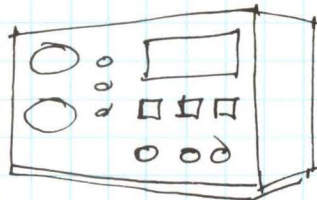

LABORATORY TEST
EQUIPMENT

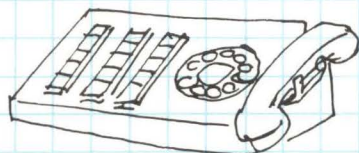

TELEPHONE SWITCHBOARD
EQUIPMENT

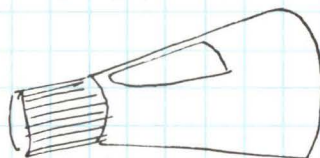
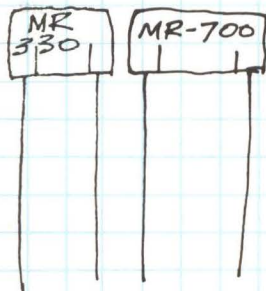

MANNED & UNMANNED
SPACECRAFT

FUNDAMENTALLY, THEY LIKE THE SIZE, COST AND
NEEDLESS TO SAY - PROVEN RELIABILITY.

I'VE LISTED THE DUREZ CAPACITOR USERS ON
THE OTHER SIDE. INCIDENTALLY, SALES ON THE
MOLDED WERE UP OVER 1000% LAST YEAR.

.047 200V
± 20% 900

DUREZ

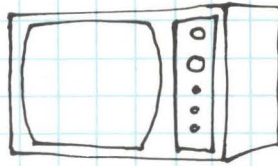

TELEVISION
RECEIVERS

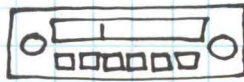

AUTOMOBILE
RADIOS

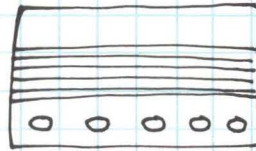

RADIOS

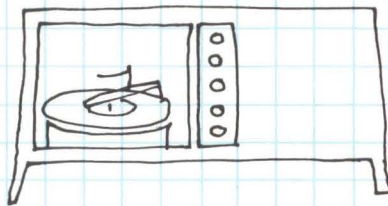

HI-FIDELITY
PHONOGRAPHS

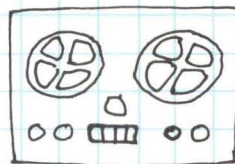

TAPE
RECORDERS

THESE MANUFACTURERS ARE THE BIGGEST AND BEST IN THE BUSINESS, SO TRACK RECORDS ARE GOOD. COMPLETE SPEC INFORMATION IS AVAILABLE ON EACH SO WHY DON'T YOU DROP THEIR OFFICE A NOTE AND THEY'LL RUSH THE MATERIAL TO YOU. AS ONE ENGINEER TO ANOTHER, YOU'LL BE DOING YOUR BOSS A FAVOR. SEE YOU AT THE NEXT ENGINEERING SEMINAR. ~~BT~~

HERE'S THEIR
ADDRESS →

PAKTRON
DIVISION ILLINOIS TOOL WORKS
1321 LESLIE AVENUE
ALEXANDRIA, VIRGINIA



Y257/4E

Y333/1E

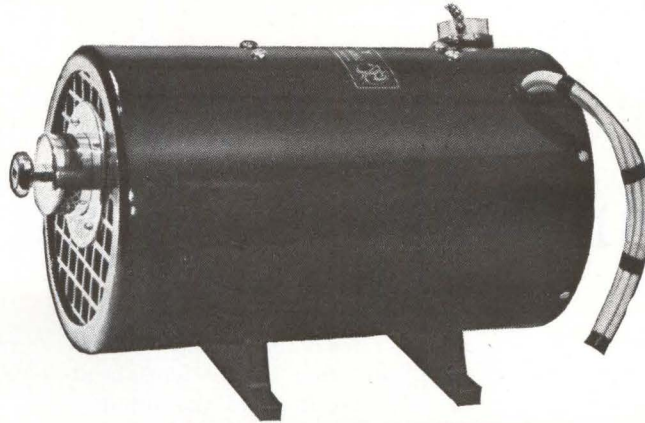

STC

BACKWARD WAVE OSCILLATORS for C-, K- and Q- bands

All now available with d.c. isolation between output terminal and slow wave structure to permit grounded cathode operation.

All fitted with grids for amplitude modulation or feedback to obtain smooth output with swept frequency.

| Frequency (Gc/s) | Band | Type | Line Voltage (kV) | Focusing | Output |
|------------------|------|---------|-------------------|----------|---------|
| 4 to 7.5 | C | Y257/4E | 0.27 to 1.25 | Magnet | Coaxial |
| 18 to 26.5 | K | Y322/1E | 0.7 to 2.8 | Solenoid | W.G. |
| 26.5 to 40 | Q | Y333/1E | 0.7 to 2.8 | Solenoid | W.G. |

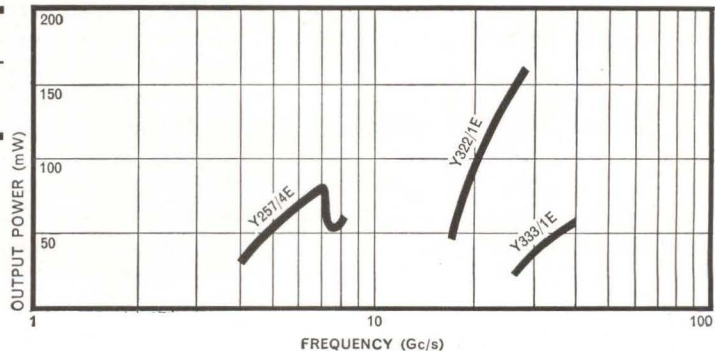

Ask for Brochure MS/113

Standard Telephones and Cables Limited

VALVE DIVISION:
BRIXHAM ROAD · PAIGNTON · DEVON · ENGLAND
USA enquiries for price and delivery to
ITT COMPONENTS DIVISION · P.O. BOX 412, CLIFTON N.J.



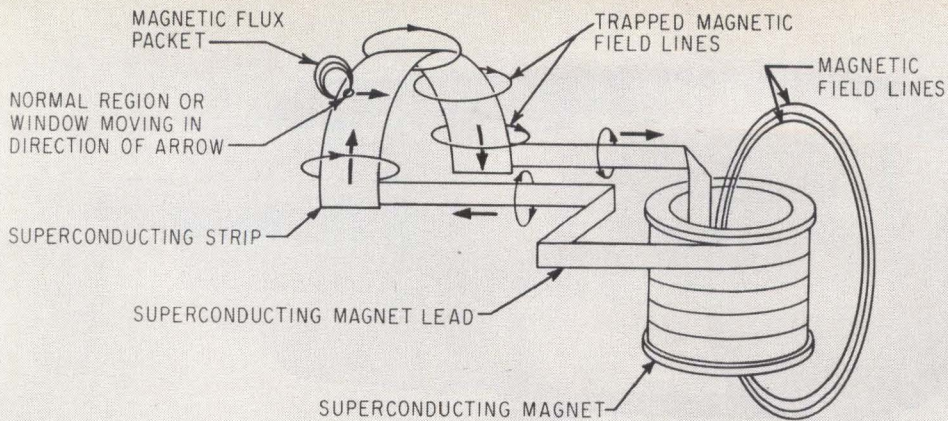

MAGNETIC FIELD is induced in superconducting magnet by "walking" field from C-magnet across strip of superconductor. Energizing technique permits low current to build up high magnetic fields

RINGS of coherent light, running from yellow to blue, surround red laser beam passing through liquid nitrogen

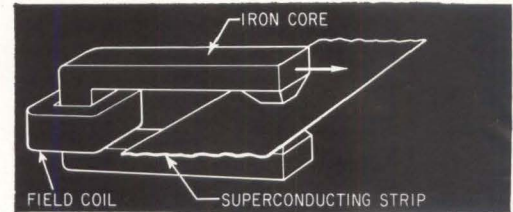

Nonlinear Effects Convert Laser Beam, Amplify Light

Physicists also report low-current energizer of superconducting magnets

By WARREN KORNBERG
McGraw-Hill World News

WASHINGTON—Laser beams can now be tailor made in any frequency from the infrared through the long-sought blue-green into the far ultraviolet.

A series of breakthroughs in exploiting the nonlinear effects of molecularly symmetrical liquids and piezoelectric crystals on coherent light culminated in two developments reported at last week's American Physical Society meeting—both by a team from Ford Motor Company Scientific Laboratory.

Robert W. Terhune, a leader in the rapid development of laser harmonics since 1961, reported both the tailor-making of laser frequencies almost without limit and the development of a parametric amplifier for light—both the result of the nonlinear optical effects.

He said the nonlinear effects make it possible to do with light anything that can now be done in the microwave frequency ranges.

Terhune's results are being

called "remarkable" and "unexpected" by other laser scientists at the APS meeting and the simultaneous National Academy of Sciences meeting.

CONVERSION—Several laboratory teams have harmonically stepped laser beams into previously unavailable frequencies.

But the emissions in the harmonic multiples of the 7,000-Å ruby emission were weak.

Terhune this year applied megawatt power. Rather than the expected 100 watts of power in the "second harmonic" blue beam, he got 200 Kw—20 percent.

Even more recently, scientists at the University of Michigan are getting 10 Kw of green light out of a 300-Kw neodymium laser.

Others are reportedly exploring other green and blue-green frequencies applicable to highly classified Navy work in submarine detection and communication areas. Terhune's contribution, said one scientist, "is raising a number of naval personnel to a highly excited state."

Terhune says that, by proper selection of nonlinear materials—molecularly symmetrical liquids like benzene or nitrogen in which to focus the red beam and ADP or calcite crystals to pass the resulting beams through—he can add or sub-

tract frequencies to get results anywhere in the visible spectrum.

The liquid has the effect of creating beams at two relatively close frequencies—6,940 and 8,000 Å for example. The crystal's nonlinear effect then is to recombine them in a predetermined way—either to add them or subtract them into the desired frequency, up to the second or third harmonic of the input.

The new light loses none of the coherence of the original beam.

AMPLIFICATION—The second nonlinear effect Terhune reported—and this work is less than two weeks old—is that suggestive of parametric amplification.

Laser light passing through liquid nitrogen, he said, results in a series of rings of coherent light on multiples of the laser frequency, surrounding the core of original red light. The rings around the red run from yellow to blue.

He explained the effect as a four-photon process in which two photons of the laser beam are annihilated and simultaneously two new photons are created—displaced equally above and below the laser frequency by some multiple of the molecular vibration frequency of the liquid nitrogen.

The liquid, he explained, can serve as the parametric amplifier

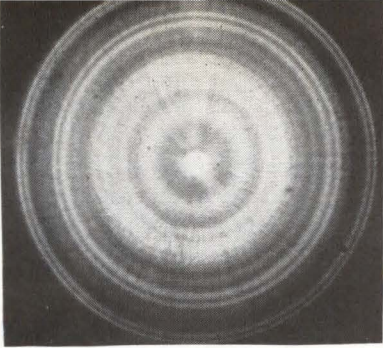

for a light signal passing through it and drawing amplifying power from a selected "displaced" photon from the laser beam.

"As with microwave parametric amplifiers," he said, "the insertion of energy at either the signal or idler frequencies triggers the creation of additional photons in both frequencies."

MAGNETICS—A method of energizing superconducting tape-wound magnets without massive hot leads and high currents—by hemstitching normal "holes" in the material's superconductivity—was described by Avco Everett Research Laboratory scientists at the APS meeting.

Ethan D. Hoag and Z. J. J. Stekly say the electromagnetic "energizer" "is especially adapted to superconducting magnets using large currents, since it eliminates the large power supply required to energize such magnets."

Using an inch-wide niobium-zirconium superconducting strip and a 20-amp input to the energizer, they built a 4,000-gauss field in 90 minutes in the experimental model.

They expect to be able next to build a 33-kilogauss field in 10 minutes in a magnet of 5-inch i-d.

The energizer is essentially a small C-shaped electromagnet, wound with either normal or superconducting wire. The superconducting strip is placed, in its liquid hydrogen bath, between the cusps.

The magnetic field creates an eddy current at the edge of the superconductor, normalizing a small region and looping a line of force through the normal region.

"Walking" the field across the strip creates a series of normal regions through which the field lines pass, until the field is looped around the entire superconducting strip. There it is self-sustaining.

Beginning over again at the edge, additional lines are "walked" across the strip until the superconductor

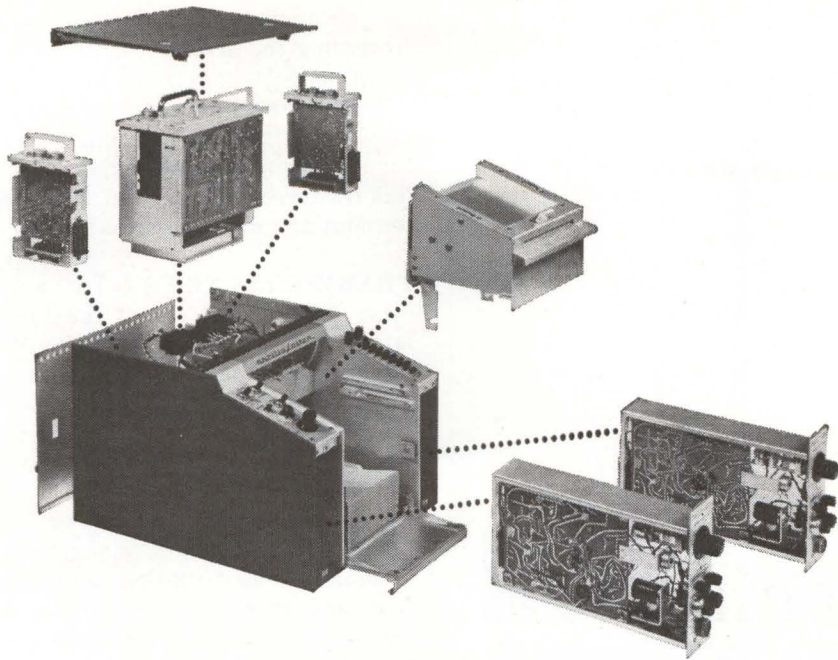

All the features you want in a medium frequency recorder

The *oscillo/riter** recorder incorporates all the features you want for top performance, convenience and reliability. Modular construction and all transistorized electronics provide complete accessibility and maximum reliability; interchangeable

able amplifiers handle more recording jobs; extended frequency response; top panel push buttons select 8 chart speeds from 1 mm/sec to 250 mm/sec; choice of roll or Z-fold chart paper, interchangeable ink or heat writing with Texas Instruments exclusive rectilinear recording system. Write for full information.

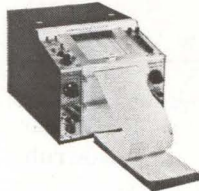

*A trademark of Texas Instruments Incorporated.

INDUSTRIAL
PRODUCTS
GROUP



TEXAS INSTRUMENTS
INCORPORATED
P. O. BOX 66027 HOUSTON 6, TEXAS

SENSING • RECORDING • TESTING • DIGITIZING INSTRUMENTS
THE INSTRUMENTS OF TEXAS INSTRUMENTS

569

CIRCLE 31 ON READER SERVICE CARD

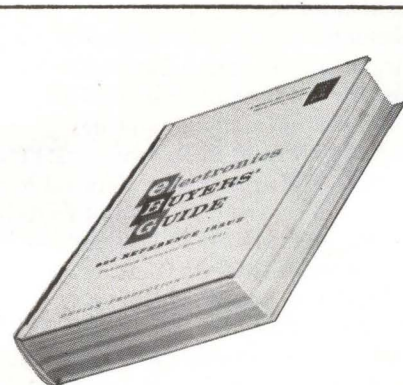

Your **electronics BUYERS' GUIDE** should be kept in your office at all times—as accessible as your telephone book.

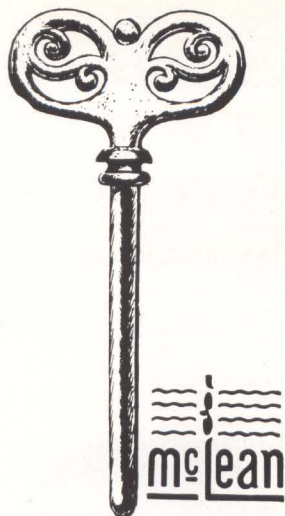

McLEAN BLOWERS

*The KEY to System
RELIABILITY*

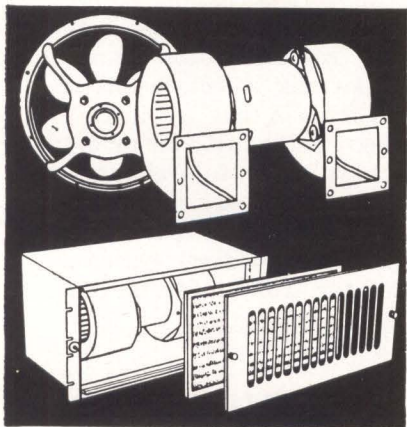

RFI SHIELDED — MIL-SPEC AND COMMERCIAL

*Over 100 Models in a wide
variety of sizes & CFM's*

Our '63 catalog contains complete engineering data on packaged blowers, ring fans, panel fans, centrifugal blowers and accessories. Write Today.



McLEAN ENGINEERING LABORATORIES

World Leader in Packaged Cooling
P.O. Box 228, Princeton, New Jersey
Phone Area Code 609 WALnut 4-4440
TWX 609-799-0245

**TOPS IN RELIABILITY & PERFORMANCE
FOR OVER 23 YEARS**

has accumulated the desired field. Reversing the process removes field force.

By arraying electromagnets across the strip and triggering them in sequence, Hoag says, he can link the force rings around the strip without any moving parts.

THERMOELECTRICS—In another development out of the Ford lab, L. L. Van Zandt and A. W. Overhauser reported on a theoretical explanation of giant thermoelectric effects in dilute paramagnetic alloys. This contributes to understanding of a variety of apparent anomalies in alloys containing impurities of chromium, manganese, titanium, cobalt, nickel and the like, and may open thermocouples and other thermoelectric devices to greater control.

Van Zandt built on Overhauser's earlier description of spin density waves—periodic areas of “up” and “down” spinning electrons.

The introduction of the impurities to create the dilute alloys, Van Zandt told an APS session, intensifies the wave effect in the region of the impurity, creating anomalies of temperature and magnetism.

He said the effect was one of unbalancing the electron drift in the metal carrying an electric current. Impurity atoms can act as a “bank” for electron energy.

Since thermoelectric power is very sensitive to slight changes in the energy current, he said, at low temperatures the “change in the thermoelectric power can be as much as a thousand times what would be expected if there were no spin density wave present.”

School for Key Engineers

*New study center to
update education of
engineering managers*

NEW YORK—New kind of engineering education program was launched last week by a \$5-million grant from the Alfred P. Sloan Foundation to the Massachusetts Institute of Technology.

MIT will establish a Center for Advanced Engineering Study. At the center, engineering managers, technical group leaders and engineering professors will take updating courses in relatively new scientific and engineering fields—such as modern atomic, nuclear and solid-state physics and engineering, information theory and advanced communications, computers and their application in engineering analysis and design.

Dean Gordon S. Brown, of MIT's School of Engineering, pointed out that “there are thousands of engineers now in their late 30's and 40's who studied what was essentially a pre-World War II curriculum. Many of them have had little or no opportunity for sustained advanced study in the scientific fundamentals of new areas of engineering.”

The plan is to begin in the fall of 1964 offering specialized and broad courses, ranging from a week to a year in length. During the first three years, the center will be experimenting with the programs offered.

Since one of the major purposes is to make engineering managers more effective in directing the applications of new scientific advances in industry, the center's sponsors are hopeful that employers will underwrite the expenses of those attending the Center.

Flight Computer



RESERVATIONS computer installed at New York International Airport by Teleregister for TWA will process overseas bookings received by teletypewriter

**MODEL CFI
TRANSISTORIZED
CALIBRATED
MICROWAVE
FIELD-INTENSITY
(RI/FI) METER
—1,000 to 10,000 MC.**



Category A Air-Force Approval For MIL-I-26600 and MIL-I-6181. Transistorized, portable, compact, ruggedized.

Combines an impulse calibrator, field-intensity meter, and calibrated antenna system. Provides accurate measurements of the frequency and the absolute power level of conducted or radiated microwave energy. Choice of 12V battery or line-power operation.

FEATURES: UNIDIAL® tuning; Direct-reading digital frequency dial; $\pm 1\%$ frequency accuracy; Choice of 3 impulse bandwidths — 1 MC, 5 MC, wide band; Direct reading output level, microvolts, db above 1 microvolt and db above 1 microvolt per MC; Image and spurious response rejection better than 60 db; Max. RF input, 3 volts. Audio, video, recorder outputs. AM, FM, CW, and Pulse Reception Capability. Four interchangeable plug-in tuning units cover 1,000 - 2,040; 1,900 - 4,340; 4,200 - 7,740; and 7,300 - 10,000 MC.

**MODEL FIM-2
CALIBRATED
MICROWAVE
FIELD-INTENSITY
(RI/FI) METER
—1,000 to 10,000 MC
(Extension to 21,000 MC
nearing completion)**



Category A Air-Force Final Approval For MIL-I-26600 and MIL-I-6181. Widest frequency range ever offered in a microwave RI/FI meter!

Combines internal CW signal generator, field-intensity meter, and calibrated antenna system. Provides accurate absolute power level and frequency measurements. The signal level indication is in microvolts, db above 1 microvolt, and db above 1 microvolt per MC.

- Only microwave Field Intensity Receiver with self-contained CW signal generator which calibrates entire system under test at any level.
- First single microwave test system to determine radiated r-f interference and susceptibility.
- Front-panel meter directly reads average, peak, slide-back peak or quasi-peak value of r-f signals.
- Six interchangeable tuning heads cover 1,000 to 21,000 mc.
- Outputs for video, audio and recorder.
- Single UNIDIAL® tuning control simultaneously tunes the receiver and signal generator.
- Calibrated antenna system includes an omni-directional broadband antenna and separate directional antennas to match each tuning unit.
- Frequency Dial Accuracy: $\pm 1\%$.
- Maximum RF Input: 3 volts
- Sensitivity: -81 dbm minimum
- Impulse Bandwidth: 5 mc
- Image and Spurious Response Rejection: Better than 60 db
- Attenuation: 0 to 80 db in steps of 1 db

HAVE YOU MADE RESERVATIONS YET?



Polarad's new "Project Mohammed" will be bringing the "Mountain" (our new Mobile Microwave Calibration Laboratory) to "Mohammed" (your microwave instruments) starting next month. Be sure to take advantage of this opportunity to have your gear checked — at your doorstep. Save weeks of delay and needless expense. Call your Polarad field engineer for details and schedules!

How To Select An RI/FI Meter

In noise-and-field-intensity measurement, Polarad has three major competitors. They are all competent. They build good equipment. Give or take an adjective, they describe and rate their equipment accurately. We respect their designs, their equipment, and their integrity as manufacturers. We believe they return that respect.

As an engineer, you know that no two design groups ever produce exactly the same instrument for a specific purpose. Experience and backgrounds differ. Approaches differ. Even basic concepts differ. Then, too, each group has its own view of the needs of the user. In a complex design, one approach will favor sensitivity over bandwidth, or, perhaps, cost over durability. We all must draw the line somewhere, in reaching each design decision. In an RI/FI meter, there are dozens of such decisions. The final "mix" of characteristics is, at best, an intelligent compromise . . . never the ultimate.

We believe that the two instruments described on this page represent by far the best "mix" of performance, economy, and versatility for the majority of applications.

You don't buy an RI/FI meter every day. Once you buy it, however, you may use it every day, for many years. Therefore, we urge you to consider the "mix" carefully. Limited range or restricted utility may seem tolerable now, but what about next month, or next year? Initial cost may dominate your thinking now, but how much does an extra man-hour a day (or one questionable result a week) cost . . . over five years?

Consider the "mix". We think you'll choose Polarad.

We can't resist listing the outstanding features of our "mixes", below — but don't decide until you have the complete technical data in front of you.

Call your Polarad Field Engineer.

- | | | |
|----------------|---|--|
| CFI "mix" | <ul style="list-style-type: none"> • Portable, Rugged, Compact • Battery and AC Operation • Direct Reading without Charts • Directly Calibrated Long-Life Impulse Calibrator • Digital Frequency Display • -85 dbm Minimum Sensitivity • 70 db Dynamic Range • Standard Calibrated Horn Antennas • Air Force Approved | <p>Which one is just right for you?</p> |
| FIM-2 "mix" | <ul style="list-style-type: none"> • Integral CW Generator for Accurate Calibration & Direct Substitution Measurements • Separate Generator Output for Susceptibility Measurements • Direct Reading without Charts • -81 dbm Minimum Sensitivity • Standard Calibrated Horn Antennas • Air Force Approved | |

POLARAD

Polarad Electronic Instruments

A Division of Polarad Electronics Corporation
World Leader in Microwave Instrumentation
34-04C Queens Blvd., Long Island City 1, New York

**“OUR Panoramic* ANALYZERS
ARE AN ABSOLUTE NECESSITY...”**

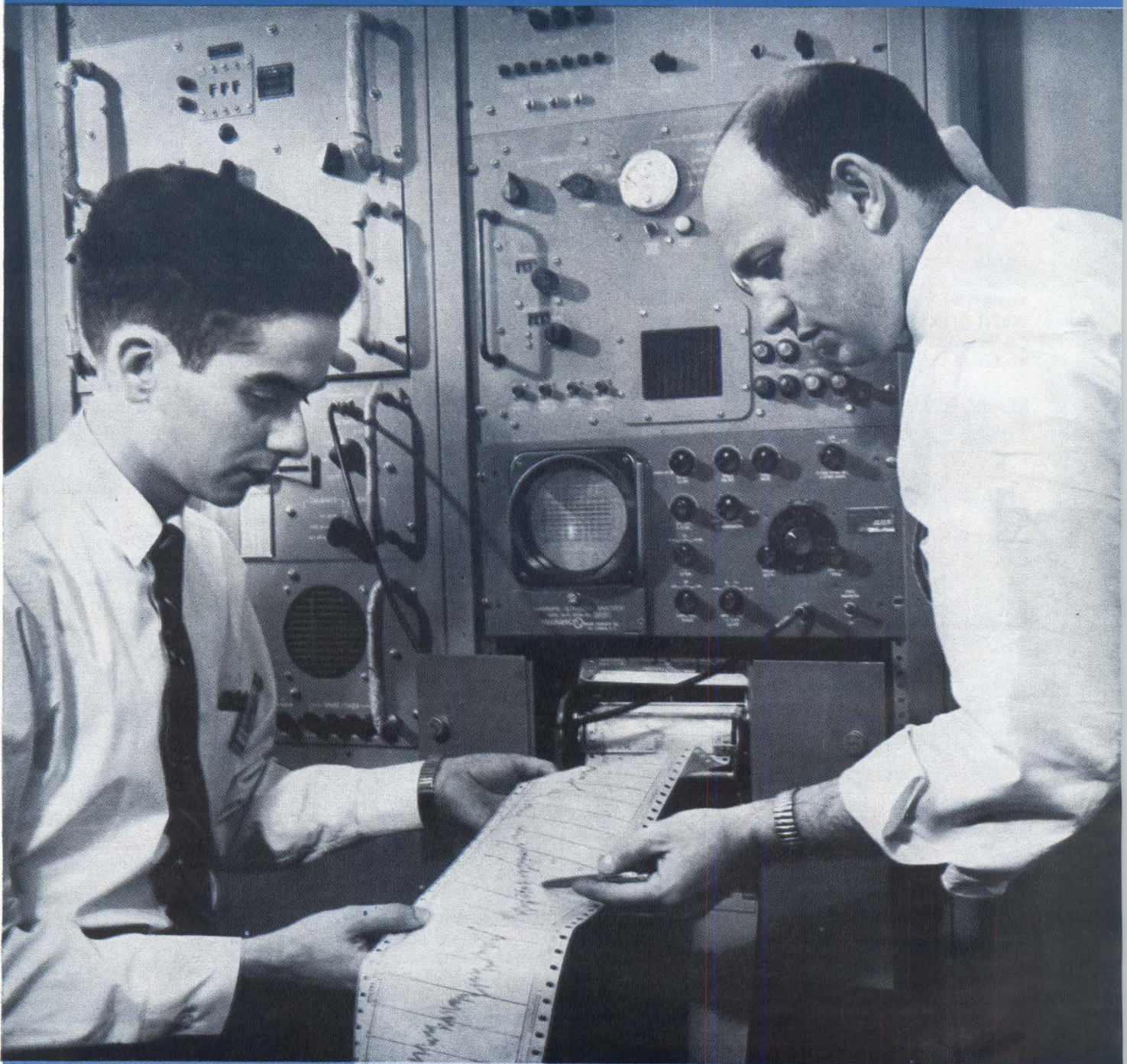

GPL Division engineers study recording of spectrum distribution of test signals from Doppler Radar Signal Simulator. The instrument is a PANORAMIC Ultrasonic Spectrum Analyzer Model SB-15 with optional PANORAMIC Recorder Model RC-3a/15.

*A Trademark of THE SINGER MANUFACTURING COMPANY.

INTERVIEW WITH GPL DIVISION,
GENERAL PRECISION AEROSPACE, ON TESTING
OF AN/ASQ-28 DOPPLER RADAR EQUIPMENT

"We have one chronic complaint about spectrum analyzers," said the project engineer. "There aren't enough of them."

We were standing in a busy corner of GPL's test section in Pleasantville, N. Y., where this Division of General Precision Aerospace produces, among other electronic gear, advanced Doppler Radar Systems under Navy and Air Force contracts.

"Take this set-up," he continued, indicating a test in which one of the Model SB-15 PANORAMIC Ultrasonic Spectrum Analyzers was connected to a GPL-designed Doppler Radar Signal Simulator. "There's really no other way to do it. It's interesting that the accuracy of the simulator signal we're testing here must be at least an order of magnitude greater than the airborne system we will test with it."

He switched out the sweep rate derived from the RC-3a Recorder and selected the more rapid sweep rate of the SB-15 for a "quick-look" analysis.

"That's a complicated audio signal," said our host, pointing to the screen trace. "It's generated and then shaped to simulate the signal received by our airborne navigation system. Right now we're measuring signal-to-noise ratio. However, at any time we may want to run a whole program of qualitative tests on the same signal. PANORAMIC analyzers give us the needed flexibility and resolution."

He demonstrated this point with a series of quick manipulations of the continuously variable center frequency and scan-width controls.

"We use the analyzer for trouble shooting, too," he continued. "If a Simulator signal looks wrong, we work back through its audio circuitry with the SB-15 and find the cause."

We asked about reliability.

"Very rugged," was the answer. "This particular PANORAMIC unit was here four years ago when I joined the section. We have several. Some are the newer Model SB-15a. This one is a special 400-cycle power line job that's been pulled out of the lab and used in a number of actual flight tests. Aside from our own checks and routine trips to our calibration lab, it's almost constantly in use."

We commented on what seemed a large amount of gear for an air navigation project.

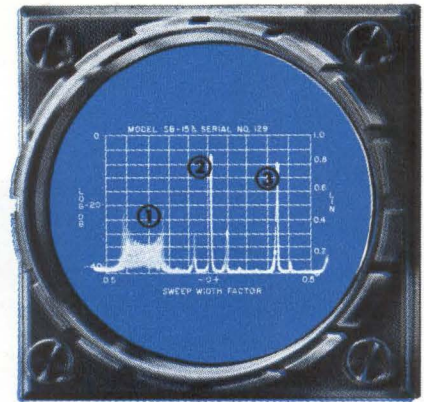

Screen photo shows versatility of the SB-15a: (1) FM display measures dynamic deviation; (2) and (3) are AM and SSB signals, respectively, with sine wave modulation.

"Oh, this is all test equipment," our guide explained. "For instance, our AN/APN-153 Doppler Navigation unit itself is only one cubic foot in size and weighs under 50 pounds. We're very proud of that."

Had he any general comments about the equipment?

"Well..." He thought a moment. "In my judgment, for anyone requiring rapid analysis of sonic or ultrasonic signals, the spectrum analyzer is an absolute necessity."

DESCRIPTION

Model SB-15a PANORAMIC Ultrasonic Spectrum Analyzer automatically and repetitively scans spectrum segments from 1 kc to 200 kc wide through the entire range (100 cps to 600 kc) with a 60 db dynamic range. It plots frequency and amplitude along the calibrated X and Y axes of a long-persistence 5" CRT or also on a 12" x 4 1/2" chart with optional RC-3b. Sweep rates are adjustable from 1 to 60 cps. Adjustable resolution permits selection and detailed examination of signals as little as 100 cps apart. Self-checking internal frequency markers are provided at every 10 kc. The unit has an internal amplitude reference at 100 kc. The compact SB-15a, only 8 3/4" high, needs no external power supply or regulator. The optional recorder RC-3b permits very slow scans for high resolution at broad sweep widths and statistical analysis of complex signals. The recorder is compatible with a wide variety of PANORAMIC instruments.

APPLICATIONS

- Ultrasonic noise and vibration analysis
- Communications system analysis
- VLF radio and carrier channel analysis
- General Fourier analysis
- FM Telemetry subcarrier channel analysis

SPECIFICATION HIGHLIGHTS

- Frequency Range: 100 cps to 600 kc
- Sweep Width: Adjustable, calibrated from 1 kc to 200 kc
- Center Frequency: Adjustable, calibrated from 0 to 500 kc
- Markers: Crystal controlled, 10 kc and 100 kc plus harmonics, usable throughout band; also provides amplitude reference
- IF Bandwidth: Adjustable, 100 cps to 4 kc
- Sweep Rate: Continuously adjustable, 1 cps to 60 cps (30 seconds to 16 hours in steps with the RC-3b PANORAMIC Recorder)
- Amplitude Scales: Linear, 40 db log (extendable to 60 db) and 2.5 db expanded
- Sensitivity: 200 μ v to 200 v full scale deflection
- Accuracy: ± 0.5 db
- Input Impedance: 50,000 ohms

GPL Division of General Precision Aerospace is just one of hundreds of users who find PANORAMIC Spectrum Analyzers indispensable for monitoring, testing, and trouble-shooting in the audio, ultrasonic, and low rf frequency bands. Our applications engineers will be glad to discuss your requirements at your convenience and without obligation. Write today, outlining your application, for literature and prompt recommendations.



MANUFACTURED BY



The measure of progress . . .

SINGER METRICS DIVISION
THE SINGER MANUFACTURING COMPANY
915 PEMBROKE STREET • BRIDGEPORT 8, CONNECTICUT • (203) FOREST 6-3201



SEC. 2900

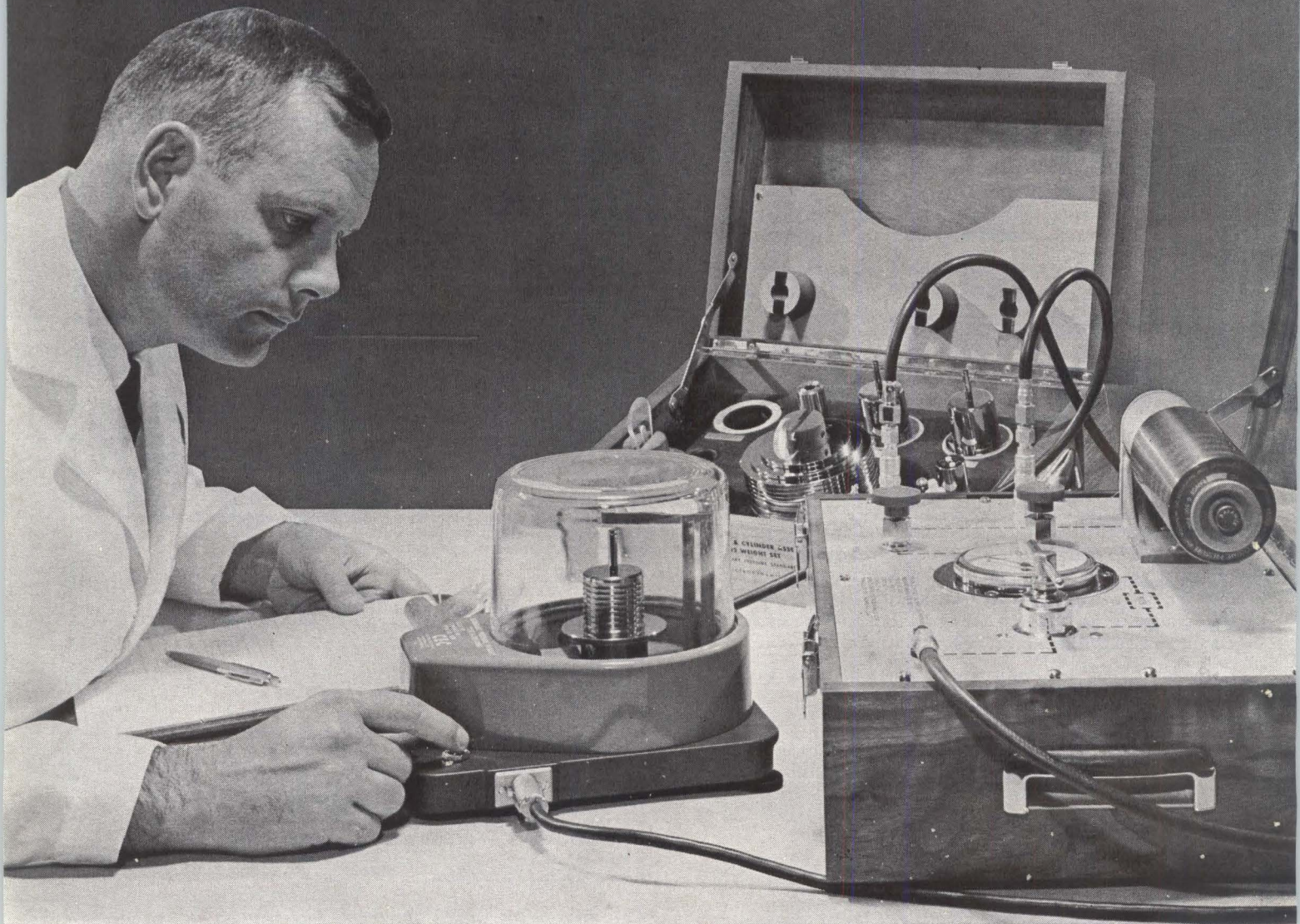

Now — an easy-to-use, portable calibration pressure system

CEC's 6-201 Primary Pressure Standard combined with new 6-003 Calibration Pressure Controller

In field or lab, CEC's great new calibration answer saves you time and money... the first factory-made system on the market. It's highly accurate, highly reliable, and highly portable.

CEC's Type 6-003 Pressure Controller makes this calibration pressure system possible. All essential controls are included: pressure volume regulator, input and output connections, coarse control, gage, feed

and vent valves to control pressure to the pressure standard and built-in filter. Portability allows you to take it from field to field...plug it in and get faster, precise answers. Type 6-003 fits a 19" rack with all connections and controls on a single panel, comes in a hardwood carrying case.

Other part of the calibration pressure system is CEC's Type 6-201 Primary Pressure Standard, lightweight, easy to operate

and portable. Why not investigate? Call your nearby CEC office, or write for detailed specifications contained in Bulletins CEC 6201-X8 and 6003-X8.

CEC
Transducer Division

CONSOLIDATED ELECTRODYNAMICS

A Subsidiary of Bell & Howell • Pasadena, California

CIRCLE 36 ON READER SERVICE CARD

FOR

fast
calibration...

CEC's Miniature Electromanometer System

Here's a versatile, all solid-state system for fast calibration of large quantities of pressure transducers ...in lab, field or process control applications. Using the force-balance principle, it's exceptionally stable and reliable — accuracy equal to mercury manometers, with wide choice of readouts. System includes:



1-156 Servo Amplifier:

Solid State, portable, ± 10 volts, 0.1 sec. response.

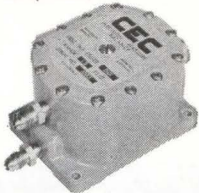

4-333 Precision Pressure Balance:

Operates over ranges ± 1.5 , ± 5 , ± 15 , ± 30 and ± 60 psid.



37-003 Multi-Channel Adapter:

Solid-state switching unit for 2 to 6 pressure balances. Zero and calibrate adjustments with external controls. Further data? Call or write for Bulletins CEC 1156A-X1.

CEC

Transducer Division

CONSOLIDATED ELECTRODYNAMICS

A Subsidiary of Bell & Howell • Pasadena, Calif.

Microcircuits Go Aloft

Integrated circuits will soon be operational in Navy's airborne systems

WASHINGTON — Introduction of microcircuits into Naval avionics equipment appears to be moving ahead rapidly. Col. Arthur C. Lowell, director of the Bureau of Naval Weapons' Avionics Division, told ELECTRONICS last week that most microelectronics fabrication problems have been solved and 1-Mc digital circuits can be implemented now with existing devices, while 3 to 5-Mc circuits will be achievable with off-the-shelf microelectronic devices by December.

Production of h-f communications sets with no moving parts and Mtb's greater than 1,000 hours also appears feasible, he said.

MEETA T—All phases of Navy's MEETA T (Maximum Improvement in Electronic Effectiveness Through Advanced Techniques) program are presently being implemented.

Under phase I significant numbers of silicon integrated circuits will be introduced in June or July into airborne digital computer that Litton is building for BuWeps, Col. Lowell said.

Phase I calls for substituting microcircuits directly for conventional circuits, while phase II has the development of a maintenance module as its object (ELECTRONICS, p 18, Dec. 7, 1962).

In phase III, which calls for developing complete equipments using microelectronic circuits, Col. Lowell cited the following developments:

- Sperry's Loran-C receiver has now been adequately demonstrated. Hardware fabrication is 60 percent complete and a qualified receiver will be delivered to BuWeps in December.

- Naval Air Development Center has a functioning breadboard of a one-way microelectronic data link that will be test flown this month.

- Westinghouse has built a working ecm receiver.

(continued on page 38)

INDUSTRY OPTIMISTIC ABOUT FUTURE

Electronics industry this year will be spending less but expecting more than U. S. manufacturers as a whole.

Electronics producers have earmarked 8 percent more for new plants and equipment this year than they spent on these items last year. But the increase is 1 percent less than the increase for manufacturers generally.

Other manufacturers see unit sales rising only 4 percent this year while electronics firms are predicting an 8 percent jump. Between now and 1966 firms generally are hopeful of an 18 percent increase but those in electronics are expecting a whopping 29 percent.

Electrical machinery manufacturers, with whom some electronics firms are grouped, are anticipating a 7 percent climb in sales this year and a 23 percent rise by 1966, according to the annual survey of business plans conducted by the McGraw-Hill Department of Economics.

Manufacturers generally said they consider 22 percent of their stock of plants and equipment technologically outmoded. The figure was only 11 percent for the electrical machinery industry.

All business now plans to spend a record \$40 billion on new plants and equipment this year, a 7 percent increase over 1962. Of this amount, manufacturing firms alone account for \$16 billion

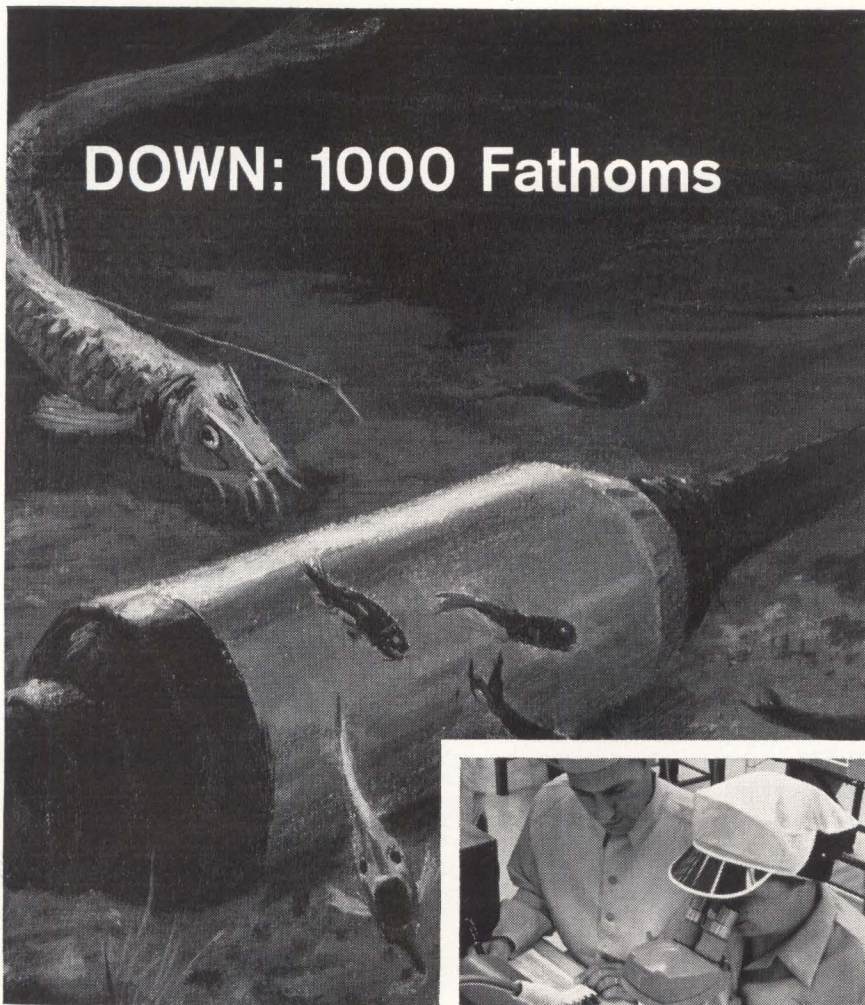

StereoZoom[®]
helps build
20-year reliability
in this Western Electric
undersea rigid repeater

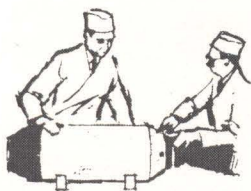

Talk about reliability! Each of these 36" x 13" diameter repeater amplifiers contains more than 5000 precision parts . . . and each is rated for a minimum of 20 maintenance-free years on the ocean floor. Spaced every 20 miles in Bell Telephone's new single-cable transoceanic system, these repeaters

help transmit 128 two-way messages simultaneously.

To make sure, Bell System's Western Electric Company uses StereoZoom Microscopes for the assembly and inspection of the high-voltage capacitors. StereoZoom's big, bright, natural, 3-dimensional views make sure of alignment, bond, and freedom from flaws or foreign particles. Its shockproof, dustproof optical system shrugs off punishing industrial use.

Have you got big problems with tiny parts? Call your dealer, or write for an on-the-job demonstration of StereoZoom Microscopes. Bausch & Lomb Incorporated, 61441 Bausch Street, Rochester 2, New York.

BAUSCH & LOMB 

These equipments use silicon integrated circuits. Hybrid thin-film circuits are being used in a personnel transceiver being built by Sylvania.

SYSTEMS— Complete microelectronic systems currently envisioned (phase IV) are an integrated helicopter/VTOL avionics system and an integrated light attack system. Request for bidders for seven items that make up a communications and navigation IFF package for naval aircraft went out last week.

As emphasis turns to applying microcircuits to operational hardware, Col. Lowell said the major problem now lies in making the design engineer aware of the new design techniques and how to apply them. Some pitfalls he warned against: putting *pnp* and *nnp* characteristics into a single chip in cases where it would be better to separate them, trying to put too many functions into a single chip, and attempting to get components in a silicon chip that should be in discrete or thin-film form.

Overall MEET AT program encompasses use of microcircuits, digital data processing, visual fault location, modular construction, majority-type redundancy, and reliability and maintainability testing.

Polaris Navigator

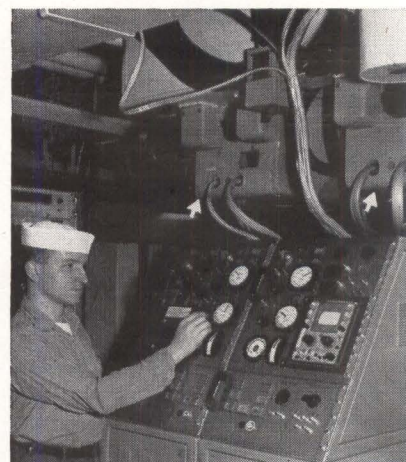

ADVANCED inertial navigation system for Polaris submarines uses electrically suspended gyros (see p 29, Nov. 17, 1961). New system built by Honeywell will monitor present Polaris systems. Installation above is on test ship USS Compass Island

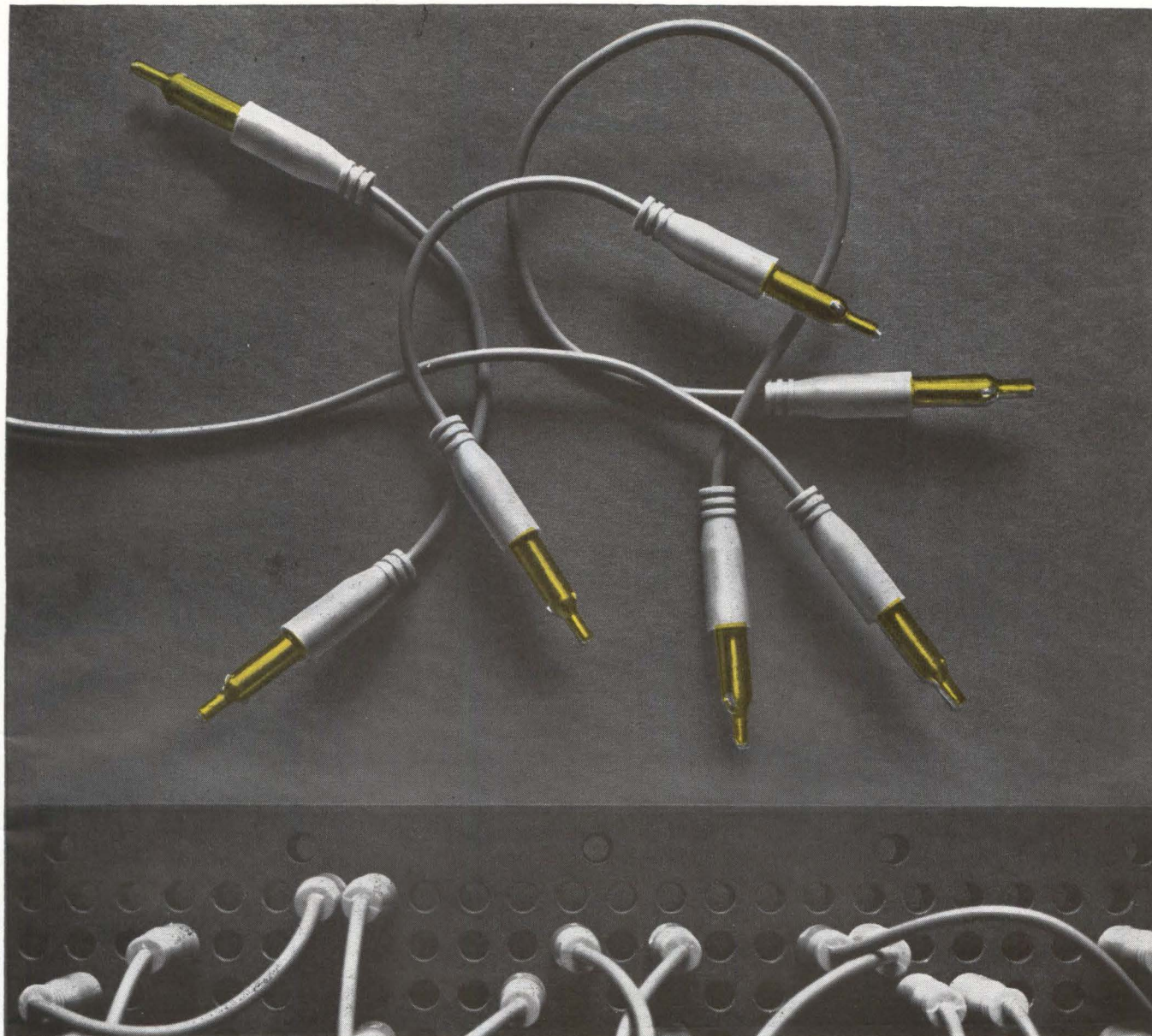

Programming reliability starts here ...

This new A-MP* Twin Detent Patchcord offers positive retaining action with a unique spring member which makes insertion-extraction easy and accidental dislodgement next to impossible. When seated, patchcords stay put even through the roughest handling. Force applied to the patchcord tip causes displacement of a plunger which acts on the Twin Detent spring. In addition, the force is distributed evenly over a larger patchboard area eliminating board chipping usually caused by application of excessive pressures. The contact area of the pin is unaffected by accumulated dust, oil, grime, or other contaminants.

Leads are better, too. AMP uses fine stranded wire and more of it (41 strands per conductor), for a more flexible lead and greater flex life. Polyvinyl chloride insulation withstands temperatures up to 105° C; and because PVC only is used, color coding won't wear off, fade or discolor.

AMP products and engineering assistance available through subsidiary companies in: Australia • Canada • England • France • Holland • Italy • Japan • Mexico • West Germany

Check these reliability features:

- Pins are precision crimped to leads.
- Twin Detent action assures retention of pins in board.
- Nickel plating on pins for ordinary applications—hard gold alloy for dry circuit requirements.
- Extended moulded shroud for larger wire bending radius, easier handling and longer flex life.
- PVC insulation withstands temperatures up to 105° C and 1,000 V.D.C. operation.
- Cords are color coded by length.

Write today for the full story on the new Twin Detent Patchcord.

*Trademark of AMP INCORPORATED



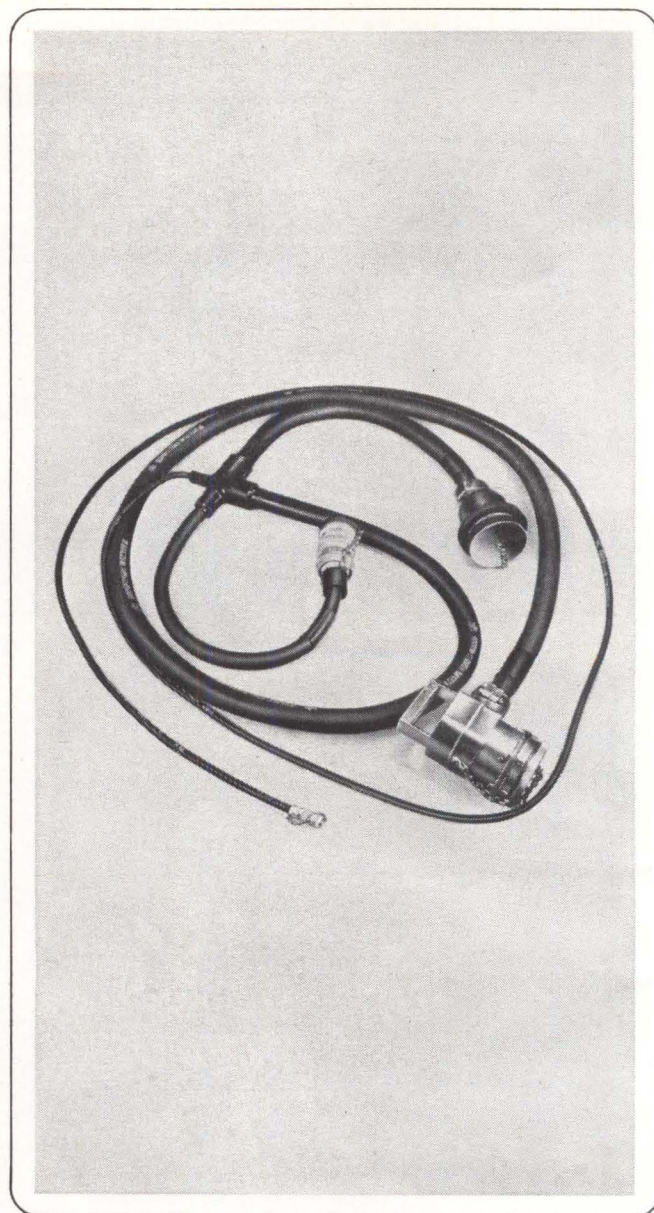
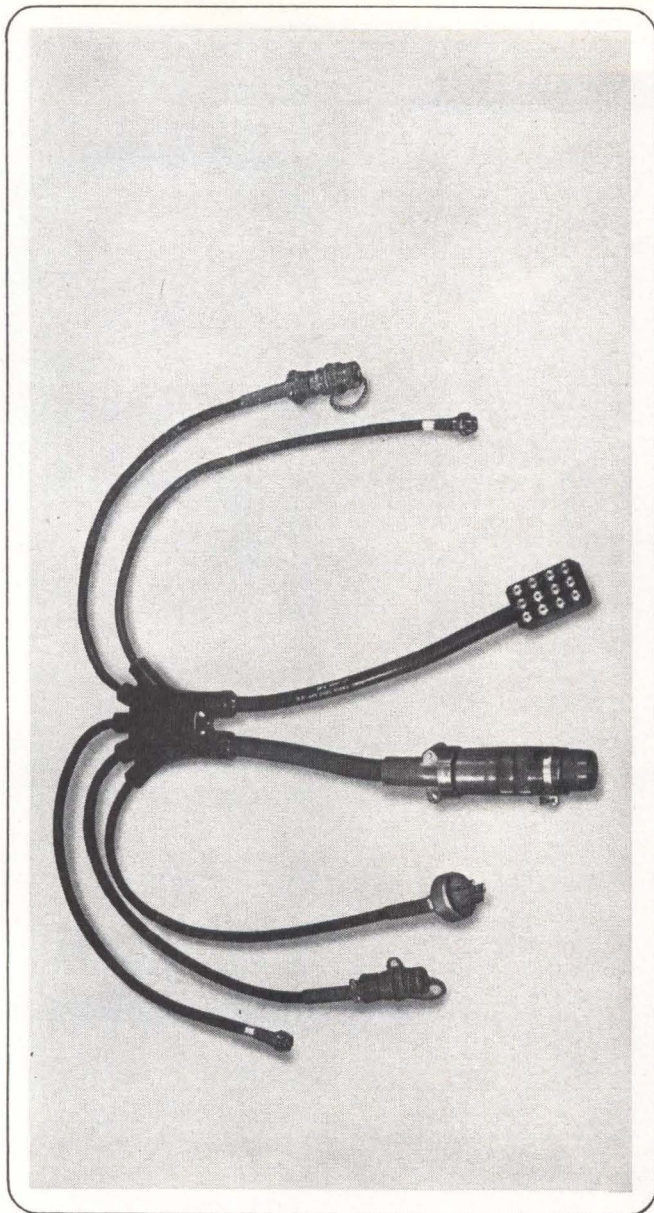

We've already solved scores of unique

You'll probably never need any of these three cables.

But somebody did. And the same versatility and reliability control which fit these special cables to special needs are now available to solve your cable problems.

These are products of Rome's Special Products Facility, where unique cable constructions are everyday products.

Cables like these can't afford to fail—there often isn't a second chance. So Rome assures reliability with a quality control program second to none. It tests each cable construction continuously throughout construction and inspection.

The program has been so successful that we recently won the first aerospace reliability contract ever awarded to a cable manufacturer. Its goal is to

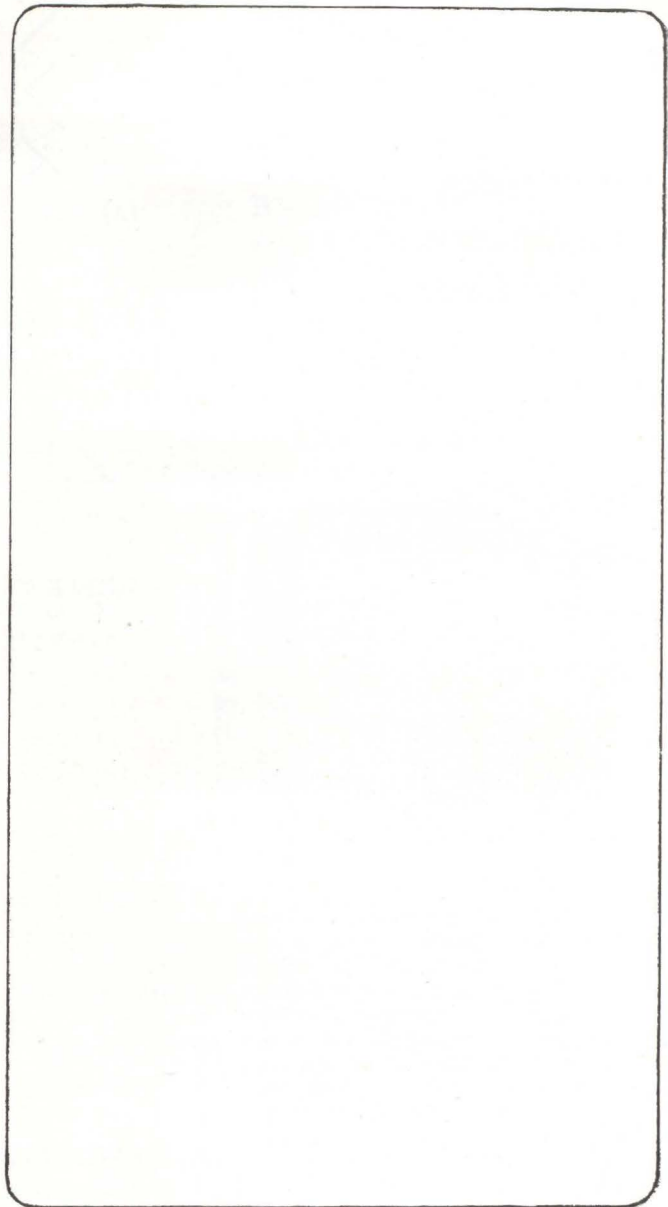
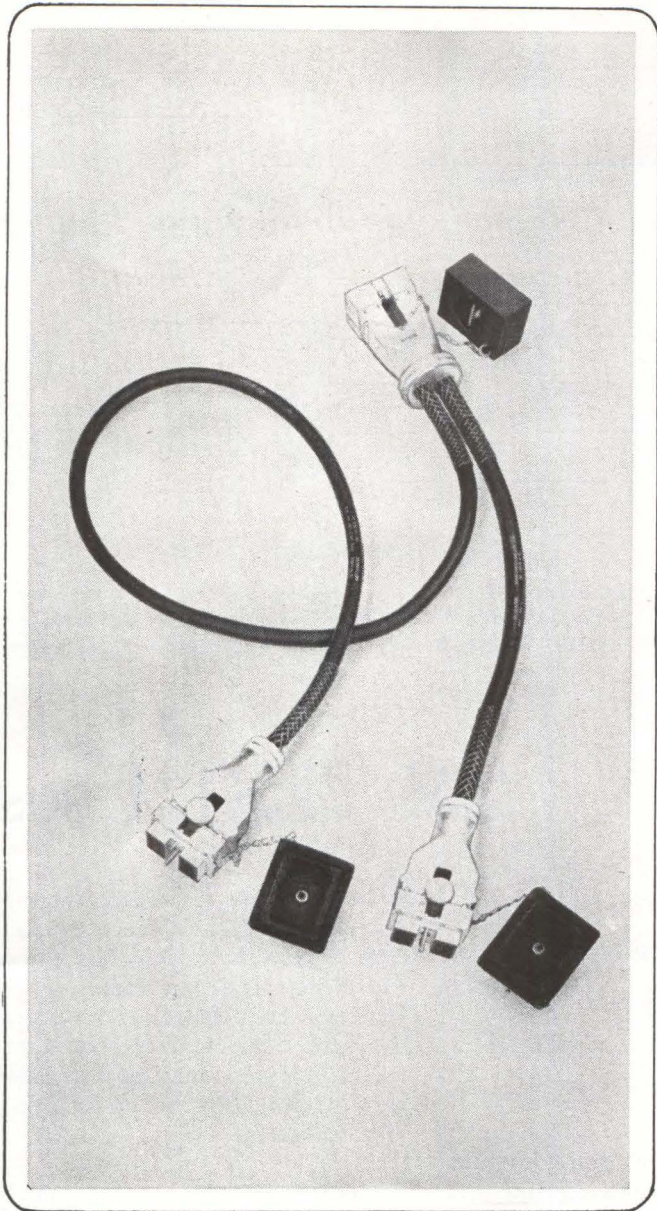

cable problems... can we help you?

prevent cable assembly malfunctions in the Minuteman missile.

Other cable constructions from Rome's Special Products Facility have proved themselves reliable on such projects as Hound Dog, Atlas, Mercury, and Sergeant.

Our Special Products Facility brochure explains how you can fit Rome's unique experience, skills and equipment to your specific problems. Just send the coupon.



Special Products Facility
Rome Cable Division of Alcoa
2937 South Tanager Avenue
Los Angeles 22, California

Please send my free copy of your brochure describing how I can benefit from Rome's Special Products Facility.

NAME _____

COMPANY _____

ADDRESS _____

CITY _____ ZONE _____ STATE _____



SOLIONS IMPROVE INSTRUMENTATION

IN MEASURING INSTRUMENTS:
INTEGRATION WITH VOLTAGE MEASUREMENT EASE!

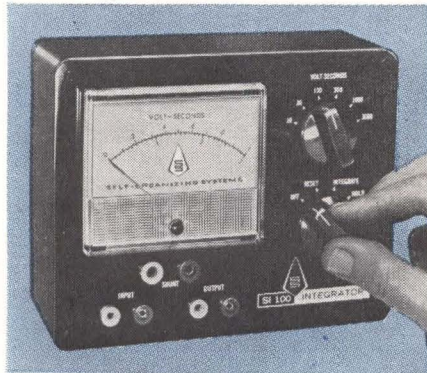

SI-100 General Purpose Integrator

A versatile, battery-powered integrator for general laboratory use. Integral ranges of 10, 30, 100, 300, 1000 and 3000 volt-seconds are provided to permit a wide variety of input signals. The integral of the input is displayed on a meter calibrated in volt-seconds. An auxiliary electrical output is provided. Highly linear ramp functions can be generated with durations of 10 seconds to one hour. Input 1-100 volts, impedance 30K to 10 megohms. Accuracy within 3%. Current integration shunts optional.

Price \$99.50, FOB Dallas. Available from stock.

IN AMPLIFIERS:

MICROVOLT DRIFT WITHOUT CHOPPERS!



SA-112 DC Amplifier

The SA-112 employs solion tetrodes to achieve low drift rates comparable to that of chopper stabilized amplifiers. Unlike chopper amplifiers, two small batteries will provide power for over one month of continuous operation. The SA-112 is ideal for use with thermocouples, strain-gauges, pyrheliometers, and other low-level sources.

Price \$295.00, FOB Dallas. Available from stock.

Write for complete information or order from:



SELF-ORGANIZING SYSTEMS, INC.
6612 Denton Drive, Dallas 35, Texas, FL 2-4814
(Formerly R&E Division of Texas Research & Electronic Corporation)

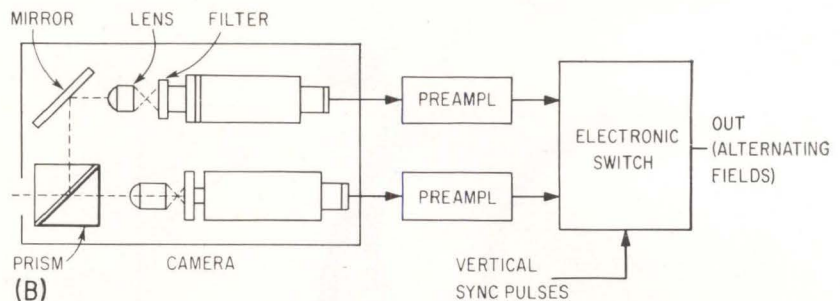
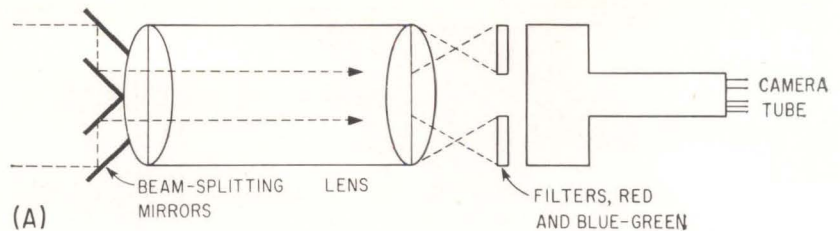

SIMPLE TWO-COLOR camera uses a double-speed sweep to pick up both Two-tube camera picks up both colors and transmits them alternately presents red and blue-green images to color picture tube in black-and-

TV TEST Uses

Mexican system puts color picture tube in black-and-white set

By WESLEY PERRY, JR.
McGraw-Hill World News

MEXICO CITY—For an hour each weekday evening during the past two months, curious viewers have crowded around 28 storefronts here to peer at the first color-television broadcasts south of the border.

The experimental receivers project two primary colors instead of the three of the NTSC system.

According to the inventor, Mexican station XHGC-TV owner Guillermo Gonzalez Camerena, color tv's success in Latin America will be determined more by the availability of low-cost receivers than by equaling the NTSC color capacity.

Color quality of his system is around 9 percent below the U.S. system, but he feels they have equal entertainment value. He says receiver cost is half of U.S. set.

In the receiver, the color r-f, color video amplifier and regulated power supply are replaced by their less expensive black and white equivalents. Only a synchronized

pulse generator is added. There is no color burst, so no such modulation is necessary. Only black-and-white controls are needed.

The system repeats 60 vertical exploration fields a second, alternating colors, to form 30 interlaced frames and 30 pairs of bichrome views a second.

CAMERA—Three interchangeable techniques are being used in experimental broadcasts.

In one, two optical filters and four image-splitting mirrors (see diagram A) project two images onto a vidicon or image orthicon.

The vertical-sweep speed is doubled so that both red and blue-green images are displaced alternately during one normal sweep time.

Second, (diagram B) the camera has two image pick-up tubes that operate with simultaneous horizontal and vertical sweeps. The optics direct the images through complementary color filters. One tube is set back further from the aperture, so the images match.

The switching circuits alternately amplify each video signal. Mixing tubes are switched by a square-wave multivibrator. Time base is adjusted to 30 cps, 60 polarity changes per second.

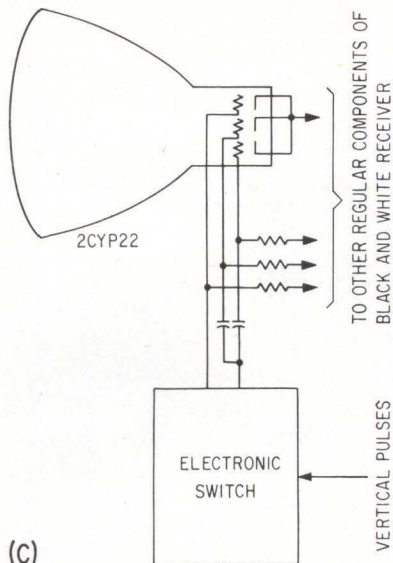

(C)
red and blue-green images (A).
(B). Receiver switch alternately
white receiver

Two Colors

RECEIVER—The receiver can be either the common NTSC three-gun type, or black and white sets with a three-gun chromatic kinescope. A synchronized key-pulse generator (diagram C) produces alternate square waves of negative polarity. One output eliminates red brilliancy of the screen with each key pulse. The other dulls green and blue.

The system's persistence-flicker problem was solved by selecting a picture tube with relatively long red and green persistence. The type preferred is 21CYP22.

The time base of the input for vertical sync pulses is adjusted so that each pulse coincides with each field. When the key pulses are alternated the complete frames in color are integrated.

The generator is composed of two sections: a conventional multivibrator that gives the time base synchronized to the vertical synchronism pulse, and an amplifying section that elevates the potential of the key pulses, for required polarity.

The two-color-disk concept can also be used. One disk spins in front of a camera lens in synchronization with complete changes of the frame. Another whirls before the receiver in sync with vertical pulses.



NOW Priced for
ALL Your
Power Supply Needs...

SILICON Transpacs[®]



- Ultra Stable
- Meets High Temperature Requirements
- All Components Accessible for Repair and Replacement
- Miniaturized . . . Replaces Bulky, Expensive Equipment
- Complete Line . . . Over 30 Models to Choose From

**Compare Silicon Transpac Prices with Other Make
Germanium Power Supplies and Compare Specs!**

SPECIFICATIONS

Input: 105-125 VAC 50-400 cps
Output Voltage Ranges (nom): 6, 12, 18, 24, 28, 32 VDC Models
Adjustment Range: ± 1 volt
Output Current Ranges: 500 MA, 1 amp, 2 amp, 4 amp, 8 amp Models
Ripple: Less than 800 Microvolts RMS
Line Regulation: Less than $\pm 0.01\%$ or 5 millivolts for full input change
Load Regulation: Less than 0.05% or 8 millivolts for 0-100% load change
Transient Response: Less than 50 Microseconds for step line or load change
Maximum Operating Temperature: 71°C, free air, full ratings
Maximum Permissible Temperature (Stud): 110°C
Temperature Coefficient: Less than 0.01% per degree C or 3 MV

Long Term Stability: Within 5 millivolts for 8 hours, after 20 minute warmup (line, load, temperature constant)
Interconnection: Series or parallel operation permissible
Voltage Adjustment: External screw driver voltage control
Remote Voltage Control: Provision for external control of output voltage
Remote Sensing: Remote sensing facilities available
Short Circuit Protection: Automatic short-circuit protection with automatic recovery
Output Connection: Ungrounded outputs, either positive or negative terminals may be grounded
Physical: Modular construction, all components fully accessible
Heat Sinking: Internal, Convection cooled. Provision for remote location of internal heat sinks

Price Range: \$115. to \$395. Off-the-Shelf Delivery on Most Units.

. . . and for Low Cost Applications, Use GERMANIUM TRANSPACS

for literature and detailed information, write:



ELECTRONIC RESEARCH ASSOCIATES, INC.

Dept. E-5 67 Factory Place • Cedar Grove, N. J. • CEnter 9-3000

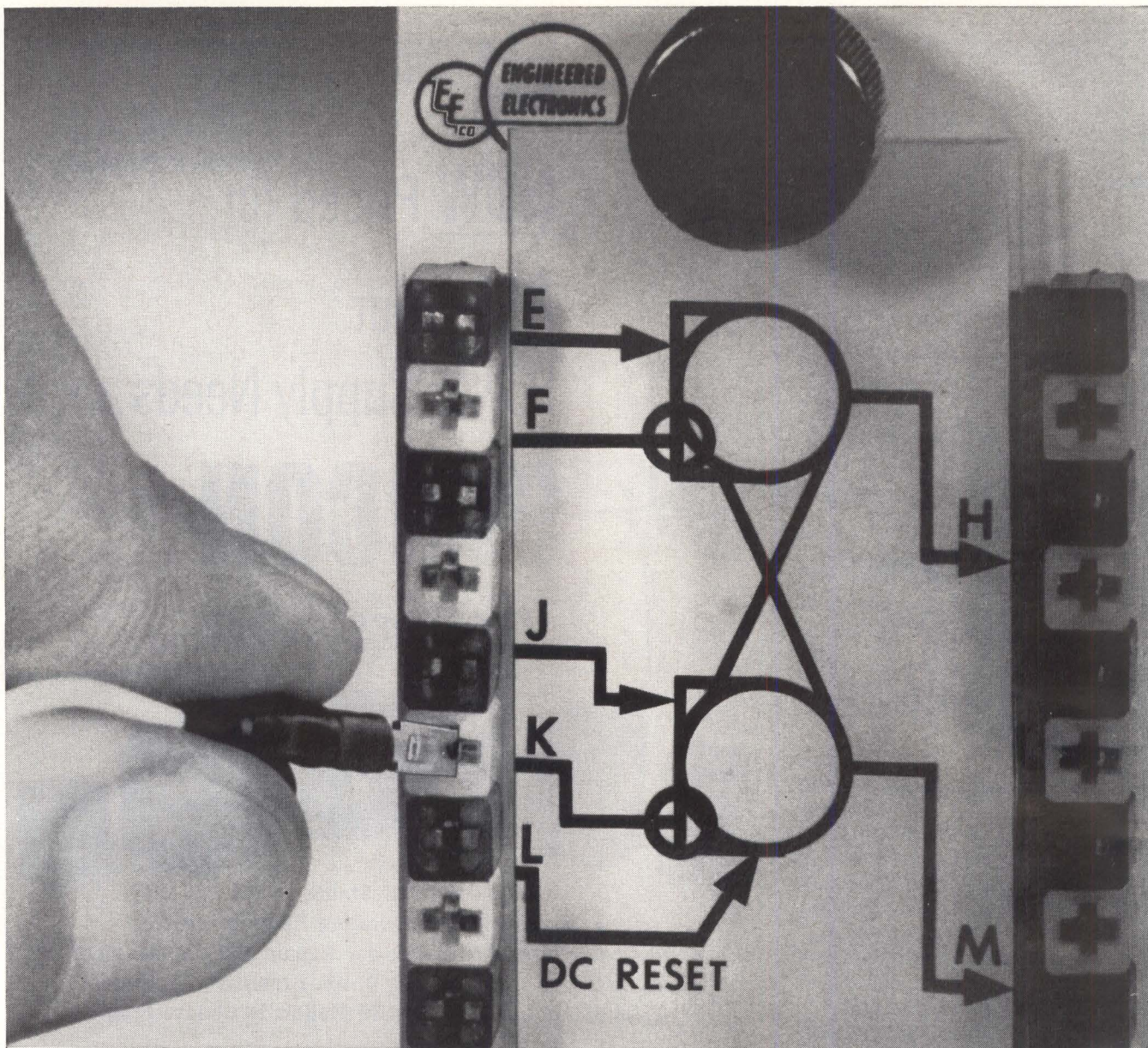

HOW TO BREADBOARD A 10 MC DIGITAL SYSTEM—FAST

Your fastest, surest means is EECo's new high-speed system breadboard. This transistor unit lets you: (1) patch up trial circuit combinations with the same catalog modules that go into the final system, (2) perform tests at operating frequencies by pushbutton and (3) get a "stop-action" look at the over-all logic flow.

Using patchcords, you can hook up, take down or change circuitry at will to study the effects of wiring, propagation delay, clock duty cycle and alternative design approaches. And, because you use field-proven modules in the breadboard, you know that the final system will work.

EECo equipment has no equal for practicality or versatility. It is com-

pletely self-contained, but has provision for external test equipment. The built-in clock source lets you apply pulses singly or in pairs. You may operate the system slowly to watch individual operations or at high speeds to simulate end-system performance. To help you patch your circuits together, EECo provides handy symbol cards — cards that indicate module circuitry, part numbers and input-output pin connections to give you a road map of the system as you assemble it.

The more you value your time and ability, the more you can benefit by using EECo breadboard equipment. Write today for the full story.

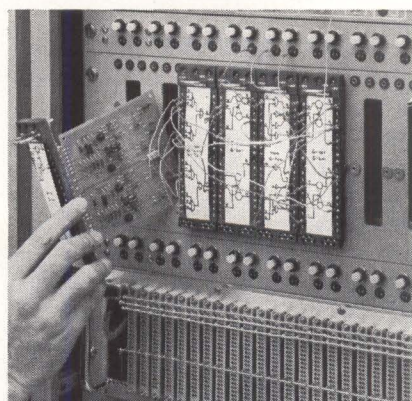

Breadboard (first stage shown) uses standard EECo catalog modules, permits pushbutton tests at operating frequencies.

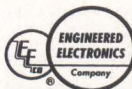

ENGINEERED ELECTRONICS Company
1441 East Chestnut Avenue, Santa Ana, California
Telephone 547-5651 • Cable Address: Engelex

EUROPEAN AFFILIATE/Electronic Engineering S.A., C.P. 142 Fribourg, Switzerland

JAPANESE EXPORTS

Keep Climbing

By CHARLES COHEN, McGraw-Hill World News

One-fifth of country's electronics production is shipped overseas

TOKYO—Electronics exports from Japan rose much faster than production during 1962. This year, the trend will be the same but exports will not rise so rapidly, according to statistics from the Finance Ministry and the Ministry of International Trade and Industry.

Exports in 1962 increased 26 percent over 1961 to \$317 million. During 1962 production totaled \$1.607 billion, an increase of 14 percent. Japan's Electronics Industries Association predicts that this year's exports will increase about 16 percent. Production will again increase about 14 percent.

EIA-J estimates that in 1963 Japanese electronics plants will produce 16.75 million radios, 5 million tv sets, 1.77 million tape recorders, 237.6 million receiving tubes and 270 million transistors.

In 1962, entertainment electronics such as radios, tv sets and tape recorders, made up 54 percent of all electronics production. Largest single item was tv sets—4.89 million sets worth \$527 million. Next to the U.S., this is the largest such production figure in the world.

But growth has leveled off and efforts are being made to develop new types that will stimulate sales. Last year many companies concentrated on expanding their production of transistor tv. Production will continue to expand this year.

This year, there is a concerted effort to make color tv a paying proposition in Japan. Major effort is development of inexpensive receivers using square-corner 16-inch 70 and 90-degree deflection color tubes developed in Japan. An industry standard tube type (either

90 or 70-degree) would help achieve lower costs, but sets using both types have been announced. It will be difficult now to achieve standardization because the companies using the rejected size will lose face.

Production of components for both entertainment and industrial electronics also increased in 1962. Increases in production of tubes and semiconductor devices ranged from 20 to 23 percent; production of components rose over 16 percent.

INDUSTRIAL ELECTRONICS—Many companies feel that the future of the Japanese electronics industry lies in the industrial electronics field. Biggest gain in the group in 1962 was in computers, whose production was twice that of 1961. Production of most other items went up 20 to 30 percent.

There is great hope for a rapid rise in industrial electronics exports.

In the charts, miscellaneous wireless equipment is wireless equipment not used for communications. Miscellaneous electronic equipment includes nonwireless electronic equipment not included in the other categories, such as computers.

Detailed production statistics for 1960 and 1961 were reported in *ELECTRONICS*, p 18, June 22, 1962.

PLAN FOR 1967—Electronics production will total 1,146,280 million yen (approximately \$3.2 billion) in 1967, according to MITI's new five-year plan. This is 171 percent of the value of 1962 production. Production increased 300 percent during the previous five-year period, from 1957 to 1962.

MITI says electronics here will change from primarily a consumer-oriented business to an industry-oriented one. Consumer production is expected to increase

1962 ELECTRONICS EXPORTS

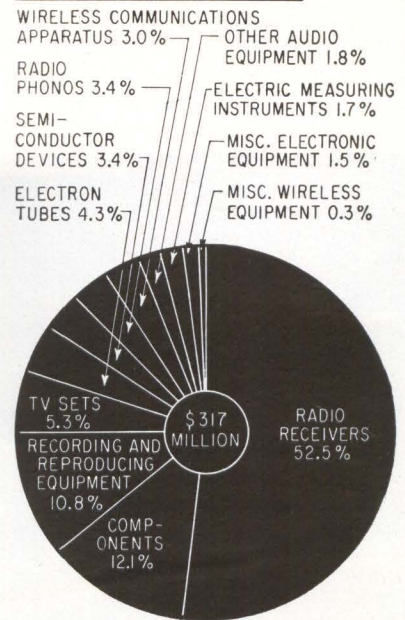

1962 ELECTRONICS PRODUCTION

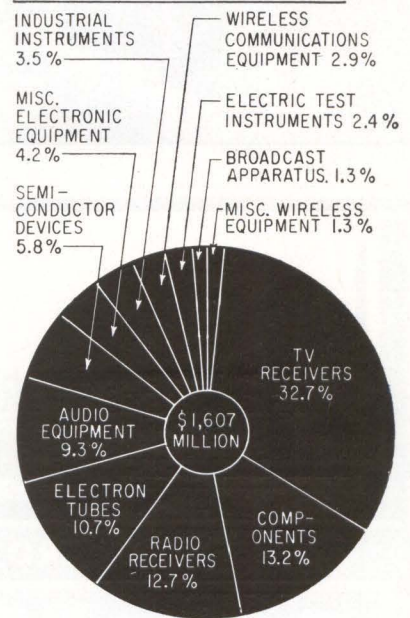

only 32 percent in value, mainly because of the leveling off of the demand for tv sets. Commercial and industrial production is seen rising 184 percent.

The plan envisions 1967 production as: entertainment electronics, \$1.16 billion; communications equipment and noncommunications wireless equipment, \$770 million; miscellaneous electronic equipment, \$248 million; electric measuring and industrial instruments, \$155 million; electron tubes and semiconductor devices, \$341 million; other components, \$508 million.

MICROTRON, microwave power source for electronic food preparation units, featuring a CW magnetron from our line of microwave tubes and display devices. San Carlos, California. In Europe, Box 110, Zurich 50, Switzerland.

LITTON INDUSTRIES
ELECTRON TUBE DIVISION

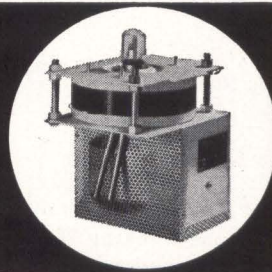

CIRCLE 201 ON READER SERVICE CARD

**HERE IS THE WORLD'S SMALLEST MOTOR
YET IT'S SO POWERFUL . . .**

MITSUMI MICRO MOTOR

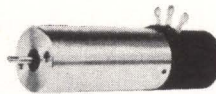

MODEL MI-100

Less than 20mm in diameter, the new Mitsumi Micromotor provides a startling efficiency of over 50%, the barrier which miniature motors are not allowed to pass.

A novel construction principle helped to make this accomplishment possible. The form is more simplified by setting all the terminals at one position. Because the entire mechanism is given full protection against irregular revolution and above all, electrical noise is entirely eliminated, you may call this the most perfect micromotor yet devised. Please write for complete information on Mitsumi Micromotor, and we will send you specifications and data.



MITSUMI PARTS
MITSUMI ELECTRIC CO., LTD.
TOKYO • OSAKA • NEW YORK

MEETINGS AHEAD

AEROSPACE RELIABILITY & MAINTAINABILITY CONFERENCE, AIAA, SAE, ASME; Marriott Twin Bridges Motor Hotel, Washington, D. C., May 6-8.

NATIONAL AEROSPACE INSTRUMENTATION SYMPOSIUM, ISA; Jack Tar Hotel, San Francisco, California, May 6-9.

ELECTRONIC COMPONENTS CONFERENCE, IEEE, EIA; International Inn, 14th & M Streets, N. W., Washington, D. C., May 7-9.

EAST CENTRAL & ALLEGHANY OHIO VALLEY DISTRICT MEETING IEEE; Commodore Perry Hotel, Toledo, Ohio; May 8-10.

PULP & PAPER INSTRUMENTATION SYMPOSIUM, ISA; Peabody Hotel, Memphis, Tenn., May 8-10.

NATIONAL AEROSPACE ELECTRONICS CONFERENCE, IEEE, AIAA; Biltmore Hotel, Dayton, Ohio, May 13-15.

NATIONAL POWER INSTRUMENTATION SYMPOSIUM, ISA; Bellevue Stratford Hotel, Philadelphia, May 13-15.

ELECTRONIC PARTS DISTRIBUTORS SHOW, Electronic Industry Show Corporation; Conrad Hilton Hotel, Chicago, May 20-22.

IMPACT OF MICROELECTRONICS CONFERENCE, Armour Research Foundation and **ELECTRONICS Magazine**; Illinois Institute of Technology, Chicago, Ill., June 26-27.

WESTERN ELECTRONIC SHOW AND CONFERENCE, WEMA, IEEE; Cow Palace, San Francisco, Calif., Aug. 20-23.

ADVANCE REPORTS

CANADIAN ELECTRONICS CONFERENCE, IEEE; Exhibition Park, Toronto, Sept. 30-Oct. 2. May 15 is the deadline for submitting a 100-word abstract and a 500-1,000-word summary to: Dr. J. L. Yen, Chairman, Technical Program Committee, Canadian Electronics Conference, 1819 Yonge Street, Toronto 7, Canada. Papers in electronics and related areas are looked-for. Authors need not be members of IEEE.

NATIONAL ELECTRONICS CONFERENCE, National Electronics Conference, Inc.; McCormick Place, Chicago, Oct. 28-30. May 15 is the deadline for submitting 5 copies of a 150-word abstract and 2 copies of completed paper or 700-word summary to: Dr. H. W. Farris, EE Department, University of Michigan, Ann Arbor, Mich. All scientific and engineering aspects of entire technical range of electronics are of interest.

NORTHEAST ELECTRONICS RESEARCH & ENGINEERING MEETING, IEEE; Commonwealth Armory and Somerset Hotel, Boston, Nov. 4-6. June 7 is deadline for submitting 600-1,000-word condensed versions of paper in triplicate and 35-50-word abstract to: Arthur O. McCoubrey, Boston Section, IEEE, 313 Washington Street, Newton 58, Mass. Papers should describe significant original advancements in the various electronic fields.

Smaller diameter for complex hook-ups with Beldfoil* shielded cables

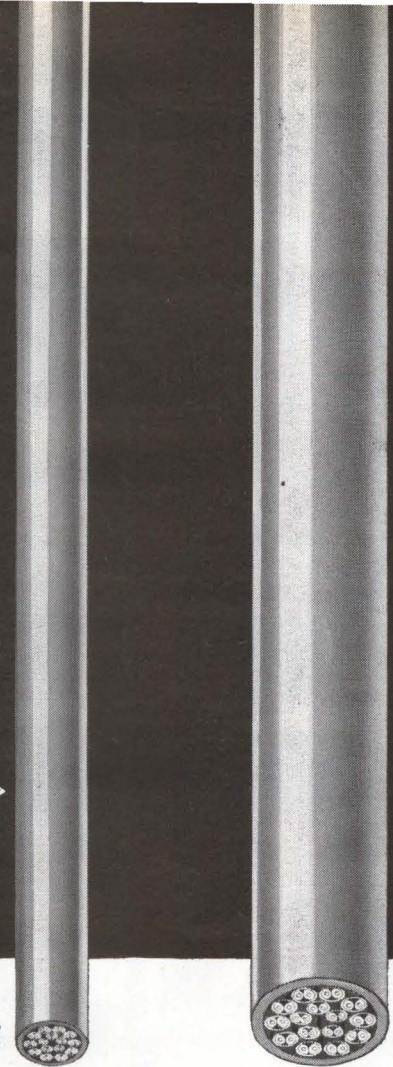

Beldfoil*
Shielding

Conventional
Shielding

Where shielding is required you can reduce the size and weight of your cable with Beldfoil shielding. This new development can greatly reduce the diameter of multi-conductor cables.

Multi-cable hook-ups can also be confined to less area. In many applications Beldfoil shielded cables can replace combined and complex hook-ups of twisted pairs and individual conductors laced together.

Beldfoil is a lamination of aluminum foil with Mylar† which provides a high dielectric strength insulation that is small in diameter, light in weight and low in cost. Its superior characteristics give 100% isolation between shields and adjacent pairs.

For audio and radio frequency applications, it eliminates cross-talk and is ideal for stationary or limited flexing.

The cable cross sections shown below (outer jacket not shown) are just a few of the many intricate and diverse ways Beldfoil has been used to solve a specific shielding problem for a customer.

If you have a space or design problem on shielded cables Belden engineering can help you.

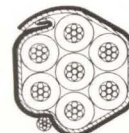
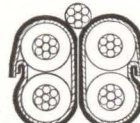
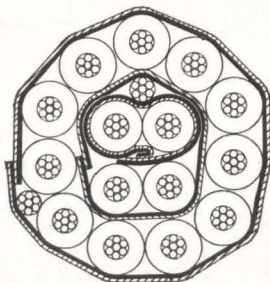
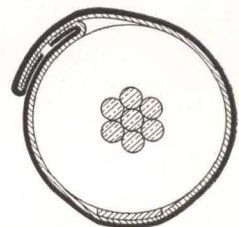
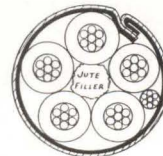
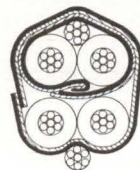
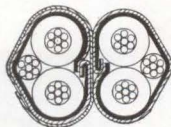
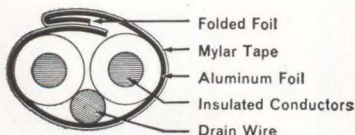

power supply cords • cord set and portable cordage
• electrical household cords • magnet wire • lead wire
• welding cable • automotive wire and cable

*Belden Trademark Reg. U. S. Pat. Off.

†du Pont Trademark



HAMMOND ORGAN COMPANY USES THE POPULAR TYPE J TO INSURE LONG LIFE AND LOW NOISE IN THE SWELL PEDAL CONTROL OF THEIR NEW SPINET ORGAN.

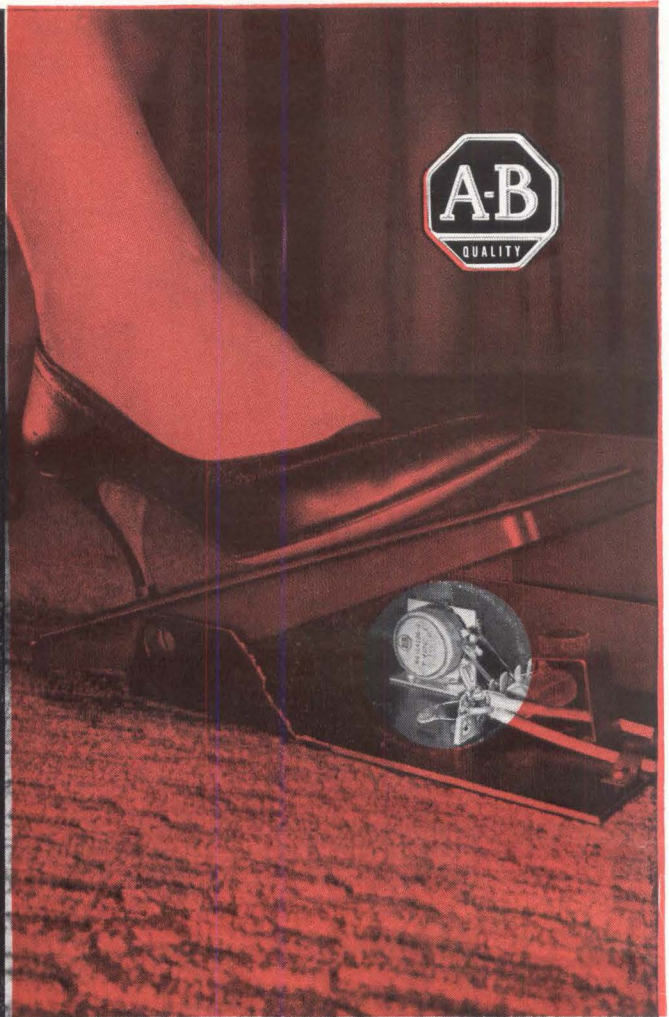

SWELL CONTROL PEDAL FOR L-100 SERIES ORGAN SHOWING WHERE ALLEN-BRADLEY TYPE J VARIABLE RESISTOR IS USED.

Hammond engineers — through tough tests — sold themselves on A-B Hot Molded Variable Resistors

■ In selecting components for the swell control pedal, which is in constant use, Hammond Organ Company exercised traditional care to make certain their new spinet will remain a lifelong companion. Therefore, Hammond engineers conducted extensive tests to determine the control that would provide the longest life in this quite abusive application. Because of the wide degree of amplification, an *extremely low noise level* is tremendously important. Based on such tests, the Hammond engineers selected the Allen-Bradley hot molded Type J variable control as their No. 1 choice. The special tapers necessary for this type of application are easily accomplished in the Type J control.

Hammond Organ Company's new spinet also uses A-B hot molded fixed resistors, which are world famous for their consistently uniform characteristics, low noise level, and complete freedom from catastrophic failures.

You can be certain of protecting the reputation of your equipment by always insisting on A-B fixed and variable

resistors. For more complete information on the entire line of A-B quality electronic components, please write for Publication 6024.

Type J controls are rated 2.25 watts at 70°C and are available in standard tapers and standard total resistance values up to 5 megohms. Special tapers and special, as well as higher resistance values, are also available.

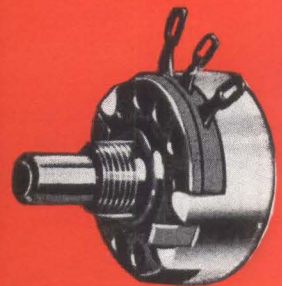

Allen-Bradley Co., 110 W. Greenfield Ave., Milwaukee 4, Wisconsin • In Canada: Allen-Bradley Canada Ltd., Galt Ontario

QUALITY ELECTRONIC COMPONENTS

ALLEN-BRADLEY



Small-screen tv is back with vigor, color tv sets will be smaller and imported ones will be sold here, a new type of electronic organ is coming out, and this year should be the best yet for tv, radios, phonographs and tape recorders

By STEPHEN B. GRAY,
Assistant Editor

ELECTRONICS FOR ENTERTAINMENT will have its biggest year in 1963, even if only half the predictions come true. The makers of color sets are sure that tinted tv will bring down the house this year, and U.S. black-and-white receiver makers are getting in on the small-screen money. Also, rapidly decreasing microelectronics prices may soon permit using thin-film and integrated-circuit electronics for tv, radio and phonographs.

TINYVISION—Several tv companies are predicting that 6 million black-and-white sets will be sold this year. Estimates on how many small-screen sets will be sold run from 100 to 200 thousand. The Japanese small sets are selling well, despite the fact that U.S.-made small-screen tv, from 8 to 14-inch, got a lukewarm reception in 1956 and 1957. However, those sets were vacuum-tube types, and although the screen was small, the set was not. The size of the Japanese sets has made them popular for their novelty and portability, and some of the more expensive ones have become status symbols. If it were

not for the competition, the pioneering Sony Corporation might well have left the price of their 5½-inch 8-pound transistor model at \$230, instead of bringing it down to \$190.

Not to miss out on the microtelevision market, General Electric and Admiral will bring out 11-inch vacuum-tube models this summer for \$100.

THE LATEST TV RECEIVER by Zenith is a 16-inch portable which, to provide a rugged assembly, has a superstructure attached to the chassis for mounting the tuner and loudspeaker at the top (see photo). According to Zenith, the chassis is "horizontal, handwired, handsoldered and handcrafted."

The circuits are almost identical to those of Zenith's 19-inch 114-degree table model sets, except that the power transformer has been eliminated to reduce weight. A 13J10 tube, which combines the 6BN6 audio detector and an audio pentode similar to the 6AQ5, was used to save space.

This receiver uses a 16AVP4 picture tube incorporating the new low-drive high- g_m gun developed by the Rauland Corporation, a Zenith subsidiary, which provides a much higher brightness for a

given amount of video drive, by designing for a greater amount of available beam current when the grid-to-cathode voltage approaches zero during peak white video information.

Even though a much larger amount of beam current is available when it is needed (during highlights), the design provides that the beam current is greatly restricted when the tube accidentally loses its bias or the set is turned off. This eliminates the

PAST PERFORMANCE

Last year was the best since 1956 for tv, and the best ever for radio sales, according to EIA. Nearly 5 million phonographs were sold in 1962, almost a million more than previous year, with stereo outselling monaural almost 3 to 1



STEREO TAPE RECORDER, model 605 by Concertone

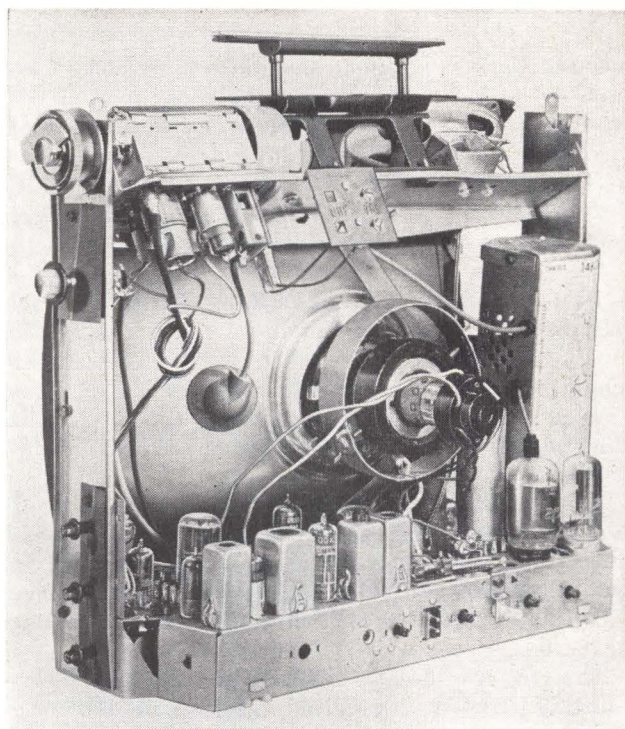

PORTABLE TV receiver with 16-inch screen, by Zenith

hazard of screen spot burn without complicated external circuits. The new gun is also used in all Zenith 19-inch tubes and most of the 23-inchers.

The 16-inch portable tv receiver has the automatic fringe-lock circuit that is on all Zenith tv sets. On previous receivers, the degree of noise immunity was determined by the adjustment of a fringe-lock control in the noise-gating grid of the agc and sync clipper tube, which was set by the serviceman to suit local signal conditions. In some instances, where both strong and weak signals exist, the noise protection of the weak signal had to be compromised so that a "paralysis" or "split-phase" condition would not occur when switching to a strong-signal channel.

The automatic fringe-lock circuit uses a varistor instead of an adjustable control (Fig. 1). As the signal level to the detector decreases, the video screen decreases in potential. Since the varistor is connected to the video screen, less potential is applied across the varistor. This action is the same as adjusting the fringe-lock control.

THE "COOL CHASSIS" construction that Philco has featured for the last three years in their black-and-white console tv sets was extended last year to their 19-inch portables, and is now used in the 16-inch Courier portable.

This ventilation design features extra openings in the chassis, all components mounted on top of the chassis, heat barriers to isolate high-heat components, and elimination of heat traps. Philco claims a heat reduction of, for instance, as much as 24 percent in operating temperature in the sync separator area, equivalent to 15 deg C.

The Courier black-level circuit (Fig. 2A) d-c couples a signal reference level from the video output stage to the crt cathode. This reestablishes a uniform d-c signal level, which is relatively unaffected by the changing picture information. The d-c reference level is taken from the plate of the video output stage, and is applied to the crt cathode through peaking coil L_1 and resistor R_1 . With the d-c level once established, the video information is then fed to the cathode through the contrast control and capacitor C_1 .

In the Courier, a varistor limits the maximum vertical pulse amplitude before applying it to the vertical output transformer (Fig. 2B) and adjusts vertical drive in compensation for slight component-value changes that occur as the set warms up. Pulse limiting is required to prevent damage to the vertical output transformer by the high-amplitude vertical spike. During pulse time, capacitor C_1 , which is connected to the plate of the vertical output stage, charges through varistor R_v , causing a high potential to appear across the varistor. Varistor resistance decreases, causing C_1 charging current to increase. Thus, the amplitude of the vertical pulse is reduced or damped by the C_1 and R_v shunt load. However, during the time between pulses, the reverse situation exists. The potential across C_1 and R_v is low, which increases the varistor resistance, and thus the effect of the $C_1 R_v$ shunt path is lessened, resulting in no appreciable loading or damping of the sweep voltage during line time.

For regulation of the vertical output-stage bias, a negative potential is developed across the varistor in proportion to the pulse amplitude. The bias path is from the junction of R_1 and C_1 , through the vertical size control to the grid of the vertical output stage. If there is an increase in yoke impedance during warm-up of the set, the vertical sweep decreases, and the resulting lower-amplitude vertical pulse that appears across C_1 and R_1 causes the varistor resistance to increase, the charging current through C_1 to decrease, the negative potential across the varistor to decrease, the negative potential at the R_2 end of the vertical size potentiometer to decrease, and the negative grid bias on the vertical output stage to decrease. Thus, vertical output conduction is increased, which increases vertical scan.

Among the latest innovations in Philco tv receivers is the extended use of frame-grid tubes in tuners, i-f and video stages. A new circuit often requires that changes be made elsewhere: the reduction of B-plus voltages for longer life of, and less stress on, components required the development of low-voltage, high-efficiency sweep tubes, high- G_m picture tubes and a frame-grid video tube. The use of high- G_m picture tubes necessitated new production techniques for gun alignment and spacing jigs. The introduction of modular construction for i-f circuits required development of a system to provide built-in capacitances and inductances in etched-circuit subassemblies. The use of d-c coupling in video stages required new developments in contrast controls. Other recent innovations are: introduction of toroid vertical deflection coils in the yoke, for greater efficiency in the vertical circuit, and use of varistors as regulating devices for sweep circuits.

COLOR TELEVISION—Predictions on 1963 sales of color tv run from 250 to 700 thousand sets. Last year, 400,000 color receivers were made, but only half that many ended up in homes, mainly because of price. The GE base price for a color set is \$495, unchanged from last year. RCA is so optimistic over the color market that after this year they will no longer supply their color chassis to other users, claiming they will need the entire production for their own sets.

The current producer of all picture tubes for color sets, RCA, will have competition shortly. This fall, National Video Corporation plans to market a 23-inch 90-degree rectangular color picture tube, which will permit color tv sets to be reduced more than 20 percent in depth from the present 27-inch front-to-rear bulk. A Zenith subsidiary, Rauland Corporation, will shortly begin production of a 21-inch 70-degree color tube, the same size as the RCA tube.

A Japanese 14-inch color set that weighs 70 pounds will be sold here in June for \$369 by Delmonico International, along with a 17-inch color receiver for \$429. Unlike previous Delmonico receivers, which had a U.S.-made color tube on a Japanese chassis, both these sets feature Japanese color tubes.

TAPE RECORDERS—Over half a million tape recorders were sold in 1962, with a rising rate of increase that may result in 50 percent more sales for

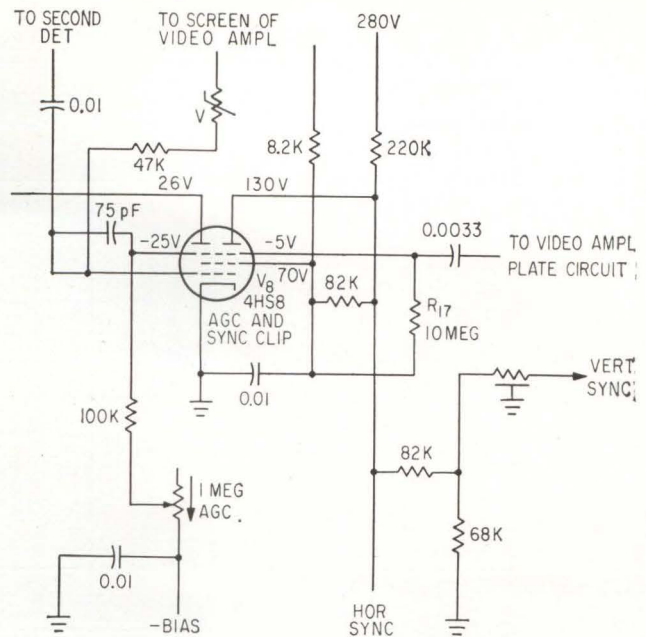

AUTOMATIC fringe-lock circuit for tv receivers, by Zenith—Fig. 1

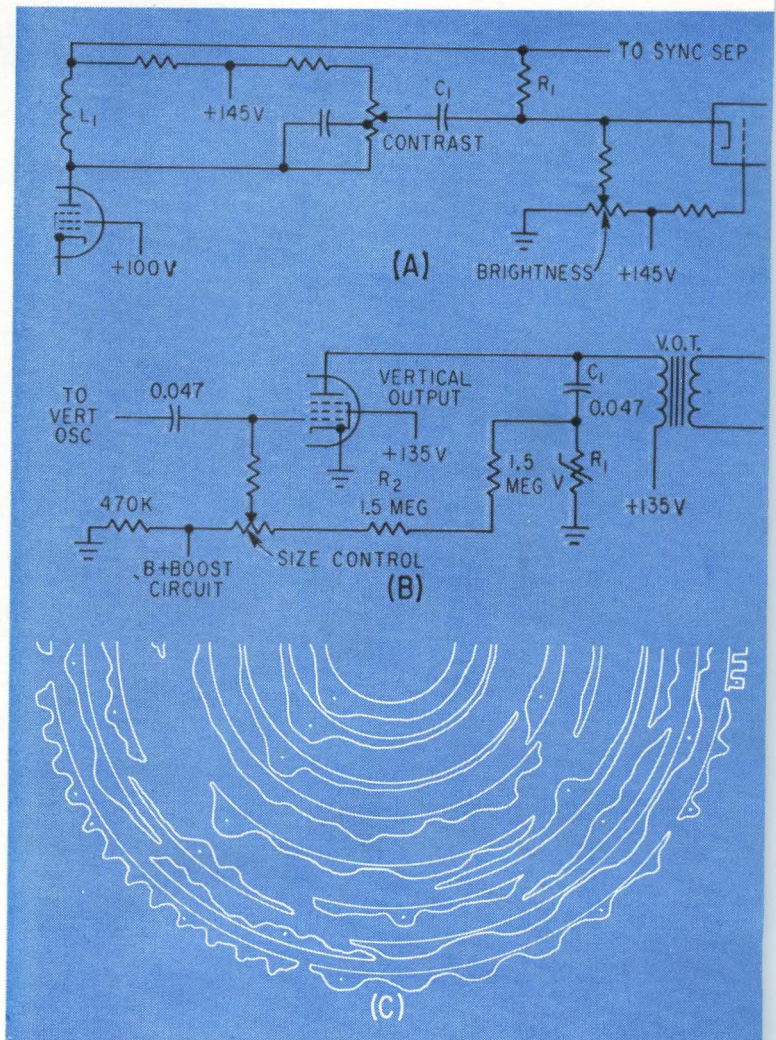

BLACK-LEVEL circuit (A) and vertical compensation circuit (B), both featured in Philco Courier 16-inch portable; half of stator-plate tone generator (C) used in Electro-Voice electrostatic organ—Fig. 2

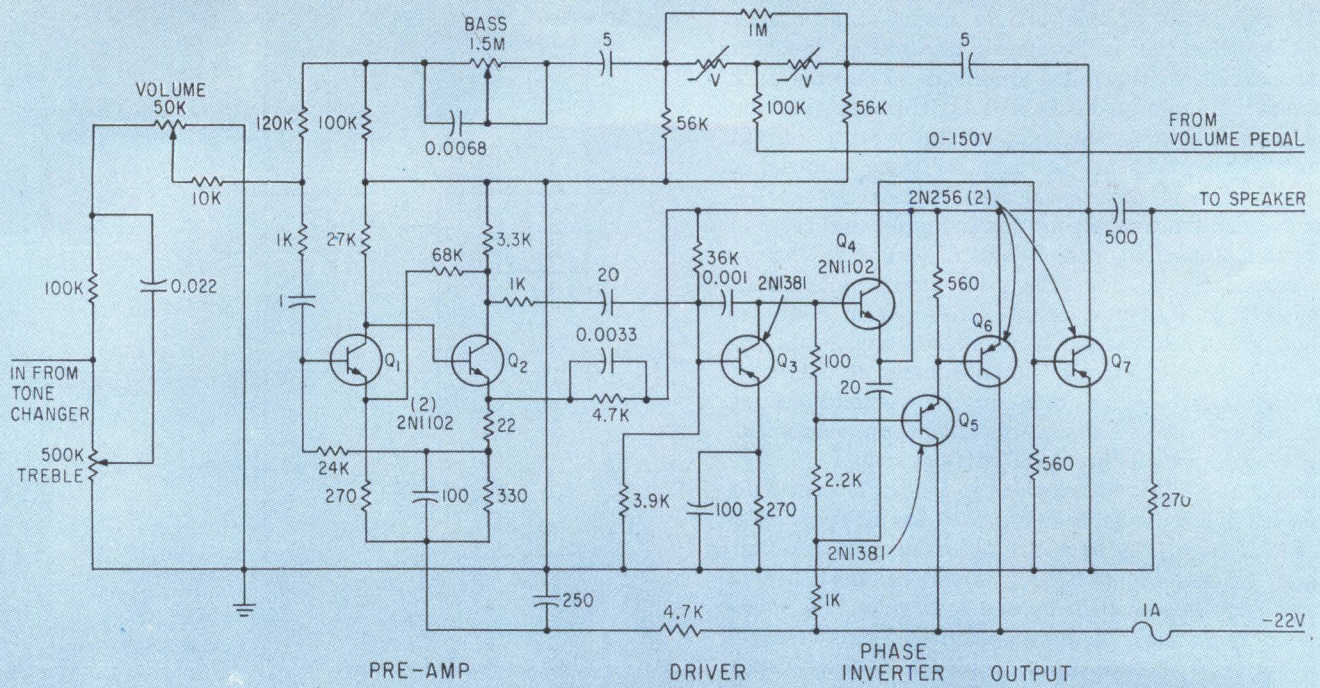

AMPLIFIER, one of five in multichannel chassis for do-it-yourself Artisan organ—Fig. 3

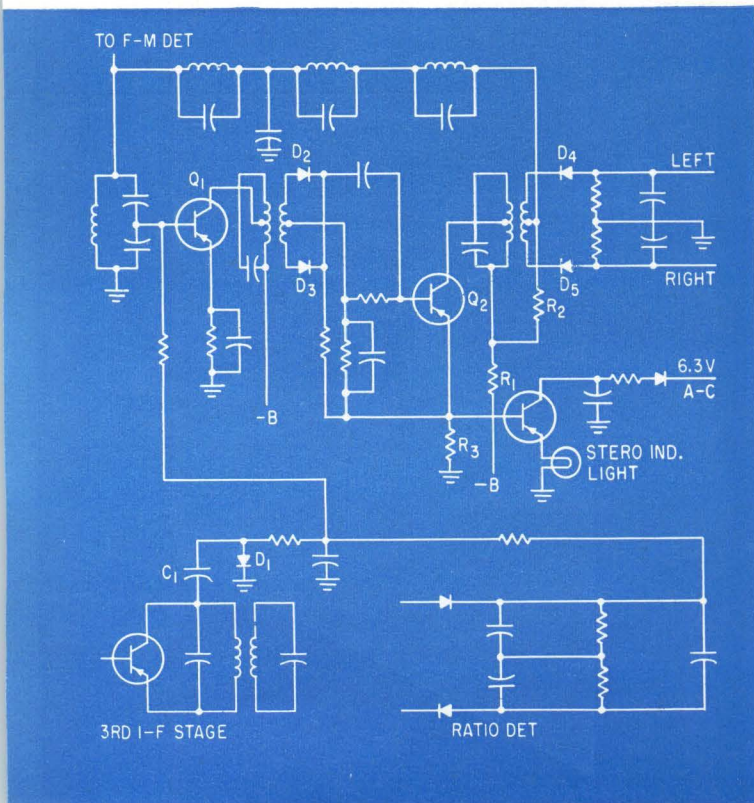

F-M MULTIPLEX receiver, partial schematic, by Admiral—Fig. 4

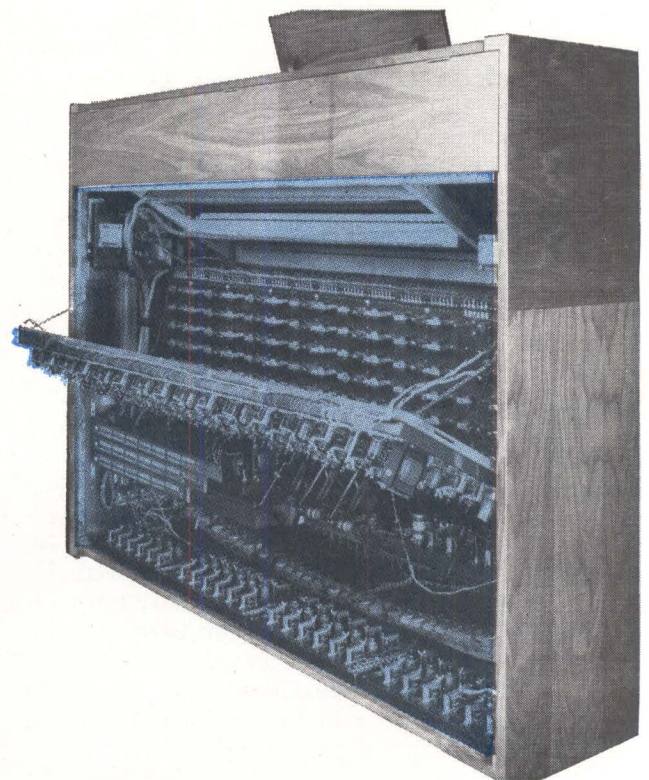

REAR VIEW of Artisan build-it-yourself organ, Imperial model, with over 250 independent oscillators and 30 preamplifiers

1963 over last year. It is expected that an increasing number of manufacturers will incorporate tape decks in consoles, one reason being that a tape recorder goes well with f-m stereo in a console. The current mixture of recorders sold is 50 to 60 percent complete monaural; 30 percent stereo playback and monaural record; 15 percent full stereo; and about 5 percent component decks.

The 44-pound Concertone model 605 stereo recorder (see p 50) has a double-gap ferrite-core erase head. With a bias frequency of 100 Kc, nickel alloys get hot due to eddy-current losses, but ferrite at that frequency operates with virtually no heat. Thus the tape can remain stationary while the machine is in record mode without burning or warping. The double gap erases the tape twice, in effect, and permits an erasure of 65 to 70 db. The play head is completely shielded with Mu-metal to help eliminate reverse-channel crosstalk when four-track heads are used: the flux on the tracks not being played is shorted across the Mu-metal front. By holding the play head gap to 0.0001 inch, a 15-Kc response at $7\frac{1}{2}$ ips results. The entire head assembly can be unplugged and replaced with other head combinations, for full-track, two-track or four-track recording.

The Norelco 4-track stereo recorder, model Continental 401, features four speeds, including $\frac{1}{8}$ ips for up to 32 hours of recording on a 7-inch reel, using half-mil tape and one track at a time. Using a 0.0001-inch head-gap, the reported frequency at ± 3 db at this speed is 60 to 4,500 cycles.

ELECTRONIC ORGANS—A new type of organ will be introduced by Electro-Voice in the latter part of this year, based on electrostatic pickup of organ tones from physical analogs of the complex waveforms.

Pipe organs of outstanding timbre were recorded, and the recordings converted to circular waveform patterns (Fig. 2C) on a six-inch stator plate. The organ contains 24 of these plates, two for each different note of the octave, with each pair providing all the various voices in the different octaves for that note. The outer waveforms are for the top octave; pedal notes are in the center. A synchronous motor rotates over the waveform plates, producing a variable capacitance that is fed to a stator connector which carries only that one waveform signal.

The Electro-Voice organ has only four basic units: stator-plate tone generator, key switches, power amplifier and loudspeakers. The amplifier of the integral audio system has three tubes, and three more are in the power supply. Tone cabinets have been developed that will include loudspeakers such as the 30-inch woofer, to produce fundamental base frequencies down to 15 cps. These low frequencies are felt physically as well as heard.

The Wurlitzer Company introduced their first all-transistor organ this year. Previously, their organs were either of the vacuum-tube or amplified-reed types. The new organ uses 87 diodes and 84 transistors, in a two-keyboard configuration with a 13-note pedalboard and 22 tone-controls tabs. An earphone plug permits silent playing. Twelve tran-

sistor oscillators and a divider chain produce square waves for such organ voices as the woodwinds, stepped flute and tibias. Diode keying and shaping circuits produce a sawtooth pattern, for voices such as the strings, open flutes, reeds, brass and diapason. By pressing the volume control to the right with the foot, all the organ frequencies slide up in a half-tone for creating such effects as the Hawaiian guitar, slide trombone, and the portamento of bowed instruments. This feature was used on the Lowery organ several years ago.

A recent Artisan build-it-yourself vacuum-tube organ is the three-manual Imperial model (see p 52), with a 32-note radiating pedalboard. It features the theater-type horseshoe console, which is becoming more and more popular. The Allen Organ Company is now building four theater-type models.

Optional accessories for the Artisan organs include chimes, glockenspiel and band box. The Imperial has both theater and concert-type voices. Artisan feels that "although several organ firms have gone over to transistor oscillators, the tone quality of the transistor does not compare with that of the vacuum tube, and the cost factor offers no advantage either."

The latest Artisan transistor 5-channel amplifier has a varistor control circuit that allows one or more amplifiers to be controlled by a single line from the volume pedal. Each channel (Fig. 3) has its own volume, bass and treble controls, for flexibility in voicing the stops with which each amplifier is used.

The two-transistor preamplifier circuit was chosen because of its inherent low-noise characteristics, temperature stability and economy. The driver circuit, which uses full negative feedback and therefore has no effective voltage gain, supplies the base currents to the output transistors with the required phase relationships to drive the power-output half-bridge circuit.

The half-bridge varistor circuit was chosen because it introduces the least noise into the amplifier circuit and can provide the desired level control. The shot noise produced by a thyrite seems to be most active during the period when the bias voltage is applied, and is usually reduced noticeably within 15 or 20 seconds.

F-M STEREO—A transistor f-m multiplex receiver will be introduced this month by Admiral, with noise squelch, automatic stereomonaudio switching and an incandescent-lamp multiplex beacon.

Noise squelch is obtained between stations by using transistor Q_1 (Fig. 4) as an r-f controlled 19-Kc amplifier. With no signal to the receiver, Q_1 is cut off by a small positive voltage from the ratio detector, developed by noise. The combination of capacitor C_1 and diode D_1 senses the presence of a signal and develops a bucking voltage sufficient to turn on Q_1 , activating the subcarrier regenerating channel. Because this activating point is at a level approaching quieting, effective noise squelch between stations is accomplished.

The Q_2 circuit is a switched 38-Kc amplifier. In the absence of 19-Kc information to D_2 and D_3 , no bias is developed between the base and emitter of Q_2 , thus

cutting off the amplification of this stage. When 19-Kc signal is applied to these diodes, they act as a full-wave rectifier, doubling the frequency and developing a d-c component that turns on Q_2 .

Simultaneously, resistors R_1 and R_2 adjust the operating conditions for the multiplex decoding diodes D_1 and D_5 . When Q_2 is not amplifying (in the absence of a 19-Kc multiplex sub-carrier), there is no voltage drop across R_1 as a result of Q_2 collector current, and thus D_1 and D_5 are forward-biased through R_2 to allow undistorted transfer of the monaural signal through the diodes. When Q_2 receives subcarrier information, it passes current through R_1 , which in turn lowers the voltage at the junction of R_1 and R_2 , to reduce the bias for D_1 and D_5 for proper stereo operation.

The d-c current change through Q_2 is also passed through R_3 to control the stereo indicator light. Transistor Q_3 acts as an emitter follower, turning the light on when voltage is developed at the base of Q_3 , and turning it off when there is no voltage.

Supplementary carrier authorization (SCA) rejection is performed by a filter network that attenuates the entire SCA service band while passing the sum and difference information and adjusting the delay between the two for proper detection at D_1 and D_5 . This removes commercial f-m services.

SPEAKERS—The recently developed Matsushita MF-800 loudspeaker and amplifier combination features what the manufacturer calls a variable acceleration-velocity type of motional feedback (MFB) system. This system obtains adjustable damping and frequency response in the low-frequency range of the speaker by a differential circuit in the feedback loop.

Motional feedback refers to feedback of a voltage in proportion to the vibration of the MFB speaker cone, to the driver stage of the amplifier (Fig. 5A). The source of the voltage pickup is an electromechanical device in the loudspeaker. Previous systems fed back the voltage in proportion to the velocity of the

loudspeaker cone; this system feeds it back in proportion to the acceleration of the loudspeaker cone, to the driver stage of the audio amplifier. The results are, according to Matsushita, an extended reproduction range and reduced distortion.

When the velocity-type MFB is applied to a cone-type loudspeaker mounted in an infinite baffle or in an enclosed box, the response characteristics will change as shown in Fig. 5B. The lowest response frequency does not change; rather, the sharpness Q of the resonant point of the loudspeaker movement changes. Therefore, as the velocity feedback increases, the low-range response will be lowered proportionally and tends to become overdamped, requiring preemphasis in the preamplifier circuit.

When acceleration-type MFB is applied to a cone-type loudspeaker, the axis of the frequency response changes, as shown in Fig. 5C. The apparent lowest resonance frequency will be lowered and the resonance sharpness is increased, resulting in an expansion of the reproduction range at low frequencies. There is less distortion in the acceleration-type MFB than in the velocity type, according to Matsushita, because there is no decrease of feedback even in the high-frequency range. When the feedback of the acceleration type increases, the sharpness of the resonance Q at the lowest resonance frequency becomes wider, and the value of Q changes. Therefore, the combination of velocity and acceleration types gives a more flexible method of changing the response at the low-frequency range.

The MF-800 picks up the voltage in proportion to the velocity of the loudspeaker cone by a pickup coil moving in the magnetic field, and feeds back this voltage change in proportion to the acceleration, through a differential circuit. The phase shift of the feedback voltage increases in the high-frequency range, and unless acceleration feedback is reduced, an unstable feedback system may result. Also, less acceleration feedback will cause an increase in gain.

MOTIONAL FEEDBACK: feedback loop, with partial schematic of amplifier (A); effect of velocity-type MFB (B) and of acceleration-type MFB (C) in loudspeaker-amplifier system by Matsushita—Fig. 5

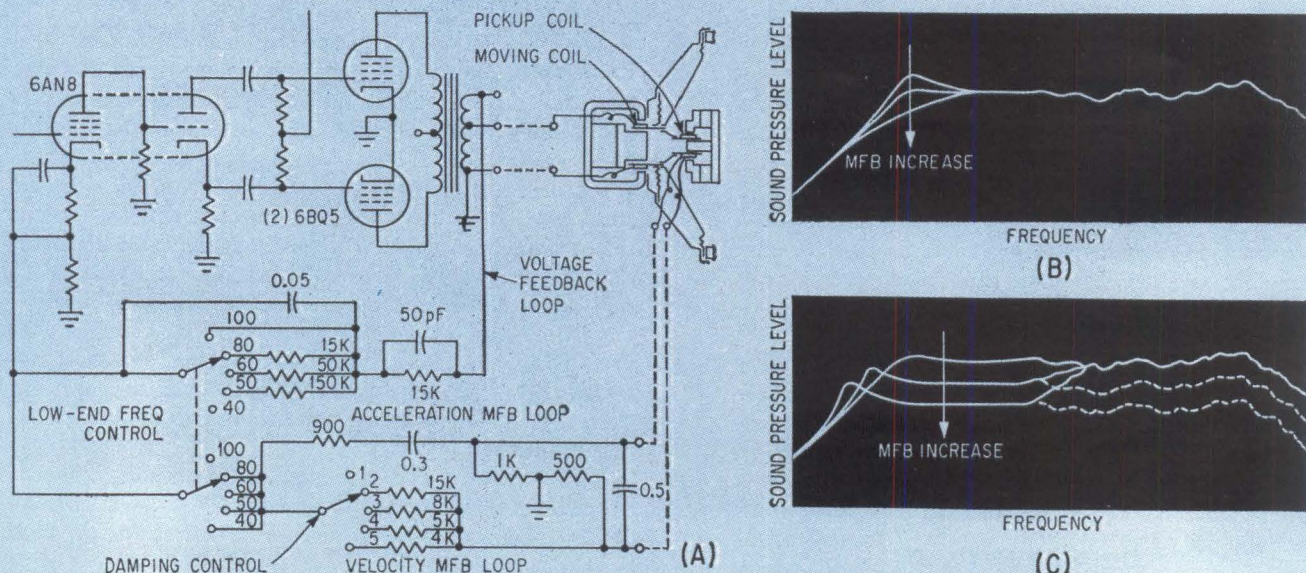

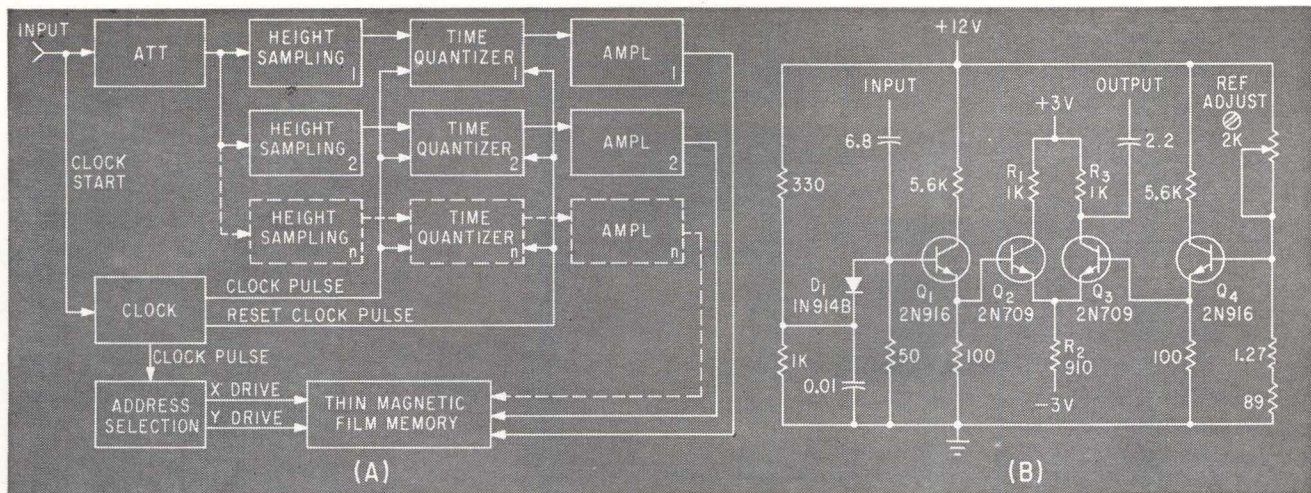

ANALOG-TO-DIGITAL converter (A) and one of the sampling circuits (B)—Fig. 1

New Digital Conversion Method Provides Nanosecond Resolution

This analog-to-digital converter uses a bank of 8 sampling circuits that simultaneously receive a signal but fire at different levels to quantize the signal

By A. A. FLEISCHER and EDWARD JOHNSON

Santa Barbara Laboratories,
Edgerton, Germeshausen & Grier, Inc., Santa Barbara, Calif.

ANALOG - TO - DIGITAL conversion systems usually consist of an analog storage device (delay line, capacitor, pulse-stretcher) ramp generator, coincidence circuits, and digital clock or scaler. These circuits record the number of clock pulses between a start pulse and the coincidence between the height of a ramp function and the unknown stored analog signal. The delays inherent in such systems (scaler resolution, data address, etc.) usually limit time response to 10^{-5} to 10^{-4} sec. Faster time response may be achieved by using one analog stor-

age device per data point.

A new method of analog-to-digital conversion that lends itself to much shorter resolving times is the parallel sampling of an unknown input signal at predetermined levels and time intervals. Figure 1A is a block diagram of a system that employs parallel sampling to provide nanosecond analog-to-digital conversion. A signal source such as a scintillator-photodiode converts a nuclear signal to its electrical analog and transmits it to the height sampler. The number of height samplers determines the number of binary bits

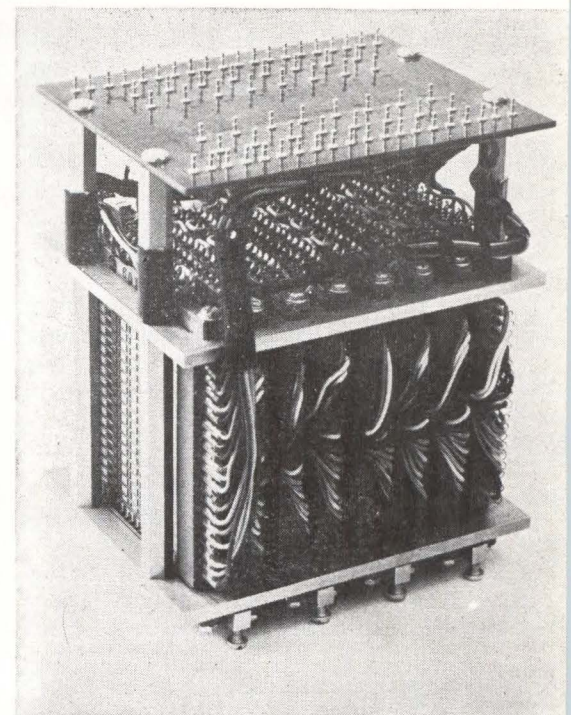

MEMORY PACKAGE used in the analog-to-digital converter has storage capacity of 160 eight-bit words

per digital word. The input voltage signal is sampled and digitized by comparing it with known discrete levels. It is then coupled to a gating circuit (time quantizer) where time information is added which results in an output of digital-pulse-height per unit of time. The sampling and gating circuits, contained on one circuit board, consist of eight 4-transistor difference amplifiers and 8 tunnel diode gating circuits.

SAMPLING CIRCUIT—One of the sampling circuits is shown in Fig. 1B. The input impedance of this

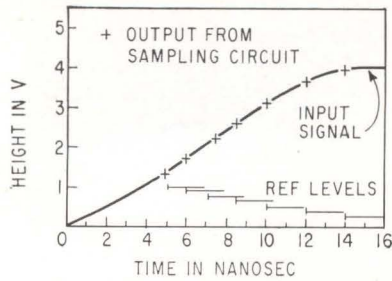

SAMPLING a fast-rising pulse—
Fig. 2

circuit is 50 ohms; however, the use of balanced emitter followers Q_1 and Q_2 increases the apparent input impedance seen by the input and reference signals to greater than 10,000 ohms. The input signal is compared to the reference signal in the emitters of Q_2 and Q_3 . In the quiescent condition Q_3 is conducting and generates a current I_3 . The voltage $I_3 R_2$ keeps Q_2 cutoff until the emitter current I_2 through Q_2 is greater than I_3 . Then Q_3 is driven to cutoff and Q_2 is turned on. Between cutoff and saturation both Q_2 and Q_3 act as amplifiers whose voltage gain is a function of R_1 , R_2 , R_3 and the beta of Q_2 and Q_3 . A positive output signal is generated across R_3 . These currents have 1-nanosecond switching and 4-nanosecond delay time.

Eight of these sampling circuits are connected in parallel and divide the input signal at each point in time into eight basic levels. A change in the absolute value of the reference voltages does not effect the ratio between any two levels. Sampling may be accomplished on input signals ranging from millivolts to 10 v and in a linear (2 decades) or logarithmic manner (3 decades). Figure 2 shows the results of sampling a fast rising pulse.

GATING CIRCUIT—The signals from the sampling circuits are connected to one input of the fast tunnel diode gating circuits (Fig. 3).

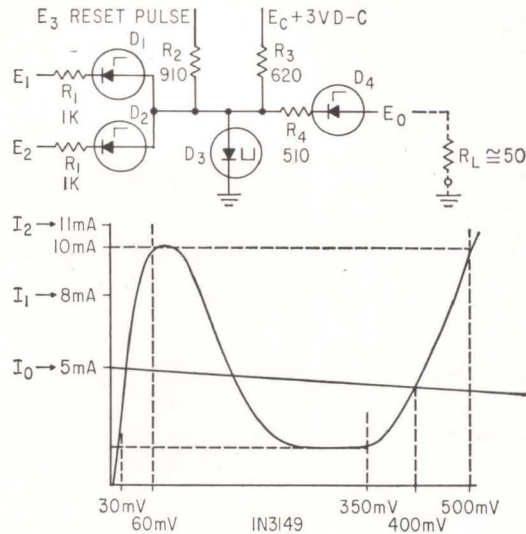

ONE INPUT of this fast tunnel diode gating circuit receives signals from the sampling circuits—Fig. 3

A 100-Mc clock pulse is connected to the other input and a coincidence between the signals occurring at the two inputs quantizes the signal being analyzed in time. A pulse occurring at the same rate as the clock pulse but delayed by 4 nanoseconds resets the tunnel diodes. This type of tunnel diode gating circuit is also referred to as analog threshold logic circuit. The current through R_3 holds tunnel diode D_3 in the low voltage state. An input to E_1 from the height samplers causes the current through D_3 to increase from 5 to 8 ma. If this input is coincident with a clock pulse at E_2 , an additional 3-ma current flows through D_3 causing D_3 to switch from the low voltage state to a high voltage state. Low voltage state is 60 mv, high voltage is 400 mv. Diodes D_1 and D_2 isolate the inputs from each other and R_1 limits the current through D_1 when D_3 is in the high voltage state. Diode D_4 passes current when D_3 is in the high voltage state. The switching time of this circuit is better than 1 nanosecond. The output of the

gating circuits is digital-pulse-height per unit of time.

Amplifier circuits (Fig. 4) provide sufficient current gain to store the digital information from the gating circuits in the memory. This wideband amplifier consists of four class A common emitter a-c coupled cascaded amplifiers with negative feedback at every second stage. The amplifier has a voltage gain of 12 and a bandwidth of 100 Mc (upper 3 db point). The rise time of the circuit is 3 nanoseconds; pulse pair resolution is 5 nanoseconds. The signal-to-noise ratio is better than 100 to 1 for input voltages from 0 to 200 mv. The drive circuits produce currents in the word and information lines of the memory during the read or write mode and develop 4 and 2 amp in their associated lines.

MEMORY—The memory package (see photo) has a storage capacity of 160 eight-bit words. It is connected for parallel input and access. It consists of a work-oriented, current-coincident, thin, magnetic film memory. Each 8 by 20 memory plane is fabricated by vacuum deposition of the thin film in a strong magnetic field. The work lines are parallel to the hard direction and generate a field parallel to the preferred direction. The sense lines are located between the information conductors and reduce the capacity between the sense and information lines. Pulses of 5 nanoseconds width with 1-nanosecond rise time occur-

A/D CONVERTER USES

Extremely fast analog-to-digital conversion of singly occurring transients or randomly occurring pulses can be achieved with this analyzer. It can also sense a zero slope per unit time and in this mode it can be used as a multichannel pulse height analyzer with a dead-time dependent only on the rise of pulses it is analyzing

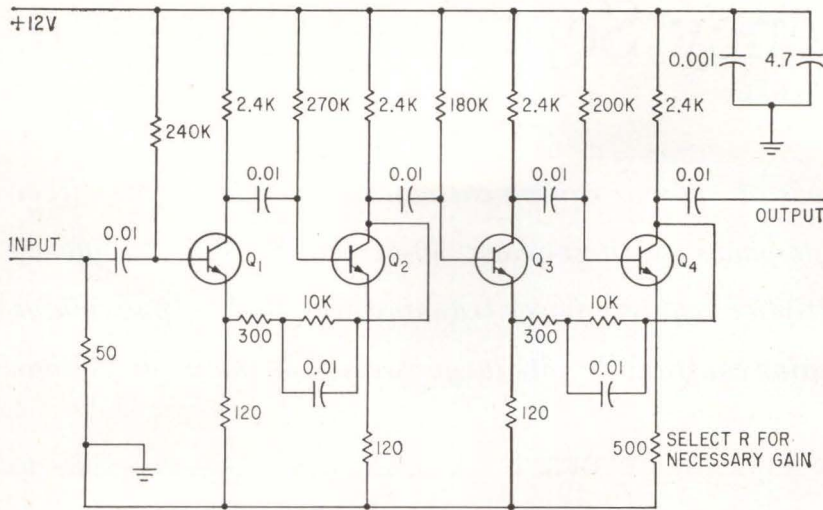

ALL Q's 2N917 (4th CASE LEAD ON EACH GOES TO GROUND)

WIDEBAND AMPLIFIER provides sufficient current gain to store digital information from gating circuits in the memory—Fig. 4

ring at a 100 Mc rate have been stored in the existing memory.

Sense amplifiers have been developed to read the information stored in the memory. An amplifier (Fig. 5) amplifies the small signals stored in a desired memory location while simultaneously rejecting noise appearing from partially selected bits on the same sense line. It consists of a completely isolated differential amplifier operating from a low impedance source.

If the converter is to be used as a pulse height analyzer for rapidly occurring random voltage pulses, a height logic card is provided. This logic circuit senses the maximum pulse height of incoming signals and causes the information to be

stored in the memory as a function of pulse height.

Temporary storage circuits provide buffer operation and circuit time compatibility between the fast memory and a slower digital-to-

analog converter and furnish binary-to-decimal data to Nixie tubes for visual readout. The parallel-to-serial converter transfers serial word data to a telemetry unit for space and field operation.

CONCLUSION — This analyzer provides extremely fast analog-to-digital conversion of singly occurring transients or randomly occurring pulses. It senses a zero sense per unit time and in this mode can be used as a multichannel pulse height analyzer with a dead-time which is dependent only on the rise of pulses it is analyzing (pulse pair resolution of 10^{-7} sec for random pulses with a 0.1 μ sec time is possible).

It has a 160 eight-bit word storage capacity and is limited to 10 nanosecond sampling time by the available memory devices. Silicon transistors and a thin film memory in modular design provide temperature stability and physical rigidity of the entire system.

BIBLIOGRAPHY

- R. L. Chase, Recent Developments in Multichannel Pulse-Height Analysis, *IRE Trans on Nuclear Science*, NS-9, 3, p 278, 1962.
- H. Schultz, G. Pieper, and L. Rosler, Multichannel Pulse-Height and Time of Flight Analysis, *Rev Sci Instr*, 27, 7, p 437, 1956.
- S. Wald, Analog-to-Digital Conversion Techniques, *Electronic Design*, Hayden Publishing Co., August 2, 1962.
- G. Klien and J. J. Zaalberg van Zelst, Circuits for Difference Amplifiers, *Philips Tech Rev*, 23.
- General Electric Co., "Differential Amplifiers," Silicon-Controlled Rectifier Manual, 2nd ed., 1961.
- General Electric Co., "Simple Analog-

- Threshold Logic," Tunnel Diode Manual, 1st ed., 1961.
- Transitron Electronic Corp., "Switching Circuits," The Tunnel Diode Circuit Design Handbook, AN-1359-A, 1961.
- Burroughs Corp., "Thin Film Memory," Bulletin No. 1007 and Addenda, 1961.
- N. Scott, "Storage in the Digital Computer," Analog and Digital Computer Technology, McGraw-Hill Series in Information Processing and Computers, 1960.
- R. Ledley, "Memory Selection," Digital Computer and Control Engineering, McGraw-Hill, 1960.
- W. Kopek, A Transistorized Digital-to-Analog Converter, Armed Services Technical Information Agency, Report R-130, 1961.

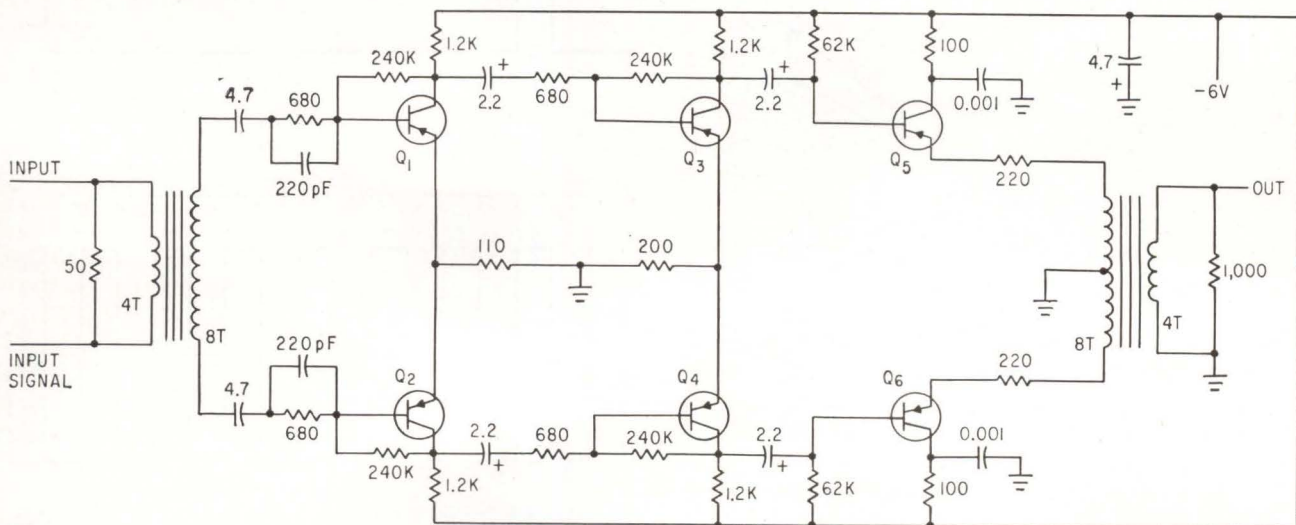

SENSE AMPLIFIER used to read information stored in the memory—Fig. 5

Frequency Septupler Provides

Standard 400-cps equipment can be operated from either single-phase or three-phase 60-cps lines. This frequency multiplier requires fewer transformers, and output voltage remains constant despite large variations in supply voltage

By WILLIAM A. GEYGER, U. S. Naval Ordnance Laboratory, Silver Spring, Md.

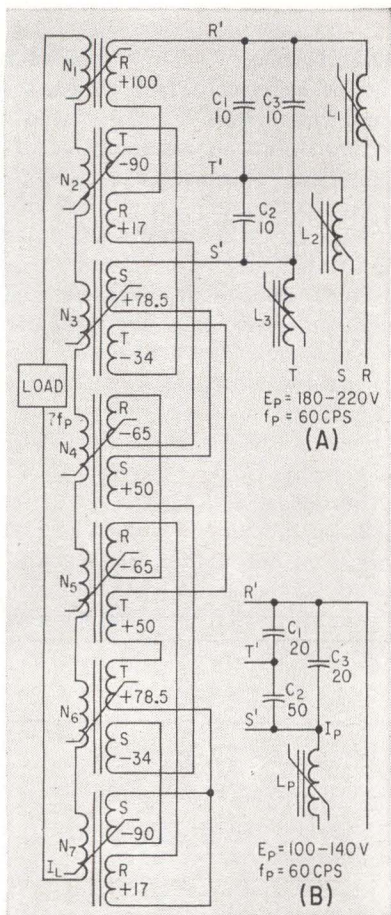

EQUIPMENT can be operated from three-phase (A) or single-phase (B) power—Fig. 1

STATIC 60-to-420 cps frequency multiplier provides constant square-wave voltage despite large variations in supply voltage. The highly reliable septupler can be used to operate 400-cps equipment from either single-phase or three-phase 60-cps lines. Since the output terminals can be permanently short-circuited, the multiplier protects itself and the equipment it supplies from overloads.

Seven saturable transformers are used in the frequency multiplier. The multiple primary windings are series-star connected and the secondaries are series-aiding connected. The use of capacitors and linear reactors in the primary circuit permits operation from a single-phase source as well as pro-

viding excellent stability in the output voltage.

The possibility of using saturable-core transformers as static frequency multipliers has attracted interest since the beginning of the century.¹ Recent developments, particularly in the fields of magnetic amplifiers and flux-gate magnetometers, have revived interest in methods of producing even or odd-harmonic multiples of power supply frequency. The phase-multiplier type stabilized 60-to-420 cps frequency transformer² has increased in importance for operation of standard 400-cps equipment from 60-cps lines.

Conventional frequency multipliers operating from three-phase supplies at frequency ratios of $n =$

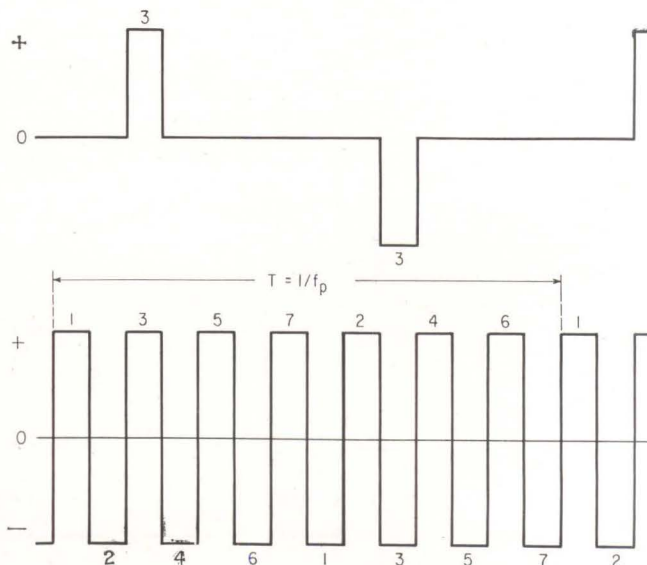
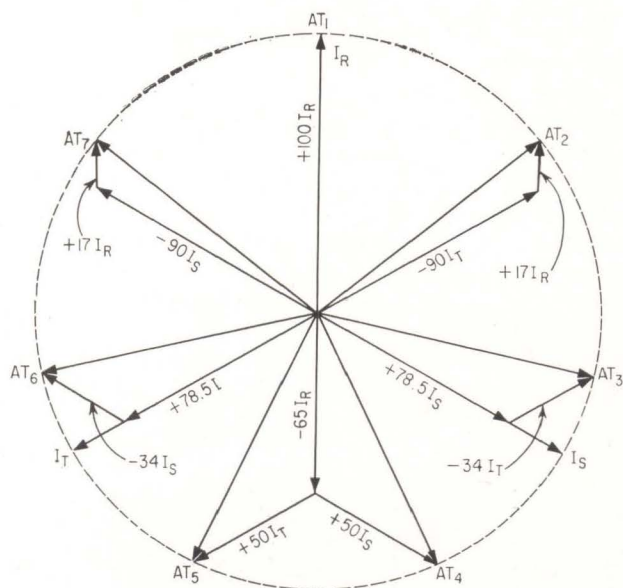

VECTORS show relationship of seven phase-displaced currents (A). Idealized waveforms (B) show voltage across one secondary and across all secondaries in series—Fig. 2

Stable 420-Cps Voltage

5, 7 or 9 require additional transformers for deriving n saturable-reactor supply voltages.³ By providing multiple primary windings in this multiplier, the need for these additional phase-changing transformers is eliminated. By combining the primary circuits of the seven saturable transformers with three power-factor correcting shunt capacitors and three series-connected linear reactors, excellent stability of the output voltage is obtained.⁴ Thus this magnetic frequency multiplier has the properties of ordinary ferroresonant constant-voltage transformers.

Only minor modifications are needed to operate this three-phase frequency multiplier from a single-phase supply.⁴ By using a single linear reactor instead of three separate linear reactors, the seven saturable-core transformers with three shunt capacitors function as a phase converter, establishing a substantially symmetrical three-phase system.

A stabilized 60-to-420 cps frequency multiplier providing output power up to about 40 watts was required for several laboratory projects. Two similar prototype designs have been developed using these basic concepts. The three-phase design operates from a source in the range of 180 to 220 volts, while the single-phase design operates in the range of 100 to 140 volts. Measured total efficiency (watts out divided by watts in) of both multipliers is about 60 to 70 percent with a purely resistive load.

PRINCIPLE—The magnetic frequency septupler in Fig. 1A is a special form of the phase-multiplier frequency transformer.^{2,4} With an odd-harmonic frequency ratio, n , a substantially sinusoidal magnetizing current is produced by suitably interconnecting n saturable transformers into an n -phase group from which the n th harmonic voltage is filtered by a polygon-winding connection. Frequency multiplication ratio n may be an odd number, generally 5, 7 or 9.

Actual magnitude of the square-

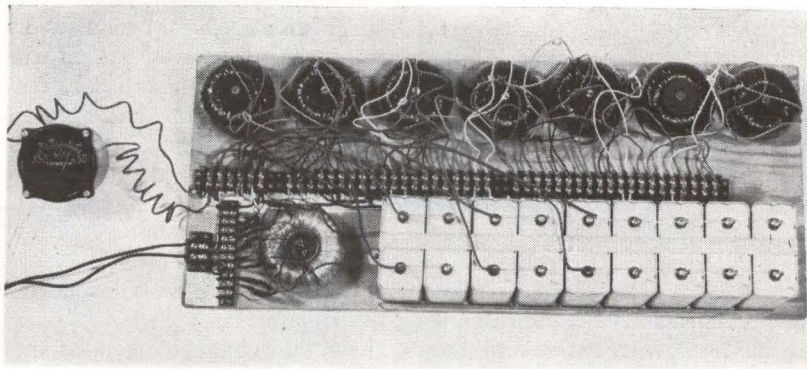

BREADBOARD model is three-phase type frequency multiplier that provides up to 40-watts output power

WHAT TO LOOK FOR IN A FREQUENCY MULTIPLIER

Power for developing and testing 400-cps equipment can be provided in a variety of ways. However, an ideal power source for this application is difficult to realize. Many of the required characteristics are common to most electronic equipment: reasonable original cost, limited maintenance requirements and high reliability. The frequency converter should also operate from either single-phase or three-phase 60-cps power lines. This frequency multiplier does. It also provides stable output voltage

wave output voltage of a frequency n times supply frequency f_p can be maintained nearly constant by the saturated magnetic cores. Thus, the circuit also serves as a constant-voltage transformer. Power-factor correction is achieved by shunt capacitors and series-connected linear reactors. Also, capacitive compensation of the inductive impedance of the multiplier can be used.

The frequency septupler in Fig. 1A has $n = 7$ saturable transformers with the indicated percentage of turns in the multiple primary windings and series-connected secondary windings. The corresponding star-connected groups of primary windings are supplied with three substantially sinusoidal currents I_R, I_S, I_T displaced 120 degrees apart and derived from the three-phase, three-wire supply R, S, T .

In the three-phase circuit in Fig. 1A, shunt capacitors C_1, C_2 and C_3 and series-connected linear reactors L_1, L_2 and L_3 are used to obtain constant output voltage E_L despite

large variations in power supply voltage E_p . These stabilizing and power-factor correcting components are connected between power supply terminals R, S, T and inner terminals R', S', T' of the frequency-transforming system.

In the single-phase version in Fig. 1B, only linear reactor L_p is required. Power supply voltage E_p is injected to only two of the inner group terminals (such as R' and S'). The saturable transformers function as phase converters, establishing a symmetrical three-phase system. The three line-to-line voltages across inner terminals R', S', T' are made equal by the same voltage-controlling process that stabilizes output voltage against variations in power supply voltage.

A small voltage at the fundamental frequency appearing in output voltage E_L can practically be eliminated by suitable adjustment of capacitors C_1, C_2 and C_3 . In the two branches not connected directly across the single-phase supply leads,

phase angle must lead by 60 degrees in one branch and lag 60 degrees in the other. To obtain these phase angles, it is necessary only to overcorrect phase angle slightly in one branch and undercorrect it in the other.

CURRENT VECTORS—To derive seven primary ampere-turns, AT_1 through AT_7 , displaced $360/7$ degrees apart from the three 120-degree displaced supply currents, several properly rated ampere-turn components are added or subtracted vectorially. The relationship be-

tween the currents is shown in Fig. 2. In the phase-transforming circuit in Fig. 1A, the three currents are used to produce seven ampere-turns displaced 51.4 degrees apart to excite the seven transformers. The phase relationship between the seven-legged star that forms the seven-phase magnetic-flux system and the three-phase primary-current system is irrelevant in principle. However, some circuit symmetry is desirable.

The preferred distribution of the multiple primary windings over the three star-connected phases is that

which results in the most suitable phase range of ampere-turns that can be produced with the greatest economy (least copper resistance of primary windings) by each pair of 120-degree displaced phase currents. In the actual arrangement corresponding to Fig. 2, circuit symmetry is achieved by choosing saturable transformer 1 in the axis of current I_R so that it is excited by only one phase current. In the remaining six transformers, two currents contribute to the exciting ampere turns. The number of primary turns in transformer 1, associated with phase current I_R , serves as a reference for designing the other units. The relationship among the primary ampere-turns is indicated in Fig. 1 and 2.

Series-connected secondary windings N_1 through N_7 have the same number of turns. By selecting this number in accordance with the actual load impedance, optimum operating conditions can be obtained. A capacitor can be connected in series with the load to obtain capacitive compensation of the inductive internal impedance of the multiplier.

WAVEFORMS — Generally, any phase-symmetrical distribution of n distorting elements connected to a three-phase system of sinusoidal supply voltage eliminates from the three-phase input current all harmonics of any order below $2n \pm 1$. This elimination of harmonics occurs because of mutual cancellation of harmonic currents in parallel-connected branches or by mutual cancellation of harmonic voltages in series-connected branches. For this reason, the series-star connection to guide the nearly sinusoidal phase currents through the multiple windings is essential.

Analysis of this type frequency multiplier shows that with n series-excited cores in symmetrical phase sequence, only one core is taken out of saturation at any time. Also, at this instant, the core taken out of saturation generates a counter emf opposing the instantaneous values of any of the three line-to-line voltages in its primary windings. Conversely, any one of the three line-to-line voltages can be considered as cut up in block sec-

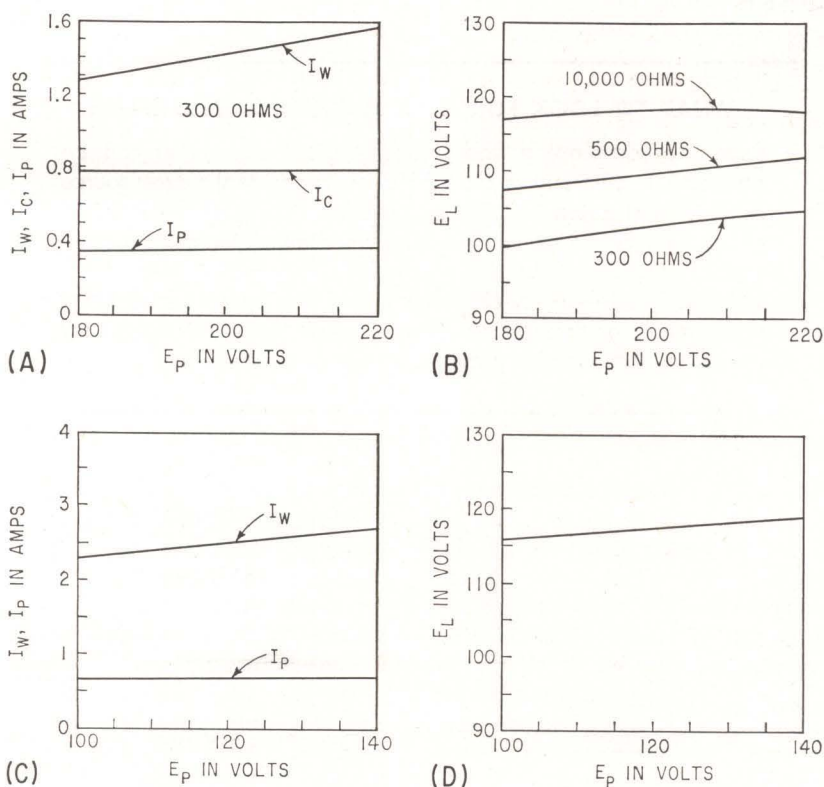

CURRENTS (A) and output voltage (B) are shown for three-phase multiplier. Currents (C) and voltage (D) are shown for single-phase multiplier with magnetic-amplifier load—Fig. 3

PRIMARY WINDING TURNS

| | Three Phase | Single Phase |
|--------|-------------------------------------|-------------------------------------|
| AT_1 | $+ 400 \times I_R$ | $+ 230 \times I_R$ |
| AT_2 | $- 360 \times I_T + 68 \times I_R$ | $- 207 \times I_T + 39 \times I_R$ |
| AT_3 | $+ 314 \times I_S - 136 \times I_T$ | $+ 180 \times I_S - 78 \times I_T$ |
| AT_4 | $- 260 \times I_R + 200 \times I_S$ | $- 150 \times I_R + 115 \times I_S$ |
| AT_5 | $- 260 \times I_R + 200 \times I_T$ | $- 150 \times I_R + 115 \times I_T$ |
| AT_6 | $+ 314 \times I_T - 136 \times I_S$ | $+ 180 \times I_T - 78 \times I_S$ |
| AT_7 | $- 360 \times I_S + 68 \times I_R$ | $- 207 \times I_S + 39 \times I_R$ |

tions that are displaced $180/n$ degrees in phase and that vary in height by a sine-law distribution depending on the numbers of turns involved.

All of these sections must be approximately rectangular so that a counter emf is always generated in at least one core at a time and so that the counter emf fits into the pattern of all three line-to-line voltages at the same instant. Because of the deviation between applied voltage and the generated counter emf, it also follows that ripple currents of the predominating order, $2n \pm 1$, are generated in the three-phase input current. With $n = 7$, the resulting deviations from the precise sine wave therefore consist of the 13th and 15th harmonics.

Since the voltage waveform is cut up into approximately rectangular blocks of the same width ($180/n$ degrees), the voltage per turn generated during each zero passage of primary ampere-turns is the same in all cores. The idealized waveform of the individual secondary voltages, appearing across winding N_1 through N_7 , corresponding to the zero passage of primary ampere-turns is shown in Fig. 3. The individual contributions of the seven transformer units to square-wave output voltage E_L at frequency $7f_p$ is also shown.

WINDING DATA—The three-phase design in Fig. 1A provides up to 40 watts output power with a 60-cps input of 180 to 220 volts. The toroidal transformer cores are made of 2-mil Orthonol tape in 180 wraps. Tape width is 1 inch, inside diameter is 1.5 inches and outside diameter is 2.5 inches. The number of ampere-turns in the primary windings corresponding to the vector diagram in Fig. 2 is shown in the table.

Secondary windings N_1 through N_7 are each made of 230 turns of No. 25 wire. Linear reactors L_1 , L_2 and L_3 have MoPermalloy powder cores and are Arnold type A-438,-281-2 with an inside diameter of 0.95 inch, outside diameter of 1.84 inches and are 0.71 inch high. Each reactor has 1,000 turns of No. 26 wire (9 ohms). Nominal permeability is 125 and nominal inductance is 0.281 henry.

The same toroidal transformer cores are used in the single-phase design in Fig. 1B, which operates from a 60-cps input of 100 to 140 volts. The primary windings are made of No. 18 wire, and the number of ampere-turns for the single-phase system is also shown in the table. The secondary windings are again formed of 230 turns of No. 25 wire.

Linear reactor L_p , has two stacked MoPermalloy powder cores and are Arnold type A-899,142-2 with an inside diameter of 1.938 inches, outside diameter of 3.063 inches and are each 0.5 inch high. The reactor has 600 to 1,200 turns of No. 20 wire (2 to 4 ohms) and

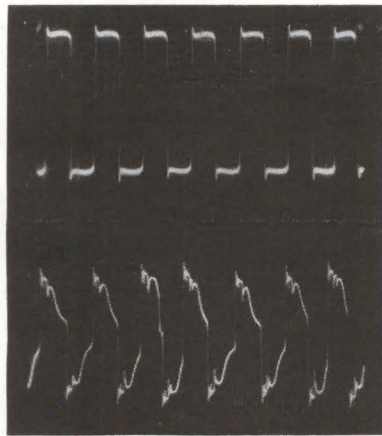

WAVEFORM at top is for resistive load and below is for magnetic amplifier load—Fig. 4

is adjustable with taps. Nominal permeability of these cores is 125, and nominal inductance of the two stacked cores with a 1,000-turn winding is 0.284 henry.

RESULTS—The three-phase system in Fig. 1A with the symmetrical input circuit has been designed for a nominal supply voltage of 208 volts and requires three relatively small capacitors. The single-phase system in Fig. 1B requires considerably larger capacitors. However, this system can be used where a three-phase, 208-volt supply is not available. For example, this frequency multiplier can be used with small 400-cycle magnetic amplifiers operating from single-phase, 120-volt, 60-cycle supplies.

The satisfactory stabilization achieved is indicated by the per-

formance characteristics obtained in the three-phase system and shown in Fig. 4A. The rms values are shown of primary winding current I_w (one of the phase currents I_R , I_S or I_T), capacitor current I_C and linear reactor current I_p . Also, output voltage is shown across resistive loads of 300, 500 and 10,000 ohms.

Similar characteristics in Fig. 4B for the single-phase system are for the special case of a load consisting of two magnetic instrument amplifiers connected in parallel. These push-pull type two-stage amplifiers, which supply a two-channel ink recorder, present a substantially constant inductive load of about 40 volt-amperes. In this application, a 3-microfarad capacitor was connected in series with the load for capacitive compensation of the inductive impedance in the output circuit. The measured rms values shown in Fig. 4B are primary current I_w , input current I_p through linear reactor L_p and load voltage E_L , which is the 420-cps power supply voltage of the magnetic amplifiers.

The output voltage waveform of the three-phase system with a purely resistive load of 300 ohms is shown at the top of Fig. 5. Output of the single-phase system with the magnetic amplifier load is considerably distorted from the rectangular waveform, as shown at the bottom of Fig. 5. However, this distortion was found not to affect operation of the magnetic amplifiers.

A breadboard model of the single-phase system is shown in the photograph. All the components can be contained in a portable case about 12 by 10 by 6 inches. This system, which offers the advantages of ordinary constant-voltage transformers such as ruggedness, reliability and almost unlimited life, does not require servicing.

REFERENCES

- (1) W. A. Geyger, "Magnetic-Amplifier Circuits," McGraw-Hill Book Company, New York, p 322 and 339, 1957.
- (2) E. Friedlander, Frequenzwandler (Frequency Transformer), German patent No. 679,577, August 9, 1939.
- (3) L. J. Johnson and S. E. Rauch, Magnetic Frequency Multipliers, *AIEE Trans.* 73, p 448, November 1954.
- (4) E. Friedlander, Principle and Analysis of a Stabilized Phase Multiplier Type of Magnetic Frequency Converter, *Electrical Energy*, 1, p 55, October 1956.

Four-layer diodes alone, or with transistors or vacuum tubes, form a pulse-modulation technique to produce variable pulse lengths at high repetition rates with rapid rise and fall times

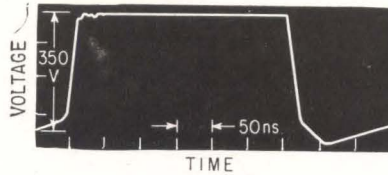
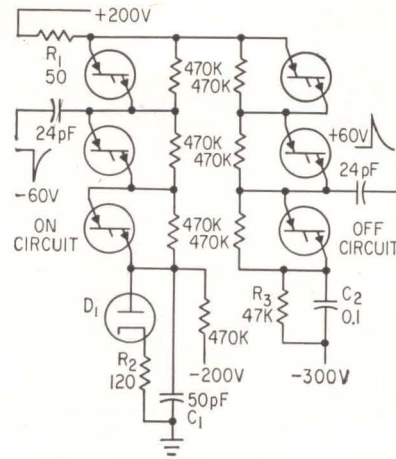

SERIES-resistor modulator uses four-layer diodes to produce 350-v 1-ampere pulses—Fig. 1

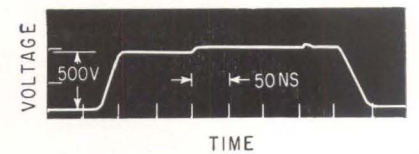
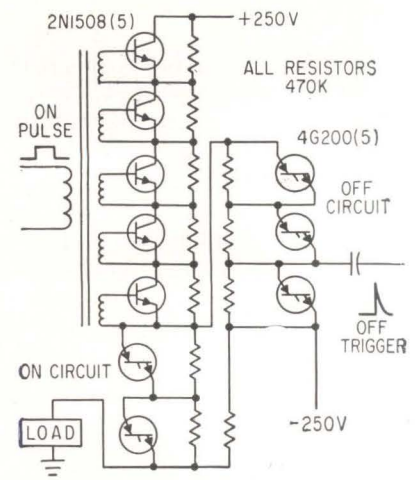

TRANSISTOR and diode modulator can produce up to 5 μsec pulse width at high prf—Fig. 2

THREE NEW APPROACHES

By E. H. HECKMAN
Systems Management Department,
Westinghouse Defense Center,
Baltimore, Maryland

PULSE MODULATION THE NEW WAY

The three circuits covered in this article use various combinations of four-layer diodes, transistors and vacuum tubes to produce low prf pulses with any length, high prf pulses with widths up to 5 μsec and pulses of any length with close spacing between pulses. They can be used to modulate a twt or in any application where fast-rise, flat, variable-width, ampere-pulses are required for repetition rates to 300 Kc

MANY high-power traveling wave tubes are gridded, enabling the output to be controlled by a relatively low-power modulator. Some of these have an over 10 Kw output, yet are controlled by grid pulses of 500 v with grid interception of 0.6 amperes or less.

The three modulators described here can modulate two tubes in parallel, or may be used in other applications wherever fast-rise, flat, variable-width, ampere-pulses are required at repetition rates up to 300 Kc. Pulse width is variable from 0.1 to 5 μsec for all circuits, and two circuits will produce millisecond pulses at low prf. The circuits were designed to operate between -250 volts and +250 volts, but may be altered to operate between other limits.

The circuits described are on-off types in which the B+ is switched on by a trigger to charge the inherent load capacitance (twt grid-to-cathode plus strays) of up to 60 pf in less than 20 nsec. The pulse

remains flat until a second trigger returns the load to the negative bias, discharging circuit capacitance in 15 to 50 nsec, depending upon the circuit design chosen.

Triggers required to pulse the modulators may be obtained by differentiating the output of a commercial low-voltage pulse generator, except in the third design where a higher voltage is required.

SERIES RESISTOR MODULATOR—A combination of four-layer (*pnpn*) diodes and a series resistance makes a simple modulator that will produce an excellent pulse shape at low repetition rates. Figure 1 shows an experimental circuit that produces 350-v, 1-ampere pulses. A negative trigger produces an over-voltage on the top four-layer diode of the ON circuit causing it to avalanche and apply full voltage across the rest of the load, minus the *IR* drop through *R*₁. Diode *D*₁ in series with resistance *R*₂ paralleled by capacitor *C*₁ simulates the

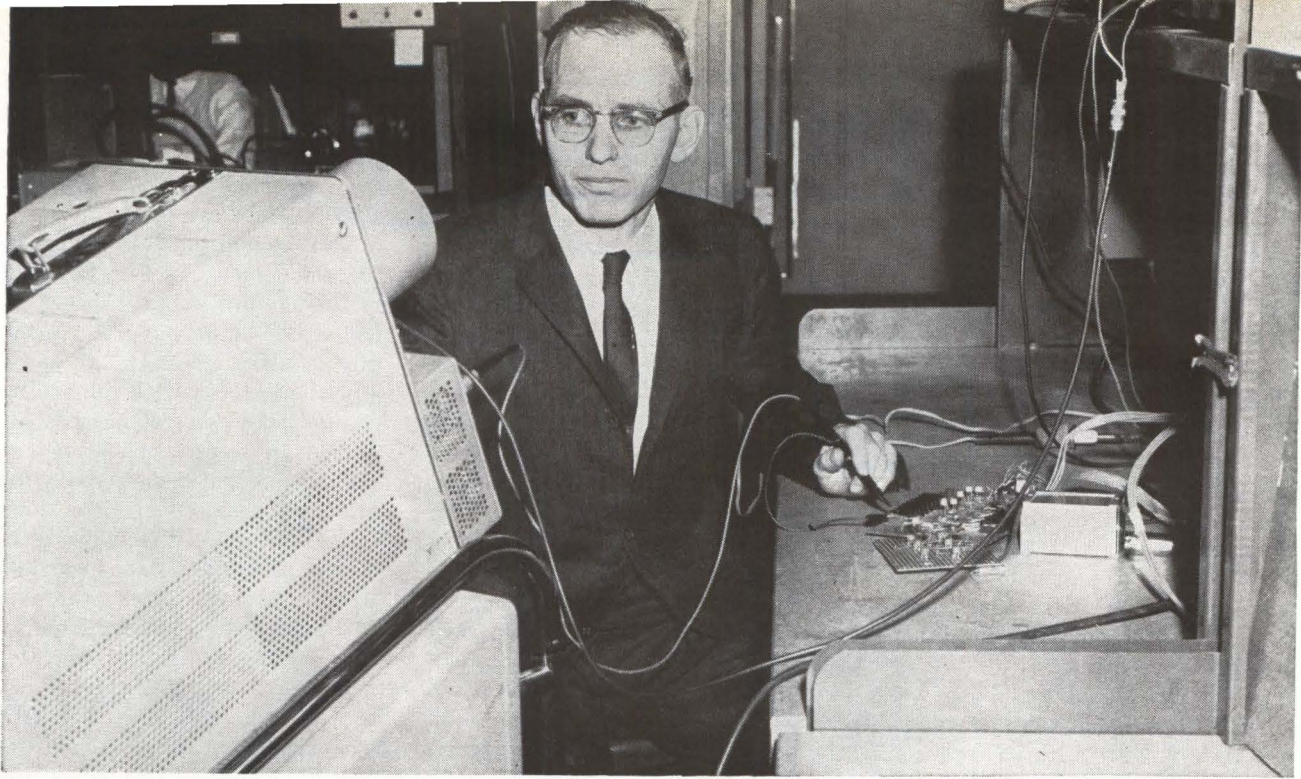

AUTHOR Heckman checks results of one of the semiconductor modulator circuits

TO PULSE MODULATION

load of a twt grid for test purposes. In the test setup, a 5687 was diode-connected to handle the one ampere pulses. The resistance and capacitance values were determined from the characteristics listed by the twt manufacturer to duplicate the grids of two tubes in parallel. When the positive spike triggers the OFF string of four-layer diodes, the voltage at the lower end of R_1 is depressed to $B-$. The current reverses in the ON string so the diodes turn off (recover). When capacitor C_2 charges, current through the OFF circuit is limited by R_3 to a value below the holding current of the OFF string of four-layer diodes, and they recover. Then C_2 discharges through R_3 , and the cycle is repeated. This circuit produces the pulses shown at the bottom in Fig. 1.

The Shockley 4G200 diodes used in the circuit require several microseconds to recover so that C_2 must be relatively large and R_3 must be a high resistance to turn off diodes that have low holding current.

Thus, the circuit produces only one or two hundred pulses a second. The prf can be increased by selecting diodes for fast response and high holding currents and by replacing R_3 and C_2 with an LC network. Pulse voltage can be raised to 500 v by using an additional diode in each string.

TRANSISTOR AND DIODE MODULATOR—High prf may be realized by replacing the series resistor of Fig. 1 with transistors. To obtain rise times faster than the turn-on time of transistors, four-layer diodes are again used in series in an ON circuit (Fig. 2). The transistors are pulsed on and when the lower end of the string reaches a voltage near $B+$, the two ON four-layer diodes avalanche, applying a fast rise pulse to the load. The pulse to the transistor bases must be maintained to hold the transistors on. At the end of the pulse, they turn off but continue to conduct due to internal de-

lay. At the end of the delay period, the OFF string of four-layer diodes is triggered and the load is brought rapidly to $B-$.

Heavy surge current through the transistors reduces their turn-off fall time and when transistor current ceases, the four-layer diodes recover and the circuit is ready for another pulse. Diodes can be selected from 4G200 units that will permit 100-Kc repetition rate. Special experimental Shockley diodes, manufactured by a gold-diffusion technique resulting in faster recovery, allow three-microsecond pulse spacing.

The 2N1508 transistors were used for experimental tests under overvoltage conditions. The bases were pulsed by a special transformer with five secondaries with each secondary rated at 8 v for 80-ohms load and would hold up a 5- μ sec pulse. The OFF trigger can be provided from the trailing edge of the ON pulse by reversing the transformer to work with negative

pulses and by using a 50-nsec delay line to connect to the OFF circuit.

Figure 2 also shows the pulse obtained with this circuit. Note that rise time is about 20 nsec, fall is 40 nsec and the top of the pulse is virtually flat.

HYBRID MODULATOR—Voltage limitations of fast-response transistors available during this development required an impractically large number of expensive transistors. Accordingly, a hybrid circuit was developed to combine the flat pulse obtained with four-layer diodes and the current handling capabilities of tubes.

The hybrid modulator is shown in Fig. 3. Both ON and OFF triggers determine pulse width. However, both ON and OFF triggers must be about 250-v amplitude. The method of triggering the four-layer diodes is unconventional, but turns on a string of diodes faster than methods previously reported.

Tube V_1 is normally ON, operating self-biased through R_3 , and cur-

rent is returned to the reference supply to hold the cathode at about 400 volts. The four-layer diodes are switched ON by a positive pulse across diodes D_1 and D_2 supplied from 1:1 isolating transformer T_1 . These avalanche, followed immediately by avalanche of the rest of the string. Increased current through V_1 drops the cathode about 100 v, supplying the load (twt grid) at +300 volts. The grid of V_1 is held at approximately zero bias during the pulse by resistor R_3 . Current from the +350-v supply is limited by R_2 during the pulse. The result is a pulse that will remain flat indefinitely. The OFF trigger turns on V_2 and pulls down the grid of V_1 to cut it off, terminate the pulse and discharge the capacitance of the load. The grid of V_1 is recharged to the self-biased state through the L_1 - R_2 series combination. The inductance holds off the grid rise to allow time for recovery of the special four-layer diodes. Closest pulse spacing with this circuit is about 3 μ sec. The L_1 - R_2 cir-

cuit must be changed to increase recovery time to about 10 μ sec if 4G200 diodes are used.

The hybrid modulator produces the pulse shown in Fig. 3. Rise and fall times are about 15 nsec for a 550-v, 1.4-ampere pulse. A minor dip near the leading edge can possibly be reduced with minor circuit changes. An extra clamp may be required in some applications since the output pulse voltage is determined by the 400-volt drop through output tube V_1 . Extensive tests of clamp circuits were conducted. Semiconductor diodes were found to be superior to thermionic types in clamping the initial 100 nsec of a pulse. A string of 1N697 diodes to a positive reference will provide an excellent clamp. A series resistance of about 50 ohms should be inserted ahead of the clamp. Without the additional pulse clamp, changes over the tube life will change the pulse voltage.

All three modulators described have turn-on and turn-off delays on the order of 50 to 100 nsec. Such a delay is also inherent in vacuum-tube circuits. However, extreme care is required for four-layer diode circuits to insure that the delay remains constant. Changes may occur due to variations of trigger voltage, B+ or B- voltage, ambient temperature and aging.

The first circuit (Fig. 1) presented is preferred for low prf pulses of any length. The second (Fig. 2) is preferred for high prf and pulses up to 5 μ sec while the hybrid circuit (Fig. 3) will produce pulses of any length with close spacing subject to component duty cycle.

The circuits are unique in their ability to produce fast rise time, flat pulses at high power levels. This is accomplished with a minimum of components in an efficient compact package. Newer types of semiconductors which are becoming available will allow even higher pulse repetition rates and higher power outputs. Until semiconductor breakthroughs are made, it is probable that the circuits will find application when high power, variable width pulses are required for twt modulator or similar applications.

The author is indebted to M. L. Jones for suggestions regarding the circuit designs.

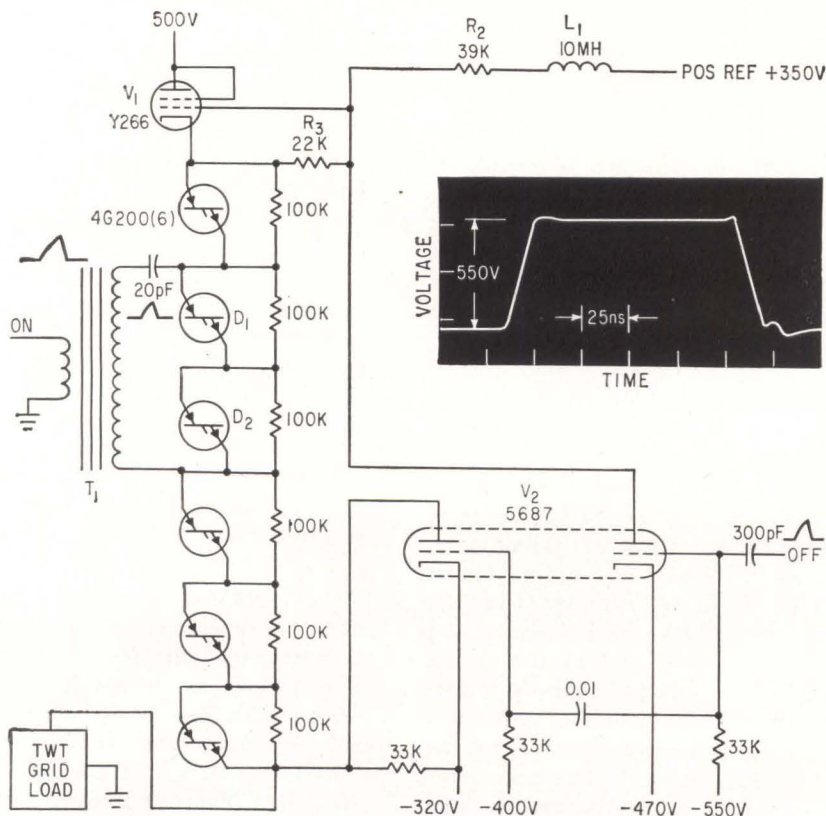

HYBRID modulator produces a 550-v, 1.4-ampere pulse with rise and fall times of 15 nsec. The circuit will produce pulses of any length with close spacing—Fig. 3

HIGH PRECISION D-C Level Shifter Reduces Output Impedance

Circuit uses balanced bridge techniques to maintain constant current through reference zeners; only one d-c supply source is needed

By JOHN WILLIS, Southern Instruments Limited, Camberley, England

THE OUTPUT SIGNAL of this circuit is a replica of the input signal but it appears at lower impedance, and shifted in d-c voltage level by a predetermined amount. The circuit is a precision one, giving high linearity and low drift. The basic circuit uses only two transistors, two zener diodes and three resistors, plus one supply line which need not be stabilized.

The circuit may be used to shift the output level from any voltage source having a moderately low internal resistance. Originally the circuit was developed as an output

stage for a frequency-voltage converter of the saturating-core type, the combined circuit being used as a precision frequency discriminator. Here the output circuit was used to back-off the steady output produced by the carrier frequency, so that the demodulated sidebands produced output voltages varying about ground potential.

SIMPLE CIRCUIT—Consider the conventional solution to the problem shown in Fig. 1A. The backing-off (level shifting) voltage is provided by a chain of zener diodes

D_1 - D_3 , biased by a constant current I supplied by transistor Q_1 . The input, V_{in} , is applied at the lower end of the chain and the output voltage V_{out} , taken from the top through an isolating stage Q_2 . Transistor Q_2 is needed partly to reduce the output resistance, but mainly to ensure that changes of load current do not modify the value of I , otherwise the resulting change in Zener diode working point would result in a non-linear relationship between V_{in} and V_{out} .

This basic circuit, Fig. 1A, has a number of disadvantages. Both

BASIC CIRCUIT has limited current gain, requires tapped supply, is sensitive to temperature change and susceptible to noise on the supply line (A). Balanced-bridge technique combats these disadvantages, providing greatly increased stability and precision (B)—Fig. 1

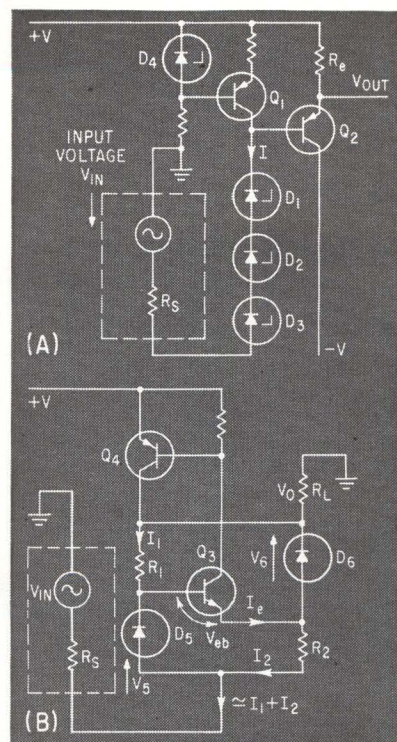

A SHIFTY CIRCUIT

Conventional solid state level-shifting techniques, using zeners as reference elements, stem more-or-less directly from vacuum-tube work, where cold-cathode tubes provided the constant-voltage reference. However, fundamental improvements invariably come from a departure from tradition, and this circuit is no exception. Figure 1 caption outlines the advantages of the new level shifting circuit, while the references show how its evolution follows earlier developments described in ELECTRONICS

positive and negative supply lines are needed. The positive line voltage V_p must be high enough to accommodate maximum positive signal voltage swing on the output, plus bias requirements for zener diode D_6 , which may be an extra six volts. The single emitter-follower Q_2 has only a moderate performance. Noise on the supply bus can reach the output terminals through R_6 for the positive line and through the collector capacitance of Q_2 for the negative line. The constant current I from Q_1 may vary with temperature, resulting in output drift if the source resistance R_s is appreciable. Also, the output resistance of Q_1 is finite, so that I may vary with output voltage, giving rise to non-linearity.

IMPROVED CIRCUIT—The alternative circuit of Fig. 1B uses fewer components but gives a better performance. This circuit maintains a constant voltage between input and output terminals; it also provides an impedance transformation between these terminals.

Transistors Q_3 and Q_4 , Fig. 1B, are connected in a d-c negative-feedback loop. Transistor Q_4 supplies the current demanded by the bridge network R_1 - D_5 - R_2 - D_6 , while Q_3 detects any unbalance in the bridge and corrects it by changing the bias on Q_4 , thus modifying the bridge input current. The current out of the bridge is made up of two components, $I_1 = (V_6 - V_{cb})/R_1$ and $I_2 = (V_5 - V_{cb})/R_2$ neglecting Q_3 base current. The zener diodes D_5 and D_6 are biased by currents I_1 and $(I_2 - I_e)$; I_1 and I_2 are fixed while I_e is small and near-constant, as will be shown shortly. The voltage between the input and output terminals of the circuit is

$(V_5 + V_6 - V_{cb})$, and will thus be constant, apart from temperature effects. The temperature coefficient of the whole backing-off voltage is the sum of the coefficients of D_5 , D_6 and Q_3 emitter-base voltage. By choice of diodes, this may be set to near zero, or to a small positive or negative value.

The impedance transformation occurs as follows. Input signals are applied to Q_3 base through D_5 , and taken from Q_3 emitter through D_6 . Transistors Q_3 and Q_4 are connected as a compound emitter follower². Any change in the collector current of Q_3 changes the bias on Q_4 , so that Q_4 collector feeds back into Q_3 emitter a current which reduces the original change by a factor B_1 , where B_1 is somewhat less than the grounded emitter current gain of Q_4 . Transistor Q_3 thus behaves as if its current gain were not its normal value (say β_3), but rather $B_1\beta_3$, giving an impedance transformation of this magnitude between input and output.

The circuit can deliver an appreciable current into a load resistor. Current fed into the load is supplied directly from the collector of Q_4 , and can be large assuming adequate precautions against overload. Current drawn from the load flows into the bridge network, the current supplied by Q_4 being reduced by the same amount. The maximum swing in this direction is thus limited to less than $(I_1 + I_2)$. For a current I_0 into the load, the working point of Q_3 and the zener diode D_6 change by I_0/B_1 . The resulting change in backing-off voltage can be calculated on this basis and can be made small.

The minimum backing-off voltage available is that developed across two zener diodes in series. Larger

voltages can be obtained by adding more such diodes in series with the input lead. The backing-off voltage can be made variable by including a variable resistor R_3 , Fig. 2A, in series with the input lead. The current $(I_1 + I_2)$ approx in this resistor is defined, so the voltage across it will be virtually constant, and the increase in resistance seen at the output terminals will only be $R_3/B_1\beta_3$. However the temperature coefficient of the total current through R_3 is slightly different from that of the backing-off voltage, since V_{cb} (for Q_3) occurs once each in the equations for I_1 and I_2 , but only once in the equation for the backing-off voltage.

Incidental advantages of the circuit are that it requires no separate negative supply line, and the positive line voltage need be only slightly higher than the most positive output voltage excursion. The circuit is largely insensitive to changes of supply line voltage at d-c or low frequencies. The small residual effect, which arises from the finite output resistance of Q_3 , can be cancelled by inverse feedback through a resistor R_4 into Q_3 emitter circuit (Fig. 2A). The optimum value for R_4 is best found experimentally. Figure 2A also gives circuit values.

DESIGN DETAILS — This level-changing circuit has, in addition to its normal operating state, a second stable condition in which both transistors are cut off and no current flows. This cut off condition, which can be mistaken for circuit failure, is avoided by ensuring that the circuit output is always connected to some finite value of load resistor.

The circuit must also be pro-

Moseley Model 680 series solid state recorders

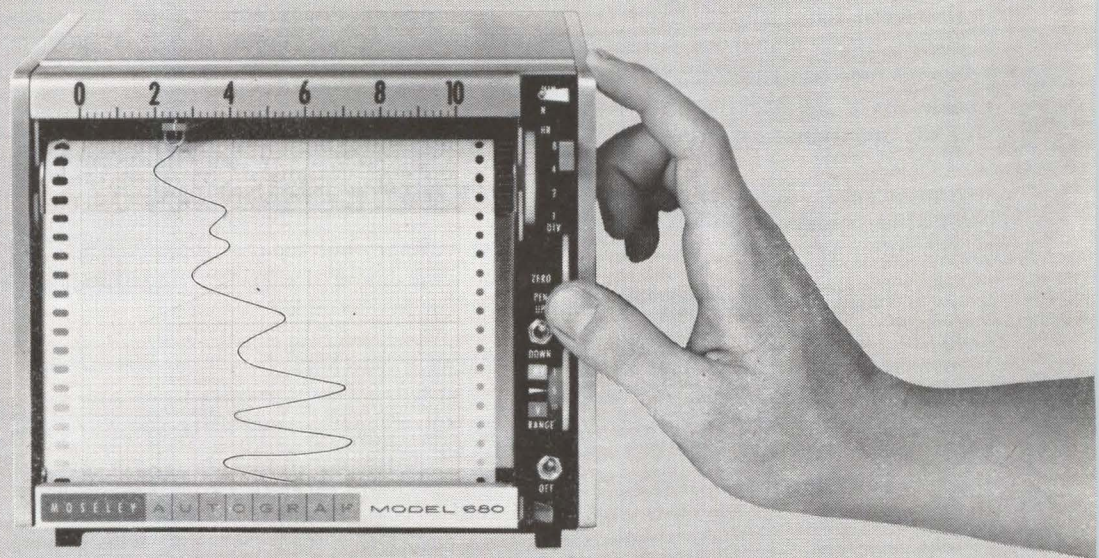

- Ultra-compact 6" Strip-Chart Recorder
- Low-power cool and reliable
- Instant load, tilt-front chart carriage; dual mode paper take-up or tear-off
- Ten calibrated input ranges from 1 millivolt/inch
- Eight instantly selected chart speeds
- Clean, disposable plug-in ink cartridge with start bulb. Inkless writing modes optional
- Drives output-potentiometers, limit switches, digitizers
- Any mounting—rack, table; or industrial panel in sealed, rugged, locked case
- Also thermocouple, milliammeter, single range dual-speed models, 1 mv full scale models

SPECIFICATIONS

| | |
|------------------------------------|-----------------|
| Full scale balance time | 0.5 second |
| Accuracy | 0.2% full scale |
| Power | 10 watts |
| Weight | 10 pounds |
| Zero set and remote pen lift | |
| Input isolated 500 volts to ground | |
| Zener reference voltage | |
| All solid state circuitry | |
| Plug-in modular construction | |

| | Model | Price |
|--------------------------|-------|-------|
| Multi-Range, Multi-Speed | 680 | \$750 |
| Single Range, Dual Speed | 681 | 625 |
| Thermocouple Recorder | 682 | 675 |
| Milliammeter Recorder | 683 | 625 |

F. L. MOSELEY CO.
409 N. Fair Oaks Ave., Pasadena, California
an affiliate of Hewlett-Packard



tected against damage by short circuit across the output. If the output voltage is positive when the short circuit is applied, Q_4 (Fig. 2A) will be turned fully on, so its maximum current must be limited by a resistor R_5 in the collector circuit. Current through Q_3 is limited to a safe value by R_2 . Alternatively, if the output is negative, a short-circuit cuts transistors Q_3 and Q_4 off, and the emitter-base junction of Q_3 becomes reverse-biased. The reverse voltage rating of this junction should preferably be large enough to withstand the largest expected reverse voltage; if this is not possible, the junction should be protected by a shunt diode D_p (a series diode would be better, but would increase the temperature coefficient of the backing-off voltage). The maximum current flowing through D_5 , D_6 and D_p is then limited only by the characteristics of the source, which must be chosen appropriately.

TEMPERATURE EFFECTS—The major effect of temperature change on the circuit performance is a change in backing-off voltage resulting from the temperature coefficients of D_5 , D_6 and V_{eb} of Q_3 . Variation of temperature will also change other parameters of Q_3 and Q_4 ; the resulting changes in circuit performance can be deduced from the current-flow dia-

gram of Fig. 2B. First consider transistor Q_4 . Feedback action holds the collector current of Q_3 at an I_c value sufficient to turn-on current ($I_1 + I_2 - I_c$ approx) in Q_4 collector. An increase in the temperature of transistor Q_4 reduces its emitter-base voltage, increases I_{co} and increases B_4 , the in-circuit current gain from base to collector. All three effects reduce the Q_4 base current required to turn on a given collector current in Q_4 , so as the temperature of Q_4 is raised, the current I_c falls. This affects the backing-off voltage, though only because the current through D_6 and the emitter-base junction of Q_3 is slightly reduced. The current out of the bridge into the input terminal is also affected, being decreased by an amount I_c/β_3 .

Considering Q_3 the temperature dependence of V_{eb} in this transistor has been discussed; changes in β_3 and I_{co} hardly affect the backing-off voltage, but modify the current flowing out of the bridge circuit as shown in Fig. 2A.

SMALL SIGNALS — The circuit constitutes a negative feedback amplifier, so for loop stability the Nyquist criterion must be satisfied. The bridge R_1 - D_5 - R_2 - D_6 , Fig. 2A, will always give the correct sense output if $R_1 \cdot R_2 \gg r_s \cdot r_e$, where r_s and r_e are the incremental resistances of zeners D_5 and D_6 . This con-

dition is always satisfied in practice. Inside the feedback loop, Q_3 operates in grounded base and Q_4 in grounded emitter configuration; Q_3 should therefore be chosen to have an equal or higher cut-off frequency than Q_4 , because then Q_4 will provide a dominant lag in the loop, giving unconditional stability. The closed-loop performance of the circuit should thus be constant up to about the beta cut-off frequency of Q_4 ; above this frequency, the loop gain falls off.

FURTHER IMPROVEMENTS—It should be possible to improve circuit performance still further by substituting for Q_4 a compound pair of transistors as shown in Fig. 2C. The improvement in performance appears as increased isolation of the load from the input circuit; the temperature dependence of the circuit is still controlled by the bridge network. Against this improvement must be balance the extra cost and the greater difficulty experienced in stabilizing the loop at high frequencies.

REFERENCES

- (1) C. H. Barnes & R. M. Tillman, A New Transistor-Magnetic FM/AM Sub-carrier Discriminator, *Trans IRE TRC-3*, 1, 1957.
- (2) T. K. Heminway & J. Willis, Transistor Pairs Improve Emitter-Follower Performance, *ELECTRONICS* p 48, May 25, 1962.
- (3) D. Watson, Two Transistors Equal One Constant Current Diode, *ELECTRONICS*, July 6, 1962.

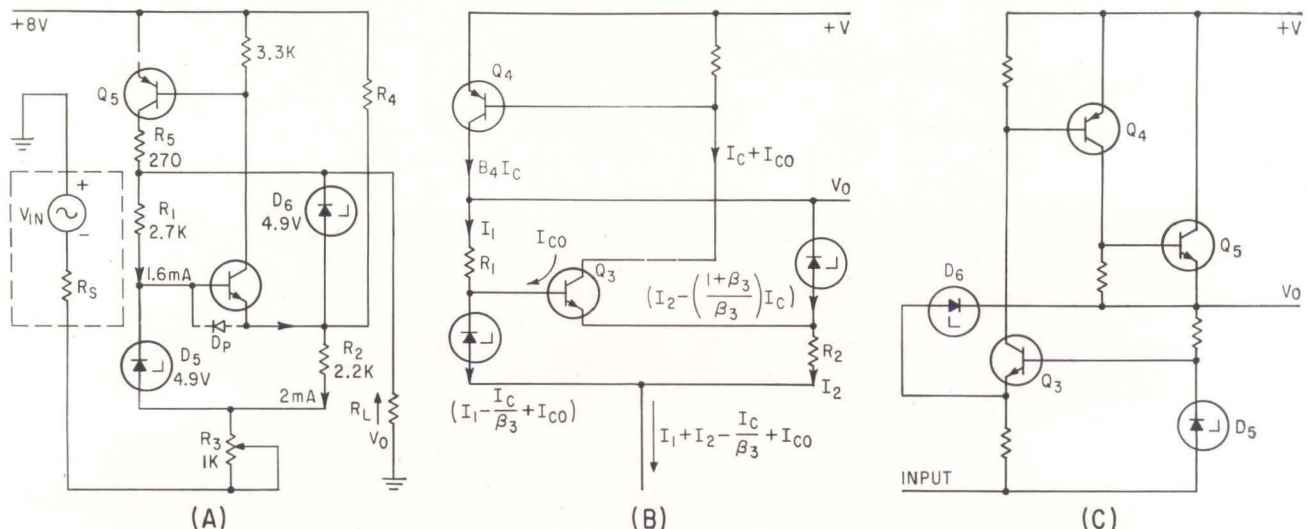

PRACTICAL CIRCUIT has stable operating mode with both transistors cut off—finite load permanently connected prevents this (A). Current flow diagram aids circuit analysis (B); additional transistor provides complementary output stage (C)—Fig. 2

| VARIAN TWO-CAVITY OSCILLATORS—9.5-10.6 Gc | | | | | | | |
|---|--------|--------|--------|--------|--------|--------|--------|
| CHARACTERISTICS | VA-520 | VA-519 | VA-518 | VA-514 | VA-516 | VA-517 | VA-511 |
| 200 W, 13.0 kV | | | | | ● | | |
| 50 W, 10 kV | | | | | | ● | ● |
| 2 W, 4 kV | ● | ● | ● | ● | | | |
| FIXED FREQUENCY | | ● | | ● | ● | | ● |
| TUNABLE 250 Mc SINGLE SHAFT | ● | | ● | | | ● | |
| CONDUCTION COOLED | ● | | | ● | | | |
| LIQUID COOLING | | ● | ● | | | ● | ● |
| EBULLIENT COOLING | | | | | ● | | |



VA-514



VA-517

WHICH VARIAN LOW-NOISE OSCILLATOR BEST SUITS YOU?

Varian's low-noise X-band klystron oscillators for CW-doppler or pulse-doppler systems are available with several power ratings and a wide selection of tuning and cooling arrangements. These two-cavity klystrons can be used to meet your requirements for drivers or power oscillators. Improved manufacturing techniques provide a long life of low-noise performance which is guaranteed for at least 500 hours. Frequency stability: excellent. Write for additional information.



MICROWAVE TUBE GROUP: PALO ALTO TUBE DIVISION • BOMAC DIVISION • S-F-D LABORATORIES, INC. • SEMICON OF CALIFORNIA, INC. VARIAN ASSOCIATES OF CANADA, LTD. • SEMICON ASSOCIATES, INC.

NORTHEASTERN FIRST AGAIN!

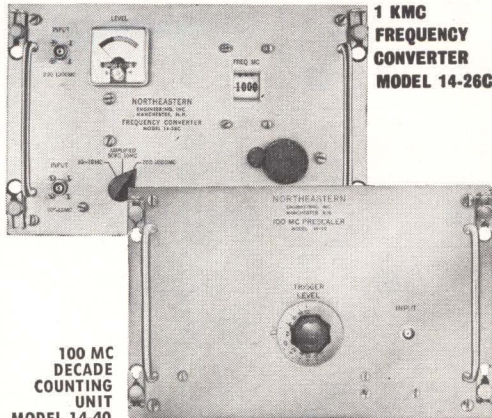

100 MC
DECADE
COUNTING
UNIT
MODEL 14-40

1 KMC
FREQUENCY
CONVERTER
MODEL 14-26C

a new counter for only \$425!

Just plug in Northeastern's
1 KMC Frequency Converter
or 100 MC Decade Counting Unit

Model 14-26C extends the capability
of your basic 10 mc counter from
200 to 1000 mc. **\$425.**

The 14-40 counts events from DC to
100 mc, directly, *WITHOUT TUN-
ING*. Pulses, only 5.0 nanoseconds
wide and separated in time by only
10 nanoseconds, are seen and counted
discretely, whether they occur singly,
in pairs or bursts of any length. FM
signals can also be counted. Low
frequency extension is possible with
the Model 14-40 plug-in from 10
cycles to DC **\$425.**

Both models can be plugged into
most 10 mc counters as well as
Northeastern's Model 14-20C.

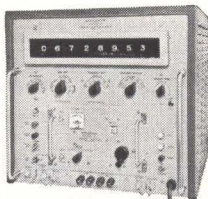

Model 14-20c
\$2200.

**NORTHEASTERN
ENGINEERING INCORPORATED**
A SUBSIDIARY OF ATLANTIC RESEARCH CORPORATION
DEPARTMENT 6-A MANCHESTER, NEW HAMPSHIRE

Employment Opportunities Open At All Levels

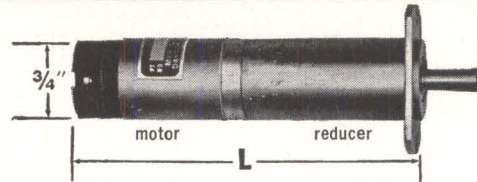

NEW 3/4" GEARHEAD MOTOR

Now you can get up to 300 oz. in. torque from a precision miniature gearmotor only 3/4" in diameter. Globe's new SD permanent magnet d.c. motor with integral planetary gearhead provides 19 standard ratios, wound for 4 to 50 volts. Armatures can be wound to produce any speed-torque combination within the capacity of the motor. Can meet environmental and other applicable portions of MIL-8609. Request Bulletin SDG from Globe Industries, Inc., 1784 Stanley Ave., Dayton 4, Ohio.

| Speed Reduc. Ratio | Max. Cont. Torque In. Oz. | L | Speed Reduc. Ratio | Max. Cont. Torque In. Oz. | L |
|--------------------|---------------------------|----------------------------------|--------------------|---------------------------|---------------------------------|
| 14.58 | 3.0 | | 733 | 100 | |
| 22.03 | 4.5 | 2 ³ / ₄ " | 1108 | 150 | 2 ⁶ / ₄ " |
| 33.28 | 7.0 | | 1853 | 200 | |
| 55.66 | 10 | | 2799 | 300 | |
| 84.11 | 14 | 2 ⁵ / ₃₂ " | 4230 | 300 | 3 ¹ / ₈ " |
| 127.1 | 21 | | 6391 | 300 | |
| 192 | 30 | | 10689 | 300 | |
| 321 | 45 | 2 ⁶ / ₄ " | 16150 | 300 | 3 ¹ / ₄ " |
| 485 | 70 | | 24403 | 300 | |
| | | | 36873 | 300 | |

**GLOBE
INDUSTRIES,
INC.**

CIRCLE 202 ON READER SERVICE CARD

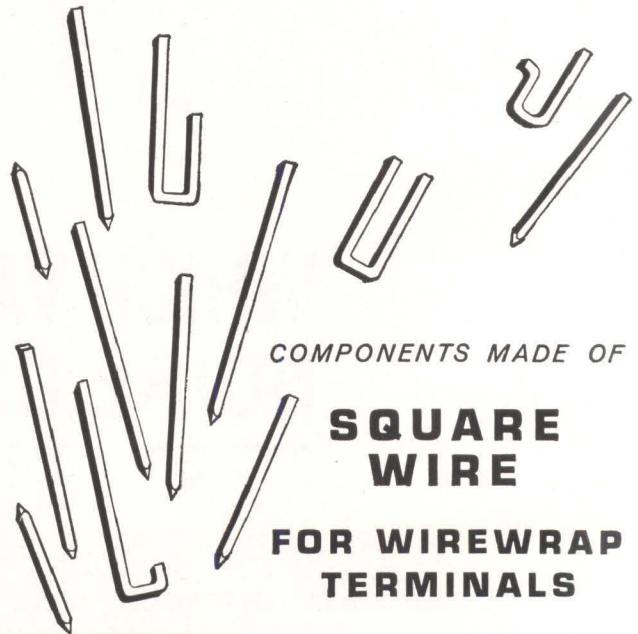

COMPONENTS MADE OF

**SQUARE
WIRE**

**FOR WIREWRAP
TERMINALS**

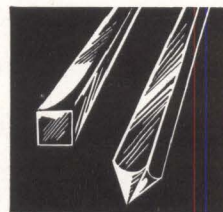

Precision-made on high speed production machines for faster, tighter, more economical connections. Straight wires, square cut-off; straight wires, pointed on one or both ends; or formed wires to specifications. Minimum corner radii. From .015 square to .093 square. Send a blueprint or sample for estimate.

ART WIRE AND STAMPING CO.
18 Boyden Pl., Newark 2, New Jersey

CIRCLE 203 ON READER SERVICE CARD

May 3, 1963 • electronics

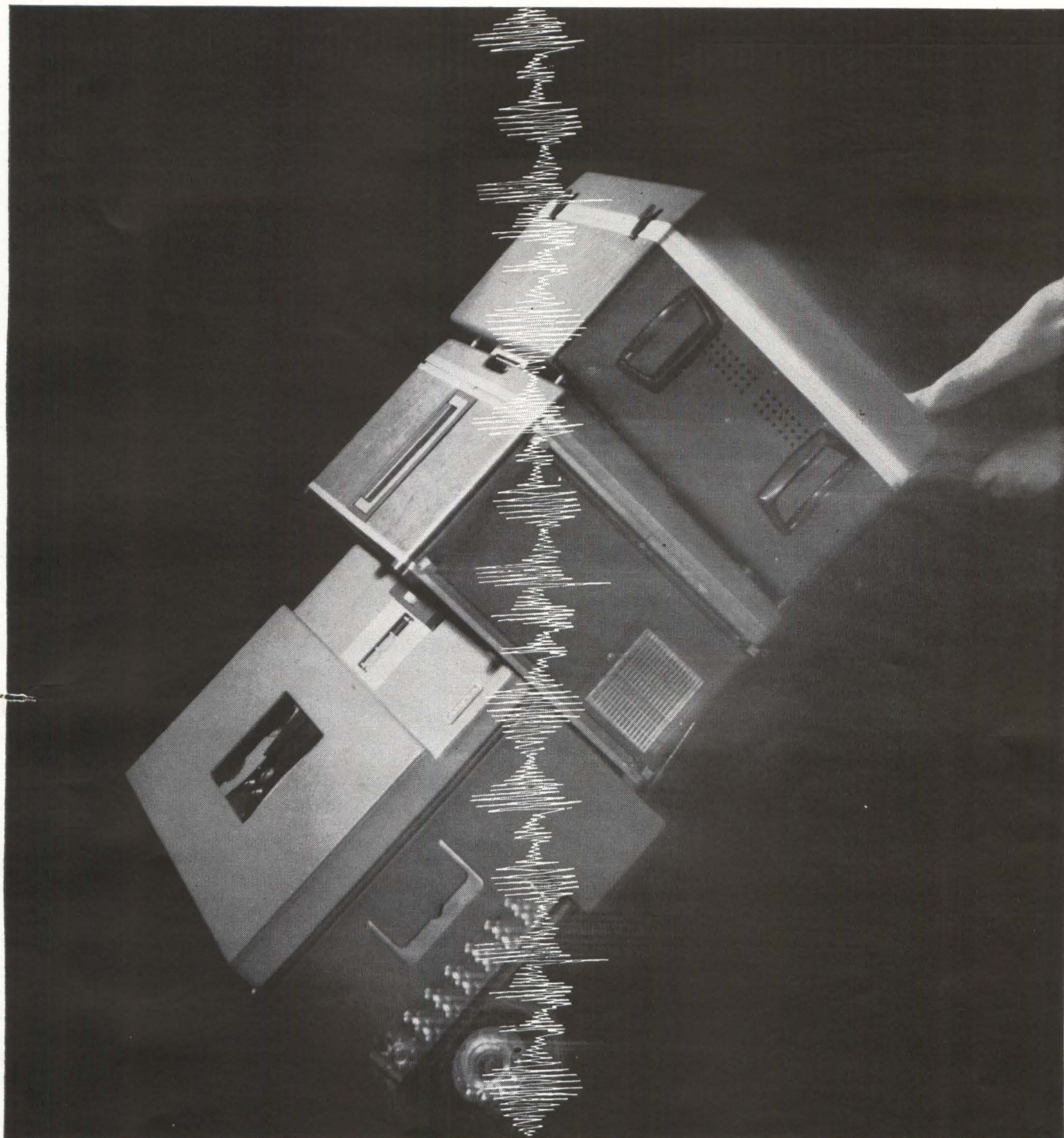

Who can deliver the most complete line of portable instrumentation recorders?

AMPEX

And what a line it is. There's a portable for medical, for industrial, for research applications, for rugged applications—for almost every data acquisition need. And there's a price to fit almost every budget. Behind each recorder stands the name of Ampex—to assure you true instrumentation performance all the time. On the top, above: the low-cost SP-300. It has four speeds, four tracks, push-button selection for FM or Direct recording, plus built-in attenuation, monitoring, calibration and erase. In the middle is the FR-1300. It offers 14 tracks, 300 cps to 300 KC capability on Direct, DC to 20 KC on FM and six speeds precisely controlled by a unique servo-driven capstan. On the

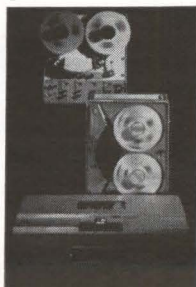

bottom: the rugged CP-100. It records Direct, FM-Carrier and PDM. Has a closed loop drive, six standard speeds, 14 tracks, a frequency response of up to 250 KC on Direct, down to DC on FM. And it operates on almost any source of power—including batteries. In other words, Ampex has a portable line so complete you can pick a recorder to fit your needs instead of having to modify your requirements to fit the recorder. For more information write the only company providing recorders, tapes and core memory devices for every application: Ampex Corp., 934 Charter St., Redwood City, Calif. Term financing and leasing available. **AMPEX**

Optical Computers Approach Reality

By JAMES T. TIPPETT and HAROLD E. PUTHOFF

Department of Defense, Washington, D. C.

Subnanosecond computing elements may use fiber optics, glass lasers

A MAJOR BARRIER in speeding up the operation of computers from submicrosecond to subnanosecond range is the demarcation between circuits whose speed is limited primarily by the active component speed, and those whose speed is limited by transmission delays between elements and stray effects surrounding the elements.

New devices are needed that will have faster active elements, that will be substantially reduced in size, and that will have a minimum of energy stored in stray effects.

Promising developments are tak-

ing place in optical and optoelectronic devices. These include the invention of the laser, use of fiber optics as both passive and active transmission lines, recent advances in high-speed photodetection, and both incoherent and coherent light-emitting semiconductor diodes.

Many photon processes are inherently fast: the natural lifetime of an isolated nonmetastable atom is in the nanosecond and subnanosecond range for photons at optical frequencies (2 e.v.) and higher. Such processes are the basis of fluorescence phenomena in activated solids. Laser processes also occur at nanosecond speeds.

The size of light generators, detectors and transmission lines is competitive with today's electronic circuits. Whereas the smallest co-

axial cables in use are about 30 mils in diameter, optical fibers in the micron range have been used successfully, and ones in the 1 to 5-mil range are commonplace. Their loss characteristics are better than those of smallest coaxial cables, and crosstalk can be either enhanced for coupling or reduced to negligible amounts for isolation.

THE STRAY REACTANCE problem does not play a significant role in the optical elements, which are photon-controlled, rather than charge-controlled as conventional electronic devices. In a laser, for instance, the bulk movement of charge has been replaced by a bulk movement of photons, thus eliminating the need for a major redistribution of relatively large-scale fields.

The ability of optical systems to process information in parallel is well known, beginning with the simple lens and including fiber optic bundles. In the slower (millisecond) optical and optoelectronic systems already developed, fan-in factors of 1,000 have been obtained.

Some of the engineering considerations and advantages of new optical devices are:

Light frequencies, of the order of 10^{14} cps, potentially provide larger bandwidth and higher information-handling rates, if suitable modulation techniques are found.

Because photons can be treated both as waves (interference effects) and as particles (quantum interactions), it may be possible to obtain circuits and utilize effects not possible in electronic circuits.

The higher frequencies are a natural research candidate for faster computers. Although research has been performed with microwave computer circuits, the complexity of metallic waveguide structures has made microwave

Miniature Radiometer on a Leaf

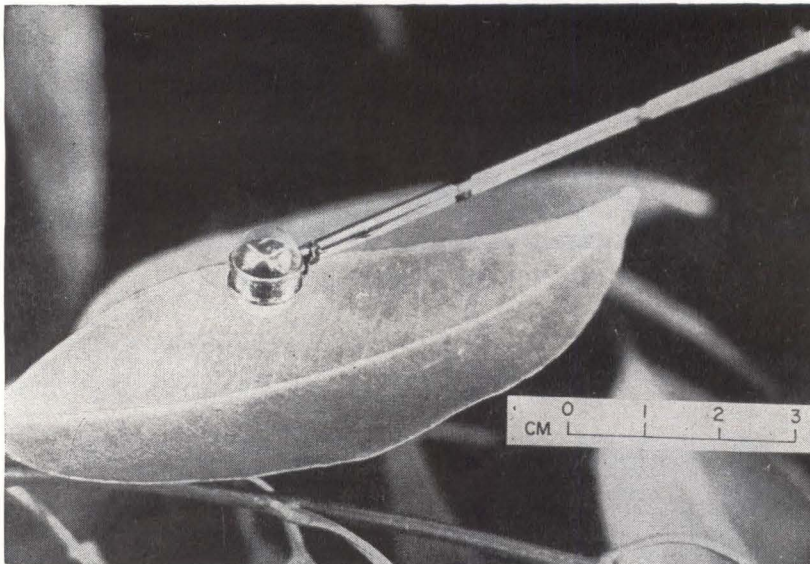

DEVELOPED FOR AGRICULTURAL research, such as measurements of net heat intake by small objects like single leaves or flowers, a miniature net radiometer has been made by Middleton & Co. Pty. Ltd, Melbourne, Victoria, Australia. Half an inch in diameter, the unit contains a thermopile shielded by two plastic hemispheres. The thermopile's current, proportional to net radiation density, operates a meter

can you use the advantages of Kepco's STATIC MAGNETIC VOLTAGE STABILIZER

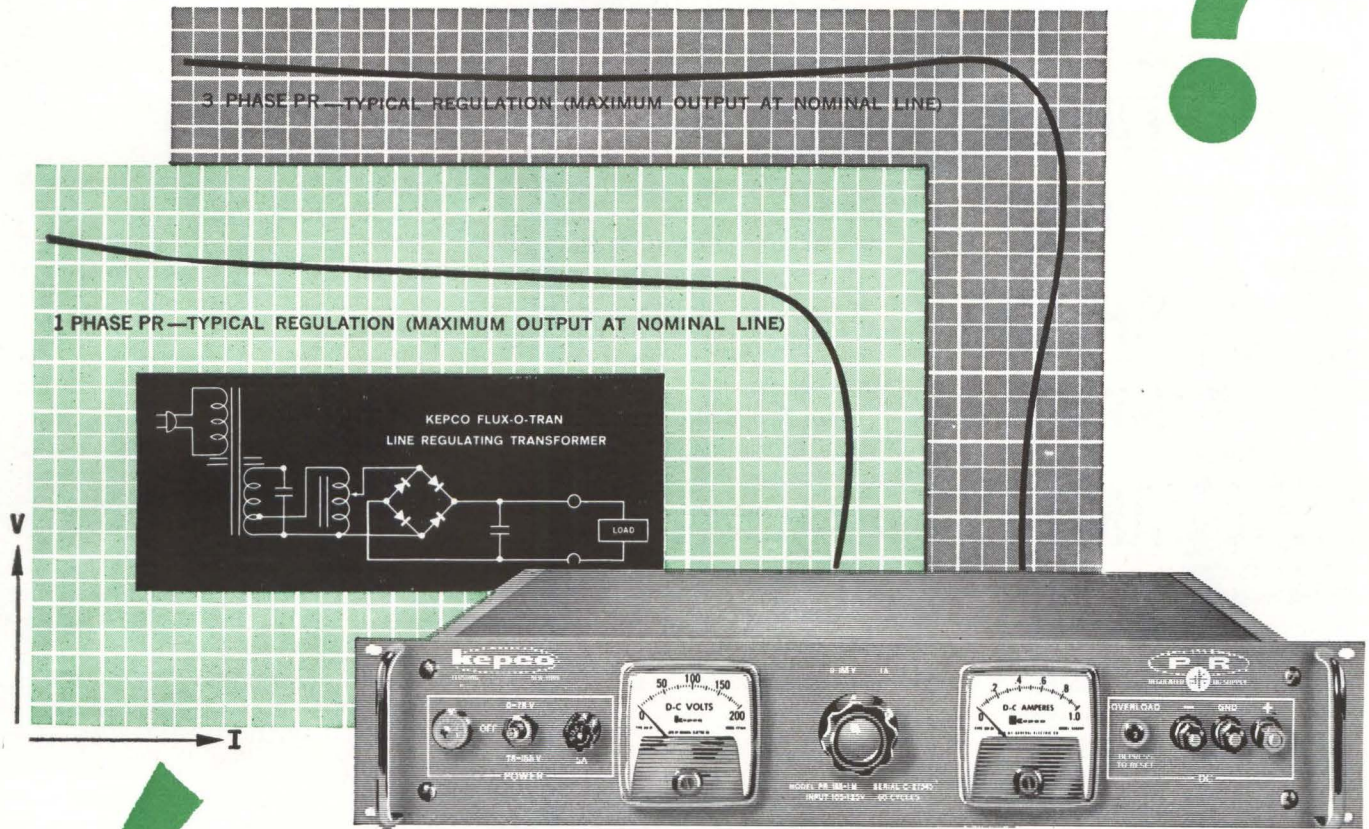

Model PR 155-1M



KEPCO POWER SUPPLIES

Kepco's **FLUX-O-TRAN** is a ferro-resonant static magnetic voltage stabilizer. Its design characteristics feature:

- output essentially free of line voltage variations
- isolation of line transients
- current limiting protection from current overloads and external short-circuit

The **FLUX-O-TRAN** is the heart of Kepco's PR GROUP of DC Power Supplies. By delivering a squared-waveform to the rectifier, the **FLUX-O-TRAN** increases rectifier utilization and improves the loading characteristics of the filter capacitors. This characteristic

provides a relatively low intrinsic source impedance, improving load regulation and affording a low ripple content. The result is a simple FOOL-PROOF, high efficiency source of regulated DC power in *minimum* space and at *minimum* cost.

The PR GROUP offers a wide choice of adjustable output voltage and output ratings with:

- typical ripple values 0.5 to 3%
- overcurrent protection
- no voltage overshoot
- power efficiency typically 50-70%
- reliable, efficient silicon full-wave rectification

| | ± 1% LINE REGULATION — 105-125 V AC, 60 CPS ± 5% — 1 PHASE | | | | | | | | | | ± 2% LINE REGULATION 208/230 V AC ± 10% 60 CPS ± 5% — 3 PHASE | | |
|-------|--|-----------|----------|-----------|------------|----------|-----------|-----------|-------------|-----------|---|-----------|----------|
| VOLTS | 0-7.5-15 | 0-15 | 0-19-38 | 0-38 | 0-40-80 | 0-80 | 0-78-155 | 0-155 | 0-165-310 | 0-310 | 0-20 | 0-40 | 0-50 |
| AMPS | 0-10 | 0-30 | 0-5 | 0-15 | 0-2.5 | 0-8 | 0-1 | 0-4 | 0-0.6 | 0-2 | 0-100 | 0-50 | 0-40 |
| MODEL | PR 15-10M | PR 15-30M | PR 38-5M | PR 38-15M | PR 80-2.5M | PR 80-8M | PR 155-1M | PR 155-4M | PR 310-0.6M | PR 310-2M | PR 20-100M | PR 40-50M | PR 50-40 |
| PRICE | \$345 | \$495 | \$325 | \$475 | \$325 | \$450 | \$325 | \$430 | \$345 | \$430 | \$1,125 | \$950 | \$950 |

for complete specifications on more than 250 standard models, write for NEW Catalog B-631

See our Catalog in  Sec. 4000



131-38 SANFORD AVENUE • FLUSHING 52, N.Y., U.S.A.

Phone (212) IN 1-7000 • TWX# (212) 539-6623

Cable Address: KEPCOPOWER, NEWYORK

VITREOSIL®

**PURE FUSED
QUARTZ
TAKES
MORE
SHOCK,
HEAT
AND
ACID**

**THAN GLASS
OR PORCELAIN —**

**RESISTS
TEMPERATURES TO
1050°C —**

**HANDLES
MOST HOT ACIDS
WITHOUT ETCHING —**

**WITHSTANDS
CONSTANT THERMAL
SHOCK —**

**EXCELLENT
ELECTRICAL AND
OPTICAL
PROPERTIES —**

**LABORATORY AND
INDUSTRIAL WARE —**

**SPECIAL
FABRICATION —**

**SPECTROSIL®
FOR PURITY**

**ASK FOR
32 PAGE FREE
CATALOG —**

**THERMAL
AMERICAN
FUSED QUARTZ CO.**

**RT. 202 AND
CHANGE BRIDGE RD.
MONTVILLE, N. J.**

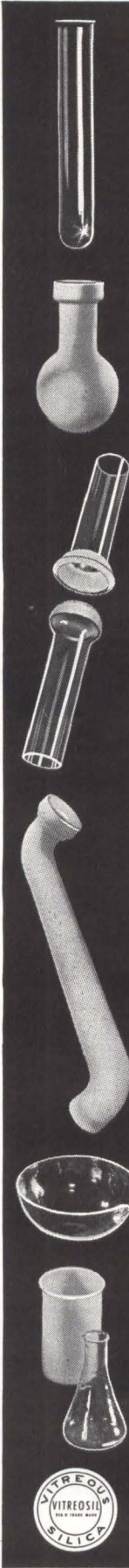

computer elements difficult to work with. With optical frequencies, optical fibers may be used for interconnections.

In an area 10 microns square, 100 closely packed optical fibers of 1 micron diameter can be contained, offering a substantial size reduction over the typical 30-mil diameter coaxial cables used in some advanced tunnel-diode circuits. Also, an optical fiber connection requires no ground wire. Several effects not found in microwave waveguides can be exploited: for instance, optical fibers have a propagation mode that has no lower optical frequency cut-off. Energy can be carried on the outside as well as the inside of the fiber.

Nanosecond phenomena have been found in the last year or so in optical devices, but have not been applied to higher speed computers.

The neuristor is an example of a continuous type of device which may be more easily obtainable in optical fibers than with electronic devices.

Glass fiber lasers, which make the

active transmission line a reality for optics, have been demonstrated and could be used to overcome any undesirable loss of signal.

There are three types of computer circuits possible using optics. The first one is the optoelectronic type circuit, which uses a combination of photons and electrons as carriers of information, such as the light-emitting diode and photodetector. Then there is the purely optical type in which photons control photons, such as the glass laser. The other type of optical logic element is the hybrid combination of purely optical and optoelectronic circuits.

The frequency spectrum of the optical elements is in the visible (4,000 to 7,500 Å) and the near infrared (7,500 to 20,000 Å), where most optical devices and components developed to date operate.

OPTICAL ELEMENTS—The principal all-optical element is the active or passive optical fiber (sometimes referred to as the dielectric waveguide). Such fibers

Inverse Pinch Plasma Generator

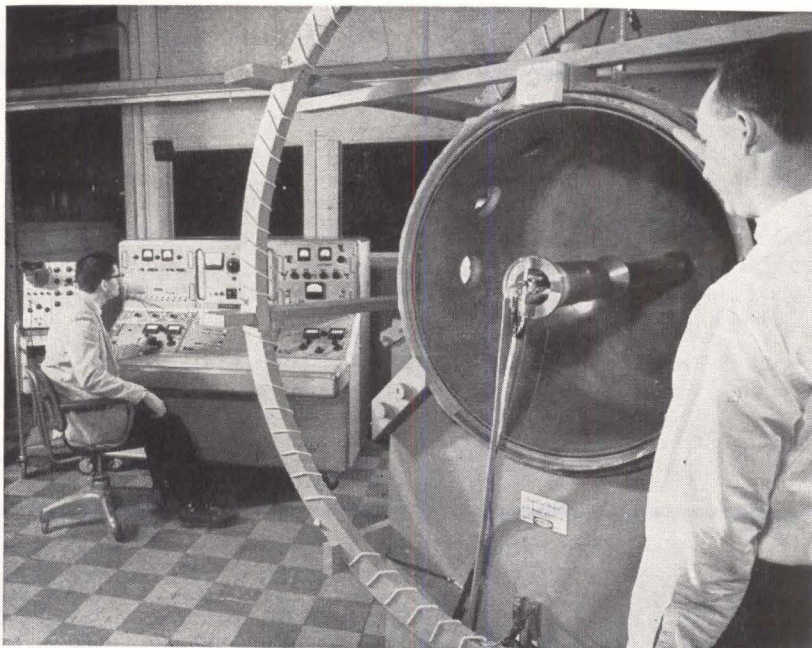

PLASMAS can be expanded at rates up to 10^7 cm/sec into magnetic fields as strong as 2 kilogauss with this generator developed by Aracon Laboratories, division of Allied Research Associates, Inc. in Concord, Mass. The generator is complete with vacuum chamber and electrodes, Helmholtz coil, vacuum system, high-voltage capacitor bank and operating console. Various gases can be quickly injected into the chamber; the expanding plasma can be observed visually or by electronic methods

(see *ELECTRONICS*, June 1, 1962, p. 37) vary in size down to 0.1 micron in diameter.

The passive optical fiber is an excellent means of interconnecting optical circuits where gain is not needed to overcome losses. Typical passive fibers have a loss of about 1.1 db per meter; this compares with 1.8 db per meter at 1 Gc for a specially made 35-mil diameter coaxial cable. Losses in fibers are due to line losses and end losses. Line losses are caused along the fiber by absorption in the material and scattering at the core-cladding interface, and are analogous to attenuation losses in electrical transmission lines. End losses are a measure of the amount of light that can be injected into and removed from the fiber, and are analogous to the impedance-matching losses in electrical transmission lines.

Velocity of propagation in optical fibers is about 8 inches per nanosecond, about the same as the propagation velocity of electrical signals along coaxial cables.

ACTIVE FIBERS—If the optical fiber is doped to provide laser action, it can act as an active transmission line; it then shows a net gain. This may overcome device loss in signal transmission paths thereby becoming an extremely valuable adjunct to lumped active devices.

NEURISTOR FIBERS — It has been shown (Walter Kosonocky, RCA) that an optical computer system is possible, using only optical lasers as active elements, operating as a laser neuristor computer. Kosonocky discussed the realizability of neuristors as active transmission lines in the form of optical fibers containing active-emissive ions and saturable-absorptive ions. Analysis has shown that optical logic devices are realizable; for example, using a one-micron-diameter optical fiber with a pulse duration of 100 picoseconds at a frequency of 1 Gc, a logic device can be realized that operates at a 10-milliwatt power level.

Two problems must be solved before the attractive neuristor laser concept can be realized. They are (1) to find a suitable combination of emissive and absorptive ions in an appropriate transmission me-

**Sid
Herman
can
show
you ...**

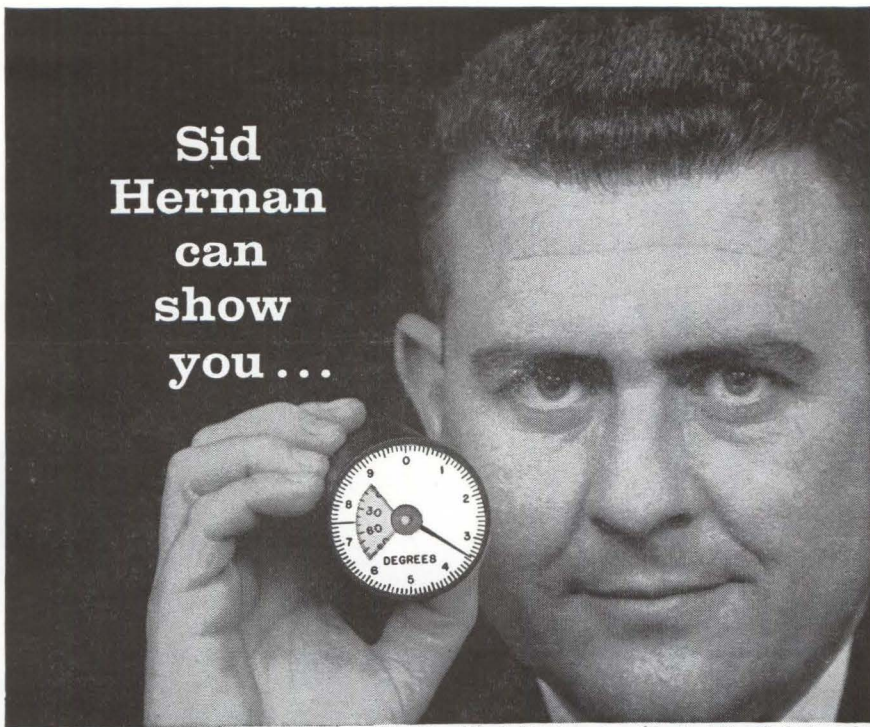

Vice-President, Engineering, North Atlantic Industries

how North Atlantic's instrument servos fill the five major systems jobs ... exactly.

Measurement, remote display, data conversion, control, computation . . . Name the task and it's probable that the North Atlantic man can show you how to meet it precisely from NAI's comprehensive line of 3" and 2" vacuum tube and all solid state instrument servos.

Production models are available for high- and low-level ac, dc, synchro, strain gage, thermocouple, resistance bulb and other inputs. Most can be supplied with choice of pointer, counter, torque shaft or digitizer outputs. All utilize flexible design that permits any combination of input-output features to be supplied rapidly to user requirements, for both ground and airborne applications. Some are described below.

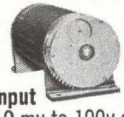
| SBI-201 Single Pointer DC Radiometer | SBI-401 A-to D Converter | SBI-501 Shaft Position Repeater | SBI-502 Three-Digit Counter Readout | SBI-503 Dual Scale Readout |
|---|--|---|--|--|
|  |  |  |  |  |
| Input Denom. 5-50v Num. 10 mv-100v Accuracy $\pm .2$ to $\pm .5\%$ fs Resolution .1 to .2% Response .25 sec. fs | Input 10 mv to 100v dc Accuracy $\pm .1\%$ fs Resolution from 0.05%* Response from 2 sec fs* *depending on encoder used | Input ac, dc or synchro Accuracy $\pm .1$ to $\pm .5\%$ fs Resolution .05 to .25% Response 7 sec. @ 15 oz-in | Input ac, dc, or synchro Accuracy $\pm .5$ to .1% fs Resolution .02 to .05% Response 15 sec. fs | Input ac, dc, or synchro Accuracy .05 to .1% fs Resolution .02 to .05% Response 6 sec. fs |

If there's a critical job for an instrument servo in your system design, it will be worth your while to talk to your North Atlantic engineering representative. For his name, call or write today. Or request Catalog SFC-1 for complete data.



NORTH ATLANTIC industries, inc.
TERMINAL DRIVE, PLAINVIEW, L. I., NEW YORK • Overbrook 1-8600

Diffraction pattern produced by monochromatic laser beam illuminating a pinhole of approximately 500 microns diameter.

SPECTRA-PHYSICS - a leader in CW Gas Laser technology

In January of 1963, a scientist at Spectra-Physics' laboratories in Mountain View pushed a button and turned on a light. It was no ordinary light; the yellow-orange beam was the first 6118Å continuous-wave gas laser transition ever seen by human eye.

In producing this transition, the shortest laser wavelength yet observed, Spectra-Physics employed a novel technique—use of an intra-cavity prism to remove all competing wavelengths from the cavity resonator except for the one of interest.¹

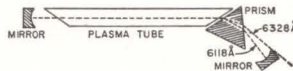

By demonstrated ability to conceive and carry through advanced ideas in laser technology, Spectra-Physics has become identified as a leader in bringing the laser to practical reality. Further evidence of Spectra-Physics' leadership in gas laser technology includes many more original contributions, such as:

discovery of the first high-gain CW gas laser transition—3.39 microns, helium-neon;²

achievement of the highest power CW gas laser output yet observed—over 0.1 watt

Over 70% of all commercial CW gas lasers in use today were developed and produced by Spectra-Physics

Spectra-Physics offers, in addition to its off-the-shelf gas laser product line, competent application-oriented research services for systems developers interested in the exploration and application of laser techniques. Write for details.

1. A. L. Bloom, "Observation of new visible gas laser transitions by removal of dominance," *Applied Physics Letters*, Vol. 2, No. 5, pp 101, March 1, 1963.
2. A. L. Bloom, W. E. Bell, and R. C. Rempel, "Laser operation at 3.39 microns in a helium-neon mixture," *Applied Optics*, Vol. 2, No. 3, pp 317, March 1963.

SPECTRA-PHYSICS
INC.

738 Terra Bella/Mountain View 3/California
(415) 968-4467

dium, and (2) to provide pumping power sufficient for gigacycle repetition rates.

LASER COMPUTERS — It has been shown in principle that a laser can be used as a threshold-triggered active element. The laser is pumped externally to just below threshold, and an input signal then applied to raise the laser above the threshold. In an all-optical system, this input signal takes the form of an additional pump signal. In an electro-optical approach, an electrical signal induces polarization changes by the Kerr or Faraday effect, to couple more efficiently the pump power already present. At present, the former approach appears more promising, as the electro-optical effects are second order in magnitude. Considerable research remains to be done in this field.

A NOR-gate operation in a laser has been demonstrated by Koester of the American Optical Co. Here the input signal quenches the laser oscillation, thereby inhibiting the output signal.

Other potentially useful effects exist in optical fibers, such as the use of different modes of propagation to represent binary information. This may be a way to implement an optical computer which does not use the pulse-no pulse basis as the one-zero representation. Interference and coupling effects between individual fibers in either common or separate claddings may be useful in ultra-high-speed computers.

OPTOELECTRONIC ELEMENTS

—One recent development in this area is the semiconductor laser, in which a *p-n* junction is electrically pumped to produce an optical output. Such a device has excellent isolation between electrical input and optical output, eliminating a major source of feedback encountered in all-electronic devices. A thorough understanding of how to fabricate devices with specified characteristics is not yet well developed.

As suggested by Iwerson, Bell Telephone Laboratories, the combination of light-emitting diodes and photodiodes may make the optoelectronic relay a reality. These types of circuits should permit inte-

gration into an all-semiconductor package.

The best type of logic to be used in nanosecond computing systems has yet to be settled. Majority or threshold logic may be found convenient, or possibly multilevel or parallel logical circuits will be indicated.

Precise Pointing Control

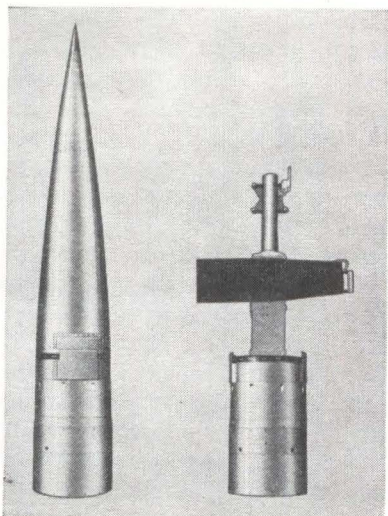

DEVELOPMENT of a new pointing control for orientation of scientific instruments in rockets has been announced by Ball Brothers Research Corporation, Boulder, Colorado.

In a recent flight the new control, called the SPC 400, pointed a spectrographic monochromator biaxially at the center of the sun and held it there within 15 seconds of arc, for a period of about 5 minutes.

The instrument has two servos, operating in the azimuth and the transverse axes. In each axis, coarse and fine light-sensitive detectors provide the error signal.

Used with the Aerobee rocket, the pointing instrument can be recovered by locking in a stowing position and landing by parachute. A standard Aerobee ogive-shaped nosecone assembly is used, allowing space for instrumentation.

Largest Neutron Monitor To be Built in Dallas

DALLAS—A new instrument to observe cosmic radiation and its variations with time is being planned at

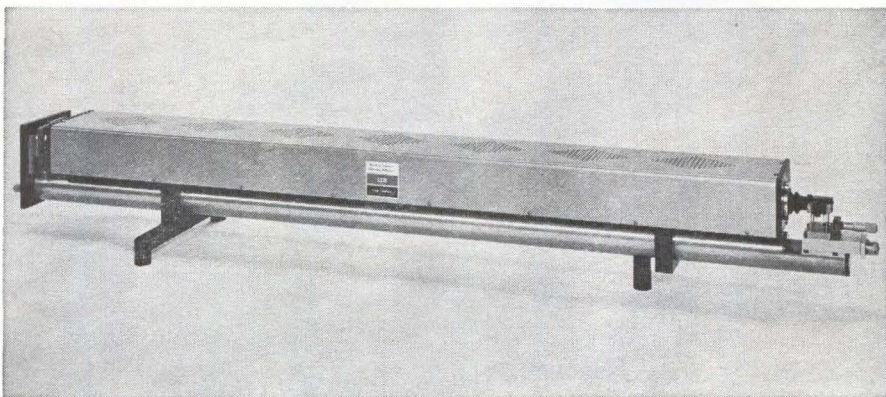
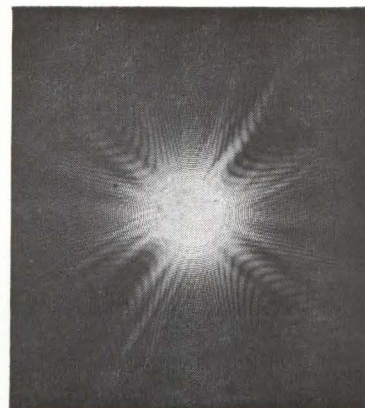
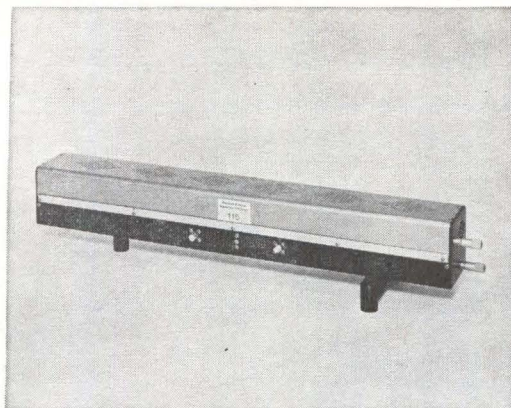

SPECTRA-PHYSICS

-leading producer of CW Gas Lasers

Throughout the scientific disciplines, continuous-wave gas lasers built by Spectra-Physics have achieved acceptance as primary equipment for every use from simple demonstration to the most sophisticated research. They are in use in many leading universities, aerospace laboratories, government and military research centers, and industrial facilities.

The availability of these highly practical, reliable, and thoroughly proven CW gas lasers — built by Spectra-Physics, sold and fully guaranteed by Perkin-Elmer/Spectra-Physics — has been the key to success in a number of significant advances in laser application.

Current production models of high-precision laboratory gas lasers include:

Model 115 (upper photo) — lightweight (8 lbs.) source of continuous-wave, highly monochromatic light from a helium-neon plasma; visible and infra-red; 6328Å, 11,523Å, and 33,912Å; interchangeable confocal and hemispherical resonators; plane-parallel resonator option.

Model 112 — advanced research model; provides, in addition to capabilities of Model 115, stable operation in plane-parallel resonator configuration; capacity for precision experiments such as optical heterodyning.

An unmatched continuity of experience and user-proven performance stand behind every Perkin-Elmer/Spectra-Physics CW gas laser.

Would you like to receive bulletins bringing you application information and describing how others employ laser technology? A current bulletin explores properties of coherent light as compared to those of incoherent radiation.



Send your name today to receive this bulletin, subsequent application information, and our newest product brochure.

SPECTRA-PHYSICS
INC.
738 Terra Bella/Mountain View 3/California
(415) 968-4467

NEW
FROM WESTON



Portable Standard replaces eleven other standards

New Weston Portalab® is an ac-dc portable laboratory voltammeter with unusual features. It combines $\pm 0.05\%$ accuracy of indication, plus light, rugged construction for field and production testing. Truly portable, it performs the measurements of eleven precision instruments, permitting lab accuracy on location.

Direct readout and a movable, lighted decimal point eliminate interpolation, make reading easy. A highly-stable Zener reference source is contained in a temperature controlled oven. The Portalab is designed for use from -10 to $+40\text{C}$, ambient. Fuses and instrument relays protect measuring circuit against overload, and a diode network guards thermo elements against damage.

Range, dc: 0.01 to 1,500v; 100 μa to 1.5 amperes. True RMS response is provided in ac measurements: 1 to 1,200v; and 0.01 to 12 amperes. Frequency span: dc and 50 to 2,500cps (5,000cps to 120v). Input power: 105/130v, 50/440cps. Write for details on Model 1572 Portalab.

WESTON 
Instruments & Electronics
614 FRELINGHUYSEN AVENUE, NEWARK 14, NEW JERSEY

Division of
Daystrom,
Incorporated

the Science Research Center in Dallas. A working model of the neutron monitoring station has been built by Kenneth G. McCracken at SCR's Atmospheric and Space Sciences Division.

When the full-scale instrument is completed, it will weigh 40 tons, and will be placed in operation by next January 1 somewhere in the North American polar cap, close to the North magnetic pole.

Fluctuations of cosmic rays will be monitored on a minute-to-minute, hour-to-hour and day-to-day basis. Eventually a complete network of neutron monitoring stations will permit measurements from different angles.

McCracken said that the new monitor, the biggest one built, will increase by a factor of 20 the amount of neutrons counted, compared to present-day instruments.

Work on the station is supported by a \$111,100 National Science Foundation grant. The Science Research Center is temporarily housed in facilities of the Southern Methodist University; permanent facilities are being raised on a 1,400-acre campus north of Dallas.

Maser Telescope Probes Planetary Radiation

LINEAR polarization of microwave radiation received from Saturn indicates that the planet has an extensive Van Allen belt.

This was announced by a U.S. Naval Research Observatory research team, which used an 84-foot radio telescope with a maser amplifier designed at the Columbia Radiation Laboratory. The telescope was used to measure each of the vibration components of microwave radiation. It was found that polarization in one plane was much stronger than in the other.

It is thought that Jupiter's radiation is polarized by very fast electrons spinning above its equator. Jupiter's polarization would therefore be in its equatorial plane; however, radiation from Saturn is polarized in the plane of the planet's axis. This is explained by two alternative hypotheses: that Saturn's rings have modified its Van Allen belt, or that the magnetic poles of Saturn are close to the equator.

QUICK, SLICK WAY TO PROTECT PRODUCTS



MADE OF TOUGH, FLEXIBLE POLYETHYLENE
WON'T CHIP, BREAK, SHRED OR COLLAPSE
SAFEGUARD PRODUCTS IN PROCESS, STORAGE
AND TRANSIT

OVER 700 SIZES IN NUMEROUS STYLES AND
COLORS NOW IN STOCK

Caplugs

GET FREE SAMPLE KIT IN EXCHANGE FOR THIS COUPON

**CAPPLUGS DIVISION
PROTECTIVE CLOSURES CO., INC.**

205-11 ELMWOOD AVE., BUFFALO 23, N. Y.

MAIL a free assortment of Caplugs, literature and prices to us, without obligation.

name _____
title _____
firm _____
address _____
city _____ zone _____ state _____



AMPERITE

Thermostatic DELAY RELAYS

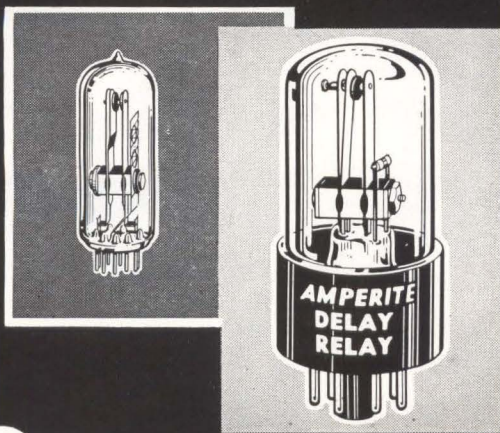

Only a glass seal
offers true hermetic sealing
.. assuring maximum stability and life!

Delays: 2 to 180 seconds . . . Actuated by a heater, they operate on A.C., D.C., or Pulsating Current . . . Being hermetically sealed, they are not affected by altitude, moisture, or climate changes . . . SPST only—normally open or normally closed . . . Compensated for ambient temperature changes from -55° to $+80^{\circ}$ C. . . Heaters consume approximately 2 W. and may be operated continuously . . . The units are rugged, explosion-proof, long-lived, and—inexpensive!

TYPES: Standard Radio Octal, and 9-Pin Miniature . . . List Price, \$4.00. Also — Amperite Differential Relays: Used for automatic overload, under-voltage or under-current protection.

PROBLEM? Send for Bulletin No. TR-81

AMPERITE

BALLAST REGULATORS

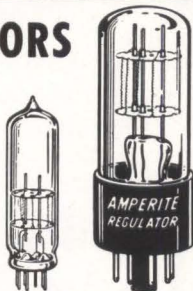
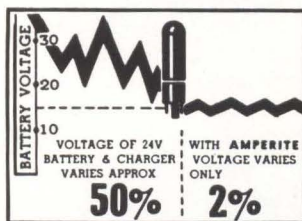

Hermetically sealed, they are not affected by changes in altitude, ambient temperature (-50° to $+70^{\circ}$ C.), or humidity . . . Rugged, light, compact, most inexpensive . . . List Price, \$3.00.

Write for 4-page Technical Bulletin No. AB-51

AMPERITE

561 Broadway, New York 12, N. Y. . . . CAnal 6-1446
In Canada: Atlas Radio Corp., Ltd., 50 Wingold Ave., Toronto 10

Conference on

THE IMPACT OF MICROELECTRONICS

Wednesday and Thursday
June 26 and 27, 1963

GROVER M. HERMANN HALL
Illinois Institute of Technology
Chicago, Illinois

Co-Sponsored by
ARMOUR RESEARCH FOUNDATION
of Illinois Institute of Technology
and ELECTRONICS
A McGraw-Hill Publication

Keynote address by

*James M. Bridges, Director,
Office of Electronics,
Department of Defense:*

*"Government Needs and Policies in
the Age of Microelectronics."*

Comprehensive discussions will be presented
by eminent authorities such as:

*R. Galvin of Motorola, Inc.
R. C. Sprague of Sprague Electric Co.
Dr. P. B. Myers of Martin-Marietta Co.
F. J. Van Poppelen, Jr. of Signetics Corp.
Dr. J. T. Wallmark of RCA Labs, and
Dr. E. R. Jervis of ARINC Research Corp.
Dr. J. Bardeen of U. of Illinois*

Sessions will cover the Impact of
Microelectronics on:

*The Changing Technical and Financial
Structure in the Component Industry
Product Status and Forecasts
Changing Vendor-User Relationships
Education and the Changing Role of the
Engineer
Future Trends
Recent Technological Advances*

For detailed program and registration
information write to:

*James J. Hill
Electronics Research Division
Armour Research Foundation
Chicago 16, Illinois*

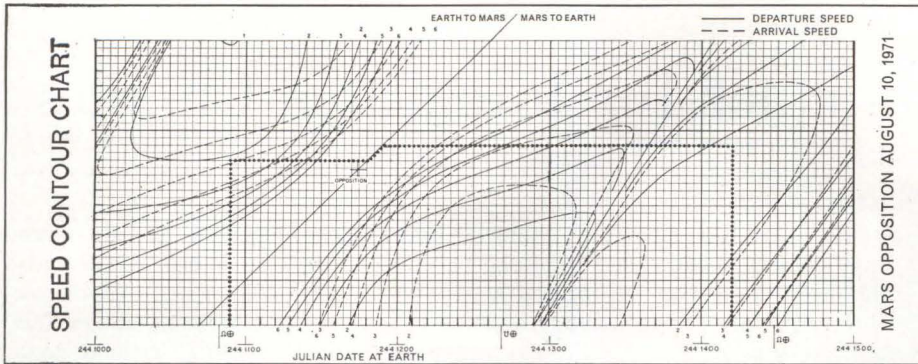

At Lockheed Missiles & Space Company, a dedicated team of scientists devotes its entire attention to problems in interplanetary navigation. Of particular interest are problems attendant to the guidance of a manned vehicle to another planet. With many successful accomplishments to their credit (such as the Polaris and various Agena missions), this group faces every new challenge with confidence.

A promising means for manned spacecraft guidance includes taking celestial and planetary optical sightings, feeding that information into an onboard computer, and computing the spacecraft's position and velocity to predict its future course. The computer will then calculate the predicted destination planet error, decide if a correction is necessary, and

compute its value. These procedures would be repeated continually until the planet is reached. The optimum timing and magnitude of correction, in view of the information obtained from the observations, is the subject of continuing study.

Even before work on hardware for an interplanetary mission is begun, orbit characteristics must be determined to set the requirements to be built into the spacecraft. An optimum trajectory must be shaped for the specific mission, in order to realize ultimate effectiveness. An outstanding accomplishment by Lockheed scientists is the computation of some 250,000 different orbits to Mars and a similar number to Venus. Each orbit varies as to speed, fuel, departure, arrival, and elapsed time.

LOOK AT LOCKHEED...AS A CAREER

Consider Lockheed's leadership in space technology. Evaluate its accomplishments—such as the Polaris missile, the Agena vehicle's superb record of space missions. Examine its outstanding advantages—location, advancement policies, creative climate, opportunity for recognition.

Then write for a brochure that gives you a more complete Look at Lockheed. Address: Research & Development Staff, Dept. M-47 D, P.O. Box 504, Sunnyvale, California. Lockheed is an equal opportunity employer.

SCIENTISTS & ENGINEERS: In addition to positions relating to flight mechanics, such as mission & trajectory analysis, guidance & controls analysis, other important openings exist for specialists in: Orbit thermodynamics • Electromagnetics • Gas dynamics • Chemical & nuclear propulsion • Systems engineering • Computer research • Electronic engineering • Communications & optics research

LOCKHEED
MISSILES & SPACE COMPANY
A GROUP DIVISION OF LOCKHEED AIRCRAFT CORPORATION

Sunnyvale, Palo Alto, Van Nuys, Santa Cruz, Santa Maria, California • Cape Canaveral, Florida • Huntsville, Alabama • Hawaii

LOOK AT LOCKHEED IN FLIGHT MECHANICS:

Further advances in space flight leadership

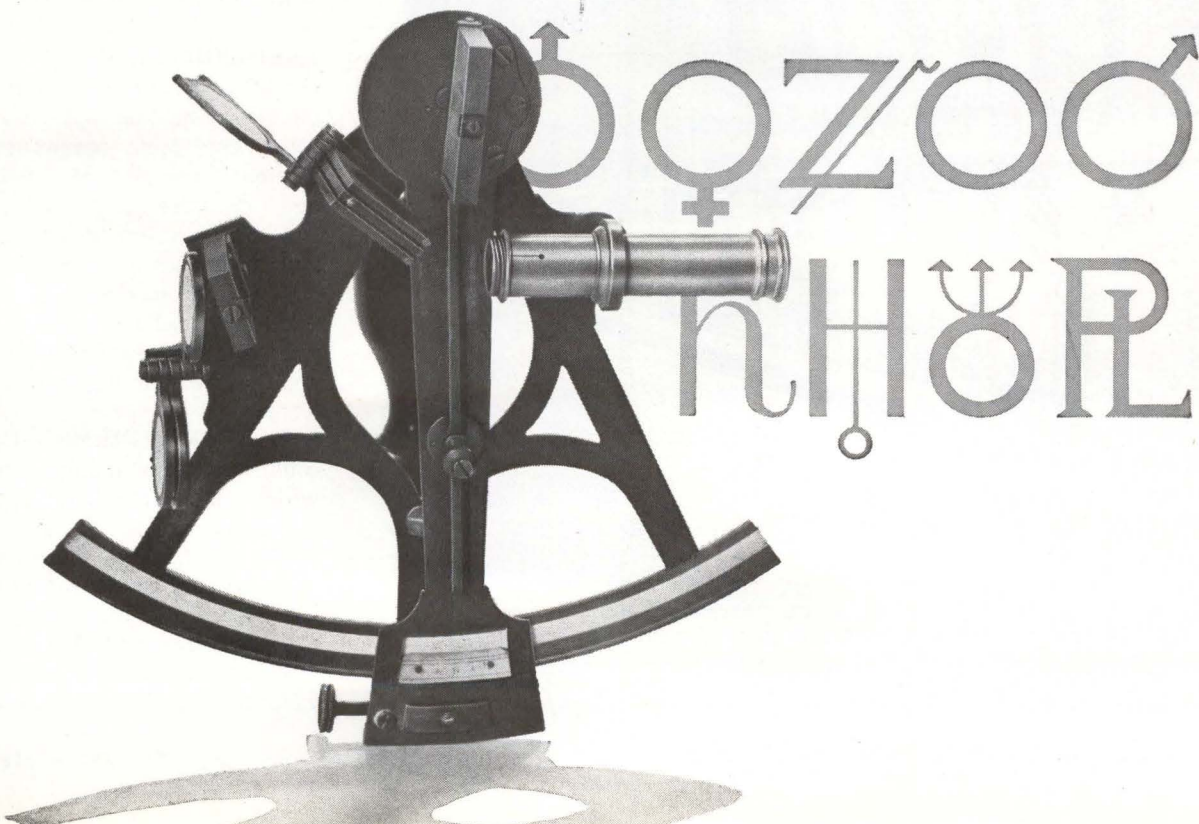

Compatible Techniques for Integrated Circuits

Combined thin-film and silicon block techniques improve performance

PROGRAM to develop compatible techniques for fabrication of complete integrated circuit functions utilizing semiconductor, thin film and other solid-state technologies as required was discussed at Electrochemical Society meeting, April 17 in Pittsburgh.

J. R. Black of Motorola discussed techniques for successful integration of thin film and semiconductor techniques to produce useful circuit functions which are inherently reliable and reproducible. Main point brought out in this talk was that utilization of a wide variety of materials to construct

circuit elements provides wider range of component values to closer tolerances than can be presently achieved if only one technology and material is used.

BETTER CONTROL—Black said that the component parasitic parameters such as temperature coefficients, voltage sensitivity and loss factors can be better controlled if more than one material is available to construct components. Of great importance is the electrical isolation of critical circuit elements which is achievable when thin films are combined with silicon elements. Possibility also exists of reduced manufacturing costs due to design flexibility.

A partial list of some of the bounds placed upon materials selection and processing which

have been identified to date were outlined. Silicon is the initial substrate material. Final functions shall be capable of being stored for long periods at 300 C without degradation. Diffusion temperatures are near 1,000 C. Silicon dioxide can be thermally formed at 900 C. To provide organic free contact areas, the semiconductor block must be heated in oxygen to 550 C. After metalization of contact areas the block should not be subjected to temperatures exceeding 500 C. Due to migration, diffusion and alloying problems, use of gold shall be avoided. Aluminum metal is used for the interconnection due to its electrical conductivity and excellent adherence to metals and glass. Minimum sealing temperature should be 440 C for 15 minutes. And the use of physical masks for the delineation of thin film components should be avoided.

Black said that effort was made to modify the material and processing parameters of the thin-film components to assure compatibility. Thin film components and processes which have received attention at Motorola were outlined.

Kiln Speeds Ferrite Production

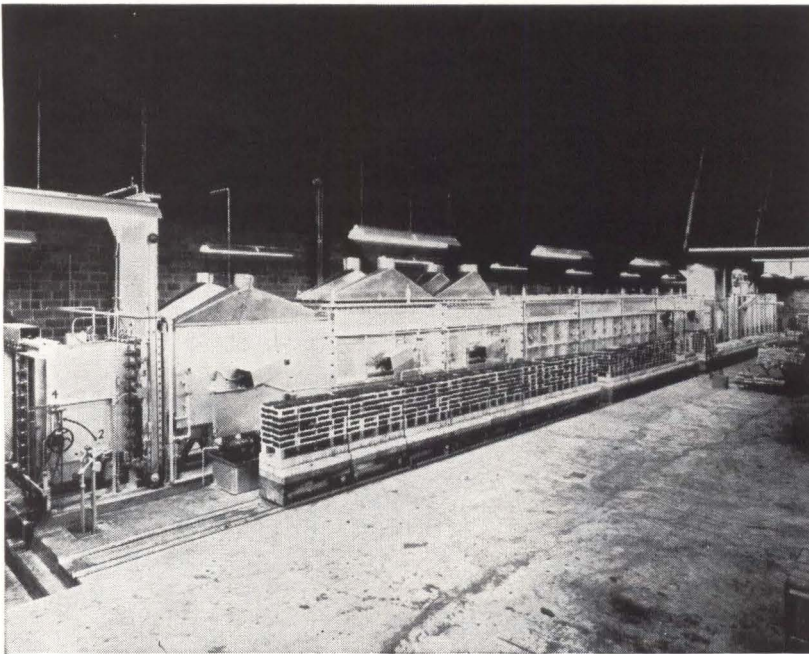

HUGE electric kiln, 155 feet long, is used exclusively for the manufacture of ferrites. Indiana General facility is part of company's manufacturing and research complex. Last year company's progress in memory field produced organized memory system with read-restore time of one microsecond. Products extend from digital computer memory systems to lifting magnets

RESISTOR FILMS — Desirable characteristics for thin film resistor elements include materials having relatively low temperature coefficients, absence of reverse leakage parasite and reduced distributed capacitance. Tin oxide films receive attention for large value resistors by gas plating. Nichrome films are used for moderate to low valued resistors. These are deposited by vacuum evaporation.

DIELECTRIC FILMS — Capacitor considerations include materials which can provide low loss, voltage stability, and are isolated devices. Materials used are alumina silicate glass, silicon oxide, tantalum oxide and alumina. Processes for the alumina compounds are by gas plating. The others are deposited by vacuum evaporation, and also wet

New SANBORN 30-channel EVENT RECORDER

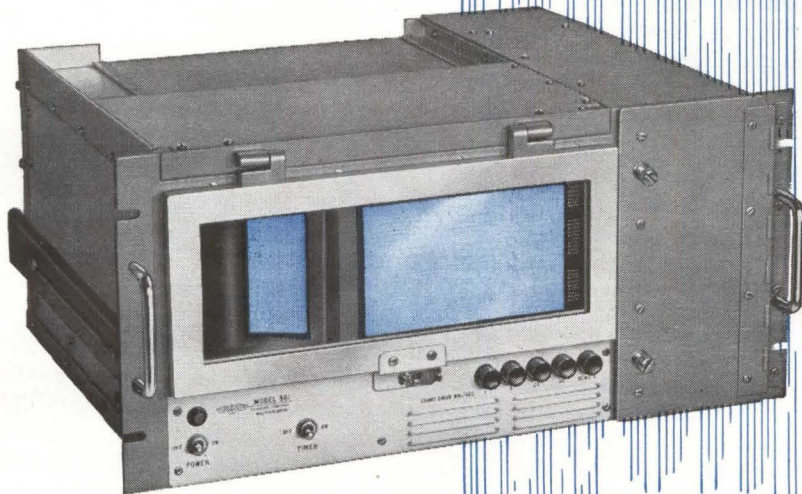

only 8 $\frac{3}{4}$ " high, with solid-state plug-in writing control: \$2050 complete

- Compact portable case or rack mounts in 8 $\frac{3}{4}$ " of panel space
 - Meets MIL-I-26600/2 Class 1B RFI Spec.
 - Choice of 6 solid-state plug-in Writing Controls
 - Simple front-loading of 4.07" wide, 300-foot charts, built-in paper take-up
 - Solid-state pulse generator and power supply
 - Confidence: under worst combination of low line voltage and short duration signals, probability of marking exceeds 99%
 - Response to events as short as 1.3 ms
 - Constant trace intensity at all speeds
 - Self-cleaning, reversible styli replaceable individually or in groups of 30; stylus pressure automatically maintained
 - 4 pushbutton-selected chart speeds, 1 to 100 mm/sec.; remote controlled chart speeds available on special order
 - Signal return isolated from chassis (1 megohm min.)
- CIRCLE 83 ON READER SERVICE CARD**

This economical new 30-channel operations monitor provides immediate, permanent recording of on-off events on dry, electrosensitive charts — using "pulsed writing" for maximum clarity, stylus life and economy of power. Six different interchangeable, plug-in 10-channel solid-state Writing Control cards are available to match your signal voltage and recording requirements. Included are types which operate with logic levels between +6 and +40 volts or -6 and -40 volts. Also, "precision types" for monitoring low level signals are available with adjustable threshold or balanced input (with respect to signal return). Model 361 system, for rack mounting or portable case, is 8 $\frac{3}{4}$ " x 19" wide x 14 $\frac{1}{2}$ " deep, weighs approx. 50 lbs. Complete 30-channel system, with either +6 v to +40 v or -6 v to -40 v Writing Control, is \$2050 F.O.B. Waltham, Mass. Prices with other Writing Controls on request.

FOR UP TO 120 CHANNELS of on-off recording, Model 360 uses 16" wide, 450-foot charts; has 9 standard and 9 optional additional speeds; takes only 14" of panel space complete with integral cooling system. Solid-state plug-in Writing Control cards described above are optional. Model 360 120-channel Recorder alone, \$3900; prices with various Writing Controls on request.

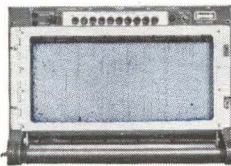

Call your nearby Sanborn Sales-Engineering Representative for complete specifications and application assistance. Offices throughout the U.S., Canada and foreign countries.

INDUSTRIAL DIVISION
SANBORN COMPANY

WALTHAM 54, MASSACHUSETTS

A Subsidiary of Hewlett-Packard Company

RELIABLE MODULES ARE POTTED IN *TIMONIUM*

timonium (ti-mō'ny-
yum), n, Mod. L., an ex-
tremely rare and reliable ele-
ment, found only in a certain
political subdivision of Mary-
land, and having a consistent
and very distinctive set of
physical (both organic and
inorganic) properties, e.g.,
facilities, people, experience,
and a composition that can be
expressed only by the for-
mula EMC.

EMC

ELECTRONIC
MODULES
CORPORATION

1949 GREENSPRING DRIVE • TIMONIUM, MD.
Clearbrook 2-2900

DIGITAL LOGIC MODULES • DIGITAL
EQUIPMENT AND CUSTOM PACKAGING

chemistry in the case of tantalum oxide.

Conductor films use aluminum, for metallizing around corners and also for interconnection patterns on ceramic or plastic for interconnecting functional electronic blocks. Black also discussed techniques for reduction of pinholes in thermally-grown silicon dioxide.

TIN OXIDE can provide high valued resistors which can be readily etched to fine patterns using KMER, according to Black. This can make stable electrical contact to silicon. At elevated temperatures, the tin oxide reacts with aluminum and can form an insulating aluminum oxide interface resulting in an open contact. A film of nickel, approximately 1,000 Å thick can provide a satisfactory stable interface between the tin oxide and aluminum.

Present effort is being devoted at Motorola to develop a 300-350 C deposition process which uses phosphorus, silicon or aluminum as a dopant. Resulting films are said to show promise in obtaining lower temperature coefficients for a given sheet resistance than do films deposited by the older processes. Furthermore, it is believed that im-

proved aging characteristics can be achieved and better control obtained over thin film properties than is available with the higher temperature process.

The Nichrome films are seen to possess excellent long term aging characteristics as well as low and reproducible temperature coefficients. Nichrome maintains good electrical contact to silicon as well as aluminum and adhere well to silicon dioxide. Methods presently developed to accurately etch Nichrome patterns 0.001-inch wide used photoresist techniques.

Work is now directed towards improvement of reproducibility for depositing a stable mixed oxide glass system of higher dielectric strength and volume resistivity than either thermally-grown or reactively-sputtered quartz films.

Organo-aluminum compounds are being investigated which pyrolyze at lower temperatures for the deposition of conductors for multilayered printed wiring interconnect boards.

Work at Motorola shows that capacitors of tantalum oxide possess a voltage-capacitance of 2.5 microfarad volts per sq cm when rated at one-fourth breakdown potential. Films are formed by vacuum

CRT Photos Taken Through Trap Door

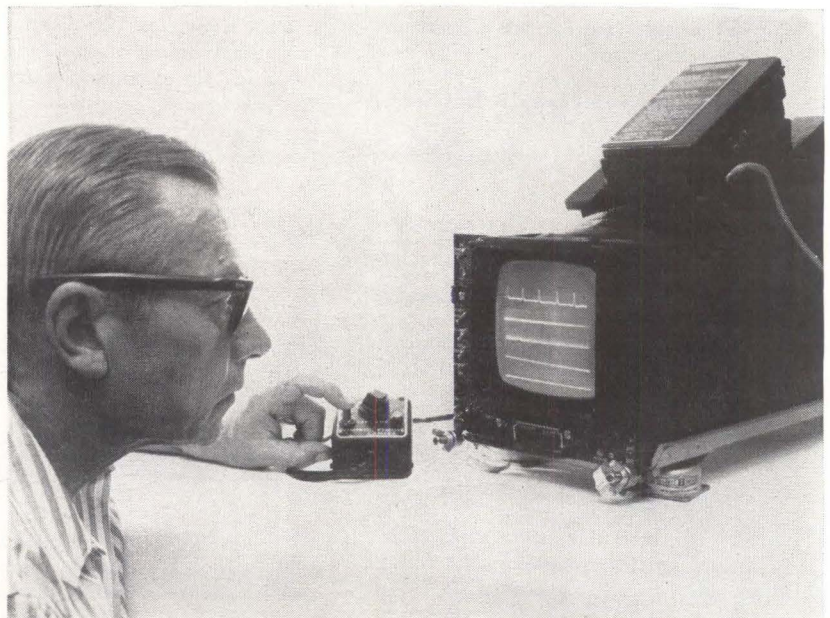

EXPERIMENTAL oscilloscope tube designed by Army Electronics R&D Lab and General Dynamics has camera mount on back instead of front. Advantage: viewer doesn't have to use viewing port while taking crop photos

small
change



FOUR-LAYER INTEGRATED CIRCUIT AND LOGIC MODULE CARRIER

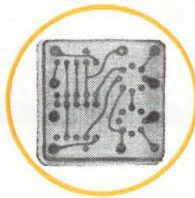

Small change? Yes—but it guarantees big performance. This little board is one sample of our leadership in the field of precision multilayer circuitry. It costs just about what you see here. Why not send us **your** requirements?

CINCH-GRAPIK

DIVISION OF UNITED-CARR FASTENER CORPORATION



200 South Turnbull Canyon Road, City of Industry (Los Angeles), California • Phone (Area Code 213) 333-1201
Offices in 22 Principal Cities throughout United States, Canada, England and Australia listed under Cinch Mfg. Co.
or United-Carr Fastener Corporation • Cinch • Ucinite • Monadnock Mills • Howard B. Jones • Palnut

New BALLANTINE True RMS VTVM

Measures 10 μ V to 320 V regardless of Waveform

You can read voltages with the same high precision and accuracy over the entire five inch logarithmic scale.

Our accuracy specification of "2% of reading" is far more accurate over half the scale than for a linear meter rated at "1% of full scale."

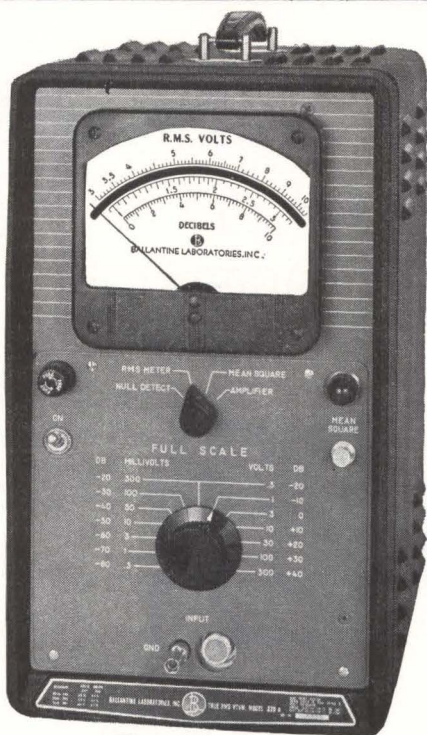

Model 320A Price: \$465

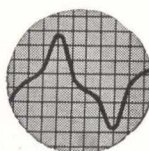
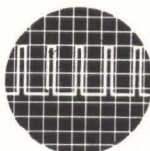
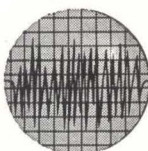
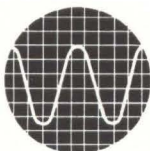

SPECIFICATIONS

Voltage Range.....10 μ V to 300V
(to 10,000 V with optional accessory)
Frequency Range.....5 cps to 4 Mc
(3 db bandwidth is 2 cps to 7 Mc)
Measures signals with Crest Factor...5 full
scale to 15 down scale
**Accuracy above 300 μ V, in % of READING AT
ANY POINT ON SCALE, 2%, 20 cps to 400
kc; 3%, 10 cps to 2 Mc; 4%, 5 cps to 4 Mc**
Input Impedance.....10 megohms in parallel
with 11 or 27 pF

Amplifier..Choice of balanced or single ended,
5 cps to 4 Mc, up to 90 db gain, 50 V into
20K load
DC Output.....Proportional to mean square
of ac input, for connection to recorder;
output 1V; source resistance 1000 ohms
Power requirements.....115/230 V,
50-420 cps, 90W
Accessory (optional).....To measure up to
10,000 volts, use Model 1320 Multiplier
(40 megohms, 3pF)

Write for brochure giving many more details on both portable and relay rack versions



— Since 1932 —

BALLANTINE LABORATORIES Inc.

Boonton, New Jersey

CHECK WITH BALLANTINE FIRST FOR LABORATORY VACUUM TUBE VOLTMETERS, REGARDLESS OF YOUR REQUIREMENTS FOR AMPLITUDE, FREQUENCY, OR WAVEFORM. WE HAVE A LARGE LINE, WITH ADDITIONS EACH YEAR. ALSO AC DC LINEAR CONVERTERS, CALIBRATORS, WIDE BAND AMPLIFIERS, DIRECT-READING CAPACITANCE METERS, AND A LINE OF LABORATORY VOLTAGE STANDARDS, 0 TO 1,000 MC.

evaporation of tantalum followed by an electrochemical process which converts the outer layer of tantalum to tantalum oxide. Pinhole problems are said to be avoided by removing the tantalum metal behind a pinhole by a reverse-etch process prior to the addition of the second electrode.

LOW RESISTIVITY — Effort is being devoted to reducing the dissipation factor of such capacitors at moderate frequency due to the series resistance of the somewhat resistive tantalum electrode, and such efforts are reported as successful. An aluminum film is deposited onto the substrate just prior to the evaporation of the tantalum film. The highly conducting aluminum is said to provide the desired low sheet resistivity for the tantalum electrode.

Problems are being worked on to provide compatibility with silicon substrates. These include development of the second electrode which is stable with the oxide dielectric and aluminum metal. Also, development of a technique to provide a low resistance contact to the tantalum and aluminum electrode after anodization.

Work at Motorola on compatible techniques for integrated circuits was written up by J. R. Black and C. R. Madland. Program was sponsored by Wright Field.

Carrier Transport Through Thin Organic Films

UNIQUE properties of organic materials may open up a whole new range of basic insulating materials for electronic applications, according to L. C. Scala of Westinghouse Research Laboratories.

Using special techniques, organic insulating films may be prepared under conditions such that their thickness, structure and composition are subject to careful experimental control. Well defined layers of organic materials, and their ordered organic structures, facilitate analysis of thin insulating layers, less than 500 Å thick.

Scala discussed carrier transport mechanisms through thin organic films at Electrochemical Society meeting, April 18, in Pittsburgh. Metal-insulator-metal sandwich

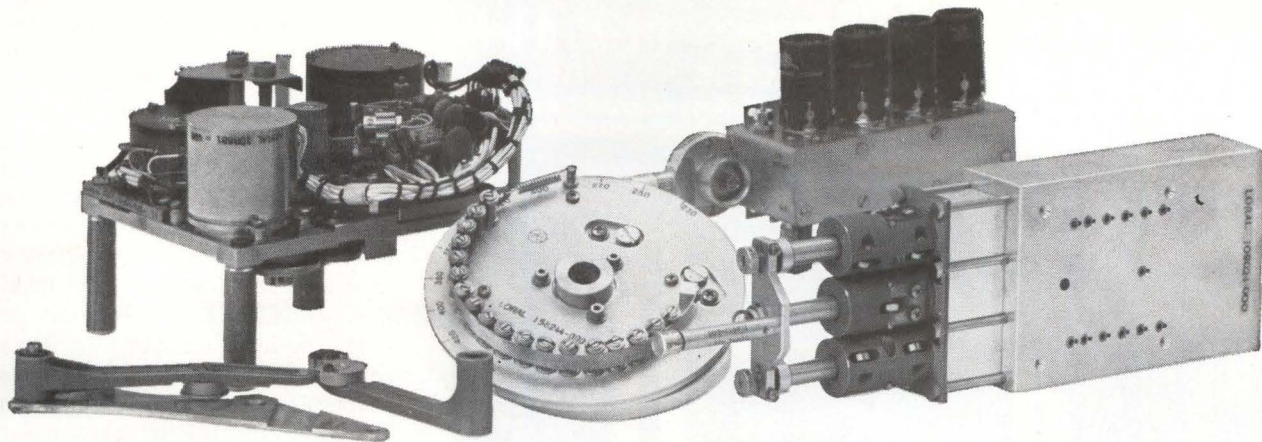

You needed cams, drives, mounts, gears and follower arms for microwave preselection...



until YIG

Now there's a microwave filter that's virtually maintenance-free and reliable to a degree once unattainable. Why? No moving parts. Loral YIG (Yttrium-Iron-Garnet) Filters are all solid state . . . replacing electromechanical preselector mechanisms consisting of cams, drives, follower arms and other moving parts—they sweep over wide bandwidths at high speeds, making possible substantial savings in weight as well as in improved performance.

Furthermore, these units are not merely laboratory developments. They have been flight-tested and completely meet applicable airborne Mil-Specs.

This advance in the art of sweeping frequencies exemplifies Loral's R & D capacity to create electronic components that are the best possible buy in the smallest, most reliable package—Value Engineered throughout.

Loral's General Products Division may already have a product virtually "on the shelf" that could save your company many, many months of development. For further information on our line of precision microwave products, write:

General Products Division
 LORAL ELECTRONICS CORPORATION
 825 Bronx River Avenue, The Bronx 72, New York

| REPRESENTATIVE PERFORMANCE SPECIFICATIONS For Four Cavity Units | | |
|--|--------------------------|------------------------------------|
| Specifications are for tuned YIG and gallium-substituted YIG filters. All can be supplied with transistor driver circuits and, where required, temperature control circuits. | | |
| Frequency | Bandwidth at 3 db points | Maximum insertion loss across band |
| 500-1,000 mc | 10 mc | 12 db |
| 1-2 gc | 15 mc | 10 db |
| 2-4 gc | 25 mc | 8 db |
| 4-8 gc | 30 mc | 6 db |
| 8-12 gc | 35 mc | 6 db |

Scan rate: 0-100 cycles
 Operating temperature range: -55° to +71°C
 Weight: 29½ oz.
 Environmental: meets shock and vibration requirements of MIL-E-5400



MOISTURE RESISTANCE TEST
per MIL-R-10509D Characteristics C and E

TEMPERATURE CYCLING TEST
per MIL-R-10509D Characteristics C and E

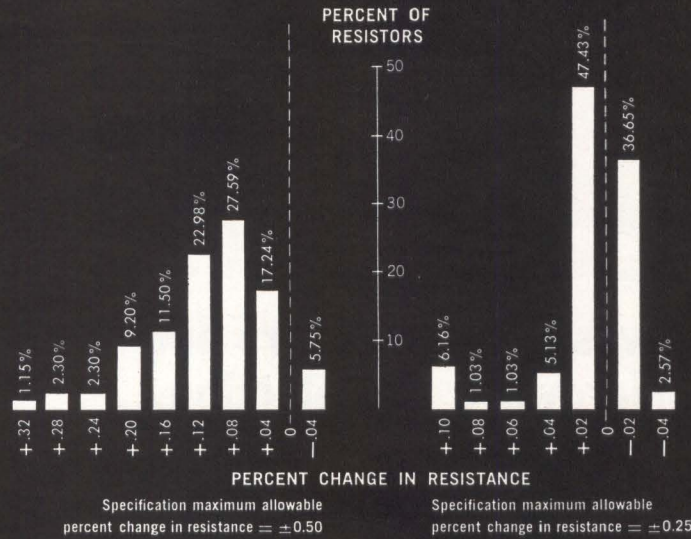

METOHM—charts new plateaus in metal film resistor performance

Ward Leonard reports unmatched test results

Top reliability in metal film precision resistors—highest known today—is proved in Ward Leonard's new Bulletin 50A. Ward Leonard tested over 700 resistors over a 12 month period to document these results.

Example: take two critical tests (of the 22 run)—moisture resistance and temperature cycling.

Here's the MIL Spec and the Ward Leonard Result—

| Test | MIL-R-10509D Maximum Deviation | METOHM Performance |
|---------------------|--------------------------------|--------------------|
| Moisture Resistance | ±0.5% | -0.04 to +0.32 |
| Temperature Cycling | ±0.25% | -0.04 to +0.10 |

Other rigorous tests such as vibration, load life and shock show equally impressive results. In addition, each METOHM® resistor logs 7 inspections, 8 quality-control checks, and 7 tests prescribed by MIL-R-10509D and MIL-STD 202B specifications.

Write for Bulletin 50A and ask for samples—available in these ratings: RN55-1/10 W; RN60-1/8 W; RN65-1/4 W; RN70-1/2 W.

For Stock Orders call your nearest Authorized Industrial Distributor. Ward Leonard Electric Co., Metal Film Division, 30 South Street, Mount Vernon, N. Y. 2.28



METAL FILM DIVISION
WARD LEONARD
ELECTRIC CO. MOUNT VERNON NEW YORK
RESISTORS • RHEOSTATS • RELAYS • CONTROLS • DIMMERS

structures using organics are being employed as a source of hot electrons for the creation of cold cathodes and amplifying devices.

Calcium stearate is used as the film material. Extensive electrical measurements are in progress to identify the operative conduction mechanisms, as well as to obtain detailed correlation with the formation conditions. Preliminary results indicate that more highly compacted films possess superior properties in terms of freedom from electrical shorts and abrasion resistance.

Powdered Silicon Forms Solid Electrolyte Capacitor

CONTROLLED purity silicon has been studied as a basic material for the production of a solid electrolytic capacitor both by Texas Instruments and Nippon Electric.

J. H. Van Tassel and R. R. Haberecht of TI described their development at Electrochemical Society meeting on April 17 in Pittsburgh. Y. Ishikawa and S. Inowaki will present a paper on what is believed to be a similar development at the Electronic Components Conference

Star Spotting Elements Set Course to Moon

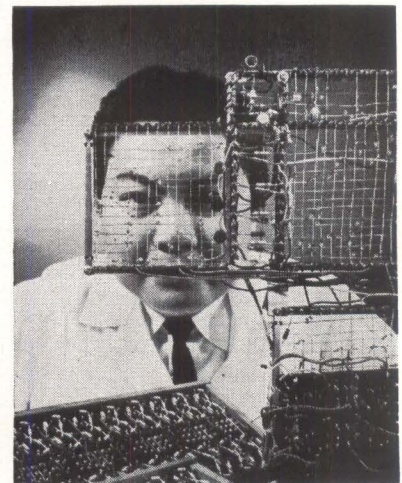

NETWORK above is part of an experimental electronic computer developed by Republic Aviation to record the lunar vehicle's trajectory and velocity from continuous star sightings. If vehicle is off course, the computer will initiate the firing of course-corrected rockets

ONLY

In Mincom's CM-100 instrumentation recorder/reproducer, the series elements before data

THE MINCOM CM-100

storage have been reduced to receiver and mixer, only one step from the antenna. With the

IS NOW PERFORMING

CM-100's 1.5-megacycle response and linear phase equalization at all speeds, an original

OPERATIONAL

IF signal thus can be heterodyned so that the carrier swing and its sidebands fall within the

PREDETECTION RECORDING

Mincom CM-100's frequency range—in FM, FM/FM modulation, PCM and PCM/FM.

...and actually doing it at defense facilities as you read this page.

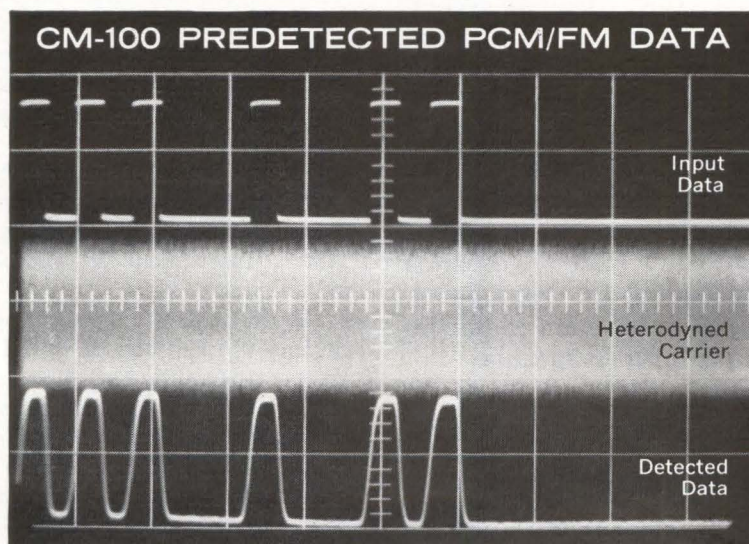

5.0-mc IF carrier heterodyned down to 750 kc. Random-spaced pulses, 20 μ s on-20 μ s off-type information. Sweep rate: 50 μ s/cm.

Write for brochure.



Mincom Division **3M**
COMPANY

2049 South Barrington Avenue, Los Angeles 25,
425 13th Street N.W., Washington 4, D. C.

NEW FROM NRC

thin film vacuum coater



NRC's Model 3176 Vacuum Coater is a unique vacuum evaporation system for thin film deposition in R&D and production programs. Unmatched for versatility, reliability and ease of operation, the Model 3176 is used in the areas of solid state electronics, optics, magnetic films, memory planes and solar cells.

Exclusive features include: ■ **Fastest Useful Pumping Speed . . .** with high performance, lowest backstreaming NRC diffusion pump rated at 1500 liters/sec. ■ **Highest Conductance/Lowest Outgassing . . .** with the new NRC Slide Valve which was specifically developed for maximum pump efficiency. ■ **More Efficient Baffling . . .** with single circular chevron cold trap-baffle combination. ■ **Easy, Fast Operation . . .** with all controls (manual or automatic) conveniently mounted on front panel. ■ **Maximum Versatility . . .** used with 18" or 24" work chambers — electrical and mechanical feed-throughs interchangeable.

The Model 3176 has a new sophisticated appearance and is ready to operate. Merely connect power and water supply. Write or call for data sheet.

SYMBOL OF
PROGRESS



IN VACUUM
EQUIPMENT

NRC EQUIPMENT CORPORATION
A Subsidiary of National Research Corporation
160 Charlemont Street
Newton 61, Massachusetts
Area Code 617 DEcatur 2-5800

to be held in Washington on May 7.

Texas Instrument reported on the effect of particle size, particle shape, resistivity and nature of impurities.

PELLETS—At TI, anode bodies of silicon are fabricated by pressing powdered silicon. The body is hardened by sintering in a vacuum between 1,350 C and 1,400 C or in inert atmospheres at somewhat higher temperatures. The authors discussed the effects of pressure, powder size fraction and sintering conditions upon the density of the anode body. During the entire anode fabrication procedure, the pellet is maintained in an oxygen-free atmosphere to prevent oxide doping during sintering and to insure the electrical integrity of the sintered anode.

The TI paper outlined the influence of resistivity of the starting silicon material upon the electrochemical processing steps and gave final device characteristics. The dissipation factor measured on the system was found to vary directly with the base material resistivity. Rate of anodization also increases with increasing material resistivity for equal surface areas. P-type silicon, ranging in resistivity from 0.001 ohm cm to 213 ohm cm was used in this portion of the study. Electrolytes evaluated included N-methyl acetamide made 0.04 N in potassium nitrate, water-phosphoric acid, monoalcohol-phosphoric acid and polyalcohol-phosphoric acid.

The influence of the acceptor impurity of the base material upon the dielectric film was investigated at Texas Instrument by radio-tracer techniques.

Various power application programs were discussed by TI. The current densities used were considerably higher than those normally used in the formation of anodic tantalum oxide films because of the relatively low current efficiency for the anodization of silicon.

Anodized silicon pellets are processed at TI in a manner similar to that used in fabricating solid electrolytic tantalum capacitors. Finished device operating parameters, as related to starting material characteristics were discussed and compared to those of other solid electrolytic capacitor systems.



Ravenous Tiger

It's late evening. All the Tiger pickup trucks are empty. In five minutes, the last shipment will be fed into the huge cargo hold of the Swingtail-44 and the dock will be clear. Three minutes later, everybody's shipment will be on its way. Everybody's.

That's the beauty of the Swingtail-44. It has a big appetite—33 tons. It carries off every package on the dock. Nothing

waits to go out. Nothing gets left behind.

And when you've got a whole fleet of 44's . . . and a fleet of trucks for door-to-door service . . . and a gang of detail-minded people to expedite your shipment all along the way . . . then you've really got airfreight service. The fast kind. The kind you can depend on. The Flying Tiger kind.

first in airfreight with airfreight first **FLYING TIGER LINE**



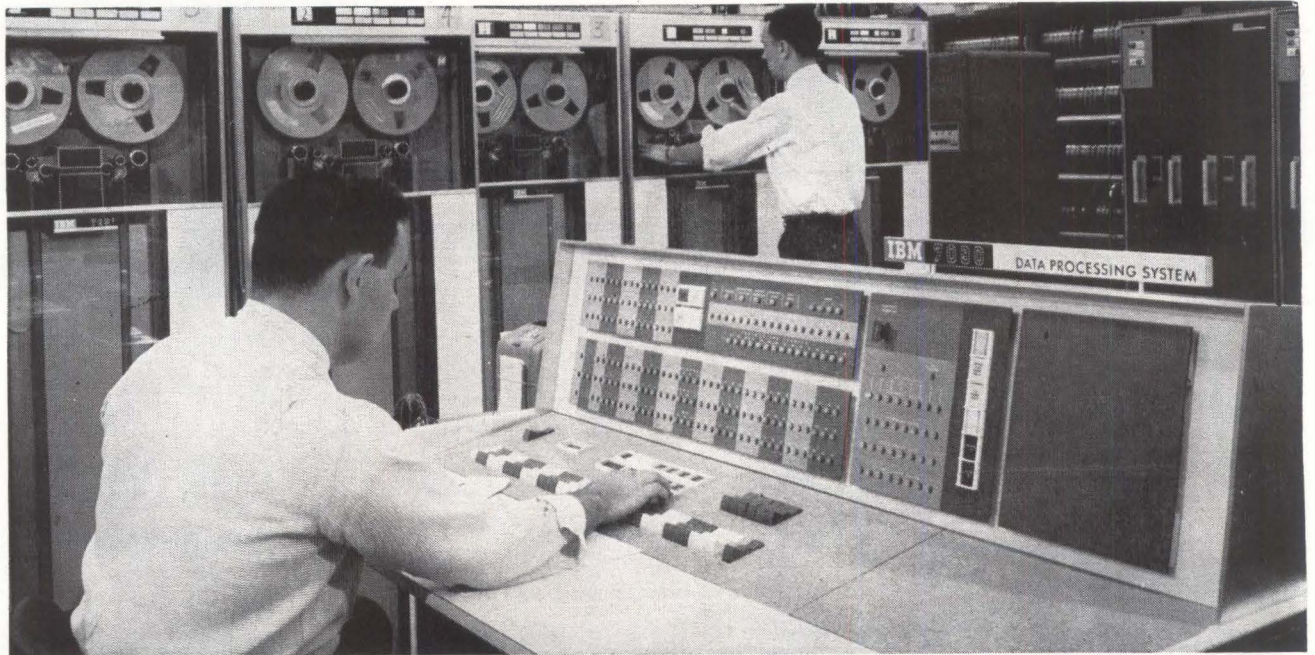

DESIGN AUTOMATION system provides fast recording and printout of design changes of in-production computer equipment. Basic technique can be used during production of other electronic equipment

Notation Language Speeds Production Changes

By R. P. PREISS and L. C. VARUZZO

Data Systems Division, International Business Machines Corp., Poughkeepsie, N. Y.

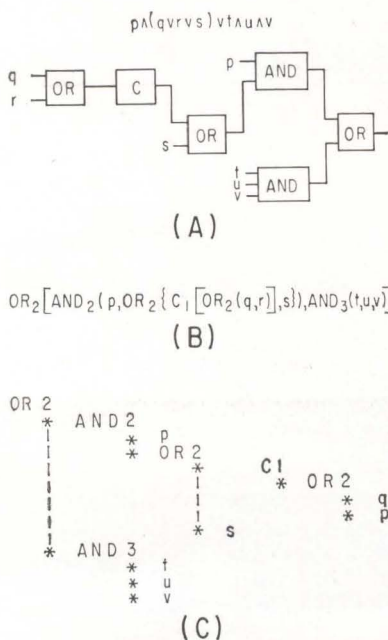

CONVENTIONAL block-diagram approach for implementing simple Boolean expression (A) and functional notation (B) provide basis for listing notation (C)—Fig. 1

Softens impact of specification changes on production schedule

HANG-UP conditions in production schedules caused by specification changes may be a thing of the past when a special notation language is used to transcribe designs and design changes on magnetic tape. In this discussion, specific reference is made to design and production of computer products. However, basic technique may be applied to design and production of other electronic equipment.

When carried-out manually, changes and re-changes require hundreds of man-hours. The magnetic-tape recording technique, used in a "design automation" system at IBM produces a new computer printout for every design change and provides designers with clean,

original sheets for their work in a matter of minutes.

New technique and computer language developed for it are based on the applications concept of taking partial designs and combining them into bigger ones, thus being able to add more details on existing designs.

CRITERIA—Just as algebra can describe certain static conditions while calculus must be used to describe more dynamic conditions, notation language or coding for recording designs and changes is tailored to perform these recording functions. Four requirements met:

- Language can be understood by man and machines without intermediary translation
- All design information necessary for building, testing and servicing the manufactured product can be summarized on one diagram
- Language permits grouping of

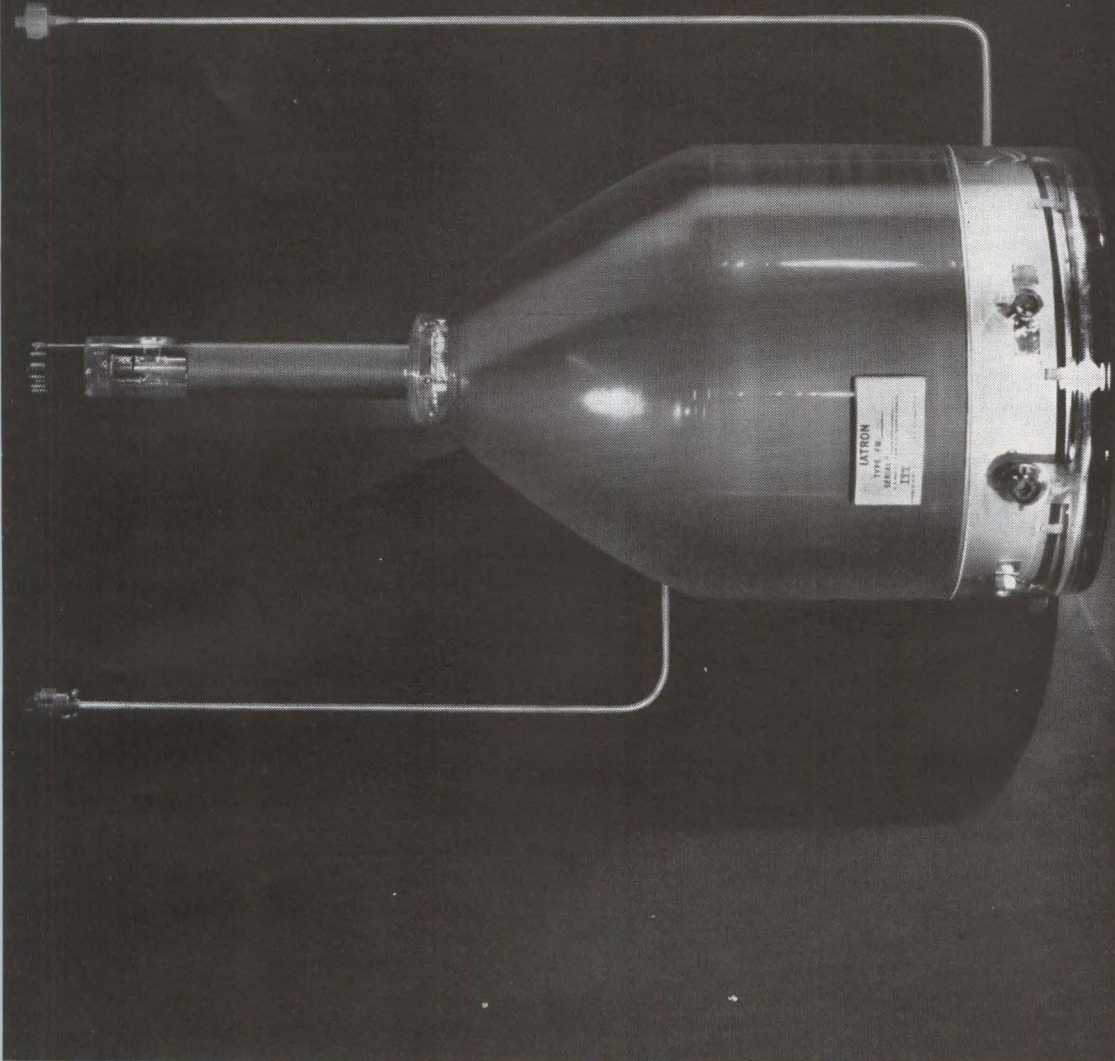

ITT 10-INCH HIGH-RESOLUTION RING-FLOOD-GUN STORAGE TUBE.

ITT

How to solve today's 8 toughest storage tube applications problems

1. **Faster writing speeds.** Supersonic radar targets require superfast writing speeds. Only ITT offers writing speeds up to 500,000 ips.
2. **Slower writing speeds.** Narrow bandwidth picture transmission requires slow writing speeds. ITT provides the slowest: less than 1.0 ips.
3. **Erase time.** Fast erase time is essential to high-speed multiple target tracking and for TV presentation at TV rates. ITT storage tubes have erase times as low as 1 millisecond—the fastest available.
4. **Resolution.** Resolution is the key limiting factor on virtually all display systems.

At 50% brightness, conventional ITT storage tubes provide up to 70 raster lines/inch.

5. **Brightness.** High ambient light conditions demand maximum brightness capability. ITT tubes are unsurpassed in average brightness of saturated display. The F-7174 is capable of 22,000 foot lamberts.
6. **Optimum display diameter.** For every application there is one "best" size storage tube. ITT makes the broadest range: 2½, 4, 5, 6, 7, 7½, 10 and 11 inch. Available with electromagnetic or electrostatic focus and deflection.

7. **Distortion.** Accurate readout calls for the elimination of distortion. Only ITT positions writing and flood guns concentrically to eliminate trapezoidal distortion.

8. **Direct vs. projection readout.** Direct readout tubes have their limitations in very large display applications. ITT's exclusive projection type tubes provide the high resolution and brightness needed to do the job.

Write for comprehensive brochure.

ITT ELECTRON TUBE DIVISION
CLIFTON, NEW JERSEY
International Telephone and Telegraph Corporation
CIRCLE 93 ON READER SERVICE CARD



HANDS OFF!

MALLORY WET SLUG TANTALUM CAPACITORS



The original high reliability, high temperature tantalum capacitor. On 40,000-hour tests Mallory type XT capacitors have *twice* the anticipated mean time to failure of comparable tantalum capacitors. 8 models: ratings up to 200°C. Write for complete data.

Even the cleanest of hands carry minute traces of moisture and contaminants that can eventually wreck a tantalum capacitor. That's why "no hands" is the order of the day at the Mallory capacitor plant at Greencastle, Ind. Only freshly laundered cotton or sterile rubber gloves are ever permitted to touch assemblies during critical manufacturing operations.

Surgical cleanliness is routine at our ultra-modern tantalum capacitor facility, where every possible means of assuring quality was engineered into the production line when it was built. All this extra care pays off in the product; Mallory tantalum capacitors consistently equal or exceed MIL specs for electrical parameters and resistance to environmental conditions. Mallory Capacitor Company, Indianapolis 6, Indiana . . . a division of P. R. Mallory & Co. Inc.

WET SLUG, FOIL AND SOLID TANTALUM CAPACITORS

CIRCLE 94 ON READER SERVICE CARD

P. R. MALLORY & CO. INC.
MALLORY

Mallory tantalum capacitors delivered from stock at factory prices by these distributors:

- Baltimore, Md.**
Radio Electric Service
- Binghamton, N.Y.**
Wehle Electronics
- Birmingham, Ala.**
MG Electronics & Equipment Co.
- Boston, Mass.**
Cramer Electronics
DeMambro Radio Supply Co.
Lafayette Radio
QPL House, Inc.
- Bridgeport, Conn.**
Westconn Electronics
- Buffalo, N.Y.**
Summit Distributors, Inc.
- Chicago, Ill.**
Allied Electronics Corp.
Newark Electronics Corp.
- Cincinnati, Ohio**
United Radio
- Cleveland, Ohio**
Pioneer Electronics
- Dallas, Texas**
Engineering Supply Co.
Hall-Mark Electronic Corp.
- Dayton, Ohio**
Stotts-Friedman Co.
- Denver, Colo.**
Denver Electronics
- Houston, Texas**
Harrison Equipment Co., Inc.
Lenert Company
- Indianapolis, Ind.**
Graham Electronics
- Kansas City, Mo.**
Radio Lab
- Los Angeles, Calif.**
California Electronics
Kierulff Electronics, Inc.
Lynch Electronics
Radio Product Sales
- Minneapolis, Minn.**
Northwest Electronics Corp.
- Montreal, Que.**
Canadian Electrical Supply Co.
- Muskegon, Mich.**
Fitzpatrick Electric Co.
- Nashville, Tenn.**
Electra Dist. Co.
- Newark, N.J.**
Lafayette Radio
- New York, N.Y.**
Harrison Radio Corp.
Harvey Radio Co., Inc.
Lafayette Radio
Milo Electronics
Terminal Hudson Electronics
- Oakland, Calif.**
Elmar Electronics, Inc.
- Oklahoma City, Okla.**
Radio, Inc.
- Orlando, Fla.**
Hammond Electronics, Inc.
- Ottawa, Ont.**
Wackid Radio-TV Lab.
- Palo Alto, Calif.**
Zack Electronics
- Perth Amboy, N.J.**
Atlas Electronics
- Philadelphia, Pa.**
Herbach & Rademan
Philadelphia Electronics
- Phoenix, Ariz.**
Kierulff Electronics, Inc.
- Pittsburgh, Pa.**
Radio Parts Co.
- Salt Lake City, Utah**
Kimball Electronics
- San Antonio, Texas**
Perry Shankle
- San Francisco, Calif.**
Kierulff Electronics, Inc.
- St. Louis, Mo.**
Olive Electronics
- Seattle, Wash.**
F. B. Connelly Co.
- Springfield, N.J.**
Federated Purchaser, Inc.
- Toronto, Ont.**
Alpha Aracon Radio Co.
Electro Sonic Supply
Wholesale Radio & Electronics
- Tulsa, Okla.**
Engineering Supply Co.
- Washington, D.C.**
Capitol Radio Wholesalers
Electronic Industrial Sales
- White Plains, N.Y.**
Westchester Electronic Supply Co., Inc.
- Winston-Salem, N.C.**
Electronic Wholesalers Inc.

$$n = OR_2 [AND_2 (p, OR_2 \{ C_1 [OR_2 (q, r)] , s \} ,) AND_3 (t, u, v)] \quad m = OR_2 [w, x]$$

(A)

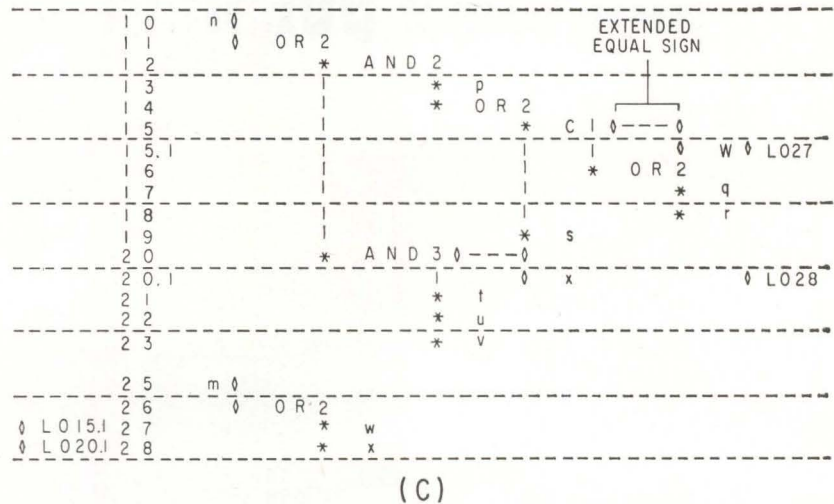
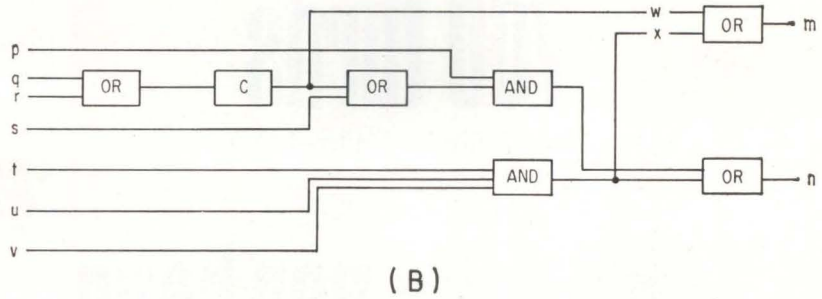

NOTATION CONCEPT is extended to multi-output circuits using branching technique—Fig. 2

design data in a manner facilitating easy changing of design

- Other computer programs are able to read design data

DERIVATION — Language developed has a listing format that can be directly key punched for writing on magnetic tape. Bases for the new language is a combination of block diagram and parenthesis-free notation.

Conventional block-diagram approach on implementing a simple Boolean expression is shown in Fig. 1A using two-input OR's. With functional notation this single-output block diagram can be formulated as shown in Figure 1B, where p, q, r, s, t, u, v could stand for: manual control, backspace, rewind, skip forward, automatic control, in use, sample.

But engineers must rely on additional information: where are lines generated, where are they driven,

what voltage levels are the lines capable of achieving, what are the physical location of circuits, what test points must be probed, what circuit types are involved, what is the change level at which designs are documented? To be able to include such information in the form of additional properly coded notations on each design sheet the following approach was worked out.

Each function and variable is placed as the "central field" on separate lines forming a list (Fig. 1C). Functionally, input and output notations of "list" are read as follows: Starting at the left and proceeding down and then to the right, first OR circuit has two inputs, both outputs of AND circuits. One of these AND circuits has two inputs, the other three. One of two inputs to first AND is the p variable while other input is out-put of two-input OR circuit.

Adequate space is available to left

700 turns

No. 37 Single Enamel Wire
Insulation on Both Leads Stripped
Finished Coil Taped

800 coils per hour

Leesona No. 116 Automatic
Bachi Bobbin Winder
automatically:

- Closes the tail stock.
- Insulates starting lead with tape.
- Winds coil.
- Stops winding at ± 2 turns.
- Strips insulation from start and finish leads.
- Tapes finished coil.
- Waxes finished coil.
- Indexes wire guide.
- Cuts wire.
- Ejects finished coil.
- Sorts coils of two different specifications.
- Counts number of coils produced.



At 7250 turns, No. 39 single formex wire, 585 coils per hour is a typical production rate reported by prominent manufacturers who use the No. 116. Operator merely loads bobbin on arbor of individual head as table rotates, and clips starting lead. Production can be cycled to operator's loading time by controlling clockwise table rotation from $\frac{1}{4}$ to 2 rpm. Winding speed of each head can be set according to number of turns desired. Write Leesona Corporation, Warwick, Rhode Island.

Or call Leesona at 5700 W. Diversey Ave., Chicago 39, TU 9-5735; 1500 Walnut St., Phila. 2, KI 6-1720, or A. R. Campman & Co., 1762 W. Vernon Ave., Los Angeles, AX 3-6265.

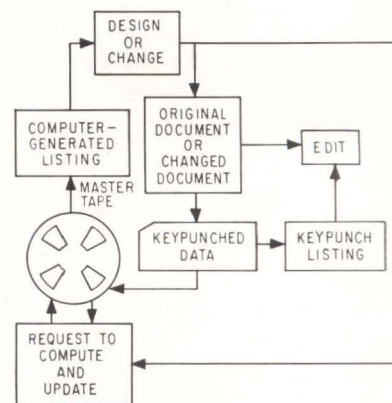

TRANSCRIPTION SYSTEM makes use of keypunched data obtained from notation listing—Fig. 3

and right of logical field for indicating cross references, physical locations, circuit types, explanations of signal-line names, etc.

MULTI-OUTPUT CIRCUITS — Same notation concept is extended to multi-output circuits.

Using Fig. 2A, one function is n . Another function, m , is OR of two parts which were also used in producing n . In the functional notation, output of CONVERT block is named as a variable, say w . Similarly, output of the three-input AND block will be called x . An equation can now be produced as a function of w OR x . Relationship between m and n is illustrated in Fig. 2B.

The relationship between m and n in functional list is illustrated in Fig. 2C. Notice that each line of print bears a reference number for quick identification. Two "diamonds" are used as equal signs. Primary output of first equation is n , and primary output of the second equation is m . Secondary outputs within these equations are w and x , which, for clarity, are preceded by "extended diamonds" as equal signs.

In line 15, output of CONVERT block has two branches. One branch drives directly into OR circuit of line 14, and the other branch drives to line 27 feeding into OR circuit of line 26. This cross-referencing can be considered as a "where used" listing or net listing (because it identifies the complete set of fan-outs from individual sources). Also, as shown in line 27, an input refer-



Actual size

Mighty Micropot® for close quarters

Tighten up your parameters all you want because some good things still come in small packages.

3/8" DIAMETER, +2 MILLION REVOLUTIONS
Like the new, miniaturized (3/8" diameter) 2150 Micropot. Here is a tiny, 10-turn precision potentiometer that delivers over 2 million revolutions with high accuracy and good resolution. Independent linearity holds to $\pm 0.25\%$.

In fact, the only modest thing about this Micropot is its price (under \$10—and much less in production quantities).

GANG IT, HEAT IT TO 105°C
Looking for component versatility?

The 2150 ignores heat up to 105°C. You can gang it (2 units). Tap it. Even add rear-shaft extensions, if you want to. Torque and noise are extremely low.

Compare specs and prices. We believe you won't match our 2150 Micropot anywhere for either commercial or military applications.

NEED SPECIALS?

Take advantage of the Borg *Quick Reaction Facility*. Get fast delivery of prototypes built exactly to your specifications.

Call your nearby Borg representative or distributor. Or a letter to R. K. Johnson will put the 2150 story on your desk in short order.

2150-2160 SERIES TEN-TURN MICROPOT®

Mechanical rotation.....3600° +10° -0°
Electrical rotation.....3600° +10° -0°
Resistance range, ohms.....100 to 100 K
Resistance tolerance..... $\pm 3\%$
Standard linearity..... $\pm 0.25\%$
Power rating.....3 watts at 40°C
Noise.....100Ω equiv. noise resist. max.
Temperature range.....-55°C to +105°C
Resolution.....from .054% at 100Ω
to .0088% at 100K
Torque.....Start 0.5 oz/in; Run 0.4 oz/in
Shaft dia.....1/4" (2150) and 1/8" (2160)
Weight......1 oz
Life.....2,000,000 revolutions



BORG EQUIPMENT

A Division of Amphenol-Borg Electronics Corporation
Janesville, Wisconsin

CIRCLE 97 ON READER SERVICE CARD

CHESTER

MULTI- CONDUCTOR CABLES

Custom constructions to meet your exact requirements. Any combination of conductors, Plastico® insulations, shields, jackets, color coding, etc.

Send for brochure, today!

**CHESTER
CABLE CORP.,
CHESTER, NEW YORK**

a subsidiary of
TENNESSEE CORPORATION



ence is made showing that w comes from line 15.1.

TRANSCRIPTION—Coded notation listing is designated as “original document” or “changed document” and, as mentioned before, lends itself readily to furnishing keypunched data that can be recorded on magnetic tape. Thus, the design-recording-change system shown schematically in Fig. 3 was developed to facilitate design and design changes during production.

Handle Test Probes Like Chopsticks

By CHARLES L. COHEN
McGraw-Hill World News

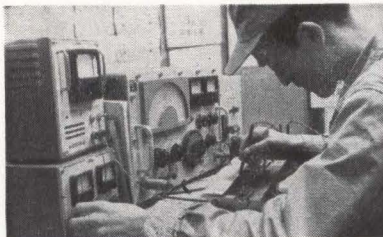

CHOPSTICK technique with test probes is demonstrated by Japanese technician

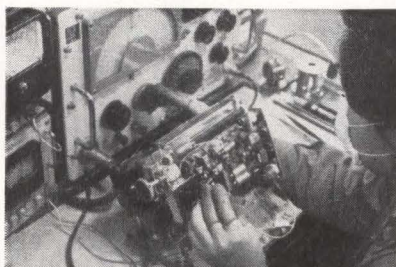

TIME for aligning radio receiver is greatly reduced by girl operator using two hands—use of both hands simultaneously is not easy for some operators

TOKYO—Handling two test probes in one hand while checking-out circuits is done easily by Japanese technicians. They often find it convenient to perform in this way and can work many test operations faster than with two hands. Lifelong use of chopsticks prepares them for it—no special training is given.

Management at Toshiba's Yanagicho Works takes this ability for granted. They are really proud, however, of girl operators' ability

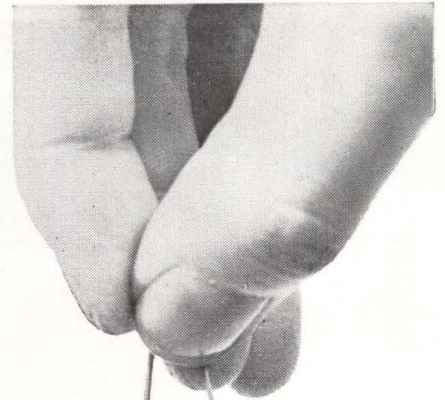

Let us help you cut costs!

CARBON FILM RESISTOR

Rohm

**TOYO
ELECTRONICS
INDUSTRY
CORPORATION**

P, O, BOX 103 CENTRAL
KYOTO JAPAN

CIRCLE 204 ON READER SERVICE CARD

May 3, 1963 • electronics

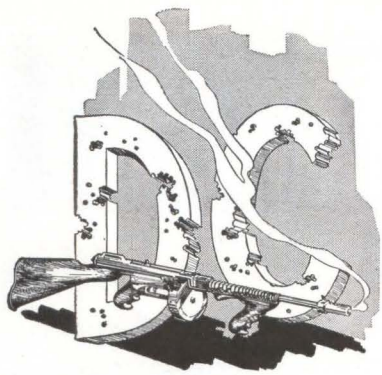

ACTUAL SIZE
(Model 50A)

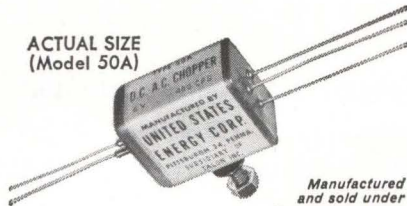

Manufactured
and sold under
Patent # 2,959,648
and pats. pend.

WHICH CHOPPER WOULD YOU DESIGN INTO YOUR SYSTEM?

Under certain extreme environmental circumstances, the larger chopper, pictured above, has been used with dramatic results.

Electronically, we feel that equally dramatic results may be achieved by the use of USEC's new line of Talon DC-AC choppers. Due to extremely low noise levels (in the sub-microvolt region), the new line of Talon DC-AC choppers insures vastly improved signal-to-noise ratios so necessary in small signal applications. They will withstand extremes of shock and vibration and they offer extremely high reliability and life. Operation is from a DC-450 cps 6V source and they are hermetically sealed.

Write today for complete operating specifications. Manufacturer's representatives territories are open.

usec / UNITED STATES ENERGY CORP.
(A Subsidiary of Talon Inc.)
300 MT. LEBANON BLVD., PITTSBURGH 34, PA.
Telephone (412) 561-3440

CIRCLE 205 ON READER SERVICE CARD
electronics • May 3, 1963

to align radios—using two hands: simultaneously, a trimmer is adjusted with a screwdriver in one hand while the other hand adjusts signal generator frequency or output.

Vapor Pressure Sprays Two-Part Encapsulants

TWO-PART EPOXY, urethane and other viscous materials can be applied with a spray system using vapor pressure as propellant rather than air pressure. Reportedly, such materials could not be sprayed using air pressure because of tendency to coagulate. With Chemtronic Vapor System developed by Zicon Corp., highly viscous materials are atomized and sprayed by action of hot water vapor having a molecular weight 3 times that of air—this supplies "pushing" effect. Application of materials on circuit-board assemblies is claimed to be much more efficient and effective than hand brushing, dipping or flow coating. Mil thicknesses can be controlled easily with solid fillets obtained around and under components.

Evaporator Doesn't Use Nitrogen Cold Trap

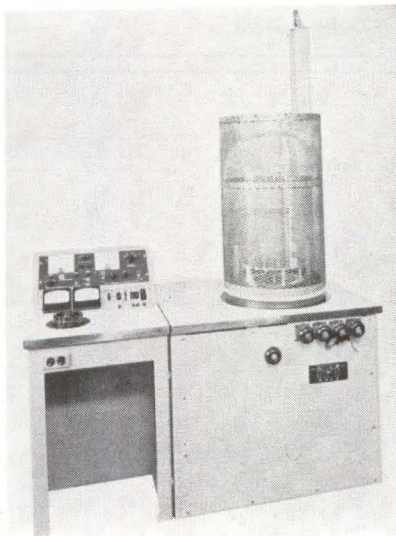

FOUR MINUTE production vacuum coating is provided by a new Vacuum Evaporator developed by Vacuum Specialties. Pressure of 5×10^{-5} is normally used with ultimate pressures of 5×10^{-7} attainable without use of a liquid nitrogen cold trap

COAXIAL CABLES



Accepted by industry as the quality line of Coaxial cables.

Conform to Military Specifications including MIL-C-17C—or your own special requirements.

Send for complete Coaxial Cable catalog.

**CHESTER
CABLE CORP.,
CHESTER, NEW YORK**
a subsidiary of
TENNESSEE CORPORATION

CHESTER



CIRCLE 99 ON READER SERVICE CARD 99

HITACHI TRANSISTORS

SPECIFY "MESA" TYPE TRANSISTORS FOR HIGH FREQUENCY USE

2SA233, 2SA234, 2SA235

Hitachi PNP germanium diffused "Mesa" type transistors provide outstanding high frequency characteristics compared with conventional alloy junction or drift transistors.

Exclusive "Mesa" type transistors are indispensable for FM receivers used in tuner circuits and intermediate frequency amplifiers and also in TV receivers in intermediate

frequency amplifiers. They can be used effectively in short-wave converters, medium wave converters and all high frequency applications.

For superior performance, specify Hitachi "Mesa" type transistors . . . another engineering achievement from one of the world leaders in electronics.

Maximum Ratings ($T_a = 25^\circ\text{C}$)

| Items | Symbol | Unit | 2SA233 | 2SA234 | 2SA235 |
|-----------------------|-----------|------------------|--------|--------|--------|
| Collector Voltage | V_{CBO} | V | -20 | -20 | -20 |
| Emitter Voltage | V_{EBO} | V | -0.5 | -0.5 | -0.5 |
| Collector Current | I_C | mA | -10 | -10 | -10 |
| Emitter Current | I_E | mA | 10 | 10 | 10 |
| Junction Temperature | T_j | $^\circ\text{C}$ | 85 | 85 | 85 |
| Collector Dissipation | P_C | mW | 80 | 80 | 80 |
| Ambient Temperature | T_A | $^\circ\text{C}$ | 60 | 60 | 60 |

Characteristics ($T_a = 25^\circ\text{C}$)

| Items | Symbol | Conditions for measurement | Unit | 2SA233 | 2SA234 | 2SA235 |
|--------------------------------|----------------|---------------------------------------|---------------|--------|--------|--------|
| Max. Collector Cut-off-Current | I_{CBO} | $V_C = -20\text{V}$ $I_E = 0$ | μA | -30 | -30 | -30 |
| Max. Emitter Cut-off-Current | I_{EBO} | $V_E = -0.5\text{V}$ $I_C = 0$ | μA | -50 | -50 | -50 |
| Current Amplification Factor | h_{fe} | $V_C = -6\text{V}$ $I_E = 1\text{mA}$ | | 50 | 60 | 80 |
| Alpha Cut-off Frequency | $f_{\alpha b}$ | $V_C = -6\text{V}$ $I_E = 1\text{mA}$ | Mc | 90 | 110 | 125 |

Typical Operation ($T_a = 25^\circ\text{C}$)

| Items | Conditions for Measurement | Unit | 2SA233 | 2SA234 | 2SA235 |
|----------------------------------|---|------|--------|--------|--------|
| Power Gain at FM Radio Frequency | $V_C = -6\text{V}$ $I_E = 1\text{mA}$ | db | — | — | 12 |
| | $f_s = 100\text{Mc/s}$ | | | | |
| | $R_g = 75\Omega$ $R_L = 2\text{k}\Omega$ | | | | |
| Mixer Gain at FM Radio Frequency | $V_C = -6\text{V}$ $I_E = 1\text{mA}$ | db | — | — | 13 |
| | $f_s = 100\text{Mc/s}$ $f_{osc} = 110.7\text{Mc}$ | | | | |
| | $R_g = 3\text{k}\Omega$ $R_L = 15\text{k}\Omega$ | | | | |

10.7 Mc Intermediate Frequency Amplifier Circuit

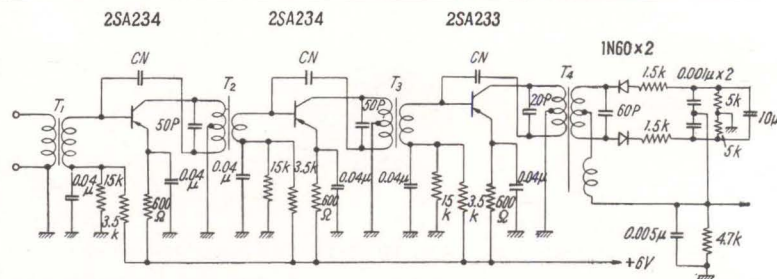

Hitachi New York, Ltd.
666, 5th Avenue, New York 19, N.Y., U.S.A.
Sole Agent:
International Importer Inc.
2242 South Western Avenue, Chicago 8, Illinois, U.S.A.

 **Hitachi, Ltd.**
Tokyo Japan

LIKE HAPPY ENDINGS?

Here's one from the Saturn program about a new telemetry technique — and a Collins Mechanical Filter.

The Saturn missile brought up a tough telemetry question: How to provide adequate transmission capacity for wideband data such as vibration measurements. □ Bandwidth capacity of available telemetry systems was too low. A new kind of transmission, using single sideband modulation of an AM subcarrier and providing 10 times the equivalent bandwidth, had been proposed. □ Filters were key factors in the system's operation. In addition to the extreme selectivity demanded of the bandpass filters, they had to be tough enough to operate under 20 G's vibration from 50 cps to 200 cps without modulation and spurious signals. They had to withstand a 100 G shock. And they would have to reduce insertion loss and passband ripple to new minimums. □ Because of these rigorous requirements, the logical answer was a Collins Mechanical Filter, but with significant state-of-the-art improvements. For the transducer, Collins developed a new ferrite material, increasing the mechanical strength of the filter and reducing insertion loss. Another benefit of the ferrite transducer was a 3 db to 1 db drop in passband ripple. □ Specs for frequency stability of the filters under radical temperature changes sounded impossible at first. But with new heat treatment techniques for the nickel-alloy discs that are the filter's resonant elements drift was held to within 1 ppm/C° temperature change. □ This Collins Mechanical Filter, packaged in less than 1/3 cubic inch, was a key to development of this new SS-FM telemetry technique at NASA's George Marshall Space Flight Center. The new technique has been invaluable in transmitting the avalanche of vibration data and other wideband information through two successful Saturn launchings. □ More than 100 standard mechanical filters for the 60 kc to 600 kc range are in the Collins catalog today, and if one of these won't do, the industry's *only* mechanical filter design staff is ready to help you with special designs. Call Collins today or write for Data File 202. □ COLLINS RADIO COMPANY • Components Division,

19700 San Joaquin Road, Newport Beach, California, Phone: KImberly 9-2911

• International Division, Dallas, Texas.

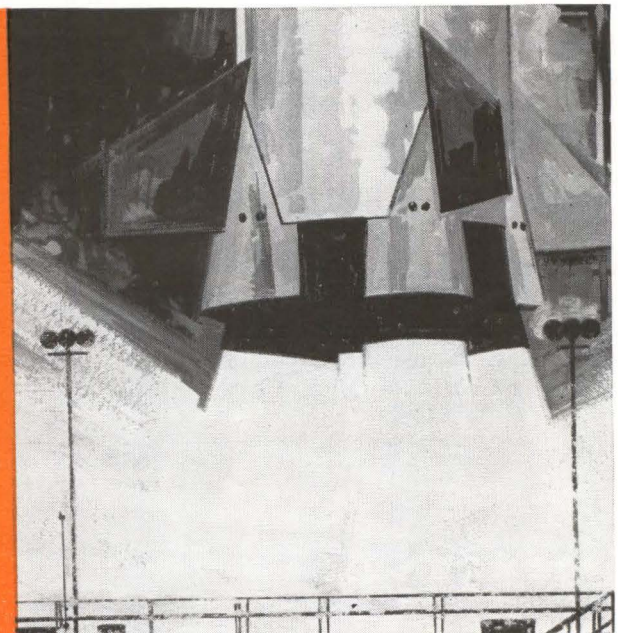
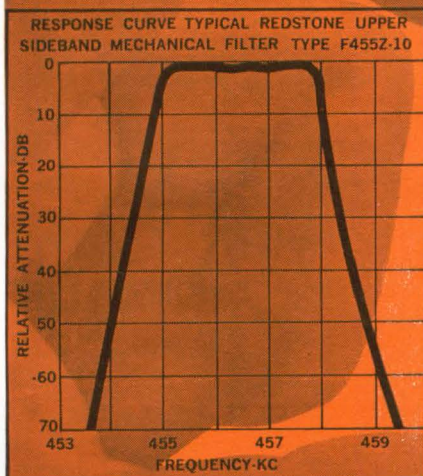

Aging Correction Stabilizes Frequency

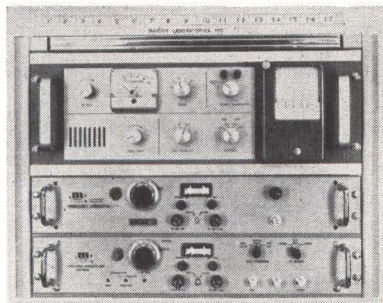

Crystal oscillator has time accuracy within 8 milliseconds per year

LONG-TERM frequency stability using a corrected crystal oscillator to produce an independent frequency standard accurate to within 5 parts in 10^{10} per year is featured in the BRAVO (best rate of aging verified oscillator) manufactured by Manson Laboratories Inc., 375 Fairfield Ave., Stamford, Connecticut. Output frequency is 100

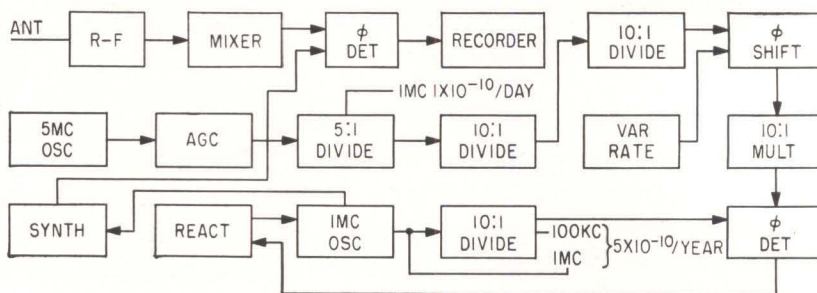

Kc and 1 Mc at 0.75 v into a 50-ohm load. Time accuracy is within 8 milliseconds per year. Corrected stability is within 5 parts in 10^{10} per year and uncorrected is 1 to 2 parts in 10^{10} per day. Frequency settability is better than 1 part in 10^{11} and the internal oscillator can be fine adjusted. Operating from conventional power sources, the unit also has internal batteries for 35 hours emergency operation. Size is approximately $10 \times 17 \times 19$ inches and weight, including batteries, is 100 lb. The device uses a 5 Mc crystal oscillator whose output is divided

by 5 to produce 1 Mc at 1 to 2 parts in 10^{10} per day. The 100 Kc output of the 10:1 divider is uncorrected and represents $10 \text{ Kc} + \Delta f(t)$ where $\Delta f(t)$ is frequency change due to aging. This is reduced to zero in the correction circuit. A variable rate device anticipates required aging reduction with time and compensates accordingly. The remainder of the circuit drives a synthesizer whose output is compared with a low-frequency standards transmission. Any difference between synthesized and received signals is recorded on a strip chart.

CIRCLE 301, READER SERVICE CARD

Breaker Saves Components

PROTECTING solid-state components from overvoltage and overcurrent is the purpose of the Circuit-Saver developed by Siltronics, Inc., 2231 Saw Mill Run Blvd., Pitts-

burgh 10, Pennsylvania. A visual trip indicator calls attention to the excesses, and resetting is by depressing the illuminated trip indicator. Designed for 28-v operation, the device has trip currents from 250 ma to 5 amperes, overvoltage protection occurs at 125-percent of rated voltage and voltages up to 45 v can be blocked in the tripped condition. Series impedance varies from approximately 5 ohms at 250 ma to 0.25 ohm at 5 amperes. (302)

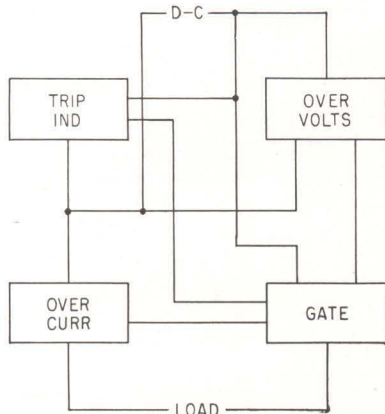

Step-Frequency Generator Tests Chart Recorders

CALIBRATING frequency measuring equipment such as doppler data and

strip-chart and other recorders is the purpose of the model 1104 step frequency generator made by the EDP Corp., 3501 South Orange Blossom Trail, Orlando, Florida. The unit generates a program of output frequencies linearly spaced over the spectrum of interest. Ten sequential frequencies, in increments of 10-percent full-scale frequency are generated at a rate variable from one per second to one per thirty seconds. Only one setting is necessary to select full-scale output in the range from 5 to 50 Kc. The program of sequential output frequencies is initiated by pressing a front-panel button. All operations are automatic. Full-scale frequencies are continuously adjustable from 5 to 50 Kc, incremental frequencies are generated in 10-percent steps of full-scale setting, dwell time on each frequency is 1

RELAY NEWS FROM ALLIED

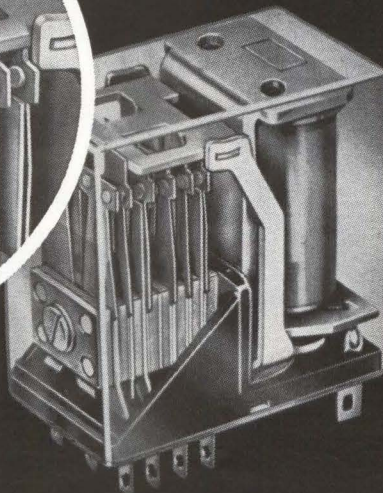
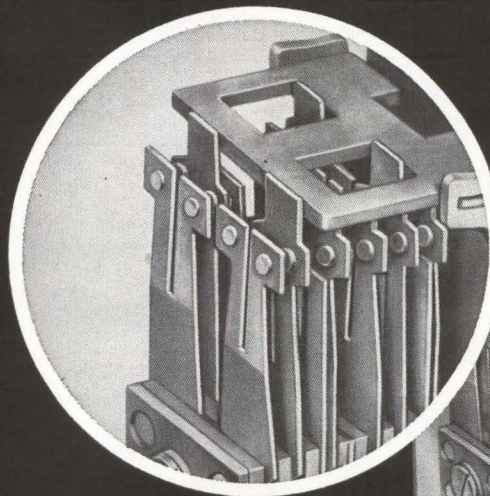

T-163-4C
1½ times actual size

NOW THE CRADLE RELAY IS AVAILABLE with bifurcated contacts

**NEW ALLIED T-163 RELAY • PROVIDES GREATER SWITCHING RELIABILITY
STAYS IN SERVICE FOR MILLIONS OF OPERATIONS • HAS GOLD PLATED
TERMINALS AND CONTACTS FOR LONGER SHELF LIFE.**

The versatile T-163 "cradle" relay also offers simplicity of design—it has no internal wiring, contact arms are extended to form combination solder and plug-in terminals along with ease of installation—it mates with easy-to-plug-in solder and printed circuit type sockets.

On every count—bifurcated contacts, exceptionally long life, quality design—Allied's T-163 gives you relay value. For quick service, call your nearest Allied representative. Also, write for Allied's T-163 Catalog Sheet.

OPERATING CONDITIONS (at +25°C)

| | |
|----------------------|---|
| Contact Rating: | Available with low level or 2 ampere contacts for resistive loads up to 29 volts d-c. |
| Contact Arrangement: | Up to four pole double throw |
| Ambient Temperature: | -55°C to +71°C Higher temperature available |
| Operate Time: | 15 milliseconds maximum |
| Release Time: | 8 milliseconds maximum |
| Weight: | From 0.80 to 1.0 ounces maximum |

AVAILABLE FROM YOUR ALLIED DISTRIBUTOR



ALLIED CONTROL COMPANY, INC. 2 EAST END AVENUE, NEW YORK 21, N. Y.
OUR 25TH YEAR IN THE RELAY INDUSTRY

AL 243

Well Known
by Reputation



Now for Printed
Circuit Boards

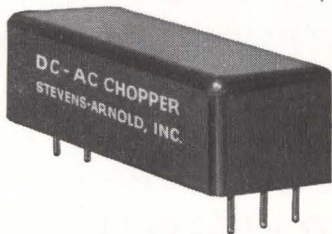

LOW NOISE LEVEL
TWIN CONTACT RELIABILITY
LONG LIFE

AC Drive Models
DC Drive Models
SPDT or DPDT
MBB or BBM

Request
Catalog No. 515



STEVENS
INCORPORATED
ARNOLD

QUALITY SINCE 1943

7 ELKINS ST., SOUTH BOSTON 27, MASS.

S/A-32-1/3

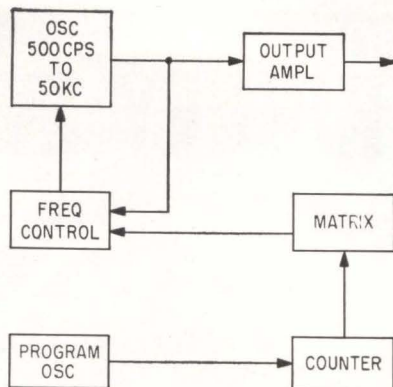

through 30 seconds adjustable, switching time between consecutive frequencies is less than 30 ms without signal interruption and reset-ability is 0.1 percent. Accuracy is 1 percent, output voltage is zero to 1 v rms at 600 ohms. The device contains an RC oscillator that generates the selected output frequency. The highest (100-percent) frequency is selected by manually adjusting the capacitance of the RC time constant and the 10-percent increments are generated by automatically switching the resistive elements. The 10 discrete steps are programmed by a very low frequency (1 pps to 2 ppm) pulse oscillator driving a counter and switching matrix.

CIRCLE 303, READER SERVICE CARD

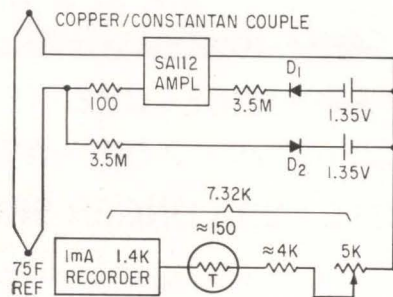

Amplifier Drifts 10 μ v per Day

SOLION TETRODES eliminate the need for mechanical choppers in the SA-112 amplifier from Self-Organizing Systems, Inc., 6612 Denton Drive, Dallas 35, Texas. Voltage gain is 500 to 10,000, rise time is 0.5 second, drift is less than 10 μ v per day and noise is 3 μ v rms. Input impedance is infinite at d-c and 25,000 ohms at 0.1 cps. Power requirement is 60 mw and the device can be operated continuously for one month from two batteries. It

will also drive a galvanometer-type recorder. The sketch shows use for thermocouple signal recording with compensation for the non-linearity of the thermocouple curve. Voltage-temperature curve for the copper-constantan thermocouple is approximately three straight-line segments. The circuits with the battery, diode and resistor change amplifier gain at upper and lower temperatures. The circuit using D_2 introduces a little positive feedback to increase gain at low temperatures while the D_1 circuit provides negative feedback to reduce gain at high temperatures. Gain changeover points are adjusted by varying the voltage in series with the diodes while the value of gain is changed by varying the resistors in series with the diodes. (304)

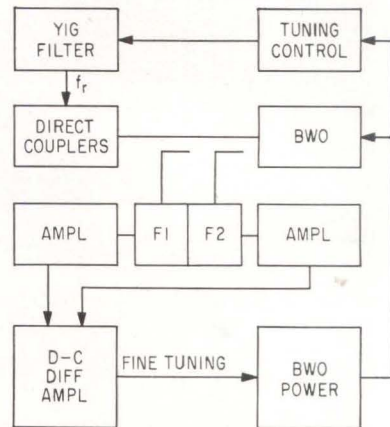

Tunable YIG Filter For Microwave Receivers

YTRIUM iron garnet microwave tunable filter, manufactured by Physical Electronics Laboratories, 2493 Pulgas Ave., E. Palo Alto, California, operates between 2.0 and 4.0 Gc with low sensitivity to temperature changes. Frequency drift between -30 and $+80$ C is less than 15 Kc per degree C and tuning sensitivity is 22.2 Mc per ma with the internal electromagnet. D-c tuning power is 2.5 w and a-c sweep is 0.25 w for sweeping ± 1 Gc at 3 Gc at a 1 Kc rate. For 10 Kc sweep, power is 0.63 w. Bandwidth at 3 db point is 18 to 20 Mc over entire tuning range at -30 db point is 100 Mc. Insertion loss is less than 1 db over most of the range increasing to 3 db from 2.1 to 2 Gc. Off-resonance isolation is greater than 40 db and strongest spurious response, 700 Mc

KINNEY EVAPORATORS

**FROM
2" to 6"
SINGLE
OR
DOUBLE**

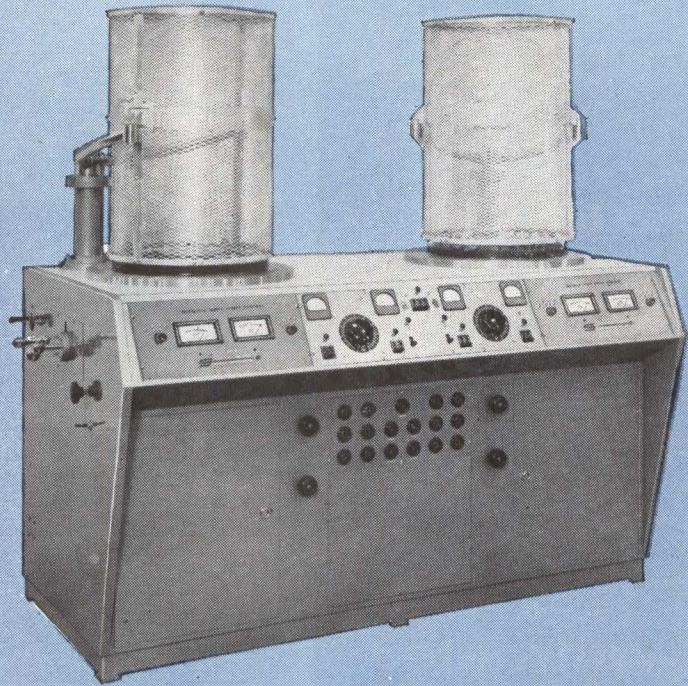

**KINNEY . . .
EVERYTHING
IN VACUUM**



**KINNEY
VACUUM**

DIVISION THE NEW YORK
AIR BRAKE COMPANY
3529 WASHINGTON STREET
BOSTON 30, MASS.

MEET ALL VACUUM REQUIREMENTS

Kinney Evaporators are designed for laboratory, pilot plant or production applications where versatility, dependability, and speed are required. These evaporators offer rapid evacuation and ultimate pressures as low as 5×10^{-7} torr when using liquid nitrogen. They are furnished complete with filament power supplies and vacuum gauges. Utilizing dependable Kinney components, each system is housed in a compact, functionally designed cabinet finished in hammertone grey enamel and topped with a durable formica work surface. All electrical controls and meters are grouped on a sloping console for optimum operator control and visibility. Its versatility is enhanced by a complete line of Kinney accessories. Kinney's standard models include 2" to 6", single and double evaporators; custom-designed systems can be built to your specifications.

measure dc



100mv to 500v

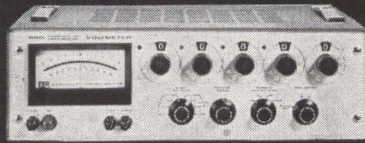

within 0.02%

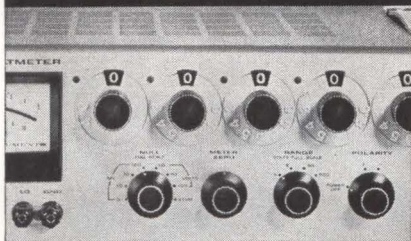

New Differential Voltmeter

Keithley 660 measures dc voltages with the accuracy and stability of a laboratory standard and the ease and low cost of an ordinary VTVM.

Features include:

- 0.02% limit of error
- reference supply stable to 0.005% indefinitely, without periodic re-standardization
- 100 μ v f.s. null range
- 2 μ v resolution
- infinite resistance at null, to 500v
- 0.005% repeatability
- 25 mv recorder output
- fully guarded input
- positive, negative or floating

Model 660 Differential Voltmeter . . . \$575
Model 6601A Voltage Divider . . . \$175

Send for four page Engineering Note on the Model 660

latest catalog available upon request



KEITHLEY INSTRUMENTS

12415 Euclid Avenue • Cleveland 6, Ohio

below main response is down 24 db. Sketch shows receiver circuit using 2 YIG filters for stalo discriminator operation and a third as a pre-selector for elimination of spurious radiation and image rejection. The dual filter can be swept at a high rate of speed by modulating the electromagnetic current control. Simultaneously, the two can be made to track accurately with desired sweep rate as well as tracking the input filter unit. Use of YIG filters eliminates slow tuning speed and mechanical complexity of the usual stalo cavity pair.

CIRCLE 305, READER SERVICE CARD

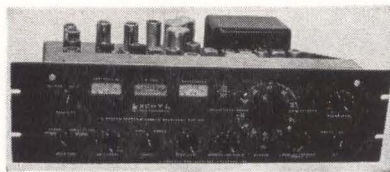

F-M Broadcast Monitor For Professional Use

DESIGNED for critical professional applications, the 4310R is a wide band f-m multiplex tuner with provision for diversity reception and automatic selection of mono-stereo performance depending on signal conditions. Overall signal strength tuning meter and separate VU meters for each channel provided. Sensitivity is 1.9 μ v; signal to noise, 60 db; harmonic distortion, 0.5 percent; tubes and solid state devices, 27; selectivity, 50 db. H. H. Scott, 111 Powder Mill Road, Maynard, Mass. (306)

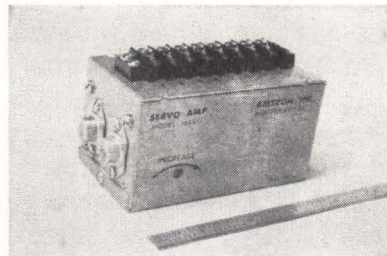

D-C Servo Amplifier Uses No Relays

COMPLETELY transistorized model 1465 d-c servo amplifier can be used as part of a closed loop position control. High accuracy and fast response time make it suited for rapid cycling, manual positioning, or modulating systems. It is designed

HART

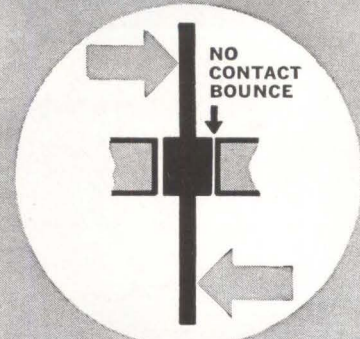

high-speed, superstable polarized relays



Hart's Series P offers extreme reliability in high-speed polarized SPDT relays. With sufficient power drive, the relay can repeat and shape pulses at a rate well in excess of 1,000 cycles per second. Because of its bounce-free character, distortion factors can be virtually eliminated.

Applications—high-speed switching, control programming, telegraphy, pulse forming, pulse repeating, circuit analyses.

Contact Ratings—to 2A with voltages to 120 a-c or d-c, depending on amperage employed.

Long Life—hundreds of millions of cycles on telegraphic loads of 65MA, 120 v d-c, arc suppressed (Silver nickel vs. palladium-ruthenium contacts).

For complete information on Series P Relays to meet your specific requirements, call or write



HART
MANUFACTURING CO.
202 Bartholomew Avenue
Hartford 1, Connecticut

Telephone: Area Code 203 525-3491
A Subsidiary of Oak Manufacturing Co.

CIRCLE 206 ON READER SERVICE CARD
May 3, 1963 • electronics

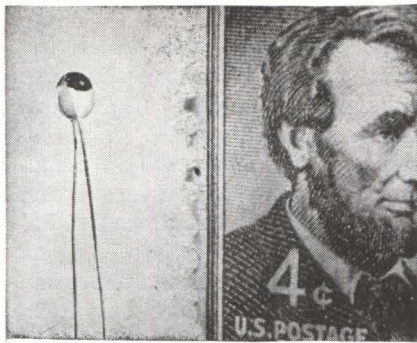

**new low cost
precision
THERMISTORS**
match standard curves
-40° to 150° C.

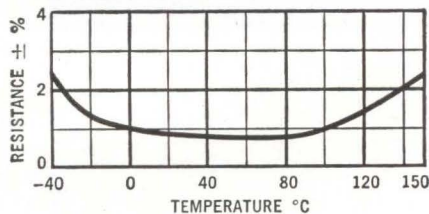

Resistance Tolerance
30K thermistor No. 44008

■ YSI precision thermistors can now be stocked by the thousands, used interchangeably. The high cost problems of matching, padding, auxiliary resistances or individual calibration have been eliminated.

■ Stock base resistances at 25° C. of:
100 Ω 1K 10K
300 Ω 3K 30K
 100K

■ For 5 years YSI has manufactured precise, interchangeable thermistors for laboratory instrumentation.

■ Now we offer as components a family of precision thermistors which match the same Resistance-Temperature curves to within ± 1% over a wide temperature range.

■ \$4.90 each, with substantial discounts on quantity orders.

■ Quantities under 100 available from stock at Newark Electronics Corporation and its branches.

For complete specifications and details write:



CIRCLE 207 ON READER SERVICE CARD
electronics • May 3, 1963

to work from a potentiometer bridge circuit using 1,000 ohm pots and to drive a 27 v at 0.6 amp shunt or permanent magnetic d-c motor. Unit is extremely stable and relatively immune to changes in supply voltage. A sensitivity adjustment is provided to compensate for various inertia and friction loads. Unit will operate over a temperature range of from -50 C to +55 C. Amtron Inc., 14631 S. Waverly Ave., Midlothian, Ill. (307)

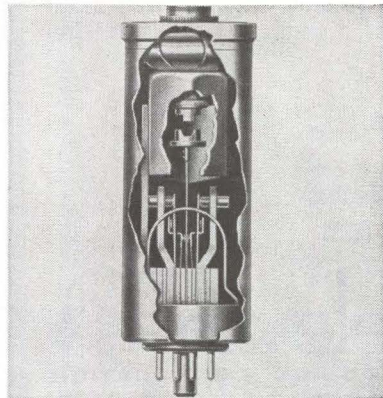

**Low Noise Choppers
Have High Reliability**

CHOPPERS designed to give high performance over a minimum of 13,000 hr of continuous operation, with low noise level and freedom from pickup, are announced. Both electrostatic and magnetic shielding isolate the low-level circuit from the a-c driving coil. Contact materials are chosen to reduce parasitic emf's at the contacts to a minimum; contact points themselves are gold. Contact rating is 10 v d-c, at 1 ma. Dissymmetry of closure (dwell) time is 3 percent max; bounce, 2 percent max during closing and opening contact; operating temperature, 0 to 70 C; storage temperature, down to -60 C. Leeds & Northrup Co., 4901 Stenton Avenue, Philadelphia 44, Pa. (308)

**Spectrometer Uses
Solid-State Circuits**

GAMMA RAY spectrometer using solid-state circuits has been introduced. The SC-530T enables accurate detection of the individual radiation properties unique to each isotope through a combination of a pulse-

measure
true
rms
to
50
mc



**NEW
Wideband
Voltmeter**

- 20 cps to 10 megacycles ±1%
- 18 cps to 20 megacycles ±3%
- 15 cps to 50 megacycles ±5%
- 100 microvolt to 300 volt range
- crest factor, 6 at full scale
- crest factor, 60 at tenth scale
- 1 megohm, 20 pf input impedance
- ac amplifier output—100 mv, rms
- ac amplifier response—6 nsec
- dc output—100 millivolts

Model 121 True rms Wideband Voltmeter \$870
Model 1201 Cathode Follower Probe \$120

Send for Engineering Note describing the Model 121

ALSO AVAILABLE
Model 120 Peak Reading Voltmeter-Amplifier \$775



**KEITHLEY
INSTRUMENTS**
12415 Euclid Avenue • Cleveland 6, Ohio

CIRCLE 107 ON READER SERVICE CARD 107

ELECTRONICS ENGINEERS WITH VISION WILL RECOGNIZE THIS COIL DESIGN ADVANCEMENT AS A NEW INDUSTRY STANDARD FOR COIL FABRICATION AND PACKAGING.

Now Electronics Engineers can expect more from a molded coil. Delevan's new Molded Shielded Fixed Coil reaches out to high inductance values in a miniature size. Electromagnetic shielding, feature of Series 1537-700 parts, is fully effective not only along the body but also at the ends of the coil guaranteeing efficient shielding regardless of your packaging configuration. The length of the molded body permits lead mounting of .400" PC hole spacing.

Series 1537-700 is a high quality product with reliability built into every design feature and manufacturing process. You will find it worthy of the Delevan name.

SPECIFICATIONS:

- Size: 0.157" Diameter; 0.375" Length
- Shielding: Less than 2% coupling
- Inductance: 0.1 uh thru 120,000 uh (74 values)
- Environment: Grade 1, Class B, MIL-C-15305

Delevan 
ELECTRONICS CORPORATION
 A Subsidiary of American Precision Industries, Inc.
 270 QUAKER RD • E 5 • EAST AURORA, N. Y.

1537-700 MOLDED "SHIELDED" FIXED COILS



Write for further information on 1537-700 Molded "Shielded" Fixed Coils Today.

CIRCLE 108 ON READER SERVICE CARD

**HELP YOUR POST OFFICE
 TO SERVE YOU BETTER
 BY
 MAILING EARLY IN THE DAY
 NATIONWIDE IMPROVED MAIL SERVICE
 PROGRAM**

height analyzer, scaler, timer, h-v power supply and linear amplifier. It makes it possible to use several radioactive isotopes in a single experiment and measure each separately, to count primary radiation in the presence of scattered radiation, or to identify an isotope by its characteristic radiation. Tracerlab division of Laboratory For Electronics, Inc., 1601 Trapelo Road, Waltham 54, Mass.

CIRCLE 309, READER SERVICE CARD

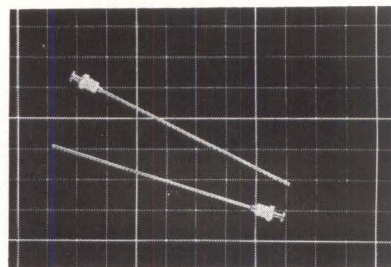

Tiny Feed-Through Features Long Lug

TURRET TOP microminiature Press-Fit feed-through Teflon terminal features a long lug for easier soldering access in extremely tight space applications. Type FT-MM-50 TUR incorporates a brass, gold flash over silver plate lug measuring 2 in. long. The Teflon bushing measures 0.140 in. overall with 0.093 in. as the minor diameter and 0.125 in. as the seating diameter. The Teflon bushing is pure virgin Teflon and is available in all ten standard EIA colors. Sealectro Corp., 139 Hoyt St., Mamaroneck, N. Y. (310)



Capstan Motors for Tape Recording Use

SERIES 43H precision, direct drive capstan motors for use in the tape recording industry are available in one, two and three-speed models with speed combinations available between 300 rpm and 1,800 rpm

add this new
Visicorder Oscillograph
 to your
 data system

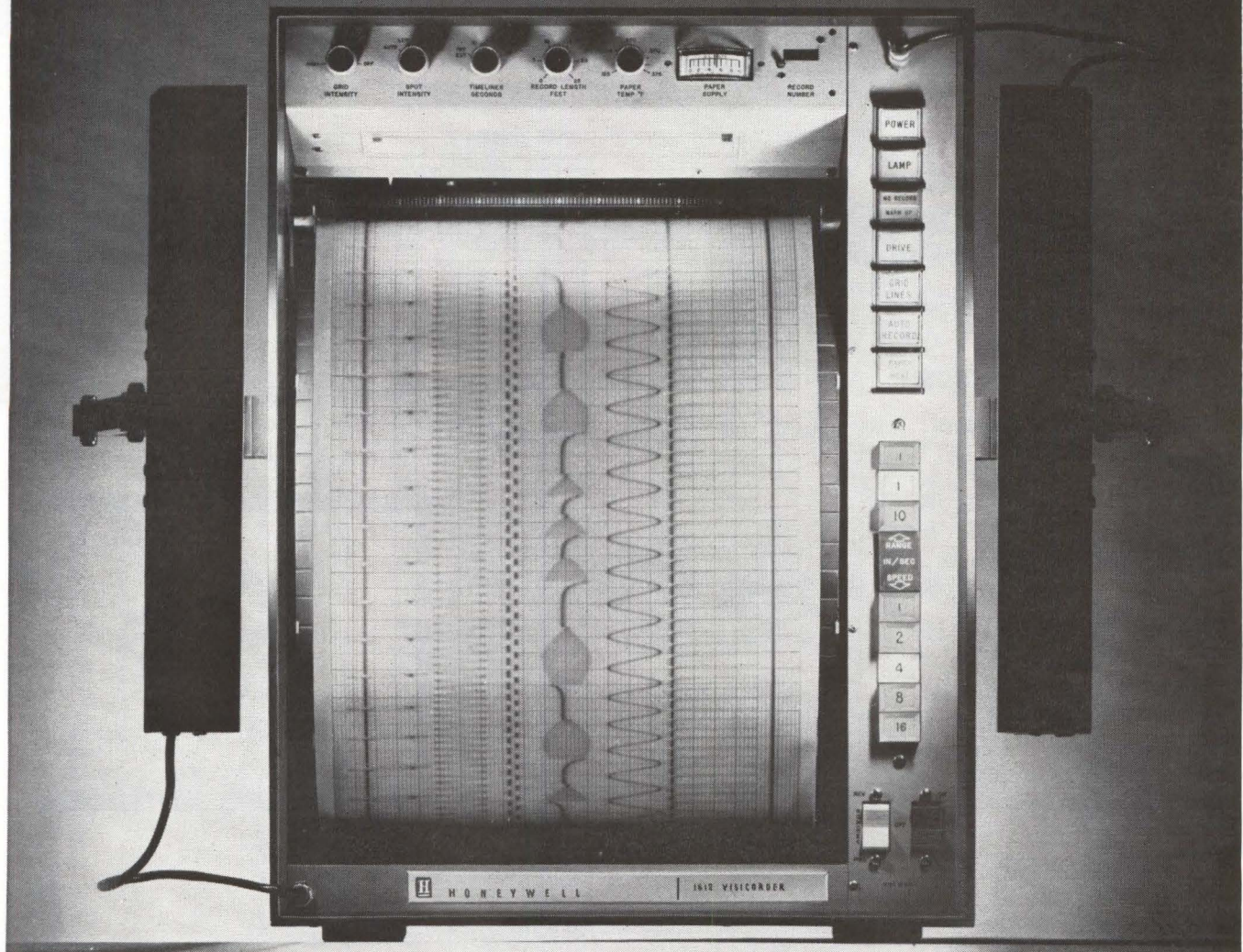

The Honeywell 1612 Visicorder Oscillograph is a completely new 36-channel instrument. It was designed from the base up for systems use. Features such as a built-in heated platen, modular electronics, and push-button controls make it the most versatile oscillograph ever built by Honeywell, pioneer in direct writing oscillography using light beam galvanometers.

The built-in heated platen, a factory-installed option, serves as a standard platen until heat is desired, at which time the operator

simply pushes a button. Platen heat improves the quality of the record and gives better contrast. In conjunction with the two latensifier lamps, it provides immediate read-out of records at speeds up to 16 inches per second.

Other examples of the 1612's functional design are:

15 forward recording speeds (from 0.1 to 160/ips) and 10 reverse speeds—all pushbutton controlled.

All controls on front surface.

Paper loading accomplished in seconds.

HONEYWELL INTERNATIONAL SALES AND SERVICE OFFICES IN ALL PRINCIPAL CITIES OF THE WORLD.

Instrument may be operated in the rack, pulled out on slides, or bench-mounted. Uses Type M miniature galvanometers, interchangeable among other Honeywell oscillographs.

For full details on all Visicorder Oscillographs, tape systems, and signal conditioning equipment, write to Honeywell, Denver Division, Denver, 10, Colo., or phone 303-794-4311.

DATA HANDLING SYSTEMS

Honeywell



True TORQUE CONTROL

NO STRIPPED THREADS

**METER MANUFACTURER CHOOSES
CLECOMATIC* BECAUSE . . .**

(1) Previous fastener driving methods proved inadequate for precise Quality Assurance Standards.

(2) SERIES 3 and 6 CLECOMATICS provided the precise control required to meet those quality standards.

(3) Automatic shut-off prevents fracturing of meter box coatings, stripping of threads and damaging of screws resulting in dramatic reduction in the number of rejects.

What the precision torque, fully automatic CLECOMATIC has done for this manufacturer, it can do for you. Call your CLECO Representative, he will be glad to help you with your production line problems.

**Fully warranted for one year by the GOLDEN CIRCLE guarantee*



A DIVISION OF
REED ROLLER BIT COMPANY
P. O. Box 2541 • Houston, Texas

synchronous speeds. Shaft run-out is 150 μ in. max. A typical motor will provide direct drive tape speeds of 3 $\frac{3}{4}$, 7 $\frac{1}{2}$, and 15 ips at shaft speeds of 300, 600 and 1200 rpm, respectively. Windings are for 115 v, 60-cycle excitation; 50-cycle motors available on special order. Typical torque values range from 6.0 to 12.0 in.-oz. Motors measure 4 $\frac{3}{8}$ in. diameter by 4 $\frac{1}{8}$ in. length to the mounting flange. Beau Electronics, Inc., 41 Haig St., Hamden 14, Conn.

CIRCLE 311, READER SERVICE CARD

Conductive Paint For P-C Boards

A SILVER conductive paint is available for applications where a temporary common conductive path is required for the precious metal plating of "fingers" on a printed-circuit board. The silver paint is applied with an artist's pen or draftsman's ruling pen, air dried, and can later be removed, when necessary, by wiping with xylene. Price: \$8 for a 2-oz kit. Etchomatic Inc., Newton St., Waltham, Mass. (312)

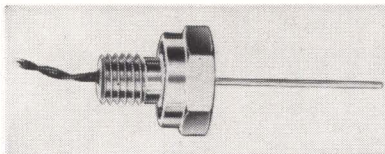

Disk Thermistors Are Epoxy Encapsulated

DESIGNED for mounting on p-c boards, these epoxy-encapsulated disk thermistors (measuring approximately $\frac{1}{2}$ in. by $\frac{1}{2}$ in. by $\frac{1}{4}$ in.) are provided with 0.025 diameter stiffened nickel leads, and facilitate both automated and manual mounting. Molded construction serves to extend the vibration, shock, acceleration and humidity characteristics of the units. A broad range of resistance values are available in the new configuration. Fenwal Electronics, Inc., 63 Fountain St., Framingham, Mass. (313)

Static Relays Offer Ultrasensitivity

SERIES 650 Mag relay combines a magnetic amplifier and silicon con-

NEW MINIATURE DELAY LINES

$\frac{1}{4}$ CU. INCH PER μ SEC.

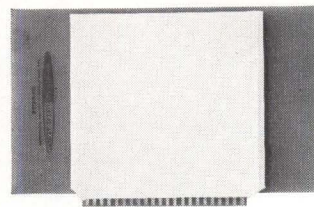

Total delay of 24.65 μ sec. in
a 4 $\frac{1}{8}$ " x 4" package



- Total weight: 8 $\frac{1}{2}$ oz.
- Total delay accuracy better than $\frac{1}{2}$ of 1%
- Total delay to rise time ratio better than 40:1
- Distortion under 4%
- Temp. coefficient: 50 ppm \pm 20 ppm/ $^{\circ}$ C

WRITE FOR DETAILS

Opening exists for a Delay Line Design Engineer

ADMIRAL PALO ALTO

Palo Alto Division of Admiral Corporation
Stanford Industrial Park, Palo Alto, California

CIRCLE 208 ON READER SERVICE CARD

AM-FM Tuner Unit

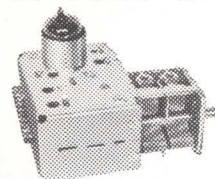

AM SEC. CAPACITY: MAX. 377PF
: MIN. 12PF
TUBE: 6AQ8, 12DT8, 17EW8

PLASTIC VARIABLE CONDENSER

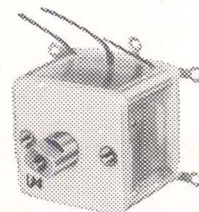

Square Size :
15mm., 17mm.,
20mm., 21mm.,
Single band :
2 band, 3 band
and for FM only.



SANKAISHA CO., LTD.

Cable address: SANESVARICON TOKYO
1425, 4-chome, Higashinakanobu,
Shinagawa-ku, Tokyo, Japan.

CIRCLE 209 ON READER SERVICE CARD

May 3, 1963 • electronics

7½ TEST YEARS

CUT TO 18 MONTHS FOR

60 MILLION DATA TEST HOURS!

BETTER
MEASURING
FROM



In determinations of acceleration factors for metal and carbon film resistors for the high reliability MINUTEMAN Program, Electra Manufacturing Company uses an Automatic Resistor Data Logging System designed and built by Electro Instruments.

This system, in conjunction with other test equipment, has accumulated over 60 million resistor hours of data in the last 18 months. *Without this accelerated testing system, 7½ years of test time would have been required!* Most important, the EI system gives Electra the confidence that their products meet stringent government specifications.

As in this EI system created for Electra, EI *all solid state* Digital Multimeters are the basis for *better measuring* at greater speed, higher reliability, significant cost savings and a much lower investment.

Whether your interest lies in spacecraft, electronic components or industrial processes, we can demonstrate to you the advantages of EI digital instruments in measuring DC volts, AC volts, DC ratios, resistance, capacitance, inductance and impedance. Let EI *all solid state* Digital Multimeters or Complete Systems provide swift, accurate, low cost solutions to your measurement and display problems!

For full details on EI's individual digital instruments, or our complete capabilities in the field of measurement, display and recording—write direct to Electro Instruments, Inc.



Technician at Electra Manufacturing Company inserts test resistors in the Automatic Resistor Data Logging System designed and built by Electro Instruments. Over 60 million resistor hours of data were accumulated in 18 months.



Electro Instruments, Inc.

8611 Balboa Avenue, San Diego 12, California

PRECISION TIMING A PROBLEM?

HERE'S HELP...

New, complete catalog describes full line of Standard precision timers. Various models have scale divisions from 1/1000 sec. to 1/5 sec., totalize from .360 sec. to 60 min., are available in accuracy range from $\pm .0002$ sec. to $\pm .1$ sec.

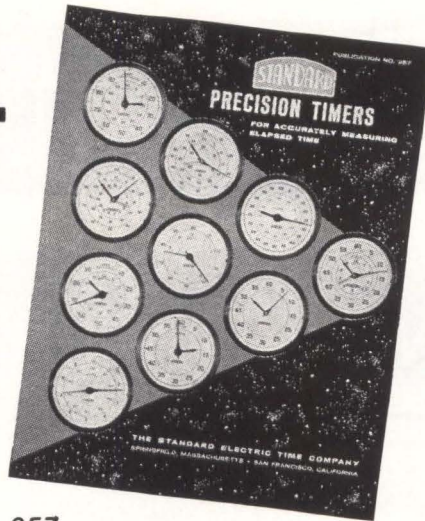

REQUEST Catalog No. 257



THE ONE TIMER WITH ALL THE FEATURES

THE STANDARD ELECTRIC TIME COMPANY

89 LOGAN STREET • SPRINGFIELD, MASSACHUSETTS

CIRCLE 210 ON READER SERVICE CARD

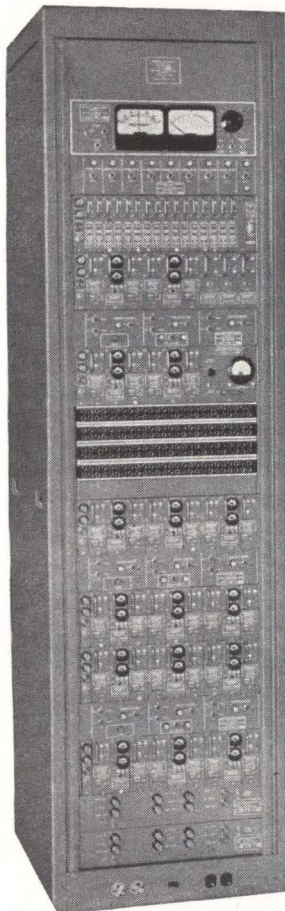

NEW BETTER-THAN-EVER
RELIABILITY
for long-distance point-to-point communications



NORTHERN RADIO

NEW 16-CHANNEL TRANSISTORIZED
VOICE FREQUENCY DIVERSITY CARRIER
TELEGRAPH TERMINAL TYPE 235 MODEL 3
MIL DESIGNATION AN/FGC-61A

... All units militarized: components and design approved by U.S. Military.

... Converters have equalized gain and adjustable time delay in each channel for better diversity performance and interchangeability.

... Switching Panels provide "local" or "remote" selection of 2-channel or 4-channel diversity modes.

... Combiners have adjustable gains in each channel, for complete switching flexibility, and the combining follows an ideally modified square law function for both 2-channel space or frequency and 4-channel space plus frequency diversity.

... Keyers have adjustable "threshold" sensitivity control and simplified input circuit selection.

... Dotter and Delay Indicator provides test keying signal source for keyers and delay equalizers in all channels.

Write for complete literature.

Pace-Setters in Quality Communication Equipment.

NORTHERN RADIO COMPANY, inc.
147 WEST 22nd ST., NEW YORK 11, NEW YORK

In Canada: Northern Radio Mfg. Co., Ltd., 1950 Bank St., Billings Bridge, Ottawa, Ontario.

trolled rectifier to perform the functions of meter relays, and similar devices. It is available in current and voltage ranges as low as 50 μ a or 25 mv with a bandwidth and repeatability of less than 0.5 μ a or 0.25 mv. The bandwidth can be reduced to less than 0.05 μ a or 20 μ a depending on the application. Electronic Control Systems, Inc., P.O. Box 1232, Fairmont, West Virginia.

CIRCLE 314, READER SERVICE CARD



Snap-Action Switch For Slow Actuation Use

SNAP-ACTION switch series E14 is UL approved, 25 amp 125/250 v a-c, 1 h-p 125 v a-c, 2 h-p 250 v a-c. Designed with new tease-proof mechanism that assures simultaneous electrical and mechanical action regardless of rate of actuation, this series is available in both momentary and reset action types. Featuring coil spring construction it has a contact carrying blade that maintains full contact pressure as actuator approaches operate and reset points. Cherry Electrical Products Corp., Box 438, Highland Park, Ill. (315)

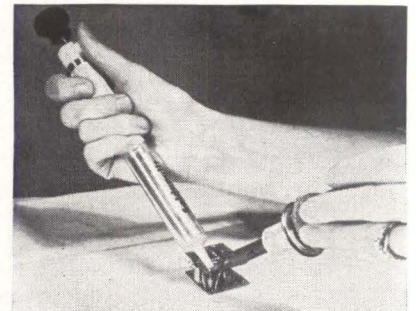

Solder Remover for Component Rework

DESIGNATED Soldapullt, this portable hand tool provides a convenient method of desoldering components on p-c boards. It features a high impulse of 25 in. of Hg vacuum and a self-cleaning tip. It reduces solder splash and overheating of solder connections. Also it simplifies re-



Print top and side together at 3200/hour

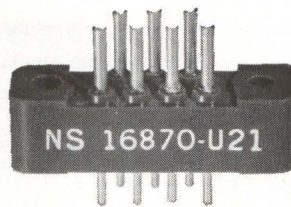

Identify products with inks that meet government specs

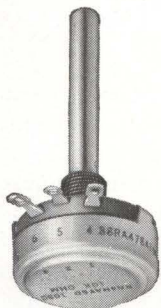

Print 1500 hard-to-hold items per hour with complete uniformity — change to new imprint in seconds

cut your identification costs with modern methods like these

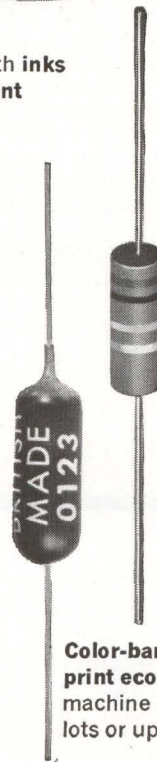

Color-band and/or print economically by machine — in sample lots or up to 6000/hour

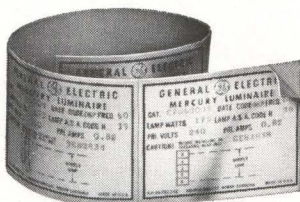

Save purchase, inventory and obsolescence costs by making your own labels exactly as needed



Get sharp, durable imprints on extremely irregular shapes or rough surfaces

Looking for faster identification . . . imprints that meet government specs . . . flexibility to meet changing requirements . . . a practical way to mark prototype or sample lots? Would direct printing or making your own labels cut costs, give higher print quality? Ask Markem to analyze your identifica-

tion needs now — without obligation — and show you *how* and *where* you can save money. Frequently, a Markem in-plant identification system pays for itself in a few months. Contact the Markem Technical Representative near you, or write Markem Machine Co., Keene 5, New Hampshire.



New 12-page Catalog describes Electrical/Electronic Identification Methods and Equipment. Copy on request.

MARKEM

TECHNICAL ASSISTANCE AND INDUSTRY-PROVEN EQUIPMENT
WORLDWIDE . . . TO HELP YOUR PRODUCT SPEAK FOR ITSELF

TRIMMING POTENTIOMETERS

NEW ATOHM HCL PROGRAM GIVES ASSURANCE OF ULTRA-HIGH RELIABILITY AT NO EXTRA COST!

Tired of paying the high, extra cost of so-called, ultra-high-reliability trimmer pot programs and putting up with delivery delays? Then, here's good news. The Atohm High-Confidence-Level reliability program, which meets and exceeds testing required by MIL-R-27208A, is now available at *no extra charge*.

Specifically, the new Atohm HCL program provides:

1. Quality assurance testing to paragraph 4.5 and sub-paragraphs 4.5.1.3, 4.5.1.4, and 4.5.1.5 of MIL-R-27208A.
2. Units which have been conditioned by temperature cycling in the process of manufacturing: 1 cold cycle (-65°C) and 8 heat cycles (over 200°C); a total of 18 hours of hot and cold cycling.
3. Units which have been tested and inspected for a total of 88 electrical, mechanical and functional tests.
4. Three additional tests in the Group A or final inspection tests above that required by MIL-R-27208A: (1) Insulation resistance; (2) Immersion; (3) Operational cycling (20 cycles under power).
5. Units that have been subjected to full military requirements, not watered down screening tests which specify lower ambient temperatures and reduced loads.
6. Quality assurance testing and scheduled testing and test reporting performed under surveillance of the U.S. Navy Quality Control Representatives. Documentation upon request.

This program of testing is performed continuously at the Atohm plant on all military units as a standard production technique. Such testing is not limited to special orders or lots, and is available without extra cost.

Your Atohm representative can answer any specific question you may have regarding the HCL program. Call him today.

ATOHM ELECTRONICS

7648 San Fernando Road, Sun Valley, California • TR 7-9873



CIRCLE 211 ON READER SERVICE CARD

removal of multi-component terminal connections, expediting component replacement. Edsyn, Box 868, Arleta, Calif.

CIRCLE 316, READER SERVICE CARD



Counter-Timer Has Plug-In Design

NEW 10 Mc counter-timer, model 1034, is a general purpose digital test instrument featuring front-panel plug-in design, transistorized plug-in construction, and a wide range of selectable modifications to satisfy specific customer requirements. Standard features include a seven digit readout with blanking of display during count cycle, and an oscillator with a stability of ± 3 parts in 10^7 per week. Also provided in the universal input plug-in model 1926 are variable controls for each input amplifier and convenient front panel jacks for setting trigger levels on an oscilloscope. Systron-Donner Corp., 888 Galindo St., Concord, Calif. (317)



MARK II MODULATED BEAM PHOTOMETER

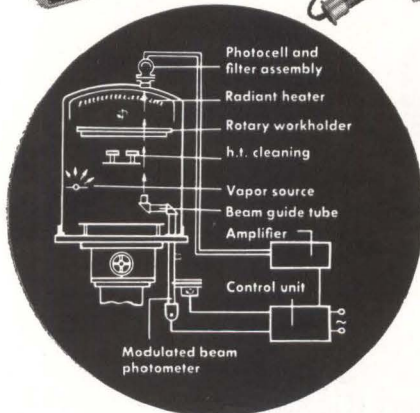

The "Speedivac" Modulated Beam Photometer provides a method of controlling the optical thickness of films deposited by evaporation or sputtering by indicating the changing optical characteristics of the films as their thickness increases. The instrument measures the reflection from or the transmission through coated glass surfaces as a function of wave-length. Both these quantities can be measured alternately if two light sensing elements are used.

SPEEDIVAC MULTIPLE VAPOR SOURCE VACUUM COATING UNITS

EDWARDS HIGH VACUUM has pioneered the design and development of evaporation systems and accessory equipment from small versatile laboratory units to high capacity production plants.

EDWARDS HIGH VACUUM, INC. 3279 GRAND ISLAND BLVD., GRAND ISLAND, N. Y.

114 CIRCLE 114 ON READER SERVICE CARD

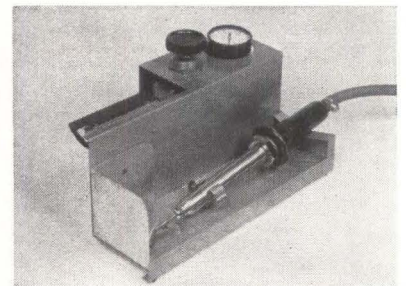

Instrument Stand For Plastic Welding

INSTRUMENT stand for use with plastic welding torches has an integral torch rest for operator convenience and features a new combination gas regulator and filter unit. The compact, lightweight regulator-filter provides accurate flow control for precise temperature regulation and assures a clean gas supply for consistent weld integrity. Stand has an aluminum heat shield to confine the hot gas. The instruments, filter and regulatory assembly, are

NEW

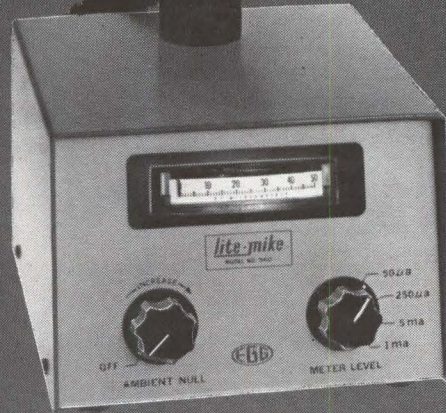
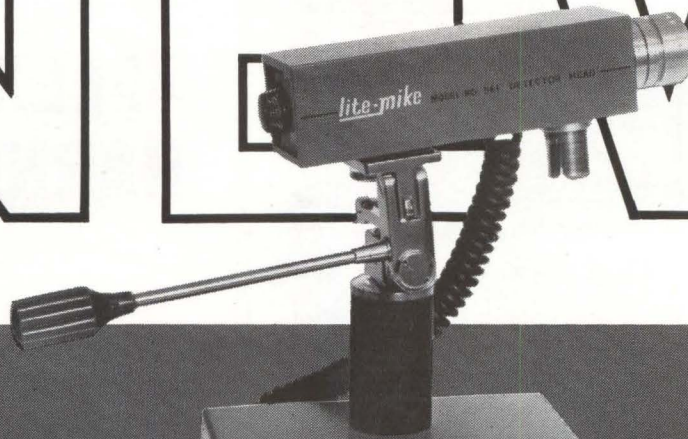

lite-mike

Measures
this →
HERE

| MEASUREMENT | MONOCHROMATIC SPECTRUM | | CHROMATIC SPECTRUM |
|--|------------------------|------------------|--------------------|
| | LASER | GALLIUM ARSENIDE | |
| WAVESHAPE Rise time Fall Time Duration Amplitude | Yes | Yes | Yes |
| Average Power (watts) | Yes | Yes | * |
| Energy (joules) | Yes | Yes | * |

*Can be calculated within spectral response capabilities.

RESPONSE RANGE 1.13μ 0.35μ

| 40,000 | 30,000 | 20,000 | ANGSTROMS | 10 ⁴ | 9,000 | 8,000 | 7,000 | 6,000 | 5,000 | 4,000 | 3,000 | 2,000 | 10 ³ |
|--------|--------|--------|-----------|-----------------|-------|-------|-------|-------|---------|-------|-------|-------|------------------|
| 4 | 3 | 2 | NEAR IR | 1 | 0.9 | 0.8 | 0.7 | 0.6 | VISIBLE | 0.5 | 0.4 | 0.3 | NEAR UV |
| | | | MICRONS | | | | | | | | | | 10 ⁻¹ |

This is a uniquely versatile, factory-calibrated instrument for making pulsed-light measurements in the visible and near-infrared spectrum. Average power readings are indicated directly on a built-in meter; waveshape, rise time, fall time, duration and energy measurements are easily displayed on a fast oscilloscope. Utilizing EG&G's new ultrafast,

SD-100, silicon photodiode, the LITE-MIKE detector head is swivel-mounted for ease of alignment with the light source to be measured. Compact (only 10" high) and lightweight, the LITE-MIKE incorporates built-in controls for sensitivity selection and balancing of ambient light.

For data sheets and further information, contact:

Marketing Dept., 176 Brookline Avenue, Boston 15, Massachusetts



EDGERTON, GERMESHAUSEN & GRIER, INC.

BOSTON • LAS VEGAS • SANTA BARBARA

BARKER AND WILLIAMSON



HARMONIC **B&W** AND SPURIOUS TOTALIZER

B&W Harmonic and Spurious Totalizer, Model HST, measures total harmonic and spurious radiation from radio transmitters.

Frequency Range:

for transmitters operating from 2-32 mc, measures harmonics and spurious to 90 mc.

Total spurious and harmonic levels as low as 65 db below the carrier can be measured.

A measurement can be made in a matter of minutes.

Ideal for:

Periodic check of spurious emissions at radio transmitting stations.

Development of transmitter equipment.

Production testing of radio transmitters.

Write for Sales Bulletin #106 for description and specification.

BARKER & WILLIAMSON, Inc.
Radio Communication Equipment Since 1932
BRISTOL, PENNSYLVANIA • Stillwell 8-5581

protected by the formed metal of the stand panel. A thermometer for reading of gas temperature is built into the stand. Laramy Products Co., Inc., 220 Beechwood St., Cohasset, Mass.

CIRCLE 318, READER SERVICE CARD

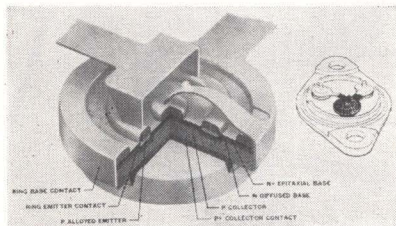

Power Transistor for High-Speed Switching

DEVELOPMENT of an epitaxial-base germanium power transistor series for high-speed, high-voltage switching applications is announced. Internal construction of the devices, types MP721A, -B and -C, gives rise to extremely fast switching characteristics particularly applicable to flyback circuits in transistorized tv circuits and similar applications. Pertinent specifications for tv flyback circuits include a fall time of 0.7 μ sec at 8 amperes of collector current. Motorola Semiconductor Products Inc., P.O. Box 955, Phoenix, 1, Ariz. (319)



H-V Test Set Is Portable Unit

A PORTABLE Hi-Pot Tester has been developed which supplies high potential voltage up to 5 Kv for testing such items as cables, connectors and other devices and components subjected to high potential insulation. Unit incorporates fixed and variable sensing circuits which automatically remove high potential voltage when current exceeds pre-

EXTEND RETRACT FLEXIBLE HARNESSES

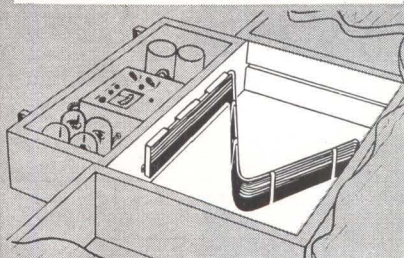
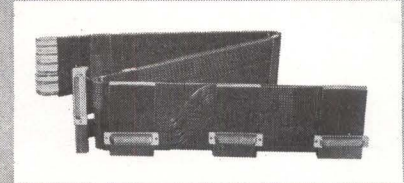
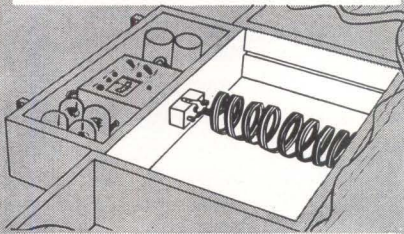
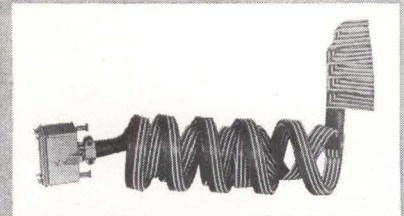

SPECTRA-FLEX CABLES®

Spectra-Flex Cables are efficiently neat, flexible, compact and easily handled. Comes in all sizes from #10 to #30 AWG. Made to your specifications, any wire with a vinyl jacket.

Write for information regarding extensible, retractable harness.

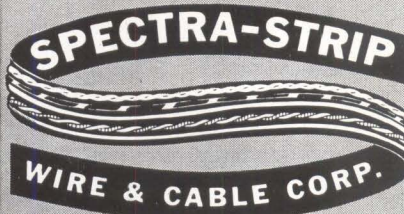

P.O. BOX 415, Tel.: 714 537-4530
TWX 714 530-0313
GARDEN GROVE, CALIF.

CIRCLE 212 ON READER SERVICE CARD
May 3, 1963 • electronics

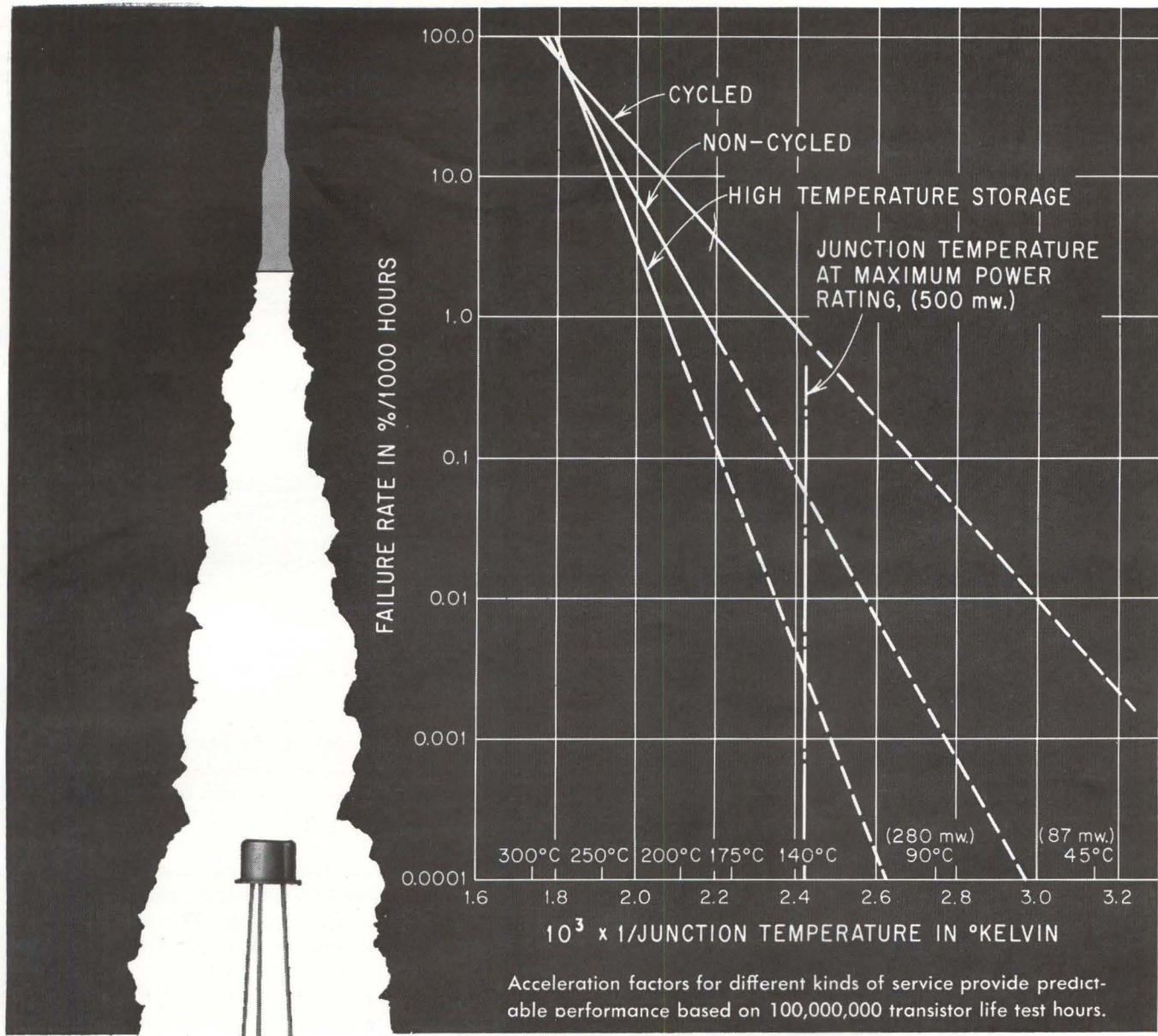

Acceleration factors for different kinds of service provide predictable performance based on 100,000,000 transistor life test hours.

General Electric transistors exceed Minuteman 99.999% reliability objective

General Electric has completed a silicon transistor reliability improvement program for the MINUTEMAN airborne guidance and control system where data on a single product has been accumulated for over 100,000,000 life test hours . . . unsurpassed in the semiconductor industry. The result is reliability without parallel. For instance, final phase testing of 4,650 G.E. MINUTEMAN transistors to approximately 24,000,000 transistor hours at 288 mw resulted in ZERO failures. The

MINUTEMAN Part transistor made by General Electric substantially exceeds the MINUTEMAN objective of an average failure rate of 0.001%/1000 hours in continuous operation at 87 mw (25°C ambient) (see graph).

You can have this kind of reliability in *your* military and commercial applications. Just check the chart for MINUTEMAN Part Numbers, similar EIA Types, and additional MINUTEMAN Types, all produced simultaneously on the same production lines and under the same exacting conditions.

For complete specifications see your G-E Semiconductor District Sales Manager, or write Section 16E151, Semiconductor Products Department, General Electric Company, Electronics Park, Syracuse, New York. In Canada: Canadian General Electric, 189 Dufferin St., Toronto, Ontario. Export: International General Electric, 159 Madison Ave., New York 16, N.Y.

| Transistor Minuteman Part No. | Silicon Transistor Description | Maximum Dissipation | V _{BE} | Nearest EIA Type No. | "Additional Minuteman Types" |
|-------------------------------|--------------------------------|---------------------|-----------------|----------------------|--|
| 551B | Unijunction | 600 mw | 60 | 2N489 | MM/2N490/M MM/2N491/M MM/2N492/M MM/2N493/M MM/2N494/M |
| 703B | Fixed-Bed Grown-diffused | 500 mw | 60 | 2N335A | MM/2N332/M MM/2N333/M MM/2N336/M |
| 801B | Grown-diffused | 250 mw | 45 | 2N337 | MM/2N338 |

* Furnished to either A, B or M MINUTEMAN level units.

GENERAL  ELECTRIC

NEW

HIGH VOLTAGE POWER SUPPLIES

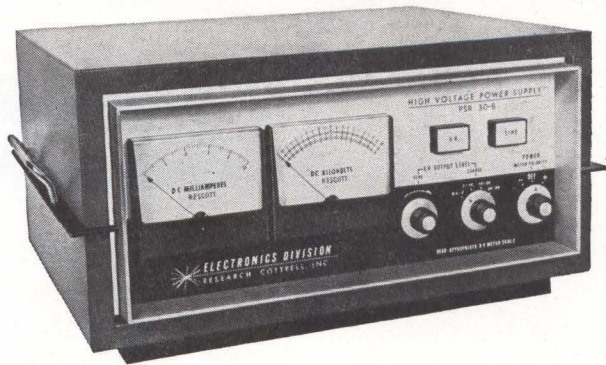

PSR Series, pictured above offer these important features: Range 5 to 30 KV, 2 to 30 MA • Regulation $\pm .05\%$ • Ripple .1% RMS • Completely Solid State Circuitry • Light Weight • Rack Height $8\frac{3}{4}$ " maximum • Dry Insulation • Overload Protection • Reversible Polarity • Simplified Controls; coarse and fine voltage, ON-OFF meter reversing switch • Triple-Range Kilovoltmeter and Milliammeter. Write for New 1963 High Voltage Bulletin.



ELECTRONICS DIVISION

RESEARCH-COTTRELL, INC., BOUND BROOK, NEW JERSEY

CIRCLE 213 ON READER SERVICE CARD

REMOTE DATA RETRIEVERS, EVENT AND DATA RECORDERS

1-1000+
EVENTS RECORDED
SIMULTANEOUSLY

HOGAN FAXimile recorders are available with up to 2000 individual styli for simultaneous recording. A wide range of stylus spacings is offered—up to 100 to the inch for high-speed facsimile, television and radar recorders and high resolution printers and plotters. Chart widths to 30" and feed rates to 50" per second.

Hogan specializes in electrolytic techniques for event, spectrum analysis, oscillograph and facsimile recording, frequency time analysis and special purpose binary and gray scale record applications. Hogan electrolytic faxpapers provide a permanent high contrast black on white record which is reproducible on most conventional office duplicators.

Whatever your recording problem may be—contact HOGAN FAXimile, a subsidiary of TELautograph Corporation, 635 Greenwich Street, New York 14, N. Y.

HOGAN FAXimile Corporation • 635 Greenwich St., New York 14, N. Y.
A SUBSIDIARY OF TELAUTOGRAPH CORPORATION

118 CIRCLE 118 ON READER SERVICE CARD

set values of currents from 0 to 7.5 ma. Model 4023 contains a voltage operated duration timer which can be set from 0 to 180 sec with time delay, before voltage charge, adjustable from 0 to 50 sec. Color coded safety probes are insulated to 15 Kv with contacts sheathed at all times by spring loading to protect operator. Aerospace Electronics, Inc., P.O. Box 48-495, Miami, Fla.

CIRCLE 320, READER SERVICE CARD

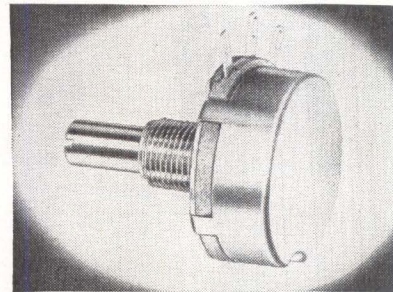

Variable Resistor Features Long Life

NEW RV4 3-w variable resistor is offered at the price of a 2-w conventional control. Carbon-ceramic resistance element of the series 320 provides excellent heat sink qualities and surpasses requirements of MIL-R-94B Characteristic Y for stability, moisture resistance and thermal cycling. The element also exceeds the wattage rating of MIL-R-94B Style RV4 by 25 to 50 percent with a full 3-w at 70 C derated to zero at 150 C. Resistance range is 250 ohms through 2.5 megohms, linear taper. CTS of Berne, Inc., Berne, Ind. (321)

B-W Oscillator Can Be Ambient Cooled

FEATURED in the SYB-4403 backward wave oscillator is a novel packaging which makes external cooling unnecessary. Tube is tunable over the 2.0 Gc to 4.0 Gc range, with a power output of 100 mw, and a power variation of less than 2 db from a straight line. It contains a control electrode to facilitate low-voltage pulsed or amplitude modulation. Unit is used in test equipment and as a local oscillator for frequency-diversity systems. Sylvania Electric Products Inc., Williamsport, Pa. (322)

May 3, 1963 • electronics

-10db/decade

LOG VOLTMETER - CONVERTER

70 db RANGE 0.2 db ACCURACY

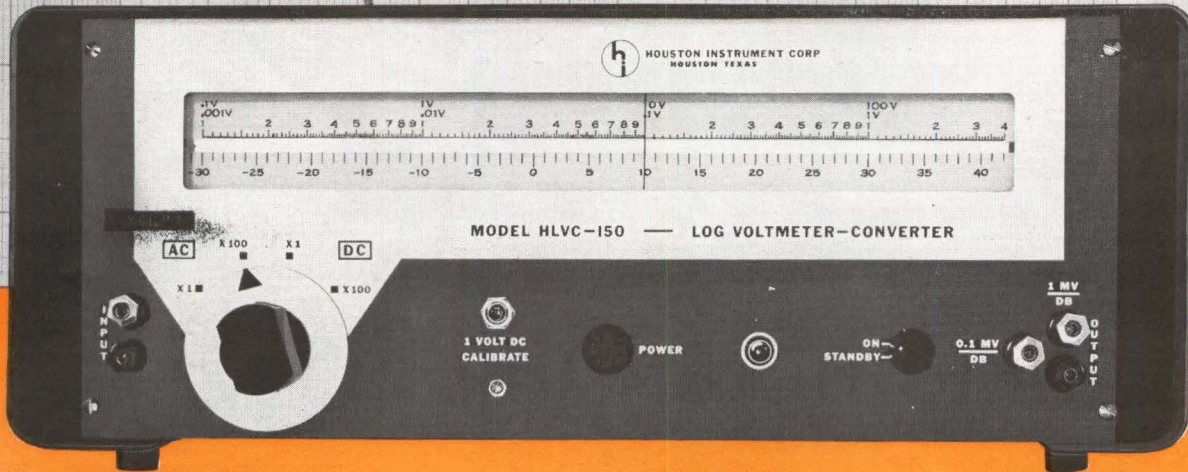

NEW DESIGN PRINCIPLE PERMITS MEASUREMENTS ACCURATE TO 0.2 db OF AC OR DC VOLTAGES OR VOLTAGE RATIOS ON TRUE LOGARITHMIC SCALE OVER 3160:1 OR 70 db CONTINUOUS RANGE

DC OUTPUT FOR RECORDING 60 db/sec SLEWING SPEED MODEL HLVC150 \$1450.



houston instrument corporation

4950 Terminal Avenue / Bellaire 101, Texas

MOhawk 7-7403 / Cable HOINCO

TWX 713-571-2063

Write for 8-page Brochure

CIRCLE 214 ON READER SERVICE CARD

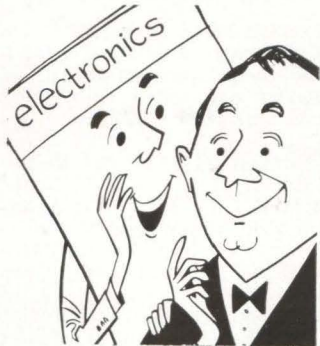

electronics
IS EDITED
TO KEEP YOU
FULLY INFORMED
— a "well-rounded"
engineer

What's your *present* job in electronics? Do you work on computers? (**electronics** ran 158 articles on computers between July, 1961 and June, 1962!) Are you in semi-conductors? (For the same period, **electronics** had 99 articles, not including transistors, solid-state physics, diodes, crystals, etc.) Are you in military electronics? (**electronics** had 179 articles, not including those on aircraft, missiles, radar, etc.)

In all, **electronics'** 28-man editorial staff provided more than 3,000 editorial pages to keep you abreast of all the technical developments in the industry. No matter where you work today or in which job function(s), **electronics** will keep you fully informed. Subscribe today via the Reader Service Card in this issue. Only 7½ cents a copy at the 3 year rate.

electronics

electronics • May 3, 1963



*Induction Heating's Most
Trusted and Creative
Craftsmen Since 1926*

High Frequency INDUCTION HEATING UNITS

for

- BRAZING
- MELTING
- SOLDERING
- ZONE REFINING
- HEAT TREATING
- CRYSTAL GROWING
- BOMBARDING
- PLASMA TORCH

ELECTRONIC TUBE GENERATORS

*Kilocycle Frequency Units
Megacycle Frequency Units
Dual Frequency Units*

- SPARK GAP CONVERTERS
- ACCESSORY EQUIPMENT

FREE APPLICATION ENGINEERING SERVICE—Our engineers will process your work samples and submit recommendations.

WRITE FOR NEW LEPEL CATALOG
Lepel HIGH FREQUENCY LABORATORIES, INC.

55th St. & 37th Ave., Woodside 77, N.Y.C.
Chicago Office for Sales & Service: 6246 W. NORTH AVE.

CIRCLE 119 ON READER SERVICE CARD 119



OFFERS THE WIDEST RANGE OF RESISTANCE VALUES

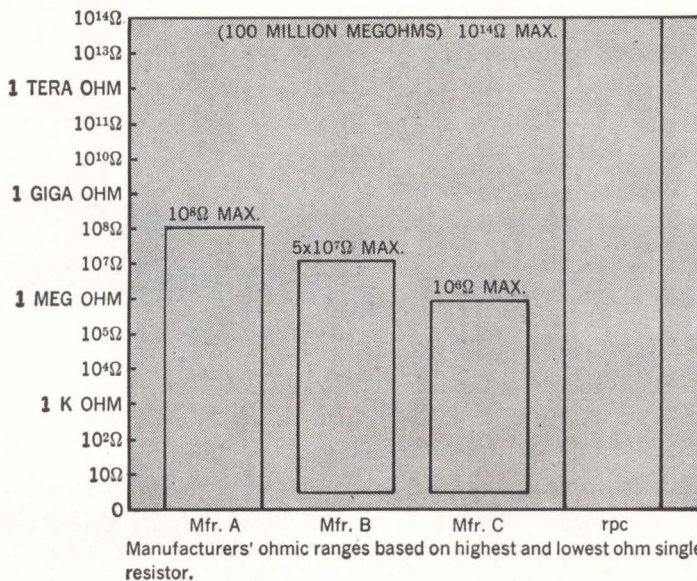

WIREWOUND RESISTORS DRIFT ONLY 25 PPM IN 3 YEARS

(If applicable to your needs)

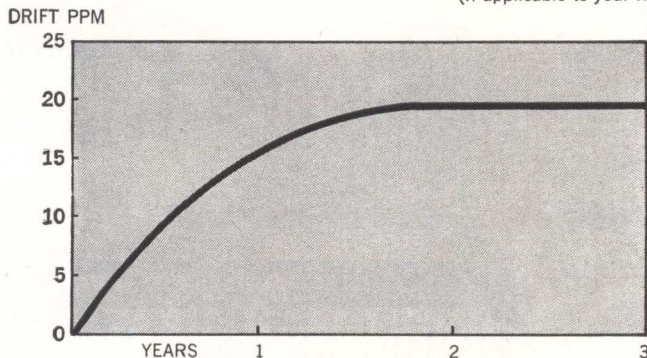

Drift in PPM. Resistors stored and measured at room temperature without the use of controlled atmosphere.

In addition to brilliant performance and outstanding reliability, RPC offers you a wide choice of quality resistors and a highly competent engineering department that can help you solve sticky problems involving resistance.

- PRECISION WIRE WOUND
- CARBON FILM
- PRECISION METAL FILM
- RESISTANCE NETWORKS



Resistance Products Co.

914 S. 13th Street, Harrisburg, Pa.

Literature of the Week

BEARINGLESS TACHOMETER GENERATOR Vibrac Corp., Route 129, Alpha Industrial Park, Chelmsford, Mass. A 4-page brochure describes an inexpensive means to precise measurement of shaft speeds. CIRCLE 323, READER SERVICE CARD

POWER SUPPLIES Kepco Inc., 131-38 Sanford Ave., Flushing 52, N. Y. Catalog B-631 provides a convenient guide to the selection of a wide variety of high-reliability, d-c regulated power supplies. (324)

LASER MICROPROBE Jarrell-Ash, 26 Farwell St., Newtonville, Mass. Preliminary bulletin 45-600 describes an optical ruby laser for exciting spectral emission from analytical samples. (325)

WIRES AND CABLES Standard Wire and Cable Co., 3440 Overland Ave., Los Angeles 34, Calif. Publication entitled "Comparison Chart" shows major characteristics of aircraft and electronic wires and cables covered by military specifications. Copies are available upon letterhead request.

HIGH-SPEED PRINTER Potter Instrument Co., Inc., 151 Sunnyside Blvd., Plainview, L. I., N. Y. Product data sheet 3-206 describes a high-speed militarized printer. (326)

ULTRAPURE ELEMENTS L. Light & Co. Ltd., Colnbrook, Bucks, England. Over 700 forms and compounds of 84 elements are listed in catalog M-4 now available. (327)

WIRE AND CABLE INSULATIONS Radiation Materials Inc., 36-32 37th St., Long Island City 1, N. Y. A 20-page catalog describes the company's irradiated polyolefin wire and cable insulations. (328)

ELECTRON TUBES General Electric Co., Owensboro, Ky. A 16-page booklet contains details of 22 recent developments in Compactrons, receiving tubes, ceramic tubes, photoconductive cells, and reed switches. (329)

POWER WIREWOUND RESISTORS International Resistance Co., 401 N. Broad St., Philadelphia 8, Pa. High temperature power wirewound resistors featuring fireproof construction are described in bulletin P-7b. (330)

R-F INDUCTORS Nytronics, Inc., 550 Springfield Ave., Berkeley Heights, N. J. Ultrareliable shielded subminiature r-f inductors with inductances from 0.1 μh to 180,000 μh in 76 values are offered in a catalog sheet. (331)

MILITARY COMPONENTS Ohmite Mfg. Co., 3640 Howard St., Skokie, Ill. Catalog of military components (50C) contains information on new rheostats and resistor styles and expanded listings of hat shape tantalum slug capacitors. (332)

PROTECTIVE COATING Columbia Technical Corp., 24-30 Brooklyn-Queens Expressway West, Woodside 77, N. Y., offers a data sheet on Humi-Seal type 1B23, a fast drying coil dope for applications over a wide range of frequencies. (333)

PREAMPLIFIERS Brush Instruments, division of Clevite Corp., 37th and Perkins, Cleveland 14, O. Five data sheets describe the 4200 series of interchangeable solid-state preamplifiers for use with oscillograph recording systems. (334)

FIXED DELAY LINE Helipot Division of Beckman Instruments, Inc., 2500 Harbor Blvd., Fullerton, Calif., has available data sheet 63437 on a miniature fixed delay line. (335)

EXTRUSIONS Mideast Aluminum Corp., U. S. 130, Dayton, N. J. Brochure describes the company and its services for the extrusion of shapes for the electronic and electrical industries. (336)

PRINTED CIRCUIT PROTOTYPES Rowe, Inc., 68 Union Ave., Clifton, N. J. Brochure describes the company's special facilities for printed circuit prototype development and short run production. (337)

TELEGRAPH REKEYER Ortronix Inc., P.O. Drawer 8217, Orlando, Fla., offers a short form catalog on a transistorized, solid state telegraph rekeyer that is a 10th the size of conventional vacuum tube types. (338)

D-C FEEDBACK AMPLIFIER Airpax Electronics Inc., Cambridge, Md. Part 2 in the series of chopper articles describes d-c feedback amplifiers and their utilization of micro-midget electromechanical choppers. (339)

TUNNEL DIODE AMPLIFIERS Aertech, 1074 Alma, Mountain View, Calif. A technical data sheet describes S-band and C-band low noise, high gain tunnel diode amplifiers. (340)

PRECISION MOLDINGS Gries Reproducer Corp., 400 Beechwood Ave., New Rochelle, N. Y. Brochure 1018 describes the design advantages of automatically-molded small precision thermoplastic parts. (341)

X-Y RECORDER Varian Associates, 611 Hansen Way, Palo Alto, Calif. The all-transistor model F-80 X-Y recorder is illustrated and described in a new folder. (342)

LINE FAULT ANALYZER Sierra Electronic Division of Philco, 3839A Bohannon Drive, Menlo Park, Calif. Model 371A line fault analyzer with its 200 mile ranging capability is covered in a 4-page folder. (343)

DEFLECTION YOKE Constantine Engineering Laboratories Co., Mahwah, N. J. Celco bulletin Y18 details technical information concerning a new deflection yoke for direct display storage tubes. (344)

DIGITAL DELAY LINES Microsonics, Inc., 60 Winter St., Weymouth 88, Mass., has published a bulletin dealing with digital delay lines. (345)

electronics • May 3, 1963

SHRINKS DOWN 1/2

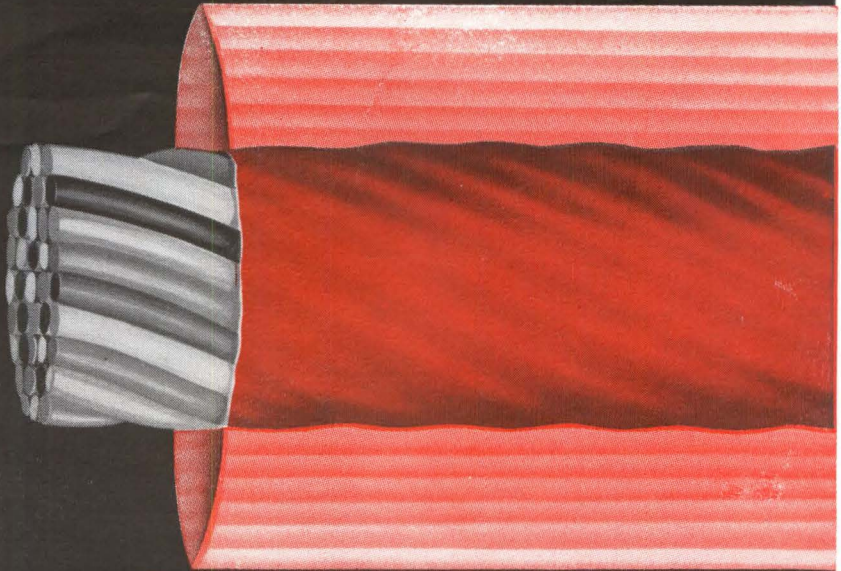

**7
SECONDS
TO
YOUR
JACKETED
CABLE**

**WITH
ALPHLEX®**

FIT™
SHRINKABLE
TUBING
WITH CONTROLLED SHRINKAGE

Alphlex FIT-105 Tubing with "controlled shrinkage" is an economical, easy-to-use, irradiated PVC tubing that provides a snug, extremely flexible cable covering.

Cable cores may be pulled through FIT-105 Tubing with ease and shrunk down to form a jacket with all the qualities of the finest extruded plastic jackets. The tubing is supplied in expanded form and in continuous lengths and shrinks 50% upon application of heat (325°F). Heat may be applied through the use of the Alpha Heat Gun, or other heat sources. FIT-105 conforms to MIL-I-631C (105°C).

FIT-105 Tubing is available at your local electronics distributor in 14 sizes ranging from 3/64" to 4" I.D. before shrinking.

Write for your FREE Alphlex Catalog AT-63 describing the industry's most complete tubing line.



**ALPHA WIRE
CORPORATION**

Subsidiary of LORAL Electronics Corporation
200 Varick Street, New York 14, N. Y.
PACIFIC DIVISION:
11844 Mississippi Ave., Los Angeles 25, Calif.

CIRCLE 121 ON READER SERVICE CARD

121

H-P To Build \$2-Million Plant

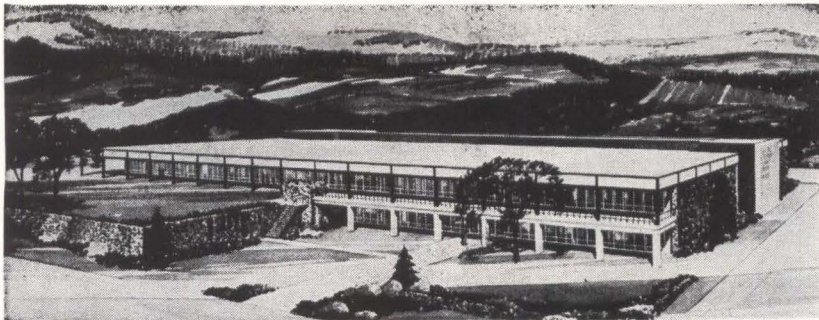

DAVID PACKARD, president of Hewlett-Packard Co., has announced the company will build a new plant in Colorado Springs, Colo., for the design and manufacture of oscilloscopes.

Construction of the \$2-million plant will begin about June 15, according to Packard. He said the new facility, a single 137,500-sq-ft building on a 30-acre site, is expected to be completed within a year, and eventually employ about 650 people.

"According to our long-range plans, this building will be only the first unit of a four-building complex which will provide some 400,000 sq ft and employ more than 2,000 people," he added.

Hewlett-Packard, headquartered in Palo Alto, Calif., is one of the largest manufacturers of electronic measuring instruments. The company already has two facilities in Colorado—a 140,000-sq-ft plant in Loveland, and a 20,000-sq-ft leased plant in Colorado Springs.



McCoubrey Heads Up Varian Solid State Unit

VARIAN ASSOCIATES has announced the formation of a new Solid State

Packard pointed out that H-P has been producing oscilloscopes for only the past six years. During that time the company's oscilloscope sales have increased at an average rate of 30 percent per year.

"We anticipate that this growth will continue, and for this reason are moving as quickly as possible to expand our productive capacity," Packard said.

At present the bulk of Hewlett-Packard oscilloscopes are produced in Palo Alto, Calif. However, Packard stated that over the next 18 months the company will transfer its entire Oscilloscope division to Colorado Springs.

Hewlett-Packard and its subsidiaries now produce more than 900 different types of precision instruments which are distributed throughout the U.S. and in some 70 foreign countries. The company has a dozen manufacturing plants, including two in Western Europe. Total employment, including subsidiaries, is approximately 6,000.

Activity at its Beverly, Mass., facility.

Under the direction of Arthur McCoubrey, the new activity will be located at the Beverly site together with the Bomac division of Varian.

McCoubrey's group will take over development and production of Varactor subminiature diodes formerly produced by the Bomac division. It will also develop and introduce a new line of microwave devices useful for the generation and amplification of microwave energy, and for other purposes. The group will function as a unit of Varian's

Microwave Tube Group, reporting to group vice president Emmet G. Cameron.

McCoubrey has been with Varian since 1960.

Piland Takes Over Key NASA Post

ROBERT R. GILRUTH, director of NASA's Manned Spacecraft Center, Houston, Texas, has named Robert O. Piland to be acting manager of the Apollo program, with the additional responsibility as chief, Command and Service Module.

Piland was formerly chief, Lunar Excursion Module, and is being replaced in that position by James Decker.



General Capacitor Elects Bieseke

R. L. BIESEKE, JR., formerly manager of operations of the Palo Alto plant of the Clevite Corp., has been elected president and chief executive officer of General Capacitor Co. of Palo Alto, Calif. He has also been elected to the board of directors of the company.

General Capacitor manufactures a line of high voltage capacitors and pulse forming networks for use in high power search radars, linear accelerators, and pulsed laser applications.

Kolste Takes New Management Post

LOREN KOLSTE has been appointed manager of operations of Good-All

INSIDE



AND OUT...



The all-new CUBIC V-85 is your best buy in a 5-digit voltmeter!

The new V-85 five-digit reed relay voltmeter has more unique quality features inside and out than any other instrument. New lifetime, encapsulated, sub-miniature reed relays in the bridge switching circuit are good for more than a billion cycles of maintenance-free operation. These reed relays are virtually noiseless! The precision Julie Research Lab resistors in the bridge circuit are the best and most expensive obtainable—and they yield unparalleled accuracy.

MILITARY GRADE CIRCUIT BOARDS: Cubic uses extra thick epoxy-glass circuit boards of military grade. All etched circuits are on one side of the boards and all components on the other to simplify maintenance. For rapid repairs, a new board may be slipped into place within seconds. Boards fit into molded connectors mounted on the mother board. This construction technique is much more substantial and eliminates the mis-alignment problems common to many plug-in board designs. Extender boards are furnished to bring circuit boards out into the open to provide external test points for checking.

WITHSTANDS RUGGED ENVIRONMENTS: The V-85 offers military reliability. An independent laboratory put this new DVM through all applicable MIL SPEC environmental tests, and it passed with flying colors. If you're looking for a digital voltmeter that not only looks good on the *outside* but also gives you far superior construction on the *inside*, see the Cubic V-85 before you buy. Write for more information to Department B-143.

GUARANTEED SPECIFICATIONS

Speed: three readings a second
Sensitivity: 100 microvolt
Accuracy: .01% ± 1 digit (of reading)
Reference Stability: .005% per month;
.01% 1 year; temperature coefficient
.002%, 15°C to 45°C
Input: front and rear. Full-floating,
10 megohms at balance, 1 megohm
minimum, 1000 megohms on ratio
and low range
Balance Time: 300 msec average,
600 msec maximum
CMR: 80 db at 60 cps
Power: 40 VA, 50-400 cps, 115-230 V
Ranges: DC Volts ± 0.0001 to ± 9.9999 ,
 ± 10.000 to ± 99.999 ,
 ± 100.00 to ± 999.99 ; DC-DC Ratio
.00000 to .99999 (bi-polar)
Functions: AC, DC, Ratio, Remote
Automatic Features: Range, Polarity



CUBIC
CORPORATION
SAN DIEGO 23, CALIFORNIA
INDUSTRIAL DIVISION

OTHER OFFICES AND REPRESENTATIVES IN PRINCIPAL U. S. AND CANADIAN CITIES

new

Pat. Nos.
2,337,849
2-918-208

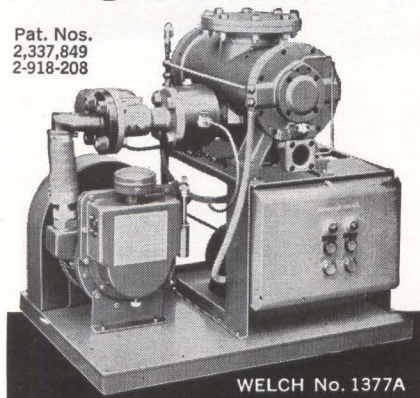

WELCH No. 1377A

Ultra High Vacuum Pumping System

140 Liters per Second Ultimate Vacuum 1×10^{-9} mm Hg (Torr)

**WITH CONSTANT SPEED
OVER WIDE PRESSURE RANGE**

The new Welch 1377A Turbo-Molecular Pumping System produces an ultimate vacuum of 1×10^{-9} mm Hg (Torr) and better; constant speed of 140 liters per second, over a range of 1×10^{-2} to 1×10^{-8} mm Hg (Torr).

The clean, *vapor-free* Turbo-Molecular Pump is combined with the well known Welch Duo-Seal 1397 two-stage mechanical pump, providing a completely assembled and tested pumping system, ready for use.

Advance design of the Turbo-Molecular Pump permits the use of an air slit ten times the size of previous designs and greatly reduces risk of damage by impact, heat expansion and dirt particles.

TYPICAL USES:

- Evacuation of power tubes and X-ray tubes.
- Solid state research.
- Semi conductor production.
- Thin film metallizing.
- Purification of metals.
- Optic coating.

The Welch 1377A is particularly useful in processes involving separation of materials or isotopes with different molecular weights, as in particle acceleration work.

Send for Bulletin 1377A
TODAY!



SINCE 1880 THE WELCH SCIENTIFIC COMPANY
foremost manufacturers of scientific equipment
1515 Sedgwick St., Dept. 906, Chicago 10, Ill.

Capacitors/TRW Electronics, Ogalala, Neb.

A member of the Good-All organization for the past eight years, Kolste had spent the past year and a half setting up the Good-All Tantulum Capacitor facility in Lawn-dale, Calif., and returns to Ogalala to assume all manufacturing, engineering and sales responsibilities for the division.

Transitron Names Division Managers

TWO major divisional appointments have been announced by Transitron Electronic Corp., Wakefield, Mass.

Roderic E. Hall, who has served as division manager-special products since 1961, has been appointed division manager-transistors.

Appointed division manager-special products was William Edgar who had previously been associated with Raytheon Company for some 15 years in semiconductor and tube departments.

Both men will report to the president.



Ford Instrument Appoints Simon

SIDNEY L. SIMON has been named vice president-engineering of Ford Instrument Company, division of Sperry Rand Corporation, Long Island City, N. Y. He was formerly chief engineer of RCA's Aerospace Communications and Controls division.

For more than 12 years, Simon was associated with the National Advisory Committee for Aeronautics (predecessor of NASA), earning promotion to chief, Physics of Solids Branch, Lewis Laboratory, Cleveland, O.

Honeywell Announces Management Changes

HONEYWELL has announced key management changes at two company divisions in the Boston area.

John W. Anderson, formerly vice president of engineering for the Electronic Data Processing division, was named general manager of the newly expanded Aeronautical division facility in Boston.

Succeeding Anderson at EDP is J. Chuan Chu who was named vice president for planning and engineering. Chu had been director of product planning for EDP.

Also, Robert J. Keeler was appointed director of engineering for the Boston Aeronautical facility. He had been head of the advanced product planning departments for both Boston and Florida operations.

Controls Company Promotes Barthell

JOHN P. BARTHELL has been appointed vice president and assistant general manager of Lake City, Inc., Crystal Lake, Ill., a subsidiary of Controls Company of America.

Prior to the promotion, Barthell served as operations manager of Controls Company's Chicago plant.

Lake City, Inc., manufactures synchronous motors, timing devices and automatic controls.

Appoint Lancaster Vice President

APPOINTMENT of Jess F. Lancaster as vice president, production, of Cooke Industries, Inc., a subsidiary of Cooke Engineering Co., Alexandria, Va., is announced. The firm was formerly known as Capital Capacitor Co. before its acquisition earlier this year by Cooke Engineering.

Lancaster was employed by the parent company for five years, engaged in planning and installation of communications equipment.

Announce Formation of New Company

A NEW FIRM, Micro-Beta Laboratories, Inc., has opened in Chicago,

and is offering prototype and consulting services in (1) radar, navigation, and communication components and systems; (2) special consumer electronic products.

In addition to these services the company manufactures a line of r-f and microwave products.

President of Micro-Beta Labs is R. B. MacAskill, and director of engineering is H. H. Sandgathe.

Fancher Assumes New Post

H. BRAINARD FANCHER, formerly general manager of General Electric's Semiconductor Products Department in Syracuse, N.Y., has been named general manager of GE's Apollo Support Department of the Command Systems Division.

His new headquarters will be in Daytona Beach, Fla.



Polytronics Labs Names Doremus

JOHN A. DOREMUS has been named chairman of the board and chief executive officer of Polytronics Laboratories, Inc., Clifton, N. J.

Before joining Polytronics, Doremus was vice president and general manager of the Westrex division of Litton Systems, Inc.

Established in 1958, Polytronics produces a complete line of citizens band communications equipment.

Beckman/Berkeley Hires Stalker

APPOINTMENT of James I. Stalker, formerly with Thompson Ramo Wooldridge, Inc., as manager of manufacturing engineering for the Berkeley division of Beckman In-

NOW from DEI

Versatile . . . Proven . . . Modular

VHF/UHF Telemetry Receiver

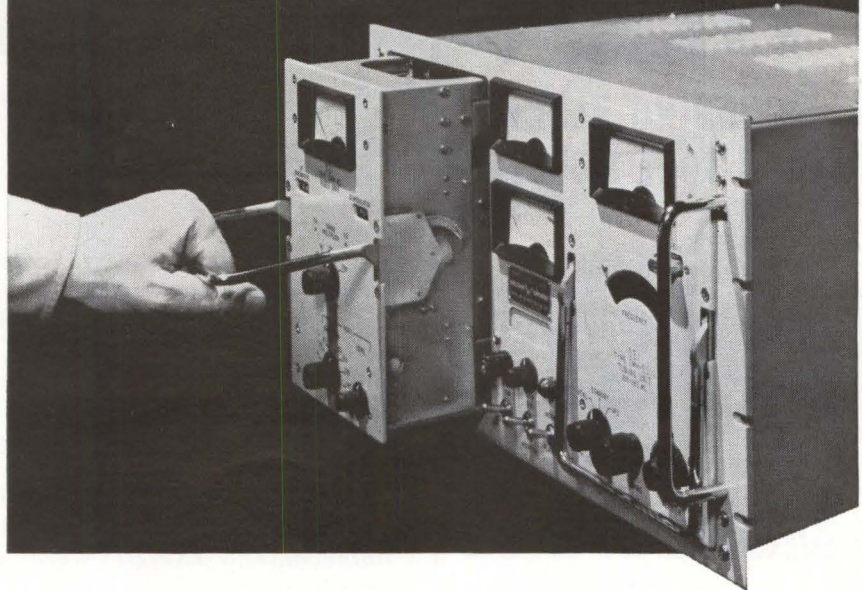

- Video Amplifier Response DC to 1 mc with Impedences Selectable 75 or 600 ohms
- AFC Optional on all RF Heads
- Multiple Bandwidth Front Panel Switchable IF Amplifiers
- Multi-Range Deviation Meter Calibrated Directly in KC

Immediately available from Defense Electronics, Inc. is the versatile, field-proven, completely-modular TMR-5A telemetry receiver.

This reliable unit will currently accept 14 plug-in tuning heads . . . 14 plug-in IF strips and six demodulators . . . any one of which can be easily removed from the receiver in seconds. Additional heads, demodulators and IF amplifiers are available upon request.

Plug-in RF heads can be instantly installed or removed from the receiver to provide the required frequency range by merely using the "single-action" pull out handle.

The video drawer also can be speedily converted by the various plug-in IF strips, ranging from 3 KC to 2.4 MC, and plug-in demodulators for FM, AM, PM and FM phase-lock applications.

This unit is particularly suitable for conical scan antenna tracking, dual diversity combining and predetection record/playback applications.

Write for DEI bulletin TMR-5A . . . or call:



DEI
SERVING
GOVERNMENT
AND INDUSTRY

Defense Electronics, Inc.

Main Office:

5455 Randolph Rd.
Rockville, Md.

Phone: WH 6-2600
TWX: 301-949-6788

Regional Office: Sherman Oaks, Calif. Phone: 873-4322

NEW!

"BUILDING BLOCK" MULTI-TONE MODULES

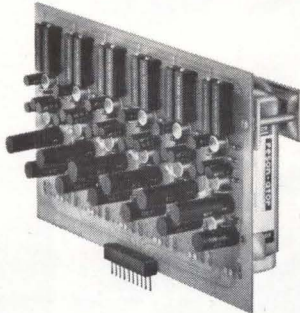

MODULTONE ENCODER

**HIGH Stability LOW Cost
SPACE-Saving**

Standard 6-tone encoder and decoder modules supplied with choice of frequencies from 67 to 1600 cps. Patented, proven RESONATORS assure superior frequency stability. Entire circuit printed . . . rugged, dependable.

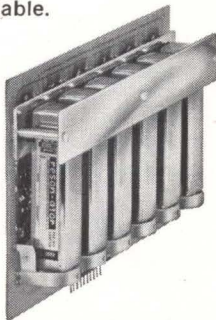

MODULTONE DECODER

WRITE for additional information
on MODULTONE encoders
and decoders.

SOL SECURITY
DEVICES
LABORATORY
ELECTRONICS DIVISION OF
SARGENT & GREENLEAF, INC.
17 Seneca Ave.
ROCHESTER 21, N.Y.

struments, Inc., Richmond, Calif., is announced. He will be responsible for manufacturing methods, engineering standards, and facilities and equipment for the division.

The Berkeley division manufactures electronic test instruments and analog computers for industrial, laboratory and space-defense applications.

PEOPLE IN BRIEF

Lothar Harzdorf, formerly with ITT Communications div. laboratories, joins Communicom, div. of Chaskin-Dimmick Corp., as chief network design scientist. **James G. Houser** promoted to director of advanced programs by Martin-Orlando. **James W. Jones** leaves Hoffman Electronics to head the Washington, D.C. office of Singer Metrics div. of The Singer Mfg. Co. **Stanley Rothman** and **Everett Stone** advance to mgr. of the special development dept. and mgr. of the satellite control dept., respectively, in the System Development Corp. Development div. **G. Graham Whipple** and **Ray C. Stiff, Jr.** move up to v-p's at Aerojet-General Corp. Motorola ups **Walter P. Czeropski, Jr.** to program mgr. of its Random Access Discrete Address program. **Torben R. Dreyer**, AMF divisional v-p in charge of Brooklyn Operations, appointed asst. group exec for mfg. of AMF's Advanced Products Group. **Edward S. Goodridge**, former president of Induction Heating Corp., has set up a technical counselling service in New York City. **Robert W. Blucke** promoted to branch mgr. of Honeywell Electronic Data Processing's New England branch. **Amperex Electronic Corp.** elevates **John Messerschmitt** to chairman, management committee, Tube div., and **Irwin Rudich** to chairman, management committee, Semiconductor and Receiving Tube div. **Paul Smith**, v-p of Esquire Radio Corp., elected to board of directors of parent company, Esquire Radio & Electronics Inc. **David B. Medved**, from GD/Astronautics to Solid State div. of Electro-Optical Systems, Inc., as mgr. of advanced concepts.

Acme Electric
Has The Solution
To Your
**POWER
SUPPLY
PROBLEM**

Acme Electric has the experience and "know-how" in developing and building Power Supplies to help you determine the practical operating parameters essential to the application.

Acme Electric engineers have developed and produced more than 1000 different Power Supply designs, ranging in capacities from 1/8 watt to 600 KW; 5 ma to 4800 amps; with voltages from 0.7 to 27000 DC. More than 43,000 complete Power Supplies were shipped from our plants in a recent 12 month period.

Custom Power Supplies are designed with regard to regulation, frequency, response, recovery time, transient disturbances, ripple noise level, isolation, temperature drift, stability and the most practical physical size consistent with the component and circuitry requirements.

If you have a power supply problem and need experienced assistance, send your specs to Acme Electric.

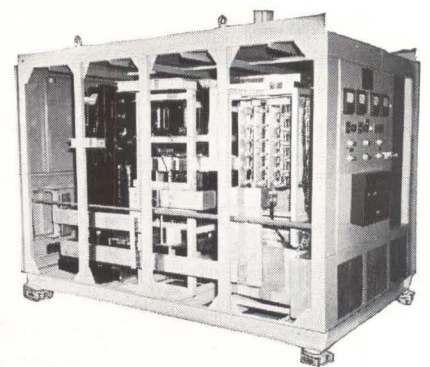

Typical construction of 600 KW, 250 volt dc power supplies designed by Acme Electric for use at Brookhaven National Laboratory. Similar units furnish the reliable power for other nuclear research installations at Cambridge, Argonne, Oak Ridge.

ACME ELECTRIC CORPORATION
315 WATER ST. SAA 3650/2087 CUBA, N.Y.
In Canada: Acme Electric Corp. Ltd., 50 Northline Rd., Toronto, Ont.

Acme Electric



**Are you a
COMPLETELY INFORMED
electronics engineer?**

Today you may be working in microwaves. But on what project will you be working tomorrow? You *could* have read **electronics** this past year and kept abreast of, say, microwave technology. *There were 96 individual microwave articles between July, 1961 and June, 1962!*

But suppose tomorrow you work in some area of standard electronic components, in semiconductors, in systems? Would you be up-to-date in these technologies? Did you read the more than 3,000 editorial pages that **electronics'** 28-man editorial staff prepared last year?

electronics is edited to keep you current *wherever* you work in the industry, *whatever* your job function(s). If you do not have your own copy of **electronics**, subscribe today via the Reader Service Card in this issue. Only 7½ cents a copy at the 3 year rate.

electronics

PRODUCT
NEWS from EPL

... for environmental extremes

HERMETICALLY SEALED

**Electro Magnetic Pickups
break temperature,
moisture barriers**

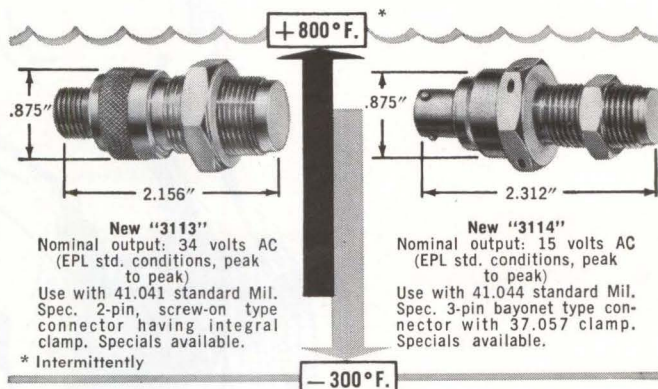

**Pickups generate voltage/frequency without contact
... link mechanical motion to instrumentation**

They actuate electronic or electrical circuitry, usually without amplification. External power supplies, mechanical linkage, bearings are not needed.

Indicate . . . angular position, linear position, motion, RPM, speed variations, sequences, vibration, etc. **Synchronize** . . . oscilloscopes, rotating machinery, etc. **Control** . . . magnetic amplifiers, solid state switching, etc. **Actuate instruments** . . . electronic counters, recorders, tachometers, servo-mechanisms, etc. **Provide data for telemetering** . . . missiles, aircraft, satellites.

Hermetically sealed, 300 series stainless steel construction gives absolute moisture protection, even when immersed. Heliarc welding, ceramic insulated coil wire and ceramic-to-metal contact pin seals insure perfect seal and dependable performance from -300°F. to +800°F. continuous . . . intermittently at more extreme temperatures.

Off-the-shelf delivery. Over 13 other standard models available. Voltage output to 450 volts. Sizes range from ½" to 2½" in length.

NEW DATA SHEET EMP-363
NEW APPLICATION IDEA GUIDE 12B
NEW DETAILED CATALOG MP-562

Literature offers 68 application ideas, characteristics, performance and selection data.

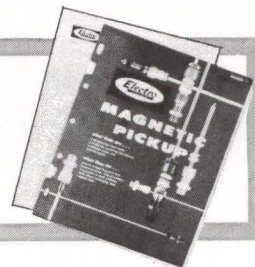

**ELECTRO PRODUCTS
LABORATORIES**

6125-F Howard, Chicago 48 (Niles), Ill.
Phone: 647-6125

3138

Canada: Atlas Instruments Ltd., Toronto

Proximity Switches • Magnetic Pickups • Pres-con Controls
Tachometers • Dynamic Micrometers • DC Power Supplies



The day when the designer selected his materials all by his lonesome is past—especially in electronics. Lots of engineers, from many departments, get into the electronics buying act with the design engineer today. Production engineers, for example, feel free to bare their fangs at any specified product they feel would snafu the production line. Procurement people growl for their freedom to respecify for the sake of better prices or delivery. Service engineers, once burned by a faulty component or subassembly, are twice shy and thrice loud about its inclusion in future equipment. And management's oxen are notoriously goreable. That's what makes electronics (marketers turn gray. The advertiser today must

reach the design engineer *and* everyone else in electronics engineering. He can do so either through a passel of splinter publications, or through electronics.

Well, that's the price of progress.

electronics is the weekly, contemporary engineering publication of the modern electronics industry. It integrates the interests of 57,000 engineers in all phases and functions of electronics—the people who pass on your products before they are bought. In a field abounding with free publications, these 57,000 engineers pay up to \$6 a year to subscribe to electronics. They need electronics. You need them. Advertise in electronics.

electronics: *your basic buy for electronics advertising* | A McGRAW-HILL PUBLICATION

330 West 42nd St., New York 36, N. Y.



electronics

WEEKLY QUALIFICATION FORM FOR POSITIONS AVAILABLE

ATTENTION: ENGINEERS, SCIENTISTS, PHYSICISTS

This Qualification Form is designed to help you advance in the electronics industry. It is unique and compact. Designed with the assistance of professional personnel management, it isolates specific experience in electronics and deals only in essential background information.

The advertisers listed here are seeking professional experience. Fill in the Qualification Form below.

STRICTLY CONFIDENTIAL

Your Qualification form will be handled as "Strictly Confidential" by ELECTRONICS. Our processing system is such that your form will be forwarded within 24 hours to the proper executives in the companies you select. You will be contacted at your home by the interested companies.

WHAT TO DO

1. Review the positions in the advertisements.
2. Select those for which you qualify.
3. Notice the key numbers.
4. Circle the corresponding key number below the Qualification Form.
5. Fill out the form completely. Please print clearly.
6. Mail to: Classified Advertising Div., ELECTRONICS, Box 12, New York 36, N. Y. (No charge, of course).

| COMPANY | SEE PAGE | KEY # |
|--|----------|-------|
| ATOMIC PERSONNEL INC. Philadelphia, Penna. | 130 | 1 |
| GENERAL DYNAMICS/ELECTRONICS A Div. of General Dynamics Corp. Rochester, New York | 131 | 2 |
| GYRODYNE COMPANY OF AMERICA INC. St. James, L. I., New York | 93* | 3 |
| LOCKHEED MISSILES & SPACE CO. Div. of Lockheed Aircraft Corp. Sunnyvale, California | 81 | 4 |
| NATIONAL SECURITY AGENCY Ft. Geo. G. Meade, Maryland | 122* | 5 |
| SCHLUMBERGER WELL SURVEYING CORP. Ridgefield, Conn. | 130 | 6 |
| UNION CARBIDE NUCLEAR COMPANY A Div. of Union Carbide Corporation Oak Ridge, Tennessee | 130 | 7 |

*These advertisements appeared in the April 26th issue.

(cut here)

electronics WEEKLY QUALIFICATION FORM FOR POSITIONS AVAILABLE

(cut here)

(Please type or print clearly. Necessary for reproduction.)

Personal Background

NAME
 HOME ADDRESS
 CITY ZONE STATE
 HOME TELEPHONE

Education

PROFESSIONAL DEGREE(S)
 MAJOR(S)
 UNIVERSITY
 DATE(S)

FIELDS OF EXPERIENCE (Please Check)

5363

- | | | |
|--|--|---------------------------------------|
| <input type="checkbox"/> Aerospace | <input type="checkbox"/> Fire Control | <input type="checkbox"/> Radar |
| <input type="checkbox"/> Antennas | <input type="checkbox"/> Human Factors | <input type="checkbox"/> Radio-TV |
| <input type="checkbox"/> ASW | <input type="checkbox"/> Infrared | <input type="checkbox"/> Simulators |
| <input type="checkbox"/> Circuits | <input type="checkbox"/> Instrumentation | <input type="checkbox"/> Solid State |
| <input type="checkbox"/> Communications | <input type="checkbox"/> Medicine | <input type="checkbox"/> Telemetry |
| <input type="checkbox"/> Components | <input type="checkbox"/> Microwave | <input type="checkbox"/> Transformers |
| <input type="checkbox"/> Computers | <input type="checkbox"/> Navigation | <input type="checkbox"/> Other |
| <input type="checkbox"/> ECM | <input type="checkbox"/> Operations Research | <input type="checkbox"/> |
| <input type="checkbox"/> Electron Tubes | <input type="checkbox"/> Optics | <input type="checkbox"/> |
| <input type="checkbox"/> Engineering Writing | <input type="checkbox"/> Packaging | <input type="checkbox"/> |

CATEGORY OF SPECIALIZATION

Please indicate number of months experience on proper lines.

| | Technical Experience (Months) | Supervisory Experience (Months) |
|-------------------------------------|-------------------------------|---------------------------------|
| RESEARCH (pure, fundamental, basic) | | |
| RESEARCH (Applied) | | |
| SYSTEMS (New Concepts) | | |
| DEVELOPMENT (Model) | | |
| DESIGN (Product) | | |
| MANUFACTURING (Product) | | |
| FIELD (Service) | | |
| SALES (Proposals & Products) | | |

CIRCLE KEY NUMBERS OF ABOVE COMPANIES' POSITIONS THAT INTEREST YOU

1 2 3 4 5 6 7 8 9 10 11 12 13 14 15 16 17 18 19 20 21 22 23 24 25

EMPLOYMENT OPPORTUNITIES



The Advertisements in this section include all employment opportunities—executive, management, technical, selling, office, skilled, manual, etc. Look in the forward section of the magazine for Additional Employment Opportunities advertising.

Positions Vacant
Positions Wanted
Part Time Work

Civil Service Opportunities
Selling Opportunities Wanted
Selling Opportunities Offered

Employment Agencies
Employment Services
Labor Bureaus

DISPLAYED

The advertising rate is \$40.17 per inch for all advertising appearing on other than a contract basis. Contract rates quoted on request.

An advertising inch is measured 3/4" vertically on a column—3 columns—30 inches to a page.

Subject to Agency Commission.

RATES

\$2.70 per line, minimum 3 lines. To figure advance payment count 5 average words as a line.

Box Numbers—counts as 1 line.

Discount of 10% if full payment is made in advance for 4 consecutive insertions.

Not subject to Agency Commission.

UNDISPLAYED

Send NEW ADS to CLASSIFIED ADV. DIV. of ELECTRONICS, P. O. Box 12, N. Y. 36, N. Y.

PROFESSIONAL SERVICES

GIBBS & HILL, Inc. Consulting Engineers

Systems Engineering
Operations Research • Development
Field Studies • Design • Procurement
Power • Transportation • Communications
Water Supply • Waste Treatment
393 Seventh Avenue New York 1, N. Y.

ELECTRONIC ENGINEERS

Our openings are for graduate electronic engineers with a minimum of 3 years' experience in industry or in a research laboratory.

The experimental projects underway in our Electronic Systems Section are concerned with solid state and digital circuitry and analog circuitry design. Military electronics experience would be useful.

Our Laboratory is located in a small Connecticut town about 50 miles northeast of New York City. The facilities at the Laboratory are extensive and modern. Working conditions and fringe benefits are consistent with the highest industrial standards.

Please send brief resume to

Mr. H. F. Schwede

SCHLUMBERGER WELL SURVEYING CORP.

P. O. Box 307

Ridgefield, Connecticut

INSTRUMENT TECHNICIANS THE OAK RIDGE NATIONAL LABORATORY Operated by UNION CARBIDE NUCLEAR COMPANY

at
Oak Ridge, Tennessee
HAS OPENINGS FOR

highly skilled instrument technicians to work with engineers in the installation and maintenance of process control and electronic instrumentation for nuclear reactors and associated experiments. Nuclear reactor control system experience desirable but not essential.

Minimum high school education, with additional training in either the physical sciences, instrumentation, or electronics, and at least 3 years experience in installation and maintenance of complex instrumentation and control systems. Entrance rate \$3.19 per hour; \$3.25 per hour after six months. Reasonable interview and relocation expenses paid by the Company.

Excellent Working Conditions
and

Employee Benefit Plans
An Equal Opportunity Employer

Send detailed resume to:

Central Employment Office

UNION CARBIDE NUCLEAR COMPANY

A Division of Union Carbide Corporation
Post Office Box M Oak Ridge, Tennessee

WANTED

Ingenious and Ambitious Engineers and Scientists

To form the technical nucleus of a new industrial applied research laboratory. Positions are available for Inorganic Chemists, Physical Chemists, Solid-State Physicists, Electrical Engineers. Opportunities and advantages are:

- 1) Freedom to initiate areas of investigation
- 2) Responsibility for technical programs
- 3) Top salaries for qualified people
- 4) Northern New Jersey location

CALL COLLECT

(201)—HU 5-2100, Ask for Dr. Kaufman



E. E.'s

for FEE-PAID Positions
WRITE US FIRST!

Use our confidential application for professional, individualized service . . . a complete national technical employment agency.

ATOMIC PERSONNEL, INC.
Suite 1207L, 1518 Walnut St., Phila. 2, Pa.

FOR MORE INFORMATION

about Classified Advertising

contact the McGraw-Hill office nearest you.

ATLANTA, 9 I. Hill
1375 Peachtree St., N.E.

TRinity 5-0523

BOSTON, 16

Copley Square
CHICAGO, 11 W. J. Higgins
645 No. Michigan Avenue

Congress 2-1160

MOhawk 4-5800

CLEVELAND, 13 E. Hughes

1164 Illuminating Bldg.

SUPERior 1-7000

DALLAS, 2 F. LeBeau

1712 Commerce St., Vaughn Bldg.

RIVERSide 7-9721

DENVER, 2 J. Patten

1700 Broadway, Tower Bldg.

ALPine 5-2981

DETROIT, 26

856 Penobscot Bldg.

WOODward 2-1793

HOUSTON, 25 J. Page

Prudential Bldg., Room W-724 Holcombe Blvd.

RIVERSide 8-1280

LOS ANGELES, 17 R. McGinnis

1125 W. 6th Street

HUNTley 2-5450

NEW YORK, 36 H. T. Buchanan

D. Hawksby

LONGacre 4-3000

PHILADELPHIA, 3 Wm. B. Sullivan

R. Lewis

Six Penn Center Plaza

LOCust 8-4330

PITTSBURGH, 22

4 Gateway Center

EXPress 1-1314

ST. LOUIS, 3 J. Crowe

7751 Carondelet Avenue

PARKview 5-7285

SAN FRANCISCO, 11 J. A. Hartley

255 California Street

DOUGlas 2-4600

SEARCHLIGHT SECTION

(Classified Advertising)

BUSINESS OPPORTUNITIES

EQUIPMENT - USED or RESALE

DISPLAYED RATE

The advertising rate is \$27.25 per inch for all advertising appearing on other than a contract basis. Contract rates quoted on request. AN ADVERTISING INCH is measured 3/4 inch vertically on one column, 3 columns—30 inches—to a page. EQUIPMENT WANTED or FOR SALE ADVERTISEMENTS acceptable only in Displayed Style.

UNDISPLAYED RATE

\$2.70 a line, minimum 3 lines. To figure advance payment count 5 average words as a line.

PROPOSALS, \$2.70 a line an insertion.

BOX NUMBERS count as one line additional in undisplayed ads.

DISCOUNT OF 10% if full payment is made in advance for four consecutive insertions of undisplayed ads (not including proposals).

RADIO RESEARCH INSTRUMENT CO.

AUTO-TRACK & TELEMETRY ANTENNA PEDESTALS
3 & 10 CM. SCR. 584 AUTOTRACK RADARS
AN/TPS-10 SEARCH. AN/TPS-10 HT. FINDERS
AN/FPM-32GCA. AN/APS-10 NAVIG. & WEATHER.
AN/APS-15B PRECISION. AN/APS-38B PRECISION.
AN/APS-31A SEARCH. DOZENS MORE.
5-1/2 MEGAWATT HIGH POWER PULSERS.

RADIO RESEARCH INSTRUMENT CO.
550 Fifth Ave., New York Judson 6-4691

RADAR SYSTEMS & COMPONENTS/ IMMEDIATE DELIVERY

CIRCLE 950 ON READER SERVICE CARD

5 BAR GENERATOR \$4.95!



Telephone type generator with 90 volt output. Will ring standard telephone bell. Good experimental item. Write for free list. Shipments FOB Simpson, Pa.

TELEPHONE ENGINEERING CO.
Dept. E-533, Simpson, Penna.

CIRCLE 951 ON READER SERVICE CARD

LOOKING FOR USED/SURPLUS ELECTRONIC EQUIPMENT/COMPONENTS?

For an up-to-date listing of such equipment see Searchlight Section of Dec. 14th.

IF YOU ARE OR WANT TO BE A TOP
**ELECTRONIC
DESIGN
ENGINEER**

HAVE YOU CONSIDERED THE
**UNIQUE
OPPORTUNITIES**

...At General Dynamics / Electronics in Rochester, N.Y.?

Work is in progress here on electronic equipment intended for the most advanced tactical aircraft under design. This includes the most sophisticated equipment that can be designed in the areas of airborne radar, airborne communications, navigation and fire control.

The singular advantage to the Design Engineer at General Dynamics/Electronics is the opportunity to learn at the inception stage the complete equipment — its operation, capability, circuitry — and to grow with a long range program.

Positions Are Open for Graduate EE's with Design Experience in the Following Areas:

Space communications
Telemetry receivers & transmitters
Tracking equipment
Mobile communication sets
Reconnaissance/countermeasures
Doppler systems
Data communications

Computer logic circuits
Navigation aids
USW/ASW equipment
IFF equipment
Aerospace ground equipment
RF circuitry
Advanced pulse circuitry

UNIQUE LIVING ADVANTAGES, TOO. When you come to General Dynamics/Electronics you join two professional communities — the Company and the city of Rochester, which has the largest percentage of professional people for a city of its size (500,000) in the nation. And, in many ways Rochester is an ideal spot for an engineer or scientist to live and raise a family — noted for its cultural advantages, excellent educational opportunities, friendly neighborhoods, modern hospitals, unrivaled city parks, exciting nearby historical and vacation spots.

If you would like to get in on this unique opportunity, send a resume now to Mr. R. W. Holmes, Registered Engineer, Dept. 22

GENERAL DYNAMICS | ELECTRONICS

An Equal Opportunity Employer

1400 N. GOODMAN ST., ROCHESTER 1, N. Y.

INDEX TO ADVERTISERS

| | | | | | |
|---|--------|---|-----------|---|-----|
| • AMP Incorporated | 39 | • Keithley Instruments, Inc. | 106, 107 | Thermal American Fused Quartz Co., Inc. | 74 |
| • Acme Electric Corp. | 126 | • Kepco, Inc. | 73 | • Toyo Electronics Ind., Corp. | 98 |
| • Admiral Corp. | 110 | • Kester Solder Co. | 13 | • Tung-Sol Electric, Inc. | 5 |
| • Allen-Bradley Co. | 48 | • Kinney Vacuum Div. of New York Air Brake Co. | 105 | United States Energy Corp. | 99 |
| • Allied Control Company, Inc. | 103 | • Kintel A Division of Cohu Electronics Inc. | 3rd Cover | Varian Associates | 69 |
| • Alpha Wire Corp. | 80 | • Klein & Sons, Mathias. | 14 | • Ward Leonard Electric Co. | 88 |
| • Armour Research Foundation. | 80 | • Leesona Corp. | 96 | • Welch Scientific Co., The. | 124 |
| • Amperite | 80 | • Lepel High Frequency Laboratories, Inc. | 119 | • Weston Instruments & Electronics A Division of Daystrom Inc. | 78 |
| • Ampex Corporation | 71 | • Litton Industries Electron Tube Div. | 46 | • Yellow Springs Instrument Co., Inc. | 107 |
| • Art Wire & Stamping Co. | 70 | • Lockheed Missiles & Space Co. | 81 | | |
| • Atohm Electric Inc. | 114 | • Loral Electronics Corp. | 87 | | |
| • Ballantine Laboratories, Inc. | 86 | Mallory and Co., Inc., P. R. | 94, 95 | | |
| • Barker & Williamson, Inc. | 116 | • Markem Machine Co. | 113 | | |
| • Bausch & Lomb, Inc. | 38 | • McLean Engineering Laboratories. | 32 | | |
| • Belden Manufacturing Co. | 47 | • Minneapolis-Honeywell Denver Division | 109 | | |
| • Borg Equipment Division Amphenol-Borg Electronics Corp. | 97 | • Precision Meter Division. | 17, 18 | | |
| • Bourns Inc. | 15 | • Minnesota Mining & Mfg. Co. Mincom Division | 89 | | |
| • Bulova Electronics Div. | 26 | • Mitsumi Electric Co., Ltd. | 46 | | |
| • Bussmann Mfg. Co. Div. of McGraw Edison Co. | 16 | • Moseley Co., P. L. | 67 | | |
| • Chester Cable Corp. | 98, 99 | • Motorola Military Electronics Div. | 22, 23 | | |
| • Cinch-Graphik | 85 | • NRC Equipment Co. | 90 | | |
| • Cleco Division of Reed Roller Bit Co. | 110 | • North Atlantic Industries, Inc. | 75 | | |
| • Collins Radio Co. | 101 | • Northeastern Engineering, Inc. | 70 | | |
| • Consolidated Avionics Corp. | 6 | • Northern Radio Co., Inc. | 112 | | |
| • Consolidated Electrodynamics Corp. | 36, 37 | | | | |
| • Corning Electronics Div. of Corning Glass Works. | 19 | | | | |
| • Cubic Corp. | 123 | | | | |
| Delevan Electronics Corp. | 108 | | | | |
| • Edgerton, Germeshausen & Grier Inc. | 115 | | | | |
| • Edwards High Vacuum Inc. | 114 | | | | |
| • Electro Instruments Inc. | 111 | | | | |
| • Electro Products Laboratories. | 127 | | | | |
| • Electronic Modules Corp. | 84 | | | | |
| • Electronic Research Associates, Inc. | 43 | | | | |
| • Engineered Electronics Co. | 44 | | | | |
| Flying Tiger Line. | 91 | | | | |
| General Dynamics/Electronics | 10, 11 | | | | |
| • General Electric Co. Semiconductor Products Dept. | 117 | | | | |
| • Globe Industries Inc. | 70 | | | | |
| • Hart Manufacturing Co. | 106 | | | | |
| • Hewlett-Packard Company Inside Front Cover | | | | | |
| • Hitachi, Ltd. | 100 | | | | |
| • Hogan Faximile Corp. | 118 | | | | |
| • Honeywell Denver Div. | 109 | | | | |
| • Honeywell Precision Meter Div. | 17, 18 | | | | |
| • Houston Instrument Corp. | 119 | | | | |
| • International Telephone and Telegraph Corp. Electron Tube Div. | 93 | | | | |

CLASSIFIED ADVERTISING

F. J. Eberle, Business Mgr.

EMPLOYMENT OPPORTUNITIES 130, 131 EQUIPMENT

(Used or Surplus New)

For Sale

INDEX TO CLASSIFIED ADVERTISERS

| | |
|---|-----|
| Atomic Personnel Inc. | 130 |
| General Dynamics/Electronics | 131 |
| Kaufman, Dr. | 130 |
| • Radio Research Instrument Co. | 130 |
| Schlumberger Well Surveying Corp. | 130 |
| Telephone Engineering Co. | 130 |
| Union Carbide Nuclear Company Div. of Union Carbide Corporation. | 130 |

• See advertisement in the July 25, 1962 issue of Electronics Buyers' Guide for complete line of products or services.

This Index and our Reader Service Numbers are published as a service. Every precaution is taken to make them accurate, but **electronics** assumes no responsibilities for errors or omissions.

electronics



Audit Bureau of Circulation



Associated Business Publications

Audited Paid Circulation

JAMES T. HAUPTLI

Advertising Sales Manager

BEN ANELLO

Market Services Manager

DAVID CUNNIFF

Promotion Manager

Electronics Buyers' Guide

R. S. QUINT

General Manager

RICHARD J. TOMLINSON

Business Manager

ADVERTISING REPRESENTATIVES

ATLANTA (9):

Michael H. Miller, Robert C. Johnson
1375 Peachtree St. N.E., Trinity 5-0523
(area code 404)

BOSTON (16):

William S. Hodgkinson, Donald R. Furth
McGraw-Hill Building, Copley Square,
Congress 2-1160 (area code 617)

CHICAGO (11):

Harvey W. Wernecke, Robert M. Denmead
645 North Michigan Avenue, Mohawk 4-5800
(area code 312)

CLEVELAND (13):

Paul T. Fegley
55 Public Square, Superior 1-7000
(area code 216)

DALLAS (1):

Frank Le Beau
The Vaughn Bldg., 1712 Commerce St.
Riverside 7-9721 (area code 214)

DENVER (2):

John W. Patten
Tower Bldg., 1700 Broadway,
Alpine 5-2981 (area code 303)

HOUSTON (25):

Joseph C. Page, Jr.
Prudential Bldg., Halcombe Blvd.,
Riverside 8-1280 (area code 713)

LOS ANGELES (17):

Ashley P. Hartman, John G. Zisch,
William C. Gries
1125 W. 6th St., Huntley 2-5450
(area code 213)

NEW YORK (36):

Donald H. Miller, Henry M. Shaw,
George F. Werner
500 Fifth Avenue, LO-4-3000
(area code 212)

PHILADELPHIA (3):

Warren H. Gardner, William J. Boyle
6 Penn Center Plaza, LOcust 8-4330
(area code 215)

SAN FRANCISCO (11):

Richard C. Alcorn
255 California Street, Douglas 2-4600
(area code 415)

LONDON W1:

Edwin S. Murphy Jr.
34 Dover St.

FRANKFURT/Main:

Mathiee Herfurth
85 Westendstrasse

GENEVA:

Michael R. Zeynel
2 Place du Port

TOKYO:

George Olcott,
1, Kotohiracho, Shiba, Minato-ku

Why settle for too little or pay for too much in a digital voltmeter?

...now you can get
exactly what you need at a
sensible price from KIN TEL

These eight KIN TEL instruments, plus off-the-shelf accessories, meet every known requirement for digital voltmeters. This means you no longer have to over- or under-buy. You just select the one instrument that delivers the exact degree and combination of speed, accuracy, stability, adaptability, range, and reliability your particular applications call for.

Militarized Digital Voltmeter (Model 412). Rugged, programmable, differential input. Auto ranging, displays polarity. Measures AC and \pm DC potentials between 0.001 and 999.9 volts. Accuracy is 0.01% (of reading) ± 1 digit for DC, 0.1% of full scale for AC. Designed to MIL-E-4158A. Ideal for use in automatic systems. Price, in quantities of five or more: \$10,000.

DC Digital Voltmeter (Model 864A). New! High speed, solid state, programmable, modular construction. Measures 0.000 to ± 999.9 volts to an accuracy of 0.02% of full scale $+0.01\%$ of reading ($23^{\circ}\text{C} \pm 1^{\circ}$) or 0.05% of full scale (10°C to 40°C) within approximately 0.02 second – within 0.005 second when programmed to any single range scale. Bidirectionally follows inputs changing as fast as 10 volts per second on the low range, 100 volts per second on the 100-volt range, or 1000 volts per second on the high range. Has electrical outputs for BCD, BCD excess-3, or 10-line parallel signals which are accessories. Price: From \$3180.

AC/DC Digital Voltmeter/Ratiometer (Model 551). New! First to bring you 5-readings-per-second speed with mercury-wetted relays. Full 5-digit, measures DC from 0.0000 to ± 999.99 volts to an absolute accuracy within 0.005% of full scale $+0.005\%$ of reading, AC from 30 to 10 kc between 0.0000 and 999.99 volts to an accuracy within 0.05% of full scale $+0.05\%$ of reading. Ratio accuracy is 0.005% of full scale $+0.001\%$ of reading. Adaptable without modification to fit a variety of data-logging systems. Ideal for laboratory use. Accessories include projection readout, BCD mercury-relay output, 10-line mercury-relay output, and AC converter. Price (without optional visual readout) for the basic 5-digit instrument with buffer register and auto/manual/command range: \$4150.

DC Digital Voltmeter and Ratiometer (Model 507D). Measures voltages between ± 100 microvolts and ± 1000 volts, ratios between $\pm 0.0001:1$ and $\pm 999.9:1$ with 0.01% (of reading) ± 1 digit accuracy. Accessories permit AC/DC and AC/AC ratio measurements. Stepping switches guaranteed for 2 years. Price: \$3835.

DC Digital Voltmeter (Model 501B). Four-digit, fifth-digit over-ranging. Measures DC between ± 100 microvolts and ± 1000 volts, with 0.01% (of reading) ± 1 digit accuracy. Automatic or programmable range; auto polarity. Combines the useful accuracy of a 5-digit voltmeter with the price advantage of a 4-digit voltmeter. Stepping switches guaranteed for 2 years. Price: \$2995.

DC Digital Voltmeter (Model 501BZ). Similar to Model 501B (see above). Circuit is automatically and continually calibrated against a Zener diode reference source instead of against an unsaturated mercury-cadmium standard cell. For submarine and other special environment applications. Price: \$3160.

AC/DC Digital Voltmeter (Model 502B). Gives you AC accuracy within 0.1% of reading; over-ranging on both AC and DC; automatic ranging and remote (programmable) control. Measures DC between ± 100 microvolts and ± 1000 volts, AC from 30 cps to 10 kc between 1 millivolt and 1000 volts. Five-digit readout. Stepping switches guaranteed for 2 years. Price: \$4245.

AC/DC Digital Voltmeter (Model 502BZ). Similar to the Model 502B (see above). Circuit is automatically and continually calibrated against a Zener diode reference source instead of against an unsaturated mercury-cadmium standard cell. Price: \$4410.

Write for detailed literature or a demonstration of any of these exceptional instruments. Representatives in all major cities. All prices FOB, San Diego, Calif. Additional export charge.

5725 Kearny Villa Road
San Diego 12, California
Phone 277-6700
(Area Code 714)

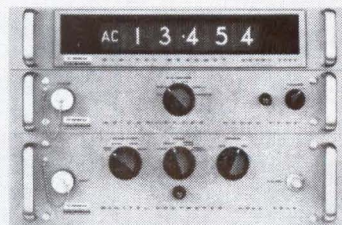
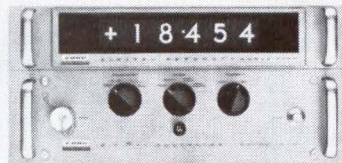
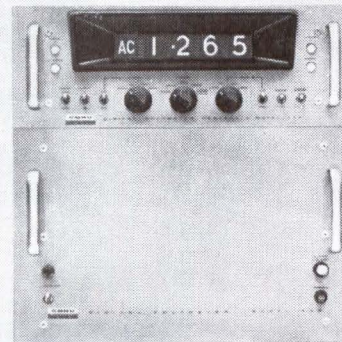

CIRCLE 901 ON READER SERVICE CARD

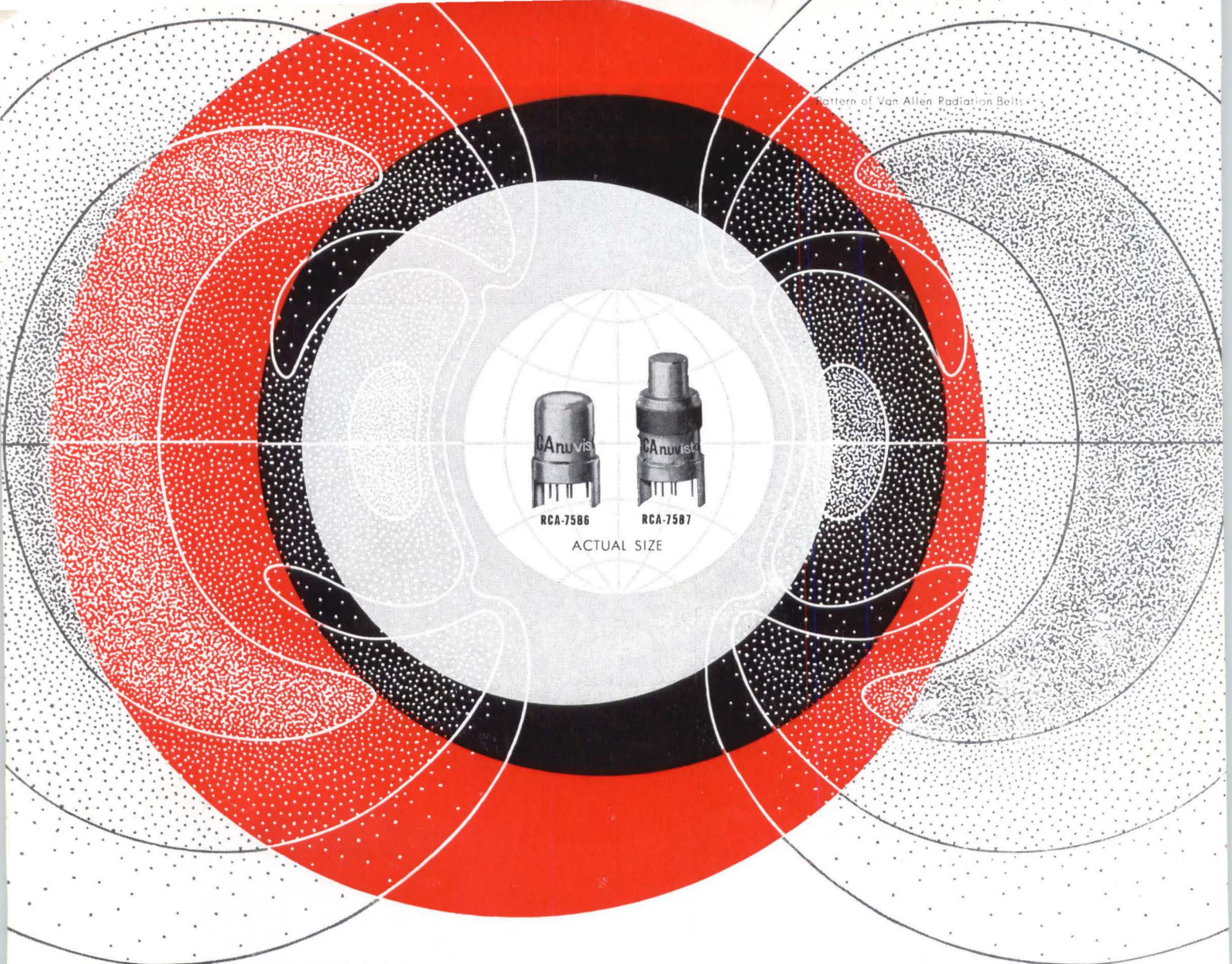

*For electronic equipment that must perform dependably
in the presence of nuclear radiation fields*

SPECIFY RCA NUVISTORS

**The RCA nuvistor is in the class of active electronic-circuit components
least susceptible to catastrophic failure from nuclear radiation.**

Tests have demonstrated the rapid recovery and dependable performance of the RCA-7586 triode and the RCA-7587 tetrode after these nuvistors were subjected to both pulse and steady-state nuclear radiation as specified in the Neutron Radiation Damage Test, Military Standard MIL-STD-446A, November 25, 1960.

Specific test exposure levels and results for commercially available nuvistors are:

Pulse Nuclear Radiation. Nuvistor types 7586 and 7587 were operated in a 15-kc amplifier circuit and monitored during exposure to pulse nuclear radiation under the following conditions: neutron flux intensity, $\cong 10^{16}$ neutrons per square centimeter per second; energy level, $\cong 2.5$ million electron volts; pulse duration, 65 microseconds; integrated total neutron flux, 2×10^{12} neutrons per square centimeter. In both the 7586 and 7587, recovery of the output signal was achieved in less than 0.5 millisecond after the end of the radiation pulse.

Steady-State Nuclear Radiation. Samples of the 7586 nuvistor tube were exposed to steady-state nuclear radiation under the following conditions: neutron flux intensity, $\cong 10^{13}$ neutrons per square centimeter per second; energy level, $\cong 1$ million electron volts; integrated total neutron flux, 10.8×10^{16} neutrons per square centimeter. After exposure, all of the 7586 nuvistor tubes remained operable and exhibited an average change in transconductance of less than one percent compared to the initial reading.

These facts, plus the already established advantages of nuvistors, are of vital importance to the designer of electronic equipment for use in the presence of nuclear-radiation fields.

Whatever your specialty in the field of electronics, it will be to your advantage to know more about nuvistors. Call the RCA Electron Tube Division Field Office nearest you for information on specific nuvistor types or write Commercial Engineering, Section E-19-DE-1, RCA Electron Tube Division, Harrison, N. J.



The Most Trusted Name in Electronics

FIELD OFFICES

EAST: 32-36 Green Street, Newark 2, New Jersey, (201) 485-3900 • **MIDWEST:** Suite 1154, Merchandise Mart Plaza, Chicago 54, Illinois, (312) 527-2900 • **WEST:** 6801 E. Washington Blvd., Los Angeles 22, Calif., (213) RAYmond 3-8361 • 1838 El Camino Real, Burlingame, Calif., (415) OXford 7-1620