

electronics[®]

PRE-DETECTION RECORDING

New approach in telemetry

SOLID STATE IN HOME APPLIANCES

Design changes coming fast

SAMPLE-AND-HOLD CIRCUIT

Improves analog-digital conversion

MULTI-EMITTER TRANSISTOR. Five squares are emitter contacts, bar in the middle is the base

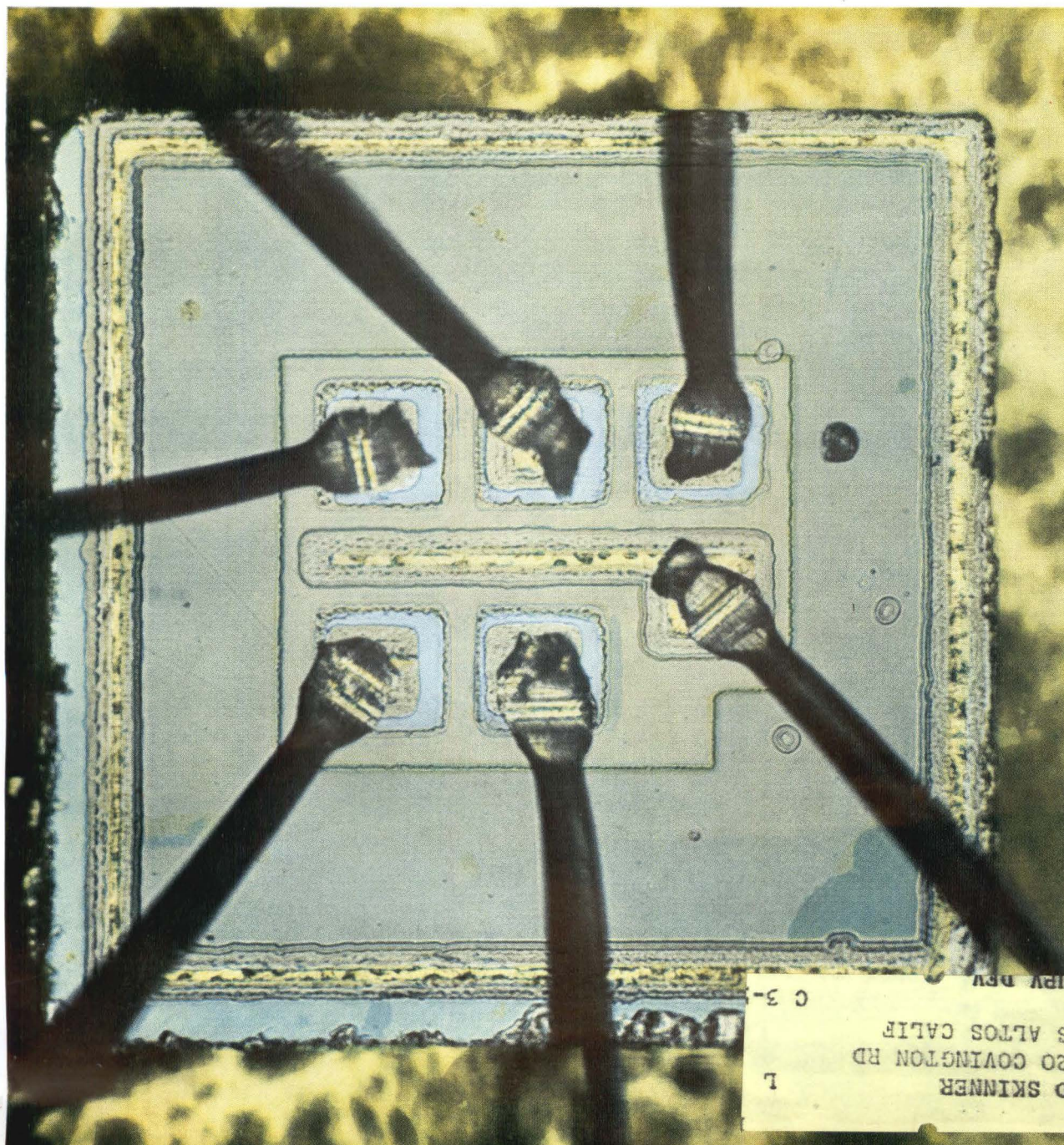



DEVELOPING NEW FRONTIERS...

(2ND IN A SERIES)

**TRANSFORMERS
INDUCTORS
TOROIDS
ELECTRIC WAVE FILTERS
HIGH Q COILS
MAGNETIC AMPLIFIERS
SATURABLE REACTORS
REFERENCE UNITS
PULSE TRANSFORMERS**

Design and application engineers with unique requirements have utilized UTC's advanced research and design capabilities for over 30 years. These engineering services are supported by the most complete manufacturing facilities for military and commercial production. Both stock and special custom built iron core components are available in long and short run quantities.

TOMORROW'S PRODUCTS—NOW at UTC!

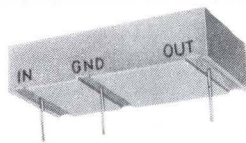

HIGH FREQUENCY LOW PASS FILTER

Zero to 700 KC within 1 db.
1.95 mc to 10 mc 40 db minimum.
Source and Load 1000 ohms.
Molded flat construction for printed circuit applications.
Size: 1 x 2 x 1/2"; Wt: 1 oz. MIL-F-18327B.

TRANSISTOR INTERSTAGE TRANSFORMER



Specially designed configuration. Molded to Grade 5 MIL-T-27B. Plug-in and weldable mounting. Primary: 20K ohms; Secondary: 1K ohms; Frequency: 400 cycles.
Size: 7/16 x 1 x 11/32" high; Wt: 0.15 ozs.

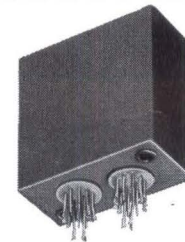

PRECISION REFERENCE TRANSFORMER

Input 14 V, 400 cycles. Twelve secondaries held to low phase shift and .1% tolerance. MIL-T-27B; Size: 1 3/4 x 2 x 1 7/8"; Wt: 4.5 oz.

LOW FREQUENCY BAND PASS FILTER

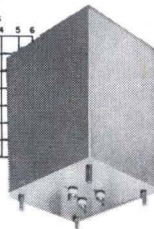
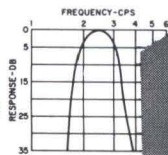

Designed for 2.5 cps center frequency. At 2 to 3 cps within 3 db. At 1.5 cps and lower, and 4 cps and higher, greater than 30 db.
Source and Load 10K ohms.
Size: 4 x 4-11/16 x 6". MA MIL case, MIL-F-18327B.

CHOPPER INPUT TRANSFORMER

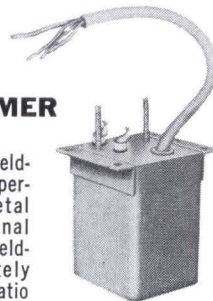

High magnetic shielding—four high permeability mu-metal shields. Exceptional electrostatic shielding, approximately 120 db. Turns ratio 1/2 primary to secondary 1 to 11. Inductance of 1/2 primary 10 Hys minimum at 100 MV—60 cps. Available in other impedance combinations.
Size: 1-11/16 x 2-1/16 x 2-3/4" high, less mounting flanges.

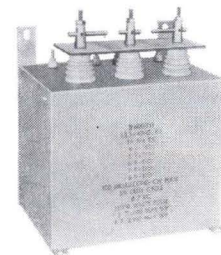

SONAR OUTPUT TRANSFORMER

36 KW pulses, 100 millisecc @ 5% duty cycle. Input 4K ohms CT, output 120-180 ohms. Hipot 29 KV. Hermetic, MIL-T-27B Grade 4. Size: 6 1/2 x 9 x 8"; Wt: 37 lbs.

...THROUGH ADVANCED RESEARCH & DESIGN

Write for catalog of over
1,200 UTC HIGH RELIABILITY
STOCK ITEMS
IMMEDIATELY AVAILABLE
from your local distributor.



UNITED TRANSFORMER CORP.

150 VARICK STREET, NEW YORK 13, N. Y.

PACIFIC MFG. DIVISION: 3630 EASTHAM DRIVE, CULVER CITY, CALIF.
EXPORT DIVISION: 13 EAST 40th STREET, NEW YORK 16, N. Y. CABLES: "ARLAB"

electronics

A MCGRAW-HILL WEEKLY 75 CENTS

W. W. MacDONALD, Editor
Telephone Area Code 212 (971-2645)

J. M. CARROLL, Managing Editor (2293)

SENIOR EDITORS
Samuel Weber (2371)
George W. Sideris (3444)

SENIOR ASSOCIATE EDITORS
Michael F. Wolff (2600)
John F. Mason (2666)

ASSOCIATE EDITORS
Michael F. Tomaino (2071)
William P. O'Brien (2297)
George J. Flynn (2188)
George V. Novotny (3151)
Leon H. Dulberger (3446)
Alexander A. McKenzie (2685)

ASSISTANT EDITORS
Stephen B. Gray (2245)
Barry A. Briskman (2306)
Dan Smith (2472)
Joel A. Strasser (2127)

REGIONAL EDITORS
Harold C. Hood,
1125 W. 6th St., Los Angeles 90017, Calif.
(213-482-5450)
Laurence D. Shergalis,
John Hancock Bldg., 255 California St.,
San Francisco 94111, Calif. (415-362-4600)
Thomas Maguire
McGraw-Hill Bldg., 607 Boylston St.,
Boston 02116, Mass. (617-262-1160)
Cletus M. Wiley,
Blair Bldg., 645 N. Michigan Ave.,
Chicago 60611, Ill. (312-664-5800)

ART DIRECTOR
Howard R. Berry (2430)

ASSISTANT ART DIRECTOR
John C. Wright, Jr. (3430)

EDITORIAL ASSISTANTS
Lorraine Rossi, Virginia T. Bastian,
Lynn Emery, Ann Mella, Lorraine Werner,
Alice M. O'Brien, Sharon Parks,
Claire Benell, Kay Fontana

FOREIGN NEWS BUREAU
DIRECTOR, John Wilhelm, (2532);
Lawrence Mihlon (2997), Alyne Elias
(2998)
LONDON—John Shinn, Derek Barlow,
Nicholas Landon, 34 Dover St., London
W.1, England
BONN—Bruce Bendow, Richard Mikton,
Silke McQueen, Mittelstrasse 39, Bad
Godesberg, Germany
BRUSSELS—27 Rue Ducarle, Brussels,
Belgium
PARIS—Robert Farrell, Arthur Erikson,
17 Ave. Matignon, 3rd Fl., Paris 8,
France
MILAN—Marc A. Messina, Via Manzoni
No. 12, Milan, Italy
MEXICO CITY—Wesley Perry, Jr.,
Lafragua 4-314, Mexico 1 D.F. Mexico
RIO DE JANEIRO—Leslie Warren, Rua
Mexico 3-S/1507 1509, Rio de Janeiro,
Brazil
MOSCOW—Stewart Ramsey,
Kutuzovsky Prospekt 19, Apt. 28-29,
Moscow, USSR
TOKYO—Richard Halloran, Charles Cohen,
John Yamaguchi, Toranomon Sangyo
Bldg., 1 Kotohiracho Shiba, Minato-Ku,
Japan

CIRCULATION MANAGER
Hugh J. Quinn (2310)

W. W. GAREY, Publisher (2016)

MULTIEMITTER TRANSISTOR (MET). This five-emitter planar transistor is formed at Plessey Ltd. by double diffusion into an *n*-type silicon substrate that forms the collector region. The base electrode is the bar that comes between the emitter electrodes. The MET is a versatile device that affords many of the advantages of integrated circuits. *For its use in logic circuit design, see p 25*

COVER

NAVY RDT&E Offers Big, Varied Market This Year. Program totaling \$1½ billion emphasizes advances wanted in antisubmarine warfare equipment, integration and automation of ship-board equipment. *Delayed release of new funds promises to unleash flood of contracts*

10

HOME APPLIANCES: New Market for Solid State. Controlled rectifiers in laundry dryers, thermistors in refrigerators set pace. *Designers are looking for efficient combinations of sensors and controls*

14

LOGIC PRINCIPLES FOR MULTIEMITTER TRANSISTORS
—The multiemitter transistor is a Darwinian link, an electronic duck-bill platypus, midway in evolution between a transistor and an integrated semiconductor circuit. Its sections can provide transistors, diodes, breakdown diodes or varistors. *Here's how to use the critter in several logic circuits—direct coupled, emitter coupled and high level.*

By P. M. Thompson, Plessey Ltd., Ilford, England 25

PREDETECTOR RECORDING: A Solution to the Telemetry Dilemma? Use of new and complex modulation schemes on test ranges creates a problem in recording data for off-line processing. The solution may be to record the i-f signal, suitably translated in frequency, on a wideband tape recorder. *A 1.5-Mc recorder can make up to seven standard channels available on ½-inch tape.*

By V. A. Ratner, Defense Electronics, Inc. 30

USING A NEW COMPONENT: Designing NRE Monostable Multivibrators. The negative-resistance element (NRE) is a composite semiconductor device with a stable S-type characteristic. It permits designing monostable multivibrators whose behavior is stable and predictable. *Three bias supplies are needed but breakdown diodes can cut the requirement to one.*

By C. D. Todd, Hughes Aircraft 34

NEW TRACK-AND-HOLD CIRCUIT Improves Analog-Digital Converter Accuracy. This circuit reduces aperture, a measure of A-D converter performance, to 100 nsec and attains 0.05-percent accuracy at 50 kc. *The circuit requires no chopper; offset errors and nonlinearities are cancelled out at the hold capacitor.*

By L. Jasper and H. K. Hail, Texas Instruments Incorporated 38

Published weekly, with Electronics Buyers' Guide as part of the subscription, by McGraw-Hill Publishing Company, Inc. Founder: James H. McGraw (1860-1948).

Title ® registered U.S. Patent Office; © copyright 1963 by McGraw-Hill Publishing Co., Inc. All rights reserved, including the right to reproduce the contents of this publication, in whole or in part.

Executive, editorial, circulation and advertising offices: McGraw-Hill Building, 330 West 42nd Street, New York, N. Y., 10036. Telephone Area Code 212 971-3333. Teletype TWX N. Y. 212-640-4646. Cable McGrawhill, N. Y. PRINTED IN ALBANY, N. Y.; second class postage paid at Albany, N. Y.

OFFICERS OF THE PUBLICATIONS DIVISION: Shelton Fisher, President; Vice Presidents: Joseph H. Allen, Operations; John R. Callahan, Editorial; Ervin E. DeGraff, Circulation; Donald C. McGraw, Jr., Advertising Sales; Angelo R. Venezian, Marketing.

OFFICERS OF THE CORPORATION: Donald C. McGraw, President; Hugh J. Kelly, Harry L. Waddell, L. Keith Goodrich, Executive Vice Presidents; John L. McGraw, Treasurer; John J. Cooke, Vice President and Secretary.

Subscriptions are solicited only from those actively engaged in the field of the publication. Position and company connection must be indicated on orders. Subscription rates: United States and Possessions and Canada, \$6.00 one year, \$9.00 two years, \$12.00 three years. All other countries \$20.00 one year. Single copies, United States and Possessions and Canada 75¢. Single copies all other countries \$1.50.

THE PUBLISHER, UPON WRITTEN REQUEST TO OUR NEW YORK OFFICE FROM ANY SUBSCRIBER, AGREES TO REFUND THAT PART OF THE SUBSCRIPTION PRICE APPLYING TO COPIES NOT YET MAILED.

Subscribers: Please send change of address notices, subscription orders or complaints to Fulfillment Manager, Electronics, at the address below. Change of address notices should provide old as well as new address, including postal zone number if any. If possible, attach address label from recent issue. Allow one month for change to become effective.

Postmaster: Please send Form 3579 to Fulfillment Manager, Electronics, P. O. Box 430, Hightstown, New Jersey, 08520.

Contents continued

ORBITING SPACE STATIONS Will serve as Electronics Labs. NASA plans to use manned satellites for development of communications satellites, propagation studies, components tests. *Three stations are under study* 42

TRIPLE NAVIGATOR To be Tested by Air Force. Stellar-Inertial-doppler system is developed for long aircraft flights. *Heart of automatic star tracker is a new digital navigation computer* 45

VALUE ENGINEERING Now the Rule. Beginning this month, value engineering clauses will be written into most defense contracts. *Contractors and the military will share in savings from cost-reduction programs—with contractors getting up to 75 percent of savings* 46

DEPARTMENTS

Crosstalk. Can We Stand Up to Mama? 5

Comment: Transistor Symbol. Fragmented Engineer 6

Electronics Newsletter. Doctors Begin Treating Patients With New Ophthalmoscope-Laser 17

Meetings Ahead. International Nonlinear Magnetics Conference 18

Washington This Week. Small Business Administration Redefines Small Business—for R&D, Over \$1 million Is Allowed 20

Research and Development. Infrared Vidicon Tube Uses New Principle 48

Components and Materials. Radioactive Source Generates Probabilities 54

Production Techniques. Sparks Shape Alnico Magnets 60

New Products. PCM System Achieves High Flexibility 65

Literature of the Week 76

People and Plants. General Radio Still Growing 78

Index to Advertisers 85



Now from Sprague!

SEPT®

SILICON PLANAR EPITAXIAL TRANSISTORS 2N2217 thru 2N2222

| TO-5 (P _D =.8W) TO-18 (P _D =.5W) | 2N2217 2N2220 | 2N2218 2N2221 | 2N2219 2N2222 |
|---|------------------|------------------|------------------|
| BV _{CBO} | 60 V (max.) | 60 V (max.) | 60 V (max.) |
| I _{CBO} @ 50V | 10nA(max.) | 10nA(max.) | 10nA(max.) |
| h _{FE} @ I _C =150 mA | 20-60 | 40-120 | 100-300 |
| V _{CE} (SAT) @ I _C =150 mA | .4 V | .4 V | .4 V |
| C _{ob} @ 10 V | 8 pF | 8 pF | 8 pF |
| f _T @ V _{CE} = 20 V I _C = 20 mA | 400mc(typ.) | 400mc(typ.) | 400mc(typ.) |

Sprague N-P-N SEPT® Transistors are designed for optimum emitter perimeter-to-area ratio, providing outstanding gain uniformity from 0.1 mA to 500 mA and f_T (typ.) of 400 mc. Sprague epitaxial techniques guarantee high BV_{CEO} (30V) and low V_{CE} (SAT) (.24 V @ 150 mA).

SEPT® TRANSISTORS FILL A WIDE RANGE OF APPLICATIONS AS SWITCHES, CORE DRIVERS, AND AMPLIFIERS!

For application engineering assistance, write to Transistor Division, Sprague Electric Co., Concord, N. H. For technical data, write for Engineering Bulletins 32,000, 32,005 and 32,010A to Technical Literature Service, Sprague Electric Co., 35 Marshall St., North Adams, Mass.

SPRAGUE COMPONENTS

TRANSISTORS
CAPACITORS
RESISTORS
MICROCIRCUITS
INTERFERENCE FILTERS

PULSE TRANSFORMERS
PIEZOELECTRIC CERAMICS
PULSE-FORMING NETWORKS
TOROIDAL INDUCTORS
ELECTRIC WAVE FILTERS

CERAMIC-BASE PRINTED NETWORKS
PACKAGED COMPONENT ASSEMBLIES
BOBBIN and TAPE WOUND MAGNETIC CORES
SILICON RECTIFIER GATE CONTROLS
FUNCTIONAL DIGITAL CIRCUITS



*Sprague' and 'Q' are registered trademarks of the Sprague Electric Co

Two reliable techniques for finding faults on cables

TRADITIONAL

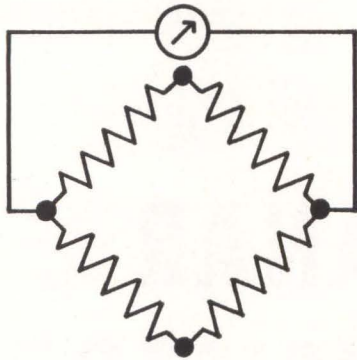

Step 1. Dispatch a field engineer to closest cable termination beyond the fault site.

Step 2. Field engineer attaches a pair of test leads to the tie point, completing a Wheatstone bridge circuit to the central station.

Step 3. Fault on cable changes resistance on one side of the bridge; an operator at the central station adjusts resistance on opposite side of circuit to balance the bridge.

Step 4. When the galvanometer reaches the zero point, the operator reads amount of resistance in ohms required to balance the bridge.

Step 5. Turning from meter to map file, he consults a table to find the gauge of cable section under test.

Step 6. Operator calculates resistance of that gauge cable in ohms-per-feet.

Step 7. Resistivity of cable in ohms-per-feet is divided into ohms resistance required to balance bridge circuit.

Step 8. Dividend equals distance in feet from tie point back to cable fault (without compensating for changes in ambient temperature and humidity which can affect performance of the bridge circuit).

For further information on this widely used technique of fault-finding, collar any power engineer who has had extensive experience on a test board.

MODERN



Step 1. Assign an operator to scan up to 30 miles of cable through a Sierra 370A Cable Fault Locator.

Step 2. See opens, shorts, or impedance variations the instant they occur; read distance to fault directly in feet from the pip on the scope.

For further information on this time and labor-saving technique of pinpointing cable faults, get in touch with Sierra Electronic Division of Philco. Ask for data on the Model 370A Cable Fault Locator. While you're at it, you might call in your nearest Sierra sales representative for a fault-finding demonstration.

SIERRA ELECTRONIC DIV.

OF
PHILCO

A SUBSIDIARY OF Ford Motor Company.

Sierra Electronic Division/3885 Bohannon Drive/Menlo Park 1, California

Can We Stand Up To Mama?

THE RELATIONSHIP between our industry and government seems like that which exists between a hardworking husband and a domineering mother-in-law. At least this is the impression we get from a recent study made by Stanford Research Institute for the Aerospace Industries Association.

According to SRI, the Relationship—and that's how it is referred to, with a capital R—is characterized by:

- *A feeling by industry that it is beset by over-regulation, conflicting regulations, close and sometimes incompetent surveillance*

- *An attitude by government officials that without close supervision industry can't be depended upon*

- *A lack of mutual confidence and respect.*

Does the hardworking son-in-law ever talk back to mama? Hardly ever, the survey says, because of the industry's great dependence on government business. And, according to George T. Hayes, under whose direction the study was made, some government people count on this submissiveness.

Among several recommendations made in the report, one seems to us to be particularly important: take steps to consolidate and present industry's point of view on critical issues, and exert constructively positive pressure on the Relationship rather than merely responding to pressures. The report is frank on why this is so urgent. It says, "Industry is usually blamed for the fact that the Relationship is not as creative, productive or satisfactory as it should be. As a consequence, industry must either assume a more assertive role in developing the rules of the Industry-Government Relationship, or see its own effectiveness continue to diminish."

Although mama holds the rolling pin through control of funds, definition of goals, and power to terminate contracts and reduce prices and profits, the study urges industry not to "dissipate its talents by devoting its entire attention to defending itself, occasionally without justification, and often ineffectively against . . . overregulation and overmanagement."

We endorse two steps suggested by SRI: (1) initiate a series of top-level industry-government policy discussions on the nature of mutual problems and their solutions and (2) organize a series of educational seminars for industry and government working-level liaison personnel to improve understanding of such policies and procedures.

Our experience has been that better communication can only improve a bad situation. In this case, it won't get mama out of the house, but it might make her easier to live with.



COMING OF AGE. Once, aerodynamic requirements dictated aircraft design. Electronic subsystems were stuck in the nooks and crannies left over. Nor did the pilot-oriented designer of World War II bombers worry about where the navigator developed blisters during long flights—Senior Associate Editor Mason recalls the times he sat on an ammunition box during a mission.

Aircraft design concepts changed as the electronics and their operators became more essential. The airframe became the vehicle for an integrated weapons system.

Now, Navy is adopting this concept for its ships. As Mason points out in a review this week of Navy RDT&E plans (p 10), a new kind of vessel, the *Sea Hawk*, will be the first built completely as a system. Ultimately, says Navy, the approach will be used on all Navy ships.

It's not that Navy wasn't on the ball. For a long time, there was plenty of extra space on a ship for electronics. Now ships pack so much electronics that space and weight are real problems—both equipment and the logistic support for the operators. So, integrated, automatic equipment will replace many individual equipments and their operators. There'll be fewer bunks and storerooms and more equipment inside. Outside, both hull and superstructure will be designed for the electronic equipment and the mission it will perform.

In time, the new Navy will look different, perform more efficiently, and be as electronic as a B-58.

Coming In Our September 20 Issue

GATLING-GUN LASER. There's a new way to get high pulse-repetition frequencies in an optical radar or communications system. Fire a number of laser crystals in sequence like a machine gun. How it's done will be described next week in a five-page feature article.

Also on tap are feature articles on nanosecond switching, a new type of voltmeter and a high-resolution, electroluminescent image amplifier.

now
available
for
immediate
delivery:

**JERROLD
RF SWEEP
EQUIPMENT
...the industry's
finest!**



**Model 900B
Super Sweep Generator**

Wide plus narrow band in one versatile instrument. Handles all IF, VHF, UHF sweep requirements. Sweep widths from 10kc to 400mc. Frequency range from 500kc to 1,200mc. Built-in crystal-controlled harmonic markers, dc or ac scope preamplifier, precision attenuator.

\$1,980.00



**Model LA-5100
rf Log Amplifier**

Accurate within ± 1 db over 80db dynamic range. Frequency range 500kc to 100mc. Lets you make exact measurements of attenuation in networks, filters, amplifiers with dynamic ranges down to 85 db. Total rf response displayed in precise log ratio on standard dc-coupled scope.

\$795.00

Model 900A Wide-Band Sweeper

Sweep widths from 100kc to 400mc. Frequency range from 500kc to 1,200mc.

\$1,260.00

Model 707 Ultra-Flat Sweeper

Flatness of ± 0.05 db in highest single octave. Plug-in oscillator heads.

\$840.00

All for immediate delivery. Prices f.o.b. Philadelphia. Write for complete technical data on these and other Jerrold rf test instruments.

**JERROLD
ELECTRONICS**

Industrial Products
Division,
Philadelphia 32, Pa.

A subsidiary of THE JERROLD CORPORATION

COMMENT

TRANSISTOR SYMBOL

Reading your *Crosstalk* article, Defeat in Venice (p 3, July 12), I could not help being reminded of "our" inches, furlongs and ounces, in addition to the incredible mess of the vacuum tube and transistor numbering systems.

An electronic symbol should indicate the electrical function of a device and not the mechanical layout as the present symbol does. I do not say that the Swedish symbol is the best in the world, but it is definitely better than the presently used one.

Adopting a standard requires a considerable sacrifice from everybody. We seldom want to do that, or when we finally decide to adopt something, usually it is too late. A few more years of indecision and lack of action, and we will also reach the point of no return with the metric system.

GEORGE PAMLENYI

Franklin Manufacturing Company
Minneapolis, Minnesota

FRAGMENTED ENGINEER

Your editorial, The Fragmented Engineer (p 3, July 19), is a maze of contradictions. The recognition of competence in any field, even including Engineering, is spontaneous and grateful. There is so little of it that its value is recognized immediately as inestimable, hence it must be put to work!

You downgrade the value of competence in assuming, in your editorial, that an engineer must be so one-sided that he cannot recognize human values. If, as you say, he is an engineer, I believe he is quite competent to delegate those functions which, to use his phrase, "would dilute his time."

Circuits be damned—it's the connections that count!

JOHN B. MOORE

J. B. Moore Laboratories, Inc.
Opa-Locka, Florida

• We did not mean that the engineer should keep to his work exclusively and stay out of public life. We are mainly pointing out that many times the demands of public life remove the competent engineer completely from his work at the most productive point of his career.

GAUSS

Nelson Cooke and I both appreciate the publicity that you gave our "Electronics and Nucleonics Dictionary" in the July 26 *Comment* (p 4).

Although your correspondent states that Webster's second gives gausses as the plural of gauss, you will be pleased to learn that your judgement in using our book as your guide has been justified; the third edition of Webster's International dictionary conforms to the style of ELECTRONICS and our dictionary by specifying that gauss is the preferred plural form.

JOHN MARKUS

McGraw-Hill Book Company
New York, New York

HALL GENERATOR

The meeting of the American Committee for TC 47, mentioned in your article on Hall-effect device standards (p 47, July 5) took place in June. A first draft was made of a United States proposal for Hall generator standards; however, Hall generators will not be on the October 1963 agenda, but will be acted on next year.

The work on Hall generator terminology and measuring methods being sponsored at NBS by the Navy Department, Bureau of Naval Weapons, has been extended to include magnetoresistive devices.

Incidentally, the Hall generator lead color code that is included in Mil-Std-681-A, is red for positive and black for negative control current leads, and blue for positive and yellow for negative Hall voltage leads. Your article gave that last color as black.

SHERWIN RUBIN

National Bureau of Standards
Washington, D. C.

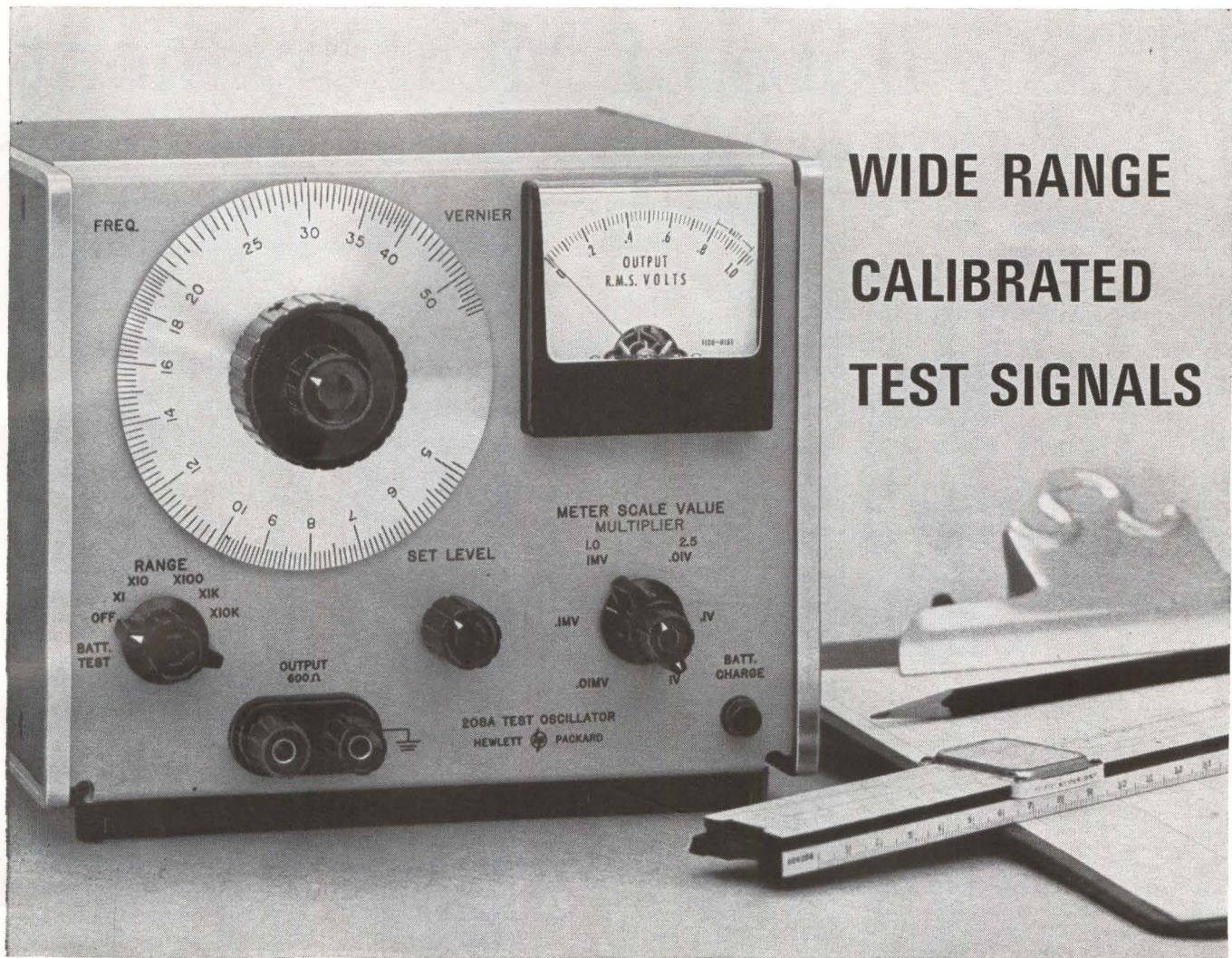

WIDE RANGE CALIBRATED TEST SIGNALS

5 cps to 560 kc, 5 μ v to 2.5 v into 600 ohms

SPECIFICATIONS

- Frequency range:** 5 cps to 560 kc, 5 ranges
- Dial:** logarithmic calibration, \pm 3% accuracy
- Frequency response:** \pm 3% into rated load
- Output:** 10 mw (nominal 2.5 v rms into 600 ohms)
- Output impedance:** 600 ohms
- Output attenuator:** 6 position, 10:1 steps from 0.01 mv to 1 v; times 2.5 multiplier gives 10:1 steps from 0.025 mv to 2.5 v
- Output monitor:** transistor voltmeter monitors level at input to attenuator and after set level
- Set level:** continuously variable attenuator with 10:1 (20 db) minimum range
- Distortion:** less than 1%
- Hum and noise:** less than 0.05%
- Power:** four rechargeable batteries (furnished), recharge during ac operation; 30 hours per charge, more than 500 recharges
- Size:** 6½" high, 7¾" wide, 8" deep, 8¼ lbs.
- Price:** hp 208A, \$525

Data subject to change without notice. Prices f.o.b. factory.

Also available: Model 208A-DB for audio, communication system testing. Model 208A-DB, same as 208A except that output is calibrated in dbm, has a 110 db attenuator calibrated in 1 and 10 db steps. Price: \$535.

New hp 208A Test Oscillator

Solid state and operated from a rechargeable battery pack or ac line, the 208A can be used anywhere to provide stable, accurate signals that are calibrated with a built-in attenuator and voltmeter. The precision attenuator adjusts the output in 20 db steps from 0.01 mv to 1 v or from 0.025 mv to 2.5 v. A metered set level control provides continuous adjustment between 20 db steps. Output is calibrated into 600 ohms, single ended.

While operation on rechargeable battery pack makes the 208A ideal for field use, battery operation is also useful in general lab work, providing isolation from power line ground to avoid hum and ground loop problems. The long-life nickel-cadmium batteries recharge automatically while the oscillator is operated from the ac line so that the 208A is always ready for portable use. Output is flat within \pm 3%; frequency stability is typically better than 5 parts in 10^4 .

This portable source of stable, wide range, calibrated test signals can save you time and trouble. Call your hp field sales office today for a trial on your bench.



HEWLETT-PACKARD COMPANY

1501 Page Mill Road, Palo Alto, Calif. 94304, (415) 326-7000. Sales and service in all principal areas. Europe, Hewlett-Packard S.A., 54 Route des Acacias, Geneva, Switzerland; Canada, Hewlett-Packard (Canada) Ltd., 8270 Mayrand St., Montreal, Que. 8636

Classic Jobs of Measurement Performed by Electro Instruments



A Foreword by
Dr. Walter East
President, Electro Instruments, Inc.

"You name it, we'll find a way to measure it," our brash engineers keep assuring me. I like their spirit, even if it has been costly to me in the way of expensive dinner bets!

It was with a measuring breakthrough that Electro Instruments was born. Our original Stepping Switch Digital Voltmeter was the first to substitute electronically driven switches for mechanical needle movement devices. It quickly proved itself an ideal instrument for speedier, more accurate, more reliable measurement—with useful applications in many industrial operations.

Since that time we have pioneered 19 other electronic "firsts."

These have led to ways of refining many older measuring systems. But, more important, they have extended the areas in which our instruments, and our systems, can serve industry.

The end result for which industry employs measurement is economy . . . be it in personnel . . . time . . . materials . . . investment. Looking through our "case histories," I ran across a number of outstanding examples of economies effected by use of Electro Instruments.

I thought we might usefully present these to industrial engineers, executives, superintendents, as ideas they might consider for their own operations.

Many readers, I appreciate, will have industrial measuring problems quite different from those cited in the examples. On this point, I think our engineers are worth re-quoting: "You name it, we'll find a way to measure it!"

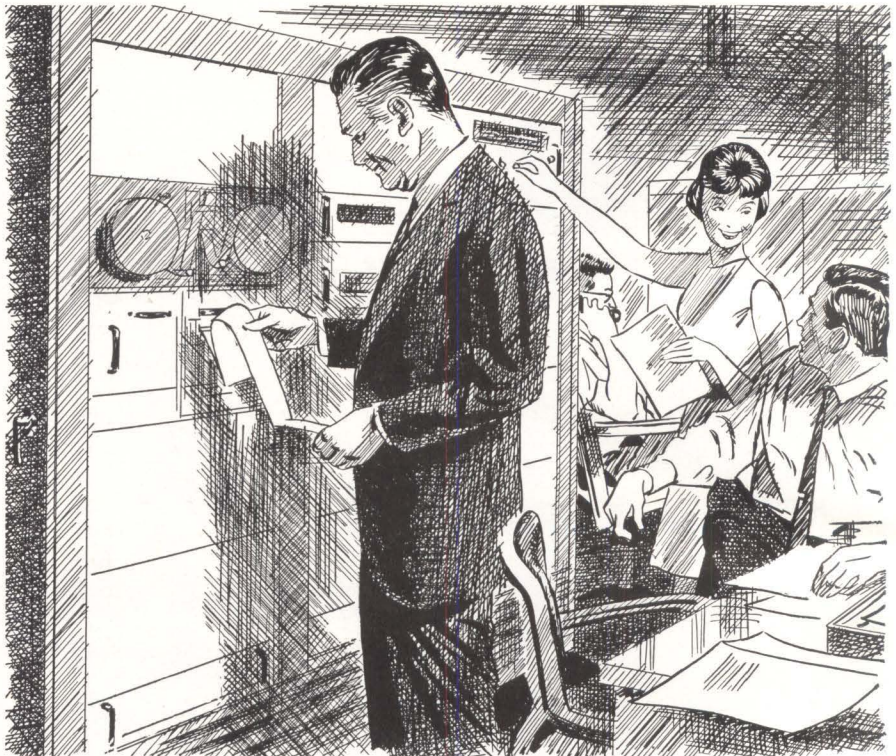

Electro Instruments' *solid state* Digital Multimeters bring greater speed, higher reliability to many jobs of measurement, and at a lower investment.



Electro Instruments offers the world's most carefully designed X-Y Recorders.

Spectra performance recorded without need for photography

In many biochemical operations, recorded profiles are necessary for accurate identification of compounds, and for purposes of quantitative assay. Used in connection with newly developed instruments capable of exciting molecules to a state of phosphorescence, Electro Instruments X-Y Recorders have proved a means of producing visual display of spectra without need for photographic equipment or processes.

500 man hour job cut to 33 1/2!

Telescoping a job that once required 500 man hours into a 33 1/2-hour operation is no mean feat! Yet a system employing an Electro Instrument Digital Multimeter accomplished just that — for one of America's major spacecraft* companies.

What was involved was the testing of printed circuit cards. Each of 1000 cards produced daily by the company had to be given 32 separate tests for quality. It took an experienced electronics technician and inspector 15 to 45 minutes per card to perform the job.

In the interest of speeding up this tedious job, experiments with an automatic electronic testing machine were begun. The eventual solution proved to be a punched tape system — designed, incidentally, by one of the company's engineers — with an Electro Instruments Digital Multimeter employed as a key parameter.

Each of the 1000 cards are now given the 32 quality tests in *less than 2 minutes*—with results being displayed at the push of a button! (*Name on request)



Electro Instruments, Inc.
8611 Balboa Avenue, San Diego 12, California

ELECTRO INTERNATIONAL, INC., ANNAPOLIS, MARYLAND • TRANSFORMER ENGINEERS, SAN GABRIEL, CALIFORNIA

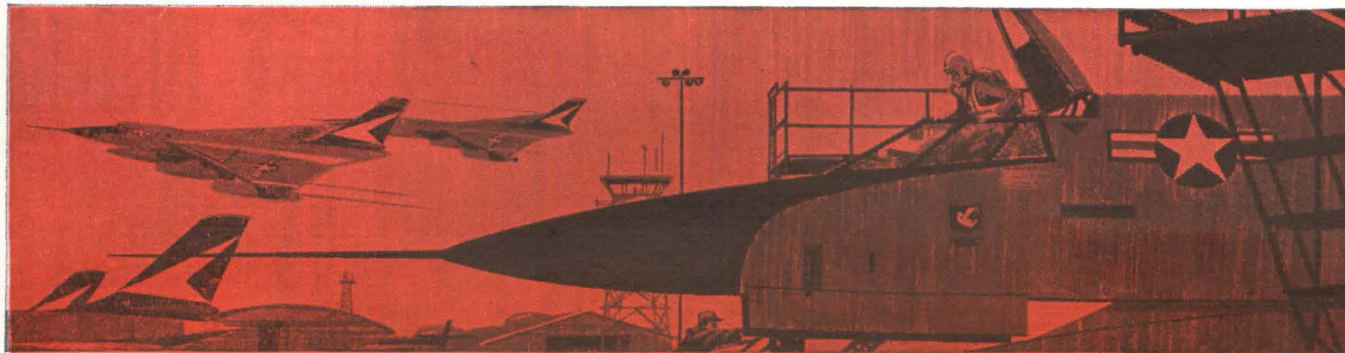

***in national defense—the words
“reliability” and “necessity” are synonymous***

■ With the Strategic Air Command at *instant readiness*, any break in communications could seriously impair its total defense capability—and possibly also our national survival. To achieve the unusually high reliability demanded in this critical military application, Electronic Communications, Inc., uses Allen-Bradley Type G controls in the airborne transmitters they build for the SAC.

In the Type G control, the solid resistance element, collector track, terminals, and insulating material are hot molded into a single, solid structure that—for all practical consideration—is indestructible. In addition, molded contact brushes are used—no sliding metal contacts. This design assures a low initial noise factor, which

actually improves with use. There's virtually infinite resolution—so control is always smooth and completely devoid of sudden changes in resistance during adjustment.

A-B Type G potentiometers are rated 0.5 watt at 70°C, and will operate reliably in ambient temperatures from -55°C to +120°C. Also, the operational life exceeds 50,000 cycles with less than 10% resistance change. They can be furnished in maximum resistance values from 100 ohms to 5 megohms. For full details on these quality controls, please write for Technical Bulletin B5201. Allen-Bradley Co., 110 W. Greenfield Ave., Milwaukee 4, Wisconsin. In Canada: Allen-Bradley Canada Ltd., Galt, Ontario.

ALLEN-BRADLEY TYPE G HOT MOLDED VARIABLE RESISTORS
Shown Actual Size

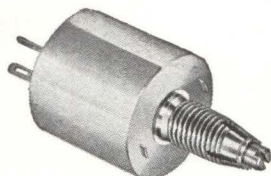

TYPE GWEL
WITH ENCAPSULATION

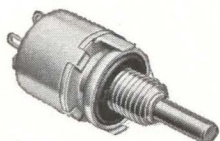

TYPE GWP AND LWP
WITH WATERTIGHT PANEL SEAL

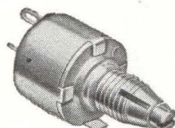

TYPE GWL AND LWL
WITH LOCKING BUSHING

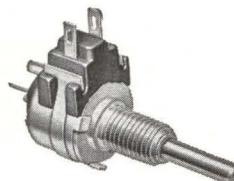

TYPE GWX
WITH LINE SWITCH

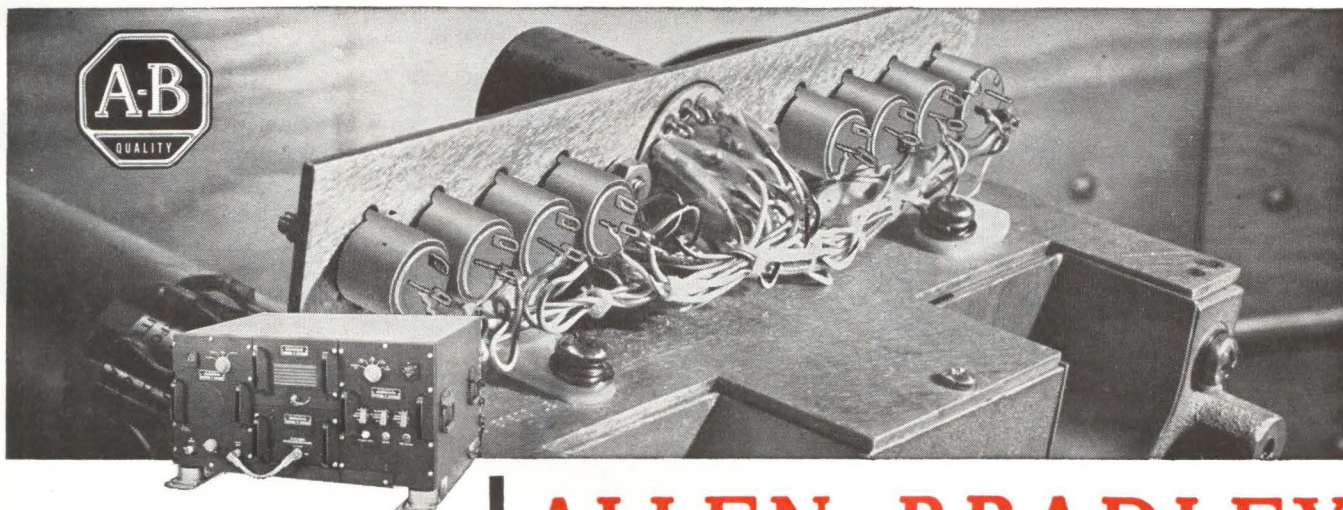

Electronic Communications' AN/ART-42 UHF 1 KW AM/FM Transmitter in service with the SAC, and internal view showing use of A-B's Type G controls.

ALLEN-BRADLEY
QUALITY ELECTRONIC COMPONENTS

Stand By for Those Navy

1964 appropriations will unleash flood of new contracts—ASW ahead

By **JOHN F. MASON**
Senior Associate Editor

WITHIN DAYS, Navy's \$1½-billion program for research, development, test, and evaluation (RDT&E) for fiscal year 1964 will be approved and ready for contractual proceedings. Not only will the market be challenging to the electronics industry's technology, but also to industry's preparedness.

Already 2½ months overdue because of other pressing matters in Congress, passage of the Defense Department appropriations bill will undoubtedly unleash a number of contracts, right off the bat, that the services have been wanting to award for a long time.

ANTISUBMARINE WARFARE—

Amply reflected again this year is the need for improved ASW equipment. More than 25 percent (\$372.9 million) of the RDT&E funds will be spent to improve our capability for detecting and destroying enemy subs, and to foil enemy techniques for detecting our own submarine fleet. Besides the great need for improved sensor techniques (described in detail in *ELECTRONICS*, p 10, Sept. 6), improvements

are needed in almost all subsystems used in ASW ships. Equally important, the subsystems will be fully integrated through computer complexes and data displays.

Although breakthroughs are hoped for, the emphasis now for combating the submarine threat is on better engineering of existing equipment. Not only in ASW, but throughout all areas of Navy development, there are stricter requirements for improved integration of equipment, reduction of weight, space, and cost, microminiaturization, self-monitoring devices, modular design, centralization of electronic control, shorter cabling, multipurpose antennas, digital computers, reliability, ease of maintenance, and reduction in personnel. Equipment that can take the place of a man is always welcome; the space and logistics required to maintain a floating barracks skyrockets cost and makes for an unwieldy operation.

SEA HAWK—An exciting project in which Navy's new integrated weapon system concept will be built and tested is the R&D ship, *Sea Hawk*. This will be the first ship built completely as a system. All subsystems will be improved: sonar and other sensors, classification techniques, weapon systems (probably *Sea Mauler*, a shipboard version of Army's surface-to-air missile), fire control, command and

control, communications, navigation—all handled by one master digital computer. *Sea Hawk* will also be equipped with a smaller version of the Naval Tactical Display System, NTDS (*ELECTRONICS*, p 30, Sept. 16, 1960).

The entire ship—hull and superstructure—will be designed for the



TEEPEE radar can detect missiles at 5,000 mile ranges, seconds after launch, by h-f ionospheric backscatter. Cro shows different patterns for missile firings and explosions

electronic equipment. Called Coordinated Ship Electronics Design (CSED), the approach has already been used on attack submarines, will be used on 10 escort ships (DE) to be built with 1964 funds, and ultimately will be used on all Navy ships.

Close attention will also be given to human engineering in both design and installation of electronic equipment for *Sea Hawk*, and for the 10 escort ships.

Preliminary testing of *Sea Hawk's* subsystems will be made on land and on board an AGDE. In 1966, work will begin on the first *Sea Hawk*, and in 1968 or 1969 on *Sea Hawk II*. Funds for the *Sea Hawk* program in 1964 amount to \$30 million.

SONAR—Development work continues on the SQS-26 sonar, and the variable-depth SQS-35. The "26"

STATUS OF RDT&E FUNDS FOR 1964

Navy will spend at least \$1,525,713,000 for research, development, test and evaluation (RDT&E) in fiscal 1964.

This is the amount now approved by the House Committee on Appropriations. It represents a cut of \$47,187,000 from Navy's original request for \$1,572,900,000. The Senate, due to take up the bill any day now, could restore some or all of the money, or it could go along with the House recommendations. Even if the money is not restored, Navy's funds for RDT&E will still be almost \$50 million more than it was in 1963.

Since reductions are slight—relatively speaking—and not yet fixed, figures used in this article are Navy's original requests

RDT&E Contracts: \$1½ Billion

mounts in the bow of the ship, has shown about twice the range of current sonars in service, and will enable ships to use bottom-reflected and convergence zone acoustic propagation paths. The "35" has shown capability to obtain ranges on subs formerly protected by thermal layers. These two sonars will

correct the present deficiencies of fleet broadcasts; 2) the ehf system will provide a short range tactical communications system with a controllable detection range; 3) Hicapcom II (high-capacity communications system) will be a small-ship version of Hicapcom; 4) the frequency-propagation-prediction sys-

communications system on a modular concept. Space and personnel requirements will be reduced, and the system must be compatible with the evolving National Military Command System (ELECTRONICS, p 20, Apr. 26).

One task of Southern Cross is Cape (communication automatic processing equipment) — a shipboard switching system that automatically designates addressees.

As the communications demand gets greater, so does interference. Techniques to reduce interference in a shipboard environment are being sought. One Navy requirement is a broadband antenna of reasonable size that covers the spectrum from vhf (10 kc) to ehf (50 Gc).



FLIPPING into vertical position is Flip (Floating Instrument Platform), an important tool for making accurate measurements of sound transmission in the ocean and for other tests important for ASW work. Total Navy spending for oceanography in 1964 will be \$106.9 million. Other government agencies will spend an additional \$82.5 million

probably go on *Sea Hawk*, and will go on the 10 DE's this year. Another sonar, the SQS-23, will be adapted for variable depth use.

Detection capabilities of the new BQQ-2 sonar are said to be improved, and tests of the system in combination with the digital fire control system of Subroc will be continued in 1964—these tests were interrupted by the loss of the *Thresher*.

Applied research is underway, with development scheduled to start next year, on a helicopter-towed sonar that will enable one helicopter to operate on missions now requiring a team of two helicopters.

COMMUNICATIONS—*Sea Hawk* will try out seven communication systems, all currently under development: 1) the naval broadcast system will provide multichannel broadcasts from vlf through h-f to

tem will determine propagation characteristics on desired frequencies; 5) the advanced communication system will provide for higher reliability; 6) the communication distribution system will provide for message distribution intraship to eliminate message delay; and 7) the central time and frequency system will provide precise time and frequency for general ship use.

With precise frequency stability and synchronization, Navy envisions locking time together over an entire ocean, thus providing frequency and time sources of a high order of accuracy.

A big effort is going into Southern Cross—a three part project to 1) integrate all shipboard communication equipments, 2) to integrate the individual smaller systems currently under development into a series of larger systems, and 3) to develop by 1970 an integrated ship

STRATEGIC OFFENSE—Work continues (\$209 million) on improving the Polaris missile. There is an undisclosed amount for an extension of Polaris referred to enigmatically as "the advanced sea-based deterrent." All that is known is that it is a mass destruction weapon with improved launching facilities, and is now in the study stage.

MISSILES—RDT&E on other missiles (\$234 million) includes the long-range air-to-air Phoenix for the TFX being built by Hughes; the Terrier, Tartar and Talos, Subroc, Asroc, Shrike, Bullpup, Sidewinder, Sparrow III, Typhon and Sea Mauler. Some \$31.5 million will be spent for guided missile exploratory development, for R&D studies, analysis and tests in such areas as guidance, fire control, warheads.

COMMAND AND CONTROL—Full development is starting in 1964 on an integrated command and control system for attack submarines. This development is the outgrowth of the Submarine Integrated Control (Subic) project. Navy also wants \$204.2 million for aircraft, \$147 million for Pacific Missile Range, and \$41.5 million for astro-nautics.

ES Product of the month: RECOVERABLE TOW TARGET

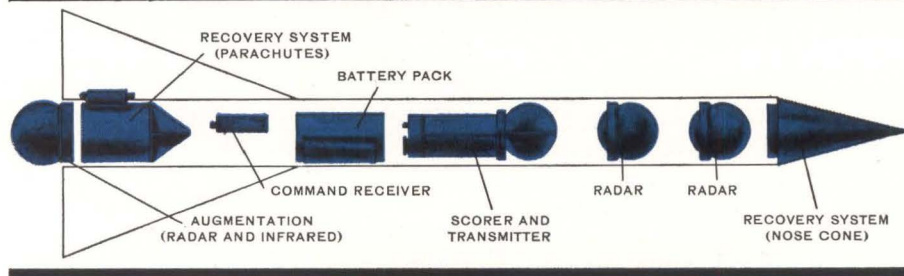

The most versatile and complete aerial tow target system in the industry—the ES-11—has just been developed by Electronic Specialty. Capable of being towed by aircraft or drone at supersonic speeds, the target is sequence-programmed upon air or ground command. The ES-11 can be recovered either by reeling into the towing vehicle or by self-contained parachute. The lightweight target system has all equipment mounted on removable trays for rapid and easy maintenance. This easy access to operating equipment permits many different missions to be accomplished by a single system merely by changing internal equipment. The ES-11 can provide both radar and infrared augmentation, and Miss Distance Indicator scoring systems may be incorporated. ECM equipment may be installed and additional power can be supplied through a wind-driven alternator. □ For complete information on the ES-11 Tow Target System, write to William Marcy, Director of Marketing, address below.

ES is a diversified, dynamic, multi-divisional organization serving defense and industry over a broad range of vital areas with advanced systems, sub-systems, and state-of-the-art components. Major contributions are currently being made in the following:

ELECTRONIC AND ELECTROMECHANICAL CONTROLS:

gyroscopes, relays, static switching devices, sensors, flashers, regulators, converters, rotary and linear actuators, motors, generators, weapon and camera controls, electromechanical assemblies for aerospace applications.

COMMUNICATIONS:

antennas, flexible and rigid waveguides, coaxial switches, diplexers, power dividers, filters, radio telescopes, solar furnaces, matching networks, antenna drive motors and controls.

POWER:

precise power systems, dynamotors, computer power sources, motor-generators, actuators, starter generators, power conversion systems, transmission towers for public utilities.

SPACE CONDITIONING:

electronically programmed environmental controls and systems for industrial, commercial, and military applications.

SYSTEMS:

Systems Laboratories conduct research, development and study programs in reconnaissance, electronic countermeasures, interferometer phased array systems, and total energy packages; integrating divisional components, sub-systems, and specialized technical skills.

For information concerning the corporate systems capability, product line, or research and development programs, write to the Director of Marketing, address below.



ELECTRONIC SPECIALTY CO.

5121 San Fernando Road • Los Angeles 39, California

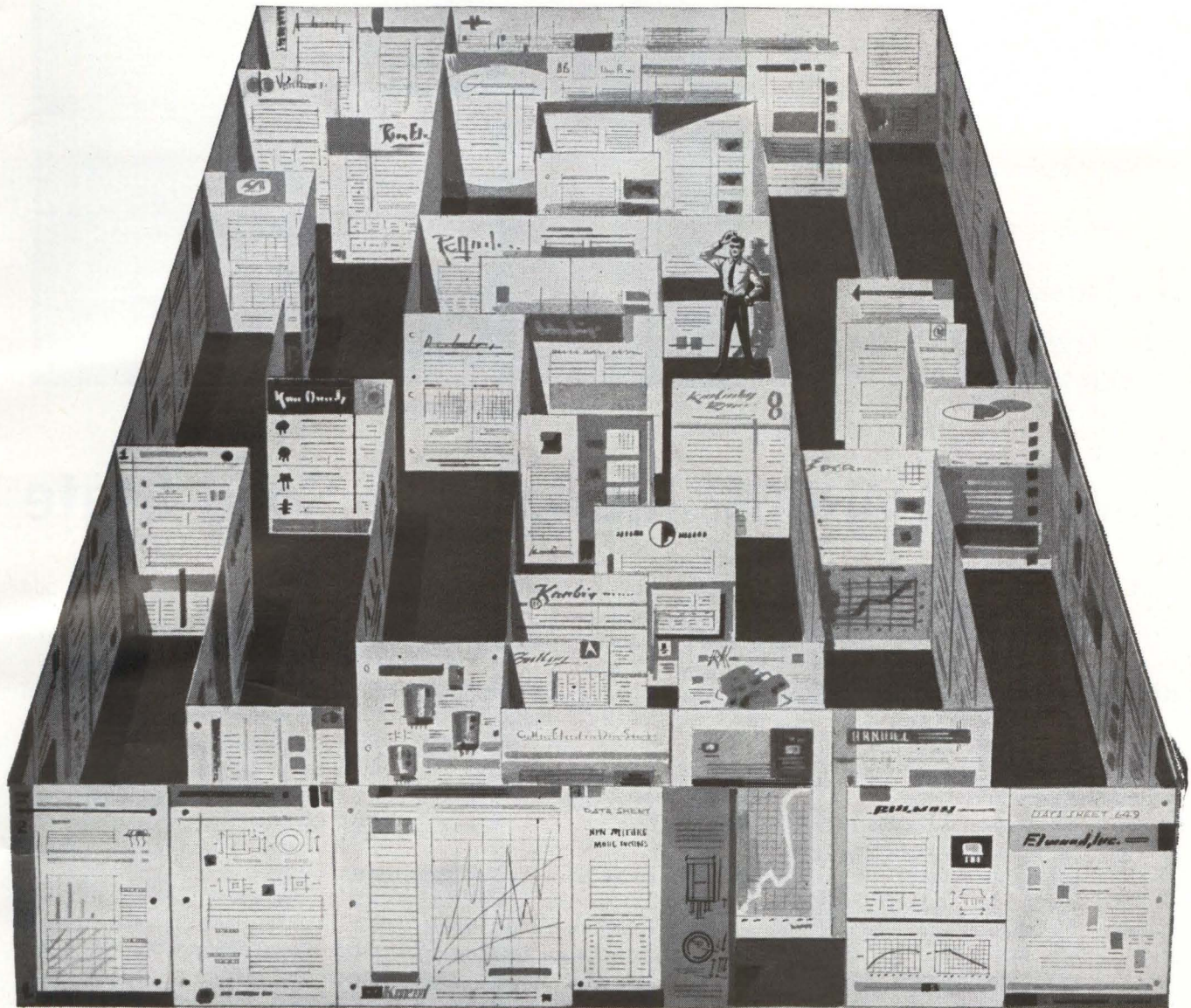

To solve a maze from entrance to goal, start on any path, drawing a line on the right of your path. At a juncture, take any alternative path. At a previously visited juncture take a new path if available, or reverse direction (still drawing a line on your right, though

it is now on the opposite side or wall). At a dead end, reverse direction. Never enter a path marked on both sides, or retrace a marked side. When you reach goal, the path to the entrance will be that only one side of which is marked.

WHICH WAY OUT OF THE SPECIFICATIONS MAZE ?



The valuable time lost searching through hundreds of data sheets and catalogs for the optimum Transistor and/or Semiconductor Diode costs you money, productivity, and creative energy. The way out is a time-proven, use-proven reference tool — D.A.T.A. Tabulations. D.A.T.A. organizes and indexes these devices — each group in a single volume — on a world-wide basis . . . guides you in **less than a minute** to the key parameters, and to all characteristics, type and MIL Spec. numbers, manufacturer-sources. Published semi-annually as a subscription service, D.A.T.A. today serves more than 40,000 engineers in industry, government and the military. Its modest cost can be written off on a single important problem solved. Write for illustrated brochure with more details. Derivation and Tabulation Associates, Inc., 43-19 South Day Street, Orange, N. J. 07050

==== THE INDEX TO DESIGN EXCELLENCE =====

 **D.A.T.A. TABULATIONS**

'TRANSISTORS • SEMICON. DIODES • MICROWAVE TUBES

CONTROL SYSTEM proposed by Fred Stearns, of TI, illustrates how a variety of sensors could be used to operate an appliance

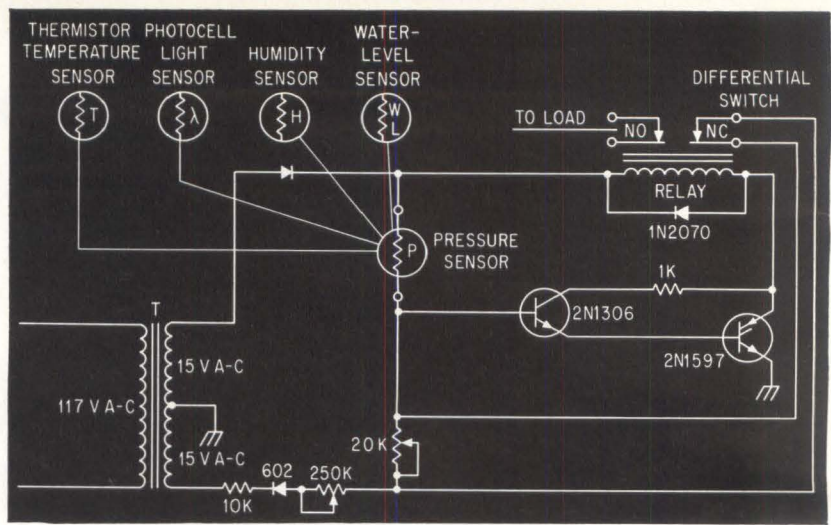

Controlled rectifiers in laundry dryers, thermistors in refrigerators set pace

HOME APPLIANCES: Market for Solid State

By CLETUS M. WILEY
Midwest Regional Editor

CHICAGO—Silicon controlled rectifiers and efficient solid-state sensors now look like the best bets to get electronics into the huge home-appliance market. So far, the lower cost of electromechanical controls has largely prevented electronic controls from tapping the market.

But home-appliance makers are carefully re-evaluating solid-state devices. They would like to add more automatic controls to their products to increase customer inter-

est in new models. And they would like solid-state reliability to back up extended consumer guarantees.

Likely to turn the trick is the recent availability of low-cost scr's. Units that sold for around \$30 a few years ago now cost only a few dollars, making them attractive for such functions as variable speed control.

NEW APPLIANCES—One of the first appliances to use solid-state devices is a Whirlpool laundry dryer that uses an scr control to provide continuously variable speed. The company has been test marketing it,

hopes for greater reliability and easier serviceability.

As for sensors, one advanced model refrigerator uses a thermistor to detect frost. Before frost can build up, a defrost cycle is initiated. The advantage is that defrost cycles initiated on demand avoid the power that can be wasted by pretimed defrost cycles.

Delco has been experimenting with a photoelectric-cell-controlled sewing machine. Treadle-controlled variation in light intensity causes proportional change in a light-dependent resistor to continuously vary speed.

But what designers hope for ultimately is efficient combinations of sensors, sensor-signal amplification and control. They shy away from an attempt to directly duplicate the functions of present electromechanical controls—solid-state duplicates of electromechanical devices would probably be too costly for the consumer market.

SCR'S LEAD—John Mungenast, of GE Rectifier Components, says the silicon controlled rectifier is the most versatile and still the most promising solid-state device for appliance controls.

Biggest gain from scr variable-speed motor controls is the ability to use small outside stimuli to control speed automatically, Mungenast says, as an alternative to continuous manual control of speed.

Scr-controlled laundry machines could thus integrate load, weight,

First Look at Nike X Radar

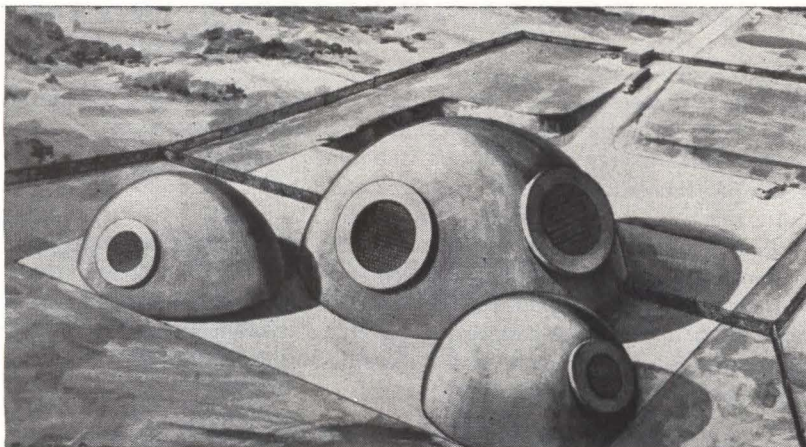

MALFUNCTION ARRAY RADAR for Army's Nike X antimissile system will look something like this. Artist's concept is first declassified illustration of the radar, being developed by Sylvania under a \$28-million contract from Bell Telephone Labs. Sketch indicates that circuits will be in hardened underground bunker, with only end elements of the array in the above-ground domes. Lens-like objects are presumably waveguide end arrays.

water hardness and temperature into decisions on how fast the agitator and motor should run, and vary speed accordingly.

Scr inverters are considered promising for converting standard 60-cycle power into higher frequencies for ultrasonic cleaning. They could also drive smaller, higher-speed a-c motors in future appliances.

SENSORS—Direct coupling of solid-state sensors to power switching modules will be the next step in electronic appliance control, predicts Fred Stearns, of Texas Instruments Incorporated's Metals and Controls division. Transistors, rectifiers and resistors will be integrated with relays to produce resistance-sensitive switches.

Semiconductor appliance controls make direct sensing and switching available to the appliance control designer, Stearns says. For example, resistance-controlled dryers automatically shut off machines at pre-set specific dryness level.

Solid-state sensors emerging from development labs include voltage, resistance, capacitance and inductance sensors, and special thermistors with both negative and positive coefficients and sharp discontinuities for direct triggering.

Kitchens offer greatest opportunity for improvement in conditioning environment, work patterns and functions in the next decade, Stearns said. New sensors will permit automatic control of comfort index. Temperature, humidity, pollen, grease and oil content will be detected, measured and controlled directly from a central module. Direct new solid-state sensor and switch building blocks will control packaging and dispensation of ingredients and food preparation cycles. Resistance sensors may control doneness of steak, through method similar to laundry sensing dryness of clothes.

Appliances are expected to multiply so rapidly during the next decade that by 1973 they may require more power than heating systems do today. This possibility has industry thinking ahead to power-conserving controls, according to Stearns. These could be proximity initiated and terminated, much like solid-state controlled lights that go on automatically when one enters a room.

2" Vidicon

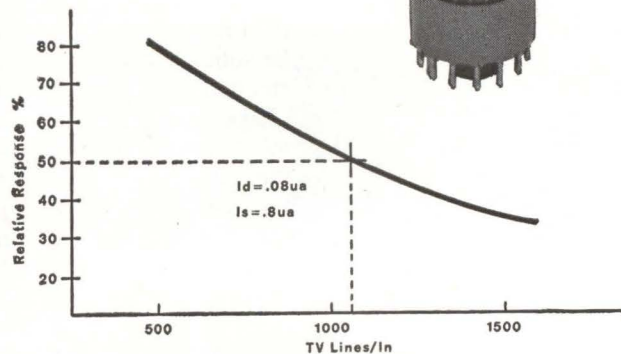

Only one vidicon has resolution exceeding 2000 TV lines

The new ML-2058G 2-inch diameter TV pickup vidicon is the only vidicon that provides this high detail resolution. Features of the ML-2058G include: 1.4" diagonal working area; a limiting resolution exceeding 2000 TV lines; 50% amplitude modulation at 1100 TV lines. It is designed for operation with conventional image orthicon deflection coils. Length is 12". Available with x-ray sensitive photoconductor.

For complete details write The Machlett Laboratories, Inc., Springdale, Conn. An affiliate of Raytheon Co.



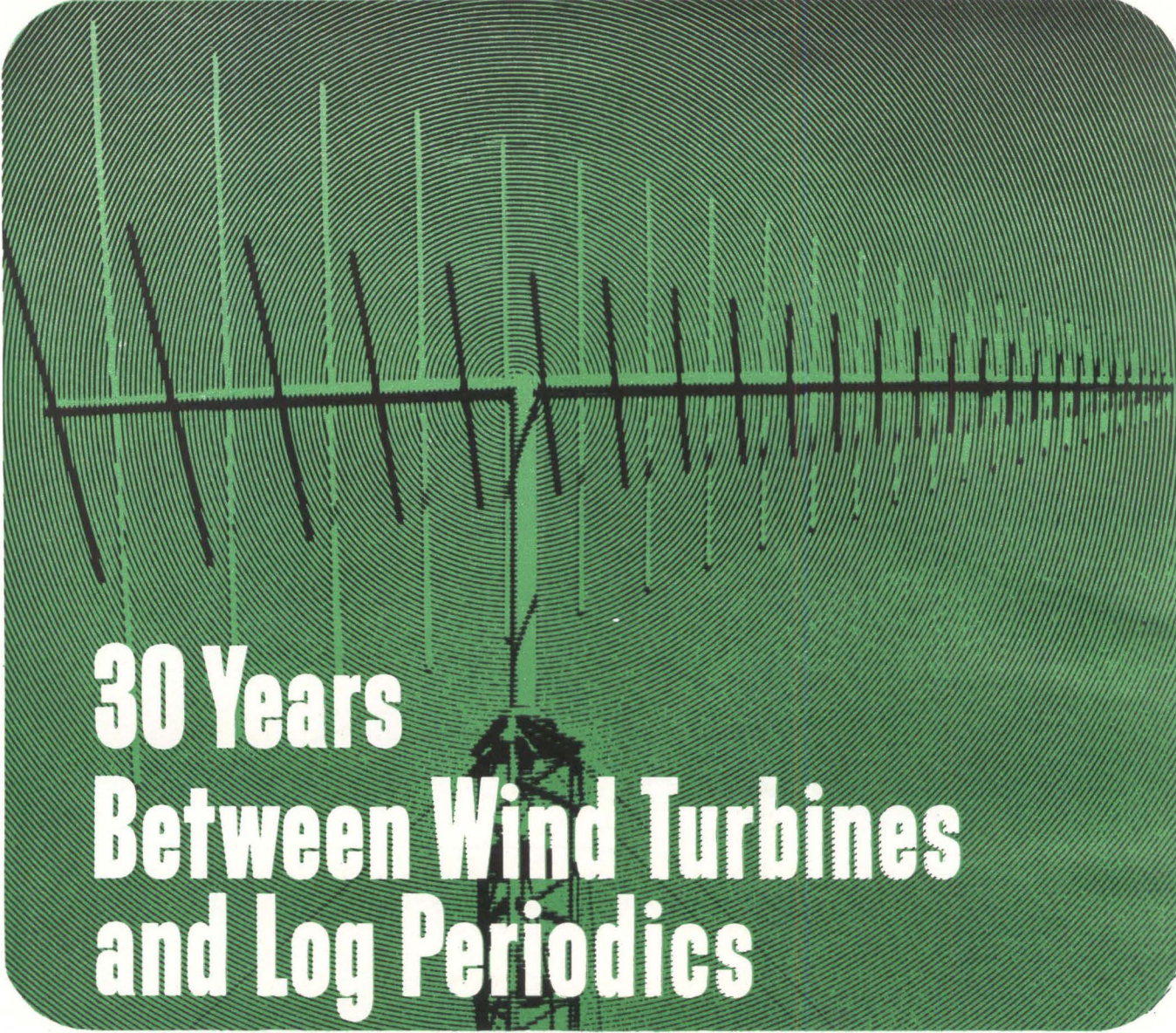

30 Years Between Wind Turbines and Log Periodics

In 1932 while Marconi was experimenting with VHF techniques, Wind Turbine Company began designing and producing advanced wind-driven electrical generators. Now, with a new name . . . TRYLON . . . the same knowledge gained through over 30 years of meeting rigid electrical and structural specifications continues uninterrupted. This experience will help you plan ahead to cover all the details of antenna and tower installations right down to the last custom built insulators.

During thirty years, TRYLON designs have pioneered antenna applications in the 10 Kilocycles to 2.5 Gigacycles range. In 1955 the TRYLON Broadband Curtain Antenna, in 1957 TRYLON-LAPORT Rhombic, in 1963 new ideas in TRYLON Log Periodic Antenna systems . . . all these ideas developed, produced and proved by TRYLON.

TRYLON combines antenna design, complete structural fabrication, and on-site service in one source. Crossing the Pacific through Asia, Africa, Europe, North and South America there are TRYLON Antenna installations. Even at both poles and around the world, whatever the electrical and mechanical problem, you can be assured TRYLON has already met a similar situation.

**Write for the NEW facilities brochure,
Bulletin C8053.**



ELVERSON, PA. 19520 • (215) 942-2981

Diode Receives Optical Signals

SPERRY RAND says it has combined photodetection and parametric amplification into one small semiconductor diode that can increase by 100 times the receiver sensitivity of laser space communications and radar systems.

With other all-integrated, solid-state devices, the diode could make up a complete optical receiver as small as a matchbox.

The 1/8-inch device, called a photoparametric diode, has detected and amplified less than 1 nw of light, the firm said this week. It has a frequency response from d-c to about 2 Gc and when coupled to more advanced electronics, will produce detection and amplification of 10^{-18} -w signals.

Band limit is being increased to 5 Gc, says its developer, David E. Sawyer. Further experiments will extend into 25-Gc frequencies. Sawyer said he also plans to use germanium instead of silicon to raise the modulation frequency limit into that range and the optical detection limit to about 1.7 microns.

Vidicons Called Key To Space Reconnaissance

PALO ALTO, CALIF.—Reconnaissance by synchronous satellite is impractical now, says Duncan MacDonald, Itek vice president. Vidicons capable of resolution of 20 lines per millimeter are needed for effective observation and these will not be available until 1970, he said. He spoke here last week at the Open Space and Peace Symposium at Stanford University.

He sees the possibility of good surveillance from an eight-hour orbit in the near future. Only one-tenth of the earth's surface need be covered, he said. Another speaker, J. E. Fournelle of Boeing, said flight hardware for basic, satellite observation systems could cost as much as \$2 billion.

Laser Tested on Human Eyes

SAN FRANCISCO—Stanford Medical Center here is testing the ophthalmoscope-laser developed by Optics Technology, Inc. (p 30, April 19) on human patients. The laser-coagulator operation has so far been performed on two patients with detached retinas, and further operations are planned. Previous trials were restricted to rabbits.

The experimenters, Dr. H. Christian Zweng and Dr. Milton Flocks, said evaluation of the first two operations is not complete. They declined to say whether the tests were successful.

The laser uses a synthetic, chromium-doped ruby crystal, 1/4 by 3 inches and operates at 6,943 A. Dichroic mirrors filter the wave-length, and the area of treatment on the retina can be as wide as 3 degrees or as small as 0.5 degree, or a 0.25-mm lesion

U. S. and USSR Plan Multiple Antennas

AIR FORCE is considering construction of a special radio observatory in the southwest. The climate and broad, flat areas in the section would be ideal for the proposed observatory's principal instrument, a multiplate antenna (cover and p 39, Sept. 7, 1962 and p. 72, April 26, 1963).

Coincidentally, Russian radio astronomers are apparently also await-

ing approval for construction of a similar antenna in the Caucasus. On his return from Russia, British astronomer Sir Bernard Lovell reported that radio astronomers at Pulkovo propose an antenna consisting of 550 plates, each 15 meters by 6 meters and having an effective aperture of 2 kilometers.

The proposed U. S. antenna, designed by Alan C. Schell, of AF Cambridge Research Laboratories, is similar in concept.

High-Power Lasers May Guide Missiles

ORLANDO, FLA.—High-power single-pulse lasers are feasible illuminators in optical semiactive missile guidance systems—where high performance demands 20 to 30-cycle pulse repetition frequencies without cryogenic cooling, according to Glen L. Taylor of the Martin Co. (See next week's issue for complete technical details.)

An experimental multiple-cavity unit, combining outputs of six laser cavities, will test lasers for this application, Taylor said. So far it has been operated with only two cavities working. The two neodymium-doped calcium-tungstate lasers have

Company Cuts Back Transistor Production

PHILADELPHIA—Philco's Lansdale Division will stop making transistors for sale outside the firm—a decade-old operation. Instead it will concentrate on microelectronics while continuing to fill its own needs for transistors.

The move came as a result of pricing that makes transistors "no longer profitable," one spokesman said. "We're not going to get into the current dogfight." Cutoff date is still undetermined, and until customers for these items find other suppliers, Philco will continue to fill orders

thresholds between 5 and 15 joules of pump energy and in tests radiated at 1.06 microns, Taylor said. Motor-driven Q spoiler controls optical cavity's Q and aligns multiple beams coaxially for collimation. Modifying the programming distributor achieves pulse-code modulation.

In another development aimed at optical radar, peak power of 50 w has been attained by a helium-neon laser and kw-range outputs are "not far off," Martin reports. Peak pump input is 50 kw, prf is 2 kc.

Army Sets November For Satellite Award

FT. MONMOUTH, N.J.—The U.S. Army Satellite Communications Agency here plans to award, sometime in November, a contract to complete work on its proposed Initial Satellite Communication Control Center.

The award, said spokesmen last

Navy Spending More On Ocean-Floor ASW

PROJECT CAESAR, Navy's network of hydrophones stationed on the continental shelf off the U. S. coasts to detect enemy subs, will be stepped up in 1964. Navy wants \$87 million this year—as opposed to only \$15 million last year—to buy new stations that will extend the existing coverage. Prime contractor, Western Electric, subcontracts from 45 percent to 55 percent of the work

week, could go to one of the three firms that last June received program definition contracts of about \$150,000 each—RCA, Philco, and Sylvania.

The center is seen as a centralized computational facility, manned by the military, to control and to schedule communication between various ground stations and orbiting satellites.

U. S., Russia Unite For D-Layer Probe

WASHINGTON—U.S. and Soviet physicists will open a radar cosmic ray probe in Antarctica during the next summer there as a forerunner of a multination effort to learn about cosmic rays by their effects on the reflecting qualities of the ionosphere's D layer. Beams in the 25-Mc range will be bounced between stations 600 miles apart by equipment specially designed for the forward-scatter experiments by the National Bureau of Standards.

U.S. and Soviet teams, both using U.S. equipment though parallel Soviet sets may also be installed, will transmit between a Soviet station on the Antarctica polar plateau and the U.S. Byrd Station at the Pole. Later equipment will be installed at the Soviet station on the eastern coast, other U.S. stations and those manned by the British, French and Australians.

MEETINGS AHEAD

INDUSTRIAL ELECTRONICS ANNUAL CONFERENCE, IEEE, ISA; Michigan State University, East Lansing, Mich., Sept. 18-19.

NATIONAL POWER CONFERENCE, IEEE, ASME; Netherland-Hilton Hotel, Cincinnati, Ohio, Sept. 22-25.

INTERNATIONAL TELEMETERING CONFERENCE, IEE, IEEE, ISA, IAS; London, England, Sept. 24-27.

PHYSICS OF FAILURE IN ELECTRONICS SYMPOSIUM, Armour Research Foundation and Rome Air Development Center, Illinois Institute of Technology, Chicago, Sept. 25-26.

ELECTROCHEMICAL SOCIETY FALL MEETING, ECS; New Yorker Hotel, New York, Sept. 29-Oct. 30.

CANADIAN ELECTRONICS CONFERENCE, IEE REGION 7; Automotive Bldg., Toronto, Ont., Canada, Sept. 30-Oct. 2.

SPACE ELECTRONICS NATIONAL SYMPOSIUM, IEEE-PTG-SET; Fontainebleu Hotel, Miami Beach, Fla., Oct. 1-3.

ELECTROMAGNETIC RELAYS INTERNATIONAL CONFERENCE, IEEE, ICER, IEE, Tohoku University, Science Council of Japan; Sendai, Japan, Oct. 8-11.

ELECTRICAL - ELECTRONICS CONFERENCE, Aerospace Electrical Society; Pan Pacific Auditorium, Los Angeles, Calif., Oct. 9-11.

NATIONAL AEROSPACE CONFERENCE, National Society of Professional Engineers; Lafayette Hotel, Long Beach, Calif., Oct. 10-11.

SOCIETY OF MOTION PICTURE-TELEVISION ENGINEERS CONVENTION, SMPTE; Somerset Hotel, Boston, Mass., Oct. 13-18.

AUDIO ENGINEERING SOCIETY FALL CONVENTION—EXHIBIT, AES; Barbizon-Plaza Hotel, New York, Oct. 14-18.

NATIONAL ELECTRICAL MANUFACTURERS ASSOCIATION ANNUAL MEETING, NEMA; Edgewater Beach Hotel, Chicago, Ill., Oct. 21-24.

NATIONAL ELECTRONICS CONFERENCE, IEEE, IIT, Northwestern University, University of Illinois; McCormick Place, Chicago, Ill., Oct. 28-30.

ELECTRON DEVICES MEETING, IEEE; Sheraton Park Hotel, Washington, D. C., Oct. 31-Nov. 1.

ADVANCE REPORT

INTERNATIONAL NONLINEAR MAGNETICS CONFERENCE, IEEE; Shoreham Hotel, Washington, D.C., April 6-8, 1964; Oct. 25, Dec. 27 are deadlines for abstracts and manuscripts respectively. Submit to R. C. Barker, Program Chairman, Department of Engineering and Applied Science, Yale University, Dunham Laboratory, New Haven, Conn. Topics include computer magnetics, superconductive devices, recording, instrumentation, power control, properties of magnetic materials.

Army Seeks Innovation In Blind Landings

FORT MONMOUTH, N.J.—Army is hunting new ways to land aircraft in combat and in zero-visibility weather. The project, with possible commercial applications, is being carried out under a \$200,000 feasibility award to RCA's Aerospace Communications and Controls division.

The Army hopes for delivery early in the next decade to meet predicted needs for a tactical landing control system operable at front or rear lines. It would apply to VTOL, VSTOL and troop-carrying helicopters.

The system's exact nature, after two months of study, is so far uncrystallized, RCA says. The 12-month investigation will explore all methods, "from acoustics to gamma rays." The system is to be automatic, lightweight, transportable and compatible with ILS-GCA systems in use now.

New Post to Coordinate Nets

WASHINGTON—A new national communications system being created under a Presidential order will help coordinate the government's massive internal communications network.

To do the job, President Kennedy has tied the post of Director of Telecommunications Management (DTM) closer to him by adding to it the title of Special Assistant to the President for Telecommunications. The DTM job customarily falls to an assistant director in the Office of Emergency Planning. That position is now vacant; it will be filled by a man who will wear all three hats.

In the interim, the post is being filled by Jerome B. Wiesner, director of the White House Office of Science and Technology.

White House sources say the new Special Assistant would give critical attention to such matters as the dependence of the government on common-carrier facilities and the possible needs for closer cooperation between the carriers and government to form government systems into a tighter-knit web.

Coordination of communications has been done primarily by the Defense Communications Agency. Creation of the new post is not expected to affect DCA's role, nor control of their networks by the individual government agencies.

The new Special Assistant will also exercise the President's statutory responsibility for the Communications Satellite Corp.

Output of Ruby Laser Measured at 700 Joules

MASER OPTICS INC. has built a pulsed ruby laser with an output of 700 joules (measured by resistance change of a glass-enclosed mass of fine wire when a pulse was shot into it). The multicavity device uses automatic liquid-nitrogen cooling of the ruby rod. Energy for the four flashlamps in the laser head is stored in a capacitor bank totalling about 10,000 microfarads. By Q-spoiling techniques, a peak power output in the gigawatt range is obtained. The laser was built to order for ITT Industrial Laboratories which will use it for materials and biomedical research.

Video Tape Recorder Sells for \$1 Million

LONDON—Cinerama Inc., producer of the wide-screen process for movie houses, last week paid an estimated \$1 million, plus royalties, for the rights to manufacture and market the Telcan tv type recording system (p 7, Aug. 16 and p 8, July 5) in

the western hemisphere. Cinerama will also carry out research and development on the device, one aim being to produce color tapes.

Phased-Array Radar Going Up in Florida

IT'S ONE of the tallest structures in Florida—perhaps the tallest, but it's not an office building or luxury hotel. It's a radar installation, now under construction.

Known officially as the AN/FPS-85, it is an experimental phased-array radar, about 14 stories high, and it will eventually become a major element of the U.S. aerospace surveillance and warning system. Located at Eglin AFB, the FPS-85 will cost an estimated \$30 million. It will be ready for power tests by the end of this year and hopefully will be in full operation by the end of 1964.

Its primary purpose will be to operate as an experimental second-generation space track radar—to detect, track, identify, catalog and determine the mission of orbiting satellites, known and unknown.

IN BRIEF

TASS, the Soviet press agency, reports Russia has set up in Armenia automatically controlled two mirror radiotelescope of unsurpassed sensitivity. Each bowl measures 656.2 feet, Tass says, and can track moving objects for periods unmatched anywhere.

ALMOST 85 of 100 checks clearing through Federal Reserve offices, compared with 68 of 100 last year, bear preprinted magnetic ink identification of banks they are drawn on.

GT&E will produce high-speed switching centers under a \$17 million Air Force contract to interconnect the DCA's world-wide defense communications system. Plans call for installing 23 centers in 15 countries.

OSCAR III, a repeater satellite, will be launched this year or early next year in conjunction with amateur radio enthusiasts. Its two predecessors were beacons.

KOLLSMAN Instrument has signed a \$7,658,000 contract to supply NASA with guidance and navigation equipment for the Apollo project. This will include an air map and data viewer, related ground support, and an optical subsystem to help astronauts make visual celestial sightings.

MAGNAVOX has received a \$2.6 million contract to develop and build emergency homing radio beacons for the Air Force. Device would guide rescuers to downed aircraft.

SPERRY GYROSCOPE has received a \$10-million award from the Navy to build new navigation equipment for Polaris submarines.

COLLINS RADIO will supply electronic systems to four of the Goddard Space Flight Center's satellite tracking stations under a \$5.8 million contract.

TIROS VI will turn itself off Sept. 18 after one year of successful operation in which 63,000 pictures will have been returned to earth. Tiros VII, launched June 19, will have operated 90 days by Wednesday, transmitting about 21,000 pictures back to earth.

U. S. DEPT. of Commerce last week estimated 1962 factory shipments of electronic components by U.S. producers at \$3.9 billion, 8 percent above the 1961 level.

For R&D, Small Company Can Be Bigger, Says SBA

Small Business Administration has reversed itself on how small an R&D contractor must be before the company is eligible for contract preference under small-business set-aside regulations. The reason: loud complaints from industry.

On July 1, SBA set a tight, new standard: the company's gross sales receipts had to be \$1 million or less. This was considered too small, so now SBA says R&D contracts requiring prototype production will be open to bidders meeting the relevant manufacturing industry standard of smallness. Where no prototypes are required, the standard is 1,000 employees or less, depending on product.

Herter Heeds Tariff Request

Electronic Industries Association is mounting a "massive effort" for new restrictions on imports of foreign-made electronic products. Details on the impact of imports on the U.S. electronic industry will be compiled and disseminated. Christian A. Herter, President Kennedy's special representative for trade negotiations, told EIA the industry will be given a separate hearing on its request that certain electronic products be considered apart from general electrical equipment in tariff negotiations under the Trade Expansion Act (ELECTRONICS, p 20, Sept. 6).

New Products From Space: Few, So Far

NASA's Efforts to turn up dramatic evidence of commercial applications derived from space R&D have fallen flat. But the Denver Research Institute, hired for \$90,000 two years ago to research NASA's claims, balanced its negative findings with long-range optimism.

Significance of new products spawned by space research "appears to be rather small," DRI says. But its study finds promise for future impact in such areas as the stimulation of research, new or improved processes and techniques, product improvements and increased availability of materials, testing and laboratory equipment.

Communications Outlays Steady

Capital Investment by the communications industry remains fairly steady. Latest Commerce Department-SEC survey rates the outlay by communications at \$3.55 billion and \$3.65 billion, respectively, in the first and second quarters. In last year's four quarters, the rates were \$3.70 billion, \$3.65 billion, \$3.60 billion and \$3.60 billion.

Outlays by all industry are expected to rise from \$38 billion in the second quarter to a record \$40-billion third quarter and \$41-billion fourth quarter. However, many economists had expected capital spending to gather more steam during the last half of 1963.

Navy: New Controls

General Accounting Office has uncovered a 1956 case in which the Navy incurred "unnecessary costs" of about \$1.1 million because it bought a radar altimeter (the AN/APN-120) built for operation in an unauthorized frequency band. The altimeter had to be completely redesigned. The Navy says it has established new administrative controls to prevent such snafus.



Guess how many Honeywell Meters in this fishbowl. Win a baby shark.

Imagine the fun of having your very own shark! Imagine the delighted laughter of neighbors when they discover it in your swimming pool! All you do is guess how many Honeywell miniature meters are in that fishbowl. Come closest, and the shark is yours for life! (Why the contest? To dramatize how many different miniature meters we make—most in the business—and just how miniature our miniatures are. Like the HS-1 Ruggedized that shrugs off vibra-

tion, is immune to dust and moisture; the MCE-1 Edgewise; the stylish MM-1 Medalist meter; and the new, square-shaped MS-1.) Entries must be postmarked before midnight, Nov. 15, 1963. In case of tie, earliest postmark wins. People who work for Honeywell may compete but we warn them: they won't win. Send your guess to Honeywell, Precision Meter Division, Manchester, N.H.

While you're at it, ask for our latest catalog. Fascinating poolside reading.

Honeywell

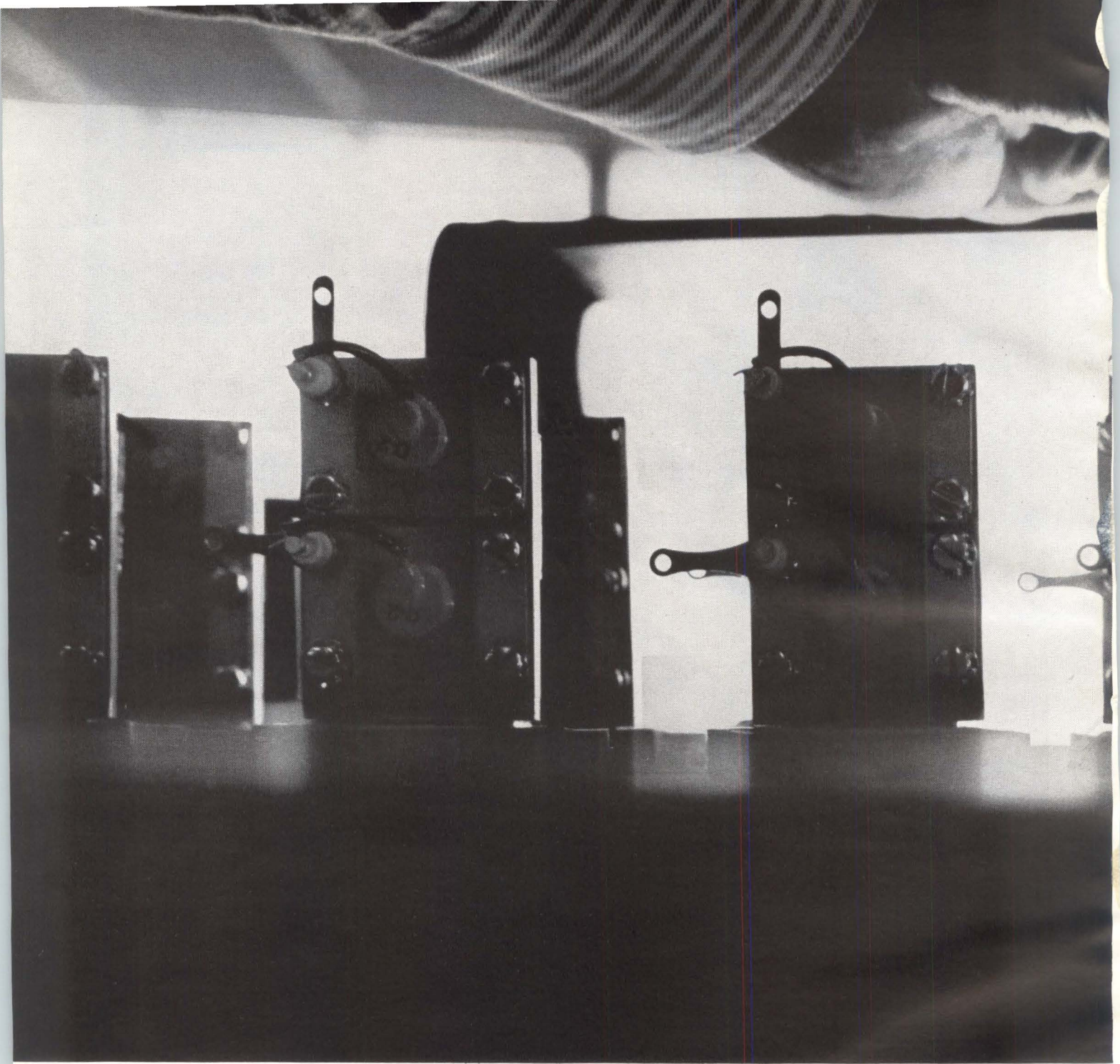

The eighth one is no good. Do something about it—now.

Before the same defect shows up in #12 or #14.

While the component is still on the line.

Before the component goes into a sub-assembly.

An IBM computer can help you. It brings the speed and accuracy of electronic data processing to in-process production quality assurance. Right on your production line.

An IBM Industrial Testing System—your present testing equipment coupled with an IBM computer—collects, analyzes and evaluates mass test data on a real-time, on-demand basis. Problems are caught, corrections made *immediately*.

Product quality and production efficiency go up. Waste and rejects go down.

Do something about your quality assurance now. Call IBM.

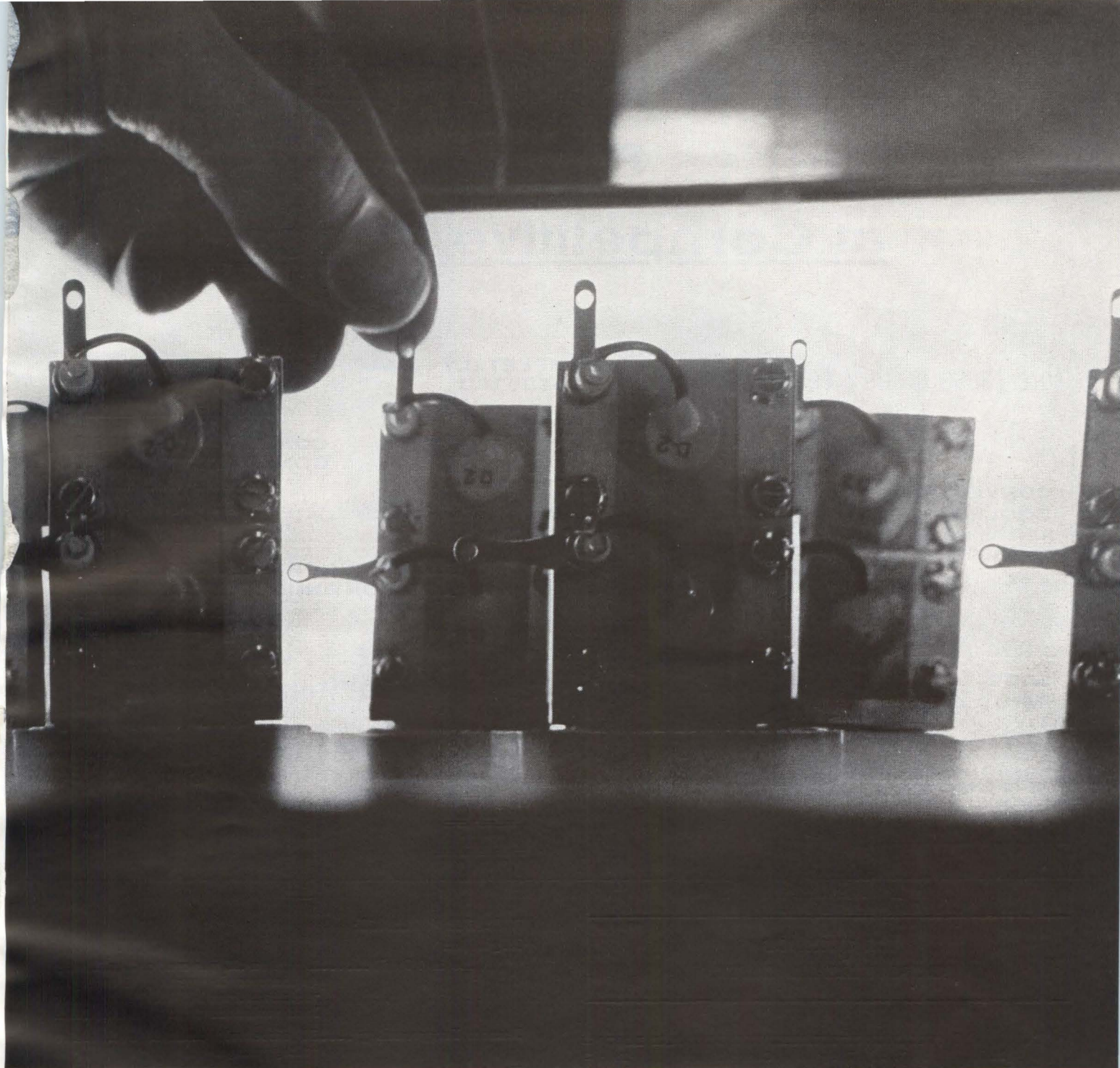

IBM's new Industrial Testing System can help you with your quality assurance program. Several different IBM computers, such as this 1710 Control System, are available to meet your exact requirements in collecting, analyzing and evaluating mass test data.

IBM[®]
DATA PROCESSING

CIRCLE 23 ON READER SERVICE CARD

Lambda Environment-Engineered LE Series Power Supplies at Competitive Prices

Note these quality design features

CONVECTION COOLED

No blowers or filters; maintenance free.

WIDE INPUT RANGE

Wide input voltage and frequency range)
—105-135 VAC, 45-66 CPS and 320-480 CPS in two bands selected by switch.

COMPLETELY PROTECTED

against—short circuit and electrical overload; input line voltage transients; excessive ambient temperatures. No voltage spikes due to "turn-on, turn-off" or power failure.

9 models available

CONSTANT VOLTAGE CONSTANT CURRENT

by automatic switchover.

REMOTELY PROGRAMMABLE AND CONTINUOUSLY VARIABLE

Voltage continuously variable over entire range. Programmable over voltage and current range.

OTHER FEATURES

- All solid state.
- Adjustable automatic current limiting.
- 0°C to + 50°C ambient.
- Grey ripple finish.
- Ruggedized voltmeters and ammeters per MIL-M-10304B on metered models.

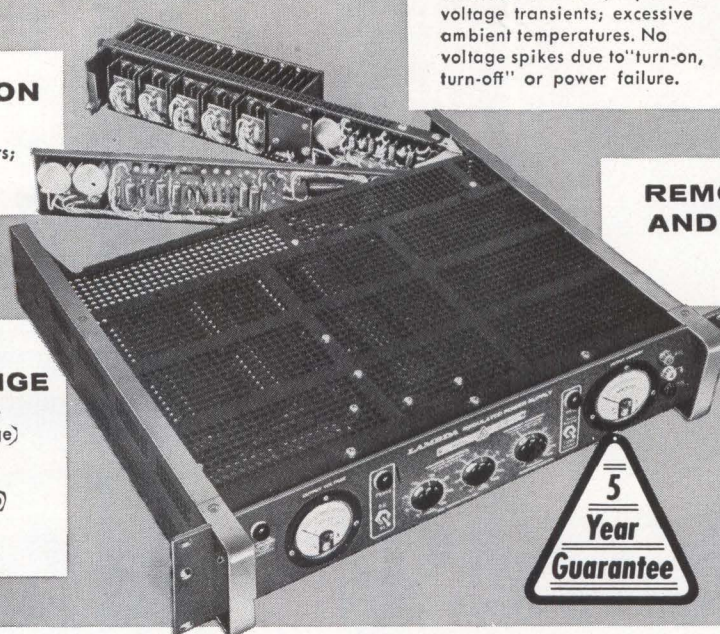

LE SERIES CONDENSED DATA

DC OUTPUT (VOLTAGE REGULATED FOR LINE AND LOAD)⁽¹⁾

| Model | Voltage Range | Current Range | Price ⁽²⁾ |
|-------|---------------|---------------|----------------------|
| LE101 | 0-36 VDC | 0- 5 Amp | \$420 |
| LE102 | 0-36 VDC | 0-10 Amp | 525 |
| LE103 | 0-36 VDC | 0-15 Amp | 595 |
| LE104 | 0-36 VDC | 0-25 Amp | 775 |
| LE105 | 0-18 VDC | 0- 8 Amp | 425 |
| LE106 | 0-18 VDC | 0-15 Amp | 590 |
| LE107 | 0-18 VDC | 0-22 Amp | 695 |
| LE109 | 0- 9 VDC | 0-10 Amp | 430 |
| LE110 | 0- 9 VDC | 0-20 Amp | 675 |

⁽¹⁾ Current rating applies over entire voltage range.

⁽²⁾ Prices are for nonmetered models. For models with ruggedized MIL meters add suffix "M" to model number and add \$40 to the non-metered price. For metered models and front panel control add suffix "FM" and add \$50 to the nonmetered price.

REGULATED VOLTAGE:

Regulation

(line and load) Less than .05 per cent or 8 millivolts (whichever is greater). For input variations from 105-135 VAC and for load variations from 0 to full load.

Remote Programming 50 ohms/volt constant over entire voltage range.

Ripple and Noise Less than 0.5 millivolt rms.

Temperature Coefficient Less than 0.015%/°C.

AC INPUT: 105-135 VAC; 45-66 CPS and 320-480 CPS in two bands selected by switch.

PHYSICAL DATA:

Mounting Standard 19" rack mounting.

Size LE 101, LE 105, LE 109 3½" H x 19" W x 16" D

LE 102, LE 106, LE 110 5¼" H x 19" W x 16" D

LE 103, LE 107 7" H x 19" W x 16½" D

LE 104 10½" H x 19" W x 16½" D

SEND FOR LAMBDA CATALOG.



LAMBDA ELECTRONICS CORP.

515 BROAD HOLLOW ROAD • MELVILLE, L. I., NEW YORK • 516 MYRTLE 4-4200

SALES OFFICES AND REPRESENTATIVES CONVENIENTLY LOCATED IN MAJOR CITIES

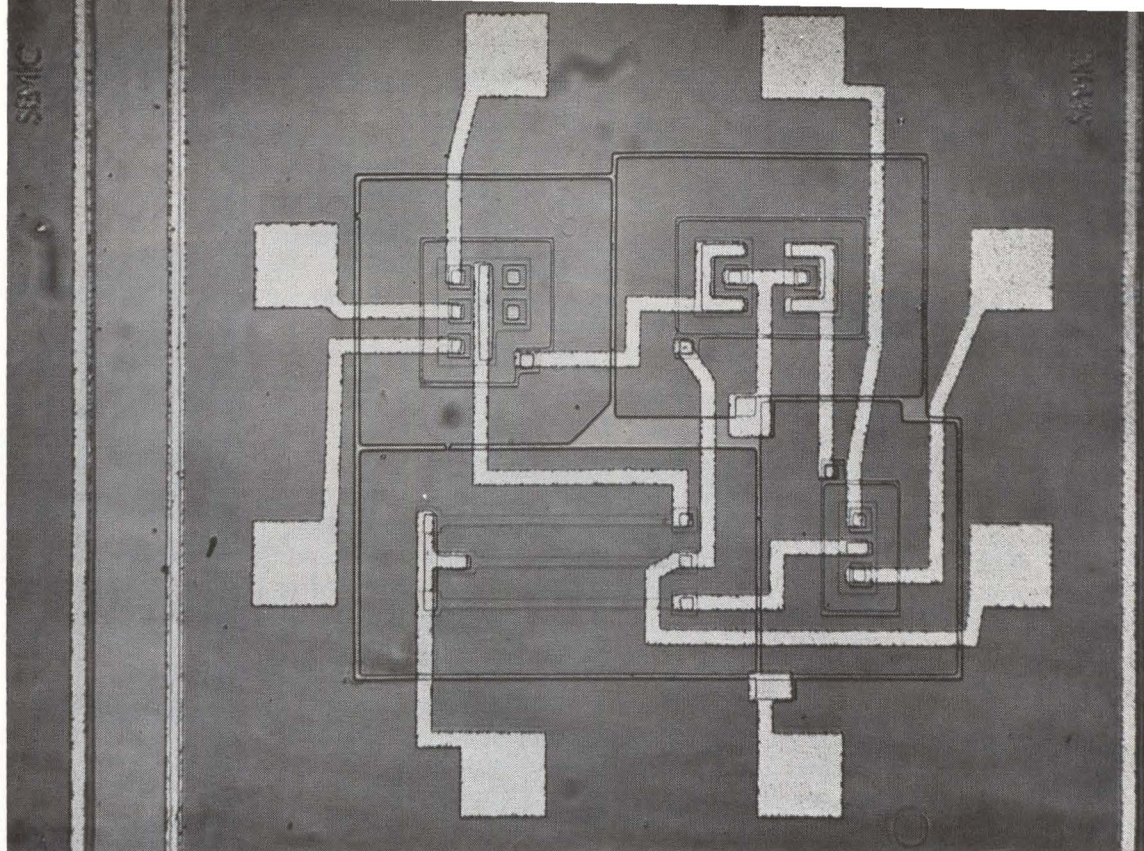

SOLID STATE logic block of the type diagrammed in Fig. 2C

LOGIC PRINCIPLES FOR Multi-emitter Transistors

Devices with more than one emitter represent an evolutionary step on the way to fully integrated circuits. Their special qualities make some logic circuits simpler

By P. M. THOMPSON, The Plessey Co. (U.K.) Ltd., Ilford, Essex, England

SOLID-STATE circuits, with their sometimes unique solutions to the problems of element isolation and interconnections, have made semiconductor manufacturers aware of some new approaches to circuit design. A first step to take on the road to complete circuit integration is to add one or more extra emitters to basic transistors.

The resulting multiemitter transistors take the form shown on the cover of this issue; in this example

five emitters are grouped around a single base, following the scheme shown in Fig. 1A. The emitters, in addition to being used in the normal forward conduction mode, can be used in the reverse conduction mode and also as capacitors.

Most of the applications are in logic circuits but multiemitter transistors can also be used in linear circuits. Figure 1B shows the conduction curve of a single emitter. If the emitter is biased negative with

respect to its grounded base, it conducts in its normal forward mode; if it is biased positive, it conducts when its zener or avalanche voltage is reached. At voltages in between, the emitter can be used as a small capacitor.

If the transistor has several emitters, one emitter can be used in the forward mode with normal transistor action, another can be used in the avalanche mode and behaves as a zener diode connected to the base,

WHAT IS IT?

Still king of all semiconductor devices despite the growing threat of integrated circuits is the transistor. The diode has been around longer but nobody ever diodized a circuit.

But now we have the multiemitter transistor. It can act like a transistor with respect to one emitter, like a zener diode to another, and like a capacitor to still another. Is it still a transistor? Or is it an integrated circuit? Or is it something in between?

Maybe it's just a multiemitter transistor

while a third can be used as a small base input capacitance.

FORWARD MODE—Although the emitters of a transistor can be used in any of the three modes, in most circuits they are used in the forward conduction mode only. Since the reverse conduction mode is not used there is no need to control the breakdown voltage, and the conductivities of the base and emitter regions can be optimized without this additional limitation.

DIRECTLY COUPLED TTL —

The application of multiemitter transistors as a replacement for a diode logic gate, illustrated in Fig. 2, occurred to several workers independently about two years ago.^{1, 2, 3, 4} The multi-input gate using a multiemitter transistor has several features not found in the diode gate. These result from transistor action, and can be made clear by a comparison of the two circuits.

If a positive signal represents ONE in both Fig. 2A and 2B, transistors Q_2 and Q_3 represent a logical OR gate and inverter. Also, diodes D_1 to D_4 in Fig. 2A and multiemitter transistor Q_4 in Fig. 2B represent a logical AND gate. The fan-out of the circuit is from the collectors of Q_2 and Q_3 , while the fan-in is to diodes D_1 and D_3 , or the emitters of Q_4 respectively, and the collector of Q_1 represents the output of a previous stage driving the AND gate.

Circuit operation is as follows. If a collector of a transistor attached to any of the inputs of the AND gate is switched on (Fig. 2A and 2B) current in resistor R is diverted through it to ground. Point A will be approximately one-diode-forward-voltage drop positive with respect to ground and the base of transistor Q_2 will be at ground potential. Thus Q_2 will be switched off. If all the transistors connected to inputs

of the AND gate are switched off, the current in R flows through D_4 in Fig. 2A or the collector of Q_4 in Fig. 2B, and switches on Q_2 . In Fig. 2A an extra resistor R from a negative supply to the base of Q_2 ensures that it switches off rapidly. An advantage of the multiemitter transistor is that this resistor and the negative supply can be eliminated, because current can flow from the collector of Q_4 to any of its emitters by normal transistor action. Thus, the output current of Q_1 is available to switch off Q_2 rapidly.

In addition to the multiemitter transistor having normal forward transistor action, it also has some transistor action in the reverse direction: the collector can act as an emitter and the emitters can collect the resulting carriers. Thus in the circuit of Fig. 2C when all the transistors connected to emitters of the multiemitter transistor are switched off, and the collector of Q_4 is conducting as a forward-biased diode, a current will flow into the emitters. This current would appear to other multiemitter gates connected to the collector of Q_1 as a collector current in Q_1 , and it is desirable to place a resistor in the collector of Q_1 to supply this current. The maximum value of this current i_1 is

$$i_{1 \max} = i_2 \times (\text{fan-out}) \times (\text{max reverse } \beta)$$

Typically, with a maximum fan-out of five, and a reverse β of 0.1, the circuit will be safe if i_1 is greater than $i_2/2$; there will be some extra current to charge the stray capacitances if $i_1 = i_2$. This type of circuit has proved useful for logic at high speeds (approximately 5 to 10 nanoseconds) and at medium speeds with low dissipation. A solid-circuit logic block based on this type of circuit is shown in the photograph.

EMITTER COUPLED — Although the directly coupled circuit is ade-

quate for small systems, designers of large systems frequently call for higher logic levels (2 volts or greater) to swamp out noise impulses induced in the interconnections. Another requirement in large systems is an accurately defined discrimination level set preferably half way between the ONE and ZERO voltages to obtain equal discrimination against interference for both states. For the emitter coupled OR gate shown in the photograph and diagrammed in Fig. 3A, the discrimination level is defined accurately as ground potential and the outputs are +1.3 volts for ONE and -1.3 volts for ZERO. The ONE level is set by R_2 and R_3 , and the emitter base voltage of Q_4 , while the ZERO level is set by being the forward conduction voltage of a collector diode and an emitter diode in series. These circuits may be coupled either directly or by multiemitter transistor AND gates.

This emitter coupled OR gate is amenable to solid-circuit fabrication since only one transistor, Q_3 , has a collector load, and only two isolated lands are required for the whole circuit. Much of the area in the photograph of the OR gate is taken not by the circuit elements but by the distance it is necessary to leave between the components and the edge of the isolated lands. Thus a circuit that needs only a few isolated lands occupies little space on a silicon chip. Furthermore, transistor Q_3 represents a single transistor on a land; since the land can be made small, the stray capacitance at the collector can be reduced to a minimum.

The operation of the circuit of Fig. 3A is as follows. If the base of either Q_1 or Q_2 is positive with respect to ground, the respective emitter supplies current to R_4 and turns off Q_3 . The collector of Q_3 and the emitter of Q_4 then have the positive potentials shown on the diagram. However, if the bases of Q_1 and Q_2 are both negative with respect to ground, Q_3 will saturate and the collector of Q_3 and the emitter of Q_4 adopt the negative potentials shown. Transistor Q_3 switches rapidly, although it saturates, because its total emitter current is supplied or removed by the input circuit and no current gain is demanded.

This circuit, unlike most logic circuits, provides the output in the

ONE FORM of multiemitter transistor is shown at (A). Emitter-base circuit (B) shows the three ways the emitter can operate—Fig. 1

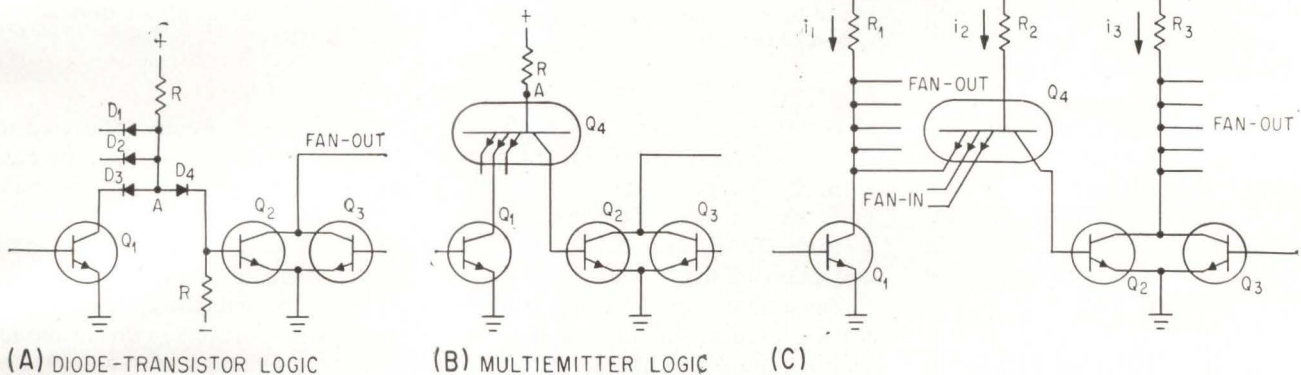
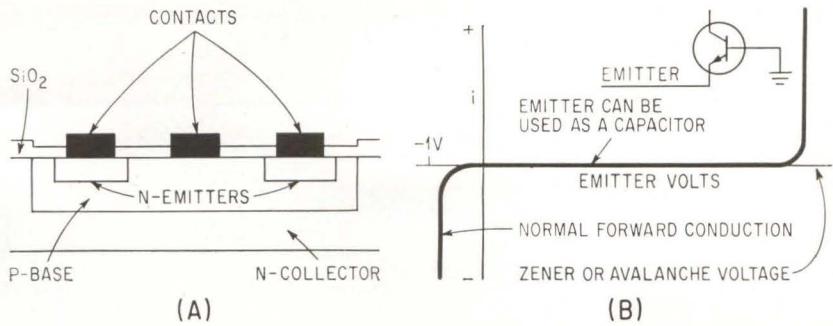

(A) DIODE-TRANSISTOR LOGIC (B) MULTIEMITTER LOGIC (C) DIODE GATE (A) is transformed into a multiemitter gate (B). In (C), for a fan-out of five and reverse beta of 0.1 for Q_4 , the circuit is safe if i_1 is greater than $i_2/2$ —Fig. 2

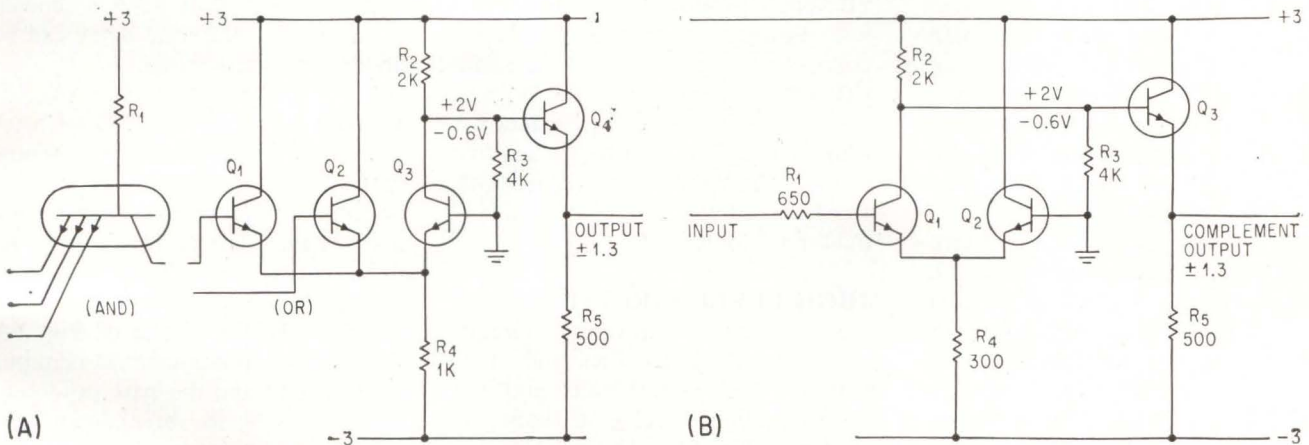

MULTIEMITTER and gate with emitter coupled OR gate (A). Circuit at (B) can be used with (A) to obtain a complement output—Fig. 3

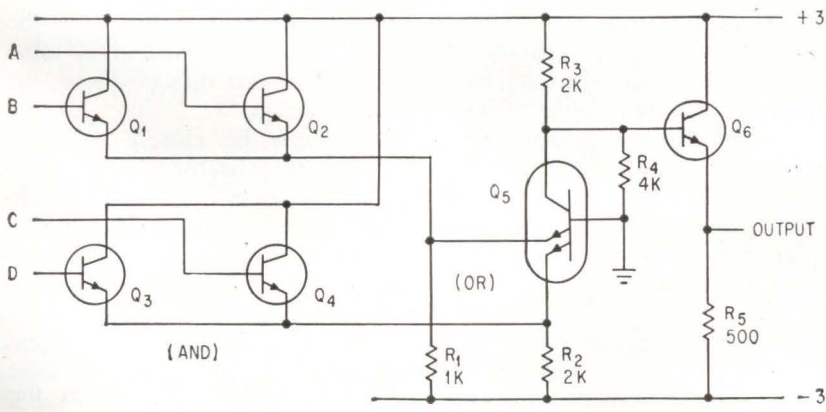

REPLACING Q_3 of Fig. 3A with multiemitter transistor allows an extra logic function without increasing the number of isolated lands—Fig. 4

same sense as the input, instead of inverting. If a complement output is required, the circuit of Fig. 3B will provide it. This circuit, in common with the circuit of Fig. 3A, has only one transistor that has an isolated collector, so if the circuits are combined only three isolated lands are needed. However, if this type of logic is used, it should be organized to use the minimum number of inversions.

The operation of the circuit in Fig. 3B is as follows. Transistor Q_1 is an inverting amplifier whose emitter is held one diode forward voltage negative of ground potential by Q_2 and R_4 ; R_4 is chosen so that Q_2 remains conducting at all times. Resistor R_1 is in series with the base of Q_1 to prevent the circuit that drives it from being overloaded; the remainder of the circuit is similar in operation to the output section of the circuit of Fig. 3A.

MULTIEMITTER COUPLED—If transistor Q_3 in Fig. 3A is replaced by a multiemitter transistor, an additional logic function can be performed without the addition of extra isolated lands. The modified circuit is shown in Fig. 4. It is convenient with this circuit to let a negative signal represent ONE, so that the circuit performs first the AND function, then the OR function. Operation is similar to the circuit of Fig. 3A, except that the collector circuit of multiemitter transistor Q_5 can be saturated by current at either emitter instead of only one. Also, in common with the circuit of Fig. 3A, the circuit requires an additional inverter if a complement output is required.

Multiemitter transistors, with the emitters in the forward conduction mode, are useful for low-level logic circuits. However, for logic circuits for applications where large noise voltages are introduced, as in many industrial environments, higher logic levels are desirable and can be obtained with reverse conduction.

REVERSE CONDUCTION — A convenient way to achieve high logic levels is to use the reverse breakdown voltage of emitter junctions. If one emitter of a multiemitter transistor is used in the reverse conduction mode, and another in the forward mode, the transistor performs as a conventional transistor with a

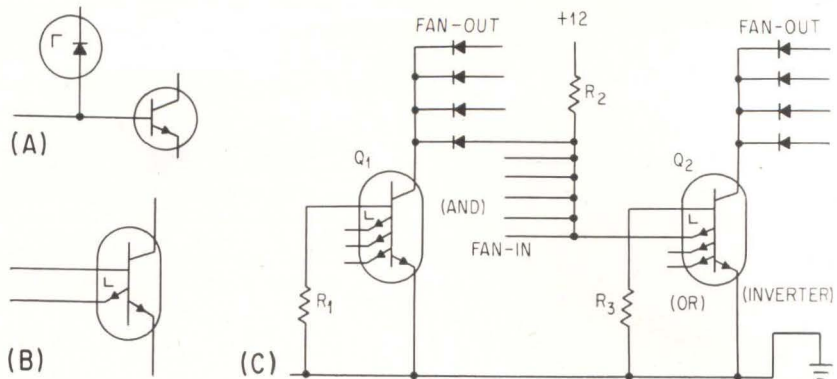

WHEN EXTRA emitter is used in breakdown mode, circuit is as at (A) and can be represented as at (B). High level saturating circuit using emitters at breakdown point (C)—Fig. 5

zener diode connected to the base; the configuration is useful for performing voltage translations in circuits where the collector voltage may be high. To aid in understanding the operation of the circuits where different emitters of the same transistor are used in different modes, the emitters are differentiated in the circuit symbols. Figure 5A shows the conventional circuit analog of a two-emitter transistor, with one emitter used in its breakdown mode; Fig. 5B shows proposed combined symbol. Emitters used as a base input connections are shown on the same side of the transistor as the normal base connection, and the breakdown symbol is drawn next to the emitter arrow. The symbol is in accord with IEEE standards for new semiconductor symbols.

HIGH LEVEL CIRCUIT—A simple high-level saturating circuit, where the levels for ONE and ZERO can be +12 and 0 volts and the discrimination level +6 volts, is shown in Fig. 5C. The major component in this circuit is a simple n -type silicon substrate on which is diffused a multiemitter n pn transistor and several p -on- n diodes. The base region of the transistor is extended to form the base resistance (R_1 in Q_1) and connected to one of the emitters. The remaining emitters are used as an OR gate at the input, and the fan-out of diodes on the collector substrate is used as part of AND gates for the following stages. These major components can be connected as follows.

Each input terminal used is connected to the positive supply through a resistor (R_2 in Fig. 5C) and to the output diodes of other circuits.

Then, if all the circuits connected to an input are nonconducting, the current in R_2 can flow into the base circuit and switch on Q_2 . If transistor Q_1 is conducting, the OR gate input terminal is held close to ground potential, the emitter cannot conduct in its reverse current mode, and Q_2 is switched off.

This type of circuit has good discrimination against noise and its speed is limited primarily by the total capacitance and the current available to charge it. If 1 ma is allowed at each input, the total delay can be about 0.5 microsecond.

CURRENT SWITCHING—Corresponding to the maximum switching speed for any type transistor is an optimum range of collector current and voltage. The current can be defined by resistors and the mean voltage by the reverse breakdown of emitters. In the circuit of Fig. 6A the collector potentials are clamped near ground and the base potentials are defined by the breakdown voltage of the input emitters.

The emitters of Q_2 and Q_3 are connected such that the current in R_5 will be conducted by one transistor or the other, depending on which base is more positive. If the transistors are fabricated at the same time on the same slice of silicon, the reverse breakdown voltage of the emitters can be closely matched. Thus, if the collector of Q_1 is positive with respect to ground, Q_2 conducts; if the collector is negative, Q_3 conducts; also, the discrimination level is close to ground potential.

Any conventional clamp technique can be used and the logic levels—negative and positive with

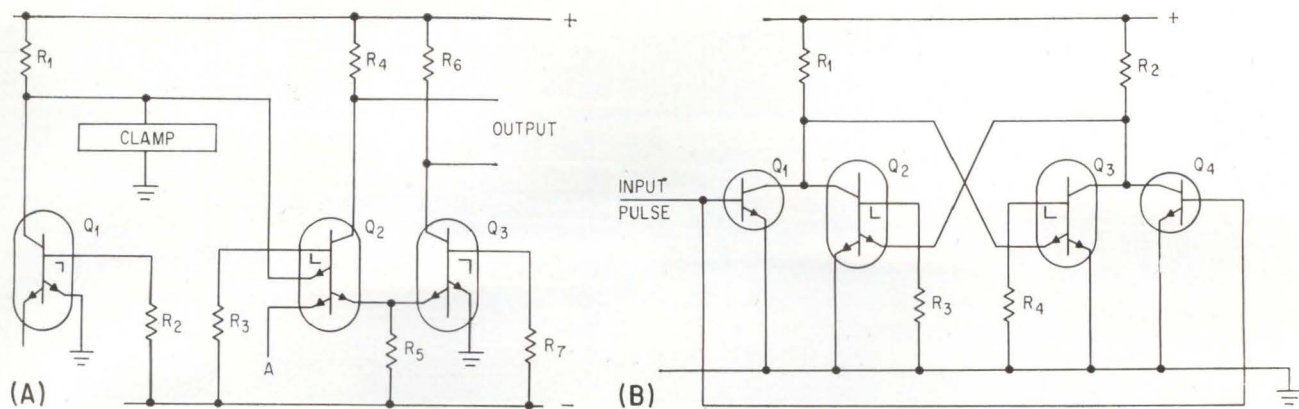

CURRENT switching circuit with collectors clamped near ground and base voltage defined by input emitter (A). Binary counter (B) uses cross-coupled emitters as capacitive inputs—Fig. 6

respect to ground—can be chosen as the best compromise between the requirements of speed and discrimination against noise. Point *A* in Fig. 6A represents a second input to Q_2 , which conducts if either input is positive. There are many variations of current switching logic and the techniques illustrated in Fig. 6A are generally applicable.

EMITTER AS CAPACITOR—A large-area emitter performs as a satisfactory input capacitance to the base of a transistor. The addition of this large emitter results in an increase of collector area but the ratio of the emitter capacitance to the increase in collector capacitance is not unfavorable; the capacitance per unit area of an emitter junction can be approximately five times that of the collector. There are many circuits in which it is useful to connect a capacitance to a base of a transistor and a good example is the simple binary counter shown in Fig. 6B.

The bistable circuit consists of Q_2 and Q_3 , which are triggered by Q_1 and Q_4 being switched on and saturated by a short pulse at their bases.

Circuit operation is as follows. Assume Q_2 is nonconducting. Then its collector will be positive and R_1 will supply current to the base of Q_3 through an emitter operating in its reverse conduction mode. Thus Q_3 will be saturated, holding its collector at ground potential. An input pulse causes the collectors of both Q_1 and Q_4 to be driven to ground potential. Thus at the input of Q_2 there will be no change of voltage, but at the input of Q_3 the voltage changes from the emitter breakdown potential to ground potential and the input emitter capacitance discharges

into the base. Some of this charge switches off the transistor and the excess causes it to become negative with respect to ground. If Q_1 and Q_4 switch off before this charge leaks away, Q_2 will switch on before Q_3 and thus hold off Q_3 . The next input pulse switches Q_3 back into conduction and completes the cycle.

At the present state of the art it is not feasible to fabricate emitters with close capacitance tolerances. As with all $p-n$ junctions the capacitance varies with voltage, but it is a useful capacitance when its value need not be precise or where the charge rather than the change of potential is defined.

LINEAR CIRCUITS—The multi-emitter transistor is generally more applicable to logic circuits than to linear amplifiers but it does have applications, one of the best known being as an integrated chopper in d-c amplifiers.⁵ Here a two-emitter transistor is used as a switch and the off-set voltage between the two emitters is usually much lower than that between the emitter and collector of a conventional transistor chopper.

Another application of an extra emitter on a transistor is as a coupling element between a base and the collector of the previous stage, as in the counter circuit of Fig. 6A; as a coupling element an extra emitter can be used either in the reverse conduction mode or as a capacitor. As a capacitor it provides a low impedance to high frequencies between the collector of one stage and the base of the next; in its reverse conduction mode it provides a low impedance at all frequencies. Emitter-capacitance coupling is a useful technique in designing solid circuit

feedback amplifiers because it enables the output capacitance of one stage to be lumped with the input capacitance of the next and be treated as a single phase shift element, rather than as two separate elements with their attendant effects on high frequency stability.

INTEGRATED CIRCUITS—It is widely believed that solid state circuits, as we know them, where the separate elements can be related directly to components in a conventional circuit, are only a stage on the way to fully integrated circuits. It is not likely that this will happen immediately, because circuit engineers think in terms of components they know and device engineers rely on circuit engineers to design the circuits for fabrication in the solid form. The multiemitter transistor is thus a step towards integrating circuit several functions in a single part of a solid-state circuit.

The author thanks W. Holt and his staff for fabricating the devices discussed, and the Directors of the Semiconductors Ltd. for permission to publish the work.

REFERENCES

- (1) P. M. Thompson, The Plessey Co. (U.K.) Ltd., British Patent application No. 24222/61.
- (2) R. H. Beeson, H. W. Ruegg, New Forms of all Transistor Logic, Digest of technical papers, p. 10, International Solid State Circuits Conference, Philadelphia 1962.
- (3) B. A. Boulter, A New Active Device Suitable for use in Digital Circuits, *Electronic Engineering*, 35, No. 420, p. 86, Feb. 1963.
- (4) B. T. Murphy, High Speed Integrated Circuits with Load-Compensated Diode-Transistor Logic, *ELECTRONICS*, p. 68, March 15, 1963.
- (5) B. Mitchell, B. Bell, The Inch, Discussion and Applications, National Semiconductor Corp., General engineering memorandum No. 7, Jan. 6, 1962.

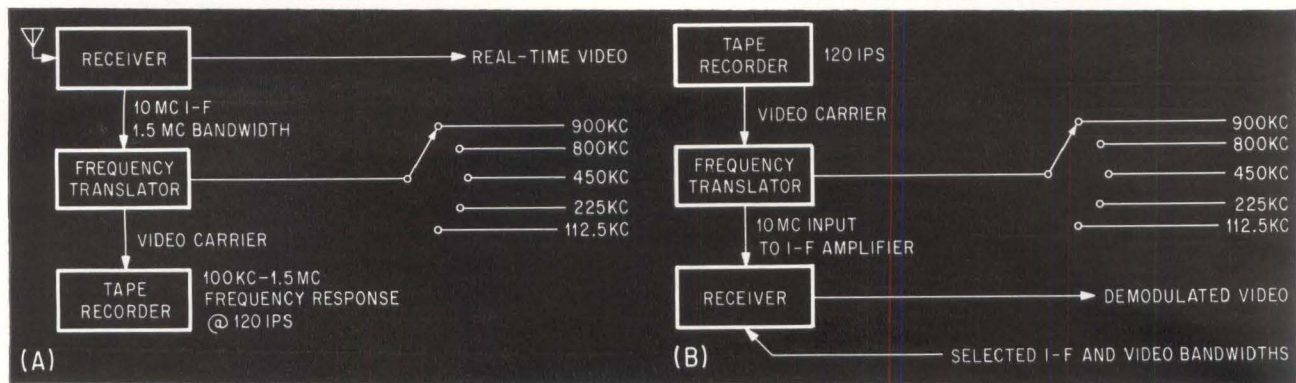

PREDETECTION RECORDING: Solution

Newer and more sophisticated modulations are creating data-storage problems for missile ranges. PreD recording may be a universal solution

By V. A. RATNER, Director, Systems Div., Defense Electronics, Inc., Rockville, Md.

DIVERSIFIED modulation techniques and the growing complexity of modern telemetry systems have produced a need for a universal method of data recording. Reduced to practice but recently, predetection recording has been gaining wide acceptance throughout the field and some experts feel that PreD may provide a solution to range instrumentation problems. Agencies like NASA and the Pacific Missile Range have taken action to incorporate these new techniques. Moreover, the Atlantic Missile Range recently awarded a \$6 million contract for updating all AMR range sites with predetection recording equipment.

Ten years ago, when telemetry was predominantly frequency multiplexed (f-m/f-m), a tape recorder

with reasonable dynamic range and linearity between about 200 cps and 100 kc was adequate. The state-of-the-art for this type of magnetic recording was developed to a high degree and evolved from audio techniques. When time-division multiplex came into use, recording techniques required modification. For example, pulse-duration modulation (pdm/f-m) was not adaptable to direct linear recording due to the inability of this technique to furnish d-c response. Pulsed signals were differentiated and processed in a different manner. In most cases, recorder manufacturers were able to apply the same tape-handling mechanisms but had to modify the electronics to accommodate nonlinear signals that could be reconstructed into the desired pulse format.

Pulse-amplitude modulation signals were easier to record in earlier days because they were already on a subcarrier and required no special treatment for use with analog recorders. Accuracy, however, was a problem since flutter contributed a direct first-order frequency variation that resulted in amplitude inaccuracies in the pam wavetrain. Moreover, the secondary time-displacement error also had an effect on decommutator sync with pam.

PROGRESS—As the recording art progressed, speeds were increased to yield necessary frequency response and tape width was made larger to expand the number of available channels. The advent of pulse-code modulation digital telemetry further aggravated the recording situation because no single recorder was suitable for f-m/f-m, pdm, pam and pcm.

Tighter accuracy requirements produced intense activity aimed at reducing or eliminating dropouts, an effect that was no problem with analog telemetry techniques. In order to be useful, pcm data had to be recorded at less than 1 error per million bits. Thus, industry swung over to computer techniques and recorders designed specifically to

IS ONE WAY THE BEST WAY?

Evidence of the increasing popularity of predetection recording techniques is demonstrated in the recent award of a letter contract for multichannel predetection-telemetry recording systems to Defense Electronics by Martin-Marietta Corporation. Equipment supplied will be used for ground checkout purposes on U. S. Air Force Titan III standard space booster for quick-reaction military missions. Titan III is presently planned to boost Air Force's delta-winged X-20 and possibly Gemini, too

RECORDING mode uses the widest predetection bandwidth capability of of the system (A), while optimum bandwidth selection is accomplished during reproduction (B)—Fig. 1

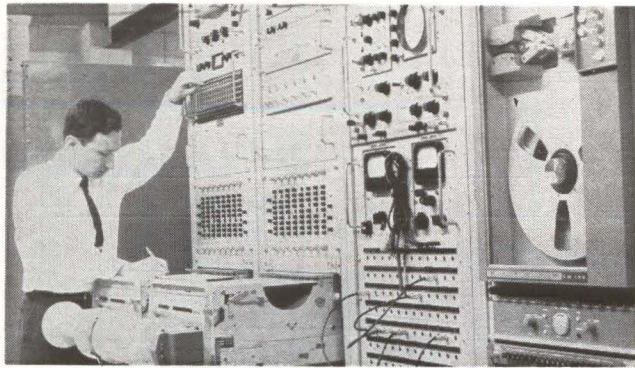

AUTHOR adjusts the data-insertion converter of pcm telemetry system

to the Telemetry Dilemma?

employ saturation and parallel-data recording were pressed into service. Here, a great deal of processing equipment was required to convert data from serial to parallel form for recording; the skew produced by the tape transport had to be minimized and electronically compensated for, and the tape transport itself had to be kept under near-sterile conditions to prevent particles of dust from settling on the tape and causing signal dropouts. As the state-of-the-recording-art progressed further, manufacturers were able to improve resolution, packing density or frequency response and produce wideband instrumentation recorders. This extension of frequency response permitted recording the serial-data train directly from the output of a telemetry receiver, either with or without signal processing. This technique has met with some success, although at this stage, it still suffers from the dropout problem and other serious defects. While there were acceptable techniques for recording all types of telemetered data, the problem of providing a universal capability to support the various missile and space programs using various modulation techniques still existed. The typical range station may have had to incorporate four or five different tape recorders with associated racks of processing equipment and myriads of critical adjustments.

PREDETECTION—The search for a universal method of recording be-

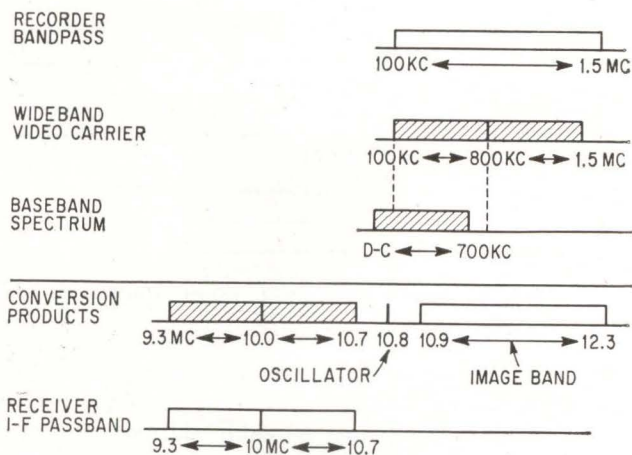

FREQUENCY translation is necessary for wideband recording; special techniques eliminate spurious responses during reproduction—Fig. 2

came successful with the introduction of predetection, or i-f recording. With it, all types of telemetered data may be received and recorded with common equipment having a minimum of adjustments and without regard to modulation technique.

With predetection, the receiver i-f is frequency translated to a portion of the spectrum compatible with the frequency response of commercially available wideband magnetic tape recorders. In the record mode of operation, the widest predetection bandwidth that the system is capable of accepting is used. Optimum bandwidth selection is then accomplished during the reproduction process as shown in Fig. 1. Thus, no changes in field setup are required to accommodate the various types of data transmission. During playback, the

recorded spectrum is reconverted or translated back up to the original i-f frequency and reinserted into the receiver i-f amplifier where it is demodulated just as though it were the original r-f signal.

To produce a practical predetection system, there are several factors which must be considered. By making the system linear through the record process, it is possible to accommodate a-m, f-m or p-m signals and to preserve the spectral distribution of noise and signal power thus preventing the establishment of a system threshold. Secondly, the widest bandwidth feasible is used in the record mode; hence, all significant sidebands are recorded. Optimum bandwidth selection is accomplished during the reproduce mode of operation. For another, direct

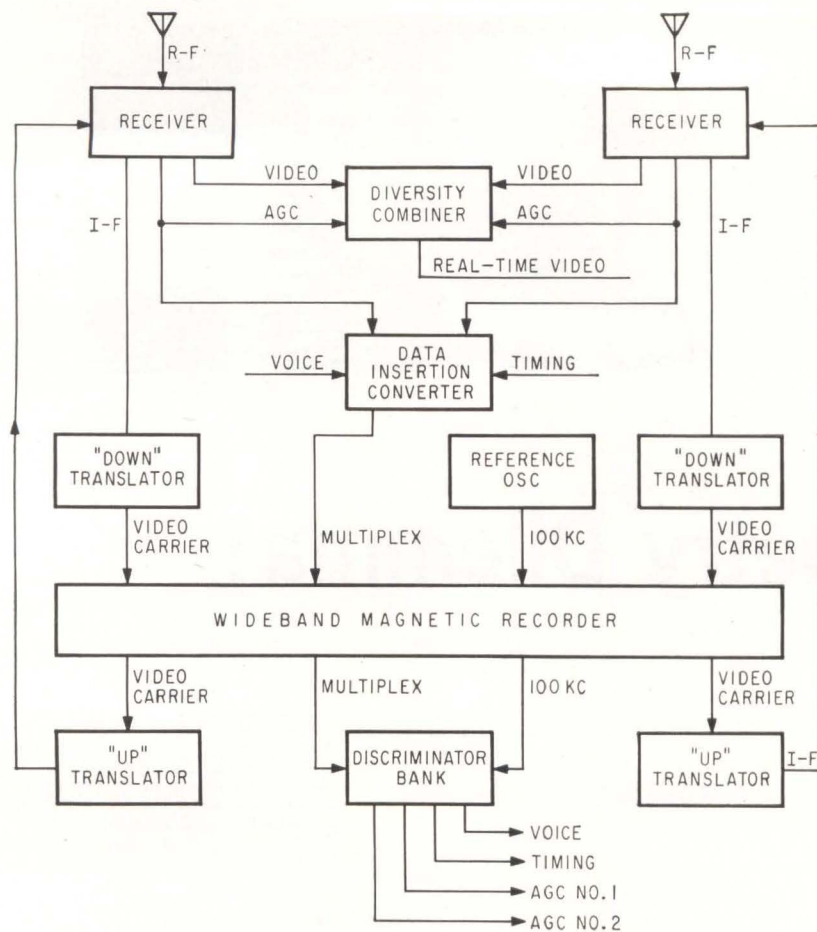

PREDETECTION system includes "up" and "down" translators that feed signals to and from a wideband recorder—Fig. 3

demodulation is incompatible with effective recorder bandwidth utilization since the video-carrier and baseband spectrums overlap. Frequency translation is therefore, necessary for wideband recording, as shown in Fig. 2, and special techniques are used to eliminate spurious responses during reproduction.

The commercial availability of standard stationary-head recorders having response to 1.5 Mc makes the use of longitudinal recording desirable since up to seven channels can be made available with standard IRIG format on half-inch tape.

The benefits of PreD are manifold. With the data stored in an undemodulated condition, computation centers have unlimited freedom in signal processing especially with regard to correlation techniques. In a practical situation, a compromise must be made between bandwidth and signal-to-noise ratio in order to maintain low data error under varying propagation conditions. This optimization may now be accomplished following a spectral analysis of several successive

playbacks with no fear of data lost due to poor selection of i-f bandwidth during real-time recording. If a signal lends itself to the use of phase-lock demodulation this too may be accomplished during playback. Compensation for transmitter or receiver drift and unpredicted deviation limits, become a data reduction function instead of a one-shot field decision.

A typical predetection recording installation as shown in Fig. 3, may consist of the following basic components: Receivers, having special i-f input and output provisions as well as plug-in tuning heads, i-f and demodulator modules as shown in Fig. 4A; translators, for up and down conversion of the i-f signals as shown in Fig. 4B and 4C; wideband tape recorders with frequency response to 1.5 Mc; diversity combiners for improving signal-to-noise ratio of real-time signals and/or a data insertion converter for multiplexing auxiliary information such as timing, signal strength and voice on a single tape channel as shown in Fig. 5.

A station of this sort may consist of only 2 or 3 racks of equipment including the tape recorder and could replace an entire roomful of specialized equipment in an installation where several programs are being supported. At major field stations or centralized computation centers, the predetection installation may be more formidable to permit more comprehensive data separation and display but will always be less complex than for comparable post-detection recording.

F-M/F-M—This multiplex method is by far the oldest and most widely used telemetry technique. It is an analog frequency-division system capable of combining up to 18 channels of low-frequency data on a single r-f link with accuracy approaching 1%. The subcarriers range in frequency from 400 cps to 70 kc and are frequency modulated by transducers or other sensors with maximum frequency response of about 2 kc for the upper channels. The complex mixture frequency modulates a transmitter in the 215-260 Mc region.

On the ground, the output of an f-m receiver is conventionally fed to a magnetic recorder with frequency response between 200 cps to 100 kc. The recorder playback is then fed to a bank of subcarrier discriminators for channel separation and demodulation.

The most prevalent problems encountered in f-m/f-m are concerned with speed variations (flutter) and dynamic range of the recorder, both of which tend to degrade the accuracy of the lower-frequency subcarrier channels.

PDM/F-M—This type of telemetry is gradually falling into disuse, but merits discussion since some of the older missile programs are continuing to use original tried and proven schemes. As the term denotes, pdm/f-m is a time-division system where each data channel is periodically sampled and its instantaneous value used to vary the duty cycle of the individual pulses in a serial-pulse train.

A system of this sort requires near d-c response in both the receiver and the tape recorder to faithfully reproduce the pulsed waveform, and hence the recorder used for f-m/f-m is not suitable for post-

detection recording of pdm/f-m signals. It is common practice to employ specialized recorders with signal-conditioning circuits that differentiate the pulse train and record only the transitions between pulses. The reproduce circuits then recreate the original waveform using the transitions as triggering pulses. Predetection recording has an advantage here since it is inherently capable of d-c response. Additional noise immunity is also achieved, since the differentiation process is avoided.

PAM/F-M—This is also classified as a time-division or sampling technique in that the data-channel information is used to vary the amplitude of the individual pulses rather than the period. Although still in wide use, pam/f-m suffers from the defects of both the f-m/f-m and the pdm/f-m systems, and has few advantages over other methods.

Recording is especially difficult since most instrumentation recorders are designed for excellent speed regulation at the expense of amplitude stability. Closed-loop tape transports have notoriously poor tape-to-head contact consistency which renders the amplitude of the output subject to variations that directly effect pam f-m data accuracy.

Here too, predetection recording has advantage. Undemodulated data is insensitive to amplitude variations and does not suffer from tape-to-head contact problems.

PCM/F-M—Pulse-code modulation or pure digital telemetry is by far our most sophisticated and complex telemetry technique. The ever-increasing use of pcm in newer space

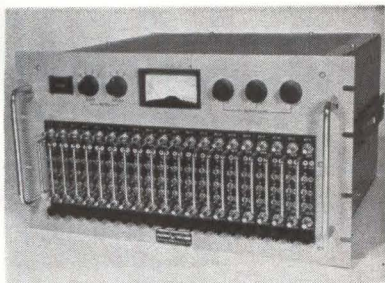

DATA insertion converter features modular construction. Unit multiplexes timing, signal strength and voice information on a single tape channel—Fig. 5

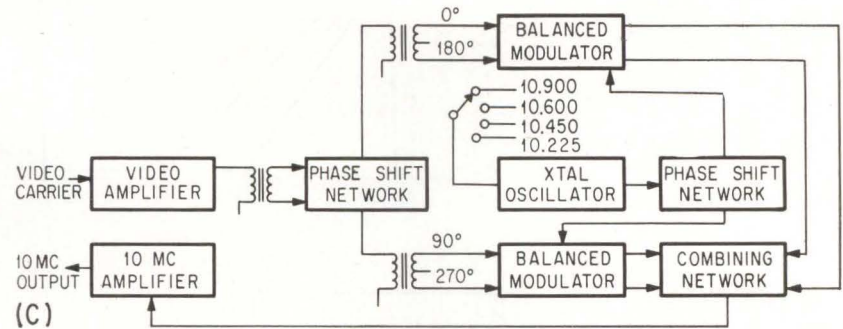
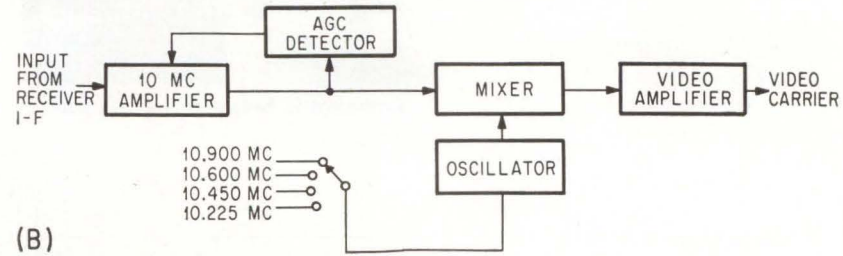
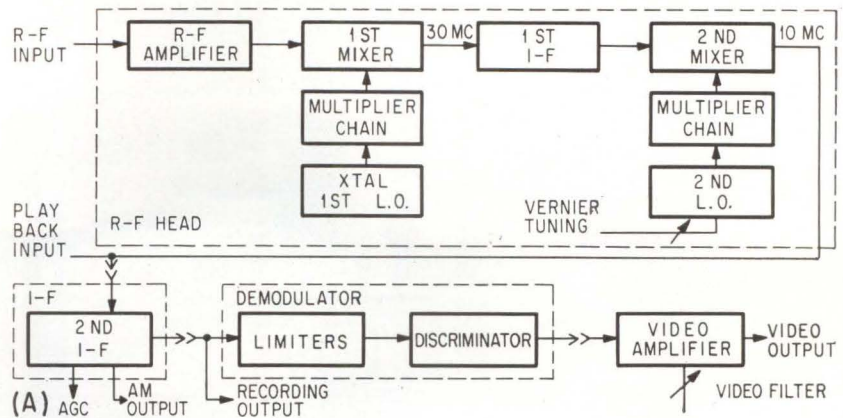

TELEMETRY receivers such as the TMR-5A have plug-in tuning heads and i-f and demodulator modules (A), while "down" converters translate receiver i-f data into suitable recording form (B). "Up" converter changes video-carrier data back to 10 Mc for receiver reinsertion (C)—Fig. 4

programs has created problems in data acquisition never before encountered. The data is converted to binary form and transmitted as a continuous train of pulses where only the presence or absence of a pulse in its respective time slot is relevant, with distortion of the received wavetrain being of little consequence to the data accuracy.

Recording of the digital telemetry signals is conventionally accomplished by serial recording, where the wavetrain is recorded directly from the receiver's output or by parallel recording, where data is broken up into words of several bits and recorded simultaneously on several tracks of a multi-track machine.

Serial recording usually involves high packing densities and is therefore sensitive to tape dropouts that destroy data accuracy. The use of

serial recording requires almost surgical cleanliness and constant attention to critical recorder adjustments representing an intolerable field situation. Parallel recording requires extensive processing equipment ahead of the recorder as well as electronic skew correction to avoid timing difficulties.

Predetection recording is not particularly sensitive to these problems since it is a direct record process with many recorded cycles-per-bit interval and also has true d-c response.

Thus it can be seen that while adequate diverse methods exist for recording various types of telementered signals, predetection is the only method that uses common equipment for all signal formats and performs adequately under field conditions.

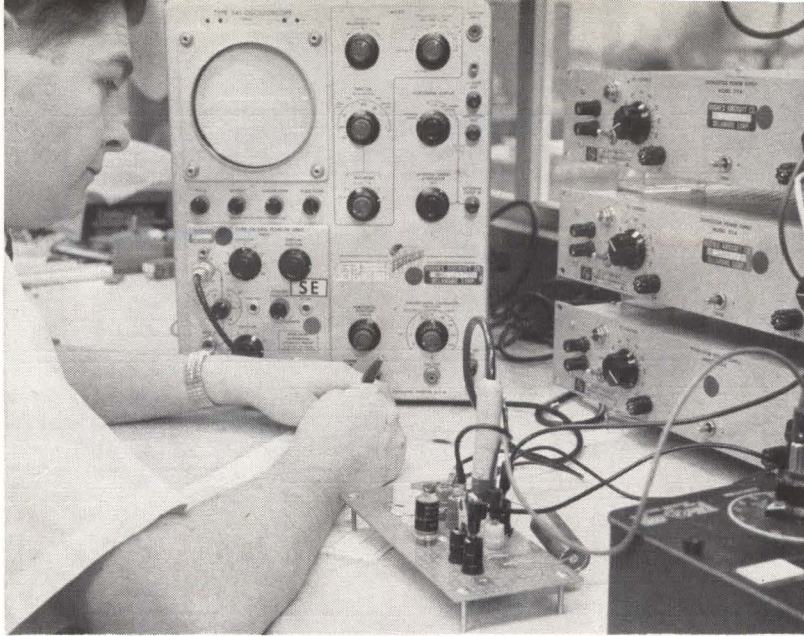

NRE in this monostable multivibrator breadboard is between the two sets of plug jacks

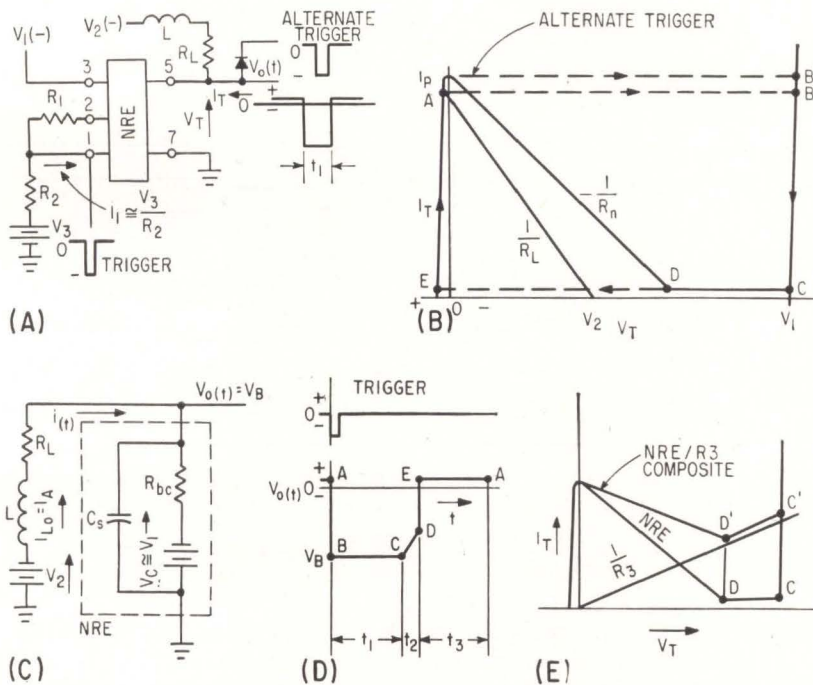

MONOSTABLE multivibrator circuit (A) requires three bias voltages. Rest position is point A in (B), and arrows indicate the switching path. Equivalent circuit (C) applies as point B is reached. Typical output waveform (D), with t_2 exaggerated. External loading produces a composite characteristic (E)—Fig. 1

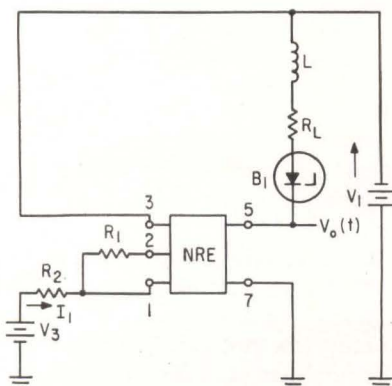

BREAKDOWN diode allows operation with two supplies—Fig. 2

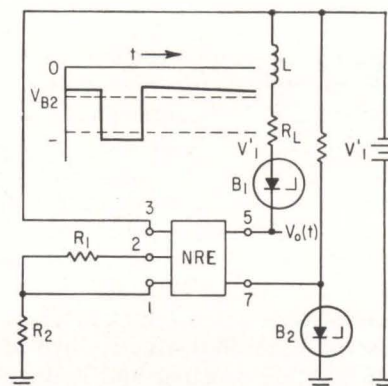

SINGLE VOLTAGE supply circuit uses two breakdown diodes—Fig. 3

USING A NEW Designing

Basic circuit of the NRE used to bring the supplies

NEGATIVE RESISTANCE elements (NRE) have a stable and predictable S-type or voltage controlled negative resistance characteristics. The stability of the characteristic is particularly useful for designing monostable multivibrators that are likewise stable and predictable. The design principles and equations should aid similar applications of the devices. Like all S-type or voltage-controlled negative-resistance devices, the NRE requires an inductor as the energy-storage element when used as a monostable. A typical circuit is shown in Fig. 1A.

Operating characteristics for the NRE monostable are given in Fig. 1B. Monostable operation requires that the d-c load line, determined by R_L , intersect the NRE characteristic curve at only one point and this point must lie within one of the positive resistance regions.

BIASING—Figure 1B illustrates the case where the load line intersects the characteristic curve in the low voltage positive resistance region. This can be assured by keeping V_2 less than the valley voltage, V_D , and keeping R_L greater than V_2/I_p . Since required trigger current is a function of the difference between I_p and the operating bias current (I_A , corresponding to point A in Fig. 1B), it is desirable to make the load line intersect the NRE characteristic just below the peak point.

Monostable operation can also be achieved by establishing an operating point within the high-voltage positive resistance region. In this case V_2 must be greater than V_D

COMPONENT

NRE Monostable Multivibrators

monostable requires three separate bias supplies. But breakdown diodes can be down to one By **CARL DAVID TODD**, Hughes Aircraft Co., Newport Beach, Calif.

and R_L must be less than R_n , the magnitude of negative resistance.

OPERATION—At rest, the d-c operating point will be at A in Fig. 1B. The output voltage is low and slightly positive (for the negative voltage family of NRE). A current I_A corresponding to point A flows through L , R_L , and the output terminal of the NRE. This current will be less than the normal peak current, I_p , as established by bias current I_2 and hence will not cause the NRE to switch.

A negative current pulse applied to the trigger input, terminal 1, will momentarily cause the peak current to drop below I_A . This will cause the NRE to switch along the line indicated to B and the output voltage to increase sharply. Inductor L will maintain the current during switching but as soon as B is reached the current will begin to fall at a rate determined by the L/R time constants of the circuit.

As the operating point moves from B to C the output voltage remains relatively constant because of the steep slope of the characteristics in this region. After C is reached, the operating point moves along the curve at a faster rate due to the higher resistance of the character-

istic and hence lower L/R time constant. The output voltage will change appreciably in this region and will drop from approximately V_1 when the operating point is at C to valley voltage V_V when the operating point reaches D .

At D the energy conditions are still such that V_2 cannot increase the current in the load circuit. Hence the operating point must switch to E as the terminal current attempts to fall below the valley current corresponding to D . Now V_2 is able again to supply energy to the inductor and the terminal current increases until the original steady state bias point A is reached. The operating point remains here until the next trigger pulse.

An alternate triggering action can be obtained by applying a negative pulse through a diode to the output terminal, as shown. This causes the peak current of the NRE to be momentarily exceeded and hence a switching action will occur. The current immediately after switching, however, will still be equal to I_A if the pulse width of the trigger is small.

ANALYSIS—Figure 1C gives the equivalent circuit for the monostable circuit as B is reached. Solv-

ing for t_1 , the time required to go from B to C , yields

$$t_1 = \frac{L}{R_L + R_{bc}} \ln \left[\frac{\frac{V_1 - V_2}{R_L + R_{bc}} + I_A}{\frac{V_1 - V_2}{R_L + R_{bc}} + I_C} \right] \quad (1)$$

As the operating point moves from C to D , the dynamic resistance R_{cd} of the NRE is much higher and hence, t_2 , the time required, is short.

$$t_2 = \frac{L}{R_L + R_{cd}} \ln \left[\frac{\frac{V_2}{R_L + R_{cd}} - I_C}{\frac{V_2}{R_L + R_{cd}} - I_D} \right] \quad (2)$$

In most instances t_2 may be neglected.

As the current through the inductor decreases below I_D , corresponding to point D , a switching takes place from D to E . Output voltage changes rapidly from a negative V_D , equal to the valley voltage, to a slightly positive voltage V_E .

The operating conditions are now such that V_2 supplies energy necessary to increase the current through L and move the operating point from E back to steady state A . The time required, t_3 , is the recovery time.

$$t_3 = \frac{L}{R_L + R_{ea}} \ln \left[\frac{\frac{V_2 - V_E}{R_L + R_{ea}} - I_D}{\frac{V_2 - V_E}{R_L + R_{ea}} - I_A} \right] \quad (3)$$

If a trigger pulse is applied before the end of the recovery period, the monostable either will not start or t_1 will be shortened due to a lower initial current in the inductor.

Width of the trigger pulse should

PUTTING A NEW DEVICE TO WORK

Negative resistance elements are proving themselves to be versatile circuit elements. In the May 31 issue, the author presented characteristics of the NRE and mentioned the monostable multivibrator circuit briefly. Here he develops the design equations and shows how to get bias voltages from one supply

be shorter than t_1 or the circuit may fire a second time or more.

WAVEFORM—The output waveform is shown in Fig. 1D. Points labeled correspond to points on the characteristic curve of Fig. 1B.

The resulting waveform is nearly flat on both top and bottom because of the self limiting action of the characteristic curve. In the high-voltage state, as the operating point moves from *B* to *C*, the output voltage changes only a few tenths of a volt. In like manner, the output voltage is nearly constant as the operating point goes from *E* to *A*.

Except for the transition represented by the line *C-D*, the rise and fall times are short and depend only upon the various shunt capacitances and the frequency response of the transistors used in the NRE. To eliminate this slower transition, the circuit biases are changed such that V_1 is equal to V_{bc} , which is equal to $I_p \times R_n$.

The peak amplitude of the monostable output voltage is almost entirely dependent upon supply V_1 . If the trigger pulse width is less than t_1 , the output pulse width will be independent of the trigger.

LOADING—The preceding discussion assumed negligible loading at the output of the monostable. If a load resistor R_3 is connected, R_3 and the NRE form a composite characteristic as shown in Fig. 1E. The composite curve is formed by adding the respective currents of the load resistor and the NRE.

If the currents corresponding to *C'* and *D'* are used for those of *C* and *D*, Eq. 1, 2 and 3 still apply.

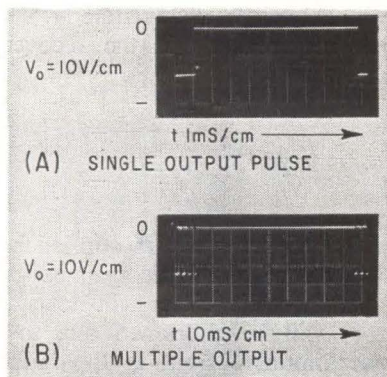

TYPICAL waveforms of NRE monostable circuit—Fig. 4

The three power supply circuit can be simplified. For the monostable bias condition where the steady state bias point is in the low voltage region, V_2 must always be less than V_1 . From Eq. (1) the period t_1 is a function of $(V_1 - V_2)$, not just V_1 or V_2 . This leads to Fig. 2.

Since at least a small current always flows through the inductor, R_L , and the breakdown diode, a relatively constant voltage exists across B_1 . This supplies an equivalent V_2 , which is equal to the difference between V_1 and the breakdown voltage V_{B1} ; $(V_1 - V_2)$ is thus V_{B1} , a constant.

The bias technique of Fig. 2, therefore, not only simplifies the supplies but yields relative immunity of the time period t_1 to changes in voltage supply V_1 . The time t_2 , to go from *C* to *D*, is still a function of supply voltage, as is recovery time t_3 .

The output waveform is the same as for the three-supply circuit.

By using an additional breakdown diode as shown in Fig. 3, only one supply is needed. Bias current I_1 is developed by voltage regulator diode B_2 and resistor R_1 . Voltage regulator diode B_1 provides V_2 supply as in Fig. 2.

With a few modifications, Eq. 1, 2, and 3 may still be used for the time periods. Note that the supply for V_1 , connected between terminals 3 and 7 in Fig. 1 and 2, will now be equal to $(V_1' - V_{B2})$ in Eq. (1); V_2 will be $(V_1' - V_{B1} - V_{B2})$.

The output waveform will be different in that the voltage level is shifted by an amount equal to V_{B2} , as shown in Fig. 3.

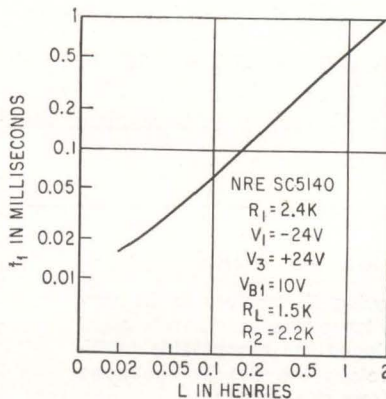

TEST RESULTS of two-supply circuit as a function of inductance—Fig. 5

DESIGN EXAMPLES—Assume a monostable circuit is to operate from -24 and $+24$ supplies and have a 1-ms output pulse.

An SC5140 NRE is used with a 10-volt regulator diode. Peak current of the NRE characteristics is determined by I_1 . Assume I_p is to be -10 ma. For a 24-v source, R_2 should be 2,200 ohms.

The steady state bias point must intersect the NRE curve in the low-voltage positive resistance region. Since the required trigger current will be the difference of I_p and operating current I_A , I_A should be roughly $0.9 I_p$ to have a low trigger current with adequate margin.

The effective value of V_2 is the difference in V_1 and V_{B1} , or -14 volts. This gives a net value of $(V_1 - V_2)$ of -10 volts. With V_2 and I_A fixed, the d-c load resistance is computed as $(-14v)/(-9ma)$ or 1,560 ohms. This includes the dc resistance of the inductor.

Typically, R_{bc} is around 50 ohms for the SC5140. The value of H , the ratio of peak to valley currents, is roughly 50, giving a valley current equal to -0.18 ma. By choosing the value of R_n , determined by the value of resistance R_1 applied between terminals 1 and 2, *C* and *D* of Fig. 1B can be the same point. To do this, make R_1 equal to V_1/I_1 ; for this case, 2.4 ohms.

Solving Eq. (1) for L

$$L = \frac{(t_1)(R_L + R_{bc})}{\ln \left[\frac{V_1 - V_2 + I_A}{R_L + R_{bc}} + I_A \right] \left[\frac{V_1 - V_2 + I_C}{R_L + R_{bc}} + I_C \right]}$$

$$= \frac{(10^{-3})(1560 + 50)}{\ln \left[\frac{-10}{1610} + (-9 \times 10^{-3}) \right] \left[\frac{-10}{1610} + (-0.18 \times 10^{-3}) \right]}$$

$$= 1.9 \text{ h}$$

Waveforms of the circuit are given in Fig. 4. Output amplitude is approximately 25 volts peak; a $10 \mu s$ trigger pulse was used at 100 pps.

With the repetition rate reduced to 10 pps, the trigger pulse width was increased to 1 ms to obtain pulse bursts. While the trigger is negative, the circuit actually is operating in an astable mode. The amplitude of the trigger must remain constant. Overall circuit performance is indicated in Fig. 5.

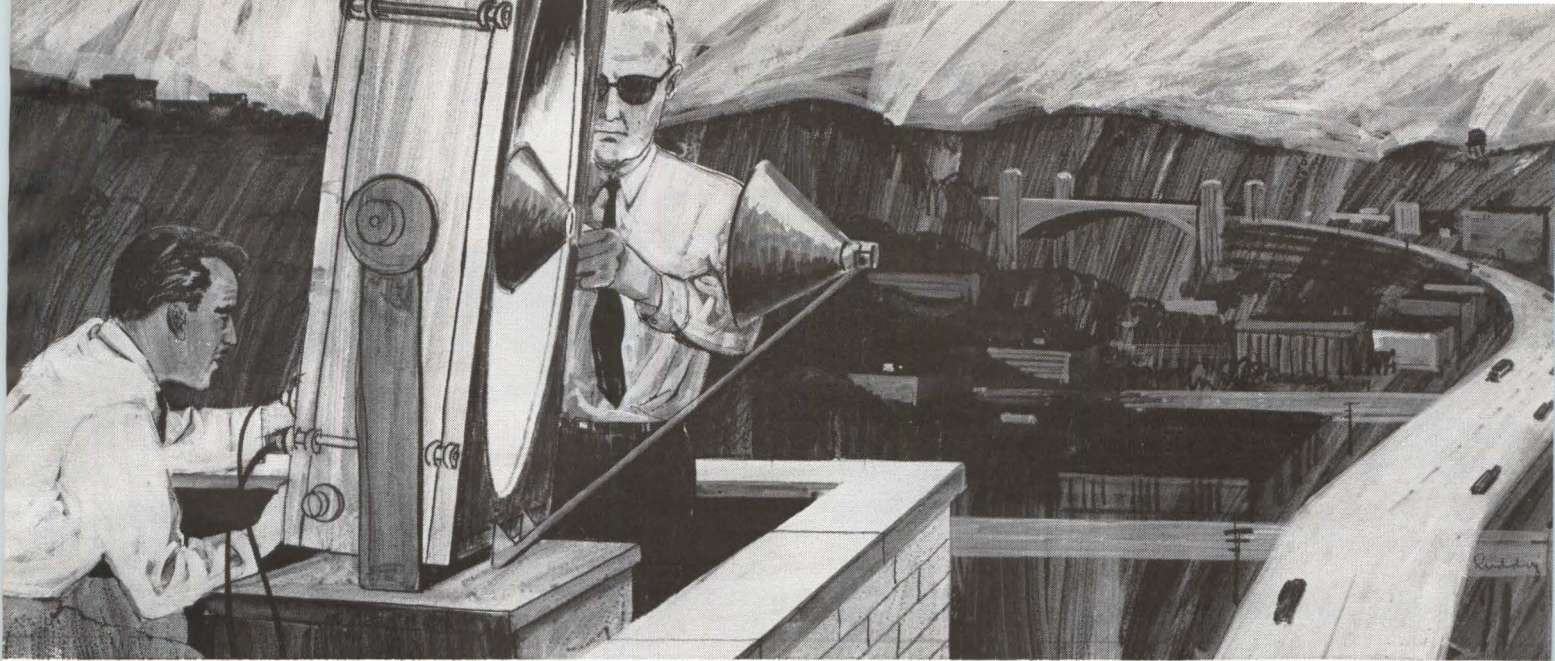

1933 target: vehicles on a highway

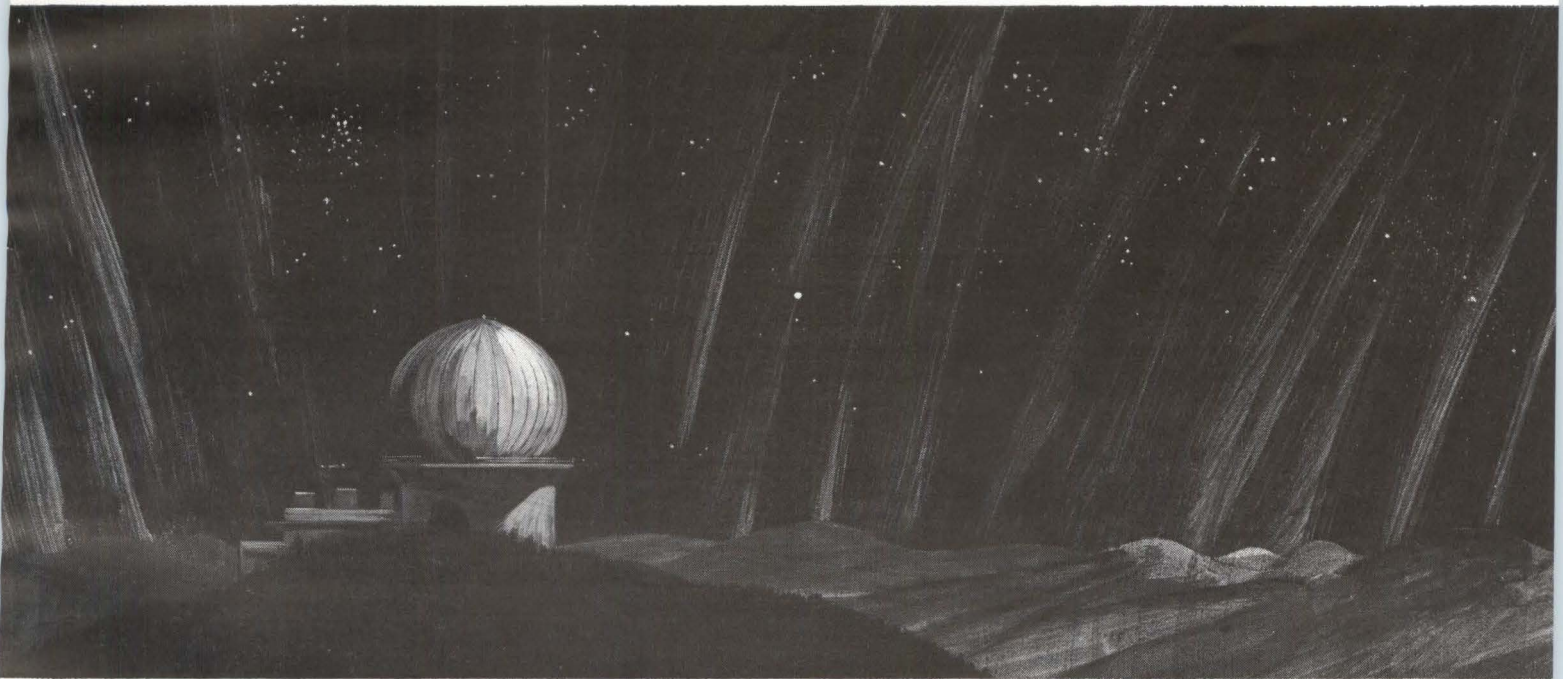

1963 target: vehicles in space

Thirty years ago, Westinghouse engineers in East Pittsburgh beamed radio waves from the plant roof and detected moving autos a block away. They didn't call it "radar"—the word hadn't been invented yet.

Radar development at Westinghouse has traveled many paths since 1933. Defense Center scientists have consistently pioneered in advancing the art—from the rooftop experiments to detecting enemy

planes approaching Pearl Harbor to tracking vehicles in space.

Systems in action today include radars for airborne and space missions, search and weapon control, tactical and fixed air defense, shipborne and ground-based acquisition and tracking. Typical of current projects of the Westinghouse Defense Center are the AN/SPG-59 shipboard fire control radar for the Navy's TYPHON program and the land-based

AN/FPS-27, a long-range air defense radar in the Air Force's SAGE system.

Continuing Westinghouse leadership in radar research and development emphasizes a unique capability for the future. It is a capability to be reckoned with in any serious discussion of advanced radar systems. Write to Westinghouse Electric Corporation, P.O. Box 868, Pittsburgh 30, Pennsylvania. You can be sure . . . if it's Westinghouse.

J*02351-A

We never forget how much you rely on Westinghouse



CIRCLE 37 ON READER SERVICE CARD

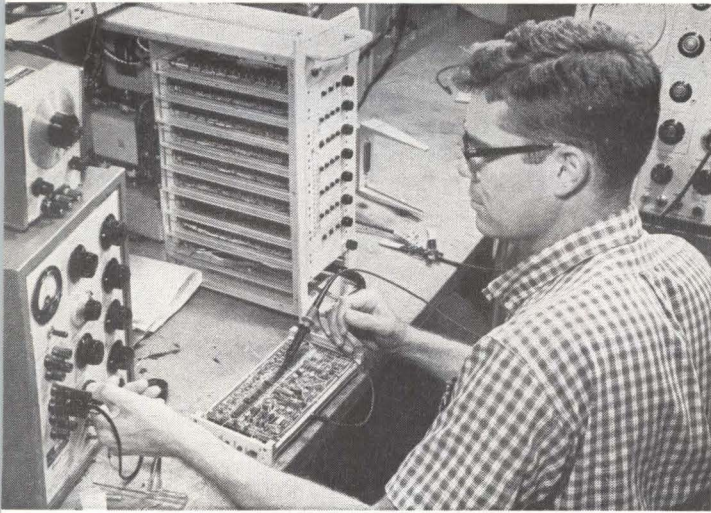

ANALOG MODULE undergoing final check. A complete a-d converter rests on its side at center

USING THE CONVERTER

The unique sample-and-hold design of this analog-digital device provides a short aperture time suitable for encoding rapidly varying sinusoidal inputs and short duration pulses. Units are presently used in pam ground tracking stations, for oceanographic data acquisition, voice digitization, radar pulse digitization, pcm signal simulation, Vela Uniform major crustal studies and other applications

Improving A-D Converter Accuracy

Chopperless 50-kc device attains 0.05 percent accuracy and 100 nsec aperture time by bucking out offset errors and cancelling nonlinearities

By LES JASPER and H. K. HAILL Data Acquisition Systems Engineering, Industrial Products Group
Texas Instruments Incorporated, Houston, Texas

APERTURE time of an analog-digital converter effectively limits the upper frequency of the input signal for a given digital accuracy. In many applications this upper frequency limit is several hundred cycles per second. Typical examples are voice and other multifrequency amplitude-modulated signals, or digital pulses for which a passband up to ten or twenty times the basic pulse repetition rate is needed for proper fidelity in digitization. If high accuracy is also needed, a short aperture time is dictated.

Parallel sampling provides short aperture time. But, the circuits are complex and good accuracy is difficult to achieve. Serial circuits usually result in aperture times exceeding 100 nanoseconds. Chopper-stabilized comparator circuits recover slowly from large signals.

The converter to be described has an upper frequency limit of 1,000 cps and 0.05-percent accuracy. The analog sampling and comparator circuits are the key portions.

TRACK-AND-HOLD—When the sampling process begins upon receipt of a command signal, the d-a converter in Fig. 1 is set to zero output and switches numbered

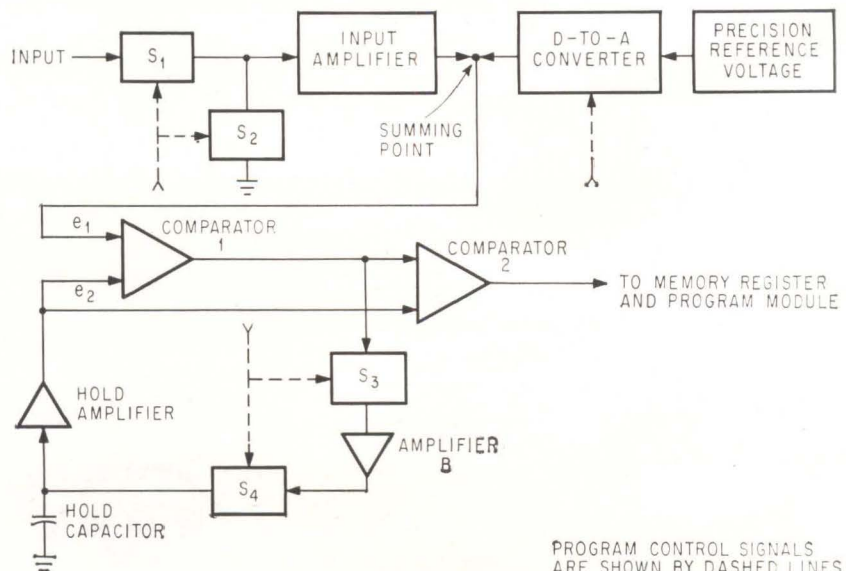

ELEMENTS of the track-and-hold circuit—Fig. 1

PROGRAM CONTROL SIGNALS ARE SHOWN BY DASHED LINES

How to put Siliconix UNIFETs* to work . . .

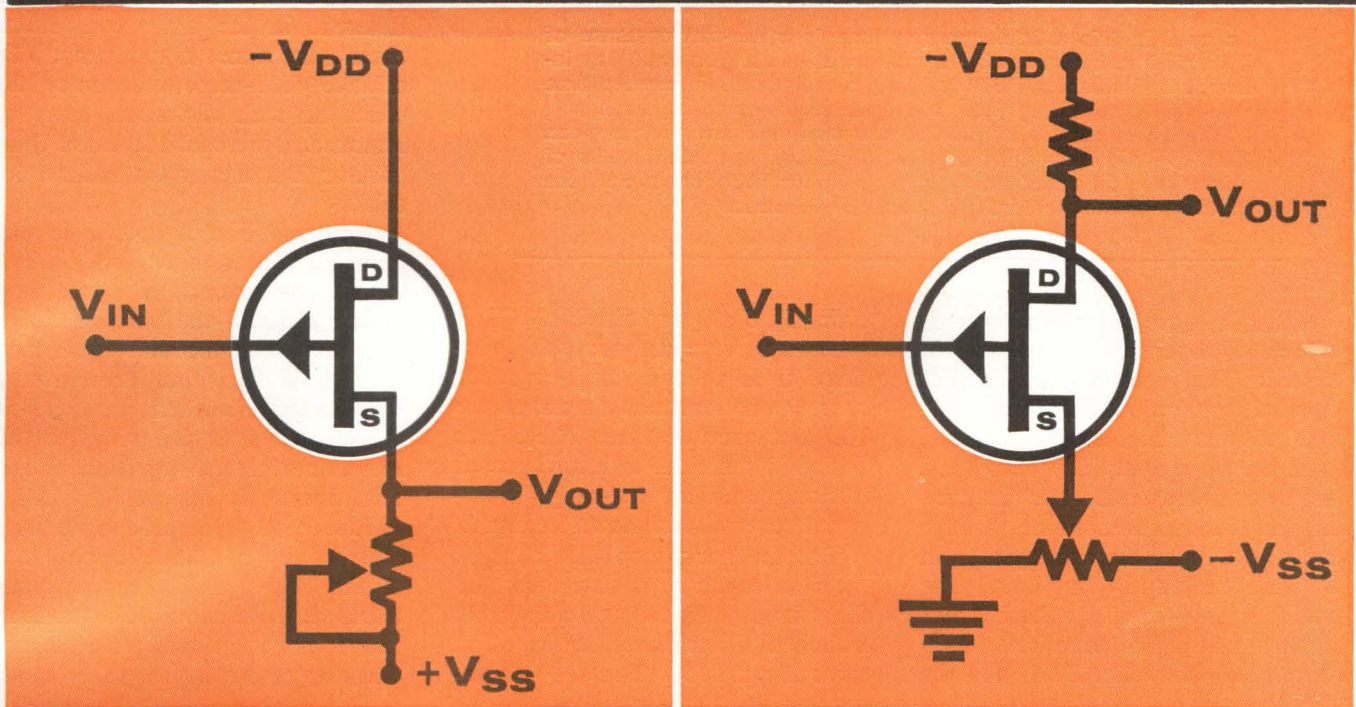

DRIFT – LESS THAN 1 mv/100°C

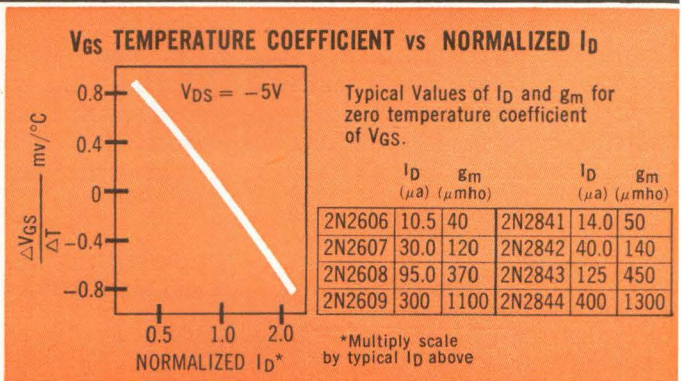
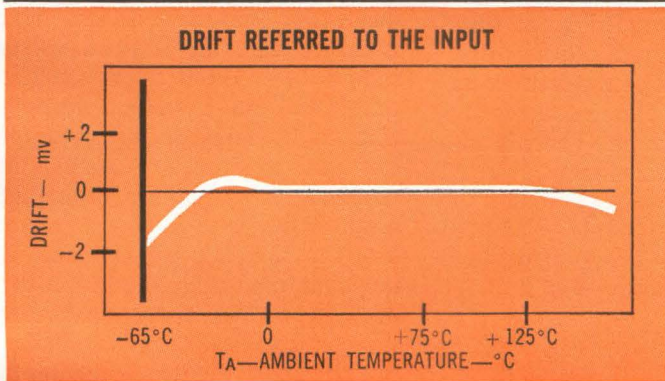

YOU NO LONGER HAVE TO MONKEY WITH DIFFERENTIAL AMPLIFIERS, MATCHING TRANSISTOR PAIRS, BATTLING STEADY STATE AND TRANSIENT THERMAL GRADIENTS. HERE IS A HIGH-INPUT-IMPEDANCE D-C AMPLIFIER THAT CAN BE BIASED TO NEARLY ZERO $\Delta V_{GS}/\Delta T$. UNIFETS ARE RADIATION TOLERANT, TOO. WRITE FOR FILE 100C. IT EXPLAINS THE WHOLE THING.

*Unipolar Field-Effect Transistors



Siliconix incorporated

1140 West Evelyn Ave. • Sunnyvale 33, California
Telephone 245-1000 • Area Code 408 • TWX 408-737-9948

APERTURE TIME

As used in this article, aperture time is a two-part measure of dynamic-tracking accuracy. It comprises phase (or time) lag inherent in finite-bandwidth tracking circuits and disconnect time uncertainty caused by jitter and finite switch-operating time.

The effect can be considered an amplitude error for a given time or a time error for a given amplitude. Aperture time is of minor importance for slowly varying inputs; the more rapidly the input varies the greater its significance becomes

1 through 4 are set as follows: S_1 closed, S_2 open, S_3 closed and S_4 closed. The input voltage is thus applied to the input amplifier. Output of this amplifier is summed with the d-a output (now zero) and fed to comparator 1. Also included in this comparator input voltage are any offset errors accumulated in S_1 and the input amplifier. The total signal—input voltage plus errors—drives a feedback loop through S_3 , amplifier B , S_4 and the hold amplifier.

By this action the hold capacitor is charged until inputs e_1 and e_2 at comparator 1 are equal. The hold-capacitor voltage is effectively equal to the input signal plus offset errors.

At this point, approximately 3 μsec after the command signal occurred, a program command reverses switches 1 through 4 in the

order S_4 , S_3 , S_1 and finally S_2 . This switching sequence prevents transients from affecting hold-capacitor charge and represents most of the 100-nsec aperture time. The 3- μsec period is sufficient to insure proper tracking even for full-range input-signal reversals as shown in Fig. 2.

The feedback loop that charged the hold capacitor is now open and the input signal disconnected. Switch S_2 is trimmed so its offset error matches S_1 . Thus e_1 at comparator No. 1 input will include the same offset errors present during sampling, plus whatever output is generated by the d-to-a converter. Input e_2 is the sampled input voltage, now trapped, plus offset errors. Polarities are such that offset errors are opposed and eliminated during subsequent digitization. There is automatic zero stabilization.

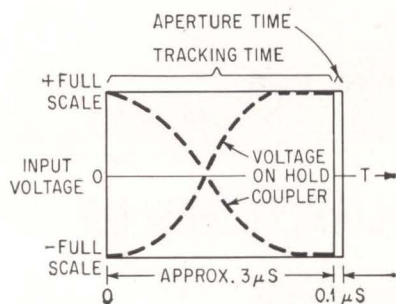

TRACKING TIME for worst-case (full range) input voltage swings—Fig. 2

SEQUENCE of successive approximations—Fig. 3

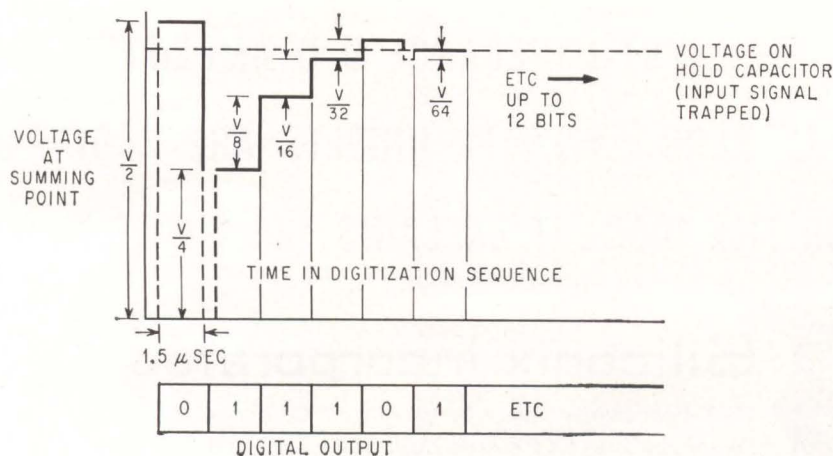

NONLINEARITY—A similar cancellation scheme is used at comparator 2 but for a different reason. Inherent in the basic comparator circuit is some nonlinearity. To achieve 0.05-percent accuracy the effect of such distortion must be removed. Differential action of comparator 2 achieves the desired results.

Although Fig. 1 is a logic diagram and does not show specific circuit components, it is complete in one respect—the only stabilizing element within the unity gain loop is the hold capacitor. There are no time delay elements elsewhere in the circuit. It is primarily for this reason that an aperture time of 100 nanoseconds is achieved.

Reduction of circuit complexity is afforded by a unique combination of the held-signal comparator and track-and-hold circuit. Conventional converter design calls for these two portions of the device to be made separate units.

DIGITIZATION — This process starts by generating a signal from the d-to-a converter. If this signal is larger than the trapped voltage sample (with offset errors cancelled out), the d-to-a output drops to zero to be replaced by an output one-half as large. Actually, the switching is essentially instantaneous so the d-to-a output merely drops to half its previous value. At the same time a flip-flop is set to 0 or 1 depending upon whether the sample corresponding is retained or rejected. Figure 3 shows the process. Conversion takes place at a rate of 1.5 microseconds per bit.

The converter is capable of generating a 12-bit word. It may also be wired for shorter words if full accuracy is not needed. Additional outputs may be obtained at any desired bit position. They can be used to start a companion multiplexer prior to the end of digitization so that multiplexer settling time is completed while the previous digitization is in process.

By using a recirculating delay-line clock technique, sampling and aperture times are uniquely defined in time. If a free-running clock generator had been used, a time uncertainty would exist since conversion could start only as soon as the first clock pulse was produced after the enable pulse.

SMALL PART PROBLEMS ?

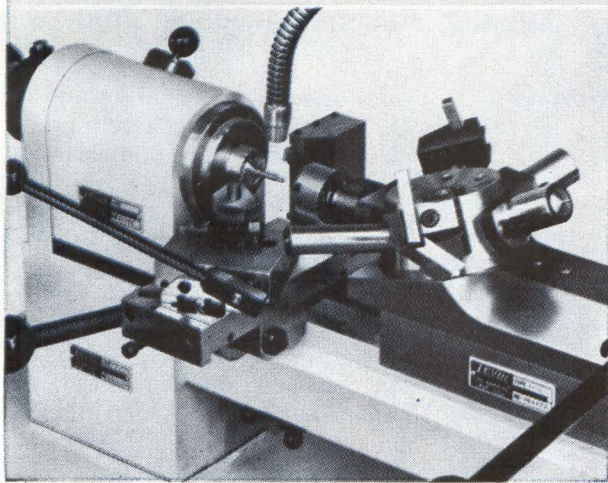

Shown above, an ACAF turret lathe set up to produce the small needle valve, illustrated, with a 0.0118" bleed hole. The self indexing turret is extremely sensitive for fine work. Speed regulation is continuously variable from 0 to 4000 r.p.m. with IR drop compensation.

SEND FOR COMPLETE CATALOG

LEVIN Heavy duty instrument lathes offer the best solution to small part lathe operations. 29 standard models for first and second operation work in 3/16", 5/16", and 1/2" collet capacities.

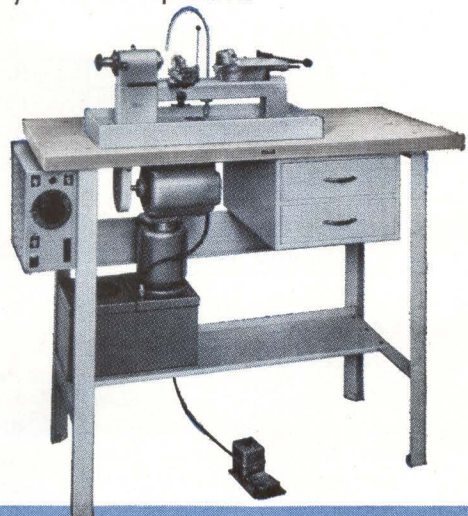

LEVIN INSTRUMENT LATHES

LOUIS LEVIN & SON, INC.
3573 Hayden Ave., Dept. E • Culver City, California

New York Representative and Showroom
RUSSELL-HOLBROOK & HENDERSON, INC.
292 Madison Ave., New York 17, N. Y.

New from Sprague!



**HIGH VOLTAGE
HIGH SPEED**

TO-9
CASE

2N1499B

LOW COST

GERMANIUM P-N-P

LOGIC SWITCH



Significant process improvements in the manufacture of the popular 2N1499A provide substantial increases in performance, power, and reliability. Sprague's new 2N1499B Transistor features improvements in voltage, leakage current, gain, saturation, and speed.

check these key parameters

| | |
|-------------------------|-----------------|
| BV _{CBO} | 30 volts |
| BV _{CEO} | 20 volts |
| I _{CBO} at 15V | 3 μ A max. |
| H _{FE} | 40 min. |
| V _{CE} (SAT) | 0.15 volts max. |
| f _T | 150 mc min. |

**AVAILABLE IN
PRODUCTION QUANTITIES**

For application engineering assistance, write to Transistor Division, Sprague Electric Co., Concord, New Hampshire. For technical data, write for Engineering Bulletin 30,223 to Technical Literature Service, Sprague Electric Co., 35 Marshall Street, North Adams, Massachusetts.

SPRAGUE[®]

THE MARK OF RELIABILITY

45T-144-63

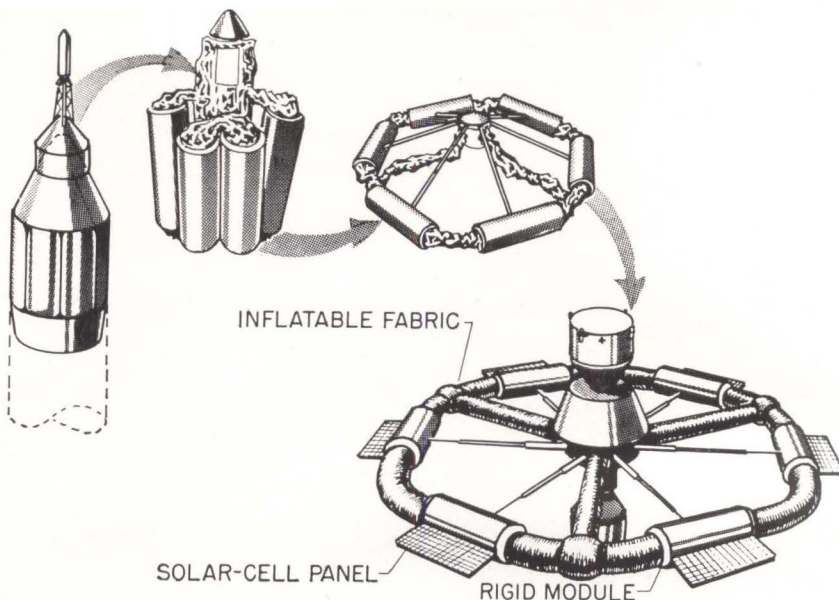

FOR SPACE, An

Orbiting stations now under study will

By **JOEL A. STRASSER**
Assistant Editor

WASHINGTON — Next month, NASA is scheduled to receive three reports that are expected to provide a conceptual base for a new class of satellites—manned orbiting space stations.

These stations, NASA project officials reveal, will serve as sophisticated laboratories for communications experiments in space. Thought is also being given to using space stations as giant active communications satellites. They could serve as communications centers for future manned flights.

The studies due in October are:

- Configurations extending the Apollo spacecraft concept to house 3 men for 100 days to a year. The study is being made by North American Aviation under a NASA-Houston contract for about \$100,000.

- A small station that would be manned by 4 to 6 men for a year. NASA-Langley let contracts worth about \$400,000 each to Boeing and Douglas Aircraft.

Next April, two studies are due, for large stations that could house 24 men for 1 to 5 years. Lockheed-Burbank is studying a rotating sta-

tion, under a \$300,000 award, and Douglas is studying a zero-gravity station under a \$150,000 contract.

EXPERIMENTS—One set of proposed experiments calls for development and erection of passive communications satellites at the station, according to Michael I. Yarymovich, assistant director of advanced studies for NASA's Office of Manned Space Flight. Astronaut-scientists would perform deployment and dynamics tests with satellite structures. Two areas of interest are obtaining increased bandwidth from a 1,000-foot balloon, and making the balloons stronger.

Free-space antenna measurements are planned, and studies of the effect of interplanetary media on propagation between 10 Gc and 500 Å. Problems of transmission through engine exhaust plumes would be studied. Tests will be performed with a small rocket fired at the station.

Tests will also be conducted on electronic components and systems. Efforts will be made to stabilize lasers and determine their practicality in space—lasers are expected to be useful for range finding, communications and rendezvous.

FLIGHT PLANS—Present plans

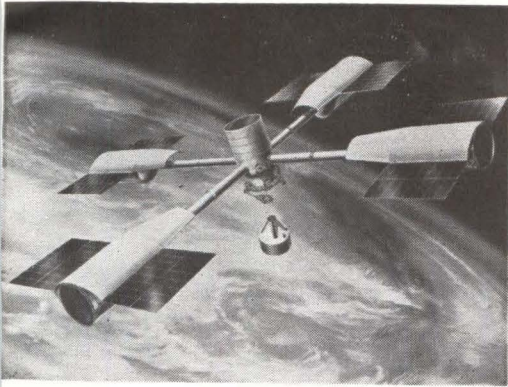

SMALL STATIONS would carry 4 to 6 men. This is a Boeing sketch

◀ LARGE STATION being considered by NASA. Station would be formed after launch from rigid modules connected by inflated sections

Electronics Lab

test communications, lasers

call for launching either the extended Apollo or the small station on a Saturn IB, or the large station on a Saturn V-class vehicle.

The first manned orbiting laboratory will probably orbit at an altitude less than 200 miles and at an inclination of 30 degrees. At higher altitudes, the stations would be closer to solar flares and more subject to radiation. Radiation-shielding systems based on superconducting magnets are being considered.

NASA has also let contracts for studies of power systems, environmental and life-support facilities, shuttle ferries, biomedical, human factors and logistics. Power systems being considered include solar, nuclear and chemical. Power requirements are 1 kw a man.

MILITARY—A proposal for a military space station study is now pending at the Department of Defense. The military is exploring relationships with NASA's program, with an eye toward combining efforts. Goals of a military station would initially be to prove out military equipment in space and check on feasibility of using stations for missions. Among the missions envisioned by the Air Force are command, control and communications centers.

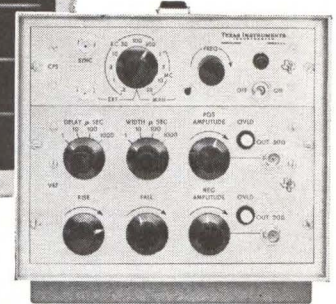
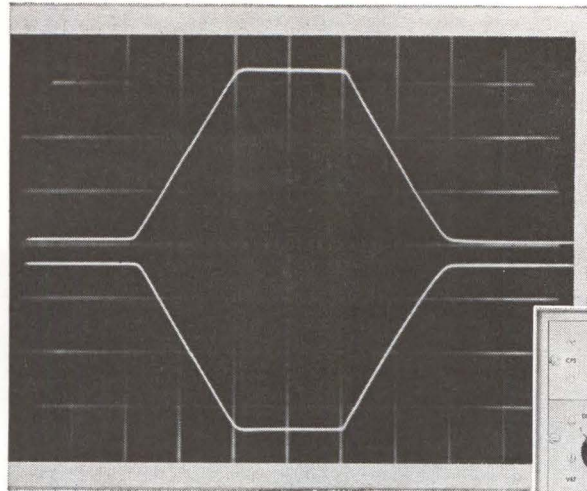

Clean waveforms with TI Model 7505 variable rise/fall time pulse unit

Clean waveforms are characteristic of TI pulse generators. The Model 7505 provides coincident positive and negative 10 volt pulses into 50 ohms with unlimited duty cycle . . . and both pulses can be simultaneously controlled in width, rise time, fall time and delay. Amplitudes are independently variable and outputs are short-proof, with overload indicators and reset buttons. Specifications, briefly . . . rise/fall times from less than 20 to 500 nanoseconds; width 40 nanoseconds to 1 millisecond; delay 90 nanoseconds to 1 millisecond; repetition rates to 25 megacycles. Like all Texas Instruments pulse generators, the Model 7505 is compact, lightweight and portable, extremely convenient to use. Circuitry is all solid-state.

Write for complete information.

INDUSTRIAL
PRODUCTS
GROUP



TEXAS INSTRUMENTS
INCORPORATED
P. O. BOX 66027 HOUSTON 6, TEXAS

SENSING • RECORDING • TESTING • DIGITIZING INSTRUMENTS
THE INSTRUMENTS OF TEXAS INSTRUMENTS

602

CIRCLE 43 ON READER SERVICE CARD

**HELP YOUR POST OFFICE
TO SERVE YOU BETTER
BY
MAILING EARLY IN THE DAY
NATIONWIDE IMPROVED MAIL SERVICE
PROGRAM**

METAL GLAZE RESISTORS AVAILABLE FOR MIL-R-22684

Compare this new breed of IRC Resistors
to MIL specifications

| Test | Typical IRC Metal Glaze Film Resistor Performance | Specifications | | |
|---------------------------------|--|--------------------------------------|----------------------------|---|
| | | MIL-R-10509 Char. B & D | MIL-R-22684 Char. A & D | MIL-R-11 Char. G & F |
| Temperature Coefficient: ppm/°C | +150 (Avg.) | Char. B ±500 Char. D +200 -500 | ± 200 | ±600 to ±3125 depending on resistance value |
| Load Life | ± 0.60% | ± 1.0% | ± 2.0% | ± 10% |
| Moisture Resistance | ± 0.35% | ± 1.5% | ± 1.5% | ± 15% |
| Temperature Cycling | ± 0.05% | ± 0.5% | ± 1.0% | ± 4% |
| Short Time Overload | ± 0.11% | ± 0.5% | ± 0.5% | ± 2.5% |
| Low Temperature Operation | ± 0.03% | ± 0.5% | ± 0.5% | ± 3% |
| Dielectric Withstanding Voltage | ± 0.02% | ± 0.5% | ± 0.5% | No Breakdown |
| Terminal Strength | ± 0.02% | ± 0.2% | ± 0.5% | ± 1% |
| Effects of Soldering | ± 0.02% | ± 0.5% | ± 0.5% | ± 3% |
| Shock | ± 0.03% | ± 0.5% | ± 0.5% | ± 3% |
| Vibration | ± 0.03% | ± 0.5% | ± 0.5% | ± 3% |

The high performance of these metal glaze resistors is indicated by their excellent load-life and temperature coefficient characteristics. These show an average resistance change of less than 0.6% after 1,000 hours, full load at 70°C. Average temperature coefficient is plus 150 ppm/°C.

With its unique resistance element of glass and precious metal alloys fused to a crystalline ceramic core, metal glaze is up to 100 times thicker than conventional films. This provides an exceptionally rugged resistance element. It defies catastrophic failure. Power density is twice as high as comparable deposited carbon units.

Metal glaze resistors are an economical approach to stability, reliability and precision. Write for bulletin. International Resistance Company, 401 N. Broad St., Philadelphia 8, Pa.

CAPSULE SPECIFICATIONS

Actual Size



| MIL-R-22684A | RL07 | RL20 |
|-------------------------|-------------------------------|---------------------------|
| Wattage | ¼W @ 70°C | ½W @ 70°C |
| Resistance | 51 ohms to 150K ohms | 51 ohms to 470K ohms |
| Tolerance | ±2%, ±5% | ±2%, ±5% |
| Temperature Coefficient | ±200 ppm/°C -55°C to 150°C | (plus 150 ppm/°C average) |
| Voltage | 250V max. | 350V max. |
| Size | .250 x .090" dia. | .375 x .138" dia. |
| IRC Type | L07 | L20 |



USAF to Test Triple Navigator

Star tracker added to doppler-inertial system for long air flights

By **HAROLD C. HOOD**
Pacific Coast Editor

LOS ANGELES—Under a \$2.5-million Air Force contract, the Guidance and Control Systems division of Litton Industries is developing a three-way SIDS (stellar, inertial, doppler) navigation and control system which promises to provide long-range aircraft with unprecedented accuracies for reconnaissance and other critical missions.

A Litton spokesman told **ELECTRONICS** that this latest version of a series of Litton navigation systems "purposely is not tied to any specific program so that its design is not compromised by the unique requirements of such a program. It is intended to be a versatile package whose outputs can be adapted to the requirements of many types of aircraft and missions." The new system has been tentatively designated the LN-16.

The four systems called for under the initial contract are slated for flight testing at Holloman Air Force Base in New Mexico.

Long a major supplier of airborne navigation systems, Litton has built over 1,000 LN-3 systems for USAF's F-104, developed the LN-12 for the McDonnell Phantom II, and is providing both the Army and Navy TFX's with LN-14. All three versions are pure-inertial systems.

TRIPLE SYSTEM—In a pure-inertial system, acceleration data is sensed by accelerometers, integrated once to get velocity information, and integrated again to obtain position. Position error naturally increases with time.

By applying corrective doppler information to the output of the first integrator, a more accurate end reading is obtained. Such a scheme has been used in the LN-2 series and for the LN-9A, designed for the Navy's controversial VAX aircraft.

Adding a star-tracking capability, as has been done in the LN-16, provides an additional corrective function which toes in behind the second integrator.

While the LN-16 relies far more heavily on conventional cordwood and welded module fabrication techniques than do the smaller LN-9A and some of the Navy versions of the LN-2 (which uses a substantial number of integrated circuits), it is,

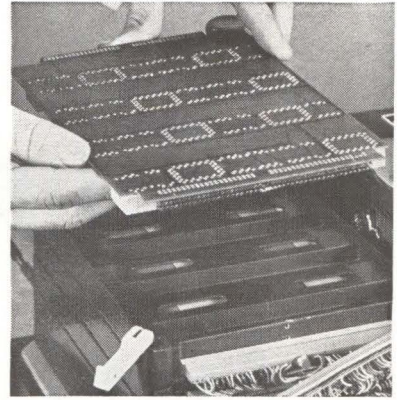

COMPUTER for new guidance system uses welded-wire circuit modules assembled on printed-circuit laminates and stacked on heat-conducting trays next to drum memory

according to its developers, "the most sophisticated system electromechanically and from the standpoint of basic concept." Unlike the LN-9A, which uses 4 basic circuits, the LN-16 has in excess of 20 circuit types.

STAR COMPUTER—Heart of the high-speed, automatic star-tracker subsystem is a company-proprietary optical encoder "of highly advanced design."

Star catalog information is provided by the brand new C-900 computer, the first digital computer developed by Litton specifically for a navigation system. Containing approximately 68 flip flops, 900 logic gates, and 200 logic amplifiers, the C-900 has an overall mtbf figure of roughly 2,400 hours, occupies ½ cubic foot, and contains about 8,400 discrete components. The 6-inch memory drum has a capacity of 7,680 words of 25 bits each. Clock rate is 426 kc.

Actually three computers in one, the C-900 has a general-purpose section capable of 3,000 operations per second and its dda section functions at 133 or 266 iterations per second, depending upon how many integrators are involved.

The entire LN-16 system weighs 128 pounds, and occupies 3 cubic feet. Continuous display of exact position data is accomplished by latitude and longitude counters, and the same data could be hooked to a moving-map display.

New Computer Is Liquid-Cooled

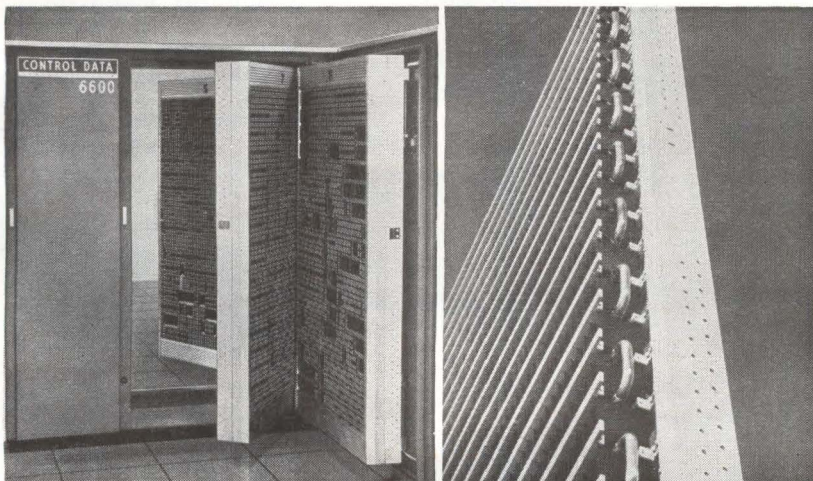

COOLING SYSTEM for Control Data 6600 digital computer (p 7, Aug. 30) circulates Freon through a continuous copper tube in the module-row separator, connected to a refrigeration unit on each frame wing and accessible through door. Each of the 16 page frames, hung four to a wing, is kept at 130 to 140 deg F

EXTEND RETRACT FLEXIBLE HARNESSES

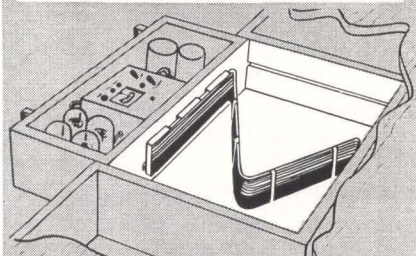
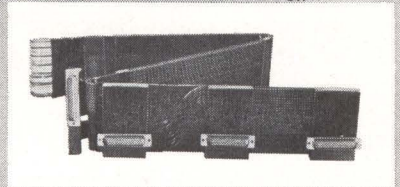
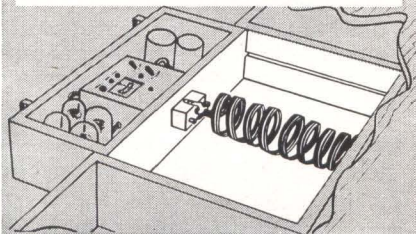
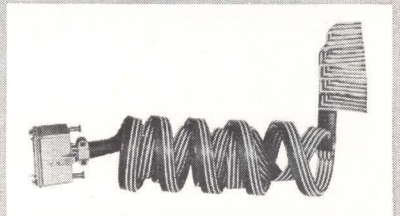

SPECTRA-FLEX CABLES®

Spectra-Flex Cables are efficiently neat, flexible, compact and easily handled. Comes in all sizes from #10 to #30 AWG. Made to your specifications, any wire with a vinyl jacket.

Write for information regarding extensible, retractable harness.



P.O. BOX 415, Tel.: 714 537-4530
TWX 714 530-0313
GARDEN GROVE, CALIF.

VE Now the Rule

Value engineering will now be part of most defense contract terms

BEGINNING THIS MONTH, value engineering (VE) clauses can be written into many existing defense supply contracts, and will be inserted automatically into most new contracts, both procurement and R&D.

This marks the implementation of the Department of Defense's declared aim: to pare \$100 million a year from defense contracts through VE. Formerly VE clauses were inserted into contracts only in special cases.

Two types of VE clauses are:

- VE incentive clause. This allows the contractor to perform value analysis if he so desires and then to share the resulting savings with the government. It applies to contracts over \$100,000, other than cost-plus-fixed-fee types. The contractor gets as high as 75 percent of the savings.

- Required VE program. This will be written into most cost-plus-fixed-fee contracts over \$1 million, and may be used in certain other types of contracts. VE analysis is part of the contract. If the VE analysis results in a contract change, the contractor will normally share 10 percent, on cost-plus-contracts, or up to 25 percent on fixed-price and incentive type contracts.

The program will require contractors to establish a value-engineering effort in accordance with prescribed procedures. However, says DOD, an existing VE department is not a requirement for a contract award.

VE INFORMATION—Program specifications are being prepared; a handbook giving guidance on key subjects has been issued by DOD (Value Engineering, Handbook H 111, available from the Office of the Assistant Secretary of Defense, Installations and Logistics, Washington 25, D. C.).

DOD and all three services are establishing their own VE staffs,

and training present procurement personnel. VE training is available to industry in special courses offered by some 15 colleges on a post-graduate engineering level.

George E. Fouch, deputy assistant secretary of defense, said that sharing arrangements, similar to those developed for the government-industry interface, should also be extended to prime-subcontractor and vendor relationships, as has already been done by several companies. Fouch spoke at a symposium, sponsored by the National Security Industrial Symposium, last week in New York.

As one example of what VE can accomplish, a Navy spokesman quoted the development by Loral Electronics of the ASA 25 computing system. Value engineering applied to the contract resulted in a net return of \$418,634 to the Navy.

India Plans to Build Electronics Capability

NEW DELHI—An electronics assembly and parts-manufacturing complex will be developed near Bombay. U.S. and British technicians, coming here to set up radar and communications network for joint air exercises, will train Indian scientists and technicians as a first step.

Long-Playing Record



BACKGROUND MUSIC system introduced by 3M Company's Revere-Wollensak division plays 2,100 selections—75 hours—from 8-inch reel of 14-track, 1-inch-wide tape moving at $\frac{1}{8}$ ips. Tapes are changed twice a year

How do you take a picture of something you can't see?

Transient oscilloscope traces in the sub-nanosecond range move too fast for the human eye. How can you study them?

Use Polaroid 10,000-speed Land film. It's fast enough to make clear, high-contrast pictures of the most fleeting traces. And the results are fast, too.

Your pictures are fully developed in 10 seconds. If you are studying sequential traces, you can click off a full roll (8 exposures) in 20 seconds. Simply let the film stay in the camera back for 2 seconds, then pull the tab,

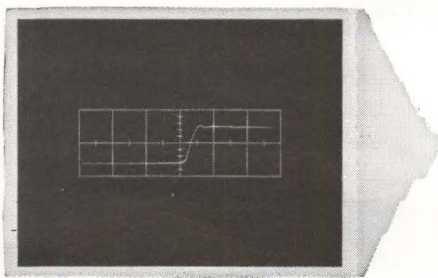

repeating the process for each exposure. Strip away the negative and you've got eight finished pictures.

The catalog name for this film is Polaroid PolaScope Type 410. It's panchromatic, responds best to blue phosphors such as P-11. The film's extreme sensitivity lets you use small camera apertures and low beam intensities too, so your trace pictures are really sharp.

Try Type 410 Land film the next time you need oscilloscope pictures. And see.

POLAROID®

Polaroid 10,000-speed Land film.

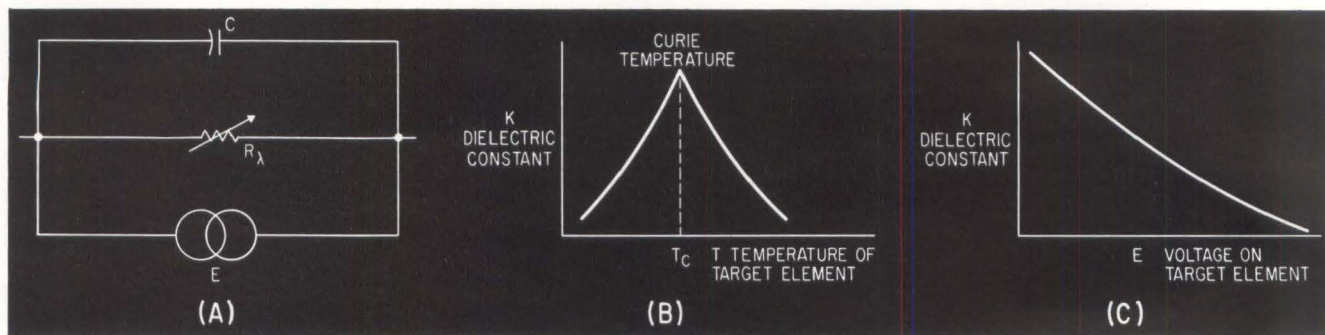

TARGET ELEMENT, equivalent circuit, (A); variation of dielectric constant against temperature near the Curie temperature of the material (B); variation of the dielectric constant with applied electric field, (C)

Infrared Tv Tube Uses New Principle

By V. A. BABITS, Applied Research Laboratories, General Dynamics/Astronautics, San Diego, Calif.

Dielectric constant variation is used to increase IR sensitivity

VIDICON—type television pickup tubes, operating in the infrared region, are generally based on the photoconductive sensitivity of the target material. A new type of infrared pickup tube, operating on a different principle, shows higher sensitivity and a more convenient mode of operation.

The target of a vidicon usually consists of a translucent, electrically conductive layer, on which semiconducting granules are deposited in a layer on the side facing the electron gun.¹ The translucent layer is connected, through a resistor, to a bias voltage source. If an electron beam sweeps the semiconducting layer on the side facing the cathode, and a picture is focussed on the junction of the two layers, video signals appear across the resistor.

Each target element, corresponding to a picture element, can be

represented by the equivalent circuit of Fig. A, where C is the capacitance of the target element, R_{λ} its photoresistance and E the voltage due to the photovoltaic effect.

Vidicon type tubes usually operate on the principle of using the elementary changes in R_{λ} , or the elementary photovoltaic E changes, or both. The new device, however, makes use of the fact that the elementary capacitance C changes when exposed to infrared radiation.²

NEW PRINCIPLE—In the new tube, the target electrode consists of a translucent, electrically conducting layer facing the picture side, and a second semiconducting layer, deposited on the first, facing the cathode.³ The second layer is made of a ferroelectric substance or the like, such as barium titanate.

This type of material has the important property that its permittivity, or dielectric constant, varies with temperature, particularly when close to the material's Curie temperature (Fig. B). Also, the dielectric constant changes in the presence of an electric field (Fig. C).

These two effects can be used

together to advantage. Each target element can be regarded as an elementary capacitor, with one plate facing the electron gun and the other plate connected to the resistor and bias source, and each elementary capacitor can be considered as charged, by the bias source, to the bias potential. If an infrared picture is focussed on the target, the heat it produces will decrease the dielectric constant of each elementary capacitor, provided that the ambient temperature is just above the material's Curie temperature. As a result, the potential difference across each elementary capacitor will change, reflecting the intensity of the corresponding picture element.

VIDEO SIGNAL—As the electron beam scans the target, it hits one electrode of each elementary capacitor, and increases the potential difference across the capacitor. This, in turn, further decreases the dielectric constant, causing a still further change in the potential difference. The sudden change of potential difference across each capacitor appears as a current pulse across the resistor.

Accordingly, as the beam sequen-



How tube skills made these new Sylvania Ni-Cd batteries more efficient than any others

Especially for designers of transistorized equipment who are thinking small, here are rechargeable nickel-cadmium batteries which occupy up to 50% less space per unit output than any others—ideal for field radios, beacons and other low-rate-discharge equipment.

Key to this remarkable high efficiency is the Sylvania film forming process, by which nickel is cast and sintered to form a por-

ous, self-supporting film. Then this nickel "sponge" is loaded with chemicals to form cell plates. Because there's no need for a plate backing, and because each cell is an easily stacked rectangular shape, the result is very high output per unit volume and weight.

What's the connection with tubes? In addition to benefiting by our experience in heliarc welding and hermetic sealing, these

batteries are the second big payoff from pioneer work in film forming. First was the Sarong cathode, which has a wraparound emission coating that greatly improves tube performance.

The broad, integrated capabilities that produced these developments are working in many ways to advance electronics. Electronic Tube Division, Sylvania Electric Products Inc., Box 87, Buffalo, N. Y.

SYLVANIA

SUBSIDIARY OF

GENERAL TELEPHONE & ELECTRONICS



NEW CAPABILITIES IN: ELECTRONIC TUBES • SEMICONDUCTORS • MICROWAVE DEVICES • SPECIAL COMPONENTS • DISPLAY DEVICES

HOW TO FABRICATE

in model shop
or production
with

di-acro
PRECISION
METALWORKING
EQUIPMENT

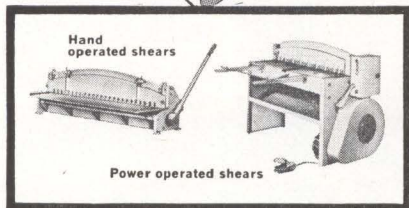
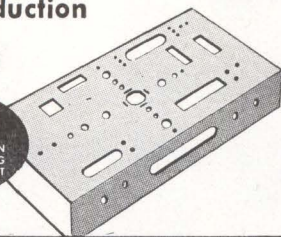

SQUARING

Power shear blanks to die accuracy at high speed—up to 16 gauge mild steel. Heavy duty construction for efficient, accurate and trouble free performance.

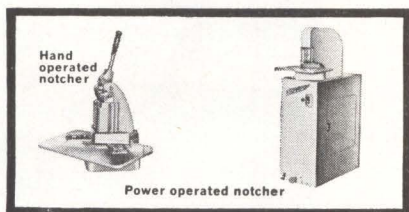

NOTCHING

Notcher cuts up to 6" x 6" in 16 gauge mild steel in one operation. No expensive dies, no punch press set-up—just set the gauges and toe the switch.

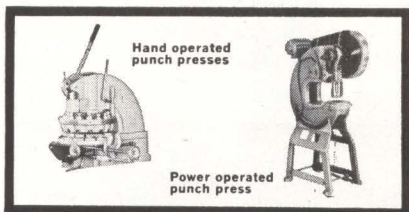

PUNCHING

OBI 5-ton punch press—single or automatic cycling—up to 190 strokes a minute. It's accurate and easy to set up. Safe to operate no special skills needed.

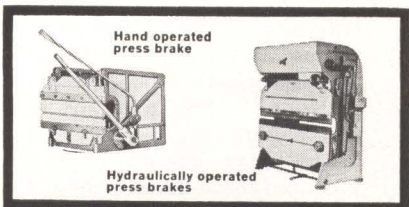

BRAKING

Hydraulic powered press brakes give full control. Dual speed cycle . . . fast approach and return—safe work speed. Available in 12, 25 and 35 ton models.

For complete information on these and all Di-Acro machines see your Di-Acro distributor or write for Catalog 62.



DI-ACRO CORPORATION
439 Eighth Avenue • Lake City, Minn.

tially covers each elementary capacitor, the pulses add up to a complete video signal of the infrared image.

REFERENCES

- (1) V. A. Babits: Semiconducting Materials in Vidicon-type television pickup tubes, Jour Television Soc, 8, No. 12, Dec. 1958.
- (2) V. A. Babits: Vidicon, ELECTRONICS, p 338, Dec. 1951.
- (3) V. A. Babits: Latest Television Inven-

tion, Radio News, p 77, Aug. 1935.
(2) T. M. Odarenko, German Wartime Developments in Infrared, Review of Reports and Documents released by the U. S. Government, March 1948.
(3) V. A. Babits: U. S. Patent applied for April 18, 1960.

Mariner Hunts Cosmic Rays

Data from deep space will be compared with data from earth-orbiting satellites

IOWA CITY, IOWA—Four detectors that gather low-energy cosmic-ray data are being readied by State University of Iowa for use in the Mariner program. The experiment, headed by James A. Van Allen, will study planetary radiation belts as well as interplanetary space.

Data will be compared with observations from similar SUI gear on Injun III, Injun IV, EGO (Eccentric Geophysical Observatory), POGO (Polar Orbiting Geophysical Observatory) and other satellites orbiting the earth when the deep space probe is launched.

New to the Mariner program is a solid-state *p-n* junction detector (identified as detector D) that measures protons, but not electrons. It is similar to those flown by SUI on Relay, and currently being readied for Injun IV and EGO. Detector D has a 70-degree angle of axis with the probe-sun line and detects protons in two channels from 0.5 to 8 Mev, and 0.9 to 5.5 Mev, respectively. Working with detectors B and C, it is designed to provide a more definitive resolution of the particle beam into electrons and protons than was possible with the comparable Mariner II experiment. Weight, power and telemetry capacity restrictions limited Mariner II studies.

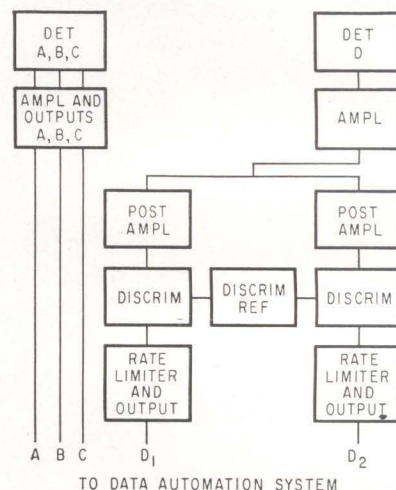

TRAPPED RADIATION detector is being readied by SUI for the Mariner program. Solid state *p-n* junction detector, D, senses protons in two channels from 0.5 to 8 Mev, and 0.9 to 5.5 Mev, respectively

Three other detectors are similar to those which operated successfully for over four months on Mariner II. Detectors A, B and C are thin-window (1.2 mg/cm² mica) Geiger-Mueller tubes, type EON 6213. Detectors A and B are sensitive to electrons of more than 40 kev and protons greater than 0.5 Mev. Detector A has a 135-degree angle of axis to the probe-sun line, while detector B's is 70 degrees. Detector C is sensitive to electrons greater than 70 kev and protons greater than 0.9 Mev. All detectors will have a conical field of view of 60 degrees and dynamic range of 0.1 to 50,000 counts per sec.

Electronic Pen Uses Ink Instead of Electron Beam

DEVELOPED by a Stanford University engineer, a new type of electronically controlled recording instrument operates on a principle similar to that of the cathode-ray tube, only it uses a fine stream of ink impinging on a paper screen instead of electrons and a fluorescent screen.

Richard G. Sweet's pen squirts fountain-pen ink at the paper in drops two thousandths of an inch in diameter. It is capable of recording on paper oscillations up to 10 kilocycles. There is no contact between pen and paper, and different pens with different color inks can be used simultaneously.

The 0.0013-inch stream of ink is broken up into fine droplets by vibrating the fine-drawn glass nozzle at 100 kilocycles. The drops then pass through a cylindrical electrode, which gives each drop an electrostatic charge proportional to the signal amplitude to be recorded. The stream of drops then passes between two charged plates, which attract or repel each drop according to the amount of its charge. The drops then strike the paper at different angles.

A full-scale, half-inch deflection of the stream takes only 10 microseconds. The new technique permits instantaneous recording of wave-shapes at low cost, as an alternative to the conventional oscilloscope-camera chain.

Dish-Shaped Satellite May Fly Late in 1965

NASA IS NOW hoping to flight-test in late 1965 or early 1966 models of a passively oriented passive-communications satellite (ELECTRONICS, p 24, Sept. 6). Good-year's feasibility and preliminary design study, under a \$191,000 contract, is due in April, 1964. Then it would take at least 18 months to build a flight model.

The design under study is a 50-foot-diameter model (simulating a 400-foot balloon), light enough to be placed into orbit by a Scout rocket. The saucer-shaped satellite would be inflated by gas.

**Mort
Mann
can
show
you...**

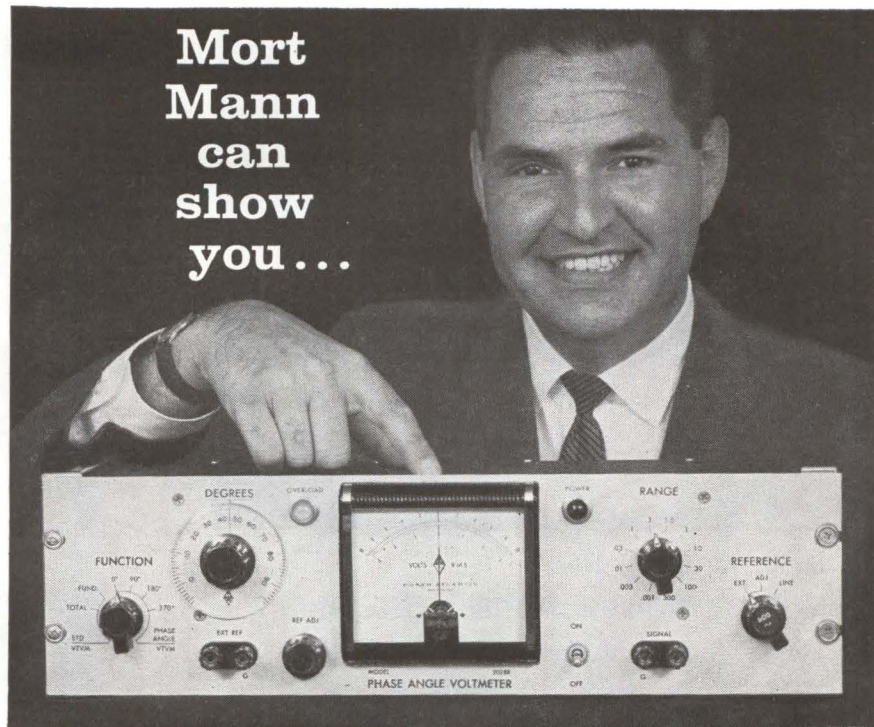

Sales Engineer, North Atlantic Industries

how North Atlantic's Phase Angle Voltmeters* solve tough ac measurement problems ... in the lab or in the field.

Designed for critical tasks in circuit development, production and testing, North Atlantic's Phase Angle Voltmeters provide direct reading of phase angle, nulls, total, quadrature and in-phase voltages—with proven dependability even under field conditions. Your North Atlantic engineering representative can quickly demonstrate how they simplify ac measurement jobs from missile checkout to alignment of analog computers—from phasing servo motors to zeroing precision synchros and transducers.

Shown below are condensed specifications for single-frequency Model VM-202. Other models include high sensitivity, three-frequency and broadband types.

| | |
|--------------------------|---------------------------------------|
| Voltage Range..... | 1 mv to 300 v f.s., 12 ranges |
| Voltage Accuracy..... | ±2% f.s. |
| Phase Accuracy..... | dial: ±1°; meter: ±3% of F.S. degrees |
| Signal Frequency..... | 1 Freq., 30 cps—10 kc |
| Input Impedance..... | 10 megohms |
| Reference Input..... | 100 K, 0.25 v min. |
| Meter scale..... | 3-0-3, 10-0-10 linear |
| Phase Angle Dial..... | 4 scales, 90° (elec.) apart |
| Nulling Sensitivity..... | 2 microvolts (phase sensitive) |
| Harmonic Rejection..... | 55db (with filters) |
| Dimensions..... | 5¼" h. x 19" w. x 7⅞" d. |

The North Atlantic man in your area has full data on standard and special models for laboratory, production and ground support. Call today for his name, or request Bulletin VM-202.

**Trademark*



NORTH ATLANTIC industries, inc.
TERMINAL DRIVE, PLAINVIEW, L. I., NEW YORK • OVERBROOK 1-8600

EXTREME ENVIRONMENTS

test field reliability of
instrument
motor



MANUFACTURER FINDS:

HANSEN SYNCHRON® MOTOR EXCEEDS OTHERS, makes "good" instruments "even better"

Hansen SYNCHRON Instrument Motors were test run by a leading instrument manufacturer, packed in dry ice and then in ovens — at ambient temperatures (-40° to $+140^{\circ}$ F.) beyond most field conditions. Not one failed.

ALL SYNCHRON® MOTORS are carefully built and are tested in all stages of manufacture. They have lifetime custom-formula lubrication, 100 per cent inspection of gears, final testing with stroboscopic light and electronic listening devices.

At 1 RPM, torque ratings of 8, 20, and 30 inch ounces are standard and 90 inch ounces of static torque may be applied to the output shaft without ruining the motor or stripping gears. Depending on the gear train specified, SYNCHRON offers 179 speeds varying from 600 RPM to one revolution per week.

Hansen engineers are ready to apply more than 50 years of concentrated timing motor experience to your problems. Hansen will make prototypes of special adaptations, design drives for your needs, or follow your blueprints. If you have a problem, we'll be pleased to work with you.

APPROXIMATE SPACE REQUIREMENTS

Round Mount — 2" diameter, 1 3/8" deep

Pear Shape — 2" wide, 2 1/2" high, 1 3/8" deep

OUTPUT DRIVES

Pinion drives, flatted, threaded, cross-drilled, knurled, or slotted shafts; adapters, or crank assemblies. OR HANSEN WILL INTEGRATE PINIONS, GEARS, OR SPECIAL DRIVE ASSEMBLIES OF YOUR OWN MANUFACTURE.

Information on D.C. motors available on request.



Sweet's Product
Design File

HANSEN
MANUFACTURING
COMPANY, INC.
PRINCETON, INDIANA

HANSEN REPRESENTATIVES:

R. S. HOPKINS COMPANY
Sherman Oaks, Calif.

EICHORN & MELCHIOR, INC.
San Carlos, Calif.

THE FROMM COMPANY, Chicago, Ill.

H. C. JOHNSON AGENCY, INC.
Binghamton, N.Y., Fayetteville, N.Y.,
Rochester, N.Y., Schenectady, N.Y.,
Williamsville, N.Y.

WINSLOW ELECTRIC COMPANY
Essex, Connecticut, New York City,
Philadelphia, Pa.

EXPORT DEPARTMENT
15 Moore Street, New York City

Handled exclusively in Canada by Sperry Gyroscope Ottawa Ltd., Ottawa, Canada

BARKER & WILLIAMSON MATCHING TRANSFORMERS AND RECEIVING BALUNS...

**BROADBAND
High Frequency
MATCHING
TRANSFORMERS
(1 KW to 20 KW)**



**Unbalance to Balance or Vice-Versa
and Impedance Matching . . .**

Frequency range: 2 to 30 mc.

Power ratings: 1 KW, 5 KW and 20 KW:

These high frequency transformers are ideal for matching unbalanced radio transmitter outputs to balanced amplifiers and balanced antennas. Standard impedance transformations: 50 to 70 ohms unbalanced to 150, 300 or 600 ohms balanced as required. Other impedance ratios available on special order.

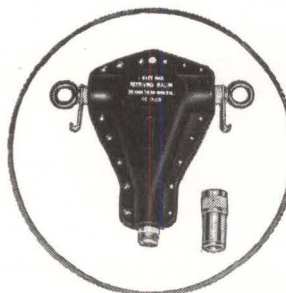

**RECEIVING
BALUNS
FOR
COMMERCIAL
APPLICATIONS**

Balanced to Unbalanced

Couples a balanced antenna to unbalanced coaxial cable.

Frequency Range: 2 to 32 mc.

Ideally packaged — acts as a center insulator in a doublet antenna. The coupling transformer is sealed inside a rugged aluminum casting providing shortest possible connections to both antenna and coaxial cable.

Insertion loss less than 1/2 db.

Available in twelve impedance transformations.

**Pioneers in the development of baluns
and unique RF coupling devices B&W
again sets a standard.**



Drop us a card requesting Spec Sheets.

BARKER & WILLIAMSON, Inc.
Radio Communication Equipment Since 1932
BRISTOL, PENNSYLVANIA • Stillwell 8-5581

ANOTHER APPROVAL FOR EL-MENCO...

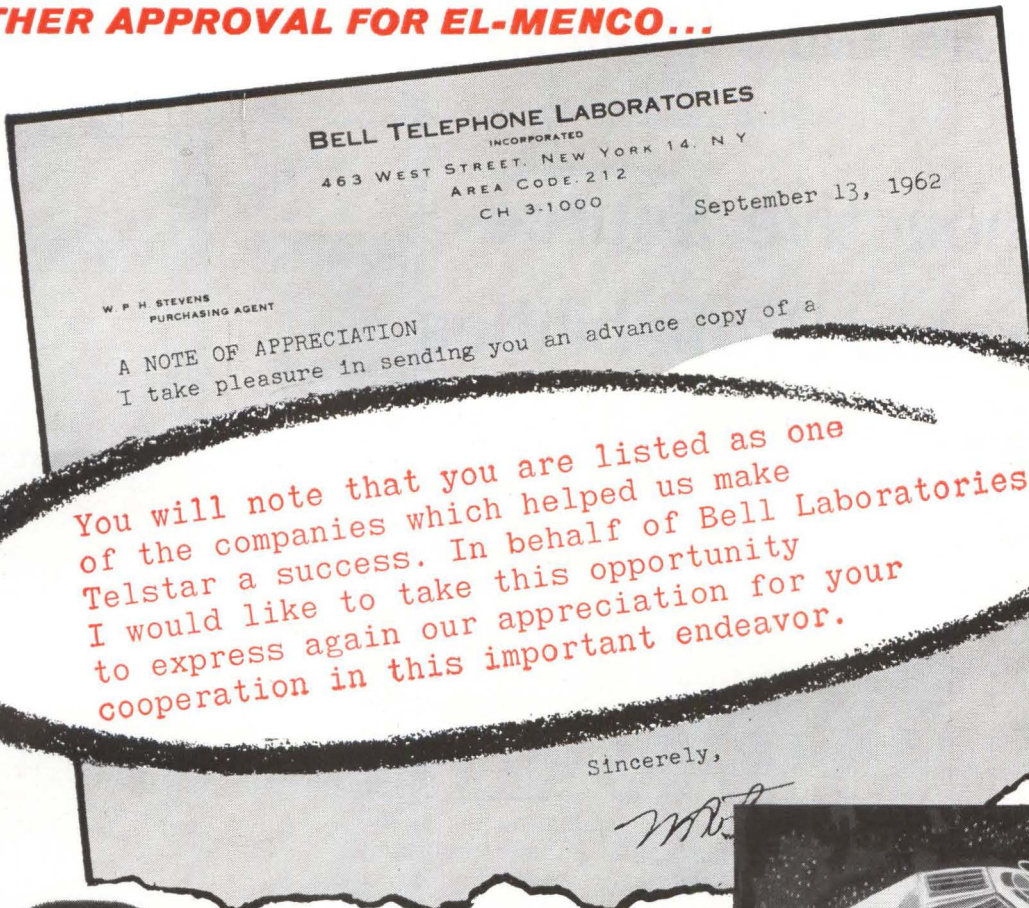

You will note that you are listed as one of the companies which helped us make Telstar a success. In behalf of Bell Laboratories, I would like to take this opportunity to express again our appreciation for your cooperation in this important endeavor.

Sincerely,

**a
star
performer-
TELSTAR,
we
mean**

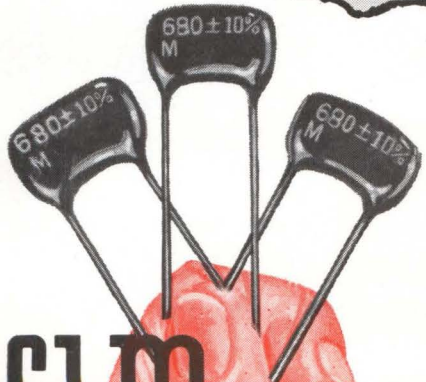
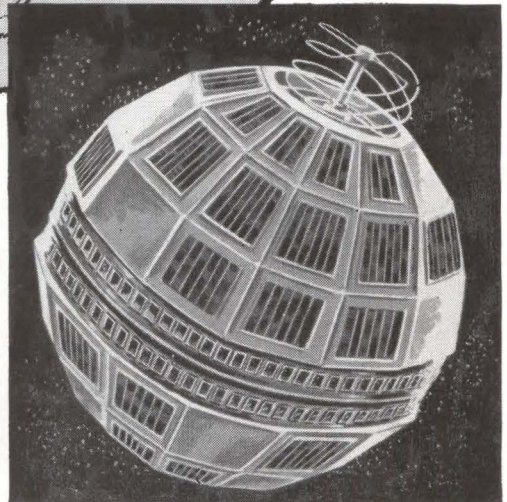

**El-Menco
were selected
for
TELSTAR**

MICA CAPACITORS

■ In the words of the Bell Telephone System, El-Menco was chosen "because of its competence in its field for the job required." ■ At El-Menco we believe that competence in our work of designing and building the best practical capacitors will instill your confidence in our product. This philosophy has resulted in our producing capacitors which have a high order of *quality, reliability, and availability.* Hence the selection of El-Menco mica capacitors for many important missile and satellite programs. ■ Still widely discussed is the *RCA test evaluation of El-Menco high reliability dipped mica capacitors in which enough actual test unit-hours were accumulated at *elevated temperature and with 225% of the rated voltage applied* to verify failure rates on the order of 0.0001% and 0.00004% at a 90% confidence level.

*The El-Menco high reliability dipped mica capacitors are being supplied to the Radio Corporation of America for a high reliability military ground electronics project.

THE ELECTRO MOTIVE MFG. CO., INC.
WILLIMANTIC, CONNECTICUT



*Dipped Mica • Molded Mica • Silvered Mica Films • Mica Trimmers & Padders
Mylar-Paper Dipped • Paper Dipped • Mylar Dipped • Tubular Paper*

ARCO ELECTRONICS, INC.,
Community Drive,
Great Neck, L. I., New York
Exclusive Supplier to

West Coast Manufacturers Contact:

COLLINS & HYDE CO.,
535 Middlefield Road,
Palo Alto, California

Jobbers and Distributors in the U. S. and Canada

5380 Whittier Boulevard, Los Angeles, California

Write for reliability study
and technical brochures.

Radioactive Source Generates Probabilities

By FREDERICK W. KANTOR, Consultant, Silver Spring, Maryland

Inexpensive module can solve problems by sampling random pulses

EMISSION of radiation from a radioactive source is random and, for times short compared to the half life, occurs at a nearly constant average rate. Thus, the probability that a particle will be detected by a counter in a specified time can be used as a random pulse source with a specifiable probability.

This probability can be varied by adjusting the time interval and the radiation level. It is typically easier to vary the radiation level by moving the source or interposing shielding between it and the detector. A micrometer feed can be used to do either, Fig. 1, A and B, and could be motor driven.

However, it is much simpler and, if the overall control system is analogue, more precise to use electroplating instead of mechanical motion, Fig. 1 C and D. A radioactive material is electroplated from one end of a tube to the other, with a thin metal wall being used for the end near the radiation detector. Material at the end of the tube away from the detector is shielded from it both by the increased distance and the intervening electrolyte. Electrolytic action moves an amount of material exactly proportional to the charge which passes through the tube and permits a wide range of adjustment, with great precision and reproducibility.

TIME INTERVAL—Several devices can have their probabilities accurately ganged by connecting

their plating tubes in series. The time interval can be adjusted to cancel mechanical variations between devices for initial calibration, and can be varied to introduce a scale factor, if desired, in the probability dependence on charge. For high probability with a short delay time, it is desirable to use a 'nor' gate on the random output, as this permits use of a lower probability (complementary probability) device with a much lower radiation level. Thus, the device only has to vary between probabilities 0 and $\frac{1}{2}$, all other probabilities being obtainable by 'nor' gating. Such a device lends itself to modular use, Fig. 2.

Such modules might prove quite useful in tracking equipment, simulating game theoretic solutions to military strategy problems, and similarly for studying social systems and the nervous system. It would be possible to randomize the path of an attack plane to a considerable extent, making interception more difficult.

Monopulse radar could also be made truly random. Problems for simulators for military training could be disordered, preventing undesired patterns of conditioned behavior. Similarly, it is often desirable to randomly reenforce test animals, which could also be done automatically, freeing research personnel.

FAILURE RATES—Such a module could also be useful in simulating reliable networks. Each component of the network for which information on the effect of failure on system performance was desired could be connected to a gate operated by a modular random

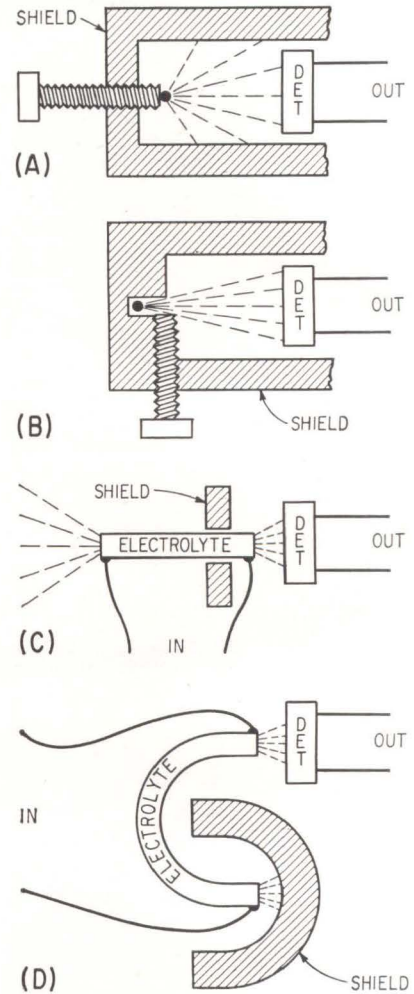

RADIATION level can be adjusted by a micrometer feed, (A) and (B); or by using high precision plating of radioactive material, (C) and (D)—Fig 1

source. With all such modules set to the same multiple of the failure rate of the attached component, the system will display a high true failure rate. In a short time the system will display all of the modes of failure, and will do so with very nearly the same probability distribution among them that it would normally, with times to scale. The only error introduced is that of ignoring the failure of one part of the system on the rate of failure of another part. This might be corrected by letting the time interval in the control module, and hence its probability, depend on parameters at the device to which it is attached, e.g. voltage.

Circuit for a modular pulse repeater is shown in Fig. 2. The probability of an *in* pulse at in-

\$.25

TYPICAL UNIT COST

Capacitors of "Mylar"[®] polyester film cost about the same as paper!

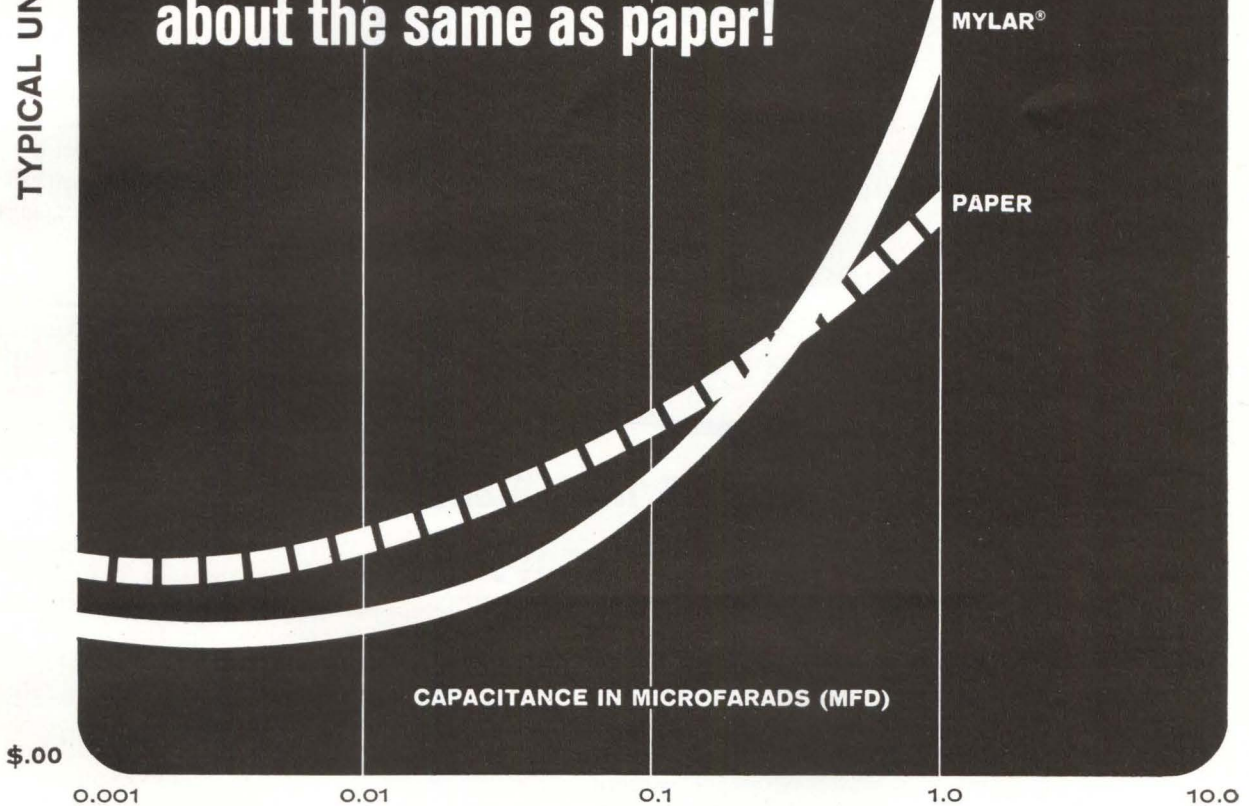

For capacitors, specify the extra performance of "Mylar"

Studies of manufacturers' average prices show that capacitors of "Mylar"* are comparable in cost with paper units, over a range of capacitances and voltages. At comparable cost, the higher reliability you get makes capacitors of "Mylar" a better value by far.

Only "Mylar" gives you the extra performance of higher dielectric strength, wider temperature range and higher moisture resistance—at about the same price! Also, capacitors of "Mylar" are smaller than paper units with the same capacitance. In circuits for home-entertainment radio and TV they're perfectly compatible with AC voltages imposed on a DC circuit as long as total voltage doesn't exceed the rated voltage of the capacitor,

and the AC component does not exceed the AC corona level. Remember, within the range from .001 to 1 mfd under 600 volts DC, you can get the added reliability of "Mylar"—at costs similar to paper.

For the full story, write for our detailed booklet comparing performance and prices of various insulation systems. Du Pont Co., Film Department, N-10452, Wilmington 98, Delaware.

*Du Pont's registered trademark



BETTER THINGS FOR BETTER LIVING
... THROUGH CHEMISTRY

only DU PONT makes

MYLAR[®]
POLYESTER FILM

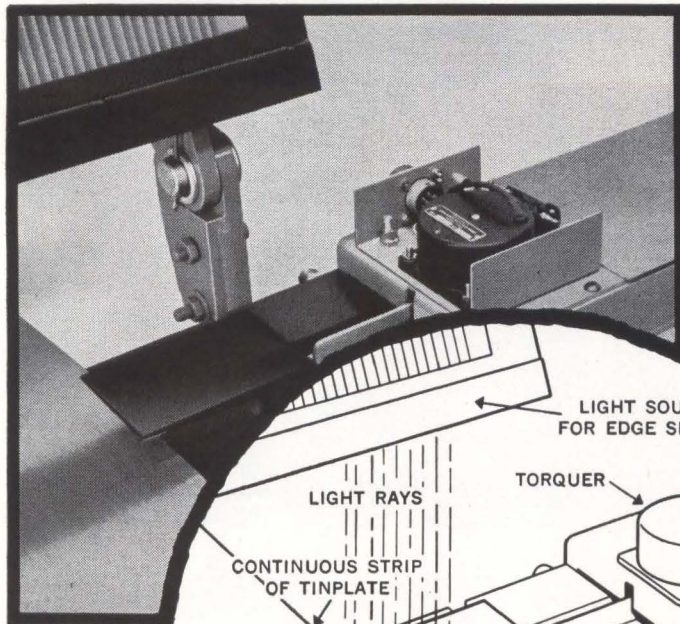

Pinhole detector for continuous inspection of tinplate has an automatic edge shield system developed by Bethlehem Steel Co.

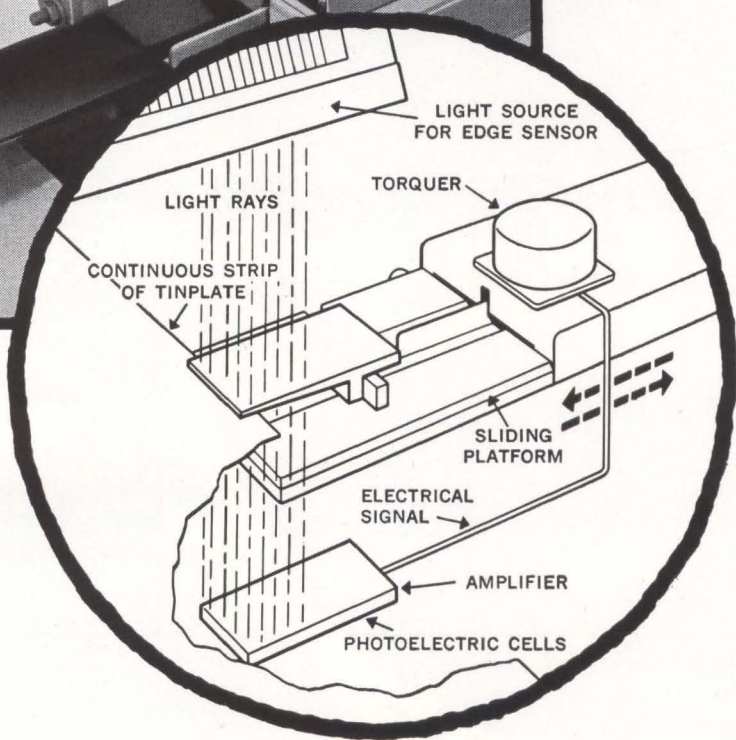

Inland Gearless Torquers help make pinhole detection fool-proof!

Bethlehem Steel Company runs tinplate at high speed through a photo inspection device. Purpose is to detect pinholes. Side-to-side movement of the continuous strip creates a problem. The least light entering at the edges of the strip can cause false pinhole indications.

Fast-response positioning of edge guides by two Inland Gearless Torquers on signal from photoelectric sensors blocks out "false-alarm" light. These direct-drive d-c torque motors have peak torque of 60 ounce-inches.

Rapid, high-resolution response to servo-position error signal has earned for Inland Gearless Torquers a place in all major missile and space programs to date, as well as in an increasing number of industrial applications. Their superior performance comes from torque-to-inertia ratios 10 times higher than equivalent gear-train servo motors. Moreover, their compact, pancake configuration overcomes space and weight limitations.

What's your problem? If you're currently planning a servo system calling for output torque between 20 ounce-inches and 3000 pound-feet*, compare Inland Gearless Torquers with any alternative. Write for all the facts today, 347 King Street, Northampton, Mass.

*Higher torque output levels can be provided on special order.

 **INLAND MOTOR**
CORPORATION
SUBSIDIARY OF **KOLLMORGEN**

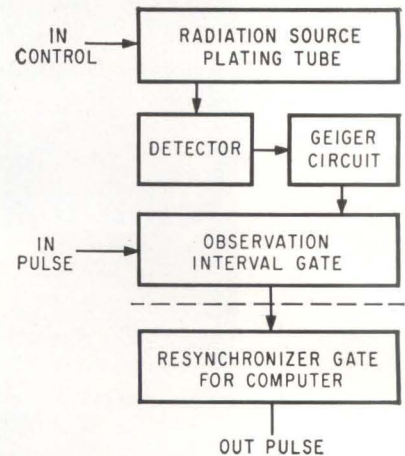

MODULE suggested for simulating reliable networks—Fig. 2

interval gate triggering an *out* pulse at resynchronizer is controlled by *in* control to radiation source.

Each complete repeater is separately radiation shielded to prevent cross-talk. The *in* pulse opens one shot gate, requires coincident pulse from detector, with gate open, to produce *out* pulse from resynchronizer. For high probability with low radiation level, anti-coincidence gate is used for blocking at interval gate.

Photo Motor Uses Light In Place of Brushes

DIRECT-CURRENT electric motor, developed by The Boeing Co., has a stationary core, instead of a central spinning armature, and uses light in place of brushes.

Photoelectric cells are used as switches. The rotating case covering the cells has a shutter which



LIGHT from match activates photo-cells to operate motor

turns on the power as light strikes each cell in turn. Only a small amount of light, such as that from the match in the girl's hand (see photo) is needed.

Boeing has assembled two prototypes of the Photo Motor. Both models are self-starting, have relatively high efficiencies, and may be controlled precisely from zero to full speed. Company has no present plans for the motor, but visualizes its use in applications where heavy loads need to be moved slowly, as in mining.

Elimination of the brushes means that the motor can run faster, last longer, and operate more quietly than conventional motors of the same size, according to Robert Weigel, Boeing engineer who directed the development.

Failure Rates Announced For Tin Oxide Resistors

ALMOST a quarter-billion part-hours of data from three major load life testing programs on tin oxide resistors show no catastrophic failure and a failure rate of 0.0004 percent per thousand hours, according to a Corning Electronic Components report.

Some of the load life testing reaches back more than six years, company says. The resistors under test were Corning N-20 precision 1/2 watt, the N-60, 65 and 70 precision 1/8, 1/4 and 1/2-watt, and the A-51, A-52 and A-53 general purpose 1/8, 1/3 and one watt units. Some are under continuing test.

The basic resistive element consists of a tin oxide film bonded chemically to alkali-free glass substrate at red heat. Resistance values were obtained by helixing.

Gyro Gets Jewels 0.005-Inch Thick

INSTRUMENT bearings, believed to be the smallest yet manufactured in this country, are being made by Bulova Watch Company for Litton Systems, Inc.

Disc-shaped bearings, having an outside diameter of 0.010-in. will be used in gyroscopes for flight control systems.

The bearings are made of synthetic jewels material.

JENNINGS VACUUM CAPACITORS

OVER 300 TYPES

TO MEET HIGH VOLTAGE CIRCUIT DESIGN PROBLEMS

Of course this unusually large selection didn't just happen overnight. It represents the accumulation of twenty years experience in the manufacture of vacuum capacitors. During this time Jennings has developed exclusive vacuum processing techniques. Examine the representative types shown below, all of them proven successful in thousands of applications.

HIGH VOLTAGE

Type VMMHHC
Capacitance Range 25 to 200 mmfd
Peak Voltage 120 kv
RF Current 125 amps RMS
Length 20 1/4 inches



HIGH CURRENT

Type VMMHCW
Capacitance Range 50 to 400 mmfd
Peak Voltage 55 kv
RF Current 500 amps RMS
Length 17 inches



HIGH RATIO OF CAPACITANCE CHANGE

Type UCSSL
Capacitance Range 7 to 1000 mmfd
Peak Voltage 5 kv
RF Current 42 amps RMS
Length 7-9/16 inches



SMALL SIZE

Type ECS
Capacitance Range 3 to 30 mmfd
Peak Voltage 15 kv
RF Current 20 amps RMS
Length 4 1/2 inches



Our radio frequency laboratory with 12 functioning transmitters ranging from 17 KC to 600 MC and up to 100 KW CW power is at your service to test our products under your particular circuit conditions.

Write for our special brochure describing our complete line of vacuum capacitors.

RELIABILITY MEANS VACUUM / VACUUM MEANS *Jennings*

JENNINGS RADIO MFG. CORP., 970 McLAUGHLIN AVE., SAN JOSE 8, CALIF., PHONE CYpress 2-4025

Now SYSTEMS & SUBSYSTEMS COMPONENTS for INPUT - OUTPUT EQUIPMENT

INVAC Corporation announces for the first time its completely solid state on-line and off-line equipment for special punched paper tape applications.

This off-the-shelf equipment provides for system flexibility . . . military applications — low RFI — uses photoelectric principle to eliminate electrical contacts..

Fast delivery assured — large or small quantities. For additional information write or call: Area Code 617 899-2380.

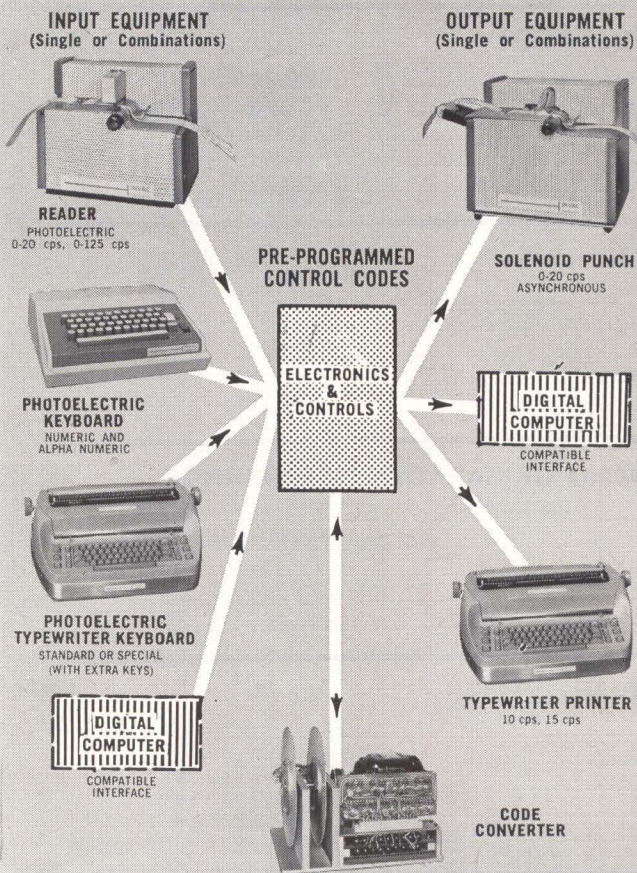

INVAC
CORPORATION

26 FOX ROAD • WALTHAM 54, MASS.

Area Code 617 - 899-2380

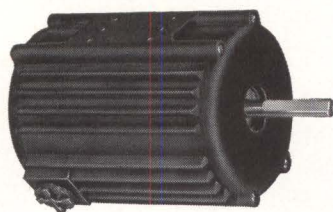

NEW

HIGH TORQUE 2½" MOTOR

For high torque from a compact 60 cycle motor you can't beat Globe's family of Type YC precision induction motors. They are available in three standard stack lengths (longest is illustrated), and provide a wide range of speed-torque options to 12 oz. in. of torque at 3,000 rpm. Standard windings are for 115 and 230 v.a.c., 60 or 50 cycles, single or three-phase. These MIL spec-quality motors have finned aluminum housings, stainless steel bearing seats, life-lubed ball bearings; heaviest weighs only 26 ounces. Mounting is by tapped holes in front face or by tapped holes in top and bottom mounting pads. Many variations are possible to suit your application exactly. Request Bulletin YC-1.

Globe Industries, Inc., 1784 Stanley Avenue, Dayton 4, Ohio.



| Globe motor type | length | nom. cont. dy. HP at 3000 rpm |
|------------------|--------|-------------------------------|
| YCS | 1½" | ¼ ₀₀ |
| YC | 2½" | ½ ₀ |
| YCL | 3½" | ¾ ₅ |

CIRCLE 202 ON READER SERVICE CARD

NEW

- 4-8 GC
 - High Power
 - Log Conical Spiral
- ## ANTENNA

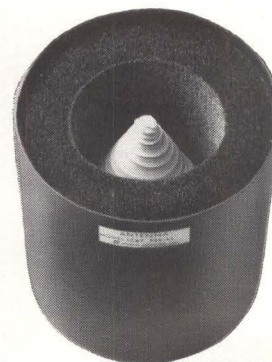

A unique design solution, this conical spiral antenna is shielded by an aluminum housing that rejects interference from adjacent radiating structures. Ideal for tight packaging applications in ECM and other broadband systems, the new antenna operates over a frequency range of 4.0 to 8.0 GC with a gain of 4.0 db at 5 GC (per IEEE definition). Power capacity is 1000 watts peak in a Class II environment. Size 3.8" dia. by 4.7" deep, excluding connectors. Price—\$450, with substantial discounts in quantity.

CREATING NEW DIRECTIONS IN ELECTRONICS SANDERS TRI-PLATE STRIP TRANSMISSION LINE

SANDERS ASSOCIATES, INC.
Canal Street
Nashua, New Hampshire
Rush me complete details on
Antenna Model LC67.



Name..... Title.....
Company.....
Street.....
City..... Zone..... State.....

©Reg. T.M.; Extensive Patent Coverage. Sanders Associates, Inc

CIRCLE 203 ON READER SERVICE CARD
SEPTEMBER 13, 1963 • electronics



newest
idea in
decades

Decade Counter Modules Utilizing Biquinary Counting

with built-in, automatic, error-detection capabilities

with fewer components in simpler circuits, and hence:

with the reasonable price you have been looking for

with ruggedized construction

with high reliability

New BQDC-100 (illustrated with faceplate removed) is available in production quantities in two versions: as a complete 100 kc or 1 Mc biquinary decade counter card, including counter, driver and Amperex *Bi-Qui* numerical indicator tube; as a biquinary driver card including *Bi-Qui* numerical indicator tube and a conversion matrix to match your special requirements.

For detailed information, write: Amperex Electronic Corporation, Components Division, Hicksville, Long Island, New York.

In Canada: Philips Electron Devices, Ltd., 116 Vanderhoff Ave., Toronto 17, Ont.



CIRCLE 59 ON READER SERVICE CARD

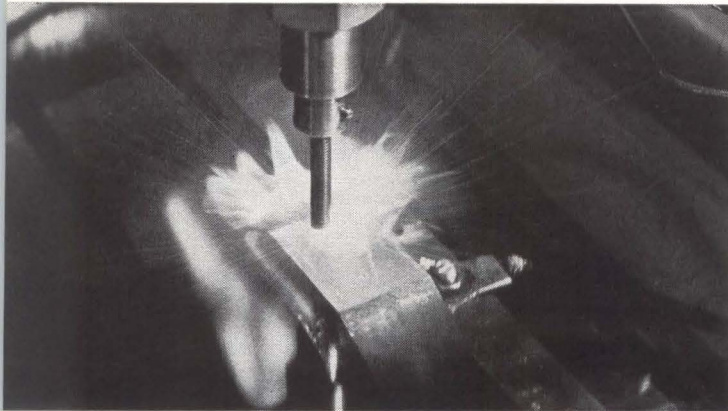

THREADED ANODE in electric discharge machine taps hole in Alnico. Gap is held to constant width by servomechanism

ANODE VANES of magnetron tubes produced by electric discharge machine have tolerances of ± 0.0001 inch

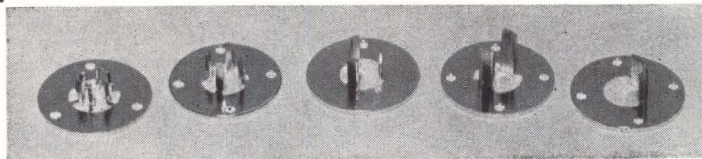

Production machining of hard materials eased by electric-discharge method

Sparks Shape Alnico Magnets

By CARL PIEPER, Power Tube Department, General Electric Company, Schenectady, N. Y.

PRODUCTION of voltage tunable magnetrons is enhanced by electric-discharge machining (EDM) at GE's Power Tube Department. Highlighting EDM's contributions is the easy machining of Alnico magnets used with the magnetrons; conventional machining of this hard-to-work material is almost impossible. Tolerances of ± 0.0001 inch are theoretically possible when machining holes.

Until now, EDM has mainly served with advantage in the development shop. Its further use in low - to - medium - scale production greatly extends its value. Significant savings have been made by EDM's elimination of: high initial tool costs for developmental dies; difficulty in holding required tolerances; costly hand removal of large burrs left by conventional techniques.

CAPABILITIES — EDM allows machining of parts regardless of

structure, strength or hardness of metals. Machining geometries are limited only by the shape of the electrode and delivery of electrode to the workpiece. Usually, very intricate shapes can be obtained with electrodes made of brass, Gentrode 10 and copper-tungsten alloy, which lend themselves readily to conventional machining.

EDM is based on the wearing away of workpiece surfaces by a spark discharge between the electrode and the workpiece. Sparking is created by very rapid capacitor discharges which can be varied both in frequency and intensity to produce a succession of individual sparks of very high current density.

Important to the production capability of EDM at GE is a precision servo arrangement that maintains a constant spark gap of 0.0001 inch between the electrode and the workpiece. Also important to optimum electrical conduction between

electrode and workpiece is a special dielectric oil in which these two elements are submerged. Oil also acts as a cooling agent and helps flush out the debris from the gap area.

Although cutting action is seemingly confined to workpiece, sparking also wears away electrode material. Therefore, allowance is made for electrode wear to achieve accurate dimensions. Proper selection of electrode material for use with a certain workpiece material greatly extends the ratio of work wear to tool wear. For example, commonly used combinations are brass and Gentrode 10 electrodes used with steel workpieces, Gentrode 10 with copper and copper tungsten with molybdenum.

ZERO FORCE—Since the electrode is not in physical contact with the work, the cutting force is regarded as being zero. This makes possible the cutting of delicate metal

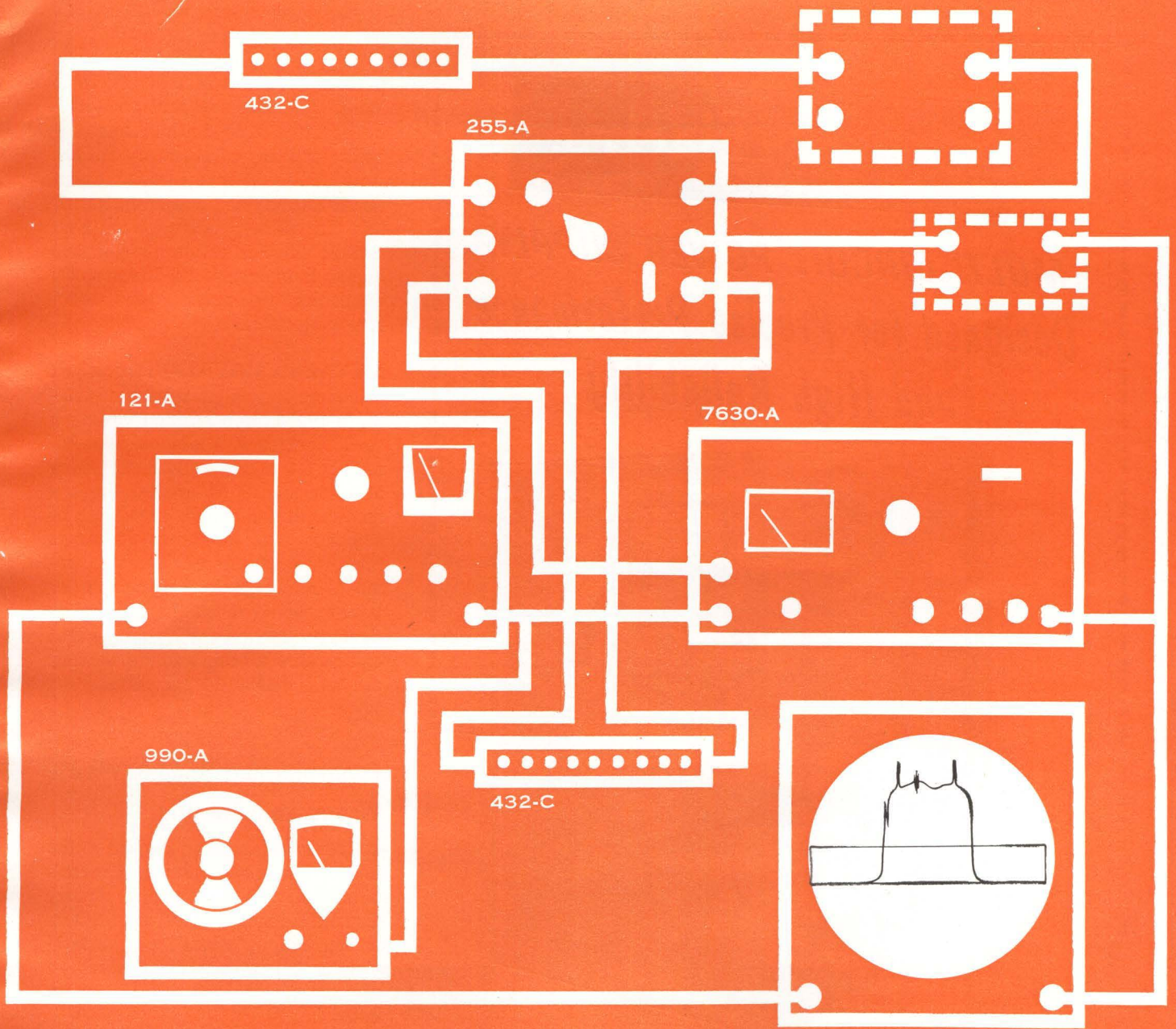

Wide-Swept, Marked, Calibrated... by **KAY**

A broad amplifier with critical roll-off, marked in frequency (fixed and variable) by the 7630-A and 990-A on a 300 mc wide frequency sweep of the 121-A, with calibrated level line set by the 432-C, switched in by the 255-A.

121-A Sweeping Oscillator

0.5 mc to 1100 mc
Full 300 mc sweep

Price: \$1,295.00

990-A CW Oscillator

4.5 to 220 mc
1.0V rms, AGC'd

Price: \$373.00

7630-A Frequency Marker

200 kc to 220 mc
40 crystal markers

Price: \$425.00 (plus markers)

432-C Attenuator

DC to 500 mc
0 to 101 db in 1-db steps

Price: \$110.00

Write for complete catalog information

KAY
ELECTRIC COMPANY

Maple Ave, Pine Brook, Morris County, New Jersey
Dept. E-9 • Capital 6-4000

255-A Coaxial Electronic Switch

DC to 500 mc
70 db "off" at 200' mc

Price: \$295.00

Acme Electric

MULTI-CIRCUIT POWER SUPPLY Designed for Precise Performance and High Reliability

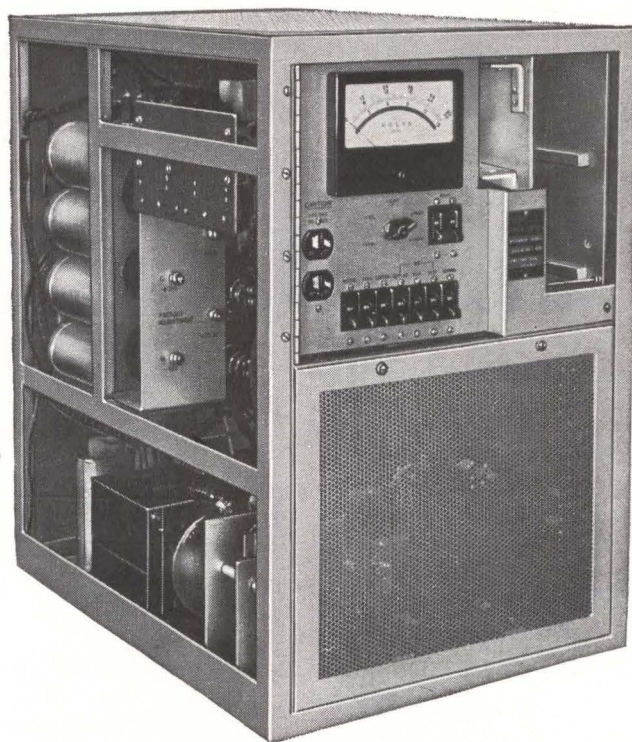

Straightforward circuitry provides automatic correction for input line changes in the range of 170 Volts to 240 Volts AC.

Five regulated DC outputs between 6 volts and 50 volts can be used simultaneously or independently without affecting regulation. Three AC outputs provide stabilized voltage for auxiliary equipment. This is another example of how Acme Electric designs power supplies to meet the application rather than to exotic and needlessly expensive general specifications.

Acme Electric has an abundant experience, in developing hundreds of successful power supply designs, in power levels ranging from miniwatts to megawatts, and can probably adapt an established type to your application.

Acme Electric

Engineers and Builders of...

931 WATER STREET, CUBA, NEW YORK

In Canada: Acme Electric Corp. Ltd.
50 Northline Rd., Toronto, Ont.

SAE 3695/3022

REGULATED POWER SUPPLIES
STATIC POWER RECTIFIERS
VOLTAGE STABILIZERS
VOLTAGE REGULATORS

parts to tolerances of ± 0.0001 inch. With adequate power and frequency, the zero cutting force enables control of surface finishes from 250 to 32 microinches; exceptional finishes of 10 microinches or less are also possible. The finer surface finishes result by going to higher frequencies and lower spark intensities, with much slower metal-removing rates.

METAL REMOVAL—Typically, a discharge setting on a machine having a brass electrode and cutting a steel workpiece would be approximately 14 microfarads, discharging at a frequency of 65,000 times a second. If the cutting area were of sufficient size to draw 15 amps (about $\frac{1}{2}$ square inch), a steel removal rate of 0.003 cubic inch per minute would result. In addition to direct production applications, EDM can be used for tool making. Savings are estimated to 30 percent.

Programming Speeds Wire Wraps and Routing

AUTOMATION is being applied to the fabrication of computers at Univac's Utica, New York facility. Sperry Canada's numerical control system automatically drives a Gardner-Denver Wire-Wrap machine at an average rate of 700 connections an hour.

The numerical control system is fed with information from punched cards by a card reader. This information sets up the transistor sequencing logic and reed-relay dimension selectors that generate command signals for each of two planes. These signals are fed to



NUMERICAL positioning control drives wire-wrap machines to connect 700 terminals per hour

rotary synchro resolvers for coarse measurements and to precise linear transducers for fine measurements. Feedback from the measuring section is compared with the original signals and the resultant error signal corrects the Wire-Wrap machine member before the connection is made. Positioning accuracy can be held to ± 0.0005 inch.

The Gardner-Denver machine has two movable carriage groups which can be positioned in two planes in any multiple of 0.025-inch increments. Each group, 3 carriages, consists of a rear dressing finger, a forward dressing finger and the wrapping tool. A panel of terminals located on a 0.025 inch grid is placed on a pallet under

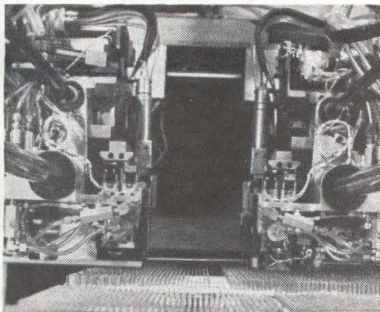

WIRE-WRAP machine moves in three dimensions. Wrapping heads cut, strip and wrap wire on prearranged commands

these carriage groups. The panel can also be rotated and the combined movement of the pallet and the carriages allows a connection to be made to any two terminals within an area of 22×42 inches. The fingers are used for routing the wire in a predetermined series of patterns. The wrapping tool does the stripping of the wire and the winding of the selected terminal at any one of three levels.

Wire is fed continuously through one wrapping head to the other. All six carriages are positioned together at the start of any wiring cycle. Any two of the dressing fingers will guide the wire on a programmed course. Direct wiring between two points, curved paths around other terminals, or one wire placed over others are some of the usual routing possibilities.

BURNPROOF LACING TAPE AT NO ADDITIONAL COST —FROM GUDEBROD



THE CABLE-LACER

increases worker
efficiency
by
25%



The first production tool available to ease, speed and improve the wire tying operation—producing tighter knots and more uniform harness.

Handle holds bobbin of cable lace, feeds as needed. Easily refilled. Eliminates handling long sections of tape, reduces splicing. Get your Production Department to investigate.

The specification of non-combustible materials in electronic equipment has, until now, required the use of special, higher priced lacings for harness tying. Through extensive work in their R&D Department, Gudebrod is producing two new burnproof lacing tapes—both available at no additional cost!

The first of their kind, these new tapes are made of Dacron* fibers and are flat braided for excellent handling and knotting qualities. In addition to meeting or exceeding all requirements for MIL-T-713A, the burnproofing exceeds ASTM-D626-55T.

Two types are being produced—Stur-D-Lace FLH, impregnated with a flame-proof fungistatic synthetic rubber finish, and Stur-D-Lace-R impregnated with a flameproof fungistatic vinyl finish. Both are essentially stable at -100° to 350° F. Neither will burn, but they will melt when a hot flame is applied. Each type is available in seven different strengths. Gudebrod Technical Product Bulletin #6 gives details.

The introduction of burnproof lacing tapes at standard prices represents another advancement in cable lacing practice by Gudebrod. The Gudebrod line of lacing tapes covers the entire range of wire harness tying requirements for both military and commercial equipment. Send for the Data Book on Gudebrod Tapes.

*"Dacron" is Du Pont trade name for its polyester fiber.



GUDEBROD BROS. SILK CO., INC.

FOUNDED IN 1870

Electronics Division



12 SOUTH 12TH STREET, PHILADELPHIA 7, PENNSYLVANIA

A MIGHTY BIG STEP



A MIGHTY IMPORTANT STEP FOR YOU! YOU CAN NOW BUY PRINTED CIRCUITS WITH YOUR CONDUCTOR AND HOLE PATTERN... WITHOUT ARTWORK... WITHOUT QUOTATIONS... WITHOUT TOOL CHARGES, AND IN MOST CASES, AT HALF THE USUAL COST AND IN HALF THE USUAL DELIVERY TIME!

Our new Standard Circuit Division reduces printed circuit manufacturing overhead to the barest minimum by automation and standardization. Mass production techniques drastically reduce costs, delivery time, and improve quality—yet still give you flexibility in board design. Sound exciting? For complete information write today for our 16 page brochure detailing this major printed circuit breakthrough.

Photocircuits
CORPORATION • GLEN COVE, N.Y. • ANAHEIM, CALIF.

PCM System Achieves High Flexibility

Compact ground facility accommodates all telemetry formats

MODEL DDS-1000 solid-state pcm ground station uses silicon-passivated epitaxial semiconductor devices throughout to achieve high reliability and performance over a wide temperature range. Capable of demodulating and processing serial-digital that originates in a receiver, a tape system or any other serial data source, this system is said to require only a single seven-foot instrumentation rack and to provide processed signal outputs in a wide variety of serial or parallel digital formats for direct entry into computing, recording or processing equipment. Moreover, model DDS-1000 can also provide outputs as analog signals suitable for driving oscillographs, strip-chart recorders or meters to permit real-time visual analysis of data.

System is adaptable to all of the bit, word, frame and code formats currently in use, and will handle

data in RZ, NRZ, bipolar and split-phase formats at bit rates ranging from 1 bit-per-second to 10^6 bits-per-second. Frame length is variable from 2 to 512 words and up to 4 independent sub-frames can be accommodated, each having lengths between 2 and 256 words. Primary frame word lengths are independently variable from 2 bits to 64 bits in integral bit steps with each word

assuming a structure having up to 10 syllables. Direct or truncated standard serial and parallel digital outputs are presented in binary and BCD form. Bipolar analog outputs capable of directly driving strip-chart recorders are provided with accuracies of 0.1 percent. Bendix Corp., 5630 Arbor Vitae St., Los Angeles 45, Calif.

CIRCLE 301, READER SERVICE CARD

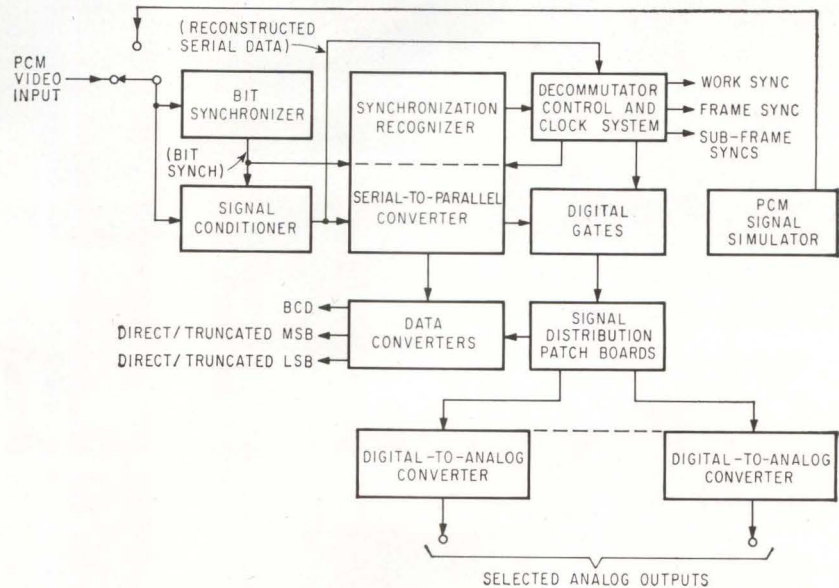

Shift Register Requires Only 17 MW Per Bit

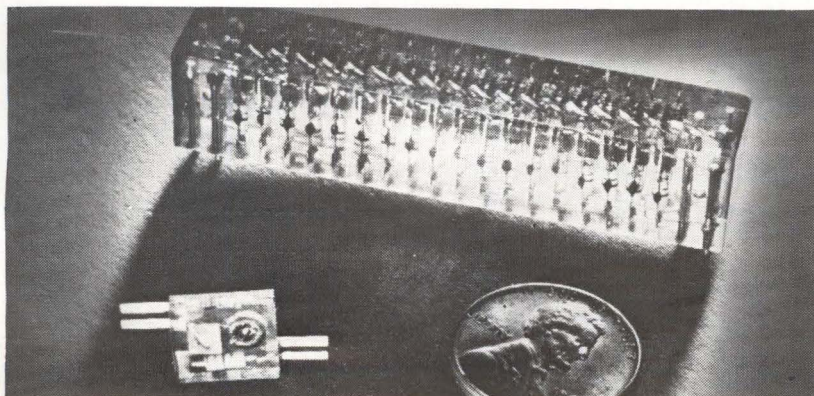

MINIATURE low-power magnetic shift register for missile and space applications requires a volume of less than 0.03-cubic inch per bit. Available at speeds up to 500 kc per second, the serial-driven, gated-shift device is supplied in an encapsulated package comprised of as many as 25 bits. Featuring permanent memory, the unit requires power only when information is being transferred, eliminating the need for standby power characteris-

BUSS
quick-acting
fuses

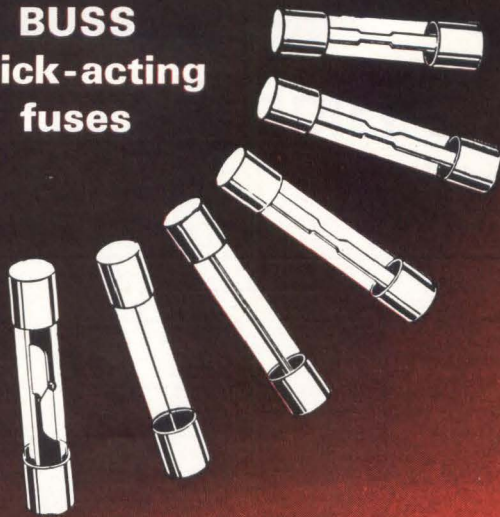

"Fast Acting" fuses for protection of sensitive instruments or delicate apparatus;—or normal acting fuses for protection where circuit is not subject to starting currents or surges.

BUSS

Write for BUSS
Bulletin SFB.

BUSSMANN MFG. DIVISION, McGraw-Edison Co., St. Louis 7, Mo.

FUSETRON
dual-element fuses
time-delay
type

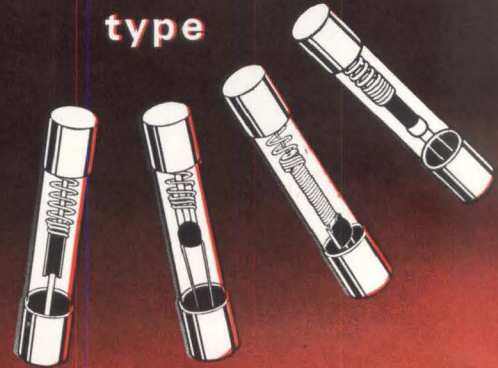

"Slow blowing" fuses for circuits where harmless surges occur. These fuses prevent needless outages by safely holding starting currents or surges, — yet they provide safe, positive protection against short-circuits or continued overloads.

BUSS

Write for BUSS
Bulletin SFB.

BUSSMANN MFG. DIVISION, McGraw-Edison Co., St. Louis 7, Mo.

BUSS : the complete line of fuses .

CIRCLE 67 ON READER SERVICE CARD

CIRCLE 67 ON READER SERVICE CARD

TO ORDER REPRINTS

Fill in, cut out coupon below, insert in envelope and mail to:

electronics Reprint Dept.

330 W. 42nd Street, New York, N. Y. 10036

REPRINT ORDER FORM

For Listing of Reprints Available See Reader Service Card

(To help expedite mailing of your reprints please send cash, check or money order with your order.)

For Reprints of the latest Special Report; Radio Frequency Interference

Send me Reprints of Key No. R-39. I—10 copies 75¢ each, II—24 copies 60¢ each, 25 or more 50¢ each.

For Reprints of previous **Special Reports** or **Feature Articles** fill in below:

Send me Reprints of Key No.(s) @ ¢ each. (For prices, see Reader Service Card.)

*For orders of **Bulk Reprints** of other editorial articles in **this issue or past issues:**

Send me Reprints of pages no.(s) of issue date of article entitled

*Minimum bulk order 100 copies. You will be advised of costs by return mail.

Name

Number and Street

City, Zone No., State

tically required by other devices. Average operating power of the unit is as low as 17 milliwatts per bit; at 500 kc, average power is 55 milliwatts, without increase in package size.

Typical uses are in advanced computing and data processing equipment such as guidance or navigation memory, counters and data-transfer buffer storage. According to the manufacturer, high reliability results from low parts count per bit. The shift register is designed for operating temperatures ranging from -55 to $+100$ C, and price varies between \$6 and \$12 per bit, depending upon design. General Electric, Schenectady 5, N. Y.

CIRCLE 302, READER SERVICE CARD

Broadband Coupler Goes to 140 GC

DIRECTIONAL broadband coupler covers the full waveguide bandwidth

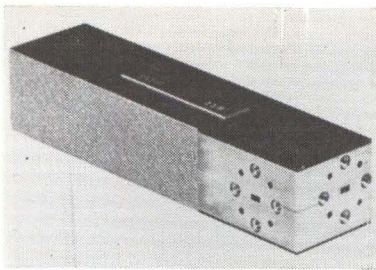

of 90 to 140 Gc with a nominal accuracy of ± 0.5 db. Unit has directivity of 40 db and frequency sensitivity of ± 0.6 db.

Called model F610, the unit is precision machined from solid tellurium copper with the coupling arm off the side wall and is available in coupling values of 3.8 db, 6 db, 10 db and 20 db. Mainline vswr for all values is 1.1, and auxiliary line vswr is 1.2 maximum. The company manufactures other couplers covering the entire microwave spectrum from 2.6 Gc into the millimeter range. Model F610 is priced at \$750. FXR, 25-26 50th St., Woodside 77, N. Y. (303)

Audio Oscillators Produce Stable Output

MODEL 10 series a-f oscillators produce a sine wave output with low distortion and a high degree of frequency stability. They can be gated on and off. Standard units are available set precisely to any frequency between 500 and 5,000 cps. The output frequency can be externally controlled over a typical range of 10 percent. Frequency variation is

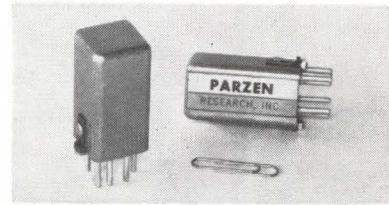

limited by the transistor RC circuitry to less than ± 0.2 percent with supply voltage changes of ± 10 percent and to less than ± 0.5 percent over the temperature range

..... of unquestioned high quality

BUSS FUSEHOLDERS

- LAMP INDICATING SERIES HK AND HJ FOR $\frac{1}{4} \times 1$ and $\frac{1}{4} \times 1\frac{1}{4}$ INCH FUSES

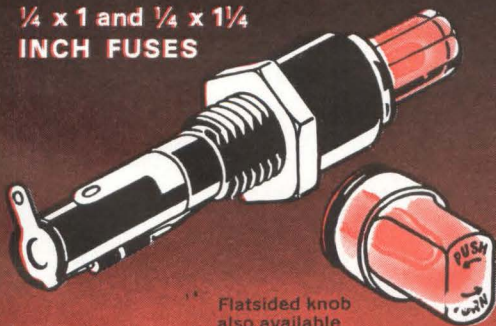

Provides quick, positive visual identification of faulted circuit. Transparent knob permits indicating light to be readily seen.

Bayonet type knob-molded body-strong, coil spring provides positive contact on ends of fuse.

Fuseholder designed to withstand vibration such as occurs in aircraft applications. Terminals held mechanically as well as by solder.

Holder can be used in panels up to $\frac{3}{16}$ inches thick.

BUSS

Write for BUSS
Bulletin SFB.

BUSSMANN MFG. DIVISION, McGraw-Edison Co., St. Louis 7, Mo.

CIRCLE 67 ON READER SERVICE CARD

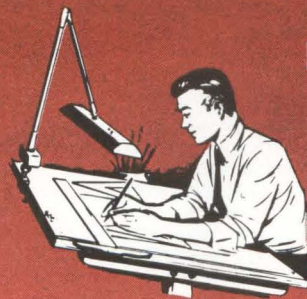

If you should have a
special problem
in electrical
protection ...

... we welcome your request either to quote or to help in designing or selecting the special type of fuse or fuse mounting best suited to your particular conditions.

Submit description or sketch, showing type of fuse to be used, number of circuits, type of terminal, etc. If your protection problem is still in the engineering state, tell us current, voltage, load characteristics, etc. Be sure to get the latest information BEFORE final design is crystallized.

At any time our staff of fuse engineers is at your service to help solve your problems in electrical protection.

BUSS

Just call
or write:

BUSSMANN MFG. DIVISION, McGraw-Edison Co., St. Louis 7, Mo.

CIRCLE 67 ON READER SERVICE CARD

VOLTRON ANNOUNCES A FUNDAMENTAL ADVANCE IN THE CALIBRATION ART

The VOLTRON-GALMAN
AVERAGE VALUE TRANSFER STANDARD

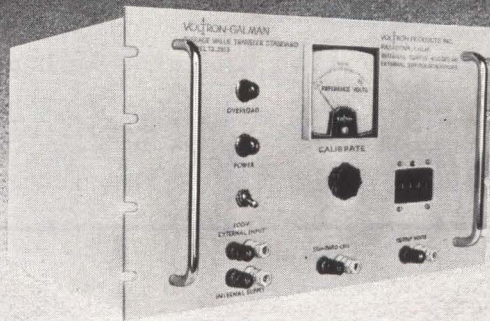

WITH { $\pm 0.01\% \pm 1$ MV absolute ACCURACY
 $\pm 0.001\%$ REPEATABILITY
10 MV RESOLUTION

Based on the unique Voltron-Galman Operational Rectifier configuration (patent applied for), this instrument permits rapid, positive calibration of digital voltmeters, transducers, analog data channels, and related average-sensing equipments, at secondary-standard levels of accuracy, with COMPLETE CONFIDENCE. Rectifier non-linearities, harmonic effects, and frequency distortion are all rendered negligible by this exclusive new circuit. This device responds to TRUE-FULL-WAVE-RECTIFIED-AVERAGE VALUES — it does not employ peak-sensing or RMS-sensing.

The Voltron-Galman circuit is as fundamental and as readily standardized for average values as the well-known Hermach thermal standard configuration is for RMS values. Performance levels are comparable.

Model 12.583, shown above, generates 0-300 volts, in 10 MV steps, at low impedance, at discrete frequencies between 50 and 3000 cps; distortion <0.1%. An unsaturated standard cell is the primary reference.

The Model 12.583 is COMPLETELY SELF-CONTAINED, including not only an ultra-stable oscillator, precision toroidal dividers, and operational rectifier, but also a standard cell, normalizing and standardizing networks, and a null-indicating galvanometer. No auxiliary equipment is required.

VOLTRON

PRODUCTS, INC.

1020 So. Arroyo Parkway, Pasadena, California

We have prepared a complete technical exposition of the theory of operation of this new circuit, including performance specifications. May we send you a copy?

from 0 to 55 C. Distortion of the 0.5 v rms minimum output is down 20 db. Price is \$10 each in quantities of 100 or more. Parzen Research, Inc., 48 Urban Ave., Westbury, L. I., New York.
CIRCLE 304, READER SERVICE CARD

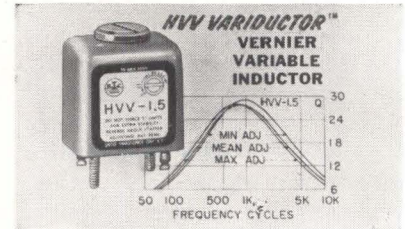

Variable Inductors Offer High Stability

MINIATURE narrow range vernier variable inductors, the HVV Variductors, are suited for applications where precise matching to other components, such as tuning to capacitors with standard 10-percent tolerances, is required. All are hermetically sealed to MIL-T-27B, MIL type TF4RX20YY, and provide a vernier inductance variation of ± 10 percent of nominal value through an adjusting screw with a 900-deg range on top of case. Units are ruggedized and designed to provide high stability with both temperature and level. Nominal inductance falls between 0.006 hy and 150 henries with a minimum of 0.0054 hy and a maximum of 165 henries. United Transformer Corp., 150 Varick St., New York 13, New York. (305)

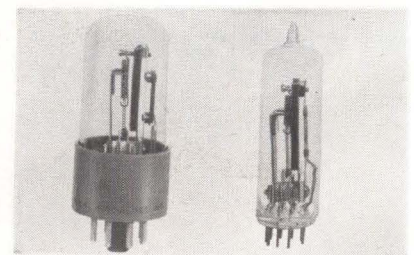

Time-Delay Relays With Snap Action

SERIES 200 (9 pin, miniature) and 300 (8 pin, octal) relays have all parts manufactured of inorganic materials insuring high reliability and excellent repeatability at low

cost. Relays are thermally operated by a separate heating circuit employing treated stainless steel actuating members. The basic snap action mechanism for switching from one contact to another is achieved by the transfer of a contact arm. High contact pressure, wiping action and quick make and break are advantages of this snap-action assembly. Time delays are 5 to 60 sec. Relay Specialties Inc., 511 Victor St., Saddle Brook, N. J.
CIRCLE 306, READER SERVICE CARD

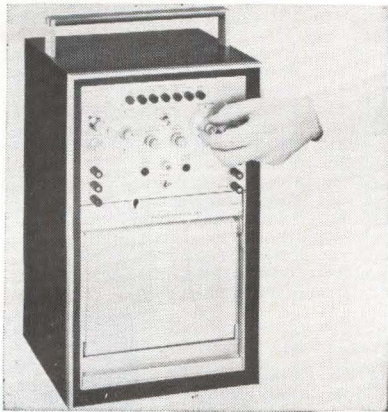

Direct Writer Offers Portability

PORTABLE two-channel rectilinear direct-writing recorder writes on channels 80-mm wide at frequencies beyond 35 cps full scale. Mark 280 is said to afford dynamic writing speed better than 10 times greater than previously achieved on channels of such width. Possible applications, beyond the normal range of conventional direct-writing recorders, include spectrophotometry, chromatography, diffusion, shock and vibration and process quality assurance studies as well as many aspects of medical and laboratory analysis. Unit incorporates a pen-position feedback servo system, which insures both static and dynamic accuracy of $\frac{1}{2}$ percent full scale. Brush Instruments, Division of Clevite Corp., 37th and Perkins, Cleveland 14, O. (307)

Potting Compound Is 100% Solids System

NEW HumiSeal type 2A58 is a polyurethane base compound that com-

Unusual stability

in miniature, surface-mounted platinum temperature sensors

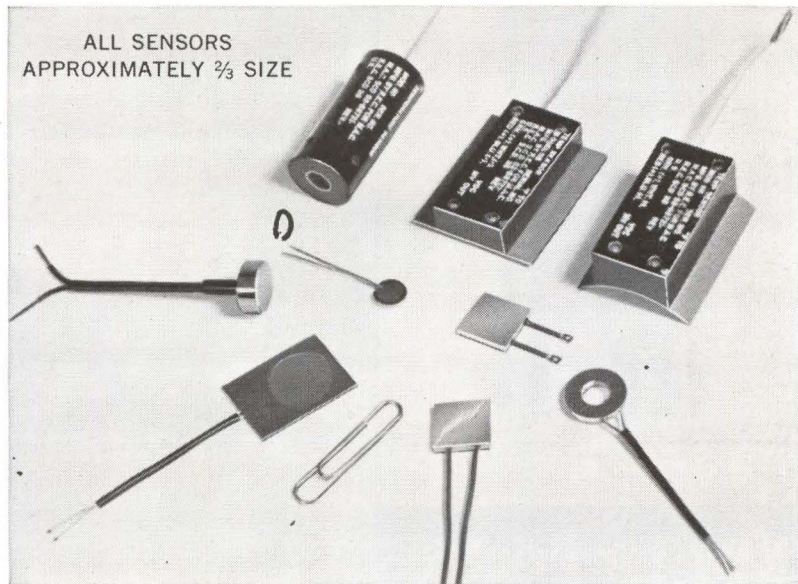

Performance is excellent for such small sensors in the REC line of miniature surface sensors. Range covered is from -435° F. to $+1800^{\circ}$ F. Repeatability after 10 consecutive shocks from liquid nitrogen at -320° F. to silicon oil at 300° F. is within $\pm 0.1^{\circ}$ F.

The easily attached sensors can be cemented, spot welded or clamped to surfaces. Cylindrical models fit around standard small pipe sizes.

REC surface sensors have elements of highest purity platinum wire, fully annealed and mounted so that the resistance wire is well isolated from any strain in the surface. Outer cases are platinum, stainless steel, epoxy compounds, or ceramic, depending on the model. Some have interchangeable bridge networks to provide a choice of temperature-voltage relationships.

For more details, write for Bulletin 9625, Platinum Resistance Surface Temperature Sensors.

A complete precision line

Rosemount Engineering Company designs and manufactures high quality precision equipment in these lines:

- | | |
|--|--|
| Air data sensors | Surface temperature sensors |
| Total temperature | Pressure sensors |
| Pitot-static tubes (de-iced) | Accessory equipment and aeronautical research |
| Immersion temperature sensors (including cryogenic) | |

For more information please write for the REC catalog. Specific questions on any temperature or pressure problems are welcomed.



**ROSEMOUNT
ENGINEERING
COMPANY**

4900 West 78th Street • Minneapolis 24, Minn.

SPECIALISTS IN TEMPERATURE & PRESSURE MEASUREMENT

**Well Known
by Reputation**



**Now for Printed
Circuit Boards**

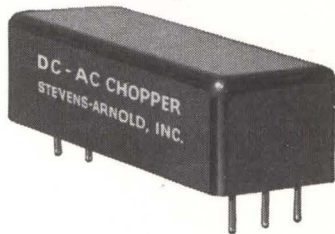

**LOW NOISE LEVEL
TWIN CONTACT RELIABILITY
LONG LIFE**

**AC Drive Models
DC Drive Models
SPDT or DPDT
MBB or BBM**

**Request
Catalog No. 515**



**STEVENS
INCORPORATED
ARNOLD**

QUALITY SINCE 1943

7 ELKINS ST., SOUTH BOSTON 27, MASS.

S/A-32-1/3

prises a 100-percent solids system. This potting compound is recommended for use as an impregnant or as a casting resin for electronic components and assemblies. The mixed compound is transparent and offers excellent electrical and mechanical properties, including high dielectric strength, excellent flexibility, and high resistance to weathering and moisture. Columbia Technical Corp., 24-30 Brooklyn-Queens Expressway West, Woodside 77, N. Y. CIRCLE 308, READER SERVICE CARD

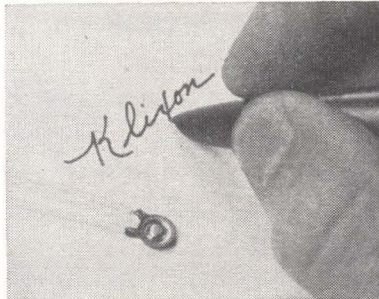

**Thermal Switch
Has Fast Response**

MINIATURE, snap-acting thermal switch combines the functions of a thermistor and its electronic circuitry in a unit no larger than the thermistor alone. It is said to respond five times faster than comparable units and replaces, at lower cost, thermistor systems used for direct sensing and switching in computers, memory systems, p-c boards, crystal ovens and electronics test equipment. Designated the Klixon 4BT Tiny-Stat, this spst, all-welded, Class A hermetically-sealed device is small enough to be placed anywhere in a system; weighs only 0.2 gram; has an operating temperature range of zero F to 350 F and is available in an encapsulated version for electrical insulation. Metals & Controls Inc., a corporate division of Texas Instruments Inc., 34 Forest St., Attleboro, Mass. (309)

**Connectors Come in
Four Sizes**

CLOSED-END connectors are made of pure Nylon with a copper insert. They come in four sizes ranging from Awg 8 to Awg 22. Length of

new concept in
**HIGH
VACUUM
MOTORS**

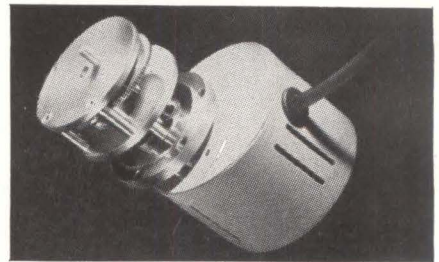

Remarkably different design! No rotary feed-through! No contamination, no leakage! Ready now... a dramatically different AC motor designed to provide mechanical motion and carry on manufacturing processes within an ultra-high vacuum system. No coils, electrical leads nor terminals inside the vacuum. No rotary feed-throughs. Will not contaminate the system. Easily degassable, easily cleaned, needs no lubricants. Offers a wide variety of advantageous applications, including sources and mask-changing apparatus in thin-film applications, crystal growing, food processing, and metallurgy. Features interchangeable, stainless steel, non-magnetic gear boxes. Available in several speeds and torques, with choice of Viton, Indium or gold gasket.

For complete descriptive bulletin with specifications and prices, write:

PHOTONICS CORPORATION
Dept. HVM-102
Walker Valley, New York



CIRCLE 204 ON READER SERVICE CARD

**WANT
TO DO
BUSINESS
WITH THE
GOVERNMENT**

????????????

Then check the Military and Government Procurement Guide in the orange section of your **ELECTRONICS BUYERS' GUIDE**.

!!!!!!!!!!!!!!!!!!!!

the connectors ranges from $\frac{7}{8}$ in. to $\frac{39}{64}$ in., and the flared opening ranges from $\frac{31}{64}$ in. to $\frac{5}{16}$ in. Samples are available. Berger Electronics Corp., 74-16 Grand Ave., Maspeth 78, N. Y. (310)

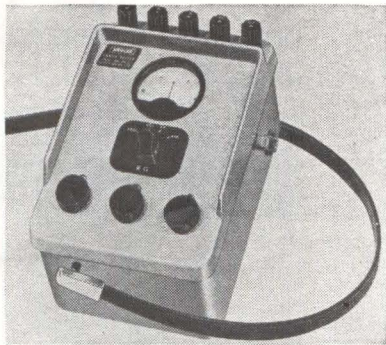

Earth Tester Is Compact and Light

THIS MEGGER (null balance) instrument embodies a highly sensitive method of measuring earth resistivity. Its accuracy is not affected by electrode resistance. It features accuracy of ± 1 percent of range in use—even on the lowest range with probe resistances up to 1,500 ohms. Range is 0.01 ohm to 9,990 ohms in four overlapping ranges. The guard terminal is provided for use when probe resistances are high or unbalanced to prevent leakage currents being introduced into the reading. Variable a-c output eliminates effects of stray currents and soil electrolysis effects. Unit offers digital read-out at a glance—readings remain visible until next test, thus eliminating reading errors. James G. Biddle Co., Township Line & Jolly Rds., Plymouth Meeting, Pa. (311)

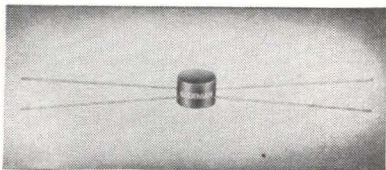

Pulse Transformers For Aerospace Use

EPOXY transfer molding and ferrite toroidal cores have been combined to produce a line of miniature molded pulse transformers capable

How to cut your handling time winding bobbin type coils

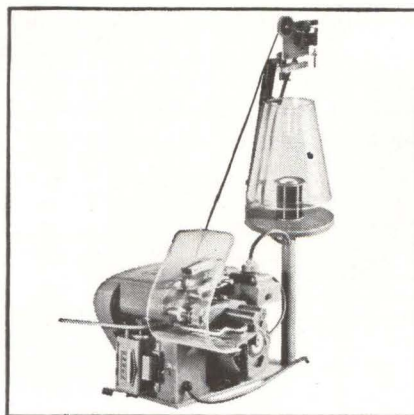

The Leesona No. 115 Bachi Bobbin Winder reduces coil handling time to a minimum for a single-head machine. All the operator has to do is load the bobbin on the arbor, close the tailstock, let the wire slip into the wire guide, and close the safety guard.

The No. 115 automatically:

- Starts
- Runs smoothly and quietly to 12,500 rpm
- Stops at ± 2 turns
- Re-indexes the wire guide
- Resets counter

Also available is the No. 115-B winder with bonding attachment to produce perfectly self-supporting coreless coils.

For full details write Leesona Corporation, Warwick, R. I. Or call Leesona at 5700 W. Diversey Avenue, Chicago 39, TUxedo 9-5735; 1500 Walnut St., Philadelphia 2, KIngsley 6-1720, or A. R. Campman & Co., 1762 Vernon Ave., Los Angeles, AXminister 3-6265.



23.3.27

for your silicon power transistor

AVNET

requirements specify STC

over 150 2N type nos. in 12 package sizes in power ratings from 5 to 300 watts. 21 MIL approvals; features major breakthrough in miniaturized power without heat sink; isolated collector in 75-85 watts; PNP transistor with NPN complements.

contact Avnet for on-time delivery

S.T.C.

of STC silicon power transistors



call your nearest Avnet office

AVNET

10 Local Headquarters, coast to coast

CIRCLE 205 ON READER SERVICE CARD

How To Get Things Done Better And Faster

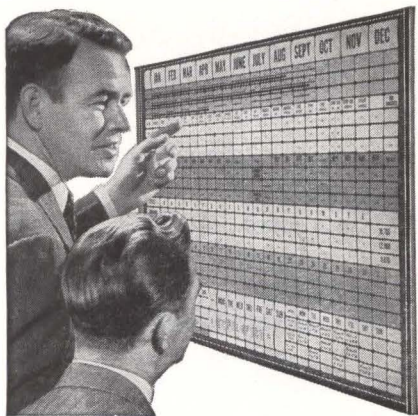

BOARDMASTER VISUAL CONTROL

- ☆ Gives Graphic Picture—Saves Time, Saves Money, Prevents Errors
- ☆ Simple to operate—Type or Write on Cards, Snap in Grooves
- ☆ Ideal for Production, Traffic, Inventory Scheduling, Sales, Etc.
- ☆ Made of Metal, Compact and Attractive. Over 750,000 in Use.

Full price **\$4950** with cards

FREE 24-PAGE BOOKLET NO. C-20
Without Obligation

Write for Your Copy Today
GRAPHIC SYSTEMS
YANCEYVILLE, NORTH CAROLINA

of withstanding wide variety of moisture, vibration and other environmental conditions. The molded pulse transformers have a diameter of 0.410 in., a height of 0.280 in. and lead spacing of 0.210 in. Designed to meet all requirements of MIL-T-21038B, Grade 5, Class Q, units are available in most common turn ratios with any primary inductance up to 10 millihenries. The Gudeman Co. of California, Inc., 7473 Avenue 304, Visalia, Calif. CIRCLE 312, READER SERVICE CARD

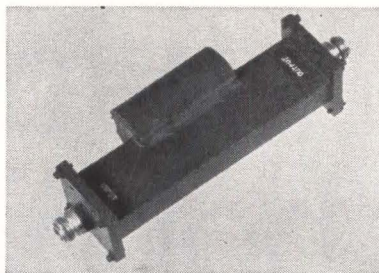

UHF Coax Isolators Occupy Small Space

SIZE and weight of these uhf coaxial isolators coupled with their high performance readily permits usage in radar and communication systems, as well as in general laboratory applications. Model U151, with a frequency range of 400 to 450 Mc, has a minimum of 12-db isolation; insertion loss of 1.3 db maximum, and vswr of less than 1.25. Through the use of special techniques, this performance is obtained in a unit that is only 6 in. long and weighs less than 1.5 lb. Microwave Technology Inc., 235 High St., Waltham 54, Mass. (313)

Standoff Terminal For Thin-Chassis Use

SUBMINIATURE Press-Fit standoff terminal, the ST-SM-18, is designed for application in chassis or circuit boards no thicker than 0.035 in. Unit features a bushing depth of only 0.075 in. below the 0.050 in. shoulder. Major diameter of the unit is 0.150 in., which makes it ideal for use in high density electronic packages. Only Teflon is used in the manufacture of the bushing. The brass lug is plated

BOOKS



10 DAYS' FREE EXAMINATION
BY MAIL

PRINTED AND INTEGRATED CIRCUITRY

Just Out. Treats the subject from viewpoint of the materials and processes involved. Covers mechanical and electrical engineering, graphic arts, chemistry, and other disciplines affecting the engineering, design, and manufacture of these types of circuitry. By T. Schlabach & D. Rider, Bell Tele. Labs. 424 pp., 125 illus., \$13.50

MICROELECTRONICS

Just Out. Acquaints you with basic concepts, design procedures, and fabrication of microminiature and integrated circuits. Includes design and manufacture of microminiature electronic circuits, thin-film integrated circuits, and semiconductor integrated circuits. Ed. by E. Keonjian, Amer. Bosch Arma Corp. 400 pp., illus., \$12.50

PROFESSIONAL ACHIEVEMENT for ENGINEERS AND SCIENTISTS

Just Out. Helps the engineer and scientist enhance his personal, managerial, social, and other non-technical skills that improve the quality of his professional achievement and increase his earning power. By T. G. Hicks, Cooper Union Sch. of Engg. 384 pp., illus., \$7.95

ANALYSIS OF LINEAR TIME-INVARIANT SYSTEMS

Just Out. Develops operational analysis in depth, and its application to the study of linear time-invariant systems. Stresses fundamentals but is slanted toward system evaluation and optimization rather than design work. By W. M. Brown, Univ. of Mich. 352 pp., illus., \$11.75

RADIO ASTRONOMY

Just Out. Provides an authoritative study of radio waves of extraterrestrial origin. From solar radio emission to galactic radio emission, fully explains the new techniques of radio astronomy, then presents these results in close conjunction with the results of optical observation. By J. Steinberg & J. Lequex, Paris-Meudon Observatory. 260 pp., illus., \$9.95

USE PUBLISHER'S COUPON

McGraw-Hill Book Co., Dept. L-9-13
327 W. 41st St., New York, N. Y. 10036

Send me book(s) checked below for 10 days' examination on approval. In 10 days I will remit for book(s) I keep plus few cents for delivery costs, and return unwanted book(s) postpaid. (We pay delivery costs if you remit with this coupon—same return privilege.)

- Schlabach & Rider—Print. & Integr. Circuitry, \$13.50
- Keonjian—Microelectronics, \$12.50
- Hicks—Prof. Achieve. for Eng. & Sci., \$7.95
- Brown—Analy. of Lin. Time-Invar. Sys., \$11.75
- Steinberg & Lequex—Radio Astron., \$9.95

Name

Address

City..... State..... Code.....

Company

Position

For price and terms outside U.S. write McGraw-Hill Intl., N.Y.C. 36

L-9-6

with an electro-solder finish. A B-6 insertion tool is available for fast installation into a prepared chassis hole. Sealectro Corp., 139 Hoyt St., Mamaroneck, N. Y. (314)

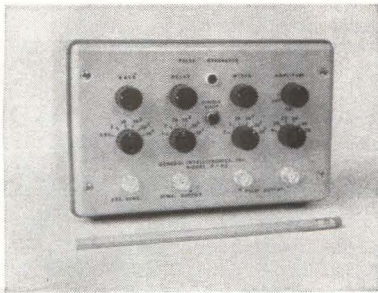

Pulse Generator Is Compact Unit

MODEL P-63 pulse generator features repetition rates of 10 cps to 5 Mc with pulse widths of 30 nsec to 0.1 sec. Simultaneous positive and negative outputs available at amplitudes of zero to 12 v from 50 ohms. Rise times less than 20 nsec. Price \$290. General Intel-litronics, Inc., 900 Nepperhan Ave., Yonkers, N. Y. (315)

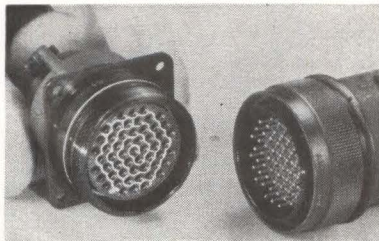

Connector Provides Go-No-Go Reliability

ENVIRONMENT-RESISTANT connector provides absolute go-no-go reliability in aerospace electronic circuits. The Ultra-Mate will prevent a circuit checking out on the ground and later malfunctioning due to connector failure. A new hard-front dielectric that is serviceable from the front and foolproof once installed is responsible for this reliability. Ultra-Mate is completely interchangeable and intermateable with other MIL-C-26500 connectors and uses the same standard MS-26636 contacts. Amphenol-Borg Electronics Corp., 1830 S. 54th Ave., Chicago 50, Ill. (316)

FASTENERS FROM

GRC

DIE CAST ZINC ALLOY

Wing Nuts

Cap Nuts

Thumb Nuts

Thumb & Wing Screws

MOLDED NYLON & DELRIN

Screws

Hex Nuts

Washers

Screw Insulators

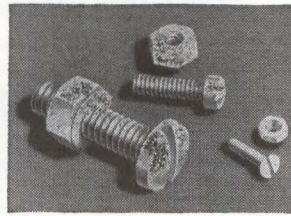

NYLON SCREWS AND NUTS

also available in Delrin

MACHINE SCREWS from miniature #0 thru 1/4" in wide range of lengths and head types.

Also SET SCREWS, NUTS from #2 thru 5/16".

GRC's exclusive methods—die casting zinc alloy or molding Nylon and Delrin fasteners in one high speed automatic operation—assure high quality at lowest possible cost.

Write, wire, phone TODAY for SAMPLES, prices, your copy of GRC's NEW INDUSTRIAL FASTENER CATALOG.



GRIES REPRODUCER CORP.

World's Foremost Producer of Small Die Castings

151 Beechwood Ave. • New Rochelle, N. Y.

Phone: (914) NEW Rochelle 3-8600

CIRCLE 206 ON READER SERVICE CARD

specify the new U.S. Semcor Products

AVNET

contact Avnet for best service



on-time delivery of

SEMCOR

diodes and capacitors

5 watt miniature Zener Diodes, high voltage temperature compensated Reference Elements, non-polar solid and hermetically sealed wet Tantalum Capacitors, 400MW Glass Zeners Mil Types USN 1N 962BM -USN 1N 984BM

call your local Avnet Headquarters

AVNET
The Avnet System, coast to coast

CIRCLE 207 ON READER SERVICE CARD

HERE IS THE WORLD'S SMALLEST MOTOR
YET IT'S SO POWERFUL . . .

MITSUMI MICRO MOTOR

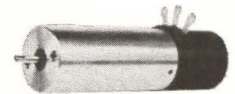

MODEL MI-100

Less than 20mm in diameter, the new Mitsumi Micromotor provides a startling efficiency of over 50%, the barrier which miniature motors are not allowed to pass.

A novel construction principle helped to make this accomplishment possible. The form is more simplified by setting all the terminals at one position. Because the entire mechanism is given full protection against irregular revolution and above all, electrical noise is entirely eliminated, you may call this the most perfect micromotor yet devised. Please write for complete information on Mitsumi Micromotor, and we will send you specifications and data.



MITSUMI PARTS
MITSUMI ELECTRIC CO., LTD.
TOKYO • OSAKA • NEW YORK

CIRCLE 75 ON READER SERVICE CARD

75

When the need is critical . . .

ALITE[®] MISSILE NOSE CONES



with
**MAXIMUM PERFORMANCE
CHARACTERISTICS**

As requirements become more demanding, high alumina ceramic—with its ability to withstand temperatures in excess of 3000°F — is being used more frequently for missile nose cones.

Increasingly, missile manufacturers are turning to Alite for their alumina nose cones for two principal reasons:

- *Alite's capability for the electromagnetic and mechanical design of a nose cone with maximum transmission efficiency and structural reliability.*
- *Alite's capability for the production of nose cones which are uniformly accurate—physically and electrically—in production lots. Here, not only close dimensional tolerances but also absolute uniformity of high purity ceramic formulations from batch to batch is essential.*

Produced under rigid Quality Control procedures, you can rely on Alite high alumina ceramic nose cones' low loss tangent . . . zero water absorption . . . dimensional and chemical stability . . . and high temperature resistance.



Let us review your specific requirements — without obligation: send us prints and other pertinent data. Or, write for free bulletins giving complete information about Alite.

ALITE

DIVISION

U. S. STONWARE

BOX 119

ORRVILLE, OHIO

62-J

CIRCLE 76 ON READER SERVICE CARD

**WANT TO
DO BUSINESS
WITH THE
GOVERNMENT ????????**

Then check the Military and Government Procurement Guide in the orange section of your **ELECTRONICS BUYERS' GUIDE**.

LITERATURE OF

CARRIER DELAY MODULE Delttime Inc., 608 Fayette Ave., Mamaroneck, N. Y. Data sheet DT-9 describes a unity gain carrier delay module for a-m, f-m, or pulse modulation.

CIRCLE 317, READER SERVICE CARD

COMPUTER GLOSSARY TRW Computer Division, 8433 Fallbrook Ave., Canoga Park, Calif., has published a 12-page glossary of computer and process control terminology. (318)

PRECISE FREQUENCY METERS Crydom Laboratories, Inc., 12850 Western Ave., Garden Grove, Calif., has released a catalog listing its line of standard precise frequency meters. (319)

COMMAND-AND-CONTROL SYSTEMS General Precision, Inc., Tarrytown, N. Y. Brochure describes the company's technical skills in large-scale digital data processing, displays and communications and how they meet the requirements of command-and-control systems. (320)

PLANAR PROGRESS REPORT Fairchild Semiconductor, 545 Whisman Road, Mountain View, Calif., has available a brochure describing the state of the art of the planar process. (321)

MAGNETIC VOLTAGE REGULATORS Raytheon Company, Richards Ave., South Norwalk, Conn., Data folder lists 40 tubeless units with outputs stabilized to within ± 1 percent for input changes of up to 15 percent. (322)

SILICON BRIDGE RECTIFIERS International Rectifier Corp., 233 Kansas St., El Segundo, Calif., has published a bulletin on miniaturized encapsulated silicon bridge rectifiers. (323)

MICROWAVE EQUIPMENT General Radio Co., West Concord, Mass. A 20-page illustrated brochure describes an extensive line of vhf-uhf instruments and components. (324)

FACILITIES BROCHURE Electronic Research Associates, Inc., 67 Factory Place, Cedar Grove, N. J., offers an 8-page brochure describing its capabilities, facilities and services now available. (325)

SOLID STATE RELAY Ortronix Inc., P. O. Drawer 8217, Orlando, Fla. Bulletin ORT-14A-3 describes a miniaturized, neutral-to-neutral solid state relay for signal communications networks. (326)

SUBMINIATURE CONNECTORS Winchester Electronics, Inc., Willard Road, Norwalk, Conn. A 6-page technical brochure illustrates and describes high current, subminiature, rectangular connector series SRM. (327)

TEMPERATURE TEST CHAMBERS The Sci-onics Corp., 8900 Winnetka Ave., Northridge, Calif. Two new data sheets provide detail specifications on precision temperature test chambers. (328)

A-C POWER CONTROLLER Niagara Electron Laboratories, Andover, N. Y. The

THE WEEK

Niatrol proportional temperature and general purpose control that features no moving parts, no vacuum tubes, no maintenance and 0.02-deg precision, is described in a four-page bulletin. (329)

ZENER DIODES Solitron Devices, Inc., 500 Livingston St., Norwood, N. J. Four-page technical bulletin describes a new temperature compensated Zener diode series. (330)

MAGNETIC TAPE MAINTENANCE Cybetronics, 132 Calvary St., Waltham 54, Mass., offers a 6-page brochure to help the computer user upgrade the efficiency of magnetic tape systems while cutting costs due to computer down time and unnecessary purchase of new magnetic tapes. (331)

INSTRUMENT CASES W. A. Miller Co., Oquosoc, Maine. A 4-page brochure describes ruggedized Formica cases for quality precision instruments. (332)

A-C MOTOR Globe Industries, Inc., 1784 Stanley Ave., Dayton 4, O. Brochure 108 outlines the type FC 60- and 400-cycle a-c motor for military applications stressing high output in a compact package. (333)

AIRCRAFT TEST SET Airpax Electronics Inc., Fort Lauderdale, Fla. Bulletin F-71 describes model 4B portable, all-purpose aircraft test set. (334)

COOLING DEVICE Rotron Mfg. Co., Inc., Woodstock, N. Y. Complete information on the new Gold Seal Muffin Fan is contained in a four-page catalog. (335)

CERAMIC TRIMMERS Erie Resistor Corp., 644 W. 12th St., Erie, Pa. Bulletin 527, a two-page data sheet about a new line of miniature ceramic trimmers, is now available. (336)

FERRITE ISOLATORS Microlab, 570 West Mt. Pleasant Ave., Livingston, N. J. Types FA and FB ferrite isolators are described in a new 4-page catalog. (337)

TRAVELING-WAVE TUBE Sylvania Electric Products Inc., 1100 Main St., Buffalo 9, N. Y., offers a booklet describing its 100-w c-w traveling-wave tube. (338)

PNPN STANDARDS Solid State Products, Inc., One Pingree St., Salem, Mass. Standard S100 is a comprehensive treatment of definitions, symbols and abbreviations in the pnpn switching device field. (339)

SHAFT POSITION ENCODERS Datex Corp., 1307 S. Myrtle Ave., Monrovia, Calif. Six-page bulletin illustrates and describes C-100 and C-200 series shaft position encoders. (340)

MICROWAVE MULTIPLEX SYSTEM Lynch Communication Systems Inc., 695 Bryant St., San Francisco 7, Calif. A 20-page descriptive brochure, B910A-SB-1, is available on the type B910A solid-state high-density microwave multiplex system. (341)

Go ahead,
promise
long tube
life

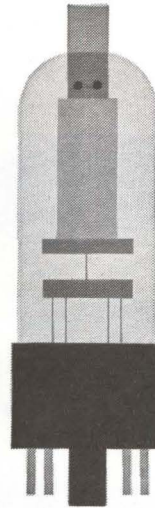

Superior
cathodes
will back
you up

Once your electron tubes are plugged into a circuit, your reputation will depend on the performance of the cathodes you use. Do you want tubes with long life, high shock resistance, uniformity, high-temperature tolerance, and various other desirable characteristics? Choose your cathodes from the broad Superior line. Write us for a copy of Catalog 51. Superior Tube Co., 2500 Germantown Ave., Norristown, Pa., 19404.

Widest choice of cathode alloys

Includes regular commercial materials, plus the versatile Cathaloy® series, developed by Superior. Each heat tested by Superior before approval for production.

Cathaloy A-31. For extreme stress applications. 4% tungsten. Approximately twice as strong as tungstenfree alloys.

Cathaloy A-32. Contains 2% tungsten. Excellent emission, rapid activation, very low sublimation and interface impedance.

Cathaloy A-33. All-purpose cathode alloy. Combines high emission with freedom from sublimation and interface impedance.

Cathaloy P-50. Long-life passive alloy for high-reliability power output tubes requiring low grid emission.

Cathaloy P-51. 100% stronger than P-50 at high temperatures. For use in tubes subject to shock and vibration.

Nickel 220, Nickel 225, Nickel 230 and Nickel 233 ("330 Nickel"). Contain silicon and magnesium. Rapid activation.

Driver-Harris 399, 599 and 799. Silicon activated. Rapid activation, plus high-level d-c emission.

Widest choice of cathode forms

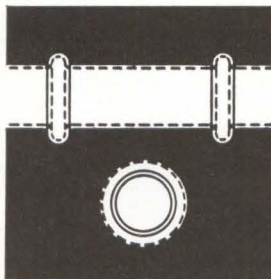

Seamless WELDRAWN.® No seam. Can be made to close tolerances.

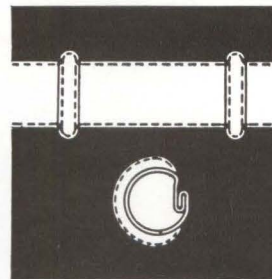

Lockseam.* Available with serrations, vertical rib or integral tab.

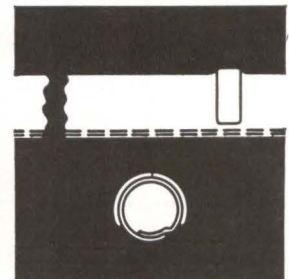

Lapseam. Gives tighter fit in mica. Available in rounds and shapes.

*Manufactured under U.S. patents

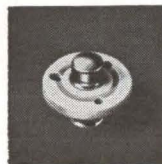

Disc cathodes. One of four basic types. Separate cap alloy. Close control of E-dimension. Shadow groove. Flared shank.

Superior Tube 

The big name in small tubing
NORRISTOWN, PA.

West Coast: Pacific Tube Company, Los Angeles, California

Johnson & Hoffman Mfg. Corp., Carle Place, N.Y.—an affiliated company making precision metal stampings and deep-drawn parts

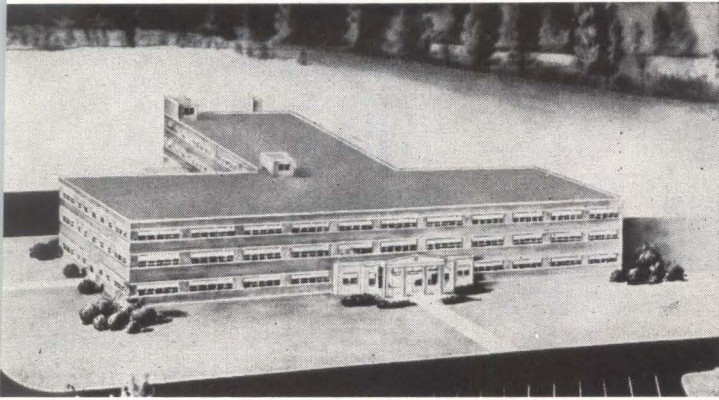

General Radio Still Growing

ARTIST'S SKETCH shows General Radio Company's new plant in Bolton, Mass., scheduled for occupancy early in 1964. The three-story, 75,000-square foot plant is situated on a 100-acre tract in a rural setting about 30 miles west of Boston.

The building is patterned after the company's head-

quarters in Concord, Mass., with the T-shaped unit sited to allow for later addition of three adjoining similar units. This would make the Bolton facility a duplicate of the Concord plant, which currently employs just under 1,000. Initial employment at Bolton will be about 125, mostly transfers from Concord.

Bolton will function as a vertical subdivision of General Radio, housing operations relating to the design and manufacture of GR's microwave and signal-generator lines. This decision largely reflects the company's increasing sales of coaxial connectors and elements, and of microwave instruments. The company plans to operate Bolton as an autonomous division, as far as it is possible, including its own manufacturing and processing departments, development engineering, and drafting. Sales activities, however, will remain at Concord.

Company says the Bolton plant is the most noteworthy in a series of expansion announcements by GR: New sales engineering offices in Cleveland and Montreal are opening this month, while within the past few years a wholly owned subsidiary, General Radio (Overseas), has been established in Zurich, Switzerland, and sales engineering offices have been opened in Syracuse, Orlando, and Dallas.



IBM Promotes Bickford

PROMOTION OF Lawrence R. Bickford, Jr., to director of the IBM Research Laboratory in Japan is announced. He was formerly director of general science research at IBM's Thomas J. Watson Research Center in Yorktown, N.Y.

The new research laboratory is being established in cooperation with the Japanese scientific community. Plans for the laboratory were originally announced in June, 1962. It will be situated in the Tokyo-Yokohama area, and it is planned that initial operations will

start by the end of this year. It will be operated as a branch of IBM Research Laboratory, Inc., which was set up to conduct IBM's future research activities outside the U. S.



Ford Instrument Elevates Manion

EDWARD F. MANION has been named vice president, marketing, of Ford Instrument Company, division of Sperry Rand Corporation, Long Island City, N. Y.

With the company since 1952, Manion has been general sales manager for the past two years.

Baird-Atomic Upgrades Richardson

CARL RICHARDSON has been appointed vice president, analytical and electronic instruments at Baird-Atomic, Inc., Cambridge, Mass. Prior to assuming this new responsibility, he had been chief engineer for commercial products.

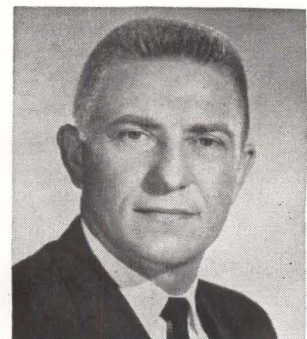

Koch Named Head of Mallory Electronics

ORAL D. KOCH has been appointed general manager of the Mallory

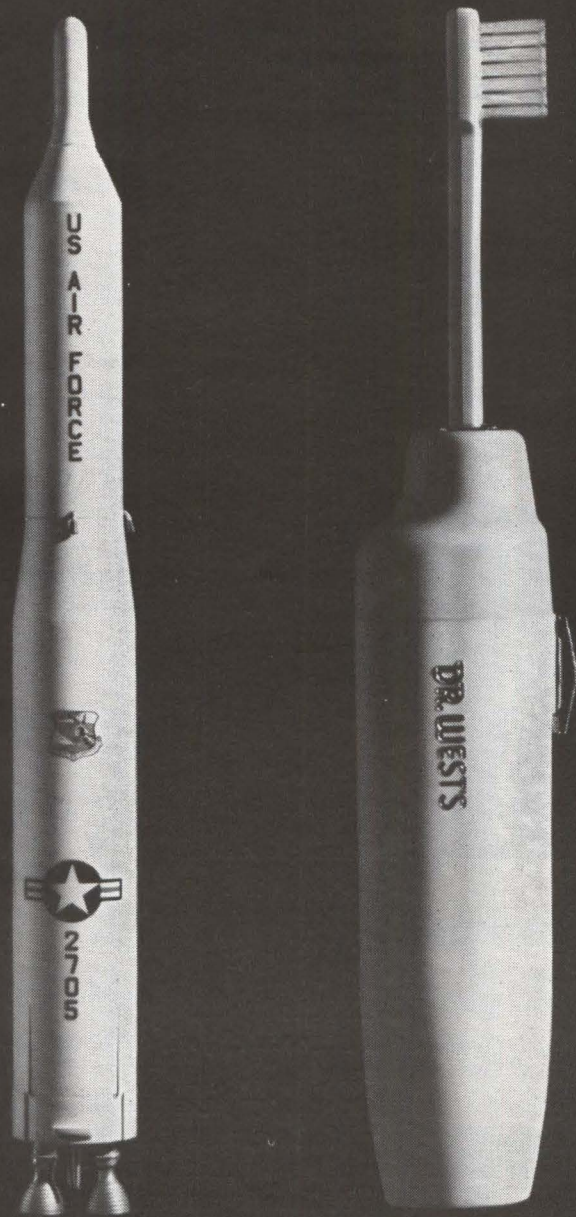

from Titan to Toothbrush

Sonotone batteries spark portable power to action!

Mite or might—if it's portable, the chances are it relies on Sonotone rechargeable sintered-plate, nickel-cadmium cells and batteries. That goes for everything from space satellites and missiles to cordless razors and toothbrushes, and even to small, delicate medical instruments. The reason is this: Sonotone pioneered in the development of high-power/low-weight rechargeable batteries. With more years of experience in this field than any other American company, Sonotone has built up an unmatched record of reliability...and an unmatched reputation for cooperation with design engineers. What new product are

you working on? Let Sonotone help you solve your power problem. Write today for technical data, stating your application requirements...and we'll be happy to lend you a hand.

Sonotone Batteries MM-13 have been used in U.S. ICBM Titan I and Sonotone Batteries MM-14 have been used in the emergency ground support. Many electric toothbrushes use Sonotone Sealed Battery S-113. These are just three of more than 300 Sonotone rechargeable sintered-plate, nickel-cadmium cells and **Sonotone Batteries** portable power for progress 

Battery Div., Dept. B24-93, Sonotone Corp., Elmsford, N.Y. • Aircraft, Missile and Satellite Batteries • Power Supplies • Battery Chargers • Audio Products • Hearing Aids



Mars probe!



"Off-the-shelf" ERA TRANSPAC® TC222 DC to DC Converters were used successfully in the recent flight of the Stratoscope II to power the Perkin-Elmer telescope's telemetry transmitters. Stratoscope II was launched to determine the presence of life-sustaining elements on Mars.

The specified low-end temperature for ERA stock converters is minus 20°C. . . the actual operating temperature during flight at 79,000 ft. was *minus 65°C*.

ERA's conservative specmanship is your best assurance of engineering and manufacturing integrity. Select *your* power supplies from the ERA catalog . . . then conduct *your own* comparison evaluation . . . or, better yet, compare against other makes. We sell *more power supplies* that way!

Check the full range of solid-state TRANSPAC DC Power Modules, Converters, Inverters and Frequency Changers. Send for *your* ERA catalog today!



ELECTRONIC RESEARCH ASSOCIATES, INC.

Dept. E-9, 67 Factory Place • Cedar Grove, N. J. • CEnter 9-3000

SUBSIDIARIES: ERA Electric Co. • Advanced Acoustics Co. • ERA Dynamics Corp. • ERA Pacific, Inc.

Electronics Company, a division of P. R. Mallory & Co. Inc., Indianapolis, Ind. He joined Mallory in 1960 and has been manager of a West Coast facility of the division.

In his new position, Koch is responsible for a division specializing in the development and manufacture of power supplies, military communications equipment and commercial electronic devices.



CBS Laboratories Appoints McMann

PROMOTION of Renville H. McMann, Jr., to vice president of the Military and Industrial Systems department of CBS Laboratories, Stamford, Conn., has been announced.

McMann has been director of engineering for the department since 1960. He joined CBS Laboratories in 1955 as a project engineer.

Packard Bell Hires Underhill

J. T. UNDERHILL has joined Packard Bell Electronics, Los Angeles, Calif., as director of engineering, Space and Systems division. He came to Packard Bell from the Lockheed Missiles and Space Co., where he was a department manager responsible for development and design engineering.

National Shifts Key Personnel

NATIONAL COMPANY, INC., Malden, Mass., has appointed Saul Fast vice president, engineering. He was

formerly vice president and technical assistant to the president.

Samuel J. Davy, formerly vice president, engineering, has been appointed vice president and assistant to the president.

Herbert A. Finke, president and chief executive officer, said the appointments are designed to apply the skills of the executive staff more broadly toward meeting current needs of the diversified electronics firm.

Langstroth Joins Hoffman Electronics

FRANK D. LANGSTROTH, formerly vice president, government and industrial relations for the Electronic Systems division of Sylvania Electric Products, Inc., has been elected a vice president by the board of directors of Hoffman Electronics Corp., Los Angeles, Calif., and will be responsible for the direction of the company's marketing activities.



United Research Names Cowan

ELECTION of Stuart D. Cowan as president and chief executive officer of United Research Inc., Cambridge, Mass., is announced. Cowan was formerly vice president, Raytheon Co., Lexington, Mass.

Aero Geo Astro Has New Subsidiary

AERO GEO ASTRO CORPORATION, Alexandria, Va., has established a subsidiary, Radio Frequency De-

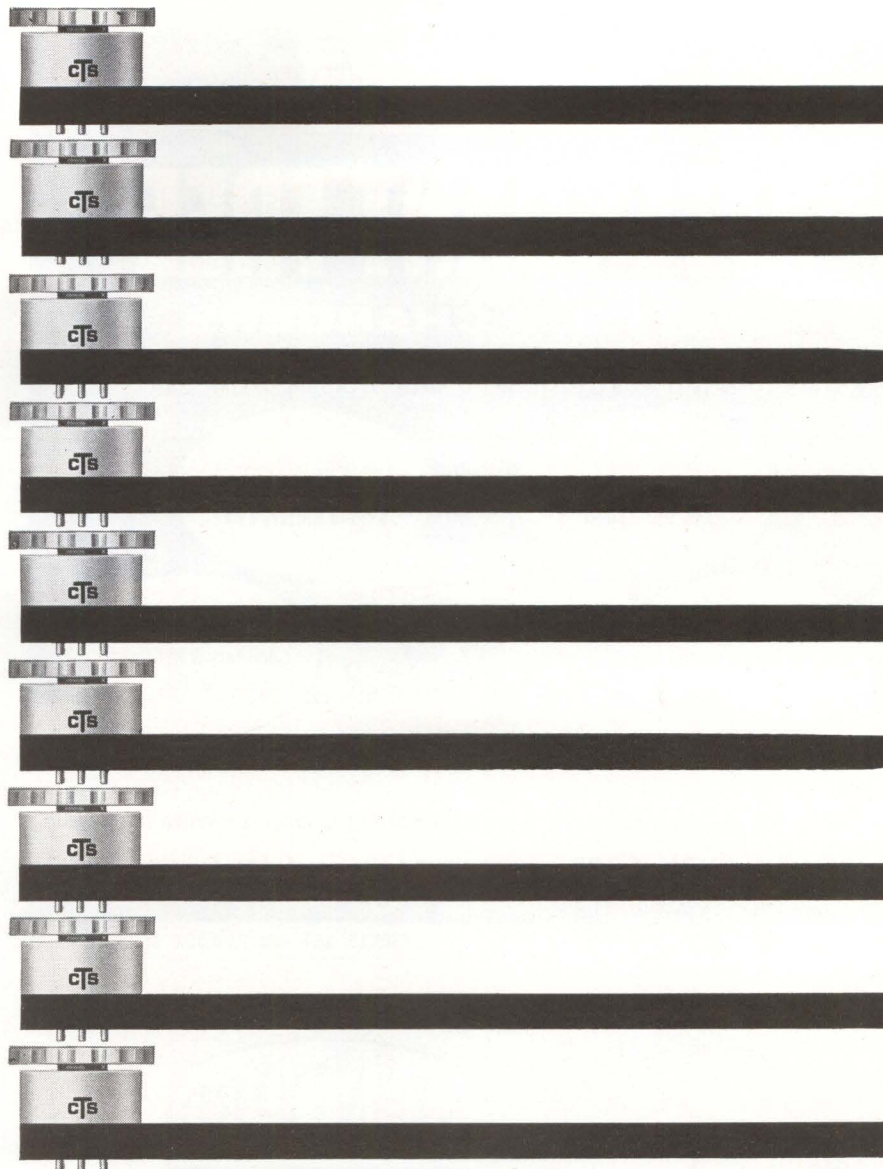

STACK 'EM

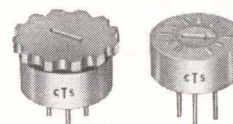

ACTUAL SIZE

... and be able to adjust 'em. The new CTS Series 350, single turn 1/2" diameter, subminiature, wire wound trimmer potentiometer is available with knob or screwdriver slot. Both are inexpensive and easy to adjust. The knob stands only .335" above a printed circuit board. The slotted model has easy-to-read indicator marks every 30° for fast, accurate settings. Meets or exceeds MIL-R-27208. Low residual end setting due to **exclusive LOKWELD™** element termination.



CTS of Berne, Inc., Berne, Indiana

subsidiary of **CTS CORPORATION • ELKHART, INDIANA**

West Coast: Chicago Telephone of California, Inc.,
1010 Sycamore Ave., So. Pasadena, Calif.

In Canada: CTS of Canada Ltd., Streetsville, Ontario

CHRISTIE

SINCE 1929®

"ATTENDANT FREE"

BATTERY CHARGERS

FOR LEAD ACID • NICKEL CAD • SILVER ZINC BATTERIES

6 to 120 volt d-c
3 to 125 amp
1% Regulation

Volt/Amp Regulation
Reduce Battery Heating
Extend Battery Life

Electric Vehicle,
All-Purpose and
Float Charging

Silicon Rectifiers
Military & RFI Specs
No Fan

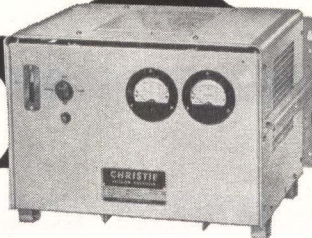

Also 200 other Models of Power Supplies & Battery Chargers • Write for Catalog
CHRISTIE ELECTRIC CORP. 3400 West 67th Street, Los Angeles 43, Calif.

CIRCLE 208 ON READER SERVICE CARD

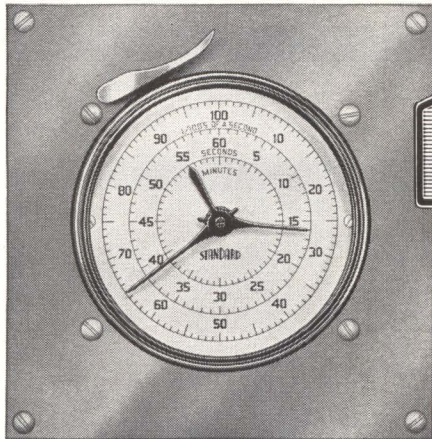

THE ONE TIMER WITH ALL THE FEATURES

- Portable, Panel or Wall Mounting
- Scale Divisions from 1/1000 sec. to 1/5 sec.
- Totalize from .360 sec. to 60 min.
- Accuracy range from $\pm .0002$ to $\pm .1$ sec.

Since 1932 Standard Electric Time Company has been developing and manufacturing units for the precise measurement of elapsed time. Accuracy, rugged construction and long life are Standard features.

For full details request free 20 page catalog No. 257.



THE STANDARD ELECTRIC TIME COMPANY

89 LOGAN STREET • SPRINGFIELD, MASSACHUSETTS

vices, Inc., of Tampa, Fla., with Charles A. Beaty as president. The company will be engaged in the development and production of radio frequency power sources.

Establishment of RFD is part of AGAC's pattern of developing suppliers of state-of-the-art devices. The initial supplier established was Western Microwave Laboratories, Inc., of Santa Clara, Calif., last year, which has a complete line of broadband ferrite devices.

PEOPLE IN BRIEF

William D. Jobe leaves Ling-Temco-Vought to join Sigma Systems Corp. as mgr. of engineering. **Edward J. Bacon** promoted to research director at Booz, Allen Applied Research Inc. **Alvin M. Dearolph** advances to director of engineering for Televiso Electronics. **Bruce K. Nelson** moves up to senior scientist at Sylvania Electronic Systems. **Dimitri R. Stein**, ex-Columbia Technical Corp., has formed a new firm, Cable Consultants Corp. Sealectro Corp. ups **Gordon S. Westbrook** to group g-m to head its English branch and European operations. Bryant Computer Products promotes **Donald D. Merry** to product assurance mgr. Rockwell Mfg. Co. elevates **R. A. Schlegel** to v-p and g-m of its Industrial Measurement and Control div. in addition to his duties as president of Republic Flow Meters Co., a Rockwell subsidiary. **John F. Stephens**, Col. U.S.A. Ret., appointed chief engineer of R&D at Sperry Utah Co. **Francis M. Joseph**, associated with Inland Motor Corp. since 1959, raised to v-p for engineering. **John W. Coolidge**, previously with Power Systems, Inc., elected president of Applied Engineering Products Co. **William S. Simpson**, director of Pearce-Simpson, Inc. until this year, has announced formation of Simpson Electronics, Inc. **William L. Gordon** moves up at Honeywell EDP to asst. to the v-p of planning and engineering, succeeding **Charles Michaels**, who was named director of engineering.

H.P. model 300 Wave Analyzer \$250.00
 H.P. model 200I Audio Generator \$150.00
 Boonton 100A Q Meter.....\$150.00
 Boonton 260A Q Meter.....\$325.00
 Boonton UHF Q Meter.....\$375.00
 Tektronix type 107 Sq. Wave Gen. \$ 75.00
 G.R. VTVM type 762A.....\$ 75.00
 Measurements Model 84 Sig. Gen. \$300.00
 RCA WO88A Scope.....\$ 99.50
 RCA WO78A Scope.....\$ 69.50

SORENSEN POWER SUPPLIES
 E-28-5 not metered.....\$ 75.00
 E-28-5 metered\$ 99.50
 E-28-10 not metered.....\$125.00
 E-28-10 metered\$150.00
 E-28-30 metered\$199.50

All equipment is unconditionally guaranteed

SELECTRONICS
 1207-25 S. Napa St., Philadelphia 46, Pa.

CIRCLE 954 ON READER SERVICE CARD

ELECTRON TUBES
 KLYSTRONS • ATR & TR • MAGNETRONS
 SUBMINIATURES • C.R.T. • T.W.T. • 5000-
 6000 SERIES
 • SEND FOR NEW CATALOG A2 •
 A & A ELECTRONICS CORP.
 1063 PERRY ANNEX
 WHITTIER, CALIF.
 AN 92865 OR 943-2829

CIRCLE 955 ON READER SERVICE CARD

FREE Catalog
 OF THE WORLD'S FINEST
 ELECTRONIC GOV'T
 SURPLUS BARGAINS



HUNDREDS OF TOP QUALITY
 ITEMS—Receivers, Transmitters,
 Microphones, Inverters, Power Sup-
 plies, Meters, Phones, Antennas,
 Indicators, Filters, Transformers,
 Amplifiers, Headsets, Converters,
 Control Boxes, Dynamotors, Test
 Equipment, Motors, Blowers, Cable,
 Keys, Chokes, Handsets, Switches,
 etc., etc. Send for Free Catalog—
 Dept. E-3

FAIR RADIO SALES
 2133 ELIDA RD. • Box 1105 • LIMA, OHIO

CIRCLE 956 ON READER SERVICE CARD

Color DIAL TELEPHONES \$10.95
 Complete

Factory rebuilt Western Electric
 in white, beige, ivory, pink, green,
 or blue. If 4 prong plug is re-
 quired add \$2.00. Fully guaranteed.
 Write for free list. All ship-
 ments FOB.



SURPLUS SAVING CENTER
 Waymart Dept. E-9133 Penna.

CIRCLE 957 ON READER SERVICE CARD

TUBES & COMPONENT
FREE...CATALOG
BARRY ELECTRONICS

512 BROADWAY 212-WALKER 5-7000
 NEW YORK 12, N.Y. TWX-571-0484

CIRCLE 958 ON READER SERVICE CARD

VARIAN KLYSTRONS—BRAND NEW!
 Immediate delivery from stock

| | | | |
|----------------|----|-------|-------|
| V-28 | KU | 14W | \$700 |
| VA-64F | KU | 15W | \$700 |
| VA-64G | KU | 15W | \$500 |
| VA-67B | KU | 1W | \$700 |
| VA-201 H, J | X | 40mW | \$200 |
| VA-217F | X | 60mW | \$220 |
| VA-242 E. F. G | X | 700mW | \$130 |

U. S. MICROWAVE
 P. O. Box G, Collingswood, N. J. 609-W06-2929

CIRCLE 959 ON READER SERVICE CARD

Advertisement

Unique Relay Catalog Now Available

NEW YORK, N. Y. Sept., 1963. Universal Relay Corp., 42 White St., New York 13, N. Y. announces the publication of their latest 32 page catalog. Universal's normal inventory includes over 2,000,000 relays in approximately 30,000 types. In most cases stock is sufficient to give immediate delivery of production quantities. This catalog is not just a listing of items available "on order" but it is an indication of in-stock items (either as complete units or as ready-to-assemble components). Average shipment is made within 48 hours. Where coils and frames require assembly, or relays require special testing or adjustment, shipments are made within one week to ten days.

Universal is completely equipped to assemble, adjust and thoroughly test any type of relay. A personal interest is taken in every order. This interest is maintained as the order is processed and continues even after the customer receives the merchandise, until he makes sure that it satisfies his needs. All merchandise is guaranteed, subject to customers' inspection and approval and may be returned within 30 days for replacement or credit. Catalog E-763 may be obtained by writing directly to:

UNIVERSAL RELAY CORP.
 42 White St., New York 13, N. Y.
 Telephone 212 WA 5-6900

CIRCLE 951 ON READER SERVICE CARD

LIFSCHULTZ
FASTEST...

4th DAY between Chicago and West Coast
 2nd DAY between Chicago—Milwaukee and Eastern Terminals

Specialists in Shipment of Electronics Products

LIFSCHULTZ
FAST FREIGHT
 NEW YORK — CHICAGO — PHILADELPHIA — BOSTON
 HOLYOKE — BALTIMORE — BLOOMFIELD, N. J.
 NEW HAVEN — PROVIDENCE — MILWAUKEE
 LOS ANGELES — SAN FRANCISCO

CIRCLE 952 ON READER SERVICE CARD

SMALL AD but BIG STOCK
 of choice test equipment
 and surplus electronics
 Higher Quality—Lower Costs
 Get our advice on your problem

ENGINEERING ASSOCIATES
 434 Patterson Road — Dayton 19, Ohio

CIRCLE 953 ON READER SERVICE CARD

POTTING APPLICATORS
 MANUAL AND DISPOSABLE
 6cc 12cc 30cc
 FOR POTTING, ENCAPSULATING, AND
 SEALING OF MINIATURE COMPONENTS
 PHILIP FISHMAN CO.
 7 CAMERON ST., WELLESLEY 81, MASS.



CIRCLE 960 ON READER SERVICE CARD

AUTOTRACK ANTENNA MOUNT
TYPE SCR 584, MP 61B
 360 degree azimuth, 210 degree elevation sweep with better than 1 mil. accuracy. Missile velocity acceleration and slewing rates. Amplitude and servo control. Will handle up to 20 ft. dish. Supplied complete with control chassis. In stock—immediate delivery. Used world over by NASA, ARMA, USAF.

AIRBORNE AUTOTRACK MOUNT
 Gimbal mount, compl. w/all servos & drives for full sweep. \$475.

SCR 584 RADARS AUTOMATIC TRACKING
3 CM & 10 CM
 Our 584s in like new condition, ready to go, and in stock for immediate delivery. Ideal for telemetry research and development, missile tracking, satellite tracking, balloon tracking, weather forecasting, anti-aircraft defense tactical air support. Used on Atlantic Missile Range, Pacific Missile Range, N.A.S.A., Wallops Island, A.B.M.A. Desc. MIT Rad. Lab. Series, Vol. 1, pps. 207-210, 228, 284-286.

PULSE MODULATORS
MIT MODEL 9 PULSER
1 MEGAWATT—HARD TUBE
 Output 25 kv 40 amp. Duty cycle .002. Pulse lengths .25 to 2 microsec. Also .5 to 5 microsec. and 1 to .5 msec. Uses 6C21. Input 115v 60 cycle AC. Mfr. GE. Complete with driver and high voltage power supply. Ref: MIT Rad. Lab. Series Vol. 5 pps. 152-160.

500KW THYRATRON PULSER
 Output 22kv at 28 amp. Rep. rates: 2.25 microsec. 300 pps. 1.75 msec 550 pps. 4 msec 2500 pps. Uses 5C22 hydrogen thyatron. Complete with driver and high voltage power supply. Input 115v 60 cy AC.

2 MEGAWATT PULSER
 Output 30 kv at 70 amp. Duty cycle .001. Rep rates: 1 microsec 600 pps, 1 or 2 msec 300 pps. Uses 5948 hydrogen thyatron. Input 120/208 VAC 60 cycle. Mfr. GE. Complete with high voltage power supply.

15KW PULSER—DRIVER
 Biased multivibrator type pulse generator using 3E29. Output 3kv at 5 amp. Pulse lgths .5 to 5 microsec. easily adj. to .1 to .5 msec. Input 115v 60 cy AC. \$475. Ref: MIT Rad. Lab. Series Vol. 5 pps. 157.

MIT MODEL 3 PULSER
 Output: 144 kw (12 kv at 12 amp.) Duty ratio: .001 max. Pulse duration: 5.1 and 2 microsec. Input: 115 v 400 to 2000 cps and 24 vdc. \$325 ea. Full desc. Vol. 5 MIT Rad. Lab. series pg. 140.

MICROWAVE SYSTEMS
300 TO 2400MC RF PKG.
 300 to 2400MC CW. Tuneable. Transmitter 10 to 30 Watts. Output. As new \$475.

X BAND DOPPLER SYSTEM
 AN/APN-102 G.P.L. ANT/RCYR/XMTR PKG. 4 Beam Pulsed Janus Planar Array—New \$1600.

AN/TPS-ID RADAR
 500 kw 1220-1359 mcs. 160 nautical mile search range P.P.I. and A Scopes. MTI. thyatron mod. 5326 magnetron. Complete system.

10 CM. WEATHER RADAR SYSTEM
 Raytheon, 275 KW output S Band. Rotating yoke P.P.I. Weather Band. 4, 20 and 80 mile range. 360 degree azimuth scan. Supplied brand new complete with instruction books and installation drawings. Price \$975 complete.

AN/APS-15B 3 CM RADAR
 Airborne radar. 40 kw output using 725A magnetron. Model 3 pulser. 30-in. parabola stabilized antenna. PPI scope. Complete system. \$1200 each. New.

10KW 3 CM. X BAND RADAR
 Complete RF head including transmitter, receiver, modulator. Uses 24J2 magnetron. Fully described in MIT Rad. Lab. Series Vol. 1, pps 616-625 and Vol. II, pps. 171-185 \$375. Complete System. \$750.

AN/APS-27 X BAND RADAR
 Complete 100 kw output airborne system with AMTI, 5C22 thr. mod, 4J52 magnetron. PPI. 360 deg az sweep, 60 deg. elev. sweep, gyro stabilizer, hi-gain rvr. Complete with all plugs and cables \$2800.

M-33 AUTO-TRACK RADAR SYSTEM
 X band with plotting board, automatic range tracking, etc. Complete in 2 van complete incl. 1 megawatt acquisition radar.

AN/APS-45 HEIGHT FINDER
 Airborne system, 40,000 ft. altitude display on PPI & RHI. 9375 mcs. 400kw output using QK-172 megatron, 5622 thyatron.

L BAND RF PKG.
 20 KW peak 990 to 1040 MC. Pulse width .7 to 1.2 microsec. Rep rate 180 to 420 pps. Input 115 vac. Incl. Receiver \$1200.

200MC RF PKG
 175 to 225 mc. Output: 200 to 225 kw. 5 microsec 60 pps. Input: 115v 60 cycle AC. \$750.

QUARTZ DELAY LINE
 500 Microsecs. 30 MC. 1000 OHMS Termination Resistance—with Calib. Curve. Price \$275 each.

Radio-Research Instrument Co.
 550 5th Ave. New York 36, N.Y.
 Tel. JUdson 6-4691



CIRCLE 950 ON READER SERVICE CARD

EMPLOYMENT OPPORTUNITIES



The Advertisements in this section include all employment opportunities—executive, management, technical, selling, office, skilled, manual, etc. Look in the forward section of the magazine for Additional Employment Opportunities advertising.

Positions Vacant
Positions Wanted
Part Time Work

Civil Service Opportunities
Selling Opportunities Wanted
Selling Opportunities Offered

Employment Agencies
Employment Services
Labor Bureaus

DISPLAYED

The advertising rate is \$40.17 per inch for all advertising appearing on other than a contract basis. Contract rates quoted on request.

An advertising inch is measured $\frac{1}{8}$ " vertically on a column—3 columns—30 inches to a page.

Subject to Agency Commission.

---RATES---

\$2.70 per line, minimum 3 lines. To figure advance payment count 5 average words as a line.

Box Numbers—counts as 1 line.

Discount of 10% if full payment is made in advance for 4 consecutive insertions.

Not subject to Agency Commission.

UNDISPLAYED

Send NEW ADS to CLASSIFIED ADV. DIV. of ELECTRONICS, P. O. Box 12, N. Y., N. Y. 10036

COMPUTER AND ELECTRONIC TELEPHONE SWITCHING ENGINEERS

Leading electronics company in West Germany has immediate openings for:

- Laboratory Managers** to head a group of engineers and designers for systems development and equipment design
- Engineers** to be responsible for equipment models
- Designers** to work right behind the engineer in designing models for engineering and manufacturing.

Rapid expansion in this new and interesting field will easily create promotions for qualified and experienced men.

Knowledge of the German language is essential.

Apply to: P. O. Box No. 392, Schenectady, N. Y. 12301

FOR INFORMATION

about Classified Advertising

contact the McGraw-Hill office nearest you

ATLANTA, 30309
I. HILL—R. JOHNSON
1375 Peachtree St., N.E.
875-0523 (Area Code 404)

BOSTON, 02116
J. WREDE
McGraw-Hill Bldg., Copley Square
CONgress 2-1160 (Area Code 617)

CHICAGO, 60611
WM. HIGGINS—G. AMBROSE
645 No. Michigan Avenue
MOhawk 4-5800 (Area Code 313)

CLEVELAND, 44113
R. HARTER
55 Public Square
SUperior 1-7000 (Area Code 216)

DALLAS, 75201
F. LeBEAU
1712 Commerce St., Vaughn Bldg.
Riverside 7-9721 (Area Code 214)

DENVER, 80202
J. PATTEN
1700 Broadway, Tower Bldg.
255-2981 (Area Code 303)

Detroit, 48226
T. JAMES
856 Penobscot Building
962-1793 (Area Code 313)

HOUSTON, 77025
K. GEORGE
Prudential Bldg., Holcombe Blvd.
Riverside 8-1280 (Area Code 713)

LOS ANGELES, 90017
R. McGINNIS
1125 West Sixth Street
HUnley 2-5450 (Area Code 213)

NEW YORK, 10036
D. HAWKSBY—H. BUCHANAN
500 Fifth Avenue
971-3596 (Area Code 212)

PHILADELPHIA, 19103
WM. SULLIVAN—R. LEWIS
Six Penn Center Plaza
LOcust 8-4330 (Area Code 215)

PITTSBURGH, 15222
4 Gateway Center
391-1314 (Area Code 412)

ST. LOUIS, 63105
J. CROWE
7751 Carondelet Avenue
PARKview 5-7285 (Area Code 314)

SAN FRANCISCO, 94111
J. A. HARTLEY
255 California Street
DOuglas 2-4600 (Area Code 415)

QUALIFIED ENGINEERS

BY THE THOUSANDS

PAY to read **electronics** every week because its high calibre editorial content is designed and edited for engineers. . . . That's why your

RECRUITMENT ADVERTISING

in **electronics** can pinpoint a most concentrated source of experienced engineers. **electronics** selective circulation is your inexpensive, efficient, most direct link to these qualified, specialized men!

YOUR AD GETS RESULTS NOT WASTE CIRCULATION.

* If your recruitment program calls for qualified technical personnel, plan to use **electronics** EMPLOYMENT OPPORTUNITIES now!

electronics

A MCGRAW-HILL PUBLICATION
CLASSIFIED ADVERTISING DIVISION
POST OFFICE BOX 12 NEW YORK 36, NEW YORK

INDEX TO ADVERTISERS

| | | | | | |
|--|-----------|--|-----------|--------------------------------------|----|
| • Acme Electric Corp. | 62 | • Jennings Radio Manufacturing Corp. | 57 | U. S. Stoneware | 76 |
| Allen-Bradley Co. | 9 | Jerrold Electronics Corp. | 6 | • United Transformer Corp. 2nd cover | |
| • Amperex Electronic Corp. | 59 | | | Voltron Products Inc. | 68 |
| • Avnet Electronics Corp. | 74, 75 | | | Westinghouse Electric Corp. | 37 |
| | | Kay Electric Co. | 61 | | |
| Barker & Williamson, Inc. | 52 | | | | |
| • Bussmann Mfg. Co. Div. of McGraw Edison Co. | 66, 67 | • Lambda Electronics Corp. | 24 | | |
| | | Leesona Corp. | 73 | | |
| CTS of Berne | 81 | Levin and Son, Inc., Louis. | 41 | | |
| • Christie Electric Corp. | 82 | | | | |
| | | Machlett Laboratories, The | 15 | | |
| Derivation and Tabulation Associates, Inc. | 13 | McGraw-Hill Book Co. | 74 | | |
| Di Acro Corp. | 50 | Mitsumi Electric Co., Ltd. | 75 | | |
| du Pont de Nemours & Co., Inc., E. I. | 55 | | | | |
| | | • North Atlantic Industries, Inc. | 51 | | |
| • Electro Instruments Inc. | 8 | Photocircuits Corp. | 64 | | |
| • Electro Motive Mfg. Co., Inc. | 53 | Photonetics Corp. | 72 | | |
| Electronic Research Associates, Inc. | 80 | Polaroid Corp. | 47 | | |
| Electronic Specialty Co. | 12 | Radio Corporation of America | 4th cover | | |
| | | • Rosemount Engineering Co. | 71 | | |
| Fairchild Semiconductor Corp. | 86 | | | | |
| | 3rd cover | Sanders Associates, Inc. | 58 | | |
| | | Sierra Electronic Div. of Philco | 4 | | |
| • Globe Ind. | 58 | Siliconix Inc. | 39 | | |
| Graphic Systems, Inc. | 74 | Sonotone Corp. | 79 | | |
| Gries Reproducer Corp. | 75 | Battery Div. | 46 | | |
| Gudebrod Bros. Silk Co., Inc. | 63 | Spectra-Strip Wire & Cable Corp. | 3, 42 | | |
| | | Sprague Electric Co. | 82 | | |
| Hansen Mfg. Co., Inc. | 52 | Standard Electric Time Co., The | 72 | | |
| • Hewlett-Packard Company | 7 | Stevens-Arnold, Inc. | 77 | | |
| Honeywell Precision Meter Div. | 21 | • Superior Tube Co. | 77 | | |
| | | Sylvania Electric Products, Inc. Electron Tube Div. | 49 | | |
| IBM Corp. | | | | | |
| Data Processing Div. | 22, 23 | Texas Instruments Incorporated Industrial Products Group. | 43 | | |
| • Inland Motor Corp. | | • Tylon Inc. | 16 | | |
| Sub. of Kollmorgen | 56 | | | | |
| International Resistance Co. | 44 | | | | |
| Invac Corp. | 58 | | | | |

CLASSIFIED ADVERTISING

F. J. Eberle, Business Mgr. (2557)

EMPLOYMENT OPPORTUNITIES .. 84

EQUIPMENT

(Used or Surplus New)
For Sale

CLASSIFIED ADVERTISERS INDEX

| | |
|--------------------------------------|----|
| • A & A Electronics Corp. | 83 |
| Barry Electronics | 83 |
| Engineering Associates | 83 |
| Fair Radio Sales | 83 |
| Fishman Co., Philip | 83 |
| Liftschultz | 83 |
| • Radio Research Instrument Co. | 83 |
| Selectronics | 83 |
| Surplus Saving Center | 83 |
| U. S. Microwave | 83 |

• See advertisement in the July 25, 1963 issue of electronics Buyers' Guide for complete line of products or services.

This Index and our Reader Service Numbers are published as a service. Every precaution is taken to make them accurate, but **electronics** assumes no responsibilities for errors or omissions.

electronics

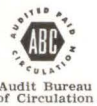

Audit Bureau of Circulation



Associated Business Publications

AUDITED PAID CIRCULATION

JAMES T. HAUPTLI (2210)
Advertising Sales Manager

DAVID CUNNIFF (3139)
Promotion Manager

HENRY M. SHAW (3485)
Market Research Manager

electronics Buyers' Guide

R. S. QUINT (2335)
General Manager

RICHARD J. TOMLINSON (3191)
Business Manager

THEODORE R. GEIPEL (2044)
Production Manager

NEW YORK TELEPHONE: Dial Direct:
971 plus number in parenthesis,
Area Code 212

ADVERTISING REPRESENTATIVES

ATLANTA, GA. 30009
Michael H. Miller, Robert C. Johnson
1375 Peachtree St. N.E.,
Trinity 5-0523 (area code 404)

BOSTON, MASS. 02116
William S. Hodgkinson
McGraw-Hill Building, Copley Square,
Congress 2-1160 (area code 617)

CHICAGO, ILL. 60611
Harvey W. Wernecke,
Robert M. Denmead
645 North Michigan Avenue,
Mohawk 4-5800 (area code 312)

CLEVELAND, OHIO 44113
Paul T. Fegley
55 Public Square, Superior 1-7000
(area code 216)

DALLAS, TEXAS 75201
Frank Le Beau
The Vaughn Bldg.,
1712 Commerce St.
Riverside 7-9721 (area code 214)

DENVER, COLO. 80202
John W. Patten
Tower Bldg., 1700 Broadway,
Alpine 5-2981 (area code 303)

HOUSTON, TEXAS 77025
Kenneth George
Prudential Bldg., Halcombe Blvd.,
Riverside 8-1280 (area code 713)

LOS ANGELES, CALIF. 90017
Ashley P. Hartman, John G. Zisch,
1125 W. 6th St., Huntley 2-5450
(area code 213)

NEW YORK, N. Y. 10036
Donald H. Miller (212) 971 3615
George F. Werner (212) 971 3617
Donald R. Furth (212) 971 3616
500 Fifth Avenue

PHILADELPHIA, PA. 19103
Warren H. Gardner, William J. Boyle
6 Penn Center Plaza,
LOcust 8-4330 (area code 215)

SAN FRANCISCO, CALIF. 94111
Richard C. Alcorn
255 California Street,
Douglas 2-4600 (area code 415)

LONDON W1:
Edwin S. Murphy Jr.
34 Dover St.

FRANKFURT/Main:
Matthee Herfurth
85 Westendstrasse

GENEVA:
Michael R. Zeynel
2 Place du Port

TOKYO:
George Olcott,
1, Kotohiracho, Shiba, Minato-ku

ALL-SILICON COMPLEMENTARY MEMORY CIRCUIT NEEDS NO TRANSFORMERS

NPN/PNP Core Drivers Simplify Computer Design

No transformers are required with the silicon Planar transistors in the sample complementary read/write memory core driver circuit shown at right. The new high speed, low leakage PNP 2N2927 core drivers operate at high current and breakdown voltage, making it possible for them to drive the memory core lines without transformers.

This advanced computer circuit design, using exclusively silicon Planar epitaxial devices, features the use of only one memory address line. This is made possible through bi-polar address selection networks for read and write operation.

This simplified complementary driving system eliminates transformers and their associated problems. Other advantages are over-all economy of core mat construction and faster speed (access and cycle times are not limited by the speed of the driving transistors or the diodes). The 1N3600's, used for line isolation, are high current Fairchild silicon Planar epitaxial diodes.

NPN/PNP high current drive circuits can also be applied to other types of memories. For example: rod, twister, biax, transfluxor and thin-film memories can also use complementary driving to great advantage.

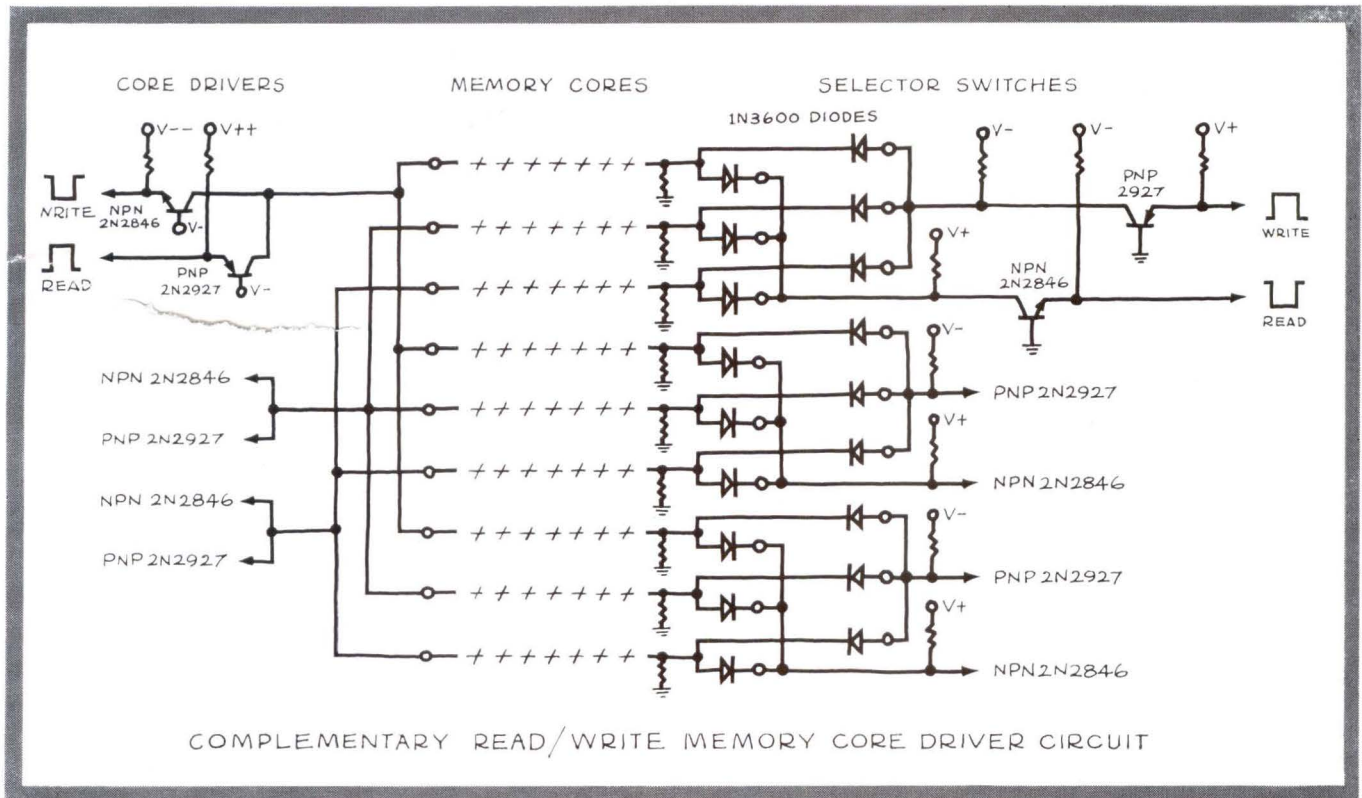

NPN 2N2846

- C_{ob} 8.0 pF max @ $I_E = 0$, $V_{CB} = 10$ V
- f_T 250 mc min @ $I_C = 50$ mA, $V_{CE} = 10$ V
- $V_{CE(sat)}$ 1.0 V max @ $I_C = 500$ mA, $I_B = 50$ mA
- LV_{CEO} 30 V min @ 30 mA

PNP 2N2927

- C_{ob} 20 pF max @ $I_E = 0$, $V_{CB} = -10$ V
- f_T 100 mc min @ $I_C = 50$ mA, $V_{CE} = -3.0$ V
- V_{CE} -1.0 V max @ $I_C = 300$ mA, $I_B = 30$ mA
- LV_{CEO} -25 V min @ 10 mA

1N3600 DIODE

- C 2.5 pF max @ $V_R = 0$ V, $f = 1.0$ mc
- t_{rr} 4.0 nsec max @ $I_F = I_R = 10$ mA to 200 mA, $R_L = 100$ ohms
- I_R 0.1 μ A @ $V_R = -50$ V
- V_F 0.87 V to 1.0 V @ $I_F = 200$ mA

SILICON PLANAR EPITAXIAL DEVICES AVAILABLE FROM DISTRIBUTOR STOCKS

FAIRCHILD
SEMICONDUCTOR

**EXCEPTIONAL
VOLTAGE
STABILITY
AT AN
ATTRACTIVE
PRICE...**



1/4 Times Actual Size

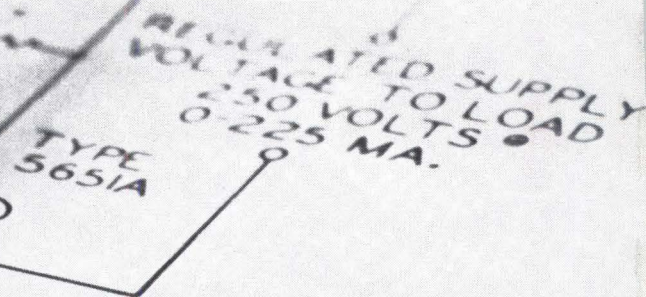
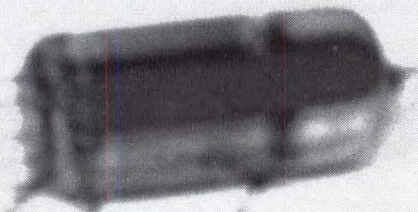

The new RCA-5651A miniature voltage-reference tube

The highest degree of voltage stability yet achieved in a miniature voltage-reference tube is available from the new RCA-5651A. A 7-pin, cold-cathode, glow-discharge type, it is similar to and unilaterally interchangeable with the popular 5651—but offers substantially better voltage stability. And the price is very attractive, when related to the 5651A's superior operating characteristics.

RCA-5651A CHARACTERISTICS AND ADVANTAGES

- Exceptionally stable voltage characteristic at a very low dc operating current. The maximum voltage drift for the RCA-5651A compared with that of the Type OG3 Voltage-Reference Tube is:

| | RCA-5651A | OG3 |
|---|------------|-----------|
| DC Operating Current | 2.5 ma | 6 ma |
| Voltage Drift | | |
| • During first 300 hours of operation (from initial dc operating voltage) | 0.1% max. | 0.3% max. |
| • Between 300 and 1,300 hours of operation (from dc operating voltage at 300 hours) | 0.1% max. | 0.2% max. |
| • During any 100-hour period between 300 and 1,300 hours of operation | 0.05% max. | 0.1% max. |

- Small variation in initial tube drop from tube to tube: 4 volts max. at any specific current value within the operating range:

| DC Operating Voltage | | | |
|----------------------|------|------|------------|
| | Min. | Av. | Max. |
| At 1.5 ma | 83 | 85 | 87 volts |
| At 2.5 ma | 83.5 | 85.5 | 87.5 volts |
| At 3.5 ma | 84.5 | 86.5 | 88.5 volts |

- Excellent voltage stability—not only initially but throughout life. Instantaneous voltage fluctuation 0.1 volt max. at any current level within operating range (1.5 to 3.5 ma).
- Operating characteristic essentially independent of ambient temperature in the -55°C to $+90^{\circ}\text{C}$ range.

The exceptional performance of the 5651A is due to: ■ Special processing to stabilize tube characteristics ■ Special cathode design for effective utilization of cathode at all current values within the operating range ■ Special coating inside envelope to minimize slow voltage drift.

APPLICATIONS: for use in critical industrial and military dc power supplies incorporating electronic voltage regulation.



The Most Trusted Name in Electronics

Field Offices—EAST: 32-36 Green Street, Newark 2, N. J., (201) 485-3900.
MIDWEST: Suite 1154, Merchandise Mart Plaza, Chicago 54, Ill., (312) 527-2900 • WEST: 6801 E. Washington Blvd., Los Angeles 22, Calif., (213) RAYmond 3-8361 • 1838 El Camino Real, Burlingame, Calif., (415) 697-1620.

For full technical information, call your nearest RCA Field Office,
or write Commercial Engineering,
RCA Electronic Components and Devices, Harrison, N. J.