

electronics®

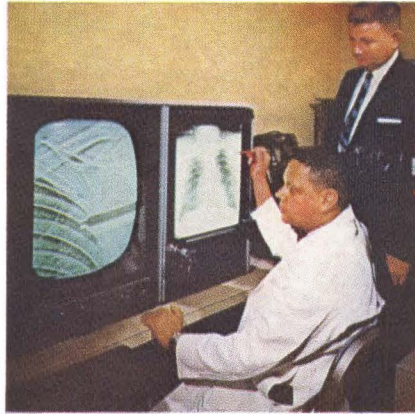

SPECIAL REPORT
ELECTRONICS
MARKETS
NEW DIRECTIONS:
1964

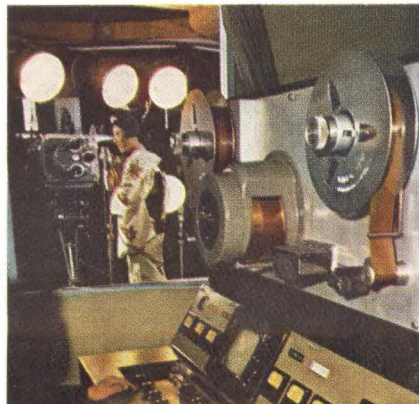

- * INDUSTRIAL
- * MILITARY
- * GOVERNMENT
- * CONSUMER
- * COMPONENTS
- * INTERNATIONAL

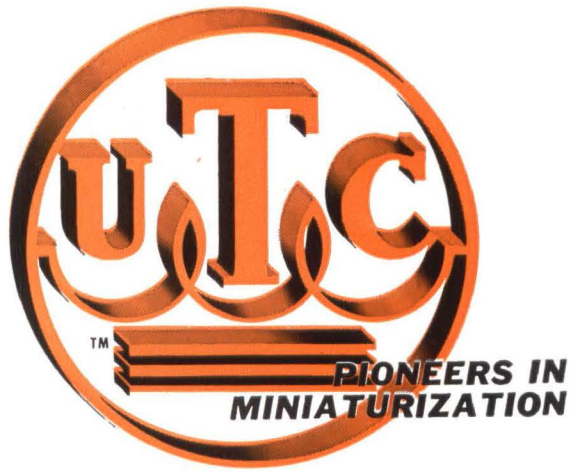

"SPECIAL" CUSTOM BUILT FILTERS

TO YOUR SPECIFICATIONS

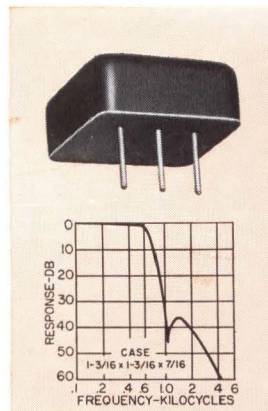

560 — Telemetering low pass filter. Available from 400 ~ to 70 KC. $\pm 7.5\%$ bandwidth flat to 1 db. Attenuation greater than 35 db beyond the 2nd harmonic of $\pm 7.5\%$ frequency. Impedance 47K ohms. MIL-F-18327B. Wt. 0.8 oz.

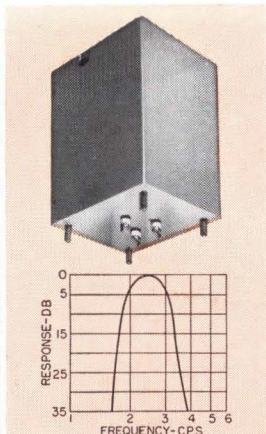

Low frequency band pass filter. Designed for 2.5 cps center frequency. At 2 to 3 cps within 3 db. At 1.5 cps and lower, and 4 cps and higher, greater than 30 db. Source and Load 10K ohms. Size: 4 x 4-11/16 x 6". MA MIL case, MIL-F-18327B.

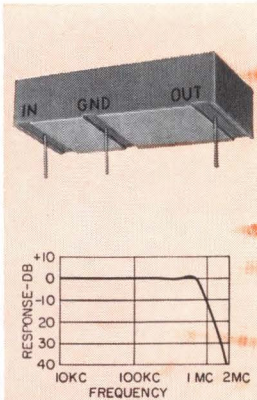

High frequency low pass filter. Zero to 700 KC within 1 db. 1.95 mc to 10 mc 40 db minimum. Source and Load 1000 ohms. Molded flat construction for printed circuit applications. Size: 1 x 2 x 1/2"; Wt: 1 oz. MIL-F-18327B.

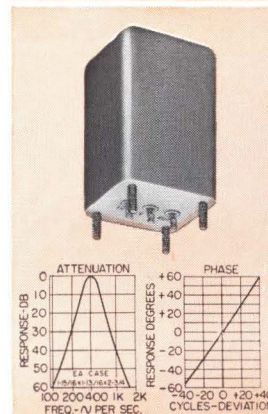

Band pass 400 cycle Gaussian filter. Linear phase response in pass band. Attenuation 380 cps to 420 cps within 0.5 db. 2nd harmonic down 25 db, 3rd harmonic down 45 db. Source and load 5K ohms. MIL-F-18327B Wt., 0.9 lbs.

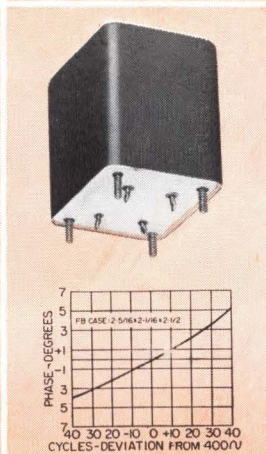

Minimum phase shift 400 cycle band pass filter. Within ± 1.5 db 370 to 430 cycles, greater than 45 db beyond 1100 cycles. 1K ohms to 100K ohms. MIL-F-18327B; 1 lb.

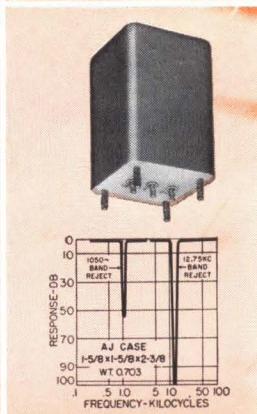

Band reject filters (two shown). The 1050 ~ filter has 50 db attenuation and is only 3 db at 950 and 1150 cycles. The 12.75 KC filter has more than 100 db attenuation and is only 3 db at 10.8 and 15 KC. Source and load 600 ohms, both are MIL-F-18327B.

Over thirty years of experience in the design and production of special filters have resulted in UTC being a first source for difficult units. Present designs both military and commercial incorporate a wide variety of core structures, winding methods, and capacitors to provide maximum performance, stability, and reliability. Fully experienced, top engineering talent backed by complete environmental testing and life testing facilities assure the highest standard in the industry. Full analysis and evaluation of materials are conducted in UTC's Material and Chemical Laboratories. Rigid quality control measures coordinated with exhaustive statistical findings and latest production procedures results in the industry's highest degree of reliability. The units illustrated show a few of the thousands of specials produced by UTC, to customers' requirements, and only slightly indicate the possibilities in present special filter design. Range of frequencies on special units is from .1 cycles to 400 MC.

MILITARY AND COMMERCIAL TYPES FOR EVERY PHASE OF THE ELECTRONICS ART

POWER TRANSFORMERS • AUDIO TRANSFORMERS • INDUCTORS • PULSE TRANSFORMERS • ELECTRIC WAVE FILTERS • LUMPED CONSTANT DELAY LINES • HIGH Q COILS • MAGNETIC AMPLIFIERS • SATURABLE REACTORS • REFERENCE UNITS

Write for catalog of over 1,200 UTC HIGH RELIABILITY STOCK ITEMS IMMEDIATELY AVAILABLE from your local distributor.



UNITED TRANSFORMER CORP.

150 VARICK STREET, NEW YORK 13, N. Y.

PACIFIC MFG. DIVISION: 3630 EASTHAM DRIVE, CULVER CITY, CALIF.
EXPORT DIVISION: 13 EAST 40th STREET, NEW YORK 16, N. Y. CABLE: "ARLAB"

CIRCLE 900 ON READER SERVICE CARD

W. W. MacDONALD, Editor
 Dial Direct: (971-2645)
 Area Code 212

J. M. CARROLL, Managing Editor (2293)

SENIOR EDITORS

Samuel Weber (2371)
 George W. Sideris (3444)

SENIOR ASSOCIATE EDITORS

Michael F. Wolff (2600)
 John F. Mason (2666)

ASSOCIATE EDITORS

Michael F. Tomaino (2071)
 William P. O'Brien (2297)
 George J. Flynn (2188)
 George V. Novotny (3151)
 Leon H. Dulberger (3446)
 Alexander A. McKenzie (2685)

ASSISTANT EDITORS

Stephen B. Gray (2245)
 Barry A. Briskman (2306)
 Dan Smith (2467)
 Joel A. Strasser (2127)
 Vincent S. Acunto (2592)
 C. R. Whetstone (3495)
 Eric Valentine (2710)
 Louis S. Gomolak (2472)
 G. G. Tirellis (2187)

REGIONAL EDITORS

Harold C. Hood,
 1125 W. 6th St., Los Angeles 90017, Calif.
 (213-482-5450)

Laurence D. Shergalis,
 John Hancock Bldg., 255 California St.,
 San Francisco 94111, Calif. (415-362-4600)

Thomas Maguire
 McGraw-Hill Bldg., 607 Boylston St.,
 Boston 02116, Mass. (617-262-1160)

Cletus M. Wiley,
 Blair Bldg., 645 N. Michigan Ave.,
 Chicago 60611, Ill. (312-664-5800)

ART DIRECTOR

Howard R. Berry (2430)

ASSISTANT ART DIRECTOR

John C. Wright, Jr. (3430)

EDITORIAL ASSISTANTS

Lorraine Rossi, Virginia T. Bastian,
 Lynn Emery, Ann Mella, Lorraine Werner,
 Alice M. O'Brien, Sharon Parks,
 Claire Benell, Kay Fontana,
 Sandra A. Le Mond, Mary Jo Jadin

FOREIGN NEWS BUREAU

DIRECTOR, John Wilhelm, (2532);
 Lawrence Mihlon (2997), Alyne Elias
 (2998)

LONDON—John Shinn, Derek Barlow,
 Nicholas Landon, 34 Dover St., London
 W.1, England

BONN—Richard Mikton,
 Silke McQueen, Mittelstrasse 39, Bad
 Godesberg, Germany

BRUSSELS—Arthur Erikson, 27 Rue Ducarle,
 Brussels, Belgium

PARIS—Robert Farrell, 17 Ave. Matignon,
 3rd Fl., Paris 8, France

MILAN—Bruce Bendow, Via Manzoni
 No. 12, Milan, Italy

MEXICO CITY—Wesley Perry, Jr.,
 Lafragua 4-314, Mexico 1 D.F. Mexico

RIO DE JANEIRO—Leslie Warren, Rua
 Mexico 3-S/1507 1509, Rio de Janeiro,
 Brazil

MOSCOW—Donald Winston,
 Kutuzovskiy Prospekt 19, Apt. 28-29,
 Moscow, USSR

TOKYO—Richard Halloran, Charles Cohen,
 John Yamaguchi, Toranomom Sangyo
 Bldg., 1 Kotohiracho Shiba, Minato-Ku,
 Tokyo, Japan

CIRCULATION MANAGER

Hugh J. Quinn (2310)

C. C. RANDOLPH, Publisher (2016)

electronics

A MCGRAW-HILL WEEKLY 75 CENTS

NEW DIRECTIONS: 1964. Exemplifying next year's market picture a special-forces soldier carries command communications pack set for brush-fire wars (Sylvania), an analog video signal conditioner views medical radiographs (IBM), GE image-orthicon camera picks up pageant for educational tv, Tradex radar near Cape Kennedy tracks space vehicles at 32,000 miles (RCA), and single-head video recorder tapes program for Japan Broadcasting Co. (Toshiba). *See p 37* COVER

INTERAMERICAN TELECOMMUNICATIONS. The Latin-American nations are well on their way to realizing a long-time goal—a modern communications system linking every country to every other country. *The main routes, mostly microwave, extend 18,851 miles. They'll be ready by 1967, instead of 1969* 10

RADAR'S NEW PARTNER. Scientists are planning a new method of using bistatic radar for space research. The transmitter will remain on earth, but the receiver will be millions of miles away in space. *Planetary, lunar and solar studies are being planned* 24

RADAR MEASURES ARTILLERY BALLISTICS. Field artillery is still one of the most valuable methods for delivering both conventional and nuclear explosives to the enemy. But a cut-and-dry process of "bracketing" the target is necessary to realize its inherent accuracy. Knowledge of projectile muzzle velocity can improve first-round hit probability. *This portable c-w doppler set determines velocity directly by counting during a preset interval.* 31
 By H. D. Raynes, Aircraft Armaments Inc.

NEW HIGH-FREQUENCY ANTENNA. The passive network array is a physically small antenna which gives a free-space directivity gain of 9 to 11 db above an isotropic radiator over the frequency range from 2 to 30 Mc. *It consists of two closely spaced end-loaded dipoles fed by two matched broadband baluns and a hybrid.* 34
 By J. H. Dunlavy, Jr., Antenna Research Associates

SPECIAL REPORT: ELECTRONICS MARKETS. Our staff's look into 1964 and beyond reveals a possible plateau in military spending and increased spending for space electronics. A turn towards civilian markets may result from another rising year for consumer electronics and improved profit margins on industrial and commercial sales. Overcapacity persists in the components business with microelectronics making major technical advances. International opportunities continue to lure manufacturers. *A four-page full color foldout chart reports detailed predictions based on our own survey of the Industry.* 37
 By L. H. Dulberger, J. A. Strasser and J. M. Carroll

Contents continued

electronics

January 3, 1964

Vol. 37, No. 1

Published weekly, with Electronics Buyers' Guide as part of the subscription, by McGraw-Hill, Inc. Founder: James H. McGraw (1860-1948).

SUBSCRIPTIONS: Available only by paid subscription. Publisher reserves the right to refuse non-qualified subscriptions. Subscriptions to Electronics solicited only from those actively engaged in the field of the publication. Position and company connection must be indicated on subscription orders forwarded to address shown below. Subscription rates for individuals in the field of the publication: U. S. and possessions and Canada \$6 one year, \$9 two years, \$12 three years (single copies 75¢). All other countries \$20 one year (single copies \$1.50).

EXECUTIVE, EDITORIAL, CIRCULATION and ADVERTISING OFFICES: McGraw-Hill Building, 330 West 42nd Street, New York, N. Y., 10036. Telephone Area Code 212. 971-3333. Teletype TWX N. Y. 212-640-4646. Cable McGrawhill, N. Y. Printed in Albany, N. Y. Second class postage paid at Albany, N. Y. Title reg. ® in U. S. Patent Office. Copyright © 1964 by McGraw-Hill, Inc. All Rights Reserved. The contents of this publication may not be reproduced either in whole or in part without consent of copyright owner.

OFFICERS OF MCGRAW-HILL PUBLICATIONS: Shelton Fisher, President; Vice Presidents: Joseph H. Allen, Operations; John R. Callahan, Editorial; Ervin E. DeGraff, Circulation; Donald C. McGraw, Jr., Advertising Sales; Angelo R. Venezian, Marketing.

CORPORATION OFFICERS: Donald C. McGraw, President; L. Keith Goodrich, Hugh J. Kelly, Harry L. Waddell, Executive Vice Presidents; John J. Cooke, Vice President and Secretary; John L. McGraw, Treasurer.

UNCONDITIONAL GUARANTEE: The publisher, upon written request, agrees to refund the part of the subscription price applying to the remaining unfilled portion of the subscription if service is unsatisfactory.

SUBSCRIBERS: Please address all correspondence regarding subscriptions, change of address notices, and subscription orders to Fulfillment Manager, Electronics, P. O. Box 430 Hightstown, N. J., 08520. Change of address notices should be sent promptly; provide old as well as new address; include zip code or postal zone number if any. If possible, attach address label from recent issue. Please allow one month for change of address to become effective.

POSTMASTER: Please send Form 3579 to Fulfillment Manager, Electronics, P. O. Box 430, Hightstown, N. Y., 08520.

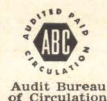

Audit Bureau
of Circulation



Associated Business
Publications

- IMPEDANCE AND PHASE-ANGLE METER.** Direct-reading impedance meter compares current flowing through a calibrated resistor with the current through an unknown impedance. Vector sum of the two currents is displayed on a calibrated meter to determine phase angle. *The instrument uses a modified Grutzmacher bridge which eliminates null-adjustment problems*
By P. Lund, Radiometer, Copenhagen, Denmark 57
- TRANSISTOR BRIDGE SWITCHES MICROVOLTS.** Even though silicon switching transistors with low leakage in the OFF state are available, at least 0.2 volt must be applied before appreciable collector current flows in the ON state. *However, two sets of series-connected npn and pnp transistors arranged in a bridge circuit permit switching microvolt signals.*
By M. V. Kalfaian, Los Angeles 60
- JAPANESE COMPUTERS.** With the aid of U.S. licensing, Japanese firms have expanded their production of digital computers until they now make a competitive range of small and medium-sized systems. *The Japanese hope to begin exporting in two years* 63
- LIFE DETECTORS.** At least eight different life-detector systems are vying for berths on the Mariner and Voyager spacecraft that NASA plans to send to Mars in the next decade. *Here's a quick rundown on the candidates* 71

DEPARTMENTS

- Crosstalk.** Cadillac or Tricycle? 5
- Comment.** Space Telecommunications. Cascode Follower 6
- Electronics Newsletter** 17
- Meetings Ahead.** Third Annual Microelectronics Symposium 18
- Washington This Week.** Nuclear Rocket Program Cut 20
- Research and Development.** Atom Smasher Beams 10^{13} Protons 81
- Components and Materials.** New Plastic Fillers Solve RFI Problems 84
- Production Techniques.** Tube Is Own Vacuum Gage 89
- New Products.** Microwave Stability Analyzer 92
- Literature of the Week** 107
- People and Plants.** Cutler-Hammer To Build New Headquarters and Research Building 108
- Index to Advertisers** 114

New from Sprague!

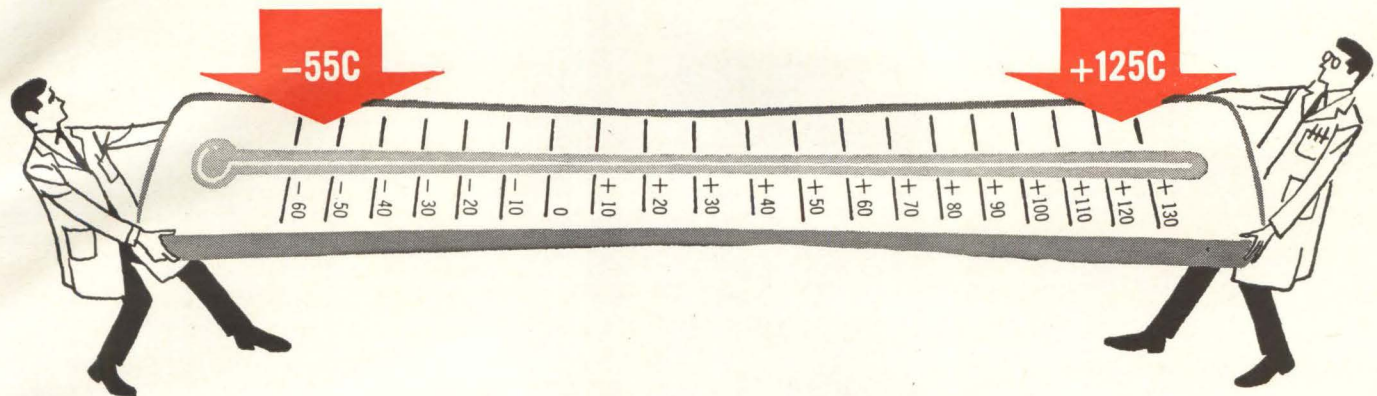

E-X-T-E-N-D-E-D T-E-M-P-E-R-A-T-U-R-E R-A-N-G-E

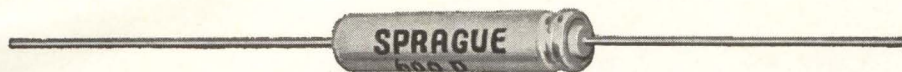

TYPE 600D **EXTRA-LYTIC*** ALUMINUM ELECTROLYTIC CAPACITORS

VOLTAGE RATINGS TO 150 VDC, unlike other so-called "wide temperature range" aluminum electrolytics with compromise voltage ratings only to 60 volts.

CAPACITANCE STABILITY over entire temperature range. Even at -55 C , capacitance drop is very small.

OPERATING AND SHELF LIFE comparable to or better than that of foil tantalum capacitors.

LESS EXPENSIVE than foil tantalum capacitors, yet in many cases meet the electrical requirements of MIL-C-3965 for tantalum capacitors.

SMALLER AND LIGHTER than tantalum capacitors in equivalent capacitance values and voltage ratings.



For complete technical data, write for Engineering Bulletin 3420 to Technical Literature Service, Sprague Electric Company, 35 Marshall Street, North Adams, Massachusetts.

*TRADEMARK

SPRAGUE COMPONENTS

CAPACITORS
TRANSISTORS
RESISTORS
MICROCIRCUITS
INTERFERENCE FILTERS

PULSE TRANSFORMERS
PIEZOELECTRIC CERAMICS
PULSE-FORMING NETWORKS
TOROIDAL INDUCTORS
ELECTRIC WAVE FILTERS

CERAMIC-BASE PRINTED NETWORKS
PACKAGED COMPONENT ASSEMBLIES
BOBBIN and TAPE WOUND MAGNETIC CORES
SILICON RECTIFIER GATE CONTROLS
FUNCTIONAL DIGITAL CIRCUITS

SPRAGUE[®]
THE MARK OF RELIABILITY

'Sprague' and '®' are registered trademarks of the Sprague Electric Co.

48C-155-63

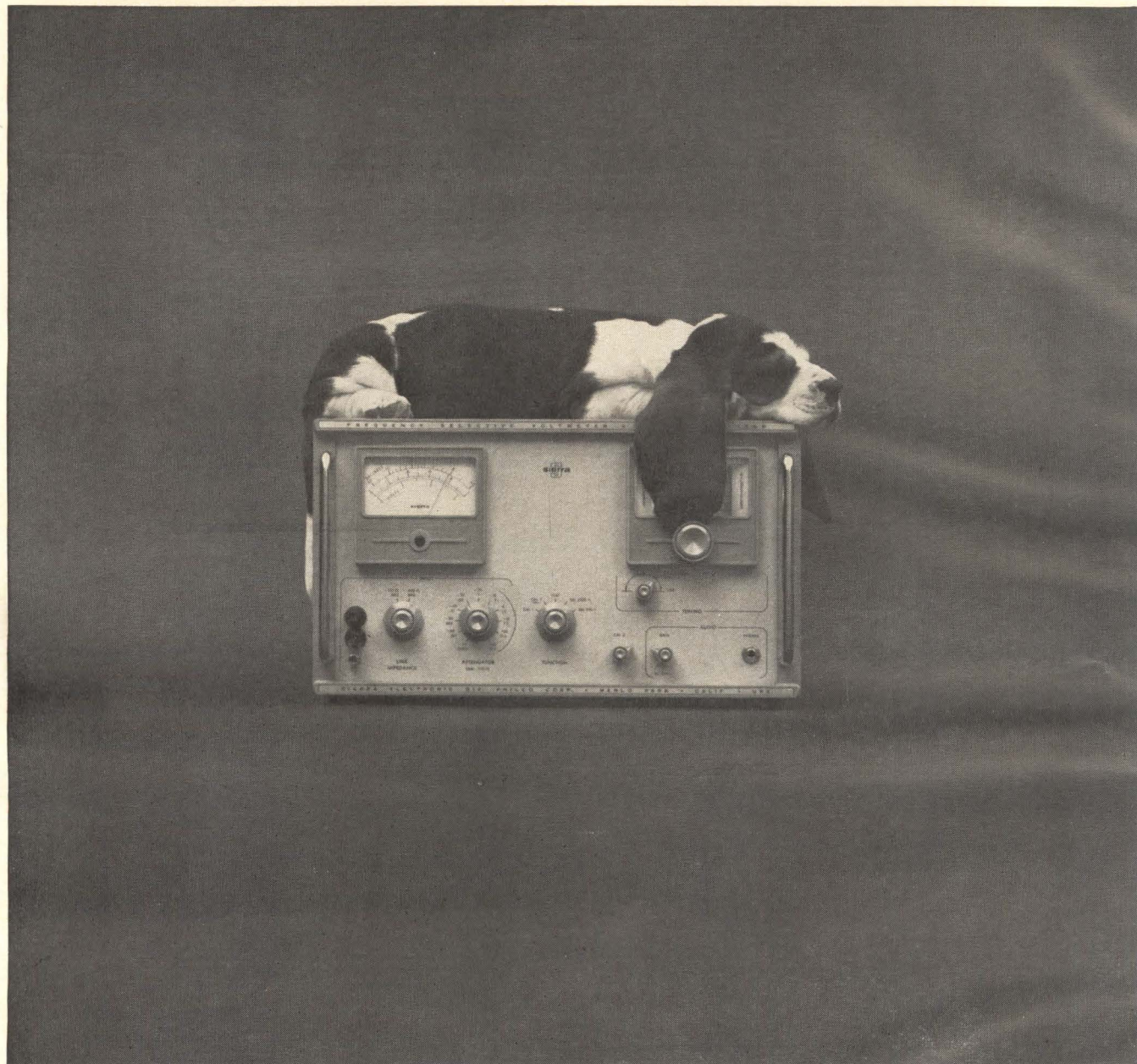

Sierra is a Warm Voltmeter

This is the frequency selective voltmeter that took "voltmeter" out of the language of telephone company maintenance engineers. To them, it's a "Sierra." You'll find them keeping their Sierras warm through constant use: tracking down fugitive harmonics; tracing out complex wave forms; performing the numerous check-out functions required to keep complex carrier equipment humming.

Telephone people have been using Sierras since 1947, the year the line was born. Some have been using the same instrument for 16 years. One of the early '47's came in recently with its first request for service! The same kind of lasting power is being built into this year's models.

Today Sierra means more than voltmeters. It could be the assurance of power levels measured on an r-f calorimeter that sets industry standards for accuracy.

Or the security of a transistor passed through quality control after a thoroughgoing physical in a power transistor tester. More than a half-hundred meanings of the word Sierra can be found in the pages of the Quick Reference Catalog.

There's a Sierra Electronic Division to define, too. It's the builder of precision electronic test instruments, backed by the engineering resources of Philco Corporation and the Ford Motor Company. And it's a reputation, backed by 16 solid years of performance, for building superb products from soundly conceived designs . . . without compromise.

The Quick Reference Catalog presents basic information on the products of Sierra Electronic Division of Philco. Ask for your free copy by writing to the address below.

SIERRA ELECTRONIC DIV.
OF
PHILCO
A SUBSIDIARY OF *Ford Motor Company*

Sierra Electronic Division/3875 Bohannon Drive/Menlo Park, California

Cadillac or Tricycle?

ANNOUNCEMENT of a manned orbiting laboratory (MOL) is greeted by dramatic newspaper headlines. To the cursory reader it looks like a giant step forward in developing a military capability in space.

Careful reading of the actual announcement is recommended, however. Major billing goes to the estimated \$100-million saving over the present 1964-1965 military space program. This saving is achieved by cancelling Dynasoar—an action whose effects are played down by stressing the limited role of that program.

Apparently it is hoped people forget what Dynasoar might have been. In February 1961 we quoted USAF Deputy Chief of Staff-Development Lt. Gen. R. C. Wilson as saying "The Air Force considers Dynasoar the most important R&D project it has. It will open a new era. It is the first step toward practical man-in-space flight."

The same article went on to quote Lt. Gen. Bernard Schriever's statement that later versions of the reentry vehicle could be made to orbit the earth many times and then reenter the atmosphere for a specific mission. "Such a vehicle could be used as a satellite interceptor to inspect, board and disable hostile satellites," he said.

What have we to replace Dynasoar? At his press conference announcing the MOL program, Defense Secretary McNamara emphasized that MOL is an experimental program not related to a specific military mission. It is proposed, he said, "because we feel that we must develop certain of the technology that would be the foundation for manned military operations in space *should* the specific need for those ever become clear and apparent" (italics are ours). The DOD news release on the program ended with a statement that *if* results of the MOL and the unmanned reentry programs warrant, a new and more advanced ferry vehicle program *may be* initiated some years in the future (italics again ours). Furthermore, the release also stated that "Preliminary ground or aircraft simulation will be made in all cases before full commitment to space experimentation."

We believe the MOL is an important project both for its own potential, which is tremendous, and because it apparently gets the Air Force firmly into space—a step we have been advocating for a long time. Nevertheless, the many ifs and maybes surrounding the initial announcement make us fearful that its full potential may never be realized. Other programs of great potential have fallen by the wayside. If the same fate is not to befall the MOL, the Air Force personnel who have been pushing for this assignment will have to work fast to develop the hardware which, once in orbit, we are confident will finally convince doubters of the need for a military role in space.

We wish them luck, for if this program too is side-

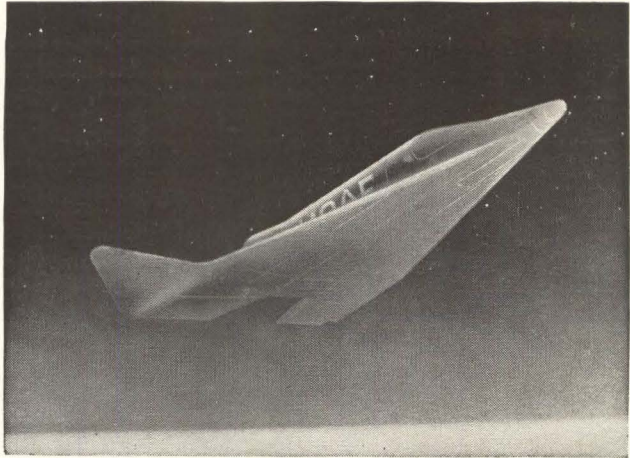

tracked then the gloomy prophecy of the one Air Force colonel will have come true. When first told of the decision he said: "We traded off a Cadillac for a promissory note on a tricycle."

MARKETING. While gathering data for this week's special report, we were constantly reminded by executives and marketing men of the increased reliance on product planning.

One marketing vice president of a major electronics firm relates that a few years ago he was given 20 minutes at a top-level meeting to outline the future needs of the electronics industry and how his firm could best serve it at a profit. The head of manufacturing held forth on his problems and forecasts for two hours.

In a very recent top-level executive meeting of a similar nature, the marketing executive was called on to provide marketing information, including forecasts, for three hours. The same manufacturing executive provided counsel for only 45 minutes.

This underlines the growing dependence on what should be manufactured, rather than how it will be manufactured. Manufacturers concede that products can be created to serve any desired market.

The problem today is identification beyond doubt of the product desired by customers, determining the form it will take, where and how best to manufacture it, how to sell it, how best to service it if required. Competition within the electronics industry is accelerating swiftly. Along with cost cutting in manufacturing operations, industry experts agree that marketing—from planning through sales—provides the solution to healthy profits and assured growth.

EXCEPTIONALLY STABLE WAVEFORMS

EVEN AT 5,000 MC,
TRACES ARE UNMARRED
BY DOT-SPLATTER

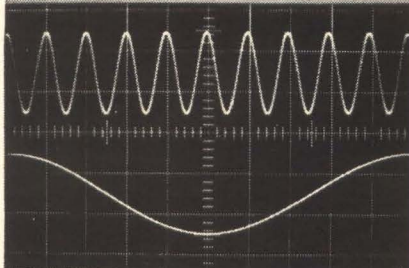

Unique triggering stability of Analab Type 701 plug-in demonstrated by display of 5,000-mc sine wave. Bottom trace shows same waveform expanded 10:1 (a double exposure).

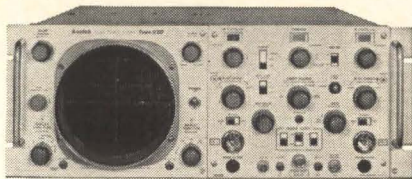

Analab Type 1120R/701 sampling oscilloscope (rack mounting). Also available as portable scope.

ONLY WITH

Analab

SAMPLING OSCILLOSCOPES

using the completely transistorized
TYPE 701 sampling and sweep plug-in

Now, with the new Analab scope system, you can obtain signal-repetition rates to 5,000 mc and over, without external pre-trigger signals, countdown generators, or delay lines. Waveforms can be plotted with slaved x-y recorder, or stored indefinitely on the Analab storage scope (type 1220/701). The most undistorted deflection, brightest displays obtainable on any high-frequency oscilloscope.

Type 701 plug-in features:

- Built-in trigger circuits with one-knob control...triggers directly from the signal.
- Built-in sweep circuits, sweep ranges from 10 picoseconds/cm to 2 micro-seconds/cm.
- Built-in direct-coupled dual-channel amplifiers, nominal risetime 350 picoseconds.

Write or phone for complete technical data and demonstration.

**Analab Instrument
Corporation**

Cedar Grove, N. J. • (201) 239-6500

COMMENT

SPACE TELECOMMUNICATIONS

I note in your Nov. 22, 1963, issue that an article is included on space frequencies, entitled, ITU Allocations: Final List (p 14). I also note that the article does not include those frequencies that were made available to the aeronautical services when employing space telecommunication techniques. The arrangements made at the Space Conference are:

In the band 117.975-132 Mc and in the band 132-136 Mc where the aeronautical mobile (R) service is authorized, the use and development, for this service, of systems using space communication techniques may be authorized but limited initially to satellite relay stations of the aeronautical mobile (R) service. Such use and development shall be subject to coordination between administrations concerned and those having services operating in accordance with the Table, which may be affected.

The bands 1,540-1,660 Mc, 4,200-4,400 Mc, 5,000-5,250 Mc and 15.4-15.7 Gc are reserved, on a world-wide basis, for the use and development of airborne electronic aids to air navigation and any directly associated ground-based or satellite-borne facilities. The bands 1,540-1,660 Mc, 5,000-5,250 Mc and 15.4-15.7 Gc are also allocated to the aeronautical mobile (R) service for the use and development of systems using space communication techniques. Such use and development shall be subject. . . .

CHARLES A. BROOKS

Chief

International and Allocation Branch
Frequency Management Division

Federal Aviation Agency
Washington, D.C.

- The list we printed was as received from the International Telecommunication Union in Switzerland.

CASCODE FOLLOWER

Reading R. W. Johnson's article, Circuit with a Twist; The Cascode Follower, (p 69, Dec. 6, 1963) was like meeting an old friend. A search revealed essentially the same circuit at the end of Chapter 6, p 120, of the first edition of Seely's "Electron Tube Circuits" (McGraw-Hill).

Hewlett-Packard audio oscillators Models 200C and 200D use essentially the same circuit to provide a stable low-source-impedance output amplifier. The circuit there used differs, however, in that the tubes are in parallel as far as the power supply is concerned.

LAWRENCE W. JOHNSON

Los Altos Hills, California

This follower circuit is not exactly a new one, although it does deserve to be better known. In this country it is usually called a "White" cathode follower. At least three other references come to mind.

GRANINO A. KORN

University of Arizona
Tucson, Arizona

I found the article on the cascode follower very interesting. This is a very useful circuit. Your application note states that a transistor version should be possible. We have been using one for several years. This connection is unsurpassed for low impedance driving.

JOHN K. DIXON

Bendix Research Laboratories
Southfield, Michigan

• Several other interested readers have pointed out that the cascode follower has a long and honorable history of service (the author himself supplied one reference), and that a transistor version is not only possible but has been used successfully.

NEW
volt-pac[®]
variable transformers

We've just run circles around the heat problem

Our new exclusive heat-sink ring quickly dissipates heat . . . reduces chance of burnouts

Heat—the byproduct of contact resistance—is the arch enemy of the variable transformer. If excessive at the point where the brush contacts the track—heat can result in raised windings, broken brushes, and burnouts.

We've reduced the possibility of a heat problem for our new **volt-pac** variable transformers—with a basic design: the circle. And a working example of thermal conductance: the heat sink.

By making a metal heat sink in the shape of a circle, we can embed it in the phenolic insulating shield directly beneath the circular brush track (See x-ray photo). At whatever point the sliding brush and brush track come in contact, the heat sink—with its high thermal conductivity—is there to quickly absorb and dissipate the heat.

You can't see the exclusive **volt-pac** heat sink at work . . . but you can see the results of its work. In side-by-side tests with

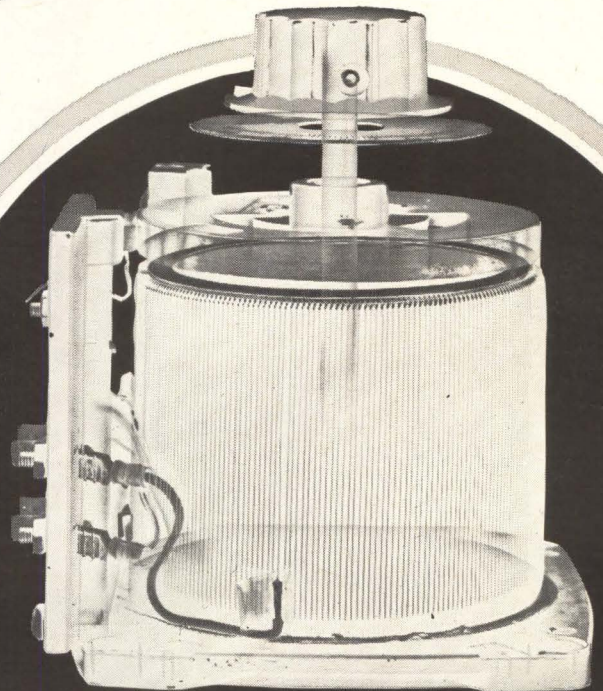

This x-ray photograph reveals the heat sink ring directly beneath the circular brush track.

competitive models of the same physical size, **volt-pac** variable transformers offer up to 33% more electrical capacity, and 30-100% greater overload capability.

Take advantage of this improved life and reliability, and save money by selecting from a wider range of **volt-pac** ratings.

See your G-E sales engineer or franchised **volt-pac** distributor for complete information. Write for free bulletin GEC-1559 to Section F458-03, General Electric Company, Schenectady 5, New York. **Volt-pac** variable transformers—another high-quality product line of Voltage Regulator Products Section, Pittsfield, Mass.

GENERAL  **ELECTRIC**

CIRCLE 7 ON READER SERVICE CARD

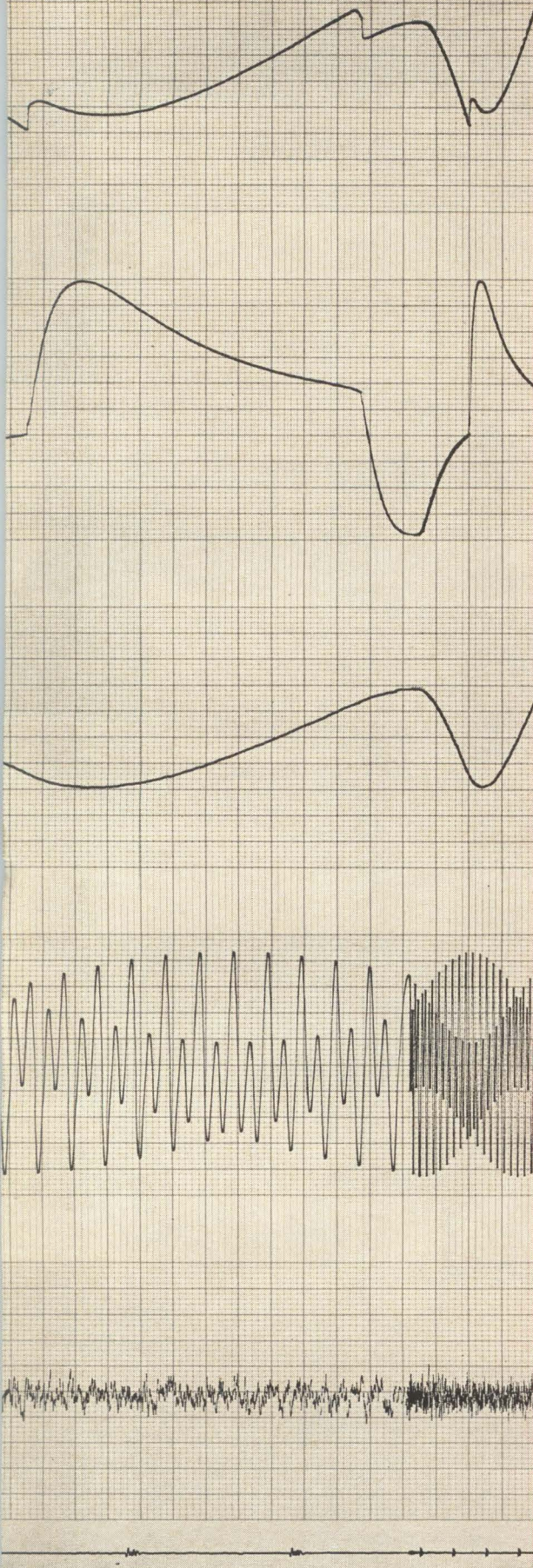

AC or DC, LOG or LINEAR

Record complex audio, noise signals, 5 cps to 100 kc . . . or DC voltages. In log mode, recording is on db basis, one chart div/db. On AC, seven ranges available from 100 mv f.s. to 100 v f.s. On DC, one 50 db range, 60 v full scale. (1400 Log Audio Preamplifier.)



ELECTRICAL, MECHANICAL FREQUENCIES

Measure pulse rates, Doppler effects, speed, fuel flow, RPM . . . 30 cps to 50 kc. Sensitivity 30 mv p-p to 10 kc, 150 mv p-p on 50 kc range. Expand any 10%, 20% or 50% to full scale. (2800 Frequency Meter Preamplifier.)



ACCELEROMETER OUTPUTS

Measure the output of any AC transducer, including piezo-electric types . . . p-p, zero-to-peak or average values, over 2 cps to 100 kc. Input impedance 100 megohms. (3900 Accelerometer Preamplifier.)



FREQUENCY DEVIATION FROM 400 CYCLES

Full-scale recording of ± 2.5 , ± 5 , ± 12.5 or ± 25 cps deviations from 400 cps, independent of input voltage waveform, over 0.5 v (zero to peak) to 225 v (zero to peak) range. Also available: 60 cycle center frequency model. (2600 400 cps Frequency Deviation Preamplifier.)



GYRO, SERVO or AC TRANSDUCER OUTPUTS

For analyzing servo system, AC transducer outputs by measuring magnitude of inphase or 180° out-of-phase AC signals with respect to 60, 400, 1000 or 5000 cps reference frequencies. Max. sensitivity 25 mv full scale. (1200 Phase-Sensitive Demodulator Preamplifier.)



AC POWER . . . 2 mw to 1.25 kw

Measure average AC or audio frequency power over 50 to 10,000 cps, with low insertion loss, input floating or grounded, calibration without disturbing test set-up. Resolve power factor angle in any quadrant with Hall-Effect multiplier. (2300 AC Wattmeter Preamplifier.)



TRUE RMS VOLTAGES, CURRENTS

Ranges: $\frac{1}{2}$ to 6 v per chart div. (25 to 300 v full scale), 1 to 100 ma (0.05 to 5 amps full scale), 20 to 5000 cps. Crest factor 5:1. (2500 RMS Volt/Ammeter Preamplifier.)

Measure more
"special"
signals

and read more from
the Sanborn
heated stylus record

Accurately condition and control the "special" signals you're interested in — and get a precise, permanent, high resolution record of the results on inkless Permapaper® charts — using a Sanborn direct writing oscillograph equipped with exactly the plug-in preamplifiers you need. They can be all alike — all different — or a combination of specialized types plus carrier, straight DC or similar units. Features typical of most of these preamps include: calibrated zero suppression; built-in calibration signal; function, attenuation, range, gain, balancing and position controls; front panel input and output connectors. You have the further flexibility of an extremely wide system choice: 1-channel portables . . . 2-channel mobile cart, portable case or rack-mounted versions . . . 4-, 6- and 8-channel consoles. And here are the combined advantages of Sanborn heated stylus recording:

- ¼ division LINEARITY (½ % of 50 div. chart)
- 3.5 ms RISE TIME (10 div. deflection, 10% to 90%)
- 4 cycles/mm RESOLUTION even at small amplitudes
- NO DOWN TIME for filling reservoirs, priming, unclogging styli . . . no ink on your hands or clothes
- TRUE RECTILINEAR WRITING without linkages
- NO PARALLAX ERROR or "NEGATIVE" TIME ERROR . . . all styli contact chart along a fixed line common to all channels
- NO LOSS OF WRITING AT HIGH OR LOW TEMPERATURES . . . no pressurized, temperature-sensitive writing medium container
- RELIABLE, SIMPLE, FIELD-PROVEN ELECTRONICS . . . the only electromechanical transducer in the system is the recording galvanometer. Driver amplifier uses heavy current feedback with only linear, passive elements in the feedback loop.

Call the H-P Field Engineering Office near you for complete information and help on your specialized signal conditioning / recording / data amplification requirements. Or write Sanborn Company, Industrial Division, Waltham, Mass. 02154.

SANBORN
A SUBSIDIARY OF HEWLETT-PACKARD 

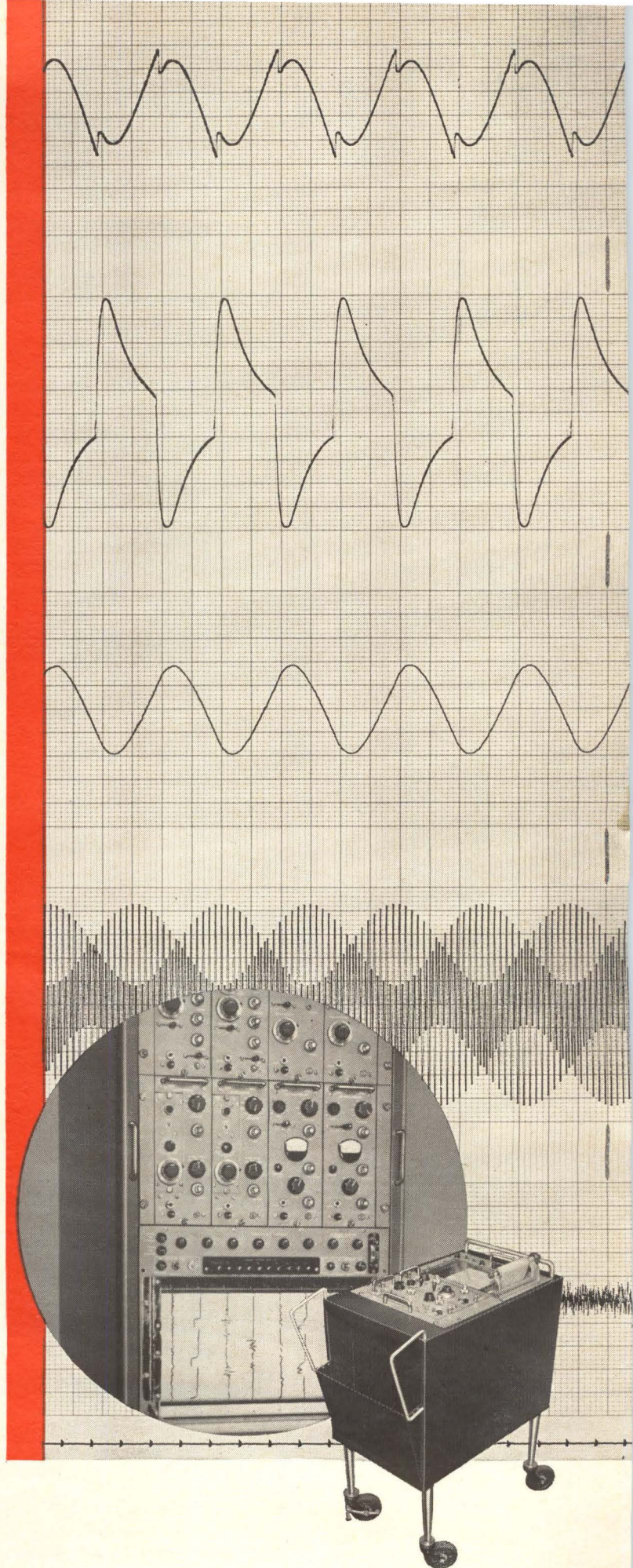

Latin America's Communications

Main routes, 18,851 miles long, will be ready by 1967 instead of 1969

MEXICO CITY — Despite Latin America's traditional revolutionary character and political instability, mail service and telecommunications, where they exist, have rarely been interrupted for more than 24 hours at one time.

For this reason, among others, financing of the vast new Interamerican Telecommunications Network has been progressing virtually

snag-free. The network is heading for completion in 1967 of its main routes of 18,851 miles costing \$232 million. This is two years ahead of original estimates, which called for a completion date sometime in 1969, and that was once a seemingly visionary estimate.

An additional 7,976 miles of auxiliary routes, valued at \$87 million, should be completed before the end of 1970, according to the plan's originator, Carlos Nunez A., chief of the International Affairs Department of Mexico's Telecommunications Secretariat.

Carlos Nunez' new pet project, which he has just started to develop

fully, is to put the Interamerican network, once completed, into the space age, by connecting it to other networks with communications satellites.

Main Routes—More than 25 percent of the most important portion of the system has already been completed (see map). Most of the remaining portion is under construction or ready to get underway almost immediately.

The first main routes are designed to connect every country of Central and South America, except British Guiana, Surinam and French Guiana, where only second-class lines now exist. These countries will go on the circuit later, as, it is hoped, will the rugged areas of northern Brazil.

The plan for such a telecommunications network was conceived in 1956, presented to the Organization of American States two years later, and acted upon favorably in 1959. A group of Latin American communications experts met in 1960 to draw together the individual plans of various countries through a directive body which would work with regional groups within each country.

Last November, a new commission formed in Sao Paulo called CITEL (Commission Interamericana for Telecomunicaciones) under the auspices of the OAS, to further promote and implement the plans for integrating international telecommunications systems in Latin America. Once again the OAS put its full weight behind the program.

Overwater Links—The system will be made up of submarine cables (120-60 channels) through the Caribbean, microwave equipment (960-120 channels and 120-60 channels) overland, and scatter systems (120-60 channels) between Mexico and Havana, and Santiago de Cuba and Haiti (other scatter paths on map are alternate routes).

It has been conceded that the cables are not likely to be built. Most of the Caribbean linkage has

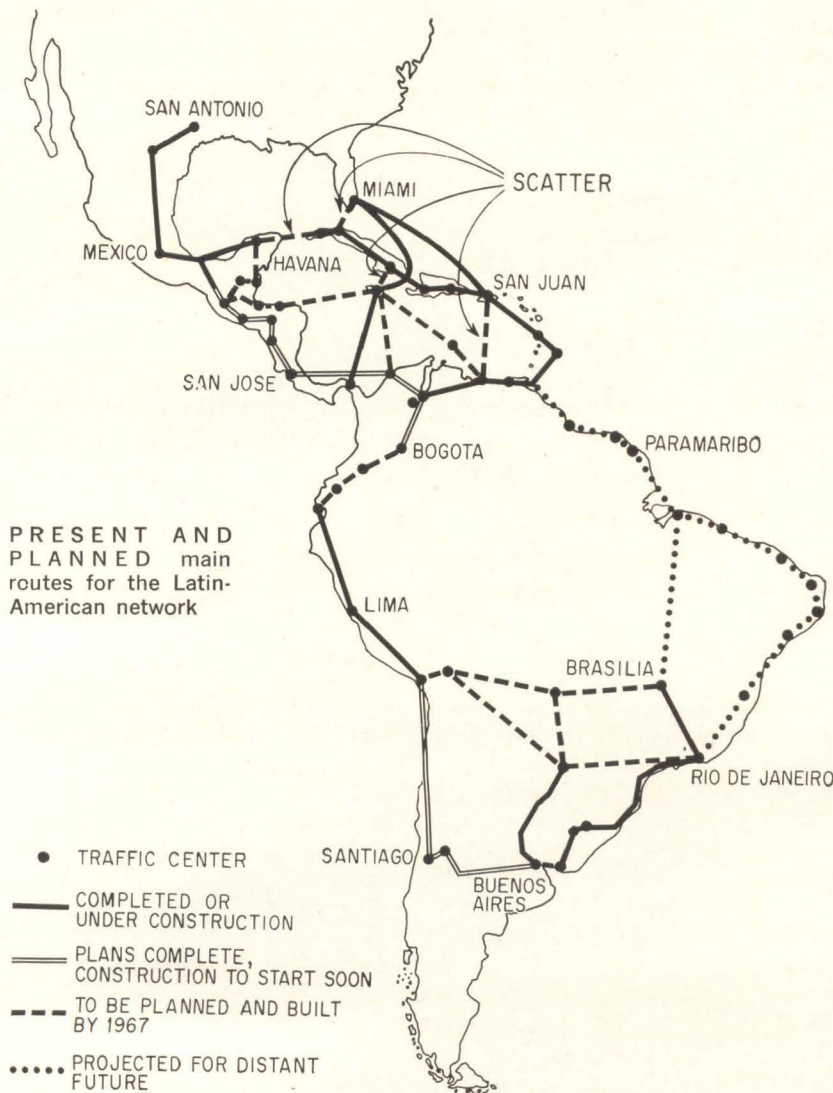

Network Nears Completion

By WESLEY PERRY
McGraw-Hill World News

already been established, with AT&T underwater cables from Miami to Jamaica and the Leeward Islands, and from Jamaica to Colon, Panama. Meanwhile, AT&T and the Columbian government have agreed to another from Colon to Barranquilla on the coast.

A microwave route from Barranquilla to the south will link the Caribbean and Central American systems to that of the South American continent. There are to be 44 international switching stations and 12 regional ones.

Country by Country—Mexico, with more than 2,000 miles of microwave circuit within the system, has just completed its final section from Mexico City to the Guatemalan border, making it the first country to complete all its requirements. The northern terminus of the network is San Antonio, Texas.

The Central American republics of Costa Rica, Nicaragua, Honduras, El Salvador and Guatemala have not yet built a component, but the World Bank Mission has just finished a study to establish a Central American Corporation to build and manage the Central American section, cost of which is estimated at \$9 million. If all goes as smoothly as expected, the Central American section should be ready to operate in two and a half years. Latin Americans have been quick to see the advantages of the communications network.

The main bottleneck at the moment is Ecuador. That country has done nothing to start a program and has made no overtures to do so. Colombia on the north and Peru on the south are building to the Ecuadorian border, expecting that mountainous little country to carry its share of the load. If it doesn't, however, the country is small enough to bypass easily. A straight line from Lima to Bogota avoids Ecuador completely and could be drawn without affecting the operation of the Interamerican network one whit.

Chile has just finished drawing up

its plan for a line from Santiago to the Peruvian border, nearly 1,500 miles away, and is now seeking financing. Chile expects to be in operation in three to three and a half years.

Equipment—One of the most important problems confronting the builders of the system is that the majority of repeater stations are located at high altitudes in the mountains, which lack facilities and electrical power. This problem in itself represents half the total investment, since it requires construction of roads through difficult terrain, in addition to special buildings and towers.

There has been no pattern in choosing suppliers for the network. Equipment is being supplied by the Japanese, Italians, England, the United States and others, and most manufacturers are quite willing to finance the equipment and train technicians. The training requires patience, time and expense.

In Mexico, frequencies are fixed at recommendations of the CCIR. The radio equipment operates on the band from 3,800 to 4,200 Mc. Separation of adjacent transmission and reception channels is 29 Mc. To increase the isolation between the transmitting and receiving equipment at repeater stations, alternate vertical and horizontal polarization is employed. Typical of the radio equipment selected by Mexico is the wideband type FM 960/TV-4000, made by Standard Elektrik Lorenz, of West Germany, and the French CSF's FH610 equipment. The SEL systems use two klystrons, for transmitting and receiving, in terminal stations, and single klystrons in repeater-amplifier stations.

Standardization—The Comité Consultivo Internacional Telegráfico and Telefónico (CCITT) and the Comité Consultivo Internacional de Radiocomunicaciones (CCIR) have made technical recommendations that the countries are expected to follow.

Main microwave routes are sup-

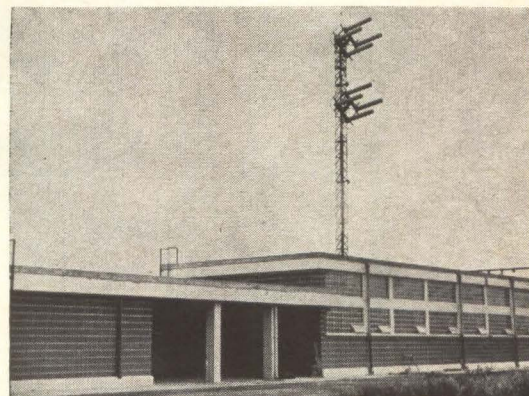

STATION built in the State of Mexico for the microwave system and to handle international Telex traffic via RCA Communications

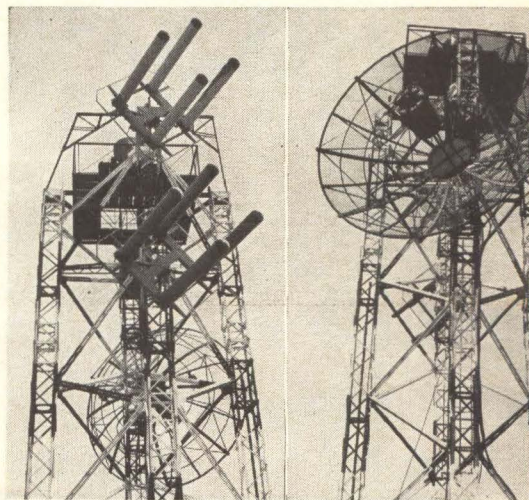

ANTENNA TOWERS. Reflectors are mesh to reduce wind loading

posed to operate at 4,000 and 6,000-Mc bands and have enough bandwidth for 960 channels, or a tv channel or equivalent. Secondary international routes can use systems mutually acceptable to the countries concerned. Where frequencies differ the countries can decide among themselves how to make the interconnection.

Other CCITT and CCIR recommendations outline codes to be used and operating and supervisory procedures. For measurement and regulation, a pilot signal at 8.5 Mc is used.

DC-TO-50 MC, 10 MV/CM

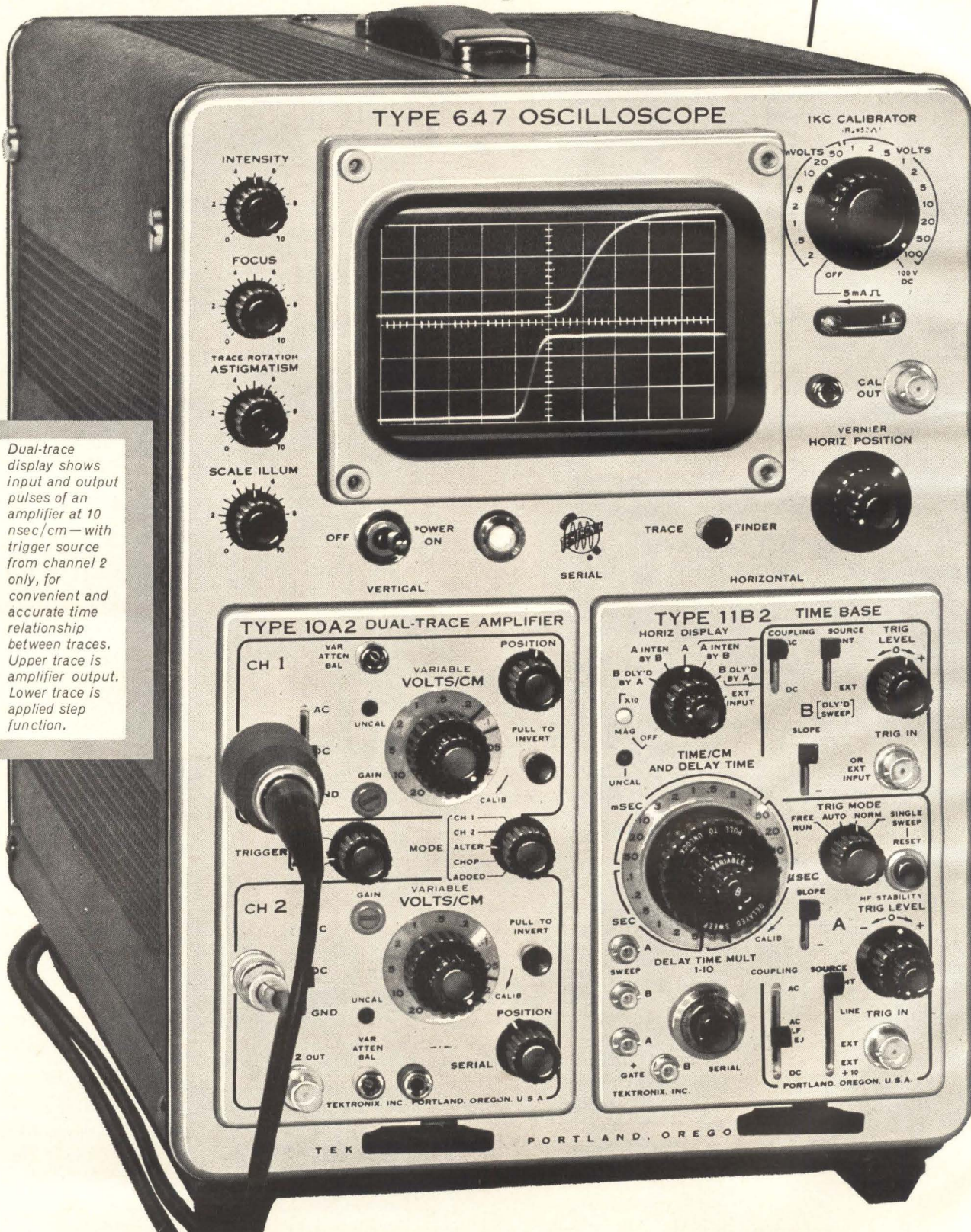

Dual-trace display shows input and output pulses of an amplifier at 10 nsec/cm—with trigger source from channel 2 only, for convenient and accurate time relationship between traces. Upper trace is amplifier output. Lower trace is applied step function.

Tektronix Solid-State Oscilloscope

- For accurate, reliable measurements . . . even in difficult environments.
- The type 647 Oscilloscope and plug-in units add new convenience to display and measurement of high-sensitivity, wide-band, dual trace applications.
- Adaptable and versatile, the oscilloscope retains accuracy, *within stated specifications*, under extensive temperature variations . . . under fluctuating line voltages . . . under other difficult conditions.



TEMPERATURE
Non-Operating —55°C to +75°C. Operating —30°C to +65°C.



SHOCK
Non-Operating 20 G's max, 2 shocks, each direction, along each of 3 major axes.



VIBRATION
Non-Operating or Operating 0.025" pk-pk, 10-55-10 cycles, (4 G's max), 1 min cycles, 15 min each major axis.



ALTITUDE
Non-Operating 50,000 ft. Operating 15,000 ft. 50-to-400 cps line freq.



HUMIDITY
Non-Operating meets Mil-Std-202B, Method 106A, except freezing, vibration, through 5 cycles (120 hours).

Type 647 Features with 10A2 and 11B2 Plug-In Units

■ 100 v—130 v line voltage. No calibration changes with line fluctuations. 50-to-400 cps line frequency. Low power—185 watts, approximately. Convection cooled—no fan needed.

■ Dual-trace operation. 10 mv/cm sensitivity. Dc-to->50 Mc passband. Less than 7-nsec risetime.

■ 6-cm by 10-cm display area. Internal, no-parallax graticule. Controllable graticule illumination. 14-kv accelerating potential.

■ Bright line automatic triggering. ÷10 external trigger attenuator, (on main time-base triggering). 'Ground' input positions on each vertical channel.

■ 2 time bases, independent triggering. Sweep rates to 0.1 μ sec/cm. 10X sweep magnifier.

■ Sweep delay 50 sec to 1 μ sec. Single-sweep operation. Wideband (>50 Mc) triggering. External horizontal input.

■ 1-kc voltage calibrator, (crystal controlled). Push-button trace finder. Dc-coupled Z-axis amplifier. Current-probe calibrator.

| | |
|---|--------|
| Type 647 Oscilloscope | \$1225 |
| (without plug-ins) | |
| Type 10A2 Dual-Trace Unit | \$675 |
| Type 11B2 Time-Base Unit | \$825 |
| 2 P6008 Probes | \$ 70 |
| U. S. Sales Prices f.o.b. Beaverton, Oregon | |



**FOR MORE INFORMATION—OR TO
ARRANGE A DEMONSTRATION—
PLEASE CALL YOUR TEKTRONIX
FIELD ENGINEER.**

Tektronix, Inc.

P.O. BOX 500 • BEAVERTON, OREGON 97005 • Phone: (Area Code 503) Mitchell 4-0161 • Telex: 036-691
TWX: 503-291-6805 • Cable: TEKTRONIX • OVERSEAS DISTRIBUTORS IN 25 COUNTRIES
TEKTRONIX FIELD OFFICES in principal cities in United States. Consult Telephone Directory

Tektronix Australia Pty., Limited, Sydney, New South Wales • Tektronix Canada Ltd., Montreal, Quebec and Toronto, Ontario
Tektronix International A.G., Zug, Switzerland • Tektronix Limited, Guernsey, Channel Islands • Tektronix U.K. Ltd., London, England

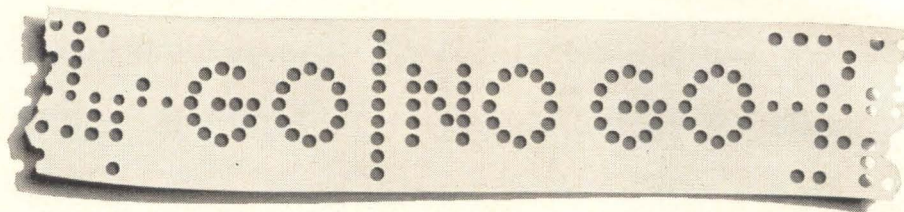

DATA PROCESSING SYSTEMS FOR SPACE

Advanced STL digital telemetry units, decoders, and command distribution assemblies are now being used on NASA's OGO and Pioneer, and the Air Force's Nuclear Test Detection spacecraft. STL hardware and experience with on-board data processing equipment is being applied in the development of new systems which will perform checkout and maintenance functions in space. This advanced technology requires circuit designers, logic designers, and digital systems engineers. For Southern California or Cape Canaveral opportunities, write Professional Placement, One Space Park, Dept. G-1, Redondo Beach, California, or P.O. Box 4277, Patrick AFB, Florida. STL is an equal opportunity employer.

TRW **SPACE TECHNOLOGY LABORATORIES**
THOMPSON RAMO WOOLDRIDGE INC.

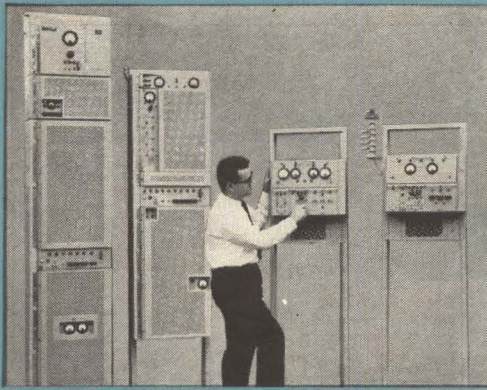

Solid-state units show 5 to 1 reduction over standard AN/FRC-39 A(V) radio equipment (left) for 'copter-lift communications terminals (below).

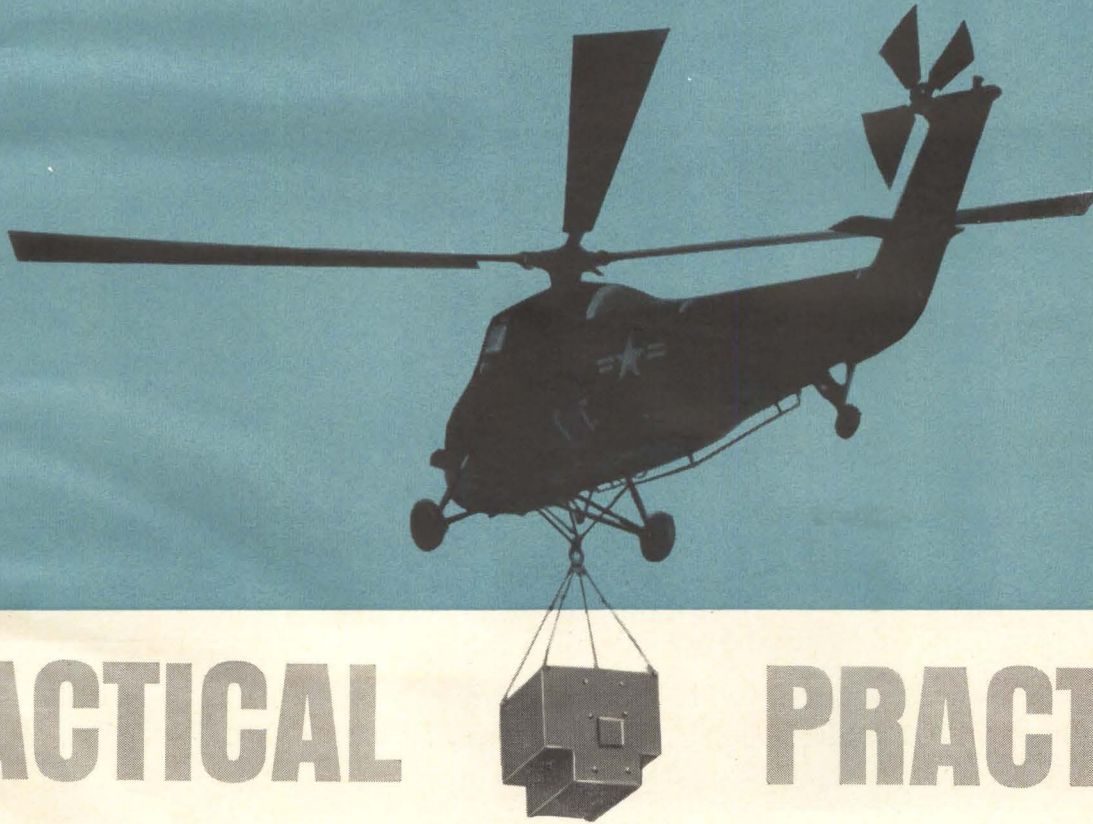

TACTICAL

PRACTICAL

REL's completely solid-state tropo scatter radio equipment — new 2600 Series — permits utilization of small TACTICAL communications terminals installed in shelters such as the S-144 Heli-Hut.

Advanced solid-state design also makes the 2600 Series the most PRACTICAL solution for transportable and fixed-plant configurations in both tropo and line-of-sight applications.

This new solid-state system meets and exceeds performance standards of REL's famed AN/FRC-39 A(V) radio equipment — yet provides additional advantages over

conventional systems:

- Size reduction.....5 to 1
- Weight reduction.....5 to 1
- Power-drain reduction.....5 to 1

The 2600 Series... a new generation of ultra-reliable modular-constructed tropo scatter radio equipment... another dimension of creative engineering by REL. Today, as in the past, REL leadership in engineering and performance meets telecommunications requirements of military and commercial customers throughout the world.



RADIO ENGINEERING LABORATORIES

A division of Dynamics Corporation of America
Long Island City 1, New York

For additional information on REL's 2600 Series solid-state system, write for Brochure SSE-1

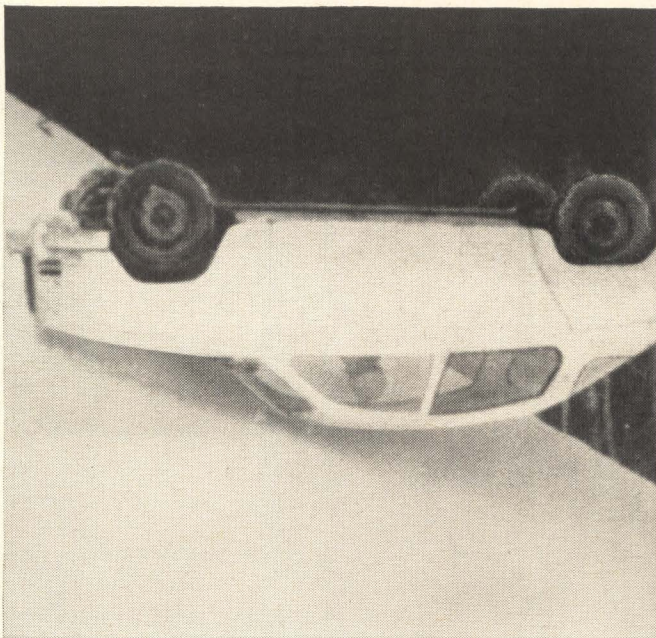
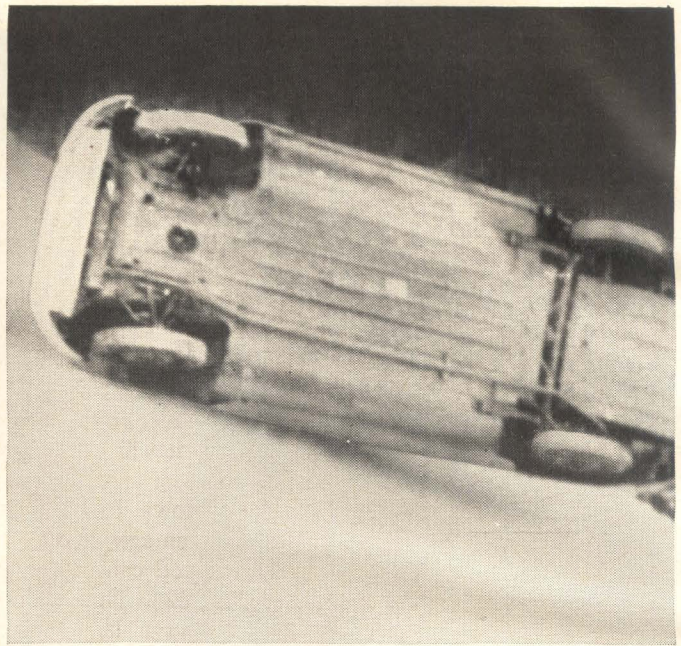

Actual photos from film of SAAB safety test on Norwegian ski slope.

SAAB engineers don't take safety lightly. Don't you!

This SAAB was deliberately rolled down a Norwegian ski slope, with a man in it. It turned over 25 times, and the driver walked away. It proved that the SAAB body can take an awful beating, if it has to. A comforting fact to know, if you're inside.

In a SAAB, safety is not just a matter of seat belts and a padded dash. A SAAB is safety-engineered throughout. You may never need everything we've built into SAAB to keep you safe; we hope not. But if you're at all concerned about safety, you'll be glad to learn that the 1964 SAAB has: an almost uncrushable unitized body, heavy reinforced steel columns front and rear, pop-out windshield, strong 18- to 20-gauge body steel throughout, a collapsible steering column, safety-padded dash and sun visors, seat belt fittings, 95% visibility from the driver's seat, sure-traction front-wheel drive, a rear gas tank, and a new supersafe braking system (dual independent master cylinders with hydraulic lines that diagonally connect front and rear wheels). SAABs are built this way because we don't take your safety lightly. If you don't either, see your SAAB dealer soon. He sells one of the safest cars on the road. Only **\$1895, P.O.E.**

*Engine, transmission and differential warranted for 2 years or 24,000 miles.

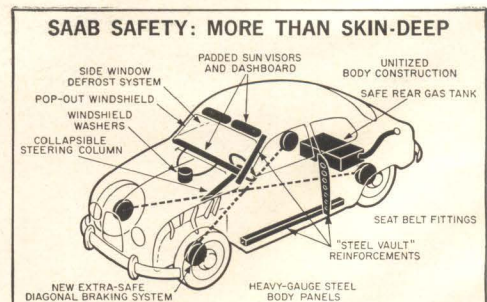

Shopping imports? Write for full descriptive literature on SAAB. SAAB Overseas, Inc., Department 401, 405 Park Ave., New York, N.Y.

SAAB STURDY • STYLISH • SWEDISH
New York • New Haven • Denver • Jacksonville

NASA Upgrades Mercury Network

NASA's \$50-Million Dilemma

NASA'S PROPOSED \$50-million space electronics center has been sent into political orbit. Where it will come down, no one knows.

Two more states, New York and Iowa, have put in their bid for the research facility, citing advantages similar to those mentioned by the previously-announced candidates. Massachusetts and Michigan (p 19, Nov. 22). These include the presence of industry, universities and a large number of scientific and technical personnel.

In the beginning, where to locate the center was no problem. NASA said it wanted to build it in the Boston area and that seemed to be that. Then came charges of political favoritism and the eventual decision by NASA to appoint a special panel to study possible locations (p 17, Oct. 25). That opened the door to other candidates.

In Massachusetts, there is talk that the center should be built in the late President Kennedy's home state as a memorial to him

GROUND STATIONS in the Project Mercury tracking and communications network are being improved and expanded by NASA for the more difficult task of tracking both Gemini and Agena stages.

Pcm equipment, by Electro-Mechanical Research, will replace Mercury f-m gear because of the large amount of telemetry data required for Gemini. And, Bendix Radio will supply the acquisition bus systems that will slave all of each station's radars to each other.

Eleven display console systems, to be built by Bendix-Pacific, will be grouped in clusters of five with positions for two doctors, two flight controllers (one for each vehicle) and one maintenance console to handle timing, telemetry, and command signals. Bendix has a \$4,750,000 contract.

Air Force Will Airlift Tiros Ground Stations

HANSCOM FIELD, MASS. — An air-transportable version of the Fairchild-Stratos APT ground station (p 20, July 26, 1963) has been developed here for use by the Air Force Weather Service. Twenty of the stations will be deployed around the world, to receive from Tiros weather satellites facsimile pictures of cloud cover over the region. The pictures will be used by local operators for weather analyses.

6-Inch Color Tv Set Employs Dichroic Mirrors

TOKYO—Mitsubishi Electric has introduced a 6-inch color tv receiver with three 6-inch cathode-ray tubes and dichroic mirrors. The set will sell here for the equivalent of about \$255, less than half that of conventional sets.

One picture tube, with green phosphor, faces forward with face-

Antenna Uses Passive Dish

TOKYO—Circularly polarized microwave antenna for space applications has been developed by Toshiba. The conical scanning unit needs no rotary transmission line joint or feeder lengthening, but instead scans by means of a rotating, parabolic sub-reflector. The passive sub-dish is mounted face-to-face with the main dish at its focal plane, while a helical reflector, arranged on the main dishes' principal axis, radiates a circularly polarized wave—illuminating the sub-dish with a plane wave-front. From the sub-dish, reflected energy converges at its focal point to act as the main dish's primary source. For conical scanning, the sub-dish is de-focused and rotated around the principal axis of the main dish. A micromotor powers the rotation. Because it is passive, the sub-reflector requires no connections.

Aerospace Flying High

AMERICAN aerospace industry sold approximately \$20 billion worth of goods and services during 1963 and should sell \$20 to \$21 billion in 1964, according to Karl G. Harr, Jr., president of Aerospace Industries Association. The total for 1962 was \$19.5 billion. Harr says the government/civil ratio will continue at about 85/15 percent. Increased sales are expected for jet freighters, helicopters and general aviation aircraft.

Harr reports that as of Sept. 30, the backlog of unfilled orders for 67 aerospace companies was approximately \$14.7 billion, compared with \$13.1 billion on the same date in 1962

plate about halfway back from front of set. In front of it are two dichroic mirrors slanted 45 degrees from vertical. Below each mirror is a picture tube with faceplate pointed up. Faceplate of vertical tube nearer front of set, with red phosphor, is below that of other picture tube, with blue phosphor, so that optical paths from all three tubes to viewer's eyes are equal.

Mitsubishi says the set is ten times brighter than color sets with shadow-mask picture tubes and can be easily viewed outdoors.

One-Watt Radio Buoys Transmit Data 600 Miles

VERY-LOW-POWER radio-equipped buoys anchored off Bermuda have been used to transmit oceanographic

measurements to a station in Long Island, N. Y., ITT said last week. More than 280 successful experiments were conducted with the buoys, which transmit at 6,970 kc with an output of less than one watt. ITT said it found relatively small seasonal variations in signal strength over the 600-mile path.

Fluid and Glass Amplifiers Studied for Computer Use

CORNING will build fluid amplifier analog computing components for the Army's Harry Diamond Laboratories. Objective will be to make components that will perform multiplication by a constant and by integration. Corning and Diamond Labs had previously used chemically machined photosensitive glass in devel-

oping multistage, thermally laminated devices with relatively high gain. Present work should result in a rudimentary five-stage analog multiplier utilizing feedback circuitry thermally fused in a single block.

Design Specs Given For Laser Space Link

IBM SAYS the experimental injection-laser communications system it is building for NASA (p 17, Dec. 13) will provide a one-way voice link over a slant range of 1,500 nautical miles. The gallium-arsenide laser in the transmitter will be a forward-biased semiconductor diode without cryogenic cooling. It emits energy at a wavelength of 0.9 microns at room temperature. The transmitter will use pulse-frequency modulation and have pulse-code potential. Power requirement will be 10-w peak and 10 milliwatts average from a self-contained battery. Signal-to-noise ratio will be at least 10 db at maximum range. The optical receiver will include a folded reflector with a diameter of 2 to 3 feet on a Nike-Ajax pedestal slaved to FPS-16 tracking radar. The pedestal will be modified by Metric Systems Corporation.

MEETINGS AHEAD

RELIABILITY-QUALITY CONTROL NATIONAL SYMPOSIUM, IEEE, ASQC, ASME, EIA; Statler Hilton Hotel, Washington, D. C., Jan. 7-9.

ENGINEERING INSTITUTE: LASERS, University of Wisconsin; University, Madison, Wisconsin, Jan. 9-10.

INTEGRATED CIRCUITS SEMINAR, IEEE New York Chapter; Stevens Institute of Technology, Hoboken, New Jersey, Jan. 15.

CHARGE TRANSFER COMPLEX SYMPOSIUM, USAF Scientific Research Labs; Denver, Colo., Jan. 19-24.

ANTENNA RESEARCH APPLICATIONS FORUM, Midwest Electronics Research Center; University of Illinois, Urbana, Ill., Jan. 27-30.

MANAGEMENT CONFERENCE, ERA; New Orleans, La., Jan. 28-31.

ANNUAL MEETING-SEMINAR, Precision Potentiometer Manufacturers' Association, Hollywood Beach Hotel, Hollywood, Fla., Jan. 29-31.

INSTRUMENTATION SYMPOSIUM, ISA North Central Area; New Sheraton-Ritz Hotel, Minneapolis, Minn., Jan. 30-31.

MILITARY ELECTRONICS WINTER CONVENTION, IEEE-PTGMIL; Ambassador Hotel, Los Angeles, Calif., Feb. 5-7.

ELECTRONIC COMPONENTS INTERNATIONAL EXHIBITION, FNIE, SDSA; Paris Exhibition Park, Paris, France, Feb. 7-12.

PHYSICAL METALLURGY OF SUPERCONDUCTORS MEETING, AIMMPE Metallurgical Society; Hotel Astor, New York, N. Y., Feb. 18.

INTERNATIONAL SOLID STATE CIRCUITS CONFERENCE, IEEE, University of Pennsylvania; Sheraton Hotel and University of Pennsylvania, Philadelphia, Pa., Feb. 19-21.

NUMERICAL CONTROL PRESIDENTS' CONFERENCE, Numerical Control Society; Hotel Plaza, New York, N. Y., Feb. 20-21.

SCINTILLATION-SEMICONDUCTOR COUNTER SYMPOSIUM, IEEE, AEC, NBS; Hotel Shoreham, Washington, D. C., Feb. 26-28.

ADVANCE REPORT

MICROELECTRONICS THIRD ANNUAL SYMPOSIUM, IEEE St. Louis Section; Chase Park Plaza Hotel, St. Louis, Mo., April 13-15; Jan. 15 is deadline for submitting in triplicate 100-word abstracts, 350-word summaries, and brief biography to Mr. Thomas F. Murtha, Program Chairman, P. O. Box 4104, St. Louis, Mo. 63136. Some topics include vapor deposition processes, advanced semiconductor development, device packaging parameters, interconnection systems and methods, diffusion processes, photo-etching and masking, materials development and application, plus advanced concepts in molecular engineering.

GAO Blames Army Agency For Buying Faulty Radiacmeters

WASHINGTON—Army bought 59,776 faulty gamma radiacs from several firms over five years at a cost of \$2.9 million, says the General Accounting Office; 10,800 have already been scrapped and none of the ones left is acceptable.

GAO blames the Army Electronic Materiel Support Agency at Fort Monmouth on these grounds: early tests (1958) showed that the instruments, for determining troop exposure to nuclear explosions, failed to meet shock, immersion sensitivity and calibration requirements. Accuracy, supposed to be within 10 percent plus or minus, was really 67 to 78 percent inaccurate, the GAO report says.

Too, jarring adversely affected the tube filament and after some use, the batteries showed unusual voltage drops—making accuracy unreliable. But despite these deficiencies, GAO says that during and after the first production contract, four more contracts were let on the hope that the failures could be worked out during the production period.

Good Year for NASA, 0.933 Batting Average

WASHINGTON—Stricter adherence to reliability standards was credited by NASA at year's end for the space agency's record of 10 successful satellite launches in 10 attempts, and five other launch tests, four of them successful—a batting average of 0.933 for the 15 attempts. NASA also chalked up a record of 70 successes with sounding rockets launched from Wallops Island, Va. Five years ago, NASA had only one success in five tries.

Billion-Dollar Market Seen for EDP in 1964

ELECTRONIC DATA PROCESSING industry should grow 15 percent over 1963's \$900-million total, said Walter W. Finke, president of Honey-

Laser Makes Accurate Thin-Film Resistors

PULSED RUBY laser is now being used to vaporize metal from thin-film resistors—achieving accuracies of one part in 2,000, says its developer, Maser Optics Inc. of Boston. The firm says that its use at the Daven Company, N. J., marks the first use of a laser as a "practical production tool"

well's electronic data processing division, last week. "The number of general-purpose EDP systems installed should pass the 15,000 mark, an increase of about 3,000 systems," Finke said, "with the total cumulative market easily exceeding \$5 billion."

Apollo Fuel Cells Supply Power and Drinking Water

THREE PROTOTYPE fuel cells, to supply the Apollo moon spacecraft with on-board electricity and—as a by-product—water for drinking and component cooling, have been delivered by Pratt & Whitney. Already vibration and vacuum tested, the units will aid three powerplants driving Apollo's guidance, communications, and environmental controls. The firm said that acceptance tests will come next to assure power output conforming to NASA criteria; i.e., in a range of about 500 to more than 2,000 watts. Also under development is a smaller fuel-cell system for the Apollo Lunar Excursion Module being built by Grumman Aircraft.

The powerplants being developed by Pratt & Whitney use hydrogen as fuel and oxygen as oxidizer. Hydrocarbon types are planned.

IN BRIEF

NORTH AMERICAN is conducting feasibility studies for the Air Force on a three-man, lightweight capsule to rescue crewmen from damaged, orbiting space stations.

SWEDEN will supply Argentina with 12 automatic, omnidirectional radio beacons. They'll help modernize shipping control between Buenos Aires and Tierra del Fuego.

TV AND RADIO production rose in October, EIA says, but only tv showed gains during January-October, compared with the same period last year. Phonograph sales were up also that month but picture tubes dropped.

SOVIET radar has been bounced off Jupiter, says the Communist newspaper Pravda, setting a long-distance record in radar astronomy. The experiment was to study the planet's surface reflectivity and long-distance radiowave propagation.

AIRPORT DEFICIENCIES, not traffic-control inadequacies, are the main cause of airline flight delays, says a study made for the FAA. Traffic control does play a part, however; so does weather.

RELAY II, NASA's second medium-altitude communications satellite, has been scheduled for launch Jan. 21.

NASA WILL negotiate with Control Data for \$25 million in computer systems. Equipment would be used in Apollo preflight checkout.

ISRAEL is planning to cut customs duties on electronic components to encourage industry expansion.

AIR FORCE'S radio-relay network from England to Turkey has been completed with the acceptance of the troposcatter station at Athenai Airport, Greece.

MITSUBISHI will make and install in the U. S. two neutron diffractometers by the end of 1964. They're Japan's first to get AEC approval for use here.

AEC HAS ORDERED the first digital computer for solvent-extraction control. The GE 412 will be installed at Hanford labs.

\$1.2-MILLION in studio telecasting equipment will be purchased by Subscription Television Inc. from RCA.

Nuclear Rocket Program Grounded, But Still Alive

Officials sitting in when the administration pared Project Rover back from \$200 million to \$150 million for the next fiscal year figure that backers of the nuclear rocket engine program were lucky to save it at all. Difficulties with nuclear reactors and lack of a clear purpose for the program made it vulnerable for the cutback to no more than \$70 million for the year, recommended by Jerome Wiesner, the President's science adviser. Only President Johnson's keen interest in the program preserved it at the \$150-million level, according to these reports.

Lockheed Missile & Space Co. was the big loser in the Rover slowdown. The decision to confine the deep-space engine to ground R&D, wiping out the reactor flight test (Rift) portion of the program, cost the company a job that called for big spending in future years, even though it has only brought the firm \$14 million in work in the last two years. Lockheed will try to absorb the 400 people who have been working on Rift. Lopping off Rift will save \$182 million in funds this year and next, including National Aeronautics and Space Administration and Atomic Energy Commission spending.

Kiwi, Rover's ground reactor project, will be phased into the higher-powered Phoebus graphite reactor system, while Nerva (Nuclear Engine for Rocket Vehicle Application) will have its flight plan deferred. NASA said it will delay work on flight systems for Kiwi and Nerva until knowledge already gained from them is firmly established.

Clean Air Law Means Boost for Pollutant Controls

Sharp stimulation of industrial demand for sensing, sampling and monitoring equipment for the control of air pollutants is expected from the new clean air law. The legislation gives the government broad enforcement powers, and will stimulate state and local pollution control programs. Over the next several years, this is expected to double or triple the industrial investment—now running at several hundred millions of dollars annually—in pollution-control devices and their electronic components, such as sensors, transducers, electrostatic precipitators, control circuits, and the like.

The government itself will spend more on development of new control devices and techniques. For instance, \$50,000 a year is now being spent in R&D work on electrostatic precipitators. This should grow to \$250,000 within two years. Community purchases of monitoring equipment should also be spurred by federal grants for local control programs. Congress may appropriate up to \$5 million to upgrade local control programs in the next budget, increasing it gradually in succeeding years.

High-Level Board To Probe Impact Of Defense Cuts

President Johnson is seeking to give some centralized direction to separate efforts by government agencies to plumb the economic impact of reduced defense spending. He has named a high-level committee to review and coordinate the various studies, and to pin down where and to what extent defense cutbacks will be felt most severely. The next step will be working out a program to minimize the disturbances. A member of the Council of Economic Advisers will head the group. The Departments of Defense, Labor and Commerce, National Aeronautics and Space Administration, the Budget Bureau, the Atomic Energy Commission and the Arms Control Agency will be represented. The inter-agency group will report directly to the President, and also give its findings to Congress. The Senate Manpower Subcommittee expects to recommend specific legislation early next year aimed at encouraging the application of defense technology to civilian needs.

High frequency

will burn out
this rectifier

but not this
Unitrode

Now Unitrode eliminates excessive reverse power dissipated in the diode during turn-off. This means you can reduce ripple and the size of transformers and filters by increasing operating frequency.

At 100 KC, the rectification efficiency of the Unitrode® fast-recovery rectifier is only 1% less than at 60 cps. Reverse recovery time is typically 75 nanoseconds . . . and continuous average rectified current ratings are 2 amps even with PIV's of 600 volts!

Unitrode makes this possible by a novel silicon diffusion process that nearly eliminates the reverse current spike during turn-off — and considerably shortens turn-off time. Further, the new fast-switching series has the unique one-piece Unitrode construction that survives long term overloads without damage and is immune to aging effects.

With a hard glass sleeve fused to all exposed silicon surface, the resulting void-free junction cannot be contaminated. And they're no bigger than . . .

. . . this 

Individually inspected, 100% tested, Unitrode fast-recovery rectifiers have to cost more than ordinary rectifiers. But if performance is more important to you than pennies, compare all the remarkable devices based on the Unitrode principle: 3-amp silicon diodes, 3-watt zeners, high-voltage stacks and bridge assemblies. They're stocked by Unitrode representatives nation-wide.

For information, product demonstration and samples, contact UNITRODE TRANSISTOR PRODUCTS, INC., 214 Calvary Street, Waltham, Mass. 02154. Tel. (617) 899-8988, TWX (617) 894-9876.

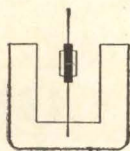

UNITRODE

We warrant our paper tape readers for 12 months— parts and labor.

Why won't anybody else?

We're a small company. We can't out-shout our competitors. We can only out-perform them. (Which is why we can give you the longest, most complete warranty in the industry.)

For example, we'd like to shout that we test our tape readers until they break down. But we can't. They simply will not break down. Even after 125 million cycles, 24 hours a day, seven days a week.

What else is so hot about our reader? It's bi-directional. At 30 CPS either

way. And works on the modern star-wheel reading principle, reading 5, 6, 7 or 8 channel paper tape.

The cost is \$350.00. (Our phone number is 201-HU 9-8080.)

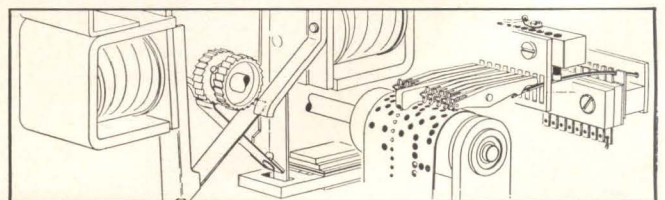

OHR-TRONICS, INC.

516 Fifth Ave., New York 36, N.Y., 212-MU 7-8465
PLANT: 289 Huyler Street, South Hackensack, N.J., 201-HU 9-8080

Need Potentiometers That Meet MIL-R-27208A? Only Bourns Gives You All Four



MIL-SPEC STYLE
RT10
Bourns TRIMPOT®
Model 220



MIL-SPEC STYLE
RT11
Bourns TRIMPOT
Model 3010



MIL-SPEC STYLE
RT12
Bourns TRIMPOT
Model 224



MIL-SPEC STYLE
RT22
Bourns TRIMPOT
Model 3250

(units shown actual size)

| | Model 220 | Model 224 | Model 3010 | Model 3250 |
|----------------|-------------|-------------|-------------|------------|
| Resistances | 100Ω to 30K | 10Ω to 100K | 10Ω to 100K | 10Ω to 50K |
| Power Rating | 1.0W | 1.0W | 1.0W | 1.0W |
| Humidity-Proof | YES | YES | YES | YES |



The TRIMPOT Division Environmental Laboratory is capable of performing tests to MIL-R-27208, MIL-R-22097 and MIL-R-12934.

These four potentiometers not only meet the specs, they beat the specs. All four have higher operating temperature, lower end resistance, better shock and vibration performance, lower temperature coefficient, higher dielectric strength and higher insulation resistance than the specs call for.

Where MIL-R-27208A sets a maximum operating temperature of 150°C, Bourns gives you 175°C. Where Mil Specs ask for 50G shock and 20G vibration, Bourns provides 100G shock and 30G vibration. Where Mil Specs call for a temperature coefficient of 70PPM max., Bourns offers 30PPM nominal and 50PPM max.

All four models exceed MIL-STD-202B, Method 106, for cycling humidity. In addition, all units have solid electrical grade-A nickel, gold-plated pins suitable for soldering or welding, and feature Bourns' exclusive, indestructible SILVER-WELD® termination.

To be sure of specifications, don't MIL-SPECulate—SPECify Bourns!

Write now for latest TRIMPOT potentiometer brochure.



BOURNS

BOURNS, INC., TRIMPOT DIVISION
1200 COLUMBIA AVE., RIVERSIDE, CALIF.
PHONE 684-1700 · TWX: 714-682 9582
CABLE: BOURNSINC.

MANUFACTURER: TRIMPOT® & PRECISION POTENTIOMETERS, RELAYS; TRANSDUCERS FOR PRESSURE, POSITION, ACCELERATION. PLANTS: RIVERSIDE, CALIFORNIA; AMES, IOWA; TORONTO, CANADA

CIRCLE 23 ON READER SERVICE CARD

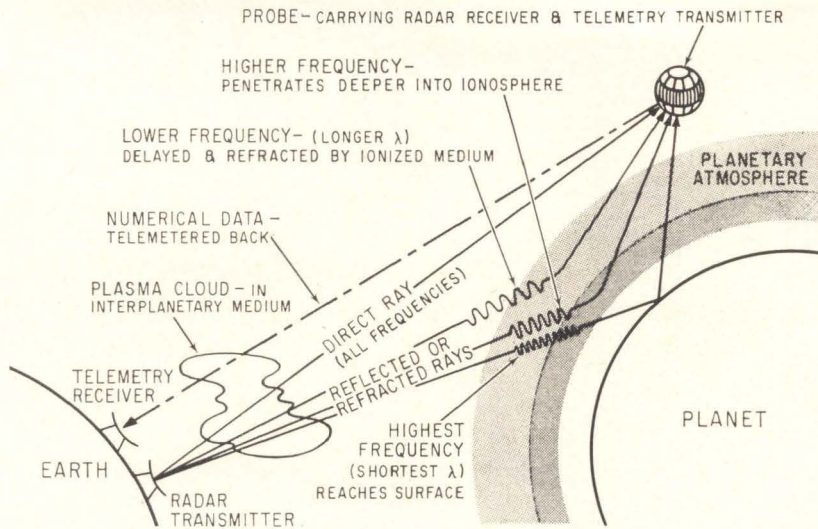

COMPARISON of direct and reflected and refracted signals is made aboard space probe carrying receiver end of bistatic radar system. Data on planetary atmospheres or surfaces is telemetered back to earth

Radar's New Partner: SPACE PROBE

By LAURENCE D. SHERGALIS, Regional Editor, San Francisco

Bistatic radar system's receiver will travel millions of miles away

PALO ALTO, CALIF.—Two of the most useful tools available for space research are bistatic radar and interplanetary spacecraft. Scientists here are working up plans for a unique combination of the two, to investigate lunar and planetary surfaces and atmospheres and solar winds.

Radiosciences Laboratory of Stanford University is planning a series of bistatic radar experiments, using a transmitter on earth and receivers in a Pioneer space probe. Later experiments may employ the Lunar Orbiter spacecraft.

Bistatic Radar—Unlike conventional or monostatic radar, in bistatic radar the receiver is some distance from the transmitter. This system has several advantages: ef-

fectiveness of transmitted power is multiplied since the reflected signal path is greatly reduced; effects of the intervening medium are minimized; variations in polarization of the signal, intensity and pulse shape, provide information about

the media through which signals travel.

With a Space Probe—Pulse or wave trains from the transmitter on earth are reflected from the surface of the planet under study, and may also be refracted by the medium surrounding the planet. Receivers aboard the spacecraft pick up both the direct signal from the earth transmitter, and the reflected signal from the planet. Equipment aboard the probe measures the time interval between arrival of the direct and reflected signals. It may also compare polarization of the two signals, phase difference of modulated signals and the shape of the pulses. This information is telemetered back to earth in real time.

Stanford researchers use two different radar systems. Frequencies of 49.8 Mc, and $8\frac{1}{2}$ times that or 423.3 Mc were chosen because commercial equipment is available, and the frequencies were available in the radio astronomy spectrum allotment. Two frequencies are needed because one serves to calibrate the other. Plasma measurements are made at the lower frequency, with the higher one mostly for calibration.

Work at Stanford is presently directed to getting this equipment aboard the Pioneer probe.

Experiments—Three major experiments are planned.

Highest priority experiment aboard Pioneer will be the measure

One More for Command and Control



THIS IS FIRST PHOTO released for publication of data-processing system that Librascope is building for Air Force's 473L command and control system. System includes mass-memory disk file (left), central computer (center) and magnetic tape consoles (left and right). This system is to be used in the Pentagon

of electron density with time, or phase path measurement. Both frequencies will be beat together aboard the vehicle and the beats transmitted back to earth. Phase velocity of radio waves changes when the content of electrons over the path changes.

The second experiment calls for modulating both frequencies at 10 kc. They are modulated at the earth station in phase. Passing through a dispersive medium, they get out of phase. This phase difference gives an average value of electron density.

Third experiment, measure of polarization, indicates average bulk velocity of the solar wind. The vehicle will spin around its axis at about 1 rev/sec. An antenna, tilted from the spin axis, will have a linear pattern that will tilt and spin with the vehicle. A circularly polarized signal transmitted from earth will pass through the ionosphere without change. But solar electron streams will change polarization from circular to elliptical to linear and back through several cycles along the way from earth to the probe. The spinning antenna will detect the state of polarization at any instant and telemeter changes.

One other experiment may be possible. Stanford has asked NASA to schedule the launch date so that the probe will pass behind the moon on its trajectory. Stanford hopes to measure the time difference between cutoff of the two signals (50 and 400 Mc). This time depends upon refraction caused by the moon's ionosphere, and would thus give a very sensitive measurement of the moon's ionosphere. Several seconds difference is expected.

Future Studies—Stanford researchers plan to use the bistatic radar technique for solar probes. They expect to measure the sun's corona and gas density. Planet surface measurements are an exciting possibility because of higher frequencies that are possible at reduced transmitter powers. Stanford looks to the Lunar Orbiter program for detailed studies of moon's surface. This is best done using higher frequencies—possibly to 10 Gc—for better resolution. Better receivers are needed. Also there are mechanical problems such as vibration in the vehicle that are still bothersome.

**UNIQUE MACHLETT DP-30 FOR...
SWITCH TUBE OR PULSE AMPLIFIER**

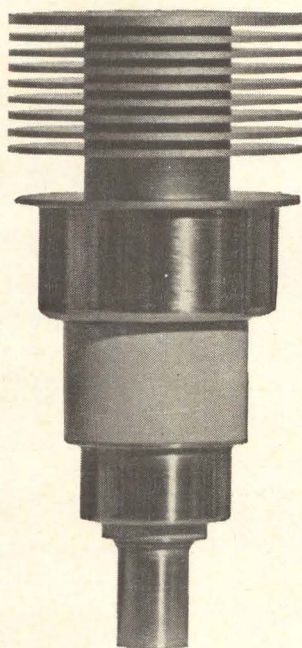

as switch tube:
30kw switch
at 0.0033 d

OR

as pulse amplifier:
20kw peak pulse
at 1Gc

The unique DP-30 planar triode does double duty as an rf pulse amplifier (or oscillator), or modulator/switch tube. Typical performance as an rf amplifier: 20kw peak pulse power at 1Gc, 0.001 d. Typical performance as a switch tube: 5a x 6kv for 30kw switch power at 0.0033d. ■ For data write: The Machlett Laboratories, Inc., Springdale, Connecticut. An affiliate of Raytheon Company.

MACHLETT

ELECTRON TUBE SPECIALIST

EE's & ME's—Find Your Opportunity in Product Design and Development From These New Openings at Delco Radio

■ A constant flow of new electronic products has helped Delco Radio Division, General Motors Corporation, establish a position of leadership in the electronic field. From Delco research come such exclusive developments as the unique 1964 Cadillac Comfort Control. With only one setting of the thermostat, this recent Delco development automatically maintains a constant, comfortable atmosphere within an automobile, regardless of changes in the weather outside.

As the search for new products continues at Delco, challenging opportunities prevail—in many areas—for capable engineers:

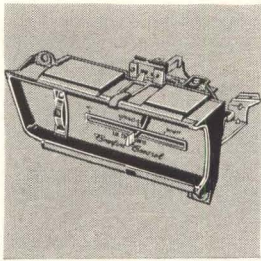

HEATER, AIR CONDITIONER, AND VENTILATION CONTROL

ME's—with 3-5 years experience, for development, engineering production liaison, and re-designing of comfort control systems including vacuum valves and mechanical controls.



SUBMINIATURE MILITARY COMMUNICATIONS EQUIPMENT

EE or ME—for assignment to development group designing all-transistor portable transmitters and receivers, operat-

ing in 2-100 mc range. FM—AM—FSK—CW—SSB modulation.

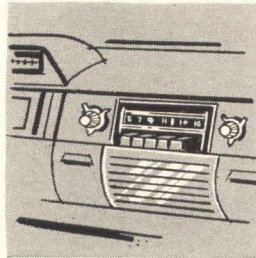

AUTOMOTIVE RADIO DESIGN AND DEVELOPMENT

EE—to work with Senior Engineer on advanced development of auto radios and other entertainment devices, including FM-AM, miniaturized circuitry and components.

ME—for design of small electronic mechanisms, including FM-AM, Signal Seeking and push-button tuners, and components modules.

EE or ME—for packaging of auto radios and associated tuners, solenoids, etc. Required to make some engineering contacts with automobile manufacturers.

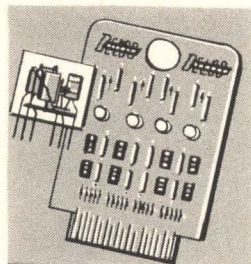

DIGITAL CIRCUITS AND SYSTEMS—includes card, module and digital systems design, and production liaison involving components and special purpose systems operating from 200 kc to 10 mc.

Project Engineer—to direct efforts of design engineers and technicians in designing and releasing digital circuits for production. Supervisory experience highly desirable.

EEs—for design and development testing and packaging of transistorized digital switching circuits from 200 kc to 10 mc.

RELIABILITY ASSURANCE

Project Engineer—to handle tests and evaluations of transistorized systems and components, both power and small signal type. Must evaluate results and associated statistical data. Also includes failure analysis work with suppliers and production.

EE—for design and development work on test equipment for semiconductors and special products.

ME or METALLURGIST—for specification writing and testing of materials and finishes. Experience in this area desirable.

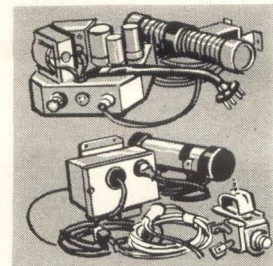

AUTOMOTIVE ELECTRONICS—nonentertainment automotive electronic development including radio control for Garage Door Operators; other transistor applications in automobile, usually involving electromechanical transducers—**ME**—for advanced development work in electromechanical systems used in automotive field.

EE—for design and development of transistorized automobile equipment.

EE or ME—with electromechanical interests for development of electronic equipment for the automotive service market.

● If your interests and experience fall in the above areas and if you're looking for an opportunity to fully exercise your personal competence . . . among men of like talent . . . in unmatched facilities . . . then let's talk. Send your resume today to the attention of Mr. Carl Longshore, Supervisor Salaried Employment.

An equal opportunity employer



DELCO RADIO DIVISION OF GENERAL MOTORS
KOKOMO, INDIANA

NEW PRODUCTS FROM LTV

TWO SOLID STATE SERVO ANALYZERS

NEW
301 PORTABLE All solid-state circuitry • Small (11 x 5 x 9 inches) • Light weight (less than 20 lbs.) • Self-contained indicator for phase and response measurement • In-line numerical readout — no parallax • Power source from 50 to 400 cps 115V

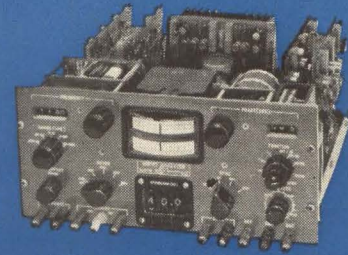

NEW
501 AUTOMATIC Automatic in-line presentation of phase and gain response • High-speed operation for production-line testing • All solid-state circuitry — modular construction • Self-check capability • Analog outputs for response plot

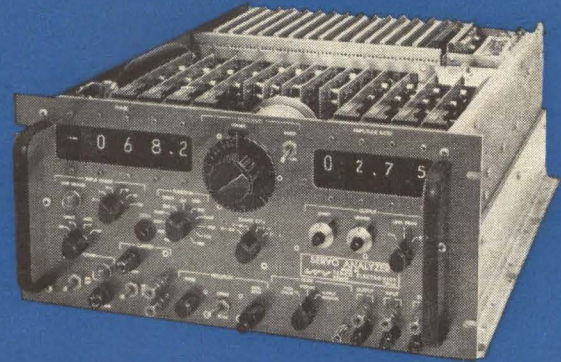

201 STANDARD Industry standard — proven operation for 3 years • All electronic — no mechanical parts • Wide frequency range • Modulated or direct sine, step, ramp driving functions

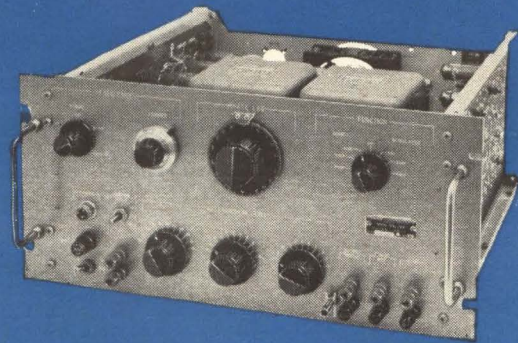

COMPARATIVE SPECIFICATIONS

| | | Model 201 | Model 301 | Model 501 |
|------------------------------|--|---|---|---|
| DIRECT OUTPUT: | Functions Freq. Range Freq. Accuracy Output Voltage Output Impedance | Sine-Step-Ramp .005 — 1 KC ±2% of dial 15 V RMS 600 ohms | Sine-Step-Ramp .005-1.2 KC 1% or 1 dial count 20 V p-p 600 ohms | Sine-Step-Ramp .02-200 cps 0.1% 20 V p-p at 20 ma <60 ohms |
| MODULATED OUTPUT: | Carrier Input Carrier Range Phase Shift Modulated Functions (Suppressed Carrier) | 115 V or 26 V RMS 50cps-10KC <2° (50cps-5KC) <5° (to 10KC) Sine-Step-Ramp | 115 V or 26 V RMS 400cps-10KC <2° (400cps-5KC) <5° (to 10KC) Sine-Step-Ramp | 115 V or 26 V RMS 400cps-10KC <2° (400cps-5KC) <5° (to 10KC) Sine-Step-Ramp |
| MEASUREMENT ACCURACY: | Attenuation Phase | 1% or 0.1 db 2° | ±0.2 db 2° | ±1% 1° |
| POWER REQUIREMENT: | | 450W 115V 60 cps | 18W 115V 50-400 cps | 150W 115V 60 cps |
| ANALOG OUTPUTS: | DC Voltage Proportional to log mod. freq. Phase Shift Amplitude Ratio | — — — | — — — | 2% ±1° ±0.4 db |

LTV MILITARY ELECTRONICS DIVISION
 Post Office Box 6118 • Dallas 22, Texas

MITSUBISHI MICROWAVE ANTENNAS FOR TELECOMMUNICATIONS

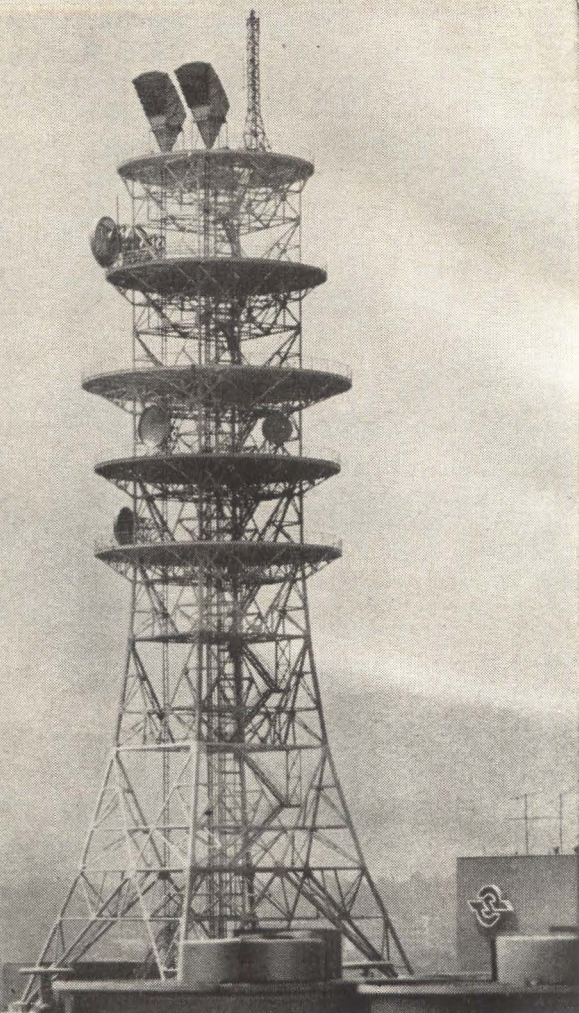

Japan today has the second largest microwave network in the world. Mitsubishi Electric, with the longest microwave antenna experience in Japan, has supplied 90% of the antennas used in the trunk lines of this extensive network. Mitsubishi antenna systems include parabolic, scatter, horn reflector and radar types, as well as a complete line of waveguide components and accessories. Frequencies from 900 Mc. to 24 KMc. are covered. The IU-62, shown above and specified at the right, is typical of the outstanding performance of Mitsubishi microwave antennas. Full technical information on any of these types of antennas is available at your request.

IU-62 Horn Reflector Antenna

Frequency Range : 3,000-12,000 MC
 Aperture : 9m²
 Max. width : 4,050mm
 Max. depth : 2,560mm
 Max. height : 7,418mm
 Gain at 3,900MC : V 41.5 db
 H 41.2 db
 Gain at 6,100MC : V 44.9 db
 H 45.0 db
 VSWR : 1.01
 Front/Back : 67.70 db
 (over 60 degrees)
 Discrimination of : V 57 db
 cross polarization : H 78 db (at 3,900MC)
 V 45 db
 H 37.5 db (at 6,100MC)
 Guaranteed wind velocity : 140 miles/hr



MITSUBISHI ELECTRIC CORPORATION

Head Office: Mitsubishi Denki Bldg., Marunouchi, Tokyo. Cable Address: MELCO TOKYO



■ 20 meter diameter antenna for satellite communication

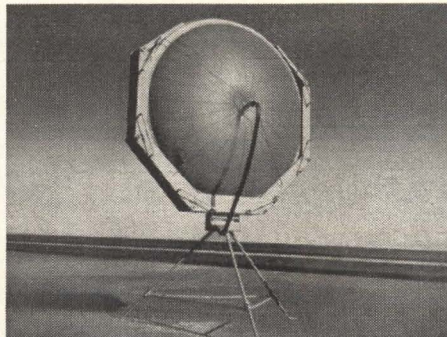

■ Air inflated parabolic antenna

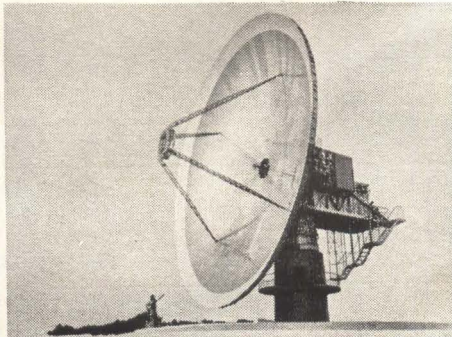

■ IU-61 parabola antenna

New Radiation-Proof Type XTG Wet Slug Tantalum Capacitors

The new XTG line of Mallory wet slug tantalum capacitors, specifically designed to resist the effects of radiation, has successfully passed radiation tests in the Ground Test Reactor of the Lockheed Missiles and Space Company, Sunnyvale, California.

The capacitors were subjected to both gamma ray and neutron bombardment at 75°F. During the 6744 minutes of reactor build-up time, the following accumulated dosage levels were reached:

Fast neutron bombardment: 6.579×10^{13} neutrons/cm², at energy level greater than 0.1 Mev.

Gamma radiation: 79.56×10^6 gamma rad. (C) from carbon source.

Capacitance, dissipation factor and DC leakage were measured for each capacitor at 120, 400 and 800 cps, both before test and

at the end of the dosage period. No detrimental change in electrical characteristics occurred as a result of the radiation dosage.

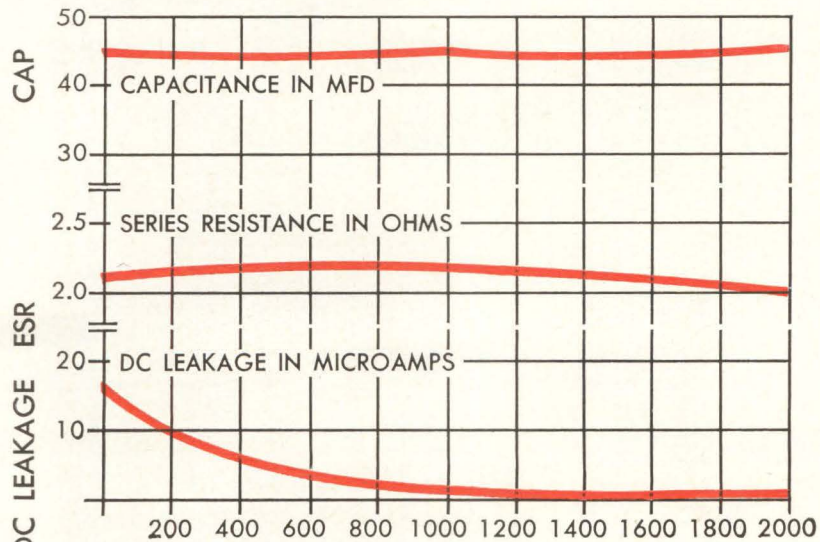

Typical Life Test 16 mfd., 90 V rating

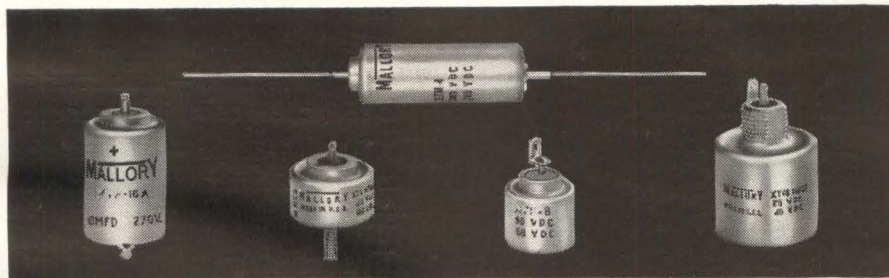

Range of ratings: Type XTG Radiation-Proof Tantalum Capacitor

| | Mfd. | DC Volts 85°C | Case Size of min. and max. mfd. value |
|------------------|---------------|------------------|---|
| (XTL equivalent) | 3.5 to 120 | 630 18 | $\frac{7}{8}$ " dia. x $2\frac{1}{32}$ " $\frac{7}{8}$ " dia. x $\frac{1}{2}$ " |
| (XTH equivalent) | 7 to 240 | 630 18 | $\frac{7}{8}$ " dia. x $4\frac{1}{16}$ " $\frac{7}{8}$ " dia. x $1\frac{1}{16}$ " |
| (XTV equivalent) | 12 to 2200 | 630 12 | $1\frac{1}{8}$ " dia. x $2\frac{3}{4}$ " $1\frac{1}{8}$ " dia. x $1\frac{1}{16}$ " |
| (XTK equivalent) | 2 to 70 | 340 8 | .656" dia. x $1\frac{5}{16}$ " .656" dia. x $\frac{7}{16}$ " |
| (XTM equivalent) | 4 to 140 | 340 8 | .656" dia. x $1\frac{25}{32}$ " .656" dia. x $\frac{9}{16}$ " |

The XTG line utilizes special materials and construction to achieve radiation resistance. The capacitors operate in a temperature range from -55°C to +85°C. In capacitance and voltage ratings, this line covers the same values as standard Mallory XTL, XTH, XTV, XTK and XTM wet slug tantalum capacitors. All MIL terminal configurations are available in the XTG line.

For complete data and prices, write or call Mallory Capacitor Company, Indianapolis 6, Indiana—a division of P. R. Mallory & Co. Inc.

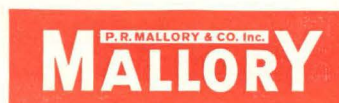

WET SLUG, FOIL AND SOLID TANTALUM CAPACITORS

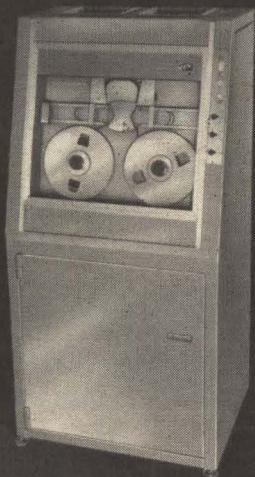

the MT-24

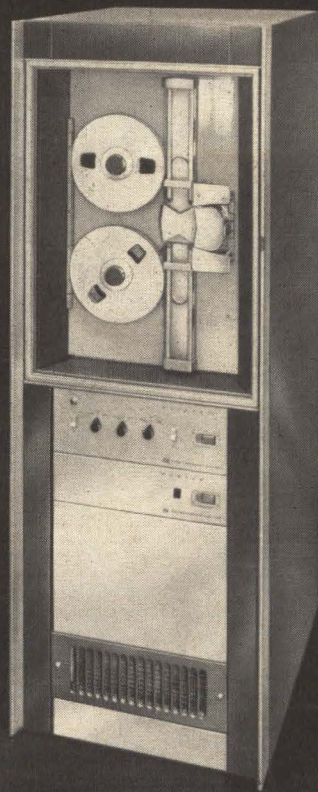

the MT-36

and now...the MT-75

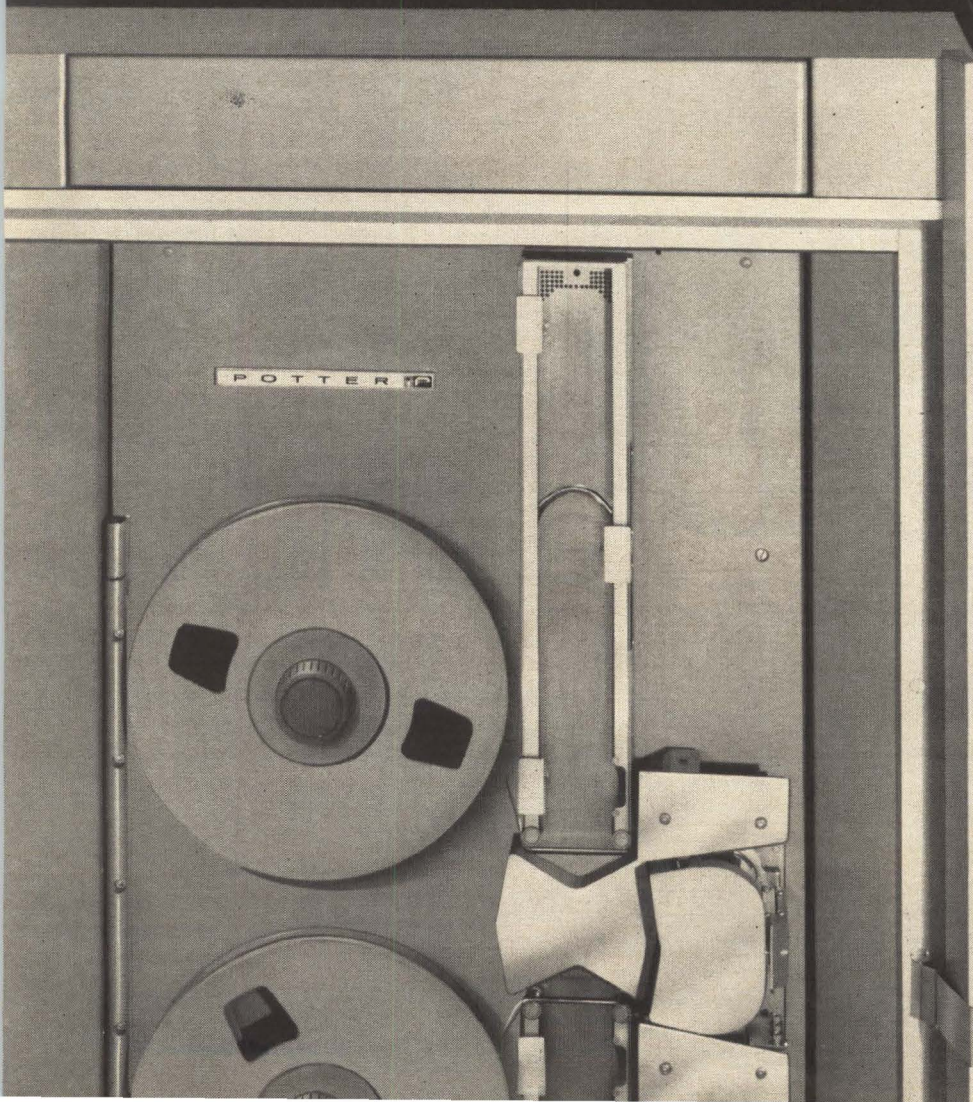

Small cost . . . **BIG PERFORMANCE**

Now, with the introduction of the new MT-75, Potter offers a complete family of high-performance, vacuum-column magnetic tape transports, featuring packing densities to

800 b.p.i.

These new Potter transports, the MT-24, the MT-36, and the MT-75, have been thoroughly value-engineered for the highest possible reliability at minimum cost. They cover a tape speed range of 1 to 75 ips; provide data transfer rates to 60kc. All are IBM-compatible. Here are the facts:

MT-24: 1-36 ips — data transfer to 28.8kc, 200 commands per sec.

MT-36: 1-50 ips — data transfer to 40kc, 200 commands per sec.

and the NEW MT-75: 1-75 ips — data transfer to 60kc, 200 commands per sec.

Interested? Complete data is available on these, as well as many other Potter models for speeds to 150 ips and packing densities to 1200 b.p.i. For information on the broadest line of digital transports available anywhere, just write to Sales Manager.

POTTER
INSTRUMENT CO., INC.
151 Sunnyside Boulevard, Plainview, New York



RADAR CHRONOGRAPH for measuring shell velocity is aligned on gun's boresight axis before firing. Jeep mounting is also used. ▶



C-W RADAR Measures Artillery Ballistics

Portable c-w radar develops doppler frequency of projectile in flight and gives velocity directly by counting during a preset interval. Changes caused by gun wear and ammunition aging can then be compensated for

By **HERMAN D. RAYNES**
Aircraft Armaments Inc., Cockeysville, Maryland.

IN SPITE OF MODERN techniques of rocketry and bombing, field artillery is still one of the most valuable methods of delivering explosives to the enemy. Field artillery advantages over other means of firepower are superior accuracy, greater reliability, and ready availability. Principal advantage of the other techniques is the capacity to deliver large amounts of explosives at great distances. In warfare with limited areas of battle as in brushfire wars, artillery is still needed.

Firing tables, prepared by the Ordnance Corps for each type of artillery piece, are based on data gathered from extensive test firings. The tables give the range of the projectile for elevation of the piece at standard conditions of material and weather, and give corrections for some nonstandard conditions. Presumably, if a weapon is fired in accordance with the tables, a hit will be scored every time. Normal dispersion is not a miss in this context.

In actuality however, conditions are seldom standard and the degree they are nonstandard is frequently unknown. Thus the first projectile rarely hits the target. Normally, observers or spotters observe the firing and communicate results to the weapon commander. Bracketing, commonly used, consists of deliberately firing beyond the target, then firing short of the target; by extrapolation the third round is adjusted to hit the target.

Improvement in first-round hit probability would

save many rounds and would preserve the advantage of surprise.

Variations from standard conditions affect both interior and exterior ballistics. The most significant exterior ballistic factor is the state of the atmosphere or weather. Interior ballistic factors determine muzzle velocity. The radar chronograph measures muzzle velocity, and all errors in estimating effects due to ammunition aging and gun tube wear are thus eliminated. Using measured rather than estimated muzzle velocity gives a large improvement in first round hit probability, as proved by tests at various proving grounds.

Under battlefield conditions, one radar chronograph

AIMING A CANNON

When a cannon is fired, the path the projectile takes is determined primarily by the angle of elevation and the square of the velocity of the projectile as it leaves the gun, although atmospheric conditions such as rain, wind, and air density also affect the path. Impact point is of course the intersection of the ballistic path and the terrain. Thus if the muzzle velocity can be estimated accurately before the gun is fired, the angle of elevation can be adjusted accordingly to improve first-hit probability. Doppler radar has shown that it can be used for such measurements

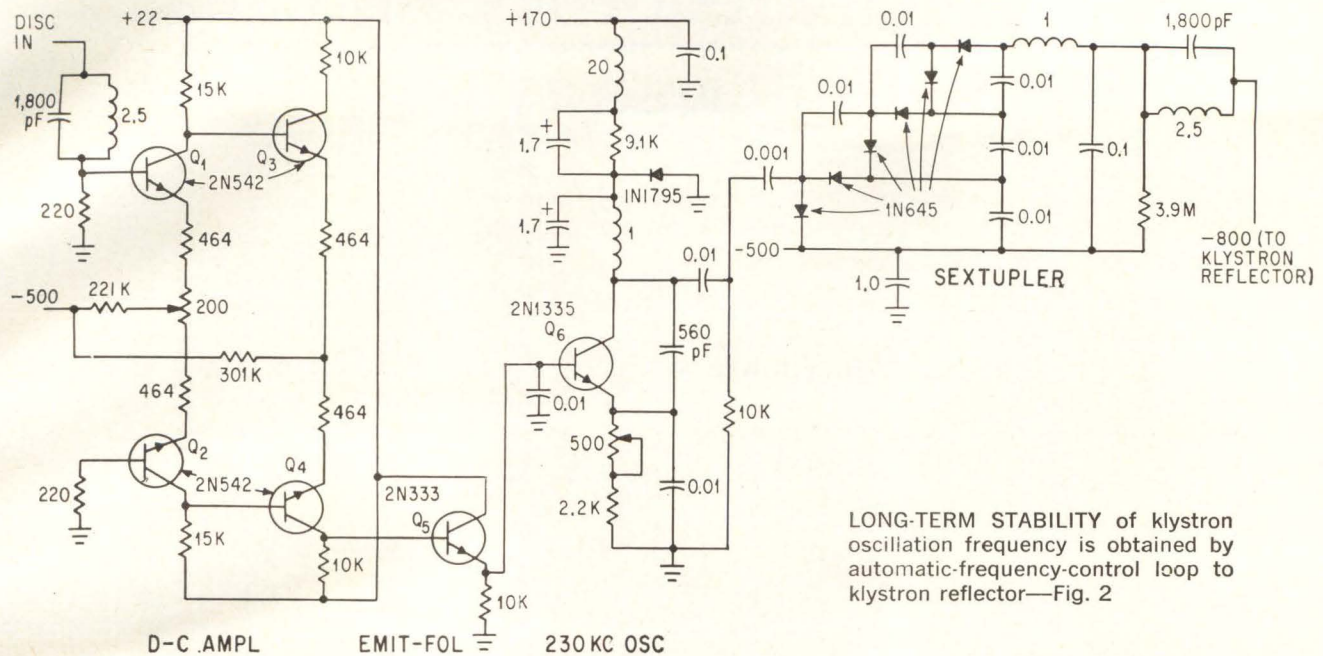

applied to the 4,096 divider; the divider has 12 binaries in cascade.

Thus the frequency applied to the delay gate is 23.3 cps; the period is 42.8 milliseconds. A logic circuit in the delay gate counts until a preselected period occurs and then operates the doppler gate. The doppler signal then feeds the counting circuits. The first circuit, the thirds counter, counts to three, then actuates the next circuit, the units counter, which is a conventional decade counter as are the tens, hundreds and thousands circuits. The count is displayed on neon numeric indicators and retained until manually reset. To maintain decimal readout, the thirds counter has displays of 0, 0.3 and 0.7.

Frequency Control—Since the doppler frequency varies directly with transmitter frequency, both long time (milliseconds and up) and short time (microseconds) stabilities are critical. An Invar microwave cavity is used as the reference element in an automatic frequency control loop. This reference element is a dual mode cavity operating in two orthogonal TE_{11} modes. Tuning screws distort the symmetry sufficiently that the modes are tuned to slightly different frequencies. Two coupling apertures, one for each mode, feed detectors. One detector is reverse polarity compared to the other, so combined output is a typical discriminator S curve. Discriminator output is amplified by a differential d-c amplifier, Fig. 2, and applied to a 230-Kc oscillator to vary output ± 20 percent. This is stepped up by a voltage sextupler, filtered, and applied to the klystron as reflector voltage.

Loop gain is sufficient to maintain klystron frequency within a few tenths of a megacycle. Stabilization is obtained within 50 milliseconds to accomplish long-time stabilization. Short-time stabilization is concerned with any shift in transmitter frequency

between transmission and reception of the r-f signal. This time is of the order of 10 microseconds. Allowing 0.1 Mc as the maximum allowable drift, a drift rate of $0.1/10 \times 10^{-6}$ or 10,000 Mc/sec² is obtained. Since 0.1 Mc/sec² would be a pessimistic value of klystron drift, no special short-time stabilization is required.

Other Features—Since actual operating time of the chronograph is only 43 milliseconds for each firing, tests or adjustments during this time are impractical. Self-checking the transmitter-receiver section is obtained by waving a hand in front of the antenna; the audio counter circuits are checked by applying a 75-Kc crystal-controlled test signal to the audio circuits and tapping the microphone. The counter should give a count of 1,070.3.

A problem common to all c-w radars is leakage from transmitter to receiver. Since the receiver is tuned to the transmitter frequency, leakage can saturate the i-f amplifier and cause false doppler indication due to noise components. The two main sources of leakage—terrain reflections and reflections in the chronograph waveguide—can be considered a single reflection appearing at the balanced mixer. A tuner, installed between the hybrid and the antenna, introduces another reflection whose amplitude and phase are variable. When adjusted, cancellation of the original reflection is achieved; this is part of the initial adjustments.

The chronograph uses replaceable modules. Major components—i-f amplifier, afc chassis, audio amplifier, counter and power supply—are removable in less than one minute. The i-f amplifier is shock mounted but everything else is rigidly mounted to the main frame. Front-panel indications are sufficient to localize trouble to a replaceable module. Test points are provided on a slide-out rack for higher echelon maintainance.

New High-Frequency Antenna: The Passive Network Array

The passive network array (PNA) is a physically small antenna using a hybrid and two matched baluns as the passive circuit with which it spans the 2 to 30-Mc frequency range with an overall gain of 9 to 11 db

By JOHN H. DUNLAVY, Jr. President, Antenna Research Associates, Inc., Beltsville, Md.

MOST RECEIVING antennas in the h-f range are too large and costly for their applications—are too efficient. A new approach, indicative of good engineering principles, dictates that for most h-f applications the antenna need be only large enough to receive sufficient atmospheric noise (assuming signal received is above atmospheric noise) to mask receiver input noise for optimum reception efficiency.

This, the principle criterion used

in the basic PNA (passive network array) design, has been recognized for years. However, little effort appears to have been expended so far in the area of actually applying this criterion to produce a practical antenna.

Antenna Size vs Noise—Small antenna size (8-feet wide by 12-feet high) is possible because of the intensity or amount of atmospheric and man-made noise in the h-f range. Atmospheric interference is propagated by the ionosphere in the same manner as radio transmission. A technical report published by the Navy concluded: "The commonly accepted receiver-antenna design criterion is that the antenna should be long enough to collect sufficient minimum atmospheric noise to exceed receiver noise. . . . The (system) signal-to-noise ratio will not be impaired if receiver noise is small compared to atmospheric noise. A 5-foot tuned antenna is satisfactory 100 percent of the time . . . over the 0.5 to 30-Mc band, for a nominal field intensity of $1 \mu\text{V}/\text{meter}$."¹

Other investigators also reported similar conclusions, recommending small antennas for h-f receiving applications.² PNA design, using this basic criterion, limits overall size to that which effectively satisfies necessary system signal-to-noise requirements using a receiver with a maximum noise figure of 10 db. (A statistical reliability of 90 percent and a geographical location within a noise grade of 2 or higher are assumed.)^{3,4}

Theory—The PNA (patent pending) is an end-fire couplet array consisting of two closely spaced end-loaded dipole elements with currents of equal amplitude having a relative phase difference equal to 180 degrees minus the dipole spacing in electrical degrees. The spacing between the elements in electrical degrees varies from approximately 6 degrees at 2 Mc to 90 degrees at 30 Mc. Although the physical length of the dipole elements is only 12 feet, an electrical length of approximately 25 feet is achieved by the effect of the 1-foot radius end-loading disks. The super-gain principle is used to achieve the degree of directivity gain realized from the small aperture employed.⁵ Figure 1 shows the basic electrical 'hook-up' of the PNA antenna. Both elements are fed or driven by the transmission line. A normal two-element array can be made to exhibit good directivity and a high front-to-back only over a relatively narrow bandwidth, that is, 10 percent, largely because of certain undesirable currents which tend to flow through the feeder circuit. These currents are the result of the mutual coupling between the two elements; the value of the current is a function of what is termed the mutual impedance. The effect of the mutual currents is to make the feed point impedance of one element different from the other element in a manner which varies with frequency. A hybrid combines two separate signal inputs into a single output while maintaining a high isolation between the two inputs. As used in the feed system of this array,

FIBER GLASS 20-foot mast supports an 8-foot wide by 12-foot high array

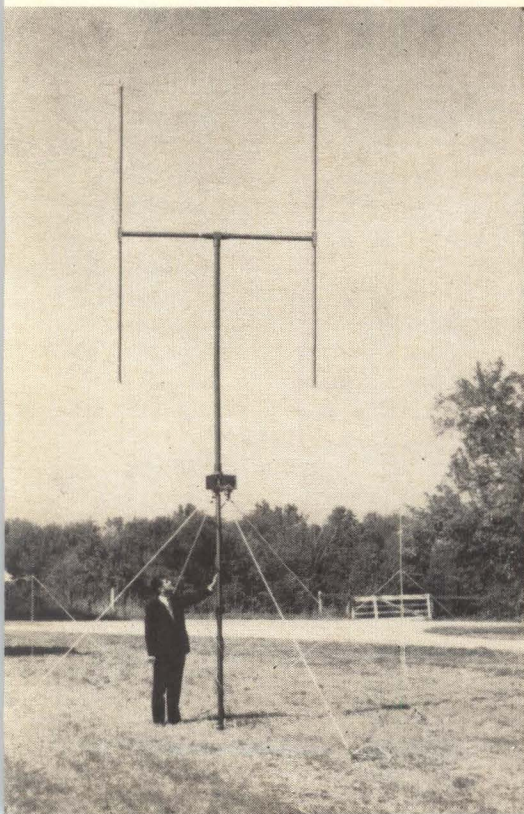

DAVID VS GOLIATH

This small rotatable antenna is said to offer major advantages over larger fixed-azimuth antennas in that it not only allows the operator to null-out both interfering signals and noise, but also provides the same coverage over the 2 to 30-Mc h-f range as a rosette of four log-periodic monopole antennas, requiring a 130-foot tower and some four acres for installation

it suppresses mutual-current flow and allows wide-band operation. The hybrid, in conjunction with two matched broadband baluns, forms the essential passive circuit of this antenna.

Construction—The balun uses a multiturn bifilar winding on a high permeability toroidal core. The winding yields an impedance transfer of 4:1 with a balanced input and an unbalanced output (300 to 75 ohms). Each antenna requires an identical pair of baluns. This pair must have exactly the same vswr, phase, insertion loss, and balance ratio characteristics as a function of frequency over the entire 2 to 30-Mc range. The baluns must also exhibit characteristics that fall within narrow tolerance limits for all the parameters. The difficulty of the pair selection problem has been reduced, by at least an order of magnitude, by the design of special test equipment permitting rapid differential-type balun comparison.

The hybrid circuit yields equal conjugate impedances, high isolation, low input vswr, and low insertion loss. Both baluns and hybrids are potted in a low-loss epoxy compound.

The phase delay line used consists of a length of 75-ohm Teflon coaxial cable (RG-140/U) packaged as a coil sealed in a tubular container to assure mechanical rigidity and electrical stability. The magnetic field insulators are small diameter, high permeability, cylindrical cores having a length of approximately one inch. The insula-

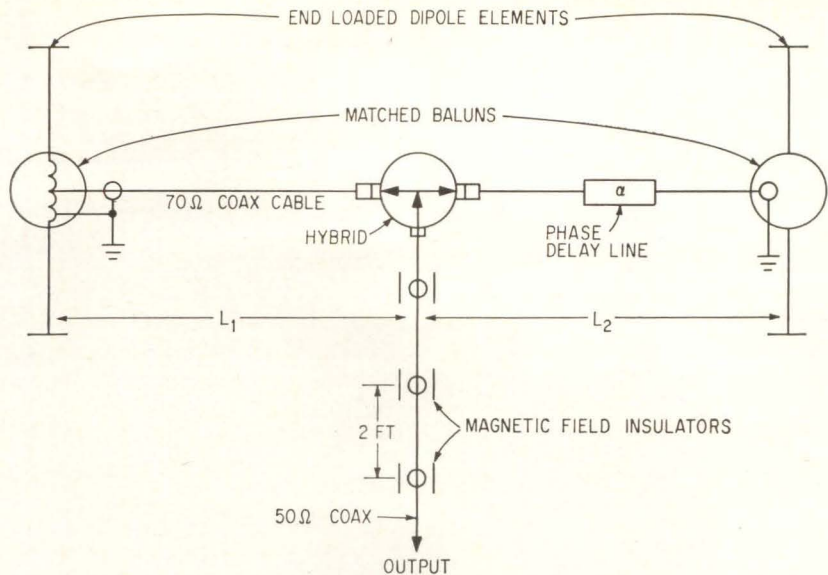

BASIC electrical hook-up of the passive network array antenna—Fig. 1

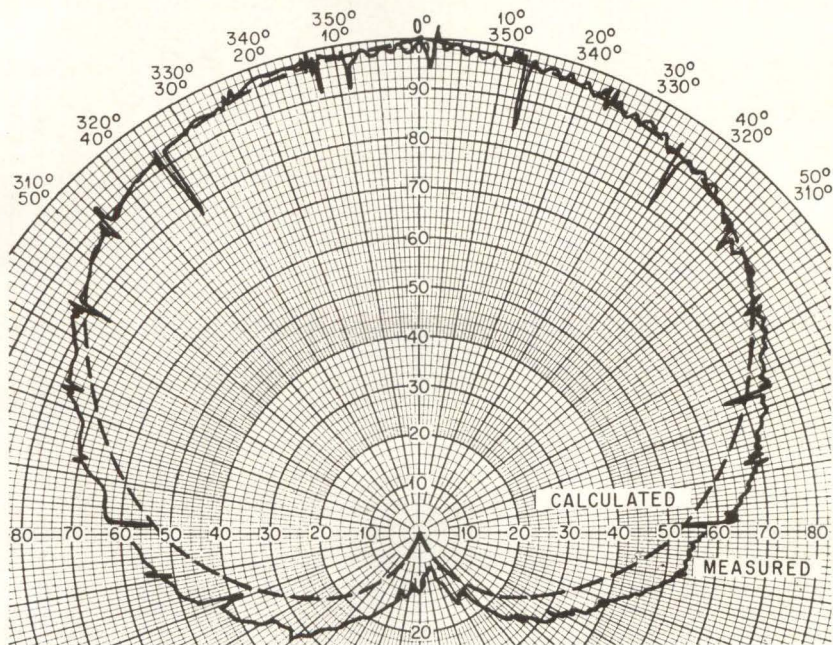

CALCULATED and measured patterns plotted for 10-Mc frequency—Fig. 2

tors are arranged concentrically along the outside of the coax and make no electrical contact with the outer or inner conductor. Each core acts as a lossy one-turn magnetic loop, effectively preventing the magnetic component of any electromagnetic wave from propagating further along the outside of the coax.

To preserve symmetry within the antenna system, it is necessary to use an insulated support mast at the center of the antenna that is approximately 10 feet in length. The PNA uses a glass-fiber mast for support, and the magnetic-field decoupling devices are evenly positioned at intervals of approximately 2 feet along the length of the top

section of coaxial feed line.

Without tight tolerances on the matched baluns and the hybrid the design of a practical array would be impossible without compromising overall performance — particularly front-to-back ratio.

Performance — Measured patterns under actual field conditions over a 7-mile range using the carrier of NBS station WWV at 2.5, 5, 10, 15, 20, 25, and 30 Mc indicated a minimum front-to-back ratio of approximately 15 db. Measured patterns are in very close agreement with theory. Based on $f_s = \cos [(S^\circ/2) \cos \phi + (a/2)]$ where: S° equals the spacing in electrical

degrees between the elements and a equals the phase shift between the currents in the elements, the calculated H-plane pattern is shown in Fig. 2 for a spacing of 30 degrees and a phase shift of 150 degrees. For comparison, the measured pattern for the same parameters (corresponding to a frequency of 10 Mc) is also shown.

The free-space directivity gain of the antenna above an isotropic varies from over 6 db at 2 Mc to approximately 5 db at 30 Mc. The exact theoretical gain was calculated at 2 Mc based on the expression $r\theta\phi = \frac{1}{2} \sin \theta (1 + \sin \theta \cos \phi)$ which describes the shape of the antenna pattern in spherical coordinates. Using the expression

$$G_{db} = 10 \log \left[4\pi / \int_0^{2\pi} \int_0^\pi r^2 \theta_\phi \sin \theta d\theta d\phi \right]$$

integration over the entire sphere yielded a free-space gain of 6.35 db above an isotropic. Over a perfectly conducting ground, the antenna gain would increase by approximately 3 db at 2 Mc and 6 db at 30 Mc above an isotropic. Thus, a system gain of from 9 to 11 db is realized over the entire h-f range. This is nearly the same as a log-periodic monopole array having an alpha angle of 30 degrees with a height of 123 feet and a length of 210 feet. Note that the gain of a vertical dipole element above ground can realize a gain of as much as 3.5 db above a vertical monopole element.⁶

Since the antenna is designed only for receiving it is necessary to define the equivalent vswr or mismatch for reception only. The system loss due to the mismatch between the self-impedance of the dipole elements and the impedance at the balun input to the array feed network has been accounted for and included in the absolute gain calculation and measurement. The most meaningful vswr or mismatch rating should therefore include the entire feed network and transmission line harness.

The maximum vswr of the entire array, measured at either balun input, was found to be better than 1.3:1 over the 2 to 30-Mc range with antenna output terminated in a 50-ohm load. This low vswr is essential to achieving a high front-to-back ratio and uniformly high directivity gain over the entire operating frequency range.

The effectiveness of the antenna in the presence of atmospheric noise is illustrated in Fig. 3. The value of thermal noise (KTB) corresponding to a temperature of 290 deg is normalized to 0 db. The equivalent input noise of a receiver having a noise figure (NF) of 6 db is shown as being 4.7 db above KTB ($NF_{db} = 10 \log 1 + t_r/t_o$ where $t_r =$ temperature of receiver and $t_o = 300$ deg). The curve of rms atmospheric noise power available at the output terminals of the PNA-2A system is shown as varying from + 3.5 db at 2 Mc to a peak of 21.4 db at approximately 15 Mc to just over 4.7

db at 30 Mc (bottom curve).

However, a more meaningful parameter for practical applications is the level of average atmospheric noise peaks, which is shown in the curve just above the rms power curve.⁷ The design of the antenna has been optimized in relation to efficiency so that the average-peak-atmospheric-noise-to-receiver-input-noise ratio is essentially constant at 20 db over the 2 to 30 Mc frequency range. The top curve depicts the amplitude of signals received by the array based on "Minimum Required Incident Field Intensity to Assure Radio Telephone Communication 90% of the Time in the Presence of Atmospheric and Cosmic Noise."⁴ The small effective capture area of the PNA-2A, calculated and measured as being 61 db less than that of an isotropic radiator at 2 Mc, is offset by the high intensity of average peak atmospheric noise, 83 db above KTB at the terminals of an isotropic radiator.

In actual use, the directivity gain of the array is most evident in improving the signal-to-noise ratio of weak signals as compared to an omnidirectional, vertically polarized reference antenna. The system has been successfully used to determine the general direction of arrival of atmospheric noise at frequencies as low as 2 Mc.

Other Designs—The basic design may be considered a building block for more elaborate designs. Examples would be: a four-element end-fire array using two PNA antennas arrayed in a plane and fed 180 degrees out of phase; a monopole version above a ground plane for fixed-station applications; or a large circularly disposed array or Wullenweber array using the basic PNA design as an element.

REFERENCES

- (1) J. H. Raleigh, 'Design of Receiver Antenna Systems, Considering Noise Limitations,' U. S. Navy Electronics Laboratory Report 166, p. 18, Apr. 1950.
- (2) Jasik, *et al.*, 'Antenna Engineering Handbook,' p 19-2, par. 19-1, McGraw-Hill, New York, 1961.
- (3) Crichlow, Smith, Morton, Corliss, 'Worldwide Radio Noise Levels Expected in the Frequency Band 10 Kilocycles to 100 Megacycles,' NBS Circular 557, U. S. Dept. of Comm., Aug. 1955.
- (4) "Ionospheric Radio Propagation," NBS Circular 462, U. S. Dept. of Comm., June 1948.
- (5) Schelkunoff, "Antennas, Theory and Practice", page 195, John Wiley & Sons, New York, 1952.
- (6) Schelkunoff, 'Antennas, Theory and Practice,' pp 187 & 188, John Wiley & Sons, New York, 1952.
- (7) 'Reference Data for Radio Engineers,' 4th Ed., International Telephone & Telegraph Corp., New York.

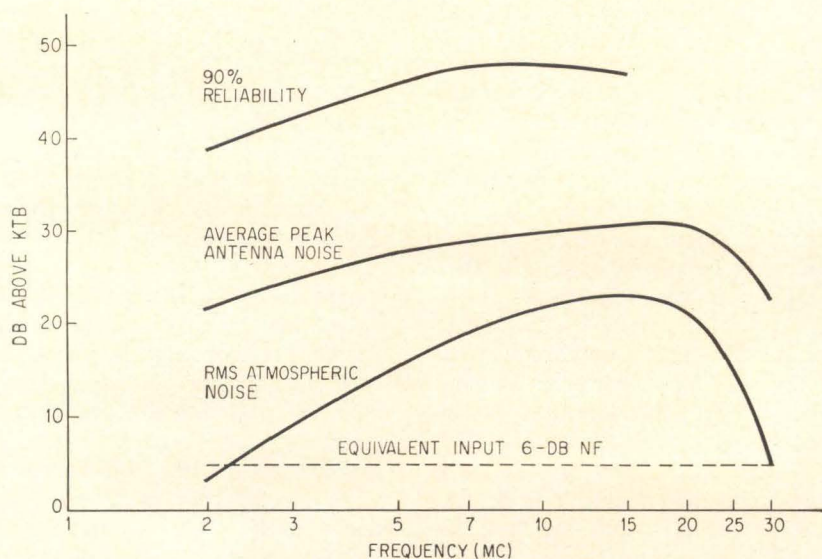

EFFECTIVENESS of antenna in the presence of atmospheric noise—Fig. 3

NEW DIRECTIONS: 1963 1964 1967

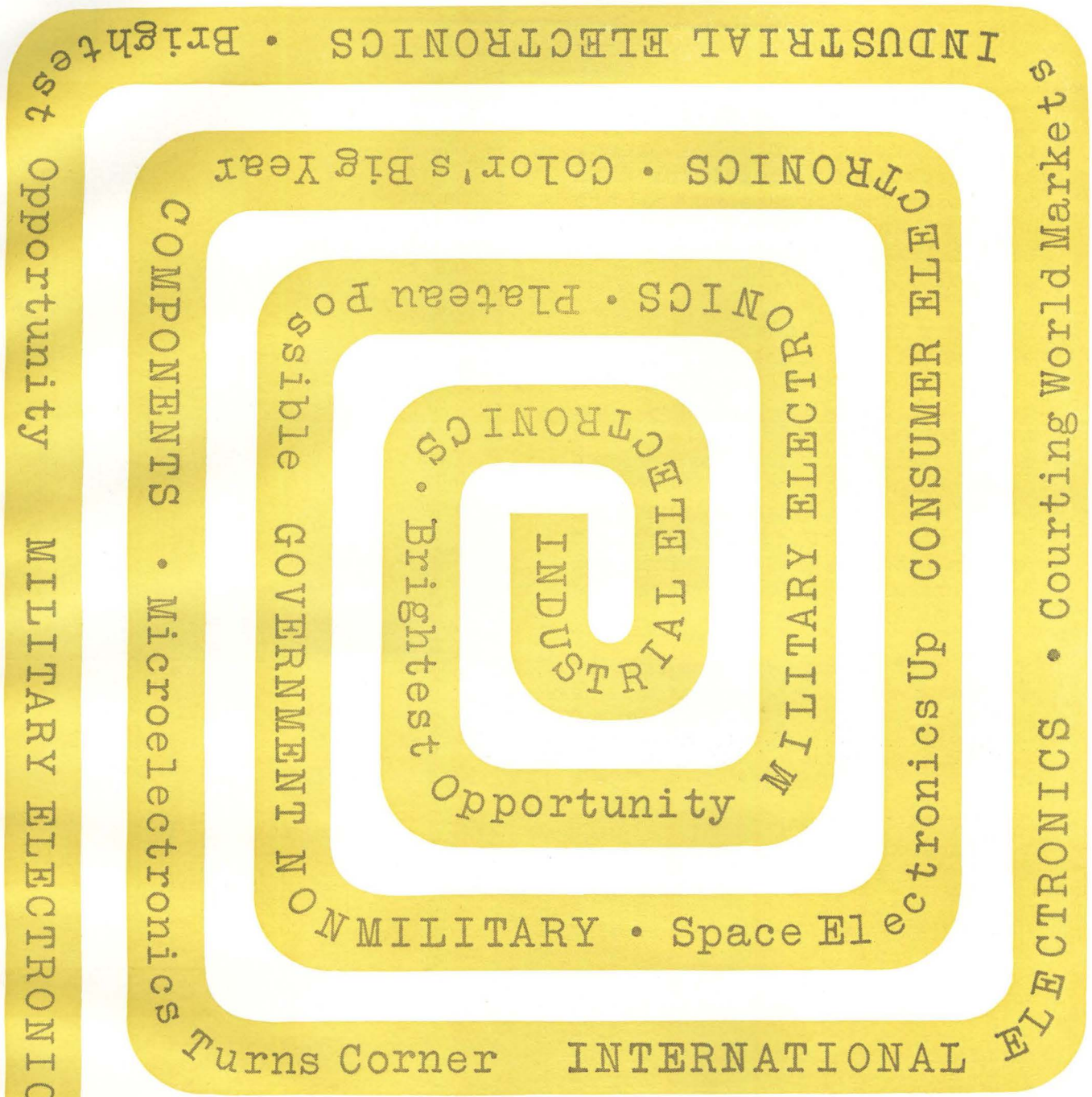

ELECTRONICS MARKETS

By LEON H. DULBERGER, Associate Editor

JOEL STRASSER, Assistant Editor

JOHN M. CARROLL, Managing Editor



REPRINTS AVAILABLE
SEE READER SERVICE CARD

© copyright 1964 **electronics**® A MCGRAW-HILL WEEKLY

INTRODUCTION

- *Industrial and commercial electronics are bright sales areas. Communications, computers, data reduction and process control are pace setters. Medical electronics will attract increasing commercial attention.
- *Military spending continues at a high level, but slackening in some areas is evident. Command and control, limited warfare, and aviation electronics will receive major funding. Most government and industrial experts hope for at least a plateau in spending this year, but expect a possible decline after that. Research and development funding may be the first to reveal this trend.
- *Space electronics spending is increasing with equipment for ground support, telemetering and tracking among the largest markets.
- *Consumer electronics will see a rising year, with color tv the big money maker. Inexpensive small-screen b & w sets will imprint a new pattern of sales on the industry.
- *Manufacturing overcapacity in components will cause dropouts of manufacturers in various conventional-component markets. Micro-electronics will make major technical advances and take on increasing commercial importance.
- *International opportunities, and domestic competition in the electronics industry, will draw more U.S. firms deeper into world trade, seeking markets now served by foreign manufacturers.

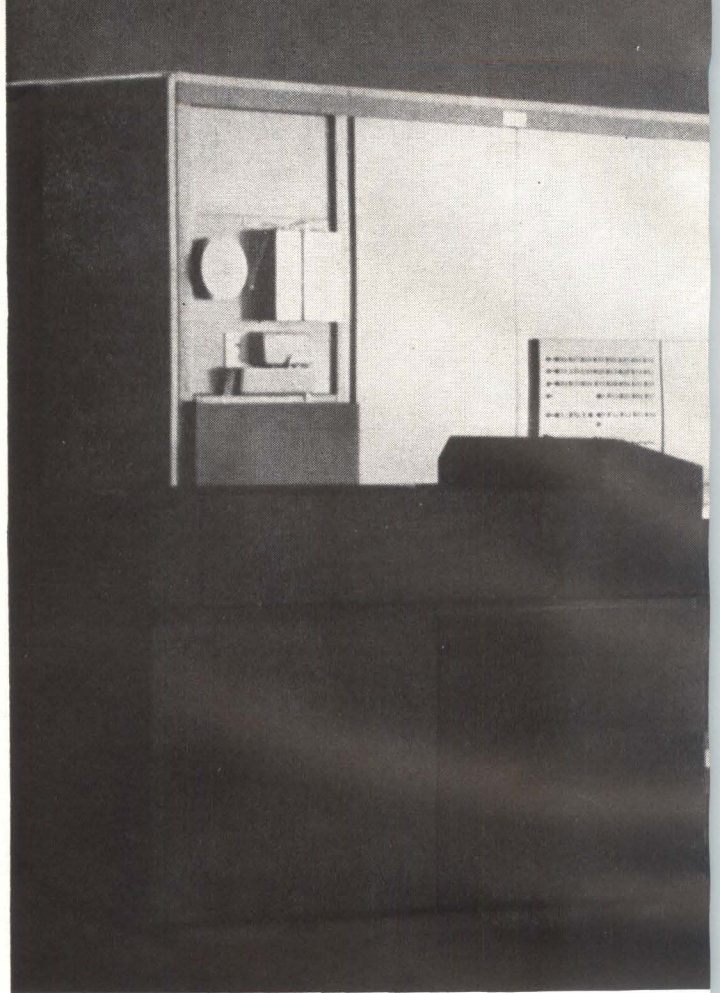

INDUSTRIAL

ELECTRONICS MARKETS **Brightest**

INDUSTRIAL OPPORTUNITIES—The attractive profit margin in industrial electronic products is inducing many firms to concentrate more of their operations in this area. However, it's becoming one of keen competition. Slackening of military spending is driving many electronics firms that serve the military primarily, into industrial operations. The often limited profit possible on military contracts is providing an additional fillip. Some experts predict that in time, more firms will be attempting to serve industrial customers than will be required. They point out that the concept that there are a host of industrial and commercial markets awaiting exploitation by the electronics industry, is a largely platitudinous one, which neglects to consider the finite limits of the requirements of various portions of these markets. Most agree that firms must uncover areas that have been relatively untapped until now—but more important, they must actually create new needs to bring into being markets that have not existed until technology and marketing created them.

Selling industrial equipment and systems requires that firms show an economic advantage over competitors, not



HYBRID COMPUTER developed by Electronic Associates, Inc., performs both analog and digital operations. Inclusion of digital aids in analog computers is emerging trend in large-scale simulation systems

ELECTRONICS

Opportunity

always a factor in dealing with the military. Designing for best possible performance is required in military contracting, and elaborate engineering is used. Such procedures are too expensive for industrial products where customers look for simple engineering solutions with attendant monetary savings.

According to Robert B. Liepold, Vice President and General Manager of Automatic Electric Sales Corp., a unit of GT&E, there will be a fall out of equipment and systems firms now operating in industrial electronics. Firms will require better and more sophisticated engineering practices in the future, and an effective marketing organization able to go into the field and sell. Success here will require improved advertising, market research, product planning, line selling effort and staff engineering support. Liepold also predicts that many of the huge multidivision electrical-electronics firms, will begin to operate heavily in industrial electronics.

Experts feel that many of the big airframe manufacturers are planning to enter the electronics field on a large scale. They also hold that foreign competition for U.S.

industrial and commercial electronics markets will further challenge the profitable operation of domestic firms in the future. It is suggested by many international marketing experts that U. S. firms should seek to operate on an international basis if at all feasible, thus offsetting the problems created by purely domestic manufacturing and sales practices.

An example of the range of problems to be overcome in civilian sales is given by Lawrence J. Straw, Marketing Vice President for Sylvania Electronic Systems, a unit of GT&E. He points out that companies like his own that have extensive and long-term experience in consumer and industrial products, will maintain their advantage in the coming competition for nonmilitary business. The firm also expects to maintain profitable growth in their military and space operations due to continued application of commercial business techniques to government program management. Mr. Straw looks to fierce competition among firms that will attempt to operate in the commercial and industrial market of the future. Conversion from military to commercial operations will present problems to many

firms. While some of these difficulties will be unforeseen, others can be readily identified. These include achieving effective management, distribution, advertising, technical recruitment, and economical use of facilities. This last may require loft-like operations with basic facilities, in contrast to the sometimes ornate buildings of some firms selling to the military.

Among the most promising industrial electronics market areas for the future are communications of all kinds, computers and their applications, data processing including information storage and retrieval, instruments for test and measurement, process control, medical electronics, and laser machining.

COMMUNICATIONS—Most industry observers feel that communications, in the broadest sense, represents the segment of the electronics industry which holds the greatest potential for growth. There will be continued effort to advance satellite communications to practical, everyday operations. This will require solving political and international difficulties. Some observers note that the major market resulting for electronics will not be in orbiting equipment but in ground facilities.

The largest market for two-way mobile radio is to taxicab fleets, with several firms now participating. Selling practices are highly competitive, and some firms have lost money in taxi radio operations. Two-way radios for construction site use, railroad operations, and a plethora of other uses are expected to grow.

Data communications, linking computers and business machines, represents an important future market. Development and sales of interface equipment, to couple business machines to existing wire and microwave facilities will continue to gain impetus.

One of the most promising new markets for television is in the educational field. Educators are still resolving their preferences for either local school service—or statewide (or regional) coverage using long lines and microwave. Right now more money is being spent for statewide systems, and by 1965 it is expected this will become the dominant format. General Electric Co. has supplied cameras, transmitters, antennas and other equipment for Alabama's statewide educational system. A market for additional studio equipment to make educational video tapes is expected to emerge with the growth of educational tv.

Specialized applications for closed-circuit tv include use in psychological clinical studies and applications in medical schools. Security systems using closed-circuit tv are gaining popularity, with many banks installing equipment to forestall robbery.

Electronically controlled telephone exchanges using solid-state devices for control and dry-reed switches for the cross points of the system will find increasingly greater application in the future.

LASER COMMUNICATIONS—Use of the laser for commercial communications continues to receive attention. Many feel the laser may find its greatest commercial application here. During the past year, progress has been made in laser modulation and demodulation. The extremely high information-carrying capability of the laser underlines its appeal for communications. Application of the laser to intercity communications awaits its commercial advantage over existing wire and microwave systems. It may require a heavy rate of future information traffic to achieve this turnover. In linking cities with laser communications, a pressurized pipe may be used to exclude fog and dust. Known as a surveyed system, it would employ mirrors at turns, perhaps with servo systems to maintain alignment. Beam spreading may require

recombination with image intensifiers or amplifying lasers used as repeaters.

Injection electroluminescent devices are under study for communications systems and show promise. Both coherent and noncoherent devices are being considered, with several experimental systems already tested.

DATA PROCESSING—One of the highest growth rates in the electronics industry will be experienced in data processing. It will expand on an interplant, and an intra-plant basis. Information storage and retrieval will gain along with this upsurge, though some experts question whether heavy expenditures for information storage and retrieval development by some firms will pay off. New methods for storage of bulk material will be offered, and thin-film memories will appear in new computers as well as high speed ferrite memories.

PROCESS CONTROL—The process industries are making greater use of the analog computer than in the past. They are used where control of multivariable inputs and multivariable outputs are required. The analog computer provides continuous and dynamic control of processes, instead of inspecting set points and then applying corrections, as is done with digital control. Often though, in process work, digital computers are basically data loggers, and a man makes the correction to the system. Digital computer control is expensive and may be too slow. Additionally, analog computers are now smaller and more reliable than in the past, both factors helping them to gain acceptance.

To make process control and telemetering sales, firms will have to take the systems approach more often in the future. Thus in a gas pipe line they will be required to do the systems engineering consisting of microwave communications, computers and most other elements.

ANALOG COMPUTERS—The market for analog computers of all types is growing rapidly. Included are large-scale simulation systems, small-scale—generally desktop—instruments, and process-control computers. The large-scale instruments are used for simulation in aerospace, electronics and process industries, as well as government research operations. These computers now have digital logic and memory functions built into them to permit high-precision solutions of problems which could not formerly be solved with pure analog computers. An example is the space-age requirement for long-term integration of altitudes from a few feet to thousands of miles. The resulting hybrid computers now solve a broad range of simulation problems which could not be handled with straight analog or digital computers.

According to Robert L. Yeager, Manager, Computer Product Sales, Electronic Associates, Inc., one of the most significant trends in the analog computer field is the use of small machines in colleges and universities. Over the last four to five years over a thousand small-scale analog computers have gone to government, military and universities, indicating that more people are learning to use analog machines. The ones going into universities are being integrated into the curricula. This will have the effect of training more engineers to express systems mathematically and put them on computers for design solutions. It will satisfy the need to get away from basic handbook designs.

DIGITAL COMPUTERS—One of the fastest growing markets in dollar volume is digital computers. The field is still led by IBM, which holds the major portion of the market. Computers are being applied to a kaleidoscopic variety of new tasks, and many firms are expanding their sales and programming operations to sell to the new

markets. However, few firms in this field operate at a profit, though most hope that when income from leasing rolls in through the years, that may change.

Applications for computers abound, ranging from book-keeping operations for all manner of business such as accounting and payroll through more esoteric uses, such as employing a recorded vocabulary to reply vocally to a Wall Street's query for a stock quote. Applications of computers to PERT-like scheduling in industry and government are gaining. Computers are helping advertising men select media, farmers in their agrarian planning pursuits, medical researchers in treatment planning, and engineers and scientists in a broad spectrum of endeavors.

INSTRUMENTS—The instrument market is attracting much attention, and there are a flood of new instruments appearing. Those which are designed to serve a specialized research need are expected to do particularly well, in part due to the government's increasing attention to research.

The trend begun last year of requiring increased accuracy in test and measuring instruments is moving ahead even faster this year. In test and measuring instruments such as voltmeters, signal generators and similar equipment, along with improved accuracy, new designs now employ solid-state components such as transistors and optical choppers as a matter of practice. This is possible through the lowering of component prices, and reflects a desire to achieve increased reliability. Solid-state components produce less heat and operate with less power. No moving parts are required; as for example in use of mechanical choppers compared to optical choppers.

Laboratory standards are an even bigger market this year than last, with smaller firms as well as large prime contractors now having to up-grade their lab standards facilities and techniques.

Along with the need for increased measurement accuracy there is a growing shortage of skilled technicians able to make these measurements. Data obtained and recorded must be done by knowledgeable, technically trained personnel. Human engineering and automation of test equipment will help here, but cannot solve the problem.

According to Emil G. Nichols, Director of Planning at Weston Instrument and Electronics Div., Daystrom Inc., within the general area of indicating panel meters two distinct classes of instruments are evolving. The first is a class of measuring instruments designed for increased accuracy, resolution, stability, and repeatability. All four requirements must be met to satisfy the general concept of accuracy as broadly understood in the industry. The second class of indicating panel meters is designed for relative readings—go, no-go; level of battery charge—without reading in absolute values. However, reliability is of high importance, while at the same time inexpensive meters are demanded.

MEDICAL ELECTRONICS—The largest market for medical electronics today is still in the area of x-ray equipment. Though many tasks are discussed for electronics to aid the medical profession, volume applications gain momentum slowly as physicians spell out their needs and equipment is developed and field tested. Many electronics firms facing the slackening expenditures on military electronics have declared themselves anxious to turn to medical electronics products. There are indications that keen competition for this market will result.

Among the areas receiving heavy attention are patient monitoring facilities for post-operation recovery rooms with many firms developing equipment and techniques. Some feel that in time this will be a large market. Development of prosthetic devices, such as artificial limbs which

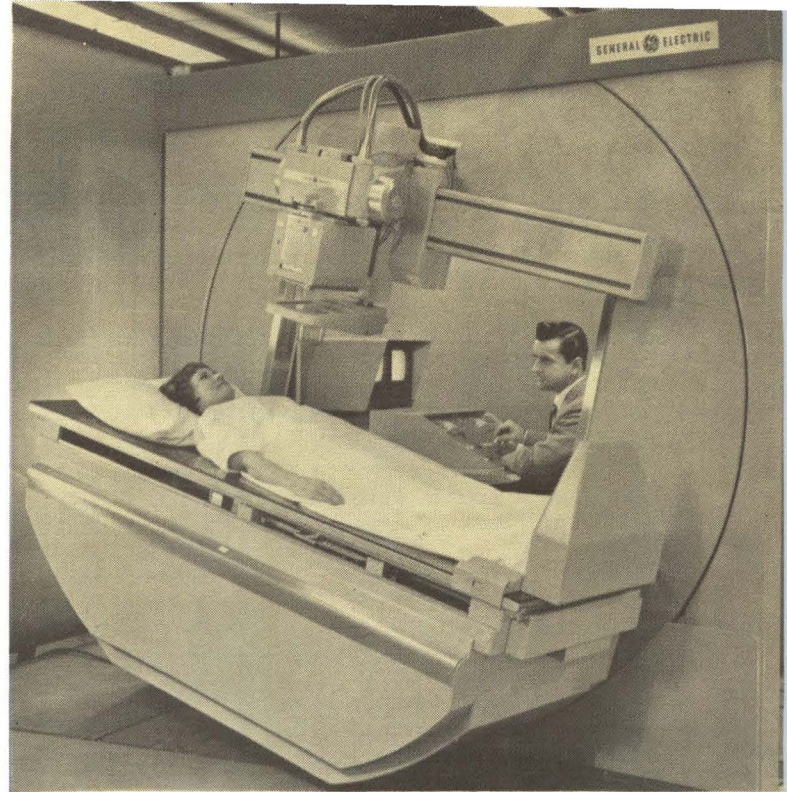

REMOTE POSITIONING of patient is provided in GE fluoroscope system. Instrument uses closed circuit tv to intensify image, and present it for study by radiologist in shielded viewing area. Cine recordings are made if desired

LASER CUTTING of extremely hard tantalum metal. Hughes ruby laser pierces metal sheet in under one thousandth of a second

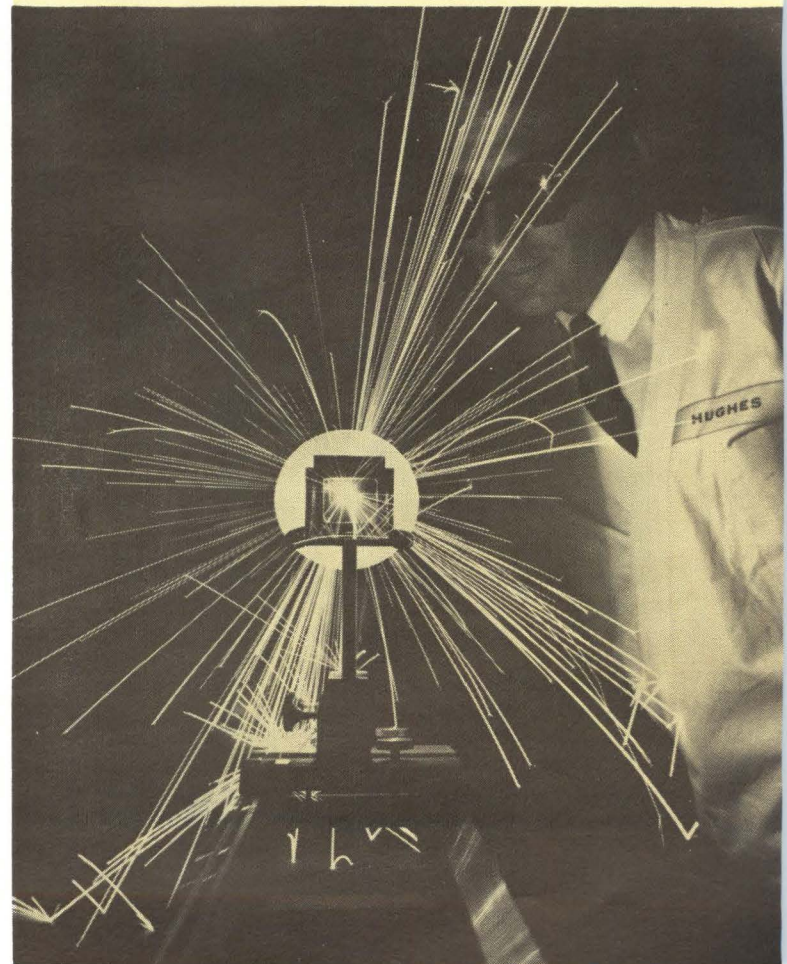

are controlled by servo amplifiers tied to body muscle signal voltages are receiving attention.

Medical electronics will gain from advances in microelectronics—in prosthetic devices for the most part, and also in diagnostic devices. It may prove possible to place sensors in artificial fingers, making them capable of detecting temperature and position, as well as obtaining motion by tie-in to muscle voltage.

Diagnostic techniques using infrared sensors are receiving much attention, but it has been pointed out by experts that practical application awaits further research.

Extensive research is being carried out to develop the laser as a practical medical device. Experiments on the eye, where the laser is employed as a precise surgical tool used to weld retinas, have been carried out. The laser beam also appears to be useful in treating diseased human tissues.

There is commercial interest in a class of medical instruments designed to induce sleep in humans. By application of controlled currents to the brain, and without surgery being required, what appears to be true sleep has been induced in humans. Transistor operated instruments are manufactured right now for this use. It may be that such instruments will eventually lead to reduced slumber time requirements in humans under certain con-

ditions. Another application for this class of instruments may be in treatment of certain mental and related physical disorders, where treatment is aided by induced sleep.

Work on developing surgical anesthesia techniques using electrical currents is being carried out, and shows promise. Instruments used for these studies include transistor constant-current generators and have proven effective on animals.

LASER MACHINING—High volume applications of lasers for welding and machining operations are about five years away. This is considered by most experts to be the area of greatest promise for industrial application of the laser. The device will find favor in the cutting of refractory metals. High precision machining and welding will eventually be done best by lasers. Many jobs now done with electron beam welding could be handled with the laser, and without the requirement of operating in a vacuum. Most of the high power lasers used for these tasks employ Q-spoiling techniques to increase the peak power of the laser, for a given amount of available energy.

ADAPTIVE TRAINING—A new technique now under study in the field of teaching machines is that of adapt-

ARMY TESTS field radio, one of a series developed by RCA. Transmitter-receiver uses micromodule packaging technique, similar to sample displayed in inset



ive training. The concept may prove useful in teaching motor skills such as eye-hand coordination. Adaptive training techniques may be employed in the design of simulators, such as one intended to teach flight control of helicopters. In an adaptive trainer, special internal circuits are used to automatically change the difficulty of the task being learned, depending on the student's learning rate. Dr. Edwin Hudson, head of Human Factors at Otis' Defense and Industrial Div., points out that in learning initial stages of complex skills, adaptive learning techniques may prove invaluable, saving both time and money. He suggests that adaptive learning machines may be useful as a selection tool, to indicate how fast a potential trainee may learn. Still under study, adaptive training is regarded as a potentially efficacious technique, which if successful could lead to its use in simulators by 1965.

ADAPTIVE TRAINER which automatically adjusts to efficiency level of the operator, is a new teaching machine concept under study. Internal circuits in this Otis Defense and Industrial Div. system, speed learning of motor skills by adjusting difficulty of positioning spot on oscilloscope

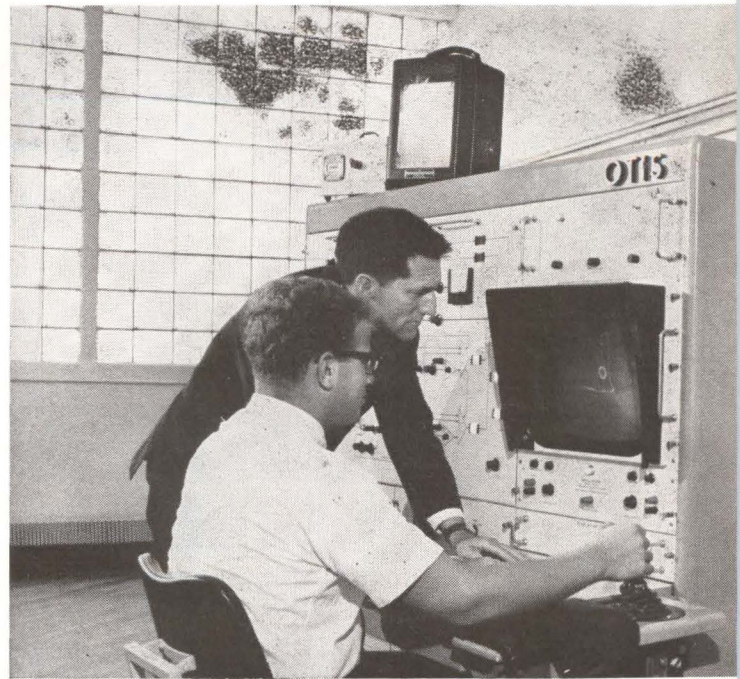

MILITARY ELECTRONICS

ELECTRONICS MARKETS Plateau Possible

MILITARY FUNDING—The electronics industry in recent years has found the major portion of its market in sales of military products and services. The upward trend of military electronics procurement, and research and development, appears to be at an end. And during the coming year, most experts predict a slackening of military expenditures for electronics, primarily in research and development.

The dominant planning factor in sales to the military, is geopolitics. Any significant change in the international situation, reflects itself in military spending. The hoped for easing of cold war tensions, or sudden hot war conditions, can wreck attempts at forecasting future military electronics markets. Additionally, a change in the Administration, or a shift in its policies will also distort market predictions. Barring these uncertainties a trend to leveling military electronic equipment and systems procurement for this year is clearly defined. Money spent for operations and maintenance will go up in the future. Spending for military research, development, test and evaluation, will go down after the coming year, and may slacken this year.

However, observers note that announcement before year's end of a major military weapon system, using extensive electronics is possible. This too, may alter the military marketing picture. Additionally, it may be that money already appropriated for existing military projects,

but not released, will be released to contractors later this year, offsetting slackening military expenditures.

Future money spent for exotic electronic research and development activities by the military will be distributed even more carefully than in the past.

Efforts by the government to channel military R&D efforts into nonmilitary endeavors is an observed trend. However, some observers feel that for reasons of maintaining the general defense posture of the nation, military spending will not go down in the next few years, and that only a beginning effort will be made to reduce spending after that time.

COMMAND AND CONTROL—Within the category of military command and control is found the broadest framework of opportunities for future electronics sales to the military. Included are communications, data processing and display. The most important single market for high volume sales of equipment and services to the military is for communications, in the broadest sense. Included are all modes of communications, radio and wire, analog and digital, speech and data. Right now extensive procurement, and research and development efforts for military global communications are being advanced. Specialized communications for limited-warfare operations are of continuing high importance.

The requirements of modern warfare demands com-

mand and control capabilities stretching from global strategic systems through small tactical systems. Ability to couple the highest priority government directives into a command and control network which filters down to local field military operations is required.

COMMUNICATIONS—The market for communications equipment for all three armed services is growing. Army is particularly well funded. The service demands equipment to satisfy its increasing mobility, and quick reaction time capability. They also require a smooth transition in all operations, should a small war grow to a larger one. Reliable field operation without need for field engineering, even when the equipment is first placed in service, is also a requisite. Additionally, the service's communications must operate in a time frame of seconds, compared to commercial practices of hours or even days. The jungle environment, that Army is often forced to operate in, places stringent demands on equipment. A means of penetrating the presently radio-opaque tropical vegetation is sought. New techniques for over the horizon communications are desired. Use of repeaters, such as satellites, or balloons are possibilities here.

LIMITED WARFARE—The second largest market for military electronics lies in the area of equipment to satisfy the needs of limited warfare. Major funding will go to the Army, to increase its capability in brushfire war. DoD is anxious to see microelectronics techniques employed in equipment designed for this application.

Robert J. Brown, General Manager of Defense Programs Operation, General Electric Co., suggests that the weapon system approach be applied to man, to aid him in penetrating defenses and carrying out his mission. The weapon-system technique used with aircraft has produced outstanding results. Brown suggests that many of the major disciplines in electronics, such as bioelectronics, sensory electronics, and human engineering can be applied to man to make him a more effective weapon system. Determining man's intrinsic needs in a military field situation is the key to long range planning in this area. The great number of men can lead to a healthy market for successful firms.

Surveillance techniques which include a great variety of sensors are receiving heavy attention. These include photographic, infrared, radar and low light level systems. In radar, for example, more effective moving target identification is sought as well as other means to help determine the military significance of a target, such as examination of surface texture.

AVIATION ELECTRONICS—High performance military aircraft for limited warfare and broader scale operations is creating an important market for avionics, for all three services. Again, the growing needs of Army and increased funding to that service provides an important market. Army aviation is being developed to transport troops into enemy territory, and armed with offensive weapons is an important program. Aircraft electronics requirements include identification equipment, more effective air navigation systems, as well as communications advances. Electronics for the Air Force-Navy TFX aircraft now in development will use present state-of-the-art electronics now, go to microelectronics in later versions. Evolving V/STOL aircraft demands advanced electronics. The next generation manned bomber which Air Force proposes requires extensive electronics also.

MISSILES—Updating of Minuteman and Polaris are continuing, but represent a limited future market. Titan III may represent a big opportunity for microelectronics companies, however.

Two possible future missile projects are the mobile medium range ballistic missile and an antimissile defense system based on Nike-X. The MMRBM is intended for targets roughly 2,000 miles from the launch point. Possible ship deployment of MMRBM's under NATO control is being considered. A go-ahead on this missile could result in heavy electronics funding. However, a decision in favor of the medium range missile might eliminate a next-generation manned bomber.

The Nike-X system is an outgrowth of Army's Nike-Zeus and would probably be used for point defense of military and civilian targets rather than blanket national protection. It would incorporate a short range missile, Sprint, as well as the Nike-Zeus. Right now, development work on the system is under way, but production and deployment await future government decisions.

MILITARY AIRCRAFT—Development of a next-generation manned bomber is still advocated by Air Force. They see important advantages in the option to recall a bomber, which is under continuous human control compared to ICBM's which drive on inexorably to a target. A manned bomber may gain favor because discrimination techniques will not advance quickly enough to permit determination of the mission of suspect objects in space, or the atmosphere, within the 15 minutes required by the ICBM philosophy. Right now three XB-70 supersonic aircraft are in prototype development, but prospects of flight testing remains uncertain. Other variations of a next generation manned bomber include a craft designed to operate at very low altitudes at target areas, thus come in under enemy radar, after high altitude approach. Another craft, designed for extended loitering ability is also under study. Development work on one of these versions appears probable, based on latest DoD attitudes toward them.

The development of supersonic military transports seems fairly definite. Their creation would also serve to advance this country's position in the international commercial air transport market.

MILITARY SPACE—Spending for military space electronics will continue roughly at its present level, until DoD sees definite future system needs beyond present communications and navigation systems. An important forthcoming space effort will be Air Force's manned orbiting space laboratory. It will be carried out in cooperation with NASA with the space agency paying Air Force for desired experiments. Military use of a space station could include early warning systems, communications, weather prediction and ballistic missile defense. Manned flight of the Air Force orbiting laboratory by 1967 is considered possible. The project is intended to provide data on man's military usefulness in space. A modified Gemini will be attached to the manned orbiting laboratory during launch. A Titan III will lift the laboratory into orbit.

Some military planners believe a manned space interceptor is needed to assure the nation's security. The craft would take off from earth, carry out its mission in space, such as inspecting or destroying a hostile satellite, and return to a controlled earth landing.

Armament of the manned spacecraft would include rockets. A more favorable climate toward development of such a weapon system is expected by some market planners.

ANTISUBMARINE WARFARE—Navy continues to depend heavily on sonar for surveillance and weapon system control in ASW operations. However, the number of sonars needed is limited and up-dating of equipment, such as higher power transducers, deep dip sonars,



ANTISUBMARINE DUTIES may evolve for a class of hydrofoil boats designed to "fly" above the surface at speeds over 100 knots. Boeing developed this craft, which uses electronic stabilization of submerged foils



NAVY'S NUCLEAR powered aircraft carrier, **Enterprise**. Electronic scan radar including rows of diagonal bars, encircle a portion of the island. Other radar, communications, and navigation gear bristles from the control center

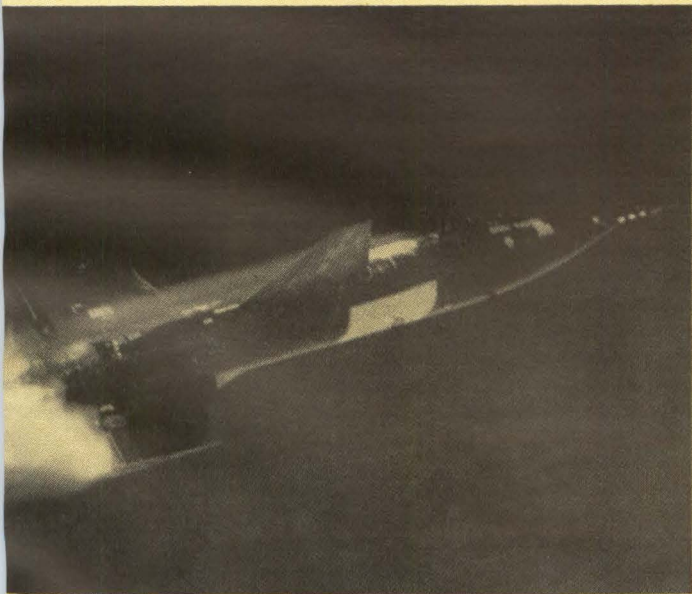

ROCKET PLANE X-15 under full power. Air Force craft is holder of many speed and altitude records continues to gather data on high altitude flight and reentry heating problems

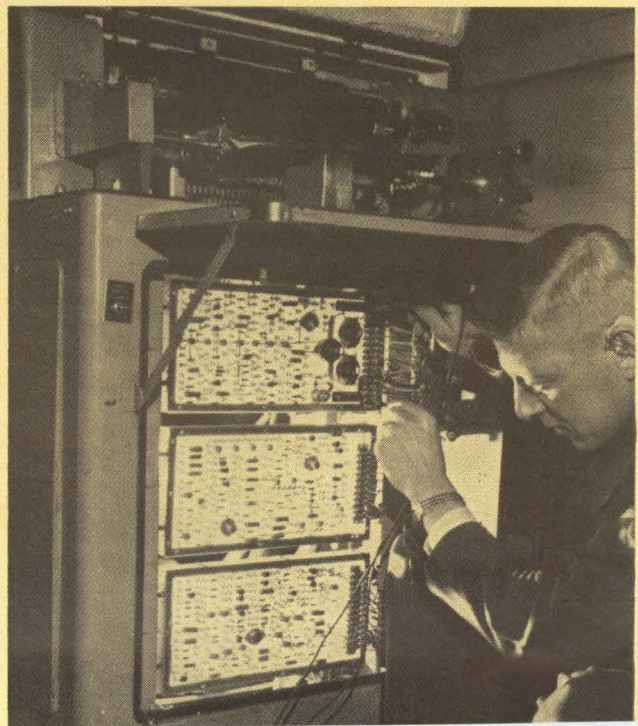

HIGH SPEED printer is part of mobile digital computer system developed by Sylvania for Army. Data processing support of maintenance items is provided with system, evolved under technical direction of Army

and more sensitive receivers, is not expected to provide an important new market. Increasing use of magnetic anomaly detectors which record changes in the earth's magnetic field for target pinpointing and discrimination purposes, is expected. Use of higher sensitivity MAD equipment such as proton free precession magnetometers is under study.

A brand new submarine detection technique must be discovered to produce a sudden change in the ASW marketing picture. Much effort is being expended here by Navy. Possible new techniques include temperature measurement of the water's surface with airborne infrared equipment to detect the heat imparted by a submarine's passage. Inspection of dead microbiological life may be possible using ultraviolet techniques to reveal bioluminescence. Measurement of: radioactivity in water caused by an atomic sub, generation of voltage produced by dissimilar metals in sea water, nature-generated lightning which penetrates water, and reflection of high intensity light in water, may all be under study as possible means of detecting submarines.

Much effort will be expanded to develop greater knowledge of the ocean medium as an aid to ASW system development and operations.

Navy will use microelectronics in future ASW equipment. This will permit including more and varied equipment within the space limits of a single aircraft or vessel.

Mine detection equipment may not achieve volume

status because in modern warfare, the airlifting of troops and supplies may preclude the need for some mine-sweeping operations.

ASW ATTACK SYSTEMS—Navy looks to development of extremely long range torpedoes, able to destroy submarines at any depth. The SUBROC format may be used, which employs a rocket fired by a submerged submarine that reenters the water to attack enemy subs. The slower airborne weapon system using helicopters guided by radio are finding qualified acceptance.

Use of aircraft carriers as control centers for ASW operations is producing greater emphasis on integrated command systems for these vessels. Advanced data processing systems and possible use of communications satellites are expected for future ASW carriers.

Navy is testing hydrofoil boats designed to fly with their hulls above the surface at over 100 knots for possible ASW service. Navy would outfit these craft with advanced ASW weapons and electronics, for tracking and destroying high speed submarines. Extensive electronic stabilization systems are used with the craft in the foil borne mode. Various electronic sensors provide information on roll, pitch, heave-rate, altitude and other parameters, which are fed to amplifiers that operate control surfaces on the submerged foils. A larger ocean-going hydrofoil boat is also under development by Navy, and it too requires electronic stabilization. A class of hydrofoil



GOVERNMENT NONMILITARY

ELECTRONICS MARKETS Space Electronics Up

CIVILIAN SPACE—The electronic portion of NASA's fiscal 1964 budget of roughly \$5 billion, will be of the order of \$2 billion. Of this expenditure, the greatest segment will be spent for electronics used on the ground. Within areas of NASA space effort it is estimated that forty to sixty percent of a booster's cost is for electronics, while roughly seventy percent of the money spent for space craft is for electronics. The latter reaches eighty percent if batteries are included. Approximately ninety percent of the money spent for ground tracking and data acquisition is for electronics. This includes ground-support equipment such as pre-launch instrumentation.

The largest amount of electronics spending will go to the Apollo project, which extends through this decade. Included are instrumentation for the spacecraft and Saturn booster, plus additional tracking and data facilities. Apollo requires a new mission center, additional tracking stations, more tracking ships, and new instrumentation at the launch area. Some boosters have as many as two thousand instrumentation points requiring

standard test equipment and specialized test instrumentation. Government space efforts will see increased emphasis on electronic component reliability. Albert J. Kelley, Director, Electronics and Control, NASA, points out that this need is based largely on NASA's requirements for a high single shot probability of success. He looks for more attention to qualification and test of individual components to help achieve the agency's goals.

Right now, in-being equipment and components are often used for space efforts, including ground systems, but in the late sixties a new market for equipment designed for the space environment will evolve. When a high volume of space shots are reached, equipment designed for a given task rather than adaptations will be a must. Components and technology which are up to the state-of-the-art will be demanded by NASA.

NASA will join the DoD in the manned space station project planned for the Air Force. Gemini will also see combined military efforts.

Some industry spokesmen feel that the market for space is for people and not equipment. There is a feeling

amphibious landing boats using electronic stabilization is under development for the Marines.

LASER RANGING—Short-range laser ranging units will become a large volume item with the military. Lightweight units capable of a high degree of accuracy and able to penetrate fog better than standard optical instruments will find broad use. The high intensity light possible with a laser can be many times that of the sun for a given bandwidth, and aids in piercing fog and smoke. Army is evaluating one-man portable laser ranging units with digital readout, right now.

Secure communications using laser light beams are of interest for battlefield use. However, submillimeter systems may be pre-eminent for secure communications, because they attenuate rapidly, as well as provide a narrow beamwidth, and are not subject to attenuation by fog or smoke.

OPTICAL DEVICES—Locating a camouflaged enemy under brushfire war conditions is creating a demand for ir systems that sweep an area to reveal hot spots. Flash detectors to record battlefield flashes, perhaps using a low-level tv detector, computer and display, could become a mass produced item for front-line use by observers. There is continuing need for efficient low-light-level night-driving equipment for Army.

The possibility of developing military antipersonnel or

antimateriel weapons using high energy light, sound or other format remains an important prospect. The high intensity laser beam which has many times demonstrated steel plate piercing ability is much discussed. Possible application to anti-ICBM systems designed to destroy re-entering warheads is not precluded by military electronics experts. High energy ultrasonic beams are also being discussed as a possible antipersonnel weapon.

Some observers feel that a satellite discrimination network will eventually come into being. Passive and active detection will be used to aid in determining a satellite's mission. The ability to tell that a single satellite has suddenly proliferated a hundred additional units could signal a dangerous action.

PHASE-SCAN RADAR—The technique of inertialess scanning and beam forming without mechanical techniques will find major application in multipurpose radars. An example is radar able to search and track a number of targets simultaneously. However, when a single task is to be performed, a moving dish antenna is cheaper and will be chosen for this reason.

Side-looking radar for airborne surveillance use, employing synthetic aperture antennas, will be a high volume market. Computer techniques are used to produce a continuous map during reconnaissance. Forward-looking airborne radar using side-looking techniques is being developed for Army.

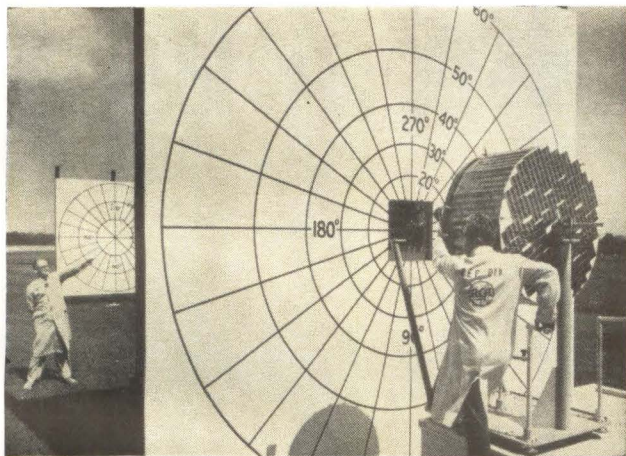

TIROS METEOROLOGICAL SATELLITE is prepared for orbit at RCA. Television cameras are adjusted for focus and field of view using large targets

that space electronics will not begin to take up the slack in military electronic spending. They also point out that one communications space satellite replaces many ground repeaters, and a single weather satellite may replace many weather stations now in operation. However, the command and control market required to operate remote stations, correlate and transfer data, is increased.

FEDERAL AVIATION ADMINISTRATION—The upcoming era of supersonic commercial transports will probably lead FAA to develop extensive electronics systems to meet the complex needs of supersonic flight operations. Areas where activity will be directed include

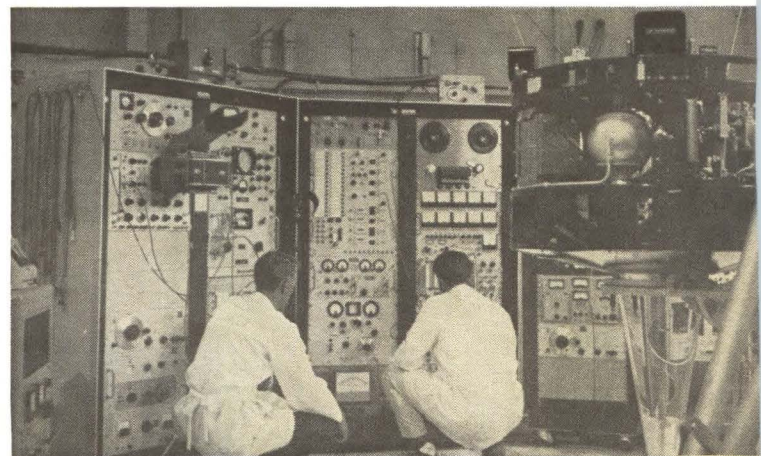

COMMUNICATIONS SATELLITE designed for synchronous earth orbit undergoes test at NASA. Hughes-designed active repeater will hover in space as relay station

creation of an all weather landing system to assure passenger safety and airline profits. Right now, at subsonic velocities, aircraft detouring beyond fogged-in airports represents an economic strain. At supersonic speeds this problem could not be borne. Advances in electronic altimeters to afford precision altitude measurement seems certain. Improvements over present readout technique, such as digital formats, are considered desirable.

A complete, well organized, air traffic control system for supersonic flight is a must. Reliance on altitudes reported by radiotelephone is already an obsolete technique. Greater reliability as well as speed of operations will be needed. SLATE, or equipment of similar format will be developed, to automatically respond with flight

identification and altitude. Ground radar, which also provides altitude information, perhaps in digital form, appears to be desirable.

When V/STOL aircraft come into being for commercial aviation, the air traffic control problem will take on formidable proportions. The ability to maneuver in another dimension rapidly will see military-like command and control systems developed for commercial VTOL aviation.

NUCLEAR ELECTRONICS—Continued building of nuclear reactors, for university research and commercial power generation, provides an unflagging market for nuclear electronic controls. The SNAP series of nuclear electric power generators for space, and possible military use, also requires electronic controls. Test instrumentation will continue to expand with the production of nuclear equipment of all types. The test ban treaty which restricts atomic testing to underground facilities, is providing a stimulus for increased electronic instrumentation to advance this nation's ability to detect underground tests.

RADAR ALTI-METER under development at Sperry Gyroscope operates in C band. Instrument uses f-m technique to obtain aircraft altitude at low levels within accuracy of 2 feet

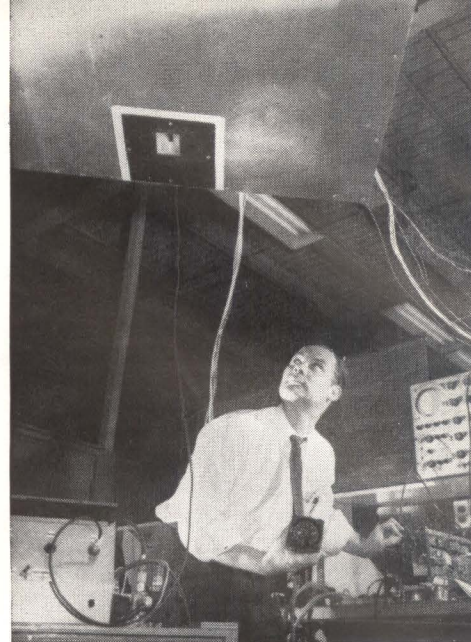

CONSUMER ELECTRONICS

ELECTRONICS MARKETS Color's Big Year

COLOR TELEVISION—The outlook for consumer electronics during the coming year is bright, with sales of color television receivers leading the uptrend. Roughly 1.4 million color sets will be built by the end of 1964, with a million or somewhat more sold by year's end. Several firms are now producing color tubes, and also the special yoke required. However, the number of sets that receiver manufacturers would like to produce, will be limited by the supply of components, primarily the color tube. As technical experience is gained, tube makers will increase their production. Some price cutting of receivers has begun, but stable prices for most of the year are expected. The addition of more programming by the networks, and a healthy financial climate are combining with consumer enthusiasm for color tv, to force sales up. Good profits are expected by color tv set manufacturers, and sales of color sets represent a chance to make money for the first time in a long time in the tv receiver industry.

Black and white television sales for the year may go down in total, but healthy new product trends are developing. Personal, portable receivers are finding acceptance by the consumer, the low cost providing a fillip to sales. Manufacturers see a pattern developing of several b & w sets sold to each family. General Electric's portable 11 inch receiver is an example of a set produced to satisfy this trend.

Tiny portable television receivers, using transistors and able to operate from battery packs, are selling well. The sets, with screens down to 4½ inches, are produced primarily by foreign manufacturers.

ALL CHANNEL TV—Edgar Messing, Vice President of F. W. Sickles Division of General Instrument Corp. points out that a big change in the entertainment picture lies in the required production of all-channel tv sets starting May 1, with the resultant impact on uhf broadcast

station growth. The fact that the new sets will be able to receive all 82 channels could be a stimulant to set sales. Messing observes that the use of separate uhf tuners with various forms of control linkage to the vhf tuner will be the major design during 1964 and probably most of the following year.

Automobiles are selling well, and another good year for auto radios is expected. Semiconductor devices are finding increased use in automobile electrical systems. An example is transistor-operated ignition. High-volume use of transistor ignition probably awaits a price comparable with conventional ignition systems.

The more expensive types of high-fidelity equipment are beginning to use transistors. This represents one of the first major applications of the device to the home entertainment field. The often cited advantages of smaller size and less heat are among the reasons for increased use in hi-fi systems, though snob appeal may have something to do with it.

Small table model radios are also beginning to use transistors to a greater extent.

Increased f-m stereo broadcasting services are providing sales gains for stereo radios.

In the amateur radio (ham) market, single sideband is finding increased application, with gear designed for this form of modulation selling well. Transceivers for mobile and fixed applications are in favor. Vhf and uhf operations for short distance communications are expanding.

Sales of microwave electronic ovens for use in restaurants and other commercial operations are an important new market, with rising sales. Use of these ovens in homes however, has not become prevalent.

FUTURE MARKETS—The leveling off of military spending, and possible decline in the future, is sparking interest in consumer products by military electronics firms. While it is considered a wise move to gain capability in consumer products, experts point out the limited size of the market at present, and domestic and international competition now and in the future. Another factor is the discovery by researchers that man has spent roughly the same portion of his income for entertainment during recent times. Decades ago it may have been stereopticons and pianos, today it may be tv and electronic organs, but the total is roughly the same. An important goal is to find new entertainment concepts to gain a larger portion of the wage earner's income. With the free time that modern technology is making available to man, certain to increase in the future, electronics is considered to have a glowing opportunity to capitalize on the need to avert boredom.

THEATER TELEVISION—Color television projection for possible use in nationwide closed-circuit theater hook-ups appears to have a bright future. Several firms may be producing this equipment; and sales on an international basis are possible. Experts feel that by 1966 the color tv theater projection industry will be an important one. Operating in existing theatres, it would permit broadcasting live theater and cultural events from major cities to small towns. It would allow the viewer to dress up and go to the theater in his home town, perhaps watching a Broadway opening as it occurs on the boards, considered an important psychological factor which will contribute to the format's success. Alternately, video tapes of special performances of live shows may be routed to theaters through film distributors. General Electric Corporation has a theater projection system called Talaria, a color light valve projector. Two projection output beams project three primary colors on the theater screen, to produce a full color image. The firm is selling the equipment overseas, as well as to the domestic market.



COLOR PICTURE TUBES move along conveyor at RCA plant. Glare-proof windows are bonded to face in this operation

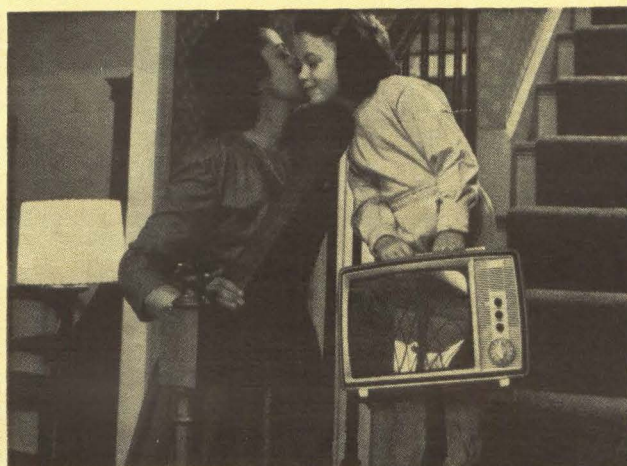

PORTABLE TV SET with 11 inch screen, by General Electric, is representative of inexpensive receivers gaining favor. The tv industry looks to a new pattern of b & w set sales, with several sets to a family becoming the norm

UHF TUNER for all channel television receiver coverage is aligned by technician. Transistor-operated designs, such as this General Instrument Corp. unit, are creating a new market for semiconductors





COMPONENTS

ELECTRONICS MARKETS Microelectronics Turns Corner

COMPONENT COMPETITION—The electronic component industry will continue to see a reduction in the number of firms, with pressure on marginal suppliers. Intense domestic competition and growing foreign imports continues to reduce profits for some items. More component firms will accept merger situations or other failure-avoidance arrangements.

Advances in microelectronic techniques are occurring rapidly, with the military, government agencies, and the electronic industry itself, showing extraordinary interest in the emerging technology.

Right now, the requirements of military and space electronics are providing a market for microminiature component packaging techniques. An example of such high density packaging is Cordwood. As thin-film and integrated semiconductor circuits advance in application, use of discrete components will fall off. However, hybrid techniques combining discrete components, such as inductors and capacitors, with microelectronics, will continue. Circuit techniques to eliminate inductors and capacitors in microelectronics are being researched. These include negative capacity, R-C phase shifting, and digital approaches.

NEW INDUSTRY—Microelectronics may prove as devastating to the transistor as the transistor was to the vacuum tube. However, a new industry using semiconductor active elements will emerge, employing the same personnel and to an extent the same plants formerly used to make transistors.

With the continuing emphasis on limited warfare electronics, microelectronics will be an important factor in the military. Electronic equipment designed for the foot soldier would gain from the minuscule construction possible with these techniques. A fair portion of the

equipment designed for the foot soldier will employ microelectronics in 3 to 4 years.

Some immunity against foreign component competition in the industry will be provided by microelectronics because considerable custom building and a close relationship between equipment builder and supplier is required.

SEMICONDUCTORS—Lowering prices of silicon devices and their intrinsically desirable technical characteristics promise to give them a dominant market position over germanium devices. Integrated circuits will probably still be subordinate to single semiconductor devices, even by 1970. A handful of large firms will dominate the single device industry, plus a few specialists. Industrial applications for high power semiconductors are growing rapidly. Transistors, diodes and SCR's are finding application in industrial controls, automotive systems, and household appliances.

Sales of special-purpose vacuum tubes should continue at a healthy level, with the market for traveling wave tubes growing. Twt's are needed for broad band communication systems. Megawatt twt's find application in phased array radar. Magnetrons and klystrons will continue to be sold at a healthy level. However, profits on sales of military special-purpose tubes in general continues to shrink, as government competitive bidding practices force down the price of these components.

Heaterless vacuum tubes, able to operate without filaments, are under development by several firms. Techniques include efforts to take advantage of the tunneling effect in the cathode. Heaterless tubes would drastically reduce power requirements and permit more accurate control of tube parameters in production. Tubes as small as transistors could be built, and would have the added advantage of affording high input impedance axiomatic



INTERNATIONAL ELECTRONICS

ELECTRONICS MARKETS Courting World Markets

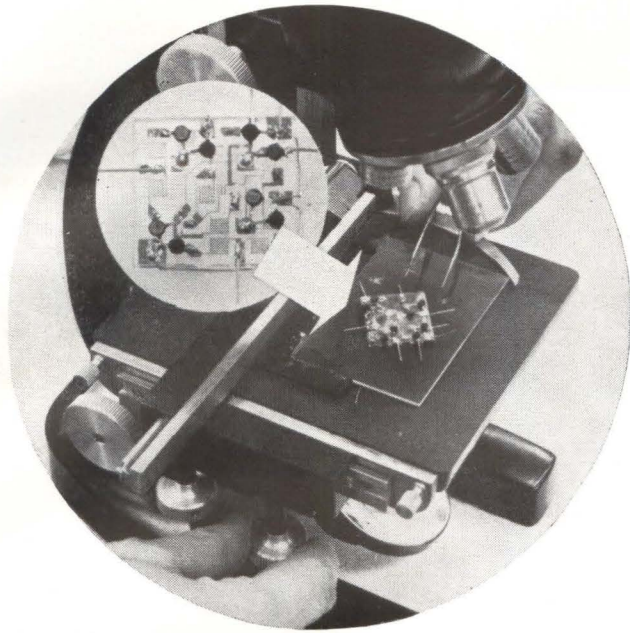

THIN-FILM resistors are used in General Instrument Corp. eight transistor logic circuit (inset) shown undergoing microscopic study

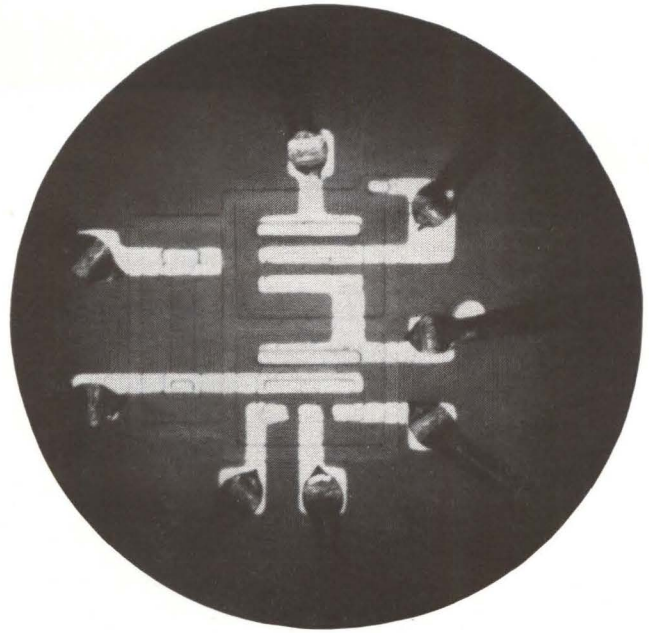

INTEGRATED CIRCUIT built on a silicon chip no larger than a transistor chip. Sylvania circuit forms logic gate that replaces four diodes, a transistor, and a resistor

cally. However, production applications are not expected for some time.

COLOR PICTURE TUBES—Several firms will produce color tv tubes this year to meet the heavy demands of receiver manufacturers. Well over one million tubes will be built in 1964, with RCA turning out from 800,000 to one million tubes. Some new color tube manufacturers are experiencing production problems but most look forward to a profit by the year's end. Unlike black and white picture tubes where the glass envelope is the major expense, technical labor is the greatest expenditure in color tubes. For economic and technical reasons the 70 degree tube will be standard for 1964, with a 90 degree rectangular appearing toward the end of the year.

Extensive uses for coherent and noncoherent injection electro-luminescent devices, are expected. Tom Bray of GE's Electronics Laboratory observes that computers

using light emitting diodes show promise. Advantages would include high speed and inherent electrical decoupling. If such computers fulfill their promise field operation by 1970 is possible.

Electroluminescent displays are turning up in industry and the military at an increasing rate. Use of bar graph el instruments are gaining favor, with several firms in the field. A bar graph uses a series of tiny el strips which are excited progressively, to provide a vertical display, similar to the format of a mercury thermometer. A translator is used to convert digital or analog input information to the form required by the bar graph. Several bar graph instruments side by side can give comparative readings readily.

Alpha numeric, cold cathode, gas readout tubes are also finding favor. They employ several cathode segments to form characters, similar to the display format of el character displays.

GOING INTERNATIONAL—The fervid goal of an increasing number of U. S. electronic firms is to become truly international companies. They seek to capture a larger portion of the world market for electronics products. Growing competition within our domestic electronic industry, coupled with production overcapacity, is providing U. S. firms with the stimulus to pursue foreign markets aggressively. Increasing exports to this country, of electronic products—mostly consumer items—is providing further awareness of the need to go international.

The impressive advances in international electronic sales made by the Common Market countries, by Japan and the United Kingdom, are providing additional motivation to American firms. Many U. S. electronic companies have long been active in foreign markets, and a number

have operated plants overseas for years. These firms now seek to broaden and intensify their operations.

The traditional export department within a domestic firm is grossly inadequate today. It has become mandatory to create local manufacturing and sales operations, in, or near, the country that forms the major market for a product. As well as providing transportation and tariff advantages, the foreign manufacturing and sales operation is able to operate as a local firm. Staffing the company with managers who are nationals of the host country multiplies effectiveness of the operation. It permits an easy relationship with government officials and military leaders, wherein all share the same goals. The barrier of a different set of mores, and attendant language problems is broken. A firm maintaining a world network of manu-

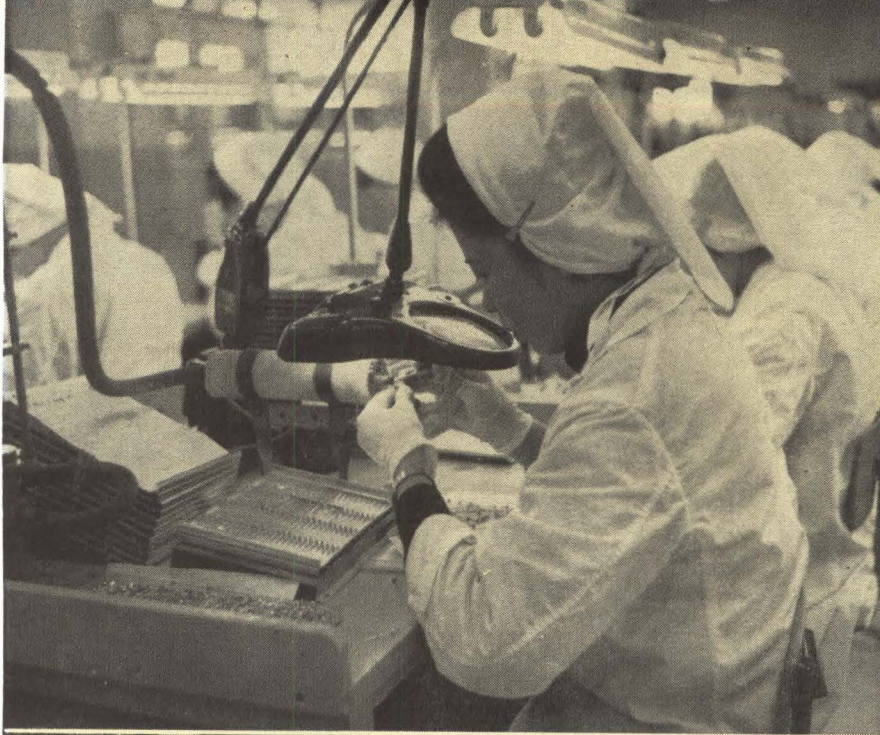

JAPANESE TRANSISTOR production supplies a large part of the world market. Tokyo Shibaura Electric Co. turns out 50 million transistors a year in air-conditioned factory



OVERSEAS MANUFACTURING plant of Leeds and Northrup Co. This subsidiary turns out electronic recorders, thermocouples and other equipment in Birmingham, England

facturing plants will produce a product in the country best suited for that operation, and sell it in the country that affords the best market.

These business concepts have long been the format of successful international business complexes, begun in Europe many years ago. They have been outstandingly successful in the electronics field.

Smaller American firms, operating exclusively in this country, are also seeking entree into foreign sales. For bantam sized companies, an exporting firm may be the only possible means of participating, though it is considered the least effective way. Smaller electronic companies are often preoccupied with survival, and may not be researching broader international sales concepts. One way for them to participate is to hire an international sales licensing firm to guide them in selling their U.S. produced products, and in making licensing agreements.

CONSUMER PRODUCTS—Because the military is the major customer, U.S. electronic firms have been pre-eminent in developing manufacturing techniques to serve it. This includes emphasis on high reliability of electronic products, complex engineering, and attention to evolving microelectronics techniques and sophisticated automation. Because the international market is largely one for consumer products, these techniques and this orientation will be of limited immediate usefulness. However, on a long term basis, the same technologies will assure this nation's leadership. Only by staying ahead of international

competition on a technical and manufacturing technique basis, can we hope to gain a greater share of foreign markets, many experts hold.

But foreign firms tend to copy our military and industrial electronic technology, thus undermine our lead.

Executives with international experience point out that foreign firms tend to gather generous amounts of technical information from American firms, largely by sophisticated probing techniques used in visits to our plants and talks with our engineers.

It is believed we should try to gain more technical information from European firms than has been our habit, using of course, ethical methods.

Experts advise the granting of licenses only where a market will not be lost as a result. Some firms will be less anxious to grant them in the future.

JAPAN—The Japanese electronic industry is expected to gain an even greater portion of the world market in the future. A key to this nation's success has been their willingness to please customers, rather than seek to force products on them.

The Japanese are beginning to concentrate more attention on producing industrial electronic products. Toshiba, for example, a leading exporter of consumer electronics items, is pressing ahead with a line of electronic medical instruments, including portable x-ray equipment. They are also producing process control equipment, but for use at home, right now.



ELECTRONICS MARKETS

BEHIND THE MARKET FORECAST

Forecasting the market for electronic products is far more difficult than forecasting the market for most commodities. This difficulty arises from the size, breadth, diversity and complexity of the electronics industry. Electronics is more than an industry. It is also a field of technology impinging upon many industries.

WHAT IS THE ELECTRONICS INDUSTRY?

Portions of the electronics industry may be found within several of the basic two-digit Standard Industrial Classifications (SIC) of the Dept. of Commerce. Electronics constitutes about 38.5 percent of classification 36—electrical machinery. It also represents about 14 percent of SIC 37—transportation equipment, mostly airborne electronics. Electronic computers make up about 1.5 percent of SIC 35—machinery, nonelectrical. Scientific and medical electronic instruments make up about 33.3 percent of SIC 38—instruments. Electronics, mostly missile guidance systems, makes up about 20 percent of SIC 19—ordnance; while electronic photographic devices and electronic organs constitute about 20 percent of SIC 39—miscellaneous manufacturing. The percentages are based on a detailed analysis of the 1958 Census of Manufacturers. They should be applied to "value added in manufacturing" totals rather than "value of shipments". This helps to avoid multiple counting of intra-industry sales.

PROBLEMS IN FORECASTING

The major problems in forecasting the market for electronic products are: definition of electronic products, handling intra-industry sales, measuring the Federal market, and identifying exports and imports.

The first specific problem in forecasting the electronics market is a definition of electronic products. ELECTRONICS magazine defines an electronic product as either (a) a piece of equipment that depends for its operation on the functioning of electron devices such as tubes and semiconductors or (b) a component or basic part used in the fabrication of such equipment.

Traditional reporting practices make it impossible to be altogether consistent in applying these rules. The tower of a broadcasting station would be counted as an electronic component; the building would not, nor would emergency generators or batteries. However, the figure for a military radar system might include vans, shelters and generators.

The machine bed, prime mover and cutters of an electronically controlled machine tool are excluded yet tape handlers, punched card, tape and typewriter inputs to a digital computer are in-

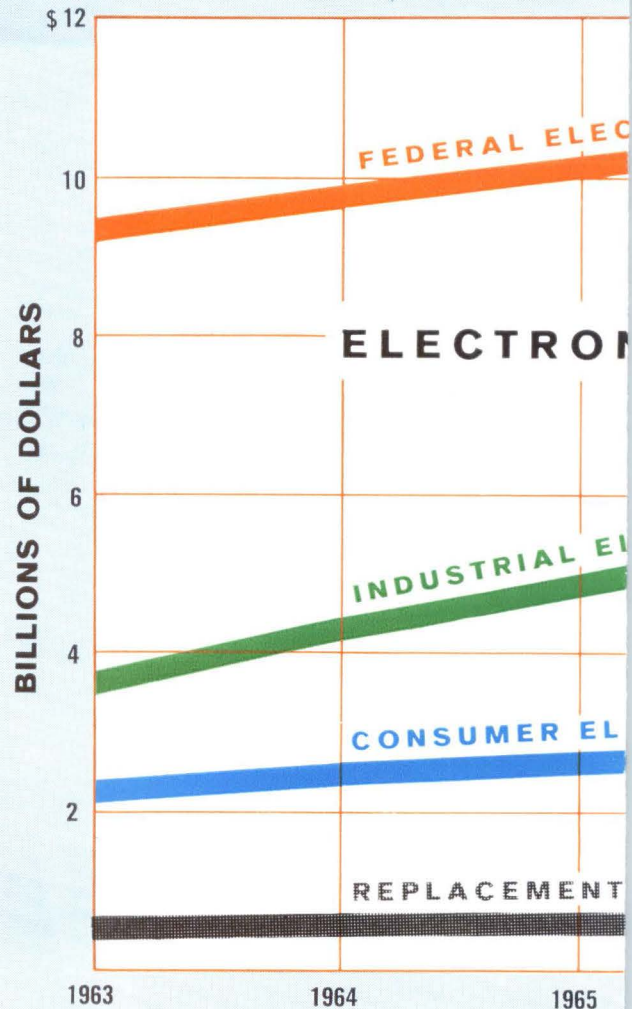

cluded. Sales of time and talent by broadcasting stations and common-carrier message tolls are not counted; however, sales of phonograph records and prerecorded tape are included.

Only the value of replacement parts is counted out of income arising from servicing of radio and tv sets, industrial and commercial equipment. Yet, the Operation and Maintenance figures and the Research Development, Test and Evaluation figures from the Department of Defense undoubtedly include sales of services as well as products.

The second major problem in measuring the market for electronic products is that of intra-industry sales. It has been said that a capacitor may be sold five times or more before it appears in an end product. This report is based on factory sales of original equipment and replacement components; rebuilt equipment and components and parts used in manufacturing are specifically excluded.

Nevertheless, it is impossible to avoid inadvertently counting certain items twice or even more. For example, a recording potentiometer may be counted when shipped from the factory and again after it has been built into an industrial-control console.

A related and even more difficult problem is measuring the Federal market. Spending by the Dept. of Defense and other agencies is estimated as a portion of Federal Budget categories. This technique is essential because reporters obviously cannot ask contractors how much radar, sonar or countermeasures equipment they shipped or will ship. However, many items bought by the Dept. of Defense, for example, replacement parts, test equipment and instruments, may be counted also among the "industrial" products shipped by manufacturers. Furthermore, Federal Budget figures may include costs that inflate the estimated value of military hardware above basic factory price.

PONENTS

| | 1963 | 1964 | 1967 |
|---|-----------------------|------------|------------|
| | (millions of dollars) | | |
| Electron Tubes Total | 886 | 872 | 822 |
| Receiving Tubes | 304 | 270 | 154 |
| Power & Special Purpose | 319 | 337 | 383 |
| High Vacuum | 71 | 74 | 82 |
| Gas & Vapor | 27 | 28 | 31 |
| Klystrons | 60 | 62 | 66 |
| Magnetrons | 39 | 38 | 37 |
| Traveling Wave Tubes (Incl. BWO) | 55 | 62 | 86 |
| Light Sensing | 20 | 22 | 26 |
| Storage, Light Emitting, Display | 30 | 33 | 36 |
| Other | 17 | 18 | 19 |
| TV Picture Tubes | 263 | 265 | 285 |
| Ferrite Devices | 17 | 19 | 23 |
| Filters | 45 | 53 | 66 |
| Loudspeakers | 65 | 66 | 68 |
| Magnetic Tape | 80 | 91 | 130 |
| Audio | 22 | 23 | 27 |
| Instrument | 52 | 61 | 92 |
| Video | 6 | 7 | 11 |
| Microwave Components (Less Tubes & Antennas) | 60 | 65 | 90 |
| Quartz Crystals | 27 | 34 | 46 |
| Resistors Total | 326 | 359 | 384 |
| Fixed | 172 | 190 | 186 |
| Composition | 65 | 74 | 69 |
| Carbon, Deposited | 29 | 28 | 22 |
| Metal Film | 25 | 34 | 43 |
| Wirewound | 53 | 54 | 52 |
| Variable (Potentiometers) | 128 | 140 | 163 |
| Nonwirewound | 44 | 45 | 50 |
| Wirewound | 84 | 95 | 113 |
| Attenuators, Meter Resistors | 8 | 9 | 10 |
| Other (Incl. Varistors & Thermistors) | 18 | 20 | 25 |

| | 1963 | 1964 | 1967 |
|--|-----------------------|------------|------------|
| | (millions of dollars) | | |
| Relays Total | 204 | 212 | 233 |
| Electromagnetic | 104 | 108 | 113 |
| Telephone Type | 33 | 34 | 36 |
| Crystal Can | 14 | 12 | 18 |
| Stepping | 13 | 13 | 13 |
| Thermal | 7 | 8 | 8 |
| Other (Dry Reed & Mercury Wetted; Motor Driven) | 33 | 37 | 45 |
| Semiconductors Total | 571 | 607 | 682 |
| Transistors | 305 | 317 | 320 |
| Silicon | 135 | 155 | 210 |
| Germanium | 170 | 162 | 110 |
| Diodes & Rectifiers | 188 | 198 | 233 |
| Silicon | 130 | 143 | 180 |
| Germanium | 39 | 37 | 35 |
| Selenium & Copper Oxide | 19 | 18 | 18 |
| Special Devices | 78 | 92 | 129 |
| Silicon Controlled | 21 | 30 | 59 |
| Microwave & Variable | | | |
| Capacitance Diodes | 9 | 11 | 13 |
| Tunnel Diodes | 2 | 2 | 2 |
| Light Sensitive | 13 | 14 | 15 |
| Voltage Reference & Regulator Diodes | 33 | 35 | 40 |
| Servos & Synchros Total | 65 | 67 | 62 |
| Resolvers | 7 | 7 | 6 |
| Gyros | 13 | 12 | 9 |
| Servo Motors | 16 | 16 | 15 |
| Synchros | 23 | 24 | 22 |
| Rate Generators | 3 | 4 | 5 |
| Motor Generators | 3 | 4 | 5 |
| Timing Devices | 60 | 69 | 82 |
| Transducers Total | 158 | 167 | 207 |
| Transformers & Reactors | 216 | 215 | 217 |
| Wire & Cable | 241 | 256 | 289 |

is the total of its subdivisions; all totals read upwards

TRONICS

| | 1963 | 1964 | 1967 |
|----------------------------------|-----------------------|------------|------------|
| | (millions of dollars) | | |
| 6,592 | 320 | 383 | 538 |
| Industrial Controls Total | | | |
| Induction & Dielectric Heating | 22 | 25 | 30 |
| Welding Controls | 20 | 22 | 30 |
| Industrial Rectifiers | 85 | 94 | 110 |
| Numerical Controls | 43 | 60 | 120 |
| Ultrasonics | 24 | 28 | 40 |
| Photoelectric Controls | 3 | 4 | 5 |
| Computer Control | 30 | 40 | 60 |
| Infrared | 25 | 29 | 41 |
| Temperature Controls | 9 | 10 | 12 |
| Other Process Controls | 59 | 71 | 90 |
| Closed Circuit TV Total | 25 | 26 | 39 |
| Industrial | 20 | 20 | 27 |
| Educational | 5 | 6 | 12 |
| Telemetry Equipment | 65 | 75 | 90 |
| Dictating Devices | 30 | 35 | 45 |
| Medical Equipment Total | 198 | 200 | 225 |
| Radioactive Tracer Equipment | 2 | 3 | 5 |
| X-Ray Equipment | 95 | 100 | 120 |
| Hearing Aids | 53 | 55 | 55 |
| Electrocardiographs | 11 | 12 | 14 |
| Monitoring Systems | 4 | 5 | 9 |
| Other | 33 | 25 | 22 |

| | 1963 | 1964 | 1967 |
|--|-----------------------|--------------|--------------|
| | (millions of dollars) | | |
| Computers & Related Equipment Total | 1,570 | 1,790 | 2,470 |
| Digital | 1,300 | 1,400 | 1,740 |
| Analog | 70 | 90 | 170 |
| Peripheral Equipment | 200 | 300 | 560 |
| Converters A to D | 40 | 100 | 200 |
| Converters D to A | 29 | 48 | 156 |
| Converters Card to Tape | 1 | 2 | 4 |
| Readers, Paper Tape | 20 | 25 | 40 |
| Readout Devices | 10 | 15 | 30 |
| Magnetic Tape Equipment | 80 | 85 | 100 |
| Other | 20 | 25 | 30 |
| Communications Equipment Total | 1,023 | 1,275 | 1,807 |
| Land Mobile | 130 | 140 | 170 |
| Microwave & Radio Relay | 105 | 120 | 155 |
| Terminal & Switching | 45 | 48 | 60 |
| Marine | 10 | 11 | 13 |
| Facsimile | 12 | 14 | 21 |
| Airborne | 80 | 85 | 92 |
| Carrier Current | 15 | 17 | 21 |
| Intercom & Sound | 175 | 180 | 185 |
| Navigational Aids | 205 | 210 | 215 |
| A-M Station Equipment | 24 | 28 | 36 |
| F-M Station Equipment | 24 | 44 | 59 |
| TV Station Equipment | 43 | 110 | 200 |
| Amateur & Citizens | 65 | 68 | 80 |
| Digital Communications | 90 | 200 | 500 |

ing is the total of its subdivisions; all totals read upwards

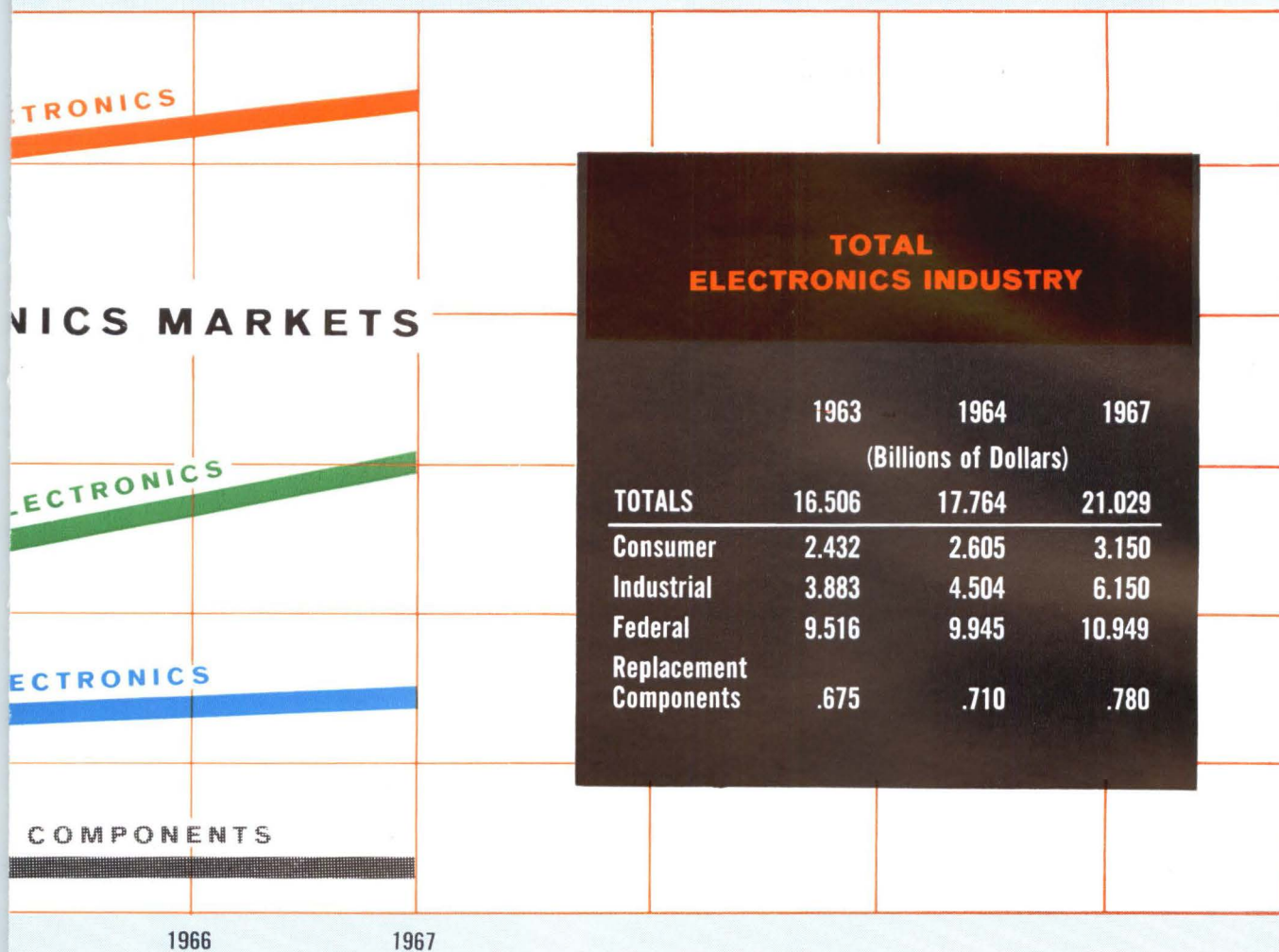

Thus the necessary practice of adding Federal market figures to industrial market figures may count some items twice or even more.

Finally, although this study is intended to include only domestically produced products to be sold within the United States, it is, as a practical matter, impossible to exclude exports and imports entirely. All forecasts are reported, in so far as possible, in constant 1963 dollars.

METHODOLOGY OF FORECASTING

Our principle technique for estimating current and future markets is the use of a mail survey. A random sample of electronics manufacturers stratified as to size of company, geographical location and principal product is selected and a questionnaire sent to the marketing manager or corresponding corporate planner. These questionnaires request estimates of the total market for specific products for the current year, the next year and for four years hence. The questionnaires are distributed during the third quarter of the current year.

Naturally, all estimates do not agree and a measure of central tendency must be computed in each category. First the arithmetic mean and median are computed for each category having four or more respondents. In small-sample cases, a formula such as

$$m = \frac{2a + 3b + c}{6} \quad \text{or}$$

$$m = \frac{3a + 2b + c}{6}$$

where **m** is the adjusted mean value, **a** is the highest estimate,

b is the lowest estimate and **c** is the "most likely" estimate may be used. Choice of weights depends upon whether the analyst has more confidence in the respondent contributing the highest or the lowest value.

Sometimes it may be necessary to exclude one or two data points. This is done only when it is felt that the data may be erroneous—such as a firm reporting its own sales rather than its estimate of total industry sales or reporting in inflated dollars.

Next, independent market estimates and projections are made based upon benchmark figures such as: Census data; Business and Defense Service Administration reports for the past year and for the first quarter of the current year projected, in some cases, on a full-year basis; Electronic Industries Association factory shipment reports issued during the current year, adjusted for seasonal and projected on a full-year basis; Internal Revenue Service excise taxes collected from manufacturers; license applications filed with the Federal Communications Commission during the preceding year; Dept. of Defense Controller's Status of Funds reports adjusted from their fiscal to a calendar-year basis; and public statements of leading figures in government and industry.

These projections are correlated with the consensus of marketing managers responding to the mail survey. As a final check, staff members conduct personal interviews with certain market forecasters having reputations for accurate prediction over the years in specialized areas and make final modifications in the data.

ELECTRONICS market survey is not infallible. But it is felt that, within its limitations, no market study short of a complete census of manufacturers is as comprehensive or of more value to the electronics industry.

CONSUMER ELECTRONICS PRODUCTS

| | 1963 | 1964 | 1967 |
|-----------------------------------|-----------------------|--------------|--------------|
| | (millions of dollars) | | |
| CONSUMER ELECTRONICS TOTAL | 2,432 | 2,605 | 3,150 |
| TV Receivers Total | 980 | 1,070 | 1,440 |
| Monochrome | 730 | 640 | 550 |
| Color | 250 | 430 | 890 |
| Radio Sets Total | 385 | 380 | 350 |
| A-M & F-M | 175 | 170 | 150 |
| Auto | 210 | 210 | 200 |
| Phonographs Total | 408 | 415 | 450 |
| Monaural | 32 | 31 | 30 |
| Stereophonic | 376 | 384 | 420 |
| Tape Recorders | 76 | 95 | 150 |
| Records & Tape | 255 | 280 | 330 |
| High Fidelity Components | 78 | 80 | 85 |
| Organs, Electronic | 165 | 175 | 180 |
| Kits | 45 | 50 | 60 |
| Nonentertainment | 40 | 60 | 105 |

• The figures are listed so that the amount shown after each heading is the total of its subdivisions; all totals read upwards

FEDERAL ELECTRONICS EXPENDITURES

| | 1963 | 1964 | 1967 |
|--|-----------------------|--------------|---------------|
| | (millions of dollars) | | |
| FEDERAL ELECTRONICS TOTAL | 9,516 | 9,945 | 10,949 |
| Department of Defense | 8,123 | 8,068 | 8,900 |
| Procurement | 4,521 | 4,374 | 4,600 |
| Aircraft | 1,297 | 1,309 | 1,500 |
| Missiles | 1,549 | 1,520 | 1,500 |
| Ships | 533 | 420 | 500 |
| Mobile & Ordnance | 93 | 95 | 100 |
| Electronics & Communications | 1,049 | 1,030 | 1,090 |
| Research, Development, Test & Eval. | 1,935 | 1,988 | 2,470 |
| Operations & Maintenance | 1,568 | 1,610 | 1,730 |
| Other (Incl. Construction) | 99 | 96 | 100 |
| National Aeronautics & Space Adm. | 1,195 | 1,674 | 1,800 |
| Federal Aviation Agency | 160 | 165 | 210 |
| Atomic Energy Commission | 38 | 38 | 39 |

• The figures are listed so that the amount shown after each heading is the total of its subdivisions; all totals read upwards

ELECTRONIC COM

| | 1963 | 1964 | 1967 |
|---|-----------------------|--------------|--------------|
| | (millions of dollars) | | |
| COMPONENTS TOTAL | 4,049 | 4,587 | 5,141 |
| Antennas & Hardware | 200 | 252 | 278 |
| Capacitors Total | 347 | 362 | 398 |
| Paper & Film | 126 | 127 | 128 |
| Electrolytic | 123 | 129 | 140 |
| Mica (Incl. Glass and Vitreous Enamel) | 33 | 36 | 50 |
| Ceramic | 36 | 38 | 42 |
| Variable | 29 | 32 | 38 |
| Complex Components* (Incl. Microminiature) | 170 | 470 | 660 |
| Connectors Total | 289 | 325 | 373 |
| Coaxial | 38 | 45 | 59 |
| Standard | 21 | 24 | 29 |
| Miniature | 17 | 21 | 30 |
| Cylindrical | 102 | 108 | 123 |
| Rack & Panel | 70 | 77 | 84 |
| Printed Circuit | 39 | 45 | 59 |
| Special Purpose and Fused | 40 | 50 | 48 |
| Delay Lines | 17 | 20 | 22 |
| Electroluminescence | 5 | 6 | 9 |

*Includes packaged components — two or more components packaged and shipped as a single unit but not a complete circuit function; modules with several components packaged and shipped as a single unit comprising a complete circuit function; and integrated circuits — monolithic chips.

• The figures are listed so that the amount shown after each heading

INDUSTRIAL ELECT

| | 1963 | 1964 |
|---|-----------------------|--------------|
| | (millions of dollars) | |
| INDUSTRIAL ELECTRONICS TOTAL | 3,883 | 4,504 |
| Test & Measuring Total | 550 | 600 |
| Spectrum Analyzers | 9 | 10 |
| Signal Generators | 39 | 42 |
| Oscilloscopes | 70 | 75 |
| Recording Instruments | 45 | 51 |
| Voltage, Current & Power Meters (Multimeters) | 18 | 20 |
| Components Testers (Tube, Transistor, Etc.) | 18 | 19 |
| Calibrators, Instrument (Standards) | 27 | 28 |
| Power Supplies (Lab Type) | 40 | 45 |
| Counters | 35 | 37 |
| Panel Meters, Indicating | 24 | 26 |
| Microwave Test Equipment | 30 | 32 |
| Digital Voltmeters | 24 | 30 |
| Spectrophotometers | 7 | 10 |
| Other | 164 | 175 |
| Nuclear Instruments & Controls Total | 102 | 120 |
| Reactor Controls | 17 | 22 |
| Amplifiers | 4 | 5 |
| Detecting Heads | 4 | 6 |
| Portable Survey Instruments | 8 | 10 |
| Power Supplies | 8 | 10 |
| Monitoring Instruments | 7 | 8 |
| Pulse Height Analyzers | 12 | 14 |
| Other Equipment | 42 | 45 |

• The figures are listed so that the amount shown after each heading

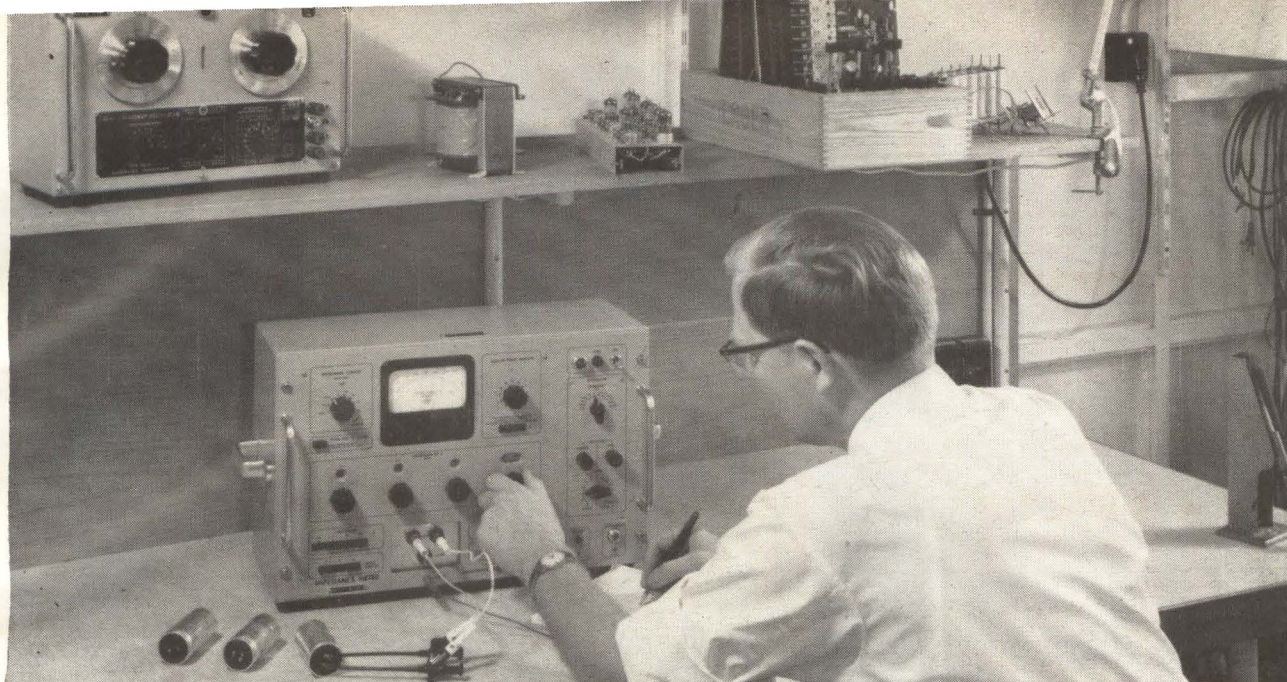

IMPEDANCE METER with direct readout of magnitude and phase angle

DIRECT-READING METER

Gives Impedance and Phase Angle

Impedance magnitude is measured by comparing current through a calibrated resistor with the current through an unknown impedance. Phase angle is determined by reading the vector sum of the two currents on a calibrated meter

By **PREBEN LUND**,
Radiometer, Copenhagen, Denmark

THE Grützmacher impedance measuring bridge, which is commonly used in Europe, has several

advantages over impedance measuring bridges based on a null method. The Grützmacher bridge¹ offers convenient and fast operation because no tedious null-adjustment is necessary as with the well-known Wheat-

stone bridge, and it presents the result in terms of magnitude and phase angle. However, the Grützmacher bridge has some drawbacks that limit the performance when, for example, the impedances to be measured are balanced to ground or d-c polarized, or if a guard circuit is needed.

Described here is the principle of a new direct $Z-\theta$ reading impedance meter, in which the above disadvantages have been overcome and some improvements introduced.

Basic Principle—The impedance meter is based on a modified principle of the Grützmacher bridge, the voltage measurement of the latter being changed into a current meas-

ADVANTAGES OF THIS DIRECT-READING METER

- Fast and convenient operation because only one variable resistive standard is used, eliminating tedious null adjustment and achieving a fast convergence
 - The impedance is measured in terms of magnitude and phase angle, which in many applications is the most convenient representation
 - Negative impedances can be measured
 - Voltage-dependent impedances are easily measured
 - Guarded, balanced-to-ground and d-c polarized measurements can be made
-

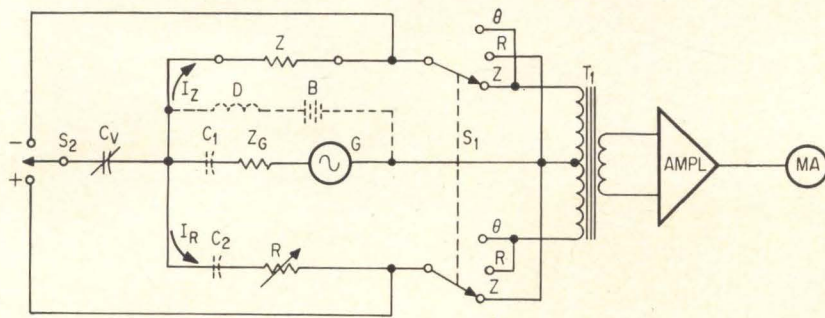

MEASURING CIRCUIT in simplified schematic; dotted circuit and components refer to d-c polarized measurements—Fig. 1

urement. The operating principle appears from the simplified schematic diagram in Fig. 1. With switch S_1 in position Z , current I_Z through the unknown impedance Z is measured by the milliammeter. Similarly, with the switch in position R , current I_R through standard resistor R is measured. If R is adjusted so that the magnitude of these two currents are equal, the magnitude of Z is equal to that of R if the primary of the differential current transformer T_1 is strictly symmetrical, and that the impedance of the two halves is negligible. Therefore, the magnitude of the unknown can be read directly from the standard resistor dials. By keeping generator impedance Z_G sufficiently low compared with the impedance of Z and R it is possible to adjust R in the first or second trial.

The new principle makes possible a more convenient adjustment than does that of the Grützmaier bridge, especially when measuring voltage-dependent impedances.

Phase angle θ of the unknown impedance can be determined by setting switch S_1 to position θ . Then the milliammeter indicates a current

I_D that corresponds to the vector difference $|\bar{I}_Z - \bar{I}_R|$. Phase angle θ can now, in accordance with the vector diagram shown in Fig. 2A be determined from

$$\sin \frac{\theta}{2} = \frac{1}{2} \cdot \frac{I_D}{I_Z}$$

The milliammeter can be calibrated directly in degrees. If the sensitivity of the milliammeter is adjusted so that current I_Z causes a deflection to a reference mark determined as $1/\sqrt{2} = 0.707$ of full-scale deflection ($I = I_{max}$)

$$\sin \frac{\theta}{2} = \frac{I_D}{\sqrt{2} \cdot I_{max}}$$

Full-scale deflection corresponds to 90 degrees, and the reference mark to 60 degrees. A further calculation will prove that the phase angle scale turns out to be practically linear. In addition to the 90-degree scale, a 26-degree scale can be had by increasing the sensitivity by $\sqrt{10} = 10$ db when difference current I_D is measured.

Finally the sign of the phase angle

can be determined. When switch S_2 in Fig. 1 is set to position $+$ or to position $-$, a stepwise variable capacitor C_v is connected in parallel with R or Z , respectively. The sign of phase angle θ is then indicated by the switch position that causes the highest meter deflection. This appears from the vector diagram of Fig. 2B and 2C.

For physical reasons the principle is not suited for measurements of either very high or very low impedances because the standard resistor may have to be as high as 1 megohm or as low as 1 ohm, respectively. However, by using an unsymmetrical current transformer, a wide measuring range can be obtained with reasonable values of the standard resistor. The modified current transformer is shown in Fig. 3A, where the number of turns is stated in brackets. The four multipliers 0.1, 1, 10, and 100 make possible a measuring range from 1 ohm to 1 megohm with a standard resistor ranging from 10 ohms to 10 kilo-ohms.

Measuring Modes—The new principle makes it possible to adopt

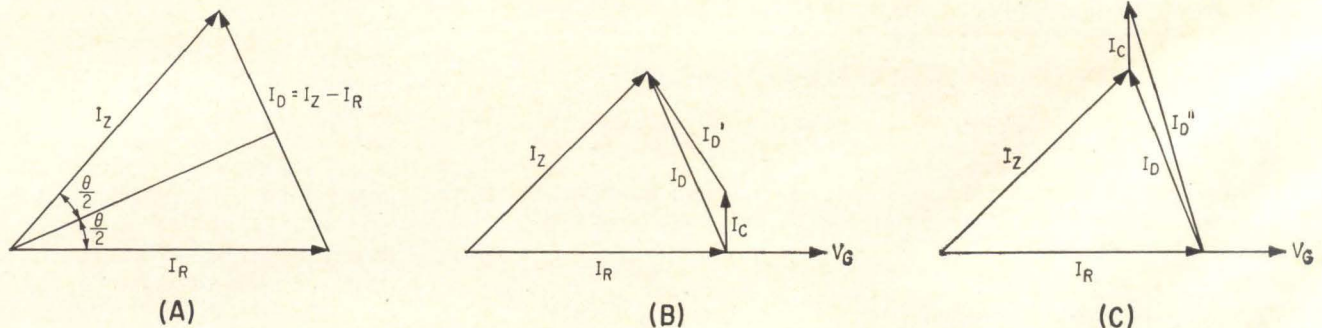

VECTOR DIAGRAM for determining phase angle (A); with S_2 in plus position (B), C_v in parallel with R ; with S_2 in minus position (C), C_v in parallel with Z . Phase angle is negative because the absolute value of I_D'' is greater than that of I_D —Fig. 2

three measuring modes. Switch S_3 in Fig. 3B connects the ground either to the guard terminal (for direct measurements of floating impedances), or to one of the Z terminals (for measurements of grounded impedances), or it leaves the circuit floating (for measurements of the compound impedance of balance-to-ground impedances). In the first two modes, components Z_{10} and Z_{20} of the unknown impedance Z are disregarded, because they are connected as a load of generator G only and across the low-impedance winding of T_1 , respectively. In the third mode the compound impedance; that is, Z_{12} in parallel with $Z_{10} + Z_{20}$, is measured. Here it is necessary that the measuring circuit be balanced to ground, and this can be achieved by a double screening system.

Contrary to the Grützmaier bridge, the new principle makes possible impedance measurement on d-c polarized components. This is achieved by adding to the circuit choke D and two blocking capacitors C_1 and C_2 as shown in Fig. 1. The d-c current is passed through choke D to Z , the two blocking capacitors preventing the current from flowing back through generator G or standard resistor R . As the current will pass through and magnetize the current transformer, the latter must be designed with care, as a high permeability core material is used.

An impedance meter based on the principle described can be utilized

for the measurement of negative impedances. This necessitates a minor modification of the basic circuit, the R -part of the current transformer's primary being accessible for connection of the unknown. The magnitude is determined in the normal way. When, however, the phase angle is to be determined, the unknown must be connected to the R -part instead of the Z -part of the current transformer's primary because of the reverse phase condition. In this manner it is possible to determine the phase angle in the range 180 deg to 180 deg ± 90 deg.

Using The Principle—The new principle is utilized in the type GB11 impedance meter, with new measuring convenience and facilities in the determination of complex impedances which can be balanced to ground, floating, grounded, or grounded and d-c polarized. It is briefly characterized by measuring impedances in magnitude and phase angle from 1 ohm to 1.1 megohms and from 0 to ± 90 deg, respectively. Also negative impedances are measured in terms of magnitude and phase angle from 1 ohm to 110 kilohms and from 180 deg to 180 deg ± 90 deg, respectively. In the basic frequency range from 25 cps to 100 kc, a built-in oscillator supplies 12 spot frequencies, and with an external oscillator the impedance meter may be operated at any frequency from 25 cps up to 1 Mc. Test current may

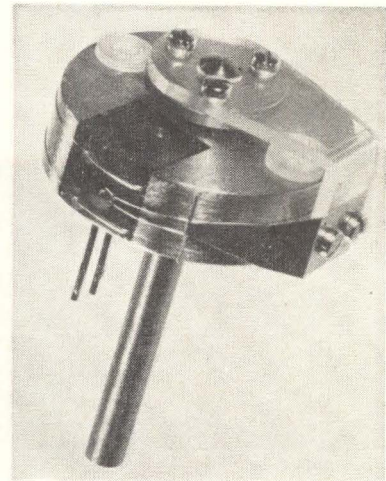

CONSTRUCTION of 10-ohm variable capacitor

be varied from 3.2 μ amp to 1 amp. Optional plug-in filters make possible selective measurements.

The principle of operation was suggested by Professor J. Oskar Nielsen of the Technical University of Denmark^{2,3}. The author thanks J. Gilat of Radiometer's Development Laboratory for his assistance in the development program.

REFERENCES

- (1) M. Grützmaier, Eine neue Brücke für betriebsmäßige Messungen von Wechselstromwiderständen nach Betrag und Phase, *Telegraphen- und Fernsprechtechnik*, 23, p 27, Feb. 1934.
- (2) J. Oskar Nielsen, En ny Z- θ -Impedansmåler, *Teleteknik* 1958, No. 4.
- (3) J. Oskar Nielsen, A New Z- θ Impedance Measuring Instrument, *Inginiøren*, International Edition, June, 1960.

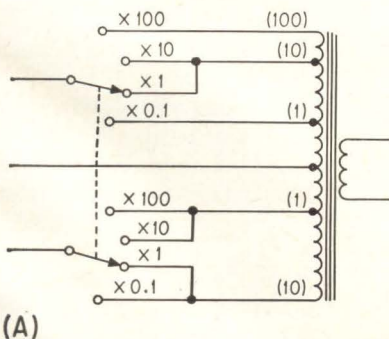

(A)

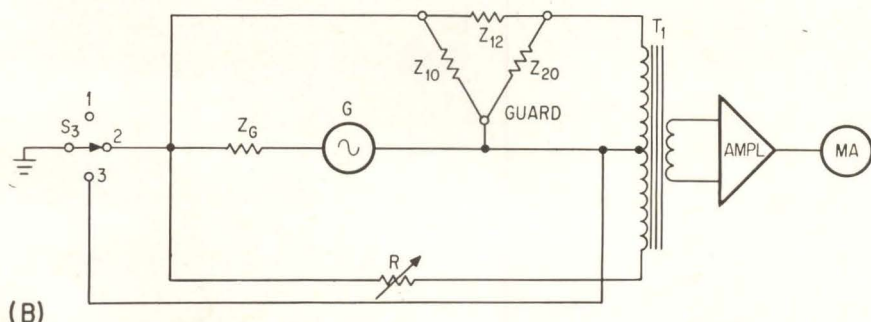

(B)

EXTENDING the measuring range with an unsymmetrical current transformer (A); simplified schematic of mode switching (B), with switch position 1 for balanced-to-ground, 2 for one terminal grounded, 3 for grounded guard—Fig. 3

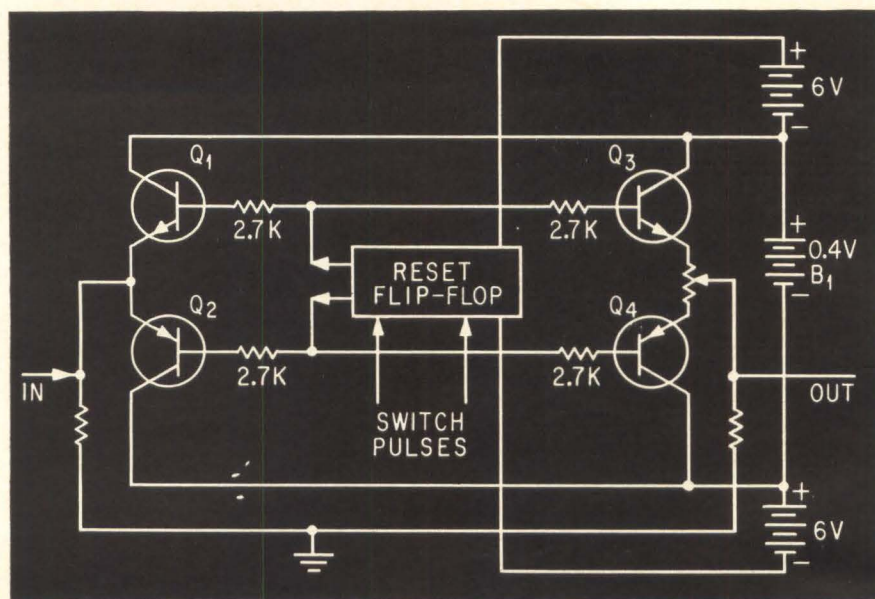

TWO SETS of series-connected silicon transistors rapidly switch, input to output, voltages from a microvolt on up, in low and medium frequency applications

TRANSISTOR BRIDGE Switches Microvolts

Lowers emitter-to-collector conductance gap to zero

By MEGUER V. KALFAIAN, Los Angeles, Calif.

IDEAL transistor switching characteristics would be infinite impedance during off-state, and high conductance, starting from zero applied voltage, during on-state. Such characteristics are desirable when small signals are to be switched from an input to an output, or, when a charged capacitor is to be discharged down to zero at a constant rate.

Silicon transistors with low leakage in off-states are available, but they have a gap of collector conduction, with undesirable transfer impedance variation. By arranging a bridge circuit with these types of transistors, as illustrated, even a microvolt can be switched from input to output. The bridge circuit was originally for a special switching arrangement. A slave capacitor had to be switched directly to a

charging capacitor, at the instant of its zero value, for parallel charging, and disconnected at a given voltage value. It was then switched to different charged capacitors in series with prefixed timing resistors. These capacitors, in turn, had to be discharged to zero value. Available switching transistors did not work, but the bridge circuit did.

The circuit is shown in universal form, so that it may be modified as needed. The circuit consists of two set of series-connected npn and pnp transistors, Q_1 through Q_4 , connected across the voltage supply, B_1 . When these transistors are highly conducting, the voltage between the junction points of Q_1 , Q_2 , and Q_3 , Q_4 is zero, because of the bridged arrangement. Since the input and output load impedances across these two zero points are

divided to a common ground terminal, any voltage applied to the input must cause a current flow in the output circuit, by an amount sufficient to restore zero balance. During the on-states of the transistors any voltage level above zero can be transferred from the input to the output terminal. During off-states the input is isolated from the output, except of course, by a certain amount of leakage current.

Input and output terminals may be taken either from the junction points of Q_1 , Q_2 , and Q_3 , Q_4 , or, between Q_1 , Q_2 , and a center tap on supply voltage B_1 , depending on circuit use in a floating or grounded application. A reset flip-flop, such as shown, can be used for the on-and-off operation of the transistors. When this circuit is used in the floating application, the inputs of the flip-flop may then be excited by pulse transformers.

When the circuit is to be used in a floating arrangement, the inherent capacity to ground of the power supply must be considered. In its original use, the slave capacitor was connected to a center tap of B_1 , and the total capacity was adjusted to the desired value, so its presence was nullified. For this reason, it may be best to use a low impedance input source, and connect it to a center tap of B_1 , taking the output from one of the junction points of the switching transistors. In this case, the output resistor may be 100K, or higher, when applied to a field-effect transistor.

The balance of the circuit is maintained within the operating curves of Q_1 through Q_4 , where they act as variable resistors linearly with varying collector voltages. The center of this curve is generally about 0.1 to 0.2 volt, and the voltage of B_1 may therefore be adjusted between 0.2 and 0.4 volt. Similar transistors can be matched much more accurately than complementary ones. Only npn transistors (2N2102) were used, and perfect balance was obtained. But this required an extra flip-flop, with an extra power supply, for controlling each of the series-connected transistors separately. However, complementary transistors can also be matched, and a 50— to 75— ohms pot will provide the required balance.

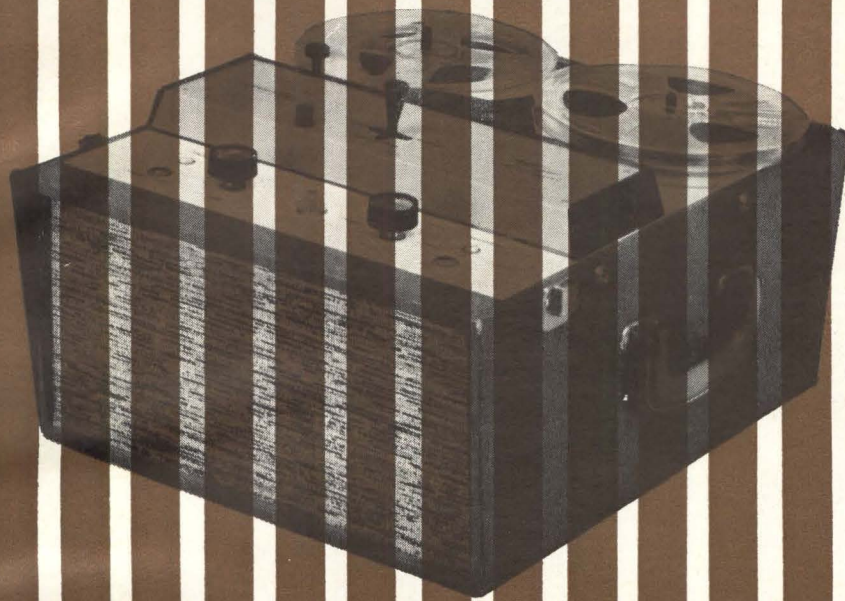

Quality in Magnetic Recording depends on the Specialized Uses of Magnetic Iron Oxides . . .

Recording devices are as good as their reception media. Tapes, film sound tracks, computer memory drums, carbon transfers and even the code numbers on the bottom of your checks depend on the proper use of magnetic iron oxides of consistently high quality.

This indispensable requirement for continuous, uninterrupted recording is provided by C. K. Williams & Co. Here, magnetic iron oxides are created with a wide range of controlled magnetic properties. Both the black ferrosferric and brown gamma ferric oxides are described in a Data Sheet listing magnetic properties of six grades.

Write to C. K. Williams & Co. to find "solutions" to your specific recording problems. Our research laboratories are available to help you. Write today.

WILLIAMS
COLORS & PIGMENTS

DIVISION, CHAS. PFIZER & CO., INC.
Dept. 30, 235 East 42nd Street, New York 17, New York

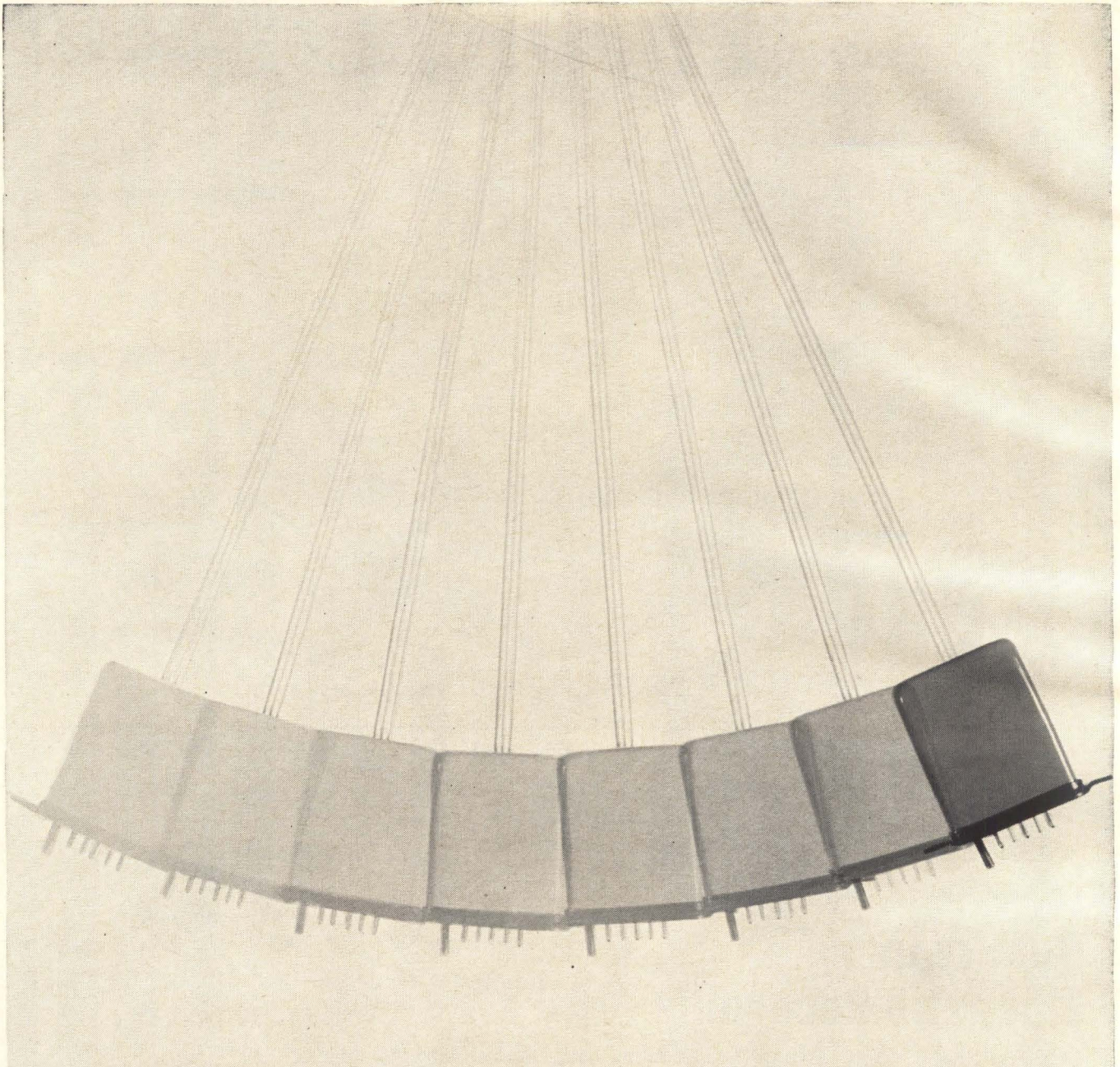

Now! 50ms to 3 year time delay capability!

New Leach Electronic Timers offer delays from 50ms to 300 hours in standard units unmatched for minimum size and weight. Also, units can be custom-built with a three year time delay capability!

It's the breakthrough you've been waiting for! Nine small standard units are now available with timing range capabilities unobtainable just yesterday. Leach made it happen by new applications of magnetic counters and time-base generators, plus the use of Leach-developed magnetic cores.

These units are available with solid state or relay output, fixed or adjustable timing, and with delay on operate or release. Over 2½ million variations of these standard time delays can be supplied, and with accuracies of $\pm 3\%$, $\pm 5\%$, and $\pm 10\%$. Depending on oscillators used, you can achieve accuracies of $\pm 0.02\%$.

New capabilities do not mean bigger sizes. The standard ms size unit above, with a 300 hour capability, takes up as little space as a unit that previously had only a 200 second capability. At the other end of the size spectrum, the half-size crystal can has a time delay range of 50ms to 10 seconds.

When long time ranges, accuracy or minimum size are essential to your specs, then specify Leach. We have off-the-shelf time delays ready for prompt delivery. Or we will custom-build them to your requirements. Write or call your nearest Leach office for more information.

LEACH
CORPORATION
CONTROLS DIVISION
717 N. Coney Ave., Azusa, California
Export: Leach International S.A.

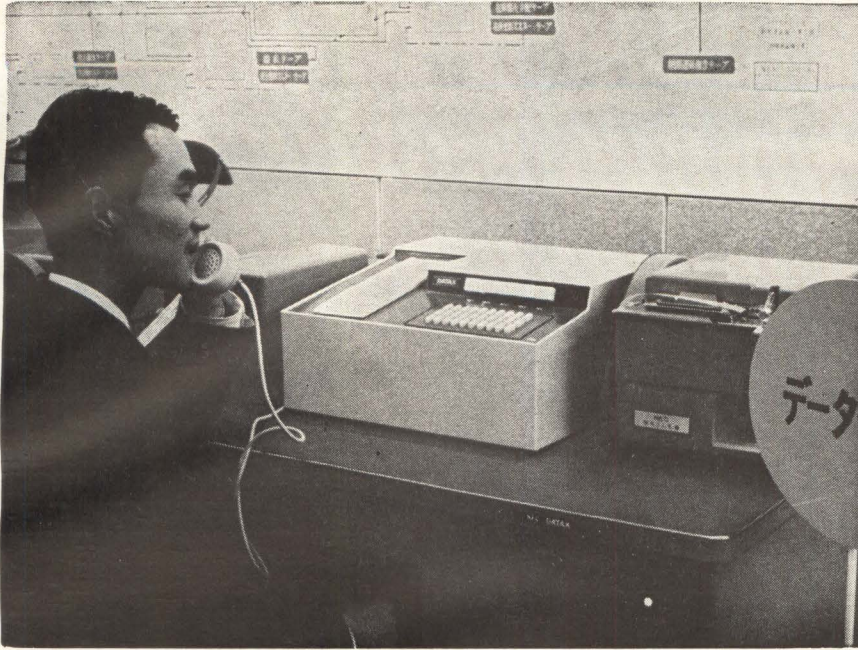

ON-LINE application of Hitachi 3010 is demonstrated at show

DIGITAL TRANSMISSION system similar to Bell's Dataphone is also a telephone. Made by Nippon Electric, it has automatic dialing to prevent prohibited use on ordinary local telephone lines

U.S. Licensing Spurs Japanese Computer Industry

Manufacturers nailing down domestic market, see exports in 2 years

By CHARLES COHEN
McGraw-Hill World News

TOKYO—Japan's digital computer industry is driving hard toward a dominant share of the domestic market and hopes to begin exporting computers in two years.

The industry is already producing a variety of small and medium-sized computers—both domestic-designed and American-licensed models—and expects to come out with large systems in a year.

Imports now represent slightly more than half of the growing Japanese market, estimated at \$75 million for 1963 (for earlier reports, see *ELECTRONICS*, p 18, Dec. 14, 1962, and p 26, Sept. 7, 1962). Rentals are estimated at \$2.4 million for 1963.

Exports When?—No Japanese manufacturer is exporting computers

yet. The most frequent answer to the question "when?" is two years. Hitachi says it has already received inquiries from West Germany for "small, good computers," and that even computers built under RCA license can be exported to all countries except the U. S. and Canada. Other domestic manufacturers are also optimistic, and IBM definitely plans to export its 1440, which it has started to assemble here.

Why U. S. Licensing?—Although computers built here under license are identical to their U. S. prototypes, the Japanese are not building them because they can't design hardware. Japan's big problem is a shortage of software, and lack of funds and personnel to turn it out quickly enough. American licenses enable manufacturers to offer proven hardware and software very quickly.

Behind the industry-government drive to build up the industry rapidly are plans to remove in 1965 all government restrictions on use of funds to buy imported computers. International pressure is responsible for this. Domestic manufacturers

are striving to become strong enough to retain the majority of sales of small and medium computers, despite liberalization of imports. They do not expect to compete across the board against American large computers.

Seven Favored Companies—Manufacturers of domestic digital computers are Hitachi, Fujitsu, Nippon Electric, Toshiba, Oki Electric, Mitsubishi Electric and Matsushita, and also IBM's Japan branch. It is the policy of the Ministry of International Trade and Industry (MITI) to prevent an increase in the number of manufacturers. Companies outside the seven get no government help in obtaining capital to float computer rental, and no government-sponsored loans or subsidies for computer development. However, industrial control firms, such as Hokushin Electric and Shimadzu Seisakusho, might make special-purpose digital computers for control.

Domestic Designs—While all Japanese computer manufacturers are

New from Sprague!

GERMANIUM P-N-P 2N2962



**Extends High-Efficiency
ECDC[®] Transistor
Performance to
VHF POWER RANGE**

- High Voltage—40 Volts
- High f_T —800 mc (typ.)
- Isolated Mounting Stud offers Design Freedom

| TYPE | V_{CES} | $P_G @ 160 \text{ mc}$ | $P_o @ 160 \text{ mc}$ |
|--------|-----------|------------------------|------------------------|
| 2N2962 | 40 V | 6 db | .5 W |
| 2N2963 | 40 V | 5 db | .5 W |
| 2N2964 | 30 V | 6 db | .5 W |
| 2N2965 | 30 V | 5 db | .5 W |



For application engineering assistance, write to Transistor Division, Sprague Electric Co., Concord, N. H. For technical data, write for Engineering Bulletins 30,452 and 30,454 to Technical Literature Service, Sprague Electric Co., 35 Marshall St., North Adams, Mass.

SPRAGUE[®]
THE MARK OF RELIABILITY

45T-165-03



COMPUTER SHOW crowd gathers around Toshiba's small scientific and control computer (left). Americans will be able to inspect the Fujitsu 231 (right) at the New York World's Fair. Small sign says "genuine domestic product"

licensed under basic IBM patents, Fujitsu and Matsushita have no direct ties with any U. S. company and say they use little foreign technology in their computers.

Fujitsu says its line of small and medium-size computers were developed with almost no use of foreign patents. Fujitsu claims its 231 is comparable to the IBM 1620. The standard 231 sells for 13.55 million yen (\$37,639) and rents for 300,000 yen (\$833). Fujitsu also makes computers the size of IBM's 1410 and 7070. The 231 is to be shown at the New York World's Fair.

Matsushita is still not an important factor in the industry. It has sold several small computers for scientific use, but only just finished the prototype for its first medium-size general-purpose computer.

The most ambitious, purely Japanese computer now in the works is a joint effort by Fujitsu, Oki Electric and Nippon Electric to build the Fontac (Fujitsu Oki Nippon Electric Triple Alliance Computer), which will be the same scale as IBM's 7090. The prototype is scheduled for completion by the end of this year.

Licensed Computers—At the Computer Show in late 1963, both completely domestic and licensed computers were shown by those manufacturers having license agreements.

Hitachi showed the Hitac 3010, a domestic version of the RCA 301, and the Hitac 201, a small computer. Next year it plans to start selling the Hitac 4010, the domestic version of the RCA 3301. The 3010 has been selling well, causing a sharp increase in Japan's imports of computer-quality transistors and diodes in the first half of 1963. Hitachi is also

working on its Hitac 5020, a scientific computer with speed similar to the IBM 7090. Kyoto University will get the first one in 1965.

Nippon Electric showed their Neac-2400, its version of the Honeywell H-400, and the Neac-1201A, a small computer. Next year Nippon Electric plans to market the Neac-3400, a domestic version of the Honeywell 1400.

Oki Electric showed its 5090H, a higher-speed version of the 5090 series, which has been the mainstay of the company's computer business.

Oki Electric formed a joint venture company with Sperry Rand Univac last fall at a capitalization ratio of Oki 51, Univac 49. The joint venture company will produce the Okitac 5090, future Oki computers and Univac computers, starting with the 1004. All the computers will be sold by Oki.

Toshiba showed its Tosbac-4200 medium-size general-purpose, Tosbac-1100 (IBM 632 size) business machine, and Tosbac-3300 small scientific computer. Toshiba had an agreement with Sperry Rand, but has broken with it and is now negotiating one with General Electric. Toshiba desires to share GE's know-how in the control field, and will probably produce one or more GE computers when the agreement, now awaiting MITI approval, is concluded.

Mitsubishi showed the Melcom 1530, a domestic version of the TRW 530, and the Melcom 1101, a small scientific computer.

One-Word Characters—No new technical developments were revealed at the Computer Show. Some manufacturers claimed originals, but nothing startling. Toshiba, for example, says its computer requires



ANOTHER domestic small computer is Neac-1201A

only one word of memory for each character that must be stored. Imported machines generally require two words per character because of the large number of characters required of Japanese computers: Roman alphabet, Arabic numerals, about 50 Japanese kana characters, and other symbols.

The emphasis was on proven circuits and devices. Japanese developments such as woven matrix memory and the Esaki tunnel-diode memory or logic circuits were not used in the computers on display. An exception were the parametrons in some small computers.

Light-Helicopter Model Uses Much Electronics

PALO ALTO, CALIF.—Hiller Aircraft has delivered to the Army the first light-observation helicopter, the OH-5A, in a three-firm contract competition for 4,000 aircraft. The Army won't say when the other firms, Bell and Hughes Tool, will deliver their versions. One-third of Hiller's model, which costs \$60,000, is electronics equipment. This consists of an inverter module and pitch and roll channels.

The static-inverter part of the stability augmentation system converts 28 v d-c to 400 cps a-c to satisfy power requirements. A self-exciting oscillator sets a-c reference and drives power output stage. A saturating toroidal transformer drives two low-power transistors and output is fed back positively to the transformer primary to create the oscillation. Zener diodes are used to regulate oscillator frequency. The inverter is frequency regulated.

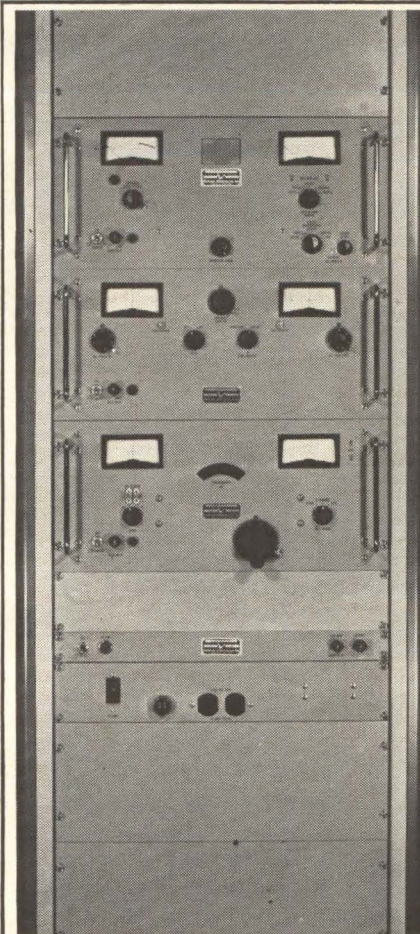

WATCH DEI

TTR-1

TRACK AND DEMODULATE
SATELLITE DATA
SIMULTANEOUSLY

Dual Purpose Monopulse 215-260 mc Receiver

- Crystal Controlled or Continuous VFO Tuning
- Complete Telemetry Facilities
- Three Channel Monopulse with DC and AC Error Signals
- Plug-In IF Amplifiers with Switchable Bandwidths
- Optional Phase Lock Demodulators

The ability to track and demodulate IRIG satellite signals *simultaneously* is now possible with the TTR-1 Monopulse Tracking and Telemetry Data Receiver from Defense Electronics, Inc.

Designed for use in advanced aerospace programs, the unit has been refined not only to obtain instant antenna direction for a satellite, but to demodulate and record the signals in conventional telemetry formats.

As a 3-channel tracking receiver in the 215-260 mc band, the TTR-1 has the capability of tracking the RF carrier in a narrow band mode up to the point where good data can be received. Switching to wide band, signals can be demodulated as in other DEI telemetry receivers.

A space saver, the modular TTR-1 employs single-knob tuning with a tuning indicator, choice of two crystals or VFO operations over the complete 215-260 mc band, front-panel switchable IF and video bandwidths. The solid state correlation detectors have excellent noise balance over a bandwidth in excess of 2 mc, allowing use of 1.5 mc IF bandwidths.

To combine the best in a tracking and telemetry receiver, ask about the TTR-1 . . . and Watch DEI.



DEI
SERVING
GOVERNMENT
AND INDUSTRY

Defense Electronics, Inc.

ROCKVILLE, MARYLAND

PHONE (301) 946-2600 TWX 301-949-6788
SHERMAN OAKS, CALIFORNIA PHONE (213) 873-4322

CONQUERING

CAPACITANCE
CURVATURE

... or, the

HAPPILY
HARMLESS

HYPERBOLA

[a drama in one masterful act]

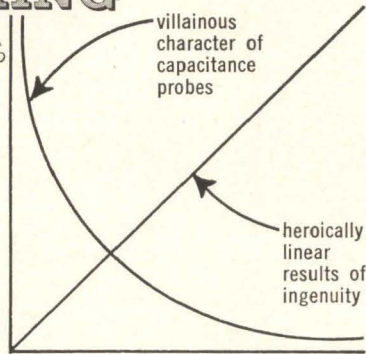

PROLOGUE: After high accuracy and stability, the greatest virtue one can hope for in transducer instrumentation is linearity. If a transducer is *absolutely linear*, initial "offset" in a test set-up just doesn't matter... the sensitivity is *constant*.

THE PROTAGONISTS: Now, then — in our Models DM-100 and B-731-A Distance, Motion, and Vibration-analysis instruments of boundless versatility and unbelievable accuracy, stability, and resolution) we employ as a non-contacting probe, a *capacitance transducer*. (So do our esteemed competitors.)

THE PLOT: Capacitance, however, is not a linear function of distance (plate-spacing, that is) — it is an inverse function... inherently messy. The competition (poor old chaps!) are apparently content with this hyperbolic state of affairs. Not us. Never.

THE PLOT RESOLVED: We (cleverly!) introduce the probe capacitance into a feedback circuit in such a way that the current fed back is itself inversely proportional to the capacitance. Result? *Linearity Regained. Absolutely Constant Sensitivity. Virtue triumphant.*

EPILOGUE: Do you test things that spin? vibrate? writhe or creep? ... barely *breathe*? You need a DM-100 (measures down to 1 micro-inch with external CRO) or the B-731-A (same, plus direct-reading P-P vibration amplitude, 50-500,000 micro-inches) ... to "straighten you out", so to speak. *Anywhere* you position the probe, the sensitivity will hold true to the range setting you have selected. Recorder/scope drive outputs on both. Ultra-sensible prices, too. Ask us to introduce you to its whole family of companion instruments and accessories. They are, literally,



THE END



WAYNE KERR

CORPORATION

1633 RACE STREET, PHILADELPHIA 3, PA. LOCUST 8-6820

INNOVATIONS in INSTRUMENTATION

Attitude Gyro Employs "Crab" Configuration

HONEYWELL's 82-pound electronic/reaction jet attitude control system, for use in the four-stage Athena solid-fuel rocket, employs two attitude reference gyros in an unusual "crab" configuration. The orthogonal yaw-pitch gyro momentum vectors are rotated 45 degrees from the vehicle's axis. The firm says this setup permits unlimited pitch maneuvers without gimbal lock or gyro tumbling and minimizes spin drift errors in the inner gyro gimbals.

The system will be mounted on a single-base circular casting behind the third-stage Athena engine. The entire package, 18 inches in diameter and 14 inches long, will be

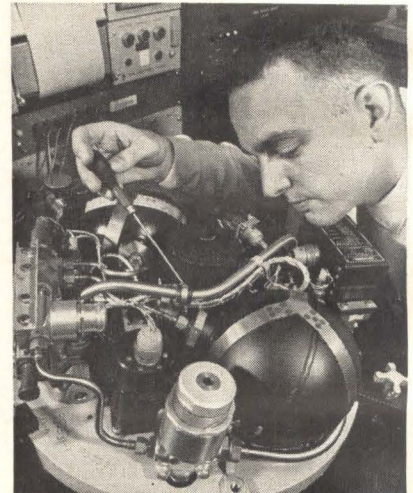

PACKAGE includes reaction-jet fuel supplies, five gyros, command guidance transducers, power supply, plus control and telemetry electronics

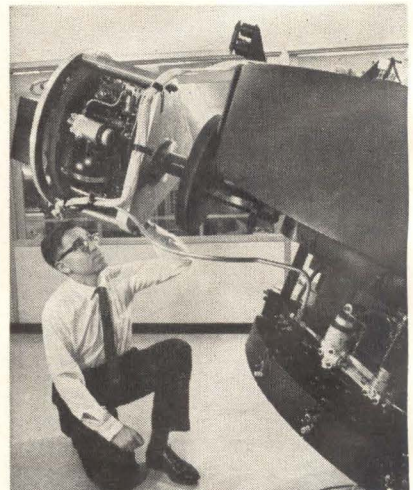

ATTITUDE control system is readied for a reliability test

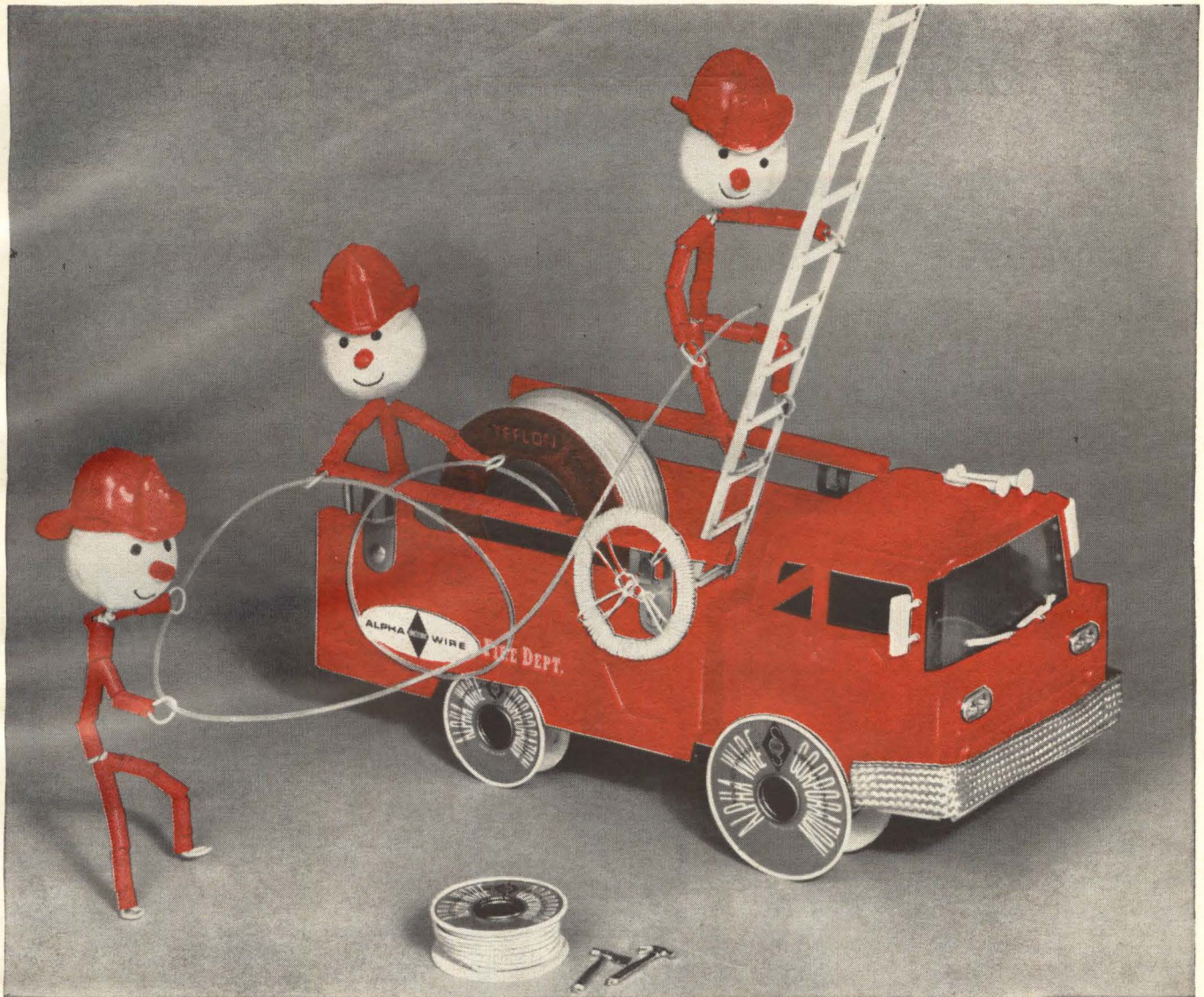

Alpha makes the wire that fights **heat**

TEFLON*

ALL TYPES OF WIRE, CABLE, TUBING

ENGINEERED

You name the need, we'll make the wire to suit — through complete control from raw materials, wire drawing to finished product.

FAST PRODUCTION

Just tell us where the fire is. Emergencies met quickly — over 600 different Teflon wire, cable and

tubing items **always in stock**, distributed through 1000 hook-and-ladder companies coast to coast.

RELIABILITY

Your fire insurance is with a 40-year old-timer. And complete MIL specs and tests on every product underwrite uniformity whenever you order or re-order.

PRICED RIGHT

Your money won't go up in smoke. Complete manufacturing facilities for greatest economy.

Got hot problems with wiring and cabling? Call Alpha Wire. Write for new 52-page Catalog W4 describing 6000 wire & cable items — the industry's most comprehensive line.

*TM DuPont



ALPHA WIRE CORPORATION

Subsidiary of LORAL Electronics Corporation
Executive Offices and New York Plant
180 Varick Street, New York, N. Y. 10014

PLANTS IN:

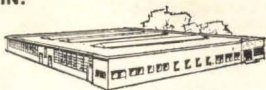

UNION, NEW JERSEY

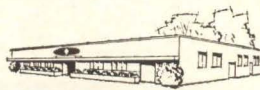

LOS ANGELES, CALIFORNIA



HOLBROOK, NEW YORK

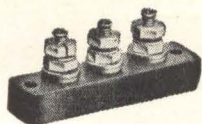

No. 1-A—Connecting Block

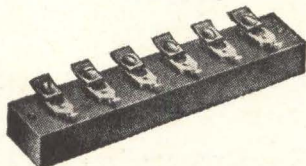

No. 8-A—Connecting Block

1908

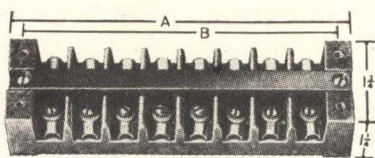
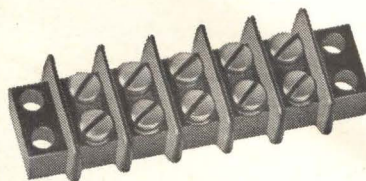

FIG. 57—AN 8-CIRCUIT MOLDARTA TERMINAL BLOCK

1930



1941



What's new in terminal blocks?

camblock is new!

(AND BETTER)

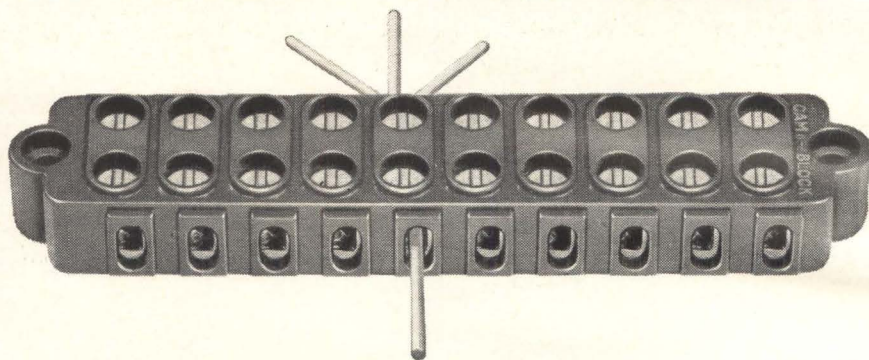

*ACTUAL SIZE . . . MEDIUM SERIES . . . DIMENSIONALLY INTERCHANGEABLE WITH CONVENTIONAL TERMINAL BLOCKS. THE FIRST NEW CONCEPT IN WIRE FASTENING IN 60 YEARS.

Necessity is the mother of invention! More stringent performance and economic demands required improved terminal blocks.

The best ideas are often the most simple! Camblock's new concept employs a cam, captive in a large cross section busbar, encompassed bottom and top . . . as well as between terminals . . . by a high dielectric, unbreakable plastic body. A small turn of the cam compacts and wedges the wire firmly against the busbar. Camblock solid bottom and feed-thru terminal blocks offer:

■ FASTER, MORE POSITIVE LOCKING CONNECTIONS ■ MORE EFFICIENT CONDUCTION AND LARGE CURRENT-CARRYING CAPACITY ■ BETTER INSULATION AND HIGHER BREAKDOWN AND FLASHOVER VOLTAGES BETWEEN STATIONS ■ RELIABLE PERFORMANCE UNDER HIGH VIBRATION AND SHOCK CONDITIONS ■ SUBSTANTIAL SAVINGS IN WIRING LABOR COSTS ■ SIMPLIFIED IN-FIELD SERVICE AND MAINTENANCE

• No Lugging • No Screws • No Solder
• No Loose Parts • No Special Tools • No Breakage • No Dust Covers • No Nicked Wires • No Short Circuits

Write for Catalog 636

camblock

285 Whites Street
Danbury, Conn.
Tel: Area Code 203
743-2353

Connector Division
WALTHAM PRECISION INSTRUMENT COMPANY, INC.

jettisoned just before third stage ignition, after the craft completes pitchover and aiming maneuvers.

The Athena project is expected to provide a controlled test environment for reentry body and decoy feasibility studies as well as for development of advanced reentry systems. Air Force plans 77 launches. Honeywell will produce 78 central systems under a \$4.5-million contract from Pan Atlantic Research Corp. announced last month.

Electronic Photo Correlator Achieves 99.9% Accuracy

AKRON, OHIO—Electronic-optical refinements of Mace microwave missile correlation techniques have developed a 99.9 percent accurate positioner for space photography at Goodyear Aerospace Corporation.

An angular-rate detector using similar correlation techniques to track lunar surface areas could control a soft landing on the moon, the company suggests.

A daylight photo positioner is already being flight tested by Research Technology division of the Air Force Systems Command at Dayton. A more sensitive night version, still in development, will be delivered during 1964.

An electronic storage tube holds successive images of ground scenes, recorded while a satellite progresses along its orbit. Simultaneous vidicon scans of the area covered are correlated with the reference images on the storage tube, to derive velocity over height as output of the correlator's longitudinal channel.

Integrator-developed error signals control longitudinal travel of the camera lens, tracking it back proportionally so it frames an apparently stationary picture of the ground scene while the shutter closes.

Meanwhile the correlator's lateral channel measures drift, to develop error signals that enable x and y-axis deflection coils to correctively torque a platform holding the camera.

Experimental tracking of a moving aerial photo strip on a laboratory wall—to simulate space vehicle motion over earth—held tracking errors to 0.09 percent, according to



we've got your number

... in binary coded decimal format at 50,000 conversions per second, including sample and hold. Texas Instruments new Model 846 A-D Converter features 100 megohm input impedance, voltage ranges from 1 to 10 volts (manual or external selection) and 100 nanosecond aperture time.

Available options include three digits (± 999) or four digits ($\pm 1,999$), differential input, decimal or BCD display and digital to analog conversion capability. The 846 is another high-speed, high-accuracy instrument in TI's line of digital data handling equipment.

Model 844 and 845 high-speed Multiplexers are ideal companion instruments for use with TI A-D Converters.



Addressable, sequential and addressable/sequential models are available, sampling at 50,000 channels per second. Features up to 160 channels, variable frame length, accuracy $\pm 0.02\%$ full scale with input levels to ± 10 volts.

Write for complete information.

INDUSTRIAL
PRODUCTS
GROUP



TEXAS INSTRUMENTS
INCORPORATED
P. O. BOX 66027 HOUSTON, TEXAS 77006



An RMC "JF" discap

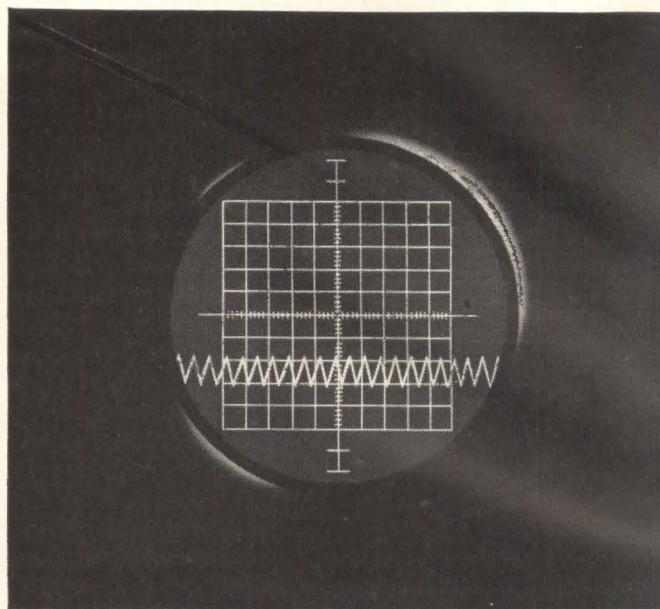

...can go through phase

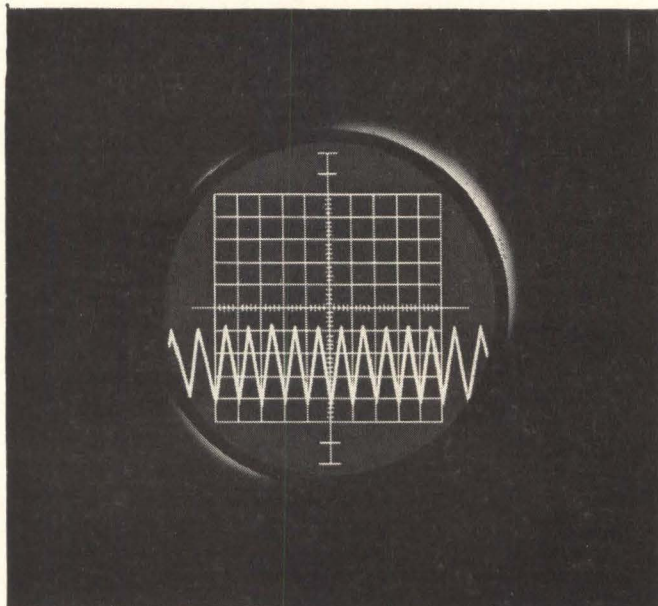

...after phase

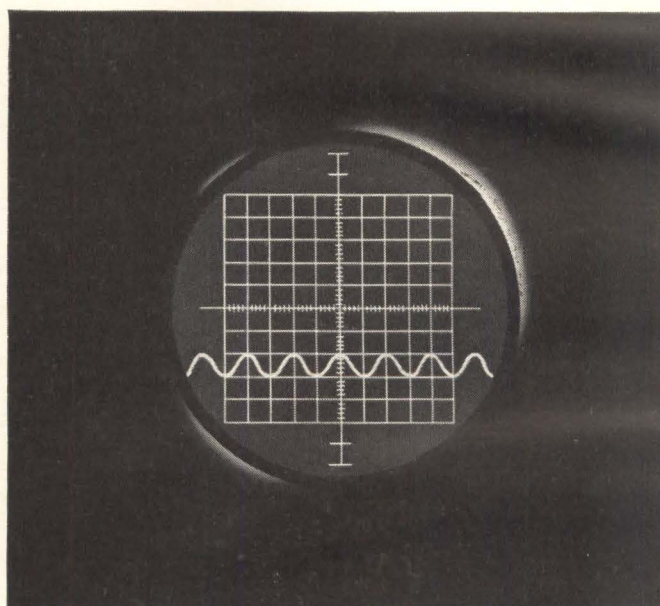

...after phase...without a faze!

RMC Type JF DISCAPS exhibit superior stability in applications where a wide range of frequencies is present. Rated at 1000 V.D.C., these capacitors are manufactured in capacities between 150 MMF and 10,000 MMF.

Between 10° and 85°C., Type JF DISCAPS exhibit a capacity change of only $\pm 7.5\%$ and are available in tolerances of $\pm 10\%$, $\pm 20\%$, $+80-20\%$ at 25°C. Write on your letterhead for information on these and other quality RMC DISCAPS.

DISCAP
CERAMIC
CAPACITORS



RADIO MATERIALS COMPANY

A DIVISION OF P. R. MALLORY & CO., INC.
GENERAL OFFICE: 4242 W. Bryn Mawr Ave., Chicago 46, Ill.
Two RMC Plants Devoted Exclusively to Ceramic Capacitors
FACTORIES AT CHICAGO, ILL. AND ATTICA, IND.



MULTIVATOR would try to get an enzyme reaction in dust samples, thus producing detectable fluorescence

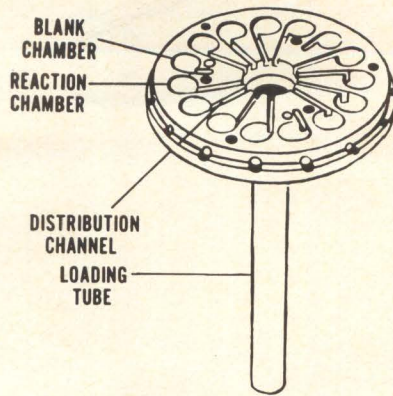

Is There Life on Mars?

Life-detector systems on Mariner and Voyager may provide the answer

By **JOEL A. STRASSER**
Assistant Editor

WASHINGTON—NASA is expected to decide soon what kind of extra terrestrial life detectors will go on the first voyages to Mars. There are at least eight candidates for the job.

Three of the proposed life detectors are earmarked as possible experiments on Mariner B, scheduled for launch in 1966 or 1968. The Voyager spacecraft will carry one of the other five devices, in 1969, 1971 or 1973. Both of these spacecraft are to soft-land on Mars instrument

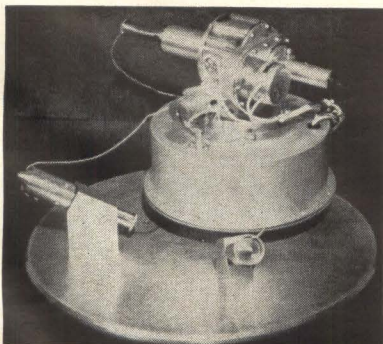

GULLIVER would tag organisms with radioisotope

packages that would telemeter data back to earth.

Mariner B Devices—Possible experiments for Mariner B are Gulliver, designed by G. V. Levin, of Resources Research, Inc., and the multivator and vidicon microscope experiments designed by Dr. Joshua Lederberg, of Stanford Medical Center.

Upon landing on Mars, Gulliver would fire three strings coated with a sticky substance, then reel the strings in. Any adhering microorganisms would grow in a nutrient broth, tagged with radioisotopes, and thus produce a radioactive gas. A miniature geiger counter would detect the gas.

The multivator is designed to analyze dust samples for microscopic organisms. Twelve chambers contain reactive materials to amplify certain metabolic processes. An enzyme reaction would produce a fluorescence measurable with a multiplier phototube.

The vidicon microscope experiment would seek visible signs of life with a lens system able to cover an object field of 100 microns with a 0.5-micron resolution. Pictures, in at least four shades of grey, will be transmitted to a miniature telemetry system for relay to Mariner and then back to earth.

Voyager Life Detectors—Candidates for the second trip to Mars on Voyager include: the Wolf Trap by

NO MORE POWER FAILURES!

Not even a flicker of the lights as an **ELECTRO-PAC "A"** Standby Power Supply maintains uninterrupted power to the load

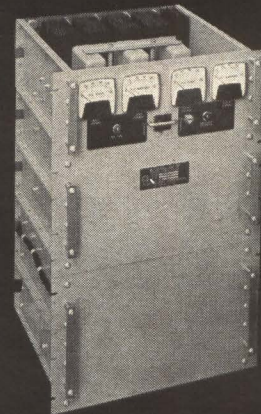

The ELECTRO-PAC "A" is more than an emergency inverter which changes a reserve power battery source to ac... it is a full-time voltage regulator, maintaining the ac line within $\pm 5\%$ of 120 volts.

For emergency power when a few cycles interruption can be tolerated, the economical ELECTRO-PAC "B" is available... to "invert" dc to sinusoidal ac... for use with dc generators... to provide an ac source while "floating" on a battery.

ELECTRO-PAC "A" or "B" units are available for outputs of 0.5 to 5 KVA and for use with inputs of 22-28 v., 42-56 v., and 100-140 v., dc. Efficiencies up to 80%.

Write for application bulletins on standard "A" and "B" units. Complete standby power systems also available.

**ELECTRO-SEAL
CORPORATION**

946-C North Avenue
Des Plaines, Illinois



POLAROID CORPORATION USES CLAIREX[®]

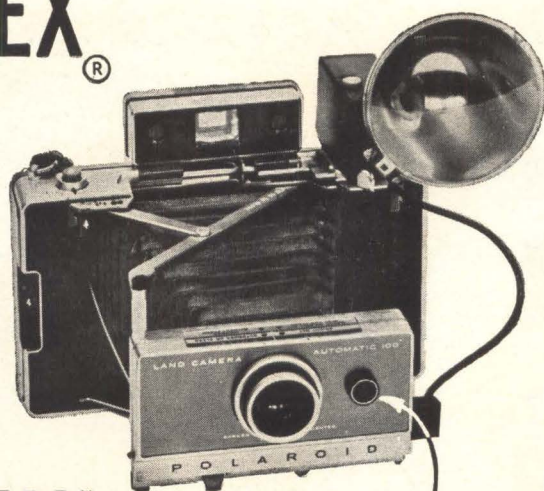

...AGAIN!



- **FIRST FLASH EXPOSURE CONTROL USING PHOTOCONDUCTIVE CELL**

The world's most advanced camera, the **Polaroid Land Automatic 100**, contains a most advanced photoconductive cell by **Clairex** capable of high speed operation over a ratio of light levels greater than 10,000/1. This cell is a key component—a "light valve"—in the new camera's electronic shutter which permits perfect exposures in both color and black and white under all conditions, including flash operation. Precisely controlled characteristics, as well as speed and reliability, prompted **Polaroid** to rely on **Clairex** photoconductive cells for such an important task . . . a second time!

- **FIRST STILL CAMERA WITH PHOTOCONDUCTIVE CELL CONTROL**

Over four years ago, **Polaroid Corporation** came to **Clairex** and asked it to supply the critical photoconductive cell component for its "Microeye" exposure control device, a "first" for still cameras!

Have you considered the "light touch" . . . in your automation or control problem?

CLAIREX CORPORATION

The Finest in Photoconductive Cells . . . in and out of This World

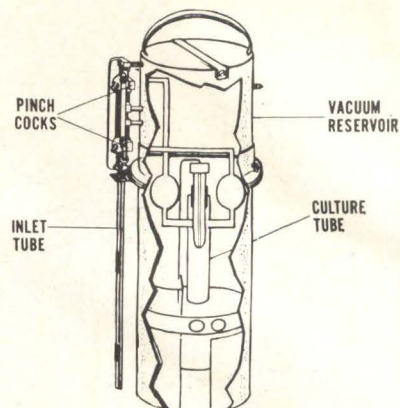

WOLF TRAP would detect chemical changes in cultures

Wolf Vishniac, of University of Rochester; optical rotary dispersion profiles, and u-v spectrophotometer, headed up by Ira Blei and Saul Nelson, of Melpar; J-band life detector by R. E. Kay and G. E. Walwick, of the Aeronutronic division of Ford Motor Co., and a mass spectrometer experiment by Klaus Biemann, of MIT.

Soil samples are drawn up into Wolf Trap by vacuum and drop into culture tubes. If bacteria are present, changes in turbidity would be sensed by a photoelectric cell and changes in acidity by a pH electrode.

Optical-rotation experiments would detect deoxyribonucleic acid (DNA), a substance that exists only where life exists. Absorption spectroscopy would detect DNA, using photoelectric cells. DNA can be detected by measuring wavelength absorption and energy absorbed per unit weight. The nitrogenous base of DNA has an absorption band at 2,600 Å. Finally, optical rotation is used to find evidence of an adenine-sugar chemical bond—a positive check on the presence of DNA.

J-bands are intense absorption bands of extremely high wavelength. They are positive evidence of protein, and thus probably life. In the J-band life detector, when protein from interplanetary dust mixes with a dye solution, a J-band forms. Absorbed light energy changes the electric current generated by a metered detector.

Melpar's u-v spectrophotometer will look for proteins and peptides. MIT's mass spectrometer would detect amino acids, principal components of proteins.

salon
international
des

COMPOSANTS

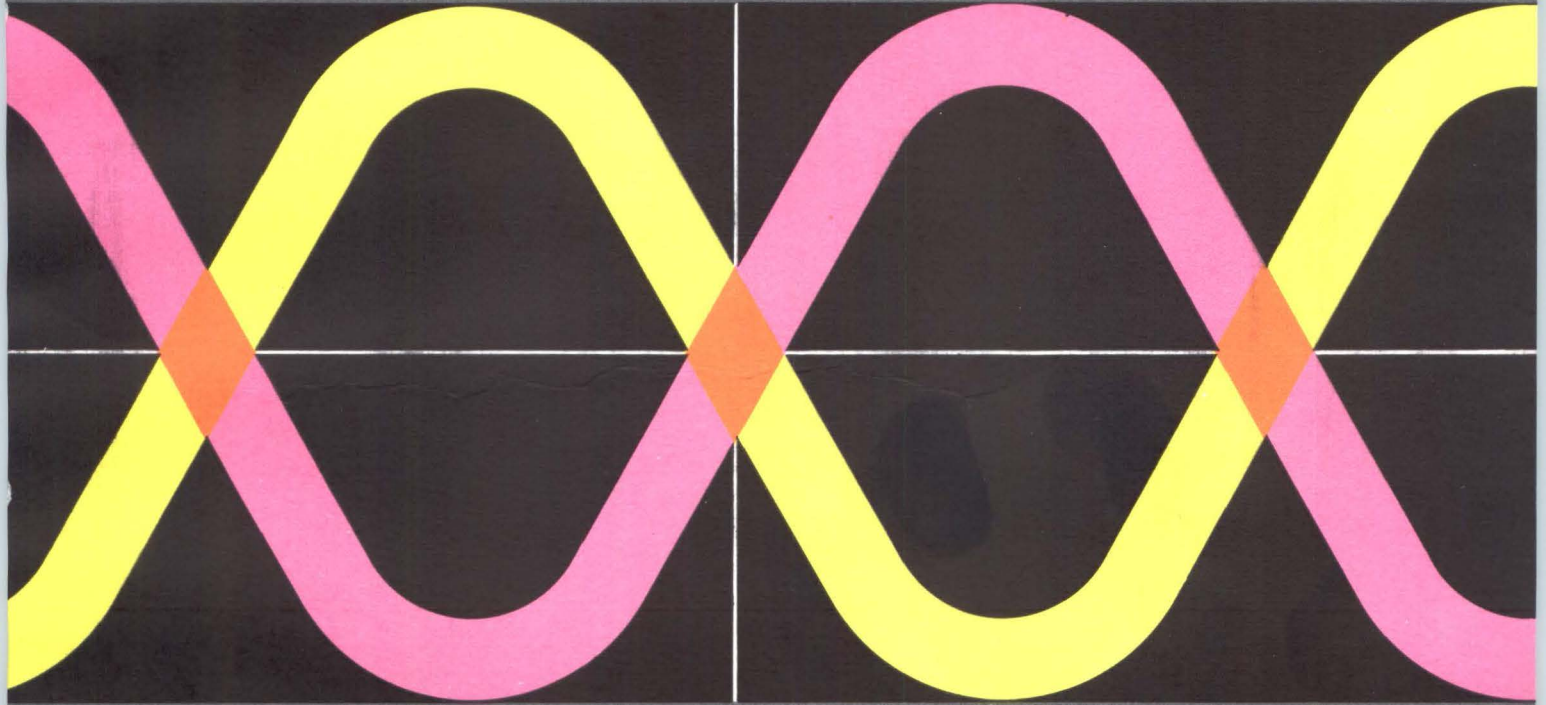

ÉLECTRONIQUES

Renseignements : S. D. S. A.
23, rue de Lubeck
PARIS 16^e

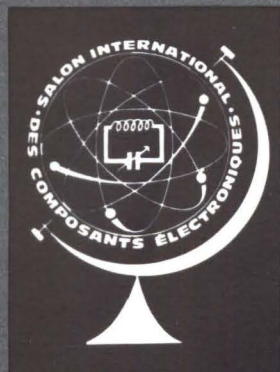

**7 AU 12
FÉVRIER
1964**

PORTE DE VERSAILLES
PARIS

Visit
the international exhibition,
of

ELECTRONIC COMPONENTS

held in PARIS
Porte de Versailles

7th to 12th February 1964
open from 9.30 a.m. to 7 p.m

**SPONSORED BY THE FEDERATION
NATIONALE DES INDUSTRIES ÉLECTRONIQUES**

this is the world's most famous exhibition
in the field of electronics.

Exhibitors are only manufacturers
of electronic components, tubes, semiconductors,
measuring and electro-acoustical equipment.

THE OLDEST,
THE LARGEST,
THOROUGHLY INTERNATIONAL IN SCOPE

To secure the invitation card available to
" Electronics " readers, please send this reply coupon
either to one of the firms advertising
in the following pages or to :

S. D. S. A. - Relations Extérieures
23, rue de Lübeck - Paris 16^e (France)

The invitation card can also be handed to you
at the Welcome Centre of the Exhibition
on presentation of this coupon
and your business card.

You will be most welcomed.

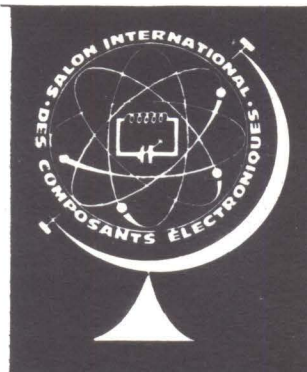

Name :

Title :

Company :

Address :



INTERNATIONAL EXHIBITION OF ELECTRONIC COMPONENTS PARIS



French group manufactures all electronic components

CSF - COMPAGNIE GÉNÉRALE DE TÉLÉGRAPHIE SANS FIL

78, BOULEVARD HAUSSMANN - PARIS 8^e - ANJ 84 60



*Safety electronic tubes
and special tubes*

CSF - DIVISION TUBES ÉLECTRONIQUES
79, BOULEVARD HAUSSMANN - PARIS 8^e

*Quartz - Quartz Filters
Crystal controls*

CSF - DÉPARTEMENT DE PIÉZO-ÉLECTRICITÉ
6, RUE ADOLPHE-LA-LYRE - COURBEVOIE (SEINE)

*Millimetric microwave
components*

**CSF - DÉPARTEMENT DE PHYSIQUE
APPLIQUÉE**
DOMAINE DE CORBEVILLE PAR ORSAY
(SEINE-ET-OISE)



*Components for wireless and T.V. sets
Printed circuits - Magnetic materials
and plastics - Inductors - AF and sup-
ply transformers - Mechanical parts*

OREGA

106, RUE DE LA JARRY - VINCENNES (SEINE)
*Export : CSF. Composants exports ;
128, rue de Paris - MONTREUIL/S/BOIS
(Seine)*



Relays - Synchros - Motors

**CSF - DÉPARTEMENT PIÈCES DÉTACHÉES
ÉLECTRO-MÉCANIQUES**
52, RUE GUYNEMER
ISSY-LES-MOULINEAUX (SEINE)

*Special electric alloys
Sintered alloys*

Very high capacity resistors

**CSF - DÉPARTEMENT DE
RECHERCHES PHYSICO-CHIMIQUES**
12, RUE DE LA RÉPUBLIQUE - PUTEAUX (SEINE)

Transformers

CSF - DÉPARTEMENT TRANSFORMATEURS
7, RUE HENRI - LEVALLOIS-PERRET (SEINE)
*Export : CSF. Composants export
128, rue de Paris - MONTREUIL/S/BOIS
(Seine)*



*Any industrial and electronic cera-
mics - Thermistors - Transistors headers
Thermoelectric modules.*

CICE

63, RUE BEAUMARCHAIS - MONTREUIL/S/BOIS
(SEINE)



*Carbon film resistors
Metal film resistors*

EURISTA

128, RUE DE PARIS, MONTREUIL/S/BOIS (SEINE)



*Ceramic, plastic film, mica,
tantalum capacitors - Delay lines*

L.C.C. STEAFX

128, RUE DE PARIS - MONTREUIL/S/BOIS (SEINE)
*Export: CSF. Composants export
128, rue de Paris - MONTREUIL/S/BOIS
(Seine)*

Italian affiliated companies

*Ceramic, plastic film, paper and
electro-chemical capacitors. Variable
capacitors*

DUCATI - MICROFARAD

Semi-conductors **MISTRAL**

DUCATI : ELECTROTECHNICA EXPORT

CASELLA POSTALE 572 - BOLOGNE ITALIE

Distributor in France :

L.C.C. steafx, 128, rue de Paris
MONTREUIL/S/BOIS (Seine)



Semi-conductors

COSEM (joint venture of SACM and BELVU)
12, RUE DE LA RÉPUBLIQUE - PUTEAUX (SEINE)

*Export: CSF. Composants export
128, rue de Paris - MONTREUIL/S/BOIS
(Seine)*



*Connectors
Rotary switches
Microphones
Earphones*

SOCAPEX

9, RUE ÉDOUARD-NIEUPORT - SURESNES (SEINE)



*Ferrite cores for radio and T.V.
Ferrinox high grade pot cores for
telecommunications - Memory and
switching cores. Memory stacks.
Ferrite microwave devices.*

COFELEC (joint venture of CFTH, Bull and UGINE)

128, RUE DE PARIS - MONTREUIL/S/BOIS (SEINE)

*Export : CSF. Composants export,
128, rue de Paris - MONTREUIL/S/BOIS
(Seine)*



INTERNATIONAL EXHIBITION OF ELECTRONIC COMPONENTS PARIS



Alcatel

SOCIETE ALSACIENNE DE CONSTRUCTIONS ATOMIQUES,
DE TELECOMMUNICATIONS ET D'ELECTRONIQUE
69, rue de Monceau—Paris (8ème)

ALCATEL GENERAL ACTIVITIES

In its laboratories and factories ALCATEL exercises its research or production activities in the following fields:

- 1—Telecommunications: long-distance liaison by frequency carriers; radiodiffusion equipments.
- 2—Nuclear energy; control panel and charge-discharge of the reactors.
- 3—Sub-marine acoustics and detection.
- 4—Numerical codifying of information.
- 5—Navigation by inertia: platforms and components.
- 6—Physic of the solid: thermo-electricity, piezo-electricity.
- 7—Measurement instruments and nuclear instrumentation.
- 8—Vacuum techniques and electronic shelling.

PARTICIPATION IN THE PARIS ELECTRONIC COMPONENTS SHOW

Alcatel presents:

- an analogic-digital multi-channel converter.
- standard logical moduls.
- transistorized generators and millivoltmeters.
- numerical voltmeter.
- resistors boxes, capacitors and precision-damping boxes.
- thermo-electricity applications: cooling plates, photomultipliers, coolers, stable-zero, refrigerated rooms.
- piezo-electricity applications: ceramics and welding and cleaning transducers.
- nuclear instrumentation.

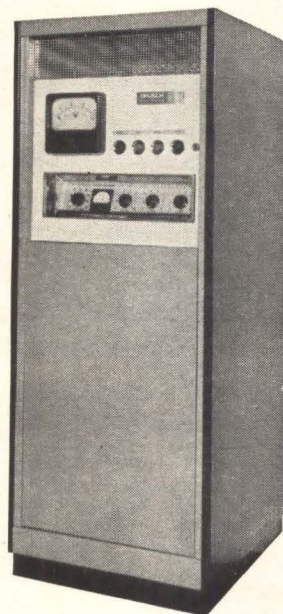

HIGH SPEED STATIC VOLTAGE REGULATORS

Input:

- Mains supply voltage fluctuation $\pm 15\%$
- Mains supply frequency 48-52 cycles
- Power factor of regulator at full load more than 0.86

Output:

- Regulation accuracy $\pm 0.2\%$
- Overall harmonic distortion. Less than 3%
- Admissible load variation 0 to 100%
- Recovery time constant:
 - For 20% mains variation 0.04 sec.
 - For 95% load variation 0.03 sec.
- Efficiency at full load 96%
- Radiation free — Instantaneous start up
- 10 Standard ratings: 0.5—1-2-5-10-15-20-30-40-60 Kva
- Mains supply: 110-117-127 and 220 V.

SATURABLE REACTORS

- Power rating from 0.05 to 300 Kva (oven supply, motor control, etc.)

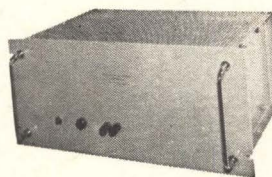

MAGNETIC AMPLIFIERS

- For proportional temperature control

STATIC CONSTANT-CURRENT SUPPLIES FOR ELECTROMANETS

Input:

- Single-phase or three-phase mains supply $\pm 10\%$

Output:

- Power rating 1 to 100 Kva
- Regulation accuracy: Drift less than 0.002% in 8 hours
- Set point adjustment 2 to 100%
- Recovery time constant for 10% mains supply fluctuations, 3 millisecc.
- Also: field stabilization with Hall effect and nuclear resonance-devices

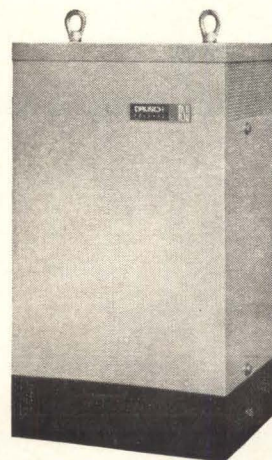

STABILIZED POWER SUPPLIES

- For electron-beam furnaces

DRUSCH

V O L T R E G

138, RUE GALLIENI-PARIS/RUEIL-MALMAISON (S.-&-O.)

Tel.: 967-11-33 et 967-20-54

RAPY



INTERNATIONAL EXHIBITION OF ELECTRONIC COMPONENTS PARIS



Presented at the "Mesucora",

THE NEW RANGE OF OSCILLOSCOPES RIBET-DESJARDINS

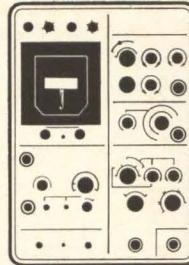

| TYPE | n. of Traces | SWEEP | | VERTICAL AMPLIFIER | | | |
|--|--------------|-------------------------|----------|--------------------------|----------------------------|----------------|------------------------------------|
| | | SWEEP RATES | Expander | Band Width c/s - Mc/s | Sensitivity mv/cm | Rise time | Cathode ray tube ∅ mm and V. |
| 205 A Special researches | 1 | 2 ns/cm - 1000 ns/cm | no | 0 - 1000 | 10 v/cm | 0,35 ns | 125 24 KV |
| 204 A Special researches | 1 | 0,005 μs/cm - 2 s/cm | no | 0 - 50 | 25 (10 KV) 50 (20 KV) | 7 ns | 125 20 KV |
| 241 A Transient phenomena Laboratory - Radar | 1 2 | 5 s/cm - 0,02 μs/cm | x 5 | 0 - 30 0 - 30 | DC 50 AC 5 DC and AC 50 | 12 ns 12 ns | 125 10 KV |
| 242 A Transient phenomena Television | 1 2 | 5 s/cm - 0,02 μs/cm | x 5 | 0 - 15 0 - 15 | DC 50 AC 5 Dc and AC 50 | 24 ns | 125 10 KV |
| 243 A Transient phenomena Computers | 1 2 | 5 s/cm - 0,02 μs/cm | x 5 | 0 - 15 0 - 15 | DC 50 AC 5 DC and AC 50 | 24 ns | 125 10 KV |
| 244 A Simultaneous Transient phenomena | 2 | 0,5 μs/div - 0,5 s/div | x 5 | 0 - 6 | DC 50 AC 5 | 0,06 μs | 100 4 KV |
| 255 B Field application | 1 | 0,16 μs/div - 0,32 s/cm | x 5 | 0 - 6 10 - 6 | 160 16 | 0,06 μs | 70 1,6 KV |
| 245 A Field application | 1 | 2 s/div - 0,04 μs/div | x 5 | 0 - 15 10 - 10 | 50 5 | 25 ns 35 ns | 70 4 KV |
| 246 A V.L.F., Teaching | 2 | 2 s/cm - 0,2 μs/cm | x 5 | 0 - 1 | DC and AC 10 | 0,35 μs | 125 3 KV |
| 247 A Versatile oscilloscope | 1 | 1 s/cm - 0,1 μs/cm | x 5 | 0 - 1 | DC 50 AC 5 | 0,35 μs | 125 3 KV |
| 248 A Television, Teaching | 1 | 1 s/div - 0,1 μs/div | x 5 | 0 - 5 | DC 50 AC 5 | 0,07 μs | 70 |

THE GENERATORS AND WOBBLATORS
RIBET-DESJARDINS
WILL BE PRESENTED IN THE FOLLOWING
ISSUES OF THIS PUBLICATION

DETAILED INFORMATION ON REQUEST FROM

RIBET-DESJARDINS

INSTRUMENTS DIVISION. CABLE ADDRESS : PILACELECT-MONTROUGE - PARIS (France)
CIRCLE 202 ON READER SERVICE CARD

SOURIAU ET CIE

ELECTRICAL
CONNECTORS

AERONAUTICS
NAVY
ELECTRONICS
RADIO

9 Rue Gallieni
BOULOGNE
BILLANCOURT
FRANCE

SOURIAU ELECTRIC
G. m. b. H. Dusseldorf
Rathausufer 17

SOURIAU ITALIANA
S. p. A. Milan
Piazza Velasca 5

SOCIÉTÉ ÉLECTRIQUE
BENELUX SOURIAU
Bruxelles
Rue Royale 163

S. E. B. S. NEDERLAND
Rotterdam





INTERNATIONAL EXHIBITION OF
ELECTRONIC COMPONENTS
 PARIS



TUBES FOR V.H.F.-U.H.F. & S.H.F. BANDS

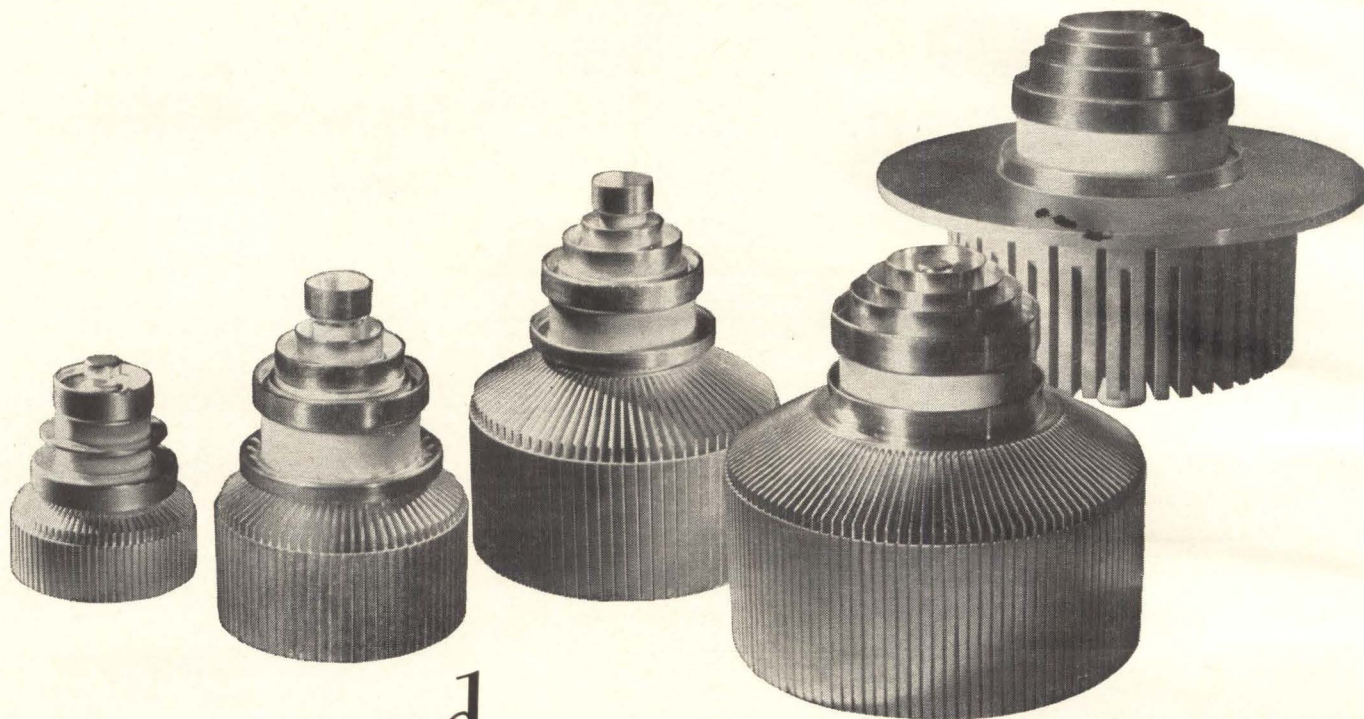

*Engineered
 to be the finest
 a wide range of*

TRANSMITTING TUBES

*From 100 W up to 300 kW
 From 30 mc/s up to 200 mc/s
 Convection cooled
 Air cooled
 Vapor cooled (Vapotrons)*

TRANSMITTING TUBES

METAL CERAMIC

*From 20 W up to 25 kW
 From 200 mc/s up to 300 mc/s
 Air cooled and vapor cooled triodes and tetrodes*

RECTIFIER & INDUSTRIAL

HIGH VACUUM OR GAS FILLED TUBES

*From 0,003 A up to 25 A
 Kenotrons—Phanotrons
 High and Low voltage thyratrons—Ignitrons*

IMAGE TUBES

*Pick-up tubes (vidicons, image-orthicon)—Monoscopes
 X Rays image intensifiers—Image converters*

SPECIAL PURPOSE TUBES

*Pulse or CW TWT
 High temperature tubes—Energy converters
 Gas-tight through-terminals
 for high temperature and ultra high vacuum*



COMPAGNIE FRANCAISE THOMSON-HOUSTON

DIVISION TUBES ELECTRONIQUES—6, RUE MARIO NIKIS—PARIS XV^e—Tel. SUFFREN 91-00
 U. S. REPRESENTATIVE: THOMSON ELECTRIC CO.—50 ROCKEFELLER PLAZA—ROOM 916—NEW YORK—20 (N.Y.) U.S.A.

CIRCLE 78 ON READER SERVICE CARD



INTERNATIONAL EXHIBITION OF
ELECTRONIC COMPONENTS
PARIS

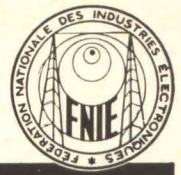

HIGH POWER PULSED KLYSTRON
CW KLYSTRONS
REFLEX KLYSTRONS
MAGNETRONS
TR-ATR
SOLID STATE DEVICES

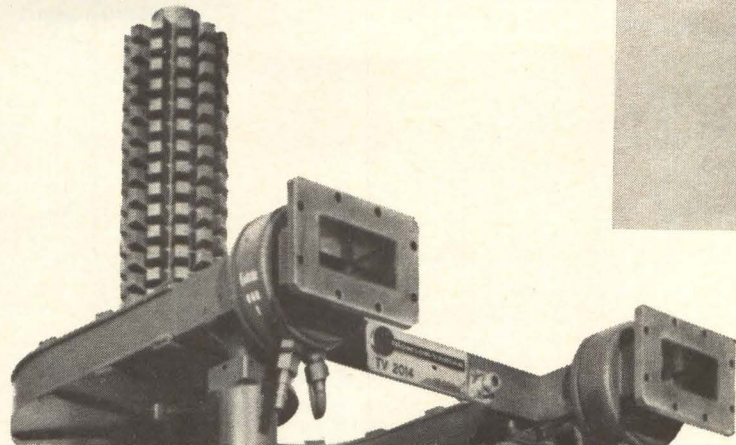

ALL MICROWAVE TUBES AND COMPONENTS

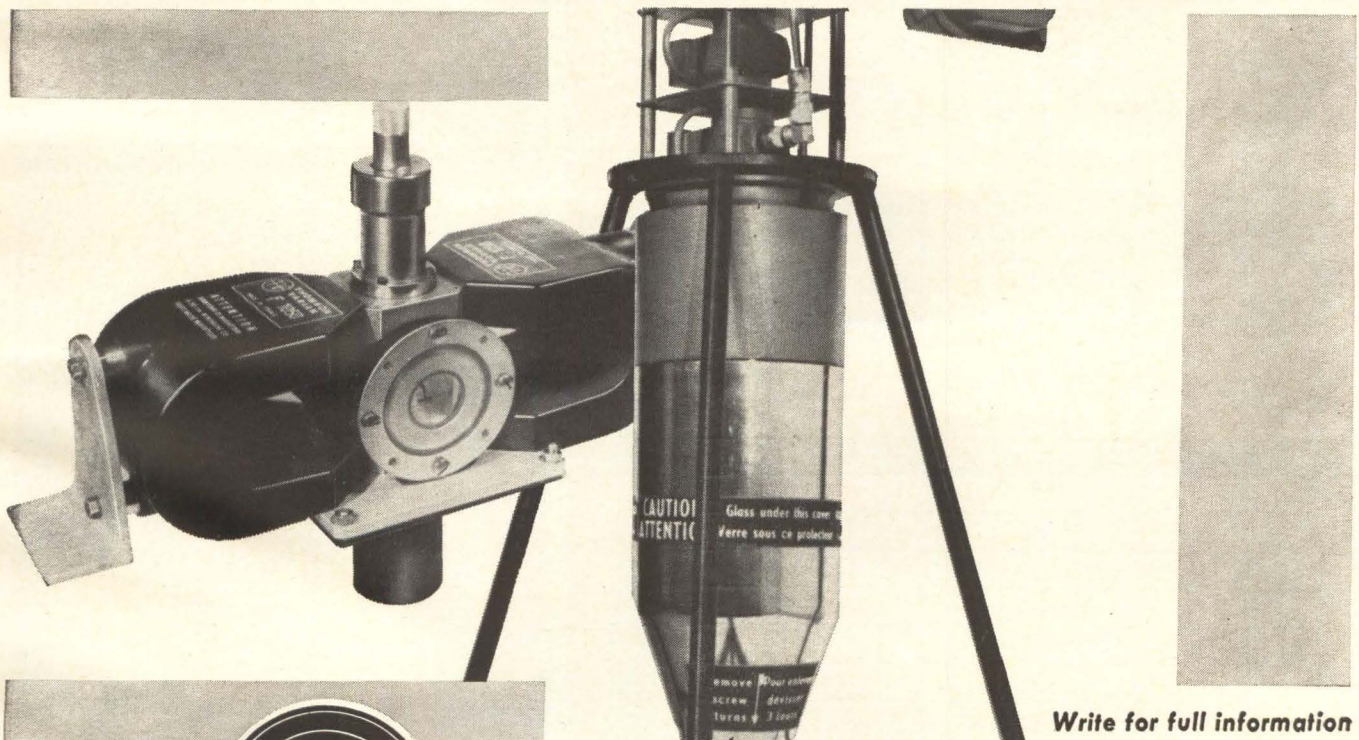

Write for full information



THOMSON-VARIAN

THOMSON-VARIAN TUBES ET COMPOSANTS HYPERFREQUENCES - 6, RUE MARIO-NIKIS - PARIS 15^e - TEL. SUFFren 91-00
VARIAN ASSOCIATES - PALO ALTO - CAL. FOR THE U. S. AND CANADA



INTERNATIONAL EXHIBITION OF ELECTRONIC COMPONENTS PARIS



actual size

PUBLIC SERVICE

A reliable tube

7320 AF POWER AMPLIFIER PENTODE *

Power output class AB1: 17 watts with 300 volts anode.

dependable life and reliable service under the exacting conditions encountered in mobile and aircraft applications.

- mechanical ruggedization.
- materials specially chosen for better dissipation capabilities of anode and grids.
- heater-cathode construction withstanding many-thousand cycles of intermittent operation.
- low microphony.

| 7320 | | class A - 1 tube | class AB1 - 2 tubes |
|------|------------|------------------|---------------------|
| Eb | V | 250 | 300 |
| Ec 1 | V | - 7.3 | - 14.7 |
| I p | mA | 48 | 2 x 46 |
| S | μ mhos | 11,300 | |
| Vi | Vpk | 6.1 | 14 |
| Po | W | 5.7 | 17 |

* reliable version of 6 BB 5



**COMPAGNIE INDUSTRIELLE
FRANÇAISE
DES TUBES ÉLECTRONIQUES**

Write for information :

C.I.F.T.E.

50 rue J.-P. Timbaud - COURBEVOIE
(Seine) FRANCE

Téléphone : DEF 37-50

Telegram : CIFTE-COURBEVOIE



More than half of all television receivers manufactured in France use **VIDEON** components: the first French specialists in manufacture of UHF tuners, VHF rotary switches, intermediate-frequency coils, deflection coils, high-voltage transformer, chokes, etc.

VIDEON

95 rue d'Aguesseau, Paris/Boulogne-sur-Seine, France

Tel.: VAL 55-95

Plant in Monville near Rouen (Seine Maritime)

RAPY

CIRCLE 203 ON READER SERVICE CARD



LOUDSPEAKERS AUDAX FRANCE

Société Anonyme au Capital de 6.000.000 NF
45, Avenue Pasteur
MONTREUIL (Seine) FRANCE
Téléphone : AVRon 50-90 +
Telegrams : OPARLAUDAX-PARIS

CIRCLE 204 ON READER SERVICE CARD

January 3, 1964 electronics

Atom Smasher Beams 10^{13} Protons

Argonne accelerator will double world's particle research capabilities

By CLETUS WILEY
Regional Editor, Chicago

MOST intense beam of particles ever delivered by an atom smasher yet, 3 to 10 trillion protons a second at 12.5 billion electron volts, is produced by Argonne National Laboratory's new ZGS (Zero Gradient Synchrotron) proton accelerator.

The 12.5-Bev beam power places the ZGS second only to Brookhaven, New York, Laboratory's atom smasher, which produces only one-fortieth as many particles, and uses more than twice as much power. Other more powerful accelerator is at Geneva, Switzerland.

Unique features of the ZGS design are magnet sections shaped to focus the proton beam without a potential gradient. This enables the 200-foot diameter ring to achieve higher maximum fields, and to contain higher energy protons inside a smaller diameter circle.

Hydrogen Source—An electrical discharge strips electrons from hydrogen atoms, thus providing the protons to be accelerated. A pulsed Cockroft-Walton accelerator charges electrodes along an evacuated tube, delivering the protons in bunches every four seconds. Between each pair of electrodes, the protons are accelerated by 750 Kev.

The protons are next further accelerated by alternating voltages in a resonance of linear accelerator (linac), in which a 500-Kw power supply generates a 200-Mc electromagnetic field. The linac delivers the protons, carrying 50 Mev at 59,000 miles a second, to the main synchrotron loop.

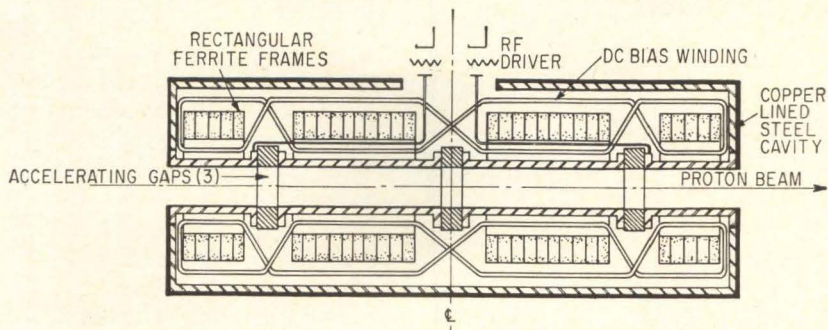

SECTION through r-f cavity, filled with ferrite frames and biased with d-c bias winding. Proton beam is accelerated between each pair of electrodes

After injection into the doughnut-shaped synchrotron, an r-f cavity at a gap in the magnet ring (see diagram) delivers a 10-Kv boost each time the circling beam passes. As the proton speed increases, magnetic field is gradually raised from 500 to 22,000 gauss to keep the protons in orbit while they circle 1.5 million times.

The r-f cavity at the magnet-ring gap tracks closely, from the 500-Kc proton injection frequency up to 1.75 Mc at maximum energy.

The resonant r-f cavity is powered from anodes of a hard-vacuum-tube amplifier, which ranges from 4 to 14 Mc—eighth harmonic of the orbiting protons. Accelerating voltages are applied across insulating spacers in the vacuum chamber of the synchrotron. The cavity is loaded with high-frequency ferrite, biased by a coil which can be energized with a programmed current flow.

Permeability of the ferrite can be changed by applying a magnetic field. The adjusted permeability then tracks the frequency of the cavity as required to keep accelerating the bunches of protons.

The r-f cavity contains three accelerating cells in series, along the path of the proton beam. Up to 10 Kv may be applied across each of these gaps to produce nearly

30 Kev as maximum proton energy gain per orbit of the accelerating system.

Proton Target—During the second before the magnetic field decays, up to 10 trillion protons have been accelerated to 12.5 Bev. They are then slowed down, and drawn off into two separate experimental areas by deflecting them out of the machine with a series of bending and

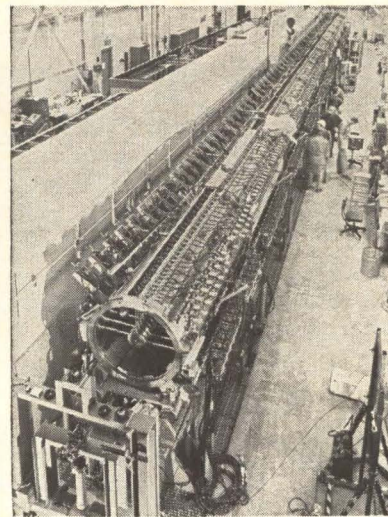

LINAC, or linear accelerator, of the ZGS during final assembly. The linac is a single resonant cavity powered by a large r-f supply, capable of providing peak power of 5 million watts

Pick the Vacuum Pump that Fits Your Needs!

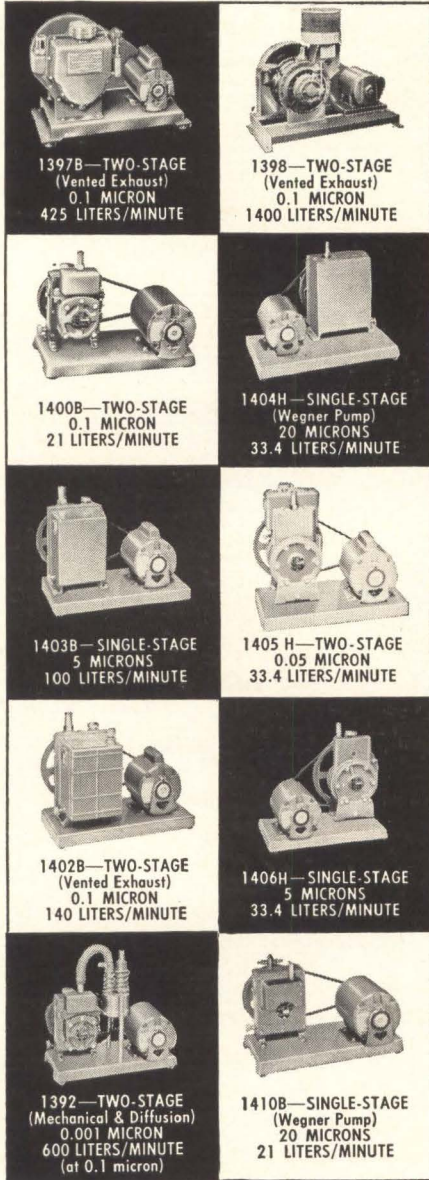

Pat. No: 2,337,849

WELCH DUO-SEAL VACUUM PUMPS

are designed to fit almost every application better and at less cost . . . in the laboratory, industry and school. Ten different models to choose from . . . capacities from 21 to 1400 liters per minute . . . ultimate pressures from 2×10^{-2} mm Hg down to 1×10^{-4} mm Hg and better . . . two-stage and single-stage mechanical pumps with vented exhaust, and mechanical and diffusion combination pumps.

Over the years, Welch Duo-Seal Pumps have built a world-wide reputation for best performance, greatest reliability and quietest operation. *When you use a Duo-Seal Pump, you're using the best!*

For complete specifications and prices, ask for Duo-Seal Catalog

SINCE 1880 THE WELCH SCIENTIFIC COMPANY
 Foremost manufacturers of scientific equipment
 1515 Sedgwick St., Dept. 906, Chicago 10, Ill.

deflecting magnets. Protons may also be used to bombard targets in their direct path. Resulting secondary particles may be studied in an experimental area, or diverted to a bubble-chamber building where the particle tracks can be photographed.

The vacuum system of the ZGS is said to be so efficient that over 93 percent of the injected protons survive the 1.5 million orbits during the one-second cycle.

Argonne, Northwestern University and Carnegie Tech investigators are studying the possibility of using superconducting magnets up to 50,000 gauss to form fields around bubble chambers.

Argonne's applied mathematics division is cooperating with physicists to develop electronic means to scan and analyze photos of particle tracks from the bubble and spark chambers.

Pulses every four seconds provide opportunities to photograph particle tracks from up to five simultaneous experiments, each requiring as many as 100,000 pairs of stereo pictures.

ZGS has been planned so it can run 24 hours a day, seven days a week.

UV Gauge Monitors Width of Strip Steel in Mill

DEVELOPED to measure the absolute width of hot or cold strip steel during processing, the optical-scanner width gauge, by Gulton Industries, provides digital output with absolute accuracy up to 1/16 in. on strips to 80 in. wide, regardless of cold edges, strip speed and temperature.

Gulton Industries is presently building this solid-state, modular-logic system for a midwestern steel mill. It uses a scanning head, mounted 17 feet from strip pass-line. Ultraviolet backlighting avoids errors that uneven strip cooling can cause in infrared systems.

Absolute digital width is displayed. In addition, deviation from nominal can be shown on recording/indicating equipment, and digital signals can be fed directly to a computer. Periodic calibration check is automatic, and heads need not be repositioned when changing strip size. Digitizing accuracy is independent of scan motor speed and

scanning linearity, since the reading is digitized spatially in the optical system.

New Explanation Suggested For Whistler Behavior

SEATTLE, WASH.—Behavior of whistlers, an ionospheric phenomenon caused by the electric discharge of lightning, drew considerable attention at the fall URSI meeting in December at the University of Washington.

J. F. Walkup, of Stanford University's Radioscience Laboratory, took issue with a generally held view that whistlers that return from one hemisphere to the other are reflected by the ground. Studies of some 10,000 echo trains at the Dartmouth College whistler station contradicted theoretical predictions about absorption of whistler-mode waves, Walkup said.

Since the echo of a daytime whis-

Helmet Subject to 5,000 G Impacts

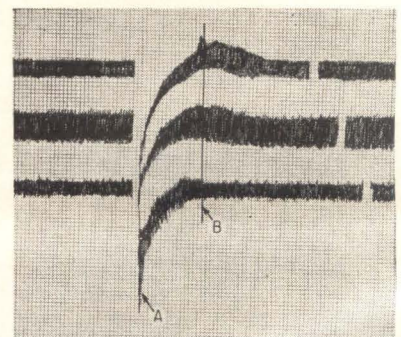

FOOTBALL PLAYER'S helmet gets impacts greater than 5,000 g's, according to Northwestern U. scientists. Telemetry equipment in special helmet measures impacts and transmits data to sideline equipment — see chart, above. Studies are expected to aid in designing safer head-gear for football players

tlar would make several more passes through the absorbing D-region than the whistler itself, whistlers occurring around noon should have fewer echoes than whistlers occurring at night, under the ground reflection theory. The Dartmouth studies, however, show that although the average whistler rate is much higher at night than during daytime, the probability of a whistler having an echo shows virtually no change from midnight to noon.

Furthermore, intensity of an echo varied only a few db from its noon-time whistler, much less than theoretical predictions indicate. Walkup discounted the possibility that whistler echo could be magnified in the magnetosphere, pointing out that "in no cases studied by us has the whistler echo been more intense than the whistler itself."

"A model consistent with our results would be one in which a large fraction of the energy of a down-coming daytime whistler is reflected above D-region heights," Walkup said. "In this model, a whistler may be pictured as bouncing back and forth between the ionospheres of the two opposite hemispheres, with some of the energy leaking through to the ground at the end of each bounce."

Whistlers are under study because of the fluctuations they are considered to affect in reception of VLF transmissions.

British Develop New Way To Find CRT Resolution

LONDON—A new method of quantitative determination of crt resolution has been developed by the Royal Radar Establishment, Malvern, using as an independent standard a grating with equal-sized opaque and transparent bars covering the spatial frequency of 10-300 cps per centimeter in seven discrete steps.

The image of the focused spot on the crt under test is transferred to the grating by a lens system. As the spot scans the crt face, its image traverses the grating at right angles to the bars. The modulation depth of the transmitted light is detected by a photomultiplier and displayed as a direct modulation index proportional to the crt's resolution.

IT'S ONLY LACING TAPE— WHY ALL THIS GUDEBROD QUALITY CONTROL?



WHAT'S THE ADVANTAGE OF GUDEBROD FLAT BRAIDED LACING TAPE?

When tying round lacing cord there is a tendency for the cord to create a sharp cutting edge which may knife through the insulation, the cord itself or the worker's hands.

With Gudebrod Flat Braided Lacing Tape the stress is distributed over the flat surface. Firm, flat contact is made, cold flow is eliminated, hands are safe.

Even a minor detail such as lacing tape becomes important when your electronic equipment must meet exacting specifications. So that you can specify Gudebrod Flat Braided Lacing Tapes with complete confidence Gudebrod goes to great lengths to back up its guarantee of quality. The lot number on every package of Gudebrod Tape assures that it has been made under strict control. Close tolerances have been met on such characteristics as slip resistance, fray resistance, tensile strength, finish, fungus resistance, and many others. Where MIL-T-713A Specifications apply, Gudebrod Tape meets or exceeds the requirements.

Whatever your lacing needs—Teflon*, Dacron*, nylon, glass—for general use, for burn proof requirements, for high temperature, for fungus resistance, Gudebrod makes a tape or will produce one. And you'll know that knots will not slip, harnesses will stay tied and assemblies remain firm. Workers prefer Gudebrod Tape, too, because it does not cut either insulation or hands.

If you want to inspect a sample, want more information, get in touch with your Gudebrod representative, or write to the Electronics Division.

*Du Pont registered trademarks



GUDEBROD BROS. SILK CO., INC.

FOUNDED IN 1870

Electronics Division

12 SOUTH 12TH STREET, PHILADELPHIA, PENNSYLVANIA 19107

New Plastic Fillers Solve RFI Problems

Conductive plastic, used in caulking compounds, gaskets, forms low-cost seals

A **LOW-COST** method, developed for making electrically-conductive plastics, involves imbedding spherical metal particles in plastic forms. The filler consists essentially of copper spheres, coated with silver (see diagram).

The process for making these plastic forms was developed by John E. Ehrreich of Chomerics, Inc., Cambridge, Mass.

Conductive metal fillers can be incorporated in various plastics to provide a variety of adhesives and caulking compounds. Conductive plastics are now being successfully applied to difficult radio-frequency suppression and shielding problems and are being used on major military programs.

The recent development of high-performance silver-coated conductive metal fillers ranging in sizes from 2-3 mils to 12-16 mils, has reduced the cost of stable conductive plastics, in some cases, to less than \$6 per pound.

Conductive plastics in the form of putty-like caulking compounds have been used to seal seams and static joints in shielded rooms, equipment cabinets, and other enclosures in place of welding, soldering, clamping or knurled surfaces and similar methods (ELECTRONICS, June 15, 1962, p 70).

Final Forms — Radio-frequency caulking compounds are now available as thermosetting adhesives, thermoplastic putties and nonsetting resins. The molded forms are available in homogeneously-conductive systems or as a unitary gasket containing a conductive area and a rubbery area for sealing at very low pressures. Whatever the form, ade-

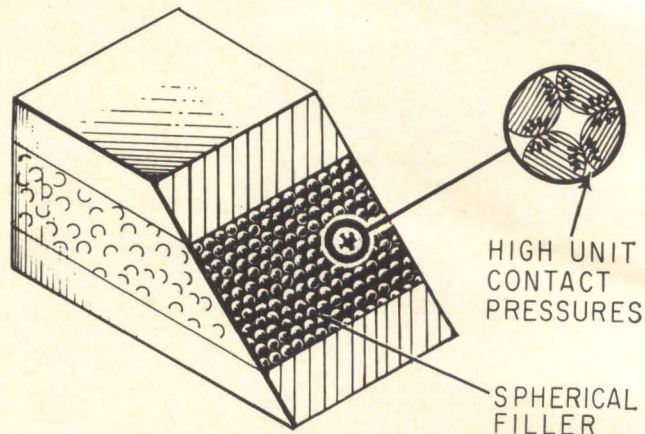

SPHERICAL and coarse nature of new inexpensive metal fillers improves the performance of conductive resins in rfi applications

quate particle-to-particle contact of the metal filler must be obtained within plastic mass to insure good conductivity.

Conductive gaskets are used for O-rings or as replacements of rubber-metal shields where the geometry of the fittings allows a groove to contact the gasket and application of high pressures for sealing. The shielding effectiveness of this type of gasket runs between 94-100 db at microwave frequencies.

Plastics filled with spherical conductive metal fillers have overcome three different problems which are prevalent in making an effective electrical seal: insulating oxide coatings on the fillers; insulating films created by the plastic; insulating films on the surface to which the conductive plastic is applied.

The silver coated spheres have a clean, stable surface which allows the powder to be conductive in free-form even after long-term aging.

The tangential contacts of the spherical fillers allows high point pressure contacts. In addition, the conductive filler makes up about 90 per cent of the total weight of the system, giving the system the extra mass which is often needed. The plastic binder serves as a mois-

ture barrier in preventing galvanic action from taking place between dissimilar metals.

The presence of insulating films on the metal surface is a major reason why conventional conductive plastics filled with metal flakes are usually ineffective in making r-f type joints, and why grittiness imparted by the silver-plated spherical powders is an advantage.

Waveguide gaskets in the form of an electrically-conductive plastic reinforced with a wire screen have proven successful. These provide a pressure seal as well as an electrical seal at microwave frequencies. This form of material can be used as conductive washers and seals in other applications.

No Fade—The large area of interest for conductive plastics, at present, is rfi shielding. Attenuations obtained from Chomerics' conductive plastic systems are in the range of 75 to 100 db over the frequency range of 50 Kc to 10 Gc. Volume resistivities run as low as 10^{-4} ohm-cm. The conductive plastics are extremely effective at frequencies over 7 to 8 Gc where mesh gaskets tend to fade out.

A conductive plastics caulking

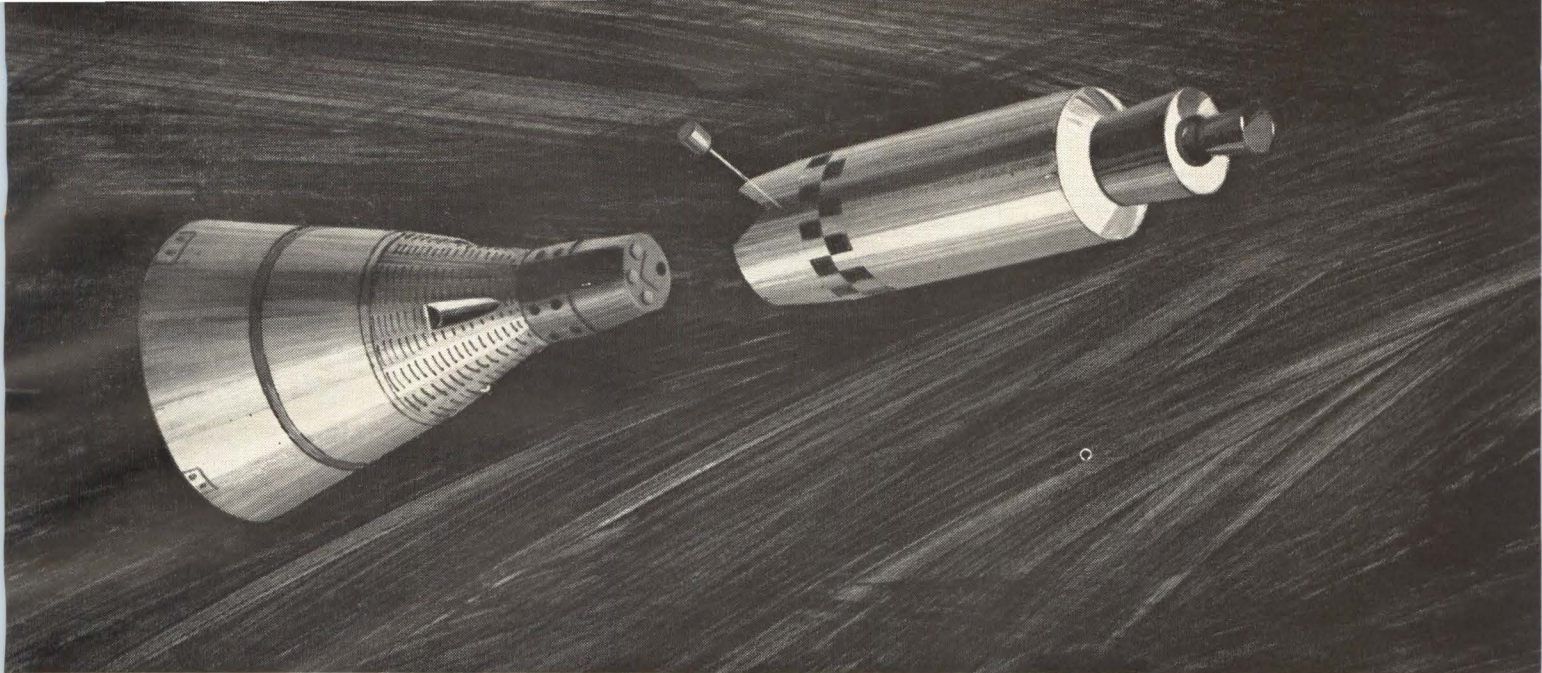

Westinghouse radar will guide the first orbital rendezvous



Westinghouse is working on advanced radar systems for other space missions

When the Gemini two-man spacecraft first performs rendezvous and docking maneuvers in earth orbit, a new Westinghouse radar system will help assure the success of the mission.

The Gemini spacecraft itself, one important mission of which is the perfection of rendezvous techniques, is being built by McDonnell, prime contractor for the Gemini project, under the technical direction of

NASA's Manned Spacecraft Center.

Using a unique interferometer system developed by Westinghouse's Aerospace Division, the spacecraft interrogator will transmit a series of pulses to the target transponder. Reply pulses received by the spacecraft will be used to measure range and azimuth and elevation angles.

The first of its kind in space the Westinghouse radar system for Gemini is the be-

ginning of a new generation of advanced radars now being evaluated at Westinghouse for lunar landings, planet exploration, space station logistic support and other space missions. For more information on Westinghouse Aerospace Division space programs, write for brochure No. AD-R-3M1163, to Westinghouse Electric Corporation, P.O. Box 868, Three Gateway Center, Pittsburgh, Pennsylvania 15230.

J-02348-R

You can be sure if it's Westinghouse



CIRCLE 85 ON READER SERVICE CARD

WHY SETTLE FOR LESS?

0.01%

ACCURATE

SIZE 23 RESOLVER

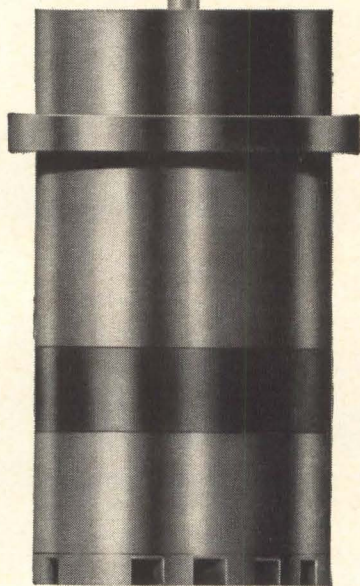

Type 23RV4al

Here's a top rated resolver that's priced surprisingly low. So why settle for less than Ford Instrument's highly accurate Size 23 Resolver... the resolver that exceeds MIL-E-5272A.

SPECIFICATIONS:

- Maximum Functional Error (over 360° of shaft rotation)...0.01% of input voltage at maximum coupling
 - Maximum Total Null Voltage... 1 mv/volt input maximum
 - Maximum Interaxis Error (rotor) ... 1.5 minutes
 - Maximum Interaxis Error (stator) ... 1.5 minutes
 - Maximum Variation of Transformation Ratio (with input voltage from 6-18 volts with 12 volts input as reference) ... 0.03%
 - Maximum Variation of Transformation Ratio (with input voltage from 0.3 to 6 volts) ... 0.02% of 6 volts
- 0.025% accuracy available in size 15
Bulletin FR 62-1 gives full specifications. It's yours for the asking. Write:

FORD INSTRUMENT CO.

Division of Sperry Rand Corporation
31-10 Thomson Ave., Long Island City 1, N. Y.

compound has been applied to all nonferrous expansion metal joints in radome housings for antennas; for sealing housing and insulation screens in blowers and air conditioning units; and for conduit threads and junction box covers.

Spot-welded units such as box covers can be quickly and economically sealed at less than half the price of brazed covers without the difficulty of providing an r-f seal along the brazed seam. In one example, a flat panel was spot welded to an extruded peripheral rib and then caulked with conductive plastic. The original technique had been to braze the panel to the extrusion, after which inspection usually revealed one or two r-f leaks. This did not occur with the caulking compound.

Rectifier Firms Eye Sales, Get Standards

NEW YORK—SALES of rectifiers and silicon controlled rectifiers are expected to reach a combined total of \$86,300,000 in 1964, and to surpass that figure by \$8,300,000 in 1965.

It is anticipated that sales of these two products will total \$79,200,000 this year.

This bright view of the industry's future was forecast here by representatives of the Power Semiconductor Component Section of the National Electrical Manufacturers Association (NEMA). This group also announced publication of the first set of comprehensive standards for silicon rectifier diodes and stacks.

The new standards were prepared by the JS-1 committee on power rectifier diodes of the Joint Electron Device Engineering Council (JEDEC), which is sponsored by NEMA and the Electronic Industries Association (EIA).

Purpose of the standards is to clear up the confusion which has existed in manufacturing and specifying diodes and stacks because of wide variations in testing and rating methods.

The 65 page book on NEMA-EIA Standards for Silicon Rectifier Diodes and Stacks sells for \$5 per copy and can be obtained from NEMA, 155 East 44th Street, New

York 17, N. Y. Standards were made possible because of close cooperation between semiconductor manufacturers, Department of Defense, the Institute of Electrical and Electronic Engineers (IEEE) and other large industrial groups during the two years the standards were in preparation.

Arc Melting Furnace Features Third Hand



EXTREMELY-reactive titanium, or highly-refractory tungsten can be melted with an electric arc struck from a nonconsumable water-cooled tungsten electrode.

Third hand, or manipulator can move samples, add alloys, without opening the chamber. Chamber may be maintained either at reduced pressures, or with an inert gas atmosphere. Interchangeable water-cooled copper hearths permit casting of various shapes.

Unit shown can be used to melt virtually all metals in the laboratory, according to manufacturer, the MRC Manufacturing Corporation, Orangeburg, New York.

Data Verifies Merits Of Integrated Circuits

INTEGRATED circuits used in digital applications are potentially as reliable as a single discrete transistor used in digital applications.

This finding resulted from a program to determine quality assurance

requirements for specific semiconductor devices. The program was conducted by ARINC Research Corporation with the cooperation of the JS-11 Committee on Sampling Procedures of the Joint Electron Device Engineering Council, representing device manufacturers.

Another finding of significance is that the distribution of field removal rates for diodes in regulator and rectifier applications is about the same as the distribution of field removal rates for transistors used in amplifier or high-power applications. On the average, the removal rates for devices in analog (amplifier) applications are approximately 300 times higher than the rates for digital applications.

Eight manufacturers supplied test data on 24 popular types, or 20 families, of semiconductor devices. Data analyzed represented 10,300 individual devices and approximately 200,000 individual life test measurements.

New Polyester Glass For Die Molded Parts

A HERETOFORE unobtainable combination of properties of high track resistance plus arc-suppressing action is claimed for a new polyester-glass molding material offered by Thiokol Panelyte Industrial, Trenton, New Jersey. Company's Premix material is said to be flame resistant and self-extinguishing within 30 seconds after flame source is removed. Toughness is due to glass fiber reinforcement, according to report.

Inorganic filler content, 40 to 70 per cent, reduces shrinkage in curing operation. Inorganic glass fiber and resin content is 20 to 40 per cent. Fibers impart strength, the resins are binding and act as flow agents.

The first of what will probably be a series of Premix materials from Panelyte is presently available in red, but any color can be obtained.

Company advises potential users that if shape and complexity of a proposed part corresponds to that of a metal die or sand casting, Premix molding is generally indicated.

Samples of molding compounds are available for evaluation and examination.

MIL-SPEC 1/4" TRIMMER POTENTIOMETER



Enlarged
cutaway
model

AS LOW AS
\$2 50
EACH

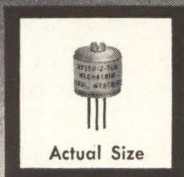

Actual Size

TYPE HT 250-2 MECHATRIM

A UNIQUE INFINITE RESOLUTION DEVICE OFFERING PERFORMANCE CHARACTERISTICS NOT OBTAINABLE IN WIREWOUND UNITS. THE LOWEST PRICE MINIATURE TRIMMER COMPLYING WITH MILITARY SPECIFICATIONS. MEETS CHARACTERISTIC C OF MIL-R-22097B.

(Copies of Qualification Test Report
available upon request)



SERVOMECHANISMS/INC.

MECHATROL DIVISION

New York — Home Office 1200 Prospect Ave., Westbury, L. I., N. Y. 516 ED 3-6000

California — Branch Office 200 North Aviation Blvd., El Segundo, Calif. 213 OS 5-7111

RESET MOVEMENT

features SYNCHRON® motor

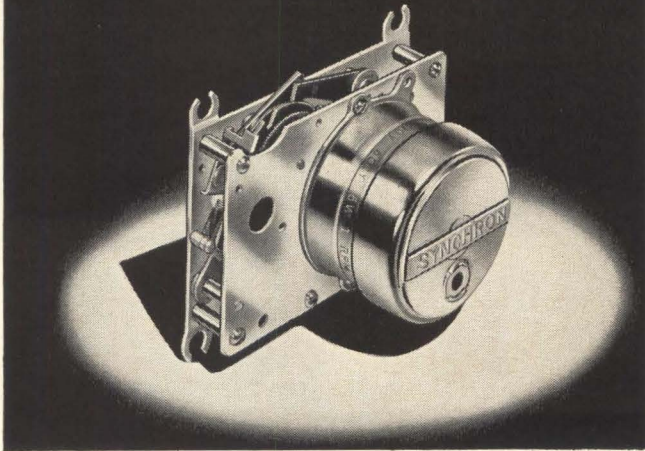

LEADING MANUFACTURER rates performance high

Hansen Manufacturing Company is proud of its long and pleasant association with the Simplex Time Recorder Company, manufacturer of a time systems line of highest quality. Hansen manufactures reset movements built to Simplex specifications, and powered by SYNCHRON motors.

Application requires that the reset movement function as part of a system controlled by a Simplex Master Time Control. The reset automatically adjusts a secondary or "indicating clock." Errors in minutes are corrected hourly. Errors in hours are corrected every 12 hours.

Today, this reset movement is marketed throughout the country by Simplex. In addition, reset clock movements powered by the SYNCHRON motor, are featured in the time systems of the majority of other U.S. manufacturers.

ALL SYNCHRON MOTORS have hardened steel rotor rings with patented rim markings to delineate residual magnetic fields. Polished rotor shaft moves inside two burnished, permanently lubricated genuine Babbitt bearings. Patented inner and outer fields are shaded for directional rotation and self-starting.

SYNCHRON MOTORS are available in a full range of voltages at 25, 50, or 60 cycles and produce guaranteed minimum torques of 8, 20, or 30 ounce inches at 1 RPM. Gear trains withstand 90 ounce inches of static torque and all motors above 1 RPM can be stalled indefinitely without damage.

SEND TODAY for Data Sheet No. 1200, featuring standard SYNCHRON Clock Movements. Information on D.C. motors available on request.



Sweet's Product
Design File



HANSEN REPRESENTATIVES;
R. S. HOPKINS COMPANY
Sherman Oaks, Calif.
EICHORN & MELCHIOR, INC.
San Carlos, Calif.
THE FROMM COMPANY, Chicago, Ill.
H. C. JOHNSON AGENCY, INC.
Fayetteville, N.Y.,
Rochester, N.Y., Schenectady, N.Y.,
Williamsville, N.Y.
WINSLOW ELECTRIC COMPANY
Essex, Connecticut, New York City,
Philadelphia, Pa.
EXPORT DEPARTMENT
15 Moore Street, New York City

Handled exclusively in Canada by Sperry Gyroscope Ottawa Ltd., Ottawa, Canada



MICRO-MINIATURE INDICATOR LAMP

Brite-Eye can be mounted on less than .250 centers. Brite-Eye available with 1½ to 28 volt. lamps. Brite-Eye needs no tools for mounting or relamping. Brite-Eye is installed and relamped from front panel. Brite-Eye lenses available in round or square and five colors. Send for Brite-Eye literature: Cal-Glo Company, Saugus, California.



CIRCLE 205 ON READER SERVICE CARD

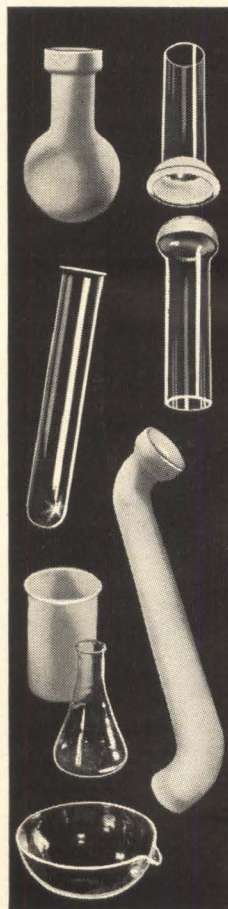

VITREOSIL®

PURE FUSED QUARTZ
TAKES
MORE
SHOCK,
HEAT
AND
ACID

THAN GLASS OR PORCELAIN —
RESISTS TEMPERATURES TO 1050°C—
HANDLES MOST HOT ACIDS WITHOUT
ETCHING —
WITHSTANDS CONSTANT THERMAL
SHOCK —
EXCELLENT ELECTRICAL AND OPTICAL
PROPERTIES —
LABORATORY AND INDUSTRIAL WARE—
SPECIAL FABRICATION —
SPECTROSIL® FOR PURITY

ASK FOR 32 PAGE FREE CATALOG —
THERMAL AMERICAN
FUSED QUARTZ CO.
RT. 202 & CHANGE BRIDGE RD.,
MONTVILLE, NEW JERSEY
CIRCLE 206 ON READER SERVICE CARD



Tube Is Own Vacuum Gage

Count of released ions in operating tube predicts probability of arcing

By **FRED KOHLER**
Thermatool Corp.
New Rochelle, N. Y.

RESIDUAL gas in vacuum tubes has long been a problem to both the manufacturer and consumer. Opposing actions of the getter to the release of gas by metal tube elements and diffusion of gas through the envelope cause the pressure inside the tube to rise or fall during periods of high dissipation. A dif-

ference in pressure of only 10^{-2} Torr is enough to cause internal arcing.

There are many gages available to determine gas content but using the tube being tested as its own vacuum gage is simple and accurate. This non-destructive test is particularly important to both manufacturers of high-voltage tubes and end users.

Principle—The same principle used in a commercial high vacuum gage, enables the vacuum tube to become its own gage.

By adjusting positive grid voltage, grid current can be brought up to rated value. As the anode is negative, the electrons attracted by the positive grid cannot actually reach the anode but will be collected by

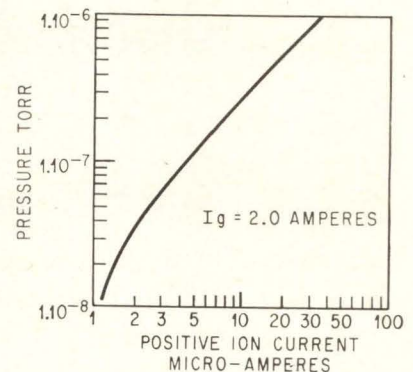

CALIBRATION curve of a typical tube acting as its own vacuum gage against pressure in torr

the grid. On their path through the tube, they produce collision ionization with remaining gas molecules. The number of ions produced is proportional to the product of the number of gas molecules left in the envelope and the quantity of electrons flowing to the grid. The positive ions so produced can only be attracted to the anode. As no electrons are collected by the negative anode, the current measured in the anode circuit is basically a positive ion current and will, consequently, at any given value of grid current, be proportional to gas pressure.

Evaluation—It is possible, for any particular vacuum tube, to calibrate the tube when used as its own ion gage against a true vacuum gage reading. This can be done while the tube is being pumped by connecting auxiliary power supplies and at the same time comparing the readings obtained with a high vacuum gage connected to the pumping system.

It is not generally necessary to actually know the true vacuum inside the tube. Ion current readings for a number of tubes that are known to perform well are used as standards. These readings may be compared with those of faulty tubes that have a tendency towards internal arcing. Generally, the gas

Materials Delivered Directly



AUTOMATED TRANSPORTER is designed to speed work flow for electronics production by reducing process time with a high degree of production and process control. Main advantage of the new system is high-speed routing of materials and work pieces directly to a designated operator. Up to 60 bench positions are readily handled on a single line. Designed and developed by United Shoe Machinery Corp., of Boston, Mass., the system is flexible and may be used in any modular or special combination of work stations

HIGH-CAPACITY Magnet Charger

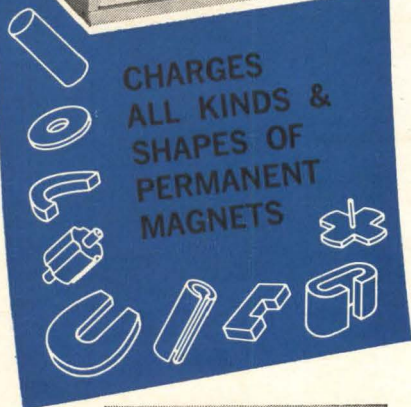

CHARGES
ALL KINDS &
SHAPES OF
PERMANENT
MAGNETS

RFL
Model
2470



**Built-in Interlocks
provide Operator Protection
for Semi-Skilled Personnel**

The RFL Model 2470 quickly and conveniently energizes any permanent magnet within its energy-storage capability (225 joules); saturates up to 2½ pounds of Alnico V, or smaller barium ferrite pieces. (Accessory boosters increase energy storage to 450 joules, or more.)

Low output emf (adjustable from 35 to 150 volts in 7 steps) simplifies magnetizing fixture design so fixtures can be safely made by the user from materials readily at hand.

Model 2470, used with Models 889B Magnetreater and 1890 Gaussmeter, provides a complete integrated system for precision charging, stabilizing and measurement of permanent magnets.

Write for Technical and Application Data

**Radio Frequency
LABORATORIES, INC.**
Boonton, New Jersey, U. S. A.

current of such tubes will be much higher. On the basis of many readings there is a good correlation between gas current readings obtained by the method described and the tendency of the tube to arc internally during use. Simple equipment (see illustrations) is used to actually measure the gas current of a large power tube in a high frequency oscillator. This method permits monitoring of the condition of the vacuum in a tube at regular intervals and actually permits prediction that a tube is likely to give trouble before it occurs. It also permits use of tubes for long periods of time on the basis of consistently low gas-current readings.

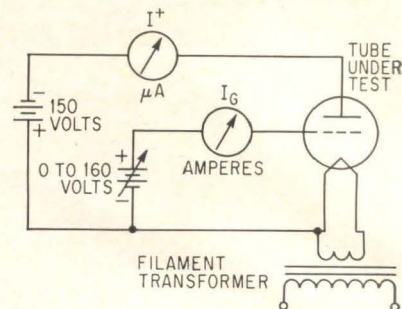

BASIC METHOD of testing for gas with tube used as its own vacuum gage. Negative anode collects ions produced by collision of electrons with gas molecules. Positive ion anode current is proportional to gas pressure

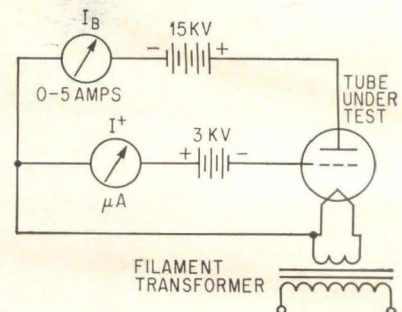

CONVENTIONAL method using large power supplies measures collision ions as grid current

Conventional Method — Manufacturers generally specify a different method for measuring so-called gas current. This method is usually part of the Mil Specs. In this method, the tube is run at rated anode voltage and a current sufficient to produce the full rated plate dissipation. Positive ions are again produced by collision, and are attracted to the grid. The grid current obtained under these conditions is taken as gas current. The primary grid emission current must first be subtracted. But, this test has two major drawbacks. It cannot readily be used in the field where tubes are installed in equipment, as large power supplies

and some handling skill is required. Also, the method has an inherently high x-ray limit. Bombardment of the anode, at relatively high-voltage

Foam Poured Continuously

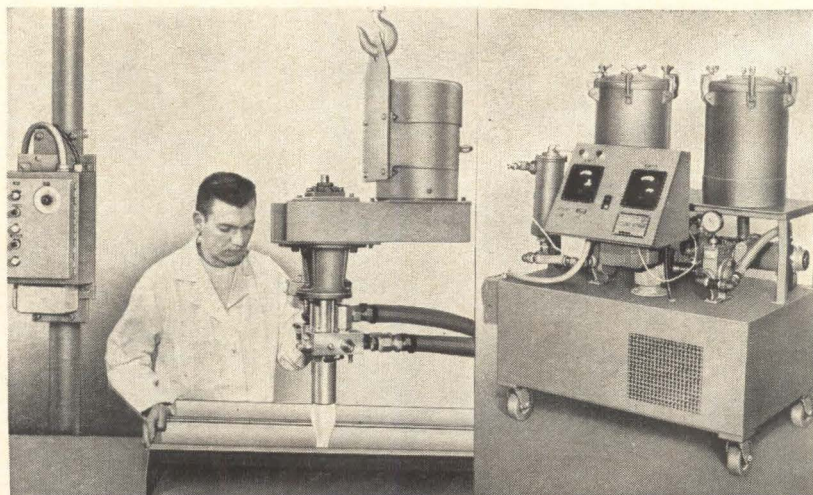

URETHANE FOAM machine produces rigid or flexible foam at the rate of 10 to 50 pounds per minute with fully automatic temperature control. Designated model 50-A220 it was developed by the Martin Sweets Co. of Louisville, Kentucky

and drawing heavy current produces these x-rays inside the envelope. Intercepted, the rays cause photo emission of electrons from the grid and are measured as part of the so-called gas current. This photo emission cannot be distinguished from the gas current because x-rays are proportional to current. When the vacuum in the tube is better than about 1×10^{-7} torr, most of the so-called gas current measured is actually photo emission current and it is difficult to distinguish a tube, with high-vacuum of 1×10^{-9} torr, from a tube, which has a low-vacuum in the order of 1×10^{-7} torr. At high voltage, the difference between these two pressures causes a significant change in the probability of an internal arc during a given time period.

Self-Gaging Method—The self-gaging method of measuring the residual gas also has an inherent x-ray limit. This is due to x-rays generated at the grid as a result of the electron bombardment and these x-rays produce photo emission of electrons from the anode. However, due to the much lower energy of bombardment at the grid, the x-ray limit inherent to this negative anode method of gas testing is between 1 and 2 orders of magnitude lower than that of the conventional method. This is enough to make a crucial difference in evaluating the quality of high vacuum tubes used in critical applications.

Lithography Feasible on New P-C Laminates

EARLY USE of poor laminates discouraged the use of lithography in printed-circuit boards. At present, great progress has been made by the lamination industry in developing copper-clad materials that are more predictable and reliable, says S. Call, of Ampex Components division.

Cost of a plate to print an 18-by-24-inch panel is less than \$2, including labor and material. The accuracy of images transferred to copper-clad laminates by the litho process is up to 0.001 inch over the entire panel and the repeatability of the press is 0.0002 inch.



(Illustrated: New Portable Speedservo. Flush Panelgraph with 8" x 8" front also available.)

New Portable Speedservo (fast, sensitive, simple, versatile)

New, high-speed, high-capability Portable Speedservo—another new generation "Graphline" instrument from Esterline Angus—designed to handle *all* your recording needs, tomorrow's as well as today's.

High Speed: $\frac{1}{8}$ second full scale response. Records 4 cycle signals without significant attenuation. **Sensitive:** 0-1 MV DC without jitter. Many higher ranges. Accuracy $\frac{1}{2}\%$. **Versatile:** Accommodates DC circuits with output impedance 100,000 ohms or less. Portable unit features sloped stainless steel writing surface. Chart tear-off bar. Full 6" wide 100' long chart. **Convenient:** Dial 14 chart speeds from $\frac{3}{4}$ " per hour to 6" per second. Input terminals, multi-range and feed selectors mounted at front for convenience. Hinged doors provide easy access to writing system and re-roll mechanism. **Less Maintenance:** Simple linear motion pen motor (unique *shuttle* type, not rotary); no strings, no pulleys. Zener reference voltage. Infinite resolution potentiometer prevents hunting.

In addition to the new Speedservo, the radically new EA "Graphline" of rectilinear recorders includes both single and two-channel DC Microammeters, DC Milliammeters, AC or DC Ammeters or Voltmeters, plus inkless and ink-type event recorders. *Your inquiry is invited.* If desired, Esterline Angus will gladly adapt standard instruments to your needs, or develop new ones for you. Write for new "Graphline" Brochure.



ESTERLINE ANGUS INSTRUMENT COMPANY, INC., Box 596E, Indianapolis 6, Indiana

ESTERLINE ANGUS

Excellence in instrumentation for over 60 years

Analyzer Aids Stability Measurements

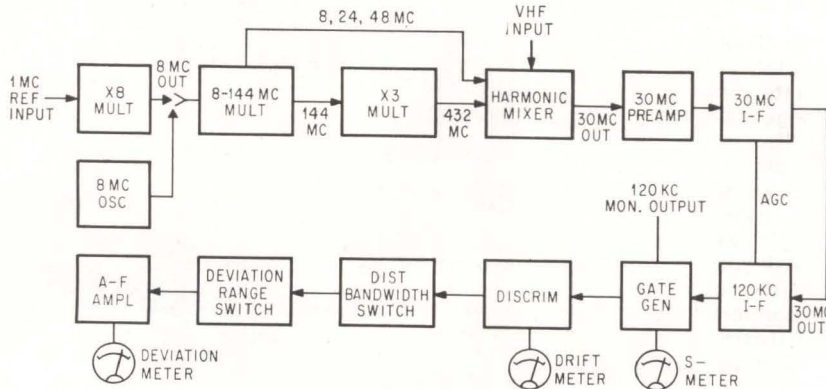

Unit indicates drift, incidental f-m and peak deviation

STABILITY analyzer model SA-220-20C analyzes microwave signals between 2.0 Gc and 12.4 Gc in one continuous band with a minimum-measurable peak deviation indication of 2.0 cps at L-band. The

unit presents long-term drift and deviation indication in terms of incidental peak-frequency modulation contained in a band from 15 cps to 20 kc. Operation is simplified by a minimum number of controls, while the design permits use of the instrument for long periods without recalibration or maintenance.

The millimeter source utilizes an ultrastable oscillator operating at a lower frequency as a transfer os-

illator, and synchronizes the millimeter signal to a harmonic of the lower - frequency oscillator with phase-lock techniques.

A sample of the 8th harmonic of the lower-frequency oscillator is fed into a mixer together with a small sample of the millimeter range signal. A 30-Mc difference frequency is generated, amplified and compared in a phase detector with the output of a 30-Mc crystal. The system has a wide acquisition range derived from a frequency discriminator; since both the frequency and exact harmonic are known, an accurate setting of the millimeter frequency is obtained.

Applications include spectrum analysis of precision signal sources, stability testing of microwave signal sources and equipment, and new equipment development. Frequency Engineering Laboratories, P.O. Box 527, Farmingdale, New Jersey.

CIRCLE 301, READER SERVICE CARD

Wattmeter Transducers Use Hall Effect



POWER may now be measured between 50 cps and 50 cps with a burden to the circuit of only 1 watt at full line current with a wattmeter transducer that utilizes the Hall effect and allows use of standard, off-the-shelf metering equipment.

Transducer is a series of two units housed in plug-in cans, that provide an output voltage of 50 mv for a 500-watt load at 120 volts. Both

60 cycle and 400 cycle circuits may be measured. The first model, HP-5000 is temperature compensated so the output varies less than 1% from -25 C to 65 C. Model HP-5001 has a temperature coefficient of -0.2% between -25 C and 65 C. Units also provide remote monitoring at control-panel locations. Model HP5000 is priced at \$95.50, while model HP5001 sells for \$74.50. F. W. Bell Inc., 1356 Norton Ave., Columbus, Ohio. (302)

Tiny BWO's Can Reach 86 Gc

TWO backward-wave oscillators have unusually small size and weight. Tubes are focused by ex-

tremely-small permanent magnets and cooled by convection. Model SBM-4212 tunes the range between 50 Gc and 63 Gc with output power between 5 and 45 mw. The second BWO (SBE-4022) operates between 68 Gc and 86 Gc and delivers between 2 and 25 mw output power.

Improved efficiency, reduced fine-grain, power-output fluctuations and excellent reproducibility have been

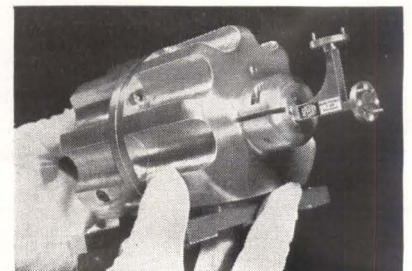

"When Success Hangs On A Thread"...specify



Angelica's
NEW
"Super IV" T.M.

UNIFORMS for CLEAN ROOMS

People are dirty! Skin flakes and lint from ordinary laboratory clothes contaminate your clean work areas. Angelica's engineer-designed line of Clean Room uniforms prevent contamination and insure product cleanliness. Head covers, coveralls, smocks, gloves, boots, wiping cloths. Ask your Angelica office to help fill your garment needs with comfortable, practical non-linting uniforms...or write for FREE CATALOG.

Angelica
UNIFORM CO.

700 Rosedale Ave., St. Louis 12, Mo.
107 W. 48th St., New York 36, N. Y.
445 N. LaSalle St., Chicago 10, Ill.
1900 W. Pico Blvd., Los Angeles 6, Calif.
1224 Collier Rd., N. W., Atlanta 18, Ga.



CIRCLE 207 ON READER SERVICE CARD

**HOW TO USE YOUR
ELECTRONICS
BUYERS' GUIDE**

Page Number References

For your convenience, advertisers in the ELECTRONICS BUYERS' GUIDE have the page numbers of their advertisements listed adjacent to their listings in the Product Listings (yellow paper) section of the book. Refer to these advertisements for full specifications on products. Keep your ELECTRONICS BUYERS' GUIDE at your work area at all times.

ELECTRONICS BUYERS' GUIDE
A MCGRAW-HILL PUBLICATION

41,000
CLAMPS
EXPLAINED!

FREE!
TA'S New '64
Clamp Engineering
Design Manual →

Features 72 pages of prints, tables, illustrations, specifications, applications and installation tips for ANY clamp problem... military or otherwise. Plus the latest developments in clamp design, cushioning and insulating materials for space age requirements. Illustrates sizes and styles of loop clamps, bonding clamps, multiple clamps, center clamps, wire harness clamps, wave-guide clamps... plus blocks, brackets, bus-bars, line supports and related items. Sizes 1/8" to 6" diameter in aluminum, titanium steel or stainless in wide selection of high and low temperature insulating materials. BEFORE YOU DESIGN OR-BUY, CHECK WITH TA FIRST. Over 41,000 clamp designs at your fingertips, ready for shipping at tremendous off-the-shelf savings. Write, wire, or phone today for a quotation.

Send for the new 1964 Clamp Catalog and Manual today!



TA Mfg. Corp. 4607 Alger Street, Los Angeles 39, Calif.
Foremost in clamp design since 1948

PHONE: (213) CH 5-3748 • TWX 213-240-2118 L.A. OR WUX CAT. L.A., CALIF.
CIRCLE 208 ON READER SERVICE CARD

**NEW! Weld on top of
p.c. boards...thin films...
and inside transistors with
the MINI-WELDER!**

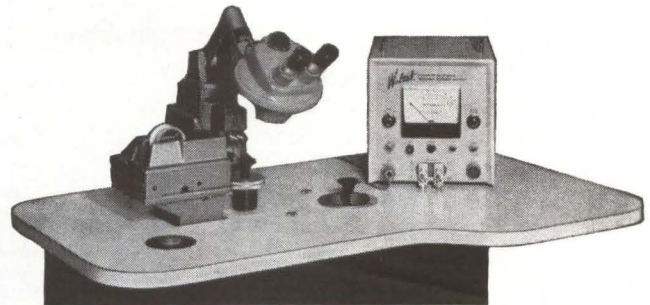

New Model 500 "Mini-Welder" welds wire from .0003" up to .030" or ribbon from .000125" up to .020" on top of thin films (down to 1000 Å), copper p.c. boards, many kinds of depositions, laminates, and etched circuits. Console is equipped with: Power supply, parallel gap or "one-sided" weld head, XY micropositioner, fine wire feeder, product holder, B&L StereoZoom optics, Formica topped table and actuating system. Welds many different materials. For lab or production use. Write for details.

FREE WELD SAMPLE SERVICE!

We'll help you with your welding problems. Send sample materials to Weltek Sales Mgr.

Weltek **Precision Welders**
by **WELLS ELECTRONICS, INC.**
1701 S. Main Street, South Bend, Indiana, U.S.A.

BUSS FUSEHOLDERS

LAMP INDICATING SERIES HK
AND HJ FOR
 $\frac{1}{4} \times 1$ and $\frac{1}{4} \times 1\frac{1}{4}$
INCH FUSES

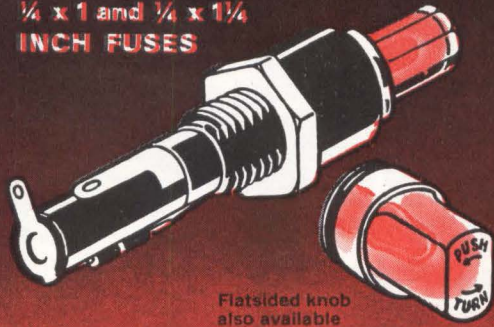

Flatsided knob
also available

Provides quick, positive visual identification of faulted circuit. Transparent knob permits indicating light to be readily seen.

Bayonet type knob-molded body-strong, coil spring provides positive contact on ends of fuse.

Fuseholder designed to withstand vibration such as occurs in aircraft applications. Terminals held mechanically as well as by solder.

Holder can be used in panels up to $\frac{3}{16}$ inches thick.

BUSS

Write for BUSS
Bulletin SFB.

BUSSMANN MFG. DIVISION, McGraw-Edison Co., St. Louis 7, Mo.

BUSS Sub-Miniature PIGTAIL TRON FUSES

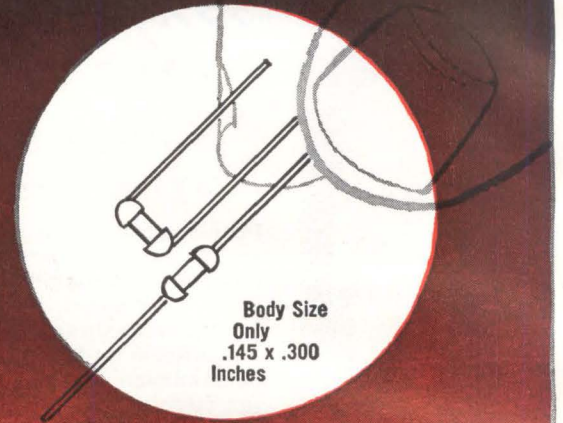

Body Size
Only
.145 x .300
Inches

Tron fuses are so small they can be used as an integral part of circuit—to protect miniaturized devices—or gigantic multi-circuit electronic devices, without sacrifice of space.

They are hermetically sealed for potting without danger of sealing material affecting operation and have high resistance to shock or vibration. Operate without exterior venting. May be teamed with other components in replaceable unit.

BUSS

Write for BUSS
Bulletin SFB.

BUSSMANN MFG. DIVISION, McGraw-Edison Co., St. Louis 7, Mo.

BUSS: 1914-1964, Fifty years of Pioneering.

CIRCLE 95 ON READER SERVICE CARD

CIRCLE 95 ON READER SERVICE CARD

achieved by using photoetching techniques in the fabrication of the precision slow-wave circuit. Moreover, a specially-designed triode gun permits full r-f modulation with as little as 200 anode volts. Only heater, control-anode and beam-power supplies are required. As backward-wave amplifiers, these tubes can provide gain in excess of 25 db with a 0.02% bandwidth. Sperry Electronic Tube Div., Gainesville, Fla.

CIRCLE 303, READER SERVICE CARD

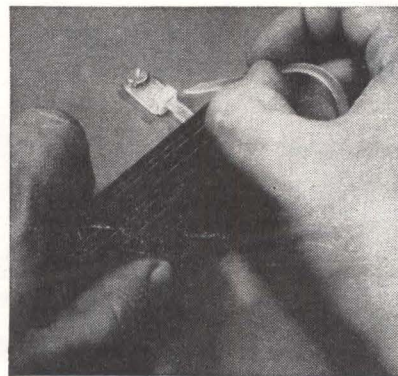

ing force 125 lb plus. Panduit Corp., 17301 Ridgeland Ave., Tinley Park, Ill. 60477. (304)

Heavy-Duty Clamp Is Self-Clinching

A RUGGED, hand-installed, self-clinching Sta-Strap clamp has been introduced. This all-Nylon clamp, designated SSC-4-H, will accommodate a diameter range of $\frac{1}{16}$ in. to 4 in. Temperature range — 65 F to + 350 F, self-extinguishing, hold-

Standing-Wave Detector Features High Accuracy

PRECISION vswr detector is capable of providing a minimum of 50 db return-loss error from 1 Mc to 800 Mc and 45 db from 800 Mc to 1 Gc.

This corresponds to maximum vswr errors of only 0.63% and 1.3%, respectively, and permits the user to make extremely accurate measurements throughout the unit's range.

Called Rho-tector, the device is basically an accurate impedance comparator, utilizing a frequency-insensitive r-f bridge with a detector circuit. The unknown vswr is compared to a known standard and the resulting signal expressed on a meter or oscilloscope.

The unit, model TRB-3, is optimized for operation at a 50-ohm impedance level. It has a negative

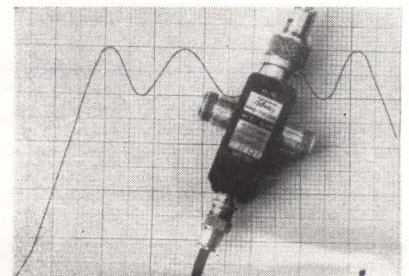

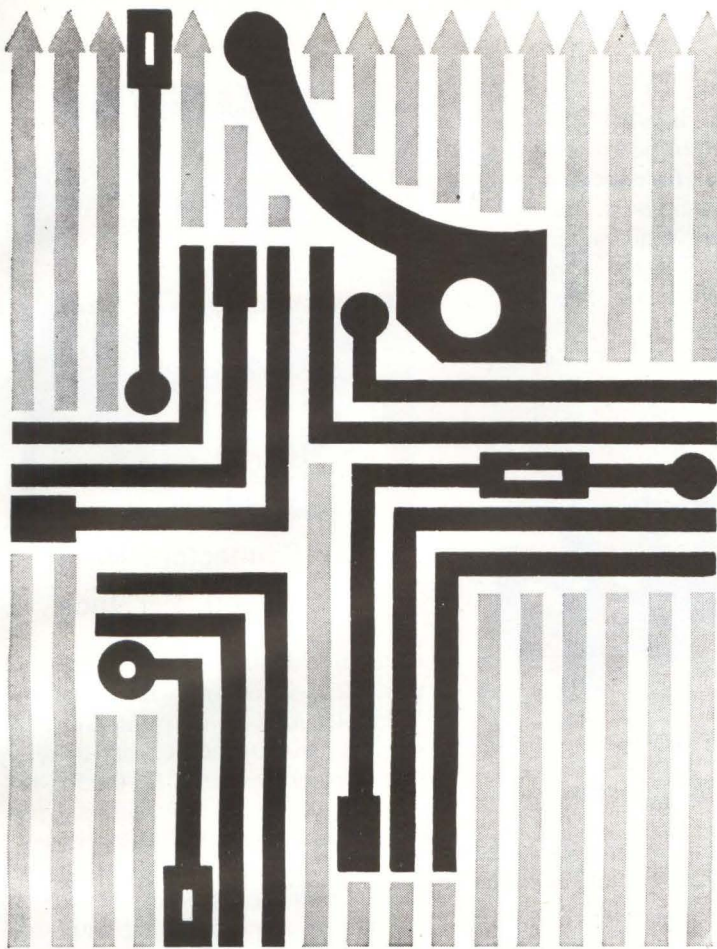

CHECK THESE PROPERTIES IN HITACHI COPPER-CLAD LAMINATE AND COMPARE

The copper foil used contains a minimum purity of 99.5% with no wrinkles or defects, no pinholes or discoloration. Composite sheets are uniform quality with smooth, even surfaces. There are no defects such as strains, cracks or wrinkles. Even after aging you'll find no extreme distortion, swelling, shrinkage or delamination. Dimensions are set at 1,000×1,000 mm or 500×500 mm. In both cases tolerance is ±10 mm.

These are the properties Hitachi boasts and delivers. For free samples and complete details write to Hitachi, Second Overseas Division, 8-2, Ote-machi, Chiyoda-ku, Tokyo, Japan.

A Half-Century of Progress — In Industry and the Home

 **Hitachi, Ltd.**
Tokyo Japan

Cable Address: "HITACHY" TOKYO

CIRCLE 209 ON READER SERVICE CARD

..New Developments in Electrical Protection

BUSS
quick-acting
fuses

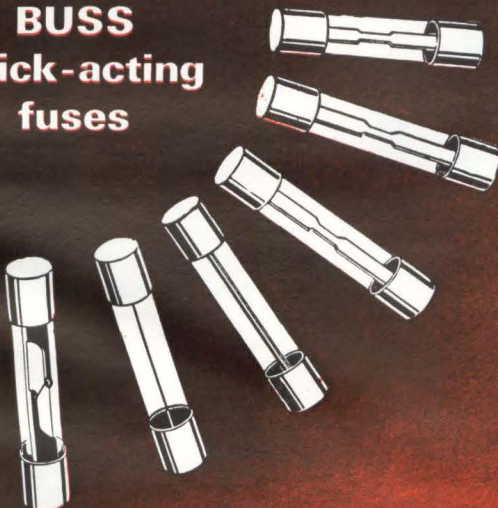

"Fast Acting" fuses for protection of sensitive instruments or delicate apparatus; —or normal acting fuses for protection where circuit is not subject to starting currents or surges.

BUSS

Write for BUSS
Bulletin SFB.

BUSSMANN MFG. DIVISION, McGraw-Edison Co., St. Louis 7, Mo.

CIRCLE 95 ON READER SERVICE CARD



If you should have a
special problem
in electrical
protection ...

... we welcome your request either to quote or to help in selecting the type of fuse or fuse mounting best suited to your particular conditions.

Submit description or sketch, showing type of fuse to be used, number of circuits, type of terminal, etc. If your protection problem is still in the engineering state, tell us current, voltage, load characteristics, etc. Be sure to get the latest information BEFORE final design is crystallized.

At any time our staff of fuse engineers is at your service to help solve your problems in electrical protection and save you engineering time.

BUSS

Just call
or write:

BUSSMANN MFG. DIVISION, McGraw-Edison Co., St. Louis 7, Mo.

CIRCLE 95 ON READER SERVICE CARD



Your
ingenuity

PLUS

simple
tools

can
transform

BUD IMLOK

extrusions
and
↓
connectors

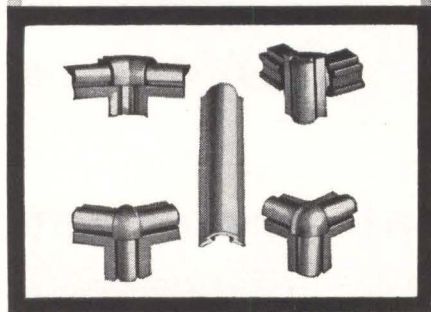

↓ into housings
like these

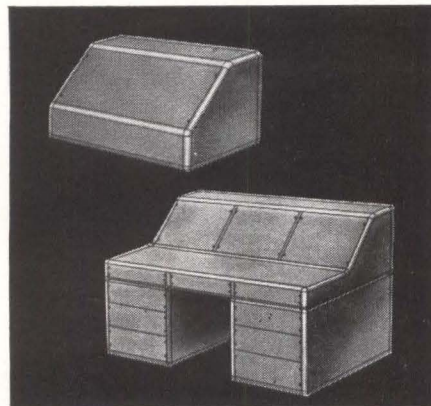

When you need cabinets, racks or cases for experimental or prototype work, make them, quickly and inexpensively with BUD IMLOK extrusions and connectors. No tooling costs or expensive labor are involved. The new BUD IMLOK manual gives complete details on this system. Write us for a copy or obtain one at your local BUD distributor.



BUD RADIO, INC.
WILLOUGHBY, OHIO 44094

output polarity, 10 μ sec time constant and will handle 0.5 watt of power. It is equipped with standard N connectors for the r-f input, standard and unknown, and a BNC for r-f output. Unit weighs 8 oz. Price: \$150. Telonic Engineering Corp., 480 Mermaid St., Laguna Beach, Calif.

CIRCLE 305, READER SERVICE CARD

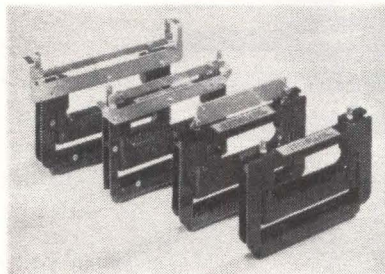

Extracting Tool for Handling P-C Boards

A BASIC TOOL for reliable extraction and handling of circuit boards is announced. Manufacturer has designed a tool to fit most boards; however, modifications can be made at reasonable cost to fit almost any application. Hewson-Waltz Corp., 3851 Sepulveda Blvd., Culver City, Calif. (359)

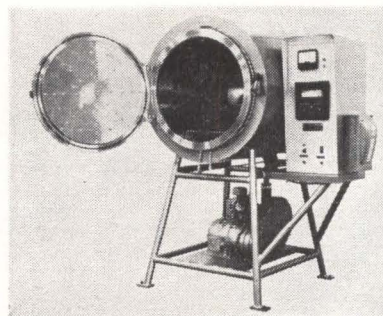

Vacuum Oven Made of Stainless Steel

LOW-COST stainless-steel vacuum oven, 24 in. in diameter by 30 in. long, has been developed. Complete package includes removable heavy gage shelf, vacuum pump, gages, instrumentation and controls, and is suitable for continuous operation at temperatures up to 400 C. It can be used for either hard or soft vacuum; requires 10 kw at 220 or 440 v, single or 3 phase. Tri Metal Works, Inc., 1600 Bannard St., Riverton, N. J. (306)

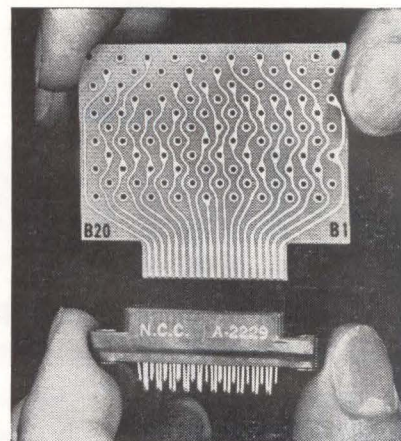

Tiny Connectors Have 40 Contacts Per Inch

LINE of sub-subminiature card receptacle connectors which accepts a double-sided $\frac{1}{2}$ in. printed-circuit board is announced. Center-to-center contact spacing is 0.050 in. which allows 20 connections per side with an overall 1-in. length giving a total of 40 contacts within 1 inch. Contacts are gold plated over nickel and are terminated with soldering tails, or provisions for weld terminations can be made. The new sub-subminiature design is available for various card lengths and mounting configurations. National Connector Corp., Science Industry Center, Minneapolis 28, Minn. (307)

UHV System With Modular Design

MODULAR ultra high vacuum system is equipped with an oil-diffusion pump and cold trap, with all necessary associated valving and controls, mounted in a roll-around cabinet which will withstand repeated bake-out to 450 C. Without bakeout, the system produces vacuums to



less than 5×10^{-9} Torr. Lower pressures can be attained with bakeout. Heart of the system is the Cryosorb cold trap, which prevents release of previously-trapped particles and eliminates oil creep into the vacuum system. Granville-Phillips Co., Boulder, Colo. (308)



Power Supply Is All Solid State

MODEL CS-151 all-solid-state current source supplies 0 to 10 ma at 0 to 10 v d-c with a guaranteed long-term (100 hr) stability of better than 10 parts per million. Typical performance is 2 parts per million. Features include high reliability, temperature controlled references, window in-line readout, 1 part per million resolution, plus or minus output, and low temperature coefficient. Applications include gyro torquer supply, current standard, precise resistance and semiconductor measurements, current controller for potentiometric measurements, magnetic field control. North Hills Electronics, Inc., Glen Cove, N. Y. (309)

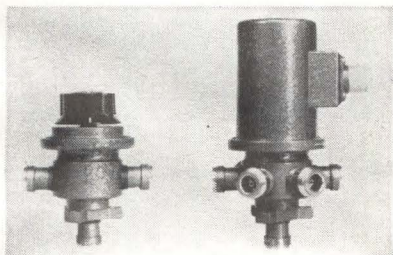

Microwave Switches Provide Low Loss

IN PRODUCTION is a series of coaxial rotary switches providing max vswr of 1.5 and max insertion loss of 0.5 db, from d-c to 12 Gc. R-F power is 400 w or better, and minimum voltage rating is 1500 v rms. Isolation is greater than 50 db over the range. Operating temperature

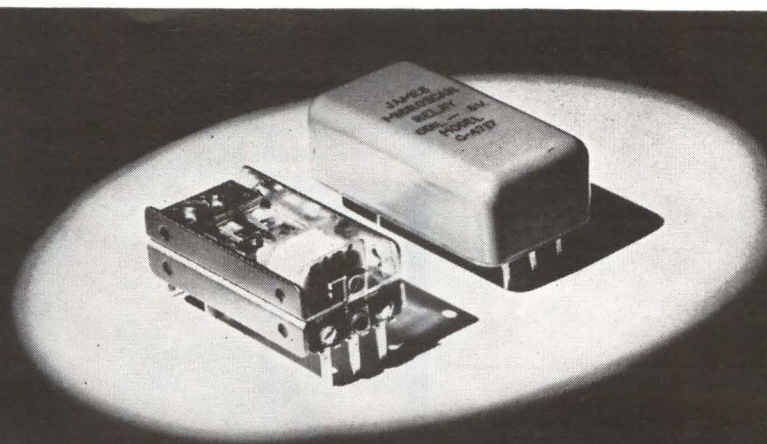

**HIGH SPEED—LESS THAN 1000 μ SEC.
LOW THERMAL—LESS THAN 1 μ VOLT
HIGH RELIABILITY—OVER 10^9 OPERATIONS
LOW CHATTER—BOUNCELESS OPERATION
LOW COST—AS LOW AS \$8.00 FOR A THREE WIRE TRANSDUCER CHANNEL**

JAMES

MICRO-SCAN RELAYS ARE THE ONLY COMPLETE AND COMPETITIVE SWITCHING FOR

**Data Acquisition
Process Control
Analogue Integrators
Signal Selection**

A MODEL TO FIT THE APPLICATION AND THE ASSEMBLY

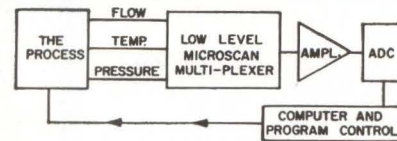

PROCESS CONTROL

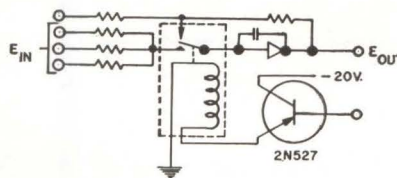

ANALOGUE INTEGRATOR CIRCUIT

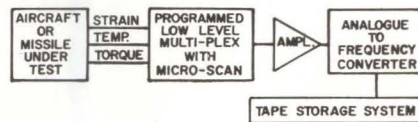

DATA ACQUISITION SYSTEM

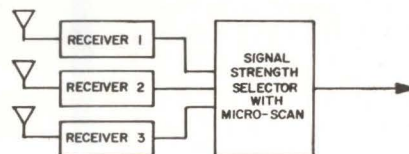

SIGNAL SELECTION SYSTEM

JAMES ELECTRONICS, INC.

4050 North Rockwell • Chicago 18, Illinois • 463-6500

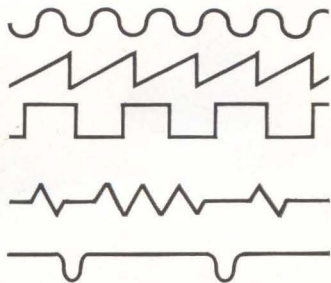

Over 25 different output/modes

Type 255 FUNCTION GENERATOR



FEATURES

- * SIMULTANEOUS OUTPUTS
- * SINE—SQUARE—RAMP—
TRIANGLE WAVEFORMS
- * 0.001 TO 10,000 cps
- * 0.3 TO 25 V P-P
- * SEPARATE RAMP TIMING
CONTROLS
- * FREE-RUNNING WAVEFORMS
- * TRIGGERED WAVEFORMS
- * GATED OUTPUTS
- * DELAY-GATED MODES
- * DELAY-TRIGGERED MODES
- * 19 lbs NET WEIGHT
- * 5 X 15 X 15
- * \$785.00 F.O.B. FACTORY

EXACT ELECTRONICS



Exact Electronics, Inc.
455 S. 2nd Avenue
Hillsboro, Oregon
(503) 648-6661

range is -60 C to $+100\text{ C}$, and life exceeds 100,000 operations. Manual and remote (solenoid-operated) models are available. Sage Laboratories, Inc., 3 Huron Drive, Natick, Mass.

CIRCLE 310, READER SERVICE CARD

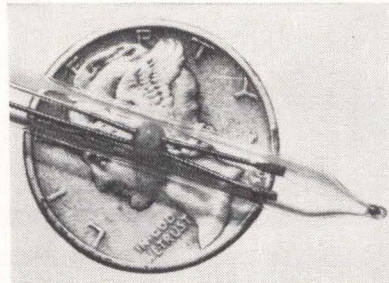

Tiny Thermistors Are Spherically Shaped

THERMISTORS, less than 0.020 in. in diameter, spherically shaped, are available for use in microminiature sensors. The tiny type NTC beads have a vitreous enamel coating and platinum alloy lead wires. They are available in resistance values from 1,000 ohms to 680,000 ohms, with tolerance of ± 20 percent. They have a negative temperature coefficient of from 3 percent to 6 percent resistance change per deg C, and an operating temp range from -70 C to $+10\text{ C}$. Ferroxcube Corp. of America, Saugerties, N. Y. (311)



Centrifugal Blower Offers Adaptability

MODEL D-201 squirrel cage centrifugal blower is adaptable to almost any type of power supply with the large variety of driving motors now available. Motors for 1 or 3 phase, 50-60 cps, 400 cps, 350-1,000 cps

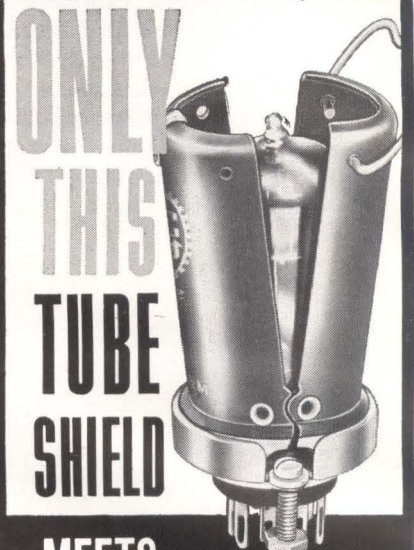

ONLY THIS TUBE SHIELD MEETS CHARACTERISTIC A of Mil-S-19786C (Navy)

- Reduces bulb temperature well over 50%.
- Puts no pressure on tube envelope during insertion or withdrawal.
- Requires no twisting motion to lock firmly in place.
- Absence of twisting and torque eliminates strain on fragile tube pins.
- Will not pull tube from socket upon withdrawal.
- Specially designed spring insert holds tube with firm "glovelike" grip.
- Rigid shell and spring insert combine to minimize vibration, shock and microphonics.
- Locks positively in place when snapping is closed.
- Full contact and firm pressure at mating base provide superior path for dissipating heat from tube envelope to chassis.
- Simple adapter permits retrofitting to JAN socket with tube in place.
- Meets or exceeds all applicable requirements of MIL-S-19786C (Navy), MS-24233 and MS-24233 revised.

Shields for tube sizes T5½ and T6½ short, medium and long available from stock.

Complete specs and prices available in Atlee Bulletin S-1.

Write for your copy today.

atlee corporation



2 LOWELL AVENUE, WINCHESTER, MASS.

CIRCLE 210 ON READER SERVICE CARD
January 3, 1964 electronics

and 115, 200, 208-v operation can be provided. A special type of induction motor called the Altivar, which will change shaft speed inversely with air density to provide constant mass flow at all altitudes, is also now available. The D-201 is recommended for installations requiring high static pressures to overcome the airflow resistance, such as those involving duct work, forced air-cooled high power electronic tubes, and airborne instrumentation systems. Rotron Mfg. Co., Inc., Woodstock, N. Y. (312)



Transformer Fits in Tight Assemblies

MOLDED transformers are designed for unusual space considerations affording unique positioning within tight assembly requirements. Unit shown has two mounting inserts spaced $1\frac{1}{8}$ in. on center line, manufactured for either top or bottom mounting. This unit is a pushpull transistor driver transformer. Primary impedance is 500 ohms. Secondary impedance is 1,000 ohms split. Level up to 2 w. Frequency range from 10 cps to 10 kc. Manufactured and guaranteed to MIL-T-27B. Size: $2\frac{3}{8}$ in. by $1\frac{3}{16}$ in. by $1\frac{5}{16}$ in. high. United Transformer Corp., 150 Varick St., New York 13, N. Y. (313)

Power Supplies Offer All-Silicon Design

ALL-SILICON, wide range d-c, precision regulated bench or relay-rack type power supplies are available. They feature the use of silicon transistors and semiconductors which provide for maximum stability, maximum protection against over-loads and surges, and stable operation at extended temperatures. Off-the-shelf models operate with

NEW FROM NRC

thin film vacuum coater



NRC's Model 3176 Vacuum Coater is a unique vacuum evaporation system for thin film deposition in R&D and production programs. Unmatched for versatility, reliability and ease of operation, the Model 3176 is used in the areas of solid state electronics, optics, magnetic films, memory planes and solar cells.

Exclusive features include: ■ **Fastest Useful Pumping Speed . . .** with high performance, lowest backstreaming NRC diffusion pump rated at 1500 liters/sec. ■ **Highest Conductance/Lowest Outgassing . . .** with the new NRC Slide Valve which was specifically developed for maximum pump efficiency. ■ **More Efficient Baffling . . .** with single circular chevron cold trap-baffle combination. ■ **Easy, Fast Operation . . .** with all controls (manual or automatic) conveniently mounted on front panel. ■ **Maximum Versatility . . .** used with 18" or 24" work chambers — electrical and mechanical feed-throughs interchangeable.

The Model 3176 has a new sophisticated appearance and is ready to operate. Merely connect power and water supply. Write or call for data sheet.

NRC EQUIPMENT CORPORATION

A SUBSIDIARY OF NATIONAL RESEARCH CORPORATION



A Norton Company Affiliate



160 CHARLEMONT STREET • NEWTON, MASSACHUSETTS • 617 332-5800

Squeezed by PW Assembly Headaches?

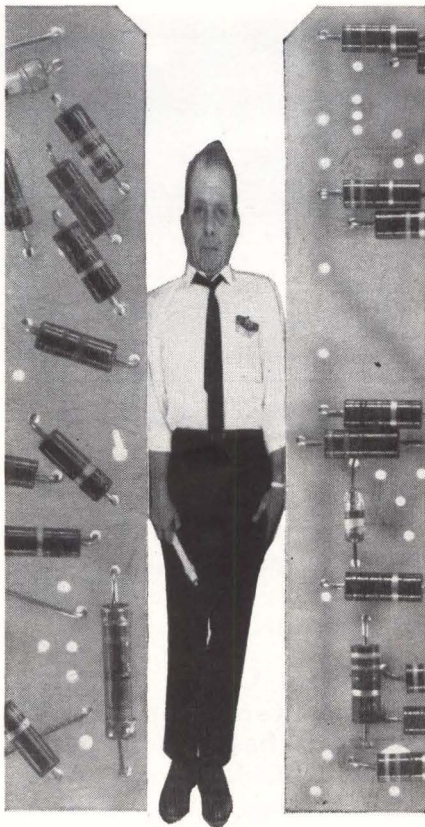

Look into **DYNASERT**[®] automatic inserting equipment for the fast, efficient, economical remedy. This is modern, automated, high-speed component inserting: up to 10 times faster than costly hand methods. Examples: a single machine can average 800 insertions per hour. A fully automatic system up to 1200 boards an hour with just two operators. Dynasert delivers product uniformity. Greater efficiency. Superior quality. Greater circuit design flexibility. It automatically feeds, cuts, and bends leads, inserts and clinches all types of axial lead components. Little operator training required. Changes made from one board or component type in seconds. Savings can pay for a Dynasert installation in less than a year. Want more facts? Send for a free copy of: Dynasert — Production Equipment for Electronics. Dynasert Dept. 2, United Shoe Machinery Corp., Boston, Massachusetts.

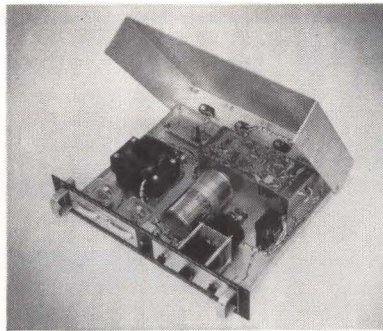
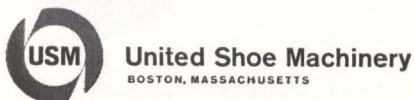

an input of 105-125 v a-c, 50-400 cps and there is the choice of six models covering the voltage range 0-36 v d-c with max current ratings of 0-2, 2 dual, 4, 8, 12 amperes respectively. Line regulation is better than ± 0.025 percent for full input and frequency change and load regulation is better than 0.05 percent for 0-100 percent load change. Ripple is less than 1 mv rms. Prices range from \$215 to \$435 dependent on rating. Electronic Research Associates, Inc., 67 Factory Place, Cedar Grove, N. J. CIRCLE 314, READER SERVICE CARD

Power Divider Features Small Size

MODEL D2029 measures 7 by 4 by 1½ in. and features three equal outputs, frequency range 150 to 200 Mc with maximum vswr 1.2. Small size is achieved through the use of semi lump constant circuitry. Price is \$113. Radar Design Corp., Pickard Drive, Syracuse 11, N.Y. (315)

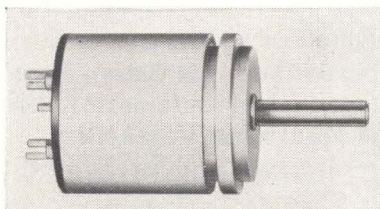

Servo Potentiometer Rated 2 W at 40 C

DESIGNED to meet the high precision and reliability requirements of aircraft, missile and automation instrumentation, model 75-M92 ¾-in. servo pot has a power rating of 2 w at 40 C. It features a double wiper design. It is equipped with bronze sleeve bearings. Shaft rotational torque is 0.3 oz-in. max. Guarant-

OPPORTUNITIES IN MELPAR'S RAPIDLY EXPANDING ELECTRONICS DIVISION

Melpar's Electronics Division has an immediate need for Engineers to fill these important positions:

MICROWAVE RECEIVER DESIGN

Specific problems include parametric amplifiers, varactor techniques, microwave filters, ultra-stable programmable oscillators, and dual and triple channel balanced receivers for monopulse and guard antenna gating.

DATA PROCESSING SYSTEMS DESIGN

Perform the logic design of digital equipment to process real time flight data. Problems include specifying necessary digital/analog interface equipment and the design of computer systems for a variety of applications.

COMPUTER PROGRAMMING

Generate programs for fixed point real time computers to be used with special purpose digital and analog equipment.

COMMUNICATIONS

Perform design studies of terminal equipments for time frequency dodging, matched filters, adaptive highly reliable communications throughout the electromagnetic spectrum. Techniques of interest include spread spectrum circuitry, error detection and correction coding, and privacy and security circuitry.

For Further Details,
write in confidence to:

John A. Haverfield
Manager—Professional Placement

MELPAR  **INC.**

(A Subsidiary of Westinghouse
Air Brake Co.)

**3436 ARLINGTON BLVD.
FALLS CHURCH, VA.**

(A Suburb of Washington, D.C.)

an equal opportunity employer

teed service life is 1,000,000 revolutions at 40 rpm in an operating ambient of -55 to $+105$ C. Maurey Instrument Corp., 4555 W. 60th St., Chicago 29, Ill. (316)

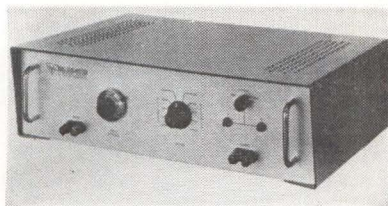

D-C Amplifier Uses Modular Construction

THIS low level, very low noise d-c amplifier, model 4S, extends the range of 10-millivolt and 100-millivolt strip chart recorders to the sub-microvolt region. Its stability and strong power frequency rejection suit the instrument for both continuous observation of process variables and laboratory measurements in low impedance transducers and circuits such as thermocouples, thermopiles and bridges. Price is \$810. Applied Research Associates of Texas, Inc., 6541 North Lamar Blvd., Austin 5, Texas. (317)

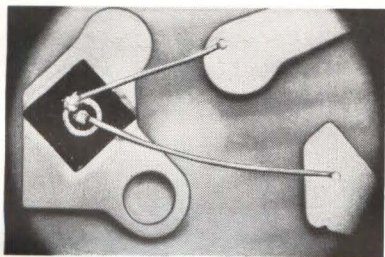

Chip Transistors Have High Gain

TYPES CC706, CC914 and CC930 silicon *npn* passivated planar chip transistors are available. They are 500 Mc f_T devices with a max C_{ob} of 6 pf. The V_{cbo} is 50 v minimum at I_c equals 100 μa . The h_{fe} equals 200 min at I_c equals 1 ma. This family of chip transistors provides high gain, low C_{ob} units for switching and general purpose applications and further increases the potential usage of chips. Aluminum ribbon leads with ultrasonic bonding to aluminum metalizing eliminate problems encountered with gold, aluminum and silicon systems. Conti-

A MAJOR Breakthrough

ALL NEW COAXIAL DIODES

low noise
broadband
high temperature
hermetically sealed

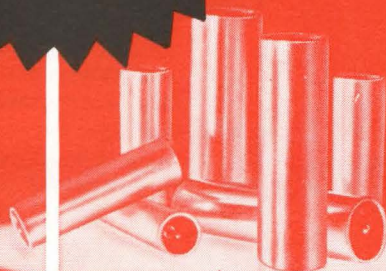

Microwave Associates announces a major breakthrough in Coaxial Diodes. The new MA-490 series is truly broadband (13 to 18 Gc), with a noise figure of only 8.0 db measured at 16 Gc. Mixer noise figure of 7.5 db is typical.

This entirely new diode has a burnout rating of 1 erg (higher burnout ratings available), maximum conversion loss of 6 db, and maximum VSWR of 1.5 at 16 Gc. IF impedance: 400-565 ohms. Maximum noise ratio: 1.9. Temperature rating: 150°C.

Write or call for broadband characteristic curves, mixer performance data and additional information.



MICROWAVE ASSOCIATES, INC.

BURLINGTON, MASS. • WESTERN UNION FAX
TWX: 617-272-1492 • TEL: 617-272-3000

Overseas Sales: Microwave Associates International, Inc.
Burlington, Massachusetts

United Kingdom Sales: Microwave Associates, Ltd.
Craddock Road, Luton, Beds, England

Whatever the Special Size or Need in Wiring Duct . . .
TAYLOR = *the Reliable Source*

Two Important Considerations . . .

1. Here at Taylor, requests for special sizes and needs in wiring duct — typical of the electronics industry — are given immediate attention by experienced engineers in order to expedite delivery. Competent experts always available to help solve any problem in wiring duct design.
2. No matter where you are located there's a Taylor representative in your area to service your requirements.

Some TAYLOR DUCT Advantages . . .

- Smooth finished edges — no sharp, disagreeable corners
- The time saving one-piece channel
- More usable wiring space
- Choice of colors in high impact self-extinguishing PVC

For PROMPT quotation
 send your drawings



TAYLOR Electric, Inc.

Fisher Road / Howell, Michigan

CIRCLE 211 ON READER SERVICE CARD

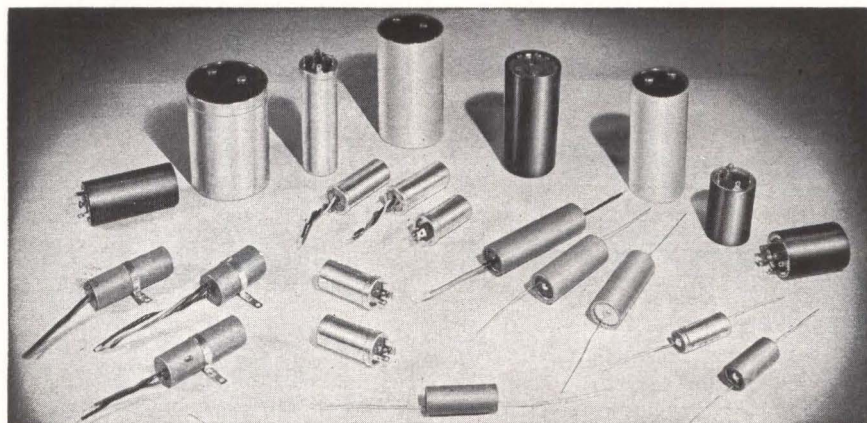

ELECTROLYTIC CAPACITORS RELIABLE, COMPETITIVELY PRICED

Reliability of Electro-Mec Capacitors begins with the materials and is built into the product through every process involved in its manufacture. The result: Electro-Mec capacitors far surpass the requirements specified in EIA standards and offer long and stable operating life, minimum low temperature impedance and capacitance drop off, and excellent shelf life.

The broad range of capacitors is described in a 12 page catalog available to you upon request. Among the types included: ■ tubular, axial lead types ■ upright can types with twist prongs or printed circuit ring and lugs ■ larger energy storage types used for a wide range of filtering applications in computers, power supplies, instruments.

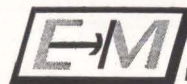

**ELECTRO-MEC
 CAPACITORS**

EAST ORCHARD STREET • TERRYVILLE, CONNECTICUT 06786
 Telephone: Area Code 203 LU 2-8104 • Teletype: BRIS 277

102 CIRCLE 102 ON READER SERVICE CARD

mental Device Corp., 12515 Chadron Ave., Hawthorne, Calif.

CIRCLE 318, READER SERVICE CARD

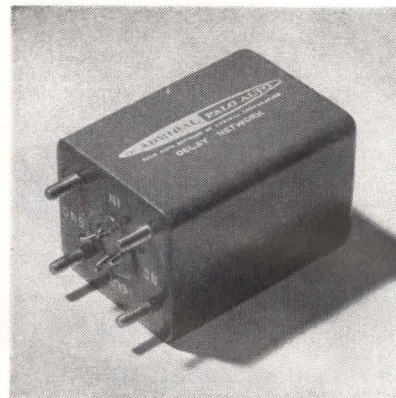

Miniature Delay Lines Are Shock-Protected

NOW AVAILABLE is a delay line that takes up 6½ cu in. of space, yet delivers pulse delays of 25 μsec into 500 ohms. Rise time of ½ μsec adds up to an efficient 50:1 total delay to rise time ratio. Potted, hermetically sealed construction protects delay line from shock and vibration. Delay tolerance is held to 2 percent. Distortion factor is less than 5 percent. Excellent thermal stability is assured in a range of - 55 C to + 125 C. In this region, nominal coefficient of delay is 50 ppm/deg C. Admiral/Palo Alto, Stanford Industrial Park, Palo Alto, Calif.



Static Inverter Protected for Misuse

MODEL PS-63-92 is an all solid state 28 v to 115 v, 400 cps, single phase inverter which requires only 100 cu in. and weighs less than 5 lb. The 100-va inverter is protected against every type of misuse. These include overvoltage, undervoltage,

January 3, 1964 electronics

reverse voltage, short circuit and overload. Capable of operating with an input between 24 and 32 v d-c, this unit also features close voltage and frequency regulation as well as low output distortion. Unitron Inc., 1624 North First St., Garland, Texas. (320)

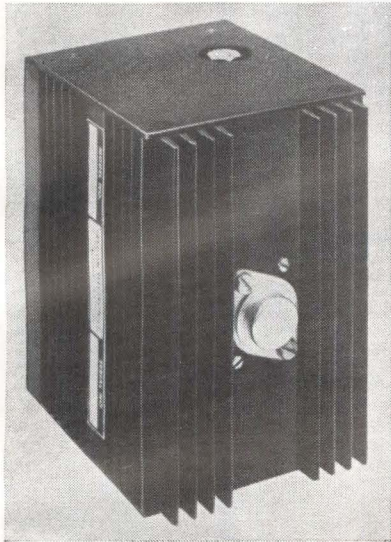

Modular Supplies Come in 16 Models

LINE of modular d-c power supplies is designed for complete, automatic self-sufficiency. Total silicon semiconductorization coupled with a generous, integrated heat sink allow in spec operation up to an ambient temperature of 71 C. Current limited short circuit protection make the modules impervious to short overload conditions and, when the fault is removed, the supplies automatically resume the normal operating mode. Remote sensing provides rated regulation at the load while remote programming allows voltage adjustments without touching the supply. Series is available in 16 models with outputs ranging from 3 v d-c at 1.5 amp to 48 v d-c at 400 ma. Trygon Electronics, 111 Pleasant Ave., Roosevelt, N.Y. (321)

Coax Attenuator Spans 2.0 to 12.4 Gc

NEW COAXIAL ATTENUATOR, variable from 0 to 20 db, features a broad frequency range of 2.0 to 12.4 Gc. It is convenient for both

electronics January 3, 1964

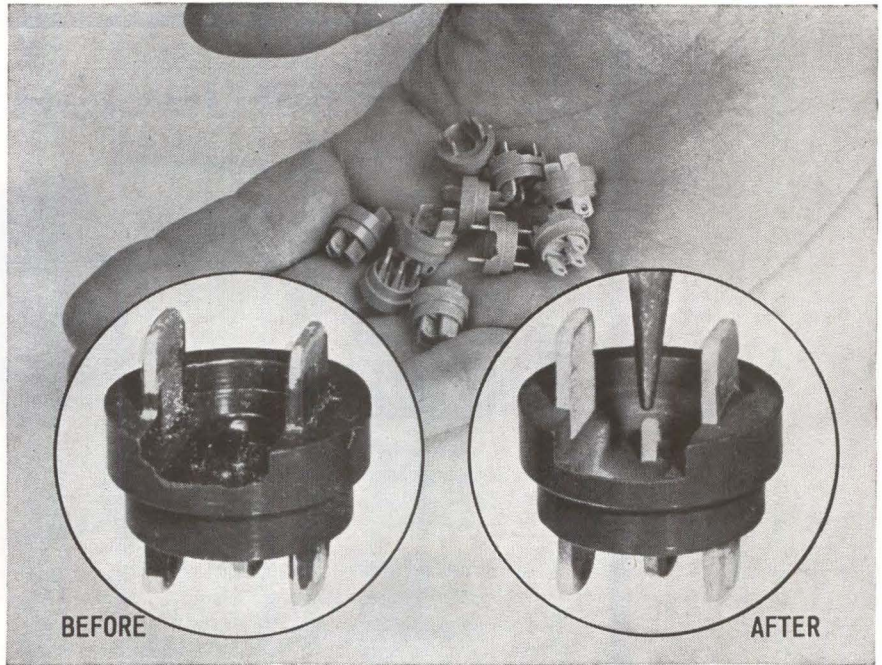

Airbrasive® deflashing... reduced cost of this product 60%

It used to take nine weary-eyed girls a total of 72 hours of picking and scraping with hand tools to deflash and clean these tiny switch bases, according to Molded Insulation Company, Philadelphia, Pa. Now, with the S. S. White Airbrasive, *three* girls deflash the same number in only 24 hours!

What's more, the reject rate dropped from a burdensome 300% to practically nil. Result: the Airbrasive reduced the cost of producing the product by 60%.

Deflashing isn't the only use for this amazing industrial tool. It also cuts, scores, abrades, shapes, wire-strips... in fact, it has a real talent for solving all kinds of seemingly impossible production bottlenecks.

The secret is in the Airbrasive's precise, gas-propelled stream of microscopic particles that cut hard, brittle materials without heat, shock or vibration. Use it in the laboratory or in automated production. Glass, tungsten, ferrites, ceramics, germanium, and other fragile materials. For under \$1,000 you can set up your own Airbrasive cutting unit.

Send us samples of your "impossible" jobs
and let us test them for you at no cost.

SEND FOR
BULLETIN 6006
... complete information

S. S. WHITE INDUSTRIAL DIVISION
DEPT. EU, 10 East 40th St., N. Y. 16, N. Y.
Telephone MU 3-3015 collect

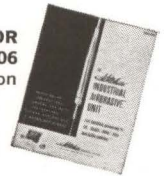

for superfine cutting · deburring · cleaning

hard brittle materials

S.S. White INDUSTRIAL AIRBRASIVE®

CIRCLE 103 ON READER SERVICE CARD

103

JUST PUBLISHED!

IMPACT OF MICROELECTRONICS

Edited by George T. Jacobi,
IIT Research Institute
and Samuel Weber, **electronics**



The Proceedings of the Conference on the Impact of Microelectronics, co-sponsored by the Armour Research Foundation (now IIT Research Institute) and **electronics**, a McGraw-Hill Publication, has just been published by **electronics**. The Conference, held last June 26-27 at the Illinois Institute of Technology, was acclaimed by the attendees and the industry at large. Now, in book form, all the invited papers and talks presented at the conference are available to you.

To whet your appetite, here are some of the contents:

The Electronics Components Industry and Microelectronics
by Robert C. Sprague, Chairman of the Board, Sprague Electric Company.

Profit and Loss in Microelectronics
by Robert W. Galvin, President, Motorola Inc.

Government Needs and Policies in the Age of Microelectronics
by James M. Bridges, Director of Communications and Electronics,
Department of Defense.

Management of Research and Engineering for Microelectronics Systems
by Dr. Peter B. Myers and Arthur P. Stern, Electronic Systems and
Products Division, Martin Company.

In House or Not: The Changing Buyer — Vendor Interface
by F. J. Van Poppelen, Jr., Vice President-Marketing, Signetics Corporation.

Current Technical Status and Problems in Microelectronics
by Jack S. Kilby, Integrated Circuits Dept., Texas Instruments, Inc.

Ultimate Limits of Microelectronics
by Dr. J. T. Wallmark, RCA Laboratories, David Sarnoff Research Center

Reliability in Microelectronics
by Ernest R. Jervis, ARINC Research Corporation.

Engineering Education in an Era of Changing Technology
by Dr. John Bardeen, University of Illinois.

IMPACT OF MICROELECTRONICS is must reading for men with a marketing and technical interest in this dynamic field of activity. Crammed with useful information, this neatly designed, 120 page volume keeps you up-to-date on this fast moving technology. Order today. Only \$3.50 per copy.

ORDER FORM

electronics Reprint Department
McGraw-Hill Publishing Co., Inc.
330 West 42nd Street
New York, N.Y. 10036

Dear Sirs:

Send me _____ copies of **IMPACT OF MICROELECTRONICS**
(\$3.50 per copy)

I am enclosing _____ (cash or check)

Bill me later _____ Bill my company _____

MY NAME _____ POSITION _____

COMPANY _____

ADDRESS _____

field and laboratory and is excellent for providing panel level adjustment and for isolating the effects of variable or mismatched impedances on such circuit elements as oscillators and resonant cavities. Vswr is 1.3; insertion loss, 0.6 db; power rating, 10 w. Model 792 is priced at \$150. Narda Microwave Corp., Plainview, N. Y.

CIRCLE 322, READER SERVICE CARD

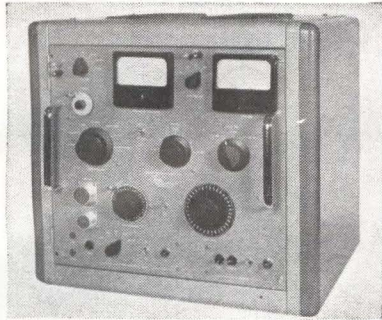

Synchro Tester Meets MIL-S-20708B

FEATURING semiautomatic operation and direct-reading outputs, model MST-5SSA synchro test set conforms to the requirements of MIL-S-20708B. It tests electrical zero, electrical error, fundamental null, and total null. According to the manufacturer, 1000 synchros per month may be completely tested by an unskilled operator. Specifications: Electrical error measured every 5 deg through 360 deg; nulls measured every 60 deg; self-contained, solid-state, phase-sensitive and a-c voltmeters. Price is \$4,500. Theta Instrument Corp., Saddle Brook, N.J. (323)

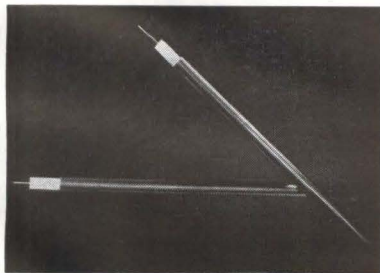

Miniature Coax Is Solid-Jacketed

A RUGGED 93-ohm miniature solid-jacketed cable, UT-93 is announced. The 93-ohm impedance cable is

THE
EXTRA
MEASURE
OF
JULIE
IS

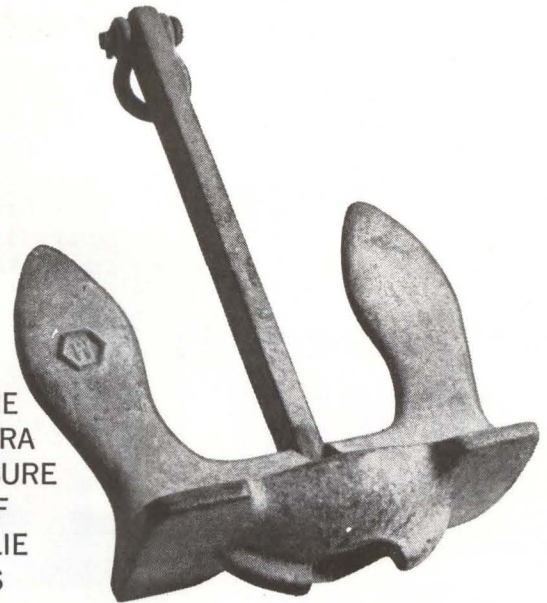

STABILITY

Changes in laboratory temperature—or voltage supply—don't affect the accuracy of the Julie SCO-106 voltage reference. And only the SCO-106 offers the convenience and simplicity of an air-bath* with the accuracy formerly attainable only with large, high performance oil baths. Voltage accuracy is 1 part per million. Cell stability is better than 1 part per million per year, and the three saturated cells composing the SCO-106 are of the type used by government primary standards laboratories for decades without apparent deterioration. Such stability is the extra measure of Julie, the company that developed the RATIOMETRIC™ System of Calibration. Ratiometry is accurate, reliable, simple and versatile. The SCO-106 and the other certifiably accurate Julie instrument modules have been developed to meet the demands of the Ratiometric System. They are, of course, unequalled as individual instruments for all your instrumentation requirements. They perform to specifications without excuses, double-talk or cumulative error.



Write or call collect for a no-obligation demonstration in your office, as well as complete information about the SCO-106 and details of the Julie RATIOMETRIC System. You'll also learn how to institute your own DC primary standards laboratory.

**JULIE RESEARCH
LABORATORIES, INCORPORATED**

211 WEST 61st STREET, NEW YORK 23, NEW YORK • 212 CI 5-2727

*Covered by US Patents



© Julie Research Laboratories, Inc., 1963

specify the new Microdot Products
contact Avnet for best service

AVNET

on-time delivery of Microdot
Connectors and cable

Multipin connectors with up to 61
power or 19 coaxial contacts in
1/8" o.d. plug; microminiature coax
connectors in 50, 70, 90 ohm types;
coax, twinax, triaxial cables (RG
types approved to MIL-C-17C).

many other Microdot Products are
available immediately from Avnet

MICRODOT

call your local Avnet Headquarters
The Avnet System, coast to coast



Westbury, L. I.; Chicago; Phoenix;
Burlington, Mass.; Syracuse, N. Y.;

LOCAL

Salt Lake City; Bellevue, Wash.;
San Diego, L. A., Sunnyvale, Cal.

CIRCLE 212 ON READER SERVICE CARD

AM-FM Tuner Unit

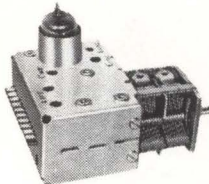

AM SEC. CAPACITY: MAX. 377PF
:MIN. 12PF
TUBE: 6AQ8, 12DT8, 17EW8

PLASTIC
VARIABLE CONDENSER

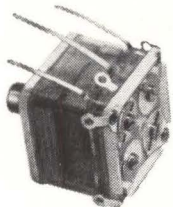

Square Size:
15mm., 17mm.,
20mm., 21mm.,
Single band:
2 band, 3 band
and for FM only.



**SAN ESU
ELECTRONICS
CO., LTD.**

Cable address: SANESVARICON TOKYO:
1425, 4-chome, Higashinakanobu,
Shinagawa-ku, Tokyo, Japan.

106 CIRCLE 106 ON READER SERVICE CARD

only 0.130 in. o-d, features solid
copper outer jacket, Teflon TFE di-
electric and silver-plated copper-
weld center conductor. Continuing
operational integrity is promised
under extreme environmental condi-
tions. Uniform Tubes, Inc., Micro
Delay Division, Collegetown, Pa.
CIRCLE 324, READER SERVICE CARD

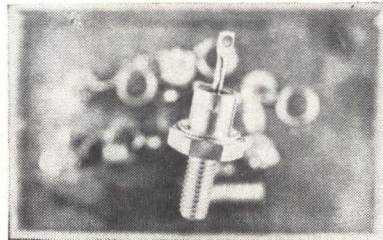

Varactor Diode Handles High Power

POWER VARACTOR DIODE, type
MV705, usable in frequency multi-
pliers at frequencies up to 300 Mc
and capable of handling input pow-
ers exceeding 50 w has been added
to a r-f line of semiconductor de-
vices for communications circuit
applications. The varactor will
triple 50 w of 50 Mc input power
to 150 Mc with about 70 percent
efficiency. Power dissipation is 25
w; reverse breakdown voltage, 150
v; series resistance, 2.0 ohms; junc-
tion capacitance, 50 pf. Motorola
Semiconductor Products. Box 955,
Phoenix, Ariz. 85001. (325)

Reed Relay Uses Flat Sealed Contact

DRAMATIC space reduction in elec-
tronic exchanges is made possible
by the FSC (flat sealed contact)
reed relay. Company says the FSC
will allow up to 48 percent savings
in size of exchanges while providing
high reliability with very little main-
tenance. Sealed in a gas-filled con-
tainer, the contact is not exposed
to friction-wear, dirt or grime. The
FSC is magnetically powered. An
electronic exchange furnished with
relays of the FSC can perform effi-
ciently for practically an unlimited
time. High speed switching also
features the new system. Tele-Norm
Corp., 32-31 57th St., Woodside,
N. Y. (326)

Manufacturing Quality Resistors under Rigid Reliability Control

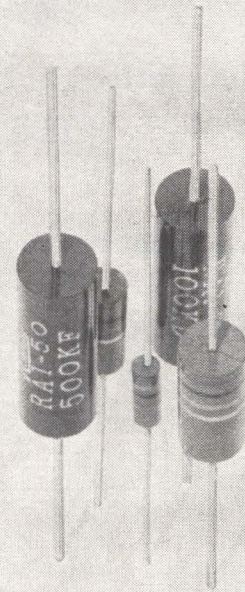

Rohm

METAL FILM RESISTOR
CARBON

**TOYO
ELECTRONICS
INDUSTRY
CORPORATION**

P. O. BOX 103 CENTRAL
KYOTO, JAPAN

CIRCLE 213 ON READER SERVICE CARD
January 3, 1964 electronics

LITERATURE OF THE WEEK

PREAMPS AND AMPLIFIERS Radiation Instrument Development Laboratory, 4505 West North Ave., Melrose Park, Ill., has published a 48-page book entitled "Preamps and Amplifiers for Nuclear Instrumentation." Single copies will be sent in reply to letterhead requests.

NOVAL SOCKET Connector Corp., 6025 No. Keystone Ave., Chicago, Ill., 60646. Data sheet 25A illustrates and describes type 422 all molded noval socket's pin circle keyway feature which permits 20 design options. (360)

SUBMINIATURE CONNECTORS ITT Cannon Electric Inc., 3208 Humboldt St., Los Angeles, Calif. 90031. Catalog RD-1 describes the Royal-D line of subminiature connectors. (361)

SWEEP FREQUENCY GENERATOR General Radio Co., West Concord, Mass., has issued a mailing piece illustrating and describing the 1025-A standard sweep-frequency generator. (362)

PAPER TAPE READER Oh-Tronics, Inc., 289 Huyler St., So. Hackensack, N. J. Bulletin on the model 119 paper tape reader includes isometric drawing, photograph, electrical schematic, dimensions drawing, general description and technical specifications. (363)

COMMUNICATION SYSTEMS Vitro Corp. of America, 261 Madison Ave., New York 16, N. Y., has issued a brochure containing full data on its telemetry and other electronic communication systems. (364)

SILICON RECTIFIER STACKS Tung-Sol Electric Inc., One Summer Ave., Newark 4, N. J., has published a catalog covering high current silicon rectifier stacks. (365)

DELAY TIMER Leeson Moos Laboratories, Community Drive, Great Neck, L. I., N. Y. Technical data sheet describes the Betachron model D5307 acceleration-actuated delay timer. (366)

VACUUM FURNACES Brew Vacuum Furnace Division, Richard D. Brew & Co., Inc., Airport Road, Concord, N.H., has available a 6-page brochure illustrating and describing a line of high temperature vacuum furnaces. (367)

SYNCHRO TESTING BRIDGES Theta Instrument Corp., Saddle Brook, N. J. A series of experimental procedures for evaluating synchro and resolver testing bridges is outlined in a new 6-page bulletin. (368)

COMPUTER MODULES National Transistor, 500 Broadway, Lawrence, Mass., has issued an engineering bulletin describing two computer modules recently registered with JEDEC. (369)

ELECTRONIC SYSTEMS Interstate Electronics Corp., Anaheim, Calif. A 24-page brochure provides source material for those engaged in the procurement and application of electronic instrumentation data systems for defense and space-age programs. (370)

PHASE LOCK REPORT Polarad Electronic Instruments Div. of Polarad Electronics Corp., 34-20 Queens Blvd., Long Island City, N. Y., has available a technical note describing phase locked signal generators and spectrum analyzers. It can be obtained by writing on company letterhead.

TOROID COIL WINDER M-Y Co., P. O. Drawer M, Jerome, Ariz. Bulletin 103 describes a low cost toroid coil winding machine designed for prototype and moderate production uses. (371)

AUDIO ISOLATION TRANSFORMER Solar Electronics Co., 5909 Melrose Ave., Hollywood 38, Calif. Bulletin 110 describes an audio isolation transformer designed for screen room use in making a-f susceptibility tests. (372)

SYSTEMS BROCHURE Scientific Data Systems, Inc., 1649 Seventeenth St., Santa Monica, Calif. Brochure discusses the company's policy of free digital systems engineering and checkout programming, which can reduce total systems cost by as much as 25 percent. (373)

CORE MEMORY STACK Electronic Memories, Inc., 12621 Chadron Ave., Hawthorne, Calif. Technical bulletin describes a 30-mil., 4096-word core memory stack. (374)

PROXIMITY SWITCH SYSTEMS Micro Switch, a division of Honeywell, Freeport, Ill. A 24-page catalog 85 presents specifications and ordering information on a broad line of proximity switch systems for detecting ferromagnetic metals. (375)

THERMOELECTRIC TEMPERATURE STABILIZATION Carter-Princeton, Electronics Division of Carter Products, Inc., 178 Alexander St., Princeton, N. J. A brochure, "When to Specify Thermoelectric Temperature Stabilization", is complete with charts, figures, examples and definitions. (376)

LINE VOLTAGE REGULATORS George Kelk Limited, 5 Lesmill Road, Don Mills, Ontario, Canada, has published a brochure on Stedivolt a-c line voltage regulators. (377)

PRESSURE TRANSDUCER Consolidated Electro-dynamics Corp., 360 Sierra Madre Villa, Pasadena, Calif. Operational characteristics of type 4-390 high output pressure transducer are described in a bulletin. (378)

TOROIDAL CORES Genalex Division, Connelly & Co., Inc., 914 Rengstorff Ave., Mountain View, Calif., has prepared a 16-page design handbook for application of toroidal magnetic cores over a range of 200 cps or 200 kc. (379)

IR DETECTORS Philco Corp., Landsdale, Pa., has made available a 16-page brochure entitled, "Indium Antimonide Infrared Detectors." (380)

GROUND-BASED DATA PROCESSING SYSTEMS Radiation Inc., Melbourne, Fla. A 12-page brochure discusses ground-based data processing systems. (381)

specify the new circuit breakers
by Mechanical Products, Inc.

AVNET

contact The Avnet System
for best service & on-time delivery

the line includes breakers with
both standard commercial and
Mil Spec part nos. Mechanical
Products' circuit breakers meet
requirements of MIL C-5809
and MIL C-7079.

for MP circuit breakers

MECHANICAL PRODUCTS

call your Local Avnet Headquarters



Westbury, L. I.; Chicago; Phoenix;
Burlington, Mass.; Syracuse, N. Y.;

LOCAL

Salt Lake City; Bellevue, Wash.;
San Diego, L. A., Sunnyvale, Cal.

CIRCLE 214 ON READER SERVICE CARD

OPTICAL BENCHES AND ACCESSORIES



**SECOND
HARMONIC
GENERATOR
CONVERTS
RED LASER
LIGHT TO
BLUE.**

COVER PICTURE
FROM ELECTRONICS
MAY 10, 1963

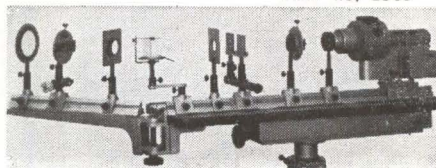

STRAIGHTNESS TO 0.1 mm

All the rails and carriages are standardized and interchangeable with parts made by other manufacturers.

WRITE FOR CAT. 81F

KLINGER SCIENTIFIC
APPARATUS
83-45 Parsons Blvd., Jamaica 32, N. Y.
Tel: 212 Olymphia 7-0335

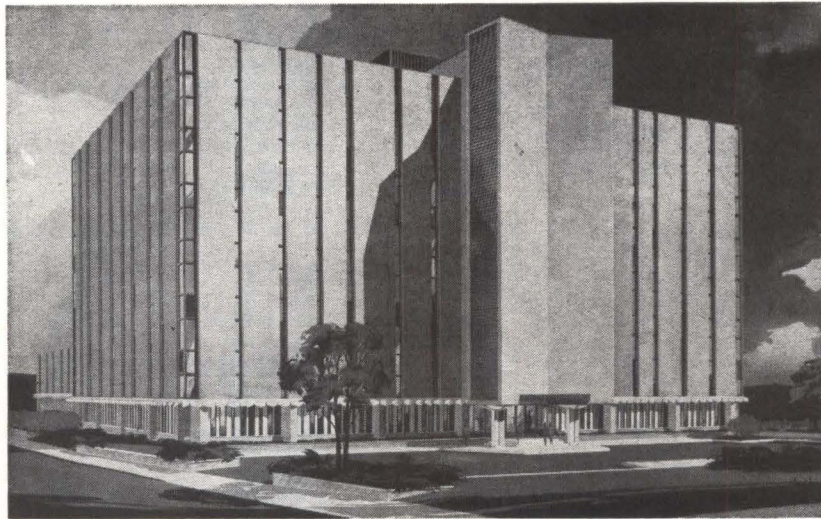

Cutler-Hammer To Build New HQ

CUTLER-HAMMER president Philip Ryan has announced plans for the construction of a new headquarters building in Milwaukee, Wisc.

The seven-story office and research center, expected to be completed early in 1965, will contain 216,000 square feet of floor space and will accommodate about 1,000 employees. It will house administrative, development, production planning and marketing personnel now located at two of the company's other plants in Milwaukee. The building will cost over \$3 million, according to company officials.

A 33,000-square-foot addition to another of the firm's plants, adjacent to the new office and research center site, was completed and occupied in November. Ryan said the addition provides extra engineering and sales department floor space.



Bendix Promotes Weingarten

MURRAY WEINGARTEN has been promoted to vice president for operations at the Bendix Field Engineering Corporation, Owings Mills, Md., subsidiary of The Bendix Corp.

In this new position, Weingarten will be responsible for the operation

and direction of programs under Department of Defense contracts of all the military agencies. He also will retain his responsibilities as manager of field-engineering programs on space projects to NASA.

EAI Names Baumann Chief Engineer

DONALD A. BAUMANN has been appointed chief engineer of Electronic Associates, Inc., Long Branch, N.J. He succeeds William Kindle who recently was named new product program manager.

Since 1957, Baumann has been engaged in research and development for analog-digital computer linkage systems as a senior electronics engineer for EAI.

General Electric Advances Cross

HERSHNER CROSS has been advanced to vice president and group executive in charge of General Electric Company's Industrial Group. The Industrial Group, with more than 50,000 employees, accounts for roughly a quarter of GE's total business.

Cross formerly headed GE's Radio & Television division, with headquarters at Electronics Park, Syracuse, N. Y., since 1959. His new office will be in New York City.

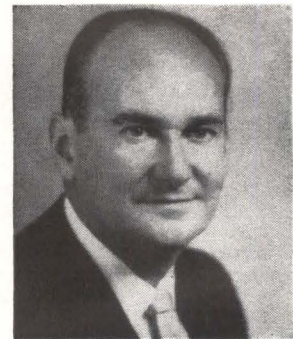

Litton Industries Elects Adler

ELECTION of Benjamin Adler as vice president of Litton Industries has been announced.

Adler was president of Adler Electronics. The latter firm, with plants in New Rochelle and Pelham Manor, N. Y., has been acquired by Litton Industries, and now is a part of Litton's Systems Group headed by George T. Scharffenberger, senior vice president of Litton.

IBM Announces Two Promotions

THE PROMOTION of Arthur G. Anderson to assistant director of the Research Division of International Business Machines Corporation, Yorktown, N.Y., has been announced. He was previously manager of IBM's research laboratory in San Jose, Calif.

Succeeding Anderson is Jerome

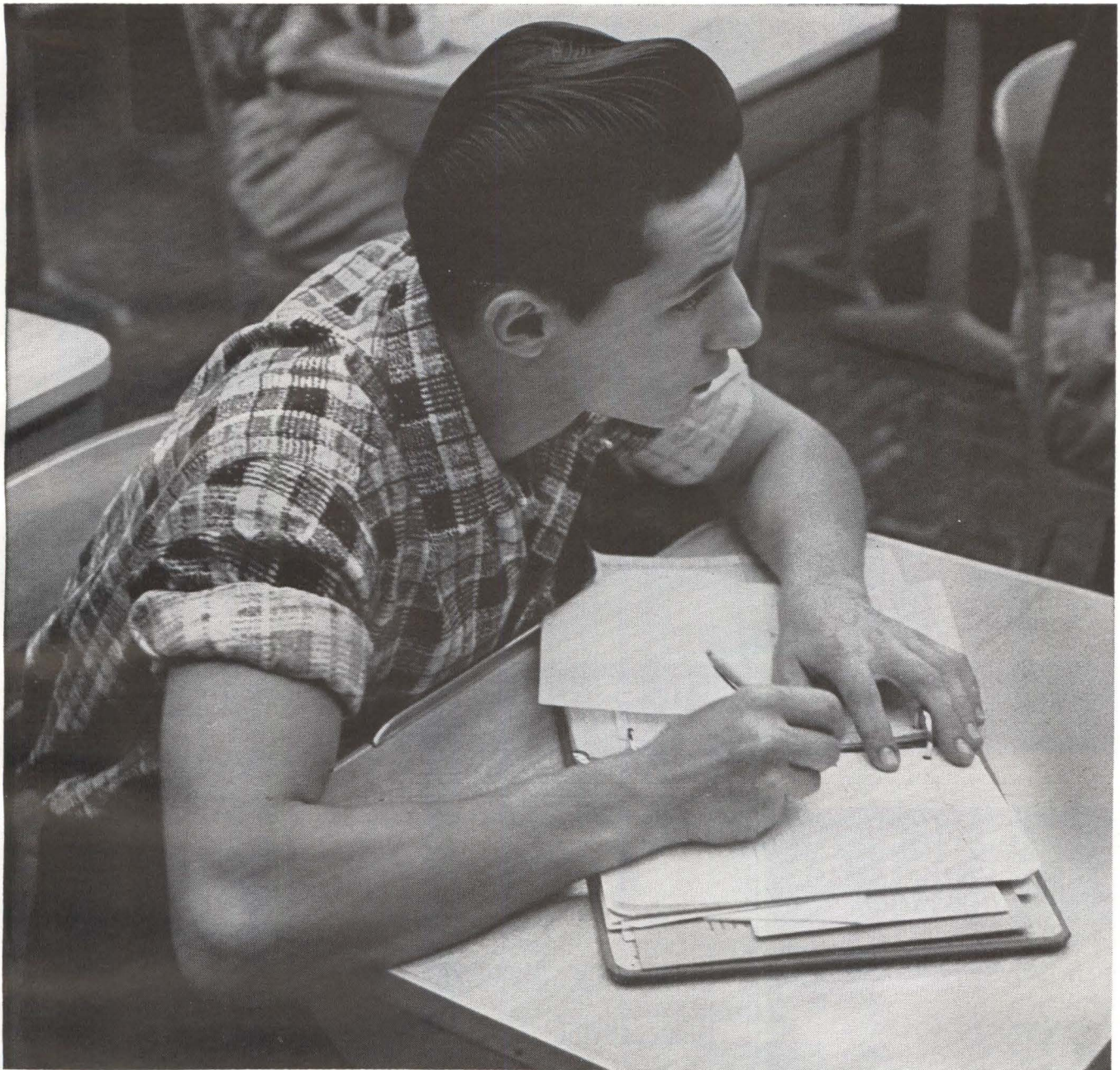

Investment Opportunity

The tools this young apprentice is learning to make will one day be used to turn out your company's products.

A great investment in time, money, effort and faith will have to go into making him productive. Every one of us has a stake in his success—and every one of us must invest something—for on the developing skills of America's young tool-makers depends the continued functioning of all industries.

You can protect your investment by joining with other leading American businessmen to promote the Treasury's Payroll Savings Plan for U.S. Savings Bonds. The Treasury Department's Plan helps safeguard the individ-

ual liberties, and encourages the industrious and responsible attitudes so necessary for the growth of our economy and the well-being of our society.

When you bring the Payroll Savings Plan into your plant—*when you encourage your employees to enroll*—you are investing in the next generation of America's skilled craftsmen and technicians. You are investing in our future. In freedom itself.

Don't pass this investment opportunity by. Call your State Savings Bonds Director. Or write today to the Treasury Department, United States Savings Bonds Division, Washington, D.C., 20226.



in your plant...promote the PAYROLL SAVINGS PLAN for U.S. SAVINGS BONDS



The U. S. Government does not pay for this advertisement. The Treasury Department thanks, for their patriotism, The Advertising Council and this magazine.

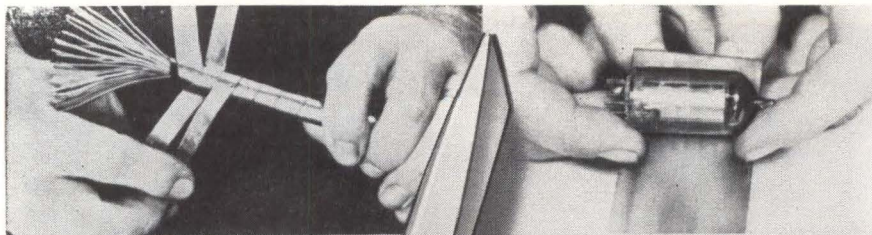

CUT IT, WRAP IT!

**NETIC AND CO-NETIC
MAGNETIC SHIELDS
APPLIED
IN SECONDS**



Guard against performance degradation from unpredictable magnetic field conditions to which your equipment may be exposed. Economical CO-NETIC and NETIC Magnetic Shielding Foils are adaptable to any size or shape components. Simply cut with ordinary scissors. Available in continuous lengths on rolls up to 15" wide. Furnished in final annealed state.

Co-Netic and Netic alloys are not affected significantly by vibration or shock, assuring components performance repeatability over a wider range of flux intensities. They are also non-retentive and do not require periodic annealing. When grounded, they shield electrostatic as well as magnetic fields. They have many applications in satellite instrumentation and many other magnetically sensitive devices.

MAGNETIC SHIELD DIVISION

Perfection Mica Co. Phone EVerglade 4-2122
1322 North Elston Avenue, Chicago 22, Illinois

CIRCLE 215 ON READER SERVICE CARD

D. Swalen, who had been manager of the physics department at the San Jose research laboratory.



Houston Instrument Promotes Bravenec

FRANK BRAVENEC has been appointed vice president of engineering to head up the newly-expanded engineering department of Houston Instrument Corp., Bellaire, Texas. He had been chief engineer for the firm for three years.

Houston Instrument Corp. manufactures electronic test equipment, x-y recorders, industrial instruments and geophysical recording heads.

MICROWAVE PHASE and TIME DETECTOR for PULSED and CW SIGNALS

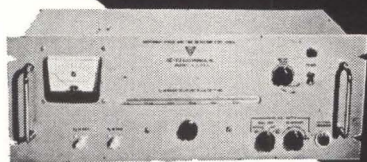

TYPE 206

Frequency Range: Type 206A - 300 mc to 6000 mc.
Type 206B - 3.95 kmc to 18 kmc.

Accuracy: $\pm 0.1^\circ$ or $\pm 1\%$.

Minimum Input Signal: Approximately ± 5 mv with receiver, 0.3v with panel meter as null indicator.

TYPE 205B1-2-3

Frequency Range: 15 mc to 1500 mc.

Accuracy: $\pm 0.05^\circ$ or $\pm 1\%$.

Minimum Input Voltage: Approximately 100 mv with panel meter, 10 mv with external receiver.

FEATURES

Infinite resolution. Readability 0.001 μ s. Accuracy not affected by amplitude fluctuation of both input signals. Capable of plotting phase vs. frequency curve on an oscilloscope or recorder.

AD-YU ELECTRONICS INC.
249 TERHUNE AVE., PASSAIC, N. J.

NIMS

NATIONWIDE IMPROVED MAIL SERVICE PROGRAM

For Better Service
Your Post Office
Suggests

That You Mail Early
In The Day!



Grohe Moves Up at Northrop Nortronics

APPOINTMENT of Lester R. Grohe as a vice president of the Nortronics Division of Northrop Corporation and manager of its Precision Products department in Norwood, Mass., has been announced.

Grohe, previously deputy manager of the Precision Products department, was named to the post following the resignation of William A. Jones, who left to establish his own company.

At Nortronics, Grohe has been instrumental in the development and

production of gyroscopes and accelerometers used in shipboard inertial navigation systems, satellites and missiles for programs such as Polaris, Minuteman and Agena.



Optics Technology Elects Schawlow

ARTHUR L. SCHAWLOW, Stanford University physics professor and a co-developer of the optical maser, has been elected to the board of directors of Optics Technology, Inc., Belmont, Calif.

Optics Technology conducts advanced research and development in the field of optics and manufactures special optical devices, including lasers and fiber optics instruments.



Burke Advances at Standard Kollsman

JAMES W. BURKE has been elected vice president and general manager of the Tuner Division of Standard Kollsman Industries Inc., Melrose Park, Ill. He joined the company in 1955, and was assistant to the president since 1962.

Standard Kollsman Industries is a diversified manufacturer of precision electronic and electrical products for defense, industry and the consumer.



Trent Raised to Vice President

ROBERT L. TRENT has been named to the new position of vice president for research and development of National Semiconductor Corp., Danbury, Conn., manufacturer of silicon transistors and integrated circuit devices in standard and micro-miniature packages. Trent has been director of research and development at NSC since 1961.



Duncan Electronics Appoints Wyman

APPOINTMENT of John C. Wyman, Jr., as vice president of marketing at Duncan Electronics, Inc., has been announced.

For the past three years, Wyman has served as sales manager of the Costa Mesa, Calif., precision potentiometer manufacturer.

GPI Announces Promotions

PROMOTIONS of Joseph W. Barron to vice president-administration and planning, and Robert J. Campbell to vice president-marketing of Link Division of General Precision, Inc.'s Simulation and Control

AVAILABLE! the most complete TECHNICAL DATA on Microwave Energy Sources

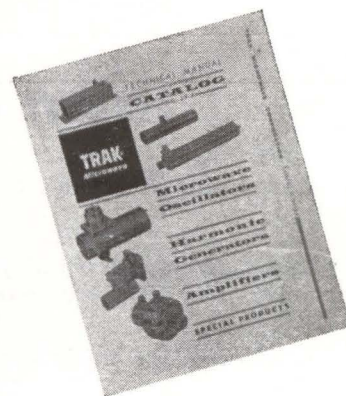

Whatever your problems in microwave energy generation the solutions can most likely be found in the new Trak Technical Manual and Catalog (63-A). It lists more than 100 stock oscillators, harmonic generators, amplifiers and special products at frequencies from 400 Mc. to 11 Gc. All can be modified to other frequencies or special requirements. In many cases, Trak devices permit development of previously impossible projects because of their small size and advanced capabilities.

SEND FOR YOUR COPY !



**TRAK MICROWAVE
CORPORATION**

5006 N. Coolidge Avenue Tampa, Florida
Phone: 877-6735

To Order Reprints

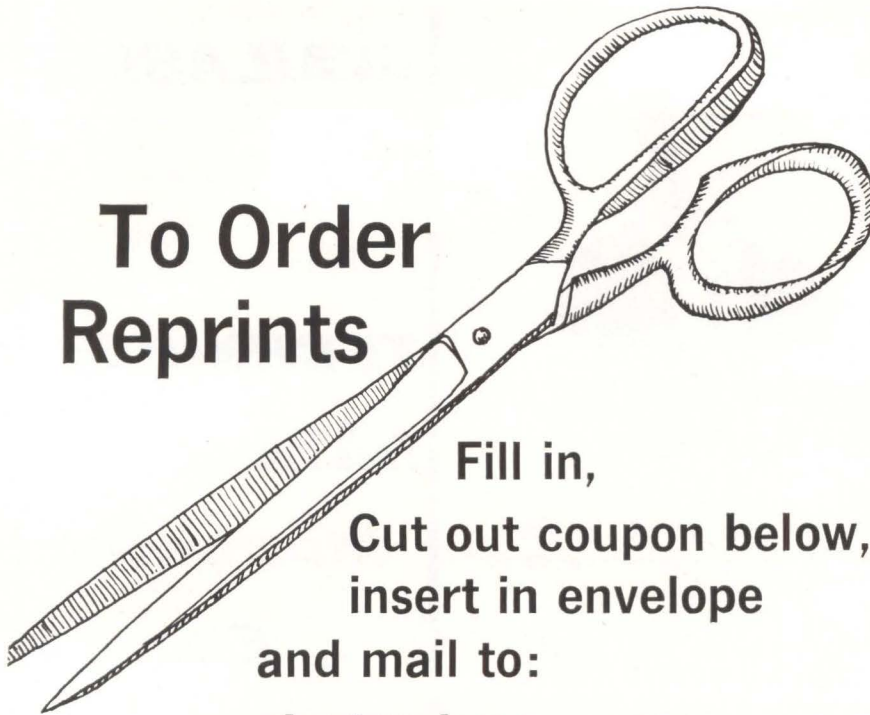

Fill in,
Cut out coupon below,
insert in envelope
and mail to:

electronics Reprint Dept.
330 West 42nd Street,
New York, N. Y.—10036

REPRINT ORDER FORM

For Listing of Reprints Available See Reader Service Card

(To help expedite mailing of your reprints please send cash, check or money order with your order.)

For Reprints of the latest Special Report:

Electronic Markets, New Directions 63-64-67

Send me Reprints of Key No. R-48 at 50¢ each.

For Reprints of previous **Special Reports** or **Feature Articles** fill in below:

Send me Reprints of Key No.(s) @ ¢ each.
(For prices, see Reader Service Card.)

*For orders of **Bulk Reprints** of other editorial articles in **this issue or past issues**:

Send me Reprints of page no.(s) of issue date
of article entitled

*Minimum bulk order 100 copies. You will be advised of costs by return mail.

Name

Number and Street

City, Zone No., State

Group, have been announced.

Concurrently, it was announced that John M. Hunt was elected to the board of directors of General Precision, Inc. Hunt is senior vice president and technical director of the Simulation and Control Group.

Barron previously was vice president, administration and marketing at Link. Campbell previously was manager, marketing.

General Precision, Inc. is the principal operating subsidiary of General Precision Equipment Corp., Tarrytown, New York.

PEOPLE IN BRIEF

Richard G. Zens moves up to v-p and g-m of Electrolab Printed Electronics Corp. **William F. Kamsler**, formerly with Astrodata, Inc., appointed mgr., advanced systems design for Scientific Data Systems. **J. M. Sterling** advances to director of Honeywell's EDP-International. **Robert F. Martin**, previously with GD/Electronics, named mgr. of quality control by Electrolab Electronics Corp. **Robert Lord** promoted to computer research mgr. for the Berkeley div. of Beckman Instruments, Inc., succeeding **Maxwell C. Gilliland**, now chief of a mathematical analysis group to serve all company divisions. **Arnold Sherman** elevated to exec v-p of College Hill Industries, Inc. **David W. Pertschuk** raised to corporate director of reliability and quality assurance for Fairchild Stratos Corp. **John Carge** moves up to mgr. of technical services at Brush Instruments, div. of Clevite Corp. **Allan Q. Mowatt**, from Atlee Corp. to Electronics Metals and Alloys, Inc., as mgr. of product development with the Sweet Industrial div. **James Gray**, ex-Univac, named mgr. of the electronic design dept., Research and Engineering div. of Xerox Corp. **Robert E. Rutherford Jr.** advances to chief engineer of CBS Laboratories Electron Tube dept. **C. A. Norman Johnson**, asst. to the president of Blackstone Corp., elected v-p. **William L. Peffer** elevated to president, and **Lars M. Runbeck** to chief engineer of Resistance Products Co.

HOW TO USE YOUR ELECTRONICS BUYERS' GUIDE

Advertising Product Sections

Advertisements in the ELECTRONICS BUYERS' GUIDE are grouped together according to the kind of product advertised. All Power Supply advertisements, for example, will be found in the same section of the book. Thus it is made convenient for you to "shop" through the specifications presented to you by advertisers, without having to flip pages back and forth constantly. Keep your ELECTRONICS BUYERS' GUIDE close to your work area at all times.

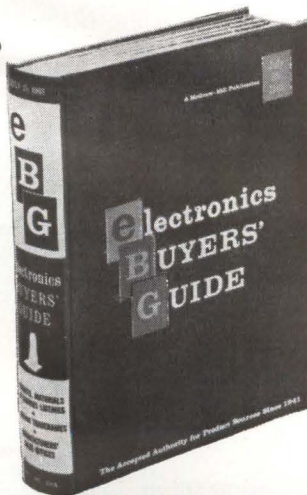

EMPLOYMENT OPPORTUNITIES

The advertisements in this section include all employment opportunities—executive, management, technical, selling, office, skilled, manual, etc. Look in the forward section of the magazine for additional Employment Opportunities advertising.

— RATES —

DISPLAYED: The advertising rate is \$52.00 per inch for all advertising appearing on other than a contract basis. Contract rates quoted on request.

An advertising inch is measured $\frac{1}{4}$ " vertically on a column—3 columns—30 inches to a page.

Subject to Agency Commission.

UNDISPLAYED: \$2.70 per line, minimum 3 lines. To figure advance payment count 5 average words as a line. Box numbers—count as 1 line.

Discount of 10% if full payment is made in advance for 4 consecutive insertions.

Not subject to Agency Commission.



E. E.'s

for FEE-PAID Positions
WRITE US FIRST!

Use our confidential application for professional, individualized service . . . a complete national technical employment agency.

ATOMIC PERSONNEL, INC.
Suite 1207L, 1518 Walnut St., Phila. 2, Pa.

PRODUCT LITERATURE MANAGER

with EE or Physics degree and experience in electronic instruments technical writing needed by growing Midwest manufacturer. Background in marketing and advertising desirable. Position offers challenging opportunity for personal growth. Salary to \$12,000. Send complete resume—will be held in strict confidence.

P-3494, Electronics

645 N. Michigan Ave., Chicago, Ill. 60611

INDUSTRIAL ELECTRON TUBES SALESMAN

DYNAMIC, WITH BROAD MARKET CONTACTS AND FOLLOWING. SALARY PLUS LIBERAL COMMISSION.

METROPOLITAN SUPPLY CORP.

443 PARK AVE S., NEW YORK 16, N. Y.
(212) MU 6-2835

EMPLOYMENT SERVICES

Resumes and application letters that make employers want you. Composed, printed by Executive Resumes, Dept. F, Executive Suite, 744 Broad St., Newark, N. J.

SEARCHLIGHT SECTION

(Classified Advertising)
BUSINESS OPPORTUNITIES
EQUIPMENT - USED or RESALE

RADAR AUTO-TRACK & TELEMETRY ANTENNA PEDESTALS 3 & 10 CM. SCR 584 AUTOTRACK RADARS. M-33 RADAR TPS-1D SEARCH. APS-45 TPS-10D HT. FINDERS. WX RADARS. FPN-32GCA. APS-10 APS-15B APS-27 (AMTD) SEARCH. APN-102 DOPPLER. DOZENS MORE CARCINOTRONS. PPN'S. 25-61-23-6 MEGAWATT PULSE MODULATORS. CAVITIES. PULSE TRANSFORMERS. IF STRIPS. WAVEGUIDE. BENDS 200 MC. 1 KMC. 3 KMC. 6 KMC. 9 KMC. 24 KMC. RF PKGS.

RADIO RESEARCH INSTRUMENT CO.
550 5TH AVE., NEW YORK 36, N. Y. JU 6-4691

CIRCLE 950 ON READER SERVICE CARD

OPTICAL BENCHES
\$13. to \$13,000. New Catalog

THE **Ealing** CORP.

2250 Massachusetts Avenue, Cambridge, Mass., 02140

CIRCLE 952 ON READER SERVICE CARD

WRITE FOR NEW **KEYSTONE**
free catalog

We are the leading producers of BATTERY HOLDERS, TERMINALS, TERMINAL BOARDS & ELECTRONIC HARDWARE.

KEYSTONE ELECTRONICS CORP. 49 BLEECKER ST. NEW YORK 12, N. Y.

CIRCLE 951 ON READER SERVICE CARD

Engineering

EXPLORE THE FUTURE

with the advanced
production team at

BENDIX KANSAS CITY!

ELECTRONIC DESIGN ENGINEERS

BSEE or Physics with experience in any of the following fields: Digital circuits, logical design, semiconductor circuit design, or micro-wave design. Engineers are assigned complete project responsibilities for one or more complex systems and will maintain liaison from conception through design and production, to final delivery to the customer.

ELECTRONIC PROCESS ENGINEERS

For these positions we prefer experienced engineers with a degree or equivalent experience in light product tooling and machining methods or electronic encapsulation packaging. Responsibilities include determining manufacturing processes, procedures, approving tool designs, and capital equipment and facilities planning.

ELECTRONIC TEST EQUIPMENT DESIGN ENGINEERS

To develop, design and supervise construction of special electronic test instruments, and to direct the technical activities of others in the organization. These positions require familiarity with test equipment problems and inspection techniques. Past association with military electronic equipment or experience in precision measurement of production items would assist you in qualifying for these positions. EE degree required.

YOUR FUTURE AT BENDIX!

The Kansas City Division of Bendix, long-term prime contractor for the AEC, offers a pleasant, stimulating environment for professional growth. Kansas City is also a delightful place to live; visitors frequently call it America's most beautiful city. Living costs are moderate; recreational, cultural and educational facilities are plentiful. Choice suburban living only minutes away; no traffic problems. For prompt attention, address your confidential inquiry to:

MR. K. L. BEARDSLEY

Technical Personnel Representative

BENDIX CORPORATION

Box 303-RT

Kansas City, Mo. 64141

An Equal Opportunity Employer



KANSAS CITY DIVISION

INDEX TO ADVERTISERS

| | | | | | |
|--|----------|--|-----------|---|------------|
| • Ad-Yu Electronics Inc. | 110 | LTV Military Electronics Div. | 27 | • United Shoe Machinery Corp. | 100 |
| Alcatel | 76 | Leach Corp. | 62 | • United Transformer Corp. 2nd cover | |
| • Alpha Wire Corp. | 67 | | | Unitrode Transistor Products | |
| Analab Instrument Corp. | 6 | Machlett Laboratories Inc., The | 25 | Inc. | 21 |
| Angelica Uniform Co. | 93 | Magnetic Shield Div. of | | | |
| Atlee Corp. | 98 | Perfection Mica Co. | 110 | Videon | 80 |
| Audax | 80 | Mallory and Co., P. R. | 29 | | |
| • Avnet Electronics Corp. | 106, 107 | Melpar Inc. | 100 | Welch Scientific Co., The | 82 |
| | | Microwave Associates Inc. | 101 | Wells Electronics Inc. | 93 |
| • Bourns Inc., Trimpot Div. | 23 | Minnesota Mining & Mfg. Co. | | Westinghouse Electric Corp. | 85 |
| Bud Radio Inc. | 96 | Mincom Division | 3rd cover | White S. S. | 103 |
| • Bussmann Mfg. Co., Div. of | | Mitsubishi Electric Corp. | 28 | • Williams & Co., C. K. | 61 |
| McGraw Edison Co. | 94, 95 | | | | |
| | | • NRC Equipment Corp. | 99 | | |
| CIFTE | 80 | Ohr-Tronics Inc. | 22 | | |
| • CSF | 75 | | | CLASSIFIED ADVERTISING | |
| Cal-Glo Co. | 88 | • Perfection Mica Co., | | F. J. Eberle, Business Mgr. (2557) | |
| • Camblock, Div. of Waltham | | Magnetic Shield Div. | 110 | | |
| Precision Instrument Co., | | Potter Instrument Co., Inc. | 30 | | |
| Inc. | 68 | | | EMPLOYMENT OPPORTUNITIES | 113 |
| • Clairex Corp. | 72 | Radio Corporation of America | | | |
| | | 4th cover | | EQUIPMENT | |
| • Defense Electronics Inc. | 65 | Radio Engineering Laboratories | 15 | (Used or Surplus New) | |
| Delco Radio | 26 | • Radio Frequency Laboratories | | For Sale | 113 |
| Drusch | 76 | Inc. | 90 | | |
| | | • Radio Materials Co. | 70 | | |
| • Electro-Mec Instrument Corp. | 102 | Ribet-Desjardins | 77 | | |
| Electro-Seal Corp. | 71 | | | CLASSIFIED ADVERTISERS INDEX | |
| Esterline-Angus-Instrument Co. | 91 | Saab Motors Inc. | 16 | Atomic Personnel Inc. | 113 |
| Exact Electronics | 98 | • Sanborn, A Sub. of | | Bendix Corp. | 113 |
| | | Hewlett-Packard Co. | 8, 9 | Ealing Corp. | 113 |
| • Federation Nationale Des | | San Esu Electronics Co., Ltd. | 106 | Keystone Electronics Corp. | 113 |
| Industries Electronique | 73, 74 | Servomechanisms Inc., | | Metropolitan Supply Corp. | 113 |
| • Ford Instrument Co., Div. of | | Mechatrol Div. | 87 | • Radio Research Instrument Co. | 113 |
| Sperry Rand Corp. | 86 | Sierra Electronic Div. of Philco | 4 | | |
| | | Souriau et Cie | 77 | | |
| • General Electric Co. | 7 | Space Technology Laboratories | | | |
| Gudebrod Bros. Silk Co., Inc. | 83 | Inc. | 14 | | |
| | | Sprague Electric Co. | 3, 64 | | |
| Hansen Mfg. Co., Inc. | 88 | TA Mfg., Corp. | 93 | | |
| • Hitachi Ltd. | 95 | Taylor Electric Inc. | 102 | | |
| | | • Tektronix Inc. | 12, 13 | | |
| James Electronics Inc. | 97 | Texas Instruments Incorporated | | | |
| Julie Research Laboratories Inc. | 105 | Industrial Products Group | 69 | | |
| | | Thermal American Fused Quartz | | | |
| Kerr Corp, Wayne | 66 | Co., Inc. | 88 | | |
| Klinger Scientific Apparatus | 107 | Thompson Houston | 78 | | |
| | | Thompson Varian | 79 | | |
| | | • Toyo Electronics Ind., Corp. | 106 | | |
| | | Trak Microwave Corp. | 111 | | |

CLASSIFIED ADVERTISING

F. J. Eberle, Business Mgr. (2557)

EMPLOYMENT OPPORTUNITIES 113

EQUIPMENT

(Used or Surplus New)
For Sale 113

CLASSIFIED ADVERTISERS INDEX

Atomic Personnel Inc. 113
Bendix Corp. 113
Ealing Corp. 113
Keystone Electronics Corp. 113
Metropolitan Supply Corp. 113
• Radio Research Instrument Co. 113

• See advertisement in the July 25, 1963 issue of electronics Buyers' Guide for complete line of products or services.

This Index and our Reader Service Numbers are published as a service. Every precaution is taken to make them accurate, but electronics assumes no responsibilities for errors or omissions.

electronics



Audit Bureau
of Circulation



Associated Business
Publications

AUDITED PAID CIRCULATION

JAMES T. HAUPTLI (2210)
Advertising Sales Manager

HENRY M. SHAW (3485)
Market Research Manager

DAVID M. TEMPEST (3139)
Promotion Manager

electronics Buyers' Guide

R. S. QUINT (2335)
General Manager

RICHARD J. TOMLINSON (3191)
Business Manager

THEODORE R. GEIPEL (2044)
Production Manager

NEW YORK TELEPHONE: Dial Direct:
971 plus number in parenthesis,
Area Code 212

ADVERTISING REPRESENTATIVES

ATLANTA, GA. 30309
Michael H. Miller, Robert C. Johnson
1375 Peachtree St. N.E.,
Trinity 5-0523 (area code 404)

BOSTON, MASS. 02116
William S. Hodgkinson
McGraw-Hill Building, Copley Square,
Congress 2-1160 (area code 617)

CHICAGO, ILL. 60611
Harvey W. Wernecke,
Robert M. Denmead
645 North Michigan Avenue,
Mohawk 4-5800 (area code 312)

CLEVELAND, OHIO 44113
Paul T. Fegley
55 Public Square, Superior 1-7000
(area code 216)

DALLAS, TEXAS 75201
Frank Le Beau
The Vaughn Bldg.,
1712 Commerce St.
Riverside 7-9721 (area code 214)

DENVER, COLO. 80202
John W. Patten
Tower Bldg., 1700 Broadway,
Alpine 5-2981 (area code 303)

HOUSTON, TEXAS 77025
Kenneth George
Prudential Bldg., Halcombe Blvd.,
Riverside 8-1280 (area code 713)

LOS ANGELES, CALIF. 90017
Ashley P. Hartman, John G. Zisch,
1125 W. 6th St., Huntley 2-5450
(area code 213)

NEW YORK, N. Y. 10036
Donald H. Miller (212) 971 3615
George F. Werner (212) 971 3617
Donald R. Furth (212) 971 3616
500 Fifth Avenue

PHILADELPHIA, PA. 19103
Warren H. Gardner, William J. Boyle
6 Penn Center Plaza,
LOcust 8-4330 (area code 215)

SAN FRANCISCO, CALIF. 94111
Richard C. Alcorn
255 California Street,
Douglas 2-4600 (area code 415)

LONDON W1:
Edwin S. Murphy Jr.
34 Dover St.

FRANKFURT/Main:
Matthee Herfurth
85 Westendstrasse

GENEVA:
Michael R. Zeynel
2 Place du Port

TOKYO:
George Olcott,
1, Kotohiracho, Shiba, Minato-ku

COPY
CAT



TAPE COPY STATION FOR ATLANTIC MISSILE RANGE

Six 1.5-mc Mincom CM-100 Recorder/Reproducers form the backbone of an extremely complex tape copy station delivered to the Atlantic Missile Range. This station makes possible for the first time as many as five first-generation copies of prime data tapes in one operation. In addition to the six CM-100's, it also includes two 600-kc Mincom G-100's, two degaussers, and an advanced monitor alarm system policing forty-two 1.5-mc channels. The station is the result of Mincom's long experience with frequency responses of better than 1 mc — an outstanding reliability record since 1955.

Mincom Division **3M**
COMPANY
2049 South Barrington Avenue, Los Angeles 25,
425 13th Street N. W., Washington 4, D. C.

CIRCLE 901 ON READER SERVICE CARD

Look
again
how
RCA's
DARK HEATER
benefits
you...

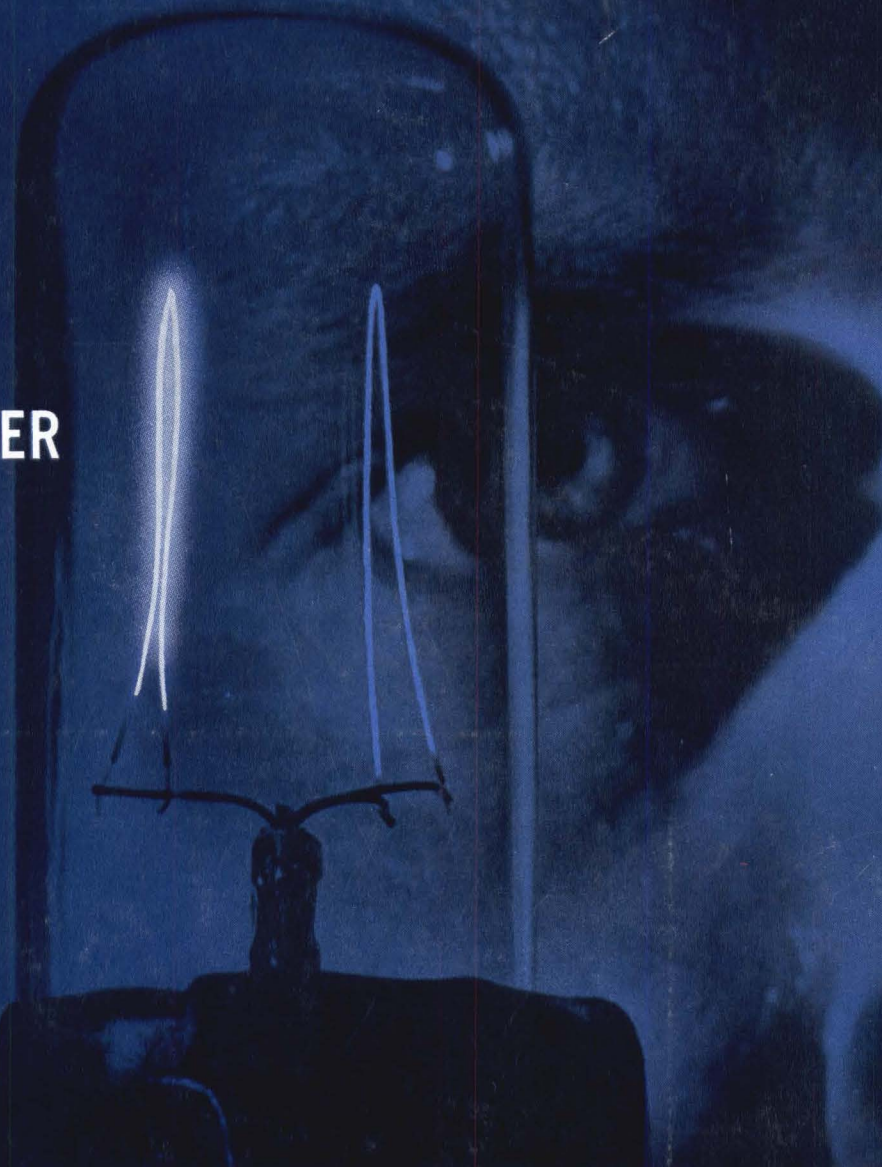

- cuts heater-associated tube defects by 20 to 1
- provides more stable tube characteristics over longer life spans

The filament at the right in the demonstration envelope is an RCA Dark Heater. Due to its superior thermal emissivity, the RCA Dark Heater produces the required cathode temperature at a heater temperature 200°K to 350°K below that of conventional heaters.

In a 500-hour accelerated heater-cycling life test, tubes with conventional heaters had 20 heater-associated defects per 100 tubes, while tubes with the RCA Dark Heater had only one! The tests were conducted at 143% of rated heater voltage (9 volts for a 6.3-volt type) and a heater-cathode voltage of 180 volts. The operating cycle was one minute on and two minutes off. These life tests are the equivalent of operation of a heater for 14,500 hours at normal heater voltage and they represent more than 250,000 tube-hours.

Features of the RCA Dark Heater which contribute to superior long-life performance include:

- **Exceptional Mechanical and Chemical Stability.** RCA's Dark Heater wire has an approximately 50% higher ultimate tensile strength when it operates at a temperature 350°K below the operating temperature of conventional heaters. Cooler operating

temperatures also minimize changes in heater shape during life. With smaller thermal fluctuations during "on-off" cycling, Dark Heater has less tendency toward recrystallization and burnout.

- **Heater-Current Stability on Life.** The Dark Heater maintains a remarkably stable current characteristic throughout life.
- **Reduced AC Heater-Cathode Leakage and Hum.** The Dark Heater reduces AC leakage and hum, particularly "spike" or pulse leakage currents. In addition, lower heater temperature reduces both AC and DC leakage from heater to cathode and heater emission to other tube electrodes.
- **Greater Safety Margin in H-K Voltage Ratings.** Cooler operation means greater safety margins in present H-K voltage ratings.

Dark Heater, now available in 231 popular O.E.M. types of RCA Receiving Tubes, is another RCA innovation to give you better performance and longer tube life. For full information on the Dark Heater, call your RCA Field Representative.

RCA ELECTRONIC COMPONENTS AND DEVICES, HARRISON, N. J.

FIELD OFFICES

EAST: 32-36 Green Street, Newark 2, New Jersey, (201) 485-3900 • MIDWEST: Suite 1154, Merchandise Mart Plaza, Chicago 54, Illinois, (312) 527-2900 • WEST: 6801 E. Washington Blvd., Los Angeles 22, Calif., (213) RAYmond 3-8361 • 1838 El Camino Real, Burlingame, Calif., (415) 697-1620



The Most Trusted Name in Electronics