

# electronics®

## TAGGING SOLAR "DEATH RAYS"

Video scanning predicts  
solar-flare activity

## MICROCIRCUITS MADE EASIER

Chip components are  
often one answer

## CONICAL SCANNING WITHOUT JOINTS

Rotating subreflector  
does the trick

MOST ADVANCED SPACE SENTRY. New phased-  
array radar scans the equator

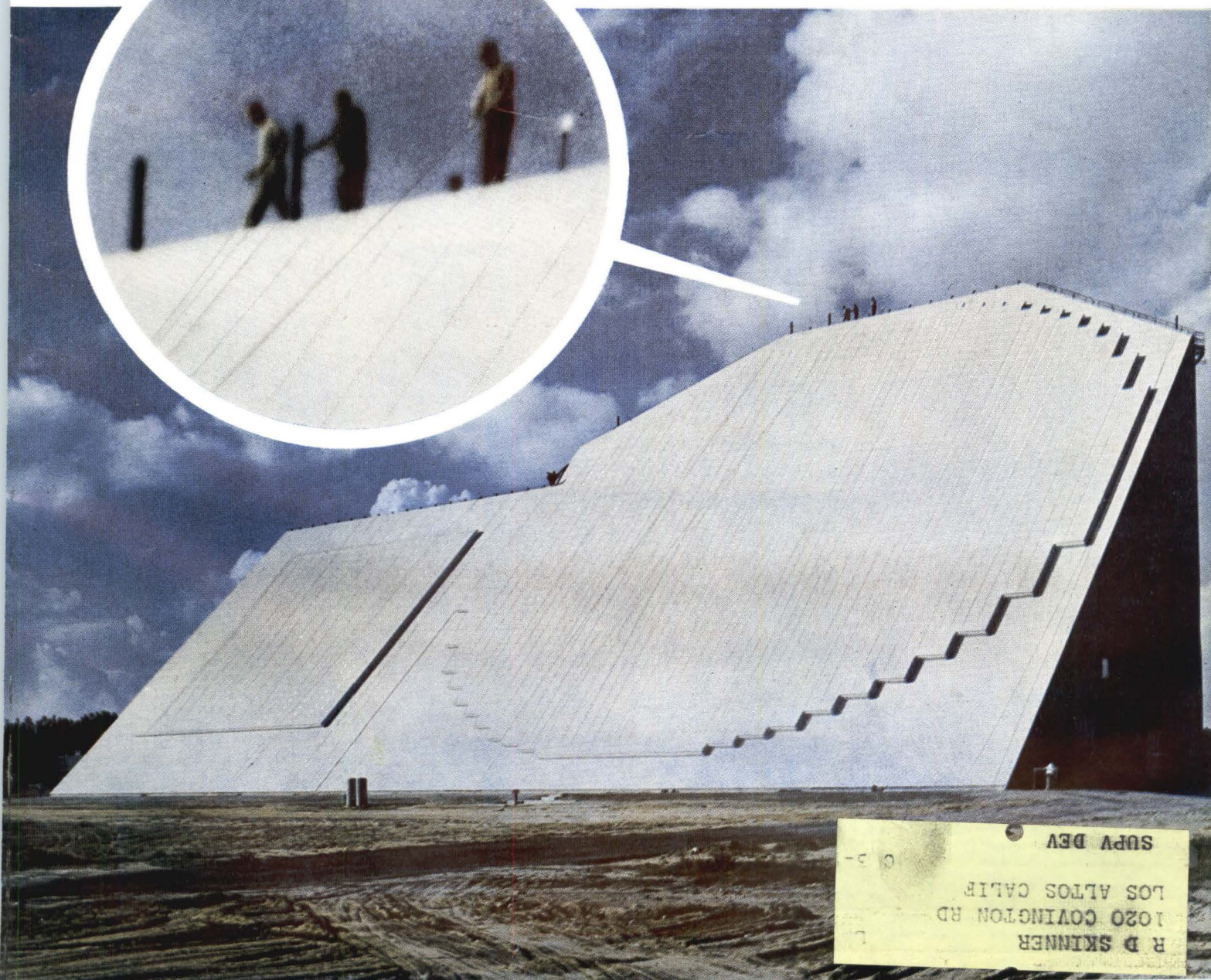

R D SKINNER  
1020 COVINGTON RD  
LOS ALTOS CALIF  
SUPV DEB





# New 20c-20kc SOLID-STATE POWER OSCILLATOR with 200-voltampere output

- ✓ Wide voltage and frequency ranges for testing equipment at other than power-line frequencies
  - ✓ Isolates sensitive equipment from power-line transients
  - ✓ Plenty of power for driving shake tables and acoustical transducers
- ✓ Useful for testing magnetic amplifiers, servo systems, transformers, and chokes
  - ✓ Provides low-distortion signal to non-linear loads
- ✓ Finds many uses as a general-purpose, audio-frequency power source

Type 1308-A Audio Oscillator and Power Amplifier . . . \$1150 in U.S.A.

- Multiple ranges match a wide variety of loads.
- Output transformer designed to prevent saturation when dc is passed through secondary.
- Capacitor-tuned, Wien-bridge oscillator combined with a low-distortion power amplifier provides true sine-wave output.
- Power amplifier can be used separately with external signal sources.
- All solid-state circuits.
- No power-factor limitations.
- Output is continuously monitored by an overload sensing circuit that activates whenever safe limits are exceeded. Reset switch restores circuit.

Openings exist for permanent positions in Development and Sales Engineering. If interested, write M. A. Nacey.

**OUTPUT:** 200 voltamperes, 50 cps to 1 kc. Beyond 1 kc, see plot.

#### Voltage and Current Ranges

0-4	0-12.5	0-40	0-125	0-400	volts, rms
0.5	0.5	0.5	0-1.6	0-0.5	amps, rms

Output transformer will pass dc equal to rated ac.  
Harmonic Distortion: 1% from 100 cps to 10 kc, 2% from 50 to 100 cps.

Hum: Better than 50 db below maximum output.

#### AMPLIFIER:

Input: 10 kilohms.

Sensitivity: Approximately 2 volts needed for full output.

**POWER REQUIREMENTS:** 105 to 125 or 210 to 250 volts, 50-60 cps, 70 to 500 watts (depending on load).

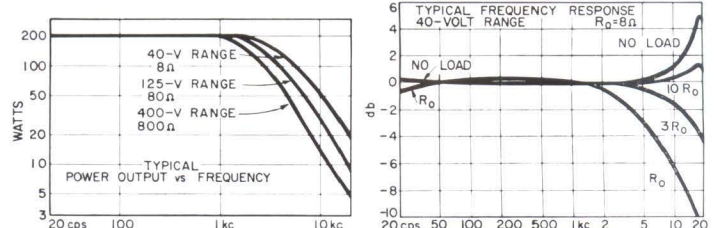

## GENERAL RADIO COMPANY

WEST CONCORD, MASSACHUSETTS

NEW YORK, N. Y., 964-2722  
(Ridgefield, N. J.) 943-3140

CHICAGO  
(Oak Park) 848-9400

PHILADELPHIA, 424-7419  
(Abington) 887-8486

WASHINGTON, D.C.  
(Rockville, Md.) 946-1600

SYRACUSE  
454-9323

DALLAS  
FL 7-4031

SAN FRANCISCO  
(Los Altos) 948-8233

LOS ANGELES  
469-6201

ORLANDO, FLA.  
425-4671

CLEVELAND  
886-0150

CIRCLE 900 ON READER SERVICE CARD



J. M. CARROLL, Managing Editor (2293)

SENIOR EDITORS

Samuel Weber (2371)  
George W. Sideris (3444)

SENIOR ASSOCIATE EDITORS

Michael F. Wolff (2600)  
John F. Mason (2666)

ASSOCIATE EDITORS

Michael F. Tomaino (2071)  
William P. O'Brien (2297)  
George J. Flynn (2188)  
George V. Novotny (3151)  
Leon H. Dulberger (3446)  
Alexander A. McKenzie (2685)

ASSISTANT EDITORS

Stephen B. Gray (2245)  
Barry A. Briskman (2306)  
Dan Smith (2467)  
Joel A. Strasser (2127)  
Vincent S. Acunto (2592)  
C. R. Whetstone (3495)  
Eric Valentine (2710)  
Louis S. Gomolak (2472)  
G. G. Tirellis (2187)

REGIONAL EDITORS

Harold C. Hood,  
1125 W. 6th St., Los Angeles 90017, Calif.  
(213-482-5450)  
Laurence D. Shergalis,  
John Hancock Bldg., 255 California St.,  
San Francisco 94111, Calif. (415-362-4600)  
Thomas Maguire  
McGraw-Hill Bldg., 607 Boylston St.,  
Boston 02116, Mass. (617-262-1160)  
Cletus M. Wiley,  
Blair Bldg., 645 N. Michigan Ave.,  
Chicago 60611, Ill. (312-664-5800)

ART DIRECTOR

Howard R. Berry (2430)

ASSISTANT ART DIRECTOR

John C. Wright, Jr. (3430)

EDITORIAL ASSISTANTS

Lorraine Rossi, Virginia T. Bastian,  
Lynn Emery, Ann Mella, Lorraine Werner,  
Alice M. Moyer, Sharon Parks,  
Claire Benell, Kay Fontana,  
Sandra A. Le Mond, Mary Jo Jadin

FOREIGN NEWS BUREAU

DIRECTOR, John Wilhelm, (2532);  
Lawrence Mihlon (2997), Alyne Elias  
(2998)  
LONDON—John Shinn, Derek Barlow,  
Nicholas Landon, 34 Dover St., London  
W.1, England  
BONN—Richard Mikton,  
Silke McQueen, Mittelstrasse 39, Bad  
Godesberg, Germany  
BRUSSELS—Arthur Erikson, 27 Rue Ducarle,  
Brussels, Belgium  
PARIS—Robert Farrell, 17 Ave. Matignon,  
3rd Fl., Paris 8, France  
MILAN—Bruce Bendow, Via Manzoni  
No. 12, Milan, Italy  
MEXICO CITY—Wesley Perry, Jr.,  
Lafragua 4-314, Mexico 1 D.F. Mexico  
RIO DE JANEIRO—Leslie Warren, Rua  
Mexico 3-S/1507 1509, Rio de Janeiro,  
Brazil  
MOSCOW—Donald Winston,  
Kutuzovsky Prospekt 19, Apt. 28-29,  
Moscow, USSR  
TOKYO—Richard Halloran, Charles Cohen,  
John Yamaguchi, Toranomom Sangyo  
Bldg., 1 Kotohiracho Shiba, Minato-Ku,  
Tokyo, Japan

CIRCULATION MANAGER

Hugh J. Quinn (2310)

C. C. RANDOLPH, Publisher (3996)

# electronics

A MCGRAW-HILL PUBLICATION

75 CENTS

**PHASED-ARRAY RADAR.** Fifteen stories high and bearing a slight resemblance to an ancient Mayan temple, this phased-array radar antenna will provide the U.S. this year with the most automatic space surveillance and warning system now achievable. *The FPS-85 at Eglin Air Force Base scans a 60-degree segment of the earth's equator with 400 to 500-MC radiation. See p 24*

COVER

**DISARMAMENT.** The nuclear arms race shows signs of plodding to a stop, as the U.S. and USSR build up mutual deterrent capability and seek an arms control agreement. *An agreement would put a serious kink in military electronics sales, but inspection would require a wide variety of sensors and systems*

10

**AUTOMATIC SPACETRACKING.** Two new Air Force installations, a huge phased-array radar able to track hundreds of orbiting objects and an electro-optical sensor, open a new era in spacetracking. *They are a major step toward Air Force's goal of an automatic space detection system*

24

**SCANNING THE SUN.** Solar flares raise hob with some radio channels and can blast spacecraft with deadly radiation. As man reaches out to the moon and beyond, effective means of predicting solar-flare activity will become essential. *Here, video techniques developed for sun study detect and locate even small flares early in their life spans.*

By N. Gutlove and S. Morrison, Republic Aviation

31

**HOW TO SIMPLIFY MICROCIRCUITS.** Transferring each element of a circuit to an integrated semiconductor block is not always the best way to fabricate a microcircuit. Often it is better to make use of the properties of semiconductor devices to achieve the required functions. *Double-base diodes, tunnel diodes and surface-controlled devices in chip form are representative circuit elements.*

By V. Uzunoglu and M. H. White, Westinghouse Electric

36

**TESTING TAPE TRANSPORTS.** Special multivibrator circuits had to be designed during development of electromagnetically operated vacuum switches for a vacuum-capstan tape transport. In these circuits, the frequency is independent of mark-space ratio and both may be varied. *Both Shockley-diode and all-transistor versions are described.*

By C. J. Dakin, Weybridge, Surrey, England

40



Published weekly, with Electronics Buyers' Guide as part of the subscription, by McGraw-Hill, Inc. Founder: James H. McGraw (1860-1948).

**SUBSCRIPTIONS:** Available only by paid subscription. Publisher reserves the right to refuse non-qualified subscriptions. Subscriptions to Electronics solicited only from those actively engaged in the field of the publication. Position and company connection must be indicated on subscription orders forwarded to address shown below. Subscription rates for individuals in the field of the publication: U. S. and possessions and Canada \$6 one year, \$9 two years, \$12 three years (single copies 75¢). All other countries \$20 one year (single copies \$1.50).

**EXECUTIVE, EDITORIAL, CIRCULATION and ADVERTISING OFFICES:** McGraw-Hill Building, 330 West 42nd Street, New York, N. Y., 10036. Telephone Area Code 212. 971-3333. Teletype TWX N. Y. 212-640-4646. Cable McGrawhill, N. Y. Printed in Albany, N. Y. Second class postage paid at Albany, N. Y. Title reg. ® in U. S. Patent Office. Copyright © 1964 by McGraw-Hill, Inc. All Rights Reserved. The contents of this publication may not be reproduced either in whole or in part without consent of copyright owner.

**OFFICERS OF MCGRAW-HILL PUBLICATIONS:** Shelton Fisher, President; Vice Presidents: Joseph H. Allen, Operations; John R. Callahan, Editorial; Ervin E. DeGraff, Circulation; Donald C. McGraw, Jr., Advertising Sales; Angelo R. Venezian, Marketing.

**CORPORATION OFFICERS:** Donald C. McGraw, President; L. Keith Goodrich, Hugh J. Kelly, Harry L. Waddell, Executive Vice Presidents; John J. Cooke, Vice President and Secretary; John L. McGraw, Treasurer.

**UNCONDITIONAL GUARANTEE:** The publisher, upon written request, agrees to refund the part of the subscription price applying to the remaining unfilled portion of the subscription if service is unsatisfactory.

**SUBSCRIBERS:** Please address all correspondence regarding subscriptions, change of address notices, and subscription orders to Fulfillment Manager, Electronics, P. O. Box 430 Hightstown, N. J., 08520. Change of address notices should be sent promptly; provide old as well as new address; include zip code or postal zone number if any. If possible, attach address label from recent issue. Please allow one month for change of address to become effective.

**POSTMASTER:** Please send Form 3579 to Fulfillment Manager, Electronics, P. O. Box 430, Hightstown, N. J., 08520.



Audit Bureau of Circulation



Associated Business Publications

**NEW CONICAL-SCANNING TECHNIQUE.** This conical scanning antenna for homing and tracking is reminiscent of the Cassegrain type but it is quite different. Circularly polarized radiation comes from a helical source at the apex of the main paraboloid. *A rotating subparaboloid reflector at the focal point of the main dish produces circular scanning.*  
By S. Tanaka and S. Okamura, Shibura Electric, Tokyo, Japan 44

**H-F ARRAY SCANS HORIZON.** Under development is a log-periodic antenna, 1,000 to 2,000 feet in diameter. *As a directional transmitter its point-to-point range may reach 3,000 miles* 50

**BIGGEST MEMORY.** New computer mass memory has a capacity of nearly 5½ billion characters. *Storage medium is a flexible magnetic card stored in a magazine* 52

**ELECTRONICA.** That's the name of a big, new parts show an American components group plans to cash in on the growing German market. *Despite German opposition, it may become the biggest electronics show in Europe* 53

**HALL-EFFECT COMPASS.** Navy has bought 150 of these solid-state compasses and may buy another 8,000. *Highly sensitive, with no moving parts, they may be used on antisubmarine sonobuoys in the Arctic* 57

**DEPARTMENTS**

**Crosstalk.** How Much for Defense? 5

**Comment.** Optoelectronics. Information Retrieval 6

**Electronics Newsletter** 17

**Meetings Ahead.** Society of Photographic Instrumentation Engineers 18

**Washington This Week.** Army Splitting Communications Staff and Command Responsibilities 20

**Research and Development.** Unique Reticle Improves Star Trackers 60

**Components and Materials.** Standard Sapphire Windows Available for Optical System 64

**Production Techniques.** Diffused Junctions Interconnect Circuits 70

**New Products.** A-D Interface Has Variable Rates 74

**Literature of the Week** 85

**People and Plants.** Tektronix Expansion Under Way 87

**Index to Advertisers** 92



**Only from Sprague!**

# PACER<sup>®</sup> FILMITE<sup>®</sup> 'E' CAPACITORS

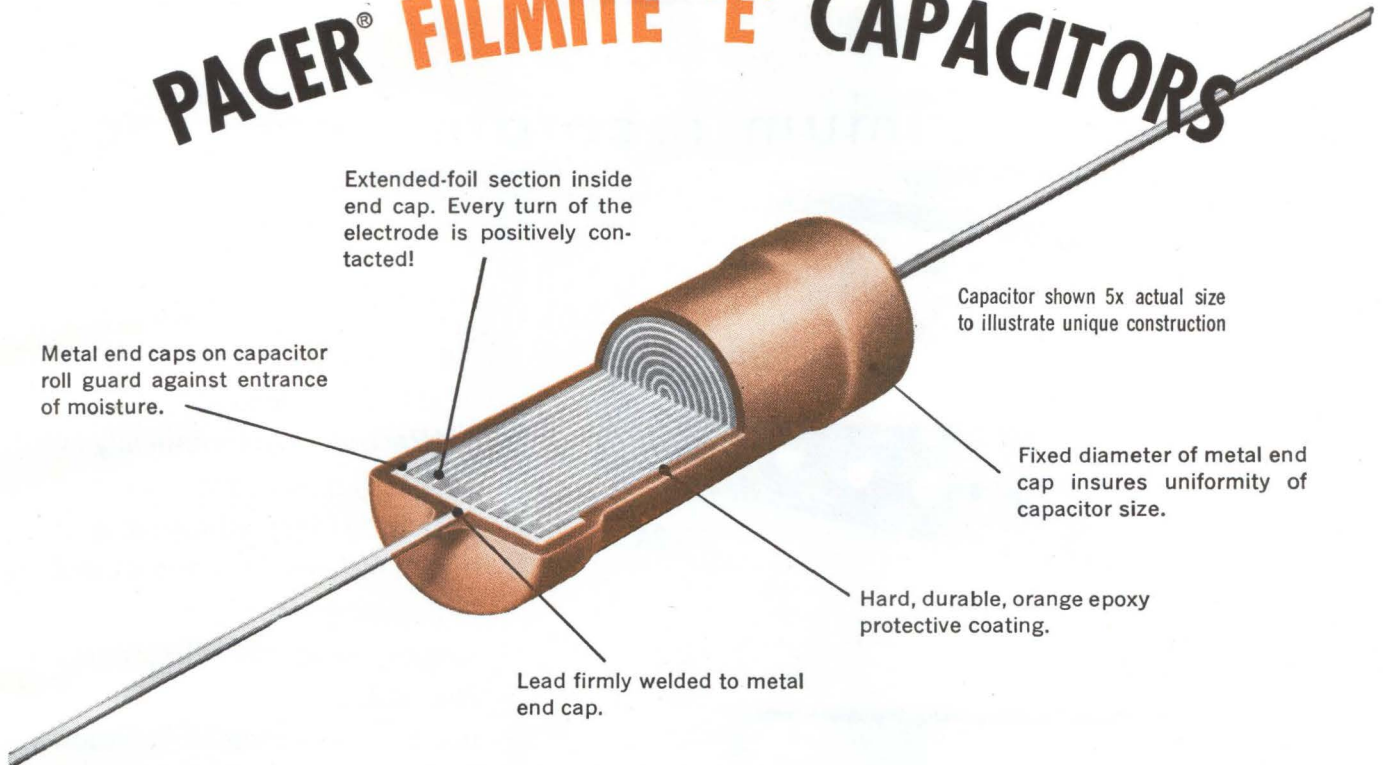

## Multi-advantage Construction in a Low-cost Film Capacitor!

### MINIFIED SIZE—

Rating for rating, Pacer Capacitors are almost one-third the size of conventional paper or paper-film tubulars, making them ideally suited for transistorized circuitry and other space-saving applications where small size with dependability is an important consideration.

### BEST POSSIBLE NON-INDUCTIVE SECTION—

Metal end caps over extended foil sections assure non-inductive capacitors, since all turns of the electrode are contacted beyond question.

### IMPROVED HUMIDITY RESISTANCE—

End caps act as effective moisture barriers. Capacitor sections are further protected by hard, durable, orange epoxy coating.

### UNIFORMITY OF SIZE—

Unlike other epoxy-coated units, the end caps on Pacer Capacitors assure the rigid fixed diameters needed for use with automatic insertion equipment. The two smallest sizes are identical with resistor and diode sizes, making them especially suitable for 'cordwood' packaging.

Pacer Capacitors are available in selected ratings for fast delivery from your Sprague Electronic Parts Distributor

For complete technical data on Pacer Capacitors, write for Engineering Bulletins 2066 and 2067 to Technical Literature Service, Sprague Electric Co., 35 Marshall Street, North Adams, Mass.

## SPRAGUE COMPONENTS

CAPACITORS  
TRANSISTORS  
RESISTORS  
MICROCIRCUITS  
INTERFERENCE FILTERS

PULSE TRANSFORMERS  
PIEZOELECTRIC CERAMICS  
PULSE-FORMING NETWORKS  
TOROIDAL INDUCTORS  
ELECTRIC WAVE FILTERS

CERAMIC-BASE PRINTED NETWORKS  
PACKAGED COMPONENT ASSEMBLIES  
BOBBIN and TAPE WOUND MAGNETIC CORES  
SILICON RECTIFIER GATE CONTROLS  
FUNCTIONAL DIGITAL CIRCUITS

**SPRAGUE<sup>®</sup>**  
THE MARK OF RELIABILITY

'Sprague' and '®' are registered trademarks of the Sprague Electric Co.



# These and other new Moseley 1 MEG X-Y RECORDERS give maximum recording accuracy

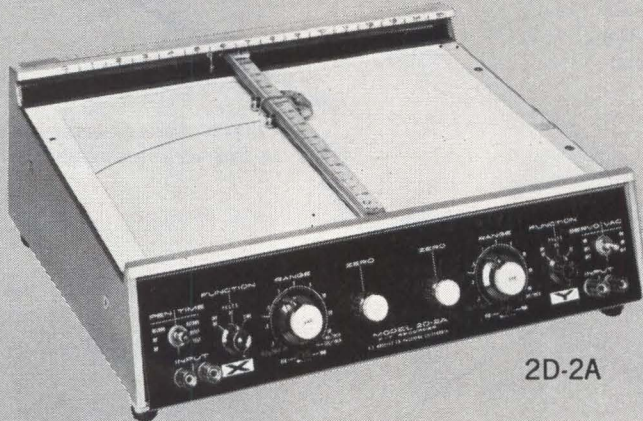

2D-2A

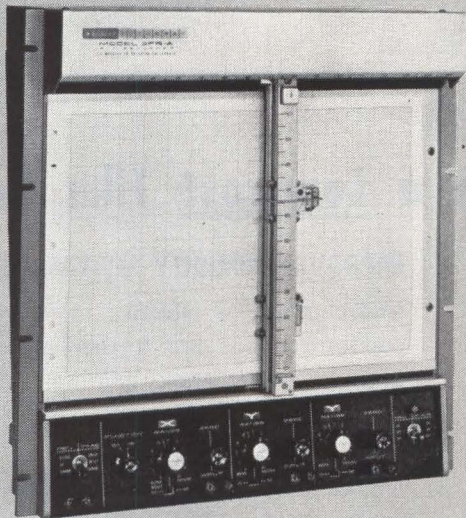

2FRA

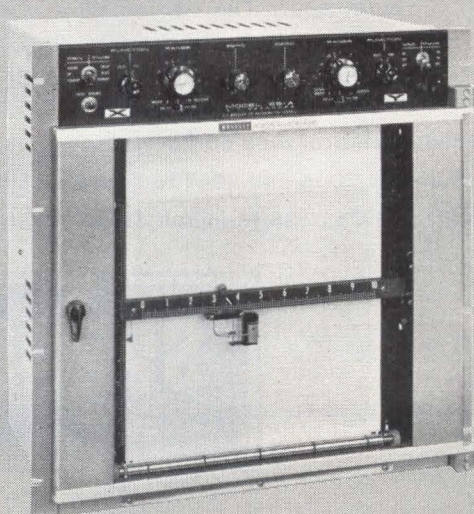

6S-A

New high-impedance models of standard Moseley Autograf® X-Y Recorders automatically increase your recording accuracy, especially in recording low-level measurements. The high input impedance (one megohm on all ranges) prevents loading of the circuit being measured, ends inaccuracies caused by such loading. This high-impedance feature, designated by the letter "A" on the model number, is available in the Moseley 135A 8½" x 11" recorder (\$1650), the 136A two-pen 8½" x 11" recorder (\$2650), the 2D-2A series 11" x 16" recorders (\$1950), the 2FRA two-pen 11" x 17" recorder (\$3575), and the 6S-A 10" x 10" automatic chart advance recorder (\$3150). The 135A and 2D-2A are also available with metric scale, as well as standard, while the 2D-2A models are available in separate bench and rack mount models, all at no increase in cost. Call your Moseley/Hewlett-Packard field engineer for information.

**F. L. MOSELEY CO.**  
409 N. Fair Oaks Ave., Pasadena, California  
an affiliate of Hewlett-Packard



## How Much for Defense?

**THE YEAR** 1964 will be one of belt tightening for those portions of the electronics industry supplying goods and services to the armed services. And by far the deepest cuts have been made in procurement of strategic retaliatory weapons and in research and development.

The sector of our industry affected by these budget cuts will doubtless in time find other channels into which to pour its output and indeed we are all happy to see our industry turn to creating true health in the form of industrial and consumer products rather than the "illth" represented by death-dealing munitions.

But while we are adjusting to these budget cuts we may reasonably inquire: is the present military procurement policy a realistic one? Or is it based in part on pious hopes? Could it be our planners have overlooked some parameter in the national defense equation?

Our strategic thinking has concentrated upon the Soviet Union as our potential adversary. But need this always be the case? Might not the course of human events alter such as to make the Soviet Union, if not a friend, at least a neutral bystander and our principal foe rather the Chinese Peoples' Republic—for example.

Such a turn of events would drastically alter our strategic thinking. The Soviet Union is an industrialized nation with its population of the same order of magnitude as our own and concentrated in a few hundred major centers of production.

China is, on the other hand, primarily an agrarian nation and its population, more than three times our own, is concentrated not in a few large cities but in thousands of teeming villages scattered throughout the countryside.

Operations researchers once studied all the major wars of the last two centuries and found that a nation usually sued for peace only after its population had been decimated.

Now the Korean War painfully demonstrated the utter futility of trying to prevail in a meaningful fashion against the Chinese on the ground. And to try to kill some 60 or 70 million Chinese by using Minuteman or Polaris missiles would either be equally futile or might result in enough radioactive fallout to render the whole Northern Hemisphere uninhabitable.

In coming to grips with the problem of winning a war with China, we must think of wholesaling death rather than merely retailing it. Missiles wouldn't do the job but wide-ranging supersonic aircraft drop-

ping appropriate atomic, biological and chemical agents, including radioactive waste materials, would be most useful.

This hypothetical exercise should serve merely to illustrate the possible folly of fixating on one, single enemy and relying exclusively on an array of weapons designed to destroy him and only him.

We must continue to anticipate and prepare for war from any quarter and carry forward a research and development effort adequate to give us the weapons to win any conceivable war thrust upon us. To do less is false economy. Even during the hungry thirties we were able to keep the B-17 Flying Fortress and P-38 Lightning on the drawing boards. Can we do less today?

It is essential that irrespective of what our most current intelligence appraisals indicate is the most *probable* threat to our national security that we maintain the productive and intellectual capacity to build up rapidly to meet any *possible* threat—otherwise we are in serious danger of compromising our future security for a small present monetary advantage.

---

Last week, the Communist Chinese leaders again made it clear that they consider the U. S. an enemy. Below are excerpts from an editorial in *Hung Chi*, the ideological journal of the Chinese Communist Party's Central Committee, as reported Feb. 4 by Reuters:

*"The leaders of the C.P.S.U. (Communist Party of the Soviet Union) have completely reversed enemies and comrades. They have directed the edge of struggle, which should be against United States imperialism and its lackeys, against the Marxist-Leninist fraternal parties and countries.*

*"The leaders of the C.P.S.U. are bent on seeking Soviet-United States cooperation for the domination of the world. They regard United States imperialism, the most ferocious enemy of the people of the world, as their most reliable friend, and they treat the fraternal partners and countries adhering to Marxism-Leninism as their enemy.*

*"They collude with United States imperialism, the reactionaries of various countries, the renegade Tito clique and the right-wing Social Democrats in a partnership against the Socialist fraternal countries, the fraternal parties, the Marxist-Leninists and the revolutionary people of all countries."*

---



**NOW...**

**THE FAMOUS  
JERROLD  
900-B  
SWEEP SIGNAL  
GENERATOR**



**OFFERS CENTER  
FREQUENCIES FROM  
500 kc to 2,000 mc  
without plug-ins**

The versatile Jerrold Model 900-B Sweep Signal Generator now extends its useful frequency range all the way up to 2,000 mc, with sweep widths ranging from 10 kc to 800 mc. A diode frequency doubler, priced at only \$150, increases the usefulness of the 900-B without the need for plug-ins.

**Frequency Doubler Specifications**

Input Frequency .... 500-1000 mc  
Output Frequency ... 1000-2000 mc  
Conversion loss at  
1 volt RMS ..... less than 12 db  
Output component, other  
than harmonic  
of input ..... 20 db or more below  
Maximum Input ..... 1 volt RMS  
Connectors ..... 50 ohm, BNC

The diode frequency doubler can also be used with the economical Jerrold 900-A Sweep Generator.

Model 900-B ..... \$1,980  
Model 900-A ..... \$1,260  
Frequency Doubler ..... \$ 150

Write for complete technical data.  
Jerrold Electronics Corporation, 15th  
& Lehigh Ave., Philadelphia 32, Pa.



A subsidiary of THE JERROLD CORPORATION

**COMMENT**

**OPTOELECTRONICS**

Regarding your *Crosstalk* editorial on p 5, Jan. 24 [which asked for an abbreviation for] "optoelectronic technology," how about Optronics?

R. E. PATTERSON

Somerset, New Jersey

... Opeltechs?

J. McWILLIAMS STONE

DuKane Corp.  
St. Charles, Illinois

**INFORMATION RETRIEVAL**

Your *Comment* column of Dec. 27, 1963 (p 6), expresses one reader's interest in an information retrieval scheme at the circuitry level. Possibly other readers would also like to know of one method available.

I am currently putting my scattered issues of *ELECTRONICS* from 1960 through 1963 into "machinable" form to be indexed by a system known as KEYWI, developed by C-E-I-R for the 1401-7090 computer configuration. This is the same system that was used for a while by the Office of Technical Services, U. S. Department of Commerce, in their "U. S. Government Research Reports."

JERRY L. OGDIN

C-E-I-R Inc.  
Washington Center  
Arlington, Virginia

**TRANSDUCER NO, SEADUCER YES**

The heck with the transducer on the back, in the photo accompanying your item, Loudspeaker for Silent World (p 45, Jan. 24). Please provide wavelength of the seaducer on the front.

W. F. RANDOLPH

Weston, Massachusetts

- We didn't think anyone would be interested in anything but the technical news.

**DETECTING INTERMITTENT FAULTS**

The article, Harness Tester Detects and Indicates Intermittent Faults (p 56, Jan. 24), seems an excellent and very useful idea.

However, the circuit should be changed by placing the CLEAR button in the common line between the NO-GO lamps and ground, instead of at the supply voltage. Otherwise after the CLEAR switch is momentarily opened, either the GO lamp or the NO-GO lamp will glow, and we are not sure which. But if the switch is moved into the common line of all NO-GO lamps, the momentary opening of the clear switch causes the extinguishing of all NO-GO lamps and the glowing of all GO lamps if all harness wires are connected.

YASUSHI NOZAWA

Cambridge, Massachusetts

- The published circuit was selected as most generally desirable, because breaking the B-plus supply turns off the entire tester and reestablishes initial conditions.

**ELECTRONICS MARKETS**

I read with considerable interest your article in the January 3 issue titled, Electronics Markets (p 37). It was an excellent presentation and contained much useful information.

VERNON R. ANDERSON

Vidar Corporation  
Mountain View, California

**LATIN AMERICAN COMMUNICATIONS**

Your article, Latin America's Communications Network Nears Completion (p 10, Jan. 3) was of special interest to me. . . . It is my belief that such a system will bring a much better relationship and understanding among all American countries. . . .

RONALDO J. ARTEAGA

East Paterson, New Jersey



# New Radiation-Proof Type XTG Wet Slug Tantalum Capacitors

The new XTG line of Mallory wet slug tantalum capacitors, specifically designed to resist the effects of radiation, has successfully passed radiation tests in the Ground Test Reactor of the Lockheed Missiles and Space Company, Sunnyvale, California.

The capacitors were subjected to both gamma ray and neutron bombardment at 75°F. During the 6744 minutes of reactor build-up time, the following accumulated dosage levels were reached:

*Fast neutron bombardment:*  $6.579 \times 10^{13}$  neutrons/cm<sup>2</sup>, at energy level greater than 0.1 Mev.

*Gamma radiation:*  $79.56 \times 10^6$  gamma rad. (C) from carbon source.

Capacitance, dissipation factor and DC leakage were measured for each capacitor at 120, 400 and 800 cps, both before test and

at the end of the dosage period. No detrimental change in electrical characteristics occurred as a result of the radiation dosage.

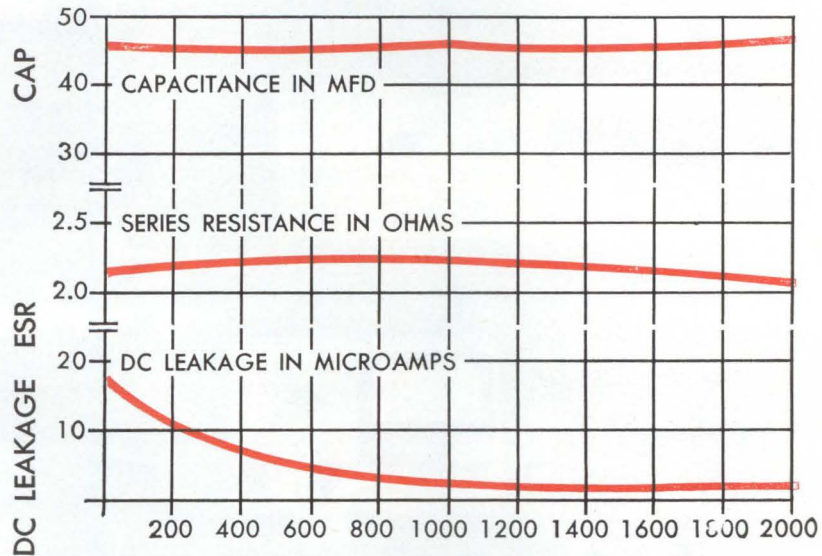

Typical Life Test 16 mfd., 90 V rating

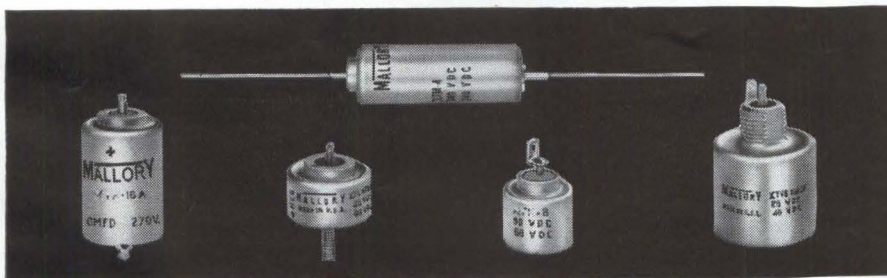

Range of ratings: Type XTG Radiation-Proof Tantalum Capacitor

	Mfd.	DC Volts 85°C	Case Size of min. and max. mfd. value
(XTL equivalent)	3.5 to 120	630 18	$\frac{7}{8}$ " dia. x $2\frac{1}{32}$ " $\frac{7}{8}$ " dia. x $\frac{1}{2}$ "
(XTH equivalent)	7 to 240	630 18	$\frac{7}{8}$ " dia. x $4\frac{1}{16}$ " $\frac{7}{8}$ " dia. x $\frac{1}{16}$ "
(XTV equivalent)	12 to 2200	630 12	$1\frac{1}{8}$ " dia. x $2\frac{3}{4}$ " $1\frac{1}{8}$ " dia. x $1\frac{1}{16}$ "
(XTK equivalent)	2 to 70	340 8	.656" dia. x $1\frac{5}{16}$ " .656" dia. x $\frac{7}{16}$ "
(XTM equivalent)	4 to 140	340 8	.656" dia. x $1\frac{25}{32}$ " .656" dia. x $\frac{9}{16}$ "

The XTG line utilizes special materials and construction to achieve radiation resistance. The capacitors operate in a temperature range from  $-55^{\circ}\text{C}$  to  $+85^{\circ}\text{C}$ . In capacitance and voltage ratings, this line covers the same values as standard Mallory XTL, XTH, XTV, XTK and XTM wet slug tantalum capacitors. All MIL terminal configurations are available in the XTG line.

For complete data and prices, write or call Mallory Capacitor Company, Indianapolis 6, Indiana—a division of P. R. Mallory & Co. Inc.

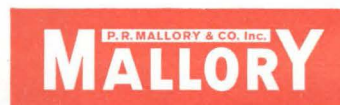

WET SLUG, FOIL AND SOLID TANTALUM CAPACITORS



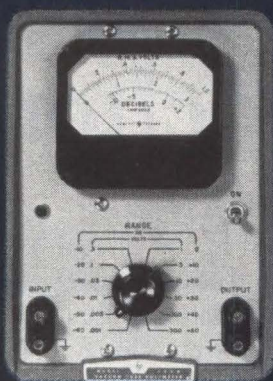

400D



3400A



403B



410C



425A

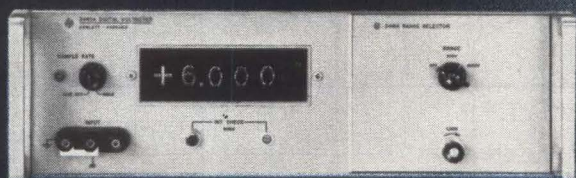

3440A with 3441A



428B



403A

# Help Yourself



413A



400H

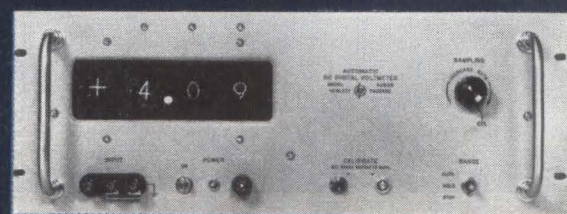

405CR



411A



412A



410B



400L



**a meter for every task...to  
measure dc voltage...dc current  
...ac voltage...resistance**

For fast, accurate basic electronic measurements, Hewlett-Packard offers a complete line of instruments to measure dc voltage and current, ac voltage and resistance. One's just right for your particular task.

Each instrument offers performance according to specs, with conservatively designed circuitry, long life and simple routine maintenance. Operation is easy, too, and each meter offers you maximum value for the dollar.

Highest accuracy is offered on a group of the Hewlett-Packard voltmeters, which incorporate individually calibrated taut-band meter movements, the most precise available on commercially pro-

duced instruments. Taut-band design provides both increased accuracy and durability, while servo calibration assures that each meter face is calibrated to match its own particular meter movement. Individually calibrated meters are standard on the 400H, 403B, 410C, 411A, 412A, 413A, 425A and 3400A.

The brief specs in the chart describe the basic characteristics of the meters available from Hewlett-Packard.

Call your hp field engineer for a demonstration of the instrument to make your work easier, more accurate.

**HEWLETT  
PACKARD  
COMPANY**



1501 Page Mill Road, Palo Alto, Calif. 94304, (415) 326-7000. Sales and service in all principal areas. Europe, Hewlett-Packard S.A., 54 Route des Acacias, Geneva, Switzerland; Canada, Hewlett-Packard (Canada) Ltd., 8270 Mayrand St., Montreal, Que.

8837

Instrument	Primary Uses	Frequency Range	Voltage or Current Range	Input Impedance	Price
<b>AC Measurements</b>					
400D	Wide range ac measurements, high sensitivity	10 cps to 4 mc	0.001 to 300 v full scale, 12 ranges	10 meg, 15, 25 pf shunt	\$250*
400H	High accuracy wide range ac measurements	10 cps to 4 mc	0.001 to 300 v full scale, 12 ranges	10 meg, 15, 25 pf shunt	\$325*
400L	Log voltages, linear db measurements	10 cps to 4 mc	0.001 to 300 v full scale, 12 ranges	10 meg, 15, 25 pf shunt	\$325*
403A	Battery-operated portable; fast, accurate, hum-free ac measurements	1 cps to 1 mc	0.001 to 300 v full scale, 12 ranges	2 megohms, 40, 20 pf shunt	\$275
403B	AC voltage measurements in lab or field; ac line or battery operation	5 cps to 2 mc	1 mv to 300 v full scale	2 megohms	\$310
3400A	True rms readings of complex ac waveforms	10 cps to 10 mc	0.001 to 300 v full scale	10 megohms, 25 pf shunt	\$525
411A	Millivolt, db readings to gigacycle range	500 kc to 1 gc	10 mv to 10 v full scale, 7 ranges	Typically 200 K at 1 mc, 1 v	\$450*
<b>DC Measurements</b>					
3440A‡	Plug-in flexibility, digital voltage measurement, automatic polarity, dc range, printer output	dc	0.001 v to 1000 v (accuracy $\pm 0.05\%$ of reading $\pm 1$ count)	10.2 megohms to dc	\$1160
405BR 405CR	Digital voltage measurement, automatic range, polarity; 405CR has printer output	dc	0.001 v to 1000 v (accuracy $\pm 0.2\%$ of reading $\pm 1$ count)	11 megohms to dc	\$890 \$960
412A	Precision voltage, current, resistance measurements	dc	1 mv to 1000 v full scale, 1 $\mu$ a to 1 amp	10 to 200 megohms, depending on range	\$400*
413A	DC null meter, dc voltmeter, amplifier	dc	$\pm 1$ mv to $\pm 1000$ v end scale, 13 ranges	10 to 200 megohms, depending on range	\$350*
425A	Read $\mu$ v, $\mu$ a; 100 db amplifier; medical, biological, physical, chemical	dc	$\pm 10$ $\mu$ v to $\pm 1$ v end scale, $\pm 10$ $\mu$ a to $\pm 3$ ma end scale	1 megohm $\pm 3\%$	\$500*
428A	Clip-on milliammeter eliminates direct connection, circuit loading	dc	3 ma to 1 amp full scale, 6 ranges		\$500*
428B	Similar to 428A, wider range, recorder output for dc to 400 cps	dc on meter, dc to 400 cps on recorder	1 ma to 10 amps full scale, 9 ranges		\$600*
<b>AC—DC—OHMS</b>					
410B	Audio, rf, vhf measurements; dc voltages; resistances	dc; ac—20 cps to 700 mc	dc, 1 to 1000 v full scale ac, 1 to 300 v full scale	dc, 122 megohms ac, 10 megohms/1.5 pf	\$245
410C	DC voltage; resistance, current; audio, rf, vhf measurements, with ac probe	dc; ac—20 cps to 700 mc	dc v, 15 mv to 1500 v full scale, dc amps, 1.5 $\mu$ a to 150 ma full scale, ac v, 0.5 to 300 v full scale	dc v, 100 megohms ac, 10 megohms/1.5 pf	\$300 \$350**
‡ Function plug-in required: 3441A Range Selector, \$40; 3442A Automatic Range Selector, \$135					
* Cabinet price, rack mount \$5 additional ** With hp 11036A ac probe					
Data subject to change without notice. Prices f.o.b. factory.					



# Is Arms Race Key to Disarmament?

Theory is that balance of nuclear power reduces need for new weapons

By **BOYD FRANCE**  
McGraw-Hill World News

**WASHINGTON** — The nuclear arms race is slowing down and shows signs of plodding to a stop.

In Geneva, delegates from the U. S., the USSR, and 15 other nations are again striving for an arms control agreement. Even if they fail, the loss of momentum in the arms race in itself is of great significance to industry, particularly electronics.

The military logic behind the slowdown, according to officials, is that in the past three years or so, the U. S. and the Soviet Union both have achieved well-nigh invulnerable "second strike" capabilities. This is fast erasing the potential advantage of striking first and de-

creases pressure to pile up new systems.

**Business Impact**—The major impact on business will come when the arms buildup stops, even if there is no big reduction of forces.

The effect on the U. S. economy as a whole even of complete and rapid disarmament theoretically would be slight—certainly much less severe than the impact of the demobilization after World War II. Defense expenditures now account for only about 9 percent of the U. S. gross national product, as compared to more than 40 percent during World War II. They declined much more rapidly—80 percent—from 1945 to 1946 than they could today.

But the impact of an end to the arms race—even without substantial actual disarmament—would be unevenly distributed in industry. Some \$16 billion a year in procurement of military equipment would be potentially affected.

Some industries—including the electronics industry—would face serious readjustment problems. Studies by the Arms Control and Disarmament Agency indicate, for example, that about 90 percent of employment in the aircraft and missiles industry, about 60 percent in shipbuilding, about 20 percent in the electrical machinery industry, and nearly 40 percent in the production of radio and communications equipment can be attributed to defense procurement.

**Signs of a Slowdown**—Signs of the diminishing pace of the arms race are multiplying. Joint U. S.-Soviet sponsorship last fall of the UN resolution banning stationing of weapons of mass destruction in space reflected the tacit recognition by both Washington and Moscow that to do so would be dangerous, expensive and a pointless supplement to their increasingly absolute terrestrial deterrents.

President Johnson's decision to start phasing out production of fissionable materials for weapons use points in the same direction. So does his proposal to the Geneva conference for an inspected freeze on missile production.

U. S. missile production, to be sure, still is going full blast. The Soviets continue to spend huge sums to increase the invulnerability and mobility of their delivery vehicles. The U. S. need for modern mobile conventional forces may well continue to increase, despite—or even because of—stabilization of nuclear power.

**New Arms Race Possible?**—The arms race conceivably could be touched off again, by an all-out effort by either the U. S. or the Soviet Union to upset the power balance. This could be attempted with antimissile missiles or massive civil defense programs designed to reduce the effectiveness of nuclear weapons.

However, U. S. officials concerned with arms or arms control think development of either an effective antimissile missile or civil

## ELECTRONIC DETECTION SYSTEMS THAT COULD BE USED IN ARMS CONTROL AGREEMENTS

Detection Area	System
Space	<ul style="list-style-type: none"> <li>Picture-taking satellites such as the Air Force's Samos system; infrared sensors in satellites such as the Air Force's Midas system</li> <li>Satellite monitoring of radiation levels in space</li> <li>Combination of photography and optical observations through manned orbiting space stations</li> <li>Radiotelescopes to detect passive satellites, similar to the present passive satellite detection net operated by the military</li> </ul>
Atmosphere	<ul style="list-style-type: none"> <li>Electronic monitoring of electromagnetic signals from nuclear detonations</li> <li>Microbarographic measurements of acoustic signals—measures small atmospheric pressure waves on acoustic signals resulting from nuclear detonations at extreme distances</li> <li>Monitoring of communications</li> </ul>
Underground	<ul style="list-style-type: none"> <li>Worldwide network of seismic stations to detect tremors created by nuclear detonations</li> </ul>
Underwater	<ul style="list-style-type: none"> <li>Worldwide net of hydro-acoustic stations to detect underwater nuclear detonations</li> </ul>

A maximum agreement on arms control and disarmament would require monitoring of nuclear weapons, conventional arms, biological and chemical warfare capabilities, and small clandestine military activities. Most of the electronic detection systems would be concentrated on nuclear weaponry development with some overlap in conventional armament developments through space photography. On site inspections and other intelligence collections would augment the electronic systems



defense system would be enormously costly and chances of success dim. This conclusion prompted U. S. agreement to the partial nuclear test ban treaty outlawing the atmospheric and space tests that could be used to develop an anti-missile system. Serious efforts for civil defense have been as good as abandoned.

As for the Soviet Union, all the evidence suggests that its resources are seriously over-strained by efforts to perfect a secure second strike capability and that it can't afford an effective antimissile or civil defense system.

**Argument at Geneva**—Still the search for formal arms control agreements with Moscow is likely to be long and halting if past Soviet attitudes and their tactics at Geneva are any guide. The Soviet reaction to President Johnson's proposals has been negative. The Soviets consider inspection, which we insist on, to be espionage.

But U. S. officials hope that Soviet suspicion of inspection may decline in time. The perfection of such U. S. inspection devices as Midas and Samos will leave the Soviets with less to hide, and reduce the need for human inspectors on Soviet territory. And to the extent that Soviet targets become invulnerable to attack there will be less need to conceal their location.

Many officials also feel that the mounting strain of rising defense costs on the Soviet economy may induce Khrushchev to swallow some inspection to cut his arms burden.

**What's Likely Now**—But for the immediate future, arms limitation or reduction is more likely to come through "mutual example", as Khrushchev puts it rather than formal agreements. Most officials, however, feel that there are strict limits on how far or fast this can go. Some obsolescent military fat, some redundant "over-kill" capability may be pared away on both sides without arms control agreements. But it probably will prove politically difficult for either Johnson or Khrushchev to go very far in this direction without the strengthening of mutual confidence on both sides which comes from enforceable, inspected arms control agreements.

**UNIQUE MACHLETT ML-8533 FOR...  
SWITCH TUBE OR PULSE AMPLIFIER**



FORMERLY DP-30

as switch tube:  
30kw switch  
at 0.0033 d

**OR**

as pulse amplifier:  
20kw peak pulse  
at 1Gc

The unique ML-8533 (formerly known as DP-30) planar triode does double duty as an rf pulse amplifier (or oscillator), or modulator/switch tube. Typical performance as an rf amplifier: 20kw peak pulse power at 1Gc, 0.001 d. Typical performance as a switch tube: 5a x 6kv for 30kw switch power at 0.0033d. ■ For data write: The Machlett Laboratories, Inc., Springdale, Connecticut. An affiliate of Raytheon Company.



**ELECTRON TUBE SPECIALIST**



## WORKHORSE



**Downtime's nemesis, rugged and reliable** as a purebred workhorse — that's Mincom. Common denominator of dependability in all four basic Mincom Recorder/Reproducers is the exclusive Mincom DC Top Plate. Here's a tape transport built with beautiful simplicity: Only 12 moving parts with four easy adjustments, full dynamic braking, instant six-speed pushbutton control, seven or fourteen tracks — plus tape speed accuracy within  $\pm 0.005\%$  using Mincom's Cycleclock®. Whether your specifications call for wideband predetection at 1.5 mc, or a comfortable 120 kc at 60 ips, there's a reliable Mincom workhorse to meet your facility's needs. Write today for details.

**Mincom Division** **3M**  
COMPANY

2049 South Barrington Avenue, Los Angeles 25  
425 13th Street N.W., Washington 4, D.C.



A-to-D Converters

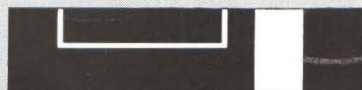

D-to-A Converters



Multiplexers

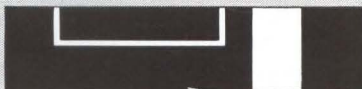

Operational Amplifiers



Sample and Hold Amplifiers

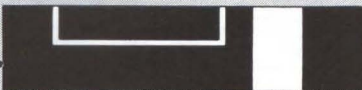

Signal Conditioners

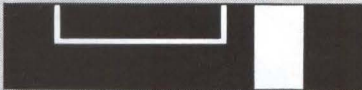

Digital Logic

## Look to the leader in the analog/digital world

Doing business with Adage gives you such a comfortable feeling. For so many reasons. For one thing, nobody is more experienced in solid-state analog/digital circuitry.

Nobody is so finicky about meeting specs (even specs that others wouldn't dare publish).

Nobody makes analog/digital hardware more reliable.

Or as handsome.

Or as mechanically perfect.

Or as well documented.

Nobody beats Adage, either, when it comes to efficient use of rack space. For example, a 60-channel

data acquisition system with a 16-bit BCD Voldicon converter and VMX Multiplexer is housed completely in a 5 1/4" box.

So whether you need a component or a custom-designed system, get a quote from Adage. The price will please you. And remember — from HZA input buffer amplifiers to output digital amplifiers — only Adage manufactures all the hardware necessary for analog/digital systems — all of it solid-state.

**Adage**  
INC

292 Main Street, Cambridge 42, Mass. ■ Offices in Los Angeles, St. Louis, Washington and New York.

*Adage, Inc. welcomes employment inquiries from professional engineers*

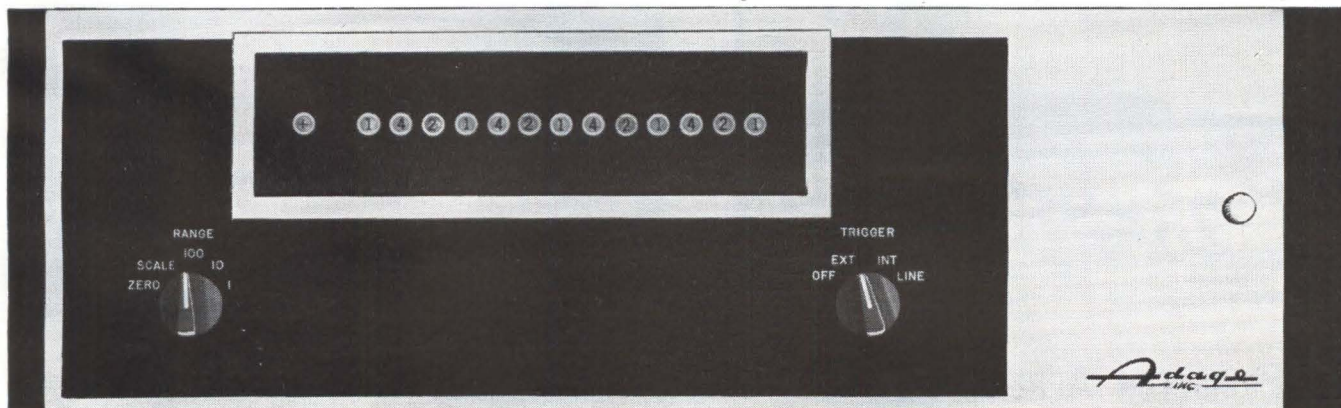



## ... up to your neck? ... trying to find a weak signal in a gooey background of noise.

The story is told that when the first crude version of the Dicke Microwave Radiometer — the heart of most present day radio telescopes — was being tested, one of the division heads expressed doubt that a piece of electronic hardware could be cajoled into responding to ordinary thermal radiation at microwave frequencies. The noise level in the primitive receivers of that time was at least 10 db above ambient thermal radiation levels, and it had been claimed that the Dicke radiometer had a sensitivity of  $1/2^{\circ}\text{C}$ . To make his point, this well-known physicist took his lighted cigar and held it up to the input wave guide of the receiver. When to his surprise the meter banged off scale, he smiled like a Cheshire cat in a cage full of ducklings.

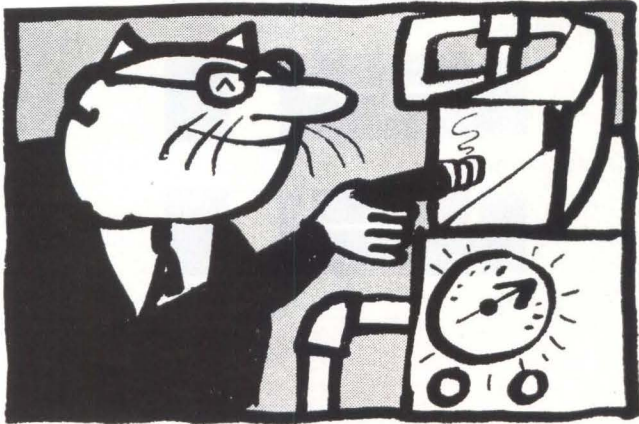

The heart of the radiometer was the lock-in amplifier, and the technique of fishing a small signal out of a thick porridge of noise became known thereafter as the "lock-in amplifier technique." After the initial success with a lock-in amplifier the technique was used in a variety of places, including nuclear magnetic resonance measurements and microwave spectroscopy experiments. The practitioners of this black art have now increased to a reasonably large number, but a far larger number of scientists in all fields are still up to their necks trying to find a weak signal in a gooey background of noise.



Write for Bulletin 109 to:

**PRINCETON APPLIED RESEARCH CORP.**, Box 565 / Princeton, N. J. / Tel. 799-1222, Code 609

Possible applications for the lock-in amplifier technique are almost endless, but in some scientific fields the amplifier is not even known, much less appreciated. The biological sciences offer many interesting challenges. Has anyone ever shone a light in a cat's eyes to see if it elicits a motor response? If the light were chopped at 5 cycles/sec. and a lock-in amplifier were connected to an appropriate strain gauge, this response could be studied, not only under conditions of very weak signal, but also as a function of chopping frequency.

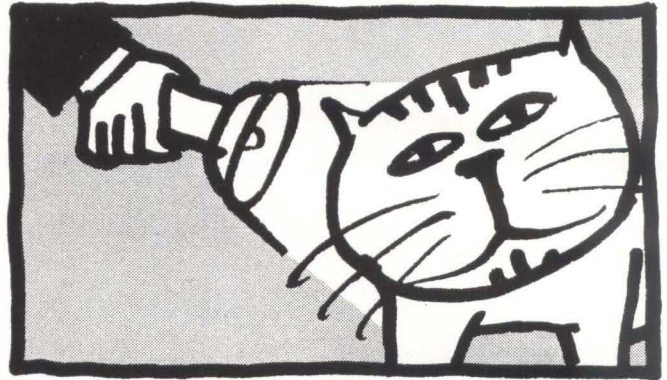

Do astronomers realize that the lock-in amplifier can be used to "see" dim stars during the day? A rotating transparent disc carrying many tiny opaque spots can be used to modulate the light from the star while ignoring the background light.

These are only two of many possible applications of the lock-in amplifier technique. If you have a problem which you think might be solved by this instrument, our staff of experts would be happy to assist you.

Surprisingly, in spite of the increased use of the lock-in amplifier technique during the past 18 years, it has only recently become possible to buy such an amplifier.

Should one wish to add such an instrument to his quality research line, we would be glad to supply him with a P.A.R. JB-4 lock-in amplifier (for \$990.00) or a P.A.R. JB-5 lock-in amplifier (for \$1350.00) and some application help (free!).

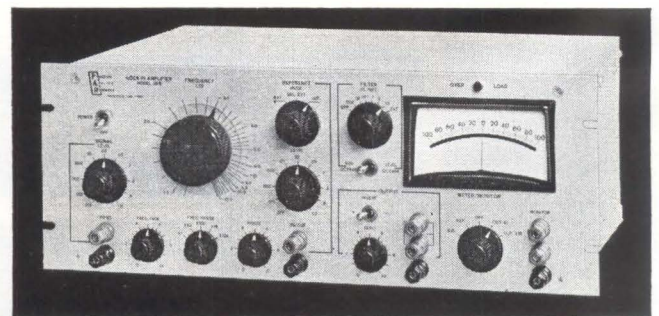

Transistorized Lock-In Amplifier — Model JB-5



# Get 3-Turn, 5-Turn And 10-Turn Precision Potentiometers From The Same Reliable Source

NUMBER 23—NEW PRODUCT SERIES

Now Bourns gives you a choice of military-quality industrial potentiometers. In addition to the proven 10-turn Model 3500, Bourns offers you the 3-turn Model 3510 and the 5-turn Model 3520. All of these  $\frac{7}{8}$ "-diameter potentiometers are shorter than comparable units available elsewhere, yet have resistance elements that are 20% longer.

They incorporate the exclusive, indestructible Silverweld® multiwire termination, and are subjected to 100% inspection and the rigorous double-check of the Bourns Reliability Assurance Program. Write for complete data.

	3-TURN	5-TURN	10-TURN
Standard Resistances (Others available on request)	50 $\Omega$ -75K ±3%	50 $\Omega$ -125K ±3%	50 $\Omega$ -250K ±3%
Meets Steady-State Humidity Requirements (optional feature meets MIL-STD-202B, Method 106 Cycling Humidity)	Yes	Yes	Yes
Standard Linearity	±0.30%	±0.30%	±0.20%
Power Rating @ 70°C	1.0W	1.5W	2.0W
Operating Temp.	-65° to +125°C	-65° to +125°C	-65° to +125°C
Mech. Life (Cycles)	100,000	100,000	100,000

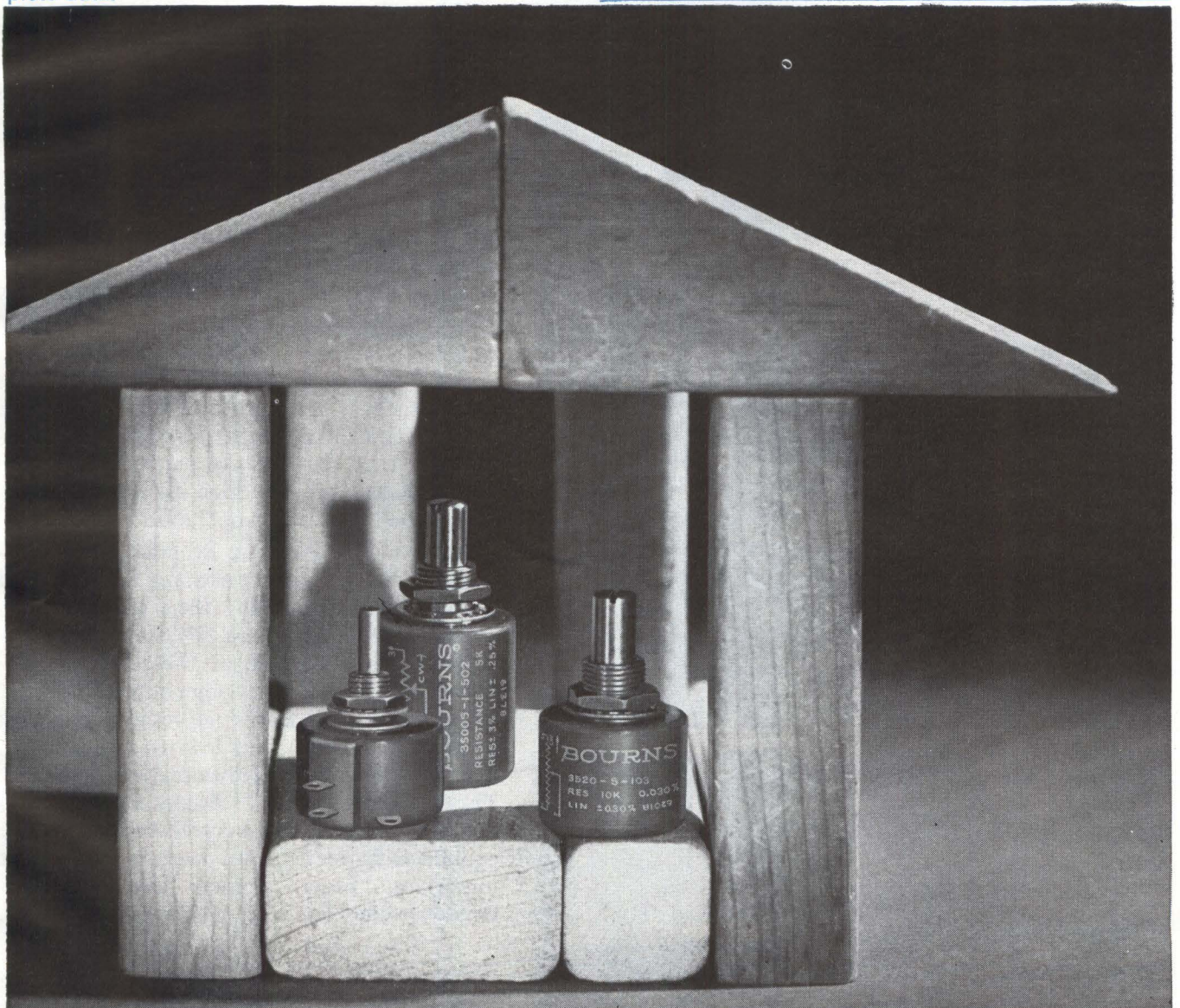

**BOURNS**

BOURNS, INC., TRIMPOT DIVISION  
1200 COLUMBIA AVE., RIVERSIDE, CALIF.  
PHONE: OVERLAND 4-1700 • TWX: RZ9222  
CABLE: BOURNSINC.

MANUFACTURER: TRIMPOT® & PRECISION POTENTIOMETERS, RELAYS; TRANSDUCERS FOR PRESSURE, POSITION, ACCELERATION. PLANTS: RIVERSIDE, CALIFORNIA; AMES, IOWA; TORONTO, CANADA



# How Potter & Brumfield precision-cleans missile relays for top reliability!

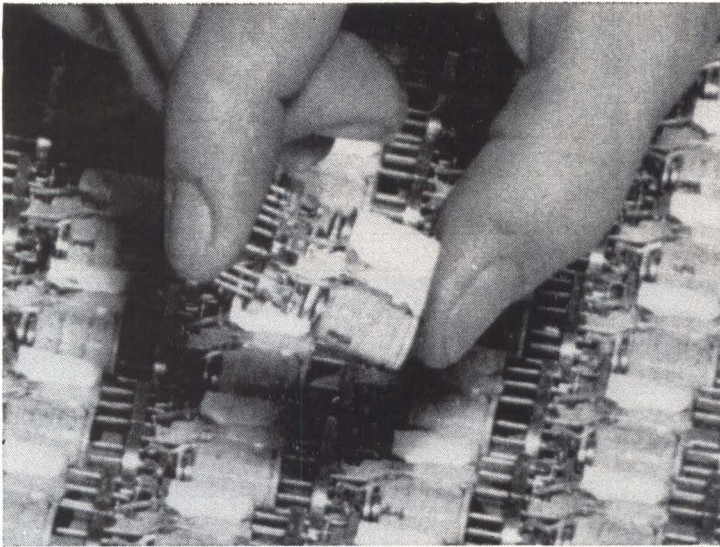

**PROBLEM:** How to reduce an unacceptably high reject rate on critical "crystal-case" electrical relays (first photo) at Potter & Brumfield, Division of American Machine & Foundry Company... eliminate employee problems of headaches and nausea due to solvent vapors.

**SOLUTION:** A new cleaning system using "Freon" fluorinated solvents. "Freon" is an excellent selective cleaning agent. It removes solder flux, dust, lint and other contaminants, yet doesn't harm delicate relay parts. Also, "Freon" is virtually non-toxic, thus eliminating complaints about vapors.

In the cleaning process, a basket of relays is first given a 15-second ultrasonic bath in "Freon" TMC, then an ultrasonic bath in "Freon" TF for 15 seconds (second photo), and a 15-second rinse in TF vapor. Because of its low surface tension, "Freon" quickly penetrates the tiny spaces in the relays, allowing precision cleaning of delicate parts.

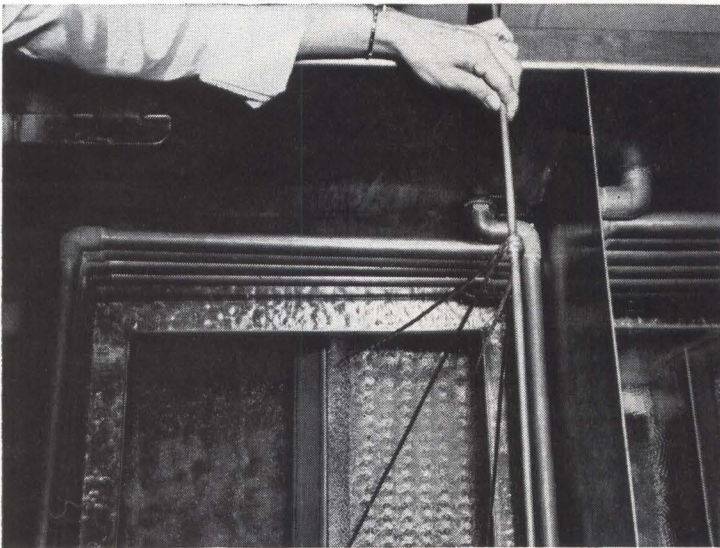

As a final cleaning step, the relay contacts are washed in a spray of "Freon" TF, while being electrically actuated (third photo). This assures that no particles are entrapped between the contacts. Only the high dielectric strength of "Freon" makes this operation possible.

According to Potter & Brumfield, the adoption of "Freon" solvent cleaning has upgraded product quality, meeting their critically high standards, equivalent to a 17% increase in production capacity while at the same time decreasing labor costs. They point out that "Freon" dries quickly and leaves no residue, and that its non-flammability and low toxicity let them operate without expensive ventilating equipment. They've found "Freon" solvents economical to use because they can be recovered in simple equipment for reuse... over and over again. Most important, "Freon" solvents have eliminated employee complaints on nausea and headaches.

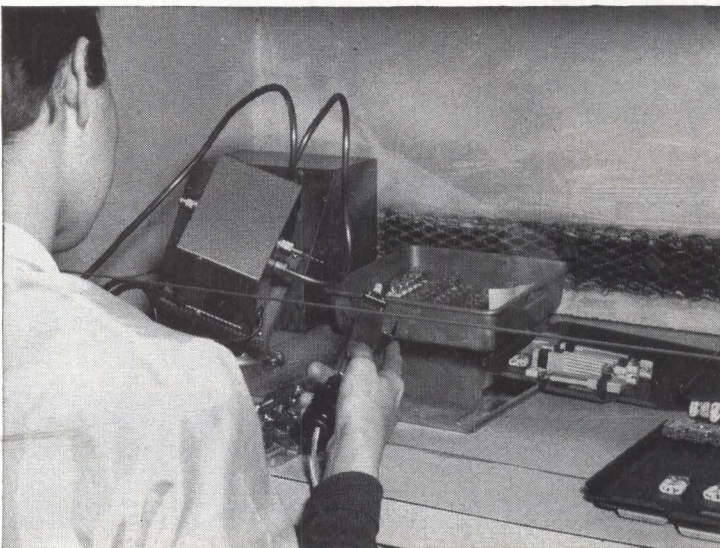

• • • •  
We'll be glad to give you help in selecting "Freon" solvents for use in your own cleaning operation. Just write on your letterhead to Du Pont, 2420E-2R Nemours Bldg., Wilmington 98, Delaware.

**FREON**<sup>®</sup>  
solvents



BETTER THINGS FOR BETTER LIVING . . . THROUGH CHEMISTRY



# Congressmen Vote Another R&D Cut

WASHINGTON—The House Armed Services Committee last week voted to cut \$270.5 million in military R&D out of the Department of Defense budget for fiscal 1965, starting July 1. If the cut remains in the authorization and appropriations bills that Congress eventually passes, the Pentagon will get \$6.3 billion in R&D funds for next year.

In its budget request, DOD asked for \$6.58 billion for R&D, compared to \$6.94 billion in fiscal 1964 (p 10 and 16, Feb. 7). The Committee cut \$121.5 million from Navy R&D, \$65 million from the Air Force request and \$62 million from the Army's.

However, in an action reminiscent of the unsuccessful attempt last year to get DOD to accelerate RS-70 and Dynasoar development, the Committee voted \$92 million for studies of new aircraft.

Defense Secretary McNamara proposed only \$5 million to examine the technical feasibility and military value of new planes that would serve as airborne missile platforms. The Committee voted \$52 million for planning a new manned bomber as a follow-on to the B-52 and B-58, and \$40 million for planning a new interceptor plane that could shoot down an enemy bomber carrying air-to-ground missiles before the enemy plane could get within range of its missiles. Air Force had requested work on such planes, but the request was turned down by DOD (p 20, Jan. 10).

The Committee approved without change DOD's request for authorization to spend \$10.6 billion on procurement of missiles, planes and ships in fiscal 1965.

## Overseas Building Seen

### Slowing Instrument Exports

U.S. INSTRUMENT firms are building more foreign-based manufacturing facilities and the rate of increase for their exports is expected to fall off, reports the U.S. Department of Commerce. Exports swelled from

\$22 million in 1958 to an estimated \$66 million in 1963. The rate of increase in 1963, over 1962, was 11.8 per cent. This year it is expected to drop to 11 percent. Production of electronic test and measuring equipment should continue its strong upward trend, predicts Commerce.

## Lab for Outer Space

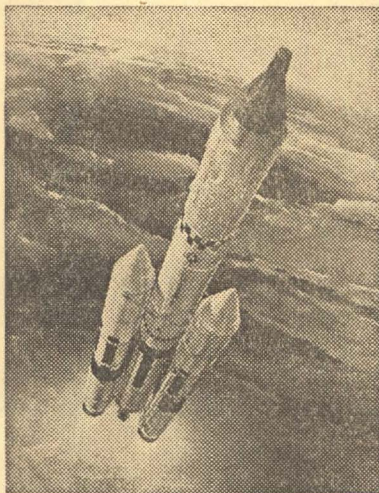

ARTIST'S conception, by United Technology Center, of the Air Force's Manned Orbiting Laboratory in which astronauts may stay aloft for as long as 30 days. MOL will consist of a modified Gemini space capsule and a pressurized cylinder about the size of a small house trailer

## Niobium Thin Films— Mass Production Coming?

CAMBRIDGE, MASS.—National Research Corp. says it has developed a process for the commercial production of superconducting niobium thin films. Electron beam vacuum deposition is used and produces niobium layers at the rate of 1,200 Å units per second, NRC said. The process is reported applicable to other refractory metals, such as tantalum. Development work was sponsored by NASA through Jet Propulsion Lab.

NRC says it has not begun mass production yet and will do so only under specific orders from manu-

facturers. It will not produce for the open market.

In its approach, niobium contained in a water-cooled copper crucible is bombarded by 20-kv electrons with power inputs up to 13 kw to attain the desired niobium vapor density. A pressure of about 1 torr is maintained to create a niobium vapor shield which prevents residual gases from contaminating the material.

## U. S. Stock Quotations Transmitted to Europe

STOCK and commodity quotations from the major American exchanges are now being transmitted to the Swiss offices of Bache and Co. in Geneva, using the Stockmaster of Ultronic Systems Corp. Quotations are read out on three Nixie tubes. The installation is experimental, as will be similar units to be installed in Bache offices in Frankfurt and Paris for a month. The quotations pass through a private channel provided by RCA and Radio Swiss routed via the Canat system (Canadian Transatlantic Telephone).

In another development, a Quotron II system was installed on a permanent basis last month by Scantlin Electronics in the Geneva offices of Merrill Lynch Pierce Fenner and Smith, providing information on about 4,000 stocks and commodities. The Quotron system, which has a printed tape output, uses an exclusive RCA wire to Geneva at present, but Scantlin is working on circuits to allow sharing of the regular Merrill Lynch private line to Europe. A future installation may be made in the Paris office of Merrill Lynch.

## Japanese Launching Space-Rocket Program

TOKYO—The Science and Technics Agency last week released preliminary plans for a five-year space



activities program including development of a rocket capable of lifting a 40 kilogram payload into orbit by 1968. Over the five years, the program will cost about \$59 million. After that, plans now call for an annual expenditure of about \$41 million on additional space research.

Even if rocket development is completed on schedule, however, it would not be in time to lift the navigational satellite now being developed, on which research is scheduled to be completed in 1966. The agency says it will consider entering into an agreement with a foreign government agency—perhaps NASA—to have the satellite lifted into orbit during 1967.

## British Showing Chinese The Latest in Instruments

LONDON—British instrument makers will be showing over \$1-million worth of equipment at an exhibition in Peking this April. This will be

the first major exhibition of British equipment in China and is being organized by the British Scientific Instrument Makers Association. Twenty-eight firms will take part. Equipment will include x-ray micro-analysis techniques for quantitative analysis of elements in the micro-structure of metals, direct reading spectographs, ionization and argon chromatographs and instrumentation for transfer function analysis using frequency-response methods to determine the characteristics of servo systems.

## Asahi Will Produce Color Tv Tube Envelopes

TOYKO—Asahi Glass Co., which produces most of the glass bulbs used in Japanese picture tubes, is now working on molds for a 19-inch, 90-degree deflection color tube. Schedule calls for shipments to start in July.

Asahi is not waiting until Corning completes its 19-inch color tube

bulb because Japanese set makers want to start selling 19-inch color sets before this fall's Olympics. But Asahi says its 19-inch color tube bulb will be physically interchangeable with the one made by Corning, with which it has a technical agreement. Initial price of the envelope will probably be about \$4.15.

## Fish Story

A University of California biophysicist, R. Stuart Mackay, has taken the body temperature of a free-swimming dolphin by feeding it a tiny radio transmitter wrapped in a dead fish. Readings were recorded continuously for 17 hours while the 280-pound dolphin moved about a sea water pool at Point Mugu, Calif.

The six-transistor transmitter was about the size of a 2-inch pencil stub. An underwater receiving antenna attached to radio telemetry equipment picked up the signals.

"We're quite certain now that we can transmit any signal that can be sensed—and from inside almost any animal," Mackay said after the experiment. He is leaving shortly for the Galapagos Islands where he will try to feed a miniature transmitter to a marine iguana

## MEETINGS AHEAD

INFORMATION STORAGE-RETRIEVAL INSTITUTE, American University; University, Washington, D. C., Feb. 17-21.

PHYSICAL METALLURGY OF SUPERCONDUCTORS MEETING, AIMMPE Metallurgical Society; Hotel Astor, New York, N. Y., Feb. 18.

INFRARED TECHNIQUES FOR ELECTRONICS MEETING, ITEC; Huntsville, Ala., Feb. 19-20.

INTERNATIONAL SOLID STATE CIRCUITS CONFERENCE, IEEE, University of Pennsylvania; Sheraton Hotel and University of Pennsylvania, Philadelphia, Pa., Feb. 19-21.

SOCIETY FOR INFORMATION DISPLAY NATIONAL SYMPOSIUM, SID; El Cortez Hotel, San Diego, Calif., Feb. 26-27.

WELDED ELECTRONIC PACKAGING SYMPOSIUM, WEPA; Miramar Hotel, Santa Monica, Calif., Feb. 26-27.

SCINTILLATION-SEMICONDUCTOR COUNTER SYMPOSIUM, IEEE, AEC, NBS; Hotel Shoreham, Washington, D. C., Feb. 26-28.

ELECTRONIC INDUSTRIES ASSOCIATION SYMPOSIUM, EIA; Statler Hilton Hotel, Washington, D. C., March 9.

EXPLODING CONDUCTOR PHENOMENON CONFERENCE, AFCRL; Boston, Mass., March 10-12.

IRON AND STEEL INDUSTRY INSTRUMENTATION CONFERENCE, ISA; Roosevelt Hotel, Pittsburgh, Pa. March 11-12.

COLD CATHODE TUBE INTERNATIONAL SYMPOSIUM, British Institution of Radio Engineers; Cavendish Laboratory, England, March 17-19.

NUMERICAL CONTROL SOCIETY MEETING, NCS; Hotel Commodore, New York, N. Y., March 19-20.

IEEE INTERNATIONAL CONVENTION, IEEE; Coliseum and New York Hilton Hotel, New York, N. Y., March 23-26.

RADIO TECHNICAL COMMISSION FOR MARINE SERVICES MEETING, RTCMS; Boston, Mass., March 31-April 2.

## ADVANCE REPORT

TECHNICAL SYMPOSIUM, *Society of Photographic Instrumentation Engineers*; Miami Beach, Fla., Aug 24-28; March 1 is deadline for submitting 400-word summaries to Mr. Gerald B. Cope, Technical Program Chairman, 933 West Whitmire Drive, Eau Gallie, Florida 32935. Some topics are satellite-borne photographic instrumentation, optical satellite tracking, automated data processing and reduction, industrial and research application of photographic instrumentation, medical application of photo-optics, new developments and applications in photographic instrumentation.

## England Takes Measure From the Metric System

LONDON—Britain has officially redefined its standards of linear and mass measurements to conform with metric standards. Under a 1963 act which has just become operative, the yard is now defined as equal to 0.9144 meter. The pound is now officially 0.45359237 kilogram. The bronze bar and the platinum cylinder that served as standards for the imperial yard and the pound were found to be less stable than the metric standards. The meter is defined in terms of the wavelength of the isotope of an inert gas, krypton-86. The international kilogram standard is made of platinum-iridium.



## Broadcasters May Use UHF Relays

WASHINGTON—FCC looks favorably on the use by broadcasters of automatic, unattended mobile relay stations.

New Mexico Broadcasting Co. (KGGM) requested permission to use automatic mobile relay stations to cover on-the-spot news events. The Commission finds merit in the argument for the use of unattended stations when the location requires it.

However, to prevent interference with other authorized frequencies, the Commission proposes to limit operations to the 450-Mc band; prohibit automatic relay stations in tandem, or at intermediate points in a studio-transmitter link or intercity relay system; require a "lock-out" device to prevent the automatic relay transmitter from being turned on if there were another signal on the same frequency; and to require selective calling to prevent accidental turn-on by another station. The Commission invited comments on the rules changes.

## Satellites Will Update Soviet Weather Net

MOSCOW—The Soviet Union plans to reorganize its weather forecasting system to take greater advantage of satellites and automatic stations.

At present, the USSR has about 3,500 hydrometeorological stations and 8,000 posts, plus 150 radio-sonde stations. In the new organization there will be 4 major regional weather centers, 20 local centers, a system of weather satellites, groups of aircraft, 300 to 500 zonal observatories, up to 4,000 semi-automatic stations manned by two or three people, up to 15,000 automatic stations and posts, research institutes, expeditions and research.

Purpose of reorganization is to take emphasis away from manned stations and to rely more on instrumentation compatible with real-time computer predictions.

## Computer Patent—Finally

A PATENT, applied for in 1947, was issued early this month to Sperry Rand on Eniac, the first general-purpose automatic electronic digital

computer, invented by John Presper Eckert, Jr., and John W. Mauchly. Although Eniac has long been obsolete, some of the basic computer principles covered in the patent may be of value for royalty claims.

## Space-Propulsion Unit Accelerates Electronics

RCA THIS WEEK reported it has successfully tested its electric-propulsion system for spacecraft. The system differs from ion propulsion in that it directly accelerates only electrons. A mercury plasma is trapped by crossed electrical and magnetic fields. The electrons in the plasma spiral around the magnetic lines of force (cyclotron resonance) until they collide with other particles and scatter at high speeds. They escape through an exhaust nozzle. No accelerating electrodes are required in the exhaust stream.

An experimental unit, RCA said, has been operated 1,000 hours with no deterioration of performance, has attained a specific impulse of 1,000 seconds, efficiency of 30 percent and power output of 100 w. Magnetic field strength was 870 gauss and pump frequency 2.4 Gc.

NASA this week guessed that arcing, while Ranger 6 was still in the atmosphere, may have damaged the lunar probe's tv system. Telemetry from the tv system came on 2½ minutes after launch, triggered by a spurious signal or for some other reason not known. The Ranger 7 launch will be held up until it can be fitted with telemetry that will better indicate the cause if any part of that system fails.

AIR FORCE will ask industry to bid on a new air-to-surface missile for use by limited-war, tactical forces. The project, currently in-house, will call for a weapon with a 30 to 60-mile range and carrying a non-nuclear warhead to knock out small targets.

NEW ASSISTANT director for communications and electronics in DOD's Research and Engineering Branch is Thomas F. Rogers. He's on leave from MIT, where he headed Lincoln Laboratory's communications division.

FIRST atomic-powered Navy automatic weather station has been installed in the Gulf of Mexico. Weather reporting gear and transmitter is powered by a 60-w SNAP-7D built by Martin.

SOVIETS have high hopes for those two space-radiation-measuring satellites launched two weeks ago on a single booster. They say the satellites will stay up several years, but don't know how long the instrumentation will survive radiation.

MIT and three Boston hospitals are using a GE 225 computer to process electrocardiograms and other data transmitted by telephone. Analyses are sent back to the hospitals where they are presented electronically in graphs and other forms.

ARGONNE National Laboratory is seeking AEC funds for experimental creation of lightning. Lab's new 12.5-Bev zero-gradient synchrotron would be aimed upward to upset electrical equilibrium in thunderclouds.

UNITED Electrodynamics won't be buying Allied Research Associates. The two boards agreed last week to terminate negotiations.

SPERRY GYROSCOPE has sold four of its 3-D radar systems to Britain. The V-beam radar system uses a single antenna (p. 24, May 3, 1963).



## **Army Splitting Communications Staff and Command Responsibilities**

**Army is reorganizing** its communications-electronics activities. The Chief Signal Officer, Maj. Gen. David P. Gibbs, is taking on broadened staff responsibilities and is being redesignated Chief of Communications-Electronics. He will become the focal point on the Army staff for coordinating all communications matters, both tactical and strategic. He will be concerned with new communications doctrines and concepts, with all the hardware aspects of new equipment—from R&D to production—and with training. He also will provide technical advice for such activities as air defense, combat surveillance, electronic warfare, target acquisition and automatic data processing.

Another major change involves separation of his staff and command functions. A new Army Strategic Communications Command is being established as a separate major command to supervise operation of Army communications-electronics systems.

## **Pentagon Plans Standard Spec for Value Engineering**

**Defense Department is considering** a general specification fixing minimum standards for value engineering (VE) programs under major defense contracts. The Department, now receiving comments on a proposed draft of the specification from industry, associations and the military services, has not yet set a date for final action.

Contractors would have to set up a specific organization responsible for directing VE efforts and clearly define its relationship to top management and such other activities as materiel, engineering, finance and manufacturing. The contractor would have to establish targets and goals for the program, set up an internal reporting system to measure progress and make available to the government results of an annual qualitative review.

VE studies of items to be delivered under the contract would have to cover specifications, hardware, tooling, facilities, testing, packaging and data. Contractors would be required to assist subcontractors in setting up VE programs and to monitor them.

## **Hornig Backs Bigger Basic Research Budget**

**Basic scientific research** will get greater federal support, if the President's new scientific adviser gets his way. Donald E. Hornig, a chemist and physicist previously at Princeton, assumed his new post this week. He says that heavy, military and space hardware development programs would in the future level off at the \$12 billion worth of requests in the fiscal 1965 budget. But Hornig sees a real need to raise the federal basic research budget, now at \$1.8 billion. Hornig mentioned air pollution, environmental contamination, the life sciences, and energy resources as some needed basic research programs.

## **Electronic Printing Cuts Navy Catalog Costs by 40 Percent**

**Navy is using electronic composition** to cut production costs of printed catalogs by as much as 40 percent. The process was worked out by the Navy and General Dynamics/Electronics.

In a test at the Naval Aviation Supply Office, Philadelphia, information on 400,000 stock items was recorded on punch cards. An IBM 1401/1410 computer produced a master magnetic tape containing all items, arranged by stock number and divided for page printing. An SC-4020 computer-recorder, that can read 7,000 tape lines a minute, converted the contents of each page to microfilm used to make page proofs and negatives for offset printing plates. The system electronically reduces letter width and space between lines and letters with little or no loss in readability. In the test, one catalog section shrank from 28,000 to 16,000 pages.





## Whale of a Tiger

You're looking down the 84-foot cargo hold of a Flying Tiger Swingtail-44. Among airfreighters it's the unique one...the one that handles outsize cargo others can't.

It's the one with the swing-away tail assembly that opens wide, giving big shipments the advantage of straight-in loading. Tigers' Swingtail-44's regularly take on shipments that side-loaders don't dare try.

Like the huge turbine rotor Tigers carried from Burbank to Newark. Statistics: length

-39', height-6', weight-18 tons, operating time saved-5 days. Or the 24' concrete cutter Tigers flew from Los Angeles to Paris, France, in 48 hours. Time saved-weeks!

Then there are the two complete F-104G supersonic jets that were transported in the big Swingtail, the bulky electronic computers, the 26' Polaris missiles, and more.

But why go on. You get the picture: Tigers' Swingtail-44 carries outsize cargo others can't.

*first in airfreight with airfreight first* **FLYING TIGER LINE**





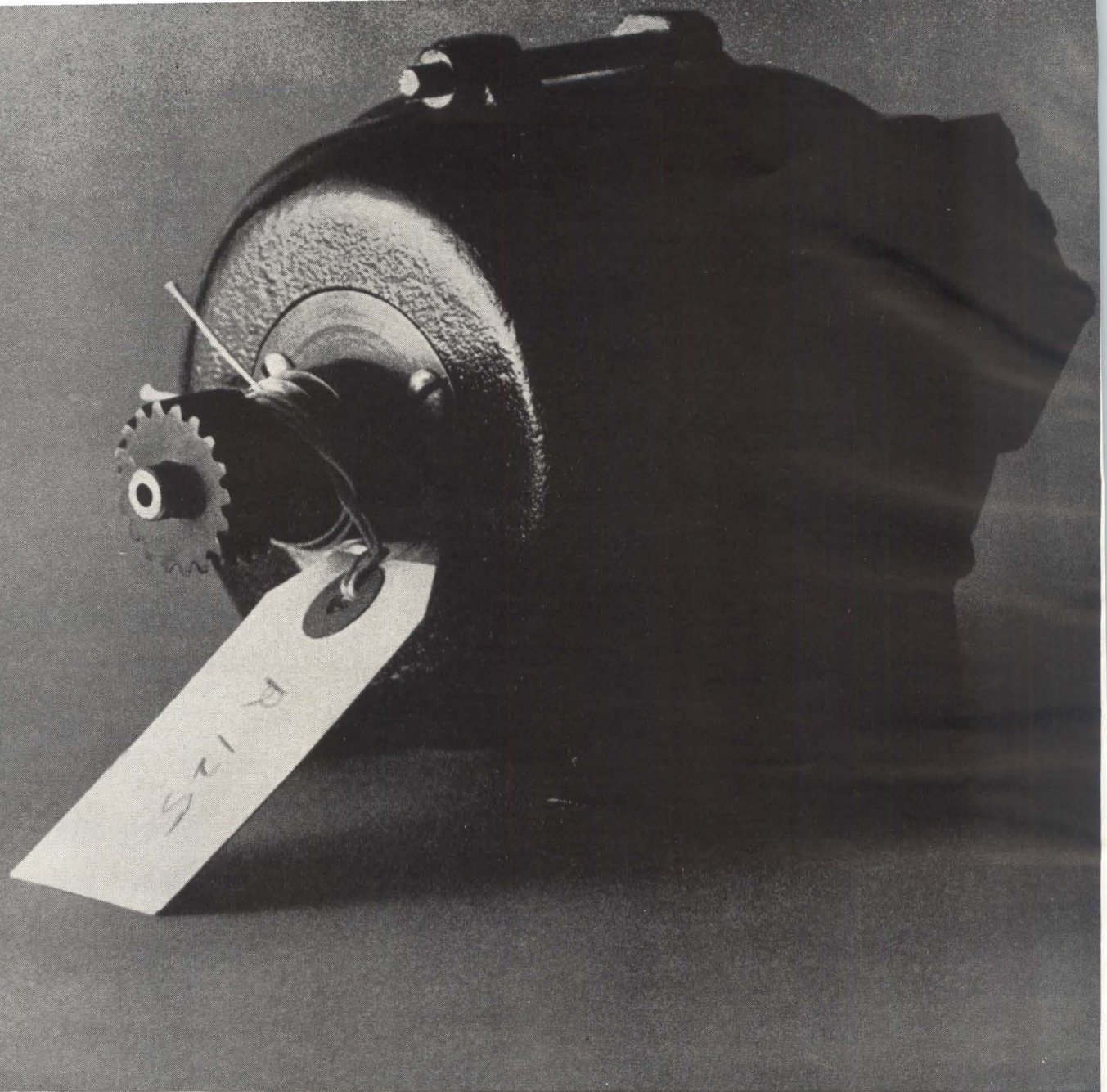

## Custom designs—in minutes

---

With IBM's new Automated Design Engineering application, you can—in just minutes—modify standard designs to meet specific customer requirements.

When customer requirements are entered into the computer this new IBM approach enables you to select, compare and analyze all design elements and to produce specifications that meet order requirements.

Your computer automatically prints a list of standard parts and standard drawing numbers for each order. And, where necessary, it even lists non-standard part specifications and instructions for the preparation of new drawings.

With Automated Design Engineering you'll find you can respond to bid requests sooner, deliver finished orders sooner, too. Engineering lead times will go down, consistent design practices will go up.

Automated Design Engineering won't replace creative talent. But it will free that talent for creative engineering.

Call our branch office for details.



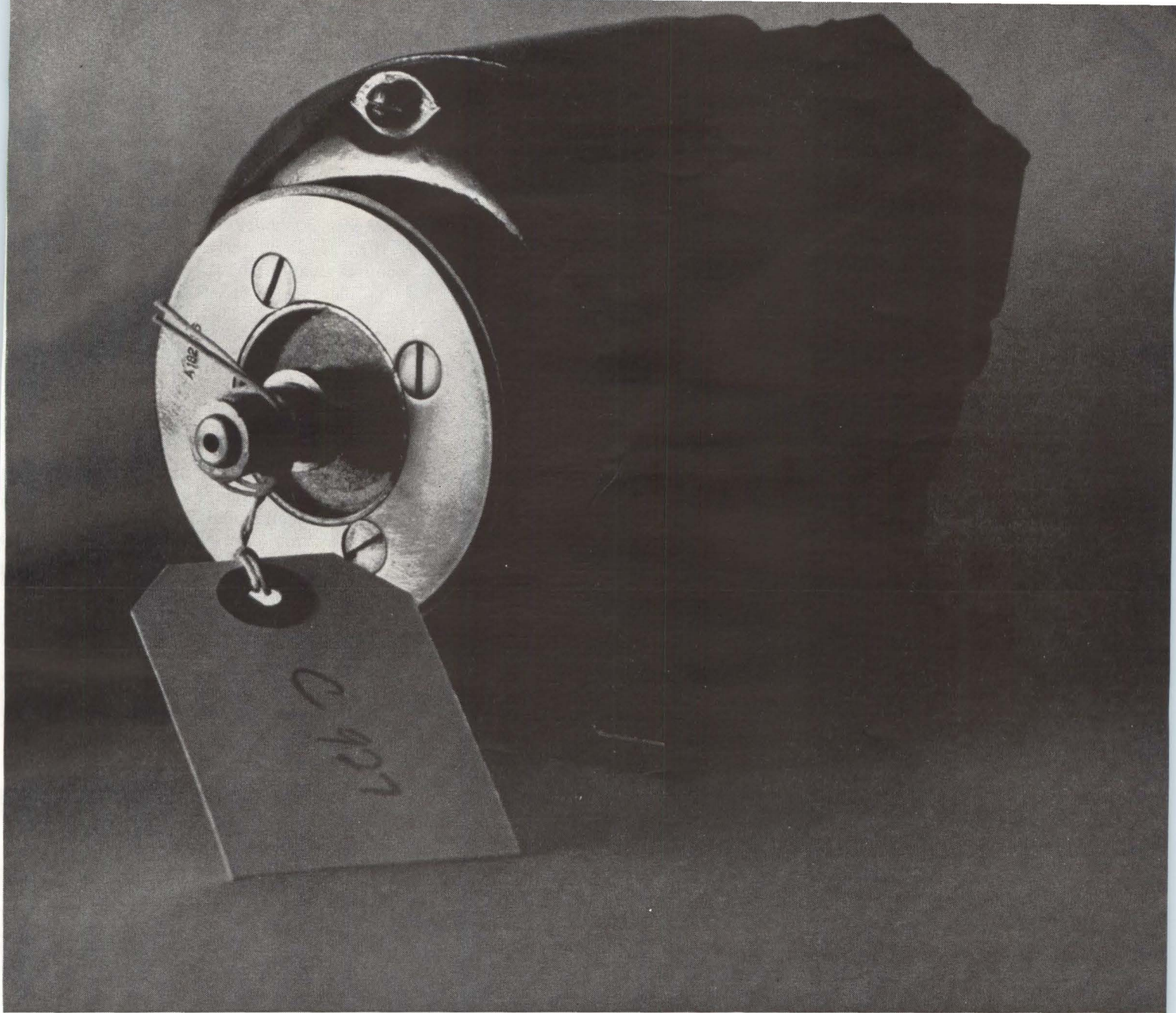

IBM's Automated Design Engineering application works for design engineers in all industries. It's adaptable to almost all IBM computers. The right system for you depends upon the complexity of the product, the customer's requirements and the number of orders you process a day.

**IBM**<sup>®</sup>  
DATA PROCESSING

CIRCLE 23 ON READER SERVICE CARD



# Automatic Spacetracking



COL. LEO W. SULLIVAN, commander of the Space Track R&D Facility, poses at the scoreboard of all earth-orbiting objects. The number of objects in orbit—satellites, old rockets and assorted space junk, is rapidly approaching 400

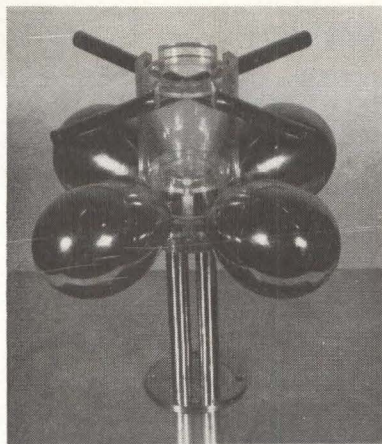

MODEL of crossed dipoles and director rods. Each receiver of the phased array has an assembly like this, and each transmitter has a pair of the pear-shaped dipole antennas

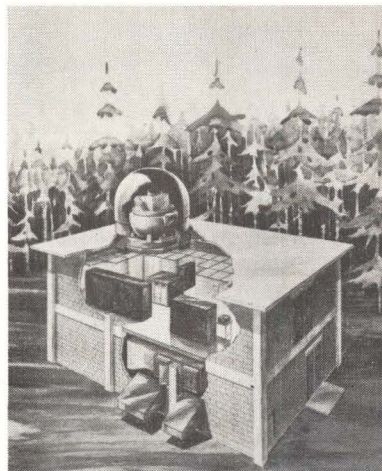

CLOUDCROFT center for the electro-optical surveillance system will look like this when completed

## Array radar and optical sensor join push toward first-orbit detection

By **THOMAS MAGUIRE**  
Regional Editor, Boston

**BEDFORD, MASS.**—A phased-array radar as high as a 15-story building (see cover) and an electro-optical system with a range far beyond radar will this year provide the U. S. with the most nearly automatic space surveillance and tracking system today's technology can achieve.

They will open a new era in the still-infant art of spacetracking, keeping the record straight on all earth-orbiting objects, announced and unannounced. They will also be useful for detecting and tracking missiles and for tracking space vehicles not in earth orbit.

Air Force is looking to the radar to upgrade the Space Track network. A goal of long standing (ELECTRONICS, p 32, Nov. 24, 1961) is sensors that will automatically track hundreds of objects simultaneously and identify new ones on their first orbit.

**Ready This Year**—The \$30-million radar, dubbed the AN/FPS-85, is nearing completion at Eglin AFB, Fla. In a month or so, power will be put on its 25,000 components. After nine months of shakedown and testing, it is hoped the system will reach full capability.

Range is classified, but Air Force officials have put it at "several thousand miles." The FPS-85 is much bigger, more complex and far more powerful than ESAR (Electronically Steerable Array Radar—see ELECTRONICS, p 115, Nov. 17, 1961). Initially a demonstration and research tool, the radar is designed so it can grow into an operational system.

The \$5-million electro-optical sensor is being built in the Sacra-

mento Mountains at Cloudcroft, N. M., 30 miles from Holloman AFB. It should be ready for test and evaluation this fall.

Called an AN/FSR-2, it will collect data with a telescope and fiber-optics television. No data will be handled manually—it will be the first system to provide an automatic flow of detection information in real time from an optical telescope.

**Space Track Goals**—Both systems will feed their data to SPADATS (Space Detection and Tracking System), Colorado Springs, for evaluation.

The 496L System Program Office at AF Electronic Systems Division, Hanscom Field, is managing development of both systems (Rome Air Development Center directs the FPS-85 technical development). Prime contractors are Bendix Radio Systems Division, for the radar, and RCA, Burlington, Mass., for the FSR-2.

The two new sensors represent a major step toward the Air Force aim of "an over-all spacetracking system as nearly automatic as man can create," says Col. Leo W. Sullivan, who directs the 496L system and commands the Space Track R&D Facility at Hanscom Field.

The new-generation Space Track's goal, according to Maj. Gen. C. H. Terhune, Jr., AF Electronic Systems Division commander, is: "... a surveillance system with a first-orbit capability for detecting, tracking, identifying and cataloging all objects (in space)." Satellite-borne systems may have to supplement ground radars, however.

**Eglin's Big One**—The transmitter of the phased-array radar is square, to get maximum beam power. It is 132 ft wide, 95 ft high and 95 ft deep. The receiver, circular for optimum control of sidelobe level, is 195 by 145 by 145 feet. Frequency is in the 400 to 500-Mc band. It will be able to track while scanning.

The computer system is built around an IBM 7044, Bendix and Airborne Instrument Lab units. Technical data will go out over a



# Era Begins

high-quality digital data link.

"The data rate will be fantastically high," says Melvin Baller, project officer. Even 4 or 5 times the present number of satellites in orbit would not swamp the system. It could track them simultaneously and still perform surveillance.

By time sharing, it can switch back and forth from search to track in microseconds.

Facing due south, the radar can scan a 60-degree segment of the equator. Six such radars could fully cover the equator, to detect all orbiting objects on their first orbit, regardless of launch location.

**Cloudcroft's Telescope**—The FSR-2 is also a feasibility model; decision to make it operational will depend on extended evaluation. It simply picks up solar energy reradiated from its targets. Operation will be essentially limited to nighttime and good weather (it's usually clear at Cloudcroft), complementing the all-weather, 24-hour capability of radar.

Tv replaces the conventional recording medium, film, and is used both for detection and signal processing. Project officer Anthony Salvucci says the system is pushing the state of the art in fiber optics. A modified image-orthicon tube will be coupled to fibers making up a focal plane of the telescope. The orthicon has a fiber-optics faceplate with a special photocathode material deposited on it.

The image from a Baker-Schmidt optical system is focused onto the face of a bundle of rigid optical fibers. They break up the field of view—and present different segments to various cameras.

The star background is kept stationary by use of an equatorial mount. Thus anything in motion is potentially an object of interest, but techniques are included which discriminate against, for example, airplanes.

Perkin-Elmer furnished the telescope and mount; Mosaic Fabrications, of Southbridge, Mass., is producing the fiber optics, and Scientific Data Systems supplied the general-purpose computer.

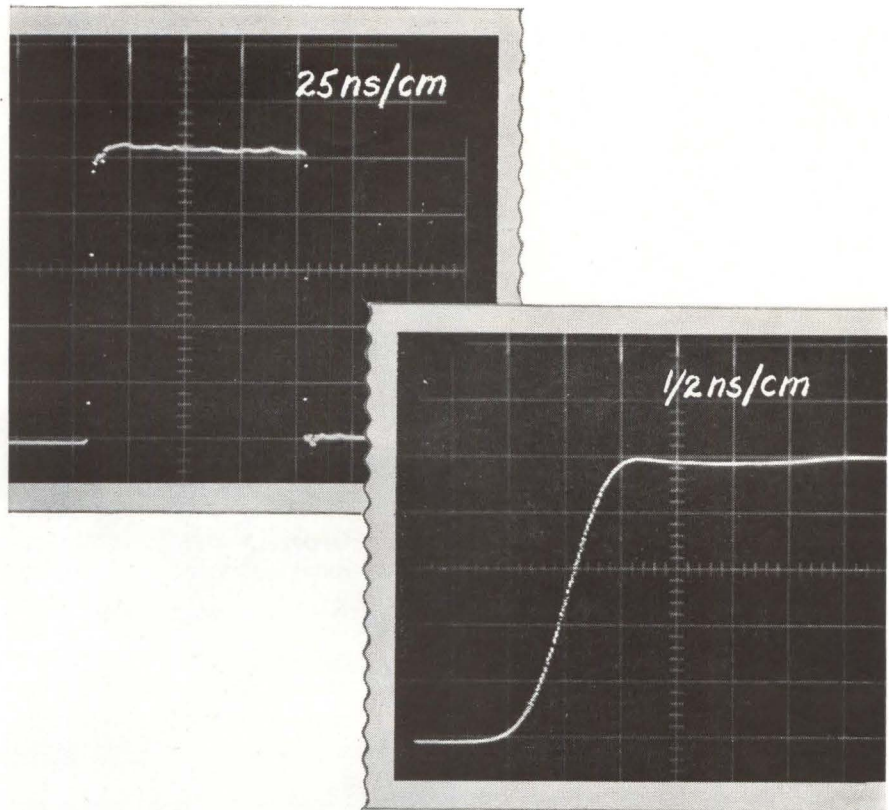

## Proof! 1 amp avalanching in less than 1 nanosecond at 1 megacycle with TI's 6701 Pulse Generator

High amplitude, high repetition rate, fast rise and fall times are features of TI's Model 6701 Avalanche Pulse Generator. Voltage amplitude is variable to 50 volts, either positive or negative, into a 50-ohm load, rise and fall times are less than 1 nanosecond, repetition frequency is variable from 100 cycles to 1 megacycle. The unit is ideal for circuit or component testing and for advanced applications such as thin film work. The 6701 furnishes selectable-width pulses by means of plug-in modules from 5 to 100 nano-

seconds or by external charge lines. Delay with respect to the sync pulse is variable from 40 to 400 nanoseconds. The 6701 can be triggered by means of an external input and provisions are made for single pulsing with a front panel pushbutton. Like all Series 6000 Pulse Generators, the Model 6701 is compact, lightweight and portable, extremely convenient to use. Circuitry is all solid state.

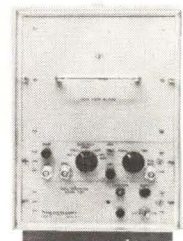

Write for complete information.

INDUSTRIAL  
PRODUCTS  
GROUP



**TEXAS INSTRUMENTS**  
INCORPORATED  
P. O. BOX 66027 HOUSTON, TEXAS 77006

635





## Wow!!! 84% use Kester Solder!

Frankly, it even surprised us as we tabulated the results of our brand preference studies. But we can't argue with figures . . . 84%! These are the results of actual brand preference studies that show Kester is preferred by 84% of the design engineers.

What makes us the unchallenged leader in solder? How did we get that way? For over 65 years Kester Solder Company has been producing the finest solder and fluxes. We've continually provided technical counsel and

personal assistance. And we're still solving soldering problems and establishing soldering procedures every day.

Wonder what happened to the other 16%? If you happen to be one of them, let us send you one of our engineers. He'd like to explain our product line and services in detail and help you with any soldering problems you may have.

**KESTER SOLDER**  
KESTER SOLDER COMPANY

4202 Wrightwood Avenue, Chicago, Illinois 60639 • Newark, New Jersey 07105 • Anaheim, California 92805 • Brantford, Ontario, Canada  
1899-1964 - 65 years manufacturing highest quality solders and fluxes



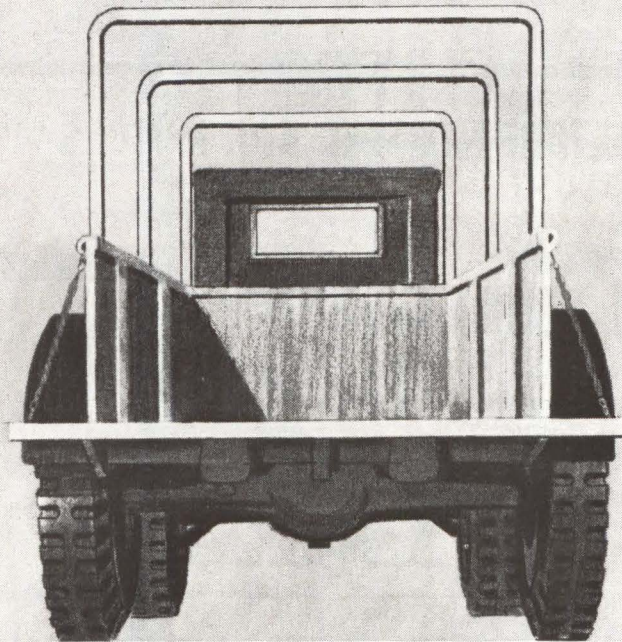

Could you put a 50 kw transmitter in this space?

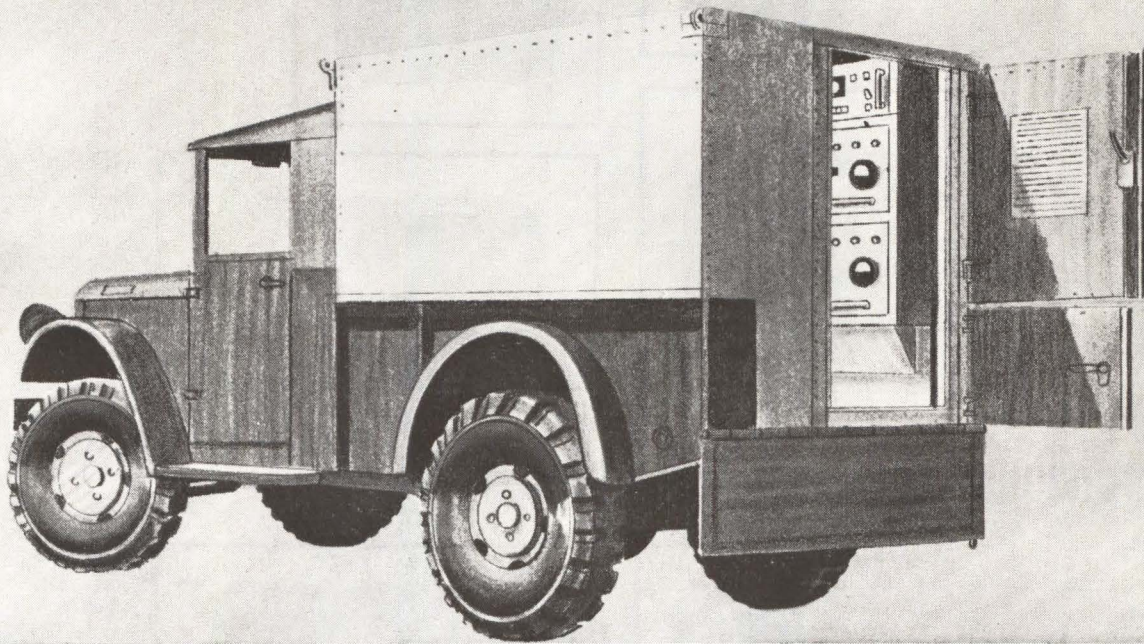

### Westinghouse can

A Westinghouse Solid State Transmitter (Series ST) fits in about one tenth the space you need for conventional designs. It weighs only one third as much, requires far less cooling, operates with 80% efficiency.

And it is 10 times more reliable on the basis of MTBF.

Series ST transmitters have made it possible to apply high power communications techniques (up to 150 kw) in many areas

where tube-type transmitters are impractical. Using Westinghouse-developed all-solid-state circuitry, such restricted environments as ships, submarines, aircraft and tactical vehicles can now support advanced high power communications systems.

Other applications include underground and underwater installations, where equipment must operate unattended for long periods.

Westinghouse Surface Division produces Series ST Solid State Transmitters in a variety of configurations for specialized defense communications systems. These highly versatile systems are but one indication of how the broad capabilities of Westinghouse can answer your most urgent needs in electronics.

Get details by writing to Westinghouse Electric Corporation, P.O. Box 868, Pittsburgh 30, Pennsylvania.

J-02354-R

You can be sure if it's Westinghouse



CIRCLE 27 ON READER SERVICE CARD



# PRECISION MINIATURE MIL SPEC A.C. MOTORS

## TYPE SC

Sub-miniature motor rated .15 oz. in. max. sync. torque. Size:  $1\frac{1}{16}$ " dia. x  $1\frac{1}{16}$ " long. 2.4 oz. To 200 v.a.c. 2, 4 or 6 poles

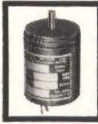

## TYPE CC

Sub-miniature motor rated .07 oz. in. torque at 12,000 and 24,000 rpm sync. speed. Size:  $\frac{5}{8}$ " dia. x  $1\frac{1}{16}$ " long. 1.5 oz. 26v a.c., 2 or 4 poles.

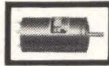

## TYPE YC

Small motor rated up to 12 oz. in. @ 3,000 rpm in three stack lengths. Size:  $2\frac{1}{2}$ " dia. x (3 lengths)  $1\frac{1}{16}$ ",  $2\frac{1}{16}$ ",  $3\frac{1}{16}$ ". 26 oz., max. To 230 v.a.c. 2, 4 or 6 poles.

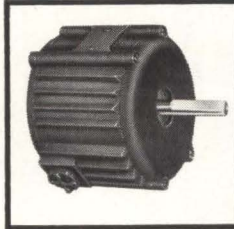

## TYPE MC

Miniature motor rated 0.8 oz. in. max. sync. torque. Size:  $1\frac{1}{4}$ " dia. x  $2\frac{1}{4}$ " long. 6.5 oz. To 200 v.a.c. 2, 4 or 6 poles.

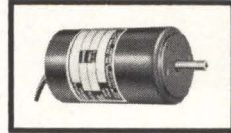

## TYPE FC

Small motor rated 1.2 oz. in. max. sync. torque. Size:  $1\frac{1}{16}$ " dia. x  $2\frac{1}{4}$ " long. 11.5 oz. To 200 v.a.c. 2, 4 or 6 poles.



## TYPE OC

This low temperature rise motor is conservatively rated at 4.5 oz. in. max. sync. torque. Size: 3" dia. x  $2\frac{3}{4}$ " long. 32 oz. To 115 v.a.c. 2, 4, 6, 8, 16 or 24 poles.

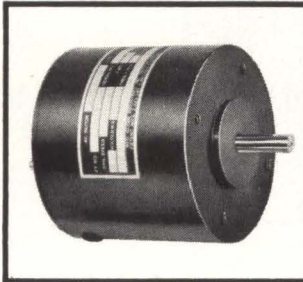

## TYPE LC

Small motor rated up to 20 oz. in. max. sync. torque in two stack lengths. Size:  $3\frac{5}{16}$ " dia. x (2 lengths)  $3\frac{1}{8}$ " and  $4\frac{1}{32}$ ". 8 lbs., max. To 200 v.a.c. 2, 4 or 8 poles.

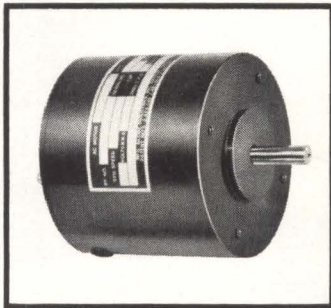

## TYPE GRL

Universal a.c./d.c. motor rated .077 hp, 5,000 to 10,000 rpm. Size:  $2\frac{1}{4}$ " dia. x  $4\frac{1}{32}$ " long. 36 oz. To 115 v.a.c., and 115 v.d.c.

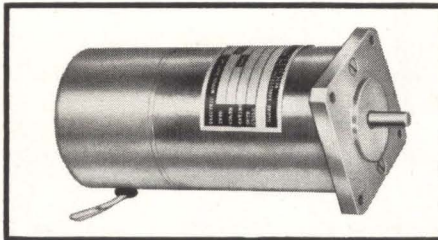

# PRECISION COMMERCIAL A.C. MOTORS

## TYPE CFC

Small motor rated 2.0 oz. in. max. sync. torque. Size:  $1\frac{1}{32}$ " dia. x  $2\frac{7}{8}$ " long. 13 oz. To 115 v.a.c. 2, 4 or 8 poles.

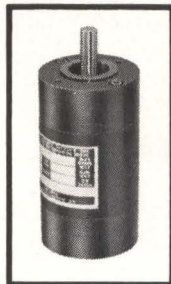

## TYPE CLC

Small motor rated 22 oz. in. max. sync. torque. Size:  $2\frac{15}{16}$ " dia. x (2 lengths)  $3\frac{7}{8}$ " and  $4\frac{3}{4}$ ". 72 oz., max. To 115 v.a.c. 2, 4 or 8 poles.

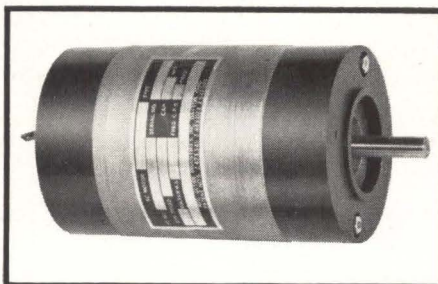

## TYPE CMC

Miniature 60 cycle motor rated up to 0.75 oz. in. max. sync. torque @ 1,800 or 3,600 rpm. Size:  $1\frac{1}{4}$ " dia. x  $2\frac{3}{32}$ " long. 7.2 oz. To 115 v.a.c., 2 and 4 poles.

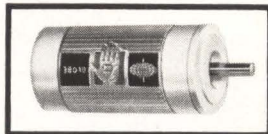

## TYPE UC

Small motor rated up to 12 oz. in. max. @ 3,000 rpm in three stack lengths. Size:  $2\frac{1}{4}$ " dia. x (3 lengths)  $1\frac{7}{32}$ ",  $2\frac{1}{32}$ ",  $3\frac{1}{32}$ ". 16 oz. To 230 v.a.c. 2, 4 or 6 poles.

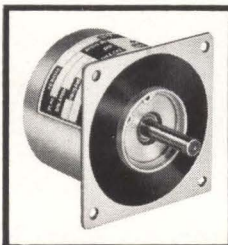

All motors shown are available with integral gear reducers. DC motors are available in comparable frame sizes.

**GLOBE INDUSTRIES, INC.**, 1784 STANLEY AVENUE, DAYTON, OHIO 45404 AREA CODE 513 222-3741

PRECISION MINIATURE AC & DC MOTORS, GEARMOTORS, TIMERS, ACTUATORS, CLUTCHES, BLOWERS, MOTORIZED DEVICES

**GLOBE**



*Looks good, doesn't it?*

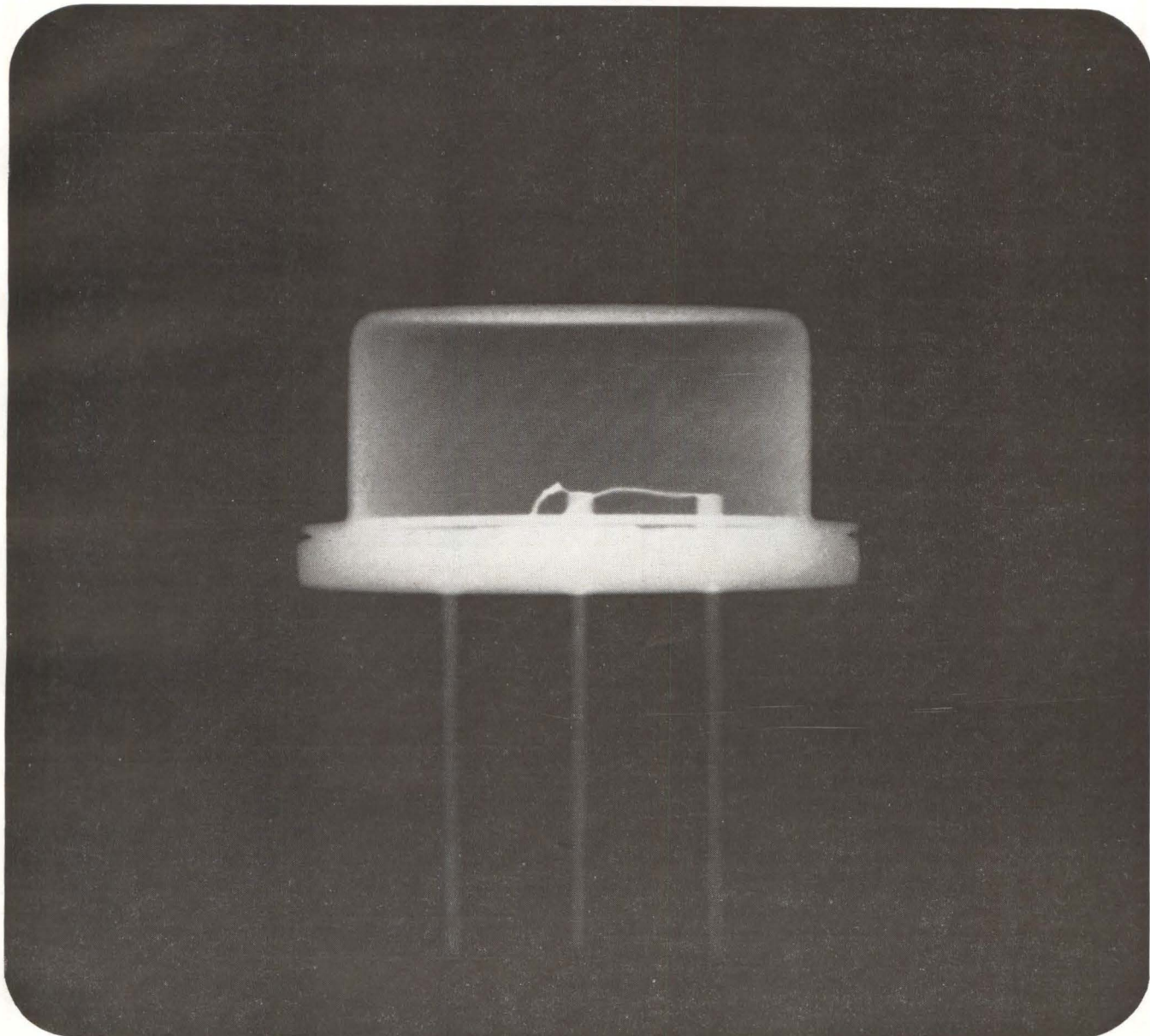
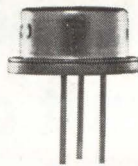

*...but, look at it this way to be sure!*

Appearances *can* be deceiving. Often a tiny defect can escape most methods of detection. That's why so many companies depend on Ansco Industrial X-ray films to make the final check on their components.

No method of non-destructive inspection shows up tiny imperfections, (especially in tiny components), more clearly or quickly than a radiograph on Ansco Superay® 'H-D' X-ray film.

This Class I film is especially designed for high definition radiography. It has an ultra-fine grain and very high contrast and provides the ultimate in image quality. Although used

primarily with low voltage techniques, Superay 'H-D' maintains its high definition characteristics and image quality throughout the full KvP range.

Ask your Ansco X-ray Products Representative how Ansco Industrial X-ray films and chemicals can be of significant value in your inspection procedures. He's always at your service.

**gef** **AnSCO**  
X-RAY PRODUCTS  
GENERAL ANILINE & FILM CORPORATION  
BINGHAMTON, NEW YORK



# This new unijunction transistor will reduce overall circuit cost, simplify circuitry.



## For 60¢, how can you go wrong?

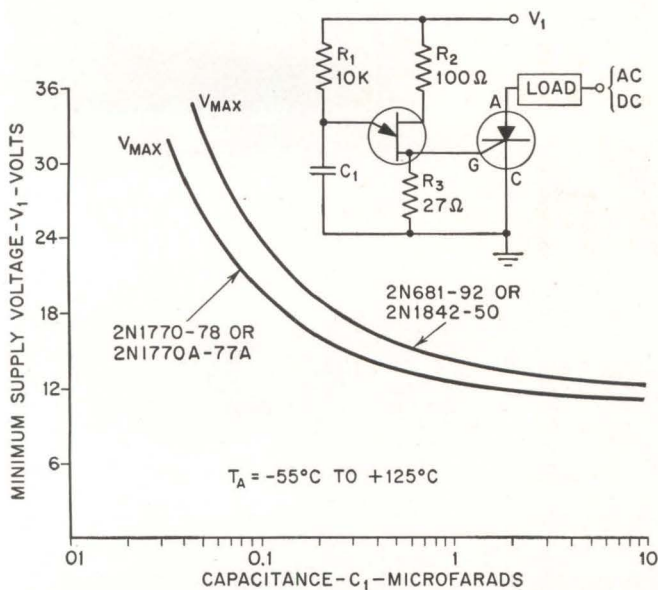

2N2646 FIRING CIRCUIT FOR LOW AND MEDIUM CURRENT SCR'S

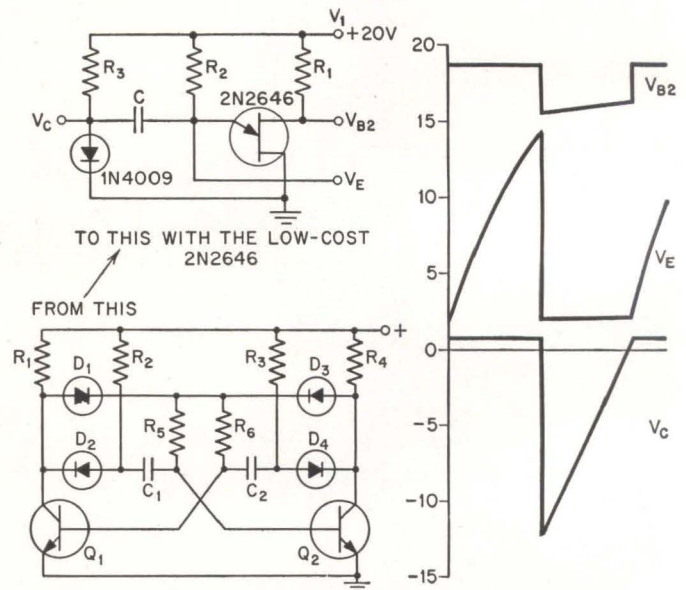

LOW-COST MULTIVIBRATOR WITH OUTPUT WAVEFORMS

The economical 2N2646 in the small TO-18 package offers a guaranteed minimum output pulse amplitude, making it ideal for firing Silicon Controlled Rectifiers with forward current ratings of 35 amperes. (The 2N2649 offers minimum output pulses capable of firing SCR's with ratings of 235 amperes.) The curves of minimum supply voltage vs. capacitance shown are for two representative SCR types. The circuit shown will operate reliably over a temperature range from  $-55^{\circ}\text{C}$  to  $+125^{\circ}\text{C}$ .

Only 60¢ in 1,000 and up quantities, the new 2N2646 silicon unijunction transistor features an entirely new structure which results in low saturation voltage, peak-point current and valley current, as well as a high base-one peak pulse voltage. And it is a much faster switch. The unijunction has always been able to simplify circuitry and reduce cost. Now

The 2N2646 in this circuit provides the ultimate in simplicity and low cost (note that you eliminate 3 resistors, 1 capacitor, 3 diodes and a transistor). Choosing the proper capacitance and resistance values you get a wide range of frequencies and duty cycles. The output can drive an NPN transistor or a gate-turnoff SCR, provides good isolation between the load and the timing circuit. You can also get selected versions of the 2N2646 (5E35 and 5E36) with guaranteed frequency and duty cycle in a standard oscillator circuit.

it saves you even more. Write for complete details to Section 16B158, Semiconductor Products Department, General Electric Company, Electronics Park, Syracuse, New York. In Canada: Canadian General Electric, 189 Dufferin St., Toronto, Ont. Export: International General Electric, 159 Madison Avenue, New York 16, N.Y.

Available through your G-E semiconductor distributor

**GENERAL  ELECTRIC**



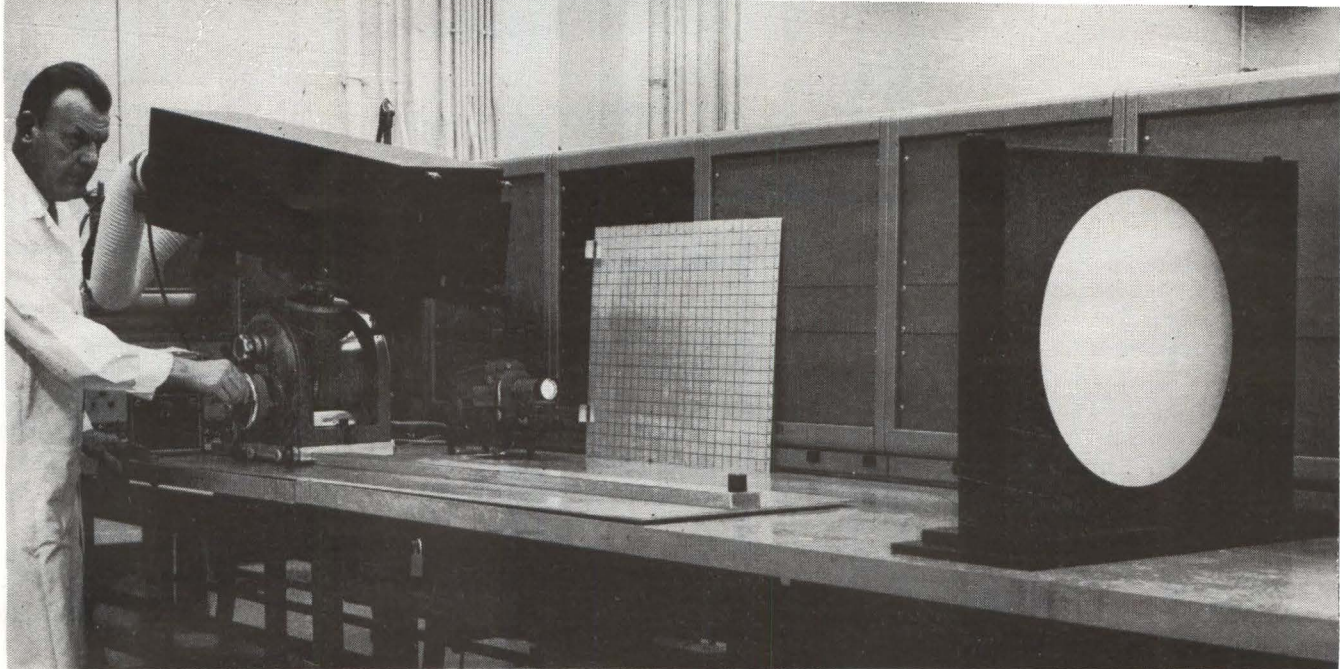

SOLAR IMAGE is produced by small projector on table top, flare images by specially built moveable projector. Flare locations for checking system accuracy are determined with grid shown near small projector

## Scanning the Sun for Solar Flares

Video techniques developed for sun study can detect and locate even small flares early in their lifespan, which is often less than an hour. Though flares are brief, they can spew deadly radiation on space craft near earth. Hopefully, they may be predictable

By **N. GUTLOVE** and **S. MORRISON**, Republic Aviation Corp., Farmingdale, New York

**SOLAR ERUPTIONS** and their effects on earth and in near space are no longer just scientific curiosities. Protected as we are by our atmospheric blanket, disruption of communications thus far has been the main consequence to us of solar activity. But when the space traveler moves out from under this blanket he faces the full force of the sun's radiation. Even at earth's orbit some solar events produce lethal radiation.

Of all radiation producing solar

phenomena, the flare is by far the most significant. Flares are catastrophic disturbances of the chromosphere, the sun's atmosphere, and produce both waves and particles of extremely high intensity. In the visible spectrum the radiation is confined to several narrow wavelengths, with the Balmer alpha line of hydrogen (6563 Å) the most significant. X-ray and ultraviolet radiations of the total sun also are greatly increased and giant streams of high-energy particles are emitted.

The particles present the greatest danger to space travel and are also responsible for additional terrestrial effects. Flare prediction therefore become vitally important, requiring vastly increased knowledge that can be obtained only by satellites.

Flares develop with explosive suddenness. A large flare may rise to maximum brightness in less than 5 minutes, then decline in from 20 minutes to one hour. Flares are classified by size and visible spectral brightness, and range from the



smallest readily observed at the earth class 1<sup>-</sup>, to the large and rare class 3<sup>+</sup> (See table in *ELECTRONICS*, p 40, Jan. 10, 1964). Flares smaller than class 1<sup>-</sup>, called microflares, have been observed in large number by the first Orbiting Solar Observatory (NASA's S-16 Scientific Satellite). Microflares too small for telescopic observation from earth are detected in a satellite by a burst of x-rays. The S-16 has refined flare prediction by discovering that a given series of microflares increase or decrease intensity peaks linearly with time.

Only the largest flares can generally be observed directly; many more can be seen with monochromatic light. The H<sub>α</sub> wavelength is convenient for this because its Fraunhofer absorption line width is only ±15 Å. Brightness of the undisturbed chromosphere as determined by H<sub>α</sub> light through either a spectroheliograph or a narrowband filter is indicated in Fig. 1; H<sub>α</sub> brightness is some 0.16 of the unfiltered or continuous spectrum (left scale). The flare image formed by H<sub>α</sub> light is relatively many times brighter, however, as shown on the right hand scale in Fig. 1. Detecting a flare near its inception is thus a matter of setting a reliable threshold relative to the chromospheric background. Flares are formed in

the plage areas of the chromosphere, which are active areas about twice as bright as the background; even class 1 flares will be detected by a system sensitive to contrasts exceeding 2.5 to 1.

Wave radiation from a flare reaches the earth 8½ minutes after inception on the sun. Particle radiation effects occur 20 to 40 hours later. Greatly increased ionization of the D layer of the ionosphere results from the ultraviolet rays and x-rays; short-wave communications are suddenly disrupted as the high-frequency waves are absorbed by the D layer instead of passing through and being reflected by the F<sub>1</sub> or F<sub>2</sub> layers. Shortwave fadeouts usually last about 25 minutes and have a slow recovery. Short radio waves from space (cosmic radio noise) are also absorbed by the D layer. The effective reflecting height of the D layer changes, affecting long-wave communications by causing interference between ground waves and reflected sky waves.

Particles also induce bursts of radio noise through interaction with the sun's corona. These long waves arrive up to several minutes—depending on frequency—behind the visible and ultraviolet radiation. More importantly, the high-energy particle showers cause ionospheric

and magnetic storms, and induce visible activity of the auroras. The ionospheric storms lower the critical frequency of the F<sub>2</sub> layer so that short-wave signals are passed through instead of reflected. Such short-wave blackouts can last for days.

The particles include protons, electrons and ionized atoms traveling at speeds up to those of primary cosmic rays. Direct exposure to such radiation would be fatal and even the secondary emission of neutrons by collision of the particles with shielding or other nearby matter could be highly dangerous. It thus is vital to predict such cataclysms with high accuracy, not only to avoid casualties but to maximize safe time for launching. Great benefits to communications would also result from improved flare prediction.

A laboratory program was undertaken to construct and test a breadboard model of a flare alarm system using video techniques. The program was aimed specifically at studying vidicon sensitivity to flare detection against the solar background, threshold limitations, system linearity, and the feasibility of eliminating spurious signals.

**Alarm System**—The flare alarm system, Fig. 2, consists of a beam splitter, a narrow bandpass filter, a vidicon camera with its associated power, drive and synchronization circuits, flare threshold and position logic circuits, and a telescope reposition command unit.

The beam splitter extracts an image of the entire solar disk; this image passes through a narrow bandwidth H<sub>α</sub> filter and falls on the faceplate of a vidicon. Video output of the tv camera is processed in the flare threshold and position circuits. In the threshold circuit, the reference bias level is adjusted for a brightness somewhat higher than that of the brightest plage region expected. As the vidicon scans the H<sub>α</sub> image of the solar disk, flares are readily detected. Frame and line synchronization pulses are processed to determine flare location. The frame synchronization pulse clears the counting circuit and sets the internal counter to zero. Thereafter, each horizontal line synchronizing pulse advances the Y-position count by one and resets the

## SPACEMAN'S WEATHER

Flares erupt suddenly on the sun, then often die within the hour. Before the flare appears, however, the sun or local solar regions appear to undergo disturbances that if sufficiently understood might allow better flare forecasting. Thus the spaceman's weather is made on the sun, and it can be just as deadly and harder to escape than a hurricane or blizzard here on earth. But flares have not yet been studied systematically enough for reliable prediction, although the authors of this article say they apparently are predictable and that gaps of days and even weeks occur between dangerous eruptions. Automating the observation and data collecting process will help

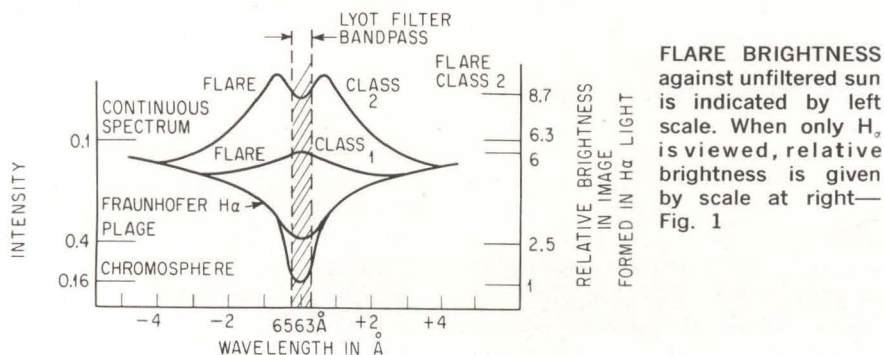



X-position counting circuit to zero. During each horizontal sweep, pulses from a high-frequency oscillator are counted to determine the X-position of the flare.

When a flare is detected and located, the circuit develops a signal to turn the telescope to the solar region of flare origin for detailed study. Simultaneously, the position of the flare can be displayed and automatic recording cameras can be turned on.

To counter spurious signals that could develop in the vidicon camera amplifier, giving flare indication when none exists, an electronic gate is included in the alarm logic. When a flare detection signal is received, the gate opens, bracketing the flare X-coordinate in the next video line. A definite indication of the flare in the next line is required before a positive identification is sent to the reposition command unit. Video amplifier noise rarely appears in the same position on successive lines so the gating system eliminates spurious signals. A slow-scan vidicon would improve signal-to-noise by integrating the signal without integrating random noise and is being considered for the prototype system.

**Lab Setup** — A laboratory setup, photograph, was made to evaluate the solar-flare alarm-system concept. Major elements are a closed circuit tv system, separate solar disk and flare simulators and instrumentation.

The television camera chain is a commercial cctv system operating at 60 fields per sec with 4 to 3 aspect ratio.

The sun image is produced by a slide with a round aperture in a standard 35 mm Mansfield slide projector. Intensity of the sun image was controlled by adjusting the projector lamp voltage. A 20-inch diameter sun image was produced on the target screen, which consisted of a section of rear projection glass.

Solar flares are simulated with a similar projection system. The apparatus uses a 500-watt projection lamp (EDK500T10/25C), a condensing lens, and a circular aperture in the focal plane to represent the flare; flare intensity is controlled by adjusting the projector lamp voltage; flare size from 1/8 to 1/2 inch diameter is controlled by changing the projection distance.

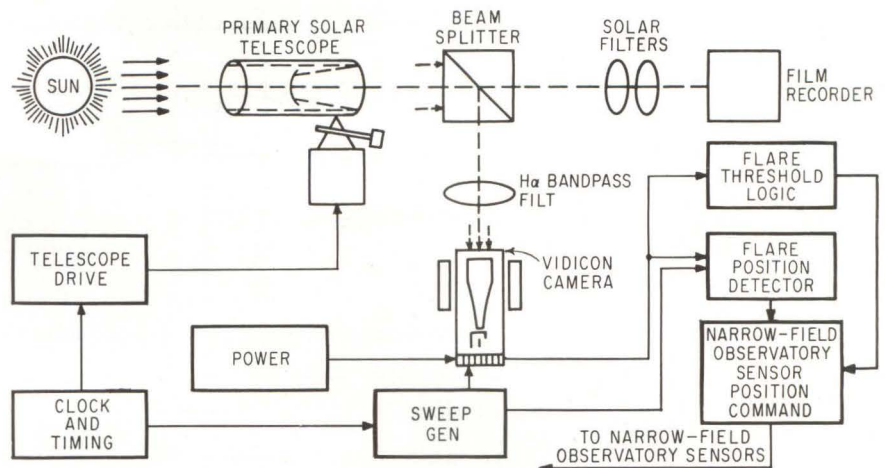

WHEN A FLARE brighter than threshold is detected—as primary telescope follows the sun—narrow-field telescopes are positioned for detailed study. Flares are detected soon after they start—Fig. 2

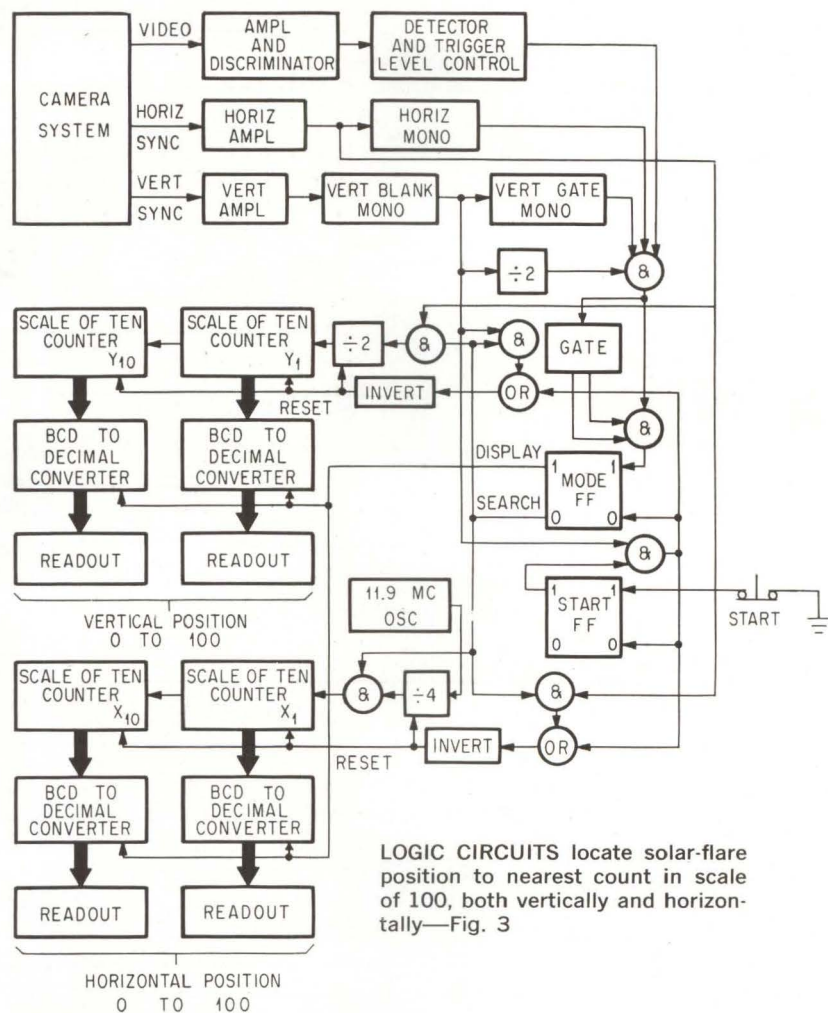

LOGIC CIRCUITS locate solar-flare position to nearest count in scale of 100, both vertically and horizontally—Fig. 3

A coordinate mask ruled horizontally and vertically at 10 lines to the inch (visible in the photograph) determines flare location on the screen prior to each run. After the flare coordinates are established, the mask is removed from the camera field of view to prevent interference

with video signal processing. A photometer and oscilloscope complete the experimental apparatus.

**Circuits**—The Y position of a flare is determined by counting the horizontal sync pulses from the camera system, Fig. 3, in two scale-of-ten



**DISCRIMINATOR PREVENTS sync pulses and low-level solar-background signals from being amplified. Amplifier then feeds higher level signals to threshold detector—Fig. 4**

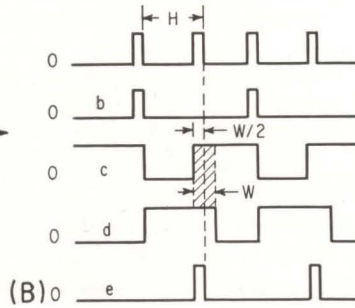
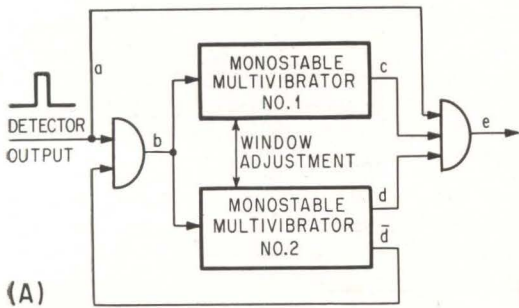
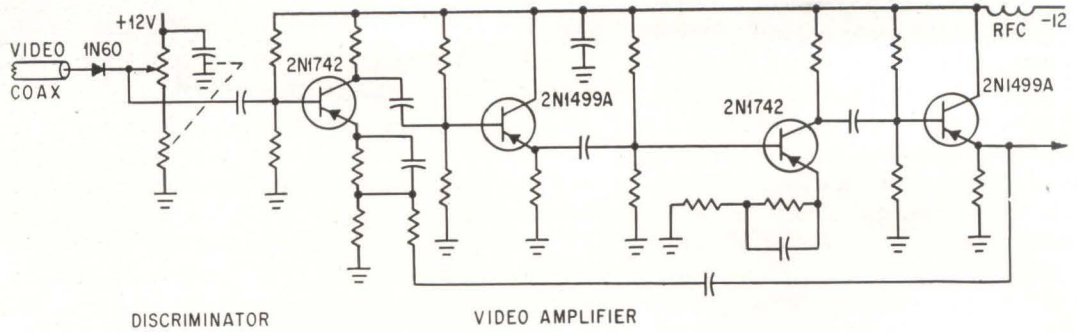

**GATE CIRCUIT (A) prevents noise pulses from being detected as flares by requiring that flare signals occur on two adjacent horizontal scans (B); actual circuit (C)—Fig. 5**

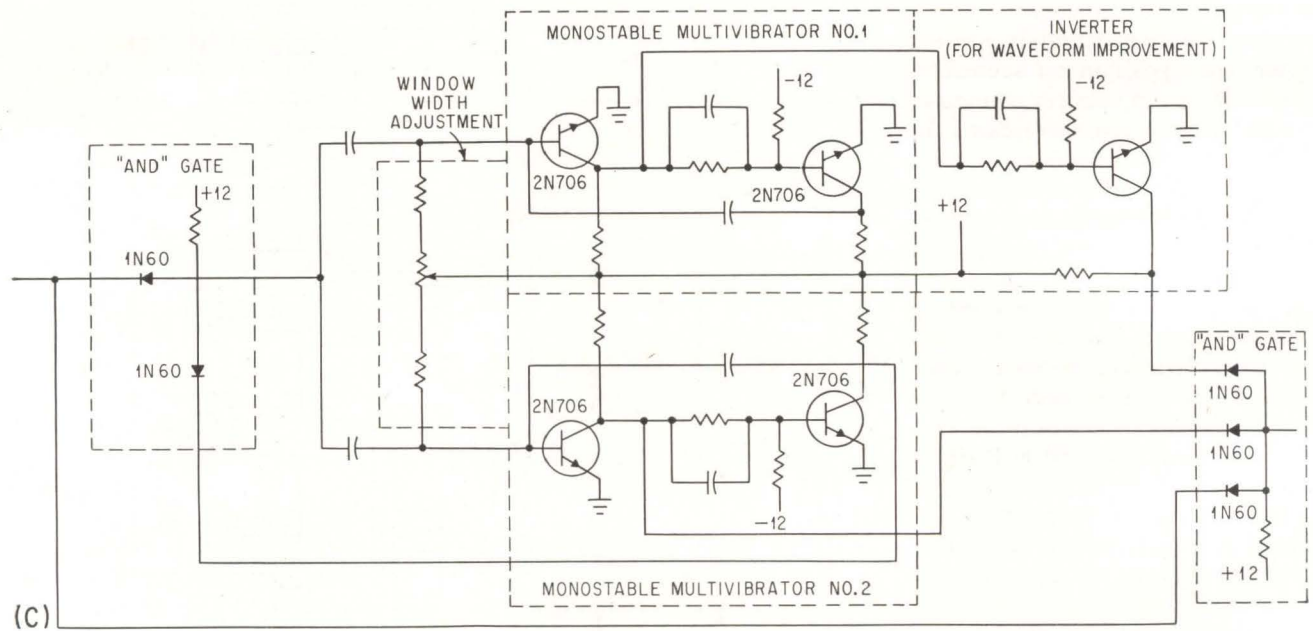

counters. The counters are cleared each frame by the vertical sync pulses. Since 200 horizontal video lines scan the solar image each frame in the laboratory demonstration model, a divide-by-two circuit is required preceding the counters to obtain two-digit readout (0 to 99).

To determine the X position of a flare, each horizontal scan line is divided into 100 time increments. This is accomplished by two scale-of-ten counters, which are cleared by each horizontal sync pulse, and which count the pulses from a high-frequency oscillator. Since the oscillator is not synchronized to the raster scan pattern of the television

camera system, the horizontal position could be in error by a full count. To prevent these large errors, the oscillator produces pulses at a frequency four times that required, and a divide-by-four circuit precedes the input to the counters. Since the divide-by-four circuit is preset by each horizontal sync pulse, the maximum error is  $\frac{1}{4}$  of a count.

Each scale-of-ten counter is connected to a converter which changes the counter's binary-coded-decimal (BCD) output to a decimal form in which one out-of-ten output lines is hot. The ten output lines from each converter are connected to driver circuits that control Nixie in-

dicator tubes. The hot output line from each converter thereby causes the correct decimal digit to be shown.

Operating modes are search and display. Search, initiated by the start pushbutton, precedes flare detection. During this mode the counters keep counting and the Nixies are off. The display mode is initiated by the detection of a flare, which causes the counters to stop at the X and Y counts indicative of the flare position. The Nixies are activated to display these positions and hold until search is again started.

The video amplifier and discrimi-



nator block of Fig. 3 is detailed in Fig. 4. The discriminator portion sets up a voltage level on each horizontal line such that the sync pulses and the lower intensity levels of the solar image are eliminated from subsequent amplification. The difference between flare and sun levels can thus be magnified more easily, allowing detection of minimum flares. The video amplifier has a bandwidth of 10 Mc and 40-db gain.

To prevent noise pulses from being detected as flares, the video data is passed through a special gating circuit. This circuit insures that a pulse occurs on two consecutive horizontal lines at the same X-position before it is interpreted as a flare. The circuit is triggered by the first pulse detected and opens a gate of narrow width at the same horizontal position on the next scan line. If a second pulse occurs while the gate is open, a flare has been detected; if not, the first pulse is ignored. Since all flares will intercept at least two lines, and spurious noise pulses will be short, false alarms are practically eliminated.

As shown in Fig. 5A, the detector output triggers two monostable multivibrators with pulse outputs respectively  $H - W/2$  and  $H + W/2$   $\mu$ sec in duration, Fig. 5B, where  $H$  is horizontal scan time and  $W$  is window width. If a pulse occurs on the next line  $H$   $\mu$ sec later, that is, in the same relative position as the first pulse, all three inputs to the second AND gate are positive and the pulse is passed through. The schematic is shown in Fig. 5C.

Horizontal and vertical sync pulses from the tv camera system are amplified and then shaped in the monostable circuits. A monostable circuit for blanking out noise at the beginning and end of each vertical raster scan was also required.

**Test Results**—During test, difficulties were centered primarily on the television camera system, which was extremely sensitive to adjustments of target voltage, beam current and focus controls. Minor changes of controls caused wide variation in video data and thus poor repeatability.

In an ideal horizontal scan, shown in Fig. 6A, the lowest level is horizontal retrace and is called the sync level; other levels are as indicated. With an ideal video signal there are

no problems in detecting flares. However, with the actual scan obtained (Fig. 6B), the intensity of the solar disk varies appreciably, primarily because of the optical properties of the slide projector used to simulate the sun. Thus threshold detection level has to be set higher than the maximum intensity of the solar disk and flares occurring on low intensity portions of the disk were not easily detected. Although  $H\alpha$  radiation from the sun varies because of sunspots, plages and limb-darkening phenomena, these variations are not as pronounced as those obtained in the laboratory setup.

Ideal and actual vertical scans, Fig. 6C, 6D and 6E, also show the variation in solar disk intensity. Noise at the beginning and end of the actual vertical scan required that these portions be blanked out. Also,

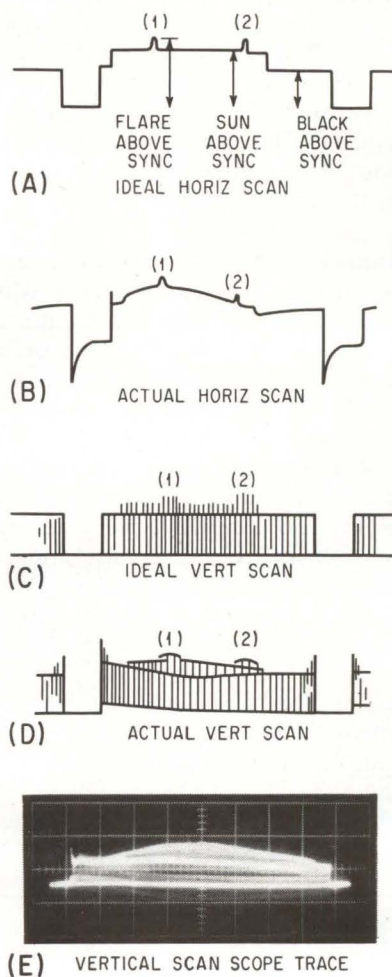

WITH IDEAL scanning signals detector locates even small flares accurately. But actual signals in laboratory setup cause loss of sensitivity—Fig. 6

the sync level itself varied during the frame time.

Tests performed on a black background (no sun), a medium-level sun, and an intense solar background show that a minimum intensity ratio of 1.5 to 1 is required for unambiguous flare detection.

Repeatability of X and Y positions of detected flares was good. The Y positions always repeated exactly; X positions varied by no more than  $\pm$  one unit, and then only rarely. But horizontal sync pulses had long fall times, thus causing difficulty in determining the exact start of each horizontal scan line.

Test of system linearity with respect to X and Y positions as read out on Nixie tubes gave maximum errors of only 2.5 percent.

**Conclusions**—Flares with intensities only 1.5 to 2 times that of the background solar disk were detected in the laboratory solar-flare alarm system, thus actual solar flares could be detected soon after they begin. For typical flares, detection at an intensity ratio of 3:1 could occur less than a minute after visible indication. Quick detection is essential for flare-buildup studies.

Obtained flare position errors of  $\pm$  2.5 percent are adequate if the flare is to be observed with a wide field optical telescope. With narrow field of view sensors, better accuracy may be required and could be achieved with a tv camera with a high-precision deflection yoke and circuit modifications.

The authors acknowledge the assistance given by S. Kass and B. Dutcher in the design of the electronic processing subsystems, and L. Maistrow and H. Leung in gathering and interpreting data.

#### BIBLIOGRAPHY

- G. Abetti, "The Sun," the Macmillan Co., 1957.
- D. H. Menzel, "Our Sun," Howard Univ. Press, 1959.
- C. W. Allen, "Astrophysical Quantities," Univ. of London, 1955.
- J. A. Hynek, "Astrophysics," McGraw-Hill, Book Co., 1951.
- J. C. Lindsay, "Solar Radiation Monitoring," Institute of Aerospace Sciences Paper No. 63-2, 1963.
- R. W. Kreplin, T. A. Chubb, and H. Friedman, *Journal of Geophysical Research*, 67, p 2231, 1962.
- H. E. Landsberg, J. Van Mieghem, "Advances in Geophysics," 8, Academic Press, 1961.
- M. Phister, Jr., "Logical Design of Digital Computers," John Wiley and Sons, Inc., 1960.
- D. G. Fink, "Television Engineering," McGraw-Hill Book Co., 1952.
- F. W. Sears, "Optics," Addison-Wesley Publishing Co. Inc., 1958.
- N. Gutlove, S. Morrison, et al., Republic Aviation Corp. Report No. RAC 1416, RDTM 63-522, June 7, 1963.



# Molecular Blocks Simplify Microcircuits

Double-base diodes, tunnel diodes and surface-controlled devices  
in single-chip form increase reliability and reduce size and cost

By VASIL UZUNOGLU and MARVIN H. WHITE  
Aerospace Division, Westinghouse Electric Corporation, Baltimore, Maryland

**ALTHOUGH** integrated circuits are beginning to be accepted widely, it has been pointed out that making use of some properties of semiconductor devices to realize some of the required functions of a microcircuit may prove more advantageous than transferring each element of a circuit to an integrated block.<sup>1,2</sup> This paper deals with this approach and shows how to use double-base diodes, tunnel diodes and oxide-coated devices to perform useful functions in microcircuits.

Analog-digital conversion can be achieved by using the double-base diode structure shown in Fig. 1A.

The  $V-I$  characteristic of each n-region with respect to common point is shown in Fig. 1B. Proper signal levels and the negative resistance region of each section are used to switch the operating point from  $H$  to  $L$ . The load lines can be adjusted to any operating point on the high positive resistance region depending on the required sensitivity. The number of junctions can be increased to a desired number depending on the conversion efficiency.

By adjusting the input biases and the load lines, it is possible to actuate each section with a different voltage level. For example, unit 1 may be turned on to its  $L$  level with lowest information available, whereas unit 3 requires the highest actuat-

ing signal. Thus, depending upon the amplitude of the information, a certain number of sections can be actuated. If all the sections are at high current level, the information has reached its peak. The information across  $R_1$ ,  $R_2$  and  $R_3$  is recovered by feeding it to flip-flop stages. Such a structure can be used also as a voltage comparator. For example, if unit 2 is turned on, the signal is less than  $\Delta V_3$  but higher than  $\Delta V_2$ . Improved performance can be obtained by isolating each diode section by a diffusion layer as shown by dotted lines in Fig. 1A.

**Tunnel Diodes**—A circuit that can be used as an analog-digital converter or as a voltage comparator is shown in Fig. 2A. The number of tunnel diodes connected in series depends on the required conversion efficiency.

The combined  $V-I$  characteristics of the tunnel diodes is shown in Fig. 2B. Initially, the load line rests on point  $A$ . A pulse applied to point  $S$  (Fig. 2A) assuming it is high enough, will shift the load line parallel to itself up to point  $D'$  because the apparent supply voltage across the tunnel diodes has increased. As soon as the pulse dies out, the load line has to return to its initial position  $A$ . In returning to its original state the load line follows

the path shown in Fig. 2B and the output voltage at point  $N_1$  (Fig. 2A) has the shape shown in Fig. 2C.

Once the load line arrives at point  $D'$  it may shift the first flip-flop stage. The voltage drop at point  $N_2$  is less by the amount of drop across  $T_1$  ( $T =$  tunnel diode). Thus the second flip-flop stage may be adjusted to change state once the second tunnel diode is actuated. Following the same reasoning the voltage at point  $N_3$  is less by the amount of drops across  $T_1$  and  $T_2$ . Thus the third flip-flop stage may be adjusted so that it flips when the load line arrives at point  $C'$ . For the largest signal available, all tunnel diodes are actuated so all flip-flop stages are in their high voltage states. The capacitors provide d-c isolation of the tunnel diodes from the flip-flop stages.<sup>1</sup> Such a circuit can be used also as a voltage comparator.

**Surface-Controlled Devices**—With the introduction of the planar diffused structures, the  $\text{SiO}_2$  layer on these devices gained considerable importance. In his articles<sup>3,4</sup> Sah introduced the idea of utilizing such devices and explained the basic theory underlying the operation of such structures. For example, an oxide layer on top of the emitter-base junction of a transistor may be used as a fourth terminal to control some important properties of the transistor. This control terminal has a high input impedance, the resistance being in the order of  $10^{14}$  ohms, and a shunting capacitance of around  $10 \mu\mu\text{f}$ . The oxide layer introduces an inversion layer on the structure between emitter and base. Normally the emitter extends into the base re-

---

## MOLECULAR BLOCKS

The concept of transferring circuit elements to an integrated block is not always the best method of approach. On the other hand, the utilization of unique semiconductor properties to realize required functions potentially simplifies design, increases reliability and reduces the size and cost of such blocks

---



gion as seen in Fig. 3A. Use of this oxide layer improves the gain-bandwidth ( $\omega\beta_0$ ) of the transistor.

**Operation**—By applying a fixed bias between the oxide layer and the emitter in the polarity shown in Fig. 1A, two basic improvements are introduced in the transistor operation. The transport factor is improved and the surface defects are reduced. Improvement of the transport factor leads to high  $\beta_0$  and the reduction of surface defects improves the leakage as well as the current gain at low levels.

An attenuation versus frequency plot has been run on a typical transistor with the result of over 20 percent improvement in the  $\omega\beta_0$  value, with an application of six volts between the control grid and the emitter. Higher improvements can be achieved by optimizing the operating bias voltage.

**Memory Device**—This structure has a long storage time and is shown in Fig. 4A. The device works as follows. The transistor, without any control bias, operates under its normal mode with a given voltage gain and current gain. If a pulse of the polarity shown in Fig. 4A is applied between the grid and the emitter, the current gain of the stage increases, increasing the output voltage at point A, as shown in Fig. 4B.

The oxide layer is composed of a capacitance shunted by a high resistance, so it has a high time constant, so it has a high time constant. The resistances measured were higher than  $10^{14}$  ohms. Owing to this high time constant, the charge created on this oxide remains for a long time, keeping the gain high. Measurements were made using a typical structure with a time constant of over 40 minutes. The increase of gain, at 2  $\mu$ amp base current, with an application of 6 volts, was over 22 percent. The advantages of such a device are: (1), the device itself has gain so that information recovery is easy. Thus the variation can be amplified without necessitating any high quality low level amplifier; (2), the change in the output level is pro-

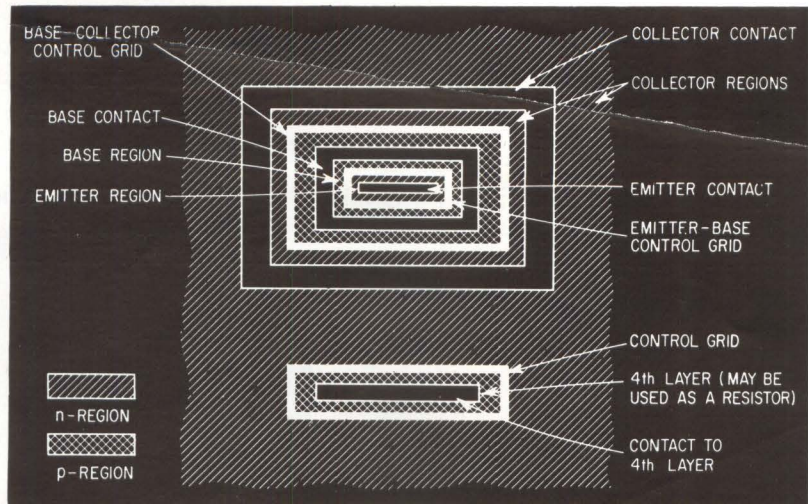

OXIDE-COATED DEVICE may be used as a three terminal device with associated resistor or as a four-layer diode

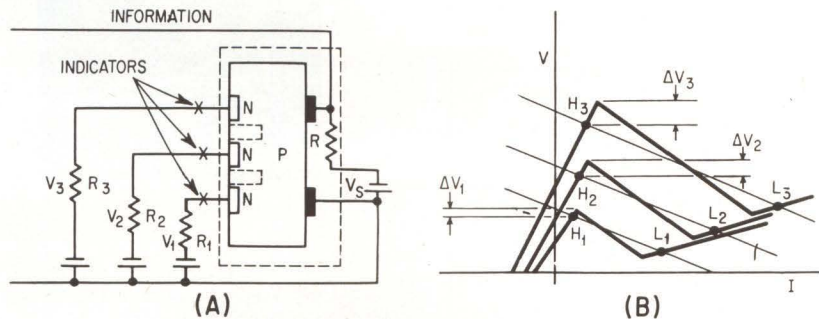

DOUBLE BASE DIODE used for a-d conversion (A) with voltage-current characteristics (B). Dashed lines connote single-chip device—Fig. 1

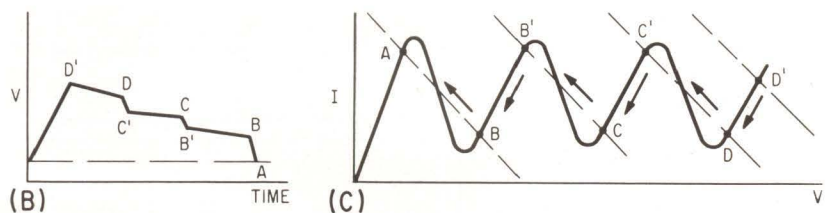
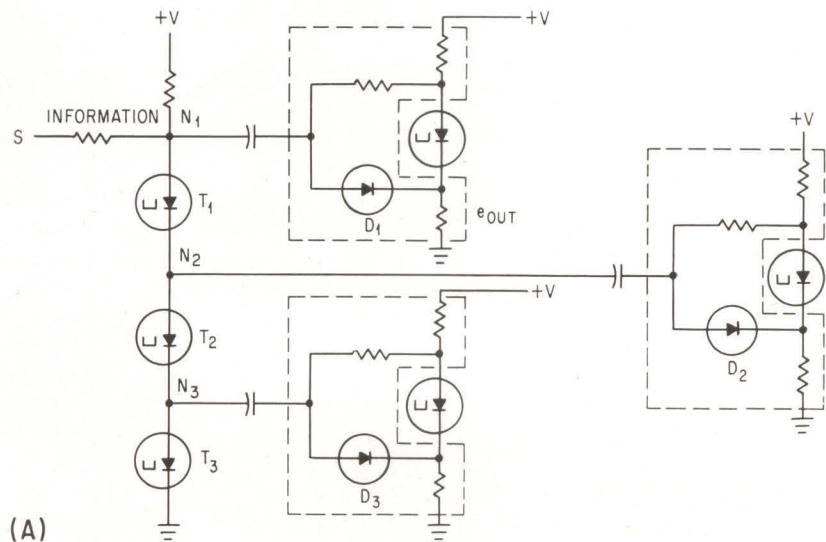

TUNNEL DIODES used for a-d conversion (A) with shape of output voltage at point N<sub>1</sub> (B) as load line returns to its original state (C)—Fig. 2



portional to the pulse level so information on the magnitude of the applied signal is present; (3), if power fails the information is stored; (4), the input impedance is high so it does not load the source; (5), it can be used as a polarity sensing element since reverse polarity across

points *G-E* reduces gain. Thus the polarity of the signal applied to the gate can be determined from the variation of gain.

**Multistable Device**—The oxide controlled device can be used also as a multistable device. This device

is unique in its performance since no other single active element exists that has more than two stable states. Moreover, it is as unilateral as any other two-stage device that performs bistable operation. From the point of stability and transient considerations, it offers a great advantage as there is no negative resistance region. Such a device operates as follows. Suppose the device rests on its high-voltage state *R* as shown in Fig. 4B. If a pulse of the polarity shown in Fig. 4A is applied between emitter and the oxide layer, the gain of the transistor increases as explained for the memory device. Thus the operating point rests on *M*. If another pulse of the same polarity is applied to the terminals and the gain is high enough ( $i_b \beta R_L > V_{cs}$ ) the transistor will be shifted to its saturation state *S*.

To bring the device back to its original state *R*, it is necessary to apply a pulse of the opposite polarity between the terminals. For such an operation the driving source must have a high impedance so each time the pulse is applied more charge is stored on the oxide layer. A capacitor can be inserted between the gate and the source to drive the device with a narrow pulse. Thus the discharge path is blocked and the driving source resistance is not critical. The time constants are expected to be in the same order as for the memory device. By proper adjustment of the oxide thicknesses, the time constants can be increased to over an hour.

**Transducer**—The operation of such a device can be explained using the circuit shown in Fig. 5A. If a capacitance is connected between the grid and the emitter and a voltage is applied across the capacitance, there will be a charge distribution across the capacitance and the oxide layer. Changing the value of *C* will result in the variation of the applied voltage across the oxide layer or grid. For effective operation the circuit shown in Fig. 5B must be used.

Any change in the transducer state, such as a piezoelectric or capacitive effect, will change the potential applied across the grid and emitter resulting in the change of gain. Also, if reasonable transconductance can be achieved between

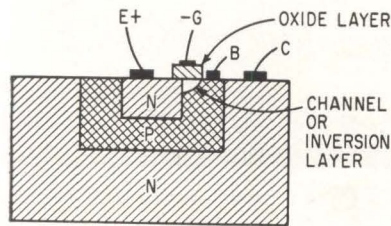

(A)

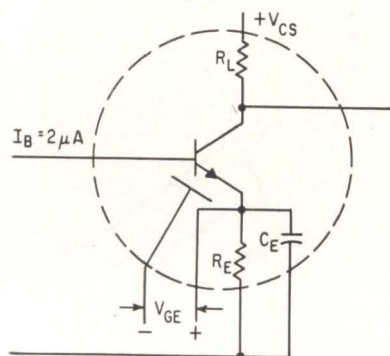

(B)

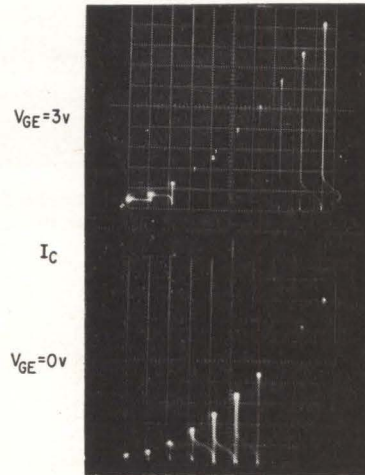

SCALES  
VERT 10 μA/DIV  
HORIZ 1 μA/STEP

(D)

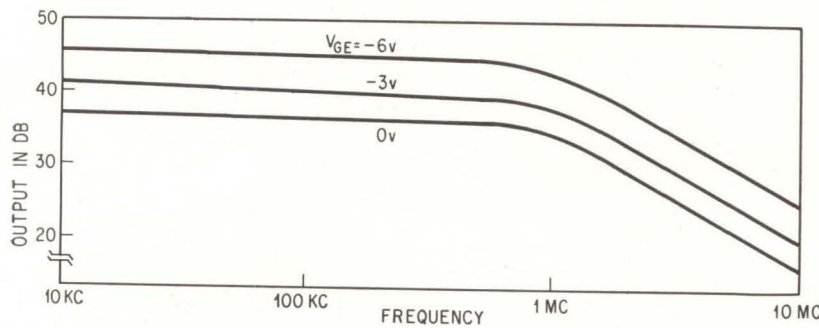

(C)

**SURFACE-CONTROLLED DEVICE** shows oxide inversion layer (A) used in a circuit (B) to improve  $\omega_p \beta_0$  (C) with  $I_C$ - $I_B$  characteristics (D)—Fig. 3

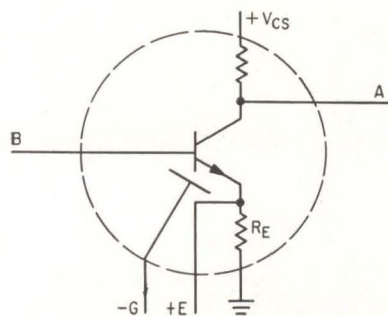

(A)

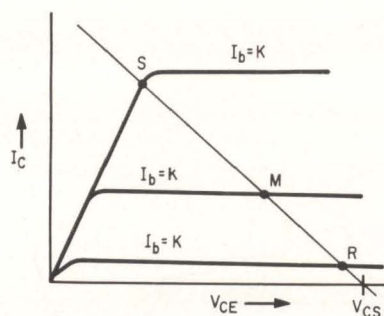

(B)

**MEMORY DEVICE** (A) uses oxide layer to provide long storage time with *V-I* characteristics (B)—Fig. 4.



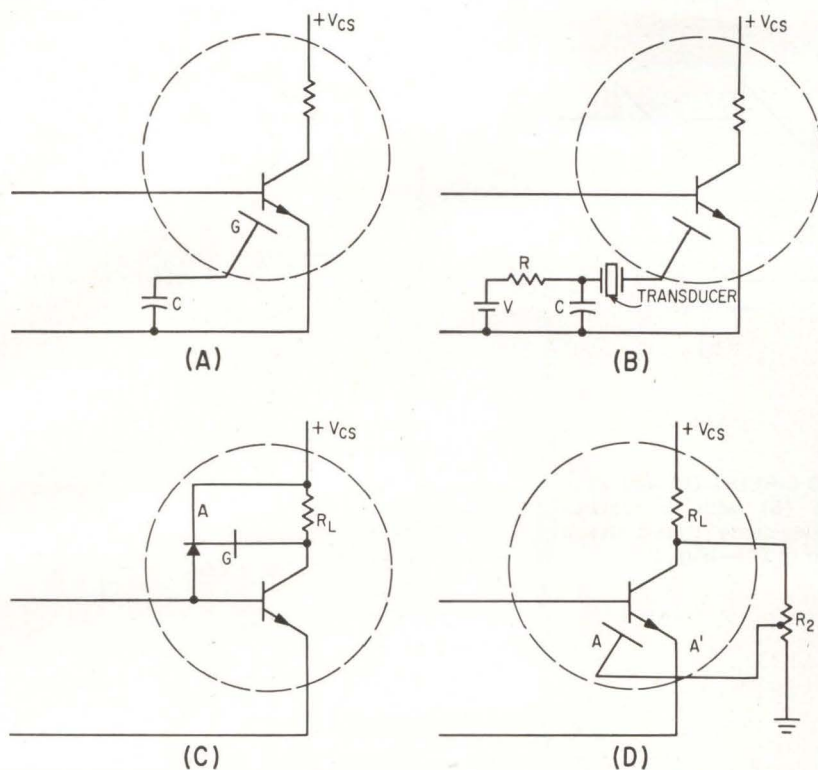

THE SIMPLE TRANSDUCER circuit (A) must be connected (B) for effective operation. The surface-biased controlled diode (C) stabilizes the transistor (D)—Fig. 5

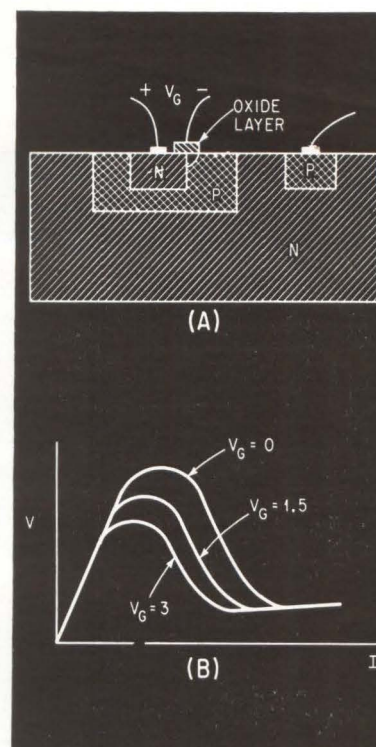

THE FOUR-LAYER DIODE (A) uses the oxide layer to control V-I characteristics (B)—Fig. 6

the grid and the output, the same structure can be used as a frequency discriminator at low frequencies.

**Grid-controlled Diode**—A simple junction with a control grid on it may be used effectively in biasing and temperature stabilizing transistor stages. Figure 5C shows a transistor stage with a surface-biased controlled diode connected between the power supply, base and collector of a *npn* transistor.

The diode with a given inversion layer and polarity will supply a biasing current to the transistor. A change in the direct voltage across  $R_L$  owing to the change in temperature will change the voltage across the grid and point A accordingly. If the right inversion layer is formed and the voltage across  $R_L$  is in proper level, an increase of voltage across  $R_L$  will cause a decrease in the inversion layer voltage and thus, a decrease in the biasing current. This is an effective means of stabilizing the transistor against collector current ( $I_c$ ) variations.

A diode with the right transconductance must be used to compen-

sate in the required level for  $I_c$  variations. The circuit shown in Fig. 5C suggests a means of adjusting the impedance level of a transistor stage. For example, if the grid is returned to a variable voltage source, it is possible to operate the transistor at desired impedance level by varying the voltage across the grid and one layer of the diode. This procedure offers the useful advantage of not degrading the input impedance of the transistor by external biasing elements. A transistor and a typical diode with a control element has been used for this purpose. Application of 6 volts across the grid and one layer of the diode increased the impedance level from 10,000 to 90,000 ohms.

**Temperature Stabilization** — The control oxide on a transistor can be used as a temperature compensating element (Fig. 5D), where the gate lead is tapped to the shunting load resistor  $R_2$ . An increase of temperature will increase  $\beta$ , the current gain of the transistor, and consequently the collector current. Thus the potential drop between points A-A' increases in the positive

polarity, tending to decrease the gain.

**PNPN Switch**—If a control grid, using an oxide layer, is introduced in the four layer diode shown in Fig. 6A, it is possible to have a control on the V-I characteristics of the device as shown in Fig. 6B.

This device has an apparent advantage over the normal *pnpn* controlled device, because it does not load the control source. Also, there is an isolation between the source and the load.

The author is grateful to P. Koenig for performing the experiments and offering suggestions during discussions, also, to R. P. Donovan for fabricating such devices and introducing information.

## REFERENCES

- (1) Vasil Uzunoglu, A new look at negative resistance devices, *ELECTRONICS*, p. 35, March 8, 1963.
- (2) Vasil Uzunoglu, Circuits using tunnel diode flip-flops and *pnpn* diodes, *IRE Trans. on Electronic Computers*, Vol. EC-11, Dec. 1962.
- (3) C. T. Sah, New semiconductor tetrode—the surface potential controlled transistor, *Proc IRE*, p 94, Jan. 1962.
- (4) C. T. Sah, Effect of surface recombination and channel on *pn* junction and transistor characteristics, *IRE Trans. on Electron Devices*, p 94, Jan. 1962.



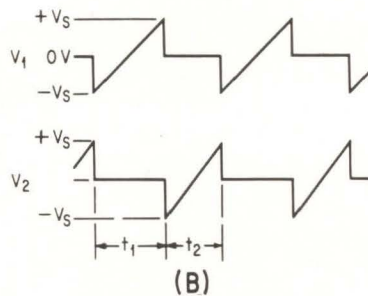
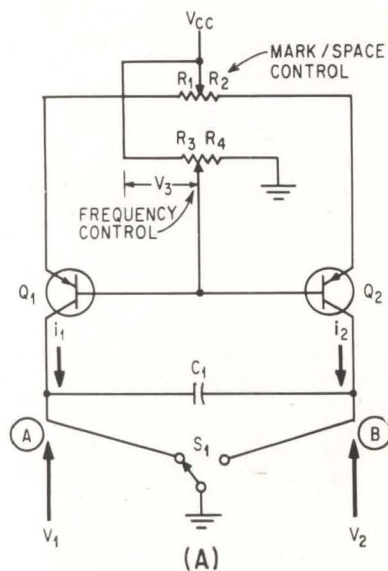

BASIC CIRCUIT (A) and waveforms (B) with a practical Shockley-diode circuit design shown in (C)—Fig. 1

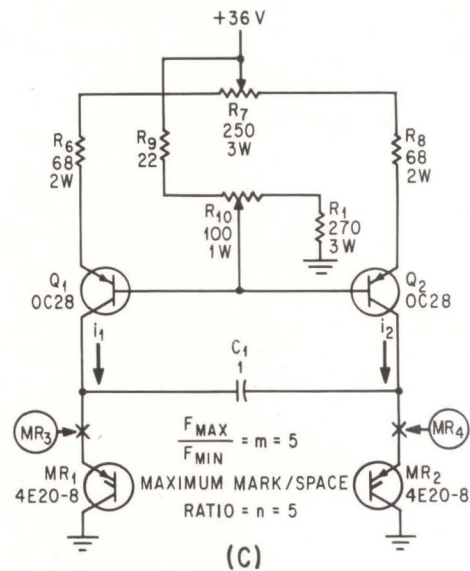

## Novel Multivibrators Test Tape

Design data for three multivibrator circuits in which frequency is independent of mark/space ratio. Frequency may be changed over a 15:1 range and mark/space ratio changed from 1:15 to 15:1

By C. J. DAKIN, Weybridge, Surrey, England

**DURING DEVELOPMENT** of electromagnetically operated vacuum switches for a vacuum capstan tape transport, the need arose for a waveform generator in which frequency and mark/space ratio were independently variable. This allowed many of the switch and capstan parameters to be more readily measured. For example, the acceleration of the tape can be examined at fixed operating rates, and various on/off ratios for the vacuum switches. Then, the converse relationships may be examined without having to calibrate each relative setting of the frequency and mark/space controls.

The circuits described have these required properties. The most complex circuit allows changes in frequency of 15:1 as the mark/space ratio is changed from 1:15 to 15:1.

**Operation**—The operation of the circuit in Fig. 1A is as follows. As  $S_1$  grounds point B,  $i_1$  charges  $C_1$ . When  $V_1$  reaches a value of  $+V_s$ ,  $S_1$  changes over and now grounds point A. This drives point B to  $-V_s$  and  $C_1$  is now charged by  $i_2$ . When point  $V_2$  reaches  $+V_s$ ,  $S_1$  changes over again. Point A is now driven to  $-V_s$

and the cycle is completed. Waveforms are shown in Fig. 1B.

The timing equations assuming ideal transistors are,  $\alpha = 1$ ,  $V_{be} = 0$ ,  $i_{cbo} = 0$ :

$$t_1 = \frac{C_1 2V_s}{i_1}, \quad \text{and} \quad t_2 = \frac{C_1 2V_s}{i_2} \quad (1)$$

Where frequency

$$f = \left( \frac{1}{C_1 2V_s} \right) \left( \frac{1}{R_1 + R_2} \right) \left( \frac{R_3}{R_3 + R_4} \right) V_{cc} \quad (2)$$

and where mark/space ratio

$$(n) = \frac{t_1}{t_2} = \frac{i_2}{i_1} = \frac{R_1}{R_2} \quad (3)$$

From Eq. 2 the frequency can be varied by changing  $R_3/(R_3 + R_4)$ , that is, by varying  $V_3$ . This does not upset the mark/space ratio which is dependent only on  $R_1$  and  $R_2$ .

From Eq. 3, the mark/space ratio can be varied by changing the ratio of  $R_1$  to  $R_2$ . Frequency will not vary provided sum of  $R_1$  and  $R_2$  is kept constant.

**Shockley Diode Circuit**—A practical circuit is shown in Fig. 1C. Design formulae are given in the box. The change-over switch is made from two Shockley



## SYMBOLS AND DEFINITIONS

$C$	Capacitance
$f$	Frequency
$i, I$	Current
$i_b, I_b$	Base current
$i_c, I_c$	Collector current
$I_{hx}$	Maximum holding current
$g, k$	Constants
$m$	Ratio, maximum to minimum frequency
$n$	Mark/space ratio
$P$	Power
$R$	Resistance
$t_1, t_2$	Parts of cycle time
$\tau$	Stored base charge time constant
$V_b$	Base voltage
$V_{cc}$	Supply voltage
$V_{ce}$	Collector to emitter voltage
$V_{be}$	Emitter base voltage, loop gain of network equals unity
$V_{be ON}$	Emitter base voltage, transistor saturated
$V_{rb}$	Reverse breakdown voltage for a Shockley diode
$V_s$	Striking voltage for a Shockley diode
$\alpha$	Transistor current gain, grounded base
$\beta$	Transistor current gain, grounded emitter
Suffix $n$	Minimum
Suffix $x$	Maximum

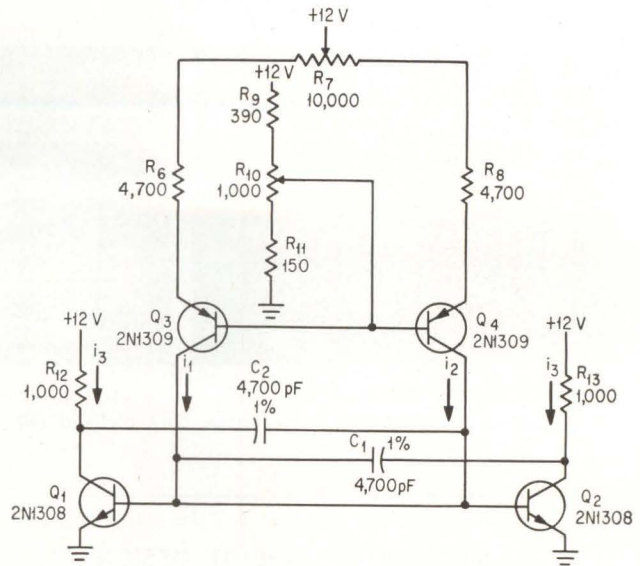

ALL-TRANSISTOR circuit is conventional astable multivibrator with timing resistors replaced by adjustable constant-current sources—Fig. 2

# Transports

diodes ( $MR_1, MR_2$ ). With  $MR_1$  conducting, the voltage drop across it is only about 1-volt provided the current through it is greater than the maximum holding current  $I_{hx}$ . The left hand side of  $C_1$  is therefore clamped at +1 volt. The right hand side of  $C_1$  has been driven negative, as  $MR_1$  switched on, and is charged positively by  $i_2$ . This produces a linear rise of voltage at the anode of  $MR_2$  until the voltage reaches the striking voltage,  $V_s$ , of  $MR_2$ . When this happens  $MR_2$  turns hard on, switches  $MR_1$  off and drives the left hand side of  $C_1$  to  $-V_s$  volts. Thus  $I_1$  now charges  $C_1$  in the reverse direction until the anode of  $MR_1$  reaches  $V_s$ . At this point  $MR_1$  strikes, the cycle is completed and a new cycle starts.

**Disadvantages**—If the reverse voltage rating of the diodes,  $V_{rb}$ , is less than  $V_s$  then additional diodes,  $MR_3$  and  $MR_4$ , must be added to handle the excess voltage. This increases the voltage drop when diodes are conducting. Due to the high value of  $I_{hx}$ ,  $i_1$  and  $i_2$  can be high and so the power in  $Q_1$  and  $Q_2$  can be high. Frequency is dependent on the supply voltage (Eq. 2). The frequency varies with mark/space ratio if the breakdown voltages are different for the two diodes

$$\Delta f = \frac{\Delta v(n-1)}{n+1+\Delta v} \quad (4)$$

Where  $\Delta v$  is the fractional difference between the striking voltages for the two diodes. Also, the output waveform often has to be reshaped.

**Performance**—Deviations from ideal waveforms are

## SHOCKLEY DIODE CIRCUIT DESIGN

Circuit parameters Fig. 1C:  $f_{max} = 700$  cps

$$n = 5; \quad m = 5$$

$$V_{cc} = 36 \text{ v}$$

Choose Shockley diode with  $V_s = 36$  v: Type 4E20-8

has a

$$V_s = 20 \text{ v nominal}$$

$$I_{hx} = 15 \text{ ma at } 25 \text{ C}$$

$$I_{fx} = 150 \text{ ma d-c}$$

Transistor type is 0C28 with  $\beta = 60$  typical at

$$I_c = 200 \text{ ma}$$

Design of Constant Current Sources  $i_1$  and  $i_2$ :

Let  $(i_1 = i_2)_{min} = 20 \text{ ma}$ , that is  $> I_{hx}$ , and  $i_f(\text{peak}) = 180 \text{ ma}$ . This has a mark/space ratio of 1:5 and is acceptable as  $i_f(\text{avg.})$  will be much less than 150 ma.

$$R_6 = R_8 = \frac{V_{cc} - 1.2V_s - V_e}{i_{IX}} = 75, \text{ say } 68\text{-ohms}$$

$$R_7 = R_6(n-1) = 272, \text{ say } 250\text{-ohms}$$

For  $R_9, R_{10}, R_{11}$  the aim is to make output resistance of potential divider about 5-percent of minimum input resistance of  $Q_1$  and  $Q_2$

$$R_{10} \cong \left( \frac{\beta R_6 n}{10(1-n)} \right) \left( \frac{(V_{cc} - 1.2V_s)(m-1)}{(m)(V_{cc})} \right)$$

where  $n = \frac{f_{max}}{f_{min}} \cong 91$ , say 100-ohms

$$R_9 = \frac{R_{10}}{(m-1)} = 25, \text{ say } 22\text{-ohms}$$

$$R_{11} = \frac{(R_9 + R_{10})1.2V_s}{V_{cc} - 1.2V_s} = 243, \text{ say } 270\text{-ohms}$$

$$C = \left( \frac{V_{cc}}{f_{max} 2V_s} \right) \left( \frac{1}{2R_6 + R_7} \right) \left( \frac{R_9 + R_{10}}{R_9 + R_{10} + R_{11}} \right) = 1.24, \text{ say } 1\text{-}\mu\text{f}$$



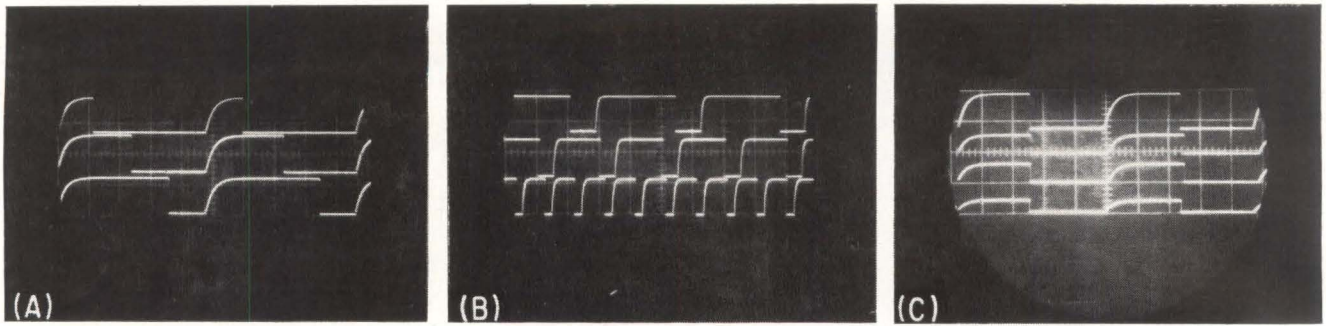

MULTIVIBRATOR collector waveforms for three setting of mark/space control with frequency fixed (A); for three settings of frequency control, with mark/space control fixed (B); and for four supply voltages, 24,12,6, and 2-volts (C)—Fig. 3

### ALL-TRANSISTOR CIRCUIT DESIGN

Circuit parameters Fig. 2:  $f_{\max} = 10 \text{ Kc}$ ,  $n = 3$

$V_{cc} = 12 \text{ v}$  and  $m = \text{maximum possible}$

$$R_6 = R_8 = \frac{0.9V_{cc} - V_e}{i_{IX}}$$

where  $V_e$  is the emitter-base voltage of  $Q_3$  and  $Q_4$ . For  $R_9$ ,  $R_{10}$ , and  $R_{11}$  the aim is to make the output resistance of the potential divider less than 1-percent of the minimum input resistance of  $Q_3$  and  $Q_4$

$$R_{10} \leq \left( \frac{9(m-1)\beta_{34}R_6n}{m(1+n)} \right)^{10^{-3}}$$

where  $\beta_{34}$  is the current gain of  $Q_3$  or  $Q_4$  (Assumed equal)

$$R_{11} = \frac{(R_9 + R_{10})}{9}$$

This allows 10-percent of  $V_{cc}$  as minimum collector-base voltage for  $Q_3$  and  $Q_4$ .  $R_7$  and  $R_9$  are computed as before. Transistors for  $Q_1$  and  $Q_2$  must have the following characteristics:  $V_{ce}$  (reverse bias available)  $> V_{cc}$

$V_{be}$  reverse  $> V_{cc}$

$$\beta_{\min} \geq 5.62nm \text{ (exponential } i_b)$$

or  $\geq 2nm \text{ (constant } i_b)$

$$i_b(\max) > i_b(\max)$$

Choosing types 2N1308 and 2N1309, and using a 12-v nominal supply:

$V_{ce}$	$V_{be}(\text{reverse})$	$\beta$ at	$I_c$	$i_b(\max)$
25	25	80	10 ma	200 ma

Allow 25-percent degradation of  $\beta$  with life and temperature,

$$\therefore \beta_{\min} = 60$$

For exponential recharging of  $C_1$  and  $C_2$

$$(nm)_{\max} = \frac{\beta_{\min}}{5.62} = 10.6$$

$\therefore$  if  $n = 3$ ,  $m_{\max} = 3.5$

From data  $i_{cboz} = 5 \mu\text{a}$  @ 25 C

$\therefore$  Let  $i_{in} = 200 \mu\text{a}$ , that is  $\gg i_{cboz}$

$\therefore i_{IX} = (nm)i_{in} = 2,100 \mu\text{a}$

$$R_{12} = R_{13} = \frac{V_{cc}}{i_{in}(\beta_n - n)}$$

where  $i_{in}$  is value at  $f_{\min} = 1,040$ , say 1,000-ohms

$$C = \left( \frac{1}{f_{\max}} \right) \left( \frac{1}{2R_6 + R_7} \right) \left( \frac{R_7 + R_{10}}{R_9 + R_{10} + R_{11}} \right)$$

$$= 4,670, \text{ say } 4,700 \text{ pf}$$

explained by the fact of different breakdown voltages for the two diodes. Also, changes in  $a$  and  $V_e$  with  $I_c$  for  $Q_1$  and  $Q_2$  cause  $i_1$  and  $i_2$  to deviate. The slider of  $R_7$ , the mark/space potentiometer, can short out small sections of  $R_7$ . This alters the value of  $(R_1 + R_2)$  and hence the frequency. Helical infinite-resolution wire-wound potentiometers are best in this respect.

**All-Transistor Circuit**—Some of the disadvantages of the Shockley diode circuit are overcome in the all-transistor circuit of Fig. 2. Design formulae are given in the box. The operation of this circuit is the same as that of a conventional astable multivibrator in which the timing resistors have been replaced by the two adjustable constant current sources  $i_1$  and  $i_2$ . The mark/space ratio is still given by Eq. 3, but the frequency equation is now modified to

$$f = \left( \frac{1}{C} \right) \left( \frac{1}{R_1 + R_2} \right) \left( \frac{R_3}{R_3 + R_4} \right) \quad (5)$$

Where  $R_1$ ,  $R_2$ ,  $R_3$  and  $R_4$  have the same meaning as in Fig. 1A and the striking voltage is now equal to  $V_{cc}$ .

Two special points should be noted about the circuit in Fig. 2. The use of two timing capacitors requires that while one is discharging the other must be recharging to the supply voltage. This means that the minimum discharge time must be greater than the maximum recharging time. The recharging may be exponential, as in the circuit or by constant-current sources which would replace  $R_{12}$  and  $R_{13}$ , Fig. 2. Also, the presence of a fixed collector load (to allow the recharging capacitor to recharge to  $V_{cc}$ ) implies a certain minimum base current to ensure saturation of the ON transistor. Both the above considerations lead to the requirement that:  $\beta_{\min} \geq 5.62nm$  (for  $Q_1$  and  $Q_2$ ) for exponential recharging, and,  $\beta_{\min} \geq 2nm$  for constant current recharging where  $m = f_{\max}/f_{\min}$ .

**Disadvantages**—The product  $(mn)$  is limited by the current gain of the transistors. The frequency varies with mark/space ratio if  $C_1$  and  $C_2$  are different. This effect is analogous to the difference in  $V_s$  in the Shockley diode circuit:  $\Delta f = \Delta c (n - 1)/n + 1 + \Delta c$ , where  $\Delta c$  is the fractional difference between  $C_1$  and  $C_2$ .



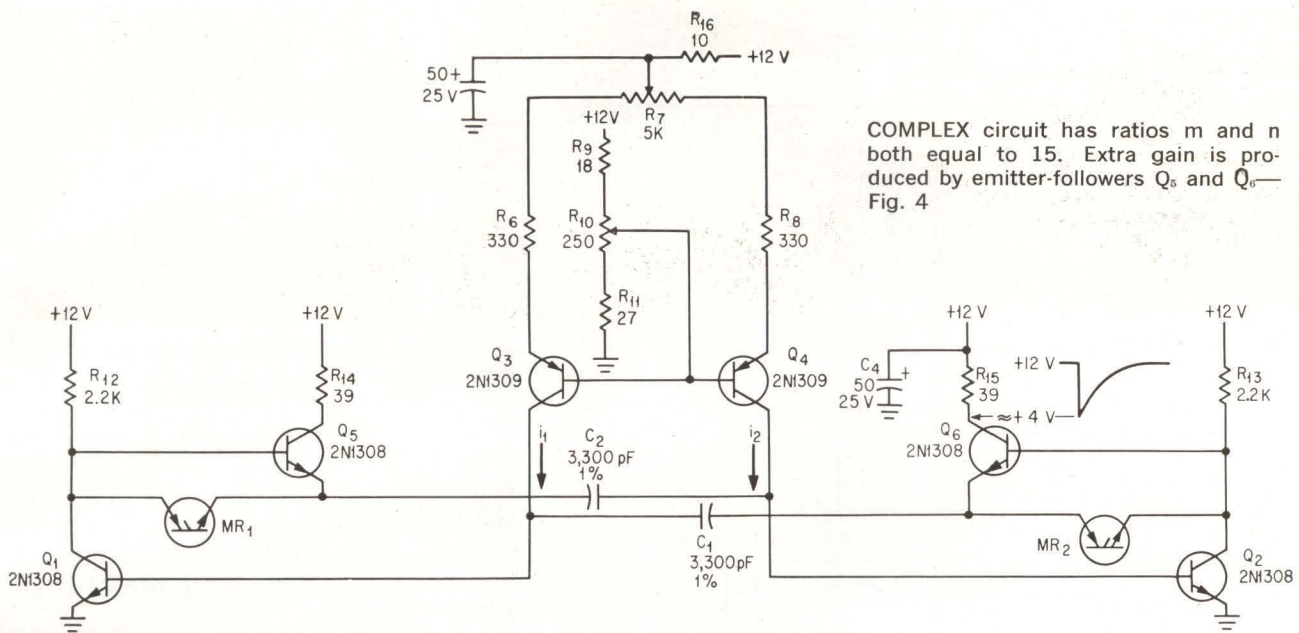

COMPLEX circuit has ratios  $m$  and  $n$  both equal to 15. Extra gain is produced by emitter-followers  $Q_5$  and  $Q_6$ .—Fig. 4

**Advantages**—Both frequency and mark/space ratio are independent of supply voltage. The power in the circuit is relatively low, and the square output waveform is generally a more useful shape.

**Performance**—Waveforms of this circuit are shown in Fig. 3A, B and C.

The deviations from the ideal are accounted for by the performance factors of the Shockley circuit and the disadvantages of the all-transistor circuit. Also,  $V_{cc}(\text{sat})$ ,  $i_{cbo}$  and the difference between  $V_{be}$  ON and  $V_{be1}$ , the base voltage at which the loop gain becomes greater than unity, lead to a step drive to the base of less than  $V_{cc}$ . This makes the frequency slightly dependent on  $V_{cc}$ . The changes in frequency are:

$$\frac{V_{cc}}{f} \left| \begin{array}{ccc} 24v & 12v & 6v \\ -1.9\% & 0 & 0 \end{array} \right. \frac{2v}{-1.9\%}$$

**Higher Values**—A more complex all-transistor circuit is shown in Fig. 4. This circuit has  $m = n = 15$ . The extra gain implied by this is given by the transistors  $Q_5$  and  $Q_6$  which are emitter-followers, providing a low-impedance path for recharging the timing capacitors (exponentially).  $MR_1$  and  $MR_2$  (OA47's) have to be added to provide a path for charging the capacitors. While limiting the recharging current  $R_{14}$  and  $R_{15}$ , also provide powerful output pulses. The design procedure for calculating the values of  $C_1$ ,  $C_2$ ,  $R_{12}$  and  $R_{13}$  is as before, but  $R_{14}$  and  $R_{15}$  are given by:  $R_{14} = R_{15} = R_{12}/\beta_{\min 56}$  where  $\beta_{\min 56}$  is min. current gain of  $Q_5$  and  $Q_6$ . The addition of  $Q_5$  and  $Q_6$  allow, in principle, an increase in frequency range,  $m$ , of up to  $\beta_{\min 56}$  or an increase in  $n$  or  $(mn)$  of something less than this. The latter amount will depend upon the values of  $n$  or  $(mn)$  chosen.

**Power Ratings**—The design procedure for the con-

stant current sources is the same as for the simpler all-transistor circuit, but it is wise in this case to check the power rating of  $Q_3$  and  $Q_4$ . For the circuit of Fig. 4,  $P_{\max}(\text{avg}) = 112$  mw. If the frequency is low, 1-cps  $> 20$ msec, then rate at  $P_{\text{peak}}(\text{max}) = 437$  mw.

**Oscillation**—At switch-on, both timing capacitors are discharged and so both  $Q_1$  and  $Q_2$  may turn-on simultaneously. This prevents oscillations from starting. If  $Q_1$  and  $Q_2$  are prevented from turning on until after the timing capacitors have acquired some charge, then it is extremely unlikely that the oscillation will fail to start. This can be done by adding the delay components  $R_{16}$  and  $C_3$  which delay  $Q_3$  and  $Q_4$  from turning on and so prevent any steady base current into  $Q_1$  and  $Q_2$  until after  $C_1$  and  $C_2$  have charged. Also,  $R_{16}$  can be replaced by a small inductance to minimize the effect upon the circuit performance.

**High-Frequency Effects**—At maximum frequency and mark/space ratio settings of the controls, the stored charge in the base of one transistor may become significant with respect to the charge available from the timing capacitors. When this happens there is an effective reduction in the expected time for the capacitor to charge and hence an increase in frequency. For high-frequency circuits transistors must be chosen which have low values of  $T_s$ . Other limits to high-frequency performance are the usual ones of collector capacitance, loss of gain at high frequencies, and stray capacitance effects.

The author thanks the directors of Decca Radar for permission to publish this article.

#### REFERENCES

- (1) R. C. Bowes, A New Linear Delay Circuit Based on An Emitter Coupled Multivibrator, Proc. I. E. E. Convention on Transistors and Associated Semiconductor Devices, May, 1959.
- (2) R. B. Hurley, Junction Transistor Electronics, Wiley 1958. Para. 21.3.



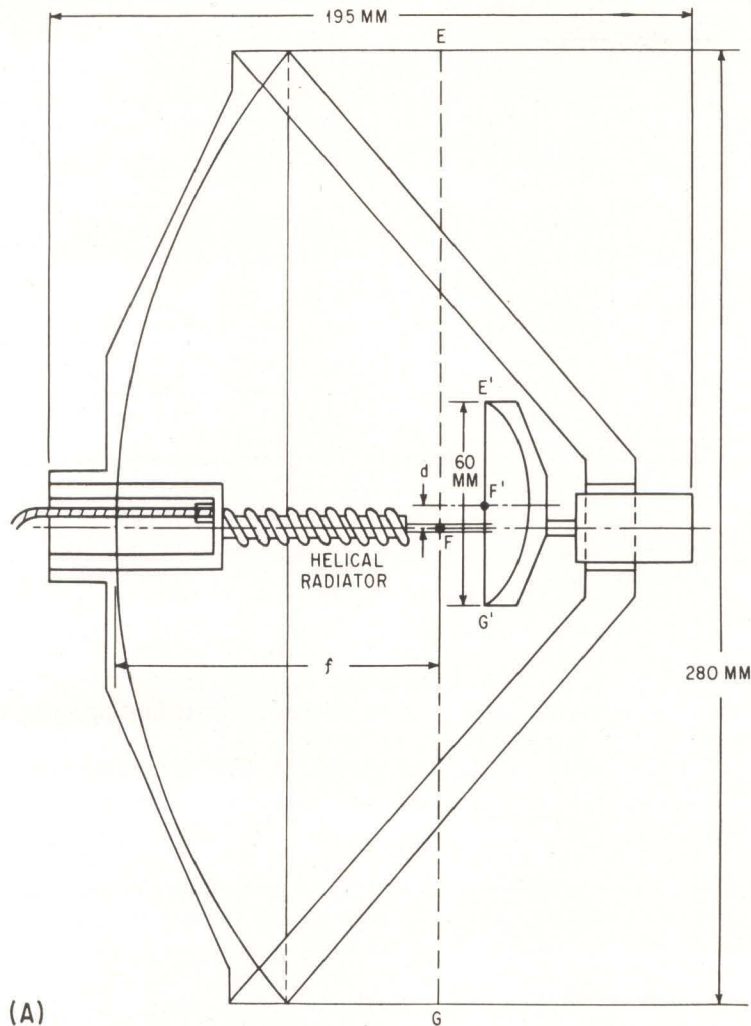

(A)

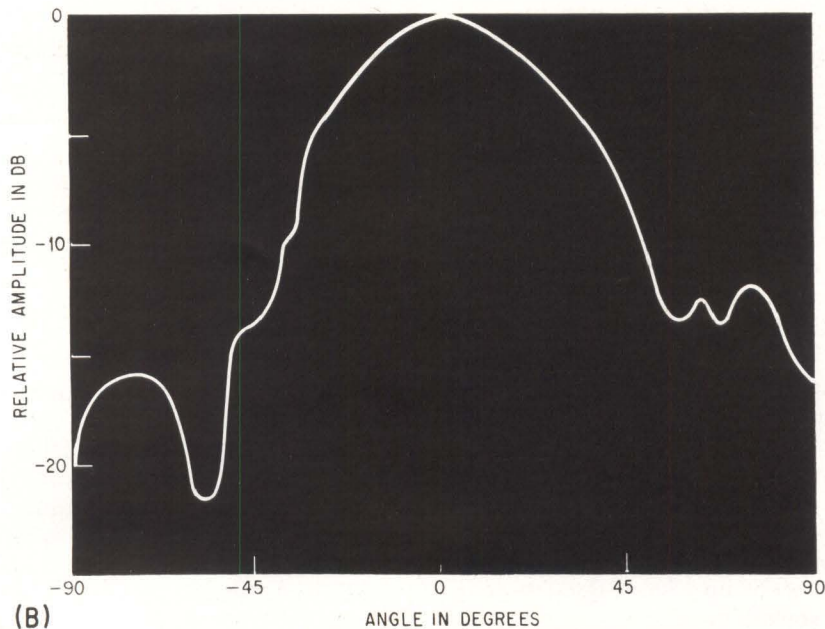

(B)

DIAGRAM illustrates method used to accomplish circular scanning. The diameter of the passive subreflector is 60 mm as compared to 280 mm for the main parabola (A), and directivity curve for the helical radiator (B)—Fig. 1

Circularly polarized scanning beam is produced by a small subreflector mounted at the focal point of a larger parabola. Circular radiation is obtained from a helical source at the apex of the main dish

## ROTATING

**MANY TYPES** of conical scanning antennas have been developed for homing and tracking. However, these often have various unfavorable characteristics such as a requirement for a rotary joint in the feed system or extended feeders.

This research was aimed at designing a conical scanning antenna from which the usual weak points are excluded. This unit is a circularly polarized, conical scanning antenna with rapid scan rate, no rotary joint in its feed system, and as short of a feedline as possible. In addition, the bulk of the structure has been reduced considerably.

The array developed consists of a helical antenna, a paraboloid subreflector, and a paraboloid main reflector. Analysis of the operation of this system has been performed with semi-optical approximation.

**Operation**—The antenna described is shown in Fig. 1. The paraboloid subdish is placed face to face with the main paraboloid dish at the latter's aperture. Theoretically, the focal plane  $E'F'G'$  of the sub-dish is centered in the focal plane of the



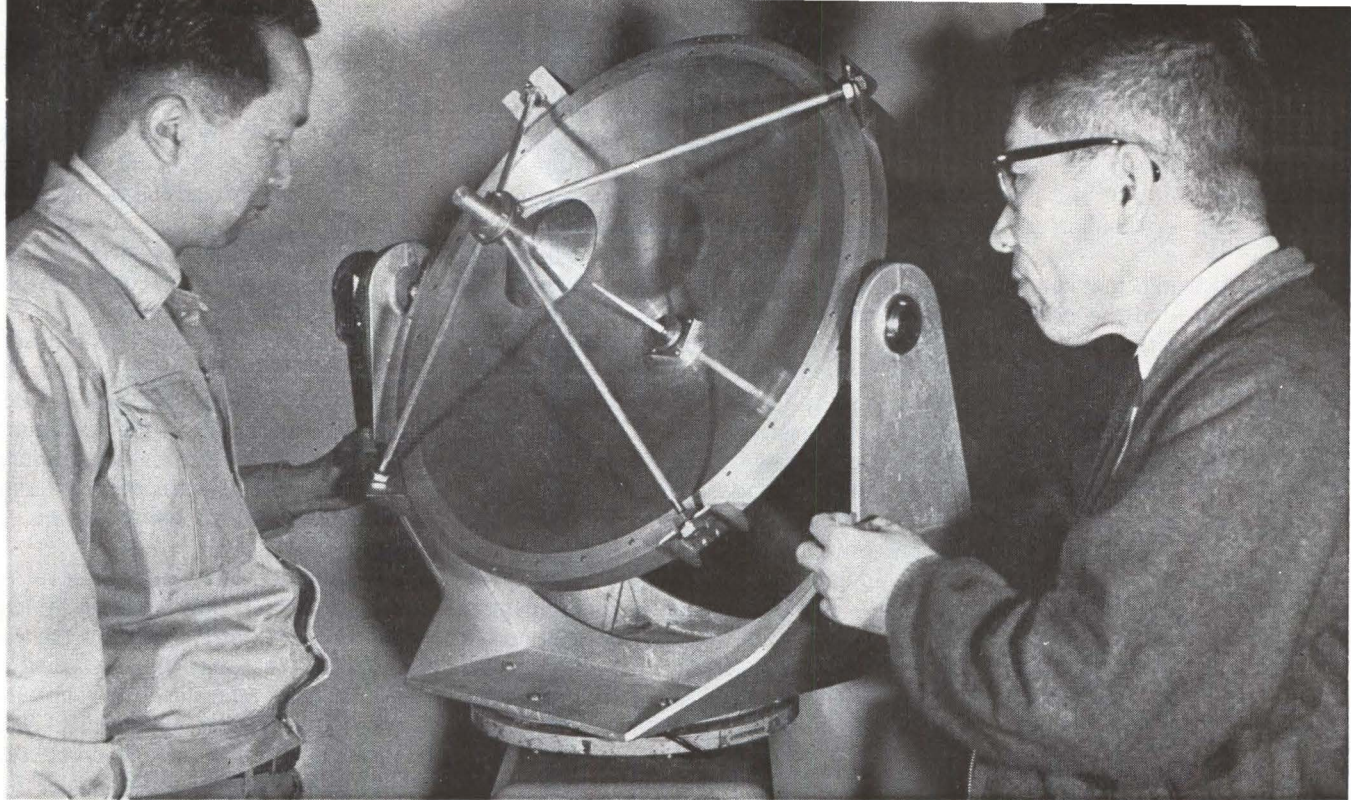

## SUBREFLECTOR Produces Circular Scanning

By S. TANAKA and S. OKAMURA, Central Research Laboratory, Shibaura Electric Co., Ltd., Tokyo, Japan

main paraboloid. The focal points of both the main and sub-dish are shown as  $F$  and  $F'$ . The helical antenna is designed to operate in the axial mode, and is mounted at the vertex of the main dish with its axis placed along the principal axis. The end of the helix is located relatively close to the sub-dish. Power is fed to the base of the helix through a short coaxial line.

Recently developed microwave antennas with double reflectors are almost all of the Cassegrain type.<sup>1,2</sup> Although this antenna also has two reflectors, it is not Cassegrainian, but may be considered a modified Gregorian.

The helical antenna excited in the

axial mode produces a circularly polarized wave along its axis, and the wave front can be assumed to be plane in its near field. As the sub-dish is placed close to the end of the helix, it is illuminated with a plane wave front by the helical antenna. Therefore, the wave radiated from the helical antenna is converged into the focal point  $F'$  of the sub-dish, while the focal point  $F'$  acts as the primary source for the main dish. More simply, the main dish is excited by the primary source, which is generated at the focal point of the sub-dish.

An endfire antenna such as a helical excited in the axial mode has an equivalent aperture in its near

field. The area of this equivalent aperture may be easily estimated from the far-field pattern of the antenna.

The optimum diameter of the sub-dish should be equal to that of the equivalent aperture of the helical antenna to reduce to minimum masking and spill-over effects at the edges of the sub-dish.

If the focal points of both dishes coincide, a pencil beam is radiated along the principal axis of the main dish. If the sub-dish is defocused, or rather if the focal point  $F'$  of the sub-dish is displaced by  $d$  from focal point  $F$  of the main dish perpendicularly to the principal axis of the main dish (whose focal length is  $f$ ), the radiated beam will be tilted by  $\phi$  radians.

The relation between the defocusing angle  $\theta = \tan^{-1}d/f$  and the beam tilt angle  $\phi$ , and the deterioration of the directivity pattern as the result of defocusing, have been also investigated with semi-optical approximation.

When the sub-dish is defocused, the phase distribution in the aperture does not remain uniform, but

---

### GOODBYE TO ROTARY JOINTS?

Conventional scanning antennas require either a rotary joint that can be both an electrical and a mechanical weak spot or some means of varying feedline length to achieve scanning.

In this article, the authors describe a simple antenna that achieves a circularly polarized conical scan at a high scanning rate. Moreover, this system appears to lack the Achilles heel of its conventional counterparts since the radiator remains in a fixed position



becomes a cubic distribution. According to calculations, the phase differences between the edges and the central point of the main dish are less than  $\pi/4$  radian in the test antenna.

By defocusing the sub-dish and rotating it around the principal axis of the main parabola with a small motor, the focal point of the sub-dish (the primary source of the main dish), moves circularly around the focal point of the main dish. Consequently, conical scanning with a rapid scan rate is accomplished.

**Performance**—To check the design principles, some experiments were performed. The main experiment involved investigating the radiation pattern of the antenna system in X-band.

A paraboloid reflector was used as the main dish. Its aperture diameter was 280 mm and the focal length was 105 mm. The angle subtended by the dish at its focal point was about 135 degrees. This angle was thought to be appropriate for the operation of this system.

A 9-turn helical antenna supported with a polystyrene rod 54 mm in length and 7 mm in diameter was used as the feed. It fulfilled the conditions for the axial mode<sup>3</sup>. The far-field pattern of the helical radiator is shown in Fig. 2A. The half-power beam width was about 45 degrees.

The diameter  $D$  of the equivalent aperture of the helical antenna is estimated from the half-power beamwidth  $\psi$ , using the equation  $\psi = \kappa \lambda/D$ . By letting  $\kappa = 80$  de-

grees (value selected at will), and with  $\psi = 45$  degrees (measured value), and  $\lambda = 32$  mm, then  $D = 60$  mm. Therefore, the diameter of the sub-dish should be 60 mm.

A rod antenna excited in circular polarization may be used, rather than the helical, if desired.

A number of subreflectors varying in diameter from 40 mm to 80 mm were used in the test. After many experiments, the optimum size of the sub-dish was determined to be 60 mm. This diameter is equal to that derived from calculations.

**Side Lobes**—The side-lobe level of the double-reflector antenna system is sensitive to any change in the position of the sub-dish. The relation of the side-lobe level to sub-dish position is shown in Fig. 2B. The abscissa shows the distance between the apex of the main dish and the focal plane of the subreflector. The focal plane of the main dish lies at a point 105 mm from the vertex. Figure 2B shows that the position of the sub-dish that minimizes side-lobe level is a little farther from the focal point of the main reflector in a direction opposite to the vertex.

Theoretically, the wave front of the radiation from the helix is assumed to be purely plane in its near field. In practice, however, it is rather spherical, and the wave radiated from the helix converges on a point outside the focal plane of the sub-dish. Consequently, the optimum position of the sub-dish is slightly farther from the focal plane of the main dish.

The radiation pattern of the conical scanning antenna is shown in Fig. 3. The full line shows the pattern in the first quadrant of the conical scan and the dotted line that of the third quadrant. The half power beam width is 7.5 degrees, the beam tilt angle  $\phi$  is about 3.5 degrees, and the side lobe level is less than  $-16$  db.

The authors thank S. Mita for his encouragement.

## REFERENCES

- (1) P. Foldes and S. G. Komlos, "Theoretical and Experimental Study of Wide-Band Paraboloid Antenna with Central-Reflector Feed", *RCA Rev*, vol 21, No. 1, pp. 94-116, Mar 1960.
- (2) P. W. Hannan, "Microwave Antennas Derived From Cassegrain Telescope", *IRE Trans*, vol AP-9, pp. 140-153, Mar 1961.
- (3) L. D. Kraus, "Antennas", McGraw-Hill Pub Co., 1950.

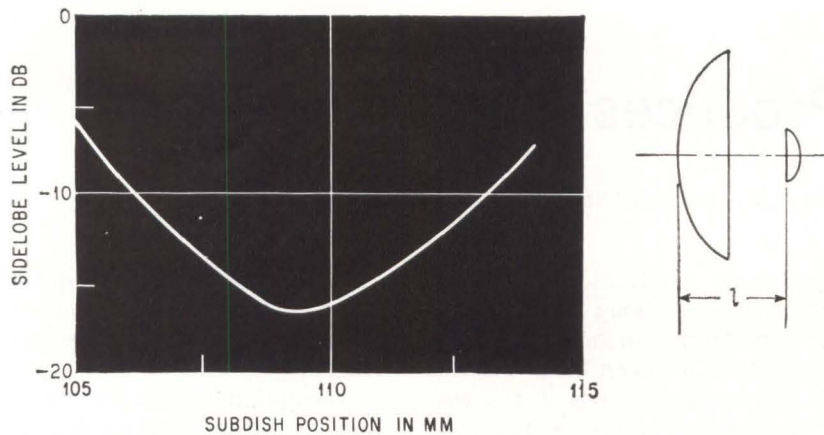

SIDE-LOBE level as a function of subreflector position—Fig. 2

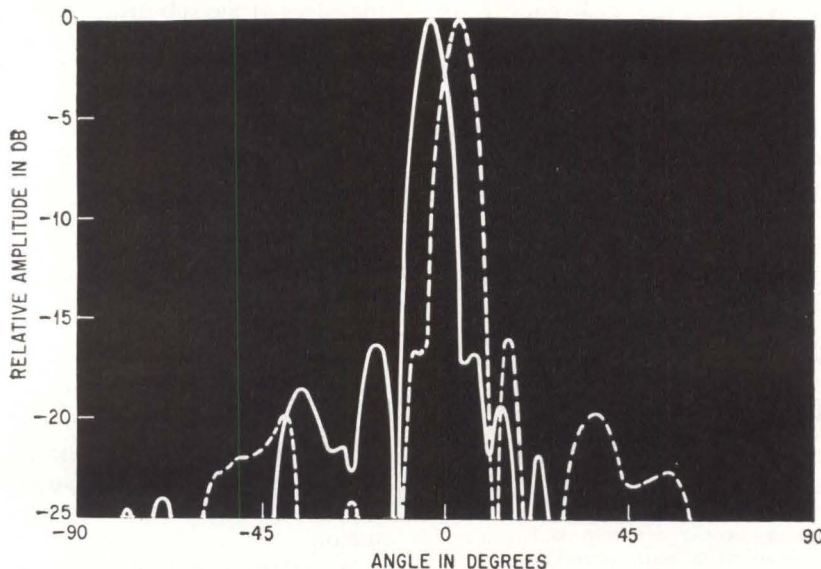

RADIATION pattern of the scanning antenna—angle in degrees versus the relative amplitude in db—Fig. 3



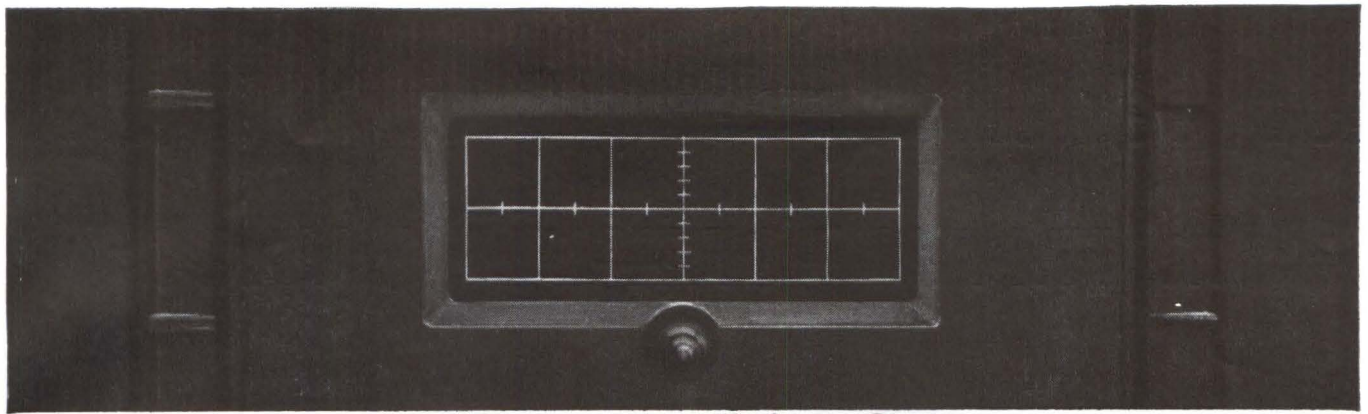

**See anything?**

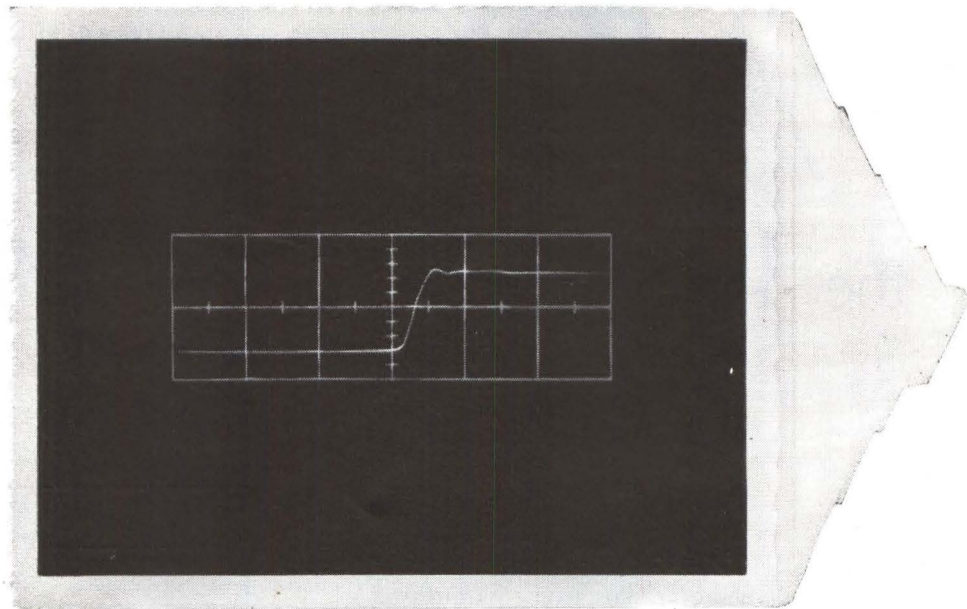

**This new film did.**

This new film saw something the eye couldn't: the rise time of a single pulse on a Textronix 519 scope at a sweep rate of 2 nanoseconds/cm. The new film, Polaroid PolaScope Land Film, actually extends the usefulness of existing oscilloscopes by supplying "brightness" that the scope hasn't got!

The reason is that this PolaScope film has an ASA equivalent rating of 10,000, which means it can see things your eye cannot. It has about twice the writing rate of the Polaroid 3000-speed film, currently the standard for

high speed oscilloscope photography. (No other commercially available films come anywhere near the speed of PolaScope film.) And because it's made by Polaroid you get a finished usable print—see above—ten seconds after exposure.

PolaScope film will also give you better shots of slower pulses and stationary waveforms. So little light is required, camera aperture and scope intensity can be reduced considerably, and that's how to get really sharp oscilloscope pictures.

And wherever else light is at a premium—such as photomicrography and Kerr Cell photography—PolaScope film will make new applications possible, old applications more useful.

PolaScope Type 410 Film is packed 12 rolls to the carton. The price is about the same as the Polaroid 3000-speed film. For the name of the industrial photographic dealer nearest you, write to Technical Sales Department, Polaroid Corporation, Cambridge 39, Massachusetts.

POLAROID®

**New Polaroid Land 10,000-speed film for oscillography**



# top performance with low voltage in FM-AM PORTABLE RADIOS



UNIFORMITY

LOW COST

CUT-OFF FREQ. 135 MC.

LOW OUTPUT CAPACITANCE

## the **HITACHI 2SA234, 2SA235** dot-mesa transistor

The HITACHI 2SA234—2SA235 are your best choice for use in many types of radios from 6 transistor pocket-portables to AM-FM stereo sets. They are germanium p-n-p dot mesa transistors with a cut-off frequency of 135 mc. Gain and S/N performance do not deteriorate at as low as 3 volts. This allows designs using as few as two standard flashlight cells, and longer effective battery life, a definite advantage over many more expensive transistor types. The very low common base output capacitance and HITACHI's careful attention to uniformity of manufacture, offer you stable, trouble free production runs of transistor radios. The performance/price ratio cannot be beat. Write us for production quantity quotations.

HITACHI	2SA234	2SA235
COLLECTOR-BASE VOLTAGE	20 V	20 V
COLLECTOR CURRENT	10 MA	10 MA
COLLECTOR DISSIPATION	80 MW	80 MW
COMMON BASE OUTPUT CAP.	2.1 pf	2.1 pf
BASE SPREADING RESISTANCE	55 $\Omega$	50 $\Omega$
CUT-OFF FREQUENCY	120 MC	135 MC
POWER GAIN	26 dB 10.7 MC	13 dB 100 MC



**Hitachi, Ltd.**

TOKYO, JAPAN

CABLE ADDRESS: "HITACHY" TOKYO

666, 5th Ave., New York 19, N.Y., U.S.A. Tel: JUDSON 6-4757  
100 California St., San Francisco, Calif., U.S.A. Tel: YUKON 1-7871

333, N. Michigan Avenue, Chicago 1, Ill., U.S.A. Tel: 726-4572/4  
Graf Adolf Strasse 37, Duesseldorf, West Germany Tel: 10846



**DON'T try  
all these tests  
on any other  
resistor!**

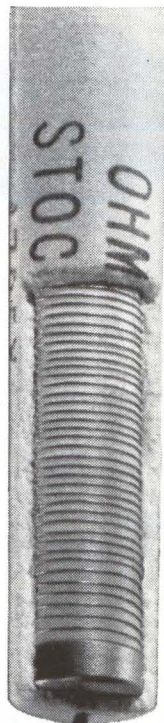

10-watt unit  
enlarged 2½ times

**OHMITE Series 99**  
Insulated, Axial Lead Wire-Wound Resistors  
"molded" in vitreous enamel  
...a new development in protective coatings.

- Proved by over 16,000,000 unit-hours of load-life testing to date.
- Meet MIL-R-26C requirements.
- 1, 2, 3, 5, 7, 10-watt sizes.
- Get the whole story on this important development. Write for Bulletin 103.

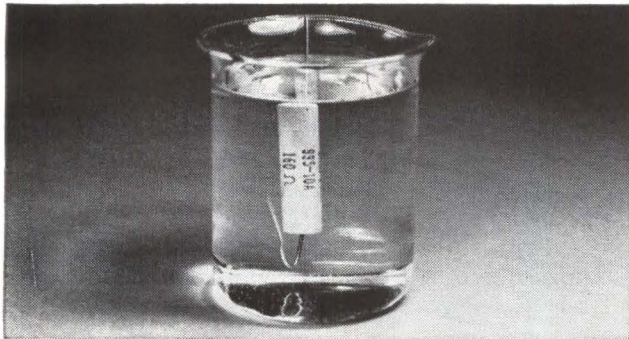

**SOAK IT IN SOLVENT!** Soak a Series 99 resistor in any organic solvent used in degreasing and flux removal. Then try to rub off the markings. You can't; they're part of the coating.

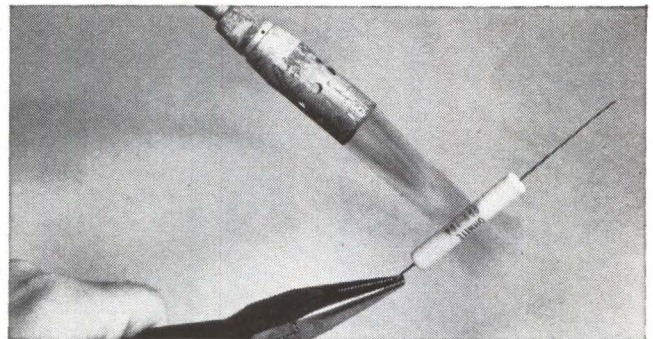

**TORCH IT!** Withstands temperatures of 1500°F without a sign of deformation. No other vitreous-enameled resistor will stand 1500°F without burning, softening, or dripping away. There's absolutely no effect on markings either.

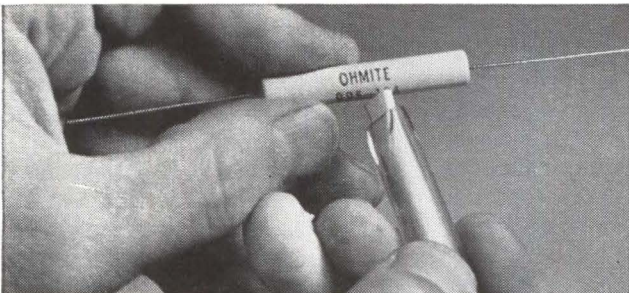

**ABRADE IT!** Use a glass fiber eraser, for example, on the markings. Rub them hard. Nothing happens. The markings don't come off, because they are vitreous ceramic, fired into the molded vitreous coating.

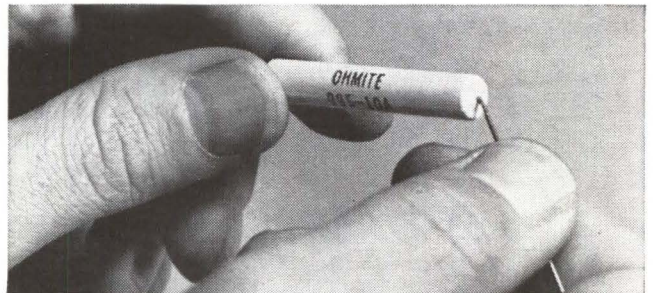

**BEND THE LEAD** at the resistor body! There's no damage. Conventional (dipped) vitreous-enameled resistors have a meniscus at this point which ruptures, damaging the coating. Series 99 (molded) have no meniscus.

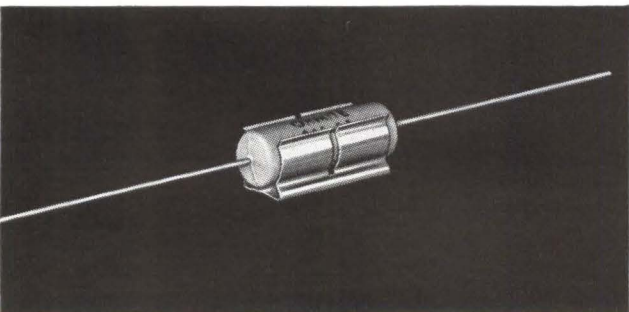

**CLIP IT!** Insert a molded Series 99 resistor into a metal clip. Don't baby it. The hard coating which provides 1000 VAC insulation won't cut, chip, or scratch. On a metal chassis, heat-sink action may increase wattage rating as much as 100%.



**OHMITE**  
MANUFACTURING COMPANY  
3610 Howard Street, Skokie, Illinois 60076  
Phone: (312) ORchard 5-2600

RHEOSTATS • POWER RESISTORS • PRECISION RESISTORS • VARIABLE TRANSFORMERS  
TANTALUM CAPACITORS • TAP SWITCHES • RELAYS • R. F. CHOKES • SEMICONDUCTOR DIODES



# Cornered by PW Assembly Problems?



## DYNASERT®

Discover how automatic inserting equipment can open new ways to profit for you. This is modern, automated component insertion. Even if your production is as little as a few hundred insertions a week, Dynasert delivers a multitude of advantages. It's high-speed: up to ten times faster than costly hand methods. It delivers uniformly high product quality. It automatically feeds, cuts, and bends leads, inserts and clinches all types of axial lead components. Requires little operator training. Changes made from one board or component type in seconds. Money saved in direct labor costs and production time can pay for a Dynasert installation in less than a year. Get complete facts. Write for a free copy of: Dynasert — Production Equipment for Electronics. Dynasert Dept. 3, United Shoe Machinery Corp., Boston, Massachusetts.



**United Shoe Machinery**  
BOSTON, MASSACHUSETTS

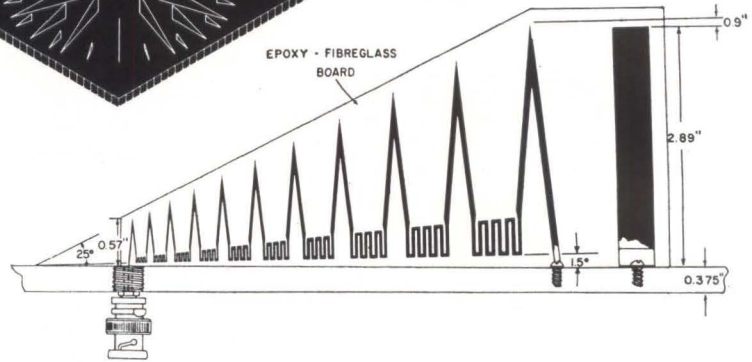
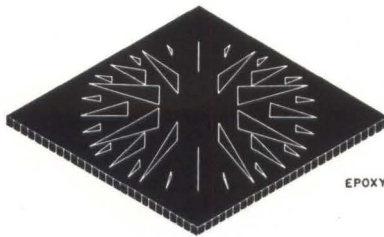

THREE-BAND configuration is proposed for full-scale model (top). Meanders are used instead of tuning stubs in printed-circuit elements

## H-F Array Scans Horizon

Big radiolocator could provide long-distance directional communications

**URBANA, ILL.** — University of Illinois' radiolocation lab is working on a new style of directional antenna array—one that would use frequency-independent, log-periodic elements. It could be used for directional long-distance transmission and reception.

Electronic scanning of 160 elements in a 1,000 to 2,000-foot-diameter array could spin a fan-shaped beam, 1 to 30 degrees wide, around the horizon several times a minute, Prof. Paul Mayes reported at the University's antenna forum two weeks ago.

The lab now operates a Wullenweber antenna. The new system, called WARLA (Wide Aperture

Radio Location Array) being developed by the University and Navy, would update that installation.

Where folded monopoles of the Wullenweber limit its operations to receiving, WARLA's log-periodic elements could be used for transmitting in a global, point-to-point, military communications network, according to John Greiser, of the lab. Frequency range of the Wullenweber is 4 to 16 Mc. WARLA's is 2 to 32 Mc. Beam width would change from 30 degrees to 1 deg, the beam's pointing accuracy from 1 degree to  $\frac{1}{4}$  deg, and gain from 35 db to 20 db as transmitting frequency rises.

Transmitter powers could range upwards from 30 kw peak and 600 w average. By exploiting skips from atmospheric layers, which could become double hops around 32 Mc, range could be 2,000 to 3,000 miles.

The lab is now working with a scale model operating at 1 to 3 Gc, with elements reduced 500:1 in size.

For a full-size antenna, a three-band configuration (sketch) could be used. At 2 to 5 Mc, 40 large elements would be activated, at 5 to 32 Mc, 40 intermediate elements would go into operation, and at 12.5 to 32 Mc, a final set of 80 smallest elements could be used. The number of elements may be reduced in the final design.

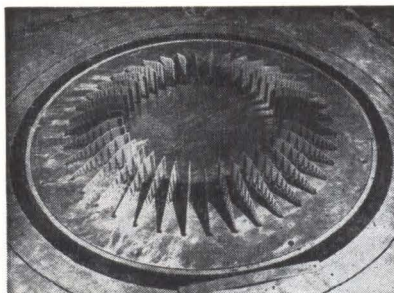

MODEL operates at 1 to 3 Gc





## THE COMPLETELY NEW MICROWELDER MARK II: **VERSATILITY PLUS**

The advanced Microwelder Mark II brings a new degree of versatility—and a number of exclusive features—to microelectronic interconnection. It can weld a .0005" wire to a thin film of less than 200 angstroms as readily as it welds .020" wire to a printed circuit board. It's equally capable of attaching leads to micro-modules, hybrid and integrated circuits and other micro-size components. ■ **Unique features:** A single point with as little as .002" diameter • solid state electronics • three ranges of weld power • precise control of AC weld energy • synchronous timing • dead weight pressure system as low as 10 grams. ■ **Price:** \$5250 — F.O.B. Azusa, California. Now available through leading electronic representatives across the country.

For complete information on the new Microwelder Mark II — and a personal demonstration, write: Commercial Products, Dept. E, P.O. Box H, Azusa, California.



COMMERCIAL PRODUCTS/Azusa, California



# Cards Form Biggest Memory

System can store 5.4 billion characters on big magnetic cards

**NEW YORK**—Described by RCA as a “major turning point in electronic computer technology—possibly the most important since the invention of the computer itself,” and “a computer mass memory with the world’s greatest data capacity,” Race (ELECTRONICS p 17, Feb. 7) does indeed have the largest capacity of any random-access system of its type, 5.4 billion

characters maximum. And an average access time of 300 msec.

Up to 256 flexible, edge-notched magnetic cards, 16 by 4½ inches in size, fit into a magazine. A card, selected by solenoid-actuated bars, is moved by pinch rollers and friction belts onto a spinning drum where it is read.

**Add-On Magazine**—An eight-magazine retrieval unit is integral with a read-write station and card-transport mechanism; another eight-magazine unit can be added on, using the same read-write and transport facilities. Four of these 16-magazine units can be operated through one control unit, and up to a maximum of eight such units through two control units, for a maximum of 128 magazines.

Each card contains 128 tracks, recorded lengthwise on one side, coated and then overcoated with a Nylon compound. The tracks are divided into 64 separately addressable bands of two tracks each, the two recorded in parallel, so that, with four blocks of 650 characters on each of the 64 bands, each card contains 166,400 characters.

Any desired block may be selected with one instruction; read-write is by an assembly of eight read-write heads that can be moved to one of 16 locations.

The rental is about 7 cents a month for 10,000 7-bit (6 bits plus parity bit) characters. An eight-magazine unit rents for \$3,500 a month, plus \$750 monthly for the control unit. An eight-magazine add-on unit is \$1,500 a month more.

**Sold Already**—The first Race system will be delivered to Chrysler in December for use in its “5 and 50” auto-warranty program. The Navy has ordered a ruggedized version for a classified land-based application.

The only other similar device is National Cash Register’s Cram, which holds one magazine of 256 cards per unit, with 7 recording tracks per card, and a maximum capacity of 5½ million alphabetic or 8⅓ million numeric characters.

A lower-priced Cram was recently announced. It has 56 tracks per card, and 128 magnetic cards in the magazine, for a total of 6.4 million alphanumeric characters in each Cram unit, 16 of which can also be connected to the NCR 315.



CARDS are fed from magazine to read-write station (right)

only **4** basic materials...  
...a new capacitor construction  
concept to give high performance  
and low cost. Filmatic® by Paktron

...mylar\*



SALESMAN at right takes an order at the U. S. Trade Center. Bookings at relatively small show last month totalled \$300,000, and potential orders from new customers are estimated at up to \$10 million

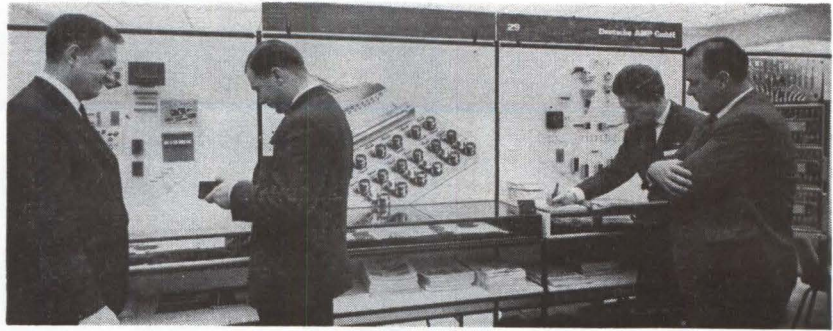

## Americans Eye Rocky German Road

Big, new show—opposed by German trade group—planned by Americans

By **RICHARD MIKTON**  
McGraw-Hill World News

**BONN**—Despite strong opposition, an American-inspired plan to launch a new series of components shows, called Electronica, is going ahead. The first show will be in Munich October 21 to 29. Its founders hope it will soon compete with the Paris Salle de Composants as Europe's largest electronics show.

Two highly successful shows—

one last month, another last year—at the U. S. Department of Commerce's Trade Center in Frankfurt convinced American companies that the market for sophisticated components in Germany warrants a show on the scale of Electronica. These shows were limited in scope. Electronica would gather in exhibitors and visitors from all over Europe, including the Communist bloc.

Opposition to Electronica is coming from the powerful Central Association of the Electro-Technical Industry (ZVEI). Some observers think ZVEI is protesting so loudly because they did not get the idea first. Others think Electronica

will be superfluous and at worse harmful to the big trade shows in Paris, London and Hanover.

Nevertheless, the recently founded American trade group, the International Electronics Association, is going ahead with its plans. IEA founders include the European branches or representatives of Honeywell, Hughes, Amphenol Borg, Harshaw Chemicals, Hewlett-Packard, Taylor Instruments and Consolidated Electro-dynamics.

These companies have long sought an all-electronics show to meet a growing demand in Central Europe. Dozens of small and medium-sized German component producers welcome Electronica as the

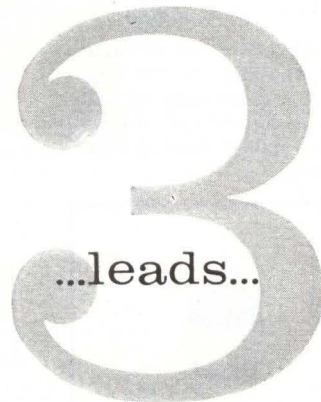

This unique combination provides a rugged self-case, high lead strength, excellent moisture resistance, improved life, high volumetric efficiency . . . all at a considerable savings in cost.

Available in three case sizes.

Range:	.001 mfd. through .5 mfd.
Voltage:	50-100-200-400-600 WVDC
Tolerance:	± 10% & ± 20%

\*DuPont

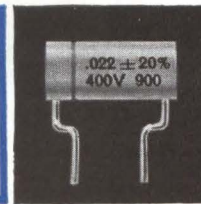

ACTUAL SIZE

**Filmatic®**  
Capacitors  
with  
RIPPLEWELD™



**PAKTRON**

DIVISION ILLINOIS TOOL WORKS INC.  
1321 LESLIE AVENUE • ALEXANDRIA, VIRGINIA



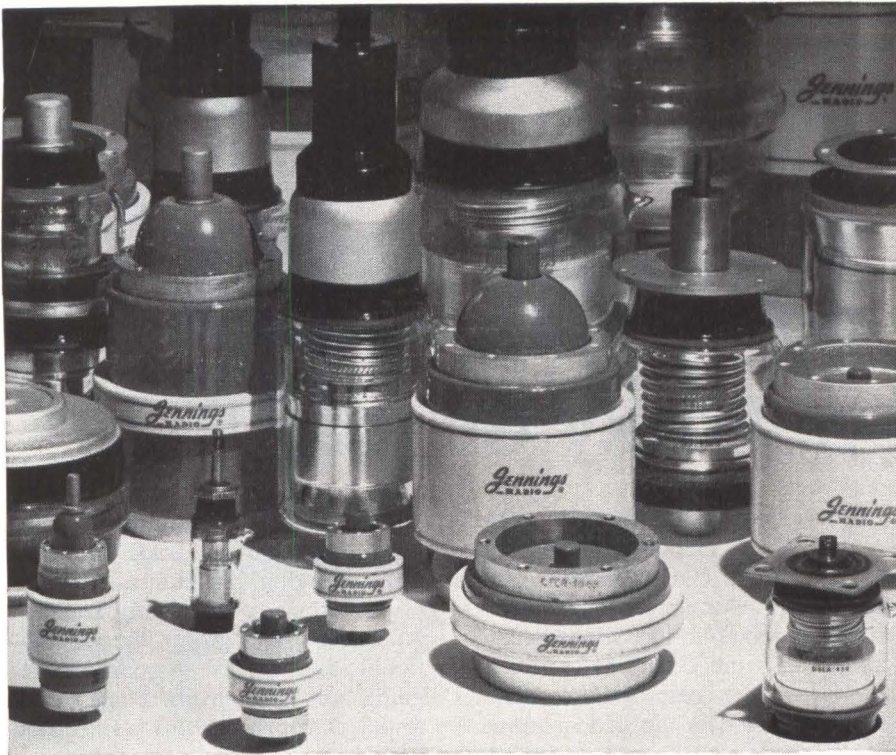



## THERE IS A JENNINGS VACUUM CAPACITOR FOR EVERY HIGH POWER RF APPLICATION

Jennings has been designing and building vacuum capacitors for 21 years. In this time we have designed vacuum capacitors for hundreds of standard and special applications. These designs are now production items—over 450 types. We can deliver from stock a vacuum capacitor to solve practically every specialized application.

But if a new design is necessary consider these resources ready to work for you at Jennings. • 21 years experience designing and building vacuum capacitors.

• Exclusive processing techniques that assure superior performance. • Qualified, experienced engineering staff. • The only complete rf laboratory in existence for proper testing of vacuum capacitors in high power rf circuits through 100 kw that duplicate actual operating conditions.

Jennings offers a complete line of vacuum capacitors for operating in the high frequency range at voltages up to 120 kv and capacities up to 5000 pf. We will be happy to send detailed catalog literature at your request.

 <p><b>MXCF 500</b></p> <p>Capacity Range . . . 20-500 pf Voltage Rating . . . 20 kv pk RF Current Rating . 45 amps rms Length . . . . . 9<sup>7</sup>/<sub>8</sub> inches Width . . . . . 4<sup>3</sup>/<sub>8</sub> inches</p>	 <p><b>MMHC 1000</b></p> <p>Capacity . . . . . 1000 pf Voltage Rating . . . 45 kv pk Current Rating . 150 amps rms Length . . . . . 13 inches Width . . . . . 9<sup>1</sup>/<sub>4</sub> inches</p>	 <p><b>CVHA 650</b></p> <p>Capacity Range . . 30-650 pf Voltage Rating . . . 55 kv pk Current Rating . 150 amps rms Length . . . . . 11<sup>1</sup>/<sub>2</sub> inches Width . . . . . 7 inches</p>
---	--	---

RELIABILITY MEANS VACUUM | VACUUM MEANS

**Jennings**<sup>®</sup>

JENNINGS RADIO MFG. CORP., 970 McLAUGHLIN AVE., SAN JOSE 8, CALIF., PHONE CYpress 2-4025

only occasion to exhibit to a specialized crowd within their own borders.

Electronica is expected to have more than 300 exhibitors. Even before the final announcement, 130 firms made inquiries. Applications have been received from Germany, England, France, Italy, the U. S. and the East bloc.

**Multimillion-Dollar Market** — The U. S. supplied nearly \$10 million of Germany's 1962 imports of communications equipment, half the \$25 million in instrument and controls imports, one-quarter of the \$45 million in components imports, and \$4 million of the \$6 million in computer imports. A rising demand for industrial electronics parts has offset declines in radio and tv parts.

Continuing vigor of U. S. sales in West Germany was demonstrated at last month's Trade Center show. Some 31 exhibitors represented more than 100 U. S. companies. Visitors averaged 250 a day. Eight companies alone reported on-the-spot sales of \$300,000 and expect to sell \$6 million to 10 million worth to new-found customers. At a July, 1963 show, sales were over \$1 million and potential sales around \$10 million.

**Selling in Europe**—An estimated 60 percent of the products shown last month were not available domestically. Those that are available here usually cost more than American parts and lack American quality.

Because many of the visitors—250 a day—were unfamiliar with the newer components, explaining applications was a large part of the selling job. Representatives of larger companies, like GE and RCA, at the show thought only 3 or 4 percent of the visitors appreciated many of the newer products.

"They don't know what we have and often they don't know what they really need," said one salesman.

Much of the business at the show consisted of lining up agents and representatives. Ten exhibitors were seeking 53 reps in 23 countries. But most company officials were cautious about making final agreements, realizing that Europe's infant space industry, its declining military market and booming industrial sector impose requirements



— still mostly unknown — that are different than in the U. S.

Most exhibitors discount possible European competition, because of lower U. S. prices and higher quality. No serious European competition exists for most of the components displayed at the show, particularly in fields like numerical control for machine tools. The U. S. has a corner on that market, and dominates the computer market.

### Triple-Function MAD's Cut Component Count

NEEDHAM, MASS.—The use of multiaperture ferrite cores for combined logic, memory and display reportedly reduces component count in the console of a major weapon system by a factor of 10.

The display system employing MAD's (magnetic multiaperture devices) was developed at Sylvania Electronic Systems.

According to engineering director Frederick Anderson, the triple role of the ferrite-core modules cuts components from 70,000 to 7,000, resulting in an estimated 400-percent increase in reliability as well as reducing cost.

The MAD's perform a logic function in decoding a stream of binary data from the weapons system computer, they control a-c power to the appropriate lamps on the display panel, and they hold the display information pending a subsequent updating of information from the computer.

The development suggests several natural sequels, including extension of the technique to alphanumeric displays and application of MAD's to all-magnetic logic.

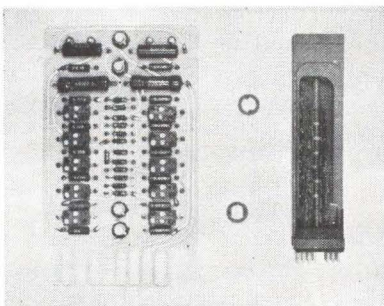

CORES shown in center decode computer output, activate a parameter display and remember parameter status. MAD assembly at right does work of eight circuit cards (left)

# BURNPROOF LACING TAPE AT NO ADDITIONAL COST —FROM GUDEBROD



## THE CABLE-LACER

increases worker  
efficiency  
by  
25%



The first production tool available to ease, speed and improve the wire tying operation—producing tighter knots and more uniform harness.

Handle holds bobbin of cable lace, feeds as needed. Easily refilled. Eliminates handling long sections of tape, reduces splicing. Get your Production Department to investigate.

The specification of non-combustible materials in electronic equipment has, until now, required the use of special, higher priced lacings for harness tying. Through extensive work in their R&D Department, Gudebrod is producing two new burnproof lacing tapes—both available at no additional cost!

The first of their kind, these new tapes are made of Dacron\* fibers and are flat braided for excellent handling and knotting qualities. In addition to meeting or exceeding all requirements for MIL-T-713A, the burnproofing exceeds ASTM-D626-55T.

Two types are being produced—Stur-D-Lace FLH, impregnated with a flame-proof fungistatic synthetic rubber finish, and Stur-D-Lace R impregnated with a flameproof fungistatic vinyl finish. Both are essentially stable at —100° to 350°F. Neither will burn, but they will melt when a hot flame is applied. Each type is available in seven different strengths. Gudebrod Technical Product Bulletin #6 gives details.

The introduction of burnproof lacing tapes at standard prices represents another advancement in cable lacing practice by Gudebrod. The Gudebrod line of lacing tapes covers the entire range of wire harness tying requirements for both military and commercial equipment. Send for the Data Book on Gudebrod Tapes.

\*"Dacron" is Du Pont trade name for its polyester fiber.

**GUDEBROD BROS. SILK CO., INC.**  
FOUNDED IN 1870



Electronics Division  
12 SOUTH 12TH STREET, PHILADELPHIA 7, PENNSYLVANIA





**ENGELHARD** pure silver contact inserts assure trouble-free performance and economy in Mackworth G. Rees 3-in-1 pushbutton switches

When Mackworth G. Rees, a division of Avis Industrial Corporation, Detroit, Michigan, designed its new 3-in-1 pushbutton switch for operating and energizing electrical control circuits, it chose the specially molded silver contact inserts developed by the H. A. Wilson Division of Engelhard Industries to provide the trouble-free performance and economy so vital to its operation. The new switch replaces the conventional three-unit switch which requires both an "on" and "off" pushbutton plus a pilot light — and can be mounted in one third the space with less installation and wiring time than needed for conventional types.

One of the essential components of the new heavy duty, oil-tight pushbutton unit is an Engelhard movable contact fabricated of double silver laminated brass. This unique contact permitted Rees engineers the lux-

ury of design flexibility plus a great savings in the cost of contact assembly. The pure silver insert is securely bonded to the brass base only where needed, thus affording economy. The brass base metal provides the mechanical strength, spring properties, corrosion resistance, electrical and thermal conductivity required for reliability.

The search never ends for devices which will save space, yet retain all the characteristics necessary for dependable electrical performance. Reliability, a result of precision engineering, is the essential ingredient in Engelhard's recipe for highest quality electrical contacts. For more details on these silver laminated brass contacts, and silver laminated copper and other contacts, write to our Technical Service Department. 52



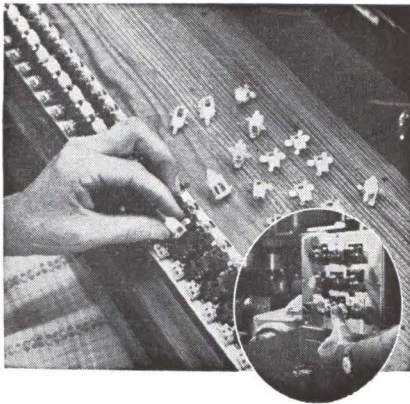

Other

**ENGELHARD**

products

**SILVER BRAZING** with easy-to-use Engaloy™ 440 provides high strength, corrosion resistance, and a minimum of diffusion into base metals for high-temperature joining. This dependable new brazing alloy renders maximum service for all high-temperature conditions.

**PRECISION-DRAWN TAPE** is supplied to specification in bimetal or solid precious metals. ECON-O-TAPE is available in any thickness, length or width (from .0095"). Shaped or rectangular sections. Excellent material for electrical contacts subject to corrosion.

**THIN WIRE AND FOIL** are produced by Engelhard's Baker Platinum Division to meet rigid electronic design requirements. Both extruded and Taylor Process thin wire are available in diameters as small as .001". Thin-gauge foil is supplied in sheets up to 8" x 18".

**TEMPERATURE-SENSITIVE METALS** are available in a complete line for applications requiring temperature response from -100° to +1,000° F. Wilco Thermometals® are supplied in a wide range of resistivity in rolls and strips or tempered and formed to specification.

**RHODIUM PLATING** is simple with Engelhard electroplating solutions. Rhodium deposits provide outstanding protection against surface corrosion, reduce electrical noise in moving parts. Efficiency is improved wherever long-wearing, oxide-free components are required.



CIRCLE 57 ON READER SERVICE CARD

HALL SENSORS are at core of the package, between wing-like flux concentrators

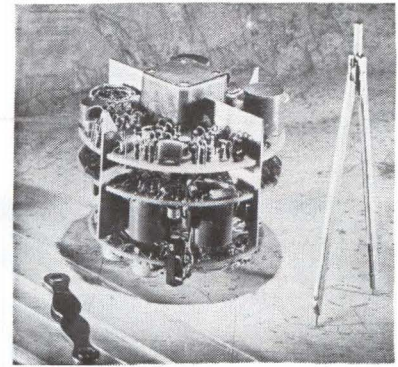

## Navy Tries Solid-State Compass

Hall-effect magnetic compass may see ASW duty in the Arctic

By **CLETUS M. WILEY**  
Regional Editor, Chicago

**CHICAGO**—Motorola is scheduled to deliver the first of 10 of its new Hall-effect magnetic compasses to Navy late this month. Another 140 will be delivered in the next four or five months. And if Navy decides to exploit the compass's greater versatility, a buy of 8,000 is possible, according to Dan Rice, the program manager.

**Destined for Arctic?**—While details of the Navy application are classified, the compasses seem destined for submarine-detection use on sonobuoys in the Arctic. At the 1962 National Electronics Conference—while the compasses were being developed—Motorola's Ernest Keller said they would be useful for localizing sounds picked up by remote data-transmitting buoys, or as a reference for sea-current direction and magnitude (ELECTRONICS, p 40, Oct. 5, 1962).

Rice says that because the compasses are solid-state, they avoid the problem of lubricants congealing on mechanical parts. In the arctic, this can prevent magnetic compasses from holding to north. The Hall compasses are also more sensitive, and in the arctic, the horizontal magnetic lines of force may be an order of magnitude weaker than at the equator.

The new compass can detect a horizontal magnetic component of

0.01 gauss in high latitudes, or 0.4 gauss near the magnetic equator. Experimental units have shown excellent linearity down to magnetic flux densities of 0.001 gauss, according to Keller.

**Using the Hall Effect**—The Hall effect is the development of a potential between opposing surfaces of a current-carrying metal strip placed in a magnetic field (for discussions of the effect and its applications, see, for example, ELECTRONICS, p 52, Aug. 25, 1961; p 68, April 14, 1961, and p 30, Jan. 17, 1963).

In the compass (see page 58) the potential is developed along the Z axis when current along the Y axis is exposed to a magnetic field in the X axis.

The sensor, a 2 x 2 x 0.1-mm indium-arsenide-ferrite sandwich inserted between the pole pieces of a pair of 2-inch Mumetal flux concentrators, reads out the magnitude of the magnetic flux through the concentrators. Butted against the sandwich, the concentrators increase flux density a hundred times.

Orthogonal, 90-degree positioning of two Hall elements results in a nonambiguous, temperature-nulled north-indicating system.

**Signal Handling**—Output of the compass is a voltage pulse, widening proportionally with the clockwise angle between magnetic north and the reference direction of the compass.

A battery-powered transistor oscillator, operating at 2.5 to 5 kc, energizes one Hall element directly, while the other is shifted 90 degrees in phase.

Combined Hall voltages are fed



**StereoZoom®**  
*is essential  
 to precision  
 assembly and  
 inspection...*



that's why it's built right into this **AUTOMATIC WAFER BONDER**. The Kulicke and Soffa machine shown here bonds transistor and microcircuit components as fine as 0.0005". The operator first uses the built-in StereoZoom Microscope to locate the bonding position. The rest is automatic—feeding, bonding, severing—but with big, bright 3-dimensional views making *sure* the job is done just right.

The advanced optical design of the Bausch & Lomb StereoZoom Microscopes gives you today's clearest, sharpest stereo views of tiny parts. Focusing is the fastest, easiest ever. Just dial the knob for continuously variable magnification—powers may be chosen within the full range (3.5× to 120×). And forget maintenance worries. These are the most trouble-free microscopes you can buy for industrial use—durable, shockproof, dustproof, vibration-free.

Choose the right model to solve your precision problem from 24 different StereoZoom Microscopes.

**BAUSCH & LOMB** 

<b>BAUSCH &amp; LOMB          INCORPORATED</b>  61402 Bausch St. Rochester 2, N. Y.	<input type="checkbox"/> Schedule a demonstration at my convenience. <input type="checkbox"/> Send me StereoZoom Catalog D-15.
	Name .....
	Company .....
	Address .....
	City ..... Zone ..... State .....

In Canada, write Bausch & Lomb Optical Co., Ltd., Dept. 614, Scientific Instrument Division, 16 Grosvenor St., Toronto 5, Ont.

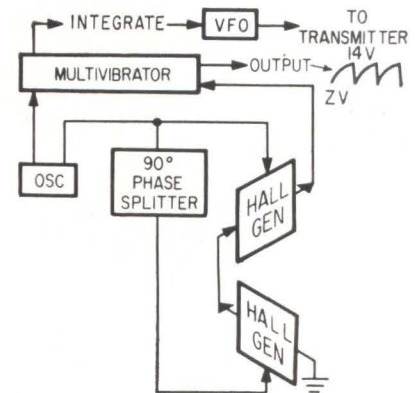
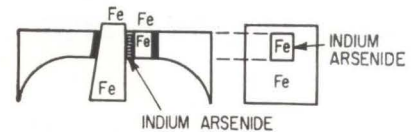
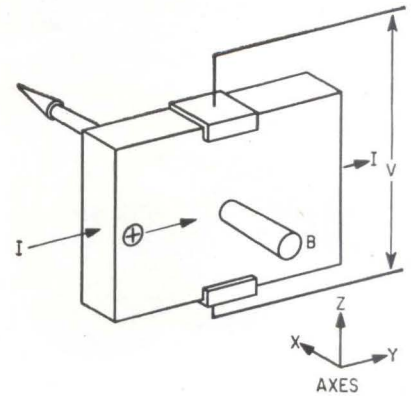

POTENTIAL develops along Z axis when magnetic field crosses current flow (top). Sensor is indium-arsenide-ferrite sandwich between flux concentrators (center). Use of two sensors nulls temperature effects (bottom)

to a bistable multivibrator, which extracts their angular rotational information. The multivibrator, triggered ON by the oscillator and OFF by the combined Hall-element output, delivers a pulse whose width is directly proportional to the compass's rotation angle.

The device's 10-millisecond time constant assures error-free bearings for special-purpose antisubmarine-warfare instruments, even when their scanning mechanisms rotate several hundred rpm, Keller said. Response time can be shortened by increasing exciter frequency.

Integration of Hall element output with that from the multivibrator can also develop a variable frequency output, ranging from 28 kc for 2 volts to 32 kc for the 14 volt maximum, Rice said.



2  
4  
5  
3

**dc volts**

**low-level dc**

**ac volts**

**resistance**

**frequency**

***You name it...  
your DY-2010  
will  
measure it***

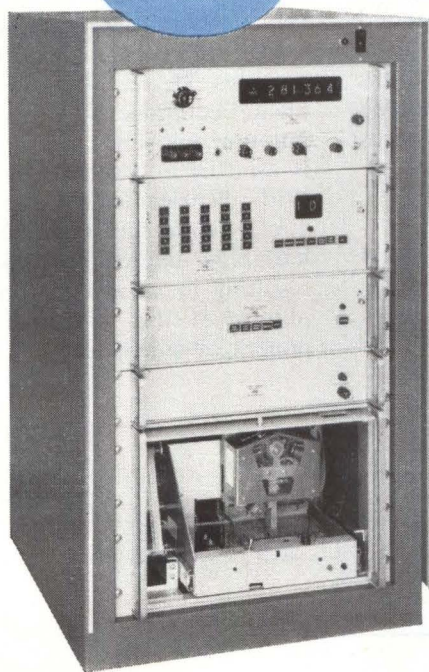

No matter what the electrical parameter, any of the seven DY-2010 Data Acquisition Systems will measure it. With a standard system, ready for delivery without special engineering, you can measure low-level dc voltages even in the presence of severe common mode and superimposed noise. You can measure dc voltages all the way to 1000 volts, with 300% overranging on the 0.1, 1, 10 and 100 volt ranges. You can measure frequency from 10 cps to 300 kc. You can measure ac voltage 50 cps to 100 kc and 10 mv to 1000 v full scale. You can measure resistance 100 ohms to 10 megohms full scale.

That means, of course, that you can measure the outputs of strain gauges, thermocouples, flow meters, accelerometers, magnetometers...every type of transducer, every phenomenon that can be converted to an electrical signal.

What's more, the measurements are automatic. You can make them fast, in any mixed sequence you require, and you can record them on printed tape, perforated tape, punched cards or even magnetic tape.

All this with a standard, packaged system built around the DY-2401B Floating and Guarded Integrating Digital Voltmeter. You never have to pay or wait for special engineering. Each is a complete system, yet as easy to use as an instrument.

Call your Dymec/Hewlett-Packard field office for all the information and specifications on the 2010 Series. The seven systems differ only in scanning capabilities, in recorded output and in speed of measurement. They range in price from \$8675 to \$14,250 with guarded data amplifier and ac/ohms converter optional at extra cost.

Data subject to change without notice. Prices f.o.b. factory.

**D Y M E C**

A DIVISION OF HEWLETT-PACKARD COMPANY

DEPT. D-1220, 395 PAGE MILL ROAD, PALO ALTO, CALIFORNIA • PHONE (415) 326-1755 TWX 415-492-9363



8942



UNIQUE RETICLE

# Improves Star Trackers

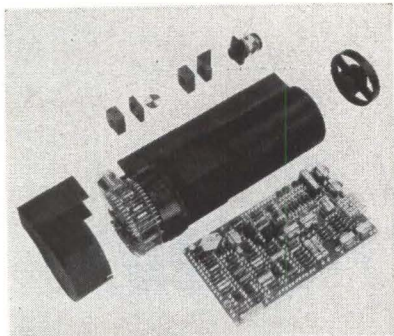

POINT SOURCE sensor developed by Perkin Elmer researchers—Fig. 1

Point-source sensor uses single sideband for wider range

A POINT SOURCE sensor for star tracking that exhibits an angular dynamic sensing range of 3,000 to 1 has been developed by Perkin Elmer researchers. The new device (Figure 1) overcomes deficiencies of present sensors using a single-sideband reticle and special signal processing electronics. In addition, it exhibits a readout linearity of 1 percent over a 0.5 deg. circular working field. The sensor output is independent of source intensity beyond a signal to noise ratio of 3 to 1, and is also immune to centroid (star center) pulling caused by double sources—as long as the sources differ in size by 2.5 orders of magnitude.

**Characteristics**—The star tracking sensor incorporates a dynamic error sensing range of 3,000 to 1, long-term null-sensing stability and high

linearity in error readout (that is, the error slope is independent of changes in source intensity). It is immune to extraneous targets and the signal processing circuits are highly reliable. In addition, the point source sensor has been compressed into a package approximately 1 foot long and 4 inches in diameter.

**Reticle**—The desired sensor performance would be very difficult to obtain with standard reticle sensing techniques. This led to the development of the four-quadrant single-sideband reticle (Figure 2). An on-axis source is nutated concentrically on the reticle to produce waveform No. 1. This waveform contains  $2f_m$ , as its lowest fundamental component—where  $f_m$  is the nutation frequency.  $2f_m$ , therefore, is used as a target presence signal. With displacement of the nutation circle from the null position, a harmonic interchange takes place resulting in an increase in the amplitude of the subharmonic component or sideband,  $f_m$ . This sub-

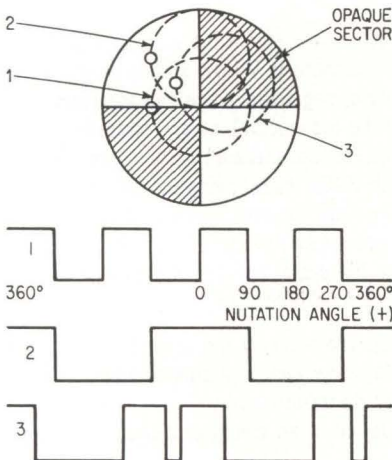

SSB RETICLE and associated waveforms: waveform 1, on center; waveform 2, completely off center; and waveform 3, shifted slightly off center—Fig. 2

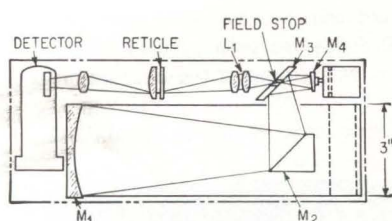

OPTICAL-MECHANICAL layout of Perkin Elmer point source sensor—Fig. 3

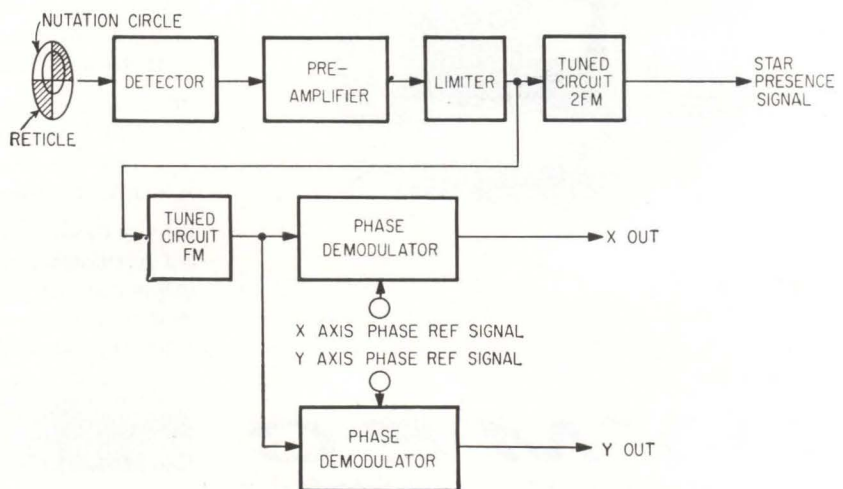

SIGNAL PROCESSING circuits of point-source sensor, block diagram—Fig. 4



# TRYGON Half Racks

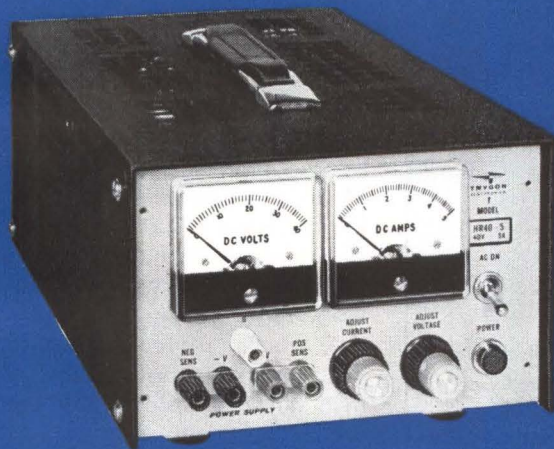

Model HR40-5A

New  
higher amp  
models available:

Model	Volt	Amps	Regulation	Ripple	Price
HR20-1.5*	0-20	0-1.5	0.01% line	0.25 mv	\$164
HR40-750*	0-40	0-0.75	0.05% load	0.15 mv	\$149
HR20-5A	0-20	0-5	0.01% line 0.01% load	0.5 mv	\$299
HR20-10A	0-20	0-10			\$379
HR40-2.5A	0-40	0-2.5			\$299
HR40-5A	0-40	0-5			\$349
HR60-2.5A	0-60	0-2.5			\$379
HR60-5A	0-60	0-5			\$449

\*Single Meter Units

## ... the most versatile power supplies going!

**In the lab**—you'll find you can't beat a Trygon Half Rack for versatility and low cost! Want constant voltage with adjustable current limiting? You've got it! Want constant current with adjustable voltage limiting? You've got it! Want to select voltage and current with a remote control? You've got this too!

But check the features at the right—and the prices—for yourself. And remember—every Trygon power supply, large or small, goes through the same test procedures before shipment. Each is aged—burned in; each is subjected to stability runs. Each must pass shock and vibration tests—your assurance of long, trouble free performance along with versatility.

**In a system**—you merely take off the Half Rack dust cover, reverse it, add an inexpensive Trygon adapter, and you have a unit that slides right into a rack. What's more, you can place two Half Racks in a 19" rack width, occupying only 5¼" of panel height.

**For complete specs**—on the Half Rack Series as well as our catalog showing the complete line of over 100 Trygon Power Supplies, write to us today. Address: Dept. E-6.



Two Trygon HR20-1.5's, rack-mounted side by side.

### FEATURES

- **CONSTANT VOLTAGE OPERATION** with adjustable current limiting.
- **CONSTANT CURRENT OPERATION** with adjustable voltage limiting.
- **COMPLETE RANGE REMOTE PROGRAMMING** furnishes voltage and current selection from a remote control.
- **REMOTE SENSING** provides rated regulation at the load, available at both front and rear terminals.
- **HIGH RESOLUTION** for setting current and voltage is provided by coarse and fine adjustments for both (4 controls).
- **AUTOMATIC OVERVOLTAGE PROTECTION**—Trygon's unique overvoltage protection is available as an option.

# TRYGON

## ELECTRONICS INC.

111 Pleasant Avenue

Roosevelt, L.I., N.Y.

(516) FReeport 8-2800

TWX (516) 868-7508





## THE YIG FAMILY LIVES HERE

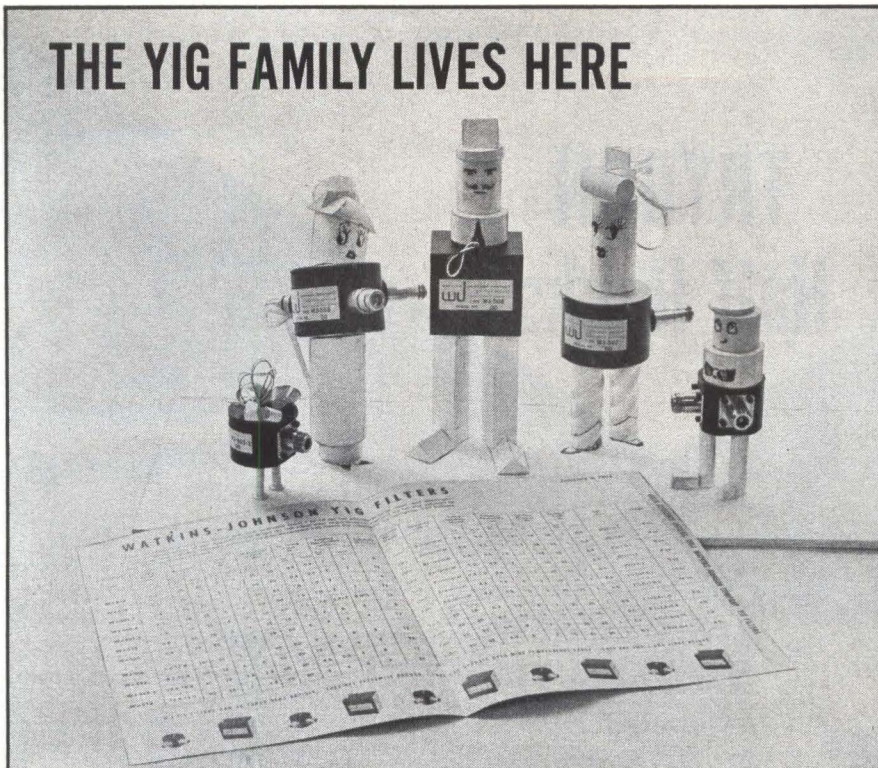

WATKINS-JOHNSON's well-bred YIG Family is unique in that it offers a full complement of desirable characteristics for search-receiver and spectrum-analyzer applications. Fast, electrically tuned YIG filters range from 1 to 18 Gc. They can be tuned very rapidly, are extremely rugged, can operate over a wide temperature range, and they are small and light weight. Watkins-Johnson has also developed YIG filters for millimeter wavelengths, YIG limiters, and YIG band-reject filters. A new detailed catalog has just been published. The W-J YIG Family would like you to have one!

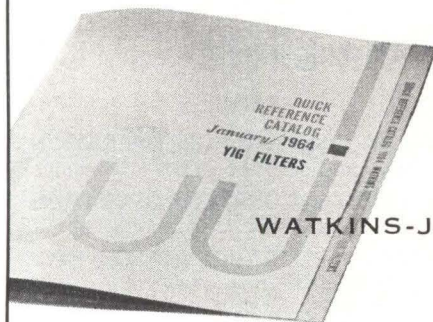

Information in more detail available from representative in your area, or from Applications Engineering

**WATKINS-JOHNSON COMPANY**

3333 HILLVIEW AVENUE  
STANFORD INDUSTRIAL PARK  
PALO ALTO, CALIFORNIA

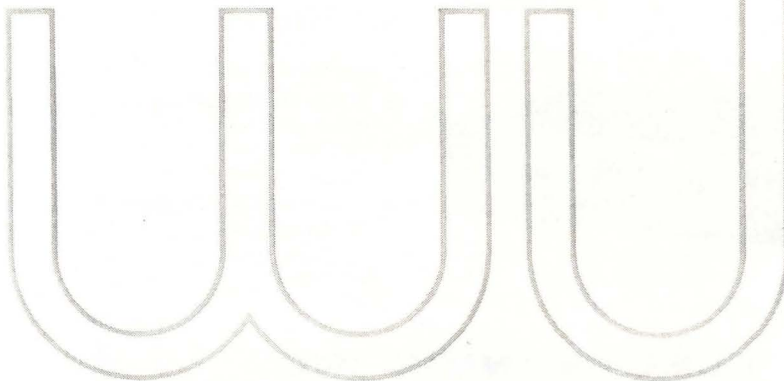

harmonic has its largest value at the maximum field displacement and is contained as the lowest frequency component in waveform No. 2. The sideband component amplitude is directly proportional to the angular displacement of the target from field center and its phase—relative to the reference phase—represents the true displacement of the source image. Waveform No. 3 shows the image nutation circle at some arbitrary intermediate position on the reticle.

**System**—Figure 3 shows a layout of the optical-mechanical configuration. Energy collected by the 3 in.-primary mirror  $M_1$  is reflected and folded onto mirror  $M_3$  by mirror  $M_2$  and then nutated at 133 cps by the motor-driven wedge-mirror  $M_4$  to effect circular image rotation in the primary field stop. The field stop has an angular diameter of 1 degree relative to  $M_1$  offering a working field of  $\frac{1}{2}$  degree diameter over which a source may be tracked. The nutating source image at the field stop is imaged by the objective transfer element onto the sensing reticle to effect a 42-inch focal length system. Source-position information is imparted by the nutation of the source image on the reticle. The energy is then applied to the detector. The condenser after the reticle keeps illumination of the detector surface independent of source image motion in the reticle plane.

Figure 4 shows the electronics block diagram. Detected energy is amplified and limited to keep signal

## High-Power Laser Will Disintegrate Diamonds

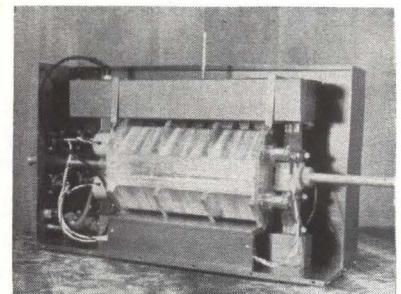

DEVICE IS rated by manufacturer—Maser Optics, Inc.—as the "world's most powerful laser." With an energy output of 1,500 joules, the power output is rated at 100 megawatts when used in conjunction with company's Q-switching accessories.



level constant for signal-amplitude, detector-sensitivity, and gain changes. Tuned circuit  $2f_m$  generates a target presence signal. Tuned circuit  $f_m$  applies the fundamental to the phase demodulators which are referenced to the system x and y axis. Synchronous excitation at frequency  $f_m$  is derived from magnetic pickoffs orthogonally disposed—and phase aligned—with the reticle. The pickoffs operate in proximity to the nutating wedge mirror which contains a mu-metal hub for pulse generation.

### Lead Iodide Used In Taking Photographs

LONDON—A new solid-state photographic technique based on photo-decomposition occurring in lead iodide requires no processing and can be operated in full daylight. Basis of the technique now being investigated by the University of Bristol is the localized decomposition that occurs in lead iodide when illuminated with green light and heated to a temperature of 200 deg C. Experimental results to date show the technique as having enlargement capabilities up to 1,000 times plus an excellent fine-detail resolution potential.

### Lasers May Seek Other-World Signals

LOS ANGELES—Lasers could be used to seek out possible signals from other planets, according to Fred Johnson of Electro-Optical Systems, Inc. At a meeting of the American Physical Society at Cal Tech, he said that a natural amplification medium similar to a laser's may exist in interstellar space. Gas or nebula surrounding an extremely hot star may be the amplifying source, capable of magnifying coherent light signals from distant planets.

Johnson proposes to scan nebulae telescopically for modulated signals at a wavelength of 4,686 Å. The telescope would collect these optical signals and focus them onto a sensitive photodetector with the subsequent electrical output examined by a spectrum analyzer.

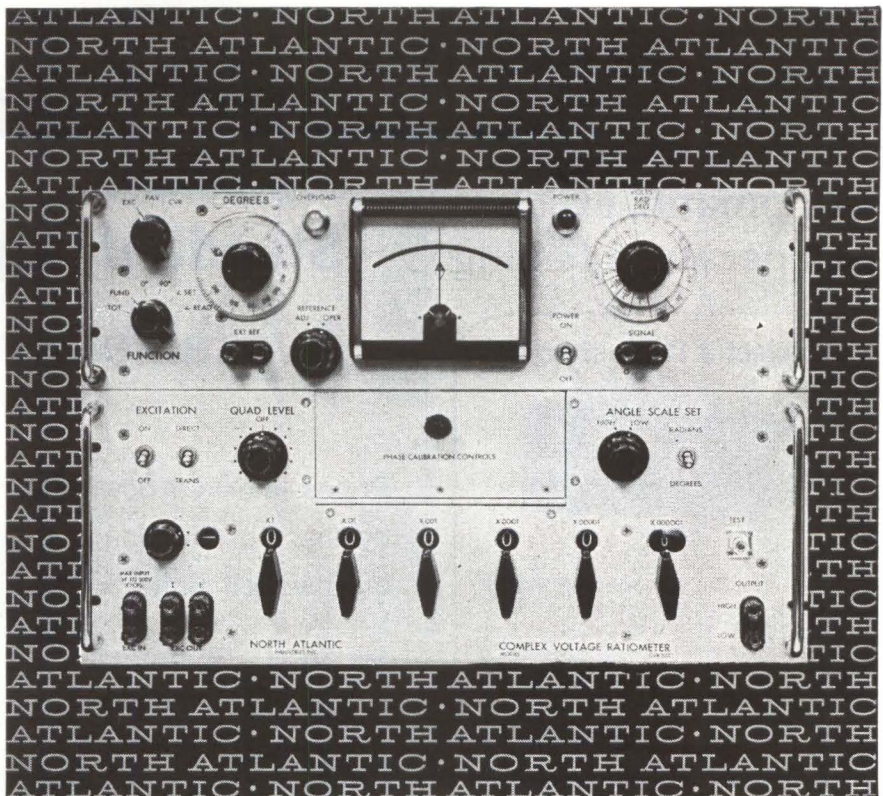

## how to measure ac ratios regardless of quadrature

North Atlantic's **Complex Voltage Ratiometer** is a completely integrated test set for measuring grounded 3 terminal networks. By providing self-calibrated quadrature injection, the Model CVR-551 permits calibrated meter readings of phase angle up to 30° or 300 milliradians full scale, and, in addition, provides direct readings of in-phase and quadrature voltages. As an added feature, the integral Phase Angle Voltmeter\* and AC Ratio Box can be used independently. Abridged specs follow:

In-Phase Ratio Range, $R_T$	.....0.00000 to $\pm 1.111110$ with full accuracy
In-Phase Ratio Error, $\Delta R_T$	..... 10ppm (typical for small angles)
Phase Angle Range, $\alpha$	..... $\pm 1.0$ to $\pm 300$ mr. (6 calibrated ranges) ..... $\pm 0.1$ to $\pm 30^\circ$ (6 calibrated ranges)
Phase Angle Error, $\Delta\alpha$	..... 0.1mr. or .006° (for lowest ranges) ..... 10mr. or 1° (for highest ranges)
Frequency	..... Any specified frequency, 50cps to 3KC
Bandwidth	..... $\pm 5\%$ with full accuracy
Phase Angle Voltmeter (used independently)	..... $\pm 2\%$ full scale ..... 300 microvolts to 300 volts (13 calibrated ranges)
Inverting AC Ratio Box (used independently)	..... 2 ppm terminal linearity ..... .35f volts (300 volts max.)

North Atlantic's CVR\* line includes 2 and 3 frequency models. All models available with optional 10 ppm Ratio Box control of quadrature injection.

Send for data sheet or contact your local North Atlantic sales representative now for complete information.

\*Trademarks



**NORTH ATLANTIC industries, inc.**  
TERMINAL DRIVE, PLAINVIEW, L. I., NEW YORK • Overbrook 1-8600



NOW FROM



## 3 simple steps to automatic, precise temperature testing

### 1 select a Delta chamber

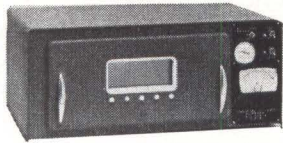

1060W

Choose from 15 well-proven models.  $-200^{\circ}\text{F}$  to  $+600^{\circ}\text{F}$  with reliable control to  $\pm 1/4^{\circ}\text{F}$ . . . 0.14 to 5.8 cu. ft. test volumes . . . go from  $70^{\circ}\text{F}$  to  $-65^{\circ}\text{F}$  in  $1\frac{1}{2}$  to 8 min.; to  $500^{\circ}\text{F}$  in 6 to 35 min. (depending upon model) . . . extremely compact.

### 2 add fixtures or drawers

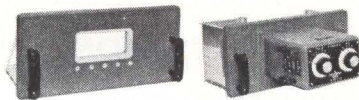

6WG

TTT 60WD

TTT 60WD — Specially designed for reliable electrical connection and switching when testing transistors, diodes, etc.

6WG — A wide variety of quickly changed drawers and doors for handling test specimens.

### 3 plug in programmers



MR-1

MR-3

MR-2

To save you time and improve testing, Delta Design offers the widest range of equipment for automating temperature testing. Examples: MR-1 cycles between any high and low for thermal shock testing . . . MR-2 also cycles to ambient, as in MIL STD 202B testing . . . MR-3 programs the rate of temperature change, using an easily changed program cam.

Now! Select from the world's broadest line of temperature chambers -197 models. All serviced by the 31 offices of Non-Linear Systems, Inc.

**NLS** non-linear systems, inc.  
Del Mar, California  
PHONE: 755-1134, Area Code 714

## — COMPONENTS AND MATERIALS —

# Standard Sapphire Windows Available for Optical System

Prices knocked down by mass production of off-the-shelf units

**MAHWAH, N. J.**—For the first time, system designers can obtain standard off-the-shelf sapphire windows for microwave and infrared systems. In the past, sapphire seals have been limited in supply because of limited demand and technical problems in their manufacture. Ceramics International Corporation here claims to have overcome these problems and to have reduced the cost of microwave and sensing components to less than half that of custom-made parts. The company has introduced a series of standard-diameter sapphire windows designed to fit standard tube e.d.'s of 0.252 in. to 0.988 inches.

Sapphire, a synthetically-grown crystal of pure aluminum oxide is

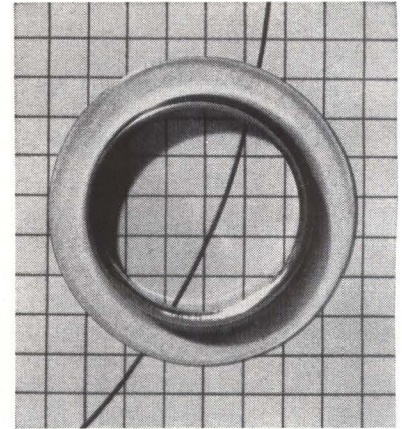

SAPPHIRE has transparency of glass, makes ideal window for optical transmission—Fig. 1

suitable for optical applications because it has excellent transmission and physical characteristics (see tables). A 2 mm-thick sample of sapphire exhibits 22 percent transmission of ultraviolet at 2000 Å. A

### DIELECTRIC CONSTANT AND POWER FACTOR (LOSS TANGENT) OF SAPPHIRE

Freq (Mc)	Field Parallel to C-Axis		Field Perpendicular to C-Axis	
	Dielectric Constant	Loss Tangent	Dielectric Constant	Loss Tangent
300	10.6	0.0001	8.6	0.0001
10,000	.....	.....	11.0	0.0002

### THERMAL EXPANSION OF SAPPHIRE

Mean Linear Expansion Coefficient of Sapphire  
(Per degree C from 20 deg. to various temperatures)

Temperature	Parallel to C-Axis	Perpendicular to C-Axis
50 C	$6.66 \times 10^{-6}$	$5 \times 10^{-6}$
500 C	$8.33 \times 10^{-6}$	$7.7 \times 10^{-6}$
1000 C	$9.03 \times 10^{-6}$	$8.31 \times 10^{-6}$



## Kodak reports on:

that oldtime physics, which is sometimes good enough for us... film for processing at 130°F...  
a bit of electronics in the photography

### Infrared advantageously reflected or refracted

To our four KODAK IRTRAN Optical Materials, we are now able to add IRTRAN 5. The new one commends itself, among other merits, for *reststrahlen*.

Being only a manufacturer instead of an institution of learning, we try to avoid robbing academic circles of too many scholars who can invoke the Fermi surface in discussing ionic crystals that behave like metals in the extent to which they reflect radiation of certain long wavelengths. The monumentally casual and clever oldtimer R. W. Wood simply tells us in his *Physical Optics* that in 1897 Rubens and Nichols worked out a scheme for using several bounces off a crystal to attenuate wavelengths subject to simple Fresnel reflection (e.g.,  $(4\%)^3 = 0.006\%$ ), so that only the metallicly reflected infrared bands remained; hence, *reststrahlen*. A thin plate of KODAK IRTRAN 5 Optical Material, largely MgO, effectively isolates  $15\mu - 25\mu$  by one bounce under the right conditions.

On the other hand, the transparency you see here is good from  $0.5\mu$  to  $8\mu$ , without the water band at  $2.8\mu$ . Thermal conductivity exceeds that of any of the other IRTRAN materials by several times. Its dispersion suggests pairing with some of the others to make achromats.

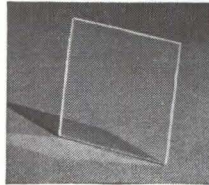

Apparatus and Optical Division, Eastman Kodak Company, Rochester, N. Y. 14650, can send much data about KODAK IRTRAN 5 Material.

### Man is a symbol-using animal

As far as we are concerned, the eyes have it. The eye is the gateway to the soul. When a blind man says "I see," he means "I understand." Literal seeing is preferred by billions to figurative seeing. Therefore where understanding is required, as in science and engineering, means are ever sought to use photography to best advantage.

Of course, photography covers more than the photographing of objects. Often it is very desirable to photograph symbols such, for example, as are drawn in some fashion or other by electronic pencil. To do such photography on more than a manual, casual basis we furnish a 16mm and 35mm film long known to those skilled in the art as KODAK LINAGRAPH Pan Film. Time has caught up with it, though, as we are pleased to be telling you instead of having you tell us.

The old LINAGRAPH Pan emulsion couldn't stand more than 90°F processing temperature. To be in the swim today, one processes film almost as hot as one launders shirts. Minutes shrink to seconds (but the shirts hardly shrink at all any more). Now KODAK LINAGRAPH Pan Film carries the legend "Improved for High-Speed Processing." It can stand 130°F.

We don't merely guarantee that the emulsion will not turn to beef bouillon at 130°F. We tell you that the photographic quality will be just as good and better than when you carefully maintained 68°F, as you were taught in youth, when there was plenty of time.

Arrangements to shoot the new KODAK LINAGRAPH Pan Film to you are made through Photorecording Methods Division, Eastman Kodak Company, Rochester, N. Y. For 16mm, we can also furnish a processing machine that delivers in 2 minutes, dry to dry. For 35mm, there is still a little challenge left in designing 130°F processing gear instead of the easy way, where you simply make out a \$12,500 equipment-purchase requisition.

Price subject to change without notice.

### The film and the eye don't see alike

When the photography and the electronics are suited to each other, a radar presentation that looked this good to the pilot

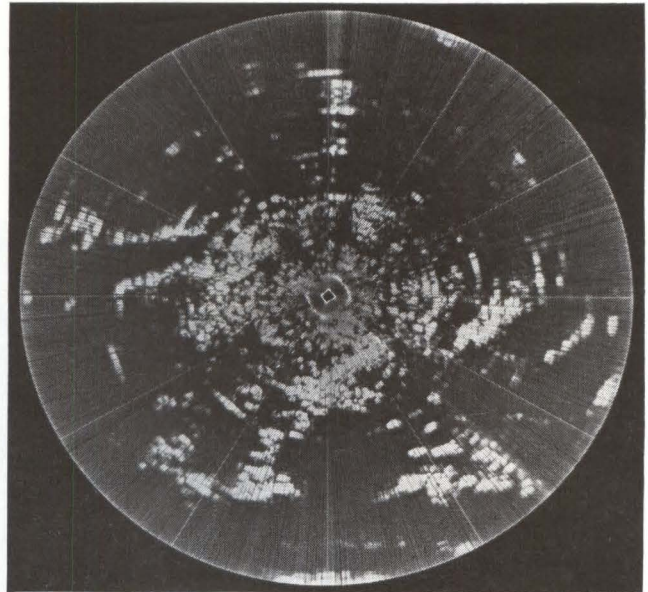

records like the above and not the below.

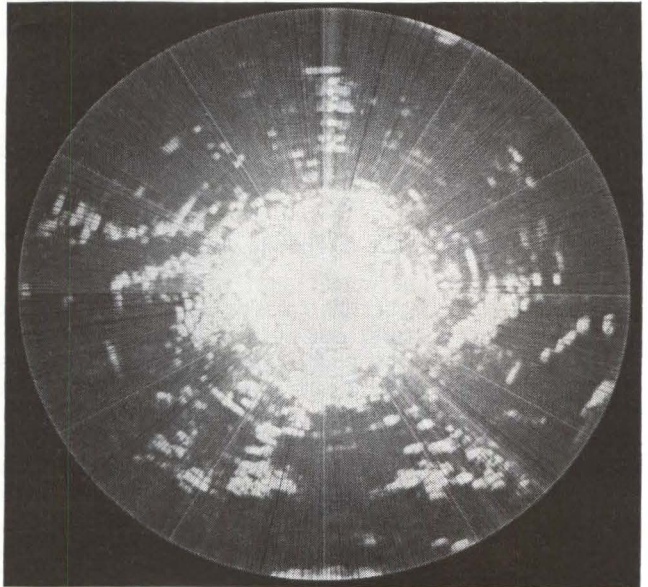

One can look to Kodak for the electronic circuitry, too. One wants a good record of what the pilot saw, TV or PPI. Or what he might have seen if he didn't have to live in real time. One can be disappointed with arrangements that just steal a picture of a presentation that has been optimized for the human eye.

Airborne radar recorders that do it right are now coming off our production lines. Organizations interested in procuring any type of hardware associated with this problem are advised to get some rough specifications together and put in a call to 716 - 562 - 6000, Ext. 764. The man who will come to the phone will be an electronics engineer employed by the Apparatus and Optical Division of Eastman Kodak Company, Rochester, N. Y. Say, "I saw those two pictures of yours in Electronics and—"

**This is another advertisement where Eastman Kodak Company probes at random for mutual interests and occasionally a little revenue from those whose work has something to do with science**



**POLAROID**  
CORPORATION



**USES**  
**CLAIREX**<sup>®</sup>

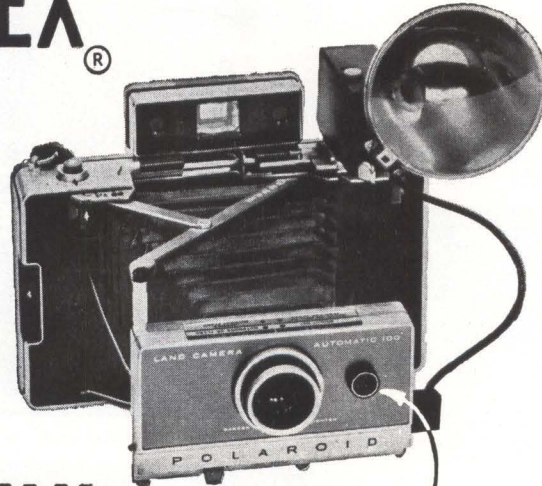

**...AGAIN!**



• **FIRST FLASH EXPOSURE CONTROL USING PHOTOCONDUCTIVE CELL**

The world's most advanced camera, the **Polaroid Land Automatic 100**, contains a most advanced photoconductive cell by **Clairex** capable of high speed operation over a ratio of light levels greater than 10,000/1. This cell is a key component—a "light valve"—in the new camera's electronic shutter which permits perfect exposures in both color and black and white under all conditions, **including flash operation**. Precisely controlled characteristics, as well as speed and reliability, prompted **Polaroid** to rely on **Clairex** photoconductive cells for such an important task . . . a second time!

• **FIRST STILL CAMERA WITH PHOTOCONDUCTIVE CELL CONTROL**

Over four years ago, **Polaroid Corporation** came to **Clairex** and asked it to supply the critical photoconductive cell component for its "Microeye" exposure control device, a "first" for still cameras!

Have **you** considered the "light touch" . . . in **your** automation or control problem?

**CLAIREX**  
CORPORATION

The Finest in Photoconductive Cells . . . in and out of This World

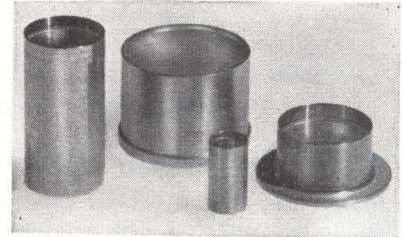

SEALED to Kovar, sapphire windows are now readily available in a variety of sizes and shapes—Fig. 2

**GENERAL PROPERTIES OF SAPPHIRE**

Compressive strength	300,000 psi at 77 F
Young's modulus	50 to 55 × 10 <sup>6</sup> psi (dependent on position of crystal C-axis)
Modulus of rupture	30 C—40,000 to 130,000 psi
	540 C—23,000 to 50,000 psi
Dielectric strength	Approx the same as alumina: 480,000 volts per centimeter
Melting point	2040 C
Specific gravity	3.98
Specific heat	0.18 calories per gram at 20 C
Porosity	0 percent
Thermal conductivity	0.065 calories per cm squared per sec per deg C per cm at 100 C

1-mm sample passes 92 percent of energy at a wavelength at 3 microns, to 50 percent at 6 microns. The material is also advantageous because it is practically inert to most reagents and at room temperature, and to a large variety of reagents at temperatures in excess of 1,000 C.

George Heitman, president of Ceramics International, says introduction of standard parts in an anticipation of customer needs, is an attempt to keep pace with growth of that business. He anticipates that sapphire seals will be used in increasingly large numbers in spacecraft, ground missile gear, electronic tubes, sensing equipment in the conversion of light to electricity, light-actuated devices, heat sensors, and other thermionic gear.

**New Magnetic Alloy Has Highest Known Remanence**

HIGHEST residual induction of any permanent magnet material is claimed for Remendur, a new cobalt-iron-vanadium alloy devel-



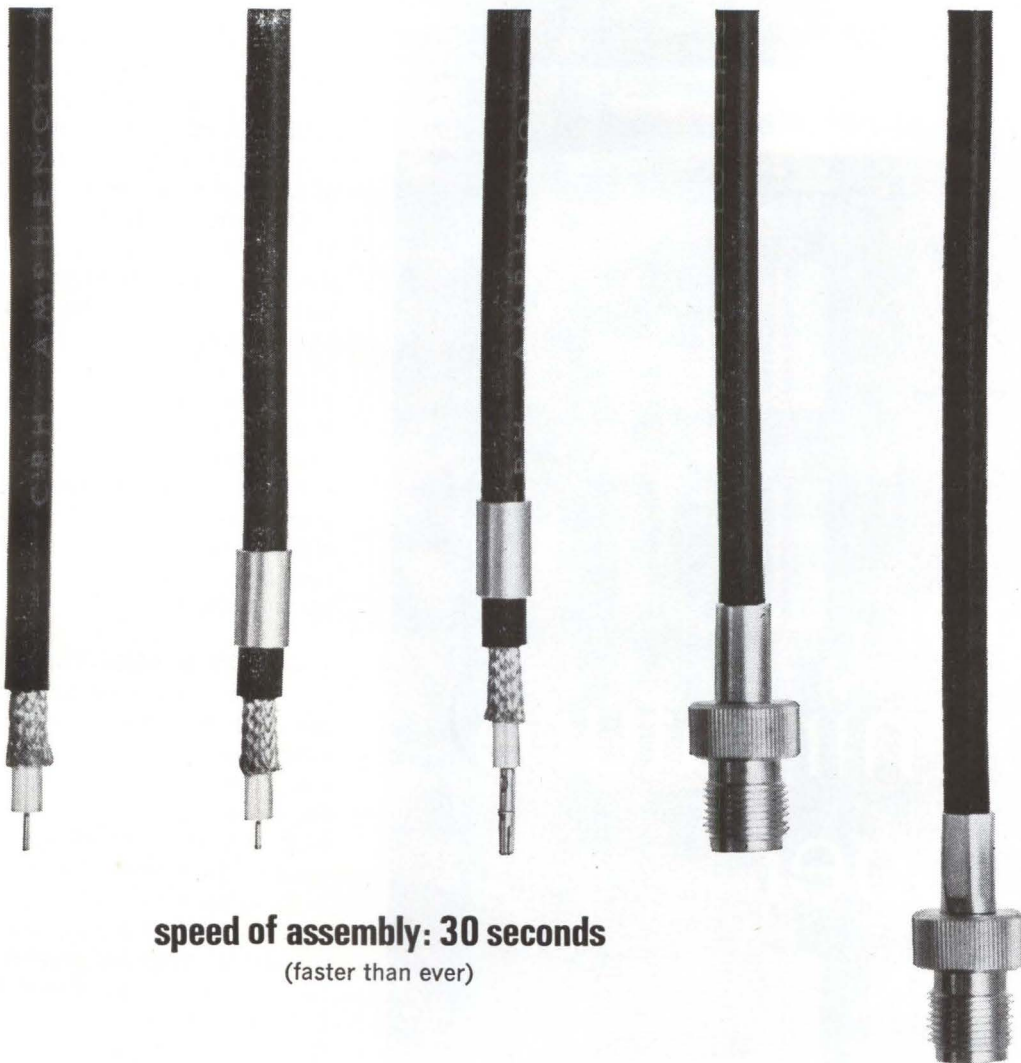

**speed of assembly: 30 seconds**  
(faster than ever)

**cost of connectors: 65 cents**  
(lower than ever)

These are FXR's new Amphenol/IPC "Quick-Crimp" TNC coaxial connectors.

TNC's three simple parts are easy to assemble with standard crimping tools. And TNC's threaded couplings make for solid, stable mating in shaky vibration environments. They have greater electrical consistency, and better cable retention, too, than standard TNC cable-clamp versions.

That 65-cent price is for the popular RG59/U jacks shown in quantities of 250 to 500. That's up to \$3.00 less than standard TNC cable-clamp versions.

Top-notch electrical and mechanical characteristics: 500 volts rating; uniformly excellent VSWR to 10 Gc; impedance matched to all 50-ohm RG cables normally associated with TNC series. They can also be used with 75 and 95-ohm cables when match is not critical.

Like FXR's "Quick-Crimp" BNC's (identical except for threaded coupling), TNC's mate with—and substitute for—any conventional TNC you're using now. Except ours cost less and work better.

You can assemble one in 30 seconds. We can ship you hundreds in 24 hours (we stock all the usual configurations). Get in touch with your local FXR representative, FXR regional office, or write directly to Kent Buell, FXR, 33 E. Franklin St., Danbury, Conn.

**FXR**<sup>TM</sup> THE RF PRODUCTS AND MICROWAVE DIVISION  
OF AMPHENOL-BORG ELECTRONICS CORPORATION





# BRISTOL sub-miniature chopper

## 0.1 CU. IN.

(shown actual size)

Featuring □ airborne environmental ratings and complete shielding for military applications. □ Unmatched noise level for low level instrument applications. Write for detailed spec sheet.

**The Bristol Company, Aircraft Equipment Division, 152 Bristol Road, Waterbury 20, Conn.** A Subsidiary of American Chain & Cable Company, Inc. In Canada: The Bristol Company of Canada Ltd. 71-79 Duchess Street, Toronto 2, Ontario.

3.4



# BRISTOL

...engineers for precision, builds for reliability.

oped at Bell Laboratories. According to Bell metallurgists, values of remanence up to 21,500 gauss are obtainable. Remanence is the magnetic induction that remains in a magnetic circuit after the removal of the applied magnetomotive force.

Developed by H. L. B. Gould and D. H. Wenny, the new alloy is slated to replace the ferrite member formerly used in the ferreed, a switching device with relay-like mechanical contacts that can be controlled at electronic speeds (Electronics, Sept. 30, 1960, p 63). The improved ferreeds will be incorporated in commercial telephone and military switching systems, including Bell's electronic switching system now being installed at Succasunna, N. J.

**Unique Properties**—The new alloy has unique magnetic and mechanical properties that overcome many of the disadvantages inherent in the ferrite used earlier. Remendur is far more temperature-stable with a high Curie temperature, has a square hysteresis loop, coercive force in the range of 20-60 oersteds, and has essentially isotropic or non-directional magnetic properties. The alloy can also be processed into thin foils, fine wires, or narrow ribbons. It exhibits a high elastic modulus and an expansion coefficient to match glass, can be readily electroplated, and responds to simple heat treatment.

Remendur's high residual induction makes possible the development of permanent magnets of extremely small cross-sections. Thus a single pound of Remendur will yield more than 2,000 ferreed switch magnets.

## Microwave Tubes Get Less Noisy

A NEW noise-cancelling technique for traveling-wave tubes involves the use of high magnetic fields close to the point where the electron beam originates.

Traveling-wave tubes are devices for amplifying microwaves.

Technique was developed by RCA. Company says method used in conjunction with a standard twt achieves the lowest noise figure ever reported for any microwave tube.



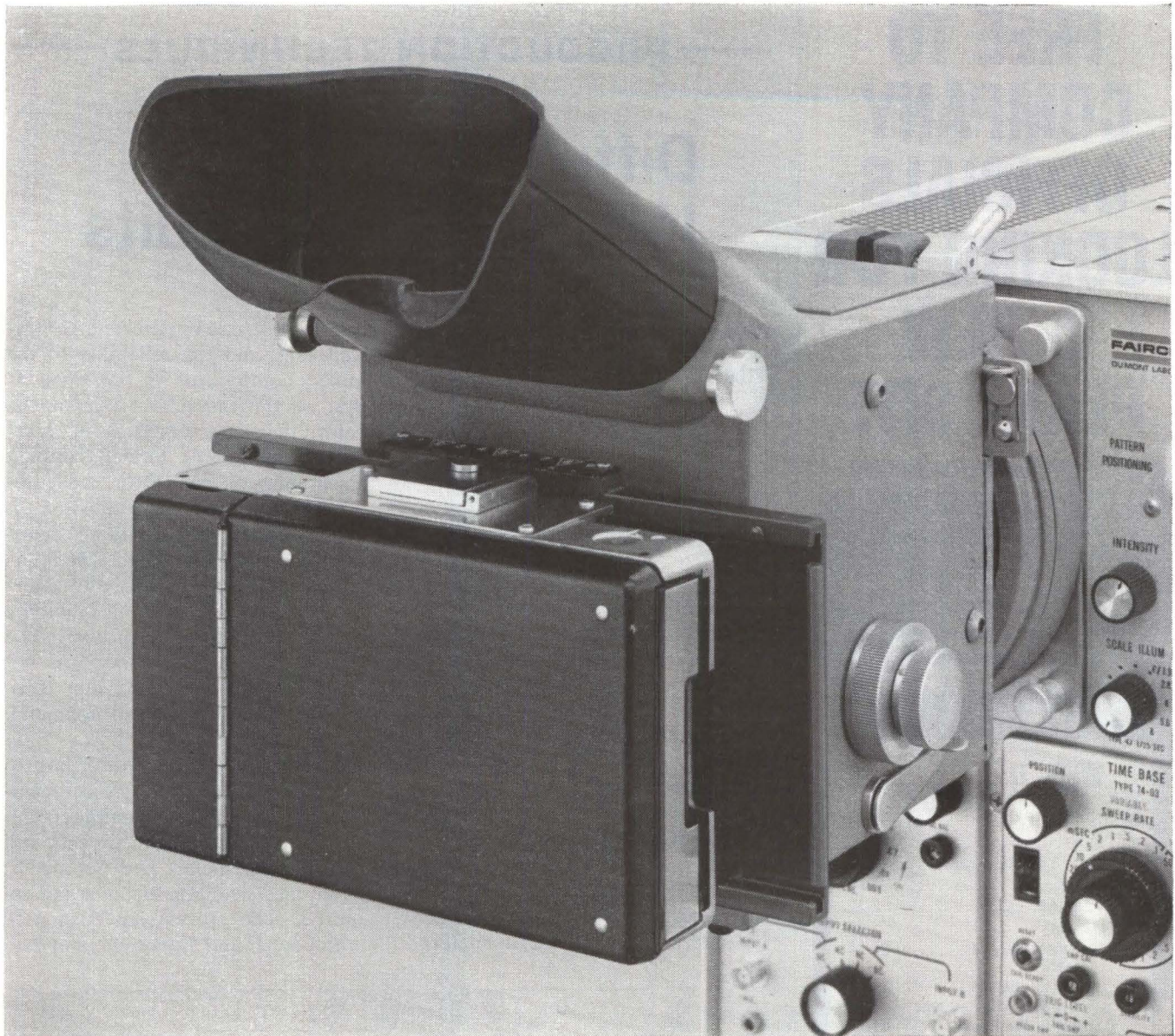

## SOMETHING NEW HAS BEEN ADDED TO THE FAIRCILD OSCILLOSCOPE CAMERA

*New Polaroid® Land Film Pack Adapter features drop-in loading, rapid-fire action.*

Speed oscilloscope photography at every step — with the new Polaroid Film Pack Adapter now available on all Fairchild Oscilloscope Cameras. Get ready faster... with drop-in film loading. Take pictures in rapid sequence... because now they can be developed outside the camera. Just shoot, pull a tab, shoot again. Finished prints are ready in only 10 seconds. Prints have a new, straight-edged format, lie completely flat. A dark slide permits removal of the adapter without loss of a single exposure.

This new Film Pack Adapter is now supplied as standard equipment on all Fairchild Oscilloscope Cameras fitted for Polaroid Land Camera backs. It is also completely interchangeable with existing scope cameras so fitted. If you have a 5" oscilloscope (any make), and a need to record its measurements, write today for complete data on the new Fairchild Oscilloscope Cameras. Or just call the nearest of 39 engineering-sales offices for a demonstration. Fairchild Scientific Instruments, Dept. 72, 750 Bloomfield Avenue, Clifton, New Jersey.

"Polaroid"® by Polaroid Corp.

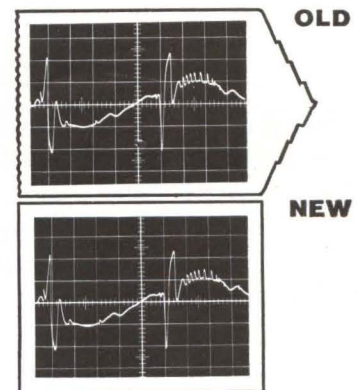

**FAIRCILD**  
DU MONT LABORATORIES  
SCIENTIFIC INSTRUMENT DEPT.



# FREE TO COMPANY OFFICIALS LOOKING FOR A NEW PLANT SITE

WE WILL PREPARE FOR YOU A  
**CONFIDENTIAL SURVEY**  
OF SELECTED LOCATIONS  
FOR YOUR NEW PLANT IN  
**NEW YORK STATE**



## TABLE OF CONTENTS

SUBJECT	PAGES
Introduction	1
Growth Trends	2-3
Climate	4-6
Public Utilities	7-22
Financial	23
Government Services	24-44
Taxes	
Protective Services	
Water Supply & Sewerage	
Community Facilities	45-73
Housing	
Education	
Recreation & Culture	
Industrial History	74-79
Labor	80-92
Natural Resources	93-94
Transportation & Markets	95-104
Sites	105-133

**TAILOR-MADE.** This confidential report is not taken off the shelf. It will be prepared specifically for you, based on the requirements for your new plant as you give them to us. Send these requirements on your business letterhead to Commissioner Keith S. McHugh, N.Y. State Dept. of Commerce, Room 257R, 112 State St., Albany 7, N.Y.

Keith S. McHugh, Commissioner  
New York State Department of Commerce

## PRODUCTION TECHNIQUES

# Diffused Junctions Interconnect Circuits

New method could provide interface-free connections for reliable operation

By **STEPHEN B. GRAY**  
Assistant Editor

**ST. PETERSBURG, FLA.**—A "total integration" process of interconnecting integrated circuits without soldering or welding, by a diffused-molecular-junction technique that eliminates interfaces has been disclosed by Honeywell's Florida Aeronautical division.

**No Interface**—The metals at connecting points are diffused into each other so that there is essentially only one element where two were before. No interface or change in material

composition can be detected, Honeywell said, and the reliability of the joined components is the same as that of the individual components before they were joined.

The junction is formed between an aluminum conductor, vacuum-deposited on the silicon substrate of the integrated circuit, and an aluminum interconnection lead. The interconnection lead is attached to a carrier that, as well as being a holding jig, is essential to the process. The composition of the carrier was not revealed, beyond stating that there are two types, metal and nonmetal.

**Metal or Nonmetal**—According to William A. England, project engineer in the advanced computers department, the diffusion process will interconnect metals and nonmetals, as an electrical conductor is not required. The process has been used with copper and aluminum, and does

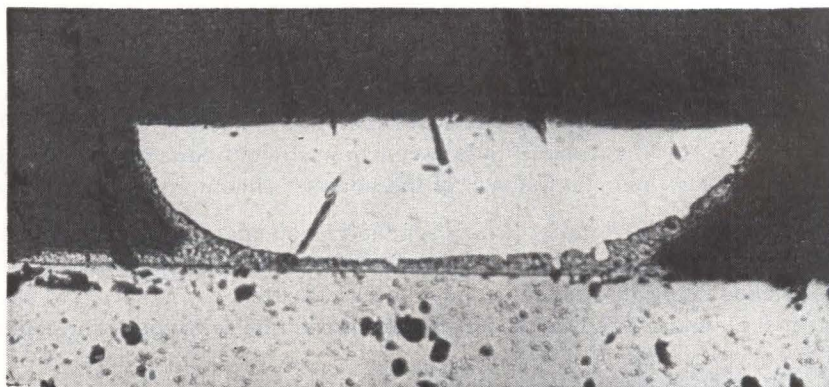
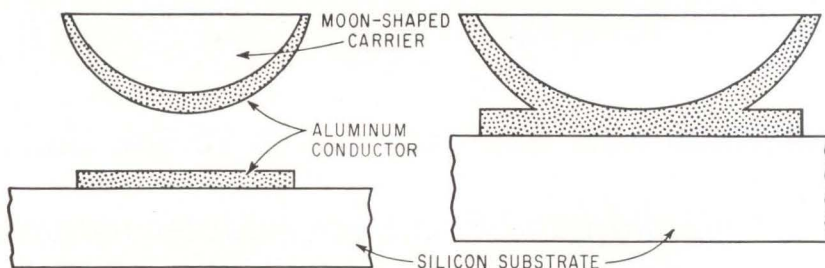

**DIFFUSED JUNCTION** with no interfaces, showing, from bottom to top—silicon substrate, aluminum layer deposited on the substrate diffused with the aluminum attached to the moon-shaped carrier



# New!

# Series 9000 SERVOPULSE® Generators

- 0.2 cps to 40 mc rep rates
- less than 5 ns rise times
- multi pulse capability

The 9000 Series SERVOPULSE® General Purpose Pulse Generators extends the modular design concept pioneered by Servo in pulse instrumentation. Many configurations are available combining modular functions of time delay; input, output, and sync amplification; time base and pulse width. Compact and uniform in dimensions, the modules can be arranged in the standard rack mounts to provide a wide range of specialized functions for little more than the cost of the standard instruments. Shown below is a typical twin pulse configuration. Many other combinations are possible, utilizing the same standard rack mount and general purpose power supply.

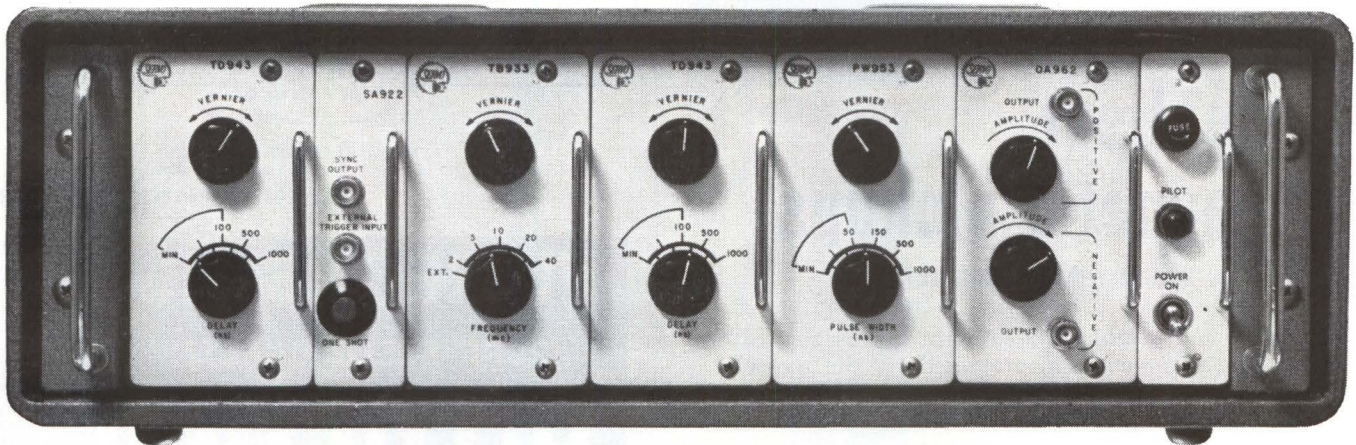

	MODEL 9350	MODEL 9450	MODEL 9455	MODEL 9550
Frequency Range	.2 cps — 5 kc	100 cps — 2 mc	100 cps — 10 mc	2 mc — 40 mc
Delay	.1 ms — 1 sec.	0 — 1 millisec.	0 — 1 microsec.	0 — 1 microsec.
Pulse Width	.1 ms — 1 sec.	.1 μs — 1 ms.	25 ns — 1 μs	25 ns — 1 μs *
Simultaneous Pos & Neg Outputs	10V open circuit 7V into 93 ohms	10V open circuit 7V into 93 ohms	10V open circuit 7V into 93 ohms	10V open circuit 7V into 93 ohms
Rise & Fall Time	Under 5 nanosec.	Under 5 nanosec.	Under 5 nanosec.	Under 5 nanosec.
Max Duty Cycle At Full Amplitude	70%	70%—40% at 2 mc	90%	90%—60% at 40 mc
One Shot/Sync & External Trigger	Yes	Yes	Yes	Yes
Price	\$660.00	\$835.00	\$975.00	\$1,390.00

Flat top for all instruments less than ±2% at max. pulse width.

\* 15 ns @ 40 mc



## SERVO CORPORATION OF AMERICA

111 New South Road • Hicksville, L.I., New York • WElls 8-9700

SEND FOR DATA ON THE NEW SERVOPULSE® SERIES 9000!

SERVOPULSE® PRODUCTS



PRODUCT  
NEWS from EPL

Now available from stock...

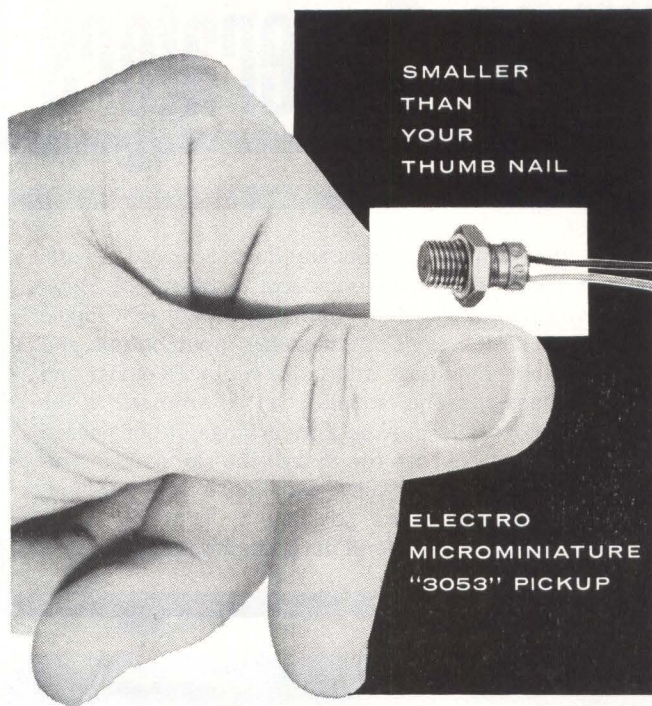

## smallest magnetic pickups

sense speed without contact

Tiny but mighty, these transducers generate voltage/frequency in proportion to the speed of ferrous metal objects interrupting their external magnetic fields.

Eliminate physical contact, mechanical linkages, and power supplies when actuating electronic circuitry. Use these EPL pickups for control, instrumentation, or for providing telemetering data.

Output: up to 3 VAC.\* Weight: less than 0.1 oz. with nut.  
Size: .250" x .500". Construction: stainless steel.

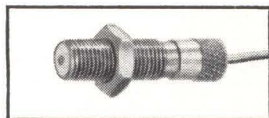

SUBMINIATURE "3055-A"

Output: up to 6.7 VAC\*  
Size: .295" x 1.00"  
Weight: 0.123 oz.

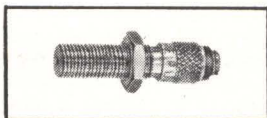

SUBMINIATURE "3056"

Output: up to 6.7 VAC\*  
Size: .295" x 1.100"  
Weight: 0.177 oz.

Other stock models... up to 450 VAC\* output

\*Under Standard EPL test conditions

Free Application Guide, Catalog, Data Sheet



### ELECTRO PRODUCTS LABORATORIES

6125-F Howard, Chicago (Niles), Ill. 60648  
Phone: 312/775-5220

Canada: Atlas Instruments Corp., Toronto

Proximity Switches • Magnetic Pickups • Pres-con Controls  
Tachometers • Dynamic Micrometers • DC Power Supplies

72 CIRCLE 72 ON READER SERVICE CARD

When you need INTERCHANGEABLE  
thermistors or thermistor probes...

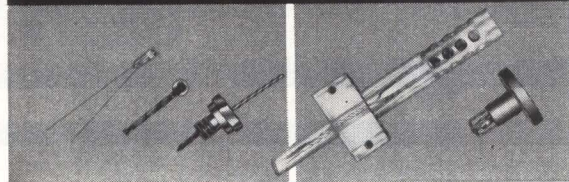

## ...Check F.E.I. ISO-CURVE Thermistors\*

(the only thermistors with identical characteristics)

- Standardized resistance/temperature characteristics
- Completely interchangeable no calibration or compensation
- Direct readout of absolute temperature
- High sensitivity
- Fast response
- Broad resistance range

**GET THE FACTS** — Send for this new brochure which gives complete specifications, selection, and application data on the only available line of completely interchangeable thermistors and thermistor probes.



\*Made under Pat. 3109227 and others.  
ISO-CURVE is a trademark of F.E.I.



FENWAL ELECTRONICS, INC.  
Dept. B, 63 Fountain St., Framingham, Mass.

CIRCLE 201 ON READER SERVICE CARD

## VITREOUS-SILICA

(PURE FUSED QUARTZ) is

# VITREOSIL®



Once a laboratory curiosity pure fused quartz now plays leading roles in American industry. It handles hot liquids or gases up to 1100°C, is virtually corrosive free, is unaffected by thermal shock and has exceptional optical and electrical qualities. Write for our 32 page catalog today for more details on "VITREOSIL".

24



THERMAL AMERICAN FUSED QUARTZ CO.

RT. 202 & CHANGE BRIDGE RD. MONTVILLE, NEW JERSEY

CIRCLE 202 ON READER SERVICE CARD  
February 14, 1964 electronics



not involve welding, pressure, friction, lasers, ultrasonics, vacuum, or chemical additives. It can be performed at room temperatures in a clean room, in about a tenth of a minute—including setup time. England said the process will be cheaper than soldering or welding, assuming automation of the diffusion process.

**Reliability**—Noting that reliability of circuits depends heavily upon the interconnections, and that computer failures most often occur at connection points, England described a typical TTL AND-OR gate that would require 138 soldered interconnections as being 1/40th as reliable as with diffused junctions; 98 interconnections if welding techniques were used, with 1/20th the reliability; and 14 integrated-circuit interfaces, with 1/3 the reliability.

Questioning brought out that the molecular diffusion process is related to Honeywell's technique for chemical deposition of a magnetic metal thick film, used in their Orthocore closed-flux memory. In the Orthocore memory ELECTRONICS, p 17, Jan, 31)—which Honeywell describes as "cored wires" rather than wired cores—a three-layer sandwich grid of conductors is constructed, tubes formed around them with molds, and the thick film deposited over the tubes, with several layers formed in one "dunking."

**To Production**—The diffusion technique, which has been performed about a thousand times in the laboratory, will be used to interconnect as many as 25 integrated-circuit chips, containing altogether 400 transistors and 250 resistors, creating "integrated" integrated circuits in a device called Micpak (molecular integrated circuit package). The Micpaks will be interconnected with the same technique to form a totally integrated basic element, about 3/4 in. by 3 in. by 7 in., of the Honeywell Adept computer, which was also announced last week. The Adept family of aerospace digital computers is said to be the first totally modular computer line of any kind (ELECTRONICS, p 17, Jan. 31). The junction technique can be used in all elements of the Adept family, including Orthocore memory modules, which, with the packaging technique, will move from research to production status this year.

*For Metrology Engineers . . .*

## Ballantine's Reference Standards for AC Voltage Measurements

*. . . enable you to calibrate your ac voltmeters, signal generator outputs, or frequency response of oscilloscopes with highest accuracy.*

### MODEL 440 MICROPOTENTIOMETER

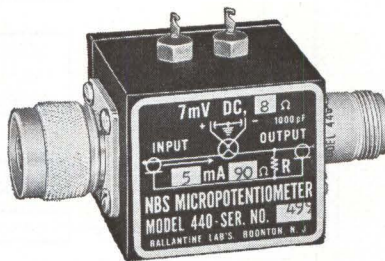

Price: \$175 per resistor, plus \$75 per thermocouple housing assembly.

Acts as a low impedance source of accurately known voltage at frequencies from 0 to 900 Mc. It consists essentially of a UHF thermocouple whose heater is in series with a special radial resistor. When connected to an external signal source, the voltage drop across the resistor can be held to a known value over a range of frequencies from 0 to 900 Mc by monitoring the dc output of the thermocouple. Each thermocouple-resistor combination can be operated over a voltage range of 4 to 1 selected between the limits of 15 microvolts and 1 volt. The device is ideal for calibration of ac voltmeters, 'scopes, or signal generators. There is probably no device better adapted to these tasks, principally because it is so simple to use over such a wide range of frequencies. It is based on designs by Mr. Myron C. Selby of the National Bureau of Standards.

### MODEL 393 HF (HIGH FREQUENCY) TRANSFER VOLTMETER



Price: \$1,270 with 6 probes, 1 to 100 volts

A device for the accurate measurement of ac voltages of 1 to 100 volts at frequencies from 25 cps to 30 Mc. Measurements are made by equating an unknown ac voltage to an accurately measureable dc voltage using a resistor-thermocouple probe. Accuracy is better than 0.1% up to 10 Mc, and better than 0.5% to 30 Mc even without application of calibration data. It is based on designs by Mr. F. L. Hermach of N. B. S.

### MODEL 390 A-T (ATTENUATOR-THERMOELEMENT) VOLTMETER



Price: \$2,250

Ask for 4-page brochure on any of these instruments.

A laboratory standard device consisting of an adjustable waveguide-below-cut-off attenuator feeding a UHF vacuum thermocouple for measurement of voltages from 1 volt to 300 volts (depending on frequency) from 10 Mc to 1000 Mc. NBS calibration is available to 400 Mc at the present time, but facilities are planned to 1000 Mc. The Model 390 is based on a design by Messrs. Selby and Behrent of N. B. S.



— Since 1932 —

**BALLANTINE LABORATORIES INC.**  
Boonton, New Jersey

CHECK WITH BALLANTINE FIRST FOR LABORATORY VACUUM TUBE VOLTMETERS, REGARDLESS OF YOUR REQUIREMENTS FOR AMPLITUDE, FREQUENCY, OR WAVEFORM. WE HAVE A LARGE LINE, WITH ADDITIONS EACH YEAR. ALSO AC DC LINEAR CONVERTERS, CALIBRATORS, WIDE BAND AMPLIFIERS, DIRECT-READING CAPACITANCE METERS, AND A LINE OF LABORATORY VOLTAGE STANDARDS 0 TO 1,000 MC.



# A-D Interface Has Variable Rates

Information and control flow in both directions between computers

**ANALOG-TO-DIGITAL** interface system, model AD-1, allows flow of information and control, in both directions, between a digital and analog computer. In addition, a large number of external pieces of equipment can be controlled by the digital computer through the AD-1 system.

To allow information flow between the two computers, the system contains analog-to-digital conversion of four channels at a rate up to 90  $\mu$ sec per channel, and digital-to-analog conversion of two channels at rates limited by the digital computer. The four analog-to-digital channels are manually selectable while the selection of the digital-to-analog channels is computer controlled. Both analog-to-digital and digital-to-analog converters have a 10 bits plus sign capability.

The analog computer can exercise functions through the use of level crossing detectors driving the digital computer interrupt lines. A total of eight interrupt sources are available. One additional interrupt source is used in conjunction with a digital integrator.

A digital decoder decodes computer commands and supplies signals and relay closures to control ex-

ternal equipment, such as a magnetic tape recorder, a graph plotter, an analog computer, a camera shutter or a scope. Total number of decoded control codes is 48 with built-in expansion capability to 64. A set of 12 relays supply contact closures for a digital word or its complements. These can be used for a high precision digital-to-analog conversion, for control of a set of 12 analog lines in the analog computer, or for 12 additional control functions.

A powerful and useful feature

of the system is the variable rate generator. Rates can be selected from 10  $\mu$ sec to 1 sec in 10- $\mu$ sec intervals. This allows the selection of sampling rate for the A-to-D and D-to-A conversion. As an example, the frequency of an analog signal can be changed by performing an A-to-D conversion at one rate and a D-to-A conversion at a different rate. Price of the system is under \$20,000. General Applied Science Laboratories, Inc., Merrick & Stewart Ave., Westbury, N. Y. CIRCLE 301, READER SERVICE CARD

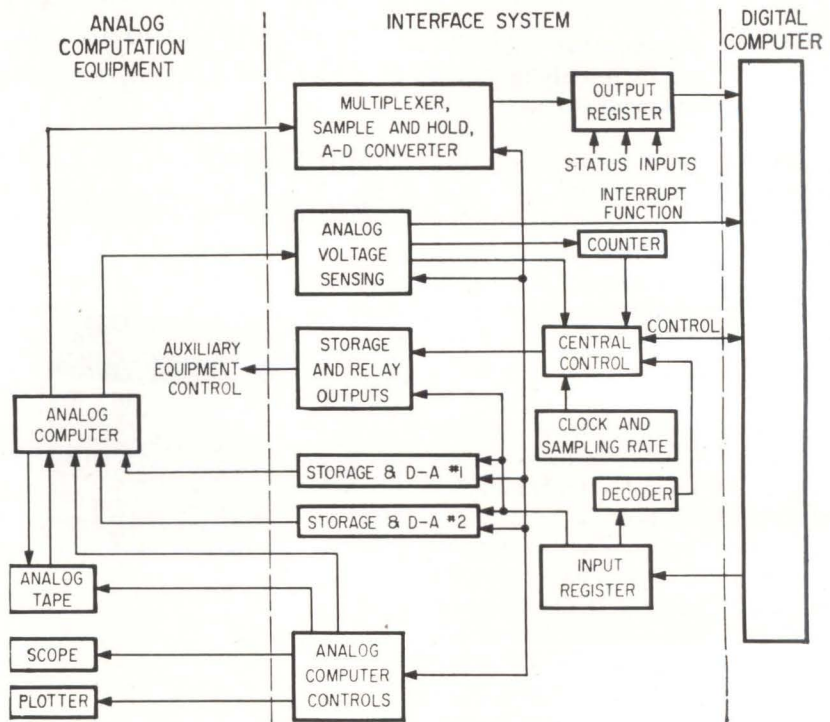

# Photocell Switches Feature Wide Angle Response

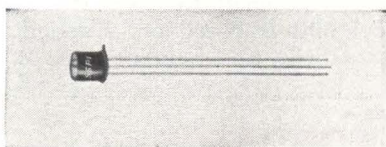

**NEW CLASS** of Photran (silicon *pnpn* photocell switches) are intended for use in light sensing sys-

tems requiring a minimum of angular sensitivity, or where aperture masking is used for high resolution. Sun or horizon sensing in space vehicles is one application. They are equally useful in other types of position sensing.

Total included angle is 90 deg (45 deg on each side of the major

optical axis) for triggering. Light level required for triggering can be readily set, by an external resistor, to any desired value above 500 ft-candles. The normal "trigger inhibit" advantage of the gate level offers further design flexibility.

The device, in TO-18 case, carries up to 300 ma continuous d-c





# MICRO SWITCH Precision Switches

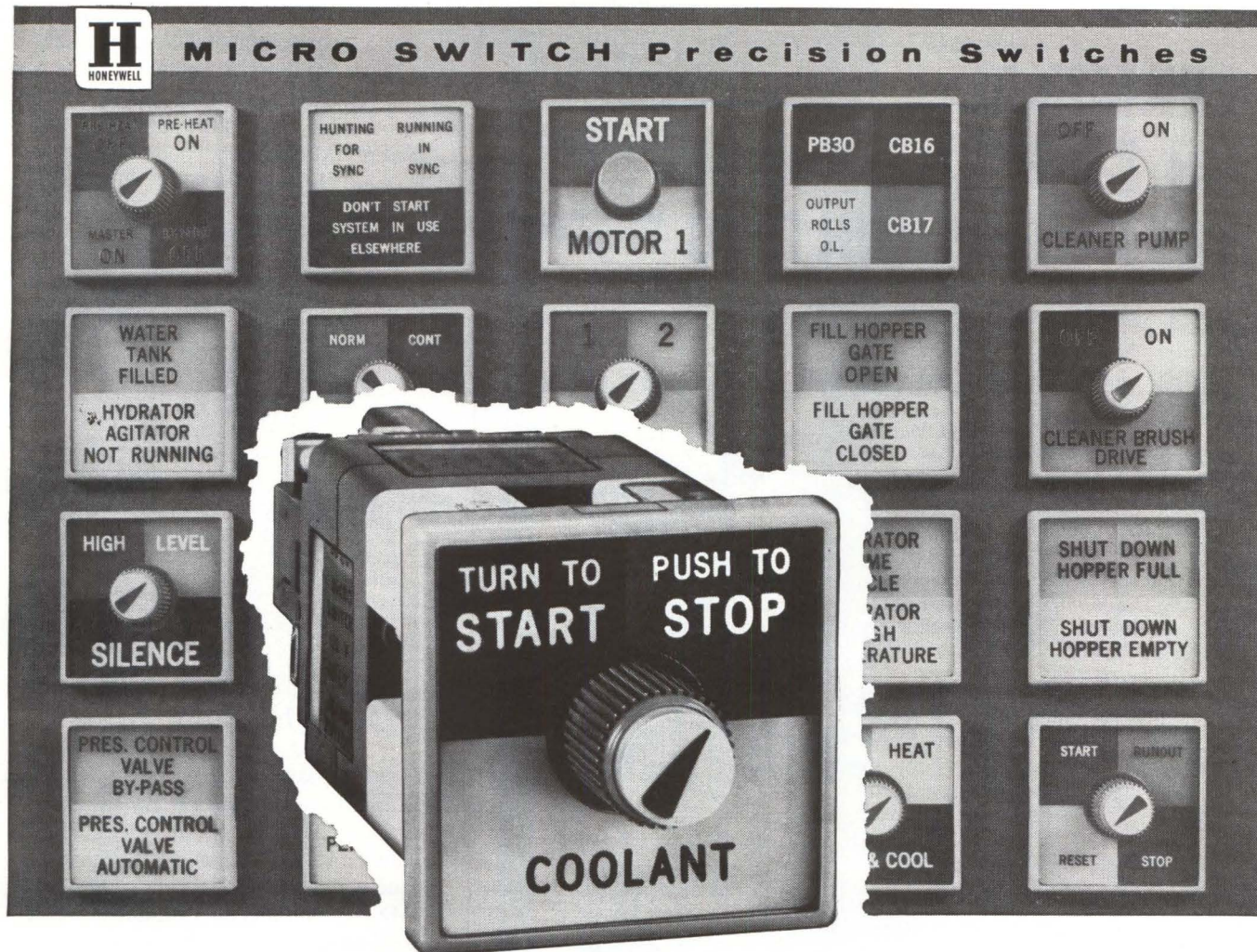

In this small  $2\frac{5}{16}$ " panel space, lighted display and control, too !

This is the new oil-tight Coordinated Manual Control in actual size—lighted legends combined with control, all in one unit that utilizes panel space only  $2\frac{5}{16}$  inches square. Yet the legends are large and easily read, even at a considerable distance.

Four basic units are available, all oil-tight: Pushbutton, Selector, Selector-Push, and Indicator unit only. Snap-in lighted legends may be custom or standard. Custom legends indicate individual system status; standard legends indicate common industrial control signals.

A wide selection of operators, contact blocks and switch arrangements provides unlimited industrial and electronic control capabilities.

Write for Catalog 69—fully illustrated and complete with circuitry, dimensions, legend and color information. Or, call our Branch Office (see Yellow Pages).

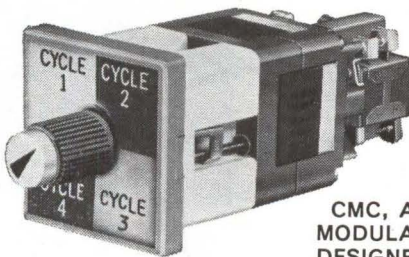

CMC, A MODULAR DESIGNED ASSEMBLY.

A wide selection of 4-lamp legend displays and six color coding.

Four types available: Pushbutton, Selector, Selector-Push, and Indicator unit only.

Heavy Duty or Electronic Duty contact blocks. May be stacked in any order.



## MICRO SWITCH FREEPORT, ILLINOIS 61033 A DIVISION OF HONEYWELL

HONEYWELL PRESENTS



SCIENCE ALL STARS • SUNDAYS 4:30 E.S.T.  
Beginning January 12

HONEYWELL INTERNATIONAL—SALES AND SERVICE OFFICES IN ALL PRINCIPAL CITIES OF THE WORLD. MANUFACTURING IN UNITED STATES, UNITED KINGDOM, CANADA, NETHERLANDS, GERMANY, FRANCE, JAPAN.



# TERMINAL OR CONTACT SETTING PROBLEMS ?

**BLACK & WEBSTER SOLVES THEM QUICK AS a b c d!**

**a** Electroset — Model FST Automatic Terminal Setter — tube fed. Sets terminals at rates up to 4200 per hour. Precision-controlled impact (up to 3500 lbs.) eliminates rejects. All-electric operation. Ideal for turret type or seamed terminals, pins, shoulder studs, plug-nuts. High reliability — tested and proven by leading electronics firms.

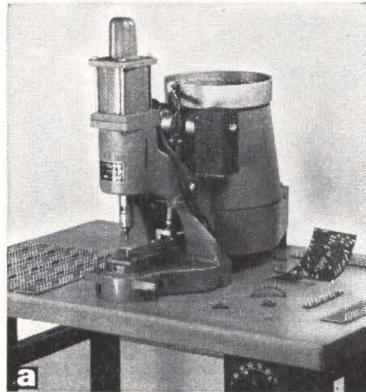

**b** Electroset — Model FST-1 Automatic Terminal Setter — raceway-fed, for split-lug, feedthrough and other terminals. Precision-impact up to 3500 lbs. All-electric operation. Capable of feeding more complex shapes than FST. Within limits, FST-1 can feed more than one type terminal in the same raceway.



**c** Electroset — Model FSTC Contact Setter — raceway-fed, for automatic contact setting. All-electric operation. Precision-controlled impact up to 3500 lbs. Adjustable rate of feed, up to 100 contacts per minute. This bench-mounted unit comes completely toolled and ready to operate on delivery.



**d** Electropunch — Model FJS — for short run terminal setting. Except for automatic feed and bench, specifications are identical with those of automatic models. All electric operation. Accommodates tool holding bolster plate and variable transformer to assure precise impact control.

Whatever your terminal setting or contact setting problem, Black & Webster has the solution. Send sample terminals or contacts and requirements — we'll return suggestions with no obligation. Write today for catalog describing our complete line of all-electric production tools. Dept. E.

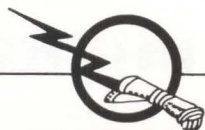

## BLACK & WEBSTER, INC.

570 PLEASANT STREET, WATERTOWN, MASSACHUSETTS 02172—(617) WA 6-0100

forward current at voltages up to 200 v. Load current is independent of light input at all intensities above the triggering level. Solid State Products, Inc., One Pingree St., Salem, Mass.

CIRCLE 302, READER SERVICE CARD

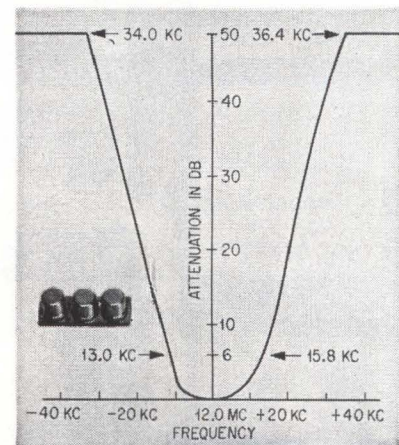

### Crystal Filters Span 11 Mc to 20 Mc

DEVELOPMENT of a new line of subminiature precision crystal filters packaged in three and five TO-5 cans and operating on center frequencies between 11 Mc and 20 Mc is announced. Designed to be size-compatible with integrated circuitry and other miniaturized assemblies and components, the filters meet MIL STD 202 for shock, vibration and humidity.

The basic three-can filter, response curve of which is shown, achieves a 50 to 6-db shape factor of 5:1, has a 6-dB bandwidth of 0.2 percent of center frequency maximum, insertion loss of 6 db maximum and bandpass ripple of  $\pm 1$  db maximum. The input and output transformers for matching impedances of 50 to 5,000 ohms are included as an integral part of the filter.

Additional pairs of TO-5 cans may be added to the basic filter assembly to further improve selectivity and attenuation. A five-can filter having a 6-dB bandwidth the same as the three-can filter provides a 60 to 6-dB shape factor of 2:1. Price is \$200 per unit in large quantity lots, typically around 100 or so. Delivery is 6 to 8 weeks upon receipt of order. Motorola Inc., Communications Division, 4501 W. Augusta Blvd., Chicago 51, Ill. (303)



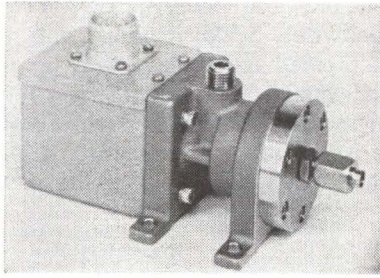

### Pressure Transducers Use Modular Circuits

INCORPORATING differential transformer pressure sensing units and solid-state symmetry-sensing electronics, a new pressure transducer converts pressures in various ranges from 0.5 to 8,000 pounds per square inch into voltages from 0 to 5v d-c. Pressure sensing elements and the differential transformer are housed in a single pressure housing. Modular electronic circuits are contained in a separate housing attached so that it can easily be disassembled for maintenance. Overall measurements are 7.2 in. by 3.5 in. by 3.3 in. Consolidated Controls Corp., Bethel, Conn. (304)



### Ampere-Hour Meter Monitors Battery Charge

PURPOSE of the model EMAM104A is to provide a direct reading of the summation of current as a function of time. The instrument integrates voltage directly proportional to battery current flowing through an external shunt. The circuitry will sense voltage of either polarity automatically and drive the ampere-



... for real Space-Age  
RELIABILITY

# Dunco

## TYPE FC-406 5-AMPERE, 6P-DT

### AIR FRAME RELAY

An inherently dependable design . . . assembled under contaminant-free, super-clean conditions . . . gives the Dunco FC-406 the ultimate reliability demanded by the most critical aerospace applications.

Components of the FC-406 are repeatedly cleaned during manufacture, assembled in white rooms and hermetically sealed in inert atmospheres to assure long, fully dependable operation under minimum current, rated load, and severe overload conditions.

Designed primarily for air frame use to MIL-R-6106C, the FC-406 design is also adaptable to MIL-R-5757D applications. A dual coil magnet operating a balanced armature assures resistance to vibration and shock. Bifurcated contacts are used to improve contact life and to insure minimum-current reliability.

Optional mounting and terminal styles as well as self-contained rectifiers for 115V ac coil operation are available. For full details, ask for Data Bulletin FC-406. Address: Struthers-Dunn, Inc., Pitman, N.J.

# STRUTHERS-DUNN

Member, National Association of Relay Manufacturers

SALES ENGINEERING OFFICES IN: Atlanta • Boston • Buffalo • Charlotte • Cincinnati • Cleveland  
Dallas • Dayton • Encino • Englewood • Houston • Kansas City • Las Vegas • Memphis • Newark  
New York • Orlando • Pittsburgh • St. Louis • Salt Lake City • San Antonio • San Diego • San Mateo  
Scottsdale • Seattle • Southfield • Wichita • Wilmette. Canadian Licensee: Renfrew Electric Co., Ltd.,  
Toronto. Export Department: 1505 Race St., Philadelphia 2, Pennsylvania, U.S.A.



# These ALITE<sup>®</sup> POWER TUBE CERAMICS

Not only  
LOOK ALIKE

**They are  
IDENTICAL**

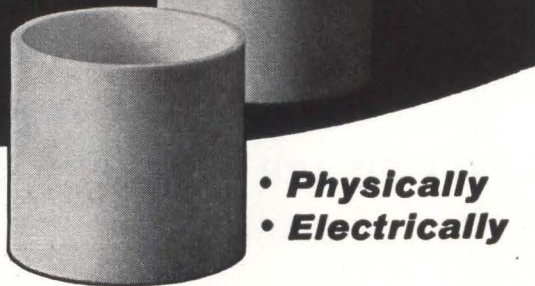

- **Physically**
- **Electrically**

Envelopes . . . spacers . . . windows . . . insulators — whatever your requirements for high alumina ceramic power tube components, you can rely on Alite for exact duplication of properties, part after part, order after order.

This repeatability is assured by Alite's rigid Quality Control procedures. For example, accompanying each group of parts through production is a card on which is kept a record of material lot code numbers, process times and temperatures, etc. In-process and final inspections are detailed and thorough.

As a result, Alite high alumina ceramics are perfectly homogeneous. Dimensional tolerances are strictly held. Several Alite formulations, with differing  $Al_2O_3$  content, are available which meet or exceed the specifications of our most demanding customers.

Alite parts can be supplied unmetallized, metallized, or as vacuum-tight ceramic-to-metal sub-assemblies.

\* \* \* \* \*

Let us review your specific requirements — without obligation: send us prints and other pertinent data. Or, write for free bulletins giving complete information about Alite.

ALITE

DIVISION

**U. S. STONWARE**

BOX 119

ORRVILLE, O. 44667

5-J

CIRCLE 78 ON READER SERVICE CARD

**WANT TO  
DO BUSINESS  
WITH THE  
GOVERNMENT ????????**

Then check the Military and Government Procurement Guide in the orange section of your **ELECTRONICS BUYERS' GUIDE**.

hour indicator clockwise or counter-clockwise. Scale readings will be maintained indefinitely with no input signal. Gulon Industries, Inc., Engineered Magnetics Div., 13041 Cerise Ave., Hawthorne, Calif. CIRCLE 305, READER SERVICE CARD

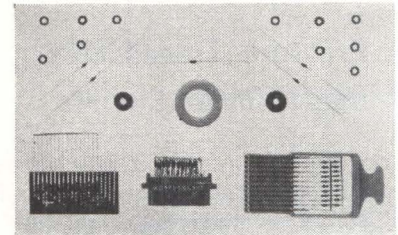

## Micro Diodes, Cores and Assemblies Offered

A LINE of individual core driver silicon micro diodes as well as assemblies of micro diodes are announced. The devices are specifically applicable to 1.5  $\mu$ sec, 2  $\mu$ sec and 2.5  $\mu$ sec read and write computer memories. Large, long duty cycle trapezoidal core pulses are handled with ease. Some individual silicon diode specifications available are less than 2-pf capacitance, less than 2-nsec recovery, greater than 400 mils conductance, low leakage and high peak inverse. Units meet or exceed all applicable specifications of MIL-S-19500C. MicroSemiconductor Corp., 11250 Playa Court, Culver City, Calif. (306)

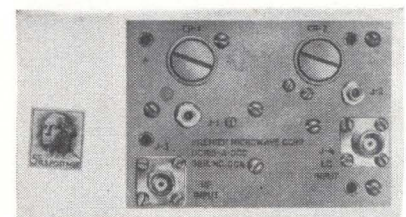

## Balanced Mixer Spans 4.2 to 4.4 Gc

AVAILABILITY of the model 815 Flat-line balanced mixer is announced. It meets the rigid environmental requirements applicable to airborne military electronic equipment. Frequency range is 4.2 to 4.4 Gc; noise figure, less than 8.0 db; i-f impedance, 200 ohms, 40 pf; l-o drive power, 0.5 mw; l-o rejection, 20 db; size, 3 in. by 4 $\frac{3}{8}$  in. (plus connec-



tors); weight, 7 oz. Premier Microwave Corp., 33 New Broad St., Port Chester, N.Y. (307)



### Attenuator Offers High Accuracy

A NEW in-line vernier attenuator provides for fine control of attenuation when used as a separate unit or in series with the company's 1.0-db step attenuators. It provides attenuation values in 0.1 steps from 0.1 to 1.1 db at frequencies up to 500 Mc. Typical accuracies are better than  $\pm 5$  percent overall at 100 Mc;  $\pm 10$  percent at 250 Mc. Maximum vswr is 1.4 at 250 Mc. The new attenuators are available in 50, 70 and 90 ohms. Kay Electric Co., Maple Ave., Pine Brook, N. J. (308)

### Slip-Ring Assemblies Are Totally Enclosed

THROUGH the use of standard wafers, slip-ring assemblies having from one to more than 50 rings can be fabricated, at very low cost, and result in packaged assemblies having ratings up to 25 amp per ring, rotational speeds to 5,000 rpm, isolation between circuits of up to 3,000 v, and extreme stability of forward drop for the most critical low-voltage circuits. The assembly can be supplied optionally in shaft diameters from 0.250 in. to 0.750 in. and shaft lengths from 1/4 in. to 6 in. Mounting can be supplied either as a threaded bushing,

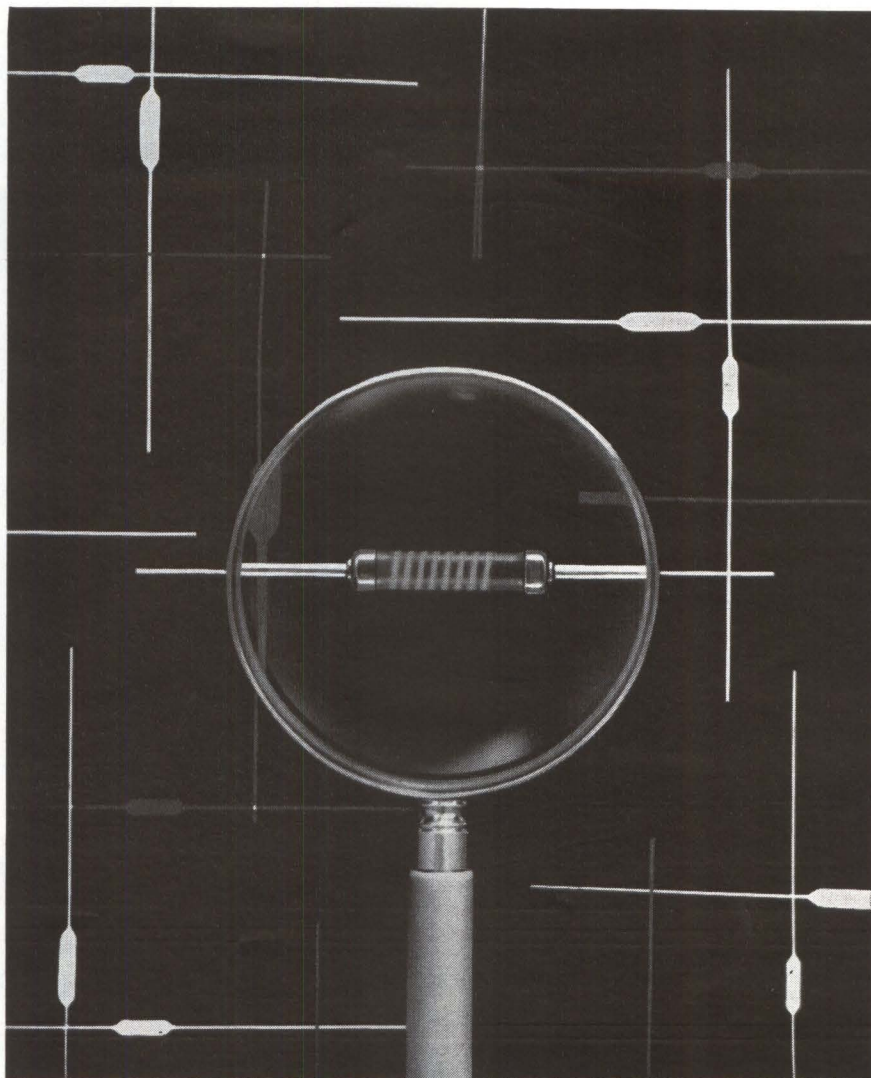
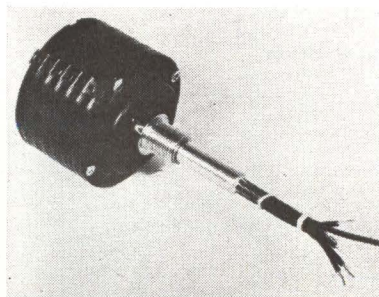

## New: a smaller, tougher METOHM with rugged end-cap construction

**New 1/10 and 1/8 watt conformal-coated metal film resistors exceed requirements of MIL-R-10509D, characteristics C,D,& E**

Ward Leonard's new Type WLC 55 & 60 METOHM® precision resistors mark a new reliability high in the components industry.

Gold-plated end-caps and gold end-terminations for lowest contact resistance, precision tolerances, low T.C.'s, and high stability make the Type WLC METOHMS ideal for critical applications in ratio dividers, timing circuits, measuring instruments, and circuit modules. For extreme miniaturization, you get double the wattage rating at an operating ambient temperature of 70°C.

Write for specifications and/or evaluation samples. Our Hagerstown, Md. plant now has double capacity—devoted exclusively to metal film precision resistors—means faster deliveries. Ward Leonard Electric Co., 30 South Street, Mount Vernon, N. Y. (In Canada: Ward Leonard of Canada, Ltd., Toronto.)

4.5

WARD LEONARD



METAL FILM DIVISION



# Save Assembly Time with Quick-Connect Terminals on BUSS Fuseholders

Eliminates soldering. Permits use of pre-assembled harness. Reduces assembly time.

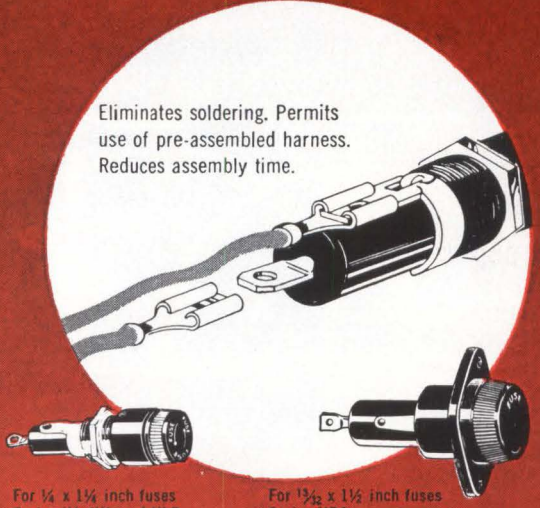

For 1/4 x 1/4 inch fuses Series HJ, HK, and HLD

For 1/2 x 1/2 inch fuses Series HPC

# BUSS

Write for BUSS Bulletin SFB.

BUSSMANN MFG. DIVISION, McGraw-Edison Co., St. Louis 7, Mo.

# BUSS FUSEHOLDERS



- LAMP INDICATING
- SIGNAL ACTIVATING
- SERIES HKA

For 1/4 x 1/4 inch BUSS GLD Fuses, 1/4 to 5 amps.

Where a visible or audible signal or both is desired to indicate trouble on a circuit, the BUSS HKA fuseholder with BUSS GLD fuses presents a practical answer.

When fuse opens, an indicating pin completes a circuit that lights knob indicating lamp and makes electrical contact on external signal circuit. The external signal can be an audible alarm, or another lamp mounted at a distance, or it can operate a relay.

# BUSS

Write for BUSS Bulletin SFB.

BUSSMANN MFG. DIVISION, McGraw-Edison Co., St. Louis 7, Mo.

## BUSS: 1914-1964, Fifty years of Pioneering...

CIRCLE 81 ON READER SERVICE CARD

CIRCLE 81 ON READER SERVICE CARD

### TO ORDER REPRINTS

Fill in, cut out coupon below, insert in envelope and mail to:  
**electronics** Reprint Dept.  
 330 W. 42nd Street, New York, N. Y. 10036

### REPRINT ORDER FORM

For Listing of Reprints Available See Reader Service Card

(To help expedite mailing of your reprints please send cash, check or money order with your order.)

For Reprints of the latest Special Report; Modern Electronic Packaging

Send me.....Reprints of Key No. R-48 at 50¢ each.

For Reprints of previous Special Reports or Feature Articles fill in below:

Send me.....Reprints of Key No.(s).....@.....¢ each. (For prices, see Reader Service Card.)

\*For orders of Bulk Reprints of other editorial articles in this issue or past issues:

Send me.....Reprints of pages no.(s).....of issue date.....of article entitled .....

\*Minimum bulk order 100 copies. You will be advised of costs by return mail.

Name .....

Number and Street.....

City, Zone No., State.....



3 hole, or size 17 synchro mount. Standard Switch Corp., 115 Moonachie Road, Moonachie, N. J. CIRCLE 309, READER SERVICE CARD

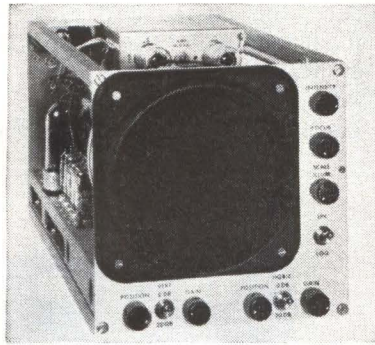

### Monitor Oscilloscope Has 5-Inch Screen

DESPITE its light weight (23 lb) and compact size (the entire front panel is only 7¾ in. square), the K-12-R monitor oscilloscope features a 5-in. flat face crt and full screen positioning. Data displayed on the large

screen can be accurately viewed from a considerable distance. Designed to meet demands for a low cost system monitor scope, the K-12-R is suited for system read-out and production control in the radio, tv, and automotive industries. General Atronics Corp., 1200 E. Mermaid Lane, Philadelphia 18, Pa. (310)

### Transducer Amplifiers Designed for Aerospace

MODELS 5000-6 and 5000A-6 amplifiers have input impedances of 500 megohms, extending their low frequency response down to 2 cps, even with transducer and cable ca-

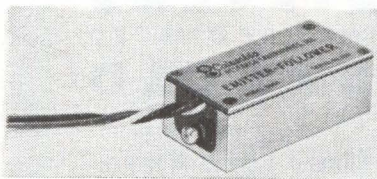

pacitance as low as 600 pf. They handle signals from piezoelectric and other transducers in missile, rocket, aircraft, and satellite studies. Noise is kept below 1 mv peak from -65 F to +70 F and below 2.5 mv at 185 F, over 2-cps to 50-kc bandwidth. Columbia Research Laboratories Inc., MacDade Blvd. & Bullens Lane, Woodlyn, Pa. (311)

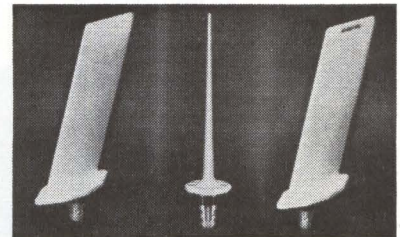

### Aircraft Antennas Cover Broad Band

MINIATURIZED uhf aircraft antennas are announced. The DM C7-8 is designed to permit the multiplexing of several equipments such as uhf

## ....New Developments in Electrical Protection

### signal or visual indicating fuses

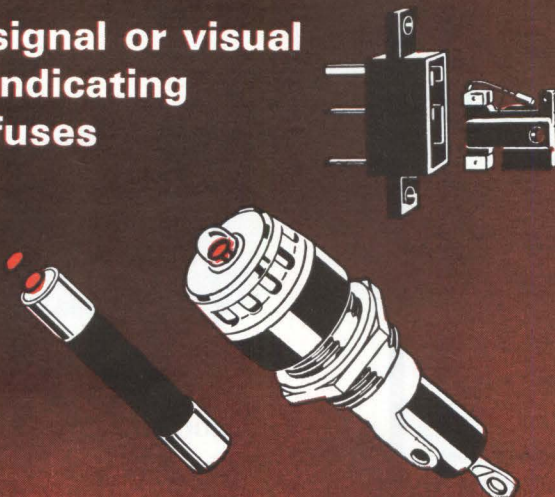

Indicating fuses provide quick, positive identification of a faulted circuit. There are fuses that give a visual signal; fuses that activate an alarm;— and fuses that give a visual signal and activate an alarm.

# BUSS

Write for BUSS  
Bulletin SFB.

BUSSMANN MFG. DIVISION, McGraw-Edison Co., St. Louis 7, Mo.

CIRCLE 81 ON READER SERVICE CARD

### If you should have a special problem in electrical protection ...

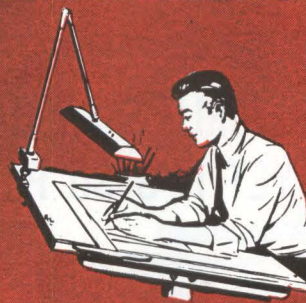

... we welcome your request either to quote or to help in selecting the type of fuse or fuse mounting best suited to your particular conditions.

Submit description or sketch, showing type of fuse to be used, number of circuits, type of terminal, etc. If your protection problem is still in the engineering state, tell us current, voltage, load characteristics, etc. Be sure to get the latest information BEFORE final design is crystallized.

At any time our staff of fuse engineers is at your service to help solve your problems in electrical protection and save you engineering time.

# BUSS

Just call  
or write:

BUSSMANN MFG. DIVISION, McGraw-Edison Co., St. Louis 7, Mo.

CIRCLE 81 ON READER SERVICE CARD



Proven Principle



Repackaged  
for printed  
Circuit Boards



LOW NOISE LEVEL  
TWIN CONTACT RELIABILITY  
LONG LIFE

AC Drive Models  
DC Drive Models  
SPDT or DPDT  
MBB or BBM



Request Catalog No. 515

**STEVENS  
INCORPORATED  
ARNOLD**

QUALITY SINCE 1943

7 ELKINS ST., SOUTH BOSTON 27, MASS.

S/A-33-S 1/3

CIRCLE 203 ON READER SERVICE CARD

communications and command guidance and covers the entire frequency range from 225 to 420 Mc. The DM C7-3, covering only the band of 225 to 400 Mc, has the virtue of being directly interchangeable with an AT-256 to facilitate modernization of the aircraft. Dorne & Margolin, Inc., 29 New York Ave., Westbury, L. I., N. Y.

CIRCLE 312, READER SERVICE CARD



**Transistor Tester  
Is Direct Reading**

MODEL 1803B transistor parameter test set provides direct readings of all small signal "h" parameters for both *npn* and *pn*p transistors over a wide range of values. It also measures transistor leakage currents ( $I_{co}$ ) down to less than 1 nano-ampere. Price is \$845. Dynatran Electronics Corp., 178 Herricks Road, Mineola, N. Y. (313)

HERE IS THE WORLD'S SMALLEST MOTOR  
YET IT'S SO POWERFUL . . .

**MITSUMI MICRO MOTOR**



MODEL MI-100

Less than 20mm in diameter, the new Mitsumi Micromotor provides a startling efficiency of over 50%, the barrier which miniature motors are not allowed to pass.

A novel construction principle helped to make this accomplishment possible. The form is more simplified by setting all the terminals at one position. Because the entire mechanism is given full protection against irregular revolution and above all, electrical noise is entirely eliminated, you may call this the most perfect micromotor yet devised. Please write for complete information on Mitsumi Micromotor, and we will send you specifications and data.



**MITSUMI PARTS  
MITSUMI ELECTRIC CO., LTD.**  
TOKYO • OSAKA • NEW YORK



**Chopper Driver in  
P-C Package**

TYPE CD230 chopper driver is designed for use with a micro-midjet electromechanical chopper set-up for 83-cps excitation. Powered by 5-7 v d-c, the unit delivers an 83-cps frequency to the center-tapped chopper drive coil. Solid-state construction within the p-c package withstands extremes of temperature, shock and vibration. Frequency stability over environmental extremes is better than  $\pm 2$  cps;



## HELPFUL McGraw-Hill Books



available by mail  
for 10 days'  
free examination

### SINGLE SIDEBAND PRINCIPLES AND PRACTICE

**Just Out.** A comprehensive treatment of the basic concepts of single sidebands, including procedures for proper circuit design. In addition to practical circuits with component values, gives tables and charts. By E. Pappenfus, Granger Assocs.; & W. Bruene & E. Schoenike, both of Collins Radio Co. 405 pp., illus., \$14.75. Payable \$7.50 in 10 days, \$7 in one month.

### MICROWAVE SOLID STATE MASERS

**Just Out.** Covers current developments in microwave maser technology. A wide range of topics are treated, including paramagnetic resonance, traveling-wave masers, performance data, applications, experimental techniques, the ruby, and more. By A. Siegman, Stanford Univ. 592 pp., illus., \$18.50. Payable \$6.50 in 10 days, \$6 monthly.

### PRINTED AND INTEGRATED CIRCUITRY

Treats fundamental aspects of printed and integrated circuitry from viewpoint of materials and processes involved. Mechanical and electrical engineering, graphic arts, chemistry, and other disciplines affecting the engineering, design, and manufacture of these types of circuitry are covered. By T. Schlabach & D. Rider, Bell Tele. Labs. 424 pp., illus., \$13.50.

### BASIC PULSE CIRCUITS

**Just Out.** Gives technical facts and data on electronic pulse circuitry used in radar sets, computers, and guided missile equipment. Network circuits, pulse amplifiers, linear wave shaping, multivibrators, time base oscillators and generators, and gates are among the many topics covered. By R. Blitzer, RCA Instit. 448 pp., illus., \$11.75.

### RADIO ASTRONOMY

Provides an authoritative study of radio waves of extraterrestrial origin. From solar radio emission to galactic radio emission, fully explains the new techniques of radio astronomy, then presents these results in close conjunction with the results of optical observation. By J. Steinberg & J. Lequex, Paris-Meudon Observ. 260 pp., illus., \$9.95.

#### 10 DAYS' FREE EXAMINATION

Convenient Mail Service  
Direct from McGraw-Hill

McGraw-Hill Book Co., Dept. L-2-14  
327 W. 41st St., New York, N. Y. 10036

Send me book(s) checked below for 10 days' examination on approval. In 10 days I will remit for book(s) I keep plus few cents for delivery costs, and return unwanted book(s) postpaid. (If you remit with coupon, plus local tax, we pay delivery costs — full refund and return privilege.)

- Pappenfus et al—Single Sideband Prin. & Prac. \$14.75  
 Siegman—Microwave Solid State Masers, \$18.50  
 Schlabach & Rider—Print. & Integ. Circuit., 13.50  
 Blitzer—Basic Pulse Circuits, \$11.75  
 Steinberg & Lequex—Radio Astronomy, \$9.95

Check here if you want to pay on terms

Name .....

Address .....

City ..... State ..... Zip .....

Company .....

Position .....

For price and terms outside U. S.  
write McGraw-Hill Intl., N.Y.C. 36 L-2-14

price is less than \$20 each in quantity. Airpax Electronics Inc., Cambridge, Md. (314)

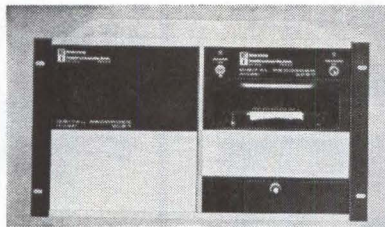

### Digital Recorder Uses Transistors

MODEL 9057 is an electromechanical recording instrument driven by solid state circuitry. It accepts information in 10-line decimal form and records it in an 11-column format on 3-in. wide paper tape. Design of the recorder is such that it will accept and record information at the rate of 3,300 characters per minute. In addition to a whole new instrument styling, the recorder offers several optional features for special data recording applications. Available for \$1,835. Electro Instruments, Inc., 8611 Balboa Ave., San Diego 12, Calif. (315)

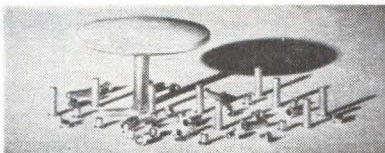

### Tiny Eyelets Offered in 29 Sizes

MICROMINIATURE eyelets, called Microlets, (shown in comparison to a thumb tack), are of copper with 24 carat gold shot-burnished finish. Series is offered in 29 different sizes in length increments of  $\frac{1}{64}$  in. in 3 different barrel diameters. Lengths from  $\frac{1}{64}$  in. through  $\frac{3}{32}$  in. are furnished in the 0.022 in. barrel o-d, lengths from  $\frac{1}{64}$  in. through  $\frac{3}{10}$  in. in the 0.031 in. barrel o-d, and lengths from  $\frac{3}{32}$  through  $\frac{3}{16}$  in. in the 0.047 in. barrel o-d. Uses include micro-circuitry, micro-modules, printed circuits, mother boards, terminals, fasteners and bearings. Circon Component Corp., Santa Barbara Municipal Airport, Goleta, Calif. (316)

measure  
true  
rms  
to  
50  
mc



### NEW Wideband Voltmeter

- 20 cps to 10 megacycles  $\pm 1\%$
- 18 cps to 20 megacycles  $\pm 3\%$
- 15 cps to 50 megacycles  $\pm 5\%$
- 100 microvolt to 300 volt range
- crest factor, 6 at full scale
- crest factor, 60 at tenth scale
- 1 megohm, 20 pf input impedance
- ac amplifier output—100 mv, rms
- ac amplifier response—6 nsec
- dc output—100 millivolts

Model 121 True rms Wideband Voltmeter . . . . . \$870

Model 1201 Cathode Follower Probe . . . . . \$120

Send for Engineering Note  
describing the Model 121

ALSO AVAILABLE  
Model 120 Peak Reading Voltmeter-Amplifier . . . . . \$775



KEITHLEY  
INSTRUMENTS

12415 Euclid Avenue • Cleveland 6, Ohio



# New FILM-THIN Copper-clad Laminates for space-saver or multi- layer printed circuits

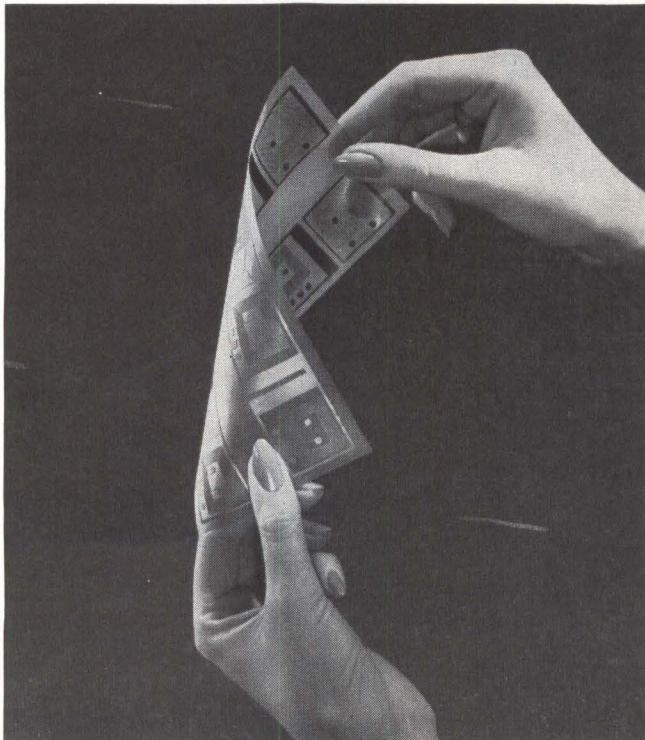

Synthane copper-clad laminates are now being produced with a base laminate of only .0035" and up—with 1 or 2 oz. cladding available on one or both sides. A pre-impregnated glass cloth with epoxy resin filler is also available for bonding multi-layer circuits. These new materials are produced under clean room conditions. Property values are comparable to military specs for the same materials in standard thicknesses. Write for folder of Synthane metal-clad laminates.

## SYNTHANE

CORPORATION **S** OAKS, PENNA.

Area Code 215 452-2211 TWX 215-666-0589

Synthane-Pacific, 518 W. Garfield Ave., Glendale 4, Calif. TWX GLDL 4417U

Synthane Corporation, 36 River Rd., Oaks, Pa.  
Gentlemen:  
Please send me Synthane metal-clad laminates folder.

Name \_\_\_\_\_

Address \_\_\_\_\_

City \_\_\_\_\_ Zone \_\_\_\_\_ State \_\_\_\_\_



GENALEX  
2way

PRECISION  
STEPPING SWITCH

for circuits which require a switch that steps positively, in either direction, around a bank of 25 contacts. **FEATURING:**

- self-cycle or remote control operation
- 65 steps per second on self-interruption
- bridging or non-bridging wipers
- 20 steps per second from external impulses

*Over 10,000,000 steps in each direction without replacement.*

for complete data on this and other unique GENALEX switches, write:

**IMTRA**  
CORPORATION 

11 UNIVERSITY ROAD, CAMBRIDGE 38, MASS.  
U. S. AGENTS FOR THE GENERAL ELECTRIC COMPANY, LTD. OF ENGLAND

CIRCLE 204 ON READER SERVICE CARD

*Around the world ...*

## KYORITSU Measuring Instruments

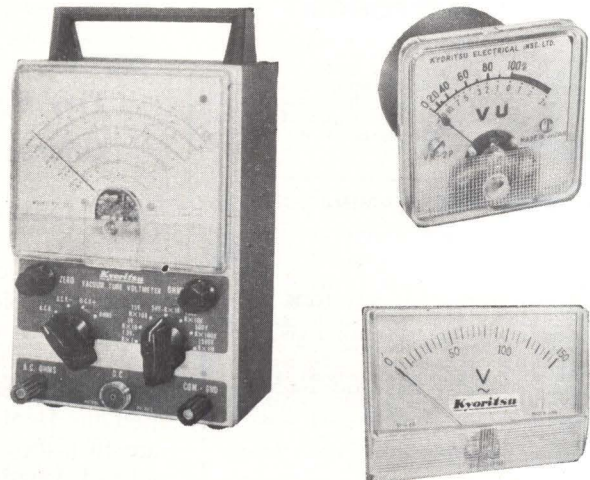

# Kyoritsu

ELECTRICAL INSTRUMENTS WORKS, LTD.

120, Nakane-cho, Meguro-ku, Tokyo, Japan

Cable address: KYORITSUKEIKI TOKYO

Telex: TK 2849

CIRCLE 205 ON READER SERVICE CARD

February 14, 1964 electronics



## LITERATURE OF THE WEEK

**CRYSTAL CAN RELAY** Branson Corp., P.O. Drawer 160, Whippany, N.J. Data sheet describes the new 6-pole-double-throw crystal can relay. (361)

CIRCLE 360, READER SERVICE CARD

**CURRENT DRIVERS** Digital Equipment Corp., 146 Main St., Maynard, Mass. Bulletin D-58/68 covers a line of solid-state current drivers—each featuring a total output capacitance of only 150 pf, including transistors, heat sink, and wiring capacitance. (361)

**STEPPING SWITCH DRIVER** Electro-Seal Corp., 938 North Ave., Des Plaines, Ill. Bulletin 6311 provides detailed circuitry of a stepping switch driver for programmed automation. (362)

**PULSE TRANSFORMERS** Sprague Electric Co., Marshall St., North Adams, Mass. Technical paper No. 63-1 is entitled "Design Notes on Low Power Pulse Transformers." Copies are available upon letterhead request.

**SPECTROMETER SYSTEMS** Varian Associates, 611 Hansen Way, Palo Alto, Calif. A data sheet describes the V-4503 35-Gc spectrometers. (363)

**MAGNETIC-TAPE RECORDING** Memorex Corp., 1180 Shulman Ave., Santa Clara, Calif., offers a 12-page glossary defining computer and instrumentation tape terms. (364)

**VENTILATING PANELS** Technical Wire Products, Inc., 129 Dermody St., Cranford, N.J. Technical data sheet RF-301 describes rfi-shielded ventilating panels for equipment enclosures. (365)

**MILITARY CONNECTORS** Amphenol, a div. of Amphenol-Borg Electronics Corp., 1830 S. 54th Ave., Chicago 50, Ill., has available a 96-page catalog of standard-size military electrical connectors. (366)

**PERMANENT-MAGNET STABILIZER** Radio Frequency Laboratories, Inc., Boonton, N.J. A technical brochure describes model 889B Magnetreater, a self-contained stabilizer for permanent magnets. (367)

**SERVO AMPLIFIER** Electronic Devices Department of Corning Glass Works, Pennel, Pa. Bulletin CE-13.01 gives performance specifications for a new solid-state servo amplifier for industrial and laboratory uses. (368)

**SILICON LOGIC MODULES** Digital Products, 355 W. 7th St., San Pedro, Calif. Data handbook DH-101 describes the Series S silicon logic modules. (369)

**LABORATORY POWER SUPPLY** Electronic Research Associates, Inc., 67 Factory Place, Cedar Grove, N.J. Catalog sheet describes an all-silicon wide-range laboratory and equipment power source. (370)

**SOCKET** Ohmite Mfg. Co., 3696 Howard St., Skokie, Ill. 60076. Bulletin 706 describes a newly developed handy socket that fits the terminal panels of the model CPR relays. (371)

# ONLY CONNECTORS

CAN BE PLUGGED AND UNPLUGGED UNDER WATER

NEW . . . \*EO-500 series embody first real improvement in underwater connectors in 20 years. Female unit open to environment at both ends when unplugged. As male plugs in, environment medium is wiped from mating surfaces and ejected leaving leakage path greater than 100 megohms in salt water. Contact pressure increases with depth, rated to 20,000 psi.

Useful anywhere a quick disconnect is required for electrical circuit in wet or damp environment. Neoprene and stainless steel construction. Available with up to 8 contacts, nominal 2 foot leads, any length available. EO-500 connectors can be furnished as an integral part of our EO-400 series feed-through bushings, using same fail-safe pressure header system we built for Navy's bathyscaph Trieste.

\*Patent applied for



↓ TRY THEM! TEST THEM! ↓

Please send sample set of Connectors Prepaid  
Single Conductor \$9 , Two Conductor \$12   
Please send E. O. Connector Brochures

NAME \_\_\_\_\_

COMPANY \_\_\_\_\_

ADDRESS \_\_\_\_\_

CITY \_\_\_\_\_ STATE \_\_\_\_\_

(Attach check or company purchase order)

**ELECTRO-OCEANICS**

669 SECOND STREET • ENCINITAS, CALIFORNIA  
TELEPHONE (AREA CODE 714) 753-1809

CIRCLE 206 ON READER SERVICE CARD

# DYNAMICS TEST EQUIPMENT

—measures voltage, current, and resistance  
—eliminates ac power lines from low-level measurements

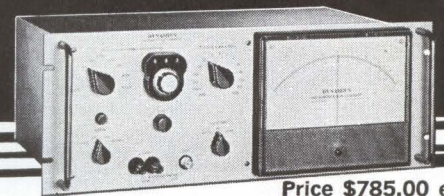

Price \$785.00 ea.

**Model 4132 dc micromultimeter**—a fully floating, all-transistorized volt-ohm-microammeter. Operation from a nickel-cadmium battery insures complete isolation from the power line. Up to 12 hours continuous battery operation. Battery recharges when unit is operated on power line. Instrument features exceptionally high input impedance on all dc voltage ranges.

**Typical applications:** Measuring differences in dc potential between points in electronic circuits; use as an electronic null indicator, or as an isolated current meter. Numerous uses in measuring resistance.

**VOLTAGE**  
full-scale range:  $\pm 100$  microvolts to  $\pm 1000$  volts  
accuracy:  $\pm 1.0\%$  of full scale, all ranges

**CURRENT**  
full-scale range:  $\pm 0.1$  microampere to  $\pm 1.0$  ampere  
accuracy:  $\pm 1.0\%$  of full scale, all ranges

**RESISTANCE**  
full-scale range: 10 ohms to 100 megohms  
accuracy:  $\pm 0.1\%$  of full scale from 10 ohms to 1.0 megohm ( $\pm 1.0\%$  of full scale for other readings.)

Dynamics manufactures a wide variety of microvoltmeters, microvolt-ammeters, micromultimeters, and general test equipment. Write for literature on Model 4132, or the entire line.

**DYNAMICS INSTRUMENTATION COMPANY**

583 Monterey Pass Rd., Monterey Park, Calif.—Phone: CUMberland 3-7773



**new**  
\* IN SITU  
**UNIVERSAL  
BRIDGE**

TRANSISTORIZED • PORTABLE

**\$ 555**

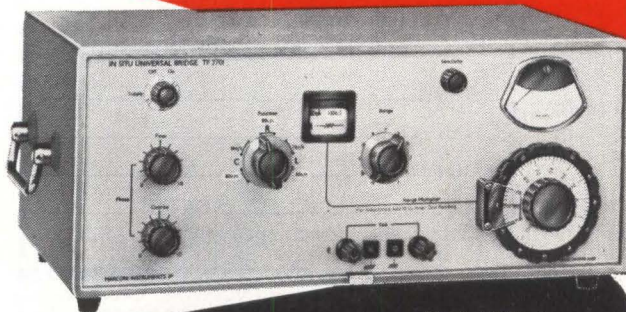

Model 2701

**RANGES:**  
C: 0.002pF to 11,000 $\mu$ F  
L: 0.2 $\mu$ H to 110,000 H  
R: 0.002 $\Omega$  to 110 M $\Omega$   
Freq. 1kc and 80cps  
Basic Accuracy: 1%

ALSO MEASURES

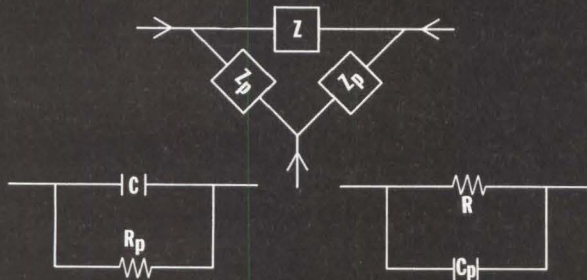

Write  
for detailed  
catalog sheet.

\* IN SITU ... In Position;  
In Its Proper Place

**MARCONI  
INSTRUMENTS**

DIVISION OF ENGLISH ELECTRIC CORPORATION  
111 CEDAR LANE • ENGLEWOOD, NEW JERSEY  
Main Plant: St Albans England

**NOW**  
in TRI-PLATE® Microwave



**HYBRID  
RINGS**

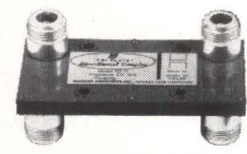

**DIRECTIONAL  
COUPLERS**

Hybrid rings, in frequency ranges from .87 DC to 6.25 GC, maintain better than 20 db isolation over a frequency bandwidth of at least 20%. Directional couplers in frequency ranges from .25 GC to 4 GC, typical VSWR less than 1.2, coupling variation less than  $\pm 1$  db over an octave of frequency range. Hybrid rings \$125 to \$145, couplers \$95 to \$115, with quantity price reductions.

Hybrid rings and directional couplers in additional frequencies (as well as other types of standard microwave products) are available in superior TRI-PLATE Strip Transmission Line.

**CREATING NEW DIRECTIONS IN ELECTRONICS**  
**SANDERS TRI-PLATE® STRIP TRANSMISSION LINE**

Sanders Associates, Inc.  
Microwave Products Dept.,  
Nashua, New Hampshire

Please send information on TRI-PLATE components.

Name.....Title.....

Firm.....

Address.....

City.....Zone.....State.....



E-2

©Sanders Associates, Inc.

CIRCLE 207 ON READER SERVICE CARD

**IN FLORIDA...**

your  
most strategic  
location is....

**PLANT  
CITY**

SEND  
FOR  
INDUSTRIAL  
SURVEY

HERE'S WHY.....

**LOCATION AND TRANSPORTATION** — Located just outside the higher cost metropolitan Tampa-St. Petersburg areas, Plant City is served by Florida's two principal railroads and by numerous truck lines. Only minutes away from the Port of Tampa and Tampa International Airport.

**LABOR ... AVAILABLE LOCALLY** — A ready supply of local production workers, male and female, already proven quickly adaptable in learning specialized skills.

**LIVING ... AN ESTABLISHED COMMUNITY** — Industry is welcome in this busy, progressive 70-year-old city with educational, civic and cultural advantages.

**LAND ... NEW, CITY OWNED INDUSTRIAL PARK** — 350 acre, municipally-owned Industrial Park, engineered for all types of industry. Has adjoining airport and spurs of Atlantic Coastline and Seaboard railroads. Utilities include natural gas. Many other excellent locations, small or large acreage, nearby.

**PLANT CITY INDUSTRIAL DEVELOPMENT COMMITTEE**

Dick Prewitt, General Manager • P. O. Box 1509 - J15, Plant City, Florida

**CITY MOST CONVENIENT TO ALL FLORIDA**



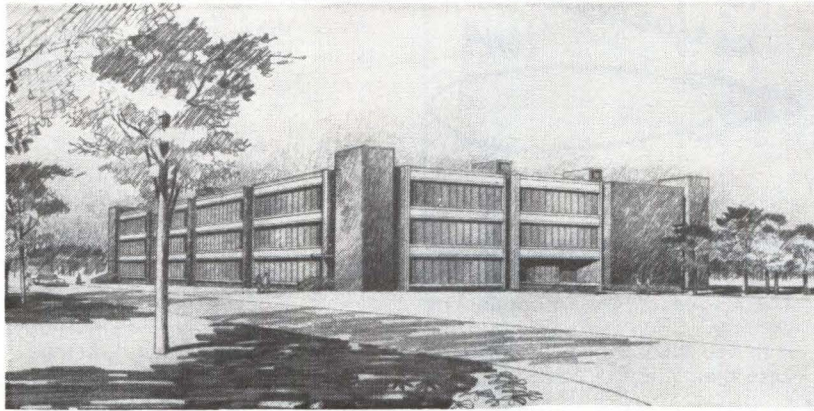

## Tektronix Expansion Under Way

A MULTIMILLION-DOLLAR building program that will group functionally-related operations and coordinate all Tektronix activities is now underway in the plant's industrial park at Beaverton, Ore.

One of the additions, completed over a month ago, is a \$658,000 electrochemical building with 35,000 sq ft of space for development and production. Included are facilities for plating, anodizing and chemical milling. Half of the building is of two-story design; the other half is a high-ceilinged single story for plating functions. The upper floor of the two-story portion houses laboratories, office and a lunchroom—all air conditioned; the lower section contains production functions, feeding into and out of the plating area.

Also completed and now occupied, is a one-story \$42,000-building storing chemicals for all Tektronix research, development and production.

Other buildings now in the design or planning stages, include a three-story 220,000-sq-ft technical center and a maintenance structure.

The technical center (architect's sketch above), planned for occupancy in late 1965, will include engineering, development and research activities. Research and display device development will be carried on in the first story, preproduction in the second, and instrument engineering and advanced circuitry in the third. Shop facilities will be housed in the basement.

The maintenance building, an 18,000-sq-ft structure, is planned for completion in April.



### Norbatrol Electronics Elects Nicholas

HERBERT R. NICHOLAS has been elected vice president of Norbatrol Electronics Corp., Pittsburgh-based

manufacturer of solid-state control systems for industry and defense. He has been in charge of sales.

Prior to joining Norbatrol, Nicholas was sales manager of the electronics department of Hamilton Standard.

### Loral Electronics Elevates Zisman

LEON ALPERT, Loral Electronics Corporation board chairman, has announced the election of Bernard Zisman, formerly financial vice president, to president and chief opera-

# GO EAST, YOUNG MAN

for a new  
plant site.

This free book  
tells why

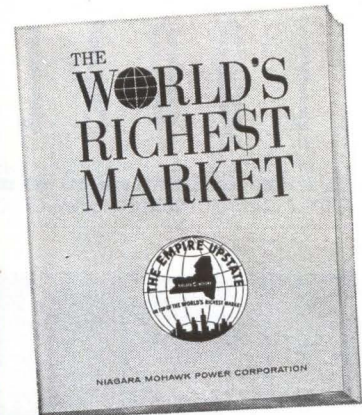

- 16 major U.S. markets, each with an effective buying income of \$1 billion or more, are within 250 miles of the Empire Upstate.

- Over one-quarter of the nation's population and income are within this area.

- Population projections show that this area now has — and will still have in 1975 — about twice the population and three times the population density of the West Coast!

Write for your FREE copy of "The World's Richest Market" on your company letterhead to: Richard F. Torrey, Director of Area Development, Niagara Mohawk Power Corporation, Dept. E-2, 300 Erie Blvd. West, Syracuse, N.Y. 13202

**NIAGARA  
MOHAWK**  
INVESTOR OWNED • TAXPAYING





specify the new circuit breakers  
by Mechanical Products, Inc.

# AVNET

contact The Avnet System  
for best service & on-time delivery

the line includes breakers with  
both standard commercial and  
Mil Spec part nos. Mechanical  
Products' circuit breakers meet  
requirements of MIL C-5809  
and MIL C-7079.

for MP circuit breakers

# MECHANICAL PRODUCTS

call your Local Avnet Headquarters

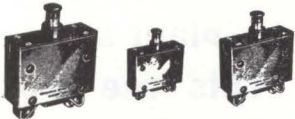

Westbury, L. I.; Chicago; Phoenix;  
Burlington, Mass.; Syracuse, N. Y.;

# LOCAL

Salt Lake City; Bellevue, Wash.;  
San Diego, L. A., Sunnyvale, Cal.

CIRCLE 209 ON READER SERVICE CARD

# Telrex

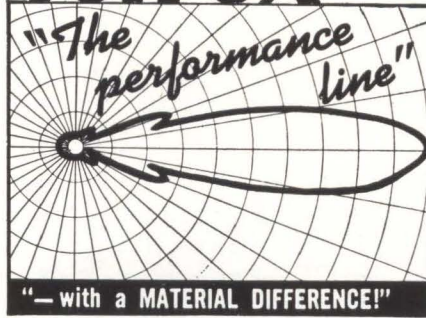

The Choice of the Discriminating  
Communication Engineer . . . the  
Man who Never Settles for Anything  
Less than THE-VERY-BEST!

## telrex "BEAMED-POWER" ANTENNAS and ANTENNA SYSTEMS

Provide optimum performance and  
reliability per element, per dollar.  
Antennas from 500 Kc to 1500 Mc.  
Free PL88 condensed data and pricing  
catalog, describes military and com-  
mercial antennas, systems, accessories,  
Towers, Masts, Rotators, "Baluns"  
and transmission line data.

ANTENNAS Communication  
and TV Antennas

SINCE 1921 **telrex**

## LABORATORIES

Asbury Park 41, New Jersey, U.S.A.  
CIRCLE 210 ON READER SERVICE CARD

tional officer, a member of the board  
of directors and of the executive  
committee.

Zisman succeeds Alpert as presi-  
dent. Alpert formerly held the dual  
posts of president and board chair-  
man. He will continue in the latter  
post.

In a statement following the an-  
nouncement, Alpert cited the case  
of two former company employees  
charged, last August, with attempt-  
ing to bribe a government employee.  
The case is still pending. He pointed  
out that, although the company re-  
mains qualified for military business,  
the strain of recent months had taken  
a toll from his own health, and  
caused his recommendation for Zis-  
man's succession. Alpert also said he  
anticipates losses for the remainder  
of this fiscal year, attributable in  
large part to the recent problems.



ITT Fills Top Slot at  
Federal Electric

ELECTION of Robert E. Chasen as  
president of Federal Electric Corpo-  
ration, International Telephone and  
Telegraph Corporation's service or-  
ganization, has been announced.

Chasen, who has held several  
executive positions within the ITT  
System since 1952, has been execu-  
tive vice president and general man-  
ager of ITT Kellogg Communica-  
tions Systems division since last  
March.

## Eimac Realigns Management

EITEL MCCULLOUGH, INC., San Car-  
los, Calif., has made a management  
realignment to further long-range  
planning and diversification for the

CEI Type  
970A & 770A  
RECEIVERS

for AM, FM, CW and  
**PULSE  
RECEPTION**



An outstanding feature of these receivers is the  
pulse AGC circuitry which has a charge time  
sufficiently short to permit pulse widths as nar-  
row as permitted by the bandwidth selected and  
as wide as a square wave. Discharge time is  
sufficiently long to permit normal operation with  
pulse repetition rates as low as 50 pps. The  
loop gain of the AGC circuitry will hold the  
output pulse amplitude within narrow limits  
with large RF input level changes. The pulse  
handling capability and selectable IF band-  
widths make these very versatile instruments.

### 970A FREQUENCY RANGE

30-300mc in two bands  
Band A: 30-90mc  
Band B: 60-300mc

### 770A FREQUENCY RANGE

235-1000 in 2 bands  
Band A: 235-500mc  
Band B: 490-1000mc

## Communication Electronics Incorporated

4908 HAMPDEN LANE, BETHESDA 14, MARYLAND



electron power tube manufacturer.

Richard T. Orth, vice president and general manager, announced that Thomas D. Sege had been named manager of operations and Luther E. Cisne has been appointed assistant for planning. In the newly-created positions, Sege and Cisne will report to Orth.

Sege had been manager of Eimac's power grid tube division, and Cisne, manager of the microwave tube division.

## PEOPLE IN BRIEF

**Jeremy P. Taylor** leaves Astro-Space Laboratories, Inc., to join the parent company, Belock Instrument Corp., as director of operations control. **Harold B. Martin** promoted to exec engineer Application Tool div., for the Thomas & Betts Co. **Donald W. Hamer**, formerly with Solar Mfg. Corp. appointed chief engineer at the Technical Materials div. of Erie Technological Products, Inc. **Martin L. Touger** advances to mgr., design engineering, at the Tucson, Ariz., facility of RCA's Communications Systems div. **W. C. Pembleton**, previously with Litton Industries, named administrative mgr., applications engineering, for Defense Electronics, Inc. **Raymond A. Ballweg, Jr.**, ex-Hycon Mfg. Co., now corporate director, data systems engineering, for Fairchild Stratos Corp. **John L. Ganley**, from Avco Corp. to Weston Instruments and Electronics div. of Daystrom, Inc., as director of plans and programs. **William S. Guttenberg** elevated to exec v-p and g-m of Bogue Electric Mfg. Co. **Irwin M. Berry**, most recently with Elpac, Inc., appointed director of research for The Potter Co. **Robert Hodges**, from Giannini Controls Corp. to Spectrolab, a div. of Textron Electronics, Inc., as g-m. **William V. Hargreaves, Jr.** moves up to v-p, engineering, at Polytronics Laboratories, Inc. **Darrell Gilliam**, formerly with North American Aviation, appointed project mgr. at Stellarmetrics, Inc. **O. E. Bassett** raised to v-p, engineering, of Avco's Electronics div. **John F. Antoniazzi** advances to asst. div. g-m of The Machlett Laboratories, Inc.

## PUBLIC AUCTION

**NO LIMIT!—NO RESERVE!**

*By Decision of Management*

\$1,135,988.54 EVALUATION  
SEMI-CONDUCTOR DIVISION

**MAJOR ELECTRONIC PLANT**

ON THE PREMISES:

**1700 W. ROSECRANS BLVD.,  
MANHATTAN BEACH, CALIF.**

**Friday, Feb. 21st, starting at  
10:00 A.M.**

*and continuing until sold*

**Test Equipment • Electronics  
Machine Tools • Electrical  
Office Equipment • etc.**

(No longer needed in future operations)

Inspection: February 17th thru Feb. 20th,  
from 9 A.M. to 4 P.M. Daily

For Descriptive Brochure,  
Contact Auctioneer's Office

**HARRY ENGELSON**

Auctioneers, Appraisers  
6515 Sunset Boulevard Suite 200B  
Hollywood 28, Calif. Hollywood 6-4195

CIRCLE 211 ON READER SERVICE CARD

*specify the new S.T.C. Products  
contact Avnet for best service*

# AVNET

*on-time delivery of the latest  
S.T.C. silicon power transistors*

*over 150 2N type nos. in 12 package  
sizes in power ratings from 5 to 300  
watts. 21 MIL approvals; features  
major breakthrough in miniaturized  
power without heat sink; isolated  
collector in 75-85 watts; PNP trans-  
istor with NPN complements.*

*many other S.T.C. Products  
are available immediately from Avnet*

# S.T.C.

*call your Local Avnet Headquarters  
The Avnet System Coast to Coast*



*Westbury, L.I.; Phoenix, Ariz.;  
Burlington, Mass.; Syracuse, N.Y.;*

# LOCAL

*Salt Lake City; Bellevue, Wash.;  
San Diego, L.A., Sunnyvale, Cal.*

CIRCLE 212 ON READER SERVICE CARD



Data Matrix No. DM-7538-18  
with Cartridges No. 39-6-1471

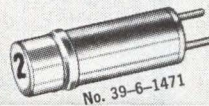

No. 39-6-1471



Holder No. 7538  
with Cartridge No. 39-6-1471



No. 249-7840-931

For computers, data  
processing, and other  
readout applications,  
DIALCO offers

*The complete line of*

## DATALITES®

Ultra-miniature DATALITES are available in several basic styles: CARTRIDGE HOLDERS that accommodate DIALCO's own replaceable Neon or Incandescent LAMP CARTRIDGES. Unit mounts in 3/8" clearance hole...For multi-indication, LAMP CARTRIDGES are mounted on a DATA STRIP or DATA MATRIX in any required configuration...DATALITES with *permanent* (not replaceable) Neon Lamps may be had with or without built-in resistors...The "DATA CAP" series features a *rotatable* read-out lens cap; accommodates a clear (colorless) cartridge. LEGENDS may be hot-stamped on cylindrical lenses...Styles shown here are only typical. Send for information on the complete line.



"Data Cap"  
No. 250-7538-1471

**Write for 8-page Datalite Brochure L-160C.**

**DIALCO**



*Foremost Manufacturer of Pilot Lights*

**DIALIGHT**  
CORPORATION

60 STEWART AVE., BROOKLYN 37, N.Y. • Area Code 212, HYacinth 7-7600



**ENGINEERING & SCIENTIFIC  
OPENINGS AT**

**GM DEFENSE RESEARCH  
LABORATORIES**

**IN BEAUTIFUL SANTA BARBARA,  
CALIFORNIA**

Located 100 miles north of  
Los Angeles

From the bottom of the sea, to the far reaches of space—this is the spectrum of advanced R&D projects now underway at GM-DRL. The compelling challenge of this vast R&D concept is being met in our modern completely equipped facilities by some of the nation's best known scientific minds.

Long famous as a sea shore resort area, Santa Barbara's relaxed atmosphere and warm climate has attracted a growing number of R&D orientated firms and top scientific personnel by providing a perfect professional environment and ideal family community. Modern, reasonable homes, excellent schools, including the University of California at Santa Barbara, are located within minutes of our 104 acre site.

The continued growth of GM-DRL, now employing over 600 personnel, has created exceptional opportunities in:

**ELECTRONIC POWER & PROPULSION**

BSEEs to PhDs at all experience levels in the following areas of interest: electro-magnetic fields, energy conversion (static and electromechanical), power inverters and frequency converters, network analysis, circuit theory, feed back control systems, and engineering analysis.

**RELIABILITY ENGINEERS**

We are seeking a select number of engineers with BS or MS in EE or Physics with 2 to 3 years experience in a Reliability function and 8 to 10 years in engineering involving electronic, electro-mechanical, and solid state devices, preferably for military products requiring a high degree of reliability to form the nucleus of a newly added Reliability function.

If you are looking for a unique environment offering all this, plus a close communication between management and the professional staff and an opportunity for personal professional recognition, we invite you to send your resume and salary requirements in complete professional confidence to: Mr. J. H. Quigley, General Motors Defense Research Laboratories, Department 2, P. O. Box T, Santa Barbara, California.

**GM DEFENSE RESEARCH  
LABORATORIES**

**General Motors Corporation**

*An equal opportunity employer*

**EMPLOYMENT  
OPPORTUNITIES**



The advertisements in this section include all employment opportunities — executive, management, technical, selling, office, skilled, manual, etc.

Look in the forward section of the magazine for additional Employment Opportunities advertising.

**— RATES —**

**DISPLAYED:** The advertising rate is \$52.00 per inch for all advertising appearing on other than a contract basis. Contract rates quoted on request.

An advertising inch is measured 7/8" vertically on a column—3 columns—30 inches to a page.

Subject to Agency Commission.

**UNDISPLAYED:** \$2.70 per line, minimum 3 lines. To figure advance payment count 5 average words as a line.

Box numbers—count as 1 line.

Discount of 10% if full payment is made in advance for 4 consecutive insertions.

Not subject to Agency Commission.

**E. E.'s**  
for FEE-PAID Positions  
**WRITE US FIRST!**  
Use our confidential application for professional, individualized service . . . a complete national technical employment agency.  
**ATOMIC PERSONNEL, INC.**  
Suite 1207L, 1518 Walnut St., Phila. 2, Pa.

ADDRESS BOX NO. REPLIES TO: Box No. Classified Adv. Div. of this publication. Send to office nearest you.  
NEW YORK, N. Y. 10036: P. O. Box 12  
CHICAGO, Ill. 60611: 645 N. Michigan Ave.  
SAN FRANCISCO, Cal. 94111: 255 California St.

**EMPLOYMENT SERVICES**

Resumes and application letters that make employers want you. Composed, printed by Executive Resumes, Dept. F, Executive Suite, 744 Broad St., Newark, N. J.

**POSITIONS WANTED**

Management—BSIE—Background Methods & Stds.—Management. Call 703 838 1467, or write PW-3630, Electronics.

*"Put Yourself in the Other  
Fellow's Place"*

**TO EMPLOYERS**

**TO EMPLOYEES**

Letters written offering Employment or applying for same are written with the hope of satisfying a current need. An answer, regardless of whether it is favorable or not, is usually expected.

**MR. EMPLOYER,** won't you remove the mystery about the status of an employee's application by acknowledging all applicants and not just the promising candidates.

**MR. EMPLOYEE** you, too, can help by acknowledging applications and job offers. This would encourage more companies to answer position wanted ads in this section. We make this suggestion in a spirit of helpful cooperation between employers and employees.

This section will be the more useful to all as a result of this consideration.

Classified Advertising Division

**McGraw-Hill Publishing Co., Inc.**

330 West 42nd St., New York, N. Y. 10036

**HOW TO  
USE  
YOUR  
ELECTRONICS  
BUYERS'  
GUIDE**

**Advertising  
Product  
Sections**

Advertisements in the ELECTRONICS BUYERS' GUIDE are grouped together according to the kind of product advertised. All Power Supply advertisements, for example, will be found in the same section of the book. Thus it is made convenient for you to "shop" through the specifications presented to you by advertisers, without having to flip pages back and forth constantly. Keep your ELECTRONICS BUYERS' GUIDE close to your work area at all times.

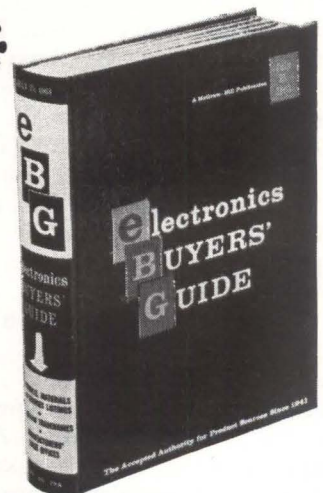











COPYRIGHT 1961

**BRUSH INSTRUMENTS**

DIVISION OF CLEVITE CORPORATION

CLEVELAND, OHIO

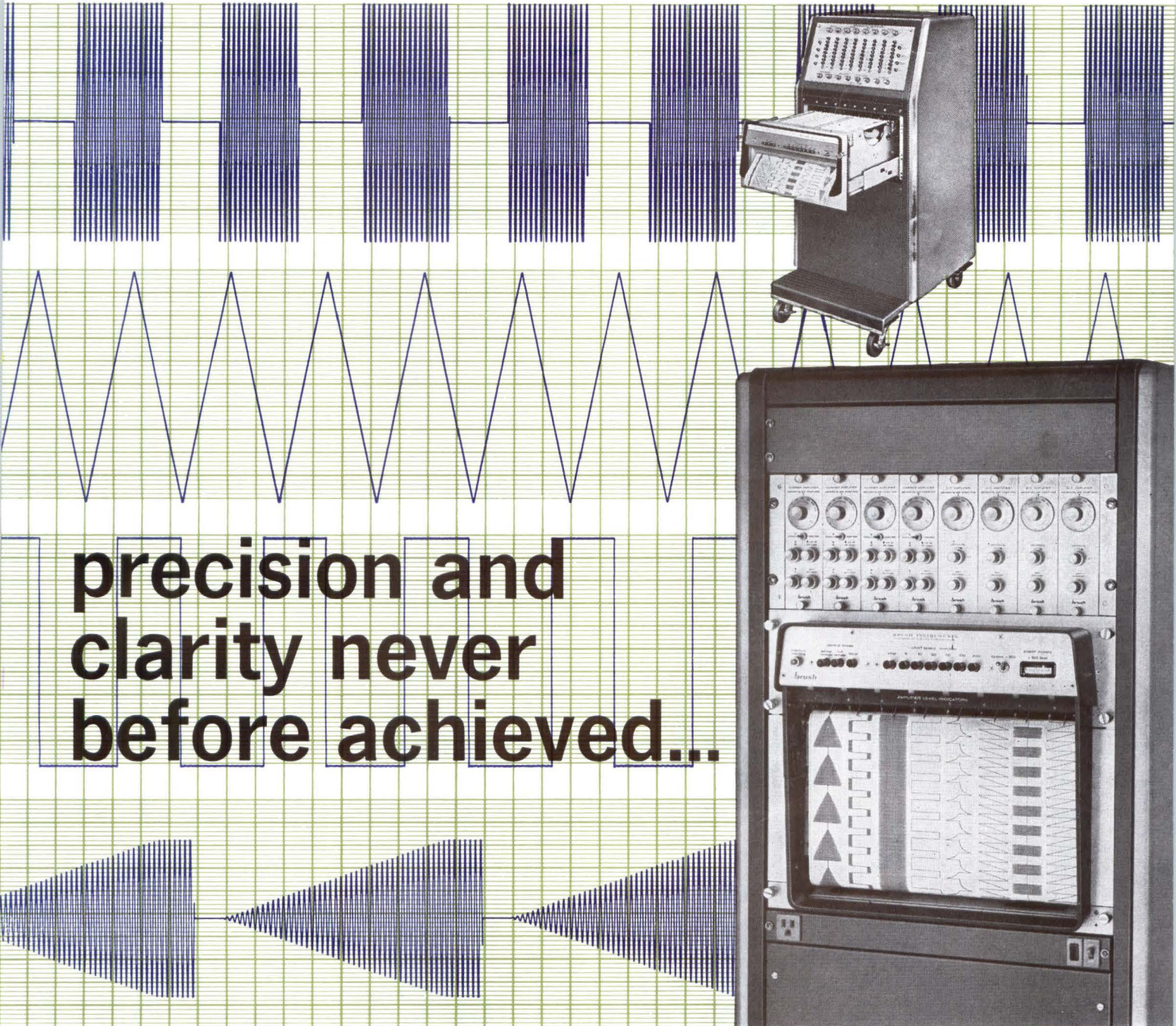

**precision and  
clarity never  
before achieved...**

**The new Brush Recorder Mark 200** made these incredibly crisp tracings. No other recorder in existence can match them. Note the line width. It never varies . . . regardless of writing velocity, regardless of chart speed. The writing mechanism is electrically signaled by the position-seeking "Metrisite" transducer . . . no parts to wear, infinite resolution, verifiable dynamic  $\frac{1}{2}\%$  accuracy. Traces are permanent, high-contrast, reproducible . . . on low cost chart paper. The Mark 200 has but three standard controls . . . attenuator, pen position, chart speed. Such fidelity, simplicity and economy are possible with no other direct writing recorder. Available in both vertical and horizontal models with interchangeable plug-in preamplifiers or signal conditioning push-button controls. Write for details . . . they'll speak for themselves.

CIRCLE 901 ON READER SERVICE CARD

**brush** INSTRUMENTS

DIVISION OF CLEVITE 37TH AND PERKINS, CLEVELAND 14, OHIO



# SEE HOW RCA RECEIVING TUBES KEEP GETTING BETTER



## 1959—N-132 Cathode Base Material

## 1960—S-311 Plate Material

Virtually ideal black-body characteristics for most effective heat dissipation

## 1961—Dark Heater

Produces required cathode temperature at a heater temperature 200°K to 350°K below that of conventional heaters

## AND NOW 1963...

## THE BONDED CATHODE

Ends cathode peeling, even after long periods of high-temperature, high-voltage tube operation.

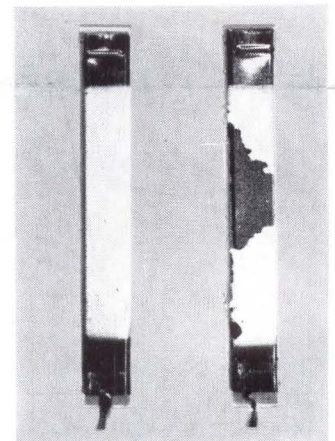

Picture on right is an example of peeling which may occur in nonbonded cathode of a horizontal-deflection-amplifier tube after several hundred hours of operation in a TV receiver.

From RCA research, another major contribution to electron-tube performance and reliability: the bonded cathode. Its emissive-oxide coating will not peel even after extended service under high-voltage, high-temperature conditions encountered in TV horizontal-deflection-amplifier tubes and damper diodes. Permanent adhesion of the emissive-oxide coating of the RCA bonded cathode improves over-all tube performance and reliability...with resultant extension of tube life. Here's why!

### THE NEW RCA BONDED CATHODE:

- virtually eliminates peeling of emissive oxide coating
- reduces cathode interface-type impedance effects during life
- reduces grid-to-cathode shorts during life

- improves stability of cathode-to-grid spacing
- improves anode-voltage-per-mil-spacing safety factor in damper diodes
- transmits heat more efficiently and uniformly—thereby, providing more uniform cathode-current density

The RCA bonded cathode was first applied with outstanding success in beam power tube types 6DQ6-B and 6JB6, and half-wave vacuum rectifier types 6AU4-GTA and 6AY3. This new development is now being incorporated in a growing number of types where service conditions indicate the need. Call your RCA Field Representative for details.

### RCA ELECTRONIC COMPONENTS AND DEVICES, HARRISON, N. J.

RCA FIELD OFFICES—EAST: 32-36 Green Street, Newark 2, N. J., (201) 485-3900 • MIDWEST: Suite 1154, Merchandise Mart Plaza, Chicago 54, Ill., (312) 527-2900 • WEST: 6801 E. Washington Blvd., Los Angeles 22, Calif., (213) RA 3-8361 • 1838 El Camino Real, Burlingame, Calif., (415) 697-1620



The Most Trusted Name in Electronics