

Electronics[®]

High-impedance bridge circuits: page 88

Identifying reconnaissance photos: page 106

Electronic detours of broken nerves: page 110

September 20, 1965

75 cents

A McGraw-Hill Publication

Below: Transistor with vibrating gate tunes integrated circuits: page 84

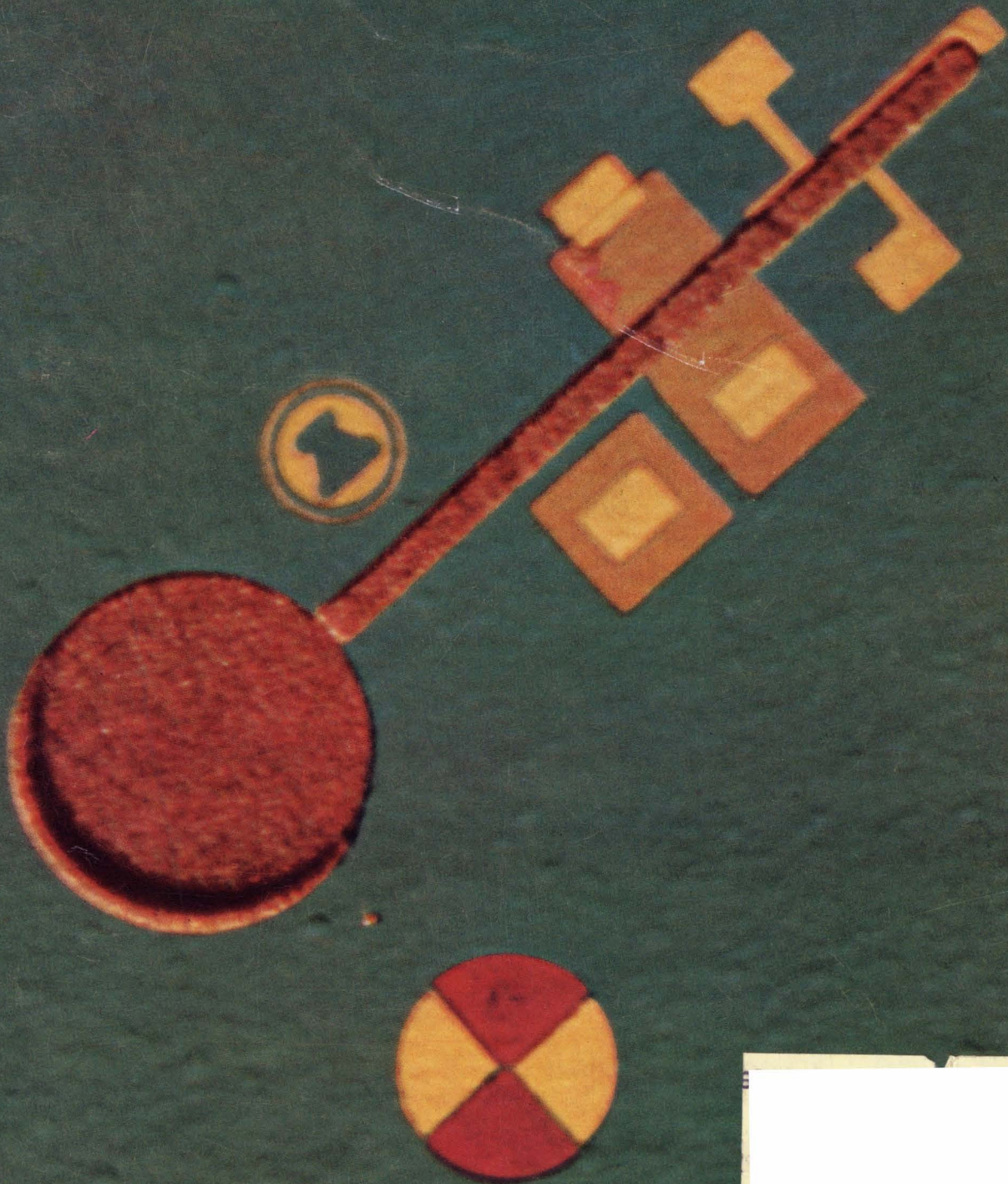



SPECIAL CUSTOM BUILT TO YOUR SPECIFICATIONS

The bulk of UTC production is on special units designed to specific customers' needs. Illustrated below are some typical units and some unusual units as manufactured for special applications. We would be pleased to advise and quote to your special requirements.

FILTERS

All types for frequencies from .1 cycle to 400 MC.

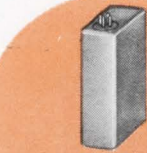

400 \sim telemetering, 3 db at \pm 7.5%, 40 db at 230 and 700 \sim , $\frac{5}{8}$ x $1\frac{1}{4}$ x 2"



15 \sim BP filter, 20 db at 30 \sim , 45 db at 100 \sim phase angle at CF less than 3° from -40 to +100°C.



LP filter within 1 db to 49 KC, stable to .1 db from 0 to 85°C., 45 db at 55 KC.

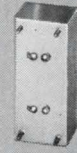

LP filter less than .1 db 0 to 2.5 KC, 50 db beyond 3 KC.

PULSE TRANSFORMERS

From miniature blocking oscillator to 10 megawatt.



Wound core unit .01 micro-second rise time.



Pulse current transformer 100 Amp.



Pulse output to magnatron, bifilar filament.



Precise wave shape pulse output, 2500 V. 3 Amps.

HIGH Q COILS

Toroid, laminated, and cup structures from .1 cycle to 400 MC.



Tuned DO-T servo amplifier transformer, 400 \sim .5% distortion.



Toroid for printed circuit, Q of 90 at 15 KC.



Dual toroid, Q of 75 at 10 KC, and Q of 120 at 5 KC.

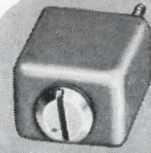

HVC tapped variable inductor for 3 KC oscillator.

SPECIALTIES

Saturable reactors, reference transformers, magnetic amplifiers, combined unit.



RF saturable inductor for sweep from 17 MC to 21 MC.

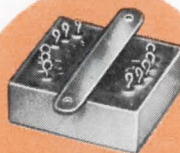

Voltage reference transformer .05% accuracy.

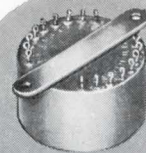

Multi-control magnetic amplifier for airborne servo.



Input, output, two tuned interstages, peaking network, and BP filter, all in one case.

POWER COMPONENTS

Standard and high temperature . . . hermetic, molded, and encapsulated.



Multi-winding 140 VA, 6 KC power transformer $1\frac{1}{4}$ x $1\frac{1}{4}$ x 1"



200°C power transformer, 400 \sim , 150 VA.



400 \sim scope transformer, 20 KV output.

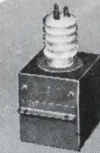

60 \sim current limiting filament transformer, Sec. 25 Mmfd., 30 KV hipot.

plus
OVER 1,300
STOCK ITEMS
with UTC
High Reliability



→ write for catalog

UNITED TRANSFORMER CORP.

150 VARICK STREET, NEW YORK 13, N. Y.

PACIFIC MFG. DIVISION: 3630 EASTHAM DRIVE, CULVER CITY, CALIF.
EXPORT DIVISION: 13 EAST 40th STREET, NEW YORK 16, N. Y. CABLE: "ARLAB"

Circle 900 on reader service card

LOW-COST SOLID-STATE

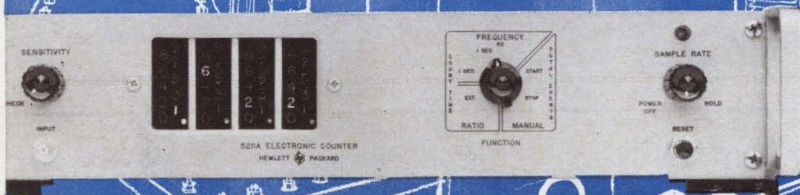

ONLY \$600



ONLY \$825

INDUSTRIAL COUNTERS

Solid-state reliability, compactness and low power consumption make the Hewlett-Packard 5211A/B Electronic Counters ideal for a wide variety of industrial applications. Using the power line as a time base (with typically 0.1% accuracy), they count frequency to 300 kc and also make direct ratio measurements.

Features include extreme versatility and operational convenience, minimum calibration problems, simple maintenance and operation over a wide temperature range, -20 to $+50^{\circ}\text{C}$.

The 5211A and B have a standard 4-digit display in improved neon columns with an in-line digital readout available as a modification, H22-5211B. Display storage holds the current display while the counter is gated for a new count, changing only if the count changes. The 5211A has gate times of 0.1 and 1 sec., while the 5211B has an additional gate time of 10 sec. Display time is determined by the front-panel Sample Rate control and is independent of gate time and variable 0.2 to 5 sec.

Manual control of gate time is by front-panel Function switch or by contact closure applied to the rear EXT con-

ductor. Manual reset is required in both modes, with automatic reset available in the EXT Ratio mode when gating by an external pulse or contact closure.

As a printer output the 5211B provides four-line 1-2-2-4 ("1" state positive with respect to "0" state) BCD to a rear panel connector. A similar output is available with the 5211A under the designation CO5-5211A. Options include a 1-2-4-8 BCD output, "1" state negative or positive.

The counters are housed in hp modular cabinets only $3\frac{1}{2}$ " high, bench or rack mount instrument in one. Access for maintenance is simple. Prices: 5211A, \$600; 5211B, \$725; H22-5211B, \$825; CO5-5211A, \$650.

To learn how useful these counters can be in measuring rpm, rps, weight, pressure, temperature, acceleration and other quantities convertible by transducers into electrical phenomena, call your Hewlett-Packard field engineer for a demonstration. Or write for complete information, Hewlett-Packard, Palo Alto, California 94304, Tel. (415) 326-7000; Europe: 54 Route des Acacias, Geneva; Canada: 8270 Mayrand Street, Montreal.

Data subject to change without notice. Prices f.o.b. factory.

HEWLETT  **PACKARD**
An extra measure of quality

NOW!
10 Mc -
1000* Mc



MODEL
3200A

VHF OSCILLATOR

*With NEW Frequency Doubler Probe MODEL 13515A

Features:

- ±0.002% Frequency Stability
- External AM and Pulse Modulation
- Waveguide-Below-Cutoff Output Attenuator
- Solid-State Power Supply

The VHF Oscillator Model 3200A is designed for general purpose laboratory use including receiver and amplifier testing, driving bridges, slotted lines, antenna and filter networks, and as a local oscillator for heterodyne detector systems in the frequency range from 10 to 500 mc.

The push-pull oscillator is housed in a rugged aluminum casting for maximum stability and extremely low leakage; six frequency ranges are provided for adequate bandspread on the slide-rule dial. Internal CW operation is provided; AM and pulse modulation may be obtained through the use of a suitable external source. The RF output is coupled through a waveguide-below-cutoff variable attenuator; in addition, an electrical RF level vernier is included as a front panel control.

An optional accessory Frequency Doubler Probe, Model 13515A incorporates a solid-state doubler circuit and provides additional frequency coverage from 500 to 1000 mc.

Specifications Model 3200A

Radio Frequency Characteristics

RF RANGE: 10 to 500 mc

RF ACCURACY:

±2% (after ½ hour warmup)

RF OUTPUT:

Maximum Power:

- > 200 mw* (10-130 mc)
- > 150 mw* (130-260 mc)
- > 25 mw* (260-500 mc)

*Across external 50 ohm load

Range: 0 to > 120 db attenuation from maximum output

Load Impedance: 50 ohms nominal

RF STABILITY:

Short Term: ±0.002° (5 minutes)

Long Term: ±0.02° (1 hour)

Line Voltage: ±0.001%° (5 volts)

*After 4 hour warmup, under 0.2 mw load

RF LEAKAGE: Sufficiently low to permit measurements at 1 μv

Amplitude Modulation Characteristics

AM RANGE: 0 to 30% (External)

AM DISTORTION: <1% at 30% AM

EXTERNAL AM REQUIREMENTS:

Approx. 30 volts RMS into 600 ohms for 30% AM

Pulse Modulation Characteristics

EXTERNAL PM REQUIREMENTS:

140 volts peak negative pulse into 2000 ohms for maximum power output; typically 10 volts peak (except 50 volts on 260-500 mc range) for 1 mw peak power output

Physical Characteristics

DIMENSIONS:

Height: 6½" (16.5 cm)

Width: 7½¾" (19.8 cm)

Depth: 12½¾" (31.8 cm)

Power Requirements

105-125/210-250 volts, 50-60 cps, 30 watts

Price: 3200A: \$475.00

F.O.B. Rockaway, New Jersey

Specifications Model 13515A

Radio Frequency Characteristics

RF RANGE: 500 to 1000 mc*

*With 3200A operating 250-500 mc

RF OUTPUT:

Maximum Power: > 4 mw*

*Across external 50 ohm load with VSWR < 1.1

HARMONIC SUPPRESSION:

Fundamental: > 16 db*

Higher Order: > 16 db* (500-800 mc)

> 14 db* (800-1000 mc)

*Below desired signal

Price: 13515A: \$95.00

F.O.B. Rockaway, New Jersey

GREEN POND ROAD
ROCKAWAY, NEW JERSEY 07866
Telephone: (201) 627-6400
TWX: (510) 238-8461 Cable Address: BOONRACO

HEWLETT
PACKARD  BOONTON
DIVISION

Electronics

September 20, 1965
Volume 38, Number 19

Page 4	Readers Comment
8	People
14	Meetings
16	Meeting Preview
23	Editorial
25	Electronics Newsletter
71	Washington Newsletter
145	New Products
181	New Books
182	Technical Abstracts
191	New Literature

Electronics Review

Page 41	Still camera	46	Ground control
42	On the road	47	A peace economy
42	A helping hand	48	Party line
43	Channel trimming	50	New phase in space
44	Gold star for Titan		

Probing the News

129	Boom market in the wings?
131	A magnetically clean Pioneer
137	What's a laser patent worth?

Electronics Abroad

193	Microcircuits in mufti	195	Switch on
194	Who's out there?	196	Electronic vulcanizer
194	War of the wrappers	196	Around the world
195	Versatile radar		

Technical Articles

I. Design

Solid state	84	Tuning forks sound a hopeful note Transistors with a mechanical gate, like a tuning fork, can tune integrated circuits H.C. Nathanson, W.E. Newell and R.A. Wickstrom, Westinghouse Electric Co.
Instruments	88	FET performs well in balancing act High impedance of field effect transistor makes it effective as the basis of a sensitive null detector W.A. Rhinehardt and L. Mourlam Jr., Iowa State
Circuit design	93	Filter design easy as pi Charts and a nomograph simplify the job Jerrald C. Shifman, Genistron, Inc.
Circuit design	97	Designer's casebook <input type="checkbox"/> Sharp discrimination of voltage differences <input type="checkbox"/> Pulse generator controls rise, fall time <input type="checkbox"/> Diode quiets input to monostable multi <input type="checkbox"/> Circuit inverts d-c voltage <input type="checkbox"/> Simple circuit increases measurement accuracy <input type="checkbox"/> Darlington maintains constant unity gain
Advanced technology	102	Controlling laser oscillation Phase-modulating the input to a laser increases the beam's ability to carry information S.E. Harris, G.A. Massey, M.K. Oshman, and R. Targ, Sylvania Electric Corp.
Avionics	106	Data dots identify aerial photos Excess-three binary-coded-decimal data is superimposed on film as photos are taken William A. Miller, Fairchild Hiller Corp.
Medical electronics	110	Electronic detours for broken nerve paths Paralysis caused by a washout in a neural road may be offset by an electronic stimulator L. Vodovnik and W.D. McLeod, Case Institute

Title R registered
U.S. Patent Office;
© copyright 1965
by McGraw-Hill, Inc.
All rights reserved,
including the right to
reproduce the contents
of this publication,
in whole or in part.

Electronics

Editor: Lewis H. Young

Senior editors

Technical: Samuel Weber
News: Kemp Anderson, Jr.

Senior associate editors: John F. Mason, George Sideris

Department editors

Advanced technology: Joan Blum
Avionics: W.J. Evezia
Circuit design: Michael Elia
Components: Michael F. Tomaino
Computers: Wallace B. Riley
Consumer electronics: Richard Lipkin
Electronics review: Stanley Zarowin
Industrial electronics: Robert Cushman
Instrumentation: Carl Moskowitz
Manufacturing: George Sideris
Military electronics: John F. Mason
New products: William P. O'Brien
Solid state: Jerome Eimbinder
Space electronics: Peter R. Sigmund
Special projects: Richard M. Machol

Regional editors

Boston: Thomas Maguire, editor; Robin Carlson
Los Angeles: William B. Wallace, editor; June Ranill
San Francisco: Laurence D. Shergalis, Edmond G. Addeo, editors; Mary Jo Jadin

Copy editors

Howard Rausch, Sally Powell, Walter Barney

Graphic design

Art director: Saul Sussman
Assistant art director: Donna M. Marchyn
Editorial production: Ann Mella
Production editor: Arthur C. Miller

Editorial secretaries: Claire Benell, Mary D'Angelo, Lynn Emery, Kay Fontana, Carolyn Michnowicz, Lorraine Longo, Lorraine Werner

McGraw-Hill news service

Director: John Wilhelm; **Atlanta:** Fran Ridgway; **Chicago:** Bruce Cross, Louis S. Gomolak;
Cleveland: Arthur Zimmerman; **Dallas:** Marvin Reid;
Detroit: Donald MacDonald; **Los Angeles:** Michael Murphy, Ron Lovell;
San Francisco: Margaret Ralston;
Seattle: Ray Bloomberg; **Washington:** Arthur L. Moore, Charles Gardner, Herbert W. Cheshire, Seth Payne, Warren Burkett, Warren Kornberg

McGraw-Hill world news service

Bonn: Robert Dorang; **Brussels:** Arthur Erikson; **London:** John Shinn;
Mexico City: Wesley Perry; **Milan:** Bruce Bendow;
Moscow: Donald Winston; **Paris:** Dan Smith;
Rio de Janeiro: Leslie Warren; **Tokyo:** Marvin Petal, Charles Cohen

Circulation manager: Hugh J. Quinn

Reprints: T.M. Egan

Publisher: C.C. Randolph

Electronics: September 20, 1965, Vol. 38, No. 19

Printed at 99 North Broadway, Albany, N.Y.
Second class postage paid at Albany, N.Y.

Subscriptions are solicited only from those actively engaged in the field of the publication. Position and company connection must be indicated on orders. Subscription prices: United States and Possessions and Canada, \$6.00 one year, \$9.00 two years, \$12.00 three years. All other countries \$20.00 one year. Single copies, United States and Possessions and Canada 75¢. Single copies all other countries \$1.50.

Published every other Monday by McGraw-Hill Inc. 330 West 42nd Street, New York, N.Y. 10036. Founder: James H. McGraw, 1860-1948.

Subscribers: The Publisher, upon written request to our New York office from any subscriber, agrees to refund that part of the subscription price applying to copies not yet mailed. Please send change of address notices, subscription orders or complaints to Fulfillment Manager, Electronics, at the address below. Change of address notices should provide old as well as new address, including postal zone number if any. If possible, attach address label from recent issue. Allow one month for change to become effective.

Postmaster: Please send Form 3579 to Fulfillment Manager, Electronics, P.O. Box 430, Hightstown New Jersey 08520

Readers Comment

Fleming on Fleming

To the Editor:

We were interested to see in your editorial [Aug. 9, p. 15] the reference to Sir John Ambrose Fleming as the inventor of the electron tube.

Fleming applied for British Patent No. 24850 on Nov. 16, 1904 for his two-electrode valve. He favored the term "valve" because of the diode one-way action.

P. A. Fleming
Engineering Secretary
Electronic Valve & Semiconductor
Manufacturers' Association
London

More on Ioran

To the Editor:

Your article [Aug. 9, p. 27] titled "End of Ioran", and R. E. Maine's letter defending Ioran [Aug. 23, p. 7] both misplace the emphasis of any controversy which may seem to exist between Ioran and Omega. First of all, the Navy has very little to say about shutting down Ioran stations or systems. A few chains exist for purely military requirements but most of them are fulfilling civil navigation needs. The Navy spokesmen I have heard, refer only to Ioran A and not the other varieties of Ioran. They state that Omega will eliminate the need for Ioran A for Navy navigational purposes. They are not concerned with other requirements.

From a philosophical viewpoint, when have we ever shut down a navigation system that was established? The FAA has had a program for an untold number of years to eliminate the airways' low-frequency range and radio beacon system. They still operate a large number of stations. Users have a considerable investment in equipment which can't be thrown overboard without repercussions. It is doubted that, even if it wanted to, the Coast Guard could shut down very many Ioran chains without serious complaints from users. These would keep the system operating, at least in this country, for the foreseeable future.

The Coast Guard is currently planning a new Ioran A chain in the

Another Industry First!

NOW...THE NEWEST **DUET*** TRANSISTOR IS A TWIN IN A FLAT PACK!

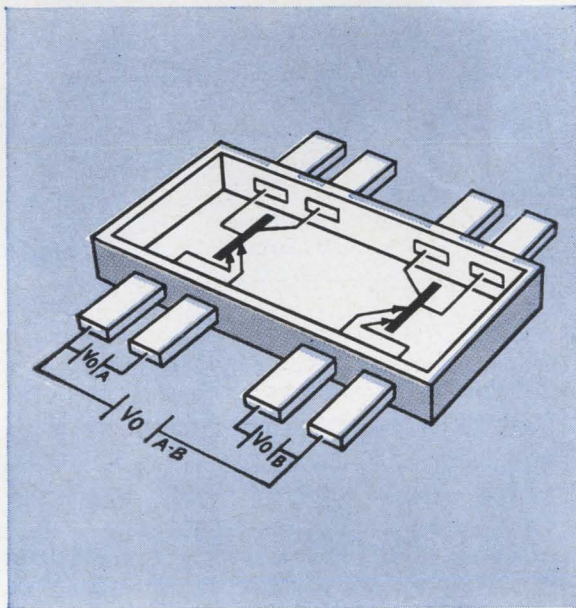

Sprague leads again with two dual-emitter chopper transistors in one flat-pack case, with tight V_{OFF} matching of both devices

CHECK THESE KEY PARAMETERS

Type No.	V_{EEO}	V_{ECO}	$ V_O $ A-B
3N112	30V	30V	20 μ V
3N113	50V	50V	20 μ V

Standard T0-18 case Duet* Transistors...the broadest line of dual-emitter choppers

Type No.	BV_{EEO}	V_O	Type No.	BV_{EEO}	V_O	Type No.	BV_{EEO}	V_O	Type No.	BV_{EEO}	V_O
3N90	30V	50 μ V	3N94	50V	100 μ V	3N110	30V	30 μ V	3N116	12V	200 μ V
3N91	30V	100 μ V	3N95	50V	200 μ V	3N111	30V	150 μ V	3N117	20V	50 μ V
3N92	30V	200 μ V	3N108	50V	30 μ V	3N114	12V	50 μ V	3N118	20V	100 μ V
3N93	50V	50 μ V	3N109	50V	150 μ V	3N115	12V	100 μ V	3N119	20V	200 μ V

For complete information, write to Technical Literature Service, Sprague Electric Company, 35 Marshall Street, North Adams, Mass. 01248

SPRAGUE COMPONENTS

- | | | |
|-------------------------|------------------------|--------------------------------------|
| TRANSISTORS | PULSE TRANSFORMERS | CERAMIC-BASE PRINTED NETWORKS |
| CAPACITORS | INTERFERENCE FILTERS | PACKAGED COMPONENT ASSEMBLIES |
| RESISTORS | PULSE-FORMING NETWORKS | BOBBIN and TAPE WOUND MAGNETIC CORES |
| INTEGRATED CIRCUITS | TOROIDAL INDUCTORS | SILICON RECTIFIER GATE CONTROLS |
| THIN-FILM MICROCIRCUITS | ELECTRIC WAVE FILTERS | FUNCTIONAL DIGITAL CIRCUITS |



*Sprague and '®' are registered trademarks of the Sprague Electric Co.

1582 Series
4.9 to 19.7 kVA

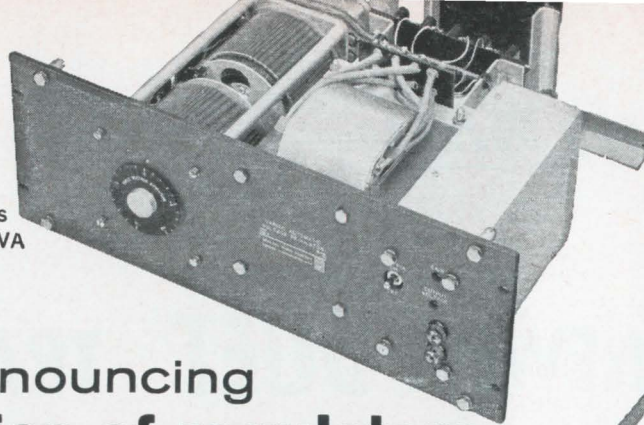

Announcing a new series of regulators . . .

designed to meet today's stringent demands
for better line-voltage control

1581 Series
2.3 to 9.2
kVA

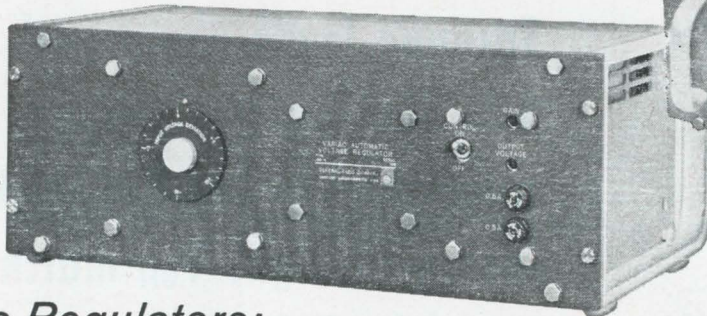

1571 Series
(Military)
2.3 to 9.2 kVA

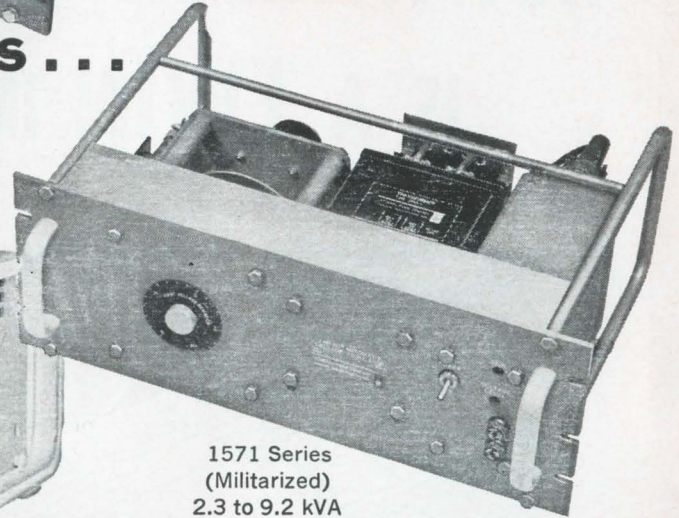

These Regulators:

- ... Hold line voltage constant to $\pm 1/4\%$ despite $\pm 10\%$ input variations . . . models are also available to hold $\pm 20\%$ variations to $\pm 1/2\%$.
- ... Do not affect the waveform . . . they introduce no distortion.
- ... Can handle transients up to 1000% of rating.
- ... Have a fast correction speed . . . 40, 80, or 160 volts per second, depending on model.

- ... Are all solid state . . . they are highly reliable and are available in industrial and militarized versions.
- ... Have high efficiency . . . better than 98%.
- ... Are not restricted by power factor of the load . . . nor do they affect the power factor of the system.
- ... Are completely nonsensitive to the load . . . they work equally well on all loads from open circuit to maximum rating.

Variac® voltage regulators are simple, reliable, true-proportional-control servomechanisms designed for fast, accurate, and distortionless control of line voltage. The regulator has only three basic elements . . . a motor-driven Variac® continuously adjustable autotransformer, a "buck-or-boost" step-down transformer to multiply the power rating of the Variac, and an all-solid-state control circuit to position the Variac automatically.

Variac® voltage regulators are available in many sizes: 2- to 20-kVA versions for industrial use and 2- to 9.2-kVA models for military applications, for use at line frequencies of 50 to 60 cycles or 350 to 450 cycles, and for nominal line voltages of 115, 230 and 460 volts. Prices start at \$495 in U.S.A.

Did you know that at 10% undervoltage:

- ... a squirrel-cage motor has 19% less starting torque and runs about 7°C hotter?
- ... in electroplating applications, deposition rate drops 10% to 20%?
- ... ultrasonic-cleaner and induction-heater output is down at least 20%?

... welding-time cycles must be increased about 20% to produce a weld as good as that made with correct voltage?

... and at 10% overvoltage:

- ... incandescent lamps must be replaced 2½ times as often as lamps operating at the correct voltage?
- ... cathode-type tubes fail at about ¼ normal life?

Maybe it's time you had a regulated line!

Write for complete information.

IN CANADA: Toronto 247-2171, Montreal (Mt. Royal) 737-3673
IN EUROPE: Zurich, Switzerland - London, England



GENERAL RADIO COMPANY

WEST CONCORD, MASSACHUSETTS

BOSTON (W. Concord) 646-0550 NEW YORK, N. Y., 964-2722 (Ridgefield, N. J.) 943-3140 CHICAGO (Oak Park) 848-9400 PHILADELPHIA (Ft. Washington) 646-8030 WASHINGTON, D.C. (Rockville, Md.) 946-1600 SYRACUSE 454-9323 DALLAS FL 7-4031 SAN FRANCISCO (Los Altos) 948-8233 LOS ANGELES 469-6201 ORLANDO, FLA. 425-4671 CLEVELAND 886-0150

Gulf of Mexico for civil use.

In my opinion Omega is a very promising system. However, I believe that the accuracy figures you quoted are those which are possible, not the ones currently realized for a 95% error probability. Propagation in the 10- to 14-kilohertz band is not well enough understood at the present time to predict corrections over all paths to the accuracy stated.

The opinions expressed above are my own and do not necessarily reflect any official Coast Guard policy. I am not currently working on any Coast Guard electronic aids-to-navigation projects.

James D. Luce
Captain, U. S. Coast Guard
Chief, Engineering Division
11th Coast Guard District
Long Beach, Calif.

▪ Reader Luce is right. Despite their shortcomings, the existing short-range loran stations will continue to operate for years. But the future seems far brighter for the long-range Omega navigational system than it does for loran.

Experimental or specific?

To the Editor:

With regard to your article "Government spurs medical market" [Aug. 9, p. 107], I would like more information about the cardiac monitoring system described at the beginning of the article.

Could you please tell me the name of the hospital and the firm that manufactured the system, or other people involved? The particular scheme described is exactly opposite to my own views on patient monitoring, so I am vitally interested to see how it operates.

I have one criticism of your article. The techniques described are almost all experimental. They are of use and interest only to a few large, specialized hospitals. In fact, almost all of the equipment described would not be bought with normal hospital funds. That is, it would be bought for an individual doctor rather than for general use in the hospital. This is the main reason for the lack of standardization in equipment.

It will take a long time for the equipment to become standardized and therefore suitable for the general hospital market. Companies intending to enter the field should be made aware of the very long time that they will have to carry the product before it is saleable, and not be blinded by the dollar value of individual sales. I would be very interested in seeing a survey of sales and profits in the different categories of medical electronic equipment.

M. B. Raber
Winnipeg General Hospital
Winnipeg, Manitoba, Canada

▪ The Electrodyne Co., Westwood, Mass., built the system which is installed at Bellevue Hospital of the New York University Medical Center in New York City. In reporting this story, Electronics found that most systems are different because the user hospital is trying to do something very specific, rather than because the system is experimental. The article concluded: "It seems clear that medical electronics has a healthy future. But it's a long-range future, definitely not appealing to a seeker of fast sales and immediately large profits."

New from Sprague!

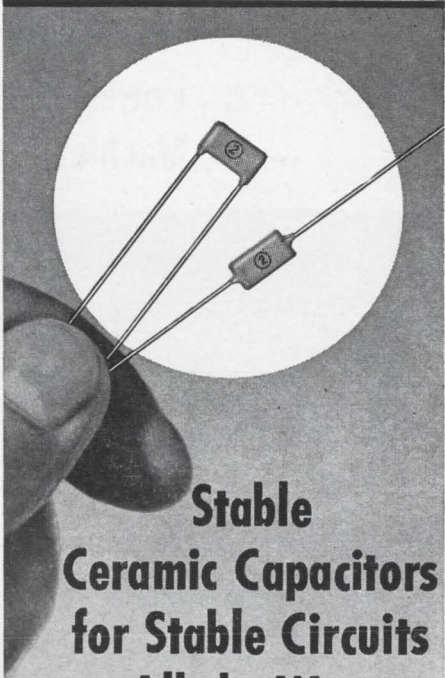

**Stable
Ceramic Capacitors
for Stable Circuits
All the Way
from -55 C to +125 C**

☐ Sprague's new temperature stable Formulation 067 Monolythic® Capacitors are guaranteed not to deviate from room temperature capacitance by more than +10, -15% over the wide temperature range from -55 C to +125 C.

☐ Layer-built construction produces reliable units with high capacitance values in small physical size. Alternately sprayed layers of ceramic dielectric and metallic electrodes are fired as a single piece into one homogeneous block. A 0.56 μ F capacitor is only .500" x .500" x .235" thin!

☐ Absence of anti-resonant points up to 1000 mc makes Monolythic Capacitors uniquely suited for d-c to high-frequency applications.

☐ Voltage rating, 100V @ 85 C or 50V @ 125 C. Available in axial-lead as well as radial-lead configurations.

For complete technical data, write for Engineering Bulletin 6205 to the Technical Literature Service, Sprague Electric Co., 35 Marshall St., North Adams, Mass. 01248.

45C 5138

SPRAGUE[®]
THE MARK OF RELIABILITY

*Sprague' and '®' are registered trademarks of the Sprague Electric Co.

SUBSCRIPTION SERVICE

Please include an Electronics Magazine address label to insure prompt service whenever you write us about your subscription.

Mail to: Fulfillment Manager
Electronics
P.O. Box 430
Hightstown, N.J. 08520

To subscribe mail this form with your payment and check new subscription renew my present subscription

Subscription rates: in the U.S.: 1 year, \$6; two years, \$9; three years, \$12. Subscription rates for foreign countries available on request

CHANGE OF ADDRESS

ATTACH
LABEL
HERE

If you are moving, please let us know five weeks before changing your address. Place magazine address label here, print your new address below.

name

address

city

state

zip code

World's Highest Power Tetrode— Machlett's ML-8545



The Machlett ML-8545 general-purpose, vapor-cooled tetrode delivers 16% more power with 25% less plate voltage (plate modulation service) than the closest competitive tube. It is capable of 300 kW continuous output as a Class C amplifier or oscillator at frequencies to 50 Mc. Maximum plate input is 420 kW. Applications include: High-power broadcast and communications; all-purpose rf generation; particle acceleration. For details on the ML-8545 and the ML-8546 water-cooled version, write: The Machlett Laboratories, Inc., Springdale, Conn. 06879. An affiliate of Raytheon Company.

MACHLETT
ELECTRON TUBE SPECIALIST

People

The appointment of **Raymond C. Sangster** as director of research at General Telephone & Electronics Laboratories, Inc., signifies a broadening of the Bayside, N. Y., labs'

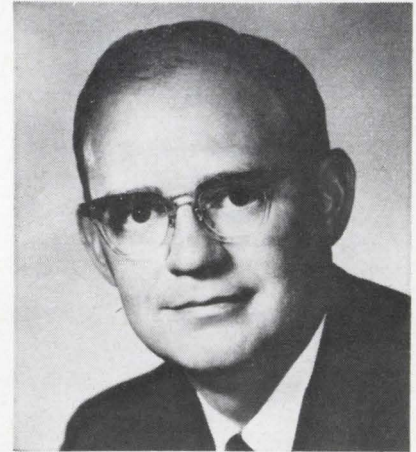

basic research activities. The GT&E Labs is a subsidiary of the General Telephone & Electronics Corp.

Sangster will be responsible for research and development in such areas as information processing, electronics, lighting, chemistry and metallurgy.

The new director formerly worked at Texas Instruments Incorporated; his posts at TI included director of the materials research department and head of the semiconductor exploration laboratory. He also was a research associate at TI's central research lab.

He was one of the men who directed the research at TI that led to the development of the pure silicon process, which put TI into the commercial silicon business.

Sangster holds a doctorate in chemistry from the Massachusetts Institute of Technology.

Back in 1950, the Raytheon Co. was test-firing Lark missiles on the West Coast under a Navy experimental program. "Missiles looked like an interesting new technology," recalls **Mike W. Fossier**. An aerodynamicist at the Douglas Aircraft Co. at that time, Fossier joined Raytheon, which was to become the only electronics company that is prime contractor in missiles for two military services. The com-



Bendix customers usually take prompt semiconductor delivery for granted.

Because Bob Brennen doesn't.

As a prime source of silicon and germanium power transistors, Bendix receives a lot of orders daily, some of which could get downright complicated. And that's why we've got Bob Brennen around. He specializes in making sure they don't. As Manager of Customer Service, he expedites all shipments by keeping tabs on every last one of them . . . from order to final shipment.

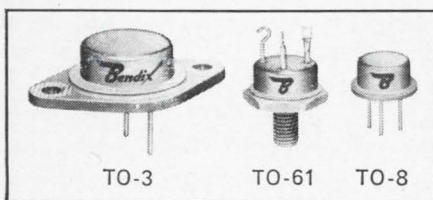

Now maybe all this doesn't mean much to you right now. But it will when you start putting the broad line of Bendix® Semiconductors to work. That's when

Bob is ready to use all of his talents (and telephones) to earn your confidence.

And there's one thing you'll particularly appreciate about Bob. When it comes to listening to your needs or requirements, he's all ears.

Bendix Semiconductor Division
HOLMDEL, NEW JERSEY



Baltimore (Towson), Md.—(301) 828-6877; **Chicago**—(312) 637-6929; **Dallas**—(214) 357-1972; **Detroit**—(313) JO 6-1420; **Holmdel, N. J.**—(201) 747-5400; **Los Angeles**—(213) 776-4100; **Miami Springs, Fla.**—(305) 887-5521; **Minneapolis**—(612) 926-4633; **Redwood City, Calif.**—James S. Heaton Co., (415) 369-4671; **Seattle**—Ray Johnston Co., Inc., (206) LA 4-5170; **Syracuse, N. Y.**—(315) 474-7531; **Waltham, Mass.**—(617) 899-0770; **Export**—(212) 973-2121, Cable: "Bendixint," 605 Third Ave. N. Y.; **Ottawa, Ont.**—Computing Devices of Canada, P.O. Box 508—(613) TA 8-2711.

*"They laughed
when I sat down to play
the Mathatron."*



"Little did they realize then that this was no ordinary \$5,000 Mathatron. All they could see was the simple algebraic keyboard, and the paper tape readout.

"But underneath the Mathatron, cleverly disguised in the table, was capacity bringing the totals to 48 individually addressable storage registers, 480 steps of program memory, 18 prewired programs of 48 steps each, increased speed, and added program control!

"By my right hand, unknown to those snickering on my left, close by the candelabra, was an additional control box which told me, by blinking lights, which of the 10 loops I was addressing. And there were other buttons there, too.

"When I finished my evaluation of the formula involving trigonometric, logarithmic and other functions, matrix manipulations, triangulation and the solution of polynomials, they applauded generously." Send for complete details.

MATHATRONICS, INC.

257 Crescent Street, Waltham, Massachusetts 02154 (617) 894-0835

Mathatron 8-48 plus Auxiliary Program Storage: ferrite core memory, 100 column number capacity, 8-9 significant digit accuracy, automatic decimal placement, all solid state logic & circuitry. Page printer, paper tape punch/reader and other accessories available.

pany is prime contractor for the Army's Hawk and the Navy's Sparrow.

In the last 15 years, says Fossier, "missiles have become almost entirely electronic." And so have Fossier's tasks in key engineering and managerial positions. At the age of 37, Fossier moved up this month to a vice president's spot with Raytheon and became assistant general manager, technical, for the Missile Systems division.

Fossier will be responsible for all technical aspects of Raytheon's missile work, both development and production of current missiles and design of new ones. But he will concentrate on the design of advanced missiles.

"Historically," he notes, "Raytheon had stressed the tactical and air-defense type of weapon. The electronics has always been the key element in these, and it will continue to be."

Independently of other Raytheon operations, the missile division is engaged in development to advance the state of the art in microelectronics, thin film, hybrid and integrated circuits, and high-density packaging techniques for guidance-system design. Missile-guidance electronics is still largely a matter of analog techniques, Fossier says; therefore, much of the developmental work follows lines other than microelectronics for digital data processing.

Fossier points out that the trend in military development, reinforced by the war in Vietnam, is to put more weapons in the hands of troops—more weapons which are reliable, small, mobile and tactical. "To a large extent," Fossier continues, "the troops have not seen the benefits from many of the advances which technology has made."

In addition to the emphasis on tactical weapons, Fossier says, the facts of life in the military market dictate more and more work on reliability and maintainability. "One of the biggest problems," he explains, "is to minimize troop training requirements by keeping the equipment simple, reliable and easily maintainable."

Fossier, a native of New Orleans, received technical degrees from Louisiana State University and California Institute of Technology.

**dual
integrated
mos
chopper**

planar II, integrated, single-chip, dual p-channel mos

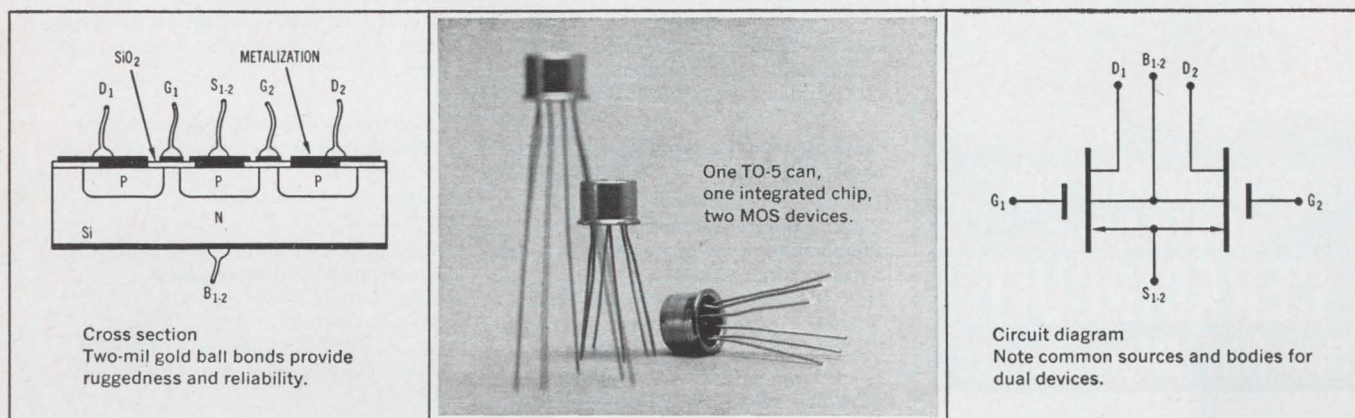

Cross section
Two-mil gold ball bonds provide ruggedness and reliability.

One TO-5 can,
one integrated chip,
two MOS devices.

Circuit diagram
Note common sources and bodies for
dual devices.

features:

- zero offset voltage.
- high gm. ■ 2000 $\mu\text{mhos min}$ * ■ ($V_{GS} = -15\text{V}$, $V_{DS} = -20\text{V}$, $f = 1\text{Kc}$)
- low ON resistance ■ 500 ohm max * ■ ($V_{GS} = -15\text{V}$, $f = 1\text{Kc}$)
- low OFF leakage ■ less than 1.0 nA ■ ($V_{DS} = -15\text{V}$)
- high input impedance ■ 10^{13} ohms min ■ (-15V)
- BV_{DSS} , BV_{SDS} ■ -30V min ■ (I_D or $I_S = 1\mu\text{A}$)
- V_{GS} ■ 3.0 to 6.0V ■ ($I_D = 10\mu\text{A}$)
- *Paralleling the two MOS devices will double the gm and halve the ON resistance.

FI0049 applications:

low level choppers and analog switches: The FI0049 can be used as a combined series/shunt chopper. It replaces dual emitter choppers, field effect transistors, and low level relay choppers. The FI0049 requires no isolation drive transformer, chops voltages as low as $1\mu\text{V}$, and has a zero offset voltage. The FI0049

is unusually valuable in analog switching because of its low ON resistance (500 ohm singly, 250 ohm in parallel).

discrete or dual: There are two ways to use the FI0049. It can be treated as two individual devices in the same can, each with 500 ohms ON resistance and 2,000 $\mu\text{mhos gm}$. By paralleling both sides it can be used as a single device with 250 ohms ON resistance and 4000 $\mu\text{mhos gm}$. Either way, it is ideal in such applications as high impedance amplifiers, linear direct coupled amplifiers and digital switching.

where you can't afford to take chances: The FI0049 utilizes the same Planar II process which has proven itself so dramatically with the FI100, tested for over one million device hours without failure and subjected to over one hundred thousand unit hours under maximum power dissipation, 150°C temperature, and reverse bias of 20 V. Still no failure.

No dual emitter device, FET or relay chopper can match the FI0049 at low levels. Your Fairchild distributor has it. Call him.

FAIRCHILD'S MOS FET IS MFRD. UNDER U.S. PAT. NOS. 3025589, 3064167, 3108359.
PLANAR IS A PATENTED PROCESS OF FAIRCHILD SEMICONDUCTOR.

FAIRCHILD
SEMICONDUCTOR

In Volume Production!

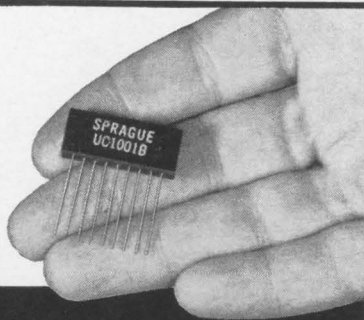

a compatible line
of DTL Logic
CERACIRCUIT[®]
Thin-film Microcircuits

5 Mc DTL LOGIC CIRCUITS

The basic member of the Sprague series of DTL Logic Modules is the UC-1001B NAND/NOR Gate (see schematic), with typical propagation time delay of 10 nsec per stage over a temperature range of -55 C to +125 C. Other DTL Logic Ceracircuits include SCT Flip-Flop, Buffer-Driver, Exclusive OR/Half-Adder, 8-Diode Gate, and 5-Diode Gate.

To facilitate contact packaging and assembly on printed wiring boards, all 5 Mc DTL Modules are encapsulated in one standard case, 1.0" wide x 0.4" high x 0.2" thick.

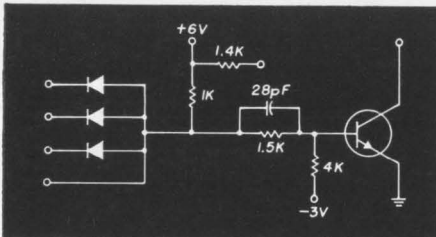

Circuit schematic, UC-1001B NAND/NOR Gate.

CUSTOM-TAILORED CERACIRCUITS

Ceracircuit Ceramic-base Microcircuits provide the circuit designer with desirable features — component familiarity, design versatility, increased reliability, circuit economy. Thin-film technology permits wide ranges of resistance and capacitance values, holding close tolerances without high-cost penalties. Each passive component keeps its identity, allowing conventional design procedures.

For complete technical data,
write to Technical Literature Service,
Sprague Electric Co., 35 Marshall St.,
North Adams, Mass. 01248.

45M-5104

SPRAGUE[®]
THE MARK OF RELIABILITY

*Sprague and ® are registered trademarks of the Sprague Electric Co.

Meetings

Electronic Data Processing Conference, National Retail Merchants Association; Fairmont Hotel and Tower, San Francisco, Sept. 20-24.

Systems Engineering Annual Conference, Clapp and Poliak, Inc.; McCormick Place, Chicago, Sept. 20-23.

Microelectronics Symposium, IEE; Univ. of Southampton, England, Sept. 21-23.

Plasma Sheath—Plasma Electromagnetics of Hypersonic Flight Symposium, OAR; New England Life Hall and Classified section at Base Theater, Laurence G. Hanscom Field, Bedford, Mass., Sept. 21-23.

AE-4 Electromagnetic Compatibility Conference, SAE; Grumman Aircraft Corp., Bethpage, L.I., N.Y., Sept. 22-23.

Military Electronics Conference (MIL-E-CON 9), IEEE; Washington Hilton Hotel, Washington, D.C., Sept. 22-24.*

IEEE Broadcast Symposium, G-B/IEEE; Willard Hotel, Wash., D.C., Sept. 23-25.

Automation Conference, Cedar Rapids Section, IEEE; Town House Motel, Cedar Rapids, Iowa, Sept. 24-25.

Optics in Space Conference, Institute of Physics and Physical Society Optical Group; Univ. of Southampton, England, Sept. 27-29.

Biennial Electric Heating Conference, IEEE; Carter Hotel, Cleveland, Sept. 28-29.

Symposium on Physics and Nondestructive Testing, Air Force Materials Laboratory; Sheraton-Dayton Hotel, Dayton, Sept. 28-30.

ERA Electronics Show, Cascade Chapter of Electronic Representatives Association; Center Display Hall, Seattle, Wash., Sept. 29-30.

National Symposium on Information Display, Society for Information Display; Commodore Hotel, N.Y.C., Sept. 29-30.

International Exhibition of Modern Electronics, Gospodarsko Razstavisce; Ljubljana, Yugoslavia, Oct. 2-10.

Canadian Electronics Conference, Canadian Region of IEEE; Exhibition Park, Toronto, Oct. 4-6.

International Scientific Radio Union (URSI), National Academy of Sciences, National Research Council; Dartmouth College, Hanover, New Hampshire, Oct. 4-6.*

National Aeronautic and Space Engineering Meeting, SAE; Statler Hilton Hotel, Los Angeles, Oct. 4-8.

Aerospace Instrumentation Symposium, ISA; Ambassador Hotel, Los Angeles, Oct. 5-7.

Switching Circuit Theory & Logical Design Annual Symposium, G-C Univ. of Mich., IEEE; Univ. of Mich., Ann Arbor, Mich., Oct. 6-8.

Pan American Congress of Electrical, Electronics, and Mechanical Engineering, Mexico Group of IEEE; Mexico Section of ASME, Mexico Group of SAE; Hotel Del Prado and Auditoria Nacional, Mexico City, Oct. 9-17.

International Electrotechnical Commission Conference, IEC; Tokyo Prince Hotel, Tokyo, Oct. 10-23.

National Communications Conference (NATCOM), Mohawk Valley Section of IEEE; Utica, N.Y., Oct. 11-13.

Convention and Exhibit of Professional Audio Equipment, Audio Engineering Society; Barbizon-Plaza Hotel, N. Y. C., Oct. 11-15.

International Motion Picture Engineers Meeting, SMPTE; Fair Grounds, Milan, Italy, Oct. 11-23.

ATA Maintenance and Engineering Conference, Air Transport Association; Deauville Hotel, Miami Beach, Oct. 26-29.

Call for papers

Symposium on Remote Sensing of Environment, ONR; Univ. of Michigan, Ann Arbor, April 12-14. **Dec. 1** is deadline for submitting one-page abstract to Dana C. Parker, University of Michigan, Willow Run Laboratories, P. O. Box 618, Ann Arbor, Mich. 48107.

International Conference on Magnetism (INTERMAG), Magnetics group of IEEE, Arbeitsgemeinschaft Ferromagnetismus; Stuttgart, Germany, April 20-22. **Dec. 7** is deadline for submission of two-page abstract to Dr. E. W. Pugh, IBM Corp., 1000 Westchester Ave., White Plains, N. Y.

* Meeting preview on page 16



and watch Astrodata's new PAM/PDM Decommulator start a revolution in set-up and performance

Just blink once and you could miss all the set-up procedures necessary for Astrodata's new telemetry decommutator. It takes less than a second to hit the AUTO-SET button. The Model 603 Decommulator does the rest unattended, adjusting the level and gain of the input amplifier automatically.

ABSOLUTELY NO RATE PLUG-INS

Model 603 does away completely with rate plug-ins. Thumbwheel switches are centralized around the front panel for entire selection of frame length (up to 128 channels), rate (1 pps through 10,000 pps), and reference channels. Touch AUTO-SET and away you go. Calibrated, synchronized and ready to unscramble the noisiest signal, extracting good data from what would have been otherwise useless data in any other decommutator.

HOW MUCH NOISE IMMUNITY?

We are prepared to demonstrate that the Model 603 Decommulator offers the most noise immune PAM-NRZ performance ever available. For example, synchroni-

zation is acquired and maintained with a 24 db peak signal-to-rms-noise ratio when all adjacent PAM-NRZ data channel excursions are limited to as little as 20% full scale. For the full technical statement on noise immunity, please ask for our 603 brochure.

What About Input Capture Range and Rise Time Limitations?

- 1) Exceptionally wide capture, $\pm 30\%$ from pre-set rate; and if you have very low pulse rates —
- 2) Virtually no rise time limitations.

SEEING IS BELIEVING

We could go on and on about unique pattern recognition, frame synchronization, zero and full-scale options, etc., but you're not going to believe how much difference these 603 design innovations can make until you see them demonstrated. So why not contact the Astrodata representative in your area and see for yourself? Or write to Astrodata direct on company letterhead and request a demonstration. Some of our most satisfied customer relationships start this way.



Complete line of faster, field-proven

MULTIPLEXERS A/D-D/A CONVERTERS BY CONTROL DATA

When you require speed and performance, don't settle for less than your long-range needs. The broad line of products developed by Adcomp, a subsidiary of Control Data, now makes it possible to select the instrument for your *specific* application. Here are typical models:

HIGH SPEED MULTIPLEXERS



Silicon solid-state switches are used in multiplexers to obtain high speed and low offset voltage. The Model 402 32-channel Multiplexer offers a speed of 500,000 samples per second with a maximum offset voltage of 250 μ v max. Linearity is better than 0.001% and input impedance is 100 megohms min. Input ranges from ± 1 to ± 100 volts are available.

ANALOG TO DIGITAL CONVERTERS

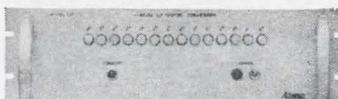

Analog to Digital Converters are available with resolutions from 8 to 14 bits, and 50 to 250,000 conversions per second. A number of inputs are offered up to ± 100 volts. Digital output is binary. Integral sample and holds and extremely stable reference supplies provide exceptional accuracy and stability.

DIGITAL TO ANALOG CONVERTERS

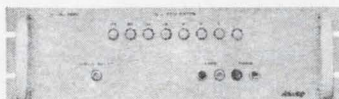

These instruments incorporate the finest components obtainable. For example, high accuracy and temperature stability are obtained with a precision resistance ladder immersed in oil. Various models offer resolutions from 8 to 14 bits, absolute accuracy to $\pm .015\%$ and an update rate up to 300 kc. Buffer amplifiers are available for various output voltages and drive capabilities.

FOR INFORMATION concerning these and other ADCOMP instruments, contact: ADCOMP CORPORATION, Dept. 302, 20945 Plummer St., Chatsworth, California 91311 (Area code 213, 341-4635)

ADCOMP CORPORATION
SUBSIDIARY OF

CONTROL DATA
CORPORATION

Meeting Preview

Radio at Dartmouth

A new radar technique indicates that the dusty layer on the surface of the moon may be less dense than conventional radar observations indicate. Details of the new technique and the new information about the lunar surface will be reported at the fall meeting of the U.S. National Committee, International Scientific Radio Union (URSI), to be held Oct. 4-6 at Dartmouth College, Hanover, N. H. Six professional groups of the IEEE are cosponsors.

Tor Hagfors of the Massachusetts Institute of Technology's Lincoln Laboratory will present first details of the new radar observations. Interest in the technique is heightened by conflicting conclusions about the lunar surface density derived from radar and from radiometric measurements.

The URSI meeting will also hear details of the Mariner 4 occultation measurements. A seven-man team from the Jet Propulsion Laboratory at the California Institute of Technology, Stanford University, and Cornell University will describe what happened to the Mariner signals as the spacecraft entered the atmosphere of Mars, disappeared behind the planet, and then reappeared. The data is expected to provide some information about the Martian ionosphere.

Communications problems in South Vietnam will make a report on ultra-short-wave propagation in the jungle, by C. R. Burrows of Radio Engineering Laboratories, Washington, D. C., a highlight of the session on propagation measurement and theories. A. P. Barsis of The Central Radio Propagation Laboratories, Boulder, Colo., will describe polarization discrimination at 100 megacycles in irregular terrain at that session.

Effects of ionospheric disturbances on radio and radar propagation will be the central theme of about a third of the 105 papers. Increased interest in very low frequency (vlf) and extremely low frequency (elf) signals is also reflected in the program. Papers include a report on fluctuations in vlf signals at Byrd Station, Antarctica.

NEW DICKSON "W" CASE TANTALUM CAPACITORS

1—projecting standoff
provide circulation for
heat transfer and an
access area for cleaning
solvents.

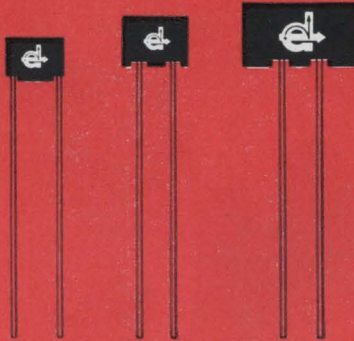

actual size

2—solderable, weldable
nickel leads are radially
positioned at .200"
centers.

■ These compact Dickson tantalum capacitors are ideal for high density and printed circuit applications. They should be, because that's what they were designed for... at the request of customers who were impressed with the quality and reliability of our standard tantalum line.

■ Units may be used at full rated voltage at the upper limits of their -55°C to $+85^{\circ}\text{C}$ temperature range. 374 types assure you of the exact unit for your application. Give them a try.

DICKSON "W" SERIES SOLID TANTALUM CAPACITORS

VOLTAGE	CAPACITANCE RANGE
6 Volts	.0047 to 220 mfd — 57 types
10 Volts	.0047 to 150 mfd — 55 types
15 Volts	.0047 to 82 mfd — 52 types
25 Volts	.0047 to 47 mfd — 49 types
35 Volts	.0047 to 33 mfd — 47 types
50 Volts	.0047 to 18 mfd — 44 types
75 Volts	.0047 to 3.9 mfd — 36 types
100 Volts	.0047 to 2.7 mfd — 34 types



can you use
TC ZENERS
with
CERTIFIED
VOLTAGE-STABILITY
of
<10PPM/1000 hrs?

NEW DICKSON 6.35 VOLT SERIES offers 3 OUTSTANDING STABILITY LEVELS.

■ This new Dickson 1N 4890-95A series of low impedance 400 mW temperature compensated reference diodes offers certified voltage-time stabilities of 10PPM, 20PPM, and 50PPM / 1000 hours... and maximum temperature coefficients of 0.001 and 0.0005%/°C.

■ For the first time, stringent test conditions and minimum equipment accuracies are tightly specified in device registration data. A certificate is supplied with each device giving —

- a — reference voltage as measured at 168 hour intervals during the unit's 1,000 hour operating period
- b — voltage drift referenced to "zero hour"
- c — chart of voltage drift in PPM
- d — detailed format of 1000 hour stability test sequence

■ Needless to say, these units are ideal for your most critical applications.

NOW FROM
DICKSON



**BOTH
P-CHANNEL
and
N-CHANNEL
FET'S**

■ Twenty-five standard JEDEC P-channel and N-channel silicon epitaxial diffused field effect transistors are now available "off-the-shelf", in quantity, from Dickson. And, because of Dickson's advanced capability and experience in silicon semiconductors, these transistors offer you significant performance advantages.

■ The following types are currently available:

N-Channel Units			
2N3066	2N3071	2N3366	2N3436
2N3067	2N3085	2N3367	2N3437
2N3068	2N3087	2N3368	2N3438
2N3069	2N3089	2N3369	2N3458
2N3070	2N3365	2N3370	2N3459
			2N3460
P-Channel Units			
	2N2606	2N2841	
	2N2607	2N2842	

One hundred lot prices range from \$4.70 to \$24.00. Custom types and matched pairs are also available.



For complete information, wire, write, phone or use this publication's Reader Service Card.

DICKSON
ELECTRONICS CORPORATION

310 WELLS FARGO, SCOTTSDALE, ARIZONA
PHONE (602) 947-5751, TWX 602-949-0146



For complete information, wire, write, phone or use this publication's Reader Service Card.

DICKSON
ELECTRONICS CORPORATION

310 WELLS FARGO, SCOTTSDALE, ARIZONA
PHONE (602) 947-5751, TWX 602-949-0146



For complete information, wire, write, phone or use this publication's Reader Service Card.

DICKSON
ELECTRONICS CORPORATION

310 WELLS FARGO, SCOTTSDALE, ARIZONA
PHONE (602) 947-5751, TWX 602-949-0146

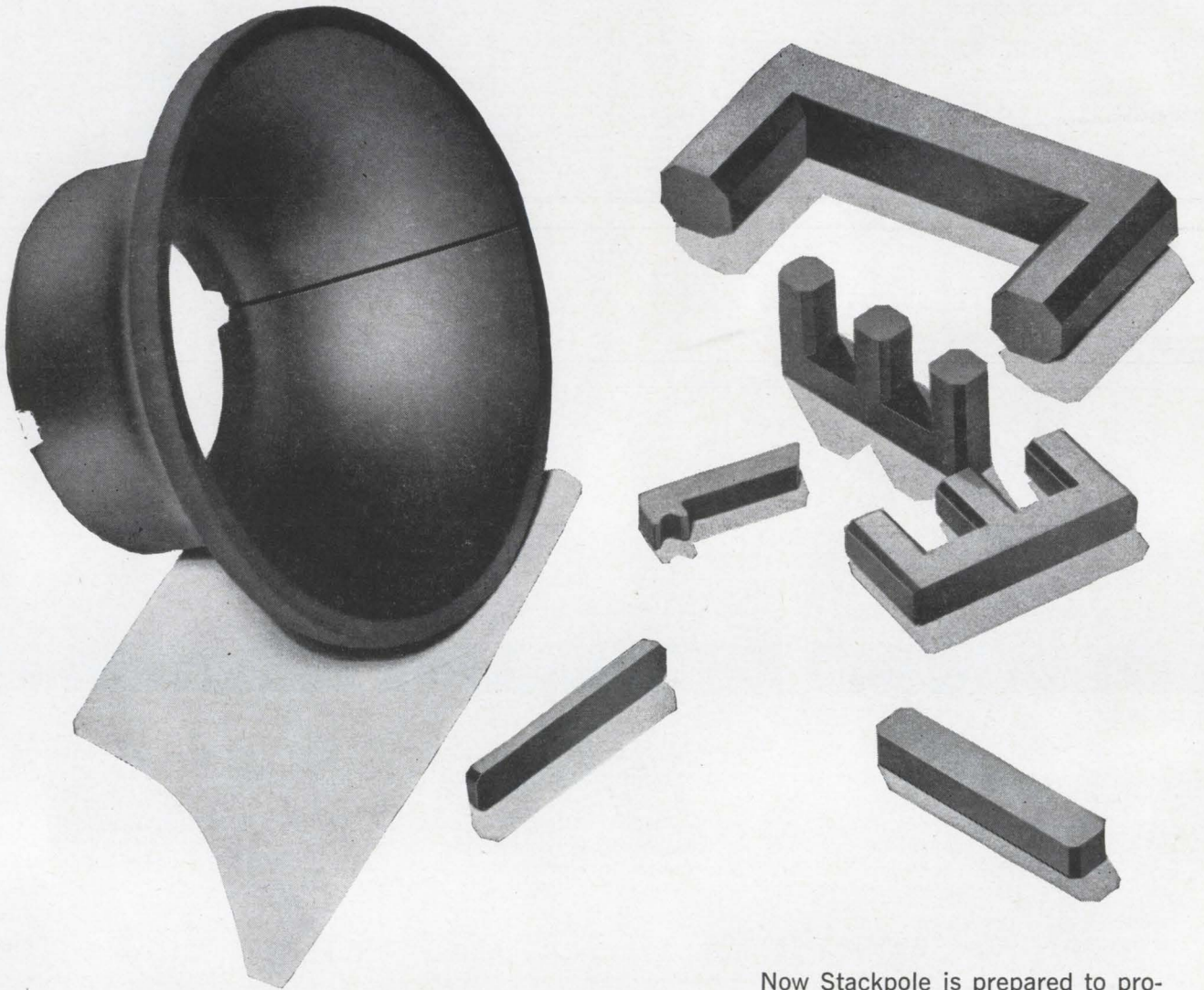

***Stackpole now has
production tooling
for all these
Ceramag[®] cores for
color television.***

Now Stackpole is prepared to provide immediate delivery of all ferrite components for the new 90° color television receivers.

Long the recognized leader in the development of ferrites for commercial applications, Stackpole continues to provide quality components to the entire television industry.

Each core for H.O.T. and pin cushioning shown is made with Ceramag[®] 24B...the NEW power ferrite. This material has already been proven extensively in current models. Its high uniformity and complete dependability make it the



first choice of many. The deflection yoke cores are made from Ceramag[®] 7B...the established ferrite material.

If you seek the highest standard in quality and performance, plus prompt delivery, then Stackpole is your answer. Choose from the most complete line of television components anywhere, made with the best ferrites available... Stackpole Ceramag[®]. Why not place your order today?

For samples and additional technical information, write: Stackpole Carbon Company, Electronic Components Div., St. Marys, Pa. Phone: 814-781-8521 TWX: 510-693-4511.

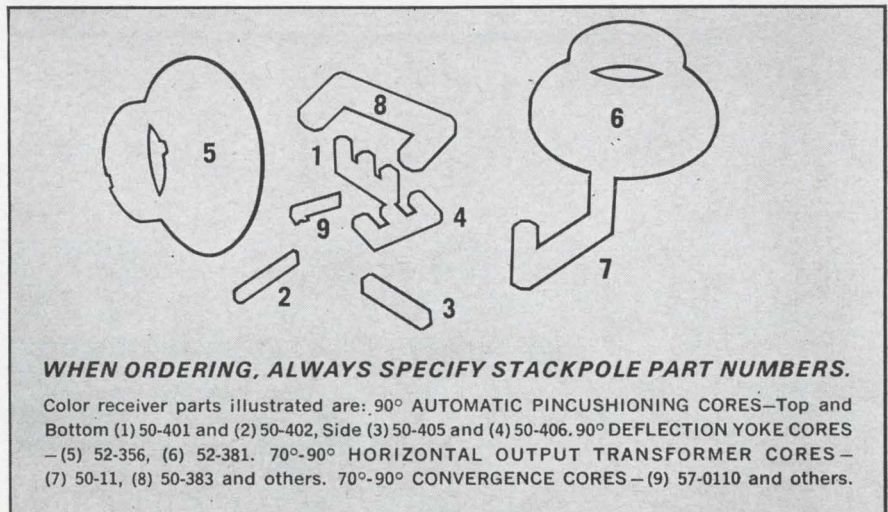

STACKPOLE
ELECTRONIC COMPONENTS DIVISION

now you see it...

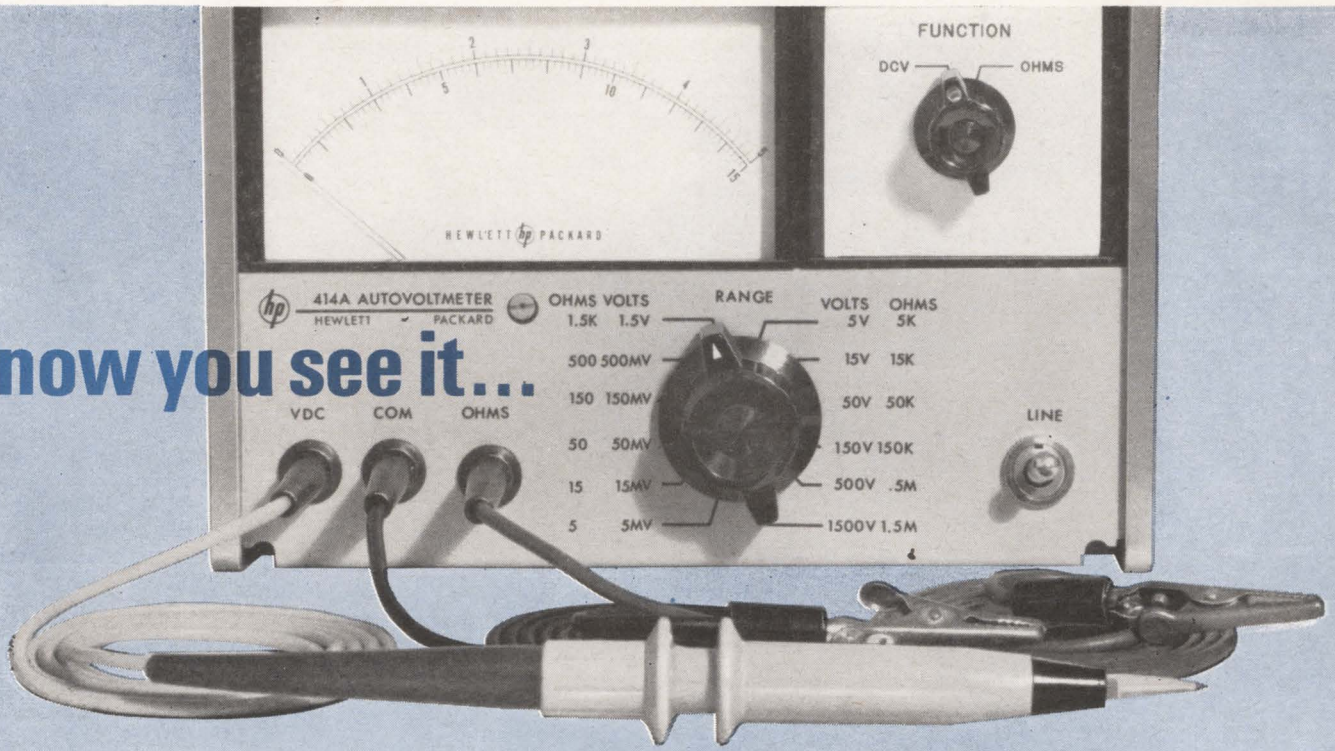

now you don't!



the case of a missing range switch SOLVED!

*A \$650 analog dc volt-ohmmeter with fast automatic ranging
plus an accuracy of $\pm 0.5\%$ of full scale $\pm 0.5\%$ of reading!*

No more manual range switching with the Hewlett-Packard 414A Autovoltmeter. Range and polarity change automatically . . . provide digital range, polarity readout in less than 300 milliseconds . . . and still give you the convenience and economy of unusually accurate analog measurements! What's more, the 414A lets you make *resistance* measurements, again with automatic ranging, on a *linear* analog meter scale!

Here's the world's first "touch-and-read" analog volt-ohmmeter with accuracy anywhere approaching what you require for trouble shooting, tweaking, peaking and nulling, probing a circuit without a schematic. Use it for maintenance testing, on the production line, in the lab.

In the dc voltage function you simply touch the point to be measured and in less than 300 msec read the range and polarity of the measurement on the digital display at the top of the 414A . . . the precise dc measurement on the individually calibrated, mirror-backed taut-band meter. Range 5 mv full scale to 1500 v full scale in 12 automatically selected and displayed ranges.

Or measure resistance 5 ohms to 1.5 megohms . . . on a linear scale that gives unprecedented accuracy, especially on the lower ranges. The 12 resistance ranges are automatically selected and displayed, as well.

Ranges also can be selected and held manually. Another feature is a Down Range control which lets you drop to the next lower range merely by pushing a front-panel button. High input resistance. All solid-state. Compact, only 10¼ lbs.

The details are in the specifications. But to get the true significance of this automatic instrument, you need to see it perform on your bench. Call your Hewlett-Packard field engineer for that convincing demonstration. Or write for complete information to Hewlett-Packard, Palo Alto, California 94304, Tel. (415) 326-7000; Europe: 54 Route des Acacias, Geneva; Canada: 8270 Mayrand Street, Montreal.

SPECIFICATIONS

DC VOLTMETER

Voltage range: ± 5 mv to ± 1500 v full scale, 12 ranges, manual or automatic ranging

Accuracy: $\pm 0.5\%$ of reading $\pm 0.5\%$ of full scale

Input resistance: 10 megohms on 5 and 15 mv ranges, 100 megohms on 50 mv range and above

Superimposed ac rejection:

insensitive to 60 cps signal with peak value less than 7 times the full-scale dc level of the range in use in "Hold" position (rejection is 20% of reading in Autoranging)

OHMMETER

Resistance range: 5 ohms to 1.5 megohms in 12 ranges (manual or autoranging with linear scale)

Accuracy: $\pm 1\%$ of reading $\pm 0.5\%$ of full scale on any range

Source current: 1 ma through unknown up to 5 K ohms, 1 μ a above 5 K ohms

GENERAL

Range selection: voltage and resistance, automatically selects correct range in less than 300 msec; a particular range may be selected manually

Polarity selection: automatic

Meter: individually calibrated taut-band meter with mirror scale; linear scale, 0 to 5 and 0 to 15

Isolation resistance: at least 100 megohms shunted by 0.1 mf between common terminal and case

Floating input: may be operated up to 500 v dc above ground

Dimensions: 6 18/32" high, 7 25/32" wide, 11" deep (87 x 130 x 279 mm); 10¼ lbs (6,4 kg)

Price: \$650

Data subject to change without notice. Price f.o.b. factory.

HEWLETT  **PACKARD**
An extra measure of quality

IN LINE REGULATED ADJUSTABLE DC POWER SUPPLIES

KEPCO'S DESIGN SIMPLICITY MAKES THE DIFFERENCE!



Model PR 155-1M

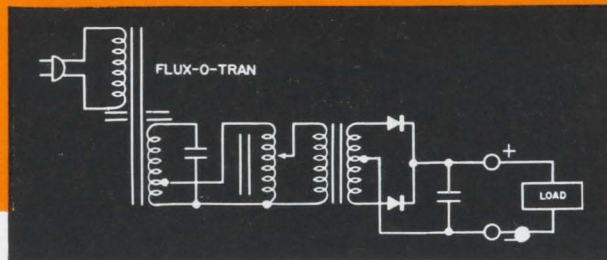

RELIABILITY GREATER THAN 40,000 HOURS MTBF

(Mean time before failure computed per RADC Reliability Notebook PB 161894 and the MIL Handbook 217)

The FLUX-O-TRAN® is the heart of Kepco's PR GROUP of DC Power Supplies. By delivering a square-wave-form to the rectifier, the FLUX-O-TRAN increases rectifier utilization and improves the loading characteristics of the filter capacitors. This characteristic provides a relatively low intrinsic source impedance, improving load regulation and affording a low ripple content. The result is a simple, highly reliable and efficient source of regulated DC power in *minimum space* and at *minimum cost*.

The PR GROUP offers a wide choice of *adjustable* output voltage and output ratings with:

- typical ripple values 0.5 to 3%
- overcurrent protection
- no voltage overshoot
- power efficiency typically 50-70%
- reliable, efficient silicon full-wave rectification
- output essentially free of line voltage variations
- isolation of line transients
- current limiting protection from current overloads and external short-circuit

± 1% LINE REGULATION

105-125 V AC, 60 CPS ± 5%* - SINGLE PHASE

MODEL	DC OUTPUT VOLTS	RANGE AMPS	PRICE
PR 15-10M	0-7.5-15	0-10	\$360.00
PR 15-30M	0-15	0-30	525.00
PR 38-5M	0-19-38	0-5	340.00
PR 38-15M	0-38	0-15	495.00
PR 80-2.5M	0-40-80	0-2.5	340.00
PR 80-8M	0-80	0-8	475.00
PR 155-1M	0-78-155	0-1	340.00
PR 155-4M	0-155	0-4	450.00
PR 220-3M	0-220	0-3	450.00
PR 310-0.6M	0-165-310	0-0.6	360.00
PR 310-2M	0-310	0-2	450.00

± 2% LINE REGULATION

208/230 V AC ± 10%, 60 CPS ± 5%* - 3-PHASE

MODEL	DC OUTPUT VOLTS	RANGE AMPS	PRICE
PR 20-100AM	0-20	0-100	1,050.00
PR 40-50AM	0-40	0-50	895.00
PR 50-40AM	0-50	0-40	895.00

*For models to operate at 104 ± 9V AC; 115 ± 10 V AC; 208 ± 18V AC or 230 ± 20V AC, 50 cps ± 5%, add suffix "-50" to model no. and derate output voltage by 20%.



OUR NEW CATALOG CONTAINING COMPLETE SPECIFICATIONS AND APPLICATIONS NOTES IS NOW AVAILABLE

WRITE FOR YOUR FREE COPY!

Applicable Patent Nos. furnished on request



KEPCO, INC. • 131-38 SANFORD AVENUE • FLUSHING, N.Y. 11352 • Phone: (212) 461-7000 • TWX #212-539-6623 • Cable: KEPCOPOWER NEWYORK

Editorial

Selling short

Though the launch date of Apollo, the manned exploration of the moon, is five years off, some nervous engineers are already doubting that it will be a success. Some of them, at an informal gathering at Wescon, were offering heavy odds that the astronauts will not get back alive if the flight is made on schedule in 1970. The doubts are rooted in the honest belief that a manned trip to the moon and back is a tremendously difficult undertaking that requires pinpoint accuracy by navigation equipment, reliability of electronic components a cut above what we are used to, and superb performance by thousands of parts and subassemblies. Apollo, these skeptics say, is a risky project whose chances of success are forbiddingly small.

The Russians, too, have been sniping at the U. S. space effort, after several polite years. The well-publicized difficulties of the Gemini 5 flight triggered an accusation that the United States was endangering its own astronauts' lives by putting them into space with untried parts, in an effort to top Soviet achievements. Then a leading Russian scientist made public his doubts that Apollo would ever meet its target date.

There is no argument that Apollo represents the most ambitious technical undertaking that man has ever attempted. The mission, right out of science fiction, stuns the imagination. The fears for the astronauts' lives are perhaps overstated; if the hardware isn't ready, the flight will be postponed. But the doubters are discounting the rapid strides that are being made in space technology today. The progress rate is almost unbelievable. Under such circumstances, it is too early to say that 1970 is premature for Apollo.

The Soviet criticism sounds like sour grapes; the U. S. aerospace industry has racked up such a string of triumphs in the past 12 months that the Russians may be getting nervous about their lead in space. All three manned Gemini flights were, after all, successful. And the Russians have had nothing to compare with the fabulous pictures of the moon televised by Ranger 9, the spectacular views of Mars radioed over 134 million miles by Mariner 4, or the smooth performance of the Early Bird satellite.

The trouble in Gemini 5's fuel cell was a painful reminder that the failure of one small part—in this case a heater—can jeopardize a complex flight. But the very fact that the fuel cell eventually worked without the heater is an indication of the high quality of technical effort that is going into the space program.

The truth is that American scientists and engineers have made these feats look so easy that almost everyone—except the men working on the projects—has lost sight of how complex each project is, and how painstakingly put together. The Mariner 4 vehicle, for example, is made up of 138,000 separate parts, of which 34,000 are electronic components. Yet it is still performing after nine months of exposure to the unfriendliest environment man has ever tried to conquer—meteorite blasts, high vacuum, nuclear radiation, and temperature differences as high as 600° across individual parts. Such performance should deter anybody, including the Russians, from predicting the failure of the Apollo mission this far off.

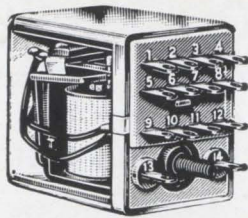

Should YOU specify this small four-pole relay by P&B?

Here is why so many engineers have

An extraordinary combination of features distinguish the KH relay. Small size (only slightly larger than one cubic inch), 4-poles, exceptional electrical stability over a long life, a wide choice of mountings... all of these and more are found in the KH.

SWITCH FOUR CIRCUITS FROM LOW LEVEL TO 3 AMPS

This is a four-pole relay normally used in a 4 Form C arrangement. It can be supplied with a 2 Form Z (DPDT-DB) configuration or, by not wiring certain contact terminations, any four-pole combination of Forms A or B may be achieved. Beryllium copper is used for the contact arms for excellent conductivity and long mechanical life.

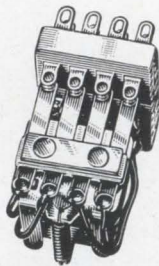

Both AC and DC relays are available. Minimum power requirement for AC relays is 0.55 volt amperes at 25° C. DC relays will operate on only 0.5 watts at 25° C. KH relays are rated at 3 amperes, as shown below. Under certain favorable conditions, KH relays will switch up to 5 amperes providing extended life is not required.

TERMINAL BLOCK CONSTRUCTION CONTRIBUTES TO RELIABILITY

Glass reinforced alkyd, a material of exceptional dimensional stability and dielectric properties, is used for the terminal block. The terminals are molded into the block. This construction serves to keep the relay in precise adjustment throughout its life. The pierced solder terminals are easily accessible, speeding hook up.

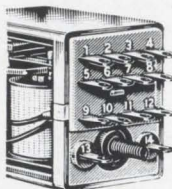

CHOOSE FROM WIDE VARIETY OF MOUNTINGS

The terminal block is uniquely embossed to allow for mounting KH relays on metal strips or angles. This embossing, around the two bottom terminals, keeps the relay from turning when the nut is tightened on the stud. The KH may be mounted in a variety of ways. A tab-and-stud mounting plate on any side or the top of the dust cover is available. Also, a choice of three sockets may be used to make the KH a plug-in relay. One socket has printed circuit tabs, the other two have pierced solder terminals.

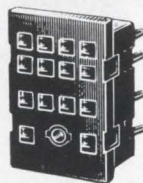
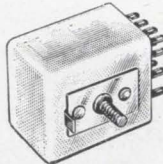

CHOICE OF ENCLOSURES TO MEET ALL REQUIREMENTS

Dust covered KH relays (KHP) can be ordered with translucent nylon or clear Lexan cases. Hermetically sealed relays are designated KHS, and are enclosed in a steel cover. The nylon cases are available on special order in red, blue, green, yellow or black so that relays in various circuits may be color coded.

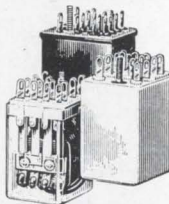

RELIABILITY OF KH SERIES FIELD-PROVED IN MANY APPLICATIONS

The KH has found its way into such diverse gear as citizens band transceivers, dictating machines, walkie-talkies, computers, aircraft communications equipment, scoreboards, alarm systems, and many others.

For full information call your local P&B distributor or Sales Representative, or write: Potter & Brumfield, Princeton, Indiana.

KH SERIES SPECIFICATIONS

CONTACTS:

Arrangements: 4 Form C (4PDT), 2 Form Z (DPDT-DB).

Rating: 3 amps @ 30 volts DC or 115 volts AC resistive for 100,000 operations.

COILS:

Resistance: DC: 11,000 ohms max.
AC: 3,900 ohms max.

Power: AC: 1.20 volt amperes nominal @ +25°C., .550 volt amperes minimum @ +25°C.

DC: 0.9 watt nominal @ +25°C., 0.5 watt minimum operate @ +25°C., 2.0 watts maximum @ +25°C.

TIMING VALUES:

Nominal Voltage @ 25°C.	Max. Values
Pull-in time	13 ms
Drop-out time	10 ms

INSULATION RESISTANCE:

1500 megohms min.

MECH. LIFE:

DC: In excess of 100 million cycles.
AC: In excess of 50 million cycles.

ENCLOSURES:

Dust cover or hermetically sealed.

TERMINALS:

Solder lug and taper tab.

SOCKET:

Solder lug or printed circuit terminals.
Available as accessory.

DIMENSIONS:

1-21/64" x 1-7/64" x 55/64"

Now available at leading
electronic parts distributors



POTTER & BRUMFIELD

Division of American Machine & Foundry Company, Princeton, Indiana
In Canada: Potter & Brumfield, Division of AMF Canada Ltd., Guelph, Ont.

Electronics Newsletter

September 20, 1965

Pacific may get sub detection

Project Caesar, the submarine detection system that extends along the East Coast of the United States [Electronics, Dec. 28, 1964, p. 77] has proved so successful that the Navy is now planning to extend the network along the Pacific Coast.

A string of hydrophones has been installed along the Atlantic's continental shelf to detect the presence of submarines hundreds of miles off the coast. The key to detecting far-off targets is the development of computer-analysis techniques for picking out the "signature" of enemy subs despite the background noise of the ocean and the electronic gear.

Problems, however, remain in the installation of the system in the Pacific. The absence of a continental shelf there makes it more difficult to place the hydrophones; and Navy researchers do not have as much information about background noise and sound transmission there.

The prime contractor for the Atlantic project, the Western Electric Co., presumably will develop the Pacific array. Western Electric is the manufacturing arm of the Bell System.

More R&D needed for fiber optics satellite detector

Better components are needed to make the electro-optical space surveillance system at Cloudcroft, N. M., do the job it was meant to do: detect and track satellites against a background of stars. The improvement program may take two years.

"As an astronomer's instrument, the system is wonderful, but it does not have the sensitivity we want in picking out artificial satellites," says Col. Thomas O. Wear, director of the 496L space track research and development program at the Air Force's Electronics Systems division Hanscom Field, Mass. [Electronics, May 3, p. 28].

Col. Wear goes to the Pentagon this month to get approval of his prescription: more R&D, specifically on how to cut losses in the system's fiber optics and to increase the gain and sensitivity of the image orthicon tubes. Says Col. Wear: "We're not going to have a new tube developed. We may want to rework some of the existing tubes. We need a scanning rate of about two frames per second. Most of the tubes are designed for a scanning rate of from 30 to 60 frames per second."

The system, which has already cost about \$5 million, was developed by the Radio Corp. of America under a cost-plus-incentive fee contract. Col. Wear says the improvements on the original design will be paid for by the government.

France moves up color-tv debut

France will begin color-television broadcasts in September, 1967—a year earlier than had been planned. She will use her Secam color-tv system, the rival of the NTSC method used in the United States.

Alain Peyrefitte, Minister of Information, says the decision is a response to "national and international demands." The French believe they will improve their chance of winning other countries over to Secam when France has a color-tv service of her own. The international demands come from Argentina and Spain, which are planning to test Secam about the end of the year.

The French government has allocated \$3 million to the national tv network for development of color facilities, and is expected to approve a

Electronics Newsletter

multimillion-dollar loan to the Compagnie Francaise de Télévision (CFT) for further development of the Secam system. CFT, a subsidiary of the Compagnie Generale de Télégraphie Sans Fil, owns rights to the sequence-and-memory technique by which France claims to have improved on NTSC.

France has not yet begun mass production of color-tv receivers. Most black-and-white sets in France cost \$250 to \$300.

Bids studied on junior Sage

The Air Force has bids from seven electronics companies for project-definition studies on a smaller version of the Semiautomatic Ground Environment system for detection of hostile aircraft and commitment of intercepting weapons. There is already a small Sage system, called the 412L, in Germany; the new system, even smaller, is designated the 407L and is managed at Hanscom Field, Mass. [Electronics, Oct. 5, 1964, p. 114]. The program will cost \$30 million; it will not include the development of new equipment. The gear will be installed in transportable shelters, each weighing no more than 3,500 pounds.

Radar and communications equipment will be bought under separate contracts. Project definition contracts will be awarded next month to two or more of the bidders: the Raytheon Co., Hughes Aircraft Co., Litton Industries, Inc., the Nortronics division of the Northrop Corp., General Electric Co., Westinghouse Electric Co. and Sperry Gyroscope Co., a division of the Sperry Rand Corp.

Gunn effect device may amplify, too

An experimental microwave oscillator—the first epitaxial Gunn effect device—has been developed by Standard Telecommunications Laboratories, Ltd., of Great Britain. The oscillator, with a volume of only 0.1 cubic inch, produces several milliwatts of continuous-wave power at 1 gigacycle. The company says the device also shows promise as an amplifier. It is investigating several modes of amplification.

The oscillator is built of a substrate of semi-insulating gallium arsenide about 100 microns thick, on which is grown a 15-micron layer of gallium arsenide. The effective cross-sectional area for the current path is determined by removing part of the layer to form a track 100 microns wide. An anode and a cathode are formed by converting two parts of the track to n^+ regions, leaving the original n-type material between them. The length of the n-type material determines the self-oscillating frequency.

STL is affiliated with the International Telephone and Telegraph Corp.

Addenda

The Air Force is trying to persuade government, industry and university scientists to put more experiments aboard the Titan 3 missile. Although four out of the five launches have been fully successful (see related story on page 44), few researchers are willing to risk sending expensive experiment packages on a test flight. The next Titan launch, slated Sept. 30, will only carry one-fifth of its potential payload in experiments; the rest will be ballast. In all, there will be 17 launches in the missile development program. . . . Manufacturers of radio-controlled openers of garage doors will have an opportunity Oct. 11 to protest the Federal Communications Commission's order that the remote-control devices get off frequencies used by military and commercial airplanes. But the order isn't expected to be changed.

READOUTS

How to design economy into EL readouts

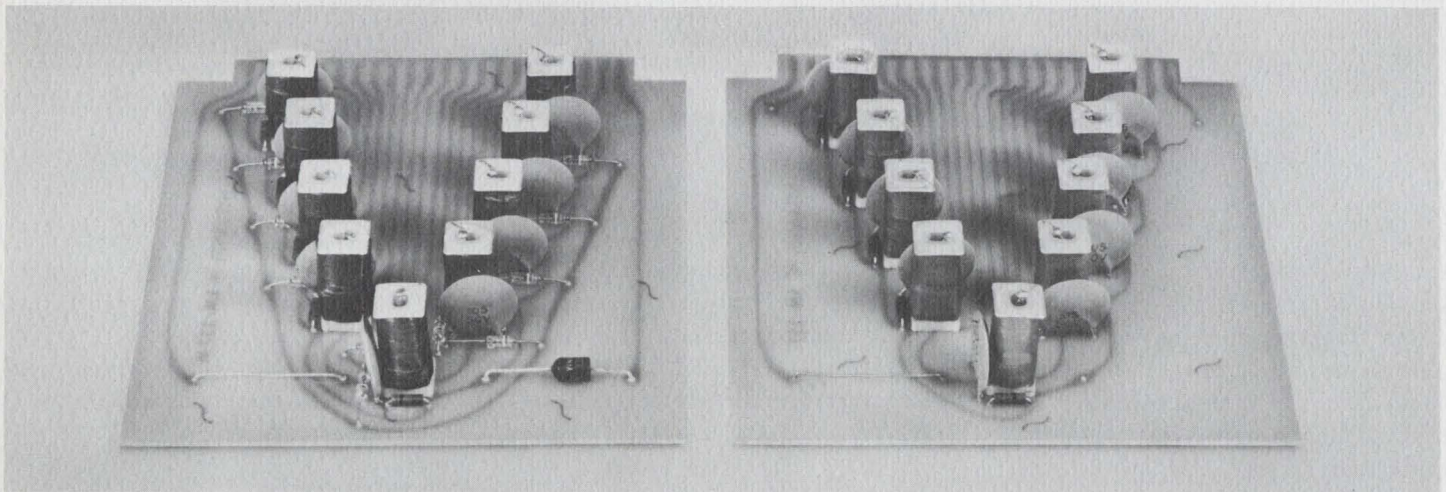

Because of a new line of EL driver modules, electroluminescent (EL) display systems are becoming more economical than ever.

With Sylvania's SM-200 series of drivers the savings are principally in reduced power requirements. Power for the EL readout is controlled by miniature reed switches which are activated magnetically. The power economies begin with the ease of character addressing inherent in the nature of magnetic coils. Another is in the fact that memory requires no power with these devices because memory magnets are *within* the reed coil itself. In large systems this can result in substantial power reductions in the overall system.

There is also a significant savings in hardware over the all-solid-state type of driver assemblies. Since reed switches are time-sharing by nature, there are cost reductions here too.

It has been demonstrated time and again that reed switching for readouts has the same high reliability as a solid-state device. Physically, the reed switch is enclosed in a miniature

glass tube with a glass-to-metal seal at each end. Both ends of the tube are sealed, making a light but rugged package with a controlled atmosphere. A coil is placed around the glass package which, when activated, pulls the contacts together. Sylvania has added the magnets to the switch for the optional feature of memory.

Because of the reduced costs of operation and power, along with small size, ruggedness and light weight, reed switch EL driver assemblies are of special interest to designers of readouts for industrial applications.

There is also the versatility factor: Sylvania's line of EL driver modules will suit many uses. For example, they perform the function of switching the segments of both numeric and alphanumeric EL readouts. Using the miniature reed switch, trigger requirements are low — 12 volts at 10ma for 4ms.

All Sylvania EL drivers are available with and without sockets and memory. Output connectors are either solder lugs or printed circuit card-edge connectors.

In sum, Sylvania's SM-200 series EL drivers offer the user an economical, extremely low-power-consuming (especially with the magnetically latched memory capability), reliable, long-life switching module to meet varied EL system requirements.

CIRCLE NUMBER 300

This issue in capsule

Integrated Circuits—how to build high-speed IC systems without sacrificing other vital characteristics.

Receiving Tubes—news on two outstanding amplifier tubes for monochrome or color TV; plus a new circuit that increases color TV signal output.

Microwave Diodes—solving X-through Ka-band problems with miniature broad-banded diodes.

Photoconductors—new series of 75mw cells, just ¼" in diameter, solves power handling problems.

Diodes—matched pairs and quads now available in a single epoxy package.

Television—a new small-neck 12" CRT simplifies portable and solid-state set designs.

Solving X- thru Ka-band problems with miniature broad-banded diodes

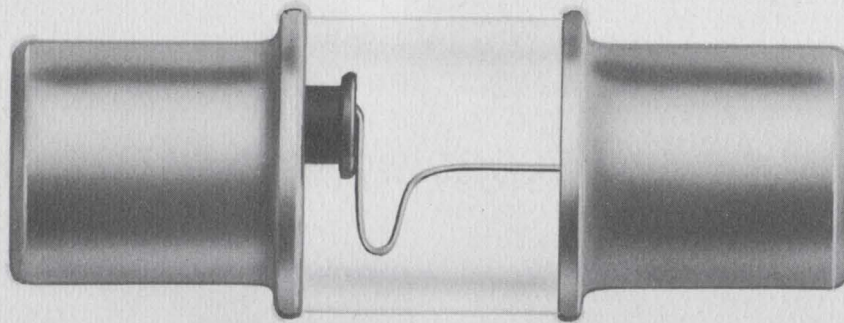

A family of point contact Sylvania microwave diodes has been designed for use in miniature circuitry where multiple band operation is required. Microwave design engineers are finding that the reason for the successful application of these MQM devices actually lies in a combination of plus-features — relatively minute size which results in low package capacitance and inductance, precision axial alignment of the mounting pins and positive hermetic seal.

The mixer diodes are constructed and tested to perform as equivalents to the premium units in the 1N21, 1N23, 1N78, 1N26 and 1N53 families. This capability permits coverage of the major microwave spectrum with packaged devices averaging 1/50th the size of their standard counterparts.

As detectors the MQM diodes are especially versatile. Their combination of high video sensitivity over a broad spectrum makes them ideal for use in modern surveillance systems.

To insure easy insertion and positive electrical contact, over 50 percent of the body length is devoted to the mounting pins. And dimensional controls on MQM diodes are considerably improved over units in the DO-7 package, making mount design inherently easier. The MQM's high self-resonant frequency enables engineers to design for broad frequency

capability while maintaining maximum circuit sensitivity. This is especially important in octave band mixers and multi-band detectors for test equipment and military systems.

The development of a special glass-to-metal seal insures hermeticity to 10^{-8} cc/sec. This low loss dielectric is another factor which suits them to high-frequency systems.

CIRCLE NUMBER 301

VIDEO DETECTOR D-5233 voltage output vs. frequency

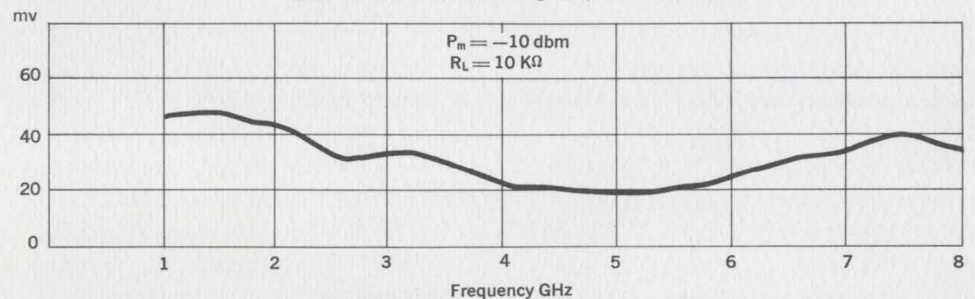

MQM Mixer Diodes

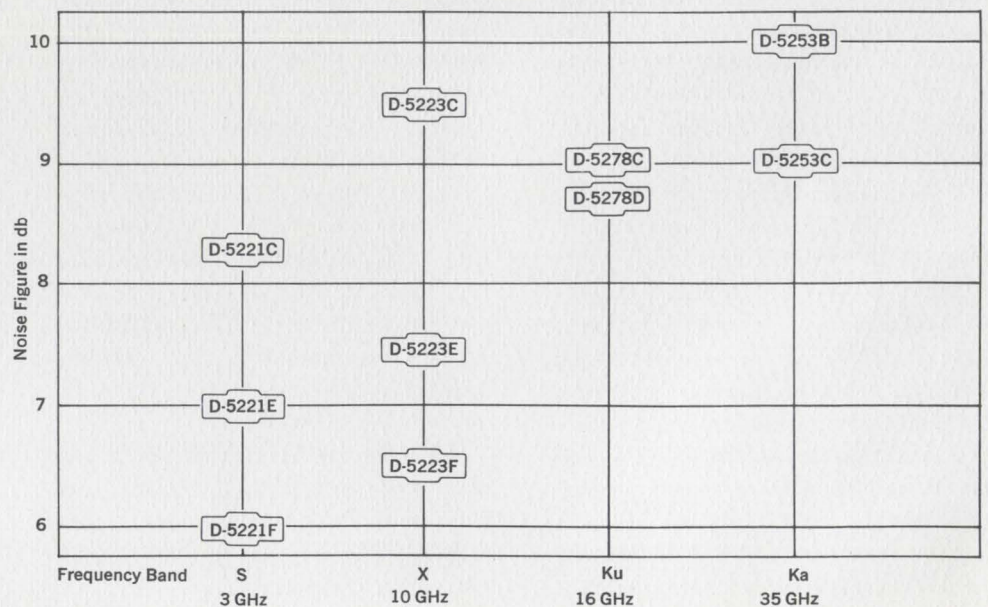

For economy & small size new small-neck 12" CRT

"Portable," "battery-operated" and "solid-state" — these are three very strong consumer demands in today's market for black-and-white television. TV set designers have found that these needs are more easily met with picture tubes designed especially for these requirements. Here's news on a tube that satisfies designers' demands and can provide cost savings too.

Television circuit designers have long known that small-neck picture tubes are essential to compactness in TV set depth. Sylvania meets this need with a 12" monochrome tube that has the added feature of making possible production economies.

With the new ST-4132A, a substantial saving is possible on deflection components. Now less expensive parts can give full deflection with a substantial savings on yokes.

Plans call for the new tube to be manufactured in 90° deflection angle. The neck is just .788-inches in diameter, 3¼-inches long, and contains a straight gun which requires no ion trap. It has a 150-milliamperere 12.6-

volt filament and a 100-volt G2.

Designers are finding that this 12" tube is equally suited to both tubed sets and solid-state types. Both light weight and small size make it ideal for portable, battery-operated sets.

CIRCLE NUMBER 302

ST-4132A TENTATIVE DATA

Electrical Data	
Focusing Method	Electrostatic
Deflection Method	Magnetic
Deflection Angles (approximate)	
Diagonal	90 degrees
Horizontal	80 degrees
Vertical	63 degrees
Direct Interelectrode Capacitances	
Cathode to all other electrodes (approx.)	5 μμf
Grid No. 1 to all other electrodes (approx.)	6 μμf
External conductive coating to anode*	850 max. μμf
	550 max. μμf
Resistance Between External Conductive Coating and Implosion Protection Hardware	
	50 min. megohms
Heater Current at 12.6 Volts, DC or AC	150 ± 10ma
Heater Warm-up Time	14 seconds
Optical Data	
Phosphor Number	P4 Aluminized
Light Transmittance at Center (approx.)	52 percent
Antireflection Treatment	None
*Measured with implosion protection hardware connected to external coating.	

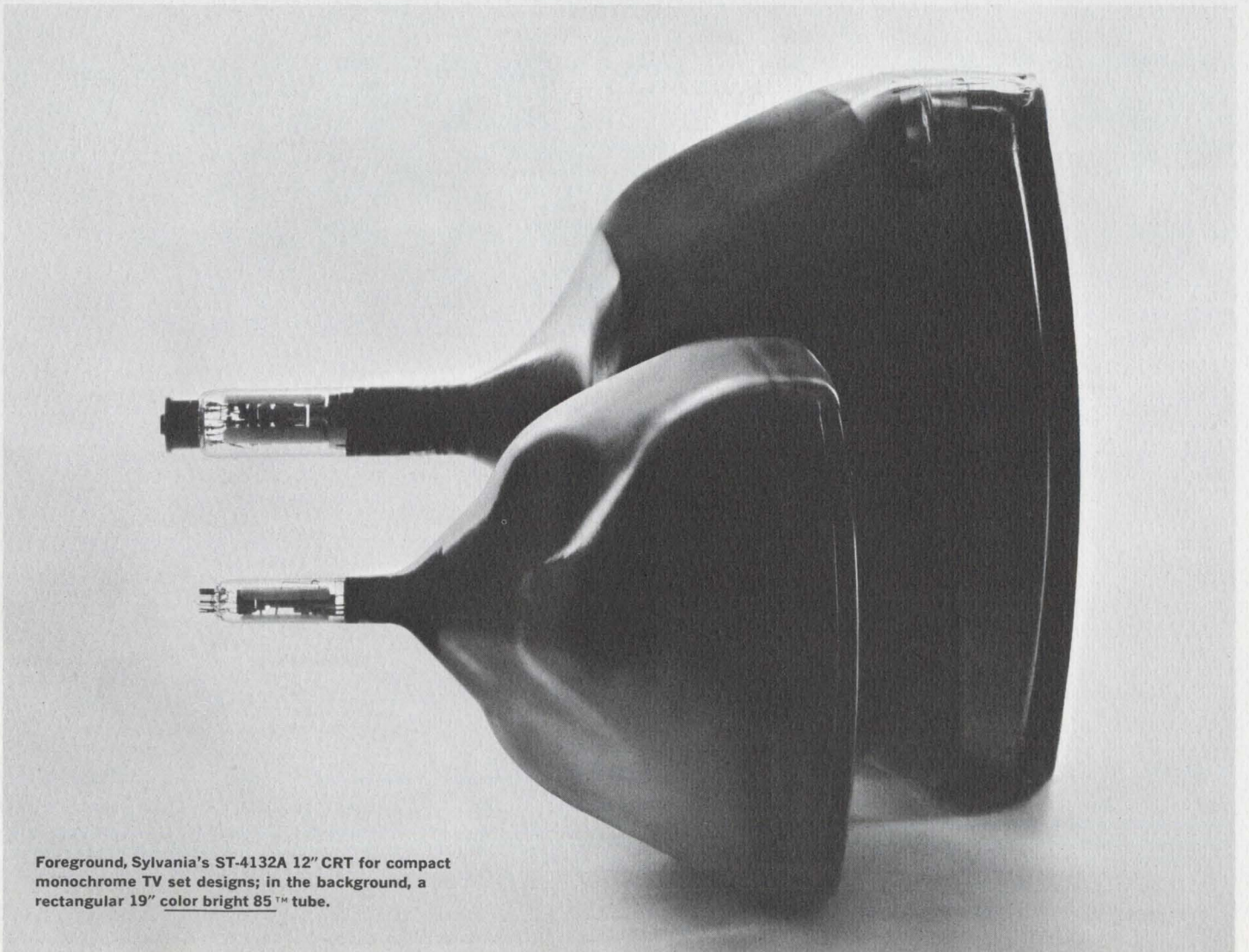

Foreground, Sylvania's ST-4132A 12" CRT for compact monochrome TV set designs; in the background, a rectangular 19" color bright 85™ tube.

Build high-speed IC systems without compromise, using SUHL II

Now there's no need to sacrifice a single important characteristic when you're building a high-speed integrated circuit system. High levels are maintained in noise immunity, logic flexibility, stability, coupled with low power dissipation and can count when you use SUHL II circuits from the extensive family of Sylvania Universal High-level Logic circuits.

The proof of the pudding is in the system demonstration shown here in the logic diagram. It displays performance in a typical system in which data is clocked into a SUHL II J-K flip-flop (SF-250 Series) and then ripples through four logic levels, each of which has a loading of 5. The output

of the last logic level is clocked into another J-K flip-flop.

The oscilloscope traces show performance at a clock frequency of 18mc. The data is clocked into the first flip-flop in approximately 15nsec and ripples through four loaded logic levels in approximately 24nsec, or 6nsec/logic level.

But each node in the system has the same high saturated logic swing, the same high noise immunity, and the same high fan-out and drive capability.

No extra cans are needed for level restoration, nor are any fan-out buffers or bias supply regulators necessary. And the average power dissipa-

tion for the entire system is only 27 mw/logic element.

All things considered, the design engineer can build high-speed systems without compromise, if he uses SUHL II circuits. The features of SUHL II don't end there. There is a complete series of logic elements in the new series, which are compatible with all other SUHL circuits.

In addition, all SUHL II circuits are available in the new hermetically sealed 100-mil pin center plug-in package, for economical system assembly in the commercial, industrial and military fields.

CIRCLE NUMBER 303

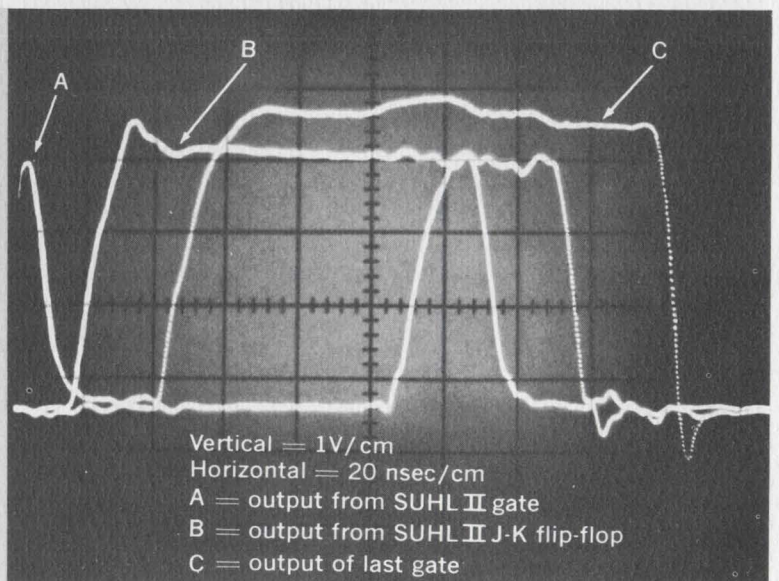
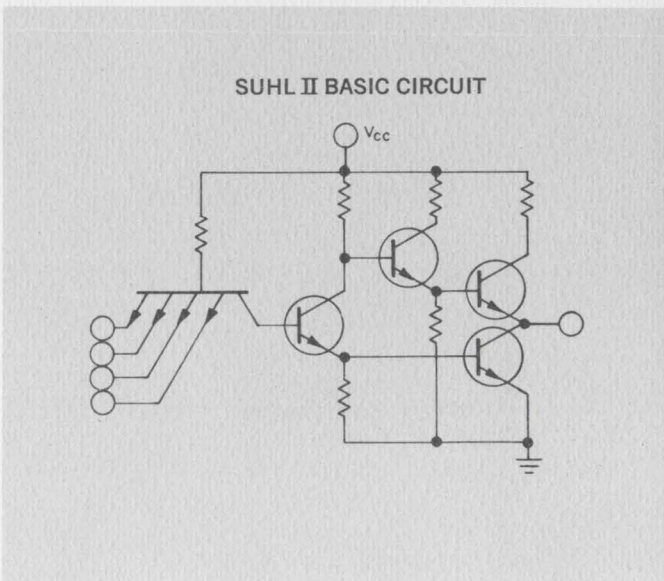
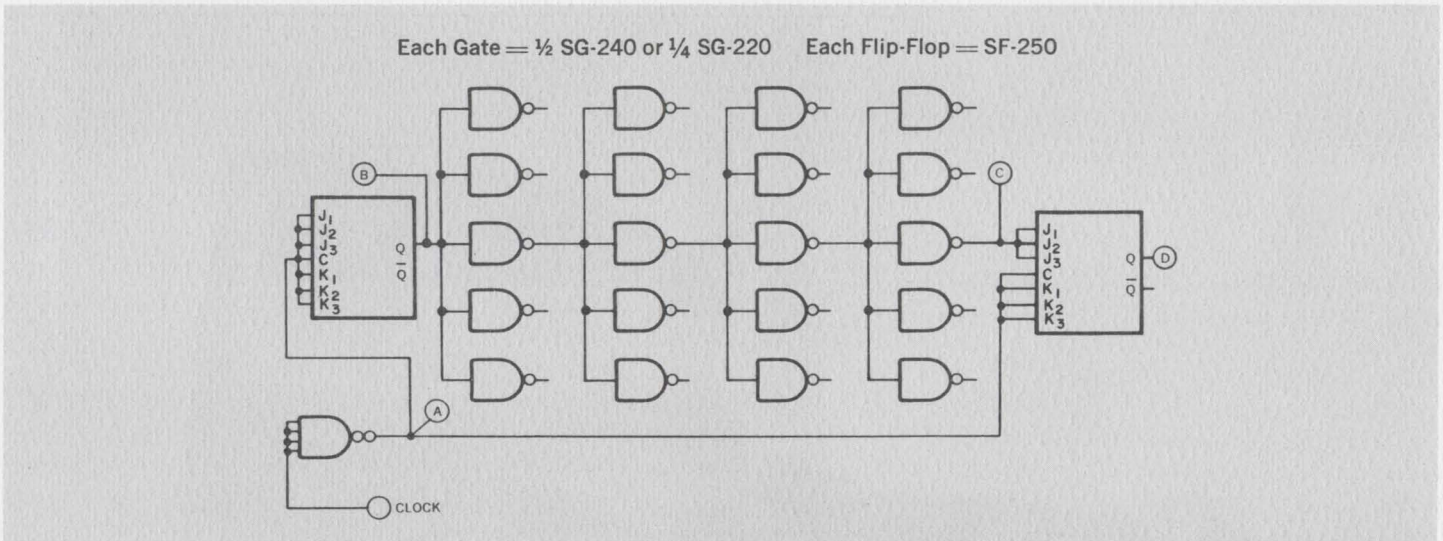

What's newest in amplifiers for monochrome and color sets

Here's news on two recent superior amplifier tubes from Sylvania that are finding increasingly wide acceptance in new television set designs.

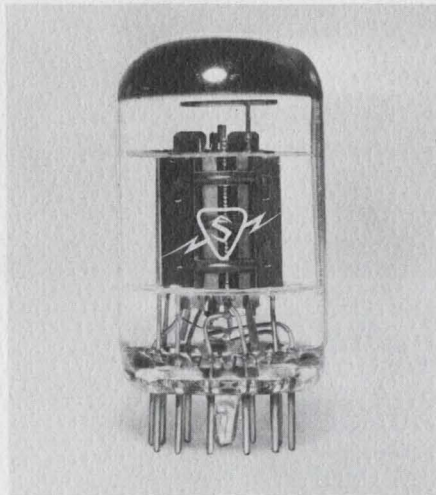

Type 6AF10

The exceptionally versatile 6AF10 can be used in virtually any general double pentode application. It serves as an amplifier for both sound IF and video in black and white television sets. In low B+ color sets, it is a vital component in the combined functions of burst and video amplifying.

This dual pentode's video output section is a frame grid design while the sound IF portion is a regular grid. Coupling capacity between these pentode sections is unusually low, assuring maximum electrical isolation.

The 6AF10 is supplied with a standard compactron 12-pin base. This affords greater flexibility to circuit designers over the 9-pin base types.

Sylvania engineers recently ran tests in which the 6AF10 was compared to a popular 9-pin base type. Results showed that the 6AF10 provided a voltage gain increase of 10% and, at the same time, the sound IF sensitivity was improved 17%. Then, when its two pentode operating points were changed to operate both sections near rated dissipations with plate voltages of 200 volts and screen voltages over 125 volts, there were no signs of spurious or parasitic oscillations. In sum, the 6AF10 performed brilliantly in these tests.

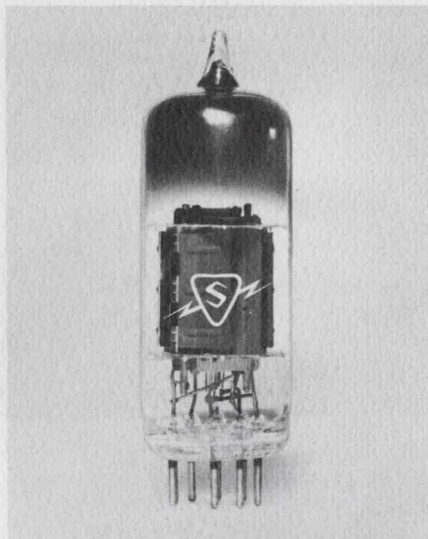

Type 12GN7A

A new video amplifier for color circuits, the 12GN7A, is the redesigned

12GN7 with an increased plate dissipation rating of 11.5 watts. It has a screen dissipation rating of 1.5 watts. A sharp cutoff frame grid pentode with very high transconductance (36,000 gm), it also has low knee voltage and a relatively linear plate current vs. grid voltage transfer characteristic.

Together with an inherent high plate current and gain, the 12GN7A's features ideally suit it for color TV requiring high video signal outputs with wide bandwidth.

Another important feature to TV circuit designers is that it eliminates the need for additional amplification. In addition there is a cost-saving feature with the elimination of a plate dropping resistor.

CIRCLE NUMBER 304

MARKETING MANAGER'S CORNER

Our man in your town

Don't just *use* your Sylvania industrial distributor. Lean on him. That's our advice. And his too.

All too often, he's considered a second-class source by manufacturers of original equipment. If this is the case where you're concerned, it would be to your great benefit to try him out on any of his multiple services.

Do you know that he's an excellent source for product data and other technical information? This includes all of our handbooks, catalogs, and Sylvania's Engineer Data Service. And because he's local, you're sure to receive the information you want promptly. Let me suggest one way you might put him to the test. First, select a product in this issue of IDEAS; then, instead of sending in the Hot Line inquiry postcard, call your Sylvania industrial distributor directly for the information. I can assure you, you'll get real action.

Do you know that he can get you prompt engineering assistance also? Throw a technical problem at him. If he doesn't have the answer at his

fingertips, a phone call to a company Sales Engineer or directly to the factory will get you an answer customized to your problem.

Most importantly though, he's the best source for a broad range of Sylvania quality electronic products. He has the distinct advantage over most manufacturer salesmen of being able to specialize in all industries in his locale. He has already become a successful specialist in gearing his inventory, delivery and competitive pricing to local needs.

In sum, he's a realistic businessman bent on making a profit by providing his specialty: service. Don't you think that you and he ought to get together?



Bill Buschmann
W. T. BUSCHMANN

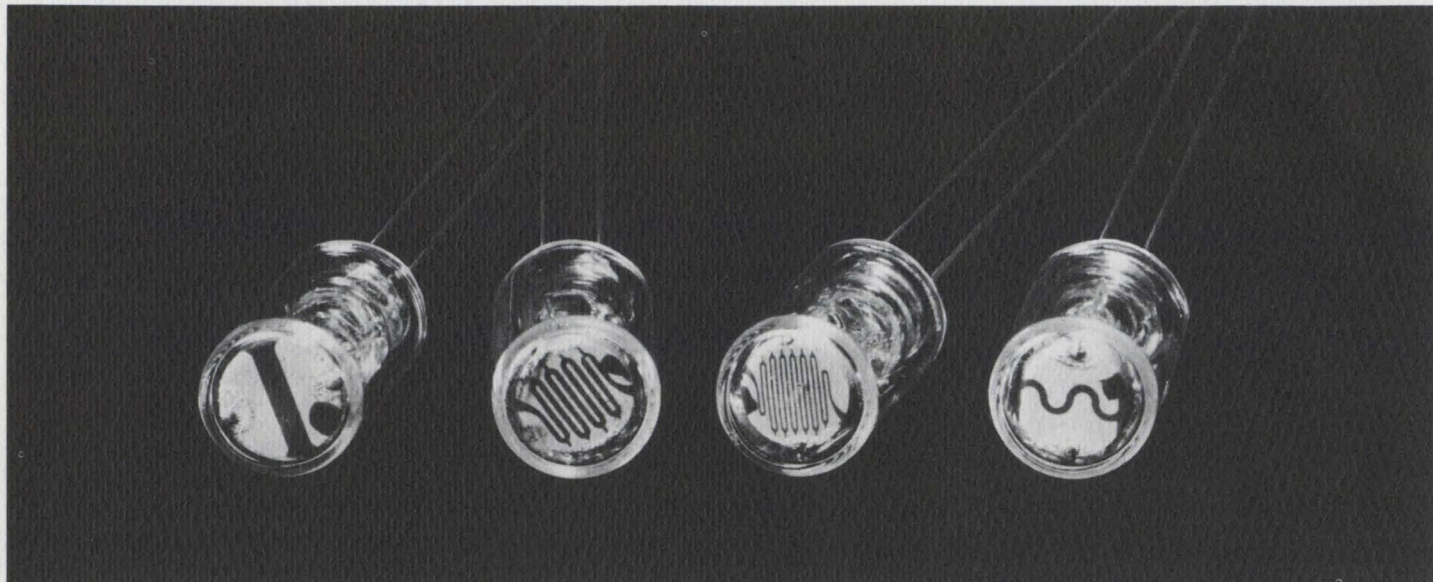

New ruggedized 75mw ¼" cells can solve power handling problems

Now, using the latest T-2 photoconductive cells, you can directly operate electromechanical actuators and indicators of 3.0 milliamperes sensitivity.

Power handling capability of this high order is no problem for Sylvania's newest ruggedized T-2 line, which has a 75-milliwatt rating at 25°C. Because of both the high power rating and inherent physical ruggedness, these miniature ¼-inch-diameter cells are especially suited to demanding industrial and commercial applications.

There are four types in this photocell line which cover the broad range of 2,000 to 128,000 ohms light resistance at 2 foot-candles. Dark resistance is at least 100 times the light resistance value. Because of this high ratio of resistance change, there is a wide operating range for both posi-

tive switching action and broad continuous control usage.

Thermal stability, long an industry problem with photoconductors, is improved in these cells with a light-sensitive cadmium sulfide wafer in a hermetically sealed atmosphere. The wafer has a medium-fast response time and a spectral response which peaks near 6100 angstroms. This closely approximates the response of the human eye.

Mechanical ruggedness is apparent from the shock and vibration rating. These miniature cells are designed to withstand 300 g's impact shock and 2.5 g's vibration for extended periods. Another important mechanical feature is the strain-free, all-glass envelope which protects the sensitive cadmium sulfide from moisture. Moisture is a major cause of failure in many types of photoconduc-

tive devices.

As an added safeguard to continued correct operation, Sylvania includes its well-known "Blue Dot" compound. This is applied to the edge of the cell wafer. In event of damage to the envelope allowing moisture to enter, the blue dot changes color to pink. The change will occur in the presence of as little as 0.02% moisture, giving ample warning of impending degradation in cell performance.

These rugged T-2 photoconductors can be used in a wide variety of industrial and commercial applications including counting, sorting, tachometry, inspection, registration, electronic volume controls, photometry, headlight dimmers, and automatic camera aperture controls.

CIRCLE NUMBER 305

Sylvania Type Number	Cell Voltage (Volts) ^{1, 2}	Light Resistance (Ohms) ³	Dark Resistance (Megohms) ⁴	T-2 PHOTOCONDUCTOR DATA					
				Cell Dissipation at 25°C (Milliwatts)	Ambient Temperature Range (°C)	Spectral Response (Angstroms)	Shock Impact Acceleration (G) ^{1, 5}	Vibration Fatigue (G) ^{1, 6}	
8318A	300	32,000	10.0	75	-40 to +70	6100 ± 400	300	2.5	
8475A	200	2,000	0.2	75	-40 to +70	6100 ± 400	300	2.5	
8477A	300	8,000	0.8	75	-40 to +70	6100 ± 400	300	2.5	
8582A	300	128,000	10.0	75	-40 to +70	6100 ± 400	300	2.5	

Notes:

- Absolute maximum values.
- Measured with cell in complete darkness at a pulse rate of 120 pps, 50 msec duration. Voltage in excess of the rated value may damage the cell. Max. DC voltage is limited by max. dissipation and min. dark resistance rating.
- Illumination 2 FC. Color temperature 2870°K. Measured after 60 minutes' minimum exposure to approximately 50 FC illumination (ambient room light).
- Minimum. Measured in complete darkness at least 10 seconds after removal of 2 FC illumination.
- 1 microsec. duration (Mil-E-1E-Method 1041).
- Vibration acceleration for extended periods (Mil-E-1E-Method 1031).

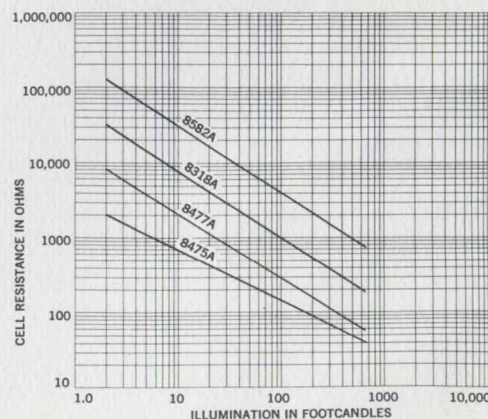

Now in a single package, hermetically sealed, matched multi-diodes

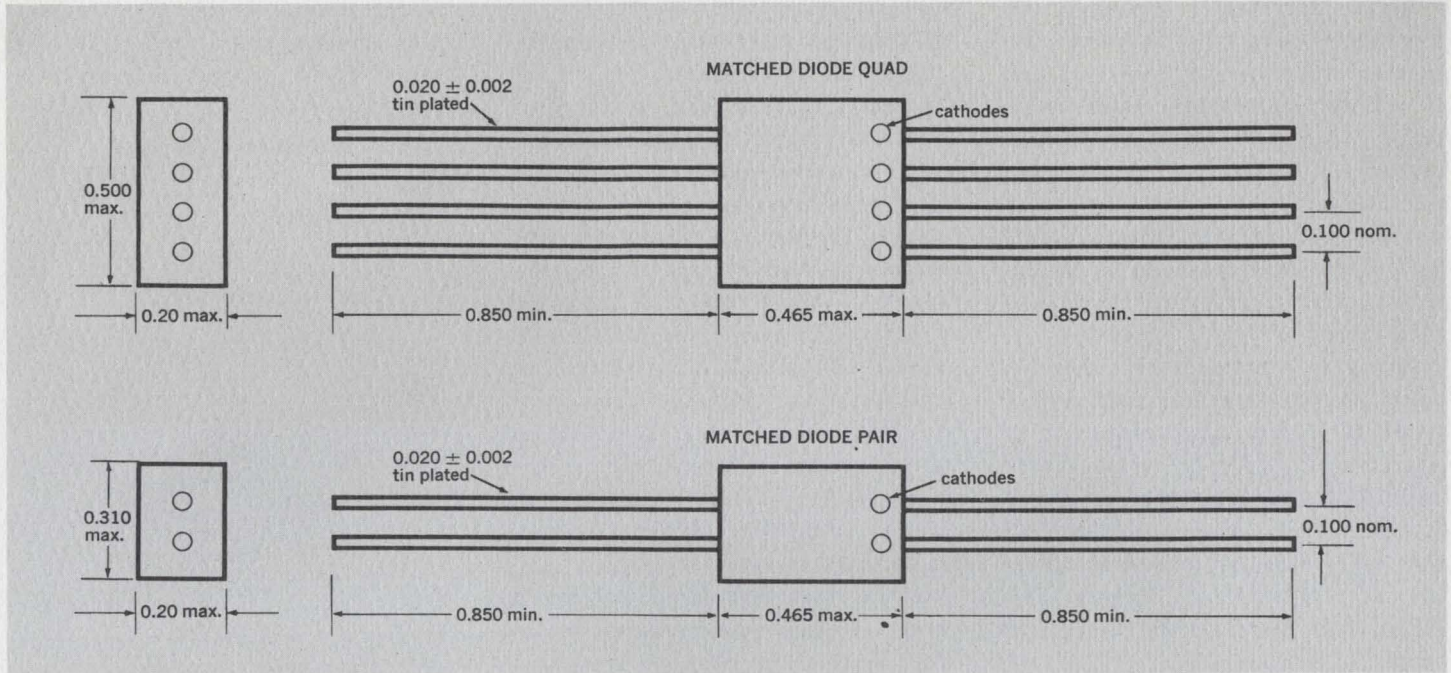

No longer need there be confusion when the design engineer needs matched diodes.

A new series of matched pairs and matched quads is now available from Sylvania. Each diode is hermetically sealed in an all-glass package and then, after matching, the pairs or quads are molded together in one epoxy package.

The result is an especially rugged pair or quad of matched devices that always maintains identity. And since interconnections are eliminated, versatility is substantially increased. The matched pairs and quads can also be supplied with common cathode, com-

mon anode, or in series.

The fact that Sylvania batch-processes these diodes is added assurance of uniform characteristics. In addition, all have passivated junctions to

insure high reliability and long life.

Sylvania also supplies matched monolithic diodes in 3- and 4-lead TO-46 packages.

CIRCLE NUMBER 306

	PIV	I _F @1V	SILICON DIODE PAIRS			C ₀	Matching*		
			I _R @25°C	I _R @150°C	T _r (30303)		I _{RGE}	ΔV	
D-9742	50V	100ma	0.1μa@40v	100μa@40v	20ns	2.0pf	2ma-5ma	15mv	
D-9732	100V	50ma	0.1μa@40v	100μa@40v	20ns	2.0pf	2ma-5ma	15mv	
D-9312	150V	100ma	1.0na@125v	1μa@125v		10. pf	2ma-5ma	15mv	
SILICON DIODE QUADS									
D-9747	50V	100ma	0.1μa@40v	100μa@40v	20ns	2.0pf	2ma-5ma	15mv	
D-9737	100V	50ma	0.1μa@40v	100μa@40v	20ns	2.0pf	2ma-5ma	15mv	
D-9317	150V	100ma	1.0na@125v	1μa@125v		10. pf	2ma-5ma	15mv	
							I _{RGE}	ΔV	
							*Other matchings available	150μa-2ma	10mv
								5ma-10ma	20mv
								10ma-25ma	30mv
I _{RGE} — Forward current range of match.									



HOT LINE INQUIRY SERVICE

Use Sylvania's "Hot Line" inquiry service, especially if you require full particulars on any item in a hurry. It's easy and it's free. Circle the reader service number(s) you're most interested in; then fill in your name, title, company and address. We'll do the rest and see you get further information almost by return mail.

FIRST CLASS
Permit No. 2833
Buffalo, N. Y.

BUSINESS REPLY MAIL

No Postage Stamp Necessary if Mailed in the United States

POSTAGE WILL BE PAID BY

SYLVANIA ELECTRONIC COMPONENTS GROUP

Sylvania Electric Products Inc.
1100 Main Street
Buffalo, New York 14209

Dept. 88

New circuit increases color TV signal output, has fewer components

With an economical high-level demodulator circuit by Sylvania, designers of color television sets can now boost picture tube drive while using fewer parts. This new circuit design is based on the excellent capabilities of the Sylvania 10JT8 demodulator. This tube features a frame grid sharp-cutoff pentode in combination with a high mu triode in a 9-T9 envelope.

Using the circuit shown here, a color receiver can increase in R-Y (red) over its original output by as much as 50%. The prime advantage of this design over the industry's standard "X-Z" system is that now the high-level demodulators drive the red and blue guns directly. This eliminates two triode amplifier stages.

The pentodes are used as the R-Y (red) and B-Y (blue) demodulators and one triode section amplifies the G-Y (green) signal taken from their common cathode circuit. This leaves a triode available for use as a color killer or sync separator. The new circuit also eliminates the necessity of several resistors.

A unique feature of this circuit is

the method by which the G-Y signal is obtained. Conventionally, matrixing in the demodulator plate circuits is used. This results in plate loading that reduces chrome output for driving picture tube grids. By taking the G-Y signal from the common cathode circuit, the plates are freed of undesirable loading, with a resultant increase in output gains. A grounded grid triode amplifier supplies the G-Y signal with phase and amplitude for efficient picture tube operation.

Chroma information is applied to the cathodes of both pentode sections from a low impedance driving source while the subcarrier voltage is applied separately to the two number one grids. The demodulated R-Y and B-Y signals are developed across the 18,000-ohm plate resistors and are used to directly drive the red and blue guns of the picture tube.

The G-Y signal is developed across the 120-ohm resistor in the common cathode circuit and is applied through a low pass filter to the cathode of the triode amplifier. This filter blocks the chroma and subcarrier voltages and at the same time prevents the triode from acting as a load

on the chroma source. The grounded grid triode circuit amplifies the G-Y signal in the proper phase to drive the green gun of the picture tube.

OPERATING CONDITIONS

Ebb	270 Volts
Chroma Input	5.5 Volts p/p
Subcarrier Input	22 Volts p/p
Demodulator Output	200 Volts p/p
R-Y	150 Volts p/p
B-Y	90 Volts p/p
G-Y	

CIRCLE NUMBER 307

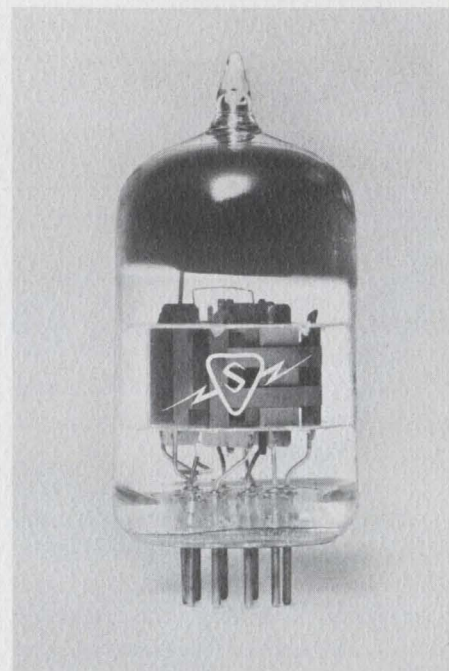

This information in Sylvania Ideas is furnished without assuming any obligations.

SYLVANIA

SUBSIDIARY OF
GENERAL TELEPHONE & ELECTRONICS GTE

NEW CAPABILITIES IN: ELECTRONIC TUBES • SEMICONDUCTORS • MICROWAVE DEVICES • SPECIAL COMPONENTS • DISPLAY DEVICES

NAME _____

TITLE _____

COMPANY _____

ADDRESS _____

CITY _____ STATE _____

Circle Numbers Corresponding to Product Item

300	301	302	303	304
305	306	307		

Please have a Sales Engineer call



HOT LINE INQUIRY SERVICE

Need information in a hurry? Clip the card and mail it. Be sure to fill in all information requested. We'll rush you full particulars on any item indicated.

You can also get information using the publication's card elsewhere in this issue. Use of the card shown here will simplify handling and save time.

GUDEBROD LACING TAPE CAN SAVE YOU MONEY—



**HERE'S
WHY-**

1 SPECIAL FINISHES SPEED HARNESING

Gudebrod has Lacing Tape that almost laces itself—the worker guides it instead of having to fight it. *Work goes fast!*

2 BETTER HARNESSSES —FEWER REJECTS

Gudebrod Lacing Tape makes proper ties that do not slip. *Saves money on assembly! Saves costly rejects!*

3 WORKER SAFETY APPRECIATED

Gudebrod Lacing Tape is easy on the hands, feels good to work with . . . so the work goes better, is faster. *Saves money on harnessing time!*

4 GUDEBROD CABLE-LACER another money saver

Handle holds bobbin of lacing tape, feeds tape as needed, grips it for knotting. *Speeds harnessing. Has paid for itself in a day. Another money saver.*

Gudebrod Lacing Tape is engineered for the job it has to do—saves money where it counts—in the harness room. More than 200 different tapes in the Gudebrod Line—Write for our Product Data Book!

Area Code 215, WA 2-1122



GUDEBROD BROS. SILK CO., INC.

FOUNDED IN 1870



Electronics Division

12 SOUTH 12th STREET, PHILADELPHIA, PENNSYLVANIA 19107



A microwave link by space creatures?

Henry Magnuski, Motorola's internationally recognized leader in microwave research, ponders the possibility that intelligent creatures in outer space, a thousand or so years ago, may have sent Earth some mysterious microwave signals. But he doesn't let that stop him from luring down-to-earth engineers and scientists to join Motorola's advanced microwave team.

Recently, a segment of the scientific community has been knee-deep in confusion, if not controversy, about CTA-21 and CTA-102, mysterious points in outer space which emit strong, short microwave signals.

As of publication time, no one knows exactly what is causing these signals... but a lot of people have strong opinions. Some say planets; some say they are gaseous disturbances like other "radio" stars; some say they were sent by space-creatures of a super intelligence!

Don't laugh. Some well-respected astronomers take the "super-intelligence" theory quite seriously (but don't take that medieval "monster" I'm pictured with seriously). The Russians even laid claim to detecting an "intelligent" 100-day pattern to the signals. In my opinion they laid an egg and most British and American astronomers agree.

So, the controversy rages. Although I accept only the "gaseous disturbance" theory, I'll never be able to prove it, unfortunately. Why not? It's simply a matter of time and distance. Best estimates put CTA-21 and CTA-102 about 1,000 light-years away, so the microwaves



our radio telescopes are picking up now were sent about 1,000 years ago. Thus, even if we could answer these signals today (and Earth engineers aren't close to having the power or technology yet), it would take another thousand years for our answers to arrive at the CTA's; and who is to say the "senders" will still be there?

Even if they did read us, it would take still another thousand years for any "intelligence" to answer us... unless microwaves can be made to travel faster than the speed of light. Who has the time to wait? And another thing—if these creatures are so blasted intelligent, why didn't they send us a more readily decipherable signal in the first place?

Maybe I'm skeptical simply because I don't like the idea of anyone being a thousand years ahead of Earth's technology... without my being able to slip him a Motorola application blank.

However, if you are a scientist or engineer with only your head in the clouds, and have a penchant for designing advanced microwave systems, we can offer you the rare opportunity to join some of the world's outstanding microwave systems engineers in work on projects like these:

ONE MAN BAND

A solid, down-to-earth microwave development is the Motorola MP-7... truly a portable one-man field terminal. It can be used for high-speed data, high-density voice, multi-channel remote control and telemetry, closed-circuit TV, radar relaying, troposcatter trunking, portable command post trunking, downhill radio transmission... *you name it, MP-7's got it!* This solid-state equipment also fits readily into existing shelters for radio-remoting of many outputs from other electronic equipment. Developed on company funds, currently in production, and operating in the field as a finalized system terminal, the MP-7 fulfills a present-day communications need... *on this planet, of course.*

KEEPING AN EYE ON EDWARDS

The Air Force Flight Test Center and NASA's Flight Research Center at Edwards AFB has to keep a close

eye on a variety of test activities over hundreds of miles of their high-speed test range. Motorola designed, engineered, installed, and maintains the microwave and multiplex system (a "turnkey" job). It allows several control centers to continuously communicate with, receive, record, and display flight test data from test vehicles in *real time* as they proceed over any point of the flight range. Data may include four 500 kc telemetry composite signals, one timing and five intercom signals, one wideband search radar and 60 control and monitoring signals.



Complex data transfer system installed at Edwards AFB high speed test range.



Portable MP-7 microwave unit for tactical use.

BACK IN THE IVORY TOWER

Our special "ever-advancing-the-state-of-the-art" group (the quotes mean I know it's a cliché, but at least you know what I'm talking about) is feverishly applying the latest thinking in advanced microminiaturized circuitry... much of it their own... to the design of microwave components and systems. In their own words, they are placing "particular emphasis upon the integration of devices such as tunnel and back diodes, varactors, microwave transistors, and ferrite devices, into miniaturized assemblies offering improved performance". They are working in these four general categories of microminiature circuitry:

THIN FILMS—deposited layers of semiconductors, or metal, on a suitable substrate.

HYBRIDS—a combination of thin film, semiconductor, and microminiaturization techniques.

MONOLITHIC—totally integrated semiconductor circuits.

THICK FILMS—a combination of high dielectric materials, etched microwave strip transmission lines and semiconductors.

NOW IT'S YOUR TURN

As you can tell by now, Motorola has plenty of opportunities for creative microwave scientists and engineers (my attitude toward CTA-102 and CTA-21 notwithstanding). If you're an R&D type, a systems or equipment designer, or if you prefer on-site field work... there may be a spot for you. Mail me the coupon below, and we'll talk about it.



MOTOROLA

An equal opportunity employer.

Military Electronics Division

SCOTTSDALE, Arizona, 8201 E. McDowell Road
CHICAGO 51, Illinois, 1450 N. Cicero Avenue

FREE TECHNICAL LITERATURE

- (1) **Microwave Solutions to Communications Problems**, new, more economical approaches to today's complex military communications problems with an eye to future needs, and
- (2) **Advanced Microwave Science & Systems**, Military and space applications beyond the boundaries of classic design patterns. For these brochures, (don't be surprised if I toss in some recruiting literature) attach this to your letterhead, and mail it to me at Dept. 205.

NEW
FROM
ELECTRO INSTRUMENTS
MODEL 620

DIGITAL
VOLTMETER

WITH

autoject*



***AUTOMATIC NOISE REJECTION INDEPENDENT**

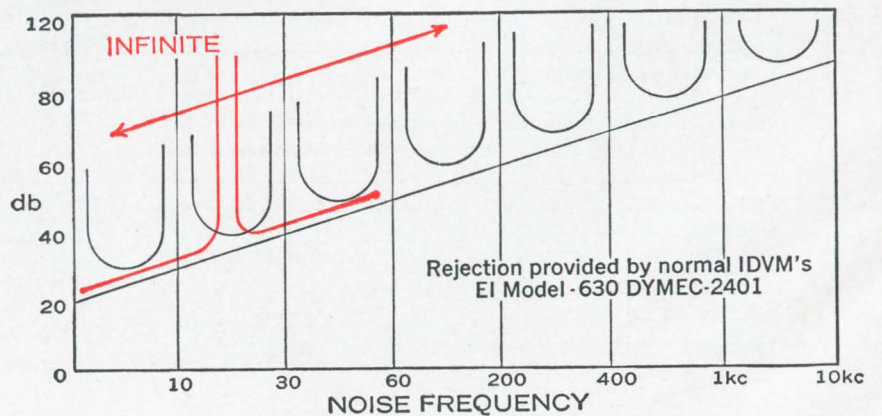



ACTUAL
SIZE

OF FREQUENCY, THROUGH INTEGRATION

*Autoject—automatically synchronizes the sample period and duration with the principal noise component such that symmetrical noise integrates to zero irrespective of its phase and frequency.

• 5 DIGIT DISPLAY • COMPLETELY SOLID STATE LOGIC • AUTOMATIC RANGE AND POLARITY PLUS OVERRANGE IDENTIFICATION 0.000-12.000, 00.00-120.00, 000.0-750.00 • POTENTIOMETRIC INPUT IMPEDANCE • ACCURACY — .01% F.S. ± .01% OF READING • 100 M/SEC SAMPLE PERIOD • TRUE DIFFERENTIAL INPUT—140 DB CMR • ELECTRICAL OUTPUTS • REMOTE PROGRAMMING • FUNCTIONS — DC AND RATIO

\$1,000



Electro Instruments, Inc.

8611 Balboa Avenue, San Diego, California 92112

PAR offers a line of superior precision voltage/current reference sources

**.001%
STABILITY**

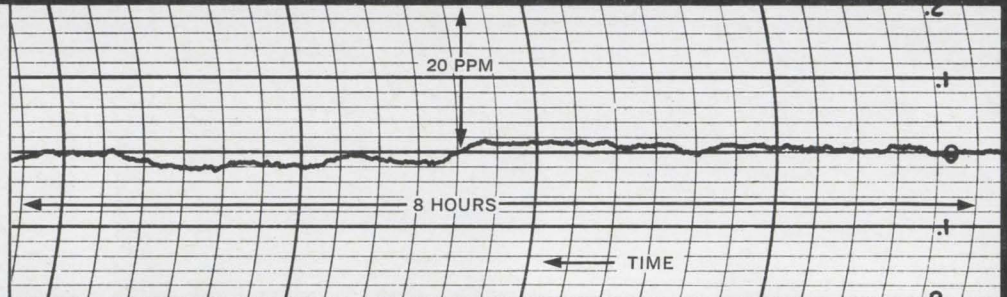

**.0001%
LINE & LOAD REGULATION**

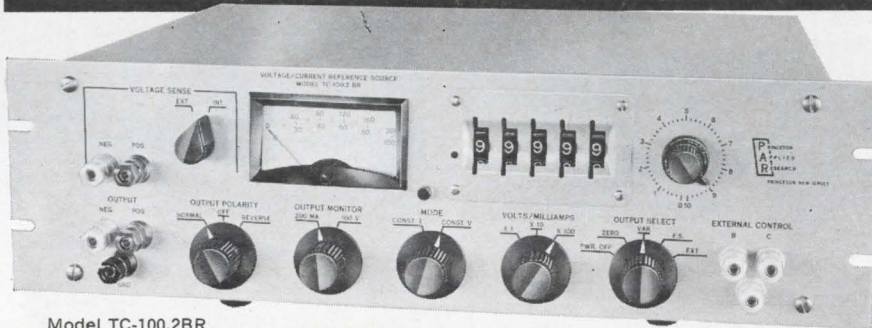
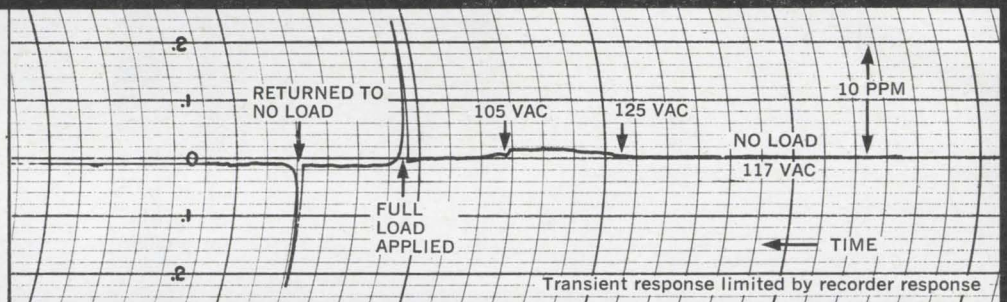

Model TC-100.2BR

INDEX OF PAR REFERENCE SOURCES

MODEL NO.	OUTPUTS		ACCURACY		RESOLUTION		8 HOUR STABILITY		PRICE
	CONST. V.	CONST. I.	CONST. V.	CONST. I.	CONST. V.	CONST. I.	CONST. V.	CONST. I.	
TC-602R	0 to 60 V @ 2 A max.	0 to 2 A @ 51 V max. (Requires Ext. Resistors)	0.1% of F. S.	Determined by Ext. Resistors	10 mv	Determined by Ext. Resistors 400 μ a max.	.001%	.001% \pm stability of external resistors	\$1,185.
TC-100.2R	0 to 100 V @ 200 ma max.	0 to 100 ma* @ 100 V max.	0.01% of F. S.	0.02% of F. S.	1 mv	1 μ a	.001%	.002%	\$1,500.
TC-602CR	0 to 6 V 0 to 60 V @ 2 A max.	0 to 60 ma 0 to 600 ma 0 to 2 A @ 60 V max.	0.01% of F. S.	0.03% of F. S.	1 μ v min.	10 m μ a min.	.001%	.002%	\$1,750.
TC-100.2AR	0 to 100 V 0 to 10 V 0 to 1 V @ 200 ma max.	0 to 100 ma* 0 to 10 ma 0 to 1 ma @ 100 V max.	0.01%	0.02%	10 μ v min.	10 m μ a min.	.001%	.002%	\$1,800.
TC-100.2BR	0 to 100 V 0 to 10 V 0 to 1 V @ 200 ma max.	0 to 100 ma* 0 to 10 ma 0 to 1 ma @ 100 V max.	0.01%	0.02%	100 m μ v min.	100 μ a min.	.001%	.001%	\$2,200.
SF-Series (Fixed)	Any fixed voltage to 100 V @ 2 amps max.	Any fixed current to 2 amps @ 100 V max.	Within setting resolution		Up to 1 ppm of adjustable range about nominal		.001%	.001%	By quotation only.

*Available to 200 ma (at extra charge).

Princeton Applied Research Corporation offers a sophisticated line of power supplies providing extremely stable voltage and current outputs whose accuracy is traceable to N.B.S. All models are completely solid state and feature a careful, conservative design leading to highly reliable operation. Indicative of the features found in these units is a unique chopper-stabilized amplifier with a DC open-loop gain of 5×10^6 , falling off no faster than 6 db/octave to unity gain. This insures extremely low output impedance (less than 10 micro-ohms at DC) and fast transient response without ringing.

PAR Reference Sources permit considerable operational flexibility, having been used in such diverse applications as serving as the reference voltage in analog computers to providing the constant current required in "bucking" coils in elaborate magnetometer systems. All units feature digital output selectors, complete short circuit protection, and low ripple and noise. Write for Bulletin No. 112.

PAR PRINCETON APPLIED RESEARCH CORP.
Dept. D
Box 565, Princeton, N. J.
Telephone (609) 799-1222

Electronics Review

Volume 38

Number 19

Industrial electronics

Still camera

If the camera or the subject moves during picture-taking, the photograph will be blurred. To a certain extent, moving objects can be "frozen" by adjusting the shutter speed; but that method won't work for industrial photography of vibrating objects, and at best it's a hit-or-miss approach to photography with a hand-held camera from a moving vehicle. The Itek Corp. of Lexington, Mass., has developed two electronic image stabilization methods—for a moving object and for a moving camera—that solve the problem in spectacular fashion, as shown in the photograph below.

The techniques were developed from an investigation into astronomical photography, where a jiggling telescope can ruin a photographic image. Itek scientist Efraim Arazi came up with a method so sensitive that it can overcome the blurring effects of scintillation, the

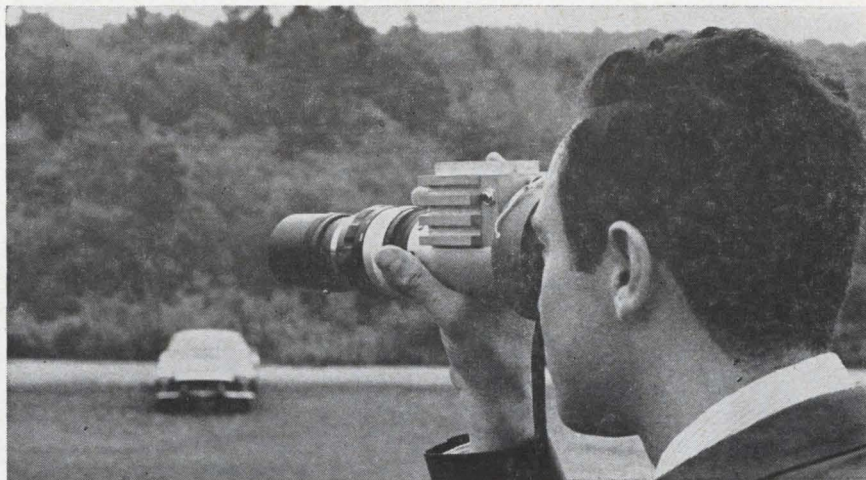

Small, electronic device developed by the Itek Corp., stabilizes images being viewed through a camera or a telescope even though the optical system jiggles. Similar device stabilizes vibrating images.

apparent "twinkling" of the stars.

Pentagon interested. Itek says the systems have wide military and industrial applications. The company already has about half a million dollars of military orders for the gear. Commercial units aren't yet available; in tests, though, stabilized cameras have photographed engine valves in operation.

Not only were the valve motions frozen, but when signals from the image stabilizer were fed into an oscilloscope, any irregularities in motion showed up as bumps on the displayed waveform.

A series of photos of a printed circuit board showed clearly that some components were affected by vibration, because they were de-

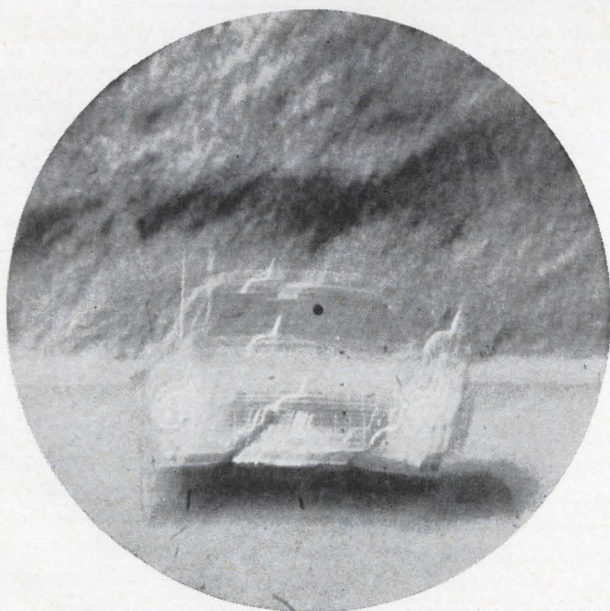

Movements of hand-held camera blur photo (left) of an automobile. But when Itek's image-stabilization device is inserted behind the camera's lens, the image is frozen, as shown in the picture on right. Such a device could hold images steady even if the pictures were being taken from a bouncing jeep or from a helicopter.

tected in motion different from that of the board itself.

Arazi says that the system has frozen action of a randomly vibrating target even when frequencies reached as high as 2,000 cycles per second. Tests are now being conducted, he adds, to determine the upper limits.

Electron deflection. The key to both systems is that they do not try to control the motion of the camera itself. "It's much simpler to move a beam of electrons," says Arazi.

The stabilization device goes between the lens and the film. The optical image modulates an electron beam which is focused on a phosphor screen. Any erratic motions of the beam caused by vibration of the target or the lens are straightened by deflection coils before the beam hits the screen.

In the system for a moving target, the coils are guided by four photomultiplier tubes. The other system, for a jiggling camera, uses horizontal and vertical inertial sensors, which trigger the coils to keep the beam centered on the screen.

At the screen, the camera takes over again; the phosphor image is recorded on film as the shutter opens.

With a moving subject and a moving camera, when not enough detail is present for either system alone, the two could be used back-to-back.

One of the major advantages of the techniques is that they are passive. For example, in some image stabilization methods, a stroboscope is used to light the target for brief moments to freeze a moving object. But in biological studies, such as eye analysis, the bright flash of light would obscure the results.

Monitor on the track

Railroad locomotives are pulled off the line for a complete inspection about once a year. The checkup takes a month and a half, and much of the labor may be wasted if the machine is found to be in good working order. The railroads

have been slow in adopting electronic techniques, but one electronic system could save millions of dollars a year in maintenance costs; it's a monitoring program developed by the Cubic Corp., a military and aerospace company.

A number of transducers are used to take readings on temperatures, pressures, and vibrations in critical parts of the locomotive. The results are stored on an incremental tape recorder. The half-inch tape, on a 2,400-foot reel, moves in increments of 0.005 inch. After each run, the tape is fed to a computer that is programmed to recognize the signature of an impending breakdown. As long as all goes well, the engine can keep rolling.

Take a sample. The system has a 50-channel commutator to sequence the recordings from the transducers. Those that monitor very critical parts may be sampled more than once during a complete scan.

All data is digitized before being recorded. Integrated circuits are used in the logic portion of the signal conditioning section to reduce size and weight and to improve reliability. The signal conditioning circuits are on plug-in cards.

William Praetorius, industrial projects manager at Cubic, says the company expects to sell the system to an Eastern railroad shortly.

Computers

On the road

The harried businessman who cannot escape the ubiquitous telephone at work or at play may soon have another prod to his conscience: the ubiquitous computer. A portable teleprinter has been developed which provides access, via any telephone, to a time-shared computer.

The instrument, an adaptation of a standard Teletype machine, was designed by Jesse T. Quatse, man-

ager of engineering development at the computation center of the Carnegie Institute of Technology.

The commercial version will be built by Electronic Systems, Inc., of Pittsburgh. It will be contained in two suitcases weighing a total of about 60 pounds. One container will hold a keyboard and printer unit. The other, connected to the printer with a short piece of cable, will contain control electronics and a cradle to hold a telephone handset.

The teleprinter is plugged into a wall socket and the computer's telephone number is dialed on the telephone, in the same way as from a standard teleprinter. Then the telephone handset is placed on the cradle in a position that allows the control unit to "talk" into the mouthpiece of the handset and "listen" to the earpiece. As the computer program is typed on the keyboard, signals are sent on the line to the computer, which solves the problem and sends back an answer. The printer types out the information received from the computer.

If the computer is fully engaged when its number is dialed, the familiar busy signal is heard.

Medical electronics

A helping hand

The Philco Corp. is extending a helping hand to amputees. Last year the company developed an experimental system that amplifies nerve signals picked up from a subject's skin to operate the knee joint of a leg brace on an artificial leg [Electronics, Nov. 30, 1964, p. 74]. Last month the company went a step further and unveiled a completely self-powered artificial arm, also controlled by minute bioelectric signals, that can bend at the elbow and turn at the wrist. And by next year, Philco hopes to have an artificial arm that can move in six basic ways, duplicating most of the movements of a real arm.

Follows order. The signal-sensing technology used in the new ar-

tificial arm is similar to the techniques used in the leg brace. In both cases, electrodes are attached to the skin near the brace or artificial limb. When the brain orders the muscle to contract, it generates minute signals called electromyographic, or EMG, potentials. The EMG's run tiny electric motors that move the limb or brace. An amputee would move his arm by "thinking" his shoulder muscles into action. (A similar technique to operate paralyzed limbs is described on page 110.)

The problem has been in getting

walk very far while hitched to a computer and a coder. In the new limb, the engineers were able to replace them with a series of discriminant circuits that would respond only to a particular pattern of EMG's. When a person moves his arms or legs, not all the muscles exert the same force; but by designing many circuits to respond to many different EMG's, the artificial limb is able to respond to various muscle signals much the same way that a real arm or leg responds to brain signals. It will exert varying degrees of force.

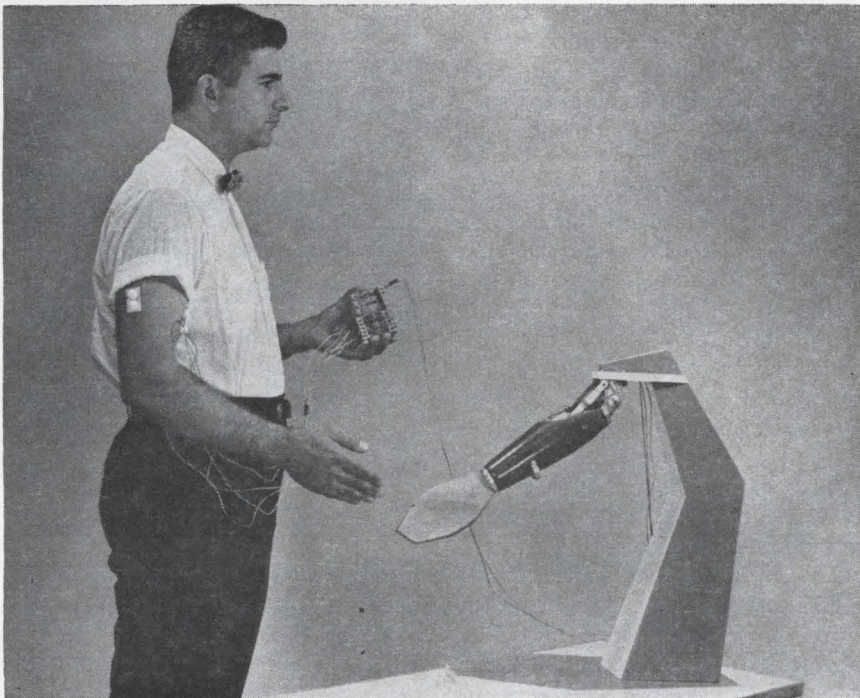

This man is literally shaking hands with himself. The electrodes on his arm pick up electromyographic signals that are amplified by the circuitry in his left hand to operate the artificial arm on the stand. The limb can bend at the elbow and twist at the wrist.

the motors to distinguish among the tens of thousands of EMG signals that can be generated by a muscle, and to respond only to a specified group. In the leg brace, the signals from the electrodes were fed into a Myocoder, an instrument that the Philco engineers developed to change the analog electrical impulses into digital values. The digital signals went to a computer, which was programmed to recognize a particular series of numbers that were representative of a standard brace movement.

Free movement. No one could

The limb was developed at Philco's Bio-Cybernetic Engineering Laboratory in Willow Grove, Pa., under the sponsorship of the Navy and the National Institutes of Health's Vocational Rehabilitation Agency. The model is still experimental. It will take another year, says W. L. Wasserman, the manager of the project, before a general arm—one that will fit any person who has lost a limb above the elbow—can be perfected.

Russian arm. Philco hasn't been alone in the development of electronically controlled artificial limbs.

Last year, Soviet scientists demonstrated a prosthetic sleeve [Electronics, Dec. 28, 1964, p. 111] that performed simple clenching motions. Although the model was only a below-the-elbow device, the Russians said they were working on artificial limbs that moved in various directions. The Russian limb cannot move with the same accuracy and sensitivity as Philco's; it responds only to a certain threshold of EMG signal, rather than to different signals. The Russian arm also lacks the selectivity of Philco's; an erratic movement, for example, could trigger it to move, whereas in the Philco device only a particular muscle movement associated with a particular order can trigger a move.

In addition, the Russian arm lacks force control. A user might have considerable difficulty in picking up delicate objects, although Russian engineers claim that with practice an amputee can learn to pick up an egg.

Consumer electronics

Channel trimming

Commercial television channels take up 4.5 megacycles of the already crowded broadcasting spectrum. Efforts to squeeze a channel even slightly produce pictures of low resolution; but a method of channel-trimming, without loss of resolution, may now be at hand.

A small electronics company, the Sonic Vee Corp. of New York, last month received a patent on a system in which 150 tv channels can be packed into the channel space that currently can carry only one tv broadcast. Each channel in the Sonic Vee system requires a bandwidth of only 30 kilocycles.

Unlike conventional television, Sonic Vee's system doesn't always reproduce a complete picture every 1/30th of a second. The technique takes advantage of the fact that not all parts of a tv picture change from frame to frame.

Split seconds. The Sonic Vee receiver contains a storage tube that

selectively reproduces only those areas of each frame that have changed. This, in itself, doesn't result in cutting the necessary bandwidth. The system still requires sufficient frequency response to be capable of producing sharp images even when the picture is changed abruptly; these shifts in black and white are transmitted as high-frequency signals. A full-resolution, slow-scan tv system operated at a 30-kc bandwidth would require a full five seconds to reproduce each frame, but the Sonic Vee system takes only a fraction of a second.

Changing scene. The key to the system is variable-speed scanning, and the amount of data—or the degree of change from frame to frame—determines the scanning rate. When the light level in the transmitted scene remains uniform, the scanning is fast. But when there is a change, the rate slows. The larger the change, the slower the scanning.

To alert the variable-velocity beam that it is approaching a change in intensity in the scene being scanned, a second beam scans the same area—but a micro-second earlier.

Two 15-kc signals are used in the system: one, similar to a conventional system, transmits light-level data, and the other transmits the beam position on the screen. The total 30-kc bandwidth can be trimmed further, to 17 kc, by multiplexing the two signals, the inventor, George Doundoulakis, maintains.

Other uses. The Sonic Vee system has a potential beyond the regular commercial tv field. For example, an f-m radio station could use one of its two available subcarriers to broadcast special tv services, such as pay-tv or stock market quotations to customers.

In addition, says the inventor, the reduced bandwidth makes it possible to use any 15-inch-per-second professional audio recorder to tape a video signal; this can be done by placing each of the two 15-kc signals on a separate recording track.

Also, Sonic Vee's technique will enable transmission of tv signals

over a few conventional telephone lines. Currently, Doundoulakis explains, the Sonic Vee system needs nine phone lines, but if the signal were reduced nine-to-one—by trimming picture size, resolution and frame rate—the picture could be transmitted over one phone line.

Contracting

Gold star for Titan

The Titan 3's development program calls for 17 launches. On Sept. 30, the Titan will be launched for the sixth time—but the Pentagon estimates that its development is already 88% complete. And with costs running 0.2% below the contract price, the program has become the showcase of the Defense Department's incentive contract system. Secretary of Defense Robert S. McNamara calls Titan "the best-managed contract in the Pentagon." The program has undoubtedly strengthened his attempts to negotiate contracts that will make defense manufacturers hold costs down while improving technical performance.

The program has been equally successful for its contractor, the Martin Co., a division of the Martin Marietta Corp. It has already collected \$18,132,000 in profits on the \$324-million contract. If Titan performs as expected in the 12 launches that will be held at two-months intervals beginning next week, Martin could collect almost \$10 million more in bonuses and go well over its profit target of \$22,680,000, or 7% of the contract.

Future rewards. And McNamara, true to his word that companies which do well on development will get production contracts, has set Martin to planning for Titan's future. Air Force officials say possible missions include putting up the first five manned orbiting laboratories, and orbiting at least six large scientific payloads, both with Titan 3-C. The Titan 3-X, a missile which could use various kinds of upper stages, depending on the

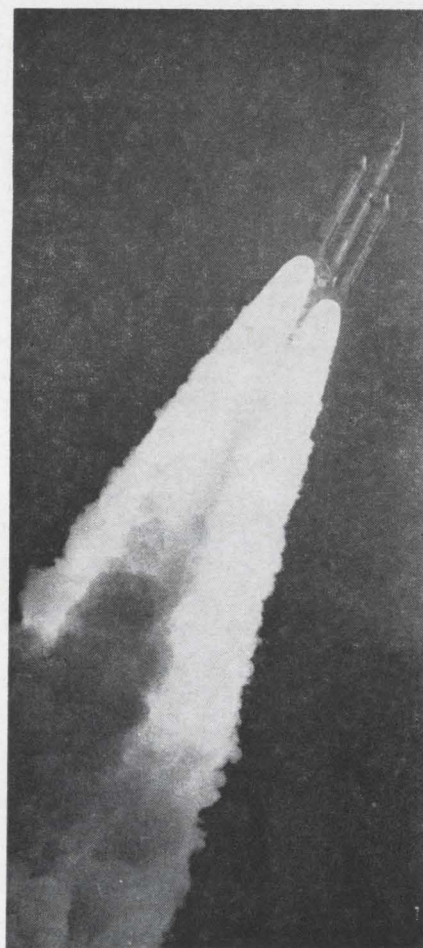

For a successful Titan launch—a bonus.

mission, may be called on to orbit a dozen Apollo-sized payloads. That adds up to about 23 more rockets which Martin could make, at a cost at least equal to that of the present 17-rocket contract.

The Titan contract carries both bonuses and penalties for holding costs down, getting rockets delivered on schedule, and assuring performance that meets or exceeds specifications. Even though Martin has stayed within its original cost estimate—despite a \$15 million miscalculation by one subcontractor—the company has collected no bonus for the feat; a 2% reduction was required for that. So far, all missiles have been delivered on time, and if the rest also meet the schedule, Martin could avoid \$147,279 in penalties.

Performance pays off. The fastest carrot—and the biggest stick—are found at Cape Kennedy. Each Titan 3 flight is worth 100 points,

TRW ANNOUNCES NEW MILITARY MYLARS



Up to 72% smaller than MIL-C-25C paper capacitors!

MIL-C-19978B/2 reduces capacitor size drastically—down to .125" diameter by 1/2" long. At the same time electrical characteristics are upgraded sharply.

MIL-C-19978B/2 hermetically sealed mylar* capacitors are available now from TRW with immediate delivery in production quantities.

- **REDUCED SIZE**—35% to 72% smaller than MIL-C-25C.
- **VOLTAGE CHOICE**—30V, 50V, 100V, 200V, 600V, 1000V.
- **CAPACITANCE CHOICE**—.001 mfd through 10.0 mfd.
- **TOLERANCE CHOICE**—±10%, ±5%, ±2%, ±1%.

For full information contact: TRW Capacitors, 112 W. First St., Ogallala, Nebraska. Phone: 308-284-3611 • TWX: 308-526-7816.

These capacitors—when designated TRW Type 693—are available to high reliability specifications, and in custom capacitances and tolerances beyond the range of MIL-C-19978B/2.

*Du Pont registered trademark

TRW CAPACITORS

GOOF-PROOF INTER-WIRING

Garlock Free-Flex® circuits minimize rework and trouble-shooting because it's impossible to hook them up wrong.

LOOK

All Garlock Free-Flex circuits are flexible circuit assemblies . . . pre-engineered mechanically and electrically so all terminations naturally go on the right terminals . . . make it impossible to miss a connection.

■ Materials and configurations to meet your specifications and the Government's.

■ Write us for your copy of *Flexible Circuits in "Teflon" FEP Have Come of Age* reprinted from *The Journal of Teflon*, published by E. I. du Pont de Nemours and Company . . . and for the FREE-FLEX Circuitry Manual.



GARLOCK
ELECTRONIC PRODUCTS
GARLOCK INC.
CHERRY HILL, N.J. 08034

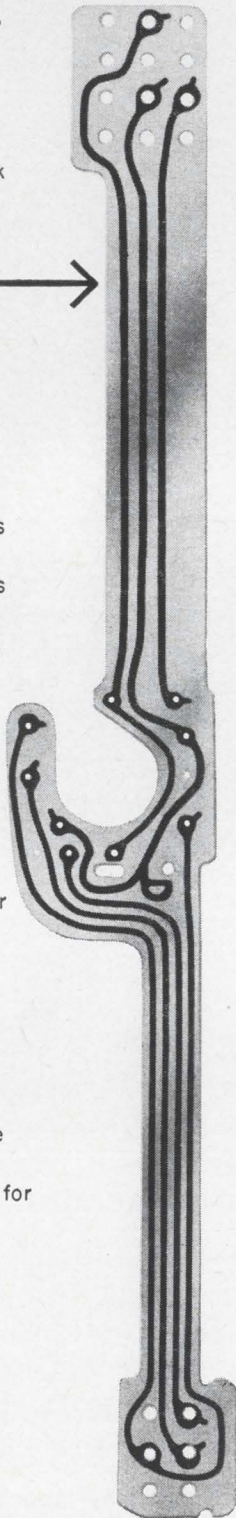

Electronics Review

which are awarded for the count-down, solid burn, solid separation, first stage burn, second stage burn, and orbit. For the first 900 points, the failure of a flight can cost Martin up to \$810,000 in penalties, each point being worth \$8,100.

There are no penalties or bonuses from 900 to 1,100 points—but then comes the payoff. From 1,100 to 1,400 points, each flight is worth \$3,240,000 in bonuses. That's where Martin stands to make the extra \$10 million.

So far, the company has had three perfect launches of the Titan 3-A, which has three liquid stages but lacks the 120-inch solid-fuel rockets strapped to the side of the Titan 3-C. The first 3-A failed to orbit. The first 3-C, launched last July 18, was a success.

Reliability program. Martin met one of its biggest problems, the reliability of electronics parts, by imposing three rules upon itself and its subcontractors:

- All critical parts for both the production rockets and the space sub-systems were ordered at once and stored until needed. "That way all the transistors, diodes and other components in any batch are either all right or all wrong," says William G. Purdy, general manager for space systems at Martin-Denver.

- Martin procurement officials signed agreements with suppliers requiring an identification of the manufacturing process and notification of any change in the process that might affect performance.

- Critical elements which could produce catastrophic error were subjected to certified quality testing at the manufacturer's plant and were retested for deterioration before being installed aboard the Titan III.

Keeping the profits. With success in sight, there is only one cloud on Martin's horizon, according to William B. Bergen, company president.

"It's been a damn good contract," he says. "The grave danger is that a cost plus incentive fee puts a major premium on performance, and you don't get performance until the end of the contract. That's when the Renegotiation

Board can look at your profits for the last year and make you give it all back."

Defense officials have sought, for more than a year, without success, a statement of Renegotiation Board policy in regard to incentive fee contracts.

Military electronics

Portable ground control

Ground-control approach radars may soon be airlifted or trucked into combat areas. The smallest, lightest tactical landing system in the Air Force, is being tested at Spence Field, Ga., and presumably will be sent to South Vietnam after it has been proved out.

The terminal air-traffic control system consists of two 6,000-pound shelters. It's a far cry from an instant Idlewild, but it can guide military planes to safe landings in treacherous terrain. Best of all, it can be moved in and out of an area in a matter of days.

The producer, LFE Electronics of Boston, a division of Laboratory for Electronics, Inc., is trying to develop a 3,500-pound shelter. The Air Force has purchased four of the earlier systems, designated TPN-17, for a total of \$1 million. The TPN-17 will fill a temporary need until advanced tactical systems are developed. Procurement is expected to start next month on tactical navigation aids for the 407-L system [Electronics, Oct. 5, 1964, p. 114], which can control fighter planes from a jeep.

Integration. Building the terminal from existing equipment was a "systems integration job," according to Joseph W. Lovoi, engineering manager of LFE. The manned operations shelter is staffed by two operators and a supervisor, with their display consoles. On its roof is the transponder interrogation antenna. The unmanned radar shelter contains the radar transmitter, receiver and power supplies. Elevation and azimuth antennas on the roof can be lowered electrically or manually

into the shelter for transportation.

The search radar is capable of detecting aircraft at up to 40 nautical miles on the plan position indicator. When the search radar is used in conjunction with the identification-friend-or-foe (IFF) display, the search capability is extended to 200 miles.

Two modes. The system's primary code is simultaneous search and precision approach. Here the radar is in precision-approach and the IFF beacon in search configuration. The IFF video is presented on one indicator as a present-position indication. Its operator can detect, identify and control military aircraft in his area. He may direct them all through, or direct them one at a time into the glide-slope "window", where responsibility is turned over to the radar controller for the landing. At this point, the radar controller identifies the aircraft again and proceeds with landing instructions.

In a secondary mode of operation, both indicators are in the search mode—one portraying radar responses, the other video responses from aircraft transponders. In this instance, the IFF beacon is used for control of planes from 200 miles to about 25 miles, at which distance the radar controller takes over. Both controllers can be on IFF search or both on radar search, depending on the density and distribution of air traffic.

In another secondary mode, both controller can be in the position-approach-radar mode, with two or more aircraft on the glide path separated by distance and time.

Toward a peace economy

A presidential committee has warned of a declining role for defense expenditures in an expanding economy, and proposed four major steps to make it easier for companies to adjust to a peacetime economy.

The Committee on the Economic Impact of Defense and Disarmament noted that defense expenditures accounted for about 10% of the gross national product from 1955 through 1963, and that the

10 ohms dynamic "on" resistance and 50 μV offset

The Amperex silicon planar/epitaxial choppers, type 2N2569 now offer not only the lowest offset voltage in the industry, but the lowest dynamic "on" resistance as well. Every factory-matched pair of 2N2569's is guaranteed not to exceed 50 μV_{off} and 10 ohms r_{ec} max. The offset voltage will remain stable over extremely wide temperature ranges.

Behind this unprecedented combination of lows for production quantity matched pairs is the 2N2569 itself with its offset voltage of only 250 μV (180 μV typ.)—and its r_{ec} of 10 Ω max., the lowest ever offered in a commercially available transistor.

A second chopper, the 2N2570 (identical to the 2N2569 but with offset voltage of 500 μV max.) is also available.

These two low level choppers offer exceptional performance at exceptional prices, singly or in pairs. They are ideally suited for low level voltage measurements, DC amplifier stabilization, analog-to-digital conversion, telemetering and wherever ultra-precise switching is the requirement.

For complete data and applications information, write: Amperex Electronic Corporation, Semiconductor and Receiving Tube Division, Dept. 371, Slatersville, Rhode Island 02876.

2N2569 and 2N2570

V_{off} : 2N2569.....	180 μV typ.; 250 μV max.....	$I_{\text{B}} = 150 \mu\text{A}$, $I_{\text{E}} = 0$
V_{off} : 2N2570.....	350 μV typ.; 500 μV max.....	$I_{\text{B}} = 150 \mu\text{A}$, $I_{\text{E}} = 0$
ΔV_{off} : Matched Pr.....	50 μV max.....	$I_{\text{B}} = 150 \mu\text{A}$, $I_{\text{E}} = 0$

BOTH TYPES (Single)

r_{ec}	10 Ω max.....	$I_{\text{B}} = 1 \text{ mA}$; $I_{\text{E}} = 100 \mu\text{A}$; $f = 1 \text{ KC}$
I_{ECS}	2 nA max.....	$V_{\text{ECS}} = 5 \text{ V}$; $T = +25^\circ\text{C}$
h_{FE}50 min.; 100 typ.....	$V_{\text{CE}} = 10 \text{ V}$; $I_{\text{c}} = 100 \mu\text{A}$
C_{ib}	10 pf max.....	$V_{\text{CB}} = 0 \text{ V}$; $f = 1 \text{ Mc}$
f_{t}	100 Mc. min.....	$V_{\text{CE}} = 10 \text{ V}$; $I_{\text{c}} = \text{mA}$

Envelope: TO-18

Amperex[®]

IN CANADA: PHILIPS ELECTRON DEVICES, TORONTO 17

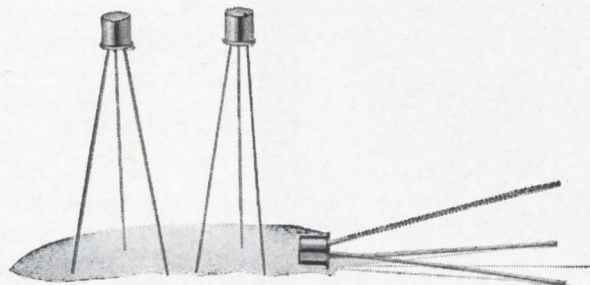

Yes, we've hit a new low in transistor choppers!

want
oscillograph
flexibility?

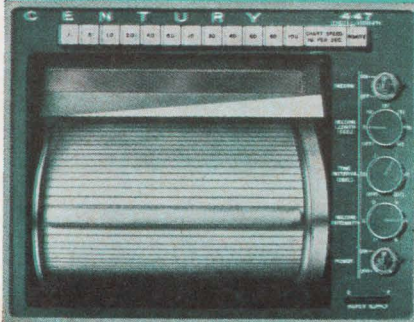

the new
Century 447
has 1,000
chart speeds!

- specify any 12 speeds
(.1"/sec. to 100"/sec.)
- change to any 12 speeds of a
possible 1,000 anytime you
wish—as often as you wish!

The new CENTURY 447 has a highly precise electronic drive which permits a wide range of speeds. Specify the speeds you require—you can quickly change to other speeds at any time.

The new CENTURY 447 also features:

- AUTOMATIC RECORD LENGTH based on time—the common base for all measurement.
- CONTINUOUSLY VARIABLE REMOTE SPEED CONTROL for optimum record analysis.

Remote control options include START, STOP, and CHART SPEED DRIVE.

Send for the
Century 447
brochure
containing
detailed
specifications.



CENTURY

ELECTRONICS & INSTRUMENTS

Subsidiary of Century Geophysical Corp.
6540 E. Apache St., Tulsa, Oklahoma 74115

Electronics Review

share is now down to 8.4%. Barring a world war, the panel said, the Pentagon's share of the national output is likely to continue to decline over the long run.

The committee's 13 members represent many governmental agencies. Its leader is Gardner Ackley, chairman of the Council of Economic Advisers.

Recommendations. The committee's 92-page report, the result of nearly two years of deliberations, made the following recommendations:

- Require defense procurement agencies to give longer advance notice to contractors when programs are to be canceled or changed; also require prime contractors to assess for the government the probable impact on their employees of any termination of major contracts.

- Allow defense companies to charge off, as a contract expense, the cost of participating in planning for community diversification. Companies can already do this in financing their own diversification studies.

- Consider allowing a contractor in a government-owned plant to use part of the plant for commercial ventures on a rental basis if defense business should be withdrawn or curtailed substantially.

- Improve the effectiveness of the federal-state employment services. In this connection, the committee reported that employment of engineers and technical personnel had bottomed out early in 1964 and has subsequently improved slightly.

Communications

Party line

The gigantic Saturn rocket that will launch the Apollo spacecraft toward the moon will be 360 feet tall; the building in which it will be built is, of course, even bigger. It could house the Pentagon and the Chicago Merchandise Mart with room left over for a few bungalows. The National Aeronautics and Space Administration, which has a number of solutions toward com-

munications in outer space, found that it needed a special system for "inner space"—the inside of the assembly building.

A conventional intercom system wouldn't work, because NASA wanted a hundred or more stations on the line, and with that many outlets, feedback would degrade the sound. The Collins Radio Co. came up with a closed-circuit radio system that can accommodate 112

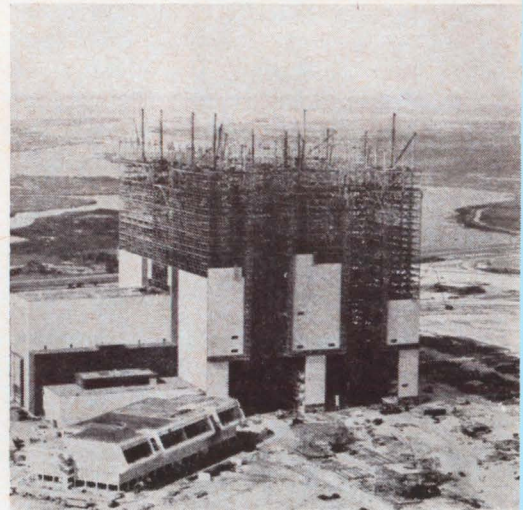

Gargantuan garage for the Saturn 5. Communications inside the building became as complex as communications in outer space.

stations, all linked on two coaxial cables, with maximum attenuation of only three decibels. The system could be expanded to 600 station without major engineering changes.

Double coax. The Collins system is called Radic, for Radio Interior Communications. Each station is a multichannel transceiver; one coax is used for sending and the other for receiving. The cables are linked by a line amplifier, and the only other wiring is for the 28-volt d-c power supply.

Since the system is a closed-circuit hook-up, it isn't susceptible to outside r-f interference; nor does it radiate interference.

Radic is a single-sideband, suppressed carrier system with an audio response of 300 to 3,000 cps; it is capable of duplex communications on a single carrier frequency.

A master 4-kilocycle reference

generator supplies a pilot signal for phase-locking the individual stations and spacing the channels. Each station has a digital frequency synthesizer that produces carrier injection signals of between 516 and 960 kc for channel selection. The selected frequency is divided to 4 kc and compared with the 4-kc reference for phase-locking and oscillator control.

Double modulation. The audio is amplified, and modulated with 500 kc, which is an exact controlled harmonic of the 4-kc reference. The modulated signal is 500 kc plus and minus the audio signal. A mechanical filter passes only the upper sideband—500.3 to 503.0 kc—which is the intermediate frequency. For an individual station to communicate with another, the i-f is modulated with a signal from the frequency synthesizer that is determined by the channel selector. The result of this modulation, the difference between the i-f and the injection signal, is the lower sideband, which is transmitted.

The signal travels down the transmitter coax to the line amplifier that boosts the power level of the signal and sends it down the receiver coax. Only the receiver whose frequency synthesizer produces the same injection carrier as the transmitter can pick up the signal.

A switch at a master station, however, permits the i-f to pass directly to the r-f output terminals for communicating with all other stations simultaneously.

Any number of stations can get together on a conference call when each operator tones his frequency synthesizers to the common injection carrier frequency. Actually, every station could be connected on a conference call, with no degradation in signal level.

Space electronics

New phase in space

Later this year, the Air Force will flight-test a phased array antenna that may be used in satellites. Such

Circle 49 on reader service card→

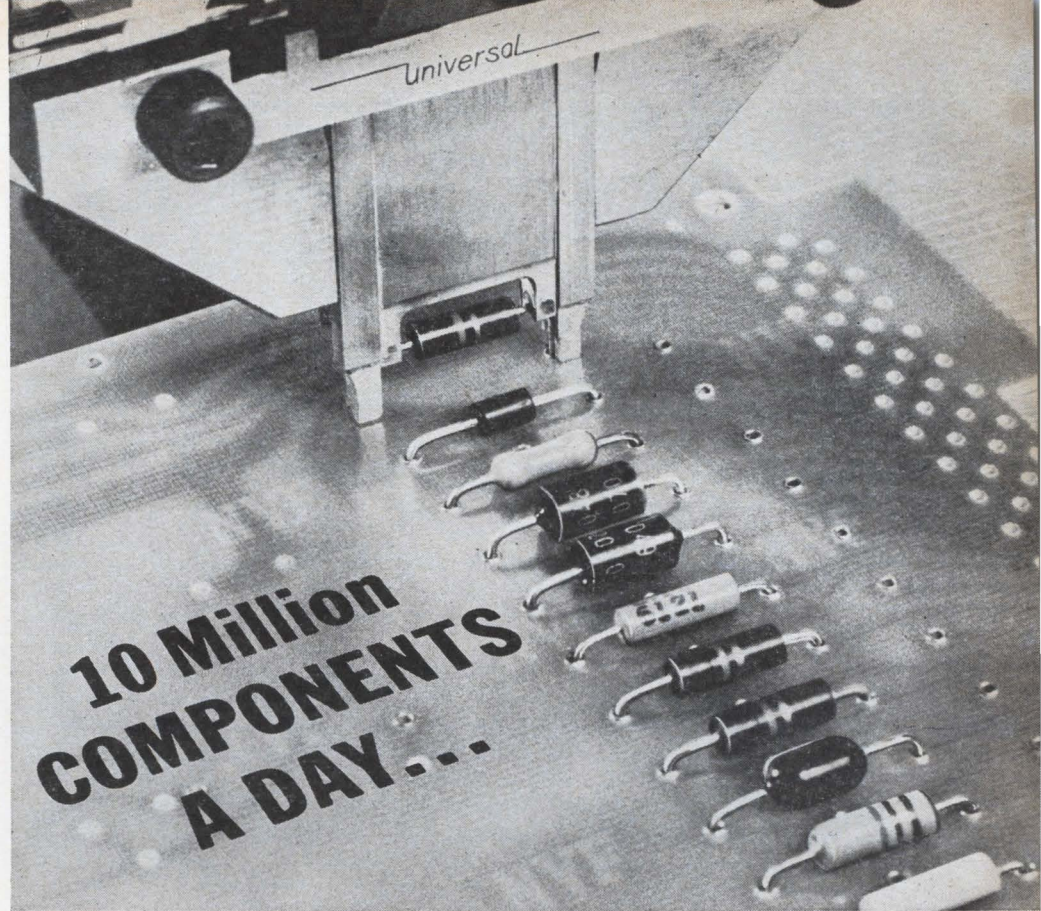

are being inserted with UNIVERSAL systems now in service

Literally hundreds of printed circuit board assembly systems have been built by Universal to date. Customer-proven reliability . . . with more than 20 systems at some facilities . . . is one of the key reasons for their ever increasing popularity. Their reputation is also built on:

- EXCLUSIVE VERSATILITY** Universal systems are designed to insert unlimited numbers of components in a programmed sequence, including components of varying physical sizes. Also available for transistors, and new multi-lead components. Any desired grid pattern may be used, board sizes are unlimited, and an entire board can be completed with a single handling.
- HIGH SPEED** Models 6001 and 6001M pantograph insertion machines insert axial lead components at production rates of 2000+/hr . . . Model 6010 with numerical control, 3000 to 5500 or more an hour per head.
- LOW COST** Both original and operating cost of Universal systems are low when compared to any other systems.

Calculate how much 2000+ to 5500+ insertions an hour per head would slice your assembly costs and speed up production. Then send for new 16-page illustrated reference on Universal's high speed systems for component insertion and sequencing. Better yet, ask for a head-to-head meeting with a Universal engineer to discuss your specific needs.

Universal INSTRUMENTS CORPORATION
139 E. FREDERICK ST., BINGHAMTON, N. Y. / 607-772-1710 / TWX: 607-772-0243

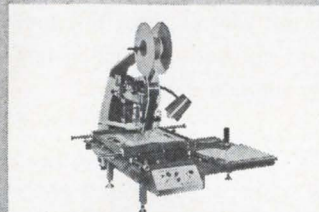

Model 6001 — Pantograph operated, for bench mounting. With custom tooling, ready-to-operate. Approximately . . . \$9,000

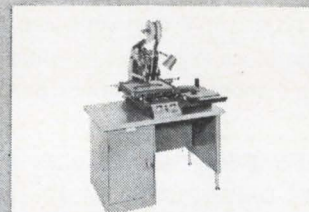

Model 6001M — Pantograph operated, free standing. With custom tooling, ready-to-operate. Approximately . . . \$9,250



Model 6010 — Fully automatic, with numerical control. With custom tooling, ready-to-operate. Approximately . . . \$22,500

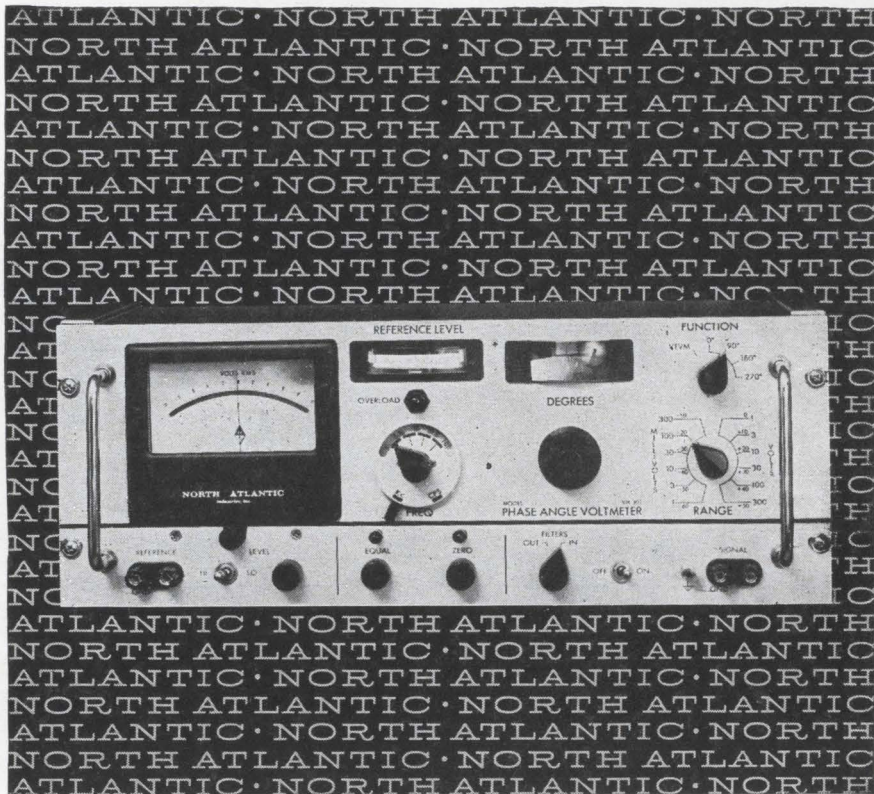

how to measure in-phase, quadrature and angle while sweeping frequency to 100 kc

North Atlantic's latest addition to the PAV line of Phase Angle Voltmeters* enables you to make measurements while frequency is varying over half-decades without recalibration. The VM-301 **Broadband Phase Angle Voltmeter*** provides complete coverage from 10 cps to 100 kc, and incorporates plug-in filters to reduce the effects of harmonics in the range of 50 cps to 10 kc with only 16 sets of filters. Vibration analysis and servo analysis are only two of the many applications for this unit. Abridged specifications are listed below:

Voltage Range.....	1 mv to 300 volts full scale
Voltage Accuracy.....	2% full scale
Phase Dial Range.....	0° to 90° with 0.1° resolution (plus 4 quadrants)
Phase Accuracy.....	0.25°
Input Impedance.....	10 megohms, 30μf for all ranges (signal and reference inputs)
Reference Level Range.....	0.15 to 130 volts
Harmonic Rejection.....	50 db
Nulling Sensitivity.....	less than 2 microvolts
Size.....	19" x 7" x 10" deep
Price.....	\$2290.00 plus \$160.00 per set of filters

North Atlantic's sales representative in your area can tell you all about this unit as well as other Phase Angle Voltmeters* for both production test and ground support applications. Send for our data sheet today.



NORTH ATLANTIC industries, inc.
 TERMINAL DRIVE, PLAINVIEW, L. I., NEW YORK • Overbrook 1-8600

*Trademark

an antenna, which has no moving parts, can pick up signals from several widely spaced ground stations simultaneously and direct messages back to the stations.

The antenna is made up of 200 individual receiving and transmitting elements, each the size of a tieclasp. Both elements of a pair operate with the same ground station.

The array is retrodirective, or self-tracking. That is, the signal arrives at the individual elements in a certain space-time relationship, or phase, which is preserved as the signal is modulated on the satellite and retransmitted back to earth. The highly directional signal has high gain and requires only a few watts of power.

The antenna itself is a disc of dielectric material about three feet in diameter. Each element is etched on the dielectric material using printed circuit techniques. Behind each pair of receiving and transmitting elements is a transceiver which modulates the received signal from earth and retransmits it at from 1,550 to 5,200 megacycles.

Most phased array antennas with retrodirectivity were developed for ground radar systems. The satellite system was developed for the Air Force by Sylvania Electric Products, Inc., a subsidiary of the General Telephone & Electronics Corp.

Electronics notes

▪ **21-inch rectangle.** The Admiral Corp. and Motorola, Inc., have announced plans to produce color tv sets using rectangular 21-inch tubes—the first of that size for the industry. The most popular black-and-white sets use 21-inch rectangular tubes. Other producers currently make rectangular color tubes ranging from 11 to 25 inches. Motorola will start pilot production of its 21-inch tubes in mid-October, while Admiral expects to start marketing its sets during the second quarter of 1966. Admiral's color tubes will be produced by the National Video Corp.

So you're changing to integrated circuits?

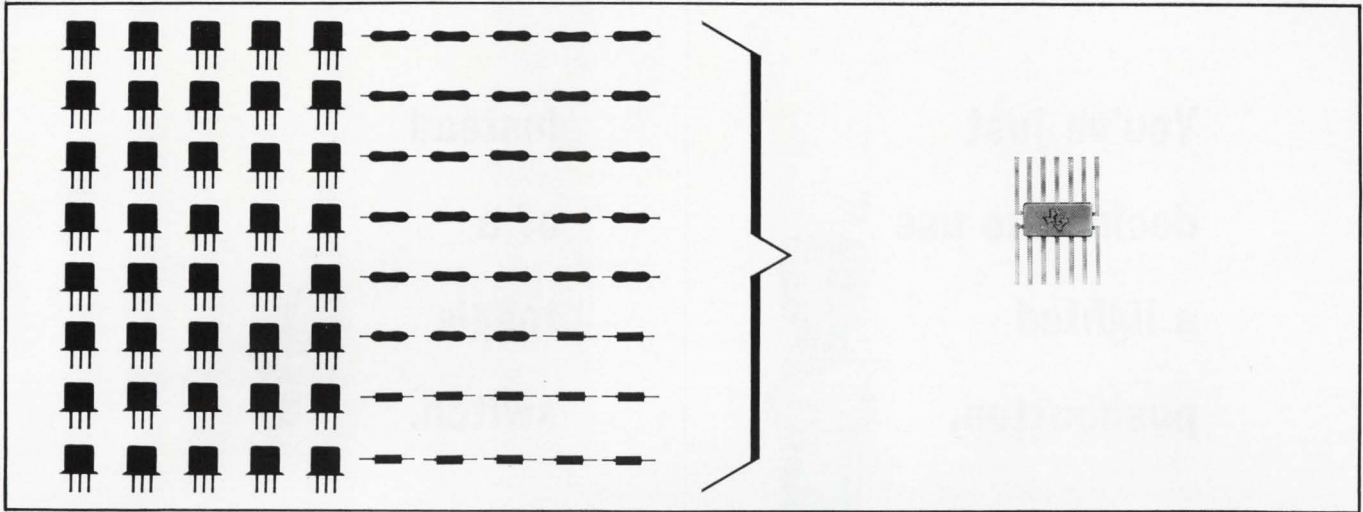

These 32 npn and 8 pnp transistors, 28 resistors and 12 capacitors (3/4 actual size) are replaced by the dual J-K flip-flop shown actual size above.

Good, we've got 'em... from Texas Instruments. And you can get 'em fast... from DEECO.

So you want speed with noise immunity? Texas Instruments Series 54 TTL logic family gives you 13-nsec propagation delay with a big one-volt noise margin... and power dissipation of only 10 mw/gate. These high-performance units are establishing a new industry standard in saturated logic. Operating temperature is -55° to $+125^{\circ}\text{C}$.

So you want low cost with reliability? Texas Instruments new Series 73 modified-DTL industrial integrated circuits give you all the economy advantages of TI's "multi-function" approach to circuit design. Since three or four

complete circuits can be built in a bar of silicon for little more cost than a single circuit, the cost-per-circuit-function goes down fast. Yet, you get this economy without any quality sacrifice — in the same welded, hermetically sealed flat pack as military units. Designed for operation in industrial environments of 0° to $+70^{\circ}\text{C}$.

So you want fast delivery? We carry full stocks of both Series 54 and Series 73 integrated circuits (and more than 50 other digital and linear types as well). You may be assured of fast, accurate service and shipment.

SO ASK — GET FULL INFORMATION ON SERIES 54 AND SERIES 73

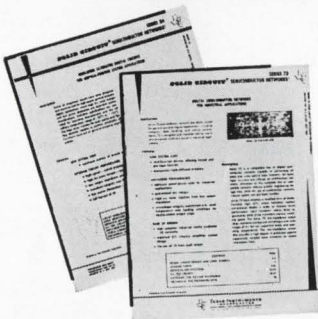

Fill out this coupon and send it to us at the address listed below for TI's new Series 54 bulletin (20 pages) and new Series 73 bulletin (28 pages). You'll get complete performance specifications on the many types available in both series.

Please send the TI Series 54 and 73 bulletins to:

Name _____
 Position _____
 Mail Station or Bldg. Code _____
 Company _____
 Address _____
 City and State _____

DEECO  **Inc.**

AUTHORIZED DISTRIBUTOR 

DISTRIBUTORS — SERVING INDUSTRIALS EXCLUSIVELY

618 FIRST STREET N. W. • CEDAR RAPIDS, IOWA • PHONE 365-7751

**You've just
decided to use
a lighted
pushbutton,**



**instead
of a
toggle
switch.**



Are you going to have to switch SWITCH suppliers?

Well, if you have been considering one of the 3,150 toggle switches we have at Control Switch, you can quietly stay right where you are and start considering one of our 1,800 lighted pushbutton switches.

Same salesman. Same distributor. Same supplier. Same superior engineering for applications where you can't afford to have a switch goof, even after a hundred thousand actuations.

You can stay with us just as easily, too, for leaf and lever, interlock and limit, hermetically-sealed and environment-free switches.



CONTROL SWITCH DIVISION
1420 Delmar Drive, Folcroft, Pennsylvania 19032



PLASTICOTE[®] WIRE & CABLE by CHESTER

CHESTER CABLE CORP.

A Subsidiary of Tennessee Corporation

CHESTER, NEW YORK

(See reverse side)

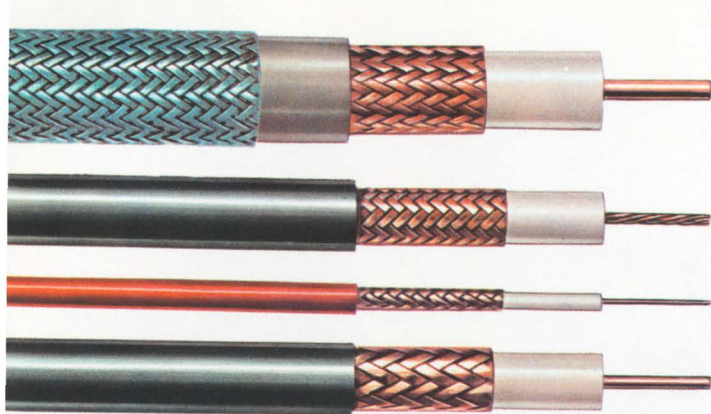

COAXIAL CABLE — Chester Cable Corp. offers a complete line of coaxial cable for military and commercial applications. Manufactured in accordance with MIL-C-17, JAN-C-17 and commercial specifications. Constructions include solid, air-spaced and foam dielectrics with conventional braid shields or flat copper tape shields, having PVC or polyethylene jackets. Custom designed constructions of triaxial cable and high frequency-high voltage cable are also available.

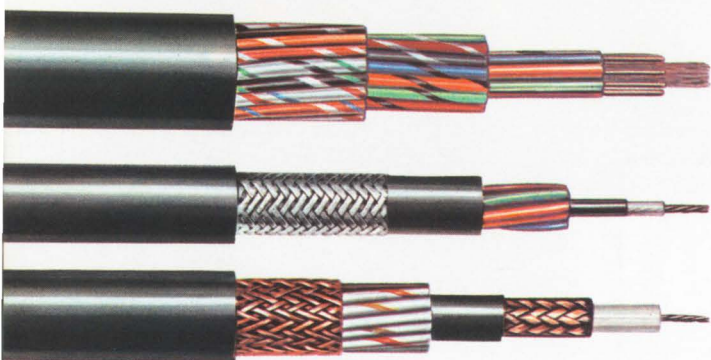

MULTI-CONDUCTOR CABLE — Wide range of custom designs available, manufactured in accordance with such industry standards as MIL specs., U/L, CSA, IPCEA, EIA, IMSA, ASTM, etc.

Chester Cable Corp. is a preferred source for quality electronic and electrical cable, insulated and jacketed with thermoplastic materials such as polyvinylchloride, polyethylene and nylon. Custom designs of shielded or unshielded cable include: Control Cable • TV Camera Cable • Missile Cable • Intercom Cable • Computer Cable • Special Hi-Voltage Cable and Parallel Bonded Ribbon Cable.



MIL-SPEC WIRE — Made in accordance with specifications MIL-W-16878 (Types B, C & D), MIL-W-76B (Types LW, MW & HW) and MIL-W-5086A for electronic systems. Available in single or multiple constructions, shielded or unshielded, with or without nylon or PVC jackets.

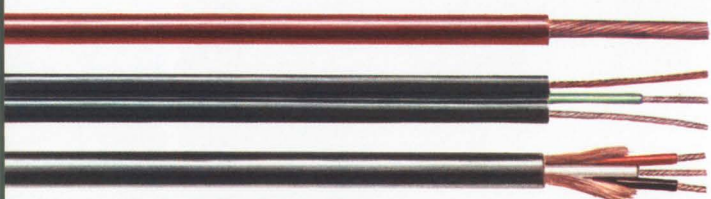

WIRE AND CORD FOR THE APPLIANCE INDUSTRY — U/L and CSA approved, 60°C — 80°C — 90°C — 105°C appliance wiring material — SVT, SJT, ST cord, SJTO & STO oil-resistant cord, SJT & ST oil-proof cord, SPT cord with or without individually insulated ground wire. Used for washers, dryers, refrigerating, air conditioning, vending, heating, X-ray and other electrical and electronic equipment.

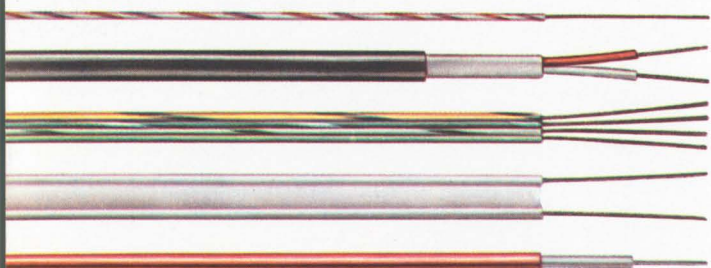

RADIO AND TV CIRCUIT WIRE AND CABLE — U/L and CSA approved, 60°C — 80°C — 90°C — 105°C appliance and radio circuit wire, microphone cable, shielded and unshielded audio circuit wire, twin lead antenna wire, phonograph cable, parallel-bonded color convergence ckt. cable, braided hook-up wire, hi-anode wire, hot chassis lead, balun-coil wire, shielded constructions with spiral, braided, aluminum-Mylar tape and conductive materials; all available in Thrif-T-Bond® tinned over-coated conductors.

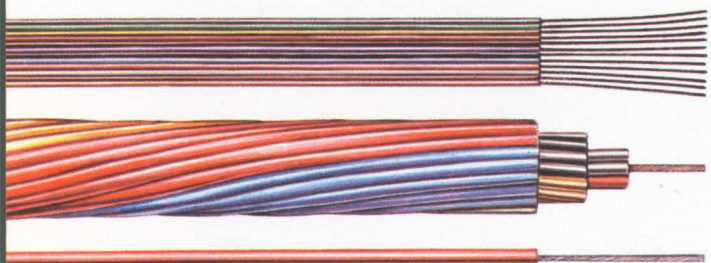

MISCELLANEOUS WIRE AND CABLE—Machine Tool Wire • Bus Drop Cable • Flexible Test Lead Wire • Municipal Signal Cable • Low Energy Circuit Control Cable • Station Control Cable • Inter-Office Communication and Signaling Cable • Deep-Well Submersible Water Pump Cable • Gas Tube Sign and Oil Burner Ignition Cable • Intercom Cable • Gasoline and Oil Resistant Wire • Computer Cable • Uninsulated Bus Wire • Parallel and Jacketed Cord • Braided Ground Strap, and special custom designed cable for your applications.



Write or phone for further information.

CHESTER CABLE CORP., A Subsidiary of Tennessee Corporation, **CHESTER, NEW YORK 10918**

Phone: 914 - 469-2141 • TWX: 914 - 469-7011

Printed in U.S.A.

Can Function Module Systems obsolete every other analog control technique?

IN A WORD, YES. From experimental laboratory to pilot plant to full scale process plant, CEC Function Modules obsolete every other means of analog computational control.

The reason: CEC Function Modules simultaneously achieve better performance, maximum utility and higher reliability — at a far lower unit cost.

The secret: CEC Function Modules are constructed of *identical operational amplifiers* — the most efficient and versatile analog design concept known today. Various amplifier arrangements produce modules for different functions. By using this inherently superior technology, CEC makes available to users of analog instrumentation, for the first time, all the potential advantages of **COHERENT DESIGN**.

Check these unique benefits . . .

VERSATILITY: Virtually any combination of functions can be employed to build computing and controlling systems, and to tailor CEC Function Module instruments to each customer's needs.

OPERATIONAL COMPATIBILITY: Using a standard 0-10 volt signal, up to 20 modules can fan out from a single module without changing the output.

PERMANENT CALIBRATION: Users never have to recalibrate Function Modules.

FREEDOM FROM DRIFT AND NOISE: Drift produced by ambient conditions is negligible. Internally generated noise is virtually non-existent.

MOUNTING CONVENIENCE: Uniform in size and shape, modules can be mounted in *any* combination inside standard CEC instruments, cases and racks.

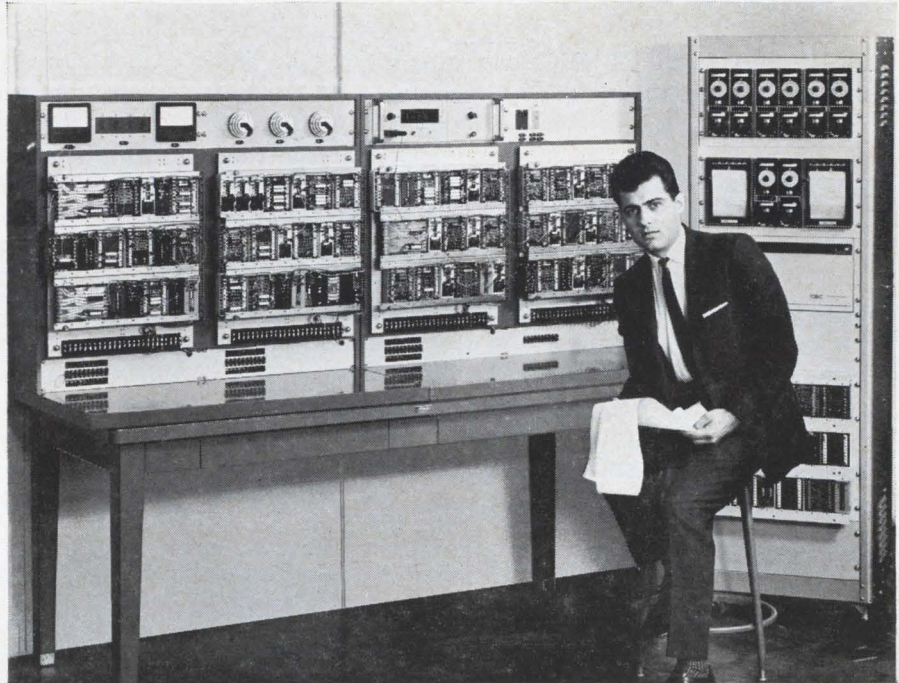

RUGGEDNESS: Hard wiring, screw terminals, encapsulation and solid-state components make Function Modules impervious to corrosion, dirt, vibration, and heat — guard instruments against substantial abuse.

Devar instrumentation meets every analog need

CEC/Devar has a complete line of standard Function Module instruments. These include computers, recorders, controllers, preamplifiers, transmitters, and transducers. In addition, a custom-products group designs computers and special-purpose control systems.

The categories of Function Modules used to construct this instrumentation are:

- Input Signal Conversion
- Output Signal Conversion
- Algebraic Functions

- Dynamic Response Functions
- Logic Functions
- Power Supplies

Function Module instrumentation can benefit every echelon of your operation from laboratory to plant. And it is equally profitable for every level of complexity.

Call your local CEC/Devar Sales Representative today for complete information on CEC/Devar instruments, instrument systems and Function Modules, or write for CEC Bulletin Package 7055-X 5.

CEC

Devar-Kinetics Division

CONSOLIDATED ELECTRODYNAMICS

706 Bostwick Avenue, Bridgeport, Connecticut 06605
A Subsidiary of BELL & HOWELL Company

Got a second?

That's all the time it takes to measure the thermal resistance of any known germanium or silicon package configuration with the new Bendix TR1-A.

Doing away with all time-consuming heat sink and oil/water bath methods, the new Bendix® TR1-A thermal resistance analyzer gives incredibly quick readings of from $\frac{1}{4}$ to 2 seconds, depending on device thermal time constant.

How? Through performance so rapid that case temperature change during measurement becomes negligible, and precise readings depend only on measurement of junction temperature at equilibrium under known power dissipation.

TR1-A gives all its answers at the touch of a button and in crystal-clear fashion, too. An oscillographic display is calibrated directly in thermal resistance or as junction temperature vs. time, depending on the wishes of the operator. This provides a direct readout of thermal time constant (τ_c) on the device under test.

In addition, you can measure thermal resistance before completing device assembly, something never before possible with the old oil/water bath techniques.

How about reliability and ease of operation? TR1-A is practically foolproof. An automatic power gate controls test time to prevent the operator from exceeding pre-set power application time. Solid state and modular construction assure reliable operation. And set-and-forget precision heating power sources rated at 200 watts maximum provide stepless control of both test voltage and current.

Taken together, all these features make the new Bendix TR1-A thermal resistance analyzer the most economical way of getting 100% thermal resistance testing with utmost confidence in the results. About \$4500. For more information write us in Holmdel, New Jersey.

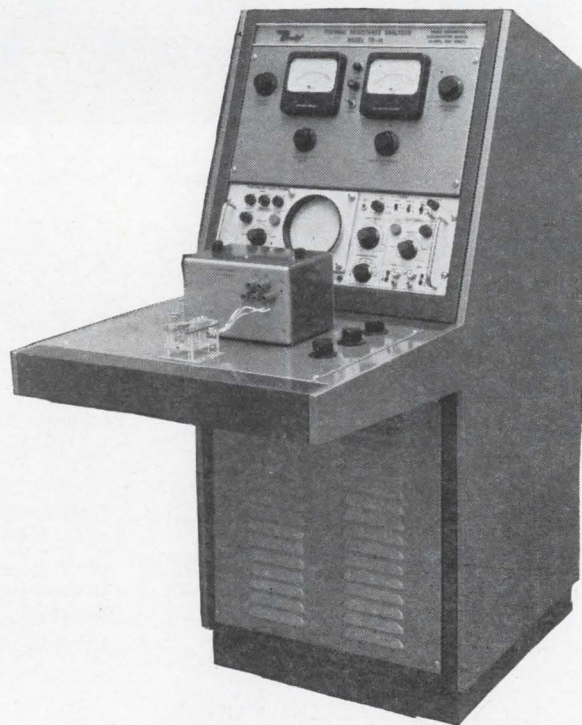

Bendix Semiconductor Division
HOLMDEL, NEW JERSEY



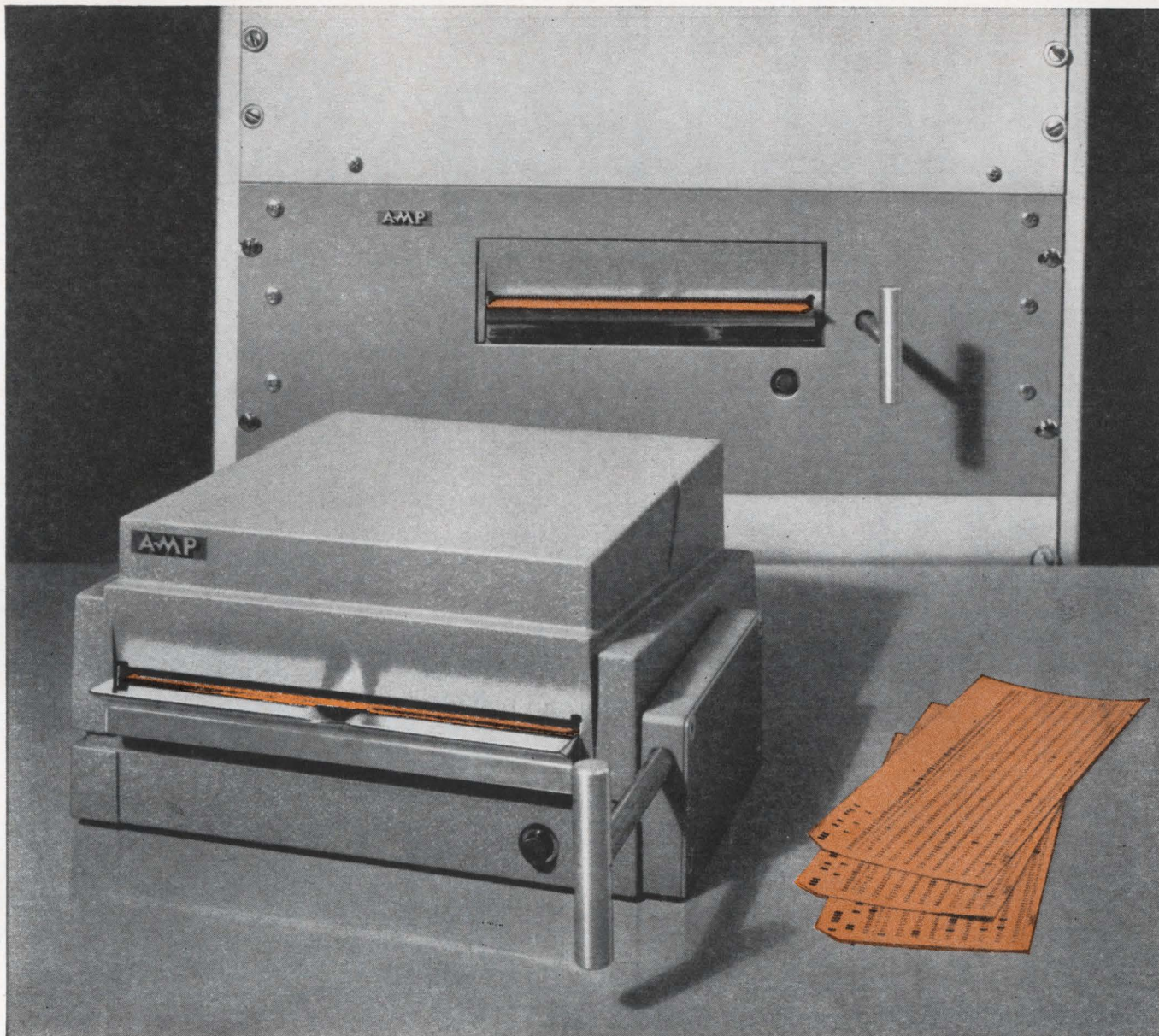

What's in the cards?

The A-MP★ Card Programming System is designed to find out what's in pre-punched tabulating cards. In fact, this system provides the answers to an unlimited number of applications which require that standard tabulating cards be translated into useful information by electrical impulses. Typical among such uses are—automated process control, test and ground support equipment programming, teaching devices, trainers and simulators, data processing, instrumentation, automated machine control, material handling equipment, and a variety of input-output switching functions.

All programming needs are not the same. That's why we designed the utmost flexibility into our card programming systems. Two versions are available, the desk top style for operation remote from the main body of equipment or the rack mount version which fits a standard 19" relay rack. A selection of pre-wired models including: **12 x 80 matrix; 12 x 80 matrix with diode isolation; 80 inputs, 960 outputs;** or because of their design flexibility, the A-MP Card Programming System can be made in many wiring variations within the basic housing.

Regardless of the wiring configuration you may choose, each system has these engineered features.

- Unique double-wiping action—contacts return from point of maximum travel on printed circuit board to pre-cleaned contact areas to assure reliable sensing
- All contacts are gold-over-nickel plated for long life
- Two-way electrical interlocks prevent false output
- Semi-automatic card ejection
- Rugged, compact construction
- AMPILLUME★ Indicator Light signals that the card is in the "read" position
- Unit can be used for data readout
- Pre-wired to customer specifications

Let us help you select the model best suited for your application. Write today for complete information.



A-MP★ products and engineering assistance are available through subsidiary companies in: Australia • Canada • England • France • Holland • Italy • Japan • Mexico • Spain • West Germany

Sampling

TEKTRONIX OSCILLOSCOPES

with 2 mv/cm sensitivity and fractional-nanosecond risetime



Type 561A—Sampling or Conventional Plug-In Units

With sampling plug-in units, the Type 561A becomes a low-drift sampling system that operates like a conventional oscilloscope—but with sensitivity and bandwidth possible only through sampling.

For sharp displays and convenient photography, the crt features a "no-parallax" internal graticule with controllable graticule lighting. Other oscilloscope features include risetime of 0.4 nsec in both channels . . . internal triggering from A and B signals . . . time measurement range down to 100 μ sec . . . calibrated vertical sensitivities from 2 to 200 mv/div . . . sweep delay through 100 nsec.

Also, a monitorable dc-offset voltage simplifies measurement of millivolt signals in the presence of a ± 1 volt dc component; and a smoothing control permits reducing time jitter and amplitude noise, if needed.

Type 561A Oscilloscope (as illustrated) \$2250

Type 567—Analog Displays plus Digital Readout

With digital and sampling plug-in units, the Type 567 shows readout of pulse amplitudes as small as 2 mv peak-to-peak . . . of pulse risetimes as fast as 0.4 nsec . . . of time differences as small as 20 psec up to 100 μ sec. After measurement points on the displayed waveform have been selected once, for all successive similar measurements, digital data of further tests can be read directly. Indicators light to designate readout status—whether *in* the present limit range, *below* it, or *above* it. The digital presentation and indicator lights show immediately if the item tested has met specifications.

Also, the Type 567 can be programmed externally for automatic test systems.

Type 567 Oscilloscope (as illustrated) \$5050

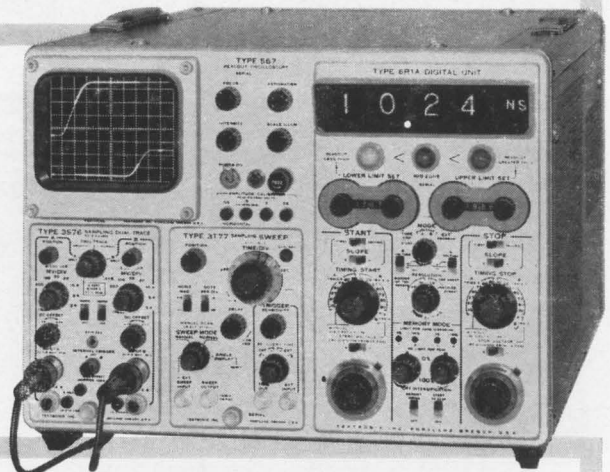

Type 661—Choice of 3 Dual-Trace Units

Most versatile Tektronix sampling system, the Type 661 features a highly adaptable timing unit and choice of 3 dual-trace units:

- 1 Type 4S1—with 0.35-nsec risetime, delay lines and internal triggering,
- 2 Type 4S2—with 0.1-nsec risetime, no delay lines or internal triggering, and
- 3 Type 4S3—with miniature low-noise direct-sampling probes, 0.35-nsec risetime, risetime control, and 100-k, 2-pf input impedance. In addition, each dual-trace unit features 2 mv/cm sensitivity, monitorable dc-offset, signal inversion, smoothing control, and 5 display modes.

Also, the Type 661 can be used with a wide range of Tektronix probes, sampling accessories, test jigs and associated instruments to utilize full capabilities of the compact and complete sampling oscilloscope.

Type 661 Oscilloscope (as illustrated) \$3500

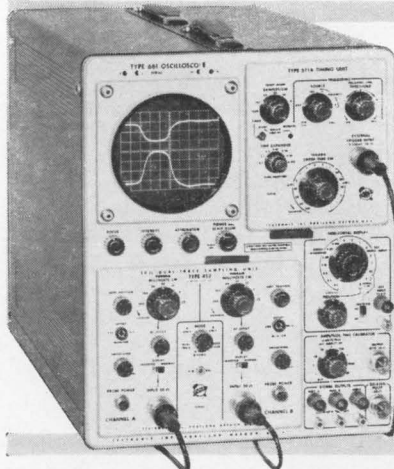

For a demonstration of any of these oscilloscopes in your own sampling application, please call your Tektronix Field Engineer.



SAMPLING NOTES available—an informative 16-page booklet on concepts and systems—by writing to the Advertising Department, P. O. Box 500, Beaverton, Oregon.

Tektronix, Inc.

P.O. BOX 500 • BEAVERTON, OREGON 97005 • Phone: (Area Code 503) 644-0161 • Telex: 036-691
TWX: 503-291-6805 • Cable: TEKTRONIX • OVERSEAS DISTRIBUTORS IN OVER 30 COUNTRIES
TEKTRONIX FIELD OFFICES in principal cities in United States. Consult Telephone Directory

Tektronix Australia Pty., Ltd., Melbourne; Sydney • Tektronix Canada Ltd., Montreal; Toronto

Tektronix International A.G., Zug, Switzerland • Tektronix Ltd., Guernsey, C. I. • Tektronix U. K. Ltd., Harpenden, Herts

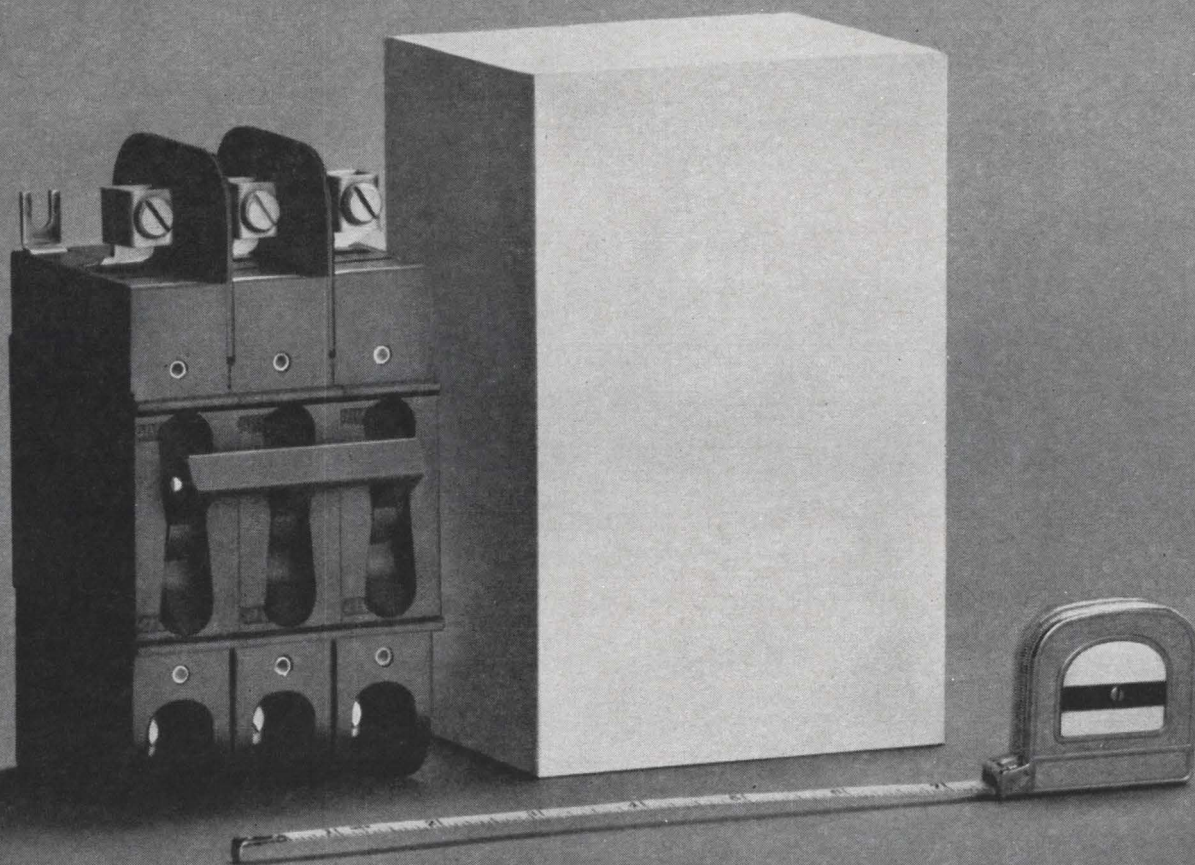

**The smallest E-Frame circuit breaker you can buy
has a Heinemann label.**

The not-so-little white box in the picture approximates the dimensions of typical three-pole E-Frame breakers of other make. As you can see, our three-pole E-Frame would rattle around inside it. Same goes for our one- and two-pole models.

Same goes, for that matter, for price. Every Heinemann E-Frame breaker is actually priced lower than its "bigger" competitors.

Our line covers one-, two-, and three-pole models for service up to 240V AC or

125V DC. Within a 0.01 to 100 amp, 60-cycle AC range, we have fourteen UL listed models. Most are held in stock for fast delivery.

Any E-Frame breaker is also available with the usual Heinemann custom features. A choice of three different time-delay responses. Any of six special-function internal circuits. Current ratings in any integral or fractional value you spec.

And in addition to small size and price,

you get one big advantage. Hydraulic-magnetic actuation. It assures temperature-stable current ratings and tripping points in every Heinemann E-Frame you order.

Our new Bulletin 3104 will give you detailed engineering information and catalog data, as well as some valuable application ideas. Yours for the asking. Write for a copy.

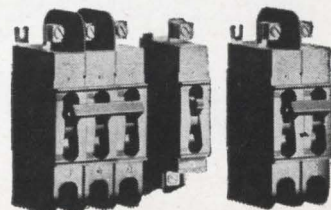

A BAKER'S DOZEN

New Products

FROM

CEI

Reviewing 12 products introduced during the past year—PLUS another new-product-of-the-month from CEI, makers of the nation's most comprehensive line of special purpose RF receiving equipment.

NEW
THIS
MONTH

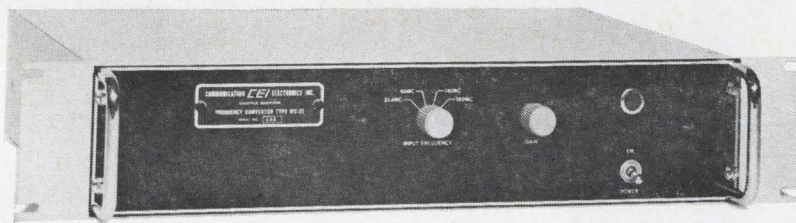

IFC-21 Frequency Converter
4 Switchable Inputs, 21.4 mc Output

CEI's new IFC-21 Frequency Converter accepts input frequencies of 160, 140, and 60 mc and converts to an output of 21.4 mc to permit the use of certain RF tuners with a standard 21.4 mc demodulator, such as the CEI DM-4. A 21.4 input to 21.4 output is also provided. Completely solid state, the IFC-21 draws just 2 watts, is 3½" high. Circle 221, Reader Service Card.

AUXILIARY UNITS



Type FC-600 Frequency Translator—This unit shifts a 21.4 mc IF down to a center frequency of 60, 600 or 750 kc for recording on wideband tape. Features include variable output, linear operation and a limiter to remove AM and noise when recording FM. Circle 222, Reader Service Card.



Type DA-1 Distribution Amplifier—From a single video input, the DA-1 provides 9 separate outputs—7 video and 2 audio. One video output feeds an oscilloscope, the other 6 are identical data signals, each of which will drive a 91 ohm line at 1 volt with extremely low distortion. Circle 223, Reader Service Card.



Type DRO-300 Digital Frequency Counter—Receiver frequencies from 30-300 mc can be read directly with automatic subtraction of the IF frequency. Bright, 6-digit Nixie display provides high resolution readout. Other counters available for use with HF receivers. Circle 224, Reader Service Card.



Types FE 1-2 and FE 2-4 Frequency Extenders—These 2 units (identical in appearance) convert 1-2 gc and 2-4 gc signals to a 160 mc IF, for reception by CEI VHF receivers. They feature tunable YIG preselectors to assure low oscillator radiation and high image rejection. Circle 225, Reader Service Card.

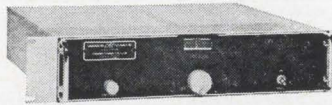

Type FE-103 Frequency Extender—Spanning 10-30 mc in a single band, the FE-103 converts signals to a 60 mc IF output compatible with CEI and other VHF receivers. The 28" dial tape assures precise tuning. Circle 226, Reader Service Card.

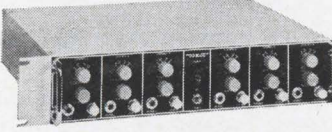

Type VOR-6 Voice Operated Relay—This solid state relay offers 6 independent channels, each actuated by audio signals from 300 cps to 3 kc. Actuating thresholds may be individually adjusted, and input filters prevent operation by noise pulses. Single VOR's also available. Circle 227, Reader Service Card.

RECEIVERS

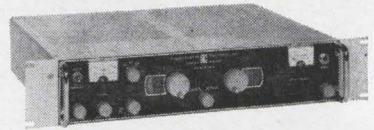

Type 960A VHF Receiver—This high performance VHF surveillance receiver covers 30-300 mc in 2 bands. Features include: 3 modes of operation—AM, FM, and CW; 3 IF bandwidths; BFO; and provisions for common or separate antenna inputs. Circle 228, Reader Service Card.



400 Series VHF Receivers and 4300 Series Signal Monitors—Two ultra-compact solid state receivers and a signal monitor require just 5¼" rack space. AM and FM receivers with 4 preset channels are available in 9 models to cover 60-155 mc. Circle 229, Reader Service Card.



Types 301A VLF and 302 LF Receivers—CEI's new LF-VLF twins receive AM and CW from 3-30 and 30-300 kc, feature manual or AGC (fast or slow), internal BFO's. Transistorized for reliability and low power requirements, they can be stacked as shown in just 7" rack space. Circle 230, Reader Service Card.



Type 965 HF-VHF Receiver—Here's a surveillance receiver especially for signals around 30 mc. It covers 10-90 mc in 2 bands, receiving AM, FM and CW. Features include 3 IF bandwidths, BFO, IF and signal monitor outputs. Circle 231, Reader Service Card.

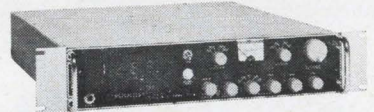

Type 351 ELF-MF Receiver—This unit covers 1 to 600 kc in one band and features 4 IF bandwidths. Modes of operation are AM, SSB, CW, MCW and FSK. A counter is used as a digital frequency readout permitting 10 cycle resolution. Weighs just 20 lbs, is only 3½" high. Circle 232, Reader Service Card.

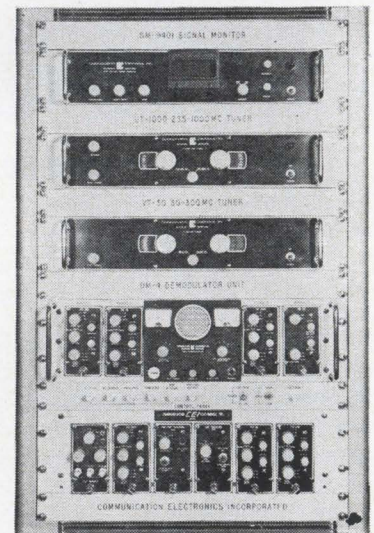

Type RS-125 VHF-UHF Receiving System—A complete system providing AM, FM, CW and Pulse reception in 4 bands from 10-4000 mc, the RS-125 includes VHF and UHF tuners, signal monitor, demodulator and storage panel. Plug-in modules include noise silencer for AM and CW, 6 IF demodulators, and box car and pulse stretching AGC. Circle 233, Reader Service Card.



For further information about these and other CEI products, please write:
COMMUNICATION ELECTRONICS INCORPORATED
6006 Executive Boulevard, Rockville, Maryland 20852 • Phone: (301) 933-2800



all the stability of a



hot molded element in

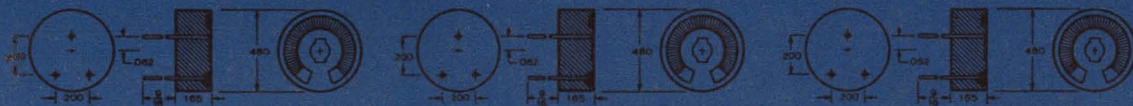

a set-&-forget trimmer

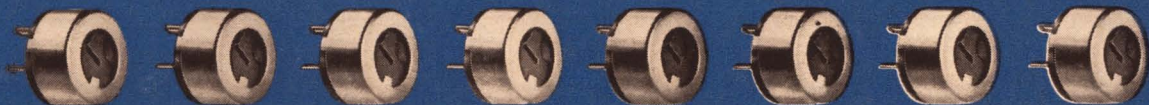

at HALF-the-COST



Clarostat 63 Trimmer

Here's a new hot molded element trimmer with more performance and dependability than you'd ever expect at the price. Electrical specifications of the new Clarostat 63 Trimmer are: .25 watt dissipation rating, at 70°C, working voltage 350 VAC between end terminals. Cost-cutting features include uninsulated

construction with contact arm grounded to case. Terminals are located for 1.1 inch grid configuration. Mechanical and electrical rotation are 295°. The Clarostat 63 Trimmer is available in resistance ranges from up to 100 ohms to up to 1 megohm. Write for prices or further information.



CLAROSTAT

CLAROSTAT MFG. CO., INC., DOVER, NEW HAMPSHIRE, U.S.A.

Specialized RFI Test Equipment

The vast experience of Electro International, Inc. in radio frequency interference control is clearly evident in these high performing, reliable units. Many have solid state circuitry—all have been designed to military and commercial standards. For detailed specifications on instrumentation ready to solve your RFI problems, call collect: Electro International, Inc., (301) 263-2661.

PREAMPLIFIERS

AP-501R — LOW NOISE TUNABLE VHF PREAMPLIFIER

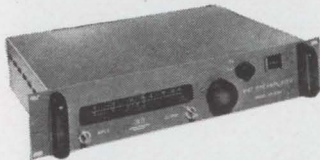

Covering the frequency range from 30 to 300 mc, this preamplifier is designed to satisfy low noise requirements in narrow band applications. Price: \$1500.

Frequency Range 30-300 mc, 2 bands
Gain 23 db (nominal) minimum (± 2 db)

Noise Figure	4.5 db maximum (less than 3.5 db below 250 mc)
Bandwidth (3 db)	Band A, 30-70 mc, 2 mc Band B, 55-300 mc, 4 mc at 55 mc at 300 mc
Input and Output Impedance	50 ohms (nominal)

AP-502R — LOW NOISE TUNABLE UHF PREAMPLIFIER

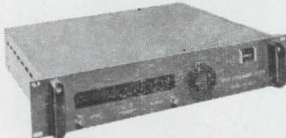

For low noise requirements in narrow band applications, this preamplifier covers the frequency range from 300 to 1000 mc. Price: \$1700.

Frequency Range 300-1000 mc
Bandwidth 3.5 mc at 300 mc
15 mc at 1000 mc

Gain	26 db (nominal) ± 3 db
Noise Figure	4.0 db at 300 mc 8 db at 1000 mc
Input and Output Impedance	50 ohm VSWR $> 1.2:1$

ARP-300S — LOW NOISE REMOTELY TUNED PREAMPLIFIER

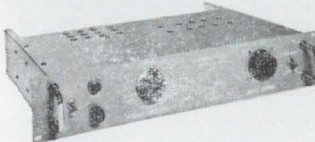

150 KC — 30 MC
Designed to increase the sensitivity of receivers using remote rod antennas and which require a 50 ohm input in the 150 kc — 30 mc range. Price: \$1020.

Tuning Range	150 kc to 30 mc
Input and Output Impedance	50 ohms
Calibrate Input	50 ohms impedance. Accepts narrow band CW generator or impulse generator

AMPLIFIERS

AW-203 & AW-203-1 — WIDEBAND AMPLIFIER GROUP

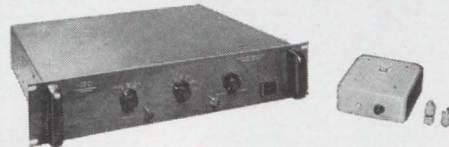

Used in the detection of low level radiated or conducted wideband interference or as a high gain, low noise, video amplifier. Price: \$1455.

Gain	80 db
Gain Control	Continuously variable output control plus compensated input step attenuation of 0, 10, 20, 30, 40 db
Bandpass (3 db)	500 cps to 6 mc or greater with load shunted by 60 pfd or less
Input and Output Impedance (10 kc)	50 ohms
Highpass Filter Cutoff Frequency	Approx. 5 kc and 25 kc
Noise Figure	6 db

AW-204 — TRANSISTORIZED WIDEBAND AMPLIFIER

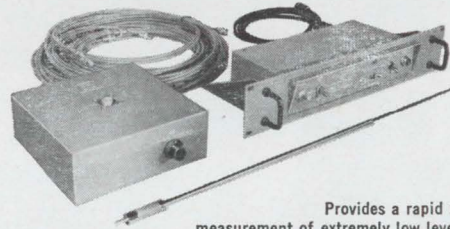

Provides a rapid means for remote measurement of extremely low level radio frequency interference in the 14 kc to 30 mc frequency range. It is used in conjunction with standard RFI meters and a calibrated signal source such as an impulse generator and employs the signal substitution method for calibration. Price: \$750.

Frequency Range	14 kc to 30 mc (2 bands) 14 kc to 2 mc 2 mc to 30 mc
Input and Output Impedance	50 ohms

POWER LINE FILTERS (r-f suppression) 130v, 60 cps

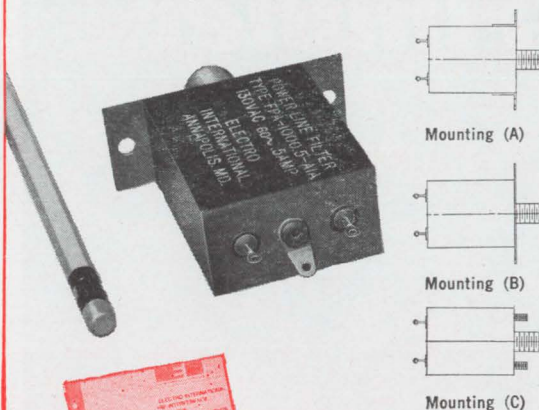

TYPE	CURRENT RATING (Amperes)	INSERTION LOSS			CASE SIZE**			NOTE
		DB	FROM	TO	WIDTH	LENGTH	DEPTH	
FPA-1000.5-A1 (°)	1/2	40	0.150 MC	1 KMC	1 3/4	2 1/4	1	
FPA-1000.5-B1 ()	1/2	60	0.150 MC	1 KMC	1 3/4	2 1/2	1	
FPA-1000.5-C1 ()	1/2	80	0.150 MC	1 KMC	1 3/4	3 1/2	1	
FPA-1000.5-D1 ()	1/2	60	0.100 MC	1 KMC	1 3/4	2 1/4	1 1/2	
FPA-1000.5-E1 ()	1/2	70	0.100 MC	1 KMC	1 3/4	2 1/2	1 1/2	
FPA-1000.5-F1 ()	1/2	100	0.100 MC	1 KMC	1 3/4	3 1/2	1 1/2	
FPA-1001-F1 ()	1	60	0.300 MC	1 KMC	1 3/4	3 1/2	1 1/2	
FPA-1003-G1 ()	3	60	0.300 MC	1 KMC	2 1/4	2 3/4	1 1/2	
FPA-1005-K1 ()	5	60	0.300 MC	1 KMC	3	3 1/2	1 1/2	
FPA-201 ()	1	70	0.150 MC	1 KMC	2 5/16	2 11/32	1 1/8	
FPA-203 (C)	3	60†	0.150 MC	1 KMC	3 1/16	3 9/16	1 9/16	(C) MTG. ONLY
FPA-205 (C)	5	60†	0.150 MC	1 KMC	3 1/16	3 9/16	1 9/16	(C) MTG. ONLY

**Not including mounting brackets, terminals and connectors † 80 db at 0.400 kc to 1 kmc
° () Letter assigned according to method of mounting desired by customer.



COMPLETE LITERATURE with detailed specifications available on request.

RADIO FREQUENCY INTERFERENCE CONTROL AND TEST SERVICES AVAILABLE
Wherever your problem exists, call for quick reaction estimates.

By Electro International, Inc.

ANTENNAS

BTA-901 — BI-TRIANGLE ANTENNA

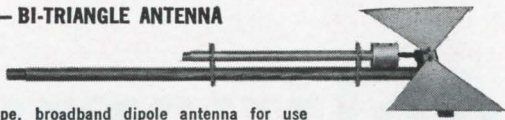

Bow-tie type, broadband dipole antenna for use with receivers operating in the frequency range of 300 to 1000 mc. The antenna is fitted with a broadband balun which permits it to operate efficiently over its frequency range without tuning. **Price: \$125.**

Frequency Range	300-1000 mc
Impedance	50 ohm unbalanced (type N fitting)

BCA-902 — BI-CONICAL ANTENNA

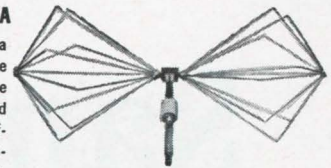

Bi-conical, broadband, dipole antenna for use with receivers operating in the frequency range of 88 to 350 mc. The antenna is fitted with a broadband balun which permits it to operate efficiently over its frequency range without tuning. **Price: \$160.**

Frequency Range	88-350 mc
Impedance	50 ohm unbalanced (type N fitting)

ANCILLARY EQUIPMENTS

ET-1A/SA & ET-1A/E — SUBAUDIO DETECTOR GROUP

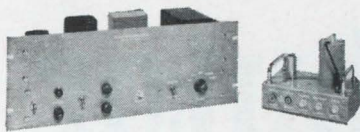

Provides a means of detecting low level electric and magnetic fields in the subaudio frequency range. The instrument is used in two modes—electric and magnetic field input. **Price: \$1630.**

Gain: Electric Field Position	50 db (nominal)
Magnetic Field Position	75 db (nominal)
MDS: Electric Field Position	40 db above 1 uv/meter or less
Magnetic Input Position	Less than 32 db above 1 microampere turns/meter
Bandpass	3-45 cps
Magnetic Input Impedance	Approx. 10 ohms or less

RG-3 — INTERFERENCE RASTER GENERATOR

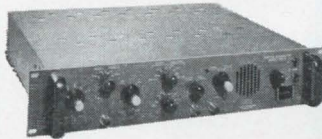

Used as an aid in determining the sources of signals interfering with computers, voice and digital communications and telemetry. **Price: \$1365.**

Video Bandpass (3 db)	5 cps to 5 mc/s
Video Gain	40 db
Input Impedance (1 kc)	100 K ohms
Output Impedance (1 kc)	50 ohms at Z axis output
Gain Control	Continuously variable gain control plus compensated input step attenuator of 0, 10, 20, 30, 40 db
"Z" Output Dynamic Range (1 kc)	30 volts pk-pk or greater
Video Amplifier Modes	Normal or inverted, linear or compressed
Low Pass Filter Cutoff Frequencies	5 mc, 500 kc, 50 kc, 5 kc, 500 cps, 50 cps
High Pass Filter Cutoff Frequencies	5 cps, 50 cps, 500 cps, 5 kc, 50 kc, 500 kc
Pulse Stretcher	Selectable bipolar, 40 microsecond discharge time constant

HF-1 — POWER LINE IMPEDANCE STABILIZATION NETWORK



Specifically designed to present a high impedance to line-conducted r-f interference in the measurement of interference levels present on the power supply line or terminal equipment under test. Reflecting a high impedance (relative to 50 ohm) the HF-1,

when used with any 50 ohm RFI detection system, precludes the possibility of inaccuracies in RFI power line conducted measurements. **Price: \$180.**

Frequency	4 mc - 1 gc	Maximum Current	8 amps
Line Voltage, DC	200 volts max.	Maximum Insertion Loss	- 15 db
Line Voltage, AC (60 cps)	220 volts max.		
Output Impedance	50 ohms (unused output must be terminated with 50 ohms)		

LF-1 — POWER LINE IMPEDANCE STABILIZATION NETWORK

Presents a high impedance to line-conducted r-f interference in the measurement of RFI levels present on the power supply line of terminal equipment under test. Reflecting a high impedance (relative to 50 ohm) the LF-1, when used with any 50 ohm RFI detection system, effectively precludes the possibility of inaccuracies in RFI power line conduction measurements. **Price: \$295.**

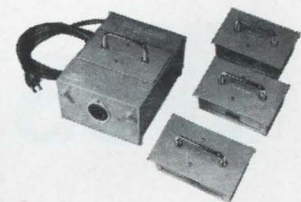

Impedance (into AC output on either BNC)	50 ohms nominal
Line Voltage, DC	200 volts, max.
Line Voltage, AC (60 cps)	220 volts, max.

LK-1 — LOW LEVEL KEYS

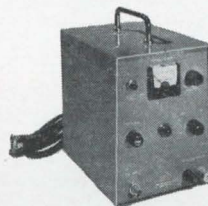

Assists in isolating the sources of radio interference from teleprinters and similar data handling equipments under test. **Price: \$290.**

Voltage Requirements 105-125 vAC, 60 cps, 40 watts

BG-7 — BAUD GENERATOR

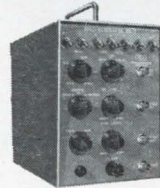

Pulse pattern generator for bench or screen-room testing of communications equipment such as demodulators, data processing equipment, low level teleprinter keys, paper tape punches, etc., at speeds less than 60 wpm to over 100 wpm. Other clock frequencies and ranges are also available. The BG-7 can be used as a DC square wave generator or keyed tone generator. **Price: \$750.**

KEYED DC OUTPUT

Baud Length	Baud length continuously adjustable to cover range of printer speeds from below 60 wpm to above 100 wpm.
Baud Sequence	7 or 8 baud cycle, each baud individually adjustable for mark or space condition. Total of 128 combinations possible. (7 & 8 bauds switched together, i.e., double stop for teleprinter. Double stop optional—switch selected.)
Voltage Level	Variable 0 to + 10 volts, 0 to - 10 volts, and + 10 to - 10 volts.
Output Impedance	600 ohms (nominal)
Keyed Tone Output Frequency	Internal, selectable 1 kc and 10 kc (nominal) External, 5 cps to 80 kc

Prices and data subject to change without notice.



For discussion on complete product line, contact representative in your area or write Electro International, Inc., Box 391, Annapolis, Maryland 21404, TEL 301-263-2661, TWX 301-267-8275

SUBSIDIARY OF ELECTRO INSTRUMENTS, INC., SAN DIEGO, CALIFORNIA

The next time, buy Weston

Same-day delivery from your Weston Distributor

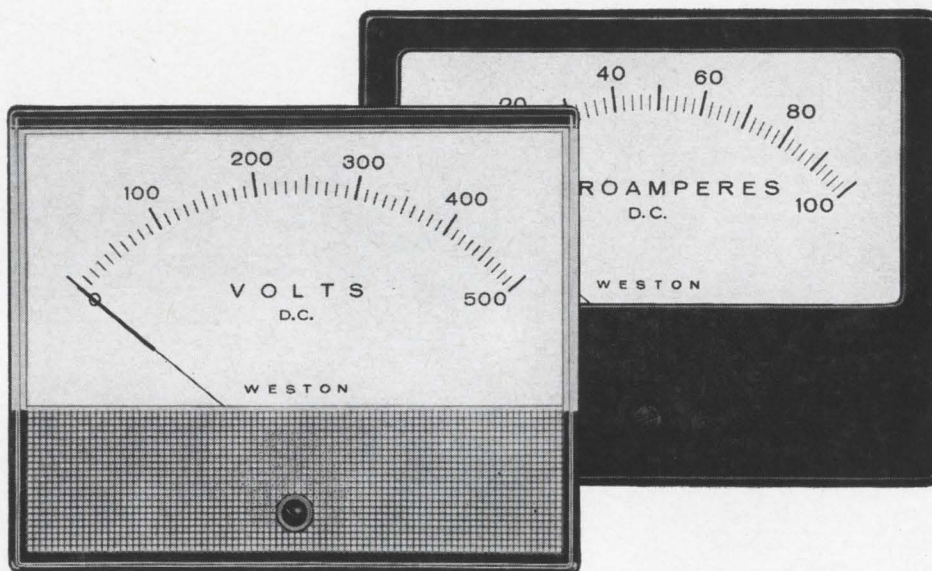

- Available off-the-shelf ■ Competitive prices
- Fastest delivery on custom designs ■ Local service from coast-to-coast

Ask for Weston...

Call your local Weston distributor or Sales-Servicenter today.
And don't forget to ask for your copy of the new Stock Panel Meter Selector.

QUALITY BY DESIGN
 **WESTON INSTRUMENTS, INC.**
614 Frelinghuysen Avenue, Newark, New Jersey 07114

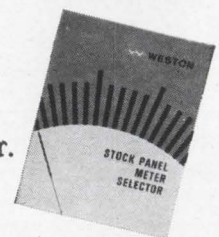

30-gage computer wire for miniaturization of circuits has tough new insulation. The material: KYNAR*—Pennsalt vinylidene fluoride plastic. Even in 5-mil wall thickness, KYNAR affords exceptional mechanical strength and cut-through resistance. Wire insulated with KYNAR is available in long lengths... goes smoothly through automatic wire-wrap machines... cuts and strips cleanly, bends readily, doesn't stretch, stays put when formed.

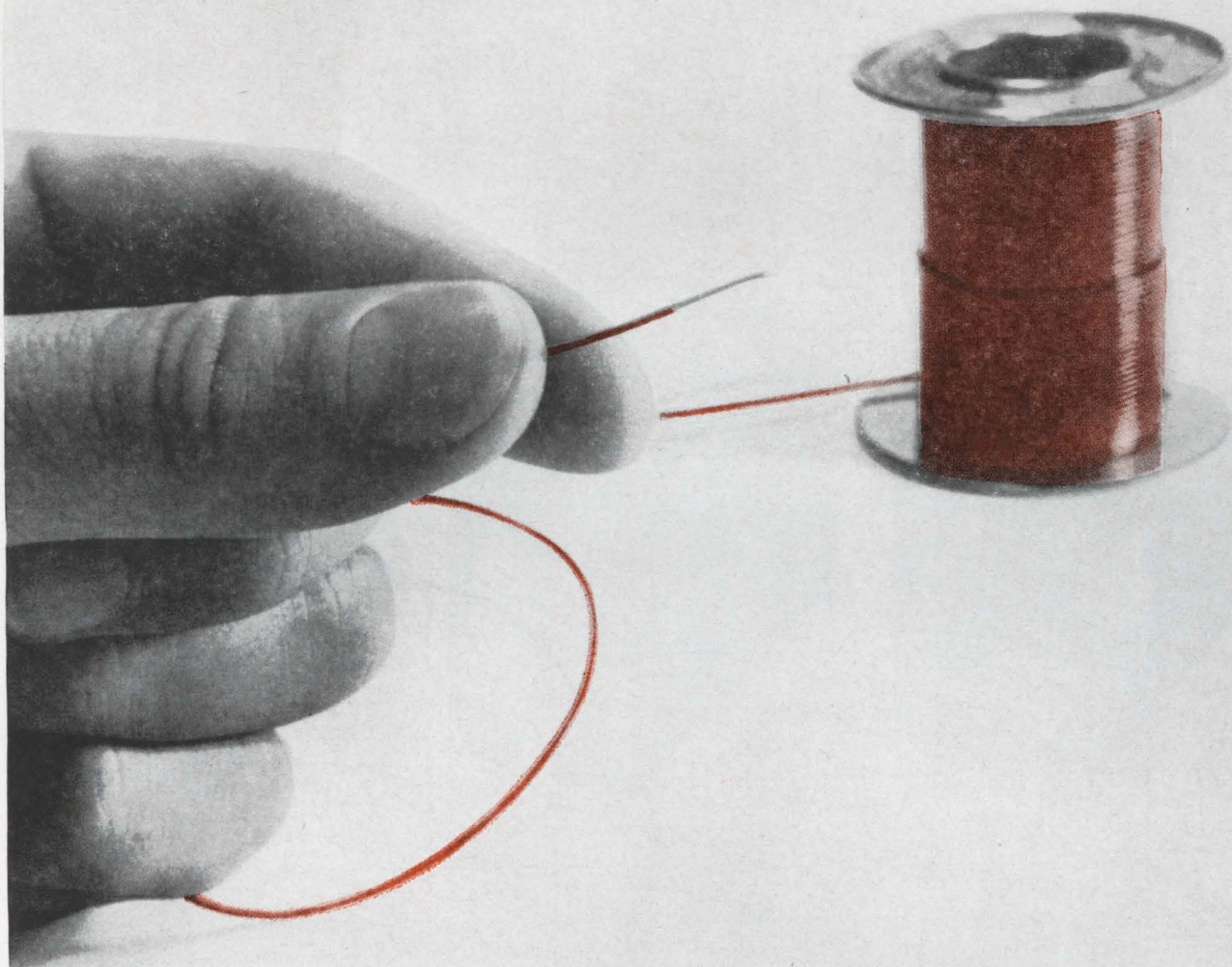

Write for information and the names of leading manufacturers who supply wire insulated with KYNAR. Plastics Department, Pennsalt Chemicals Corporation, 3 Penn Center, Philadelphia, Pa. 19102.

Kynar... a fluoroplastic that's tough!

*KYNAR is a registered trademark of Pennsalt Chemicals Corporation.



17...

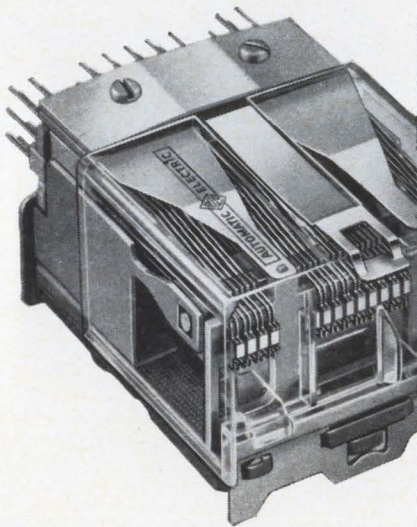

34...

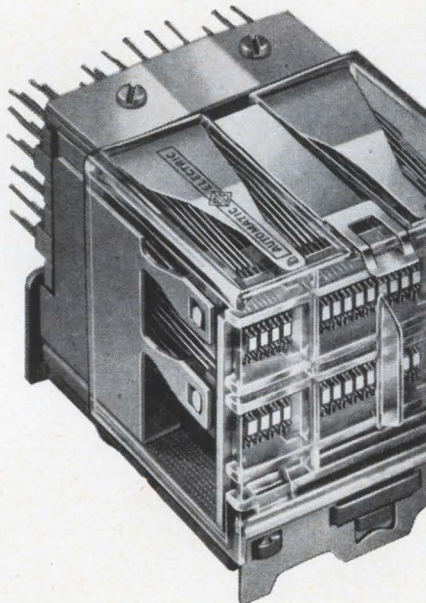

51...shift
or latch!

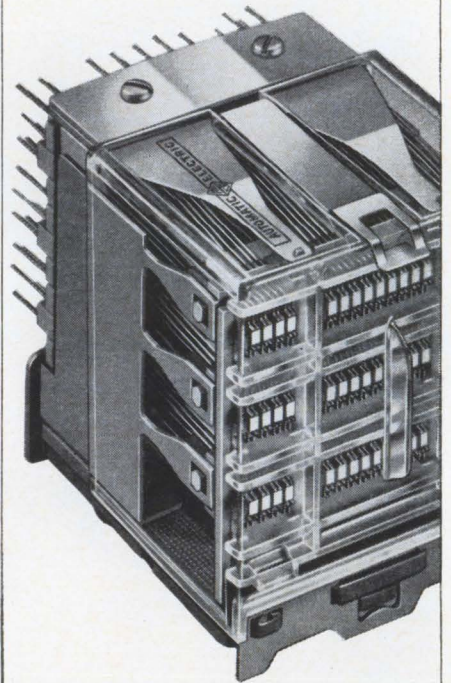

Assuring the simultaneous transfer of circuits in a multiple-relay group is one of the trickier problems faced by electrical and electronic engineers. AE's happy solution is the WQA Relay—the first industrial-control component specifically designed for uniform transfer of up to 51 circuits.

The modular construction of the WQA permits one, two or three rows of contact forms, each with a capacity for 17 circuit transfers. Unique, compact design saves valuable mounting space, replacing 4 or more "general-purpose" relays. Remarkably sensitive, even the largest pile-up requires less than 6 watts input. Continuing tests show a life expectancy of over 800 million operations without readjustment.

If you use latching relays, investigate the new WRM. It has

all WQA features plus a special one of its own. When pulsed on one winding, remanent magnetism keeps the WRM relay latched without power consumption until it is restored by a second pulse to its release winding.

• • •

For full information, ask for Circular 1957. Write the Director, Control Equipment Sales, Automatic Electric, Northlake, Illinois 60164.

AUTOMATIC ELECTRIC
SUBSIDIARY OF
GENERAL TELEPHONE & ELECTRONICS GTE



TRAFFIC JAMS

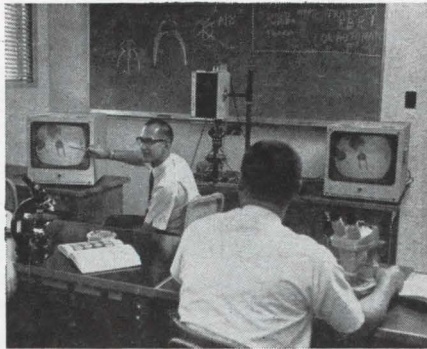

MICROFOSSILS

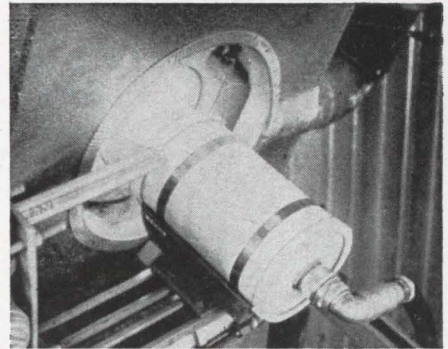

BOILER FLAMES

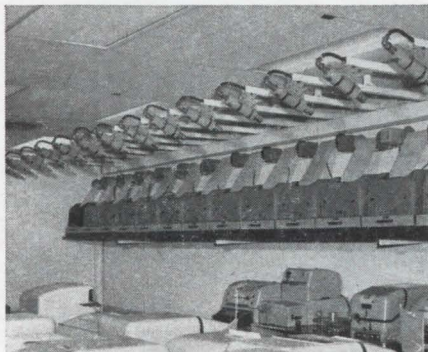

TWX MACHINES

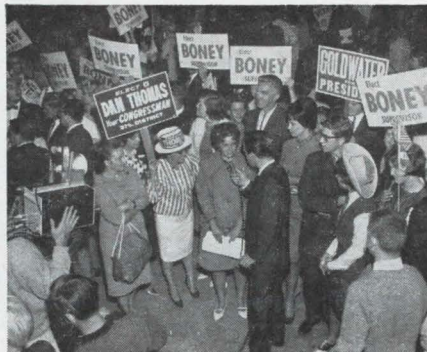

ELECTIONS

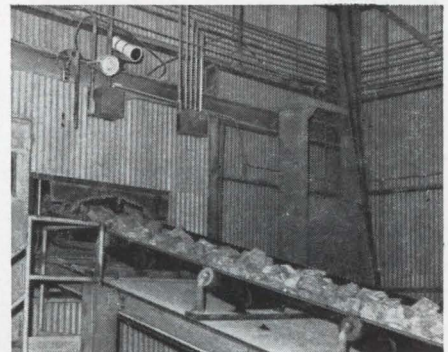

COPPER ORE



HOSPITAL PATIENTS



UNDERWATER



GOLF MATCHES

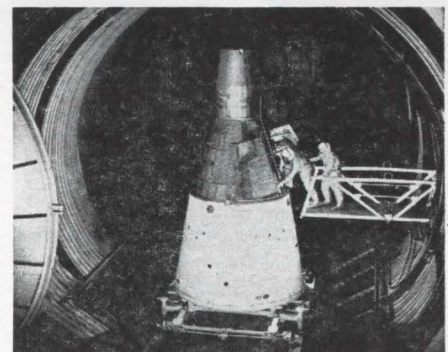

SPACE VEHICLES

COHU TV
sees everything!
 may we look
 for you?

Box 623
 San Diego, California 92112
 Phone 714-277-6700
 TWX 910-335-1244



Engineering Representatives in every major city

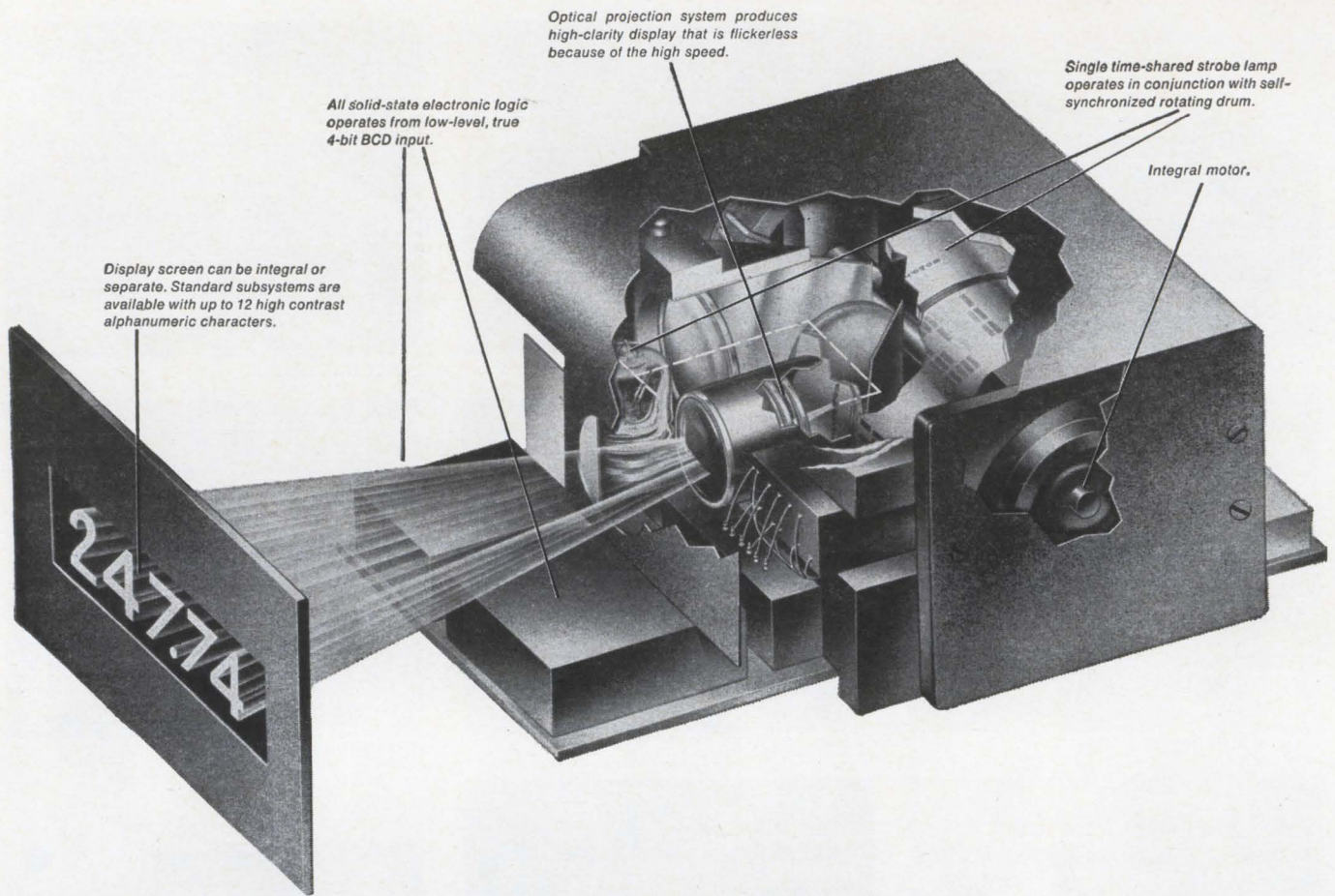

Now you can get more reliable readouts — at very low cost — with Raytheon's New Datastrobe* Digital Display

The Datastrobe subsystem employs a new concept of data display that offers you more reliable readouts and simple, flexible installations — at very low cost.

To produce high clarity displays, the Datastrobe subsystem utilizes (1) a single rotating drum operating in conjunction with a single time-shared high-speed strobe lamp (2) time-shared, self-synchronized all solid-state circuits, and (3) an optical projection to produce multi-digit, in-line and single-plane alphanumeric displays.

Reduced number of components increase reliability. Self-contained Datastrobe subsystem wires directly to logic without buffers or drivers. There are no signal amplifiers, switches or relays. One 6-digit Datastrobe subsystem can replace as many

as 66 incandescent bulbs or 6 electromechanical readouts!

Self-decoding eliminates wrong readouts. A self-decoding feature incorporated into the Datastrobe subsystem uses direct logic comparison to eliminate erroneous or ambiguous readouts. The conventional white-on-black displays are flickerless, provide high contrast and recognition.

Wide range of design options. Datastrobe subsystem display screens can be integral or separate. Standard models are available with up to 12 digits; floating decimal point is optional. Models with more digits and combinations of alphanumeric characters or symbols are available. Additional readout locations are accommodated with simplified wiring.

*Trademark of Raytheon Company

... MORE NEW RAYTHEON DATA DISPLAY DEVICES





New side-view Datavue* Numerical Indicator Tubes (left) feature long life; low unit cost; less mounting depth; close spacing; large, bright character display. (Right) Special cathode-ray tubes, available in many sizes, combine electrostatic and magnetic deflection for writing alphanumeric characters while raster scanning.

SEE THE DATASTROBE SUBSYSTEM
AT SID —
SEPT. 29 - 30, NEW YORK



For complete information of RAYTHEON DATA DISPLAY DEVICES — or for an operating Datastrobe subsystem demonstration — write to Raytheon Company, Components Division, Industrial Components Operation, Lexington, Mass. 02173

New CORNING[®] C Style Resistors give you precision stability, reliability, 1, 2 and 5% tolerances, 100 ppm T.C.



All of which boils down to this. Only one component to specify, buy and stock. One component you can use for general-purpose, semi-precision and precision use alike. One component that satisfies two military specs, as a look at the table quickly reveals. And you still get all the performance advantages of CORNING Glass-Tin-Oxide film resistor construction. Now for your tests. At our expense. Return coupon for samples.

PERFORMANCE CHARACTERISTICS

Characteristics	New CORNING C-Style Resistors			Mil-R-22684B	Mil-R-10509E Characteristic D*
	70°C	70°C	125°C	70°C	70°C
Temperature Rating	70°C	70°C	125°C	70°C	70°C
Wattage C 4 (RL07S) Resistors, 51 ohms to 150K	¼	½	1/10	¼	¼
Wattage C 5 (RL20S) Resistors, 10 ohms to 499K	½	¼	½	½	¼
Load Life Δ R	1.0%	0.5%	0.5%	2%	1%
Design Tolerance Δ R	-2 to +4%	-1 to +2.5%	-1.5 to +3%		
Temperature Coefficient from -55°C to +175°C	±100 ppm			±200 ppm	+200 -500 ppm
Dielectric Withstanding Voltage Δ R	±0.10%			±0.50%	±0.5%
Moisture Resistance Δ R	±0.50%			±1.50%	±1.5%
Short Time Overload Δ R	±0.25%			±0.50%	±0.5%
Temperature Cycling Δ R	±0.25%			±1.00%	±0.5%
Effect of Soldering Δ R	±0.10%			±0.50%	±0.5%
Low Temperature Operation Δ R	±0.50%			±0.50%	±0.5%
Shock Δ R	±0.10%			±0.50%	±0.5%
Vibration Δ R	±0.10%			±0.50%	±0.5%
Terminal Strength Δ R	±0.10%			0.50%	
Voltage Coefficient	±0.001%/Volt				
Shelf Life Δ R	+0.10%/Year				±1.0%

*For Type-marked, military lead Mil-R-10509 E Characteristic D Resistors, specify CORNING NA Style Resistors

CORNING GLASS WORKS, 3913 Electronics Dr., Raleigh, N. C. 27604.
Send complete data, test samples of new CORNING[®] C Style Resistors.

Name _____
Title _____
Company _____
Address _____
City _____ State _____ ZIP _____

CORNING
ELECTRONICS

**Read This Documented Record
of International Rectifier**

Zener Diode

**99.988% DEMONSTRATED
INDUSTRIAL RELIABILITY!**

For seven years, International Rectifier has been a major supplier of Zener Diodes. As such, in-plant reliability programs of the highest order have been the keystones to production programming. The results of these exacting programs can best be demonstrated by this fact: Of the hundreds of thousands of alloyed and diffused junction top-hat and flangeless zener diodes produced during the last two years, the documented rate of return of devices having catastrophically failed during field performance totalled 0.01197 of one percent! This is demonstrated reliability of 99.98803%, ... not a promise of reliability based on statistical calculations, manipulated acceleration factors or assumptions made from sample tests under laboratory conditions. This is practical reliability proved in every conceivable equipment type ... under every condition of field use and application. You can put your confidence in this kind of reliability and the programs that have produced it. Our customers have ... for seven years.

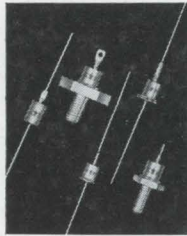

FOR AN "EXTRA-MARGIN" OF PERFORMANCE...

WITH DEMONSTRATED RELIABILITY... BUY IR ZENERS!

IR INTERNATIONAL RECTIFIER

REMEMBER?

In 1962 International Rectifier published this outstanding report on the demonstrated industrial reliability of their Zener diodes.

**NOW IR TOPS THIS UNMATCHED ZENER ACHIEVEMENT
IN QUALITY AND RELIABILITY WITH A
LIFETIME GUARANTEE**

International Rectifier's undisputed leadership in quality Zeners since 1956, coupled with unequalled demonstrated Zener reliability, makes this guarantee possible.

Only IR can offer it, and all IR Zeners are covered: glass, top hat, flangeless and stud mounted from 250 mw to 50 watts, including JEDEC types, house numbered and temperature compensated devices.

For details contact your local International Rectifier sales office or write to 233 Kansas Street, El Segundo, California.

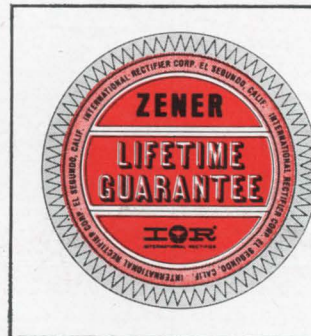

THE IR ZENER DIODE LIFETIME GUARANTEE SEAL

This seal on equipment incorporating IR Zener diodes assures end-users the ultimate in Zener diode performance—optimum performance for life.

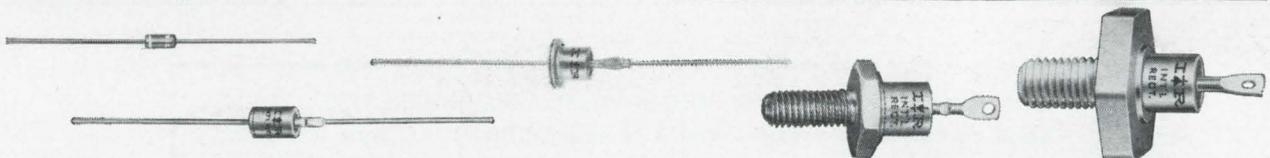

WORLD'S LARGEST RECTIFIER SPECIALISTS

IR INTERNATIONAL RECTIFIER

INTERNATIONAL RECTIFIER CORP., EL SEGUNDO, CALIF., PHONE OR 8-6281 • CABLE RECTUSA • REGIONAL OFFICES IN NEW YORK CITY, CH 4-0748 • FORT LEE, N.J., WI 7-3311 • SYRACUSE, N.Y., HE 7-8495 • CAMBRIDGE, MASS., UN 4-6520 • ARDMORE, PA., MI 9-3666, GR 3-3931 • SILVER SPRING, MD., JU 9-3305 • MIAMI, FLA., 445-5201 • CHICAGO, ILL., OR 6-4090 • CLEVELAND, OHIO, 734-4100 • DAYTON, OHIO, 223-7691 • HUNTINGTON WOODS, MICH., LI 8-1144 • ST. LOUIS, MO., TE 8-6333 • MINNEAPOLIS, MINN., 920-1200 • RICHARDSON, TEX., AD 1-2504 • SAN MATEO, CALIF., 349-2373 • LOS ANGELES, CALIF., 678-2181 • IN CANADA: TORONTO, ONT., 421-5970 • MONTREAL, QUEBEC, 861-0562
EUROPEAN GENERAL SALES OFFICE: 38 AVENUE DES ARTS, BRUSSELS 4, BELGIUM • TELEPHONE: 111774

Washington Newsletter

September 20, 1965

New unit to seek federal criteria for computer use

The National Bureau of Standards will soon create a computer sciences division. **One of the new section's first tasks will be to establish criteria for evaluating computer performance** for the government's annual \$3-billion effort in computer procurement and operations.

Meanwhile, the bureau will try to develop standardized languages to improve computer flexibility, develop test methods for manufacturer-supplied compilers, and explore time-sharing developments.

The bureau, under a mission laid out for it by the Budget Bureau, **will then be responsible for guiding other federal agencies in the best technical practices to follow in automatic data-processing.** Norman J. Ream, director of systems planning for the Lockheed Aircraft Corp., will head the new division.

The Bureau of Standards' role is part of an over-all Budget Bureau plan to improve the efficiency of government computer use. **The General Services Administration is establishing a computer-management arm to provide guidance to agencies in computer sharing, procurement and similar management areas.** Although the Budget Bureau wants the guidance applied to the one-third of the government's computers operated by contractors, Congress is in the process of restricting controls to government-operated equipment.

Foster heads Pentagon research

The naming of John S. Foster as the Pentagon's director of defense research and engineering continues the tradition that this post should be held by a specialist in nuclear physics. Like his predecessors, Harold Brown (who becomes secretary of the Air Force Oct. 1) and Herbert York, Foster moves into the job from the directorship of the University of California's Lawrence Radiation Laboratories.

Now that Foster has been named, the Pentagon can fill the post of **deputy director**, which has been vacant since Eugene Fubini resigned in mid-July. That choice has been delayed so that the new top man could have a part in making it. The new deputy will not have Fubini's additional title of assistant secretary of defense; that title has been given to Alain C. Enthoven, the Pentagon's top cost-effectiveness expert.

Comsat likely to get an Apollo contract

The Communications Satellite Corp. has all but cinched a National Aeronautics and Space Administration contract for real-time data communications during the manned Apollo space program.

NASA wants real-time communications to its spacecraft center in Houston from world-wide tracking stations. Involved are a pair each of primary and backup synchronous satellites for the Atlantic and Pacific Oceans, and four transportable ground stations, all to begin operations within a year.

Comsat's proposal to NASA, while not public, is said to be at bargain-basement prices. Besides wanting the NASA business, **Comsat reportedly sees the step as a way to lead its European partners into establishment of a global satellite communications network;** NASA will require only a fraction of the system's capacity, leaving many channels available for world-wide commercial communications.

Washington Newsletter

2 ASW contracts planned by Navy

The Navy is entering the contract phase for two key elements of its Seahawk antisubmarine-warfare project. Seahawk's aim is a ship designed from the keel up specifically for sub-hunting. This breaks away from the practice of marrying antisubmarine equipment to a standard naval vessel.

The Navy originally planned to plunge directly into a shipbuilding program, but recently decided to develop equipment in four critical areas before proceeding with over-all ship design. The equipment needs include an integrated combat system, a command-and-control system, improved transducer arrays and sonar signal processing and gas-turbine propulsion—all tailored specifically for an ASW ship.

The Bureau of Ships is now seeking contractors to conduct preliminary design studies for the integrated combat system. And the Univac division of the Sperry Rand Corp. is being awarded a \$1.9-million cost-plus-incentive fee contract covering analysis of the command-and-control system, also design and computer programing and associated technical data.

Sperry is favored for ILAAS award

The Navy is recommending to the Defense Department that the Sperry Gyroscope division of the Sperry Rand Corp. receive a contract for development of the integrated light attack avionics system (ILAAS). The system, to be utilized first in the A-7 (formerly VAL) attack plane being built by Ling-Temco-Vought, Inc., is conceptually similar to the integrated helicopter avionics system (IHAS) under development for the Navy by the Teledyne Systems Corp. Both employ a computer central complex, linking all avionics functions and organized so that the system can continue operating even if portions of it are damaged by enemy fire.

The AC Spark Plug division of the General Motors Corp. and Autonetics division of North American Aviation, Inc., competed against Sperry in the contract-definition phase.

Meanwhile, the Air Force has begun evaluating precontract-definition-phase studies submitted by five contractors for the Mark II integrated avionics system to be incorporated in the F-111 fighter plane, beginning with the 200th production plane.

Contractors in the running are the General Dynamics Corp., Sperry Gyroscope; Autonetics, and the Westinghouse Electric Corp.

Technical service centers approved

Congress has voted to establish state technical service centers to provide industry with the latest scientific information. But indications are that the centers—one in each state except where a few states combine a regional center—face some delicate problems, especially where consulting firms are concerned.

The centers will have to show that they are not competing with commercial consulting engineers. They will also have to avoid forming close relationships with engineers to whom they make referrals.

It was with these problems in mind that the House cut authorization for the program from five years to three, and appropriation from \$100 million to \$60 million in federal matching funds, before approving the Senate program. The House wants the program's administrators in the Commerce Department to have to come in for a full congressional review of the program at the end of three years, before any bad habits become too deeply ingrained.

You can cool with air...

(if you have a lot of space)

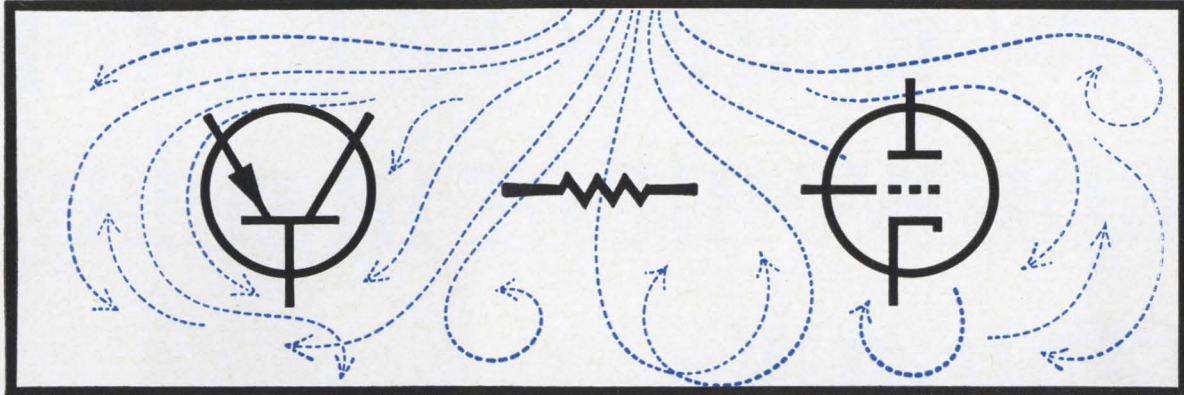

or

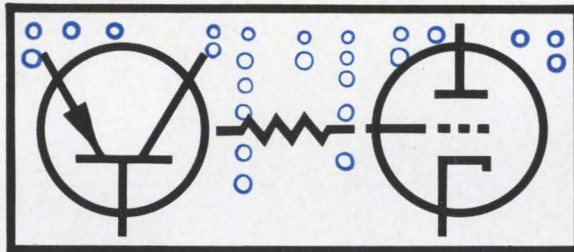

use FREON® dielectric coolants

(if you don't)

FREON carries heat away hundreds of times better than air. Close-packed assemblies can operate efficiently at safe temperatures. FREON compounds have outstanding characteristics as heat transfer media either by boiling or by convection.

These inert coolants will work for you in your high-density electronic equipment—wherever you have a reliability problem from “hot spots” in power tubes, transistors, resistors, transformers, packaged electronics, etc. FREON coolants can make your design more compact—at low to moderate cost, while improving reliability through close thermal control.

These five FREON dielectric coolants range in boiling point from +38.8°F. to +237.0°F., offering a wide range of use:

FREON-114	CClF ₂ CClF ₂	B.P. + 38.8°F.
FREON-113	CCl ₂ FCClF ₂	B.P. +117.6°F.
FREON-215	CCl ₂ CF ₂ CF ₂	B.P. +165.0°F.
FREON-112	CCl ₂ FCClF	B.P. +199.0°F.
FREON-214	CCl ₂ CF ₂ CF ₂ Cl	B.P. +237.0°F.

Send the coupon for complete technical information based on our 33 years' experience with cooling problems.

DU PONT **FREON**[®]
dielectric coolants
REG. U.S. PAT. OFF.
Better Things for Better Living . . . through Chemistry

Du Pont Company
Room 2983A
Wilmington, Delaware 19898

Please send me complete technical information on FREON dielectric coolants.

Name _____

Address _____

City _____

State _____ Zip _____

Offer good in U.S.A. only.

How to make a tenfold improvement in relay accuracy.

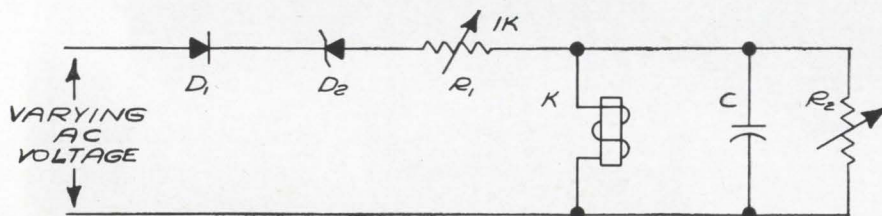

This circuit can reduce the differential of a sensitive relay by a factor of 10, and improve tenfold the accuracy of pick-up voltage and drop-out voltage. It is thus well adapted to sensing small variations in voltage, either AC or DC.

As shown, a varying AC voltage is rectified by diode D_1 . The zener diode D_2 passes current only when the voltage exceeds its zener conduction voltage. The zener voltage is selected to be a little lower than the desired circuit voltage at which the relay K must operate.

The relay senses only the difference between the input voltage and the zener voltage. It is chosen to pick-up at about one tenth the line

voltage at which pick-up must occur. A variation of 1% in the line then appears as a 10% variation in the voltage sensed by the relay. R_1 and R_2 can be used to trim the pick-up voltage.

The Sigma Series 5 relay is ideally suited for this class of service due to its large coil overload to sensitivity ratio. It can, therefore, withstand much more excess voltage than a less sensitive relay. Its sensitivity also minimizes the power drawn by the circuit and the sizes of the circuit components.

If you have a relay idea, or can improve this one, we'd like to hear from you. Your idea could be the next one we publish.

Sigma relay of the month

Compact polarized SPDT relay with microwatt sensitivity repeats 500 pps.

The Sigma Series 72 SPDT relay is one of the most popular switching devices in the broad Sigma line. It is being used in equipment ranging from data processing systems and servo controls to differential controls and telemetering equipments. It is particularly useful in modern telegraphy applications.

A main reason for its wide use is its sensitive yet precise, distortion-free response. This is made possible by its unique design. With a very small armature mass and a very high resonant frequency, contact transfer time is at a minimum and contact bounce is virtually eliminated.

There are more benefits from the exclusive design and construction features of the Series 72:
Polar switching—safely switches plus or minus 120 volts.

Versatile mounting—unaffected by gravity, adjacent relays or socket orientation.

Long life—rated at 500 million operations.

High sensitivity—to 160 microwatts.

Easy contact replacement—doubles life expectancy.

Small size— $1\frac{1}{8}$ " in diameter, $2\frac{5}{8}$ " high.

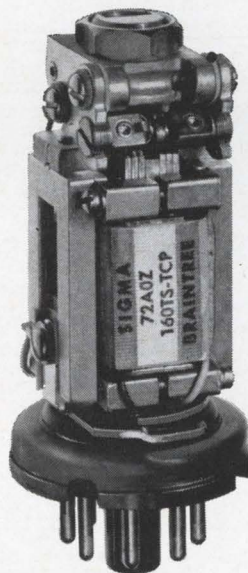

The Series 72 operates for many hundreds of millions of cycles in applications involving high speed switching, telegraphy, or pulse repetition.

You are invited to try out all the advantages of the Sigma Series 72 for yourself—free of charge. Just send for the Sigma Series 72 bulletin and a free relay redemption certificate.

SIGMA DIVISION  SIGMA INSTRUMENTS INC
Assured Reliability With Advanced Design / Braintree, Mass. 02185

PCM GROUND CHECK-OUT EQUIPMENT

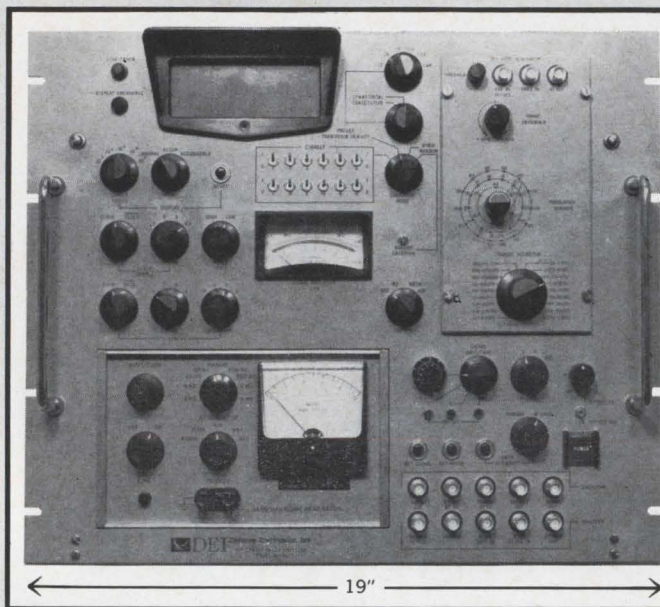

new
**BIT SYNCHRONIZER
 ANALYZER**

19 1/4" *Self-Contained—No External Test
 Equipment Required*
Special Analytic PCM Test Simulator
**Wide Range of Bit Rates: 1.2 bps to
 1.2 mb**
**Measures and Displays Bit Error Rate
 and Sync Acquisition Time**
**Built-In Gaussian Noise Source, S/N
 Ratio: -10 db to +20 db**

DEI's model BA-101 Bit Synchronizer Analyzer provides a means of evaluating operation of a PCM Bit Synchronizer (Signal Conditioner) for pre-flight confidence checks, electrical interference detection, or other analytical purposes. Design of the analyzer is such that a synchronizer may be tested for performance using accepted test conditions or using conditions which normally prevail in actual operation. This device will allow convenient measurement of the following performance characteristics: (1) Minimum signal/noise at which synchronization is acquired, (2) Sync acquisition time, (3) Minimum signal/noise at which sync is maintained, (4) Transition density to acquire and maintain sync, (5) Data error rate. A decimal counter display plus overrange indicator serve as visual output. Printer outputs for an external recorder are optional. The Bit Synchronizer Analyzer contains output terminals to monitor the results. For further information write for DEI product bulletin BA-101.

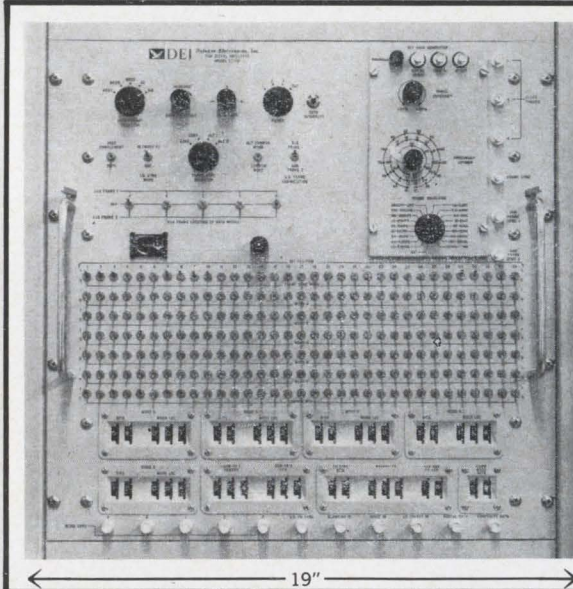

new
PCM SIGNAL SIMULATOR

19 1/4" *7 Independently Variable Word Lengths*
**Wide Range of Bit Rates: 1.2 bps to
 1.2 mb**
Complementary Sync Patterns Selectable
Complete Error Simulation Capabilities
Pre-Transmission Filter Simulation
Alternate Complement Common Word

DEI's model DS-101 is a general purpose PCM Simulator designed to generate PCM formats currently in use as well as formats developed for the future by means of simple front panel programming. Formats such as the Gemini, Titan, Saturn, and general purpose wave trains are easily generated and controlled. Up to seven words can be generated with independently variable format and word lengths within the same data train. Sub commutation synchronization of both the recycling code and the counting address (1D) types is provided. Low Z output of variable amplitude and DC offset are standard. Amplitude adjustable to ± 10 volts zero centered (20 v p-p maximum) across 50 ohms. For further information write for DEI product bulletin DS-101.

Defense Electronics, Inc.
 Rockville, Maryland



DEI
 RESEARCH
 DEVELOPMENT
 MANUFACTURING

ROCKVILLE, MD. (301) 762-5700, TWX: 302-427-4660; SHERMAN OAKS, CALIF. (213) 872-2870, TWX: 213-783-2742; COCOA, FLA. (305) 632-5400; TWX: 305-632-5442; HUNTSVILLE, ALA. (205) 881-5139; WILLOW GROVE, PA. (215) 659-5051; DALLAS, TEXAS (214) EM 3-7263; INT'L, ROCKVILLE, MD.; CABLE: DEIUSA; EXPORT (212) Circle 6-2133, TELEX: TRIL 224326, N.Y., N.Y.; OTTAWA, ONT. EMISCO Ltd. (613) Central 6-0811, Cable: EMISCO

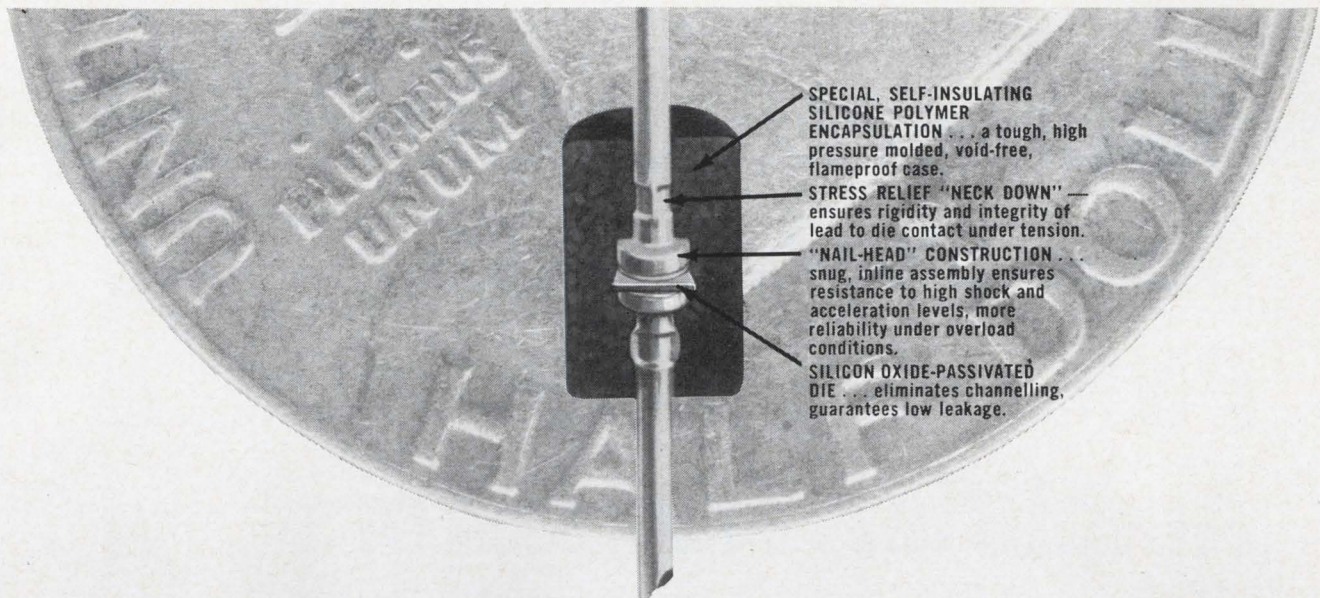

FOR THOSE APPLICATIONS YOU NEVER BEFORE CONSIDERED ECONOMICAL... Motorola's New Low-Cost Surmetic* Zener!

If you've found it difficult to justify investing several dollars in a zener diode to protect a transistor or other circuit component which cost no more or even less, you'll appreciate the advantage in value you get with Motorola's new 1N4728-64 zener diode series.

At price levels that dip substantially below \$1.00, these devices now make it possible for you to afford dependable zener diode voltage regulation for *virtually all* your applications! They're available in voltages from 3.3 to 100-volts in standard 5% and 10% tolerances.

A subminiature power package . . .

And talk about power-handling capability in a space-saving design — this new zener diode has a full 1-watt rating at 50°C ambient (up to 3-watts with adequate heat sinking) in a package no bigger than a standard glass device.

Meaningful measurements . . .

In addition to being 100% oscilloscope-tested before and after assembly (a standard practice with Mil devices) these zeners are characterized at four critical points to give you truly meaningful specifications and a sharp, clearly defined zener knee:

1. Leakage specified at 80% of voltage
2. Impedance measured at the ¼ power operating point
3. Impedance measured at the knee
4. Nominal zener voltage point

And speaking of the military . . .

The thermal-compression molded, silicon polymer case has a proven history from its use with the popular

Surmetic rectifier. This device has passed all standard Mil tests as well as special 20,000 g acceleration, 1,500 g shock, 175°C continuous power operation and high temperature lead-pull tests.

Find out today . . .

why you should specify this new breakthrough in zener value for your circuits — contact your Motorola distributor for complete data and prices or write Motorola Semiconductors, Dept. 63, Box 955, Phoenix, Arizona 85001.

*Trademark Motorola Inc.

A quick, convenient new reference . . .

Is now available for the busy engineer or purchasing agent who wants a handy guide to the most popular of more than 4,000 different Motorola zener diodes and OTC reference devices. Completely updated . . . printed in large, easy-to-read type in functional chart form . . . folds out for convenient desk or wall use. Send for yours now!

To: Motorola Semiconductor Products, Inc.
Dept. 63, Box 955
Phoenix, Arizona 85001

PLEASE SEND ME YOUR NEW, REVISED
ZENER DIODE SELECTION GUIDE

(print clearly)

Name _____ Title _____

Function _____ Dept. _____

Company _____ Phone _____

Address _____

City _____ State _____ Zip _____

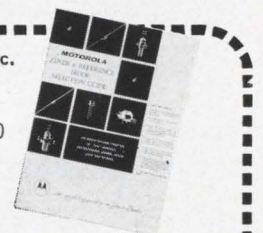

MOTOROLA
Semiconductor
Products Inc.

ONLY SPERRY Makes ALL of these PNP – NPN Differential Amplifier Transistors

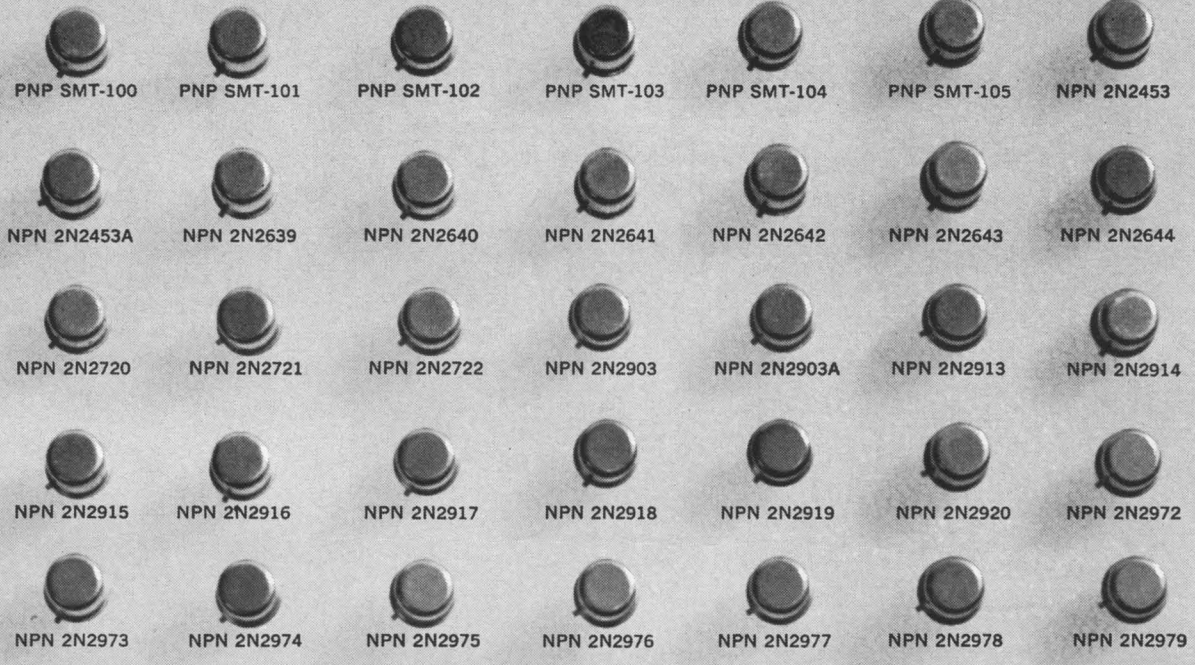
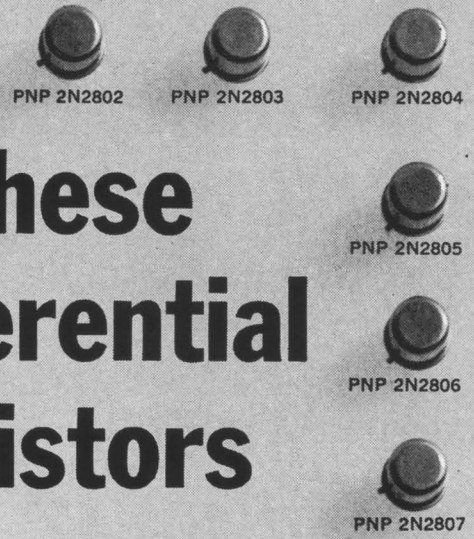

AND IN
ANY OF THESE
FOUR
PACKAGES TOO!

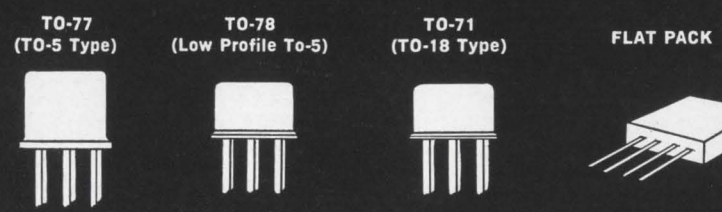

ONE HUNDRED SIXTY-FOUR COMBINATIONS NOW AVAILABLE.
Chances are which ever differential amplifier transistor you need, you can get it from Sperry and in the package you want. Get complete information today— Contact SPERRY— SPERRY SEMICONDUCTOR, Norwalk, Connecticut 06852.



Sperry Europe Continental, 7 Avenue de l'Opera, Paris 1, France

**CONTINUOUS
PULSES
OR
PULSE
BURSTS**

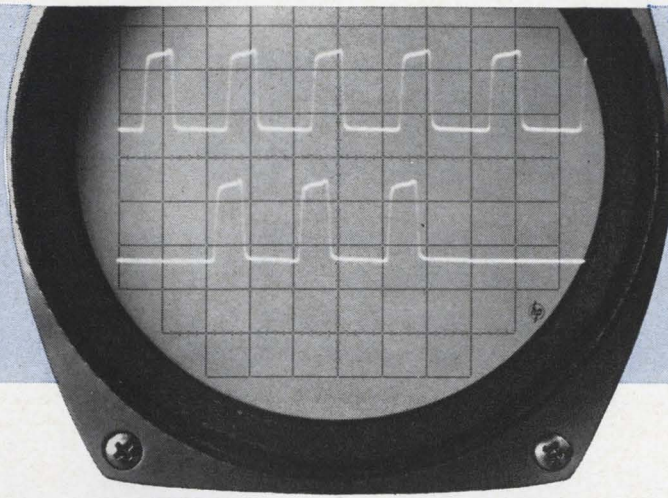

**AT
REP RATES
TO
100
MC**

New hp 216A Pulse Generator

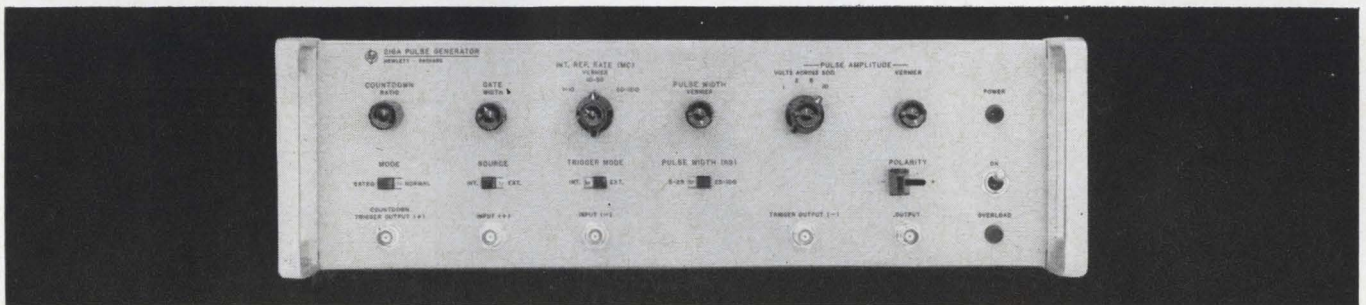

2.5 nsec rise time at 10 v output

Continuously variable pulse amplitudes

DC coupled output to eliminate baseline shift

50-ohm source impedance to eliminate error-producing reflections

Two trigger outputs

A unique combination of clean pulse shape for accurate measurements and rep rates from 1 to 100 mc for fast-circuit testing is yours with the new 216A. In addition to continuous trains of pulses, the 216A provides pulse bursts, 20 to 750 nsec in width, generated internally in sync with individual pulses within the burst.

The 216A also may be triggered externally from 0 to 100 mc for synchronization with other equipment. Trigger signals are available from the front panel at the output pulse rep rate, 130 nsec in advance of the pulse, or counted down, synchronized with the pulse rep rate and also with the burst envelope to allow viewing of burst responses on a sampling oscilloscope.

The 216A provides 10 v pulses into 50 Ω which is ample to switch almost all semiconductor devices. Pulse amplitude is continuously variable to enable you to accurately set the amplitude to match a particular test requirement. Furthermore, the 216A has a 50 Ω source impedance to eliminate error-causing re-reflections when driving non-50 Ω loads. The quality of the pulse is shown in the photo and in the specs. It is carefully controlled and specified to insure accurate, dependable measurements.

Ask your hp field engineer for a demonstration of the 216A. Or write for information to Hewlett-Packard, Palo Alto, Calif. 94304, Tel. (415) 326-7000; Europe: 54 Route des Acacias, Geneva; Canada: 8270 Mayrand St., Montreal.

BRIEF SPECIFICATIONS

Source impedance:	50 ohms \pm 3%, approx. 10 pf shunt (measured at 10 v output into 50-ohm-load)
Pulse shape:	Rise time: <2.5 nsec
	Overshoot and ringing: overshoot <4% peak, ringing <4% of pulse amplitude
Corner rounding:	occurs no sooner than 96% of pulse amplitude
Time to achieve flat top:	approx. 20 nsec
Preshoot:	<2% on leading edge; <5% on trailing edge
Perturbations on flat top:	3% of pulse amplitude
Pulse voltage:	positive or negative, 1, 2, 5-step attenuator, with vernier, provides continuous adjustment from 0.4 to 10 v (into 50 ohms)
Pulse width:	continuously adjustable, 2 ranges, 5-25 nsec and 25-100 nsec; width jitter <100 psec \pm 0.05% of pulse width
Max. duty cycle:	>45% to 50 mc, decreasing to approx. 20% at 100 mc
Price:	\$1775

Carefully controlled pulse shape insures accurate measurements; 10 v pulse; sweep speed: 10 nsec/cm.

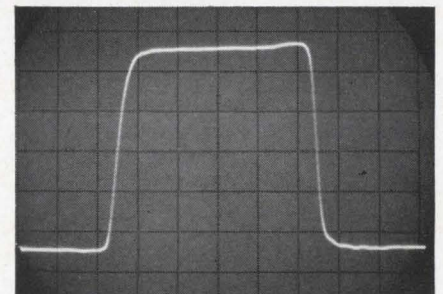

Data subject to change without notice. Prices f.o.b. factory.

HEWLETT  PACKARD
An extra measure of quality

When it comes to miniature cage jacks...

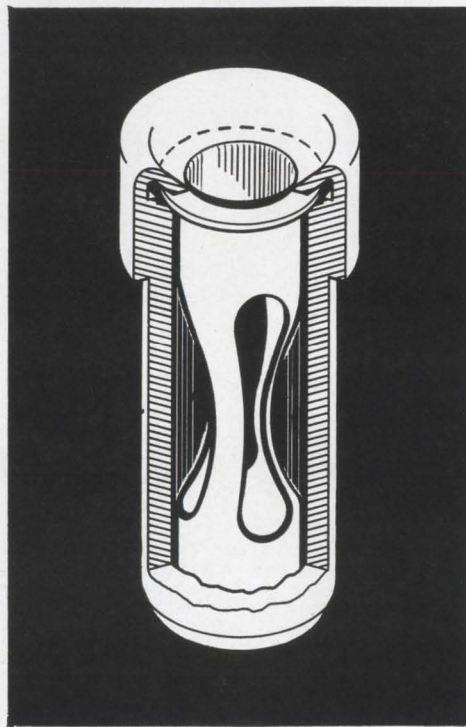

3230
Actual
Size

CAMBION[®] engineers go all out to prove a point

Reliability.

Our engineers test CAMBION miniature Cage Jacks to determine total life performance. These test histories show contact resistance of CAMBION 3230/3231 Plug and Jack Assemblies used for patch board connectors averaging only 1.90 milliohms after 65,000 test insertion and extraction cycles. This proven performance means a far greater, more useful life for these components.

To give you extra dependability, the spring cage on every CAMBION miniature Cage Jack is made with a special compound (hyperboloid) curvature. Each of the three gripper leaves curves inwardly to apply full pressure contact on 60% of the plug circumference as compared to 5 to 10% in ordinary connectors. Closed entry design insures protection of vital internal caged portion of the jack.

CAMBION'S complete line of dependable, miniature Cage Jacks is available in

.025", .040" and .080" sizes. Suitable for a variety of applications from do-it-yourself socket boards, board-to-board connectors and test points, to plug and jack solutions. CAMBION Cage Jacks are invaluable in laboratory and environmental applications, and work best where solder connections are impractical.

For special assistance in solving difficult circuit or component connection problems, there is a qualified CAMBION application engineer ready to work with you. Take advantage of this CAMBION ability. See for yourself how the tested and proven reliability of CAMBION miniature Cage Jacks can help you to solve many circuit design problems.

Component Density Possible With Cambion Cage Jacks:

- .025" Dia. on .150 Grid — 44/sq. in.
- .040" Dia. on .150 Grid — 44/sq. in.
- .080" Dia. on .200 Grid — 25/sq. in.

Standard Electrical Ratings (based on a max. voltage drop of 3 millivolts):

- .025" Dia. 0.5 amps
- .040" Dia. 2.0 amps
- .080" Dia. 8.0 amps

For on-the-spot delivery of cage type jacks or any one of CAMBION'S 15,000 guaranteed electronic components, contact your authorized CAMBION stocking distributor. For detailed product information or to find out the name of your local CAMBION representative, call (617) 876-2800, or write to Cambridge Thermionic Corporation, 401 Concord Avenue, Cambridge, Massachusetts 02138.

CAMBION[®]

DIAL-A-PART SERVICE

Standardize on CAMBION... the guaranteed electronic components

"ACTIVE"...

ERIE Definition of Advanced Component Capability



SUBMINIATURE MONOBLOC CERAMIC CAPACITORS

High capacitance to volume ratio. Hermetically sealed in glass; precision molded; and phenolic dipped types.



MINIATURE HERMETICALLY SEALED BUTTON MICA CAPACITORS

For -55°C. to $+200^{\circ}\text{C.}$ applications.



SUBMINIATURE BROAD BAND R. F. I. FILTERS

Eliminate RF noise in 10 KC to 10 KMC frequency range.



HIGH RELIABILITY TUBULAR and DISC CERAMIC CAPACITORS

General Purpose; Temperature Compensating; and High Stability types.



MINIATURE CERAMIC and GLASS TRIMMERS

Precision trimmers with capacitance and terminal arrangements to suit need.



MINIATURE FILM CAPACITORS

Designed for filter, bypass, coupling and blocking applications.



SUBMINIATURE DIFFUSED SILICON RECTIFIERS

High forward conductance, low-leakage currents and reliable performance.



MINIATURE BYPASS CAPACITOR SYSTEMS FOR TRANSMITTING TUBES

Effective capacitive bypassing and coupling or filtering of all signals in 10 to 3000 megacycle range and beyond.

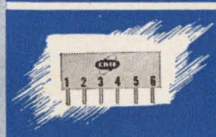

SUBMINIATURE INTEGRATED NETWORKS

Compact modules of resistor-capacitor networks with 2, 4, 6 or 8 leads . . . with or without semiconductor elements.

THE term "ACTIVE" in the Erie organization identifies a total program encompassing the research, development and production of Advanced Components Through Increased Volumetric Efficiency for aerospace, military and commercial equipment.

Project "ACTIVE" now brings to electronics and avionics a series of high performance, subminiature components designed for applications where every cubic inch of space and every ounce of weight is critical to successful equipment performance.

These Erie components have been and are being designed into the circuitry of such demanding systems as Gemini, Apollo, Minuteman, Nike X, Telstar, Polaris . . . commercial computers, oscilloscopes . . . and many other applications where size, weight and dependable performance are vital. While the advanced products illustrated at left are in quantity production, a number of components are still in the concept stage, while others are at final evaluation ready for production.

Consider the problem-solving advantages Erie ACTIVE components can offer you in your quest for reliable, subminiature components. We suggest ERIE as your quality source. A collect call or letter to your nearby representative . . . or to Erie headquarters is all that is needed as the "first step."

ERIE

TECHNOLOGICAL

PRODUCTS, INC.



Formerly
Erie Resistor
Corporation

644 West 12th Street
Erie, Pennsylvania

Erie's Project "ACTIVE"
Advanced Components through Increased Volumetric Efficiency

An open letter to users of 7 mm Precision Connectors:

Gentlemen:

If you have read some of the sales literature on precision connectors which extend coaxial techniques up to 18 GHz, you must be thoroughly confused by this time. Worse, you may have ordered connectors some time ago... and have yet to receive delivery.

This letter may serve to clarify matters.

The IEEE Sub-Committee on Precision Connectors has endeavored to standardize on a minimum number of sizes for precision connectors. Two sizes, 14 and 7 mm, have been selected.

From the early beginnings of this IEEE Committee, members of the engineering staff of Rohde & Schwarz participated as members of the Committee.

Standards Virtually Identical to Precifix

This is not surprising in view of the contribution which Rohde & Schwarz has made in the field of connectors. As a matter of fact, when the Committee was originally set up about five years ago, it established connector design principles which were virtually identical with those upon which the Rohde & Schwarz Dezifix and Precifix connectors were based. (Dr. Lothar Rohde had laid down these principles for sexless connectors about 20 years ago and developed these connectors as a prerequisite to the design of precision equipment above 30 MHz.) Connectors of this type have been built for ratings up to 100 kW.

The Committee's specifications require that the connectors (1) be sexless, (2) provide low VSWR, (3) have identical electrical and mechanical junction planes, and (4) exhibit low leakage.

Therefore, it should not come as a surprise that the new 7-mm standard proposed by the Committee is based on the Precifix Connector, as currently manufactured by Rohde & Schwarz. Production samples of the Precifix-A are now ready for immediate delivery.

Precifix-A Design for Precision Uses

The Precifix-A connector has been designed for use on precision measuring equipment and for frequencies up to 18 GHz. Its major features are:

- (1) Smallest possible dimensions: short length (19 mm), smallest diameter (20 mm), smallest weight (about 20 g).
- (2) Quick connect-disconnect, requiring less than one turn of the screw connection.
- (3) Extremely low leakage because of triple shielding.
- (4) Extremely low VSWR. (Values are well within the Committee's requirements.)
- (5) A crown facilitates mating of the connectors and protects the surface of the inner conductor. This crown is rotatable.
- (6) Finally, the design is backed up by 20 years of experience in the precision connector field.

Dezifix-A: A medium-price, high-quality 7-mm cable and equipment connector. In addition to the high precision Precifix version, there is need for a slightly less accurate and substantially less expensive type, which would possess the essential features of the Precifix-A and mate with it. Thus, the Dezifix-A has been developed. It will be used on cables such as RG8U, but also on equipments wherever an extremely low VSWR is not needed. It is easily distinguished from the Precifix-A by the fact that there is no crown.

Sample quantities of both Precifix-A and Dezifix-A are available from stock; production quantities are available for delivery starting 30 days after receipt of orders.

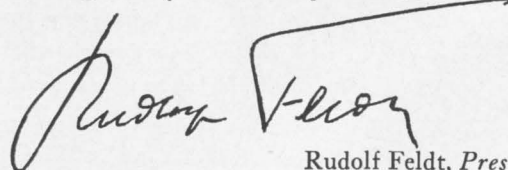

Rudolf Feldt, *President*

ROHDE & SCHWARZ SALES CO., (USA), INC., 111 Lexington Ave., Passaic, N.J. 07056

Inquiries from outside the U.S.A. should be directed to: ROHDE & SCHWARZ, Muehldorfstrasse 15, 8 Muenchen 8, West Germany

Technical Articles

**Tuning forks sound
a hopeful note:
page 84**

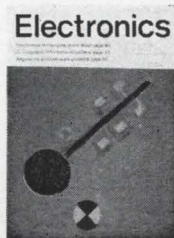

A new type of transistor tunes integrated circuits without depending on inductance. The output signal's frequency is controlled by a stable mechanical resonator that works like a tiny tuning fork. This month's cover picture, a closeup of the resonating gate, was supplied by the Westinghouse Electric Corp.

**FET performs well in
balancing act:
page 88**

In bridge circuits that must detect tiny changes in null point, the field effect transistor works well because it is a high-impedance device. In one such instrument, it produced measurements accurate to one part per million.

**Filter design,
easy as pi:
page 93**

Curves and a nomograph simplify designing the classic pi-circuit which can be used in applications as varied as a low-pass filter in communications circuits and a device for suppressing radio-frequency interference.

**Data dots identify
aerial photos:
page 106**

An electronic marking system puts identification on reconnaissance photos as they are taken, speeding up the interpretation of films. The system uses an excess-three binary-coded-decimal format.

**Electronic detours of
broken nerve paths:
page 110**

Paralysis is usually caused by a "washout" in the neural road from the brain to a muscle. An alternate route can be supplied via another muscle, using an electronic stimulator. The technique could allow many paralytics to help themselves.

-
- Coming
October 4**
- MOS integrated circuits
 - High-power applications for silicon controlled rectifiers
 - Making distortion measurements
 - A new thin-film memory for computers

'Tuning forks' sound a hopeful note

Transistors with resonant gate electrodes can tune integrated circuits. They may open broad new applications for IC's in tone generators and in micropower switches and memories

By Harvey C. Nathanson, William E. Newell and Robert A. Wickstrom

Westinghouse Research Laboratories, Westinghouse Electric Corp., Pittsburgh

One trouble with integrated circuits has been the lack of a compatible high-Q inductor. For want of a practical tuning component equivalent to a coil, circuits that require frequency discrimination—oscillators, intermediate-frequency amplifiers, timing networks—have never been made satisfactorily in single chips of silicon.¹

A new type of transistor offers a solution to the tuning problem without depending on inductance. The output signal's frequency is controlled by a stable mechanical resonator that works like a tiny tuning fork. Because the resonator is the gate electrode of a surface-field-effect transistor, the new device is called a resonant-gate transistor, or RGT.²

Hundreds of RGT's can be made on a silicon wafer, with materials and fabrication techniques that are compatible with the manufacture of integrated circuits. Resonant devices can be made in a variety of configurations, which may make integrated circuits suitable for many new applications in communications and control.

A cantilever that vibrates

A typical geometry and circuit connection for an RGT are seen at right. The frequency-selective element is a metal cantilever that is freely suspended over the silicon surface. When excited electrostatically by an input signal, the beam vibrates and the transistor detects these vibrations.

The input signal, an alternating-current voltage, is applied between the input electrode and the substrate. The cantilever is polarized by a constant voltage. Both the input electrode and the cantilever are insulated from the silicon-crystal substrate by an oxide layer.

The polarizing voltage, V_p , is necessary for RGT operation. Since electrostatic force is proportional to the square of voltage, the force due to a sinusoidal signal alone varies at twice the fundamental signal voltage. This is evident from the trigonometric identity

$(e_{in} \sin \omega t)^2 = \frac{1}{2} e_{in}^2 (1 - \cos 2\omega t)$

$$(e_{in} \sin \omega t)^2 = \frac{1}{2} e_{in}^2 (1 - \cos 2\omega t)$$

where e_{in} is the input signal voltage. Therefore excitation of the fundamental frequency requires a large constant component of voltage so that

$$(V_p + e_{in} \sin \omega t)^2 = V_p^2 + 2V_p e_{in} \sin \omega t + \frac{1}{2} e_{in}^2 (1 - \cos 2\omega t)$$

If $V_p \gg e_{in}$, the last term will be small compared with the second term. Because of the high Q and because the higher modes of resonance of the cantilever are not harmonics of the fundamental frequency, the second harmonic has a negligible effect on the cantilever vibration. Therefore, the cantilever moves appreciably only when the signal frequency is equal to the cantilever's natural resonant frequency, which is given by³

$$f_o = 0.1615 \frac{d}{L^2} \sqrt{\frac{Y}{\rho}}$$

where d = thickness of the cantilever, L = length, Y = Young's modulus, and ρ = density. When typical values are inserted, an order-of-magnitude estimate may be obtained from the relationship

$$f_o = \frac{2 \times 10^4 d}{L^2} \text{ kilocycles}$$

where L and d are in mils.

The polarizing voltage also produces an electric field between the cantilever and the silicon substrate, which is grounded. This field is sensed by its effect on the channel conductivity between the source and drain regions diffused into the silicon. The field is constant except when the cantilever moves, so there is no signal output from the transistor except at the resonant frequency.

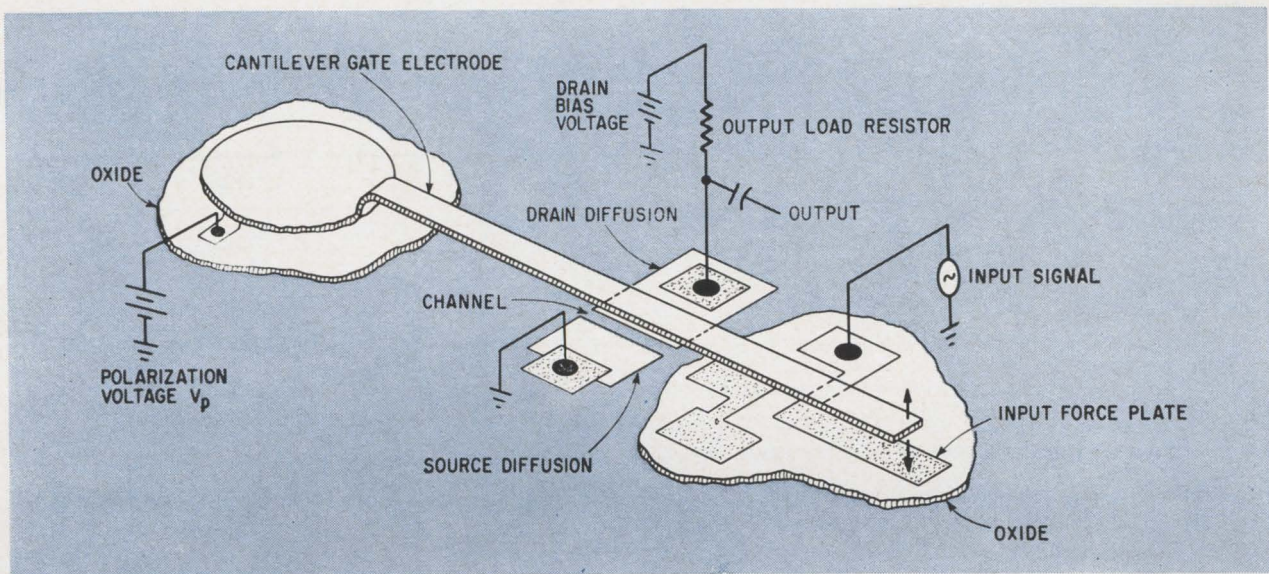

Geometry and circuit connections of a typical resonant-gate transistor. The tinted area is the substrate. In the actual device, shown below, the load resistor is the diffusion at the left of the source and drain diffusions.

The devices shown on this page exhibit a Q of about 150; their gold cantilevers are about 40 mils long and resonate at about 3 kilocycles. A typical frequency response, shown on page 87, has a bandwidth of approximately 20 cycles per second. Similar devices, with fundamental resonances from 1 to 7 kc, have exhibited Q 's up to 400.

The RGT can also be operated in an overtone mode of resonance. These overtones are not harmonically related to the fundamental resonance frequency. The first overtone occurs at 6.27 times f_0 —near 45 kc for a 7-kc RGT—and the second

overtone occurs at 17.55 times f_0 . Q 's for this mode of operation have been measured as high as 750.

Present technology should permit devices of this type to be built with resonant frequencies up to one megacycle. The lower frequency limit is determined by the maximum allowable cantilever length and by the sensitivity of the cantilever's motion to environmental forces. As the resonant frequency decreases, gravitational and external vibratory forces become significant compared with the internal electrostatic forces. Devices with frequencies of one kilocycle or less are sufficiently insensitive

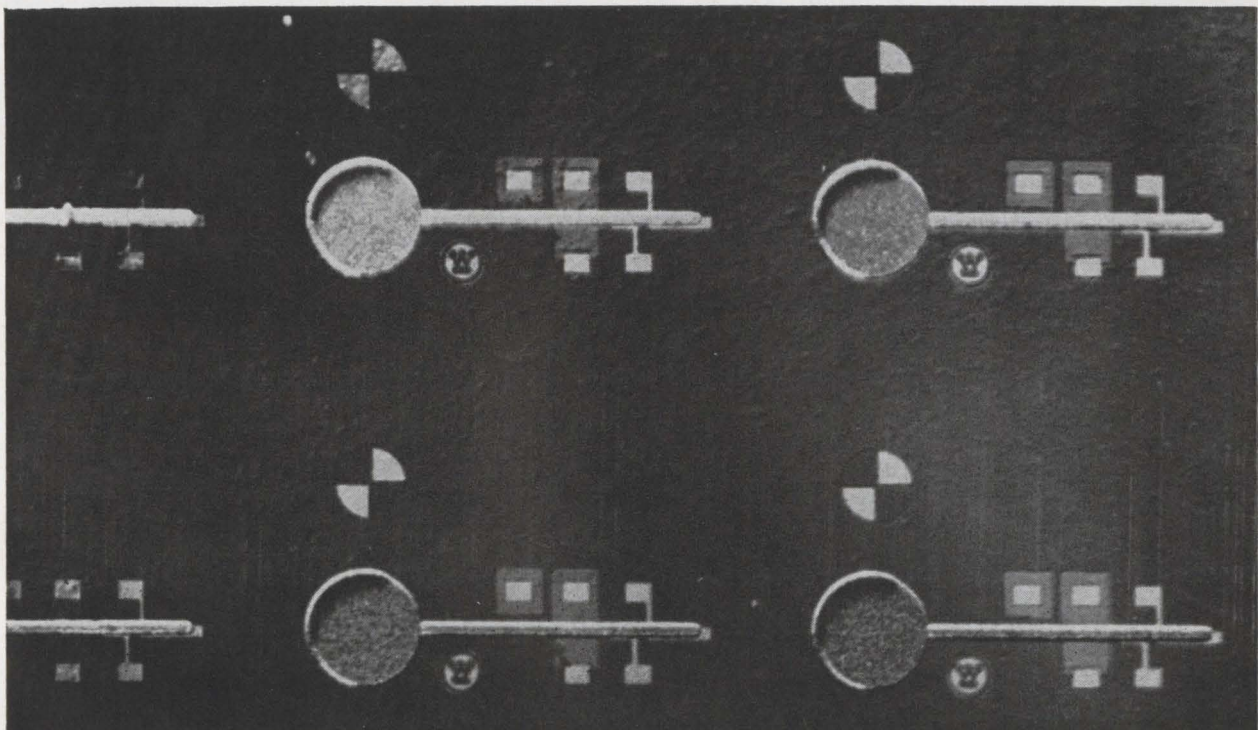

Resonant-gate transistors can be made in quantity on a silicon wafer by methods compatible with integrated-circuit production. This is a portion of an array on a wafer. A single device is shown on the cover.

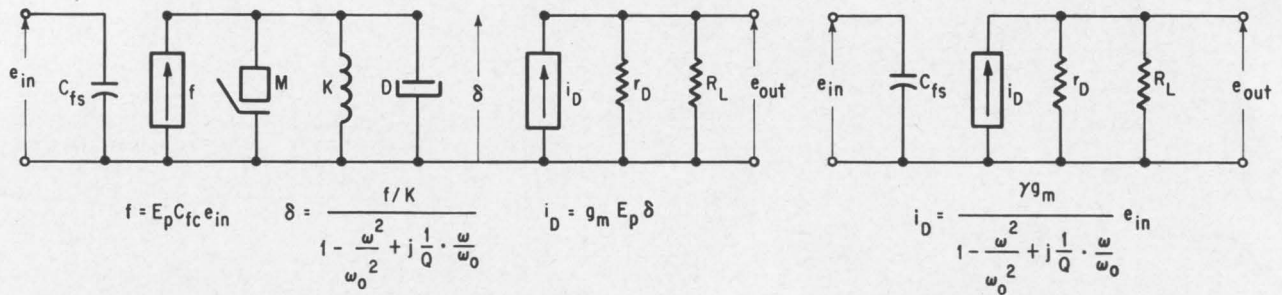

f = signal component of the electrostatic force on the cantilever
 $E_p = V_p/\delta_o$ = fixed polarization field between the cantilever and the substrate
 V_p = polarization voltage
 δ_o = equilibrium spacing between the cantilever and the substrate
 δ = displacement of the cantilever caused by f
 C_{fc} = capacitance between the input force plate and the cantilever
 C_{fs} = capacitance between the input force plate and the substrate

K, M, D = effective spring constant, mass, and damping coefficient of the cantilever
 $Q = K/\omega_o D$ = mechanical quality factor of the cantilever
 $\omega_o = \sqrt{K/M}$ = mechanical resonant frequency of the cantilever
 g_m = transconductance of the surface-field-effect transistor when the cantilever gate is clamped
 i_D = signal current in the drain of the field effect transistor
 r_D = dynamic resistance of the drain
 R_L = load resistance
 $\gamma = C_{fc} E_p^2 / K$ = ratio of the polarization force to the force required to deflect the cantilever by an amount δ_o .

Equivalent circuits for the RGT. The first-order linear equivalent is at left and a simplified version is at right.

to vibration for use in normal environments.

One schematic above shows the RGT's first-order, linear equivalent circuit, including the resonant mechanical network. The input impedance is purely capacitive, typically a few picofarads. The equivalent circuit can be simplified further by making the mechanical resonance implicit in the transfer function, as shown. Detailed analysis of the device, including the effects of the square-law relationship between voltage and electrostatic force, and the effects of the dominant substrate mode of pinch-off in the field-effect transistor, raise interesting design optimization problems that have not yet been solved. However, excellent linearity has been observed for input signals ranging from several millivolts to several hundred millivolts, and

over-all voltage gains up to six decibels at resonance have been demonstrated.

Tuning, tones and switching

The basic type of RGT described above demonstrates that mechanically resonant structures can be used for frequency-selection and tuning, as bandpass amplifiers and as narrow-band, high-Q filters. As the frequency range of the RGT is extended upward into the i-f region, wrist radios might be made entirely with integrated circuitry.

Other configurations, modes of operation and applications are also possible. For example, devices that resonate at single or multiple frequencies might be integrated with logic or amplifier circuits.

In the low-frequency region where RGT's have been demonstrated, high-Q substitutes for inductors have long been sought for tone-generation and detection circuits. For example, it should soon be possible to microminiaturize the comb filters required by vocoders.⁴

Telemetry and remote control also offer applica-

Signal

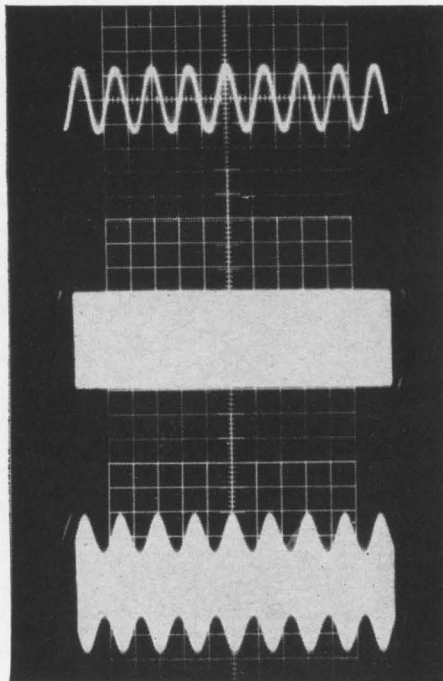

Carrier

Output

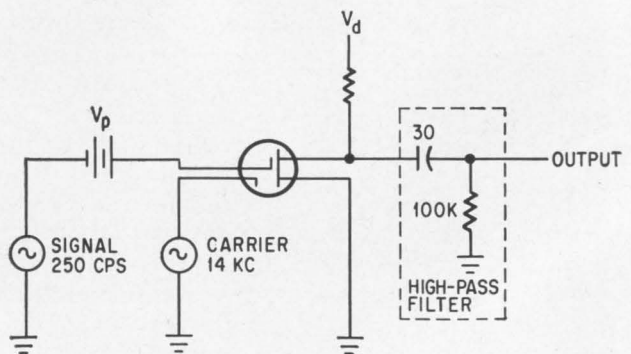

Tuned a-m modulator circuit. The 250-cps signal varies the gate's polarizing voltage, amplitude-modulating the 14-kc input signal to produce the output waveform, which is seen in oscilloscope photos at left.

Frequency response of a 3-kc RGT; bandwidth is 20 cps

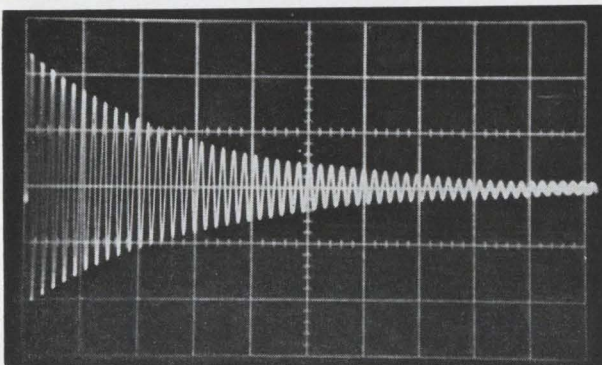
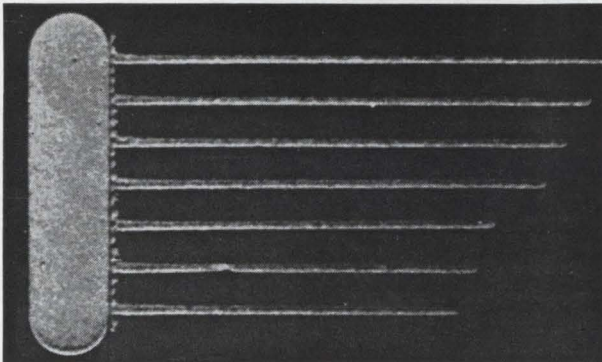
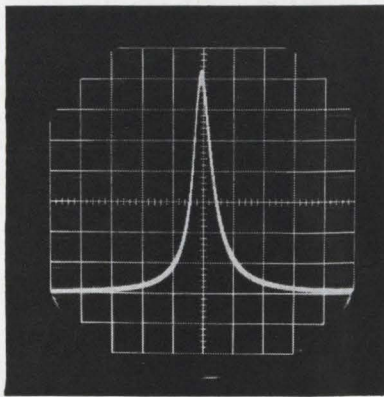

Seven-cantilever array, designed to resonate at frequencies between 700 and 1,500 cps used in push-button telephone (top). Below is the ringing output waveform of a 3-kc device. Four outputs are superimposed.

tions. The photograph above shows a structure with seven cantilevers made simultaneously. The active area of this structure, only about 0.002 square inch, is designed to resonate at the seven frequencies used in the Bell System's push-button telephone.

Tone generation in such applications can be accomplished either by using the RGT as the frequency-determining element in an oscillatory feedback loop or by pulsing the input to make the cantilever ring. The ringing output waveform shown above was obtained when the 2-pf input capacitance of a 3-kc device was driven by 30-v, 50- μ sec pulses. Four successive waveforms, shown superimposed, illustrate the output's excellent coherence.

Tuned modulation is another possible mode of operation of RGT's and related devices. Since the

RGT's gain depends on the polarizing voltage, varying this voltage will modulate the output signal's amplitude at resonance. Shown (p. 86) is the amplitude-modulated output waveform obtained by sinusoidally varying the polarizing voltage at 250 cps on a device driven by a 14-kc carrier.

In another mode of operation, the addition of a contact under the cantilever converts the RGT into a micropower electrostatic relay. With an a-c input signal superimposed on the proper value of d-c polarizing voltage, the device acts as a resonant reed relay with a bandwidth of about 20 cps.

Conversely, the contact can be closed by a d-c input signal; the stored charge alone will keep it latched for hours. Therefore it should be useful in various memory and logic applications where ultralow power, but not high speed, is needed. The switching time is approximately equal to the reciprocal of the cantilever's resonant frequency.

In effect, the RGT adds a degree of design freedom—mechanical motion—in silicon integrated circuits. Further implications of this new freedom are yet to be studied in such areas as delay lines, scanners and transducers, but far-reaching possibilities for the RGT are suggested by the filters and switching circuits already being considered.

References

1. W.E. Newell, "The Frustrating Problem of Inductors in Integrated Circuits," *Electronics*, March 13, 1964, p. 50.
2. H.C. Nathanson and R.A. Wickstrom, "A Resonant Gate Silicon Surface Transistor with High-Q Bandpass Properties," *Applied Physics Letters*, August, 1965.
3. Lord Rayleigh, *Theory of Sound*, Vol. 1, p. 280, Macmillan and Co., London (1894).
4. H.F. Olson, "Speech Processing Systems," *IEEE Spectrum*, February, 1964, p. 90.

The authors



Harvey C. Nathanson has been concentrating on semiconductor and metal-oxide-semiconductor surface phenomena and devices since receiving his doctorate in electrical engineering in 1962 from the Carnegie Institute of Technology. He is a senior engineer in the Information Devices Department at Westinghouse Research Labs.



William E. Newell was the first advocate of mechanical resonators to solve the integrated-circuit tuning problem. He taught electronics engineering four years, including two at the American University in Beirut, after receiving his doctorate from Carnegie Tech in 1957. He manages the new devices section at the labs.

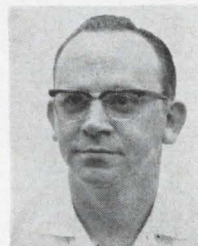

Robert A. Wickstrom, a senior electronics technician, has contributed to many research projects in his 15 years with Westinghouse. He has been specializing in integrated circuits for five years. He received electronics training in the Army and attended the University of Pittsburgh.

FET performs well in balancing act

High-impedance device can be used in bridges as the basis for a sensitive null detector, to obtain measurements accurate to one part per million

By Wayne A. Rhinehart and Louis Mourlam Jr.

Institute for Atomic Research, Iowa State University, Ames, Iowa

To measure complex impedances with an accuracy of one part per million with a low-frequency a-c bridge requires a null detector capable of sensing changes in balance as small as 30 to 40 nanovolts in 3 to 4 seconds. Such systems are susceptible to both 60-cycle-per-second pickup and interference from out-of-phase signals, factors which make it difficult to determine when the bridge is balanced.

The null detector must combine high sensitivity with 60-cps and quadrature rejection. To do the job with conventional vacuum tube circuits would require feedback-regulated d-c plate and filament power supplies and add the problem of microphonic noise. Transistors could fill the bill, but complex circuitry would be required to obtain the necessary high impedance from these low-impedance devices.

The field effect transistor, however, has high impedance, and it has made possible the design of a simplified solid state circuit for use as a sensitive

null detector. The FET is used in the high-impedance, low-noise input stage of a resonant amplifier that is the main part of the bridge null detector.

Most of the major restrictions of sensitive bridge null detectors are imposed on the amplifier section, and the most critical part of the amplifier is the input stage. It is here that the signal-to-noise ratio and input impedance are established. Only first-stage noise need be considered if, as is generally the case, the voltage gain of the first stage is such that the noise appearing at the input to the second stage is approximately ten times the noise generated by that stage.

In most cases, the largest noise contribution in the input stage is from the active amplifying device. The circuit designer can choose not only the amplifying device but also its operating point, which gives him effective ways to minimize noise. The other major noise contribution is that created in the resistors of the circuit due to heat, or Johnson noise.

It is also important that the amplifier have a bandwidth sufficiently narrow to reject the 60-cps pickup and most of the wideband noise appearing at the amplifier's input.

Parallel-T feedback amplifier

The parallel-T feedback amplifier is a good, high Q, low-frequency amplifier for use in a sensitive null detector.

In this circuit, the input signal is amplified and added to an amplified feedback signal. Theoretically, the feedback path provides degeneration for all frequencies except a small band about the amplifier's center frequency. The bandwidth is a function of the frequency-selective circuit in the feedback path and the loop gain.

The general transfer function for the amplifier is

$$\frac{e_o}{e_{in}} = \frac{K_s K_w}{1 - K_w K_f K_t} \quad (1)$$

where K_s is the signal gain of the adder, K_f the

The authors



As a nuclear instrumentation designer for the Institute for Atomic Research at Iowa State University, Louis Mourlam Jr. has devoted much time to low-level design techniques. In addition, his designs have included transistor pulse, relay switching, and pulsed r-f circuits.



Wayne A. Rhinehart is the head of the instrumentation group at the Iowa institute. He holds several patents in the field of nuclear instrumentation circuit design and is currently directing the institute's development work in solid state nuclear instrumentation.

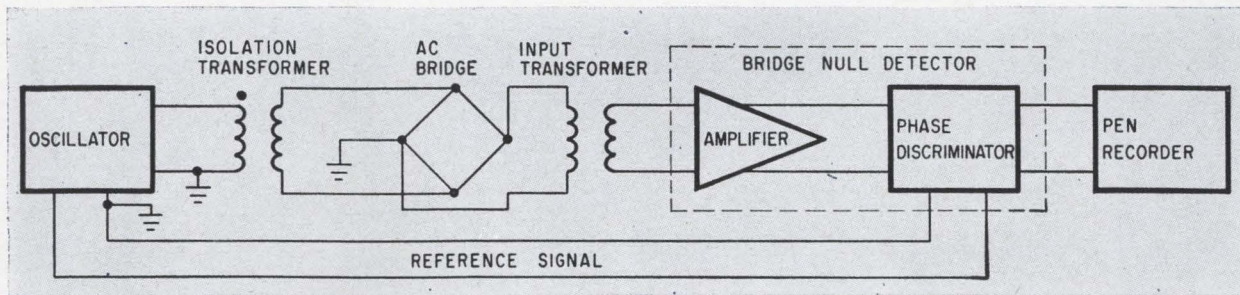

A-c bridge system generally uses pen recorder for visual observation of the null point. Most of the problems which effect bridge accuracy are centered in the null detector circuits.

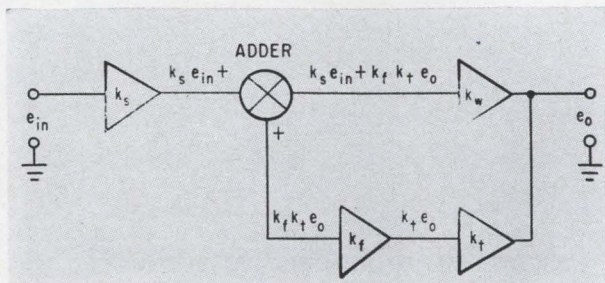

Parallel-T feedback amplifier consists of a forward loop of amplification and a feedback loop. Portion of the output that appears at the adder is determined by the transfer function, K_t , of the parallel-T filter in the feedback loop. Adder can be either a cascode or drain-coupled circuit, depending on the individual application.

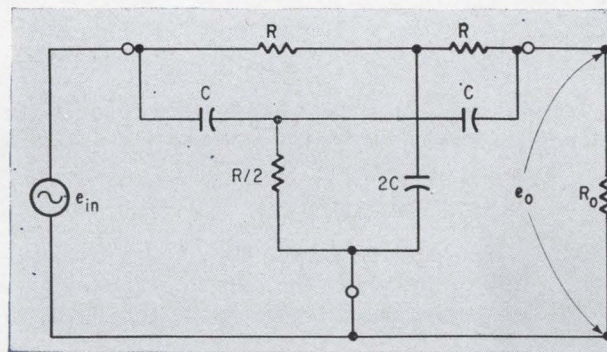

Parallel-T filter circuit parameters are selected to give the transfer function, K_t , proper gain and phase shift at the frequency of interest of the bridge. This circuit is the determinant of the amplifier's sensitivity and Q.

feedback gain of the adder, K_w the gain of the amplifier, and K_t the transfer function of the parallel-T filter.

The balanced parallel-T filter in the feedback path is shown in the diagram above, right. The transfer function, derived from nodal analysis, is

$$K_t = \frac{e_o}{e_{in}} = \frac{R_o (1 - \omega^2 C^2 R^2)}{[R_o (1 - \omega^2 C^2 R^2) + 2R] - j [2\omega CR(R + 2R_o)]} \quad (2)$$

The gain and phase angle at the bridge center frequency constitute the other transfer functions of equation 1, since the forward loop's frequency characteristic is of very narrow bandwidth.

The FET is a natural choice for the input device for the parallel-T amplifier. The low noise characteristic and high input impedance of the 2N2386 FET, for example, compare favorably with those of the low-noise 6DS4 nuvistor and the low-noise 6AC7 vacuum tubes. The operating point of the 2N2386 is not critical with respect to noise generated, since this noise does not vary appreciably with drain current and rises only slightly with increasing drain voltage.

Choose your circuit

Either of two basic FET circuits shown at the top of the following page can be used in the adder—a cascode circuit or a drain-coupled circuit. The differences in their performance are found by considering the gain from the feedback terminal and

the noise present in each.

The noise generated by the cascode circuit is due primarily to the signal transistor, since its gain makes the noise of the feedback transistor nearly insignificant. In the drain-coupled circuit, however, the noise of both signal and feedback transistors must be considered.

The gain from the feedback terminal is much lower in the cascode circuit because the signal transistor acts as a degenerative impedance in the source circuit of the feedback transistor. When placed in the parallel-T feedback circuit, the cascode adder gives a lower overall loop gain and a wider bandwidth than the drain-coupled circuit gives.

The choice depends, therefore, upon the individual application. For simplicity and greatest 60-cps rejection, the drain-coupled adder would be best; whereas for maximum sensitivity, the cascode adder would be chosen.

The circuits shown in the diagrams on page 91 are two complete parallel-T feedback amplifiers using the two types of adders. The circuits are designed for a center frequency of 400 cps.

The parallel-T filter circuit is designed with as low an output impedance as possible, since this impedance appears on the gate terminal of the feedback transistor and is, therefore, a direct contribution of input noise. The gate return resistor should be large to prevent loading the filter and broadening its characteristics.

The performance of the two circuits is summarized in the table on page 90. Since the cascode

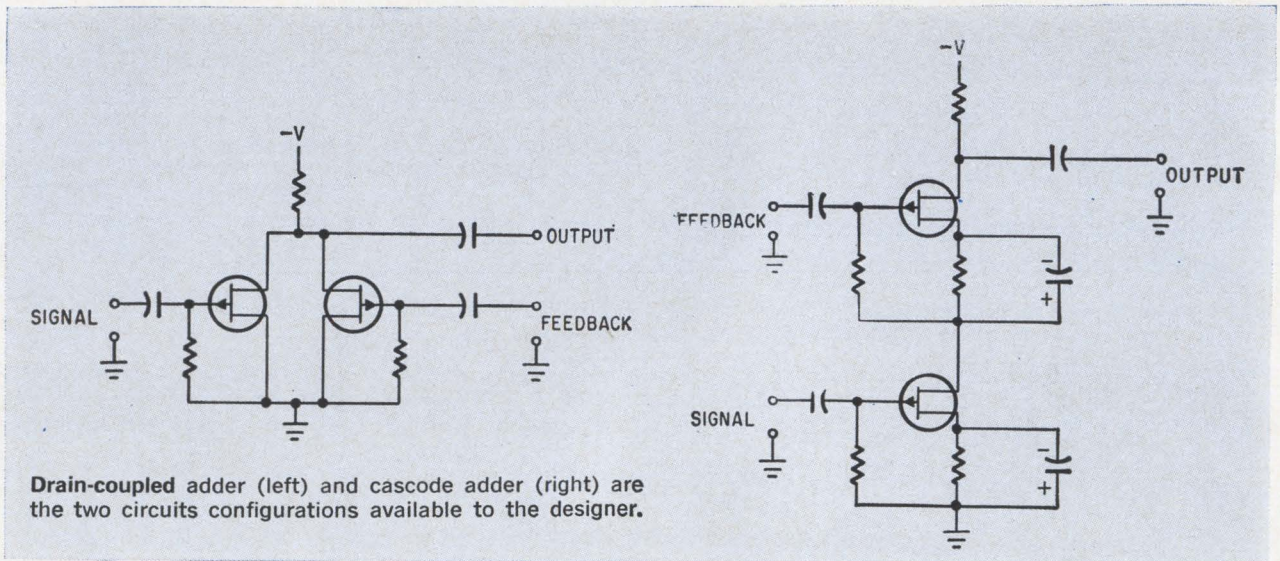

circuit's characteristics are highly dependent on the d-c levels in the adder circuit, the figures in the table can change drastically if the d-c levels are changed.

Oscillation problem

Oscillation is one of the primary problems encountered in the design of a parallel-T feedback amplifier. A feedback amplifier becomes an oscillator when the feedback contains a frequency component for which there is unity loop gain and a 180° phase shift in the loop. Since the feedback signal theoretically contains all frequencies, it is quite probable that for some frequencies the loop phase shift will be 180°.

High-frequency oscillation can be prevented, however, by restricting the high-frequency response of the loop. This is done by placing a capacitor across the load resistor of one of the wideband amplifiers, which reduces the high frequency loop gain sufficiently to stop oscillation without affecting the center frequency gain.

Oscillation may also occur at the center frequency of the amplifier, when the filter causes a regenerative signal to be fed to the feedback terminal of the adder. Regeneration can be verified by comparison of the open loop gain with the closed loop gain.

If the closed loop gain is higher, the circuit is regenerative and oscillation may result. Variation of the shunt elements in the parallel-T, while holding the RC product constant, eliminates the regeneration without shifting the center frequency.

Complete measuring system

A diagram of a complete system that can be used for the measurement of complex impedances is at the top of page 89. One side of the bridge's output is grounded to minimize the noise that would otherwise be picked up at this point since the signal level here is extremely low-level. However, to do this, it is necessary to use an isolation transformer between the oscillator and the bridge so that the

Cascode vs. drain-coupler adders

Circuit	Gain	Q	RMS Input Noise	60 cps Rejection
Cascode.....	1400	50	0.28μv	38db
Drain-coupled.....	600	400	0.50μv	51db

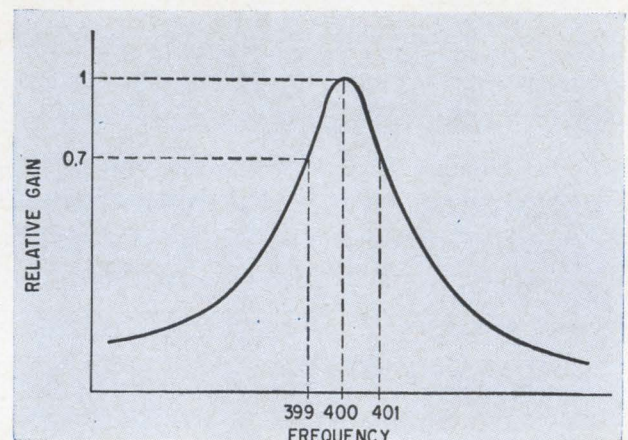

Bandwidth of the parallel-T amplifier should be as narrow as possible. A rapid drop in gain as the frequency departs from the frequency of interest results in better resolution.

reference arms of the bridge are not unintentionally grounded.

An input transformer to the null detector is used for additional gain. As shown by its equivalent circuit (diagram, p. 92), the bridge can be considered a voltage source with some internal impedance, R_B . To the amplifier's input transformer, the bridge detector presents a load impedance, R_A . For maximum sensitivity, conditions must be such as to maximize the output e_o of the detector. This output is

$$e_o = \frac{aA R_A e_B}{R_B a^2 + R_A}$$

where a is the transformer turns-ratio and e_B is the

Drain-coupled and cascode adders in parallel-T feedback amplifier.

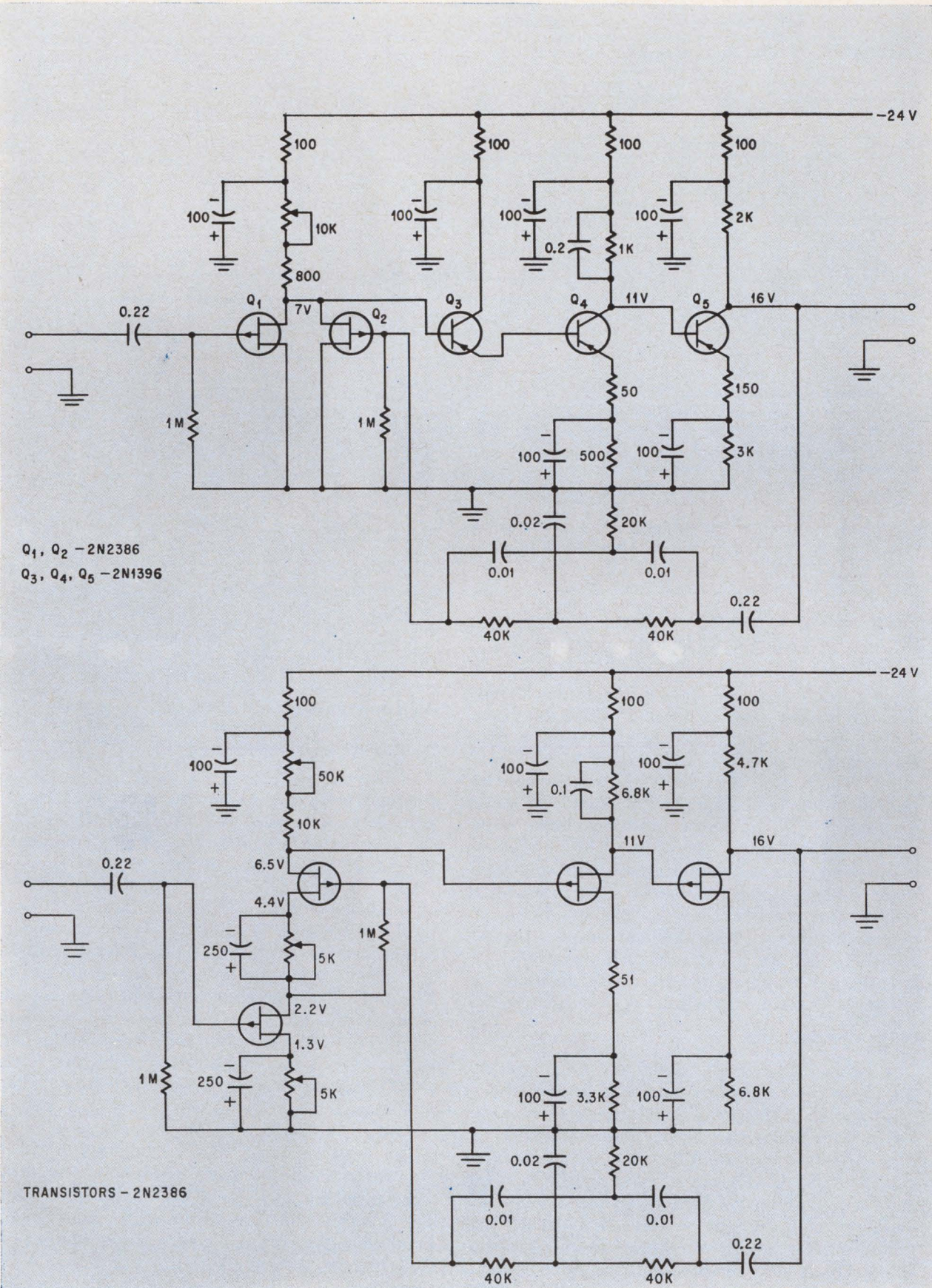

Complete parallel-T feedback amplifiers constructed with both drain-coupled, (top), and cascode adders. The performance of each of the circuits as part of the a-c bridge system is shown in the table on the preceding page. The values of the filter network in the feedback loop were selected for operation at 400 cps.

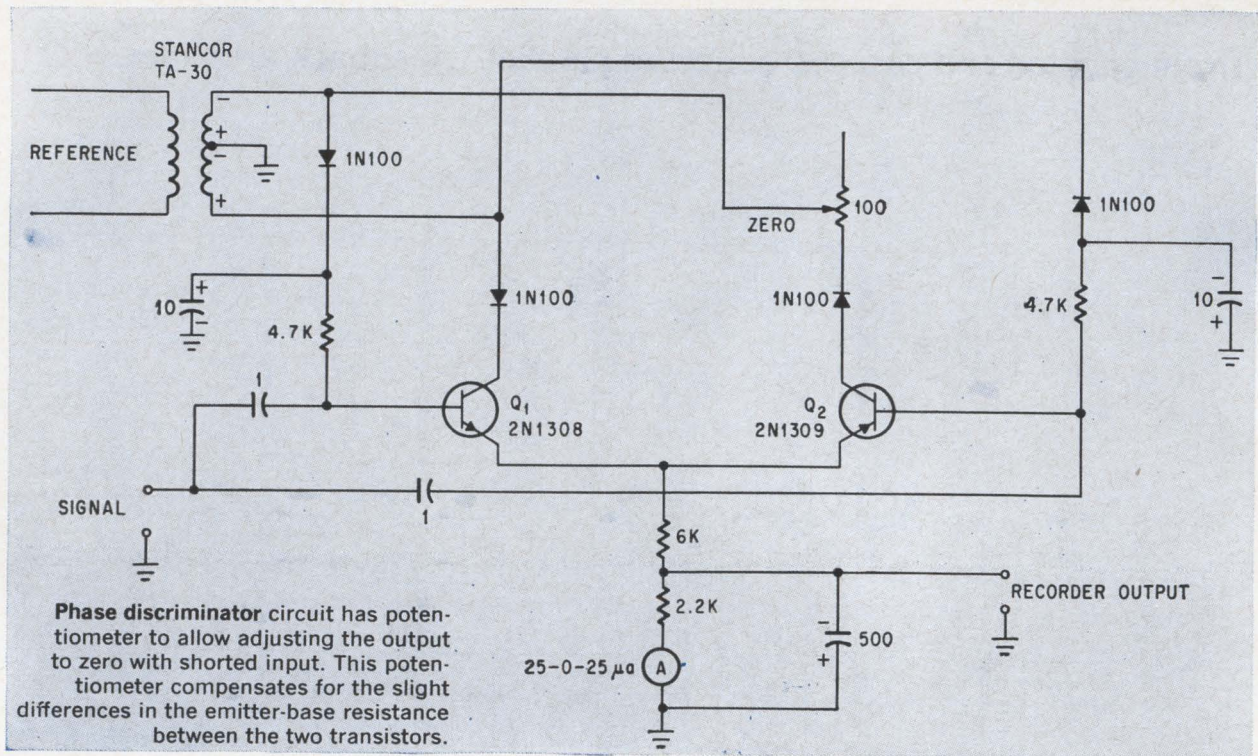

output of the bridge. To maximize the above equation with respect to a , the following relationship must hold true:

$$a^2 = R_A/R_B$$

For the bridge to operate with maximum sensitivity the load resistance must be

$$R_L = R_A/a^2 = R_B$$

Thus it is advantageous for the transformer to have as large a turns ratio as possible, since this represents noiseless gain. This can be done by making R_A as large as possible and reducing R_B to a minimum. These considerations are particularly important in low temperature work, where the power dissipated in the unknown impedance being measured must be held to nanowatts. This low power corresponds to a very low bridge voltage and maximum voltage transfer to the detector is essential.

The system oscillator is a stable, single-frequency device that drives the bridge and supplies the reference voltage for the phase discriminator. Consequently, the amplifier design can be restricted to one with a narrow bandwidth.

Phase discriminator

After the bridge output signal has been amplified, the phase discriminator produces a d-c signal that is a function of the input signal. Ideally, the output for an input signal in phase-quadrature with the reference signal is zero. A constant amplitude input signal in phase with the reference yields a maximum output of one polarity; a 180° phase difference gives maximum output of opposite polarity.

The circuit above provides these characteristics. For a zero phase difference, transistor Q_1 conducts more than Q_2 , giving a net positive output voltage. At a 90° phase difference, Q_1 and Q_2 conduct equally, resulting in no output. At 180° , Q_2

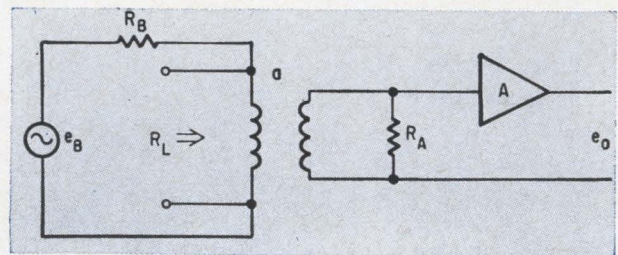

Equivalent circuit of the null detector. Analysis of this circuit points to a high amplifier input impedance R_A , as a method of increasing detector sensitivity.

conducts more than Q_1 , giving a net negative output voltage. The output filter must be selected with care, since it reduces not only the ripple content of the output, but also the circuit's response time.

The complete FET bridge null detector consists of two loops of narrow-band amplification followed by the phase discriminator. While the cascode circuit is superior for noise rejection, the voltage levels are difficult to set. Because of nonuniformity from FET to FET, these voltages must be reset if a transistor is changed. The two loops of the drain-coupled circuit followed by the phase discriminator had an overall bandwidth of 0.5 cycles per second at 400 cps and short-circuited input noise voltage of 50 nanovolts. The response time was 3 seconds, and 60 cps rejection was 100 decibels.

The detector using FET's compared favorably with vacuum tube circuits of a similar configuration which used the nuvistor 6DS4 in the input stage. The nuvistor tube was also slightly microphonic. In addition, the FET detector only required a zener diode regulated power supply while the tube circuits required both regulated high voltage and filament supplies. As a result, the FET detector was easier to build and cost less.

Filter design easy as pi

Charts and nomograph free the engineer from necessity of making many tedious calculations when he's designing pi-circuits

By Jerrald C. Shifman

Genistron, Inc., Los Angeles

Theoretically, the classical pi-circuit configuration, consisting of an inductor and two capacitors, can be used for anything from a low-pass filter in communications circuits to a device for suppressing electromagnetic interference.

Equations and charts for the design of such circuits are readily available in standard reference books. These equations and charts, however, were developed primarily for pi-networks in applications where current and voltage levels are relatively low. When they are used to design a pi-network as an emi filter, the current and voltage levels are usually so large that the elements of the pi-circuit result in impractical sizes.

For example, a Butterworth pi filter with a cut-off frequency of 10 kilocycles calls for a capacitance of 0.3 microfarads and an inductance of 1.6 millihenries. The design of this inductor presents no problem if it is required to carry only 10 or 20 milliamperes. However, if it must carry 20 amperes without saturating or overheating, it may become too bulky to be practical. The problem is solved by using a different set of element values to get a filter of practical size that yields the desired amount of insertion loss at frequencies above cutoff. Unfortunately, the component values for such modified circuits are not easily derived from the usual handbook design equations and it is difficult to determine their insertion loss as a function

of frequency (usually specified in terms of a matched 50 ohm system).

Deriving the charts

With the charts on pages 94, 95 and 96, practical low-pass filters can be designed for any application and their insertion loss determined rapidly. Two related equations are the basis for the nomograph and charts.

First, consider a simple circuit consisting of only a source and load impedance, which are equal in value. The output voltage for this circuit is simply

$$V_1 = \frac{V_{in}}{2} \quad (1)$$

Next, consider the circuit with a pi-filter inserted between the source and load impedances, shown on the next page. Writing the loop equations for this circuit and solving for the load voltage:

$$V_2 = \frac{V_{in}}{2 - 2\omega^2 LC + j \left[\frac{\omega L}{R} + 2R\omega C - \omega^3 RC^2 L \right]} \quad (2)$$

Dividing equation 1 by equation 2 and squaring both sides so that the resulting ratio is a real number, gives

$$\begin{aligned} \left(\frac{V_1}{V_2} \right)^2 &= 1 + \omega^2 \left(\frac{L^2}{4R^2} + C^2 R^2 - LC \right) \\ &+ \omega^4 \left(\frac{L^2 C^2}{2} - LR^2 C^3 \right) \\ &+ \frac{\omega^6 R^2 L^2 C^4}{4} \quad (3) \end{aligned}$$

$$\text{Insertion loss is defined as } 20 \log (V_1/V_2), \text{ or} \\ \text{I.L. (in db)} = 10 \log (V_1/V_2)^2 \quad (4)$$

The author



Jerrald C. Shifman originally joined Genistron, Inc., a division of Genisco Technology Corp., as manager of product engineering. Last year he was appointed to Genistron's Applied Research division in College Park, Md. to study interference suppression devices used with electroexplosive initiators.

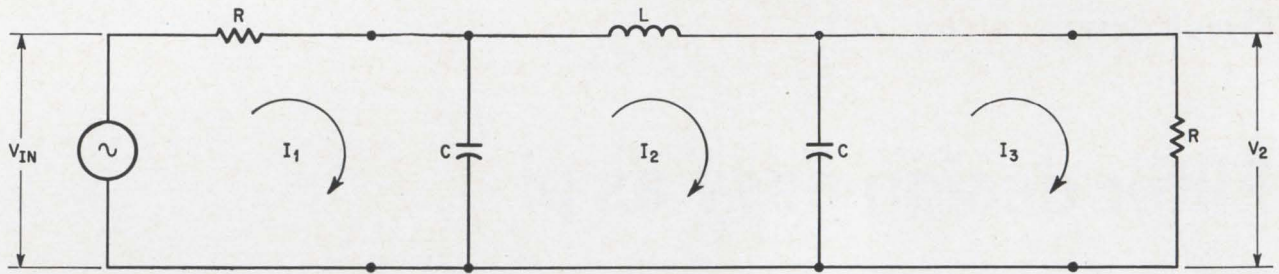

Pi-filter circuit inserted between source and load to obtain a required amount of attenuation at a specific frequency.

To simplify equation 3, let

$$d = L/2CR^2 \quad (5)$$

Further, as ω becomes very large, the ω^6 term tends to dominate the equation. A cutoff frequency $f_o = \omega_o/2\pi$ can be defined from this term, where

$$\omega_o^6 = 4/R^2L^2C^4 \quad \text{or}$$

$$\omega_o = [2/RLC^2]^{1/3} \quad (6)$$

If the expressions for d and ω_o are substituted into equation 3 and appropriately rearranged

$$\begin{aligned} \text{I.L. (db)} = 10 \log & \left[1 + \frac{\omega^2}{\omega_o^2} \left(\frac{1}{d^{1/3}} - d^{2/3} \right)^2 \right. \\ & \left. - 2 \frac{\omega^4}{\omega_o^4} \left(\frac{1}{d^{1/3}} - d^{2/3} \right) + \frac{\omega^6}{\omega_o^6} \right] \quad (7) \end{aligned}$$

This expression can be simplified further by letting

$$D = \frac{1}{d^{1/3}} - d^{2/3} \quad (8)$$

and by normalizing the frequency of interest with respect to cutoff frequency

$$F = \frac{f}{f_o} = \frac{\omega}{\omega_o}$$

The insertion loss for a pi-circuit can then be expressed as follows

$$\text{I.L. (db)} = 10 \log [1 + F^2D^2 - 2F^4D + F^6] \quad (9)$$

The insertion-loss response curves (pp. 94 and 96) are based on this equation. The response curves on the nomograph are numbered from zero to plus or minus six. These numbers correspond to the logarithm of d . Thus, for a value of $d = 0.01$, the “-2” curve represents the corresponding response.

The nomograph is based on equations 5 and 6 and represents the relationship between inductance L , capacitance C , cutoff frequency f_o and response curve. Any straight line intersects the L , C , and f_o scales at values that satisfy $\omega_o = (2/RLC^2)^{1/3}$. All straight lines having the same slope intersect the L and C scales so that the ratio $L/2CR^2$ is constant. This means that the slope of a line drawn to intersect these scales on the nomograph determines d . The sloping guide lines in the nomograph are each labeled with the log of the value of d associated with the slope.

These charts are only valid for $R = 50$ ohms.

Charting insertion loss

An example of how to use the charts to determine the insertion loss of a symmetrical pi-circuit in a matched 50-ohm system is represented by the dotted line in the nomograph. For this example, L is 50 millihenries, C is 0.1 microfarads, f_o is 7 kilocycles and the response curve is +2. The response curve is obtained by noting which of the

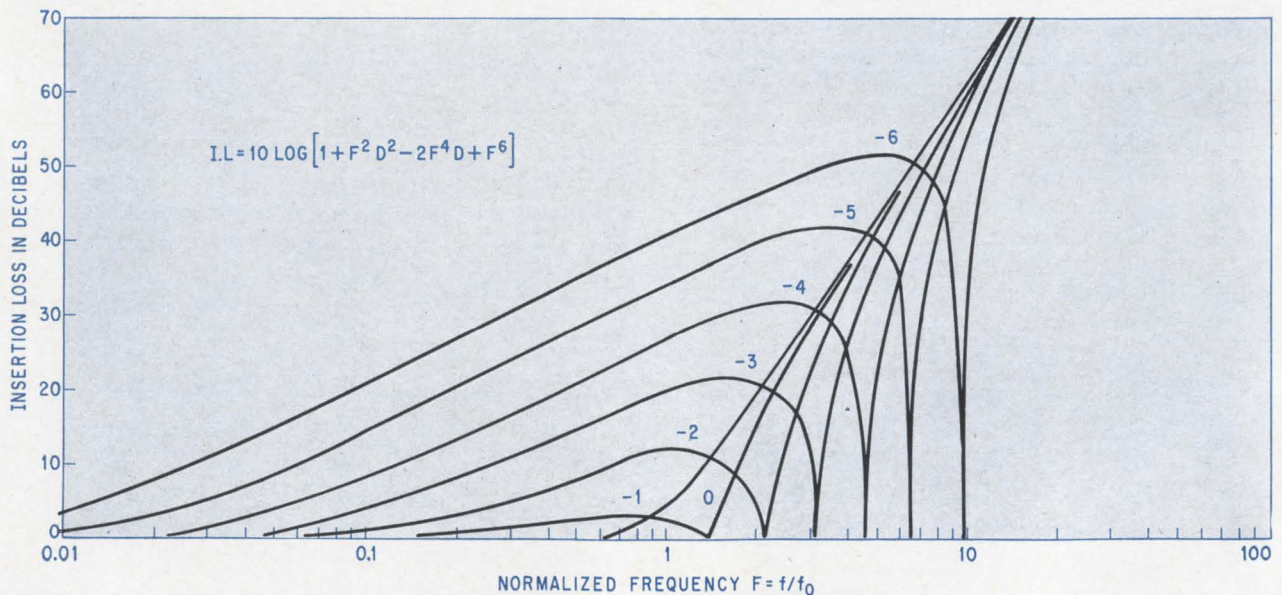

Response curves for pi-circuit. The curves are labeled with negative values of log d .

Pi-circuit nomograph

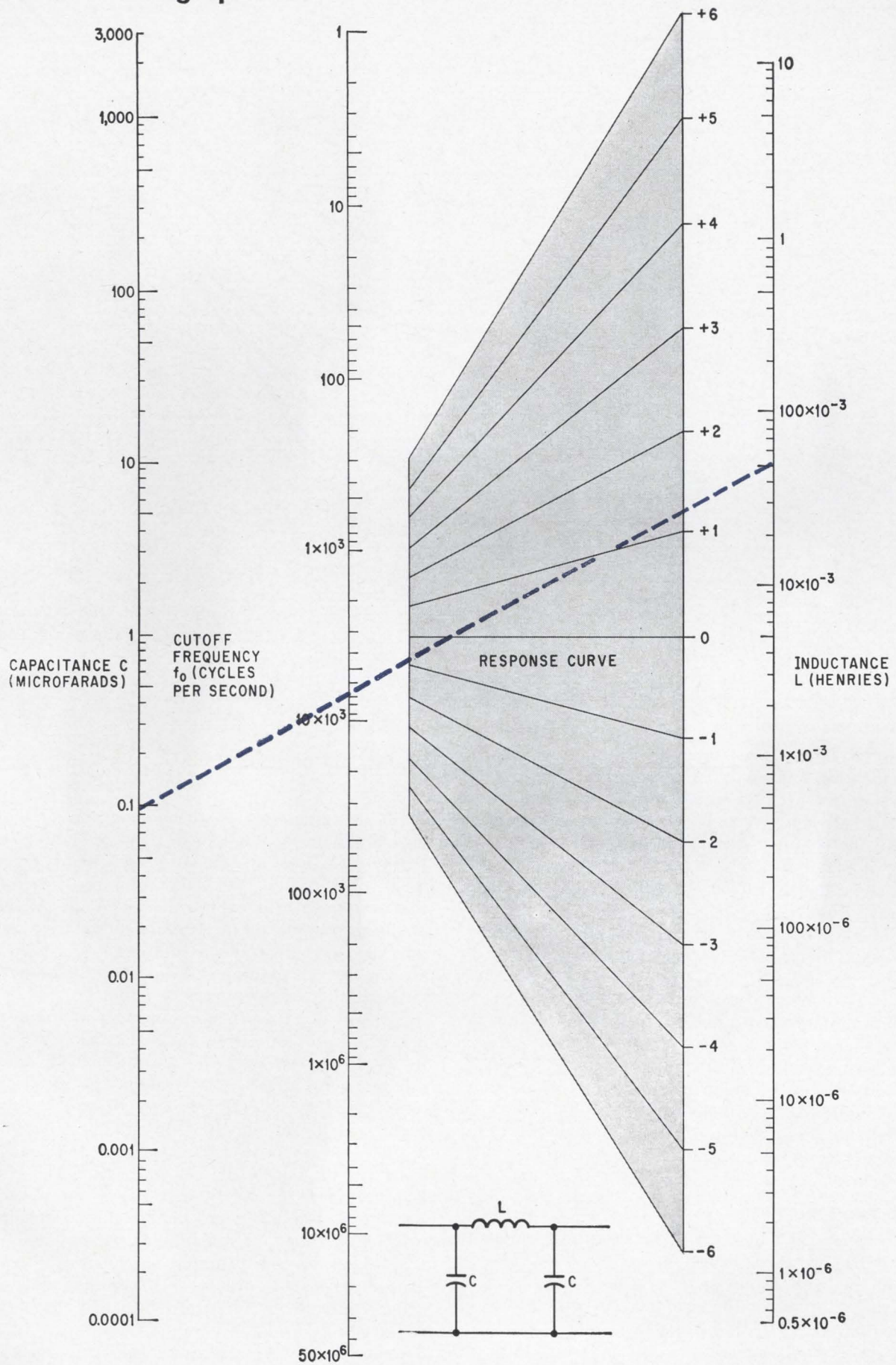

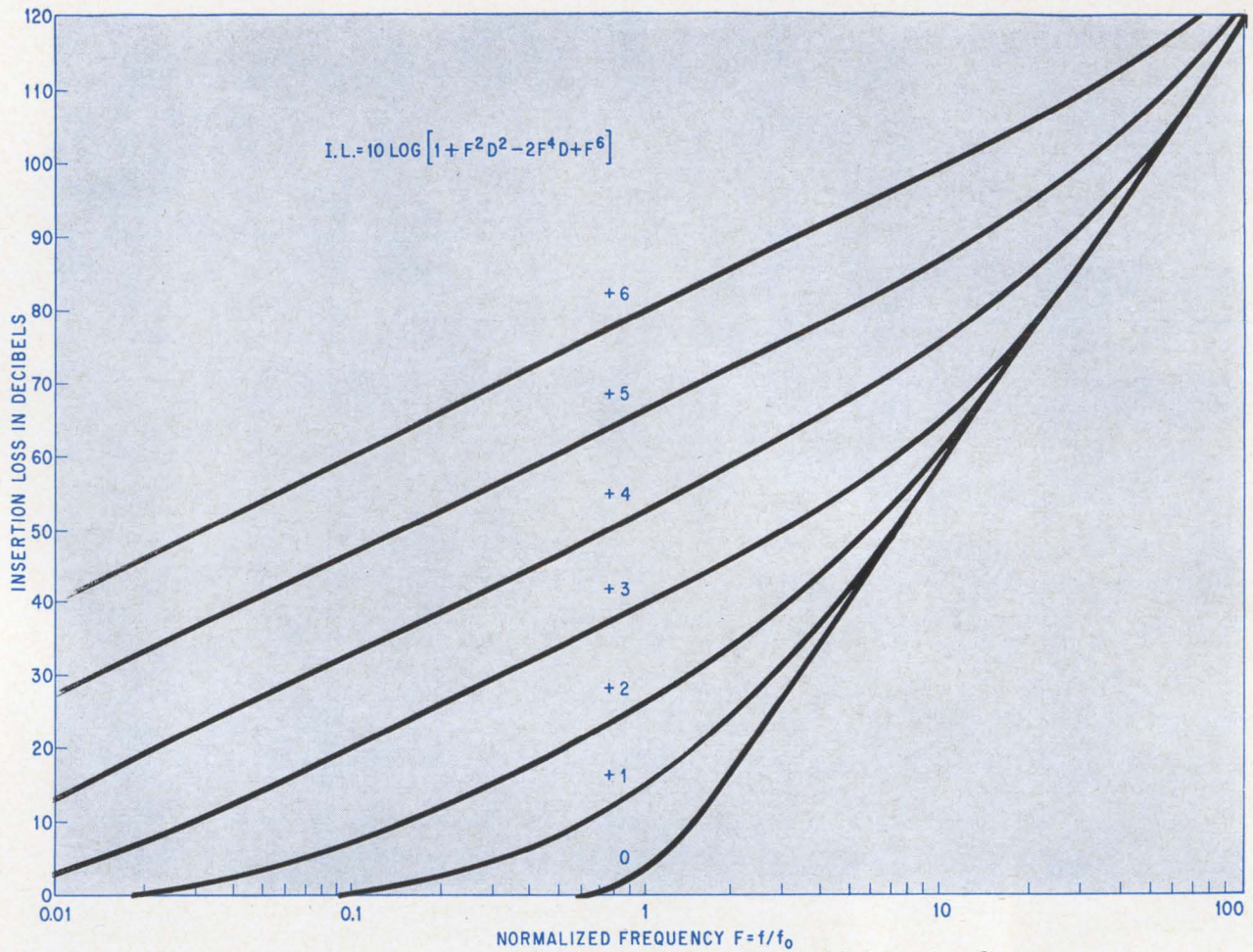

Insertion loss versus frequency response curves for the parameters numbered 0 through + 6.

slanted lines is most nearly parallel to the line connecting L, C and f_0 . Insertion loss as a function of frequency for pi-circuits having response curves lying between -6 and +6 is shown in the charts with the frequency scale normalized for $f_0 = 1$. To get actual frequency values, the frequency scale must be multiplied by the cutoff frequency determined from the nomograph.

The insertion loss for the pi-circuit determined by the dotted line in the nomograph is given by the curve labeled +2 in the chart above. For this case, f_0 is 7 kilocycles, and the frequency scale in the chart must be multiplied by 7×10^3 to obtain the actual frequency values.

The insertion loss of this circuit at 21 kilocycles is 39 decibels. The insertion loss at frequencies considerably above the cutoff frequency follows the predicted straight line up to the point where stray inductance and stray capacitance limit the circuit's response.

Pi-circuit problems

Suppose it's necessary to design a pi-circuit that has 35 db of insertion loss at 50 kc. Assume that the zero response curve is the most desirable; then, on either of the response-curve charts at 35 db read $F = 3.8$. From this determine f_0 by:

$$F = f/f_0 = 50 \times 10^3 / f_0$$

$$3.8 f_0 = 50 \times 10^3$$

$$f_0 = 13.2 \text{ kc.}$$

Place a straightedge on the nomograph so that it lies parallel to the 0 response curve line and passes through 13.2 kc on the f_0 scale. Read $L = 1.3$ millihenries and $C = 0.25$ microfarads, which are the component values for the pi-circuit. If there are no restrictions on the component values or their physical size, then the assumption of a zero response curve is valid and desirable because it provides the best transition into cutoff.

A pi-circuit in another example has a 150-microhenry inductor and 3-microfarad capacitors. Find the insertion loss at 25 kc and also at 12 kc. On the nomograph, place a straightedge so that it intersects 150 μhy on the L scale and 3 μfd on the C scale. Note that the straightedge lies parallel to the -2 response curve and intersects the f_0 scale at 5 kc. Locate the -2 response curve. Since $f_0 = 5$ kc and $f = 25$ kc, $F = 5$. For these values the insertion loss is determined to be 40 db.

Note that the -2 response curve has a dip at $F = 2.4$, or for the example above at $f_0 = 12$ kc. This dip goes to zero for ideal components. For actual components the insertion loss at the bottom of the dip depends on circuit Q; the larger the Q, the more closely the insertion loss approaches zero.

Designer's casebook

Sharp discrimination of voltage differences

By Carl David Todd

Costa Mesa, Calif.

A circuit that can discriminate sharply between two slightly different voltage levels is useful in many control and measurement applications. In the circuit at the right, as the input signal rises above a preset threshold, the output changes sharply, and as the input reaches a higher threshold, the circuit returns to its initial state.

When the input voltage is zero, current is not supplied to either tunnel diode, hence neither transistor is turned on. In this condition the output voltage, which is the collector voltage of Q_1 , is equal to the supply voltage V_{CC} . As the negative input voltage slowly increases, current I_1 flows through R_1 and tunnel diode D_1 , and I_2 flows through R_2 and D_2 . But as long as the current through either tunnel diode remains below its peak current the voltage drops across them will not turn on their associated transistors.

For an input voltage, V_1 , the peak current of D_1 will be exceeded. D_1 switches to its high voltage state, driving Q_1 into conduction. The collector voltage of Q_1 then decreases to a very low value. The circuit will remain in this condition until the input voltage reaches a larger negative value V_2 , causing the total current ($I_2 + I_3$) to reach the peak current value of D_2 . When D_2 switches to its high voltage state, it drives Q_2 into conduction, draining enough current from D_1 to drive D_1 back into the low voltage state and turning off Q_1 . Thus, for negative input voltages greater than V_2 , the circuit turns off; the collector voltage of Q_1 is constant and nearly equal to the supply voltage.

As V_{in} decreases, D_2 is held in its high voltage state by the current ($I_2 + I_3$). Because Q_2 is conducting and its base-emitter junction is in parallel with D_2 , the valley current I_{V2} of D_2 , is somewhat modified. When the input voltage decreases to V_3 , reducing the current below the modified valley current, D_2 returns to its low state, turning off Q_2 .

Designer's casebook is a regular feature in Electronics. Readers are invited to submit novel circuit ideas, packaging schemes, or other unusual solutions to design problems. Descriptions should be short. We'll pay \$50 for each item published.

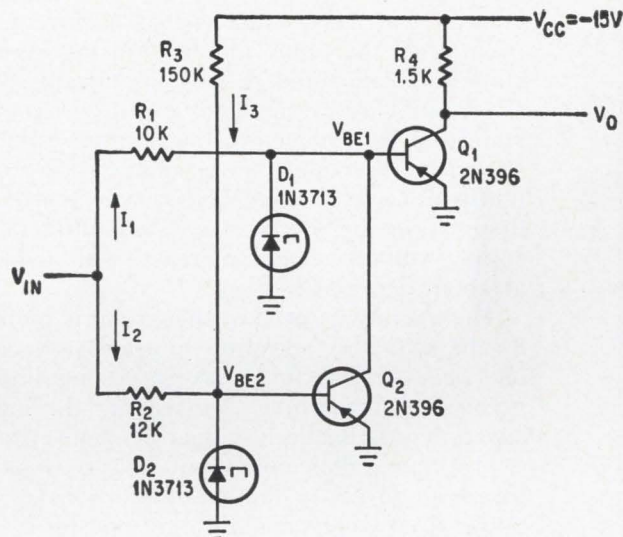

Voltage discriminator produces an output pulse width that can be adjusted by varying the values of R_1 , R_2 or R_3 .

As long as the reset voltage V_3 is less than V_1 , Q_1 remains off. V_3 then returns to V_1 .

The critical voltages are:

$$V_1 \cong -I_{P1}R_1$$

$$V_2 \cong -(I_{P2} + I_3)R_2 = (I_{P2} - V_{CC}/R_3)R_2$$

$$V_3 \cong -(I'_{V2} + I_3)R_2$$

where I_{P1} and I_{P2} refer to the peak currents of D_1 and D_2 , respectively, and I'_{V2} is the valley current for the base-emitter junction of Q_2 in parallel with D_2 .

For most cases, bias current I_3 will be unnecessary, since I_1 is usually much lower than I_{P1} when V_{in} equals V_3 , causing D_2 to switch back to the low-voltage region. Thus, R_3 may be eliminated. If I_3 is larger than I'_{V2} , the circuit will not reset even when V_1 returns to zero, since V_3 will be of the opposite polarity.

Because the threshold levels are primarily determined by the values of the resistors and the peak currents of the tunnel diodes, the discrimination band between threshold levels may be made as narrow as desired.

Typical values for turn-on and turn-off threshold levels are $V_1 = -10v$ and $V_2 = -11v$ respectively.

If the circuit must operate at high temperatures, it may be necessary to modify the circuit to pre-

vent the transistors from turning on before the tunnel diodes switch into their high voltage state. The peak voltage of a tunnel diode is about 50 or 60 millivolts. At room temperature this low voltage applied between base and emitter of a germanium transistor will not cause a very large base current to flow, thus the collector current will also be small. However, the transistor's V_{be} has a negative temperature coefficient and, as temperature increases, can cause sufficient base current to flow even when the tunnel diode is in the low voltage state (typically around 40 mv), turning the transistor on. The discriminator could be temperature-stabilized by connecting the emitters of the transistors to a low-impedance voltage source of a few tenths of a volt so that V_{be} is zero when the tunnel diode is in the low voltage state. Preferably this supply voltage should increase with temperature at about 2 mv/°C.

The operating speed of the circuit is limited only by the switching speed of the transistors, which is one μ sec or less for a 2N396. Using high-speed germanium switching transistors, the operating speed may be made less than 75 nanoseconds.

Maximum allowable input voltage beyond the threshold levels is limited in most cases by the power dissipation capabilities of resistor R_1 and R_2 .

A discriminator for positive input voltages can be built by simply using npn transistors for Q_1 and Q_2 , inverting the tunnel diodes, and using a posi-

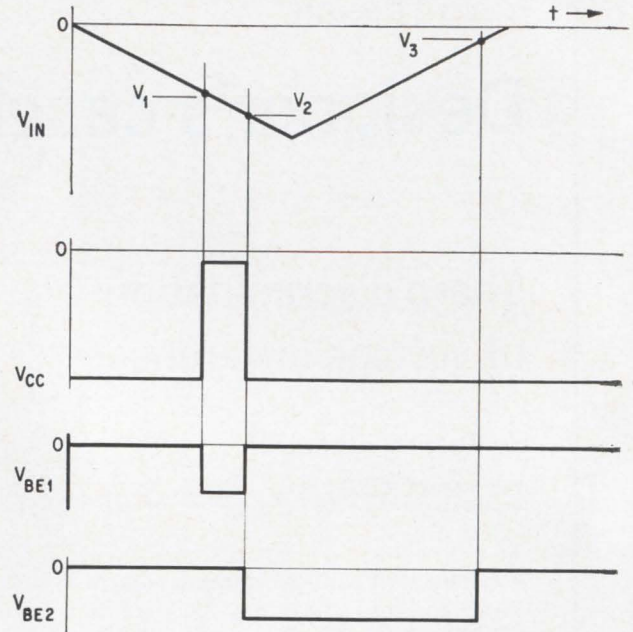

Voltage waveshapes show circuit operation for a triangular input voltage. When Q_2 turns on, circuit returns to off condition.

tive supply voltage for V_{CC} .

If the source providing the input voltage cannot supply the required current, then the circuit shown should be preceded by an emitter-follower stage.

Pulse generator controls rise, fall time independently

By Delbert G. Larsen

The Boeing Co., Huntsville, Ala.

The simple circuit on the next page can generate pulses with independently controlled rise and fall times. These pulses can then be used to great advantage in the worst-case design and testing of different pulse networks.

The linear rise and fall time is generated by alternately charging and discharging the capacitor through twice the supply voltage, and controlling the output to reflect only a portion of the charge path. The amplitude of the output pulses can almost approach that of the supply voltage, resulting in very efficient use of the power source.

Initially, with no input signal to cause the generator to change from its stable state, transistor

Q_1 is biased in the off condition, Q_2 is on, and Q_3 is off. While at this time the capacitor C_1 has no charge on it, C_2 has been charged to the power supply voltage through the diode and resistor, D_1 and R_5 . The output of the generator is zero (A in the diagram on the next page).

To generate the desired output pulse, an input pulse is used to drive Q_1 into saturation, so that its collector, and hence the base of Q_2 , drops to zero volts. Q_2 is therefore biased to the off condition, and capacitor C_1 begins to charge, causing Q_3 to start to conduct. C_2 , already charged to the power supply voltage, is joined, with reverse polarity, to the power supply through the short circuit of Q_3 . Therefore, twice the power supply voltage appears on the cathode side of diode D_1 , reverse-biasing it. Capacitor C_1 then sees this double voltage through R_1 and R_2 . The charging rate, and therefore the rise time of the output, is controlled by these resistors. As C_1 reaches the voltage level of the power supply, the base-collector junction of Q_3 becomes forward-biased. This ties the output to the power supply voltage level, V_{CC} .

The output remains at this level (B in the figure

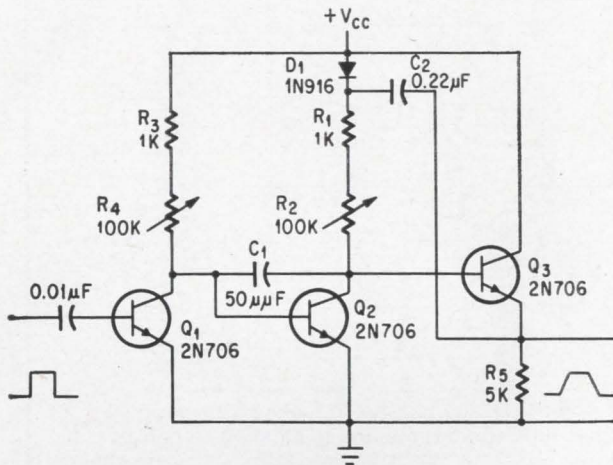

Circuit will generate pulses with amplitudes equal to V_{cc} and rise and fall times as given in the accompanying table. The quality of the switching transistors determine the minimum rise and fall times attainable.

above, right) until the input pulse returns to zero. When this occurs, transistor Q_1 is again biased off and its collector approaches the power supply level. The reverse bias that is present on the base-collector junction of Q_2 as a result of the charge on C_1 prevents Q_2 from turning on. Q_2 will come on only as C_1 discharges.

Because of the polarity of the charge that has accumulated on C_1 , it must discharge through twice the power supply voltage. The discharge time of C_1 , and the fall time of the output pulse, is controlled by the value of R_4 in combination with R_3 . As C_1 discharges and its polarity changes from positive to negative (C in the figure above, right), the base-collector junction of Q_2 is forward-biased

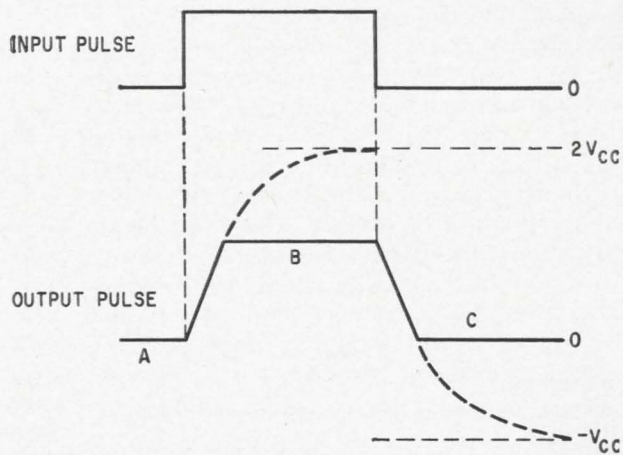

Charge and discharge path (lower curve) of capacitor C_1 . Voltage level B is maintained until the input pulse, at the top, drops to zero. Clipping the paths at one-half of their potential level results in linear rise and fall times.

and Q_2 then comes fully on, biasing Q_3 off. The output signal reflects the discharge path of C_1 through the emitter-follower arrangement of Q_3 and will therefore follow C_1 through its discharge path only to zero. After C_1 is completely discharged, the circuit stabilizes at its original state and is ready for a second input pulse.

The linearity of the rise and fall times is a result of clipping the charging and discharging paths of the capacitor C_1 before they reach their upper and lower limits.

Rise and fall time range

10 nanoseconds to 1.0 microseconds
1.0 microseconds to 100 microseconds
100 microseconds to 10 milliseconds

Value of C_1

10 $\mu\mu\text{f}$
0.001 μf
0.1 μf

Diode quiets input to monostable multi

By B. D. Simmonds

Associated Electrical Industries (Woolwich) Ltd., London

Inductive noise pulses, created by electromechanical devices such as relays and switches and spread by a system's power supply, can change the potential across a conducting transistor's base-emitter junction. This can be particularly troublesome in transistorized monostable multivibrators, which are sensitive to noise on their collector supply line. A diode in the collector circuit cures the problem.

If noise has a positive polarity, it will only cause the transistor (Q_2 in the circuit diagram on the next page) to conduct harder. But a negative polarity will reverse-bias Q_2 and increase its collector voltage, perhaps high enough to cause Q_1 to conduct and commence a timing cycle. This dangerous situation arises because Q_2 base current is diverted into the coupling capacitor between the stages. The amount of diverted current that will cause this is

$$I_B = \frac{V_B}{R_2} = \frac{10_v}{20K} = 0.5 \text{ ma}$$

where I_B = base current and V_B = supply voltage. Q_2 cuts off completely if a negative noise voltage occurs that is greater than $I_B \times R_1$ (0.5 volt). Normally the circuit triggers before the base current is completely diverted; the larger the ratio R_2/R_1 , the smaller the noise voltage value that

will be required to trigger the circuit.

Inserting diode D_2 in the collector circuit of Q_1 (dashed lines in diagram) provides the multivibrator with high noise immunity. Q_1 is normally cut off and its potential is at $+V_B$. Any reduction of supply voltage caused by noise will reverse-bias D_2 , and the leakage current will divert only an insignificant amount of I_B from Q_2 . Therefore the circuit will remain untriggered. Timing variations are avoided by shunting a resistor equal to $10R_2$ across Q_1 . This allows excess voltage, acquired by C_1 as a result of noise, to leak away.

Acknowledgment

Associated Electrical Industries, Ltd., has given permission to publish this article.

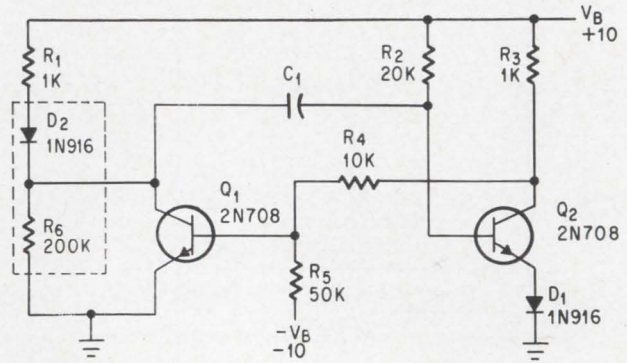

Addition of diode D_2 and resistor R_6 make a conventional monostable multivibrator immune to most noise pulses.

Circuit inverts d-c voltage

By Mohammed I. Hussain

Thiokol Chemical Corp., Los Angeles

Positive and negative voltages are often required in low-power preamplifiers and amplifiers, especially in differential and operational amplifiers. This usually means that two power supplies must be provided.

When only a positive d-c source is available, the simple circuit shown below can provide the required negative d-c voltage.

Unijunction transistor oscillator Q_1 produces a

train of positive voltage pulses V_E across resistor R_3 . During the interval between these pulses, Q_2 is forward-biased, causing C_4 to charge to a potential approximately equal to V_{BB} . Pulses at R_3 reverse-bias and cut off Q_2 and, at the same time, forward-bias Q_3 . When Q_3 conducts, C_4 discharges through R_6 . The result is a train of negative voltage pulses across R_6 , which are averaged by diode D_1 and C_5 .

For the values and components in the circuit diagram, the output is -5 volts at one milliampere, which is sufficient for low power amplifiers. If required, a $+5$ -volt output can be obtained by connecting a diode and capacitor across R_3 .

A zener diode may be added to regulate the d-c output. The unaveraged pulses can also be used as a clock or trigger.

This circuit could be very useful in integrated circuit applications where negative pulses and a negative d-c voltage must be provided.

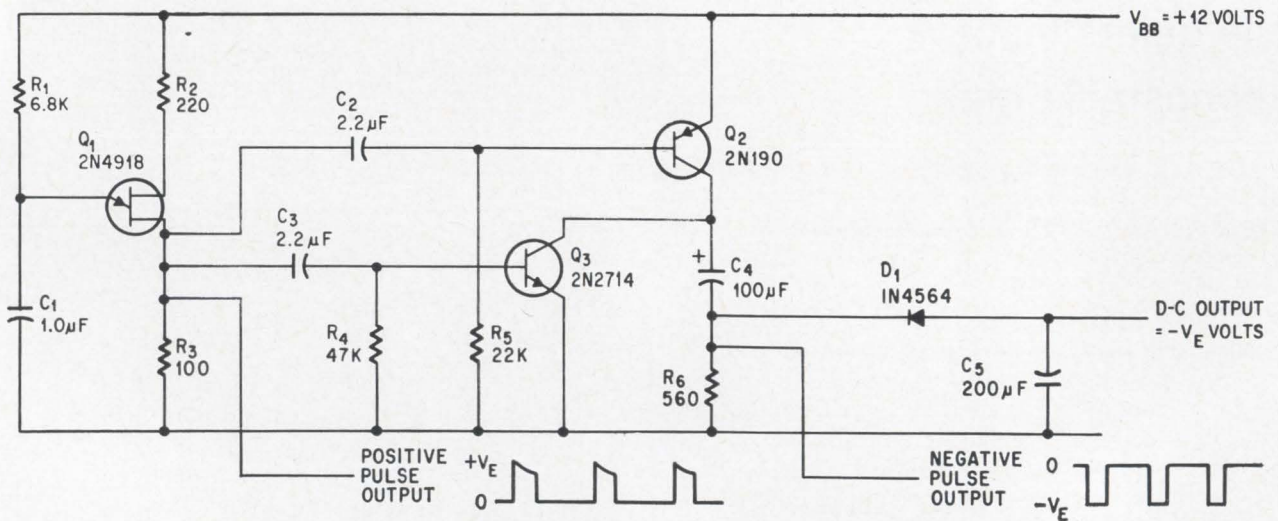

Transistors Q_2 and Q_3 invert the polarity of the pulses produced by the ujt relaxation oscillator Q_1 .

Controlling laser oscillation

Side modes can reduce a laser's information-carrying ability. An additional phase-modulated input can transpose the energy into an f-m signal whose sidebands are controlled, and further modulation gets rid of sidebands altogether

By Stephen E. Harris, Gail A. Massey, M. Kenneth Oshman, and Russel Targ

While lasers have opened up new vistas in communications, they are not without their practical problems. The basic free-running laser oscillates at many independent frequencies or modes. However, as with radio frequencies, a single carrier is desirable in order to have optimum signal-to-noise ratio and maximum information-carrying ability.

The techniques previously devised for control of laser output frequencies are generally delicate mechanically and reduce the output power of the laser. A new technique, resulting in what is termed an f-m laser, controls the relative amplitude and phase of the various frequencies. The supermode laser an extension of the f-m laser, results in a single-frequency output. These new techniques are relatively simple, but still retain the original power output of the laser.

The usual gas laser configuration is shown in the first figure on the next page. The active material (which is pumped in some manner to produce am-

plification of the optical signal) is placed between two mirrors. There are two basic conditions that must be satisfied before laser oscillation is possible. First, the optical signal in the cavity must acquire sufficient gain from the active laser material to overcome losses from absorption, diffraction, scattering, and transmission through the output mirror. Second, the frequency of the optical signal must "fit" the dimensions of the cavity; that is, it must meet the appropriate boundary conditions of the cavity. In order for the oscillation to build up as the light makes multiple passes through the cavity, the electric field at each mirror must be zero, which requires that the length of the cavity be an integral number of half-wavelengths long. Thus the frequency of oscillation must satisfy the relation

$$f = \frac{nc}{2L} \quad (1)$$

where L is the length of the cavity, n is an integer and c is the velocity of the light in the laser (which is an average number because the velocity of light is different in different parts of the cavity.)

There are a number of frequencies for which the cavity is an integral number of half-wavelengths long, which is why a laser oscillates in several modes. In the gain curve of a typical laser shown in the second figure on the next page, the "picket fence" of modes at the bottom indicates those frequencies. For a typical laser length of one meter, these frequencies are separated by about 150 megacycles. Frequency separation between modes varies inversely with the length of the cavity.

The peak of the gain curve is centered at a frequency determined by the energy levels of the laser material. For example, a helium-neon gas laser has one energy level transition in the red at a wavelength of 6,328 angstroms. For this particular transition, the width of the gain curve is approximately 1,800 Mc. For the case diagrammed in the figure, with an assumed constant loss line, there are four modes which meet the frequency requirements of the cavity and lie in a region

The authors

Stephen E. Harris is assistant professor of electrical engineering at Stanford University. His current research interests are light modulation and demodulation, control and stabilization of laser oscillation by internal time varying perturbation.

Gail A. Massey's work at Sylvania Electronic Systems, a unit of General Telephone and Electronics Corp., has resulted in the construction of optical frequency translators with frequency shifts from audio to microwave. He is interested in noise sources in the multimode laser due to intracavity modulation.

M. Kenneth Oshman joined the optics department of Sylvania in 1963. In addition to studying photoelectric emission, he has helped develop techniques for acoustical and electro-optic modulation.

Russel Targ is currently experimenting with optical modulation and demodulation with microwave phototubes, and optical heterodyning. Prior to joining Sylvania in 1962, Targ demodulated phase-modulated light by optical homodyne techniques at TRG, Inc.

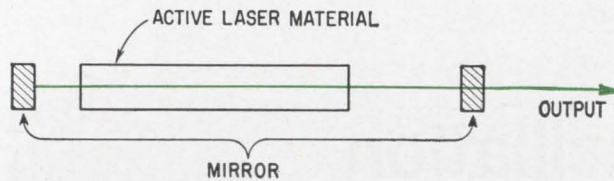

The typical gas laser cavity is bounded by two mirrors which are spaced an integral number of half-wavelengths apart to permit the amplification of the input signal.

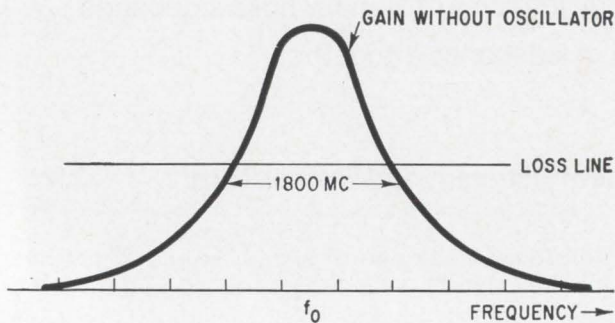

Gain profile for a helium-neon laser, whose main oscillation is at a wavelength of 6,328 angstroms. The spikes along the bottom are at the side frequencies. The loss line represents the point at which gain from the oscillation is greater than losses from absorption, diffraction, and other factors within the cavity. Any frequencies that fall within the part of the curve that rises above the loss line will oscillate; they will be the side modes shown in the first photograph of the sequence on the opposite page.

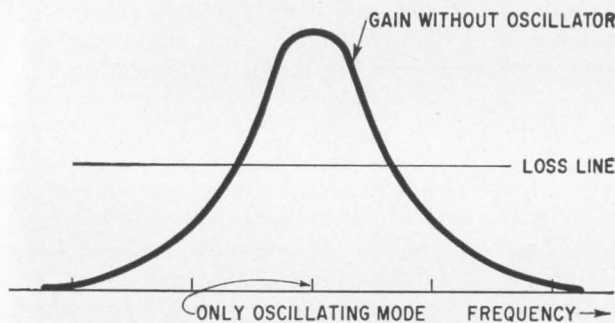

Threshold control is achieved by shortening the laser cavity so that the frequency bands between the side modes are widened. Since only the main mode has an amplitude which reaches above the loss line, only it will oscillate and there will be no side modes. However, this method reduces gain and power.

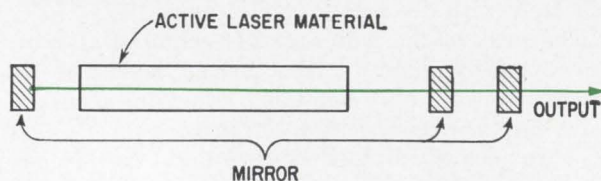

Interferometric control also eliminates the side modes, but does not require a shortening of the cavity. The added mirror (or mirrors) acts as a single mirror at the output, with selective reflectivity. Only the main mode will oscillate; however, power is reduced.

where gain exceeds loss. This is typical of the operating characteristics of helium-neon gas lasers, in which 5 to 10 frequencies may be present in the output spectrum.

Threshold control

The simplest method of achieving single-frequency oscillation is to make the laser cavity short enough so that only one mode has enough gain to oscillate. The method, which we call threshold control, is shown in the third diagram at the left. For the He-Ne laser, this requires a cavity length of about 10 centimeters, so that the modes are separated by about 1,500 megacycles, and only one mode lies within the range in which oscillation is possible.

However, reducing the size of the cavity results in lower gain of the laser and reduces output power. In addition, since only one mode oscillates, the output power is lowered by a factor approximately equal to the number of modes which would otherwise oscillate. For example, with the mirrors 10 centimeters apart, only one mode oscillates. But with the same amount of active laser material and the mirrors separated by one meter, several modes may oscillate, producing almost as many times as much output power. (Even though the laser power is low, it may be possible to use the single mode laser in conjunction with laser amplifiers to increase output power. Such amplifiers have been demonstrated, and may prove to be a practical solution.)

Interferometric control

Another method of mode control involves the use of more than two mirrors. The technique, which we call interferometric control,¹⁻⁵ is shown in the lower figure at the left. It sets tighter restrictions on the cavity boundary conditions and prevents oscillation of some previously oscillating modes. The two output mirrors may be thought of as one mirror with a frequency-dependent reflectivity.

The interferometric technique is similar to threshold control in that it allows only certain modes to meet both requirements for oscillation. With threshold control, the gain is lowered for all but one mode; with interferometric control, the frequency requirement is altered.

The real advantage of the interferometric method is that the length of the laser cavity can be increased so that even if only one mode is oscillating, this mode will exhibit a great deal of gain. Nevertheless, the power output is limited to the maximum power obtainable from a single mode, and mechanical dimensions must be closely controlled to keep the laser oscillating. In addition, it is usually impossible to suppress all the previously oscillating modes with only two mirrors.

The f-m laser

The f-m laser takes a completely different approach to the problem of spectral control. This

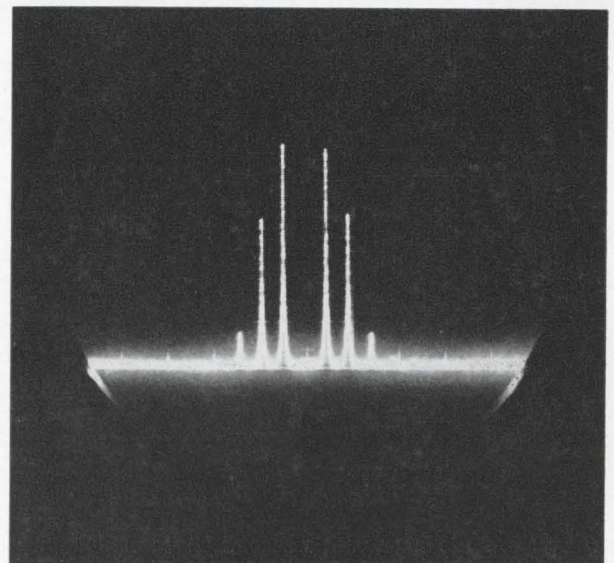
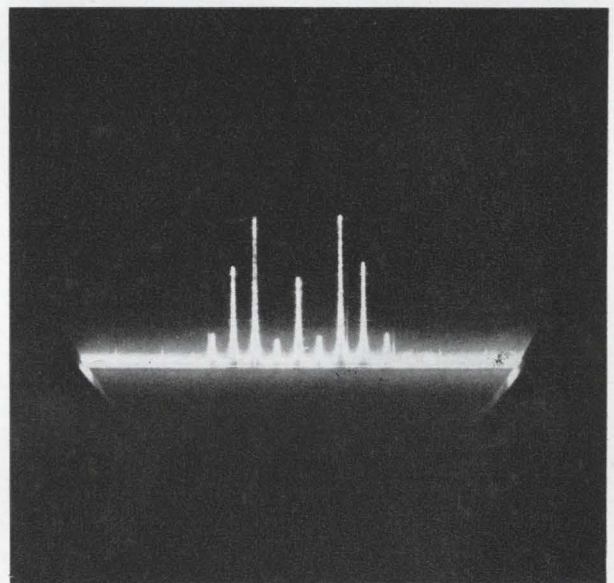
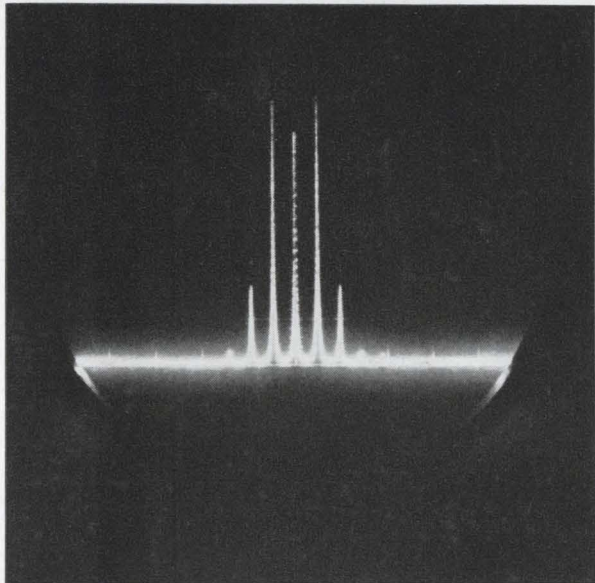
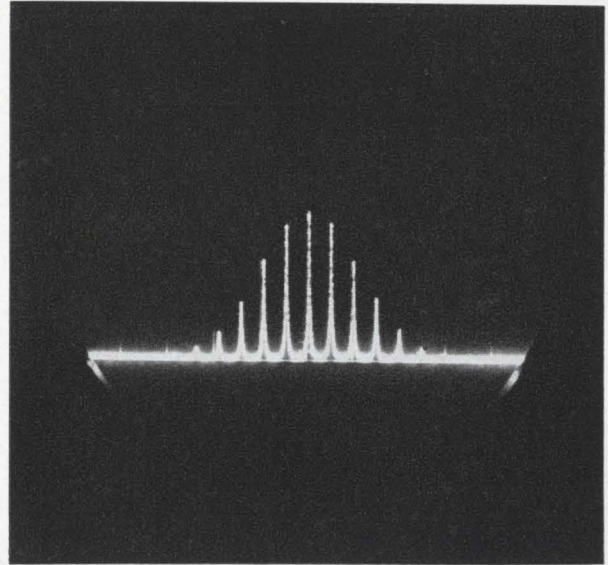
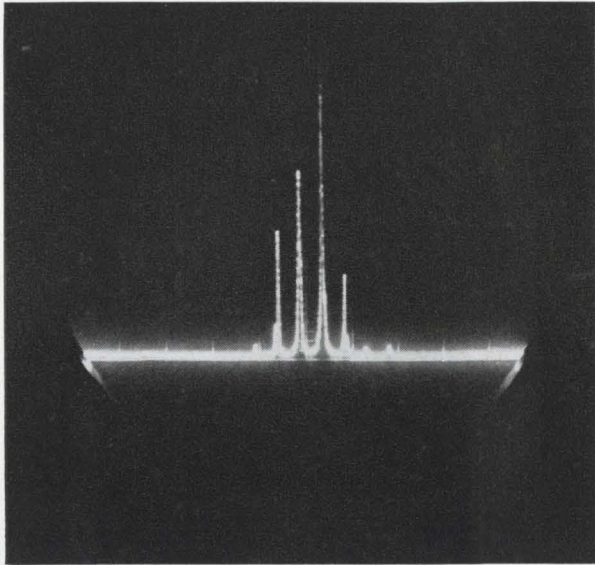

Laser spectra as shown on a cathode ray tube. The first photo is for a free-running laser; the side modes are completely random, with uncontrolled phase and amplitude. Second photo shows the f-m oscillations produced by a KDP crystal placed in the laser cavity and driven at a frequency approximately equaling the band separation of the free-running laser. The other three photos are of the output of an f-m laser with the phase modulation detuned from the intermode frequency. The oscillations have been forced to become dependent on each other so that these output spectra are completely controlled. Extending this technique, a single frequency output, or supermode, can be obtained. Both methods retain the full output power of the laser.

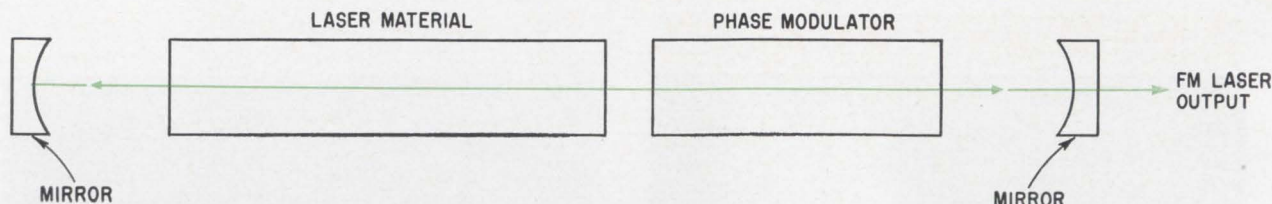

Diagram of an f-m laser shows that a phase modulator, in this case a crystal of potassium dihydrogen phosphate, has been placed inside the laser cavity. It is driven at a frequency which is almost that of the band separation of the laser modes. Phase modulation robs laser oscillations of energy, and produces an f-m output with controlled phase and amplitude at frequencies near those of the laser modes. One such output is shown in the second photo of the sequence on page 103.

technique allows all the frequencies of the free-running laser to continue to oscillate, but controls their amplitudes and phases in a prescribed manner.⁶ The method is diagrammed above.

A phase modulator is placed inside the laser cavity. The modulator is a potassium dihydrogen phosphate (KDP) crystal oriented with an electrically induced axis parallel to the laser polarization. When an r-f field is applied to the crystal, its index of refraction is changed, causing a change in the length of the optical path of the cavity.

The KDP crystal is driven at a frequency which very nearly, but not exactly, corresponds to the frequency separation of the free-running modes. Its oscillation is analogous to the vibration of one of the laser mirrors at the modulation frequency; the changing path length causes the existing laser modes to be phase-modulated, and gives rise to f-m sidebands of each mode.

Since the modulation frequency is very nearly the frequency separation of the free-running modes, the f-m sidebands very nearly coincide with these modes. A parametric energy exchange process results, in which energy of the previously independent oscillating modes is coupled by the phase modulator in the form of sidebands to the other modes. There is then a competition between these f-m oscillations for gain in the active material; and under appropriate conditions it is possible for one f-m oscillation to quench or extinguish other oscillations. The result is that the total output is made up of one f-m carrier and its sidebands. The center,

or carrier frequency, of the f-m spectrum is very near the center of the original oscillating modes.

Modulation frequency

An f-m signal, $E(t)$, can be represented as

$$E(t) = E_0 \cos(\omega_c t + \Gamma \cos(\omega_m t)) \quad (2)$$

where ω_c is the carrier frequency, Γ is the modulation index, or ratio of the peak phase deviation to the modulation frequency, and ω_m is the modulation frequency. For a He-Ne laser, with a wavelength of 6,328 angstroms, the center frequency is approximately 5×10^{14} cps, and the f-m carrier will be very close to that frequency. The relative amplitudes of the output laser modes bear Bessel function relationships to each other; the central mode will have an amplitude given by $J_0\Gamma$, the first sidebands $J_1\Gamma$, and so on.

The modulation index can be written as⁷

$$\Gamma = \frac{1}{\pi} \frac{\Delta\Omega}{\Delta\nu} \delta \quad (3)$$

where $\Delta\Omega$ is the frequency separation of the modes, $\Delta\nu$ is the difference in frequency between $\Delta\Omega$ and the modulation frequency, and δ is the single-pass modulation index of the phase modulator, in radians. For a one-meter laser with $\Delta\Omega$ equal to 150 Mc, and $\Delta\nu$ to 150 kilocycles, and using 0.01 as a typical value of δ , then Γ equals 3.19.

Equation 3 makes it clear why the modulation frequency cannot exactly equal the mode spacing. If the modulating frequency were equal to the

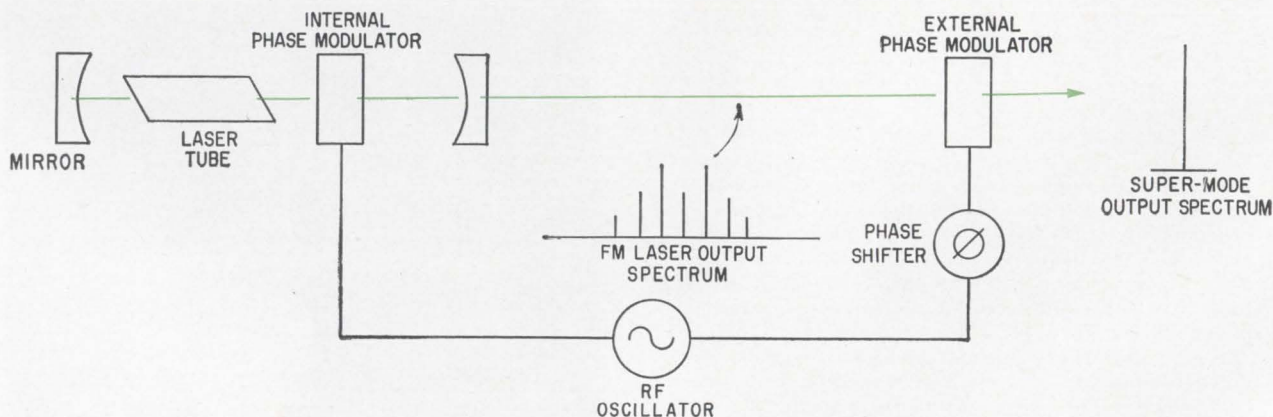

The supermode laser, with a second phase modulator placed outside the laser cavity. The second modulator, 180° out of phase with the first, nulls the f-m sidebands and produces a single mode of greater amplitude.

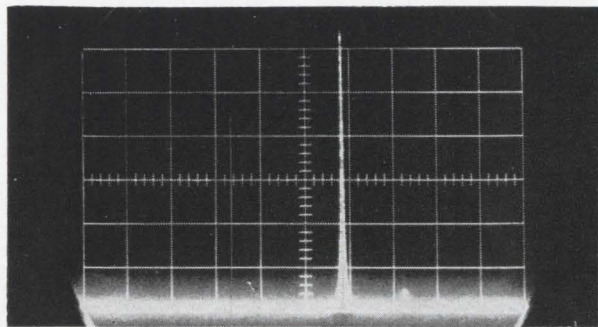

Supermode laser spectrum. The spectrum is essentially that of a monochromatic signal. The scale for this photograph is the same as those for the preceding sequence of laser spectra on page 103.

mode spacing, then $\Delta\nu$ would be zero and Γ would be infinite. At that operating point, the output no longer resembles an f-m signal; instead, all the modes would oscillate in phase and have a nearly Gaussian distribution of amplitude. This output corresponds to train of very narrow pulses with a repetition rate corresponding to the frequency separation of the modes.⁸

One very interesting property of the f-m signal is that it produces no beat signal when detected on a square-law photodetector. This is easily seen if the photocurrent intensity is considered proportional to the square of the electric field. Then

$$\begin{aligned} I &\propto E_0^2 \cos^2(\omega_c t + \Gamma \cos \omega_m t) \\ &= E_0^2 \frac{1 + \cos^2(\omega_c t + \Gamma \cos \omega_m t)}{2} \\ &= \frac{E_0^2}{2} + \frac{E_0^2 \cos^2(\omega_c t + \Gamma \cos \omega_m t)}{2} \end{aligned} \quad (4)$$

The second term represents frequencies of approximately 10^{15} cps and therefore will not be detected. This is due to the fact that the photodetector responds only to amplitude variations, whereas the f-m signal has, by definition, a constant amplitude. The photocurrent will just be an average d-c current proportional to the f-m laser intensity. This phenomenon is in sharp contrast to the case of the free-running laser, from which there are generally random components of the photocurrent at multiples of the frequency spacing between modes. (For a one-meter He-Ne laser, the photocurrent will contain frequencies at approximately 150 Mc, 300 Mc, and so on, up to about one gigacycle.)

The supermode laser

The supermode laser, diagrammed on the opposite page, is an extension of the f-m laser, which uses the controlled spectral output to produce a single frequency.⁹ The output of the f-m laser is passed through a second KDP phase modulator. Since the f-m laser output can be written as

$$E = E_0 \cos(\omega_c t + \Gamma \cos \omega_m t) \quad (5)$$

then the output of the external phase modulator (which is driven at the same frequency as the modulation frequency of the f-m laser) is

$$E = E_0 \cos[\omega_c t + \Gamma \cos \omega_m t + \Gamma' \cos(\omega_m t + \Phi)] \quad (6)$$

where Γ' is the modulation index of the external modulator and Φ is the difference in phase between the two modulations. When Γ' is made equal to Γ and Φ is 180° , then (6) reduces to

$$E = E_0 \cos \omega_c t \quad (7)$$

This is a monochromatic signal at a frequency near the center of the original free-running spectrum and is shown in the figure at the left. Briefly, the supermode laser produces a single-frequency output by first controlling the free-running modes in a specific manner through the f-m laser techniques, and then converting this controlled signal to a single frequency.

Power and control

In principle, neither approach—f-m or supermode—reduces the laser's output power. For the f-m laser, the only significant losses are in the internal modulator, and these losses can be made very low. The f-m laser has produced outputs of about two milliwatts; the supermode extension has produced one milliwatt.

Both techniques control the relative amplitudes and phases of the laser modes—not the absolute frequency of the output. The central frequency of the f-m spectrum will drift as the dimensions of the optical cavity undergo thermal changes. A change in length by half a wavelength will result in a frequency shift of the whole spectrum by about 150 Mc for a one-meter laser. This is a very important problem, and several solutions are presently being studied.

Because the full power of the laser remains available, and excellent spectral control is possible, f-m and supermode lasers are potentially applicable to information-carrying, spectroscopy and holography. The experimental work was done with a gas laser, but the methods are now being applied to solid crystal lasers.

Acknowledgement

The work upon which this article was based was partially supported by contract AF 33(615)-1938 from the Laser Technology Laboratory at the Wright-Patterson Air Force Base, Ohio, and by the independent research program of Sylvania Electronic Systems, a unit of General Telephone and Electronics Corporation, at Mountain View, Calif.

References

1. D.A. Kleinman and P.P. Kisliuk, "Discrimination Against Unwanted Orders in the Fabry-Perot Resonator," *Bell System Technical Journal*, vol. 41, Aug. 1962, pp. 453-462.
2. T.R. Koehler, "Mode Structure of a Three-Reflector Cavity," IBM Research Paper RJ-260, Aug. 1963, International Business Machines Corp., San Jose, Calif.
3. S.A. Collins and G.R. White, "Interferometer Mode Selector," *Applied Optics*, vol. 2, April 1963, p. 448.
4. H. Manger and H. Rothe, "Selection of Axial Modes in Optical Masers," *Physics Letters*, vol. 7, Dec. 15, 1963, p. 330.
5. H. Kogelnik and C.K.N. Patel, "Mode Suppression and Single Frequency Operation in Gaseous Masers," *Proc. IRE*, vol. 50, Nov. 1962, p. 2365.
6. S.E. Harris and R. Targ, "F-m Oscillation of the He-Ne Laser," *Applied Physics Letters*, vol. 5, Nov. 15, 1964, pp. 202-204.
7. S.E. Harris and O.P. McDuff, "F-m Laser Oscillation—Theory," *ibid.*, pp. 205-207.
8. E.O. Ammann, B.J. McMurtry, and M.K. Oshman, "Detailed Experiments on Helium-Neon f-m Lasers," to be published.
9. G.A. Massey, M.K. Oshman, and R. Targ, "Generation of Single-Frequency Light Using the f-m Laser," *Applied Physics Letters*, vol. 6 Jan. 1, 1965, pp. 10-11.

Data dots identify aerial photos

Electronic marking system speeds interpretation of reconnaissance and surveillance film

By William A. Miller

Fairchild Hiller Corp., Bay Shore, N. Y.

More rapid communication of wartime intelligence has been made possible by an electronic system that eliminates the time-consuming job of marking aerial reconnaissance photographs before they can be interpreted.

Supersonic RF-4C reconnaissance planes, streaking overhead, photograph Viet Cong convoys on the road from Hanoi to South Vietnam, military installations, troop movements and target areas. With six cameras aboard and each camera taking up to 12 pictures every second, a single plane sometimes returns from a mission with more than 4,000 pictures for every minute over the target. But before intelligence officers can study a picture, it must be identified; each frame correlated with the mission profile and marked with pertinent information. That job now is performed, simultaneously with the picture taking, by an airborne system developed by the Fairchild Hiller Corp.

The auxiliary data annotation set, ADAS, as the electronics system is called, marks the film with time, latitude, longitude, speed, barometric and radar altitude, heading, drift, pitch, roll, date, sortie number, detachment, radar mode, correlation counter, sensor or station identification, and photographing unit. The ADAS annotation system is flexible; it can be used to mark the film records of side-looking radars, infrared scanners, or any other systems that produce film records of their findings.

The author

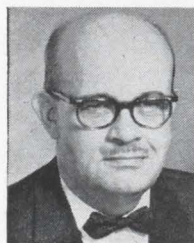

William A. Miller, a staff consultant at the Electronic Systems division specializes in radar ranging, wide-band data link and satellite navigational systems. In addition to the design of the auxiliary data annotation set, he is also engaged in special design work on high-resolution facsimile, and optical systems.

The ADAS airborne system is made up of one major assembly, the auxiliary data translator unit; several smaller subsystems and up to nine recording head assemblies that annotate the film of each sensor. A tenth recording head assembly is part of a test unit in the aircraft cockpit.

The auxiliary data translator unit contains both logic and power supply modules; it takes the mission profile data (latitude and longitude from the inertial guidance equipment, altitude from the altimeter, and so on) and translates it into a form that will drive the recording head assemblies. Some of the input to the logic modules is provided by a programed card assembly, which carries fixed data, such as date, sortie number, and so on. This assembly is inserted into the translator unit immediately before takeoff. A special timer is also used to set the translator's digital clock to the time of day.

Each recording head assembly contains a cathode-ray tube magnetically shielded and potted inside a 4½ x 1¼ inch cylindrical mount. The assembly is mounted on the film recorder of each camera, radar or infrared scanner where together with a special lens system, it projects the data display onto a previously assigned area of the reconnaissance film. Because the film sensitivity at each of the recording stations varies, the brightness of the spot of the crt must also vary; this is automatically controlled by the programed card in the translator unit.

Producing the pattern

Data is projected onto the sensor film in what is called an excess-three binary-coded-decimal data format (+3 BCD). Because this format has the advantage of high data density, less film area is required for data annotation. Two subsystems are required to produce the crt's data raster: a deflection-control subsystem, which generates vertical and horizontal sweep voltages for the crt's in the recording head assemblies; and the unblanking

control system that supplies a sequence of intensification pulses to the crt to turn the beam on. These unblanking pulses must be supplied in various widths to assure optimum exposure on different types of sensor films. It is the combination of deflection and unblanking control signals, synchronized, that produces the data raster.

The deflection-control circuits simultaneously generate column, line and section gating pulses, which are combined in a digital-to-analog converter to produce two sets of staircase waveforms. One set is used for the crt horizontal deflection voltage, and the other for vertical deflection. Supplying these two deflection voltages produces the sequential stepping of the electronic beam to every dot location in the data matrix.

Counters move the dot

Data is scanned first by line, by section, and finally by major column. A minor column is a row of vertical dots. Six minor columns make up a major column, and 16 lines, six minor columns wide make up a section. This arrangement is shown on page 108. Column, line and section counters are the framework of the deflection-control circuitry.

Frequency-divider networks and a master oscillator position the dot in the data matrix. The minor column is produced when the output from the master oscillator passes through a divide-by-six network. This network's last flip-flop triggers a line counter and moves the dot one minor column over.

The crystal-controlled clock (master oscillator), which operates at a frequency of 741.1 kilocycles, also drives a divide-by-32 counter that triggers the minor column through a retrace control circuit. This circuit simply counts the number of steps in the deflection voltages so that at the end of a column the time for one step is reserved for circuit ($\div 32$ counter) settling. This gives the crt beam one whole dot period to retrace from the bottom line of the display back to the top. The retrace control circuit also suppresses the trigger to the column counter for one count and simultaneously produces a blanking pulse, which inhibits the display during this time. A trigger from the section counter initiates the retrace action.

For proper ASA settings, dot exposure at the five different reconnaissance camera stations is varied by changing the width of the gating pulse which controls the dot display period. This control of the gating (unblanking) pulse is accomplished in the auxiliary data translation unit by combining, in a diode matrix, outputs from the same chain of flip-flops that make up the initial divide-by-32 counter in the deflection control circuitry.

Seven levels of exposure are available; the highest is achieved by allowing a dot to be displayed

◀ Aerial reconnaissance photograph shows the ADAS display at upper left. The high data-density format permits recording the maximum amount of reconnaissance information in a minimum area of sensor film.



Reading +3BCD data

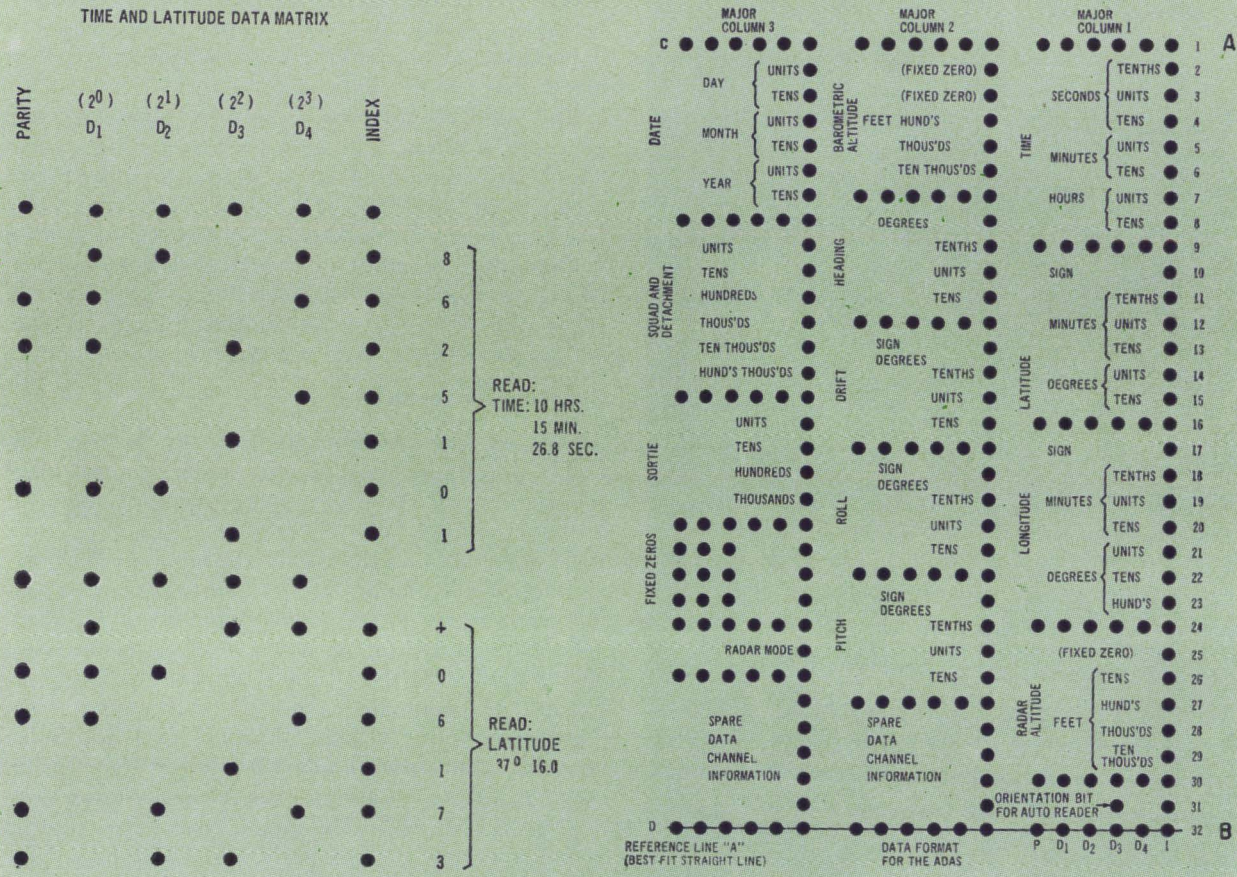

The auxiliary data annotation set uses an excess-three binary-coded-decimal format (+3 BCD). This format can be read by optical character-recognition systems that enable machines to perform at least part of the analyst's task. This is how +3 BCD format is read:

Arrangement of data in the crt raster is shown above, right. The data format is broken down into three major columns, with each column divided into data blocks bordered by index dots. In major column 1 the index dots appear on lines 1, 9, 16, 24, 30 and

32. They also occupy the entire far right hand column.

With two exceptions, all the variable data—time, latitude, longitude, drift, etc.—appears in major columns 1 and 2. The exceptions are radar mode and part of the spare data channel information. All fixed data—date, squad and detachment, sortie—appears in major column 3.

In each data block, the most significant decimal digit is at the bottom of the block and the reader should start reading at the bottom and work up. If a sign is associated with the data block it is read on the topmost line.

In the figure above, left, is a portion of the data raster consisting of the time and latitude data blocks. These blocks are lines 1 through 16 of major column 1 above. There are six minor columns in each data block, reading from right to left as follows: Index, D₄, D₃, D₂, D₁, and parity. D₄ is the 2³ bit in the binary code, D₃ is the 2² bit, and so on.

The sixth column contains the parity bit. Odd parity is used in the ADAS system; this means that when counting the 2⁰, 2¹, 2² and 2³ bits in any line, presence of a parity bit indicates an even number of bits. Conversely, if the number of bits is odd, no parity bit will appear. The index bit is not included in the count to determine parity.

In the table at left the conversion from decimal to +3 BCD is given. By using this with the sample data blocks for time and latitude it can be seen how the ADAS display is converted to decimal data.

CONVERSION FROM DECIMAL TO EXCESS THREE BINARY CODED DECIMAL (+3 BCD)				
Decimal	Excess Three Equiv. No.	+3 BCD (Least significant bit at left)		
0	3	1	1	0
1	4	0	0	1
2	5	1	0	1
3	6	0	1	1
4	7	1	1	1
5	8	0	0	0
6	9	1	0	0
7	10	0	1	0
8	11	1	1	0
9	12	0	0	1
+		1	0	1
-		1	0	0
Blank		0	0	0

for almost the full time of a linear column count—39 microseconds. For the lowest exposure level, the dot is displayed for about two microseconds.

Screw plugs inserted in the fixed-data card select the exposure levels. The pulse that regulates the exposure is passed by an AND gate in the unblanking amplifier to control the data "on" time.

In the recording head assemblies at sensor stations other than photographic reconnaissance cameras, circuitry integrally potted with the crt provides proper spot focus and intensity control. Additional diode circuitry is used for d-c restoration and amplitude clipping of the unblanking pulse. This enables the crt to have a light output pulse whose peak intensity is independent of unblanking pulse lengths.

More needed

The ADAS is only part of the solution to the problem of fast interpretation of reconnaissance and surveillance photographs. Bottlenecks still occur because the photographs and their annotation must be subjected to human analysis. The Air Force, at its Rome Air Development Center and Wright-Patterson Air Force Base, is studying systems that will mechanize and speed up interpretation of military intelligence. One approach combines a central data recorder and ADAS so that once the mission profile data is stored on magnetic tape, it can be computer-processed to generate intelligence information in near real time.

ADAS and data recorders

The armed services are making extensive use of the automatic data annotation system, ADAS, to identify reconnaissance film but they still have to use optical techniques for information readout. Recently, the Rome Air Development Center awarded the first of several contracts for central data recorders and other automatic film-processing equipment. Bids are now being submitted on a contract for similar equipment for the Aeronautical Systems division at Wright-Patterson Air Force Base.

The central data recorders will be used with real-time computers. An airborne ADAS would feed mission-profile data to the recorder; the information would be buffered, processed, and stored on recording tape. After the plane landed, the recorder's memory bank would feed the profile information to a computer. The computer could then drive a chart or map to plot the course the plane had followed.

Since all the target's coordinates would be stored in the computer's memory, intelligence officers who interpret photos could almost instantly spot a target of interest. By proper interrogation of the computer, they could constantly update or compare target data.

The Army is also investigating methods of automatically interpreting surveillance photos. According to one Army spokesman, the most urgent requirement in the surveillance program is an automated imagery interpretation system that can pick out targets such as tanks, guns, launchers, supply dumps, and so forth without human intervention. Additionally, they want the automatic system to be able to review specific areas to pick out frames in which changes have occurred. W.J.E.



Three-man photo-intelligence team at work inside a reconnaissance data-reduction shelter. The ADAS lightens their work load.

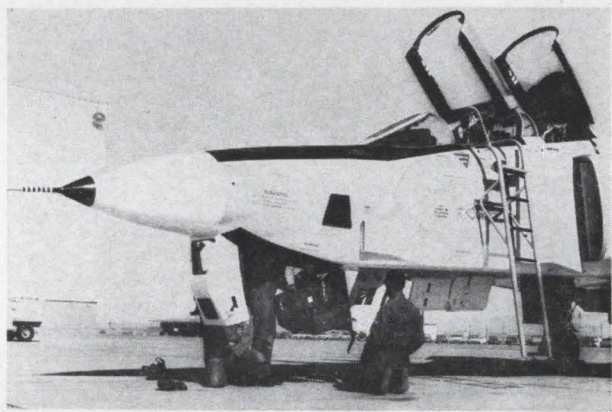

Recording head assemblies and a panoramic-camera reconnaissance system are being mounted in the nose of a supersonic RF-4C reconnaissance aircraft.

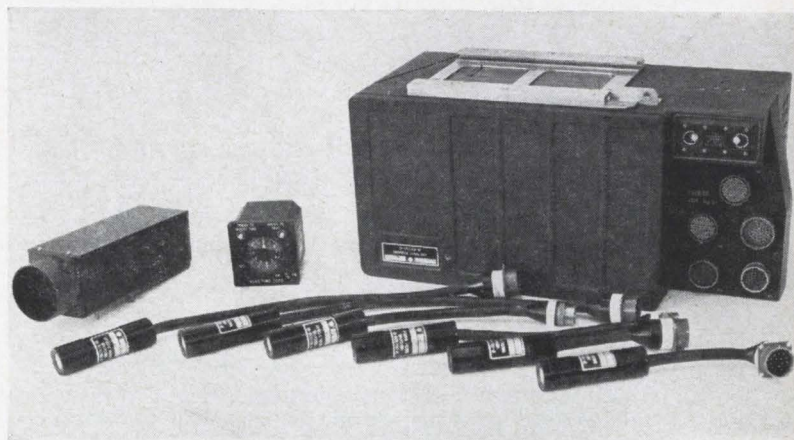

Compact assemblies make up the auxiliary data annotation set (ADAS). The special recording head assemblies are in the foreground; behind them (left to right), is the cockpit test display unit, time insertion unit, and the auxiliary data translator unit.

Electronic detours of broken nerve paths

Paralysis is often caused by a 'washout' in a neural road from the brain to a muscle. Researchers are testing an alternate route via another muscle and an electronic stimulator

By Luiji Vodovnik and William D. McLeod

Case Institute of Technology, Cleveland

A recent lunch was one of the most dramatic events of Edward Roszak's life. Trailing wires and wearing thick-rimmed glasses attached to electrodes and more wires, he was wheeled over to a table and he began to feed himself. To casual on-lookers at Highland View Hospital in Cleveland, it seemed a slow, cumbersome way to eat. But they were unaware that three years before it had seemed unlikely that Roszak would ever use his arms or legs again.

The patient looked down, and his once-useless right arm reached out over the table. He moved his head again, and the arm descended slowly upon a spoon. He shrugged one shoulder, and his fingers grasped the spoon; then his arm moved it, first to the food, then to his mouth.

This meal, repeated several times a week, was a test of an arm-aid developed by Highland View and the Case Institute of Technology. After they analyze Roszak's use of the arm, the researchers expect to develop a device for commercial use.

As with many paralytics, this patient's muscles are undamaged. His trouble is that his nerve circuits are not conducting commands from his brain to certain muscles. Now, aided by an electronic system that bypasses the damaged nerve, this man can use a shoulder muscle to generate electrical signals that cause a hand muscle to contract.

The authors

William McLeod is assistant director of the Cybernetic Systems Group at Case's Engineering Design Center. He received his bachelor's and master's degrees from the University of Toronto.

After spending a year as a research associate with the Cybernetics System group at Case, Luiji Vodovnik returned to his native Yugoslavia as an assistant professor at the University of Ljubljana.

The system, still being developed at the Case Institute of Technology, is believed to be the first to use one muscle to activate another whose neural link with the brain is broken. Although Case's experiments have been limited to restoring motion in an arm, the researchers are confident that their approach will also work on other extremities.¹

The six arm movements

The patient's glasses are not ordinary spectacles. Their frame holds a small arc lamp that activates photocells in the table top. Over each eyebrow is taped a single-pole double-throw switch.

By moving his head to aim the arc light at the proper photocell, the patient can select a program from the few that have been stored on magnetic tape. These programs control the rotation of the shoulder and of the upper arm, the movement of both toward and away from the body, the bending of the elbow, and the twisting of the wrist. By winking or blinking, he triggers a switch over an eyebrow, thereby overriding the tape to stop a movement before it is completed—for example, when the hand comes down upon an egg, it is advisable to stop its downward movement as soon as contact is made.

For the sixth movement, grasping, the researchers have developed a way to bypass a break in the neural circuit, allowing the hand-clenching muscle to be operated by electrical signals from the patient's shoulder on command from the brain.

In a healthy body, the five gross motions are controlled semiconsciously from a "program" in the brain; conscious control is required only for clenching, which requires feedback to the brain.

For the gross motions the Case system, like other electronic methods of reactivating useless limbs, uses external power—in this case, fluid power from carbon dioxide. But to drive the hand-

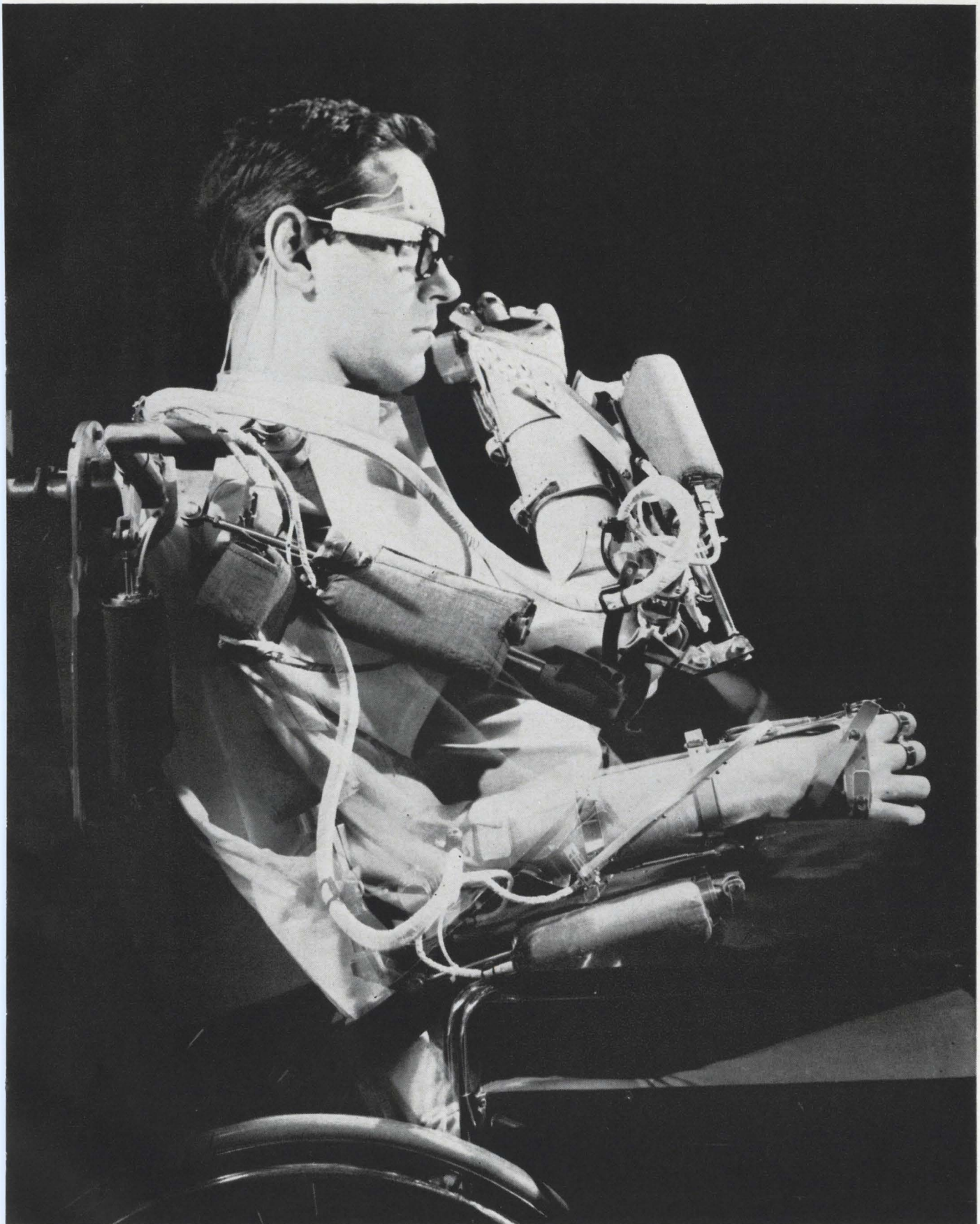

Arm aid worn by **Edward Roszak** allows six kinds of motion. Five of these movements, which involve the shoulder, elbow and wrist, receive their motive power from an external source. The sixth, the grasping of objects, is accomplished by electrical stimulation of a muscle with command signals originating at another muscle.

clenching muscle, the researchers looked for a muscle that was still under the brain's control, one that could be trained to operate the clenching muscle by means of a cybernetic link. They decided on the upper part of the trapezius, the muscle behind the shoulder blade, which controls such movements as shrugging.

There are other systems, further developed than Case's, for restoring the function of missing or damaged limbs [see panel, p. 116]. These use mechanical aids such as braces, or mechanical substitutes for limbs, such as artificial arms or legs. Most of these employ external power, with voluntary control established by a normal extremity or by another muscle operating a regulatory device.

The big trouble with such mechanical devices is that they allow the denervated muscle to remain idle, and it often degenerates through disuse. Adjacent tissues waste away, the body becomes susceptible to disease, and bones also tend to calcify, becoming brittle.

When the wires are down

Messages from the brain cannot reach the hand muscle because of damage to a neural path. The Case system provides an alternate route via the trapezius, external electrodes and an electronic stimulator.

Upon command from the brain, the trapezius contracts, generating tiny alternating currents called myoelectric signals. These signals, which travel along nerves, are picked up by electrodes attached to the patient's skin covering the trapezius. The signals are passed through the stimulator, where they are amplified, filtered and rectified. Then they are used to modulate the signals applied to the hand muscle.

The magnitude of the applied pulsating voltage is determined by the strength of the trapezius' contraction. When the applied current exceeds a certain level, the hand muscle contracts and the hand opens. Relaxing the shoulder muscle cuts off the current, and the fingers are reclosed by a spring along the hand.

The myoelectric stimulator

The stimulator is really a combination amplifier, modulator and stimulator. One major design problem was the modulation circuit. Several methods were considered, such as torque motors and tube circuits, but these were rejected because they were bulky, had limited effectiveness, required large power supplies, generated excessive heat, had slow responses and complex circuitry, and were too expensive.

The modulation circuit chosen is a simple two-transistor device that varies the power-supply voltage to the stimulator as the input signal varies. To prevent current through the patient's heart and undesirable oscillations, the modulator is decoupled from the preceding amplification stages with a transformer.

Any input signal at the transformer produces a

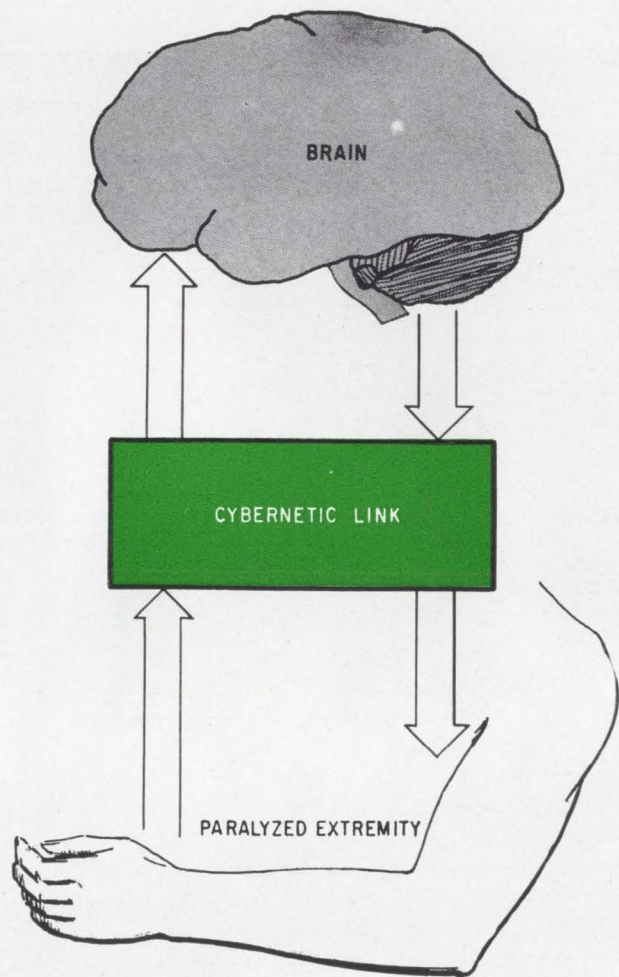

Cybernetic link provides two-way communications between brain and hand.

positive voltage, which decreases the collector current of transistor Q_4 (see diagram on page 113). The current is usually high; as it decreases, the conductance of Q_5 increases, causing its emitter voltage to rise. Therefore, Q_5 acts as a variable resistor controlled by Q_4 . The resistance of Q_5 is proportional to its emitter voltage.

The amplifier that precedes the modulator has a differential input with an impedance greater than 100,000 ohms, so it can be used with most commercially available electromyographic (EMG) or electroencephalographic (EEG) electrodes. The amplifier's frequency response is 5 to 10,000 cycles per second. The first two stages combine to give an over-all gain of 10,000; they are followed by an emitter-follower with an input impedance of 2,000 ohms. The common-mode rejection is about 5,000.

In the stimulator circuit, transistors Q_6 and Q_7 operate as an astable multivibrator. Each time Q_7 switches to its conducting state Q_8 is cut off, which induces a pulse across the inductor L_1 . The magnitude of this pulse is dependent on the power-supply voltage, which is varied by the myoelectric signals at the input to the amplifier. The pulse serves as the stimulating signal.

Several shortcomings were discovered in the myoelectric splint when it was tested. One big defi-

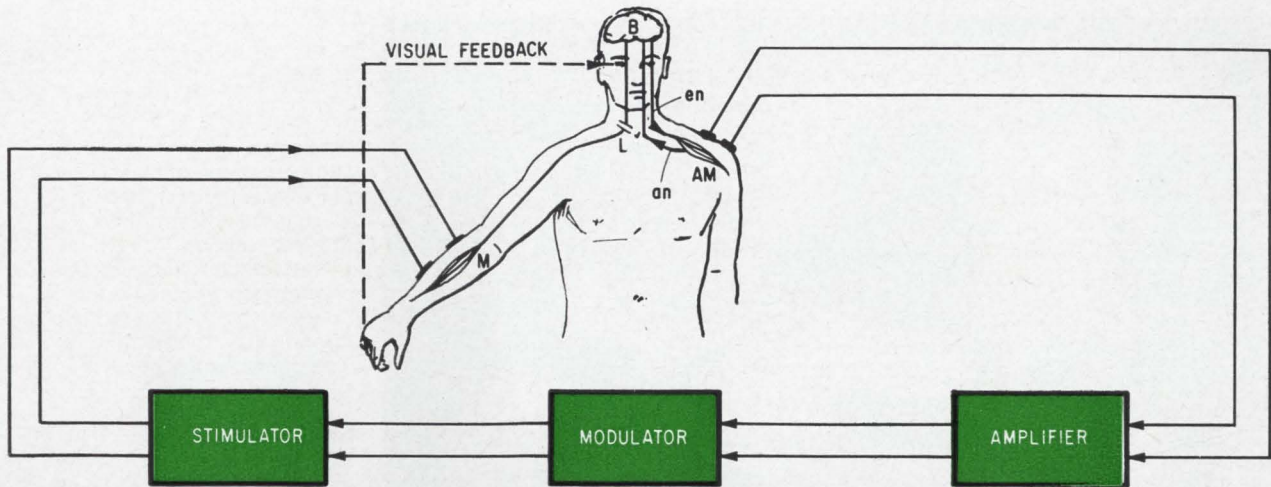

Electrical stimulator bypasses lesion that prevents conscious control of the arm. Contracting the auxiliary muscle AM creates myoelectric potentials that are picked up by surface electrodes on the shoulder. These voltages are then used to drive a stimulator, which delivers pulses to the denervated muscle, M, in the paralyzed arm. Visual feedback allows control over the position of the arm. The efferent nerve, en, and the afferent nerve, an, carry the brain's commands to and sensory data from the muscle, AM.

ciency was the patient's inability to open his hand the same way consistently. In part, this was due to the fact that the stimulator pulses varied $\pm 10\%$ for a given input. Therefore, in spite of having a controlled system that is an analog of the physical system, it was difficult to predict the hand opening accurately from the myoelectric potential.

Another problem, caused by the filter capacitors after the diode D_1 and the transistor Q_5 was the time lag between the command and the stimulating signal. Case is working on ways to solve these problems with circuitry that will yield smooth control with minimum time lags.

The first known attempt to stimulate a muscle by means of another muscle's EMG was made in

1963 by D. H. Thomas and W. J. Crochetiere.² It was not repeated soon, because it sent 70 volts through Crochetiere, the subject, at 10 kilocycles per second. Crochetiere fainted momentarily, then managed to pull off the electrodes.

Mindful of this episode, the researchers at Case and Highland View place the stimulating anode and cathode almost in contact. The cathode is placed directly over the motor point of the muscle so that a minimum of current is needed to contract the muscle.

In deciding upon electrode configuration for the myoelectric pickup, the Case engineers compromised between signal strength and noise.

The amplitude of the myoelectric potential be-

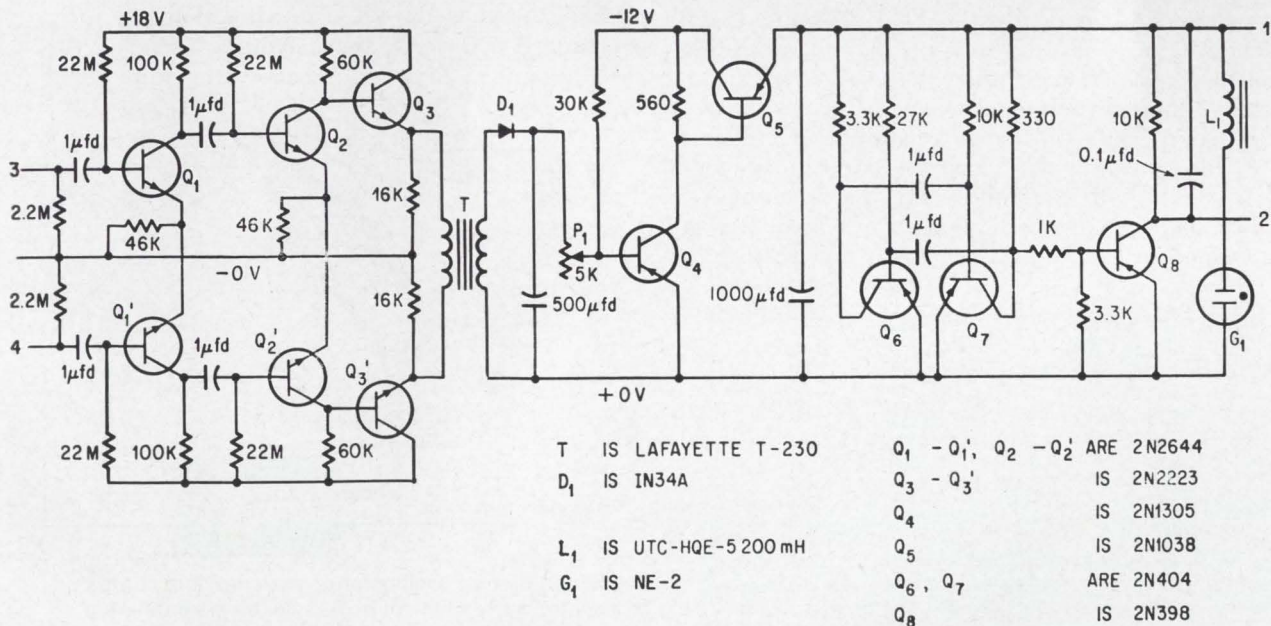

Amplifier-modulator-stimulator uses a transformer, T, to decouple the amplifier stage from the modulator. The circuit is mounted on three cards and enclosed in a box. A rechargeable battery is used, which can be recharged through an external connector. The glow-discharge tube, G, prevents Q_5 from being damaged by high-voltage spikes.

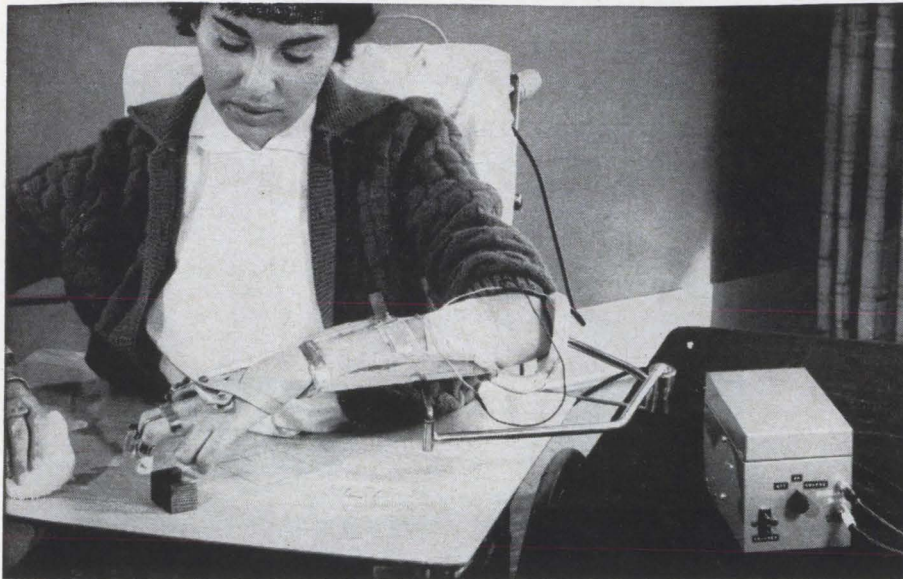

Myoelectric splint is evaluated with a sequence of tasks. The ease of manipulating the device is found from the patient's reaction. The box at the patient's left contains the complete electronics for the stimulator. Spring along top of hand keeps it clenched when no current is applied.

tween to electrodes on the same muscle increases directly with the distance between them, but the noise from a-c lines and nearby muscles also increases with this separation. Several groupings were tried to arrive at the optimum distance—one which would give a low noise level, but still provide a myoelectric signal of sufficient magnitude to operate the system. The electrode placement that gives the best signal-to-noise ratio has an inter-electrode distance of four centimeters. A third electrode, located midway between the two for the best rejection of inphase noise signals, is connected to the ground of the amplifier.

Originally, the electrodes were attached with tape. However, to reduce the time of application and to keep the distance between the electrodes constant from one application to the next, an electrode assembly was constructed of Silastic, a rubber compound made by the Dow Corning Corp. Electrode paste is used to keep the skin-electrode resistance low, also to prevent the electrode from polarizing after prolonged exposure to the salinity of the skin. The skin's surface is abraded, because any difference in the electrode-skin impedances from electrode to electrode would introduce noise.

The patient fitted with the Case system has to be trained to contract the trapezius muscle to pro-

duce the greatest possible myoelectric output. He begins by watching the amplified EMG signals on a meter or oscilloscope, observing the exact electrical response every time he moves his shoulder. After some practice, the system is connected and the patient can then watch his hand open in response to shoulder movements; in this way he can develop techniques for fine control of his hand.

Controlled electrical stimulation

Electrical stimulation in the Case arm aid is an open-loop process. Changes in the arm's position due to load disturbances and fatigue can be detected visually, and the brain can send compensating signals; but delays in the system make these corrections slow and painstaking. Moreover, the Case researchers have stimulated only one muscle so far; because a muscle is a unidirectional motor, motion in the opposite direction has to be accomplished through some external force, in this case a spring. In nature, however, bidirectional

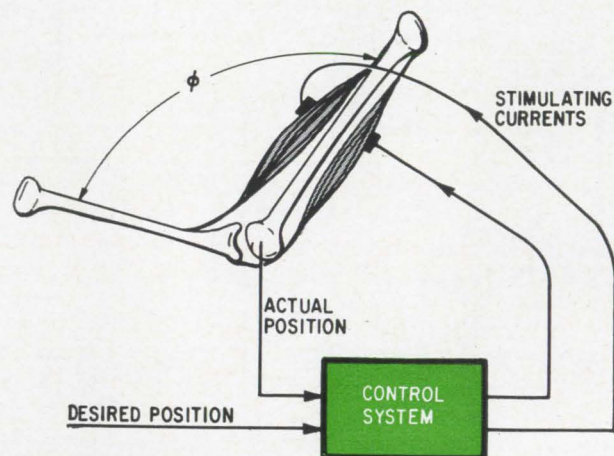

Actual and desired position of an extremity are compared in a control system. In controlled electrical stimulation, the difference signal drives the opposing muscles on either side of the joint until the position error is zero. A potentiometer mounted on prosthetic device, can be used to measure the joint position, ϕ .

New technique in therapy

Electrical stimulation of living tissue has been used therapeutically for many years. It was not until recently, however, that electrical stimulation was applied to paralyzed patients to partially restore the use of arms and legs. The first attempts in this direction were made by W. T. Liberson³ and Charles Long II⁴.

The new technique of functional electrical stimulation of extremities is being used with increasing frequency, in the application of controlled electrical currents to muscles to restore and improve the functions of extremities. Much of the progress in this field is a result of the joint efforts of workers in neuro-physiology, control theory and electronics.

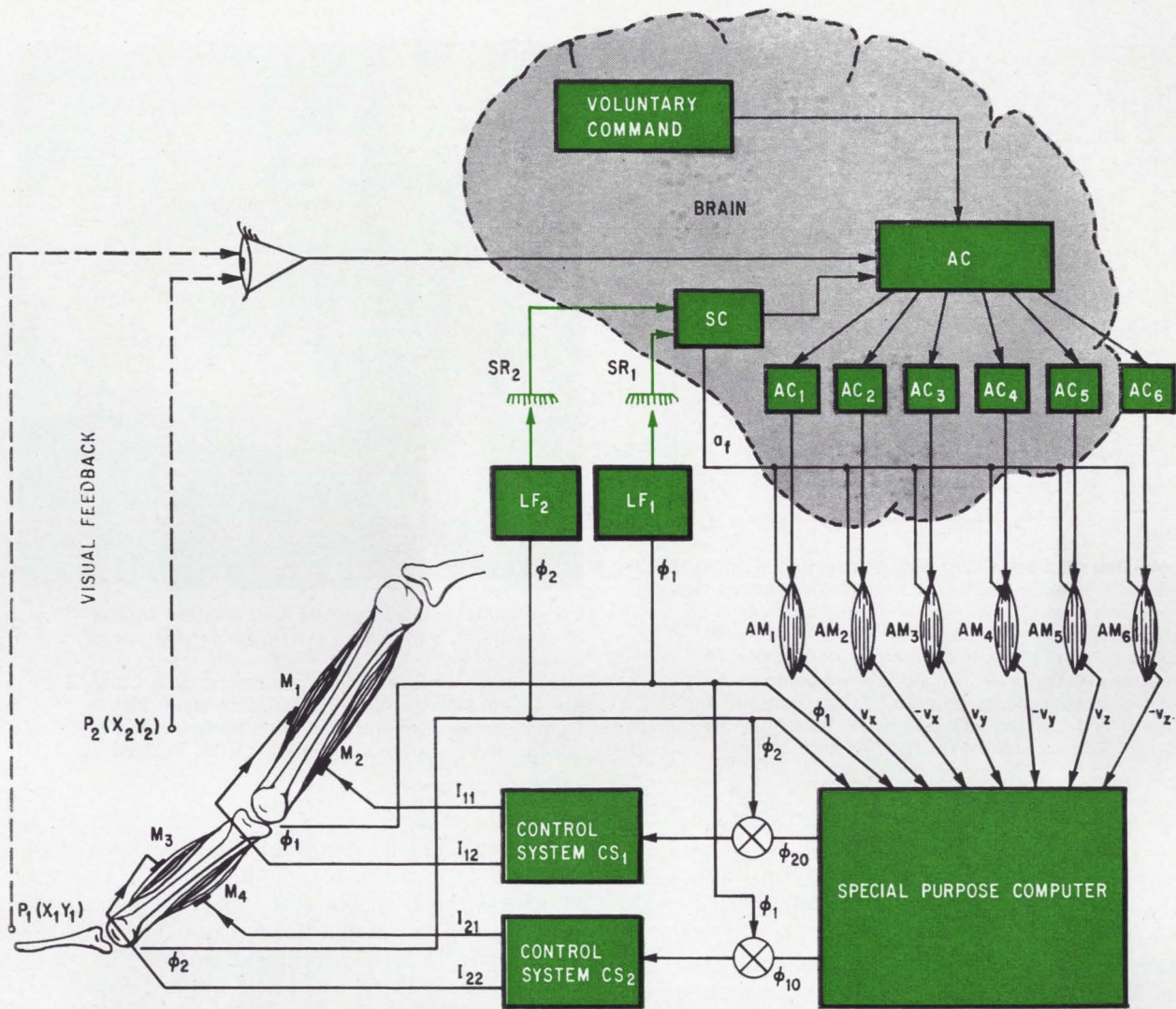

Computer-controlled device would use special-purpose computer to translate patient's desire into electrical commands for muscle. The actual and desired positions are constantly compared, and sensitive skin areas are stimulated to deliver position information to the brain so the thinking process can be modified to take into account what is taking place.

movements are performed by the action of pairs of muscles attached to opposite sides of the joint—the agonist and the antagonist. In addition, the brain receives data about the position of the extremity by feedback from special sensory nerves in the muscle and the joint, called receptors, and visual feedback is not necessary for the performance of at least gross motions.

The researchers are attempting to solve the twin problems of bidirectional motion and sensory feedback by a process they call controlled electrical stimulation.

To measure position, they mounted a potentiometer over the elbow by means of the splint structure. The control system compares the position of the arm, as measured by the potentiometer, with the desired position, corresponding to a predetermined myoelectric signal level. The resulting error signal modulates a stimulator, which generates two currents. These currents are then applied to the muscles on both sides of the joint, moving the arm in such a way as to eliminate the difference be-

tween the desired and actual positions of the arm.

Computer controlled extremities?

Electronic assistive devices for paralytics generally require a control site for each joint to be activated. For a complex movement requiring the use of 10 joints, the training and conditioning of the patient becomes complicated.

A computer system may be one way to control such a complex movement without the necessity of using one auxiliary muscle for each joint involved in the motions, and without the disadvantages of preprogrammed motions. The diagram above shows one computer-controlled system considered at Case.

Instead of defining the joints' positions, the control site's signals would represent the components of the hand's velocity vector. The patient would only have to decide where to move the hand, and express this desire by contracting a muscle still under his control. Then the myoelectric signals generated at the control site would correspond to

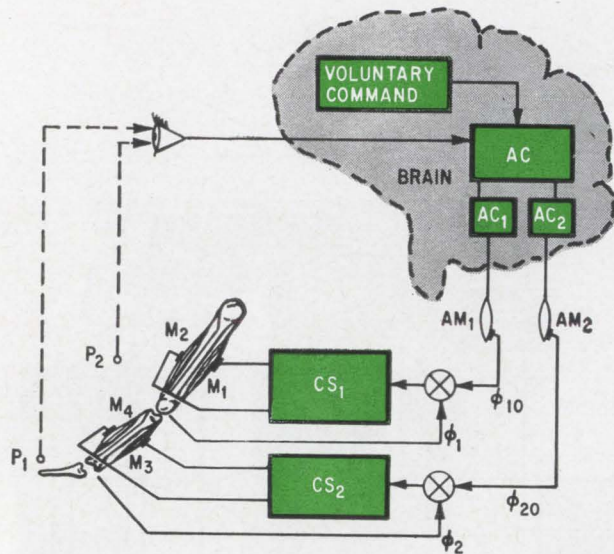

Simplified diagram shows how controlled electrical stimulation could be implemented in a device that has two joints of an extremity under voluntary control. The auxiliary muscles, AM_1 and AM_2 , control the joints. Feedback from the joints, determining position, is shown as ϕ_1 and ϕ_2 . These signals are compared with position requirements ordered by the command and control systems and adjusted to eliminate any differences. Visual feedback still makes the fine adjustments.

the velocity components of the movement, not to the position of the hands. These signals would then be fed to a computer, where they would be compared simultaneously with information about the joints' activated positions. With this information, the desired position could be computed, and the hand controlled by electrical stimulated signals sent to the correct muscles. Visual feedback would

The Philco approach

Although the Case engineers seem to be the first to have restored any function to a paralyzed arm without using external power, they are not the first to use myoelectric signals to control a paralyzed or artificial limb. Late in August, the Philco Corp. demonstrated a system that controls a prosthetic arm with these nerve currents. Previously, Philco researchers used a myocoder—an electronic processor of nerve signals—to control a leg brace [Electronics, Nov. 30, 1964, p. 74].

From the tens of thousands of signals generated by the brain, Philco used computer analysis to isolate the myoelectric signals that control specific movements. This research led to the development of an artificial arm that moves two ways—bending at the elbow and twisting at the wrist. Both movements are powered externally, but controlled in the upper arm; the signals are sensed by six electrodes placed strategically along the arm.

These signals are amplified, rectified and fed to computer-designed discriminant circuits. The circuits provide power to the motors in the artificial arm only when the pattern of the myoelectric signals corresponds to that required for the designed motion. The wrist motion is an on-off type, while the elbow is controlled by the magnitude of the signals exceeding a predetermined level.

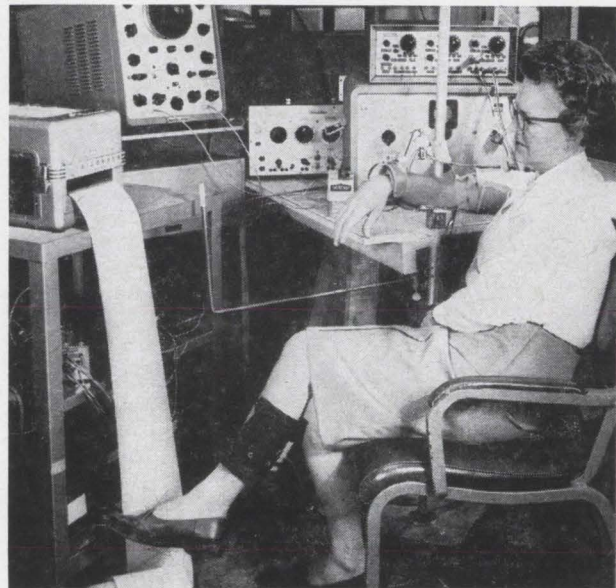

Experimental setup for closed-loop position control of elbow joint. Stimulating electrodes for the opposing muscles on either side of the elbow are placed over the biceps and triceps. The common electrode, ground, is on the patient's calf. Input to stimulating electrodes is from an externally controlled potentiometer, but will eventually be operated from myoelectric signals.

still be necessary.

Sensory feedback would also be necessary if the patient was to perform tasks in the dark. One way to achieve this is shown in the diagram on page 115.

Voltages proportional to joint positions could be transformed to corresponding stimulating impulses, LF_1 and LF_2 . These would be applied to sensory points on the patient's skin. Skin receptors, SR_1 and SR_2 , would transmit to the brain information about the position of the extremity. Such an artificial sensory path might also improve the patient's ability to use the electronic assistive system because it would perform the same function as the biological feedback link between the receptors and the motor neurons.

Bibliography

- A. Kantowitz, "Electronic Physiologic Aids," A Report of the Maimonides Hospital of Brooklyn, N.Y., 1963.
- L. Vodovnik, C. Long II, E. Regenos, and A. Lippay, "Plain Response to Different Tetanizing Currents," Archives of Physiological Medicine and Rehabilitation.
- J.B. Reswick, L. Vodovnik, C. Long II, A. Lippay and D. Starbuck, "An Electronic Bypass for Motor Neuron Lesions," Proceedings of the 17th Conference on Biomedical Engineering, Cleveland, 1964.

References

1. R.W. Corell, "Design Studies of the Development of the Case Research Arm-Aid," Report No. EDC 4-64-6, Case Institute of Technology, Cleveland, 1964.
2. D.H. Thomas, W.J. Crochetiere, Personal Communication, Highland View Hospital, Cleveland, May 1964.
3. W.T. Liberson, H.J. Holmquest, D. Scot and M. Dow, "Functional Electrotherapy: Stimulation of the Peroneal Nerve Synchronized with the Swing Phase of the Gait of Hemiplegic Patients," Proceedings of the Third International Congress of Physical Medicine, Washington, 1960, pp. 705-710, Westlake Press, Chicago, 1962.
4. C. Long II and V.D. Masciarelli, "An Electrophysiologic Splint for the Hand," Archives of Physiological Medicine and Rehabilitation, pp. 499-503, September, 1963.

NEW *Linde* CRYSTALS

Electro-optical
crystals:

KTN
 LiNbO_3

NEW *Linde* CRYSTALS

Laser
crystals:

$\text{Nd}^{3+}:\text{CaMoO}_4$
YAG

NEW *Linde* CRYSTAL PRODUCTS

Sapphire
products:

ETALONS
ELECTRONIC
SUBSTRATES

These are the newest in the world's most complete line of electronic and electro-optical crystals, and related chemicals. For information on these products—or for data on products with compositional, size, geometrical or other variances to meet your specifications—contact your nearest Crystal Products Regional Sales Office.

LINDE is a registered trade mark of Union Carbide Corporation.



SALES OFFICES:

NORTHEAST: 300 First Avenue, Needham Heights, Mass. (617) 444-5400.

EAST: 2065 Route 22, Union, N. J. (201) 688-1800.

MIDWEST: 4120 Kennedy Avenue, East Chicago, Ind. (219) 397-3100.

WEST: 3651 Del Amo Boulevard, Torrance, California (213) 772-2511.

All LINDE Crystal Products are made in America.

Designing Circuits with CERMET* Passive Elements

Designers attracted by 10 to 300,000 ohms per square sheet resistance range and proven reliability record.

Economies realized from CTS mass production techniques and low tooling costs.

CTS CERMET resistance elements are produced by screening formulations of conductive, resistive, and insulating materials onto ceramic substrates. After firing above 650°C, a semiconducting matrix is formed which is permanently bonded onto the dielectric substrate.

Since the middle '50's, the CERMET resistance element has been designed successfully into many types of resistor-capacitor modules and microcircuits. Apollo, Tiros, Minute Man, Talos and numerous other high performance military and industrial applications use CERMET resistors.

Wide resistance range simplifies design, improves performance, saves space and provides design flexibility.

The designer is offered an unusually wide range of sheet resistance from 10 to 300,000 ohms per square. Short straight resistance paths, in a range from 10 ohms to 10 megohms, simplify design, reduce size and improve frequency capabilities. For example, at 100 ohms, resistance is constant to at least 250 mc. Other resistance values have limited predictable change through several hundred megacycles.

192,400,000 hours of unmatched reliability

See Table I for the story of unmatched reliability of the CERMET resistance element.

Tests are run continuously on sample quantities from current production.

Typical CERMET resistor module test data

CERMET resistors from 50 ohms to 100K ohms were applied to both sides of a .310" x .310" x .010" ceramic dielectric substrate.

1) Temperature Cycling—168 resistors tested: Substrates were subjected to 5 cycles from -65°C to +125°C. Each temperature noted was held for 30 minutes.

2) Short Time Overload—2876 resistors tested: Resistors were subjected to 6¼ times rated wattage for 5 seconds per MIL-R-10509B.

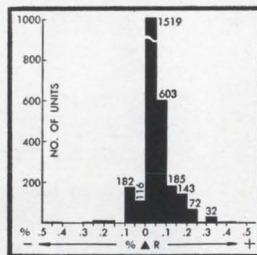
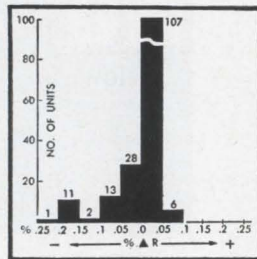

3) Moisture Resistance—168 resistors tested: Substrates were tested per Method 106A, MIL-STD-202B, ¼ watt per resistor, 93% to 95% RH, 10 cycles.

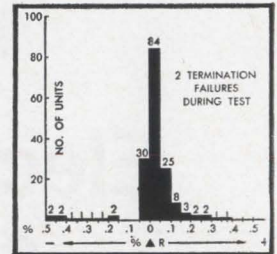

Economy

Low tooling and start-up costs effect significant economies for CERMET circuitry over integrated circuits. Cost savings are also substantial over discrete components, including elimination of interconnections, much smaller physical size, and the elimination of costs incurred in purchasing, stocking, handling and inserting various components. Additional economy is effected by efficient CTS proprietary mass production techniques.

Other design parameters

In addition to wide sheet resistance, unequalled reliability and economy, CERMET resistors and capacitors offer the designer these additional characteristics:

- 1) Stability at end of life: ±2% for resistors, ±3% for capacitors.
- 2) Low temperature coefficient over a wide temperature range: For resistors; ±200 PPM/°C (T.C. on individual substrates can be matched to ±25 PPM/°C.) For capacitors: -300 to -700 PPM/°C.
- 3) Low current noise: -30db at 100 ohms per square. -10 db at 10K ohms per square. +20db at 300K ohms per square.
- 4) Initial tolerances as low as ±0.10% for resistors, ±2% for capacitors.
- 5) Moisture resistance: less than ±1% change under ordinary humidities. For extreme humidity conditions, encapsulation or cover coat is recommended to maintain ±1% max.
- 6) Vibration, shock and abrasion resistant because all CERMET passive circuit elements and conductors are fused to the substrate and to each other.
- 7) High overload capacity due to superior heat sink capability.
- 8) Relatively low capacitance losses—dissipation factor less than .002 ("Q" greater than 500) @ 1 Meg C—before and after processing and throughout life.
- 9) Very low (0.5pf max.) parasitic capacitance introduced by CERMET crossover and parallel conductors.

Unaffected by severe environments

The CERMET resistance element is virtually indestructible. It remains unaffected by the most severe environmental conditions

*Trademark of CTS Corporation

TABLE 1 RELIABILITY DATA	RELIABILITY	FAILURE RATE	RESISTANCE	POWER DENSITY	
	95% Confidence Level ±3% Failure Criterion	95% Confidence Level ±3% Failure Criterion	RANGE	Watts/sq. inch of resistor area	Watts/sq. inch of substrate area
A. 12.4 million resistor hours documental 10,000 hours with ½ watt per substrate; 97° C ambient resulting in a 125° C hot spot temp.; encapsulated, 1236 resistors; ½ watt applied to each resistor; 1½ hours ON, ½ hour OFF.	99.962% per 1,000 hours	0.038% per 1,000 hours	47 ohms to 100K ohms	9 to 55	5
B. 94 million resistor hours documented 10,000 hours with 1.2 watts per substrate; 25° C ambient resulting in a 116° C hot spot temp.; unprotected resistors; 9420 resistors; 0.1 watt applied to each resistor.	99.990% per 1,000 hours	0.010% per 1,000 hours	50,000 ohms	11.4	3.2
C. 86 million resistor hours documented 10,000 hours with 1 watt per substrate; 25° C ambient resulting in a 99° C hot spot temp.; unprotected resistors; 12,000 resistors; 0.1 watt applied to each resistor.	99.9946% per 1,000 hours	0.0054% per 1,000 hours	1K to 55K ohms	8.6	2.6

and oxidizing atmospheres up to 500°C. Designers are using CTS CERMET resistance elements successfully under such adverse conditions as nuclear radiation, solvents and cesium atmospheres.

Packaging techniques

An infinite array of package designs to fit every designer's need is possible with CERMET circuitry. TO-5 headers, flatpacks, or various sizes and shapes of molded housings can be used. Round or flat leads can be attached in any configuration parallel or perpendicular to the substrate. Leads can be bonded to pads, swaged into the substrate or anchored through holes in the substrate.

Three classes of CERMET elements available to designers

- 1) Element groupings: Resistor modules, capacitor modules, and resistor/capacitor modules. All are available with or without assembled active devices such as dice, flip chips, and pico, micro or conventional leaded types.
- 2) Interconnections: In addition to the fired conductive network, pads can be provided for soldering, welding, alloying, die bonding, thermocompression, ultrasonic and wedge bonding, beam lead bonding, and flip chip bonding.
- 3) Auxiliary elements: Edge-around conductor, plated-through-hole conductor, lead crossover, insulative cover, and reconnect conductor.

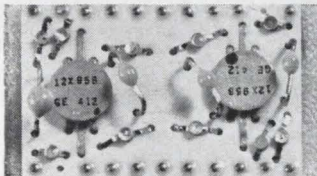

Top view of CTS hybrid integrated circuit showing attached discrete components and terminal pins soldered through holes in substrate.

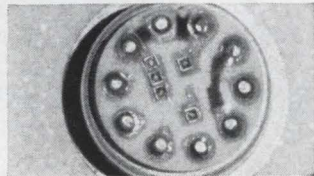

TO5 header showing cermet resistors and transistor dice.

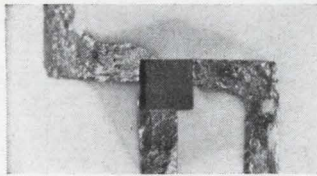

Enlarged view of flip chip assembly to ceramic substrate with platinum gold conductors.

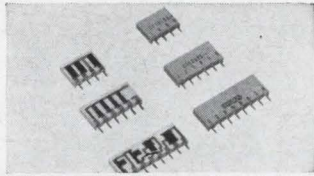

750 series resistor network package. Modules on left show circuitry before coating.

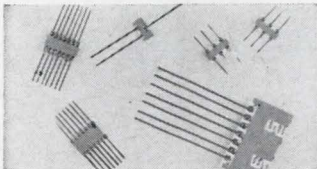

Typical cermet passive circuit modules with leads attached.

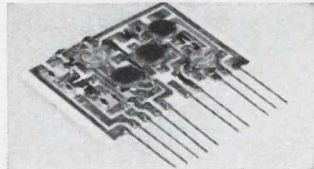

CTS hybrid integrated circuit showing attached discrete components soldered to terminating pads.

Delivery

4-5 weeks for prototypes, 5-6 weeks in production quantities. Several hundred thousand CERMET microcircuits are being shipped by CTS weekly.

Latest data available to designers

Many of the nation's leading designers have already been attracted by the unique properties and design flexibility of CTS CERMET elements. Great strides have been made every year by CTS engineers in the art of microcircuitry. Send for the latest technical data or forward your circuit. CTS engineers will analyze your requirements and recommend a CERMET microcircuit design to your exact specification. Just contact your nearest CTS office or rep.

Sales offices and representatives
conveniently located throughout the world.
founded 1896

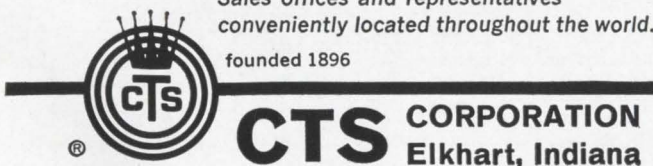

Solid Status Report 9/65

If you ever want your power sources to get off the ground, read on:

When it comes to power sources and frequency multipliers we are tempted to say: We offer more of what you go to solid state for—excellent stability, high reliability and high efficiency in remarkably small, lightweight packages.



Take our P8004 Ku-band power source. This gives you a 16.5 Gc output frequency with 6mw output power in just 25

cubic inches, weighing 22 oz. Stability is crystal-controlled as part of the high reliability and long-life design. Input power requirements are unusually low.

For telemetry systems, the P8003 S-band power source gives you 20mw output power at a 2.2Gc output frequency, in 12 cubic inches weighing 8.5 oz.

As an example of broad bandwidth and high efficiency, consider the P8405 VHF multiplier: x3 multiplication factor, 360 to 420 mc output frequency, for a 15% bandwidth and greater than 42% efficiency. 12 watts output power.

Our unrelenting effort to achieve maximum reliability in our power sources gets an assist from this fact: we utilize our own demonstrably reliable varactors.



We pride ourselves, in addition, on a quick reaction to your custom-design requirements. Give us a try. For detailed information and prompt technical help, call, write or wire Russ Wright, or at least send in the Reader Service Card. (Phone: 215-855-4681.)

SOLID-STATE PRODUCTS OPERATION

PHILCO
A SUBSIDIARY OF Ford Motor Company,
LANSDALE DIVISION • LANSDALE, PA.
In Canada, Don Mills Road, Don Mills, Ontario, Canada



***When this headline was current news...
digital recording tapes
had a packing rate of 200 bpi.
Today, 800 bpi is standard;
improvement in tape and base is the reason.***

In analyzing the sensational development of EDP over the past decade, most of us naturally talk in terms of improvement of hardware. But when you stop to examine them, the contributions made by tape manufacturers have been quite remarkable.

The tape of today *looks* like the tape of 1954 . . . but think of the differences: improved oxide coatings to increase total capacity; reduce fluctuations in performance; much stronger binders to reduce dropouts and flaking, lengthen tape life; smoother surfaces to give longer, error-free wear; thinner coatings and better production controls to guarantee reel-to-reel uniformity.

Working hand in hand with the tape manufacturers during this time has been Du Pont. Improvements in the uniformity, stability and overall reliability of the base of MYLAR* have played a vital role in making possible the sophisticated tape in use today. Continuing cooperation of research and development facilities assures continuing improvements in the future. Your guarantee of the most advanced tape is the manufacturer's brand and a base of MYLAR polyester film.

*Du Pont's registered trademark for its polyester film.



Better Things for Better Living . . . through Chemistry

At the base of all tape improvements: Mylar®

Leadership in Digital Measurement

**ELDORADO'S
MODEL 950
MEASURES TO
6 GHz DIRECT?**

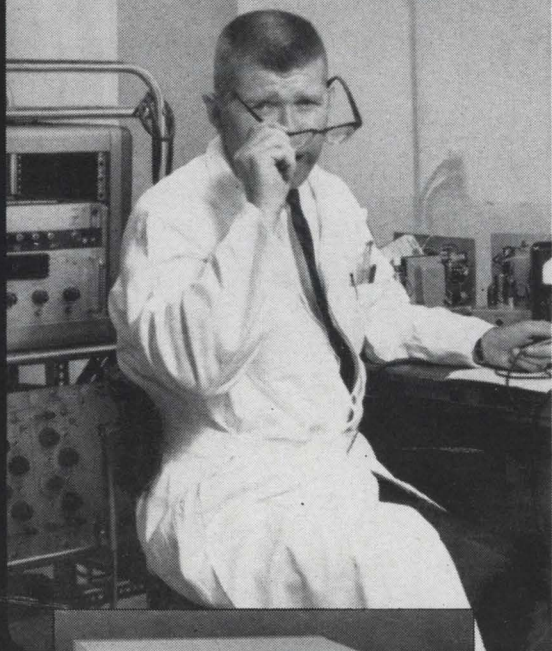

PROVE IT!

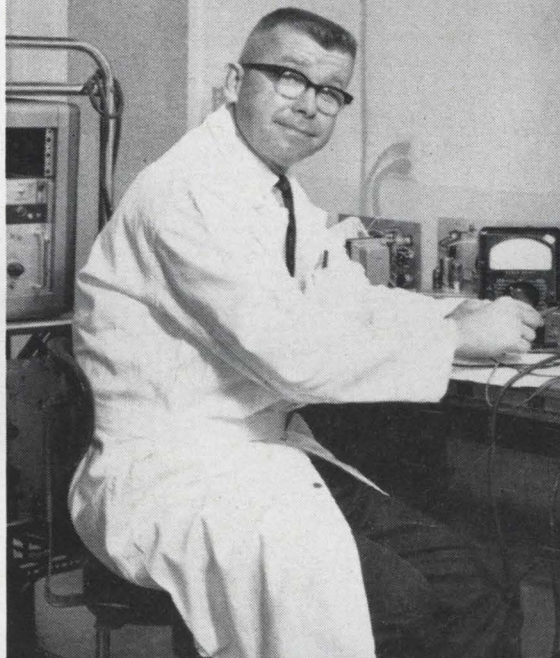

Are you skeptical too? We're not surprised... many purchasers have been. The Model 950 does make direct frequency measurements from 10 Hz to 6 GHz. Zero beating, calculating and hunting harmonics, reinterpreting the readout... all are outmoded. And using the Model 950 is a one-control operation: automatic trigger level combined with a parity check feature leaves only a three-position range switch to set. Parity check gives you an added bonus too—total elimination of operator error.

As if that weren't enough, the Model 950 now has a preset reset feature that allows you to preset the five most significant digits to reset at any desired frequency. So what? Preset reset gives you direct readout of frequencies from 6 GHz to 26.6 GHz with Eldorado's series of frequency extenders (which, by the way, require no tuning or adjustments). Preset reset also permits direct readout of the received frequency when monitoring a receiver's local oscillator.

Input sensitivity of the Model 950 is typically 50 mv rms into 50 ohms (-13 dbm, 0.05 mw). Measurements are accurate to within ± 1 count \pm oscillator stability, and readings are visually presented on a 7-digit readout while print-out signals for all digits and decimal point are simultaneously available in a binary coded decimal format.

OTHER ELDORADO GHz DIRECT FREQUENCY COUNTERS.

Model 951: 10 Hz to 6 GHz with 9-digit readout, automatic trigger level and selectable resolution. **Model 945:** 10 Hz to 4 GHz with 7-digit readout. **Model 946:** 10 Hz to 4 GHz with 9-digit readout and selectable resolution. **Model 920:** 10 Hz to 2.5 GHz with 7-digit readout; fully automatic operation; IF offset compensation; remote programing; and RFI per MIL-I-26600, Class III.

A CHALLENGE. Don't take our word for it that Eldorado's GHz Direct Frequency Counters perform as described. Make us prove it! For complete specifications and a demonstration, contact your nearest Eldorado representative, or contact:



ELDORADO ELECTRONICS

601 Chalomar Road • Concord, California
Telephone (415) 686-4200

Senior Design Engineers: Are you interested in advancing the state-of-the-art in digital instrumentation? If so, we need you in our Research and Development group. Call or write David C. Condon, Chief Engineer.



GENERAL ELECTRIC

Who put the "Cad" on TV?



New Cerro Cadmium Ball Anodes — more "throwing" power — better, faster plating.

Leading television and stereo set manufacturers did it!

They use cadmium plating on chassis and vital components for superior corrosion resistance and sales-stimulating eye appeal. Cadmium plating is also specified on military-grade gear which must operate reliably in environments that would humble other platings.

Leading fastener manufacturers, too, feature cadmium plating — both they and their customers know its intrinsic value.

Cerro produces quality cadmium high in the Peruvian Andes . . . and availability is excellent. To find out more about Cerro cadmium or the other high-purity, nonferrous metals we produce, contact us.

CERRO SALES CORPORATION

SUBSIDIARY OF **CERRO CORPORATION**

300 Park Avenue, New York, N.Y. 10022

CERRO

FAIRCHILD'S WAVE ANALYZER

Scans electronically

Plots automatically

20 CPS to 50 KC

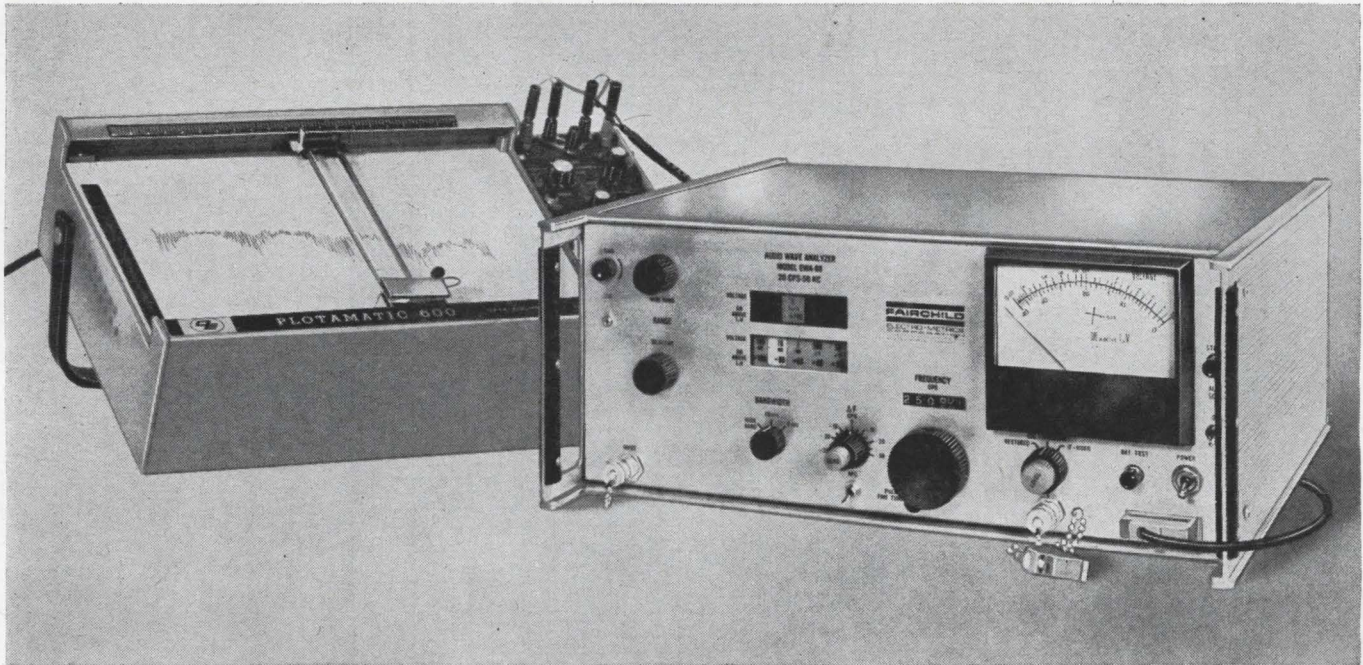

No cranking. No motors. Less chance of error with Fairchild's Model EWA-88 Audio Wave Analyzer. Works with any X-Y plotter!

First, on the wideband setting "see" all signals simultaneously, from 20 CPS to 500 KC. Adjust attenuator

to protect measurements from overload. Select a narrow bandwidth of 5 CPS or 50 CPS and push the "Start" button. The instrument does the rest. Your plot is obtained quickly....automatically....accurately....without further attention.

The fully solid-state EWA-88 is compact and lightweight, yet handles input levels up to 1000 volts. Use it as a wave analyzer, frequency selective voltmeter or as a transmissibility ratio indicator.

Internal electronic scan rate automatically adjusts for selected IF bandwidths: 10 KC/min. at 50 cycles, 1 KC/min. at 5 cycles. Overall dynamic range of 200 DB, with 40 DB

spread on the panel meter. Other features: AFC, five outputs, built-in calibration for frequency and amplitude, sensitivity 0.1 microvolts (in 5 cps bandwidth). Digital indication of frequency setting is accurate to $\pm (\frac{1}{2}\% + 5 \text{ CPS})$. Price \$2950. Also available with optional 8-hour internal NiCad power pack at \$200 additional.

For complete information, contact:

FAIRCHILD

ELECTRO-METRICS CORPORATION

A SUBSIDIARY OF FAIRCHILD CAMERA AND INSTRUMENT CORPORATION

88 CHURCH ST., AMSTERDAM, NEW YORK 12011

THERMISTORS

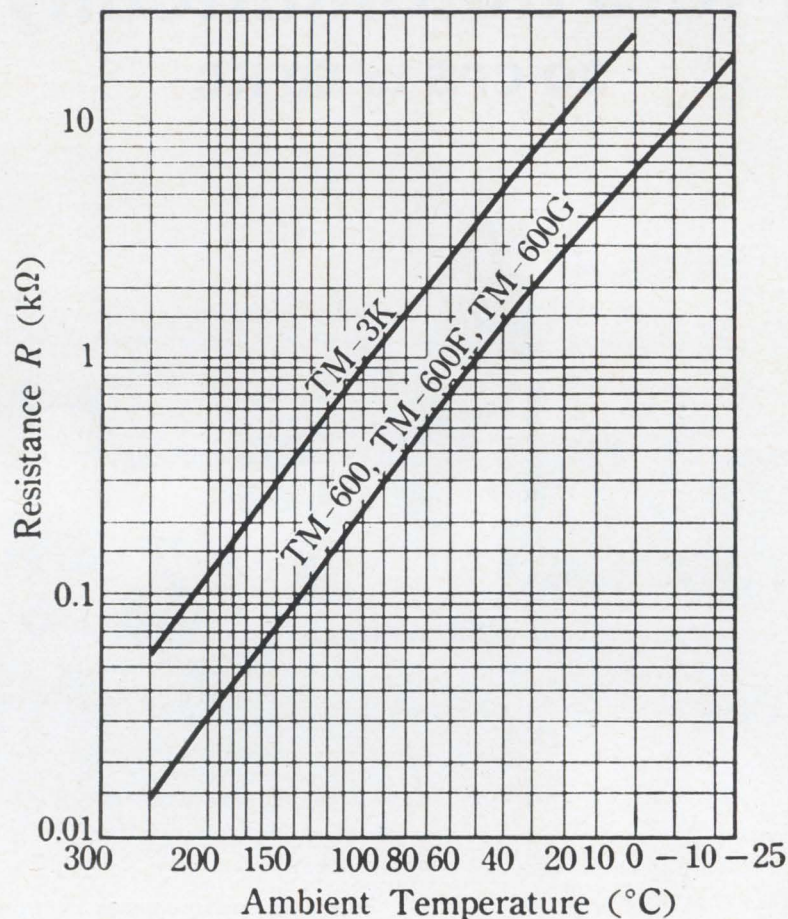

NO REFERENCES NEEDED...

Not where the name HITACHI is concerned. The very name HITACHI is guarantee enough of the most reliable, technically advanced electronic parts to be found anywhere in the world. Take HITACHI's complete range of thermistors, for professional use, as an example. These thermistors have each been devised to carry out a specific operation/s efficiently, with a surprising degree of durability for such small, complicated parts — Time Delay. Surge Resistor. Microwave Power Measuring. AGC. Temperature Compensa-

tor. Thermometer. Anemometer. Flow-Meter. Vacuum Gauge. Gas Chromatograph.

The bead type thermistors TM-600, TM-600F, TM-600G and TM-3K have been designed by HITACHI after exhaustive studies on resistivity of thermistor material and homogenization of temperature coefficient. The result... high exchangeability from thermistor to thermistor. Operating temperature range is

-50~300°C and sensitivity shows ±1.2%. In addition, this series can be used in controllers, recorders and other equipment.

For gas chromatographs too, the direct heat types VB-3 and VB-4 are superior, having a stability of approx. 2,000 hours.

HITACHI is able to supply any of these electronic components in large quantities and at prices which are keenly competitive. Contact us... we're sure we can meet your requirements of quality, price and quantity.



HITACHI SALES CORPORATION: 333, N. Michigan Avenue, Chicago 1, Ill., U.S.A. Tel: 726-4572/4 / 666, 5th Avenue, New York, N.Y. 10019, U.S.A. Tel: 581-8844 / 12715, S. Daphne Avenue, Hawthorne, Calif., U.S.A. Tel: 757-8143
HITACHI, LTD., DUESSELDORF OFFICE: Graf Adolf Strasse 37, Duesseldorf, West Germany Tel: 10846

Kodak advertises genuine photographic quality with just a kiss and a squeeze

1. This is our BIMAT[®] Transfer Film. (The [®] emphasizes the "our"!) It has no sensitivity. Instead of silver halide grains its gelatin layer holds far smaller silver particles. We can be induced to manufacture it in the same widths and lengths as data-recording and aerial films.

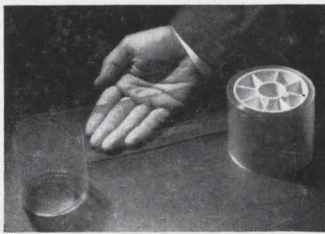

2. When BIMAT Transfer Film imbibes BIMAT Imbibant, the film looks like this. You can't see the difference. You can only feel it. But don't. Let's not leave finger marks on it. It's tacky. We say "imbibe" to indicate that the liquid is not free to

spill. If it were, we'd be calling it a monobath instead of an imbibant. A monobath is a combination developer and fixer. We offer monobaths, too, but that's another story.

3. Make the imbibed BIMAT Transfer Film kiss some exposed regular film. Squeeze them together, face to face.

[We do a sketch here because it is upsetting to photograph unprocessed film, and, more important, to broaden the principle beyond any specific mechanical arrangement. We are promoting the principle, not a specific hardware item. Several companies—large, medium, and small—are offering the hardware. They are responsible for their own advertising.]

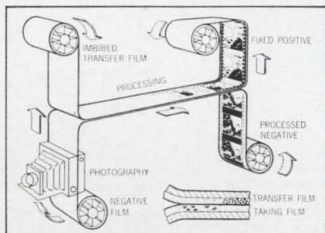

Where lots of light had hit the taking film, most of the silver halide is turning to black silver and stays put. Where less light had hit the film, there are more unstruck silver halide grains dissolving into the imbibant. When the dissolved silver halide reaches the silver particles we had put into the BIMAT Transfer Film, they serve as nucleation centers for precipitating black silver. Therefore the transfer film turns blacker wherever less light had hit the taking film, which is itself left blacker where more light had hit it.

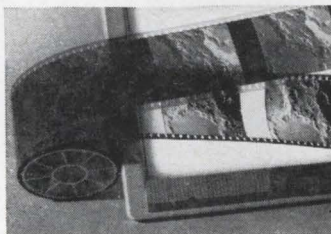

4. In short, the BIMAT Transfer Film has turned into a positive transparency, and the original film has become a negative.

How quickly? How good a positive? How good a negative? How much control is possible? How much control is needed?

Do you think we would be raising such questions if we didn't have good answers? We even sell imbibed BIMAT Transfer Film now. One thing we don't have is a pamphlet for fun-time photographers on the process. We do have one for engineers, though. Those who take a professional interest in the subject are advised to make a first move by requesting the pamphlet from Eastman Kodak Company, Department 8, Rochester, N. Y. 14650.

Kodak advertises how to get on an infrared mailing list

If you are doing anything in infrared technology beyond operating a heat lamp or a spectrometer, please inform K. T. Lassiter, Publications Service, Eastman Kodak Company, Rochester, N. Y. 14650 so that you can be cued in from time to time when we have news for you. That there will be news in this particular area of extension of the senses is hardly much of a gamble.

Kodak advertises a newly invented Q-switch dye for infrared lasers

"Q" is the quality of a tuned circuit. In 1889 Lord Kelvin (late founding director of Kodak Ltd.) defined a "q" for the Institution of Electrical Engineers of London in his presidential "Address on Ether, Electricity, and Ponderable Matter." He was groping to relate frequency to a-c "resistance." Later engineers used cavity resonators as tuned circuits. Still later ones ran the frequencies in their cavity resonators up into the optical range—with the aid of one of Einstein's theories. Those are lasers. By making high-class neodymium-doped glass for these lasers, we have shifted the frequency of interest down a bit from the visible to 1.06 μ in the infrared, which has its advantages.

Then some engineers saw that if the onset of good resonance could be delayed until a larger proportion of the ions attained the condition where they could be stimulated to emit as Einstein predicted, output power would rise. In short, the Q of the cavity should be spoiled and then suddenly restored. Various complicated arrangements to this end were devised.

Then some physicists with an engineering attitude and a knowledge of photochemistry stepped in and proposed interposing a dye that exhibits optical saturation. This means that its opacity suddenly drops when the energy-absorbing mechanism in the dye molecule gets temporarily swamped. The Q-switch dye ought to have a narrow absorption band split clean down the middle by the 1.06 μ laser line.

The dye industry, broadly considered, can prosper without taking on such strange assignments. We, in distinction, have had a team of engineer-like chemists puttering for the past 40 years with dye molecules as though they were mousetraps, in hopes that the attainment of better ones would have the well-known consequences predicted by Ralph Waldo Emerson. When handed the strange assignment, they smiled.

We are pleased to announce EASTMAN Q-Switch Solution 9740. It is supplied as 100 ml of chlorobenzene solution. The measured absorption coefficient at 1.06 μ is given on the package that safeguards it against ambient ultraviolet which would reduce the coefficient. We ship with $\alpha = 25 \pm 1 \text{ cm}^{-1}$. The \$100 kit includes a supply of solvent with which the coefficient can be cut. The user skilled in the art figures out how much to cut back the coefficient with the scaling down of his ambitions about the size of giant pulse he can expect under whatever limitations of input, rod size, and geometrical efficiency may restrict him. The way we have seen this particular dye drop its coefficient at the right nanosecond and get it back again undiminished in 500 trials by 1- to 5-megawatt pulses coursing through it and the prospects for service at much higher power levels and for reliable periodic pulsing through the self-restoring properties of this liquid Q-switch all encourage us to hope that interested engineers will send for a data sheet on EASTMAN Q-Switch Solution to Distillation Products Industries, Rochester, N. Y. 14603 (Division of Eastman Kodak Company). To accompany the request with a valid purchase order for the kit wouldn't hurt.

Price subject to change without notice.

At Signetics we stick our neck out to get above the fog level:



announcing a new kind of integrated circuit data sheet.

No foggy "typical characteristics" talk. Signetics new data sheets provide the systems designer with the clarity of *GUARANTEED WORST CASE DESIGN LIMITS*. Now you can design without calculating or worrying about any additional safety factors or guard bands. And for component and reliability engineers, each data sheet is a model procurement document, complete down to details of acceptance, quality assurance, and environmental test methods and limits in accordance with all applicable MIL specifications. Get above the fog level. Know exactly what you are buying. Mail the coupon today.

**SINETICS
INTEGRATED
CIRCUITS**



A SUBSIDIARY OF CORNING GLASS WORKS

SINETICS CORPORATION, 811 E. ARQUES AVE., SUNNYVALE, CALIF.

All right, Signetics, prove it. I want your new Data Sheets on your complete line of DTL elements.

NAME _____

COMPANY _____

ADDRESS _____

CITY _____

STATE _____

ZIP _____

→ • ← D

D is a one micron CRT spot magnified 1000 times.

Want to study it?

The CELCO Two-Slit Spot Analyzer is the only commercially available means.

And it's ready to use no calibration.



Constantine Engineering Laboratories Company

YOKES FOCUS COILS DRIVERS

Mahwah, N. J. 201-327-1123

Upland, Cal. 714-982-0215

Now-shrink your high power equipment with CBE* design SCRs by Westinghouse

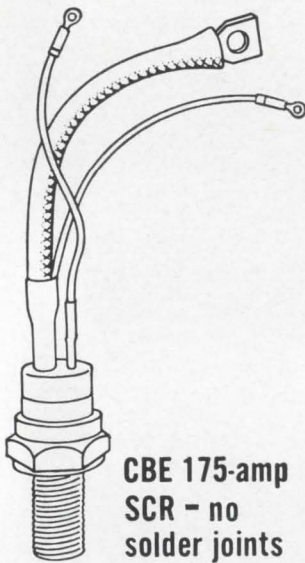

CBE 175-amp SCR - no solder joints



CBE 250-amp SCR for water cooling



CBE 300-amp SCR with integral heat sink

You can get extra power-handling ability in the same space as 150-amp devices. Just change to the Westinghouse Type 220. Added bonus: unique solderless compression-bonding construction eliminates thermal fatigue. Ratings are 4,000 amps half-cycle surge, 275 amps RMS, 175 amps average. Voltages through 1,000. Switching speeds to 20 microseconds, dv/dt 200 volts per microsecond, di/dt 200 amps per microsecond. Ideal applications of the Type 220 are in high power inverters, converters, cyclo-converters, and similar uses.

The Westinghouse 224 is the industry's only SCR specifically designed to help you get the space savings inherent in water cooling. Its base is designed for high heat transfer and easy mounting to liquid-cooled radiators, heat exchangers, or sinks. Ratings are 5,000 amps half-cycle surge, 400 amps RMS, 250 amps average. Voltages through 1,000. For applications like large motor drives, power inverters, and ignitron and motor generator replacements, the Type 224 may be just the answer you need to solve your design problem.

Only Westinghouse offers you an SCR with a truly integral heat sink. The new Type 223 produces more power at ambient temperature than any corresponding non-integral combination of SCR and heat sink, thus helps you design compact equipment. This efficiency comes from its exclusive construction concept, which eliminates a thermal interface. Ratings are 5,500 amps half-cycle surge, 470 amps RMS, 300 amps average. Voltages to 1,000. In industrial systems and other high power applications, the Type 223 is now finding wide use.

A complete line: Westinghouse manufactures a full spectrum of power SCR's from 10 amps to 470 amps, 50 volts to 1,200 volts. Get full details. Call your Westinghouse salesman or distributor now. Or write Westinghouse Semi-conductor Division, Youngwood, Penna.

*Compression Bonding Encapsulation

SC-2047

You can be sure if it's Westinghouse



Probing the News

Oceanography

Boom market waiting in the wings?

Navy's antisub and deep-submergence work is paving the way for eventual commercial exploitation of the ocean depths.

Meanwhile, industry remains wary of taking the plunge

By Seth Payne

Washington News Bureau

Before they can probe the ocean's darkest secrets and tap its fabulous riches, explorers will need electronic equipment far more ingenious, durable and reliable than any available today.

The government is conducting a \$141.6-million oceanographic program—up \$6.5 million from last year—plus \$70 million more for oceanographic work more closely related to the Navy's antisubmarine warfare effort. By 1972, the government expects the budget for pure oceanography to hit \$350 million a year.

There are also powerful commercial incentives for improved technology. With proper equipment, man will be able to harvest fish and crops, drill vast untapped oil fields far below the surface of the sea, collect billions of tons of minerals—manganese, copper, nickel, cobalt—strewn over the ocean floor, and hunt for treasure in sunken ships.

Expansion of undersea commercial ventures is being held up by two factors: money—undersea work is expensive; and information—too little is known about the deep-sea environment. Also, there is a shortage of electronic equipment sensitive and sturdy enough to gather data in a severe medium.

Industry is waiting for the government to provide more answers before they move—so to speak—into the sea. When this does hap-

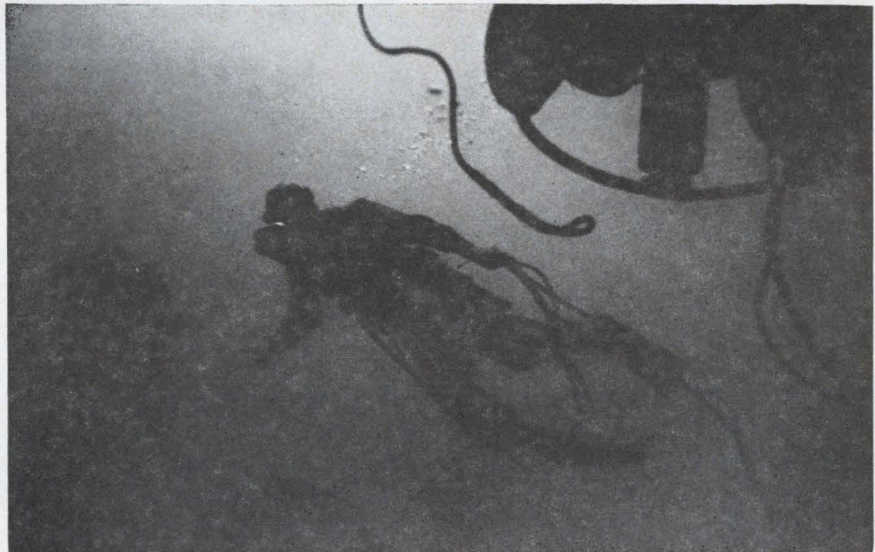

Commercial divers work on underwater oil wells. Their employer, Ocean Systems, Inc., is interested in the latest communications, navigation and oil-well equipment.

pen, the market for electronic instrumentation will be big.

1. The electronics market

The government is the most active explorer of the seas, and figures to remain at the forefront until underwater projects become more profitable. Its role is the subject of a dozen bills in Congress; one proposes creation of an oceanographic agency similar to the National Aeronautics and Space Administration.

The agencies. The Office of Naval Research relies heavily on electronic instruments in its oceanographic studies. These in-

clude research in marine geology, geophysics, circulation of ocean water, waves and tides, underwater acoustics, light-scattering effects and hydrobiology.

The Army Corps of Engineers is looking for ways to obtain sand and gravel from the ocean floor for commercial construction. The Weather Bureau is putting increased emphasis on studying the effect of weather on the surface of the sea. The Coast and Geodetic Survey is studying sea-level and tide changes, also sea-wave warning systems including deep-sea gages.

The Bureau of Mines is studying

undersea mining techniques off the coast of Tiburon, Calif., with three contractors: the Merritt-Chapman & Scott Corp., Lockheed Missiles and Space Co. and the International Minerals & Chemical Corp. Lockheed Missiles is a division of the Lockheed Aircraft Corp.

The Bureau of Public Health will buy instrumentation to measure water quality and pollution in rivers and in sea water near cities. Some money also will be spent for radiological sampling instruments.

Other agencies that spend money for oceanography are the Bureau of Commercial Fisheries, Bureau of Sport, Fisheries and Wildlife, the Atomic Energy Commission, Office of Education, the Coast Guard, the Smithsonian Institution, the National Science Foundation, and the Department of State.

Deep submergence. A project that is still small but a potential source of valuable information is the Navy's Special Projects Office's Deep Submergence Systems Program [Electronics, Feb. 22, p. 123]. The small, manned, deep-diving rescue and surveillance submersibles that will be built for the program are of great interest to industries such as oil and chemicals, which hope to mine the ocean's riches some day. Every event in the Man-in-The-Sea portion of the program, such as Sealab II, the seabottom colony off the coast of La Jolla, Calif., is also of interest to these companies [Electronics, Aug. 23, p. 111].

The Deep Submergence Systems Program is expected to spend \$16.5 million during fiscal 1966. Of this, \$3.2 million will be for sensors—\$1.8 million for optical systems, \$800,000 for navigation, \$600,000 for integrating the components, \$700,000 for telemetry and communications, \$200,000 for two sonars—a high resolution sonar to aid a rescue submarine to dock with a distressed sub three feet away, and a forward-looking vertical sonar—and \$100,000 for navigation beacons.

The budget for integrating the total system and for other electronics is expected to total \$1.7 million in 1966.

The companies. The Shell Oil Co. has a man at La Jolla observing the Sealab II project, and other big companies are anxious to see the

results—particularly of an experiment in setting up a drilling rig on the ocean floor. Jacques Cousteau, the French underwater explorer, will do the same thing soon in the Mediterranean.

Shell, with a number of drilling platforms 300 feet below the surface of the Gulf of Mexico, is more interested at this time in manned submersibles for making repairs than in undersea colonies. Shell already has a robot equipped with a television camera.

II. The equipment

Poor reliability and the absence of instruments for specific tasks are the big limitations to progress in oceanography, according to Gilbert Jaffe, director of the Navy's Oceanographic Instrumentation Center in Washington. Industry is



Gilbert Jaffe, director of the Navy's Oceanographic Instrumentation Center, shows two expendable electronic bathythermographs that, if accepted by the Navy, will comprise annual sales of half a million dollars.

not entirely to blame. The sea is a difficult environment, and the market has been too small to encourage a great deal of research into equipment and techniques.

However, with the increased emphasis on oceanography, more gear of higher quality will be required.

Testing. More emphasis, for example, is already going into testing. The Navy Oceanographic Instrumentation Center is installing a new, larger pressure-temperature tank for evaluating and calibrating oceanographic instruments.

As an example of how better testing can solve problems, Jaffe

notes that the Navy has had trouble for years with sound velocimeters. They worked well in fresh water, but in salt water the frequency changed. Tests determined that the change was caused by the effect of salt on the transducer's crystal face. A gelatin-like mixture was put behind the crystal to protect it from salt water; then the device worked well. The Navy will soon write new specifications requiring future meters to be built this way.

Throwaways. A major market in oceanography will be created if the Navy switches from mechanical bathythermographs to expendable electronic devices for measuring ocean temperature. Consisting of a thermistor connected by wire to a recorder, the electronic device measures temperature continuously to the end of the wire, then snaps off.

Although the electronic units are accurate only to about 2° F, whereas the mechanical ones are accurate to 0.1°, the electronic gear can be used at ship speeds up to 20 knots; the mechanical ones are limited to 10 knots. The Navy is willing to accept the accuracy penalty in favor of the convenience of the electronic sensor. Also, since the units are only used once, they don't have to be calibrated.

The new units cost about \$25 each. If the Navy buys half a million a year, however, the price would go down sharply.

Where the buoys are. The Navy is working toward a network of buoys, strategically placed throughout the world, to make oceanographic measurements continuously and transmit them back to collection centers. Two approaches are being examined: small submerged buoys and large ones on the surface.

The Navy's Oceanographic Instrumentation Center is working on a buoy four to five feet in diameter that would be anchored 100 feet below the surface or more. A prototype, made of spun aluminum, will be ready for testing in six months.

Although it is difficult to transmit data from submerged buoys, they have one big advantage; they do not interfere with ocean shipping. Transmission to collection centers may be by buoy-to-shore

radio or along an ocean-bottom cable. Eventually, Navy technicians hope to use satellites for reading buoys.

Surface buoys. The Office of Naval Research is experimenting with two 40-foot buoys built by the General Dynamics Corp. One of the "monsters," as they are called, was placed in the gulf stream off Florida, about four months ago. Later this year it will be moved to the vicinity of Puerto Rico for more tests. By summer this buoy and another, off the coast of California, will be operational.

The monsters can be anchored in water 20,000 feet deep; each is equipped with a data-acquisition and telemetry system that operates continuously for a year at distances up to 2,500 miles.

A 100-channel data system collects information from sensors mounted along the mooring cable and along a 40-foot mast. When interrogated, the system transmits all data collected during the preceding 24 hours. Its memory also stores all of the data collected over the full year's operation. Transmission to readout stations on shore is by high frequency over a 4.5- to 28.0-megacycle range.

The first two buoys cost a total of about \$3.5 million, but the Navy hopes future ones will cost about \$150,000 each.

Beckman Instruments, Inc., designed the electronic sensors for the buoys. Temperature pressure and salinity sensors will be mounted at 10 to 15 different depths along the mooring cable.

Acoustics. A trend in acoustics data collection is a shift toward continuous collection instead of the more usual sporadic ones. The Office of Naval Research has a large transducer, 90 feet under water off Miami, that continuously beams 64 kilowatts of focused power through a 20-foot aperture 40 miles across the Florida Straits to Bimini in the Bahama Islands, where piezoelectric receivers at various depths pick up the signal. The transducer and the reflector were built by North American Aviation, Inc. The experiment is run by the University of Miami's Institute of Marine Sciences. The Navy is considering building additional units and mounting them at different levels.

Space electronics

A magnetically clean Pioneer

Deep space probe needed special treatment to measure weak interplanetary magnetic fields

By Laurence D. Shergalis

San Francisco Regional Editor

The electronic components aboard the Pioneer spacecraft that will be launched into solar orbit this fall have had to meet unusual requirements. In deep space, magnetic fields are so weak that unless the vehicle itself and everything aboard it is magnetically clean, no measurement can be made of the interplanetary magnetic fields. The space vehicle will be a model for all future deep space probes; it will have practically no magnetic field of its own.

Pioneer will be measuring magnetic flux densities on the order of a few gammas. For such sensitive measurements the National Aeronautics and Space Administration wants to reduce the field created by the spacecraft itself to one-half gamma at the sensor. A gamma is equal to 10^{-5} oersted, the cgs unit of magnetic density; the earth's magnetic field varies from 30,000 gammas at the equator to about 70,000 gammas at the poles. To carry out its six experiments, Pioneer will be jammed with electronic equipment. Usually, such equipment is made of ferroelectric material that contains residual magnetism; in addition, the currents generated by the operation of the equipment can produce stray magnetism. It was essential to reduce the sources of residual magnetism and to compensate for the stray fields.

Some pioneer work was done for Pioneer by the three IMP (interplanetary monitoring platform) satellites launched as part of the Explorer series. Explorers 18, 21, and 28, which were placed in highly eccentric orbits in November of 1963, November 1964 and May of this year, also measured

magnetic densities. These satellites were not true space probes, since they orbit the earth; but their apogees (up to 130,000 miles) took them into deep space.

Techniques developed for IMP at the Goddard Space Flight Center at Greenbelt, Md., were borrowed and improved for Pioneer; but Pioneer will be the first spacecraft with demagnetization designed in from the start. NASA set up a laboratory at its project office at Ames Research Center, Moffett Field, Calif., to check equipment packages for the six experiments and to provide a consulting service for firms building the packages.

"Dirty" parts just won't be flown, NASA says. The incentive for manufacturers to clean them up is the fact that each 140-pound Pioneer has about 10,000 parts, which may cost \$5 to \$10 each. And the Pioneer specs will have

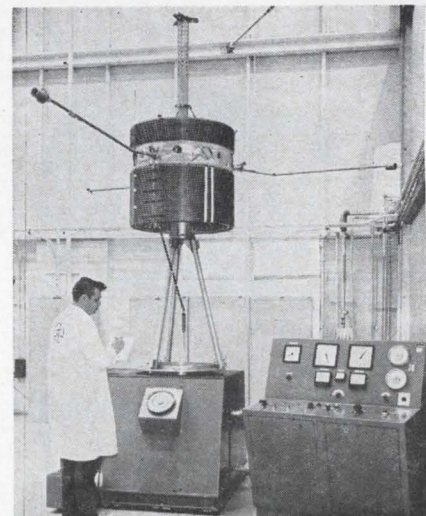

Technician at the TRW Space Technology Laboratories checks Pioneer's magnetic properties. Magnetometer to measure deep-space fields is on end of boom at upper left.

IF
 you use,
 need or
 specify
DC POWER
 you'll want
 this new
TRYGON
POWER
SUPPLY
HANDBOOK

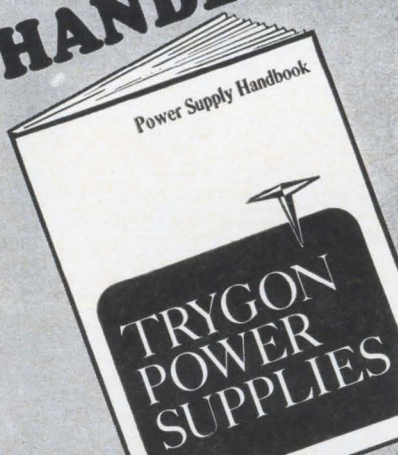

TRYGON Electronics, Inc.
 Roosevelt, L.I., N.Y. 11575

Gentlemen:
 Please RUSH me your newly published
 HANDBOOK—Free.

Name

Title

Company

Address

CityState.....Zip.....

to be met by components for future deep space probes.

I. Magnetic sources

The biggest headache in demagnetizing Pioneer came from the platinum-cobalt magnet assembly for the traveling-wave tubes used to power the high-gain antenna. IMP had no twt's aboard. Because the magnets are essential to the operation of the tubes, they couldn't be altered or eliminated. The only answer lay in compensation—that is, placing several external magnets in a way that would cancel out the field produced by the twt magnets.

Compensation is not easy. The compensating field must follow the unwanted field at various temperatures over a long period of time, and must match the shape of the unwanted field. However, twt magnets are extremely stable; traveling-wave tubes depend upon this stability for proper operation. Compensating magnets of the same material as twt magnets reduced the residual field by 95%.

Wire leads and interconnections were another problem. The usual material for welded-connection leads is nickel, which is highly magnetic. NASA is using Alloy 180, which is 23% nickel and 77% copper. It is similar to Monel, can be welded, and is nonmagnetic.

The most popular metal in glass-to-metal seals is Kovar, which is about 30% nickel, 53% iron and 17% cobalt—all magnetic materials. No good substitute for Kovar was found, so it was necessary to resort to some tricks. For example, lead lengths were clipped to a bare usable minimum; some were reduced by more than a fourth. Printed circuit boards were redesigned so that all leads were as short as possible. Clipping reduced the magnetic moment for individual components by 99%.

Search for components. Another major problem lay in the use of a large number of solid tantalum capacitors. Even with clipped leads, they could not meet the specifications. The NASA project office, under the direction of Ernest Iufer, manager of magnetics, compiled a list of every capacitor in all the on-board equipment and found there were over 2,500, of many sizes. Iufer convinced the experi-

menters to reduce the number of sizes to ten; armed with this information, he made a market survey and found one manufacturer, the Kemet dept. of the Union Carbide Corp., who was willing to tool up to make all ten sizes of nonmagnetic capacitors. The tantalum capacitors were supplied to the experimenters as government-furnished equipment.

There were a number of other approaches to demagnetization. Some transistors were placed in nonmagnetic cans. Many relays were eliminated. Where it was necessary to use electromechanical devices, an effort was made to improve the efficiency of the magnetic circuit. After certain toroids were found to produce magnetic fields because of asymmetrical windings, more careful windings reduced stray fields.

The demagnetization effort extends beyond the spacecraft itself. It will be necessary to reduce magnetic effects during launch, according to Iufer, so the satellite's transport vehicle and all hand tools will be demagnetized.

II. Experimental data

N. F. Ness of Goddard Space Flight Center will direct the magnetic experiment, in which a single flux-gate sensor will measure the interplanetary magnetic field. The sensor is mounted on the end of a boom; the magnetometer has a range of plus 64 to minus 64 gamma and a readout accuracy of plus or minus one-half gamma.

V. R. Eshleman of Stanford University is directing a radio propagation experiment. Two phase lock receivers, one at 49.8 megacycles and the other at 423.6 megacycles, will receive signals sent in phase. Data relayed to the ground will give phase differences which may be interpreted to give electron density.

An experiment directed by J. A. Simpson of the University of Chicago's Fermi Institute will measure the direction and energy spectrum of high-energy proton and alpha particles. Another cosmic ray experiment by K. G. McGracken of the Graduate Research Center of the Southwest, Dallas, Tex., will determine the properties and directionality of cosmic rays.

Two plasma probes, one di-

A NEW BREED OF . . .

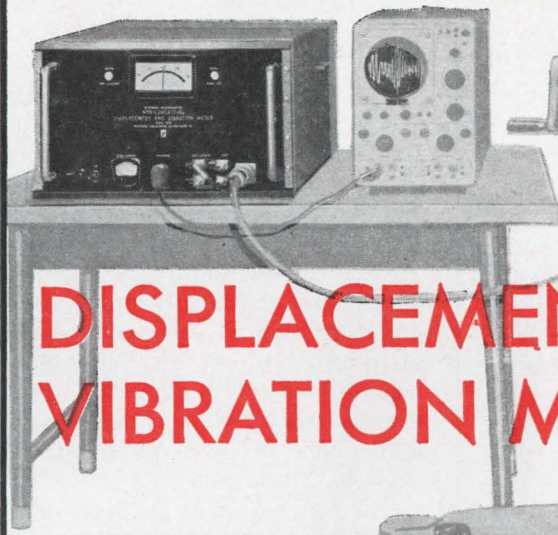

DISPLACEMENT AND VIBRATION METER

- Dynamic Resolution—1 microinch
- Frequency Response—dc to 20 kc
- Long-term Stability—10 microinches
- Non-contact Sensing—to 1 foot
- Displacement Range—to 0.1 inch

A UNIQUE APPLICATION OF MICROWAVES . . . TO NON-CONTACTING DISPLACEMENT AND VIBRATION MEASUREMENT

The Weinschel Model 1802 is a high resolution device operating at 35 gc on principles analogous to the optical interferometer. Utility to you is *not* limited by requirement for contact, optical reflection, or metallic composition. The 1802 measures random or periodic displacement of *any* surface that reflects the microwave signal. Motion or surface irregularity perpendicular to the direction of the propagation is detected and measured. Your wide range of applications include vibration analysis, accelerometer calibration, dielectric fault investigation; and measurement of surface contour, waviness, slow dimensional change, and dynamic unbalance. For additional information or a demonstration of the exciting Model 1802, contact your local Weinschel sales representative or Weinschel's home office.



DESIGNERS AND MANUFACTURERS OF PRECISION MICROWAVE EQUIPMENT

WEINSCHTEL ENGINEERING

GAITHERSBURG, MARYLAND • TEL: (301) 948-3434 • TWX: (301) 926-3730
SANTA MONICA CALIFORNIA • 1318 SECOND STREET • TEL: (213) 394-1154 • TWX: (213) 879-0490

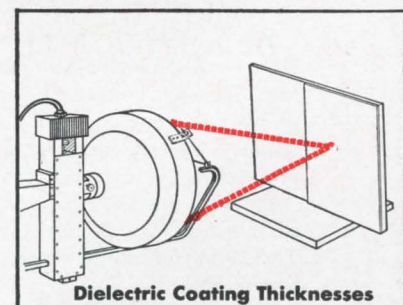
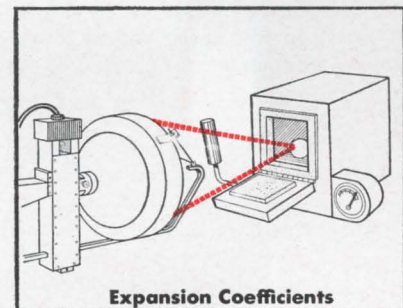
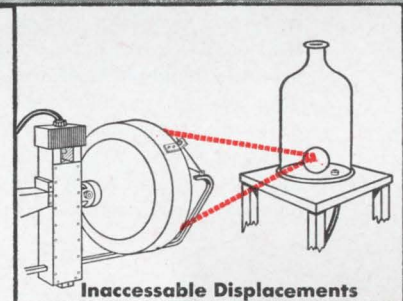
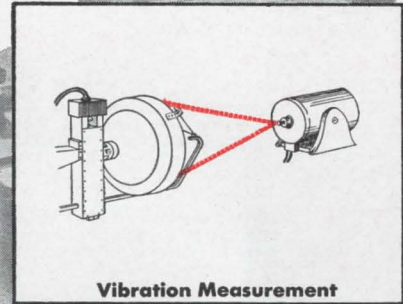

Design your own remote control systems with audio signal modules

Start with encoder. It is a solid state oscillator with a resonant reed which generates an audio tone to control a single function. You transmit over wire or radio.



Single Channel Encoder

A single pair of wires, or a leased telephone line, can carry the audio signals for a complete control system.

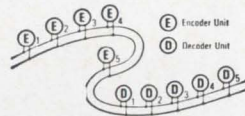

For inaccessible areas or mobile installations, a radio transmitter and receiver system can carry the signals.



Companion decoder has a solid state amplifier, resonant reed relay and transistor switch. It responds to frequency signal, translates it into control function. Because of the narrow and accurate bandwidth of the decoder, your system can have more than 30 different frequencies in the 300 to 1600 cps range. With single channel modules you can easily add channels or change frequencies.



Single Channel Decoder

Five channel decoder modules are also available, perform five functions in less space and at lower cost per function.

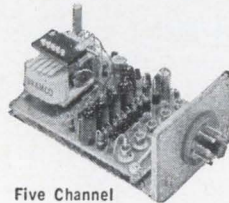

Five Channel Decoder

Solid state power supply, regulated and filtered for audio tone systems, can handle more than 30 encoder modules, or 10 single channel decoder modules or two 5-channel decoder modules, plus secondary loads.

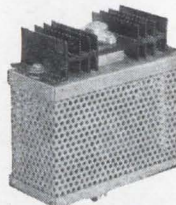

Power Supply Module

The narrow bandwidth (1%) of Bramco resonant reeds makes them ideal for simultaneous and sequential coded tone systems. The number of control functions is virtually unlimited. For example, you can control over 4800 individual functions with only 20 frequencies coded simultaneously in groups of four.

If you work with controls that command, select, regulate, or indicate, you should know about resonant reed systems. The Bramco module way is simple, flexible, economical and dependable.

We stock standard resonant reeds and modules, and design specials. Write for literature or call 513-773-8271.



BRAMCO CONTROLS DIVISION, LEDEX INC.
College and South Streets, Piqua, Ohio 45356

rected by J. H. Wolfe of the Ames Center and the other by H. S. Bridge of the Massachusetts Institute of Technology, will also be on board. The purpose of these experiments is to measure the flux, incidence angle, angular distribution, and energy spectrum of interplanetary plasma.

III. Pioneer's mission

Four Pioneers will be launched, at about six-month intervals, in the current series. An earlier series of five was launched in 1958-60. The probes will be the only ventures into deep space between Mariner 4 and the Voyager series of unmanned Mars shots in 1971, and thus will be the only source of information on solar activity in space. Essentially, Pioneer is picking up where Mariner leaves off, and much of its equipment resembles Mariner's.

The Pioneers will measure magnetic fields, the distribution in space of protons emitted from solar flares, the temperature and velocity of the solar wind, and the distribution of micrometeoroids in the region of the earth's orbit. The information on solar flares could have immediate practical application to the Apollo manned moon program; scientists fear that the flares could harm the astronauts.

The first of the new Pioneers will be launched toward the sun; in six months it will be 0.8 astronomical units (AU) from it. An astronomical unit is the distance from the earth to the sun, or 93,000,000 million miles. The second Pioneer, next spring, will be launched away from the sun, and will be 1.2 AU from it in six months; the third and fourth shots will duplicate that pattern. NASA scientists hope that the equipment aboard will stay alive past six months so that they can get data from more than one spacecraft at a time.

For later periods, Advanced Pioneer spacecraft are under consideration. These vehicles would have a lifetime of several years and would go into trajectories that would take them as near to the sun as 0.2 AU or as far away as 8.5 AU. All of these probes will carry out magnetism experiments, and this fall's Pioneer may show them how.

WHAT'S NEW IN POTS?

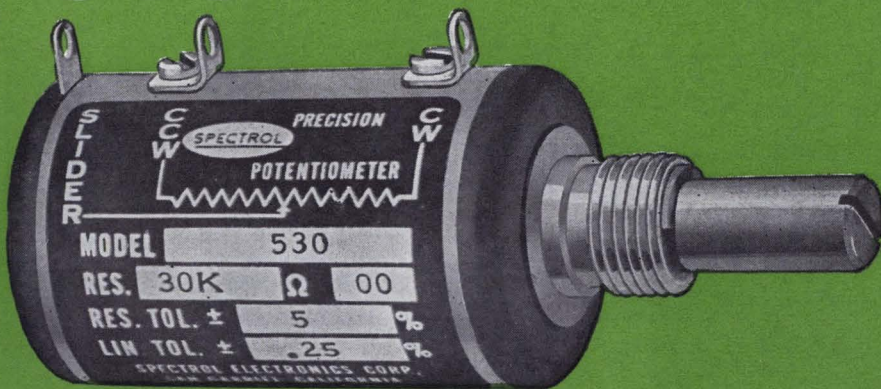

TWO NEW 10-TURN PRECISION POTS... MILITARY QUALITY AT COMMERCIAL PRICES

These all new 10-turn wirewound precision potentiometers use high reliability design techniques specifically adapted to high volume production to provide exceptional cost vs. performance characteristics.

Features include dimensionally stable, non-hygroscopic, sealed diallyl phthalate cases; precision metal contacts; gold-plated terminals and low tempo resistance elements.

MODEL 162 — ACTUAL SIZE, 1/2" 10-TURN, PRICE \$10.00.

The model 162 is a true 1/2" diameter 10-turn potentiometer with terminals molded into the rear lid to present a clean body configuration for those cramped mounting spaces.



MODEL 530 — ACTUAL SIZE, 7/8" 10-TURN, PRICE \$7.00.

The model 530 is a 7/8" diameter unit featuring a new dual slip ring contact design that eliminates noise problems.

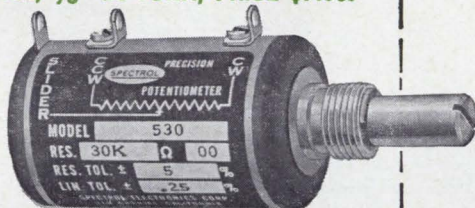

Check our spec table below against any 1/2" or 7/8" 10-turn pot.

SPECIFICATIONS	MODEL 162	MODEL 530
Standard Resistance Range...	100Ω to 50K	500Ω to 100K
Standard Resistance Tolerance	±5%	±5%
Standard Linearity	±0.3%	±0.25%
Power Rating	2 Watts at 40°C	3 Watts at 40°C
Operating Temperature Range	-55 to +125°C	-55 to +105°C
Case Dimensions—inch.....	1/2 D x 1 L	7/8 D x 1 1/10 L
Prices		
1-9.....	\$10.00	\$7.00
500.....	7.00	4.90

Call your nearest Spectrol distributor for immediate off-the-shelf delivery at factory prices, or write for complete specifications. Spectrol also manufactures a complete line of trimming potentiometers and turns-counting dials.

SPECTROL ELECTRONICS CORPORATION

1704 South Del Mar Avenue
San Gabriel, California

Adams Court
Plainview, L. I., New York

Circle 135 on reader service card

Now Lambda offers two complete lines of all-silicon

Modular Subrack

LM SERIES

Multi-Position-Rated™ and Multi-Current-Rated™ for 40°, 50°, 60° and 71°C

You can select from **22 models starting at \$79** voltages up to 60 VDC, from **0.08 AMPS. to 8.3 AMPS....** and mount these modules **three ways on a chassis or in a rack**

A-C Input—105-132 VAC
45-440 CPS

Reg. Line—.05% + 4 MV
Load—.03% + 3 MV

Ripple—1 MV rms—3 MV peak-to-peak

Temp. Coef.—.03%/°C

- Meet RFI Specifications—MIL-I-16910
- Maximum Ratings Without External Heat Sinking or Forced Air
- Thermally Protected and Short Circuit Proof—Current Limiting
- Remote Programming



mounted this way

mounted this way

mounted this way

4 DC OUTPUTS IN 3 1/2" RACK

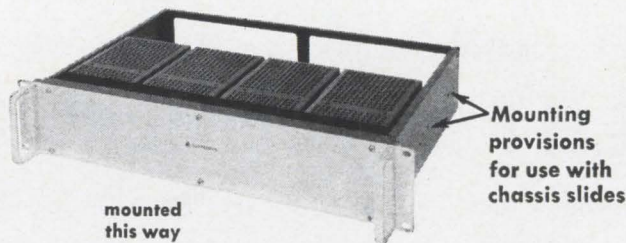

mounted this way

Mounting provisions for use with chassis slides

New

Both LM and LH Series meet these Mil. Environment Specifications:
Vibration — Shock — Humidity — Temp. Shock
Altitude — Marking — Q.C.

LH SERIES

1/4 and 1/2 rack power supplies are Multi-Current-Rated™ for 30°, 50°, 60°

You can choose from **10 1/4 and 1/2 rack models...** voltages up to 120 VDC, up to **9 AMPS....** for rack, bench and chassis mounting

A-C Input—105-135 VAC
45-480 CPS

Reg.—.015% or 1 MV line or load

Ripple—1/4 MV rms, 1 MV p to p

Temp. Coef.—.015%/°C

RFI—MIL-I-16910

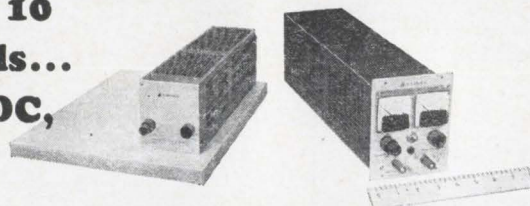

flush chassis mounting

minimum bench width

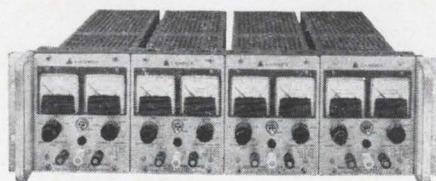

4 DC outputs in a single rack

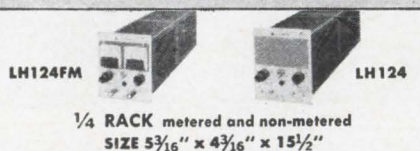

LH124FM

LH124

1/4 RACK metered and non-metered
SIZE 5 3/16" x 4 3/16" x 1 1/2"

Model ²	VDC	I MAX. AMPS ¹				Price ²
		40°C	50°C	60°C	71°C	
LH 118	0-10	4.0	3.5	2.9	2.3	\$175
LH 121	0-20	2.4	2.2	1.8	1.5	159
LH 124	0-40	1.3	1.1	0.9	0.7	154
LH 127	0-60	0.9	0.7	0.6	0.5	184
LH 130	0-120	0.50	0.40	0.35	0.25	225

¹ Current rating is from zero to I max. and applies over entire voltage range.

² Prices are for non-metered models. For metered models add suffix (FM) to model number and add \$25.00 to





LAMBDA ELECTRONICS CORP.

515 BROAD HOLLOW ROAD, MELVILLE, L. I., NEW YORK • 11749

Circle 136 on reader service card

Ambients

		Package C				
		3 3/16" x 4 15/16" x 9 3/8"				
Model	VDC	I MAX. AMPS ¹				Price
		40°C	50°C	60°C	71°C	
LM 225	0-72	4.0	3.6	3.0	2.4	\$139
LM 226	8.5-14	3.3	3.0	2.5	2.0	139
LM 227	13-23	2.3	2.1	1.7	1.4	139
LM 228	22-32	2.0	1.8	1.5	1.2	139
LM 229	30-60	1.1	1.0	0.80	0.60	149

		Package D				
		4 15/16" x 7 3/4" x 9 3/8"				
Model	VDC	I MAX. AMPS ¹				Price
		40°C	50°C	60°C	71°C	
LM 234	0-72	8.3	7.3	6.5	5.5	\$199
LM 235	8.5-14	7.7	6.8	6.0	4.8	199
LM 236	13-23	5.8	5.1	4.5	3.6	209
LM 237	22-32	5.0	4.4	3.9	3.1	219
LM 238	30-60	2.6	2.3	2.0	1.6	239

¹ Current rating is from zero to I max. Current rating applies over entire output voltage range. Current rating applies for input voltage 105-132 VAC 55-65 cps. For operation at 45-55 cps and 360-440 cps derate current rating 10%.
² To operate at 0-10 VDC—derate output current 30%.
³ To operate at 0-20 VDC—derate output current 30%.
⁴ To operate at 0-40 VDC—derate output current 30%.

and 71°C Ambients

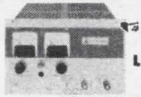
		LH125				
		LH125FM				
		1/2 RACK metered and non-metered				
		SIZE 5 3/16" x 8 3/8" x 15 5/8"				
Model ²	VDC	I MAX. AMPS ¹				Price ²
		30°C	50°C	60°C	71°C	
LH 119	0-10	9.0	8.0	6.9	5.8	\$289
LH 122	0-20	5.7	4.7	4.0	3.3	260
LH 125	0-40	3.0	2.7	2.3	1.9	269
LH 128	0-60	2.4	2.1	1.8	1.5	315
LH 131	0-120	1.2	0.9	0.8	0.6	320

price. For non-metered chassis mounting models, add suffix (S) to model number and subtract \$5.00 from non-metered price.

Patents

What's a laser patent worth?

Charles Townes' maser is accepted as the basic invention. But the question of who should get what royalties is far from being settled

Charles H. Townes invented the maser in 1954 and got around to patenting it five years later. Since then more than 200 patents have been granted on masers and on their optical cousins, lasers, and many more are pending. Potential applications range from the spectacular (communications in space) to the prosaic (the alignment of sewer pipe) to the semicom (the laser eraser). Townes' patent is accepted as basic, although it has never been tested in court; yet neither he nor the company that holds the patent has ever received a nickel in royalties.

Townes could have a fleet of Ferraris by now if the laser's glamorous potential had been translated into a solidly profitable commercial application, but it hasn't—yet. The future of the laser is so hard to predict that the question of who owns rights to what has been allowed to go unanswered—and it has become more complicated with every patent issued. Rather than carry on expensive court actions for rights that may not be worth much, companies that hold patents have preferred to try to work out agreements on licenses and royalties privately. Some have succeeded and are collecting royalties now. But with no general agreement on how valuable the laser is, the process is slow.

The market. Optimists in the electronics industry predict civilian sales of lasers will total \$300 million a year by 1970, and Townes himself said recently that sales of lasers and related quantum devices to government and commercial users would command a billion-dollar market by 1970—a reasonably good fraction of which would be commercial. If this is correct,

laser patents will be very valuable.

Yet some engineers who work with lasers think that it may be 10 to 25 years before they are a commercial success. Arthur L. Schawlow, who worked with Townes on an optical maser, does not expect any great commercial exploitation—even in communications.

"You can already communicate with radio waves," Schawlow points out. "Maybe you could communicate a little better with lasers; but some of the things you might be able to do with lasers in chemistry—such as drilling holes in a single cell—might be hard to do any other way, and these are the really exciting possibilities." Schawlow's point is that it will be a long

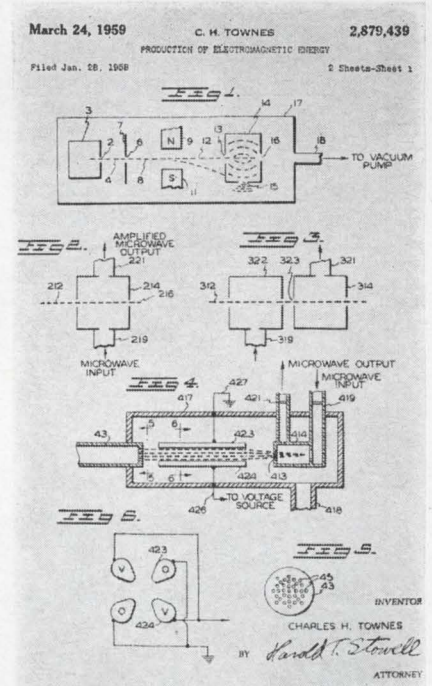

These five diagrams were part of Charles H. Townes' original patent, No. 2,879,439, for "Production of Electromagnetic energy"—the maser.

IMPROVED TONE! in S&G "Building Block" MODULTONE

for Remote Control or Monitoring
over Telephone Line, RF Carrier,
or any Two Wire System

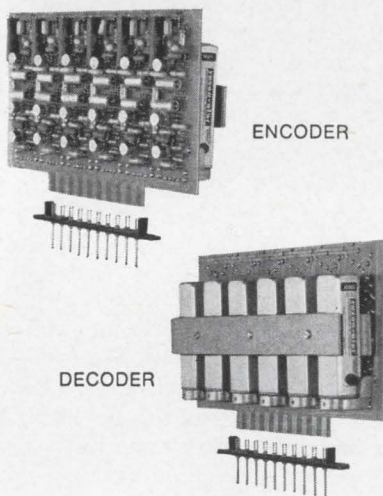

Thanks to S&G Resonator[®] resonant reeds, these encoders and decoders have superior frequency stability . . . can control or monitor hundreds of functions—over ten simultaneously!

Printed circuit boards permit ease of maintenance and easy expansion . . . as simple as building with blocks. Because of the unique encoder design there need be no current drain in either unit in an un-activated condition. S&G's encoders will stabilize in less than 200 milliseconds after the application of power. Nominal decoder response is 100 milliseconds, so overall circuit response is only 300 milliseconds.

For low-cost, high quality, stable multi-tone modules insist on S&G Modultone.

WHY NOT WRITE US NOW
FOR DETAILS.

A RESONANT
REED PRODUCT
from the leader
in the resonant
reed field

 **ELECTRONICS**
SARGENT & GREENLEAF, Inc.
ROCHESTER, NEW YORK 14621

time before anyone can show economic justification for replacing microwaves with lasers—even if it were technically possible. He feels that the device's real value is as a research tool.

I. The patent muddle

Since 1959, masers and lasers have had some success in research and in instrumentation; the very multiplicity of these applications has, inevitably, caused some difference of opinion over the scope of the basic patent and contributed to the confusion over rights.

Townes, who is now provost of the Massachusetts Institute of Technology, developed the ammonia maser while working at the Columbia Radiation Laboratory in New York under an Army Signal Corps contract. Many commercial firms sign information and invention agreements with their scientists, under which rights to all inventions belong to the employer. But Columbia Labs does not have such a policy, and Townes was free to obtain the patent himself.

To relieve himself of business details, he assigned his rights to the maser to the Research Corp., a nonprofit organization that undertakes to develop an invention as well as to protect rights to it in court. A small percentage of any royalties goes to the inventor; the rest is distributed among the corporation's several grants programs for research in the physical sciences, a feature that appealed to Townes and influenced his choice of the Research Corp. as holder of the patent rights.

The effectiveness of that first patent was clouded by the fact that Townes had written an account of his work on the maser for the Columbia Laboratory's progress reports some years before filing. If those reports constituted publication, the maser could be considered to be in the public domain—if anyone cared to try and prove the point in court. So far no one has, and it is the opinion of most patent lawyers that no one will, for to do so would require a great deal of time and money.

Six months after filing for the maser patent, Townes applied with Schawlow for a patent on a maser that radiated in the optical portion of the spectrum. Schawlow, who is



Charles H. Townes has yet to receive any royalties for his maser.

now at Stanford University, was then working for the Bell Telephone Laboratories. Royalties from that patent, which was granted in 1960, go to Bell Labs or to the Western Electric Corp., the manufacturing arm of the American Telephone and Telegraph Corp.; Bell Labs is AT&T's research arm.

Who invented it? But while most companies have conceded Townes' claim to the maser, the laser has been another story. TRG, Inc., a Melville, N. Y. company, also filed an application for an optical maser in the name of one of its researchers, Gordon Gould, claiming that Gould's ideas predated Schawlow's and Townes'. Bell complained to the Patent Office and won; but TRG brought the case to the Court of Customs and Patent Appeals, where it has lain since 1964.

Meanwhile, in May, 1960, Theodore H. Maiman demonstrated the first successful ruby optical maser at the Hughes Aircraft Corp. (It was Maiman who coined the word "laser," which caught on immediately.) Maiman left Hughes to become president of the Korad Corp. long before Hughes filed for a patent on his invention.

That application is still pending; if it is considered by the Patent Office to interfere with Bell's patent, the office's Board of Interference Examiners will decide who should have the rights. The loser can appeal. Attorneys at Bell doubt that the matter will ever reach this stage; they feel that any patent issued to Hughes will probably cover only a ruby laser and will not conflict with their patent.

More patent requests. Bell has

When you want one PLANAR POWER TRANSISTOR...



or a carload

you benefit 4 ways when you buy Transistron silicon planar power transistors

- 1 WIDEST SELECTION** — Transistron makes the broadest range of silicon planar power transistors including epitaxial and high voltage types.
- 2 PROVEN RELIABILITY** — Unmatched experience in high reliability power transistor planar techniques.
- 3 FASTEST SERVICE** — Deliveries normally made direct from large stocks. There's a Transistron office or sales representative nearby, wherever you are.

- 4 COMPETITIVE PRICING** — Transistron's high-volume production techniques and consistently high production yields permit P.A. - pleasing prices, particularly on larger quantities.

Is your Power Transistor file up to date? Send today for Transistron's data-check list for the complete line of planar power transistors.

Transistron electronic corporation 
168 Albion Street, Wakefield, Mass.

TYPICAL PLANAR POWER TRANSISTOR TYPES BY Transistron

PACKAGE	TYPE	POWER 100°C CASE	MAX. CUR- RENT RATING	V _{CEO}	h _{FE}	PACKAGE	TYPE	POWER 100°C CASE	MAX. CUR- RENT RATING	V _{CEO}	h _{FE}
NPN HIGH POWER						NPN MEDIUM POWER					
TO-53 FLANGE	2N1210-11	30W	5.0A	60V-80V	15-75 @ 2.0A	1/16" STUD	2N2150-51	30W	2.0A	80V	20, 40 min. @ 1.0A
1/16" STUD	2N1212	45W	5.0A	60V	12 min. @ 1.0A	7/16" STUD	2N2866-67	20W	3.0A	80V	15 min. @ 2.0A
TO-53 FLANGE	2N1250	45W	5.0A	60V(V _{CB0})	15 min. @ 2.0A	1/16" STUD (EPI)	ST7732	20W	5.0A	60V	30 min. @ 2.0A
1/16" STUD	2N1616-18	30W	5.0A	60V-80V	15 min. @ 2.0A	TO-5 (EPI)	ST7722	5W	3.0A	60V	30 min. @ 2.0A
TO-53 FLANGE	2N1620	30W	5.0A	80V	15-75 @ 2.0A	PNP MEDIUM POWER					
TO-53 FLANGE	2N1722, A	50W	7.5A	80V, 120V	20, 30 @ 2.0A	TO-5	2N1084	5W	2.0A	50V @ 50 ma	15 min. @ 1.5A
1/16" STUD	2N1724, A	50W	7.5A	80V, 120V	20, 30 @ 2.0A	7/16" STUD	2N2875	20W	2.0A	50V @ 50 ma	15 min. @ 1.5A
TO-53 FLANGE	2N2032	45W	5.0A	45V(V _{CB0})	15 min. @ 2.0A	TO-5	2N3660	5W	2.0A	30V @ 50 ma	15 min. @ 1.5A
1/16" STUD	ST7240	50W	10.0A	80V	10 min. @ 5.0A, V _{CE} = 0.75V	TO-5	2N3661	5W	2.0A	50V @ 50 ma	15 min. @ 1.5A
NPN INTERMEDIATE POWER						TO-5 (EPI)	ST8190	5W	2.0A	30V @ 50 ma	15 min. @ 1.5A
TO-57 SINGLE ENDED STUD	2N1047-50	22.5W	2.0A	60V-80V	12 min. @ 0.5A 30 min.	TO-5 (EPI)	ST8191	5W	2.0A	50V @ 50 ma	15 min. @ 1.5A
7/16" STUD	2N1047A-50A	22.5W	2.0A	80V-120V		TO-5 (EPI)	ST9005	20W	2.0A	50V @ 100 ma	15 min. @ 2.0A
	2N1047B-50B	22.5W	2.0A	80V-120V		NPN MEDIUM POWER — HIGH VOLTAGE					
7/16" STUD	2N1647-50	20W	3.0A	80V-80V	12 min. @ 1.0A 20 min.	TO-5	2N1052	5W	1.0A	155V @ 50 ma	20-80 @ 200 ma
	2N2018-21	20W	2.0A	125V-140V	15 min. @ 1.0A 25 min.	TO-5	2N1053	5W	1.0A	135V @ 50 ma	20-80 @ 200 ma
						TO-5	2N1054	5W	1.0A	115V @ 50 ma	20-80 @ 200 ma

CALL YOUR NEAREST TRANSISTRON SALES ENGINEER — Baltimore: (301) Chesapeake 3-3220 • Boston: (617) 245-5640 • Camden: (609) Ulysses 4-7082 • Chicago: (312) Village 8-5556 • Dallas: (214) Fleetwood 7-9448 • Dayton: (513) 224-9651 • Detroit: (313) 838-5884 • Kansas City: (913) ENdicott 2-6640 • Los Angeles: (213) MADison 9-2551 • Minneapolis (612) 927-7923 • New York: (914) 834-8000 • Orlando: (305) CHerry 1-4526 • Phoenix: (602) 277-3366 • San Francisco: (415) 961-1954 • Syracuse: (315) HOward 3-4502 • Canada: Toronto 18, (416) CLifford 9-5461



For ALL 8 Leading Micro-Welders

BECAUSE BAUSCH & LOMB STEREOZOOM adds product value, benefits users. That's why StereoZoom outsells all other stereomicroscopes combined. Why your choice should be StereoZoom whether for your own product... for your production lines... for quality control and inspection.

With StereoZoom you get the brightest, sharpest 3-D images, plus continuously variable magnification. It saves operators' time, increases production, minimizes fatigue. It's built to withstand hard industrial usage, is dust-proof, shock-proof, trouble-free.

Besides, the StereoZoom line lets you pick a complete microscope or selected components... to make sure your job is done right.

Call your dealer or write for Catalog 31-15, Bausch & Lomb, 61421 Bausch Street, Rochester, New York 14602.

BAUSCH & LOMB 

also filed for patents on Ali Javan's continuous-wave helium-neon laser and on E. I. Gordon's c-w argon discharge laser, on yttrium aluminum garnet and neodymium-doped calcium tungstate configurations, and on a number of specific laser devices.

The confusion in the third class of lasers, the injection or semiconductor laser, is even greater. The International Business Machines Corp., the General Electric Corp. and the Lincoln Laboratory of MIT all announced the observation of laser action in gallium arsenide late in 1962, and all applied for patents. Richard L. Seed, president of the Seed Electronics Corp. in Lexington, Mass., says, "I don't think anyone will get patent rights on semiconductor lasers. The work was going on at too many places simultaneously. There are too many lab notebooks showing almost identical work. The idea of semiconductors was so obvious at the time that no one could be called the inventor."

II. Who pays whom?

Even if one person held all rights to the laser, he would not collect royalties from companies making lasers for the government—the principal customer today.

The federal government, in fact, moves through the patent field like a diplomat with extraterritorial privileges; it is immune to its own laws. If it sponsors patentable research, it automatically gets a royalty-free license to make anything that may be covered by the patent. The Research Corp. found that the government's patent umbrella was even wider than the company had believed when it offered TRG a license based on Townes' original patent, for use of the maser and the laser. TRG declined to pay, claiming that its work in those areas was for the government, and that no license was required even though the government had not funded the original research. Had the Research Corp. sued and won, the government would have been liable for any royalties paid by TRG; but no suit was brought.

Some companies, notably Western Electric and TRG, are now collecting royalties on commercial manufacturing. But there is a communications problem here; not all

patent holders are sure just which companies are making lasers, and not all manufacturers are sure to whom they should pay royalties.

TRG itself holds a United States patent on a photocoauterizer (a retina welder) for eye surgery and seven British patents, one of which is for a Kerr-cell Q switch, all of which were granted to the company shortly after it became a subsidiary of the Control Data Corp.

But the American Optical Co. in Southbridge, Mass., has applied for a patent on a laser photocoagulator which is nearly the same as TRG's retina welder. American Optical claims that its device is based on earlier work than TRG's, and the Patent Office has referred the question to the Board of Interference Examiners.

Licensing. The Research Corp. has also offered a license to the Bell System for the use of traveling-wave masers in the Telstar ground station at Andover, Me.; and an agreement on this matter and a number of other laser applications is reported to be near. If so, Townes will get his first returns soon.

How much they will be is likely to be known only to Townes and his tax accountants, for few companies are willing to make royalty rates public. Western Electric is, though; it receives 3% of a maser's selling price and 4% of a laser's. Western Electric has used the Schawlow-Townes patent to license IBM, the Raytheon Corp., GE and the Perkin-Elmer Corp. to make optically pumped lasers.

III. A tangled tale.

The Research Corp. says it will go to court, if necessary, to protect Townes' patent; but the remarkable fact is that with all the conflicting claims over who owns what and who did what first, there is little litigation going on. Attorneys for the Hughes Aircraft Co. say that company is engaged in court action on lasers, but decline to give details for fear of jeopardizing their legal position. Bell says it is not suing and does not intend to.

Of course, if someone should come up with an application for the laser that promised to be profitable, the various patent holders might have more incentive to come to an agreement, in or out of court.

Our Varactron[®] diodes really swing

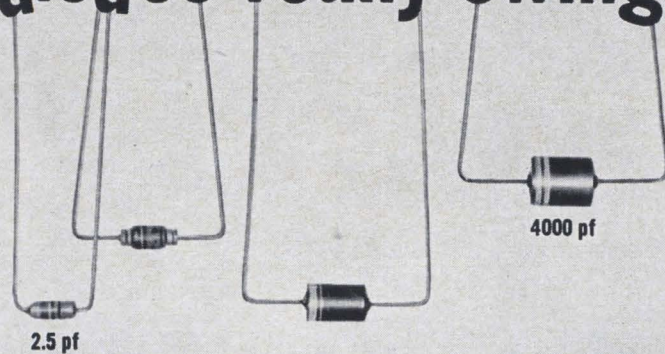

- Single junction capacitance range of 2.5 to 4000 pfd.
- Max. Working Voltage to 300V
- Tuning ratio to 15 min.
- Q at 50 MC to 200 Min.
- Large quantities from stock
- Available to MIL Specs including NASA NCP200-3

When selecting capacitance diodes, you should mind your V's and Q's. The product of the two is important to you.

Varactron[®] voltage-variable capacitance diodes feature Maximum Working Voltage (MWV)—Q products as high as 20,000 at 50 MC, thanks to our exclusive Silicon Epitaxial Junction Process. Tuning ratios range as high as 15. Using our VA-200 diodes, for example, you can change capacitance from 15 pf to 225 pf. Our diodes really swing.

Our Varactron line is the broadest of its type in the world. Single-junction Varactron diodes are available with center values from 2.5 pf to 4000 pf and MWV ratings to 300 volts.

And this quality is available in quantity. Your local distributor can ship 60 standard types from stock in large quantities. Also, myriad special combinations of C, MWV, and Q are quickly available through our Cambridge headquarters. Since 1962, we've been supplying these diodes in volume for commercial users and to all applicable government specifications, including NASA's stringent NCP200-3 quality spec.

High-Voltage High-Q Varactrons are available from \$5.50 each, in single quantities. High-Q High-Capacitance types are priced from \$16.00. General Purpose types, including the IN950-956 and V20-100G series, are priced from \$3.00. Generous quantity discounts apply to all types.

Whenever you want to vary or control frequency with a voltage, remember Varactron[®]. We have a swingin' diode to meet your every need.

OUR APPLICATIONS ENGINEERS WILL BE HAPPY TO ASSIST YOU

For new ideas on temperature and detuning compensation, send for Application Note ANVII.

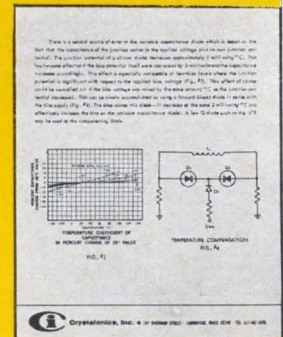
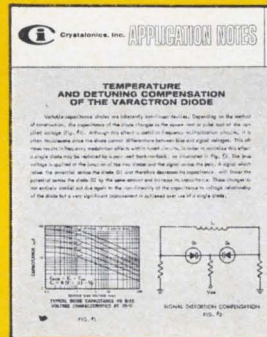

Crystalonics, Inc.

EASTERN - 147 SHERMAN STREET • CAMBRIDGE 40, MASS. • TEL: 617-491-1670
WESTERN - 6715 HOLLYWOOD BLVD. • HOLLYWOOD 28, CAL. • TEL: 213-463-6992

Con Avionics' new silicon power supply has an M.T.B.F. of 100,000 hours and a 5 year guarantee. It costs \$65.

These dc regulated power supplies are available in nearly 200 different voltage-current combinations. Silicon transistors are used throughout and the units operate in ambients as high as 75°C, with a small external heat sink.

The Mean Time Between Failure of the modules is 100,000 hours, calculated according to Mil Handbook 217. They are certified to meet the environmental tests of Mil-E-5272, and most of the requirements of three other mil specs. In addition, they meet the RFI requirements of Mil-I-6181.

Prices start at \$65. Every time you specify one of these supplies, instead of a comparable germanium unit, you save considerable money. If you're using commercial supplies, typical savings-per-unit are about \$40. For military supplies it's much more.

The fastest way to get complete technical information and prices is to write, call, TWX or wire Gerry Albers at Con Avionics.

	SPECIFICATIONS		
	STANDARD MODEL	"A" MODEL	
Total Regulation (Line and Load)	±0.5%	±0.05% or 2 mv.	Input 105-125 v ac, 47 to 440 cps
Ripple (rms. max.)	10 mv	1 mv or .003%	Temperature 75°C ambient max. 95°C base plate max.
Temperature Coefficient	0.07%/°C	0.015%/°C	Response Time 10 microseconds
			Military Specifications Certified to meet the environmental requirements of MIL-E-5272 and the RFI requirements of MIL-I-6181

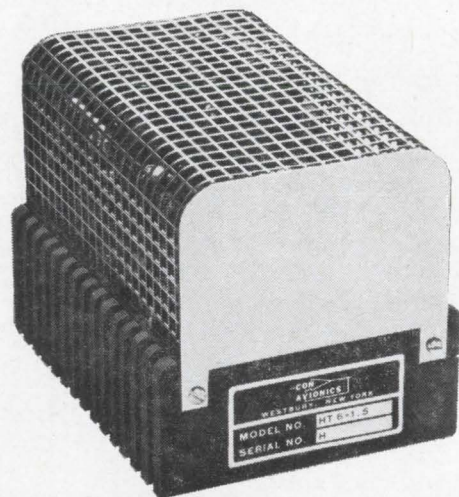

CONSOLIDATED AVIONICS

800 Shames Drive • Westbury, L. I., New York • (516) ED 4-8400

A DIVISION OF



CORPORATION

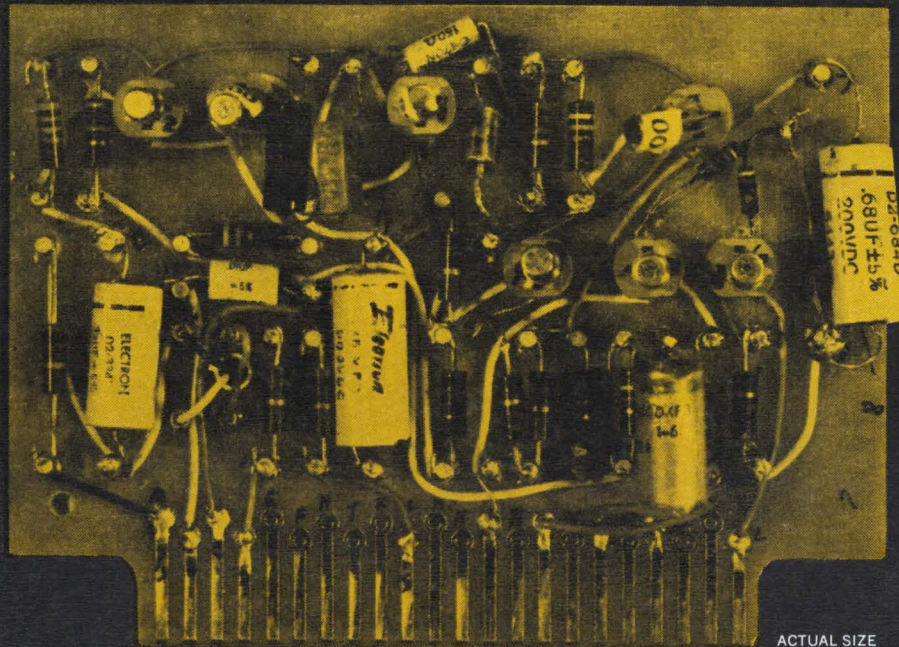

ACTUAL SIZE

What made this avionic DC amplifier circuit obsolete?



ACTUAL SIZE

Hamilton Standard's new Microcircuit Packaging Technology

The use of Hamilton Standard microcircuit modules has reduced the size and weight of temperature controls in the Navy's advanced Ling-Temco-Vought A7A light attack aircraft. They function as DC amplifiers in two identical controls for the cabin and pilot's vent suit.

Each module replaces a multi-component 3½ x 4½-inch circuit board,

resulting in a 16% weight reduction. Design, production and testing are greatly simplified. Reliability is improved by electron-beam welding of interconnections within the module, and complete hermetic sealing.

Hamilton Standard's design team is experienced in custom circuit packaging and will assist circuit designers in component selection and circuit layout.

This technology allows flexibility in interconnecting and packaging both uncased integrated circuits and semiconductors for both digital and linear applications.

For more information on this new microcircuit packaging technology, write to Sales Manager, Electronics Department, Hamilton Standard, Broad Brook, Connecticut 06016.

Hamilton Standard DIVISION OF UNITED AIRCRAFT CORPORATION

**U
A**

ELECTRONICS • ATTITUDE CONTROLS • STABILIZATION SYSTEMS • ENVIRONMENTAL CONTROLS • FUEL AND AIR INDUCTION CONTROLS
ELECTRON BEAM MACHINES • PROPELLERS • STARTERS • TURBOMACHINERY • GROUND SUPPORT EQUIPMENT • OVERHAUL AND REPAIR

If your system demands custom microcircuits we have some remarkable new process tools to make them.

Cheap? No ... just economical

At first blush custom integrated microcircuits may seem expensive; but time and again they have proved to be the most economic approach to unusually demanding system requirements. At Philco, we are currently developing dozens of such custom circuits. And applying an extensive set of new process tools, including oxide isolation, small geometry, tantalum thin-film on silicon, high voltage diffusions and custom package fabrication.

These extensive process tools are being used to make high-performance wide-band amplifiers, RF and IF amplifiers, A/D converters, sense amplifiers, special buffers, radiation-resistant circuits, high-speed gates, ladder network drivers, telemetry circuits, analog gates, diode arrays, counters, lamp drivers, RF oscillators, pre-amplifiers, and special flip-flops.

Many of these custom circuits we are already producing in quantity.

If you are up against exceptionally demanding system needs—consider Philco's custom capability. It is one more facet of Philco's total commitment to microelectronics.

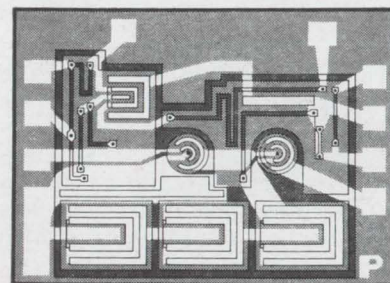

 MICROELECTRONICS OPERATION

PHILCO[®]

A SUBSIDIARY OF *Ford Motor Company*
LANSDALE DIVISION • LANSDALE, PA.
In Canada, Don Mills Road, Don Mills, Ontario, Canada

R-f power 'transmits' dielectrics

Radio-frequency sputtering system that deposits glass and ceramic films shares a vacuum chamber with d-c unit that deposits metals

Radio-frequency sputtering, a new way of depositing glass and ceramic films that cannot be formed by vacuum evaporation, is going into partnership with direct-current sputtering. D-c sputtering is already being used to form resistor and conductor films and to deposit epitaxial layers of semiconductors.

Both methods can now be combined in a single vacuum chamber to deposit conductors and dielectrics simultaneously or sequentially. Anticipated applications include glass encapsulation of semiconductor devices and microcircuits, to avoid the need for hermetic packaging; fabrication of cermet resistors and other small, high-value components for integrated circuits; multilayer interconnection of monolithic circuit arrays; and optical coatings.

In trial runs, the new r-f system has deposited glass, quartz, alumina, magnesia, barium titanate and synthetic mica. The system will be introduced Sept. 29 at the American Vacuum Society meeting in New York by the Consolidated Vacuum Corp., a subsidiary of the Bell & Howell Co.

CVC expects it to prove a show-stopper, due to the interest aroused by the International Business Ma-

chines Corp.'s recent report of success with an experimental diode-type r-f sputterer [Electronics, July 26, p. 28]. CVC says its triode design can deposit as much material, over a greater area, with less r-f power. IBM's system uses 5 kilowatts, CVC's 1 kw.

The basic d-c sputtering mechanism is this: low-pressure gas, usually argon, is ionized by a current between two electrodes. The material to be sputtered is placed on the cathode, whose negative charge pulls ions from the plasma. These atoms dislodge, or sputter, atoms from the target, which land as a film on a nearby substrate.

D-c sputtering won't work on nonconductors because a surface charge collects on the target surface and blocks the ions. Applying r-f power to the target alternates the target potential rapidly between negative and positive; electrons from the plasma break up the surface charge each time the target potential becomes positive.

In CVC's triode system, the argon is ionized by a flow of electrons between a filament and an anode, not by the power applied to the target, as in a diode system. Therefore, sputtering power and sputtering rate can be controlled inde-

pendently of the ionizing current. This enables an r-f and a d-c system, or several d-c systems, to share the same plasma and to be operated in a single vacuum chamber.

Also, CVC says, the triode system requires less argon. Argon pressure is about 1 micron, compared to 20 to 50 microns in a typical diode system. There are fewer collisions between atoms and ions or gas molecules, so more atoms get to the substrate.

Since the r-f system doesn't require a separate ionizing source or vacuum system, CVC will sell it for \$5,000 as an accessory to its PlasmaVac d-c system, which costs \$7,000.

The r-f system works much like a radio transmitter and antenna. An impedance-matching network prevents reflection of power back into the r-f amplifier from the target electrode. This enables the system to adjust to different sputtering conditions, such as changes in target material or argon pressure.

Specifications

Power supply rating	1 kilowatt
R-f output	600 watts maximum
Frequencies	13.56, 27.12 and 40.68 Mc (std, ISM)

Consolidated Vacuum Corp., 1775 Mt. Read Blvd., Rochester 3, N.Y. [350]

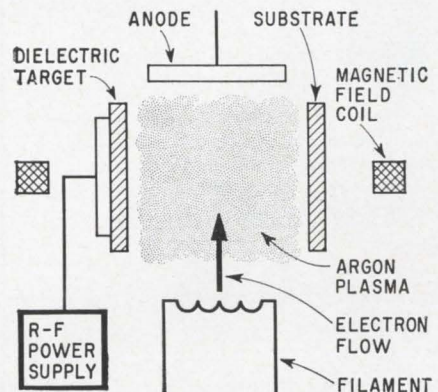
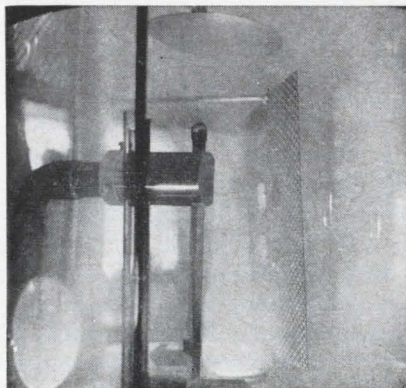
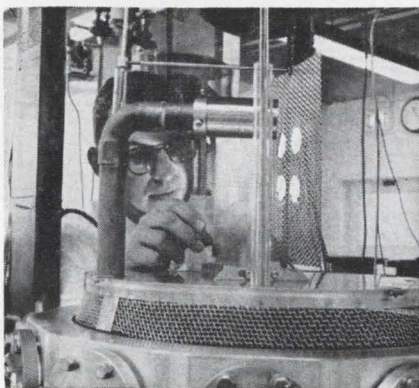

Silicon wafers (labeled substrate in sketch) are mounted on screen in first photo. In second photo, wafers are being coated with glass from the target electrode. Haze seen in second photo is the sputtering plasma.

Let Bulova solve your servo problems!

You've got more important things to do.



Bulova makes servo products faster, better, and at less cost than anyone! It's our business.

Don't take your engineers off vital programs to home-brew! Developing your own electronic components to meet servo system requirements wastes time, money and key men, while chances are Bulova's group of engineering specialists have already tackled—and solved—a problem similar to yours.

Bulova offers a full line of solid-state electronic servo products—off-the-shelf or custom designed: servo amplifiers • resolver booster amplifiers • modulators •



demodulators • quadrature rejection amplifiers • pre-amplifiers • isolation amplifiers • variable-gain amplifiers • two-speed switching amplifiers • DC torquer amplifiers.

What's more, you get prototypes as fast as you need them, and production units to your schedule! Write for complete specifications. Address: Dept. E-18.

BULOVA SERVO PRODUCTS

ELECTRONICS DIVISION
OF BULOVA WATCH COMPANY, INC.

61-20 WOODSIDE AVENUE
WOODSIDE, N.Y. 11377, (212) DE 5-6000

New Components and Hardware

Torque motor obtains precise position

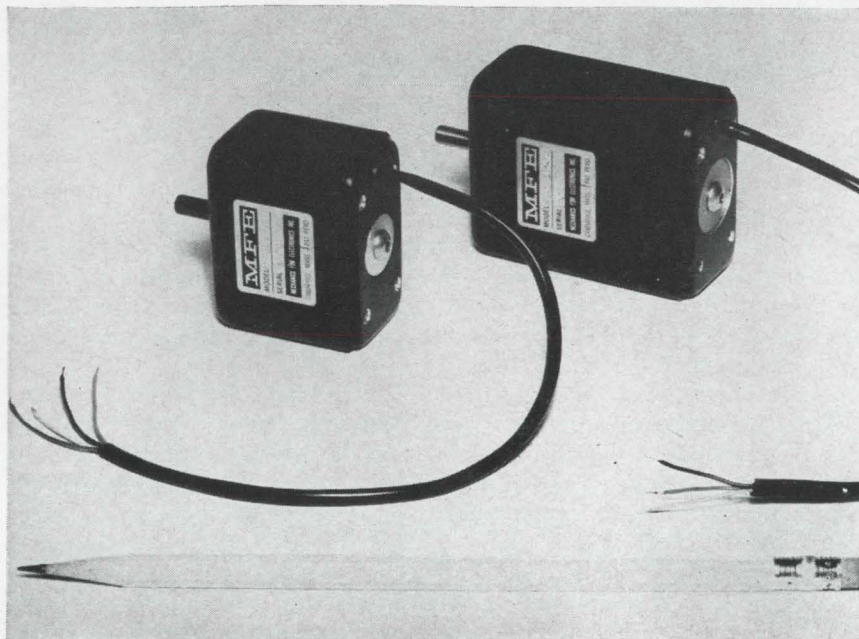

Torque motors convert an electrical signal into mechanical motion in the form of a specific angular movement. The torque is proportional to the input current. The degree of rotation can be used to position mechanical controls or to actuate electromechanical systems. Applications include strip-chart recorders, valve and pump actuators, mirror or grating positioners for optical systems, and industrial controls. Often, however, conventional torque motors fail to operate satisfactorily because of their limited output torque, slow response and inability to maintain precise positioning angles over small angles of rotation.

The new MFE Series T-2 motors, developed by Mechanics for Electronics, Inc., Cambridge, Mass., are said to overcome all of these disadvantages. Although basic design is similar to the company's Series R-4 wide-angle types, the new T-2 small-angle motors have twice the torque of the R-3 models with only one-third the rotation.

The new motors produce an output torque proportional to input current over ± 4 degrees of motion. They exhibit hysteresis of less than 0.2% compared to 2% for most

conventional torque motors. Yet output torque and speed of response are at least as high as in competing devices.

Series T-2 torque motors can be used to replace both conventional torque motors and D'Arsonval moving-coil devices.

High torque and smaller angles of rotation in the T-2 motors were achieved by eliminating non-linear motion caused by unbalanced permanent magnet forces. In conventional torque motors, the magnets induce very large, unstable forces which must be overcome by stiff torsion bars and limit stops—re-

Specifications

	T-2-077	T-2-144
Rotation in degrees... with special spring	$\pm 2^\circ$ $\pm 4^\circ$	$\pm 2^\circ$ $\pm 4^\circ$
Moment of inertia micro-in-lb-sec ² ...	4	6
Mid-position torque..	1 in. lb.	2 in. lb.
Input power.....	3.5 watts	7 watts
Resonant frequency, no load, standard spring.....	400 cps	410 cps
Linearity		
± of peak-to-peak deflection.....	0.3	0.3
Hysteresis		
± of peak-to-peak deflection.....	0.2	0.2
Weight.....	9 oz.	16 oz.
Cross-section.....	1½ x 2 in.	1½ x 2 in.
Height, over-all.....	1½ in.	2½ in.
Unit price.....	\$69	\$89

NEW MICRO SWITCH KB makes it practical for you to customize any keyboard or panel

KB gives you a complete new set of modular switch/display keyboard components—makes it practical for you to design and assemble a custom man/machine interface for each individual keyboard. KB is a totally new concept in panel design with *modular* components like these:

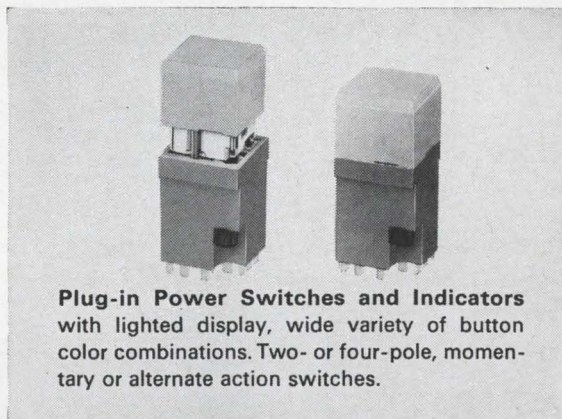
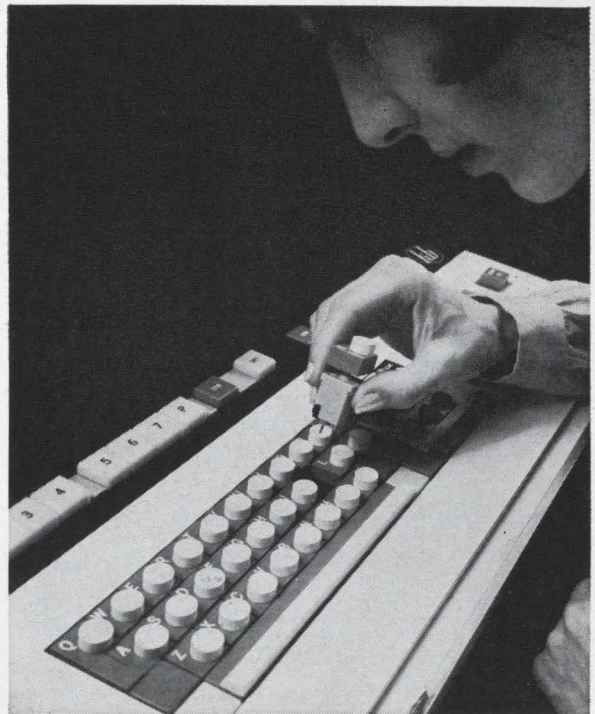

Plug-in Power Switches and Indicators with lighted display, wide variety of button color combinations. Two- or four-pole, momentary or alternate action switches.

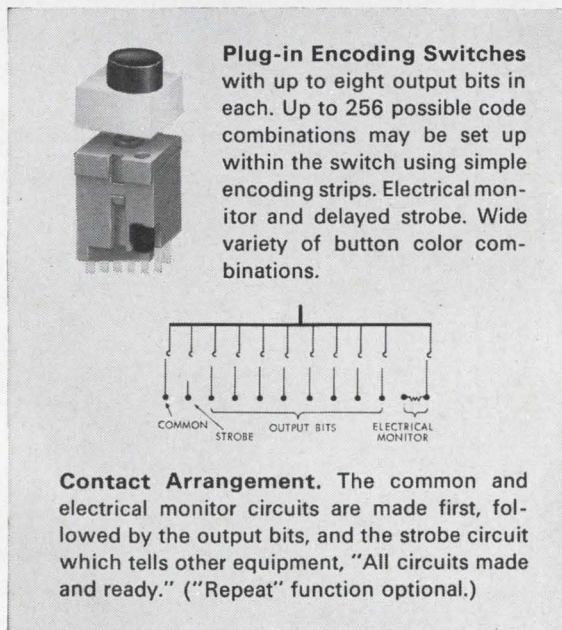

Plug-in Encoding Switches with up to eight output bits in each. Up to 256 possible code combinations may be set up within the switch using simple encoding strips. Electrical monitor and delayed strobe. Wide variety of button color combinations.

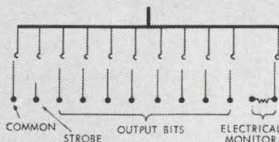

Contact Arrangement. The common and electrical monitor circuits are made first, followed by the output bits, and the strobe circuit which tells other equipment, "All circuits made and ready." ("Repeat" function optional.)

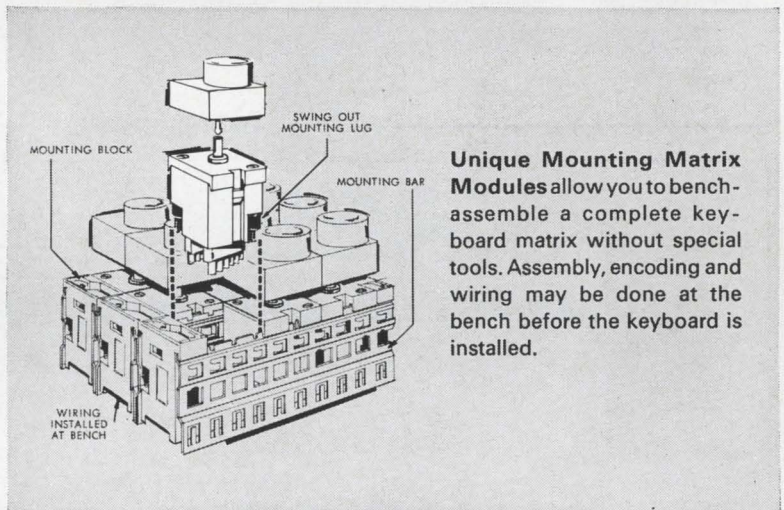

Unique Mounting Matrix Modules allow you to bench-assemble a complete keyboard matrix without special tools. Assembly, encoding and wiring may be done at the bench before the keyboard is installed.

For the first time, KB allows you to arrange all switches and indicators in only *one* panel cutout. You can now do all your encoding at the switches. Plug-in or lift-out switches without disturbing adjacent units. Use *modular* interlock components for bailing or lockout systems.

KB now makes it practical for you to customize every keyboard or control panel. KB saves on engineering time, tooling costs, assembly costs, panel space and weight.

Call a MICRO SWITCH Branch Office for a demonstration. Or, write for literature.

MICRO SWITCH
FREEPORT, ILLINOIS 61033
A DIVISION OF HONEYWELL
IN CANADA: HONEYWELL CONTROLS LIMITED, TORONTO 17, ONTARIO

VACTEC ART + SCIENCE

Vactec blends art and science to produce the ultimate in photo-sensitive devices. Cadmium sulfide, cadmium selenide and selenium photocells available from stock or we will design to meet your specific needs. Get more engineering per photocell dollar. Specify Vactec.

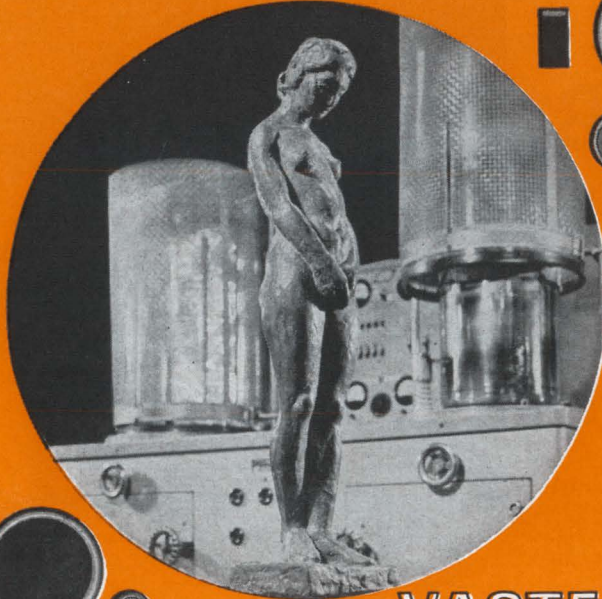

Sculpture by Rudy Torrini

Write for Bulletin SPV-4 for selenium, Bulletin PCD-3 for cadmium sulfide and selenide types.

VACTEC
1209 OLIVE WAY
St. Louis, Mo. 63130
Phone Area 314, PA. 6-0633

Circle 203 on reader service card

REMEMBER **RESE**
FOR **MAGNETIC CORE MEMORIES**

OR CALL

**/215/
GL5/
9000**

RESE ENGINEERING INC.

A and Courtland Streets, Philadelphia, Pa. 19120 (215) GL5-9000

New Components

requiring very accurately ground pole pieces as well as delicate adjustments. The new motors are free from these problems because of the special design of armature, pole pieces and permanent magnets. The wound coil armature moves around a curved segment of the pole piece, avoiding the instability caused by a variable air gap when the armature gets close to the pole piece. In addition, the new torque motors have grooves cut into the armature and pole pieces, which multiply torque over small angles of rotation.

Mechanics For Electronics, Inc., 103 Erie St., Cambridge 39, Mass. [351]

Hot molded trimmer is inherently stable

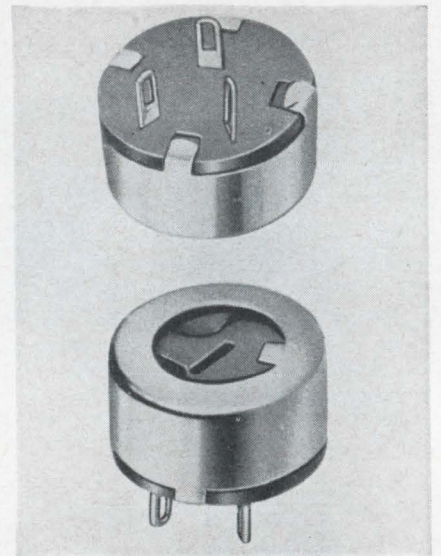

A low-cost trimmer features a hot molded carbon element, which offers inherent stability. Cost has been materially reduced by elimination of both shaft and seal. Construction consists of the stable hot molded base and resistor, with a carbon contact brush, pressure spring and cover. Adjustment is made by screwdriver engagement with the carbon contact.

Diameter is $\frac{1}{2}$ in. with a maximum height of $\frac{5}{16}$ in. Wire-lead printed-circuit terminals on 0.1-in. grid or straight solder lug terminals are available. Mechanical rotation is 295° .

Power rating is 0.25 w at 70°C

with a maximum working voltage rating of 350 v a-c. Resistance values from 100 ohms to 1 megohm are standard; higher and lower on special demand.

Clarostat Mfg. Co., Inc., Dover, N.H.
[352]

Ceramic capacitors mount on flatpacks

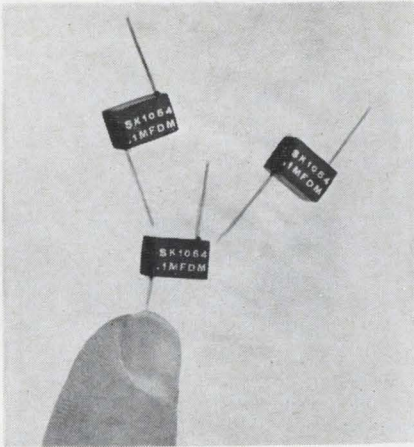

A line of rectangular molded ceramic capacitors can be mounted either conventionally or directly on top of microcircuit flatpacks. The gold-plated Kovar leads are located to match most standard flat-pack output lead configurations.

Capacitance values through 0.1 μ f, in both 50-wvdc and 100-wvdc ratings, and through 0.25 μ f in a 50-wvdc rating, are standard; higher values are available. Maximum case size is 0.375 x 0.250 x 0.150 in. Temperature range is -55° to $+125^{\circ}$ C. Specifications exceed the requirements of MIL-C-11015.

Chem-Electro Research, 11144 Penrose St. Sun Valley, Calif. [353]

Miniature connectors resist radiation

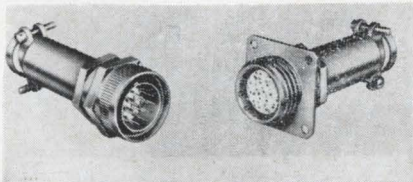

A series of high-temperature, radiation-resistant connectors has been designated the 4RM. The miniature

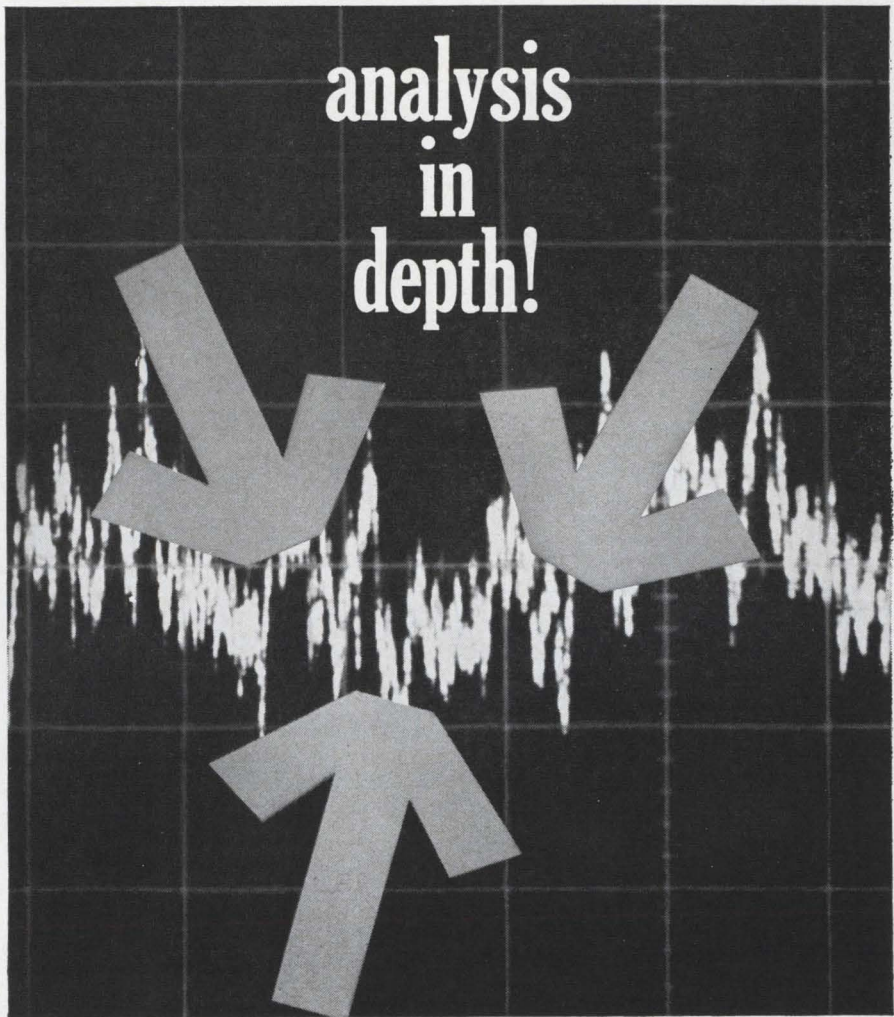

new center provides fast, low-cost analysis of dynamic test data

WAC — Weston's Waveform Analysis Center — offers complete facilities to provide time-to-frequency conversion of transient and random tape recordings. The Center is equipped to detect and evaluate random signals in dynamic systems, processes or environments, and to determine signal content, power spectra and transfer function.

In addition, WAC can provide detailed analyses of short test runs performed under adverse signal/noise conditions. Results approach the ultimate which theory indicates possible in signal and transfer function determination.

WAC equipment operates in real time from 0.01 to 1,000 cps or higher. Bandwidths as low as .01 cps in real time are available. Significance of coherence and phase data be-

tween two channels can easily be evaluated. Sine waves are identified in amplitude down to 40 db, and frequency to 1 part in 500.

WAC service is fast . . . cost is low . . . typically only \$350 for a preliminary tape analysis with written report and visual presentations. And, technical assistance is always available from Weston-Boonshaft & Fuchs engineers. Their unique experience includes nuclear reactor, space vehicle, oil exploration, earth magnetic field, star mapping, meteorological, medical, automotive, and seismological measurements for major industrial, military and aerospace projects.

Write for complete information on procedures, recording data and WAC services: Weston-Boonshaft & Fuchs, Dept. E-9, Hatboro, Pa.



WESTON INSTRUMENTS, INC.

WESTON-BOONSHAFT AND FUCHS

Hatboro, Penna. 19040

We'll send you a FREE SAMPLE

instant lettering[®]

dry transfers

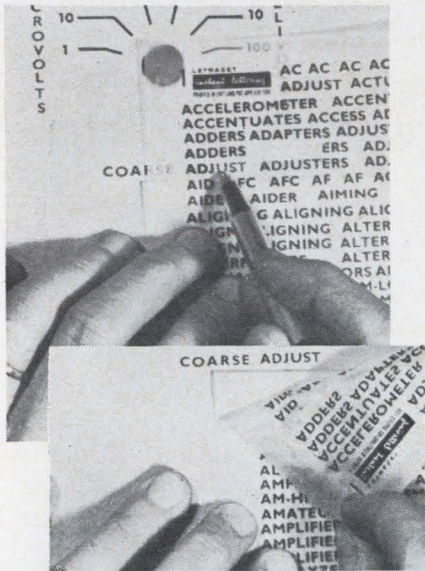

Just rub and it's transferred... what could be easier? Electronics drafting symbols, preset words, switch patterns, numerals, etc. are all printed on a special transparent carrier film. Rubbing over one of these elements with a ballpoint pen releases it from the carrier film and adheres it to your working surface. INSTANT LETTERING[®] words, symbols, etc. transfer to almost any surface including glass, plastic, film, metal... even cracked finish metals. The reproduction quality of these transfers is clean and sharp, they leave no background haze or film, make prototypes look like production equipment, give all drawings and equipment the finished look of fine printing.

CHOOSE THE SET THAT FITS YOUR REQUIREMENTS

TITLES for ELECTRONIC EQUIPMENT

Hundreds of preprinted titles researched to give up to 95% of all electronic marking on control panels, drawings, prototypes, etc.

No. 958—Black.....\$4.95 No. 959—White.....\$4.95

TERMINAL & CHASSIS MARKING KIT

All the necessary letters, letter combinations and numerals for marking chassis, printed circuit and terminal boards, rotating components, etc.

No. 966—Black.....\$4.95 No. 967—White.....\$4.95

METER & DIAL MARKING KIT

Arcs, dial patterns, lines, wedges, graduation lines, switch symbols, alphabets and numerals in black, white, and red (for contrast) for marking standard and special rotary tap switches, potentiometers and prototype and especially calibrated meter dials.

No. 968—Meter & Dial Marking Kit.....\$4.95

ELECTRONIC SYMBOL DRAFTING SET

For fast and easy preparation of better, more readable schematics and drawings. Contains all the commonly used electronic drafting symbols. Less frequently used symbols are easily made from elements in the set. A 16-page booklet gives complete details on drawing with dry transfers.

No. 970—Electronic Symbol Drafting Set.....\$15.95

WRITE TODAY FOR FREE SAMPLE PLUS COMPLETE DETAILS ON THESE SETS

THE DATAK CORPORATION

63—71st Street (Dept. 633), Guttenberg, N. J.

New Components

circular connectors are made of stainless steel with alumina ceramic insulators, and are designed to operate reliably in temperatures up to 1,300°F.

Additional design features include a special Acme thread coupling to prevent thread seizure after exposure to high temperatures for long periods; multiple key polarization of shells; and a closed-entry socket insulator which is interchangeable between the plug and receptacle.

Stainless steel contacts, size 20, are designed for butt-weld termination.

ITT Cannon Electric, 3208 Humboldt St., Los Angeles, Calif., 90031. [354]

Film capacitors occupy little space

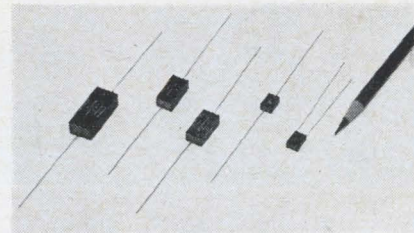

Miniature, rectangular-case capacitors are available with a metalized polycarbonate-film dielectric. Called Deltafilm LP7, they are expected to be attractive to equipment designers because of their performance characteristics and their high packaging density. Units are available with axial leads or single-ended for use in either conventional or printed wiring board equipment.

The capacitors are designed for operation from -55° to +125°C without voltage derating. Use of metalized polycarbonate as the dielectric results in extremely high insulation resistance, minimum capacitance change with temperature, and excellent capacitance stability with time. Because of low dielectric absorption, these capacitors are expected to find use in precision timing and integrated circuits, while their high Q suits them for use in electric wave filters and similar applications.

Standard voltage ratings include

High-Protean Diet of Optical Devices

Photo-Coupled Transistors:

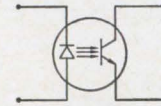

DC, AC, and pulsed signals • True electrical isolation (up to 25 kv in special packaging) • High current output • GaAs light source drives photosensitive multijunction device • Hermetically sealed TO-5 or TO-18 case; 4 leads

Phototransistor:

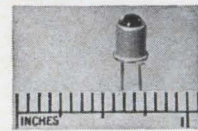

Quantum efficiency of photoconductive sensor >1000 • Spectral response, visible region to near infrared • Low unit cost • Applications for computer systems, industrial controls, optical tracking, optical relays • Standard enclosure, hermetically sealed TO-18 with lens • Special, line arrays and mosaics up to 100 x 100

Ultra-Low Capacitance Silicon Optical Detector:

Capacitance down to 3 pf/cm² • Peak response at 1.06 microns • Available in singles, arrays, quadrants

High D* Silicon Photovoltaic Sensor:

D* to 10¹³ • Peak at 9000A • Single chip and multiple chip mosaics up to 1000 detectors

Two-Color Detector:

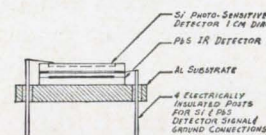

Antireflection-coated Si detects visible and transmits infrared to rear detector (PbS or other). Circular and quadrant assemblies. Special hemispherical Si acts as a 2π front detector and as an IR lens.

GaAs Light Sources:

• High efficiency diodes for DC, AC, and pulsed operation • TO-5, TO-18, Varactor diode mount (0.050 dia. x 0.125 L) • Peak emission >10⁻³ watts/steradian DC at room temp. (TO-5 lens mount)

For a rich and varied diet of technical data, write or call ENL. You're also invited to ask for special servings in configurations designed to meet the requirements of specific applications.



ELECTRO-NUCLEAR LABORATORIES

2433 Leghorn St., Mountain View, Calif. 94041

100, 200, 300, and 400 wvdc with equivalent 400 cps a-c ratings of 40, 85, 140, and 165 v a-c. A 5 μ f, 100 v d-c capacitor measures only 0.56 in. wide by 0.572 in. high by 1.50 in. long.

Dearborn Electronics, Inc., a subsidiary of the Sprague Electric Co., P.O. Box 530, Orlando, Fla., 32802. [355]

Metal film resistors exceed MIL-R-10509

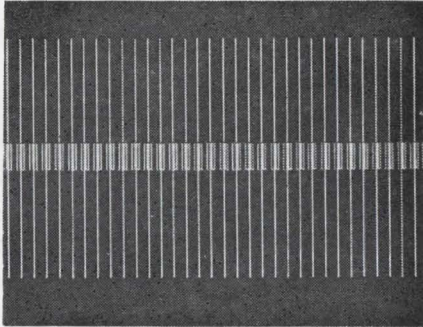

The MAF60 series precision metal film resistor is a highly stable, low cost unit designed for use in military, computer and industrial markets. Over two million component hours of pre-production testing have been completed with results exceeding MIL-R-10509.

A complete range of values is available in the $\frac{1}{8}$ w size with tolerances of $\pm 1\%$ and $\pm 0.5\%$ and temperature coefficient of resistance to ± 50 ppm/ $^{\circ}$ C. Other wattages will be added this fall.

P.R. Mallory & Co. Inc., Indianapolis, Ind. [356]

Wirewound trimmer rated at 1 w at 70 $^{\circ}$ C

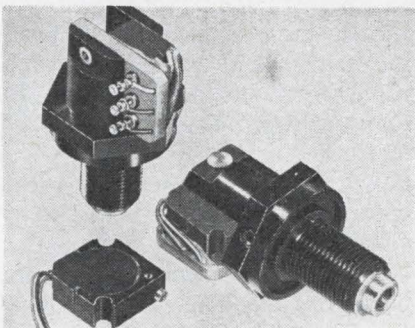

Model 5050-107 is a wirewound precision trimmer potentiometer designed to maintain setting stability under conditions of severe

LAPP GAS FILLED CAPACITORS ARE DESIGNED FOR

HIGH
VOLTAGE

HIGH
CURRENT

HIGH
CAPACITANCE

APPLICATIONS

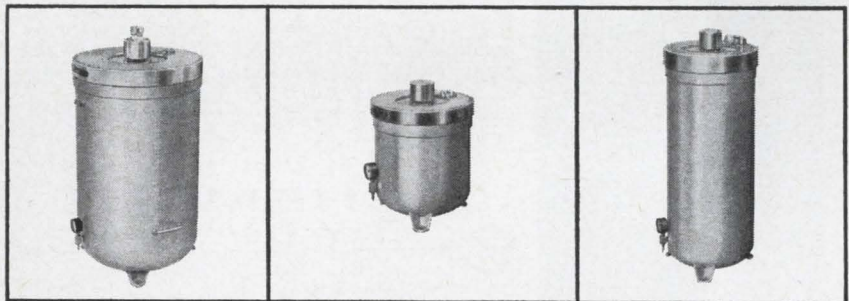

These uniquely designed Lapp Gas-Filled Capacitors are completely unaffected by atmospheric or dust conditions. They are precision built and of extra strong construction to assure years of accurate, trouble-free operation. ■ Lapp Gas-Filled Capacitors are available in either fixed or variable models. All are equipped with an external safety gap to protect against internal flashover on excess voltage peaks. Capacitance available up to 30,000 mmf, safety gap settings up to 85 kv peak and current ratings up to 400 amps at 1 mc. ■ Write for Bulletin 302... get our complete Gas-Filled Capacitor story. Lapp Insulator Co., Inc., Radio Specialties Division, 236 Sumner St., LeRoy, N.Y. 14482.

Lapp

"bugged" BY A PRINTED CIRCUIT PRODUCTION PROBLEM?

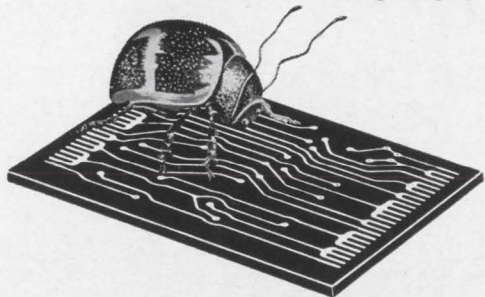

BRING IT TO CHEMCUT

Whether it's a microminiature or mammoth board, Chemcut has the spray etcher to produce it for you—accurately and economically. Chemcut, the pioneer and leader in the spray etching field, has units ranging in size from laboratory models to fully automatic, conveyorized systems for high volume production. (Model 502 horizontal,

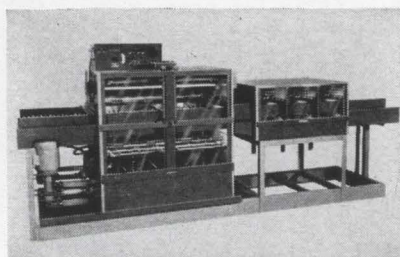

conveyorized etcher is shown at left.) Also available is a complete line of Chemcut equipment for printing, developing, resist removal and other auxiliary functions. There are over 1800 units in use throughout the world. One that will fill your production needs is available through your nearby Chemcut distributor.

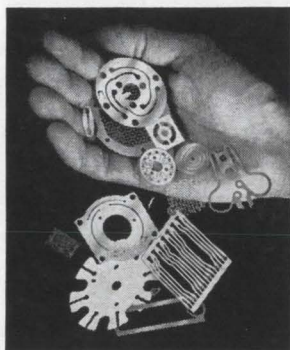

HOW ABOUT PART PRODUCTION?

With continued emphasis on miniaturization, manufacturers of electronic devices are finding spray etchers ideally suited to the production of a variety of parts. We welcome the opportunity of exploring your part production problems with you.

CHEMCUT Corporation

1101 North Atherton Street,
State College, Pennsylvania 16801

Circle 152 on reader service card

To order reprints: Fill in, cut out coupon below, insert in envelope and mail to: **Electronics Reprint Dept., 330 W. 42nd Street, New York, N.Y. 10036**

Reprint order form

For listing of reprints available see the Reader Service Card.

The Overlay Transistor

Send me reprints of Key no. R-78 at 75¢ each.

For reprints of previous special reports fill in below:

Send me reprints of Key No.(s) @ ¢ each.
(For prices, see Reader Service Card)

Name

Number of street

City, State, Zip code

New Components

shock and vibration. It is being used to provide remote setting control for jet engines.

To provide stability under extreme conditions, a series of spring detents are used to lock the adjustment screw securely. The trimmer is an integral part of a panel mount housing which contains the detent mechanism. As many as 250 detents can be provided, thereby allowing full use of the trimmer's adjustment range. Adjustments can also be made to provide variable torque for the trimmer shaft.

Electrically, the 5050-107 is rated at 1 w at 70°C, derating to 0 at 175°C. It is available in a resistance range from 10 ohms to 50,000 ohms with a standard tolerance of ±5%. It has a maximum over-all length of 1.40 in. Behind-panel dimensions are 0.74 in. long by 0.75 in. wide by 0.985 in. high.

Dale Electronics, Inc., P.O. Box 488, Columbus, Nebr. [357]

Stepping relay for aerospace use

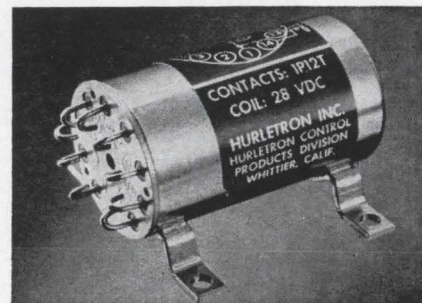

A stepping relay has been designed to employ a rotary motor with low power budget, positive indexing mechanism and unique programed rolling contacts, according to the manufacturer. The standard configuration uses a 10- or 12- position deck programed for break-before-make or make-before-break contact system. An independent latch and pawl mechanism insures positive indexing. Low-friction miniature ballbearings have been added.

Contacts are gold-clad for low-level applications and are furnished standard with solid silver-cadmium oxide for ratings up to 10 amps at

28 v d-c or 115/200 v a-c single or three phase. The relay, designed for aerospace application, meets MIL-R-6106. Class B8 environmental and load tests. Hurlertron Inc., 750 West Rivera Road, Whittier, Calif. [358]

Capacitors offered in molded ceramic

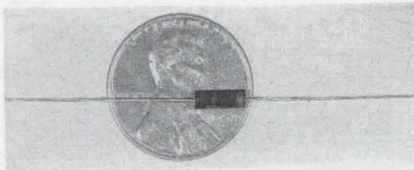

A wide selection of molded ceramic capacitors is available in cordwood size with capacitance range of 10 to 20,000 pf. Types MC70 and MC705 also meet environmental requirements of MIL-C-11015, MIL-C-38100 and MIL-C-39014.

Manufactured in a uniform molded case, the units are supplied with gold-plated dumet leads. Aerovox Corp., New Bedford, Mass. [359]

Air-wound coils come in 55 types

A line of 55 standard types of air-wound coils has been developed for use as components in the manufacture of transmitters and other similar equipment. These inductors are used for the efficient transfer of r-f power from one circuit to another. They may be used as auto-transformers, as an element in an impedance matching network, as antenna loading coils or as tank coils. Two or more coils may be coupled together and used as an r-f transformer.

The Polycoil design features the use of special D section support rods for minimum power absorption. This results in lower losses and a higher coil Q. Polycoils are available in lengths up to 10 in., diameters from 1/2 in. to 3 in. and pitches from 4 turns per in. to 24 turns per in.

Special Polycoils are available in larger sizes. Polyphase Instrument Co., Bridgeport, Pa. [360]

5 CPS ACTIVE FILTER

(DESIGNED BY GUILLEMIN)

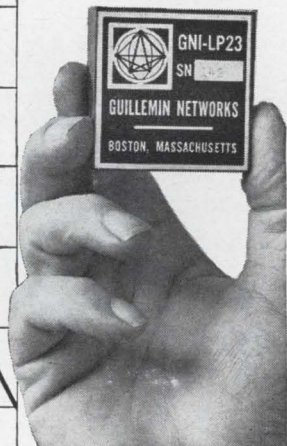
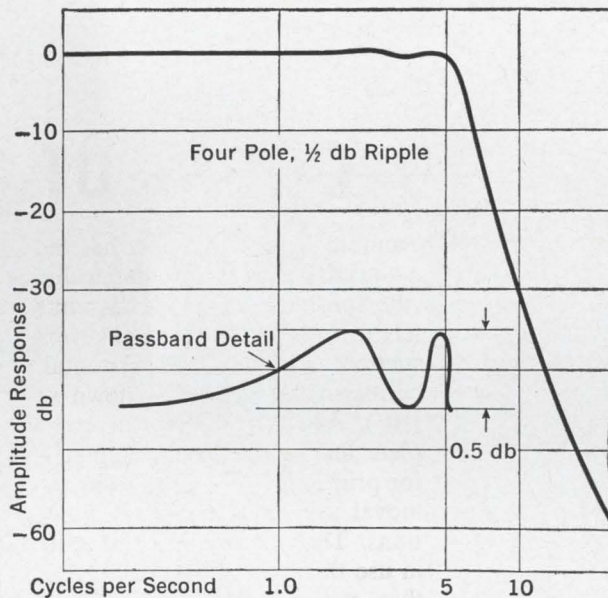

SPECS

- 4-pole, 5-cycle Filter
- 0.5 db ripple Tchebycheff Low Pass Response
- Passband Tolerance: ± 0.2 db
- Stopband Tolerance: ± 1.0 db
- Volume: 2.5 cubic inches

The characteristic curve shown above typifies the difficult active filter design problems Guillemin tackles every other day. We also fulfill custom passive filter requirements which cannot be met by off-the-shelf items.

Advantages: Reduction of size, weight and system cost by replacing amplifiers and heterodyne circuits with one small solid state filter that provides low frequency cut off, sharp skirt, tight production tolerance and considerably improved performance.

Applications: Audio AM detector requirements, including satellite communications, medical electronics, spectrum analysis, transducer and microvolt instrumentation, radar data conversion, analog temperature sensing, ULF receivers, inertial guidance and low frequency seismographic and oceanographic equipment.

For complete technical data on the GNI filter line, contact your local EG&G representative, or Guillemin Networks, Inc., 170 Brookline Avenue, Boston, Massachusetts 02215. Or phone 617, 536-5810. TWX: 617-262-9317.

GUILLEMIN NETWORKS INC



a subsidiary of EG&G, Inc.

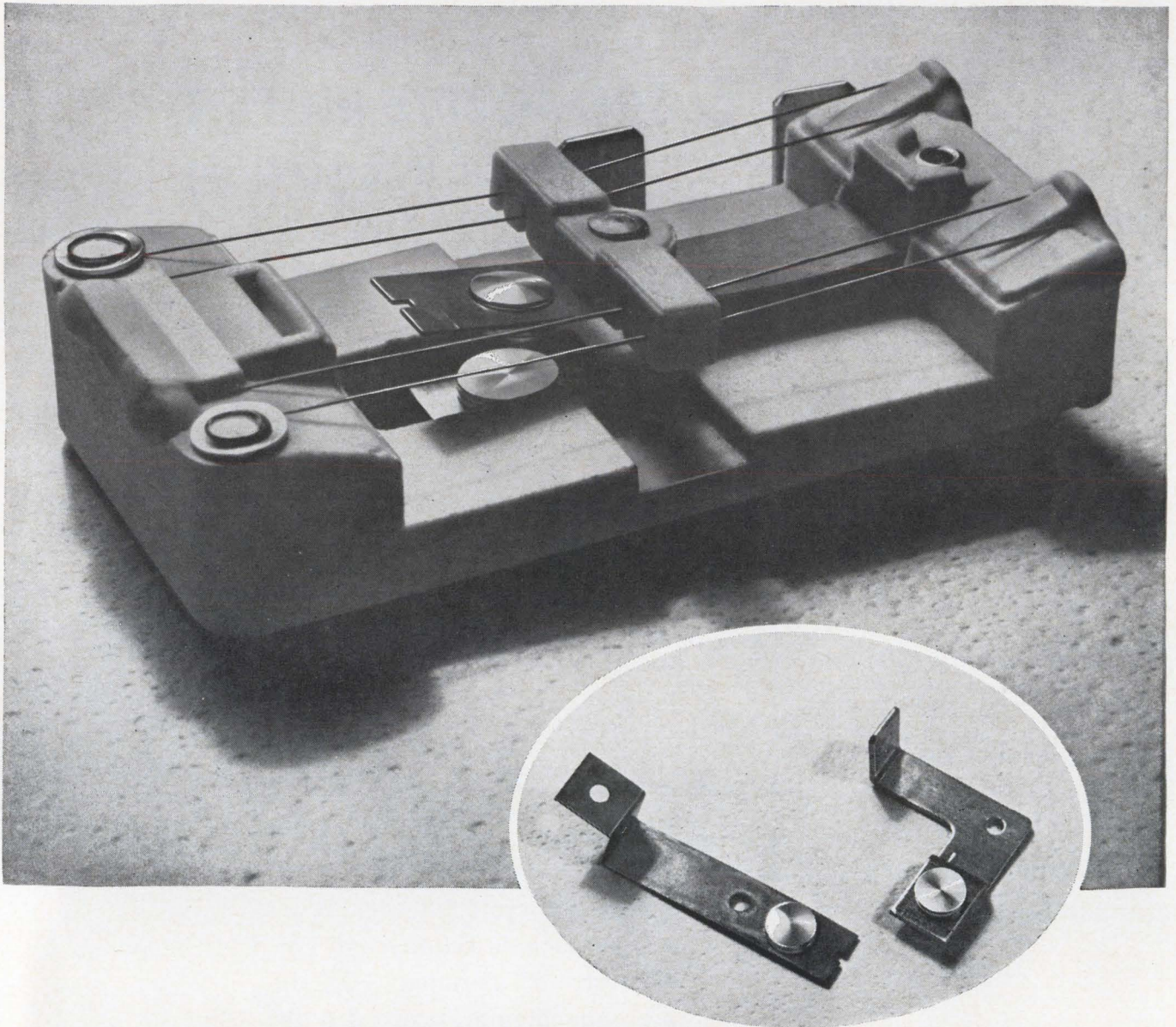

ENGELHARD Wilco[®] products prove their superior reliability in King-Seeley's new main relay switches

Designers at the King-Seeley Division of the King-Seeley Thermos Company in Ann Arbor, Michigan, take great care in selecting components for their high temperature control units. One of the key factors in the design of their new main relay switches for electric ranges and ovens was the selection of electrical contacts which would provide superior reliability at lowest cost. King-Seeley research proved that Engelhard 877 and 2816 contacts made of specially fabricated silver alloy and responder blades made of Wilco Morflex[®] Thermometal[®], manufactured by the H. A. Wilson Division of Engelhard Industries, were more reliable, durable and economical than all others tested.

The Engelhard 877 and 2816, two of a large group of Wilco sintered metal contacts, were chosen for their high resistance to arc erosion, sticking and welding. The Wilco Thermometal, called the "responder" in the King-Seeley unit, was chosen for its exceptional stability in properties, shape and calibration. Specially processed by Engelhard to insure this stability, the

Morflex Thermometal has an extremely high deflection rate and high electrical resistivity.

Thermometals such as these, engineered and quality controlled by Engelhard for positive uniformity and dependability, make possible the design of very sensitive temperature controls, which in turn enable manufacturers to design ranges which heat food rapidly, yet prevent overshoot of temperatures.

Engelhard alloys 877 and 2816 are available in rod, wire, solder-backed strip or any shape required. Wilco Morflex Thermometal is available in strip form and may be slit to almost all fractional widths and cut to any desired lengths. This material is also available in fabricated shapes made by Wilson to customer specifications.

Whatever your design requirements, Engelhard offers you a wide choice of precious metal, metal alloy contacts, or Thermometal. Call or write our Technical Service Department for our Data Files on Wilco Electrical Contacts and Wilco Thermometals.

53

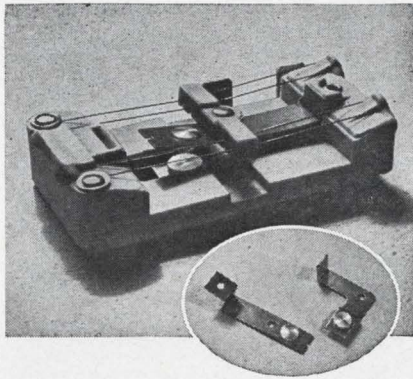

Some other **ENGELHARD** products

SILVER BRAZING with easy-to-use Engaloy™ 440 provides high strength, corrosion resistance, and a minimum of diffusion into base metals for high-temperature joining. This dependable new brazing alloy renders maximum service for all high-temperature conditions.

SILVER PLATING with Silva-Brite® Solution provides a high degree of protection to metal products. Plating is quick, easy, and non-critical at current densities from 10 to 40 amperes. Operation at normal room temperature minimizes fumes and bath decomposition.

PLATINUM-CLAD MATERIALS are custom produced for a wide variety of electronic applications. Clad thickness is held uniform to close tolerances. True metallurgical bond to base material prevents flaking and blistering under heat. Cladding is 100% dense.

PRECIOUS METAL RECOVERY yields high returns from filings, floor sweeps and other industrial residues. Engelhard will return recovered metals or offer highest purchase prices. Our modern facilities are backed by an experienced technical service group.

FUSED QUARTZ is manufactured and fabricated in shapes and sizes for all applications . . . tubing, containers for pure molten metals, and piping up to 25" in diameter. Also available in high-quality ingots and plates processed to meet individual needs.



New Semiconductors

MOS FET for analog switching

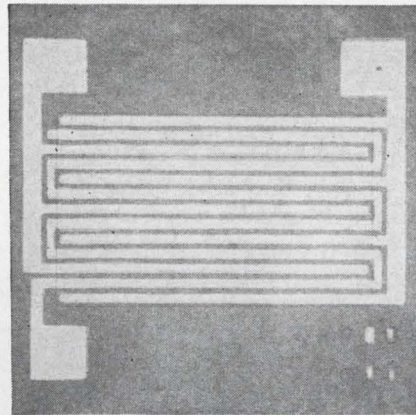

Field-effect transistors have not been widely used as analog switches because their "on" resistances are usually not low enough to prevent signal attenuation. Except for this drawback, however, they are ideally suited for analog switching applications, because they eliminate the transformer drive usually needed for analog gate circuits. This, in turn, allows simplified circuit design and solid-state analog switching systems; it also permits the combining of discrete solid-state devices with integrated circuits in analog data-processing systems.

Typical applications of analog switches include multiplexers, sample-and-hold, modulator, and chopper circuits, analog-to-digital converters and analog computers.

A new power metal-oxide-semiconductor FET, developed by the General Instrument Corp., has a drain-to-source "on" resistance of only 25 ohms at 20 volts, which makes it suitable for use in analog switches. While this resistance is still not quite as low as the 10 to 20 ohms provided by some chopper transistors, it is adequate, according to its manufacturer, to meet most circuit applications.

The new transistor, designated MEM517, carries a 2-watt case-dissipation rating. It is a silicon, p-channel, enhancement transistor packaged in a 4-lead Jedec TO-5 case.

The MEM517 has an avalanche diode diffused into the chip along

with the MOS transistor. The diode prevents unsafe operating voltages from reaching the gate, which protects the thin oxide layer from damage.

A 3-lead version of the MEM517, known as the MEM517A, is also available. It has a drain-to-source capacitance of 0.15 picofarad, compared with only 0.1 pf for the MEM517. Prices for the MEM517A start at \$19.20 in volume quantities.

Specifications

Drain-to-source voltage	30 volts
Drain current	250 mA
Storage temperature	-50 to +150°C
Junction temperature	-50 to +125°C
Dissipation at 25°C case temperature	2.0 watts
Dissipation at 100°C ambient temperature	0.6 watt
Transadmittance at 10 volts (typ.)	12,000 micromhos
Drain leakage current at 20 volts (max.)	10 nanoamperes
Gate-to-source cutoff voltage (max.)	5 volts

General Instrument Corp. Hicksville, N.Y. [371]

Axial-lead zeners cover 9.1 to 200 volts

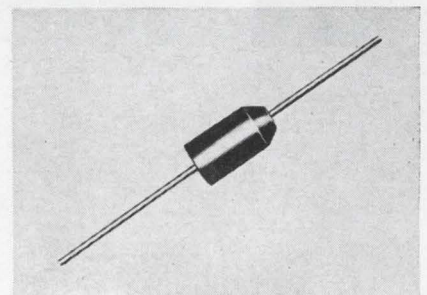

A series of 2-watt silicon zener diodes are available covering a 9.1- to 200-volt range in a hermetically sealed, axial-lead insulated package. Series 2R diodes have a maximum d-c zener current of 165 ma for the 9.1-v unit, ranging down to 7.5 ma for the 200-v unit.

The zeners may be used at full rating up to 50°C; they derate linearly to zero at 175°C. Standard tolerances are 20%, 10%, or 5%, with tighter tolerances available to

All BIODEGRADABLE!

1 FOR
CRITICAL
CLEANING
NEEDS IN THE
ELECTRONICS
INDUSTRY!

Today, component parts require the same degree of cleanliness as analytical glassware and surgical instruments. That's why leading industrial plants have turned to Alconox Products.

A "MUST" FOR ULTRASONIC WASHERS!

Holds minute soil particles in suspension, prevents re-attraction to and re-depositing on surface as articles are lifted from the ultrasonic field for rinsing.

Completely soluble and rinsable! Remarkably effective in decontamination of radio-active contaminating materials.

USE ALCONOX
To Clean
**CAPACITORS,
RESISTORS,
TRANSISTORS**

or any other precision
component parts

For wetting power, sequestering power and emulsifying effect you, too, will find the BEST RESULTS with

ALCONOX



**THE MASTER
CLEANER**



For manual cleaning. In 3 lb. boxes, and 25, 50, 100, 300 lb. drums.

ALCOJET



prevents water-spotting from final rinse, for scientifically-clean glass, metals, plastics, etc., in all mechanical washers. In 5 lb. boxes and drums as above.

LIQUI-NOX

**THE WORLD'S
FINEST LIQUID
DETERGENT!**

For manual cleaning. Mild (neutral pH). Equally effective in hard or soft water. In quarts, gallons and 15 gal. drums.



REQUEST FREE SAMPLES and literature, or order from any leading Laboratory, Hospital, Surgical or Industrial Supply Dealer.

ALCONOX, INC.

853 BROADWAY, NEW YORK, N. Y. 10003

New Semiconductors

special order. All units meet environmental requirements of MIL Standard 202, methods 103A and 106A; MIL E-1D paragraph 4-9-10; and MIL Standard 202, method 202A.

Price is \$1 to \$4.65 depending on rating and quantity; availability, from stock.

Solitron Devices, Inc., 256 Oak Tree Road, Tappan, N.Y., 10983. [372]

Junction diode has fast switching time

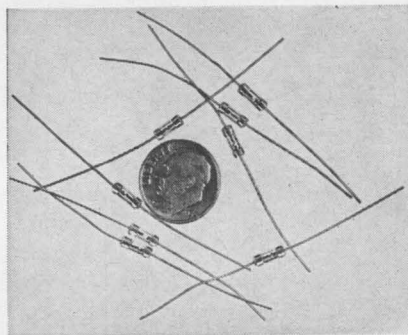

The metal-semiconductor junction diode, series IL2480, features switching times on the order of 100 picoseconds.

Voltage breakdown range is 5 to 15 v. Leakage current is less than 10 na at 3 v. Junction capacitance range is 0.6 to 10 pf. Frequency cutoff is 10 Gc. Forward current is 10 to 100 ma at forward voltage of 1 volt. Temperature cycle is -65° to $+150^{\circ}\text{C}$. Storage life is 1,000 hours.

Applications include microwave switching, sampling-scope bridge circuits, and high-speed computer applications. Price range is from \$4 to \$25; availability from stock. IL Semiconductors, Inc., 12 Unicorn St., Newburyport, Mass., 01950. [373]

R-f power transistor operates at low voltage

A silicon r-f power transistor has been specially designed for mobile communications equipment operating at low supply voltages. Type 3TE350 develops 5 w of output at 400 Mc with an 18-v supply without the necessity of emitter tuning.

**HIGH
LIGHT
INTENSITY**

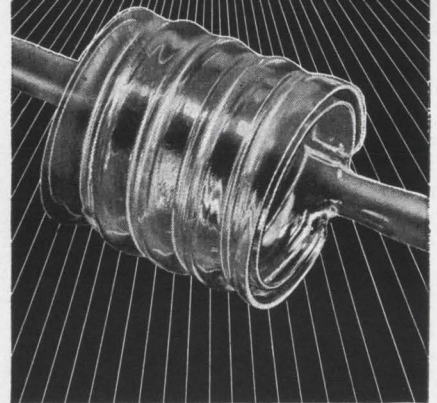

LAM-O-LUME

PURE FUSED QUARTZ LAMP ENVELOPE

The envelope features rugged, unitized construction of great dimensional accuracy, that is produced by centering a cylindrical quartz tube within a second tube of larger diameter. The annular space between the tubes becomes a helical coil as a special high temperature burner fuses inner and outer tubes together along a narrow helical path.

Excellent for outdoor lighting, Ultra-violet irradiation, laboratory heat exchangers, laser pumping, photography and Xenon lamps to provide light intensities many times brighter than the sun.

Comes in lengths up to 30 inches and in diameters of greater than 1 inch, has high chemical purity, low thermal shock, and operates indefinitely up to 1050°C .

Write for details.



**THERMAL AMERICAN
FUSED QUARTZ CO.**

RT. 202 & CHANGE BRIDGE RD.
MONTVILLE, NEW JERSEY

It will generate 5 w at 150 Mc from a 13.5-v supply.

The transistor has a specially designed stud package for soldering into stripline circuits. The unit has grounded-emitter design and low-inductance leads, and will give 7 db of power gain and up to 5 w output in 400-Mc broadband amplifier circuits.

The 3TE350 is applicable to broadband multiplex, telemetry satellites, and mobile radio equipment. Price is \$28 in quantities of 1 to 99; availability, two weeks after receipt of order.

ITT Semiconductors, Palo Alto, Calif., 94304. [374]

Light-sensitive FET provides high speed

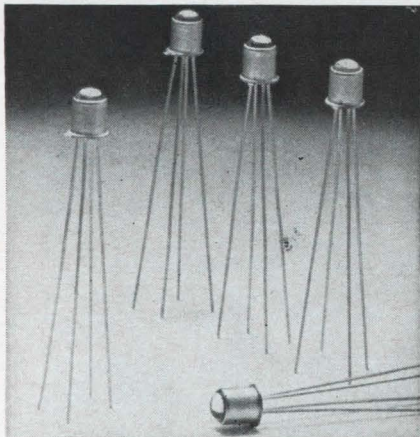

The FF400 Fotofet is a light-sensitive field-effect transistor which, the manufacturer says, provides significant advantages of sensitivity, speed, and circuit simplicity over conventional photo transistors and diodes. Typical drain-current sensitivity is 30 μ a per foot-candle. Gate dark current is typically 0.05 na. Measured rise and fall times are 30 and 50 nsec, respectively. Because Fotofet is a voltage-operated device, the circuit designer can adjust the sensitivity over a million-to-one range by varying the size of the gate resistor.

Fotofet is designed for optical switching applications such as photo-choppers, computer card readers, and light-sensitive relays. The spectral response of the device peaks at 0.9 micron, making it ideal for infrared or laser detection systems and photon-coupled amplifiers.

Crystalonics, Inc., 147 Sherman St., Cambridge, Mass., 02140. [375]



IT'S NEW RJ2A



High Current Ceramic Vacuum Relay

The era of ceramic vacuum relays was first ushered in by Jennings with the introduction of the fabulous 50 kw interruptive RF10. Now comes the equally great RJ2A with outstanding design features of its own.

In the RJ2A Jennings has combined field-proven patented design with two important additions not usually found in lesser relays.

1. A thorough knowledge of the problems involved in designing relays for high voltage airborne, mobile or marine communications systems.
2. The best combination of elements; vacuum for unchanging, low, contact resistance and high voltage withstand, copper to carry high current, and ceramic to withstand shock and high temperature.

In such applications as airborne electronic systems these advantages are invaluable. Especially for antenna switching, switching between antenna couplers, tap changing on RF coils, switching between transmitter and receiver, or pulse forming networks. The proof of superiority is evident in the following ratings which reflect only the minimum capabilities of the relay.

Contact Arrangement	SPDT
Operating Voltage (60 cycles)	12 KV peak
16 mc	8 KV peak
Test Voltage (60 cycles)	18 KV peak
Continuous Current	
60 cycle	25 Amps RMS
16 mc	15 Amps RMS
Contact Resistance	.012 Ohm
Net Weight	3 oz. Nom.

We will be pleased to send you more detailed information about the RJ2A and the rest of our complete line of vacuum transfer relays.

RELIABILITY MEANS VACUUM-
VACUUM MEANS

ITT Jennings

JENNINGS RADIO MFG. CORP., 970 McLAUGHLIN AVE., SAN JOSE, CALIF. 95108, PHONE 292-4025

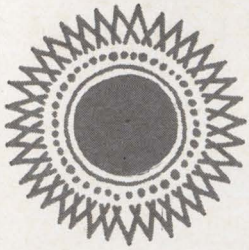

September 1965

Make a Date With Success

It's career month at NCR, Los Angeles. Advanced digital systems on the board, in production and on the market tell you that this is opportunity in the present tense. At NCR, you'll work with the people who created the NCR 315 RMC Rod Memory Computer, CRAM and the 420 Optical Journal Reader. You'll help provide business systems for more than 120 countries. And you'll enjoy the good Southern California life. Bring your career up to date... investigate NCR now.



NCR
ELECTRONICS DIVISION

Fast, corrosion-proof temperature control

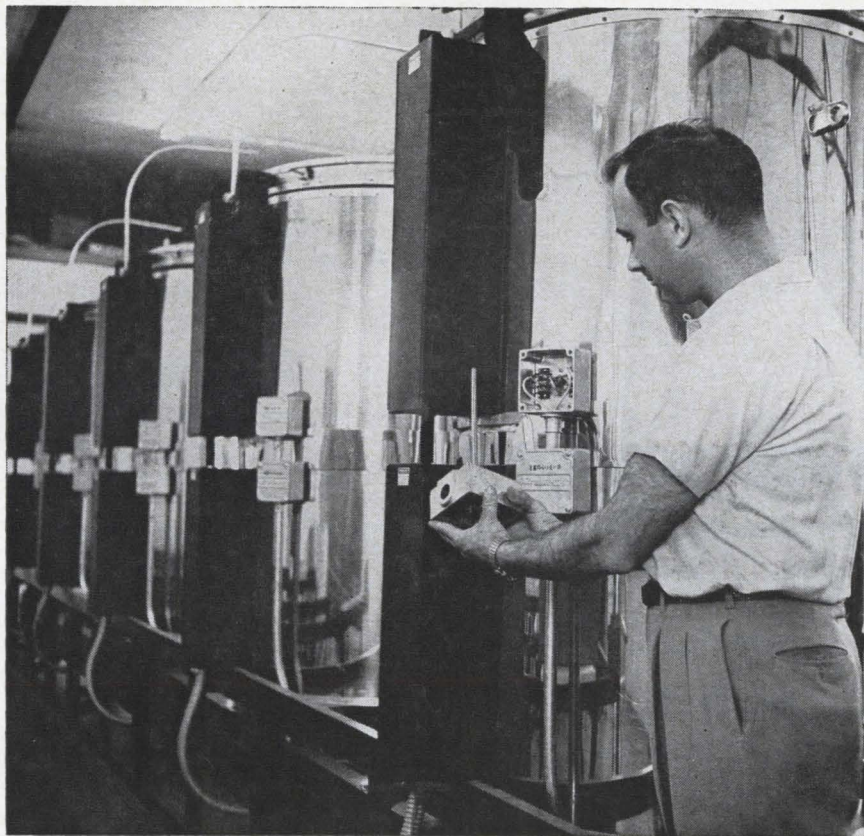

Controlling temperatures accurately in a corrosive atmosphere is difficult because if the temperature probes are protected against corrosion, they will have lower sensitivity and therefore a slow response time. One of the most critical temperature-sensing requirements in industry is in the production of large single crystals. Temperature control within half a degree centigrade is usually required—often for more than a month without shut-down.

Although designed for this specific application, a new thermocouple made by Pall Trinity Micro Corp., of Cortland, N. Y., has demonstrated a level of sensitivity which, coupled with its low cost, should make it suitable for other critical temperature-sensing processes. It was developed for use in the new crystal-growing ovens of Isotopes, Inc., Westwood, N. J.

Crystals for use in radioactive detection devices are grown from

the liquid state of the pure compound. At Isotopes, the compounds used are sodium iodide and other alkali halides. The liquid is held at a temperature just above the melting point of the compound—651°C for sodium iodide—and the crystal is held just below this temperature. They are in separate sections of the oven, and one thermocouple is used for each section.

If the temperature is too high, crystallization will not occur; if it is too low, many crystals will form, one on top of the other. Thus, the ovens had to be equipped with temperature sensors able to measure temperature changes as small as 0.5°C. The new thermocouples actually can sense changes down to 0.2°C.

Other temperature-sensitive devices, such as platinum resistance probes, have as good if not better accuracy. But they are not corrosion-resistant, and they are delicate and expensive. In addition, they

DIGITAL SYSTEMS OPPORTUNITIES AT NCR, LOS ANGELES

ADVANCED COMPUTER DEVELOPMENT

SYSTEMS DESIGN / Senior-level positions in advanced development and preliminary design of beyond-the-state-of-the-art data processing equipment. Considerable experience required in the over-all system design and integration of commercial computing equipment. BSEE required with advanced degree highly desirable.

MEMORY DEVELOPMENT / Analysis and design of advanced thin-film memory systems, both linear select and coincident current. Also advanced random-access development on magnetic-card and disk-file systems. BSEE required, advanced degree desired.

LOGIC AND CIRCUIT DESIGN / Advanced integrated-circuit computers, buffering systems, on-line computing and transmission systems, and computer peripheral equipment. BSEE and good knowledge of state of the art required.

MECHANISMS DESIGN / Senior-level positions working with new techniques for development of advanced high-speed random-access memories. Work requires 5 years' experience in servomechanisms and BSEE or BS in physics; or considerable experience in high-speed mechanisms with BSME and MSEE or BSEE and MSME.

PRODUCT ENGINEERING

ELECTRONIC PRODUCT ENGINEERS / Positions require BSEE with experience in designing digital computer equipment and maintaining liaison with manufacturing.

PACKAGING / Layout and design of packaging for computer systems. Experience required with electronic computers or electromechanical devices. Background in miniaturization with thin films and integrated circuits desirable. BSEE required.

PROGRAMMING DEVELOPMENT

SOFTWARE PROGRAMMERS / Development of software for computer input/output routines, operating systems and monitors. Programming experience with machine language on a large-file computer required.

DESIGN AUTOMATION PROGRAMMERS / Positions require experience in programming for design automation, good understanding of engineering and hardware problems, and BS in math, engineering or related field.

SYSTEMS FORMULATION

Openings at all levels to study and formulate systems for commercial and industrial on-line computer applications, with emphasis on communications interface. Minimum of two years required in specifying or programming real-time systems for banks, airlines or industry. Engineering, business administration or related degree required.

MEMORY RESEARCH

Advanced work requiring MS in EE or physics plus experience with nanosecond pulse technique and high-speed applications of magnetic cores or thin films to memories with computer systems logic and hardware.

ARRANGE NOW FOR AN INTERVIEW IN YOUR AREA

Confidential interviews will be held soon in various parts of the country. Openings above are in Los Angeles. Additional openings in Dayton, Ohio, for mechanical, electrical and chemical engineers, physicists, chemists (MS or PhD level). Send resume immediately to Bill Holloway, Technical Placement.

The National Cash Register Company

NCR

ELECTRONICS DIVISION

2816 W. El Segundo Blvd., Hawthorne, Calif.

Telephone: Area Code 213-757-5111

An equal-opportunity employer

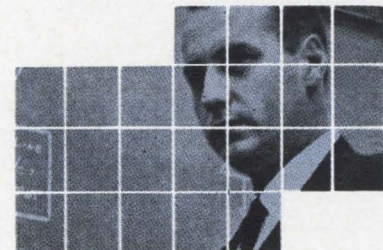

NATVAR IN SWEDEN



Natvar Isolastane[®] sleeving solves an insulation problem for ASEA

The world-renowned firm of ASEA, pioneers in the development of many types of electrical equipment, chose Isolastane sleeving for insulating the coil connections in their random-wound type motors. The reason for their decision to select Natvar Isolastane is best illustrated by quoting from their report:

"Good insulation of the connections between groups of coils in a random winding is of great importance, as these connections pass very close to coils from other phases. ASEA has found that the application of sleeving is the most suitable way to solve this insulation problem. Only the use of a sleeving of very good quality will guarantee proper functioning of the motor, and, therefore, ASEA for Class B and Class F applications uses Natvar Isolastane Fiberglass Sleeving Grade A. This sleeving combines good flexibility with toughness and high dielectric strength as well as good thermal properties."

Isolastane sleeving is made from heat-resistant cross-linked resin, coated on braided fiberglass, for use at temperatures of 155°C (Class F). It is available in three grades: A, B, and C, in accordance with ASTM and NEMA voltage levels. It is furnished in black or white as standard, and in several colors on special order; in sizes #24 through 1/2"; in coils and in straight lengths. Isolastane has been used for many years here and abroad in a variety of electrical insulating applications: for motors, transformers, switchgear, and for connecting apparatus components of many kinds. Send for complete data and samples.

NATVAR PRODUCTS

- Varnished cambric, duck, silk and papers
- Cable tape, V.C. and silicone rubber coated fiberglass
- Oil packed tape for cable splicing
- Varnished polyester film
- Fiberglass — varnished, silicone varnished and silicone rubber coated
- Epoxy and polyester coated fiberglass
- Teraglas[®], Isoteraglas[®], Acryliglas[®], Isoglas[®], Isolastane[®] and Polyteraglas[®]
- Slot insulation, Aboglas[®] and Isoplex[®]
- Vinyl coated, Isolastane[®] and silicone rubber coated fiberglass sleeving
- Extruded vinyl tubing and tape
- Styroflex[®] flexible polystyrene

Send for complete information on any Natvar Products.



Natvar CORPORATION
201 Randolph Avenue • Woodbridge, N. J.
Telephone: 201-388-8800 • TWX: 201-381-8056
Cable: NATVAR, Rahway, N. J.

Circle 160 on reader service card

To order reprints: Fill in, cut out coupon below, insert in envelope and mail to: **Electronics Reprint Dept., 330 W. 42nd Street, New York, N.Y. 10036**

Reprint order form

For listing of reprints available see the Reader Service Card.

Overlay Transistor

Send me reprints of Key no. R-78 at 75¢ each.

For reprints of previous special reports fill in below:

Send me reprints of Key No.(s) @ ¢ each.
(For prices, see Reader Service Card)

Name

Number of street

City, State, Zip code

New Instruments

have a slow response time.

Rapid response was considered first. An unshielded thermocouple junction gives almost instantaneous response, but its life expectancy is sharply decreased in a corrosive atmosphere. During crystal-growing, sodium iodide vapors would react with the thermocouple if it were exposed. But a corrosion-protecting shield would have to be penetrated by the heat, increasing the response time considerably.

A compromise design was chosen. The thermocouple—actually made up of three separate units—is protected by a thin tube of about 3/8 inch in diameter. The tube is made of Inconel, welded shut at the end that penetrates the furnace. The tube is packed with a temperature-resistant ceramic insulation, which separates the three thermocouples as well as each pair of wires.

Each of the three thermocouples in the unit consists of one Chromel wire and one Alumel wire. All six wires are welded into one hot junction. This results in both protection from the corrosive elements and fast response—about 1.5 seconds.

Two of the three thermocouples are in parallel, one serving as a backup for the other. Both lead directly to a controller. The third couple serves as the input to a recorder for a permanent record of all the variables of the operation.

Cost for the assembly is approximately \$35, depending on the quantity ordered.

Specifications

Type	Chromel-Alumel
Wire size	16-gauge
Accuracy	±0.2°C
Response time	1.5 to 3 seconds
Maximum output voltage	50 millivolts
Upper temperature limit	800°C

Pall Trinity Micro Corp., Route 281, Cortland, N.Y. [381]

Power-limited voltage for d-c instruments

Model 820 generator provides power-limited voltage for bridges, potentiometers and other d-c instruments. It consists of a variable

power supply and three power-limiting resistors switched to match the output load. The assembly is mounted on a guard chassis to maintain at least 10^{14} ohms between the high terminal and ground, eliminating measurement errors that are often present when unguarded d-c supplies, such as batteries, are used. The output power is continuously variable to a maximum of one watt into a matched load. Full scale output voltages are 2 v, 20 v, and 200 v. The input voltage requirement is 117 v a-c, 50 to 400 cycles.

Electro Scientific Industries, Inc., 13900 N.W. Science Park Dr, Portland, Ore., 97229. [382]

Transistor analyzer makes in-circuit tests



Model 970 Transistor Analyst permits in-circuit testing of almost any analog or a-c or d-c coupled transistor circuitry. No alteration in printed circuits or removal of soldered-in transistors is normally necessary to make the test.

The unit works by injecting a d-c signal into the transistor stage to be checked. It meters the total power-supply current in a sensitive, easily balanced bridge circuit. Go, no-go indication of the transistor stage operation is shown on the meter.

With its low-ripple built-in power supply, which delivers up to 5 amps, the Analyst can be used with equipment that requires from 1.5 to 15 v d-c. This built-in power supply also has an adjustable bias output which can be used either for bias voltage or to stimulate the d-c level from a photoresistive bridge, potentiometer or other typical industrial transducer.

Power transistors may be accurately tested out of circuit with currents up to 1 amp. The Analyst also generates an unmodulated or a-m

LITTLE CHOPPER



Bristol Subminiature Chopper
Actual Size

BIG PERFORMER

Where component space is limited—Bristol's Subminiature Chopper offers:

- 0.1 cu. in. size
- complete shielding
- radiation resistance
- airborne environmental ratings
- lowest noise level

Write for detailed spec sheet. **The Bristol Company**, Aircraft Division, 152 Bristol Road, Waterbury, Conn. 06720.

A subsidiary of American Chain & Cable Company, Inc. 4.7



BRISTOL . . . engineers for precision, builds for reliability

Here's the tunable Coil to fit the little space on your PC board

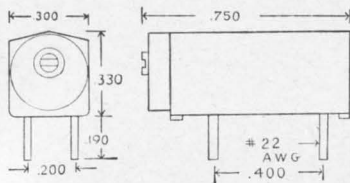

Only 1/2 the physical size of existing units

These miniature tunable inductors are encapsulated with transfer molded epoxy material and incorporate an "O" ring-sealed tuning device for maximum moisture protection. Their small size makes them ideal for compact packaging and weight is just slightly more than an equal value fixed coil.

- Nominal L values available from .10 to 1000 microhenries (RETMA values)
- Tuning range $\pm 15\%$ minimum
- 48 nominal L values to choose from
- Q values approximate 50 on all units thru entire range of tuning
- Tuning torque remains stable with repeated usage
- Testing confirms ability to meet requirements of MIL-C-15305 Grade & Class 4

Off The Shelf/In Stock Now

Delevan Electronics Corp.
Subsidiary of American Precision Industries Inc.
270 Quaker Road, East Aurora, N. Y. 14052

New Instruments

or f-m modulated carrier frequency from 240 to 2,000 kc, 10 to 11.4 Mc, and 88 to 108 Mc.

Sales price of less than \$200 makes the instrument practical for industrial and commercial testing. B&K Mfg. Co., 1801 West Belle Plaine Ave., Chicago, Ill., 60613. [383]

High-precision time programmer

A digital time programmer now available is particularly adaptable for radio and tv program control, process control, test sequencing and missile countdown launch check-out sequencing. The manufacturer says the model TP programmer provides more precise timing accuracy than cam timers or other similar devices. It was designed for use with the company's standard electromechanical or solid-state digital clocks and countdown/elapsed-time systems.

Easily changeable program plugs permit contact closures or output pulses at predetermined precise time points. Inherent accuracy of program time is that of the clock time, and programmers can be provided with up to 0.1-second resolution. Program output is generated by sensing the coincidence between digital clock time and the prewired program time.

Parabam, Inc., 12822 Yukon Ave., Hawthorne, Calif., 90250. [384]

Laboratory laser is compact and portable

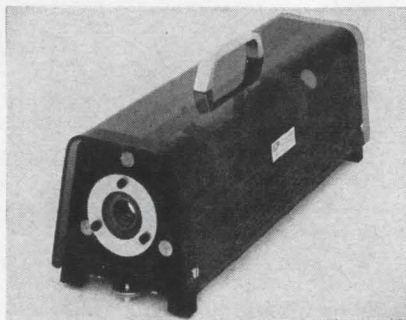

The LAS-101 helium-neon gas laser operates at 6,328 angstroms with guaranteed output of 1 mw multi-

THE MARK OF QUALITY



Ultra-sensitive relays

HELPFUL DATA FOR YOUR CIRCUITRY IDEA FILE

The circuit drawing below indicates just one of the hundreds of ways many manufacturers utilize Micropositioner® polarized relays to solve complex control problems.

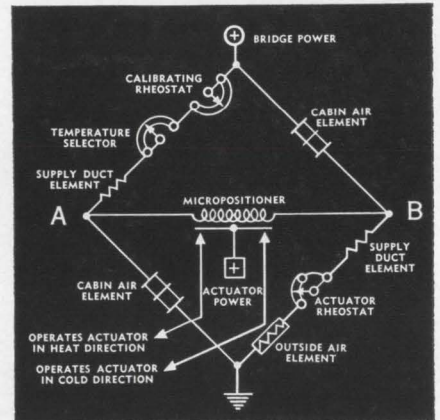

TEMPERATURE CONTROL

One of the most common applications of the Barber-Colman Micropositioner is in Wheatstone Bridge control circuits. In the above diagram of a temperature control application, the bridge arms incorporate temperature-sensitive transducers.

The Micropositioner is a polarity sensitive relay, so the direction of current flow in AB will close one or the other of its contacts from the normally floating neutral position. This causes a reversible control valve actuator to make desired temperature corrections in the supply air. A rheostat coupled to the actuator provides position feedback.

The same technique can control cycling (on-off) of an electrical heater. By using potentiometers or fixed resistors, the basic Wheatstone Bridge circuit adapts to positioning and synchronizing controls, or to automatic impedance test instruments.

BARBER-COLMAN MICROPOSITIONER®

POLARIZED D-C RELAYS

Operate on input power as low as 40 microwatts. Available in null-seeking and magnetic-latching "memory" types of adjustment. Also transistorized types with built-in preamplifier. Write for our latest catalog with full information on polarized relays.

BARBER-COLMAN COMPANY
Electro-Mechanical Products Division
Dept. I, 1259 Rock Street, Rockford, Illinois

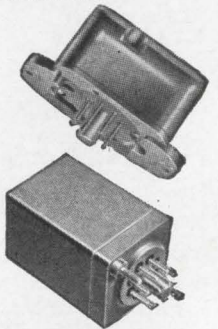

**Got a Problem of
DIMENSIONS?
TEMPERATURE?
UNUSUAL CYCLING?
SHOCK RESISTANCE?**

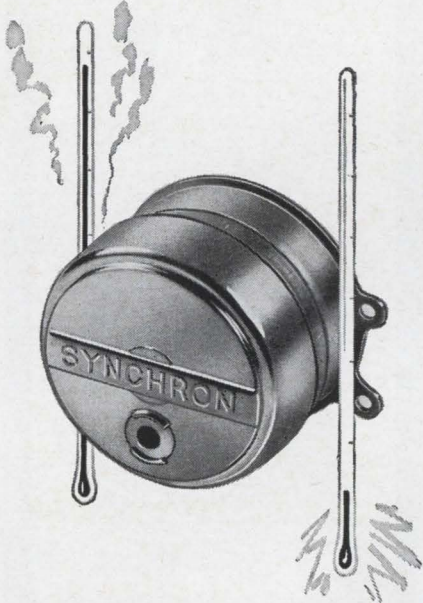

**turn the job over to
SYNCHRON® MOTORS!**

What's the motor problem you face in the design you're working on? One of tricky performance requirements? Difficult environment? Total accuracy? Before you do anything else, see how SYNCHRON Motors can be applied. (Do the same thing even when you have a simple, straightforward application in mind!) Just write us at Hansen Manufacturing Company and tell us what you want a motor to accomplish. You'll get an immediate answer and any help you need for specific problems.



HANSEN REPRESENTATIVES: CAREY & ASSOCIATES, Houston, Tex., R. S. HOPKINS CO., Sherman Oaks, Calif., EICHORN & MELCHIOR, INC., San Carlos, Calif., THE FROMM CO., Chicago, Ill., H. C. JOHNSON AGENCY, INC., Rochester, N. Y., WINSLOW ELECTRIC CO., Essex, Conn., and New York, N.Y. EXPORT DEPARTMENT, 64-14 Woodside Ave., Woodside, N. Y. Handled exclusively in Canada by Sperry Gyroscope Ltd., Ottawa, Canada.

mode and, with optional flat mirror, 0.5 mw single-mode. The precision instrument is designed for both general laboratory applications and classroom demonstrations. It measures 15 in. long, 5 in. high, and 4.5 in. wide. Weight is 6 lb.

Among its unusual features are: performance previously available only in instruments priced substantially higher; long-life, double-walled plasma tube; stable operation from low-voltage (300 v d-c, 60 ma) power source and therefore maximum operating safety; rugged and completely open construction (molded clear plexiglass cover), ideal for demonstration purposes.

Available accessories include: flat mirror in quick-interchange mount for single-mode operation, and transparent green cover to eliminate glare of discharge light. Price, without optional accessories, is \$450; delivery, about 45 days after receipt of order.

Electro Optics Associates, 3335 Birch St., Palo Alto, Calif., 94306. [385]

**Current sensor
consumes little power**

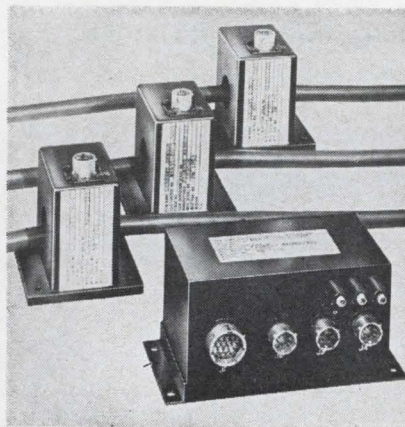

The CRS current sensor makes it possible to produce an output signal that is directly proportional to the current in a d-c current carrying cable, without breaking the integrity of vital cables. A 0- to 5-v d-c output signal is provided which is completely isolated from ground and supply power by over 100 meg-ohms. Internal impedance of the output is less than 1,000 ohms. Linearity is better than 1%. The output ripple is less than 20 mv, although the response time is better than 10 msec. The sensors utilize

DEVELOPED FOR PHASED ARRAY APPLICATIONS

**NEW!
SOLID-STATE
I-F AMPLIFIER**

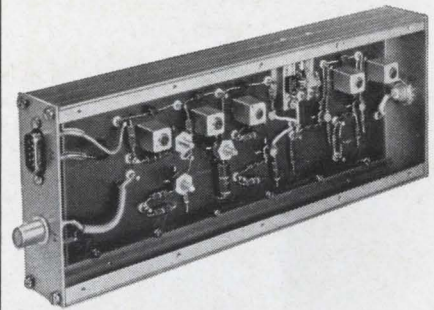

*For phase matched,
high power,
multi-channel applications*

This new I-F amplifier features low phase shift with gain variation... built-in phase shift control... excellent linearity. It's another example of AIL's capability to develop special I-F designs to handle demanding applications. Check these specs:

- Center Frequency.....60 Mc.
- Bandwidth.....5 Mc nominal
- Gain Control.....15 db typical
- Phase Tracking
Between Channels.....±1.5°
- Phase Shift With Gain
Control Change.....1.5°/db for 8 db
change
- Phase Shift Control.....30° with less than
3 db change in
gain
- Power Output.....100 mw for less
than 0.5 db
compression
- Source and Load
Impedance.....50 ohms

AIL's complete Mixer-Amplifier and I-F Amplifier line includes many stocked models. These and a large number of special designs can be quickly modified to customer specifications. We have a team of I-F amplifier experts ready to go to work on your requirements right now.

For prompt service contact your AIL Sales Representative. Specifications subject to change without notice.

For a FREE CATALOG circle publication number.



**AIRBORNE INSTRUMENTS
LABORATORY**

Division of Cutler-Hammer, Inc.
Deer Park, Long Island, New York

▲
**Who
 makes a
 Solid-State
 Amplifier only
 0.4" high for less
 than \$50 and
 with a slew
 rate of 10v/
 μsec?**
 ▼

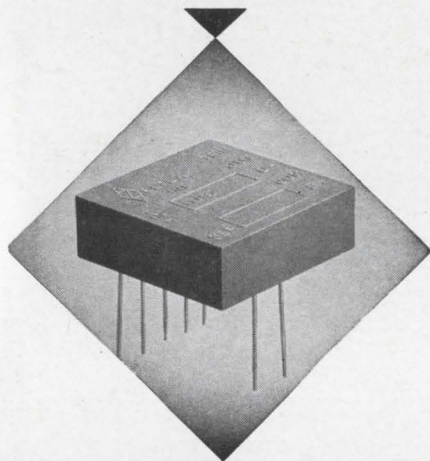

**Just who you'd expect
 ...ZELTEX!**

New from Zeltex, a modification of the field-proven 115 series, the 116 and 116B Differential Amplifiers. These exceptionally small units feature all silicon semiconductors, are short-circuit proof, and offer excellent stability. Their small size permits a large quantity of amplifiers to be mounted on a single card on 1/2 inch centers, providing excellent density to the designer. And, the 1-9 prices of \$47 (116) and \$32 (116B) make quantity use economical, as well.

Check these important specifications:
 Output Capability: 10 v at 4 ma
 Input Impedance: 10 megohms
 Gain Bandwidth Product: 2 mc
 Slew Rate: 10v/μsec (Model 116), 0.6v/μsec (Model 116B)
 Gain: 50,000 (Model 116), 20,000 (Model 116B)

Want more information on these or other Zeltex products? Call your nearest representative or contact,



ZELTEX, INC.
 2350 Willow Pass Road
 Concord, California

The Broadest Spectrum of Amplifiers
 and Computer Elements

New Instruments

only solid state components.

The power consumption is unusually low, and in most cases is a fraction of the power that would be consumed in a conventional 50-mv shunt measuring the same current. For example, the assembly illustrated has three independent current channels rated at 150 amps, 150 amps, and 300 amps. Total power demand is less than 250 ma from a 24-v source or less than 6 w. The power consumption of the equivalent 50-mv shunts would have been 30 w.

The sensors are completely qualified for space environment operation, and NASA quality assurance requirements. Shock and vibration of 30 g to 2,000 cps are readily accepted. Ambient temperature of -65° to +165°F will not depreciate performance. The illustrated sensors weigh less than 21 oz each and can be calibrated for 100 to 300 amps operation. The three-channel electronics package weighs less than 2 1/2 lbs.

Pioneer Magnetics, Inc., 1745 Berkeley St., Santa Monica, Calif. [386]

Edgewise panel meter is self-shielding

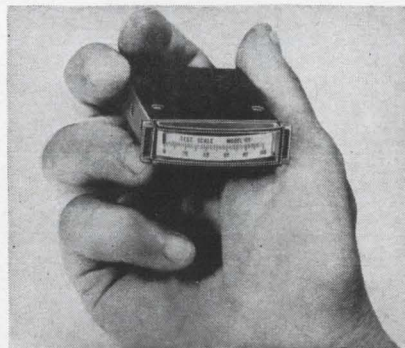

A miniature, edgewise panel meter has been developed with a true 1/2-in. Cormag mechanism. The Thin-Line device measures 1.6 in. across the front window, 0.5 in. high, and less than 2.5 in. deep behind the front panel. It uses only one-fourth the space presently required by 1 1/2-inch panel meters.

Model 111 meter offers an inherent self-shielding feature which allows it to be mounted on magnetic and nonmagnetic panels without

GET MORE COOLING PER DOLLAR

New, patented Zero all-angle blower

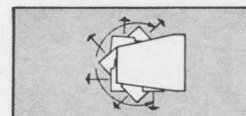
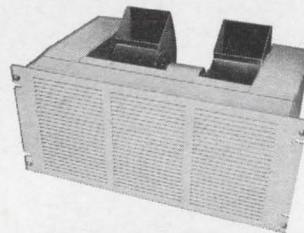

Air flow directed at any angle through 230°

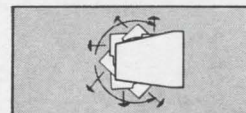

Motor-rotor assembly turned for this air flow pattern

Because cooling air flow can be directed at any angle through 230°, this new blower replaces thirteen older types, accurately directs air to exactly where it is needed, without efficiency-robbing sharp-angle ducting. Rotate each of the twin scrolls independently to the angle you need, or, reverse the motor-rotor assembly and create an entirely new flow pattern. You can even use one scroll for cooling and one for exhaust.

CHECK THESE FEATURES: Assured 400 CFM output • Mounts to standard EIA rack panel • MIL quality, heavy duty construction • Easy maintenance • Interference-free operation • Sealed ball bearings for long life • Cleanable filter — disposable filters available.

Other blowers available to suit your every requirement

Rack mounting. Many standard models with single or twin blowers. Refrigerated (6,000 BTU) units recirculate air and maintain pre-set temperature in cabinet. Quiet, interference-free.

For complete data and information, write for CATALOG R

Zero Manufacturing Co.

1121 Chestnut Street
 Burbank, California 91503
 Telephone Victoria 9-5521
 area code 213
 TWX 213-846-8094



Factories in Burbank, Calif. and Monson, Mass.

need for adjustment. Furthermore, the shielding permits side-by-side stacking of the meters without any electrical interaction. The self-shielding feature is the result of the Cormag design, which places the meter mechanism's magnet inside the moving coil. The mechanism has a shock-absorption jewel arrangement to assure long life.

The meter meets ASA C39.1 specifications. Ranges are from 50 μ a through 2 amps d-c, and from 50 mv through 300 v d-c. Rectifier types are also available. A red lance pointer is standard. Unit cost in lots of 100 is approximately \$10. Weston Instruments, Inc., 614 Frelinghuysen Ave., Newark, N.J. [387]

Pulse adapter tests microwave tubes

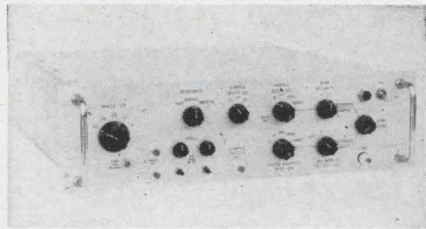

Model 306 pulse adapter extends the measurement capabilities of the Pha-Rho meter for use on pulsed r-f signals. It provides the new capability of being able to make phase, gain, and impedance measurements all with a pulsed signal as short as 0.25 μ sec or as long as desired.

The new instrument makes it possible to separate the characteristics of the microwave tube from the characteristics of its power supply. This has often been a trouble in the past due to the interaction between power supply ripple and regulation with the phase and amplitude characteristics of microwave amplifiers.

Another useful area for pulse measurements is in checking microwave mixers and receivers to measure the true impedance and phase shift characteristics for short input pulses. Price of the model 306 is \$3,900 and delivery is eight weeks.

Wiltron Co., 717 Loma Verde Ave., Palo Alto, Calif. [388]



converting a couple of hundred analog inputs directly to IBM-format mag tape was no sweat

for the world's worst bridge player.
How do you figure some guys?

George Stout's the red-hot who designed the EECO 755 Data Recording System. But he'd have trouble making a small slam with 13 spades in his hand.

He's very glib in pointing out the EECO 755 digitizes as many as 200 inputs at sampling rates up to 166 channels a second. With $\pm 0.05\%$ accuracy. And that it records 500 tape characters per second, and that it handles inputs from ± 50 mv full scale to ± 5 volts with 100-megohm impedance. He says it's in the same price range as much slower recording systems.

But try to get an intelligent bid out of him. He doesn't know the Blackwood convention from a hole in the card table.

The system itself looks pretty much standard on the outside ... tape recorder up top, a few dials here, a couple of patch panels there. So we thought you'd rather see a picture of George in action. Of course if you want to get stuffy about it, we do have a data sheet on the EECO 755 we'll part with (reluctantly). It's got specifications and a few block diagrams. George is very proud of it. He thinks he's a writer, too.



Electronic Engineering Company

of California

Box 58. Santa Ana, California 92702 • Phone (714) 547-5501

AT LAST!



A Temperature Chamber You Can Set... and Forget!

Automatically heats or cools from -300° to $+1000^{\circ}$ F, with 0.1° F control accuracy. Enjoy complete programming flexibility; remarkable temperature uniformity throughout the chamber, $\pm 3/4^{\circ}$ F/ 100° F.

Contact Delta or your nearest Delta/Non-Linear Systems office. Prices start at \$810, and available now!!



The Environmental Control People
 8000 Fletcher Parkway • La Mesa, Calif.
 Phone: (714) 465-4141
 Overseas Representative: Microwave International Corp., 420 Lexington Ave., New York, N.Y., U.S.A.
 Cable: Microken—N.Y.

New Subassemblies and Systems

Compact multiplexer-converter



To multiplex, sample, and convert to digital form a larger number of analog data channels usually requires three separate units. Any of the units, or the connections between them, may degrade accuracy, and the whole system is fairly complex. The Raytheon Computer division of the Raytheon Co. has simplified matters by putting the entire assembly into a single box. Its Multiverter (a contraction of multiplexer-converter) contains a 96-channel multiplexer, a sample-and-hold amplifier, an analog-digital converter, and a power supply in one chassis. Raytheon claims that its system accuracy of $\pm 0.02\%$ is better than that of a system built with discrete units.

The Multiverter also includes

timing, sequencing, and control logic, which in conventional systems must be externally supplied. Thus, the Multiverter requires only one external timing pulse; timing adjustments between sections are made internally.

The Multiverter is available with various configurations of multiplex channels and analog-to-digital conversions. It can operate in either sequential or random-address mode. In addition, control switches provide modes for calibration and dynamic testing. In the "short cycle" mode, fewer than 96 channels may be sampled in any desired sequence pattern, for test or checkout.

Aperture time of the sample-and-hold amplifier is only 50 nanosec-

Specifications

	Without attenuators	With attenuators
Analog inputs		
Channel capacity	96 channels	48 channels
Input range	± 10 volts full scale	± 100 volts full scale
Input impedance		
unselected channels	1,000 megohms	20 kilohms
selected channels	100 megohms	20 kilohms
Max. voltage overload	100% full scale	25% full scale
Crosstalk	80 db with 1K source at 400 cps	
Max. source impedance	1000 ohms for specified performance w/o atten.	
Accuracy at d-c (typical at 25° C)	is within 0.02% of full scale)	
Linearity	0.01 $\pm 1/2$ least significant bit	
Long term drift	0.01% typical	
Voltage reference stability	0.001%	
Digital signals		
Logic level (input)	Binary "1", -6 to -12 volts Binary "0", $+1$ to -1 volt	
Clock output	Transformer coupled 8 volts 0.2 usec $Z_0 = 10$ ohms, $I_{max} = 20$ ma.	
Serial output	Same as clock output; a pulse for every binary "0"	

Polaroid Land film makes you wait 10 seconds for an oscilloscope picture. The suspense can be unbearable.

We're sorry we can't do anything about that 10-second wait.

But if you can bear up under the strain, you'll get a sharply detailed, high-contrast, trace record.

You can study it, attach it to a report, send it as a test record along with a product shipment, or file it for future reference.

You also get a choice of four films for oscilloscope recording in pack, roll, and 4 x 5 formats.

The standard film has an ASA equivalent rating of 3000. And if you think that's fast, you haven't heard of our special film called Polaroid PolaScope Land film.

With an ASA equivalent rating of 10,000, it's the fastest thing in films. It can actually record a trace too fleeting for the human eye [for instance, a scintillation pulse with a rise time of less than 3 nanoseconds].

Of course, Polaroid Land films are as quick to point out a mistake as they are to point out a success.

If your trace shows an error, you know it right away. And you never go through the tedium of darkroom procedure only to find out that your blip was a blooper.

To use these films on your scope, you need a camera with a Polaroid Land Camera Back. Most manufacturers have them. Such as: Analab, Beattie-Coleman, BNK Associates, Fairchild, EG&G, General Atronics, Hewlett-Packard, and Tektronix.

You can get complete details by writing to one of these manufacturers or to Polaroid Corporation, Sales Department, Cambridge, Massachusetts 02139.

By the way, if 10 seconds fray your nerves, just imagine what it was like when Polaroid Land film made you wait 60 seconds to see your trace.

"Polaroid" and "PolaScope"®

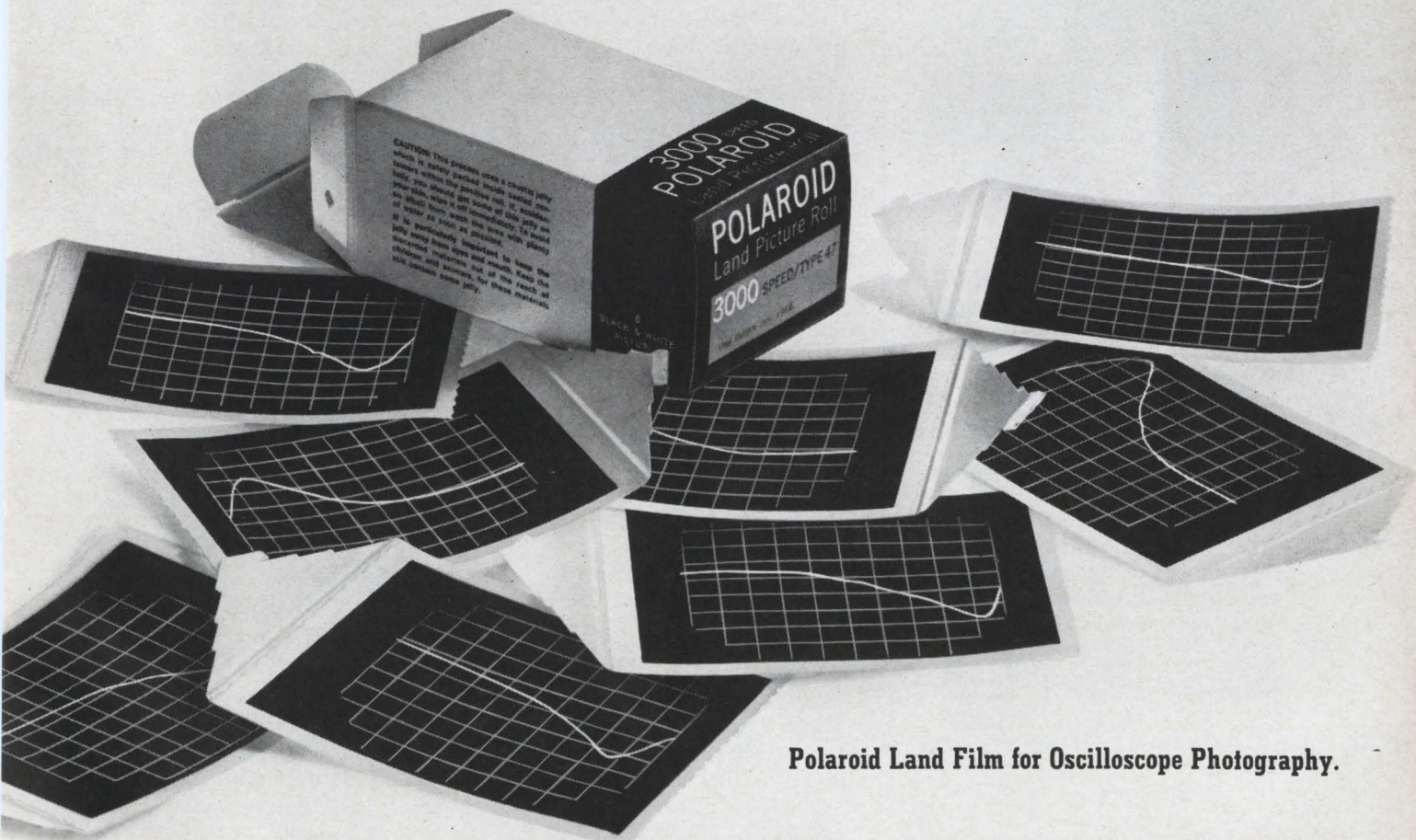

Polaroid Land Film for Oscilloscope Photography.

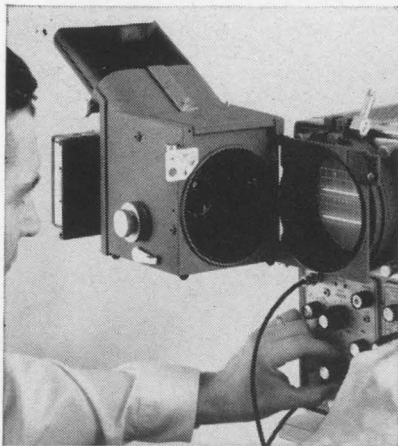

SEE IT...

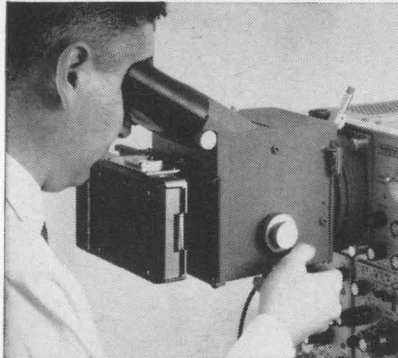

SHOOT IT...

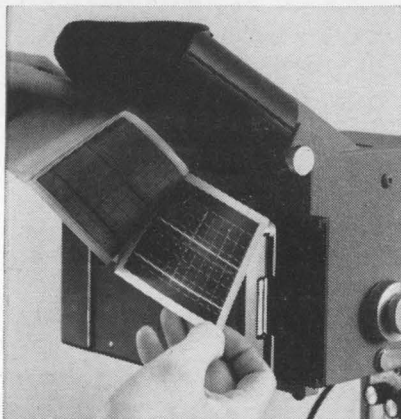

HAVE IT...

WITH SCOPE CAMERAS BUILT BY THE LEADER... FAIRCHILD

Available from the industry's most complete line of high precision scope cameras are models for high speed atomic research, radio astronomy, medical observations and general lab work. Prices start at \$350. Application assistance is available from your local Fairchild Field Engineer. Call him, or write for details, then compare design features. Fairchild Instrumentation, 750 Bloomfield Avenue, Clifton, N. J..

FAIRCHILD
INSTRUMENTATION
A DIVISION OF FAIRCHILD CAMERA
AND INSTRUMENT CORPORATION

New Subassemblies

onds. (The aperture time is the interval between the initial sampling command and the stabilization of the sample pulse. The analog variable being sampled may change during this time, thus introducing a source of error.)

The multiplexer switch contains 16 channels per circuit card. This packaging density is made possible with metal-oxide-semiconductor field effect transistors having four channels per chip. The FET circuits are manufactured by outside

vendors to Raytheon specifications. Use of FET's, Raytheon says, kept the price of the Multiverter about 30% less than that of conventionally assembled systems.

Multiverter applications include oceanographic data acquisition systems, computer-controlled data systems, hybrid computing systems, process control systems, precision voltage measurements, and medical data systems.

Raytheon Computer, 2700 S. Fairview St., Santa Ana, Calif. 92704 [401]

Phase-linear preamp operates to 350 Mc

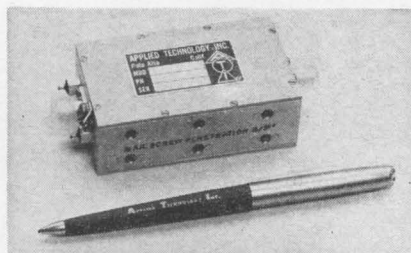

The SP-120-4 is an ultralinear, all-silicon transistor preamplifier that operates from 150 to 350 Mc. The unit is designed to operate to stringent specifications from 210 to 270 Mc, but its performance is only slightly reduced when used over the wider band. Guaranteed specifications from 210 to 270 Mc include better than ± 0.1 db gain flatness, 1.12:1 input vswr, and less than $\pm 3^\circ$ phase linearity deviation, with 25 db gain.

The preamplifier has been designed to meet the environmental requirements of MIL-E-5400, Class 2, and MIL-E-16400.

Applied Technology Inc., 3410 Hillview Ave., Stanford Industrial Park, Palo Alto, Calif., 94304. [402]

Three-wire dual-output amplifier

Model 3630 is a three-wire, dual-output amplifier that is suitable for driving wideband and narrowband

devices simultaneously at the same system ground. It is one of the manufacturer's direct-coupled differential amplifiers in the 3000 series.

The wideband output has a full-scale load current of 100 ma at ± 10 v; Variband output has a passband that is switch-selectable from 10 cps to full bandwidth, and a full-scale load current of 10 ma. Shorting or grounding the Variband output does not affect the wideband output. The modular dimensions of model 3630 allow five amplifiers to fit into one model 3005 rack enclosure.

Basic price is \$688, with quantity discounts available. Delivery is 30 to 60 days.

Dana Laboratories, Inc., Irvine, Calif. [403]

Wideband amplifier is flat to 25 Mc



A 5-watt wideband r-f amplifier has been announced. Model 91289, available as a bench instrument or rack-mounted, features a linear gain of 20 db minimum over the fre-

DC POWER SUPPLIES

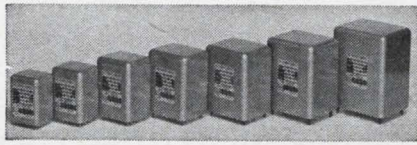

CONTINUOUS VOLTAGE COVERAGE—4.7 to 60 vdc.
 Input: 105-125 vdc, 50-400 cps.
 Regulations: From $\pm 0.05\%$
 Ripple: From .002% or 1 mv, rms
 Temp. Coeff.: From $\pm 0.01\%/^{\circ}\text{C}$
 Voltage Adjustments: $\pm 5\%$
 Max. Temp of Base: 65°C

- WIDE VARIETY OF CURRENT RATINGS
- ELECTRONIC SHORT CIRCUIT PROTECTION
- FULLY REPAIRABLE
- 7 STANDARD SIZES (OVER 450 MODELS)
- PRICE RANGE **\$45-\$225**



INSTRUMENTS: EEM ('63-64 Pg. 902)
 EBG (1964 Pg. 462)

POWER SUPPLIES: EEM ('64-65 Pg. 1341)
 EBG (1963 Pg. 307)

VOLTAGE STANDARDS: EEM ('64-65 Pg. 929)

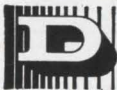

DYNAGE, inc.

390 CAPITOL AVE., HARTFORD, CONN.
 Circle 209 on reader service card

A treat for puzzle fans!



FUN WITH FIGURES
 By R. F. LAUSMANN

200 pp., \$6.95

An intriguing collection of 220 mathematical puzzles — number sequences and operations . . . tricks and enigmas . . . algebraic equations . . . puns . . . riddles . . . ratios . . . and many more.

BUY AT YOUR BOOKSTORE OR MAIL COUPON

McGRAW-HILL BOOK CO., Dept. 23-L-95
 330 WEST 42 STREET, N.Y., N.Y. 10036

Send me R. F. Lausmann's FUN WITH FIGURES for 10 days on approval. In 10 days I will remit \$6.95 plus a few cents for delivery costs, or return book postpaid. SAVE MONEY: We pay delivery costs if you remit with coupon; same examination and return privilege.

NAME (print) _____

ADDRESS _____

CITY _____

STATE _____ ZIP _____

For price outside U.S. write McGraw-Hill Int'l., N.Y. 10036 23-L-95

frequency range of 150 kc to 25 Mc. It contains its own regulated solid state power supply.

Designed to be used for stringent electromagnetic interference measurements, the wideband amplifier is useful in testing sweep frequency interference characteristics of ground systems and aerospace components. It is also a versatile communications carrier signal amplifier. The front panel contains 50 ohm input and output type N connectors, r-f power output meter, and primary power controls. Resdel Engineering Corp., 990 South Fair Oaks Ave., Pasadena, Calif., [404]

Read/write amplifier has variable speeds

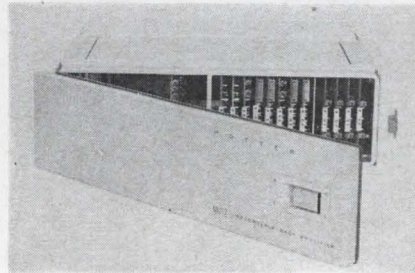

A multispeed read/write amplifier has been developed for use with digital magnetic tape transport systems. The MA212 is IBM 7-9 channel (self-clocking) or 8-channel (center clock) compatible, and can also be adapted for 9 channels (IBM 360 and ASCII compatible). Eight- and sixteen-channel internally strobed or clocked systems are also available.

The MA212 amplifier, offered for 200 bpi and skew-compensated for 200/556/800 bpi, is designed to operate with tape transports at speeds between 2 and 120 ips (up to 96 kc). Speeds to 150 ips (120 kc) are also available for special applications. Any of four speeds can be selected. Simultaneous write/read can be used above 12 ips.

Differential read preamplifiers for high noise rejection with individual gain adjustments are automatically selected as a function of speed; skew compensation is selected as a function of speed and density. Provision is made for all external controls and for odd or even lateral parity check.

The solid state amplifier uses

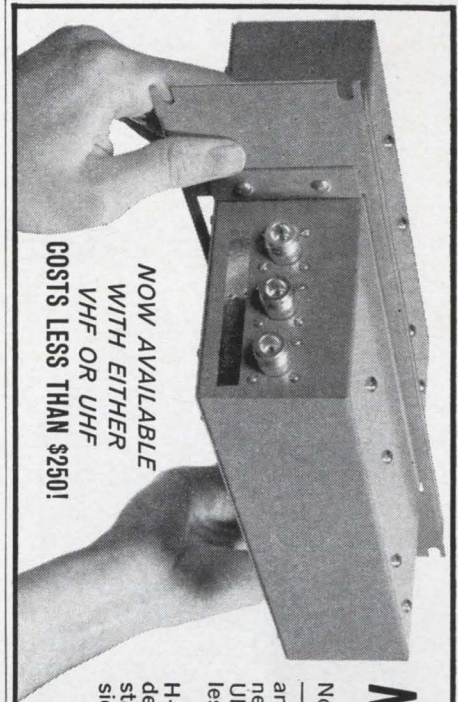

NOW AVAILABLE WITH EITHER VHF OR UHF COSTS LESS THAN \$250!

NEW... SMALLEST BASE STATION DUPLER (ONLY 2" HIGH)

Now—in a fourth or less of the space formerly required—you can stack a duplexer right with your transmitter and receiver . . . all at eye level. Only 3" of rack space needed for Sinclair's new VHF Duplexer . . . 3" for the UHF model. And these surprisingly compact units cost less than \$250!

Don't let the low price throw you! These new Model H-150 and H-450 duplexers are packed with all the dependable quality features of larger Sinclair base station duplexers. They allow simultaneous transmission and reception from a common antenna with separation between frequencies as low as 3 Mc at 150 Mc and 5 Mc at 450 Mc. Returning to a new frequency—if desired—is easily done by returning the cavities. Neither cable nor harness need be changed. Though small in size, these new duplexers have standard power rates of 100 watts (optional ratings up to 200 watts are available). The temperature range of from -20°F to 150°F makes them exceptionally versatile in either base station or repeater station applications. Investigate today! Write for complete FREE information on all Sinclair duplexers, antennas and multicouplers.

SINCLAIR RADIO LABORATORIES, INC. 523 FILLMORE AVENUE, DEPT. 101, TONAWANDA, NEW YORK

A 20 amp contactor in a 10 amp can?

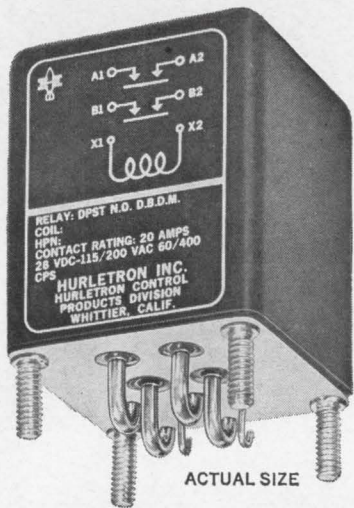

ACTUAL SIZE

That's about the size of it...

That's right. We designed a 20 amp Balanced Armature Contactor and put it into a package which is 1.5" x 1.5" and 1.812" high, exactly the size shown above.

It weighs only 7 ounces and meets MIL-R-6106E requirements.

Despite its small size and weight, this unit has double-make, double-break contacts rated 20 amperes at 28VDC or 115VAC, 400 cycle, *single phase or three phase loads*.

Balanced Armature design allows this unit to withstand 50 G's of shock and 15 G's of vibration to 3,000 cycles. Best of all, it is a *production item*, available for *today's* needs.

Write today for your free copy of Hurlatron's "Design Engineers Relay Handbook." It will give you full details on the entire series of Hurlatron Balanced Armature Relays and Contactors.

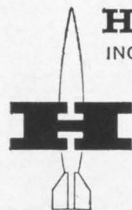

HURLETRON
INCORPORATED

HURLETRON CONTROL
PRODUCTS DIVISION
750 West Rivera Road
Whittier, California 90606
213-723-4861 213-698-9824
TWX 213-685-6261

New Subassemblies

modular construction with accessible test points at the front of the chassis. Extension frames are included to expose all plug-in modules for circuit testing under actual conditions. The power supply is overload-protected and short-circuit-proof.

Potter Instrument Co., Inc., 151 Sunnyside Blvd., Plainview, N.Y., [405]

Auto detector aids traffic control

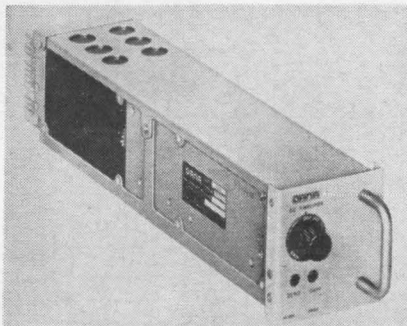

An all-transistorized, ultrasonic auto detector has been developed for traffic control. The miniature, radar-like device uses subaudible sound waves to detect vehicle presence or motion. Mounted either above or to the side of a highway, the detector can be used with a one, two or three lane highway.

Comprising the equipment are one or two detector heads (4 in. by 7 in. by 3 in.), a power supply (2 in. by 10 in. by 3 in.) and a detector amplifier (2 in. by 10 in. by 3 in.). Its power requirement is 117 v 60 cps with a 10-watt input. It emits a sound wave at 40 kc. Price is \$575.

Sperry Rand Corp., Sperry Gyroscope Co. division, Great Neck, N.Y. [406]

Q-switched laser delivers, 1,000 Mw

A Q-switching laser system has been developed with an output capability of 1,000 megawatts. It features a split elliptical cavity, the use of four flashlamps for uniform illumination of the ruby rod, and the use of a 9-x-3/4-in. brewster-angle fabricated rod for

LFE ULTRASTABLE MICROWAVE INSTRUMENTATION

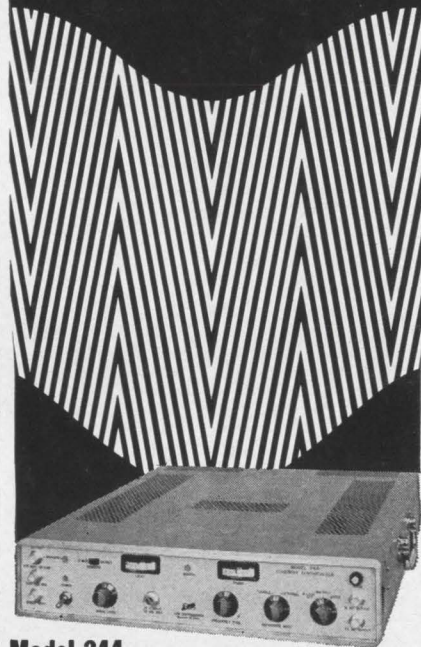

Model 244

TUNABLE COHERENT SYNCHRONIZER and MARKER GENERATOR

One coherent reference covers 2 Gc to 15 Gc continuously. Will phase-lock BWO tubes, klystrons, VTMs, Triodes and Voltage Tunable Solid State Sources. Stability—Short Term 5 part 10⁹—Long Term 1 part 10⁷. Use of external quartz or cesium standard would provide stabilities in order of 1 part 10¹⁰. As Marker Generator 10 mc and 50 mc markers selectable over 85 mc to 15,000 mc range. Model 244 is also usable as a transfer oscillator when coupled with a standard 10 mc counter.

This instrument is typical of the advanced instrumentation available off-the-shelf from LFE, including phase-locked and other oscillators, frequency and pulse stability testers, and noise measuring equipment. Custom-engineered instrumentation for even more critical requirements.

Incidentally, one of our secrets (which we share with other leaders in instrument and systems design) is our advanced components group, which delights in taking on the really tough problems in delay lines and associated circuitry, transformers, temperature controllers and amplifiers.

For full information on Model 244, and other ultrastable microwave instrumentation, write to:



LFE ELECTRONICS

A Division of Laboratory For Electronics, Inc.
WALTHAM, MASSACHUSETTS 02154

Microwave Measurement & Signal Generation Equipment • Delay Lines
Filters • Transformers • Amplifiers, and Associated Electronics

holding reflection losses to a minimum at the rod's end faces.

The new system can use either a high-quality ruby rod or a special neodymium-doped glass rod as the basic lasing medium. When the glass rod is used, the maximum Q-switched output is 300 megawatts. Rods of both types are provided with the system along with the four flashlamps. Changing of rods requires only a few minutes, and there is no possibility of either optical or mechanical misalignment, the company says.

The split elliptical cavity facilitates changing rod and flashlamps. The Q-switching technique involves combinations of a rotating prism and a suturable cell, the latter requiring no additional salts ever. Another design feature of the system is its compatibility with resonant reflectors, wedge front reflectors, pellicles and other front-reflector devices.

Applied Lasers, Inc., 72 Maple St., Stoneham, Mass., 02180 [407]

Solid state preamps offered in 2 types

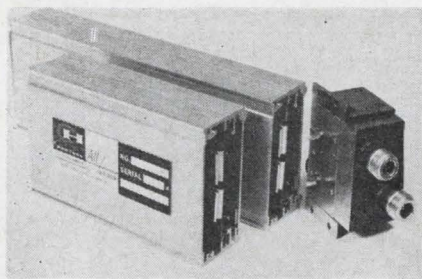

Solid state preamplifiers are available in two new types. One is designed for low-noise-figure applications, the other for high power use.

The low noise preamp has an i-f noise figure of 2.3 db at 30 Mc, a gain of 45 db, and a 4-Mc bandwidth. The high-power type offers a maximum power output of +28 dbm; maximum linear power output, +15 dbm at 0.1 db compression; i-f noise figure, 10 db; and bandwidth, 2 Mc.

Readily detachable r-f mixers are available for the 125 Mc to 72 Gc frequency range. Prices are \$550 to \$1,400 depending on mixer selected.

Airborne Instruments Laboratory, a division of Cutler-Hammer, Deer Park, N.Y., 11729. [408]

CHRISTIE

SINCE 1929

"ATTENDANT FREE"

BATTERY CHARGERS

FOR LEAD ACID • NICKEL CAD • SILVER ZINC BATTERIES

6 to 120 volt d-c
3 to 125 amp
1% Regulation

Volt/Amp Regulation
Reduce Battery Heating
Extend Battery Life

Electric Vehicle,
All-Purpose and
Float Charging

Silicon Rectifiers
Military & RFI Specs
No Fan

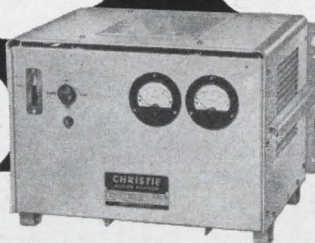

Also 200 other Models of Power Supplies & Battery Chargers • Write for Catalog
CHRISTIE ELECTRIC CORP. 3400 West 67th Street, Los Angeles 43, Calif.

Circle 211 on reader service card

MITSUMI COMPONENTS

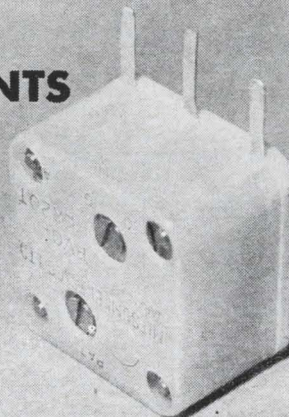

New Precision Variable Capacitor

Model PVC-LX20T Polyvaricon is AM two gang miniature-sized Polyethylene Variable Capacitor which has a capacity tolerance $\pm (1pF + 1\%)$. Maximum variable capacity is 140pF ANT., 82pF OSC. "Q" characteristics is over 500 at 10Mc 50pF. Trimmer capacity is over 8pF. The Dimension being 20mm \times 20mm \times 13mm.

Main Products

Polyvaricon • IFT • Oscillator coil • Antenna coil • Composite coil
• Special coil • Micro motor • Synchronous motor • Variable resistor
• Trimming potentiometer • FM tuner • TV tuner • Various sockets • CdS photoconductive cell.



MITSUMI ELECTRIC CO., LTD.

New York office: 11 Broadway, New York, N.Y. 10004, U.S.A.
Phone: HA-5-3085, 3086

Main office: 1056, Koadachi, Komae-machi, Kitatama-gun,
Tokyo, Japan Phone: Tokyo 415-6211/23

Operate any motor vehicle
more efficiently with a

MARK[®] TEN Thunderbolt



CAPACITIVE DISCHARGE IGNITION SYSTEM

The true electronic solution to one of the major problems of engine operation

The Mark Ten, using SCR (Silicon Controlled Rectifier) Switching, provides brand new levels of engine performance and economy.

Unaffected by extremes of temperature and operating conditions, the Mark Ten installs quickly and easily without rewiring. It operates on any 6 or 12 volt negative or positive ground system.

Compare these proven benefits:

- ▲ Up to 20% Increase in Gasoline Mileage
- ▲ Installs in Only 10 Minutes on any Car or Boat
- ▲ Spark Plugs Last 3 to 10 Times Longer
- ▲ Instant Starts in all Weather
- ▲ Dramatic Increase in Acceleration and General Performance
- ▲ Promotes More Complete Combustion

Literature and complete technical information sent by return mail.

BETTER YET — ORDER TODAY!



DELTA PRODUCTS, INC.

P.O. Box 1147 E • Grand Junction, Colo.

Enclosed is \$_____. Ship prepaid.

Ship C.O.D.

Please send:

Mark Tens (Assembled) @ \$49.50

Mark Tens (Delta Kit) @ \$34.95

SPECIFY — Positive Negative
 6 or 12 Volt

Car Year _____ Make _____

Name _____

Address _____

City/State _____ Zip _____

DP 5-5

New Microwave

Miniature magnetron puts out 1 kw

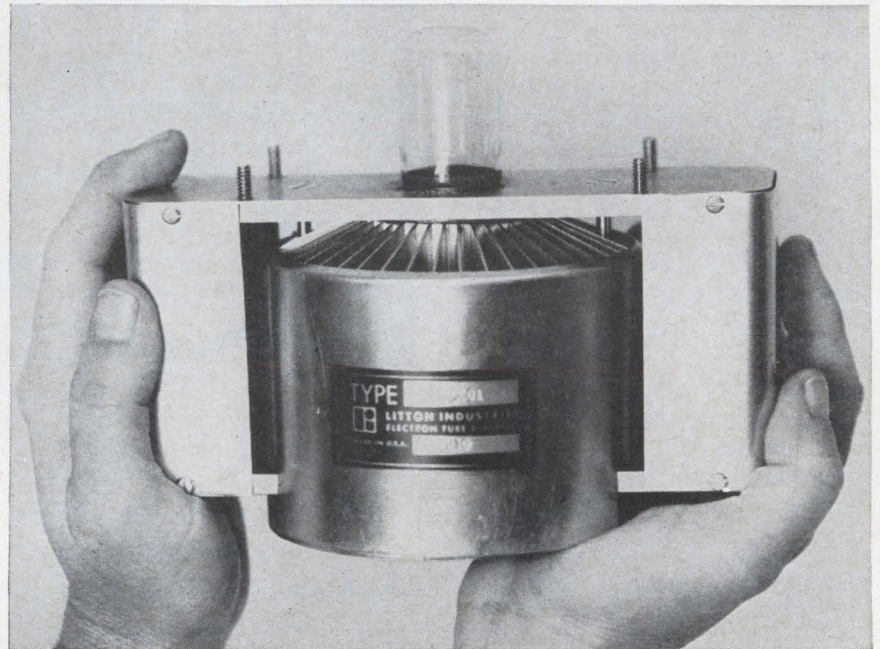

A 6.3 x 7.5-inch magnetron, smaller than any other operating at the same frequency and power, has been developed by Litton Industries' Electronic Tube division. It can provide up to 1,000 watts continuous wave at 2,450 megacycles.

The tube, designated the L-5001, was developed especially for microwave cooking and heating applications, but it may have other uses since the 2,450 Mc operating frequency is shared by industrial, scientific and medical users. Total weight of the tube and magnet is only seven pounds.

Several innovations helped reduce the size of the tube. The cathode is shorter than in standard tubes, and the electron beam is focused with a permanent magnet instead of an electromagnet, which is larger and heavier. Instead of being water-cooled, the tube is cooled by air forced over its heat sink, which is made of lightweight aluminum; eliminating the water fittings and coolant jacket helped cut the size of the magnetron. An additional bit of miniaturization was obtained by reducing the required anode voltage from 6,000 to 3,600 volts. This not only makes the tube smaller, because less high-

voltage insulation is needed, but also makes the power transformer for the tube much smaller.

Litton's Atherton division has already put its miniature magnetron into a commercially available microwave oven that is only half the weight of conventional ovens, but whose inside measures 12 inches square by 6 inches high, big enough for any conventional food service container.

Specifications

Operating frequency	2,450 megacycles
Power output	1,000, 750, or 500 watts continuous wave
Weight	7 pounds for tube and magnet
Height	6.3 inches
Width, max.	7.5 inches
Delivery	Immediate
Price	On request, depending on quantity

Litton Industries, Electronic Tube Division. San Carlos, Calif. [421]

Microwave sweeper comes in 5 models

Model N900 microwave sweep oscillator is available in 5 models covering the range from 1 to 12.4 Gc. The L-band model furnishes a minimum of 100 maw from 1 to 2 Gc, and the X-band version pro-

The most advanced oscillograph is now available with the DataDigit^{T.M.} Character Generator

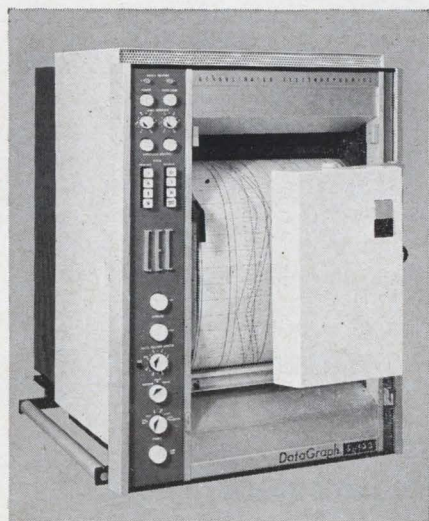

5-133 - BENCHMOUNT CONFIGURATION

CEC's 5-133 DATAGRAPH® has long been accepted as the world's finest recording oscillograph for those applications where no compromise is acceptable.

However, the state-of-the-art is constantly changing. As a result, a companion instrument has been perfected which gives the 5-133 an additional capability undreamed of a short while ago. And that is . . .

DataDigit—the new Datagraph Accessory

When used with the 5-133 or any CEC oscillograph, the new DataDigit Accessory literally provides a new dimension in data recording. Speed, accuracy and flexibility that were previously unattainable can now be realized even at moderate and slow paper speeds.

The DataDigit is virtually a quantum jump in recording technique, combining the features of the fastest digital printer and an analog light beam oscillograph in one instrument. And, being a completely

self-contained accessory, this instrument can be used with existing oscillographs *without modification.*

Fundamentally, this accessory generates the necessary waveforms to print decimal data on standard photographic papers. Up to 26 columns can be printed at speeds to 1600 lines-per-second. So economical is this instrument, it soon pays for itself in paper savings alone.

Compared to the best previous methods, recording capabilities with DataDigit become impressive indeed.

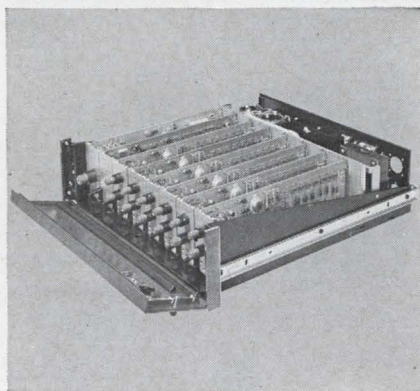

DATADIGIT^{T.M.} CHARACTER GENERATOR

Specifications:

Print-Out — 0 thru 9 • **Input Data Format** — 10 line decimal • **Input Voltages** — Select command + 5 v min. to + 70 v max. • **Input Impedance**—Select command signal 20 k ohm resistive min. • **Print Command** — rise time 1 μ sec; duration 2 μ sec min. — 400 μ sec max.; voltage + 5 v min. to 25 v max.; input impedance 550 pf • **Power Requirements** — voltage 90 — 135 v or 180 — 270 v; frequency 48 — 420 cps; wattage 120 max. • **Physical Characteristics** — 5¼" H x 19⅜" D x 19" W. Mounts in standard EIA rack, slide rackmount available.

	Conventional	DataDigit
Accuracy	1.5% to 2%	0.01% or better with digital techniques
Frequency Limit	15 kc	1 mc with digital techniques
Channel Separation	Visual	Digital identification
Channel Capability	52	Unlimited
Timing	Paper speed	Digital clock
Data	Continuous	Continuous or multiplexed

Other important accessories:

The Remote Control Unit operates the 5-133 from distances up to 1000 feet. Complete remote *control* of all electrical functions is possible — including all *speed selection*, power ON/OFF and recording lamp ON/OFF.

The Latensification Lamp Assembly uses four 8-watt cool white fluorescent lamps to latensify slow-speed recordings. A readable record is immediately available when recorded at low speeds up to 4 ips.

The Ambient Light Shield permits recording with no latensification, allowing the record to be chemically processed for maximum contrast needed for oscillograms of archival quality.

For complete information on DataDigit, plus the 5-133 and its other accessories, call your CEC Sales and Service Office, or write for CEC Bulletins 5133-X7 and 30100-X2.

CEC

Data Recorders Division

CONSOLIDATED ELECTRODYNAMICS

A SUBSIDIARY OF BELL & HOWELL/PASADENA, CALIF. 91109
INTERNATIONAL SUBSIDIARIES: WOKING, SURREY, ENGLAND
AND FRIEDBERG (HESSSEN), W. GERMANY

WRAP-AROUND MAGNETIC SHIELDS

APPLIED IN SECONDS

Cut to any size or outline
with ordinary scissors



Co-Netic and Netic foils are ideal for initial laboratory or experimental evaluation . . . also for production applications and automated operations. Dramatically enhance component performance by stopping degradation from unpredictable magnetic fields. When grounded, foils also shield electrostatically. They are not significantly affected by dropping, vibration or shock, and do not require periodic annealing. Available in thicknesses from .002" in rolls 4", 15", and 19-3/8" wide. High attenuation to weight ratio possibilities. Every satellite and virtually all guidance devices increase reliability with Netic and Co-Netic alloys, saving valuable space, weight, time, and money.



CRT

Audio Transformer

Cable Shielding

Printed Circuit Module

Automated Operation

MAGNETIC SHIELD DIVISION

Perfection Mica Company

1322 N. ELSTON AVENUE, CHICAGO 22, ILLINOIS

ORIGINATORS OF PERMANENTLY EFFECTIVE NETIC CO-NETIC MAGNETIC SHIELDING

Circle 212 on reader service card

MICO

NEW SIX-RATIO
STANDARD ENGRAVER

CAT. NO.
259

FOR LIGHT
AND MEDIUM
DUTY WORK



AMERICAN
MADE

- Engineered for ruggedness and simplicity.
- Six pantograph ratios—from 1.5:1 to 4:1.
- Ball-bearing spindle uses 1/8" shank cutters and has true .250" micrometer depth control.
- Sturdy one-piece ratio studs anchor in ESNA stop-nuts for quick locking of pantograph arms.
- Master copy and work right-side up—in full view of operator. Raising stylus raises cutter.
- Attachments available for increasing versatility.

Send for bulletins and prices

MICO INSTRUMENT CO.

77 Trowbridge St. Cambridge 38, Mass.

174 Circle 174 on reader service card

DO YOU HAVE Reed Relay Problems?

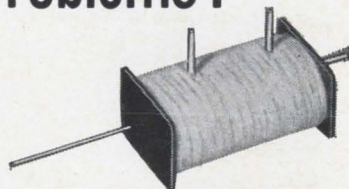

Problem: The National Bureau of Standards needed a Form B Relay to latch open with a minimum of power.

Solution: Coto-Coil designed and produced a Mercury-Wetted Relay requiring less than 2mW to operate, with contacts to handle 28W (1A or 100V max.) . . . a power gain of 14,000 in a package of only .15 cu. in.!

Can We Solve Your Problem?

Write for catalog and prices of our standard line of magnetic reed relays. For special requirements, give complete details for quotation.

Coto-Coil COMPANY INC.
65 Pavilion Ave.
Providence, R. I. 02905
Phone: (401) 941-3355

(Key Sales areas available for representation. Please Inquire.)

Circle 213 on reader service card

New Microwave

vides a minimum of 20 mw from 8.2 to 12.4 Gc. The N900 is operable at c-w or with 1-kc built-in internal square-wave modulation. Provisions for external a-m and f-m modulation are included, through the mod input and the sweep input connectors, respectively. The sweep output connector provides a sawtooth signal for synchronization purposes.

The internal sweep is capable of a slow speed for use with most X-Y recorders, and faster sweep speeds for scope presentation. The sweep range is over the band specified for each instrument; there are no provisions for limiting the frequency range, to keep the instrument as straightforward as possible for general utility. The 19-in. rack-mounted model is 5 3/8 in. high by 18 in. deep by 17 in. wide; weight is 43 lbs.

Price is \$1,995; delivery, 30 days. MSI Electronics Inc., 116-06 Myrtle Ave., Richmond Hill, N.Y., 11418. [422]

Phase compensator uses line stretcher

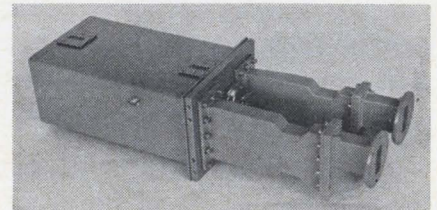

The D24C1 phase and line length compensator is designed specifically for applications in phase-sensitive systems. It permits channel balancing by providing line length variations by means of a line stretcher, as well as phase shifts using a frequency independent phase shifter.

Operating over the frequency range of 5.4 to 5.9 Gc, the D24C1 permits minimum line length variations of 4 wavelengths using a re-settable line stretcher, and provides 360° of phase shift which is frequency independent. With this unit, a physical line length adjustment can be made and then an electrical phase match superimposed upon the physical match.

For any adjustment setting the maximum insertion loss is 0.6 db, and the vswr is 1.3 maximum. All units are rated at 100 kw peak, 100 watts average and, by actual test, will withstand a 100% overload. This electrical performance will be maintained over the range of 0° to +65°C. Price is \$3,430; delivery, 4 to 6 months.

Sperry Microwave Electronics Co., P.O. Box 1828, Clearwater, Fla. [423]

Four new water loads cover 1 to 8.2 Gc

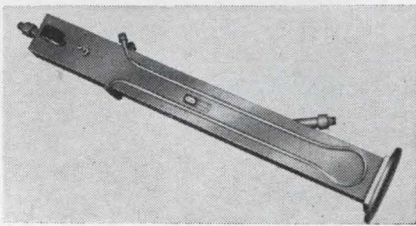

Accurate power measurements of high power microwave systems are facilitated by a series of four new calorimetric water loads. These accessories were developed originally in conjunction with the manufacturer's extensive application of microwave energy at high power levels for industrial processing systems.

Covering a frequency range of 1 to 8.2 Gc, the units are of both waveguide and coaxial types. They are reported to feature higher average power handling capabilities, wider bandwidth and greater ruggedness than previously available devices. The waterloads also serve as essential system terminations for laboratory equipment or off-the-air testing of installed systems.

In order of ascending frequency, the four devices are: K2000AH, 1 to 1.7 Gc with average power capacity of 8kw and peak power of 3 Mw; G2000H (illustrated), 2.7 to 3.5 Gc with average power capacity of 60 kw and peak power of 20 Mw; F2000H, 5 to 6 Gc with average power capacity of 25 kw and peak power of 10 Mw; and E2000H, 5.8 to 8.2 Gc with average power capacity of 15 kw and peak power of 5 Mw. All have maximum vswr of 1.10.

Raytheon Co., Foundry Ave., Waltham, Mass., 02154. [424]

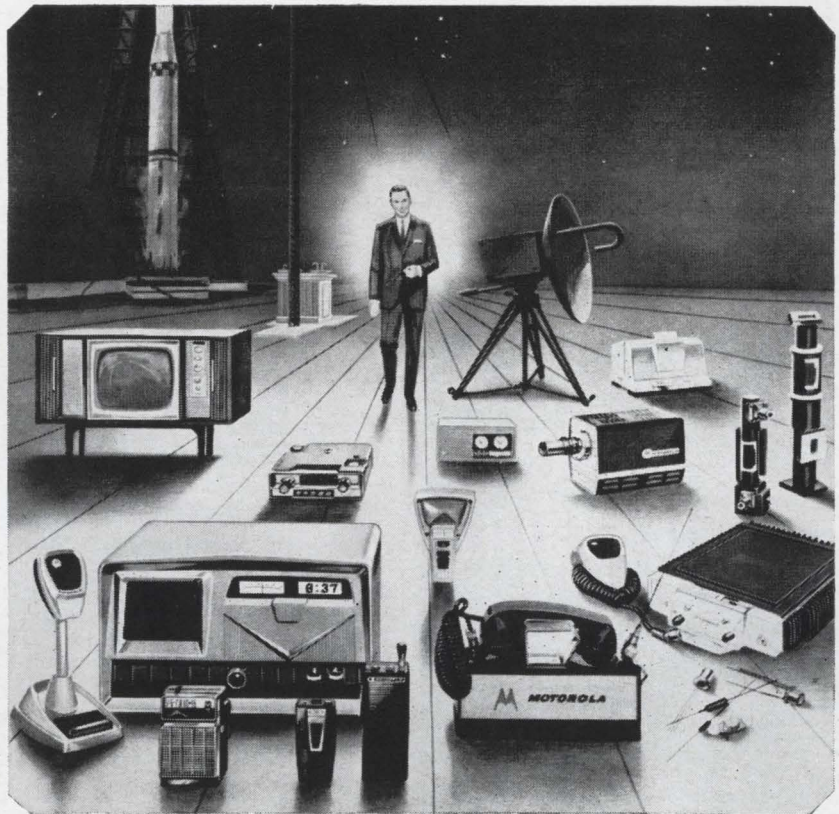

What does "diversification" mean to you?

Radar • Radio communications • Microwave • Transistors • VHF/UHF
• Missile guidance • Data processing • Every advanced phase of electronic engineering!

Which offers you the greatest challenge? The greatest potential? The greatest reward?

Here at Motorola, exceptional diversification offers you the widest possible choice of the entire state of the art. The horizons are unlimited—and so are the rewards. Engineers are discovering a new sense of achievement and personal fulfillment in selecting the specialized field that parallels their own interests.

You can take your own measure at Motorola. Here you can find the diversification you want. Challenging new assignments. True professional status. Association with highly creative engineering and scientific minds. Unlimited advancement. Write us about yourself today.

SYSTEMS ENGINEERS advanced R & D in radio communications systems related to Two-way, portable, mobile and radio-telephone equipment.

EQUIPMENT DESIGN high performance solid state receivers, transmitters, and data processing equipment for radar, communications, command and control, tracking and telemetry.

FAMILIARITY WITH STATE-OF-THE-ART statistical communications theory, advanced signal processing techniques, solid state r.f. techniques, ultra-reliability, antenna systems, advanced structural and thermal designs.

SECTION MANAGER direct engineers and support personnel in state-of-the-art communications, including r.f. systems and input-output devices.

CHIEF ENGINEER technical management of R & D group in advanced technology related to solid state r.f. communications.

CIRCUIT DESIGN ENGINEERS advanced R & D in receivers, transmitters, RF, digital, Color TV and automotive electronics.

DEVELOPMENT ENGINEERS advanced communications products in consumer, industrial and military electronics.

Excellent opportunities also available in Phoenix, Ariz.

Mr. W. H. HAUSMANN, Engineering Personnel Mgr., Dept E, 4545 Augusta Blvd., Chicago 51, Illinois

An equal opportunity employer.



MOTOROLA inc.

FOR
DRILLING
AND ROUTING
CIRCUIT BOARDS
AND
REINFORCED
RESINS

SOLID CARBIDE

◀ DRILLS

◀ FLUTED
ROUTERS

◀ FIBERGLASS
ROUTERS

UNEQUALLED METAL REMOVAL
COMPANY SERVICE, QUALITY
AND SELECTION INCLUDING:

1. World's largest inventory of centerless ground drill blanks and finished tools ready-for-shipment.
2. Fifteen centerless grinders in production of drills and rotary carbide tools.
3. Every size carbide drill, ground from-the-solid . . . the smallest — .008" diameter to the largest — 1.500" diameter.
4. Precision ground to 5 micro-inch finish or better.
5. Delivery from stock, through our distributors, of any standard solid carbide tool in 48 hours.

Your assurance of product quality, lowest cost and dependable service is the fact that the nation's leading carbide tool users are placing their tool contracts with The Metal Removal Company.

THE METAL REMOVAL COMPANY
1859 W. Columbia Avenue
Chicago, Illinois 60626

Plants Located in CHICAGO • LOS ANGELES • SAN JUAN



MASTER TOOL AND WHEEL
MAKERS FOR THE WORLD

New Production Equipment

Pump keeps solder clean

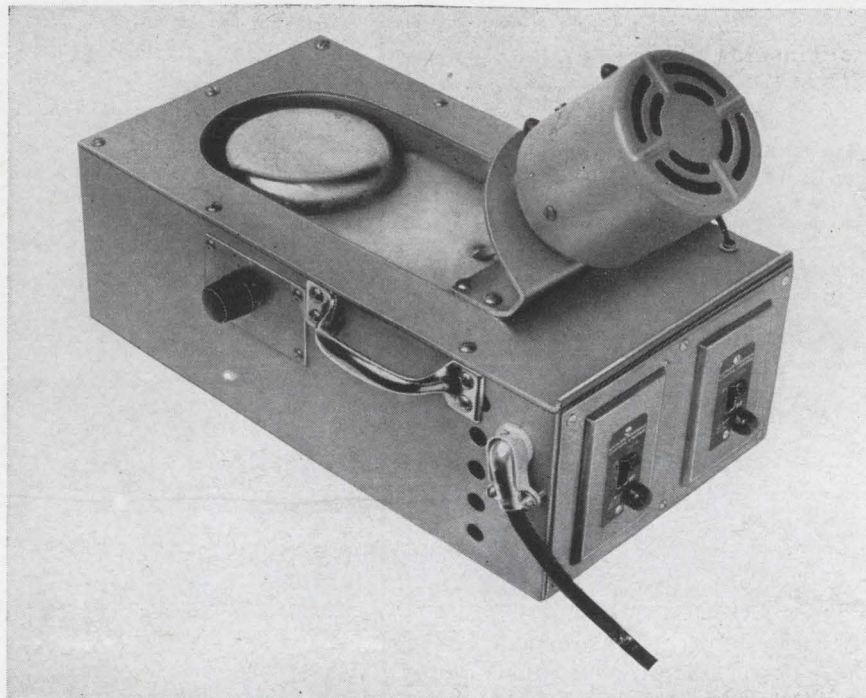

There are several drawbacks to conventional solder pots for tinning component leads and dip-soldering small parts. Dross collects on top of the solder; solder temperature can fluctuate at the surface; and the level in the pot drops as solder is used. A new pot, called the Wavedipper, solves all three problems by continuously pumping fresh solder up through a hole—a principle that has been used for years in wave-soldering machines for printed-circuit boards.

A pump in the Wavedipper forces the molten solder up into a well, forming a flat surface four inches in diameter that is raised above the main solder reservoir. The pump recirculates the solder so that it constantly flows over the edges of the well back into the reservoir. The result: a clean, constant-level, constant-temperature dipping surface. Dross collects on the surface of the solder that has overflowed, where it retards oxidation of the reserve solder.

Until the solder is fully melted, a thermostat switch prevents the pump motor from operating. This is done to prevent overloading and

overheating of the motor, but it also helps solve another problem: when a conventional pot is started up, the tin-rich solder at the top melts first. If the top is used before the lead-rich solder at the bottom is melted and mixed with the top, the solder will become deficient in tin.

Specifications

Size	16¾ by 8¾ by 5¾
Solder capacity	40 pounds
Power	110 volt, 60-cycle input; 800 watts used
Well diameter	4 inches
Temperature	400° to 600° F
Price	\$990

Electrovert, Inc., 240 Madison Avenue, New York, N.Y. 10016 [451]

Ultrasonic bonder for semiconductors

The ultrasonic stitchbonder for internal semiconductor connections is capable of attaching a 0.005-in. to 0.002-in. aluminum or gold wire from semiconductor chip to package lead within two seconds. Wire feeding is fully automatic, and leaves no pigtailed.

The machine is available with

ITT Heat-Shrink Tubing meets tougher new Mil-spec **MIL-I-23053A**



New ITT Heat Shrink Tubing easily fits over coax connector, yet, because it shrinks to 50% of its original size with the application of heat, the tubing forms a tight insulating bond around both the coax and the connector.

Specify ITT 50% Shrinkable Tubing for Assured Performance... it conforms to revised, and now far more stringent, specification MIL-I-23053A. Ideal for use in military electronics, and for general industrial applications, the tubing shrinks to *half* its original size upon application of heat. ITT tubing is fluorine- and chlorine-free, can't cause corrosion. It's especially suitable for use directly on contacts, even those in the millivolt signal range.

ITT Heat-Shrink Tubing vibration-proofs and weather-proofs electrical connectors, mechanical and hydraulic couplings, and other metallic fittings. It is tight, form-fitting insulation for connections,

splices, wire harnesses, cables, and wear points. Available from stock in 14 diameters from 3/64 to 4 inches, clear and in five permanent colors. It retains its flexibility and form stability from -65° to $+275^{\circ}$ F, and is highly resistant to impact, perforation and abrasion.

For detailed specifications, technical assistance with applications, or engineering samples, write: Dept. E, ITT Wire and Cable Division, International Telephone and Telegraph Corporation, Clinton, Mass. In Canada, write or call ITT Royal Electric Company (Quebec) Limited, Pointe Claire.

wire and cable division **ITT**

Vector Semi- Conductor Devices

Standard EIA Devices
or
Special Units
To Your Specification



TO-5
2N2631
2N3553
2N3374
V-600



7/16 STUD
2N2876
2N3375
2N3632
2N3733
V-610



Si Dioxide
CAPACITORS
5 PF
1800 PF



TO-18
TO-46
TO-51
2N2784
2N3633
2N709A
2N918
V-120
V-222 (series)



TEMPISTORS
Positive
Temp.
Comp. Si
Resistors
1/2 Watt
1/4 Watt



VX-3375
Advanced
RF package
with
improved
character-
istics,
simplified
strip line
mounting.

- High Voltage Versions of These Transistors Available
- Special Low Voltage High Gain Units For Mobile And Airborne Applications

Contact Local Representatives For
Additional Details. Telephone: (215)
EL 7-7600

Vector

U
A

DIVISION OF UNITED AIRCRAFT CORPORATION

SOUTHAMPTON, PENNSYLVANIA

Production Equipment

rotating chuck for all popular integrated circuit packages (TO5 flatpack) and with rackfeed for transistor bonding (TO5, TO18). Operation is extremely simple, requiring only a short training time for new operators. Minimum bond area is 0.001 by 0.002 in. Simplicity of design and rigid quality control during manufacturing and assembly assure a reliable and maintenance-free machine, the manufacturer says.

E.M.B. Corp., 4151 Middlefield Road, Palo Alto, Calif. [452]

Lead forming tool speeds p-c assembling

A low-cost forming tool that makes precision bends in component lead wires for mounting in P-C boards offers speed, uniformity and high-quality workmanship. The plastic tool resembles a caliper having a sliding section within a fixed mounting. Right-angle trammel points on the end of each section are positioned to coincide with the hole spacing desired.

To use the tool, the operator adjusts the spacing of the trammel points to coincide with the desired hole spacing in the printed circuit board. This spacing is precisely duplicated by V slots, one located in the sliding section and one in the fixed section of the device. A locknut maintains the interval. Once spacing is established, the component is placed midway between the V slots with a lead in each slot. A simple push of the fingers forms the bend.

The new device reduces forming time drastically, allowing 5 to 10 times as many forming operations than the customary plier or stick-forming method. It reduces component handling and accommodates all standard lead wire sizes. The plastic construction prevents damage to the wire and the circuit board as well as protecting the component itself from rough handling. The forming tool is priced at \$6.95 (or \$5.95 in quantities of 6 or more).

Davey Products, Box 567, Fairfield, Conn. [453]

See us at the PRODUCTION ENG. Show-Booth #1133

GRCtiny parts



die cast
ZINC ALLOY



molded
PLASTICS

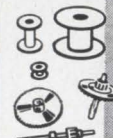

Coil Bobbins
Gears & Pinions



COIL
BOBBIN
WORK
SHEET

Get this valuable data on GRC's wide range of small bobbin sizes, shapes and designs. GRC's methods give you quality and accuracy in small parts of die cast zinc alloy, Nylon, Delrin and other engineering thermoplastics. Exclusive single cavity, automatic techniques allow new designs, new production and assembly shortcuts. Write, wire, phone for samples and bulletins. Send prints for quotations. No Minimum Size! Maximum sizes:

Zinc Alloy—
2" long,
1/2 oz.
Plastic—
1 3/4" long,
.05 oz.



GRIES REPRODUCER CO.

Division of Coats & Clark Inc.
World's Foremost Producers of Small Die Castings
151 Beachwood Ave., New Rochelle, N. Y.
(914) NE 3-8600

Circle 214 on reader service card

NOW! APPLY KODAK PHOTO RESISTS this new AEROSOL way



QUICK
CONVENIENT
ECONOMICAL

Three types to suit all
your etching needs
now available at local
industrial photo dealers

TYPE-P containing Kodak KPR*
—for copper, copper-clad
laminates, other metals. 16 oz.
\$5.95

TYPE-M containing Kodak
KMER*—for aluminum, stain-
less steel, titanium, other
metals. 16 oz. \$5.95

TYPE-T containing Kodak
KTR*—for high resolution
etching of thin films. 16 oz.
\$6.95

*KPR, KMER, KTR are prod-
ucts of Eastman Kodak Co.

INDUSTRIAL CHEMICAL
SPECIALTIES CORPORATION

1595 Black Rock Tpke., Fairfield, Conn.

Please rush me more information on Spray Resist
products and, also, name of nearest dealer:

NAME _____

COMPANY _____

CITY _____ STATE _____

WHERE CAN MAN GO... IN ELECTRONICS?

Electronics is a discipline unlike any other. For whatever name we give to these fast paced times in which we live—the Age of Space, the Age of Mass Communications, the Age of Transportation—electronics plays a vital role. Through advances in this single key technology, advances in all others are brought nearer to reality. And nowhere is this truth more evident than at Lockheed, where to all programs, electronics is essential. Research. Development. Systems. At Lockheed, those knowledgeable in the nuances of

electronics help to
ment upon this planet.
ity to investigative
as Lockheed's Deep



research submarine. They permit land vehicles of the future to achieve reality. And they extend the reach of mankind heavenward through spacecraft systems such as Agena. Undersea, on land, and in space environments, Lockheed electronic systems control and guide, communicate and compute. Now, generalists and specialists, experienced and interested in a broad spectrum of electronics assignments, are invited to write Mr. K. R. Kiddoo, Professional Placement Manager, Sunnyvale, California. Lockheed is an equal opportunity employer.

LOCKHEED
MISSILES & SPACE COMPANY
A GROUP DIVISION OF LOCKHEED AIRCRAFT CORPORATION

NEW!

40 AMP. BINDING POST offers these plus features

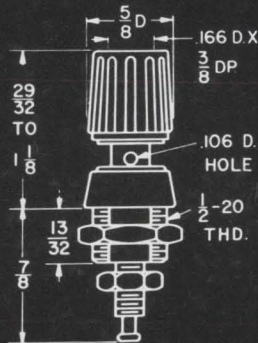
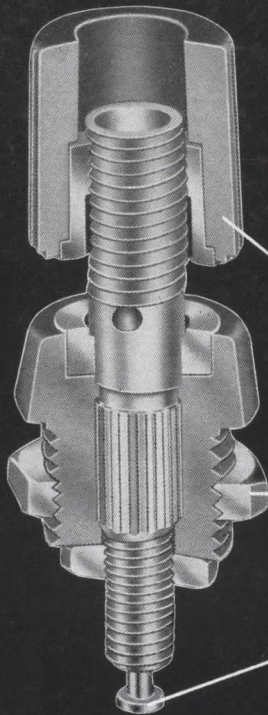

self captivated thumb nut

single 1/2-20 mounting nut

silver-plated brass stud

Here's a new compact, pre-assembled "6-way" binding post that's designed for fast, easy installation and high reliability! Designated the 111-300 Series, it's rated at 40 amps, with a voltage breakdown of 7,000 volts DC. Insulation resistance is greater than 200 megohms after MIL-T-5422B humidity test. Capacity to 1/8 inch panel is 3.5 pf. Mounts in 1/2 inch diameter circular hole, "D", or double flat hole—.422 across flats. Post is available in six standard colors to Federal Standard 595 for coded application. Molded of tough, low-loss polyamide; 6 methods of electrical connection; single 1/2-20 mounting nut; silver-plated brass stud; self captivated fluted thumb nut; circuit connection may be made at the solder terminal, or a lug may be slipped over the threaded portion of the stud and secured with a nut.

Also available—111-100 Series binding post, rated at 15 amps, with voltage breakdown of 8,000 volts DC.

NEW SET SCREW TYPE BANANA PLUG

Versatile... designed for wide variety of applications! Voltage breakdown: 10,000 volts DC. Capacity plug-to-plug: 1.3 mmf. Current carrying capacity: 15 amps. Available in 10 colors for coded applications.

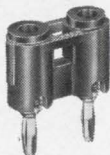

WRITE TODAY for your FREE copy of the E. F. Johnson Company Components Catalog!



E. F. JOHNSON COMPANY
3039 TENTH AVE. S.W. • WASECA, MINNESOTA 56093



Induction Heating's Most
Trusted and Creative
Craftsmen Since 1926

High Frequency INDUCTION HEATING UNITS

- for
- BRAZING
 - MELTING
 - SOLDERING
 - ZONE REFINING
 - HEAT TREATING
 - CRYSTAL GROWING
 - BOMBARDING
 - PLASMA TORCH

ELECTRONIC TUBE GENERATORS

Kilocycle Frequency Units

Megacycle Frequency Units

Dual Frequency Units

WORK HANDLING EQUIPMENT AND ACCESSORIES

FREE APPLICATION ENGINEERING SERVICE—Our engineers will process your work samples and submit recommendations.

SALES AND SERVICE FACILITIES THROUGHOUT THE UNITED STATES AND CANADA

WRITE FOR NEW LEPEL CATALOG

Lepel HIGH FREQUENCY LABORATORIES, Inc.
55th St. & 37th Ave., Woodside 77, N. Y. C.

Circle 216 on reader service card

New EVENVOLT DIFFERENTIAL VOLTMETER — low cost!

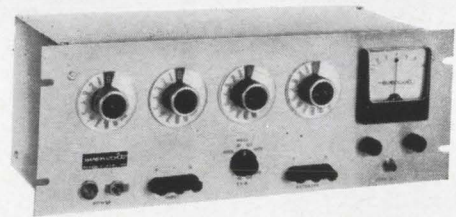

Moderate accuracy to $\pm 0.03\%$ \$435.

New EVENVOLT DV-300 POTENTIOMETRIC DIFFERENTIAL VOLTMETER is line operated — available in rack mounting or bench top cases. The solid state DV-300 permits infinite impedance potentiometric measurements from 0 to 11110.0 mv DC with 100 uv resolution. Input divider permits measurements to 1000 VDC. Utilizes proven EVENVOLT zener references and summation potentiometric circuits.

APPLICATIONS: Zero suppression for laboratory recorders ■ Used with recorders to detect source instability ■ Accurate calibration of power supplies, meters ■ Standard cell comparison ■ Thermocouple measurements ■ Precision transducer & attenuation measurements ■ can be used as a VTVM.

WRITE FOR DATA SHEET NO. DV-300

evenvolt™ (TM of Instrulab)

INSTRULAB, INC. 1205 Lamar Street
Dayton, Ohio 45405 • Area Code 513 — 223-2241

New Books

Control systems

Modern Control Systems Theory, Cornelius T. Leondes, editor; McGraw-Hill Book Co., 486 pp., \$17.50

This graduate-level book, for engineers engaged in the design of complex control systems, is a joint effort by five engineers working in the aerospace industry and six faculty members of California universities. It is the outgrowth of a summer program given at the University of California at Los Angeles.

The book has three failings. First, except for chapters 2 and 12, it is inadequate in the extremely important area of practical applications for advanced theoretical techniques. Despite the aerospace background of several of the authors, the material on aerospace control systems is too sketchy. Very few equations are presented—not nearly enough to help the reader grasp practical procedures for solving aerospace control problems. And not enough material is given to help the reader relate his own problems to those being discussed.

A second shortcoming is that the chapters are not coordinated. The flow of material through the book is not smooth, and much thumbing around may be required to find all the information relating to any specific subject.

The third failing is the index, which is completely inadequate for a book of this scope.

The first five chapters cover some recent advances in linear, stochastic and nonlinear systems. Linear time-variable systems and the synthesis of systems having random inputs are covered; and there is an interesting discussion on functional analysis and its application to mean-square error problems, which is presented very clearly with worked-out examples in detail. Shaping filters for stochastic processes, and Lyapunov's direct method in the analysis of nonlinear control systems are discussed. New topics in Lyapunov function techniques are covered, including Schultz's variable gradient techniques and methods for the generation of Lyapunov functions for nonautonomous systems.

Chapters 6 through 9 cover cer-

tain aspects of adaptive systems and optimal control theory. This section starts with a review of adaptive systems, which is well done, although much of the material is old hat. Other material in this section includes Pontryagin's maximum principle, the minimum norm problem and some other control-system optimization techniques. Analytical design techniques for an optimal control problem are covered in chapter 9, but the chapter fails to develop the basic principles of optimal control theory.

The final four chapters are concerned with analysis and synthesis of discrete-time systems and some specialized subjects, including stochastic approximation theory. There is a very well-developed discussion of the general question of a mathematical description of the human operator in control systems. The book concludes with a rather sketchy chapter on the application of modern control methods to aerospace vehicle control systems.

Each of the chapters contains an excellent set of references.

Stanley M. Shinner

Sperry Gyroscope Co.
Great Neck, N. Y.

Recently published

Aerospace Ranges: Instrumentation, J.J. Scavullo, S.J. Paul, D. Van Nostrand Co., 457 pp., \$15.75

Active Network Synthesis, K.L. Su, McGraw-Hill Book Co., 369 pp., \$13.50

Information, Computers, and System Design, I.G. Wilson and M.E. Wilson, John Wiley & Sons, Inc., 341 pp., \$12.50

Mathematics for Electronics, A Self-Instructional Programed Manual, Federal Electric Corp., Prentice-Hall, Inc., 598 pp., \$15

Progress in Biocybernetics, Vol. 2, edited by N. Wiener and J.P. Schade, American Elsevier Publishing Co., 273 pp., \$14.50

Basic Electrical Engineering, A. Kasatkin, M. Perekalin, Gordon and Breach Science Publishers, 386 pp., \$9.50

Methods in Computational Physics, Advances in Research and Applications, Vol. 4, 1965, edited by B. Alder, S. Fernbach and M. Rotenberg, Academic Press, Inc., 385 pp., \$14

Elements of Linear Circuits, R.E. Scott, Addison-Wesley Publishing Co., 408 pp., \$9.75

Molecules and Life, R.F. Steiner and H. Edelho, D. Van Nostrand Co., 207 pp. \$1.95

Diode Reference Book, Vol. 1, D.G. Kilpatrick and W. A. Dittrich, M.W. Lads Publishing Co., 261 pp., \$3.95

Nothing
is
tighter
than
MUCON

When it comes to skinny, space scrimping subminiature ceramic capacitors

Try TIGHT FITTING

NARROW-CAPS
SUBMINIATURE
CERAMIC CAPACITORS

.095" WIDE MAX. x .095" THICK MAX.

38 STOCK VALUES

Part No.	Capac. mmf.	Tol.	W.V. D.C.	Max. Body Lgth.
NC-5	5	±15%	50	1/4"
NC-7.5	7.5	±15%	50	1/4"
NC-10	10	±15%	50	1/4"
NC-15	15	±15%	50	1/4"
NC-22	22	±15%	50	1/4"
NC-33	33	±15%	50	1/4"
NC-47	47	±15%	50	1/4"
NC-68	68	±15%	50	1/4"
NC-82	82	±15%	50	1/4"
NC-100	100	±20%	50	1/4"
NC-150	150	±20%	50	1/4"
NC-220	220	±20%	50	1/4"
NC-250	250	±20%	50	1/4"
NC-330	330	±20%	50	1/4"
NC-470	470	±20%	50	1/4"
NC-500	500	±20%	50	1/4"
NC-680	680	±20%	50	1/4"
NC-750	750	±20%	50	1/4"
NC-1000	1000	±20%	50	5/16"
NC-1500	1500	±25%	25	5/16"
NC-1500B	1500	±20%	50	5/16"
NC-2000	2000	±25%	25	5/16"
NC-2000B	2000	±20%	50	5/16"
NC-3000	3000	±30%	25	5/16"
NC-3000B	3000	±20%	50	5/16"
NC-4000	4000	±30%	25	5/16"
NC-4000B	4000	±20%	50	5/16"
NC-5000B	5000	±20%	50	5/16"
NC-6500B	6500	±20%	50	5/16"
NC-7500B	7500	±20%	50	5/16"
NC-01B	10000	±20%	50	5/16"
NC-015B	15000	±20%	25	5/16"
NC-02	20000	±30%	10	5/16"
NC-02B	20000	±20%	25	5/16"
NC-03	30000	±30%	10	5/16"
NC-05	50000	±30%	10	5/16"
NC-075	75000	±30%	10	5/16"
NC-1	100000	±30%	10	5/16"

Republic Electronics makes a broad line of Mucon Subminiature Ceramic Capacitors to meet any requirement.

Write for Catalog "A."

REPUBLIC ELECTRONICS CORP.

176 E. 7th ST., PATERSON, N. J. 07524
201-279-0300

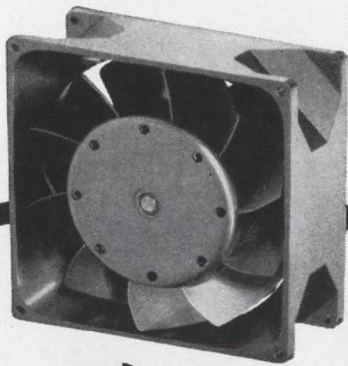

New
4½"

**SHADED-POLE
Model 2500
PAMOTOR
Miniature
Axial Fans**

- 20,000+ operational hours at 45°C
- Low-cost design
- All metal construction
- Unexcelled performance and reliability
- Universal 4½" mounting for interchangeability
- 50-60 cycles at 110 or 220 vac
- In stock for immediate delivery

Write for technical data on the Model 2500 and other PAMOTOR axial fans to:

PAMOTOR, INC.
312 SEVENTH STREET • SAN FRANCISCO, CALIF.

Technical Abstracts

Brushless d-c motors

Modifications of basic drive motors and applications
R. D. Kincer, B. F. DeWitt
Sperry Farragut Co., a division of the Sperry Rand Corp., Bristol, Tenn.

Brushless d-c motors are free from friction drag, wear, and electrical arcing problems because they do not use brushes or commutators that make sliding contact with a moving part. Instead, the motor shaft of the brushless motor is rotated by an electronic switching system that is completely isolated.

As a result, the brushless motor not only has longer life than a brush motor, but it does not generate electrical or acoustical noise. The motor can be switched to obtain a wide range of variable speeds.

The basic drives of brushless motors will operate, with only slight modifications, in a vacuum, or when immersed in a gas or liquid. They can be used to drive fans in outer space, to clock input pulses, to control electronic switching networks, or to transmit rotary motion through sealed enclosures.

The motors achieve power outputs ranging from about 1.35 watts to 358 watts, and speeds from 0.8 to 15,000 revolutions per minute.

One 9-ounce fractional watt drive motor has a torque of 0.5 inch-ounce at 3,000 revolutions per minute, stall torque of 3.7 inch-ounce, and a servo time constant of less than 0.005 seconds. This hermetically sealed unit operates in a vacuum of 1×10^{-9} millimeters of mercury. It can be integrated with a harmonic drive to provide high torques at low speeds. Motor bearings are completely protected against any environment. The basic drive has been used to evaluate bearing torques, or modified to transmit mechanical motion through a sealed wall.

Pulses generated by the motor can be synchronized with input reference pulses. This method of synchronous control has been used in a tape recorder drive.

A 19.5-watt brushless d-c motor will be used to circulate oxygen for life support of astronauts in the Lunar Excursion Module. A

motor with a 358-watt drive will be used to cool instrumentation in Saturn 1B and V. This motor is immersed in liquid, and the rotor cavity of the motor is also filled with the same liquid, to lubricate graphite bearings and cool the motor itself.

Presented at the 1965 Western Electronic Show and Convention, San Francisco, Aug. 24-27.

Computer emulation

Emulation on RCA Spectra 70 systems
William R. Lonergan
Radio Corporation of America
Cherry Hill, N. J.

When a computer user replaces an old outgrown computer with a new one of a different type, he must convert all his old programs in one way or another to run on the new machine. This is an enormous difficulty to overcome, since the old programs may have been developed over a period of many years. A new technique for making this conversion, and making it nearly painless, is to emulate the old computer on the new one.

Emulation is defined as a combined hardware-software approach to simulation, which in turn is defined as a version of the old computer contained in the memory of the new computer. Emulation has the advantage of complete conversion—that is, no changes need be made in an old program to run it on a new machine—with little or no increase in running time. Simulation is contrasted with translation, or an actual instruction-by-instruction replacement of an old program by a new one. Simulation can be complete, but at the cost of a large increase in running time of a program. Translation from one computer language to another is like translation from one natural language to another; computers can be made to do it, but not well and not completely.

Emulation has become practicable with the new generation of computers, such as the RCA Spectra 70 series, that are controlled by microprograms contained in a read-only memory. The read-only memory specifies sequences of machine operations for each micro-instruc-

The only thing small
about this rectifier
is its size!

SLATER
RECTIFIER

COMBINATIONS OF SPECIFICATIONS PREVIOUSLY UNAVAILABLE IN SUBMINIATURE PACKAGES.

SLA-01 to SLA-020

- 1000 to 20,000 V PIV
- 100 to 200 Mils average rectified current
- Extremely low leakage
- Low forward voltage drop

SPECIFICATIONS		
VOLTS	DIA. "	LENGTH "
5,000	.200	.3
10,000	.375	1.0
20,000	.500	2.0

LESS THAN 1/5 VOLUME OF COMPARABLE RECTIFIERS.
LOWEST PRICE PER VOLTAGE
AND AMPERE RATING IN
INDUSTRY.

ALL
OTHERS

ACTUAL SIZE

ALSO AVAILABLE:
1N1730 — 1N1734
1N2382 — 1N2385
1N1730 — 1N1734A
1N2382A — 1N2385A

Send for Catalog and Price List

SLATER ELECTRIC INC., Semiconductor • Glen Cove, N.Y.

Circle 218 on reader service card

NEW--solid state, regulated DC Power Supply

with only .0005V Ripple

... at less than \$100.

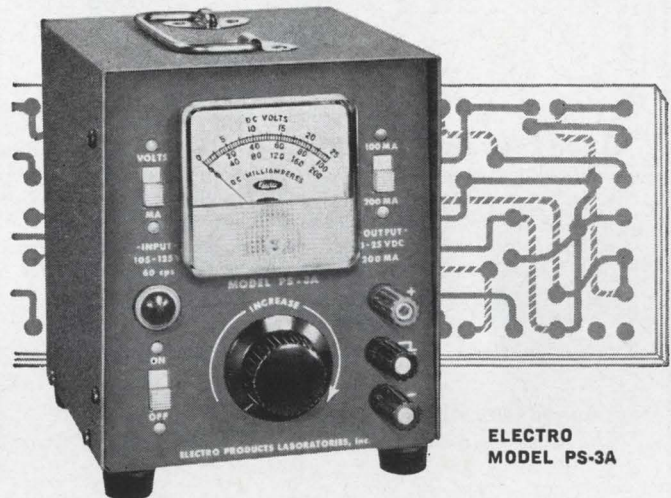

ELECTRO
MODEL PS-3A

0-25 VDC at 0-200 MA, 0.02% regulation

12 to 1 ratio voltage adjustment

(FOUND ONLY ON EXPENSIVE UNITS)

GENERAL SPECIFICATIONS

Voltage output 0-25VDC
Amperage output 0-200MA
Load regulation 0.02%
Line regulation ±0.02%
Maximum ripple 0.5MV
Size overall 6¼ x 5 x 6"
Net weight 3½ lbs.
Price, wired \$99.50

For transistor circuit design, development and experimental use requiring a stable, extremely low ripple, well-regulated voltage source. This new power supply is ideal for design, development, testing, and equipment operation applications in industry and educational institutions.

Again, the PS-3A offers Electro's rare combination of performance, quality, and reasonable price... and a 1-year guarantee!

Write for complete information and name of your Electro distributor.

18 other models from 6 to 500 VDC starting at \$27.50



Since 1936—Pioneers in Low Voltage DC Power Supplies
• Proximity Switches • Magnetic Pickups • Tachometers
• Pres-Con Controls • Dynamic Micrometers

5184

ELECTRO PRODUCTS LABORATORIES, INC.

6125-F HOWARD, CHICAGO, ILL. 60648 • 312/775-5220

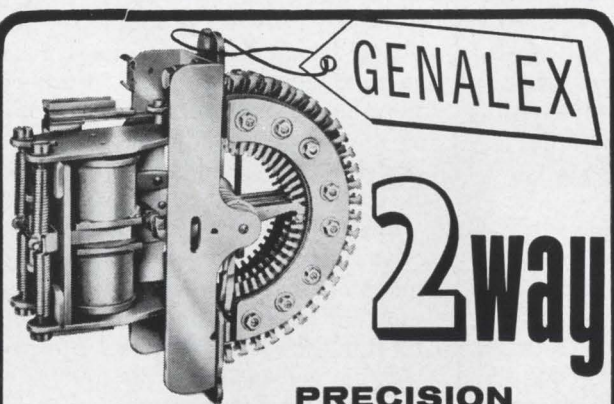

PRECISION STEPPING SWITCH

for circuits which require a switch that steps positively, in either direction, around a bank of 25 contacts. **FEATURING:**

- self-cycle or remote control operation
 - 65 steps per second on self-interruption
 - bridging or non-bridging wipers
 - 20 steps per second from external impulses
- Over 10,000,000 steps in each direction without replacement.

for complete data on this and other unique GENALEX switches, write:



11 UNIVERSITY ROAD, CAMBRIDGE 38, MASS.

U. S. AGENTS FOR THE GENERAL ELECTRIC COMPANY, LTD. OF ENGLAND

Circle 219 on reader service card

Circle 183 on reader service card

183

**PLAYING
THE GAME
WITH A
SEVERE
HANDICAP?**

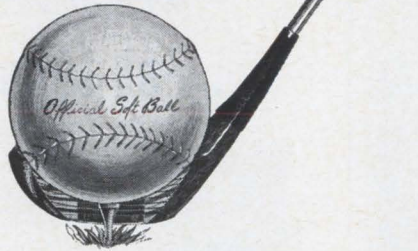

Then Let's Talk Quality. Reliance in a critical product is often confidence in its manufacturer. We've got the name because we're quality happy. Our superb new plant facilities are built around quality control, and nothing is too good to suit us . . . or you. We're efficient, too!! That's why you'll pay the lowest prices for our semi-conductors in the industry . . . 6,000 different types, immediately available to you throughout our nationwide distribution network . . . More than any other three manufacturers combined. And each unit is quality coded . . . because it bears our name.

Lowest Cost...Highest Quality...Immediate Availability

Your Western Distributor . . .

The One Source for All Your Customers' Semi-Conductor Needs!!

WESTERN TRANSISTOR CORPORATION

DEPT. D-2 • 11581 FEDERAL DR. • EL MONTE, CALIF. 91731 • PHONE: 442-5507



Circle 220 on reader service card

we are your best bet
for electronic materials

**"What did you say?"
"WE SAID, WE ARE
YOUR BEST BET
FOR ELECTRONIC
MATERIALS!"**

We are a primary fabricator and supplier of high purity metals and alloys, compound semiconductors and thermoelectric cooling materials.

PHONE AREA CODE 509 747-6111
TWX 509-328-1464 Telex 032 610

IMMEDIATE SHIPMENT BY AIR PRE-PAID

COMINCO PRODUCTS, INC.

electronic materials division

818 West Riverside Ave.,
Spokane, Washington 99201

5603

Reprint order form

Send to: **Electronics Reprint Dept.**
330 West 42nd Street
New York, N. Y. 10036

For listing of reprints available see the reader service card.

To help expedite mailing of your reprints please send cash, check or money order with your order.

For reprints of the latest special report:

The Overlay Transistor

Send me . . . reprints of key no R-78 at 75¢ each.

For reprints of previous special reports fill in below:

Send me . . . reprints of key no.(s) . . . at . . . ¢ each.

For prices see the reader service card.

Name

Number & Street

City, State

Zip code

Technical Abstracts

tion in the stored program. New data may be stored in a read-only memory only by physically taking it apart and putting it together again in a different way; this is contrasted with the conventional read-write memory in which new data may be stored in microseconds under control of the program, an input-output device, or the machine operator. A different read-only memory must be used for each old machine that is to be emulated on the new machine; these are all different from the read-only memory that the new machine uses to run with its own instructions. In the Spectra 70/45 three read-only memories can be installed at once with a program-controlled switch to select the memory for normal Spectra-70 operation, or for emulation of either the RCA 501 or the RCA 301.

Several considerations affect the design of an emulator. These include the following; How many optional or special features of the old machine will be emulated? Will old input-output equipment be used on the new machine? Will the ability to run old programs be restricted in any way—with respect to time dependency, for instance? How much emulation will be done in hardware (read-only memory) and how much in software (error recovery procedures, for instance)?

It is, of course, to the user's great advantage to reprogram for the new machine in the new machine language. Emulation makes it possible to run the new computer at reasonable speed with the old language and takes away the pressure of having to reprogram everything right away.

Presented at the 1965 Western Electronic Show and Convention, San Francisco, Aug. 24-27.

Smaller power converters

Miniaturized power conversion techniques

Don E. Wuerflein
Gulton Industries, Inc., Engineered
Magnetics Division
Hawthorne, Calif.

The problems and projected solutions in designing extremely small power converters are discussed.

Since the transformer and filter at low frequencies take up to 70% to 90% of the volume in a d-c to d-c inverter, its size can be reduced by operating the inverter at high frequencies—up to 100 kilocycles.

One of the problems in increasing the inverter frequency, is that the transistor storage time becomes significant. When the transformer is saturated, the transistor continues conducting for a time after the base drive is removed, because of the charge stored in the transistor. This causes higher transistor dissipation and increases transformer losses. An inverter whose transformer doesn't saturate avoids this problem. Several inverter circuits are shown that reduce the effects of the transistor storage time and eliminate the voltage spikes—that occur during the transformer switching time—which could damage the transistor.

At high frequencies, the transformer losses could be reduced by using High-mu 80 or Supermalloy cores consisting of ¼ or ½-mil tape. But these thin tapes must be stacked efficiently. Although ferrite cores have a low maximum flux density, they should be considered for inverter transformers because of their low losses at high frequencies.

Skin effect losses, which occur above 10 kc, can be reduced by winding several wires in parallel to make up the total cross sectional area required for the transformer windings. In designing transformers for high frequencies, leakage inductance and interwinding capacitance must also be considered.

Filter capacitors should be thoroughly investigated and evaluated for each specific high frequency application. Solid tantalum capacitors were found most suitable, but should be derated to at least 60% of their maximum voltage rating.

For miniaturization and improved efficiency, the ideal method of regulating the output of a power converter is to combine the power conversion with regulation. This is done by varying the phase angle (depending on the required regulation) between the pulses provided by two inverters and summing their outputs. For fast response a series switch regulator, should be used.

Presented at Wescon/65, San Francisco, Aug. 24-27.

**precision
time base
generation
stability to
 $\pm 2 \times 10^{-9}$
per 24 hours**

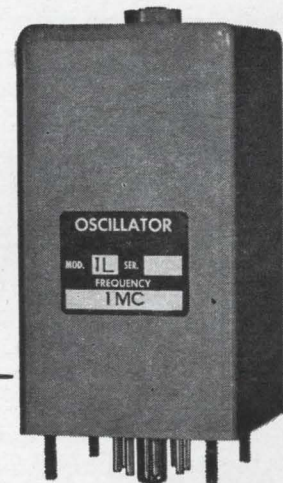

**SULZER
Model 1L**

Output: 1 mc/s
Stability: $\pm 2 \times 10^{-9}$ per 24 hours
MTBF: in excess of 15,000 hours
Low Drain: 50 ma at 27 vdc at 25°C
Weight: 10 ounces
Size: 2 ½" x 2 ¼" x 4 ¼"

This new SULZER packaged crystal oscillator is a rugged, compact, lightweight frequency source with low power drain designed for use in precision time base generators, counters, synthesizers, and phase-locked VLF receivers.

Other plug-in SULZER crystal oscillators in the same package have the aging rates of $\pm 1 \times 10^{-8}$ (Model 1J) and $\pm 5 \times 10^{-9}$ (Model 1K).

Telephone 512-476-6601 or write TRACOR, Inc., 1701 Guadalupe Street, Austin, Texas 78701, for complete specifications.



**SULZER
Precision Oscillators**

REPRESENTATIVES IN PRINCIPAL CITIES

QUALIFICATION FORM FOR POSITIONS AVAILABLE

ATTENTION: ENGINEERS, SCIENTISTS, PHYSICISTS

This Qualification Form is designed to help you advance in the electronics industry. It is unique and compact. Designed with the assistance of professional personnel management, it isolates specific experience in electronics and deals only in essential background information.

The advertisers listed here are seeking professional experience. Fill in the Qualification Form below.

STRICTLY CONFIDENTIAL

Your Qualification form will be handled as "Strictly Confidential" by Electronics. Our processing system is such that your form will be forwarded within 24 hours to the proper executives in the companies you select. You will be contacted at your home by the interested companies.

WHAT TO DO

1. Review the positions in the advertisements.
2. Select those for which you qualify.
3. Notice the key numbers.
4. Circle the corresponding key number below the Qualification Form.
5. Fill out the form completely. Please print clearly.
6. Mail to: Classified Advertising Div., Electronics, Box 12, New York, N. Y. 10036.

COMPANY	PAGE	KEY #
ATOMIC PERSONNEL INC. Phila. 2, Pa.	190	1
ELECTRONIC COMMUNICATIONS INC. St. Petersburg, Fla.	189	2
GENERAL DYNAMICS Electric Boat Div. Groton, Conn.	189	3
GENERAL DYNAMICS Electronics Div. Rochester, NY 14601	172*	4
GENERAL DYNAMICS/FORT WORTH Fort Worth, Texas	161*	5
GENERAL ELECTRIC CO. Adv. & Sales Promotion Dept. Schenectady, NY	188	6
IBM CORP. Space Guidance Center Owego, New York 13827	173*	7
LOCKHEED MISSILES & SPACE CO. Sunnydale, Calif.	173	8
MCDONNELL St. Louis, Mo. 63166	187	9
MITRE CORP. Bedford, Mass.	171*	10
NATIONAL CASH REGISTER CO. Electronics Div. Hawthorne, Calif.	158-159	11
PIFIZER & CO. INC., CHARLES New York, NY 10017	174*	12
RCA Camden, N. J.	190	13
TRW SYSTEMS Redondo Beach, Calif.	119*	14
TELONIC ENGINEERING CO. Laguna Beach, Calif.	169*	15
UNION CARBIDE CORP. Nuclear Division Oak Ridge, Tenn. 37831	174*	16
PV 7433	190	17

* These advertisements appeared in the Sept. 6 issue.

(cut here)

Electronics WEEKLY QUALIFICATION FORM FOR POSITIONS AVAILABLE

(cut here)

(Please type or print clearly. Necessary for reproduction.)

Personal Background

NAME
HOME ADDRESS
CITY ZONE STATE
HOME TELEPHONE

Education

PROFESSIONAL DEGREE(S)
MAJOR(S)
UNIVERSITY
DATE(S)

FIELDS OF EXPERIENCE (Please Check)

9/20/65

- | | | |
|--|--|---------------------------------------|
| <input type="checkbox"/> Aerospace | <input type="checkbox"/> Fire Control | <input type="checkbox"/> Radar |
| <input type="checkbox"/> Antennas | <input type="checkbox"/> Human Factors | <input type="checkbox"/> Radio-TV |
| <input type="checkbox"/> ASW | <input type="checkbox"/> Infrared | <input type="checkbox"/> Simulators |
| <input type="checkbox"/> Circuits | <input type="checkbox"/> Instrumentation | <input type="checkbox"/> Solid State |
| <input type="checkbox"/> Communications | <input type="checkbox"/> Medicine | <input type="checkbox"/> Telemetry |
| <input type="checkbox"/> Components | <input type="checkbox"/> Microwave | <input type="checkbox"/> Transformers |
| <input type="checkbox"/> Computers | <input type="checkbox"/> Navigation | <input type="checkbox"/> Other |
| <input type="checkbox"/> ECM | <input type="checkbox"/> Operations Research | <input type="checkbox"/> |
| <input type="checkbox"/> Electron Tubes | <input type="checkbox"/> Optics | <input type="checkbox"/> |
| <input type="checkbox"/> Engineering Writing | <input type="checkbox"/> Packaging | <input type="checkbox"/> |

CATEGORY OF SPECIALIZATION

Please indicate number of months experience on proper lines.

	Technical Experience (Months)	Supervisory Experience (Months)
RESEARCH (pure, fundamental, basic)
RESEARCH (Applied)
SYSTEMS (New Concepts)
DEVELOPMENT (Model)
DESIGN (Product)
MANUFACTURING (Product)
FIELD (Service)
SALES (Proposals & Products)

CIRCLE KEY NUMBERS OF ABOVE COMPANIES' POSITIONS THAT INTEREST YOU

1 2 3 4 5 6 7 8 9 10 11 12 13 14 15 16 17 18 19 20

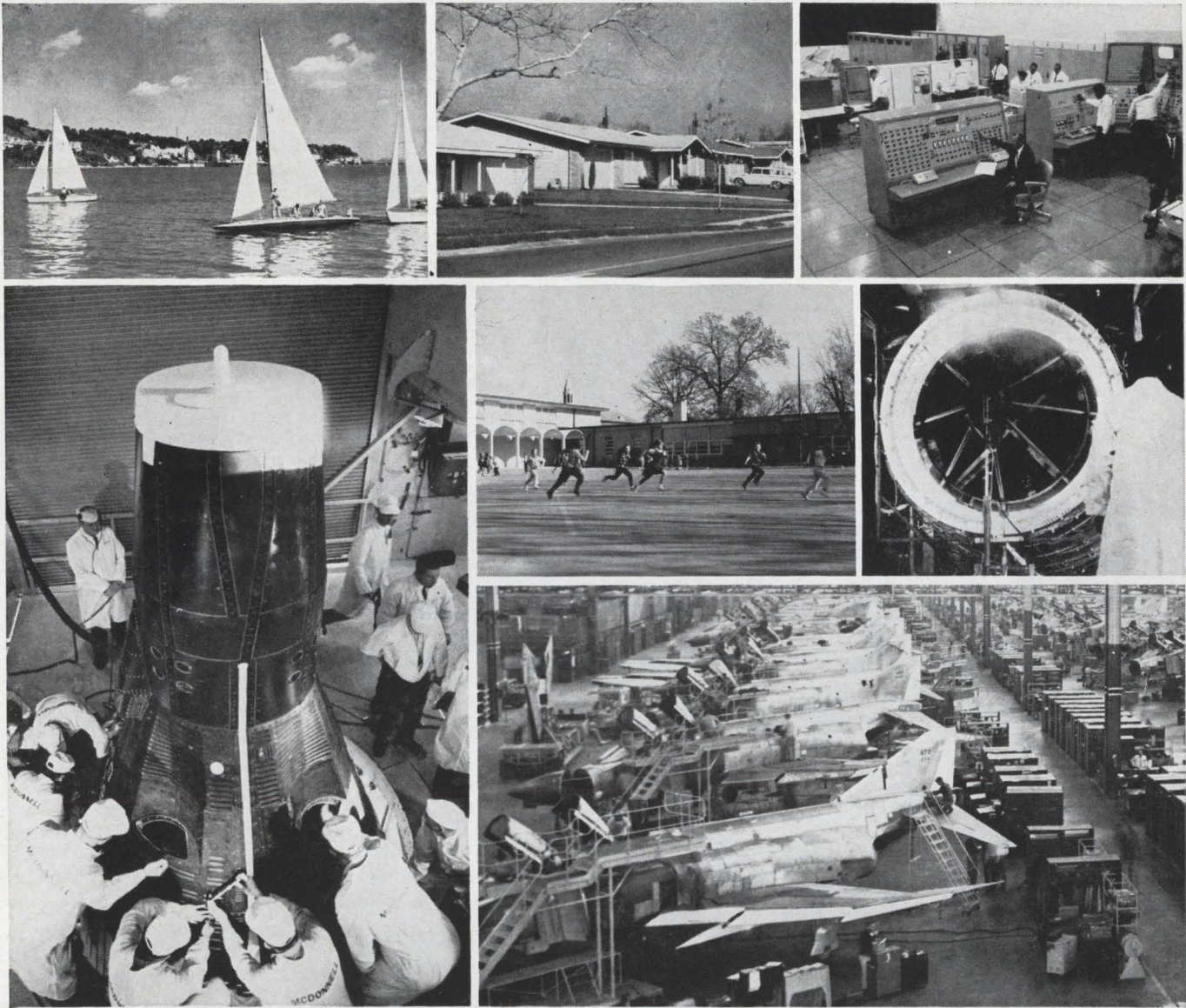

MEET "MAC" If you think growing room is at a premium, look to McDonnell where there's no ceiling on professional growth. McDonnell's many more active programs in-house—in *spacecraft, aircraft, missiles, electronics, precise time reference systems, and automation* have kicked the lid off. ■ The McDonnell Team enjoys group insurance (McDonnell pays 90%); retirement income (McDonnell pays 2/3); patent compensation; 8 paid holidays; educational assistance (up to full sponsorship and reduced work weeks); professional recognition; beautiful communities and natural vacationlands. ■ To arrange an interview appointment in your area of interest, please send your résumé with the completed coupon. *We will answer every inquiry.*

MCDONNELL

A Plans for Progress Company and
An Equal Opportunity Employer

Long-term positions are immediately available for the following specializations:

- Aircraft Structural Design Engineers
- Electronic Systems Engineers
- Structural Test Engineers
- Propulsion, Aerodynamics Engineers
- Operations Analysis Engineers
- Guidance & Control Mechanics Engineers
- Thermodynamics Engineers
- Industrial Engineers
- Stress Analysts
- Loads, Weights Engineers
- Plant Design Engineers
- Facilities Engineers
- Specifications Engineers
- Engineering Psychologists
- Flight Test Engineers
- Aerospace Ground Equipment Designers
- Chemical Engineers
- Systems Analysts
- Scientific Programmers
- Electronic Equipment Engineers

MCDONNELL, P.O. Box 516, St. Louis, Missouri 63166
Att: W. R. Wardle, Engineering Employment Office, Dept. V-920

Name _____

Home Address _____

City & State _____

Phone _____

Present Position _____

Degree _____



Engineering career opportunities

Tie your career to the world's most advanced radar/sonar systems... at G.E.!

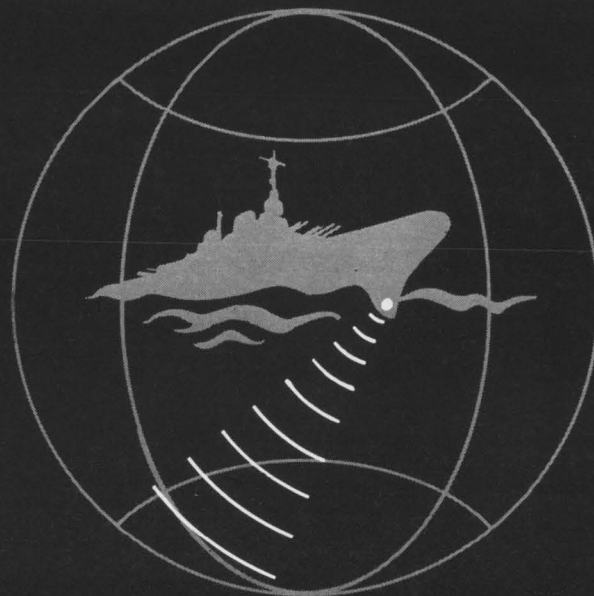
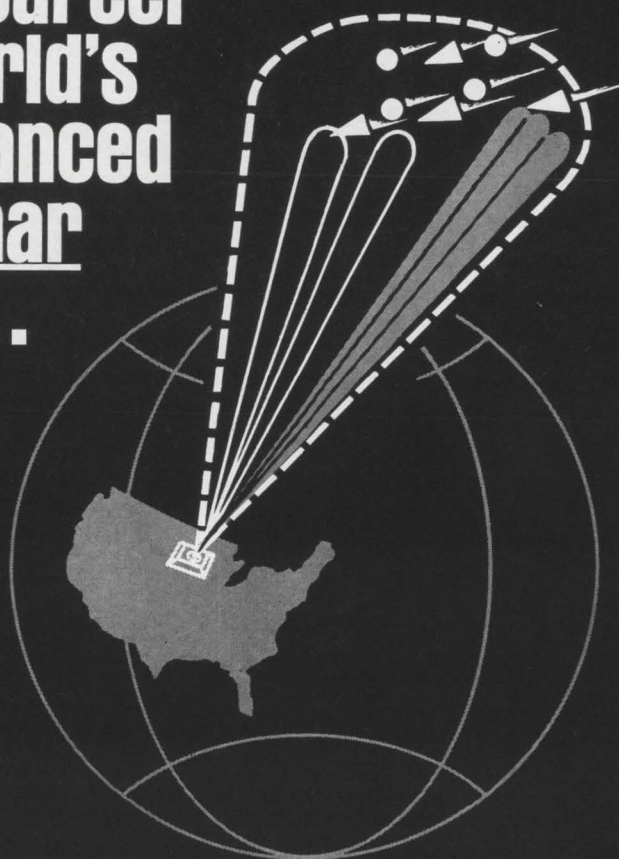

Investigate your career now in missile-defense radar; advanced sonar engineering at General Electric.

G.E.'s Heavy Military Electronics Dept.—whose capabilities include the design, development and fabrication of the world's largest and most advanced ASW and radar systems—announces long-term career openings for continuing contributions to large military contracts.

HMED offers you stability based on its broad capability for handling large programs and the experience that goes with front-rank performance on this decade's most advanced projects. Your growth is tied to that of a lean, highly professional engineering group backed by top-flight facilities—both within HMED and throughout General Electric.

At G.E., you'll be treated as a professional who's expected to handle well-defined, delegated responsibility. In most instances you'll deal directly with your customer's organization.

You will be given every opportunity to develop yourself professionally through continuing Company-taught courses and advanced tuition-paid study at nearby Syracuse University. And, in the course of your work, you'll have access to information developed by other G.E. facilities throughout the country.

WHY NOT MATCH YOUR EXPERIENCE AND CAREER DESIRES AGAINST THESE REQUIREMENTS?

SONAR: Advanced Sonar Engineers; Array Beamformer and Signal Processing Development Engineers; Digital Logic Engineers; Sonar Solid-state Circuit Design; Transducer Development; Solid-state Transmitter Development; Pattern Recognition Analysis; Adaptive Filtering Research; Display Development; Propagation Analysis; Sonar Subsystem Development.

RADAR: Monitor and Control Analysis Engineers; Digital Control Eqpt. Engineers; Microwave Component Design Engineers; Consultant, Circuit Design and Development; Instrumentation Circuit Engineers; ME's for Signal Processing Modules; Consultant, Array Radar Subsystem Requirements.

INVESTIGATE NOW! For full information, send a resume of your experience in confidence to J. L. Wool, Professional Placement, Heavy Military Electronics Dept., Section 108 General Electric Co., Court St., Syracuse, New York.

177-65

An Equal Opportunity Employer

GENERAL ELECTRIC

SEEKING A LEADERSHIP POSITION ?

If so, one of these demanding descriptions may fit you

■ **SECTION MANAGER, TRANSMITTERS.** To direct aggressive development programs for UHF, high power and state-of-the-art miniaturized RF transmitters. He should have ten years of experience in the design and engineering supervision of military communications equipment: it should have given him personal drive, demonstrated leadership ability, unusual technical understanding and keen administrative insight.

■ **SENIOR STAFF ENGINEERS, RECEIVERS.** Leadership capability sufficient for immediate assumption of key roles in vigorous development programs for solid-state microminiature receivers. Positions require six to eight years of experience and in-depth knowledge of receiver design fundamentals.

■ **PROJECT ENGINEERS, SPACE INSTRUMENTATION.** Technical ability of the very highest order is required. Six to eight years of experience, preferably data handling, control, or analog instrumentation.

■ **MICROELECTRONICS SPECIALISTS.** Senior- and intermediate-level responsibilities in a rapidly expanding microminiaturization and thin-film program. Sound technical knowledge and demonstrated supervisory skill required.

If you qualify, there's a leadership position open for you at Electronic Communications, Inc. You can increase your professional rewards and personal satisfaction by contacting ECI today.

ECI has built a solid, successful reputation in airborne communications, multiplexing and space instrumentation. The Company offers pleasant living conditions and unusual educational and cultural opportunities in St. Petersburg, Florida. And it offers you a chance to participate in further growth through technological contribution. Call collect Duane Meyer (813) 347-1121, or send him your resume at ECI, Box 12248B, St. Petersburg, Florida 33733. (An equal opportunity employer.)



ELECTRONIC COMMUNICATIONS, INC.
St. Petersburg, Florida

ELECTRICAL & ELECTRONIC ENGINEERS

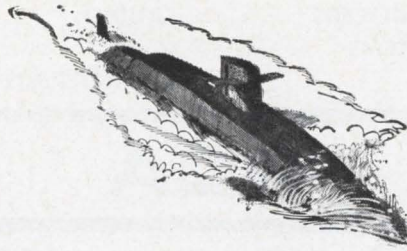

A small electric motor started it all.

When William Woodnut Grissom patented his electric motor way back in 1880, the theory of electronics was many years away from discovery, and the submarine was yet an inventor's frustrated dream. Today electric motors are still in use, and electronics applications abound, on America's nuclear powered submarines, the first man-made miniature worlds deployed in inner space.

At Electric Boat, where the U.S. Navy's first submarine was built in 1900, and the free world's first atomic submarine designed and launched in 1955, Electrical and Electronic Engineers are still facing new challenges. Not only on submarines, which carry all of the electrical equipment necessary to generate light, heat and power 24 hours every day for months, and the electronic equipment associated with communications, navigation, fire control, ECM and ASW—but on the Company's recently broadened product line of surface ships.

Electrical and Electronic Engineers interested in variety—and an opportunity to work ahead of most fields—are invited to consider a position in one of the following areas:

Power Distribution & Control Systems
Electrical Propulsion Systems
Nuclear Power Plant Electrical Instrumentation & Control Systems
Process Control Instrumentation
Digital Control Systems
Communications & Signal Data Processing
Test Instrumentation
Sound & Vibration

Resumes should be addressed to Mr. Peter Carpenter.

GENERAL DYNAMICS *Electric Boat Division*

128 Eastern Point Road, Groton, Connecticut
An Equal Opportunity Employer

ENGINEERS

SOLID STATE DESIGN
SONAR
COMPUTER SYSTEMS
RADAR RECEIVERS
OFFENSIVE SYSTEMS
CCTV

RELIABILITY
SPACE TRACKING
RFI
AUDIO
ASW
MECHANICAL
ENGINEERING WRITING

RCA

CHALLENGE DIVERSITY OPPORTUNITY
VARIED LOCATIONS U.S. & OVERSEAS
MEDICAL COVERAGE TUTION REFUND
MERIT REVIEWS RETIREMENT PLAN
BONUS AND PER DIEM ASSIGNMENTS
EXCELLENT SALARIES AND GROWTH

RESUME TO:

J. H. BARNES, JR., MGR. RECRUITING, RCA SERVICE CO.
DEPT. Y-198, CHERRY HILL, CAMDEN 8, N. J.



The Most Trusted Name in Electronics

An Equal Opportunity Employer

MANAGER OF ELECTRONIC MANUFACTURING

Will direct electronic assembly production division of Major Southern California Aerospace Company. Requires extensive experience at top management level in the manufacturing of complex solid state electronic systems under competitive production criteria.

You are invited to send resume with statement of salary requirements. All replies completely confidential.

PV-7433, Electronics 255 California St.
San Francisco, Calif., 94111

an equal opportunity employer

PROFESSIONAL SERVICES

GIBBS & HILL, Inc.
Consulting Engineers

Systems Engineering
Operations Research • Development
Field Studies • Design • Procurement
Power • Transportation • Communications
Water Supply • Waste Treatment
393 Seventh Avenue New York 1, N. Y.

E. E.'s
for FEE-PAID Positions
WRITE US FIRST!
Use our confidential application for professional, individualized service . . . a complete national technical employment agency.
ATOMIC PERSONNEL, INC.
Suite 1207L, 1518 Walnut St., Phila. 2, Pa.

EMPLOYMENT OPPORTUNITIES

The advertisements in this section include all employment opportunities—executive, management, technical, selling, office, skilled, manual, etc.

Look in the forward section of the magazine for additional Employment Opportunities advertising.

— RATES —

DISPLAYED: The advertising rate is \$52.00 per inch for all advertising appearing on other than a contract basis. Contract rates quoted on request.

An advertising inch is measured 7/8" vertically on a column—3 columns—30 inches to a page.

Subject to Agency Commission.

UNDISPLAYED: \$2.70 per line, minimum 3 lines. To figure advance payment count 5 average words as a line. Box numbers—count as 1 line.

Discount of 10% if full payment is made in advance for 4 consecutive insertions.

Not subject to Agency Commission.

Send new ads to:

ELECTRONICS

Class. Adv. Div., P.O. Box 12, N.Y., N.Y. 10036

CLASSIFIED ADVERTISING

SEARCHLIGHT SECTION

BUSINESS OPPORTUNITIES
USED OR SURPLUS EQUIPMENT

BIG CATALOG

World's "BEST BUYS"
in GOV'T. SURPLUS
Electronic Equipment

FULL OF TOP QUALITY ITEMS—
Transmitters, Receivers, Power Supplies,
Inverters, Microphones, Filters, Meters,
Cable, Keyers, Phones, Antennas, Chokes,
Dynamotors, Blowers, Switches, Test Equip-
ment, Headsets, Amplifiers, etc., etc. SEND
25¢ (stamps or coin) for CATALOG and
receive 50¢ CREDIT on your order. Address
Dept. E-5

FAIR RADIO SALES
P. O. Box 1105 • LIMA, OHIO • 45802

SPOT WELDING TWEEZERS



TWI - 36" Lead \$11.65
AC and Stored Energy Power Supplies
and Welding Heads

EWALD INSTRUMENTS
KENT, CONN. 06757

CIRCLE 951 ON READER SERVICE CARD

RADAR AUTO-TRACK & TELEMETRY ANTENNA PEDESTALS
3 & 10 CM. SCR 584 AUTOTRACK RADARS. M33 RADAR
TPS-1D SEARCH. APS-45 TPS-10D HT. FINDERS. WX RADARS.
FPN-32GCA. APS-10 APS-15B APS-27 (AMTI) SEARCH. ■ ■
APN-102 DOPPLER. DOZENS MORE. CARCINOTRONS. PFM'S.
.25-5-1-2-3-6 MEGAWATT PULSE MODULATORS. CAVITIES.
PULSE TRANSFORMERS. IF STRIPS. WAVEGUIDE. BENDS
200 MC. 1 KMC. 3 KMC. 6 KMC. 9 KMC. 24 KMC. RF PKGS.
RADIO RESEARCH INSTRUMENT CO.
550 5TH AVE., NEW YORK 36, N. Y. JU 6-4691

CIRCLE 952 ON READER SERVICE CARD

SEMICONDUCTORS MAJOR BRANDS

INTERGRATED CIRCUITS • DIF. AMPS DAR-
LINGTONS • POWER DIODES & TRANSISTORS
• SPECIAL DEVICES

Write for Catalog S-1

SEMICONDUCTOR SALES OF CALIF.
1063 Perry Annex Whittier, Calif.
(213) 696-7544

CIRCLE 953 ON READER SERVICE CARD

free catalog
POTTING APPLICATORS
MANUAL AND DISPOSABLE
6cc 12cc 30cc
FOR POTTING, ENCAPSULATING, AND
SEALING OF MINIATURE COMPONENTS
PHILIP FISMAN COMPANY
7 CAMERON ST., WELLESLEY 81, MASSACHUSETTS

CIRCLE 954 ON READER SERVICE CARD



U.S. ARMY EE-8

Telephone fully reconditioned at
2 for \$19.95. Any number can
be used on same line. Wire 2c
per ft. or \$65.00 per mile. Write
for complete telephone list.

TELEPHONE ENGINEERING CO.
Dept. E-9205
Simpson, Pa.

CIRCLE 955 ON READER SERVICE CARD

WRITE FOR NEW **KEYSTONE**
free catalog

We are the leading producers of BATTERY HOLDERS, TER-
MINALS, TERMINAL BOARDS & ELECTRONIC HARDWARE.
KEYSTONE ELECTRONICS CORP. 49 BLEECKER ST. NEW YORK 12, N. Y.

CIRCLE 956 ON READER SERVICE CARD

Electronics | September 20, 1965

New Literature

Bar-graph oscilloscope. ITT Industrial Products division, 15191 Bledsoe St., San Fernando, Calif., offers a data sheet describing the technical characteristics of its 10- to 100-channel bar-graph oscilloscope.

Circle 461 on read service card.

Random access memory. Potter Instrument Co., Inc., 151 Sunnyside Blvd., Plainview, N.Y., 11803. Product data bulletin 1-103 describes model TLM-4550 dual-cartridge random access memory system. [462]

Ceramic magnets. D.M. Steward Mfg. Co., Chattanooga, Tenn., has prepared an eight-page brochure on ceramic magnets that covers several grades of both isotropic (nonoriented) and anisotropic (oriented) types. [463]

Rotary, slide and lever switches. Centralab Division of Globe-Union, Inc., P.O. Box 591, Milwaukee, Wis., 53201. A new rotary, slide and lever switch catalog contains 44 pages of emergency ideas. [464]

H-v power sources. Electronic Research Associates, Inc., 67 Sand Park Road, Cedar Grove, N.J. A technical bulletin, designated 54-265-4, describes the company's silicon/hybrid high-voltage power sources. [465]

Quartz crystal products. Microsonics, Inc., 60 Winter St., Weymouth, Mass. A four-page brochure outlines the company's capabilities to the buyer and user of ultrahigh-stable crystals, crystal filters, crystal oscillators, and other crystal-controlled products. [466]

Pcm signal simulator. Telemetrics, Inc., 2830 S. Fairview St., Santa Ana, Calif. Data sheet 14B gives complete description and specification information on model 510 pcm signal simulator. [467]

Precision audio equipment. Hi-Q Division, Aerovox Corp., 1100 Chestnut St., Burbank, Calif. Catalog 32-EF covers a line of variable equalizers, line equalizers, diameter equalizers, dip filters, transmission measuring sets, and power supplies. [468]

Mixer-amplifier. International Electronic Research Corp., 135 W. Magnolia Blvd., Burbank, Calif., 91502. A low-distortion mixer-amplifier, model 753, is described in a technical bulletin. [469]

Miniature trimmer potentiometer. Min-elco, 600 South St., Holbrook, Mass. A bulletin describes the model MS37 miniature trimmer potentiometer, a wire-wound device available in standard resistance ranges from 20 to 25,000 ohms. [470]

Silicon rectifiers. Semicon, Inc., Sweetwater Ave., P.O. Box 328, Bedford, Mass., has issued a 16-page booklet on

silicon rectifiers for industrial, military and commercial applications. [471]

Inductance bridge. Boonton Electronics Corp., Route 287, Parsippany, N.J. A technical bulletin describes the model 63H, a precision 5- to 500-kc bridge for measuring low values of inductance. [472]

Rtv encapsulants. Dow Corning Corp., Midland, Mich. An eight-page selection guide contains properties of six room-temperature-vulcanizing silicone rubber encapsulants designed for electronic packaging. [473]

Digital averaging technique. Nuclear Data, Inc., P.O. Box 451, Palatine, Ill. An electronic averaging technique that extracts weak signals from backgrounds of nonfilterable, random electrical noise is described in a 16-page booklet. [474]

Hermetic connectors. The Deutsch Co., Electronic Components division, Municipal Airport, Banning, Calif. Capsule catalog STH-64 gives the specifications of the new high-density STK hermetic connector series with Tri-Kam, bayonet-lock coupling design. [475]

Video camera magnetic shields. Magnetic Shield division, Perfection Mica Co., 1322 N. Elston Ave., Chicago, Ill., 60622. Data sheet 180 covers new Netic Co-Netic magnetic shields for closed-circuit video cameras used in high-density magnetic environments and high ambient temperatures for remote observation of industrial processing equipment. [476]

Cleaner and rosin flux remover. Alpha Metals, Inc., 56 Water St., Jersey City, N.J., 07304. Technical bulletin 18B describes Alpha No. 563 cleaner and rosin flux remover—a special blend of distillable organic solvents used as a quick, efficient removal agent for grease, oil, flux residues and other contaminants. [477]

Piezoelectric technology. Clevite Corp., Piezoelectric division, 232 Forbes Road, Bedford, Ohio. A comprehensive 45-page piezoelectric data book has been developed for designers of electronic devices, circuits and systems. [478]

Modular power supplies. Trygon Electronics, Inc., 111 Pleasant Ave., Roosevelt, N.Y., 11575. An eight-page brochure describes the company's expanded line of all-silicon modular power supplies, intended for use in critical system installations where reliability and size are of prime importance. [479]

Vacuum relays. High Vacuum Electronics, Inc., 538 Mission St., South Pasadena, Calif., offers a vacuum relay selector chart that measures 17 in. by 22 in. and is suitable for wall mounting. [480]

INSULTITE

heat-shrinkable tubing

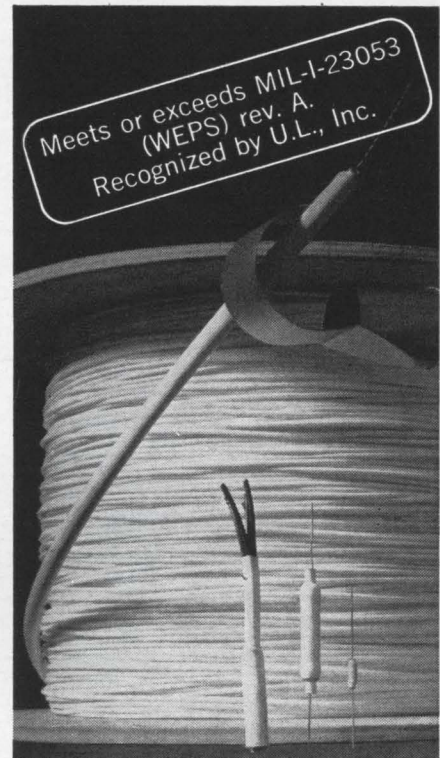

first of the INSULRAD family of irradiated polyolefins from E.C.C.

Now there's an important new source of heat-shrinkable tubing—INSULTITE from Electronized Chemicals Corporation.

INSULTITE meets competitive heat-shrinkable tubing requirements spec for spec—*outperforms* other shrinkables in volume resistivity, longitudinal change, water absorption, and resistance to solvents.

INSULTITE is the answer wherever skin-tight packaging or encapsulating covers are needed. Apply heat: INSULTITE molds itself around smooth or irregular shapes to form a tight protective jacket.

INSULTITE is available in standard colors and sizes and is supplied in four-foot or specified lengths.... all competitively priced and available now. For more information on this new product, write, wire or call Electronized Chemicals Corporation, Burlington, Massachusetts. Telephone 617-272-2850.*



**ELECTRONIZED
CHEMICALS
CORPORATION**

a subsidiary of

HIGH VOLTAGE ENGINEERING

5 SIMULTANEOUS DISPLAYS

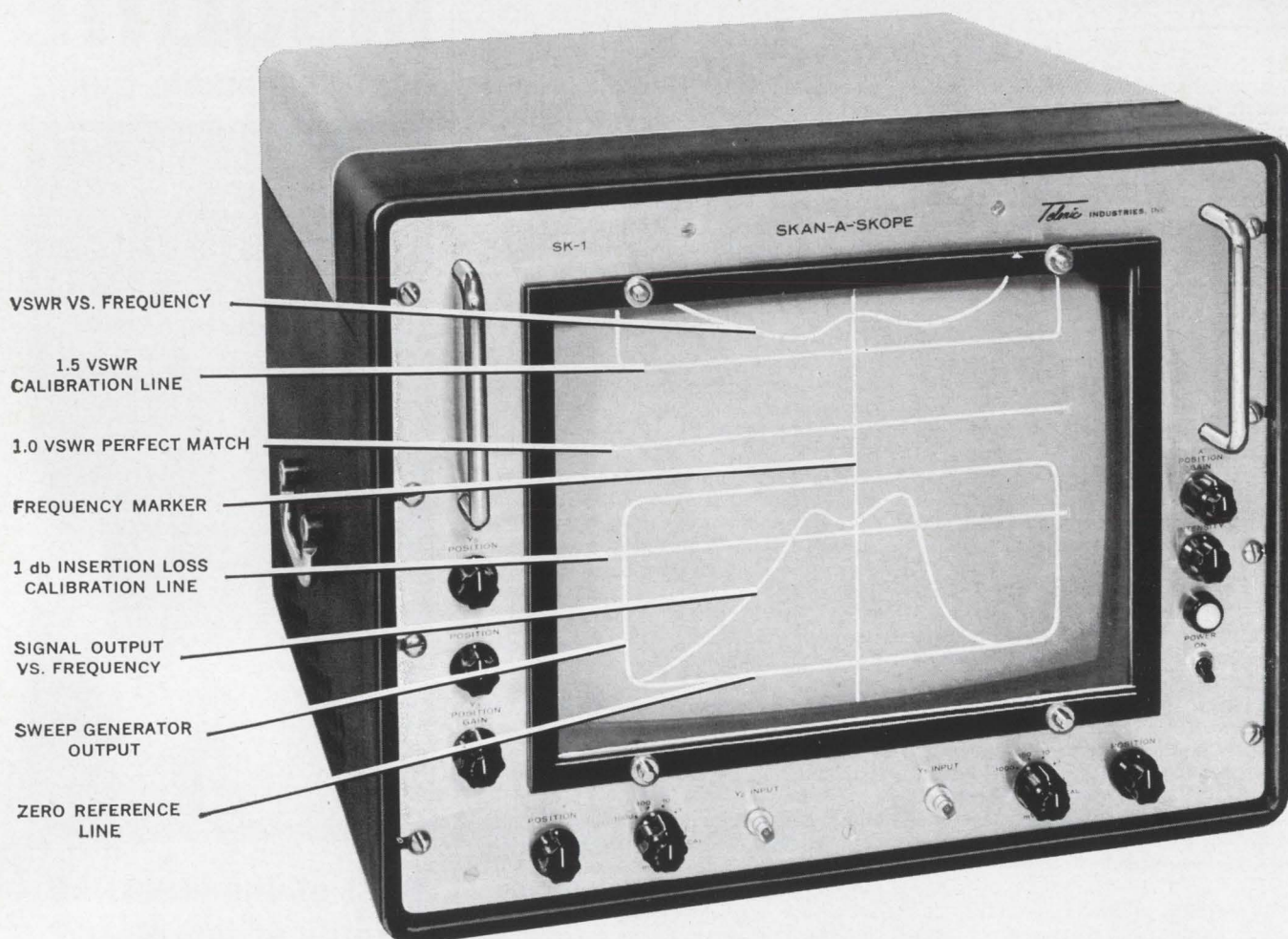

**3 TRACES plus 2 REFERENCE LINES or
2 TRACES plus 3 REFERENCE LINES or
1 TRACE plus 4 REFERENCE LINES**

SKAN-A-SKOPE

Telonic now provides a whole new concept of swept frequency response measurement with this versatile new display oscilloscope. The SKAN-A-SKOPE is capable of displaying five traces on a single-gun 17 inch CRT in a unit containing its own power supply. Traces may be shown in separate positions along the Y axis or may be superimposed. Birdy or pulse-type markers, which appear as vertical lines (electronic graticules), may also be displayed.

SKAN-A-SKOPE flexibility permits almost unlimited applications. Two standard wave forms can be displayed to provide

upper and lower limits for a wave form generated by the test unit. This unique display unit may be used to monitor three inputs simultaneously from remote locations. The SKAN-A-SKOPE unit can check gain in an amplifier at three places in the circuit, and can show bandpass, VSWR, and insertion loss wave forms of filters at the same time. This amazing new display unit also has many applications in VHF/UHF tuner testing procedures.

SKAN-A-SKOPE accepts three Y inputs, one X input and one marker input.

SPECIFICATIONS

Number of Vertical (Y) inputs	3
Deflection Factor (Y ₁ & Y ₂) Inputs	1 mv/cm, 10 mv/cm, 100 v/cm, 1 v/cm Switch selected 10:1 cont. adj.
Bandwidth	DC to 10 kc (3 db point)
Deflection Factor Y ₃	25 mv/cm
Bandwidth	DC to 10 kc
Reference Line Y ₄ & Y ₅	May be positioned at any vertical position to identify signal levels.
X Input	Medium gain DC coupled
Deflection factor	100 mv peak-to-peak/cm
Marker Input	Used with pulse or birdy type markers
Input Signal	50 mv @ 10 kΩ
Display	
CRT	17" Rect.
Screen Material	P-7 Double Layer
Usable Screen Area	8.64" x 12.58"
Price	\$1495.00



60 North First Avenue, BEECH GROVE, INDIANA

DOMESTIC SALES OFFICES: Baltimore, Boston, Chicago, Cleveland, Dallas, Dayton, Denver, Huntsville, Indianapolis, Los Angeles, New York City, Orlando, Philadelphia, San Francisco, Seattle, St. Louis, Syracuse •

TELONIC—INTERNATIONAL LEADER IN SWEEPED FREQUENCY MEASUREMENT

Electronics Abroad

Volume 38

Number 19

International

Microcircuits in mufti

Next summer at Leatherhead, Surrey, a simulated power plant will be operated under automatic control by Britain's Central Electricity Generating Board. It will be the first all-civilian task for the Myriad computer, Britain's first to use microelectronics throughout.

In Brussels, a transistor radio will soon be introduced by ITT Europe, Inc., which masterminds the European operations of the International Telephone and Telegraph Corp. The radio's intermediate-frequency amplifier is a thin-film microcircuit.

Japan's electronics industry is watching a newcomer, Kyodo Electronic Laboratories, Inc. Established last year by five Japanese parts manufacturers and an American engineer, Bernard Jacob, Kyodo plans to concentrate on the manufacture of planar epitaxial circuits for computers—the only Japanese company aimed principally at the microelectronics market.

Italy's television monopoly, RAI-TV, has 36 unusual repeaters along its tv transmission lines; each contains about 200 integrated circuits.

Seeking a market. On such civilian applications rest the hopes of European and Asian microelectronics companies. Squeezed out of the military and aviation markets by United States concerns, whose technology is generally considered to be 1½ years ahead, foreign companies are looking to computers, radios, television sets and telephone switching centers to provide the demand that would permit mass production and price cuts of 50% and more, to match American firms' prices.

Such industrial and consumer markets now account for one-third of the microcircuits sold in Europe. Here's how companies around the

world are trying to expand those markets.

Britain. The Myriad computer, made by English Electric-Leo-Marconi Computers, Ltd., has been used chiefly in air-traffic control and in radar defense systems; 17 machines have been sold for these purposes. Its first all-civilian task will be to operate a simulated power plant to help to study ways of meeting Great Britain's future needs for electric power. It will

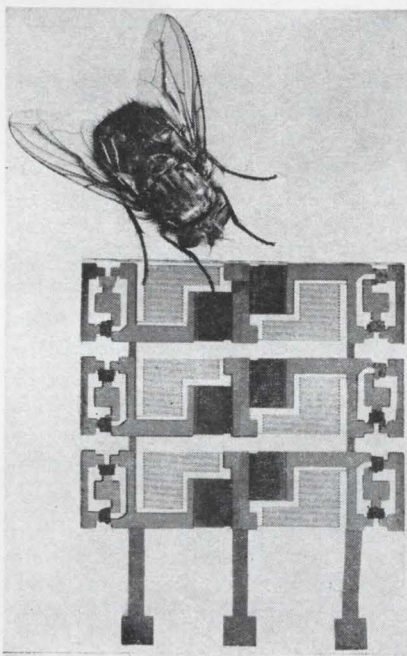

Landing field for a fly is formed by six integrated circuits. Photo, to dramatize circuits' small size, was made by Standard Elektrik Lorenz, West German subsidiary of the International Telephone and Telegraph Corp.

help to decide the best locations for future generators and the most efficient ways to operate them.

The Myriad is faster than most machines that use discrete components [Electronics, Aug. 9, p. 220]. It can add and subtract in 2.5 microseconds and multiply in 11 microseconds. By comparison, the IBM 7090 requires 4.4 microseconds to perform an addition.

Britain's microelectronics industry is getting a strong new competitor: Hughes International (UK), Ltd., a division of the Hughes Aircraft Co. in California. Hughes International is preparing to produce hybrid circuits at a new plant in Glenrothes, Scotland. The availability of American technology could give Hughes a big advantage over many British companies.

Belgium. When Europe's nationalized telephone services turn to electronic switching, they probably will leapfrog generations of electromechanical techniques and settle on integrated-circuit systems. That's the prevailing opinion at the Brussels headquarters of ITT Europe. However, company officials don't expect that jump to take place much before 1970.

ITT Europe relies heavily on the technology of its parent company across the Atlantic. But two British affiliates are developing thin-film and monolithic integrated circuits, as well as metal-oxide semiconductors, for commercial applications. Unlike American companies, which are moving swiftly into automated production, ITT's European facilities use manual techniques for masking and other operations.

A monolithic circuit is made in a single chip of silicon. A hybrid circuit is made by attaching semiconductor devices to a thin-film passive circuit.

Japan. While most European producers of microcircuits adopt American technology [Electronics, Aug. 9, p. 220], Japanese companies are independent of direct United States influence. Yet the Japanese seem to be second only to the United States in both monolithic and hybrid technology.

Japan's only strong link with an American company is the Nippon Electric Co.'s license agreement to share planar technology with the Fairchild Camera & Instrument Corp. Nippon Electric, the leader in integrated circuits and in planar

epitaxial transistors, claims to be the only Japanese company to use integrated circuits in a computer. Still, the company's production of microcircuits is estimated authoritatively at only 2,000 a month; most of these are monolithics.

The Mitsubishi Electric Corp. manufactures microcircuits at about the same rate as Nippon Electric does, but stresses hybrid circuits rather than monolithics.

Kyodo Electronics, the new company with a capitalization of only \$278,000, has not yet moved fully into IC's; Kyodo now manufactures high-speed diodes and transistors.

France. Next year France will have a new mass producer of integrated logic circuits. Sesco (European Semiconductor Society) plans to sell mostly to military suppliers.

France's two biggest producers at present are the Compagnie Générale de Télégraphie Sans Fil (CSF) and la Radiotechnique, a subsidiary of Philips Gloeilampenfabrieken N.V. of the Netherlands.

West Germany. Monolithics are the trend in West Germany. They are already being used in the Siemens 4004 computer, made by Siemens & Halske AG. Telefunken AG also is concentrating on single-chip integrated circuits.

The companies differ, however, in their preference for resistors in the integrated circuits. Telefunken deposits its resistors by evaporation; Siemens uses both diffused and deposited resistors.

Italy. Microcircuits already have broken into Italian television. RAI-TV, the government tv service, employs integrated circuits in automatic repeater equipment.

Only one Italian company, SGS-Fairchild, is known to be producing silicon planar microcircuits. The country's two other producers of integrated circuits are Ing. C. Olivetti & Co. and Selenia, an affiliate of the Raytheon Corp. Selenia's IC's are only for its own use; they are not for sale.

Sweden. Scandinavia's first commercial manufacture of microcircuits may be the result of studies at a research institute supported by Sweden's electrical and electronics manufacturers. Sweden is an im-

portant user of microcircuits, but imports them—mostly from the United States.

Hafo, the Institute for Semiconductor Research, has developed a family of hybrid microcircuits and plans to produce enough of them for evaluation by Swedish industry. If the circuits prove satisfactory, Hafo hopes to obtain financial backing and to go into mass production.

Soviet Union

Who's out there?

The highlands of Armenia and the waters of the Gulf of Riga, 1,100 miles to the northwest have at least one thing in common: a relative absence of man-made electrical noise. They may soon have another. Both may become listening posts for Soviet radio astronomers.

Last March professors Nikolai Kardashov and Iosif Shklovsky announced plans to build an antenna system for the study of radio-wave sources in space. Their aim was to detect signals that might originate with intelligent creatures. No location was mentioned, but recently the technical journal *Nauka y Tekhnika* described plans to build a giant radio telescope in Armenia that would attempt "to establish contact with intelligent inhabitants of distant planets."

The system would be particularly suitable to study signals on wavelengths between 0.8 and 21 centimeters; it probably would be narrowed to the band from 2.1 to 10 centimeters.

Dial a star. In Latvia, another part of the Soviet Union, a 43-mile-long interferometer is being considered that would extend over part of the Gulf of Riga and would be capable of tuning to separate stars almost anywhere in space. Presumably its resolving power would compare with the best anywhere.

An interferometer measures the interferences between two wave trains coming from the same

source. It permits high resolution by using two low-resolution antennas, separated by many wavelengths but connected to the same transmission line. Because the antennas are identical, the wave patterns at the antennas also are identical. The resultant multilobed pattern from all the antennas is the product of isotropic point sources whose wavelength separation is the same as the antennas'. The number of lobes in the pattern is directly proportional to the separation distance in wavelengths.

The Soviet instrument would employ three antennas, two along the coast and one on an island in the Gulf of Riga. Russian engineers say it would be impractical to build such a telescope entirely over land because of the need for vast flat spaces and for a minimum of static. The plan is being studied by the Radio Astronomical Center of the National Academy of Sciences.

Great Britain

War of the wrappers

Is a slow, inexpensive machine as attractive economically as a faster, more costly one? Standard Telephones and Cables, Ltd., the British subsidiary of the International Telephone and Telegraph Corp., has developed a machine that routes wires along terminal boards and fastens them to pin contacts. The company says its "wrapped joint" machine will cost much less than conventional systems, but mentions no price; however, it operates at less than half the speed.

The current best seller is the automatic Wire-Wrap machine, costing \$90,000 to \$135,000, made by the Gardner-Denver Co. in the United States. Gardner-Denver's \$105,000 model can wrap 650 wires an hour, compared with 240 an hour for the STC entry.

Tried and abandoned. To Gardner-Denver, the STC system is old hat. "We tried that approach 10 years ago and it wouldn't sell," says Donald Brouwer, sales manager. It

was too slow, he says, and its error rate was 100 times greater than the present system's. To be economically feasible, Brouwer says a 200-wire-an-hour machine would have to cost \$23,000 or less.

Retorts an ITT spokesman: "Maybe they couldn't make it work, but we have."

STC mounts a terminal board on a table that can move 20 by 15 inches in the x and y axes. The wire is fed and stripped, wrapped and cut by a head positioned permanently over the table.

Dual controls. The wires are routed by the table's motion, which can be numerically programed by

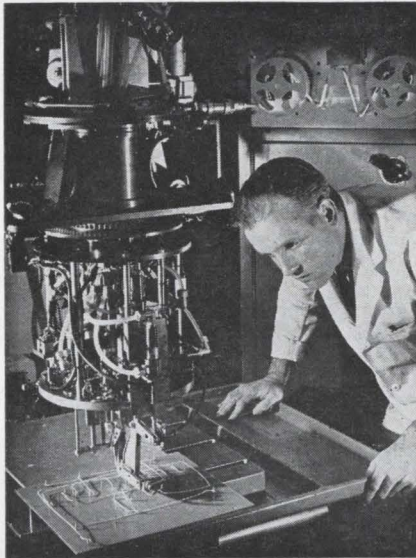

Wrapping machine lays out wires and wraps joints on flat circuit panel.

punched paper tape or operated manually. The original STC system was built on an automatic drilling machine, with the wiring head replacing the drill head. Since then, STC has developed an improved table. The STC system has been tried out on a production line for telephone switchboards.

The Gardner-Denver system keeps the pin matrix in a fixed position, and routes and fastens wires with two moving heads that are controlled by a punched-card programmer.

In the U.S., the Western Electric Co. is said to be developing a wire-wrap system similar to STC's,

France

Versatile radar

A radar system that can analyze and display returns from 2,000 range elements simultaneously was described in Paris this month at a symposium on optoelectronics. It would be particularly useful for electronic surveillance. The meeting was sponsored by the Advisory Group for Aerospace Research and Development, a unit of the North Atlantic Treaty Organization.

Roger Voles of EMI Electronics, Ltd., of Great Britain, said the system—still under construction—uses a vidicon, a cathode-ray tube and a magnetically focused image intensifier. Their combined linear resolutions are expected to yield overall resolution of 600 information elements; the system would derive the Doppler spectrum of radar returns while preserving range resolution.

Brightness modulation. The returns from each Doppler-radar pulse are written as brightness modulation along the face of a high-resolution crt. The light from the tube's face is focused by a lens to an image of the line on the image intensifier's input photocathode, which is provided with a horizontal deflection circuit. The light from the image on the output phosphor is focused by a second lens onto the signal plate of a vidicon or other suitable camera.

At the input photocathode, incoming photons release electrons that pass through a solenoid lens onto an output phosphor. The photons generated on one side of this electrode cause electrons to be released on the other side; these in turn are accelerated to an output phosphor.

Returns from the radar pulse are written on the crt's face as they are received. The intensifier is then switched on and is deflected horizontally at a constant rate until it is caused to fly back before returns from the next pulse are received. The gain of the intensifier's first stage is varied sinusoidally, so that

during the linear sweep the system gain passes through a number of cycles corresponding to the position of a specific pulse in the train. After the pulses are processed, the vidicon screen will contain a spectrum analysis of the returns, mapped out with the vertical scale representing range and the horizontal representing frequency.

Communications. Among other papers delivered, two seemed especially interesting to the delegates, a proposed optoelectronic NOR gate for a computer logic system and noncoherent light for optical communication.

The computer application was described by A. D. Berg and R. W. Smith of the Imperial College of Science and Technology in England.

In his paper on optical communication, David E. Wright of Edgerton, Germeshausen and Grier, Inc., noted that the glamor of the laser has overshadowed the recent development of noncoherent sources that can form the basis of a "reliable, rugged, versatile and inexpensive optical system."

Switch on

Aristote is dead, long live Socrate and Platon. That's the status of three electronic switching systems in France, named after Socrates, Aristotle and Plato.

The National Center for Telecommunication Studies has decided to halt research and development on Aristote and will concentrate instead on two computer-controlled systems: Socrate, which uses conventional crossbars, and Platon, which is based on time-division multiplexing.

Costly circuits. Andre Pinet, director of electronic switchboard R&D for the National Center, blames economics for the demise of Aristote, which was field-tested early this year [Electronics, Nov. 16, 1964, p. 176].

Aristote began in 1957 with gas tubes, and in 1962 changed to transistors for crosspoints. But transistors could not do the job without unacceptable signal losses, Pinet explains. International standards

set a maximum of one decibel in signal loss from one subscriber to another; with transistors there was a 3-db loss in the French system.

To boost the signal sufficiently, the French had to add negative impedance amplifiers to the switching circuits. But the amplifiers increased the cost of point connection circuits to \$2 apiece. Even with mass production, Pinet says, the cost could not be cut to 20 cents—a level competitive with existing nonelectronic systems.

The computer. The only positive benefit from Aristote is its central command computer, called Ramses I. Many of the computer's design features are being carried over into the Platon system.

Ramses performs real-time processing with seven levels of priority interruptions. Transfer is possible from the fast memory to secondary memories with magnetic drums of 16,000 words each. Access time is two microseconds, with cycle time of five microseconds.

Expanding Socrate. Socrate will go into limited use in the Paris area in 1967, serving about 2,000 telephone subscribers at first. It will be similar to a system that has been tested at the National Center's laboratory complex at Lannion; one probable change will be the substitution of reed relays for conventional crossbars, Pinet says.

With conventional crossbars, Socrate's speed is still about the same as that of nonelectronic systems, according to officials of the National Center, but the new system can handle 25% more calls with the same amount of central office equipment. Reed relays would cut switching time 90%, to one millisecond, they say.

IC's to be used. The National Center has a working model of Platon, the time-division multiplexing system scheduled to be installed in 1968 to serve 5,000 subscribers in Lannion. Telephone officials say the government has approved the installation.

The model employs printed circuits with discrete components, but Pinet predicts the use of integrated circuits in the production version. He expects the IC's to be available

from French concerns; otherwise, he says, the circuits will be purchased in the United States.

Like Aristote, Platon calls for a general-purpose computer at each central office serving 50,000 subscribers. It will also perform billing, maintenance and route changes. Unlike Aristote's computer, however, Platon's will not place the calls; this will be done by smaller, specialized computers at subcenters. Splitting up these tasks means that the general-purpose computer needs no backup computer, as Aristote's did, because it is unconcerned with message-handling. Also, the Platon computer can be relatively slow and inexpensive.

Canada

Electronic vulcanizer

An electronic method of vulcanizing rubber quickly and uniformly has been patented by William E. Hodges, a Toronto inventor. It employs an electric field acting upon particles of magnetite mixed into the rubber compound.

The 25-kilowatt field needed to vulcanize an automobile tire is generated by a one-turn coil operating at one megacycle. Magnetite was chosen as the ferromagnetic compound, Hodges says, because it retains its magnetic properties at temperatures beyond the 275° to 315°F at which rubber is vulcanized.

Aluminum mold. When the method is used for automobile tires, he says, a mold of silver-plated aluminum or another nonmagnetic metal can be the one-turn heating coil; the coil would be the secondary winding of a transformer because the power source's output coils would surround the aluminum mold.

The product's durability is still being tested. One industry official has speculated that the magnetite might cause internal abrasion in the rubber and shorten its life. But Hodges notes that uniformity of heating by his method eliminates

damage to the outer skin that may be caused by dehydration during ordinary vulcanization, where all the heat is applied at the outside.

As a corollary, Hodges says, his method can produce rubber with built-in magnetic shielding; this might be useful for coaxial cable.

Around the world

Great Britain. Radiotelephones are now available for private cars in Britain. Until now, such service was permitted only for the police, firemen, hospitals, taxis and a few trucking companies. The London Radiophone Service extends as far as 30 miles from the city center. Within this service area, subscribers can make and receive calls to and from anyplace in the country.

France. Computerized centers for information retrieval are finally coming to France, nearly a decade after their beginning in the United States. Francis Levery, chief of information retrieval projects at IBM-France, a subsidiary of the International Business Machines Corp., says centers are planned by medical research institutes, the French Atomic Energy Commission, and private companies. The French put much more care into reading and indexing documents than do the Americans, Levery says. A French specialist spends about half an hour reading each document while his American counterpart, less specialized, may spend five minutes with an abstract. About 20 centers are expected to be in operation in two years.

Finland. Automated traffic-light control is coming to Helsinki. Finland's capital has ordered \$370,000 worth of equipment from Siemens & Halske AG of West Germany. By completion, late in 1967, the city will have spent \$3 million to control 237 crossings.

Ghana. A three-station television service, said to be the most comprehensive in Africa, has been installed in Ghana by the Marconi Co. of Britain. The cost was \$8.4 million.

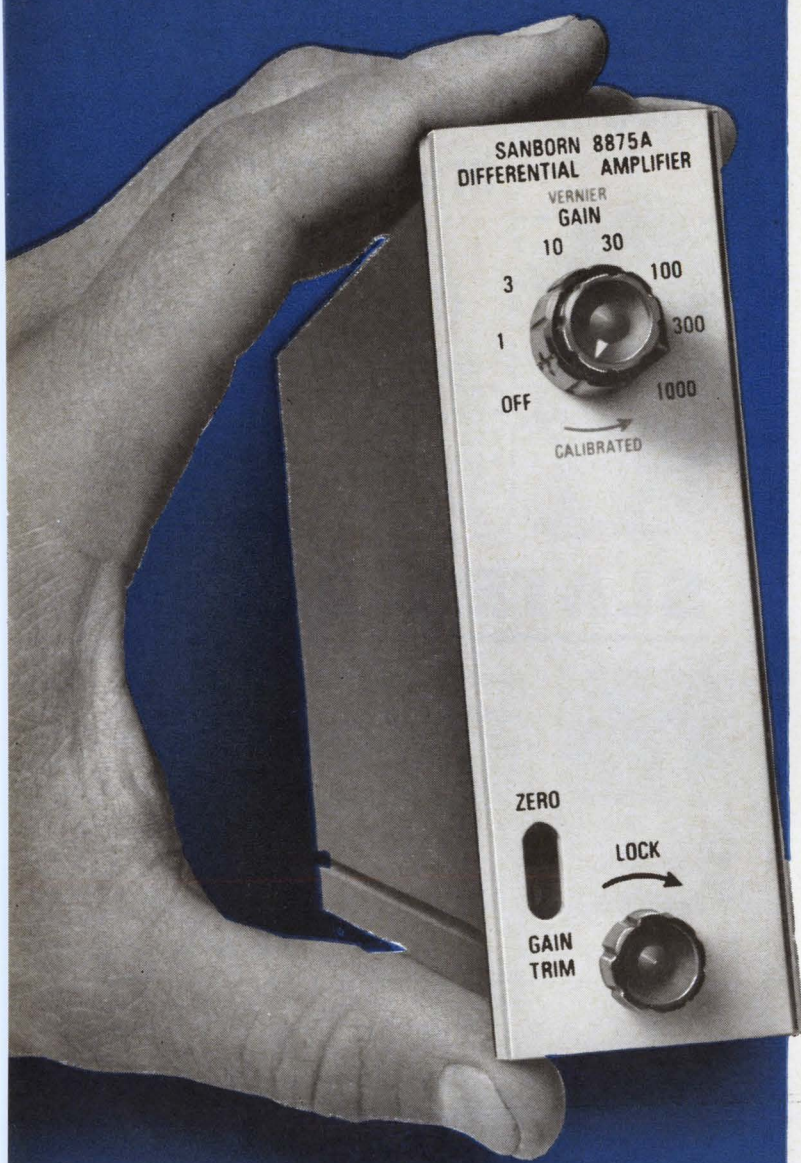

NEW wideband DC data amplifier for \$495

including integral power supply

- ★ SOLID-STATE ★ DC — 75 KC
- ★ GAIN OF 1000 ★ NO CHOPPER

Precisely measure thermocouple, strain gage and similar low level dc outputs with this high performance new Model 8875A Data Amplifier. Use it with modern data acquisition systems employing analog-to-digital converters, digital printers, magnetic data recorders, oscillographs, digital voltmeters, and other readout instrumentation. The new 8875A is a solid-state wideband dc amplifier with an output of ± 10 v, 100 ma and features dc — 75 kc bandwidth, 1000x amplification, $\pm 0.1\%$ gain accuracy, $\pm 0.01\%$ gain stability, and 120 db common mode rejection — at \$495 including power supply.

This new Sanborn amplifier measures just 4-3/4" high by 1-9/16" wide by 15" deep, weighs 3.5 lbs., including integral power supply. For multi-channel use, ten units can be mounted in a 5" x 19" modular cabinet which contains input and output connections, power cable, on-off switch, cooling, fuse, and mating connectors for ten amplifiers. These modules can be stacked, or equipped with tilt stands for bench-top use. When used individually, the completely enclosed amplifier requires no cooling.

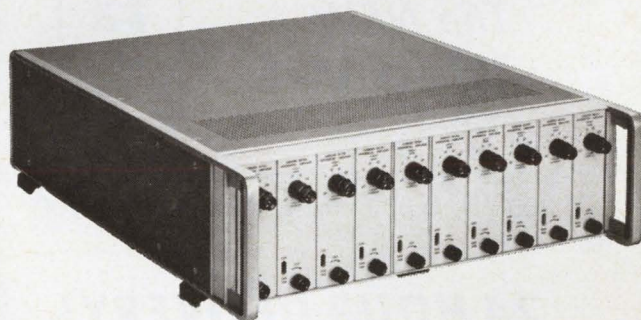

SPECIFICATIONS

Bandwidth:	dc to 75 kc within 3 db.
Gain:	from 1 to 1000 in seven fixed steps
Gain Accuracy:	$\pm 0.1\%$.
Gain Stability:	$\pm 0.01\%$.
Vernier Gain:	continuously adjustable between fixed steps.
Gain Trim:	$\pm 3\%$ with sufficient resolution for setting any one gain to $\pm 0.01\%$.
Common Mode Rejection:	120 db from dc to 60 cps, 40v p-p tolerance.
Output Circuit:	± 10 volts across 100 ohms and 0.2 ohms max. output impedance at dc.
Drift:	$\pm 3 \mu\text{v}$ referred to input, ± 0.2 mv referred to output.
Non-Linearity:	Less than 0.01% full scale value, 10 volts.
Overload Recovery Time:	recovers to within 10 μv R.T.I. +10 mv R.T.O. in 10 msec. for 10 v overload.
Power:	115/230 volts $\pm 10\%$, 50-400 cps, 6 watts.
Available options:	Switch-selected filtering, dual output (± 10 v, ± 10 ma; ± 10 v, ± 100 ma; a short on one output has negligible effect on the other output).

For complete specifications and application assistance, call your local HP/Sanborn field engineering office, or write: Sanborn Division, Hewlett-Packard Company, 175 Wyman Street, Waltham, Mass. 02154.

HEWLETT
PACKARD  SANBORN
DIVISION

**NOW! a NEW Shielded
High Q Variable Inductor
with exceptional stability!**

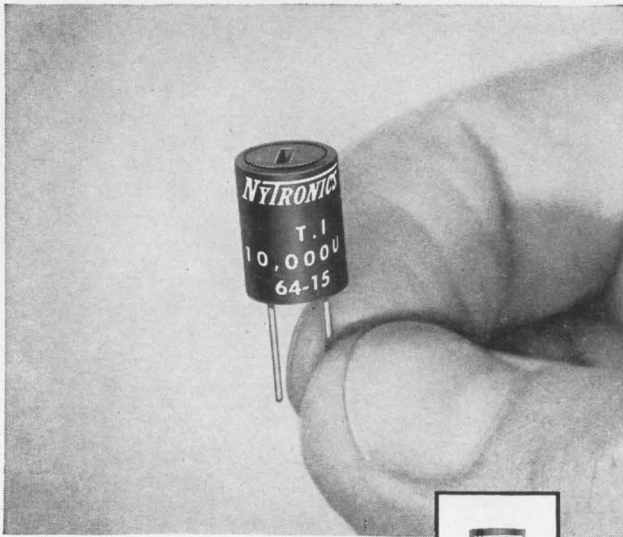

*The NEW
Wee V-L*

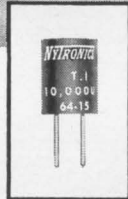

ACTUAL SIZE

Adjustable Inductance range 0.15 μ h to 100,000 μ h in 0.300" by 0.400" molded case with 0.200" grid spacing.

24 HOUR DELIVERY!

The new Wee V-L now offers the design engineer these important advantages: Meets requirements of MIL-C-15305C; unitized epoxy molded construction; 77 stock values; and shielded for minimum coupling.

The Wee V-L is the newest product to join the Nytronics subminiature family of inductors, ceramic capacitors, precision wire wound resistors, thin film resistors and delay lines. Use coupon for engineering data!

NYTRONICS

Design leaders
STANDARD components to meet
CUSTOM requirements

550 Springfield Ave., Berkeley Heights, N. J.

**MAIL COUPON TODAY FOR COMPLETE
ENGINEERING DATA ON THE NEW WEE V-L**

TO: NYTRONICS, INC. Dept. E

550 Springfield Avenue, Berkeley Heights, N. J.

Please send complete engineering data on the Wee V-L

NAME _____

TITLE _____

FIRM _____

ADDRESS _____

CITY _____ STATE _____ ZIP _____

**Doesn't anyone make a
subminiature full wave
bridge rectifier
with
these specs?**



- 200 to 1000 Volt PIV per Leg
- 5 Ampere Average Rectified Current
- Extremely Low Leakage
- No Heat Sink Required
- Subminiature Package 1" x 1" x 7/16"
- Priced as low as units with only 1/10 of the current rating

SLATER DOES!

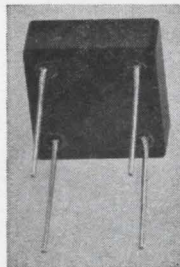

**SPECIFICATIONS NEVER BEFORE
POSSIBLE IN ANY SUBMINIATURE
FULL WAVE BRIDGE RECTIFIER.**

Send for Catalog and Price List

SLATER ELECTRIC INC.,
Semiconductor
45 Sea Cliff Avenue • Glen Cove, N.Y.

Circle 235 on reader service card

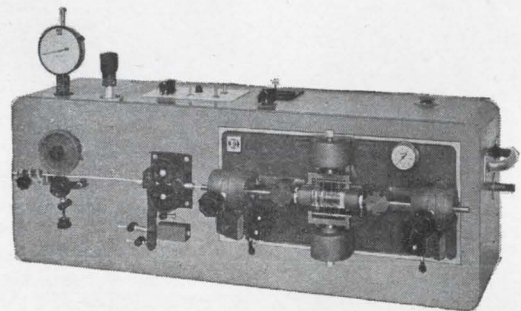

**Cut your wire preparation costs with
high-speed wire strippers**

Eubanks wire strippers are noted for easy set-up changes, high-speed operation, and clean stripping without nicking or scraping. Whether you need battery cables, printed circuit board jumpers, leads for electric watches, coaxial cables, or washing machine harnesses, chances are excellent that we have a machine to meet your requirements. Pictured is our Model 87 Utility Wire Stripper, which produces up to 12,000 leads an hour. Write for free information on this and other Eubanks wire stripping machines to Eubanks Engineering Co., 225 W. Duarte Rd., Monrovia, California.



EUBANKS
ENGINEERING COMPANY



AMP Incorporated	57	DuPont de Nemours & Co. Inc., E. I.	73, 120	Kepeco Inc.	22
Garceau, Hargrave & McCullough Inc.		Batten, Barton, Durstine & Osborn Inc.		Weiss Advertising	
Airborne Instruments Laboratory	163	Dynage Inc.	169		
Campbell-Mithun, Inc.		F. W. Prella Advertising			
Alconox Inc.	156			Laboratory for Electronics	170
Miller Adv. Agency, Inc.				Hepler & Gibney Adv.	
Amperex Electronics Corp.	47	Eastman Kodak Company	125	Lambda Electronics Corp.	136, 137
Sam Groden Incorporated		The Rumrill Company Inc.		Michel Cather Inc.	
Astrodatta Inc.	15	Eldorado Electronics	121	Lapp Insulator Company Inc.	151
Bonfield Associates Inc.		Sturges and Associates		Wolff Associates Inc.	
Automatic Electric Company	66	Electro Instruments Inc.	38, 39	Ledex Inc.	134
Tatham-Laird & Kudner Inc.		Teawell Inc. Advertising		Yeck & Yeck	
		Electro International Inc.	62, 63	Lepel High Frequency Laboratories Inc.	180
		Emery Advertising Corp.		Apex Graphic Company	
Barber-Colman Company	162	Electro-Nuclear Laboratories	150	Linde Div., Union Carbide Co.	117
Howard H. Monk & Associates Inc.		Hal Lawrence Incorporated		J.M. Mathes Inc.	
Bausch & Lomb, Inc.	140	Electro Products Laboratories, Inc.	183	Lockheed Missiles & Space Company	179
Wolff Associates, Inc.		C. M. Gotsch, Advertising		McCann-Erickson Inc.	
Bendix Semiconductor Products	9, 56	Electronic Engineering Co. of California	165		
MacManus, John & Adams Inc.		Jansen Associates		Machlett Laboratories Inc., The	8
Boonton, Div. of Hewlett Packard Co.	2	Electronized Chemicals Corporation	191	Fuller & Smith & Ross Inc.	
George Homer Martin Associates		Kenyon & Eckhardt Inc.		Magnetic Shield Div. of Perfection Mica	174
Bristol Company, The	161	Englehard Industries Inc.	154, 155	Burton Browne Advertising	
Chirurg & Cairns, Inc.		Keyes, Martin & Company		Mathatronics Inc.	10
Brush Instruments, Div. of Clevite Corp.	3rd Cover	Erie Technological Products Co. Inc.	81	Kalb & Schneider Inc.	
Carr Liggett Adv. Inc.		Altman-Hall Associates		McGraw-Hill Book Co. Inc.	169
Bulova Watch Company, Electronics Div.	146	Eubanks Engineering Company	198	Metal Removal Company, The	176
Ted Gravenston Inc.		Moore-Bergstrom Company		Advertising Producers Associated Inc.	
				Mico Instrument Company	174
		Fairchild/Electro-Metrics	123	Micro Switch	147
CTS Corporation	118, 119	Herbert Lindauer Associates		Batten, Barton, Durstine & Osborn Inc.	
Burton Browne Advertising		Fairchild Instrumentation	168	Mitsumi Electric Co., Ltd.	171
Cambridge Thermionic Corporation	80	The Wexton Company Inc.		Dentsu Advertising Ltd.	
Chirurg & Cairns Inc.		Fairchild Semiconductor	12, 13	Motorola Inc.	175
CELCO	127	Faust/Day Inc. Adv.		K&A Inc.	
Stano Advertising				Motorola Inc., Military Electronics Div.	36, 37
Century Electronics & Instruments Inc.	48	Garlock Electronic Products	46	Charles Bowes Advertising Inc.	
Writing & Advertising Inc.		Richardson, Thomas & Bushman, Inc.		Motorola Semiconductor Products Inc.	77
Cerro Corporation	122	General Radio Company	6	Lane and Bird Advertising Inc.	
Feeley Advertising Agency		K. E. Morang Co.			
Chemcut Corporation	152	Gries Reproducer Corp.	178	National Cash Register Company	158, 159
Adams Associates Inc.		Harold Marshall Advertising Co. Inc.		Allen, Dorsey & Hatfield Inc.	
Chester Cable Corp.	53, 54	Guderbrod Bros. Silk Co. Inc.	35	Natvar Corporation, The	160
Lewis Advertising Agency		Lee Ramsdell & Co. Inc.		Sanger-Funnell Inc.	
Christie Electric Corp.	171	Guillemin Networks Inc., sub of EGG	153	North Atlantic Industries Inc.	50
Len Woolf Co. Advertising		Reach, McClinton & Co. Inc.		Murray Heyert Associates	
Clarostat Mfg. Co.	61			Nytronics Inc.	198
Lescarboura Advertising Inc.		Hansen Mfg. Co. Inc.	163	The Stukalin Advertising Agency	
Cohu Electronics, Kin Tel Div.	67	Keller-Crescent Co.			
Erwin Wasey, Ruthrauff & Ryan		Heinemann Electric Co.	59	Pamotor Inc.	182
Cominco Products Inc.	184	Thomas R. Sundheim Inc.		The Harry P. Bridge Co.	
McKim Productions Limited		Hewlett-Packard Company	1, 20, 21, 79	Pennsalt Chemicals Corporation	65
Communications Electronics Inc.	60	Lennen & Newell Inc.		The Aitkin-Kynett Co.	
Consolidated Avionics	142	Hitachi Ltd.	124	Philco Corp.	119, 144
The Stanley Schwartz Company		Dentsu Advertising Ltd.		Batten, Barton, Durstine & Osborn Inc.	
Consolidated Electrodynamics Corp.	55, 173	Hurtletron Inc.	170	Polaroid Corporation	167
Hixson & Jorgensen Inc.		Feldman Everett Advertising		Doyle, Dane, Bernbach Inc.	
Control Data Corporation	16			Potter & Brumfield Div. of American Machine & Foundry Co.	24
Barnes Chase Advertising		Imtra Corporation	183	Grant, Schwenck & Baker Inc.	
Controls Company of America	52	S. Gunnar Myrbeck & Company		Princeton Applied Research Corp.	40
The Harry P. Bridge Company		Industrial Chemical Specialties Corp.	178	Mort Barish Associates	
Corning Glass Works	69	Robert A. Paul Adv. Agency			
The Rumrill Company Inc.		Instrulab Inc.	180	Radio Corporation of America	4th Cover
Coto Coil	174	Berner & Berner		Al Paul Lefton Co.	
The Williams Company		International Rectifier Corp.	70	Raytheon Company	68
Crystalonics Inc.	141	Communication Associates		Fuller & Smith & Ross Inc.	
Impact Advertising Inc.		IT&T Jennings	157	Republic Electronics Corporation	181
		L. H. Waldron Adv. Agency		Seymour Charles Advertising Inc.	
Datak Corporation	150	IT&T Wire & Cable Div.	177	Rese Engineering Inc.	148
Einhorn-Stern Inc.		West, Weir & Bartel Inc.		Joseph Gering/Graphic Design Associates	
Defense Electronics Inc.	76	Johnson Company, E. F.	180	Rhode & Schwarz Sales Co.	82
H. Durand Associates		Firststone Advertising Inc.		Ted Gravenston Inc.	
Delevan Electronics Corporation	162				
Clayton A. Stahika Adv. Company					
Delta Design Inc.	166				
Barnes Chase Advertising					
Delta Products Inc.	172				
Ball & Davidson Inc.					
Dickson Electronics Corp.	17				
N. A. Winter Advertising Agency					

Executive, editorial, circulation and advertising offices: McGraw-Hill Building, 330 West 42nd Street, New York, N.Y., 10036. Telephone Area Code 212-971-3333. Teletype TWX N.Y. 212-640-4646. Cable: McGrawhill, N.Y. Officers of the Publications Division: Shelton Fisher, President; Vice Presidents: Joseph H. Allen, Operations; Robert F. Boger, Administration; John R. Callahan, Editorial; Ervin E. DeGraff, Circulation; Donald C. McGraw, Jr., Advertising Sales; Angelo R. Venezian, Marketing. Officers of the Corporation: Donald C. McGraw, President; L. Keith Goodrich and Hugh J. Kelly, Executive Vice Presidents; John J. Cooke, Vice President and Secretary; John L. McGraw, Treasurer. Title R registered U.S. Patent Office; © copyright 1965 by McGraw-Hill, Inc. All rights reserved, including the right to reproduce the contents of this publication, in whole or in part.

LASER DIODE PULSER

■ 5 Microsecond Pulse Width

■ Peak Pulse Current To 40 Amps

- Repetition Rates From 100 to 9,000 Pulse/Second
- Self-Contained Metering for Both Peak Pulse Current and Pulse Repetition Rate
- Integrally Contained Dewar for Low Temperature Operation

IF ORDERED BY OCT. 15
\$850.00 ea.

ELECTRO-OPTIC SINGLE CRYSTALS

- Lithium Niobate
- Potassium Tantalum Niobate
- Cuprous Chloride
- ADP ■ KDP ■ KDA
- HMTA

Available From Stock

SPECIAL

Large as Grown
ADP
SINGLE CRYSTALS
Nominal Dimensions
of over 2" x 2" x 2"

\$165.00 ea.

If Ordered by
Oct. 15

For Complete Literature
Write Dept. E-6



emi-elements, inc.

Saxonburg Boulevard,
Saxonburg, Pa.
Phone: 412-352-1548

Sanborn Co., Div. of Hewlett-Packard Co.	197
Culver Advertising Inc.	
Sargent & Greenleaf Inc.	138
Wolff Associates Inc.	
Semi-Elements Inc.	200
Axelband & Brown & Associates Inc.	
Signetics Corporation	126
Cunningham & Walsh Inc.	
Sigma Instruments Inc., The	74, 75
The Marschalk Company Inc.	
Sinclair Radio Laboratories Inc.	169
John E. Hayes Company Inc.	
Slater Electric Inc.	183, 198
Light Advertising Service	
Spectrol Electronics Corporation	135
Jones, Maher, Roberts Adv.	
Sperry Farragut Co.	11
Lavidge, Davis & Newman, Inc.	
Sperry Semiconductor, Div. of Sperry Rand	78
Armand Richards Advertising Agency	
Sprague Electric Company	5, 7, 14
The Harry P. Bridge Company	
Stackpole Carbon Company	18, 19
Meek and Thomas Inc.	
Sylvania Electric Products Inc.	27-34
Tatham, Laird & Kudner Inc.	
TRW Electronics	45
Fuller & Smith & Ross Inc.	
Tektronix Inc.	58
Hugh Dwight Adv. Inc.	
Telonic Industries Inc.	192
Jansen Associates	
Texas Instruments Incorporated	51
Semiconductor-Components Division	
Don L. Baxter Inc.	
Thermal American Fused Quartz Company	156
Kniep Associates	
Tracor Inc.	185
David G. Benjamin Inc.	
Transitron Electronics Corporation	139
Larcom Randell Adv. Inc.	
Trygon Electronics	132
The Wexton Company, Inc.	
United Transformer Corporation	2nd Cover
Philip Stogel Company Inc.	
Universal Instruments Corporation	49
Caroe Marketing Inc.	
United Aircraft Corp., Hamilton Standard Div.	143
Cunningham & Walsh Inc.	
Vactec Inc.	148
Ron Coleman Agency	
Vector Dept. of Norden Div. of United Aircraft Corp.	178
Cunningham & Walsh Inc.	
Weinschel Engineering Company	133
S. Gunnar Myrbeck & Company	
Western Transistor Corp.	184
Alden Advertising of California Inc.	
Westinghouse Electric	128
ITSM	
Weston-Boonschaft & Fuchs	149
Basford Inc.	
Weston Instruments Inc.	64
Basford Inc.	
Zero Manufacturing Co.	164
Guerin, Johnstone, Gage Inc.	
Zeltex Inc.	164
Sturges and Associates	

CLASSIFIED ADVERTISING	
F.J. Eberle, Business Mgr.	
PROFESSIONAL SERVICES	190
EMPLOYMENT OPPORTUNITIES	187-190
EQUIPMENT	
(Used or Surplus New)	
For Sale	190
Advertisers Index	
Atomic Personnel Inc.	190
Electronic Communications Inc.	189
Ewald Instruments	190
Fair Radio Sales	190
Fishman Co., Philip	190
General Dynamics Electric Boat	189
General Electric Co. Adv. & Sales	
Promotion Dept.	188
Keystone Electronics Corp.	190
McDonnell	187
RCA	190
Radio Research Instrument Co.	190
Telephone Engineering Co.	190
Semiconductor Sales of Calif.	190



Advertising sales staff

Gordon Jones [212] 971-2210
Advertising sales manager

Atlanta, Ga. 30309: Gus H. Krimmier, Michael H. Miller, 1375 Peachtree St. N.E., [404] TR 5-0523

Boston, Mass. 02116: William S. Hodgkinson McGraw-Hill Building, Copley Square, [617] CO 2-1160

Chicago, Ill. 60611: Robert M. Denmead, J. Bradley MacKimm 645 North Michigan Avenue, [312] MO 4-5800

Cleveland, Ohio 44113: Paul T. Fegley, 55 Public Square, [216] SU 1-7000

Dallas, Texas 75201: Richard P. Poole, The Vaughn Building, 1712 Commerce Street, [214] RI 7-9721

Denver, Colo. 80202: Joseph C. Page, David M. Watson, Tower Bldg., 1700 Broadway, [303] AL 5-2981

Detroit, Michigan 48226: Paul T. Fegley 856 Penobscot Building [313] 962-1793

Houston, Texas 77025: Kenneth George, 2270 Humble Bldg., [713] CA 4-8381

Los Angeles, Calif. 90017: Ashley P. Hartman, John G. Zisch, 1125 W. 6th St., [213] HU 2-5450

Minneapolis, Minn. 55402: J. Bradley Mackimm 1st National Bank Building 120 South Sixth Street [612] FE2-7425

New York, N. Y. 10036: Donald R. Furth [212] 971-3615 Frank LeBeau [212] 571-3615 George F. Werner [212] 971-3615 500 Fifth Avenue

Philadelphia, Pa. 19103: William J. Boyle, Warren H. Gardner, 6 Penn Center Plaza, [215] LO 8-6161

Pittsburgh, Pa. 15222: Paul T. Fegley, 4 Gateway Center, (412) 391-1314

Portland, Ore. 97204: James T. Hauptli, Pacific Building, Yamhill Street, (503) CA3-5118

St. Louis, Mo. 63105: Robert M. Denmead The Clayton Tower, 7751 Carondelet Ave. [314] PA5-7285

San Francisco, Calif. 94111: James T. Hauptli, 255 California Street, [415] DO 2-4600

London W1: John W. Patten, Edwin S. Murphy Jr., 34 Dover Street, Hyde Park 1451

Milan: 1, via Baracchini Phone: 86-90-617

Frankfurt/Main: Gerd Hinske, 85 Westendstrasse Phone: 77 26 65 and 77 30 59

Geneva: Michael R. Zeynel, Joseph Wuensch, 2 Place du Port 244275

Paris VIII: Denis Jacob, 17 Avenue Matignon ALMA-0452

Tokyo: Nobuyuki Sato Shiba, Minato-Ku (502) 0656

Osaka: Kazutaka, Miura, 163, Urmegee-cho, Kilita-ku [362] 8771

Nagoya: International Media Representatives, Yamagishi Bldg., 13, 2-Chome, Oike-cho Naka-ku

Hugh J. Quinn: [212] 971-2335 Manager Electronics Buyers' Guide

David M. Tempest: [212] 971-3139 Promotion manager

Milton Drake: [212] 971-3485 Market research manager

Wallace C. Carmichael [212] 971-3191 Business manager

Theodore R. Geipel: [212] 971-2044 Production manager

Another Brush Innovation in Recording:

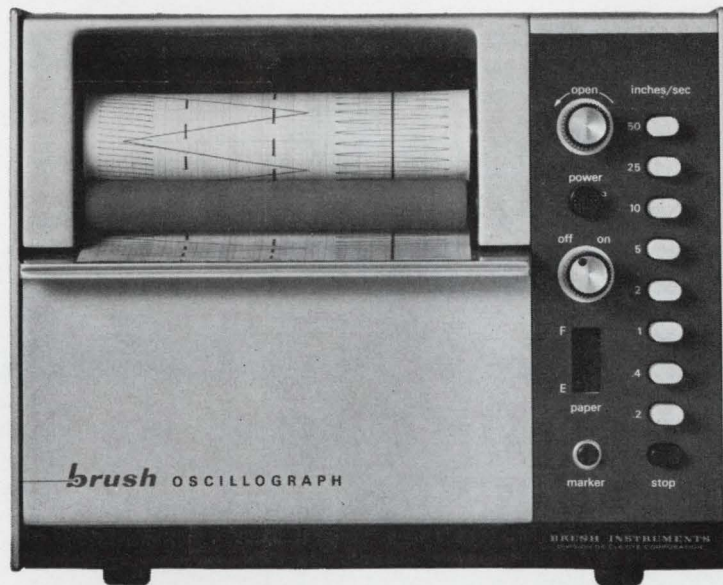

The Brush 2300. Best recorder around for getting lots of data down on one piece of paper.

No wonder the Brush 2300 light beam recorder can handle just about any industrial recording job you can name.

It's available with 1 to 16 analog channels. Writing speeds from 0 to 30,000 inches per second. Push-button choice of eight different chart speeds—or sixteen if you like. And all the frequency response you'll ever need.

Power requirements? Next to nothing . . . even operates off a car battery. One model operates off flashlight batteries!

And here's the topper. *Anyone, anywhere* can operate a 2300. The controls are logically grouped, chart paper loads from the front and the

galvos can be switched and adjusted in seconds. Simple. Rugged. Lightweight. Low cost per channel. That's the 2300. The common-sense selection for almost every industrial recording requirement.

A demonstration will prove it.

Get in touch with your local Brush Sales Engineer. Or, call us collect . . . 216—EN 1-3315. An illustrated brochure is yours for the asking. Brush Instruments Division, Clevite Corporation, 37th & Perkins, Cleveland, Ohio 44114.

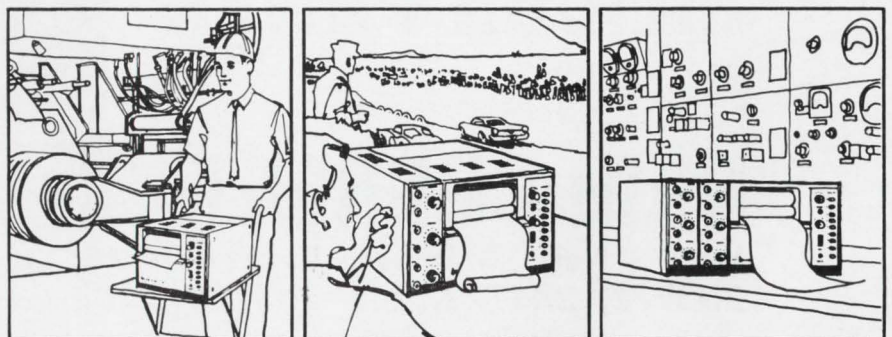

brush INSTRUMENTS DIVISION
CLEVITE

Circle 901 on reader service card

Now Silicon Savings to 150 W, 30 Amps

1.0A I_C Max TO-5 & Flange TO-5	4A I_C Max TO-66	15A I_C Max TO-3	30A I_C Max TO-3
12.5 VOLTS SUPPLY			
2N3053 h_{FE} @ 150 ma = 50-250	40250 h_{FE} @ 1.5A = 25-100	40251 h_{FE} @ 8A = 15-60	2N3771 V_{CEO} (sus) = 40V h_{FE} @ I_C = 15A 15-60 P_T Max = 150 W f_T = 700 Kc/s (typ)
	MEDIUM VOLTAGE SUPPLY		
	2N3054 h_{FE} @ 0.5A = 25-100	2N3055 h_{FE} @ 4A = 20-70	2N3772 V_{CEO} (sus) = 60V h_{FE} @ I_C = 10A 15-60 P_T Max = 150 W f_T = 700 Kc/s (typ)
HIGH VOLTAGE SUPPLY, HIGH TRANSIENTS			
2N3440 h_{FE} @ 20 ma = 40-160 40256 θ_{j-c} = 15° C/W	2N3441 h_{FE} @ 0.5A = 20-80	2N3442 h_{FE} @ 3A = 20-70	2N3773 V_{CEO} (sus) = 140V h_{FE} @ I_C = 8A 15-60 P_T Max = 150 W f_T = 400 Kc/s (typ)



RCA ECONOMY SILICON POWER GOES HIGH CURRENT

With 3 New 30-Ampere Types—
2N3771, 2N3772, and 2N3773

RCA's broad economy silicon line of power transistors now includes three new types—RCA-2N3771, 2N3772, and 2N3773, which extend present current limits of the line to 30 amperes.

This economy silicon power line now offers you a wide performance span for:

- Inverters to 1kW
- Audio Power to 300 Watts
- Regulators to 25 Amps
- Power Switches to 1kW
- Deflection Circuits

Check out the power-handling capability of RCA's silicon line, including standard units and those recommended to meet military specifications. For prices and delivery information, see your RCA Representative. For technical data on specific types, write: RCA Commercial Engineering, Section I-N-9-3, Harrison, N.J.

AVAILABLE THROUGH YOUR RCA DISTRIBUTOR

RCA ELECTRONIC COMPONENTS AND DEVICES



The Most Trusted Name in Electronics