

Electronics

APR 19 1966

Transistor circuits for color tv: page 99

Protecting against voltage surges: page 109

Production techniques: page 116

April 18, 1966

75 cents

A McGraw-Hill Publication

Below: Experimenting with nonlinear optics: page 82

LIBRARY
UNIVERSITY OF TENN MED UNIV

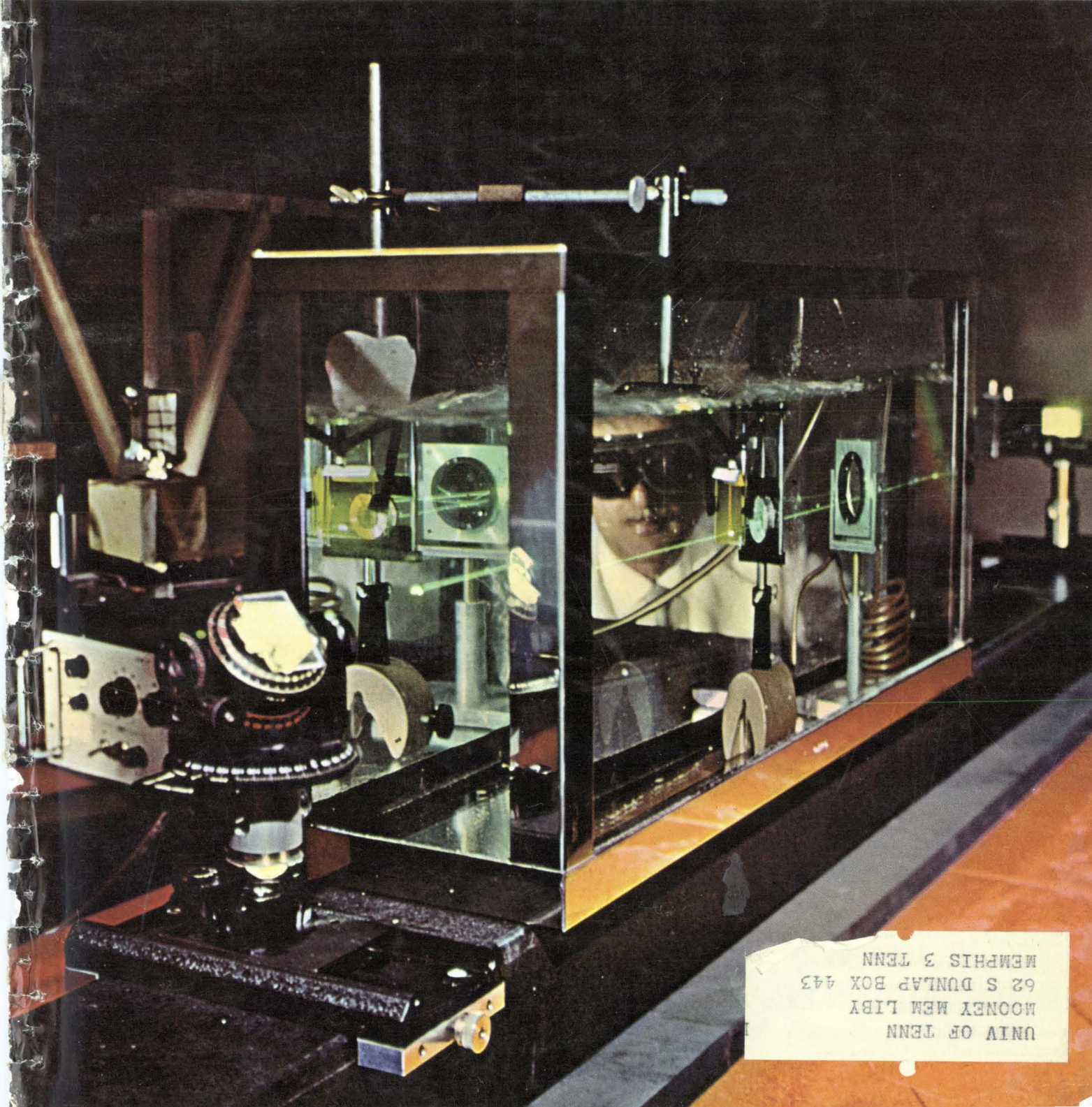

UNIV OF TENN
MOONEY NEW LIBRY
62 S DUNLAP BOX 443
MEMPHIS 3 TENN

WIDE RANGE and FINE RESOLUTION In a \$190 Decade Capacitor



- 50 pF to 1.11115 μ F
- Double shielding . . . capacitance for 2- and 3-terminal connections differs by only 1 pF
- Low-loss polystyrene dielectric in all decades
- $\pm 1\%$ Accuracy
- Bright, in-line readout



Type 1412-BC
Decade Capacitor

This decade capacitor combines precision decade steps and a high-resolution variable capacitor for continuous adjustment to better than 1 pF between steps. The four decades make possible settings from 100 pF to 1.1111 μ F in 100-pF steps; nearly the entire range of commonly used capacitance is covered. The built-in 0-100 pF vernier extends the resolution still further for fine comparisons and allows precise calibration for demanding laboratory work. Small size (a mere 3 $\frac{1}{2}$ " high) and clean styling make this capacitor equally useful on a bench or in a rack. With all of its features, the Type 1412-BC is priced reasonably.

Other Decade Capacitors available from General Radio

For 0.5% Accuracy . . .

Type 1419-K

Decade Capacitor...\$385 in U.S.A.

This three-decade unit covers the zero to 1.110- μ F range in 1000-pF steps; capacitance at zero setting is 41 pF when used as a two-terminal device, and 13 pF in three-terminal connections. Silvered-mica dielectric ensures extremely low dissipation factor (less than 0.0003) and temperature coefficient ($\pm 35 + 10$ ppm/ $^{\circ}$ C). The 1419-K is ideal for the demanding 2- and 3-terminal capacitance requirements.

For the Highest Accuracy
and Stability in a

Decade Capacitor . . .

Type 1423-A

Precision Decade Capacitor

. . . \$750 in U.S.A.

0.05% accuracy, 0.01%-per-year stability, and a 100-pF to 1.111- μ F range (in 100-pF steps). The Type 1423-A is especially valuable for precise comparison and substitution work, since its high accuracy and stability eliminate the need for repeated recalibration.

For

High Values of Capacitance:

Type 1424-A Standard Decade Capacitor,
Polystyrene Dielectric
10 μ F in 1- μ F steps, 0.25% accuracy
\$345 in U.S.A.

Type 1424-M Decade Capacitor,
Paper Dielectric
10 μ F in 1- μ F steps . . . 1.0% accuracy
\$210 in U.S.A.

Type 1425-A Standard Decade Capacitor,
Polystyrene Dielectric
100 μ F in 10- μ F steps, 0.25% accuracy
\$1400 in U.S.A.

Write for Complete Information

BOSTON • NEW YORK • CHICAGO • PHILADELPHIA • WASHINGTON, D.C.
SYRACUSE • DALLAS • SAN FRANCISCO • LOS ANGELES • ORLANDO
CLEVELAND • TORONTO • MONTREAL
GENERAL RADIO COMPANY (Overseas), ZURICH, SWITZERLAND
GENERAL RADIO COMPANY (U.K.) Ltd., BOURNE END, ENGLAND

GENERAL RADIO
WEST CONCORD, MASSACHUSETTS

ECONOMY!

**Versatile,
Value-priced
x-y recorder
...just \$895!**

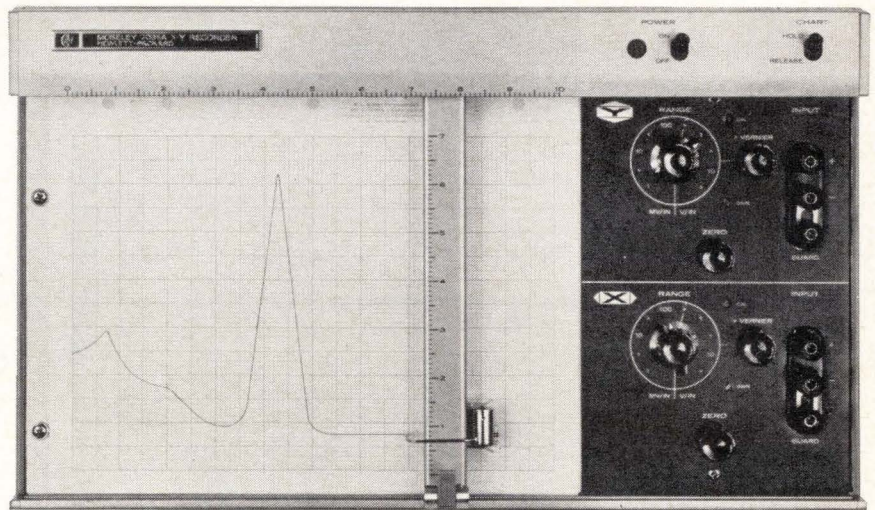

THE MOSELEY 7035A

This is a high-performance, low-cost solid-state recorder for every-day applications not requiring high dynamic performance. Five fixed calibrated ranges 1 mv/inch to 10 v/inch. High input impedance, floating guarded input, 0.2% accuracy at full scale. Adjustable zero set.

Each axis has an independent servo system with no interaction between channels. Maintenance-free AUTOGRIP* electric paper holddown, new writing system with inexpensive disposable unit. Options available include electric pen lift, locks for zero and variable range controls, rear input, re-transmitting potentiometers.

For general-purpose applications, you can't beat the Moseley Division 7035A. Ask your Hewlett-Packard field engineer for a demonstration. Or write for complete specifications to Hewlett-Packard, Palo Alto, California 94304, Tel. (415) 326-7000; Europe: 54 Route des Acacias, Geneva.

*Data subject to change without notice.
Price f.o.b. factory.*

**HEWLETT
PACKARD**  **MOSELEY
DIVISION**

An extra measure of quality

*Trade Mark Pat. pend.

automate your DVM

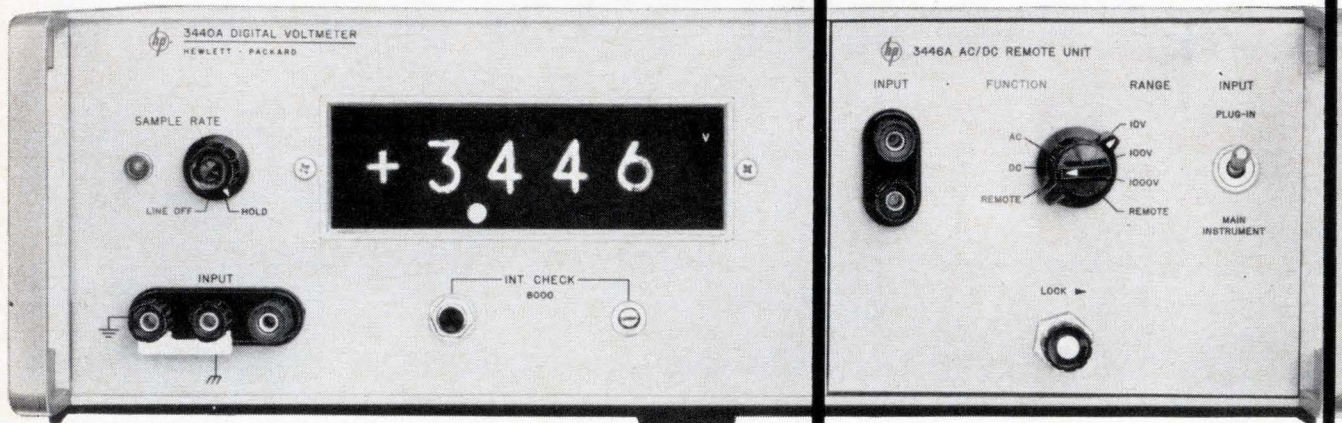

with remote function, range plug-in

The new 3446A AC/DC Remote Plug-in unit lets you automate your Hewlett-Packard 3439A or 3440A Plug-in Digital Voltmeter by permitting remote programming of function (ac or dc measurements) and/or range (10, 100, 1000 v full scale). An ideal instrumentation package for automatic test stations, programmable routine measurements, measurements required at a distance from the DVM.

The DVM's themselves are compact instruments with a selection of plug-ins to provide the choice of manual, automatic and remote ranging, extra-high sensitivity, ac/dc voltage/current/resistance measurements; dc accuracy better than $\pm 0.05\%$ of reading ± 1 digit; 4-digit readout; 30 db ac rejection at 60 Hz; capability of floating input pair up to 500 v above chassis ground. The 3440A (\$1160) is systems oriented. The 3439A (\$950) is a bench model. Both use the same plug-ins.

The specifications tell the performance story of the DVM's and this new plug-in. Ask your Hewlett-Packard field engineer for a demonstration of the voltmeter most useful for your application, or write for full specifications to Hewlett-Packard, Palo Alto, California 94304, Tel. (415) 326-7000; Europe: 54 Route des Acacias, Geneva.

Data subject to change without notice. Prices f.o.b. factory.

SPECIFICATIONS, 3446A

Voltage range (ac and dc):	4-digit full-scale readings of 9.999, 99.99 and 999.9 v; 5% overrange capability, indicator.
Voltage accuracy (ac):	50 Hz-20 kHz, $\pm 0.1\%$ of reading ± 2 counts. 20 kHz-50 kHz, $\pm 0.1\%$ of full scale ± 2 counts. 50 kHz-100 kHz, $< \pm 0.3\%$ of full scale ± 2 counts, from 20°C to 30°C, including $\pm 10\%$ line variations. Temperature coefficient = $\pm 0.005\%/^{\circ}\text{C}$ from 0-20°C and 30-50°C.
Voltage accuracy (dc):	$\pm 0.05\%$ of reading ± 1 digit, including 10% line variation, +15°C to +40°C ($\pm 0.1\% \pm 1$ digit 0°C to +50°C).
Range selection (ac):	Manual, remote; auto reading < 2 sec; max. remote ranging time 40 msec.
Range selection (dc):	Manual, remote; auto reading < 1 sec; max. remote ranging time 40 msec.
Function selection (ac or dc):	front panel or remote.
Input impedance:	10 megs shunted by < 35 pf, all ac ranges; 10.2 megs, dc.
Price:	\$575

HEWLETT  PACKARD

An extra measure of quality

1187

Electronics

April 18, 1966
Volume 39, Number 8

Page	4	Readers Comment
	8	People
	14	Meetings
	16	Meeting Preview
	23	Editorial
	25	Electronics Newsletter
	69	Washington Newsletter
	165	New Products
	207	New Books
	208	Technical Abstracts
	209	New Literature

Electronics Review

Page	37	Beating the blackout	40	Braided memories
	38	Plug-in teacher	44	Woven wiring
	39	A LID with legs	46	IR thermometer
	40	Laser beam tracking	47	Electronics notes

Probing the News

139	Holography: the picture looks good
145	Tactical satellite program gets moving
149	Where the action is

Electronics Abroad

213	Three-in-one color gun	215	Germany's antenna war
214	On-time transistor	216	Changing exchanges
214	Thin lines	216	Infrared viewer

Technical Articles

I. Design

Advanced technology	82	Filling in the blanks in the laser's spectrum (cover) High-power beams are generated at many new frequencies in nonlinear dielectrics Fred M. Johnson, Electro-Optical Systems, Inc.
Reference sheet	88	Nomographs calculate values for twin-T notch filter Just two graphical steps are required with these charts Tom G. Purnhagen, U.S. Air Force
Circuit design	90	Ringing choke simplifies d-c to d-c conversion Alternately storing and retrieving energy from a magnetic field boosts d-c voltage J.F. Howell, General Electric Co.
Circuit design	94	Designer's casebook <ul style="list-style-type: none">■ Two unijunctions form low-cost level detector■ Exclusive OR circuit requires no voltage supply■ Single component changes bandpass into general filter■ Diode quad modulator suppresses carrier 65 db

II. Application

Consumer electronics	99	Solid state appears in big-screen color tv New design generates less heat and improves components' reliability Derek Bray, Fairchild Semiconductor Div.
Components	109	Voltage transients tamed by spark-gap arresters A version of a radar switch protects semiconductors from power line surges V. W. Vodicka, Applied Magnetics Corp.

III. Manufacturing

Production	116	Production tips <ul style="list-style-type: none">■ Machine soldering gets IC's into tighter spots■ Fixture shaves 10 minutes from module-making time■ Coordinate measurer puts old boards into new line
------------	-----	---

Title R registered
U.S. Patent Office;
© copyright 1966
by McGraw-Hill, Inc.
All rights reserved,
including the right to
reproduce the contents
of this publication,
in whole or in part.

Electronics

Editor: Lewis H. Young

Senior editors

Design: Samuel Weber
Application: George Sideris
News: Kemp Anderson Jr.

Assistant to the editor: Sally Powell

Senior associate editor: John F. Mason

Department editors

Advanced technology: Joan Blum
Avionics: W.J. Evanzia
Communications: Leonard Weller
Computers: Wallace B. Riley
Consumer electronics: Richard Lipkin
Electronics abroad: Arthur Erikson
Electronics review: Stanley Zarowin
Instrumentation: Carl Moskowitz
Military electronics: John F. Mason
New products: William P. O'Brien
Solid state: Jerome Eimbinder
Space electronics: Robert Henkel

Regional editors

Domestic

Boston: Thomas Maguire, editor; Robin Carlson
Los Angeles: William B. Wallace, Walter Barney, editors; June Ranill
San Francisco: Laurence D. Shergalis, Edmond G. Addeo, editors; Mary Jo Jadin

Foreign

European: Derek Barlow, (London)
Bonn: John Gosch
Tokyo: Charles Cohen

Copy editors

Howard Rausch, James J. Moran

Graphic design

Art director: Saul Sussman
Assistant art directors: Donna M. Griffiths, Ann Mella
Production editor: Arthur C. Miller

Editorial secretaries: Claire Benell, Mary D'Angelo, Lynn Emery, Lorraine Fabry, Kay Fontana, Lorraine Longo, Carolyn Michnowicz

McGraw-Hill News Service

Director: John Wilhelm; **Atlanta:** Fran Ridgway; **Chicago:** Reck Johnson;
Cleveland: Arthur Zimmerman; **Dallas:** Marvin Reid;
Detroit: N. Hunter; **Houston:** Ron Lovell; **Los Angeles:** Michael Murphy, Gerald Parkinson;
San Francisco: Margaret Ralston;
Seattle: Ray Bloomberg; **Washington:** Arthur L. Moore, Charles Gardner, Herbert W. Cheshire, Seth Payne, Warren Burkett, Warren Kornberg

McGraw-Hill World News Service

Bonn: John Johnsrud; **London:** John Shinn;
Mexico City: Bruce Cross; **Milan:** Ronald Taggiasco;
Moscow: Donald Winston; **Paris:** Peter Kilborn;
Rio de Janeiro: Wes Perry; **Tokyo:** Marvin Petal

Reprints: T.M. Egan

Publisher: Gordon Jones

Electronics: April 18, 1966, Vol. 39, No. 8

Printed at 99 North Broadway, Albany, N.Y., 12207
Second class postage paid at Albany, N.Y.

Subscriptions are solicited only from those actively engaged in the field of the publication. Position and company connection must be indicated on orders. Subscription prices: United States and Possessions and Canada, \$6.00 one year, \$9.00 two years, \$12.00 three years. All other countries \$20.00 one year. Single copies, United States and Possessions and Canada 75¢. Single copies all other countries \$1.50.

Published every other Monday by McGraw-Hill Inc. 330 West 42nd Street, New York, N.Y. 10036, Founder: James H. McGraw, 1860-1948. Corporate officers: Shelton Fisher, President; John J. Cooke, Secretary; John L. McGraw, Treasurer.

Subscribers: The Publisher, upon written request to our New York office from any subscriber, agrees to refund that part of the subscription price applying to copies not yet mailed. Please send change of address notices, subscription orders or complaints to Fulfillment Manager, Electronics, at the address below. Change of address notices should provide old as well as new address, including postal zone number if any. If possible, attach address label from recent issue. Allow one month for change to become effective.

Postmaster: Please send Form 3579 to Fulfillment Manager, Electronics, P.O. Box 430, Hightstown, New Jersey 08520

Readers Comment

'Clash' continues

To the Editor:

Your recent article on standards, "Clash of symbols" [Jan. 24, p. 137], contains some errors of fact and unfortunate insinuations concerning the experts who advised the IEEE symbol standards coordinating committee on insulated gate field effect transistors (Igfet).

Our IEEE committee did not, as stated in the article, "appoint three experts in FET work." We requested advice on this subject from other IEEE and JEDEC committees concerned with the FET field.

The chairman of IEEE 28.4 originally offered the services of his subcommittees. Mr. Drusdow, a long time member of our committee, was asked to coordinate the FET project. Dr. S. R. Hofstein was a member of the IEEE 29.4.16 task group on field effect transistors and the IEEE 28.9 committee on microelectronic systems. D. M. Griswold was chairman of the JEDEC JS-8 committee on consumer product devices and a member of the JEDEC JS-9 task force on FET registration form. Such existing committees are a good source of advice in their respective fields.

The gentlemen did not represent RCA but, rather, served as a channel through which the views of others in the IEEE and in industry might reach our committee. The symbols adopted by our committee are somewhat different from the "RCA" version [Electronics, Dec. 14, 1964, p. 76]. The fact that these experts were all employed by RCA is an interesting comment on the degree of employer support and engineers' interest concerning participation in professional and industry committees attempting to solve problems in the electronics field.

While we certainly did not discuss our proposals with everyone in the electronics industry, our proposed symbols were developed from a sound technical analysis of the problem and are based on the rules and symbols of ASA Y32.2 item 73, with the addition of a new idea, the gate. Facts, not emotion

New from Sprague!

1966
SPRAGUE
METFILM 'A'
CAPACITORS



1963
ULTRA-THIN
METALLIZED
POLYESTER FILM
CAPACITORS

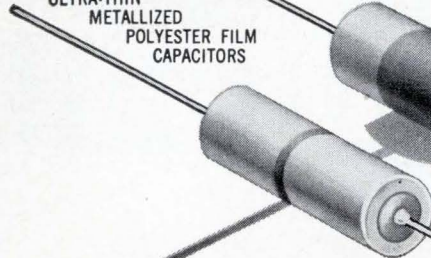

1956
METALLIZED
POLYESTER FILM
CAPACITORS

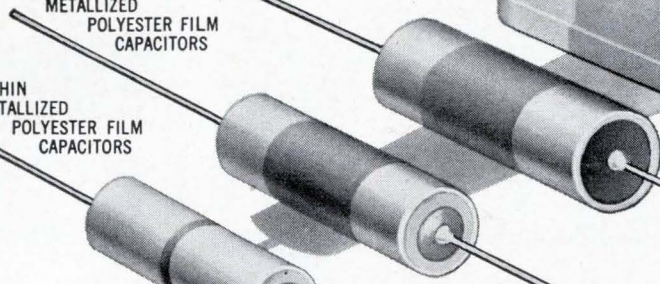

1947
METALLIZED PAPER
CAPACITORS

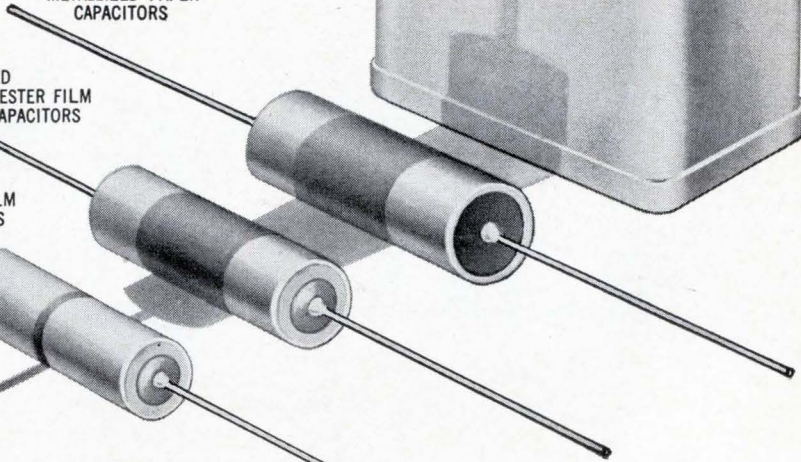

1944
OIL-IMPREGNATED
PAPER
CAPACITORS

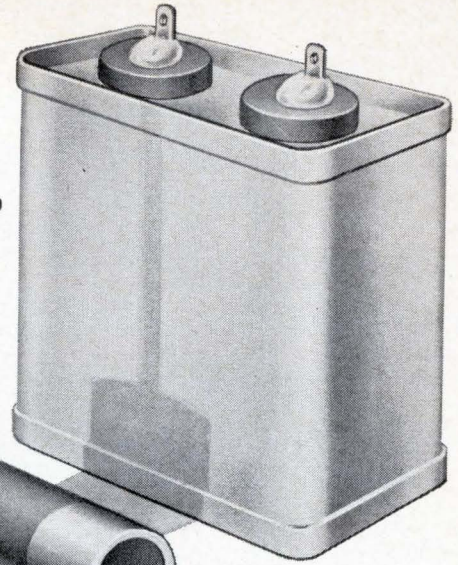

METFILM* 'A' CAPACITORS ... dramatically smaller in size, yet more reliable than military-grade capacitors of the past!

Just a few years ago, the only 10 μ F capacitor considered dependable enough for military applications was Type CP70 (to JAN-C-25), and was a block-busting 3 $\frac{3}{4}$ " wide x 1 $\frac{3}{4}$ " thick x 4" high. Today, you can get a military-quality 10 μ F tubular capacitor measuring only $\frac{1}{2}$ " in diameter x 2 $\frac{1}{4}$ " long. And it's more reliable than any capacitor of the past!

Sprague Type 680P Metfilm 'A' Metallized Capacitors meet all environmental requirements of MIL-C-18312, yet they occupy only one-third the volume of conventional metallized film capacitors of equivalent capacitance and voltage rating. Employing a new thin organic film dielectric system, Type 680P capacitors use a dual film totalling only 0.00008" thick, as compared to conventional polyester-film capacitors with a single film measuring 0.00015".

*Trademark

Another distinct advantage of the Metfilm 'A' dielectric system is minimum degradation of electrical properties during life.

Hermetically sealed in corrosion-resistant metal cases, capacitor sections are effectively of non-inductive construction, resulting in capacitors with performance characteristics superior to those of comparably-sized capacitors.

Type 680P Metfilm 'A' Capacitors are available with capacitance values to 10 μ F in both 50 and 100 volt ratings.



For complete technical data, write for Engineering Bulletin 2650 to Technical Literature Service, Sprague Electric Company, 35 Marshall St., North Adams, Mass. 01247.

SPRAGUE COMPONENTS

CAPACITORS
TRANSISTORS
RESISTORS
INTEGRATED CIRCUITS
THIN-FILM MICROCIRCUITS

PULSE TRANSFORMERS
INTERFERENCE FILTERS
PULSE-FORMING NETWORKS
TOROIDAL INDUCTORS
ELECTRIC WAVE FILTERS

CERAMIC-BASE PRINTED NETWORKS
PACKAGED COMPONENT ASSEMBLIES
BOBBIN and TAPE WOUND MAGNETIC CORES
SILICON RECTIFIER GATE CONTROLS
FUNCTIONAL DIGITAL CIRCUITS



'Sprague' and '®' are registered trademarks of the Sprague Electric Co.



This 5 MHz counter/timer from Monsanto is only 3½ inches high, and weighs just 16 pounds. Yet it gives you a time base range from 1 μ second to 100 seconds in decade steps, and resolution for frequency measurement of 0.01 Hz.

HOW COME? Integrated circuits. In 90% of the active circuits. That's how Monsanto builds big performance into a small package. Plus speed, accuracy, reliability, low power consumption, low heat generation and easy maintenance. Six of the 13 printed circuit boards are interchangeable.

HOW MUCH? Just \$1575. And that low selling price

goes with these "high-priced" specs:

- Measures average frequency: 0–5 MHz
- Measures average periods: 0.2 μ sec. to 1 sec.
- Measures single periods: 1 μ sec. to 10⁶ sec.
- Measures frequency ratios: 10⁻⁶ to 10⁶
- Measures time intervals: 1 μ sec. to 10⁶ sec.
- Counts: random or uniformly spaced signals.

Want to know more? Just clip the coupon.



MONSANTO, ELECTRONICS DEPT. 800 NORTH LINDBERGH BLVD. • ST. LOUIS, MO.

Details, please, on the Model 1010 5 MHz Counter/Timer
 Model 1000 20 MHz Counter/Timer

Name/Title _____

Firm _____

Address _____

City/State/Zip _____

or industry bias, were the basis for our choice.

Your article would have been a more valued contribution if it had explained the technical reasons behind the construction of the FET symbols in the IEEE proposed form.

C. R. Muller

Chairman
IEEE Symbol Standards
Coordinating Committee for
Letter and Graphic Symbols

▪ The article made no insinuations about the competency of the three-man committee nor did it say their choice of circuit symbols was better or worse than others now also in use. It merely pointed out some facts that are unalterable.

Despite reader Muller's protests, it is true that all three members of the committee that drew up the symbols work for the same company so the symbols do represent RCA's rather than the industry's thinking. For example, RCA is the only company that uses field-effect transistor symbols that have an off-set gate and arrows whose only function is to distinguish between n-channel and p-channel types.

Other companies, such as the Fairchild Semiconductor division of Fairchild Camera & Instrument Corp. and Texas Instruments Incorporated use a symbol in which the direction of current flow is shown.

We would have presented the technical reasons behind the choice of the proposed IEEE symbols, if there had been any. According to Drusdow, his group had two main goals: to make the symbols as simple as possible and to make sure they couldn't be misinterpreted.

Drusdow points out there is no rule that a symbol must attempt

to duplicate the function of a device. As a result, he adds, his committee made no attempt to indicate the direction of current flow through the transistor.

Credit, where it's due

To the Editor:

In the article "Putting superconductors to work," [February 7, 1965, p. 95] by Donald K. Fox, the 6-foot diameter superconducting magnet pictured was completely designed and constructed by S. R. Hawkins and associates at Lockheed's Palo Alto Research Laboratories. However, no reference whatsoever is made in this article to S. R. Hawkins or to Lockheed.

C. F. Kooi, Sr. Member
Electronic Sciences Laboratory
Lockheed Missiles and Space Co.
Palo Alto, Calif.

▪ The unintended omission is corrected.

Wrong connection

To the Editor:

There appears to be an error in the schematic of the article "Adjustable current limiter for regulated power supply" [Designer's casebook, March 7, 1966, p. 107].

The common connection of both Q4 and Q5's collector to R₆ will cause the output to sit at a value much lower than the stated 12 volts. It would appear that the collector of Q4 should be connected to the output voltage line.

Karl Hoffman

Bendix Research Labs
Southfield, Mich.

▪ Reader Hoffman's sharp eyes caught a wrong connection.

AS
LOW
AS
~~30~~ **¢** EACH



NPC High Reliability Zener Diodes

1N714 (10V 250mW) to 1N745 (200V 250mW) incl., 1N961 (10V 400mW) to 1N991 (180V 400mW) incl. in DO-7 miniature glass package.

Ask about NPC's new, lower price on these 100% reliability and electrical inspected zener diodes.

Each unit receives rigid quality control inspection, which includes temperature cycle, thermal shock, storage life test at elevated temperature, and hydrostatic pressurized bomb and radioactive radiflo tests.

These NPC diodes are manufactured with an advanced controlled process in accordance with standard military specifications.

For high reliability, lower cost, and stock delivery write or call NPC for a quotation today.

**NUCLEONIC
PRODUCTS
CO., INC.**

3133 East 12th St., Los Angeles
Calif. 90023 • Tel: (213) 268-3464
TWX: 910-321-3077

SUBSCRIPTION SERVICE	
<p>Please include an Electronics Magazine address label to insure prompt service whenever you write us about your subscription.</p> <p>Mail to: Fulfillment Manager Electronics P.O. Box 430 Hightstown, N.J. 08520</p> <p>To subscribe mail this form with your payment and check <input type="checkbox"/> new subscription <input type="checkbox"/> renew my present subscription</p> <p>Subscription rates: in the U.S.: 1 year, \$6; two years, \$9; three years, \$12. Subscription rates for foreign countries available on request</p>	<div style="border: 1px solid black; padding: 5px; text-align: center;">CHANGE OF ADDRESS</div> <p>ATTACH LABEL HERE If you are moving, please let us know five weeks before changing your address. Place magazine address label here, print your new address below.</p> <p>name _____</p> <p>address _____</p> <p>city _____ state _____ zip code _____</p>

How can you send him a radio message that hills and jungles can't stop?



Granger Associates has the answer

now Intervening hills and jungles won't stop a radio signal from G/A's new short-range skywave antenna. Its signal travels to the ionosphere and bounces back to earth a few yards to 300 miles

away, by-passing all obstacles on the surface. Other omnidirectional HF transmitting antennas are monopoles which can't reach close-in jungle points well. The ground waves they emit are absorbed within a few miles by jungle foliage. The skywaves they launch are concentrated at low elevation angles so that they glance off the ionosphere and return to earth far away. Only Model 798 beams skywaves at high elevation angles so that they bounce back to earth nearby. It will handle all short-range HF frequencies, 2 to 20 MHz, without tuning and with a maximum VSWR of 2:1.

Send for complete technical data on Model 798, the world's only omnidirectional short-range skywave antenna.



CAREER OPPORTUNITIES FOR ENGINEERS IN ANTENNAS AND TRANSMISSION PRODUCTS

1601 California Ave., Palo Alto, California / Telephone: 321-4175 / TWX: 910-373-1291
Granger Associates Ltd.
Russell House, Molesey Rd., Walton-on-Thames, Surrey, England / Telephone: 29913

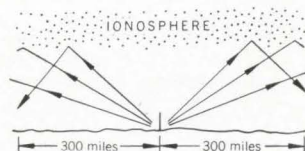

The low-angle skywaves launched by a monopole skip over all points less than 300 miles away.

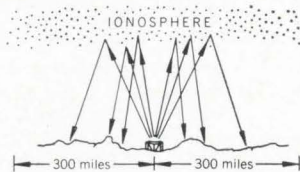

High-angle radiation from G/A's short-range antenna reaches all points zero to 300 miles distant.

People

Leon Bess' new job is to help man find where in the world he is. He has been named staff physicist at LFE Electronics, a division of Laboratory for Electronics, Inc., of Boston; his role will be to help develop new navigation techniques for aircraft.



In tackling the problem, Bess is taking a unique approach. Since all navigation aids introduce error, he reasons, the best practical approach may be to use several navigation aids, determine the extent of the errors of each under different circumstances and then use only the best information from each. Under the plan, an airborne navigation system would use doppler radar, inertial navigation instruments and hyperbolic signals generated by loran or omega navigation stations. A data processor in the craft would filter out the errors and, if all went well, come up with an extremely accurate position fix.

Faster than the mind. The key to the approach is the Kalman filter theory, a sort of mathematical recipe for estimating error and determining which information is the most useful. In a sense, Bess explains, the technique will work like the human mind, only a lot faster—shifting from one source of information to another, rejecting parts of some data and putting more emphasis on other data, depending on the error probabilities.

The mathematical theory was first advanced about six years ago by R.E. Kalman of the Research Institute for Advanced Study, Baltimore. Recently industry has been proposing to apply it to advanced navigational systems, and government users are now soliciting proposals.

Before joining LFE Electronics, Bess taught solid state physics at Indiana State University, where he did research on noise in semiconductors. Earlier he taught at the University of Illinois, where he had earned a doctorate in theoretical physics, and at Columbia Univer-



Highest Power Level for RF operation at C-Band: MACHLETT miniature planar triodes

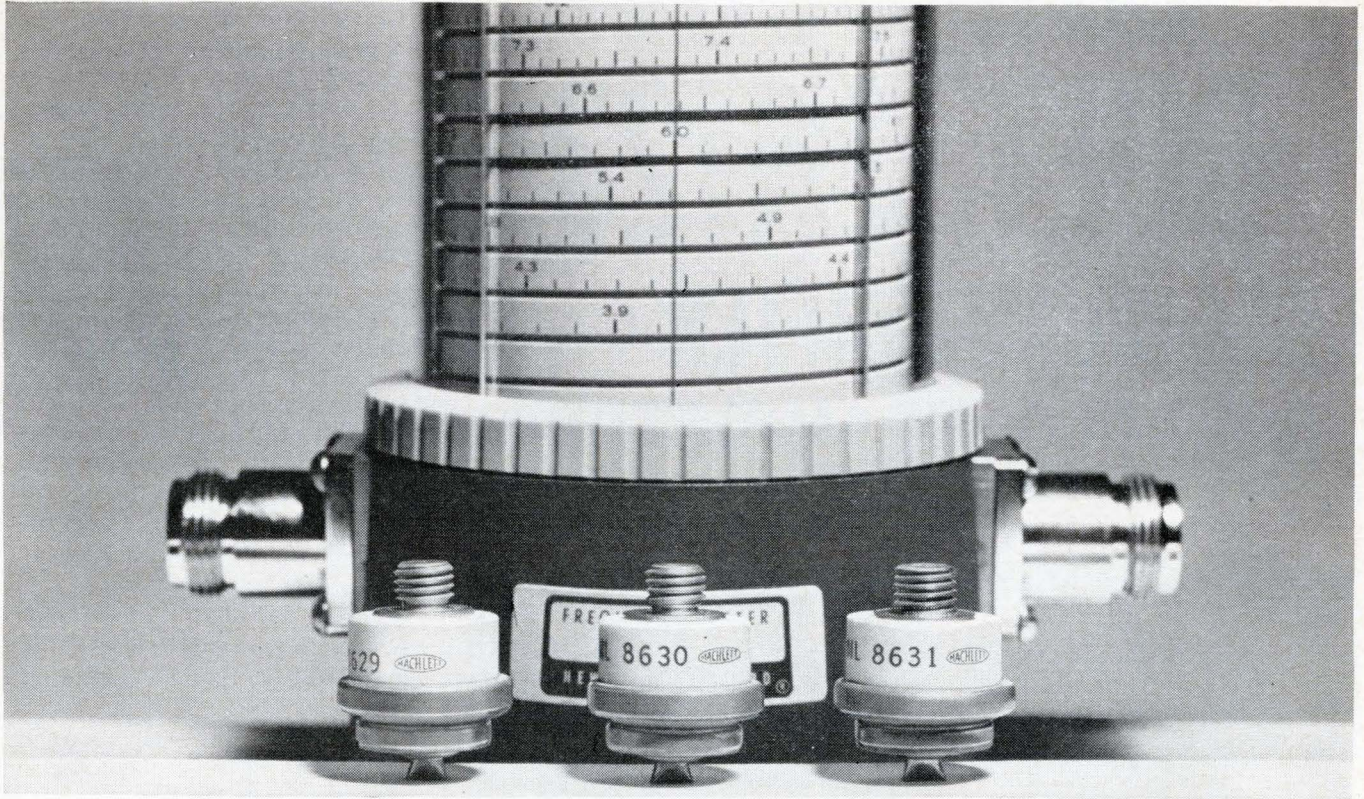

For comparable size and weight in the C-Band region, and higher, the Machlett miniature planar triode provides the highest plate dissipation capability with correspondingly high duty cycle and rf power output. 1 kW grid pulse operation is currently being achieved at 6 Gc with the ML-8630. From cathode rf heater contact to anode rf surface contact, these new tubes ML-8629, ML-8630 and ML-8631 measure only .565 inches high by .7 inch diameter. These "8600 series" tubes will dissipate 100 watts, or more, with suitable cooling devices. Frequency stable for quick on-frequency performance. Phormat cathode for high voltage stability.

For complete details, write
The Machlett Laboratories, Inc.,
Springdale (Stamford), Conn. 06879.

RAYTHEON

THE MACHLETT LABORATORIES, INC.

A SUBSIDIARY OF RAYTHEON COMPANY

New from Sprague!



LOW COST DUET* 3N123 DUAL-EMITTER CHOPPER TRANSISTORS

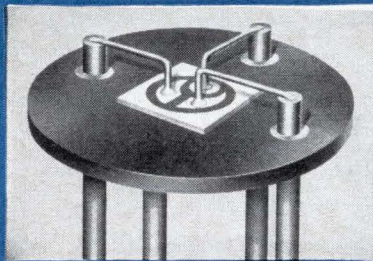

CHECK THESE FEATURES!

$$BV_{EEO} > 25 \text{ VOLTS}$$

$$/V_o/ < 250 \mu\text{V}$$

$$/\Delta V_o/T_A < 2.3 \mu\text{V per } ^\circ\text{C}$$

$$f_T > 6 \text{ mc}$$

HIGH VOLTAGE! RELIABLE PLANAR CONSTRUCTION!

Sprague offers more dual-emitter transistor types than any other source!

TYPE No.	BV _{EEO} (volts)	V _o (μV)	TYPE No.	BV _{EEO} (volts)	V _o (μV)	TYPE No.	BV _{EEO} (volts)	V _o (μV)	TYPE No.	BV _{EEO} (volts)	V _o (μV)	TYPE No.	BV _{EEO} (volts)	V _o (μV)
3N90	30	50	3N95	50	200	3N104	20	50	3N109	50	150	3N116	12	200
3N91	30	100	3N100	10	50	3N105	15	250	3N110	30	30	3N117	20	50
3N92	30	200	3N101	30	50	3N106	30	250	3N111	30	150	3N118	20	100
3N93	50	50	3N102	40	50	3N107	50	250	3N114	12	50	3N119	20	200
3N94	50	100	3N103	50	50	3N108	50	30	3N115	12	100	3N123	25	250

*Trademark

For complete information, write to Technical Literature Service,
Sprague Electric Co., 35 Marshall St., North Adams, Mass. 01248

SPRAGUE COMPONENTS

- TRANSISTORS
- CAPACITORS
- RESISTORS
- THIN-FILM MICROCIRCUITS
- INTEGRATED CIRCUITS
- INTERFERENCE FILTERS
- PACKAGED COMPONENT ASSEMBLIES
- FUNCTIONAL DIGITAL CIRCUITS
- MAGNETIC COMPONENTS
- PULSE TRANSFORMERS
- CERAMIC-BASE PRINTED NETWORKS
- PULSE-FORMING NETWORKS



*Sprague and ® are registered trademarks of the Sprague Electric Co.

People

sity. In the 1950's, he worked in solid state research at the Philco Corp. and at the Lincoln Laboratory of the Massachusetts Institute of Technology.

Warren P. Waters, who has been named manager of Hughes Aircraft Co.'s solid state research center at Newport Beach, Calif., described his new role as that of a "middle man."

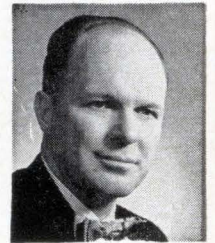

"We are working with the research people, and when they find something that has an application, they come and talk to us. On the other hand, we are working with the designers and production people who come to us with the requirements," he explains.

In his new liaison role, he will be directing research in three general areas: microwave and optical, advanced solid state, and microelectronics.

Place to work. To encourage the circuit design people from other divisions of Hughes to bring in their problems and ideas, the center is setting up a special circuit design facility where they can work, he says.

This is not Waters first association with Hughes. Four years ago he left Hughes and went to work with Texas Instruments Incorporated, where he was manager of a semiconductor and development laboratory.

Waters has been in the solid state business since 1952, when he joined Hughes to work on the development of transistors. One project involved the development of npn alloys for germanium and he has retained a strong interest in germanium ever since. Most of his time at TI was spent in developing a planar germanium transistor process. It's his opinion that no real effort has been devoted to germanium. Waters says that's because companies have neglected germanium's possibilities in their rush to get on the silicon bandwagon.

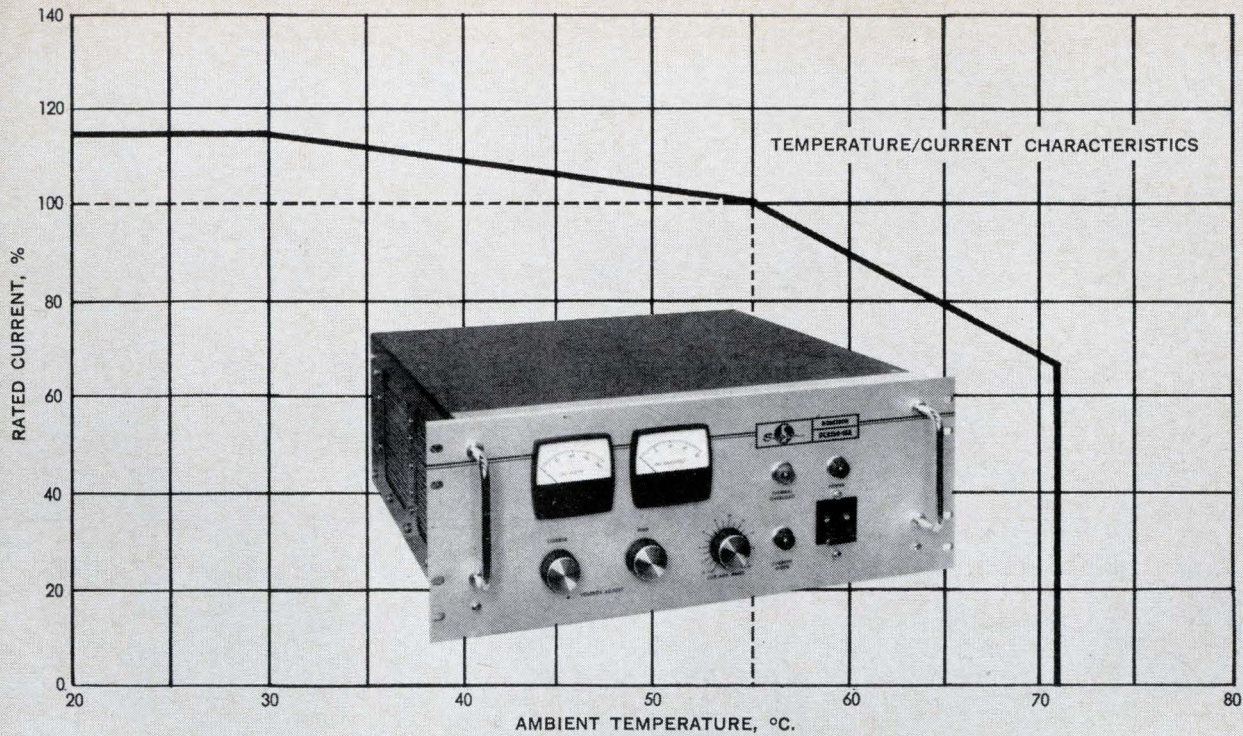

Sorensen DCR Series now with temperature capability to 71°C.

All-Silicon Power Supplies to 20 kW.

Sorensen's wide range DCR Series has been up-dated and improved. What's new about the DCR's? They are now 100% silicon; ambient temperature capability is now to 71°C. • Four 3-phase models have been added extending power capability to 20 kW; 24 models are now available with ranges up to 300 volts. • Multiple mode programming—voltage/current/resistance. • Voltage regulation, line and load combined, is $\pm .075\%$ for most models • Constant current range 0 to rated current. • DCR's meet MIL-I-26600 and MIL-I-6181

specifications and conform to proposed NEMA standards. • Front panel indicator for voltage/current crossover. These features of the improved DCR (model numbers will have an "A" suffix) are offered at no increase in price.

For DCR details, or for data on other standard/custom power supplies, voltage regulators or frequency changers, call your local Sorensen representative, or write: Sorensen, A Unit of Raytheon Company, South Norwalk, Connecticut 06856.

MODEL SELECTION CHART

Voltage	Amps.	Model	Price	Amps.	Model	Price	Amps.	Model	Price	Amps.	Model	Price
0- 20	125	DCR 20- 125A	\$1055	250	DCR 20- 250A	\$1495	—	—	—	—	—	—
0- 40	10	DCR 40- 10A	325	20	DCR 40- 20A	525	35	DCR 40- 35A	\$ 710	60	DCR 40-60A	\$925
0- 40	125	DCR 40- 125A	1350	250	DCR 40-125A	1995	500	DCR 40-500A	2950	—	—	—
0- 60	13	DCR 60- 13A	525	25	DCR 60- 25A	710	40	DCR 60- 40A	900	—	—	—
0- 80	5	DCR 80- 5A	325	10	DCR 80- 10A	525	18	DCR 80- 18A	710	30	DCR 80-30A	875
0-150	2.5	DCR 150- 2.5A	325	5	DCR 150- 5A	525	10	DCR 150- 10A	710	15	DCR 150-15A	825
0-300	1.25	DCR 300-1.25A	325	2.5	DCR 300- 2.5A	525	5	DCR 300- 5A	710	8	DCR 300- 8A	825



Circle 11 on reader service card



**Bendix announces the
B-5000: (25 watts at 2.5 amps,
10 volts and 100° C)
a significant cost
breakthrough in silicon
power transistors.**

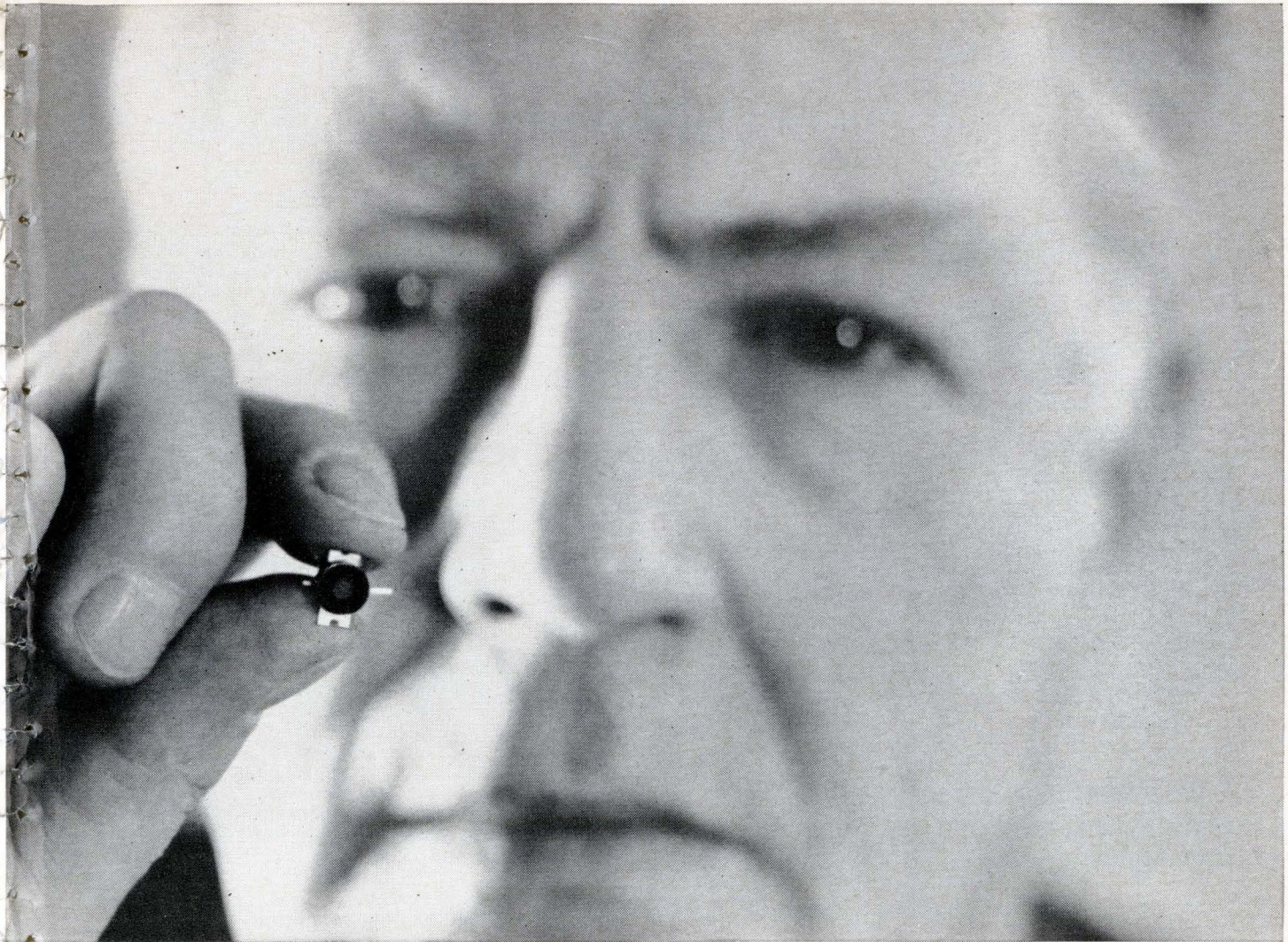

It costs under 40¢.*

New manufacturing and packaging techniques make the B-5000 possible. These techniques include new internal device element assembly, along with new-concept plastic molding operations. The result is a simple, low-cost, reliable silicon power transistor *with no power compromise*, when mounted upon the normal heat sink.

B-5000's low cost opens up whole new application areas for you. Now you can afford to put silicon power to work in many industrial and consumer products. Lighting equipment, TV sets, audio amplifiers, appliance sensing amplifiers and industrial controls, to mention a few. Compare the cost of the Bendix® B-5000 with any other silicon power unit of equal rating. You'll discover significant savings.

B-5000 offers advances in size, weight and thermal resistance. Leads and collector strips are highly conductive silver, offering excellent solderability, strength and ability to withstand flex and pull. Plastic encapsulant offers outstanding insulation resistance, hermeticity, adhesion ability and high temperature characteristics. In no way does B-5000 compromise traditionally accepted reliability practices.

With B-5000 you can tailor mounting techniques to fit your needs exactly. Depending on heat sink, available space and degree of assembly line mechanization, B-5000 can be mounted in the fashion best suited to your operation. For example, B-5000 is readily adaptable to the newer assembly solder techniques without degradation.

B-5000 lends itself equally well to other commonly used production line techniques.

Electrical specifications

Characteristic	Limits			Test Conditions				
	Min.	Max.	Unit	V _{CB} V	V _{CE} V	I _C A	I _B mA	T _J °C
V _{CEO}	35	—	V	14	25	0.2		150
I _{CEO}	—	10	mA					
I _{CBO}	—	1.5	mA					
V _{BE}	—	1.2	V		14	0.5		
h _{FE}	30	250	—		14	0.5		
h _{FE}	20	—	—		14	1.0		
V _{CE(s)}	—	1.2	V				50	

Absolute maximum ratings

V_{CEO} = 35 volts, I_C = 3 amps, I_B = 1 amp, T_{stg} = -65 to 175°C, T_J = -65 to 150°C.

For complete information about the new Bendix B-5000 silicon power transistor, write to us in Holmdel, New Jersey.

*In volume quantities

Bendix Semiconductor Division
HOLMDEL, NEW JERSEY



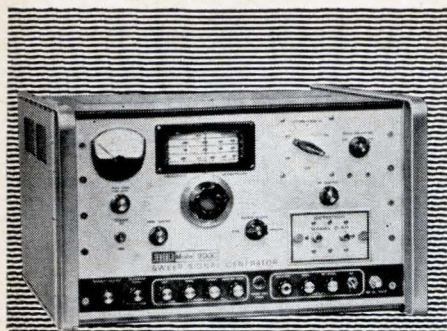

Jerrold's new Model 900-C is the most conceited sweep signal generator on the market!

We get a little embarrassed. The many thousands of Model 900's now in the field have built up such a tremendous reputation for dependability and service that they're beginning to act smug. They "show off" with gut features like built-in oscilloscope pre-amp, four mode operation and continuously variable sweep widths from 10 kHz to 400 MHz (center frequencies from 500 kHz to 1200 MHz) — just to name a few.

But that's not the worst of it.

The New 900-C really gets overbearing when it starts performing. Say you want to observe the entire frequency range of a unit under test... or examine a narrow 10 kHz beamwidth... or make a quantitative analysis of the response of a wide range of electronic devices such as receivers, amplifiers, filters, transformers, or transmission lines.

It does these chores so easily, so accurately, and so efficiently, we despair of ever deflating its ego.

One small revenge. Our New Model 900-C literature is very, very modest. Send for a copy.

JERROLD

MEASUREMENT AND
TEST INSTRUMENTATION

JERROLD ELECTRONICS CORPORATION
Government and Industrial Division
Philadelphia, Pa. 19105

Meetings

Audio Engineering Society's Convention, AES; Hollywood Roosevelt Hotel, L.A., April 25-28.

IEEE Region Conference, IEEE; Pioneer International Hotel, Tucson, April 26-28.

Relay Conference, National Association of Relay Manufacturers and School of Electrical Engineering Oklahoma State University; Oklahoma State University, Stillwater, April 26-27.

Spring Joint Computer Conference, American Federation of Information Processing; Boston, Mass., April 26-28.

International Electronics Congress, German Association of Electro-Technicians; Congress Hall on the Hanover Fairgrounds, April 30-May 8.

Symposium on Electrode Processes, Electrochemical Society; Sheraton-Cleveland Hotel, Cleveland, May 1-6.

Aerospace Instrumentation Symposium, ISA; Marriott Motor Hotel, Philadelphia, May 2-4.

Communications Satellite Systems Conference, AIAA; Washington, May 2-4.

Integrated Circuit Economics and Basic Technology Seminar, Integrated Circuit Engineering Corp.; Washington, May 2-6.

Industrial Communications Conference, ICA; Queen Elizabeth Hotel, Montreal, Canada, May 2-5.

Computer Aided Solid State Circuit Design, University of Wisconsin; Madison, May 3-4.

Bionics Symposium, Air Force Systems Command; Sheraton Hilton Hotel, Dayton, Ohio, May 3-5.

Electronic Components Conference, Electronics Industry Association; Marriott Twin Bridges Motor Inn, Washington, May 4-6.

Symposium on Human Factors in Electronics, IEEE G-HFE; Radisson Hotel, Minneapolis, May 5-6.

Conference on Photographic Science and Engineering, SPSE; San Francisco Hilton, San Francisco, May 9-13.

Design Engineering Conference, American Society of Mechanical Engineers, McCormick Place, Chicago, May 9-12.

Institute on Systems Science, American University Center for Technology and Administration; Twin Bridges Marriott Motor Hotel, Washington, May 9-12.

Standards Laboratory Conference, NBS; National Bureau of Standards, Gaithersburg, Md., May 9-12.

AE-4 Electromagnetic Compatibility Conference, SAE; U.S. Navy Engineering laboratory, Annapolis, Md., May 10-11.

Packaging Industry Conference, IEEE G-IGA; Hotel America, Hartford, Conn., May 10-12.

Symposium on Hydrogen Thyratrons and Modulators, U.S. Army Electronics Command Advisory Group on Electron Devices; Hexagon Building, Fort Monmouth, May 10-12.

Telemetry Conference and Exhibit, ISA, AIAA, IEEE; Prudential Center, Boston, May 10-12.

National Aerospace Electronics Conference (NAECON), IEEE; Dayton Sheraton Hotel, Dayton, Ohio, May 16-18.*

Call for papers

Automatic Support Systems for Maintainability, IEEE; Colony Hotel, Clayton, Mo., Nov. 7-9. **May 1** is deadline for submission of 500-word abstract on computer applications to automatic test equipment, advanced testing techniques, dynamic analysis, failure prediction methods, and multi-maintenance level compatibility to Mr. Don L. Reed, Program Chairman, P.O. Box 4124, St. Louis, Missouri 63136.

Symposium on the Physics of Failure in Electronics, Rome Air Development Center, Battelle Memorial Institute; Columbus, Ohio, Nov. 15-17. **June 17** is deadline for submission of 500-word abstract on physical, chemical, and metallurgical processes that contribute to the degradation or failure in electronic materials and devices to Theodore S. Shilliday, Symposium Co-Chairman, Columbus Laboratories, Battelle Memorial Institute, 505 King Ave., Columbus, Ohio 43201.

* Meeting preview on page 16



new disciplines in DC

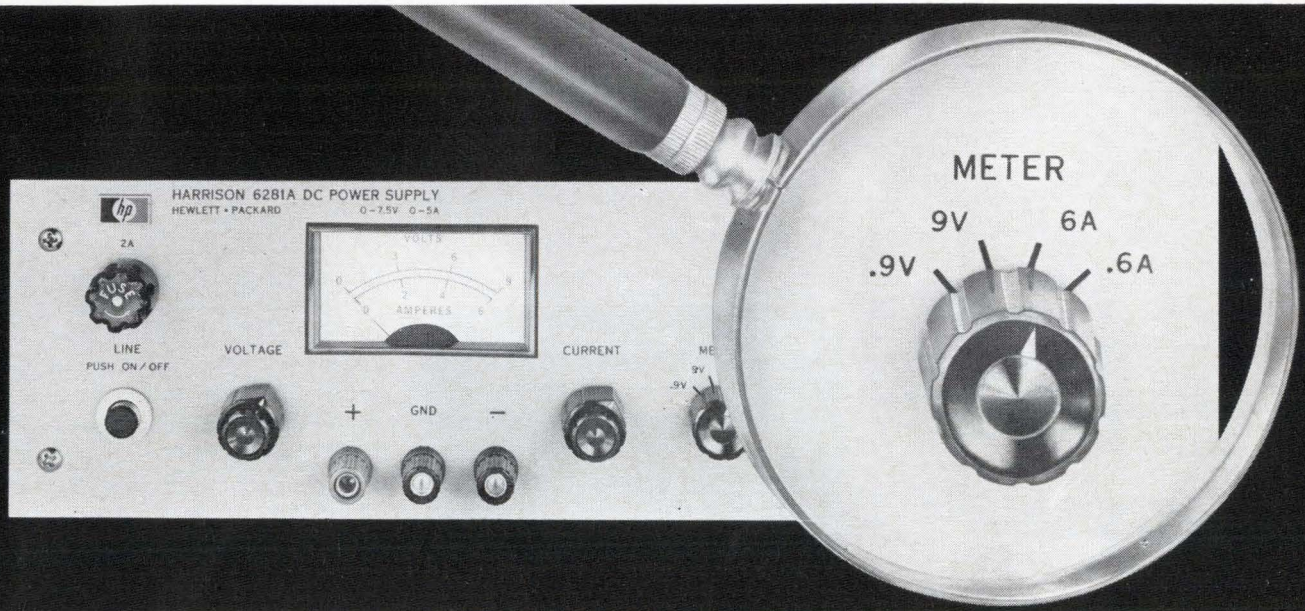

take the models with magnified meter ranges

Multiple Range Meter provides increased resolution and accuracy at low output

DC OUTPUT	SIZE*	MODEL	PRICE
0-7.5V, 0-3A	3½"HxHRW	6203B	\$169
0-7.5V, 0-5A	3½"HxHRW	6281A	210
TWIN 0-7.5V, 0-5A	3½"HxFRW	6251A	445
0-10V, 0-10A	5¼"HxHRW	6282A	350
0-20V, 0-.6A/0-40V, 0-.3A DUAL RANGE	3½"HxHRW	6204B	144
TWIN 0-20V, 0-.6A/0-40V, 0-.3A DUAL RANGE	3½"HxHRW	6205B	235†
0-20V, 0-1.5A	3½"HxHRW	6201B	169
0-20V, 0-1.5A/0-40V, 0-.75A DUAL RANGE	3½"HxHRW	6200B	189
0-20V, 0-3A	3½"HxHRW	6284A	210
TWIN 0-20V, 0-3A	3½"HxFRW	6253A	445
0-20V, 0-5A	5¼"HxHRW	6285A	350
0-20V, 0-10A	5¼"HxHRW	6286A	395
0-40V, 0-.75A	3½"HxHRW	6202B	169
0-30V, 0-1A/0-60V, 0-.5A DUAL RANGE	3½"HxHRW	6206B	169
0-40V, 0-1.5A	3½"HxHRW	6289A	210
TWIN 0-40V, 0-1.5A	3½"HxFRW	6255A	445
0-40V, 0-3A	5¼"HxHRW	6290A	350
0-40V, 0-5A	5¼"HxHRW	6291A	395
0-60V, 0-1A	3½"HxHRW	6294A	210
TWIN 0-60V, 0-1A	3½"HxFRW	6257A	445
0-60V, 0-3A	5¼"HxHRW	6296A	395
0-100V, 0-.75A	3½"HxHRW	6299A	225
TWIN 0-100V, 0-.75A	3½"HxFRW	6258A	445
0-160V, 0-.2A	3½"HxHRW	6207B	194
0-320V, 0-.1A	3½"HxHRW	6209B	194

*HRW = half rack width, FRW = full rack width
†Also available with standard meters @ \$195

A four-position meter range switch sets the full scale voltmeter and ammeter values at either 100% or 10% of the nominal output rating (approximately). Meter and associated circuitry are foolproof — no danger of burnout for any DC output combined with any meter range.

Chart lists 25 low and medium power models from LAB, MPB, and DPR series — all have multiple range meters at no extra price — all are recently updated or added instruments featuring all-silicon circuitry. Typical specs include: Regulation, Load or Line, 0.01%; Ripple, 200 μ V Constant Voltage, 500 μ A Constant Current; Transient Recovery Time less than 50 microseconds. All units are designed for both bench and rack use.

Front and Rear Output Terminals • No Overshoot on Turn-On, Turn-Off, or Power Removal
Constant Voltage/Constant Current Operation with Automatic Crossover, Except Constant Voltage/
Current Limiting on Some Dual Range Models • Remote Programming • Remote Error Sensing
Special High Speed Programming Circuitry on Models 6200B, 6201B, 6202B, and 6203B
Auto-Series, Auto-Parallel, and Auto-Tracking Operation • Floating Output, Ground Either Side
Full Output Rating to 50°C • Convection Cooling, No Moving Parts
Options Include Overvoltage Protection "Crowbar" and 10-Turn Front Panel Output Controls

HEWLETT
PACKARD  HARRISON
DIVISION

Contact your nearest Hewlett-Packard Sales Office for full specifications.

100 Locust Ave., Berkeley Heights, New Jersey 07922 AREA CODE 201 464-1234 TWX 201-464-2117

6 Reasons Why SPRAGUE is a Major Resistor Supplier

FILMISTOR® PRECISION FILM RESISTORS



metal-film, molded case

Distinct limited temperature coefficients and low tolerances to meet exacting application requirements. Rugged end cap construction for long-term stability and reliability. Superior resistance to humidity and mechanical damage. Surpass MIL-R-10509E requirements. Send for Bulletin 7025B.



deposited-carbon, molded case

Approach precision wirewounds in reliability and stability, yet are smaller in size and have lower self-inductance. Low, controlled temperature coefficient. Dense molded case provides outstanding humidity protection. Send for Bulletin 7000A.



deposited-carbon, conformal coated

Full rated load operation at 70 C with no wattage derating. Assured uprated loads at lower operating temperatures. Ideal for circuitry where small size, humidity resistance, and close tolerance ($\pm 1\%$) are required. Send for Bulletin 7005A.

Circle 270 on reader service card

ACRASIL® PRECISION/POWER WIREWOUND RESISTORS



silicone-encapsulated

Combine the best features of both precision and power wirewound types. Resistance tolerances to $\pm 0.05\%$. Unusually tough encapsulation protects against shock, vibration, moisture, fungus. Meet MIL-R-26C requirements. Smaller than conventional wirewounds, yet greater in stability. Send for Bulletin 7450.

Circle 271 on reader service card

BLUE JACKET® VITREOUS ENAMEL POWER WIREWOUND RESISTORS



All-welded end cap construction with special vitreous coating for long-term dependability. Axial-lead style for conventional wiring or on printed boards. Tab terminals for higher wattage applications. Meet MIL-R-26C requirements. Send for Bulletins 7400B, 7410D, 7411A.

Circle 272 on reader service card

KOOLOHM® CERAMIC-SHELL POWER WIREWOUND RESISTORS



Exclusive ceramic-insulated resistance wire permits "short-proof" multilayer windings for higher resistance values. Standard and non-inductive designs. Non-porous ceramic shell for moisture protection and electrical insulation. Axial-lead, axial-tab, and radial-tab styles. Send for Bulletins 7300B, 7305, 7310.

Circle 273 on reader service card

GLASS-JACKETED POWER WIREWOUND RESISTORS



Ferrule terminals soldered to metallized ends of glass casing for true hermetic seal. Virtually failure-proof, even in extremely corrosive industrial and salt atmosphere. Standard and non-inductive windings. External meter-multiplier types also available. Send for Bulletins 7350, 7420, 7421.

Circle 274 on reader service card

STACKOHM® POWER WIREWOUND RESISTORS



Flat silhouette permits stacking of resistor banks in close quarters. Aluminum thru-bar simplifies mounting and conducts heat from resistance element. Vitreous enamel protective coating. Meet MIL-R-26C performance requirements. Send for Bulletin 7430.

Circle 275 on reader service card

For complete technical data, write for engineering bulletins on the resistors in which you are interested to: Technical Literature Service, Sprague Electric Company, 35 Marshall Street, North Adams, Massachusetts.

4 SR-166-63 R2



*Sprague' and '®' are registered trademarks of the Sprague Electric Co.

Meeting preview

Two firsts for NAECON

The National Aerospace and Electronic Conference will concentrate for the first time on interdisciplinary systems that are growing more typical in the development of aeronautical systems. The conference, to be held May 16-18 in Dayton, Ohio, is sponsored by the Institute of Electrical Engineers, the American Institute of Aeronautics and Astronautics and the Institute of Navigation, which is participating for the first time.

In the opening session on low-altitude high-speed flight, papers will be presented on environment, aircraft structures, cockpit displays, control problems and human factors. The session will attempt to relate the operation of military aircraft at low altitudes to strategies that decrease vulnerability to radar detection and anti-aircraft weapons.

Adaptive systems. Advances in adaptive flight-control systems will be explored in a special session moderated by Prof. H. Phillip Whitaker of the Instrumentation Laboratory of the Massachusetts Institute of Technology. H. N. Tobie and E. M. Elliott of the Boeing Co. will examine criteria for adaptive control systems, such as the blend of pitch rate, pitch acceleration and normal acceleration. Donald T. Makers of the General Electric Co. will discuss an automated design procedure for flight-control systems. Hybrid simulation of self-adaptive techniques and mechanization of adaptive systems techniques by a programable computer will be examined. A temperature-rate flight control system using thermocouples as primary sensors will be discussed by J. Stanlony-Dobrzanski of Northrop's Norair division.

Other sessions will survey trends in inertial navigation systems and the application of integrated electronics to the development of aircraft instruments.

On the last day of the convention, a special classified session will be held at Wright-Patterson Air Force Base. Base commander Maj. Gen. C. H. Terhune Jr. will deliver the keynote address.

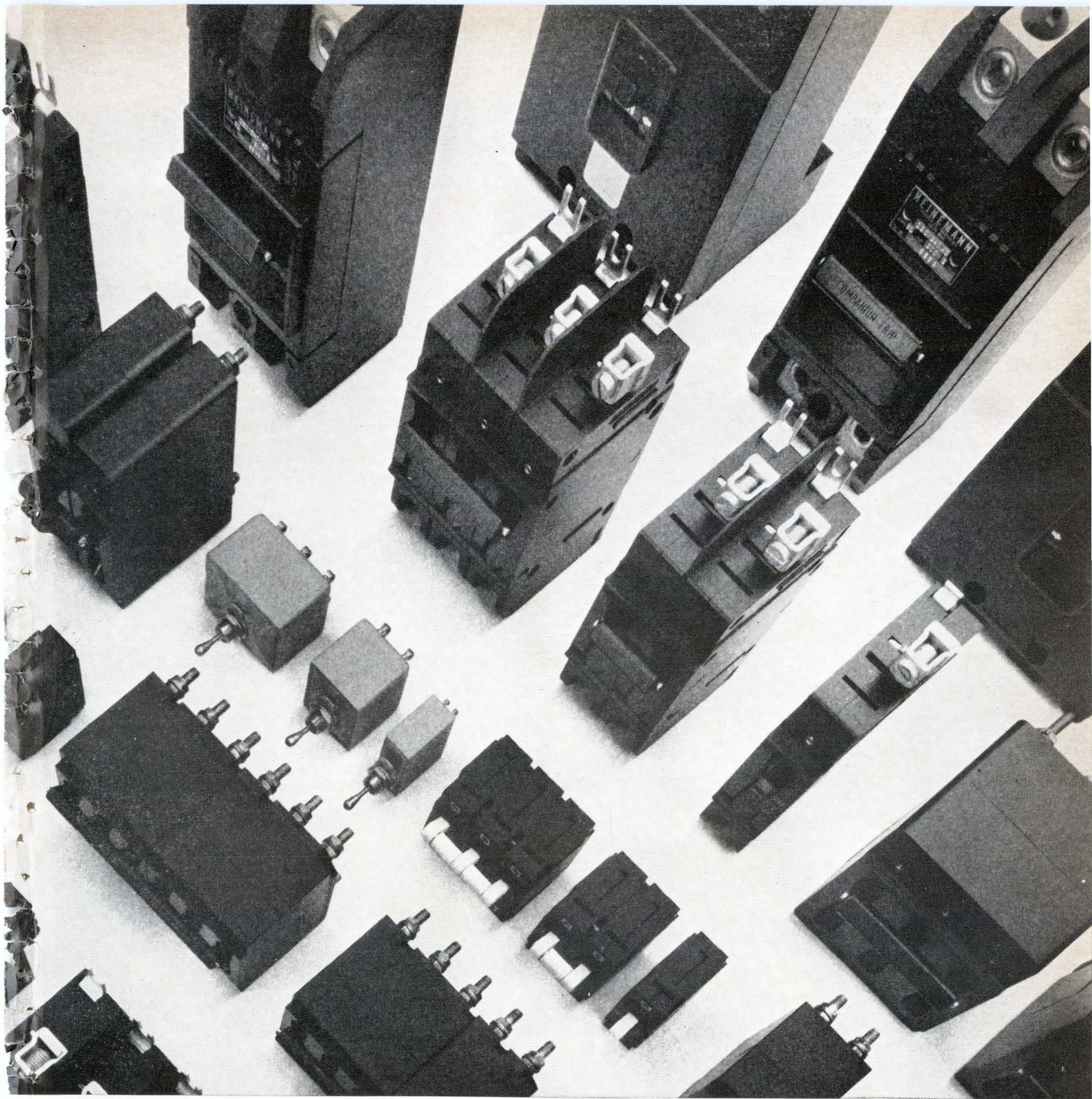

Over 60% of all Heinemann hydraulic-magnetic circuit breakers produced each year are rather odd in one way or another.

By the usual standards, at any rate. But for us the far-out is all in a day's work. We're tooled up to manufacture the out-of-the-ordinary as a matter of routine.

The fact is, we have an extensive roster of options for you to work with when you want really tight overload protection. Current ratings in any integral or fractional value, from 0.010 to 225 amps. A choice of several time-delay characteristics or instantaneous trip. A selection of special-function internal circuits — relay-trip, shunt-trip, etc. A broad array of models, from one to six poles, from subminiature on up.

The cost of a job-matched Heinemann breaker will probably be a good bit less than you would expect. The reason is simple enough. 'Specials' are our specialty—60% every year.

If you've got a knotty protection requirement, get in touch with us. For a starter, try our Bulletin 302; it covers our entire line of breakers. We'll put a copy in the mail as soon as we hear from you. Heinemann Electric Company, 2626 Brunswick Pike, Trenton, N.J. 08602.

 **HEINEMANN**

Circle 17 on reader service card

CASE FOR THE MAN FROM E.A.G.L.E.

NEW TWISTER... ACCURATE TIME/COUNT CONTROL

New and consistently better! At the left is the new face of our famous Microflex® reset timers and counters. High-visibility, direct reading dials enable you to make highly accurate settings, easier! The larger, 20-turn scale, for example, may be in minute divisions with the inner in seconds. Settings as short as $\frac{3}{60}$ th of a second with $\pm \frac{1}{60}$ th second accuracy are readily obtained. Other dial selections to 120 hours are available. After the desired pre-set time period, a variety of 15 amp. contacts can be opened or closed to control motors, solenoids, valves, etc. Uniform new lettering and attractive neutral grey color make units compatible with all other Eagle Signal types and with your most advanced machine designs. For full details about these new timers and counters, use Reader Service Card, circle number 472.

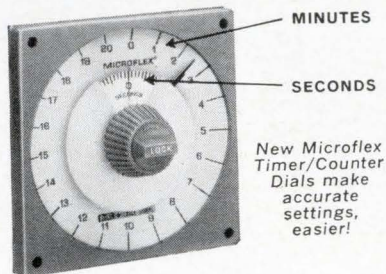

TURN...TURN...TURN...

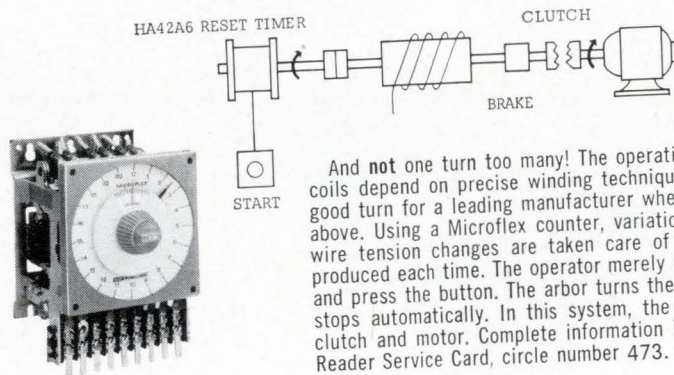

And not one turn too many! The operating characteristics of radio tuning coils depend on precise winding techniques. The Man from E.A.G.L.E. did a good turn for a leading manufacturer when he suggested the system shown above. Using a Microflex counter, variations in motor speed resulting from wire tension changes are taken care of . . . and an accurate product is produced each time. The operator merely needs to set the high-visibility dial and press the button. The arbor turns the pre-set number of revolutions and stops automatically. In this system, the Microflex counter controls brake, clutch and motor. Complete information is in Bulletin 730. For a copy, use Reader Service Card, circle number 473.

FILL'ER UP...

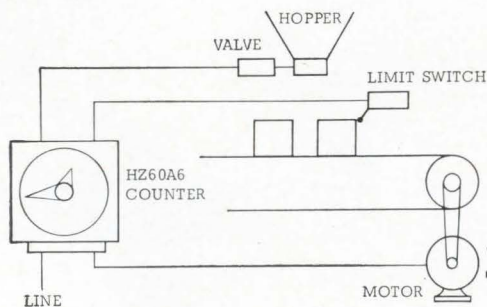

And not one ounce too many! A leading food supply manufacturer presented the Man from E.A.G.L.E. with the packaging requirement shown at the left. This manufacturer wanted to accurately fill containers. A versatile Microflex timer was the answer. It moves the containers under the hopper . . . filling and advancing them by the time lapse technique. The limit switch in this system activates the Microflex which controls hopper-valve and motor circuits. An accuracy of $\frac{1}{10}\%$ of full scale is consistently maintained and the manufacturer can vary the container sizes and amounts he wants them to carry. Intriguing? Write for Bulletin 110 for full data. Use Reader Service Card, circle number 474.

The Man from E.A.G.L.E. would like you to see his complete "showcase" of process control ideas. May we send you our catalog? For your copy, use the handy Reader Service Chart, circle number 475, or write directly to Eagle Signal Division, E. W. Bliss Company, Federal Street, Davenport, Iowa 52803.

BLISS  **EAGLE SIGNAL**

A DIVISION OF THE E. W. BLISS COMPANY

CASE FOR THE MAN FROM E.A.G.L.E.

UNDERCOVER OPERATOR

22AP Plug-in General Purpose Relay

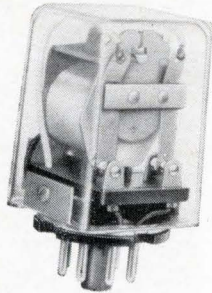

... the epitome of relay craftsmanship and design. Versatile to the Nth degree on loads to 10 amps. Available in 8- and 11-pin styles for AC, DC and plate circuit requirements. Features include: forms to 3PDT plus specials on request; standard units have gold-plated contacts for longer shelf life; lower pull-in voltages (DC: 70% of nominal, AC: 75% of nominal); AC operating voltages 0.5 to 250, DC 0.2 to 130 in current ranges from .005 to 10 amp. Complete information is in our new relay bulletin. For your copy, use Reader Service Card, circle number 479.

SPECIFICATIONS

- *Contacts: SPDT, DPDT, 3PDT*
- *Contact Rating: 5 and 10 amps.*
- *Pull-in: 22 milliseconds average*
- *Drop-out Speed: 12 milliseconds average*
- *Size: 1 $\frac{7}{8}$ " x 1 $\frac{1}{32}$ " x 1 $\frac{1}{2}$ "*
- *Weight: 3 ounces*

POWERFUL PARTNER

25PS Medium Power Relay

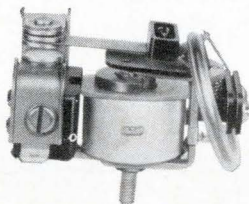

... toss your toughest medium-power-handling assignments to this workhorse. 25PS types carry loads to 20 amps. on a fast duty cycle in a breeze. UL listed. Features include: rugged $\frac{3}{8}$ " diameter silver cadmium oxide alloy contact; lower pull-in voltages (DC: 75% of nominal, AC: 76% of nominal); AC operating voltages 4 to 250, DC 1 to 130 in current ranges from .02 to 10 amp. For full technical information on this and other Eagle Signal general purpose and medium power relays, use the Reader Service Card, and circle number 478.

SPECIFICATIONS

- *Contacts: SPDT*
- *Contact Rating: 20 amps. 115/230 VAC 60 cycle resistive • 1 HP @ 115/230 VAC motor-inductive*
- *Pull-in: 50 milliseconds max.*
- *Drop-out Speed: 30 milliseconds max.*
- *Size: 2 $\frac{1}{4}$ " x 1 $\frac{1}{32}$ " x 1 $\frac{13}{16}$ "*
- *Weight: 3 ounces*

RELAY DESIGNERS' RELAY

25AA Open Frame General Purpose Relay

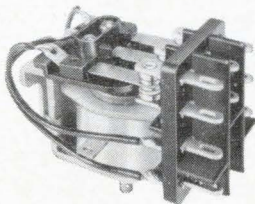

... and boy what a relay it is! Versatile, dependable, economical. You'll find hundreds of uses for these 5 or 10 amps., UL listed high-reliability types. Standard units have gold-plated contacts which permit longer shelf life. Other significant features include: lower pull-in voltages (DC: 70% of nominal, AC: 75% of nominal). AC operating voltages 0.5 to 250, DC 0.2 to 130 in current ranges from .005 to 10 amp. Detailed specifications on these and other Eagle Signal general purpose relays are given in a new technical bulletin. For your copy, use Reader Service Card, circle number 477.

SPECIFICATIONS

- *Contacts: SPDT, DPDT, 3PDT*
- *Contact Rating: 5A and 10A @ 115 VAC • 5A-1/10 HP @ 115 VAC, 1/6 HP @ 230 VAC • 10A-1/6 HP @ 115 VAC, 1/3 HP @ 230 VAC*
- *Pull-in: 22 milliseconds average*
- *Drop-out Speed: 12 milliseconds average*
- *Size: 1 $\frac{7}{8}$ " x 1 $\frac{1}{32}$ " x 1 $\frac{1}{2}$ "*
- *Weight: 2 ounces*

Ask the man from E.A.G.L.E. to open his "showcase" of ideas for you. Many can help solve your process control problems. Want our complete catalog? Use the handy Reader Service Card, circle number 476, or write: Eagle Signal Division, E. W. Bliss Company, Federal Street, Davenport, Iowa 52803.

BLISS



EAGLE SIGNAL

A DIVISION OF THE E. W. BLISS COMPANY

GET MORE

from the new hp dual-beam scope!

Only with the hp 132A do you get this combination of performance features:

- Two completely independent beams that let you:
 - display signals at different sweep speeds
 - make simultaneous x-y and y-t plots
- Two 100 $\mu\text{v}/\text{cm}$ vertical amplifiers offering:
 - common mode rejection of 40,000:1
 - constant 500 kc bandwidth 1 mv/cm to 20 v/cm - 200 kc at 100 $\mu\text{v}/\text{cm}$
 - shock mounted nuvistor input stages for stable displays
- Recorder outputs from each vertical amplifier
- 3.5 kv aluminized, internal-graticule crt - for bright traces with no parallax error

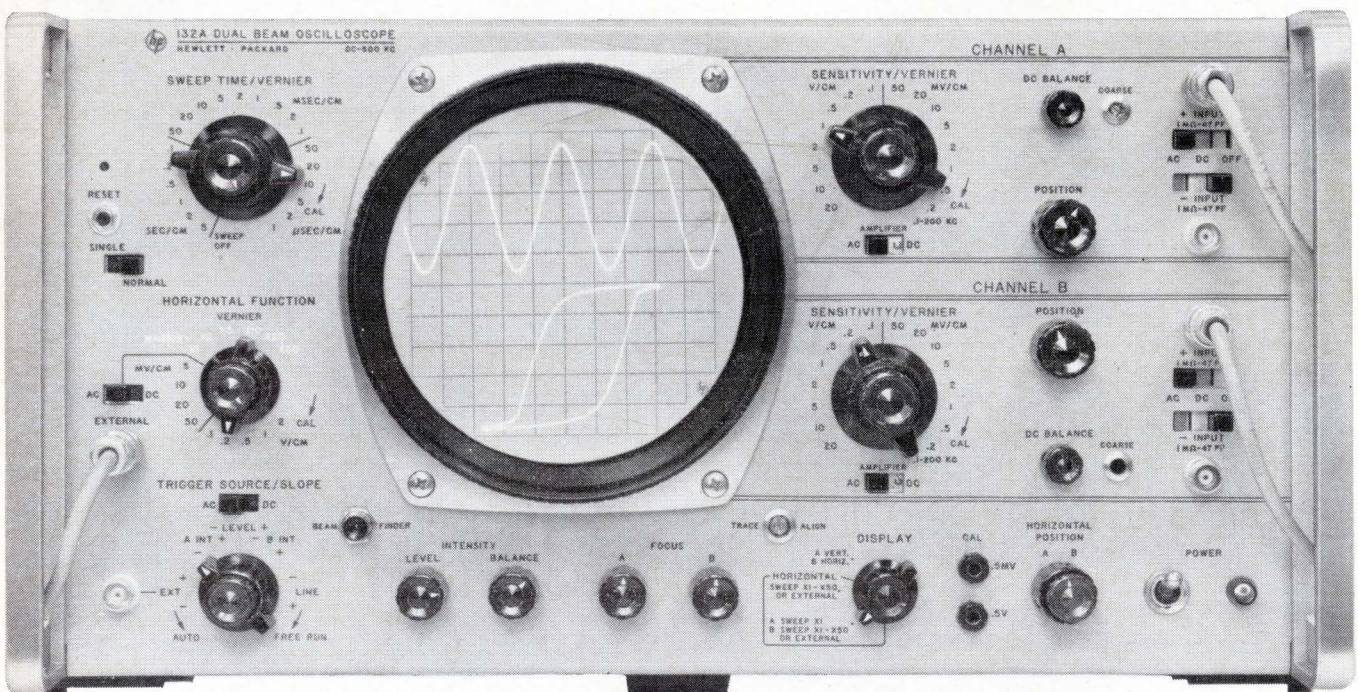

LOOK AT WHAT YOU CAN DO WITH THE NEW hp 132A:

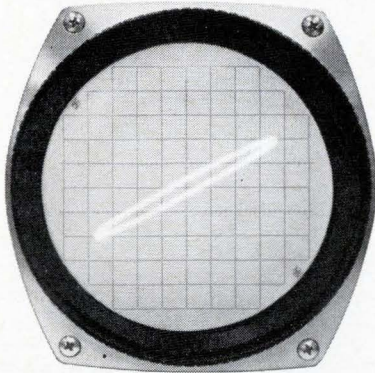

Make x-y plots with 100 $\mu\text{v}/\text{cm}$ sensitivity!

To get x-y plots of low-level signals, such as transducer outputs, just plot Channel A against Channel B. No need for external preamps with the 100 $\mu\text{v}/\text{cm}$ sensitivity of both channels. Phase shift between the two vertical amplifiers is less than 2° for frequencies up to 50 kc.

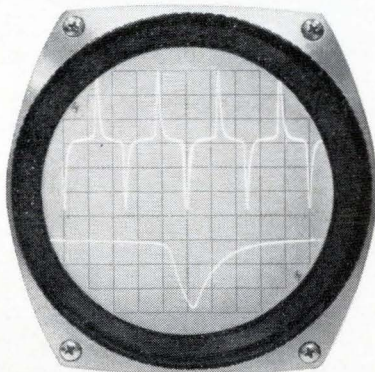

Observe an entire signal plus a magnified portion simultaneously!

You can simultaneously see fast and slow signal changes with a unique feature on the 132A that lets you magnify the Channel B sweep while leaving the Channel A sweep unmagnified. Thus, for example, in amplifier tests, you can apply the output to both scope inputs and simultaneously observe overall pulse response and the response to the leading edge in detail. The horizontal position control lets you observe any part of the unmagnified waveform . . . and you can identify that part by an intensified area (the magnified area) on Channel A. Essentially, you have the equivalent of two time

bases and a unique arrangement that takes the place of a costly sweep delay generator for most applications.

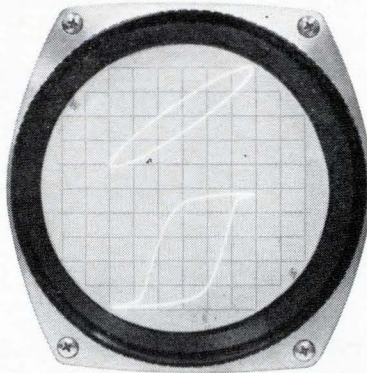

Plot two signals against a common third!

Plot both vertical amplifiers against a common 5 mv/cm 300 kc horizontal amplifier. Measure phase shift in two parts of your circuit at one time or compare phase shift of a test circuit with the standard. Relative phase shift between vertical and horizontal amplifiers is within 2° for frequencies to 10 kc, insuring accurate measurements.

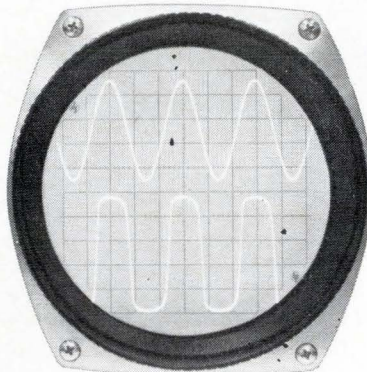

Measure two signals vs. time — simultaneously!

Measure gain, delay time, pulse response. For comparing two signals at the same sweep time, the 132A is a regular dual-beam scope. No need for preamplifiers for displaying small signals . . . both vertical

amplifiers offer 100 $\mu\text{v}/\text{cm}$ sensitivity and constant 500 kc bandwidth from 1 mv/cm to 20 v/cm. And bandwidth is 200 kc at the most sensitive range. Because bandwidth is constant over a wide range of sensitivities, displays remain the same as the range switch is changed. Nuvistor input amplifiers mounted in a common shock mounted heat sink assure steady displays even in the presence of vibration and shock; 40,000:1 common mode rejection, too. Thus, you get accurate displays of differential signals. Each vertical amplifier provides outputs for driving a recorder or other external equipment.

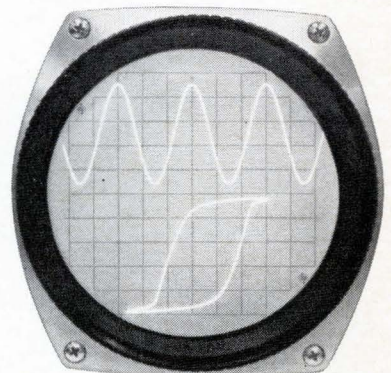

Make simultaneous x-y and time plots!

Here's an exclusive feature that lets you monitor phase shift in a circuit while simultaneously measuring another signal against time. Just use Channel B and the horizontal amplifier for the x-y plot, while displaying the signal vs. time on Channel A. Ideal for servo and audio work, it lets you do many tasks that previously required two scopes. Added to the advantages inherent in the unique 132A design is the scope's low price of just \$1275. Compare 132A performance with that of any other comparable scope. You'll see how much more you get from the new Hewlett-Packard instrument. For complete data or a demonstration, call your hp field engineer, or write for complete information: Hewlett-Packard, Palo Alto, California 94305, Tel. (415) 326-7000; Europe: 54 Route des Acacias, Geneva.

HEWLETT  PACKARD
Price f. o. b. factory.
An extra measure of quality

9845

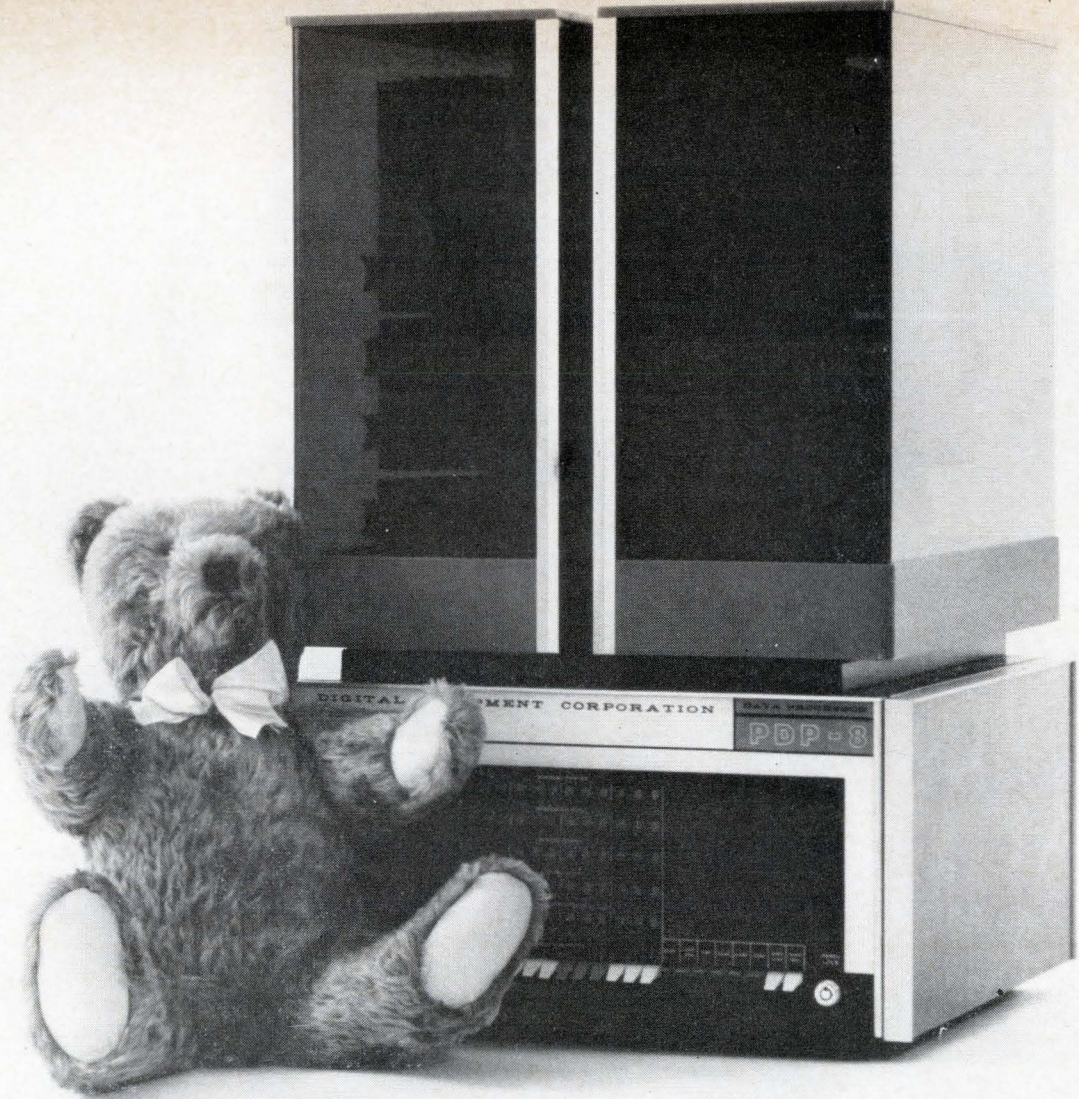

**An assistant professor at State
grew attached to his PDP-8.
When he tried to express it,
he was told to repress it,
for hugging might NOR an OR gate.**

We don't sell the PDP-8 for its emotional value. We sell it as a small, high speed, core memory, full general purpose computer that scientists can afford.

But it gets personal.

It's a real-time, on-line computer that becomes part of the experiment. And it's a computer that a man can talk to (FORTRAN), play with, fit to a special mold, then change the mold, if need be. Scientists involved

with their work sometimes develop special feelings for the machine.

There are 101 standard Digital modules available for building and interfacing special inputs and outputs. There are 35 standard plug-in options. There are 85 Digital field engineers to advise. And if the PDP-8 is not perfectly suitable, there are the LINC-EIGHT, the larger PDP-7, and the very large PDP-6 behind it.

DIGITAL

COMPUTERS • MODULES

Editorials

Sounding the tocsin

Almost everybody in the electronics industry agrees: business was never better. Semiconductor and component producers have backlogs piled up to ceilings; some have even stopped accepting new orders until the autumn. At communications companies, the manufacturing floors are crammed with gear earmarked for South Vietnam and production workers toil round the clock to meet schedules. Instrument companies are adding on new plant facilities to meet the rush of orders. Shortages of essential materials and components are pinching more than they have at any time since World War II.

The glow of current good business is so blinding that many people can't see some dark clouds on the horizon.

Probably the blackest is the inflationary trend that is threatening to make U. S. electronic equipment noncompetitive in price with equipment made elsewhere in the world, particularly in Europe and Japan. The labor market is suffering most. High school graduates with technician experience in semiconductor processing techniques, for example, are being offered salaries of \$13,000 a year, though the rate for such an experienced technician was \$9,000 just two months ago. Ph.D. candidates graduating in June with a specialization in electronics are being offered as much as \$16,000 a year to start, even though they have no industrial experience.

At first glance, the situation appears to be a bonanza for engineers. Now is the time to get a new high paying job because many companies have thrown reason to the wind.

All this sounds horrifyingly familiar. People were talking like this in 1960—then came the layoffs of 1963 and 1964, driving thousands of engineers into the insurance and real estate business because there were no engineering jobs for men who had job-hopped up the salary ladder. The job with the higher salary often led to a career cul de sac.

Unhappily, the industry seems bent on repeating that disastrous circle once again.

On top of the inflationary climb, economists see two other reasons for alarm, signals that often mean trouble in the economy. One is the rate at which inventories are growing, currently far faster than the economy as a whole. Second is the high rate of capital spending. Companies are also expanding manufacturing facilities at a faster rate than the economy is growing.

In general, economic chart-watchers believe the boom will continue for about 12 more months, and then trouble can set in. Electronics companies stand a good chance of getting trapped. Concentrating on production to meet the order backlogs, many are putting nothing into the bank for the future. They've slowed new product development and almost stopped exploring and cultivating new markets.

Though the state of the industry's health has changed radically for the better since 1964, one fact has not changed at all. The greatest potential for the future in electronics lies in new fields that are not now great users of electronic equipment: industrial electronics, educational electronics and medical electronics.

In the flood of orders and fast-rising profits, companies and engineers are forgetting a well-established truism. The best time to plan for the future is when things are going well. Clearly, that is right now.

An embarrassment

An engineer who attended many of the technical sessions at the annual meeting of the Institute of Electrical and Electronics Engineers in New York last month summed up the quality of the meeting nicely. "If a foreign engineer came to IEEE and hoped to learn the state of our technology from the papers presented," he said, "he would have to conclude that the U. S. trails slightly behind Ghana."

Long rambling papers on the history of devices like the cathode-ray tube, and product pitches on old established equipment soured even those who continue to hope for improvement in technical papers. Microelectronics, probably the most talked-about industry development today, was represented in only two of IEEE's 80 sessions. And, maddening to anyone interested, both sessions took place at the same time.

Happily, this year there seems to be increased resentment at the continued mediocrity of the technical sessions. The vice president of engineering at a West Coast communications company asked, "Is it really necessary to send all those engineers to New York every year?"

The brutal recruiting and the high cost of maintaining people in New York hotels and bars have led some companies to take a second look at participating in the show at all.

If the IEEE show has in fact lost some of its appeal to the men who buy exhibit space, IEEE may well be forced to take some action to improve the technical sessions so they will no longer be an embarrassment to engineers.

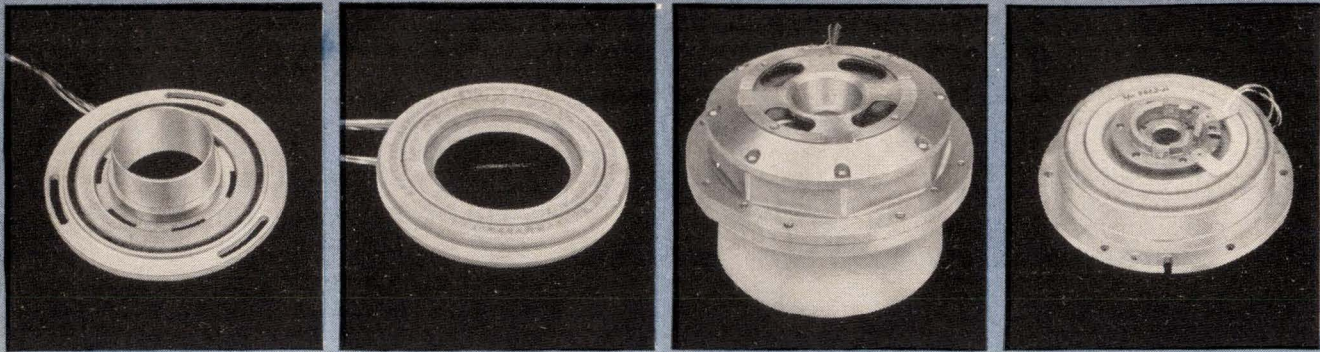

cppc

Multispeed Gimbal Pickoff Synchros and Resolvers

The table below shows a small sample of the multispeed pickoff units produced by CPPC for such high reliability programs as Apollo, SIDS, Titan, Pace.

The data listed below are representative of the input/output parameters that we have supplied to meet customer requirements. The accuracies reflect the maximum errors allowed. Clifton units usually are well below these specified maximums.

The outline dimensions given in the table are applicable to rotor-stator combinations; although, as the photographs on this page show, our multispeed units are usually supplied in housings.

If you have a requirement for a high accuracy, high

reliability multispeed component, contact CPPC Sales Engineering for additional information.

Clifton Precision Products, Division of Litton Industries, Clifton Heights, Pa., Colorado Springs, Colo. 215 622-1000, TWX 215 623-6068.

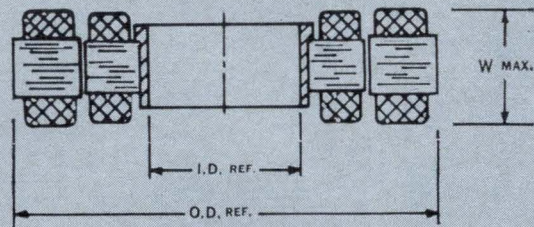

CLIFTON Multispeed Gimbal Pickoff Synchros and Resolvers

Function	Input	Primary	Common Input Impedance	Output Imp., Prim.Shorted		TR & Phase Shift		Accuracy		Dimensions		
				Ix	Nx	Ix	Nx	Ix	Nx	I.D.	O.D.	W.
1x, 8x Resolver	26v 800-	Rotor	85 + j190	100 + j20	20 + j15	.220 - 9°	.220 - 24°	10'	1'	1.437	2.687	.500
1x, 15x Synchro	26v 400-	Rotor	105 + j165	150 + j25	160 + j130	.390 - 21°	.390 - 47°	10'	20"	1.500	3.400	.600
1x, 16x Resolver	28v 800-	Rotor	175 + j600	200 Max	100 Max	1.00 - 4°	.179 - 12°	2'	20"	1.687	3.687	.675
16x Resolver	28v 800-	Stator	40 + j350	-	450 + j800	-	1.00 - 6°	-	20"	1.687	3.687	.675
1x, 32x Resolver	15v 3200-	Rotor	100 + j300	100 Max	350 Max	.333 - 3°	.333 - 13°	10'	15"	2.187	3.750	.500
1x, 16x Resolver	28v 800-	Rotor	165 + j600	175 + j100	100 Max*	1.00 - 3.5°	.179 - 12°	4'	20"	2.187	4.000	.610
36x Resolver	28v 800-	Stator	120 + j200	-	230 + j200	-	.300 - 28°	-	8"	1.400	3.500	.850
1x, 64x Resolver	28v 4800-	Rotor	70 + j220	70 + j45	80 + j120	.400 - 2°	.270 - 15°	30'	7"	2.250	4.000	.700
64x Resolver	28v 800-	Rotor	260 + j200	-	350 + j260	-	.179 - 55°	-	5"	2.250	4.000	.700

cppc **CLIFTON** PRECISION PRODUCTS
DIVISION OF LITTON INDUSTRIES



Electronics Newsletter

April 18, 1966

RCA considers outside customers first in IC sales

The Radio Corp. of America, in rushing to catch up with its competitors in the production of integrated circuits, is favoring its commercial customers over its in-house customers.

Last fall, when RCA started producing linear IC's for outside customers, it cut back some production lines of digital IC's for its Spectra 70 computers; this forced RCA to turn to outside suppliers for more Spectra 70 digital circuits. Now, RCA plans to divert some of its semiconductor facilities in Somerville, N. J., to the manufacture of a series of linear IC's for use in the f-m sound channel of television receivers produced by other manufacturers. [Electronics, March 21, pp. 140-141]. The biggest customer for the IC's is the Home Instruments division of RCA.

It's rumored that RCA's Somerville management is planning to add metal-oxide-semiconductor IC's to its production line later this year.

New computers made in Japan

A pair of Japanese companies may reverse the direction of the prevailing one-way flow of computer technology from the United States to Japan.

The Nippon Electric Co., which is licensed to build Honeywell, Inc.'s H-200 series, has developed a computer that could round out the large end of Honeywell's line. NEC sees a chance that Honeywell will produce its design in the U.S.

Hitachi, Ltd., the Japanese licensee for the Radio Corp. of America's Spectra 70 computers, plans to market a model smaller than any made by RCA. RCA is investigating the possible U.S. import market for the small Hitachi computer.

Mass producing hologram plates?

A method of stamping out hologram plates like phonograph records has been developed by the Xerox Corp. Scientists John C. Urbach and Reinhard W. Meier have worked out a technique for making the plates on thermoplastic materials instead of conventional silver halide photographic plates or films.

Thermoplastic holograms do not require chemical developing and are free of grain patterns characteristic of photographic plates. They can be duplicated by a simple mechanical pressing technique.

Army to buy first equipment using a laser

After years of research and development, the Army is ready to procure its first field equipment using a laser—a portable range finder for artillery observation. A call for bids will go out about June, 1967; the order could amount to as much as \$70 million.

The 31-pound range finder, the XM23E1, was developed at the Frankford Arsenal in Philadelphia. It uses a ruby Q-switched laser with a peak pulse of two megawatts with a 0.5-microsecond duration.

The Army's next piece of laser field equipment will probably be a helicopter-borne target-locating and range-finding system. It is being developed by the Bell Aerospace Corp. for use in the Bell UH-1 helicopter; the range finder will undergo tests next year.

Work also is proceeding on a laser range finder for tank fire-control systems and tactical aircraft. The military also is interested in the possibilities of using lasers for illumination in night photography and other

Electronics Newsletter

reconnaissance and as homing beams for missiles. This year the Defense Department is spending nearly \$15 million on laser research and development.

Observatory orbits but mission fails

The United States' first astronomical satellite, plagued by a series of launching delays, was finally orbited last week only to be rendered useless by a battery problem. The \$44-million Orbiting Astronomical Observatory, designed to gather data on the stars, failed before it was able to relay its first pictures of space above the earth's atmosphere.

Although the National Aeronautics and Space Administration is receiving intermittent signals from the satellite, space officials doubt that it will perform any useful functions.

However, the mission isn't a total loss; NASA checked out the system's star tracker, which successfully stabilized the two-ton observatory to the degree necessary for conducting experiments in space.

Three more orbiting observatories are planned; the next will be launched late this year.

Research improves Gunn devices

Continued Gunn-effect research may bring these solid state microwave devices out of the laboratory and into commercial use.

Researchers at Cornell University are stringing several Gunn oscillators together and using them with conventional microwave circuits. And scientists at the International Business Machines Corp. have found an easy way to produce gallium arsenide with high purity and resistivity.

In the Cornell development, under an Air Force contract, Lester Eastman, Lee MacKenzie and G. Conrad Dalman of the electrical engineering department are coupling the devices with conventional microwave circuits and using mechanical tuning of the cavity to provide a wide frequency range. Also by stringing several Gunn oscillators in parallel, in a resonant ring, power outputs are added. With several smaller pieces of GaAs, heat does not build up and burn out the devices—a problem with larger pieces of GaAs.

At IBM, J. M. Woodall and J. F. Woods of the research division, heat-treated bulk GaAs and found they could obtain material with a resistivity between 0.5 and 1,000 ohm-centimeters. For continuous-wave operation, Gunn devices generally need a resistivity between 1 and 100 ohm-cm. Previously, high-purity GaAs could be produced by epitaxial growth, or fortuitously in certain bulk samples.

Woodall and Woods heat GaAs to between 600°C and 950°C, and keep it there for from a few hours to two weeks. Mobilities of the heat-treated material average 7,500 cm²/volt-second, excellent for Gunn device operation.

Disposable antenna being developed

A paper radar antenna that can be inflated with air and thrown away after use is being developed for the Air Force by the Westinghouse Electric Corp. The tactical antenna is sprayed with a metalized epoxy coating.

Westinghouse also is developing a three-dimensional radar antenna made of metal-coated polyfoam. It will be about two-thirds lighter than a comparable metal antenna but just as strong. The antenna has the same kind of stacked beam and planar array of conventional tactical 3-D radars.

IDEAS

from SYLVANIA Electronic Components Group

INTEGRATED CIRCUITS

New dual AND gate and OR expander increases logic functions, reduces can count

As with any electronic device, a new integrated circuit must be evaluated both on its function and on how well it performs that function. But just as important is how well the new IC works with other units in the line. Two new units in Sylvania's SUHL II line get excellent ratings on all three points. As individual devices, they perform significant logic functions in a minimum number of packages, in a minimum amount of time, and with minimum power consumption. With these additions to the Sylvania IC line, circuit designers can find within SUHL II the answers to any basic logic scheme they choose.

An extraordinary new dual gate now adds AND/OR logic to Sylvania's SUHL II integrated circuit line. This development means that now designers can choose any basic logic function (NAND/NOR, AND-NOR, AND/OR) in designing systems with transistor-transistor-logic.

Each member of the new SG-280

series contains two four-input AND gates with non-inverting amplifiers. Each dual gate unit functions either as an AND element in positive logic or as an OR element in negative logic. By combining the AND function with a non-inverting amplifier, Sylvania's SG-280 performs in a single package and on a single chip the same function that requires three separate packages in other IC lines. It can do this in less time too: 12 nsec compared with the 24 nsec time of the 3-package method.

The logic diagram for the SG-280 series (Figure 1) shows that an internal tie point (terminals M and I) is brought out on each gate. A new series of Expander gates (SG-290) provides single wire feed-in at this terminal to perform the wired-OR function without degrading the fan-out, noise immunity or wave-form integrity of the SG-280. Decrease in speed is negligible.

Why this happens can be more eas-

ily seen by first redrawing the SG-280 and SG-290 function to show the internal logic action (Figure 2). The wired-OR is performed without any (Continued)

Figure 1 SG-280

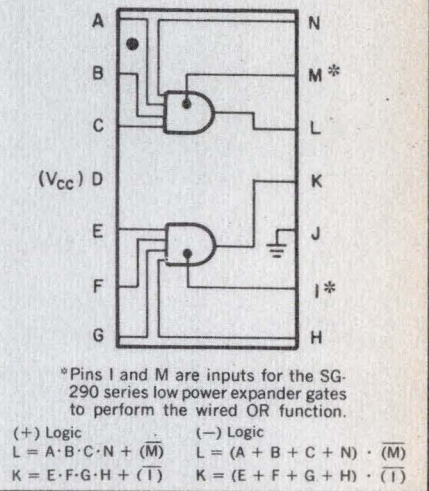

This issue in capsule

Photoconductors—simplified UV detection using a new, small-size cell.

Microwave diodes—you can get the exact varactor you need, in the package that best suits your paramp design.

Spark gaps—how two simple electrodes can protect equipment from destructive electromagnetic surges.

Integrated circuits—now you can build an eight-stage, 50 nsec fast adder using only 12 IC packages.

Diodes—news of a silicon epitaxial product line perfect for communication, computer and consumer product use.

Photoconductors—how photoconductor/lamp assemblies can solve musical instrument problems.

Figure 2 Performing the wired OR

Redrawing the SG-280 and SG-290 functions, as shown, illustrates the internal logic action.

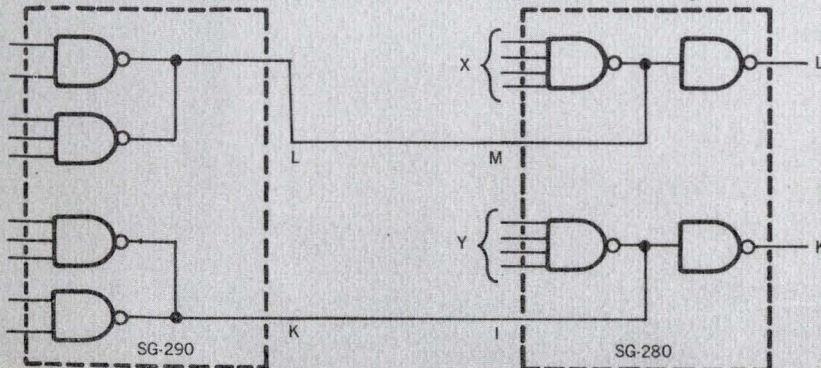

Notice the wired OR is performed without loading the SG-280 output. Therefore fanout of SG-280 is maintained as well as wave form integrity.

capacitive or D-C loading on the output of the SG-280. Thus, performance characteristics are not degraded.

These new monolithic epitaxial circuits are designed for high-speed operation over the military temperature range of -55°C to 125°C or for the range of 0°C to 75°C for industrial applications.

Compatibility with other units in the SUHL II line can be seen in the Up-Down Counter shown in Figure 3. This particular circuit uses Sylvania SF-260 flip-flops, SG-280 gates, and half an SG-290 Expander gate.

CIRCLE NUMBER 300

Figure 3 BCD UP-DOWN COUNTER (8, 4, 2, 1 CODE)

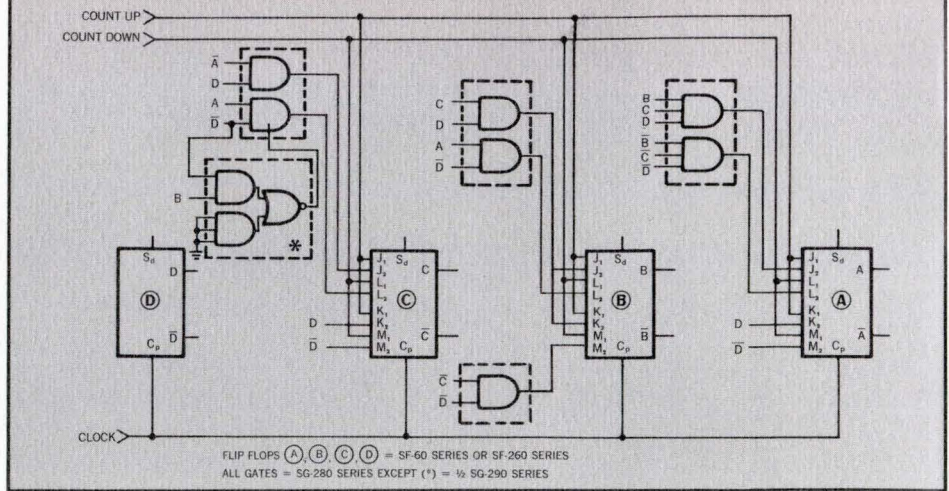

INTEGRATED CIRCUITS

Build an eight-stage, 50 nsec fast adder using only 12 IC packages

Introduction by Sylvania of a new basic TTL fast adder digital subsystem, part of a family of Monolithic Digital Functional Arrays, makes possible a whole new breed of large-scale, high-performance, general-purpose digital computing systems. These systems not only offer significant speed advances over conventional computers; they will be smaller, more reliable and far less costly than equivalent systems built from standard integrated circuits.

Using only 12 of Sylvania's new single-stage fast adder circuits, you can build an 8-stage fast adder with anticipated carry having a total add time of only 50 nanoseconds. Only 96 of the new packages are needed to make a fast anticipated carry adder of 64 bits having a 300-nanosecond total add time. An equivalent 64-bit fast adder using conventional integrated circuits would require at least

320 separate packages.

This new transistor-transistor-logic circuit array represents the first time that highly complex fast adders with anticipated carry have been integrally formed on a single monolithic silicon chip without compromising system performance characteristics. This Sylvania circuit has a noise margin of ± 1.0 volt, power dissipation of 120 milliwatts, and a fan-out of 6 to 15.

The basic fast adder circuit configuration is interconnected with three standard metalizations to form either a single-stage full adder (SM-10 series), a single-stage dependent carry fast adder (SM-20 series), or a single-stage independent carry fast adder (SM-30 series). To build parallel fast adders larger than 4 bits, the independent and dependent fast adder are used in conjunction with a specifically designed carry decoder package, the

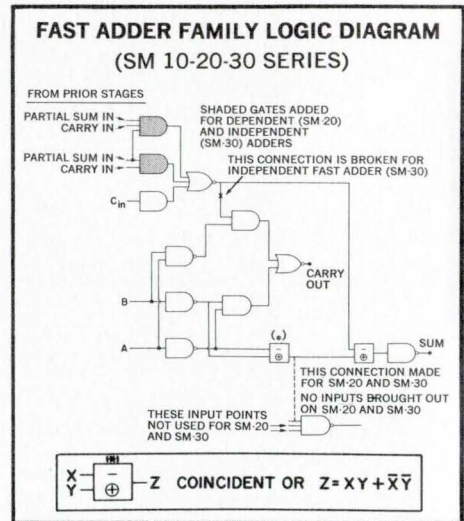

SM-40, which extends the anticipated carry operation beyond four stages. Two dependent adders, SM-20 circuits, form the first and last stages of each of eight stages to provide for end-around carry operations.

Circuits in the fast adder family are available in Sylvania's standard 14-pin dual in-line plug-in package as well as in the TO-85 flat pack.

These circuits are completely compatible with all circuits in Sylvania's

8-STAGE ANTICIPATED CARRY FAST ADDER MADE FROM SM-20, SM-30 & SM-40 MONOLITHIC DIGITAL FUNCTIONAL ARRAYS

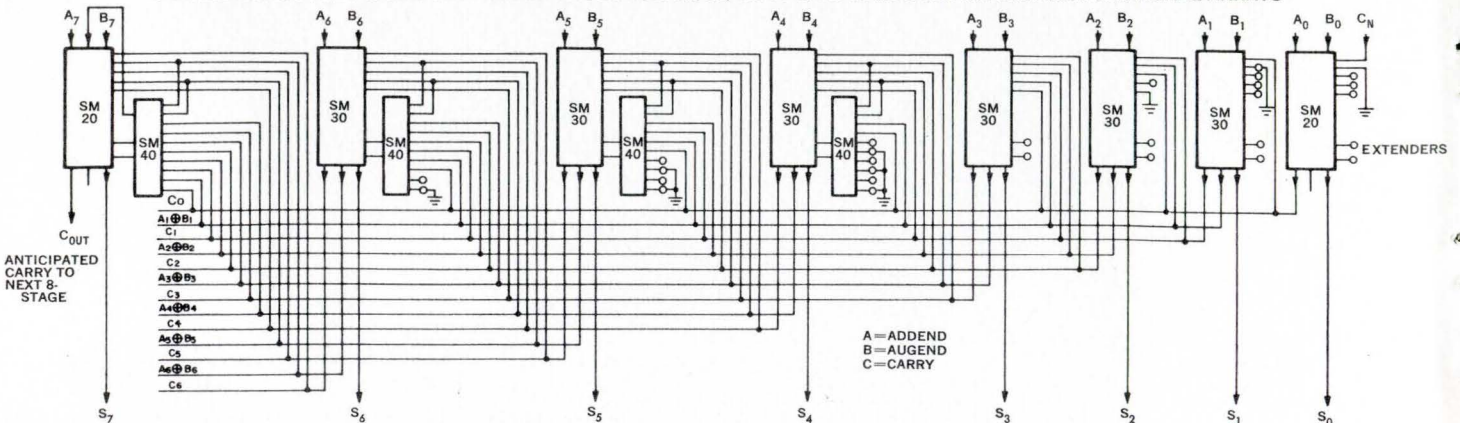

advanced SUHL (Sylvania Universal High-level Logic) line. SUHL has a total of 120 circuits, by far the biggest TTL line in the industry. In all,

these integrated circuits provide superior performance in terms of speed, fan-out, noise immunity, high logic swing, and low power consumption.

SUHL is the fastest saturated logic available for applications down to 5 nanoseconds.

CIRCLE NUMBER 301

DIODES

High-performance silicon diode line perfect for communication, computer & consumer product use

The Sylvania silicon epitaxial diode (DF-22) product line is especially suited for logic circuits, high-frequency detectors, choppers, and clippers in rugged applications.

By careful in-process control, Sylvania's DF-22 diodes are able to stand up under the most rigorous in-plant testing program given any diode product. They meet or exceed such tests as: 4500-g shock perpendicular to the whisker, 15,000-g centrifuge, 0°C to 100°C thermal shock, -65°C

to 150°C temperature cycling, 300 psi internal pressure, 300-pound water bomb, +200°C storage, and ion drift (back bias at elevated temperature).

Sylvania uses a stud body (see cross section) and rates its silicon epitaxial diode at 400 milliwatts when customer specifications require this rating.

Reliability is enhanced by the solid silver sphere which Sylvania deposits on every epitaxial chip to assure forward current stability.

Types from DF-22 which are QA-

approved, and the specifications they meet, include: JAN 1N251 (MIL-S-19500/188A), JAN 1N662 (-/256B), JAN 1N663 (-/256B), and USN 1N3064 (-/144A).

Another significant reason why there's reliability throughout Sylvania's entire DF-22 family is batch processing. Here thousands of compatible diodes are fabricated simultaneously assuring a uniformity of characteristics from product to product.

CIRCLE NUMBER 302

Type	Maximum Peak Reverse (volts)	Forward Current @ 1.0V (ma)	Maximum Reverse Current			Temp °C	Relative Reverse Recovery Time (ns max.) @ I _R =I _F =10 ma	Cap. (typ.) (pf)
			I _R @ 25°C and V _R μa	I _R @ Temp and V _R μa	V _R V			
*1N251	30	5	.1	10	10	125	150	3
1N252	20	10	.1	5	10	5	125	3
1N659	75	6	5	60	25	60	100	3
1N816	15	100@1.5V	.5	5	10	5	125	3
1N903	50	10	.1	40	10	40	100	8
1N903A	50	20	.1	40	10	40	100	8
1N904	40	10	.1	30	10	30	100	8
1N904A	40	20	.1	30	10	30	100	8
1N905	25	10	.1	20	10	20	100	8
1N905A	25	20	.1	20	10	20	100	8
1N906	25	10	.1	20	10	20	100	8
1N906A	25	20	.1	20	10	20	100	8
1N907	40	10	.1	30	10	30	100	8
1N907A	40	20	.1	30	10	30	100	8
1N908	50	10	.1	40	10	40	100	8
1N908A	50	20	.1	40	10	40	100	8
1N914	100	10	.025	20	50	20	150	8
1N914A	100	20	.025	20	50	20	150	8
1N914B	100	100	.025	20	50	20	150	8
1N916	100	10	.025	20	50	20	150	8
1N916A	100	20	.025	20	50	20	150	8
1N916B	100	30	.025	20	50	20	150	8
1N3062	75	20	.1	50	100	50	150	4
1N3063	75	10@.85V	.1	50	100	50	150	4
*1N3064	75	10	.1	50	100	50	150	4
1N3069	65	50	.1	175	100	175	150	50
1N3070	200	100	.1	50	100	50	150	50
1N3604	75	50	.05	50	50	50	150	4
1N3605	40	20@.88V	.05	30	50	30	150	4
1N3669(400mw)	80	400@1.1V	.05	50			200	3
1N3731(400mw)	100	100	.05	50	50	50	150	6
1N4009	35	30	.1	25	100	25	150	4
1N4086(400mw)	80	200	.25	70			200	10
1N4087	70	30@.97V	.09	50	100	50	150	2.5
1N625	30	4@1.5V	1	20	30	20	100	1000
1N626	50	4@1.5V	1	35	30	35	100	1000
1N627	100	4@1.5V	1	75	30	75	100	1000
*1N662	100	10	1	10	100	50	100	500
*1N663	100	100	5	75	50	75	100	500
1N799	120	50	5	100	30	100	100	500
1N4092	50	5	1	10	5	20	70	10
1N4093(matched pair of 1N4092s)								

*Types available to Mil Spec

ABSOLUTE MAXIMUM RATINGS

Average Rectified Current, I _O	75 ma
Peak Forward Current, I _{PK}	225 ma
Forward Surge Current (8.3 μ sec)	500 ma
Power Dissipation, P _T	250 mw
Storage Temperature, T _A	-65°C to +200°C

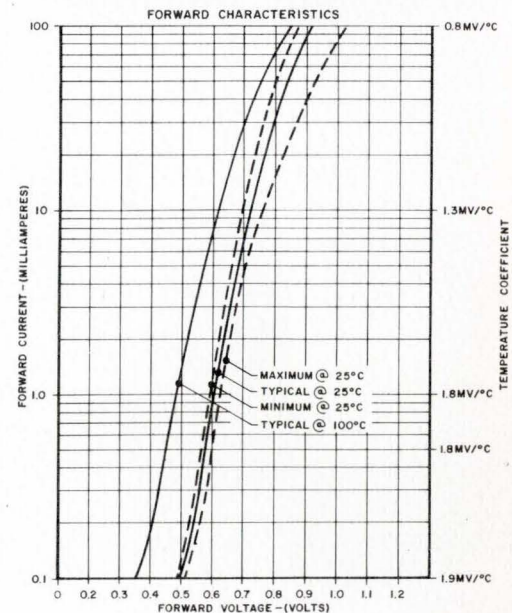
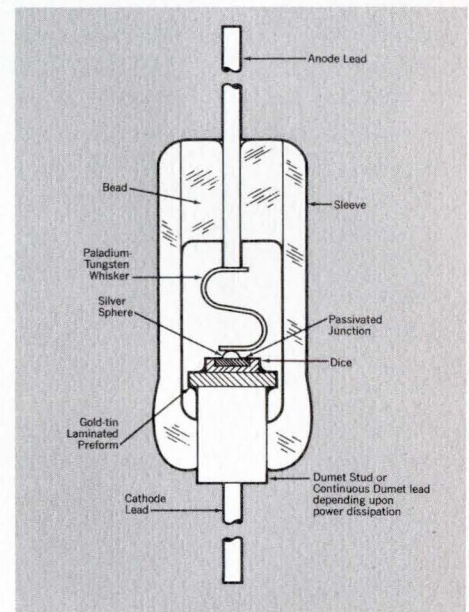

PL assembly is an economical, efficient new approach to musical effects

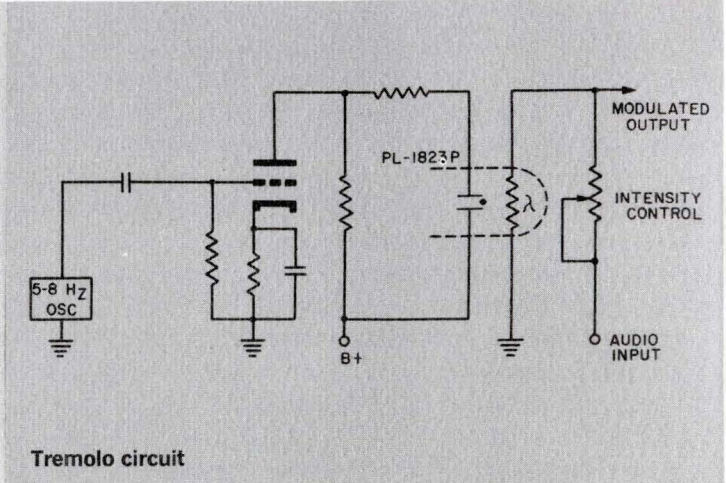
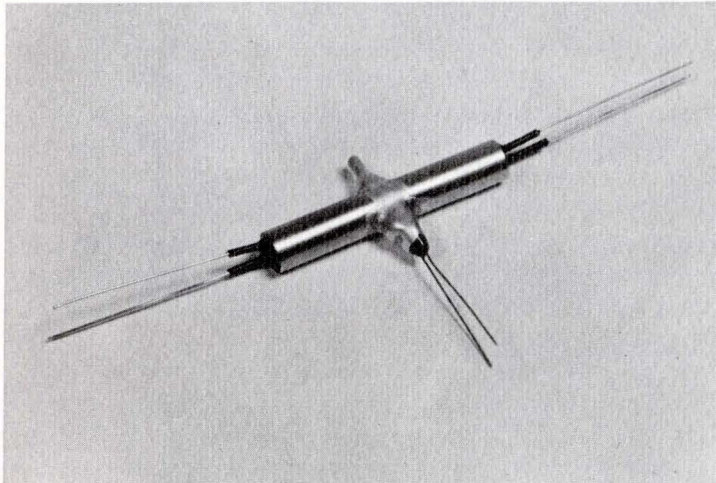

Tremolo circuit

Not long ago we would have been hard put to relate music and electronics. Electronic components now play a large role in creating musical effects...so much so that these effects today take on electronic definitions. Vibrato is a frequency or phase modulation of the audio at subsonic values. Tremolo is subsonic amplitude modulation of the audio.

Before photoconductor-lamp assemblies, vibrato and tremolo effects in electrical musical instruments were created by mechanical means—shutters, vibrators, and other devices. But these techniques were too often subject to irregular variations and abrupt changes. The resulting effect is not always pleasing to either the musician or the average listener.

Now, with a new photoconductor-lamp device from Sylvania, a gradual rise and lowering of the desired effects (amplitude or frequency) can be designed into electronic organs, guitar amplifiers, and other instruments. The PL-1823P, a double-ended device having one neon lamp and two

cadmium sulfide photoconductors, is the most effective approach yet to the problem, from the standpoints of both performance and economy.

Functionally, tremolo is most effectively used with fixed frequency tone generators while vibrato is used to control oscillating generators. The PL-1823P is designed especially for use in these areas.

The tremolo circuit for a single channel is shown on this page. Since the device's neon lamp is always in the conducting state, there is no perceptible "thump" when the unit is switched in or out of service. Also,

the intrinsic characteristics of cadmium sulfide provide a response envelope waveform with a gradual "attack" and "decay," both of which are mandatory for the effect to be pleasing to the listener. The latter is the chief reason for incorporating optical devices in the music instrument field.

Since vibrato is more pleasing to the listener, this effect is used in instruments with tone generators whenever possible. If the tones are produced by phase shift or Wein bridge oscillators, the type PL-1823P may be readily used for the subsonic frequency modulation as shown.

Because of the relatively high extinguishing voltage of the neon lamp, the device is not readily available for wide-range attenuation as are tungsten lamp-photoconductor combinations. However, this device does lend itself to applications where a DPST switch function with solid-state reliability, electrically isolated input-output circuits and silent operation is desired.

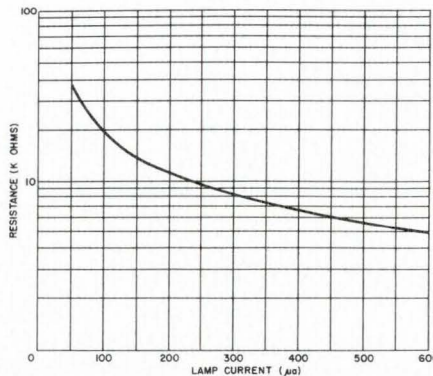

CIRCLE NUMBER 303

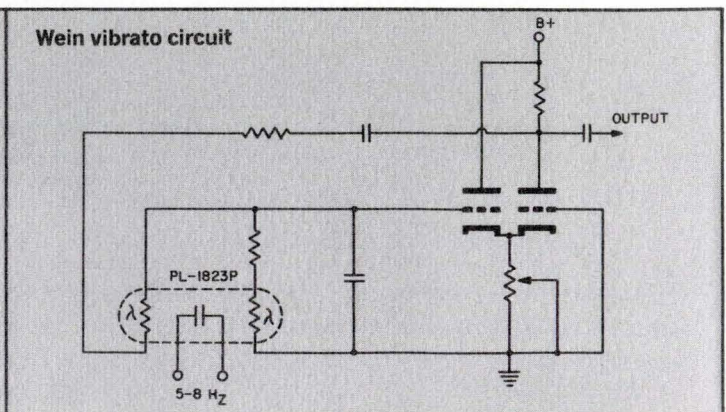
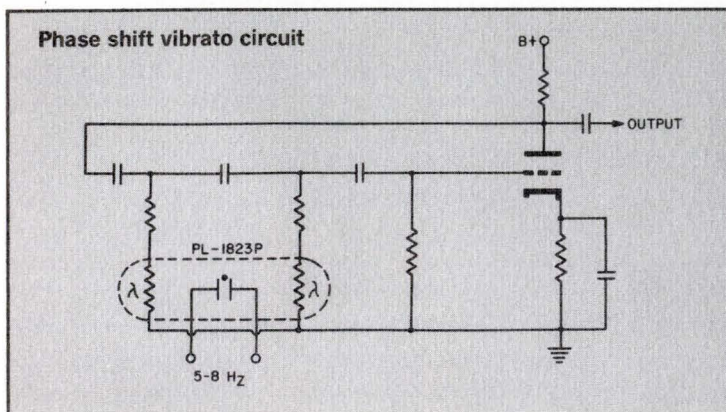

Simple, economical route to surge protection for industrial and commercial equipment

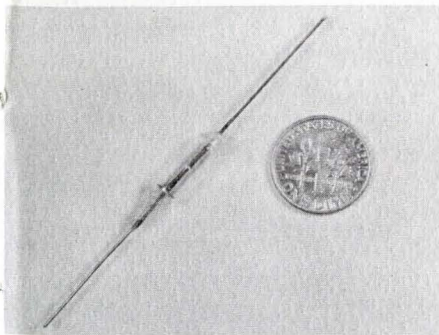

Two simple electrodes can protect your electronic equipment from catastrophic failure caused by high-voltage electromagnetically induced pulses. They can, that is, if the two electrodes are part of Sylvania's new SG-1361 spark gap. In this secondary protector, two electrodes enclosed in a gas-filled, hermetically sealed glass envelope provide an economical way to protect critical electronic circuits and components used in non-military applications.

The new device offers protection against high-voltage transients by shorting the surge to ground. By design, the device is then immediately ready to quench the next disturbance. The one-inch-long SG-1361 fires at from 500 to 900 volts and handles currents of up to 25ma for 30 seconds. A minimum open line impedance of 100 megohms insures that the SG-1361 acts as an open circuit when not conducting.

Typically, the new spark gap can be applied as a protective device in industrial and commercial controls as well as in lighting systems. Also it can be used to guard relays and capacitors against sudden power line pulses. Control, computer and communications equipment (which must be protected against downtime, malfunction or even destruction when subjected to surges) offer ideal application areas for these protective devices.

The recommended protection for high-energy surges up to 110 coulombs is Sylvania's SG-1360 spark gap. Used in both new and retrofit, this device is built to meet the most rigid military and industrial specifications. It can prevent transient overloads, such as those generated with a lightning strike, and even withstands repeated high-energy charges.

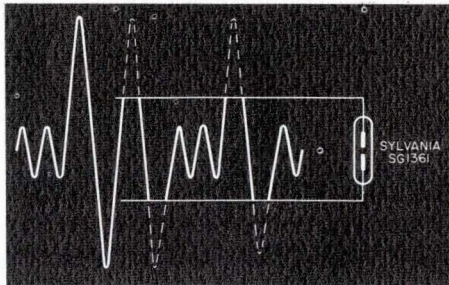

SG-1361 ELECTRICAL DATA

Firing Voltage at 60 Hertz	600 volts
Firing Voltage Range (at 60 Hertz)	500-900 volts
Maximum Firing Current (time duration = 30 sec. max.)	25ma
Maximum Operating Temperature	80°C
Minimum Open Line Impedance	100 Meg.

CIRCLE NUMBER 304

PRODUCT MANAGER'S CORNER

Would you believe 35,000,000 CRTs?

Think back for a moment. It's 1932... the year Pearl Buck received a Pulitzer Prize for "The Good Earth"... Walt Disney created Mickey Mouse... Manchuria became Manchuko... FDR was elected... France won the Davis Cup; the Yankees beat the Cubs in the World Series.

In 1932 in Salem, Massachusetts, Sylvania was making Type 902P1 3-inch cathode ray tubes. General Radio was the customer. They built 902P1s into oscilloscopes housed in cabinets of wood.

Today, 35,000,000 cathode ray tubes later, we're still busy at Sylvania taking care of all kinds of CRT needs. To fill your needs, Sylvania has designed and produced many outstanding innovations in cathode ray technology through the years. But we're not alone. Other companies have contributed also to advances in the state of the art.

For example, aluminized picture tubes. We don't claim to have invented this technique, but we're proud to have been one of the pioneers in mass-producing aluminized

picture tubes. In cooperation with glass suppliers, we also invested a lot of research and engineering to produce the newest methods of building safety factors (e.g. implosion protection) in picture tubes.

Sylvania has been especially active in the development and mass production of color television picture tubes. Color picture tube production was started at our Seneca Falls, N. Y., plant in the early fifties. The *color bright 85™* picture tube with its rare-earth phosphor was undoubtedly one of the most significant advances in the state of the art in recent years. Several months ago, we introduced new 12" CRTs for battery-operated, portable black-and-white TV receivers. The neck is just .788 inches in diameter and 3¾ inches long. It has a 150ma 12.6 volt heater and a 100 volt G₂. Several set makers have already designed this new 12" CRT into their 1967 lines.

In commercial and military displays, we developed a low-heater power tube that consumes 94% less power than conventional CRTs for

battery-powered portable oscilloscopes. High-speed electrostatic charge printing tubes (for address label printing and computer readout), high-resolution assemblies (for photographic recording), console and rear window tubes (for computer readout or radar navigation), and fiberoptic CRTs are among the more recent developments in which Sylvania has participated.

While we were innovating in CRT technology, our engineering people intensified Sylvania's continuing CRT reliability program. This has resulted in significant advances in furnishing tubes with the longest possible life and, equally important, optimum performance throughout tube life.

Today and tomorrow Sylvania will continue to offer the broad range of quality cathode ray tubes, all benefiting from long experience plus the very latest advances in modern technology.



J. W. Ritter
J. W. RITTER

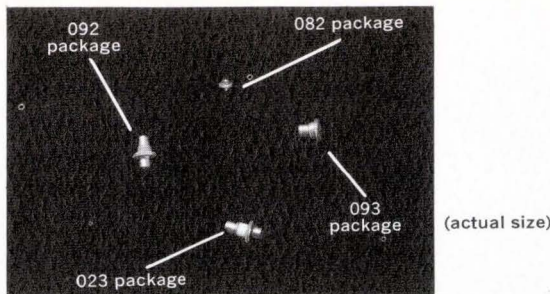

Get the paramp varactor you need, in the package you want

When it came to designing paramps, for too long the engineer had to design around standard varactor packages. The diode of his choice actually offered him little or no choice in physical dimensions. But today, because of Sylvania's custom packaging capability, the chances are that his precise varactor need can now be met.

Now you can get the exact electrical device characteristics you need, in the package you desire, from Sylvania. Pick the varactor, be it silicon or gallium arsenide, from the biggest line in the industry and we'll put it in almost any standard or special package. What's your special parametric amplifier diode requirement? Broadband or low noise? Aerospace or cryogenic use? Whatever the requirement, no longer is your choice of device or package limited.

For paramps where a low noise figure is the prime consideration, our varactor series D-5046 offers unusually high cutoff frequencies of up to

200 GHz, in combination with a minimum beta of 3.0 at -3V. For broadband operation, the D-5146 or D-5371 series is the answer, with minimum beta of 8.0 along with a cutoff frequency as high as 125 GHz min. at -3V. Varactors with beta ratings as high as 12 are available (with F_{co} -3V rating of 100 GHz or less). Exceptionally high-gain-bandwidth products can be achieved with both these series. Because they do not require external cooling, these silicon units make possible systems of small overall size.

Gallium arsenide varactors take over in the higher frequency ranges, generally above X-band, and are used for very low noise applications. Sylvania's GaAs devices excel at both cryogenic and room temperature operation. When cooled with liquid nitrogen, noise temperatures of about 75°K in the 6 to 8 GHz range can be attained. With liquid helium, 35-50°K temperatures are possible.

Sylvania's D-5337 GaAs varactor

improves performance at operating temperatures as low as 10°K. This is due in part to the use of molybdenum heat sinks. The moly's excellent thermal conductivity actually improves at low temperatures, thereby maintaining the low junction temperature necessary for improved noise performance. Its thermal expansion coefficient matches that of the semiconductor material, insuring reliable operation under severe environmental conditions.

Sylvania's work in paramp varactors is based on a solid foundation of long and continuing work with microwave diodes. In addition to the units described above, Sylvania produces two series of general-purpose silicon epitaxial varactors, four series of step recovery diodes, a series of gallium arsenide varactors for harmonic multiplier applications, PIN switching diodes and silicon diffused epitaxial switching diodes.

CIRCLE NUMBER 305

<p>PACKAGE 082</p>	<p>PACKAGE 093</p>	<p>SILICON PARAMP VARACTORS</p> <table border="1"> <thead> <tr> <th>Type Number</th> <th>Package Outline</th> <th>F_{co}-3V (min. GHz)</th> <th>C_{jo} (typ. pfd.)</th> <th>β (min.)</th> </tr> </thead> <tbody> <tr><td>D-5046</td><td>023</td><td>150</td><td>0.3-0.8</td><td>3</td></tr> <tr><td>D-5046A</td><td>023</td><td>200</td><td>0.3-0.7</td><td>3</td></tr> <tr><td>D-5146A</td><td>082</td><td>100</td><td>0.3-0.6</td><td>8</td></tr> <tr><td>D-5146B</td><td>082</td><td>125</td><td>0.3-0.6</td><td>8</td></tr> <tr><td>D-5371A</td><td>023</td><td>100</td><td>0.3-0.8</td><td>8</td></tr> <tr><td>D-5371B</td><td>023</td><td>125</td><td>0.3-0.8</td><td>8</td></tr> <tr><td>D-5371C</td><td>023</td><td>150</td><td>0.3-0.7</td><td>7</td></tr> <tr><td>D-5371D</td><td>023</td><td>175</td><td>0.3-0.6</td><td>6</td></tr> </tbody> </table>	Type Number	Package Outline	F_{co} -3V (min. GHz)	C_{jo} (typ. pfd.)	β (min.)	D-5046	023	150	0.3-0.8	3	D-5046A	023	200	0.3-0.7	3	D-5146A	082	100	0.3-0.6	8	D-5146B	082	125	0.3-0.6	8	D-5371A	023	100	0.3-0.8	8	D-5371B	023	125	0.3-0.8	8	D-5371C	023	150	0.3-0.7	7	D-5371D	023	175	0.3-0.6	6																				
Type Number	Package Outline	F_{co} -3V (min. GHz)	C_{jo} (typ. pfd.)	β (min.)																																																															
D-5046	023	150	0.3-0.8	3																																																															
D-5046A	023	200	0.3-0.7	3																																																															
D-5146A	082	100	0.3-0.6	8																																																															
D-5146B	082	125	0.3-0.6	8																																																															
D-5371A	023	100	0.3-0.8	8																																																															
D-5371B	023	125	0.3-0.8	8																																																															
D-5371C	023	150	0.3-0.7	7																																																															
D-5371D	023	175	0.3-0.6	6																																																															
<p>PACKAGE 023</p>	<p>PACKAGE 092</p>	<p>GaAs PARAMP VARACTORS</p> <table border="1"> <thead> <tr> <th>Type Number</th> <th>Package Outline</th> <th>F_{co}-3V (min. GHz)</th> <th>C_{jo} (typ. pfd.)</th> <th>$\Delta n C_j$ (min.)</th> </tr> </thead> <tbody> <tr><td>D-5047A</td><td>023</td><td>200</td><td>0.4-1.0</td><td>.45</td></tr> <tr><td>D-5047C</td><td>023</td><td>300</td><td>0.4-0.9</td><td>.50</td></tr> <tr><td>D-5047E</td><td>023</td><td>400</td><td>0.5-0.7</td><td>.50</td></tr> <tr><td>D-5147A</td><td>082</td><td>200</td><td>0.4-1.0</td><td>.45</td></tr> <tr><td>D-5147C</td><td>082</td><td>300</td><td>0.4-0.9</td><td>.45</td></tr> <tr><td>D-5147E</td><td>082</td><td>400</td><td>0.5-0.7</td><td>.45</td></tr> <tr><td>D-5347A</td><td>092</td><td>200</td><td>0.4-1.0</td><td>.45</td></tr> <tr><td>D-5347B</td><td>092</td><td>250</td><td>0.4-1.0</td><td>.45</td></tr> <tr><td>D-5357A</td><td>093</td><td>200</td><td>0.4-1.0</td><td>.45</td></tr> <tr><td>D-5357B</td><td>093</td><td>250</td><td>0.4-1.0</td><td>.45</td></tr> </tbody> </table> <p>10°K Diodes</p> <table border="1"> <tbody> <tr><td>D-5337</td><td>023</td><td>150</td><td>.4</td><td>.45</td></tr> <tr><td>D-5337A</td><td>023</td><td>200</td><td>.4</td><td>.45</td></tr> </tbody> </table>	Type Number	Package Outline	F_{co} -3V (min. GHz)	C_{jo} (typ. pfd.)	$\Delta n C_j$ (min.)	D-5047A	023	200	0.4-1.0	.45	D-5047C	023	300	0.4-0.9	.50	D-5047E	023	400	0.5-0.7	.50	D-5147A	082	200	0.4-1.0	.45	D-5147C	082	300	0.4-0.9	.45	D-5147E	082	400	0.5-0.7	.45	D-5347A	092	200	0.4-1.0	.45	D-5347B	092	250	0.4-1.0	.45	D-5357A	093	200	0.4-1.0	.45	D-5357B	093	250	0.4-1.0	.45	D-5337	023	150	.4	.45	D-5337A	023	200	.4	.45
Type Number	Package Outline	F_{co} -3V (min. GHz)	C_{jo} (typ. pfd.)	$\Delta n C_j$ (min.)																																																															
D-5047A	023	200	0.4-1.0	.45																																																															
D-5047C	023	300	0.4-0.9	.50																																																															
D-5047E	023	400	0.5-0.7	.50																																																															
D-5147A	082	200	0.4-1.0	.45																																																															
D-5147C	082	300	0.4-0.9	.45																																																															
D-5147E	082	400	0.5-0.7	.45																																																															
D-5347A	092	200	0.4-1.0	.45																																																															
D-5347B	092	250	0.4-1.0	.45																																																															
D-5357A	093	200	0.4-1.0	.45																																																															
D-5357B	093	250	0.4-1.0	.45																																																															
D-5337	023	150	.4	.45																																																															
D-5337A	023	200	.4	.45																																																															

How to simplify UV detection using a new, small-size cell

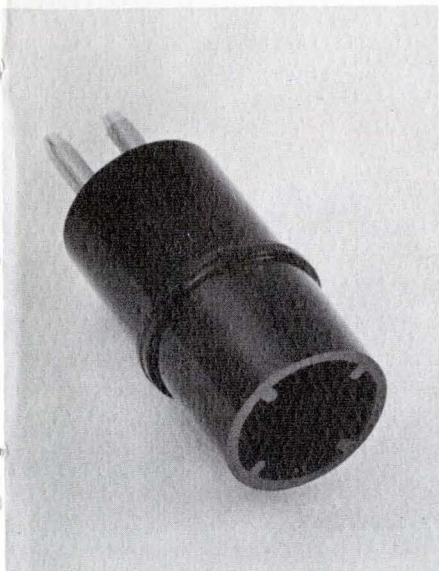

**SRP-3614A ELECTRICAL DATA
RATING (ABSOLUTE MAXIMUM VALUES)**

Dissipation at 40°C	300 mw
at 70°C	25 mw
Temperature Range	-40 to +70°C

CHARACTERISTICS

Cell Resistance	5,500 Ohms
Dark Resistance	1,000,000 Ohms

Detecting and measuring the presence (or absence) of ultraviolet radiation has been simplified by a new sensitive photoconductive device from Sylvania. Requiring only simple low-voltage circuitry, the Type SRP-3614A combines the properties of small size, long life and analog response characteristics to obtain substantial cost savings and high reliability.

Simplified circuit requirements result from high power ratings and high dark/light resistance ratios. A power handling capability of up to 300mw enables the device to translate UV to immediately usable signal levels, operating a sensitive relay directly if required. Dark-to-light resistance ratios of up to 400 further simplify circuit design.

The device retains the proven high reliability of Sylvania's hermetically sealed cadmium-sulfide photoconductors, and includes an integral filter to

optimize the response to spectral energy in the ultraviolet region. The Type SRP-3614A can be used to pick out the UV in ambient exposures containing both infrared and ultraviolet radiation.

Electrical characteristics are enhanced by physical advantages of small size (T-4 envelope, 0.670" diameter by 1½" long) and rugged construction, offering significant advantages in such application areas as UV detection and control, UV regulation, intrusion alarm systems, fire detection and control, and medical electronic systems.

The low operating voltage, the simplified associated circuitry, and the inherently long life and reliability of expertly manufactured semiconductors make this new unit ideal for your critical applications.

CIRCLE NUMBER 306

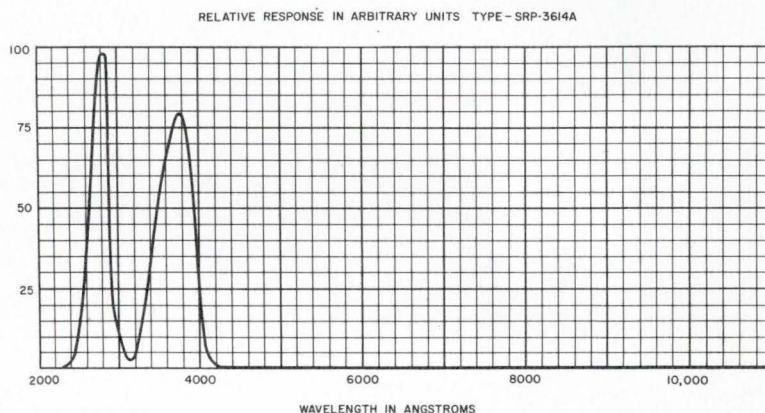
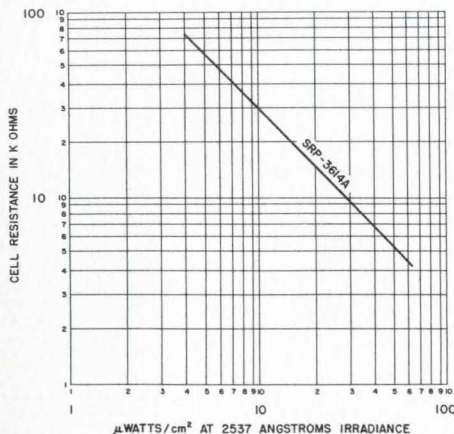

HOT LINE INQUIRY SERVICE

Use Sylvania's "Hot Line" inquiry service, especially if you require full particulars on any item in a hurry. It's easy and it's free. Circle the reader service number(s) you're most interested in; then fill in your name, title, company and address. We'll do the rest and see you get further information almost by return mail.

BUSINESS REPLY MAIL
No Postage Stamp Necessary if Mailed in the United States

POSTAGE WILL BE PAID BY

SYLVANIA ELECTRONIC COMPONENTS GROUP

Sylvania Electric Products Inc.
1100 Main Street
Buffalo, New York 14209

FIRST CLASS
Permit No. 2833
Buffalo, N. Y.

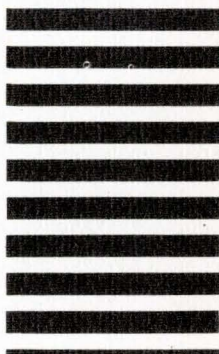

Product specifying made easy with one-stop shopping

In the past year, increasingly more specifiers of electronic products have found they can maximize time by consulting the supplier with the broadest capabilities. It's the same basic principle as one-stop shopping, providing the source has behind it all the essential inputs—product line diversity, depth within each of those lines, a progressive R&D policy, an experienced sales engineering team, and a vigorous sales policy.

Any specifier, especially one who is concerned with diverse needs, will find these advantages in Sylvania's Electronic Components Group. It's been a year since Sylvania's diverse electronic component facilities were combined into an integrated team of specialists in semiconductors, tubes, microwave devices, readout systems and special components.

Sylvania sales engineers therefore are in the best position to advise you

on which product to use, be it solid-state or vacuum.

In all, this change made strictly in the best interests of our customers is proving to be increasingly successful. If you haven't dealt with Sylvania ECG in recent months, we'd suggest you take advantage of this new team. Here are the sales office locations and phone numbers to call:

ATLANTA

31 Sylan Road, S.W.
Atlanta, Georgia 30310
404-766-3633

BALTIMORE

31 Allegheny Avenue
Towson 4, Maryland 21204
301-823-2550

CHICAGO

2001 North Cornell Avenue
Melrose Park, Illinois 60160
312-345-0100

CLEVELAND

4848 West 130th Street
Cleveland, Ohio 44135
216-252-0500

DALLAS

100 Fordyce Street
Dallas, Texas 75207
214-741-4836

DAYTON

333 West First Street
Dayton, Ohio 45402
513-223-6227

DENVER

4700 E. 48th Avenue
Denver, Colorado 80216
303-355-2303

DETROIT

10800 Ford Road
Dearborn, Michigan 48126
313-582-8754

EMPORIUM, PENNSYLVANIA

West Third Street
Emporium, Pa. 15834
814-483-3301

FLORIDA

1520 Edgewater Drive
Orlando, Florida 32804
305-241-9681

FORT WAYNE

4740 Coldwater Road
Fort Wayne, Indiana 46805
219-483-1145

HARTFORD

100 Constitution Plaza
Hartford, Connecticut 06103
203-249-7611

KANSAS CITY

450 Funston Road
Kansas City, Kansas 66115
913-371-3773

LOS ANGELES

6505 East Gayhart Street
Los Angeles, California 90054
213-723-5371

MASSACHUSETTS

Wakefield Office Building,
Lakeside Park, Door 2
Wakefield, Massachusetts 01880
617-933-3500

MINNEAPOLIS

2211 E. Hennepin Street
Minneapolis, Minnesota 55413
612-331-9363

NEW ORLEANS

5510 Jefferson Highway
New Orleans, Louisiana 70123
504-733-6970

NEW YORK

1000 Huyler Street
Teterboro, New Jersey 07602
201-288-9484

NEW YORK—UPSTATE

Johnson Street
Seneca Falls, New York 13148
315-568-5881

PHILADELPHIA

4700 Parkside Avenue
Philadelphia, Pennsylvania 19131
215-477-5000

PITTSBURGH

300 Mount Lebanon Boulevard
Pittsburgh, Pennsylvania 15234
412-531-4974

ST. LOUIS

5010 Kemper Avenue
St. Louis, Missouri 63139
314-664-8974

SAN FRANCISCO

1811 Adrian Road
Burlingame, California 94010
415-697-3500

SEATTLE

750 S. Michigan Street
Seattle, Washington 98108
206-725-2600

SPRINGFIELD, VIRGINIA

6610 Electronic Drive
Springfield, Virginia 22150
703-354-3100

SYRACUSE

5700 West Genesee Street
Camillus, New York 13031
315-672-3111

WASHINGTON, D. C.

1120 Connecticut Avenue, N.W.
Washington, D. C. 20036
202-337-6600

INTERNATIONAL

730 Third Avenue
New York, N. Y. 10017
212-551-1000

CANADA

6233 Cote de Liesse Road
Montreal 9, Quebec, Canada
514-631-4201

EUROPE, AFRICA, NEAR EAST

21—Rue du Rhone
Geneva, Switzerland

This information in Sylvania Ideas is furnished without assuming any obligations.

SYLVANIA

SUBSIDIARY OF
GENERAL TELEPHONE & ELECTRONICS **GTE**

NEW CAPABILITIES IN: ELECTRONIC TUBES • SEMICONDUCTORS • MICROWAVE DEVICES • SPECIAL COMPONENTS • DISPLAY DEVICES

NAME _____

TITLE _____

COMPANY _____

ADDRESS _____

CITY _____ STATE _____

Circle Numbers Corresponding to Product Item

300 301 302 303 304
305 306

Please have a Sales Engineer call



HOT LINE INQUIRY SERVICE

Need information in a hurry? Clip the card and mail it. Be sure to fill in all information requested. We'll rush you full particulars on any item indicated.

You can also get information using the publication's card elsewhere in this issue. Use of the card shown here will simplify handling and save time.

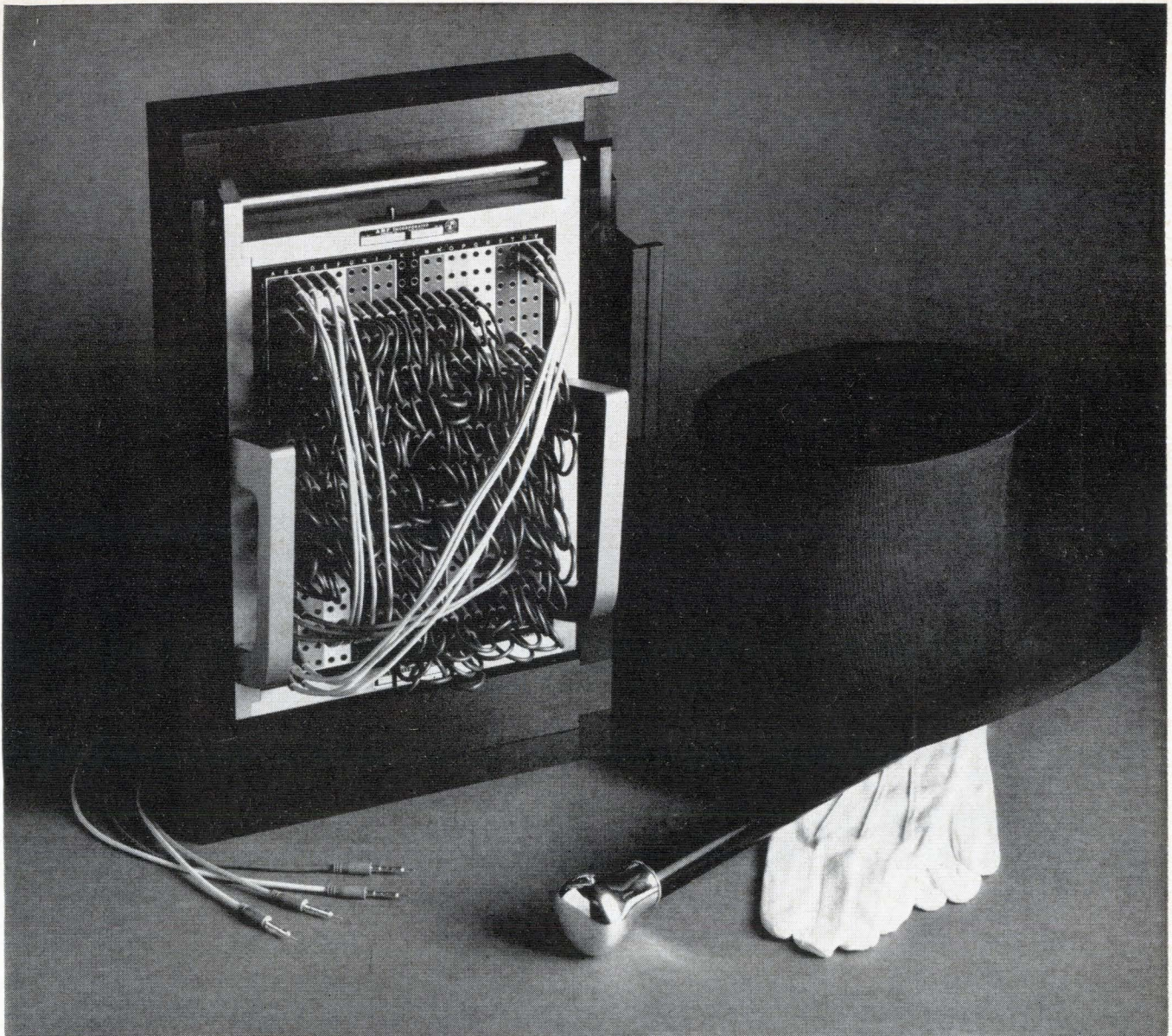

Soft-spoken coaxial programming for your low-level circuits

The very low crosstalk and VSWR values of this Coaxial Programming System are easy on low-level circuits. It's perfect for programming HF communications, telemetry equipment, analog computers and similar low-voltage switching applications. And it lets you change up to 2024 coaxial circuits in seconds!

Pre-program a panel with the coaxial patchcords and slip it into the frame for convenient, quick-change programming. The exclusive camming action of AMP's Coaxial Patchcord System provides a unique wiping action that pre-cleans each coaxial contact. Excellent shielding between inner and outer conductor and between adjacent cells reduces losses and interference to the minimum. When necessary, patchcords may be removed and inserted after the patchboard is in place, permitting program changes without any interruption to other circuits.

Worried about installation? That's easy too—permanent wiring of the rear board is accomplished with one crimp on each coaxial contact for rapid, reliable connection to the equipment. The patchboards and rear panels are made of diallyl phthalate (or proven equivalent) and are retained by rigid aluminum frames; the operating mechanism is of stainless steel; result—rugged, compact design. Some other features of this out-of-the-ordinary Coaxial Programming System:

- Redundant contacts on both center and outer conductor
- Standard sizes—506, 1012, 2024, 3036—plus hybrid systems
- Unique contact cleaning action
- Adjacent circuit crosstalk —60db at 100 Mc
- Individual coaxial contacts
- Exclusive AMP gold over nickel plating
- Maximum VSWR of 1.2 at 100 Mc

If you need a reliable coaxial programming system for your critical low-level equipment, go no further—this is the only one available. But investigate first. Write today for all the facts about AMP's full line of programming systems.

★Trademark of AMP INCORPORATED

AMP
INCORPORATED
Harrisburg, Pennsylvania

A-MP★ products and engineering assistance are available through subsidiary companies in: Australia • Canada • England • France • Holland • Italy • Japan • Mexico • Spain • West Germany

Suddenly, there's a simpler, faster approach to system design—

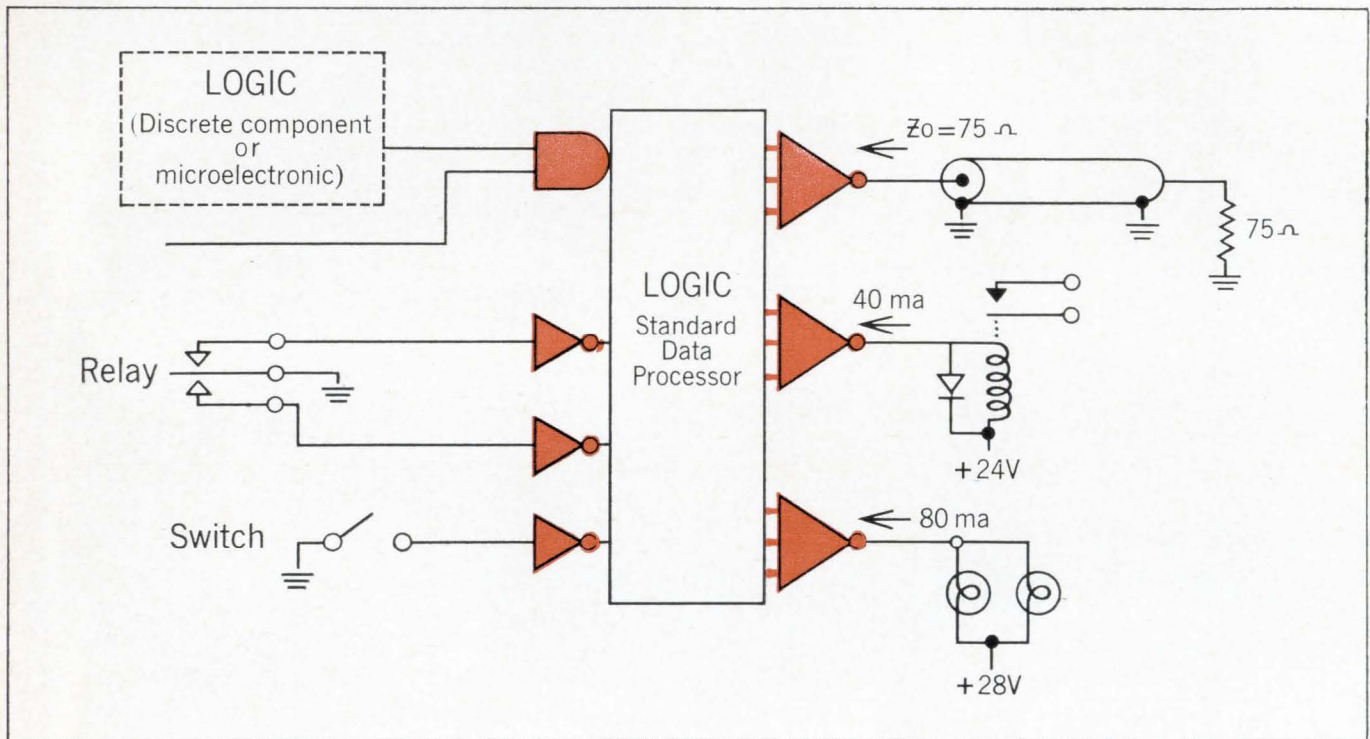

with Philco's new monolithic "interface" circuits!

Up to now, your standard operating procedure as a system designer has been to pick your microcircuit logic family, design the logic system, then sit your own designers down to improvise all the necessary interface circuits, from input to logic, from logic to output. And possibly from one logic type to another.

This obviously takes time and costs money. Why hasn't somebody *done* something about this?

At Philco Microelectronics, we've done something. We are in production on four exceedingly useful interface circuits. With these silicon planar monolithic devices you can take inputs from relays, toggle switches, discrete component logic systems, DTL systems up to 28 v, all to Standard RTL logic systems. And outputs from RTL systems to drive an 80 ma lamp, a 40 ma relay, or a 75 Ω

line. These four circuits are, clearly, only the first of a line of interface circuits from Philco (and other producers are likely sooner or later to follow our lead). But the point is, the four microcircuits listed below are here today. Specified. Available. Off the shelf. And ready to help you shorten system reaction time and cut your design cost.

3-Input Driver Switches

PL 9606 and PL 9607. For high-current outputs from RTL. Output driver for filament lamps (80 ma). Relay driver (40 ma). Coaxial cable driver (75 Ω). High fan-out DTL driver. These two circuits differ only in the output resistor networks.

Triple Level Shifter Circuit

PL 9611. Three conveniently packaged independent interfaces. For relay contacts, toggle switches to RTL logic. High noise immunity—rejecting up

to 700 millivolts at 125°C.

Pulse Threshold Circuit

PL 9610. Specifically designed for inputs from any DTL or discrete component system up to 28 v to RTL, DTL or other logic families. High noise immunity. Pulse level restoration.

Why not take this opportunity to re-think your system design problems?

We'll be glad to furnish more detailed information about Philco monolithic interface circuits. Write or phone us (213-855-4681), or contact your Philco distributor for prices, specifications and delivery.

PHILCO
A SUBSIDIARY OF Ford Motor Company
LANSDALE DIVISION • LANSDALE, PA.
In Canada, Don Mills Road, Don Mills, Ontario, Canada

Electronics Review

Space electronics

Beating the blackout

Since the earliest Mercury flights, space engineers have wrestled unsuccessfully with the problem of the communications blackout that occurs during the launch and reentry of a space vehicle. For years, engineers have probed a method of piercing the hot sheath of ions that envelopes the craft while, at the same time, they have downgraded the importance of the blackout. "We consider it a luxury to be able to keep in constant touch with a bird—not a necessity," says one high official of the National Aeronautics and Space Administration. Luxury or not, the intensive study appears to have paid off, and a solution—employing millimeter waves—may be at hand.

The first flight test of a millimeter telemetry system is only weeks away; this spring engineers at the Marshall Space Flight Center in Huntsville, Ala., will aim a six-foot diameter parabolic antenna at an airplane and try to track it automatically and pick up 35-gigahertz (gigacycles per second) signals transmitted by it. If the test is successful, the next step will be to try to pass the millimeter signals through the flaming trail of a booster. And if that's successful, the telemetry system may be designed into the Saturn V—the booster that will lift the Apollo on its trip to the moon.

Channel space. If the use of the millimeter band of frequencies is approved, it will be a milestone for NASA. So far, the highest frequencies officially planned by the space agency are S band—1,550 to 5,200 megahertz. Although S band provides more channel space, the signals can't penetrate the sheath of ions that builds up like a wall around the nose of the incoming spacecraft and the nozzle of a rocket at lift-off. The sheath

acts like a reflector to all frequencies below the 35-Ghz level because of an interaction between the ions making up the sheath and the radio signals. When a signal below 35 Ghz strikes the sheath, the wave imparts some of its energy to the ions and the ions eventually absorb the entire signal; in the millimeter region, however, this transfer of energy doesn't occur, and the signals can pass easily through the sheath.

In the current round of tests,

manager of the radio-frequency branch of the astronics laboratory at Marshall: "Currently we're planning to use a klystron to transmit the data, but eventually we'll turn to solid state components because a klystron just can't stand the rough treatment it'll encounter on a booster."

Power push. The klystron will have an output of only 1.5 watts. If the telemetry tests are successful, Barnes says, NASA probably will push intensive research for a

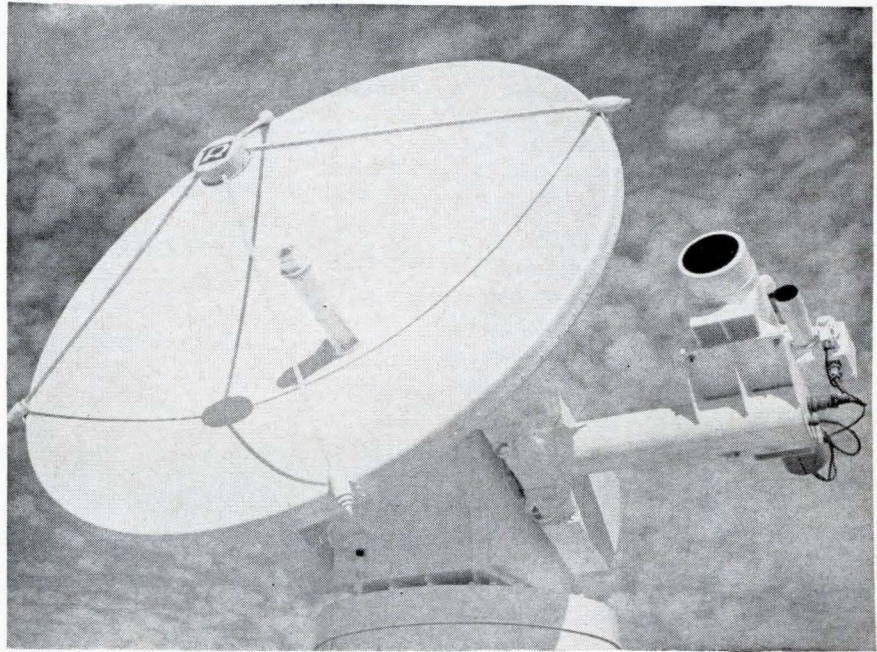

Automatic tracking antenna, designed by Radiation, Inc., operates at millimeter wavelengths. It is expected to provide a solution to the communications blackout problem caused by the ion sheath that envelopes a spacecraft during reentry and lift-off.

NASA turned to Radiation, Inc., of Melbourne, Fla., for a 35-Ghz receiving system. The antenna automatically tracks at 38° per second—exceeding the space agency's design requirements of 25° per second. Radiation's antenna probably will be used only to pick up telemetered data from the Saturn during the first 200 seconds after lift-off—a distance of from 60 to 75 miles.

Says Thomas G. Barnes, project

solid state transmitter with up to 20 watts of power. "Clearly, that's beyond the state of the art," he concedes, "but several companies are confident it can be done."

A solid state 35-Ghz transmitter with that much power "will give us the capability of a communications link between a spacecraft in earth orbit and a ground station," Barnes adds.

But he notes: "This is still speculation—we haven't even made a firm

decision to go to millimeter frequencies yet."

Millimeter waves will provide other assets besides solving the blackout problem. They will make available a vastly wider spectrum for communications. For example, there will be room on the millimeter band for television and other telemetry data—far more than is available on S band. Also, millimeter waves offer the possibility of secret communications without complex electronic scramblers. The reason is that the beamwidth can be kept very narrow (Radiation's antenna has a beamwidth of only 0.33°), so messages beamed from a spacecraft can only be picked up by a ground station in the transmitter's line of sight. Such an advantage obviously is of interest to the military and much work on millimeter waves is secret.

Some problems. The turn to millimeter waves has created problems. There are relatively few commercially available high-power components that can transmit at 35 Ghz. However, NASA engineers believe this problem can be overcome with more research. A second problem is attenuation of the millimeter signal by moisture in the atmosphere, but Barnes brushes this aside, saying: "With the power levels we're talking about, only a severe rainstorm will blot out the signals."

The millimeter waves are being tested to eliminate blackout during both lift-off and reentry but each has its own peculiarities. In lift-off, the blackout varies in intensity and is greatest during the crucial intervals when one stage of the booster separates from another. Blackout time is longer during reentry; signals are blocked out as long as half an hour as the craft plunges into the atmosphere.

Always on target. Accurate tracking is, of course, an important part of the millimeter system. The Radiation antenna achieves it with a technique involving simultaneous lobing of the received signal, commonly called monopulse. In such a system, sum-and-difference radiation patterns are used to derive a signal that is proportional to the position of the target off the axis

of the antenna. This signal is then used to steer the antenna. Tracking errors of less than 0.05° for tracking speeds of less than 5° per second are claimed by Radiation.

Company engineers also have included provisions for manual steering. A closed-circuit television camera is attached to the side of the antenna and provides the operator with a view of the soaring spacecraft. If the automatic tracking system fails, the antenna switches to a manual mode and the operator is able to steer the dish with a joy stick, keeping tabs on the spacecraft through the tv system.

Computers

Plug-in teacher

First-graders at the Brentwood public school in East Palo Alto, Calif., will be getting an unusual teacher this fall: a computer that not only knows all the answers but can handle the most sensitive child with kid gloves and the smart aleck with a stern hand. Although many teaching computers are being

tested, this is the first to play a regular part in a school curriculum.

The computer is a prototype developed by the International Business Machines Corp. and is called the IBM 1500. It is based on the central processing unit of the IBM 1130, the smallest IBM computer using solid state hybrid microcircuits. Patrick Suppes, a professor at the Institute for Mathematical Studies at Stanford University, developed the computer's program and its curriculum.

Two-way program. The computer will control as many as 16 teaching consoles, each with two remote stations for pupils. Each station provides four different modes for pupil-computer communication: a cathode-ray tube on which the computer writes information and questions; a teletypewriter; a screen on which the computer can flash any of 1,000 slides; and a headset for recorded commands. In addition, each pupil will have a light pen with which he can write on the crt. The light pen can be used, for example, to indicate the correct answer to a multiple-choice question. Data on student performance is collected in a disk storage unit and can be printed out

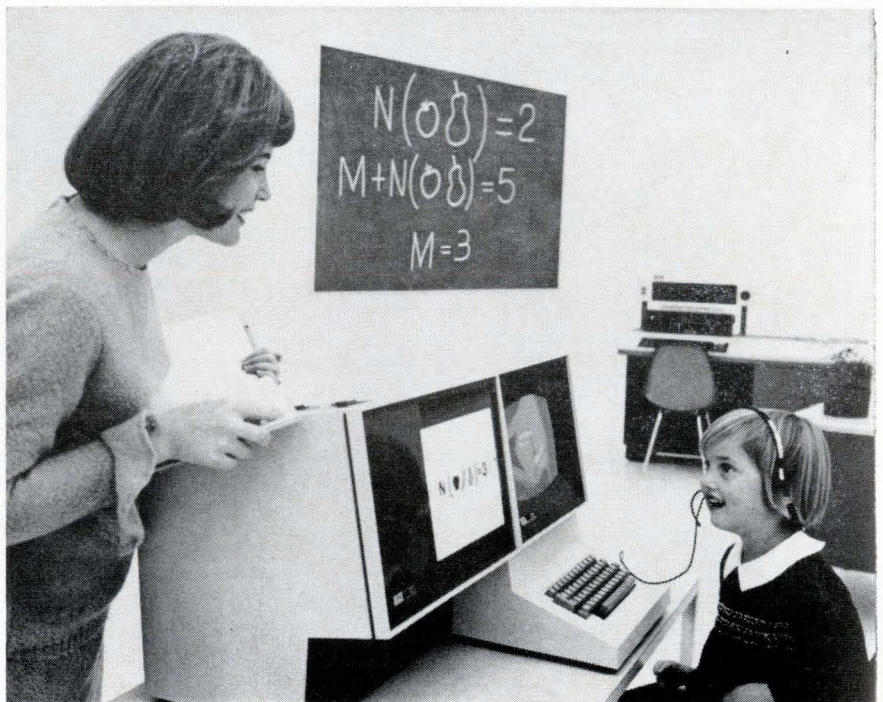

Teacher, student and computer work together.

for analysis by the teacher.

The computer can be programmed to deal with a variety of responses in a lesson. Should a pupil answer a question correctly, he proceeds with the lesson. If he answers incorrectly, a recorded gentle voice informs him of his error and suggests another approach. The computer thus patiently guides the pupil to the correct answer and, theoretically, to a better understanding of the subject matter. If the pupil is having difficulty, the system also can inform the teacher of the need for personal attention.

Programed psychology. The computer also can be programmed to handle a cantankerous pupil. If the pupil attempts to answer questions in a smart-alecky manner, the computer admonishes him with a curt reply.

Stanford University will start trying out the IBM 1500 at the Brentwood school in September. Pupils will work with the machine and their regular teacher for at least an hour each day. Other computer makers will start marketing similar teaching machines soon.

A production model of the IBM 1500 will cost from \$6,000 to \$12,000 a month to rent and \$250,000 to \$450,000 to buy. Educators, however, do not see the cost as prohibitive to computerizing classrooms. Richard L. Bright, director of research at the United States Office of Education, says that "classrooms around the country will probably be completely computerized" within the next 10 to 15 years [Electronics, April 4, p. 8].

Solid state

A LID with legs

Three years ago Alloys Unlimited, Inc., introduced a tiny ceramic U-shaped channel, the CM67, for use in mounting active-device chips to substrates of hearing aids. Hearing aid manufacturers mounted the active-device chip onto the channel. The channel, rather than the chip, was then mounted to the sub-

strate. This provides a number of advantages: automatic assembly is much faster and easier, damage to the chips, because of handling, is reduced and degradation of other circuit components by the heat needed to bond the chips to the substrate is eliminated. These advantages appealed to builders of hybrid integrated circuits; and CM67's and similar devices have since found wide use in hybrid-IC equipment [Electronics, Feb. 21, pp. 110-114].

Now an improved channel, called a leadless inverted device (LID), has been developed by Alloys Unlimited. Each side of the channel has a slot through its center, making it a four-legged device. The active-device chip is placed inside the channel and covered with an epoxy coat. The channel can be flipped over and attached by its legs to the substrate.

The LID's advantages:

- LID's can be tested like discrete transistors because, within the epoxy layer, wire leads connect the emitter, base and collector to the various channel legs.

- All of the LID's can be placed on the substrate simultaneously, shortening production time. Even when mass production equipment is used, it's customary to place chips down one at a time.

- LID's can save space on the substrate. The area under the LID's can be used for connection paths. Even the LID's themselves can be used for crossovers when needed.

- LID's can eliminate the need for wire bonding by the user. If chips are used, precision handling equipment must be employed to attach the chip to the substrate and the wire leads to the chip. Only simple tools or jigs are needed to position LID's.

- The danger of damage to the passive-component network by high bonding temperature is eliminated.

- LID's can be color-coded or marked for easy identification during testing or assembly.

- Attaching LID's to the substrate is easily accomplished. A temperature of about 200°C melts the tinned bonding pads, soldering

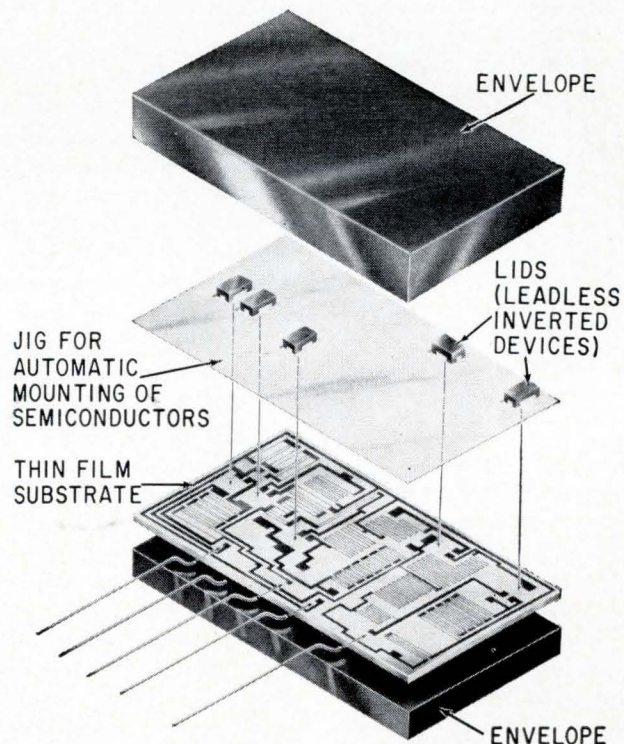

Simple jig arrangement used by Amperex Electronic Corp. for automatic, multiple insertion of leadless inverted devices (LID's). LID's used by Amperex measure 75 by 40 mils and are 30 mils high.

the channel legs into place.

The LID's cost 3.2 cents each in quantities of 10 million or more and come in two widths, 40 mils (the CM182) and 60 mils (the CM-177); both are 75 mils long and 30 mils high.

Alloys Unlimited's first customer for LID's is the Amperex Electric Corp., which is offering two families of transistors in LID's; one series is intended for switching applications, the other for general-purpose amplifier service. Amperex also plans to bring out a line of dual diodes in LID's shortly.

Amperex uses thermocompression bonding to attach the leads from the legs to the chip and conventional silicon-gold eutectic bonding to attach the chip to the ceramic channel. The bases of the legs and the area of the channel to which the chip is attached have a layer of moly-manganese, which is gold plated. Amperex puts the same chips it uses for its conventional low-power transistor line into the LID's. Typical chip sizes are 12 by 15 mils; however, Amperex says chip sizes up to 30 by 30 mils can go into the LID's.

Alloys Unlimited also has a LID for integrated circuits, the CM181, which can be supplied with as many as 14 legs. Two additional LID's are still on the drawing board: one will eliminate all wire bonding and will accommodate a flip chip; the other is hermetically sealed.

Communications

On the beam

The very factor that makes a laser beam such a secure and versatile means of communication—the concentration of energy in a pencil-thin beam—is one of the biggest headaches in actually achieving such communication. Locking onto a laser beam and tracking it has proved to be a far more difficult task than overcoming atmospheric attenuation.

Most laser communications sys-

tems are forced to use a comparatively wide beam to solve the tracking problem. The laser experiment in the Gemini 7 flight, for example, employed a beam that diverged at 10 minutes of arc. But this method dissipates the power of the laser, and aggravates the attenuation problem. For the last couple of years, a group at the Space and Information Systems division of North American Aviation, Inc., has been experimenting with a system that can acquire and track a beam that diverges only 30 seconds of arc. The work has been company-funded, but has progressed to a stage where the Navy recently gave the concern a one-month, \$10,000 contract to run tests on voice transmission up to five miles.

The system has two lasers and two photomultiplier tube receivers, for two-way transmission. The beams and the photomultipliers move in a dual raster scan until they acquire and lock on to each other.

Transmission powers are one milliwatt for voice and video, and a tenth of a milliwatt for voice only. The experimental system sits atop a two-story building at the division's Anaheim, Calif., headquarters and is aimed at a trailer 3,500 feet away.

On track. After tracking 3,500 feet, the laser beam has expanded to about eight inches in diameter and can be tracked by telescope and aimed roughly to an area half-a-degree square. In a long-distance system—in space, for example—the rough alignment would be made from guidance data or by any conventional navigational method.

The half-degree area that is scanned after rough alignment is divided into 64 imaginary squares, in an eight-by-eight array. Station A, which is the remote station, holds at square one while station B scans all 64 in sequence. Then, station A moves to square two and station B goes through the process again. Obviously they will hit each other once each complete scan—but it is only when the angle between them is zero that the scanning process stops and tracking begins.

As a further refinement, one station is equipped to make a super-fine scan. It divides the correct square into 64 smaller squares and then moves square-by-square through the small areas, looking for the best one. The mean time to acquisition is 30 to 40 seconds.

A rule of thumb derived from tracking equations is that for a beam to successfully track its target, it must be pointed with an accuracy an order of magnitude greater than the beam's width. Thus, this system must have an accuracy of three seconds of arc. "We're doing better than that," says Robert Parkinson, the head of the company's Communications Systems division. "How much better I can't say, because it's more accurate than we can measure at the present distance."

Good results. The long-distance Navy tests also will provide more information on attenuation. The present setup gives good voice and video transmission even though the beams are passed about a foot above the roof of the building so that air turbulence generated by the heat of the building will affect the beam.

"But it could be that we have had no attenuation problem because we haven't tested the system enough," Parkinson says. "For instance, we have never used it in rain or heavy fog."

The Navy will take care of that.

Manufacturing

Braided memories

Centuries ago pre-Columbian tribes in Peru braided colored ropes of hemp, called quipu, to record the phases of the moon and celestial events. Soon, electronics engineers may do about the same thing to store information in a computer that will guide a spacecraft.

Engineers at the Instrumentation Laboratory of the Massachusetts Institute of Technology are developing a technique for producing a random-access memory they hope will eventually contain as many as

A PROBLEM SOLVER RECTIFIER... FOR FREQUENCIES TO 100 KC

INTERESTED?

Read on and learn how fast recovery rectifiers helped one designer

CASE HISTORY

George had a problem--the bridge rectifiers in a 30 KC static inverter power supply were running much too hot. This perplexed him since the bridge output current of 1 Amp was within the rating of these rectifiers, 1N3189s. Although crowded for space, George decided to try larger stud mounted 1N1124As. No help! They also ran hot and in addition reduced output voltage and operating efficiency.

What George needed was a fast recovery rectifier to eliminate the severe reverse recovery losses at this frequency. Such losses cause conventional diodes to overheat and drop their output voltage. The solution... UNITRODE UTR22s which have recovery times of 100 nanoseconds in the standard 1 Amp to 30 volt test circuit. In contrast the 1N3189 has a typical recovery time of 2 microseconds; a stud mounted 1N1124A is even slower.

In addition, George picked up some other bonuses--much smaller size, lighter weight, higher thermal efficiency and increased reliability because of the unique Unitrode monolithic construction.

P. S. Note the Unitrode 50 watt surge zeners (the same small size as the UTR 22) used to protect the expensive power transistors from burnout due to voltage spikes.

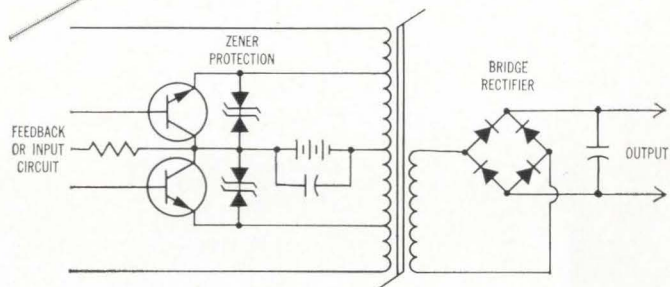
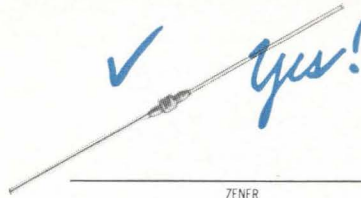
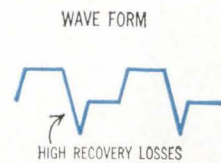
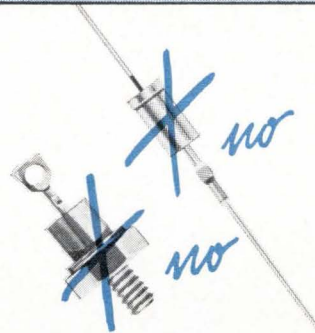

YOU CAN HELP YOUR DESIGNS TOO.

Contact the factory, call your local COMPAR office, or circle the reader service number on this magazine's reply card. All will insure your receiving data sheets and samples of Unitrode Fast Recovery Rectifiers (including the new 50 nanosecond UTX series) plus information on other Unitrode devices immediately.

REPRESENTATIVES IN PRINCIPAL CITIES THROUGHOUT THE WORLD

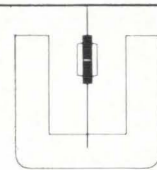

UNITRODE®
"better always/by design"

UNITRODE CORPORATION
580 Pleasant Street, Watertown,
Mass. 02172 Telephone (617) 926-0404
TWX (710) 327-1296

three million bits per cubic foot. And that includes the electronics, the sensing equipment and the chassis—everything except the power supply.

Won't forget. Work on the memory has been funded by the National Aeronautics and Space Administration, but its applications needn't be limited to space use. Braided memories are fixed memories; as such, they can't be reprogrammed or erased. Hence, an electrical malfunction or a human error can't harm the memory; once data is fed in, it's stored permanently. A memory with such an asset would be valuable in industrial process control, too.

The read-only digital memory is made by using a loom to braid information into a wire harness. The harness is then placed on an array of ferrite transformer cores.

"The loom process makes braid

manufacture fast and economical," says Ramon L. Alonso, leader of the MIT group. "It promises to be cheaper, less complex and provide higher density than any wired-in memory now realizable."

Tedious job. Alonso also heads the core rope group at the lab that designed the computer for the Apollo's guidance and navigation system. The wired-in memory for Apollo isn't braided but consists of ropes of wire on which cores are strung. Stringing cores is tedious, even if done by machine.

The MIT braided memory consists of an array of U-shaped linear transformer cores interwoven by a number of word lines that either thread or bypass each transformer so that when a particular word is pulsed, energy is transferred to sense windings. After the wires that forms the lines are woven by a loom and bundled into a harness

with temporary separators, the harness is placed over the core array. Caps are then added to close the flux path of the cores.

The number of memory bits is the number of wires times the number of cores. This makes for very high density storage plus high speed. Sometime in the future, says Alonso, the technique will permit manufacture of a million bits in an eight-hour day.

Alonso says a working model has only 256 transformer cores for a memory capacity of 16,384 words of 16 bits each, totaling about a quarter-million bits. It has a cycle time of two microseconds and its power consumption is less than 3.5 watts. A half-million bit model also has been made.

Alonso adds that the electronic circuitry costs less than conventional memories.

Wire weaver. W. Bard Turner of

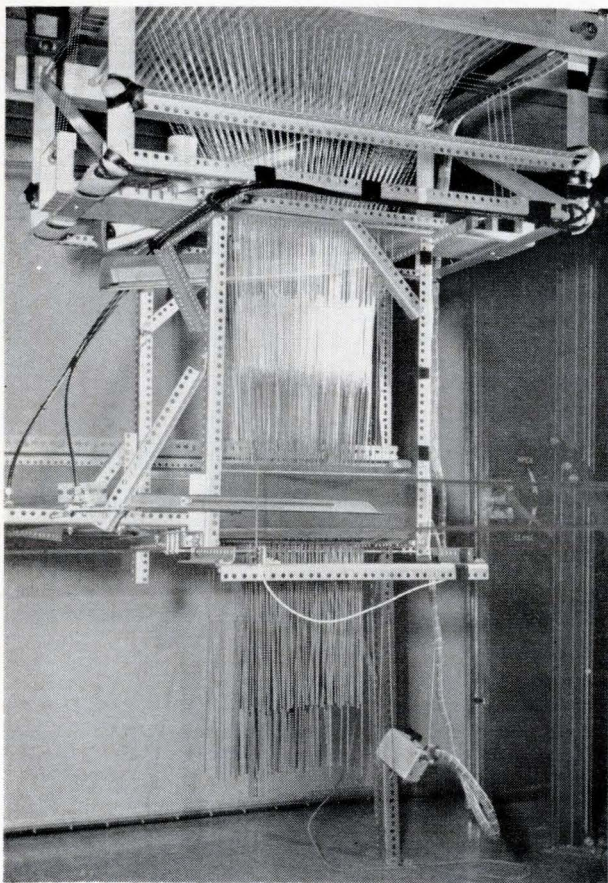

Loom weaves computer memories at MIT lab. Jacquard lift mechanism designs the memory under control of a tape program. After a coming off the loom, the wires are laced into a braid. The memory is nonprogrammable and isn't affected by a system failure.

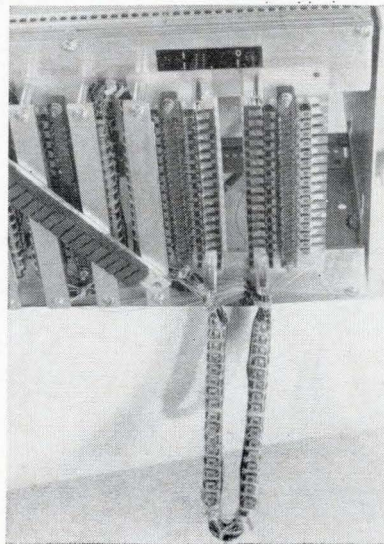
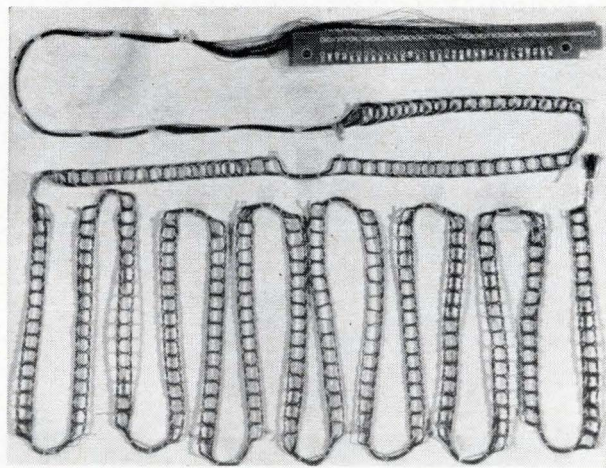

Braid section (top) of experimental memory consists of a bundle of 64 zero and one wires. The holes fit over legs of the U-shaped cores, which are then capped to form toroids. On left is a portion of the braid memory with a section of the braid removed. Coils and other associated electronics are situated along the lines of the cores.

COMPONENT COMMENTS *From Speer*

How to find the carbon composition resistor that does the most for you...when all U.S. brands are good

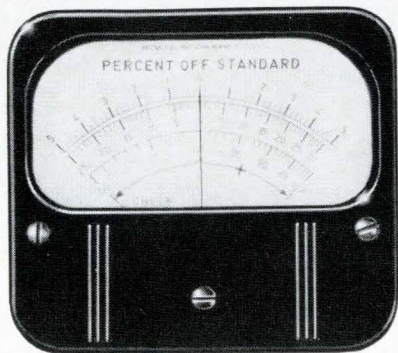

Before we show you how to do it, let's clear up some of the confusion surrounding this question of resistor reliability.

You have been exposed to some 4-color full-page advertising citing "10 billion field proven resistors" and "not even one catastrophic failure."

When you get right down to cases—unless U. S. made composition resistors are badly abused, failures are virtually nil. As a rule, malfunctions are the result of failures of other circuit elements. Long life and reliable performance are sure fire results when operating conditions are reasonable.

It's true that composition resistors are susceptible to ambient influences. But if you plan your design to accommodate the modest and completely defined resistance changes that might occur, you'll be more than compensated by the resistors' work-horse performance. (Not to mention their rock-bottom price.)

Which brings us back to our original problem—how to find the best composition resistor among the many equally reliable U.S. brands.

Solution? Come to Speer.

Before you accuse us of shameless subjectivity, consider the following points. (1) We produce billions of completely reliable carbon composition resistors for hundreds of satisfied repeat customers. (2) We have

a high-volume production schedule, which permits us to offer realistic pricing without sacrificing product quality.

And (3) we offer quite a bit more in the way of technical support and service.

We'd be delighted to send you complete documentation on Speer resistor characteristics. Just mail us the coupon.

Will our new custom resistor networks steal the Show at SWIEEEO?

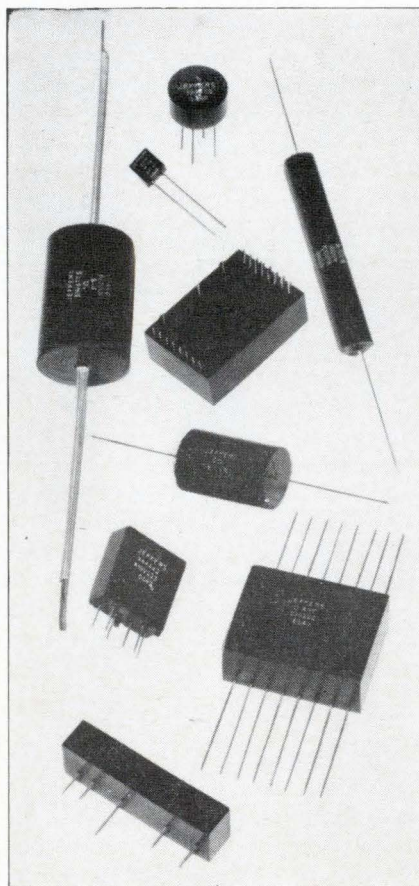

All we know for sure is that they'll be there—in the Speer Electronics Booth (524).

If you missed these new precision resistor networks and packaged as-

semblies at the IEEE Show, here's another chance to see them in action. You'll find, for example, that they can be calibrated to tolerances better than .02%, with characteristics of very low temperature coefficient of resistance and compatible stability.

What's more, they can be designed to meet any network application. They offer broad environmental capabilities, at the lowest possible cost, with the shortest delivery schedule—

You know, those clever little devils might just end up stealing the Show after all.

Postscript: if you can't make it to the Dallas Auditorium, use the coupon. We'll send you more information about our Jeffers Electronics Division's new networks.



SPEER® Carbon Co.

SPEER CARBON COMPANY
St. Marys, Pennsylvania 15857

A Division of
Air Reduction Company, Inc.

- Show me why I should switch to Speer carbon composition resistors.
 Tell me more about your new metal film resistor networks.

Name _____

Title _____

Company _____

Address _____

City _____ State _____ Zip _____

the MIT lab originally suggested that a loom be used for manufacturing the memory, and two 64-wire looms were built to test mechanical selection techniques. Turner is now completing a 256-wire loom that will simultaneously handle 1,024 wires—four bundles of 256 wires each. The loom uses a jacquard lift mechanism, nearly identical to the jacquard used by textile plants for more than 100 years [see story below for other wiring techniques using a jacquard].

In a standard jacquard, the weaving pattern is controlled by rods positioned by a punched card. However, MIT needs a fairly elaborate procedure to provide a proper separation of zeros and ones in the long braids. The instrument division has developed a tape-controlled equivalent of the punched card for selection of one and zero wires.

Initially, the rods on the loom are set in the vertical position. The tape control sends signals, allowing one rod, for example, to fall; the selection mechanism is solenoid-controlled. An electronic monitoring system compares the tape with signals generated each time a wire is selected and a rod drops. The rod actuates a switch that sends a signal to the monitoring circuit.

In addition, to protect against memory errors, the group is investigating the possibility of building the memory with redundancy and alternate paths.

All wires are terminated in a work area next to the loom, and the separators are inserted there.

Woven wiring

Stan Rask is an electronics engineer doubling as a textile salesman. Until recently, he hasn't had much luck selling his wares to his peers.

Rask isn't selling woven-wire computer memories, which have been catching on in commercial computers, or braids for core memories [see preceding article]. The textiles he has been toting around for two years are a form of wiring matrix for component interconnection, similar in design principle to welded wiring matrixes [Electron-

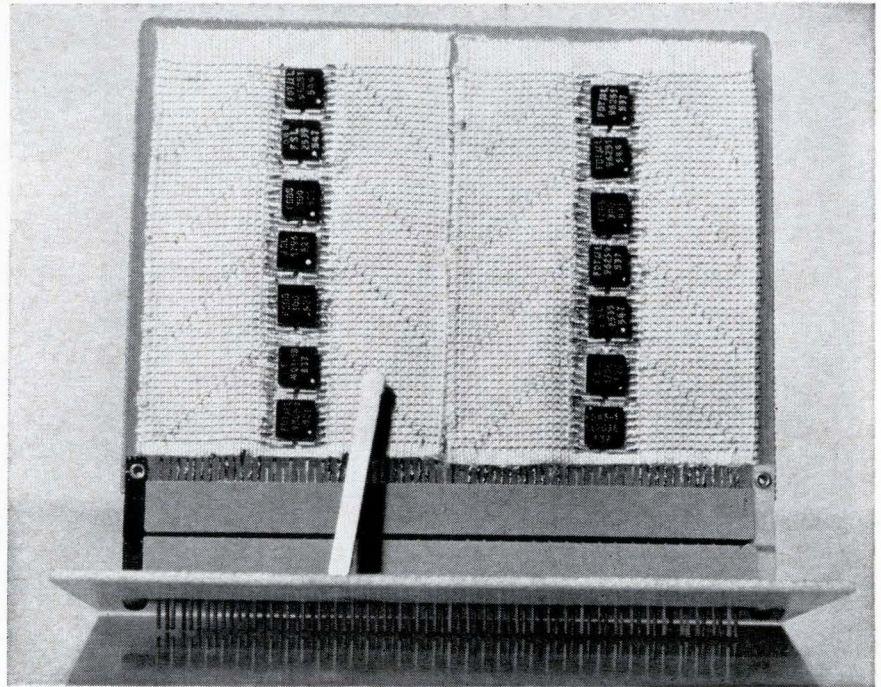

Fourteen integrated circuits interconnected by a woven wire matrix two inches square. The horizontal wires are welded to the IC leads and the vertical wires to the connector.

ics, Oct. 9, 1959, p. 62], but made by weaving wire and glass-fiber yarn on jacquard looms.

Doors in the electronics industry are starting to open now for Rask because systems manufacturers are searching for more efficient ways of interconnecting integrated circuits. Among the companies considering IC interconnection with woven matrixes, Rask says, are the Hughes Aircraft Co. and Lockheed Aircraft Corp.

The matrixes aren't cheap. Rask's employer, the Southern Weaving Co., is charging \$1 an inch for matrixes with wires spaced 20 to the inch (50-mil spacing, the same as IC flatpack leads). But \$50 worth may do the job of a \$500 multilayer printed-circuit board, contends Odes Tatum, another salesman for the company.

The price prevents competition with conventional printed circuits in routine applications. A radio set was built with the cloth and discrete components, but it is only used now to show that the wiring works at radio frequencies. However, the Western Electric Co. is reportedly evaluating woven wiring for relay interconnection and the Chrysler Corp. is considering

it for harness wiring in autos. The Elco Corp. is developing connectors for the woven wiring.

Chip and wire. IC assemblies like the one shown are made by soldering or welding the flatpack leads to the horizontal, or fill, wires. The warp wires run under the glass yarn except when they cross over the fill wires at locations called nodes. The nodes, dip soldered after the cloth is woven, form the herringbone pattern in the photo. Another way of making assemblies is to solder the IC's to long strips, which are rolled up like bandages.

The nodal patterns are varied in the weaving process. The looms are usually used to make patterned tapes, such as the labels in men's suits. Patterns are changed by making changes in the hole patterns of punched cards that control the location of warp and fill crossover points—a form of design automation invented a century before electronic data processing.

This design flexibility is one reason that Erwin Pease, a senior engineer with Lockheed, likes the process. Another reason, he says, is that solid wiring can be used for easy soldering to component

Four reasons for using heat-shrinkable tubing of Kynar*! (1) It's two to three times tougher than any other shrinkable plastic tubing. (2) It's thermally stable...operates at 150°C, flexible at -65°C. (3) It shrinks 50% at 175°C. (4) It's UL approved for 600 volt rating at 150°C. And how can you use it? Here are just five of the many ways.

For corrosion protection—Resists chemicals and weathering at battery terminals.

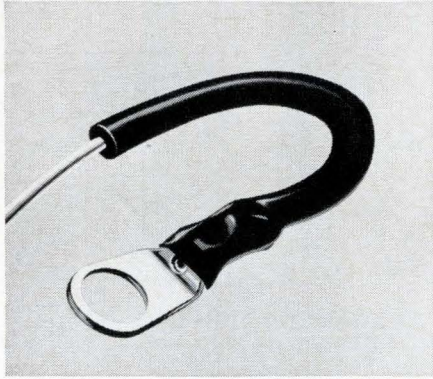

For strain relief—Transfers flex stress away from joint; protects conductors.

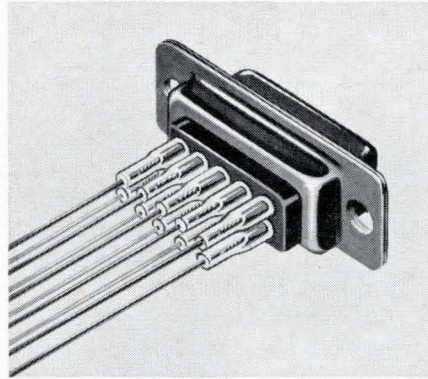

For insulation and mechanical protection—Capacitors, resistors, diodes.

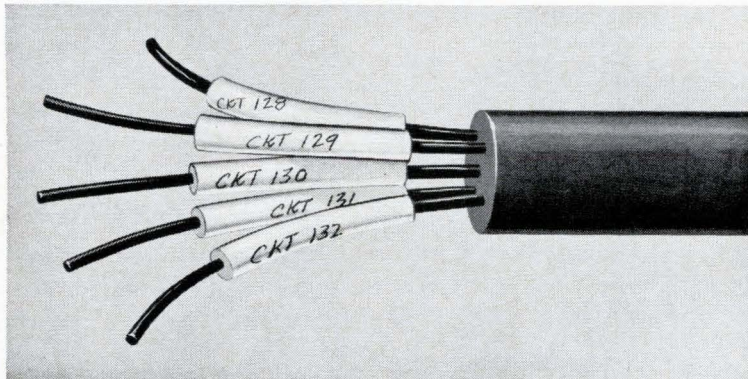
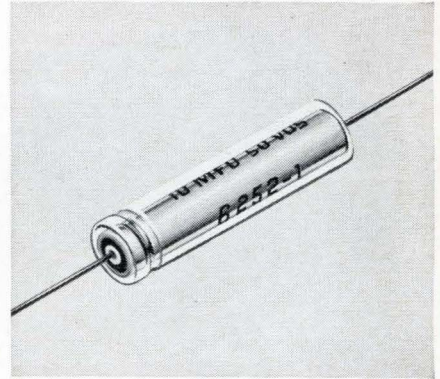

For identification—Eliminates the need for stocking colored or printed wire.

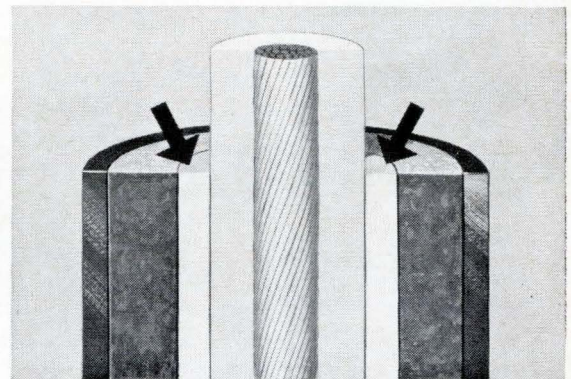

For sealing out moisture—Used over TFE insulation to bond with potting compounds.

If you are using or considering heat shrinkable tubing, investigate all the advantages of specifying Kynar. It's available in a range of diameters from Raychem Corporation as Thermofit** Kynar. For information, write Plastics Department, Pennsalt Chemicals Corporation, 3 Penn Center, Philadelphia, Pa. 19102.

Kynar...a fluoroplastic that's tough!

*Kynar is a registered trademark of Pennsalt Chemicals Corporation for its vinylidene fluoride resin

**Registered trademark of Raychem Corporation



maintenance

tools

for

the

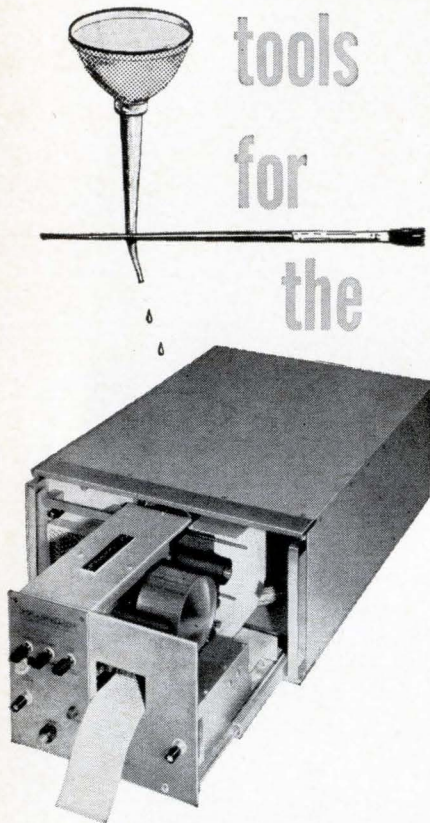

World's Fastest, Low-Cost Digital Printer

Apply several drops of oil to the drive-motor shaft-ends each year (or every fifty-million lines). Brush out any accumulated dust or lint. Clean the air filter periodically.

That's the extent of maintenance for a Franklin Model 1000 . . . the only digital printer that offers a printing rate of 40 lines per second (or less) at low, low, OEM prices.

REQUEST BULLETIN 2301

FRANKLIN
electronics, inc.

East Fourth St. • Bridgeport, Pa. 19405
A Division of the Anelex Corporation

leads and stranded wiring can also be used for crimping to terminals. Pease is at Lockheed's Georgia division, where electronic systems for the military transport plane, the C-5A, are being developed.

Lockheed is considering the interconnection of unpackaged IC's with woven wiring. The wire ends can be soldered directly to thick-film printed interconnections of ceramic-based hybrid IC's, Pease says. If very fine wires make up the cloth, bonds might be made directly to monolithic IC chips, but Pease thinks that it would be safer to employ channel-mounted chips.

"It looks real promising," Pease says. However, he stresses that Lockheed has not completed its evaluations and hasn't decided whether to use the woven circuits. One electrical problem that has cropped up, he says, is high capacitance between parallel wires.

Dielectric fill. The capacitance shouldn't be a problem, Rask replies. The capacitance can be adjusted by using a different insulating yarn—nylon, for example, instead of glass—and by impregnating the cloth with a dielectric such as silicone rubber as part of the processing or during encapsulation of the assembly.

The woven circuits are still in development, Tatum of Southern Weaving points out. Electrical tests are still being made, special connectors are being designed and experiments with different types of wires and wire spacing are being run. Some circuits have been made experimentally with wires spaced only 25 mils apart and others with twisted-pair transmission lines for high-speed circuitry.

Meanwhile, at the company's plant in Greenville, S.C., a new loom is being installed. It has three shuttles—one for the wire, one for the glass and one to weave identification numbers into the cloth.

Medical electronics

IR thermometer

Taking the temperatures of patients in a ward is at best a time-

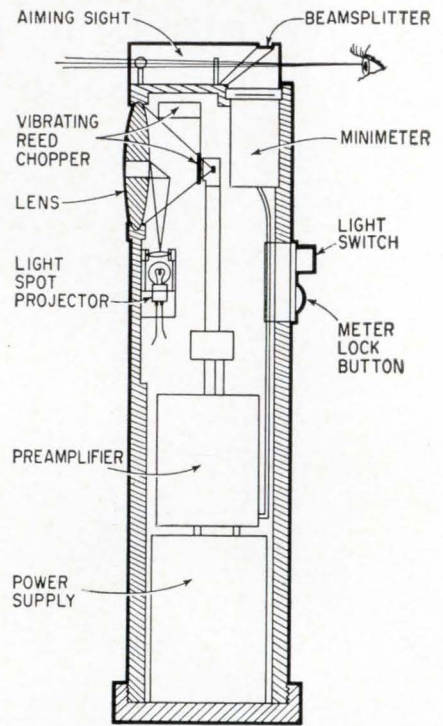

Infrared thermometer gives instant temperature reading without touching the patient.

consuming chore. At its worst, particularly when infants are involved, it can even result in fatal injuries. Now all this may be changed—thanks to an infrared fever thermometer that gives an instant reading of a patient's temperature without touching him.

The instrument is a battery-powered radiometer the size of a flashlight and uses a thermistor bolometer infrared detector as its sensing element. The instrument was developed by Stephen Boba, manager of the infrared techniques and systems group of the Raytheon Corp.

Say "Ahhhh." To use the infrared thermometer, the operator stands three to seven feet from the patient and aims the instrument at the patient through a lens. The patient's open mouth, nasal cavity or eye is used as a target; each is a sufficient source of radiant energy for an accurate reading. The instrument's lens is pierced to accommodate a light-spot projector that operates in the visible spectrum so the operator can see where the infrared detector is focused. A reading is available immediately and a beam splitter built into the aiming sight superimposes an

image of the scale on the target. Thus it is possible for the operators to see both the patient and the reading.

With such a thermometer, a nurse can take the temperatures of all the babies in a hospital nursery in the same time normally required to take the temperature of one baby—and without disturbing any of them.

Flip a switch. The thermometer is calibrated between 96° and 106° F. It has a sensitivity of 0.2° F and an accuracy of $\pm 0.1^\circ$ F. A switch on its side turns on the power, and a knob under the switch recalibrates the instrument. Recalibration is necessary after one hour of use and can be done by aiming the thermometer at a person whose temperature is normal or with a special calibration device with a standard infrared source.

A vibrating reed chopper converts the infrared signal to an a-c electrical current for processing.

Raytheon says it is considering sale of the manufacturing rights for the thermometer but will not produce it commercially itself. Raytheon estimates the price in production quantities at less than \$300 each.

Electronics notes

▪ **Weather laser.** Scientists at Stanford Research Institute's Electromagnetic Techniques Laboratory have designed a two-headed laser system that produces four colors: red-infrared and green-ultraviolet. By comparing the reflections of the laser pulses that are aimed into clouds, for example, the scientists hope to gather meteorological information since different color laser beams are attenuated and reflected to different degrees by clouds.

▪ **Portable microwave link.** The International Telephone and Telegraph Corp.'s ITT Federal Labs has developed a portable microwave terminal that weighs about 55 pounds and fits into two packages, each no bigger than an attaché case. The terminal can multiplex 12 channels for voice communications.

basic measuring tools from

**HEWLETT
PACKARD**



hp 3439A Plug-in Digital Voltmeter

versatile, 4-digit DVM—for only \$950 plus plug-in accuracy better than $\pm 0.05\%$ of reading ± 1 digit, $\pm 15^\circ\text{C}$ to $\pm 40^\circ\text{C}$ with line voltage variation of $\pm 10\%$
5% overranging, high ac rejection (30 db at 60 Hz)
signal common floatable up to 500 v dc from chassis ground
automatic ranging

Use it for:

mv to kv dc autoranging voltage measurements: thermocouple, bridge measurements, production and maintenance testing
 μa to a dc current measurements: power supply currents, collector and base currents, leakage currents
mv to kv ac voltage measurements: average responding (rms with hp 3440A), servo measurements, turns ratios
ohms to megohms resistance measurements
programmable ac, dc voltage ranges

Plug-in capability makes this DVM an economical bench instrument with a wide range of uses. The basic instrument, priced at \$950, offers high accuracy, dc isolation, speed (readings in a fraction of a second), ac rejection, economy, reliability. Plug-ins permit manual range selection 10 v to 1000 v full scale (3441A); automatic range selection with remote range feature (3442A); measurement ranges 100 mv to 1000 v full scale, with automatic and remote ranging (3443A); voltage (100 mv to 1000 v), current (100 μa to 1 amp) and resistance (1000 Ω to 10 M Ω) measurements (3444A); ac/dc measurements, 10 v to 1000 v full scale with manual, automatic

and remote ranging (3445A), and remote function and/or ranging (3446A). Plug-ins priced from \$40 for the manual ranging unit (required) to \$525 for the ac unit and \$575 for the multi-function unit.

Your Hewlett-Packard field engineer will give you a demonstration of the voltmeter and the plug-ins most useful for your application. Just give him a call. Or write for complete specifications to Hewlett-Packard, Palo Alto, California 94304, Tel. (415) 326-7000; Europe: 54 Route des Acacias, Geneva.

Data subject to change without notice.
Prices f.o.b. factory.

HEWLETT  **PACKARD**
An extra measure of quality

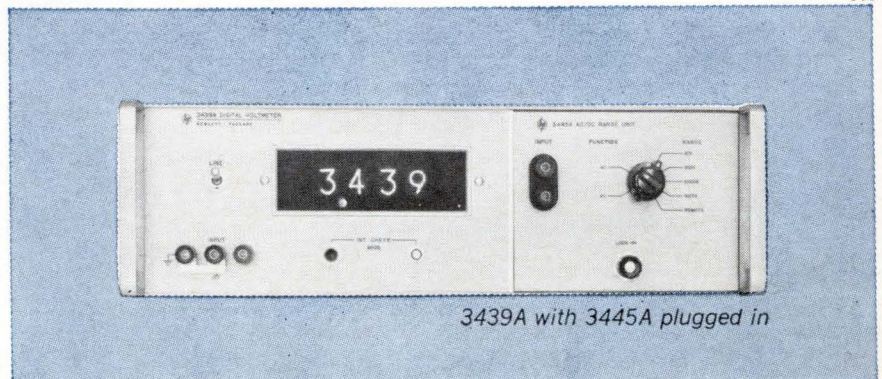

3439A with 3445A plugged in

The capabilities of microwave technology

Solving today's scientific and industrial problems frequently requires the application of new disciplines. How two of these problems are being solved—by microwave technology—is described here.

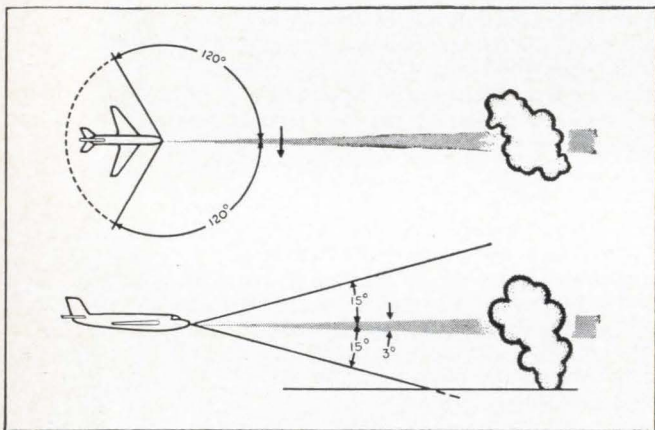

The problem: Build an ultra-reliable magnetron and modulator package for an airborne radar system that "sees" weather 180 miles ahead.

The advanced system is the Bendix Corporation's RDR-1E airborne weather radar, now widely used on commercial jet aircraft.

For this Bendix system, Raytheon's Microwave & Power Tube Division combined several capabilities. It built a magnetron tube and a pulse modulator package designed to work extremely well together to provide Bendix with an ultra-reliable system.

The magnetron is a Type 2J55, a super-high frequency oscillator capable of delivering 70 kw of peak power. The modulator package is a complete module containing pulse transformer, pulse forming network and charging choke. All are combined into one compact package that is dynamically tested with the tube to ensure matching the characteristics of the magnetron. Because of this compatibility, the magnetron's life is extended and the system's efficiency improved.

By utilizing the single Raytheon magnetron-modulator source, Bendix gained reductions in system size, more reliable operation, and significant engineering savings.

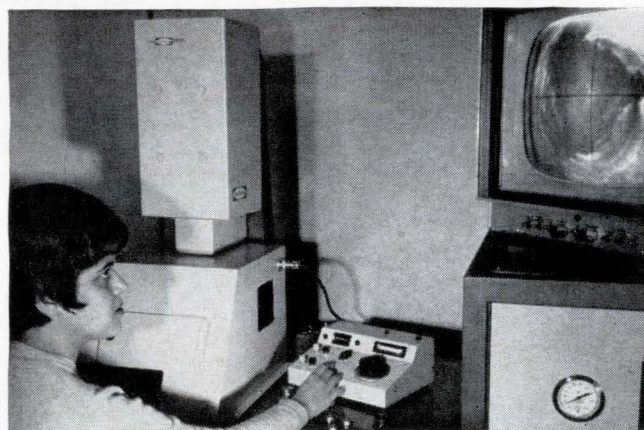

The problem: Build a laser system to pierce—on a mass production basis—diamond dies used in drawing small diameter copper wire.

The laser system for Western Electric's Buffalo plant had to be capable of one pulse per second operation—with extremely high repeatability—while piercing holes in diamonds.

To meet Western Electric's requirements, Raytheon's Laser Advanced Development Center developed the LE-1 laser system. This system combines an efficient water cooling method and optical pumping scheme by which, once set, variations in output energy are virtually negligible. Controllability is essential in piercing holes having extremely small diameters. With a modified LE-1 system, hole diameters as small as 0.0025 inch through $\frac{1}{16}$ "-thick diamonds are feasible.

The LE-1 is capable of producing more than 10 joules of energy per pulse at the rate of one pulse per second. Pulse width is variable from 1 to 10 milliseconds.

Building lasers for production line use indicates the ability of Raytheon laser technology to meet the needs of today's industrial requirements.

For additional examples of our capabilities in solving scientific and industrial problems, write to Raytheon Company, Microwave & Power Tube Division, Dept. A, Willow Street, Waltham, Mass. 02154.

RAYTHEON

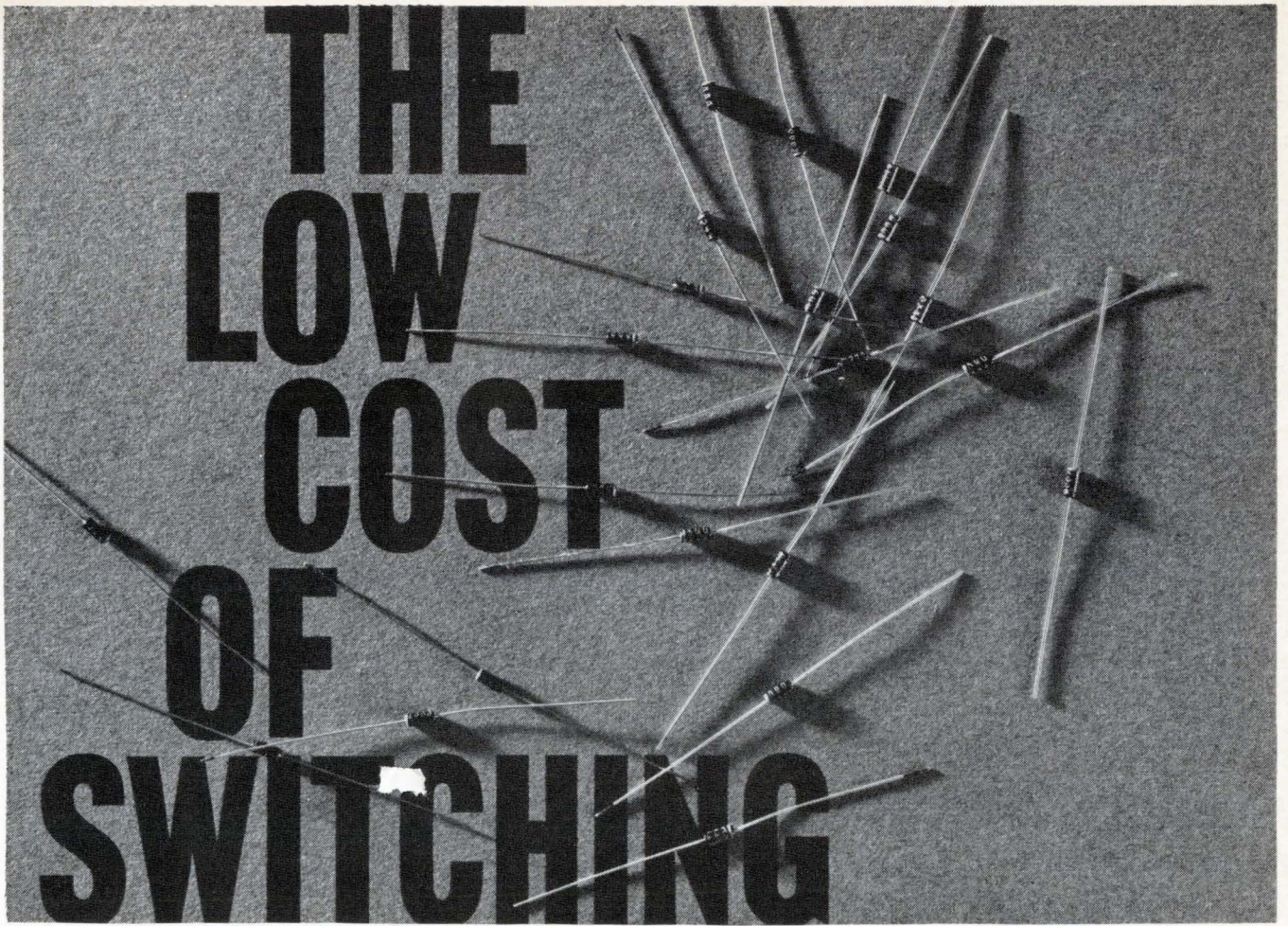

**...new value
from new pricing
on hot carrier diodes
from hpa**

Ultra-fast switching with hp associates 2900 Hot Carrier Diode is now more economical than ever. New production techniques and experience have reduced the cost of these popular devices, and the savings is passed on to you.

The performance characteristics and pricing listed in the chart make the hpa 2900 ideally suited for use in TV tuners, commercial communications limiters, detectors and mixers, and multiplexing in signal processing.

Contact your Hewlett-Packard field engineer for complete data.

TYPICAL SPECIFICATIONS, hpa 2900		
Forward Current I_{F1}		Breakdown Voltage BV_R
20 ma min. @ $V_F = 1.0$ v 1.0 ma min. @ $V_F = 0.4$ v		10 v @ $I_R = 10$ μ a
Leakage Current I_R	Lifetime τ	Price
100 na @ $V_R = -5.0$ v	100 ps	1 to 99, \$3.00 100 to 999, \$2.25

Data subject to change without notice. Prices f. o. b. factory.



hp associates 620 PAGE MILL ROAD,
 PALO ALTO, CALIF. 94304, (415) 321-8510
 An Affiliate of Hewlett-Packard

New Epoxy Packages make Amelco FET's more economical than ever before!

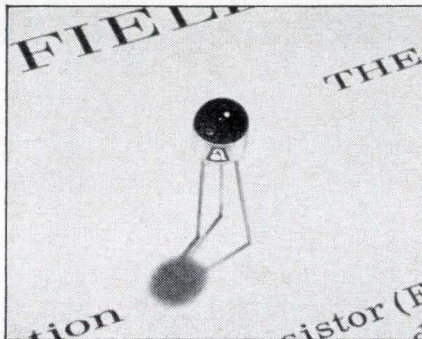

KEY SPECIFICATIONS

	2N4302	2N4303	2N4304
I_{DSS} (max. mA)	5.0	10	15
g_m (min. μ mhos)	1000	2000	1000
V_p (max. volts)	4.0	6.0	10
C_{DG} (max. pf)	2.0	2.0	2.0
I_{GSS} (max. nA)	1.0	1.0	1.0
Price ea. (1000 qty.)	\$1.45	\$1.75	\$1.15

WRITE FOR COMPLETE SPECIFICATIONS

Amelco Semiconductor, world's largest manufacturer of N Channel Field Effect Transistors, has just reduced prices drastically by offering several types in moisture resistant, high quality epoxy packages. These epoxy FET's will do virtually everything the Amelco metal can line does except fly classified missions. Don't let that bother you, though — Amelco Epoxy FET's will meet all requirements of MIL-S-19500.

So, if the cost of converting your circuits to the advantages of Field Effect Transistors has been a problem, forget it. Once again, Amelco has found the answer!

AMELCO SEMICONDUCTOR

DIVISION OF TELEDYNE, INC.

1300 TERRA BELLA AVENUE • MOUNTAIN VIEW, CALIFORNIA

Mail Address: P. O. Box 1030, Mountain View, California
Phone: (415) 968-9241 / TWX: (415) 969-9112 / Telex: 34-8416

REGIONAL OFFICES

Southwest—Suite 213, 8621 Bellanca Ave., Los Angeles, California 90045, (213) 678-3146 • Northwest—1300 Terra Bella Avenue, Mountain View, California, (415) 968-9241 • East—P. O. Box 2091, Paterson, New Jersey 07509, (516) 334-7997 • Northeast—543 High Street, Westwood, Massachusetts, (617) 326-6600 • Midwest—650 West Algonquin Road, Des Plaines, Illinois, (312) 439-3250; 3020 Woodlark Lane, St. Paul, Minnesota, (612) 646-1161.



new

Allen-Bradley line of subminiature low pass filters provide...

HIGHER PACKAGING DENSITIES AND EFFECTIVE FILTERING TO 10 GHz



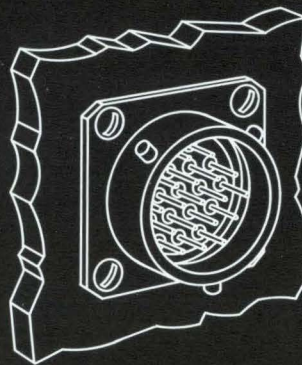

Tiny FO type filter shown mounted on connector pin. (Approximately three times actual size.)



especially designed for use in cable connectors

TYPICAL SPECIFICATIONS

	A	B	C
			
	ACTUAL SIZE	ACTUAL SIZE	ACTUAL SIZE
Pin Size	#16 (0.062" dia.)	#20 (0.040" dia.)	#24 (0.030" dia.)
Max. O.D.	0.160"	0.100"	0.075"
Approx. Length	0.625"	0.450"	0.350"
Voltage Rating (V.D.C. max.)	500 v	200 v	100 v
Feed-thru current rating	25 amp	10 amp	5 amp
Attenuation, min. (at max. operating temp.)	50 DB	50 DB	50 DB
Temp. Range	-55°C to +125°C	-55°C to +125°C	-55°C to +85°C

TYPICAL CURVES @ 25°C

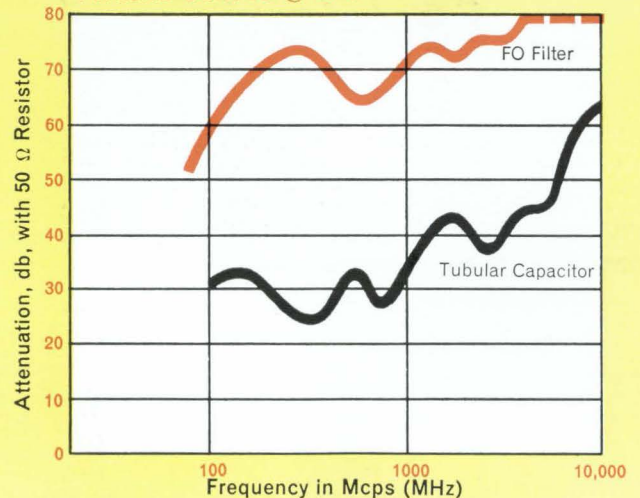

■ This new line of FO type subminiature low pass filters is designed to provide maximum reduction of RFI *in a minimum of space*—attenuation is greater than 50DB over the frequency range from 100 MHz to 10 GHz.

The exclusive Allen-Bradley design allows unusually close spacing. The filters can be introduced into connectors with no reduction in the number of terminals, still providing the possibility of individual replacement of filters if desired.

With these filters mounted through a ground plane in the connector, there's complete shielding to prevent the possibility of rf coupling between input and output.

A-B engineers will be pleased to cooperate with you in the application of these new subminiature filters. For more details, please write: Allen-Bradley Co., 222 West Greenfield Avenue, Milwaukee, Wisconsin 53204.

Export Office: 630 Third Ave., N.Y., N.Y., U.S.A. 10017.

ALLEN-BRADLEY

QUALITY ELECTRONIC COMPONENTS

* "Allen-Bradley hot molded resistors have always proved **absolutely reliable and superior to any others . . . foreign or domestic**"

*H. H. Scott, Inc.
Maynard, Mass.*



In the Scott 344 transistor FM stereo tuner/amplifier, Allen-Bradley hot molded resistors provide excellent gain stability, low noise, at top operating voltages.

* "Based on our use of more than 30,000,000 Allen-Bradley hot molded resistors over the past 18 years, under a continuous re-evaluation program for all component parts."

The known reputation of Scott hi-fi equipment is based on their unquestioned engineering excellence and their rigid quality standards. And Allen-Bradley hot molded resistors have played an important role in this achievement.

The consistently high quality of Allen-Bradley resistors — year after year, and million after million — is the result of an *exclusive* hot molding process developed and used only by Allen-Bradley. It produces such uniformity that the long term performance of Allen-Bradley resistors can be accurately predicted . . . and catastrophic failures *never* occur.

You can be certain of this same "built-in" resistor reliability and superlative performance *only* when standardizing on Allen-Bradley hot molded resistors. For more

complete specifications, please send for Technical Bulletin 5050: Allen-Bradley Co., 222 West Greenfield Avenue, Milwaukee, Wisconsin 53204. Export Office: 630 Third Avenue, New York, New York, U.S.A. 10017.

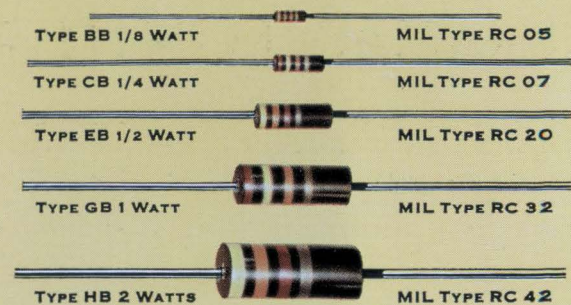

HOT MOLDED FIXED RESISTORS are available in all standard EIA and MIL-R-11 resistance values and tolerances, plus values above and below standard limits. **Shown actual size.**



ALLEN-BRADLEY
QUALITY ELECTRONIC COMPONENTS

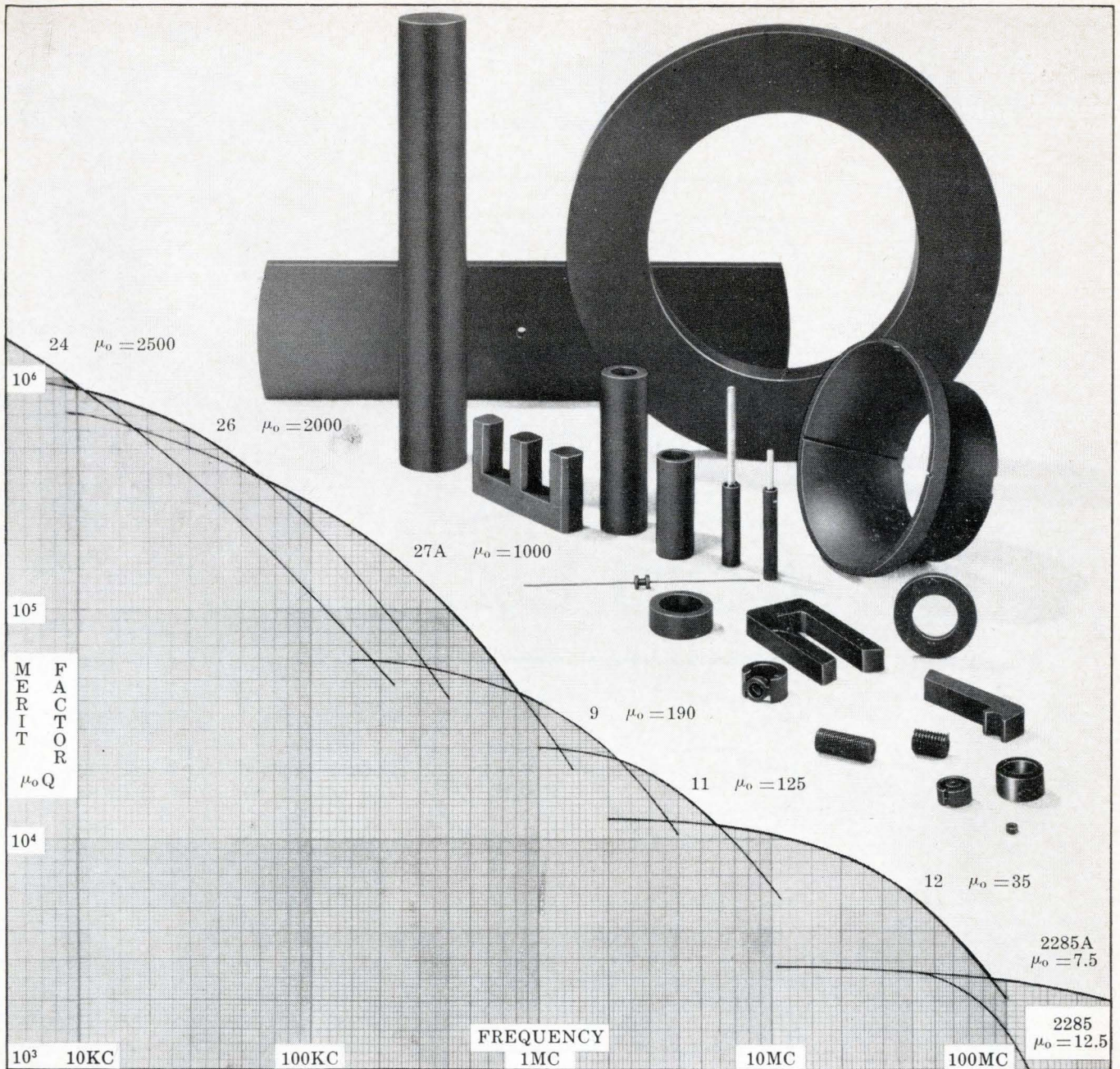

CERAMAG® FERRITE PARTS ARE CONSISTENT

Stackpole offers over 30 grades of Ceramag® material. More are being developed continually. Such up-to-the-minute technology permits you to specify Ceramag® on every new application. Discover the unique advantages of the versatile Ceramag® ferrites: complete moldability to virtually any shape, and the important savings over steel alloys for low frequency applications. When high permeability is an important factor, Ceramag® is the answer.

Hundreds of Ceramag® parts are already tooled as toroids, cup cores, insert cores, transformer cores, deflection yokes and rectangular solids. Special tooling is also available.

Stackpole is a name long associated with quality components in the electronic field. Only the closest attention to every production detail can result in the kind of product uniformity available with Ceramag® ferrites. As one of our customers

put it, "Your ferrite cores are more consistent from order to order than any of your competitors."

If you are about to select a ferromagnetic material for a new application, or if you are dissatisfied with the performance and service of your present ferrite supplier, why not investigate Stackpole's Ceramag®? To discover how you can save and still insure superior performance, write for our Bulletin 1-A, Stackpole Carbon Company, Electronic Components Division, St. Marys, Pennsylvania 15857. Phone: 814-781-8521 — TWX: 510-693-4511.





SPACE

SAVE

Miniaturization of RF communications equipment has opened a broad new range of space- and weight-saving opportunities for systems designers. Consider these examples:

AN/ART-47 and AN/ARR-71 — an airborne transmitter/receiver combination covering 3500 UHF channels with

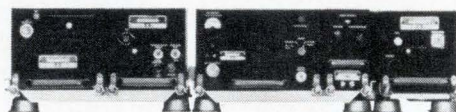

AM or FSK duplex capability. Transmitter output is 1 kW. Transmitter and receiver, embodying latest solid-state techniques, fit into 2.65 cubic feet.

AN/GRC-112 — 1-kilowatt data link radio, all solid-state except power amplifier stages, selectable AM or FM, in a tactical configuration occupying only 9.5 cubic feet for duplex operation.

AN/SRC-27 — a shipboard transceiver now being evaluated by the U. S. Navy, this ECI development requires only 5 cubic feet. Yet it delivers 100 watts of AM UHF power and permits communication on 3500 channels, 20 of them preset.

AN/GRC-134 — in the Marine Tactical Data System, this transceiver offers 50 watts of UHF AM power and covers 3500 channels from a 2.6 cubic foot package.

You can probably use ECI's outstanding solid-state design capability on your next communication system. Use the coupon at left for full details.

I need _____ watts for airborne AM shipboard data application. ground mobile

I have _____ cubic feet available. Please send me more information about your capability.

Name _____ Title _____
Company _____
Address _____
City _____ State _____ Zip _____

BONUS

A two-year head start on your miniaturized multiplex system

Please send me information on airborne shipboard
 ground transportable multiplex equipment.

Name _____

Title _____

Company _____

Address _____

City _____

State _____ Zip _____

You can cash in on more than two years of production experience with miniaturized solid-state multiplex already accumulated by Electronic Communications, Inc. Reliable ECI multiplex is field proved through service with the Post Attack Command and Control System (ACC-1 and ACC-3), and with Marine Corps and U.S.A.F. troposcatter communication terminals (AN/GCC-5 and AN/GCC-6). This means that you can design your system around multiplex gear that's ready to go without costly, time-consuming engineering and development. ECI multiplex is available in building-block units of 3, 4, 12 and 24 channels. The equipment is fully qualified to military specifications. Whether you're working on airborne, shipboard or air transportable multiplex systems you can enjoy a free design head start. For full details, use the coupon above.

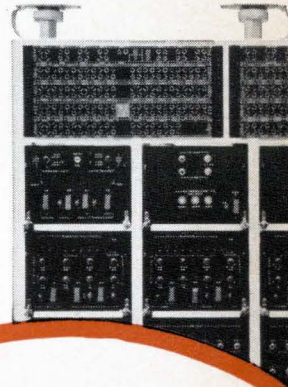
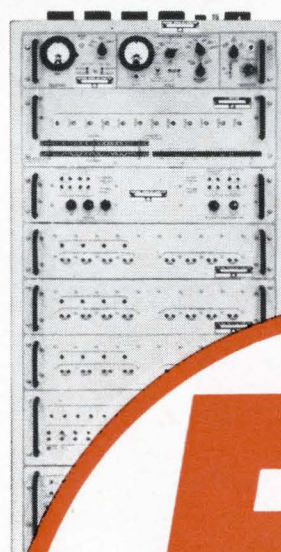
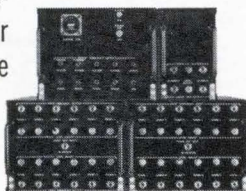

ELECTRONIC COMMUNICATIONS, INC.
P.O. BOX 12248, ST. PETERSBURG, FLORIDA

Circle 55 on reader service card

EC

ECI's microelectronic flight control computer now under development for advanced space programs.



I need details of space instrumentation for

- flight control voice communications
 telemetry

Name _____
Company _____
Title _____
City _____
State _____

Learn how Saturn experience has proved reliability of ECI space instrumentation

ECI's capabilities in the field of space instrumentation have been clearly demonstrated by the Company's success in assigned responsibilities for Saturn.

ECI flight control computers flew aboard the last six Saturn I vehicles and have performed well within mission requirements. Improved triple-redundant versions are part of the Saturn IB and Saturn V programs. ECI now has under development a microminiaturized flight control computer for follow-on space programs.

In telemetry, ECI has produced solid-state transmitters from VHF to L and S band for the U. S. Air Force, U. S. Navy and NASA's Saturn program.

ECI meets NASA's MSFC 200-4 specification for fabrication and assembly facilities.

ECI missile system experience includes the design, development and manufacture of special solid-state receiver equipment for the Minuteman program.

To learn how ECI's successful space instrumentation background can be applied to your system, use the coupon above.



ELECTRONIC SYSTEMS INTEGRATION



Evaluate ECI experience in solving interface problems

If your present system problem includes complex interfaces involving RF equipment, multiplexing, telemetry and switching systems, find out how ECI's broad systems integration experience can help you.

To date, Electronic Communications, Inc., has successfully performed on major system integration contracts for three generations of the Strategic Air Command's Airborne Command Posts and ground terminals; for airborne command programs for the Pacific and European Commands; and for Marine Tactical Data System. These and other system integration assignments have built an experience backlog which reaches into air-to-air, air-to-ground, ship-to-ship and ship-to-ground command and control communications.

If you would like to find out how experience in systems engineering and systems management can help you — it's easy — just ask ECI.

CAREERS ARE BUILT WITH ECI

ECI has unusually attractive career opportunities for qualified professionals in the fields of RF engineering, space instrumentation, thin-film circuit design and systems integration. For more information, fill the coupon at right. (An equal opportunity employer.)

ELECTRONIC COMMUNICATIONS, INC.

P.O. BOX 12248, ST. PETERSBURG, FLORIDA

I'm interested in
ECI's career opportunities in

space instrumentation RF engineering

systems integration thin-film circuits

Name _____

Title _____

Company _____

Address _____

City _____

State _____ Zip _____

CONSIDER COLORADO

. . . transportation gateway . . . East or West. North or South. Inter-State. Intra-State.

Air, rail, truck or bus, consider Colorado, the distribution center for a 13 state area. The state is served by 7 Class I railroads, on 3,671 miles of track within our borders. It's served by 75 transcontinental truck lines, five of which are headquartered in the state. Four of the five are among the largest in the nation. Also, Colorado boasts the second busiest general aviation and the 12th busiest commercial airport in the nation, with 8 commercial airlines making 269 scheduled flights per day. Throughout the state there are a total of 36 public use and 80 civic airports to keep all Colorado in commuting distance of the nation.

If transportation is a consideration in your business, consider industrial Colorado for your expansion or relocation. Complete information is available from Dwight E. Neill, Director, Division of Commerce and Development, 15 State Services Building, Denver, Colorado.



Six ratings from 1 to 3 amps...

1.0 amps, VT1

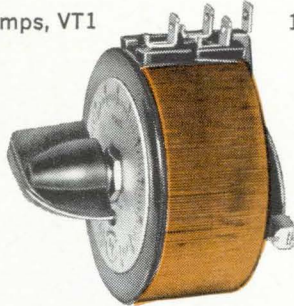

1.2 amps, VT1N

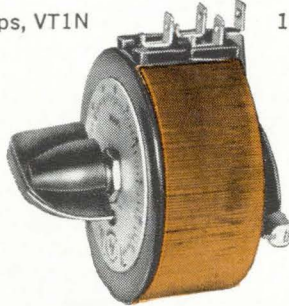

1.75 amps, VT02

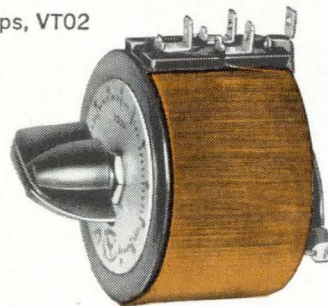

2.0 amps, VT02N

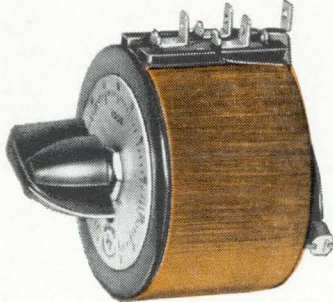

2.6 amps, VT3

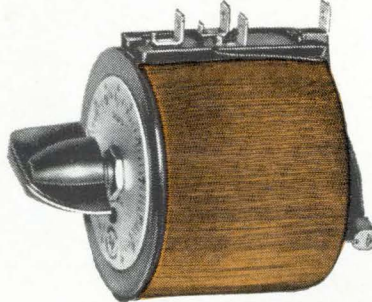

3.0 amps, VT3N

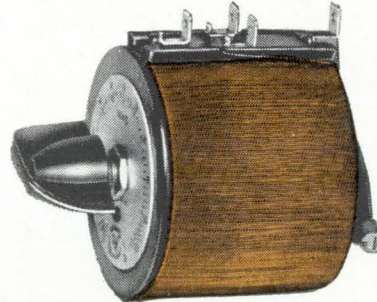

CUT COSTS by SPECIFYING CLOSER to YOUR NEEDS

with OHMITRAN v.t.[®] Low Power, Variable Transformers

You don't have to be satisfied any longer with a few meager ratings in low power variable transformers. Make your selection from 1.0, 1.2, 1.75, 2.0, 2.6, and 3.0-amp Ohmitran v.t.[®] ratings. No other manufacturer offers this extensive selection, or the exclusive series VT1 and VT3 units.

By specifying closer to actual needs, you normally can cut component cost and make your equipment more competitive.

Ohmitran units offer some unique engineering features, too:

Adjustable shaft (extends from either end) for mounting convenience or for operating auxiliary controls.

Multi-purpose terminals for soldering, quick connectors or screws.

Replaceable brushes with rapid, snap-in design and husky heat sink.

Same silhouette and mounting arrangement for all six ratings allowing standardization of panel treatment.

Model variations include fixed and portable enclosures, ganged assemblies, and motor-driven assemblies.

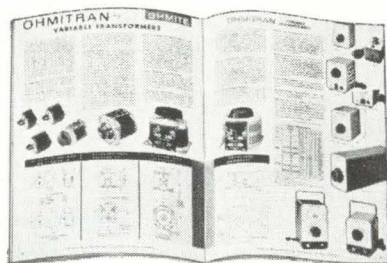

The Industry's Fastest Growing Line of Variable Transformers . . . 1 to 25 Amps, Hundreds of Stock and Made-To-Order Models. Write for Catalog 500.

OHMITE

Resistors

Rheostats

Variable Transformers

Relays

Tap Switches

Tantalum Capacitors

Semiconductor Diodes

R.F. Chokes

OHMITE

MANUFACTURING COMPANY

3610 Howard Street • Skokie, Illinois 60076

Phone: (312) ORchard 5-2600

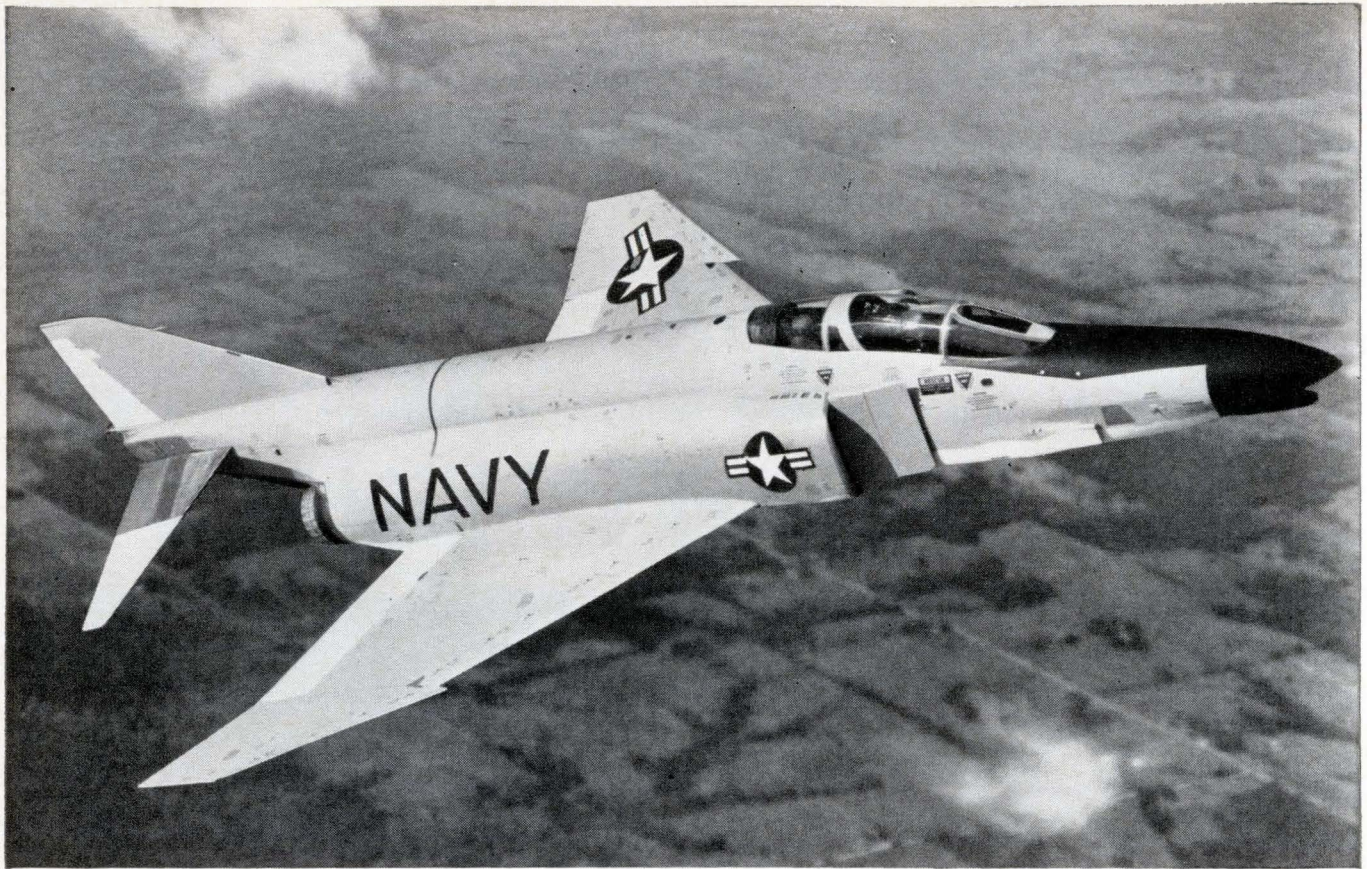

McDonnell needed a battery for the Phantom II that pilots could count on!

Mallory made it.

What can we do for you?

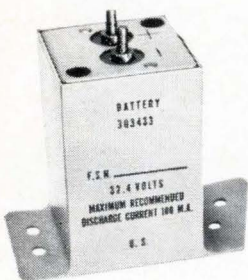

McDonnell needed a battery. A battery that could be relied on when the Phantom II's regular power system failed. A battery that would keep a warning system working in emergencies. A battery able to stand up to the extremes of temperature, vibration and pressure that a supersonic aircraft encounters. McDonnell brought its specifications to Mallory. Mallory made the battery—a mercury battery completely sealed in epoxy resin to withstand these conditions. A battery pilots can depend on!

TWO TYPES OF PATIENT BATTERIES

How long can a battery stand before it's used and still maintain useful capacity? Indefinitely! Some Mallory batteries have their electrolyte stored away from the anode and cathode. They can sit forever until they are needed—then the twist of a screw and they're ready to work.

And normal Mallory Mercury and Mallory Alkaline batteries are distinguished for long shelf life in many applications—emergency transmitters and alarms, cameras and remotely controlled instruments. Mallory Mercury batteries lose only a few percent of capacity per year at normal

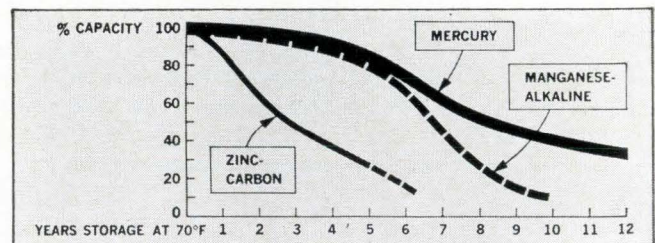

temperatures (21°C)—some have been stored for 12 years and still have retained useful capacity. Mallory Alkaline batteries are completely reliable even after two or more years of storage.

ALL SIZES, ALL CAPACITIES

Mallory is currently producing over 100 batteries of all sizes and capacities. And if we're not actually producing the battery you need, we'll be happy to work with you in designing a new one.

Please write us at the Application Engineering Department, Mallory Battery Company, a division of P. R. Mallory & Co. Inc., South Broadway, Tarrytown, N.Y. 10591. Or call 914-591-7000. In Canada: Mallory Battery Company of Canada Limited, Clarkson, Ontario.

It's good business to do business with Mallory



SCIENCE/SCOPE

A communications-satellite ground station just completed at Caddo Gap, Arkansas will enable Hughes scientists to begin long-range experiments in space communications completely independent of commercial requirements. Built and operated with company funds, the \$2-million station includes an 85-foot dish antenna capable of maintaining contact with satellites over both the Atlantic and Pacific Oceans.

First F-111B to test the Navy's new Phoenix missile landed at the 9,000-foot Hughes runway at Culver City, Calif. in early April for installation of the system. The latest in a long line of advanced airborne weapons systems, the Phoenix was brought in below the minimum size and weight prescribed by the Navy. The Phoenix mission: maintain air superiority over distant objects (beachhead landings) as well as Navy fleets in anti-air warfare.

The attenuated radio signals received from space can now be boosted by a high-power (8-10 kw) traveling-wave tube recently developed by Hughes for ground-station amplifiers. It's the first commercially available tube that can replace klystrons and that can cover the entire communications band. It carries a 2,000-hour warranty, too.

A laser rangefinder, designed for low-flying fighters, has been successfully tested at Eglin AFB. It solves a problem that has long plagued microwave radar systems: their returns get lost in ground clutter at the small grazing angles encountered in low-altitude penetration. The recent USAF tests indicate that the new laser system will definitely improve weapon-delivery accuracy.

Our new Missile Systems Division will combine all Hughes missile activities in one plant at Canoga Park, Calif. The Canoga Park force, planned for more than a thousand, is growing daily. Current programs include the Phoenix missile for the F-111B, the TOW anti-tank missile, and the AIM-4D, GAR-11, HM-55, HM-58, and other members of the Falcon missile family.

100% increase in engineering staff. Latest count at Hughes shows that one employee out of four is either a scientist or an engineer (just six years ago it was only one in eight). And the need continues to increase. So if you're interested in the advanced programs at Hughes (and the good life in Southern California), just write: Mr. D. A. Bowdoin, Hughes Aircraft Co., Culver City, Calif. An equal opportunity employer.

The GIs have a new combat radio that won't be easy to jam: a transistorized, single-sideband, two-way radio with 10,000 individual voice channels. Dubbed Manpack, it's the size of an attache case and weighs only 29 pounds. Manpack bounces its high-frequency signals off the ionosphere, which gives them far greater range than the line-of-sight signals of previous combat radios. Units communicated easily at over 500 miles in recent jungle-terrain tests. Another advantage: Manpack operates as efficiently on flashlight batteries as it does on wet cells. Hughes is producing Manpack for the U.S. Army.

Creating a new world with electronics



Circle 61 on reader service card

Who designed and constructed the world's highest power RF feed-through bushing? Lapp Insulator Company

Lapp? Yes, Lapp Insulator of LeRoy, N. Y. Matter of fact Lapp has been designing and producing Feed-Through Bushings for 42 years. They get bigger, *and* more intricate, all the time. Demanding, unusual specifications don't bother us. Why? Because when it comes to radio frequency insulating components we've got plenty of "know-how" . . . and ingenuity . . . and *ability* to produce the finished product.

Getting back to that "world's highest power" bushing, we designed and made three of these for Continental Electronics Manufacturing Company. They are a vital part of the U. S. Navy VLF transmitter at Northwest Cape, Australia. Each one is rated for 2545 amperes continuous duty at 140 kv RMS at 15.5 kc and is both internally and externally graded to assure uniform voltage distribution. These bushings are approximately 16 feet tall and weigh about 7000 pounds each.

Two other Feed-Through Bushings we've made are shown here. But there have been hundreds of others. Write or call us with *any* radio frequency insulating problem. Radio Specialties Division, Lapp Insulator Co., Inc., Dept. E, LeRoy, N.Y. 14482.

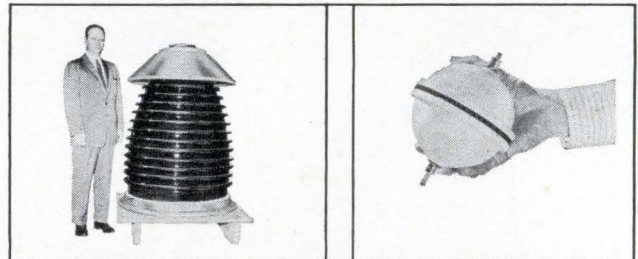
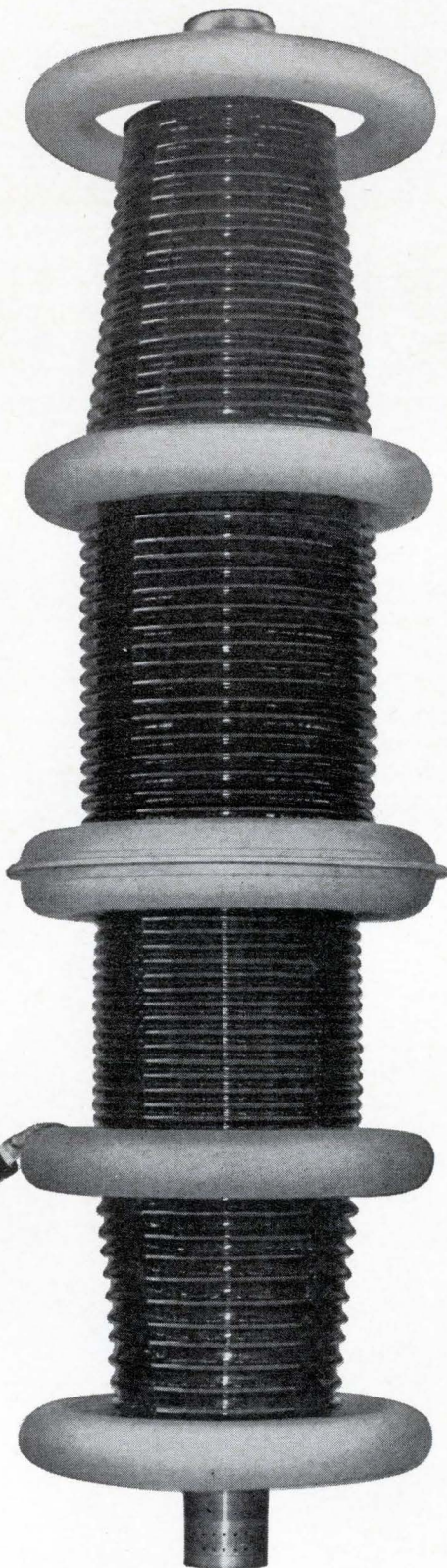

Lapp

New ULTRONIX breakthrough!

NEW ULTRONIX POWER RESISTORS WITH SOLID ALUMINUM CORES GIVE MAXIMUM HEAT DISSIPATION

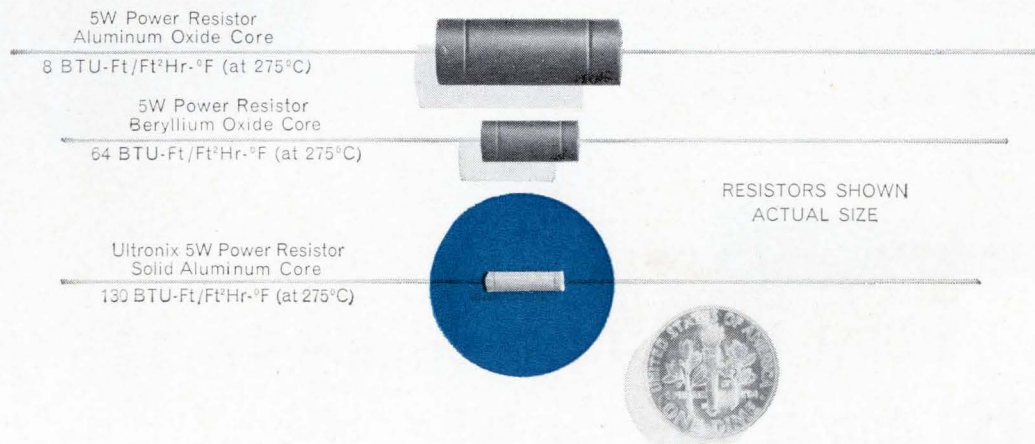

Development of a new dielectric in the Ultronix materials laboratory allows power resistor winding on a solid aluminum core—and brings you the advantages of maximum heat dissipation and design capabilities not possible before! The new Ultronix dielectric material is a high temperature, high emissivity insulation which withstands continuous operation at 350°C and intermittent temperatures in excess of 500°C. This Ultronix dielectric material also withstands high voltage tests between leads and core without flashover—under high temperature and high altitude conditions.

Pick the resulting Ultronix power wire-wound resistor advantages you need:

- **Miniaturization.** An Ultronix power resistor with solid aluminum core requires 1/5 the volume of a beryllia core resistor, and 1/18 the volume of an alumina core resistor—at the same power ratings.
- **Increased Reliability.** With the same physical size at identical power, an Ultronix power resistor with solid aluminum core will have longer life and higher stability than a BeO core resistor, because the Ultronix resistor will operate at half the temperature rise.
- **Increased Power.** When operating at the same temperature, an Ultronix power resistor will dissipate twice as much power as a BeO core resistor of the same size.

For complete electrical specifications, power ratings, heat dissipation pattern and listings of advantages of new Ultronix power wire-wound resistors, request Data Sheet R366—Ultronix, Inc., 461 North 22nd, Grand Junction, Colo. 81502, phone (303) 242-0810.

ULTRONIX

MANUFACTURERS OF THE ULTIMATE IN PASSIVE COMPONENTS

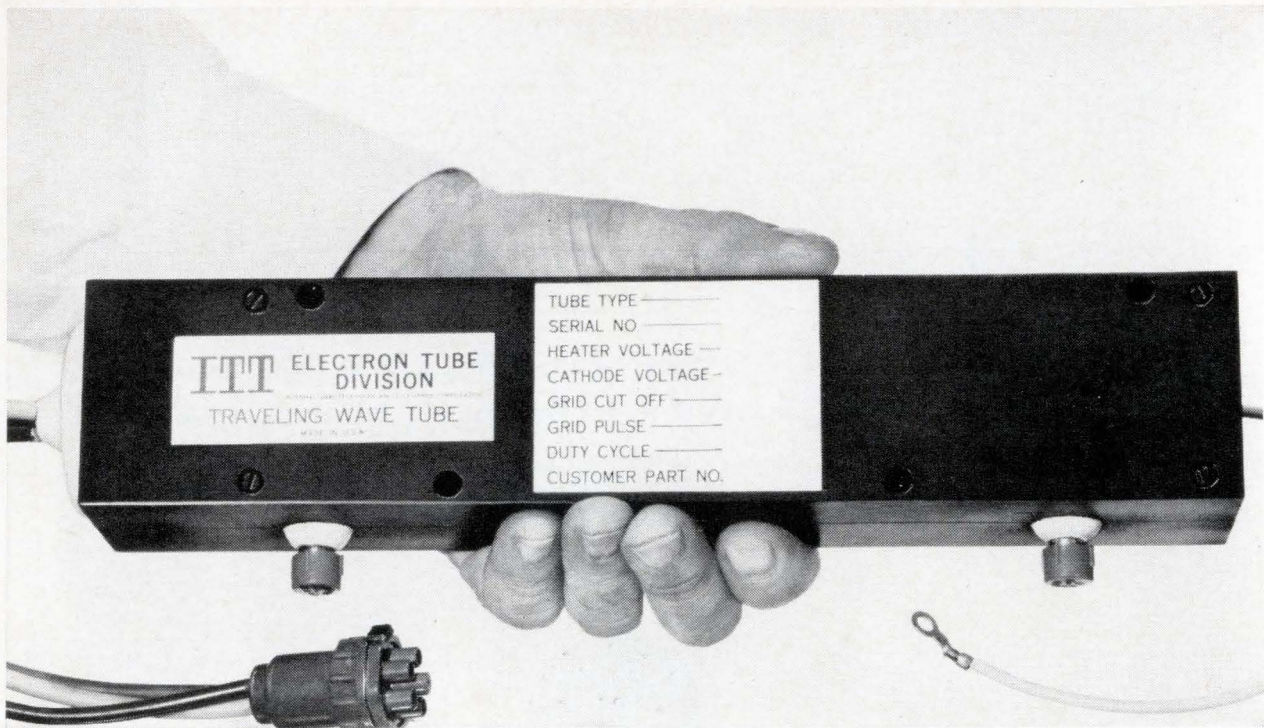

New TWT delivers 1 KW from 5.5 to 12.5 GHZ... and ITT can deliver the tube.

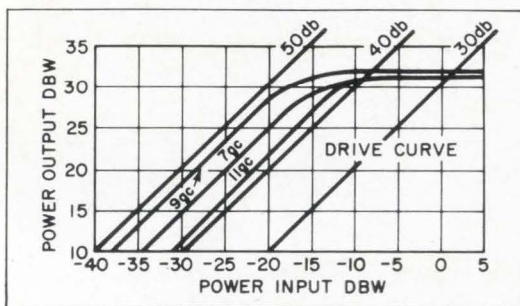
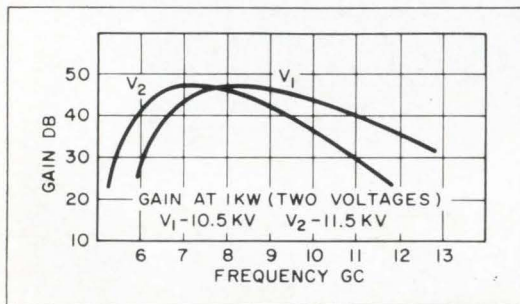

The new ITT Type F-2085 is a grid-pulsed, helix-type traveling wave tube. It features PPM focusing with temperature-compensated, low-cost ferrite magnets and compact metal-ceramic construction for conformance to MIL-E-5400 requirements. The tube is designed for optimum gain flatness from 7.0 to 11.0 GHz, but useful gain from 5.5 to 12.5 GHz can be realized at a minimum power output of one kilowatt. Rated duty is .01 with conduction cooling, or .02 with forced air cooling.

Field tests of the F-2085 have demonstrated outstanding saturation and overdrive characteristics in long-pulse or pulse-burst modes of operation. For additional details and performance data on the F-2085, or on any other tube in our complete line of special-purpose electron tubes, write: Dept. EL4, ITT Electron Tube Division, International Telephone and Telegraph Corporation, Easton, Penn.

electron tube division **ITT**

These cycle controlled tools give a precise, consistent crimp every time for terminals, lugs, splice fittings, RF fittings, connectors and special devices. They're light and have high-leverage action allowing low-closing hand pressure. Less operator fatigue means higher production . . . lower cost per crimp.

In-line die action and ratchet control provide the most uniform crimping. Tools are corrosion resistant. Available in standard and miniature models.

CT Terminal Tools crimp MS-25036 terminal lugs and MS-25181 thru-splices and other fittings. "Dial-for-Size" selector for quick crimp depth selection. Terminal locator properly positions fittings and wire for crimping. The CT-S standard-size tool crimps fittings 12-10 through 26-24. The miniature CT-M tool crimps fittings 16-14 through 26-24.

CH Tools Crimp Co-axial and Shielded Fittings and Connectors—Dies are interchangeable and provide positive bottoming. These tools will crimp BNC, TNC, and N series connectors, and many other fittings requiring hex crimps. Miniature models also available.

CD Tools for Special Custom Applications are furnished with blank dies or special dies as required

Write today for complete information on these high performance crimping tools.



1077 Floral Avenue • Union, New Jersey
(201) 289-8200 • Telex 1-25471
a subsidiary of Elastic Stop Nut Corporation of America

New Die-type tools Crimp easiest- fastest!

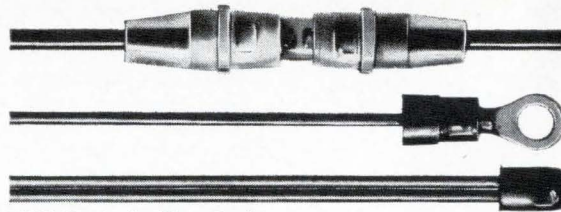

"CT" Tools for Terminals, Splices and End Caps

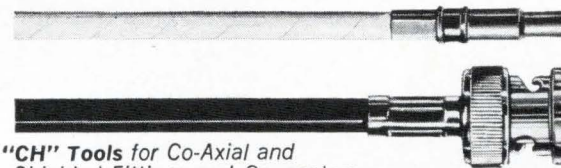

"CH" Tools for Co-Axial and Shielded Fittings and Connectors

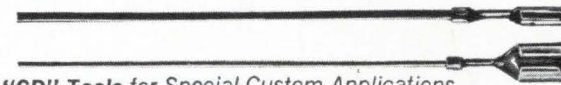

"CD" Tools for Special Custom Applications

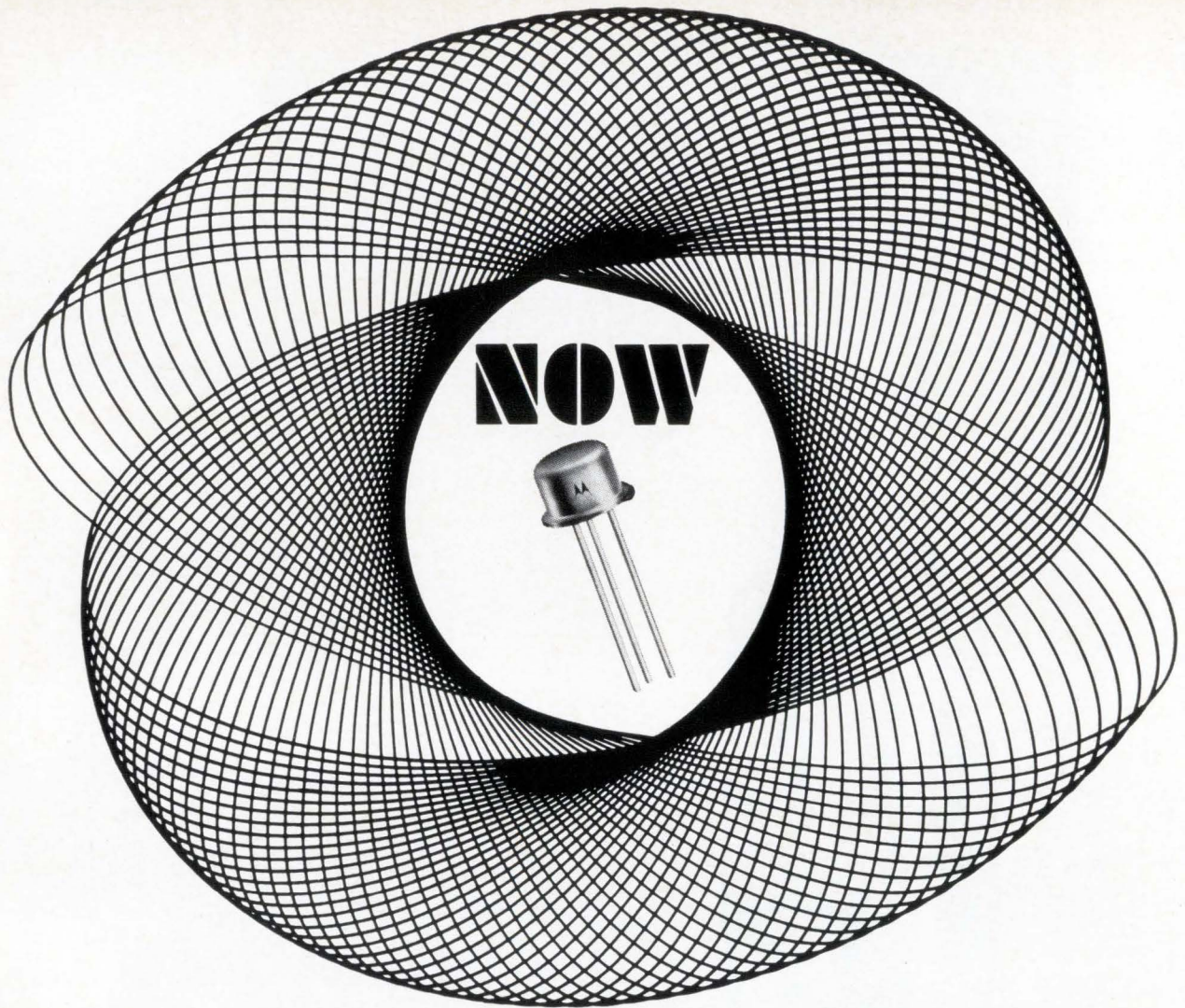

a new era for current-mode switching... with Motorola's 1800 MHz 2N3960 NPN Silicon Annular* Transistor

TYPICAL SWITCHING TIMES

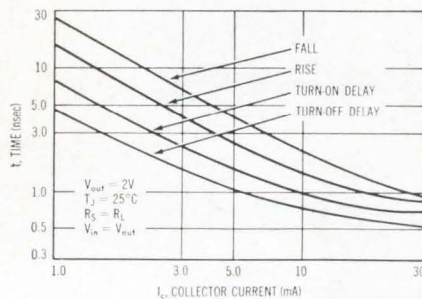

LIMIT CURVES AVAILABLE IN DESIGNERS* DATA SHEET

You'll find a full complement of limit curves on each device in a special Motorola Designers Data Sheet. Thus, you can readily explore their use in your circuits using "worst case" design techniques. Both devices are in stock in TO-18 packages. TO GET STARTED, send for your copy of the Data Sheet. Simply write Technical Information Center, Motorola Semiconductor Products Inc., Box 955, Phoenix, Arizona 85001.

A new magnitude of switching speed for non-saturated, digital systems applications is here — ready for your immediate prototype designs... with typical f_T performance of 1800 MHz!

Previously, frequency response has been limited to a range of about 1200 MHz before encountering a self-limiting trade-off with breakdown voltage. Now, Motorola's newly developed "narrow-base profile" process technique makes possible a micro-thin base thickness (on the order of 0.1 micron) and a new high level of frequency response (f_T).

And, because the 2N3960 uses Motorola's patented annular device structure, this frequency response is offered to you at no sacrifice in breakdown voltages. You've come to expect this with all annular built devices.

As a result, both 2N3960 and its sister device, 2N3959, are able to satisfy, as never before, the three key requirements for highest speed in current-mode designs — high f_T , low capacitances, and low base-spreading resistance.

Guaranteed minimum f_T values are 1300 MHz for 2N3959 and 1600 MHz for 2N3960 at 10 mA. Both are also specified at 5 and 30 mA collector currents.

Other high-performance characteristics...

Output Capacitance (C_{obo}) ($V_{ce} = 4$ Vdc, $I_e = 0$, $f = 100$ Kc)	2.5 pf max.
Input Capacitance ($-C_{ibo}$) ($V_{ee} = 0.5$ Vdc, $I_c = 0$, $f = 100$ Kc)	2.5 pf max.
Collector-Base Time Constant (τ_{bc}) ($I_c = 10$ mA, $V_{ce} = 10$ V)	25 psec max.
2N3959	40 psec max.
2N3960	20 Vdc min.
Collector-Base Breakdown Voltage (BV_{cbo}) ($I_c = 10$ μ Adc, $I_e = 0$)	40 psec max.
Collector Emitter Breakdown Voltage (BV_{ceo}) ($I_c = 10$ mA, $I_e = 0$)	12 Vdc min.

*Annular semiconductors patented by Motorola Inc.



MOTOROLA
Semiconductors

4

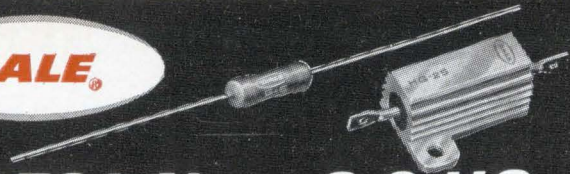

BONUS FEATURES! New G & HG resistors offer more versatility than any other wirewounds!

1. MORE POWER in MIL SPEC SIZE

G SERIES*

DALE TYPE	MIL-R-26C TYPE	MIL-R-23379 TYPE	POWER RATING (WATTS)		RESISTANCE RANGE (OHMS)	
			Dale	Mil.	.05%, .1%, .25%	.5%, 1%, 3%
G-1	—	—	1.0	—	10 to 950	1 to 3.4K
G-3	RW-70	RWP-18	2.25	1	1 to 2.7K	.1 to 10.4K
G-5C	RW-69	RWP-20	5	3	1 to 8.6K	.1 to 32.3K
G-15	RW-68	RWP-23	15	10	.5 to 73.4K	.1 to 273K

HG SERIES

DALE TYPE	MIL-R-18546C TYPE	POWER RATING (WATTS)		RESISTANCE RANGE (OHMS)	
		Dale	Mil.	.05%, .1%, .25%	.5%, 1%, 3%
HG-5	None	15	—	1 to 6.5K	1 to 24.5K
HG-10	RE-65	20	10	1 to 12.7K	.1 to 47.1K
HG-25	RE-70	35	15	.5 to 25.7K	.1 to 95.2K
HG-50	RE-75	50	20	.5 to 73.4K	.1 to 273K

Major Environmental Specifications: LOAD LIFE: 1% Max. ΔR in 1000 hours at full power. OVERLOAD: .5% Max. ΔR at 3, 5, or 10 times momentary overload per applicable Mil. Spec. OPERATING TEMPERATURE: -55°C to +275°C

*G Series models are typical: 10 resistors in complete line.

2. THE SAME POWER in LESS SPACE

1 Watt Silicone Coated Resistor

Conventional MIL-R-26C and MIL-R-23379



15 Watt Mil. Rated Housed Power Resistor

Conventional MIL-R-18546C Size

DALE HG-5

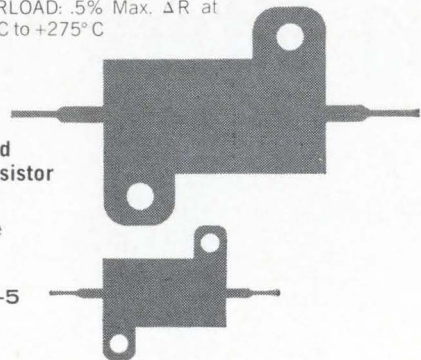

3. EXCEPTIONAL STABILITY at CONVENTIONAL RATINGS

Two RW-69, MIL-R-26C resistors (Dale G-5C and conventional silicone-coated wirewound) operated at Mil power levels.

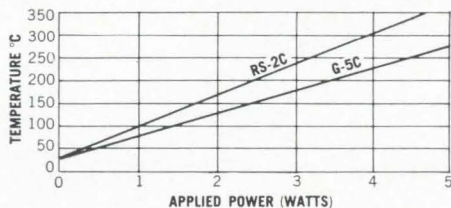

Two RE-65, MIL-R-18546C resistors (Dale HG-10 and conventional housed power wirewound, RH-10) operated at Mil power levels.

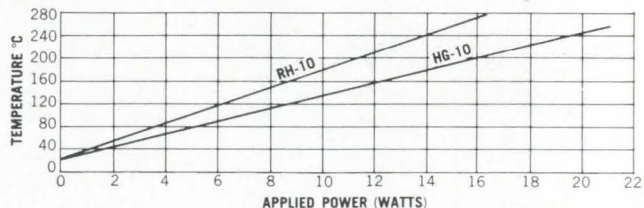

4. IMPROVED THERMAL EFFICIENCY

The chart at right shows the outstanding heat dissipation advantages which the beryllium oxide cores used in Dale G and HG resistors have over conventional core materials. To complement this advantage, Dale uses a special high temperature silicone coating on the G Series and a new extruded aluminum housing for the HG Series.

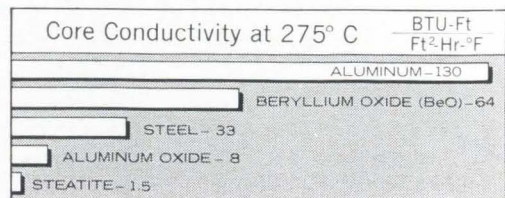

FOR COMPLETE INFORMATION
WRITE FOR CATALOG A



DALE ELECTRONICS, INC.
1300 28th Avenue, Columbus, Nebraska



Washington Newsletter

April 18, 1966

Military spending for Vietnam likely to rise again

Despite resolute White House and Pentagon silence, the widespread assumption in Washington is that **military spending for Vietnam will continue to rise and production to fill military orders will continue to run at a high-priority pace.**

It's generally accepted that President Johnson will have to ask for another hefty supplemental appropriation to finance the war. He recently received an extra \$13 billion for fiscal 1966. The outstanding questions are how much will he ask and when will he ask for it. **Guesses run all the way from a few billion dollars to \$10 billion or more, with the request coming right after the November elections.**

The fiscal 1967 defense budget, drawn up last December, assumed that the war would not continue beyond mid-1967, that equipment consumption rates would not climb faster than last year's predictions and, apparently, that the manpower commitment would remain below 300,000. Defense Secretary Robert S. McNamara held his planners to these assumptions to insure against overbuying of the type that left the Defense Department with huge surpluses after the Korean War.

New fighter plane planned by Navy and Air Force

The Navy and Air Force are proceeding toward the design of the next generation of tactical aircraft—replacements in the early 1970's for McDonnell Aircraft Corp.'s supersonic F-4 and Ling-Temco-Vought, Inc.'s supersonic A-7, just going into production. Both services want a plane with combined air-to-air combat and ground-support capability. Though they are proceeding independently, before Defense Department approval is granted to a development program, **chances are they will have to mold their ideas and come up with a common plane.** McNamara's commonality concept is still in effect despite the flap over General Dynamics Corp.'s F-111.

The Air Force Systems Command has awarded a contract for preliminary design studies to North American Aviation, Inc., the Boeing Co. and Lockheed Aircraft Corp., and hopes to enter final design competition by January. The avionics will probably incorporate an advanced version of the F-111's Mark 2, now in the contract-definition stage with the Hughes Aircraft Co., North American's Autonetics division and Sperry Rand Corp.'s subsidiary, the Sperry Gyroscope Co., competing for the development contract.

The Navy is drawing up for submission to the Pentagon a technical development plan culled from studies conducted by Boeing and the Douglas Aircraft Corp. The Navy's variable-sweep winged plane will probably incorporate a refined version of the integrated light attack avionics system being developed for the A-7 by Sperry Gyroscope.

Henry's departure may mean change in FCC programs

The resignation of E. William Henry as chairman of the Federal Communications Commission **could have a serious impact on three areas of the electronics industry:** community antenna television (CATV), nationwide pay-tv and the forthcoming investigation of the American Telephone & Telegraph Co.

Henry, a commission member since October, 1962, is credited with steering through the agency the new rules covering the operation of CATV; he is known to fully support the probe of the rate structure

Washington Newsletter

and operation of AT&T, the first such inquiry in 30 years; the pay-tv proposal is currently before the agency, and Henry is said to be in favor of it.

FTC delays action trimming tv sizes

The Federal Trade Commission has given television tube manufacturers a six-month delay, to Jan. 1, on its size-measurement rules; producers now include outside areas in their measurements.

The FTC also has exempted from the ruling tv sets manufactured before July, 1966, because most manufacturers already have printed tube-size specifications for this year. The ruling will cut the advertised size of most black-and-white tubes by one inch and the size of most color tubes by two inches.

Senate sets hearing to control sales of bugging devices

The Senate is considering federal regulations of portions of the electronics industry in an effort to stem the growth of industrial espionage. An inquiry into the extent of industrial spying, with special emphasis on the use of electronic equipment to gain access to industrial secrets, will be opened next month by Sen. Edward V. Long's (D., Mo.) subcommittee on Administrative Practice and Procedure. The subcommittee is part of the powerful Senate Judiciary Committee.

Long's investigations already have led to tightening of restrictions on bugging within the Federal Bureau of Investigation and other government investigating agencies.

Long says his subcommittee is exploring a range of possible federal controls, from regulating the manufacturer of the devices to prohibitions on their sale.

Delay expected on patent bill

This session of Congress probably won't act on legislation to loosen the government's legal hold on inventions developed during work under federal contract. Unless some concession is made to mollify those who favor tighter rules governing the ownership of such patents, Sen. Russell Long (D., La.) says he plans to filibuster against the Senate patents bill. Even if he fails to block the bill in the Senate, Long has sufficient support in the House to stalemate action this year.

Except for certain agencies—for example, the Atomic Energy Commission and the Federal Aviation Agency—federal administrators exercise wide latitude in assigning rights to inventions developed during government projects; the FAA and the AEC operate under separate laws that set patent-ownership standards.

The current round of congressional bargaining is over a bill introduced by John McClellan (D., Ark.) chairman of the Senate Patents subcommittee, which would turn over to contractors an estimated 75% of all patents arising out of federal contracts; this would represent a more liberal policy, favoring industry. The subcommittee is part of the Judiciary Committee.

Two Senators who support Long on the five-man subcommittee have said they'd back the bill provided it were amended to say that, in general, decisions on patent ownership will be made after inventions are developed, not during preliminary negotiations.

The McClellan bill, which President Johnson supports, is patterned after the current government policy on patents.

Why specify Mallory wet slug tantalum capacitors?

One reason:

- lowest weight and smallest size per microfarad-volt

Check these characteristics:

	Wet Slug Mallory MTP	Solid Mallory TAS
Mfd-volts/in ³	178,000	37,200
Wt: grams/mfd-volt	0.00067	0.0024

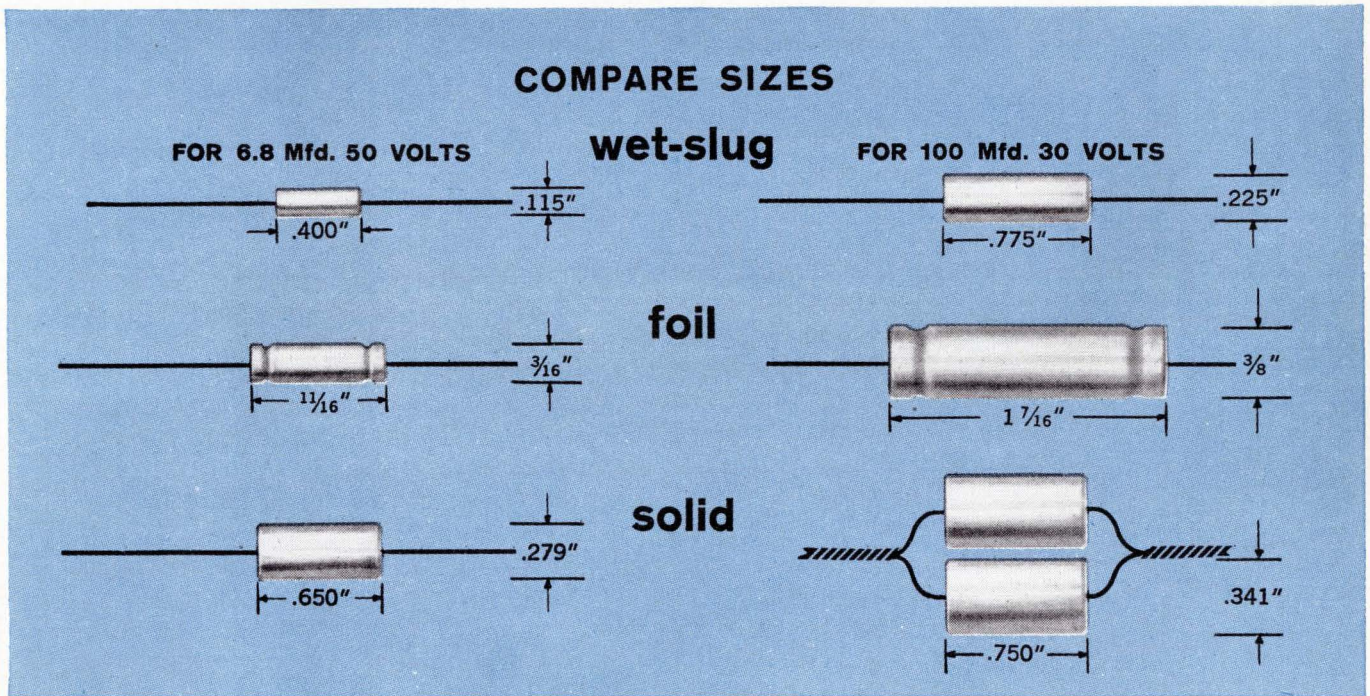

Specify Mallory wet slug tantalum capacitors wherever you need lowest DC leakage, and proven freedom from catastrophic failure. Note: they don't need voltage derating. We'll help you by recommending the best type for your application.

And we'll recommend without bias, because we make a complete line of wet slug, solid and foil types. Write or call Mallory Capacitor Company, a division of P. R. Mallory & Co. Inc., Indianapolis, Indiana 46206.

50th
ANNIVERSARY

MALLORY

A science fiction story that's not all fiction

"THE MYSTERY OF THE MISSING PEAKS"



Dick Whittington, ace space scientist, was baffled by an over-modulated data signal while testing the 7-litre rockets of his supersport moon machine. The signal looked like a stock-market cycle:

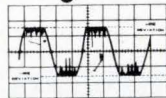

Naturally, our resourceful hero thought of A.G.C.

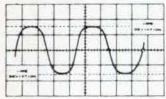

But he knew that wouldn't work.

Suddenly, he had an inspiration! With the speed of light, he contacted Sangamo Electric Company via his two-way 17-jewel wrist TV. From Springfield, Illinois, came the comforting voice of Philo Faraday, a crack Sangamo engineer, saying, "Why, that's easy as π . What you need is our Type AR-2L two-level automatic solid state Attenuator/Restorer with integrated circuits.

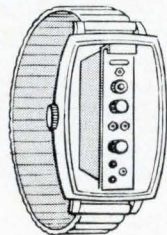

"It attenuates your data signal so that it looks like

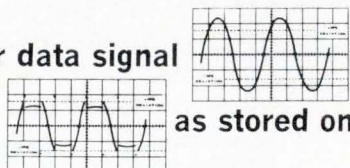

as stored on

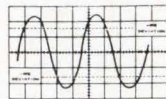
magnetic tape, and like  when reconstituted by the restorer."

"Eureka!" Dick exclaimed. "And you say it's inexpensive, too?" Excitedly, Mr. Faraday replied, "Right! And the Type AR-2L substantially broadens the effective dynamic range of your recorder, and allows for transients without sacrificing low-level data... no need for costly channel sharing, either."

"Zounds, I must have one posthaste!" allowed Dick. "Now my peaks won't look so peaked, and Sangamo's two-level automatic Attenuator/Restorer will put my missing data back on the band."

THE MORAL: No need to lose expensive data. If you don't have a wrist TV, write, wire, or phone for complete description to

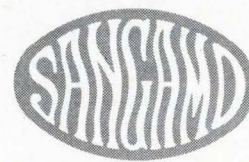

ES66-1

SANGAMO ELECTRIC COMPANY / Electronic Systems Division / Springfield, Illinois

WE DESIGN EFFICIENCY!

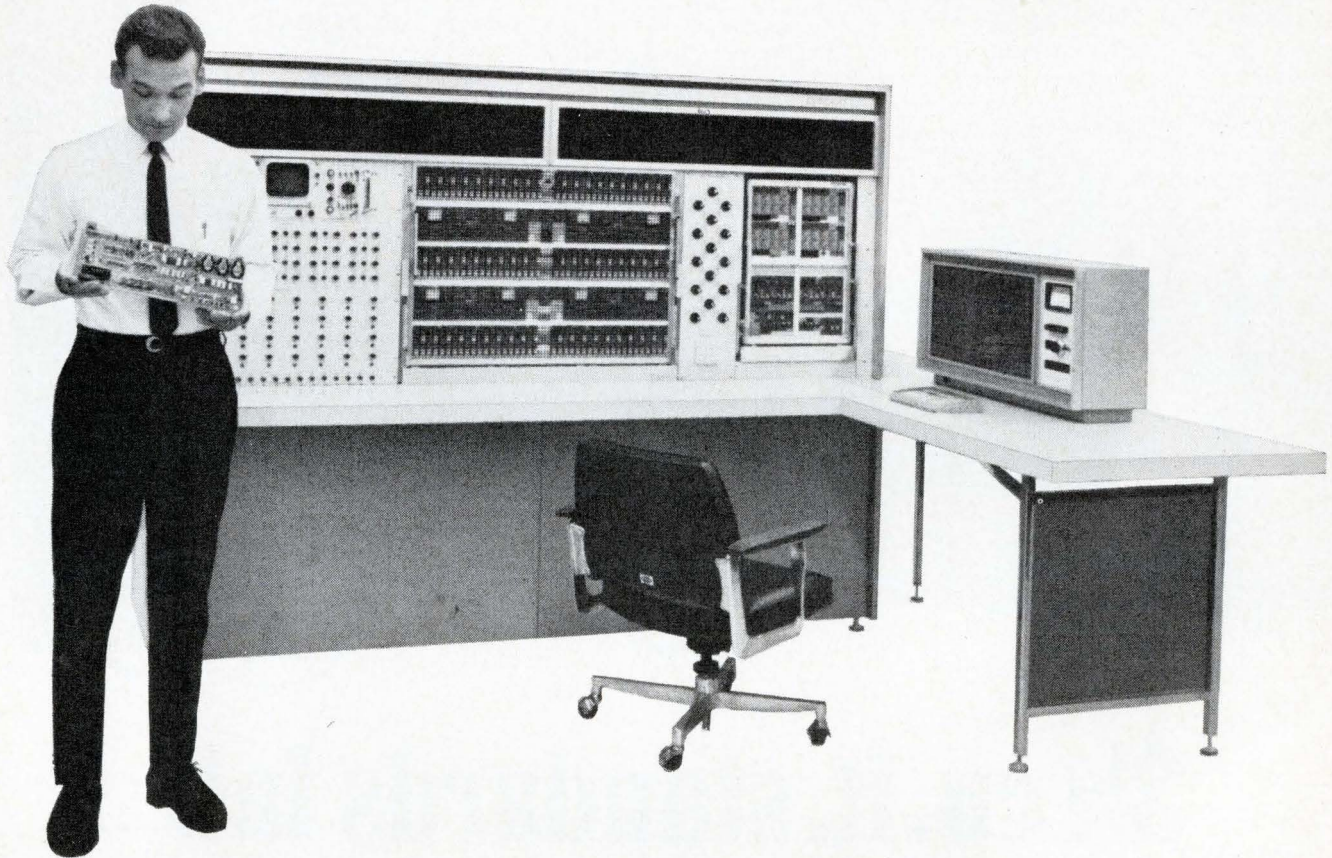

When we design special components for our systems—we're designing efficiency. That's a HODAD* our engineer is holding, it's just one of the many special subsystems in the Ci-5000 Analog/Hybrid Computer shown above. What's so special about it? It's the *first* all solid state device to replace servo-set potentiometers in a hybrid computer system! Why does it increase the efficiency? Because one

hundred HODAD's can be set-up in less than one second! Before the HODAD, it took over one second to set-up *each* potentiometer. *All* subsystems in the Ci-5000 are designed to keep set-up time to a minimum and operating time to a maximum—find out more about the "efficient" Ci-5000, see your COMCOR representative or contact COMCOR direct. Telephone (714) 772-4510. TWX 714-776-2060.

**Hybrid Operated Digital Attenuator Device*



COMCOR

A SUBSIDIARY OF ASTRODATA, INC.

1335 SOUTH CLAUDINA STREET / ANAHEIM, CALIFORNIA 92803

LET'S TALK COMCOR!



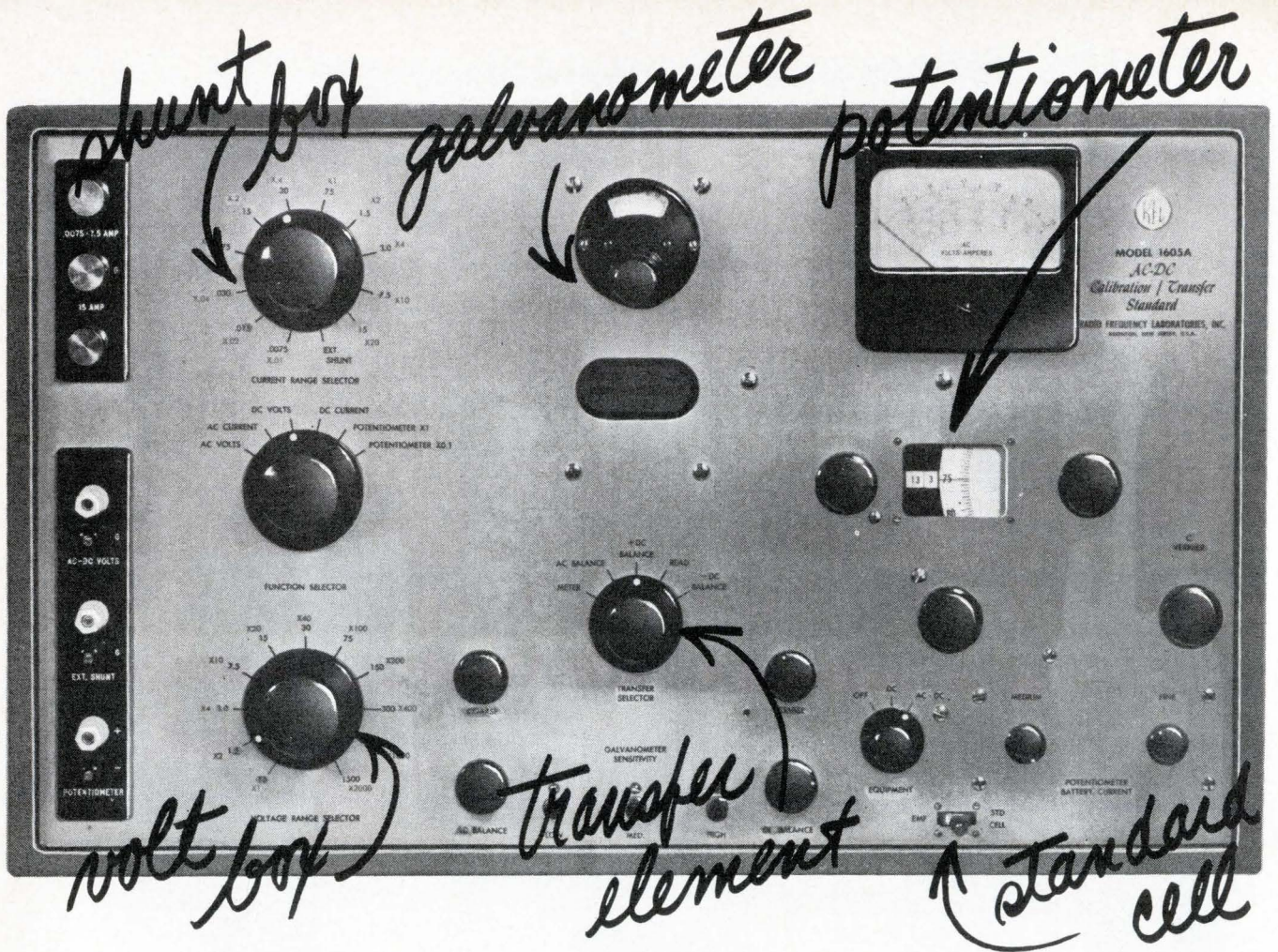

3½ cu. ft. standards lab

The RFL Model 1605A Calibration-Transfer Standard has just about everything—a potentiometer, galvanometer, volt-box, shunt-box, standard cell and thermal transfer element—in one compact cabinet (27" x 16" x 11"). There's no slaving over "patchwork" transfer standards... no fussing and fooling with interconnecting wires and separate components.

And the 1605A brings precise measurement and calibration to instruments that can't be brought to a central standards lab. Because it's all-in-one, it gives fast measurement of AC and DC emf to 1500 V and current to 15 A over frequencies from 20 Hz to 50 kHz (to 30 MHz with adapters). Long term accuracy, traceable to NBS, is .05%.... \$3,750.

model 829D

The workhorse portable meter calibrator with 77 full-scale ranges: 1.5 mV to 1500 V and 1.5 mA to 20 amps AC, 0.25 mv to 2000 V and 2 µA to 20 amps DC. Accuracy 0.5% direct reading and 0.25% with charts, traceable to NBS. Output frequency (50 to 1000 Hz) same as input. \$3,375.

model 2120A

AC-DC precision, variable frequency, supply provides 0 to 1500 VAC, 0 to 2000 VDC, and 0 to 30 amps AC-DC. Output frequency from 50 Hz to 20 kHz (up to 40 kHz with ext. osc.) at burdens to 100 VA. Used with Model 1605A for calibrating high accuracy meters. \$3,250.

For free demonstration or complete specifications, call your nearest rep listed below. Overseas customers, please contact RFL direct for the name of your nearest agent.



Radio Frequency Labs., Inc.
 BOONTON, NEW JERSEY 07005 • U.S.A.
Designers and Manufacturers of Electronic Equipment since 1922.

Call your local RFL Representative:

- | | | | | | |
|--|--|---|--|--|--|
| Needham Heights, Mass.
Cowperthwait & Brodhead
617-444-9410 | Skaneateles, New York
L-Tron Corporation
315-685-6172 | Huntsville, Alabama
Space Engineering Sales, Inc.
205-837-6060 | Chicago, Illinois
Hugh Marstand & Co., Inc.
312-676-1100 | Dallas, Texas
Scientific Sales Co.
214-528-0553 | N. Hollywood, California
O'Halloran Associates
213-877-0173 |
| Washington, D.C.
ARCO Corporation
202-296-8735 | Saddlebrook, New Jersey
L & M Associates
201-343-3070 | Cleveland, Ohio
Electro Sales Associates
216-486-1140 | Denver, Colorado
Hytronic Measurements, Inc.
303-733-3701 | Seattle, Washington
Dewar & Associates
206-722-1724 | Palo Alto, California
O'Halloran Associates
415-326-1493 |

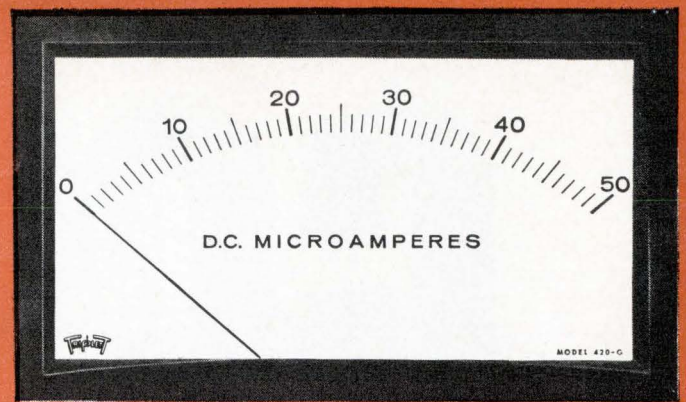
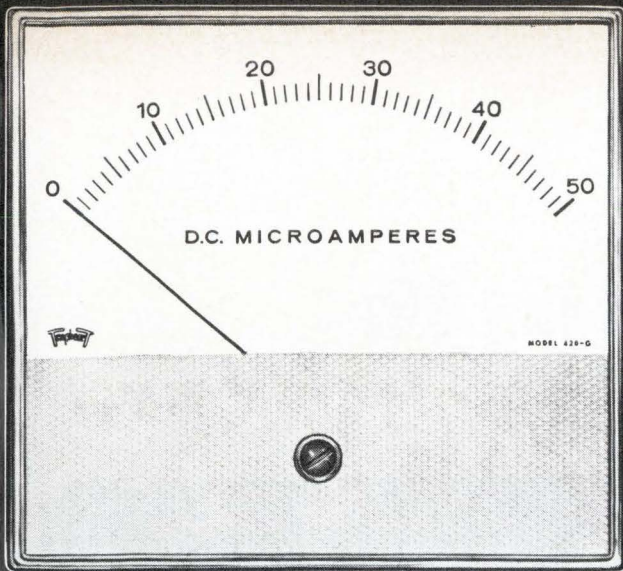

now you see it

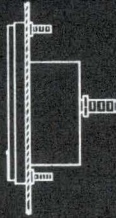

now you don't

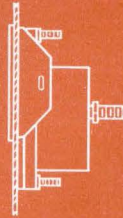

THE PANEL INSTRUMENT WITH BUILT-IN FLEXIBILITY

New Triplet G-Series Panel Instruments offer a modern design that features a greater degree of flexibility and interchangeability.

1 Two types of mounting are available—conventional flush type or behind-the-panel with a bezel for modern picture window appearance. **2** The insert shield on the front of the meter can be custom painted or printed to meet customer's requirements.

3 Triplet's famous self-shielded Bar-Ring magnet, with one-piece die-cast frame, all DC and DC suspension type instruments.

Available in three popular sizes: 2½", 3½" and 4½" models with black molded dustproof cases and clear molded plastic fronts.

TRIPLET

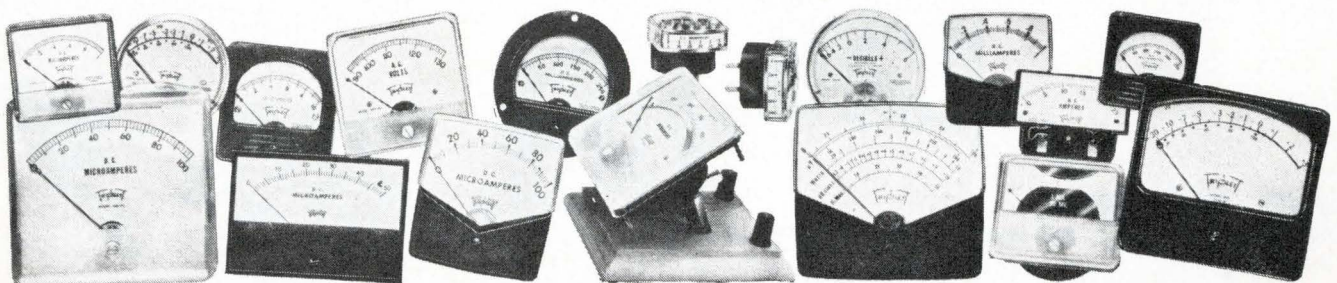

TRIPLET ELECTRICAL INSTRUMENT COMPANY, BLUFFTON, OHIO

GO ...20 Hz to 1 GHz

Kay 1500 Sweep & Marker Generator



TYPICAL PLUG-INS

Model	Center Freq.	Sweep Width
P-141	20 Hz-200 KHz	20 Hz-20 KHz
P-142	35 Hz-600 KHz	20 Hz-20 KHz
P-130	100 Hz-2 MHz	200 Hz-2 MHz
P-152	10 KHz-20 MHz	10 KHz-20 MHz
P-855	2-32 MHz	5 Hz-800 KHz
P-856	10-120 MHz	10 Hz-1 MHz
P-860	2-220 MHz	10 KHz-30 MHz
P-867	220-470 MHz	20 KHz-30 MHz
PI-123	100-1000 MHz ANY SINGLE OCTAVE	5 KHz-Octave
Freq. Marker		
PM-7631	6 Pulse & Ext.	
PM-7632	6 Pulse & Ext.	
PM-932	30 Pulse	
PM-861	6 Harmonic and CW Osc.	

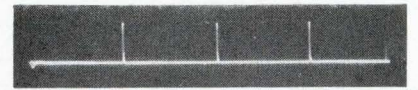

Pulse-Type Markers

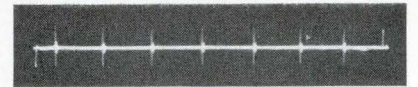

Harmonic (or Comb) Birdie Markers

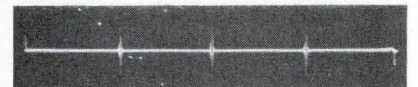

Single-Freq. Type Birdie Markers

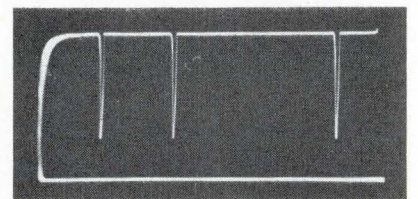

Detected Turn-Off Markers

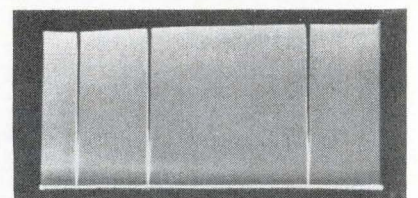

Undetected Turn-Off Markers

■ VOLTAGE CONTROLLED OSCILLATORS

■ MARKERS

Pulse
RF Turn-off
Harmonic
CW Birdie

■ SWEEP

0.2 to 60 cps
Log and Linear
External Input
Manual Control

The basic rack contains a variable, sawtooth sweep generator, a fast-acting AGC, frequency-marker control and output circuits, RF output circuits with precision attenuators, a calibrated output meter, an accurate RF detector, and carefully regulated power supplies.

KAY ELECTRIC COMPANY

Pine Brook, N. J. 07058 • (201) 227-2000 • TWX: 710-734-4347

Reducing a connector's length is one thing. Reducing its weight is another. Bendix Solder and Hermetic-Type "Pancake" connectors do both.

One thing you can say about Bendix® JT Pancake connectors: they reduce connector length by up to 50% and weight up to 60%, making them the smallest, lightest models available.

Equally impressive is the wide range of types we've got on hand, all ready to be delivered in rapid, off-the-shelf fashion. Among them are wall mount,

box mount, jam nut, straight plug and 90° plug; nine different sizes; 34 different insert patterns; 16-, 20-, 22- and 24-contact sizes that will accept a wire range of 16 through 28 gage.

(You'll find most of these types available in our crimp-type JT Pancake connector line, too.)

What about performance? These light-

weights have nine major design improvements. There are provisions for up to 128 contact pins, increased resistance to pin bending, greater contact retention, temperature capabilities to 392°F, and improved electrical characteristics through rigid, glass-filled epoxy inserts, to name a few. For complete information, write us in Sidney, New York.



Scintilla Division



Circle 77 on reader service card



Great editorial is something he takes to work

What a climate for selling! Today's busy engineer has to make good use of the time he spends on the 8:05. His is a business of lightning change, where a single "space shot" can breed a new technology overnight.

That's why more than 68,000 engineers turn to *Electronics* to keep abreast of what's important in the technical field of their

complex industry. Last year alone, *Electronics* ran 2,167 editorial pages (almost 25% more than any other industry publication.) Where the busy engineer seeks editorial, he finds ads that keep him abreast of products and services. Be there!

Electronics A McGraw-Hill *Market-Directed* Publication, 330 West 42nd Street, New York 10036

One Good Single-Turn Calls for Another... Now Bourns Offers You Eight!

Whenever it's a question of single-turn precision potentiometers, you get more and better answers from Bourns. Here's the all-star lineup:

BUSHING MOUNT	SERVO MOUNT
Model 3530, 7/8"	Model 3580, 7/8"
Model 3430, 1 1/16"	Model 3480, 1 1/16"
Model 3410, 2"	Model 3460, 2"
Model 3440, 3"	Model 3490, 3"

In this complete single-turn line, the quality matches the

quantity. Exclusive SILVERWELD® multi-wire termination eliminates the chief cause of potentiometer failure. Construction insures humidity performance that meets the cycling requirements of MIL-R-12934. One hundred per cent inspection and the double-check follow-through of the Bourns Reliability Assurance Program are your final quality guarantees. Whatever you need in single-turns, you'll find the answer at Bourns — the complete source! Write for technical data on our entire line of bushing and servo models, KNOBPOT® potentiometers, and turns-counting dials.

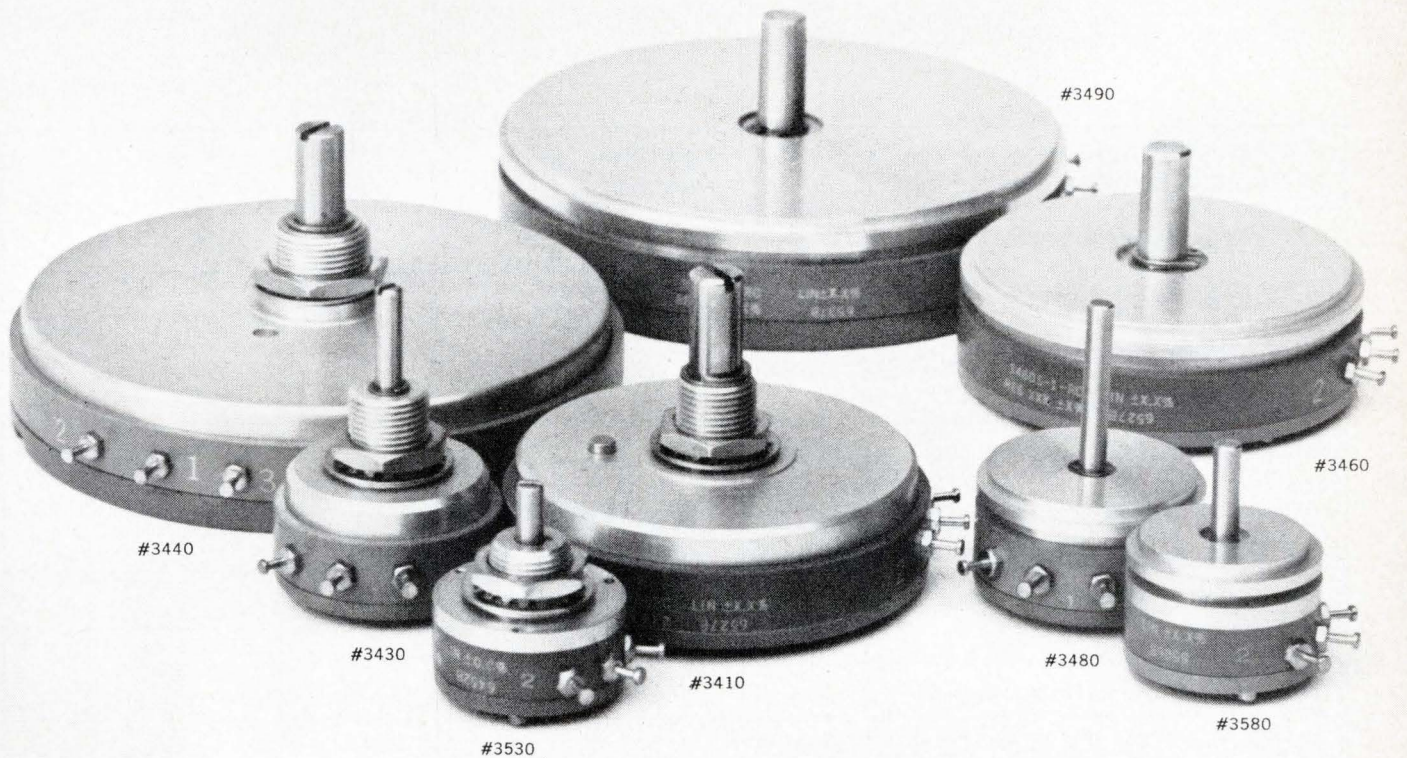

Bourns' thin design lets you gang units in minimum depth; for example, Model 3580 allows 24 cup sections in less than 6 inches.



BOURNS, INC., TRIMPOT DIVISION
1200 COLUMBIA AVE., RIVERSIDE, CALIF.
PHONE 684-1700 • TWX: 714-682 9582
CABLE: BOURNSINC.

SILVERWELD and KNOBPOT are registered trademarks of Bourns, Inc.

TRIMPOT® AND PRECISION POTENTIOMETERS — RELAYS — MICROCOMPONENTS: TRANSFORMERS, INDUCTORS, RESISTORS AND CAPACITORS

Why buy a new
Esterline Angus
Servo Recorder
instead of
brand A, B, C or D?

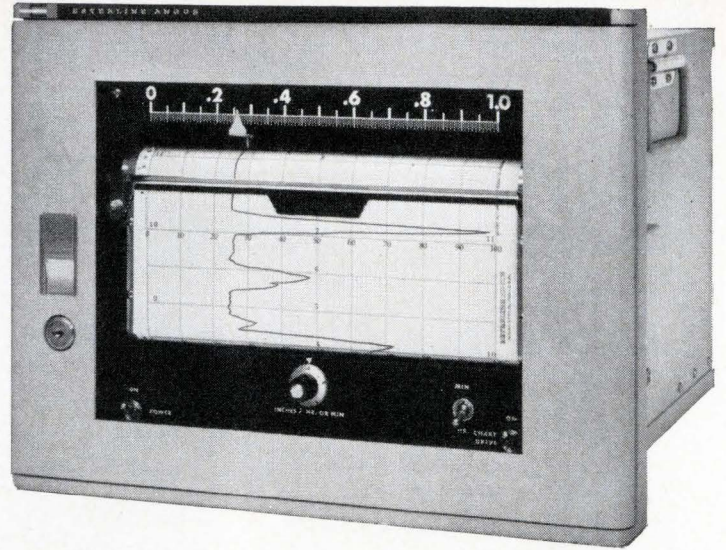

for 12 good reasons*

X's indicate standard features at no extra cost	Esterline Angus	Brands (names available on request)			
		A	B	C	D
List price, \$975 or lower	X			X	
Solid state amplifier	X		X		
50,000 ohm off balance input impedance or better	X				
Response as fast as 1/2 second even at a 1 MV range	X				
Accuracy $\pm 1/4\%$ span or $\pm 3 1/2$ microvolts	X	X	X		
Dead band 0.1% of span or less	X		X		X
Stray rejection: longitudinal 60 cycle AC, 1,000 times span or 120 volts	X		X		
Permanently sealed slidewire requires no cleaning	X				
5 chart speeds	X				
Chart tear off	X		X		
Tilt writing platen	X				
Pen lifter	X				

*Discover additional reasons for buying Esterline Angus Single and Two-channel Wide Chart (10") Servo Recorders. Write for Series "E" Catalog.

Esterline Angus Instrument Company, Inc.
Box 24000E • Indianapolis, Indiana 46224

Excellence in
instrumentation for
over 60 years



ESTERLINE ANGUS

Technical Articles

**Nonlinear effects produce
new laser frequencies:
page 82**



Laser research is turning to Raman and Brillouin effects as a way of controlling the frequency of a laser so that any desired wavelength for a particular application can be obtained. For example, our cover shows a green laser beam in an underwater communication experiment. Water is relatively transparent to green laser light.

**Ringling choke makes d-c
converters efficient:
page 90**

A well-known principle, little used outside auto ignition systems, is the basis of a converter-regulator circuit that can provide efficient and reliable conversion of d-c voltages from one level to another. The technique takes advantage of the stored energy in a magnetic field.

**Solid state circuits
for big color tv:
page 99**

Up to now semiconductor components haven't been able to cope with the design requirements imposed by large-screen color television receivers. Now, using newly available high-voltage video drive transistors and some sophisticated circuitry, one company has designed and demonstrated a 23-inch receiver that is almost completely solid state.

**Taming transients with
spark gap arresters:
page 109**

Expensive solid state equipment literally can be destroyed in a flash—by transients occurring on a-c power lines. Gas-filled surge arresters—simple devices that resemble radar transmit-receive switches—provide fast, reliable protection.

Coming ▪ **Integrated circuits in a frequency synthesizer**
May 2 ▪ **Automatic engine check-out by computer**
 ▪ **Special report: Satellite communications**

Filling in the blanks in the laser's spectrum

Nonlinear dielectrics permit high-power beams to be generated at many new frequencies. These should open new applications in medicine, chemistry, physics and communications

By Fred M. Johnson

Electro-Optical Systems, Inc., Pasadena, Calif.

In the constant search for ways to put lasers to work, a major obstacle has been the difficulty of obtaining powerful beams at several frequencies from the same laser. One of the most promising approaches to a solution is the interposition of a dielectric material in which an intense optical field produces nonlinear effects.

When the material and the original beam intensity are chosen carefully, they permit powerful new beams to be generated in almost any portion of the spectrum from the near ultraviolet to the far infrared. It may also be possible to control pulse-widths and repetition rates, and to modulate the beam externally.

The resulting nonlinear effects could be valuable in many fields:

- In biology, providing high-power beams at specific frequencies, to induce mutations and other genetic changes.¹

- In medicine, where laser-radiation therapy may be a powerful weapon against certain diseases.^{2,3}

- In chemistry, where intense radiation at wavelengths corresponding to those of molecules in an excited state may lead to new reactions and perhaps new compounds.

- In underwater communications, because high-

intensity coherent green light, produced by doubling the frequency from a neodymium laser, is the color that is best transmitted through water and also the color to which the eye and other detectors are most sensitive.

- In engineering, in applying nonlinear optics to parametric amplifiers, oscillators and IR detectors.

- In atmospheric studies, high-power beams at Raman-shifted frequencies are best for producing differential light absorption and backscattering from aerosols.⁴ This technique permits the remote determination of air density, pressure, temperature, wind velocity and concentration of oxygen, carbon dioxide and water.

When intense laser light passes through a material, electric fields associated with the light produce changes in the material's refractive index. These nonlinear and complex changes, in turn, can produce new frequencies at high intensities.

If the change in refractive index is described as an induced electric dipole, and written as a power series in terms of the electric field (E), successive components, particularly the quadratic term, of the series may be comparable in magnitude to the linear component. This is similar to radio technology, where the square law (E^2) is used to obtain modulation, demodulation and mixing.

Materials that behave nonlinearly in the presence of an intense optical field can provide almost any optical frequency with powers as high as a megawatt. One nonlinear medium, lithium metaniobate, has been tuned continuously through the infrared.⁵ Ruby and neodymium-doped glass lasers, Q-switched to provide multimewatts of power, often provide the fundamental wavelengths of 6,943 angstroms (red) and 10,600 angstroms (infrared), respectively.

With an appropriate medium, two light beams

The author



Fred M. Johnson is manager of radiation-interaction research at Electro-Optical Systems, a subsidiary of the Xerox Corp. The department studies nonlinear effects, spectroscopy and biophysics. Johnson received a doctorate in physics from Columbia University in 1958.

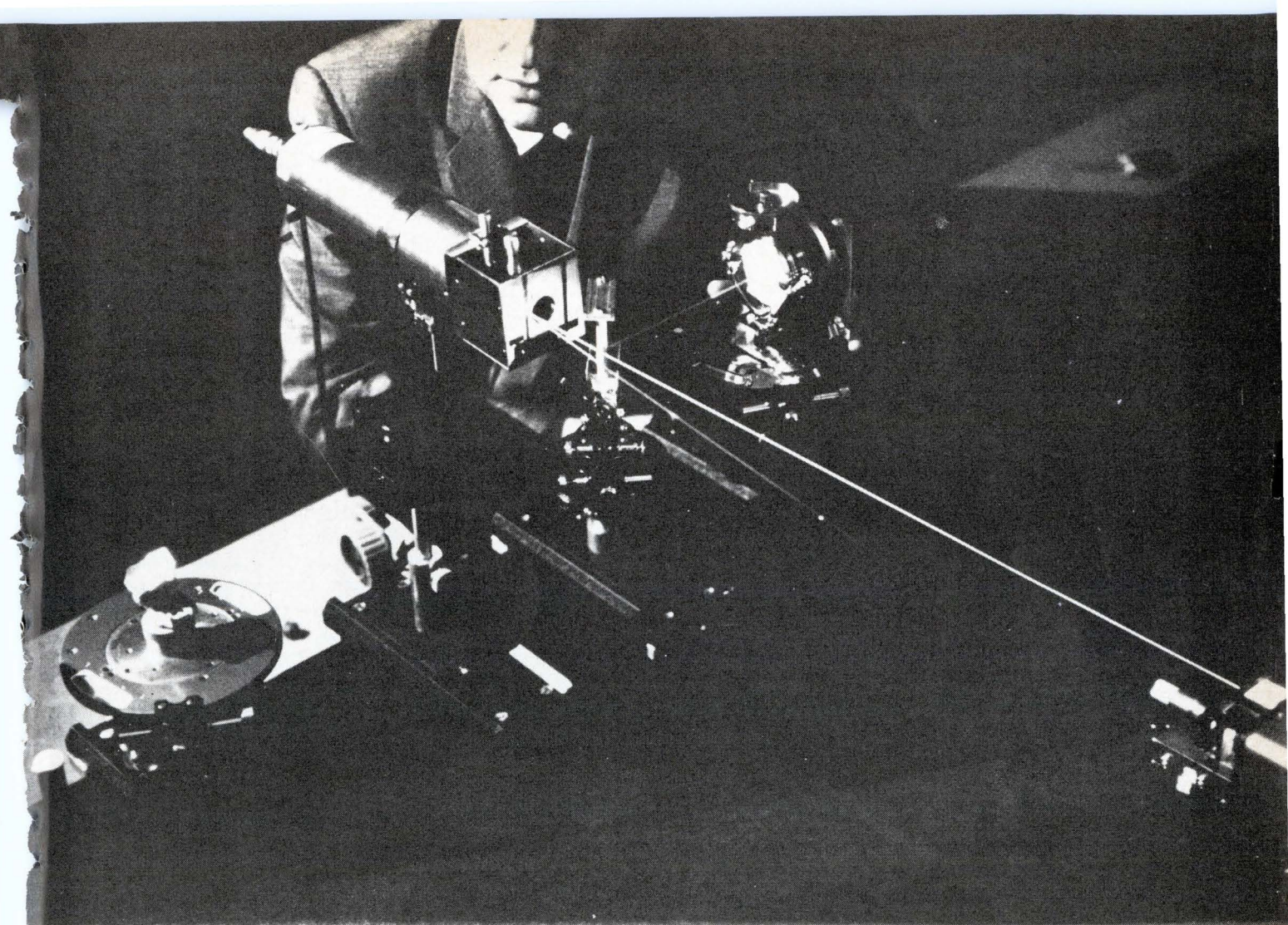

Parametric laser amplifier can be operated as an oscillator if the ends of the crystal to the right of the laser are coated with a reflective dielectric. Such oscillators are tunable and can provide high-power coherent frequencies.

may be mixed; sum and difference frequencies may be obtained,⁶ and the frequencies may be doubled, tripled or quadrupled.⁷ With a nonlinear medium and Raman-active material—which shifts wavelengths towards either infrared or ultraviolet—the number of frequency combinations can be increased even further.

Controlled scattering

Two important nonlinear effects are the Raman effect and the Brillouin effect. Raman-shifted frequencies have been studied for the applications mentioned previously.

For more than a quarter of a century, scientists have observed Raman lines—new frequencies generated in a dielectric by an intense incoherent light source. With the laser, under suitable conditions, coherent light can generate a new set of coherent frequencies, each shifted by an exact multiple of the fundamental frequency of the dielectric material.

Coherent Raman frequencies are generated when the input power exceeds a certain threshold, which varies depending on the material. However, dielectric breakdown caused by focusing the laser light with a lens to concentrate the electric field can

cause damage. If the field intensity becomes too high, it can cause deterioration of the Raman-active material, the lens and even eventually of the laser rod. Some materials, which can be made to produce Raman frequencies, can also accommodate even higher powers, enough to produce the Brillouin effect. This scattering produces intense ultrasonic energy in which acoustic waves interact with light.

High power of Raman-shifted frequencies is built up when a laser is Q-switched.⁸ The new frequencies are emitted predominately in the same direction as the original beam. Coherent Raman frequencies can be emitted by many organic liquids—benzene, nitrobenzene, chlorobenzene, carbon tetrachloride and carbon disulfide—and by some gases and solids. The Brillouin effect, on the other hand, produces its largest frequency shift in an optical beam that travels backwards, toward the original beam's source.

Both mechanisms cause high-intensity laser light to interact with phonons. In the Brillouin effect, the interaction results in a net transfer of energy; in the Raman effect, no energy is transferred among the phonons.

For the Raman effect, the phonons are present

in the crystal lattice of the nonlinear medium; they consist of dipoles whose charges move apart and together as the molecules vibrate. Although charges are displaced within the dipole, there is no net transfer of energy between adjacent dipoles.

For the Brillouin effect, energy is transferred between successive molecules as the acoustic phonons move in a wavelike manner.

In a medium where both effects can be achieved, the first to appear is the one that occurs at the lower threshold—usually the Raman effect in nonlinear materials. For some materials, however, notably water and quartz, the Brillouin threshold is lower.

At Electro-Optical Systems, Inc., a combination of Raman and other nonlinear phenomena has been observed with the experimental setup that is shown below. With potassium dihydrogen phosphate (KDP) as a dielectric, the frequency of 1.06-micron radiation from a Q-switched neodymium-doped laser has been doubled, and a pulse power of 10 megawatts produced at a new wavelength, 5,289 angstroms. This second harmonic then generates many new, coherent Raman frequencies in various organic liquids. When helium and methane were mixed under high pressure, combination lines were observed; coherent radiation in the near infrared was detected by parametric up-conversion. The

table on page 86 lists some of these frequencies.

The intense hypersonic acoustic waves generated with the Brillouin effect—30 to 60 gigahertz at up to one kilowatt of pulse power⁹—have been found valuable in materials probing. These power densities are at or near the limit that can be withstood by nonlinear materials; at higher power densities, materials either degrade severely or disintegrate completely. For example, 10^6 megawatts per square centimeter is required to stimulate Brillouin scattering in quartz, but this density produces defects in the crystal at the focus of the laser beam. Higher power densities probably would shatter the quartz crystal.

Applications for Raman-shifted frequencies have already been mentioned for biology, medicine, chemistry, communications and physics. Applications for the Brillouin effect are expected in underwater communications, because of the ease with which acoustic waves can be transmitted through water. In medicine, hypersonic waves may help to detect tumors in the same way in which they map the ocean bottom; lower frequencies already have been used to detect tumors.

For medical experiments, ruby and neodymium lasers have been the most common. Only recently have researchers begun to realize that other frequencies of high-intensity light are available. The

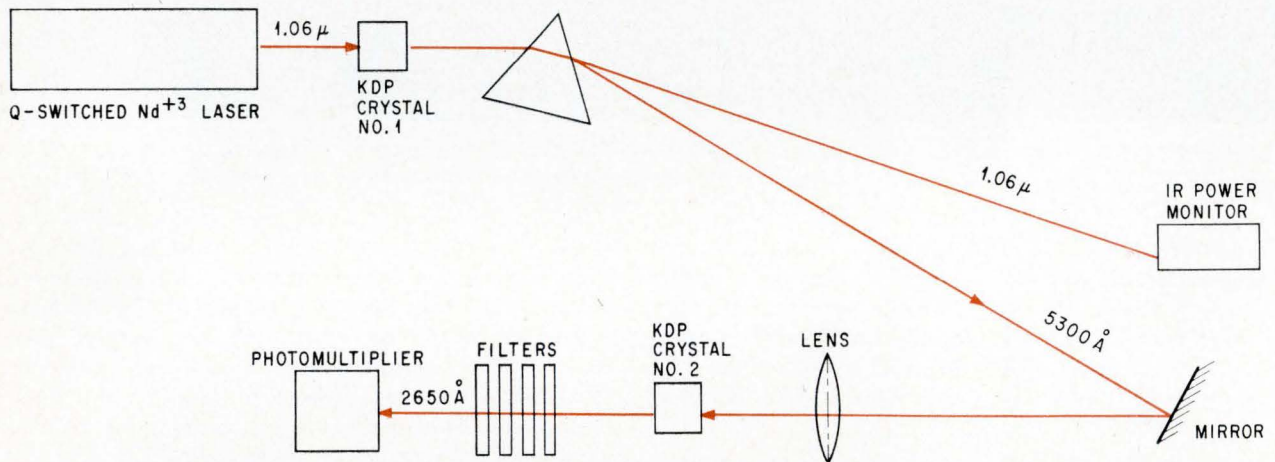

To generate the fourth harmonic, unfocused output from a Q-switched neodymium laser is passed through a crystal of potassium dihydrogen phosphate (KDP) at left to convert 1.06-micron radiation to 5,300 angstroms. A prism separates the two frequencies; the 5,300-angstrom line is reflected and focused onto the second KDP crystal. This crystal changed the 5,300-angstrom radiation to 2,650 angstroms, or four times its original frequency.

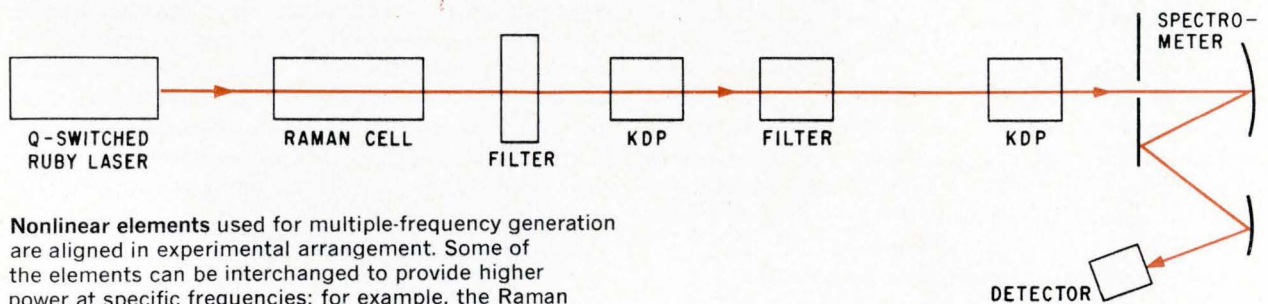

Nonlinear elements used for multiple-frequency generation are aligned in experimental arrangement. Some of the elements can be interchanged to provide higher power at specific frequencies; for example, the Raman cell can be placed behind the KDP crystal instead of in front of it. In that case, a new set of frequencies could be Raman-shifted, using the doubled frequency as the pump.



Q-switched neodymium laser and associated nonlinear crystals, used for frequency doubling. Ten megawatts of green laser light are generated by doubling the 1.06-micron output with a KDP crystal.

ruby laser even has been used as an amplifier of Brillouin-shifted light.¹⁰

Green light from a laser has been used to destroy pigmented cellular tissues on the retinas of 12-day-old embryos of chicks. Radiation as low as one megawatt per square centimeter was enough to destroy the cells; this result is explained by the fact that the retina is most sensitive to the green portion of the spectrum. Also observed was a slowing of the rhythmic muscular contraction in cardiac muscle cells of a five-day-old embryo following exposure to 5,300 Å radiation. The lethal effects on tissue cultures of an intense 2,650 Å line in the ultraviolet are now being studied.

These experiments have been conducted by Donald E. Rounds of the Pasadena Foundation for Medical Research, and the author.

A mathematical model

The interaction of a laser beam with a nonlinear medium can be represented by Maxwell's equations for electromagnetic radiation. Nonlinearity is introduced into the equations as an inhomogeneous current. This model permits the mathematical representation of some properties of nonlinearity, including dispersion, resonance and symmetry.¹¹

The dominant effect of the laser's high-intensity field on the dielectric medium is an induced electri-

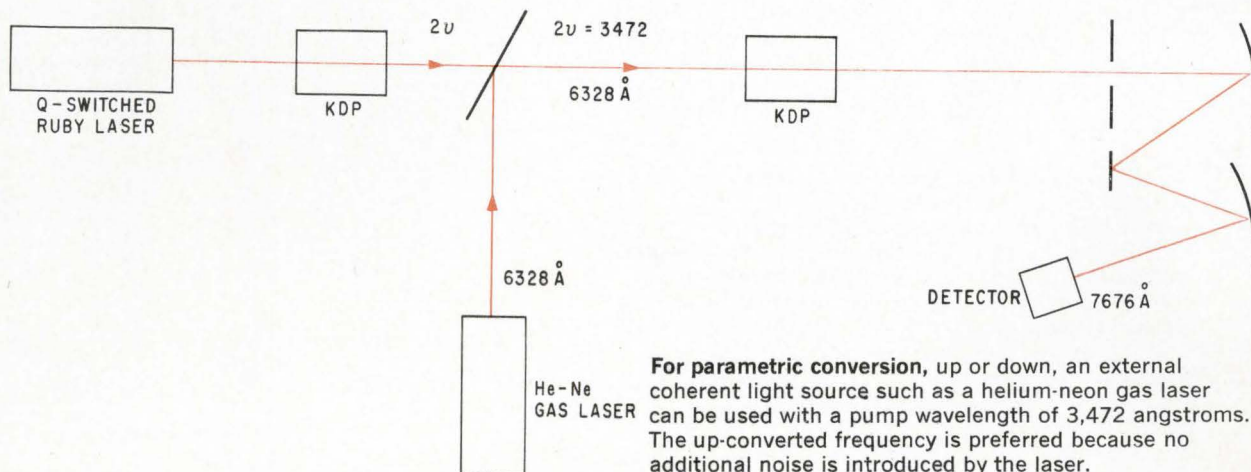

Intensities of new Raman frequencies⁶

Compound	Raman shifts excited by 5289 Å second harmonic of Nd ³⁺ -doped laser $\Delta\nu$ (cm ⁻¹)		
	With ruby laser (6943 Å)	With second harmonic of Nd ³⁺ -doped laser (5289 Å)	
Cyclohexane	medium	very strong	2843 ± 10 2920 ± 10
Methyl cyclohexane	medium	very strong	2855 ± 10 2935 ± 10
n-Hexane	(none)	very strong	2850 ± 10 2920 ± 10
Carbon disulfide	very strong	very strong	655 ± 20
Acetonitrile	very strong (not seen)	very strong very weak	2945 ± 10 2242 ± 10
Acrylonitrile	strong	strong	2214 ± 10
Benzene	very strong weak	medium medium	995 ± 10 3060 ± 10
Pyridine	very strong (not seen)	very weak weak	995 ± 10 3060 ± 10
Tert-butyl bromide	medium	weak	2920 ± 20
Cyclopentene	(none)	weak	2850 ± 20 2920 ± 20

cal dipole moment; a displacement occurs between the positive and negative charge. As the beam passes through the medium, the induced electric dipole oscillates either at the same frequency or at a harmonic frequency of the driving electric field—assuming that the medium is lossless and non-magnetic. The frequency of oscillation depends on the direction in which fields are applied, and on the crystal symmetry of the dielectric medium. Doubling and mixing can be observed only in asymmetrical crystals such as KDP and lithium ni-

bate (LiNbO₃).

From the induced dipole moment arise second and third harmonics as well as direct-current polarization and mixing. For generating second harmonics, the applied electric field must be in the KDP crystal's XY plane with equal components of the field applied in the X and Y directions. P. A. Franken and J. F. Ward have demonstrated generation of second harmonics, but the power was low.^{12, 13} Later, higher powers and efficiencies were obtained¹⁴ by taking into account a factor

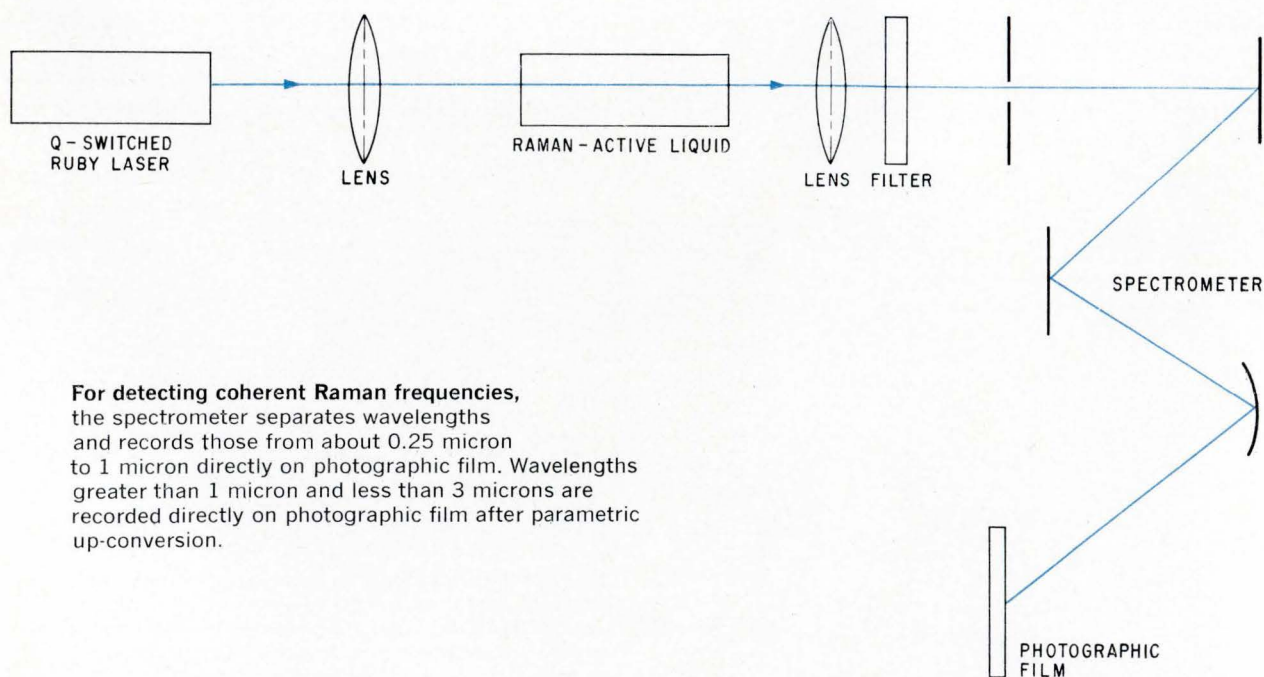

For detecting coherent Raman frequencies, the spectrometer separates wavelengths and records those from about 0.25 micron to 1 micron directly on photographic film. Wavelengths greater than 1 micron and less than 3 microns are recorded directly on photographic film after parametric up-conversion.

Frequency-quadrupling data

Wavelength	Power	Pulse width
1.06 μ	50 Mw	15 nsec
5300 Å	10 Mw	10 nsec
2650 Å	2.4 kw (minimum)	

called the coherence length. The coherence-length effect arises because most media are dispersive to some extent, and their refractive indexes vary as functions of their wavelengths. Thus, a second harmonic travels at a speed different from that of its primary driving field; the coherence length is the distance at which the second harmonic is 180° out of phase with the driving field. Beyond this length, destructive interference occurs and no additional advantage is gained from the use of larger crystals.

However, in a birefringent crystal, if the direction of the incident light is chosen so that the refractive index of the ordinary ray at the incident frequency is equal to the refractive index of the extraordinary ray at the second harmonic, both rays travel at the same speed. The locus of points for the two rays around the crystal's optical axis is a cone. However, since the input electric field is in a specific direction, the paths of the rays reduce to one particular direction. Conversion efficiencies as high as 20% have been attained with this technique. At Electro-Optical Systems, an output power of 10 megawatts at 5,300 Å has been obtained with an input of 50 megawatts at 10,600 Å.

Parametric amplifier

Parametric amplification of light at various frequencies requires three basic elements: a pump-driving field, a signal wave and an idler wave. It is not necessary to supply all three externally, however, because if the signal and pump are present the idler is generated automatically. Furthermore, if gain occurs for the signal frequency it will also occur for the idler frequency. Two conditions must be satisfied: conservation of photon energy and of momentum.

At the bottom of page 84, a Raman cell generating a single frequency is shown. In the diagram on page 85, the signal is introduced externally by a gas laser. In both cases, observations are made both at the signal and at the automatically generated idler frequency. The pump frequency is provided by doubling the frequency of the output from the Q-switched laser with a KDP crystal. Both of these approaches to parametric amplification are being followed at Electro-Optical Systems.

An optical parametric amplifier has recently been built by C.C. Wang and C.W. Racette at the Philco Corp.¹⁵

For a five-centimeter KDP crystal, a gain of 25% is expected, with a pump power of five megawatts. If a KDP crystal is to be used as an oscillator, the ends of a second KDP crystal are made reflective;

this crystal is shown at the right of the laser in the photograph, at the top of page 83, of a typical parametric amplifier.

Infrared frequencies have been recently detected by parametric up-conversion—mixing the infrared frequency with the output of a pulsed ruby laser. Infrared was detected as far as 2.2 microns in the visible region—about 5,000 Å.

Double vibration

More than 30 Raman-active liquids have been studied at Electro-Optical Systems. One such substance, benzonitrile, can be made to oscillate in two modes, one at 3×10^{13} cycles per second, the other at 6.687×10^{13} cycles. Coherent Raman frequencies are produced as a result of these two fundamental vibrations; in addition to multiples of these frequencies, sums and differences have been observed. The experimental arrangement is shown in the diagram on page 86.

So far, only a few compounds have exhibited this double vibration mode, although there also have been other experiments with mixtures of liquids and of gases. Only a few of these mixtures exhibit coherent Raman phenomena, and even fewer exhibit sum and difference effects. Their importance lies not only in extending the coherent frequency ranges, but also in clarifying the fundamental mechanisms of Raman phenomena.

Quadrupling of 1.06-micron radiation was achieved at Electro-Optical Systems by successively doubling two crystals of KDP. Tripling of the radiation from a 1.06-micron neodymium-doped glass laser in KDP also was achieved recently. The table at top left summarizes the data on frequency quadrupling. These frequencies are expected to be very useful in biological research.

References

1. D.E. Rounds, E.C. Chamberlain and T. Okigaki, *Annals of the New York Academy of Science*, vol. 122, p. 713 (1965).
2. F.M. Johnson, R. Olson and D.E. Rounds, *Nature*, vol. 205, p. 721 (1965); D.E. Rounds, R.S. Olson and F.M. Johnson, *Journal of Cell Biology*, vol. 27, p. 191 (1966).
3. L. Goldman, R. Wilson, P. Hornby and R. Meyer, *Cancer*, vol. 18, pp. 533-545 (1965); P.E. McGuff, R.A. Deterling Jr. and L.S. Gottlieb, *Journal of the American Medical Association*, vol. 195, pp. 393-394 (1966).
4. L.J. Nugent, E.D. Harris, L.W. Carrier and G.R. White, *Transactions of the Instrument Society of America* (to be published).
5. J.A. Giordmaine and R.C. Miller, *Physics Review Letters*, vol. 14, p. 973 (1965).
6. F.M. Johnson and J.A. Duardo (to be published).
7. F.M. Johnson, *Nature*, vol. 204, p. 985 (1964).
8. G. Eckhardt, et al., *Physics Review Letters*, vol. 9, p. 455 (1962).
9. R.Y. Chiao, C.H. Townes and B.P. Stoicheff, *Physics Review Letters*, vol. 12, p. 592 (1964).
10. E. Garmire and C.H. Townes, *Applied Physics Letters*, vol. 5, p. 84 (1964); R.G. Brewer, *Applied Physics Letters*, vol. 5, no. 7, p. 127 (1964).
11. J.A. Armstrong, N. Bloembergen, J. Ducuing and P.S. Pershan, *Physical Review*, vol. 127, p. 1918 (1962); N. Bloembergen, "Nonlinear Optics," Benjamin, Inc., New York, 1965.
12. P.A. Franken and J.F. Ward, *Review of Modern Physics*, vol. 35, p. 23 (1963).
13. R. Terhune, *Solid State Design*, vol. 4, p. 38 (1963).
14. J.A. Giordmaine, *Physics Review Letters*, vol. 8, p. 19 (1962); P.D. Maker, R.W. Terhune, M. Nisenoff and C.M. Savage, *Physics Review Letters*, vol. 8, p. 21 (1962).
15. S.A. Akhmanov and R.V. Khokhlov, *Journal of Experimental and Theoretical Physics* (Translated from Russian), vol. 16, p. 252 (1963); C.C. Wang and C.W. Racette, *Applied Physics Letters*, vol. 6, p. 169 (1965).

Nomographs calculate values for twin-T notch filter

In two quick steps, an engineer can easily determine the values of components needed for a twin-T filter that has a symmetrical responsive curve.

By Tom G. Purnhagen

Air Force Cambridge Research Laboratories
L.G. Hanscom Field, Bedford, Mass.

A **nomograph** greatly simplifies the design of twin-T notch filters that have symmetrical response curves. Such filters are frequently used to reject a specific frequency, or may be included in a negative feedback loop of a selective amplifier as a tuning element. Although other combinations of components may be used, the one shown in the schematic at the right has the greatest possible selectivity.

With this general configuration, any filter exhibits infinite attenuation at notch frequency f_o , which is specified by the values of R_1 and C_1 . If the aim is only to reject f_o , then the choice of one of these values is arbitrary. In most cases, however, it is also desirable to design the filter with a symmetrical response curve, so the d-c gain is equal to that at high frequencies. These conditions are accomplished when

$$R_1 = (\frac{1}{2}R_g R_L)^{1/2} \quad (1)$$

The notch frequency is determined by

$$f_o = \frac{1}{4\pi C_1 R_1} \quad (2)$$

The author



Tom G. Purnhagen is a captain in the United States Air Force and is presently assigned to the Air Force Cambridge Research Laboratories as an electronics engineer. Previously, he served as communications officer at various Air Defense Command radar stations in the U.S. and Canada.

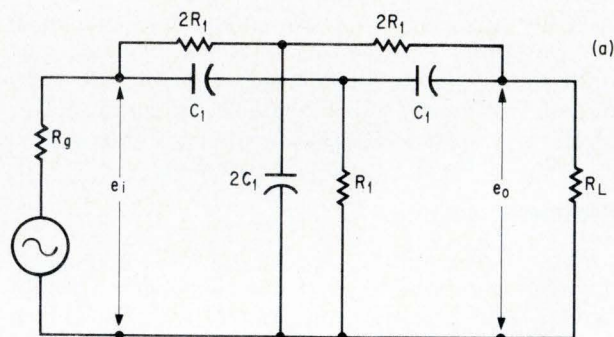

Twin-T notch filter, with component values related as shown, yields maximum selectivity and symmetrical gain-frequency response.

Two nomographs based on equations 1 and 2 are shown. The usual design problem requires the solution for values of R_1 and C_1 when f_o , R_g and R_L are known. However, the charts can be used to determine any of the equation parameters if two are specified. Chart 2 can be used alone—with R_1 or C_1 arbitrarily selected—if symmetrical response is not essential.

Design example

A filter is required to have infinite attenuation at a frequency of 800 cycles per second and it is to be inserted between a source impedance of 2,000 ohms and a load resistance of 100,000 ohms. The steps in using the nomograph to solve this problem are indicated by the dotted lines. The resulting values for the circuit elements are $R_1 = 10,000$ ohms from chart 1 and $C_1 = 0.01 \mu\text{f}$ from chart 2.

Nomographs for designing symmetrical twin-T filters

Chart 1

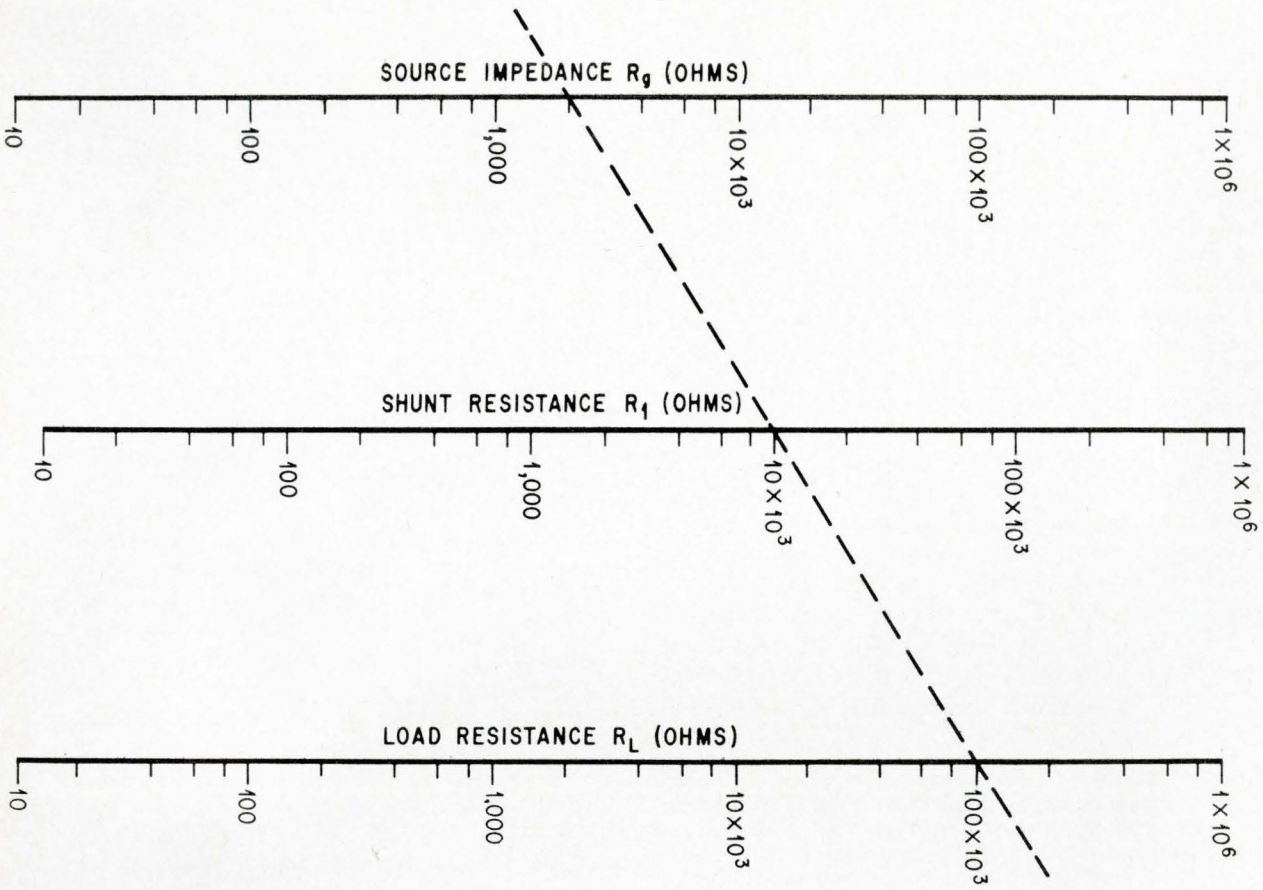
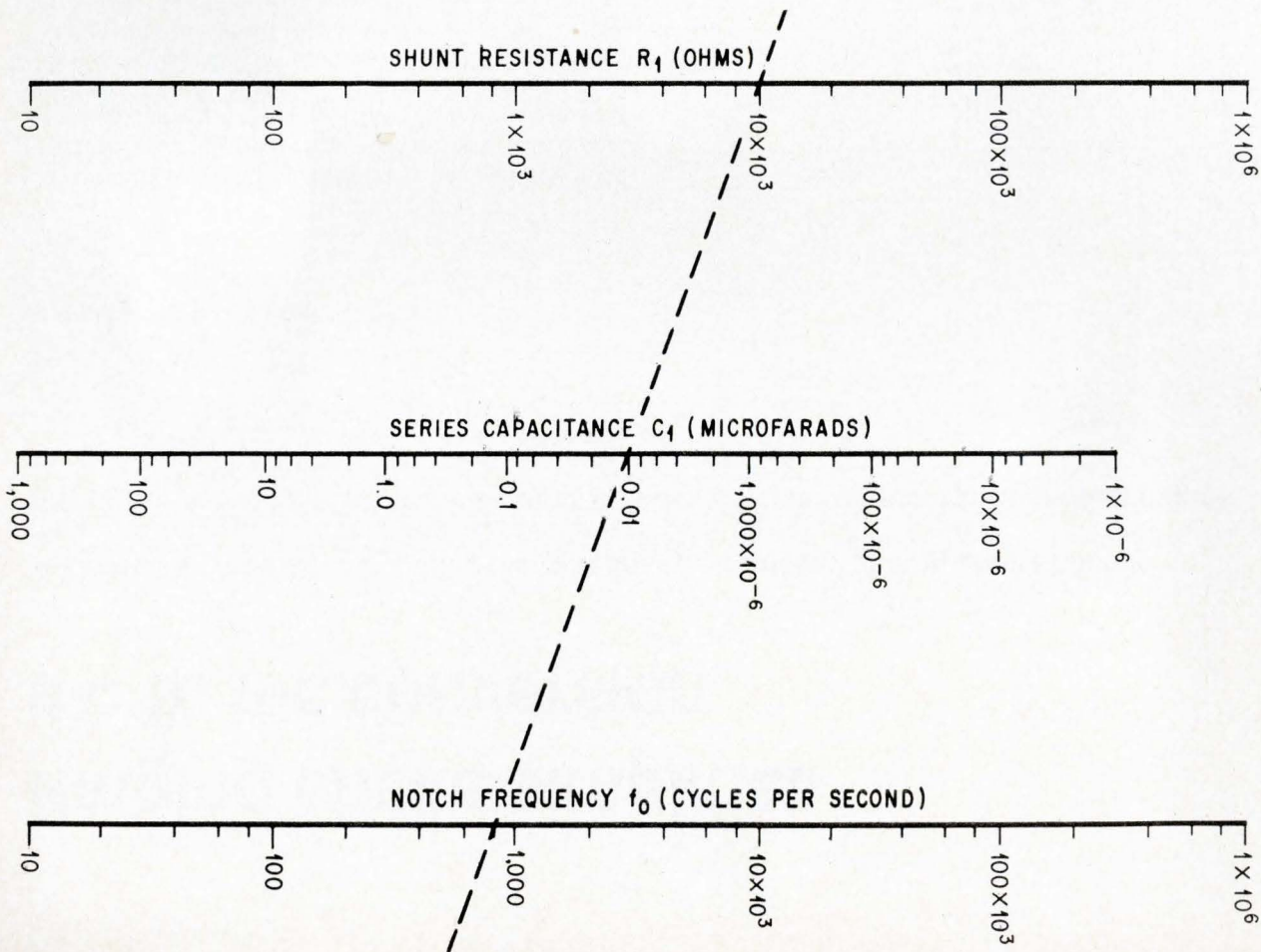

CHART 2



Ringling choke simplifies d-c to d-c conversion

Seldom-used method of boosting d-c voltage, by alternately storing and retrieving energy from a magnetic field, has important advantages over conventional techniques

By J.F. Howell

General Electric Co., Milwaukee, Wis.

Conversion of direct current from one voltage level to another usually requires at least two transistors and a special transformer. But for low-power and pulse-discharge types of applications, there is a simpler, more efficient and more reliable technique. It takes advantage of the stored energy in a magnetic field to change the voltage level. The principles of ringing choke conversion have been previously reported in technical literature, but surprisingly, application to date has been rather limited.

Basic principles

If energy is stored in the magnetic field of an inductance, and if the field is allowed to collapse, the voltage across the inductance will assume a level necessary to dissipate the stored energy. This well-known principle, used in auto ignition systems and the basis of energy conversion in the ringing choke converter-regulator, is illustrated in the circuit shown at the right. When switch S_1 is closed, current flows, and energy builds up in inductance L , according to the formula $E = \frac{1}{2} LI^2$. After the energy in the inductance has reached some arbitrary level and S_1 is opened, energy in the

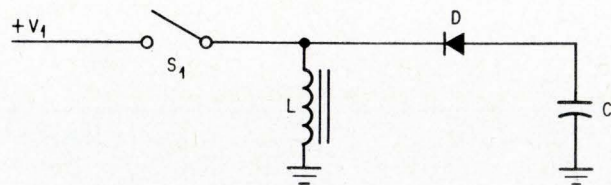

In a simplified ringing choke converter, with switch S_1 closed, energy builds up in the inductance. When switch is opened, energy in the magnetic field is transferred to capacitor C through the diode. Repeated opening and closing of switch builds up capacitor voltage to many times the input voltage.

magnetic field will be transferred to capacitor C through diode D . Repeated opening and closing of the switch gradually increases the voltage accumulating across the capacitor to many times the amplitude of the input voltage. Therefore, energy is converted from one potential level to another by storing it within and retrieving it from a magnetic field. Furthermore, regulation is achieved by controlling the number and rate of switch operations.

It is important to remember that when the switch is closed, energy is transferred only to the magnetic field, not to the capacitor. Additionally, when the stored energy of the switch is being transferred to the capacitor, the voltage across the inductance is dependent on the potential already existing on the capacitor; it is not dependent on the magnitude of the voltage V_1 , the initial source of stored energy in the magnetic field.

D-c to d-c conversion

A simplified schematic diagram of a d-c to d-c converter, in which these principles are applied, is on page 91. Transistor Q_1 , in a blocking oscil-

The author



John F. Howell has been a senior engineer with General Electric Company's X-ray department since 1950. A senior member of IEEE, he is currently active in solid state circuit design.

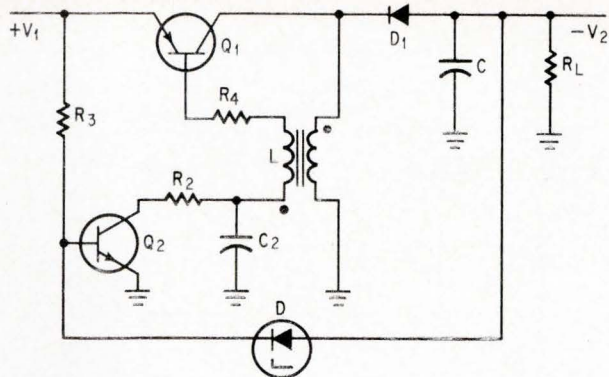

Basic schematic of a d-c to d-c converter. Transistor Q_1 serves as a fast-acting switch connected to blocking oscillator circuit. R_3 controls regulation.

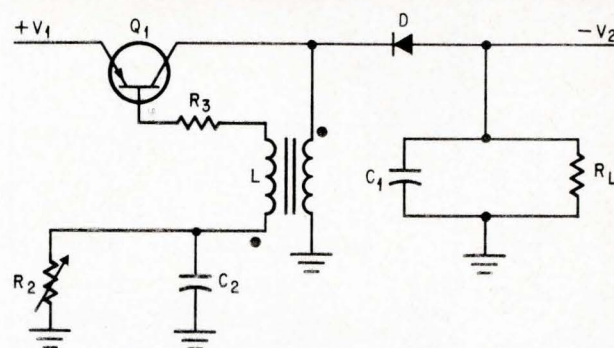

Converter-regulator circuit includes variable impedance Q_2 for controlling frequency of oscillation and a zener diode for automatic regulation.

lator circuit, serves as a fast-acting switch. It transfers energy from the power source, V_1 , to the magnetic field of the inductance, L . An advantage of the blocking oscillator circuit is that it automatically opens the switch when the magnetic core of the inductor saturates.

Therefore, a wasteful flow of current into the inductor after core saturation is prevented. The amount of energy stored in the magnetic field is identical for each blocking oscillator pulse, and the average energy transferred to the load R_L is linearly related to the frequency of oscillation. Conversely, for a constant frequency of oscillation,

the voltage V_2 is dependent on the resistance of the load, R_L . The voltage automatically results in constant power dissipation in the load.

D-c to d-c converter-regulator

In the converter diagram above, right, the frequency of oscillation can be varied by adjusting resistance R_2 . If this circuit is modified by an arrangement that senses the output voltage V_2 and controls the value of R_2 , then automatic voltage regulation results.

Such a modification is shown in the circuit directly below. Transistor Q_2 acts as a variable

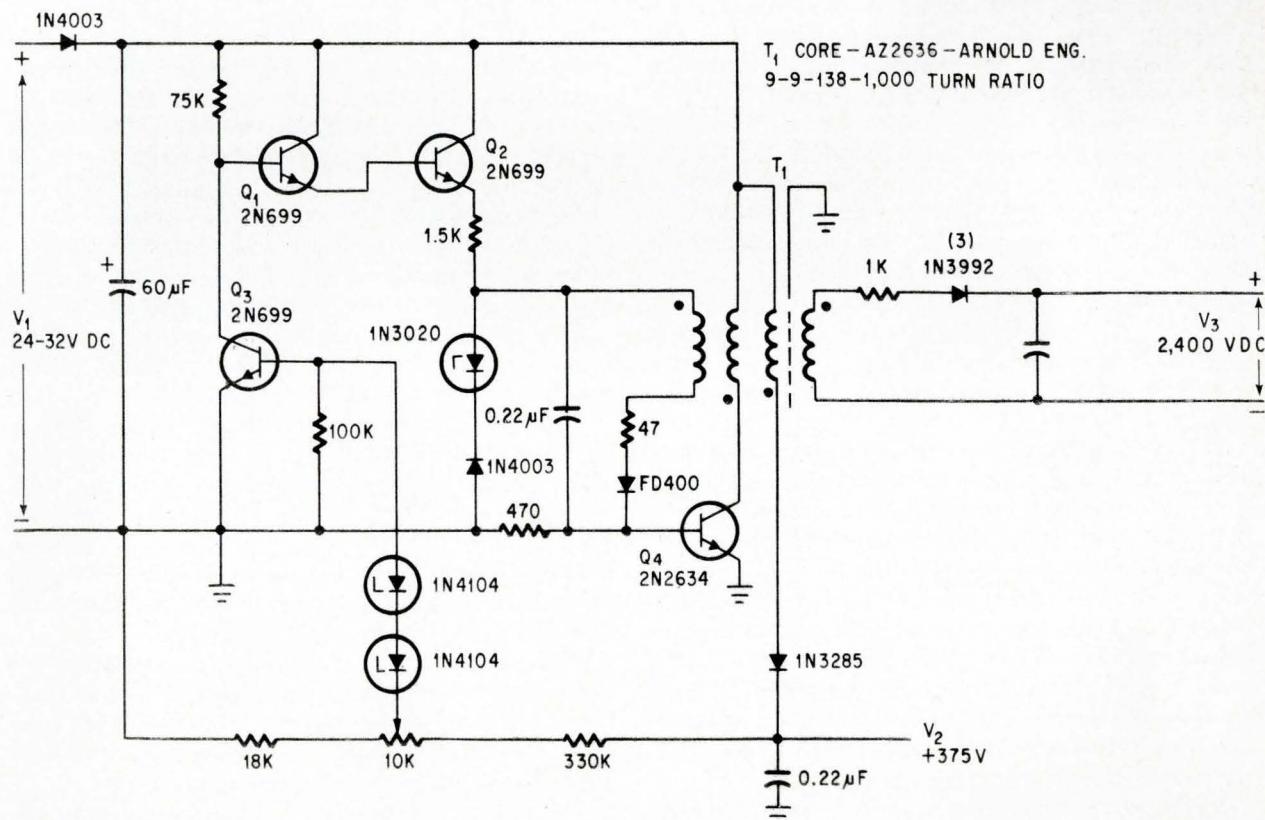

Ringing choke d-c to d-c converter-regulator uses a blocking oscillator to chop the input signal. Extra winding on inductance provides an isolated 2,400-volt d-c output. The Darlington pair, Q_1 , Q_2 , provides high input impedance. Q_3 is regulating transistor, and Q_4 is the blocking oscillator transistor.

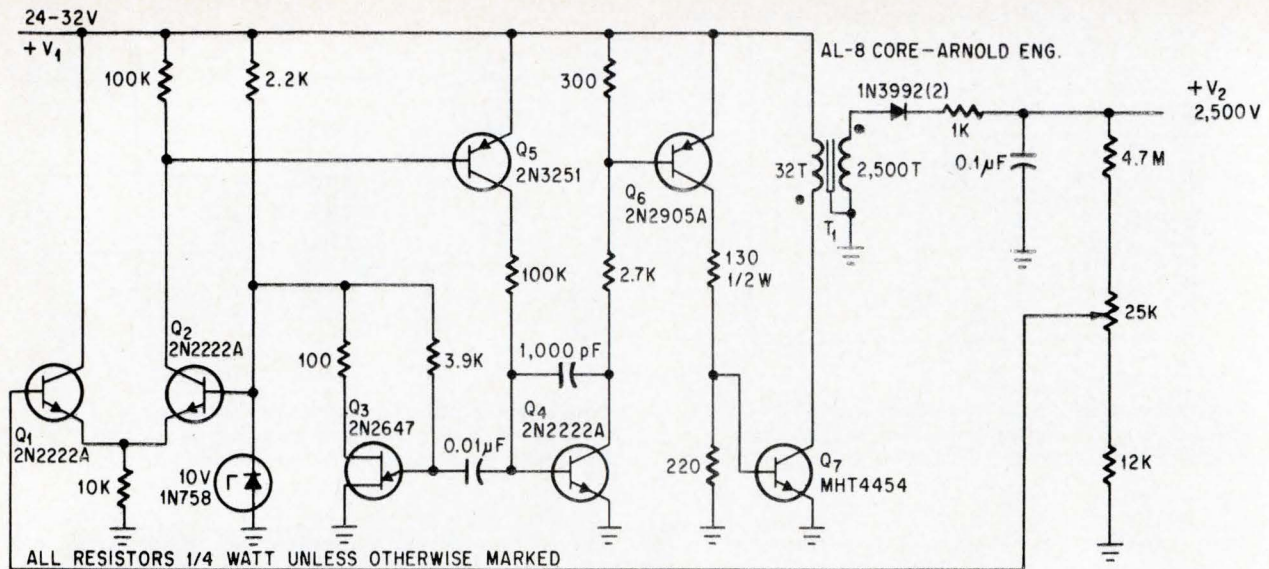

Typical ringing choke converter-regulator with unijunction transistor in the oscillator circuit. Regulation is achieved by sampling the output and feeding it back to a comparison circuit.

impedance controlling the frequency of oscillation. A zener diode, serves as a reference element for automatic regulation of the frequency of oscillation; it maintains voltage V_2 constant, despite variations of input voltage V_1 or load resistance R_L .

The frequency of oscillation, which controls the rate of energy transfer, is variable from zero to several thousand cycles per second. Transistor Q_1 is always either off or saturated. Therefore, the heat dissipated in the transistor is a minimum. The maximum voltage across Q_1 —equal to $(V_1 + V_2)$ —occurs when the transistor is off. If the output is taken off by an additional winding on the inductance, then the maximum voltage across Q_1 is the input voltage V_1 plus the output voltage as reflected to the primary by the inductance turns ratio. For a voltage step-up application, the maximum voltage across Q_1 is therefore $V_1 + V_2 (N_1/N_2)$. Another advantage: regulation is achieved by frequency control, rather than by using a series voltage dropping element, so conversion efficiency is high.

The ringing choke is relatively easy to construct from a laminated, silicon-iron split core. The high effective frequency, resulting from the relatively short transistor on-time (approximately 50 microseconds), means only a few turns are required. An air gap in the core of several mils must be provided to obtain low residual core magnetization between pulses. When input voltage V_1 is applied to the circuit shown on page 91, the output voltage V_2 responds linearly with time. Thus, its regulating action is faster than the more conventional converters, which respond exponentially.

If the output is short-circuited, peak current through Q_2 is not affected because the load is disconnected during transistor conduction. This is an important feature for pulse-discharge type ap-

plications. Shorting the output does not increase the primary current as would happen in a transformer type converter. Therefore, the components are not damaged, and the only effect of the short is an increase in the frequency of oscillation from regulator action. This frequency of oscillation is limited by the R_2C_2 time constant.

Typical circuits

Typical ringing choke converter-regulators like that shown above and on page 91 are designed to convert an input ranging from 24 to 32 volts d-c to relatively high regulated potentials. The circuit on page 91 utilizes a blocking oscillator for pulse generation, and provides two outputs, +365 volts and an isolated 2,400 volts. The isolated winding used to couple V_3 has a common volts/turn relationship with the other windings; therefore the load impedance across V_3 is also regulated.

The circuit above utilizes a unijunction transistor for pulse generation. The oscillator circuit consists of UJT Q_3 and transistor Q_4 .

Both converters operate with an energy storage pulse of fixed duration—50 to 100 microseconds—and regulate by varying the pulse repetition rate.

Another version of the ringing choke power supply maintains the frequency of the input current pulses constant, while the pulse duration is varied to provide regulation of the output voltage. Both methods work equally well.

With high-quality components, regulation of these supplies is approximately 0.02%, for combined input and temperature variations. With low-cost commercial components, the regulation will be about 0.2%, adequate for many applications.

The techniques described afford significant advantages in low average power applications and particularly in pulse discharge systems where the output supply is frequently shorted.



Our Marriage Broker

Applications of photography are diverse and technical enough so that no one man in the world could possibly answer everyone's every question on the subject. The next best thing is a man who knows where to get the answers. A "marriage broker" between problems and solution. *A man who can connect you with the right specialist.*

We have one such man. His phone number is (716) 325-2000, Ext. 5129.

He has at his fingertips the names and phone numbers of a staff of photographic engineers unique in its wide knowledge of all facets of phototechnology. He can con-

nect you with *the* one who is most fluent in your language and who can either answer your question or evaluate your idea.

Our people may suggest the use or adaptation of a Kodak system. Or help you invent a new one. Or (and it does happen) they may put you in touch with another company—one which specializes in your area. In any case, your problem gets solved, and the way to get started is to call or write **Special Applications, Eastman Kodak Company, Rochester, N.Y. 14650.**

Kodak

Designer's casebook

Two unijunctions form low-cost level detector

By John G. Peddie

H. Dell Foster Co., San Antonio, Tex.

The low-cost level detector shown at the right provides constant-width pulses at a fixed repetition rate while the input signal exceeds a specific level.

In the application for which the circuit was required, the main design problems were:

A maximum of 100 microamperes could be drawn from the signal source.

The reference level was negative with respect to ground and the supply voltage was positive with respect to ground.

A three-stage circuit was developed to provide the necessary level detection pulse. An emitter follower input stage Q_1 draws only $35 \mu\text{a}$, well under the maximum specified. The threshold of the circuit is set by R_2 , which forms a voltage divider with R_1 . The second stage, Q_2 , is a unijunction transistor (UJT) whose triggering level is set by potentiometer R_2 . When Q_2 fires, a series resistance is formed, consisting of R_4 , R_{bb} and R_3 . Capacitor C_1 now begins to charge. When the peak point of Q_3 ,

Designer's casebook is a regular feature in Electronics. Readers are invited to submit novel circuit ideas, packaging schemes, or other unusual solutions to design problems. Descriptions should be short. We'll pay \$50 for each item published.

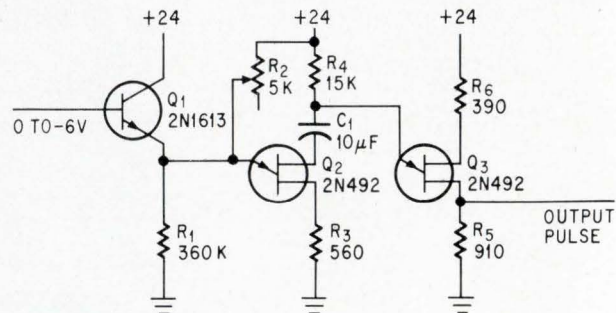

Relaxation oscillator formed by C_1 , R_4 , Q_3 and R_5 produces uniform pulses as long as threshold set by R_2 is exceeded at input.

another UJT, is reached, it fires and provides a discharge path for C_1 .

As long as the input voltage is above the threshold of the circuit, Q_2 will stay on—forming a relaxation oscillator out of C_1 , R_4 , Q_3 and R_5 . An emitter follower could replace Q_2 , but the threshold would not be as predictable and also would be more affected by temperature.

If temperature stability is not critical, type 2N2160 unijunction transistors may be used, reducing the cost still further. To improve temperature stability, R_5 can be reduced to 27 ohms, at the sacrifice of lower output pulse amplitude.

Exclusive OR circuit requires no voltage supply

By T.P. Sylvan

General Electric Co., Schenectady, N. Y.

A simplified exclusive OR circuit, useful in industrial controls, reduces the number of components required in conventional circuits of this type, and requires no voltage supply for the transistors.

An exclusive OR circuit yields a logical 1, if only one of the logic inputs is present. The logic output is 0 if none of the logic inputs is present, or, if more than one of the logic inputs are present.

This is expressed in the truth table shown at the right for the logical expression, $F = AB' + A'B$.

Usually, high speed is not required and standard transistor-resistor (TRL) NOR logic is used. With TRL, an equivalent expression is derived using double negation and by applying De Morgan's theorem¹:

$$\begin{aligned} F &= AB' + A'B \\ &= (AB' + A'B)'' \\ &= [(AB')' (A'B)']' \\ &= [(A' + B) (A + B')]'' \\ &= (A' + B)' + (A + B')' \\ &= [(A' + B)' + (A + B)']' \end{aligned}$$

An exclusive OR circuit using TRL and based on this final expression is shown in the upper diagram

Definitions of logic symbols and theorems

$A + B$ stands for "A or B".

AB stands for "A and B" (sometimes shown as $A \cdot B$).

A' stands for logic negation "not A" (sometimes shown as \bar{A}).

A'' stands for double negation.

$(A + B)'$ stands for "not A or B" (nor functions).

De Morgan's theorem states that $(A + B)' = A'B'$ or $(AB)' = A' + B'$.

at right. It has npn transistors and provides positive true outputs—a positive input or output voltage corresponds to a 1 in the truth table; a zero or negative voltage corresponds to a 0 in the truth table. Base-bias resistors are not shown but may be required, depending on logic levels, transistor characteristics, operating temperature range and noise requirements.

The simplified, exclusive OR circuit, shown at the right, is a hybrid circuit that uses TRL plus a dual-diode output gate to perform the OR function. The logic signals are applied to the base and collector of the transistors so they perform both the NOT and the AND function. Besides requiring fewer components, the circuit also has the advantage of not needing a separate transistor voltage supply. Reducing the number of stages also reduces the propagation time by about 4:1.

Truth table for exclusive OR

Inputs		Outputs
A	B	$F = AB' + A'B$
0	0	0
0	1	1
1	0	1
1	1	0

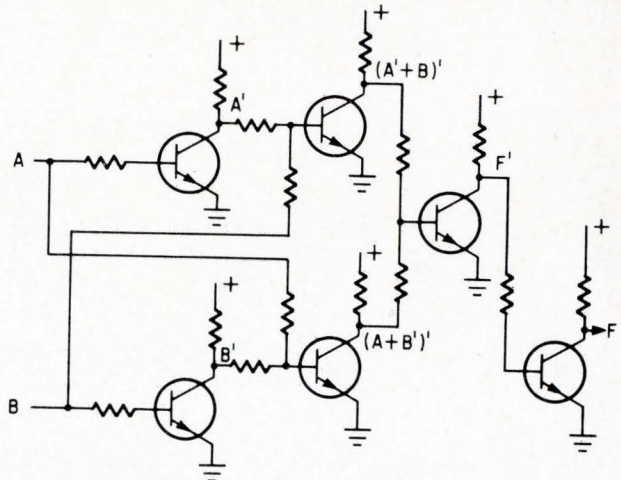

Conventional transistor-resistor NOR circuit to perform logic function $F = [(A' + B)' + (A + B')']'$.

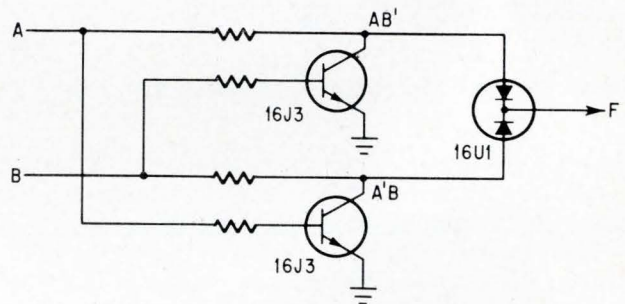

Simplified, faster exclusive OR circuit which has fewer components and operates without voltage supply, achieves output $F = AB' + A'B$.

The circuit can easily be extended to three or more inputs, requiring one transistor and one diode for each additional input.

Reference

1. GE Transistor Manual, Seventh Edition, Chapter 5, p. 123, General Electric Co., Syracuse, N. Y.

Single component changes bandpass into general filter

By Richard Kurzrok, Communications Systems Laboratory, Radio Corp. of America, New York

The general filter network at the right offers both sharp pass and reject behavior at adjacent frequencies. The characteristic is achieved simply by bridging

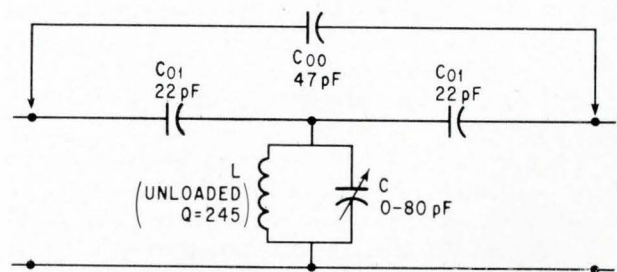

Bandpass filter is converted to general filter by bridging network with C_{00} and retuning with the variable capacitor C.

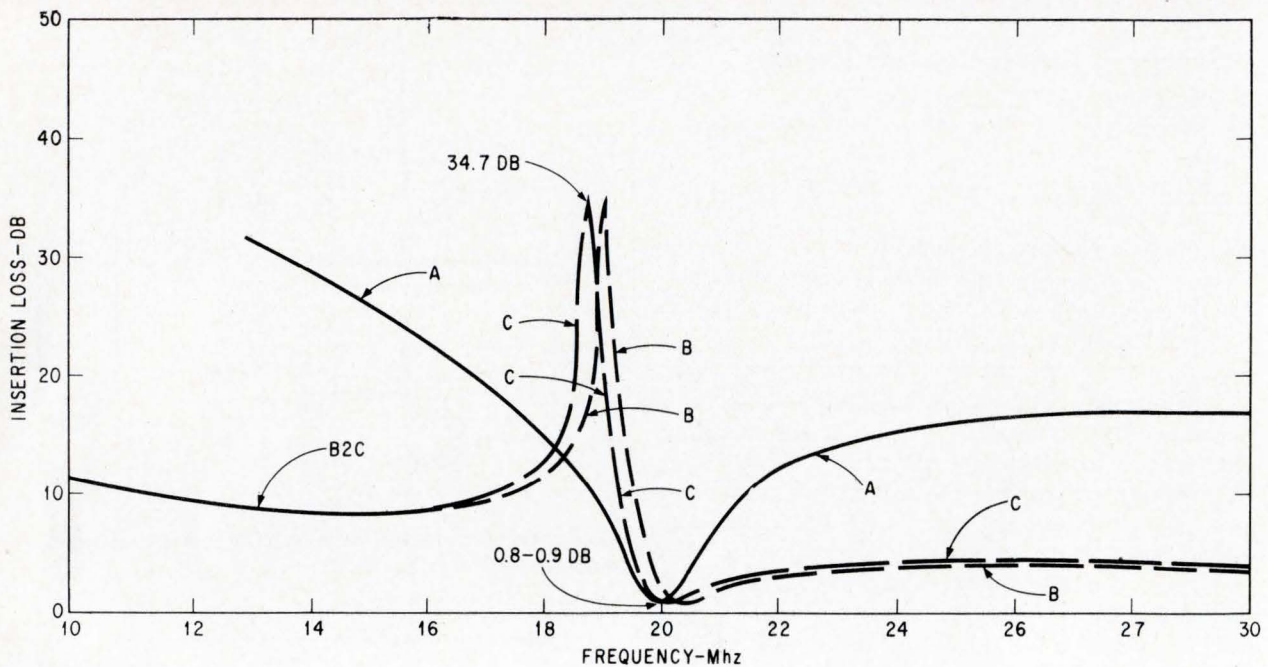

Response curves of bandpass and general filter.

ing a conventional bandpass network with a single capacitor. The circuit is useful in systems requiring asymmetrical frequency selectivity characteristics.

The general filter is formed by bridging the filter with capacitor C_{00} . Equation 1 expresses the normalized rejection frequency, X_p , with respect to the center frequency, f_0 , as obtained from nodal analysis of the circuit

$$X_p = \frac{C_{01}^2 Q_t}{C_t C_{00}} = \frac{f - f_0}{f_{3db}} \quad (1)$$

From this the value of C_{00} is

$$C_{00} = \frac{C_{01}^2 Q_t}{C_t X_p} \quad (2)$$

where

$$Q_t = \frac{f_0}{f_{3DB}} \quad (3)$$

The basic bandpass filter in the diagram is designed for a 20-Mhz center frequency, f_0 , and exhibits a large loaded Q with low insertion loss. It incorporates a commercial air-core inductor wound on $\frac{5}{8}$ " stock, chosen to resonate with C_t , the total circuit capacitance, which is equal to $C_{01} + C = 121$ picofarads.

Using equation 1 with center frequency $f_0 = 20$ Mhz and bandwidth $f_{3DB} = 1$ Mhz, $Q_t = 20$.

The normalized frequency is found to be -1.7 with the peak signal rejection frequency, f , equal to 19.15 Mhz. Negative polarity indicates that the frequency of peak rejection is below the center frequency.

Characteristics of general filter

Characteristics	Bandpass	Band reject
Center frequency.....	20 Mhz	19.15 Mhz
Peak insertion loss.....	0.9 db	34 db
3-db bandwidth.....	1 Mhz	

With all values on the right side of equation 2 known or derived, C_{00} is calculated and found to equal 47 pf. After bridging the original bandpass network with this value of capacitance, the peak rejection frequency measures 19.15 Mhz. The curves above show the response of the original bandpass and the general filter network. To evaluate the quality of band-reject behavior the theoretical insertion loss, I.L., at the frequency of peak rejection, 19.15 Mhz, is derived from a nodal analysis of the general filter circuit:

$$I.L. = 10 \log (1 + X_p^2) + 20 \log \frac{C_{01} Q_{UL}}{C_{00} C_t} \quad (4)$$

With a normalized frequency, $X_p = -1.7$ and the given values of C_{01} , C_{00} , C_t and Q_{UL} , I.L. is calculated to be 32.3 db, very close to the measured value of 34.7 db.

The generalized filter can be used as a selection filter for mixers or frequency converters.

Diode quad modulator suppresses carrier 65 db

By W.H. Ellis

Page Communications Engineers, Inc., Washington

A balanced modulator/demodulator has been developed for an experimental high-capacity communication system. It operates at a carrier frequency of 250 megahertz (megacycles per second), with a modulation rate of 110 megabits per second. The circuit at the right suppresses the carrier voltage to 65 decibels below that of the desired sidebands and suppresses the modulation signal at the output to 39 db below the modulator's input level. The input modulation level is 3 volts and the carrier level is 0.3 volt. At the modulated terminals, the sideband voltages are within 1 db of each other. Insertion loss in the circuit is 6 db.

Hewlett Packard's diode quad, made up of matched hot carrier diodes is the nonlinear element. The manufacturer guarantees greater than 50 db balance for the quad at 70 Mhz. Even at 250 Mhz, the quad was very well balanced. This eliminates bias networks to equalize the diode's operating characteristics.

In general high carrier and modulation suppression is difficult to achieve because extremely accurate amplitude and phase balance in both the carrier and modulation inputs are necessary. For example, to get rejection of 60 db, assuming no phase shift, the amplitudes must be within 0.01% of each other. Assuming identical amplitudes, the phase balance must be better than 0.006° .

Carrier balance is obtained by adjusting the length of the variable line for proper phasing and the attenuator for proper amplitude balance. Because adjustment of the attenuator changes the phasing, attenuator and line adjustment is an iterative process.

The modulation section poses a more difficult problem because it is a broadband circuit. As a result, it is not possible to make fine phase adjustments with tuned elements. Nor is it possible to use delay-line phasing because a delay in the arrival of the balanced components from the transformer is not permissible.

Phase balance in the modulation circuit is achieved by using wideband transformers that are designed to be as well balanced as possible. The modulation transformer has a frequency response from 100 kilohertz to over 100 Mhz. A degree of amplitude balance is obtained by adjusting the center tap on the high frequency potentiometer, R_2 . Using a Ruthroff balanced-to-unbalanced trans-

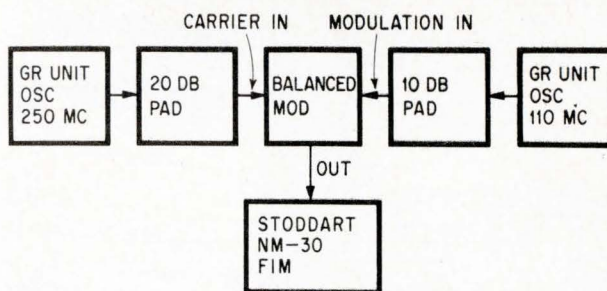

Method for determining suppression uses the type NM-30 field intensity meter as a tuned voltmeter.

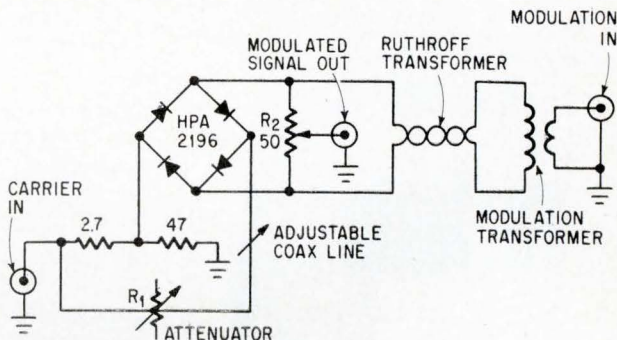

Balanced modulator/demodulator obtains high carrier and modulation suppression by using closely matched diodes and by providing adjustments for amplitude and phase. R_1 adjusts the amplitude while the coaxial line adjusts the phase. Varying R_2 allows a slight amplitude adjustment.

former to drive the modulation transformer increases the modulation rejection.

Carrier suppression is measured with the experimental arrangement shown in the block diagram above. The Stoddart type NM-30 field intensity meter is first tuned to the carrier frequency. Next the attenuator and the coaxial line are adjusted for the minimum carrier level and the reading on the output meter of the field intensity meter is recorded. After the receiver is returned to the sideband frequency, the output meter level is again recorded. The difference in the readings is the carrier suppression with respect to the sidebands.

Modulation suppression is measured in the same way except in this case the suppressed modulation signal is compared to the input modulation signal.

Insertion loss is measured by tuning the receiver to one sideband and recording its level. Next, the input signal is connected directly to the receiver and its level recorded. The difference in reading (corrected 6 db) is the insertion loss. A 6-db correction is necessary because each sideband voltage is theoretically one-half the carrier amplitude.

Sideband levels are measured simply by tuning to each sideband and recording the output level. Work is continuing on improving modulation balance and frequency response, and reducing insertion losses.

3

Tektronix Portable Oscilloscopes

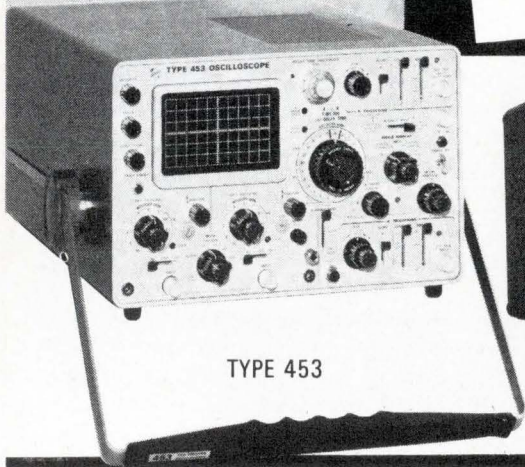

TYPE 453



TYPE 422

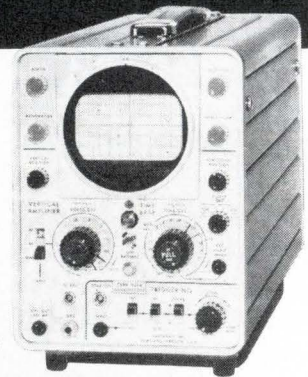

TYPE 321A

CHOOSE ONE
FOR YOUR OWN MEASUREMENT REQUIREMENTS

	<input type="checkbox"/> TYPE 453	<input type="checkbox"/> TYPE 422	<input type="checkbox"/> TYPE 321A
Bandwidth	DC-50 MHz	DC-15 MHz	DC-6 MHz
Deflection Factor	5 mV/div to 10 V/div	10 mV/div to 20 V/div	10 mV/div to 20 V/div
Channels	Dual	Dual	Single
Delay Line	Yes	Yes	No
Sweep Delay	Yes	No	No
Size	Height	7 $\frac{1}{4}$	8 $\frac{1}{4}$
	Width	12 $\frac{1}{2}$	10
	Depth	20 $\frac{1}{2}$	14
Weight (pounds)	28 $\frac{3}{4}$	22	14
Power Requirements	AC	AC, DC or Battery	AC, DC or Battery
Rack Mount Available	Yes (7" Rack Height)	Yes (7" Rack Height)	No
Probes and Accessories Included	Yes	Yes	Yes
Price	\$2050	\$1400 (AC Model) *\$1750 (AC/DC Model)	*\$900

U.S. Sales Prices f.o.b.
Beaverton, Oregon

*without batteries

A TEKTRONIX PORTABLE will fit your specific requirements. Your Tektronix field engineer will be happy to demonstrate any of these oscilloscopes at your location. Just call him, or write Tektronix, Inc., P. O. Box 500, Beaverton, Oregon 97005.

If you are interested in helping advance the state-of-the-art in oscilloscope design, write D. A. Thompson, professional placement manager.

Tektronix, Inc.

Solid state makes debut in big-screen color tv

With all functions transistorized except deflection and rectifier circuits, performance approaches quality of tube set

By Derek Bray

Fairchild Semiconductor division, Fairchild Camera & Instrument Corp., Mountain View, Calif.

The new 90° shadow-mask tube makes possible a more compact color television set. But a smaller cabinet packed with the same number of tubes means increased heat—and degrading of component reliability—a problem which a solid state receiver could overcome.

To demonstrate that an almost completely transistorized large-screen color receiver was well within the state of the art, Fairchild Semiconductor has built a 23-inch receiver that is almost completely solid state. In general, the performance of the semiconductor circuits in the set approaches that of the original vacuum-tube circuits.

A circuit in which tubes are retained is the high-voltage rectifier, which at the moment presents an economic rather than technical barrier to the use of solid state devices. In several large-screen, black and white receivers, the high-voltage rectifier remains the only circuit not transistorized. Tubes also perform this function in the otherwise all solid state Chromatron small-screen color receiver,^{1,2} which Fairchild demonstrated last year.

In the large-screen shadow-mask receiver built by Fairchild Semiconductor, three other circuits are not transistorized. One is the horizontal-scan output stage, which must handle more than 4,000 peak volt-amperes. The best solid-state devices available have ratings of less than 3,000 va. The

vertical-scan output circuit is not transistorized, though it could be by matching the yoke impedance to that of the circuit and by providing a separate low-voltage power supply. A single high-voltage power supply for both horizontal and vertical scanning is preferable.

A conventional vhf tube tuner was used, since a suitable transistor tuner was not available.

With these exceptions the receiver is transistorized, including the high-voltage video-drive circuits, built with newly available 300-volt transistors.

The receiver, which represents only one of many design alternatives, is outlined in the block diagram on the next page. For simplicity, picture-tube details, convergence coils, controls, power supplies and high-voltage circuits are omitted.

Video i-f amplifier

The video intermediate-frequency amplifier schematic, page 100, center, is a three-stage amplifier with forward automatic gain control (agc) on the first stage Q_1 . The first two stages are coupled by a low-Q circuit tuned to 43.75 megahertz (megacycles per second). The low Q ensures minimum variation in the over-all i-f response with forward automatic gain control of the first stage. The bifilar-wound T-trap at the input is tuned to the adjacent channel sound frequency and provides at least 60-db of rejection at 47.25 Mhz. The second stage Q_2 has fixed gain, and is followed by a two-pole coupling network. The two poles, one at 42.5 Mhz with a Q of 40 and the other at 45.75 Mhz with a Q of 26, help shape the desired response curve. High Q's can be used, since neither the second nor third i-f stages have agc, and no pole-shifting occurs. Both Q_1 and Q_2 are low-capacitance transistors, eliminating the need for neutralization while maintaining adequate gain stability margins.

The author

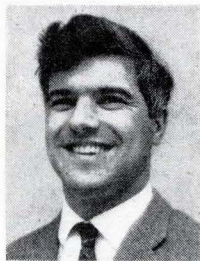

Derek Bray is a professional engineer who has written many papers on the use of semiconductors in radio and television. He heads Fairchild Semiconductor's consumer-applications circuit design group.

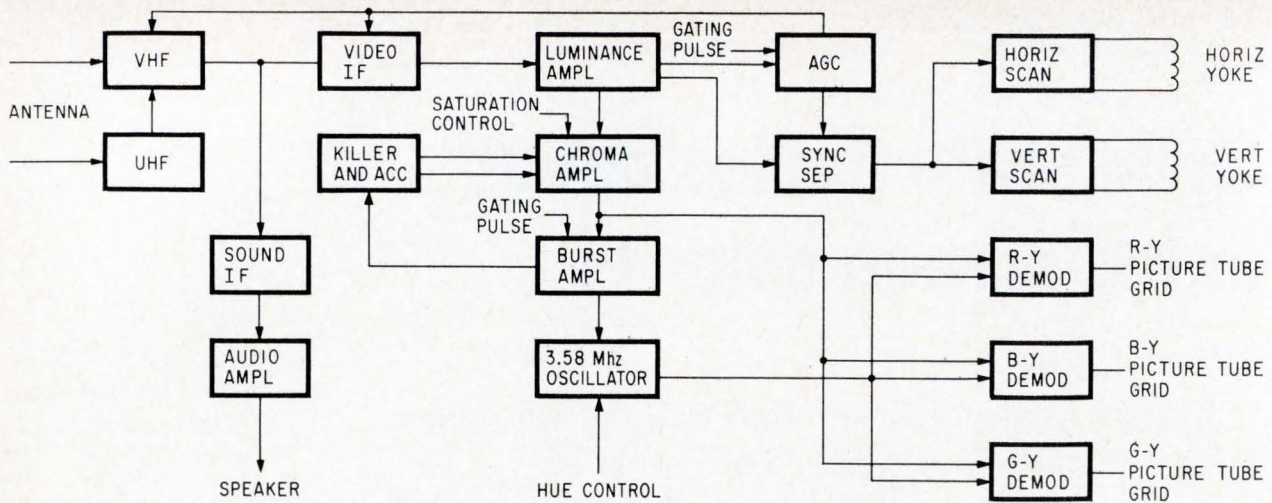

Hybrid receiver block diagram illustrates all but picture-tube details, convergence coils, controls, power supplies and high-voltage circuits. Each block represents at least one circuit.

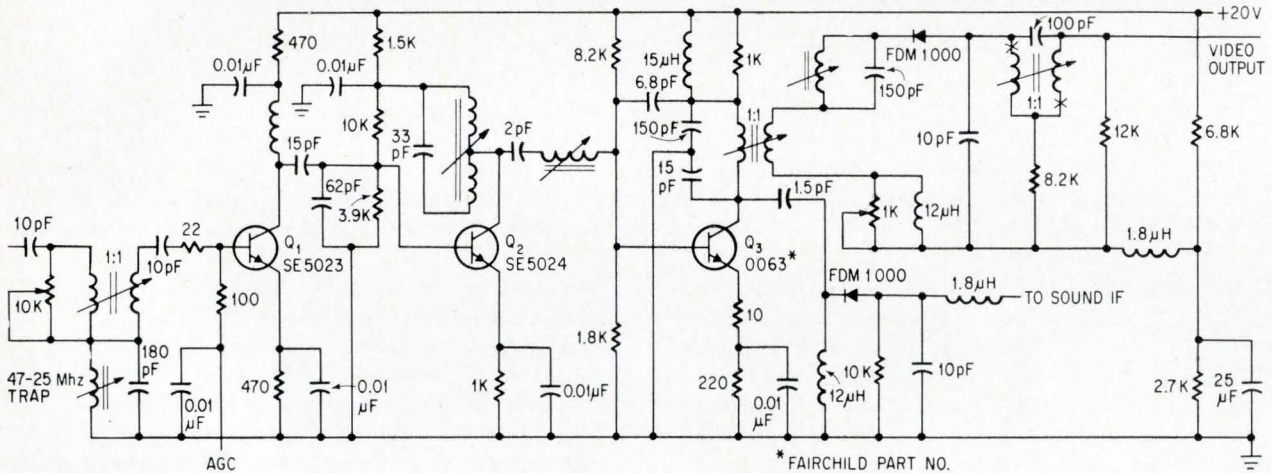

Video i-f amplifier is a three-stage amplifier with forward automatic gain control on the first stage. Third-stage transistor Q_3 was especially designed for this application.

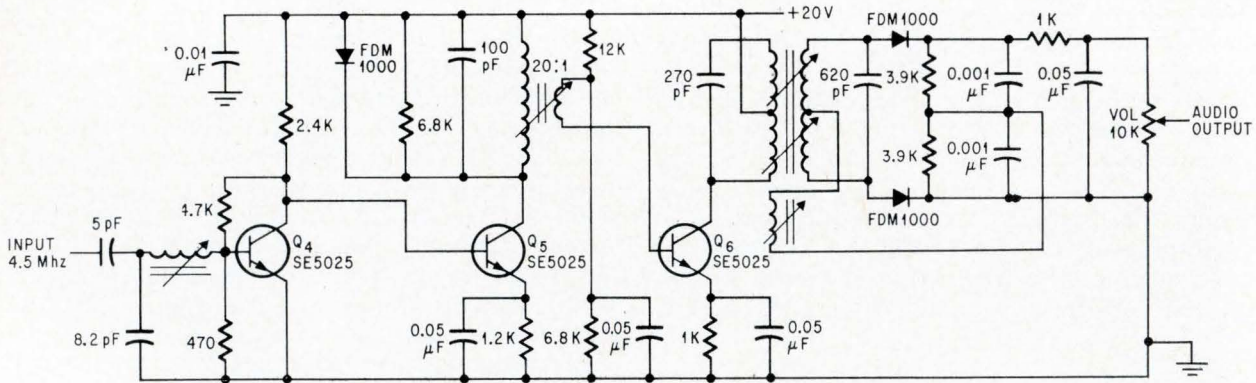

Sound i-f amplifier has three stages: wideband amplification, limiting and output. A Foster-Seeley discriminator gives the most linear possible output.

The third i-f output stage, Q_3 , uses a new transistor designed specifically for the application.⁴ The output transformer and detector circuits feature sound traps at 41.25 Mhz before detection and 4.5 Mhz after detection. Trapping before de-

tection prevents a 900 khz beat between the color subcarrier and the sound carrier. The output is biased at 18 volts and 15 ma to obtain linearity in the output video.

The over-all i-f response, in which the positions

of the dominant frequencies are reversed in relation to the transmitted tv spectrum, is shown below. The response of the chroma bandpass rolls off gradually to produce a 60-db rejection of the cochannel sound carrier. A flat chroma-bandpass response out to 41.65 Mhz with a sharp cutoff at the sound-carrier frequency tends to produce undesirable chroma phase shifts. To compensate for the high-frequency rolloff of the video i-f amplifier, the chroma amplifier has a response which is peaked at the higher frequencies.

Over-all voltage gain is 75 db and power gain is 50 db. Maximum undistorted video output is approximately 6 volts peak to peak and the maximum agc range is 60 db.

Sound i-f amplifier

The 4.5-Mhz output of the sound detector is amplified in the three-stage sound i-f amplifier, page 100, bottom. Its first stage, Q_4 , is wideband with a single-tuned 4.5-Mhz filter at the input. Limiting action is provided in the second stage, Q_5 , by the shunt diode across the tuned circuit and by saturation of output stage Q_6 .

A Foster-Seeley discriminator circuit yields the maximum output linearity. Output audio of 1 volt peak to peak is obtained with a limiting sensitivity of 0.5 millivolt at the input. The amplifier transistors are low-capacitance Fairchild SE 5025's.

Audio amplifier

The audio amplifier on page 103, top, operates class A with a capability of two watts of sine wave power. Class-A rather than class-B operation was chosen to reduce the average supply current variations and thus reduce the decoupling problems normally encountered with class-B high-power stages. Over-all d-c stability is achieved with feedback from the emitter of Q_9 to the base of the input common-emitter stage Q_7 . Emitter-follower Q_8 provides the base current for the output stage.

Over-all a-c feedback from the collector of Q_9 to the emitter of Q_7 controls the voltage gain. The turns ratio of the output transformer must reflect a load impedance of 100 ohms at the collector of Q_9 . Over-all sensitivity of the amplifier is 140 millivolts for the required full two-watt output. This high power level is required for large-screen receivers.

Luminance amplifier

The input stage Q_{10} of the luminance amplifier, page 102, top, is an emitter-follower that presents a low capacitance, high-impedance load to the i-f video detector. The 3-volt input video signal is d-c coupled throughout the amplifier, so that d-c gain is the same as high-frequency gain, and black level in the output is held constant.

Emitter-follower Q_{11} is used as the output driver stage. This provides a low impedance source required for the output stage and simultaneously presents a high-impedance load to the delay line. In this way, the Miller capacitance effect—the

Operating parameters for Fairchild's TO300

V_{ce0}	>	300 volts
h_{FE}	>	30
f_t	=	50 Mhz typ.
C_{cb}	=	10 pF typ ($I_e = 0, V_{CB} = 50$ volts)
θ_{j-c}	=	6°C/watt

increase of collector-base capacitance with voltage gain—is minimized and the delay line can be terminated in an accurately matched impedance to avoid reflections.

Brightness is controlled by shifting the base-bias voltage of Q_{12} . Contrast is controlled by varying the a-c emitter impedance, thus varying the gain of the output stage. Conventional inductive peaking is used to couple the collector of Q_{12} to the picture-tube cathodes.

The transistors used in this amplifier are: the general-purpose, low-capacitance epoxy SE5025 and 2N3638 and a high-voltage, n-p-n, video power transistor TO300 in the output stage. The TO300 was developed by Fairchild primarily for this application. Some typical parameters are given in the table above.

Automatic gain control

The automatic-gain-control circuit, page 102, bottom, is gated by a pulse from a winding on the horizontal flyback transformer. The pulse is applied to the collector of Q_{13} . The additional diode and resistor at the collector of Q_{13} invert the video signal to drive the noise inverter stage for the sync separator.

Automatic-gain-control voltage is generated at the base of Q_{14} across the base coupling capacitor. It is a function of the average current supplied by Q_{13} . The bias on Q_{14} 's emitter and the bias voltage of the video i-f amplifier's detector circuit maintain the video output amplitude at about 3 volts. To set maximum gain on the video i-f amplifier when there is no signal input, a 100-kilohms potentiometer is provided.

The agc applied to the i-f amplifier is a positive voltage taken directly from the emitter of Q_{14} . For the tuner however, the i-f agc voltage must be negative with respect to ground. An additional stage, Q_{15} , inverts the agc for the tuner.

To maintain a high signal-to-noise ratio for weak signals, the tuner agc is delayed with respect to the i-f agc. The delay is determined by the setting of the 10-kilohm potentiometer in Q_{15} 's emitter. The

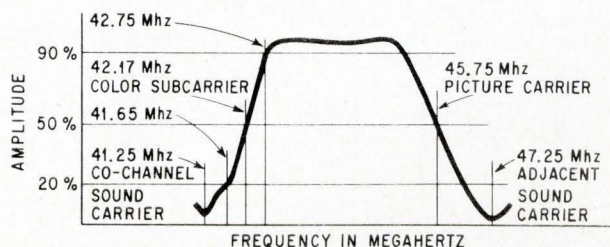

I-f amplifier response rolls off at higher frequencies in the chroma bandpass to reject the sound carrier. The rolloff is compensated for in the chroma amplifier.

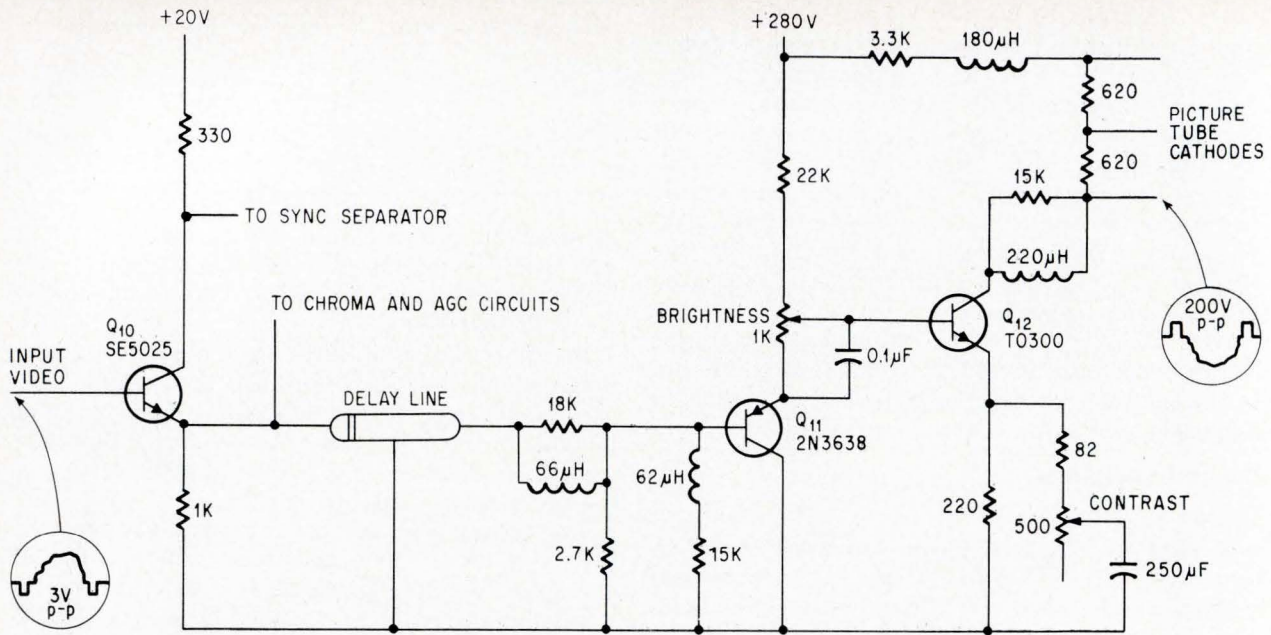

Luminance amplifier with a bandwidth of 2 Mhz provides a 200-volt peak-to-peak output. Parameters for the output transistor, developed primarily for this application, are listed in the table on page 101.

control is set so that the catching diode at the collector of Q_{15} stops conducting when the i-f agc voltage produces a 20-db gain reduction in the i-f amplifier, thus allowing the negative agc voltage for the tuner to be generated.

Sync separator

A 1-volt inverted video signal from the first stage of the luminance video amplifier drives Q_{17} , the sync separator. The sync separator conducts only during the period of the synchronizing pulses. It produces a 50-volt, negative-going pulse at the output as shown in the schematic page 103, center.

Since a noise pulse in the video might cause Q_{17} to conduct, creating a false synchronization pulse, sync-noise cancellation is provided: the inverted video signal—less sync pulses—from the agc circuit is added to the 1-volt video signal at the base of Q_{17} . Q_{16} allows the noise pulse to pass, but not the normal luminance signal. The noise threshold is established by the voltage divider in the emitter

circuit of the noise inverter stage Q_{16} .

Chroma amplifier

The chroma amplifier must have a response that compensates for the high-frequency rolloff in the video i-f amplifier's response. The chroma amplifier page 104, top, fulfills this requirement. It includes an automatic color control, to ensure that the correct color amplitude is always maintained, and a color-killer control which cuts off the chroma amplifier during monochrome operation.

The desired response is obtained with two single-tuned circuits—a series resonant input circuit, tuned to 4.1 Mhz, with a Q of 40; and a parallel resonant circuit at the collector of Q_{13} , tuned to 3.1 Mhz, with a Q of 10.

Automatic color control (acc) is achieved by voltage gain reduction on the first stage. The input to the amplifier can vary over a range of 20-db and only a 3-db variation in the chroma output voltage will be observed. The control signals for

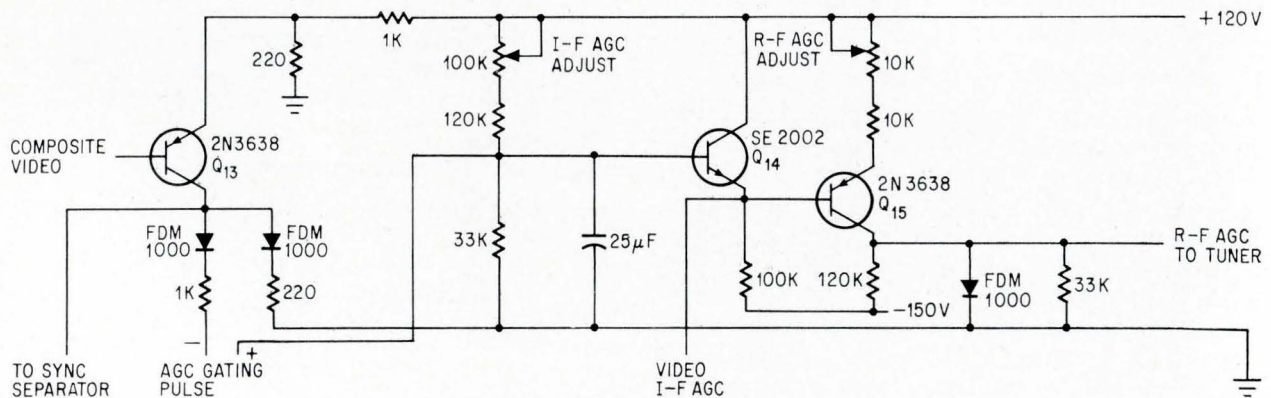

Automatic-gain-control circuit supplies bias voltage to the video i-f amplifier's detector circuit to maintain the video output amplitude at about 3 volts.

acc and for the color killer are generated in another circuit, described later.

Amplifier stage Q_{19} is a wideband amplifier with an output of 10 volts peak-to-peak. For color reception, the external color-killer voltage, biases Q_{19} to operate as a linear amplifier. With black and white transmission, the base-emitter junction of Q_{19} is reverse biased, cutting it off. Color amplitude is controlled by the 500-ohm potentiometer in the base circuit of Q_{19} .

Burst amplifier and 3.58-Mhz oscillator

The compensated chroma signal obtained at the output of Q_{18} also furnishes the burst signal reference for the 3.58-Mhz crystal oscillator, and for the acc and color-killer voltages. The schematic for the burst amplifier and locked oscillator is shown at the bottom of page 103.

The burst amplifier Q_{20} biased by the burst gating pulse from a winding on the horizontal output transformer, conducts only during the horizontal flyback period. The primary of the transformer in the collector circuit of Q_{20} is parallel resonant at 3.58 Mhz. The primary is loosely coupled to the secondary which, in series with the crystal, is resonant at 3.58 Mhz. The 10-volt peak-to-peak burst signal at the collector of Q_{20} generates the d-c control voltage in both the acc and the killer circuits.

The 3.58-Mhz crystal in its series resonant mode provides a common-base configuration for oscillator Q_{21} . Positive feedback for the oscillator is produced by the capacitive divider between collector and emitter. Because of large gain variations found in most transistors, it is necessary to stabilize the oscillator output amplitude with a local age loop. The loop consists of a common-emitter stage Q_{22} , which acts as a detector-amplifier and controls the bias of the oscillator.

The oscillator operates on the injection-lock principle. The tuned circuit in series with the crystal acts as a positive or negative variable reactance, depending on the phase relationship between the injected burst and the oscillator output. The phase stability is satisfactory—a 20° phase shift occurs for a 100-hertz change in burst frequency. The stability is determined, to a large extent, by the Q of the crystal.

The output of the oscillator is coupled to buffer stage Q_{23} , which adds gain and prevents loading of the oscillator while providing the variable phase shift required for hue control. The output transformer is tuned by a variable capacitance consisting of a 150-pF series capacitor, a section of coaxial cable and the hue control potentiometer. The effect of the variable capacitance is to shift the phase of the color subcarrier, changing the display's hue.

The inductance of the transformer primary is tuned so that the hue control provides approximately $\pm 50^\circ$ of phase shift about the resonant 3.58-Mhz burst frequency. From the output transformer, three 3.58-Mhz subcarrier signals are available—one for each color demodulator. At this

point, the subcarriers for the R-Y and B-Y demodulators are in phase with each other and 180° out of phase with the G-Y subcarrier.

Acc and color killer

Since the color burst is the only part of the color signal with a constant amplitude, it is used as an amplitude reference for the entire chroma signal. In this circuit, page 104, center, the amplitude of the color burst is measured, and the automatic-color-control signal is generated. This signal controls the output level of the chroma amplifier.

The burst from the burst amplifier is peak-detected by the shunt diode and filtered to obtain the desired bias voltage for Q_{24} . During color operation, Q_{25} remains cut off and Q_{24} acts as a d-c amplifier to provide the reverse acc voltage for the first chroma amplifier stage. When the burst amplitude falls below a fixed threshold—determined by the divider chain on the base of Q_{25} — Q_{24} cuts off and Q_{25} turns on, cutting off the second chroma amplifier stage.

Color demodulators

The three color demodulators are identical to the B-Y demodulator, page 104, bottom, except that each has a different demodulation phase angle. The chroma buffer stage Q_{28} , shown here, is common to the other demodulators. High-voltage output transistor Q_{27} conducts for only 180° of a complete cycle with its conduction angle centered along the B-Y demodulation axis. In this way, the average collector current of Q_{27} will represent the desired B-Y signal. Any 3.58-Mhz component is filtered out by the 3.58-Mhz parallel-resonant trap in series with the picture tube grid.

To obtain the half-cycle demodulation, the 3.58-Mhz output from the tint control flows either into the base of Q_{26} , or into the FDM 1000 diode on alternate half cycles. Some forward bias is applied to the diode to reduce the crossover voltage needed to switch from diode conduction to transistor conduction. Q_{26} therefore conducts with a 50% duty cycle and causes Q_{27} to conduct similarly.

The conduction current in Q_{27} is determined by the amplitude of the chroma signal from the emitter-follower stage Q_{28} . The stage is biased so that the output collector voltage is 150 volts with no chroma signal. The 5K potentiometer provides amplitude control of the color difference output signal.

References

1. Larry Blaser and Derek Bray, "Chromatron TV Color Processing Semiconductor Circuits," IEEE Transactions on Broadcast & Television Receivers, Vol. BTR-11, No. 2, July 1965.
2. H. Ebenhoech, J.S. MacDougall, T.B. Mills, S.A. Schwartz and H.S. Suzuki, "A Transistorized Chromatron Color Television Receiver," Presented at the National Electronics Conference, Chicago, Oct. 25, 1965.
3. David Bingham, Harry Suzuki and Charles Watson, "A Low Noise AGC Silicon Transistor Useful from LF to UHF," Presented at the National Electronics Conference, Chicago, Oct. 26, 1965.
4. D. Bary and P. Froess, "A Black & White & Color TV Video IF Output Transistor," Presented at the National Electronics Conference, Chicago, Oct. 26, 1965.
5. Leonard Dietch and August Spencer, "A Pierce Type Injection Locked Oscillator," IEEE Transactions on Broadcast and Television Receivers, Vol. BTR-10, No. 2, July 1964.



Data Display Devices from Raytheon

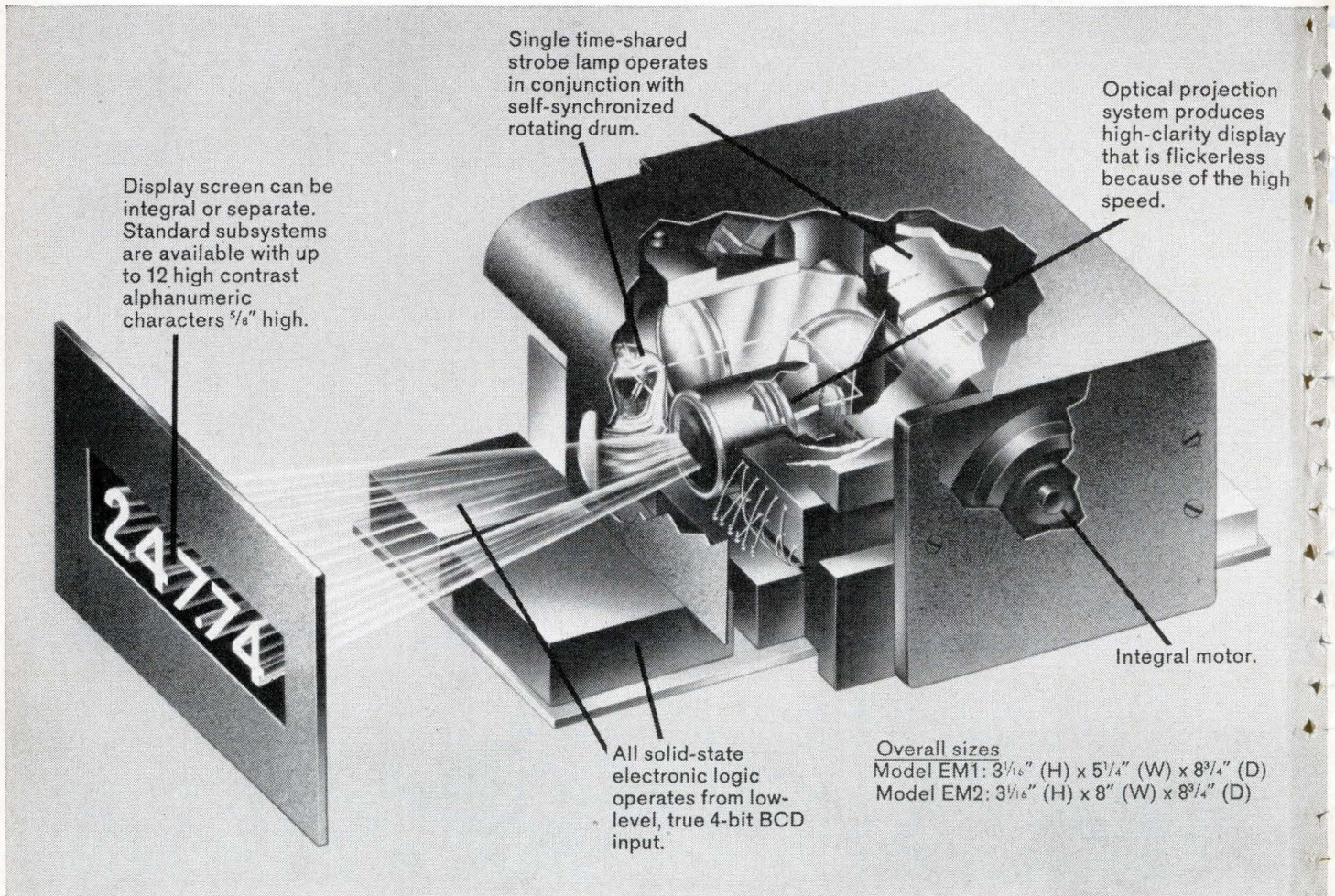

New Raytheon Datastrobe* subsystem offers you reliable readouts at very low cost

The Datastrobe subsystem employs a new concept of data display that offers you precisely registered, reliable readouts and simple, flexible installations—at very low cost.

To produce high-clarity displays of precise registration, the Datastrobe subsystem utilizes (1) a single rotating, self-synchronized drum operating in conjunction with a single time-shared, high-speed strobe lamp, (2) time-shared, all solid-state circuits, and (3) an optical projection system to produce multi-digit, in-line, single-plane displays.

Reduced number of components increases reliability. The time-shar-

ing feature reduces the number of components. Self-contained Datastrobe subsystem wires directly to logic without buffers or drivers. There are no signal amplifiers, mechanical switches or relays. One 6-digit Datastrobe subsystem can replace as many as 66 incandescent bulbs or 6 electromechanical readouts! No complementary input or 8-line to 4-line converter is required.

Self-decoding eliminates wrong readouts. A self-decoding feature incorporated into the Datastrobe subsystem uses direct logic comparison to eliminate erroneous or ambiguous readouts. The conventional white-on-black displays are

bright, steady, and provide high contrast and easy recognition.

Wide range of design options. Datastrobe subsystem display screens can be integral or separate. Standard models are available with up to 12 digits; floating decimal point is optional. Models with more digits and combinations of alphanumeric characters or symbols are available. Additional readout locations are accommodated with simplified wiring. Codes other than BCD, such as 2-out-of-5 code, are available as options.

For a Datastrobe demonstration, contact your Raytheon regional sales office.

Overall sizes
Model EM1: 3¹/₁₆" (H) x 5¹/₄" (W) x 8³/₄" (D)
Model EM2: 3¹/₁₆" (H) x 8" (W) x 8³/₄" (D)

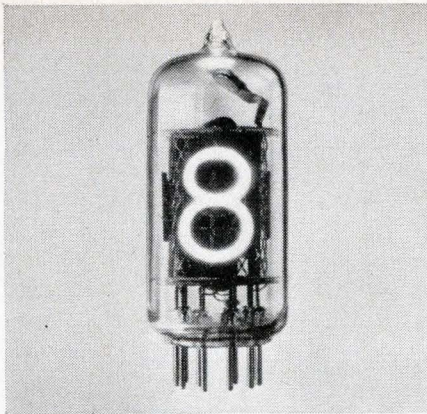

Datavue* Numerical Indicator Tubes in side-view configurations. These side-view in-line visual readout tubes display singly numerals 0 through 9 or pre-selected symbols such as + and - signs. Gas-filled cold-cathode tubes, they employ the principle of the neon lamp. And their life expectancies range upward of 200,000 hours in dynamic operation.

The $\frac{5}{8}$ " high characters are easily read from a distance of thirty feet. They're also easily read in high ambient light—where other displays tend to wash out. Erroneous readouts due to segment failure do **not** occur because the characters are fully formed.

Side-view Datavue tubes cost less because their engineering design provides manufacturing economies. They're also economical to install because the bezel and filter assembly can be eliminated, and their mating 11-pin sockets are less expensive than for end-view types.



Datavue*End-View Tubes. Raytheon end-view Datavue tubes have essentially the same characteristics as side-view types. They fit into standard-size receptacles and conform to EIA ratings. Models include round (CK8421) and rectangular (CK8422). Both models are designed for ultra-long life, with an expectancy of 200,000 hours or more in dynamic operation.

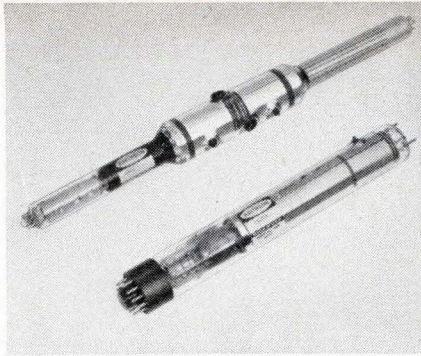

Recording Storage Tubes. Raytheon recording storage tubes are electronic input/output cathode ray storage devices. Applications include radar scan-conversion, slow-down video, signal processing, signal enhancement, time delay, and stop motion. Types include single gun and dual gun—standard and miniature sizes. Shown above are miniature single-gun (CK1516) and dual-gun (CK1519) storage tubes, which provide high resolution and erase capability of 1.2 seconds.

Recording storage tubes feature fast writing, long storage, fast erase and immediate readout capabilities. Information can be written and stored by sequential techniques or by random writing. Complete, partial, or selective erasure is possible. Many other types of recording storage tubes are available, covering a wide range of requirements and applications.

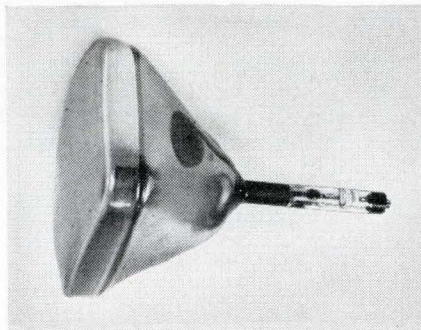

Dataray* Cathode Ray Tubes. Raytheon makes a wide range of industrial CRTs—including special types—in screen sizes from 7" to 24". Electrostatic, magnetic, and combination deflection types are available for writing alphanumeric characters while raster scanning. All standard phosphors are available and specific design requirements can be met. Combination deflection or "diddle plate" types include CK1395P (24" rectangular tube), CK1400P (21" rectangular), and CK1406P (17" rectangular).

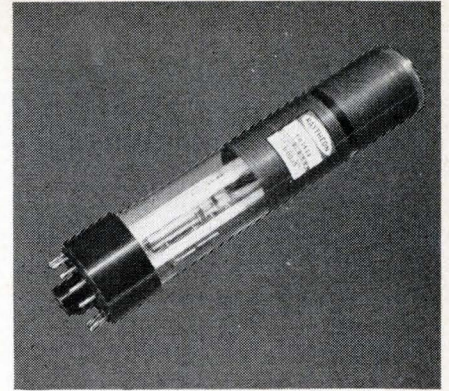

Symbolray* CRT Tube. The new Raytheon CK1414 Symbolray tube provides alphanumeric inputs for computer read-out devices. The tube's 2" target can be scanned electronically to select symbols, characters, and punctuation marks in sequence to form the readout on a display tube. This type has applications with data processing equipment as an economical method for generating characters for hard copy print-out or for cathode ray display. Design with 64 and 100 characters are available.



Send the Reader Service Card for Literature Kit containing these data sheets and catalogs—

- Datastrobe Data Sheet 501
- Datavue Numerical Indicator 502
- Tube Catalog 503
- Cathode Ray Tubes Data Sheets 504
- Recording Storage Tube Brochure 505

Or call your nearest Raytheon regional sales office, or write to *Raytheon Company, Components Division, 141 Spring Street, Lexington, Mass. 02173.*

*Trademark of Raytheon Company



Raytheon Components Division—A single source for Transistors/Diodes/Integrated Circuits/Industrial Tubes/Control Knobs/Panel Hardware/Circuit Modules/Display Devices

CALL YOUR AUTHORIZED
ERIE DISTRIBUTOR FOR...

ERIE SUBMINIATURE MONOBLOC* CAPACITORS

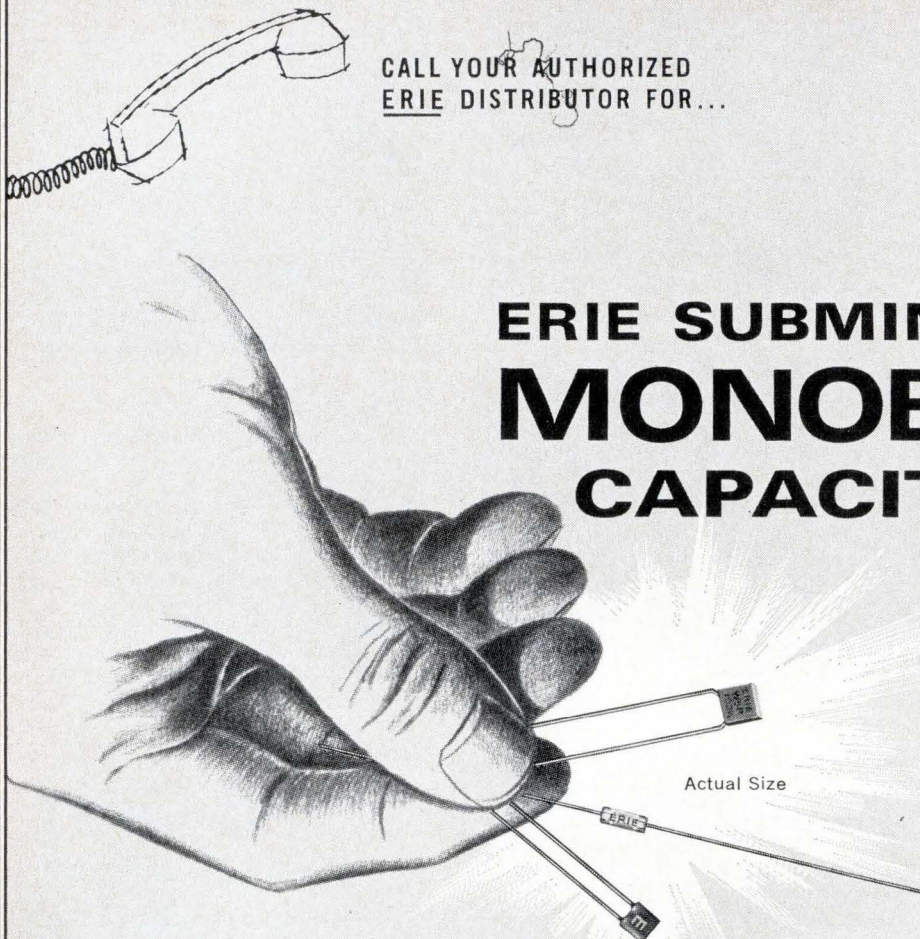

Featuring CAPACITANCE-TO-VOLUME RATIO TO 20 MF/CU. IN.
IN SUBMINIATURE, VERY RELIABLE CERAMIC CAPACITORS

Erie's new in-stock MONOBLOC ceramic film capacitors represent the most significant design advance in more than a decade. Now, Erie's exclusive Monobloc Process, in which very thin films of ceramic can be bonded into solid structures, permits virtually unlimited range of capacitance values, characteristics and sizes to suit exacting design requirements . . . most of which are stocked by your authorized Erie Distributor. Monobloc Capacitors provide volumetric efficiencies from 10 to 100 times the capacitance (to 20 mf/cu. in.) attainable in conventional components of the same size . . . and still meet Established Reliability specifications for Aerospace, Military and Commercial applications.

We stock these subminiature Erie Monobloc Capacitors encapsulated to suit the design engineers' needs; hermetically sealed, glass encased . . . precision molded . . . and phenolic coated as illustrated at right.

Design Advantages . . .

Volumetric efficiency to 20 mf/cu. in. . . Capacitance values from 10 pf. to .5 mfd . . . IR at room temperature—100 K megohms . . . 100 WVDC . . . High Reliability.

* Tradename of Erie Technological Products, Inc.

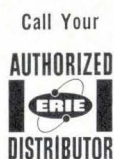

- **CAPACITORS**
Subminiature Monobloc
Tubular and Disc Ceramics
Stand-Off
Feed-Thru
Mica
Film
Solid Tantalum
Trimmers (Ceramic, Glass, Quartz)

- **FILTERS**
Broad Band EMI Filters
EMI Filters (High Freq., Low Pass)
Multi Section Filters
- **SEMICONDUCTORS**
Silicon Diodes (Diffused Junction)
Germanium Diodes
Silicon Rectifiers
Semiconductor Assemblies

Advanced Components Through Increased Volumetric Efficiency

Formerly
Erie Resistor
Corporation

**ERIE MONOBLOC
CAPACITORS
IN-STOCK**
Commercial and Military

- Hermetically Sealed Glass Encased Types
- Precision Molded Types
- Phenolic Coated Types *Weecons*

ERIE
TECHNOLOGICAL
PRODUCTS, INC.



644 West 12th Street
Erie, Pennsylvania

Voltage transients tamed by spark-gap arresters

Semiconductor equipment operating on a-c lines is susceptible to damage from voltage surges. The arrester, a version of the radar transmit-receive switch, can prevent damage to components

By V.W. Vodicka

Applied Magnetics Corp., Santa Barbara, Calif.

A gas-filled surge arrester—a spark gap enclosed in a tube—provides protection against voltage transients, a particular hazard to solid state equipment operating on a-c power lines.

The most familiar types of transients show themselves in those annoying clicks in a high-fidelity phonograph or on the line in a phone conversation. They are abnormally high pulses of short duration on power lines, cables or wiring.

The unpleasant phone click is a minor problem; more serious are errors in data transmission or destruction of expensive solid state equipment produced by undesired voltage pulses. A transient as short as a few microseconds can wreck a power transistor or rectifier.

What causes transients?

A positively charged thundercloud can induce in a long telephone line a negative charge which could become as high as tens of thousands of volts. De-energizing a transformer primary may produce voltage transients eight to ten times the normal peak reverse voltage across silicon rectifiers. Transient amplitudes as high as 50 kilovolts have been measured on a standard 120-volt a-c power line, and as high as 2,000 volts on a 28-volt d-c bus on

an aircraft. Wherever cable or wiring may be susceptible to transients, some form of protection must be used.

The gas-filled surge arrester, really a voltage sensitive switch, is a spark gap enclosed in a gas-filled tube. Gaseous gaps have generally been limited to radar applications as transmit-receive switches. Their reliability, long life and fast action make them especially suitable for protection of solid state equipment.

The gas-filled gap of today is a precision device that consists, generally, of two electrodes spaced by a glass or ceramic insulator to which the electrodes are fused to provide a hermetic seal. A gap spacing of 10 or more mils will result in a 200-volt firing level. Spacing is precisely determined for a given combination of selected gas mixtures, pressures and voltage thresholds. In most cases, the gas pressures are below atmospheric pressure and for low voltage gaps generally in the region of 100 to 200 millimeters of mercury. The electrodes may be of several types of metals; specific applications may require single or composition metals from low melting-point materials up to tungsten. In some applications, the metal is coated with low potential material, such as alkalines, halides or cesium, to improve the characteristics of the gap.

An essential component in a gas-filled gap is radioactive material. For small gap spacings, gaseous radioisotopes such as krypton-85 with predominantly beta particle emission and with radiation levels much less than those found in luminous watch dials have been used. These relatively large particles, having a short path, produce, upon collision, constant ionization between the electrodes. This stabilizes the gap and insures a precise, repetitive and fast triggering response.

The author



Vladimir Weber Vodicka earned his Ph.D. in Prague and came to the U.S. in 1958. Since 1964, he has been technical director of the advanced research and development department of Applied Magnetics

Depending upon gas pressure, type of gas, electrode spacing, electrode material and shape and inclusion of isotopes, the discharge in gaseous gaps will start with the application of a voltage higher than the breakdown threshold. The arc begins with barely measurable currents of a few picoamperes. Then, within the first few nanoseconds, several streamers appear with current flow at several microamperes. Some of the streamers cross the gap, and others form avalanche areas. During the avalanche period, current will increase to several milliamperes and the relatively high gas pressure will support further formation and spread of avalanche regions forming a conductive path within 10 to 50 nanoseconds. By now the current has reached several amperes, the gases have been highly ionized, the temperatures of the gas has increased considerably and the injection of vaporized metal particles from the electrodes begins. The metal vapors increase the conductivity of the region between the electrodes with explosive velocity and, providing that the current is not limited or the energy of the source dissipated, a fully conducting arc will form within 100 to 200 nanoseconds. The current then reaches several hundred amperes and within one or two microseconds many kiloamperes will be conducted through the gap. Since an arc has negative resistance or negative impedance characteristics, it has a tendency to conduct all the current which the source can supply. Although some limiting will occur in any gap, it is interesting to note that two electrodes formed from 16-gauge tungsten wire will reach a limiting point around 80 kiloamperes for a few microseconds before the ends are vaporized. After a time increased gap spacing interrupts the arc.

In certain cases, it is desirable to provide current limiting or external interruption to prevent a destruction of the gap or its conductors.

After ignition, the voltage appearing across the gap drops to a low value of between 10 and 40

volts. Like a fluorescent lamp, the gas continues to conduct after ignition, so long as the source voltage is higher than the arc-extinguishing voltage. It might be assumed that a neon tube could be used as a simple gas-filled protective device, but the low gas pressure, spacing and size of electrodes would limit its usefulness. Most small-size neon tubes are damaged by currents of a few amperes if their duration exceeds several milliseconds.

Carbon-block gaps

For many years the carbon-block spark gap has protected telephone lines, equipment and personnel. It performs reasonably well, provided that sufficient time is devoted to maintain and replace it. Although the cost of a carbon block is low, several factors make its use rather costly. A side effect is excessive noise produced after several firings. Carbon dust coats the holder, resulting in a noisy resistive path across the line.

Instances of wire and cable outages, caused by carbon blocks, have been widespread. The Bell Telephone Co. of Canada conducted a series of tests on carbon blocks under very similar conditions. The average outage on a carrier system protected by carbon blocks was 3,520 hours as opposed to no outages on a system protected by gas-filled gaps.¹

The present-day heavy loading of each circuit—voice or data—carries with it a high price for each minute of outage. The increased use of semi-conductors makes transients a critical and expensive problem.

A well-maintained carbon block with a 3-mil (the smallest safe spacing) gap has a nominal firing voltage of about 600 volts, fluctuating during its lifetime from 400 to more than 1,000 volts. A transient with a steep wavefront may produce a voltage five times or more in excess of the nominal firing voltage.

When testing a carbon block under ideal conditions, it has a reasonably quick and stable response, but the situation quickly changes when it is tested under typical operating conditions. In practice, the carbon block usually encounters a source with a highly variable impedance. The firing becomes erratic because of suddenly applied and reflected loads and ionization of the carbon. A considerable time will elapse before the gap stabilizes and develops a steady arc. Even then, the resulting arc voltage, because of the relatively high impedance of the gap, remains high—in the vicinity of 200 volts. This may not be detrimental to equipment using vacuum tubes, but it is catastrophic for transistorized equipment. The damage may occur not only in the section near the arc, but also, due to ground and current loops, in other sections of the system, including the power supplies.

The curves shown to the left compare the carbon block and the gas-filled gap units with respect to ionization time as a function of the voltage across the gap. They show that the voltage in excess of the firing voltage (overshoot), for the same pulse, is

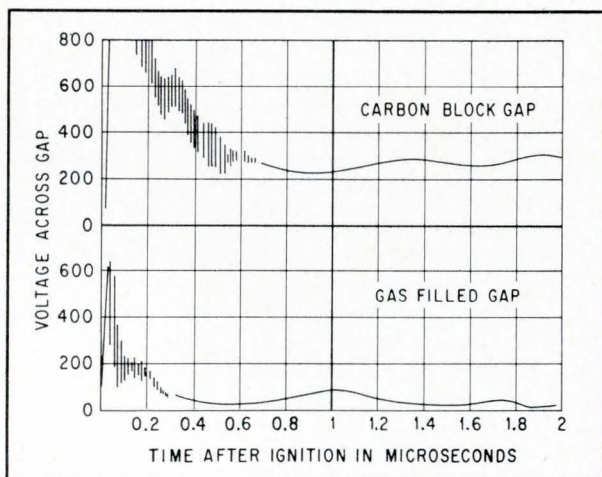

Comparison of the carbon block arrester with the gas-filled gap arrester shows resistance across the gas-filled gap decreases faster and to a lower level than resistance across the carbon block.

more than double for the carbon block.

The carbon block needs three to five times more time to reach a steady ionization level. The final voltage across the carbon gap is approximately 200 v as against 40 v across the gas-filled gap. To improve the overshoot characteristics of the carbon block, a reduction of the spacing from 3 mils to 1 or 2 mils is possible. However, reliability would be seriously reduced after the first firing.

Gas-filled gaps

In the gas-filled gap, reliability is improved by having a large gap spacing to avoid possible short circuits during maximum discharge. A gas-filled gap, operating at approximately 230 v, will have a spacing of 10 mils or more; a gap operating at the voltage of a standard 3-mil carbon gap will have spacing of 30 mils or more. The carbon block exhibits considerable variation in its firing voltage, plus or minus 100%, due mainly to previous firings, air pressure and humidity. The gas-filled gap maintains its firing level to within plus or minus 15% during its lifetime.

What is the lifetime of a gas-filled gap? When used within specified limits, and depending upon variables of the average transients, the gas-filled gap should survive more than 10,000 transients. One test was conducted in which the gap discharged a capacitor at a rate of 1 pulse per second. The gap remained in useful condition after more than 500,000 pulses. Destruction tests have shown gas-filled gaps to have excellent overload capability. The damage criteria was established at a point at which the firing level deviated more than 30% from the original firing voltage. In some cases, this point was obtained by simultaneously exceeding the current limit by 4 to 5 times and the duration by 40 to 50 times. The gap will usually withstand 4 to 5 high-energy pulses.

Some representative gas-filled isotope-prompted gaps, shown at the right, have their current/time parameters adjusted for the shapes of the transients expected in specific applications.

Manufacturers

The button type Siemens gap is about $\frac{3}{8}$ inch in diameter and ratings are available in voltage gradients from 230 to 800 v. This miniature gap has the capability of conducting 5 kiloamperes for 10 to 20 microseconds. It can replace standard carbon blocks on telephone lines. As a protective device for power supplies, connected across a 120-volt a-c power line, a current-limiting resistor, reactor, fuse or an automatic reset breaker should be provided in addition to the gap. To determine the proper gap, the expected level and frequency of transients can be established by a transient detector-recorder. A typical recorder is shown on the following page. In some cases, miniature gaps can be used in applications covering frequency ranges up to 500 megahertz (megacycles per second).

A primary gap (SG 1360) made by Sylvania Electric Products, Inc., a subsidiary of the General

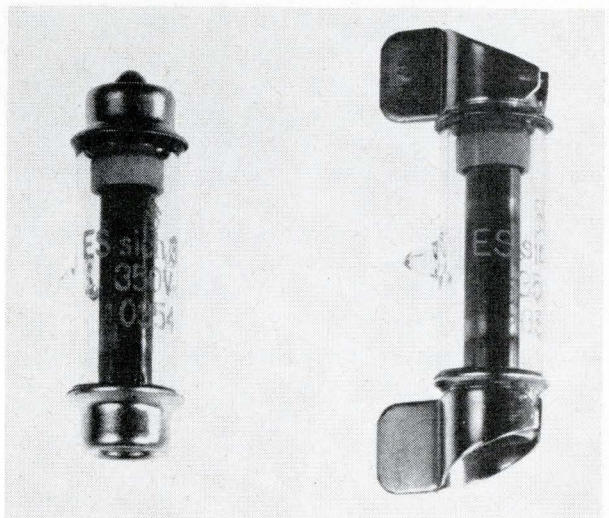
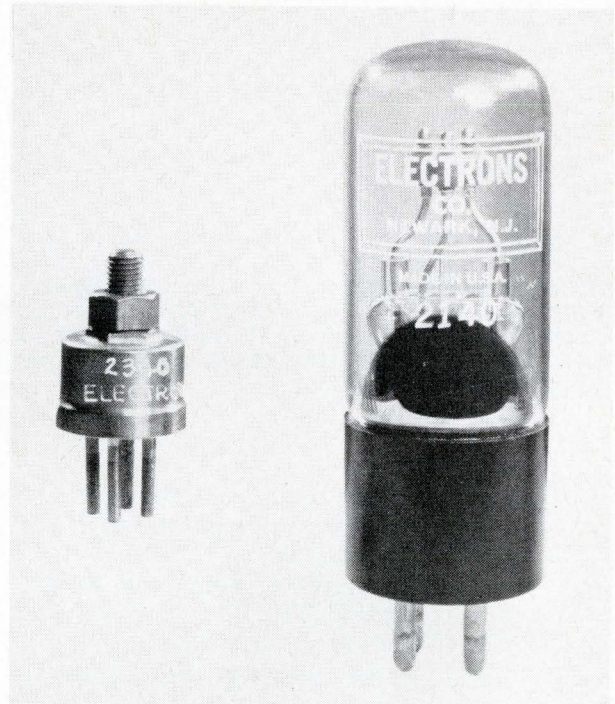
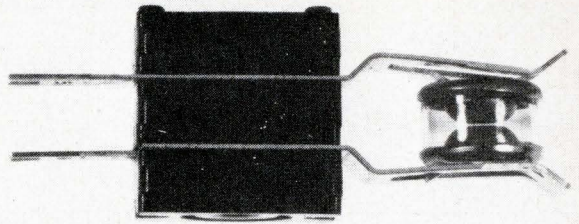

Miniature gas-filled spark gap, top, has a current carrying capacity of 5,000 amperes and a capacitance of 2 picofarads, making it suitable for high-frequency applications. Multigap arresters, middle, have a third electrode which is connected to ground. A surge on either wire of a two-wire circuit will trigger both gaps so that both lines are grounded. Unit at bottom is 2 inches long and has a rated d-c sparkover of 350 volts and sparkover surge voltage of 2 kilovolts.

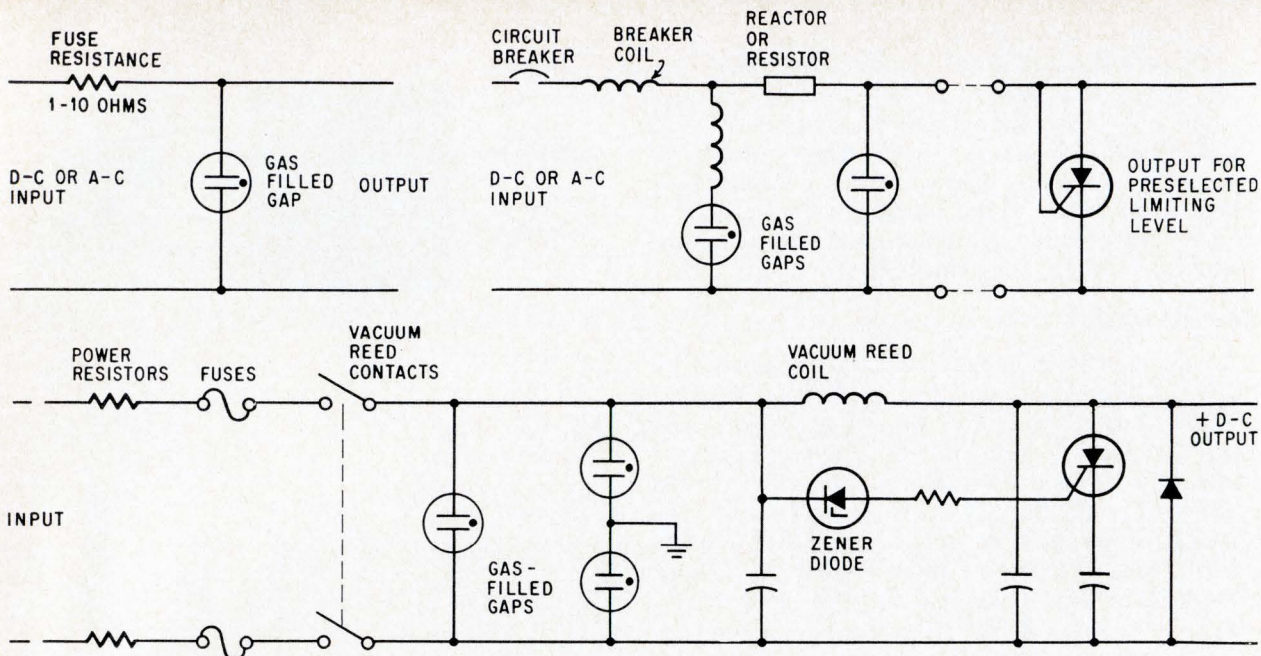

Gas-filled surge arrester, top left, simply protects against peaks of transients. A more sophisticated application, top right, uses a gas-filled gap in conjunction with a circuit breaker to extinguish the arc across the gap in the event the voltage doesn't drop below the sustaining voltage. Complete protection against very high voltages, bottom, can be obtained by using a gap to protect zener diodes and silicon-controlled rectifiers which suppress the lower voltage transients.

Telephone & Electronics Corp., is designed to protect against transients of very high energy levels, such as lightning might cause.

It can be used on telephone, power and antenna feeder lines and coaxial cables. Breakdown voltages range from 300 to 1,100 volts, and it can be used up to 30 Mhz. It will discharge 50 kilovolts at 12.5 kilojoules or 50 kilojoules if the current does not exceed 2,000 amperes. The mechanical design permits use in applications where high pressures and acceleration may be encountered.

Signalite Inc. spark gaps are available in a two-electrode structure with a wide variety of voltage breakdown ratings and a rated discharge capability up to several hundred joules. In the three-electrode structure, one electrode acts as a trigger. Triggered gaps usually have a ceramic body as a spacer-insulator. They cover a voltage range from 1,000 to 50,000 volts and can handle energies from 4 to 8,000 joules.

Multigap surge arresters made by the Electronics Co., a subsidiary of the General Signal Corp., are designed to protect telephone pairs and telephone repeaters as well as power circuits and antenna feeders. The voltage breakdown ranges from 300 to 500 volts. Of particular interest is the relatively high current capability in the 2-second to 10-minute range (20 to 50 amperes for 2 seconds and 7 amperes for 10 minutes). The gaps are rated at 300 joules. The single gaps have voltage ranges of 150 volts to 750 volts with a 300-joule rating and frequency range to 30 Mhz.

Triggered gaps made by Edgerton, Germeshausen and Grier, Inc., are designed to operate at high

voltages—1 to 25 kilovolts. For most applications, a short delay time is characteristic of these gaps—(20 nanoseconds and up) while energy ratings up to 4,000 joules are available.

Amperex Electronic Corp. gaps have been used extensively in lower voltage applications. Breakdown voltages of 80 volts d-c are available and extend to 750-volt d-c level. The energy levels are rated conservatively at 10 joules with lifetimes exceeding 50,000 discharges. The 750-volt type permits a 500-joule discharge. The very low voltage breakdown is suitable for protecting transistorized equipment, without a secondary protector such as a zener diode or a silicon controlled rectifier.

Raytheon-Elsi S.P.A. of Palermo, Italy, has several types of gaps and multigaps designed to protect telephone lines and equipment. Breakdown voltages start at 150 volts rms; four active electrodes plus one ground electrode are available per unit. A 5-second, 120-ampere rating is available in the SCA 120 A types. High-voltage types with breakdown levels up to 17.5 kv are available.

Many applications

At present, several hundred million carbon gaps are used to protect the communication equipment in telephone exchanges, repeaters, in homes of phone users, and on telephone poles.

Growing gaps

The market for gaps, at present, is estimated at nearly \$1 million a year. With the coming of solid state telephone switching centers and fail-safe gaps, it is possible to anticipate a need for 7 to

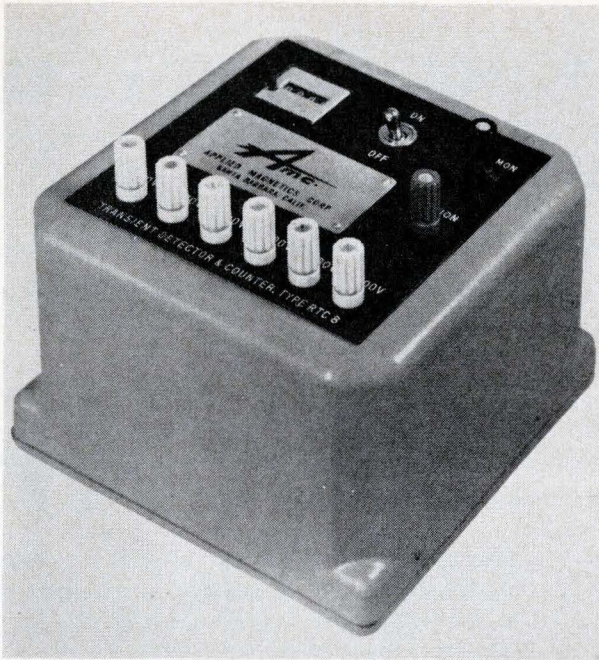

Detector-recorder is used for determining the transient level and frequency of occurrence. The data is needed in selecting the proper gap.

10 million units a year. The replacement market (one-fourth of the existing installations each year) will represent more than 25 million units annually by 1970.

Savings to operating companies and other users of gaseous gaps are difficult to express in dollars, but a rough estimate based on replacement costs, outage time and cost of damaged equipment is about \$4 to \$5 saved for each dollar invested.

The cost of gaps ranges from about 60 cents to several hundred dollars for special high-power units capable of absorbing several direct lightning hits without damage.

The simplest application uses the gas-filled gap to cut down the peaks of transients occurring on a-c or d-c power lines and supplies. The gap is placed across the power-input terminals, preferably in series with a fuse or a wire-wound resistor of 1 to 10 ohms, as shown in the drawing on the facing page. The gas-filled gap can reduce also the transients occurring on telephone lines, open wires or cables.

Gas-filled gaps can also be used to protect thyristors and modulator components; also pulse transformers, meter circuits and high-powered klystrons. They can be used in relaxation oscillators to act as pulse generators or to raise spark plug firing voltages in leaky ignition systems.

Gas-filled gaps will usually keep on conducting when connected across an a-c or d-c power line or supply unless the power is interrupted by a breaker, or fuse or unless the power-supply voltage drops to less than the minimum specified sustaining voltage for the gap. In such a case, automatic reset breakers, vacuum switches or high voltage reed relays may be used with the gaps to interrupt the circuit,

as indicated on the facing page.

Where the breakdown voltage of a gas-filled gap is too high to fully protect the equipment, a second or third stage can be added to reduce transients to acceptable levels. Silicon controlled rectifiers, zener diodes, selenium suppressors, voltage-dependent resistors and positive-temperature resistors are generally used in such applications, as shown on page 112.

Several gas-filled gaps can be used in high-frequency applications. In antenna input or output, where static discharges and over-illumination is encountered, the small-sized gaps followed by a second stage provide excellent protection. On transmit-receive switches, transmitting antennas, or antennas which may be exposed to direct lightning strikes, a high-power gas-filled gap affords great protection. The high-power gap is sometimes followed by a stage using a gap with a much lower breakdown voltage.

Work on gaps capable of operating in picoseconds is proceeding at Stanford University, and currents of several thousand amperes at kilovolt levels have been repetitively switched in a fraction of a nanosecond. This brings about a possibility of a solid state high power radar. Other work is taking place on multigap devices using metal deposition techniques which the devices may protect 12 or more circuits. Pairs of diodes or resistors may be deposited in the same case. The application is intended for solid-state telephone switchboards and other low-voltage applications. A similar device where the deposited layer has a controlled ablation rate during a transient period will not only protect, but will act as a fuse, if the duration of the transient is in excess of the device rating.

Other devices, operating at voltages as low as 40 volts, use a metalized paper approach, similar to self-restoring metalized paper capacitors, to reduce breakdown levels and produce a fail-safe gap. Experimental units are filled with argon/nitrogen gas mixtures. In the case of a gas leak, the firing level increases by 20 to 50%.

References

1. J.E.R. Lemieux, "Field Experience with Gas-Filled Protectors on Communication Lines," IEEE Communication and Electronics, July, 1963.

Bibliography

- G. Ecker, "Stabilization of the Electric Arc at the Anode and the Cathode," Zeitschrift fuer Physik, 136:1-16, 1953.
- J.M. Meek and J.D. Craggs, "Electrical Breakdown of Gases," Oxford University Press, London, 1953.
- "Lightning Protection for a Buried Telephone Cable," LTRI Report 378, Dec., 1960.
- A.H. Sharbaugh and J.C. Devins, "The Fundamental Nature of Electrical Breakdown (Gases)," Electro-Technology, Feb., 1961.
- D.A. Klopfer and G.S. D'Arcy, "Rating and Testing Selenium Surge Suppressors," IEEE Paper No. CP 63-279.
- A.L. Ward, "Effects of Space Charge in Cold Cathode Gas Discharges," Diamond Ord. Fuze Laboratories, TN 3-1909, TR-529.
- V.W. Vodicka, "Electronic Transient Suppressors," IEEE Electronic Components and Material, IEEE Intern. Conv., March, 1964.

Lambda offers the BROADEST LINE of all silicon modular power supplies

Up to 150 volts / Up to 90 amps

7 power packages

Prices starting at

\$69⁰⁰

Features and Data Meet Mil. Environment Specs. RFI—MIL-I-16910: Vibration: MIL-T-4807A: Shock: MIL-E-4970A • Proc. 1 & 2: Humidity: MIL-STD-810 • Meth. 507: Temp. Shock: MIL-E-5272C • (ASG) Proc. 1: Altitude: MIL-E-4970A • (ASG) Proc. 1: Marking: MIL-STD-130: Quality: MIL-Q-9858: Fungus Proofing (optional) all models available with MIL-V-173 varnish for all nutrient components.

Convection cooled—no heat sinking or forced air required

Wide input voltage and frequency range—105-132 VAC, (200-250 VAC, optional at no extra charge) 45-440 cps

Regulation (line) 0.05% plus 4MV (load) 0.03% plus 3MV: **Ripple and Noise**—1 MV rms, 3MV p to p

Overvoltage protection available for all models up to 70 VDC

High Performance Option—All models available with these specifications for \$25.00 extra: **Line regulation**— .01% + 1MV; **Load regulation**— .02% + 2MV; **Ripple and Noise**— $\frac{1}{2}$ MV rms; $1\frac{1}{2}$ MV p to p; **Temp. Coef.**— .01% °C

RACK ADAPTERS

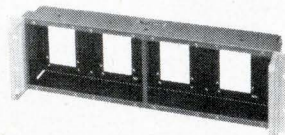

LRA-3— $5\frac{1}{4}$ " height by $2\frac{7}{16}$ " depth. Mounts up to 4 A, B or C package sizes; 2 D or 2 E package sizes; or 2 A, B or C and 1 D or 1 E package sizes. Price \$35.00

LRA-4— $3\frac{1}{2}$ " height by 14" depth. (For use with chassis slides) Mounts up to 4 A package sizes; 3 B or C package sizes; or 2 A and 1 B or C package sizes. Price \$55.00

LRA-6— $5\frac{1}{4}$ " height by 14" depth. (For use with chassis slides) Mounts up to 4 A, B or C package sizes; 2 D or 2 E package sizes; or 2 A, B or C and 1 D or 1 E package sizes. Price \$60.00

LRA-5— $3\frac{1}{2}$ " height by $2\frac{7}{16}$ " depth. Mounts up to 4 A package sizes; 3 B or C package sizes; or 2 A and 1 B or C package sizes. Price \$35.00

Send for complete information on LM series and accessories.



LAMBDA

ELECTRONICS CORP.
515 BROAD HOLLOW ROAD • MELVILLE, L. I., NEW YORK • 516 MYRTLE 4-4200

A **Veeco** SUBSIDIARY

PATENTS
PENDING

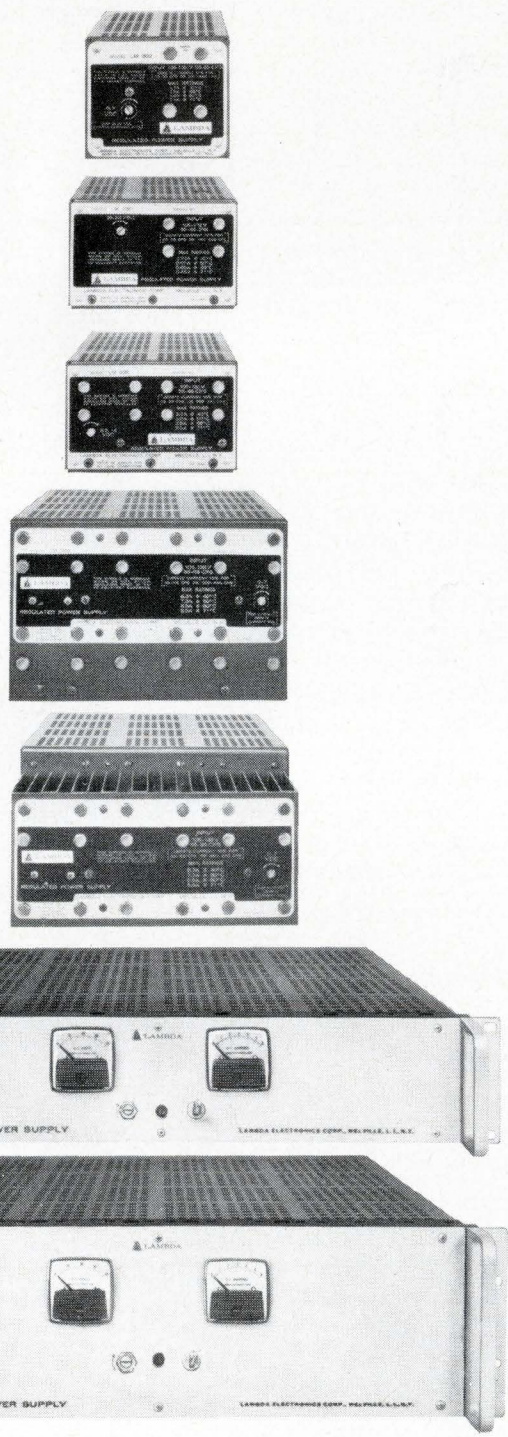

LAMBDA LM Series

Package A 3 1/16" x 3 3/4" x 6 1/2"

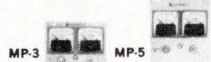

Accessory Metered Panels: \$40.00

Model	ADJ. VOLT. RANGE VDC	I MAX. AMPS				Price
		40°C	50°C	60°C	71°C	
LM 251	0-7	0.35	0.31	0.29	0.27	\$ 69
LM 201	0-7	0.85	0.75	0.70	0.55	79
LM 202	0-7	1.7	1.5	1.4	1.1	89
LM 252	0-7	2.0	1.8	1.4	1.1	99
LM 253	0-10	0.31	0.27	0.26	0.25	69
LM 254	0-10	0.65	0.55	0.50	0.45	79
LM 255	0-10	1.20	1.10	1.00	0.75	89
LM 256	0-10	1.5	1.4	1.2	0.90	99

Ordering Information

METERS—3 1/2" Metered panel MP-3 is used with rack adapters LRA-4, LRA-5 and packages A, B and C.

5 1/4" Metered panel MP-5 is used with rack adapters LRA-6, LRA-3 and packages A, B, C, D and E.

To order these accessory metered panels, specify panel number which MUST BE FOLLOWED BY the MODEL NUMBER of the power supply with which it will be used.

Note—F and G LM Packages are full rack power supplies available metered or non-metered. For metered models, add suffix M to the Model No. and \$30 to the non-metered price.

Model	ADJ. VOLT. RANGE VDC	I MAX. AMPS				Price
		40°C	50°C	60°C	71°C	
LM 257	0-14	0.27	0.24	0.23	0.22	69
LM 203	0-14	0.45	0.40	0.38	0.28	79
LM 204	0-14	0.90	0.80	0.75	0.55	89
LM 258	0-14	1.2	1.1	1.0	0.80	99
LM 259	0-24	0.18	0.16	0.15	0.14	69
LM 260	0-24	0.35	0.30	0.25	0.20	79
LM 261	0-24	0.70	0.65	0.60	0.45	89
LM 262	0-24	0.80	0.75	0.70	0.60	99

Model	ADJ. VOLT. RANGE VDC	I MAX. AMPS				Price
		40°C	50°C	60°C	71°C	
LM 263	0-32	0.14	0.12	0.11	0.10	69
LM 205	0-32	0.25	0.23	0.20	0.15	79
LM 206	0-32	0.50	0.45	0.40	0.30	89
LM 264	0-32	0.66	0.60	0.50	0.32	99
LM 265	0-60	0.08	0.07	0.07	0.06	79
LM 207	0-60	0.13	0.12	0.11	0.08	89
LM 208	0-60	0.25	0.23	0.21	0.16	99
LM 266	0-60	0.35	0.31	0.28	0.25	109

Package B 3 1/16" x 4 1/16" x 6 1/2"

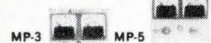

Accessory Metered Panels: \$40.00

Model	ADJ. VOLT. RANGE VDC	I MAX. AMPS				Price
		40°C	50°C	60°C	71°C	
LM 217	8.5-14	2.1	1.9	1.7	1.3	\$119
LM 218	13-23	1.5	1.3	1.2	1.0	119
LM 219	22-32	1.2	1.1	1.0	0.80	119
LM 220	30-60	0.70	0.65	0.60	0.45	129
LM B2	2 ±5%	3.8	3.3	2.6	1.6	119
LM B3	3 ±5%	3.8	3.3	2.6	1.6	119
LM B3P3	3.3±5%	3.8	3.3	2.6	1.6	119
LM B3P6	3.6±5%	3.8	3.3	2.6	1.6	119
LM B4	4 ±5%	3.8	3.3	2.6	1.6	119
LM B4P5	4.5±5%	3.7	3.2	2.5	1.5	119
LM B5	5 ±5%	3.7	3.2	2.5	1.5	119
LM B6	6 ±5%	3.2	2.9	2.4	1.4	119
LM B8	8 ±5%	3.2	2.9	2.4	1.4	119
LM B9	9 ±5%	3.0	2.8	2.4	1.4	119
LM B10	10 ±5%	2.7	2.5	2.2	1.4	119
LM B12	12 ±5%	2.5	2.3	2.1	1.3	119
LM B15	15 ±5%	2.2	2.0	1.8	1.3	119
LM B18	18 ±5%	2.0	1.8	1.7	1.3	119
LM B20	20 ±5%	1.8	1.6	1.5	1.2	119
LM B24	24 ±5%	1.4	1.3	1.2	1.1	119
LM B28	28 ±5%	1.3	1.2	1.1	1.0	119
LM B36	36 ±5%	1.1	1.0	0.90	0.85	129
LM B48	48 ±5%	0.9	0.85	0.80	0.75	129
LM B60	60 ±5%	0.7	0.65	0.60	0.54	129
LM B100	100 ±5%	0.37	0.34	0.30	0.28	139
LM B120	120 ±5%	0.30	0.28	0.25	0.23	139
LM B150	150 ±5%	0.25	0.23	0.20	0.19	149

Package C 3 1/16" x 4 1/16" x 9 3/4"

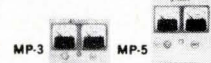

Accessory Metered Panels: \$40.00

Model	ADJ. VOLT. RANGE VDC	I MAX. AMPS				Price
		40°C	50°C	60°C	71°C	
LM 225	0-7	4.0	3.6	3.0	2.4	\$139
LM 226	8.5-14	3.3	3.0	2.5	2.0	139
LM 227	13-23	2.3	2.1	1.7	1.4	139
LM 228	22-32	2.0	1.8	1.5	1.2	139
LM 229	30-60	1.1	1.0	0.80	0.60	149
LM C2	2 ±5%	5.4	4.7	3.7	2.6	139
LM C3	3 ±5%	5.3	4.6	3.7	2.5	139
LM C3P3	3.3±5%	5.2	4.5	3.6	2.5	139
LM C3P6	3.6±5%	5.2	4.5	3.6	2.5	139
LM C4	4 ±5%	5.2	4.5	3.6	2.5	139
LM C4P5	4.5±5%	5.1	4.4	3.5	2.4	139
LM C5	5 ±5%	5.1	4.3	3.4	2.4	139
LM C6	6 ±5%	4.8	4.1	3.3	2.4	139
LM C8	8 ±5%	4.6	3.9	3.2	2.1	139
LM C9	9 ±5%	4.5	3.8	3.1	2.1	139
LM C10	10 ±5%	4.2	3.6	3.0	2.0	139
LM C12	12 ±5%	4.0	3.5	2.9	1.9	139
LM C15	15 ±5%	3.5	3.2	2.8	1.9	139
LM C18	18 ±5%	3.2	3.0	2.7	1.9	139
LM C20	20 ±5%	3.1	2.9	2.6	1.8	139
LM C24	24 ±5%	2.5	2.4	2.2	1.5	139
LM C28	28 ±5%	2.3	2.1	2.0	1.4	139
LM C36	36 ±5%	2.0	1.8	1.7	1.3	149
LM C48	48 ±5%	1.6	1.4	1.3	1.0	149
LM C60	60 ±5%	1.1	1.0	0.90	0.80	149
LM C100	100 ±5%	0.55	0.51	0.47	0.42	164
LM C120	120 ±5%	0.49	0.45	0.42	0.38	164
LM C150	150 ±5%	0.39	0.36	0.33	0.30	169

Package D 4 1/16" x 7 1/2" x 9 3/4"

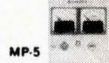

Accessory Metered Panels: \$40.00

Model	ADJ. VOLT. RANGE VDC	I MAX. AMPS				Price
		40°C	50°C	60°C	71°C	
LM 234	0-7	8.3	7.3	6.5	5.5	\$199
LM 235	8.5-14	7.7	6.8	6.0	4.8	199
LM 236	13-23	5.8	5.1	4.5	3.6	209
LM 237	22-32	5.0	4.4	3.9	3.1	219
LM 238	30-60	2.6	2.3	2.0	1.6	239
LM D2	2 ±5%	13.1	11.3	9.2	6.2	199
LM D3	3 ±5%	13.1	11.3	9.2	6.2	199
LM D3P3	3.3±5%	13.1	11.3	9.2	6.2	199
LM D3P6	3.6±5%	13.1	11.3	9.2	6.2	199
LM D4	4 ±5%	13.1	11.3	9.2	6.2	199
LM D4P5	4.5±5%	13.1	11.3	9.2	6.2	199
LM D5	5 ±5%	12.6	10.8	9.2	6.1	199
LM D6	6 ±5%	12.4	10.6	8.9	6.0	199
LM D8	8 ±5%	12.2	10.3	8.8	5.9	199
LM D9	9 ±5%	11.3	10.0	8.6	5.7	199
LM D10	10 ±5%	10.8	9.7	8.5	5.7	199
LM D12	12 ±5%	10.0	9.2	8.3	5.7	199
LM D15	15 ±5%	9.0	8.4	7.9	5.3	209
LM D18	18 ±5%	7.9	7.4	6.9	5.0	209
LM D20	20 ±5%	7.4	6.9	6.5	4.9	209
LM D24	24 ±5%	6.7	6.3	5.8	4.8	219
LM D28	28 ±5%	6.0	5.6	5.2	4.7	219
LM D36	36 ±5%	5.4	5.0	4.7	4.3	239
LM D48	48 ±5%	4.1	3.9	3.6	3.1	239
LM D60	60 ±5%	2.8	2.6	2.4	2.1	239
LM D100	100 ±5%	1.7	1.5	1.3	1.1	249
LM D120	120 ±5%	1.5	1.3	1.1	1.0	249
LM D150	150 ±5%	1.1	1.0	0.90	0.80	254

Package E 4 1/16" x 7 1/2" x 11 7/8"

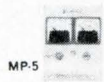

Accessory Metered Panels: \$40.00

Model	ADJ. VOLT. RANGE VDC	I MAX. AMPS				Price
		40°C	50°C	60°C	71°C	
LM E2	2 ±5%	23.0	20.0	16.5	10.0	\$269
LM E3	3 ±5%	22.0	20.0	16.5	10.0	269
LM E3P3	3.3±5%	21.0	19.0	16.5	10.0	269
LM E3P6	3.6±5%	21.0	19.0	16.5	10.0	269
LM E4	4 ±5%	21.0	19.0	16.5	10.0	269
LM E4P5	4.5±5%	20.0	18.0	16.4	10.0	269
LM E5	5 ±5%	20.0	18.0	16.4	10.0	269
LM E6	6 ±5%	19.0	17.3	15.6	10.0	269
LM E8	8 ±5%	18.0	16.4	14.7	10.0	269
LM E9	9 ±5%	17.0	15.5	14.0	9.5	269
LM E10	10 ±5%	16.0	14.5	13.0	9.5	269
LM E12	12 ±5%	15.0	13.6	12.3	9.5	269
LM E15	15 ±5%	14.0	12.7	11.5	8.6	269
LM E18	18 ±5%	13.0	11.8	10.6	8.6	269
LM E20	20 ±5%	12.0	10.9	9.8	8.5	269
LM E24	24 ±5%	11.0	10.0	9.0	7.6	269
LM E28	28 ±5%	10.0	9.0	8.0	7.1	269
LM E36	36 ±5%	8.0	7.3	6.5	5.7	279
LM E48	48 ±5%	6.0	5.4	4.9	4.3	299
LM E60	60 ±5%	3.5	3.3	3.0	2.6	299
LM E100	100 ±5%	2.0	1.7	1.6	1.5	299
LM E120	120 ±5%	1.7	1.5	1.4	1.2	299
LM E150	150 ±5%	1.4	1.3	1.2	1.0	299

Package F 3 1/2" x 19" x 16 1/2"



For metered models, add suffix (M) to model number and \$30.00 to the price below.

Model	ADJ. VOLT. RANGE VDC	I MAX. AMPS				Price
		40°C	50°C	60°C	71°C	
LM F2	2 ±5%	44.0	39.0	32.0	24.0	\$425
LM F3	3 ±5%	44.0	39.0	32.0	24.0	425
LM F3P3	3.3±5%	44.0	39.0	32.0	24.0	425
LM F3P6	3.6±5%	44.0	39.0	32.0	24.0	425
LM F4	4 ±5%	44.0	39.0	32.0	24.0	425
LM F4P5	4.5±5%	44.0	39.0	32.0	24.0	425
LM F5	5 ±5%	44.0	38.0	31.0	24.0	425
LM F6	6 ±5%	43.0	37.0	30.0	23.0	425
LM F8	8 ±5%	40.0	34.0	28.0	22.0	425
LM F9	9 ±5%	38.0	32.0	26.0	21.0	425
LM F10	10 ±5%	36.0	31.0	25.0	20.0	425
LM F12	12 ±5%	30.0	26.0	21.0	16.0	425
LM F15	15 ±5%	25.0	22.0	18.0	15.0	425
LM F18	18 ±5%	23.0	20.0	17.0	13.0	395
LM F20	20 ±5%	21.0	19.0	16.0	12.0	395
LM F24	24 ±5%	18.0	16.0	13.0	10.0	380
LM F28	28 ±5%	17.0	15.0	13.0	9.5	380

Manufacturing

Production tips

Production tips is a regular feature in Electronics. Readers are invited to submit brief descriptions of new and practical processes, assembly or test methods, and unusual solutions to electronics manufacturing and packaging problems. We'll pay \$50 for each item published.

Machine soldering gets IC's into tighter spots

By Robert Chetlan

Military Electronics Division, Motorola, Inc.
Scottsdale, Ariz.

Wavesoldering has become precise enough to produce integrated-circuit assemblies for high-reliability aerospace equipment. This means that automated soldering machines can do in about 10 minutes work that took several hours by hand.

The assembly at right, containing more than 50 IC's in TO-5 packages, is typical of those wave-soldered at the Military Electronics division of Motorola, Inc. Hand soldering of the IC assembly

by an operator certified by the National Aeronautics and Space Administration would take some five hours. The density of the soldered joints is twice that of a conventional machine-soldered assembly. In the past, it has been customary to space TO-5 leads to 0.1 inch before machine soldering to prevent solder bridging between joints.

The Motorola facility served as a proving ground for several wavesoldering techniques now specified by NASA. Put in operation with the technical assistance of the Space Flight Center at Huntsville, Ala., the facility is the first such known to meet agency specifications. Electrovert, Inc., which built the basic machine, also worked with NASA.

Techniques similar to those used for several years in commercial production are employed in the facility. The boards are automatically cleaned, fluxed, preheated, soldered by an oil-coated fountain of solder, and cleaned again. The added precision

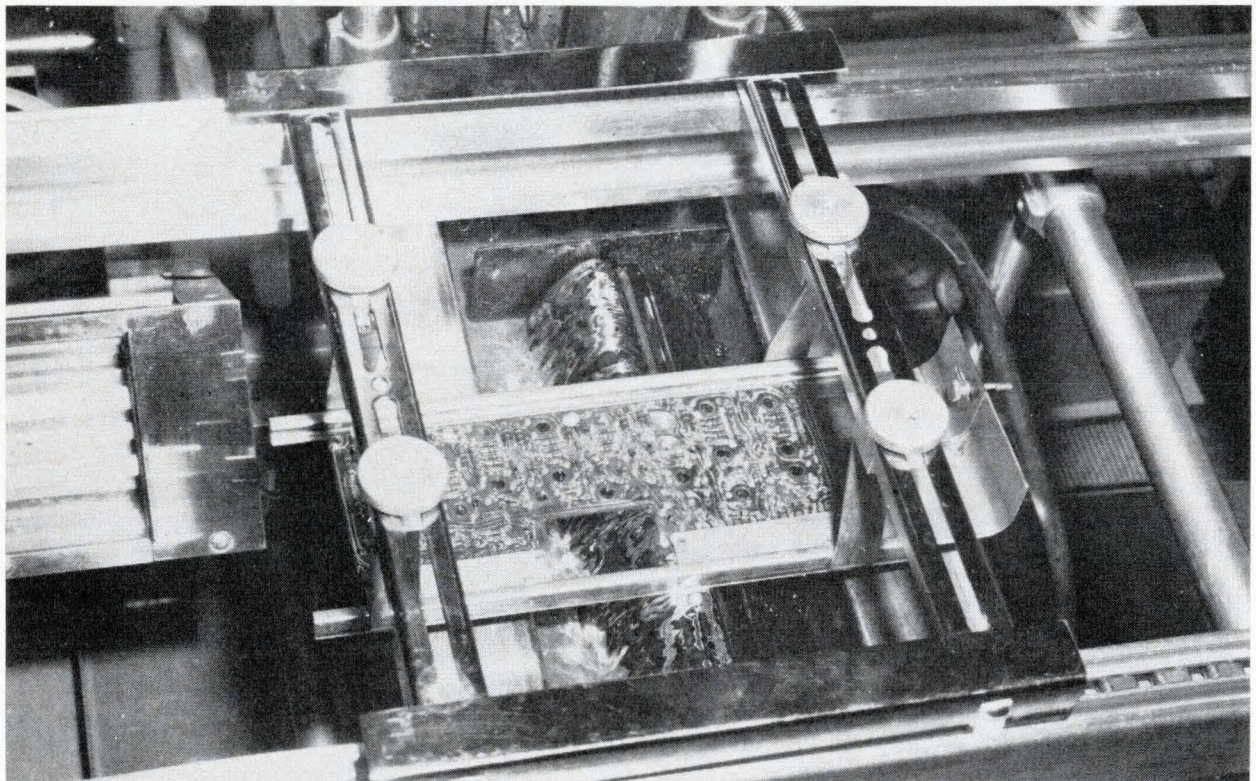

Conventional assemblies are also soldered on the machine. The oil is injected through the orifice to the right of the solder wave. The angle of the solder wave as it leaves its orifice is 60°. The used oil floats on the solder and overflows into a discard tank. The carriers ski over flanges at each side of the solder wave.

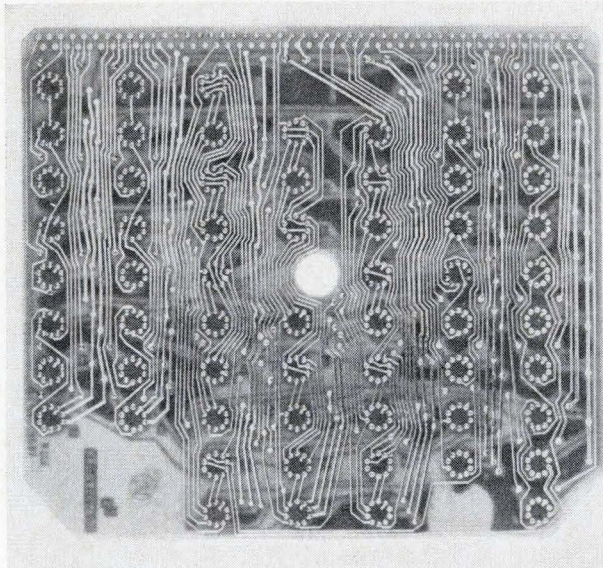

Rear of wavel soldered assembly of integrated circuits. Each TO-5 package has 10 leads located in a 0.231-inch circle. The solder lands are 0.055 inch in diameter and the space between them is 0.02 inch.

comes primarily from improved methods of oil injection and of setting the solderwave height with respect to the boards.

The boards are two sided, with plated-through holes. Top and bottom solder joints are made simultaneously as the solder flows up through the holes. Soldering surfaces are generally bare or solder-coated copper. The rosin flux is Alpha 711; the solder is Vaculoy 63/37; and the cleaner is Chlorothene NU (refined trichloroethylene) that is con-

tinuously distilled through a gravity system.

The oil is peanut oil. Unlike petroleum oils, peanut oil does not form a film and therefore does not inhibit wetting of the copper by the solder. The oil has three functions: breaking the surface tension of the solder, thus restricting icicling (formation of solder tails on the joints) and bridging (solder path connecting adjacent joints); inhibiting dross formation; and helping the flux clean the soldering surfaces.

Since prolonged heating of the oil would carbonize it and would cause it to contaminate the boards, the oil is not reused. The oil is preheated in a supply line, which runs through the solder pot. But this line is drained when the machine is shut down. The thickness of the oil on the solder wave is controlled by micrometer-type metering system on the oil pump.

The height and slope of the solder wave is adjusted for each type of assembly by making a trial run with a piece of tempered glass. The operator can determine the right height by looking through the glass. This method, originated by NASA, has been made more precise by honing the glass to simulate the surface roughness of the board material. The glass is dry-honed with 3½-mil glass beads. A large dial added to the height-adjustment mechanism facilitates a return to a setting after the height has been changed.

To make sure each board passes over the wave at the proper height, the board carriers were machined to a tolerance of a few mils. The curved piece at the front of the carrier causes it to ski over the flanges on either side of the solder wave and the fluxing and cleaning waves.

Fixture shaves 10 minutes from module-making time

By John Bellissimo,

Communications and Data Processing Operation,
Raytheon Co., North Dighton, Mass.

Assembling sandwich modules is fussy work because of their small size—an inch or so square and a half-inch deep—and because 28 or 30 axial-lead components have to be packed within that small volume. A component-positioning fixture allows modules to be made in 10 minutes less time than required by the most effective previous method. It avoids manipulating the circuit boards.

The new fixture, fastened to a standard assembly

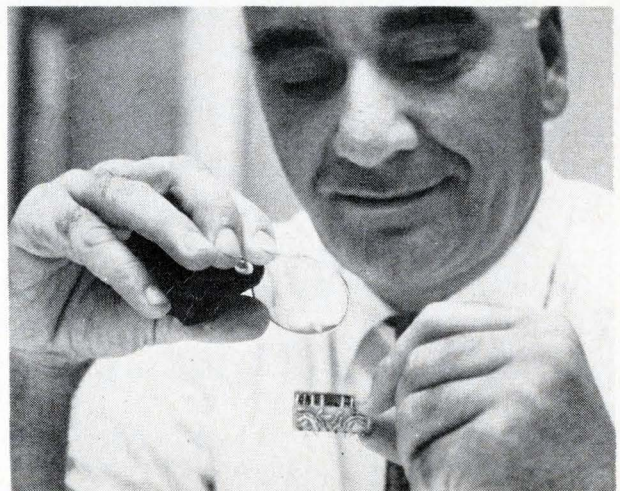

Sandwich-type module, held by John Bellissimo, is difficult to assemble because 28 or 30 axial-lead components have to be packed into small volume.

mount with a rotating arm, is at the right. The boards, held between lips in the crosspieces, are spaced at about three or four times the finished height of the module and with the corresponding holes in the boards lined up.

The bottom leads of the components are pre-cut. The assembler rotates the fixture with one hand until the bottom of the top board is visible. He picks up a component with the other hand, bends the end of the upper lead, angles the component between the boards as shown, inserts the hooked end of the lead into the upper hole, rotates the fixture until he can see the top of the bottom board, and drops the bottom lead into the proper hole in the bottom board.

The assembler is guided by a visual aid which calls for putting the first component into the rear, right corner of the module, filling the right-hand row of holes from back to front, and then following the same procedure row by row from right to left. This prevents mistakes in placement and always leaves ample room for manipulating the parts.

After all components are placed, the top cross-piece of the fixture is pushed down to the preset height (usually 0.442 inch) and spacers are inserted between the boards. Or, a plug-in base is attached to the boards. A few of the leads are tack-soldered to the boards to hold the sandwich firmly together. The leads are then trimmed and soldered.

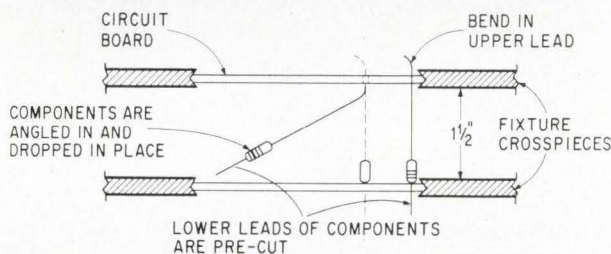
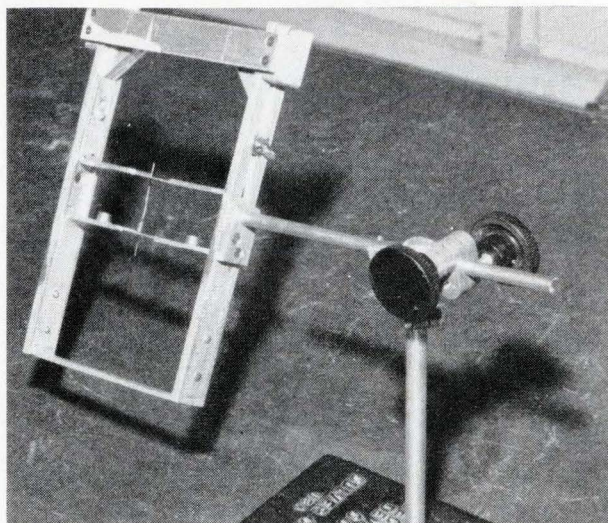

Fixture holds boards in a spread-apart, aligned position while assembler inserts component leads into board holes.

Coordinate measurer puts old boards into new line

A coordinate-measuring setup is helping the National Cash Register Co. feed automatic component-insertion machines with printed circuit boards that weren't made for automatic insertion.

In the future NCR's Electronics division in Hawthorne, Calif., will be using boards with an easily programed hole pattern spaced on a grid of 0.100 ± 0.005 inch. However, NCR wanted first to use up large stocks of boards previously made or ordered for manual assembly. These boards varied in hole locations because of differences in the processing done by vendors. Nearly 50 programs—one for each stock of boards—were needed. Each would require precise measurement of hole locations. Done manually, that would take one or two days for each kind of board.

Measuring can be done in approximately one-tenth the time with the coordinate-measuring setup, which will also be used to check the new boards. The setup consists of a Co-Check machine, made by Assembly Engineers, Inc., plus an optical com-

parator and a lamp that backlights the boards.

The machine's table moves freely in the X and Y directions and registers the amount of movement on dial indicators. When a board is mounted on the table, hole coordinates are found by centering a probe in each hole. The comparator is used to find the locations of board features other than holes.

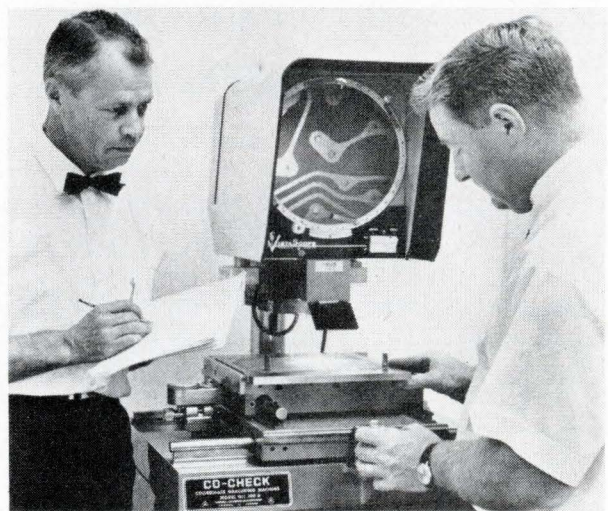

Hole coordinates are read on indicator dials.

Soliton

*announces a family
of NPN Silicon Planar
Power Transistors*

featuring

TO-66 Package

2 Amps I_C max

16 watts at

100°C!

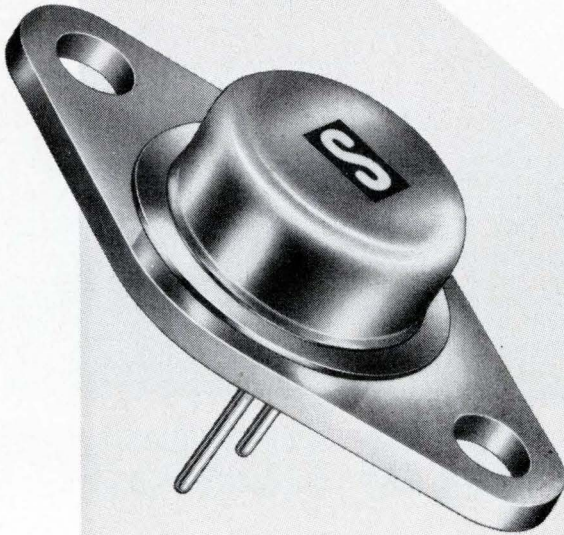

Type Number	Pkg. Size	DESIGN LIMITS							PERFORMANCE SPECIFICATIONS					
		T_J	θ	P_T	BV_{CBO}	V_{CEO} (SUS)	BV_{EBO}	h_{FE}	V_{BE} (sat)	V_{CE} (sat)	I_{CBO}		f_T	
		°C	°C/W	Watts	Volts	Volts	Volts	Min. Max.	Volts	Volts	μA		mc	
		Max.	Max.	@100°C Case	Min.	Min.	Min.	@ $I_C = 0.5A$ $V_{CE} = 2V$	@ $I_C = 0.5A$ $I_B = .05A$	@ $I_C = 0.5A$ $I_B = .05A$	$V_{CB} = 30V$	$V_{CB} = 60V$	Min.	
MHT5901	TO-66	200	6	16	60	40	8	50	150	1.2	0.35	0.1		50
MHT5902	TO-66	200	6	16	80	60	8	50	150	1.2	0.35	0.1		50
MHT5903	TO-66	200	6	16	100	80	8	50	150	1.2	0.35		0.1	50
MHT5904	TO-66	200	6	16	140	100	8	50	150	1.2	0.35		0.1	50
MHT5905	TO-66	200	6	16	180	120	8	50	150	1.2	0.35		0.1	50

Soliton TRANSISTOR DIVISION
DEVICES, INC.

1177 BLUE HERON BLVD. / RIVIERA BEACH, FLORIDA / (305) 848-4311 / TWX: (510) 952-6676

Leader in Germanium and Silicon Power Transistors, Cryogenic Thermometers, High Voltage Rectifiers, Temperature Compensated Zeners, Voltage Variable Capacitors, Random/White Noise Components and Microelectronic Circuits and High-Pac Interconnection Systems.

Precision you can trust, because it's built in.

**±50 ppm TC.
1/2% and 1% tolerances.
<0.5% load-life ΔR guaranteed.
Mil-R-10509E, Char. C.**

New CORNING® NC-style Resistors.

NC4—1/10 watt at 125° C., 49.9 ohms to 150K

NC5—1/8 watt at 125° C., 49.9 ohms to 499K

NC6—1/4 watt at 125° C., 49.9 ohms to 1 Meg.

True precision resistors with all the long-term reliability you've come to expect from CORNING glass-tin oxide film. And not just tested into some. Nor sorted out of many.

But precision that's built in . . . in a continuous manufacturing process that provides the highest inherent reliability of any resistor made today. Here's how:

The tin oxide film is bonded *molecularly* to a glass cane substrate at red heat . . . it isn't plastered on, or sputtered on.

Temperature coefficient of film and substrate match perfectly.

The substrate is chemically inert to the film.

Once cooled, the film compares in hardness to high-carbon tool steel . . . you can't scrape it off.

We make CORNING NC-styles with these materials and this technique to guarantee you constant resistivity, constant quality . . . precision that's built in.

Call your CORNING distributor for technical data and samples or send the coupon today. Evaluate the new NC-styles, and see how their built-in precision gives you new design confidence.

CORNING GLASS WORKS, 3913 Electronics Dr., Raleigh, N.C.

Please send me new NC-style Resistors data and samples.

Name..... Title.....

Company.....

Address.....

City..... State..... Zip.....

CORNING
ELECTRONICS



10514A Mixer
actual size

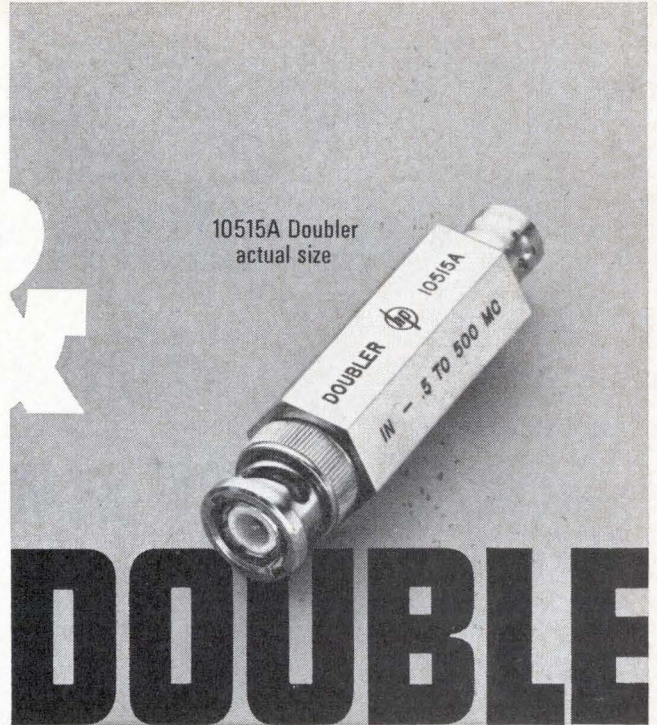

10515A Doubler
actual size

DOUBLE

NEW

hp DOUBLE-BALANCED MIXER

- Broadband application, 200 kHz-500 MHz (to dc on one port)
- Low noise (7 db max. noise figure to 50 MHz, 9 db max to 500 MHz)
- Superior balance for minimum feed-through from any of three ports
- Broadband for versatile application, yet has the high performance of limited special-purpose devices

Use the Hewlett-Packard 10514A Mixer in designing receivers, wave analyzers, single-sideband systems (no balance adjustment necessary); as a pulse modulator; phase detector for evaluating short-term stability of signal sources; for spectrum analysis outside the analyzer's normal frequency range; to measure spurious response of signal sources; as a current-controlled attenuator for smooth electronic level control; balanced modulator; phase detector; frequency doubler; spectrum or comb generator.

Specially selected hot carrier diodes and special transformer design permit this unique performance, flat frequency response (typically ± 0.2 db 0.5 to 50 MHz, ± 1.5 db overall), low intermodulation products, ± 1 nsec rise and fall times as a pulse modulator. Each unit is completely tested with highly specialized equipment not duplicated in most laboratories. \$250.

NEW

hp FREQUENCY DOUBLER

- Broadband (0.5-500 MHz input, 1-1000 MHz output) yet meets or beats the performance of narrowband units
- Flat response, low conversion loss, excellent harmonic suppression.

Use the Hewlett-Packard 10515A Doubler to double the range of signal sources without appreciably degrading performance; use it as a broadband ac-dc converter for detecting low-level AM. \$120.

Both devices offer new performance capabilities with less design and test work for you than required by previous measurement tools. They're rugged and have been type tested over a wide environmental range. Data sheets will give you an idea of what they will do for you. Use the phone to get information from your Hewlett-Packard field engineer, or write for complete information: Hewlett-Packard, Palo Alto, Calif. 94304, Tel. (415) 326-7000; Europe: 54 Route des Acacias, Geneva.

Data subject to change without notice. Prices f.o.b. factory.

HEWLETT  **PACKARD**
An extra measure of quality

Is complementary symmetry the only way to sell audio transistors today?

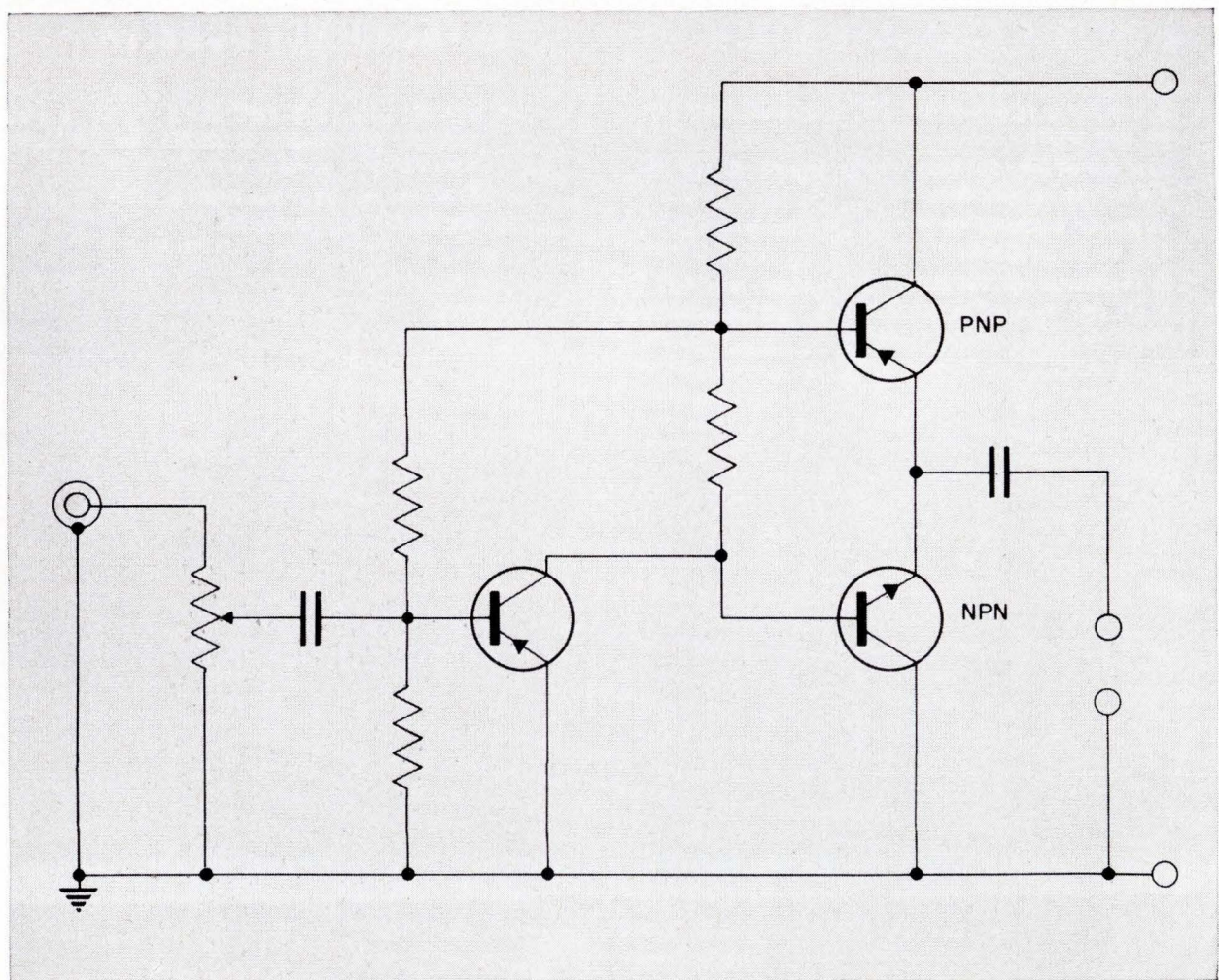

You bet it is!

Complementary Symmetry is the ultimate in economical, reliable circuitry for audio applications up to 12 watts.

FOR PHONOS (1 to 5 WATTS)

Complementary Symmetry achieves enormous manufacturing savings with no sacrifice in reliability, by using transistors as they should be used—as low voltage, low impedance, low temperature devices for Class B push-pull, instead of high voltage, high impedance (Class A) with transformers and associated components and high temperatures.

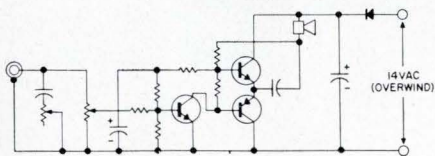

THE AMPEREX WAY

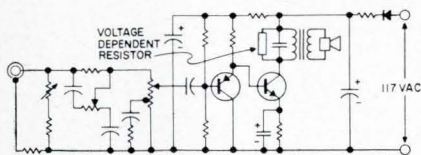

THE OLD WAY

Low voltage eliminates need for bottom plates, interlocks, etc. **Low temperatures** mean longer, more reliable component life. **Simple mounting clip** eliminates need for expensive heat sinks, mica insulating washers and mounting hardware. **No output transformers or VDR's**... low

output impedance of emitter follower output circuit obsoletes impedance-matching output transformer and related voltage dependent resistors.

Complementary Symmetry is not a new audio engineering approach! It has long been an audio designer's dream—a textbook approach! What is new, is that Amperex now provides the tools to make the textbook dream come true. We have the matched, paired transistors, dual heat-sinks, simplified circuits and application reports. Our applications department is at your service... and where required, complete bread-boarded prototypes will be provided.

2N2707 matched pair 2N2430 (NPN) and 2N2706 (PNP) for power up to one watt for low cost phonos, amplifiers and radio; TO-1 cases in dual heat-sink clip.

2N4136 matched pair 2N2430 (NPN) and 2N2431 (PNP) for power up to 2.5 watts; TO-1 cases in dual heat-sink clip.

2N4107 matched pair 2N4105 (NPN) and 2N4106 (PNP) for power up to 7 watts; TO-1 cases in extruded aluminum heat-sink.

2N4079 matched pair 2N4077 (NPN) and 2N4078 (PNP) for power up to 12 watts; TO-3 cases.

**FOR AUTO RADIO OUTPUTS
(5 watts at 13.6 volts)
THE NEW 2N4079 PAIR
IS IDEALLY SUITED**

For data and for details of the Amperex "whole ball of wax" sales and applications program (transistors, circuits, prototypes, lab reports, etc.), write Amperex Electronic Corporation, Semiconductor and Receiving Tube Division, Dept. 371, Slatersville, Rhode Island 02876.

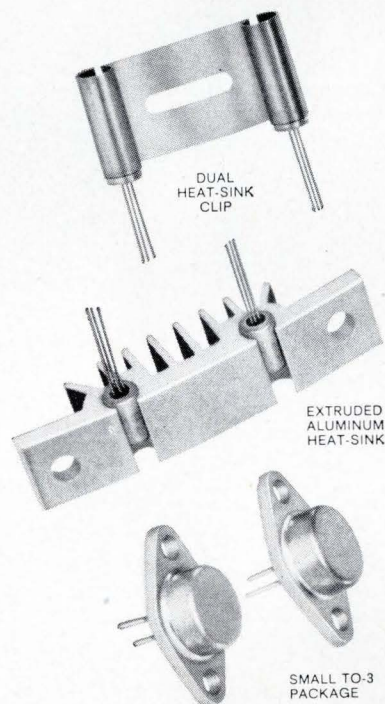

Amperex®

EIMAC introduces new family of rugged triodes for industrial heating

From Eimac comes a new family of water-cooled triodes designed especially for induction and dielectric industrial heating service. The tubes feature a new cast silicon-bronze cooler design with constant cross-section spiral water channels. This design insures uniform anode cooling with minimum water flow and back pressure. For example, the 3CW20,000H3 requires only 4 GPM water flow at 3.5 psi for 20 kW plate dissipation. The new tubes feature filament connecting leads—no sockets are required—and have grid flanges for low inductance connection to the grid. This new industrial family is rated at full power to 90 Mc, with reduced ratings to 140 Mc. All include anode tabs for ease of mounting into industrial machinery plus rugged, high-dissipation grids for industrial oscillator service. Write Power Grid Product Manager for additional technical information, or contact your nearest Eimac distributor.

CHARACTERISTICS				
	Plate Dissipation (kW)	Filament Voltage (Volts)	Input Power (kW)	Useful Output (kW)
3CW5,000H3	5.0	7.5	30	15.5 to 22.5
3CW10,000H3	10.0	7.5	40	25.0 to 30.0
3CW20,000H3	20.0	6.3	60	42.0 to 45.0
3CW30,000H3	30.0	10.0	80	55.0 to 60.0
3CW40,000H3	40.0	13.0	120	75.0 to 90.0

EIMAC
 Division of Varian
 San Carlos, California 94070

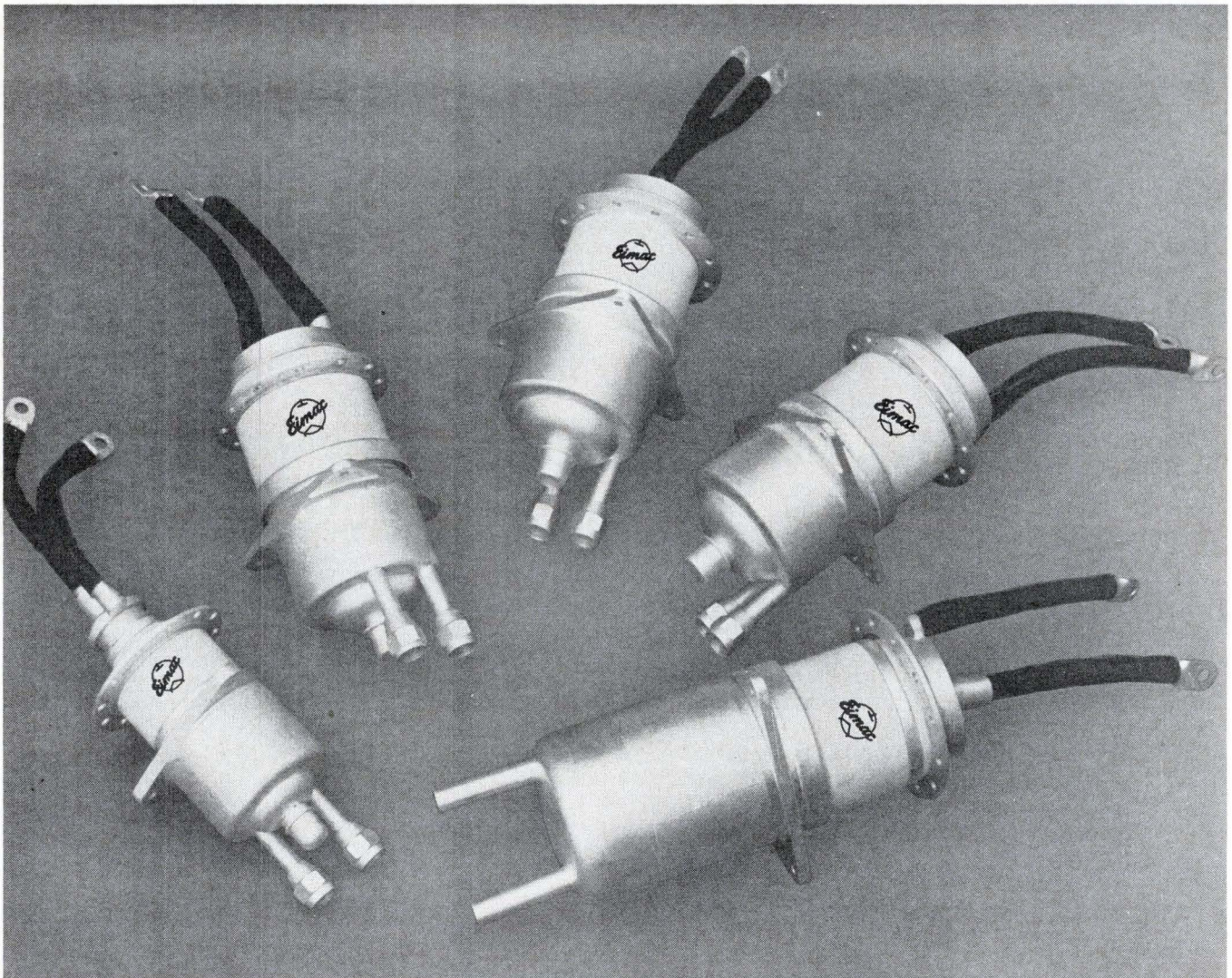

New products. New markets. New acquisition. New look.



Diversification...worldwide facilities...increasing emphasis on commercial and industrial markets...this and more is reflected in our new corporate symbol.

Over the years, the well known Bourns potentiometer and transducer lines have been augmented by relays, time-delay devices, microcomponents, medical electronic equipment and—through acquisition of more than 80 per cent of Chicago Aerial Industries, Inc.—a wide range of photographic products and services. Geographically, Bourns has expanded to include operations in Canada, Great Britain, Switzerland, the Netherlands, Puerto Rico and Japan. Behind this growth is success...and behind the success, ideas.

Our new trademark sums it up: there's dynamic expansion in the world of Bourns.



BOURNS, INC., CORPORATE HEADQUARTERS
RIVERSIDE, CALIFORNIA

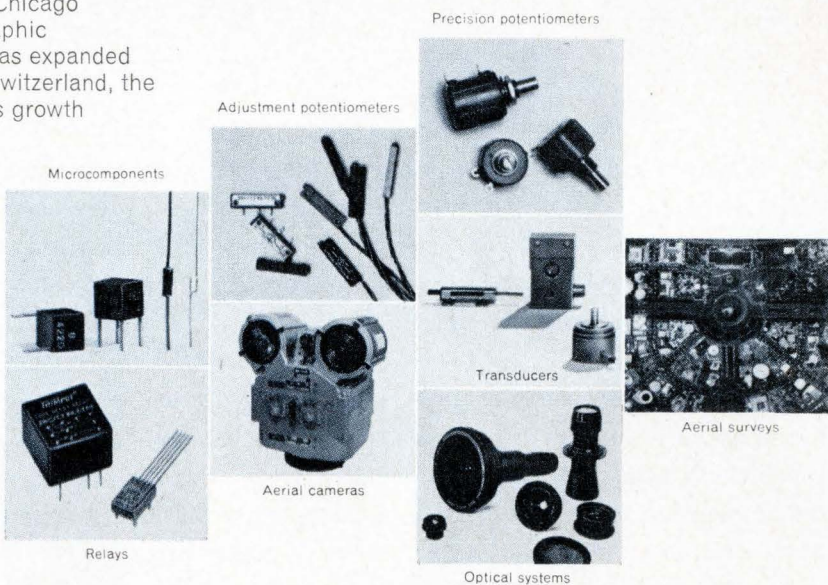

Electronic Components—Microcomponents—Transducers—Medical Electronics—Photographic Systems—Optics

for integrated circuits...

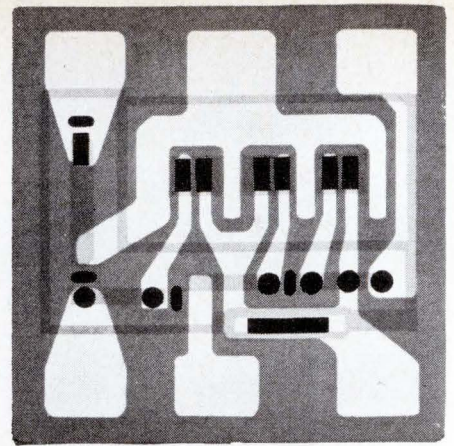

uncased Ceralam[®] close tolerance capacitors

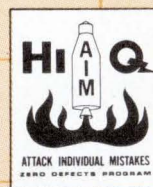
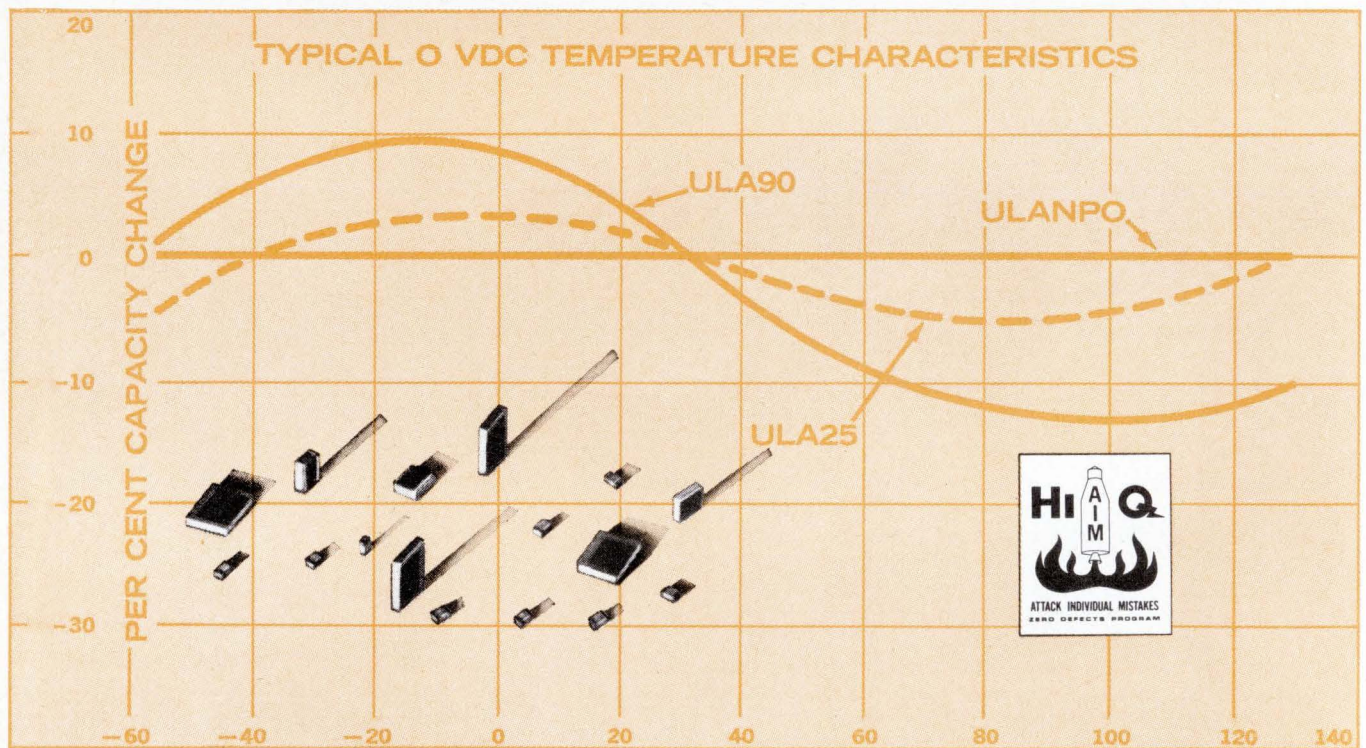

The CERALAM capacitor is a rugged, monolithic block of ceramic dielectric and metallic plate laminated into an extremely dense unit. Because of their unique structure they can be supplied unencapsulated, ready to solder into the circuitry, saving appreciably on volume.

The high ratio of capacity-to-volume achieved in CERALAM capacitors allows unusually small sizes suited to hybrid circuitry. They are also suitable because their unique construction permits an unlimited selection of geometric configuration to facilitate packaging in the hybrid circuit. CERALAMs also offer a wide range of dielectric properties: body NPO's of 0 to ± 30 ppm TC for high stability; for no

measurable aging effect; temperature compensating dielectrics, intermediate stability dielectrics; and high dielectric constant ceramics which yield very high capacity-to-volume ratios.

Some capacitors are just stumbling blocks in the way of hybrid circuit design. Replace them with CERALAM "blocks." Write us. We'll be happy to help.



AEROVOX
CORPORATION
OLEAN, N. Y.

Selected commercial and military Hi-Q products are available off-the-shelf from Authorized Aerovox Distributors.

Heat Dissipation Bonus of Beryllia Worth An Extra Two Cents?

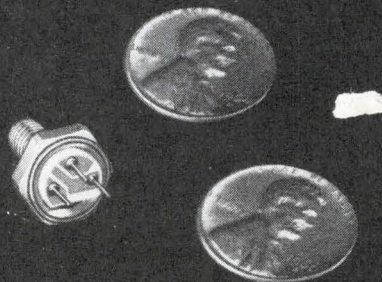

Coors Beryllium Oxide Ceramic offers you the bonus of 10 times the thermal conductivity of aluminum oxide ceramic—approximately the heat transfer qualities of aluminum metal. Ordinarily, beryllia is thought to be too expensive, except for designs where maximum heat dissipation is an essential. However, we find the additional cost of using beryllia in small metallized assemblies adds only a few cents to the total cost of the completed part. For an “extra two-cents worth” Coors offers a beryllia-to-metal assembly that allows you to use more power . . . or allows you even further miniaturization than with alumina . . . or gives you longer component life—or a combination of all three. When you design micro-substrate assemblies—Consider Coors Metallized Ceramics—and get the bonus of beryllia’s thermal conductivity. Write for Coors Metallizing Data Sheet 9502, or call the Coors “hot line”—303/279-4533, Ext. 351.

*consider
Coors metallized
ceramics*

Coors CERAMICS

ALUMINAS • BERYLLIAS • MAGNESIAS • SPECIAL OXIDES

Coors Porcelain Co., Golden, Colo.



THIS COORS
METALLIZED BERYLLIA
MICRO-COMPONENT
DISSIPATES THE SAME
QUANTITIES OF HEAT

AS THIS COORS
METALLIZED ALUMINA
MICRO-COMPONENT

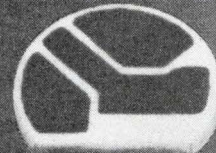

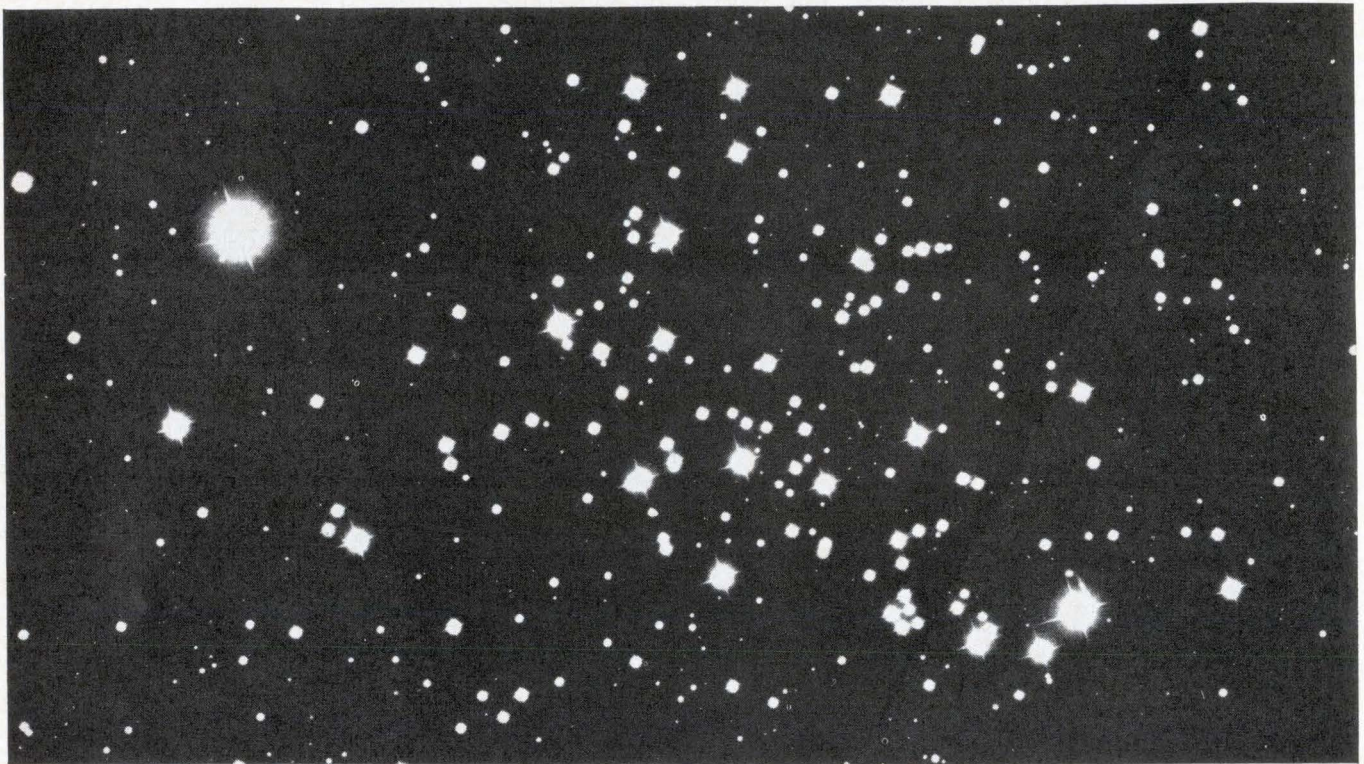

You are standing on the threshold of the future.

Take that giant step.

Step into a world of challenge and excitement. A world of intellectual stimulation. A world of real and meaningful personal rewards.

How? By joining IBM's Space Systems Center in Bethesda, Maryland.

Here you will have the opportunity to develop and integrate complete space systems—from outer space to inner space. As a member of this elite idea team, it will be your responsibility to answer our clients' immediate

challenges, and define what's going to be happening in inner and outer space in ten to twenty years. There are immediate openings for:

Atmospheric Scientists •
Communications Engineers • Data
Processing Engineers • Display
Engineers • Electrical Engineers •
Engineering Scientists • Geologists/
Hydrologists • Meteorologists •
Oceanographers/Marine
Geophysicists • Physicists • Reliability
Engineers • Spacecraft Engineers •

Space Simulation Engineers • Systems
Analysts • PERT Systems Analysts •
Systems Engineers • Cost Analysts

Please write in complete confidence
to J. B. Farrington, Dept. 554R3,
IBM Space Systems Center,
Federal Systems Division,
7220 Wisconsin Avenue,
Bethesda, Maryland. **IBM**[®]

IBM is an Equal Opportunity Employer
(M/F).

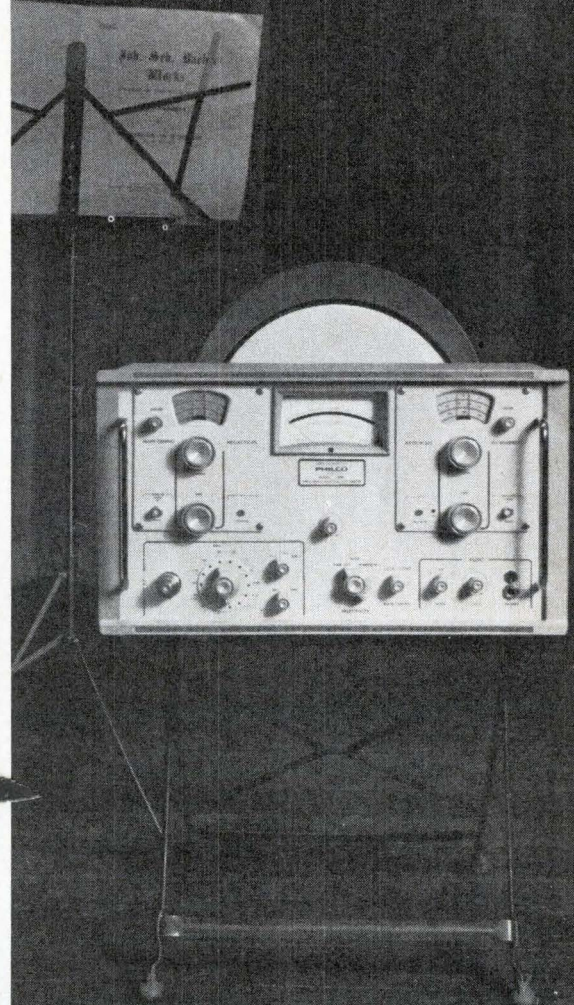

One way to increase your frequency range

When complex waveforms begin to tax your frequency range, think twice before you switch to a two-instrument combination. Chances are you'll cover those additional octaves with a single Sierra Model 128A wide-range wave analyzer. And with far more artistic results.

The all-solid-state Model 128A takes firm control over a wide 10 Kc to 15 Mc frequency scale, with single-range continuous tuning across the entire band. Crystal references assure frequency accuracy of $20 \text{ ppm} \pm 300$ cycles. Short-term frequency drift is a low 5 cycles maximum over a 15-minute period. The measurement range reaches from $3 \mu\text{v}$ to 30 V (-110 to $+32 \text{ dbm}$), with direct-reading dial indications in dbm and volts. An expanded scale meter, available as an accessory, lets you pinpoint readings down to 0.01 db. Model 128A offers years of trouble-free instrument service for an investment of \$3,250.

Your inquiry will produce an allegro one-bulletin response. Write to Sierra/Philco, 3885 Bohannon Drive, Menlo Park, California 94025.

A better way from Sierra

SIERRA ELECTRONIC DIV.
OF
PHILCO
A SUBSIDIARY OF *Ford Motor Company*

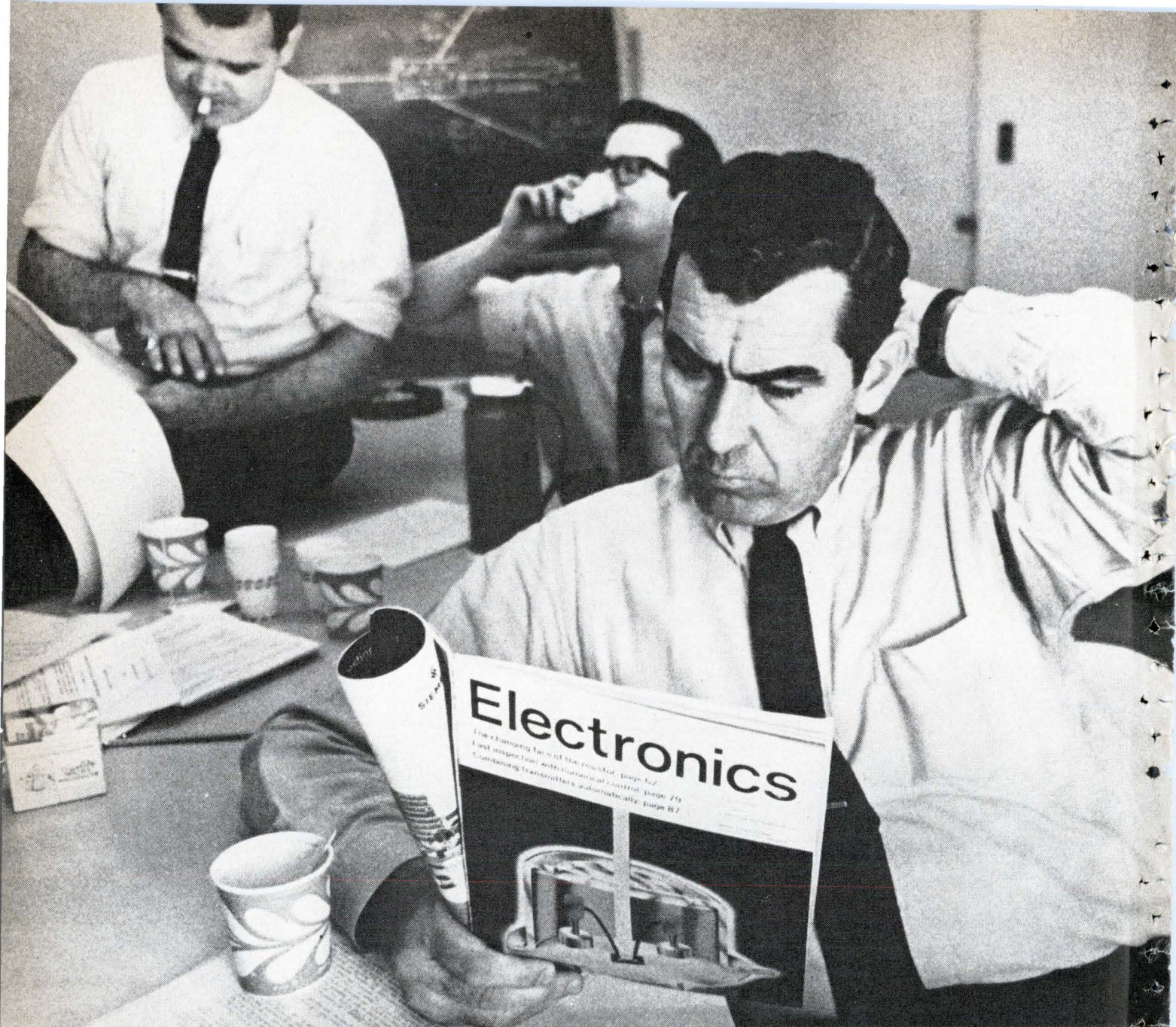

Great editorial is something he takes to a meeting

(What a climate for selling!)

Electronics

A McGraw-Hill *Market-Directed* Publication
330 West 42nd Street, New York, N.Y. 10036

MEMBER: AUDIT BUREAU OF CIRCULATIONS, AMERICAN BUSINESS PRESS

Series 53M Potentiometer for quieter performance, long life, zero backlash!

100% CARBON-TO-CARBON wiper-element contact construction completely eliminates metal-carried carbon wiper and results in an extremely long, noise and backlash free, life. One piece molded construction is the Clarostat secret . . . and for even greater reliability and stability, each unit is completely sealed against moisture, dust and other environmental hazards.



BRIEF SPECIFICATIONS

- Power Rating — 2 Watts
- Working Voltage—500VDC
- Resistance Range — 50 ohms to 10 megohms linear, 250 ohms to 5 megohms tapered
- Available with shaft seals, mounting seals, switches, high torque, ganging, non-metallic shafts, L & T Pads, concentric shafts, high-voltage standoffs, backlash assemblies, and locking bushings.
- Meets specifications per MIL-R-94 — Style RV-4.

WRITE FOR COMPLETE SPECIFICATIONS

CLAROSTAT

CLAROSTAT MFG. CO., INC. DOVER, NEW HAMPSHIRE

It's easy to put
vapor rinse and
ultrasonic cleaning
at every
work station.

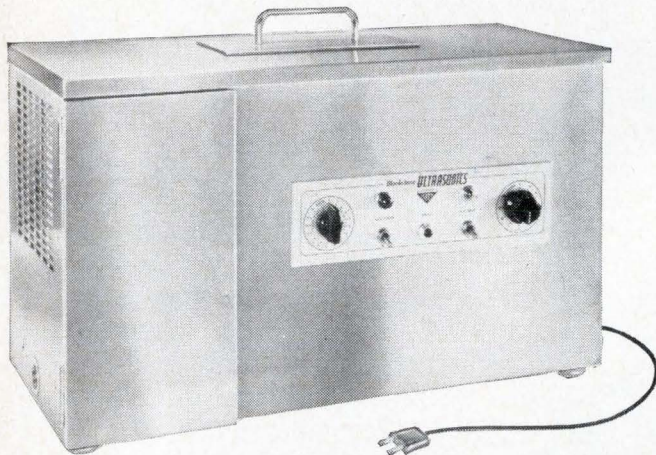

All it takes is 110 volts
and Blackstone's new VRO.

Just plug VRO into the handiest outlet. It's at the worker's elbow ready to clean each subassembly that passes the work-station.

VRO requires no water, no drains, no hoods because it has its own built-in refrigeration system. And it can't waste solvent because the cooling system condenses the solvent and returns it to the tank. And it can't waste time while parts are trotted to central cleaning stations.

You get ultrasonic cleaning, followed by jet spray rinsing, followed by rinsing in pure distilled solvent vapors. And VRO does it all without special maintenance. It gets along on a dipper-full of solvent and conserves that by constantly filtering and re-distilling it.

Look at it this way. If you're making something that can be ultrasonically cleaned at 21,000 cycles, in a tank 4" x 4" x 3" deep, in any of the DuPont "Freon"® Solvents, with particulate matter controlled down to 1 micron . . . then the Blackstone VRO can probably save you production time and white room space.

VRO's tank and exposed housing areas are 316L stainless steel; it uses a new high efficiency lead zirconate titanate transducer with an extremely reliable method of metallurgical attachment to the tank, guaranteed against failure; provides 0 to 100% power control, automatic timers and thermostatically controlled heaters.

Any other questions about VRO or any of the many other kinds of ultrasonic cleaning equipment Blackstone makes? If so, ask us. We'll be glad to hear from you.

BLACKSTONE ULTRASONICS, INC.

1400 Howard Street • Sheffield, Pa.



FOR SEMI-RIGID OR FLEXIBLE CABLES

NEW

AVAILABLE IN CRIMP, SOLDER-ON, OR CLAMP-ON CONFIGURATIONS

SERIES 2900

MINIATURE, HI-PERFORMANCE RF COAXIAL CONNECTORS

Performance of Mated GRFF 2902 - 6001 & 2922 - 6001

Because you asked for *quality* miniature connectors to mate with OSM (and others), GRFF now offers the Series 2900. They provide low VSWR and high performance in a small, precisely fabricated connector. Favorably-priced, Series 2900 are gold-plated stainless steel and are available in a complete line of plugs, jacks, adapters, etc.

General RF Fittings, Inc.

702 BEACON ST./BOSTON, MASS. 02215
Telephone: 617 267-5120

Besides making the brightest laser in the world...

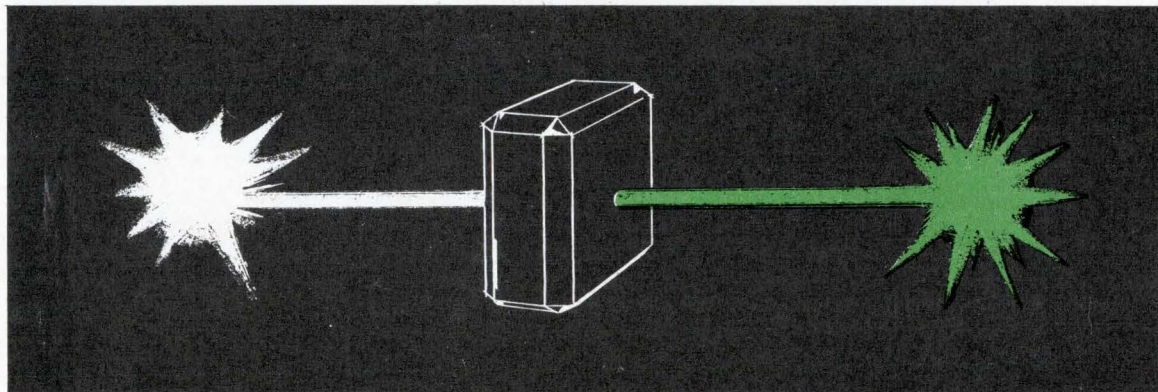

we make new improved Lithium Niobate crystals.

Our new LINDE Lithium Niobate crystals are synthesized by radically improved methods, from ultra-pure raw materials. Results: a new high in efficiency – as a frequency doubler; as well as excellent performance in modulation, delay line and other electronic applications.

But laser systems and crystals are only two of the many product lines we make. Others include integrated and modular circuits ... solid tantalum and foil-film capacitors ... field effect transistors.



These are all directed at advanced applications in the fast-moving field of modern electronics. They're all backed by the technology of Union Carbide – the corporation that's dedicated to growth through research.

If you'd like specific data on laser systems or crystal products, or if you'd like more information on our electronic activities, please write Dept. E-43, Union Carbide Corporation, Linde Division, 270 Park Ave., New York, N. Y. 10017.

LINDE is a registered trade mark of Union Carbide Corporation.



OGP
ARISTO
PRECISION LAYOUT MACHINES

Industries Choice for Performance and Reliability—
ARISTO Precision Layout Machines, (Coordinatographs), are the most widely used instruments of their kind in industry today ■ Rugged construction for ease and precision in operation ■ Standard accuracy to .0008" anywhere in plotting area—(for higher accuracy a .0001" optical readout accessory is available) ■ Horizontal arrangement for complete flexibility for drawing or scribing on glass, metal, plastic, films or paper ■ For making circuit layouts, templates, transistor masks, comparator chart-gages, dials, scales or reticle masters there's an ARISTO Model to suit your needs ■ Optical readout, electronic digital display or fully automated versions can be supplied ■ Contact your local OGP Representative, or write for NEW ARISTO catalog.

OPTICAL GAGING PRODUCTS, INC., ROCHESTER, N. Y.
Representing Unitech Corp., Clifton, N.J.—Sole Distributor in U.S. and Canada

Circle 507 on reader service card



DIALCO[®]

SECONDS
K 2.58

**BIG, BOLD
ANGULAR NUMERALS**

**LONG LIFE LAMPS and
RUGGED CONSTRUCTION
FOR
UNMATCHED
RELIABILITY**

WRITE FOR CURRENT CATALOG

Foremost Manufacturer of Indicator Lights

DIALIGHT CORPORATION
60 STEWART AVENUE, BROOKLYN, N.Y. 11237 212 HYACINTH 7-7600

Circle 508 on reader service card



This is the SSVM-1, the first broad-band high accuracy voltmeter using FET techniques. You've never seen a voltmeter like it. At least not in one case and at this price. It has the advantages of all solid-state design—portability, freedom from line voltage and the capacity for differential measurements. And it has the range and performance hitherto possible only with tube techniques—from DC through the VHF spectrum with accuracies of $\pm 2\%$ to 100 mc and ± 1 db to 700 mc. The specs: DC: 0-1000 volts in 7 ranges.

AC: 0-300 volts rms in 6 ranges. Ohmmeter: 0- ∞ in seven midscale (to 10 megohms) values. Frequency response: 20 c to 700 mc. Impedance: DC: >100 megohms. AC: as high as 15 megohms (in parallel with 2.0 pf). Power: 13.5 v. (3 mercury cells). Physical: 6" x 3½" x 8" and 5 lbs. Price: \$215 including probe. You've never seen a probe like this one either. It operates over the full AC range (to 300 volts and 700 mc) without modifications. Write Data Instruments Div., 7300 Crescent Boulevard • Pennsauken, N.J.

You've Never Seen a Voltmeter Like This One

\$215

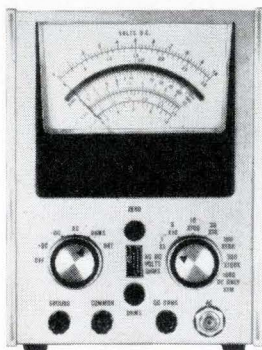

data instruments

A case for all circuits

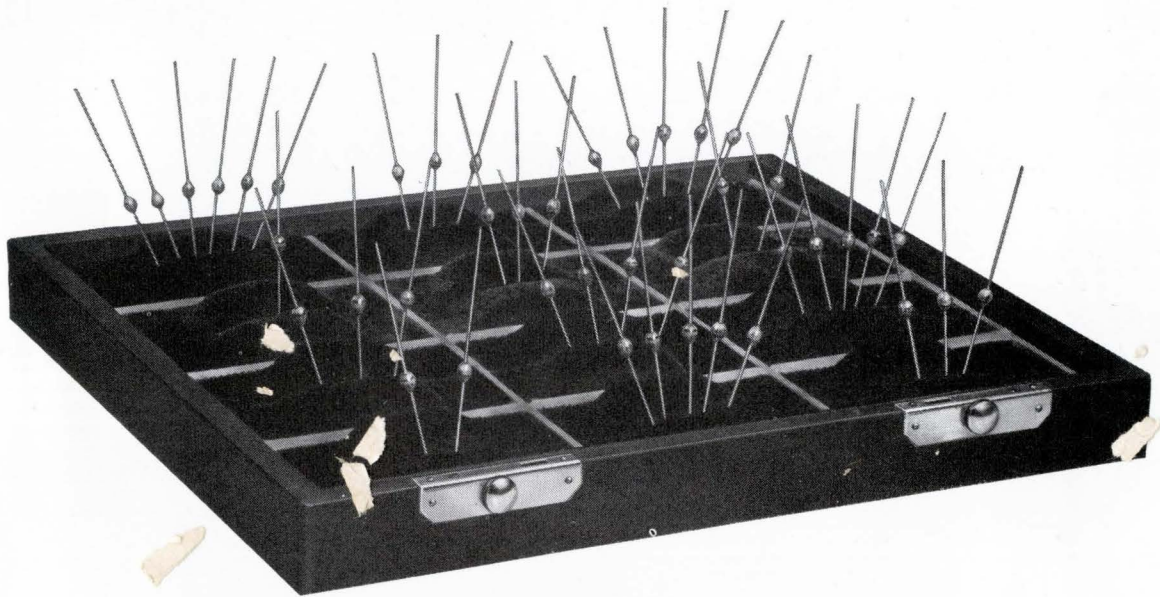

G.E.'s new, low-current rectifier line

Use these new, G-E miniature devices anywhere you need low-current power rectification . . . in TV and radio power supplies, communication equipments, small appliances, power logic circuits, free-wheeling rectifiers, arc suppression, battery chargers, and general purpose power supplies.

Try them. See why we consider them our all-purpose line of low-current, silicon rectifiers. Every device in the line can withstand peak forward surge currents as high as 100 amperes. They're all-glass en-

capsulated to keep moisture out. And they're available at competitive prices.

If you'd like to learn more about G.E.'s new all-purpose rectifier line, ask for publication 130.55 from your local G-E engineer/salesman or distributor, or write to Section 220-29A, General Electric Company, Schenectady, New York. In Canada: Canadian General Electric, 189 Dufferin St., Toronto, Ontario. Export: Electronic Component Sales, IGE Export Division, 159 Madison Ave., New York, New York.

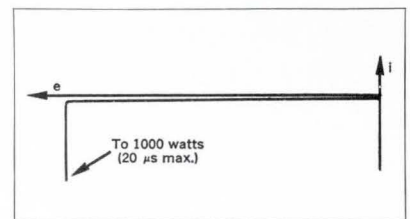

OUTSTANDING TRANSIENT VOLTAGE PROTECTION, TOO. Rated 1.5 amps and from 200 to 800 volts PRV, General Electric's new low-current rectifiers will dissipate voltage transients up to 1000 watts in the reverse direction without damage.

SEMICONDUCTOR PRODUCTS DEPARTMENT

GENERAL  ELECTRIC

Infinite resistance at null to 1100 volts is one feature of our new solid state differential voltmeter. Accuracy to $\pm 0.0025\%$ of dial setting is another. Price of \$1095 doesn't hurt our cause either. Ratio measurement lets you compare two external sources with a resolution of 0.0001%. In the TVM mode, input resistance is 100 megohms. Reference regulation is 0.0002%. Stability is 13 ppm peak-to-peak per 60 days.

Of course, that's not the whole story. Other features include 6 digit inline readout with a dial resolution of 1 ppm. The recorder output is well isolated and linear to within 0.5% of end scale. Ten percent overranging minimizes range changing and offers increased resolution on the lower end of each range. A continuously adjustable last digit allows exact null and eliminates meter interpolation for resolution. The half-rack Model 895A weighs 16 pounds.



FLUKE • Box 7428, Seattle, Washington 98133 • Phone: (206) 776-1171 • TWX: (910) 449-2850

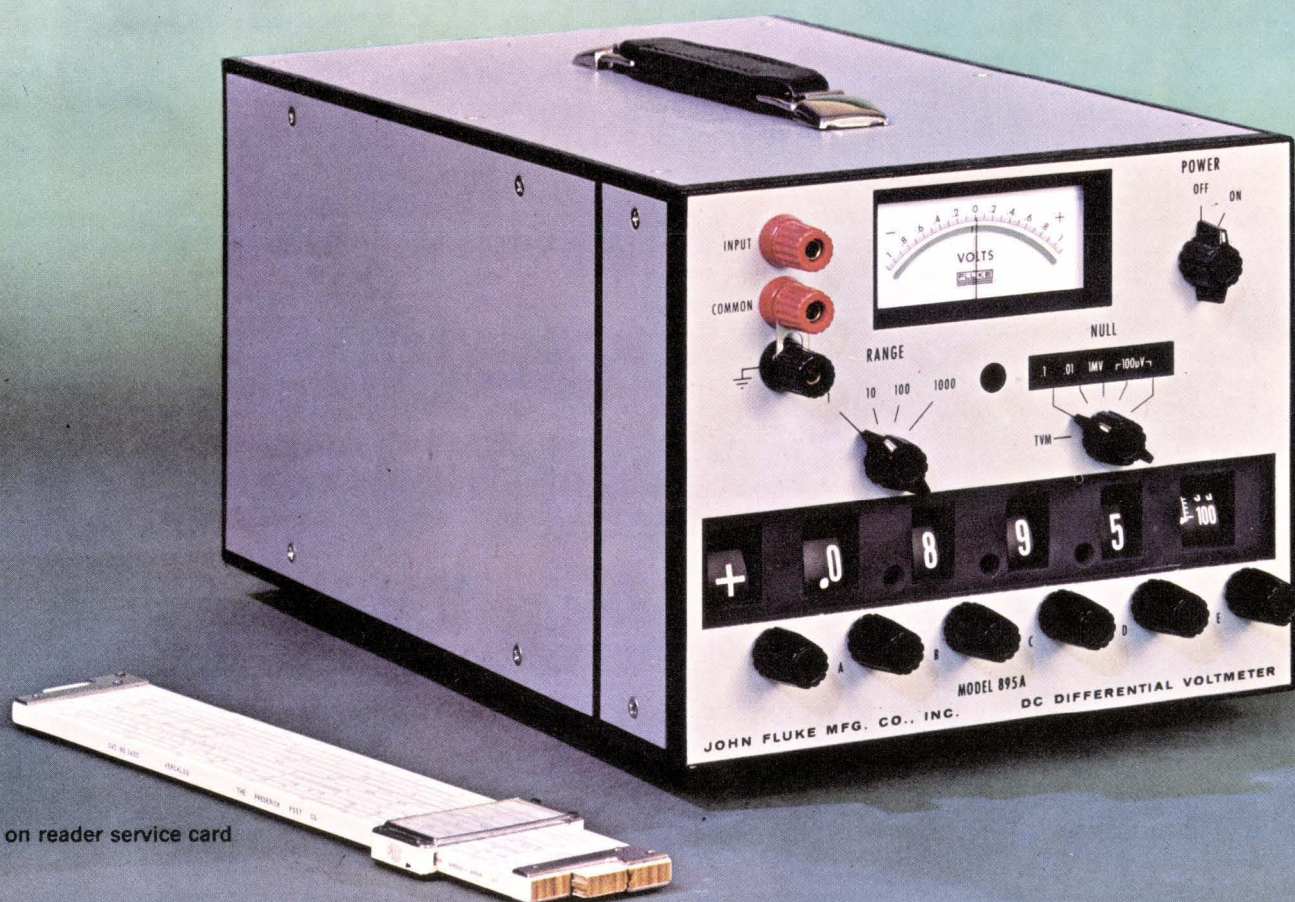

AC metrology will never be the same after the Fluke 931A, the first true rms differential voltmeter. Measure the precise rms value of virtually any waveform within 0.05% from 30 Hz to 50 KHz. Overall frequency response is 10 Hz to 1 MHz. Range is 0.01 to 1100 volts. Ten to one crest factor accounts for effects caused by voltage spikes and pulse trains. Comes with or without probe. Both line or combination line/rechargeable battery powered versions are offered. Base price is \$895.

The new Fluke Model 931A True RMS Differential Voltmeter yields accurate rms measurements of any waveform which previously could be made only by ac to dc comparison with a thermal transfer standard. Other features include high input impedance, in-line digital readout (lighted decimal), solid state design, and linear recorder output.

The null meter indicates percent deviation from the dialed voltage.

Ten percent overranging minimizes range changing.

Battery operation gives ideal isolation from ground loops.

Model 931A meets MIL-SPEC shock and vibration requirements.

For complete information, please call your Fluke Sales Engineer or write.



FLUKE • Box 7428, Seattle, Washington 98133 • Phone: (206) 776-1171 • TWX: (910) 449-2850

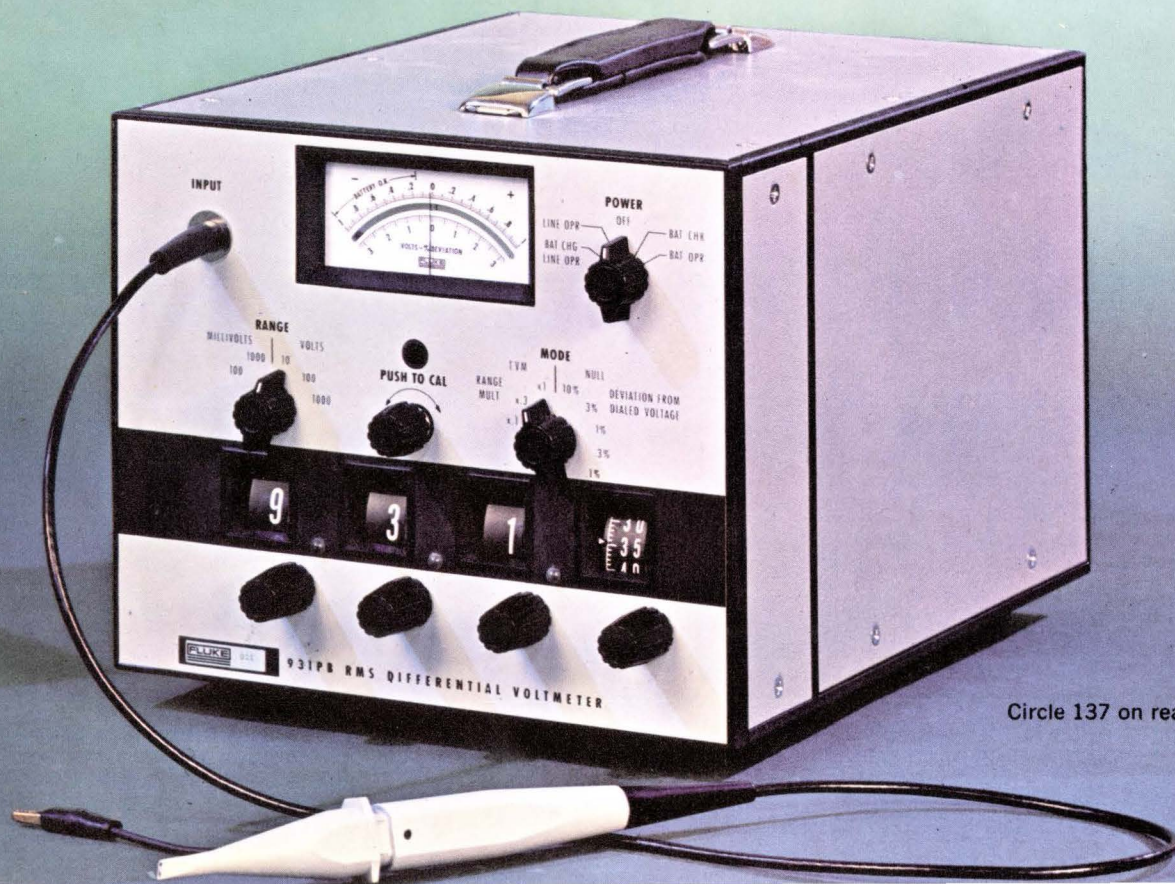

Circle 137 on reader service card

the
Huey
gave
us
a
fair
shake

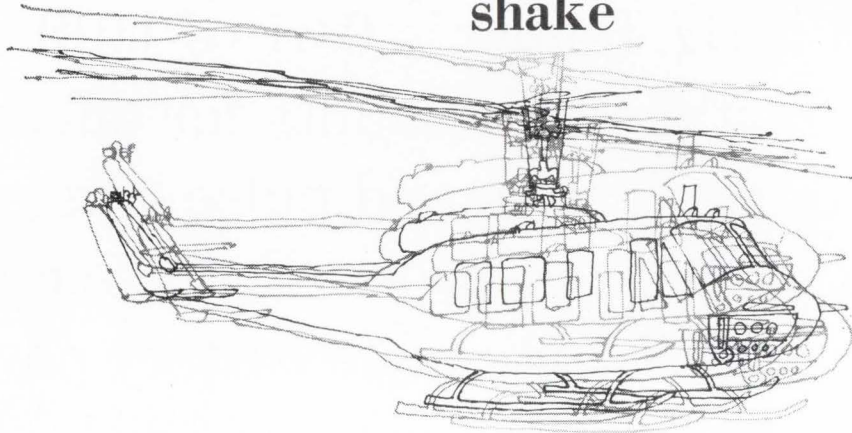

and
we
gave
it
a
steady
picture—
even
at
night

The Army tested and bought. In fact, two image orthicon cameras are now in operation for nighttime surveillance in Vietnam.

The night operation test didn't bother us since we're the largest manufacturer of low-light level TV cameras. And we know our image orthicon cameras produce high resolution pictures in near total darkness (at 1×10^{-5} foot candles). But we weren't too sure about the vibratory factor. Lab tests simply aren't like the real thing. There was no need for concern. The MTI image ortho came through with flying colors—and we mean flying. (Now we know why they call helicopters egg-beaters.)



MTI manufactures over 65 different products and a complete line of television cameras. And incidentally, our vidicon cameras will take the same kind of rough treatment. We're so particular we even make our own monitors. It's the only way we know to guarantee the best products on the market.

If you want to know anything about the closed circuit television equipment—try the specialists first.

mti

MARYLAND TELECOMMUNICATIONS, INC.
York & Video Roads, Cockeysville, Md.
301-666-2727
World's largest manufacturer of
low light level television cameras.

Probing the News

Advanced technology

Holography: the picture looks good

Engineers see promising applications, ranging from color tv to pattern recognition, in new image-producing technique

By Joan Blum

Advanced Technology Editor

Holography has come a long way since Dennis Gabor of the Imperial College of Science and Technology in London used nearly coherent light to record phase and intensity data about an object on a photographic film or plate—a hologram—and then reconstructed the object's image in space. In the last few years holography has become a discipline with a research budget of \$10 million to \$20 million, spread over about 100 laboratories.

Although there are no commercial applications yet, possibilities range from three-dimensional color television to pattern recognition.

Research has already produced several breakthroughs:

- The use of ordinary white light, rather than coherent light, to reconstruct holographic images.
- Multicolor holograms.
- Hologram movies, made from multiple exposures stored on the same photographic plate.
- Excellent quality holographic images of complex objects constructed with ordinary, incoherent light.
- Holographic contour maps.
- A holographic vibration analysis technique.
- 180° and 360° holograms.
- Synthetic, computer-generated

Image of cookie jar is produced by hologram made with three different colors from two lasers. Full color reconstruction is made with laser light.

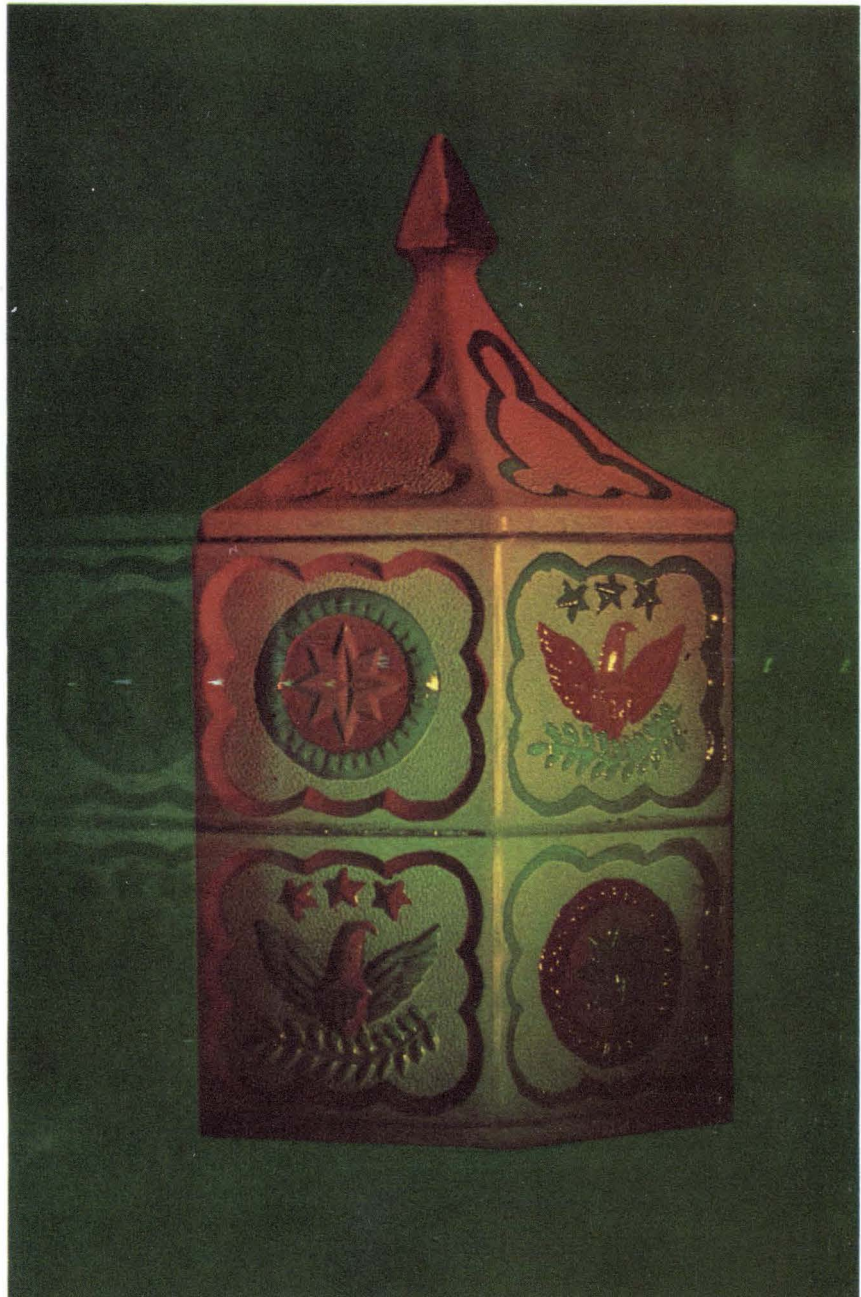

holograms, for which no physical object is required.

Interest in holography revived with the development of the laser. Research is being done, for the most part by private industry, but an estimated one-fourth of the research funds come from government agencies such as the National Science Foundation.

I. In the beginning

Gabor has been known for many years for his contributions to the fields of information theory, television and microscopy. But it is holography that is expected to win him his greatest fame.

It was in 1947, when Gabor started trying to improve the resolution of the electron microscope by overcoming the spherical aberration of the lenses, that he made the first hologram. He reasoned that if resolution of about one angstrom could be obtained, he would be able to see the individual atoms of almost any material. Unable to interest British and American companies in interference microscopy, Gabor gave up the project in 1951.

Gabor called the plate containing the phase and amplitude information describing an object a hologram, from the Greek "holos", to indicate that the whole picture was represented by such a wavefront recording. The phase and amplitude information was stored on the plate as a diffraction pattern formed by two interfering coherent light waves — one scattered by the object, the other transmitted by a transparent background. Coherent light was also used to reilluminate the plate and reconstruct the wavefronts of the object so that its image appears in space. With great effort, Gabor managed to make several good-quality holograms of two-dimensional scenes before he gave up the project. Very little was done with the idea for the next 10 years.

Much of the current effort is concentrated at the University of Michigan, in Ann Arbor. There, research has been concentrated for over a decade on coherent optical data processing.

"The work we were doing was sufficiently related to holography so that it was natural to study it. We had the necessary equipment and the related experience," recalls



Model of molecule whose three-dimensional image has been reconstructed with ordinary white light. Hologram was made with laser light.

Emmett N. Leith, head of the optics group of the Radar and Optics Laboratory.

It was at Michigan that David Falconer, a graduate student of electrical engineering, gave the new field its accepted name—holography—from Gabor's term, hologram. It was at the University in 1962 that Leith, who is also associate professor of electrical engineering, and Juris Upatnieks, a research engineer, first used two separate beams, one to illuminate a continuous-tone object, and the other to provide the interfering reference beam at an oblique angle. Using a single beam, Gabor had only been able to reproduce transparent objects, such as microfilms of text. The first holograms produced with a laser as the source of coherent light were made by Leith and Upatnieks using two-beam interferometry. Two-beam interferometry eliminated most of the out-of-focus (twin or conjugate) image previously present in all holograms, and provided images of excellent quality. This technique is now used to make most holograms.

Scene lighted. Leith and Upatnieks were responsible for another

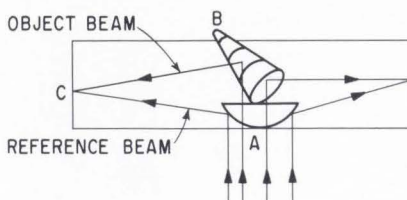

All sides of image, B, visible through cylindrical film, C, viewed head-on. Mirror, A, provides reference beam.

big stride in holography — the use of diffused light to illuminate the entire scene, rather than just a small portion of it. For the first time, holographic images could be observed without eyepieces or other lenses. An observer simply looked through the hologram plate as if it were a window to see the virtual image suspended in back of the plate and the real image in front of it.

Not only are resolution improved and flaws eliminated when a diffuser such as ground glass is placed between the point light source and the object, but, according to Gabor: "Dif-

fused holograms are almost perfect examples of ideal coding; the information from every object point is almost evenly distributed over the whole photographic plate — a development of great importance to communication theory." The new technique helped Leith and Upatnieks to make the first three-dimensional laser holograms by reflecting diffused light from a solid object, rather than having to transmit a small amount of light through a two-dimensional transparency. The University of Michigan has applied for a patent on their work with diffused light.

II. Magnification with holography

Added to the list of credits of Leith and his colleagues is a demonstration of magnification with holography — a hologram reconstruction of a fly's wing magnified about 60 times. They also have made what promises to become a classic analysis of requirements for holographic television. Most recently, they have conceived various methods for recording several separate scenes on a single hologram; each scene is observed individually, without a trace of the other. These researchers also have been credited with white-light reconstruction of holograms and with the first hologram movie recorded on a single plate.

In fact, the most dramatic recent development was the use of white light to reconstruct holograms. Leith and Upatnieks, who reported on it in March at the Optical Society



Two-dimensional scene made with red and blue wavelengths from two lasers, and reconstructed with white light. How other colors are produced is not yet understood.

of America meeting in Washington, D.C., used ordinary white light to reconstruct images from holograms made with coherent light. Bringing the reference beam in from the back of the plate, they created standing waves perpendicular to the face of the plate. Layers formed in the emulsion, parallel to the plate, allow only light of the same wavelength with which the hologram was made to reconstruct the image. The photograph on page 140 shows a model of a molecule from which a hologram was made with red laser light. The 3-D image was reconstructed with white light, and is green because of the shrinkage of the emulsion that occurs during developing. Originally the separation between fringes in the emulsion corresponded to a half-wavelength in the red portion of the spectrum. After the emulsion shrinks, the distance corresponds to a half-wavelength of the green. The emulsion filters out all wavelengths except the green.

Charles Schwartz of Battelle

Memorial Institute in Columbus, Ohio, has also used white lights in reading out holograms. Schwartz also used a reference beam incident on the back of the plate to produce a three-dimensional image of a fly and a two-dimensional picture of parallel bars.

A Soviet 'first'. The idea of white-light reconstruction was worked out both theoretically and experimentally even earlier by the Russian Y. N. Denisyuk in 1962. Denisyuk theorized that information stored in a thick emulsion could be read out in multicolor by "light with a com-

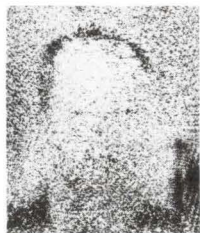

Noise that obscures image is eliminated in view at right by signal processing technique developed for radar.

plex spectrum" — white light. The basis for Denisyuk's work was provided in 1894 by the French researcher Gabriel Lippmann, who described a process for producing color photographs (not holograms), using high-resolution black and white film, illuminated with white light. The principle of reconstructing interference fringes stored in an emulsion is the same, however.

Leith also reported at the Optical Society meeting on work that his group had done on multicolor holograms by illuminating a cookie jar, shown in the photograph on page 139, with three different wavelengths provided by two lasers, and reconstructing the three-dimensional image from the resulting hologram with laser light. Extraneous images occur to the left and right of the cookie jar because each of the laser wavelengths reconstructs a separate image. The unwanted images can be almost completely eliminated by bringing the illuminating beams in from different angles or relying on a thick emulsion to separate the wavelengths within the hologram plate itself. This was the first time that multicolor holograms constructed with three separate colors had been reported. However, L.H. Lin, K.S. Pennington, G.W. Stroke and A.E. Labeyrie have made multicolor holographic images by illuminating an object with two wavelengths from two lasers, and reconstructing the image with ordinary white light [Electronics, Mar. 21, p. 42]. An image of more than two colors was produced (upper photograph on this page) by a mechanism not yet completely understood.

III. Movies by storage

Leith reported still a third innovation — hologram movies. They were made by storing several superimposed interference patterns in a thick-emulsion hologram. The position of the hologram was changed for each exposure. Readout was accomplished by rotating the hologram through successive angles in laser light. As the hologram rotates, a three-dimensional image of a bird dipping its beak is observed behind the plate, in space. Another way of achieving the effect of motion was devised in August, 1965, by Matt Lehmann and Wright Huntley of

NEW CHEMELEC® TFE SOCKETS FEATURE

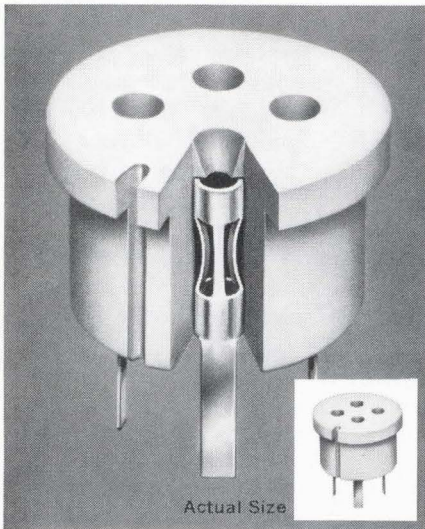

THREE-LEAF CONTACTS FOR EXTRA RELIABILITY

Unique contact design gives Chemelec sockets their extra reliability: In each pin hole are three beryllium copper leaves that bow in toward the center. When a lead is inserted, the leaves deflect to let it slide in easily, but press firmly against it to assure good contact. A built-in barb prevents accidental pull-out of the contact assembly.

The design gives practically unlimited life . . . low contact resistance (less than .010 ohm) . . . and insertion force of less than 1 oz. per lead.

These low profile 1/4" high sockets of TFE fluorocarbon plastic—to MIL-M-55068—have orientation notches visible from above and below . . . tapered entry to guide leads in easily, quickly . . . and are available with flat, flat right-angle, or flexible mounting tabs, with 3 to 14 contacts in .100 to .250 pin circles.

For more information, write for Bulletin SPC-1.

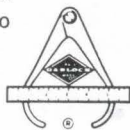

GARLOCK
ELECTRONIC PRODUCTS
GARLOCK INC.

Cherry Hill, N.J. 08034 • Phone (609) 424-1470

Stanford University in California. They made a series of still holograms and read them out in succession. The method required a separate hologram for each position of the object.

Other members of the radar and optics laboratory at the University of Michigan, Adam Kozma and Norman Massey, have been working with incoherent holograms. Such holograms can be made with ordinary white light but the resulting image is very poor when a complex, continuous-tone object is used. The superposition of many randomly spaced intensity patterns on a photographic plate produces a large amount of noise that masks the spatial intensity modulations within the film, which are necessary to reconstruct an image. Kozma and Massey have eliminated the noise, using optical signal correlation techniques developed for radar.

With a vibrating mirror, the researchers time-modulated the information-carrying component of light in one path of an interferometer. Then they compared an externally introduced sinusoid with the signal produced by the vibrating mirror. A point-by-point time correlation between the two signals is made over the hologram plane; that is, the signals are multiplied. Noise, occurring as a signal that is out of phase with the reference signal, averages to zero and thus does not appear on the hologram. Now, incoherent light can be used to obtain images of a quality comparable to those made with coherent light. The left-hand portion of the photograph on page 141 is typical of an image made with incoherent light; noise makes it almost unintelligible. The right-hand portion of the photograph is an image made after the noise had been eliminated. In some applications, it might be easier to use optical signal processing methods rather than to use a laser as the light source.

Percy Hildebrand and Kenneth Haines of Michigan have used multiple frequencies to construct contour maps of three-dimensional objects with holograms. They used a single frequency to read it out. An image on a background of reference patterns is obtained. The image has superimposed contours of constant depth. A holographic contour map consists of a series of distorted con-

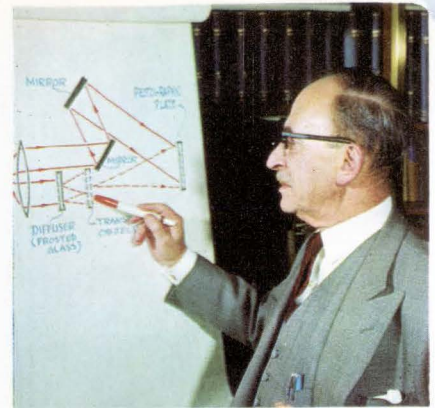

Dennis Gabor, made first holograms of two-dimensional scenes in 1947.



Emmett Leith, University of Michigan, prime mover in holography research.

centric circles that join points of equal height. The spacing between rings indicates how much a given portion of a curved object departs from planarity. The more widely spaced the rings, the more planar is the area being observed. These holograms can be used, for example, to view objects with very slight variations in dimensions such as precision-machined tools. If the hologram were to be made in the usual way—with a single frequency—the focal depth of the three-dimensional image would not display slight, relative gradations in size with precision.

IV. Deformation in materials

Karl Stetson of the G.C.A. Corp., Burlington, Mass., formerly a researcher at the University of Michigan, suggested that the diffraction of light as recorded on a hologram might be a practical method of detecting small periodic deformations in materials. If an object is vibrating or being strained, its motion, however small, will disturb its reconstructed interference patterns. The

amount of disturbance depends on the object's amplitude of vibration, and can be determined by observing the degree of degradation of the reconstructed image.

Work on synthetic holograms has been carried out by Adolph Lohmann and Dieter Paris of International Business Machines Corp.'s San Jose Research Laboratory. Instead of making a hologram of an actual object, Lohmann feeds a mathematical description of an object to a computer. The computer guides an automatic plotter that draws a picture of the object on paper, from equations. The image is recorded on film from which a hologram is made. No physical object is required for the production of the hologram. The technique is expected to have application to pattern recognition.

More views. A 180° hologram has been made by E.P. Supertzi and A.K. Rigler of the Westinghouse Electric Corp., in Pittsburgh, and a 360° hologram by Ryuichi Hioki and Takeomi Suzuki at the University of Tokyo. These techniques allow more views of an image than can be seen with ordinary rectangular holograms.

Supertzi and Rigler exposed a strip of high-resolution aerial reconnaissance film, 3 feet long and 5 inches wide, with laser light reflected from a pair of figurines. The reference beam was supplied by a spherical mirror placed in the path of the laser light. Read-out of the scene provides a view of the figurines, in 3-D, from various angles as the observer looks through different portions of the curved film.

Hioki and Suzuki made a shallow cylinder of film and placed an object in its center, as shown at the bottom of page 140. A laser illuminates both the mirror, A, to provide the reference beam, and the object, B, above it. The central portion of the mirror is transparent, and light passing through it also falls on the object as additional illumination. Interference patterns representing all the wavefronts of the object form on the cylindrical film, C. The hologram is reilluminated to reconstruct an image, which is formed at exactly the same place that the original object occupied. All sides of the image are completely visible and can be viewed by looking through various portions of the film.

4 ways to beat a hot system

1. Centrifugal Blowers
2. Propeller Fans
3. Vaneaxial Fans
4. Tubeaxial Fans

Learn about them from a 12 page booklet called the "Airmover Selector." It has a technical information section to aid you in your choice of airmovers. On the remaining pages we have plugs for our products which help pay the cost of free booklets. Or a better bargain is our 136

you meet with our technical sales reps. For very quick service contact: IMC Magnetics Corp., Eastern Division, 570 Main Street, Westbury, N.Y. 11591. Phone 516 334 7070 or TWX 516 333 3319. For the "Airmover Selector" write: Marketing Division



at the same address, or circle the Bingo number below.

**This is our 3 step.
Give us a call and see all
the steps in our routine.**

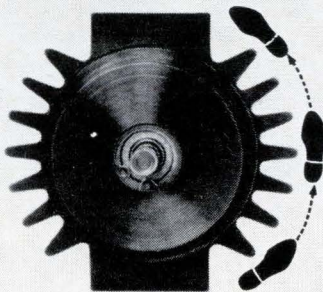

If you really want to swing you can also step 4, 8, 12, 24, 48, and 200 increments without gears.

Or to Indicate, Measure and Control using flag and remote angle indicators, synchros, resolvers, steppers, or solenoids. They are in stock at IMC Magnetics Corp., Western Division. For quick service contact the Applications Section at Western Division, 6058 Walker Ave., Maywood, Calif. 90270. Phone 213 583 4785 or TWX 910 321 3089.

If you need data sheets for references or consideration for future projects, write IMC's Marketing Division at 570 Main Street, Westbury, New York 11591.



**TRW
CAPACITORS
ARE
SMUG**



...especially our new metallized polycarbonates!

TRW has now extended its leadership in film capacitors to include metallized polycarbonate types. Two features of the X463UW are outstanding. Precise processing assures low TC through temperature ranges to 125° C. Metallized construction reduces size to less than one half that of film-foil designs. Other features of the line include:

- Capacity range from .01 to 10.0 mfd
- Low dielectric absorption
- Available in tolerances to $\pm 1\%$
- Humidity resistance per MIL-C-27287

For full information contact: TRW Capacitors, Box 1000, Ogallala, Nebraska. Phone: 308-284-3611 • TWX: 910-620-0321.

TRW CAPACITORS

Tactical satellite program gets moving

Before long, industry will be asked for proposals for the military communications system that is urgently needed for tactical operations

By Warren Kornberg

Washington News Bureau

The Pentagon seems ready to get down to the business of building a tactical communications satellite system. The first big step will come this summer when the Air Force asks industry for proposals for a satellite tailored to the tactical needs of all the services.

For systems engineers, the tactical satellite means a reversal of the strategy developed for the Initial Defense Communication Satellite system, whose first flight of the 22 satellites in the program will

be launched soon. The pioneering satellite system depends on sophisticated ground terminals and a relatively simple and light satellite. Tactical satellites, on the other hand, require small, inexpensive, lightweight and highly mobile terminals. For example, the Army wants a terminal that will be small enough to be transported by jeep or even on the back of a soldier.

But there's one big problem—small antennas require a powerful satellite beam because the power

received by an antenna diminishes proportionately with its surface area. The solution is to build a satellite with equipment that will give it enough muscle for its communication job. The Pentagon is convinced that the progress being made in satellite and booster technology makes its estimate of 1968 as the target date for a working satellite a realistic goal.

Design of ground stations is further complicated by the varying requirements of the three services.

Portable 20-foot satellite antenna being developed by Radiation, Inc., will add flexibility to Army communications, but the service wants even smaller dishes for field commanders.

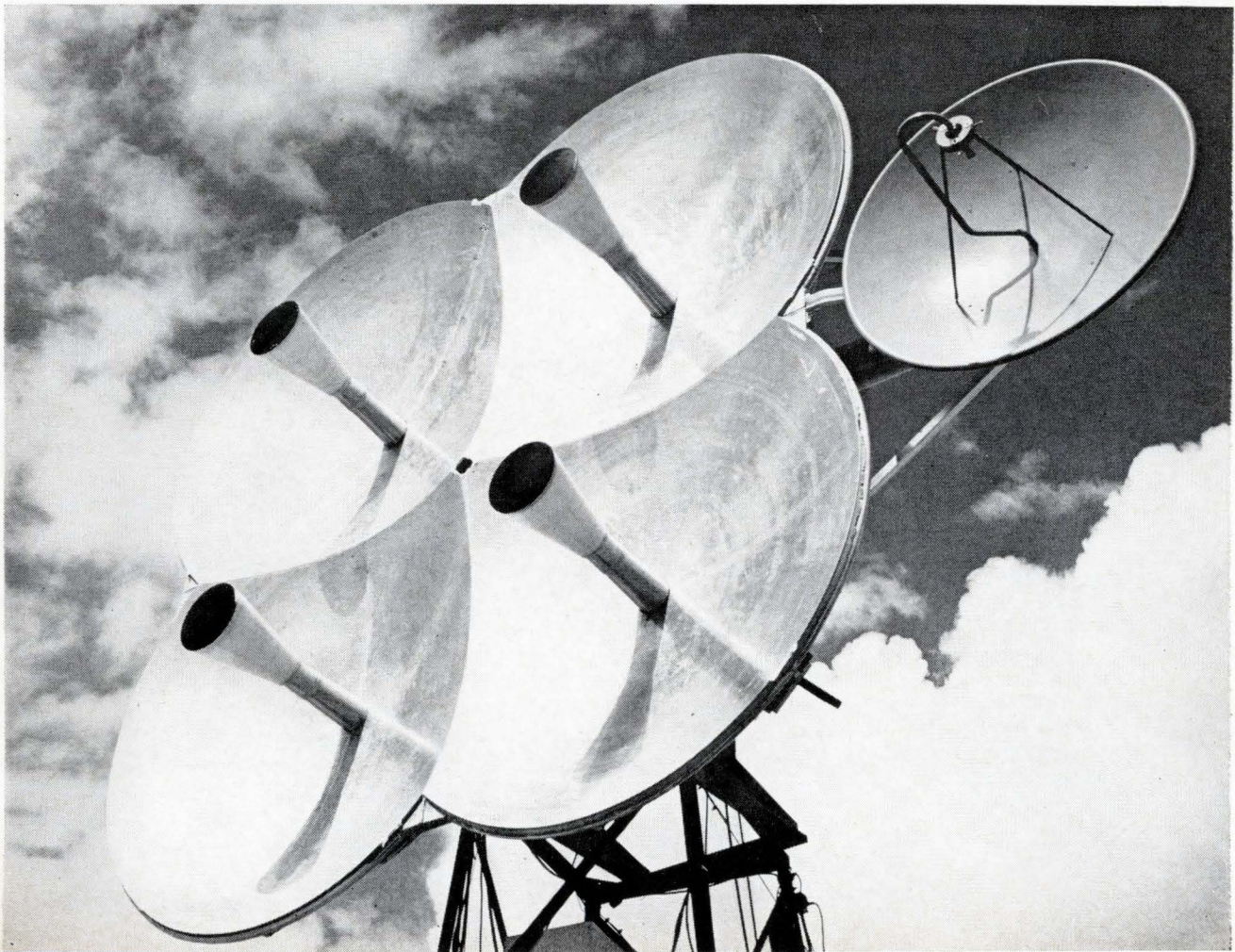

DIRECT LINE

to classified
advertising results.
Call the McGraw-Hill
office nearest you.

404-875-0523
1375 Peachtree St., N.E.
Atlanta 30309

617-262-1160
607 Boylston St.
Boston 02116

312-664-5800
645 N. Michigan Ave.
Chicago 60611

216-781-7000
55 Public Square
Cleveland 44113

214-747-9721
1800 Republic
Nat'l Bank Tower
Dallas 75201

303-255-2981
1700 Broadway
Denver 80202

313-962-1793
856 Penobscot Bldg.
Detroit 48226

713-224-8381
2270 Humble Bldg.
Houston 77002

213-482-5450
1125 W. 6th St.
Los Angeles 90017

212-971-3594
500 Fifth Ave.
New York 10036

215-568-6161
Six Penn Center Plaza
Philadelphia 19103

412-391-1314
4 Gateway Center
Pittsburgh 15222

314-725-7285
Clayton Tower
7751 Carondelet Ave.
St. Louis 63105

415-362-4600
255 California St.
San Francisco 94111

The Army wants foldable antennas; the Navy needs a simple structure that fits into the existing electronic pattern of a ship's superstructure; and the Air Force requires a flush array that won't ruin the aerodynamic characteristics of its aircraft.

Most of the development is still in the offing for tactical systems but the Advanced Defense Communications Satellite system—the planned follow-on to the Initial Satellite—scheduled for the end of this decade will have some tactical capability. The first eight of the 22 satellites in the Initial Satellite program will be launched soon. They will operate as a worldwide system for high-priority military communications.

I. Satellite requirements

Although most of the requirements for the tactical satellite are classified, Department of Defense planners have indicated that they want a synchronous orbit, with station-keeping capability. Moreover, they would like to have radiated power of the satellite in the kilowatt range.

The power problem is being attacked from a number of angles: by raising the frequency, by increasing the satellite's transmitting power, and by improving the efficiency of the receiving system.

Because of the vast range of ultrahigh-frequency equipment already in use in the services, planners prefer to think in terms of that band. However, it is currently unavailable, under international agreement, for satellite communications. If no accommodation can be made, other frequency ranges will have to be explored.

A narrow-beam capability is desired to increase effective radiated power. A satellite beacon will have to be incorporated to insure minimal tracking requirements at the station end. The satellite will also have to provide virtually instant access to hundreds of users simultaneously.

For the tactical system, as in the Initial Defense Communications Satellite program, the Army will be responsible for developing ground terminals; the Air Force will manage satellite development and all airborne equipment; and the Navy will concentrate on shipboard terminal design and development.

II. Wanted: small dishes

The Army wants a system which will provide reliable communications for its patrols. This means foldable, portable antennas ranging from two-foot to six-foot dishes. Simplicity is a requirement for the equipment since the soldier in the field must operate and service it.

At present the Army has no small, portable antennas. Officials have expressed some interest in a collapsible six-foot antenna developed on speculation by the Westinghouse Electric Co., but so far no commitments have been made.

The Army does have transportable systems. A 20-foot dish is now under development by Radiation Inc.; it can be carried by a three-quarter-ton truck. The Hughes Aircraft Co. is furnishing the AN/MS-46, a 40-foot dish that will be used in the Initial Defense Communications Satellite program.

Any new system will have to be compatible with the standard tactical Army VRC-12 family of radios that are being used in Vietnam and for which the Army has high praise. The sets will require some interface equipment on the satellite for frequency converting to the satellite's communications band.

An Army spokesman says, "Field radios might provide receiving capability, but transmitting capability directly to a satellite may be five to 10 years off."

III. Shipboard systems

The Navy can't predict the design of tactical terminals, but it knows what it wants—smaller, simpler structures that do not add to the electronic clutter on ship superstructures. It must have terminals that are stabilized so they can look up from a moving, pitching platform; that have a narrow antenna beam, and whose computerized tracking equipment has minimum bulk.

The possibility of adapting existing transmitting and receiving equipment exists, but the Navy hasn't determined if it can be done economically. Several uhf sets have been considered, but if they are to operate satisfactorily they'll have to be converted from amplitude-modulation to frequency modulation or digital transmission. Pre-amplifiers with greater sensitivity

would also have to be devised.

The Navy uses both the high-frequency and the ultrahigh-frequency ranges for communications. With uhf limited to line of sight and the h-f ranges subject to propagation anomalies and spectrum crowding—a special problem for ships—over-the-horizon uhf through a satellite looks particularly attractive.

The Navy has two six-foot dishes, the AN/SSC-2 built by Hughes, on two ships. These will soon be superseded by the AN/SSC-3, especially designed for shipboard use with the military communication satellite program.

IV. For the Air Force

The Air Force is looking for flush arrays that won't interfere with the airflow over an airplane's skin. A major problem will be guarding against multipath interference from the surface of the sea or earth. "Simple ground antennas and simple extra antennas on the airplane" is what the specifications ask for so far. The consideration of satellite needs comes at a time when the Air Force is facing replacement of existing airborne communications equipment.

The AN/ARC-34 radio systems in most military aircraft are less adequate than those used in commercial planes. Research and development is being intensified to correct this deficiency.

"We couldn't justify junking a system just to meet satellite requirements," says one officer. "But any new system will probably have to include—or be supplemented by—satellite capability."

Unless some arrangement can be made to permit use of the new uhf equipment in satellite communications, a separate satellite system will have to be bought, according to an Air Force spokesman.

The leading candidates for replacement of the ARC-34's are the ARC-109's developed for advanced aircraft, and the ARC-54's preferred by the Navy. Both have a better predicted mean-time-between-failures than the 34's, and the Air Force believes the 109's are twice as good as the 54's in time between failure. Both the 109 and 54 are built by the Collins Radio Corp. Each gives double the 1,735 channels of the ARC 34's.

NEW WANLASS R-3200 VOLTAGE REGULATORS

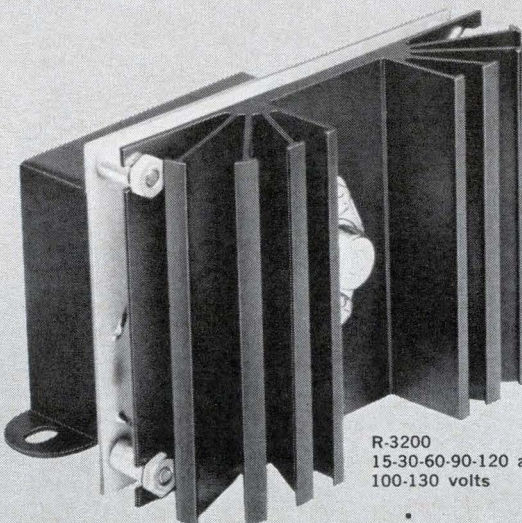

R-3200/60
REGULATOR
PATENTS PENDING

R-3200
15-30-60-90-120 and 250 va
100-130 volts

**NOW . . . A 1% LINE AND LOAD REGULATOR
WITH MICROSECOND RESPONSE
and 47-63 CYCLE OPERATION**

- Economy* • *Small size* • *Light Weight*
- Power factor insensitive* • *Current overload protection*
- No phase shift* • *All solid state* • *Optional 400 cycle operation*
- *Efficiency—up 10% more in rated tests*

PRODUCT COMPARISON CHART		
	R-3200/60 60 va Unit	Typical 60 va Ferroresonant Transformer
Price	\$20.00*	\$21.00
Line Regulation	±1%	±1%
Load Regulation	±1%	—
Frequency	47-63 cps	60 cps
Power Factor	Insensitive up to ±0.7	1.0
Phase Shift	No	Yes
Response	50 μ-sec	25,000 μ-sec
Weight	2.5 lbs.	8 lbs.
Size	3 x 3 3/4 x 4 in.	3 x 4 x 5 in.**
Units to be mounted	1	2

*F.O.B. Santa Ana. Subject to change.
**Dimensions do not include separate capacitor.

The new Wanlass R-3200 Series voltage regulators are designed specifically for a wide variety of electronic instruments and equipments. Compare cost, performance, economy of operation with other competitively priced units (see table). Wanlass R-3200 voltage regulators are the ideal choice for all original equipment applications now using constant voltage ferroresonant transformers. Write today for complete technical data. Wanlass Electric Co., 2189 S. Grand Ave., Santa Ana, Calif. 92705. (714) 546-8990.

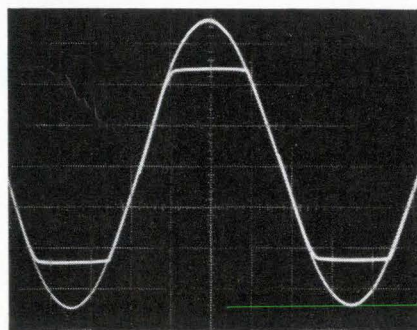

Unretouched photo shows output waveform superimposed over input. Regulation is achieved by "peak clipping."

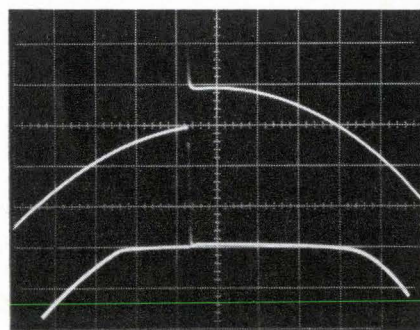

R-3200 has significant line noise suppression. Note 25-volt input change (upper) and 50 μ-second response in output (lower).

WANLASS ELECTRIC CO.



*A new edition
for your
electronics library...*



Motorola's NEW Silicon Rectifier Handbook

... A single source for Rectifier-Circuit design!

Neophyte or "old hand," you'll want this authoritative reference to rectification at your elbow when designing *any* circuit involving rectifiers! Purposely (but comprehensively) brief in device theory . . . deep in *practical* rectifier circuit knowhow and written by engineers with years of industrial experience — this 216-page guide will provide the answers to your everyday circuit design problems.

Some of the highlights:

- design charts for single-phase and multi-phase circuits
- heat sinking and proper cooling of devices
- over-voltage and current surge protection
- basic cell construction (written in layman's terms)
- how to understand data sheet terminology

- the Multi-Cell* approach to very high power rectification
- practical rectifier circuits
- . . . and much more!

Send for your personal copy now . . . contact your Motorola distributor or fill out and send in the coupon below.

*Pat. Pending

Price: only \$1.50



MOTOROLA

Please send me _____ copies of Motorola's new Silicon Rectifier Handbook @ \$1.50 each.

Name _____

Title _____

Company _____

Address _____ Div/Dept _____

City _____ State _____ Zip _____

Mail with check (payable to Motorola, Inc.) to Motorola Semiconductor Products, Inc., Box 955, Phoenix, Arizona 85001

MOTOROLA RECTIFIERS — FOR QUALITY YOU CAN MEASURE!

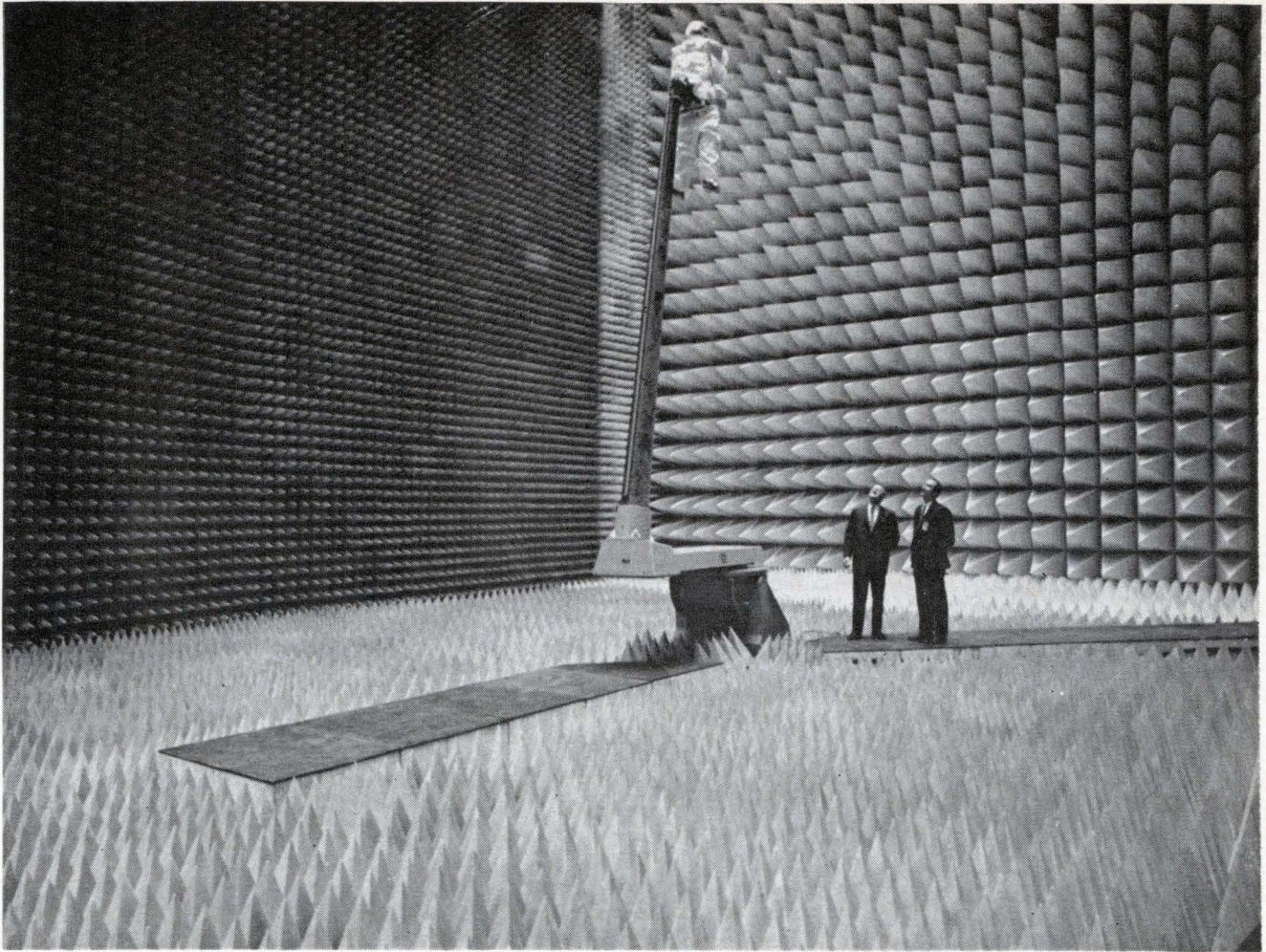

Anechoic chamber at the Manned Space Center in Houston is used to test communication systems for Apollo in radiation environments similar to those of deep space. The shielded chamber is 55 feet by 55 feet by 150 feet.

Space electronics

Where the action is

At Houston, a little known but highly influential division of the Manned Spacecraft Center plays a key role in the Apollo program

By Ron Lovell

Houston News Bureau

With little fanfare, a peripatetic group of engineers headquartered in Houston at NASA's Manned Spacecraft Center is playing a major role in the Apollo program to put a man on the moon before the end of the decade. They work for the center's Instrumentation and Electronics System division, (IESD), originally set up to provide technical support for operational manned spacecraft systems.

But often, when the National Aeronautics and Space Administration needs instruments in a hurry, the division supplies them. For example, when the first manned Apollo flight lofts off from Cape Kennedy late this year or early next year its command module will carry aboard a number of instruments that the lead contractor saw for the first time as a package that the division had developed itself.

In its role of technical adviser, and—in time of need—supplier of spacecraft communications and telemetry systems to the spacecraft center, the division deals directly with about 50 electronics companies. Its activities affect scores more.

No constraints. The division's method of working with these companies leans heavily toward direct contact. Its more than 200 engi-

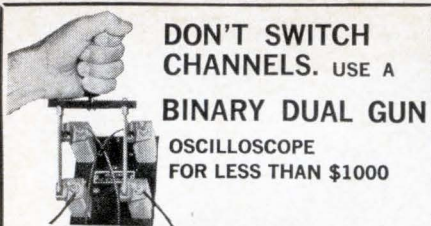

This **PROVEN — HARD WORKING INSTRUMENT** also Features

- DC to 5 MC Band Width
 - 1 Millivolt/Cm Sensitivity
 - Built-in Calibration
 - External Horizontal and Z Modulation
- All in a portable-lightweight package.
Model 5Mc 2P \$950 f.o.b. Anaheim
Write for complete specifications

BINARY ELECTRONICS OF CALIF.
1429 N. State College Blvd.
Anaheim, Calif. 714-772-3070

Circle 515 on reader service card

72 HOUR DELIVERY

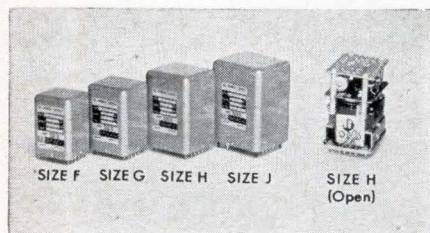

On sizes F, G, H & J Regulated DC

POWER SUPPLIES

FEATURES

- Fully Repairable
- Large Quantity Discounts
- Low Cost
- 0.5 to 60 vdc Coverage By Model Selection
- 0.05% or 0.5% Combined Regulation
- Temperature coefficient from $\pm .01\% / ^\circ\text{C}$
- See 1965-66 EEM, page 1538 (Prices are obsolete)

Contact our representative or the factory for details



DYNAGE, INC.
390 CAPITOL AVENUE, HARTFORD, CONN. 06105
TELEPHONE (203) 249-5654

150 Circle 150 on reader service card

neers and technicians are as likely to be found at the plant of the lead contractor, the Space and Instrumentation division of North American Aviation, Inc., or at one of the many subcontractors' plants as at headquarters in Houston.

Ralph Sawyer, chief of the division, sums up its role for the Apollo project like this: "It's up to us," he says, "to recognize problems in all our areas of responsibility—technical management, financial analysis, scheduling—in advance so that there are no constraints on the mission."

I. Management and support

The division was formed to manage the development of instrumentation and electronic systems for manned spacecraft, but it soon found itself also in the hardware business. The reason? "For the first Apollo shots, we couldn't rely on contractors for equipment because too many changes were involved with too little time to make them," says Carl Watkins, a special assistant to Sawyer.

"For the early flights, we have certain tests and measurements to make, and these measurements are not constant," Watkins adds. Because the tests vary, the instruments must also vary. If IESD had to put out requests for proposals and negotiate contracts for every flight, the United States might have to wait for the end of the century, rather than the end of the decade, to put a man on the moon.

The division has supplied communications and telemetry systems for both the Gemini and Apollo programs. The systems often represent a hefty investment, sometimes as much as \$300,000 to \$800,000 each. On a once-only airframe test, for instance, the division provided a system consisting of three transmitters, three telemetry packages, a commutator, a camera system, and 80 to 100 transducers. There simply wasn't time, IESD says, to go through the normal procurement procedure.

Apollo backpack. The evolution of the communications and telemetry equipment built into the Apollo astronaut's flight suits is a good example of IESD's work. Early in the Gemini program, the division developed a communications "belt pack," then delivered a printed-cir-

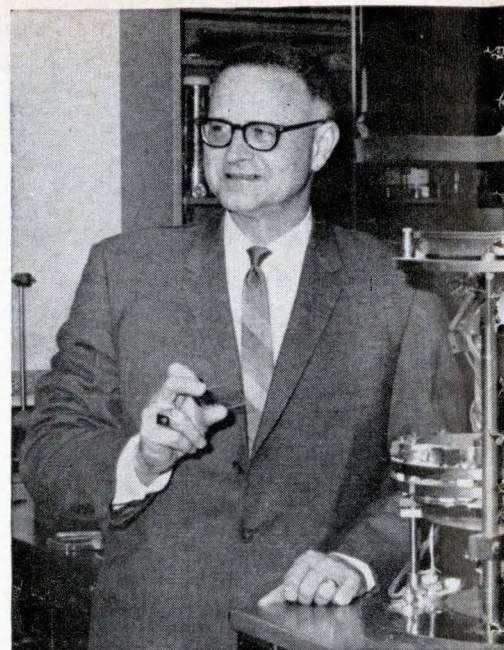

Ralph Sawyer says his group doesn't do much 'why is the grass green' work.

cuit board backpack for voice communications and physiological telemetry. This was followed up with a smaller backpack which used welded circuit techniques.

By the time the major subcontractor for the spacesuit, Hamilton-Standard, a division of the United Aircraft Corp., was ready to pick its communications and telemetry subcontractor, the Instrumentation and Electronics System Division had, in Sawyer's words, "a heavy hand in the specs." A development contract was eventually let to ITT Kellogg, a division of the International Telephone and Telegraph Corp.

Thus the division both furnished equipment and provided technical advice for the spacesuit system.

It will even, in some cases, perform experimental work that is related to specific hardware needs. One area currently under study is what Sawyer calls "the problem of spacecraft data management."

"The quantity of information required of long-distance manned flights cannot be met within the weight, power, and volume restrictions unless new techniques are developed to use narrower transmission bandwidths," he says. He believes that pretransmission analysis of data, eliminating redundant or unnecessary information, would better utilize the permissible bandwidth.

One group in the division is now

at work on mathematical analysis of actual flight data tapes to develop a computer-controlled system that would determine the correct priorities and the minimum necessary accuracy and power of transmission.

II. Organization men

The division does more, however, than perform research for future programs or take orders for flight instrumentation. (Contracts for \$10.1 million were awarded in fiscal 1966). To carry out the diversified responsibilities of the division, Sawyer has special assistants on his staff for long-term development and procurement, personnel and security, and the budget. Two other special assistants supervise activity on this level—one for general instrumentation, the other for electronic systems.

The more technical members of the staff are organized into four branch offices: flight data systems, electromagnetic systems, general instrumentation, and standards and quality control assurance.

Because the development of flight instrumentation for Apollo has a finite goal, the number of engineers and technicians on the staff is deliberately restricted by NASA. Rather than add new men to the payroll permanently for special programs, the division uses contractor personnel; it currently has 253 men from the Lockheed Space and Systems Co., a division of Lockheed Aircraft Corp., and 71 from the Philco Corp. As a result, the division's current liaison man at North American's Space and Information Systems division is an employee of Lockheed. Such anomalies are not at all rare when IESD breadboards a system and sends it to a contractor for installation on a test spacecraft.

III. In the laboratory

NASA employees or not, staff members have an opportunity to work in an ideal engineering environment. Major facilities include:

- An instrumentation and electronic facility for evaluating instruments, determining causes of failure with radioactive materials, testing circuits, evaluating flight data records, developing television systems, and developing and calibrating heat flux sensors to deter-



Latronics

CONTROLLED RECTIFIER HOUSINGS

METAL TOP

CERAMIC TOP

FIG. II

FOR LOW, MEDIUM AND HIGH POWER AP

PART NO.		A	B	C	E	F	G	
35.5254	III	.547	.422	.2	—	.100	.186	.375
35.5253	III	.671	.545	.2	—	.100	.170	.972
35.5081	II	1.043	.872	.3	.50	—	.120	.250 .781 1.375
35.5512	OHRO	1.050	.845	.265	.045	—	.218	.235 .250 .632 1.182

This is a typical sheet from Latronics new catalog on Ceramic and Glass-to-Metal Seals.

SEND for Latronics Catalog 100-266-1.

Latronics Corporation

995 Lloyd Avenue, Latrobe, Pa. 15650 • Phone 412-539-1626 • TWX 412-594-7857

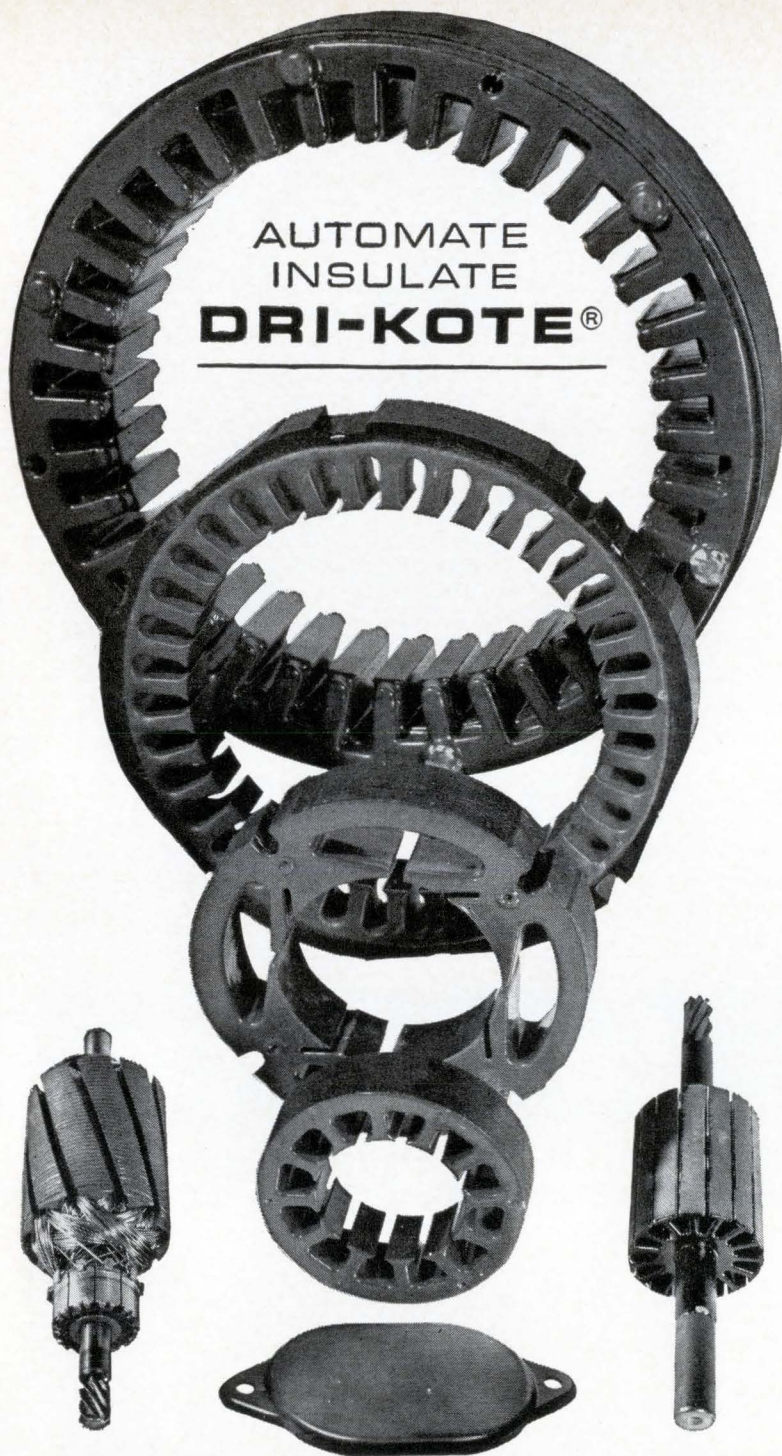

AUTOMATE
INSULATE
DRI-KOTE®

HYSOL DRI-KOTE® powders are your answer to coat, insulate and protect intricate shapes easily and economically.

- No highly trained personnel are needed to apply DRI-KOTE® •
- Automate production and reduce cost in applying by spray, flow or aerated bed processes. • Total material reclaim eliminates waste, reduces mess. • Produces wide range of thickness. • Low shrinkage
- Excellent adhesion without priming. • High (500° F.) temperature cut-thru and impact resistance to withstand a wide range of thermal shock conditions and UL recognition. • Applicable to hot or cold surfaces. • Excellent anti-corrosive coating, resistance to high temperature electrical and mechanical degradation.

Write, wire or call for application engineering assistance... Ask for Bulletins E-550, E-553 and DPE-33.

PROGRESSIVE PRODUCTS
HYSOL HYSOL CORPORATION • OLEAN, NEW YORK
THRU CHEMICAL RESEARCH Los Angeles, California / Hysol (Canada) Ltd., Ontario / London, England

mine heat shield performance. This facility also has a microcircuit lab for work on techniques and devices to miniaturize spacecraft electronic systems and for evaluation of industrial production techniques.

- An environmental qualification facility to simulate the temperature, altitude, vibration, and humidity extremes found in space.

- A standards and calibration facility where some 20,000 Manned Spacecraft Center measuring instruments, including those of outside contractors, are checked, on a continuous basis, at the rate of 90 to 120 a day.

- An anechoic chamber to test Apollo communications in radiation environment similar to those of deep space.

- A 46-acre antenna range with independently mounted 6-foot and 12-foot dish antennas that transmit between 10 megahertz (megacycles per second) and 12.4 gigahertz. Range lengths of 1,000, 2,000 and 2,500 feet are used.

- An optical frequency range for both communications and radar systems. Tests on these are carried out in a cylindrical vacuum tube 262 feet long and 13 feet in diameter.

All of this adds up to an elaborate but strictly practical lab. Most of the work is directly concerned with Apollo; "there's not much 'why is the grass green' type of work," says Sawyer dryly.

The future is now. It's almost impossible to predict the direction the activities of the Instrumentation and Electronics Systems division will take. When asked what they'll be working on next, the engineers at IESD reply, "It all depends."

In a real sense they are right. The success of Apollo depends on the practical approach to manned space flight that is characteristic of the division. Its job is not to develop the most advanced system, but to help Apollo fly on time. Any equipment that goes to Cape Kennedy is two years old, at least, because of the freeze on design. IESD's job is to translate the design restrictions into hardware that will work when the first astronaut steps onto the lunar surface. To do that, its wandering engineers will follow any path as long as it ends on the moon.

"Inside tips" for executives on getting around in Europe

Reported by *Business Week*

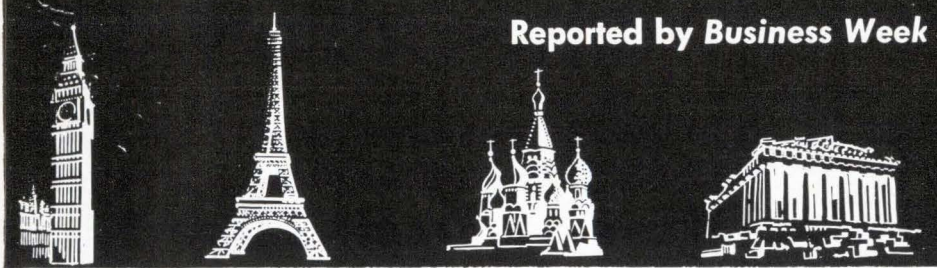

There's never been a travel guide like this before—one written exclusively for the American businessman abroad. It assembles in one place some 10,000 up-to-date facts to help you get around Europe smoothly and efficiently. Mixing the practical with the pleasurable, it tells you everything from Common Market tips and how to impress European businessmen to where to stay and where to play golf.

With its over 600 pages and scores of maps and photographs (many in color), this guide gives you the clearest possible picture of the cities of Western and Eastern Europe—their business districts, main industries, industrial suburbs, stock exchanges, businessmen's clubs,

best restaurants, and more. Cities off the tourist track such as Manchester and Düsseldorf get full treatment, as well as Communist commercial centers such as Leipzig, Poznan, Brno, and Moscow. Check the cities on your itinerary with the *Businessman's Guide*—and you'll feel "at home" when you arrive!

For that's the real purpose of the Guide: to give you the easy confidence and savoir-faire that sets you apart from the average tourist. You'll learn the special tricks of eliminating delays, clearing customs, making contacts, setting appointments, shopping and buying, and countless other tips that are the stock-in-trade of the world's most experienced travelers.

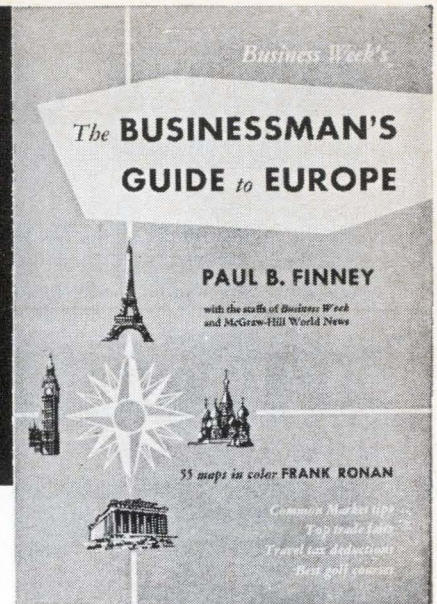

10,000 FACTS
to make your business trips
more successful—
and pleasurable

55 CAPSULE GUIDES
to countries and major cities

100 MAPS & PHOTOGRAPHS
—many in color

OVER 1,000 ADDRESSES
of interest to businessmen
and their wives

PAUL B. FINNEY

with the staffs of
Business Week
and McGraw-Hill
World News

603 pages, 5 x 7 1/2, \$10.00



The **BUSINESSMAN'S** **GUIDE to EUROPE**

A SAMPLE OF WHAT THIS BOOK PUTS AT YOUR FINGERTIPS . . .

Addresses of leading U.S. stockbrokers in Europe . . . Air mileages and fares between European cities . . . Addresses of leading U.S. law firms in Europe . . . List of 100 largest industrial companies — with their annual sales volume — in the Common Market . . . Addresses of American Chambers of Commerce in Europe . . . Names and addresses of top European golf clubs . . . List of leading free ports for buying gifts . . . Titles of useful Soviet handbooks for helping you do business with the Russians

. . . WITH ADVICE ON BUSINESS TRIPS TO EUROPE

How not to be gauche when dealing with European businessmen . . . Which hotels to choose in 50 West European and Communist-bloc cities . . . What to expect from European customs inspections . . . What services are available for businessmen aboard European trains . . . How much of your trip is tax-deductible

. . . AND ANSWERS TO HUNDREDS OF QUESTIONS

Will all your credit cards be honored, and in every country? . . . How can you see foreign factories operate—in Manchester, Warsaw, Gothenburg, Paris? . . . What is a *courette* sleeping berth? . . . What should you do about your stock portfolio while racing around the Continent?

BUY THIS BOOK AT YOUR BOOKSTORE
OR MAIL THIS COUPON

McGraw-Hill Book Co., Dept. 23-E-418
330 West 42 Street, New York, N.Y. 10036

Send me Paul B. Finney's
THE BUSINESSMAN'S GUIDE TO EUROPE for 10
days on approval. In 10 days I will remit
\$10.00 plus a few cents for delivery costs, or
return book postpaid. SAVE MONEY: We pay
delivery costs if you remit with coupon; same
examination and return privilege.

NAME (print) _____

ADDRESS _____

CITY _____

STATE _____ ZIP _____

For price outside U.S., write McGraw-Hill Int'l., N.Y. 10036 23-E

now..... a fully militarized primary cesium beam frequency standard

BY NATIONAL 

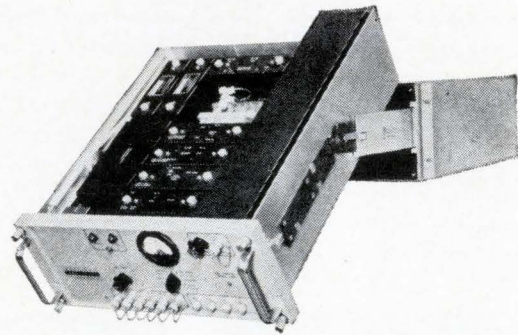

NC 3501 SPECIFICATIONS

ACCURACY: $\pm 2 \times 10^{-11}$
 LONG TERM STABILITY:
 $\pm 2 \times 10^{-12}$ TYPICAL,
 $\pm 4 \times 10^{-12}$ WORST CASE
 SHORT TERM STABILITY:
 $\pm 1 \times 10^{-11}$ TYPICAL 5×10^{-11} WORST CASE
 for 1 SEC AVERAGES
 OUTPUTS: 10MHz, 5MHz 1MHz 0.1MHz,
 14.591479MHz (UT2 OR A.1)
 TIME SCALE
 INPUT POWER: 115V/230V $\pm 10\%$
 50 cps to 400 cps or 28VDC ± 4 VDC
 CESIUM BEAM RESONATOR LIFE:
 10,000 hrs GUARANTEED
 SIZE: 7" HIGH x 17" WIDE x 20" DEEP
 (RACK PROJECTION)
 STANDARD 19" RELAY RACK MOUNTING

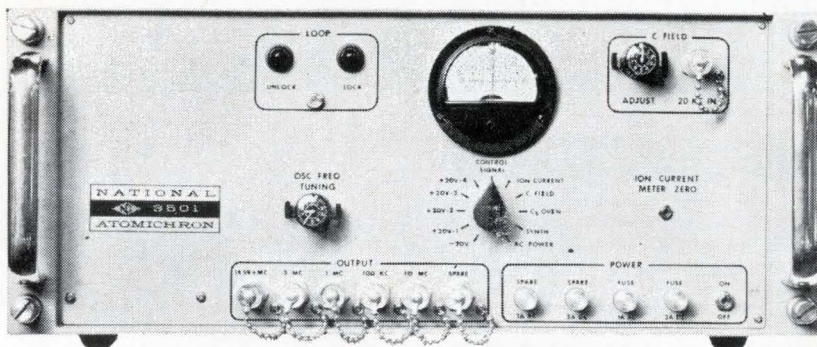

THE ATOMICHRON

SEND NOW FOR COMPLETE DATA FILE ON NATIONAL'S ATOMICHRONS



NATIONAL COMPANY INC.  MELROSE, MASSACHUSETTS

NEW functions extend state-of-the-art capabilities of versatile HL TTL series

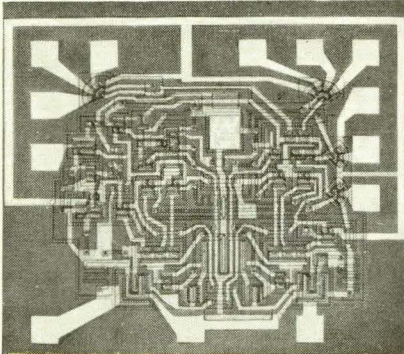

new high-speed "D" type flip-flop

- Transiltron's TFF3512 and TFF3514 raceless, dual-rank, high-speed "D"-type flip-flops represent a new addition to what is already the broadest line of flip-flops in a single logic family.
- The new high-speed unit complements, typically, on a 50-megacycle input signal. The unusually high operating speeds, which are particularly insensitive to heavy loading, have been achieved by dual steering of the second rank flip-flop.

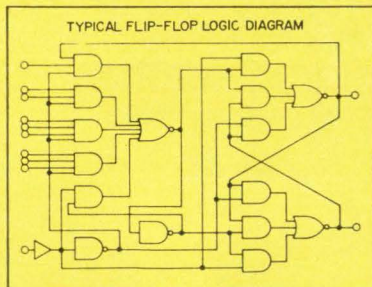

- A maximum of input gating is provided to simplify external gating requirements. The configuration chosen eliminates redundant inputs and the necessity of supplying the data complement to form the "set" function, thereby reducing interconnections. Connections for holding a logic "1" have also been incorporated into the flip-flop. A built-in clock buffer reduces the clock line driving requirements. Noise immunity in excess of 1.0 volt, and fanouts in excess of 15 are typical, with other characteristics and logic levels representative of HL TTL circuitry.
- The high speed and extended gating capability of these units make them extremely desirable for arithmetic and general register applications.

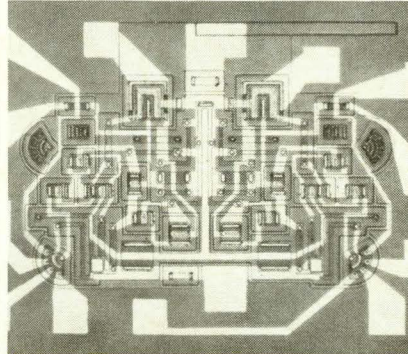

new non-inverting gates

- A new generation of non-inverting "AND" and "OR" gates has been added to Transiltron's broad HL TTL family. Developed for use in systems where simplification and higher speeds are important factors, the new gates exhibit the high capacitive drive capability, high noise margin, and high speed characteristic of the HL TTL design.

TYPICAL VOLTAGE TRANSFER CHARACTERISTICS

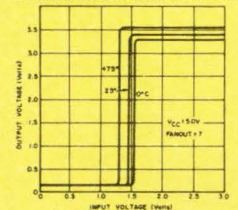

- Functions in the series include:
 TNG6222 and 6224 — Dual 4 input "AND" gate with transient control
 TNG6252 and 6254 — Expandable dual 4 input "AND" gate
 TNG6262 and 6264 — Expandable dual 3 input "AND" gate with transient control
 TNG6522 and 6524 — Expandable single 4 input driver gate with transient control
 TNG7252 and 7254 — Expandable dual 2 + 2 input "OR" gates
 TNG7712 — 8 + 3 input expander gate
 TNG7812 — 4 + 4 + 3 input expander gate
 TNG7912 — Dual 2 + 3 input expander gates

- Extremely sharp voltage transfer characteristics are provided by the series, resulting in noise margins typically in excess of 1.3 volts. Fast charge removal from the output transistor provides the ultimate in reduction of supply current during switching. Double inversion is utilized to provide the non-inverted feature with no sacrifice in propagation delay. Typical propagation delay times are 12 nanoseconds with 15 pf load and fanout of 1. Some of the circuits offer the possibility of controlling output transients through the use of an external capacitor. This is particularly useful in applications where length of interconnections would result in excessive noise coupling.

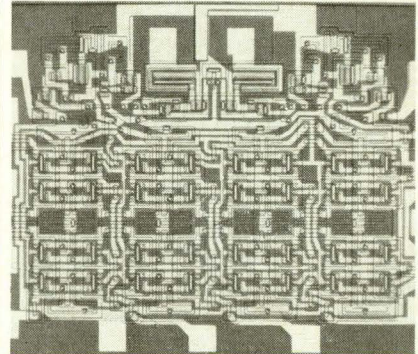

new 16-bit memory cell

- A new 16-bit, bit-oriented, non-destructive readout, integrated circuit memory cell utilizing HL TTL technology is now available from Transiltron for "scratch pad" memory applications.
- The new memory cells, designated TMC3162 and TMC3164, consist of 16 two-transistor flip-flops arranged in a 4 X 4 matrix which provides the information storage. Two write amplifiers and two sense amplifiers are also built into the element. Extremely high speed operation is achieved through a unique circuit design. The unit exhibits delay times of less than 20 nanoseconds between addressing and writing or sensing. Both data and data complement are available at the sensing terminals, which can be paralleled with those of similar units to form larger arrays.
- The memory cell operates from a nominal supply voltage of 5 volts with addressing, writing and sensing voltage levels compatible with HL TTL logic circuitry. Typical high noise margins are in excess of 1.0 volt.

PACKAGING — All of the new HL TTL units shown here are available in a 14-lead flat package (designated by the suffix "F" added to the type number), or a 14-lead dual in-line package (suffix "P" added to type number).

NEW LITERATURE

— Write today for complete specifications and details on these new additions to Transiltron's broad HL TTL line.

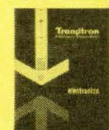

Transiltron
 electronic corporation
 Wakefield, Massachusetts

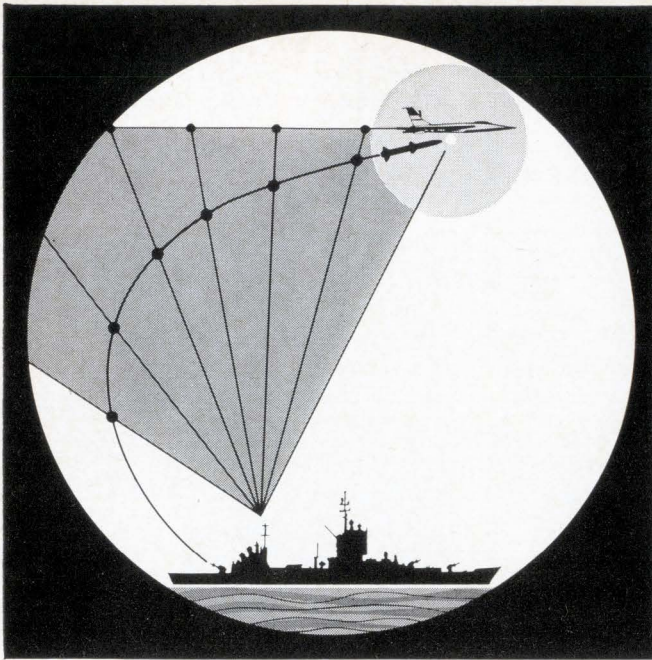

SHIP MISSILE SYSTEMS ENGINEERS AND SPECIALISTS NATIONWIDE OPPORTUNITIES TO JOIN SMS TEAM

The U. S. Naval Ship Missile Systems Engineering Station at Port Hueneme, California, and its Atlantic Detachment at Norfolk, Virginia, serves the engineering/technical needs of the fleet. This includes developing the full capabilities of the TERRIER, TARTAR and TALOS missile systems.

IN-SERVICE ENGINEERING: Concerned with all engineering actions required to ensure continued suitability of assigned Service Equipment for intended service use.

INTERFACE ENGINEERING: Identification and critical examination of equipment/systems interfaces during engineering integration so that incompatibilities, gaps or conflicts may be detected, unambiguously defined and expeditiously resolved. An interface is an inter-or-intra-ship, system, or equipment boundary through which flows functional information, physical action or relation which causes such ships, systems or equipment to be mutually dependent or responsive.

FIELD SERVICE ENGINEERING: Primarily concerned with practical application of engineering principles to complex electronic, electro-hydraulic, electro-mechanical systems presently employed in modern surface-to-air missile technology.

LOCATION OF FIELD SERVICE VACANCIES: California: Concord, Long Beach, San Diego, San Francisco, Seal Beach, Vallejo; Other Locations: Charleston, So. Carolina; Great Lakes, Illinois; Honolulu, Hawaii; Newport, Rhode Island; Norfolk, Virginia; Philadelphia, Pennsylvania; Seattle, Washington; Washington, D.C.; White Sands Missile Range, New Mexico; Yorktown, Virginia.

Professional or specialist experience in one or more of the following is desired: Aerospace, electronic and mechanical engineering; mathematics, operations research analysis; physics, computer analysis and programming; configuration management of engineering data.

Submit resume or Federal Application Standard Form 57 to:
U. S. NAVAL SHIP MISSILE SYSTEMS ENGINEERING STATION
Port Hueneme, California 93041 / Department 011 E-1

DELAYS

FROM 10 TO  10,000 μ S

delttime
MAGNETOSTRICTIVE
DELAY LINES

Delttime, with over a decade of experience in precision magnetostrictive delay line technology, offers models to fill virtually every delay requirement. Complete input-output circuit modules for carrier and RZ or NRZ digital systems... torsional, longitudinal, tapped and adjustable models as well as high vibration and shock withstanding delay lines for airborne applications are included in the standard line.

If your application requires a signal delay or extremely economical delay line memory element, contact us, our application engineers are at your service... or write for our complete technical catalog.



SUB-SYSTEMS DIVISION
SEALCTRO
CORPORATION

HOYT STREET • MAMARONECK • NEW YORK
PHONE 914 698-5600 TWX: 710-566-1110

Sealctro Ltd., Portsmouth, Hants, England

Circle 510 on reader service card

ULTIMATE IN PERFORMANCE

TOHOKU
METAL'S

NEFERRITE
POT
CORES



NEFERRITE is a new type of magnetic ferrite material highly suitable for tele-communications and electronics equipment.

NEFERRITE core can be used for coils and transformers over a wide frequency range. Its superior performance renders tremendous

improvements in functional characteristics and makes possible considerable reductions in the size and weight of coils and transformers. Further information available on request.

SPECIFICATIONS:

Item	Grade 1	Grade 2	Item	Grade 1	Grade 2
μ O	2000	2000	μ_{20} cm A	15	15
B ₁₀₀ Gauss	4200	4200	T. F	20	20
Br Gauss	1000	1000	T.C. °C	-0.5×10^{-4}	$0.8 \pm 0.5 \times 10^{-4}$
Hc Oersted	0.3	0.3		180	180
tan δ	10 kc	0.7×10^{-4}	D.F	3×10^{-4}	3×10^{-4}
μ O	100 kc	2×10^{-4}	μ Ω cm	700	700
	500 kc	15×10^{-4}			

Tohoku Metal Industries, Ltd.

7-4, GINZA-HIGASHI, CHUO-KU, TOKYO, JAPAN
Tel. Tokyo (542) 6171 Cable Address: "TOHOKUMETAL TOKYO"

ULTRASONIC spectrum analyzer

SB-15a / ultra-compact / ultra-versatile / ultra-fast!

100 cps to 600 kc

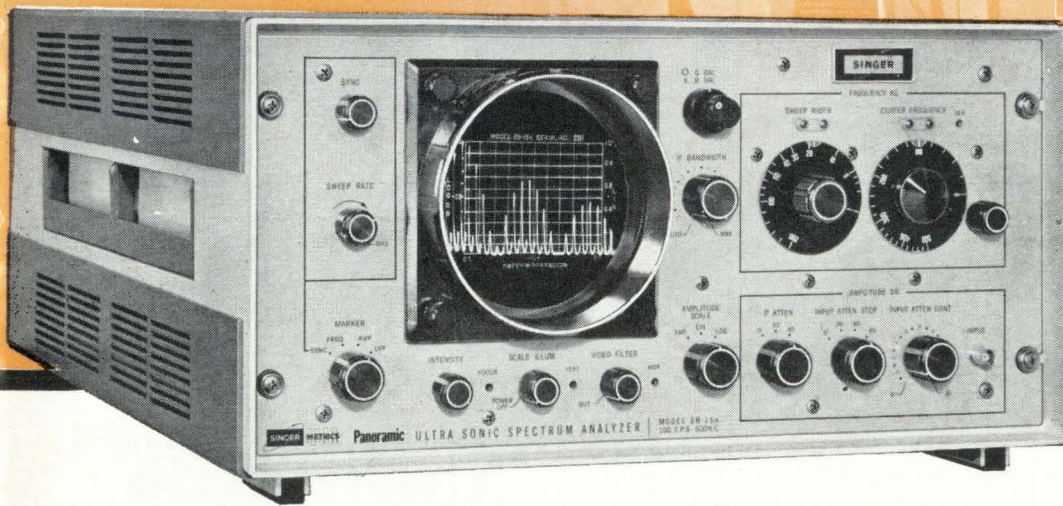

GPL DIVISION ENGINEERS SPECTRUM
ANALYZE RADAR DOPPLER SIMULATOR

Panoramic Model SB-15a Spectrum Analyzer automatically and repetitively scans 1 kc to 200 kc spectrum segments through its entire range... plots amplitude vs frequency instantly on a calibrated long-persistence CRT display, or on a 12 x 4 1/2" chart (optional RC-3b/15). Automatic optimum resolution (selectivity) provides detailed examination of signals as close as 100 cps. Selectivity can also be manually set from 100 cps to 4 kc bandwidth. The SB-15a is self-checking with internal frequency markers every 10 kc and internal amplitude reference; 8 3/4" high; and completely self-contained, including power supply.

FEATURES: ■ Quick signal location, minimum chance of missing weak signals or holes in spectrum ■ Faster measurements — no tedious point-by-point plots ■ Reliable spotting of low level discrete signals in noise ■ Positive identification and dynamic analysis of all types of modulation.

APPLICATIONS: ■ Noise, vibration, harmonic analysis ■ Filter and transmission line checks ■ Telemetry analysis ■ Communication system monitoring and testing ■ Spectral density analysis with Model PDA-1 Analyzer ■ Response plotting with Model G-15a Companion Sweep Generator.

Frequency Range — 100 cps to 600 kc, temperature stabilized
Sweep Width — Variable, calibrated from 1 kc to 200 kc
Center Frequency — Variable, calibrated from 0 to 500 kc
Markers — At 10 and 100 kc intervals, $\pm 0.02\%$ acc.
Resolution — IF bandwidth variable 100 cps to 4 kc
Sweep Rate — 1-60 cps, free-running or synchronized

Amplitude Scales — Lin, 40 db log (usable 60 db), 2.5 db EXP
Distortion — Harmonic and IM at least 60 db down
Sensitivity — 200 μ v to 100 v full scale deflection
Accuracy — ± 0.5 db any 200 kc segment 200 cps-525 kc
Attenuators — 0 to 120 db, step and smooth
Smoothing Filter — 0 to 0.25 sec time constant, low pass

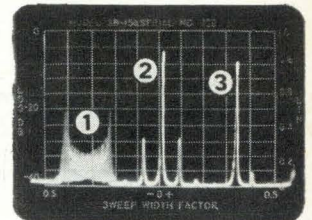

Dynamic analysis shows SB-15a versatility: (1) FM (shows dynamic deviation), (2) AM, (3) SSB with sine wave modulation.

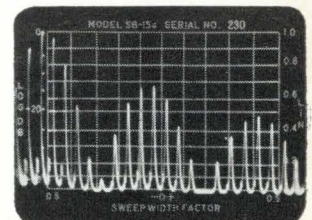

Harmonic analysis of 20 μ sec 11,000 pps video pulse waveform on SB-15a 200 kc sweep width, linear amplitude scale.

ASK YOUR METRICS SALES REPRESENTATIVE ABOUT THE NEW SINGER TIME PAY AND LEASE PROGRAMS



THE SINGER COMPANY

METRICS DIVISION

915 PEMBROKE ST., BRIDGEPORT, CONNECTICUT
TELEPHONE (203) 366-3201 • TWX 710-453-3483

Design and production of PANORAMIC • SENSITIVE RESEARCH • EMPIRE • GERTSCH instruments for measurement

Circle 157 on reader service card

Now! a NEW HIGH STABILITY CERAMIC CAPACITOR

Typical NYTcap Stability

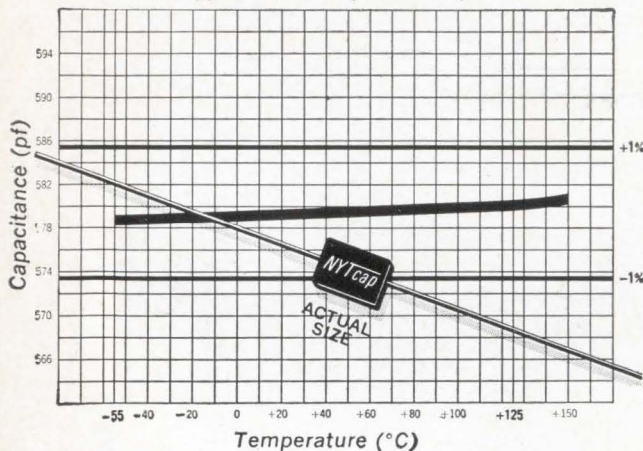

The NEW NYTcap

Temperature Coefficient: Within 1% envelope over temperature range of -55°C to $+125^{\circ}\text{C}$.

The new NYTcap now offers the design engineer these important advantages: Package size 0.350 x 0.250 x 0.1; Capacitance range 100pf. to 1000pf.; Capacitance tolerance $\pm 10\%$; Standard E.I.A. values; Loss (at 1 kc) less than 0.001 at 25°C , less than 0.002 at 125°C ; Voltage rating 200 Volts dc; and Insulation resistance at 25°C 1,000,000 megohms, and 125°C 10,000 megohms. 24 hour delivery.

The NYTcap is the newest product to join the Nytronics subminiature family of inductors, ceramic capacitors, precision wire wound resistors, thin film resistors, crystal filters, L-C filters, transformers, and delay lines. Use coupon for engineering data!

NYTRONICS

Design Leaders — STANDARD Components to Meet CUSTOM Requirements
550 Springfield Ave., Berkeley Heights, N. J.

MAIL COUPON TODAY FOR COMPLETE DATA!

TO: NYTRONICS, INC. Dept. E
550 Springfield Avenue, Berkeley Heights, N. J.

Please send complete engineering data on the NYTcap

NAME/TITLE _____

FIRM _____

ADDRESS _____

CITY/STATE/ZIP _____



30 YEARS OF SCIENTIFIC ACHIEVEMENT

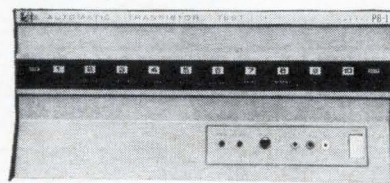
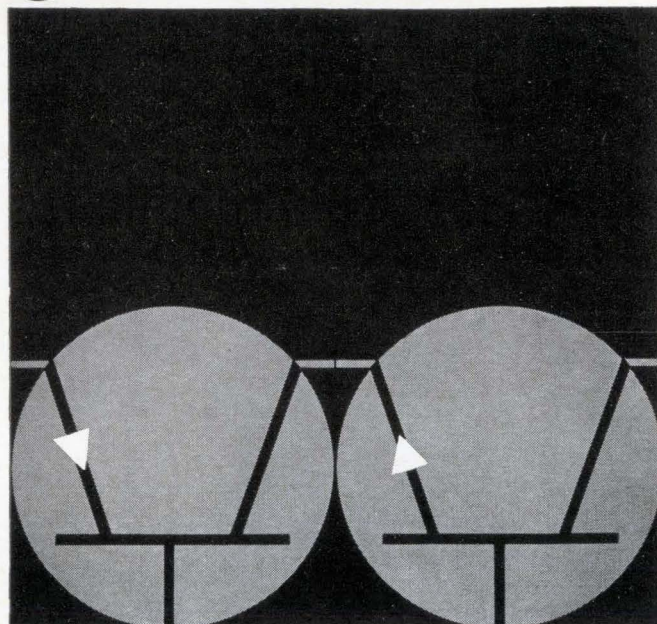

MODEL PB-1 AUTOMATIC TRANSISTOR TEST SET

FOR FAST, AUTOMATIC TRANSISTOR TESTS!!!

THE MODEL PB-1 PERFORMS UP TO 10 TESTS IN ANY SEQUENCE IN LESS THAN 1 SECOND!!

For incoming inspection — in the lab — in production — the new Model PB-1 Automatic Transistor Test Set measures DC parameters of NPN and PNP transistors on a go/no-go basis at bias levels up to 250 volts, 300 ma!

Most important, the Model PB-1 can perform up to 10 tests in any sequence within 1 second — pulse drive techniques permit direct measurement of transistor DC parameters at far greater power levels than transistors could survive employing ordinary measurement techniques!

The versatile Model PB-1 can also test many types of diodes and SCR's on a go/no-go basis. Descriptive literature is immediately available — we cordially invite your inquiries!

SCIENTISTS: Investigate career opportunities at Baird-Atomic — an equal opportunity employer.

ELECTRONIC PRODUCTS AND COMPONENTS DIVISION



BAIRD-ATOMIC

33 UNIVERSITY RD., CAMBRIDGE, MASS. 02138, Tel: 617 864-7420
OFFICES: ATLANTA BOSTON CHICAGO DALLAS DETROIT LOS ANGELES
NEW YORK PHILADELPHIA PITTSBURGH SAN FRANCISCO WASHINGTON, D.C.
EUROPE: BAIRD-ATOMIC (EUROPE) N.V., 26-27 VEENKADE, THE HAGUE, HOLLAND

ENVIRONMENTAL PROOF
is what we call it . . .



Stackpole Rotary Switches
Specially Designed to Guard Against
EXPOSURE—CONTACT CONTAMINATION—PRODUCTION DAMAGE

COMPETITIVELY PRICED—This completely enclosed, rugged switch costs no more than the open clip type.

SAMPLES IN 3 DAYS—to your exact specifications. Send your drawing and prove it to yourself.

ORDERS IN 2 TO 3 WEEKS—On-time delivery of uniform, high quality production quantities to meet your schedule.

SEND YOUR DRAWING FOR A QUOTATION AND SAMPLE. Take advantage of Stackpole quality, price and service. For additional information and technical data write: Electro-Mechanical Products Division, Stackpole Carbon Company, St. Marys, Pennsylvania 15857. Phone: 814-834-1521. TWX: 510-693-4511.



STACKPOLE
ELECTRO-MECHANICAL
PRODUCTS DIVISION

Bulk Gas

RESPONSE... by *Air Products*

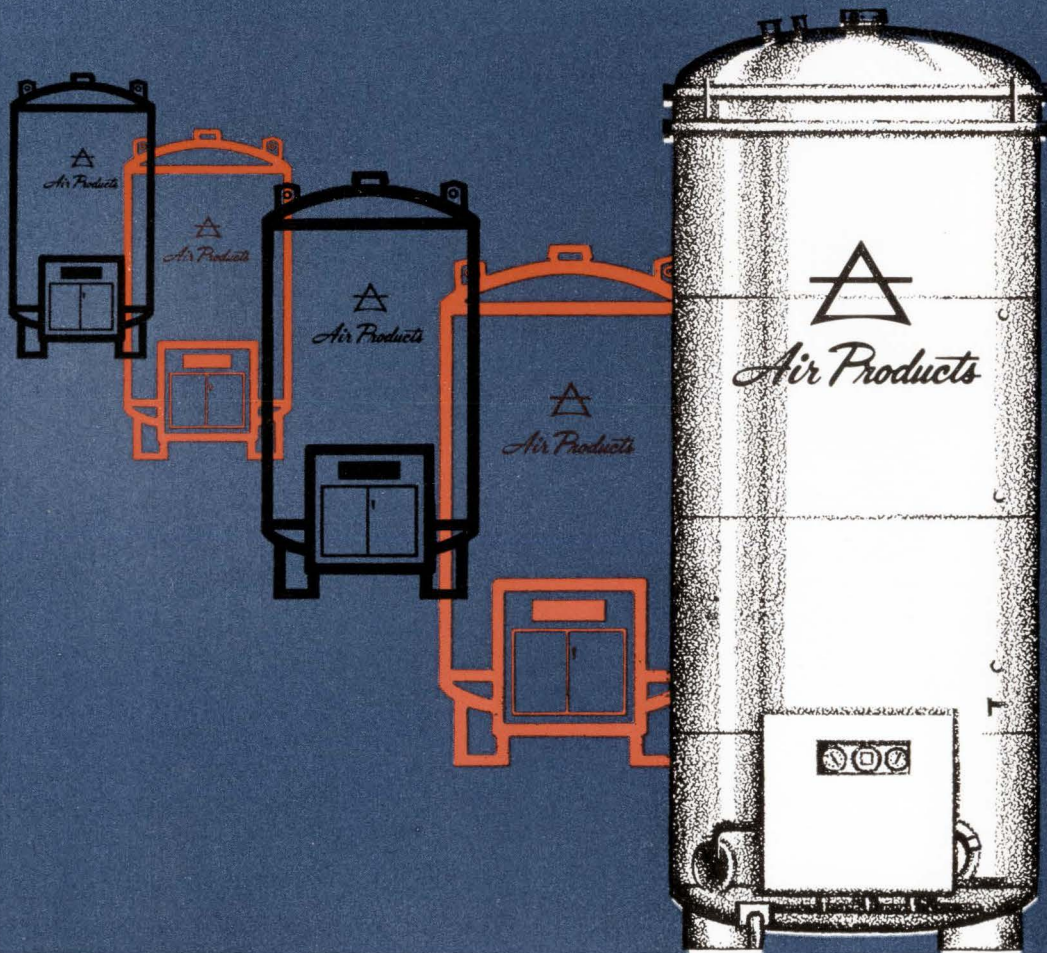

to supply your

OXYGEN, NITROGEN, ARGON, HYDROGEN requirements

Gases . . . When and Where Needed

Name the gas . . . the purity . . . the quantity . . . and Air Products responds in a manner that meets your specific requirement.

A nationwide network of Air Products cryogenic production plants and distribution centers provides a readily available supply of a full line of industrial gases. The world's most advanced fleet of distribution equipment—tank-trucks, tank-trailers, and jumbo railway tank cars—delivers these liquefied gases to bulk storage units installed by Air Products on your property. From these bulk

liquid storage units, gases are drawn off automatically as needed in your operations. Tube-trailer deliveries are also available for the direct supply of gaseous product.

Computer programmed distribution makes possible economical, on-time deliveries . . . every time.

Specified Purity

Air Products advanced production technology combined with outstanding quality control disciplines yield the product purity dictated by your industrial gas applications.

Technical Service

In-depth technical service is a key factor in Air Products response to your demands. Technical service helps you use gases more efficiently and economically.

Gases and Better Ways to Use Them

Yes, response to the total needs of industrial gas customers is our business. To put this experience and know-how to work in your business write or phone the nearest Air Products sales office today. An Air Products "RESPONSE" Brochure presenting our capabilities is available on request.



Air Products and Chemicals
INC.

Allentown, Pennsylvania



LOOK TO THE LEADER
IN INTEGRATED CIRCUITS

*Call EW for
Immediate Delivery of*

930 DTL or Series 54 TTL

Integrated Circuits from TI

For your production systems, we offer immediate availability — from stock — of 930 DTL. Texas Instruments Series 15930 DTL integrated circuits are direct equivalents . . . pin-for-pin and spec-for-spec . . . of competitive types. Both military and industrial types are in stock. Prices are competitive. And we can deliver NOW!

For your new designs, take advantage of the improved performance of TI Series 54 TTL integrated circuits — 48% higher speed, 25% higher fan-out, 15% higher noise margin than DTL. What's more, TTL prices are competitive with DTL. And again, we can deliver both industrial and military types NOW!

Call us today for further information, quotations and immediate delivery of either line.

Logic	Propagation Delay (Typical)	Fan-Out	D-c Noise Margin (Guaranteed)
Series 54 TTL	13 nsec	10	400 mV
930-series DTL	25 nsec	8	350 mV



"SERVING THE ENTIRE SOUTHEASTERN U.S."

ELECTRONIC WHOLESALERS INC.

WASHINGTON, D. C.
2345 Sherman Ave., N.W.
Phone 202-483-5200

BALTIMORE, MARYLAND
3004 Wilkens Avenue
Phone 301-945-3400

WINSTON-SALEM, N. C.
938 Burke Street
Phone 919-725-8711

MIAMI, FLORIDA
9390 N.W. 27th Avenue
Phone 305-696-1620

MELBOURNE, FLORIDA
1301 Hibiscus Boulevard
Phone 305-723-1441

Would it help your future if you were the originator of a program that cut high-density connection costs by 50%, provided absolute reliability, and required no capital investment by your company?

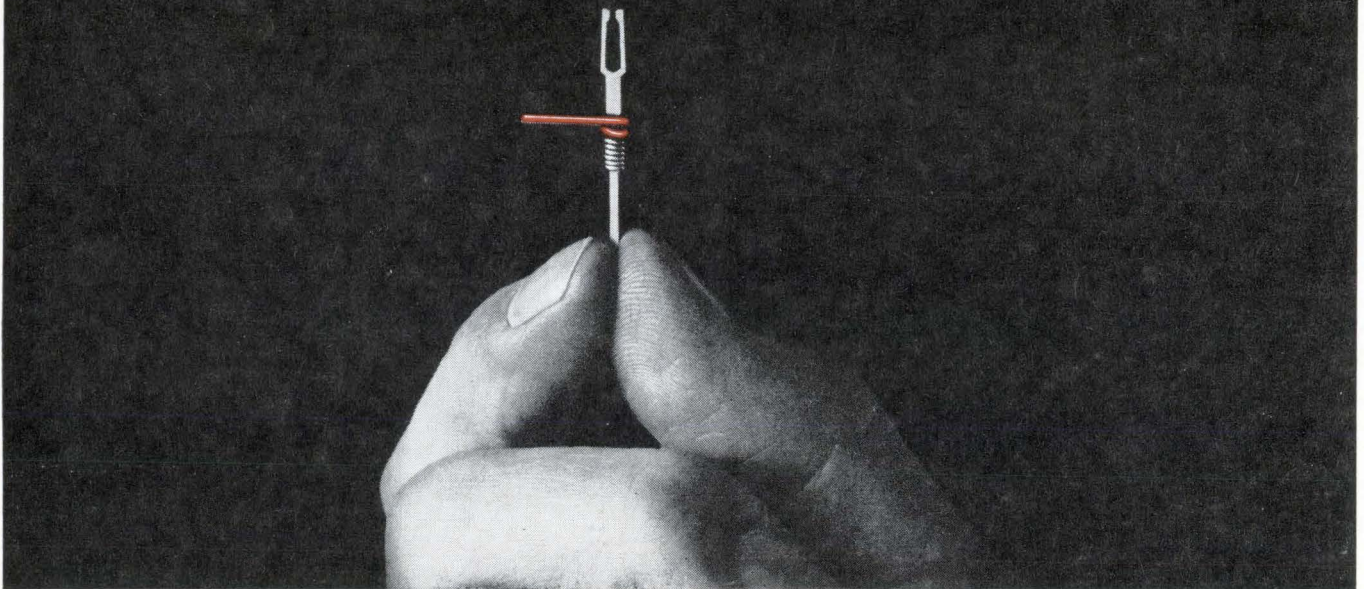

In addition to making you a company hero, Raytheon's new \$1 million automatic wire wrapping service will completely eliminate production line welding and soldering, operator training, and human error. The solderless wire wrap interconnection concept has been used by leading manufacturers in more than 30 key military programs (meets and exceeds MIL-STD-1130) including Apollo and Polaris. To date, over 37 billion commercial and military wire wrapped interconnections have been produced with no field failures. For complete information on Raytheon's unique nationwide service plus a form that will enable you to estimate your company's cost saving, mail this coupon today or call: C. E. Russ at (617) 899-8400 extension 2668, 9.



Manager, Wire Wrapping Service
Raytheon Company
20 Seyon Street
Waltham, Massachusetts 02154

Please rush me full particulars on Wire Wrapping.

Name _____ Title _____

Company _____

Address _____

City & State _____ Zip Code _____



Another star:

Technicraft cast waveguide components

Now, low cost precision cast waveguide components have been added to the famous ES/Technicraft line of high reliability flexible and rigid waveguide, and waveguide components. Utilizing the same careful selection of materials and advanced quality control methods, these precision castings provide an even greater number of micro-wave components now available from one well qualified source. Produced by Electronic

Specialty's Connecticut Division, the new line is available in 90° Cast Elbows, Precision Cast Hybrids, Narrow Band Cast Elbows and Miters and Cast Dual Choke Flanges. All castings are supplied either in beryllium copper or aluminum and are designed for rugged, long-life applications. If you're looking for precision cast waveguide components, look no further. Write for specifications and detailed information.



ELECTRONIC SPECIALTY CO. Connecticut Division
401 Watertown Road, Thomaston, Connecticut

*Los Angeles, Calif./Anniston, Ala./Ft. Madison, Ia./Harrisonburg, Va./Hurst, Tex./Pomona, Calif./Portland, Ore./Thomaston, Conn./Toronto, Ont.,
In Europe contact Elektro-Metall, Dusseldorf, Germany.*

The devil's advocate



That's one of the many roles played by our Corporate Director of Reliability. He's responsible for the reliability of all IRC products. He double-checks basic designs. Keeps an eagle eye on production. Never goes easy on inspection and testing.

He's not above stopping a shipment at the door if it doesn't meet IRC's standards. Even if it *does* meet the customer's specifications.

This IRC attitude toward total reliability has practical advantages for you. Now you can choose from several optimum economical levels of reliability in resistors, potentiometers and semiconductors. And IRC is the

first to *publish* prices for standard metal films at three reliability levels.

At IRC, reliability is a management responsibility . . . not just a specification gesture. For top management attention, address your questions on reliability to our Director of Reliability.

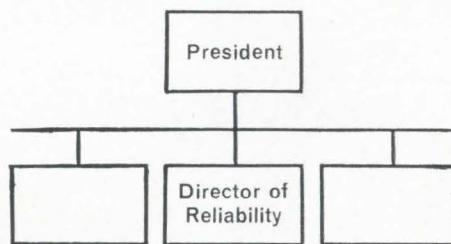

IRC, Inc., Philadelphia, Pa. 19108



Cathode-ray tube displays fast transients

Fiber-optics faceplate captures more light for film recording of nanosecond information; concentrated beam writes faster

A fiber-optics cathode-ray tube for film recording of high-frequency transient waveforms as short as 200 nanoseconds is available from Du Mont Electron Tubes, a division of Fairchild Camera & Instrument Corporation.

Because the tube gathers 30 to 40 times more light than an f/1 camera lens and uses a concentrated beam, it has a tracing speed 50 times faster than the standard crt.

The KC2427P, developed originally for the Air Force's Defense Atomic Support Agency as part of a nuclear detection system, is a 3-inch crt using electrostatic focus and deflection.

The best previous system for film recording of images from standard crt's uses camera lenses and captures flashes only as short as 10 microseconds because much of the light energy is lost when the images pass through the lens. In the fiber-optic tube, the loss in light energy is radically reduced because bundles of 10-micron-diameter glass fibers form the faceplate. The light travels directly from the phosphor coating, through the glass-fiber bundles and onto the film, which is pressed up against the faceplate.

The equivalent lens speed of the fiber-optic display approaches the speed of the phosphor—a value of $f/0.05$.

Repetitive waveform frequencies of up to one gigahertz (gigacycle per second) can be displayed and recorded because the capacitance of the deflection plates has been reduced and the beam deflection sensitivity has been increased. The reactance of the plate capacitance has disastrous effects on standard crt's at high frequencies—it effectively shorts the input signal. In the KC2427P, the deflection plates



have been chopped up, lengthened and repositioned—reducing the capacitance. The plates are close to the beam, therefore the sensibility factor, the number of millivolts needed to move the beam a distance of one trace width (2 mils), is only 15.

The speed of the trace is 10^{12} trace widths per second. To get an image at such high speed, a con-

centrated beam is used to stimulate the phosphor.

For recording, Du Mont recommends Kodak's 2475 35-mm unperforated film with an ASA rating of 1,600. The faceplate, optically finished to within one mil of absolute flatness, provides a smooth film transport surface.

The tube is available with either P11 or P16 phosphors.

Specifications

Bandwidth	1 Ghz
Trace width	2 mils
Writing speed	10^{12} trace widths/second
Acceleration voltage	10 kilovolts
Useful scan across deflection plates, d1, d2	1.6 in.
d3, d4	1.2 in.
Sensibility factor across deflection plates, d3, d4	15 mv/trace width
Delivery	6-8 weeks
Price	On request

Du Mont Electron Tubes, 750 Bloomfield Ave., Clifton, N.J. 07015

Circle 349 on reader service card

Small servo repeater features versatility

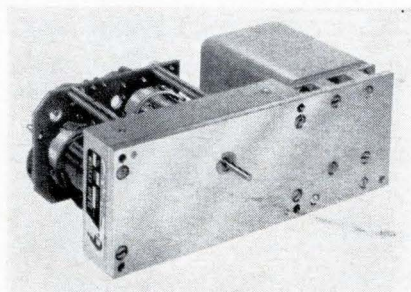

The 771E is a compact 400-cps servo repeater, which follows a 1 and 36 speed synchro bus. It is completely self-contained, and includes servo amplifier, power supply, damping and switching networks, precision gearing, feed-

back synchros and servo motor. An output shaft at 36 speed is provided, and all connections are made through a miniature connector.

Size is $6\frac{3}{4} \times 2\frac{1}{2} \times 4$ in. (depth). The repeater is designed for synchro stators rated at 90 v/line. Power required is 117 v, 400 cps. Static accuracy and top speed at the 36-speed output shaft are 0.2° and 100 rpm respectively.

With the versatile 771E, an engineer can quickly and simply assemble a two-speed synchro frequency converter, an analog multiplier, an indicator or digitizer, just by coupling the appropriate data element or dial to the output shaft provided.

Price is approximately \$1,100. Industrial Control Co., Central Ave. at Pinelawn, Farmingdale, L.I., N.Y., 11735. [350]

Bulova can supply the crystal you need



to match your specs!

Many years of supplying crystal control units for the most advanced military and space programs enable Bulova to offer a full line encompassing virtually the entire frequency spectrum—2 kc to 125 Mc for oscillator and filter applications. We can supply every type of packaging—including koldweld and glass sealed. Our military crystals meet latest MIL-C-3098D specifications. All reasons why you should make Bulova your single source of supply.

HIGH PRECISION GLASS SEALED CRYSTALS 1 Mc to 125Mc. Available in vacuum sealed, glass enclosures of the HC-26/U and HC-27/U type.

Example: Precision SSB Crystals

Frequency: 1 Mc to 5 Mc
Holder: HC-27/U
Tolerance: $\pm .0025\%$ from -55°C to $+90^{\circ}\text{C}$, or to specification
Aging: 3×10^{-8} per week after one week stabilization at 75°C

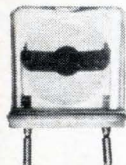

KOLDWELD SEALED CRYSTALS—low aging, high reliability, 1 Mc to 125 Mc. Now available in TO-5, HC-6/U and HC-18/U type cans sealed by the koldweld process to eliminate effects of heat and to reduce contamination.

Example: TO-5

Frequency: 15 Mc to 125 Mc
Tolerance: $\pm .0025\%$ from -55°C to $+105^{\circ}\text{C}$, or to specification
Aging: 1×10^{-7} per week after one week stabilization at 75°C



Write or call for specifications on Bulova's complete line of crystals. Address: Dept. E-17,

BULOVA FREQUENCY CONTROL PRODUCTS

ELECTRONICS DIVISION
OF BULOVA WATCH COMPANY, INC.

61-20 WOODSIDE AVENUE
WOODSIDE, N.Y. 11377, (212) DE 5-6000

New Components and Hardware

Wirewound pot with infinite resolution

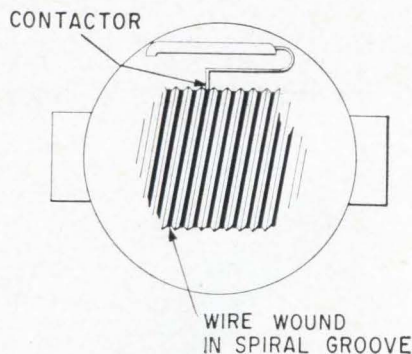

The first wirewound trimmer potentiometer allowing infinite resolution has been introduced by CTS of Canada Ltd.

The rectilinear trimmer, called IRW, combines the inherent stability of wirewounds with the infinite setting resolution previously available only in film potentiometers.

CTS uses an exclusive winding construction in the trimmer. In other wirewound potentiometers the contactor usually rides across the windings. This bridging effect precludes the possibility of infinite resolution. CTS, however, has wound the resistance wire around the mandrel in a spiral groove (see above). As the adjustment screw turns the mandrel, the contactor rides along the spiral winding. Each turn of the screw controls a relatively small resistance range. On a 2,000-ohm potentiometer, for example, 60 turns are needed to cover the full range from essentially zero to 2,000 ohms.

The IRW is designed for appli-

cations where preset ratio settings (contact to end terminals) of extreme accuracy and stability are required. These include precision voltage dividers in sensing circuits for regulating low-voltage power supplies and as the ratio arm of a wheatstone bridge.

Other applications include precise gain control of chopper stabilized d-c amplifiers and feedback stabilized a-c amplifiers.

CTS of Canada Ltd., Streetsville, Ontario, Canada. [351]

Repeat cycle timers designed for industry

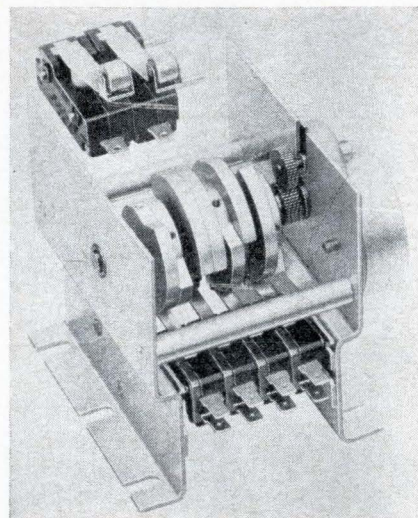

A line of low cost, industrial type, repeat cycle timers is said to offer capabilities hitherto found only in more costly timers. Series designations are L42401 and L42402.

Twenty-three models are offered, providing a selection of 170 different over-all cycle times from 6 seconds minimum to 25 hours maximum. Up to 23 possible combinations of spdt switches are available for 15 or 25 amp loads at 115 v a-c, 60 hz. The switches are snap-in types for easy replacement or maintenance and have a mechanical life rating of over 1 million operations.

These timers are synchronous motor driven, and models can be furnished for operation on 6, 12, 24,

Specifications

Resistance range	Standard 400 ohms to 2,000 ohms
Resistance tolerance	Standard $\pm 10\%$ special $\pm 5\%$
Power rating	0.5 watt at 125°C de-rated to zero at 150°C
Voltage rating	Leads to mounting screws 1,000 v a-c operating maximum 500 v d-c
Stability (contact to end terminals)	Better than 0.025% from -55°C to 70°C
Rotational life	200 cycles
Size	1.262 x 0.323 x 0.288 inch
Turning torque	2 in-oz
Housing	Diallyl phthalate
Price	\$17.60 (1,000 or more)

115 or 230 v a-c, 50 or 60 hz. Overall cycle timing accuracy is $\pm 1\%$. One-way frictions in the gear trains and split cams provide for very easy timing adjustment in the field. The A.W. Haydon Co., 232 North Elm St., Waterbury, Conn., 06720. [352]

Mylar capacitors in flat construction

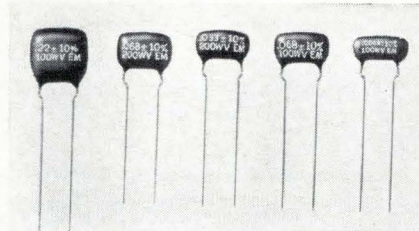

Flattened Mylar dipped capacitors (type MDEF) offer higher component densities in printed circuits because of their construction. These capacitors exhibit high insulation resistance, low dissipation factor, low capacitance change, and excellent moisture and life characteristics.

The body consists of a phenolic coating that is vacuum impregnated with epoxy. This not only improves the moisture resistance of the capacitor but also increases its ability to withstand a rugged lead pull test.

The capacitors are available in voltage ratings of 50, 75, 200 and 400 v d-c for operation up to 125°C. The Electro Motive Mfg. Co., Inc., Williamantic, Conn., 06226. [353]

Flexible circuitry reduces costs

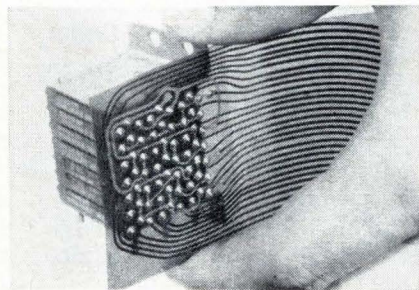

A new application of Flexmax printed circuitry has been developed. This circuit, consisting of two layers of laminated flexible circuits, solves the problem of interconnecting 21 trimmer potentiometers.

Why pay custom prices for conductive plastic pots?

Our off-the-shelf ECONOPOTS™, the industry's only standard conductive plastic precision potentiometers, provide multimillion-cycle rotational life and infinite resolution for as little as \$11.55!

Nearly every other industry has been able to standardize and take advantage of mass production. Why not the precision potentiometer industry?

Why not? This question marked the genesis of our ECONOPOT™ concept. We surveyed thousands of precision pot requirements, found definite common denominators, and designed 18 precision conductive plastic models that meet these common needs. The inherent efficiencies of standardization and automation enable us to offer these 18 models from stock at a small fraction of the prices usually paid for precision pots of this quality.

HERE'S ALL THE INFORMATION YOU NEED TO ORDER ECONOPOTS™

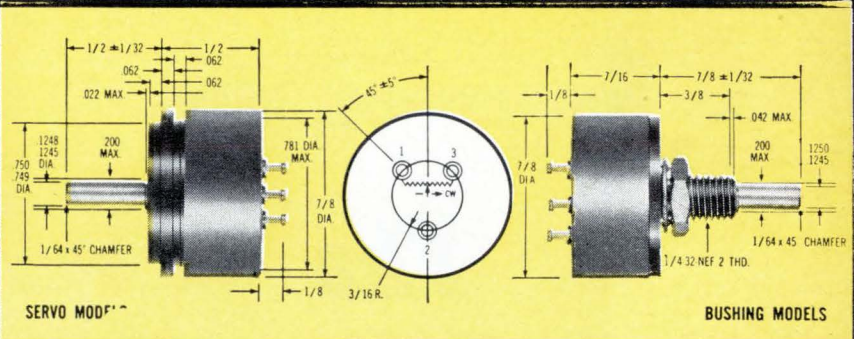

MODEL NO.	MOUNT	LINEARITY	TOTAL RESISTANCE	INTRO. PRICE
78ESA102	Servo	1%	1K	\$13.60
78ESA502	Servo	1%	5K	13.60
78ESA103	Servo	1%	10K	13.60
78ESB102	Servo	0.5%	1K	16.45
78ESB502	Servo	0.5%	5K	16.45
78ESB103	Servo	0.5%	10K	16.45
78ESC102	Servo	0.25%	1K	19.55
78ESC502	Servo	0.25%	5K	19.55
78ESC103	Servo	0.25%	10K	19.55
78EBA102	Bushing	1%	1K	11.55
78EBA502	Bushing	1%	5K	11.55
78EBA103	Bushing	1%	10K	11.55
78EBB102	Bushing	0.5%	1K	14.40
78EBB502	Bushing	0.5%	5K	14.40
78EBB103	Bushing	0.5%	10K	14.40
78EBC102	Bushing	0.25%	1K	17.50
78EBC502	Bushing	0.25%	5K	17.50
78EBC103	Bushing	0.25%	10K	17.50

Prices subject to change without notice

SPECIFICATIONS

PARAMETER	VALUE
Electrical angle	340° $\pm 5^\circ$
Noise	100 ohms maximum
Rotational life	> 10,000,000 shaft revolutions
Resolution	infinite
Power Rating	1.25 watts at 70°C, derated to 0 at 125°C
Temperature Coefficient of resistance	± 200 ppm/°C nominal
Resistance Tolerance	$\pm 10\%$
Starting Torque	< 0.5 oz-in

ECONOPOT meets all requirements of MIL-R-12934D

For as little as \$11.55, you can evaluate an ECONOPOT!

For fast service, airmail the coupon. For same-day service, call us collect.

FREE ON REQUEST . . .
4-page technical catalog plus a 25-page comprehensive report of reliability evaluation tests conducted on ECONOPOTS. Report includes results of tests for mechanical strength and high speed rotational life; and resistance to shock, vibration, humidity, solder heating, and temperature shock.

ECONOPOT
TEST
REPORT

Same-day processing on requests via coupon

nej new
england
instrument
company

new england instrument company
Kendall Lane • Natick, Mass.

Tel: 617-655-1411 TWX: 617-875-4261

If your purchasing procedures permit, NEI will honor this signed coupon as a purchase order

Ship—units of Mod. _____ at \$ _____ ea

Ship—units of Mod. _____ at \$ _____ ea

Send free copy of 29-page ECONOPOT Catalog and Environmental Test Report

Send technical literature on all NEI products & capabilities

NAME: _____

COMPANY: _____

ADDRESS: _____

CITY: _____ STATE: _____ ZIP: _____

SIGNATURE: _____

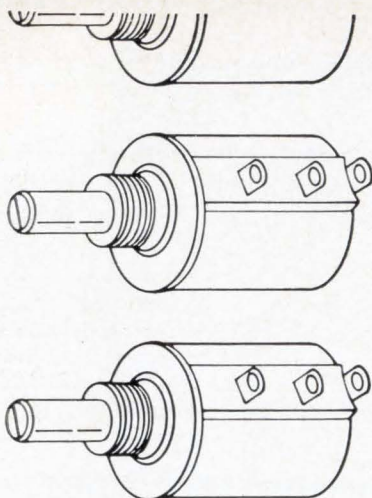

WITH FAIRCON® MULTITURNS

The Only Difference is Quality & Price

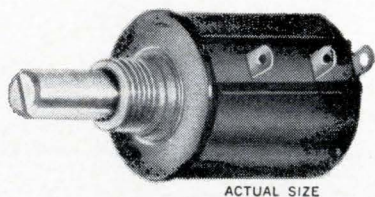

ACTUAL SIZE

HERE IT IS! The FAIRCON multiturn potentiometer with all the features of precision 10 turns yet at a price that fits the industrial OEM budget. Check these features: Standard linearity $\pm 0.2\%$ —resistance values from 500 to 125,000 ohms—high humidity, vibration, shock and acceleration resistance—2 watts power dissipation at 40°C —plus excellent resolution, long life, low noise... and complies with applicable environmental requirements of MIL-R-12934C...all for an amazingly low price. Write for our new FAIRCON short form catalog. And for immediate delivery from stock...Call ARCO.

FAIRCHILD

CONTROLS

A DIVISION OF FAIRCHILD CAMERA AND INSTRUMENT CORPORATION
225 PARK AVENUE, HICKSVILLE, L. I., NEW YORK
TELEPHONE: (516) 938-5600 • TWX: (510) 231-1854
CABLE: FAIRCON-HICKSVILLE, NEW YORK, U. S. A.

New Components

eters. Flexmax circuitry also facilitates the replacement of individual pots, eliminates wiring errors, provides high vibration reliability, and reduces installed costs 15% to 20%.

A Flexmax circuit has the key feature of reducing several layers of flexible printed circuits to a single multilayer piece. This is made possible because Flexmax design permits unscrambling of conductor routings and thus allows for freedom of pin address.

Connections are made of homogeneous copper with no interface of solder connections. All connections are completely encapsulated in FEP Teflon and protected by high temperature— 240°C —Kapton film on the external surfaces. The Flexmax interconnection technique is well suited for making complex interconnections on both electrical components and complete electronic units.

Sanders Associates, Inc., 95 Canal St., Nashua, N.H. [354]

Component-mounting shielded containers

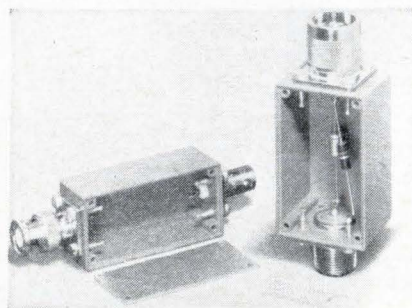

A series of shielded black-box containers is designed for mounting electronic test components. The units provide shielded protective packages for custom-designed voltage dividers, passive or active networks, attenuators, isolation networks, or other circuitry needed for specific electronic tests.

Boxes are die-cast aluminum, finished in blue paint to Federal Standard 595. Cover is 0.040 aluminum, clear anodized per MIL-A-8625A. It is secured to the box by four self-tapping screws to insure

HERE'S HOW...

THE ELECTRONIC INDUSTRY IS USING THESE TWO FAMOUS ULANO FILMS IN ULTRAMINIATURE MASK TECHNOLOGY AND COMPLEX PRINTED CIRCUITRY

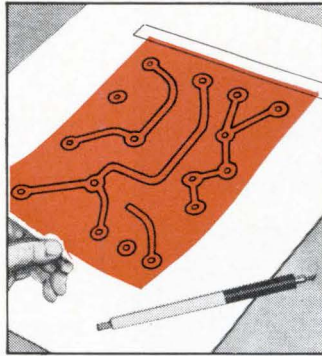

Cut a piece of the desired film large enough to cover area to be masked. Tape it down firmly at the top with dull-side up.

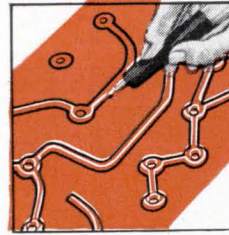

With sharp blade, outline the areas to be masked. Do not cut through the backing sheet. The Ulano Swivel Knife does the job quickly, easily.

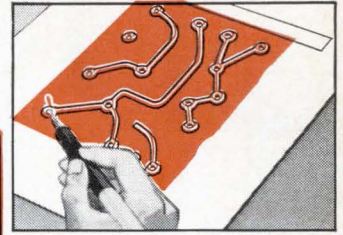

Using the tip of the blade, lift up a corner of the film thus separating it from the backing sheet.

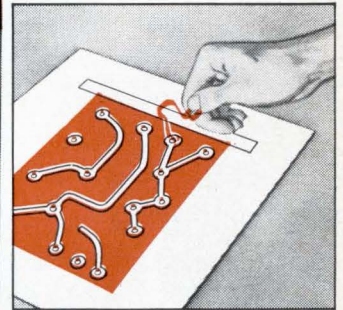

Now carefully peel off the film as outlined leaving a completed mask, positive or negative, that corresponds exactly to the desired pattern.

UlanoTM

RUBYLITHTM • AMBERLITHTM

HAND CUT MASKING FILMS FOR THE GRAPHIC ARTS

ULANO RUBYLITH . . . a revolutionary knife cut red film is laminated to a stable transparent plastic backing sheet. The red film is "light safe" so that when contacted to a sensitized emulsion and exposed to a suitable light source, light passes through the cut-out portions only . . . not through the red film. ■ The polyester backing is absolutely stable . . . insures perfect register. ■ Special effects such

as crayon tones, paste ups, benday sheets, and opaquing are easily combined with versatile ULANO RUBYLITH.

ULANO AMBERLITH . . . a companion to Rubylith serves as a color separation medium used as the master on camera copy board to secure negatives or positives.

A wide variety of Ulano films—in rolls and sheets—is readily available

ulano

NEW YORK • CHICAGO • ZURICH

610 DEAN ST., BROOKLYN, N. Y. 11238

In Europe: ULANO A. G., Untere, Hesiibachstrasse No. 22
Kusnacht, Zurich, Switzerland

"Ulano"/"Rubylith"/"Amberlith" are registered trade marks of the Ulano Companies.



WRITE TODAY

on your letterhead for free special sample kit 1848

Circle 490 on reader service card

NEW ZELTEX AMPLIFIER WITH FETS!

- New, Smaller Package
- Lower Cost
- Improved Performance

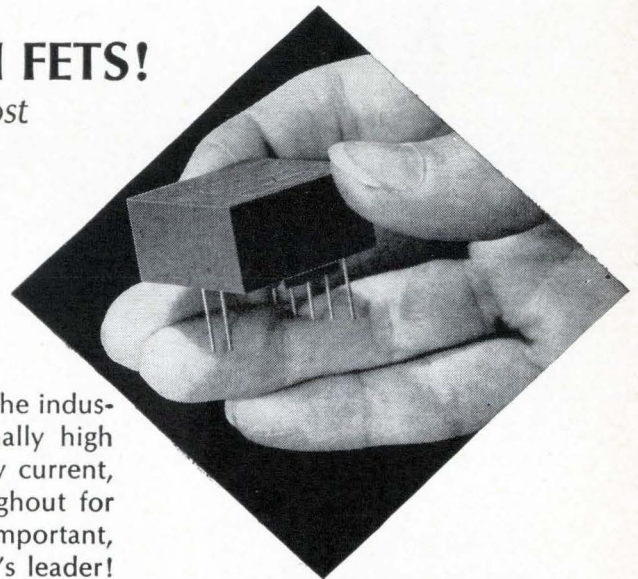

More FET amplifier news from Zeltex—true economy with the industry's most outstanding performance! Featuring exceptionally high differential and common mode input impedance with low current, this new Zeltex amplifier utilizes silicon transistors throughout for utmost reliability. Where performance, cost and size are important, the Model 132 offers the industry's best from the industry's leader!



ZELTEX, INC.

1000 Chalomar Road, Concord, California

Phone: (415) 686-6660

The broadest spectrum of Amplifiers
and Computer Elements

Check these key specifications:

Input Current: 100 picoamp

Voltage Gain: 100,000

Voltage Drift: 20 μ volt/ $^{\circ}$ C

Input Impedance: 10,000 meg

Slew Rate: 10 v/ μ sec

Model 132 Differential Operational Amplifier with Field Effect Transistors...

Also available in a 0.4 in. high enclosure, this remarkable new Zeltex FET Amplifier is available virtually from stock. For complete information, write or phone today.

D

DAMON

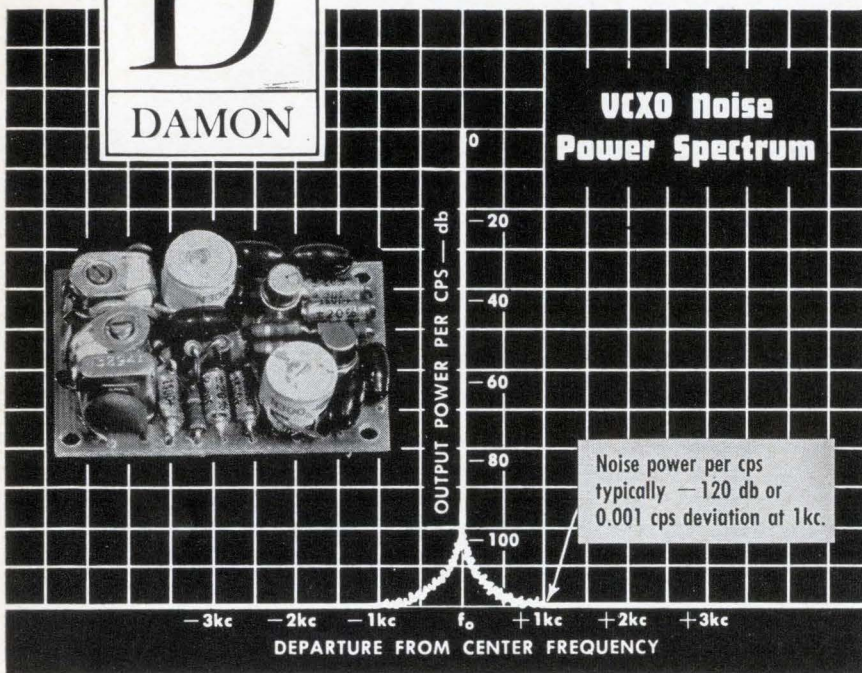

Low Noise VCXOs (Voltage Controlled Crystal Oscillators)

for an Important Reduction in Phase Jitter

Another FIRST from DAMON . . . Low Noise VCXOs with extremely low phase-jitter (—120 db or 0.001 cps deviation at 1kc.) This excellent short term stability is typified in the VCXO output spectrum illustrated, above.

Damon Low Noise VCXOs may now be inserted into systems as simple components with no auxiliary compensating circuitry. Only a source of power and a control signal are required.

Applications include: Doppler Radar (CW, CW-FM, FM and Pulse Doppler); Phase Locked Receivers and Transmitters; Doppler Simulation and Compensation; Frequency Synthesizers and other applications requiring electronic frequency control with crystal stability and extremely low phase jitter.

Write for Data on Low Noise VCXOs

DAMON ENGINEERING, INC.
240 HIGHLAND AVENUE, NEEDHAM HEIGHTS 94, MASS.
(617) 449-0800

New Components

100% effective r-f shielding.

The series consists of 12 individual models in two sizes. Twelve different connector combinations are offered to fit an exceptionally wide range of existing test equipment. Solder turret terminals provide noise-free connections for components. Operating range is —55° to +150°C.

Pomona Electronics Co., Inc., 1500 E. Ninth St, Pomona, Calif., 91769. [355]

Mercury-wetted reed switches

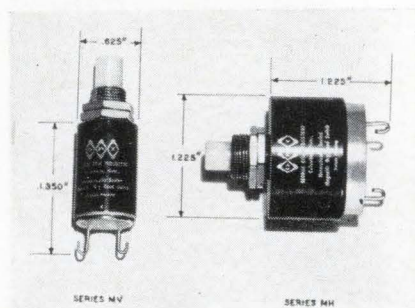

Two series of hermetically sealed mercury-wetted reed switches have no contact bounce and very low contact resistance. Series MV and MH are both momentary action. They have identical electrical and environmental characteristics but differ dimensionally. Series MV, for vertical mounting, is 1.350 in. long by 0.625 in. wide. Series MH, for horizontal mounting, is 1.225 in. long by 1.225 in. wide. Both have contact ratings of 3 amps and are capable of 10 million operations under full load.

The no-bounce characteristic of the switches is assured by the use of permanent magnetic lines of force to actuate the mercury contacts. This produces strong contact holding pressure completely independent of push-button actuating pressure. Initial contact resistance is 50 milliohms maximum and will not increase during the life of the switch.

Double-sealed in epoxy and glass, both switches are ideal for dry circuits in explosive or corrosive atmospheres. Housings are of black anodized aluminum with the

housing on series MH keyed for proper horizontal panel positioning. Standard button-actuating pressures are 17 grams or 8 oz with others available to customer specifications. Switch forms presently available are single-pole single-throw normally open, and spst normally closed.

George Risk Industries, Inc., P.O. Box 907, Columbus, Neb., 68601. [356]

Reverse stand-offs for dense packaging

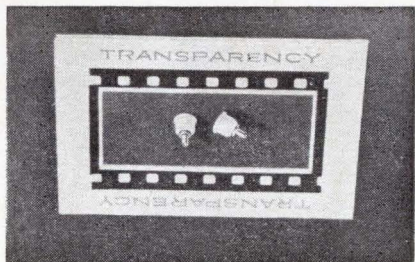

Subminiature reverse stand-off terminals are designed for use in panels where dense packaging is required. The parts are designated type No. RST-SM-14.

With a major diameter of 0.150 in., this Press-Fit terminal can fit on 0.170-in. centers in a 0.050-in.-thick panel. To conserve additional space, the solder-plated brass lug is 0.100 in. long. Over-all length of the new unit is 0.210 in. For simple installation, insertion tool No. B6-X3, which is also available from the manufacturer, is used for mounting.

Press-Fit terminals are fashioned of 100% pure virgin Teflon and are available in any of the standard EIA colors for coding.

Sealectro Corp., 225 Hoyt St., Mamaroneck, N.Y., 10544. [357]

P-c board heat sink for TO-5 transistors

Series 150 is a lightweight heat sink, which takes up a small board area and has good performance characteristics with TO-5 cases. The case temperature rise is 36°C at 1 w with bright aluminum natural finish or 30°C rise at 1 w with black anodize finish. The area required for mounting is only 0.375 square in. Material used is 1100

VOLTROL* STABILIZERS ARE AVAILABLE FOR EVERY LOAD

from
15 VA THRU 5 KVA

One of the important reasons for specifying Voltrol Stabilizers is the advantage of being able to select from a complete line of uniformly high performance designs. If one application calls for 30 VA and another has a load of 5000 VA; or, if the installation nominal supply voltage is 230, or 460 volts, you can be supplied from one source—Acme Electric. This is a plus buying reason well worth considering.

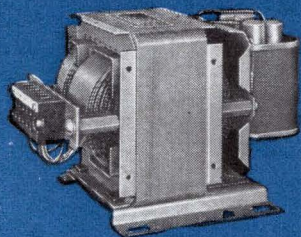

OPEN TYPE

In ratings from 15 VA thru 1000 VA, the open type design, (without end enclosures) is ideal for use as a voltage regulating component in control systems, electro-medical devices, copying machines, or other types of equipment where varying voltage affects performance.

ENCLOSED TYPE

Sizes from 30 VA thru 1000 VA can be supplied with heavy gauge steel enclosures. Conduit knockouts on four sides of terminal enclosure. Also available with cord and plug adapter set, for use with equipment not permanently installed.

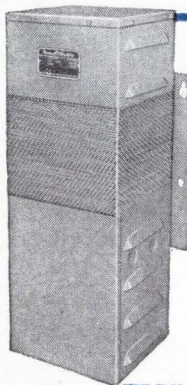
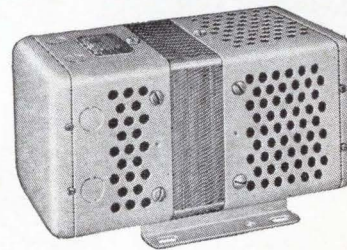

3 KVA and 5 KVA units with multi-voltage inputs and 240 or 480 volt outputs

Voltrol Stabilizers are available in many voltage variations.

Input voltage range 95-130 x 190-260: output 120 volts

Input voltage range 95-130 x 190-260: output 240 volts

Input voltage range 165-225 x 190-260 x

380-450 x 355-485 x

380-520: output 240 volts

Input voltage range 190-260 x 380-520: output 480 volts

There are many applications requiring voltage stabilizing at these power circuit voltages.

Write for Bulletin 09 for full specifications and details.

*Voltrol is a trademark of Acme Electric.

Acme Electric

Engineers and Builders of...

314 WATER STREET, CUBA, NEW YORK

Canadian Representative: Polygon Services, Ltd.

50 Northline Rd., Toronto 16, Ont.

SAA-3931-3218

REGULATED POWER SUPPLIES
STATIC POWER RECTIFIERS
VOLTAGE STABILIZERS
VOLTAGE REGULATORS

**IT'S
A
FACT**

America's principal
defense contractors,
computer builders,
instrumentation
manufacturers and
electronic systems
developers use more
Metal Removal Company
solid carbide circuit
board drills and
routers than all other
makes combined.

For more information,
may we send you our
Catalogs D63 and E65
... and name of
nearest distributor?

**SOLID CARBIDE
CIRCUIT BOARD
TOOLING**

THE METAL REMOVAL COMPANY
1859 West Columbia Avenue • Chicago, Illinois 60626

Plants Located in CHICAGO • LOS ANGELES • SAN JUAN

**MASTER TOOL AND WHEEL MAKERS
FOR THE WORLD**

To order reprints: Fill in, cut out coupon below, insert in envelope and mail to: **Electronics Reprint Dept., 330 W. 42nd Street, New York, N.Y. 10036**

Reprint order form

For listing of reprints available see the Reader Service Card.

Computer Time Sharing

Send me reprints of Key no. R-86 at 50¢ each.

For reprints of previous special reports fill in below:

Send me reprints of Key No.(s) @ ¢ each.
(For prices, see Reader Service Card)

Name
Number of street
City, State, Zip Code

New Components

aluminum alloy.

Two No. 4 by ¼ in. long sheet-metal screws are used to solidly clamp the TO-5 case in the heat sink. Three eyelets extruded from the mounting base provide keying to the circuit board. A sheet metal screw in the center eyelet anchors the heat sink to the p-c board and the two outer eyelets are set for permanent positioning.

Price is less than 3 cents each in volume quantities without black anodizing. Series 150 heat sinks are provided without screws.

Wakefield Engineering Inc., 139 Foundry St., Wakefield, Mass., 01881. [358]

**Versatile connectors
in three assemblies**

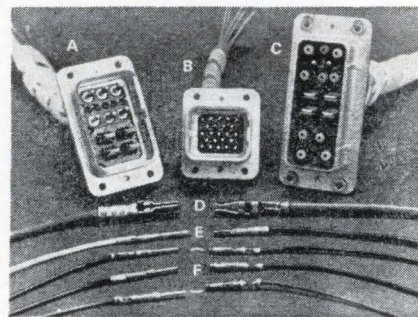

A versatile concept in connector design, called the A-MP series G connector, provides almost unlimited signal, power or coaxial circuit combinations in a single basic connector style. The series G connector allows packaging of circuit connectors in any required combination, eliminating the need for a separate connector for each type of circuit.

The series G line is currently available in three different assemblies incorporating one, two or three connector modules. Each module can accommodate 4, 8, 11, 14 or 23 circuits.

Each connector assembly consists of three parts: the shell, module insert and retainer back plate. The cast aluminum shells have polarizing grooves in the receptacle and matching tongues in the plug and are available with or without floating bushings. The shell and

When you think small ...
think Deutsch.
Mass circuitry subminiatures
for hard-to-find connector space.
All shapes and sizes ...
cylindrical, square, rectangular.
All coupling types ...
bayonet-lock, threaded, push-pull.
All applications ...
hermetics, environmentals,
non-environmentals.
When in a tight spot ...
Squeeze in your local Deutschman.



NEW
ACTUAL
SIZE

NOW — DEUTSCH SUBMINIATURES ARE AVAILABLE WITH EITHER STANDARD
OR REAR RELEASE INSERTABLE/REMOVABLE CONTACTS.



DEUTSCH

ELECTRONIC COMPONENTS DIVISION • Municipal Airport • Banning, California

ADVANCED SPECIFICATION SUBMINIATURE ELECTRICAL CONNECTORS



ULTRA SENSITIVE NANOVOLT AMPLIFIER

Never has a dc amplifier provided more versatile performance with as precise amplification for signals as low as 100 nanovolts. The completely transistorized Model 120 is specifically engineered for low-level, low frequency transducer outputs typifying geophysical, seismographic, bolometer, cryogenic, cellular, Hall-effect, and related applications. Gains from 200 to 1 million, selected by front panel switch. Operated directly from ac power line or by battery, thus eliminating 60-cycle hum interference and providing floating amplification. Built-in battery charger and front-panel monitor. Just 14 pounds light.

SPECIFICATIONS

Gain Steps . . . 200 to 1 million in 1, 2, 5, etc. sequence
 Input Resistance Greater than 1 megohm
 Bandwidth From dc to greater than 100 cps
 Gain Accuracy $\pm 1\%$ at dc
 Gain Stability $\pm 0.01\%$ /day, $\pm 0.1\%$ /6 months
 Linearity $\pm 0.02\%$
 Noise $< 0.05\mu v$ pk to pk referred to input
 Drift $< 0.05\mu v$ /hour referred to input
 Output ± 5 volts at 5 ma
 Size $6\frac{3}{4}$ "w by $8\frac{3}{4}$ "h by $10\frac{1}{2}$ "d portable cabinet
 Power 115VAC or self-contained rechargeable batteries



New Components

retainer plate are designed to provide simple module drop-in assembly.

Module inserts are made of diallyl phthalate or general purpose phenolic. Connector assemblies can be provided with die cast aluminum shields and cable clamps; a strain relief clamp is available for the three-module connector. AMP Inc., Harrisburg, Pa. [359]

10-turn precision pot is $\frac{3}{4}$ inch long

Model 7266, measuring $\frac{3}{4}$ in. long, is said to be the industry's shortest $\frac{7}{8}$ -in. diameter, 10-turn precision potentiometer. It has a wirewound resistance element and standard resistances from 10 ohms to 125,000 ohms. Standard resistance tolerance is $\pm 3\%$, with $\pm 0.2\%$ independent linearity. The bushing mount potentiometer has a power rating of 1.6 w at $40^\circ C$, derating to 0 at $85^\circ C$.

Construction features include molded plastic housing, gold-plated terminals and $\frac{1}{4}$ -in. diameter stainless steel shaft. The pot is available in ganged units as well as single sections.

Helipot division of Beckman Instruments, Inc., 2500 Harbor Blvd., Fullerton, Calif., 92634. [360]

Multilayer capacitors resist delamination

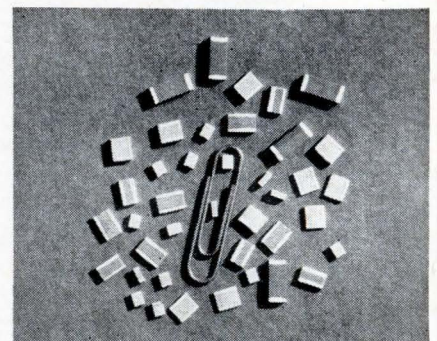

A line of ceramic multilayer capacitor chips has a high uniformity of dielectric and electrode layers and exceptional delamination resistance. Called Multi-cap capacitor

chips, they are made with high-quality AlSiMag dielectric materials, including a new NPO composition that gives 50% greater capacitance, according to the manufacturer. A special manufacturing process is said to insure a strong lamination of materials, virtually eliminating any delamination problem.

Multi-cap capacitors are available in sizes ranging from 0.152 x 0.052 x 0.055 in. to 0.375 x 0.155 x 0.065 in., with capacitance values from 330 pf to 0.5 μ f, at working voltages of 25 to 50, 100 to 200 d-c.

Prices are based on quantity, value, tolerance and voltage required. An 0.01, 50-v unit is listed at less than 30 cents. Delivery in limited quantities is possible in approximately one week, and samples are available on request in various sizes, values and voltage combinations.

Titania division, American Lava Corp., Chattanooga, Tenn., 37405. [361]

Moisture-proof Teflon terminal

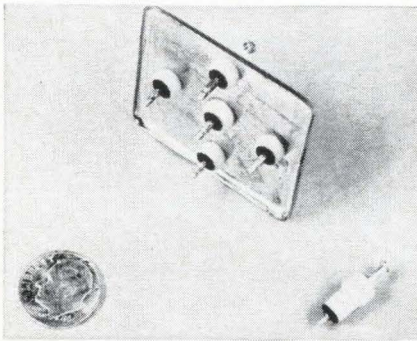

A terminal has been developed that serves two purposes—as a conventional panel feed-through or as a moisture-proof terminal for component housings.

The Teflon body is held under tension by a spring push-nut, which gives it maximum mechanical stability. Product advantages are low initial cost; fast, low-cost assembly; and mechanical reliability—plus the thermal and electrical values of Teflon.

All tests indicate that the terminal does not leak and can be used on applications to meet MIL-T-27A specifications. A sample kit that includes literature and product samples is available.

Lundey Associates, Inc., 694 Main St., Waltham, Mass., 02154. [362]

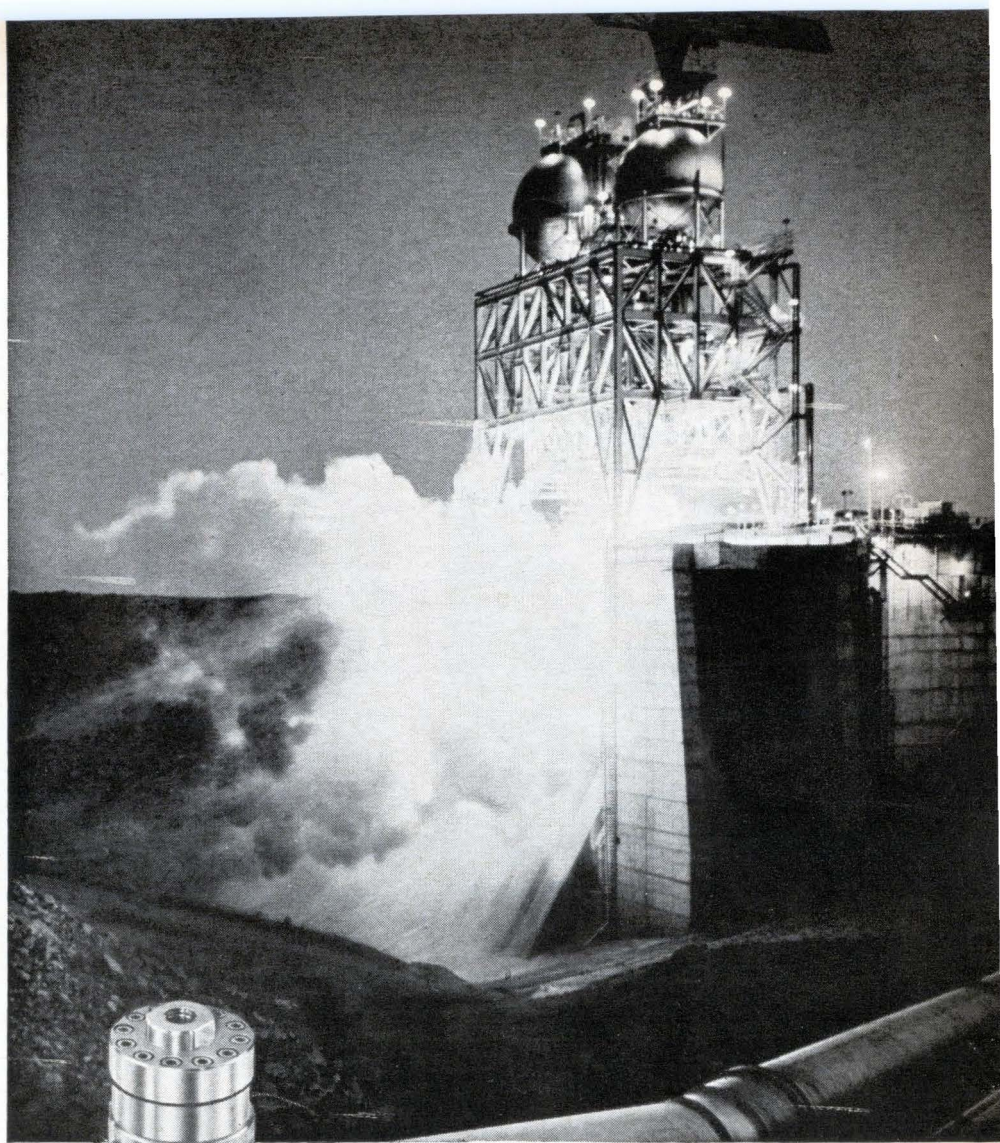

Rocketdyne *uses Taber* TELEDYNE[®] FOR F-1 ENGINE DEVELOPMENT

The F-1 is the most powerful rocket engine to be placed in production by the U.S. It was designed and developed by Rocketdyne, a division of North American Aviation, Inc., under the technical direction of NASA's Marshall Space Flight Center, Huntsville, Ala. The F-1, in a cluster of five generating 7,500,000 pounds of thrust, will power the first stage of the Saturn V space vehicle that will launch the first American astronauts to the moon in the Apollo spacecraft.

Taber TELEDYNE[®] Pressure Transducers are used by Rocketdyne for steady-state pressure measurements during static testing of both F-1 and Saturn V second and third stage J-2 engines. Pressure transducers must be accurate, rugged and dependable to withstand the extreme vibrations and pressures the engines encounter during static testing.

If that's what you're looking for in Pressure Measurement Instrumentation, Taber has probably already developed just what you need. To find out, write: Taber Instrument Corp., Section 158, 107 Goundry St., North Tonawanda, New York.

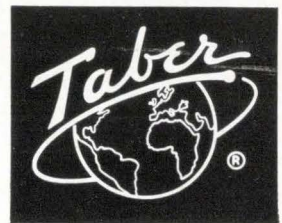

Circle 175 on reader service card

DELTA CASTINGS

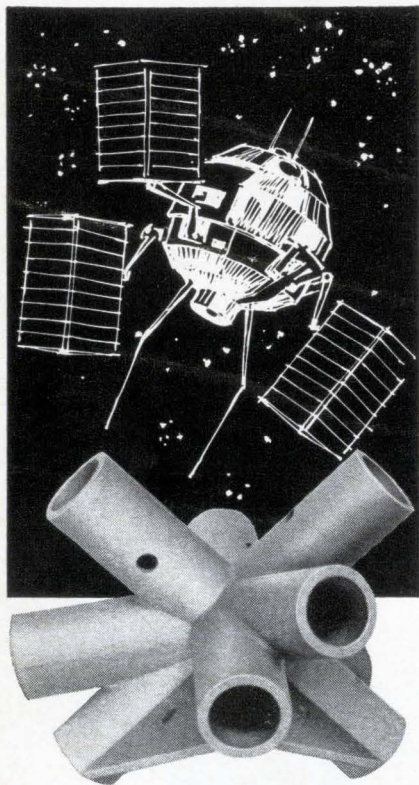

STRUCTURAL ELEMENT FOR A COMMUNICATIONS SATELLITE

The customer wanted strength and precision in a high standard, brazable 71A aluminum alloy. Delta, whose experience in casting aluminum, beryllium copper, and other nonferrous alloys to the rigid specifications required for electronic and mechanical components, produced this part to unusual center-to-center tolerances.

Delta's knowledge of tool design and ability to produce castings to the ultimate in finish, tolerance, and performance characteristics makes it very probable that you, too, can profit by dealing with Delta.



DELTA MICROWAVE
CORPORATION
HACKENSACK, NEW JERSEY 07601
Tel. (201) 343-2484

a subsidiary of
HITCHINER MANUFACTURING CO., INC.

New Semiconductors

Fast adder formed on single chip

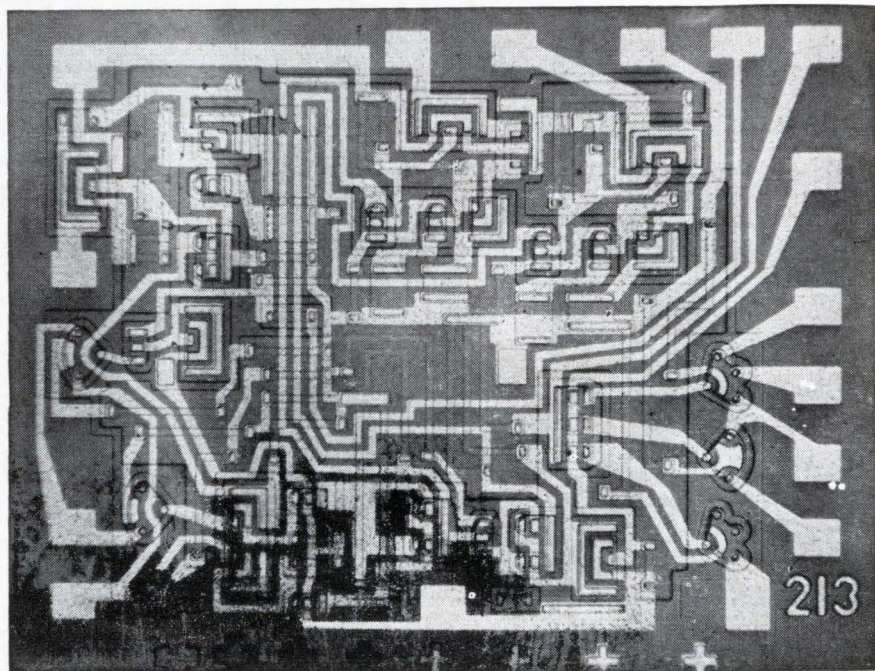

Integrated circuit digital subsystems on individual silicon chips have been introduced by Sylvania Electric Products, Inc., a subsidiary of the General Telephone & Electronics Corp. The units, called monolithic digital functional arrays, provide high reliability, low power consumption and reduced systems assembly costs, according to Alvin B. Phillips, Sylvania's general manager of integrated circuits.

One of these subsystems is a complete transistor-transistor logic (TTL) fast adder. The fast adder circuits are formed on individual 48 by 61 millimeter silicon chips. The basic adder configuration may be interconnected by three standard metal patterns to form a single-stage, independent-carry fast adder, called the SM 30 series; a single-stage, dependent fast adder, SM 20 series or a single-stage full adder, SM 10 series.

Most advanced high speed computers use parallel, anticipated-carry, fast-adder systems in which the addition of binary digits and the addition of carries between digits is performed simultaneously. To build parallel anticipated-carry fast adders larger than four bits, independent and dependent fast adders

are used in conjunction with a specially designed carry decoder package, series SM 40. The SM 20 dependent carry adders form the first and last stages of an adder system to provide for end-around carry operation. Where speed is not critical, computer systems can use ripple carry adders made from SM 10 series full adders. In ripple carry adders, a separate carry operation is performed following the addition of each binary digits.

A 64-bit anticipated carry adder that will perform 3 million 64-bit additions in less than a second can be made from only 96 Sylvania packages. Mounted on printed circuit boards, the entire system will fit into a 3-inch cube. A similar system using conventional integrated circuits would require approximately 320 individual packages, occupy approximately six times the space, and take twice as long to perform the same function, according to Phillips.

The fast adder circuits are avail-

Specifications

Propagation delay	35 nanoseconds for 8 stages to final sum (anticipated carry)
Noise margin	±1.0 volt
Power consumption	120 mw per stage
Fanout	6 to 15

24 STANDARD MODELS...

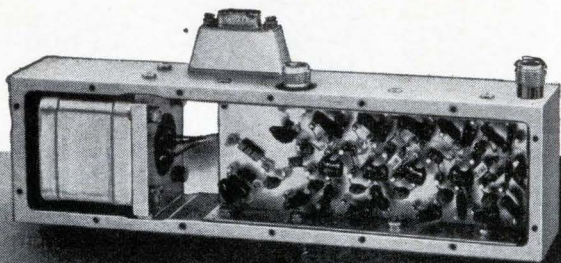

RHG OCTAVE AMPLIFIERS

FEATURING

- Noise figures to 2.5 db • Solid State Reliability • Low input and output VSWR
- RFI and Weatherproof housing • Octave coverage to 1000 MHz • With or without power supply

FOR EXAMPLE

Model B505	
Frequency:	200 - 400 MHz
Gain:	20 db (min.)
Noise Figure:	< 4 db over band
Input and Output Impedance:	50 ohms
Input and Output VSWR:	2:1 typical over band
Price:	\$495

Utilizing RHG's broad background in low noise pre-amplification, an additional 43 CUSTOM DESIGNS have been produced. The solution to your problem may be on file in our library now.

For specials, test our ONE-DAY-QUOTE Service. For standards, see complete listing in EEM Section 3400.

RHG

RHG ELECTRONICS LABORATORY, INC.

94 Milbar Blvd., Farmingdale, L.I., N.Y. 11735 ■ (516) 694-3100

MICROWAVE FM and AM RECEIVERS ■ MICROWAVE MIXER PREAMPS
LINEAR and LOG IF AMPLIFIERS ■ RF and OCTAVE AMPLIFIERS

What happens when you insulate with HYGRADE SLEEVING?

No cracking, no corrosion, no wicking, no dielectric breakdown . . . nothing! It just sits there . . . preventing trouble the way it's supposed to. In fact, you can forget it! Isn't that what you want in insulating sleeving? Just tell us where you plan to use it, under what conditions. We'll recommend the right material. You can take our word for it . . . because we've been insulation specialists for 44 years.



HYGRADE[®] INSULATING SLEEVINGS

Markel HYGRADE Sleeveings are constructed of carefully braided fiberglass yarn, impregnated and coated with specially formulated varnishes, vinyls, resins, or silicone rubber compounds. A wide range of types, grades and sizes meet virtually every conceivable requirement for dielectric and mechanical strength under all kinds of operating conditions . . . at continuous temperatures from -70°F to 1200°F. We'll be glad to send you specifications and Sample File on the entire HYGRADE Sleeveings line. Just write. No charge or obligation.

L. FRANK MARKEL & SONS
SINCE 1922

Norristown, Pa.

215-272-8960

INSULATING TUBINGS & SLEEVINGS • HIGH TEMPERATURE WIRE & CABLE

New Semiconductors

able in Sylvania's standard 14-pin dual in-line, plug-in package and the TO-85 flatpack. They are designed for operation in the temperature range -55° to $+125^{\circ}\text{C}$.

Sylvania Electric Products, Inc., subsidiary of the General Telephone and Electronics Corp., 730 Third Avenue, New York, N.Y. [365]

Optical isolator in epoxy package

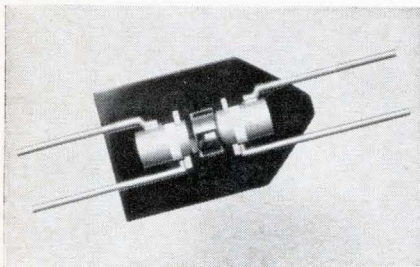

An optoelectronic coupling device permits economical high-voltage electrical isolation up to 5,000 volts. The TIXL101 optical isolator combines a planar silicon light sensor (LS600) with a gallium arsenide light source (TIXL01) in a single opaque epoxy package.

The new device is designed to provide electrical isolation where circuit feedback problems exist. As a replacement for electromechanical relays, it offers significant advantages in switching speed, reliability, mechanical ruggedness, and compactness.

Though capable of handling very high voltages, the TIXL101 is sensitive to small signal changes. Therefore, it is particularly suitable for application in h-v low-current telecommunications relay lines.

Switching speed greatly exceeds that of the fastest relays, permitting the transmission of more information with fewer devices. Capable of flat response beyond 10 khz (kilocycles per second), the device has a typical reverse switching time of $1.5 \mu\text{sec}$ and a forward switching time of $15 \mu\text{sec}$.

Input current rating is 50 ma. Output is $250 \mu\text{a}$ minimum, a highly usable signal level sufficient to drive simple amplifier circuits.

Incorporation of two hermetically sealed components in a solid, one-piece epoxy package results in a physically rugged component suitable for heavy-duty industrial applications where they are subjected to high vibration, shock, and other environmental extremes, according to the manufacturer. Contact chatter or bounce, often encountered where relays are subjected to high vibration, is completely eliminated. The device provides stable performance over a broad temperature range from -55° to $+125^{\circ}\text{C}$.

The TIXL101 is encased in an electrically isolated cylindrical package measuring only 0.22 by 0.35 in.

Price of the unit is \$34 in quantities of 100 to 999.

Texas Instrument Incorporated, 13500 North Central Expressway, Dallas, Tex. [366]

22-ampere scr's in TO-48 package

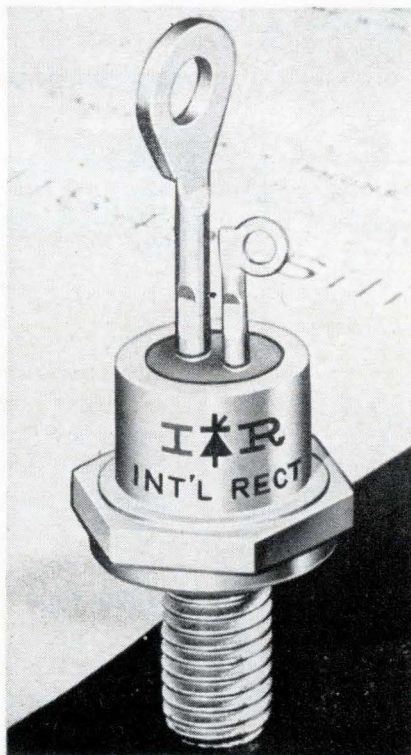

A 22-amp series of silicon controlled rectifiers is available with peak reverse voltage ratings from

DELCO RADIO SEMICONDUCTORS AVAILABLE AT THESE DISTRIBUTORS

EAST

BINGHAMTON, N. Y.—Federal Electronics, Inc.

P. O. Box 1208/PI 8-8211

PHILADELPHIA 23, PENN.

Almo Industrial Electronics, Inc.

412 North 6th Street/WA 2-5918

PITTSBURGH 6, PENN.—Radio Parts Company, Inc.

6401 Penn Ave./361-4600

NEWTON 58, MASS.—Greene-Shaw Company

341 Watertown Street/WO 9-8900

CLIFTON, N. J.—Eastern Radio Corporation

312 Clifton Avenue/471-6600

WOODBURY, L. I., N. Y. 11797

Harvey Radio Company, Inc.

60 Crossways Park West, Phone (516)-921-8700

BALTIMORE 1, MD.—Radio Electric Service Company

5 North Howard Street/LE 9-3835

SOUTH

BIRMINGHAM 5, ALA.

Forbes Distributing Company, Inc.

2610 Third Avenue, South/AL 1-4104

WEST PALM BEACH, FLA.—Goddard, Inc.

1309 North Dixie/TE 3-5701

RICHMOND 20, VA.—Meridian Electronics, Inc.

1001 West Broad Street/353-6648

MIDWEST

KALAMAZOO, MICH.—Electronic Supply Corporation

P. O. Box 831/381-4623

INDIANAPOLIS 25, IND.

Graham Electronics Supply, Inc.

122 South Senate Avenue/ME 4-8486

CLEVELAND 1, OHIO—The W. M. Pattison Supply Co.

Industrial Electronics Division

777 Rockwell Avenue/621-7320

CHICAGO 30, ILL.—Merquip Electronics, Inc.

4939 North Elston Avenue/AV 2-5400

CINCINNATI 10, OHIO—United Radio, Inc.

7713 Reinhold Drive/241-6530

KANSAS CITY 11, MO.—Walters Radio Supply, Inc.

3635 Main Street/JE 1-7015

ST. LOUIS 17, MO.

Electronic Components for Industry Co.

2605 South Hanley Road/MI 7-5505

TULSA, OKLAHOMA 74119—Radio, Inc.

1000 South Main Street/(918)-587-9124

MINNEAPOLIS, MINNESOTA 55413

Northwest Electronics Corporation

336 Hoover St., N. E./612-331-6350

WEST

DALLAS 1, TEXAS—Adleta Company

1907 McKinney Ave./RI 2-8257

HOUSTON 1, TEXAS—Harrison Equipment Company, Inc.

1422 San Jacinto Street/CA 4-9131

SAN DIEGO 1, CAL.

Milo of California, Inc.

2060 India Street, Box 2710/232-8951

LOS ANGELES 15, CAL.—Radio Products Sales, Inc.

1501 South Hill Street/RI 8-1271

LOS ANGELES, CAL. 90022—Kierulff Electronics

2585 Commerce Way/OV 5-5511

MOUNTAIN VIEW, CAL.—Kierulff Electronics

2484 Middlefield Road/968-6292

DENVER, COLO.—L. B. Walker Radio Company

300 Bryant Street/WE 5-2401

SEATTLE 1, WASH.—C & G Electronics Company

2600 2nd Ave./Main 4-4354

PHOENIX, ARIZ.—Midland Specialty Co., Inc.

1930 North 22nd Ave./258-4531

ALBUQUERQUE, N.M.—Midland Specialty Co., Inc.

1712 Lomas Blvd., N.E./247-2486

TUCSON, ARIZ.—Midland Specialty Co., Inc.

951 South Park Ave./MA 4-2315

Ask for a complete catalog

DELCO RADIO

DIVISION OF GENERAL MOTORS • KOKOMO, INDIANA

Delco Radio's new 400V silicon power transistors will change your thinking about high voltage circuitry. You can reduce current, operate directly from rectified line voltage, and use fewer components. Our standard TO-3 package stays cool (junction to heat sink 1.0°C per watt). And price is low—less than 3¢ a volt even in sample quantities—for wide ranging applications. Vertical and horizontal wide-screen TV out-

The heat's off high energy circuits

puts, high voltage, high efficiency regulators and converters. Your Delco Radio Semiconductor distributor keeps them on ice. Call him today for data sheets, prices and delivery.

RATINGS	DTS 413	DTS 423
VOLTAGE		
V _{CEO}	400 V	400 V
V _{CEO} (Sus)	325 V (Min)	325 V (Min)
V _{CE} (Sat)	0.8 (Max)	0.8 (Max)
	0.3 (Typ)	0.3 (Typ)
CURRENT		
I _C (Cont)	2.0A (Max)	3.5A (Max)
I _C (Peak)	5.0A (Max)	10.0A (Max)
I _B (Cont)	1.0A (Max)	2.0A (Max)
POWER		
	75 W (Max)	100 W (Max)
FREQUENCY RESPONSE		
f _t	6 MC (Typ)	5 MC (Typ)

FIELD SALES OFFICES

UNION, NEW JERSEY*
Box 1018 Chestnut Station
(201) 637-3770

SYRACUSE, NEW YORK
1054 James Street
(315) 472-2668

DETROIT, MICHIGAN
57 Harper Avenue
(313) 873-6560

CHICAGO, ILLINOIS*
5151 N. Harlem Avenue
(312) 775-5411

SANTA MONICA, CALIF.*
726 Santa Monica Blvd.
(213) 870-8807

General Sales Office:
700 E. Firmin, Kokomo, Ind.
(317) 457-8461—Ext. 500

*Office includes field lab and resident engineer for application assistance.

DELCO RADIO

Division of General Motors, Kokomo, Indiana



New Semiconductors

25 to 700 v (800 v nonrepetitive transient rated). The series has a maximum current rating of 22.3 amps average (35 amps rms) at up to 70°C case temperature and a junction temperature capability of 150°C. The maximum operating temperature of 150°C permits significant current ratings in higher ambient temperatures than with conventional 125°C maximum devices of identical physical size.

Applications for the new series range a broad spectrum from battery chargers and temperature controllers, to motor speed controls and process control instrumentation. The series is in the TO-48 package. Availability is two to four weeks. Price is \$10.80 to \$51 in lots of 1 to 99, and \$6.90 to \$35 in 100 to 999 lots.

International Rectifier Corp., 233 Kansas St., El Segundo, Calif., 90245. [367]

These amplifiers operate within the specified parameters over a temperature range of -55° to +125°C and can be stored at +150°C for prolonged periods. The CTC-15018 epoxy encapsulated flatpack measures 1.300 in. x 0.700 in. x 0.150 in., with gold plated Kovar leads on 0.100 in. centers.

Priced at less than \$90 in production quantities, they can be delivered four weeks after ordering. Columbia Technical Corp., Woodside, N.Y., 11377. [368]

Field effect devices offered in 11 models

Eleven advanced-design, field effect devices have been introduced. Seven transistors and four quads in the enhancement mode with insulated gates offer the many advantages of FET performance at half the price of generally available FET's, according to the manufacturer.

The RN1020, RN3020, and RN-3020R have applications as high-frequency amplifiers where high input impedance and high gain are specified. The RN1030, RN-1030A, and RN3030R are efficient in digital logic and chopper applications featuring zero offset, high input impedance and low "on" resistance.

The RM5008 is a monolithic device incorporating four p-channel enhancement mode integrated FET's on a single silicon chip. The 14-lead, flatpack quad has applications in switching, chopping, logic gating and amplifying. The RM8007 is similar except that it employs dual common source pairs and hence is a 12-lead unit. The RM5008D and RM8007D have diode protected gates.

All these devices are rated for 125°C and 6-v gate reverse bias. They are currently in production and immediately available. Prices in the 1 to 99 quantities range from \$3.95 for the RN3030 to \$35 for the RM5008D.

Raytheon Co., Components division, Lexington, Mass., 02173. [369]

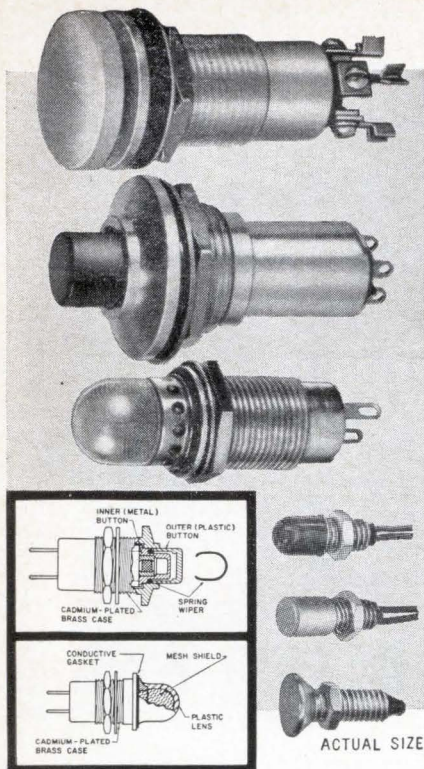

New



SHIELDED

Lights and Switches from Control Switch!

Now, check the last uncontrolled RFI leaks in otherwise well-shielded panels. New component shielding techniques by Control Switch attenuate RFI and EMI in the important 0.15 to 1,000 mc range.

Indicator lights and pushbuttons shown above now available. Lights include the world's tiniest, with diameters as small as .220".

In lights, metal mesh shield in lens absorbs emissions. Special conductive gasket provides electrical conductivity between shield and brass case in removable lens type. Incandescent and neon models, latter with resistor built into case. In switches, metal wiper contacts brass case at all points of switch travel grounding to panel.

Check into this Control Switch advance now. At your Control Switch distributor's, or direct from us.

CONTROLS COMPANY
OF AMERICA

CONTROL SWITCH DIVISION
1420 Delmar Drive, Folcroft, Pennsylvania 19032

Gated video amplifier is epoxy encapsulated

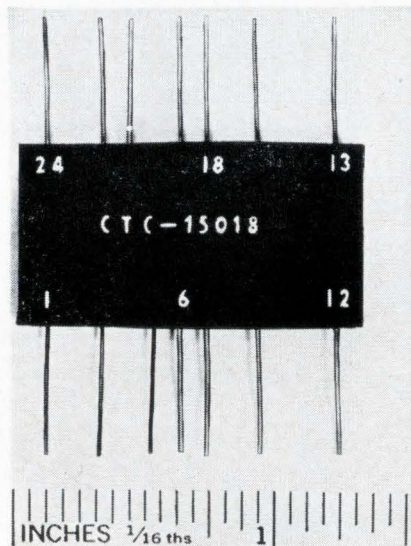

A gated video amplifier is typical of the hybrid cermet film circuits now being produced by the company. Using chip and wire techniques, these flatpacks employ switching mode and linear circuits. Operating at video bandwidths up to 10 Mhz (megacycles per second), this hybrid film component has a gain of more than 14. Gate rise and fall time is less than 50 nsec.

Is this your design department?

Bill can't find a small enough pushbutton.

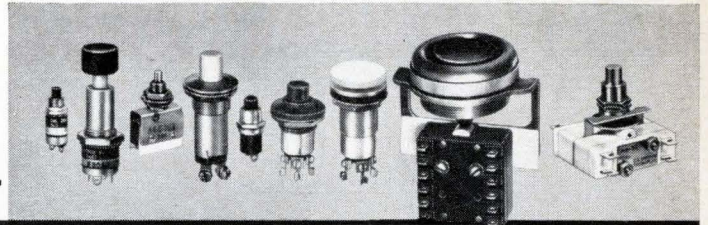

Ed wants an extra-tiny indicator light.

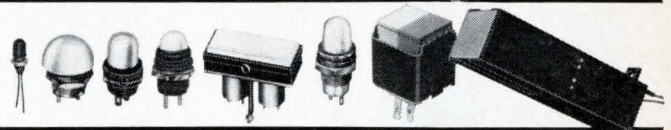

Joe's checking four sources for a toggle.

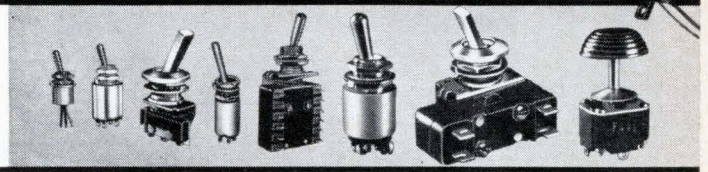

George wants a snap-in switchlite.

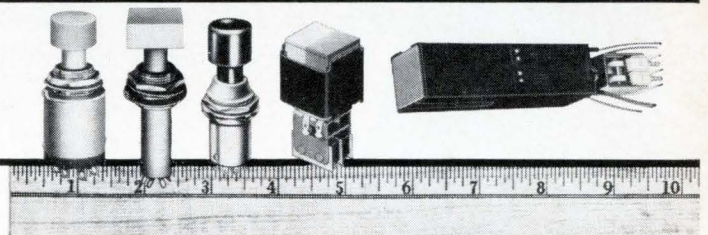

You fellows ought to know Control Switch!

Rip out the bingo card in this book now and tick off numbers for any or all of the Control Switch catalogs listed below.

If you get all seven catalogs, you'll have the most complete file you can get from any single source!

Control Switch makes more types of switches and switchlites than anybody. So our catalogs offer the best chance of finding what you want . . . first try!

In addition, some manufacturers don't make any of the switches and lights we make.

So these catalogs save chasing all over for switches.

Finally, Control Switch makes quality switches. For applications like data processing equipment, space age projects, and instrumentation systems. So our catalogs save horsing around with switches that can't deliver. *Send that bingo card now!*

Here are the Control Switch catalogs. Check numbers on the Reader Service Card corresponding to those on the left below for the catalogs you want.

- #480 Basic Precision Switch Catalog 110
- #481 Toggle Switch Catalog 180
- #482 Indicator Light Catalog 120
- #483 Hermetically-Sealed Switch Catalog 130
- #484 Switchlite Bulletins 54, 55, 63
- #485 Switchlite Catalog 220
- #486 Pushbutton Switch Catalog 190
- #487 RFI-Shielded Component Bulletin 62

**CONTROLS
COMPANY**
OF AMERICA
CONTROL SWITCH DIVISION
1420 Delmar Drive, Folcroft, Pennsylvania 19032

This 20-joule High-Q CAPACITOR has inductance of ONLY 1 NANOHENRY

- Q is 250 at 5 mc
- 0.1 microfarad
- 20 kilovolts

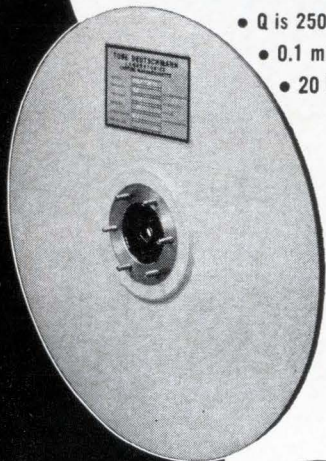

\$172

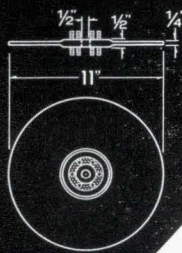

The Model ESC 247B coaxial disc capacitor is one of a series whose inductance is essentially that of the terminal.

Its coaxial construction results in maximum self-inductance of only one nanohenry for any capacitance from 250 pf to 0.5 ufd.

Capacitors in this configuration can be furnished in 50kv rating or, at lower voltage, to 500 joules. They can also be constructed to operate at high repetition rates.

The through-hole in the center of the terminal permits efficient installation of circuit components, such as the TOBE Model SBG-6 low-inductance spark-gap switch.

Ask for Bulletin EB365-20; it gives detailed information about the physical structure and electrical characteristics of coaxial disc capacitors.

And write or call us whenever you have a special or unusual requirement for capacitors.

TOBE DEUTSCHMANN

LABORATORIES



CANTON, MASSACHUSETTS 02021

Telephone (617) 828-3366

New Instruments

Low-cost dynamic IC tester

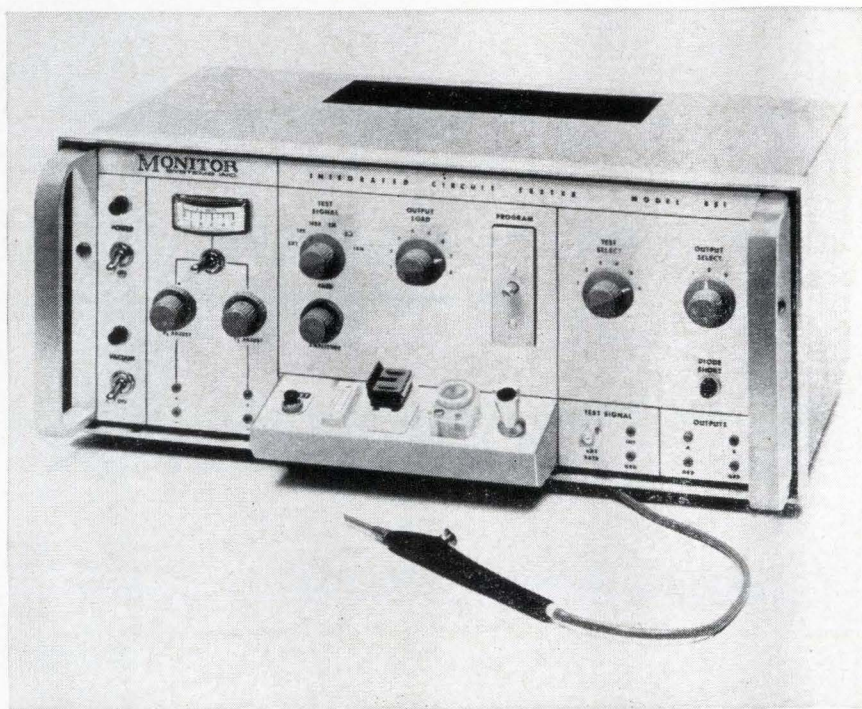

An integrated circuit tester, developed by Monitor Systems, Inc., a subsidiary of Epsco, Inc., provides the small user of integrated circuits with an inexpensive instrument for dynamically testing a variety of IC's. Other IC testers either perform only static tests or are large, complex systems that are too costly for modest users of IC's.

Monitor's model 851 is a self-contained unit that has selectable pulse rates and levels, adjustable power supplies and selectable circuit loads. The unit can test diode-transistor (DTL), resistor-transistor (RTL), emitter-coupled (ECL) and transistor-transistor (TTL) logic modules and linear circuits such as operational amplifiers. Separate plug-ins program the tester for the appropriate electrical tests for each type of IC. A typical IC module can be thoroughly checked in less than 15 seconds.

All that is necessary to test a circuit is to select the appropriate program plug-in and then set the proper bias voltages, pulse rate and load. The device is then inserted into the appropriate receptacle. As

an added safety measure, no power is applied to the circuit until the test button is pressed. The d-c outputs are monitored on a front-panel meter and the dynamic responses observed on an oscilloscope.

The test instrument accommodates all of the commonly used integrated circuit packages including flatpacks, TO-5 cans, and dual in-line packages. An optional vacuum probe facilitates rapid, foolproof lifting and positioning of flatpacks for testing. The vacuum is automatically turned on when the probe is removed from its receptacle and can be interrupted with a switch on the probe to release the IC. The vacuum is turned off automatically when the probe is returned to the receptacle.

Monitor provides two separate bias supplies for circuits under test. Each has a range of 0 to 15 volts d-c, adjustable by front-panel controls. Both supplies are floating with respect to ground and output voltages of either polarity can be selected.

Test pulses are generated by a clock circuit with a selectable fre-

1,200 Mhz is covered in two bands, with the lower from 0.5 Mhz to 300 Mhz and the upper from 275 Mhz to 1,200 Mhz. Sweep width on the low band is continuously variable from 50 khz to 300 Mhz; while on the high band it can be varied from 50 khz to 40% of center frequency.

The VS-80 is also provided with a c-w output mode. The unit has provisions for accepting up to eight single frequency or harmonic plug-in markers.

R-f output for the low band is 0.5 v, ± 0.25 db; for the high band, 0.5 v, ± 0.50 db. Impedance is 50 ohms. Weight is 18 lbs. Price is \$1,495; delivery, two to three weeks.

Texscan Corp., 51 South Koweba Lane, Indianapolis, Ind. [373]

Phase meter covers 20 hz to 10 Mhz

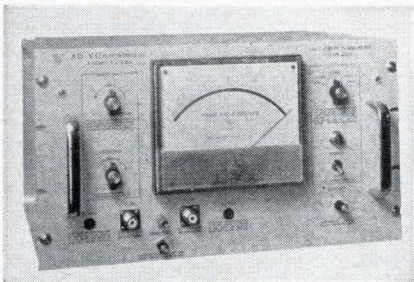

Type 422A is a video and r-f phase meter that offers the following features: 1) direct reading in degrees without amplitude or frequency adjustment; 2) amplitude fluctuation from 0.3 to 20 volts without affecting the accuracy of phase reading; 3) capability of plotting phase characteristic curve or direct reading in degrees over five decades, 20 hz to 10 Mhz; 4) equal accuracy for symmetrical waveforms of any shape; and 5) provision for self-calibration, self-adjustment identification of lead and lag.

The instrument can be used for plotting envelope delay curve up to several hundred megahertz with a sweep oscillator and type 712 group delay curve tracer. It is also suitable to use for measuring phase shift between antennas with amplitude modulated signal. No error will be introduced for signals with modulation under 70%. The signal amplitude can be varied from 0.3

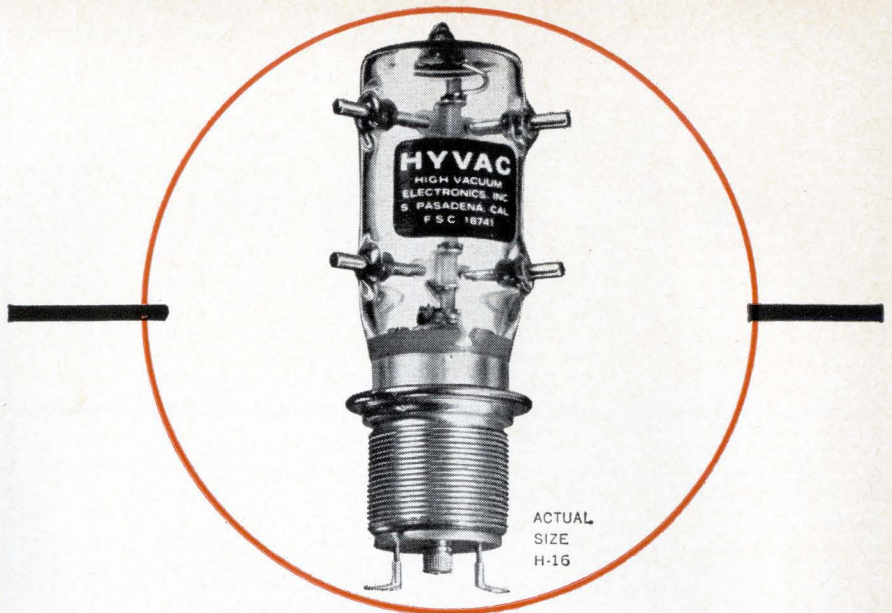

Why Hyvac puts a high voltage relay in a vacuum —
one word... **RELIABILITY!**

VACUUM RELAY RELIABILITY means short contact travel, low contact mass, contacts free of oxides and pitting and minimum contact bounce. These long-life reliability features are made possible only because of operation in a high vacuum dielectric. Vacuum technology has made high reliability, long life high voltage switching practical, with considerable savings in space and weight. Developed for high voltage, high peak current applications, Hyvac relays are well suited and widely used in radar, communications, pulse forming networks, ECM, sonar, medical electronics, antenna switching and antenna couplers, microwave systems and switching in explosive atmospheres. Hyvac's broad line and "Quick Reaction Time" is geared to your most critical delivery schedule. We have the high vacuum experience, design and production capability to provide special modifications of our standard off-the-shelf designs in unbelievably short order. Hyvac, a company small enough to be responsive, large enough to be responsible. Check the brief specifications of our "H" series:

HYVAC TYPE	H-8	H-9	H-11	H-12	H-14	H-16	H-17
Contact Arrangement	SPDT	SPST	SPST	SPDT	DPDT	DPDT	SPDT
Rated operating voltage (kv dc)	20	20	12-air 18-oil	8-air 12-oil	8-air 12-oil	12-air 18-oil	25
Continuous current, %max. (amps-rms)	15	15	15	15	15	15	25
Operating time, max (ms)	15	15	18	18	18	20	25
Coil voltage, nominal (vdc)	26.5	26.5	26.5	26.5	26.5	26.5	26.5
Approx. price (1-9 pcs)	\$98	\$98	\$105	\$110	Factory quote		

*Carry only

For complete technical information, contact your nearest sales engineering representative, or write directly to us.

HYVAC

HIGH VACUUM ELECTRONICS INC. • 538 MISSION STREET
SOUTH PASADENA, CALIFORNIA • PHONE: (213) 682-2149 • TWX 213-449-2552

New Instruments

v to 20 v without affecting the accuracy.

Ad-Yu Electronics, Inc., 249 Terhune Ave., Passaic, N.J. [374]

Programmable scope is free of d-c drift

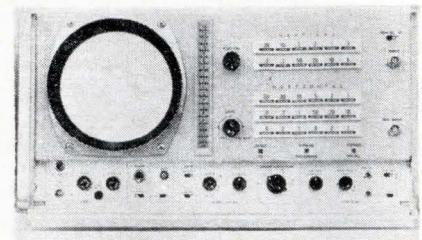

A push-button controlled oscilloscope is entirely free of d-c drift. Every major function is programmable by external circuit closures. Settings for any desired series of waveform observations may be pre-selected. Displays are presented in rapid order, and repeated exactly. With drift eliminated and correct settings assured, testing is fast and errors are reduced.

Model 155A oscilloscope is a 5 mv/cm, 25-Mhz instrument with illuminated push-button controls. D-c drift is eliminated by continual feedback corrections. Sensitivity and sweep are push-button-selected on the front panel, the setting indicated by illumination of the button pressed. D-c offset (trace position) is also indicated on an illuminated scale. A companion to the scope, the model 1550A programmer has 18 buttons, each of which will, at one touch, select an entire set-up on the scope. The present combination will include not only sensitivity, sweep, and offset (vertical position), but also input coupling (a-c or d-c), trigger source, and trigger slope. Programs are determined by the position of plug-in diodes in the programmer's circuit boards. Programmers may be cascaded, extending the number of available programs without limit.

With its programmer, the model 155A scope is especially useful in test applications where repetitive measurements must be made quickly and unerringly in the same way. Production test procedures

TC	.290	.400	.570	.660	.790	.890
P-100	1- 5 pf	6- 10 pf	11- 20 pf	—	—	—
NPO	1-15	16- 33	34- 69	70- 85 pf	86-115 pf	116-175 pf
N- 33	1-15	16- 33	34- 69	70- 85	86-115	116-175
N- 75	2-15	16- 33	34- 69	70- 95	96-130	131-190
N- 150	2-15	16- 36	37- 69	70- 95	96-140	141-230
N- 220	2-15	16- 36	37- 75	76-100	101-160	161-230
N- 330	2-22	23- 51	52- 75	76-115	116-190	191-270
N- 470	2-20	21- 51	52- 80	81-120	121-200	201-275
N- 750	2-32	33- 75	76-155	156-220	221-300	301-470
N-1500	10-74	75-140	141-220	221-399	400-550	551-800
N-2200	20-99	100-189	190-340	300-450	451-680	681-900

Temperature Coefficients up to N5200 Available on Special Order
Disc sizes under 1/2" diameter have lead spacing of .250. Discs 1/2" diameter and over have .375 spacing.

TROUBLE-FREE PERFORMANCE RMC DISCAPS

TEMPERATURE COMPENSATING TYPE C

RMC Type C DISCAPS meet or exceed all specifications of the EIA standard RS-198 and RS-165-A. Rated at 1000 working volts, Type C DISCAPS provide a higher safety factor than paper or mica capacitors.

Constant production and quality control checks assure that all specifications and temperature characteristics are met.

Throughout the years leading manufacturers have relied on RMC for quality of product and maintenance of delivery schedules. Write on your company letterhead for additional information on DISCAPS.

SPECIFICATIONS

CAPACITANCE: Within tolerance @ 1MC and 25°C

CAPACITANCE TOLERANCES: ±5%, ±10% or ±20%

WORKING VOLTAGE: 1000 VDC

QUALITY FACTOR: Greater than 1000 for 30 pf and above. Below 30 pf = $Q = 400 + 20 \times \text{cap (pf)}$

INSULATION RESISTANCE: Greater than 7500 Megohms @ 500 VDC

TEMPERATURE COEFFICIENT: As noted on capacitance chart

FLASH TEST: 2000 VDC for 1 second

LIFE TEST: Per EIA RS-165-A Class I

BODY INSULATION: Durez phenolic — vacuum wax impregnated

LEAD STYLES AVAILABLE: Long lead — #22 AWG tinned copper (#20 for .890" diameter)—and all types for printed wire circuits.

DISCAP
CERAMIC
CAPACITORS

RADIO MATERIALS COMPANY
A DIVISION OF P. R. MALLORY & CO., INC.
GENERAL OFFICE: 4242 W. Bryn Mawr Ave., Chicago 46, Ill.
Two RMC Plants Devoted Exclusively to Ceramic Capacitors
FACTORIES AT CHICAGO, ILL. AND ATTICA, IND.

may be simplified and testing time reduced, errors and training time minimized. Electronic components, circuit assemblies, and finished products all may be tested more quickly. The automated test stand, for the first time, now may include automated scope presentations. Any of the common programming devices may readily be applied—paper tape, cards, magnetic tape, etc.

Push-button convenience is also valuable to the laboratory user. Positive vertical calibration is retained, even with an off-screen d-c reference, by the no-drift feature. Sweep and sensitivity settings are obtained in one motion, without clicking through many positions. The operating condition is clearly displayed by illuminated tabs. Unintentional settings are harder to make. For lab use, the scope may be ordered without the programming feature, at reduced cost, but programmability may be added later with plug-in boards and cables.

Twelve calibrated sensitivity ranges are provided, from 5 mv/cm to 20 v/cm, with vernier extension to 50 v/cm. Eighteen calibrated sweeps range from 50 mv/cm to 0.1 μ sec/cm, with vernier extension to 0.25 sec/cm, at the slowest, and a X5 expansion speeds the fastest sweep to 20 nsec/cm. Automatic triggering is included.

Model 155A is priced at \$2,450. Model 1550A programmer is \$600. First deliveries in May. Hewlett-Packard, 1501 Page Mill Rd., Palo Alto, Calif., 94304. [375]

Expanded-scale frequency meter

Type FMS46 frequency meter, using solid state electronics to achieve 0.5 cps resolution, 0.1% accuracy and maintenance-free operation, linearly measures and displays the 375 to 425 hz frequency range. It is connected in parallel to the frequency source (100 to 130 v rms) and requires less than 2 watts of power from the source. Mounting hardware and bezel are available for recessed mounting.

This 400-cps meter is priced at \$84 and is available from stock. Airpax Electronics Inc., Seminole division, P.O. Box 8488, Fort Lauderdale, Fla., 33310. [376]

VACUUM+ CERAMIC

RF10A



RJ2A



RJ1A



JENNINGS TYPE

Operating Voltage (16 mc) 10 KV Peak
 Test Voltage (60 cycle) 20 KV Peak
 Continuous Current (16 mc) 30 Amps RMS
 Interrupting Rating 50 KW
 (dc resistive loads)
 Weight (oz.) 16

RF10A

10 KV Peak
 20 KV Peak
 30 Amps RMS
 50 KW
 (up to 5 amps or 10 KV)
 16

RJ2A

8 KV Peak
 18 KV Peak
 15 Amps RMS
 1 KW
 (up to 1 amp or 1 KV)
 3

RJ1A

2 KV Peak
 5 KV Peak
 7 Amps RMS
 1

Vacuum plus ceramic adds up to a new line of Jennings vacuum relays that brings you (1) High voltage hot switching capability (2) Highest RF current carrying ratings (3) Shock resistance (4) Small size and light weight (5) Greater reliability (6) Low unchanging contact resistance.

These new relays eliminate the necessity to redesign circuits in order to avoid difficult switching problems. Now small lightweight systems can be designed in the sure knowledge that the new Jennings vacuum relays offer as much as or more reliability and high performance than any other component in the circuit.

The RF10A relay features high power dc interrupting capability up to 50 KW.

The RJ2A and RJ1A are essentially rf relays capable of withstanding high voltage and carrying high rf currents. Even so the RJ2A will interrupt a rather remarkable 1 amp at 1000 volts for many thousands of operations.

Jennings also offers many glass vacuum relays, each designed to provide maximum performance to the particular segment of the electronic field for which they were created.

Our new catalog 102 describing our complete line of vacuum relays is available at your request.

Jennings Radio Manufacturing Corporation — Subsidiary of International Telephone and Telegraph Corporation, 970 McLaughlin Avenue. P.O. Box 1278 San Jose, California 95108.

ITT Jennings

New Subassemblies and Systems

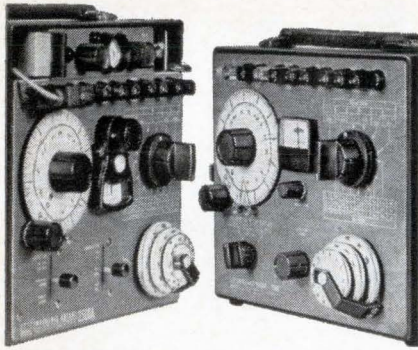

The old master has met its match.

For more than twelve years, our 250 DA Universal Impedance Bridge ruled supreme in its field. No instrument could match its measurement performance.

Now along comes a serious challenger—our new 250 DE (at right). It has all of the reliability and accuracy of the classic model. As you can see, they look alike from the outside.

But inside, we've made many improvements. The new 250 DE is completely self reliant on its four flashlight batteries. It has a new solid-state detector with greatly improved sensitivities: better than 20 microvolts on DC, 10 microvolts on AC. For simplicity, there is a single meter null detector on the front panel. And for versatility, some useful front terminals have been added.

Why did we improve on the old master when it has delighted so many thousands with its performance in countless plants, laboratories and schools? Well, we figured eventually somebody would make a truly portable impedance bridge even better than the 250 DA. And we wanted it to be us. ESI, 13900 NW Science Park Drive, Portland, Ore. (97229).

250 DE Portable Universal Impedance Bridge Specifications

Range:

Resistance: 0 to 12 Megohms
Capacitance: 0 to 1200 Microfarads
Inductance: 0 to 1200 Henrys
Resistance: 0.1% + 1 dial division
Capacitance: 0.2% + 1 dial division
Inductance (Series and Parallel):
0.3% + 1 dial division
Sensitivity: Better than 20 microvolts
DC, 10 microvolts AC
Frequency: 1 kc internal
(External terminals provided.)
Batteries: 4 D size flashlight batteries
provide 6 months of normal service.
Weight: 12 lbs. Price: \$470.00

Note: The 250 DA features exactly the same accuracy specifications as the 250 DE. However, the 250 DA is AC line-operated. Price: \$495.

Electro Scientific Industries **esi**

Laser system offers high repetition rate

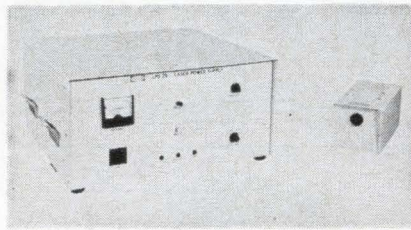

The LE-4 is a high repetition rate laser system featuring excellent reproducibility. It has an output of 3 joules minimum at pulse repetition rates of one pulse per second. At two pulses per second, output is 2 joules minimum.

The system consists of a water-cooled single elliptical cavity laser head and a 1,600-joule power supply. The LE-4 can be modified for short pulse operation with any type—mechanical, electro-optical or passive—Q switch and can operate at the same repetition rates as in normal use.

Single shot laser energy outputs are in excess of 4 joules, and maximum output energy in the one pulse per second mode is approximately 3.75 joules.

The LE-4 is presently being used in such micromachining applications as watch balancing and resistor trimming.

Price of the system is \$6,255 with delivery in 60 to 90 days.

Raytheon Co., Laser Advanced Development Center, 130 Second Ave., Waltham, Mass., 02154. [382]

Memory system uses integrated circuits

Model CI-300 is a completely self-contained random access, coincident current, ferrite core memory system that makes maximum use of integrated circuits in all logic and control functions. It was designed to meet MIL-E-5400 and for applications requiring a lightweight (less than 6 lbs), and low power (average, 20 w) memory system ca-

pable of operating in extreme environmental conditions (-55° to 100° C).

The system operates in either a read/restore or clear/write mode with a cycle time of 3 μ sec and an access time of 800 nsec. Word capacities to 16,384 words with word lengths to 32 bits are available. Maximum space requirement is 160 cu in.

Lockheed Electronics Co., 6201 E. Randolph St., Los Angeles, Calif. [382]

Digital computers for military use



Model R-11 digital computer, for military applications, features a very high speed memory—950 μ sec full memory cycle—in a 1.9 cu ft package.

Designed for such tactical command and control functions as ground and airborne weapons control, the R-11 is a real time general purpose computer built to military specifications. It has an 8,192-word memory with 24 bits plus parity per word. It weighs 100 lbs. Enclosed in the package are the memory unit, a central data processor, and a power supply available in both 60 and 400 hz (cycles per second) models.

The system can perform very high speed arithmetic operations including multiplication of two 24-bit words in 5.6 μ sec in conjunction

with all necessary memory accesses and register transfers. Two 24-bit words can be added or subtracted in 1.9 μ sec.

Available to the programmer are 70 commands including arithmetic, transfer, store, logical and shift functions. The R-11 features memory data protection in case of power failure and real time inputting at 25 megabits per second.

Missile Systems division, Bedford Laboratories, Raytheon Co., Bedford, Mass. [383]

Digital-to-analog converter module

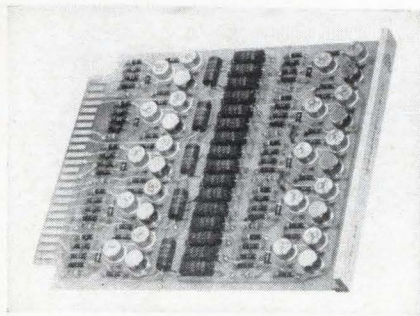

A digital-to-analog converter has been added to the company's standard family of digital logic modules.

The DA-101 module consists of a precision resistor matrix and 10 voltage-switching circuits designed to perform digital-to-analog conversion. The module has 10 digital inputs and one analog output. Conversion accuracy is $\pm 0.05\%$ of full scale; settling time is less than 2 μ sec. Several modified versions are also available.

Control Equipment Corp., 19 Kearney Road, Needham Heights, Mass., 02194. [384]

All-band receiver for field operation

The SR-219 receiver is a portable unit operating off self-contained rechargeable nickel cadmium batteries with frequency coverage from 2 Mhz to 4 Ghz by means of plug-in tuning heads. Only 10 in. wide, 3½ in. high and 17 in. deep, the receiver has a built-in battery charger. It provides a-m, f-m, c-w and pulse reception.

I-f bandwidths of 1 khz to 20 khz are available for the h-f heads and

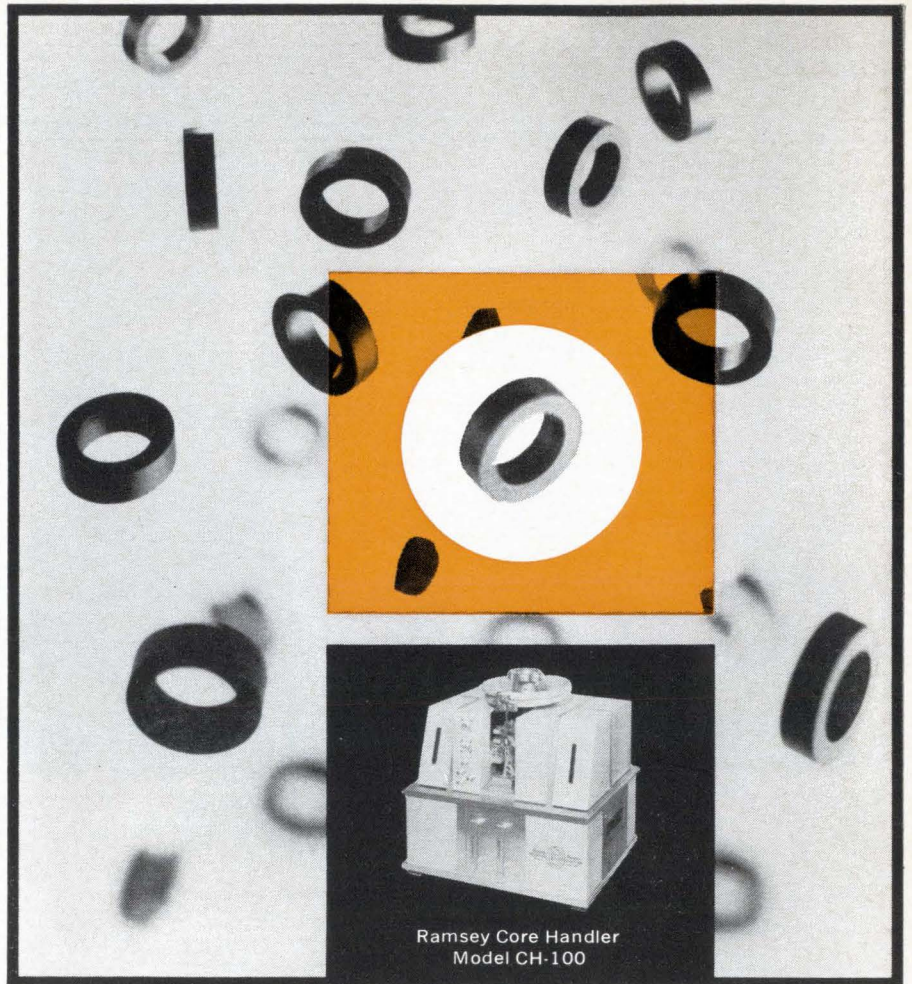

Ramsey Core Handler
Model CH-100

taking a low-cost look at memory cores is no longer a problem

For 8 years most progress in high speed handling of ferrite memory cores has been due to the innovations of Ramsey Engineering. In 1966 over 4,000,000,000 cores will pass through hundreds of Ramsey handlers operating in every major computer facility throughout the world. The CH 100 is Ramsey's most advanced handler. It is made of cams, linkages, drives, probes, contacts, and 8 years of know how. It processes 60,000 ferrites per hour and has just reduced the overall cost of core testing.



COMPUTER TEST CORPORATION

CHERRY HILL, NEW JERSEY

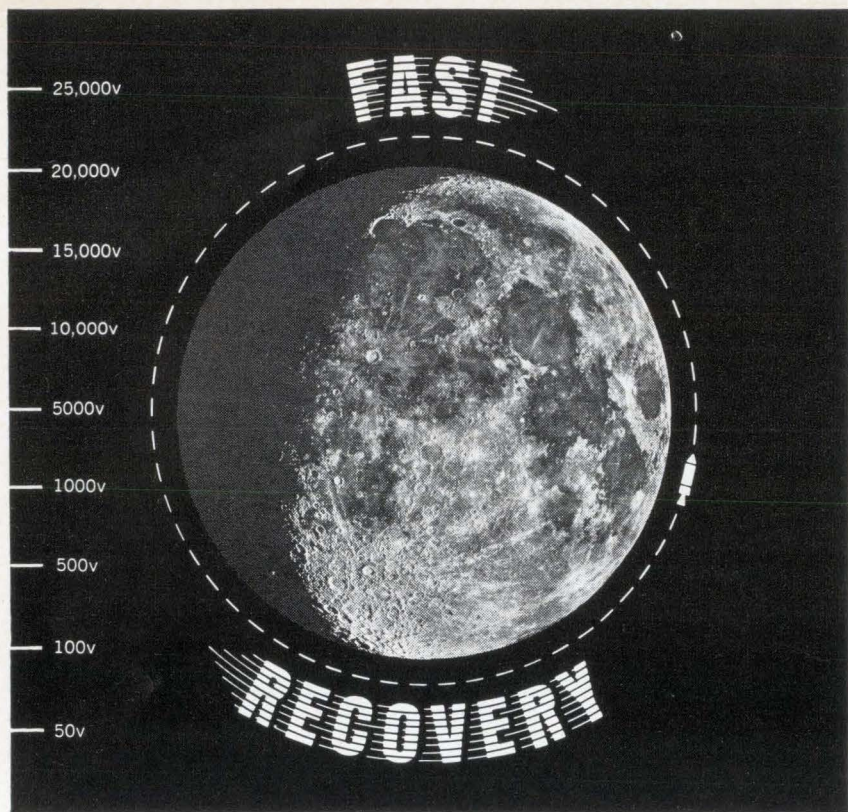

silicon rectifiers

Semtech Corporation offers the industries *FIRST* complete line of Nano-second Reverse Recovery Silicon Rectifiers in medium power ranges. The four unique configurations are designed to meet any packaging problem with improved performance. Standard units are available with ratings 1 amp from 50 to 1000 volts, 0.5 amp from 2500 to 25,000 volts. All rectifiers have rugged solid internal construction, combining high mechanical strength, superior thermal shock resistance, hermetically sealed, high dielectric strength and excellent thermal conductivity properties. Operating temperatures from -55° to $+175^{\circ}\text{C}$. Reverse Recovery (T_{rr}) is measured on each junction, 0.5 amp forward to 1.0 amp reverse, recovery time measured when rectifier recovers to 0.25 amp.

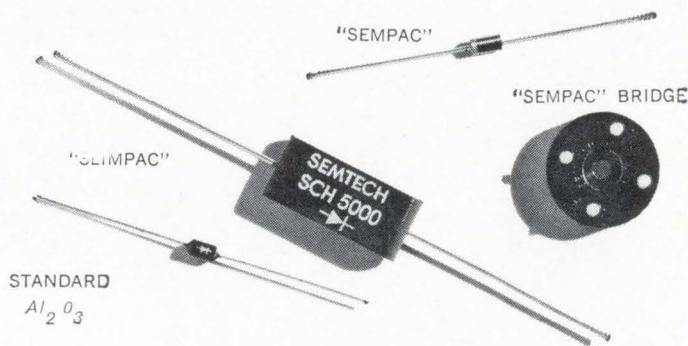

SEMTECH  **CORPORATION**

Western Office: 652 Mitchell Road, Newbury Park, California
 (805) 498-2111, from L.A., (213) 628-5392 / TWX 805-499-7137
 Eastern Regional Office: 71 West 23rd St., New York, N.Y., (212) 989-7550

New Subassemblies

from 20 khz to 4,000 khz for the vhf and uhf tuning heads. Offering completely solid state and modular type construction, the equipment weighs only 15 lbs with batteries and plug-in tuning head. The front panel contains both a tuning meter and signal strength meter plus mode selector, audio, video, r-f gain, and power switches and a carrier operated relay sensitivity adjustment.

The low noise plug-in tuning heads are designed for installation in the receiver without adjustment or alignment of any kind. They have agc to permit handling of large r-f signals.

Astro Communication Laboratory, Inc.,
 801 Gaither Road, Gaithersburg, Md.
 [385]

Modular supplies offer dual output

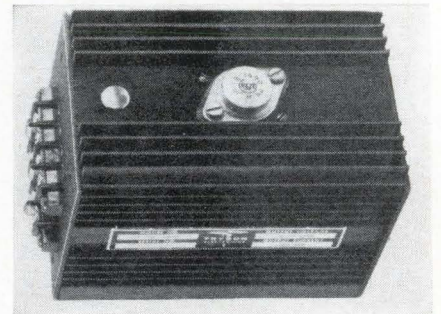

The PSD series units, PSD12-300 and PSD15-300 are dual output modules supplying ± 12 v and ± 15 v at 300 ma, respectively, and feature automatic self tracking to maintain the relative accuracy of both outputs. The compact modules are designed for system integration in critical applications. They feature 0.1% regulation, 0.5 mv ripple, remote sensing, and operate in environments up to $+71^{\circ}\text{C}$ without derating.

The series contains automatic short circuit protection to protect the supply against overloads and guarantee long and dependable service. The units measure 5 in. high x $4\frac{1}{8}$ in. deep and $3\frac{1}{4}$ in. wide. They can be mounted for use either horizontally or vertically and can be provided with barrier strips,

solder lugs, or octal sockets to fit desired applications.

Price is \$115 for quantities of 1 to 8, and as low as \$100 for 50 or more units.

Trygon Electronics, Inc., 111 Pleasant Ave., Roosevelt, L.I., N.Y., 11575. [386]

Small power supply for industrial use



Miniature model PS10 industrial power supply features a small modular cabinet with carrying strap. The supply is variable from 0 to 10 v, contains a precision voltmeter and ammeter, and has optional rack mounting brackets.

The unit has low ripple and short circuit protection, and is designed for use as a power source for transistor and integrated circuits. Input is 105 to 130 v at 55 to 65 cps. Line and load regulation is 0.05% +5 mv. Ripple is 2 mv. Maximum current is 600 ma. Other optional ranges from 0 to 50 v are available. Size is 5 in. high x 8 in. wide x 8 in. deep. Weight is 9 lbs. Price is \$124.95 each in single quantities; delivery, 3 weeks. United Computer Co., 930 W. 23rd St., Tempe, Ariz., 85281. [387]

Function generator is highly accurate

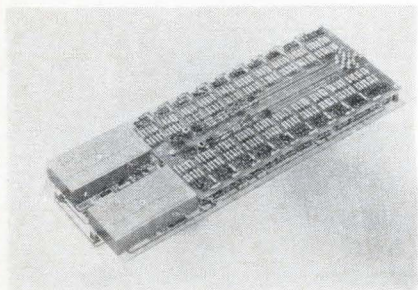

Model 530 is a two-channel function generator for analog computation of sines and cosines. This

General Electric... Top Source for Semiconductor Parts



General Electric is geared to produce a broad line of semiconductor parts. Make G. E. your one source for all components such as:

Component Assemblies—Semiconductor lead-in wires—Dumet "slug" leads—molybdenum "slug" leads—whisker welds and other 2 or 3 part welded lead wires—molybdenum diode slugs—plastic transistor headers—plastic integrated circuit packages.

Lead and Interconnection Wires—Tungsten, molybdenum, and borated Dumet wire for glass to metal sealing—unborated and gold plated Dumet for interconnections and "pigtail" leads—tungsten and molybdenum whisker wire, bare or gold plated.

Sheet and Discs—Molybdenum and tungsten sheet—molybdenum and tungsten discs (punched, pressed and sintered, cut from rod).

Evaporative Sources for Functional Coatings—Stranded tungsten metallizing wire and coils—tungsten and molybdenum boats.

And More! Get all the data. Write or call for our new booklet "Products for the Semiconductor Industry." General Electric Lamp Metals & Components Dept., 21800 Tungsten Rd., Cleveland, Ohio 44117. Tel: (216) 266-2970

Progress Is Our Most Important Product

GENERAL  ELECTRIC

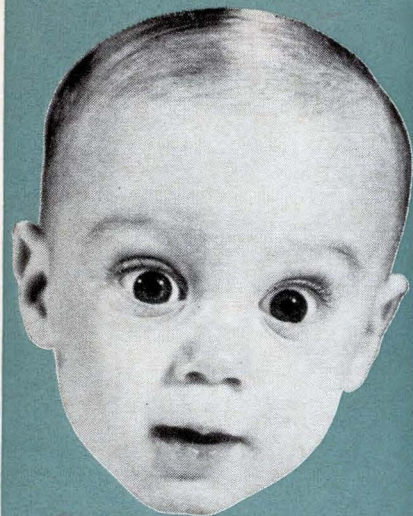

three
kinds of
recording
oscillographs?

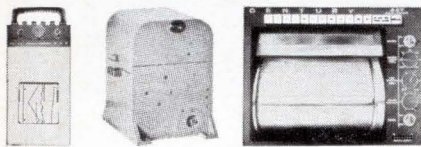

Choice of three—Portable 444,
Ruggedized 414 or 1000-speed 447

The Model 444 precision, 6 channel, wide-band recording oscillograph features big performance in a small package. Superior optics and a low-heat tungsten light source means less DC power, less cost, less weight. • The Model 414 is designed to perform under adverse conditions of humidity, shock, vibration and acceleration; provides 14 channels of data in a small, light-weight package. • The Model 447's highly precise electronic drive permits selection of any 12 of a possible 1000 speeds (.1"/sec to 100"/sec). The 447 also features Automatic Record Length based on time and Continuously Variable Remote Speed Control. (These three are just part of the line—our Model 409 is a standard in the industry for airborne recording, for example.) • Write to us indicating your areas of interest. We will send you complete specifications.



CENTURY
ELECTRONICS & INSTRUMENTS

Subsidiary of Century Geophysical Corp.
6540 E. Apache St., Tulsa, Oklahoma 74115

New Subassemblies

p-c card module is compatible with the manufacturer's other series 500 elements operating at ± 100 v output and rounds out a full analog capability. The 530 may be mounted in the model 560 cabinet with power supply, multipliers, amplifiers, and fixed function generators.

The new function generator features maximum static error of less than 25 mv, and zero signal error is less than 2 mv. Its sine capability is $\pm 270^\circ$ and cosine capability is $+180^\circ$ to -270° . Operational amplifier output generates $-\sin X$ and $-\cos X$ in the range of ± 100 volts.

An active error suppression method is used for an accuracy of better than 0.025%. Built-in amplifiers provide very stable and accurate line segments in the critical portions of the nonlinear curves and resistor-diode network drift becomes negligible. Economy and reliability result from this design advancement.

Availability of model 530 sine-cosine generator is 30 days and single quantity price is \$700.

Zeltex, Inc., 2350 Willow Pass Road, Concord, Calif. [388]

Disk file system offers mass storage

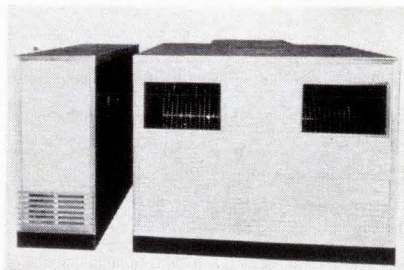

An on-line, real-time mass storage disk file system is capable of storing 3.8-billion bits of data with an average access time of 100 msec, and an estimated cost-per-bit of 0.0044 cent. Designated the model 2A, series 4000 disk file system, the module on-line mass memory system is available in three basic machine sizes with the company's standard electronic interfacing. Each basic machine size is mod-

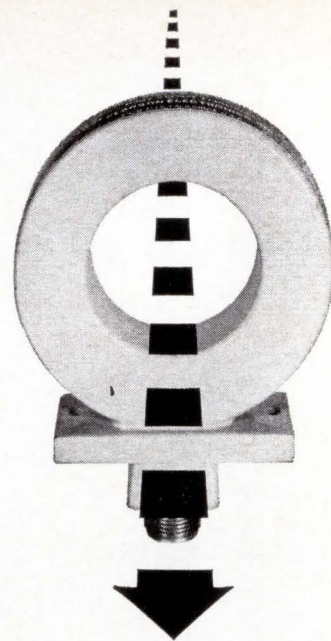

Wide Band, Precision CURRENT MONITOR

With a Pearson current monitor and an oscilloscope, you can measure pulse or ac currents from milliamperes to kiloamperes, in any conductor or beam of charged particles, at any voltage level up to a million volts, at frequencies up to 35 Mc/s or down to 1 c/s.

The monitor is physically isolated from the circuit. It is a current transformer capable of highly precise measurement of pulse amplitude and waveshape. The one shown above, for example, offers pulse-amplitude accuracy of +1%, -0% (typical of all Pearson current monitors), 20 nanosecond rise time, and droop of only 0.5% per millisecond. Three db bandwidth is 1 c/s to 35 Mc.

Whether you wish to measure current in a conductor, a klystron, or a particle accelerator, it's likely that one of our off-the-shelf models (ranging from 1/2" to 10 3/4" ID) will do the job. Contact us and we will send you engineering data.

PEARSON ELECTRONICS INC

4007 Transport St., Palo Alto, California 94303
Telephone (415) 326-7285



See us at LONDON IEA

now



TC Assured to $\pm 10\text{ppm}$

IRC Type AS Resistors Save Space and Money, Too

These precision power resistors are now available with an *assured* maximum hot side temperature coefficient of $\pm 10\text{ppm}/^\circ\text{C}$ in standard ranges above 50 ohms. This offers greater design stability with the added benefits of miniaturization and economy.

Type AS resistors provide the stability, close tolerances and superior performance of premium metal films costing 20% to 45% more. And at comparable prices you can replace axial lead vitreous enamel types with space and performance advantages.

Special AS resistors can be used as squib fuses. Inductive designs are also available for fixed rise time applications. Send resistance, wattage, frequency and rise time requirements for evaluation samples.

Write for literature and prices to: IRC, Inc., 401 North Broad Street, Philadelphia, Pennsylvania 19108.

CAPSULE SPECIFICATIONS	
POWER:	1, 2, 3, 5, 7, 10, 15 watts @ 25°C ½, 1, 2, 3, 5, 7, 10 watts @ 125°C
TOLERANCES:	±0.05%, 0.1%, 0.25%, 0.5%, 1%, 3%, 5%
TEMPERATURE COEFFICIENT:	±10ppm/°C above 50 ohms ±20ppm/°C below 50 ohms
RESISTANCE:	0.1 ohm to 175K ohms
MIL-R-26:	Characteristics G and V. Withstands 350°C hot spot.
MIL-R-23379:	RWP18, 20, 21
LEADS:	Alloy-coated copperweld. Special types available.



"bugged" BY A PRINTED CIRCUIT PRODUCTION PROBLEM?

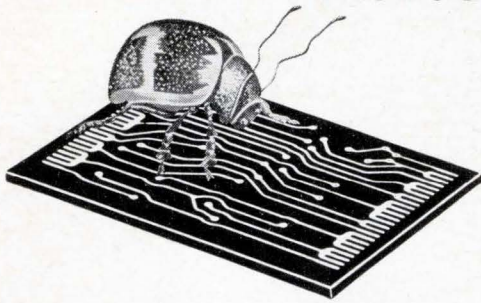

BRING IT TO CHEMCUT

Whether it's a microminiature or mammoth board, Chemcut has the spray etcher to produce it for you—accurately and economically. Chemcut, the pioneer and leader in the spray etching field, has units ranging in size from laboratory models to fully automatic, conveyorized systems for high volume production. (Model 502 horizontal, conveyorized etcher is shown at left.) Also available is a complete line of Chemcut equipment for printing, developing, resist removal and other auxiliary functions. There are over 1800 units in use throughout the world. One that will fill your production needs is available through your nearby Chemcut distributor.

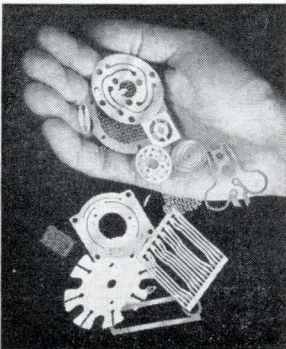
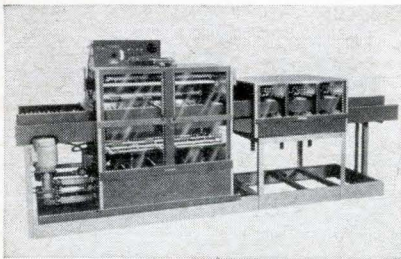

HOW ABOUT PART PRODUCTION?

With continued emphasis on miniaturization, manufacturers of electronic devices are finding spray etchers ideally suited to the production of a variety of parts. We welcome the opportunity of exploring your part production problems with you.

CHEMCUT Corporation
500 Science Park,
State College, Pennsylvania 16801.

Circle 498 on reader service card

STANDARD SOLUTIONS....SPECIAL SITUATIONS....

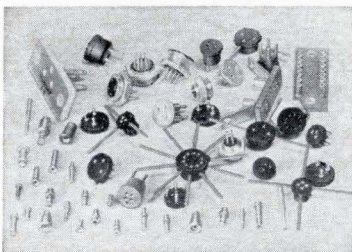

Get to know and rely on Robinson/Nugent for fast, frequent and reliable sockets and connectors for all standard TO-packages, relays, crystals, diodes, IC's, lab, test, prototype and module packages. Production packaging and unique designs ... lead lengths from .1" to -; spacing from .05" to -; diameters from .01" to .1" ... machined and molded. Robinson/Nugent ... imagination to -!

Robinson NUGENT INCORPORATED

AREA CODE 812 945-0211

802 E. EIGHTH STREET • NEW ALBANY, INDIANA 47150

194 Circle 194 on reader service card

New Subassemblies

ular on a disk basis with the capability of offering up to 3.8-billion bits of data storage. Increased capacity of the model 2A over models 1 and 2 is achieved through increased track density to 128 tracks per inch and increased bit density to 800 bits per inch.

The new system features self-contained environmental control, standard 8000 series electronics, and an improved direct addressable digital head positioning system. Dual access capability is offered as an optional feature. Deliveries of the model 2A disk file will begin in the last quarter of 1966.

Bryant Computer Products, a division of Ex-cell-O Corp., Detroit, Mich., 48232. [389]

Pulse oscillator for p-c application

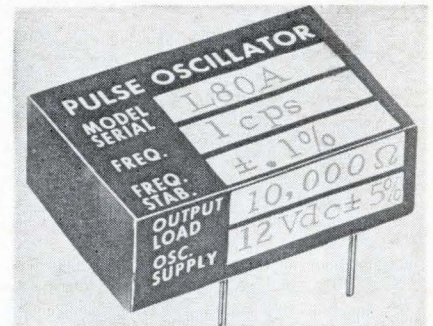

The L80A is a miniature, highly stable, solid state, negative pulse oscillator package with 10-v peak output. It is designed to work into a 10,000-ohm load in printed circuit applications. It is available in frequencies from 1 hz to 10 khz and maintains an accuracy of $\pm 0.1\%$ over a 0°C to 50°C operating temperature range.

The oscillator package is especially applicable to computer reference standards that normally utilize tuning fork oscillators and offers the added advantage of noise-free operation. It operates from a 12-v, d-c 1 ma (nominal) power supply. Domino shaped, its dimensions are 1.20 in. long x 0.8 in. wide and 0.48 in. thick. It is equipped with conventional terminal pins for mount-

Electronics | April 18, 1966

ing in printed circuit boards or cards.

Connor-Winfield Corp., Winfield, Ill. [390]

Plug-in oscillator for control chassis

A plug-in sweep oscillator now offered can cover an entire frequency octave of 500 Mhz to 1,000 Mhz in a single sweep. As a plug-in unit for the SM-2000 control chassis, the VR-50M oscillator can sweep any frequency width from 5 Mhz to the full 500 Mhz, manually or automatically at rates from 0.01 to 100 hz. The range and versatility of the new unit makes it especially useful for testing broadband video, i-f, and r-f devices, both wide and narrow-band.

A solid state unit, the VR-50M combines uhf transistors with varactor tuning. Since the output of the sweep generator is at the fundamental frequency of the oscillator, its output signal is exceptionally clean, with a flatness better than 0.75 db at maximum sweep width. The VR-50M also features a built-in, variable frequency marker covering the complete 500 to 1,000 Mhz range.

Telonic Industries, Inc., 60 North First Ave., Beech Grove, Ind. [391]

Silicon power module has selectable output

Model SR30/1-6A is an all-silicon design, d-c power module offering selectable outputs of either 3, 6, 10, 12 or 24 v d-c at 0 to 1 ampere. Each output is adjustable ± 1.5 v d-c from nominal. Output selection is by means of a convenient switch at the top of the module negating the need for removing covers or changing taps or straps within the unit.

Input is 105 to 125 v a-c, 50-400 cps; regulation, $\pm 0.05\%$ line and load; ripple, 1 mv rms; operating temperature, 65° C free air with no derating; size, 3¼ in. x 4½ in. x 5½ in. Special voltages and currents are also available on special order.

Unit price is \$125.

Electronic Research Associates, Inc., 67 Sand Park Road, Cedar Grove, N.J., 07009. [392]

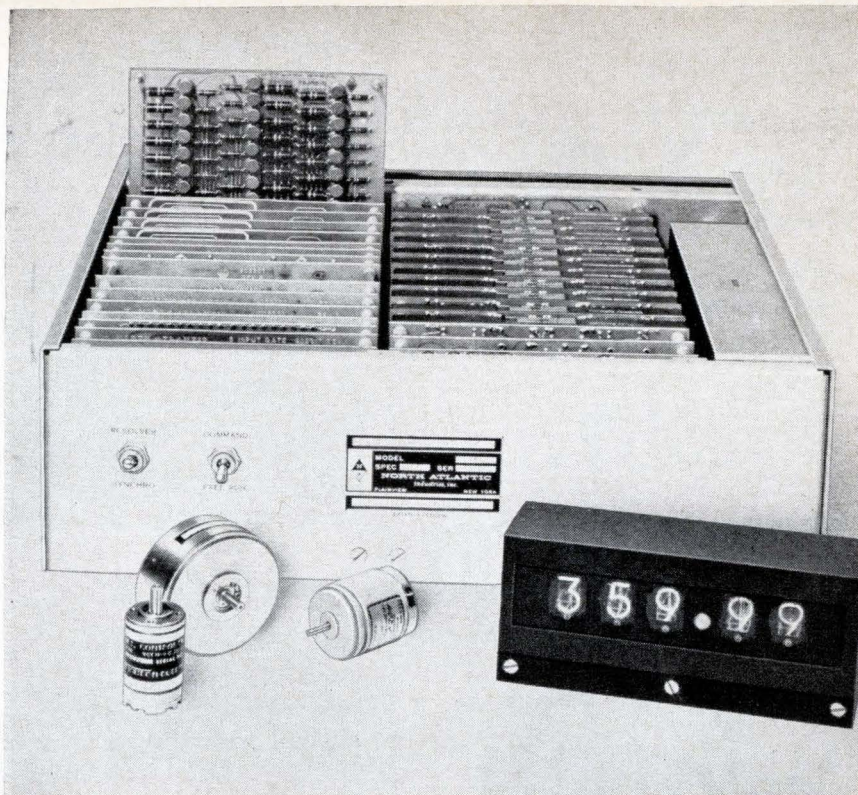

how to convert resolver and synchro angles to digits (and vice versa)

North Atlantic now brings you a new family of solid-state analog-to-digital and digital-to-analog converters for resolver and synchro data. They offer a major advance in conversion accuracy in modern navigation, simulation, data processing and measurement systems.

Typical of these new instruments is the Model API-5450 shown here. It provides both continuous and command conversion of both resolver and synchro angles, accommodates all line-to-line voltages from 11.8 to 90 volts at 400 cps. Output data is in decimal digits and is presented both as a Nixie-tube display and a five-digit printer output with supplementary print command. Accuracy is 0.01° and update time is less than 1 second.

All instruments in this family are designed to MIL-T-21200 and feature all solid-state circuitry and precision transformers—there are no motors, gears, or relays. Their flexible plug-in modular circuit design permits a wide range of variations to suit your specific requirements. For example:

- 18 bit or 10 second accuracy and resolution
- binary, BCD, or decimal inputs/outputs
- multiplexed channels
- multi-speed inputs/outputs
- high conversion speeds
- other signal frequencies

Your North Atlantic representative has complete application information. He'll be glad to help you solve interface problems in measurement and data conversion. Simply call or write.



NORTH ATLANTIC industries, inc.
TERMINAL DRIVE, PLAINVIEW, L. I., NEW YORK • Overbrook 1-8600

If you are in the Electronics Industry... you probably belong in MARYLAND

AVAILABILITY OF LABOR

The availability of personnel, particularly engineers and scientists, is recognized as a chief criterion governing the location of an electronics firm.

There are almost 30,000 scientists and over 25,000 engineers living and working in Maryland and the District of Columbia. And the number is increasing every day.

PROXIMITY TO FEDERAL AGENCIES

Proximity to major decision makers in the industry, such as federal agencies in Washington, D. C., afford the unique advantage of constant personal contact, which is considered an increasingly important locational criterion.

No other state is as convenient to as many Federal agencies as Maryland. For example, Maryland's major government scientific installations include NASA, AEC, NIH, the National Bureau of Standards, plus some 20 others.

**THESE PRIME
REQUIREMENTS,
(plus others)
CAN BE MET IN
MARYLAND!**

Get All The Facts
Write, Wire or Phone Collect

MARYLAND
DEPARTMENT OF
ECONOMIC DEVELOPMENT

Division E • State Office Bldg • Annapolis, Md.

New Microwave

Miniature triode operates in X band

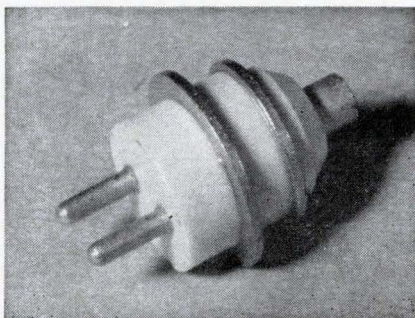

A miniature, ceramic planar-triode is now available for service at frequencies in X band. As an oscillator, the developmental tube can produce about 20 milliwatts of continuous wave power over a frequency range of 9.35 to 9.45 gigahertz (gigacycles per second).

Its manufacturer, the Tube Department of the General Electric Co., sees good potential for the tube since it is smaller than a klystron, does not require a highly regulated power supply, operates with only 4 watts of d-c power and is cheaper than a comparable solid state oscillator. It is approximately half the size shown in the photograph.

Operating life is relatively long. GE claims that a few tubes of this type have performed for as long as 1,500 hours. However, the company indicates that in the present stage of development only about 500 hours can be assured, and no guarantee is given. Previous miniature planar-triodes developed by GE for operation in X band had lives of only 50 to 100 hours, and developed only 4- to 10-mw outputs.

GE says the new tube is the highest-frequency triode available and one of the highest frequency triodes ever constructed. Also under development, but not for sale, are tubes which can produce about 10 mw at frequencies from 16 to 18 Ghz.

A cathode current density of 1.2 amperes per square centimeter is required to produce a useful output at X band. To obtain this density and still maintain good tube life, the heater and the cathode were redesigned. The heater is a flat

spiral which is bonded with ceramic to the cathode cup. This construction improves heat transfer, eliminates hot spots on the cathode and permits the cathode to operate at lower temperatures than normally would be required. The heater construction also results in a warmup time of only 3 to 4 seconds instead of the 20 seconds required with conventional heater designs.

The tube can be used in miniature equipment and in systems operating at elevated temperatures, under severe gravity (g) loading or at high radiation levels. It works at temperatures as high as 500° C. In a simulated soft moon landing, it withstood impact shocks of 3,000 g for 3 milliseconds.

GE envisions commercial applications in burglar alarms and personnel detector systems. A possible military application is hand-held radar.

The developmental X-band triodes cost \$100 each in small quantities.

Specifications

Type	Developmental ceramic planar-triode Oscillator
Function	Oscillator
Frequency	9.35-9.45 Ghz
Typical operating conditions	
Plate voltage	150-165 v
Cathode current	20 to 25 ma
Power output	20 mw
Heater voltage	6 v
Heater current	200 ma
Price (1 tube)	\$100

General Electric Co., Tube department, Owensboro, Ky. [395]

Swept oscillators offer high accuracy

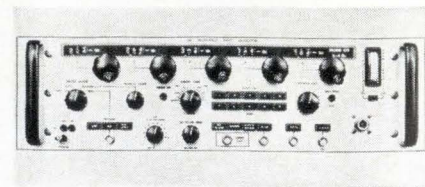

The model 570 series, a new quality standard in microwave swept oscillators, provides frequency cov-

erage from 1 to 40 Ghz (gigacycles per second) in the L, S, C, X, Ku, K, and Ka bands. The units feature better than 1% specified accuracy and stability over the entire frequency band and at all power levels.

These instruments require only 5¼ in. x 19 in. of panel mounting space; less than any other similar unit, according to the manufacturer. Output power capability has been increased (for example, 50 mw power minimum in the 8 to 12.4 Ghz band). Five independent frequency controls, each with 3-digit display, are continuously adjustable over the bandwidth of the instrument. Push-button start-stop band selection provides sweep coverage between any two of the five frequency settings, while markers are generated at the remaining three settings. With the point of interest bracketed between two markers, two buttons are depressed to sweep between the markers, without disturbing the other frequency settings.

For operating convenience, these compact sweepers also offer the following: blanked retrace select, manual sweep with frequency change; pen lift, sweep, stop pulse, and marker outputs; a wide range of sweep speeds; programable output frequency and power.

Price is \$3,460 to \$6,870 depending on frequency band selected. E-H Research Laboratories, Inc., Oakland, Calif. [396]

Traveling-wave tube delivers over 10 kw

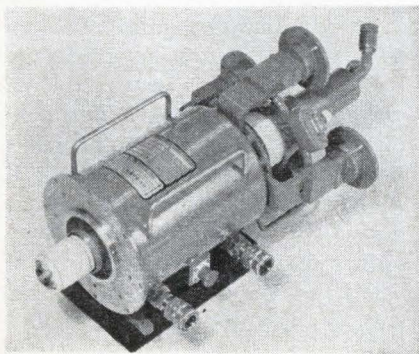

A high-gain, metal-ceramic traveling-wave tube has been designed for satellite ground terminal transmitters. The tube, designated model 614H, covers the entire

REQUEST TODAY

CHRONO-LOG CORP.
Broomall, Pa.

Gentlemen:

NEW

I want to see your **technical bulletin describing the all-in-one TIME CODE GENERATOR/READER**

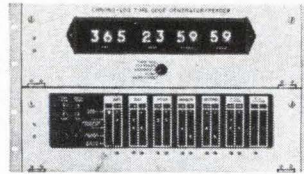

featuring —

- Both time code generation and playback in one unit
- Day-of-the-year coding with time in seconds
- Five graphic recorder slow codes
- Test and service accessibility from the front panel

I want to record real time signals on analog magnetic tape recorders and read both forward and reverse at speeds 100 times as fast or 20 times as slow for searching and analyzing masses of data . . . correlate data on a precise time basis with magnetic tape units, oscillographs, strip chart recorders and digital data systems . . . use it as a real time, elapsed time or countdown time generator.

Mail this ad or circle the code number below for Bulletin Series 23,000 with complete details or phone (215) EL-6-6771 for information about your specific requirement.

CHRONO-LOG CORP.

2583 WEST CHESTER PIKE, BROOMALL, PA.

Circle 496 on reader service card

WIDEST RANGE OF MINIATURE (TO-18) PHOTOCELLS

Clairex now offers the broadest selection of miniature CdS and CdSe Photoconductive Cells available anywhere. 23 types of CL 900 series offer:

- Resistance values from 2K to 1.4 megohms at 2 ftc
- Voltage ratings from 100 to 250 volts
- All cells hermetically sealed in low-profile TO-18 transistor case. If you need a miniature, high-reliability photocell, send for new Photocell Design Manual.

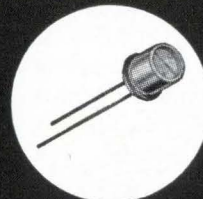

CLAIREX

"The LIGHT Touch in Automation and Control"

1239 Broadway, New York, N.Y. 10001

212 MU 4-0940

CL-103

What puts the flash in flash bulbs?

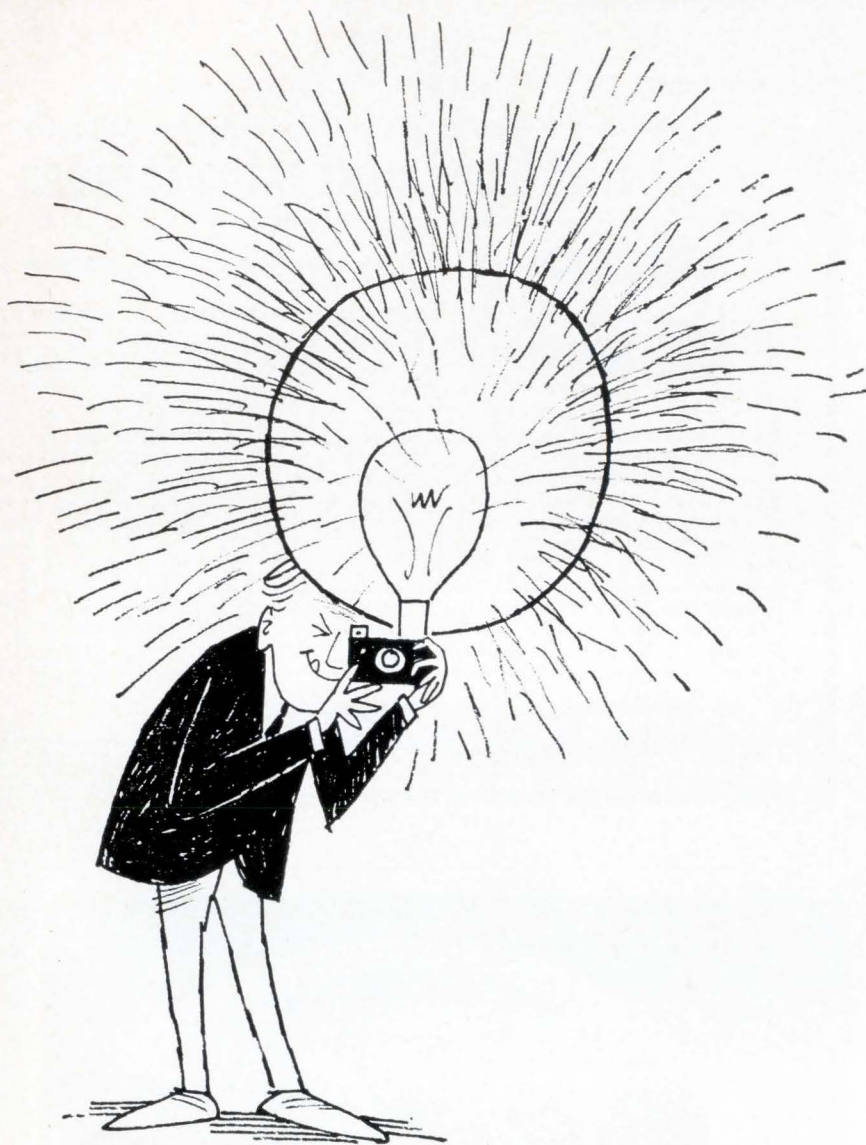

One of the big reasons for the dependable performance of many of today's flash bulbs is the Zirconium foil you see inside the bulb. Zirconium foil, Hamilton's Zircoflash®—only .0008" thick—is delivered in quantity and on time by Hamilton Precision Metals.

There are 7 proprietary metals, 112 commercial alloys and 12 pure metals now available. With expanded production facilities, Hamilton Precision Metals is now producing these metals *in quantity*. Strip and foil are available from 0.10" thick down to 0.000080" thin, and from 1/32" to 12" in width—wire in diameters from 0.1870" to as fine as 0.0010".

Check with Hamilton Precision Metals on your electronic metals requirements of precision strip, foil or wire. Write today for completely new brochure. It gives you complete information on our capabilities as well as detailed properties on over 100 metals.

HAMILTON PRECISION METALS

division of Hamilton Watch Company ■ Lancaster, Pa.

New Microwave

5.925-Ghz to 6.425-Ghz communications band without electric or mechanical adjustments, and is capable of more than 10kw c-w operation and 30% efficiency using a depressed collector. The manufacturer says the solenoid focusing with a coupled cavity interaction structure gives the tube economical long-life service.

Hughes Aircraft Co., Microwave Tube division, 11105 South LaCienega Blvd., Los Angeles, Calif., 90009. [397]

Sliding short for WR-90 waveguide

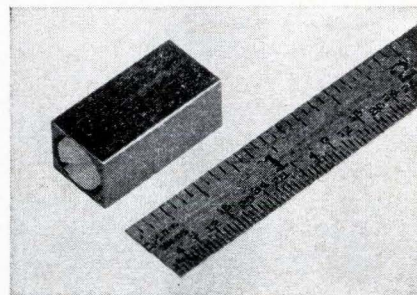

An extremely lightweight (0.25 oz) adjustable waveguide sliding short has been developed for WR-90 (0.900 x 0.400 in. inside diameter) waveguide. It is claimed to be ideal for X-band service in solid state amplifiers, multipliers, and signal sources. Frequency range is 8.2 to 12.4 Ghz.

Model X150 short consists of a precision machined 0.895 x 0.395 in. inside diameter aluminum block with a Nylon screw inserted at one end. The short is secured in the waveguide by slightly withdrawing the Nylon screw before insertion so that the short binds at the desired plane of operation. An alternate positioning method requires the user to have drilled a small hole in the waveguide side-wall to allow the Nylon screw to be tightened at the optimum short positioning during the final trimming adjustment.

Price of the X150 sliding short is \$48 each; availability, immediately from stock.

Somerset Radiation Laboratory, Inc., P.O. Box 201, Edison, Pa., 18919. [398]



ULANO EUROPEAN TECHNICAL CENTER FOR GRAPHIC ARTS

Ulano's technical center in Switzerland is headed by the very capable Mr. Henri Kunz. He is qualified by his many years of experience in the Screen Process and Graphic Arts fields. Demonstrations and technical seminars are held in many languages throughout the year. Complete laboratory facilities have been installed to provide demonstrations of the complete Ulano line. Large stocks of all famous Ulano films are available for immediate delivery to all parts of the world.

You are invited to contact Mr. Henri Kunz at ULANO A.G., Untere, Heslibachstrasse No. 22, Kusnacht 8700, Switzerland, Telephone 905959. It is our pleasure to serve you.



**DO YOU USE
SCREEN PROCESSING
IN THE PRODUCTION OF
COMPLEX
PRINTED
CIRCUITRY?**

**TWO NEW PRESENSITIZED FILMS TO
SPEED PRODUCTION — LOWER COSTS**

Ulano
T.M.



**WRITE TODAY
on your letterhead
for free special
sample kit
number 5448**

HI-FI RED

HEAVY-DUTY INDUSTRY PROVED

Presensitized photo film used by many leading electronic firms for clean, sharp, tough, durable, almost indestructible screens of unmatched quality. Adheres tightly to wire, silk, nylon and dacron.

PREP®

PRESENSITIZED FOTO FILM

.002 Polyester support guarantees good register. Does not require a dark room. Very good resolution—suitable for halftones. Excellent adhesion to silk, nylon, dacron and metal mesh. Tough, strong emulsion—good for machine printing and long runs.

J. ULANO & COMPANY, INC.

610 Dean Street, Brooklyn, N. Y. 11238, U.S.A.
Cable address: "UlanoFilm"
In Europe: ULANO A. G., Untere, Heslibachstrasse No. 22
Kusnacht, Zurich, Switzerland



NOW 12 CHANNEL 8-BIT

D/A converter: \$2,950!

12-BIT 50 KC A/D CONVERTER: \$3,025

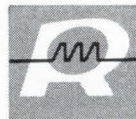

**RADIATION
INCORPORATED**

Prices reduced on all Radiation digital equipment

Increased reliability and accuracy offered by digital data acquisition and processing is now practical for all your requirements. Prices on industry's finest line of digital equipment have been substantially reduced. That's because of increased production, and lower cost of Radiation plug-in logic modules used in the design of these units.

For example, Radiation's Model 5516 A/D Converter is priced at only \$3,025, and Model 5611 D/A Converter at only \$2,950. In addition: Model 5710 Multiplexer Programmer is now \$1,225, Model 5416 16-Channel Unity Gain Multiplexer is \$1,350. Model 5817 Read/Write Electronics (for 7-track requirements) has been reduced to \$3,350, and Model 5819 (for 9-track) to \$3,790.

Write for data sheets on Radiation digital equipment, or phone for detailed information.

CONTROL AND COMMUNICATION DIVISION • DEPT. EL-04 • P.O. BOX 430 • MELBOURNE, FLORIDA 32902. PHONE: (305) 727-3711

ELGENCO Noise Generators



Model 610A

SOLID STATE NOISE GENERATORS

- Model 602A 5 cps to 5 mc, 3 Ranges \$ 290
 Model 603A 5cps to 5 mc, 3 Ranges \$ 495
 Model 610A 5 cps to 5 mc, 8 Ranges \$1,175
 Series 624 (Fixed frequency) 5 cps to 500 kc
 \$245 to \$490. Write for details on frequency
 ranges and spectral flatness.



Model 312A

VACUUM TUBE NOISE GENERATORS

- Model 301A DC to 40 cps. \$1,995
 Model 311A Two outputs DC to
 40 cps and 10 cps to 20 kc. . . . \$2,395
 Model 312A Two outputs DC to
 120 cps and 10 cps to 20 kc. . . . \$2,495
 Model 321A DC to 120 cps. \$2,095
 Model 331A 10 cps to 20 kc. \$1,275

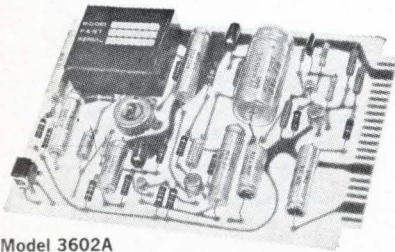

Model 3602A

NOISE GENERATOR CARDS

Series 3602, 3603, and 3606 \$144 to \$389
 Various frequency ranges and output flat-
 ness available. Size: 4½" x 6½" x 1". Write
 for details.

ENCAPSULATED NOISE SOURCE MODULES

Series 1602, 1603, and 1606. . \$95 to \$340
 Various frequency ranges and output flat-
 ness available. Size: 1¾" x 1½" x ¾". Write
 for details.

ELGENCO INCORPORATED



1550 Euclid Street
 Santa Monica, California
 Phone: (213) 451-1635
 TWX: (213) 879-0091

For a more complete listing, write for
 our short form catalog.

New Production Equipment

Temperature-sensing bonder

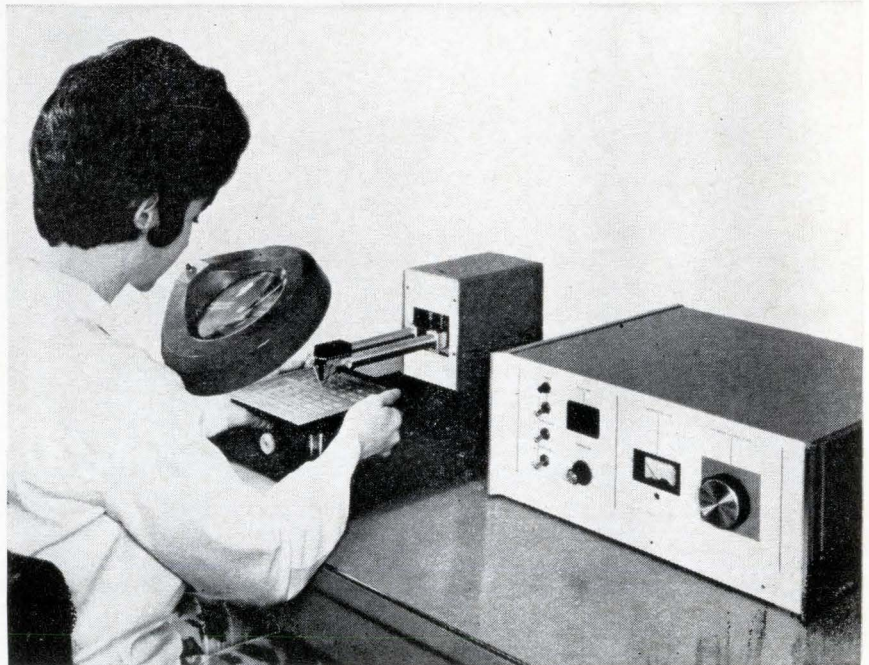

An automatic bonder that can join different metals in five different ways owes its versatility to an infrared detector. The detector determines the temperature of the joint during bonding and adjusts the heating current to compensate for variations in the heat-sinking capacities of the joint materials.

The Model 730 bonder will join component leads, integrated-circuit leads and wiring in assemblies, or component and leads to printed-circuit cards or to thin films. The joints can be formed at temperatures of 300° to 1,400° F, allowing the machine to be used for bonding, brazing, welding or hard and soft soldering.

Once the controls have been set for the bonding mode and temperature, operation is automatic. The infrared detector allows the machine to control temperature of the joint to within 3%. The power supply delivers up to 10,000 watt-seconds (500 amps at 2 volts for 10 seconds) to the bonding electrodes. Either parallel-gap electrodes, for surface bonding, or opposed electrodes can be used.

The bonders are priced in the \$2,000 range.

Industrial Products Group, Texas Instruments Incorporated, 3609 Buffalo Speedway, Houston, Tex. 77006 [401]

Electric hand tool crimps terminations

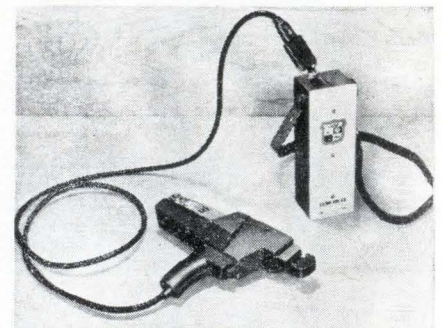

An electric hand tool weighing 4 lbs. can make hundreds of terminations an hour and features a quick-response cycle control. Company engineers say it is the first all-electric portable hand tool designed for crimping terminals and contacts.

One model can be operated from

a 110-v outlet. Another can be powered by a portable battery pack which makes it possible to use the tool in areas where electricity is not available or practical. The batteries are rechargeable and have sufficient energy for a minimum of 1,000 cycles.

The product to be crimped can be individually hand-fed into the crimping die, or manually tape-fed from 100-piece boxes mounted on the tool.

The A-MP electric hand tool features Ceri-Crimp tool performance through the use of quick-response cycle control. Tool jaws stop instantly upon release of the trigger. This cycle control assures complete and positive bottoming of the crimping dies and simultaneously prevents the dies from coasting through the completed crimp cycle.

The tool also incorporates provisions for changing the crimping head quickly and easily; and it will accommodate a wide range of individual or tape-mounted items. It has a wire range of 26-10 Awg. AMP, Inc., Harrisburg, Pa. [402]

Traversing station applies photo resist

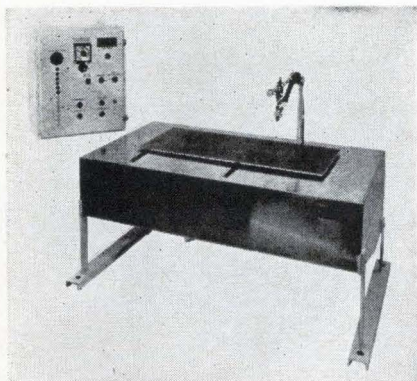

Absolute thickness control for photo resist and other special coatings can be maintained with a new automatic traversing spray station. The station provides programmed simultaneous motion of circuit substrates and the spray head of the manufacturer's Vapor Spray coating system. Even through-hole plated boards can be coated to precise tolerances without hole plugging or puddling. The equipment has also proven valuable for memory planes and

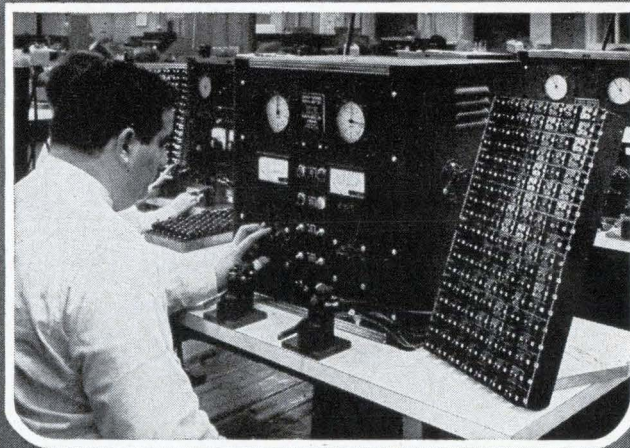
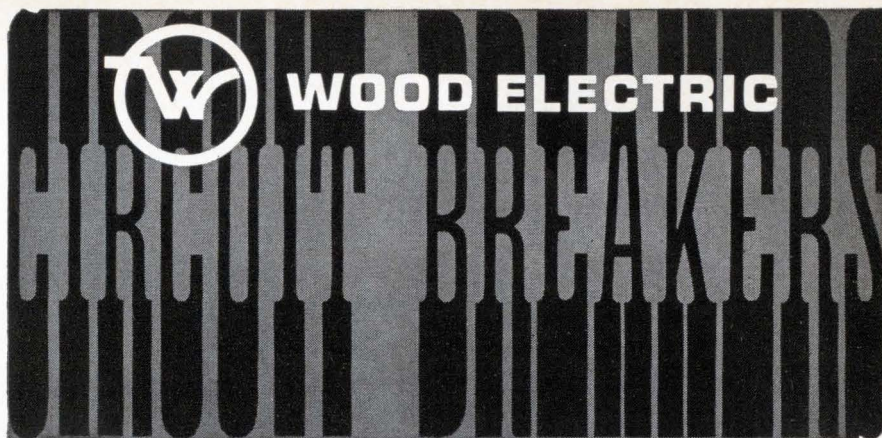

When the specs say . . .
"Must trip between
15 and 55 seconds"

You can depend on us!

The above photograph shows a Thermal Circuit Breaker Calibration Test. All units are adjusted to trip within specified trip bands and hold 100% of rated current with ultimate trip at 135% of rated current. Transfer of auxiliary contacts for remote indication is also checked during this test.

There are other specs and other tests, lots of them, but they all have one purpose in common—to assure the most reliable performance in the industry. If it's by Wood Electric—you can depend on it!

Wood Electric also manufactures a complete line of Magnetic Circuit Breakers that hold 100% of rated current indefinitely and operate at specified trip settings regardless of ambient temperatures. Choose from a wide variety of proven commercial and military type Circuit Breakers to meet the specific needs of your application. Models are available with ratings from ½ to 50 amps . . . AC or DC . . . single pole, two pole and three pole.

Write for Circuit Breaker Catalog CB-10-65



**WOOD ELECTRIC
CORPORATION**

244 Broad St. Lynn, Massachusetts (617) 598-5313

MAGNETIC SHIELDS TO YOUR SPECS



About 80% of all magnetic shield designs now in use originated here.

Maybe it's because our designs work. Maybe our designs work because we've had the most experience. All are good reasons to contact us.

Netic and Co-Netic magnetic shields are the recognized standard all over the world for military, laboratory, industrial and commercial applications. They are insensitive to ordinary shock, do not require periodic annealing, and have minimal retentivity. A few typical applications are illustrated. Our design department is yours.

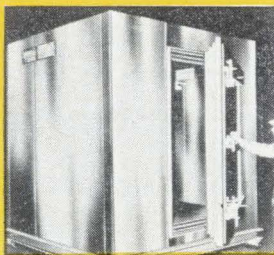

Magnetically Shielded Room

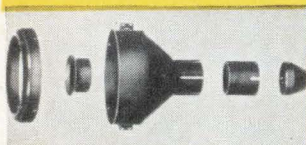

CRT Shield Complex



Scan Converter Shield

Sectionalized P.M. Shield



Nesting Cans

MAGNETIC SHIELD DIVISION

Perfection Mica Company

1322 N. ELSTON AVENUE, CHICAGO, ILLINOIS 60622

ORIGINATORS OF PERMANENTLY EFFECTIVE NETIC CO-NETIC MAGNETIC SHIELDING

Circle 497 on reader service card

Production Equipment

microelectronics.

In programming the machine, functions that can be preset include: rate of speed of the spray gun over the substrate, amount of overlap between adjacent spray passes, and number of coats. Thus, the inherent ability of the Vapor Spray process to provide high purity coatings free from surface defects can be utilized with minimum concern for operator errors.

The automatic traversing spray station can be mounted inside a laminar flow white booth for maintenance of clean room conditions while coating. All controls and function indicator lights are contained in a separate cabinet for external installation.

Complete facilities are available at the company for coating sample circuit boards to evaluate the applicability of the technique to specific customer requirements.

Zicon Corp., 63 E. Sanford Blvd., Mount Vernon, N.Y., 10550. [403]

Machine applies p-c board coating



A machine has been developed for continuous coating of copper printed circuit boards with protective solder alloy. The solder coating is said to give a far longer storage life and better assembly characteristics than varnish. Only the copper on the board becomes solder coated.

The Roltinner machine has two rollers between which the boards are fed, circuit downwards. The lower roller, which runs in a bath of molten solder, coats the circuit with solder. Continuous production can be carried out at a speed

NEMS CLARKE · NEMS CLARKE · NEMS CLARKE · NEMS CLARKE · NEMS CLARKE

NEMS CLARKE

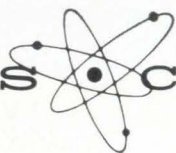

30 Day Delivery

\$875⁰⁰

1670 Series

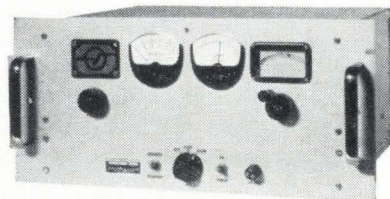

FM TELEMETRY RECEIVER

- 55 to 260 mc
- 300 or 500 kc IF Bandwidth
- 20 cps to 100 kc Video Response
- AFC Tracking better than ± 500 kc
- Excellent Sensitivity and Output Stability

A Nems-Clarke 1670 Series receiver can be the inexpensive solution for many general purpose and telemetry applications.

Vitro ELECTRONICS

Producers of NEMS-CLARKE Equipment
A Division of Vitro Corporation of America
919 Jesup-Blair Drive · Silver Spring, Maryland

NEMS CLARKE · NEMS CLARKE · NEMS CLARKE · NEMS CLARKE · NEMS CLARKE

of 6 feet a minute, using boards of any length and up to 13 in. wide and $\frac{3}{8}$ in. thick.

The upper roller, which is of stainless steel, is spring-loaded to allow for differences in board thickness. The complete roller unit can be removed for maintenance.

Solder is heated by a 1.5 kw thermostatically controlled heater normally preset at 250°C. A safety device prevents the rollers from turning before the solder is at a safe working temperature.

Fry's Metal Foundries Ltd., Tandem Works, Merton Abbey, London, S.W. 19, England. [404]

High vacuum coater for microelectronics

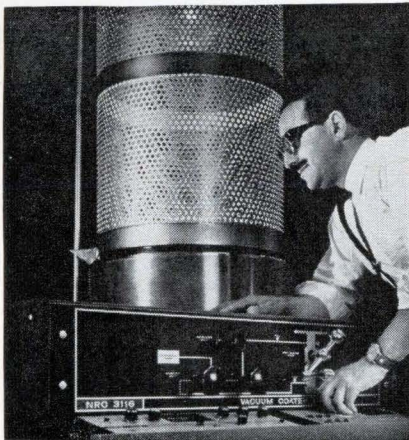

The vacuum coater illustrated was designed to deposit substrate material a millionth of an inch thick for microelectronics and optics equipment. The NRC 3116 high vacuum coater is priced at about \$4,300—approximately one-third the cost of customer units providing similar performance features.

Included among the unit's features are wide vacuum range (to 10^{-8} torr), log and linear scaled ionization gauge control, a new 6-in. vacuum pumping system and a liquid nitrogen baffle. All controls are conveniently grouped in an easy-to-read, one-position control panel.

High vacuum is essential in microelectronics and optics operations to assure freedom from gases in the atmosphere and contamination, and to assure precisely controlled, repeatable products.

National Research Corp., a subsidiary of Norton Co., 160 Charlemont St., Newton, Mass., 02161. [405]

WE'VE TRIMMED AEROSPACE RELAY SIZES ... again!

And broadened the world's largest relay line ... again!

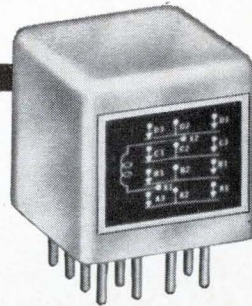

NEW! EXCLUSIVE! 1-INCH CUBE, 10 AMP RELAY

Extra compact, high-reliability 4PDT relay. Assembled under rigid white room conditions. Designed to MIL-R-6106E. Rated for 50,000 operations, 10 amps resistive at 28v dc or 115/200v 400 cycles. Weight only 3.2 oz. Type FCM-410.

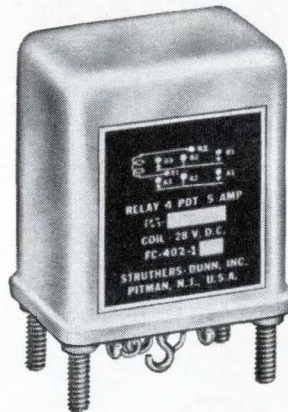

NEW! COMPACT! 2PDT, 10 AMP AC, DC COILS

Hermetically-sealed. Rated for 10 amp resistive loads at 28v dc, or 115v 400 cycles. Designed to MS 25273. Type FC-402-1 with d-c coil nominally rated at 28v, 0.25 amp. Type FC-402-2 with self-contained rectifier for a-c operation at 115v, 400 cycles, 0.07 amp.

PLUS . . . a full line of other
miniaturized relays, including . . .



FC-1 series. DPDT.
2 amp. MIL-R-5757D



FC-400 series. 4PDT.
10 amp. MIL-R-6106E
FC-404 series. 4PDT.
5 amp. MIL-R-6106E
FC-406 series. 6PDT.
5 amp. MIL-R-6106E



FC-4-250 & FC-6-250.
4 & 6PDT. 2 amp.
MIL-R-5757/7&/1

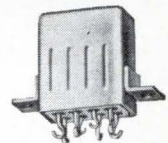

FC-215 series. DPDT.
10 amp. MIL-R-5757D

STRUTHERS-DUNN, Inc.

Pitman, New Jersey 08071

tel: 609-589-7500

twx: 609-589-1548



SALES ENGINEERING OFFICES IN: Albuquerque • Atlanta • Belmont, Calif. • Birmingham, Ala. • Boston Buffalo • Cedar Rapids • Charlotte • Cincinnati • Clearwater, Fla. • Cleveland • Clifton • Dallas • Encino Englewood • Glen Ellyn, Ill. • Houston • Kansas City • Las Vegas • Memphis • New York • Phoenix • Pittsburgh • St. Louis • St. Paul • Salt Lake City • Richardson, Tex. • Seattle • Southfield • Towson, Md. Wichita • Wilmette. Canadian Licensee: Renfrew Electric Co., Ltd., Toronto. Export Dept.: 1505 Race St., Philadelphia, Pennsylvania 19102, U.S.A.



Great editorial is something he takes home

(What a climate for selling!)

Electronics 

A McGraw-Hill Market-Directed Publication
330 West 42nd Street, New York, N.Y. 10036

New Materials

Encapsulating grade molding epoxies

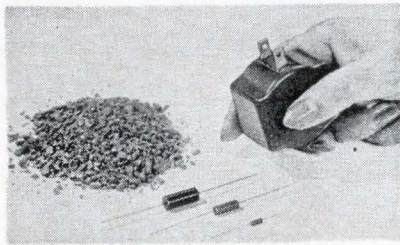

Two soft flow, encapsulating grade epoxy transfer molding powders are called Randac S-7033 and S-7034, the epoxies operate with short molding cycles resulting in higher production rates and higher operating temperatures for encapsulated electronic components. Both retain the soft flow molding characteristics, humidity resistance and electrical properties of earlier Randac molding powders.

The S-7033 is a one-component, mineral-filled epoxy molding powder. It is recommended for molding resistors, capacitors, diodes and other small parts with relatively thin-wall sections.

The S-7034 is an encapsulating grade, flaked glass reinforced epoxy transfer molding powder. It is designed for transfer molding encapsulation of solenoid, ignition, transformer and similar coil windings.

Mitchell-Rand Mfg. Corp., 738 Torne Valley Road, Hillburn, N.Y. [406]

Glass paper laminate is epoxy-bonded

Grade FR16 is a thermosetting epoxy-bonded glass paper laminate offering several property and economic advantages for use in electrical and electronics applications.

The new material, using a reinforcement of oriented glass fibers produced on a modified paper-making machine, is bonded with a flame-retardant epoxy resin. It provides designers and end-users with a glass fiber reinforcing material that fills the gap between

cellulose paper-epoxy and glass fabric-epoxy.

Advantages include excellent mechanical strength and machineability in combination with the outstanding electrical properties of woven glass laminates. In addition to lower initial cost, the material also offers economies in fabrication.

Specific gravity of the material is low because of high resin content, making it attractive for airborne electrical insulation applications. The insulation resistance of FR-16 approaches that of grades G-10 and G-11 (glass fabric-epoxy grades).

The manufacturer is producing FR-16 in sheets from $\frac{3}{32}$ in. to 1 in. thick, with copper-cladding on one or both sides.

Synthane Corp., Oaks, Pa. [407]

Resistive pastes for microelectronics

A line of ceramic resistive pastes is available for silk screen printing. The resistive glaze compositions feature superior heat stability, greater resistance to severe moisture exposure and improved long-time electrical load stability as compared to other available coatings. They may also be used for making a variety of discrete resistors or as part of a thick-film hybrid circuit.

The manufacturer is initially offering standard sheet resistivities in the decade ranges from 10 to 20,000 ohms per square. Extension of these resistance values by as much as two decades in either direction is available on an experimental basis.

The new pastes may be intermixed in all proportions, and are fired at peak temperatures of 750° to 850°C for 10 to 20 minutes. Resistance value and related characteristics vary according to the substrate, the method of application and firing conditions. Temperature coefficients generally under 300 ppm/°C are usually obtained for the normal resistance ranges, according to the company. The man-

ufacturer's silver, platinum-gold or palladium-gold conductive terminations may be used.

Electro-Science Laboratories, Inc., 1133 Arch St., Philadelphia 7, Pa. [408]

Conductive paint for high temperatures

A silver-filled, polymer-in-solvent paint has been developed for high-temperature applications requiring electrical conductance. The paint should be allowed to air-dry for removal of the solvent, then heated to 500°F for 15 to 20 minutes to obtain maximum adhesion and conductivity.

Dynaloy 2510 is self-priming, and may be applied to any dry, clean surface by dip, brush, silk screen or roller. Thin films dry tack-free in 30 minutes, and show no weight loss at 1,200°F. Coverage (1-mil dry film) is 600 sq ft per gallon, and the operating temperature range is -60 to 1,500°F.

Other tests show the volume resistivity for Dynaloy 2510 to be 0.02 ohm-cm for a film air-dried at 70°F, and 0.003 for a film baked at 500°F. Shelf life is a year for closed containers.

Dynaloy, Inc., 408 Adams St., Newark, N.J., 07114. [409]

High-purity metals in wire and foil form

Ultrahigh purity metals are available in wire and foil form for use in the aerospace and electronics fields. Copper, gold, silver, aluminum, niobium, tantalum, zirconium, titanium, vanadium, iron and nickel, in nominal purities up to 99.999%, are available for off-the-shelf delivery.

Wire diameters of 5, 10, 20, 30 and 50 mils and foil thicknesses of 1, 5 and 10 mils are the standard sizes. Other sizes are available on special order.

These materials are all processed under clean-room conditions to maintain original purities, making the materials ideal for both experimental and production applications where it is essential to eliminate the variables due to high interstitial and high substitutional impurities. Materials Research Corp., Orangeburg, N.Y., 10962. [410]

MEPCO introduces ...

S.M.A.C.

Simultaneous Mass Attachment of Components

for the mass-production of

FILM HYBRID MICROCIRCUITS

It's new from MEPCO ... the major key to Mepco's breakthrough in the art of mass-producing film hybrid microcircuits.

Ask about S.M.A.C. today.

Find out what it can mean to your present and future production schedules.



MANUFACTURERS OF PRECISION
ELECTRONIC DEVICES

MEPCO, INC.

COLUMBIA ROAD, MORRISTOWN, NEW JERSEY
07960 (201) 539-2000

INEXPENSIVE WAY TO MICROMINIATURIZE YOUR CIRCUITRY

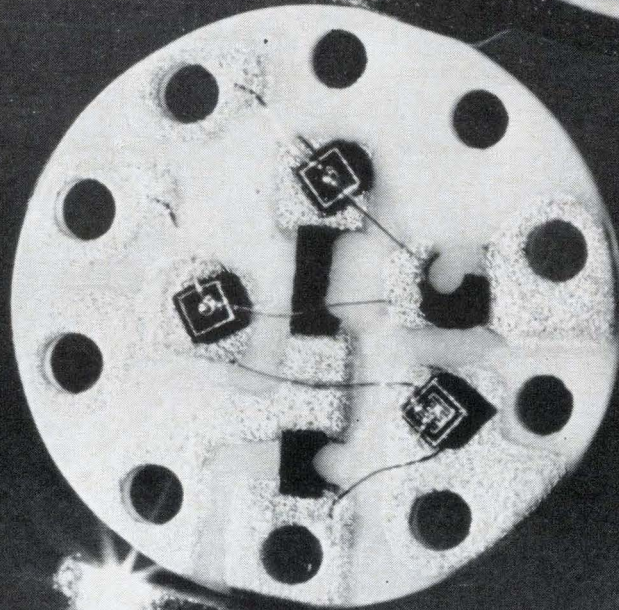

NSC's CHIC[®]

CERMET HYBRID INTEGRATED CIRCUITS

Design your circuit, breadboard it with discrete components, thoroughly test it for system compatibility and environmental performance—then let NSC microminiaturize your exact design with CHIC.

You'll keep set-up costs low, turnaround time to a minimum. The CHIC approach specifically lends itself to designs that require the newest, discrete, active devices and passive networks. These consist of high value, tight tolerance, low temperature coefficient resistors and mos capacitors. Married in the CHIC hybrid form they meet the high component density and reliability requirements of the electronics industry.

In the table at the right are some typical device types available in NSC customized CHIC circuits.

TYPICAL NSC DEVICE TYPES

Small Signal NPN	2N3246
Small Signal PNP	2N3548
Medium Power NPN	2N2219
Medium Power PNP	2N2905
Medium Power Switching NPN	2N3981
Medium Power Switching PNP	2N2905
High Speed Switches NPN	2N2369
High Speed Switches PNP	2N3829
UHF Small Signal NPN	NS9728
VHF Small Signal NPN	2N918
Inch NPN	3N70
Inch PNP	3N95
Single Ended Choppers NPN	2N2432
Single Ended Choppers PNP	2N2945
Differential Amplifiers NPN	2N2920
Differential Amplifiers PNP	NS7200

RESISTORS

Resistances	10 Ohms to 3 Meg Ohms
Resistivities	10 Ω /square—100 K Ω /square
Untrimmed Tolerance	10%
Trimmed Tolerance	To 1%
Temperature Coefficient	Typically 200 ppm/ $^{\circ}$ C from 0 to + 125 $^{\circ}$ C
Voltage Coefficient	.02% per volt
Power Dissipation	Up to 25 W/in. ²

CAPACITORS

Capacitance	10 pf to .1 μ f
Working Volt	.50 VDC Max.
Temperature Coefficient	.300 ppm/ $^{\circ}$ C from 0 to + 125 $^{\circ}$ C

PACKAGES

TO 5 • Flat Pack • Epoxy



NATIONAL SEMICONDUCTOR CORPORATION
DANBURY, CONN.

NSC 135

NSC INTERNATIONAL, 12 RUE PLOIX, VERSAILLES, SEINE LOISE, FRANCE, 950-36-43, 950-32-21

Circle 206 on reader service card

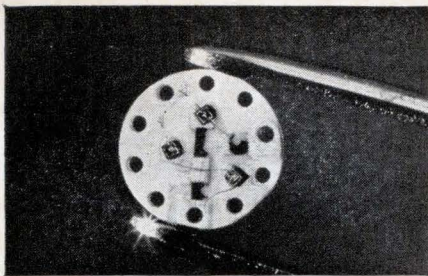

Hybrids now available for off-the-shelf delivery

NSC's STANDARD LINE OF **CHIC**[®] CERMET HYBRID INTEGRATED CIRCUITS DEVICES

AUDIO AMPLIFIER—NSC 7558

A versatile audio amplifier — efficient operation from 1 mW to over 50 mW output. Bias taps allow user to set gain and power drain to best match circuit application. Gain, once set, is extremely stable with respect to frequency, ambient temperature and power supply variations.

VIDEO AMPLIFIER—NS 7512

A two-stage, wide band video amplifier, with extremely constant gain characteristics. The gain is constant (± 2 db) from D.C. to 30mc.

OPERATIONAL AMPLIFIER—NS 7560

Provides low input offset currents, low drift, wide output voltage swing and high output current capacity suitable for use in a wide variety of digital and analog applications.

μ CHOPPERS—NS 8000

50KC to 1.5MC Operating Frequency Range. A complete, transformer isolated integrated chopper which contains a miniature toroidal transformer and an INCH. Ideally suited for low level electronic commutating and demodulating applications because of extremely low offset voltage, low leakage currents, low saturated dynamic impedance and high-speed switching characteristics.

CHOPPERS—NS 8003

0 CPS to 50KC Operating Frequency Range when used with suitable drive circuitry. Also a complete, transformer isolated, integrated chopper that includes a diode and resistor to provide the rectification necessary for low frequency operation. Ideally suited for low level commutating, demodulating, and chopper applications.

NSC
NATIONAL SEMICONDUCTOR CORPORATION
DANBURY, CONN.

New Books

Impact theory

Atomic and Ionic Impact Phenomena
on Metal Surfaces
Manfred Kaminsky
Academic Press, Inc., 402 pp., \$14.50

Here is an extensive compendium on the title subject. Kaminsky's work represents a significant updating of Chapter IX of H. S. W. Massey and E. H. S. Burhop's 1952 work, "Electronic and Ionic Impact Phenomena."

Particular emphasis is given to surface ionization and neutralization phenomena, sputtering, and electron emission due to atomic and ionic impact on metal.

Because of the great improvements in vacuum techniques and surface preparation, it has become possible to perform more definitive experiments on gas and solid phenomena. The book provides excellent coverage of such recent work within its area of emphasis and reflects the author's extensive knowledge and participation in this field of research.

One of Kaminsky's stated purposes is the facilitation of interdisciplinary contact between different fields. The technical material selected for inclusion is of common interest to many areas, including the following: plasma physics, thermonuclear reactions, thermionic energy conversion, ion propulsion, sputtering corrosion of surfaces of satellites and ion engines, ion getter pumps and deposition of thin films. To more fully achieve the interdisciplinary objective, it would have been advisable, however, to show by examples how an understanding of the basic experiments and phenomena lead to a better insight in certain areas of application.

Of particular value is the extensive bibliographical material (807 references) which is truly international and interdisciplinary in scope. A reasonable balance is achieved between the theoretical and experimental, with emphasis on experimental techniques and results. Frequently, equations are quoted with a minimum of explanation. Although this was undoubtedly necessary to limit the size of the book, a more thorough theoretical development would have been desirable

for the student audience. However, the book is primarily designed for the research worker in a related field and presupposes a thorough knowledge of quantum and statistical physics. As an example, the Saha-Langmuir equation is used repeatedly and a knowledge of its basis in statistical physics is assumed.

The general plan is good. It consists of several introductory chapters devoted to the development of a model of a metal surface including a clear discussion of the concept of work functions, binding forces between adatoms and surfaces, and thermodynamics of surface reactions. The Sommerfeld quantum model of electrons in a metal is employed with the assumption that the reader is familiar with it.

A short introductory section on methods of preparing clean metal surfaces is also included. Each of the subsequent chapters is devoted to a particular atomic or ionic impact phenomenon at a metal surface. Within each chapter, a short introductory theoretical section is followed by a section on experimental methods and then by one on experimental results.

However, the narrative on various surface phenomena would appear more unified if there were a final chapter showing the respective contributions to a theoretical model of a metal surface.

The surface phenomena which receive the greatest attention are thermal accommodation, positive ion emission due to particle impact, sputtering by ion bombardment and potential, plus kinetic, emission of secondary electrons due to atom/ion impact including resonance and Auger processes. Metal surfaces are typically considered and discussed in three conditions relative to the above processes. These are: clean single crystal surfaces, clean polycrystalline surfaces and surfaces with a layer of adatoms.

Kaminsky's work is highly recommended to the research worker in the fields covered by the book as a comprehensive treatment, with special credit to the author for a truly gargantuan bibliographic effort.

L. Lesensky

Raytheon Co.
Waltham, Mass.

High-frequency head

Magnetic scan head for high frequency recording
Marvin Camras

IIT Research Institute, Chicago

High frequency magnetic recording at high density by conventional methods requires scanning velocities in the order of hundreds of miles per hour, head gaps measured in microinches and magnetic tape of exceptional ruggedness and precise dimensions.

Although another alternative exists in the form of electron beam scanning, the method requires the use of specialized vacuum tubes which are still only in the developmental stage.

A new magnetic head has been designed which uses a different principle to obtain rapid scanning of slowly moving tape, while the head remains stationary. The head is built of stacked Permalloy laminations which define a gap of about 0.25 mil, extending across a relatively wide tape. The number of laminations determine the lateral resolution of the system; a horizontal video line requires about 350 elements.

On the head are three windings. One is for the signal and the others for the sweep. The signal winding links magnetically with a main magnetic circuit and with the gap.

The main magnetic circuit also includes smaller magnetic circuits which may be locally saturated through the sweep windings, thus interrupting the main circuit. As the tape moves slowly past the head, each lamination is activated in turn and then deactivated by the sweep circuit, selectively controlling the permeability between the signal coil and the gap.

Several experimental heads of this type were built. One video head was swept laterally at 15,750 lines per second, with its signal coil energized by the output of a television receiver. The result was a recorded tape having 60 frames per second, the magnetic counterpart of an 8-mm movie, when the images were developed with iron powder and viewed under magnification.

Another head was operated with digital input as a tape memory.

Presented at the IEEE International Convention, New York, March 21-25.

Digital image storage

Drum scanning techniques for digitizing and recording image data
W.L. Gilman

Systems Development Division
International Business Machines Corp.,
Kingston, N.Y.

An experimental system has been built that combines facsimile techniques with digital processing to provide a scanning, digitizing and playback system for the recording of displays.

Work in digital mapping and other related image-processing tasks has demonstrated a need for scanning and reproducing equipment with high resolution, and speed that matches that of data-processing systems. The experimental equipment described scans photographic or other image data, converts the gray-shade information to digital data, and stores this data on magnetic tape. Additionally, computer-generated data can be converted to photographs.

Particular emphasis was placed on high resolution and the ability to handle large formats. The equipment is capable of digitizing pictorial information in 16 discrete gray levels, at a density of 1,000 elements per inch in both horizontal and vertical directions. Formats up to 9 x 18 inches can be handled.

The images attached to the drum are scanned and a number representing reflective density, is assigned to each picture element by a quantization process. This number is stored on magnetic tape. A scan line consists of one revolution of the drum past the head; the line is stored on tape and represents 9000 picture elements.

Image data on tape, generated by computer processing can be recorded on film by the system at the same resolution and gray-shade range. In this mode, unexposed film is attached to the drum and resolved under the scanning head. A point source of light is modulated in proportion to the gray scale

digits on tape for each picture element; the film is exposed and the image data stored on tape is revealed on the film.

A signal processing element is included in the equipment to enable corrections to be applied either to scanning or recording.

Presented at the IEEE International Convention, New York, March 21-25.

CAT detectors

Investigation of techniques for detecting clear air turbulence
Wilbur H. Paulsen, Air Force
Cambridge Research Laboratories
Bedford, Mass.

Both ground-based and airborne equipment are sought as CAT (clear air turbulence) detectors. Ground equipment would pose little problems in size or weight, nor would it be limited in possible frequencies, but it could produce reliable data only on conditions in its immediate vicinity. Apparently, only an on-board airborne system could provide detailed, information to a pilot.

Sonic techniques were discarded with the development of supersonic aircraft. Star tracking or scintillation techniques are intriguing, but require the ability to detect the star field on the horizon directly ahead of the aircraft. In daytime this is difficult, and high level clouds could obscure star fields. Infrared and microwave radiometric techniques of measuring air temperatures ahead of the aircraft are being studied. These techniques assume a correlation between temperature discontinuity and clear air turbulence, an assumption not proven.

Details of low-frequency bistatic ground radar, airborne radar and optical (laser) radar systems are discussed. The author says that although each of these systems has made significant sighting of CAT, none meets an adequate level of reliability. What is needed is an instrument to detect clear air turbulence 20 miles ahead, twice the range of any present system.

Presented at the National Air Meeting on Clear Air Turbulence, Washington, Feb. 23-24.

New Literature

Thermistor testing. Victory Engineering Corp., 122-48 Springfield Ave., Springfield, N.J., 07081. An eight-page brochure contains detailed data on acceptance and design testing of negative temperature coefficient thermistors. Circle 420 on reader service card.

Sample-and-hold amplifier. Pacific Data & Controls, 6406 S.E. Foster Rd., Portland, Ore., 97206, has available a bulletin describing the model 102 sample-and-hold amplifier with built-in floating power supply. [421]

Ceramic capacitors. Republic Electronics Corp., 176 East Seventh St., Paterson, N.J., 07524, offers its 1966 catalog B-1 (12 pages) describing a complete line of subminiature ceramic capacitors in a vast choice of values, lead arrangements, lead material, physical and electrical properties. [422].

IC test system. Optimized Devices, Inc., 220 Marble Ave., Pleasantville, N.Y. Model 5000, a complete system for high-speed testing of integrated circuits, micromodules and circuit cards is described in a six-page brochure. [423]

Universal counter-timer. Transistor Specialties, Inc., Terminal Drive, Plainview, N.Y. A preliminary data sheet covers the model 600 series of counters and plug-ins—versatile, all-silicon, solid state digital instruments capable of accurately and easily performing precision measurements for a variety of applications. [424]

Integrating dvm's. Hughes Instruments, Hughes Aircraft Co., 2020 Oceanside Blvd., Oceanside, Calif., 92054. Two-color brochures provide information on the features, operating principles and specifications of the all-electronic, solid state models 5000A and 5200 five-digit integrating digital voltmeters. [425]

Transducer equations. Statham Instruments, Inc., 12401 W. Olympic Blvd., Los Angeles, Calif., 90064. Instrument Notes No. 38 reviews the electrical aspects of the transducer bridge, general bridge theory, and gives complete bridge equations for various combinations of active and inactive bridge elements. [426]

General-purpose relay. Sigma Instruments, Inc., 170 Pearl St., Braintree, Mass., 02185, offers a catalog bulletin on a one-ounce, general-purpose economy relay for switching 1-amp commercial loads from 90-mw input signals. [427]

Transducer. Dynisco division of Abex, 40 Ames St., Cambridge, Mass., 02142.

Bulletin 410 describes a transducer that measures melt pressure and temperature at the same point in plastic extrusions. [428]

MOS FET circuits. General Instrument Corp., 600 W. John St., Hicksville, N.Y., has available an eight-page technical bulletin entitled "Designing with MOS Field Effect Transistors." [429]

Teflon sockets. Barnes Development Co., Lansdowne, Pa., 19050. Bulletin 178A describes the MGR series of Teflon sockets for transistors and TO-cased integrated circuits. [430]

Elapsed time indicators. The A.W. Haydon Co., 232 No. Elm St., Waterbury, Conn., 06720. Bulletin MI 602 covers the 4200, 23200, and 25200 series of hermetically sealed, subminiature elapsed time indicators for operation on 28 v d-c, and 115 v a-c, 60 or 400 Hz. [431]

Miniature crt socket. Connector Corp., 6025 No. Keystone Ave., Chicago, Ill., 60646, offers data sheet 35A on the type 546 miniature crt socket with simplified cost reducing design for mating with the new miniature JEDEC E7-91 basing crt's. [432]

D-c digital voltmeter. Ballantine Laboratories, Boonton, N.J. A two-page technical data sheet describes the model 353, a 0.02% accurate, but low-priced, solid state d-c digital voltmeter. [433]

Thermocouple references. Acromag, Inc., 15360 Telegraph Road, Detroit, Mich., 48239, has published technical bulletin 32-B describing the theory, operation, and applications of thermocouple references. [434]

Digital strip printer. Franklin Electronics, Inc., division of Analex, E. Fourth St., Bridgeport, Pa., 19405. Bulletin 2045 describes a low-cost strip printer with a 63-chapter alphanumeric capability. [435]

Temperature controllers. API Instruments Co., Chesterland, Ohio, 44026. Bulletin 49 covers three principal types of the company's temperature controllers as well as several more specialized lines. [436]

Differential amplifiers. Dana Laboratories Inc., Irvine, Calif., 92664, offers a two-page data sheet covering its series 3800 direct-coupled differential amplifiers. [437]

Porcelain capacitors. Vitramon, Inc., Box 544, Bridgeport, Conn., 06601. Data sheet P10B covers the thin line VY porcelain capacitors with zero temperature coefficient. [438]

Telrex

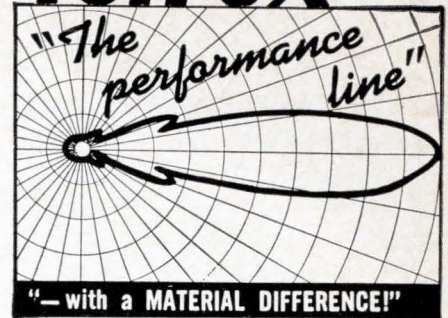

The Choice of the Discriminating Communication Engineer... the Man who Never Settles for Anything Less than THE-VERY-BEST!

telrex "BEAMED-POWER" ANTENNAS and ANTENNA SYSTEMS

Provide optimum performance and reliability per element, per dollar. Antennas from 500 Kc to 1500 Mc. Free PL88 condensed data and pricing catalog, describes military and commercial antennas, systems, accessories, Towers, Masts, Rotators, "Baluns" and transmission line data.

Communication and TV Antennas
ANTENNAS
 SINCE 1921 **telrex**
LABORATORIES
 Asbury Park 41, New Jersey, U.S.A.
 Circle 209 on reader service card

Reprint order form

Send to: Electronics Reprint Dept.
 330 West 42nd Street
 New York, N. Y. 10036

For listing of reprints available see the reader service card.

To help expedite mailing of your reprints please send cash, check or money order with your order.

For reprints of the latest special report:

Computer Time Sharing Part II

Send me reprints of key no R-86 at 50¢ each.

For reprints of previous special reports fill in below:

Send me reprints of key no.(s) at ¢ each.

For prices see the reader service card.

Name

Number & Street

City, State

Zip code

QUALIFICATION FORM FOR POSITIONS AVAILABLE

ATTENTION: ENGINEERS, SCIENTISTS, PHYSICISTS

This Qualification Form is designed to help you advance in the electronics industry. It is unique and compact. Designed with the assistance of professional personnel management, it isolates specific experience in electronics and deals only in essential background information. The advertisers listed here are seeking professional experience. Fill in the Qualification Form below.

STRICTLY CONFIDENTIAL: Your Qualification form will be handled as "Strictly Confidential" by Electronics. Our processing system is such that your form will be forwarded within 24 hours to the proper executives in the companies you select. You will be contacted at your home by the interested companies.

WHAT TO DO. (1.) Review the positions in the advertisements. (2.) Select those for which you qualify. (3.) Notice the key numbers. (4.) Circle the corresponding key number below the Qualification Form. (5.) Fill out the form completely. Please print clearly. (6.) Mail to: Classified Adv. Div., Electronics, Box 12, N. Y. 10036.

COMPANY	Page #	KEY #
ATOMIC PERSONNEL INC. Phila., Pa.	228*	1
BAUSCH & LOMB Rochester, N. Y.	226*	2
BOOZ, ALLEN APPLIED RESEARCH INC. Chicago, Ill.	210	3
ELECTRONIC COMMUNICATIONS INC. St. Petersburg, Fla.	228*	4

COMPANY	Page #	KEY #
GENERAL MOTORS CORP. Defense Research Laboratories Santa Barbara, Calif.	227*	5
GENERAL MOTORS CORP. Delco Radio Div. Kokomo, Indiana	138*	6
INTERNATIONAL BUSINESS MACHINES Data Processing Div. White Plains, N. Y.	173*	7
INTERNATIONAL BUSINESS MACHINES Bethesda, Md.	128	8
LOCKHEED MISSILES & SPACE CO. Sunnyvale, Calif.	170*	9
U.S. NAVAL SHIP MISSILE SYSTEMS ENGINEERING STATION Port Hueneme, Calif. 93041	156	10
XEROX CORP. Rochester, N. Y.	130*	11
P 8928	210	12

* These advertisements appeared in the April 4, 1966 issue.

PERSONAL BACKGROUND

Name
Home Address
City Zone State
Home Telephone

EDUCATION

Professional Degree(s)
Major(s)
University
Date(s)

FIELDS OF EXPERIENCE (Please Check)		4/18/66
<input type="checkbox"/> Aerospace	<input type="checkbox"/> Medicine	
<input type="checkbox"/> Antennas	<input type="checkbox"/> Microwave	
<input type="checkbox"/> ASW	<input type="checkbox"/> Navigation	
<input type="checkbox"/> Circuits	<input type="checkbox"/> Operation Research	
<input type="checkbox"/> Communications	<input type="checkbox"/> Optics	
<input type="checkbox"/> Components	<input type="checkbox"/> Packaging	
<input type="checkbox"/> Computers	<input type="checkbox"/> Radar	
<input type="checkbox"/> ECM	<input type="checkbox"/> Radio-TV	
<input type="checkbox"/> Electron Tubes	<input type="checkbox"/> Simulators	
<input type="checkbox"/> Engineering Writing	<input type="checkbox"/> Solid State	
<input type="checkbox"/> Fire Control	<input type="checkbox"/> Telemetry	
<input type="checkbox"/> Human Factors	<input type="checkbox"/> Transformers	
<input type="checkbox"/> Infrared	<input type="checkbox"/> Other	
<input type="checkbox"/> Instrumentation	<input type="checkbox"/>	

CATEGORY OF SPECIALIZATION

Please indicate number of months experience on proper lines.

	Technical Experience (Months)	Supervisory Experience (Months)
RESEARCH (pure, fundamental, basic)
RESEARCH (Applied)
SYSTEMS (New Concepts)
DEVELOPMENT (Model)
DESIGN (Products)
MANUFACTURING (Product)
FIELD (Service)
SALES (Proposals & Products)

CIRCLE KEY NUMBERS OF ABOVE COMPANIES' POSITIONS THAT INTEREST YOU 1 2 3 4 5 6 7 8 9 10 11 12

DEVELOPMENT ENGINEERS SYSTEMS ENGINEERS

Mechanical • Physicists • Electronics Engineers

CLEVELAND, OHIO

Once again we find we must expand the personnel requirements of the mechanical and electronic commercial/industrial hardware, systems, and process development programs being performed within our Development and Design Division facilities in Cleveland, Ohio.

As a division of an extremely fine and reputable nation-wide applications research analysis and development firm our Development and Design Division, with multiple and confining programs, offers an outstanding opportunity to enhance professional growth; career opportunities exist.

We are seeking creative individuals who believe themselves to be well trained, experienced, operationally strong, and by virtue of their education, ability, interest and temperament, to be top-flight generalists.

We are not an easy firm for which to work. We are not, for that matter, an easy firm to get into, though many have been good enough. Excellence will demand excellence. Salary, is definitely open, benefits are competitive and we tend to recognize accomplishments and results more than stability, acceptability or seniority.

If the above information seems to reflect an engineering and organizational environment that appeals to you, and if the Cleveland area is attractive to you, contact: Robert Flint, Director of Staff Selection

BOOZ-ALLEN APPLIED RESEARCH, Inc.

Development and Design Division

135 South La Salle Street, Chicago, Illinois 60603
312 — FR 2-1728

An Equal Opportunity Employer



EMPLOYMENT OPPORTUNITIES

THE MARKET-PLACE FOR ALL EMPLOYMENT NEEDS
Send new ads or inquiries to:
ELECTRONICS
Class. Adv. Div., P.O. Box 12, N.Y. 10036

SALESMEN

Calling on Electronics Manufacturers to handle line of Tapes, Threads, Cords, Commission Basis.

P-8928, Electronics
Class. Adv. Div., P.O. Box 12, N.Y. 10036

ADDRESS BOX NO. REPLIES TO: Box No. Classified Adv. Div. of this publication. Send to office nearest you.
NEW YORK, N. Y. 10036: P. O. Box 12
CHICAGO, Ill. 60611: 645 N. Michigan Ave.
SAN FRANCISCO, Cal. 94111: 255 California St.

POSITION VACANT

Instructors wanted in the field of Electronics and Radio-Television servicing. Age open—salary open—must possess a college degree or equivalent. Preference will be given to individuals with an EE Degree with Electronics option. Year round employment in South-eastern United States—excellent opportunity in growing institution. Send complete resume of education, personal data, and experience to Robert E. Paap, President, Catawba Valley Technical Institute, Hickory, North Carolina.

POSITION WANTED

Electronics Engineer, 30, resident in Germany seeks sales or after-sales representation. 3 years development, 5 years after-sales of american equipment. Fluent English, French and German. Other offers considered. Reply to PW-8446, Electronics

In electronics it's Electronics magazine to sell used equipment!

Your advertisement will produce Results in Electronics. Engineers turn to Electronics magazine for the latest technical developments — and for the latest buying information. You can reach them inexpensively in Electronics Searchlight Section.

For information:
Searchlight Section
Classified Advertising Division
Post Office Box 12
New York 10036

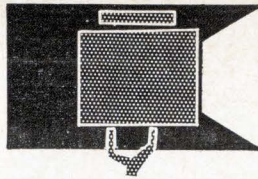

SEARCHLIGHT SECTION

• CLASSIFIED ADVERTISING • BUSINESS OPPORTUNITIES
• USED OR SURPLUS EQUIPMENT

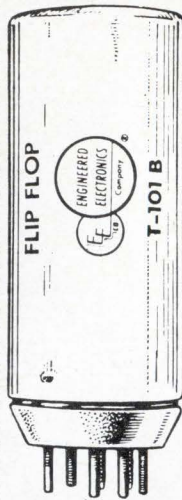

Transistorized Packaged Circuits

T-101B Flip Flop...	8.15
T-102A Flip Flop...	6.75
T-103 Flip Flop...	6.40
T-104 Multivibrator...	7.25
T-105A One-Shot...	6.65
T-106 Squaring Amplifier	5.80
TM-106* Squaring Amplifier	6.80
T-108 Amplifier...	9.40
T-109 Reset Generator	6.00
TE-109* Reset Generator	9.50
T-112 Emitter Follower, Dual	4.40
T-113 Emitter Follower, Triple	5.35
T-115 Emitter Follower, Dual	5.05
T-116 Emitter Follower, Triple	6.40
T-128 Relay Driver (0-24V)	9.05
T-129 Reset Generator	4.75
T-139 Driver 0-30V	14.30
TM-170* Driver	9.20
TM-171* Driver	10.30
TM-411* Pulse Logic	8.15
TM-620* DC Logic	8.25
TM-644* Flip Flop	11.90
TE-648* Flip Flop	11.05

Actual Size

Prices subject to change without notice. Usual terms to rated Accounts—All others 25% Cash with order—Balance C.O.D. F.O.B. Bay Area. All items subject to prior sale. Minimum order \$10.00

EMMONS ELECTRONIC SUPPLY CO.

405-10th St.,
Oakland 7, California
TWinoaks 3-7411

See Our Ad Page 913

1965 ELECTRONICS BUYERS' GUIDE

CIRCLE 951 ON READER SERVICE CARD

SEMICONDUCTORS MAJOR BRANDS

INTEGRATED CIRCUITS • DIodes • AMPs • DARLINGTONS • POWER DIODES & TRANSISTORS
• SPECIAL DEVICES

Write for Catalog S-1

SEMICONDUCTOR SALES OF CALIF.
1063 Perry Annex Whittier, Calif.
(213) 696-7544

CIRCLE 952 ON READER SERVICE CARD

free catalog
POTTING APPLICATORS
MANUAL AND DISPOSABLE
6cc 12cc 30cc
FOR POTTING, ENCAPSULATING, AND
SEALING OF MINIATURE COMPONENTS
PHILIP FISHMAN COMPANY
7 CAMERON ST., WELLESLEY 81, MASSACHUSETTS

CIRCLE 953 ON READER SERVICE CARD

Color DIAL TELEPHONES \$10.95

Factory rebuilt Western Electric
In white, beige, ivory, pink, green,
or blue. If 4 prong plug is re-
quired add \$2.00. Fully guaran-
teed. Write for free list. All
shipments FOB.

Complete



SURPLUS SAVING CENTER
Dept. E-4186
Waymart, Pa.

CIRCLE 954 ON READER SERVICE CARD

DEQUITS
BUYERS TURN TO THE SEARCHLIGHT SECTION IN ELECTRONICS
RESULTS

Unique Relay Catalog Now Available

NEW YORK, N. Y., January, 1966—Universal Relay Corp., 42 White St., New York, N. Y. 10013, announces the publication of their latest 68-page catalog. Universal's normal inventory includes over 2,000,000 relays in approximately 30,000 types. In most cases stock is sufficient to give immediate delivery of production quantities. This catalog is not just a listing of items available "on order" but it is an indication of in-stock items (either as complete units or as ready-to-assemble components). Average shipment is made within 48 hours. Where coils and frames require assembly, or relays require special testing or adjustment, shipments are made, within one week to ten days.

Universal is completely equipped to assemble, adjust and thoroughly test any type of relay. A personal interest is taken in every order. This interest is maintained as the order is processed and continues even after the customer receives the merchandise, until he makes sure that it satisfies his needs. All merchandise is guaranteed, subject to customers' inspection and approval and may be returned within 10 days for replacement or credit. Catalog E may be obtained by writing directly to:

UNIVERSAL RELAY CORP.

42 White St., New York, N. Y. 10013
Telephone: (212) WA 5-6900

CIRCLE 955 ON READER SERVICE CARD

USED LAB EQUIPMENT

HEWLETT PACKARD	
150A Scope & 152A Dual trace PIU DC to 10 MHz, 20 usec-15 sec/cm sweep...	\$ 495.00
212A Pulse Gen. 50v, 50ohm out, 20ns rt	175.00
300A Wave analyz. 30Hz-16KHz...	225.00
400R, VTVM 5Hz-600KHz, 3mv-300v...	75.00
400C, VTVM 5Hz-600KHz, 1mv-300v...	90.00
410A VTVM, DC, Ohms, AC to 700MHz...	95.00
410BR, VTVM, DC, Ohms, AC to 700MHz...	125.00
415A SWR and Null indicator...	75.00
430C/477B RF pwr, 10MHz-106Hz...	135.00
N382A, Var. Attenuator 20Hz-12GHz...	150.00
BERKELEY	
544, 100KHz counter, 100KHz xtal...	250.00
584E Dual prset counter...	145.00
FLUKE	
103 VAWmeter, AC Volts, Amps & Watts	195.00
GENERAL RADIO	
1482E, 1482H, 1482L, 1482P Induct. ea.	65.00
1217A Unit Pulser & 1203B pwr Supply	95.00
EG&G	
2236A TWT Scope, 3000 MHz response, Single & Repetitive sweep, camera...	1200.00
AMPEX	
FR400 Digital Tape Recorder, 7 level heads IBM format, 37 1/2 & 75 ips in rack with controls...	1500.00
BRUSH	
BL262 recorder & 2 BL550 Amps, 2 channel, electric pens...	225.00
RUTHERFORD	
B2A, dual Pulse Gen to 1 MHz...	495.00
TEKTRONIX	
511A Scope, 5Hz to 10MHz, 5 in CRT...	295.00
513D Scope, DC to 18MHz, 5 in CRT...	395.00
514A Scope, DC to 10MHz, 5 in CRT...	155.00
514AD Scope, DC to 10MHz, 5 in CRT...	345.00

Many others—all checked out and with manuals. All Subject to Prior Sale, 30 Day Return Privilege if not satisfied. All prices FOB.

HARLAND LABS

1043 Fern, Escondido, Calif. 92025
Phone 714-746-1327

CIRCLE 956 ON READER SERVICE CARD

RADAR AUTO-TRACK & TELEMETRY ANTENNA PEDESTALS
3 & 10 CM. SCR 584 AUTOTRACK RADARS, M-33 RADAR
TPS-1D SEARCH, APS-45 TPS-10D HT. FINDERS, WX RADARS,
FPH-326GA, APS-10 APS-15R, APS-27 (AMTI) SEARCH, ■ ■ ■
APN-102 DOPPLER, DOZENS MORE CARCINOTRONS, PFNS:
25-5-1-2-3-6 MEGAWATT PULSE MODULATORS, CAVITIES,
PULSE TRANSFORMERS, IF STRIPS, WAVEGUIDE, BENDS
200 MC, 1 KMC, 3 KMC, 6 KMC, 9 KMC, 24 KMC, RF PKGS.
RADIO RESEARCH INSTRUMENT CO.
550 5TH AVE., NEW YORK 36, N. Y. JU 6-4691

CIRCLE 957 ON READER SERVICE CARD

THE G4 IS A COMPLETELY NEW MECHANICAL CHOPPER
THE MECHANISM IS NOVEL (A PATENT IS PENDING)
OPERATION IS UNIFORM FROM 0 TO 1,500 CYCLES
THE NOISE IS MUCH LESS THAN ONE MICROVOLT
THE OFFSET IS MUCH LESS THAN ONE MICROVOLT
THE DESIGN IS INHERENTLY OF HIGH RELIABILITY
THE OPERATING LIFE WILL EXCEED 10,000 HOURS
THE G4 IS UNAFFECTED BY SHOCK AND VIBRATION

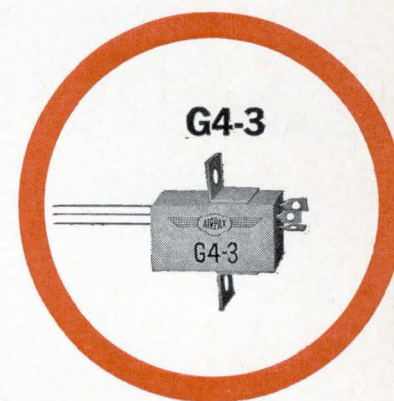
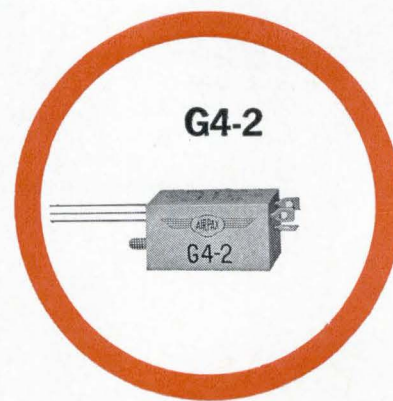
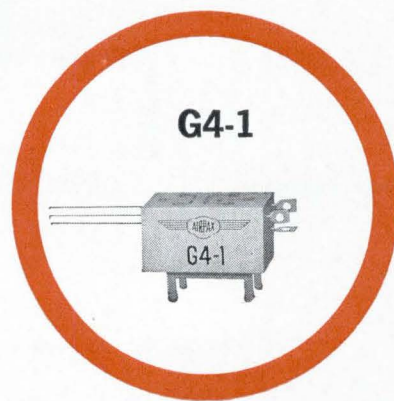
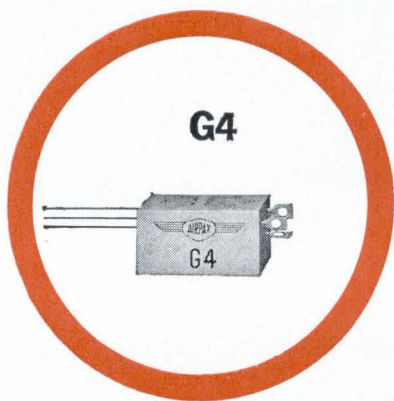

SPECIFICATIONS

CONTACT ACTION: SPDT, BBM
 CONTACT RATING: 20V 1ma resistive
 POWER CONSUMPTION: 200mw max.
 CONTACTS TO GROUND: 5uuf max.

TRANSFER TIME: 5° minimum
 DWELL TIME: 165° ± 10°
 DISSYMMETRY: 10° maximum
 PHASE ANGLE: 75° ± 10°

VIBRATION: MIL STD 202B Method 204A,
 Cond. B, maximum contact derangement 7°
 SHOCK: 100 G per Mil Std 202B Method
 202A, maximum contact derangement 10°

INSUL. RESIS.: 10 K meg. at 100 VDC
 TEMPERATURE: - 65°C to + 125°C
 CASE VOLUME: 0.11 cu. inches
 WEIGHT: 8 grams

AIRPAX ELECTRONICS

incorporated
Cambridge, Maryland

Electronics Abroad

Japan

Three-in-one color gun

The untiring search by Japanese color television set makers for something better than the shadow-mask tube seems about to pay off with still another sophisticated small-screen tube. Sony Corp. has well along in development a one-gun tube it calls the Chromagnetron. The key idea: a color-switching yoke that makes a single gun act like three.

For all its merits, the shadow-mask tube that prevails in the United States has some major drawbacks. The mask that shepherds the electron beams from each of the three color guns onto the right phosphors blocks out about 85% of the electrons. It takes high voltages and high currents—high power in other words—to get adequate brightness. And using one gun for each color is a brute-force rather than an elegant solution.

Both Sony and the Yaou Electric Co. are already marketing sets with tubes that replace the shadow mask with a grid of fine wires. This technique of landing electrons on the right phosphors, called post deflection focusing, blocks out at most 15% of the electrons. The concept was first advanced by the late Ernest O. Lawrence, best known for his Nobel-prize-winning invention of the cyclotron.

On the grid. Elegant as the Lawrence concept is, it's difficult to put into practice. Fabricating wire grids that line up exactly with vertical phosphor color stripes on the tube is tricky. What's more, for a single-gun tube, two grids insulated from one another are needed. That's because the difference in potential between alternate wires has to be reversed to deflect the electrons left or right to land on the correct phosphors; with no potential difference between wires, the

electrons pass straight through to hit the third color.

The Kobe Kogyo Corp. produces a 7½-inch one-gun tube for the Yaou portable set [Electronics, May 31, 1965, p. 81] but there isn't much chance that Kobe can make the tube much larger. Even if Kobe or someone else could pull off the feat, a set maker who tried to use a large single-gun tube would run into trouble with spurious radiation. For adequate resolution, dot-sequential operation would be required; the color-switching grid would have to be switched at a frequency of 3.58 megahertz (megacycles per second) so the beam would hit every phosphor stripe as it sweeps across a line. For small sets, low-frequency line sequential operation—scanning lines with just one color at a time—is satisfactory.

For its part, Sony has in production a 19-inch, three-gun tube with a post deflection focusing grid. Fabricating the grid for this tube—called the Chromatron—is relatively easy. All the wires operate at the same potential, so they can be welded to a rigid metal frame.

Troubles. Sony, however, ran into trouble when it tried to develop a mass-production method to turn out insulated color-switching grids for a one-gun Chroma-

tron. Along with the difficulty of anchoring and at the same time insulating the wires by embedding them in a glass frit on a metal frame, Sony had to contend with a grid pitch twice as fine as used for the three-gun Chromatron. The one-gun Chromatron uses green stripes half as wide as the red and blue stripes, and one set of grid wires must be located in front of the half-width stripes.

Angles. The company hit on the Chromagnetron configuration of a one-gun tube and a single grid after Sony realized a landing compensation device it had developed for the three-gun Chromatron could shift the electron beam for each color. To the grid, the effect is the same as if the beam originated from three different guns operating in succession.

The effect is obtained by feeding a step current to a horizontal yoke near the gun and a second step current in opposite phase to the deflection yoke. This changes the angle of the beam successively for blue, green and red phosphor strips. The same result could be obtained with the color and convergence yoke located between the deflection yoke and the grid. This would simplify the dynamic convergence circuitry, but mounting the yoke would be

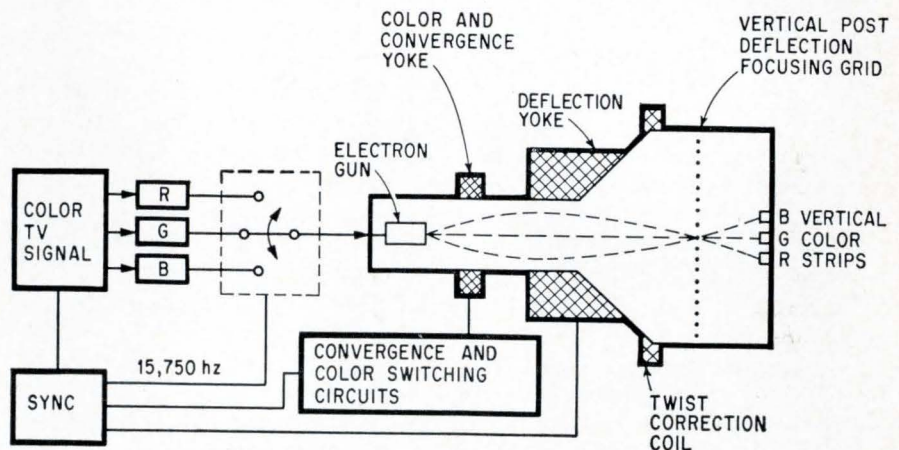

Color-switching by yoke near electron gun is key to operation of Chromagnetron, one-gun color tv tube Sony Corp. is developing.

more difficult in that case.

Inherently, operating a single gun in this fashion doesn't give as much brightness as three guns do. But Sony says there's enough room in the neck of the tube for a much larger gun that will make the display almost as bright as that of a three-gun tube.

Sony is developing a 12-inch tube using this concept. With color signals to the electron gun gated at horizontal sweep frequency, a line sequential display suitable for monitors in a closed-circuit entertainment system for aircraft can be made with little trouble. The tube also could be used for small-tube portable tv receivers.

The Chromagnetron concept, however, probably won't lead to a tube for large receivers. At the 3.58 Mhz color switching frequency required for dot-sequential operation, the large yokes would radiate too much interference.

On-time transistor

For some six years, the Bulova Watch Co. with its Accutron has had the "electronic" wristwatch market in the United States all to itself. Now Bulova will have to watch out—competition is on the horizon.

The Citizen Watch Co., a Japanese firm, plans to launch its X8 electronic wristwatch in Japan this spring; later it will move into export markets. Company officials haven't yet decided how to handle marketing in the U. S. Ironically, Citizen supplies conventional watch movements to Bulova for sale in the U. S.

Like Bulova's Accutron, Citizen's X8 uses a transistor circuit (neither watch is fully electronic), but there the resemblance ends. In the Accutron, a transistor-controlled electromagnetic tuning fork replaces the balance wheel and hairspring of a conventional watch movement. The X8, by contrast, uses a transistorized drive circuit to power a balance-wheel pendulum assembly.

Sandwiched coil. Basic oscillation in the X8 comes from a balance wheel with a hairspring; its period

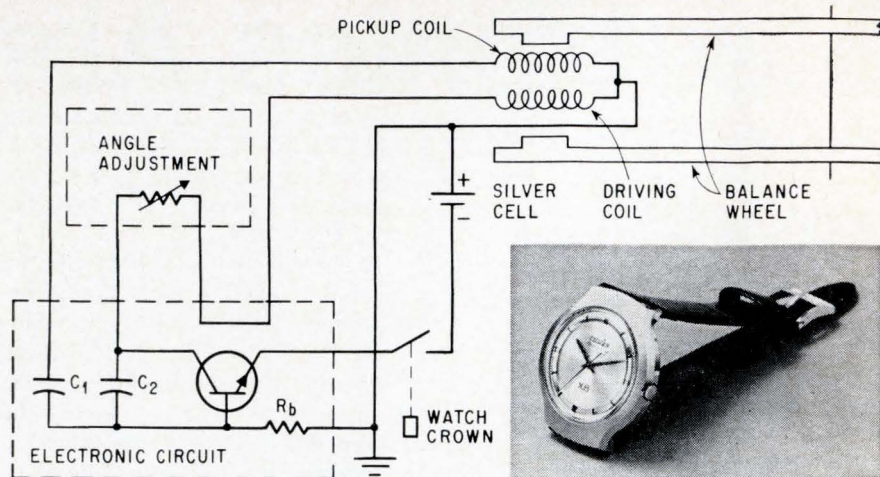

Transistor circuit drives balance-wheel assembly in Japanese "electronic" wristwatch. Periodic signal voltage develops in pickup coil as magnets on balance wheels sweep back and forth. Amplified by transistor, signal is fed back to drive coil to power the balance wheel coupled to escapement.

is 0.4 second. Below it lies a second balance wheel—without a hairspring—that drives a detached-lever escapement coupled to the gear train for the second, minute, and hour hands. Both balance wheels have platinum-cobalt permanent magnets fixed on them. Sandwiched between the wheels is a flat two-coil assembly.

One coil picks up a periodic voltage signal as the balance wheel assembly magnets oscillate back and forth over it. The signal is amplified by the transistor circuit and fed to the second coil to drive the pendulum assembly. Power source for the watch is a 1.5-volt silver cell, supplied by the Union Carbide Corp.; the cell lasts about a year.

As in a conventional movement, the hairspring of the X8 balance-wheel assembly can be adjusted to correct for fast or slow running; a variable resistor in the transistor circuit matches it to changed hairspring settings. The stem of the watch actuates a switch in the power-cell circuit so the watch can be stopped if desired.

Priced to sell. Citizen plans to produce one thousand X8's monthly at the outset and will sell them on the Japanese market for just under \$89. By comparison, Accutron prices in the U. S. start at \$125. When Citizen does tackle the U. S. market it will move into lush territory—

Bulova has sold over a half-million Accutrons in the last six years.

But both Bulova and Citizen face a long-range threat from Swiss watchmakers, fiercely jealous of their reputation as world leaders in precision timepieces. The Swiss Federation of Clock and Watch Manufacturers has mounted a well-financed effort to develop an all-electronic watch at its research center near Neuchâtel.

Great Britain

Thin lines

The upsurge of interest in thin-film integrated circuits in Great Britain has touched off a scramble among some researchers to see who can scribe the finest lines the fastest. Deposited resistors and capacitors in thin-film circuits have to be scribed to adjust their values; the race is on to develop optimum production methods to do the job. Already, both government and electronics company laboratories have come up with improved scribing techniques using sparks, electron beams or lasers.

Sparks. Standard Telephones and Cables Ltd., an affiliate of the International Telephone & Telegraph Corp., appears to be the leader with

spark engraving. In its West England plant, STC adjusts resistors and tunes inductances in thin-film circuits by engraving them with sparks. Cutting speeds range up to 0.4 inches per second, with line widths as thin as 0.002 inch. Even thinner lines are possible, STC says, with specially shaped tips on the engraving probe or by operating the probe in a dielectric fluid. The dielectric cuts widths down to around 0.0004 inch.

To keep line-width to line-depth ratio high, STC keeps energy levels in the spark low. Penetration of the evaporated film is thus held as low as a few thousand angstroms for a width-depth ratio as high as 20 to 1. The spark source is a direct-current supply that charges a small capacitor through a high resistance; that way, discharge current is limited and the film doesn't overheat when it's engraved. Typical values used by STC are a 40-volt circuit with a capacitor of 100 picofarads charged through a series resistance of 1 megohm.

Along with the benefits, low sparks levels bring a problem—how to maintain gaps small enough so the spark will form. STC solved the problem by mounting the probe on a piezoelectric transducer. Energized at 10-kilohertz (kilocycles per second) frequency, the transducer vibrates the probe with a travel of about 0.001 inch.

Electron beam. Another way to scribe fine lines is by an electron beam, a technique used on a production-line basis with computer control in the United States by Hamilton Standard Div. of the United Aircraft Corp. Britain's Royal Radar Establishment, however, has plans for a twist on the usual technique. Instead of a high-voltage, short-focus beam with accelerating voltages of 90 kilovolts or higher, RRE is developing a low-voltage (30 kilovolts) machine that operates as a high-resolution cathode ray tube.

RRE admits its low-voltage system has inherently lower resolution than a high-voltage electron beam machine. But there are advantages, RRE claims. A large scan area—up to 3 inches by 3 inches—is possible.

The Hamilton Standard equipment, by comparison, precisely scans areas only up to 0.2 inch square. Further, RRE says its design permits faster pumping and eliminates mechanical adjustments. And the low-voltage machine could be programmed for automatic operation as is Hamilton Standard's.

In an experimental unit built to machine thin films, RRE has scribed aluminum and nickel-chrome films with beam currents of 25 microamperes. Line width is about 0.001 inch, with minimum spacing between lines in the same order.

The unit has a conventional cathode-ray-tube gun mounted at one end of a long glass tube that flares out at the lower end. Sealed to the flared-out end is a conventional work chamber and vacuum pumping system. Three sets of coils control the beam. One pair aligns the beam, a second pair focuses it and corrects astigmatism, the third pair deflects the beam to obtain the desired scribing patterns.

Laser. Another government establishment, the Services Electronics Research Laboratory, wants to eliminate the need to scribe thin films in a vacuum. So SERL has developed an experimental system, built around a pulsed helium-neon laser, that can machine work pieces in air or through glass.

The gas laser develops about 200 watts peak power in 0.25 microsecond pulses. The radiation is infrared, most of it at a wavelength of 1.153×10^{-6} meters. Used with a lens of 1-inch focal length, the laser system has power of 60 megawatts per square centimeter at the focus. The lines scribed have widths between 0.0002 and 0.0004 inch.

Germany

On top

In most West German cities, television towers are familiar landmarks, skyline symbols of the booming consumer electronics industry. In divided Berlin, however, they have become weapons for the

political jousting that pits communist East Germans against capitalist West Germans.

It now looks as if the East Germans will come out on top in the tower tussle and stay there for a long time. They have started construction on a concrete tv tower that will soar to 1,181 feet—about 125 feet higher than the Eiffel Tower, currently the tallest structure in Western Europe. High as it will be, though, the East Berlin tower will be dwarfed by the 1,700-foot prestressed concrete tower under way in Moscow.

While the East Berliners build, West Berlin broadcasting officials are fretting. They're itching to match their rivals' skyward push but haven't been able to get permission from the occupying powers—the United States, France and Great Britain—to build high-rise projects. Occupation authorities claim a tall tower in West Berlin would be hazardous to air traffic.

Nice timing. Workers brigades are rushing to complete the East Berlin tower in the Alexanderplatz by August of next year. An eye-catching tower dominating the Berlin skyline then would offset the propaganda effect of the start-up of color tv broadcasting by the West Germans. The broadcasts will begin during the West Berlin radio, tv and phonograph exposition scheduled for late summer 1967.

The East Berlin tower will rise out of a 394-foot diameter base to a height of 656 feet. At that level will be the 105-foot base diameter of a cone. Eight floors in the cone will house broadcast equipment and work spaces for operating personnel. Above the cone, nine platforms will be cantilevered out from the shaft that brings the tower to its full height of 1,181 feet. The platforms will carry parabolic reflectors to beam broadcasts into every corner of the city and out to border areas in West Germany 85 miles away.

Hoping. Now that the East Germans have started to put up their tall tower, West German officials hope they'll be able to wangle permission to build a higher antenna than the 794-foot steel mast they

now have. With a 100-kilowatt transmitter, their tv broadcasts currently cover an area extending out 60 miles into the East German territory surrounding the West Berlin enclave.

"What we want is a concrete tower that will enable us to transmit deeper into East Germany," says Werner Goldberg, director of West Berlin's Fernsehturm GmbH, the television tower subsidiary of Radio Free Berlin. With a higher tower, Goldberg figures, the propaganda benefits of West German tv broadcasts could be extended to heavily populated areas around Leipzig and Dresden to the south, and to the Baltic coastal towns to the North.

An argument like that should get a sympathetic hearing from West Berlin occupation authorities, especially since the air-safety objection no longer is valid with a high tower now going up in East Berlin. Goldberg already has some possible projects in mind. One of the most recent calls for three 988-foot high concrete tubes with elevators running inside. A glassed-in observation sphere would be slung between the tubes near the top.

France

Changing exchanges

The government-run French telephone network plans to turn to electronic switching to ease the strain on the sorely overtaxed exchanges in the Paris area.

Phone officials said, at a recent international conference of electronic switching experts, that a first computer-run switching center would be installed in the French capital by late 1968. Most likely the system will be a hybrid. It will be computer controlled but line crosspoints will be switched by reed relays.

At its Lannion facility in North-western Brittany, the French postoffice department's research laboratory, Centre National d'Etudes de Télécommunications (CNET), has been

looking into three different kinds of switching systems for telephone exchanges. In a program named Aristotle, CNET has developed a 1,000-subscriber prototype exchange that uses pairs of transistors for the crosspoints. Concurrently, CNET developed Socrate, which has electronic program control but works with electromechanical crosspoints. Latest and most advanced is the Platon time-division system [Electronics, Nov. 16, 1964, p. 176].

Leading candidate. The exchange that Paris will get late in 1968 is called Pericles, almost certainly will be based on reed-relay experiments carried out as part of the Socrate development. Most likely candidate is the Artemis exchange, now well along in development at Le Matériel Téléphonique, an affiliate of the International Telephone & Telegraph Corp. LMT will have an 800-line prototype in service at its plant on the outskirts of Paris early next year.

The Artemis exchange differs in an important respect from the electronic switching system the Bell System has in full-fledged service on 7,000 lines in Saccasunna, N. J. and 4,000 lines in Chase, Md. [Electronics, Oct. 19, 1964, p. 72]. Bell's system uses electrical latching, LMT's magnetic latching.

Open and closed. In the Artemis exchange, a crosspoint consists of three reed relays. Two of them switch the phone lines; the third is scanned by the control circuits to determine if the crosspoint is occupied or free. Once a crosspoint is switched closed by a pulse to the electromagnets that actuate the reeds, it latches magnetically and remains closed without a holding current. It stays closed until a pulse to open it is transmitted. Along with the saving in current consumption, the magnetic latching circuit has the advantage of eliminating the need for a decoupling diode at each crosspoint.

Control functions in the Artemis exchange are handled by a computer developed by CNET for electronic switching systems. The computer has a semipermanent core memory to store the basic control program and a temporary memory

to store data while calls are switched. Both these memories have a capacity of 4,096 words of 32 bits. A drum memory with a 16,000-word, 32-bit capacity stores the subscriber numbers for the exchange and records of subscriber's accounts.

Switzerland

Bulls' eyes

An added occupational hazard is threatening burglars who practice their profession in Switzerland. Police forces in Zurich and some smaller Swiss cities soon will start testing an infrared scope that lets its user see at night.

The battery-powered scope looks like an oversized pistol and weighs about a pound. It can be held to the eye with one hand and needs no focusing. The lens, an integral part of the scope, has an angle between that of a normal camera lens and a wide-angle lens. With an infrared spotlight mounted on the patrol car to "illuminate" night prowlers, police can pick them out in the dark at ranges over 300 yards.

Albiswerk A.G. of Zurich built the device around a 1½-inch diameter infrared image converter tube it developed. The tube has a resolution of 650 lines per inch and a single image-converter stage. The acceleration voltage, higher than 10,000 volts, is developed in a transistor converter. Albiswerk says the image obtained is sharper than a television image.

The Swiss infrared scope differs in major respects from similar viewers produced in the United States for police work. The U. S. models have built-in illuminators. This is an advantage when a policeman has to leave his patrol car stalk a suspect at night.

On the other hand, the Swiss system based on a powerful infrared spotlight mounted on the patrol car has greater range. Range depends on the infrared illumination of the person or object viewed. And a scope without an incorporated illuminator, obviously, is cheaper.

Electronics advertisers

April 18, 1966



■ AMP Incorporated Garceau, Hargrave & McCullough	35	Damon Engineering Inc. L.K. Frank Company Inc.	170	Heinemann Electric Company Thomas R. Sundheim Inc.	17
■ Acme Electric Corporation Scheel Advertising Agency Inc.	171	■ Data Instruments Technical Marketing Inc.	134	■ Hewlett Packard Associates Lennen & Newell Inc.	49
Aerovox Corporation Lescarboua Adv. Inc.	126	■ Delco Radio Div. of General Motors Campbell-Ewald Company	178, 179	■ Hewlett Packard Lennen & Newell Inc.	1, 2, 20, 21, 47, 121
AirPax Electronics Inc. Welch, Mirabile & Company Inc.	212	Delta Microwave S. Gunnar Myrbeck & Company	176	■ Hewlett Packard Harrison Division Healy Advertising Agency	15
■ Air Products & Chemicals Inc. Arthur Falconer Associates	160	Deutsch Company, The B. Wesley Olson Company	173	High Vacuum Electronics Inc. Bonfield Associates	185
Allen Bradley Company Fensholt Adv. Agency Inc.	51, 52	Dialight Corporation H.J. Gold Company	134	■ Hughes Aircraft Company Foote, Cone & Belding Inc.	61
Amelco Semiconductor Div. of Teledyne Inc. Sturges & Associates	50	Digital Equipment Corporation Kalb & Schneider Inc.	22	■ Hysol Corporation Barber & Drullard Inc.	152
■ Amperex Electronics Corporation Sam Groden Inc.	122, 123	■ Dynage Incorporated F.W. Prella Company	150	IBM Corp. Benton & Bowles Inc.	128
Anelex Corporation James J. Cavella Advertising	46	■ Eagle Signal Div of E.W. Bliss Company Feeley Advertising Agency Inc.	18, 19	■ IMC Magnetics Corporation Monad Advertising Design	143
■ Astrodata Inc. Bonfield Associates Inc.	174	Eastman Kodak Company Rumrill-Hoyt Inc.	93	ITT, Electron Tube Division West, Weir & Bartel Inc.	64
Baird-Atomic Inc Van Christo Associates	158	Eimac Div. of Varian Associates Hoefer Dieterich & Brown Inc.	124	International Resistance Company Gray & Rogers Inc.	164, 193
■ Bendix Corporation, Scintilla Division MacManus, John & Adams Inc.	77	Electro Scientific Industries Nadler & Larimer Inc.	188	■ Jennings Radio Div. of ITT L.H. Waldron Adv. Agency	187
■ Bendix Corporation, Semiconductor Division MacManus, John & Adams Inc.	12, 13	Electronic Communications Inc. Neals & Hickok Inc.	54, 55, 56, 57	Jerrold Corporation Lescarboua Adv. Inc.	14
Binary Electronics of California	150	Electronic Specialty Company Gaynor & Ducas Inc.	163	Kay Electric Company Josephson, Cuffari & Company	76
Blackstone Corporation, Ultrasonics Division Carr Liggett Adv. Inc.	132	■ Elgenco Incorporated Wesco Advertising	200	■ Lambda Electronics Corporation Michel-Cather Inc.	114, 115
■ Bourns Incorporated Allen, Dorsey & Hatfield Inc.	79, 125	Erie Technological Products Co. Inc. Aitman-Hall Associates	108		
■ Brush Instrument Div. of Clevite Corporation Carr Liggett Inc.	3rd Cover	Esterline Angus Instrument Company Caldwell, Larkin & Sidener-Van Riper Inc.	80		
■ Buchanan Electrical Products Corp. Keyes, Martin & Company	65	Ex-Cell-O Corporation Campbell-Ewald Company	134		
Bulova Watch Company Frank Best & Company Inc.	166	■ Fairchild Controls Dunwoodie Associates Inc.	168		
■ Burndy Corporation Ted Gravenson Inc.	183	Fiberfil Incorporated Tri-State Adv. Co. Inc.	184		
Century Electronics & Instruments Inc. Writing & Advertising	192	Fluke Mfg. Co. Inc., John Bonfield Associates Inc.	136, 137		
Chemcut Corporation Adams Associates Inc.	194	Frequency Engineering Labs. Keyes, Martin & Company	67		
Chrono-Log Hill Associates	197	Garlock Company Inc. Richardson, Thomas & Bushman Company	142		
■ Clairex Corporation Michel-Cather Inc.	197	■ General Electric Company, Lamp Metals & Components Div Dix & Eaton Inc.	191		
Clarostat Mfg. Co. Inc. Lescarboua Adv. Inc.	131	■ General Electric Company, Semiconductor Products Div. George R. Nelson Inc.	135		
■ Clifton Precision Products Company Ivey Advertising Inc.	24	General Radio Company K.E. Morange Company	2nd Cover		
Colorado, State of Buchen Advertising Inc.	58	General R-F Fittings Inc. Van Christo Associates	132		
Comcor Inc. Sub. of Astrodata Inc. Marketing Directions	73	Granger Associates West Associates	8		
Computer Test Corporation James Lees Advertising	189	Hamilton Watch Company Beaumont, Heller & Sperling Co.	198		
■ Control Switch Division, Control Co. of America Harry P. Bridge Company	180, 181				
Corning Glass Works, Electronics Division Rumrill-Hoyt Inc.	120				
Coors Porcelain Company Tallant/Yates Advertising	127				
■ Dale Electronics Inc. Swanson, Sinkey, Ellis Inc.	68				

Classified advertising

F. J. Eberle, Business Mgr.

EMPLOYMENT OPPORTUNITIES 210

EQUIPMENT
(Used or Surplus New)
For Sale 210

ADVERTISERS INDEX

Booz, Allen Applied Research Inc. 210
Emmons Electronics Supply Co. 211
Fishmen Co., Pa. 211
Harland Labs. 211
Radio Research Instrument Co. 211
Semiconductor Sales of Calif. 211
Surplus Saving Center 211
Universal Relay Corp. 211

■ For more information on complete product line see advertisement in the latest Electronics Buyers' Guide

Executive, editorial, circulation and advertising offices: McGraw-Hill Building, 330 West 42nd Street, New York, N.Y., 10036. Telephone (212) 971-3333. Teletype TWX N.Y. 212 640-4646. Cable: McGrawhill, N.Y. Officers of the McGraw-Hill Publications: Joseph H. Allen, President; Vice Presidents: J. Elton Tuohig, Operations; John R. Callahan, Editorial; Ervin E. DeGraff, Circulation; Donald C. McGraw, Jr., Advertising Sales; Angelo R. Venezian, Marketing. Officers of the Corporation: Donald C. McGraw, Chairman of the Board; Shelton Fisher, President; L. Keith Goodrich, Hugh J. Kelly and Robert E. Slaughter, Executive Vice Presidents; John J. Cooke, Vice President and Secretary; John L. McGraw, Treasurer. Title R registered U.S. Patent Office; © copyright 1966 by McGraw-Hill, Inc. All rights reserved, including the right to reproduce the contents of this publication, in whole or in part.

Electronics advertisers

April 18, 1966

■ Lapp Insulator Company Inc. Wolff Associates Inc.	62	Robinson/Nugent Creative House Inc.	194
■ Latronics Corporation Downing Inc. Adv.	151		
		Sangamo Electric Company Winius-Brandon Company	72
		Sealectro Corporation Lescarboursa Adv. Inc.	156
Machlett Laboratories Div. of Raytheon Co. Fuller & Smith & Ross Inc.	9	Semtech Corporation Burruss Advertising	190
■ Mallory & Company Inc. P.R. Aitkin Kynett Co. Inc.	71	■ Singer Company, Metrics Division Hepler & Gibney Inc.	157
■ Mallory & Company Inc. P.R., Battery Division Needham, Harper & Steers Inc.	60	Soliton Devices Inc. Haselmire Pearson Adv.	119
■ Markel & Sons, L. Frank George Moll Adv. Inc.	177	■ Sorensen & Company Inc. Div. of Raytheon James Advertising Inc.	11
Maryland Dept. of Economic Development Rosebush Advertising Agency Inc.	196	Speer Carbon Company Hazard Adv. Co., Inc.	43
Maryland Telecommunications Inc. Ray E. Finn Advertising	138	Sprague Electric Company Harry P. Bridge Company	5, 10, 16
Mecco Inc. Ray Ellis Adv. Corporation	205	Stackpole Carbon Company Meek & Thomas Inc.	53, 159
Metal Removal Company, The Advertising Producers	172	Struthers-Dunn Inc. Harry P. Bridge Company	203
Monsanto Company Foote, Cone & Belding Inc.	6	Sylvania Electric Products Inc. Tatham-Laird & Kudner Inc.	27 to 34
Motorola Semiconductor Products Inc. Lane & Bird Adv. Inc.	66, 148		
		TRW Inc. Fuller & Smith & Ross Inc.	144
The National Company J.J. Joslin Advertising	154	Taber Instrument Corporation Harold Warner Advertising	175
National Semiconductor Corp. Michel-Cather Inc.	206, 207	Tektronix Inc. Hugh Dwight Adv. Inc.	98
New England Instrument Company Impact Advertising Inc.	167	Telrex Laboratories George Homer Martin Associates	209
North Atlantic Industries Inc. Murray Heyert Associates	195	Texas Instruments Inc. Don L. Baxter Inc.	161
Nucleonic Products Company Enyart & Rose Adv. Inc.	7	Tobe Deutschmann Laboratories Engineered Advertising	182
Nytronics Inc. The Stukalin Adv. Agency	158	Tohoku Metal Industries Ltd. Kokusai Tsushin-Sha	156
		Transitron Electronic Corporation Larcom Randall Adv. Inc.	155
■ Ohmite Mfg. Company Fensholt Adv. Agency Inc.	59	Triplett Electrical Instrument Co. Burton Browne Adv.	75
		Ulano & Company Inc. Byrde, Richard & Pound Inc.	169, 199
		Ultronix Tallant/Yates Adv.	63
Pearson Electronic William E. Clayton & Associates Inc.	192	Union Carbide Corporation J.M. Mathes Inc.	133
Pennsalt Chemicals Corporation Aitkin-Kynett Co. Inc.	45	Unitrode Corporation Electronic Marketing Assistance	41
Perfection Mica Company, Magnetic Shield Div. Burton Browne Adv.	202	U.S. Naval Ship Missile Systems Buxton Adv. Agency	156
Philco Corporation, Lansdale Division Batten, Barton, Durstine & Osborn Inc.	36		
Philco Sierra Company Hal Lawrence Inc.	129	■ Vitro Electronics Corp. Buchen Advertising Inc.	202
		Wanlass Electric Company Leland Oliver Co. Inc.	147
RHG Electronics Labs. Inc. S.M. Sachs & Associates Inc.	177	Wood Electric Company L.K. Frank Co. Inc.	201
Radiation Inc. Basford Inc.	199		
Radio Corporation of America Al Paul Lefton Company	4th Cover		
■ Radio Frequency Labs. Inc. Keyes, Martin & Company	74	■ Zeltex Inc. Sturges & Associates	169
■ Radio Materials Co. Div. of P.R. Mallory Edro Adv. Inc.	186		
Raytheon Company Fuller & Smith & Ross	48		
Raytheon Company, Components Div. Fuller & Smith & Ross Inc.	106, 107, 162		



Advertising sales staff

Frank E. LeBeau [212] 971-2210
Advertising sales manager

Atlanta, Ga. 30309: Gus H. Krimsier,
Michael H. Miller, 1375 Peachtree St. N.E.,
[404] TR 5-0523

Boston, Mass. 02116: William S. Hodgkinson
McGraw-Hill Building, Copley Square,
[617] CO 2-1160

Chicago, Ill. 60611: Robert M. Denmead,
J. Bradley MacKimm
645 North Michigan Avenue,
[312] MO 4-5800

Cleveland, Ohio 44113: Paul T. Fegley, 55
Public Square, [216] SU 1-7000

Dallas, Texas 75201: Richard P. Poole, The
Vaughn Building, 1712 Commerce Street,
[214] RI 7-9721

Denver, Colo. 80202: Joseph C. Page, David
M. Watson, Tower Bldg., 1700 Broadway,
[303] 255-5484

Detroit, Michigan 48226: Paul T. Fegley
856 Penobscot Building
[313] 962-1793

Houston, Texas 77002: Kenneth George,
2270 Humble Bldg.,
[713] CA 4-8381

Los Angeles, Calif. 90017: Ian C. Hill,
John G. Zisch, 1125 W. 6th St.,
[213] HU 2-5450

Minneapolis, Minn. 55402: J. Bradley
MacKimm, 1104 Northstar Center
[612] 332-7425

New York, N. Y. 10036:
Donald R. Furth [212] 971-3615
Frank LeBeau [212] 971-3615
George F. Werner [212] 971-3615
500 Fifth Avenue

Philadelphia, Pa. 19103: William J. Boyle,
Warren H. Gardner, 6 Penn Center Plaza,
[215] LO 8-6161

Pittsburgh, Pa. 15222: Paul T. Fegley,
4 Gateway Center, [412] 391-1314

Portland, Ore. 97204: James T. Hauptli,
Pacific Building, Yamhill Street,
[503] CA3-5118

St. Louis, Mo. 63105: Robert M. Denmead
The Clayton Tower, 7751 Carondelet Ave.
[314] PA5-7285

San Francisco, Calif. 94111:
James T. Hauptli, 255 California Street,
[415] DO 2-4600

London W1: John W. Patten, Edwin S.
Murphy Jr., 34 Dover Street,
Hyde Park 1451

Milan: 1, via
Baracchini Phone: 86-90-617
86-90-656

Frankfurt/Main: Gerd Hinske, Joseph
Wuensch, 85 Westendstrasse
Phone: 77 26 65 and 77 30 59

Geneva: Michael R. Zeynel,
1, rue du Temple
Phone: 31 95 60

Paris VIII: Denis Jacob, 17 Avenue
Matignon ALMA-0452

Tokyo: Nobuyuki Sato, 1, Kotohiracho
Shiba, Minato-Ku [502] 0656

Osaka: Ryosi Kobayashi, 163, Umegee-cho,
Kita-ku [362] 8771

Wallace C. Carmichael [212] 971-3191
Manager Electronics Buyers' Guide

David M. Tempest: [212] 971-3139
Promotion manager

Milton Drake: [212] 971-3485
Market research manager

Wallace C. Carmichael [212] 971-3191
Business manager

Stephen R. Weiss [212] 971-2044
Production manager