

OCT 17 1966

NO LONGER

# Electronics®

w/D 10/14

The great IC design dilemma: page 68

October 17, 1966

Static and dynamic tests for IC's: page 93

75 cents

Finding faults automatically: page 103

A McGraw-Hill Publication

Below: Testing an MOS array as IC's fan a revolution: page 68

LIBRARY  
UNIVERSITY OF TENN. MED. UNITS  
MEMPHIS

LIBRARY  
UNIVERSITY OF TENN. MED. UNITS  
MEMPHIS

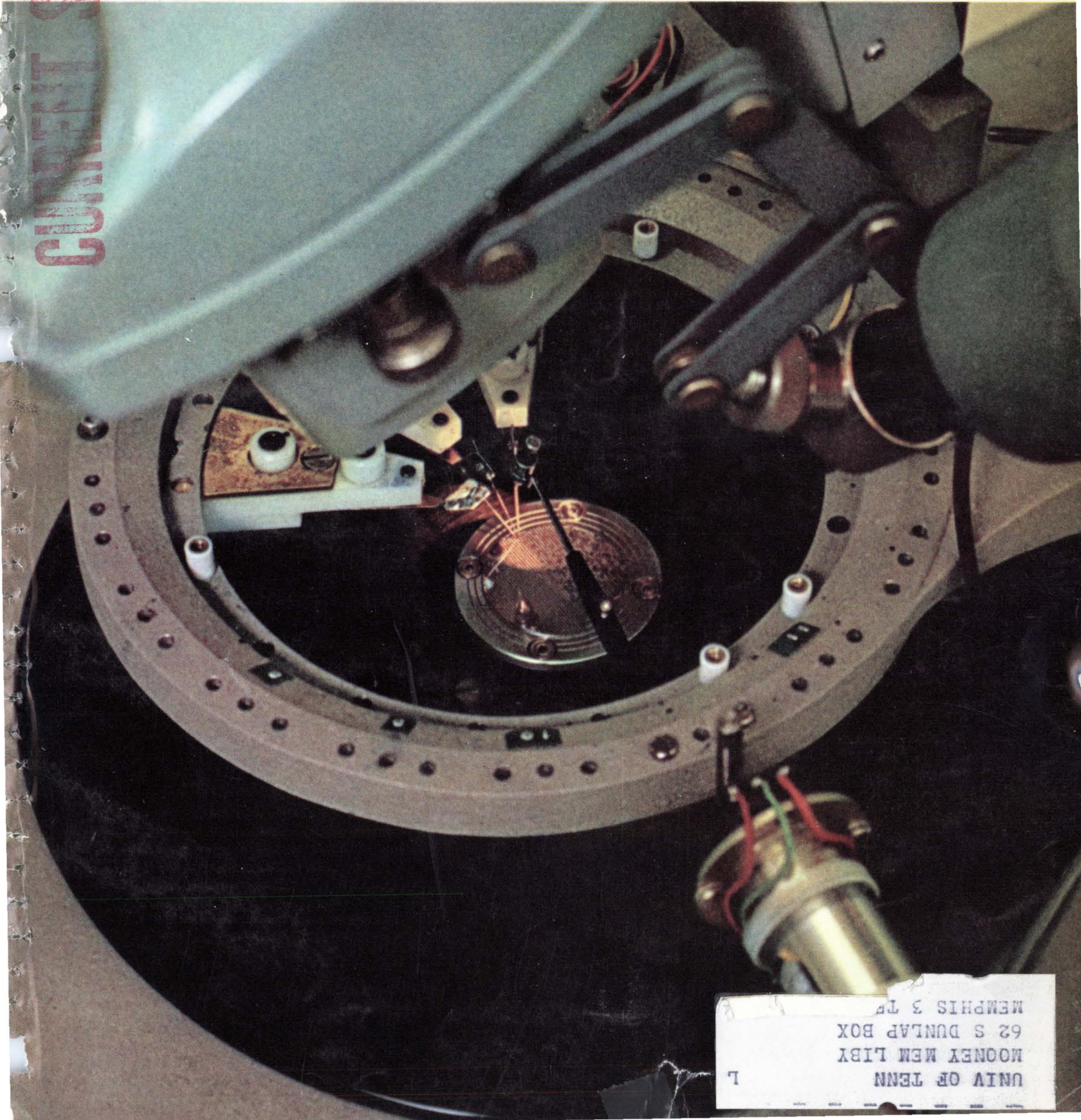

UNIV OF TENN  
MOONEY MEM LIBRY  
62 S DUNLAP BOX  
MEMPHIS 3 TN  
L





# "SPECIAL" (CUSTOM BUILT) FILTERS

## TO YOUR SPECIFICATIONS

ILLUSTRATED ARE  
TYPICAL SPECIAL FILTERS

RANGE OF FREQUENCIES ON SPECIAL UNITS  
IS FROM 0.1 CYCLE TO 400 MC.

Over thirty years of experience in the design and production of special filters have resulted in UTC being a first source for difficult units. Present designs both military and commercial incorporate a wide variety of core structures, winding methods, and capacitors to provide maximum performance, stability, and reliability. Fully experienced, top engineering talent backed by complete environmental testing and life testing facilities assure the highest standard in the industry. Full analysis and evaluation of materials are conducted in UTC's Material and Chemical Laboratories. Rigid quality control measures coordinated with exhaustive statistical findings and latest production procedures results in the industry's highest degree of reliability.

MILITARY AND COMMERCIAL TYPES FOR  
EVERY PHASE OF THE ELECTRONICS ART

POWER TRANSFORMERS • AUDIO TRANSFORMERS • INDUCTORS • PULSE TRANSFORMERS • ELECTRIC WAVE FILTERS • LUMPED CONSTANT DELAY LINES • HIGH Q COILS • MAGNETIC AMPLIFIERS • SATURABLE REACTORS • REFERENCE UNITS

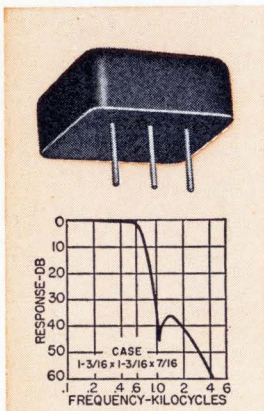

560 ~ Telemetering low pass filter. Available from 400 to 70 KC.  $\pm 7.5\%$  bandwidth flat to 1 db. Attenuation greater than 35 db beyond the 2nd harmonic of  $\pm 7.5\%$  frequency. Impedance 47K ohms. MIL-F-18327B. Wt. 0.8 oz.

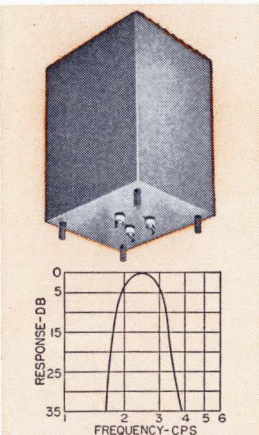

Low frequency band pass filter. Designed for 2.5 cps center frequency. At 2 to 3 cps within 3 db. At 1.5 cps and lower, and 4 cps and higher, greater than 30 db. Source and Load 10K ohms. Size: 4 x 4-11/16 x 6". MA MIL case, MIL-F-18327B.

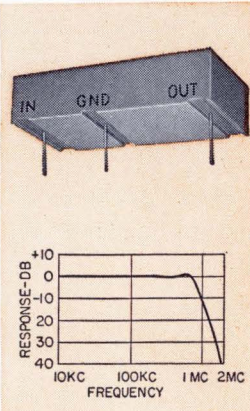

High frequency low pass filter. Zero to 700 KC within 1 db. 1.95 mc to 10 mc 40 db minimum. Source and Load 1000 ohms. Molded flat construction for printed circuit applications. Size: 1 x 2 x 1/2"; Wt: 1 oz. MIL-F-18327B.

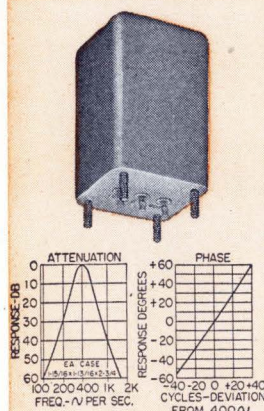

Band pass 400 cycle Gaussian filter. Linear phase response in pass band. Attenuation 380 cps to 420 cps within 0.5 db. 2nd harmonic down 25 db, 3rd harmonic down 45 db. Source and load 5K ohms. MIL-F-18327B Wt., 0.9 lbs.

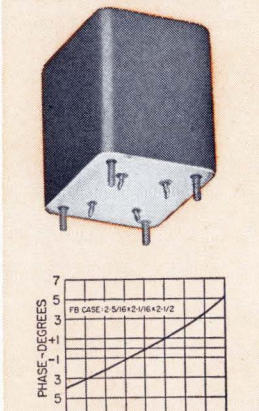

Minimum phase shift 400 cycle band pass filter. Within  $\pm 1.5$  db 370 to 430 cycles, greater than 45 db beyond 1100 cycles. 1K ohms to 100K ohms. MIL-F-18327B; 1 lb.

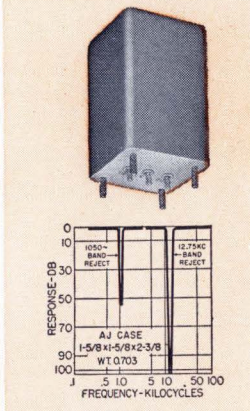

Band reject filters (two shown). The 1050 ~ filter has 50 db attenuation and is only 3 db at 950 and 1150 cycles. The 12.75 KC filter has more than 100 db attenuation and is only 3 db at 10.8 and 15 KC. Source and load 600 ohms, both are MIL-F-18327B.

Write for catalog of over  
1,300 UTC TOP QUALITY  
STOCK ITEMS  
IMMEDIATELY AVAILABLE  
from your local distributor.

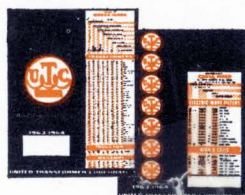

**UNITED® TRANSFORMER CO.**

DIVISION OF TRW INC. • 150 VARICK STREET, NEW YORK, N. Y. 10013



# missing link

between resistive transducer  
and data acquisition system...

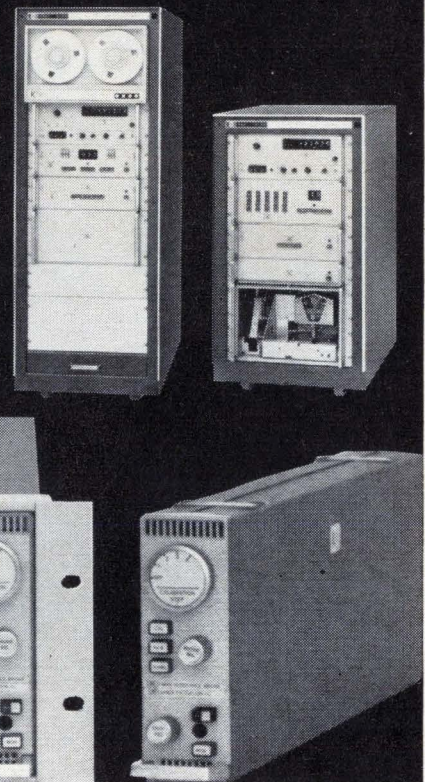

**found-**  
in a new series of  
high-performance  
signal conditioning equipment...

LIBRARY  
UNIVERSITY of TENN. MED. UNITS  
MEMPHIS

Getting accurate low-level signals from a transducer into today's high-performance data acquisition systems was always a problem... until the new Hewlett-Packard 2480 Series Signal Conditioners came along.

The 2480's are flexible, operate more accurately in the presence of noise, are compact and completely self-contained, offer performance never before available for improving the usefulness of transducer signals and increase the value of even the most sophisticated data acquisition systems.

This combination of features makes the 2480 Series provide the data acquisition missing link:

- Stable built-in transducer excitation source, constant current/constant voltage, plus a unique linear mode for single active arm bridges
- Plug-in signal conditioning card flexibility for a wide variety of transducer configurations
- Fully floating and guarded for conditioning noisy signals (can't contribute to common mode problems)
- All this in a single, rugged package that fits 10 to 5 $\frac{1}{4}$ "-high rack
- Operates under extreme environmental conditions

The first instruments in the series include dc excitation, resistance bridge balance and calibration, excitation coupler and monitor selector...everything you need for fast, efficient operation of data acquisition systems working in a broad network of measurement points. Excitation modules can be adjusted to drive up to five conditioning units. Additionally, the excitation coupler allows you to excite a number of transducers and condition a number of signals with a single external power supply.

Hewlett-Packard's experience with high-quality, standard data acquisition systems led its Dymec Division to develop this new instrumentation, formerly a limitation on overall system accuracy. You owe it to yourself to check a data sheet on the flexible 2480's and accessory equipment. Excitation/conditioning units with individual built-in power supplies are available, priced from \$310 per channel.

Call your Hewlett-Packard field engineer for complete information or write Hewlett-Packard, Palo Alto, California 94306, Tel. (415) 326-1755; Europe: 54 Route des Acacias, Geneva.

*Data subject to change without notice. Prices f.o.b. factory.*

HEWLETT  
PACKARD  DYMEC  
DIVISION



# Bring on your complex, small, noisy, difficult signals.

We'll give you traces that show them for what they really are.

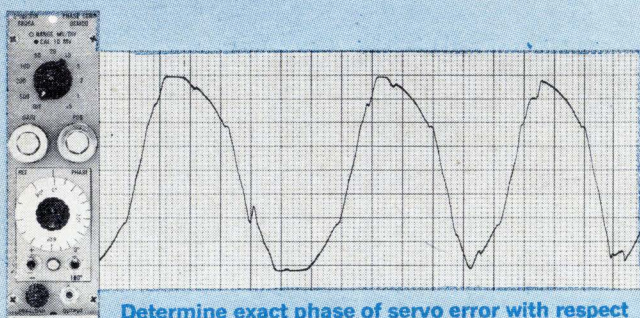

Determine exact phase of servo error with respect to reference signal of 60 Hz to 5 kHz while maximizing rejection of quadrature component.

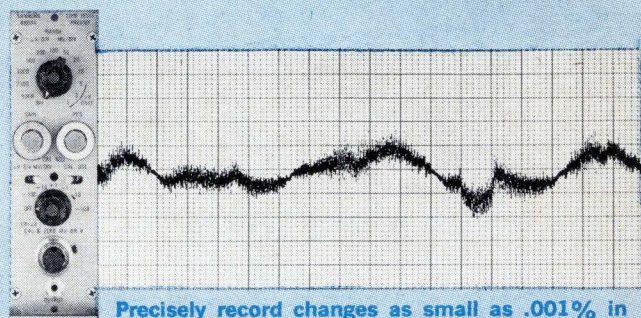

Precisely record changes as small as .001% in DC-100 Hz signals by using calibrated zero suppression.

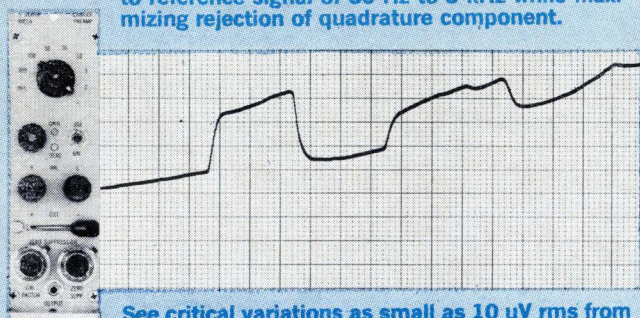

See critical variations as small as 10 uV rms from strain gages, other AC-excited transducers.

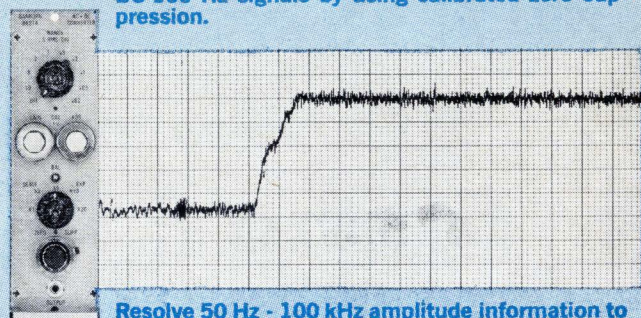

Resolve 50 Hz - 100 kHz amplitude information to 0.02% of full scale signals from 1 volt to 500 volts.

When you need the greatest possible degree of signal-conditioning precision and operational control, Sanborn 7700 Series oscillographs with solid-state "8800" plug-ins will give you chart recordings of maximum resolution and intelligibility.

Seven highly versatile signal conditioners offer unique performance capabilities: three DC types with a 1 uV - 250 V dynamic range, floating differential input and calibrated zero suppression . . . an AC-DC Converter with calibrated zero suppression and scale expansion permitting resolution better than 0.1%, 10 ms response and isolated, 1 meg. input . . . a phase-sensitive demodulator with calibrated reference phase shift, 90° calibrated dial with four quadrant selections, and a frequency range of 60 Hz to 5 kHz . . . a carrier preamp with 2400 Hz internal transducer excitation supply, calibrated zero suppression, cal. factor control and conversion gain of 10,000 . . . and a general-purpose DC preamp particularly useful for 100 mm wide chart recording.

Use any of these "8800" plug-ins in the 7700 thermal writing oscillograph matched to your packaging and channel requirements — 4-, 6- and 8-channel 7704A, 7706A and 7708A console types . . . 2-channel 7702A system in rack-mount or mobile cart versions . . . single-channel 7701A wide chart (100 mm) portable system. Every one of these thermal writers will give you permanent, rectangular-coordinate recordings whose resolution and accuracy make all your measurements more useful.

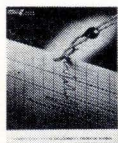

For a new brochure describing the advantages and wide choice of Sanborn thermal writing oscillographs, write Hewlett-Packard Company, Sanborn Division, 175 Wyman Street, Waltham, Mass. 02154.



HEWLETT  
PACKARD  SANBORN  
DIVISION



## News Features

### Probing the News

- 125 Semiconductor technology steps up
- 129 Laser may light ocean depths
- 133 Changing of the guard
- 137 U.S. invites NATO to share satellite

### Electronics Review

- 35 **Space electronics:** Getting off the ground . . . and through space
- 36 **Instrumentation:** Safety on the range
- 37 **Tracking:** Getting out of the hole
- 38 **Advanced technology:** Trend-setter
- 40 **Communications:** Costly split
- 40 **Software:** The BOLD librarian
- 42 **Medical electronics:** New breed
- 42 **Industrial electronics:** DDC comes home
- 44 **Packaging:** Integrated plumbing
- 46 **Electronics notes**

### Electronics Abroad

- 221 **Italy:** Soviet excursion
- 221 **Japan:** Brighter future: Sony's IC radio
- 223 **West Germany:** Uncoiled
- 223 **France:** Computer czar
- 224 **Sweden:** Wave of affluence
- 224 **New Zealand:** Static on network
- 225 **Around the world**

### Departments

- 4 Readers Comment
- 8 People
- 14 Meetings
- 16 Meeting Preview
- 23 Editorial
- 25 Electronics Newsletter
- 49 Washington Newsletter
- 155 New Products
- 203 New Books
- 206 Technical Abstracts
- 209 New Literature
- 219 Newsletter from Abroad

## Technical Articles

### I. Design

- Microelectronics** 68 **Integrated circuits in action: part 1 (cover)**  
**The great design dilemma**  
The first of a series of articles on the use of IC's examines the engineering problems facing designers and describes a variety of solutions  
Donald Christiansen, senior associate editor
- 74 **IC computer family tree**  
How an experimental project produced an impressive variety of IC multilayer packaging techniques
- 79 **In color, the IC picture**  
A group of photographs showing IC's from test to application
- Circuit design** 88 **Designer's casebook**
  - IC amplifier provides variable reference voltage
  - Reducing transients in switched inductive loads
  - Logarithmic amplifier has 66-db range
  - Low-frequency oscillator supplies high pulse power
  - Cross-coupled transistors form balanced mixer

### II. Application

- Instrumentation** 93 **Pattern of tests changing for IC's**  
Complex circuits and arrays demand new testing techniques  
Carl Moskowitz, instrumentation editor
- 94 **A-c testing of wafer components sounds early circuit warning**  
Quick check catches defective wafers before they are packaged  
John Kardash and Martin S. Cohen, Sylvania Electric Products, Inc.
- 98 **Large-scale logic arrays: testing for the millions**  
Advanced logic system zips through d-c test schedules at 5,000 permutations per second  
James W. Lind, International Business Machines Corp.
- Avionics** 103 **Built-in testing, once a luxury, essential to mission success**  
A two-part article describes principles and application of in-flight testing techniques  
H. Kelly Grounds, Hughes Aircraft Co.



# Electronics

**Editor-in-Chief:** Lewis H. Young

**Senior editors**

**Design:** Samuel Weber

**Application:** George Sideris

**News:** Kemp Anderson Jr.

**Assistant to the editor:** Sally Powell

**Senior associate editors:** John F. Mason, Donald Christiansen, Robert Henkel, Joseph Mittleman

**Department editors**

**Avionics:** W.J. Evezia

**Communications:** Leonard Weller

**Computers:** Wallace B. Riley

**Design theory:** Joseph Mittleman

**Electronics abroad:** Arthur Erikson

**Electronics review:** Stanley Zarowin

**Industrial electronics:** Alfred Rosenblatt

**Instrumentation:** Carl Moskowitz

**Military electronics:** John F. Mason

**New products:** William P. O'Brien

**Special projects:** Donald Christiansen

**Staff writer:** Jan Rahm

**Regional Bureaus**

**Domestic**

**Boston:** Thomas Maguire, manager; Robin Carlson

**Los Angeles:** William B. Wallace, manager; June Ranill

**San Francisco:** Walter Barney, manager; Mary Jo Jadin

**Washington:** Robert W. Henkel, manager; William D. Hickman, John Rhea, correspondents; Patricia C. Hoehling

**Foreign**

**Bonn:** John Gosch

**Tokyo:** Charles Cohen

**Copy editors**

James J. Moran, David Goller, William Olcott

**Graphic design**

**Art director:** Saul Sussman

**Assistant art director:** Ann Mella

**Production editor:** Arthur C. Miller

**Editorial secretaries:** Claire Benell, Lynn Emery, Lorraine Fabry, Kay Fontana, Patricia Gardner, Lorraine Longo

**McGraw-Hill News Service**

**Director:** John Wilhelm; **Atlanta:** Fran Ridgway; **Chicago:** Reck Johnson;

**Cleveland:** Arthur Zimmerman; **Dallas:** Marvin Reid;

**Detroit:** N. Hunter; **Houston:** Ron Lovell; **Los Angeles:** Michael Murphy, Gerald Parkinson

**San Francisco:** Margaret Drossel

**Seattle:** Ray Bloomberg; **Washington:** Arthur L. Moore, Charles Gardner,

Herbert W. Cheshire, Seth Payne, Warren Burkett, Warren Kornberg

**McGraw-Hill World News Service**

**Bonn:** John Johnsrud; **London:** John Shinn;

**Mexico City:** Bruce Cross; **Milan:** Ronald Taggiasco;

**Moscow:** Howard Rausch; **Paris:** Peter Kilborn;

**Rio de Janeiro:** Wes Perry; **Tokyo:** Marvin Petal

**Circulation and Research Manager:** Milton Drake

**Publisher:** Gordon Jones

**Electronics: October 17, 1966, Vol. 39, No. 21**

Published every other Monday by McGraw-Hill, Inc. Founder: James H. McGraw 1860-1958.

Printed at 99 North Broadway, Albany, N.Y. 12207; second class postage paid at Albany, N.Y.

Executive, editorial, circulation and advertising addresses: McGraw-Hill Building, 330 W. 42nd Street, New York, N.Y. 10036. Telephone (212) 971-3333. Teletype TWX N.Y. 212-640-4646. Cable address: MCGRAWHILL N.Y.

Subscriptions are solicited only from those actively engaged in the field of the publication. Position and company connection must be indicated on orders. Subscription prices: United States and possessions and Canada, \$6.00 one year, \$9.00 two years, \$12.00 three years; all other countries, \$20.00 one year. Single copies: United States and possessions and Canada, 75¢; all other countries, \$1.50.

Officers of McGraw-Hill Publications: Joseph H. Allen, President; Bayard E. Sawyer, Executive Vice President; Vice Presidents: J. Elton Tuohig, Operations; John R. Callahan, Editorial; Donald C. McGraw, Jr., Marketing; John M. Holden, Marketing Services; Huber M. Gemmill, Circulation; Angelo R. Venezan, Production; Robert M. Wilhelmy, Controller.

Officers of the Corporation: Donald C. McGraw, Chairman of the Board; Shelton Fisher, President; L. Keith Goodrich, Hugh J. Kelly and Robert E. Slaughter, Executive Vice Presidents; John J. Cooke, Vice President and Secretary; John L. McGraw, Treasurer.

Title © registered in U.S. Patent Office; © Copyright 1966 by McGraw-Hill, Inc. All rights reserved. The contents of this publication may not be reproduced either in whole or in part without the consent of copyright owner.

**Subscribers:** The publisher, upon written request to our New York office from any subscriber, agrees to refund that part of the subscription price applying to copies not yet mailed. Please send change of address notices or complaints to Fulfillment Manager; subscription orders to Circulation Manager, Electronics at address below. Change of address notices should provide old as well as new address, including postal zip code number. If possible, attach address label from recent issue. Allow one month for change to become effective.

**Postmaster:** Please send form 3579 to Fulfillment Manager, Electronics, P.O. Box 430, Hightstown, New Jersey 08520

## Readers Comment

### Something to learn

To the Editor:

In the article "Training a machine to read with nonlinear threshold logic" [Aug. 22, 1966, p. 86], we find such statements as "The brain, using fairly simple logic elements . . ." and ". . . its operation resembles the workings of the human brain." To call the biological nerve cell a "fairly simple logic element" is sheer nonsense. Further, to say that a pattern recognition device "resembles the workings of the human brain" is to stretch all credibility.

The statement that "nonlinear threshold logic can handle a greater number of functions than can linear threshold logic" must be made with care. For, as even the authors point out, any nonlinear threshold function can be performed by combining linear ones.

As an example, we have developed a machine which is very similar to that described by the authors. It is called Learn, for Logic Evaluator and Adaptive Recognition Network.

Learn is no more complex than the device of the authors, and is far more versatile, yet it uses a digital implementation of linear threshold techniques and has the following properties:

- Patterns consisting of nine binary variables may be categorized, through a "punish" only system, into four independent binary outputs as opposed to the single binary output of the authors' device.

- Learn may be trained to perform any logic function, or pattern recognition task, of nine variables categorized into four independent outputs (there are  $16^{512}$ , or about  $10^{660}$  such functions). That is, Learn is logically complete.

- Only one pass training is required, i.e., presenting the training patterns once is sufficient.

- Learn can be selectively set to generalize, or not generalize, e.g., if trained to recognize a pattern consisting of a vertical bar it will, on "generalize," recognize all vertical bars, or if taught to recognize the letter "T" it will, on "generalize," recognize the letter "T" right-side up or upside down.



# Did You Know Sprague Makes 51 Types of Foil and Wet Tantalum Capacitors?

## FOIL-TYPE RECTANGULAR TANTALEX® CAPACITORS



Type 300D polarized plain-foil  
Type 301D non-polarized plain-foil  
Type 302D polarized etched-foil  
Type 303D non-polarized etched-foil

ASK FOR BULLETIN 3650

Circle 338 on reader service card

## FOIL-TYPE TANTALUM CAPACITORS TO MIL-C-3965C

CL20, CL21 tubular 125 C polarized etched-foil  
CL22, CL23 tubular 125 C non-polar etched-foil  
CL24, CL25 tubular 85 C polarized etched-foil  
CL26, CL27 tubular 85 C non-polar etched-foil  
CL30, CL31 tubular 125 C polarized plain-foil  
CL32, CL33 tubular 125 C non-polar plain-foil  
CL34, CL35 tubular 85 C polarized plain-foil  
CL36, CL37 tubular 85 C non-polar plain-foil  
CL51 rectangular 85 C polarized plain-foil  
CL52 rectangular 85 C non-polar plain-foil  
CL53 rectangular 85 C polarized etched-foil  
CL54 rectangular 85 C non-polar etched-foil

Circle 339 on reader service card

## 125 C FOIL-TYPE TUBULAR TANTALEX® CAPACITORS



Type 120D polarized plain-foil  
Type 121D non-polarized plain-foil  
Type 122D polarized etched-foil  
Type 123D non-polarized etched-foil

ASK FOR BULLETIN 3602C

Circle 337 on reader service card

## 85 C FOIL-TYPE TUBULAR TANTALEX® CAPACITORS



Type 110D polarized plain-foil  
Type 111D non-polarized plain-foil  
Type 112D polarized etched-foil  
Type 113D non-polarized etched-foil

ASK FOR BULLETIN 3601C

Circle 340 on reader service card

## SINTERED-ANODE TUBULAR TANTALEX® CAPACITORS



Type 109D elastomer seal 85 C  
Type 130D elastomer seal 125 C  
Type 137D hermetic seal 125 C

ASK FOR BULLETINS 3700F, 3701B, 3703

Circle 341 on reader service card

## SINTERED-ANODE CUP STYLE TANTALEX® CAPACITORS



Type 131D 85 C industrial-type  
Type 132D 85 C vibration-proof  
Type 133D 125 C vibration-proof

ASK FOR BULLETINS 3710B, 3711

Circle 342 on reader service card

## SINTERED-ANODE CYLINDRICAL TANTALEX® CAPACITORS



Type 140D  
up to 175 C operation,  
1/8" diam.  
Type 141D  
up to 175 C operation,  
1 1/8" diam.

ASK FOR BULLETIN 3800

Circle 343 on reader service card

## SINTERED-ANODE RECTANGULAR TANTALEX® CAPACITORS



Type 200D negative terminal grounded  
Type 202D both terminals insulated

ASK FOR BULLETIN 3705A

Circle 344 on reader service card

## SINTERED-ANODE TANTALUM CAPACITORS TO MIL-C-3965C

CL14 cylindrical, 7/8" diam.  
CL16 cylindrical, 7/8" diam., threaded neck  
CL17 cylindrical, 1 1/8" diam.  
CL18 cylindrical, 1 1/8" diam., threaded neck  
CL44 cup style, uninsulated  
CL45 cup style, insulated  
CL55 rectangular, both terminals insulated  
CL64 tubular, uninsulated  
CL65 tubular, insulated

Circle 345 on reader service card

For comprehensive engineering bulletins on the capacitor types in which you are interested, write to:  
Technical Literature Service  
Sprague Electric Company  
35 Marshall Street  
North Adams, Mass. 01248

45C-5158 R1

**SPRAGUE**  
THE MARK OF RELIABILITY

Sprague® and "®" are registered trademarks of the Sprague Electric Co.





Type 1568-A Wave Analyzer

## New Wave Analyzer

# 1% Bandwidth

## plus

**Complete Portability** — all solid-state, operates from power line or built-in rechargeable battery, measures 13 x 13 x 8 inches and weighs 21½ pounds.

**Highly Selective Filtering** — bandwidth is 1% of center frequency; attenuation at twice and at one-half of center frequency is at least 75 dB; ultimate attenuation is over 85 dB.

**Accurate Frequency Calibration** — ±1% of reading over entire 20-Hz to 20-kHz range; logarithmic for maximum resolution at lower frequencies.

**Negligible Internal Distortion** — input-circuit distortion is at least 80 dB below input signal level.

**100-Microvolt to 300-Volt Range** — can be extended to 10 µV with accessory preamplifier (Type 1560-P40 J — \$184)

**Wide Dynamic Range** — at least 75 dB between overload and noise for signal levels above 30 millivolts; output allows convenient spectrum recording, especially with the Type 1521-B Graphic Level Recorder.

**Low Cost** — Price is \$1350 in U.S.A.

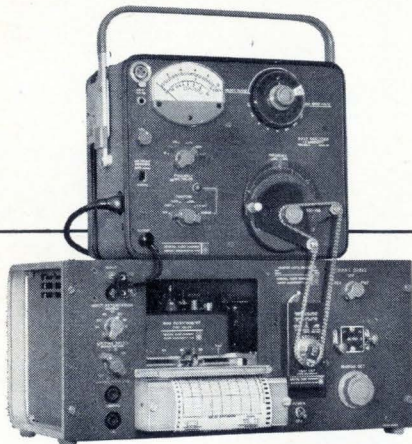
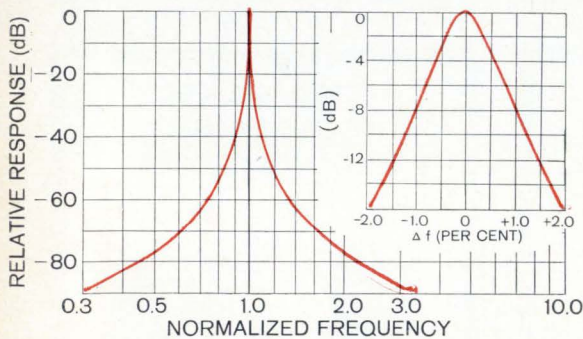

### Automatic Narrow-Band Spectrum Recording:

You need only add the Type 1521-B Graphic Level Recorder to the Type 1568-A Wave Analyzer for automatic spectrum recording and analysis. The combination features wide dynamic

range (at least 75 dB), automatic stepping of frequency ranges, broad selection of chart and writing speeds, and simple operation.

Type 1521-B . . . \$1095 in U.S.A.

BOSTON • NEW YORK • CHICAGO • PHILADELPHIA • WASHINGTON, D.C.  
SYRACUSE • DALLAS • SAN FRANCISCO • LOS ANGELES • ORLANDO  
CLEVELAND • TORONTO • MONTREAL

BOURNE END, ENGLAND      ZURICH, SWITZERLAND

# GENERAL RADIO

WEST CONCORD, MASSACHUSETTS



▪ Learn may be trained to recognize a set of patterns with any degree of noise immunity. For example, if Learn were trained to recognize a set of patterns, it may then be set to recognize these patterns even though any "N" bits (where N is selectable) in the patterns are changed due to noise.

▪ Noise immunity and generalization may also be combined. For example, if Learn were trained to recognize the previously mentioned single pattern of a 3 unit vertical bar while set on "generalize" and two bits of noise immunity, it would now recognize all three possible vertical bar patterns plus of these three patterns.

▪ Learn does not require any pre-selection of bit combinations.

Richard J. Bouchard  
Advanced Development Lab  
Sanders Associates, Inc.  
Nashua, N.H.

#### The author replies:

I agree that the analogy of an artificial intelligence system and the brain is frequently an over-worked simplification. In our article, we intended this analogy to serve merely as a starting point in introducing general concepts.

The statement that "nonlinear threshold logic can handle a greater number of functions than can linear threshold logic" was based on the capacities of a single circuit of either type.

The comparison of Learn and our trainable pattern recognizer does not support the conclusion that nonlinear threshold logic has no advantage over linear threshold logic. First, he does not state that the device uses linear threshold logic, but rather that it uses linear

threshold techniques. Without having more information, I have to question the statement that it uses an equivalent implementation.

Our device can also be trained with a "punish" only strategy; however, the addition of "reward" makes demonstrations of alternate training strategies possible. Having four binary outputs rather than one would simply require an extension of storage.

Some properties of Learn suggest that the device does not use linear threshold logic, and that it essentially "stores" correct outputs rather than "learns" them.

The manner in which Learn generalizes was probably carefully selected beforehand and designed into the device. If "generalize" is turned on when the letter "T" is present, it may recognize an inverted "T," but generalization in some other way may be desired. For example, it might be desired to recognize all patterns having a "1" in the center. Also, it seems as though using "generalize" when "T" is present should cause generalization with respect to vertical bars and horizontal bars, thus causing all characters with either type bars to be recognized as a "T."

The noise immunity feature of Learn could have undesirable aspects. Introducing a noise immunity effective for any "N" bits is bound to make the separation of certain characters, such as "O" and "Q" or "P" and "F," quite difficult, if not impossible. Our device learns to perform noise immunity (and generalization) selectively.

Preselection of bit combinations is not a requirement in our device.

E.D. Hietanen

Bendix Corp.  
Southfield, Mich.

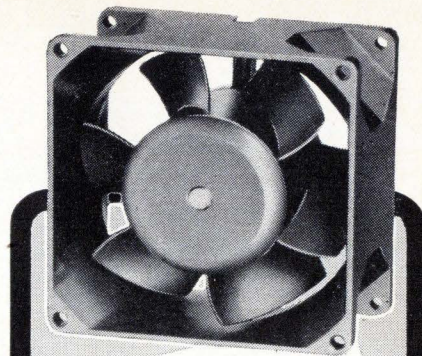

**65 cfm  
in a  
3 1/2" Package!**

## PAMOTOR Model 3000 Miniature Axial Fans

- 20,000+ operational hours at 45°C
- All metal construction
- Low-cost design
- Maximum air delivery at higher back pressures
- Unexcelled performance and reliability
- 50-60 cycles at 110 or 220 vac

**IN STOCK FOR  
IMMEDIATE DELIVERY!**

Write for technical data on the Model 3000 and other PAMOTOR axial fans to:

**PAMOTOR, INC.**  
312 SEVENTH STREET • SAN FRANCISCO, CALIF.

### SUBSCRIPTION SERVICE

Please include an Electronics Magazine address label to insure prompt service whenever you write us about your subscription.

Mail to: Fulfillment Manager  
Electronics  
P.O. Box 430  
Hightstown, N.J. 08520

To subscribe mail this form with your payment and check  new subscription  renew my present subscription

Subscription rates: in the U.S.: 1 year, \$6; two years, \$9; three years, \$12. Subscription rates for foreign countries available on request

### CHANGE OF ADDRESS

ATTACH  
LABEL  
HERE

If you are moving, please let us know five weeks before changing your address. Place magazine address label here, print your new address below.

name

address

city

state

zip code



# 414 STANDARD MODELS...

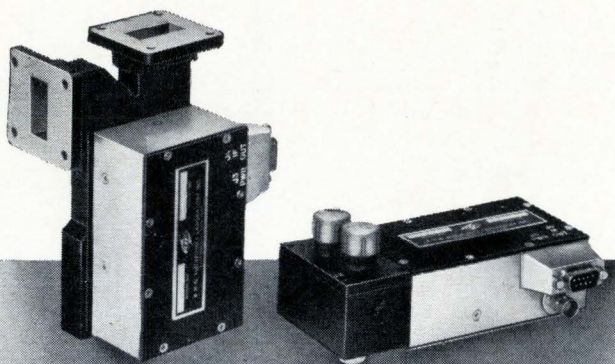

## RHG MIXER PREAMPLIFIERS

### FEATURING

- SSB Noise figures to 7.0 db • "G" Series or "hot-carrier" diodes • MIL Grade • RFI Protected • Coaxial or Waveguide • Ultraminiature models

### RANGE OF SPECIFICATIONS

RF Frequency:	250 MHz to 36 GHz
IF Frequency:	10 MHz to 300 MHz
IF Bandwidth:	2 MHz to 250 MHz
Gain:	20 db to 80 db
Price:	From \$525

Utilizing a complete complement of microwave test instrumentation backed by engineering know-how, an additional **346 CUSTOM DESIGNS** have been produced. The solution to your problem may be on file in our library now.

For specials, test our ONE-DAY-QUOTE Service. For standards, see complete listing in EEM Section 3400.

# RHG

**RHG ELECTRONICS LABORATORY, INC.**

94 Milbar Blvd., Farmingdale, L.I., N.Y. 11735 ■ (516) 694-3100

MICROWAVE FM and AM RECEIVERS ■ MICROWAVE MIXER PREAMPS  
LINEAR and LOG IF AMPLIFIERS ■ RF and OCTAVE AMPLIFIERS

NEREM BOOTH IH25

## People

In the 200 years since Benjamin Franklin set up postal service in this country the department has not hastened to take advantage of engineering advances to facilitate the swift completion of its appointed rounds.



Now along comes **Leo S. Packer**, the new assistant postmaster general for research and engineering, a man who thrives on challenge, and he aims to change the picture.

After four months in the department and only one month in his new assignment, Packer is talking about initiating the application of new technology.

**More money.** The basic change in Post Office procedures began with the appointment in November, 1965, of Postmaster General Lawrence O'Brien, who recognized the value of engineering and threw his weight behind a program to streamline the operation. O'Brien's efforts led to a doubling of the research budget—from \$8 million last year to \$16 million in the current fiscal year. The new postmaster general started a talent hunt for quality engineers and moved to make the research operation a bureau within the department with an assistant postmaster general at its head. The search led to the appointment of Packer.

**Automation.** Now Packer is searching for ideas. He lists as possibilities the use of computers to simulate post office problems and the introduction of reliability and value engineering techniques developed in the aerospace industry.

Automation has already been introduced with the use of a machine that sorts out odd-shaped pieces of mail and another that aligns a stack of mail and cancels the stamps. The department is working to develop optical readers that can interpret handwriting on envelopes.

However, much more automated equipment will be needed to keep pace with the recent explosive growth of mail volume in the



**This one  
MOS array  
is every  
bit as  
good  
as 32  
integrated  
circuits.**

**(And it costs less.)**



## **Meet our pL5216 MOS shift register.**

It has 32 bits, arranged in a flexible dual-16 sequence. It costs \$44.60 (in lots of 50-199). Or, about \$1.39 a bit. And it meets military environmental requirements.

Meets mil specs for \$1.39 a bit?

Naturally! *This* shift register is MOS.

Compatibility can easily be achieved with any integrated circuits you plan to use in your system. (Much as we'd like to see you convert all the way to MOS.) Power supply range is from -12 V to -20 V; clocks -22 V to -27 V. Frequency range is from 10 kHz to 1 MHz minimum.

Since all bits are stored in individual registers

under direct control, bits cannot be lost due to wide temperature variations.

Our MOS shift register and its companion unit—the pL4G01 dual 4-input gate—are widely tolerant. They can be used in: memory elements, counters, arithmetic units, frequency dividers, numeric filters, digital differential analyzers.

Call for the name of your nearest distributor. **Philco Microelectronics Division Sales Offices:** 2920 San Ysidro Way, Santa Clara, California (408-245-2966) / 999 North Sepulveda, El Segundo, California (213-772-6226) / 594 Marrett Road, Lexington, Mass. (617-862-6000) / Benson Manor, Suite 114B, Washington Lane, Jenkintown, Pa. (215-885-0430) / 1215 Drew Street, Clearwater, Florida (813-446-0124) / 815 Connecticut Avenue, N. W., Washington, D. C. (202-965-0903).

**Microelectronics Division** | **PHILCO.**  
SANTA CLARA, CALIF. • LANSDALE, PA. • SPRING CITY, PA. | A SUBSIDIARY OF *Ford Motor Company.*



**New from Sprague!**

# TW-3000

## MICROPOWER PNP SILICON HIGH-SPEED SWITCHING TRANSISTORS

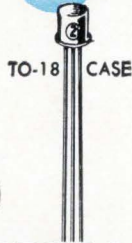

TYPICAL  
SWITCHING TIMES  
AS A FUNCTION OF  
COLLECTOR CURRENT  
AT 25°C WITH  
 $V_{CC} = 3V$ .

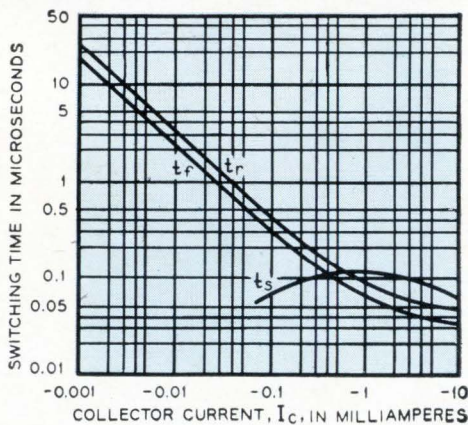

Fastest switching transistor available in the 1 to 100  $\mu A$  range.

$C_{ib} = 0.7$  pF typ., 1.5 pF max.

$C_{ob} = 1.5$  pF typ., 2.5 pF max.

Sprague Electric also makes more than 200 standard SEPT® (Silicon Epitaxial Planar Transistor) Types, including 2N2218A-2N2222A, 2N2904A-2N2907A, 2N2369A, and 2N3209.

For complete information, write to Technical Literature Service, Sprague Electric Co., 35 Marshall St., North Adams, Mass. 01247

### SPRAGUE COMPONENTS

TRANSISTORS	PACKAGED COMPONENT ASSEMBLIES
CAPACITORS	FUNCTIONAL DIGITAL CIRCUITS
RESISTORS	MAGNETIC COMPONENTS
INTEGRATED CIRCUITS	PULSE TRANSFORMERS
THIN-FILM MICROCIRCUITS	CERAMIC-BASE PRINTED NETWORKS
INTERFERENCE FILTERS	PULSE-FORMING NETWORKS



\*Sprague\* and \*®\* are registered trademarks of the Sprague Electric Co.

### People

United States. The department now handles 80 billion pieces of mail a year and Packer wants to move it faster and cheaper.

**Background.** Packer is the first PhD to run the department's engineering operation. New to Government service, the 46-year-old Romanian-born engineer spent 10 years in the academic world as head of the instrumentation section at Cornell Aeronautical Laboratory at Cornell University. From 1959 to 1962 Packer worked at the space and defense division of Bausch & Lomb, Inc., and then moved to the Xerox Corp., where he served as engineering manager. He earned his bachelor's degree at the City College of New York, his master's at Harvard University and his doctorate in engineering at Cornell.

The Westinghouse Electric Corp. has established an ocean research laboratory in San Diego, Calif., to back up its current activities in oceanographic engineering. Appointed as director is **Roy D. Gaul**, erstwhile senior research scientist with the department of oceanography at Texas A&M.



Engineering programs that will receive support from the new group are the Deepstar Fleet, a worldwide underseas exploration service, and other projects that involve oceanographic sensing equipment, sonar systems, life-support apparatus and underseas weapon systems. Another major function of the group will be to furnish basic research guidance for long-range oceanographic planning. Initially, teams will study ocean circulation, deep scattering layers, wave generation and measurement techniques with the ultimate goal of developing new instruments.

Although new at Westinghouse, basic oceanographic research is already under way at such corporations as the General Electric Co. and Lockheed Aircraft Corp.





# MACHLETT ML-8618 magnetically beamed triode requires 10 to 100 times lower drive

	IN PULSE SERVICE		IN RF TELEGRAPHY AMPLIFIER/OSCILLATOR SERVICE	
	ML-8618	Conventional Triode	ML-8618	Conventional Triode
Power Output	6 megawatts	6 megawatts	200 kilowatts	200 kilowatts
Driving Power	2.5 kilowatts	400 kilowatts	0.7 kilowatts	7.2 kilowatts
Filament Power	2.5 kilowatts	4.0 kilowatts	2.5 kilowatts	4.0 kilowatts

**RESULT: ML-8618 reduces pulse driving power by a factor of 100 or better.**

**RESULT: ML-8618 reduces rf driving power by a factor of 10 or better.**



Machlett's exclusive development, magnetically beamed tubes like the ML-8618 give you these advantages:

- By magnetically controlling the trajectory, electrons from the cathode bypass the grid structure so that nearly all emitted electrons reach the anode.
- Grid current is very low because of the great reduction in grid interception—about 3% as compared to 25% in conventional triodes.
- Low grid current means that grid dissipation no longer limits tube power.
- Parallel plane electrode structure eliminates "shielded" portion of filaments, permits 360° of the cathode surface to face anode surface and complete use is made of the filaments emission surface—result is higher cathode current per watt of heating power.

For details, write The Machlett Laboratories, Inc., Springdale, Conn. 06879.



**THE MACHLETT LABORATORIES, INC.**

A SUBSIDIARY OF RAYTHEON COMPANY



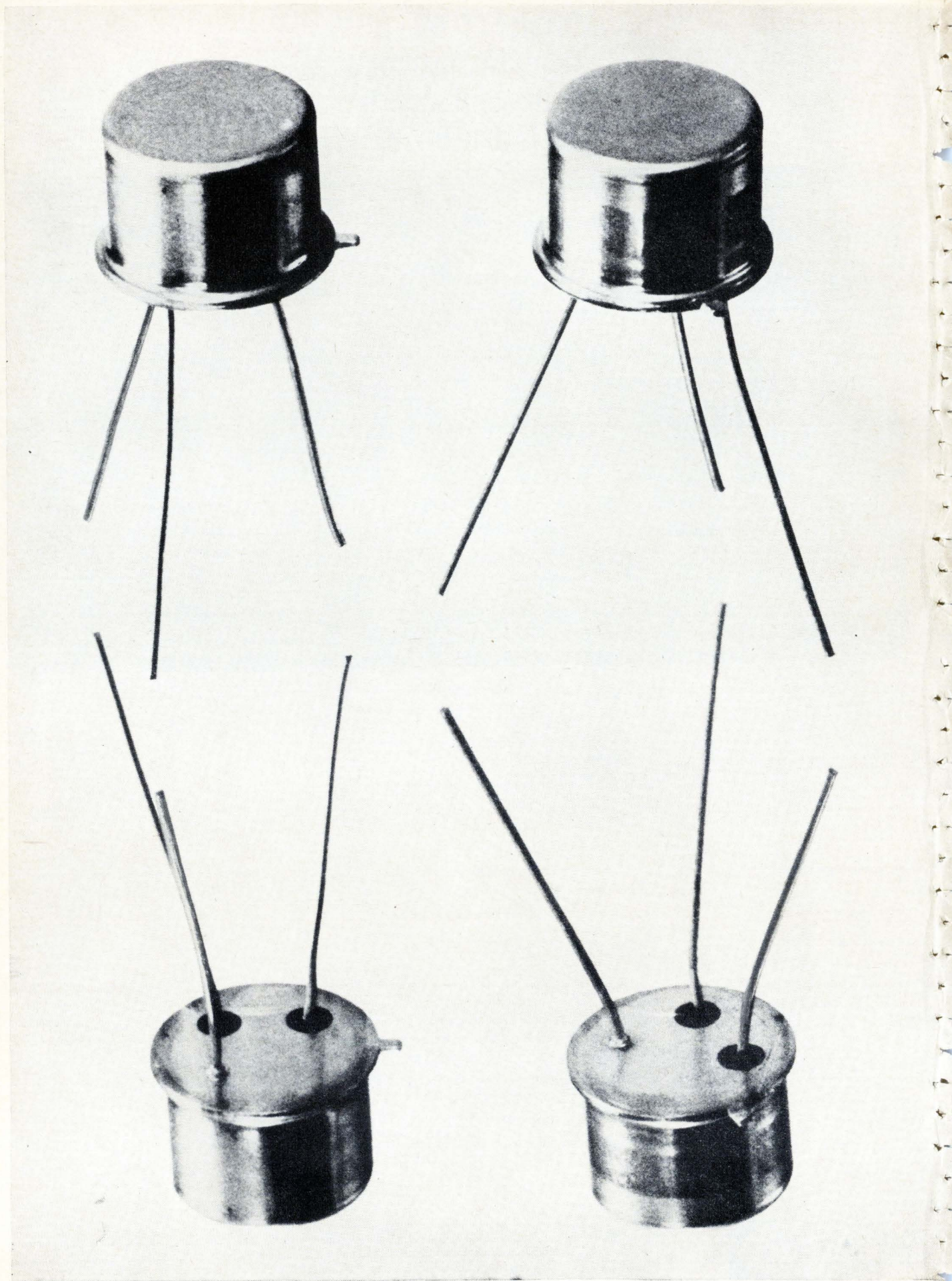



# Two for the space of one.

Fairchild dual transistors and differential amplifiers save space, give you greater design flexibility and provide uniform performance for the lifetime of the device. ■ **Space savers:** With Fairchild dual or differential amplifiers you can get the performance of two discrete transistors into the space normally occupied by one. You can manipulate the space available to you better, and at a lower cost than you'd pay for integrated circuits. ■ **Greater flexibility:** Fairchild makes more basic chips available for double encapsulation than anyone else. Mix or match virtually any of our catalog transistors to get the exact characteristics you want in your function. ■ **Uniform performance:** Two devices encapsulated in a single can are subjected to identical environmental conditions, and their performance remains uniform throughout their useful life. For differential amplifiers we select adjacent chips off the same wafer, to give you the closest possible match of electrical characteristics. ■ **Low cost, immediate delivery:** We offer you the widest chip selection, new low prices and immediate delivery. Get the complete story on Fairchild duals and differential amplifiers. It's in our new brochure. Write for it.

**FAIRCHILD**  
SEMICONDUCTOR



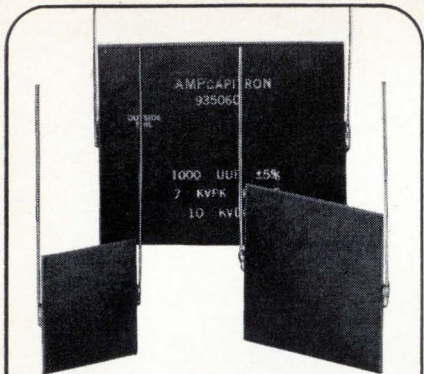

# 2,000 TO 60,000 VDC WAFER CAPACITORS ... CUSTOM OR STOCK

AMP's AMPLIFILM\* dielectric in the heart of these capacitors results in the highest joules per cubic inch available in industry. A typical unit 0.1 MFD at 40,000 VDC is only 4½" x 4½" x 6½" for an energy density in excess of 0.6 joules per cubic inch. Unique monolithic structure can be shaped to your special requirements. CAPITRON\* AMPLIFILM capacitors provide exceptional performance in industrial, military or commercial applications up to 125° C—without derating.

#### OTHER SPECIFICATIONS:

- Capacitance range: 100μf to 1.0μf
- Voltage range: 2,000 to 60,000 VDC
- Power factor: 0.35% typical
- High insulation and moisture resistance
- Dielectric absorption: less than 0.2%
- Wafer sizes: 1 sq. in. to 36 sq. in.
- Meet all applicable mil. specs.

Other CAPITRON products available: High and low voltage power supplies, high voltage receptacles and leads, radar pulse modulators and pulse forming networks. For complete details on AMPLIFILM capacitors or other CAPITRON products, write to:

## AMP INCORPORATED

### CAPITRON DIVISION

155 Park St., Elizabethtown, Pa. 17022  
TWX: 717-330-4560 Phone: 717-367-1105  
CAPITRON products and engineering assistance are available in Canada through Aircraft-Marine Products Ltd., Ontario, Canada

\*Trademark of AMP Incorporated

## Meetings

**Military Aircraft Systems Meeting,** American Institute of Aeronautics and Astronautics; Dallas, Oct. 18-19.

**International Telemetry Conference,** International Foundation for Telemetry; Ambassador Hotel, Los Angeles, Calif., Oct. 18-20.

**Symposium on Microwave Measurement,** the International Measurement Confederation; Budapest, Hungary, Oct. 18-20.

**Symposium on Information Display,** Society for Information Display; Hotel Bradford, Boston, Oct. 18-20.

**Electronic Representatives Association Electronic Show,** Electronic Representatives Association; Seattle Center Display Hall, Seattle, Oct. 19-20.

**Nuclear Science Symposium,** IEEE; Statler-Hilton Hotel, Boston, Oct. 19-21.

**International Trade Exhibition of Electronic Components,** Electronica 66; Munich, West Germany, Oct. 20-26.

**Conference on Vacuum Microbalance Techniques,** Newporter Inn, Newport Beach, Calif., Oct. 23-25.

**Instrument Society of America Conference & Exhibit,** Instrument Society of America; New York Coliseum, New York, Oct. 24-27.

**International Symposium on Microelectronics,** International Electronics Association; Munich, Germany, Oct. 24-26.

**Machine Tools Industry Technical Conference,** IEEE, general application group; Sheraton-Schroeder Hotel, Milwaukee, Wis., Oct. 24-26.

**American Vacuum Conference,** American Vacuum Society; San Francisco-Hilton Hotel, San Francisco, Oct. 26-28.

**Colloquium on Photographic Interaction Between Radiation & Matter,** Society of Photographic Scientists and Engineers, Air Force Office of Scientific Research; Marriott Twin Bridges Motor Hotel, Washington, Oct. 26-29.

**International Electron Devices Meeting,** IEEE; Sheraton-Park Hotel, Washington, Oct. 26-28.

**International Congress on Air Technology,** Valley Education and Research Foundation; Hot Springs, Ark., Oct. 26-29.

**Symposium on Switching & Automata Theory,** IEEE; University of California, Berkeley, Calif., Oct. 26-28.

**Meeting of Metallurgical Society of American Institute of Mining, Metallurgical and Petroleum Engineers;** Sheraton-Chicago, Oct. 30-Nov. 3.

**Users of Automatic Information Display Equipment Conference,** Users of Automatic Information Display Equipment; Vacation Village Hotel, San Diego, Calif., Oct. 31-Nov. 1.

**Technical & Electronic Ceramic Manufacturer's Exhibit & Seminar;** seminar committee of the Technical & Electronic Ceramic Manufacturer's Exhibit & Seminar; New York Trade Show Building, New York City, Nov. 1-3.

**Northeast Electronics Research and Engineering Meeting,** IEEE; Sheraton-Boston Hotel, Boston, Nov. 2-4.\*

**National Electrical Manufacturers Meeting,** National Electrical Manufacturers Association; Palmer House, Chicago, Nov. 14-17.

**National Conference on the Management of Aerospace Programs,** American Astronautical Society; University of Missouri, Columbia, Mo., Nov. 16-18.

**Symposium on Oceanography and Oceanology,** Institute of Environmental Sciences; Henry Hudson Hotel, New York, Nov. 17.

## Call for papers

**Congress of Canadian Engineers,** IEEE; Montreal, May 29-June 2, 1967. Abstracts should be submitted to R.H. Tanner, Engineering Institute of Canada, 2050 Mansfield St., Montreal, as soon as possible.

**International Federation of Automatic Control Symposium on Automatic Control in Space,** IEEE; Vienna, Austria, Sept. 4-8, 1967. Oct. 15 is deadline for submission of abstracts to J.A. Aseltine, TRW Systems, Space Park Drive, Houston, Texas 77058.

**IEEE Photovoltaic Specialists Conference,** IEEE; Sheraton Cape Colony Inn, Cocoa Beach, Fla., March 28-30, 1967. Oct. 15 is deadline for submission of abstracts to William R. Cherry, Sixth Photovoltaic Specialists Conference, Code 716, NASA Goddard Space Flight Center, Greenbelt, Md. 20771.

\* Meeting preview on page 16





## Dial Direct—and Save

Introducing the direct-dialing Bourns KNOBPOT® Model 3650—a digital dial, knob, and 10-turn precision potentiometer in a single assembly. At \$25, this integrated unit costs you less than a precision potentiometer and digital dial bought separately, yet gives you greater accuracy. Correlation between dial and wiper output is guaranteed accurate to 0.1 per cent! There are no phase-it-yourself problems with the Model 3650, either. Each unit is phased at the factory. You save time, trouble and expense!

Settings are fast and easy, thanks to the large, clear numerals that show turns, tenths of turns and hundredths of turns. Calibration marks beside hundredth-turn numerals allow settings as fine as 1/1000 turn.

Reliability is enhanced by extensive in-process inspection, 100 per cent final inspection, the Bourns Reliability Assurance Program, and by such outstanding construction features as the exclusive SILVERWELD® termination—the strongest in the industry. For value you can count on, specify Model 3650. Write today for complete technical data.

### MODEL 3650 1¼" dia., 10-turn STANDARD SPECIFICATIONS

Dial accuracy (correlation of dial reading and output, including linearity)	±0.1%
Repeatability of dial reading	±0.05%
Power rating	2.5W at 25°C
Humidity	MIL-STD-203 Method 103
Resistance Range	100Ω-500K

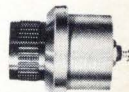

unit shown 1/4 actual size



BOURNS, INC., TRIMPOT DIVISION, 1200 COLUMBIA AVE., RIVERSIDE, CALIF.  
PHONE 684-1700 • TWX: 714-682 9582 • CABLE: BOURNSINC.

TRIMPOT® AND PRECISION POTENTIOMETERS — RELAYS — MICROCOMPONENTS: TRANSFORMERS, INDUCTORS, RESISTORS AND CAPACITORS

Circle 15 on reader service card



## Meeting preview

### Nerem in Boston

During its 20th anniversary program the Northeast Electronics Research and Engineering Meeting (Nerem) will continue a tradition of stressing the research and development, design and test fields.

Nerem will be held Nov. 2 to 4 in the War Memorial Auditorium and the Sheraton-Boston Hotel and is sponsored by the New England sections of the Institute of Electrical and Electronics Engineers.

Metal-insulator semiconductor technology will be spotlighted in an opening day discussion organized by Frank Wanlass of the General Instruments Corp. This session will include a comparison of metal oxide semiconductors with bipolar integrated circuits.

**Interest in oceanography.** At an evening meeting Nov. 2, panelists will discuss "The Deep Sea—Our Inner Frontier." A report on the Navy's deep submergence program will be given by John Craven of the Navy's special projects office.

Herbert G. Weiss of Lincoln Laboratory, Massachusetts Institute of Technology, will give a progress report on the Camroc antenna and radome studies. Camroc, the Cambridge radio observatory committee, is composed of scientists and engineers, mainly from MIT and Harvard, who propose construction of the world's largest steerable antenna, a 400-footer, in New England.

Friday, the closing day, will be devoted to integrated circuits. A morning session on digital analog circuits will feature a paper by D.A. Chung of Texas Instruments Incorporated on picosecond switching technology. An afternoon meeting on analog integrated circuits will include a paper on integrated operational amplifiers by J. Hulme and J.D. Lieux of the Fairchild Semiconductor division of the Fairchild Camera and Instrument Corp.

A session on computer-aided electronic circuit design will hear papers on automatic mask generation for integrated circuits by H. Freitag of the International Business Machines Corp., and on automatic circuit card etching layout by C.J. Fisk of the Sandia Corp.



Does it make sense to buy more resistors than you need... (try to) match them ...and then build your own

# PRECISION RESISTOR NETWORKS

...when Vishay builds the smallest, most perfect networks available with these close-to-ideal standard specifications:

- $\pm 0.005\%$  Full Scale Accuracy @  $25^{\circ}\text{C}$ .
- Guaranteed 25ppm Stability over 3 years (0.0025%)
  - $0 \pm \frac{1}{2}\text{ppm}/^{\circ}\text{C}$ . from  $0^{\circ}$  to  $+60^{\circ}\text{C}$ .
  - $0 \pm 2\text{ppm}/^{\circ}\text{C}$ . from  $-55^{\circ}\text{C}$ . to  $+125^{\circ}\text{C}$ .
    - 1 ns. Rise Time *without ringing*
    - Non-measurable noise and inductance

... and builds them at what proves to be, in every case, a lower than "do-it-yourself" cost?

Take the headache out of precision network design, construction, delivery and cost. The remedies are in this new, complete DESIGN DATA/CATALOG. Write for your free copy today.

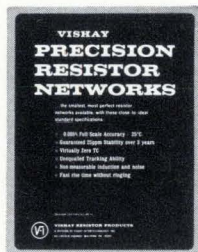

VISHAY RESISTOR PRODUCTS

a division of Vishay Intertechnology, Inc.

63 Lincoln Highway • Malvern, Pa. 19355



# What's the easiest way to make this part?

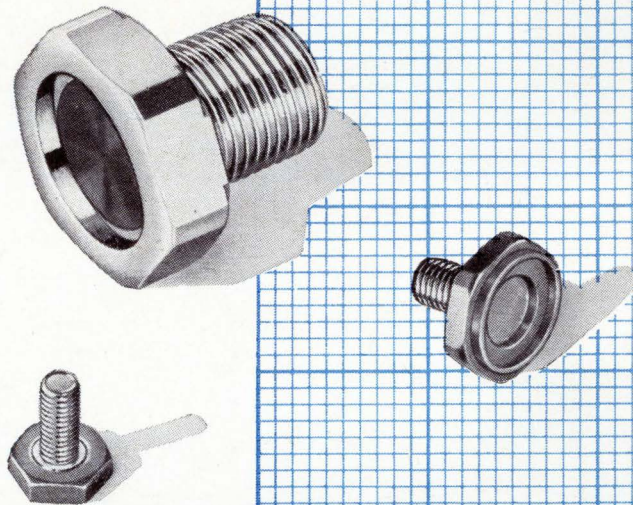

**LET FANSTEEL DO IT!** Tell us the component part you need. We'll combine our diverse technologies with your application know-how and give you a better, more economical part.

Want a for instance? Our new FANTORK<sup>T.M.</sup> Semiconductor Hex Head Heat Sink. Previous designs used scarce wrought OFHC copper for base. Copper shank threads were stripping during assembly, wouldn't stand excessive torque.

1. Experience told us that we could use Fansteel 2900 electrical grade sintered copper for the base.
2. Our engineers improved on the original design by counter-sinking and brazing a steel threaded shank into the base.
3. Nickel-plated molybdenum and tungsten backing wafers were a problem. We had the established plating technology to do it right.

Results: FANTORK packaging technology provided comparable heat dissipation to meet high current demands

...shank torque was *increased by a factor of three* and eliminated costly re-threading after assembly... Fansteel plating of wafers assured positive wetting action.

All our customers do:

mount the silicon and assemble—presto! A component made to specifications! How easy can you have it?

Don't need FANTORK? How about precision parts for thyristors, ignitions, contactors, mercury vapor arc tubes, capacitors? We can make this job easy for you, too.

Let us prove it. Contact your Fansteel representative... or write us. Just say, "O.K., show me how you would..."

## FANSTEEL

**METALLURGICAL CORPORATION**

*Electronic Parts Division*

Number One Tantalum Place • North Chicago, Illinois 60064



# Twenty-two new high voltage silicon transistors from

## Voltages up to 700 and priced for your next application.

With voltages from 250 to 700 and 5 amps, this new Bendix B-176000 series of NPN silicon power transistors is made-to-order for breaking those tough voltage and gain problems—without breaking the budget.

There are 22 types, six designed specifically for high voltage fast switching applications. With matrices that let you pick the precise voltage and gain character-

istics you require. No need to pay for an overspecified device.

The B-176000 series was designed to zero right in on the demands of CRT deflection circuits and line-operated inverters, regulators and amplifiers. The convenient TO-3 configuration makes them easy to use in many other applications as well. For complete details, write us in Holmdel, New Jersey.



**Baltimore (Towson), Md.**—(301) 828-6877; **Chicago**—(312) 637-6929; **Dallas**—(214) 357-1972; **Detroit**—(313) Jordan 6-1420; **Holmdel, N. J.**—(201) 946-9400; **Los Angeles**—(213) 776-4100; **Miami Springs, Fla.**—(305) 887-5521; **Minneapolis**—(612) 926-4633; **Redwood City, Calif.**—James S. Heaton Co., (415) 369-4671; **Seattle**—Ray Johnston Co., Inc., (206) LA 4-5170; **Syracuse, N. Y.**—(315) 474-7531; **Waltham, Mass.**—(617) 899-0770; **Export**—Cable: "Bendixint," 605 Third Avenue, New York, (212) 973-2121; **Ottawa, Ont.**—Computing Devices of Canada, P.O. Box 508—(613) TALbot 8-2711.



# the Bendix powerhouse.

4 Gain Groups	4 Saturation Groups	4 Voltage Groups	
hFE	VCE(s)	VCEX	VCEO(sus)
≥10 to 25 at 0.1 A to 2.5 A and 5 V	≤0.5 V to 2 V VBE(s) ≤1 V to 2.5 V at 0.1 A to 2.5 A and 20 mA to 500 mA	≥250 V, 400 V, 550 V and 700 V at 1 mA and -1.5 V	≥200 V and 325 V sweep tested at 2 A*
Typical fall time (tf) of 1.5 μs at 2.5A, 27V, & 4V**			
Pc=75W at TC=100°C, 15V & 5A			

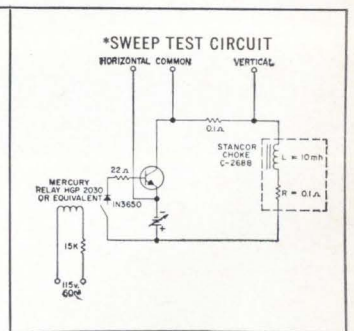
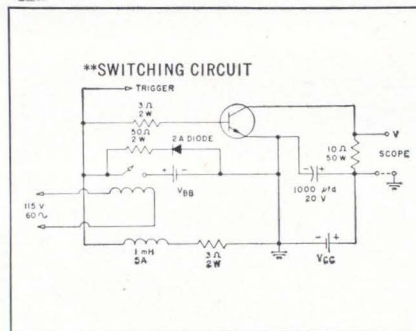

**Bendix Semiconductor Division**  
HOLMDEL, NEW JERSEY





# We're only six years old, yet we've been shaving since

It's not that we hate whiskers on faces . . .  
Just on diodes.

Fact is, we hate *any* trouble spots that might possibly impair reliability.

Which is one of the reasons we invented an entirely new method of diode construction.

And when we say invented, we mean just that. Invented. From the ground up. With entirely new design. With entirely new methods of construction.

The solid state bond that joins the silicon and

the terminal pins is stronger than the silicon itself, so the silicon will break before the bond does.

This eliminates the whisker—which, as you know, can be burned out by surges, and broken by vibration. The entire unit is fused in hard glass at over 800°C. It's voidless, so all contamination is excluded. The result? A monolithic diode that's practically invulnerable. And a major breakthrough at the same time.

Because with our diode, engineers now had the



# we were born.

first (and still the only) device that had the advantages of high power and surge capability in small size, stability of electrical parameters throughout the life of the product, *and* mechanical ruggedness and high reliability, all unaffected by any environmental testing. Go ahead, dip one in liquid nitrogen, then subject it to 300°C. Keep doing it; it can take it!

Of course, these qualities cost a bit more. But as we said, we've been shaving whiskers for

the past six years. Not cutting corners.

If the work your company is doing needs diodes with these unique characteristics, why not get in touch with us? We'll be glad to send you complete information, and samples, too.

We're at 580 Pleasant St., Watertown, Mass. 02172. Telephone (617) 926-0404.

## UNITRODE®

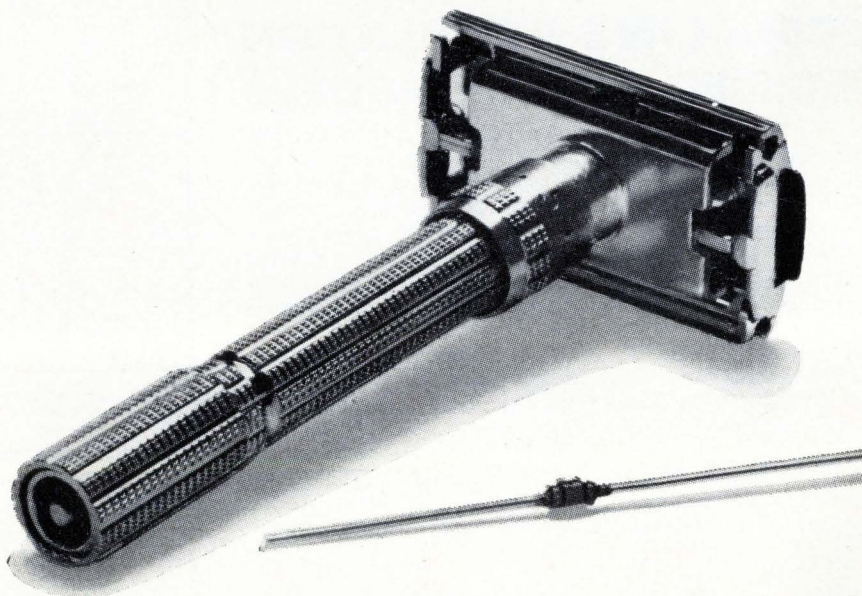



# what's in a spec?

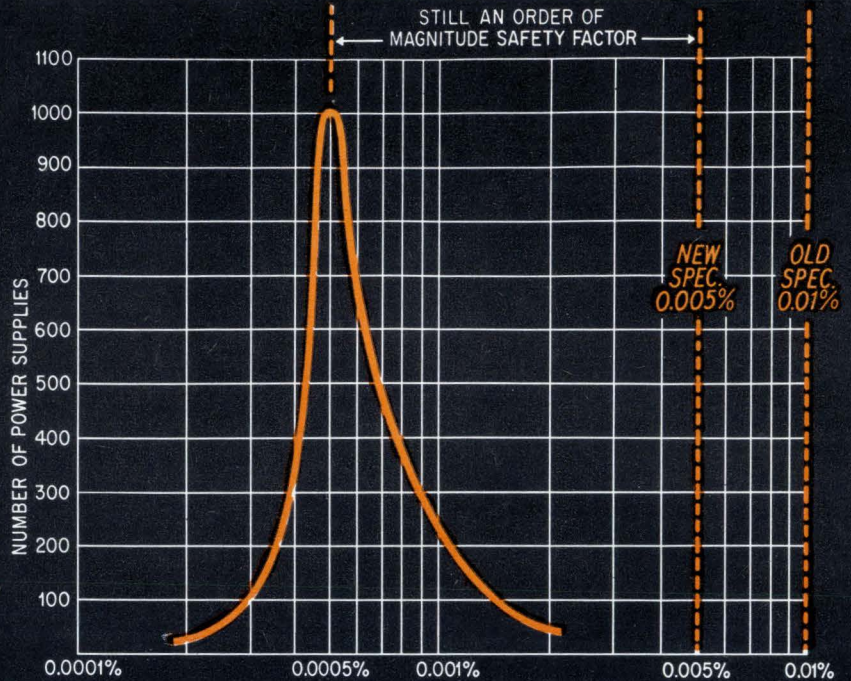

KS AND CK MODELS COMBINED DATA VOLTAGE-MODE LINE REGULATION



Model KS 36-5M



Model CK 40-0.8M

## NOW!

## 0.005% LINE REGULATION SPECIFIED FOR 26 MODELS

What's in a spec? Lots more than just wishful thinking! For example, the line regulation specification of our popular CK and KS models has been 0.01% for some years. Recently we compiled statistical performance data on thousands of production instruments, and discovered that a 0.005% specification would **still** leave a generous order-of-magnitude safety margin. As a result, Kepco will rewrite the book on voltage line regulation specifications (the amount of the output voltage change when power line input varies from 105 to 125V AC). The new line regulation specification will be 0.005% starting with 1966 production models. As the above figure shows, however, 100% of **all** delivered KS/CK Power Supplies **already meet this spec**. So **you** can rewrite the book, too . . . on existing as well as new equipment.

What's in a spec? A Kepco spec is made up of a whole lot of experience, painstaking attention to detail, a no-nonsense Quality Control attitude and a healthy dose of conservatism.



OUR NEW CATALOG CONTAINING COMPLETE SPECIFICATIONS AND APPLICATIONS NOTES IS NOW AVAILABLE

WRITE FOR YOUR FREE COPY!

Applicable Patent Nos. furnished on request



### KEPCO K S GROUP

MODEL	DC OUTPUT RANGE		DIMENSIONS			PRICE
	VOLTS	AMPS	H"	W"	D"	
KS 8-15M	0-8	0-15	3½	19	14¾	\$625
KS 8-25M	0-8	0-25	5¼	19	16	760
KS 8-50M	0-8	0-50	7	19	16	1,050
KS 8-100M	0-8	0-100	8¾	19	20	1,450
KS 18-10M	0-18	0-10	3½	19	14¾	575
KS 18-15M	0-18	0-15	5¼	19	16	725
KS 18-25M	0-18	0-25	7	19	16	970
KS 18-50M	0-18	0-50	8¾	19	20	1,360
KS 36-5M	0-36	0-5	3½	19	14¾	525
KS 36-10M	0-36	0-10	5¼	19	16	625
KS 36-15M	0-36	0-15	7	19	16	730
KS 36-30M	0-36	0-30	8¾	19	20	1,150
KS 60-2M	0-60	0-2	3½	19	14¾	525
KS 60-5M	0-60	0-5	5¼	19	16	645
KS 60-10M	0-60	0-10	7	19	16	895
KS 60-20M	0-60	0-20	8¾	19	20	1,350
KS 120-1M	0-120	0-1	3½	19	14¾	550
KS 120-2.5M	0-120	0-2.5	5¼	19	16	695
KS 120-5M	0-120	0-5	7	19	16	970
KS 120-10M	0-120	0-10	8¾	19	20	1,450

### KEPCO C K GROUP

CK 2-8M	0-2	0-8	4¼	8½	13½	\$345
CK 8-5M	0-8	0-5	4¼	8½	13½	345
CK 18-3M	0-18	0-3	4¼	8½	13½	305
CK 36-1.5M	0-36	0-1.5	4¼	8½	13½	305
CK 40-0.8M	0-40	0-0.8	4¼	8½	13½	267
CK 60-0.5M	0-60	0-0.5	4¼	8½	13½	305

CK GROUP: 19" rack adapters available for single (RA 5) or dual (RA 4) mounting . . . \$15.00 each.

WRITE FOR COMPLETE SPECIFICATIONS



**Editorial**

# Microelectronics changes the rules

**Earlier this month** when Philco Corp. announced a corporate name change to Philco-Ford Corp., Henry Ford II, chairman of the board of the parent Ford Motor Co., predicted that Philco-Ford's greatest future growth would come from activity in microelectronics and its inclusion in the nonelectronic areas of activity. Philco-Ford's 1967 consumer product line will use many integrated circuits. And even Ford's autos will be using IC's starting in 1968 [Electronics, Oct. 3, p. 187].

Acceptance of microelectronics and orders for them by what has to be considered a basically nonelectronic industry underlines just how far and how fast integrated circuits have moved in the past two years. Philco-Ford's president Robert O. Fickes, a home appliance-oriented executive, acknowledged their rapid pace when he said, "Integrated circuits have moved far faster than we expected."

Only someone with a very bad case of myopia will fail to see that the electronics industry is in the throes of a violent upheaval. Because of integrated circuits, everything an engineer has to consider in his job is changing: the engineering approach, cost criteria, product performance, and scope of electronics application.

Probably the most radical change is the one in the role of the engineer. When microelectronics are incorporated into equipment or a system, one engineer has to assume broader responsibility for the entire system. He'll have to be cognizant of design, testing, packaging and manufacturing, rather than concentrating on one aspect of the work. For with microelectronics, an enthusiastic designer can easily design far more than can be manufactured—economically. Thus microelectronics will force a broadening of the electronics engineer's horizon. He'll have to do more and he'll have to know more.

There will be a reduction of splinter engineering because you cannot atomize the job of designing a product with microelectronics. And engineers will have to use the computer more to help them with designs. In planning a large-

array integrated circuit, the next technological advance in microelectronics, determining the interconnections alone is a herculean task.

With microelectronics, for the first time, electronics engineers face a situation in which performance is not limited by the number of components the customer can afford. In large arrays, particularly, the cost of individual components becomes tiny. For example, semiconductor experts are already talking about soon reaching a cost of 0.02 cents for a transistor in a large array. Thus a given piece of equipment can perform far more functions with its complex integrated circuitry—at the same price—as the same gear with discrete components.

This extended performance will push electronics into many new areas, activities for which electronics have always been considered too expensive. Automotive men already see the implications. They are talking about an electronic transmission control, an electronic safety monitoring system, electronic instrumentation to measure speed, fuel, air pressure, and temperature and electronic control of motors, lights and windshield wipers.

But the greatest new application could be in industrial electronics and in process control. With microelectronics, engineers can design control instrumentation that is capable of performing far more functions—incorporating measurement, data transmission and decision-making into a single device—than conventional pneumatic, hydraulic, or electromechanical controls. Up to now, electronics has not been able to make much of an inroad into industrial process control because electronic devices often cost more than any other kind, although they do not do a better job. Microelectronic control, however, will be able to do far more at the same or lower cost.

The semiconductor companies do not have all the answers to the application of integrated circuits. Actually, the burden of performance will fall on the engineers who design everything but semiconductors: instruments, subassemblies, subsystems, systems, appliances, machine tools, machinery, etc. On page 68 is the first in a series of articles on microelectronics, written from the standpoint of the user engineer rather than the processing engineer. The series is intended to help an engineer who has to conceive some kind of product to choose the proper kind of integrated circuit, to understand what new problems are introduced by integrated circuitry, and to learn how others have solved these problems.

Clearly now is the time to change to microelectronics. And now is the time for engineers to learn the new rules.



# Get immediate delivery of P&B Precision Switches from authorized P&B distributors\* Factory Prices too

PRECISION  
SUBMINIATURE

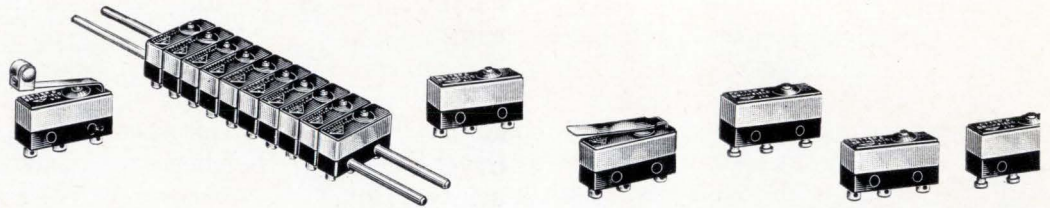

PRECISION  
MINIATURE

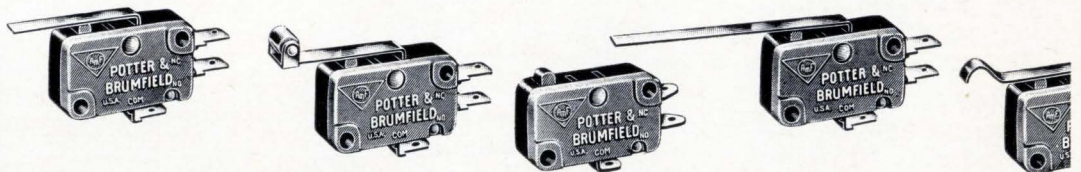

PRECISION  
GENERAL  
PURPOSE



Your authorized P&B switch distributor has a wide variety of P&B precision snap-action switches on his shelves. You can get immediate delivery at factory prices. Included are general purpose, miniature and subminiature switches in a wide choice of actuators, contact arrangements and terminations. Most are directly interchangeable with competitive types. All meet U/L and CSA requirements. Mounting dimensions and materials meet military specifications.

\* Call your P&B representative for distributor nearest you or write us direct for his address.

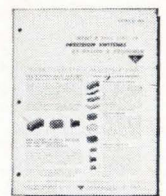

Standard switches are shown in new Catalog 400. Ask your nearest P&B switch distributor or write P&B for your personal copy.



**POTTER & BRUMFIELD**

Division of American Machine & Foundry Company, Princeton, Indiana  
Export: AMF International, 261 Madison Avenue, New York, New York



---

# Electronics Newsletter

---

October 17, 1966

## Hewlett-Packard to introduce its first computer

The Hewlett-Packard Co. is entering the computer market. A machine, small in size and computational capacity, will be introduced at the Fall Joint Computer Conference, Nov. 8 to 10, in San Francisco. The company declined to provide pricing or circuit details but a spokesman said the computer was designed to augment conventional measuring instruments; the company makes a full line of these.

Many observers consider the move a natural extension for Hewlett-Packard: its Dymec division has for years been buying computers for use in telemetry systems.

## IBM develops 400-picosecond logic circuit

A logic circuit that operates in 400 picoseconds—the time it takes a beam of light to travel five inches—has been developed by the International Business Machines Corp. The package itself accounts for 110 picoseconds of delay.

This switching speed compares with the speed of IBM's System 360 model 90, which is rated at 1.4 nanoseconds (1,400 picoseconds), and Control Data Corp.'s 6800 computer, rated at 800 picoseconds. Control Data's machine is still under development, with first deliveries scheduled next summer.

The IBM design is a monolithic silicon current-switching circuit and is built with two levels of metallization [Electronics, Oct. 3, p. 108]. Its transistors are only 75 millionths of an inch wide and are diffused 3,200 angstroms into the silicon.

The designers are V.A. Dhaka and K.D. West.

## Air Force weighs integrated control for armament

The Air Force is considering an integrated armament control system that could mean millions of dollars to the electronics industry. A decision is expected in about a month. The system—which may also be used by the Marine Corps and the Navy—could go on all future aircraft; retrofitting of present planes is unlikely. The single electronic package replaces numerous controls and switches.

A prototype, built by the Technical Measurement Corp., North Haven, Conn., has passed early tests.

## SOS advances at Autonetics

In another bullish report on silicon-on-sapphire technology [Electronics, May 30, p. 152A], Arthur C. Lowell predicted that SOS would allow computer designers to switch from the use of Boolean algebra to look-up tables in many systems. Lowell, assistant director of research and engineering at the Autonetics division of North American Aviation, Inc., said at the National Electronics Conference in Chicago that SOS matrixes containing up to 40,000 diodes are being made.

The matrixes make feasible the storing of answers to mathematical problems, such as low-order multiplication, rather than working them out with logic circuits. If logic is needed, Lowell added, it can be SOS or a combination of SOS and metal oxide semiconductor circuits.

Autonetics has also been working on pure MOS circuitry and has developed 25 MOS integrated circuits that contain more than 500 devices. One is a complete 24-bit digital differential analyzer that has 860 devices.



---

# Electronics Newsletter

---

## Sharper picture for under water

A touch of trick photography is providing sharper underwater pictures. The innovation, which employs a laser as a light source and some electronics to time the burst of light and the camera's shutter, is being investigated by several companies under a contract from the Naval Ordnance Test Station, Pasadena, Calif.

Essentially, the technique overcomes the problem of backscattering—light reflected back to the camera by the water. By keeping the shutter closed until the split second the laser light is reflected off the object and received by the camera's lens, backscatter is sharply reduced.

## Amphenol design wins competition

Standard military specifications will be written for subminiature cylindrical connectors based on Amphenol Corp. Connector division's Astro/348 design. Amphenol won a design competition, conducted by the Naval Air Development Center, over six other connector manufacturers. The three military services will cooperate in writing the new standard through the Defense Electronics Supply Center. The Astro/348 has doubled the contact density of present miniature cylindrical connectors.

## Airlines looking to film for better in-flight movies

Film is expected to sweep the in-flight entertainment market, blacking out video tape equipment.

American Airlines has awarded a \$2.3-million contract to the Bell & Howell Co. for a new type entertainment system that uses film. The Bell & Howell system will eventually replace the Sony Corp. in-flight tv system that American currently uses.

Pan American World Airways, which also uses video tape, has no immediate plans to switch, but a company spokesman says the airline is now studying film. And Air-India is testing a cabin movie projection system supplied by REA Express-Seven Arts Transvision.

## Space know-how in the hospital

Aerospace system know-how is being sent to the hospital where it is curing many institutional ailments. The Lockheed Missiles & Space Co., a division of the Lockheed Aircraft Corp., was selected recently by the famed Mayo Clinic of Rochester, Minn., for a systems study on the use of computers to support virtually every phase of the hospital's operation.

Although the largest, this is not the division's first hospital study contract. The first, in 1965, was for a California hospital; two others have been completed since.

## DDC makes headway

Direct digital control of industrial processes, slowed by reluctant acceptance by industry, may get a lift now that the Ideal Cement Co. has started operation of the first cement plant run by DDC. The great obstacle has been engineers' inability to understand the dynamics of complex processes; they have not been able to program special-purpose computers to handle the changing parameters. Experience on a handful of other DDC applications in petroleum, electric generating and chemical plants is slowly building up a backlog of process knowledge. In the Tijeras, N.M., cement plant system, developed by Leeds & Northrup Co., 18 control loops are computer controlled; each has a manual backup.



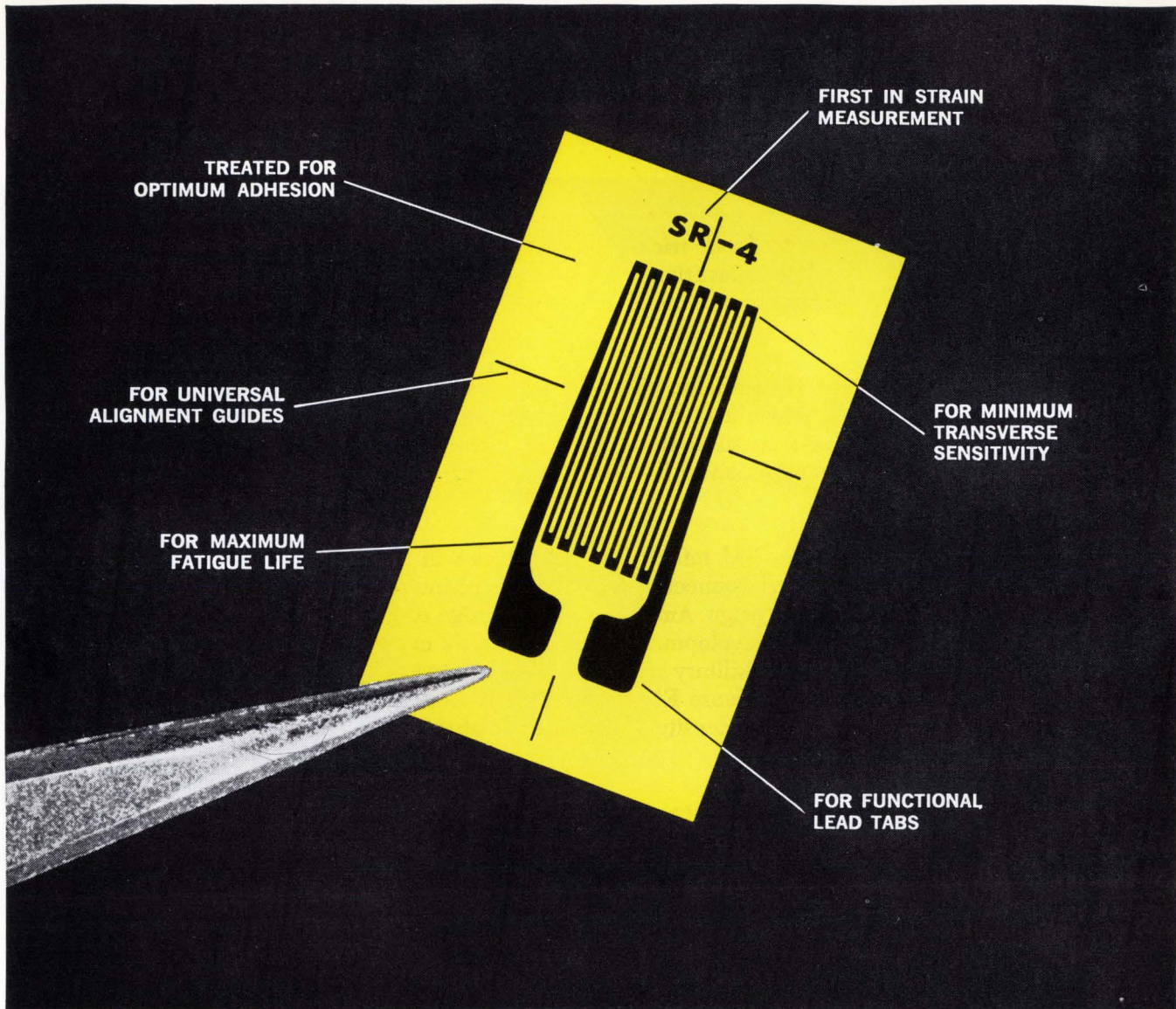

TREATED FOR  
OPTIMUM ADHESION

FIRST IN STRAIN  
MEASUREMENT

FOR UNIVERSAL  
ALIGNMENT GUIDES

FOR MINIMUM  
TRANSVERSE  
SENSITIVITY

FOR MAXIMUM  
FATIGUE LIFE

FOR FUNCTIONAL  
LEAD TABS

## ***Stress Analyzed Design Maximizes Foil Strain Gage Performance***

**Longer Life, Improved Accuracy  
and Ease of Handling head list of  
New SR-4® Foil Gage Advantages**

*BLH Electronics announces a new line of Stress Analyzed Foil Strain Gages. These new gages are the result of demands for precision foil strain gages that stand up under the rigors of dynamic forces such as encountered in rocket testing.*

*Heretofore, the use of foil gages of this quality has been restricted to precision force, pressure and torque*

*measuring transducers. Now, transducer quality foil strain gages are available for all stress measuring applications.*

*The enlarged photograph shows the pertinent design features that separate this gage from its predecessors. No other gages, commercially available for stress analysis, provide all of the advantages shown.*

*Write for complete product and technical information.*

*BLH ELECTRONICS, a division of Baldwin-Lima-Hamilton, Waltham, Mass. Plants in Waltham, Mass., Pasadena, Calif. and Darmstadt, West Germany.*

**BALDWIN · LIMA · HAMILTON**  
A subsidiary of Armour and Company





# Monsanto solves many





# problems for you



**That's why babies are healthier and why electronic instruments are more versatile than ever.**



Monsanto Counter/Timer 1020

Hospital nurseries stop deadly germ invasions with a powerful microbe-killer developed by Monsanto. It's one of the prime ingredients used to make potent disinfectants out of ordinary soaps and detergents.

Through a broad mix of over 1000 products, Monsanto serves more than 50 industries. Last year we introduced 43 basic new products and were issued as many patents as there were days in the year!

What does this mean to you? Just this: Monsanto's innovative efforts now stand behind a growing family of quality electronic instruments. These test and measurement instruments feature advanced microcircuitry. May we tell you more? Write, wire or phone us: Monsanto, Electronics Technical Center, 620 Passaic Avenue, West Caldwell, New Jersey 07006.



ELECTRONIC  
INSTRUMENTS



# Fast, convenient direct reading measurements of impedance and phase angle 500 kHz to 108 MHz...



## THE 4815A RF VECTOR IMPEDANCE METER

This new Vector Impedance Meter is a versatile instrument that provides fast, direct reading measurements of impedance and phase angle over the frequency range from 500 kHz to 108 MHz. It is continuous tuning over this frequency range, and does not require balancing or data interpretation. Thus, it is an extremely useful tool for the evaluation of the complex impedance of both active circuits and components. The convenience of probe measurement, ease of operation, and direct reading features make the instrument equally useful for laboratory, receiving inspection or production line measurements.

The 4815A is a convenient and powerful measuring tool for any application involving measurements over a band of frequencies or in-circuit measurements. It may be used to determine the self-resonance point of capacitors, the series and parallel resonance points of crystals, or the characteristics of high frequency transformers and transducers. Price: \$2650 f.o.b. factory. For complete specifications, contact your local Hewlett-Packard field engineer or write Hewlett-Packard, Rockaway Division, Green Pond Road, Rockaway, N. J. 07866; Europe: 54 Route des Acacias, Geneva.

### Advantages:

- Fast, continuous tuning from  
500 kHz to 108 MHz
- Provides data directly in impedance  
and phase angle, 1 ohm to 100K ohms  
0 to 360°
- Convenient probe for in-circuit measurements
- Analog outputs permit permanent  
data recording
- Self calibration check provides  
measurement confidence
- Low-level test signal minimizes  
circuit disturbance

HEWLETT  PACKARD  
An extra measure of quality



# *It's easy once you know how*

Surface contamination can ruin a production run of otherwise perfectly made transistors. Starting with silicon of "part-in-a-hundred-billion" purity, we maintain similarly tight levels of control through every step of manufacture. These silicon wafers, sitting in "boats" inside sterile beakers,

are being infrared dried after one of the numerous cleaning steps necessary to insure absolute freedom from unwanted impurities.

Devising means to produce pure materials—and keeping them pure through the whole manufacturing process—is another of the many problems

solved at Amperex along the road to mass-producing the world's most advanced line of silicon planar epitaxial RF transistors.

It's easy once you know how.

Amperex Electronic Corporation,  
Semiconductor and Receiving Tube  
Div. Dept. 371, Slatersville, R. I. 02876



Ask Amperex about  
Silicon Transistors for your  
RF amplifier applications

**Amperex®**

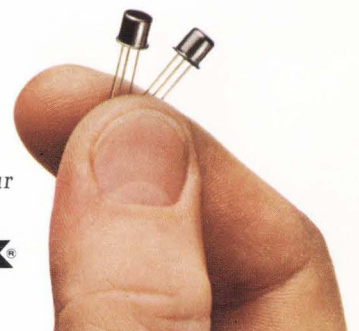



# IF YOU CAN'T LOCATE THE COAX CABLE YOU WANT IN ONE PHONE CALL:

<b>POLYETHYLENE DIELECTRIC:</b>	RG 71/U
RG 5B/U	RG 71A/U
RG 6A/U	RG 71B/U
RG 8/U	RG 74A/U
RG 8A/U	RG 79B/U
RG 9A/U	RG 164/U
RG 9B/U	RG 174/U
RG 10A/U	RG 177/U
RG 11/U	RG 212/U
RG 11A/U	RG 213/U
RG 12A/U	RG 214/U
RG 13A/U	RG 215/U
RG 14A/U	RG 216/U
RG 17A/U	RG 217/U
RG 18A/U	RG 218/U
RG 19A/U	RG 219/U
RG 20A/U	RG 220/U
RG 22B/U	RG 221/U
RG 34B/U	RG 223/U
RG 35B/U	RG 224/U
RG 55/U	
RG 55A/U	<b>TEFLON DIELECTRIC:</b>
RG 55B/U	RG 161/U
RG 58/U	RG 178B/U
RG 58A/U	RG 179B/U
RG 58C/U	RG 180B/U
RG 59/U	RG 187A/U
RG 59B/U	RG 188A/U
RG 62/U	RG 195A/U
RG 62A/U	RG 196A/U
RG 63B/U	RG 316/U

## YOU'RE PROBABLY NOT CALLING AN ALPHA DISTRIBUTOR

### ALPHA WIRE I

Headquarters: Elizabeth, New Jersey 07207  
A Division of Loral Corporation



**R-Series**  
2-sizes: 3-1/2", 4-1/2"



# TRIPLET

## "CLEAN SWEEP" PANEL INSTRUMENTS

A fresh approach to ultra-modern instrument design provides a "clean sweep" of the pointer over the full scale.

- 1** You get instant readability easier and at greater distances—plus more attractive designs to integrate into your equipment.
- 2** Self-shielded, accurate, reliable D.C. instruments have the exclusive Triplet BAR-RING movements.
- 3** Whatever your panel instrument requirement, look to Triplet for the right size and style, the right capability at the right price.



**G-Series**  
5 sizes: 1 1/2", 2 1/2", 3 1/2", 4 1/2", 5 1/2"

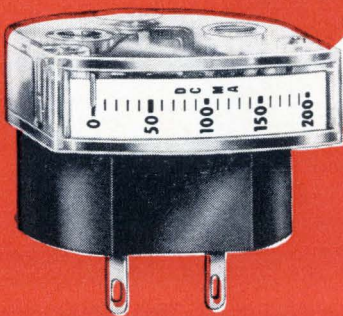

**MODEL 120 Edgewise Panel Meters**

### SHIELDED BAR-RING MOVEMENTS

ALNICO MAGNET IS MOUNTED INSIDE SOFT IRON RING; FULLY SELF-SHIELDED

Not affected by magnetic panels or substantially by stray magnetic fields for D.C.

More Torque  
Lower Terminal Resistance  
Faster Response  
Exceedingly Rugged and Accurate

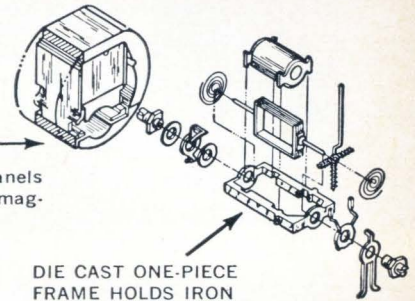

DIE CAST ONE-PIECE FRAME HOLDS IRON CORE IN EXACT ALIGNMENT

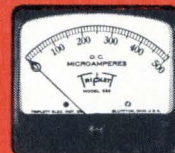
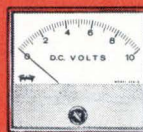

**TRIPLET ELECTRICAL INSTRUMENT COMPANY, BLUFFTON, OHIO**



# New PAR Lock-In Amplifier Measures Signals in the Presence of Noise by Crosscorrelation

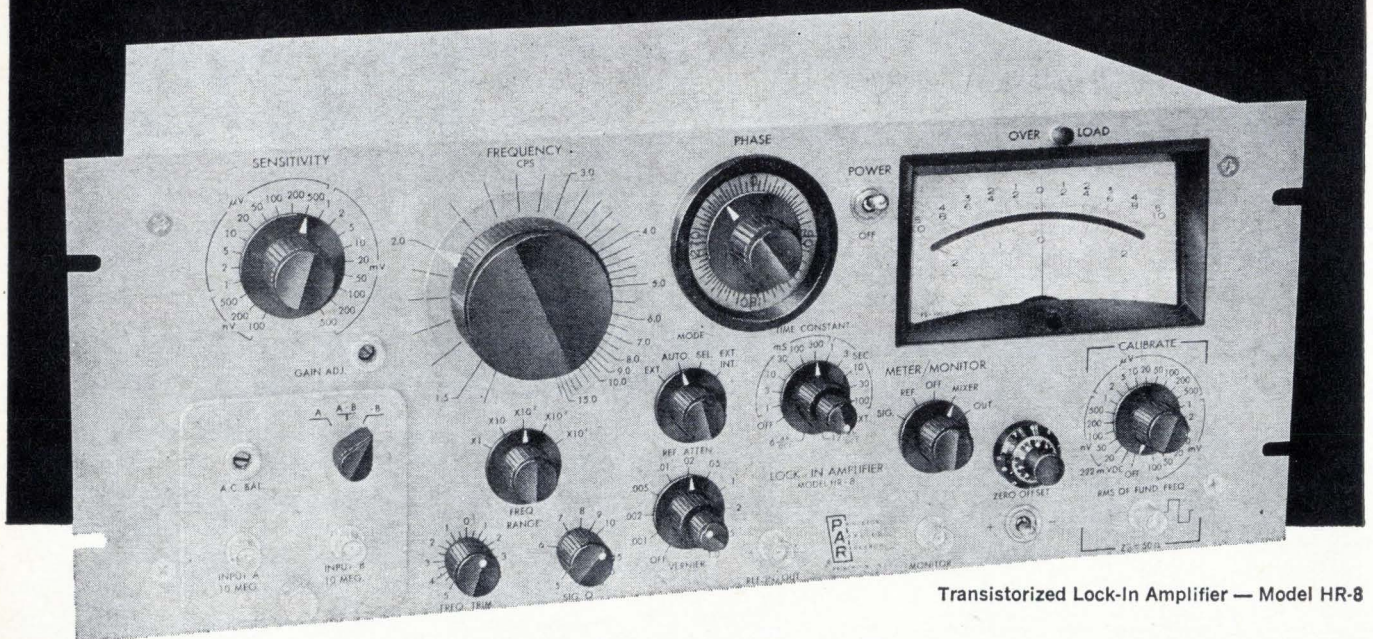

Transistorized Lock-In Amplifier — Model HR-8

The PAR Model HR-8 Lock-In Amplifier represents a significant advance in signal processing equipment for experimentalists who must measure low-level signal intensities in the presence of noise. It employs the theoretically optimum technique for signal recovery, and can be incorporated into a large class of experiments in which the signal of interest is, or can be made periodic, and in which a reference voltage related in frequency and phase to the signal can be obtained. The Model HR-8 first amplifies and bandlimits the input signal and then crosscorrelates it with the reference signal, suitably phase shifted and shaped. The crosscorrelation of input and reference signals yields a DC output voltage proportional to the signal of interest, while the crosscorrelation of the reference and noise results in no net DC voltage. The system can also be described as a continuously integrating, highly sensitive, phase conscious voltmeter, the response of which is "locked" to that particular frequency and phase at which the signal information has been made to appear.

## Technical Features:

**Frequency Range:** 1.5 cps to 150 KC continuously tunable in 5 ranges.

**Time Constants:** 11 values in 1-3 sequence extending from 0.001 to 100 seconds. Single or double section RC filtering.

**Pre-Amplifiers:** Interchangeable low-noise pre-amplifiers, operable either within the HR-8 or remotely, are used.

Type A: Differential 10 megohm input.

Type B: Low impedance transformer input for low source impedances.

**Sensitivity:** 21 calibrated full scale ranges in 1-2-5 sequence.

With Type A Pre-Amplifier: 100 nanovolts to 500 millivolts rms.

With Type B Pre-Amplifier: 1 nanovolt to 5 millivolts rms.

**Output:**  $\pm 10$  volts full scale, single-ended with respect to ground. Will drive galvanometric and servo recorders.

**Frequency Selective Amplifiers:** Notch network in negative feedback loop used in both signal and reference channel tuned amplifiers. Reference channel Q of 10. Signal channel Q adjustable from 5 to 25 with calibrated dial (no gain change with Q adjustment).

**Phase Adjustment:** Calibrated 360° phase shifter, providing continuous rotation as well as a four position quadrant switch which shifts phase in 90° increments.

**Price:** \$2,250 with either Type A or Type B Pre-Amplifier.

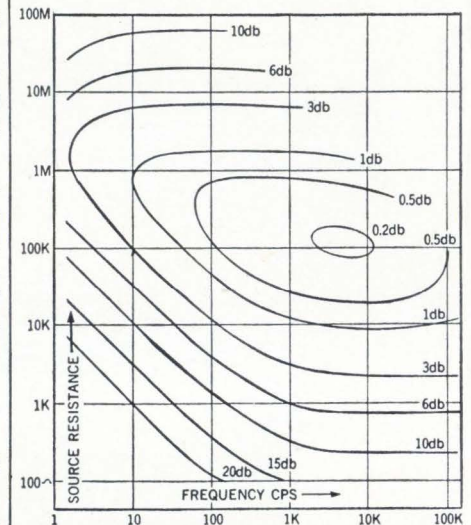

Contours of constant noise figure for a typical PAR Type A preamplifier plotted to show dependence on frequency and source resistance at 300° K. Amplifier operated single-ended.

Write for bulletin No. 120 on the HR-8 or ask for information on PAR's complete line of Lock-In Amplifiers and accessories.

**PAR PRINCETON APPLIED RESEARCH CORP.**  
Dept. D  
Box 565, Princeton, N. J., Tel. (609) 924-6835

"See us at ISA Booth 1437"



## Space electronics

### Getting off the ground . . .

For the next decade, at least, liquid fuel will propel United States astronauts into space. After that there's a strong chance solid fuel will challenge liquid motors, because they are cheaper and less complex. But before space planners can bank on solid motors for manned flights they will have to overcome a major technical barrier and install a surefire alarm to determine when the fuel isn't burning evenly. An unevenness could cause the launch vehicle to either veer off course or explode. A solution is in sight; next July engineers at Aerojet-General Corp.'s facilities in the Florida Everglades will fire a 260-inch diameter solid rocket and test a new electronic alarm system.

An understanding of the alarm system requires a basic knowledge of solid motors. Such motors are nothing more than a container that's packed tightly with a solid fuel. When the motor is produced a cloverleaf hole is left in the center of the solid block, so when the inner surface is ignited, hot gases stream out through it, providing propulsion. But if there is a crack or a bubble in the block of fuel the burning is uneven, and fire could quickly eat through to the side of the container.

**Detecting flaws.** Once misfiring is detected, the rocket's fire can be quenched by either pouring water over it or by opening holes in the side of the container, venting the hot gases out the side of the motor. But the problem is to detect the failure quickly.

The system takes advantage of the electrical properties of the hot rocket gases to trigger the alarm. As the gases reach their 5,755°F operating temperature, they become ionized and can conduct electricity. To apply this principle, the Aerojet engineers lined the mo-

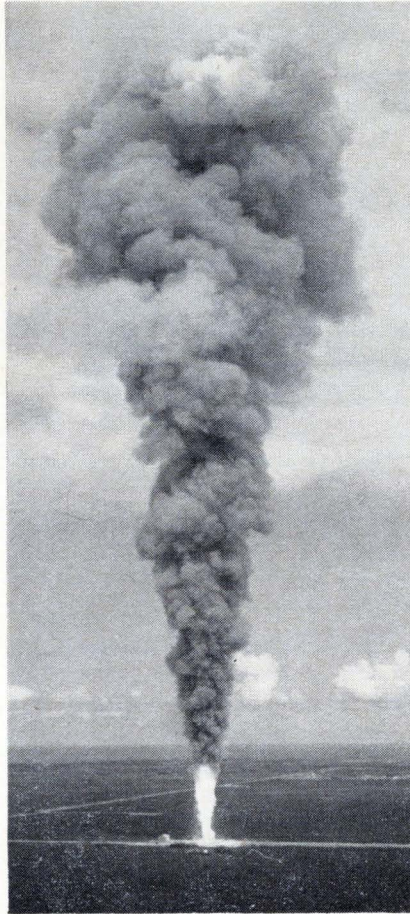

Large solid-fuel rocket belches fire and smoke during test. Key to solid rocket's success is technique to warn of motor's failure.

tor's container with two thin layers of conductive rubber that are wired to an electrical conductive probe at the top of the rocket chamber. Current is passed through the insulated layers.

When hot, conductive gases burn unevenly by eating through a section of the first rubber liner, they provide a path for the current to flow and a new circuit path results. Hence a change in the circuit's resistance signals dangerously uneven burning.

**Quick burn.** In the forthcoming Aerojet test this signal will be sent to an oscillograph to verify that electrical resistance does drop in direct proportion to the burning

through of the conductive layers. Edward Vincent, project engineer at the Aerojet Solid Rocket operations at Sacramento, Calif., says the first layer should be burned through 5 seconds after ignition and the second layer 25 seconds later. During this process the resistance is expected to drop to a hundredth of its pre-ignition level. In an operational launch vehicle, the signal would go to an onboard computer that would determine whether the problem was serious enough to shut down the rocket and eject the astronauts.

The conductive rubber material was developed for Aerojet by its corporate parent, the General Tire & Rubber Co. of Akron, Ohio. The dark green material is about ¼ inch thick and is interlaced with parallel electrical wires ½ inch apart. The test will use a sample 2 by 3 feet; an actual launch vehicle would have the material throughout the inner wall of the case.

**Test budget.** Relatively little money has been spent on the program. Of the \$10 million the National Aeronautics and Space Administration budgeted for the motor's development, only \$200,000 is going for the alarm experiment.

Although designed for space, the principle could be useful in earth-bound applications, too. William Cohen, head of NASA's large solid fuel rocket program, speculates that the conductive material could be used wherever static electricity is a problem—such as in drive belts in factories where any buildup of charge would short circuit the two rubber layers, providing a warning signal.

### . . . and through space

Getting off the launch pad is one problem [see preceding story] but equally important is providing the push to propel a spacecraft through deep space once it's beyond the



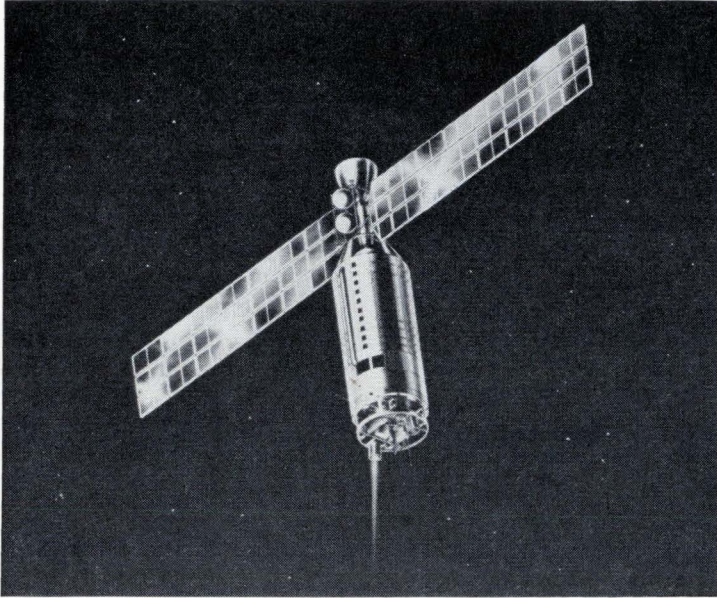

**Agena target vehicle** fitted with ion-propulsion motors. Tiny thrusters will fire to change the spacecraft's orbiting altitude.

earth's gravitational pull. After years of wavering interest and lean budgets, both the Pentagon [Electronics, Oct. 3, p. 55] and NASA are now placing more emphasis on electric propulsion. This month the space agency reported plans to fly an electric-propulsion engine in an orbiting Agena target vehicle. The craft will be launched in late 1968 or early 1969.

**Works in space.** The NASA project, called SERT (for space electric rocket test), was literally launched on July 20, 1964, when an electric engine was fired on a ballistic trajectory to prove that its stream of ions could be neutralized and thus provide thrust in space as they had in earlier lab tests.

That question answered, NASA turned to practical applications, and planned two follow-on programs: SERT 2, to study electric propulsion for manned and unmanned journeys to Mars and elsewhere in the solar system, and SERT 3, to develop small control thrusters for maneuvering spacecraft in earth orbit.

SERT 3 was later shelved because it duplicated experiments planned for the Applications Technology Satellite (ATS). Ion thrusters were not ready for the first ATS, due to be launched Dec. 6, but SERT program manager James Lazar hopes to get them on the

third flight slated for early 1968.

SERT 2 is being developed at NASA's Lewis Research Center in Cleveland. The plan is to install two ion thrusters at the base of the Agena. As the spacecraft orbits the earth in a vertical position the thrusters will be fired to change the altitude. By measuring these changes, scientists on the ground will know how well the engines are working. The Agena will be placed into a 500- to 600-nautical-mile polar orbit. In that orbit the Agena's two huge solar paddles will get maximum sunlight. The goal is to have the craft operate for six months. The whole program costs about \$11 million: \$5 million for the ion engines and associated equipment and \$6 million for the launch vehicle and the Agena.

**One at a time.** The two solar paddles each extend 19 feet from the Agena and together provide 1.5 kilowatts. This arrangement is similar to those on some of the secret Air Force satellites and provides more power than is available on any known American satellite. Each of the ion thrusters needs 1 kw, so obviously they can't both be fired at one time.

The ion engines being developed at Lewis are similar to the one developed for the first SERT. In these, mercury is heated until it becomes a gas and is forced into

an ionization chamber. Electrons emitted from a hot cathode are driven into a spiral in the chamber by magnetic fields. Ionization occurs when electrons collide with mercury gas molecules. An accelerator consisting of a beam-forming electrode and an accelerating electrode drives the ionized particles into space, resulting in the thrust.

This thrust is very small, only 0.0062 of a pound, but the specific impulse is high, at least 4,500 seconds. Specific impulse, the "miles-per-gallon" criterion of propulsion, is measured in seconds and is equal to the pounds of thrust divided by the pounds of propellant used every second. Thus, the SERT 2 thrusters would provide a pound of thrust for 4,500 seconds using one pound of propellant. Chemical rockets, either liquid or solid, have a specific impulse of about 300 seconds, a much lower performance.

**Find a buyer.** Even if SERT 2 proves the advantages of electric propulsion for interplanetary flight, the developers still need a customer. For the immediate future, electric propulsion appears best suited to maneuvering in earth orbit—particularly military satellites—or keeping a satellite stationed above a fixed point over the earth. But Lazar thinks that if advanced solar cell array techniques can provide up to 50 kw at a weight of 50 pounds per kw, small probes could use electric propulsion to travel nine-tenths of the way to the sun and out to Jupiter. And if nuclear power sources can provide megawatts at even lower weights, electric propulsion could carry astronauts throughout the solar system.

---

## Instrumentation

---

### Safety on the range

Range safety crews have to hustle to control missile launches even when they are spaced as much as a week apart. But in the 1970's liftoffs will be routinely conducted back to back and in some cases several flights may be scheduled



simultaneously. To cope with this increased load the Air Force wants a new generation of electronic equipment and is negotiating a study contract with Radiation, Inc., of Melbourne, Fla., and the Philco-Ford Corp.'s Western Development Laboratories of Palo Alto, Calif. Philco-Ford is a subsidiary of the Ford Motor Co.

The two companies won project-definition contracts for a digital system for range safety control to be installed at Cape Kennedy for the Eastern Test Range, Vandenberg Air Force Base for the Western Test Range, and at White Sands Missile Range and Eglin Air Force Base.

**Competition.** Philco-Ford and Radiation edged out the Avco Corp., General Electric Co., Radio Corp. of America and a Collins Radio Co.-Motorola, Inc., team. The contract, estimated at \$100,000, is being awarded by the Air Force Electronic Systems Division, Hanscom Field, Mass. System development will be managed by the division's directorate of aerospace instrumentation.

After the study, either Radiation or Philco-Ford will be selected to build the prototype—one ground and six airborne stations. The production contract, which could easily amount to more than \$20 million, will follow. The system will operate in the C band, around 500 gigahertz, away from the crowded 400- to 455-Mhz region now used.

**Close watch.** Range safety crews must monitor the handling and launch of a rocket on the ground, and then watch such flight parameters as critical velocity, position and impact prediction for signs of danger. They use trajectory plotting boards, closed-circuit television, telemetry skyscreen displays, recorders and data-translation gear.

The electronic controls will have a longer operating range and also give safety officers better control, particularly faster responses for simultaneous and quick-sequence launches. It's expected that rapid switching of high-power links and increased message-handling capabilities will guarantee better control over multiple launches without adding special equipment.

## Tracking

### Getting out of the hole

Even though Project Mohole was scuttled in Congress last month [Electronics, Sept. 5, p. 64], the \$36 million already paid or obligated for it may not be entirely wasted. The Western Development Laboratories division, Philco-Ford Corp. has conducted some in-house research which indicates that a stable ocean platform of the type developed for Mohole by Brown & Root, Inc., is the best base, technically and economically, for tracking missiles and satellites over the ocean.

"Wherever accurate tracking data is required, a Mohole-type platform is the best answer," says Charles E. Hanes, manager, range systems engineering. "These platforms have none of a ship's prob-

lems of maintaining headway and steering. When it comes to keeping the vessel in place and knowing where it is, they are at least 10 times more accurate than a conventional vessel."

Hanes, who has been living with the problem of ocean-based tracking stations since he was program manager for the first Western Test Range tracking ship in the late '50's, envisions a network of platforms that could be moved around the Pacific. "I can see the possibility of building at least 10 of them, of varied configuration, over the next few years," he says.

His opinion could carry considerable weight. Philco-Ford, has a number of responsibilities at the Pacific range, and has conducted a survey of future instrumentation requirements there.

Additionally, it's known that the Navy is interested in stable ocean platforms for its man-in-the-sea

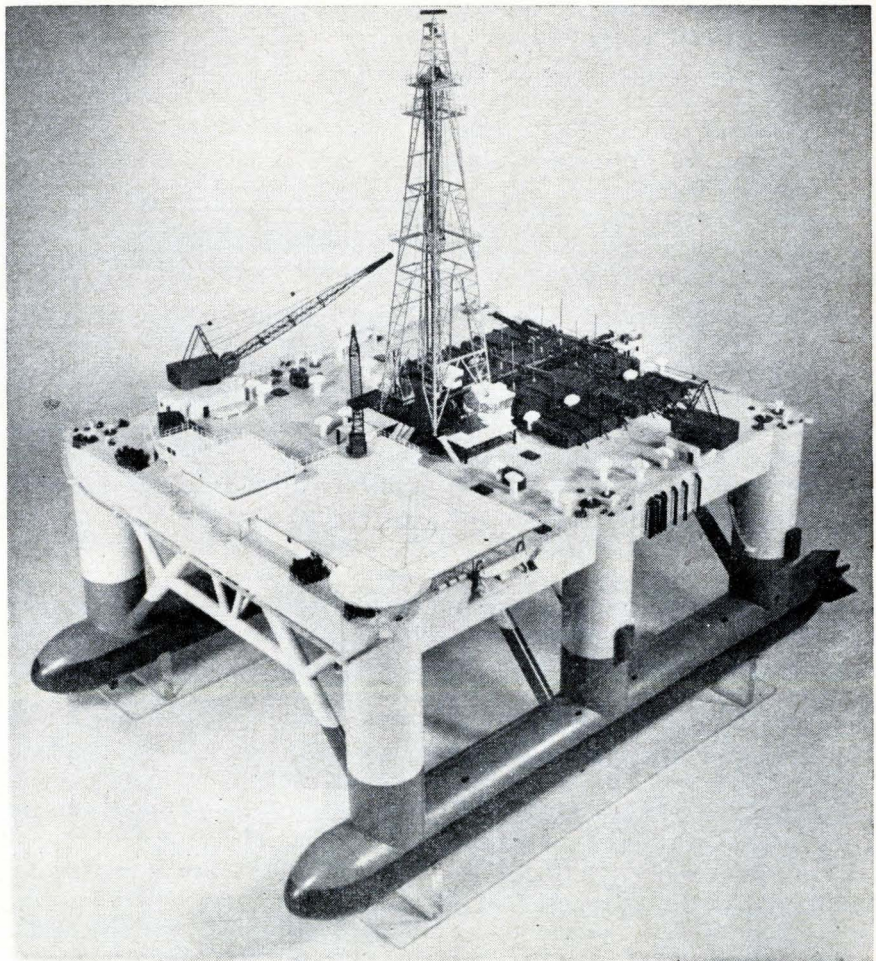

Platform designed for Project Mohole is being proposed for use as an ocean station to track missiles and satellites.



programs, for ocean bottom construction and the placement of anti-submarine warfare devices, for support of submersibles and for bottom searches.

**Proven concept.** The stimulus, though, was the need for tracking stations west of Vandenberg Air Force Base, from which ballistic missiles are fired into the South Pacific and satellites are put into polar orbit. At present, a network of ships supplements stations at San Nicholas Island and Pillar Point, on the California coast, and in Hawaii. Hanes also investigated the "flip ship" being used by the Scripps Oceanographic Institute, found it to be very stable but cramped for space and not very maneuverable.

The Mohole platform, though, Hanes says, offers plenty of space, can cruise as fast as a liberty ship, and is a proven concept as far as stability and station-keeping are concerned. The fact that its roll in a normal ocean is only 1° means that off-the-shelf, land-rated equipment can be used; most of the elaborate electronics necessary to trick a ship's radar system into thinking that the ship is level can be dispensed with.

**Smaller and cheaper.** The Mohole platform was supposed to operate in 14,000 to 18,000 feet of water and to maintain precise positioning to facilitate reentry of the drill string should contact with the hole be lost. The system, designed by Honeywell, Inc., to perform this task, was elaborately redundant; it had a long baseline sonar subsystem, two short baseline sonars and a backup radar subsystem [Electronics, Aug. 9, 1965, p. 116].

Hanes says that tracking platforms could float in much shallower water. He specifically suggests positioning them above submerged ocean mountains, where the depth is only about 1,400 feet. The shallower the water, the more accurate the sonar; given this fact and the less stringent requirement for exact positioning, Hanes figures that two subsystems at most would be needed.

The platform would also be smaller than the Mohole platform, which was to measure 279 by 234

feet. Instead of the enormous drill rig, it would support only four antennas—a C-band tracker, an S-band telemetry antenna, a command system antenna and a satellite communications terminal—plus a helicopter pad and the usual life-support equipment. A 120-foot square platform would suffice, Hanes thinks.

Low bid on the Mohole platform was just under \$30 million. A Brown & Root spokesman also says that the Honeywell system could be modified easily, since research and development, checkout, breadboarding and computer tests have already been made. "But," the spokesman says, "time is not on our side. Our Mohole project is completely shut down. We're contractors—we can't sit around and hope that the project will be rejuvenated."

Hanes himself thinks that it would take two years to get funding started for a new stable platform program. "Without Mohole, though," he adds, "it would have taken us 10 to 15 years to reach the position we're in now."

---

## Advanced technology

---

### Trend-setter

In the two years that Winston E. Kock has headed NASA's Electronics Research Center in Cambridge, Mass., he has set in motion some projects that will probably have significance far beyond space. In a speech at the National Electronics Conference in Chicago this month, Kock pointed out that the center has:

- Steered research into strapdown inertial guidance systems rather than gimballed systems.
- Probed into the development of more sensitive radio telescopes.
- And broadened the search for applications of holography.

In effect, the speech was a summing up of Kock's efforts. Only three days earlier his resignation from the National Aeronautics and Space Administration became effective; he is returning to his

former employer, the Bendix Corp., as chief scientist [Electronics, Sept. 19, p. 45].

**Strapdown guidance.** Kock told the conference that the drop in computer costs and the spiraling price of precision mechanical fabrication are tipping the scales in favor of strapdown inertial guidance over gimballed systems.

"Strapdown guidance packages provide one of many examples of a trend in which substitution of electronic functions for mechanical ones can result in lower costs," Kock pointed out. In most inertial guidance and control systems today, gyroscopes are attached to gimbals—platforms that permit them to retain their alignment despite motion of the vehicles. Because of friction, gyro drift must be corrected. And although the drift rate has been gradually reduced, it has come at a high price: precise and costly mechanical workmanship on the gyros and gimbals.

In a strapdown system, advocated many years ago, the gyroscope bearings are connected to the vehicle without gimbals and the gyros roll with the vehicle. The forces on the gyro bearings are detected by sensors and fed to a computer, which takes into account the various forces. Low-drift gyros are still desirable, but the encoder function and analog-to-digital requirements tied to gimbaling are bypassed; so the mechanical portion becomes simpler while the computer job becomes more complicated.

**Look at the sky.** Kock also disclosed an improved Dicke radiometer technique, called sequential lobing, which can provide a more sensitive method for detecting weak radio emission from stars.

The standard Dicke radiometer compares a received signal with a resistive load. The NASA technique compares signals from two lobes of the same antenna. The lobes are formed by adjacent feed horns so that the signals are nearly identical. The radiation from the earth, which degrades the performance of an antenna in radio astronomy, is the same in both signals. Only when a stellar radio



**TRW**  
*Varicap*  
**DIODES  
STRETCH  
YOUR  
TUNING  
RANGE**

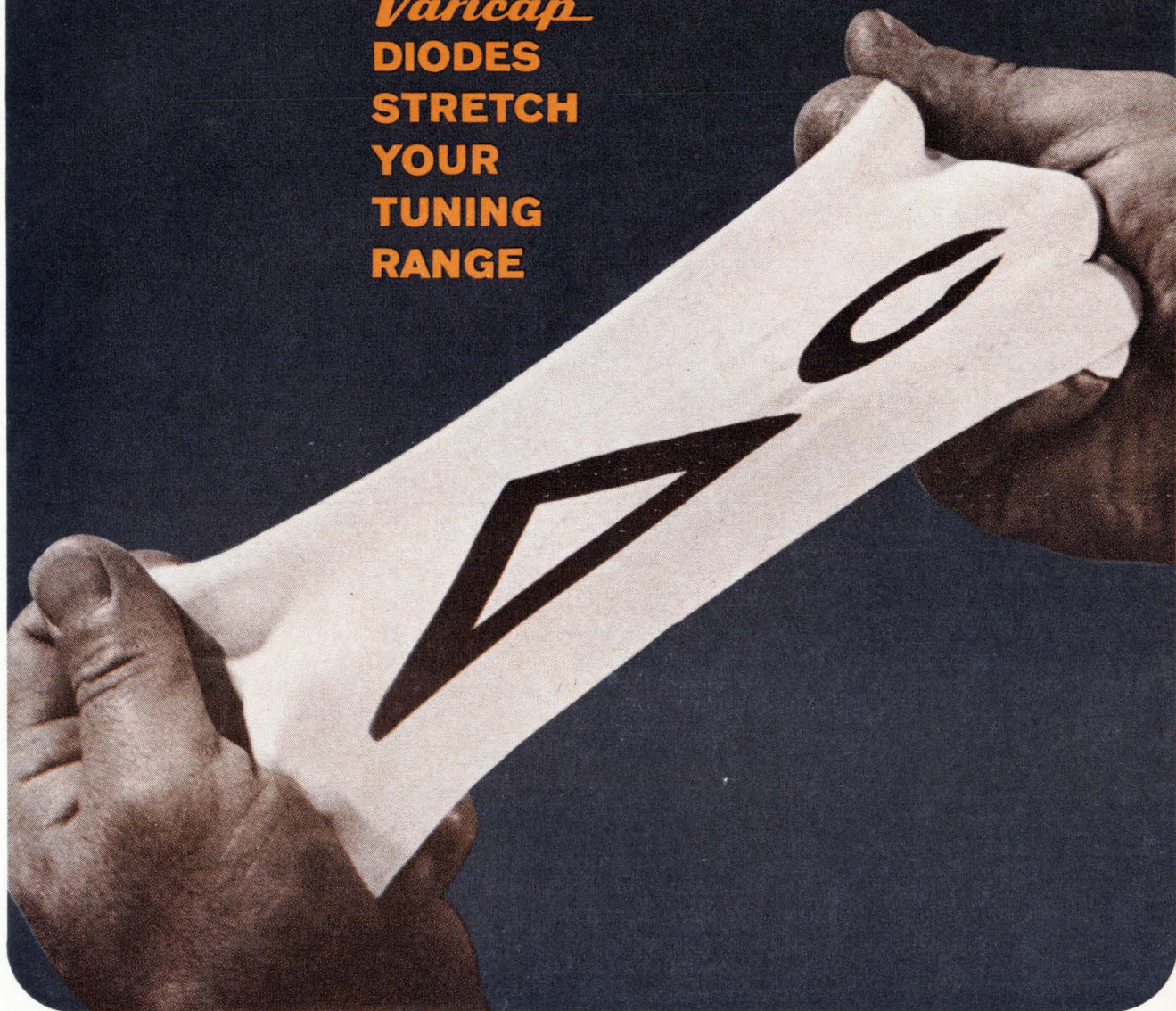

**...up to 20% greater  $\Delta c$ !**

You have a lot of things working for you when you design your tuning system around TRW Varicap diodes. First of all, your circuit will provide controlled tuning range to spare—in many cases you can eliminate additional band switching.

Circuitry is simplified and fewer components are required. Varicap-controlled tuning systems assure the performance characteristics required in the most sensitive communications and monitoring networks.

TRW Varicap diodes are true abrupt junction devices, pro-

duced by proprietary processes. This construction gives the designer maximum capacitance change with voltage; optimum uniformity and tracking and superior performance under all operating conditions.

Varicap Bulletin No. 101 discusses wide-range theory in detail. Get a copy from your authorized distributor or write TRW Semiconductors Inc., 14520 Aviation Boulevard, Lawndale, California (213) 679-4561.

Varicap is the trademark of silicon voltage-variable capacitors manufactured by TRW Semiconductors Inc.

**TRW** SEMICONDUCTORS



signal lies along the boresight of one of the two beams will there be a different signal.

**Picture landing.** Kock also told the conference of efforts to apply holograms. He described, for example, how holograms could be used in an aircraft cockpit display. In one test, he said, a model of an airport was made with holograms and "remarkable realism" was achieved.

He sees the possibility of a pilot landing his plane with the hologram presentation. "A series of holograms from each of the runways," says Kock, "could correspond to a series of actual views as seen by the pilot during a landing operation."

Radar data giving the plane's position with respect to the runway would be fed to a computer that would present the proper succession of holograms so the pilot would see a three-dimensional display of the runway.

The former NASA official also said the simplest hologram of all, made from a point source of light, becomes an optical zone plate and might be used in an orbiting optical telescope or as a lightweight focusing lens substituting for heavier glass lenses. Holograms of a point source of light were made recently by Lowell Rosen of NASA's space optics laboratory.

---

## Communications

---

### Costly split

Before the year is out the Federal Communications Commission is expected to split the overcrowded 450-megahertz band and provide some relief for land mobile radio systems. But relief figures to be costly for users.

A working group of the FCC's advisory committee for land mobile radio services recommended the split on the basis of a week-long test in New Orleans in June. It was adopted last week by the FCC technical standing committee and presumably will be approved at a meeting of the advisory committee

in San Francisco Oct. 19 before being submitted to the FCC for approval.

Under the proposal, each user's frequency space would shrink from 50 kilohertz to 25 khz. The shift will be made over a five-year period. Land mobile users with fairly new equipment would have to modify their sets and older equipment may have to be replaced entirely.

**Pressure.** FCC officials say that relief offered by the proposal will last only a couple of years and then the 450-Mhz band will be jammed again. But the agency is receiving such intense pressure to find more space for mobile radios that it is virtually certain to approve the plan. The FCC estimates that at least 10,000 mobile radios join the system every year.

There are 2.25 million land mobile radio systems in the United States. Of these, roughly 1 million are on the 450-Mhz band.

In a related development, another FCC advisory group proposed that unused Channel 6 in Los Angeles be used to test the feasibility of land mobile radios sharing part of the very high frequency tv broadcast band. The plan, supported by the FCC itself, was met with skepticism. Industry spokesmen attending the session in Washington, including those who had made the suggestion, conceded that a single test would not give the FCC the information it needs to set down rules for such a plan. Because of differences in terrain, tv channel usage and other factors, experts feel tests must be conducted on a case-by-case, location-by-location basis.

**Space search.** The need for more spectrum space for mobile radios is greatest in large metropolitan areas such as New York, Chicago and Los Angeles. But most experts at the meeting believed that sharing of tv channels by mobile radios is virtually impossible in New York and Chicago because of the relatively flat terrain surrounding these cities.

Mountains act as a natural barrier to signal transmission, but in flat sections signals may travel beyond their intended range, inter-

fering with communications in adjacent areas.

Richard T. Buesing, manager of mobile equipment engineering for the General Electric Co., said it is feasible for mobile radios to share tv channel space in most smaller cities. But there isn't any need for the extra space in those cities.

---

## Software

---

### The BOLD librarian

Despite their best intentions, librarians are often a source of irritation to engineers searching for source material. Either the engineer has to explain in exhausting detail what it is he wants, and still gets only one useful piece from every 10 pulled from the stacks, or he must make his own time-consuming or time-wasting search.

Realizing the problem, the Systems Development Corp. of Santa Monica, Calif., is developing a simple-to-use program that enables an engineer with a computer to browse through an area of interest in minutes.

The program is called BOLD, for bibliographic on-line display.

In addition to saving time, the technique allows the engineer to apply the heuristic approach. With computer and man in concert the seeker can suddenly change the direction of his search if another path shows more promise.

**Part-time job.** The hardware for the program is an International Business Machines Corp. AN/FSQ-32 computer, a large time-sharing machine which is used for this work only when it's not busy on other scientific problems at the California research concern.

To the machine has been added six sets of input and output terminals; each terminal has a teletypewriter and cathode-ray tube with a light pen for input, and a teleprinter and the crt for readout.

The program operates in two basic modes. In one, the engineer can feed identifying key words to the computer when he is able to



# high-speed

**Tektronix Oscilloscope  
with general-purpose  
convenience**

## Type 585A / 82 unit features

■ **Dual-Trace Operation** with 4 operating modes and independent controls for each channel—for individual attenuation, positioning, inversion, and ac or dc coupling as desired.

■ **Bandwidth DC-TO-85 MHz** (3-db down) at 100 mV/cm (12-db down at 150 MHz), and typically DC-TO-80 MHz (3-db down) at 10 mV/cm.

■ **Calibrated Sensitivity in 9 steps** from 100 mV/cm to 50 V/cm, and in **10X Amplifier Mode**, from 10 mV/cm to 5 V/cm, variable between steps.

■ **Internal and External Triggering** to 150 MHz.

■ **Sweep Range from 10 nsec/cm to 2 sec/cm.**

■ **Single-Sweep Photography** at 10 nsec/cm.

■ **Calibrated Sweep Delay** from 2 microseconds to 10 seconds.

■ **Bright, High-Resolution Display** with small spot size.

■ **Conventional Passive Probes** for convenience.

## plus

■ **Compatibility with Letter and 1-Series Plug-Ins** to permit differential, multi-trace, sampling, spectrum analysis, other laboratory applications—when used with Type 81 adapter.

Type 585A Oscilloscope . . . . .	\$1725
Type RM585A Oscilloscope . . . . .	\$1825
Type 581A Oscilloscope . . . . .	\$1425
No sweep-delay capabilities, but other features similar to Type 585A.	
Type 82 Dual-Trace Unit . . . . .	\$ 650
Type 86 Single-Trace Unit . . . . .	\$ 350
Type 81 Plug-In Adapter . . . . .	\$ 135

Allows insertion of 17 Tektronix letter-series plug-ins. Passband (up to 30 MHz) and Sensitivity depend upon plug-in used.

U.S. Sales Prices, f.o.b. Beaverton, Oregon

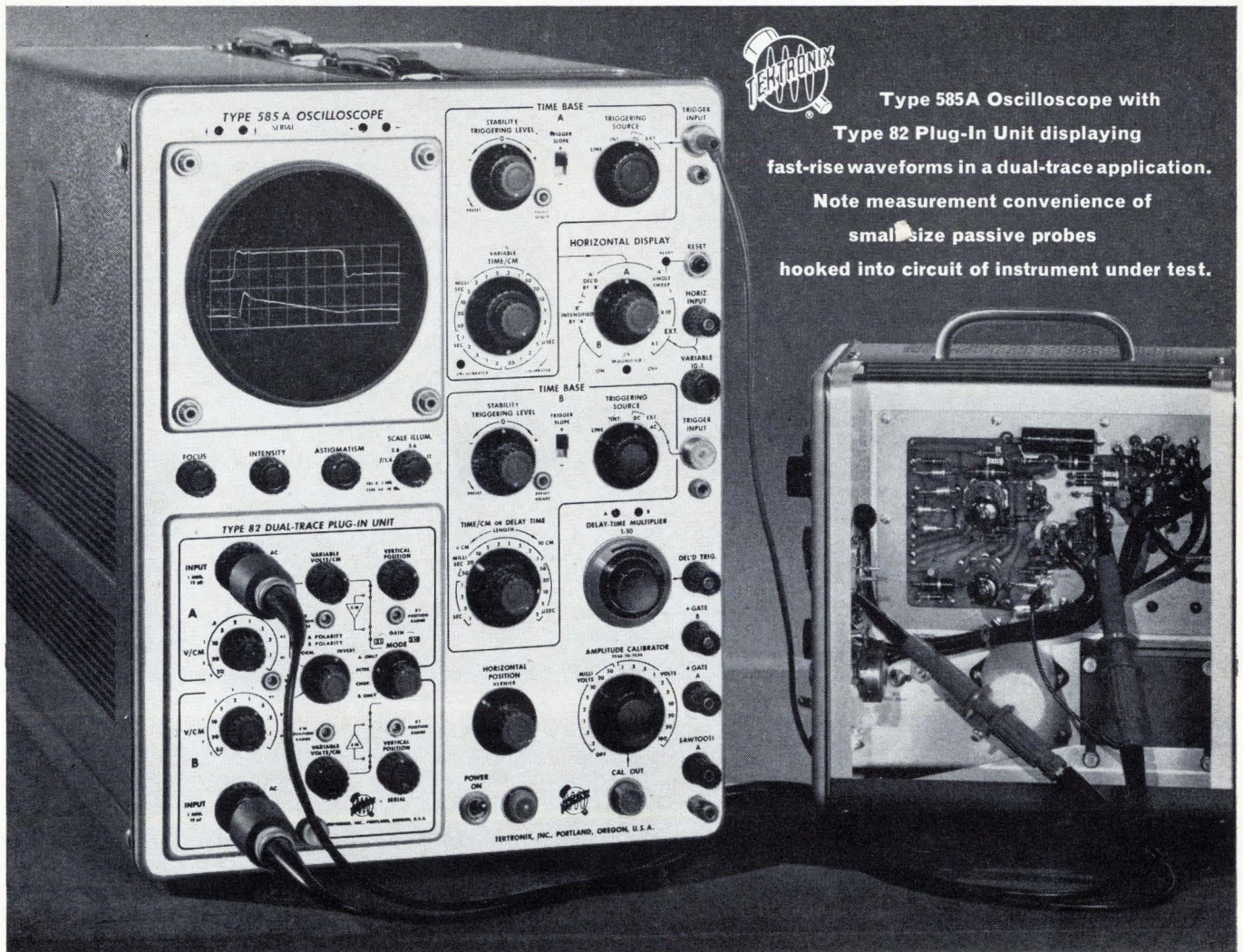

**Type 585A Oscilloscope with  
Type 82 Plug-In Unit displaying  
fast-rise waveforms in a dual-trace application.  
Note measurement convenience of  
small size passive probes  
hooked into circuit of instrument under test.**

**Tektronix, Inc.**



For complete information, contact your nearby Tektronix field engineer or write:  
Tektronix, Inc., P.O. Box 500, Beaverton, Oregon 97005



sharply define his field of interest. He uses the second mode to scan all the headings sequentially and select those that suit his general needs. He can order the computer to examine each field in more detail later.

**Pick a topic.** In the first mode, the engineer first feeds into the computer topic words he is interested in. If a topic word is not in the computer's dictionary alternates will be displayed. When all of the desired topic words have been selected and entered into the program, the retrieval function will be initiated and a matrix of the information displayed. Across the top of the display will appear all of the topic words or phrases and the retrieved documents will be displayed in a vertical column on the left with X marks indicating which topics are contained in each of the listed documents. At a glance, then, the engineer is able to make the final selection and call for abstracts. The engineer can then decide whether he wants to order the full report from the library.

**Scanning.** Another process occurs in the sequential mode, but here the engineer begins by scanning all the topics and signaling the computer when an area of interest passes along on the display. Once again he can zero in on his documents by trimming away subjects of no interest.

The project, undertaken as an in-house effort, is still under development, according to Harold Borko, an information retrieval specialist at Systems Development, and Howard P. Burnaugh, a senior programmer.

---

### Medical electronics

---

#### New breed

Since the turn of the century, when it was invented, there have been few changes in the electrocardiograph. Now, after 10 years of research, the instrumentation field station of the Public Health Service has come up with a machine that is new. It has far fewer controls

than current models, can plug into a telephone to transmit EKG readings to remote places and takes a heart reading five times faster than existing machines—cutting recording time from 15 minutes to 3 minutes.

A prototype of the machine, developed to Public Health Service specifications by the GCA Corp. of Bedford, Mass., will be introduced at a seminar on the impact of biomedical instrumentation research on industrial management, sponsored by American University in Washington starting Oct. 17.

The electrocardiograph has only three controls—a switch to change readings from lead to lead, an on-off button and a device to center the recorder's stylus. The service wants eventually to eliminate the centering control.

The agency is now evaluating the machine and if it is approved all medical electronics companies will be able to produce it.

**Capability.** The self-calibrating unit contains an analog output for telephone transmission or for recording the electrocardiogram on magnetic tape. A phone cradle is built-in so the analog signal can be fed through any telephone and then transmitted to a central recording station or a computer center for diagnosis.

---

### Industrial electronics

---

#### DDC comes home

Direct digital control has found a new customer—the electronics industry, which spawned the technique. In January, the Western Electric Co. will begin using a DDC system at its Merrimac Valley Works near Boston. A computer will control the growing of quartz crystals in autoclaves. Plans are to use the same computer, through time sharing, to control testing of telephone terminal systems. Eventually, the system may also control the growing of laser crystals and assist in other plant operations.

Roland Du Bois, the project engineer, and his assistant, A.R. Fi-

ore Jr., believe the installation will be the first application of DDC to dynamic process control in an electronics plant. DDC systems have already been installed in raw materials plants such as oil refineries and cement works [Electronics, June 13, p. 38]. Western Electric displayed a model of the system at this month's National Electronics Conference in Chicago.

For the initial system, Western Electric is leasing a General Electric Co. 4050 computer. On a trial run, two of the 27 crystal-growing autoclaves at the plant will be computer controlled. Then, two more autoclaves will be put on line. The performance of the system will determine whether Western Electric adopts digital control for all 27 autoclaves and whether it will continue using a general-purpose computer, such as the 4050, or install special-purpose computers.

**Better crystals?** An automated analog system is now used to control the autoclaves, along with recorders that warn personnel when temperatures and pressures stray off limits. The analog system will be used to back up the digital system until the engineers are satisfied that the digital system safely controls the process.

Since the process is already automated, Du Bois points out, the DDC system is not intended to reduce the work force. The goal is closer control over processing, which is expected to allow crystal properties, such as their Q, to be tailored more closely to special requirements for such components as filters and crystal-controlled oscillators. The engineers have been conducting experiments on process variables for nearly two years to gather the needed empirical data.

**Hydrothermal process.** Each autoclave can now grow up to 40 large quartz crystals at a time by a hydrothermal process that requires close control of temperature and pressure for about 25 days. Experimentally, 60 to 70 crystals have been grown in a single autoclave.

The autoclave — essentially a high-pressure tank filled with liquid—is charged with small and broken pieces of high-quality, na-



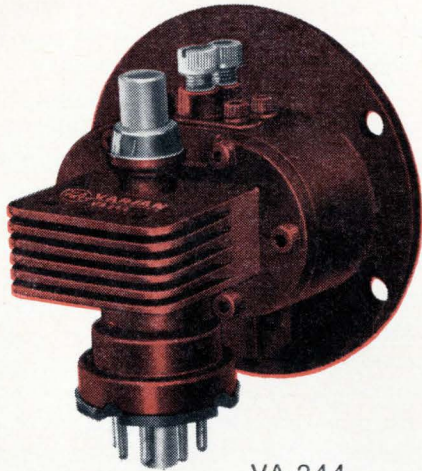

VA-244  
SERIES

# VARIAN KLYSTRONS FOR RELIABLE, MICROWAVE COMMUNICATION SYSTEMS

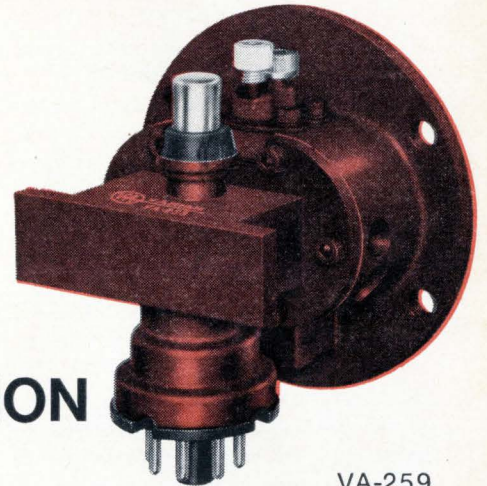

VA-259  
SERIES

**One railway microwave communication system uses 1,636 of these two Varian klystrons and, over a recent 24-month period, accumulated 1,000 years of experience with less than one day of down time (including all failures).**

For more complete information, write Palo Alto Tube Division, Executive Offices, 611 Hansen Way, Palo Alto, California. In Europe: Varian A.G., Zug, Switzerland. In Canada: Varian Associates of Canada, Ltd., Georgetown, Ontario.





tural quartz crystals. Seed crystals are hung in the liquid. The liquid in the lower part of the tank is heated so that the broken crystals dissolve and saturate the liquid. The saturated liquid rises toward the cooler upper portion of the tank, where the quartz precipitates out and grows on the seed crystals, forming large single crystals.

The top and bottom temperatures are monitored by thermocouples, and liquid pressure is monitored by a strain gauge. In the analog system, the transducer signals go to the alarm recorder and the thermocouple signals go through a heater-control loop consisting of magnetic amplifier and saturable reactor. Controlling the heaters also controls liquid pressure, which goes up to about 25,000 pounds per square inch at temperatures of several hundred degrees Centigrade. This basic technique will be used as an analog backup for the DDC system.

**Dynamic digital control.** The computer will obtain temperature and pressure data from a remote scanner made by GE. Initially, 12 points—two thermocouples and a strain gauge in each of four auto-claves—will be monitored at least once a minute. The program will include a scaling factor that will allow the scanning system to convert the analog readings to digital signals by means of a 12-bit conversion method. The data will be transmitted to the computer over a link that can handle 1,800 bits a second.

The computer will check the temperature and pressure measurements against upper and lower limits, calculate set points and initiate heater control signals. The control signals will be fed back to the heater controls by roughly the reverse of the input process. Plans are to use silicon-controlled rectifiers instead of saturable reactors for heater power control. For safety, a circuit built into the scanning system will return control to the analog system if the computer goes off line for five seconds. This safety step is accomplished by a delay that must be reset every five seconds by the program-controlled scanner.

## Packaging

### Integrated plumbing

Power tube designers have for years piped coolants through tube walls to carry off the heat generated by power dissipation. Designers of packaging for large arrays of integrated circuits are now taking a fresh look at this old technique as a way of getting the logic circuits in arrays to operate faster than 1 nanosecond.

The Hughes Aircraft Co. is considering liquid cooling of array substrates as part of a computer-packaging study being made at the Army Electronics Laboratory at Fort Monmouth, N.J. The Army is probing the possibility of boosting computer clock rates to 50 megahertz by using arrays interconnected by a multilayer circuit board. The contract calls for a module containing about 1,400 logic circuits, but William Rhoades, senior staff engineer at Hughes, thinks liquid cooling may make modules of 4,000 subnanosecond gate circuits feasible.

Although the Hughes contract does not call for array development, Rhoades says array design must be evaluated to solve the thermal problems. Weldon Lane, the contracting officer at Fort Monmouth, says the Army has not yet decided where to buy the circuits. Circuits operating at speeds of 1 nanosecond or less are under development at other companies, including Motorola, Inc.

**Too small, too hot.** Originally, the Army hoped to get a high packaging density by using welded microelectronic modules [Electronics, Sept. 7, 1964, p. 73], but thermal problems and insufficient package leads killed that idea. Now, the Army wants the arrays mounted on beryllia substrates (beryllia is a good conductor of heat) and put into flatpacks with 60 leads.

Rhoades believes that cooling such packages in a system will be difficult. If conventional metal heat sinks and heat conducting paths are used, the amount of metal that would be needed to handle total power dissipation would dwarf the

circuitry the engineer explains. Air cooling, explains Rhoades, would "require a wind tunnel."

The company has been thinking about flowing a cooling dielectric over the circuits, but is concerned that the flow could weaken interconnection bonds and that contamination of the dielectric fluid could short out the circuitry. Others are also working on such cooling. Motorola engineers Ivor Catt and Emory Garth have been running one assembly of IC's more than three months without degradation of the circuits. The circuits are not packaged—the dielectric merely flows across the bare circuits. Catt says that while initial calculations indicated the flow could weaken bonds, experiments indicate it doesn't actually happen.

**Baby refrigerator.** One alternative that might work is to circulate the cooling liquid through the beryllia substrate. Rhoades reports that Hughes is considering the idea and is also thinking about an array design that would facilitate such an arrangement.

The low-power logic circuits could be clustered in the center of the array, leaving on the periphery the circuits that match the logic to other arrays. The matching circuitry dissipates more heat than logic circuitry. Under the periphery, the substrate would be thickened, providing room for a channel to pipe the cooling fluid. The natural thermal flow would be from the substrate center to the periphery, since the channel represents a heat sink. From the channel, the heated liquid could be piped to an external heat exchanger or baby refrigerator.

**Air isolation.** Hughes and other companies have been working on air isolation of IC devices, etching away the silicon between them, as a way of improving performance and speed [see p. 125].

Asked whether this method also would alleviate thermal problems by forcing heat from the devices to flow into the beryllia, instead of through the silicon, Rhoades replied that this technique was also under consideration. It would help prevent heat from high-power components going toward the logic cir-



# Would you use Dual Transistors if they were 50% cheaper? Now you can.

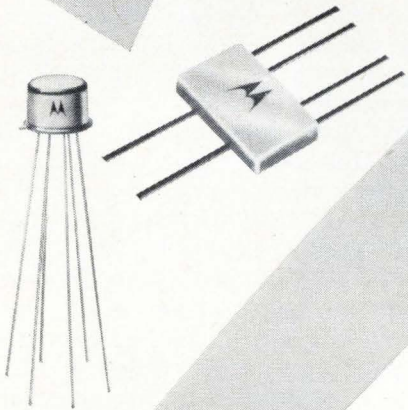

Sixty-Six new device types — plus a 50% saving for Motorola's Twins\* transistor line — offer the designer new opportunities for space-saving economical designs.

And, Motorola's rugged ceramic flat package — now available with most Twins types, gives added design potential to space-conscious engineers.

Now you can get virtually every dual combination of high-speed, high-voltage PNP or NPN silicon annular transistor . . . and select devices using a new numbering system for easier cross reference to discrete counterparts.

Send for the new Twins Selection Guide covering

132 individual Twins types — including 79 Twins differential amplifiers . . . 41 Twins dual transistors . . . 6 Twins complementary pairs . . . and 6 Twins Darlington amplifier types!

Your local Motorola semiconductor distributor or nearest district office can provide complete information (or units for prototyping). Or write: Motorola Semiconductor Products Inc., Dept. TIC, Box 955, Phoenix, Arizona 85001.

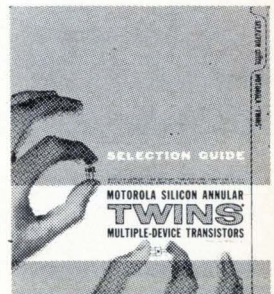

\*Trademark of Motorola Inc.



**MOTOROLA** *Semiconductors*  
*where the priceless ingredient is care!*



**“9 years ago  
we had a great  
idea that put us  
in the high-rel  
relay business.**



**It's still a great  
idea, and now  
we've put it  
in a one-inch  
package! ”**

Wedge-action\* was the great idea. By combining long precious-metal contact wipe with high contact force, it gives Electro-Tec relays the highest dry-circuit confidence level ever reached. (90%, based on a failure rate of only .001% in 10,000 operations.)



Packing wedge-action into a one-inch envelope wasn't easy. But it was worth it. It gives you maximum reliability in minimum space. And it's available for both 6PDT and 4PDT operations, in relays that exceed all requirements of MIL-R-5757/1 and /7.

The one-inch relay is just one of our family of wedge-action relays, which cover almost every dry-circuit to 2 amp application. When you need a high-rel relay that really works, remember our great idea, and put it to work for you.

\*U.S. Patent No. 2,866,046 and others pending.



**Electro-Tec Corp.**  
SLIP RINGS • RELAYS • SWITCHES • OPTICS

P.O. Box 667 • Ormond Beach, Florida  
(904) 677-1771 • TWX 810-857-0305  
Manufacturing Facilities:  
Ormond Beach, Fla. • Blacksburg, Va.

## Electronics Review

cuits. Dielectric isolation, he says, requires a glaze that is a barrier to heat removal.

### Electronics notes

▪ **Insurance.** The Communications Satellite Corp. will build a second ground station at Andover, Maine. James McCormack, Comsat chairman, said the company is not withdrawing a pending application to build a station at Moorefield, W.Va. McCormack said Comsat decided to seek the Maine site because of the prolonged negotiations with communications companies over the West Virginia site.

▪ **Optical bargain.** The Edmund Scientific Co. is selling a low-cost hologram that permits reconstruction of an image with ordinary light. The holograms are priced from \$15 to \$450, depending on size. Holograms have sold for upwards of \$75.

▪ **American made.** The Amperex Electronic Corp. of Hicksville, N.Y., will start producing Plumbicon television camera tubes next March in a plant now being built in Slatersville, R.I. Up to now all Plumbicon tubes have been imported from Philips Gloeilampenfabrieken N.V., the Netherlands, the developer. Amperex, a subsidiary of the North American Philips Co., will import from its parent company the special manufacturing equipment.

▪ **IC's use.** A module for color tv tape recorders marks the first use by the Radio Corp. of America of integrated circuits in broadcast equipment. The module, a velocity error corrector, improves color program playback quality by compensating for defects caused by mechanical tolerances.

▪ **Faster forecast.** The Federal Aviation Agency is preparing to ask for bids on an automatic data-processing system that will substantially reduce the time it takes to gather weather reports from bureaus around the country and retransmit them for aviation customers. The processor will collect weather data in two minutes—four minutes less than at present; retransmission time will be reduced

from 30 to 15 minutes.

▪ **Interception.** Motorola, Inc., has built a radar intercept calculator for the Air Force that can figure out where supersonic aircraft are headed in the time it takes a radar antenna to turn around twice. The calculator is a special-purpose digital computer that operates on the raw video signal from an air-search radar receiver. It automatically detects a target and estimates its position and course.

▪ **Purchase agreement.** The acquisition of George A. Philbrick Researches, Inc., by Teledyne, Inc., of Hawthorne, Calif., has been agreed upon in principle.

▪ **Curve follower.** An optical character reader that reads handwritten figures has been announced by the International Business Machines Corp. The IBM 1287 is the first machine on the market that can read anything other than printed type; it does it by locating a point on a character and tracing it out, rather than by scanning the character area and looking for light and dark areas. It analyzes each character it sees, translates it into machine language and sends it to the memory of a System 360 computer. However, its capability is limited to the digits 0 through 9 and four letters of the alphabet. Some other character readers on the market can read all letters of the alphabet, the 10 digits and a number of special characters and can recognize a variety of type fonts. Also the handwriting that the IBM unit reads must be on a special form; many competing machines can read from any of a wide variety of page sizes and formats.

▪ **Plus and minus.** Under a complex point system the Hughes Aircraft Co. has won a round and lost a round with its Surveyor spacecraft. The company's incentive contract with NASA calls for a bonus of up to \$2 million for performance on each of the first four flights and up to \$1 million each for the last three. Hughes is not penalized for a failure such as the Sept. 20 flop of Surveyor 2; it just loses its bonus. However, Hughes will be liable for some of the extra costs if they soar above the \$426-million contract price.



# Design a new circuit? It only takes 10 seconds to find out that maybe you didn't.

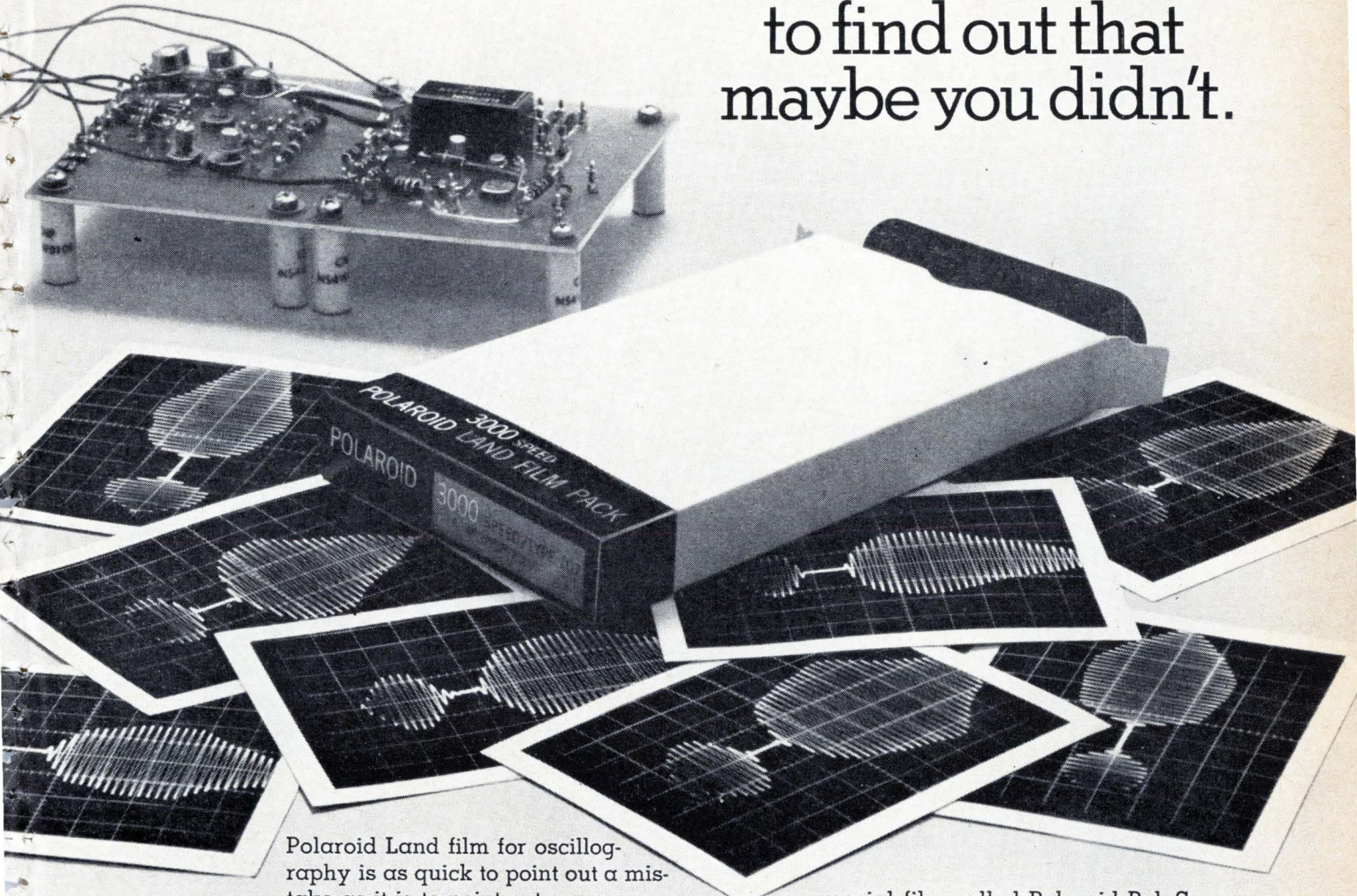

Polaroid Land film for oscillography is as quick to point out a mistake as it is to point out a success.

You never have to wait for darkroom development only to find out that your new breadboard needs more work.

You get your results in 10 seconds flat. And it's always a sharply detailed, high-contrast trace recording.

You can study it, attach it to a report, send it as a test record along with a product shipment, or file it for future use.

Choice of films? Yes. There are four different films for oscilloscope recording in pack, roll, and 4 x 5 formats.

The standard film speed has an ASA equivalent rating of 3000.

If you want to take a picture of a trace so fast you can't even see it, we've got a

special film called Polaroid PolaScope Land film with an ASA equivalent rating of 10,000. It's the fastest film around. It will actually record a scintillation pulse with a rise time of less than 3 nanoseconds.

To use these films on your scope, you need a camera with a Polaroid Land Camera Back. Most manufacturers have them (Analab, BNK Associates, Coleman Engineering, EG & G, Fairchild, General Atronics, Hewlett-Packard, Tektronix).

You can get complete details from one of these manufacturers, or by writing to Polaroid Corporation, Technical Sales, Dept. 30, Cambridge, Massachusetts 02139.

**Polaroid Land Film for Oscilloscope Trace Recording**



# THE DEATH OF AN AGGRAVATION

(An encouraging note for those concerned with the application of reflex klystrons.)

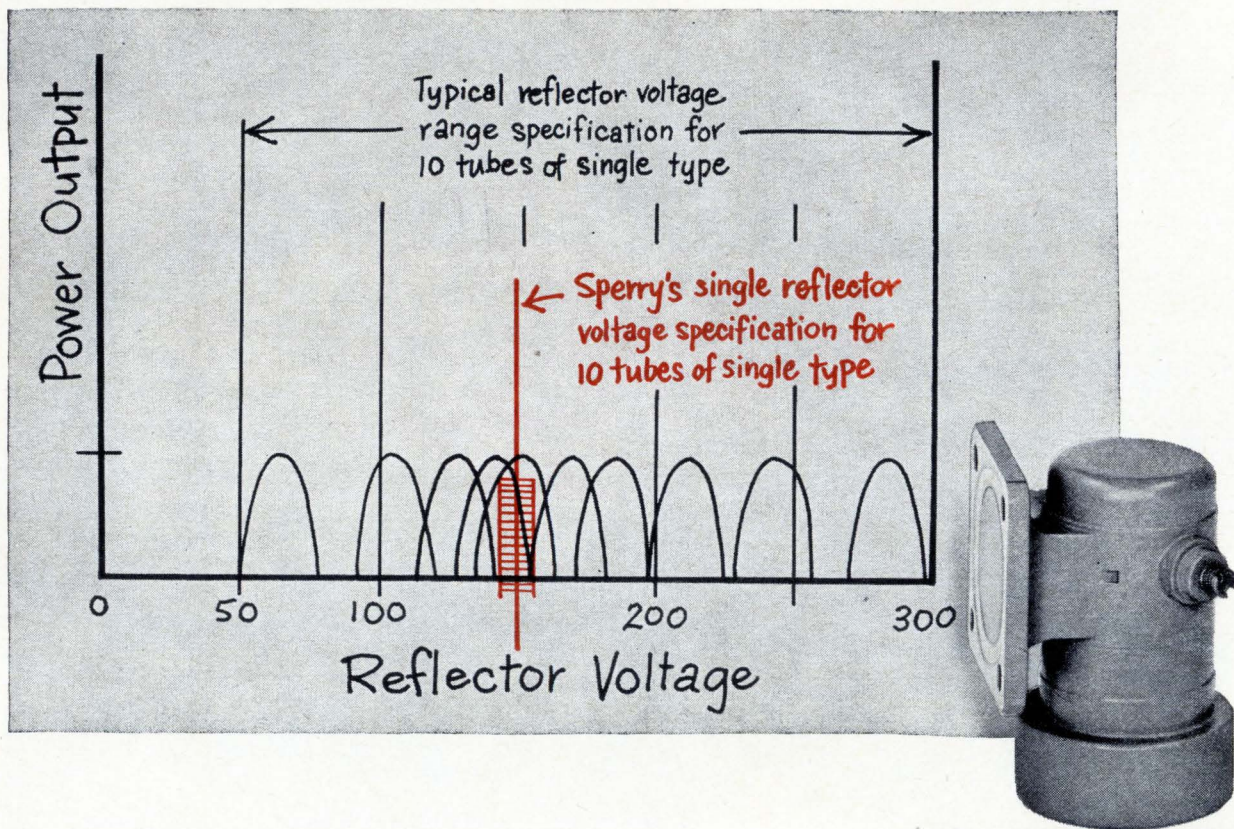

All the reflex klystrons in your next order can have the same reflector voltage! A remarkable new development from Sperry has eliminated the familiar problem of searching a wide reflector voltage range for proper tuning. Tube replacements can be made in the field with no adjustments to either tube or system.

You no longer need a power supply that can allow for large and unpredictable reflector voltage variations. You no longer need a potentiometer to adjust the reflector voltage, or the test gear required for tuning the tube in the field.

Now you simply decide what reflector voltage you want and tell us. As the chart above indicates, we

Evaluate Sperry for Value! This new development comes from the Sperry Storehouse of Knowledge . . . for more than 25 years the outstanding source of improvements in microwave tubes. Our inventory is technology. Draw on it whenever you need outstanding performance from klystrons, traveling wave tubes, or backward wave oscillators.

can put the center frequency right where you want it and deliver the tube either fixed-tuned or mechanically tunable.

There's other beneficial fallout from this concept. Many characteristics, such as modulation sensitivity, are more uniform from tube to tube. And, as far as shock and vibration are concerned, our tubes are state-of-the-art.

Sperry technology has now perfected reflex klystrons that offer the new single reflector voltage principle for a variety of applications in X, U, K and V bands.

Like to know how we do it? Write for your free copy of a new technical paper by Sperry's J. D. Feehan. It has the details.

## SPERRY

DIVISION OF  
SPERRY RAND  
CORPORATION

### SPERRY ELECTRONIC TUBE DIVISION, Gainesville, Fla.

National Representatives: Cain & Co., Los Angeles, 783-4700; Boston, 665-8600; Arlington Heights, 253-3578; Dallas, 369-2897; Dayton, 228-2433; Eastchester, 337-3445; Philadelphia, 828-3861; San Francisco, 948-6533; Syracuse, 463-0462; Washington, 296-8265; South Amboy, 727-1900; Huntsville, 534-7955; Dade City, 422-3460; Montreal, 844-0089.



# Washington Newsletter

October 17, 1966

## **Tight space funds may delay start of 2 projects**

The Apollo Applications and Voyager programs, delayed a year ago by meager budget outlays, appear to be in trouble again. Around Washington, the betting is that the fiscal 1968 budget will about equal this year's \$5 billion despite pleas by the National Aeronautics and Space Administration that the two programs can't start next year unless it gets a \$6-billion budget.

The delay of the two projects means the space electronics industry may have to forget business it counted on in fiscal 1968. Postponement of the Apollo Applications program could result in production line shut-downs and large layoffs at many Apollo contractors and suppliers.

The first launching of a Voyager would probably be pushed back two more years to 1975, which is the next launch opportunity to Mars. The first Voyager was originally planned for 1969, but funding problems caused it to slip to 1971 and then to 1973.

## **No cuts now, NASA insists**

Officials at NASA spend a lot of time denying rumors that the President has demanded a big cut in the current year's space spending because of Vietnam and the drive against inflation. Reportedly the agency has already spent \$3 billion and committed most of the remaining \$2 billion since the fiscal year began July 1.

## **Medical market: A boost from test automation . . .**

Medicare and anticipated health legislation in the next few years should prove a boon to medical electronics equipment makers.

Government programs are accelerating a trend toward automation of pathological laboratories and this segment of the market alone is seen as a multimillion dollar annual business within the next five years. The National Institutes of Health is encouraging further development of testing equipment and hopes to bring laboratory fees for a series of 12 tests down to \$2 from about \$100.

Senate hearings growing out of complaints that fees are too high were told that new equipment will make mass testing for diagnostic purposes feasible for the first time. Shown to Sen. Maurine Neuberger's (D., Ore.) subcommittee on the health of the elderly: Technicon Instrument Corp.'s auto-analyzer, the Robot Chemist by Warner-Chilcott Laboratories, and Digital Equipment Corp.'s laboratory instrument computer—which can provide a written evaluation of an electrocardiogram within 15 seconds.

## **. . . and artificial kidney machines**

Legislation will be pushed in the next session of Congress to provide money to build more artificial-kidney treatment centers and to operate them with Federal money for longer than three years. The Public Health Service's budget for the centers has grown from \$1 million in fiscal 1965 to \$6.4 million in fiscal 1967.

Thirteen of the multipatient facilities are in operation and 10 more are planned for this year. They cost \$700,000 to \$1 million to build and \$500,000 a year to operate, too costly for most hospitals and communities. Many organizations are reluctant to ask for a pilot center because they'd have to take it over after three years. Electronics account for about 60% of the cost of one \$7,200 unit, performing such tasks as fail-safe control,



---

# Washington Newsletter

---

conductivity and fluid concentration measurements, and temperature control.

## **Comsat to award design studies for large satellite**

Preliminary design studies will shortly be announced on the multipurpose communications satellite now being planned for the 1969-1972 period by the Communications Satellite Corp. Earlier this year the firm was accused of lagging on developing the large satellite which had originally been scheduled for launching in 1968-1969. Comsat has started negotiating with Hughes Aircraft Co. and Radio Corp. of America, and a third contract may be awarded to either Philco-Ford Corp., a subsidiary of the Ford Motor Co., or General Electric Co. The Boeing Co. and TRW, Inc. also bid on the \$200,000 studies.

## **Two radars won't be ready for early AAFSS...**

A lack of technical confidence in terrain avoidance and stationkeeping radars has resulted in a decision not to equip early models of the Advanced Aerial Fire Support System (AAFSS) with the sensors. The radars had been scheduled for the initial attack helicopter models due to roll off the assembly line in late 1969. The Army and the contractor, the Lockheed Aircraft Corp., decided that the radars would not be debugged in time for the first models but are designing the AAFSS so that the sensors can easily be installed.

## **... but Army craft still looks good to other services**

Despite the Army's radar troubles with its attack helicopter, the Air Force and Navy are interested in the craft. The Air Force likes the AAFSS because it will carry as much payload as the Douglas A-1 fixed wing attack aircraft. The Navy is considering the helicopter as a possible weapons platform for antisubmarine missions. AAFSS reportedly has been getting bad marks in cost effectiveness; but if the Air Force and Navy decide to buy the helicopter, it would increase the craft's cost-effectiveness score with the Pentagon.

## **NASA centers vie for tv satellite**

Intramural jockeying has begun between two National Aeronautics and Space Administration field centers to develop a satellite capable of broadcasting television programs directly to home or community receivers, although a flight project is not imminent [Electronics, Sept. 19, pp. 52-53]. The two leading contenders are the Goddard Space Flight Center, Greenbelt, Md., now running the Applications Technology Satellite, and the Lewis Research Center, Cleveland, which houses NASA's space power experts. Goddard would be the logical choice since it has had experience with communications projects, but Lewis is gaining ground on the strength of a recent assignment of its first orbiting spacecraft project [see p. 35] and the knowledge that power will probably be the biggest technical problem for direct broadcast satellites.

## **Russia nearing a space first?**

A feeling is growing in space circles that Russia is about to achieve a space spectacular equivalent to the first sputnik. No one knows just how this would affect United States space plans but top officials say privately that the Soviets are completing a booster larger than the giant U.S. Saturn-5 moon rocket.



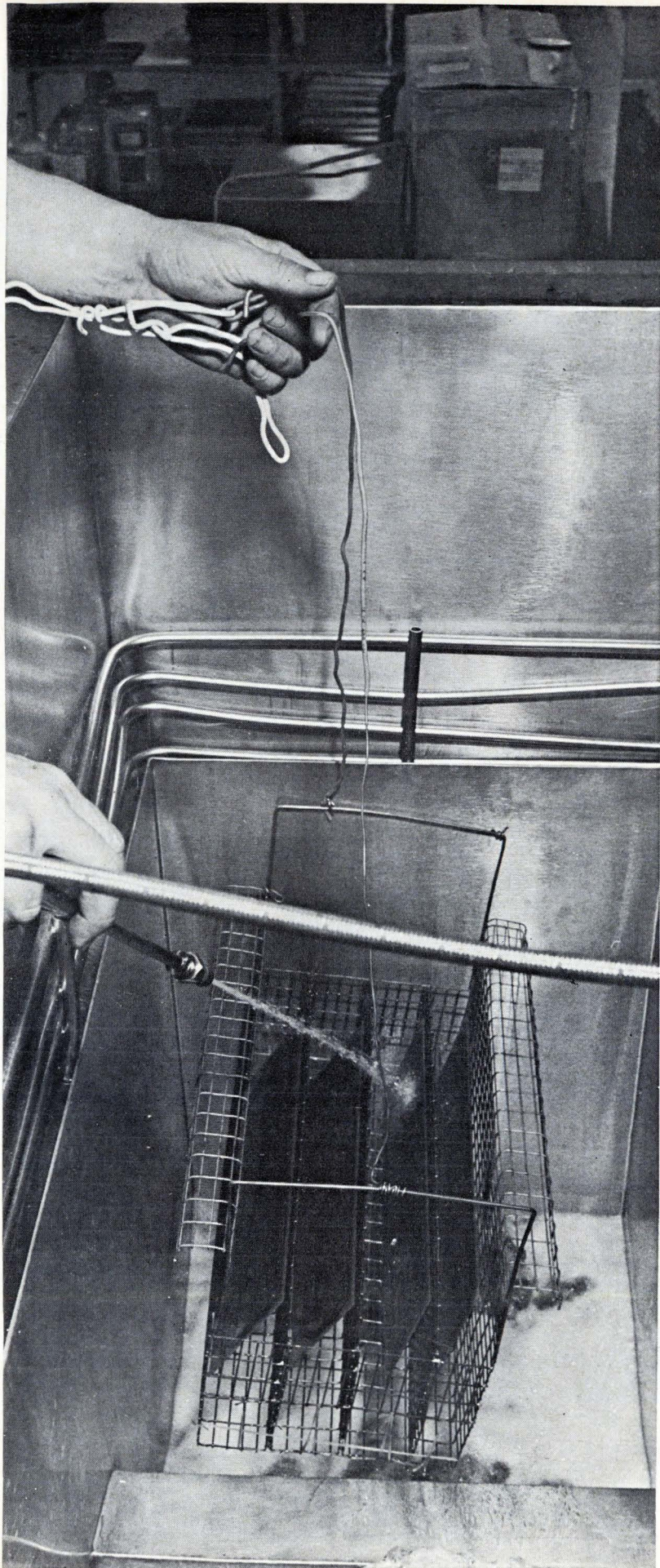

**What could  
cost less than  
detergent and water  
for cleaning?**

**At SCM, it's  
FREON®  
in a Westinghouse,  
ultrasonic unit**

SCM's Data Processing Division in Oakland, Calif., cleans printed circuit boards with FREON TMC solvent in a Westinghouse ultrasonic unit. They tried detergent and water, but found it actually costs too much! Many man-hours were lost in cleaning boards over and over again to make them acceptably clean. But with FREON, *one* cleaning does the job completely, with substantial savings in time and money. SCM found that no other solvent could match the performance of FREON.

FREON TMC (a patented azeotrope of FREON TF and methylene chloride) is only one member of Du Pont's family of tailored solvents. Like all other FREON solvents, its low surface tension penetrates the smallest pores and crevices. Its high density floats away all contaminants. Its excellent stability permits reuse after simple distillation. FREON is nonflammable and relatively nontoxic. No special exhaust systems are needed. And FREON solvents are selective—they clean without affecting materials of construction.

Chances are you could save money and get more efficient cleaning with FREON. For more information, write Du Pont Co., Room 4343, Wilmington, Delaware 19898. (In Europe, write Du Pont de Nemours International S.A., "FREON" Products Division, 81 route de l'Aire, CH 1211 Geneva 24, Switzerland.)



Better Things for Better Living  
...through Chemistry



# lumber sorting—the modern way

Allen-Bradley control panel—  
incorporating A-B dry reed switching units—  
substantially increased “output”!

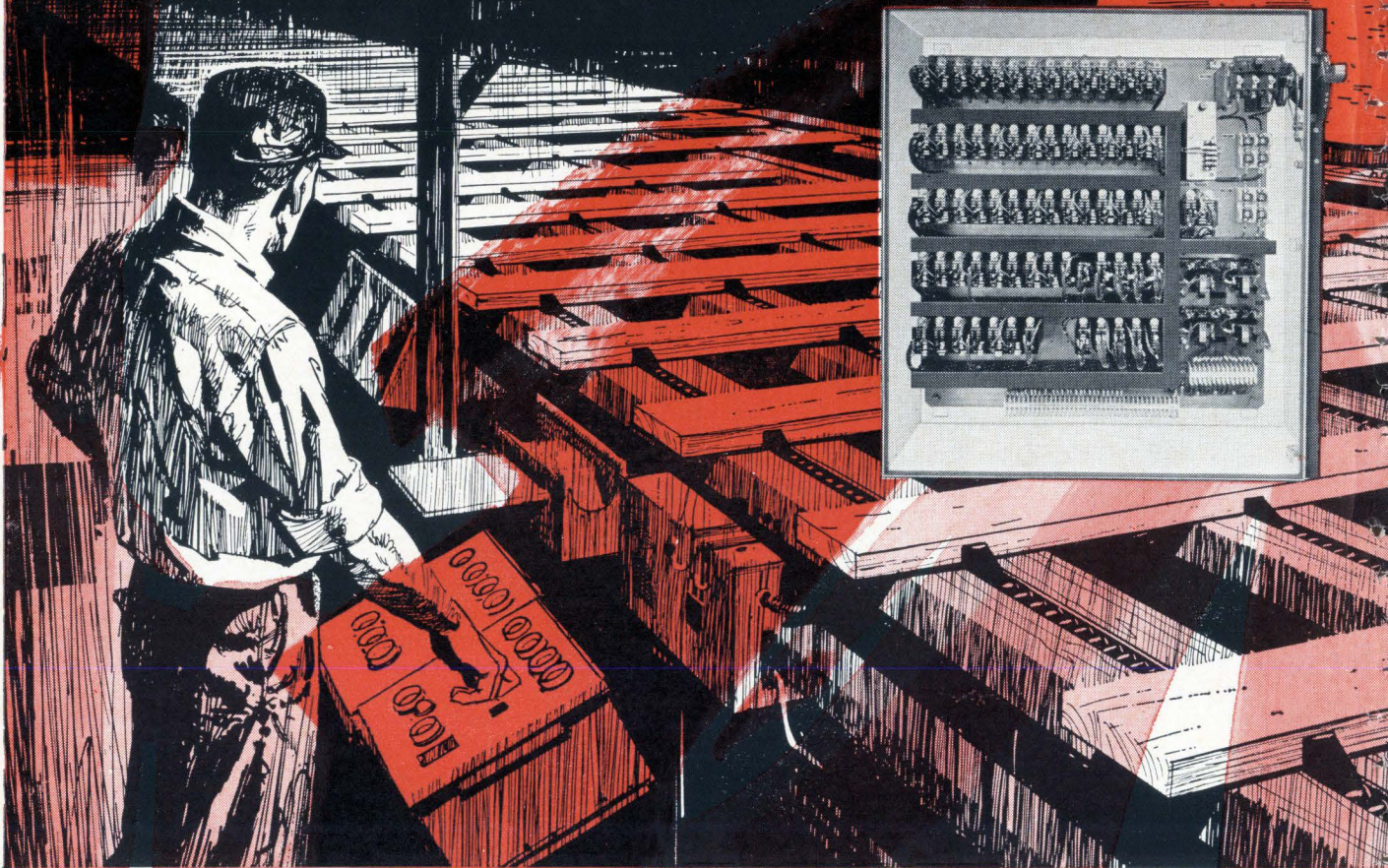

Here's a lumber sorting operation where Allen-Bradley dry reed switching solved a serious problem. It provides not only the required high speed switching for rapid sorting but also the required reliability to insure continuous operation. The unavoidable operating conditions—extreme dust with wide temperature variations—can be ignored in reed switching.

The reason for the success of this installation is self-evident. To begin with, each individual dry reed contact in the Allen-Bradley system is hermetically sealed within an inert gas filled glass tube—contact contamination cannot occur. Consequently, the A-B reed devices will provide hundreds of millions of faultless operations.

Allen-Bradley dry reed switching is in the millisecond range. Unlike solid state devices, it is insensitive to “transients” or wide temperature variations. Also, A-B dry

reed switching consists of simple relay circuits, with which electricians are well acquainted.

All Allen-Bradley units are of rugged modular construction, uniform in height and depth and arranged for panel mounting. Terminals—all accessible from the front and individually identified—simplify wiring and circuit tracing.

Allen-Bradley dry reed switching units are available in a variety of types, as described at the right, to make possible complete design flexibility. Allen-Bradley engineers will be pleased to work with you on the application of these dry reed switching units. Please let us hear from you. Allen-Bradley Co., 110 W. Greenfield Ave., Milwaukee, Wisconsin 53204. In Canada: Allen-Bradley Canada Ltd. Export Office: 630 Third Ave., N.Y., N.Y., U.S.A. 10017.



# Allen-Bradley has available a complete line of dry reed switching units

## BULLETIN 1610L Magnetically Latched Dry Reed Relays

Latching contacts have permanent magnet bias not strong enough to operate the contacts, but strong enough to hold them in position once they have been operated even if coil power is removed. Relays have coils with separate "latch" and "unlatch" windings. Available with 2, 4, 6, and 8 poles.

## BULLETIN 1614L Flip-Flop Units

Consist of prewired magnetically latched input and output relays. Output relays have four contacts. Units can be assembled to perform counting functions: binary, binary coded decimal, and decimal counters. No power is required to maintain steady state condition.

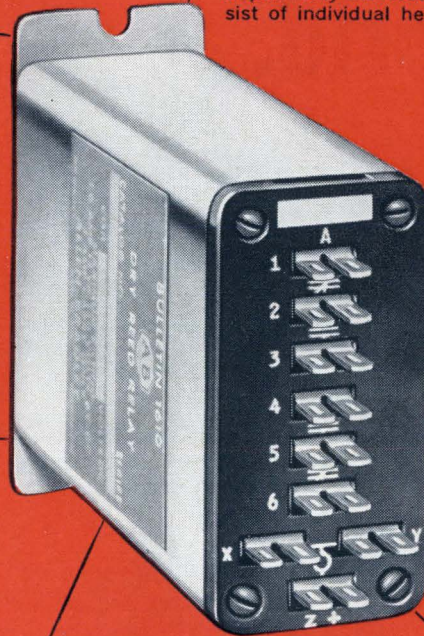

## BULLETIN 1610 Dry Reed Relays

All A-B dry reed switching units are similar in appearance and construction. Enclosures are identical in height and depth—only the width varies. The dry reed relays consist of individual hermetically sealed contacts, either N.O., N.C., or various combinations of both. A single coil surrounds all the switches in the relay. The steel enclosure completes the magnetic circuit and shields the switches from external fields. Available in four basic enclosure sizes. Standard coil voltages 24 v and 125 v dc.

## BULLETIN 1612L Shift Register Units

These are self-contained shift register stages consisting of magnetically latched storage and transfer relays. A dual coil surrounds the magnetically biased dry reed switches. Two isolated contacts are available for signal outputs. Can be furnished with various contact arrangements.

Bulletin 1610

## BULLETIN 1618 Diode Units

Are assemblies of hermetically sealed high quality silicon diodes conveniently enclosed. The units are internally wired in three ways: separate terminals for each diode, pairs of diodes with a common anode terminal or with a common cathode terminal. Number of diodes: 7 or 13; pairs of diodes: 5 or 9.

## BULLETIN 1616 Logic Units

Contain double-wound coils with the windings in opposition. Each winding will cause contact operation when energized alone. Various logic functions can be performed: nor, and exclusive-or, inclusive-or, and comparator. A variety of output contact combinations can be furnished.

Allen-Bradley has many other components and accessories to round out the complete dry reed switching line, such as:

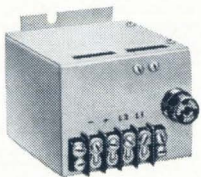

## BULLETIN 1690 Power Supply

It furnishes filtered direct current for proper operation of the high speed dry reed devices.



## BULLETIN 1691 Resistor-Capacity Network

Provides arc suppression for contact protection when switching inductive loads.



Compact clip-on pilot light units are also available. Readily visible, lights are easy to mount by slipping bracket into a recess at the top of the terminal block.



# ALLEN-BRADLEY

Member of NEMA

## QUALITY MOTOR CONTROL



# Announcing the Brush Mark 250, first strip chart recorder for the perfectionists of the world.

Meet the fastest, most accurate strip chart recorder on record: The new Brush Mark 250. When you read about all the features you'll know why we call it the first recorder for the perfectionists of the world!

**1 Unmatched frequency response.**

Flat to 10 cycles on full 4½" span! Useful response to 100 cycles. Nobody has a strip chart recorder in the same league.

**2 Wide selection of signal conditioners.**

Choose from 21 interchangeable preamps. Use one today; plug in a different one when your recording requirements change.

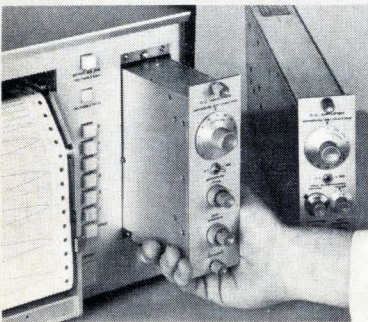

**3 Crisp, clean rectilinear writing.**

Patented, pressurized inking system puts smudge-proof trace into the paper not just on it.

**4 Contactless, non-wearing feedback system.**

Same one used in our multi-channel Mark 200 recorders. (No slide wires!) Accuracy? Better than ½%!

**5 Multiple chart speeds.**

Push-button choice of twelve... from 5 inches/second to 1/10 of an inch/minute (up to 8 days of continuous recording).

**6 Portable or Rack mounting.**

And either way you get the exclusive new dual position writing table.

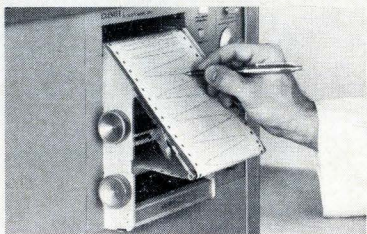

**7 Removable chart paper magazine.**

Great for desk top record reviews. Man-sized manual winding knobs let you roll chart forward and back. Chart reloading is a cinch.

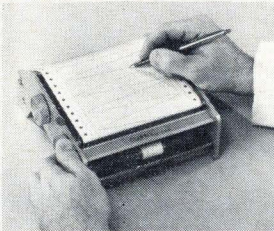

See what we mean? The Mark 250 is for the perfectionists of the world. Ask your Brush Sales Engineer for a demonstration. Or, write for chart sample and specifications. Clevite Corporation, Brush Instruments Division, 3633 Perkins Ave., Cleveland, Ohio 44114.

**CLEVITE**  
—brush INSTRUMENTS DIVISION

Shown approx. 76% of actual size with 1 μv preamplifier RD 4215-70; event markers optional.

Circle 493 on reader service card

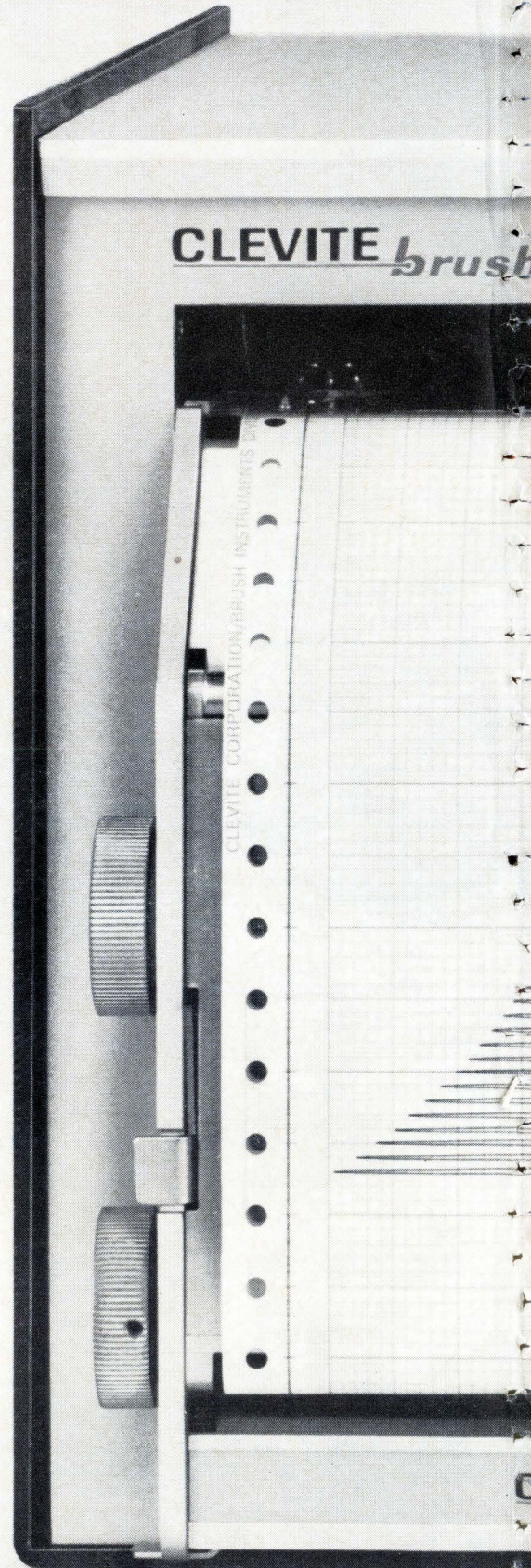



MARK 250

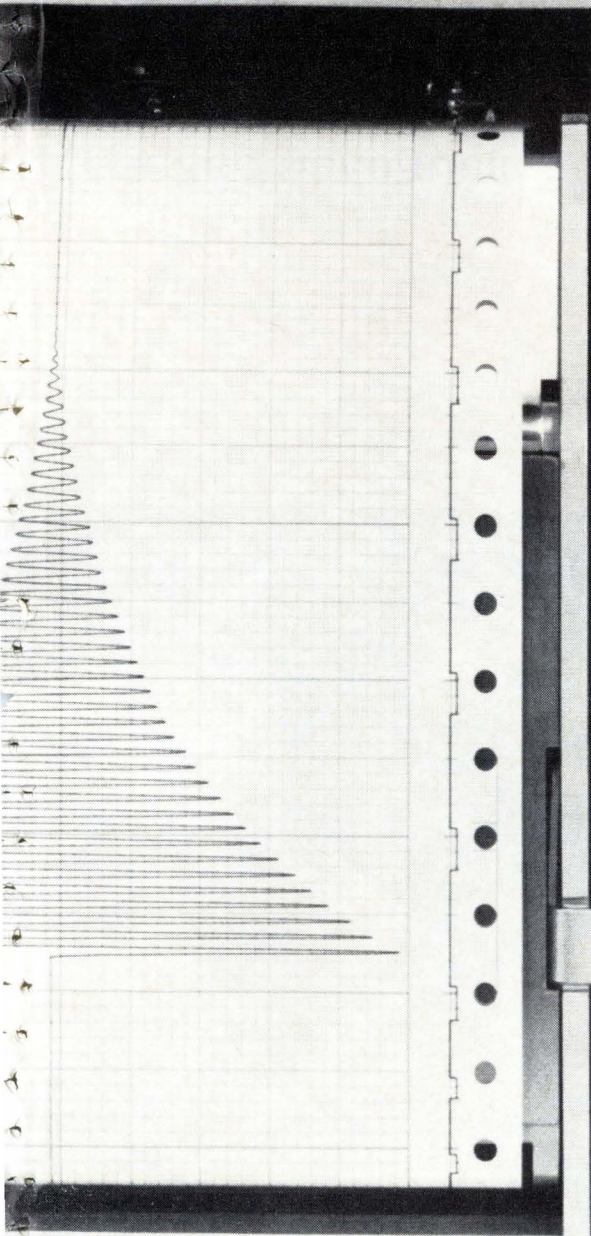

chart speed  
inches/sec

inches/min

5

2

1

.5

.2

.1

stop

paper  
F  
E

power

D.C. AMPLIFIER

sensitivity

1 2 5 10 20 50 100 200 500 1000 off

microvolts  
10  
100  
1000

x 1 x 1000

zero suppression vernier

range

off mv

sensitivity x 1

pen position

brush

interlock warning

ITE brush

# The Brush Mark 250

First recorder for perfectionists



# Honeywell 1-man Control delivers perfect temperature and humidity at new RCA plant

(and it almost paid for itself before the plant even opened)

Here in RCA's advanced Conversion Tube plant the manufacture of intricate, space-age electronic assemblies requires a precisely controlled environment without excessive humidity, temperature variations and dust and dirt. Honeywell 1-man Control monitors all air-conditioning systems and fan systems, as well as the special equipment in RCA's unique, laminar-flow clean room called the "cleanest room on earth." Vincent G. Kling & Associates, Architects. Consulting Engineers: R. J. Sigel Inc.

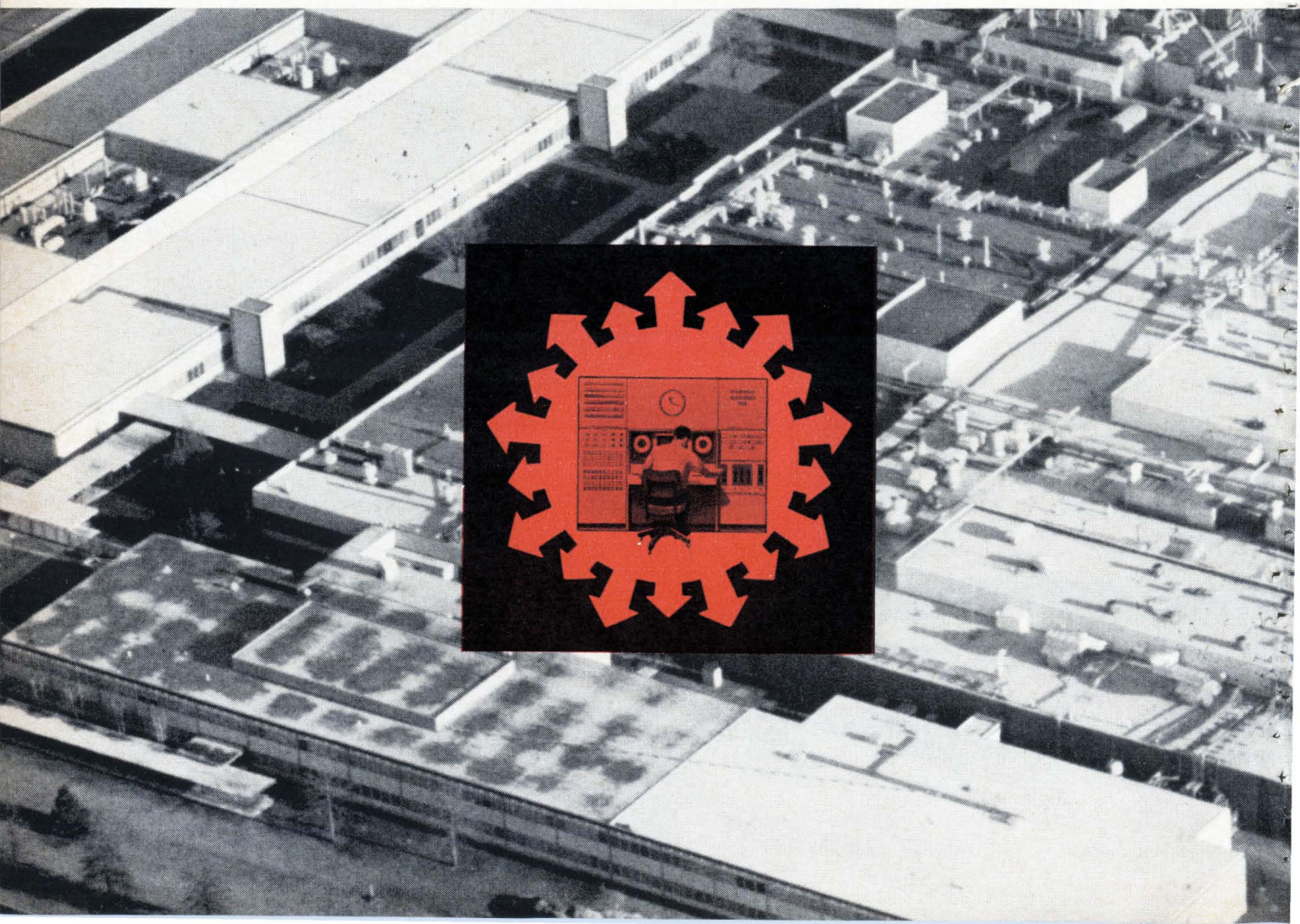



RCA's new 157,000 square foot Conversion Tube facility in Lancaster, Pennsylvania, is one of the most complex buildings in the electronics industry.

And it has the most closely controlled environment . . . the result of complex air-handling and air-conditioning equipment. Its cleanliness approaches that found in many conventional industrial clean rooms.

**One man and a Honeywell Selectographic panel control the environment in entire plant**

One man and a Honeywell centralized control monitor and record data from critical areas throughout the plant. They supervise all air-conditioning systems . . . all special "clean room" systems.

Without moving from his console, one man checks and logs key temperatures and humidities.

He adjusts temperatures, humidities and dampers. He starts and stops all equipment. He supervises alarm equipment. And he investigates and handles complaints.

Maintenance people are free to perform necessary, but often neglected preventive maintenance work.

**Almost paid for itself before the plant even opened**

"We originally had planned line-voltage wiring from all pumps and fans to a small control panel," says Mr. Frederick C. Weisbach, Facility Planning Manager.

"But for a relatively small added cost, we got a Honeywell Selectographic system that not only starts and stops our fans and pumps, but permitted us to automate the entire environmental control system as well. It almost paid for itself before we opened the doors."

But that's not quite all of it. Operating cost savings with Honeywell 1-man Control will make possible a 33 $\frac{1}{3}$ % annual return on investment . . . a payback that will continue for many years to come.

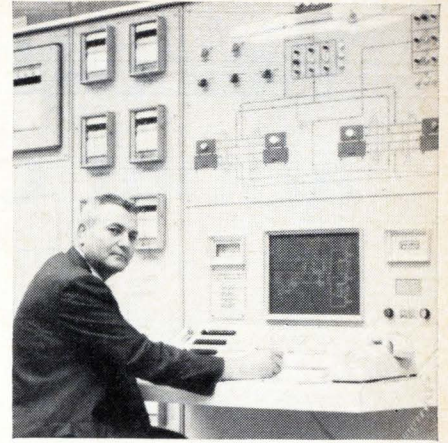

Frederick C. Weisbach, RCA's Facility Planning Manager, demonstrates operation of Honeywell Selectographic Data Center.

**Ask for a Cost Analysis**

Why not let a Honeywell engineer help you make a cost analysis? Contact your local Honeywell office or write Mr. Wm. Ortman, Honeywell, Minneapolis, Minnesota 55408.

**Honeywell**

Circle 57 on reader service card

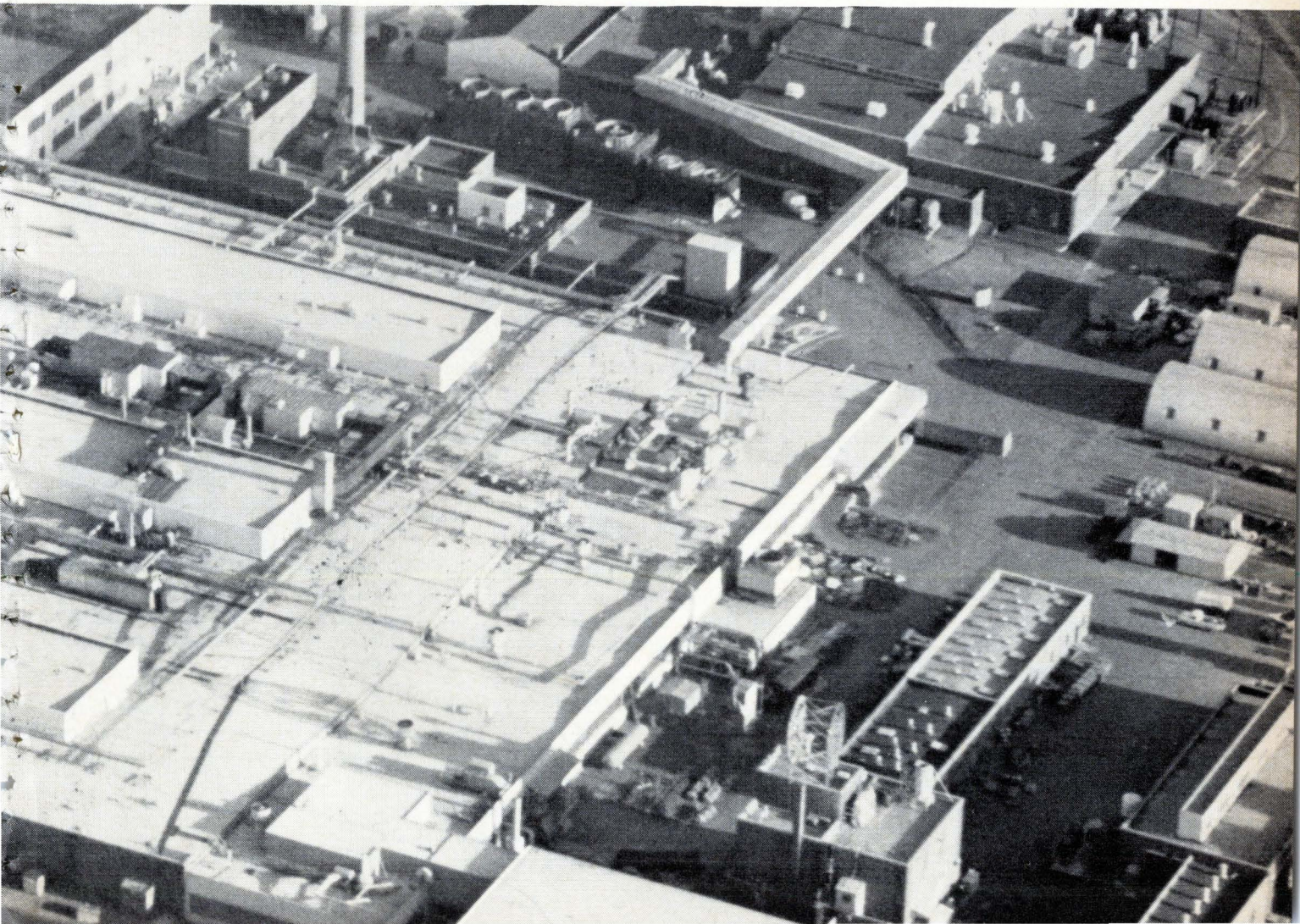



# We're thin skinned about copper at TI.

That's why we told our metallurgists, "Find us a wire to replace solid copper. One that's lighter, stronger, less costly and can be processed the same way."

That was the challenge.

This is the result.

Texas Instruments copper clad aluminum wire. The photograph is a cross section enlarged about 32 times.

Copper clad aluminum wire is a totally new materials system developed by and exclusive with Texas Instruments. Essentially it is aluminum wire

to which a thin "skin" of copper has been metallurgically bonded.

By using a thin skin of copper on aluminum wire the users' copper supply can be stretched by as much as 10:1. Weight can be reduced up to 62%. Prices reduced 15% to 40% depending on the application. Switching from solid copper to copper clad aluminum requires no new techniques or capital investments. It can be processed on the same machinery, at the same speeds, with the same dies and lubricants. And

it offers the same flexibility.

Texas Instruments copper clad aluminum wire can be used in such applications as coaxial cable and braided shield, magnet wire, battery cable, and it is now being tested for telephone conductor and appliance wire.

Are you thin skinned about copper availability? The thin "skin" of copper on copper clad aluminum wire could be the answer you're looking for. Get full information by circling reader card 496.



## Texas Instruments makes it happen in industry.

### How integrated circuits helped National Electronics leap-frog competitors with an advanced readout system.

Integrated circuits have lowered the cost, improved the reliability, increased the performance, and reduced the size of three new drivers for readout display tube systems introduced by National Electronics, Inc., a subsidiary of Varian Associates.

Developed by Texas Instruments, the drivers are preassembled modules employing advanced multi-function TTL integrated circuits. The most complex module, a decimal counter/driver with memory capability, incorporates three economy plastic-encapsulated ICs — the equivalent of more than 130 individual components. Manufacturing costs are reduced . . . there are fewer parts to assemble. Reliability is

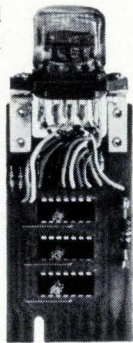

improved . . . some 300 solder joints are eliminated. Space is saved . . . the entire module fits snugly behind the readout tube itself. Performance is increased . . . typical counting rate is 15 MHz, one-hundred times faster than currently available discrete component drivers. The modular design allowed National to offer its customers complete plug-in readout systems without having to invest in a major manufacturing facility, to train manufacturing personnel, or to expand its engineering staff. TI designed and built the first prototype in only two weeks. Sixty days later the drivers were in full production.

National Electronics and Texas Instruments worked together to produce a better product with integrated circuits. How about you? Get more IC information by circling reader card 495.

### Hyperion Industries goes TI diode ovens for positive temperature control.

Diode ovens, developed by Texas Instruments, are being used by Hyperion Industries, Inc. for positive, dependable

temperature control in their high precision power supplies. These new self-regulating component ovens assure constant diode junction temperature over a wide range of ambient temperatures.

This precise control increases the performance of lower priced diodes so significantly they can be used to replace diodes costing 30 times as much. This means that, even with the diode oven cost, there's a saving of 50%. These diode ovens also eliminate the inspection required to grade precision components. Other advantages are the elimination of thermostats and temperature compensating networks enabling Hyperion to produce a simpler, more economical package.

All in all, these new TI diode ovens mean twice the diode performance for half the cost. Get full information by circling reader card 497.

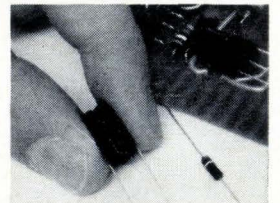

**TEXAS INSTRUMENTS**  
INCORPORATED



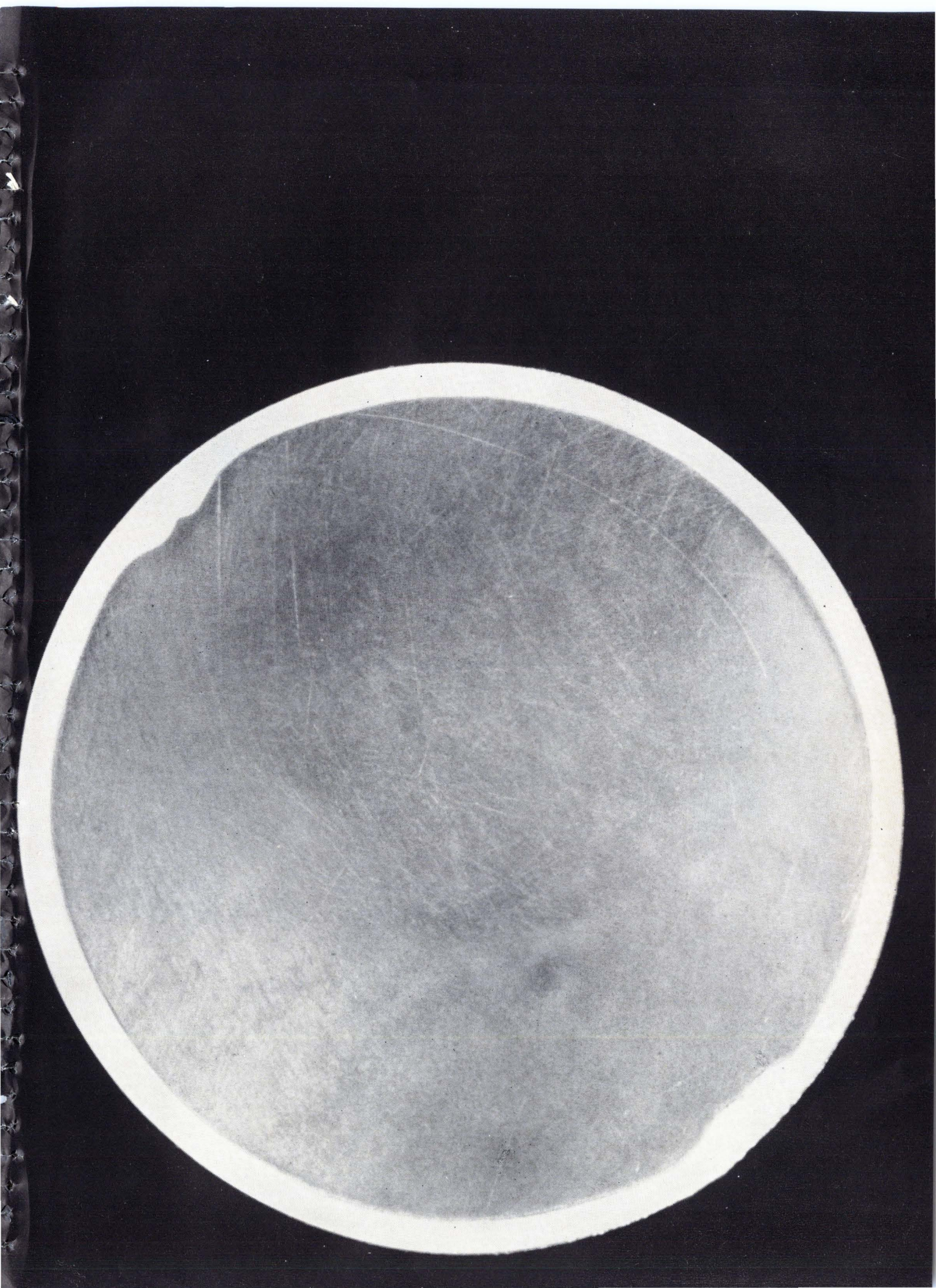



**REVISED EDITION**

# The 1966 Reference Guide to CEC Oscillographs, Direct Writing Recorders, Accessories and Support Equipment

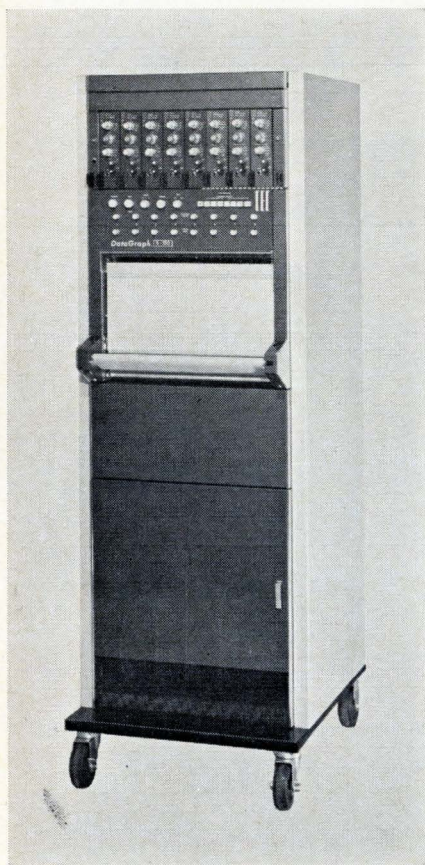

**DG 5510** — This is the newest, most advanced thermal writing recorder available today. Basically, the recorder is a solid-state, 8-channel, self-contained unit with driver amplifiers and power supply capable of accepting a broad selection of high-level signals. Significant advantages: *Electrical Signal Limiting* assures that the stylus motor and writing assembly are protected from damage by transient or other high-level signals. *Precise conditioning* of varying, wide-range ac and dc signals through your choice of three available preamplifiers. *Solid-state driver amplifiers* provide compensation and damping to stylus motors for highest accuracy throughout the entire operating limits. The *heated stylus* traveling over a "knife edge" produces the sharpest, high-contrast rectilinear traces yet achieved. *Applications* include the process monitoring, dynamic testing and "quick look" analog presentations for government and industry.



**DG 5511** — The portable, solid-state DG 5511 is the first low-cost thermal writing recorder to provide the capability formerly achieved only through use of multiple instruments. Plug-in signal conditioners accommodate a wide range of voltage inputs. *No preamp* is needed for most high-level signals. *Electrical Signal Limiting* is included. Users may convert from high-level to low-level inputs by a simple change of plug-in attenuator/amplifier units. Extreme ease of operation is combined with a high degree of resolution on heat-sensitive Datatrace® paper. A direct writing feature permits viewing of data as it occurs on high contrast or reproducible paper.

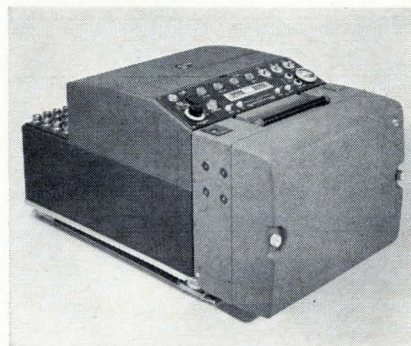

■ **Type 5-119** — A truly universal optical recording oscillograph, the 5-119 has become a popular, proven performer for laboratory, mobile, airborne and marine use offered in either dc or ac powered models. The 5-119 accepts all three types of record magazines, DATAFLASH, DATARITE, and conventional, making it possible to utilize every known photographic technique on either the 36- or 50-trace models.

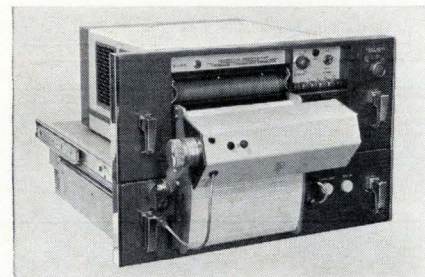

■ **Type 5-124** — Shown above with the DataFlash Takeup Accessory which requires only 1 second to readout, the 5-124 has become a new "must" for industry. Portable and easy to operate, this instrument offers big recorder capability in a small-size, low-cost package. The 5-124 provides up to 18-channel recording, 10 speed ranges, and record-drive systems with 16 speed range options from 0.25 ipm to 128 ipm.

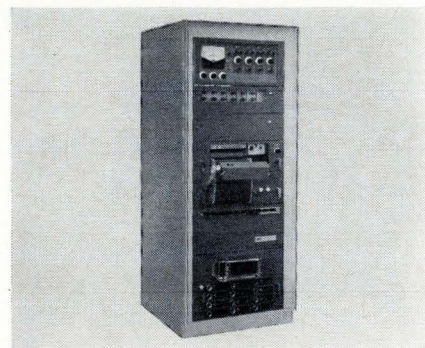

■ **DG 5124 Data Recording System** — Here is state-of-the-art oscillography combined into a complete, *universal*, programmable, data-gathering instrumentation system. Three-ways versatile, the DG 5124 System offers: (1) A wide choice of building-blocks from which to tailor-make the initial system configuration. (2) Maximum application flexibility for *any* selected system configuration through programmable building-block interconnection. (3) Economical, convenient expansion to meet future configuration requirements. Delivered complete and operational, the system consists of: 5-124 DATAGRAPH® Recording Oscillograph, Analog Signal Conditioning Equipment, Digital Signal Conditioning Equipment, System Patch Panels, System Input Panel and System Cabinet.



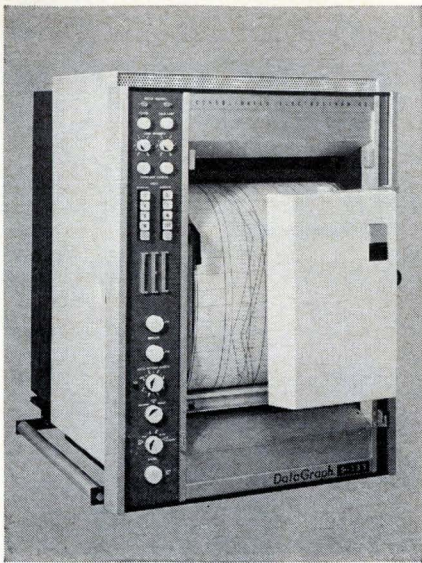

■ **Type 5-133** — Most sophisticated of all oscillographs, the 5-133 combines high speed, reliable operation and CEC-developed DataFlash® in *one universal transport*. Designed to record 12, 24, 36 or 52 channels of data on 12-inch-wide light-sensitive paper, its overall capabilities exceed the most demanding technological requirements. The 5-133's static magnetic lamp power supply provides a start-restart time of *less than a second*, regardless of input voltage variations. Available in RFI certified configurations (including the remote control unit), the 5-133 offers such other advantages as: slot-exit capability

up to 160 ips; adjustable grid line intensity; record/event numbering selected by front panel switch; automatic record length control, continuously variable from 0 to 150 feet; 12 recording speeds, push-button selectable, galvo light intensity controls; and modular construction for maximum convenience and efficiency.

■ **New options include:** Ambient Light Filter for Direct-Write/Develop-Out Recording Mode, Rewind-Rerun for reverse operation and Develop-Out Kit for true closed cassette mode.

## CEC Accessories, Signal Conditioning and Support Equipment

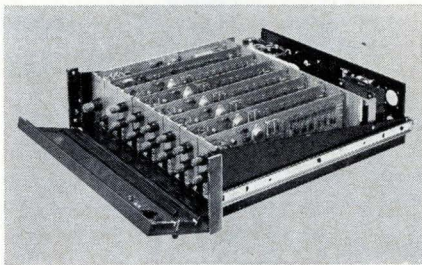

**DataDigit™** — A unique Datagraph® Accessory. When used with any CEC direct writing oscillograph, the new Data-Digit Accessory literally provides a new dimension in data recording with digital numeric high-speed optical recording. Speed, accuracy, and flexibility that were previously unattainable can now be realized even at moderate and slow paper speeds.

Fundamentally, this accessory generates the necessary waveforms to print decimal data on standard photographic papers. Up to 26 columns of data per line can be printed at speeds from 0 to 1600 lines-per-second.

The DataDigit is virtually a quantum jump in recording techniques, providing the features of the fastest digital printer in conjunction with a light beam oscillograph. And, being a completely self-contained accessory, this instrument can be used with any existing oscillographs *without modification*.

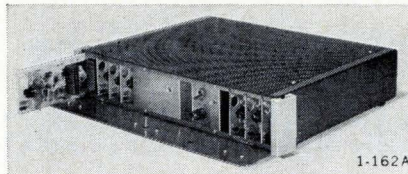

1-162A

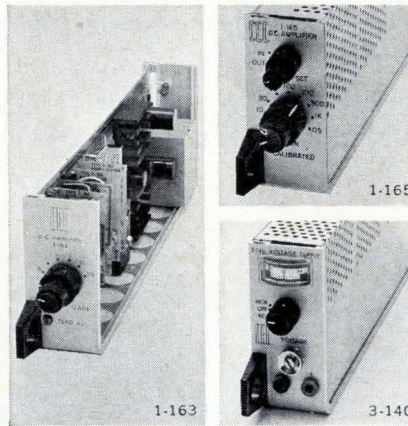

1-163

1-165

3-140

■ **Type 1-162A Galvo Driver Amplifier** — solid-state, low-gain, wideband. Designed to drive high-frequency light beam galvanometers.

■ **Type 1-163 DC Amplifier** — single-ended, low-gain, wideband.

■ **Type 1-165 DC Amplifier** — differential, high-gain, wideband.

Specifically designed for compatibility with all CEC series 7-300 Recording Galvanometers, the 1-163 and 1-165 Amplifiers have the output capability ( $\pm 10$  volts, 100 ma) and a plug-in damping assembly to properly damp and drive all other currently available recording galvanometers.

■ **Type 3-140 Constant Voltage Supply** — The 3-140 is an excellent dc excitation source for any input signal device requiring dc excitation within the range of 1 to 24 volts.

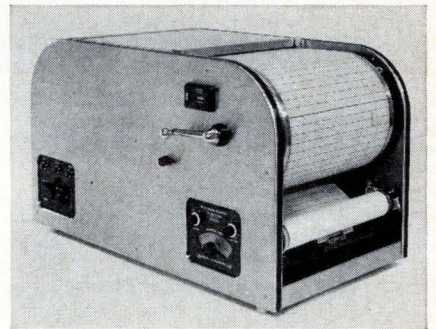

■ **Type 23-109B Oscillogram Processor** — The 23-109B is completely self-contained, needing only electric power for operation. The compact, motorized unit develops and dries oscillograms to produce "archival" quality records. Easy to operate and portable, the processor can be used by personnel with no previous photographic laboratory experience.

■ **CEC Technical Supplies** — CEC offers a complete selection of supplies needed to operate CEC Datagraph oscillographs; print-out papers, recording papers and developing solutions. For complete information on any CEC oscillograph, accessory, signal conditioning, support equipment or technical supplies, call or write CEC Data Instruments Division for Bulletin Kit #9002-X6.

# CEC

Data Instruments Division

## CONSOLIDATED ELECTRODYNAMICS

A SUBSIDIARY OF BELL & HOWELL/PASADENA, CALIF. 91109  
INTERNATIONAL SUBSIDIARIES: WOKING, SURREY, ENGLAND  
AND FRIEDBERG (HESSSEN), W. GERMANY



# MAKE AXIAL LEAD COMPONENTS

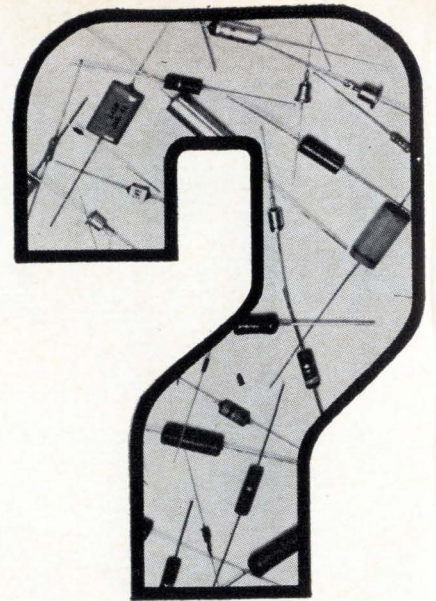

**Universal continuous process systems  
can combine almost any functions...  
with a big advantage in LABOR SAVINGS**

This new 20-page publication illustrates how to feed raw materials... assemble... coat... test... sort... code and package finished axial lead components **automatically**. By combining processing steps into complete systems, Universal enables you to maintain physical control from one function to the next.

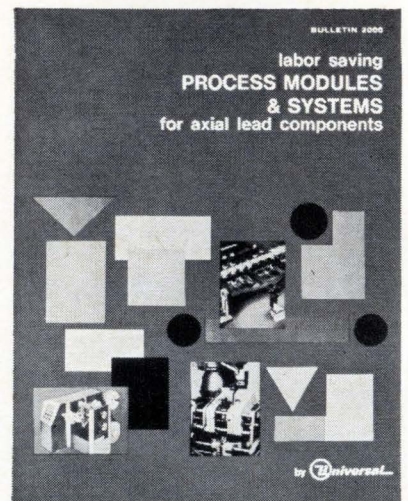

Typical process systems including bowl feed, lead straightener, line loader, multiple test, sort, orient, print and cure.

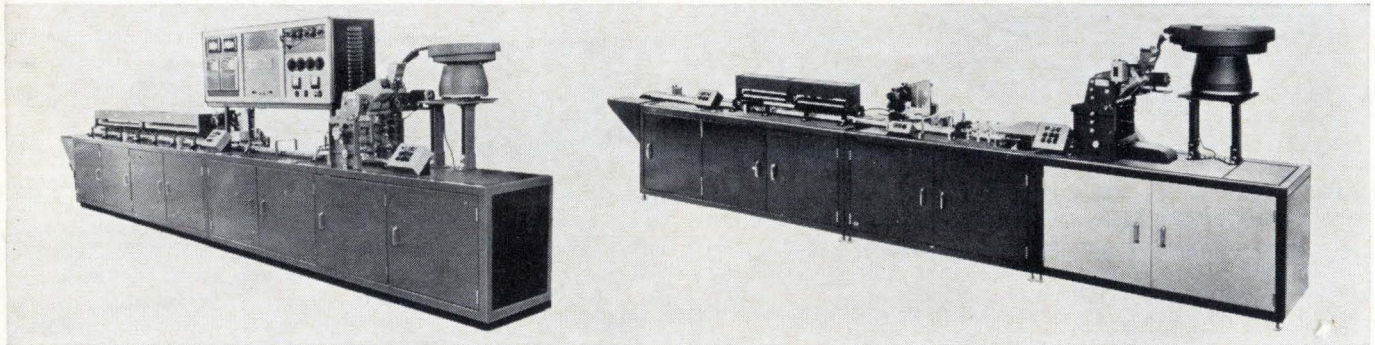

Standard modules developed by Universal are customer-proved in systems that are now producing billions of components a day. They are the building blocks for this equipment. However, these standard modules combined with customized units can be designed into systems to meet special requirements. This is an area where Universal's special technology and engineering experience can make an even greater contribution in terms of operating reliability, fail-safe design and **labor savings**.

*Send for your copy  
of bulletin 2000*



 **Universal** INSTRUMENTS CORPORATION / E. FREDERICK ST., BINGHAMTON, N. Y. 13902 / 607-772-1710

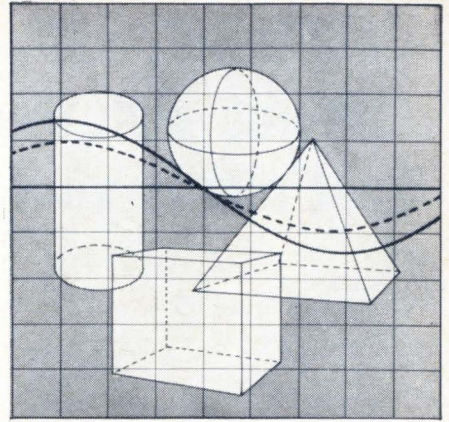

# CERASEAL®!

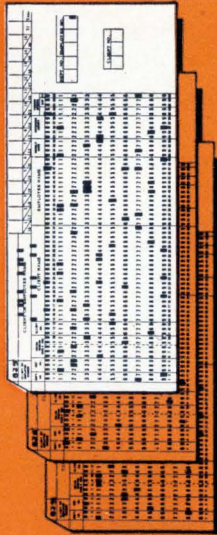

## a new solid state-of-the-art ceramic capacitor!

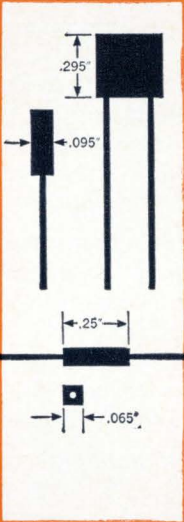
<p><b>+15%</b> WITHOUT VOLTAGE</p> <p><b>+15%</b></p> <p><b>-25%</b> WITH VOLTAGE</p> <p><b>MIL BX CHARACTERISTICS</b></p>	 <p><b>DOCUMENTED RELIABILITY</b></p>	 <p><b>MONOLITHIC CONSTRUCTION</b></p> <p><b>COMPLETE HERMETICITY</b></p>	 <p><b>RADIATION RESISTANT</b></p>	 <p><b>CKR06 &amp; CKR12 SIZES</b></p>
--	---	---	---	--



NOW FROM Hi-Q... the originators and pioneers of second generation ceramic capacitors comes the first in a series of a complete new *third generation* ceramic capacitor CERASEAL! Here is a truly solid-state capacitor featuring monolithic construction, complete hermeticity... yet *without* any exterior encapsulation. This completely new capacitor construction offers you all the guaranteed and documented reliability of our now famous second generation CERALAM capacitor.

CERASEAL offers you unexcelled characteristics including extremely high radiation resistance, MIL BX characteristics ( $\pm 15\%$  without voltage,  $+15\%$   $-25\%$  with voltage), and operating temperature range from  $-55^{\circ}\text{C}$  to  $+125^{\circ}\text{C}$ .

CERASEAL is available in the CKR06 case size in the following ratings 1200pf—100,000pf and for cordwood packaging the popular CKR12 form factor differing only slightly in that a square cross section is offered, in ratings from 10pf to 10,000pf; voltage ratings are 50, 100 and 200 VDC. Additional case sizes and ratings will be announced soon. Call or write today for complete technical details and let us show you how CERASEAL may be the only answer to your space or reliability problem.

**Hi-Q®** **AEROVOX CORPORATION**  
OLEAN, N. Y.

Selected Commercial and Military Hi Q products are available off-the-shelf from authorized Aerovox Distributors



# Only Honeywell gives you a choice of DVM logics... lets you pick the one that best meets your system needs!

Your data measuring and recording systems are tailored to specific applications. So are the signal measuring methods used in today's sophisticated digital voltmeters. Why tailor most of your system and then be limited to *one* method of voltage determination?

Of all DVM manufacturers, Honeywell offers the widest pick of logics, permitting you to choose the one which best measures *your* signal levels under *your* conditions:

1. **Successive Approximation** (EI-85 Series) 5 digits, 10  $\mu\text{v}$  resolution, normal mode rejection using 3-pole active Bessel filter, to 25 measurements per sec., DC and ratio. From \$9,300.

2. **Integrating Logic** (630 Series) 5 digits plus over-range, 1  $\mu\text{v}$  resolution, normal mode noise rejection through integration, to 6 measurements per sec., DC, frequency and time interval. From \$8,400.

The new compact Honeywell 620 integrating logic system is complete with 40-point scanner, 620 integrating dvm, and digital printer. From \$4,700.

Honeywell premium line systems also give  $\pm 0.01\%$  accuracy, 300,000 to 1 common mode interference rejection, high normal mode noise rejection, and resolution down to 1  $\mu\text{v}$  (with pre-amp, except 630 series).

"Extensions" extend systems capabilities.

In addition to a choice of logics, Honeywell systems offer a variety of extensions including AC voltage, resistance, pre-amp, transducer signal conditioning, thermocouple reference junctions, strain-gauge power supplies, scale factoring, linearizing, digital clocks and timers, patch-board or tape programmers, digital comparators, printers, typewriters, tape perforators, IBM 526 card punch and digital magnetic tape.

For complete information on Honeywell Digital Data logging systems and auxiliary equipment, contact your Honeywell Representative or mail the coupon for illustrated literature.

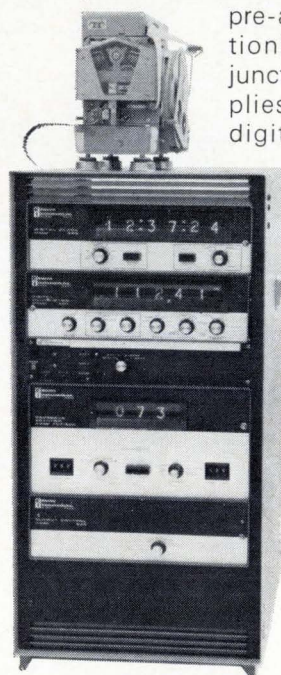

1. Successive Approximation

2. Integrating Logic

Honeywell • Mail Station 432 • Test Instruments Division  
 Denver, Colorado 80217  
 Please send Digital Data logging systems literature to:

Name \_\_\_\_\_  
 Company \_\_\_\_\_  
 Address \_\_\_\_\_  
 City \_\_\_\_\_ State \_\_\_\_\_ Zip \_\_\_\_\_

**DATA ACQUISITION SYSTEMS**  
**Honeywell**



# RECTIFIERS

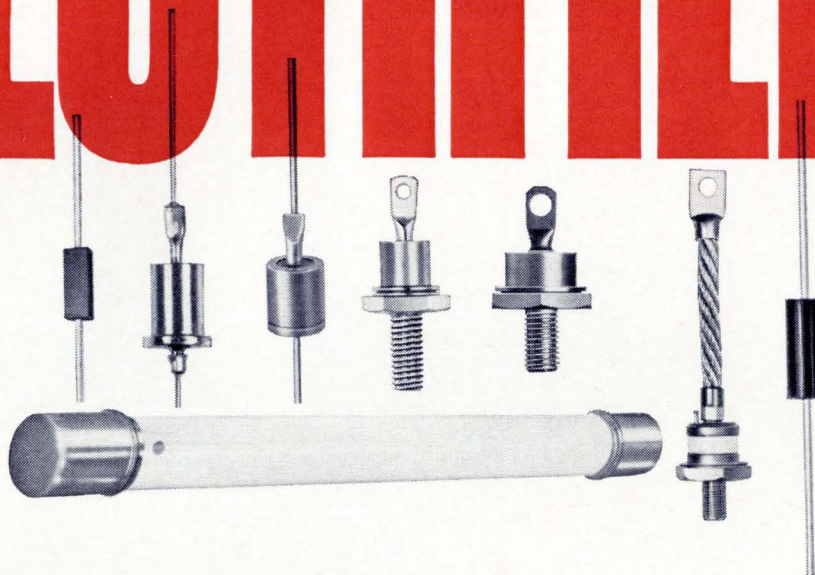

## IRC expands rectifier line

### Wide choice of MIL and industrial devices

Now, IRC is offering an even larger selection of silicon rectifiers. These devices are immediately available from stock to fill the vast majority of your MIL and industrial requirements. Most IRC rectifiers are also available in reverse polarity.

- Ratings from .045 to 250 amps, and 50 volts to 100 Kv
- MIL types meet all performance and environmental requirements of MIL-S-19500
- Subminiature, high-voltage types to 4000 volts

- 100 and 250 amp controlled avalanche units for industrial use
- Fast recovery types—200 nsec—in five package choices

If you specify or buy silicon rectifiers, you should know about the money-saving advantages of IRC's silicon rectifier line. For new semiconductor catalog, prices and samples, write: IRC, Inc., Semiconductor Division (formerly North American Electronics), 71 Linden St., West Lynn, Massachusetts 01905.



#### ZENER DIODES

MIL and industrial regulator types, silicon reference diodes, 1-watt DO-7, and solid construction Poly-Sil packaging.



#### AXIAL LEAD RECTIFIERS

AR16 thru AR24 replaces 363 JEDEC devices for 50 to 1000 V/.25 to 1A needs. Costs less than stud-mounted types.



#### SCR's

MIL and industrial devices, including fast-switching types. Choice of power ratings and package shapes.

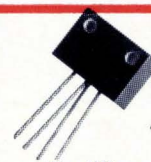

#### SPECIAL ASSEMBLIES

Rectifier stacks, potted bridges and high voltage assemblies. Available in prototype or production quantities.





now you can. . . . .

# Buy a Burroughs higher speed Memory System for your . . . next generation computer

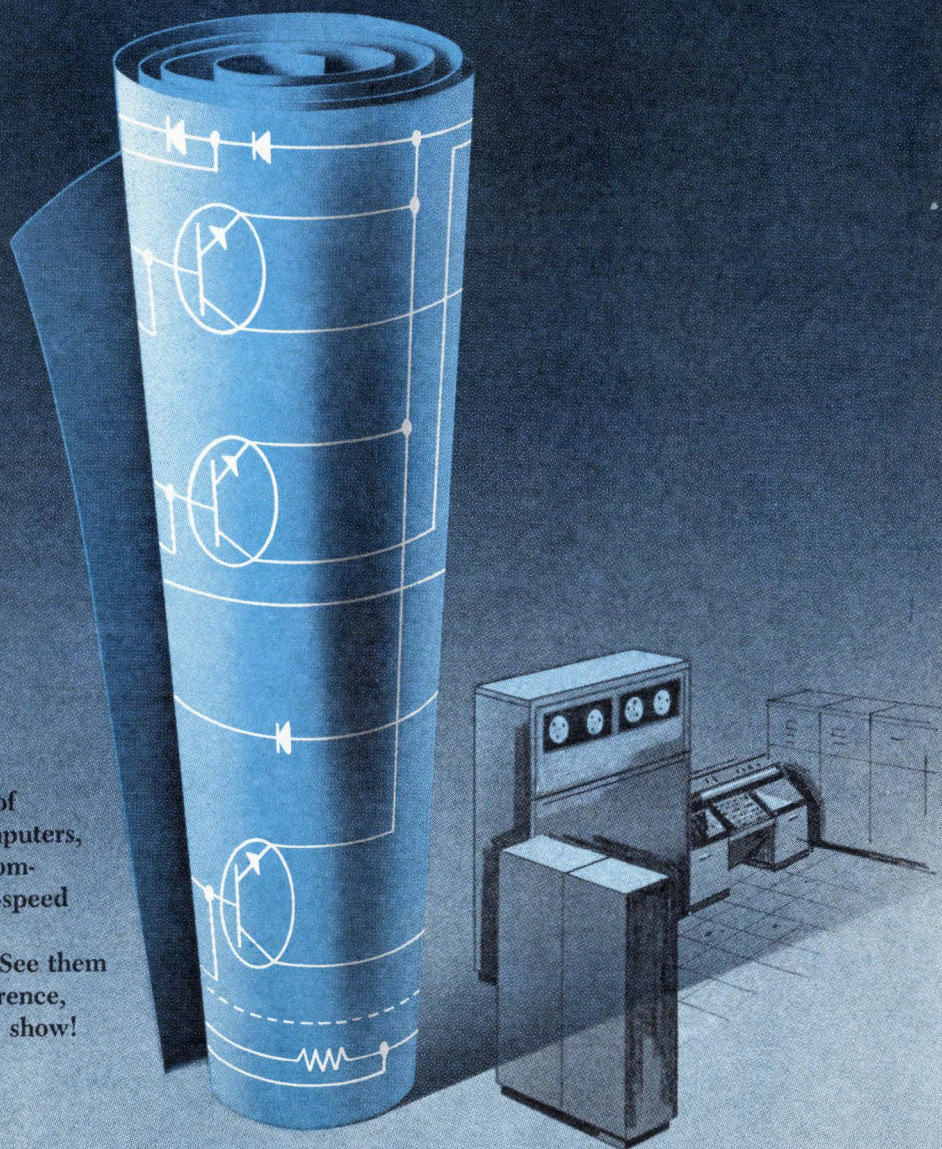

Yes, This is New! Burroughs, one of the foremost manufacturers of computers, is now making Memory Systems commercially available. They are high-speed units . . . some are higher speed than most blue prints now specify. See them at the Fall Joint Computer Conference, November 8-10. Full details at the show!

*Burroughs Booths 835-837.*

**B** Burroughs Corporation / ELECTRONIC COMPONENTS DIVISION  
PLAINFIELD, NEW JERSEY 07061



# Technical Articles

---

**Integrated circuits in action: part 1  
The great design dilemma:  
page 68**

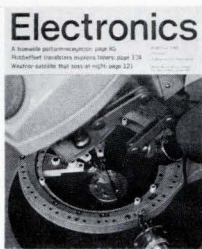

Many designers of equipment are concluding that now is the time to switch to integrated circuits. The question is which technique to choose. In this first of a comprehensive series of articles written from the standpoint of the user of integrated circuits, Electronics examines the engineering problems introduced by the use of this new approach and the several approaches available.

For the cover, Richard Saunders photographed a large microelectronic array of metal oxide semiconductors as it was being probe-tested at the Semiconductor division of General Instruments Corp.

**The pattern changes for  
integrated circuit testing:  
page 93**

From the manufacturer's standpoint, IC's have to be tested carefully and the margin for error grows smaller as circuits become more complex. Even as many as 50 tests are not enough. Now IC makers are using new methods:

1. A-c testing of wafer components sounds early circuit warning [page 94]
2. Large-scale logic arrays means testing for the millions [page 98]

**Built-in testing, once a luxury,  
is essential for mission success:  
page 103**

Avionic systems have grown so complex that customers are demanding equipment be built in to check the system hardware continually. Engineers run into confusion on what to test and where to test it. The pilot knows only that "it doesn't work."

---

**Coming  
October 31**

- Low-pass filters
- Using signal correlation in new applications
- A new computer memory is  $2^{1/2}D$
- Communication modems
- Opinion: the other side of the recruiting coin



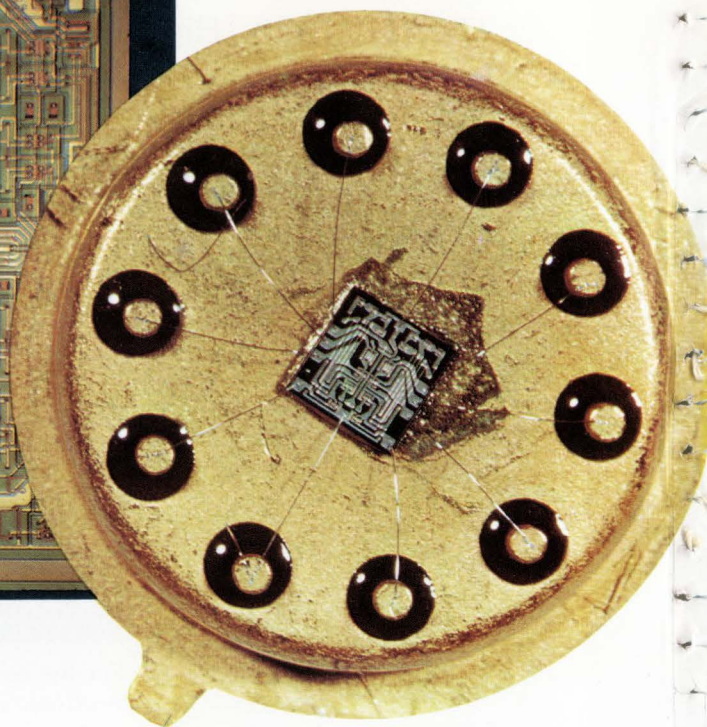
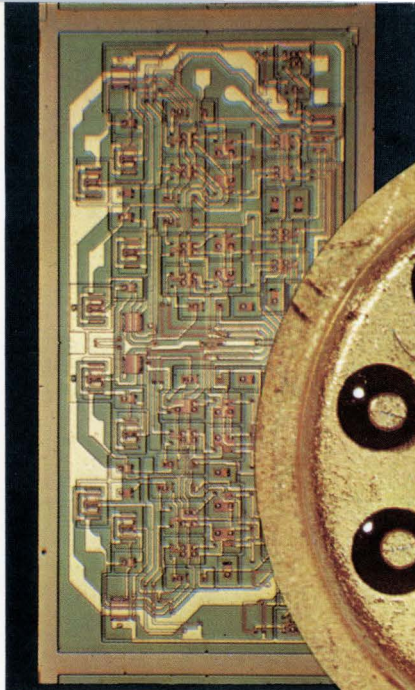
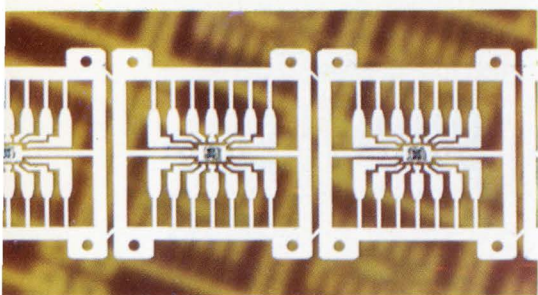
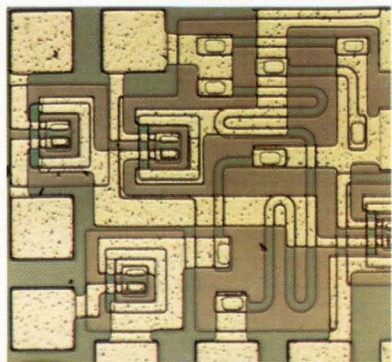

Microelectronics

## Integrated circuits in action: part 1 The great design dilemma

Manufacturers are no longer doubtful about whether they should switch to integrated circuits—the time is now and there is ample evidence to prove it; but picking the best microelectronic techniques can be a risky business

By Donald Christiansen

Senior associate editor

**From the farthest reaches** of space to the television set in the family living room the era of the integrated circuit has arrived—a time when IC's will dominate the electronics industry as transistors did before them.

Integrated circuits are already playing an important role in computers. Their use is broadening to include a variety of space, military and commercial applications. Within a decade the tiny circuits may outstrip the most optimistic prophecies of industry planners.

And the Department of Defense has reinforced the trend. A recent department memo circulated to all the military services contains a strong pitch for integrated circuitry. The memo points to IC reliability, cost reduction and savings in space and weight and calls for the widest possible use of microelectronics in all types of military equipment and systems.

The philosophy reflected in this memo is being interpreted as handwriting on the wall by designers of both military and nonmilitary equipment.



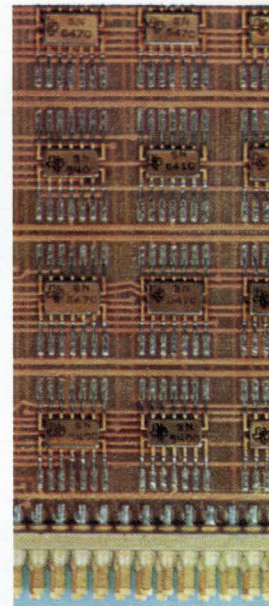
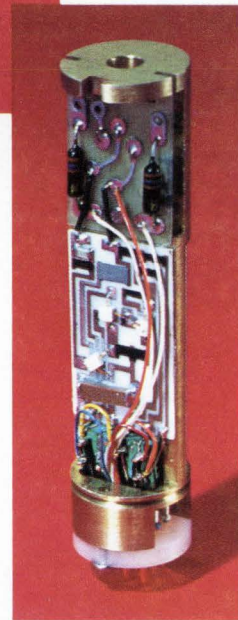
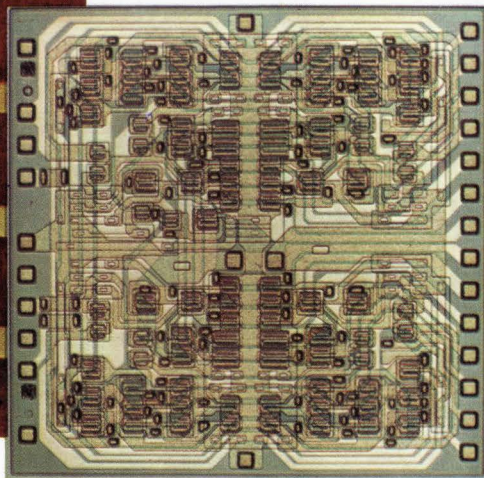
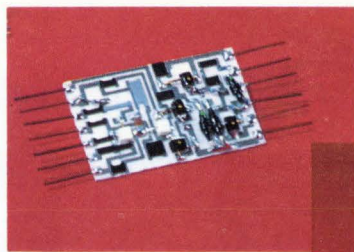
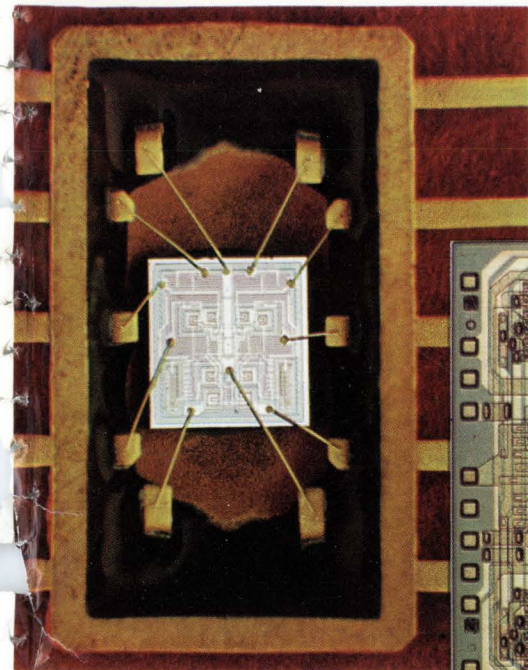

The question asked by manufacturers is no longer "Should we go micro?" but rather "How should we go micro?" They are convinced that they ought to be using semiconductor integrated circuits in some form. Designers are faced with mounting evidence that leads them to conclude it's not a question of when—the time is now—or why—the reasons have been amply demonstrated—but rather what is the route to follow. But selection of the best microelectronics techniques is fraught with hazards. The equipment designer faces endless dilemmas, made more enigmatic by the newness of the art and the variety of ways in which system designers can change system operation to use IC's. One way to get around some limitations of analog IC's is to convert the signal processing from analog to digital.

Manufacturers of integrated circuits have done yeoman work in educating potential users of IC's, but that is not enough. The stakes are too high for hasty decisions. Equipment makers, more and more, welcome a variety of inputs to help them point their projects in the right direction. They are scrutinizing their own previous feasibility experiments, examining how pilot equipment has fared or how close they've come to intended goals in first-generation integrated-circuit equipment. They put pride aside as they look carefully at how others have used IC's, hoping to profit by competitors' mistakes.

In the final analysis, it is the equipment designer who holds the bag. He must evaluate the pressures that influence his choice of techniques. These pressures take the form of demands (objective specifications, for example) that can be satisfied only by using IC's—or of opportunities that can be seized. (Small size is not really required, perhaps, but IC's will provide it as a bonus.)

Among the categorical reasons for switching to IC's are low cost, reliability, weight and volume reduction, improved performance and the ability to provide entirely new functions or perform old functions in a substantially new way.

#### Early commitment

Going to integrated circuits from discrete component circuits bears little similarity to switching from vacuum tubes to transistors. In the latter, a new circuit design discipline had to be developed from scratch. Yet the components were still recognizable in discrete form and could be readily manipulated at any stage of the design process—on paper, at the breadboard, the prototype and even during pilot production.

Not so in microelectronics, in which commitments to fabrication methods must be made at an early stage of design. Because the design of integrated circuits and integrated-circuit equipment is so closely wedded to manufacturing processes, the erroneous statement that microelectronics is nothing more than sophisticated packaging is heard loud and often.

The fact is that microelectronics offers an exceptional opportunity for joining in close-knit fashion

**The integrated circuit explosion:**  
 1 and 6: Motorola Semiconductor's monolithics  
 2, 3 and 5: TI's dual inlines, decade counter, and linear amplifier  
 4: Motorola Government division's helmet radio IC  
 7 and 8: Raytheon Missile Systems division's thick film hybrid's  
 9: Sanders Associates' flat pack IC data processor



## Tools of the trade: masks, flasks and boats

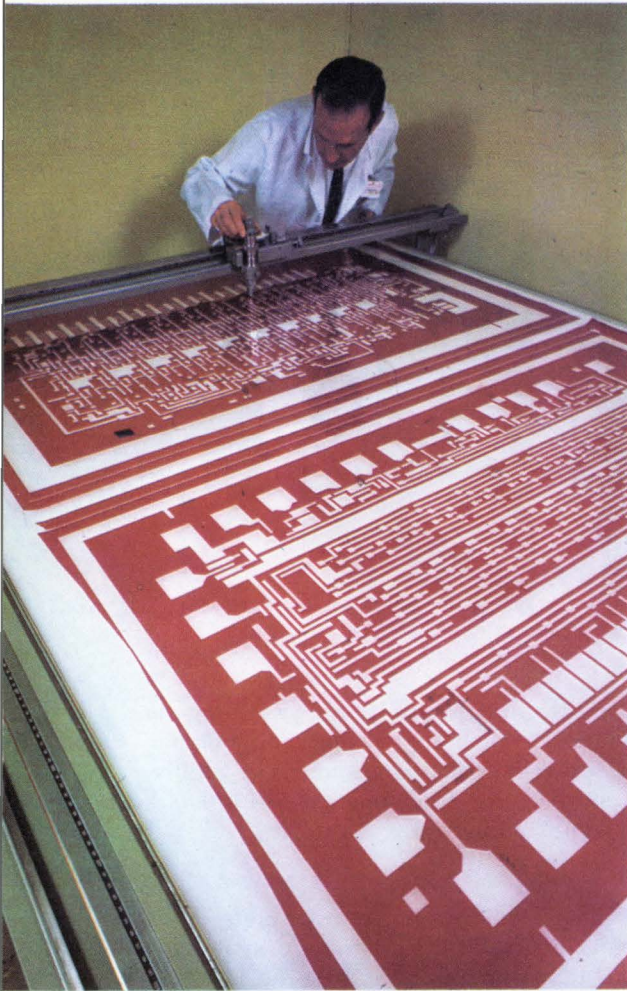

**Integrated circuit mask** is cut 500 times oversize in two-layer — one red and one clear — plastic sheet on coordinatograph at General Instrument Corp. Pattern is first reduced 50 times, then 10 times. During final reduction, step and repeat pattern is formed to yield up to 2,000 IC's on 2- by 2-inch glass master slide.

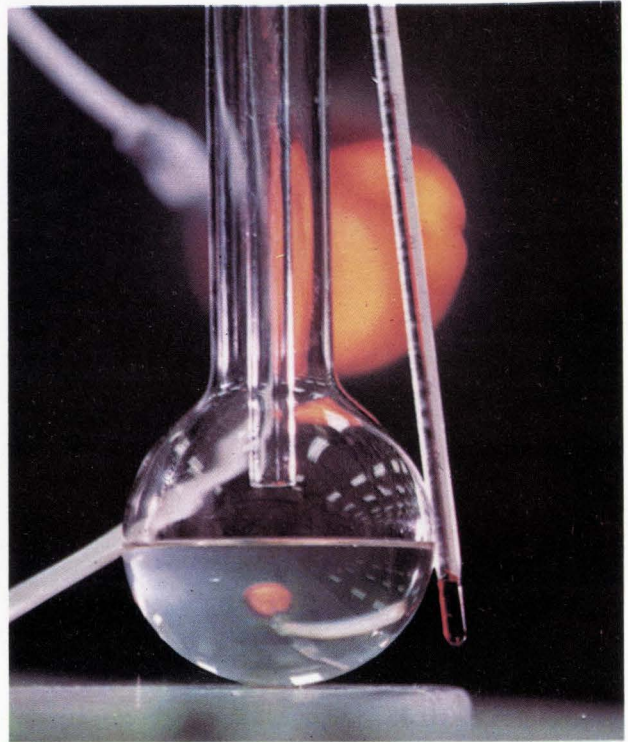

**Still life** in the laboratory. Flask is part of trap for noxious gases generated during semiconductor diffusion process (orange glow is diffusion furnace tube).

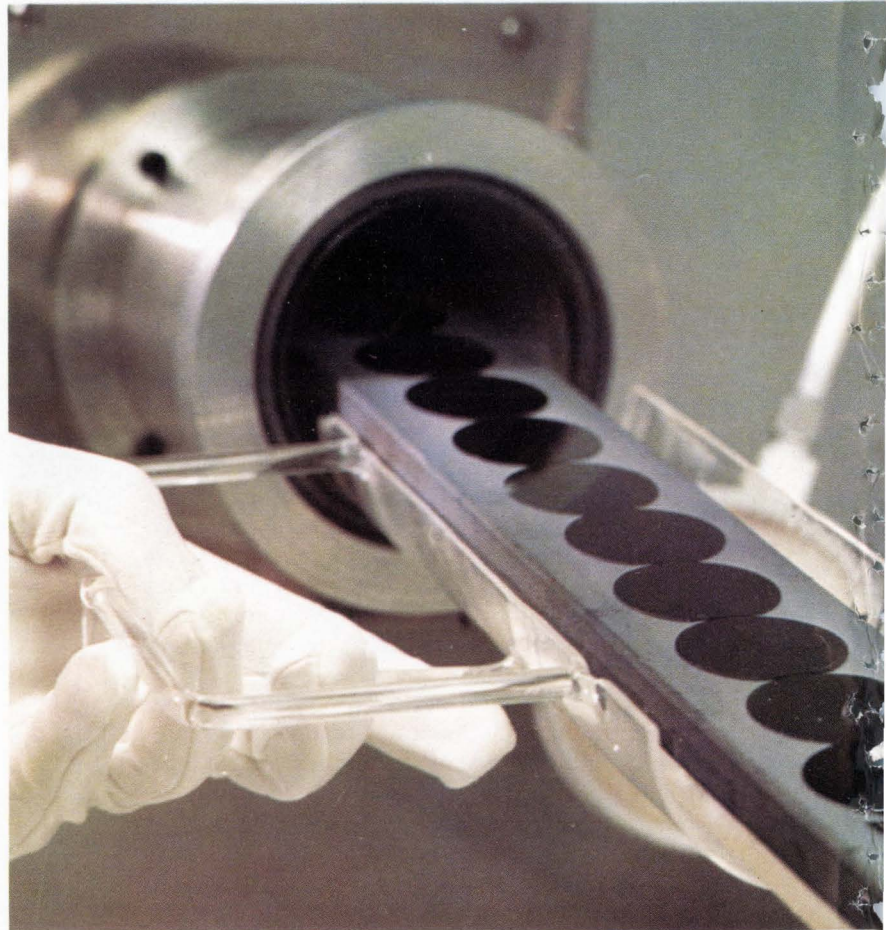

**Carbon boatload** of silicon wafers is withdrawn from an epitaxial reactor at the Westinghouse Molecular Electronics division. Since boat reaches temperatures up to 1,400°C, technicians must grasp it with special quartz fixture.



circuit elements that previously "lived alone." This symbiosis has as its goal improved equipment. Unfortunately, the inviolable rule comes into play—that any symbiosis carries with it a loss in autonomy; perhaps no other trade-off plagues the designer so unrelentingly. It confronts him at every level of interconnection, from the integrated circuit itself up to and including the final level.

Here's a specific example—one that's compounded by the improving yields of integrated circuits. The interconnection of several simple digital logic circuits into a more complex function module, such as a full adder, poses questions like "Is this module too complex? Should it have been built in two parts? Suppose it fails; is its throwaway cost low enough or must it be repaired?"

Already on the market are complex IC's like dual J-K flip-flops, 16-bit shift registers and a digital differential analyzer. With these, the equipment designer has no options—they're monolithic chunks that cannot be split in two; and if they fail, the user must throw them away. His decision to go with large committed modules thus carries with it built-in penalties, which he may or may not be willing to accept.

### **Broad prospects**

Decisions that the equipment maker once found were made for him by virtue of limitations in the art today are becoming less clear cut. For example, as costs fall, it is no longer possible to automatically exclude all consumer applications. Nor is it possible to overlook the use of IC's merely because the project at hand does not seem to call for the use of large quantities of repetitive circuits. The development costs of a satisfactory circuit may have long since been paid for by other users.

Despite the many avenues open to the potential user of integrated circuits, he is still burdened by constraints that tailor his decisions. These lead him to favor one hybrid approach over another, or sometimes to forego any type of integration in certain portions of his equipment.

Limitations involve values of components, component tolerances and stability. When many transistors are built into one chip, each cannot be optimized to provide its own very distinctive characteristics. And when resistors are diffused into the same chip, one must settle for values and tolerances compatible with fabrication techniques needed to produce transistors. Capacitors cannot be too large or they'll consume valuable silicon real estate and inductors are virtually impossible to fabricate in a form compatible with IC's. Techniques to make inductive elements are on the horizon but are mostly experimental.

### **Bag of tools**

Fortunately, the tools at the designer's disposal are becoming widely available and well debugged. Not the least important of these are the commercially available semiconductor integrated circuits, ranging from digital logic circuits through periph-

eral circuits for computers to linear circuits such as operational amplifiers.

Some 20 manufacturers produce about 50 different lines of digital IC's. These represent by far the bulk of commercial circuits. In addition, there are some 200 nondigital circuits catalogued by IC manufacturers.

### **Big three**

In the digital area, three types of logic schemes have come to the fore: diode transistor logic (DTL), transistor transistor logic (TTL) and emitter coupled logic (ECL). The last is sometimes called current-mode logic (CML). DTL and TTL are similar in many respects and, indeed, may sometimes be tied together in the same equipment and even interchanged. CML, on the other hand, is not compatible with the others, since it is a nonsaturating type of logic (its transistors do not swing into the saturated region), while DTL and TTL are saturating types.

The oldest of the three schemes, DTL, was developed by the Signetics Corp., Sunnyvale, Calif., and has proved so popular that all major IC makers produce a version. Its characteristics are good but not great; it has medium speed, power dissipation and noise margin.

TTL solves some of the shortcomings of DTL. It provides a high ratio of speed to power and offers good yields because tolerances on elements within the IC can be loose. Furthermore, a number of device manufacturers have succeeded in improving geometries and fabrication techniques and refining TTL circuit configurations so that propagation delays as low as 5 or 6 nanoseconds and power dissipation down to 10 milliwatts per gate are feasible. Major vendors who report most of their current production in DTL and TTL say that a good chunk of the DTL is a carry-over from older equipment programs such as Minuteman. Texas Instruments Incorporated reports that 70% to 80% of new equipment designs is going TTL. TTL, according to Texas Instruments, has made multifunction IC's feasible.

ECL or CML, developed by the Semiconductor division of Motorola, Inc., offers the top speed available in IC's at some sacrifice in power dissipation. It can drive high capacitance loads, but only small voltage swings are permitted to avoid saturation. Additional circuitry can be used to avoid the latter. Speeds as good as 5 nanoseconds (propagation delay) are available in ECL and speeds under a nanosecond are deemed possible.

Other logic IC's include resistor transistor logic (RTL) and, very similar to it, direct coupled transistor logic (DCTL). RTL was popularized by Fairchild Semiconductor, a division of the Fairchild Camera & Instrument Corp., Mountain View, Calif., in the widely used Micrologic lines.

Other logic schemes will be discussed in a future article in this series. Some are superior to those mentioned here for specific applications; but generally they are either more specialized or avail-



able from fewer vendors.

In linear circuits the market is opening up for operational, differential and video amplifiers, as well as voltage regulators and specialized circuits like sense amplifiers.

### Complementary techniques

But the semiconductor IC is not a do-all; it is just one element—although a key one—in the microelectronic designer's bag of tricks.

When resistors above 50 kilohms are needed or when tolerances in the order of 5% or better are required, the diffused resistor may not do. Likewise, when capacitors above 100 picofarads are required, one had better not build them into IC's. Here, techniques other than semiconductor IC's are needed. Ways of making the hard-to-get components include both thick and thin films.

Thick-film techniques—sometimes called cermetology—use pastes that contain conductive or resistive powders. They're squeegeed onto ceramic substrates and baked or voltage-aged to stabilize them. Abrasive trimming brings resistor values into line, to better than 1% if need be. It is generally not a critical process; it requires a relatively modest capital expenditure and is flexible.

Thin-film techniques comprise a variety of methods of depositing or sputtering resistive, conductive and dielectric coatings atop glass, ceramic or passivated silicon substrates. The procedures are carried out in a vacuum, leading to problems in mask setups, sequencing depositions, cross contamination and operations compatibility. For example, some operations may have to be performed outside the vacuum chamber. Nevertheless, components of good quality can be fabricated—and to very close tolerances—by using monitoring systems that measure, for example, resistance during deposition. A somewhat different approach is tantalum thin-film circuitry, in which tantalum metal is sputtered onto glass or ceramic substrates. Various oxides of tantalum are later produced by anodization to provide resistive or dielectric films.

### Experiments in automation

Elaborate automatic equipment has been designed and built to produce both types of thin-film circuits—vapor deposited and sputtered tantalum. The International Business Machines Corp., for example, in 1962 delivered an in-line vacuum setup to the Naval Avionics Facility, Indianapolis, which it designed and constructed under contract to the Navy. Later, CBS Laboratories, a division of Columbia Broadcasting System, Inc., added a chamber that was intended to provide an electron-beam machining capability. But not a great deal of output was reported from the costly experiment, and there are rumors the Navy is seeking Pentagon funds to tear the unit apart and use it more productively.

Equipment makers who successfully produce thin-film circuits usually have one or a bank of several simpler, bell jar-type vacuum depositors.

In 1963 the Engineering Research Center of the

Western Electric Co., Princeton, N.J., demonstrated a continuous-belt vacuum machine for production of sputtered tantalum passive thin-film circuits. Similar machines have since been put into production at Western Electric plants in Allentown, Pa., and Hawthorne (Chicago, Ill.). They play an important role in the Bell Telephone system, engineers report, since they have made tantalum thin films economically feasible.

### Through thick and thin

Despite its detractors, film techniques (both thick and thin) are widely and successfully used. In most cases, films are laid on ceramic or glass substrates of a convenient size—for example, one-inch squares—and chip transistors and diodes added. These can be either alloyed to the ceramic substrate and the leads connected by thermocompression bonding, or they can be flipped and face bonded to substrate pads. In other cases, particularly where most of the circuit can be made in monolithic semiconductor form, thin-film components are deposited atop the oxide layer.

Transformers and inductors tend to assume a three-dimensional shape—one incompatible with integrated circuits. Some low grade (low-Q, small-value) flat inductors have been made, but the tendency is to outboard the units required or to design around their need. Recently, the Westinghouse Electric Corp. and IBM reported experimental devices that might replace conventional inductors in some tuning applications. In IBM's device, a cantilevered silicon chip vibrates at its resonant frequency. The chip is anchored at one end like a diving board and an input signal is applied to a resistor embedded near the fulcrum. A sinusoidal thermal flux is generated at the signal frequency, causing differential thermal expansion of the silicon chip. At the chip's resonant frequency (700 hertz to 15 kilohertz in the IBM tests) a second, sensing resistor alters its own resistance and a simple sensing circuit containing the resistor and a d-c voltage source provides an output at the resonant frequency. The "tuning fork" transistor developed by Westinghouse [Electronics, Sept. 20, 1965, p. 84] is electrostatically excited. It has a metal cantilever that serves as the gate of a field effect transistor and provides an output only at the cantilever's resonant frequency.

### Microwave micromin

Microwave equipment manufacturers who want to shrink their products encounter a pair of problems. The first is finding solid-state devices with the ability to generate and amplify microwave frequencies at high power levels. The second is miniaturizing the circuit that will contain these devices. Such devices as avalanche-transit time diodes [Electronics, Aug. 8, 1966, p. 126] and Gunn-effect devices [Electronics, Feb. 21, 1966, p. 146] may go a long way to solve the first problem. Indeed, these interesting new devices may herald an era of truly functional electronic blocks—those in



which conventional circuit elements are not identifiable because they do not exist.

Though the hardware into which tiny new microwave devices will be mounted may still be several orders of magnitude larger than the devices themselves, there is hope to reduce the size of the rest of the circuit. Already strip-line techniques have helped replace bulky waveguide-style plumbing. Stripline is effectively a flat version of coaxial cable, in which a flat, narrow strip replaces the round center conductor and a pair of

ground planes, separated from the center conductor by dielectric boards or air, takes the place of the cylindrical outer conductor.

Radio-frequency components, such as directional couplers and magic tees, can also be produced by strip-line techniques. The Raytheon Co.'s Missile Systems division reported a microwave processing subsystem made with compatible strip-line methods that slashed costs to less than half that of a waveguide-type counterpart—and reduced weight and volume as well.

## Digital IC's a natural; linears loom on horizon

Most users cut their teeth on digital integrated circuits whose repetitive use and lenient tolerances make them inexpensive

**The reason that** digital circuits gained popularity as standard components is the tremendous numbers in which they are needed in computers. Linear circuits, on the other hand, have been poor cousins. Semiconductor manufacturers were reluctant to develop them because of their uncertain market potential.

Autonetics, a division of North American Aviation, Inc., was anxious to take advantage of the size and reliability of integrated circuits but was unwilling to foot the bill for development costs that might only be assignable to a relatively small production run. So Autonetics attempted to encourage more widespread use of linear integrated circuitry to help drive prices down. Certain basic amplifier circuits, Autonetics engineers noted, could serve a variety of purposes if suitable passive feedback networks or coupling circuits were added. They reasoned that if many companies making different equipment would take this approach, the industry could come up with some prime function linear IC's.

For its part, Autonetics developed several general-purpose linear amplifiers for the guidance and control system of the improved Minuteman. Then, it encouraged its suppliers to make these available to the industry in general. By 1964, Texas Instruments had listed its entire Minuteman line as catalog items.

Among the standard or prime linear functions that engineers at Autonetics developed are a general-purpose, high-gain a-c amplifier, an input differential voltage amplifier, a "midamp" differential voltage amplifier whose output voltage is an optimum fixed fraction of the supply voltage, an oper-



**Converting its tactical air navigation (Tacan) systems** from linear to digital operation, ITT Federal Lab slashed volume and weight almost in half and improved range and bearing accuracies. Equipment shown uses both monolithic and thin-film IC's.

ational amplifier and a differential current amplifier.

### Conglomerate approach

Engineers at the General Electric Co.'s semiconductor products department examined the circuit for a radio receiver that its Consumer Electronics division wanted to market this fall [Electronics, July 11, 1966, p. 40]. They noted that many of the components could be duplicated in a single monolithic IC chip. As a result, the two groups worked together to redesign the receiver to fit on one small 2- by 3-inch printed-circuit card. In the center is one 14-lead dual in-line flat-pack that contains all active circuit elements and



## An IC computer family tree

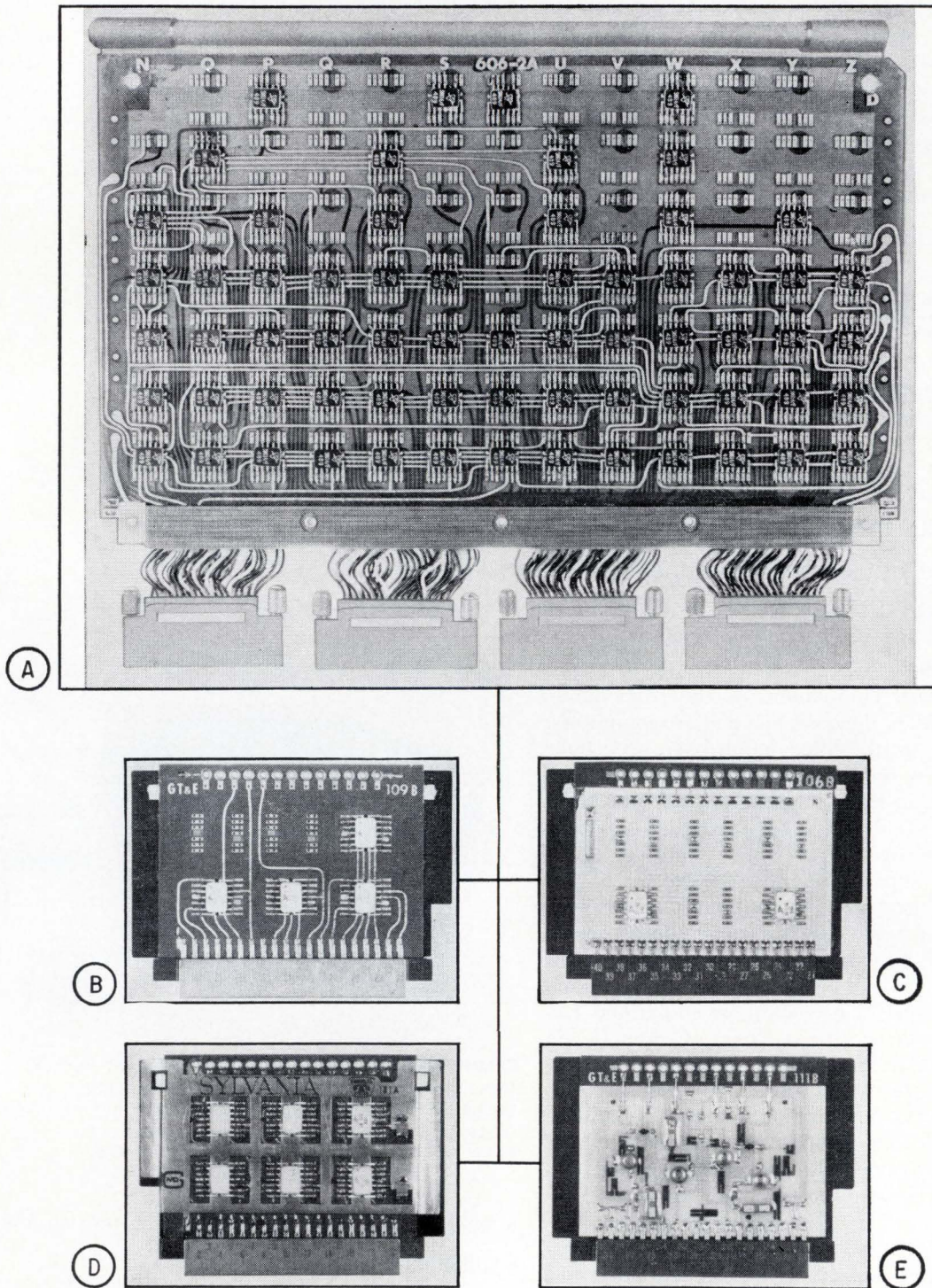

Engineers at the Sylvania Electronic Systems division tallied up the fallout from a major experimental IC project—the design and fabrication of a parallel high-speed, stored-program, general-purpose computer, MSP-24. They found an impressive array of progeny sired by the original project. Chief among them is a series of IC multilayer packaging techniques pictured

here. A large capacity board for the original MSP-24 engineering model is shown at A. It holds 178  $\frac{1}{8}$ - x  $\frac{1}{4}$ -inch flatpack IC's on two sides of the board, has 200 pins for external connection and an internal two-sided etch for power distribution and ground plane. A similar board, redesigned for production, mounts up to 144 devices and has 180 connectors as shown at H.



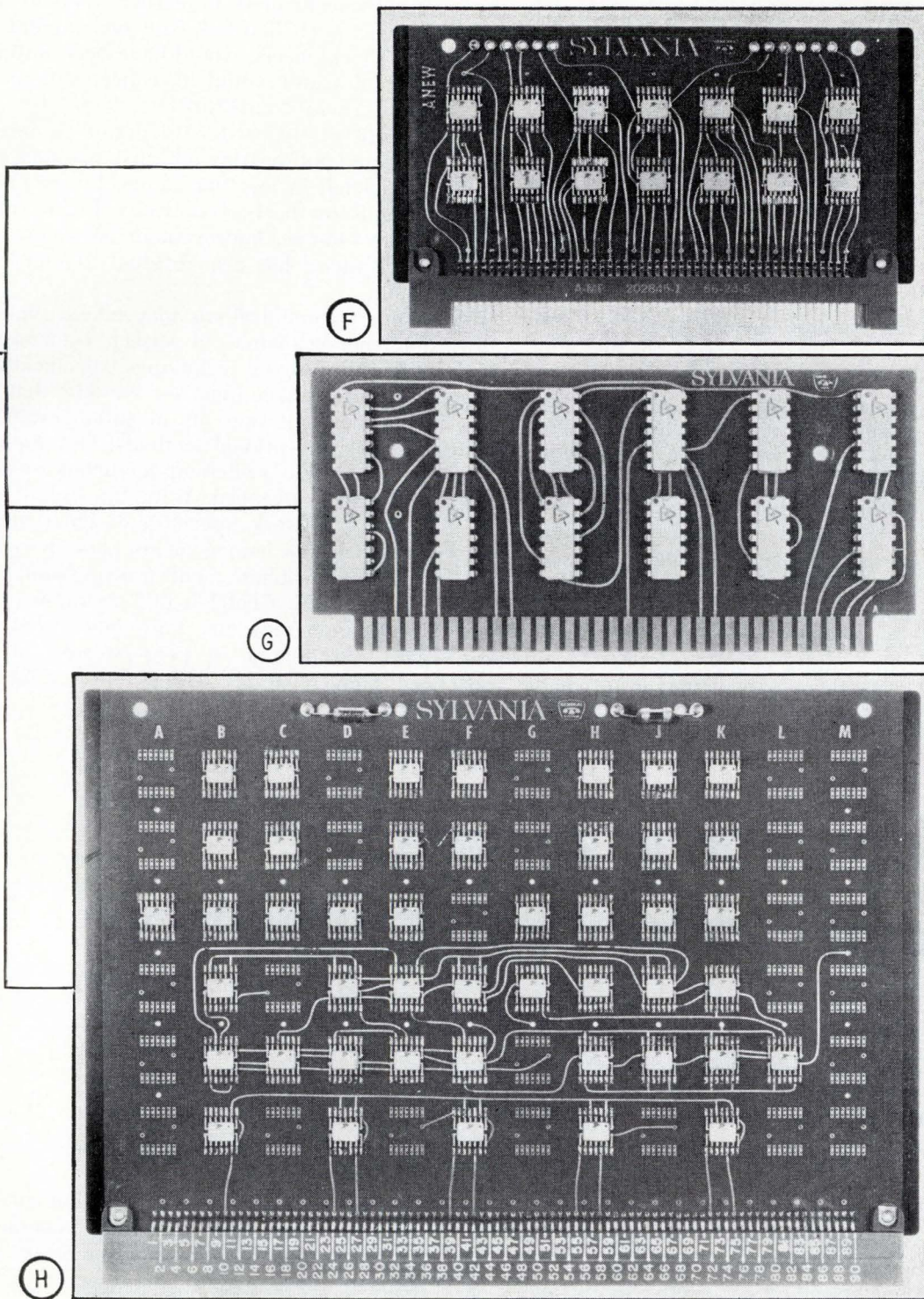

The same technique applied to a 12-device board with 40 pins is pictured at B. Ceramic replaces the epoxy boards in the three 40-pin printed-circuit boards shown at C, D and E. Copper conductors and, where needed, resistors are screened onto the boards. A buried signal layer is used in D; the ground plane is external and can serve as a heat sink. This technique has been employed

with high dissipation IC's such as 16-bit shift registers. Discrete components can be handled as in E.

A 28-device board with 100 pins is shown at F. Twelve dual in-line IC's are mounted in the 72-pin printed-circuit board at G. In this commercial package the power and ground layers are also laminated internally but the IC's are placed on one side only.



some diffused resistors. Outboarded on the card are the rest of the circuit elements, such as large passive components and transformers. The IC, whose schematic GE has not yet disclosed, doubtless falls into that category best described as an amorphous collection of devices that performs no function by itself, and for which another customer may never be found. Yet, if development costs for such a circuit can be prorated across a large enough production run—which might happen in the case of the GE radio—the approach makes a lot of sense.

### Do it digitally

The search for standard linear circuits notwithstanding, it's pretty difficult to match the wide availability and attractive prices of digital IC's. As a result, equipment designers are seeking ways to do nonlinear jobs with digital techniques.

When engineers at the International Telephone and Telegraph Corp.'s Federal Laboratories tackled the job of miniaturizing the Tacan airborne navigation system, they decided to switch to digital IC's to perform tasks previously handled in analog fashion. With digital techniques, they noted, a catastrophic failure would be required before significant errors crept into measurements. In the analog system, the sum of component drifts could result in intolerable errors—even though no single component drifted out of spec.

The new Tacan, using both monolithic IC's and thin films, has been reduced in volume and weight by over 40% compared to earlier versions and reliability has been boosted. The new digital design, say ITT engineers, would have been unthinkable with tubes and would have been out of the question even with transistors.

As a result of the switch to digital, a beacon can be selected and bearing and distance measurements completed in less than a second compared to 20 seconds in the best previous Tacan equipment. A two-to-one improvement in range and bearing accuracies has also resulted, the ITT engineers note.

Telephone communications may take a big step toward further economies if speech transmission is carried out by digital techniques, specifically by pulse-code modulation (pcm)—a system that has lain largely dormant since its invention in 1938—instead of by conventional methods. Development of digital electronic switching telephone systems are already well advanced. With the use of pcm for the speech network, speech and signal routing information become homogeneous, and the differences between switching and transmission techniques vanish. A.E. Chatelon of Laboratoire Central de Telecommunications, Paris, notes that IC's can speed introduction of pcm because of low cost and high reliability [Electronics, Sept. 19, p. 139].

## IC revolution is speeded through vendor-customer liaison

Missteps in applying integrated circuits are avoided by good communication between user and vendor

**There are two kinds** of manufacturers of integrated circuits, according to one user—the one who has a well documented off-the-shelf line and is not anxious to consider building custom circuits and the device maker who wants to encourage the user to work with him in developing new devices. Admittedly an oversimplification, the comment nevertheless contains some basis in fact. It depends partly on the vendor's philosophy and historical product lines. If, for example, he has specialized in monolithic digital IC's whose success hinges on large volume, he is less likely to be interested in development work than the device manufacturer who is concentrating on, say, large metal oxide semiconductor (MOS) arrays.

Traditionally, the burden of development time and costs has fallen upon the device people. As a result they've been reluctant to undertake projects without a reasonable assurance of a long production run, or a commitment on the part of a customer to pay a premium price if just a few circuits are involved. Unfortunately, more often than not the developer has been left holding the bag when the customer backed out at the last minute. In the future, the experts are now saying, the customer will have to pay part, if not all, of new circuit development costs for those devices with hazy market potential. One result of a trend in that direction could be that the equipment designer—because he has a financial interest—



will become more involved in the design of the integrated circuit itself.

### Working together

A good example of vendor-user teamwork was the successful conversion of linear circuitry from discrete to IC form in the shoulder-fired Redeye guided missile. Engineers at the Pomona division of the General Dynamics Corp. and Motorola's semiconductor products department, working together, made the conversion in less than a year. In a three-stage program, designers first made a multichip replica of the discrete component version. This stage—essentially breadboarding—was completed in three months. Next they studied cost trade-offs, deciding to build certain close-tolerance resistor networks of discrete parts and leave some parts of amplifier stages together because of improved temperature tracking. In the end, all but three of the circuit designs were converted to monolithic form. General Dynamics attributed the fast turnaround on the project to "concentrated participation between the component integrated-circuit manufacturer, the system manager and the customer." The result is that the Redeye, now in production at Pomona, is the first missile using all custom linear IC's. It is small and lightweight, per-

as chairman of a corporate microelectronics technical committee that meets several times yearly to report both progress and setbacks experienced by groups within Honeywell. Made up of engineering directors, chief engineers and section heads, the committee has grown from just a few members to more than 25. Everyone who attends contributes, says Nomura, and members rarely miss meetings. Swapping information helps in evaluating vendors, too, Nomura emphasizes. Sometimes the committee travels—it held a recent meeting at Motorola's Semiconductor division.

The Apparatus division of Texas Instruments in 1965 assigned a coordinator to foster internal dissemination of IC know-how. Earlier this year, Raytheon's Bedford Laboratories conducted a lecture series for Raytheon engineers covering techniques of monolithic and hybrid circuit design, interconnection and packaging, reliability and cost effectiveness. So successful was the series that an updated version began last week, this one under the sponsorship of the Boston section of the IEEE.

### Payoff on experiments

When a company wants to get its feet wet in the use of IC's or when it has a brand new idea it wants to try out using integrated circuits, it usu-

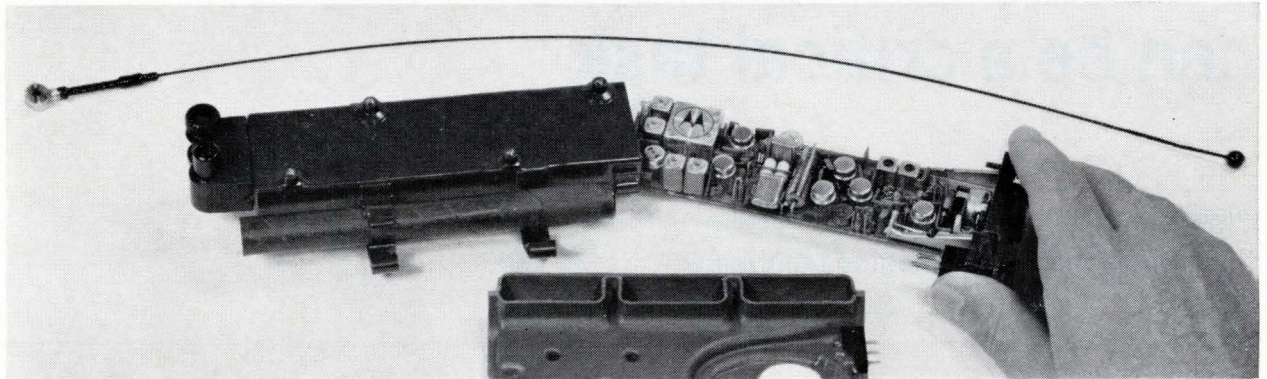

Seven cans contain IC oscillators and amplifiers in experimental helmet radio built by the Government Electronics division of Motorola, under a Signal Corps contract to study design of IC's for portable military equipment.

mitting a foot soldier to defend himself against low-flying aircraft.

### Familiarity breeds success

Equipment designers studying the use of IC's are often unaware of what their associates in the lab down the hall have already accomplished. They'll frequently restudy problems that have already been licked. To obviate costly duplication, more manufacturers are assigning coordinators the task of spreading the news of successful uses of IC's throughout an organization. These executives in charge of cross-fertilization often are placed fairly high in the management hierarchy, attesting to the seriousness of their job.

At Honeywell, Inc., Minneapolis, Minn., for example, K.C. Nomura, technical director of the corporation's solid-state electronics center, serves

ally must pay for its own experiments. Unfortunately, test vehicles used in company-sponsored studies are frequently not salable at projects' end. Instead, the company must chalk up its expenses to experience. Despite the risks, many firms forge ahead, accepting the possibility that among the fallout may be a hard-to-hide white elephant.

Occasionally a manufacturer is more fortunate, ending up with a lot of good experience as well as a practical piece of equipment. The Electronics System division of Sylvania Electric Products Inc., a subsidiary of General Telephone & Electronics Corp., undertook as an academic exercise the design and construction of an integrated-circuit processor. The result was the MSP-24, a computer with the data-processing capability of a large commercial computer or a truck-sized Mobidic field computer in just a few cubic feet. Its engineers



now say the MSP-24 could be produced for a fraction of the cost of earlier computers and would be more reliable and easier to maintain.

But the biggest payoff seen by the Sylvania MSP-24 project people is in the fallout of IC techniques — particularly in packaging — which have been applied in later equipment. Some of these are in the box on pages 74 and 75. Among the techniques worked out for the MSP-24 were the use of partially prefabricated multilayer circuit boards to cut down engineering and fabrication cycle times [Electronics, Nov. 1, 1965, p. 79].

Motorola's Government Electronics division, Chicago, came up with some interesting results from a study it began in April, 1965, under Signal Corps sponsorship, to determine how best to design IC's for portable military communications gear. The vehicle used to check its conclusions was an all npn push-pull audio amplifier designed for low-power receivers such as the helmet radio on page 77. Engineers on this project concluded that it's wise to use enough circuits and circuit

designs so that the need for close tolerances can be avoided. To keep costs down, they noted, it's possible to use a transistor to provide a number of different functions in one monolithic circuit (it can be connected in five different ways to form diodes, or its emitter-base junction can be reverse-biased to form a junction capacitor).

To minimize total component area, Motorola engineers cautioned, one ought to consider using diode voltage drops as resistor substitutes and wide-tolerance low-value resistors. In addition, they suggested, adding stages permits relaxation of gain and tolerance requirements per stage. Finally, they said, there is no substitute for an equipment man's thorough familiarity with IC fabrication methods since he is in the most favorable position to rule on design trade-offs.

The product of their philosophy applied to designing the helmet radio amplifier was a unit containing five different circuits in seven cans. At a frequency of 1 kilohertz the amplifier delivers up to 45 milliwatts with distortion under 10%.

## Packing IC's into equipment can be a critical task

Most of the gains afforded by integrated circuits can be lost through haphazard packaging techniques

**The question of how** to package integrated circuits into electronic equipment has as many answers as there are customers. On the one hand a system containing a small number of IC's would be relatively unaffected by their presence—from a packaging standpoint. Constraints imposed by conventional components dictate the packaging format of such a system. On the other hand, as the percentage of IC's in the equipment increases, the IC portion may become the tail that wags the dog. That is, the entire packaging scheme may be revamped to fully exploit the use of IC's.

Jack Staller of Sylvania's Electronics Systems division notes that few present-day packaging methods capitalize on the IC's small size. Staller's favorite description of the inefficiency is this: starting with a heaping thimbleful of IC chips, enough to build a computer, the best packaging technique will expand them into a module at least 2,000 times as large. Particularly poor, says Staller, is the use of planar printed-circuit boards that can explode the thimbleful of chips to 50,000 times their

original size.

A few years ago, cordwood stacking of miniature components was not considered the most sophisticated approach to packaging—certainly it was not thought to be compatible with IC packaging. Yet today some of the most advanced spacecraft electronics uses three-dimensional packaging. It is particularly useful when a mixture of IC's in flatpacks and conventional discrete components must be handled in close proximity.

When engineers at the Aeronautical division of Honeywell tackled the job of designing linear IC's into the already existing stabilization and control system for Apollo, they encountered a requirement that redesign of the equipment to accept the integrated-circuit amplifiers be kept to a bare minimum; they had to stick with the established welded cordwood subsystem packaging. Skirting the problem neatly, they designed a mounting adapter that holds an IC flatpack, converting it into a block format with cordwood-style leads. The result is a package easily assembled and protected during



## Magnification a must for midget circuits

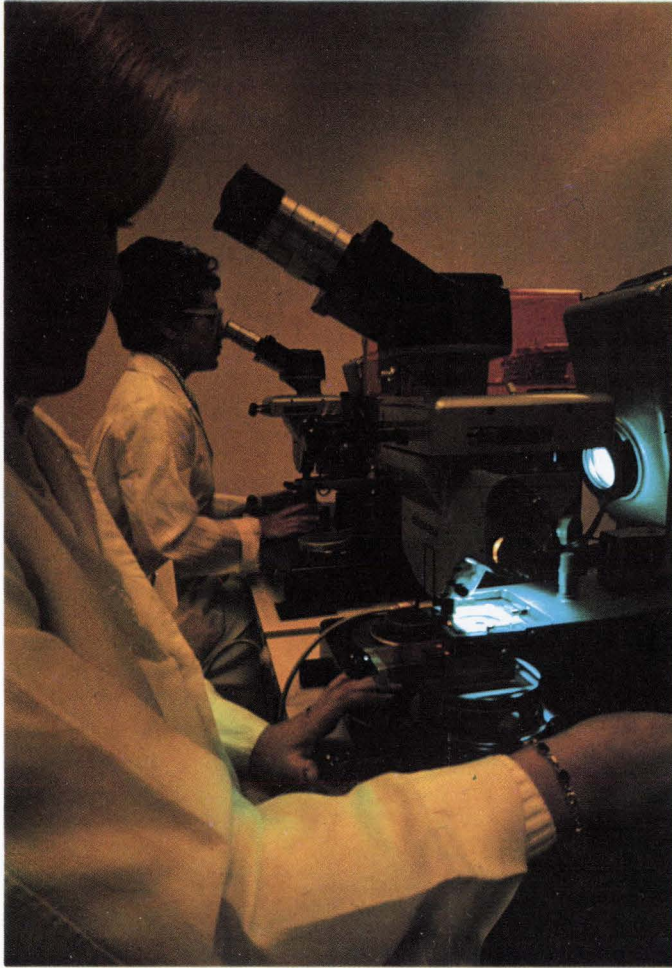

**Amber-hued photoresist room at General Instrument.** In critical task operators align masks atop photoresist-covered wafers, then expose pattern upon photoresist with ultraviolet light.



**Fine gold wires are bonded to integrated circuit under microscope by assemblers at Westinghouse.**



**Operator steers integrated circuit chip in x-y plane using controls on either side of work station preparing for die bonding.**



## Tests and more tests

**Blowup of IC wafer** helps Westinghouse Molecular Electronics division inspector pick out misaligned diffusion patterns or metal interconnection defects.

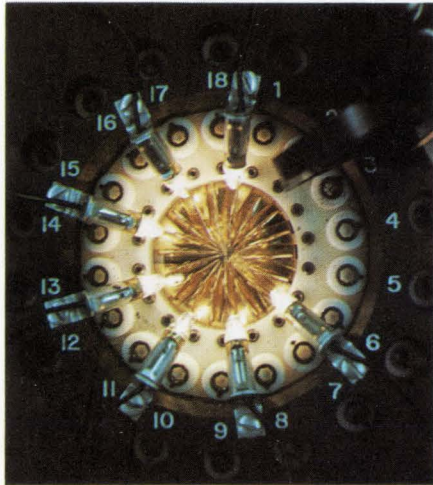

**Microscope view** provides kaleidoscopic effect as 18 test probes at General Instrument contact a waferful of IC's during electrical check of one circuit.

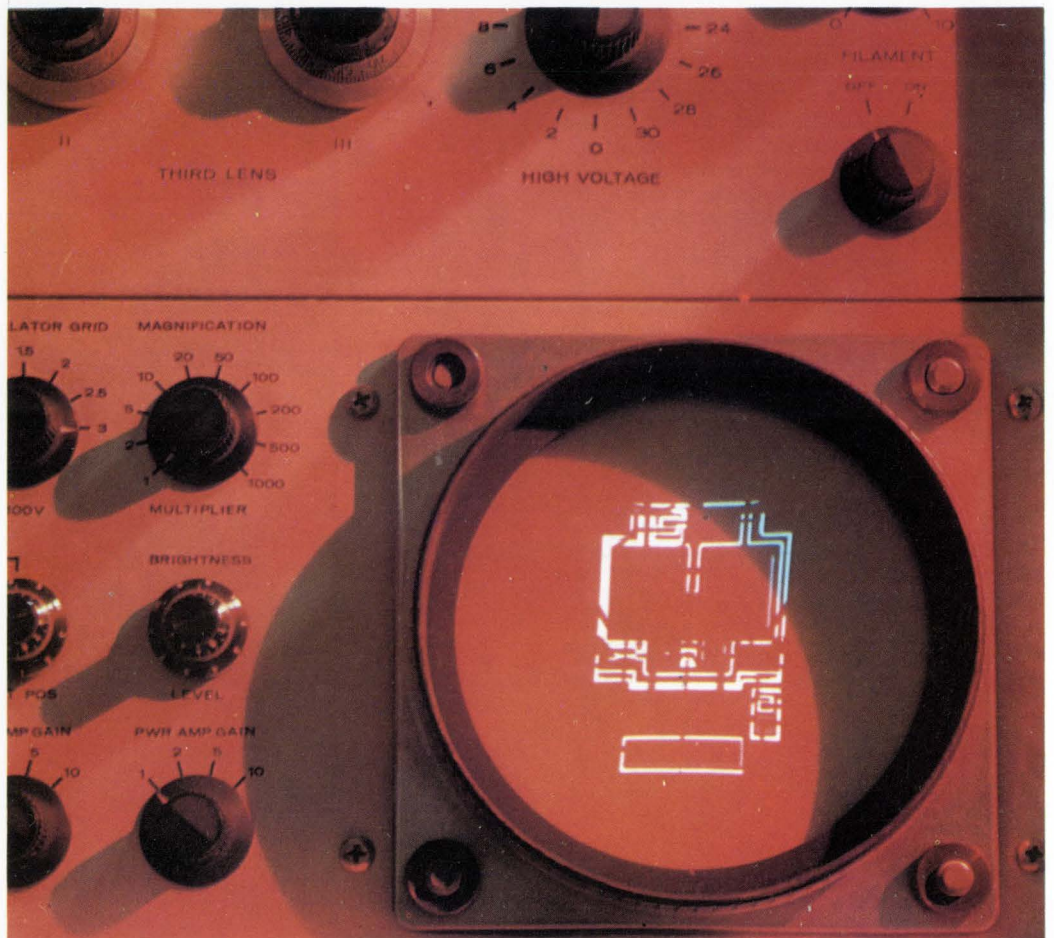
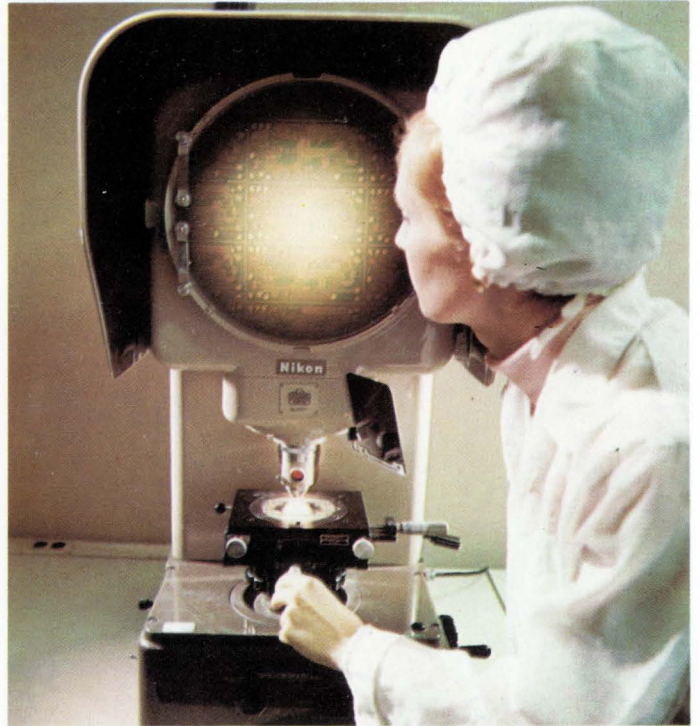

**Scanning electron microscope** peers beneath the surface of an operating integrated-circuit flip-flop at Westinghouse Molecular Electronics division. Electron probe scans device and secondary emission pattern results; it is fed to crt to provide potential map. Visibility of circuit defects can be improved through biasing techniques.



## The computer lends a hand

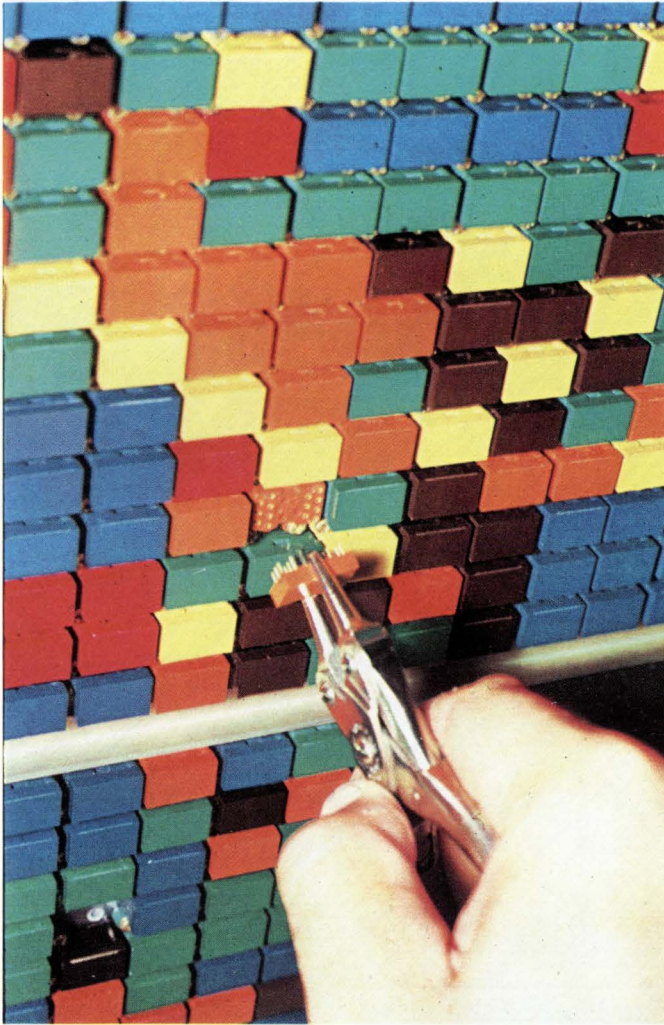

Color codes identify the six types of IC's used by the Martin Co.'s Orlando electronics and guided missile facility in a complex digital computer. Martin plugs the potted IC's into large epoxy boards and then machine-wires the module interconnections.

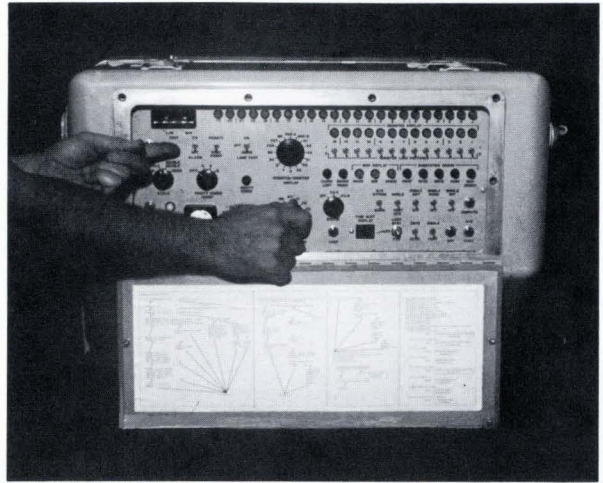

Martin digital computer fabricated using series of computer programs to speed layout and wiring.

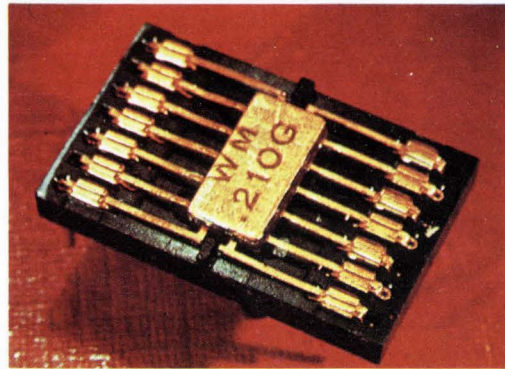

Topside of a Westinghouse DTL integrated circuit before it was encapsulated for use in the Martin computer. Leads at either end are staggered to provide wide pin spacing.

Computer-generated back panel wiring (at left of photo) joins IC modules in the Martin computer. Large motherboards are hinged to equipment for ready maintenance.

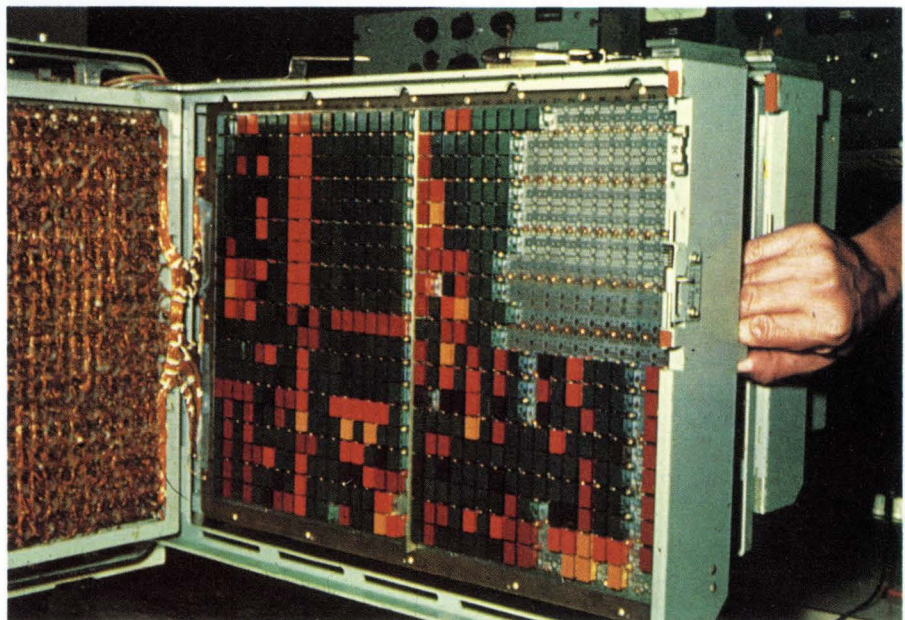



# IC applications abound

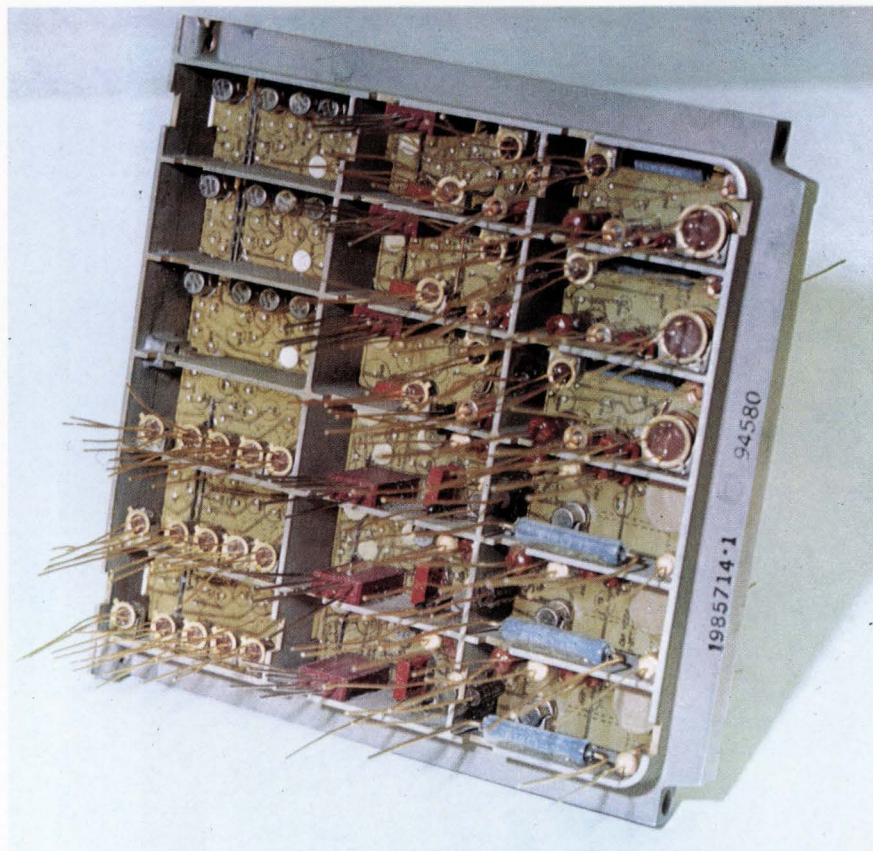

Die cast aluminum frame contains both IC's and discrete components in Apollo stabilization and control system (SCS) built by Honeywell, Inc. Potted IC's are pasted with epoxy to sides of frame.

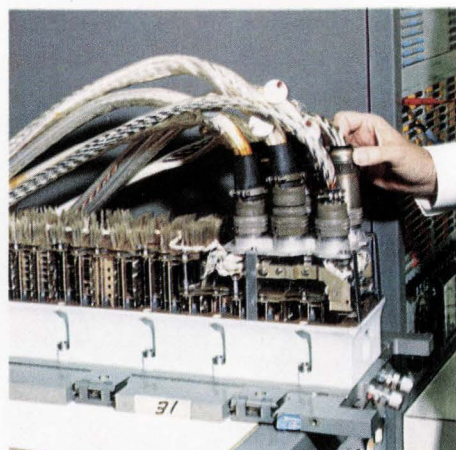

One of five major SCS modules that will be mounted in the Apollo space capsule undergoes test by Honeywell engineers. The modules contain IC's in frames as at left.

Collins Radio Co. uses hybrid IC's made with thin films and monolithic chips in this frequency synthesizer covering 2 to 11.999 Mhz in 1-khz steps.

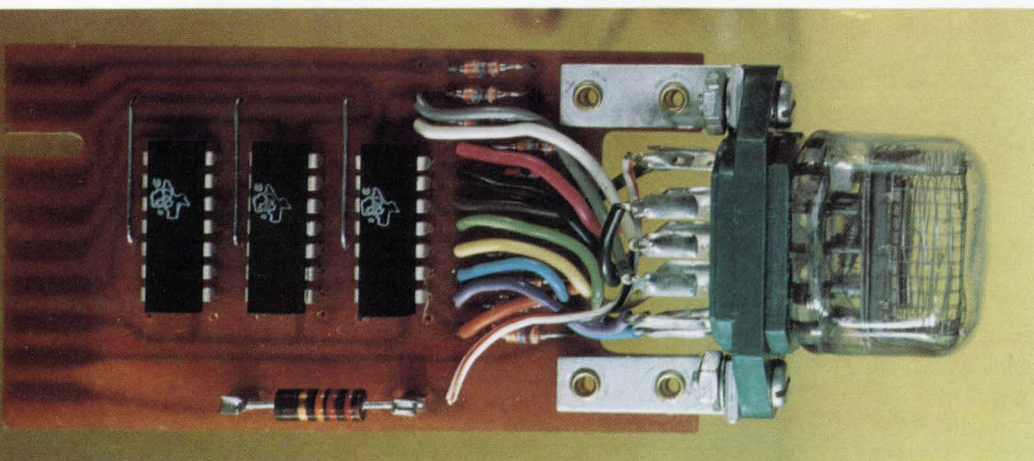
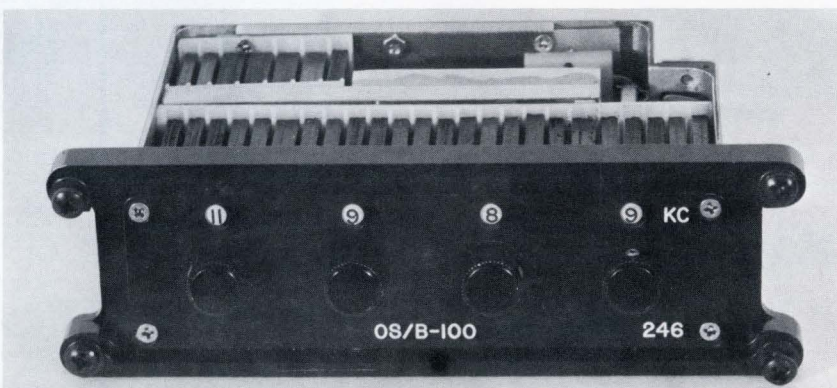

National Electronics, Inc., uses three complex-function IC's in dual in-line package for new decimal counter driver.



handling.

An altered maintenance requirement permitted a new approach to interconnection of modules in each of the five major assemblies of the Apollo stabilization and control system. First-generation assemblies were to be subjected to in-flight maintenance and modules had to be removable. But second-generation assemblies are not to be repaired in flight. For the latter, Honeywell engineers developed the welded wire matrix shown in the photograph above/below to make permanent connections; however, short lead time changes can be made using the matrix techniques.

The matrix has four to nine Mylar layers sandwiched between top and bottom fiberglass boards. A wiring pattern has been photographically reproduced on each layer. Flat nickel conductors are joined in a matrix by welding through holes in the Mylar layers. A 1-inch unsupported length is permitted; if a run exceeds an inch, the nickel strip is cemented to the Mylar.

Vertical risers are welded to each layer and brought through succeeding layers and intervening Mylar insulators through prepunched holes for connection to the subassembly modules. Resistance welding in one plane above the top fiberglass board makes all interlayer and subassembly module connections.

### Case of compatibility

A vehicle-based continuous-wave r-f system that provides information on position and velocity during launch of space vehicles is being built and tested under a NASA contract by Motorola's Government Electronics division, Scottsdale, Ariz. Called the Advanced Range and Orbit Determination (AROD) system, it uses 2,300 monolithic RTL integrated circuits and 300 multichip hybrids. Without IC's the system would not have been practical; for the first time in space ranging applications, equipment is controlled and data collected on board the spacecraft instead of in a large ground complex. It's done with two boxes of IC gear. Ground stations are simple unmanned portable units that can be used in remote locations.

For AROD, Motorola engineers came up with a compatible packaging technique that accommodates both IC's and discrete component circuits without sacrificing size or performance. Two distinct types of modules are used—but they are dimensionally compatible and can be mounted on a common printed-circuit motherboard. One is IC-oriented; the other, discrete component-oriented.

The digital subsystems are composed mostly of monolithic integrated circuits and a few discrete parts. In these subsystems the IC's and discrete parts are interconnected in "microharness" subassemblies like those pictured on page 84. These in turn are interconnected on a two-sided printed-circuit board. The technique permits ready access for test and inspection. Each frame or group of IC modules includes a power-line filter module that constrains power-line-conducted noise problems

within the frame. Since IC interconnections are accomplished largely with the microharness, radiated noise problems are minimized.

In subsystems that are a mixture of digital and r-f circuits a compatible package handles both IC's and discrete parts or all discrete parts. The package is based on cordwood modules. Used in a complex frequency synthesizer subsystem that includes many interfaces between the digital and r-f circuit, it proved ideal. The coherent noise problem is particularly important in this application since it is necessary to synthesize signals coherently related in frequency but individually pure or uncontaminated by the related coherent signals. To combat this problem, the r-f modules are completely shielded in metal cans and mounted tightly to a conductive ground plane to eliminate r-f spray from the module's internal circuitry. Carefully placed printed circuitry, functioning somewhat as a dielectrically loaded strip transmission line, lessens radiation from the module pins and interconnections. Careful functional partitioning of modules is also important to keep the most sensitive low level points inside a shielded module.

### Packaging trade-offs

Partitioning the system is one of the most difficult problems faced by the packaging engineer and one that reflects significantly on the types of interconnections needed. Maintainability usually determines the first level of interconnection, it represents the level at which card or module replacement would be made in the field, and is often selected on the basis of the module's throwaway value. With an increase in the reliability of IC's and the complexity of circuitry that can be successfully crammed into first-level modules, the designer faces a dilemma. Should he go with the larger module or cut back to a smaller one? The smaller module gives him a lower throwaway cost and permits him to stock fewer spares if many of one kind of module is used in a system. But the smaller module gives away some of the reliability the larger one affords.

A constant threat to the equipment designer is the specter of the next generation, what it will bring and, even more important, when it will arrive. The designer must embrace new techniques at the most propitious moment—neither too quickly nor too slowly. On the horizon is the technique called large-scale integration, in which a hundred or more integrated circuits such as gates are interconnected within a single silicon chip. Large-scale integration promises to bring with it a vast decrease in equipment size, new logical structures for computers and new packaging formats based predominantly on large arrays.

### Cool it

One of the penalties of packing more circuitry into a smaller space is a compounding of the heat removal problem. Staller's thimbleful of IC's [page 78] would glow like a 100-watt bulb if there were



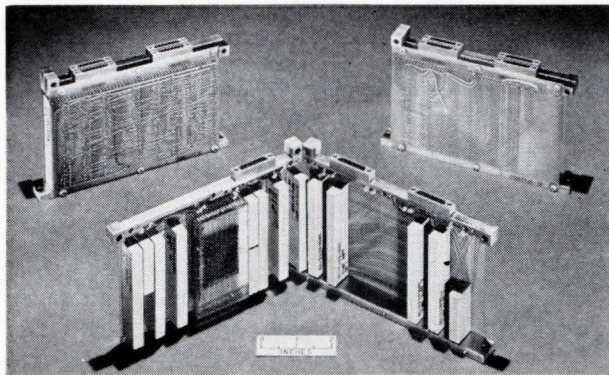

**System control logic circuitry** in the Advanced Range and Orbit Determination system built for NASA by Motorola consists of three frames containing 575 monolithic milliwatt RTL circuits, 41 hybrid IC's and a core plane (seen in the open unit). The sticks or circuit blocks are made by the microharness technique.

no cooling system.

Most designers consider the system as a whole when they tackle the cooling problem, giving scant attention to the integrated circuits it may contain. They stick to the time-tested methods of cooling by conduction, or where necessary, by forced air or liquid cooling. The use of thermoelectric coolers

for removing heat from local hot spots has been predicted for the last several years, but little evidence of actual application is seen.

In the Apollo stabilization and control system, components—including integrated circuits—are mounted in stacked cordwood fashion inside compartmented die-cast aluminum frames. Components that might run hot are "hard mounted" or pasted with epoxy cement to the inner walls of the frame. Then the cubicles of the frame are filled with potting compound loaded with aluminum or silver particles where needed to enhance heat flow. Several frames are locked together and ultimately clamped to a cold plate containing a circulating coolant. Thermally conducting silicone grease is used where the frames join the base to guarantee good heat transfer.

The Lunar Excursion Module (LEM) rendezvous radar and transponder contains digital IC's in flat-packs. Multilayer circuit boards are used to package the IC's in planar fashion. A few discrete components are mounted on the board. Fastening the circuit board to a subassembly frame provides a heat conductive path. Where parts run hot, an aluminum slug is buried in the board to give close thermal coupling to the frame.

## Not all costs are measured in dollars

The designer of electronic equipment may think he's just breaking even in his switch to IC's; but reduced cost of ownership may give the customer an unexpected bonus

**If cost is not the major** element in the decision to go to IC's, rarely is it absent as a factor. Today's low device costs, the advent of multicircuit IC's and large-scale arrays, and the development of cheaper packages and packaging schemes all make the designer think twice before concluding that discrete components would be less expensive.

In cases where initial price might be higher for IC equipment than for its conventional counterpart, the designer (and end customer) must look at cost of ownership; it could swing the decision to the IC version. Preventive maintenance and repair costs could be much lower as a result of higher reliability.

That initial cost is often misleading is emphasized by S.M. Stuhlbarg, manager of Raytheon's microelectronics facility at its Bedford Laboratories. He has calculated yearly average cost per

pound of electronic gear for various types of nonmilitary equipment. It ranges from about \$6 for vehicular equipment to \$20,000 for rocket equipment.

Throwaway cost is an important factor, particularly for battlefield equipment where repair is difficult or unlikely. In the case of the Redeye missile [see page 77], the combat infantryman will jettison the whole thing when it fails. In an emergency where it's more hindrance than help he'll abandon it even if it's still working. Consequently, one of the chief requirements for the weapon is its low-cost throwaway feature.

### Time is money

Short turnaround time is often a big influence in the decision to go with IC's. In a digital test command system (DTCS) for Apollo, engineers



Welded wire matrix replaces circuit boards in Apollo stabilization and control system, built with IC's by Honeywell, Inc.

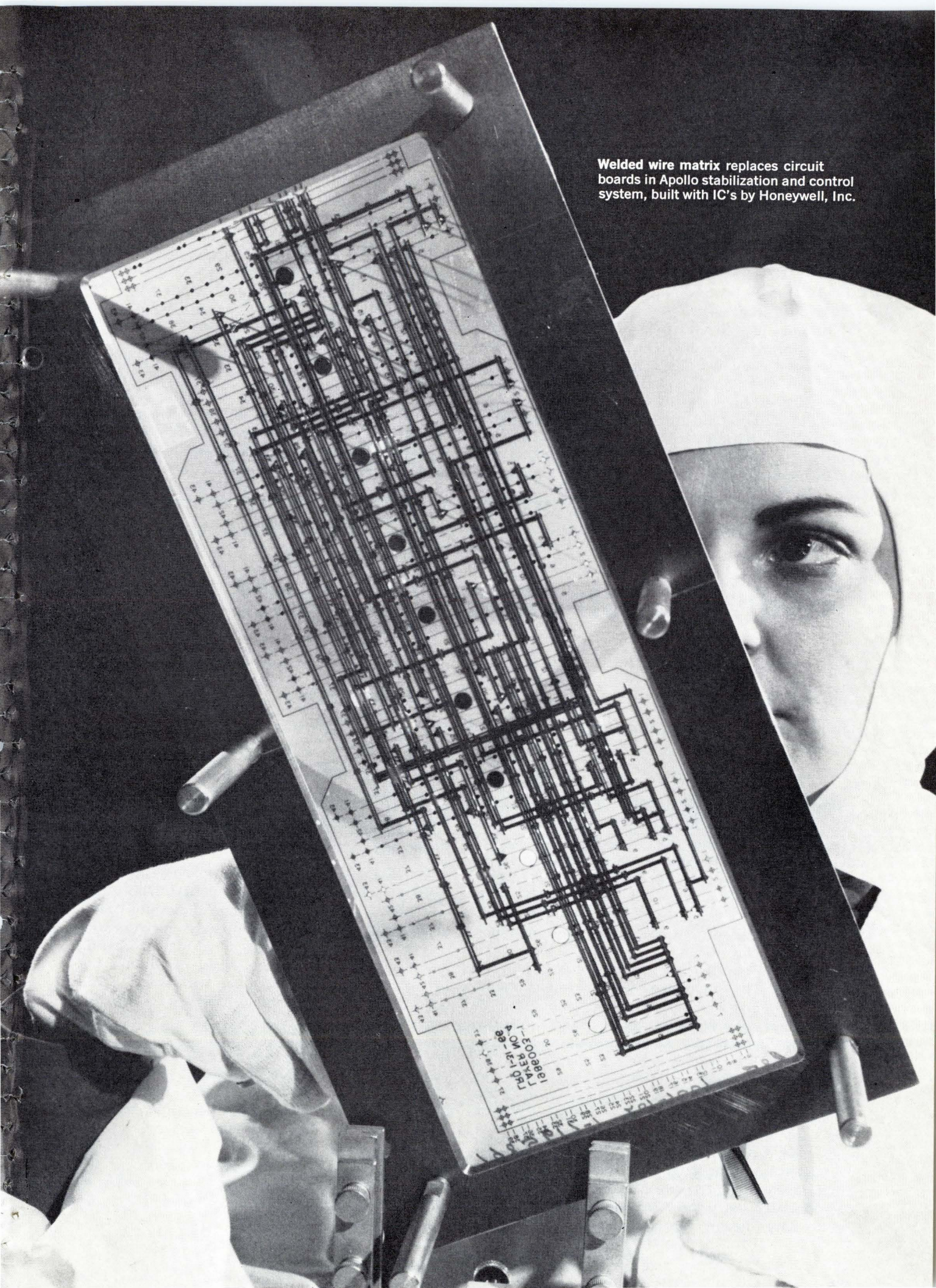



at the aerospace center of Motorola's Government Electronics division of Phoenix, Ariz., were saddled with a 6-month delivery schedule. With no time to develop a new family of logic devices, they decided to use an existing IC family that had good history behind it and that could be delivered in quantities up to 80,000 within the 6-month period. As it turned out, they chose ECL, made by Motorola Semiconductor, a sister division in nearby Scottsdale. A bonus, noted the equipment designers, was that the nearness of the vendor obviated the need for incoming inspection, eliminating dual inspection costs.

Another tack to save time is taken by engineers at the Martin Company, Orlando, Fla., who developed a computer-aided approach to go almost directly from logical equations to a finished system. Martin plugs the IC's into large epoxy glass motherboards standardized to fit a computer-controlled backplane-wiring machine. Logical equations are put on punched cards and fed into a general-purpose digital computer programmed to select wiring routes between modules and make the necessary checks for fan-out and fan-in load-

ings. The computer generates a wiring list that specifies all common points. Assignment of hardware is next done manually on a standard grid. Armed with the wiring information and hardware parameters, the computer determines the wiring sequence and the best routing for minimum wire run, then supplies a punched tape to direct the wiring machine. A computer was developed by Martin engineers using this approach. The computer employs standard DTL circuits made by Westinghouse which, Martin engineers say, had to be free from noise and close timing tolerances. They selected the line because of its satisfactory reliability history and because Westinghouse was able to supply them with a special J-K flip-flop that had built-in clock-skew protection—the ability to shut out further changes in J-K inputs after the clock pulse starts. Thus fast-changing flip-flops do not send false signals to slow-changing flip-flops. This feature is important to the automatic approach since it permits modules to be placed anywhere on the motherboards, without time-consuming checks on the effects of varying lengths of the clock-drive lines.

## Reliability: on paper or in fact?

No one disputes the inherent reliability of integrated circuits but some IC's fall by the wayside through errors committed by both vendors and users

**Small size has yielded** to high reliability as one of the reasons most frequently given for the use of integrated circuits. But while vendors of integrated circuits continue to tabulate unending hours of device operation without failure, disgruntled customers cite case after case of inoperable units at incoming inspection and cynically hang on their office walls "chamber-of-horrors" photographs that show devices that failed.

As a result, users have dug into the task of determining why integrated circuits fail. Comprehensive failure-analysis programs undertaken by researchers at Raytheon's Space and Information Systems division, the Massachusetts Institute of Technology's Instrumentation Laboratories and the Aerospace division of Westinghouse have uncovered some common denominators. Most of the blame still seems to fall into the vendor's lap. Failures for which the device maker is taken to task are caused by defective adhesion of aluminum interconnections, too much heat during lead bonding, and moisture and corrosive contaminants within the package that cause interconnections to deteriorate. Occasionally the equipment maker or user

is faulted for having jolted the circuit with too much current or voltage.

### Flunk-outs

At The Rome, N.Y., Air Development Center, reliability specialist J.B. Brauer reported that 10 IC's out of 600 purchased from one of the center's most dependable suppliers failed to pass incoming inspection. In a radar intercept calculator program only 0.5% of the IC's were "dead-on arrival", but five of these had the lids on backwards: they could not have passed even the most basic d-c static test since pin orientation was 180° out of phase. Two other IC's from the same lot had damaged resistors. One was caused by a photoresist defect; the other was damaged after photoresist application. When the center bought 179 DTL gates and retested them in accordance with the vendor's electrical acceptance test, seven of them flunked; after a 24-hour burn-in another 41 failed. Concludes Brauer, the "time-zero" problem (quality at the customer's incoming inspection) is an order of magnitude more serious than problems of continuous degradation in the field.



During parameter tests of this integrated circuit, aluminum interconnection path burned open because of a local hot spot. Theory is that a scratch on the aluminum reduced cross section of conductor resulting in high resistance. Failure analysis was performed at component analysis facility of the MIT Instrumentation Laboratories digital development group.

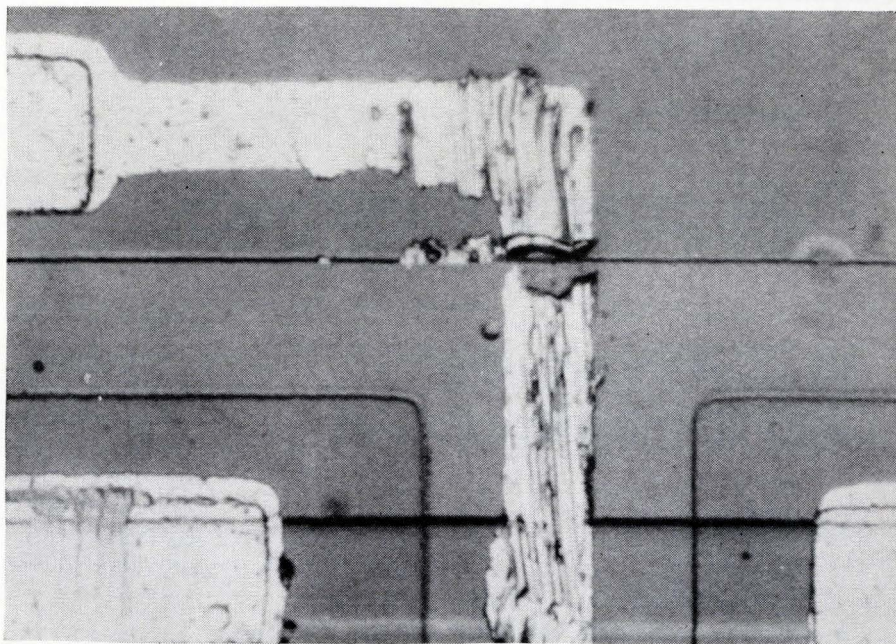

The National Aeronautics and Space Administration, on the basis of industry estimates that some 80% of space systems electronics will consist of integrated circuits by 1972, is going all out to reexamine its reliability program. At its Electronic Research Center in Cambridge, it already has under way a failure-analysis program for IC's. It charts observed abnormalities and relates them to failure modes and likely failure mechanisms. Also, it pinpoints relevant device processing steps to which each failure mechanism is related, and makes recommendations for correction. Finally, it studies instrumentation needed to detect IC misbehavior.

Part of the NASA program comprises contracts let to electronic system builders to evaluate differences in IC's from vendor to vendor. One member of an evaluating team, disconcerted at the indifference of a vendor being studied, suggested that the concern of the vendor be included as a factor in vendor evaluation.

NASA's own approach to reliability has often been criticized as wasteful of time and money. At the recent Fifth Annual Microelectronics Symposium in St. Louis, C.W. Watt, chief of the components standards branch at NASA's Cambridge Research Center, admitted shortcomings that include lack of coordination in data exchange, repetition of vendor surveys and little standardization.

As a result, NASA is scrutinizing its reliability setup and will concentrate its changes in the area of microelectronics. The revamped program is being formulated by a new microelectronics subcommittee of the existing parts steering committee of the space agency. The subcommittee has already drafted some proposed procedures and a general microelectronic specification now making the rounds of committee members for refinement. Industry representatives, anxious to have their say

on proposed procedures, have yet to pin down the agency on when they'll get a crack at them.

Key to the new space agency program could be a central data bank to permit exchange of information among agency centers and contractors. It would go beyond present programs like the Interservice Data Exchange Program (IDEP), covering results of vendor surveys, vendor procurement and reliability history, lists of qualified circuits, standard circuits and specifications. The hope, Watt says, is to make participation in the data bank a contractual obligation, since enlightened self-interest has not proved an adequate spur to wide participation in programs like IDEP.

#### Survey teams

Much of the information lodged in the proposed central data bank would come from vendor survey teams for which the space agency expects to tap experts throughout the agency and train them to do the job. The result should be fewer but better survey teams, a spokesman concluded.

The agency does not intend to dictate IC manufacturing techniques—rather it wants to “enable the vendor to prove he is aware of his own problems,” and assist him in proving he can make a consistently reliable product.

**Less than** a decade into its life span, the integrated circuit has already made startling inroads into electronic equipment. The equipment designer, caught up in the accelerating trend toward greater use of these fascinating devices, finds he must learn much and learn fast to keep ahead. This article is the first in a series which will describe the major problems in using IC's and reveal solutions already put into practice by electronic equipment designers.



# Designer's casebook

Designer's casebook is a regular feature in Electronics. Readers are invited to submit novel circuit ideas, packaging schemes, or other unusual solutions to design problems. Descriptions should be short. We'll pay \$50 for each item published.

## IC amplifier provides variable reference voltage

By John Althouse

Escondido, Calif.

A precisely adjustable reference voltage covering a range from  $-5$  to  $+5$  volts is derived from the integrated-circuit operational amplifier shown. With a resistor divider it translates a zener reference to a desired voltage. The circuit is valuable where the required voltage reference must be low (in one application, two volts power a thermistor bridge circuit).

Other advantages exist: a zener diode of moderate tolerance—and consequently of lower cost—can be used; the diode current will not change with the load, improving the stability of the reference voltage; and the zener voltage can be selected for the best diode characteristics rather than for required reference voltages.

Resistor R was selected to provide the manufacturer's recommended current through zener  $D_1$ .

This produces a stable voltage,  $V_z$ . The desired reference voltage  $E_o$  is obtained in accordance with the relationship

$$E_o = -V_z R_1 / R_2$$

Resistor  $R_1$  is adjustable so that voltage  $E_o$  can be brought to exactly the desired reference voltage regardless of variations in breakdown voltages among individual diodes of type  $D_1$ .

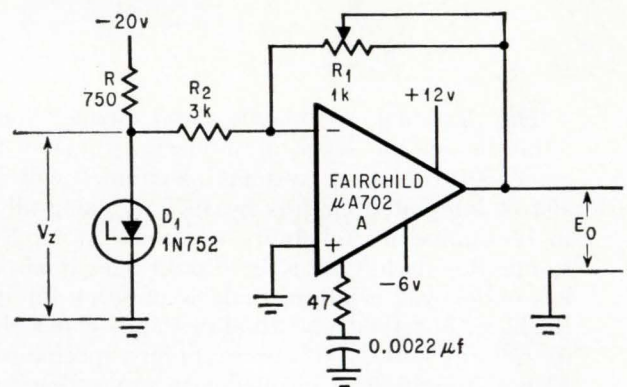

Operational amplifier network and resistor  $R_1$  and  $R_2$  reduce the zener breakdown voltage to a desired reference while isolating the zener voltage from output load. Reference voltage is adjusted with  $R_1$ .

## Reducing transients in switched inductive loads

By John L. Haynes

Endevco Laboratories, Mountain View, Calif.

Alternating-current circuits connected to electro-mechanical apparatus are protected from transients with the aid of a silicon controlled rectifier. An unsuppressed relay, solenoid or motor winding can generate kilovolt spikes with rise times in the nano-second range. The circuit shown, with the solid lines and switch S closed, eliminates turn-off transients in the a-c load, so there is no radio-frequency interference, radiated or conducted.

The circuit could be used in paper-tape punches, paper-tape readers, typewriters, motor drive for a tape transport, servo motors, plotting tables and

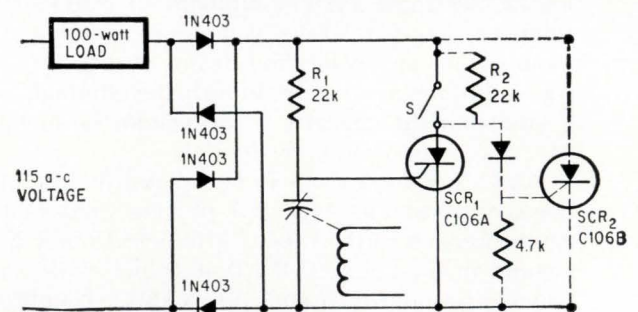

When the solid-line portion of the circuit is used, a-c turnoff transients are eliminated. Adding the dotted portion of the circuit eliminates turn-on transients.

other equipment operating from a 115 volt, a-c supply.

When the a-c current flows in the load it is full-wave rectified by the diode bridge and flows through SCR<sub>1</sub>. When the contact closes, SCR<sub>1</sub> conducts until the current in the load goes to zero.



Then SCR<sub>1</sub> turns off, so it doesn't interrupt the normal current. The circuit will work equally well with any power factor load, since turnoff is determined by zero crossings of the load current, not by zero crossings of the a-c line voltage.

Turn-on transients can also be a problem, because of two primary factors:

- If the line voltage is at or near peak when SCR<sub>1</sub> is turned on, a relatively large change in voltage with respect to time (dv/dt) results in both the load and SCR.

- If the load is switched off at or near the peak line voltage of either polarity, the iron core of the contact coil can be left magnetized near saturation at one end of the hysteresis loop. Turning the unit back on at the opposite peak of the line voltage

can drive the core into saturation, causing a large one-cycle surge current.

To eliminate turn-on transients the circuit is modified by opening switch S and including the dotted component leads. This modification offers a 2-to-1 margin for core saturation to eliminate the turn-on surge. When the contact is open, SCR<sub>1</sub> is on and SCR<sub>2</sub> is off. The load sees only the high impedance of R<sub>1</sub> and R<sub>2</sub>; the voltage across SCR<sub>2</sub> is essentially the a-c line voltage.

When the contact closes it shunts the gate drive of SCR<sub>1</sub>. So, SCR<sub>1</sub> turns off when the line voltage goes to zero. Turnoff occurs as before. When the contact opens, SCR<sub>1</sub> immediately turns on, shunting the gate drive for SCR<sub>2</sub>, which in turn shuts off at the next zero crossing of the load current.

## Logarithmic amplifier has 66-db range

By Jean F. Delpech

Institute d'Electronique, Orsay, France

**Two diodes** driven by a current generator form a low-cost logarithmic amplifier. The silicon planar diodes, D<sub>1</sub> and D<sub>2</sub> (type 1N914), are selected because they follow a nearly ideal logarithmic characteristic over more than a 60-decibel range. Selected samples can cover an 80-db range.

Because the diodes are current driven, the output impedance of their driver amplifier, Q<sub>1</sub>, must be very high so that load changes are not affected by the impedance of Q<sub>1</sub>. To accomplish this, the impedance must exceed 100,000 ohms to cover a 60-db signal voltage range. Since the maximum current through each diode could be as high as 10 milliamperes, a line voltage of 1 kilovolt is needed to achieve the high output impedance. This, of course, is impractical.

To overcome this high impedance requirement, a feedback circuit combining a line voltage of 20 volts, an output impedance of 100 kilohms and peak output current of 10 milliamperes is incorporated in the circuit.

Resistors R<sub>1</sub>, R<sub>2</sub>, R<sub>3</sub> and R<sub>5</sub> bias driver, Q<sub>1</sub>, so that its quiescent collector current reaches 10 milliamperes. To provide the required bias and at the same time a high value of a-c output impedance, a variation of the bootstrap circuit is used. The variation consists of loading the collector of Q<sub>1</sub> with the combination of R<sub>6</sub> and a Darlington pair, Q<sub>2</sub> and Q<sub>3</sub>. If Q<sub>1</sub> remains in its linear operating region, its a-c collector current, *i*, will be inde-

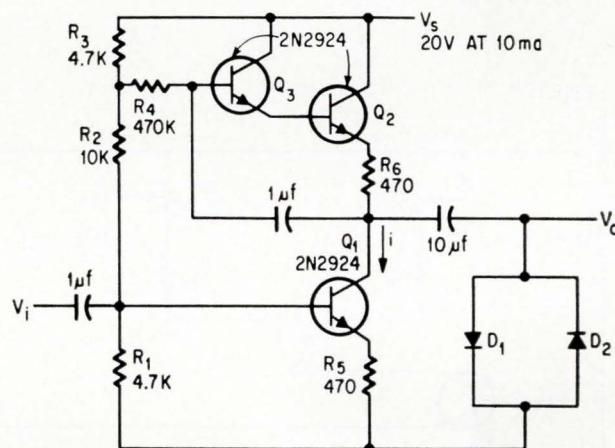

**Logarithmic amplifier** uses two planar diodes and three epoxy encapsulated silicon transistors. Diodes are current driven; Darlington circuit, Q<sub>2</sub> and Q<sub>3</sub>, gives necessary high output impedance that exceeds 100 k.

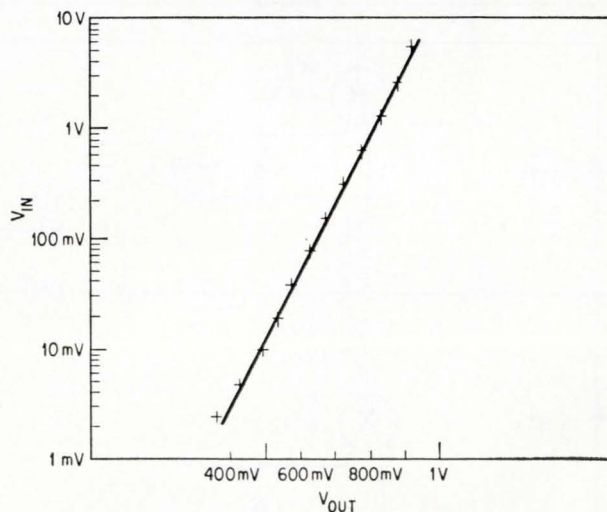

**Experimental data** indicates wide range over which the amplifier's output voltage is nearly an ideal logarithmic function of its input voltage.







and dissolved minerals in ground water. Reliable and effective operation follows when the source provides constant current over a predetermined variation in load resistance.

For geophysical applications only low frequency square waves of 0.1 to 4 hz are usually required. However, by proper choice of timing capacitors the circuit may be used to 100 hz. Above this frequency circuit losses become severe.

The low-frequency relaxation oscillator consists of transistor  $Q_1$  and unijunction transistor  $Q_2$ . The time constant  $R_T C_T$  determines oscillator frequency. Switch  $S_1$  and potentiometer  $R_1$  in combination with resistor  $R_2$  allow the time constant to be varied by a factor of 40 to 1. Transistor  $Q_1$ , which has a very low collector leakage current, supplies constant current to charge capacitor  $C_T$ .

Pulses generated at the base of  $Q_2$  synchronize the free-running, emitter-coupled multivibrator con-

sisting of  $Q_3$  and  $Q_4$ . The multivibrator's pulsed output is coupled through transformers  $T_1$  and  $T_2$  to the gate of the four scr's. This quartet is arranged in a bridge circuit that controls the power across load terminals, A and B.

When the voltage from transformer  $T_1$  fires  $SCR_1$  and  $SCR_3$ , the load current flows from left to right across terminals A and B. Autotransformer action in the center-tapped coil,  $L_1$ , charges capacitor at AB to approximately twice the supply voltage. When the voltage from transformer  $T_2$  fires  $SCR_2$  and  $SCR_4$ , the capacitor across AB charges in the reverse direction through these two scr's.

During the process of reversing the charge,  $SCR_1$  and  $SCR_3$  are back-biased and turned off. While  $SCR_2$  and  $SCR_4$  conduct, current flows through the load in the opposite direction.

Power supply capabilities rather than the scr circuit limit power levels.

## Cross-coupled transistors form balanced mixer

By Leonard E. Geisler

Radio Astronomy Laboratory,  
University of Michigan, Ann Arbor

A mixer circuit with two transistors offers advantages over the conventional diode quad: the costly transformer required with the diode quad is eliminated and the cross-coupled transistor mixer exhibits some conversion gain; the quad is inherently lossy.

The collectors of the two transistors (2N1303) are wired together to share the output load and their bases and emitters are cross-connected. Thus a positive-going carrier wave turns on one transistor while the other is kept in the off position. This produces a positive pulse across the common collector load.

When the phase of the carrier wave is reversed, the two transistors switch conditions, again producing a positive pulse across the common load. In effect frequency-doubler action is achieved without a phase-shifting transformer. When a signal is applied to the input terminal at the right a frequency-doubled output also results.

The result is a mixture of frequencies dependent on the ratio of signal levels. The mixed signals that appear across the output load are the upper and lower sidebands of the two input signals—the even order harmonics of the input and the carrier. No component at the fundamental frequency appears

in the output once the balance control is adjusted to null the carrier.

The circuit was found to function best when driven from a low impedance source of approximately 50 ohms. Signals were applied for mixing through a 50- to 500-kilohertz bandpass filter. A 1-megahertz carrier was obtained from a crystal-controlled oscillator using a capacitive voltage divider. The ratio of crystal oscillator amplitude to signal amplitude was 10 to 1. The 1-Mhz oscillator had an amplitude of 600 millivolts. Signals were amplified to produce 60 mv at the mixer input.

Because of the inherent wide bandwidth of the mixer input, the input circuits and the crystal oscillator must be shielded. This prevents external mixing of the signals before they are applied to the balanced mixer. The output of the mixer is approximately 600 ohms.

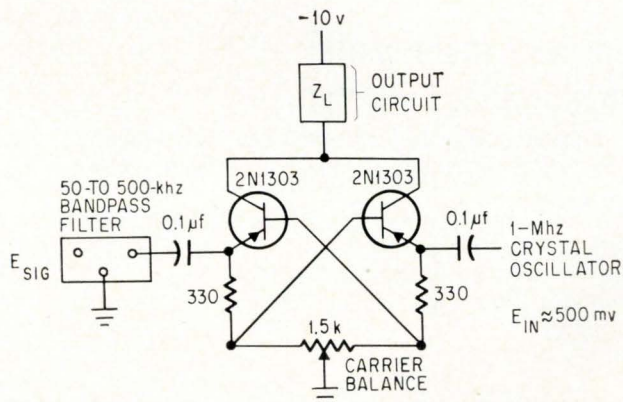

**Cross-coupled transistors** perform as balanced mixers without expensive transformers. Configuration cancels fundamental frequency and produces two sidebands.



**Q** How many dollars does it take to produce this 

**A** Incrementally: \$2850  
Digitally: \$3725  
Only by Omnigraphic™

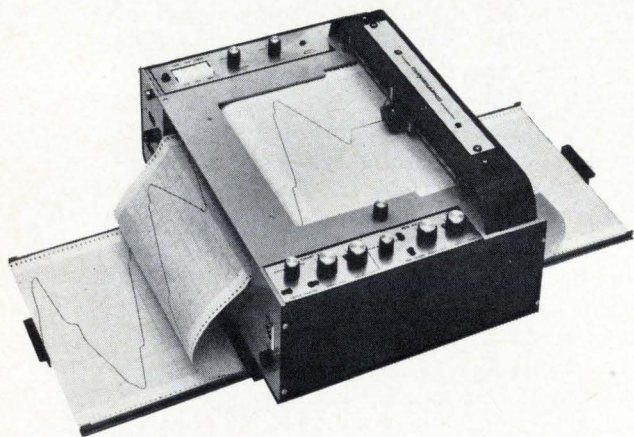

### The new incremental Omnigraphic™ Plotter

is a bi-directional recorder that operates directly from digital computers, incremental encoders, pulsers, pulse generators or any incremental signal.

- ④ Z-Fold Paper (tears out to standard 8½" x 11")
- ④ 18,000 Increments/min Speed
- ④ 0.01" or 0.005" Resolution
- ④ Infinite Scale Expansion
- ④ \$2850

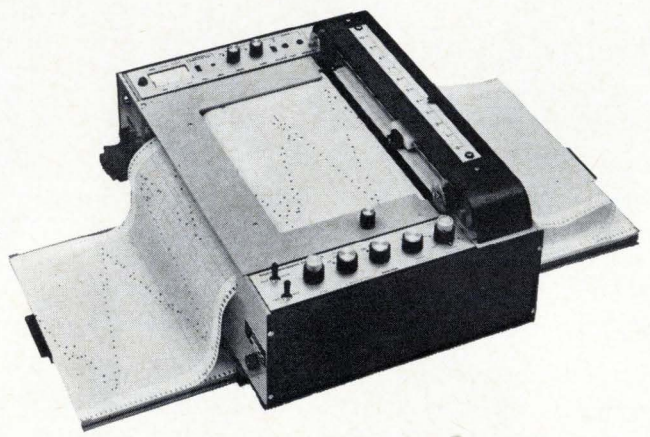

### The new direct digital incremental Omnigraphic™ Plotter

is a high speed point plotter which operates directly from binary or BCD data.

- ④ Z-Fold Paper (tears out to standard 8½" x 11")
- ④ 2400 inch/min Slewing Speed
- ④ Capable of Both Digital or Analog Operations
- ④ 2 μsec. Access—Single Point Memory
- ④ \$3725



**houston OMNIGRAPHIC corporation**

*a subsidiary of houston instrument corporation*  
4950 Terminal Ave. / Bellaire, Texas 77401  
(713) 667 7403 / cable HOINCO / TWX (713) 571 2063



# Pattern of tests changing for integrated circuits

Increasing complexity of arrays demands improved checking to detect faulty circuits early in the manufacturing process

By Carl Moskowitz

Instrumentation editor

**The margin for error** in integrated-circuit testing is getting smaller and smaller as the circuits become more complex. Still, testing is critical since it is the only way a manufacturer can demonstrate that his product performs the way it should.

The packaging of integrated circuits as simple devices gives the manufacturer two opportunities to insure performance: he can probe test the wafer and then test after packaging. The wafer-probe test provides a quick check on process control and eliminates the bad or marginal units, cutting down the packaging and further testing costs.

The manufacturer's customer can check performance by testing the packaged circuit as part of his incoming inspection.

With large arrays, however, there may not be a second chance. The integrated circuits must be tested individually on the wafer so that either a wiring arrangement tailored to the good-bad pattern of circuits can be devised or so that a standard wiring pattern can be applied to selected groups of integrated circuits. After wiring, the group of circuits must be tested as a functional unit, requiring many combinations and permutations of input signals. If an error turns up, the manufacturer must scrap the array or clean off the thin-film wiring and start fresh—a job that is fraught with additional opportunities for failure.

## Errors are costly

Once the group of integrated circuits have been packaged as a functioning unit, no amount of testing can rectify errors. It makes no difference whether the integrated circuits are wired by the manufacturer or if the customer wires externally, using leads brought out from supposedly good circuits.

A controversy exists over the best method of per-

forming tests on wafers. Some favor static testing—they apply inputs and measure responses that are d-c in nature; others feel that only dynamic tests simulate operating conditions closely enough.

A universal testing procedure is impractical since, unlike discrete components where measurement of device characteristics suffices, the information needed is functional. The number of different integrated-circuit types has produced a variety of testing methods within each of the two camps. Two of the approaches manufacturers have taken to perform high volume testing of integrated circuits are described in the articles that follow. Though other approaches exist, the object is the same—to prevent marginal or nonfunctioning integrated circuits from being processed further.

Even though the techniques described differ basically, they do have an important similarity. Both are computer controlled and in both the outputs are fed into a computer. Simple integrated circuits such as gates did not require such sophistication since usually one test was sufficient to provide a go or no-go indication. It is anticipated that the combination of the computer and the tester will eventually reduce the amount of testing on even the more complex integrated circuits.

That's the goal of work being done at Texas Instruments Incorporated. Tests there now are product checks that weed out the bad units on the production line. "But," says Jim D. Adams, TI's manager of integrated-circuit process control, "an IC has its reliability built in. Therefore, there is a need to distinguish between product and process control. Our current testing program is designed with complete process control in mind even though that may be 20 years away."

At present, testing at TI as at most other integrated-circuit makers, performs two functions. The



data developed in rejecting defective units—product control—serves as a basis for determining how manufacturing is progressing—process control.

### The computer steps in

But in the near future a computer will be combined with TI's testers to provide process information immediately. Corrective measures can then be taken before many defective units are produced. Ultimately the computer will automatically control the manufacturing process. The approach, however, implies more than simple testing. According to Adams, it is more important to emphasize techniques like failure analysis, which affect inherent reliability, rather than controls that simply weed

out defects at the end of the line. Failure analysis inputs will provide the computer with another measure of the manufacturing process.

"The complexity of the IC process requires that a total integrated control system, with inputs from all areas of the organization, control the process variable to insure a reliable product," says Adams.

On this basis, testing as it is known today is in for quite a change. The total control system approach seems destined to eliminate all product inspection. A complete understanding of why process controls vary would make possible a manufacturing process so uniform as to eliminate the need for all inspection and surveillance. Only periodic monitoring would be required.

---

## Instrumentation: 2

# A-c testing of wafer components sounds early circuit warning

Catching defective wafers before packaging saves money and gives higher production yield; one quick check tells complete story at intermediate stage of array manufacture

By John Kardash and Martin S. Cohen,\*

Sylvania Electric Products, Inc., Woburn, Mass.

**Most manufacturers** test integrated circuits with preprogrammed combinations of d-c inputs at the wafer stage of production. But since it is not feasible to provide all the input levels encountered by today's complex arrays, d-c testing can fail. Some defective integrated circuits will slip through and won't be detected until a complete functional test is made, usually after the wafer has been put into its expensive package. At this stage the reduction in yield is quite costly.

Engineers at Sylvania Electric Products, Inc., therefore, decided to run an a-c functional check at the wafer stage along with the standard d-c tests. With a single display, they reasoned, it could be learned earlier whether all components in a wafer

were operating satisfactorily. Sylvania is a subsidiary of the General Telephone & Electronics Corp.

With the a-c technique, switching characteristics of gates, flip-flops and complex arrays have been tested. Measurements have been made on Sylvania ultrahigh level (SUHL) NAND gates, J-K flip-flops, four-bit registers, adder arrays, frequency dividers and 16-bit scratch-pad memories. The test system, built with standard commercial equipment, uses clock pulses up to 20 megahertz for switching measurements with no serious oscillation or noise problems. A subsystem, comprising a 16-stage counter and its circuitry, sets the input conditions for the tests. The a-c tests can easily be adapted to the standard automated d-c probe system.

Monolithic integrated-circuit manufacturing has progressed from turning out simple gate and flip-

\* Now with Fairchild Camera & Instrument Corp., Bedford, Mass.



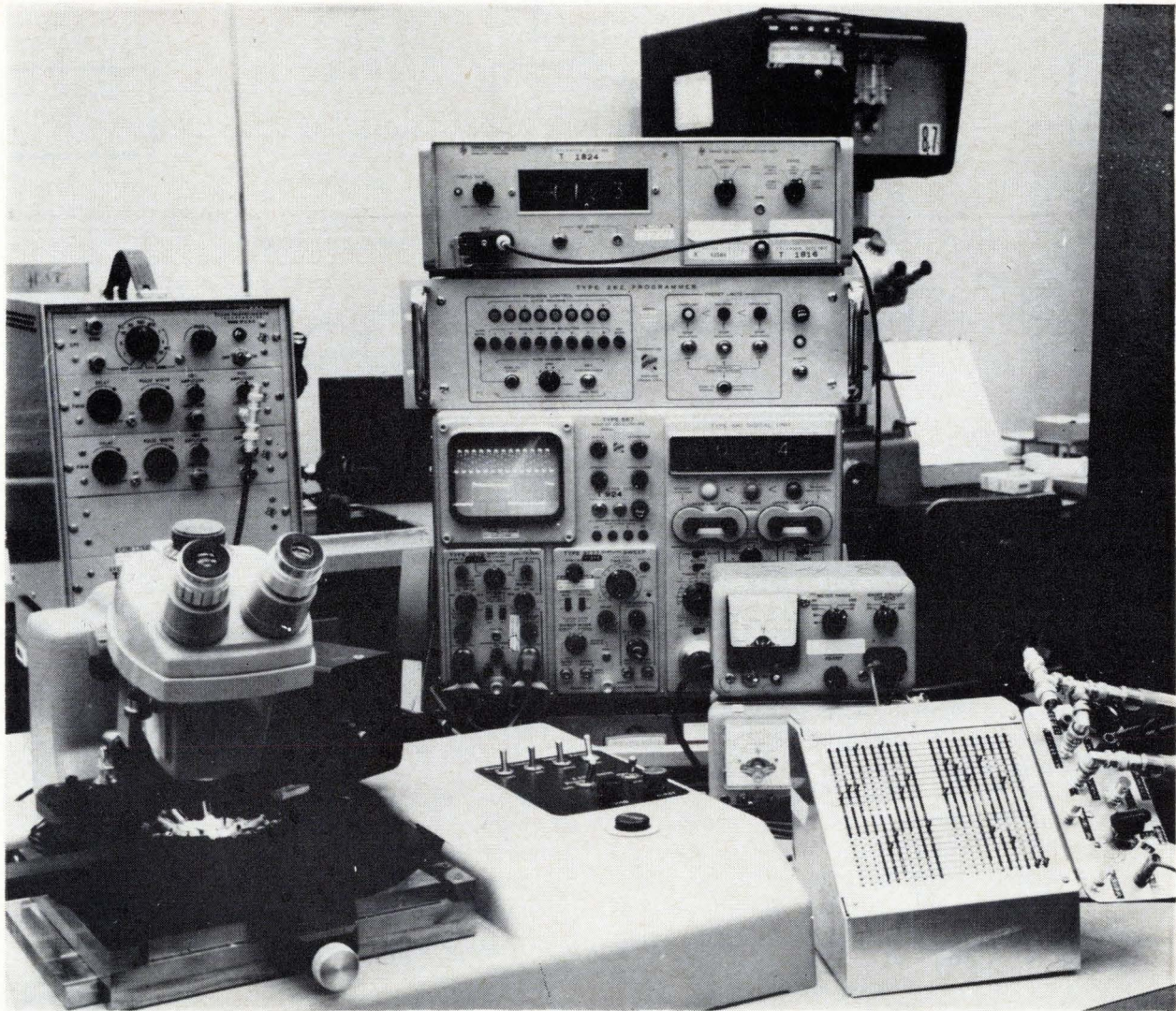

**Test setup for a-c checking** of complex integrated circuits such as a 16-bit scratch-pad memory, four-bit register and decade frequency divider. The system is constructed with commercial equipment except for the matrix control box, right, foreground. The input and output waveforms for the decade divider under test are shown on the dual-beam scope.

flop structures to large-scale production of multi-gate and multi-flip-flop structures within the same approximate chip size. Called complex arrays, these may contain as many as 16 flip-flops and their gates on a single-layer silicon chip. Complex arrays include such universal computer subsystems as counters, registers, adders and memories. In addition, the typical complex bipolar array may contain up to 250 transistors, resistors and diodes.

Manufacturers face the problem of testing such complex subsystems reliably and in volume. The user faces the same problem with systems.

Ordinarily, in the d-c testing of simpler circuits in wafer form, the initial probing serves as a screening and consists of 30 to 40 d-c tests in which each gate or flip-flop is automatically cycled through a variety of d-c conditions to eliminate both gross and limit failures.

An automatically programmed wafer probe machine performs up to 40 tests on a circuit in two seconds. If a circuit is accepted the probe tester

automatically moves on; if a circuit fails any of the 40 tests, the probe marks it with ink. When the entire wafer has been probed, the machine automatically shuts off.

After d-c probing, the accepted circuits are packaged and their d-c and a-c performance are evaluated. Since some defective circuits will pass the d-c test, fully assembled units will be lost, increasing the over-all cost of the entire batch. And the more complex the circuits, the lower the yield that can be expected at final testing.

#### One test tells story

The inadequacy of employing d-c test procedures alone with complex arrays can be demonstrated by considering the test requirements of a 16-bit scratch-pad memory. A complete check of functional performance requires 64 different input logic conditions.

With a repetitive a-c technique, however, circuit performance can be determined with one test. The



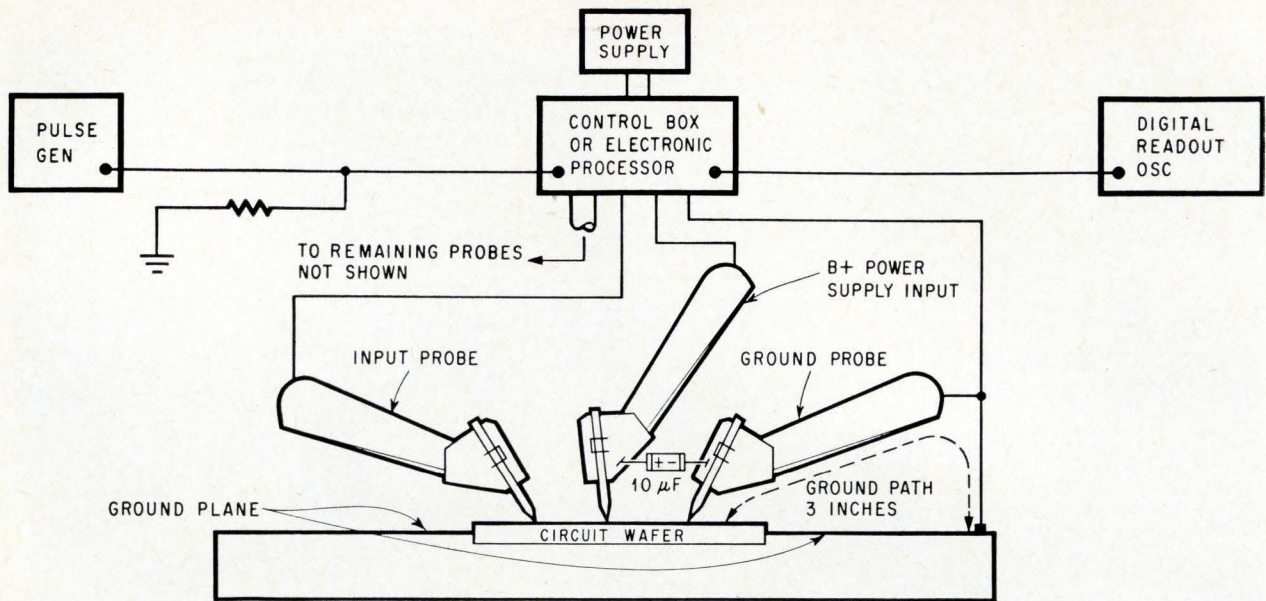

**Schematic of a-c probing system** illustrates the technique for connecting the switching signal to the probes to minimize noise, signal distortion, crosstalk and ringing.

method is compatible with high-volume automated wafer probing systems when the test data is automatically read out digitally. The digital output, fed directly to an electronic processor, determines go or no-go conditions and accepts or rejects the circuit.

The automated test system shown on page 95 can determine performance parameters such as the turn-on and turn-off delay time of the scratch-pad memory and provide digital readout. The input conditions to the circuit are controlled by a pulse generator, a 16-stage binary counter and a matrix control box.

The pulse generator, functioning as a timer, controls the switching time of the binary counter. The control box contains groups of gating circuits. Interconnections between gates, and hence the testing program, are set up by a plugboard on the front panel. The functional check is performed as the binary counter connects and disconnects groups of gates and the circuit pins on the wafer.

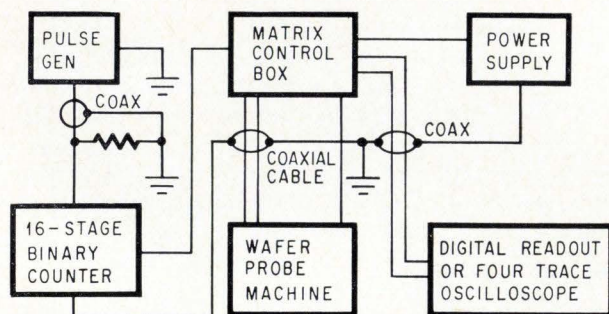

**Wafer probe system** for making a-c functional checks of integrated circuits has a matrix control box for selecting input logic states. The gates are switched to their proper states by the 16-stage binary counter. Switching time is determined by the pulse generator. System is easily converted for high-speed wafer testing by replacing counter and control box with an electronic processor or time-shared computer tester.

The output is displayed on either a Tektronix, Inc., type 467 digital readout oscilloscope with a type 262 programmer for automatic sequencing or on a Tektronix type 531 four-trace scope for manual probing.

The system has been used in a pilot-plant facility. For high speed coupled with high volume, an electronic processor or time-shared computer replaces the binary counter and matrix in automatically cycling wafers through d-c and a-c functional tests.

### Not without limitations

Reliability in a-c testing of wafers is limited by the generation of noise, signal distortion, input-output crosstalk and ringing. Each of these can be minimized by certain precautions.

- An adequate ground plane, common to the circuit under test and all associated equipment, reduces noise and ringing. In the Sylvania system the ground plane is obtained by connecting the entire back side of the circuit wafer to a-c ground. The entire probe machine's chassis is also grounded.

- Using coaxial cable with the shield connected to the common ground plane for all the probe needle input and output leads eliminates crosstalk. This shielding also provides a low-impedance path to ground for unwanted signals.

- Connecting a capacitor between the circuit power supply input at the probe needle and the a-c ground decouples the supply from the circuitry.

- Avoiding long ground loops prevents the introduction of noise and ringing.

### What the tests show

At first it was thought that picking off the repetitive a-c inputs and all output signals right at the probe needle connection would minimize cable lengths and thereby reduce ringing, oscillation and noise. However, it was found that with proper ter-



## Worth a thousand d-c tests

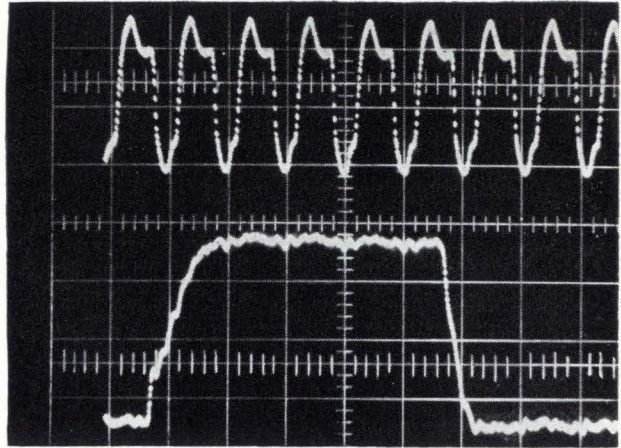
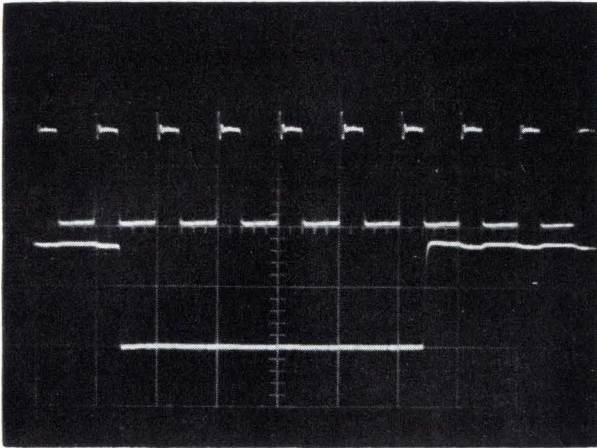

One display describes operation of decade frequency divider during functional a-c test of wafer. The left photo shows the input and output waveforms for a 2-megahertz input and the other photo for a 20-Mhz input.

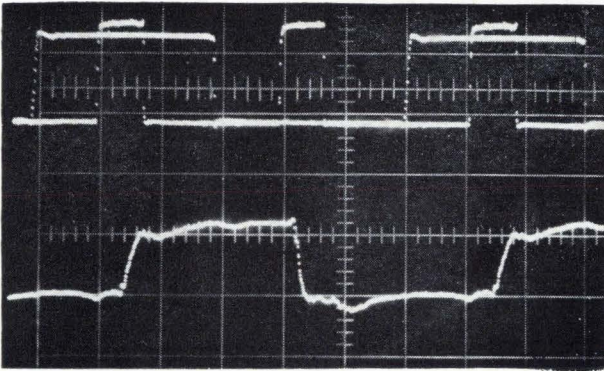

Waveforms resulting from functional a-c check of four-bit storage register. Three clock pulses are superimposed on the data input signals. The lower trace is a one-bit output from the register.

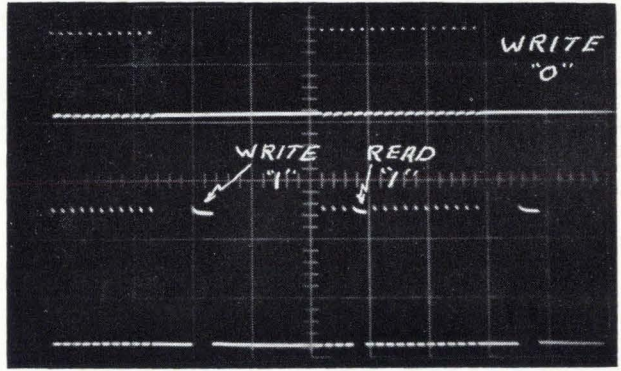

Complete functional performance of 16-bit scratch-pad memory is determined with one test. The waveforms show whether all the bits can be addressed, if all the flip-flops can be set and reset and whether any crosstalk occurs.

mination techniques and grounding of cable shields, the a-c signals could pass through six to seven feet of coaxial cable at acceptable levels. These techniques were incorporated into a setup, shown on page 95, for testing the 16-bit scratch-pad memory, a four-bit storage register or a decade frequency divider. All the logic circuits tested were SUHL circuits and, therefore, capable of driving large capacitive loads. Hence no special care was required to minimize output lead cable lengths.

This system performs a functional check which serves only as a screening process; it is not necessary to operate the circuits at the maximum frequency at this stage of testing, although the system has operated at frequencies as high as 20 Mhz.

The decade frequency divider contains approximately 125 transistors, resistors and diodes and makes use of four internally interconnected flip-flops and two separate gates. The device operates from 10 hz to 30 Mhz with a sinusoidal input and from d-c to 50 Mhz with a pulse input.

Functional a-c probe tests at different clock rates of the divider produced the top two sets of input-

output waveforms above. Both photos were taken of the scope display in the test setup shown on page 95—the manual wafer probe system.

The four-bit storage register integrated circuit performs high-speed, parallel, four-bit storage and readout. The array contains about 120 transistors, resistors and diodes with four internally interconnected flip-flops and 17 individual gates. Typical waveforms resulting from a functional a-c probe test of the register at the wafer level are shown at lower left, above. The upper waveform displays three clock pulses superimposed on the data input signals. The lower waveform shows a one-bit output from the register; a four-trace oscilloscope could have displayed the four outputs simultaneously.

One waveform, lower right, above, resulting from a test of a 16-bit scratch-pad memory, uniquely displays the complete functional performance of the entire memory. The array has four x and four y lines in addition to read and write amplifiers. Approximately 190 transistors, resistors and diodes implement 16 internally interconnected flip-flops



and eight gates in the memory. The upper waveform shows the write 0, or reset condition, applied to all 16 bits. In this condition the flip-flops are at the 0 state. A write 1 or set state can then be obtained at the readout 1 position. Each bit is addressed individually and cycled to obtain write 1, read 1 outputs. Testing of this kind insures that all 16 bits can be addressed properly and that no crosstalk crops up between the individual bits.

The assembly cost savings and increased yields are only part of the advantage of functional a-c testing at the wafer stage. In addition to virtually assuring fully operational devices at final test, determining wafer performance provides faster and more realistic appraisal of processing conditions. Controls can be maintained by the immediate feedback of test information—especially important in the development of new products and in pilot plants. The ability to feed back wafer test information is also invaluable in analyzing circuit features.

#### The authors



While at Sylvania's Semiconductor division, Martin Cohen was a senior engineer developing linear and digital integrated circuits. He also was supervisor of the integrated-circuit development pilot line.



Before joining Sylvania as a development engineer with the integrated-circuits group, John Kardash was responsible for the design of high-speed circuits for an Army Signal Corps computer. He is now designing and evaluating digital integrated circuits.

---

Instrumentation: 3

## Large-scale logic arrays: testing for the millions

To provide staggering number of inputs for d-c checking of integrated-circuit arrays, an advanced logic system was developed that can flash through test schedules at 5,000 permutations per second

By James W. Lind

International Business Machines Corp., Hopewell Junction, N.Y.

**Since an integrated-circuit array** can contain scores of interconnected circuits and dozens of inputs, the number of test inputs and their permutations can be astronomical. A d-c functional checkout of arrays can mean thousands or even millions of tests in a short time.

A recently developed advanced logic test system can handle those millions. It gets its high speed from a multiplex switch that provides complete sequential control of four programmed d-c voltage levels at the rate of 5,000 permutations per second, accurate to within 0.1% or 2 millivolts at each test

pin. The system was devised by a test equipment group at the International Business Machines Corp. to check high density logic arrays, or circuit blocks with up to 50 pins. It can easily be expanded to test arrays with up to 999 terminating pins.

The test system applies logic inputs—voltages equivalent to digital 1's and 0's—resistive loads and bias power sources to a large number of circuit pins. In addition, the logic levels are applied and the array's response is measured at a high enough rate of speed to insure a reasonable test time per circuit block.



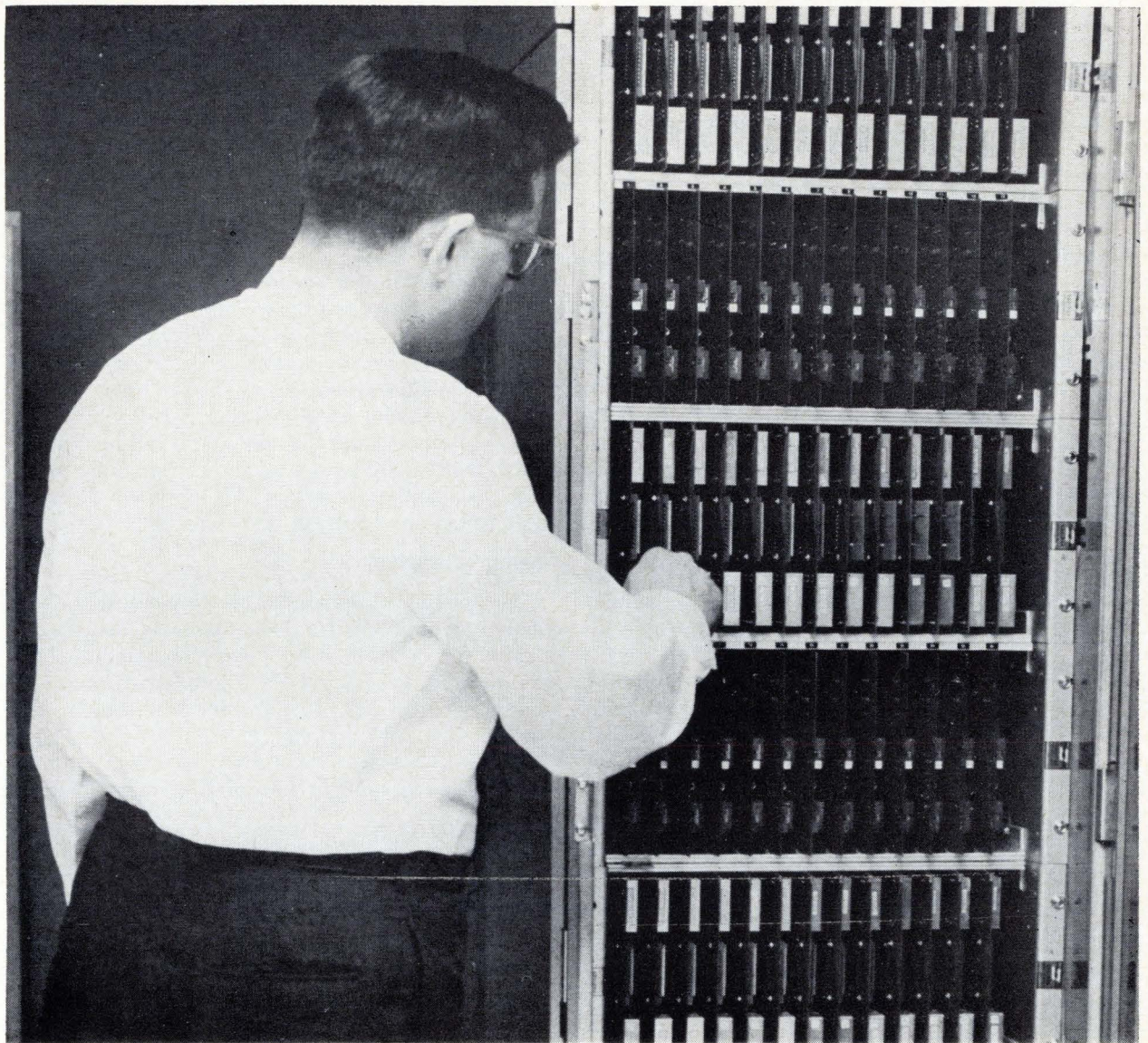

**Test system's** analog portion for functionally checking 50-pin integrated-circuit arrays requires 100 circuit cards, two for each pin. The cards slide into the equipment enclosure shown and the interconnections are made through connectors at the rear. The connectors are mounted on an epoxy glass board which has a complete ground plane. All of the buses are made from one- or two-conductor shielded cables; all outputs are four-conductor shielded cables.

The system is flexible: up to 23 different functions—applying inputs and connecting bias supplies, loads or measuring equipment—can be provided for each pin of the array. A self-checking capability provides easy maintenance and confidence checking.

The system consists of a digital computer, an analog subsystem and test fixtures.

The computer provides the digital commands for the entire system. The analog portion converts the digital commands for application to the array under test. A digital voltmeter takes measurements and feeds them to the computer. The readings are retained in a high-speed tape memory or printed on paper. Each measurement is labeled according to the circuit tested, making it easy to perform detailed analysis after testing. The test fixtures allow connection to the system of either integrated-circuit wafers or modules. The system has enough logic

circuits to enable the computer to sequence the probing system automatically from circuit to circuit on a wafer.

#### **The multiplex switch**

Speed is essential since an array of logic circuits with  $n$  inputs has  $2^n$  possible input permutations.

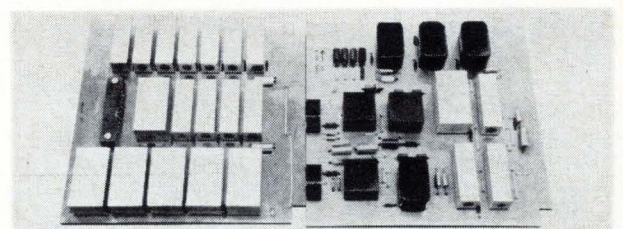

**The circuit cards** have a complete ground plane, gold plated for good conductivity.



If the array contains sequential circuits, the number of tests depends on the number of allowed sequences and might well exceed  $2^n$ . On the other hand, for combinatorial arrays with no redundancy, the number of tests that must be made can be considerably reduced.<sup>1</sup>

The push for speed is reflected in the design of the multiplex switch in the analog subsystem, which takes only 100 microseconds to change from one of four programmed voltage levels to another. Since an additional 100 microseconds is required to make a measurement with a digital voltmeter, a testing cycle time of 200 microseconds is achieved by the switch, allowing the system to make 5,000 tests per second.

The switch, diagramed below, uses an operational summing amplifier with unity gain to achieve the stability and accuracy demanded by the analog system. The desired test voltage is formed at the output of the switch by adding the input voltage levels in a prescribed sequence. Three of the programmed voltages are connected to the amplifier's summing junction by chopper switches and one is directly connected. Adding voltages prevents overshoots at the output caused by timing inconsistencies in the chopper drives or the transition from one voltage to another. The voltages available at the output of the multiplex switch are  $-V_5$ ,  $-(V_5 + V_6)$ ,  $-(V_5 + V_6 + V_7)$  and  $-(V_5 + V_6 + V_7 + V_8)$ . The output range of the switch is  $\pm 5$  volts at 20 milliamperes; this can be raised to  $\pm 10$  volts if less accuracy or speed can be tolerated. The supplies,  $V_1 - V_4$ , are bias, or service supplies.

In the chopper switches are two back-to-back transistors with a common base-to-collector drive source. The back-to-back connection<sup>2</sup> enables the emitter-to-collector voltage drops in the transistors

to cancel, resulting in less than 100 microvolts of offset voltage. The forward resistance is kept low. The switch operates from d-c to 330 kilohertz.

Switching transients and speed are a function of the chopper drive circuit, which was designed to keep the transients small enough for filtering by the operational amplifier. In addition, the chopper switch's drive source is floating, making the contact resistance constant—about 30 ohms—as a function of current and power supply variations, preventing variations in the operational amplifier's closed-loop gain. The open contact resistance—more than 500 megohms—insures negligible leakage of the programmed voltages when the switch is open.

The operational amplifier has a full power response at unity gain of 10 kilohertz and acts as an almost perfect filter to any radio-frequency noise from the chopper switches. An amplifier of minimum voltage and current drift was chosen.

### Analog subsystem

The analog subsystem of the logic test system consists of individual analog channels, diagramed at right, for each pin of the tester. The analog channels convert the computer's digital instructions to analog voltages and functions for a particular circuit pin. Each channel can:

- Connect the pin to one of the setup or bias supplies and ground or one of the seven load resistors.
- Connect the dvm's plus terminal to a pin through a solid-state switch.
- Connect one or two separate groups of pins.
- Connect the minus terminal of the dvm to a pin or to the load resistor bus.
- Connect the multiplex switch to a pin.

The analog channel has three main parts, the setup multiplexer, the multiplex switch and the output multiplexer. All the channel functions except those done by the chopper switch and output multiplexing circuitry are set up before an actual test sequence.

The four setup power supplies,  $V_1 - V_4$ , shown in the diagram at the right, are programmed over a  $\pm 5$ -volt range in 1-millivolt steps, or to  $\pm 50$  volts in 10-millivolt steps, according to the requirements of the circuit to be tested. The programming can be done manually or by computer instructions. Since programming is done before testing and only once for each type of circuit, it need not be done at high speed and is accomplished by relay closures.

The output current capability of the setup or service supplies is 2 amperes. The supplies provide the bias voltages for the array of logic circuits under test. Although precise, programmable supplies with output accuracies within 0.01% are used, the accuracy at the circuit pin need not be better than the accuracy of the logic levels which is 0.1% or 2 mv, whichever is greater than the programmed value.

The supplies can be sensed remotely at a circuit pin through the channel's output cable, or at the common resistor termination. Remote sensing of

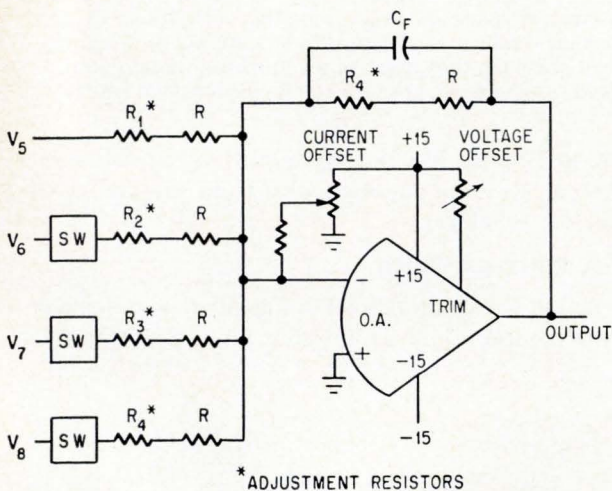

**Multiplex switch** rapidly applies any one of the four programmed voltage levels  $V_6 - V_8$  to an input on the large scale array under test. The voltages are added in a prescribed sequence, which prevents overshoots in the test voltage. The operational amplifier filters out any r-f noise in the chopper switch outputs. Resistors  $R_1 - R_4$  equalize the chopper switch's forward resistance in each of the voltage supply legs by trimming the operational amplifier's summing resistors,  $R$ .



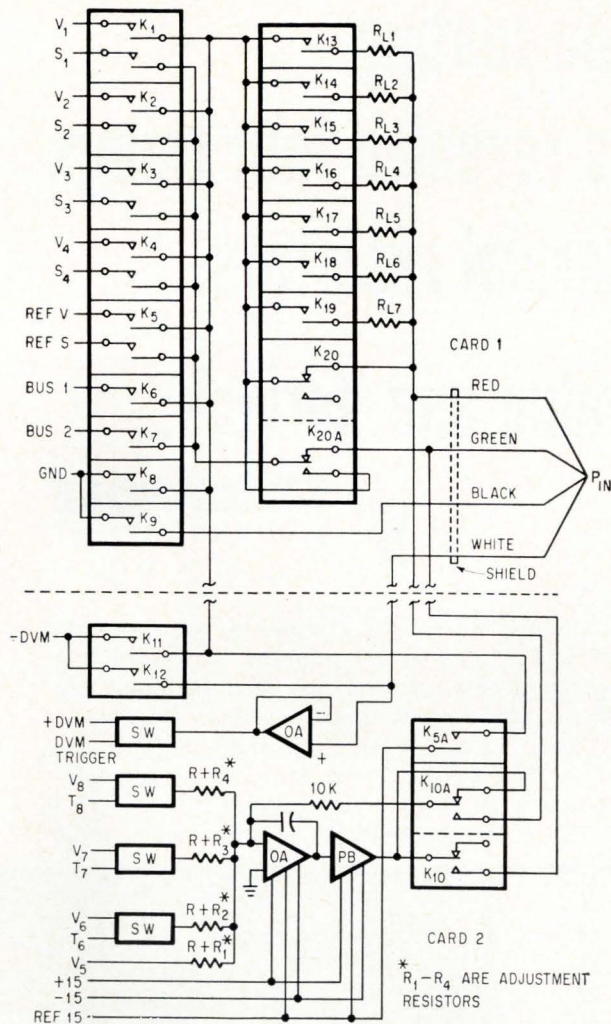

Analog portion of the logic test system is contained on two printed circuit cards. The pin's function is determined by the configuration of the 20 relays. Closing relay  $K_{10}$  applies logic levels to the pin. The feedback loop of the multiplex switch is completed simultaneously by the other half of  $K_{10}$ . The logic modules controlled by the digital computer provide the triggering pulses for the chopper switches to select the proper logic voltage level for the test. The voltage at the pin is checked by triggering the switch to connect the dvm's positive terminal to the pin. This loop also serves as the output multiplexer when the pin is connected to one of the array's output terminals.

setup voltages makes it possible to eliminate measuring errors by readjusting the supplies for voltage drops resulting from high current loads.

The figure above also shows the method by which the setup supplies are connected to a pin—with no connection to chassis ground at the individual supplies. They are referenced to ground by means of the common reference bus, enabling the current from the four supplies to return only through the reference voltage bus, eliminating any ground drop due to the large current.

The 15-volt power supplies for the amplifiers in the multiplex switch are also floating with respect to ground at the supply but have a reference to ground through the reference bus. As before, the  $\pm 15$ -volt return is through the reference voltage

bus, preventing the 15-volt supply current from returning through the ground bus.

The feedback loop of the multiplex switch is carried to the pin and is closed only when the pin applies an input voltage representing a logic input. This prevents any voltage drops in the output cable due to the currents supplied by the switch.

### Output multiplexing

The digital voltmeter can be connected to measure an input voltage, bias voltage or the current through one of the load resistors. The dvm's minus terminal can be switched directly to ground or to the common resistor connection. In addition, each of the tester's analog channel output pins is connected permanently to an operational amplifier voltage-follower which functions like an emitter-follower. The output of each voltage-follower is connected to the positive terminal bus of the dvm through the same type of chopper switch as is in the multiplex switch. The d-c input impedance of the voltage-follower is more than 100 megohms to eliminate any loading of the circuit under test. The voltage-follower isolates the output multiplex chopper switch from the corresponding pin on the circuit block. Also, a separate operational amplifier makes it possible to self-check the entire system by enabling the dvm to connect to any pin at random to monitor the voltage.

In the complete package for testing an array with 50 pins, shown on page 99, the two circuit cards with the multiplex switch and relays for each channel or pin, mate with 86-pin connectors mounted on an epoxy glass board which has a complete ground plane for each channel. Shielded, twisted wire cables are used to eliminate radio-noise effects from areas such as the driving logic and fans. Most important, however, is that the channel ground plane or reference is tied to tester's power ground at only one location, eliminating all ground loops.

Computer logic modules in an adjacent enclosure control the analog system. The computer-tester format allows expansion of the system to accommodate integrated circuits with 999 pins by adding logic modules together with 50-pin analog modules.

### References

1. D.B. Armstrong, "On Finding a Nearly Minimal Set of Fault Detection Tests for Combinational Logic Nets," IEEE Transactions on Electronic Computers, February, 1966, pp. 66-73.
2. R.L. Bright, "Junction Transistors Used as Switches," AIEE Transactions, March, 1955, Vol. 74, pp. 112-121.

### The author

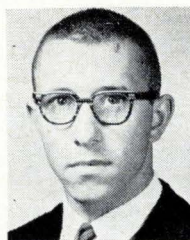

James W. Lind is a senior associate engineer with IBM's components division, where since 1964 he has concentrated on developing techniques and equipment for testing integrated circuits.



# Six months of evaluation testing by Burroughs engineers revealed four things about Stackpole commercial resistors.

## Quality, performance, value and service.



At their Plymouth, Michigan, Evaluation Testing Laboratory, Burroughs engineers put Stackpole resistors through the paces. What they discovered was a commercial resistor that more than matched their demanding requirements. Stackpole commercial resistors are manufactured carefully and backed by prompt delivery and service. Such attention to quality assures trouble-free machine or hand assembly and lifetime operation. These are but several reasons why Burroughs selected Stackpole commercial resistors for use on their E 2100 Direct Accounting Computer. Dependability, performance and accuracy are essential to Burroughs. Stackpole, too. For the full added-value story, write: Stackpole Carbon Company, Electronic Components Division, Kane, Pa. 16735.

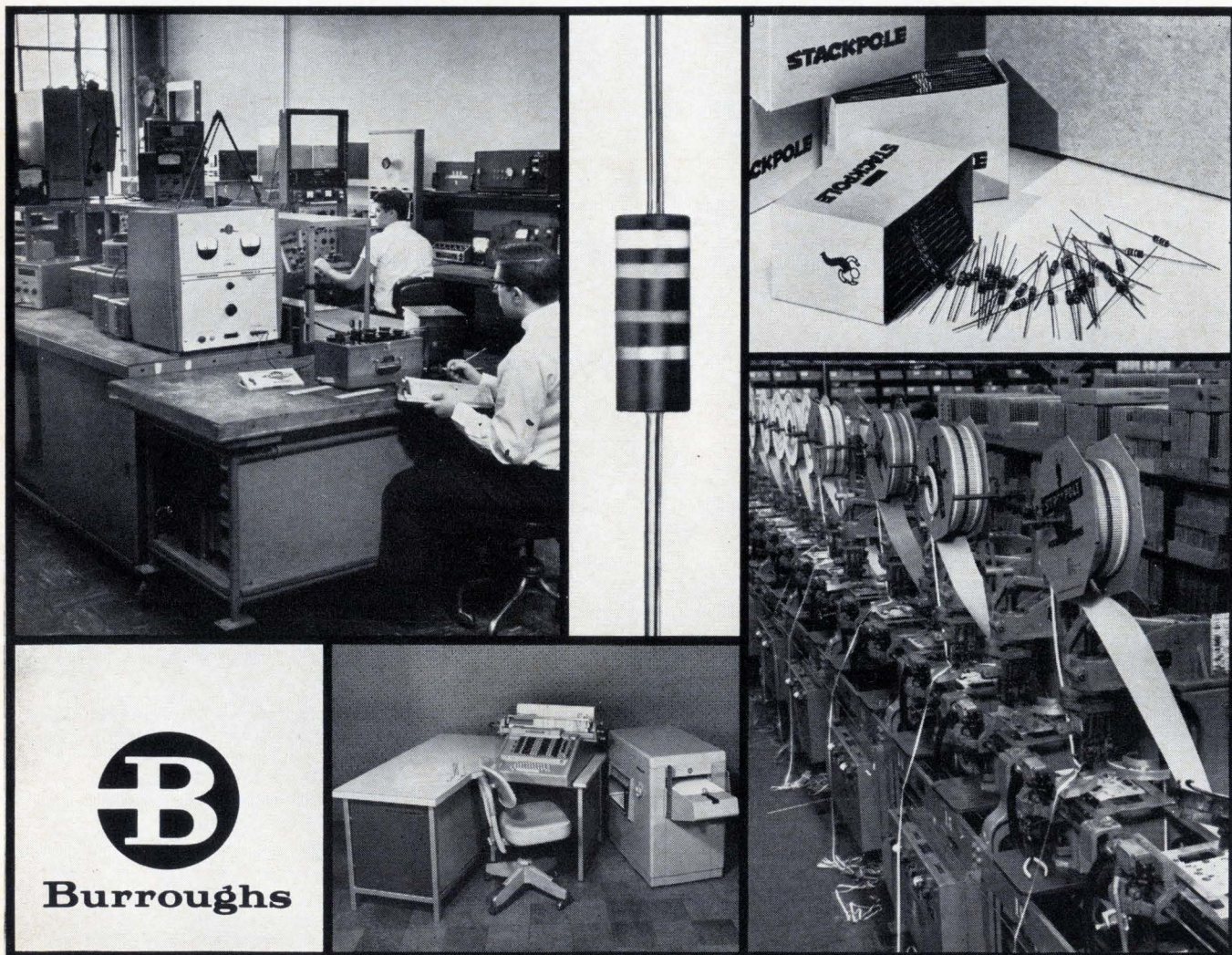



# Built-in testing, once a luxury, is essential for mission success

Complex avionic systems need built-in tests to continually check out equipment but, as shown in this first part of a two-part article continued on page 109, there is still confusion over test techniques

By H. Kelly Grounds\*

Hughes Aircraft Co., Culver City, Calif.

**When the chips are down** a pilot wants to push the firing button and be confident that his electronically guided missiles will fire. But pilots don't have the time, much less the extra test equipment, to continually check on the performance of the aircraft's flight equipment, armament and other electronic gear. The systems have become too complex. The result is that automatic testing and fault isolation are being forced into advanced avionic systems.

Even a relatively simple missile launching system in an aircraft may include dozens of systems—radar, guidance and data processing—each with another tier of subsystems. It is this growth in avionics complexity that is making military procurement officers insist on built-in test capability.

Fortunately, the use of digital computers in modern weapons systems allows testing and fault isolation to be mechanized without adding much to system complexity and cost. A computer is often essential for adequate coordination and control of the equipment in a weapons system. These func-

tions and testing can be meshed so that the computer will periodically run through a sequence of tests at high speed. It can order the subsystems to generate test stimuli, or it can provide stimuli itself. Then, the computer can analyze and display system readiness.

## What the customer wants . . .

A few years ago, the typical military request for a system proposal barely mentioned built-in tests. Now, the requirement is being spelled out. Here is an example from a recent proposal:

1. If testing or servicing is required, maximum use will be made of internal self-test features.
2. The system shall contain built-in test features to permit:
  - a. Continuous in-flight check of the weapon system functions necessary to assure system readiness.
  - b. Indication to the aircrew of the amount of degradation of functions to allow assessment of mission capability.
  - c. Isolation of a fault in the system to one replaceable assembly wherever practicable.
3. Built-in features will make maximum use of the digital computer.

The requirements are incongruous. They are the direct result of the military emphasizing only exotic tactical requirements: equipment whose operational readiness was often in doubt or that couldn't be kept operating. So the requirements are maintenance oriented. However, maintenance is done on the ground, not in the air. Industry and the military have failed to recognize that built-in testing has

\* Now with the Federal Systems division of the International Business Machines Corp., Los Angeles

## The author



H. Kelly Grounds is researching the applications of digital computers in avionic testing at IBM's Federal Systems division. Prior to joining IBM, he was a systems engineer at the Hughes Aircraft Co. and participated in developing the Phoenix missile system's in-flight test equipment.



a second responsibility—in addition to being a maintenance tool, it has operational responsibilities. The military has just begun to spell out built-in test equipment's assessment capabilities. This is a step in the right direction.

On the ground, built-in tests and fault isolation can drastically simplify maintenance by indicating subsystems that are inoperative or perform poorly. In the air, these indications tell the crew whether all subsystems are operating properly. If they aren't, the crew can decide whether to scratch the mission or formulate a new plan of attack based upon the systems that are still in operation.

### Standards are lacking

Although the requirements quoted previously do not tell the complete story, they show how the military believes it can solve some of its problems. Many of the problems have been caused by the secondary importance given built-in test features. This has caused test techniques to lag behind other advances in electronics, and, in turn, a rather narrow view of test capability has evolved. Often, a system is said to have a go no-go test capability. That can't be so, because there are degrees of system operation, not two states—operative and inoperative. Many interceptor systems have as many as

### What pilots feel . . . and technicians know

"This thing doesn't work."

"What doesn't work . . . sir?"

"How should I know. It just doesn't work. Fix it!"

Absurd? No. The conversation is typical of an electronic failure report made by a pilot to a maintenance technician. The pilot said that a system doesn't work because he felt that something was abnormal.

In the military, most maintenance actions are based on operator complaints whether or not there are legitimate malfunctions. A figure of merit that describes a system's operational condition is mean time between complaints. The justification for this maintenance concept is the premise that the operator has the ability to diagnose abnormal symptoms.

The operator reports malfunctions in what he thinks are the simplest terms possible, and the maintenance personnel must assume the responsibility for repair. They try to duplicate the symptoms reported by the operator, and if the fault can be reproduced, it is repaired. But if it cannot be duplicated, then perhaps the trouble is never cleared up and more missions are aborted or end up less than successful.

A built-in test system can narrow the gray area that exists when an operator doesn't know whether or not a system is operating correctly. There are many instances where failures show up as small changes in capability. Failures of this type should not cancel missions because system effectiveness can be retained through many failure patterns. A properly designed built-in test system will, in addition to fault detection, indicate alternate modes of operation to the operator.

six distinctly different modes of operation and it would take six no-go test results to justify an all-inclusive no-go test evaluation.

Although the era of complex avionics systems is almost 30 years old, standards for built-in test responsibilities and benefits are not yet established. The two major responsibilities of built-in tests are operational and maintenance. In operational, test information should assist the operator in making decisions under failure conditions; in maintenance, faults should be identifiable to specific nonfunctioning areas of the system. This report discusses operational and maintenance features to be considered, dominant features of a built-in test scheme, major considerations in implementing the tests and test examples. The considerations will be presented in terms of a typical modern interceptor system but the concepts have universal application.

### Building confidence

Since the basic result of built-in tests is to detect equipment faults, the design engineer must understand the relationship between the unexpected failure and the success of the mission. Another basic premise is the relationships between fault detection capability and maintenance criteria; together they indicate the operational readiness of the equipment.

Electronic equipment readiness is measured by the status of functional elements of the equipment during or just before a mission. The presentation of this information allows the operator to decide when unscheduled maintenance is required. The completeness of the information affects the probability that the equipment is really fully operative.

A test's quality is usually expressed in terms of the operator's confidence in the system after it passes the test. The confidence level is determined by the extent of testing or the percentage of system failures found by the tests. Since most confidence tests can't provide 100% certainty that no abort-producing failures exist, the confidence in the system must degenerate with time due to the failure rate of the untested components. Therefore, the custom has been to establish an acceptable limit based on equipment or tactical requirements. If confidence falls below this, the unchecked components must be checked. This is called periodic inspection.

The graph at the top right illustrates the effects of built-in and periodic tests on the operator confidence level. The basic decay rate of the curve depends on the system's reliability. Each time a built-in test is performed, a portion of the lost confidence is restored. The amount of confidence restored depends on the thoroughness of the test performed.

### Hypothetical interceptor system

Before discussing how to implement a built-in test scheme in a typical interceptor system, it is necessary to assign the interceptor a mission and examine its equipment for critical areas. The objectives of this brief analysis are:

- To dispense with the mistaken idea that a pilot can tell from his cockpit displays whether an inter-



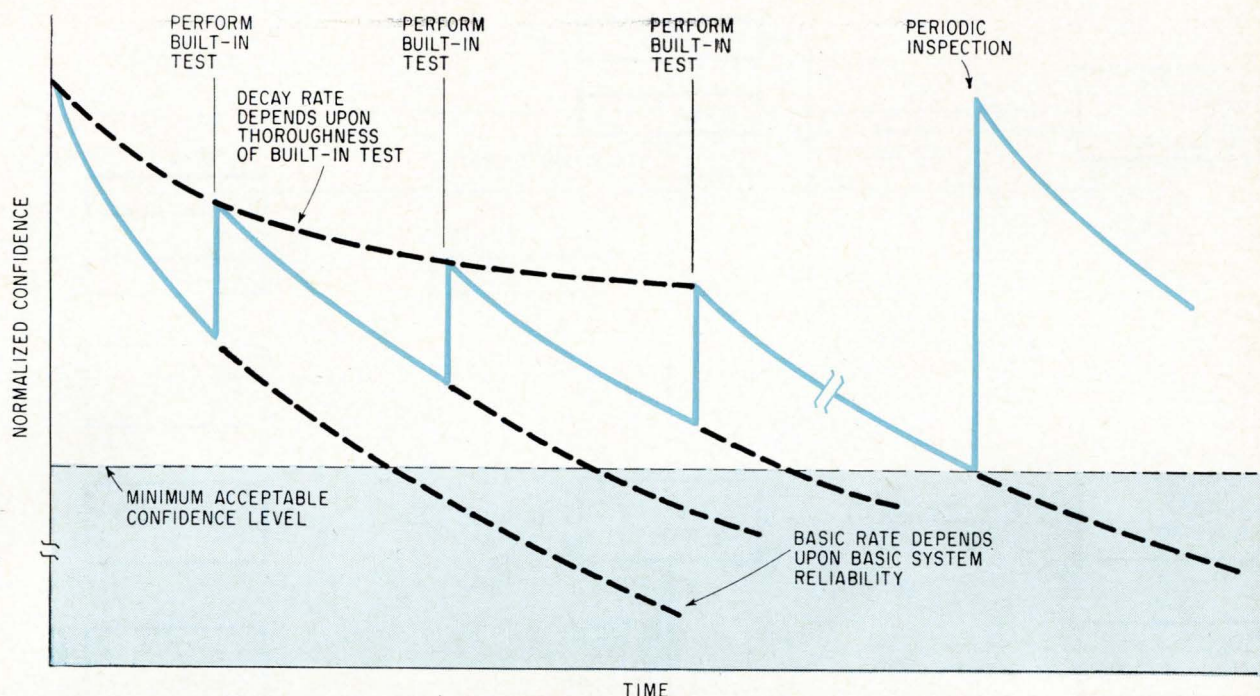

**Built-in tests** are not perfect and their performance does not restore complete confidence in a system. When the operator's confidence in system performance decays to a minimum acceptable level, a periodic inspection is required. The frequency of periodic inspection depends on the failure rate of the unchecked components.

ceptor system is operating properly, or not.

- To determine the operational benefits possible from built-in tests and the areas within a system where built-in tests should be emphasized.

An interceptor aircraft mission is usually divided into phases such as vectoring or navigating to a target area, seeking and detecting the target, attacking and delivering the armament and navigating to the home base. During the mission, many of the avionic subsystems operate independently. The radar may not be operating during the navigation phase; the range tracking circuits are inactive during the search and detection phase and the attack steering circuits aren't needed until the target

is found and lock-on is achieved.

For a typical mission there are a number of possible combinations of systems as in the diagram below. In this system there are 27 possible ways of completing an attack: three methods of navigating to the target area multiplied by three methods of attack and three types of armament. When countermeasures are considered, the number can more than double. The operator must know the system well enough to correctly select an alternate mode of attack. The built-in tests cannot help the operator select alternates that the enemy cannot counter, but they can show him the modes that are doomed by equipment failure.

### Going it alone

There are three approaches to built-in tests: don't use any, perform the tests manually or have the equipment perform them automatically.

If there are no built-in tests, the operator is expected to detect faults with his display panel. Therefore, the operator has to be able to complete the following tasks:

- Verify that the initial data from the system is accurate and that the integrity of the data is maintained throughout the mission.
- Detect system faults through visual or audible indications and correctly associate the symptom to a specific part of the equipment.
- Determine the significance of the equipment loss and correctly chose the best alternate mode of operation.

At best, an operator could detect only a limited number of malfunctions, and this is less important than assessing the capability lost through the mal-

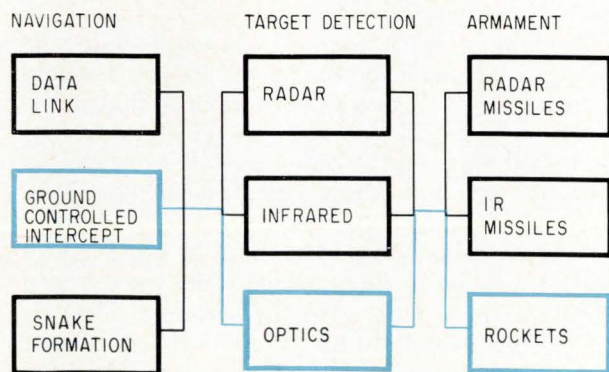

**Avionic subsystems** in this hypothetical interceptor aircraft offer 27 possible operational combinations—three methods each of navigation, target detection and attack. If the radar and infrared units failed, the pilot could still attack the target by aiming his rockets visually. The entire group would have to fail before the mission would be aborted.



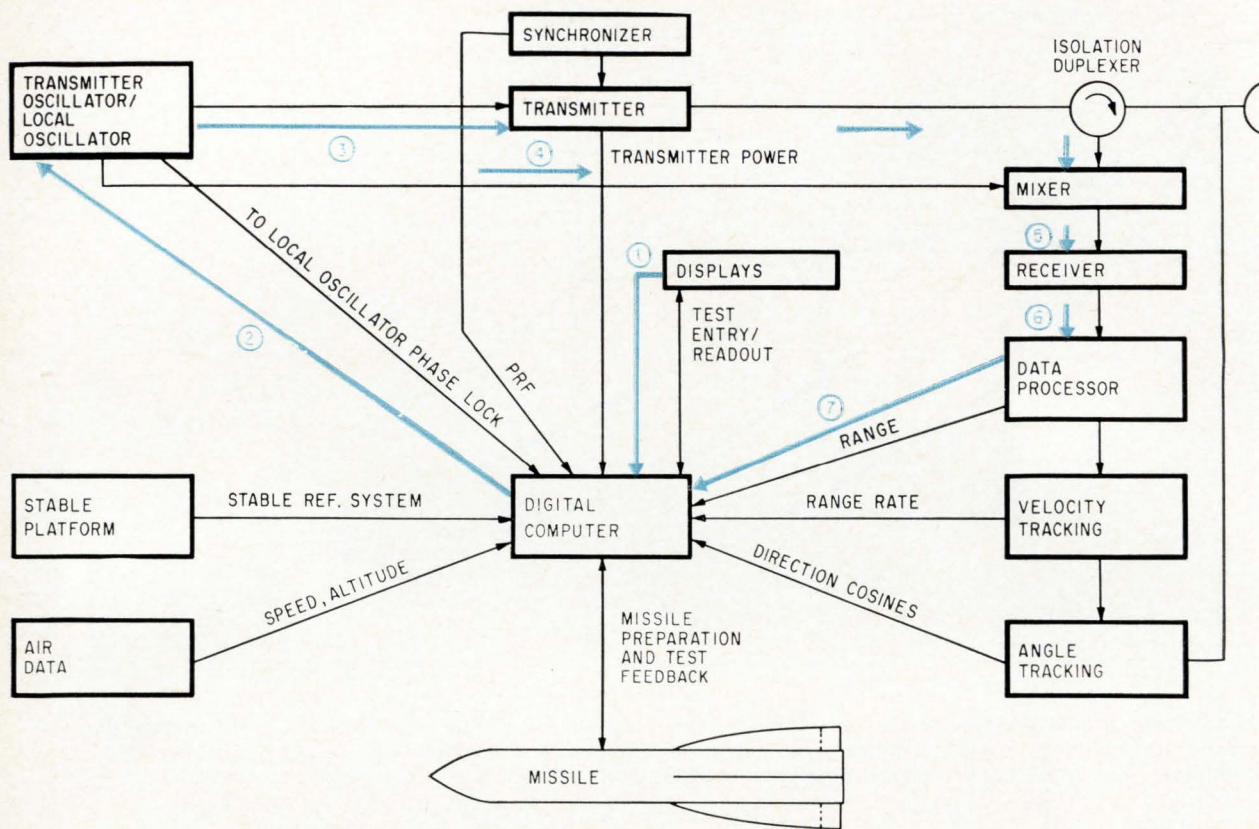

**Missile radar system tests.** If the digital computer in the coherent-pulse doppler system is working, it can be used as test equipment. When the operator observes a fault on his display (1), he uses the computer to check the oscillators (2). The outputs of the oscillators (3 and 4) are sent to the transmitter and mixer subsystems. The output of the mixer (5) is fed to the receiver and the computer checks the receiver's (6) and processor's outputs (7) for signal strength and fidelity. Simulated doppler targets from a test horn check angle tracking.

functions. His ability to perform the tests and his judgment of the result will vary with his familiarity with the operation of the system. The very fact that the choice of operating modes was variable in the first place makes this test concept undesirable.

Furthermore, a subsystem may not be in use during the mission period, so there is no continuous indication of its status. The operator does not know if any of his attack modes will work until he tries them, reducing mission performance to a "try-it-and-see" basis. The number of subsystems where failures can occur, the number of possible induced failure indications in other systems and the number of possible failures that may not show up all make built-in tests vital to insure mission performance.

### Mechanization to the rescue

Now that the operational benefits of built-in tests have been discussed, questions arise as to what the tests criteria should be and whether the tests should be manual or automatic.

It has already been implied that the test equipment must be so distributed that the operator can readily extract the tactical information he needs. He should be informed on equipment readiness—or lack of it—as soon as possible during a mission so he can make tactical decisions when there is less pressure on him.

The design must also consider how thorough the

tests need be, whether tests are to be made before or during a flight, how much the operator should be involved in the tests, how much of the system's characteristics the operator needs to know and how the characteristics of systems not directly involved in navigation, detection or weapons delivery will affect test equipment design.

Test thoroughness greatly influences the probability of completing a mission. An ideal test system would detect all abort-producing faults. However, this is not practical.

The built-in tests, however thorough, must be suitable for frequent use. The test equipment and routines cannot be made so complicated that the failure of them will significantly contribute to system downtime. And tactical capability must not be restricted unduly by the weight and volume of the built-in test equipment.

There are inherent disadvantages in using equipment in a flight environment and checking it in a different environment—on the ground. This is avoided by in-flight testing that subjects equipment to its operating temperature, pressure, vibration, humidity, power and so forth.

In-flight tests tend to make maintenance personnel less dependent upon operator reports of system performances. Lacking the more concrete data supplied by built-in tests, maintenance personnel are often obliged to make a subjective decision on



whether to initiate unscheduled maintenance. They depend upon operator complaints about equipment performance [see "What pilots feel . . . and technicians know," p. 104].

### Time limited

Test time becomes more critical to maintenance as an electronic system becomes more complex. Large systems require rapid and accurate testing. It seems reasonable to expect test time to double if a system's complexity doubles, but in reality the test time must be halved if the same no-fault probability is to be maintained. This means that the testing rate must be quadrupled since twice as much equipment must be tested in one-half the time.

In-flight testing should be as quick as possible since the system is disabled during the test and is unable to carry on its tactical operation. Lengthy preflight tests increase the probability that the equipment will fail before takeoff.

Rapid built-in tests also reduce operating time during ground maintenance and repair. This lessens the time the equipment is being operated and subject to failure. Also, built-in testing lightens the maintenance load by allowing faults to be located and repaired quickly before other failures occur in the same subsystem.

The best way to reduce test time is to restrict the operator's manual operations to a bare minimum of switching actions. This also reduces the chances of him making errors—which can lead to extra test time as well as erroneous interpretations of test results.

### Self-testing pyramids

External test equipment isn't always necessary to test large parts of a modern avionics system. Very often the prime equipment can test itself and sharply reduce the test-equipment inventory—saving on equipment, maintenance and money. Most system design engineers haven't realized that almost all types of prime equipment can be used in a test capacity.

Usually, the prime equipment is sophisticated, well designed and has electrical characteristics that are known precisely. If one part of a system is known to be operating properly, it can be utilized to test other parts of the system. This process can be repeated until the equivalent of a large inventory of test equipment is available.

An example might be a weapons system based on coherent-pulse doppler radar as diagrammed on page 106. If the digital computer is checked first and is operating, it can check out the remainder of the system by controlling a test progression such as:

- If the pulse repetition frequency is counted and found correct, the synchronizer's master trigger is operating. Further, if the transmitter oscillator and local oscillator are phase locked, both oscillators are operating.
- Since the transmitter oscillator is operating correctly, it can become part of a target generator

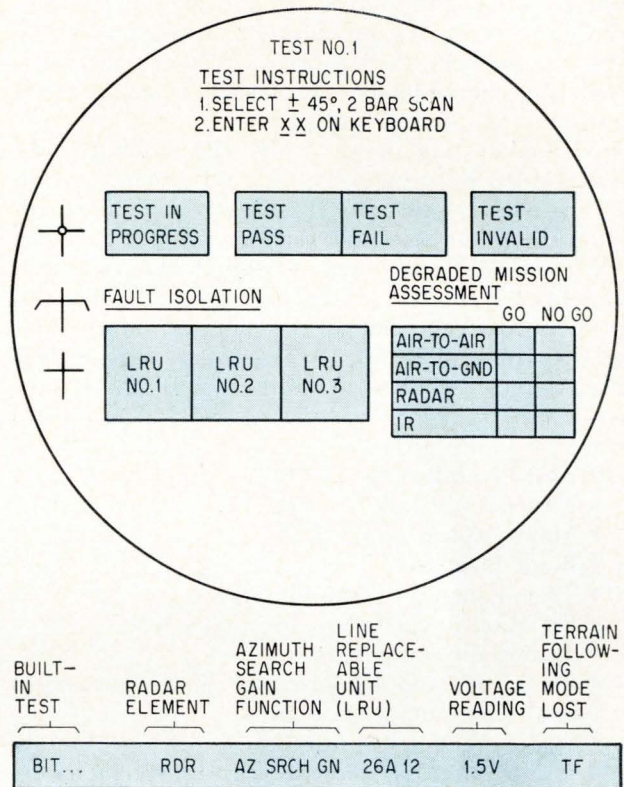

**Test readouts** for a built-in test system with a cathode ray tube display. In some systems a printed tape would also indicate the test being performed, the subsystem involved, the function under test, the failed unit, the voltage reading and the operation mode lost.

to transmit target pulses of known amplitude and doppler frequency to the receiver. These doppler targets check out the data processing section.

▪ After the receiver and data processor are verified, the processor becomes a spectrum analyzer that checks the spectral fidelity of the transmitter output.

▪ Feeding the doppler targets from the transmitter to a horn in front of the radar antenna will confirm the velocity and angle-tracking capabilities of the radar.

▪ After the radar's functions have been checked, the tested equipment—controlled by the computer—checks the responses of the missile guidance equipment to the simulated targets.

### Test readout

The best planned test concept and the most elegant mechanization will be to no avail without the right displays. Servo gain, steering, receiver bandwidth and so forth are of little concern to the average pilot. He wants to know if a system is good or bad and what action he should take to remedy any faulty condition. The absolute values of the measured parameters must be converted to terms he can easily understand. The values could be indicated as a percentage of normal, modes lost or retained or a recommended mode of operation.

On fighter aircraft, there are few readout devices that can show equipment status. A typical cockpit



has meters, lights and a cathode ray tube. These devices require the operator to participate in the testing, so the tests are static. Voltages that vary with time cannot be measured easily when the operator must be the interpreter.

Manual testing doesn't solve the readout problem. Coded light patterns, red and green areas on meters and electro-optical gadgetry will likely remain the prime source of readout.

Automatic testing with a digital computer can simplify the readout problem. There are small serial printers that can print all the required information on a permanent record as illustrated on page 107. Data typically indicated during a built-in test include:

- Test in progress
- Test invalid
- Test pass or fail
- Maintenance required
- Fault location
- Test sequence or test number
- Function in each sequence under test
- Analog measurements
- Point in computer program (if an automatic test) where failure occurs
- System modes lost or retained

The "in progress" indication forestalls interruptions in the performance of tests or test sequences which require a long time. The "invalid" indication avoids delays when complicated switching procedures are necessary to set test conditions or when inertial elements are being checked in flight. The "invalid" indication can also prevent erroneous test interpretations due to incorrect switch settings. Errors in the testing of loops containing inertial components, due to spurious inertial inputs caused by aircraft motion, can also be indicated as "invalid."

An unambiguous "pass" or "fail" indication is needed, but not all failures result in such a clear-cut decision. For example, the only true "fail" for transmitter power measurements is when the power output falls so low that the detection range is equal to or less than the minimum launch range of the armament. Probably, a mission should not be cancelled even if radar transmitter power is one-half its normal value because detection range varies as the fourth root of the transmitter power output. However, a "maintenance required" indication should be generated in this case.

Fault isolation during repair is enhanced if maintenance personnel know which function failed during a test or test sequence. Since aircraft systems usually are functionally packaged, the failures may be resolvable to a few replaceable assemblies. Analog measurements of a suspect function may also help the maintenance personnel understand the failure conditions. For instance, measurements taken on an antenna servo can readily resolve failures between the azimuth and elevation channels. Maintenance men can proceed directly to detailed troubleshooting of the failed channel and return the system to the flight line more quickly.

How well each of the design characteristics discussed above is realized depends on whether the tests are manual or automatic. The merits and disadvantages of each can also be illustrated by the hypothetical interceptor system.

Manual testing implies human involvement. In flight, the operator must set switches to generate stimuli for the circuit or function being tested and observe the response on an indicator light, meter or other cockpit displays. These are visual devices that require a quiescent response, so they all have the same limitation—extremely narrow bandwidth. This makes it very difficult to accurately measure a time interval, frequency or time varying response.

An operator usually can make only one test at a time. Since he must observe and interpret each function individually, multiplexing of data is almost impossible. Combining signals into a single response makes interpretation considerably harder.

### **Crowded cockpit**

It is rather difficult to mechanize a manual, in-flight type of built-in test. All commands must be generated from and returned to the operator's station, which is very small in a modern interceptor plane. Any signal sampling or change in scale factor not performed in the prime equipment must be done at the operator's station. Further, since the operator would probably make one test at a time, he would require as many switch positions as tests. The quantity of equipment at the operator's station could be formidable when a large number of tests had to be done thoroughly. Manual test equipment is also limited in its testing capability. The tests are basically static because of mechanization complexity. It would be very difficult, for instance, to set up a detector to measure a voltage slope. A frequency counter is seldom built to count an exact frequency or pulse repetition rate; more often the reading is a simple d-c voltage representing the average value of a pulse chain. Or, for example, to test a servo that controls a radar antenna, the antenna must be moved and the motion results in a time-varying response that is not easily interpreted by manual means.

Manual type tests are quite satisfactory for two-state determinations—presence or absence of a signal—provided there are few signals. However, the presence or absence of a signal is not enough information for an integrator where the output scale factor is in volts per second per volt input. Also, manual tests have no memory other than the operator's. The test information is not retained for further use. The operator could write down the results, but this would further tax his limited time. Thus, the needed information outputs, such as fault isolation, are difficult to get.

Coded light patterns, electromechanical annunciators and electro-optical equipment have been used for manual test readout. The coded patterns require decoding, and annunciators and optical projections from film strips usually take too much room for cockpit installation.



# Computers save time and missions

Using the principles explained in the article beginning on page 103, author H. Kelly Grounds tells how built-in tests can spot trouble quickly

**The biggest advantage** in automatic in-flight testing is saving time, and test time can mean the difference between success or failure of a mission. Equipment that is grounded for tests is of no use on a mission; the pilot busily testing his plane's systems in flight has little time to actually perform his mission; but the equipment must be tested or it may be worthless when needed [see preceding article].

The road to solving the dilemma is automatic testing of the equipment—that is, the automatic sequencing and sensing of test outputs through the time-saving capability of a digital computer. In an avionic system with a digital computer, the computer will have access to a large percentage of the subsystems and all outputs from the computer can be used as a source of test stimuli. All inputs to the computer can serve as test report lines. As a general rule, where bilateral communications

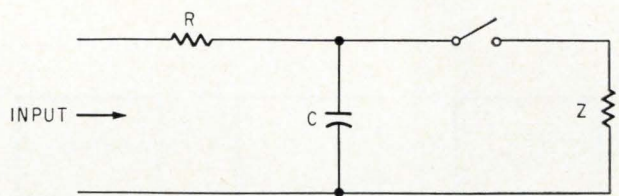

**Equivalent circuit** of an analog input. If the impedance,  $Z$ , is incorrect, it will upset system scale factors and cause measurement errors.

exist between the computer and the avionic system, the testing of the areas where the communication links exist are obtained only at the expense of the computer memory.

### Jack of all trades

An outstanding advantage of a digital computer is its measurement capability. The amplitude, per-

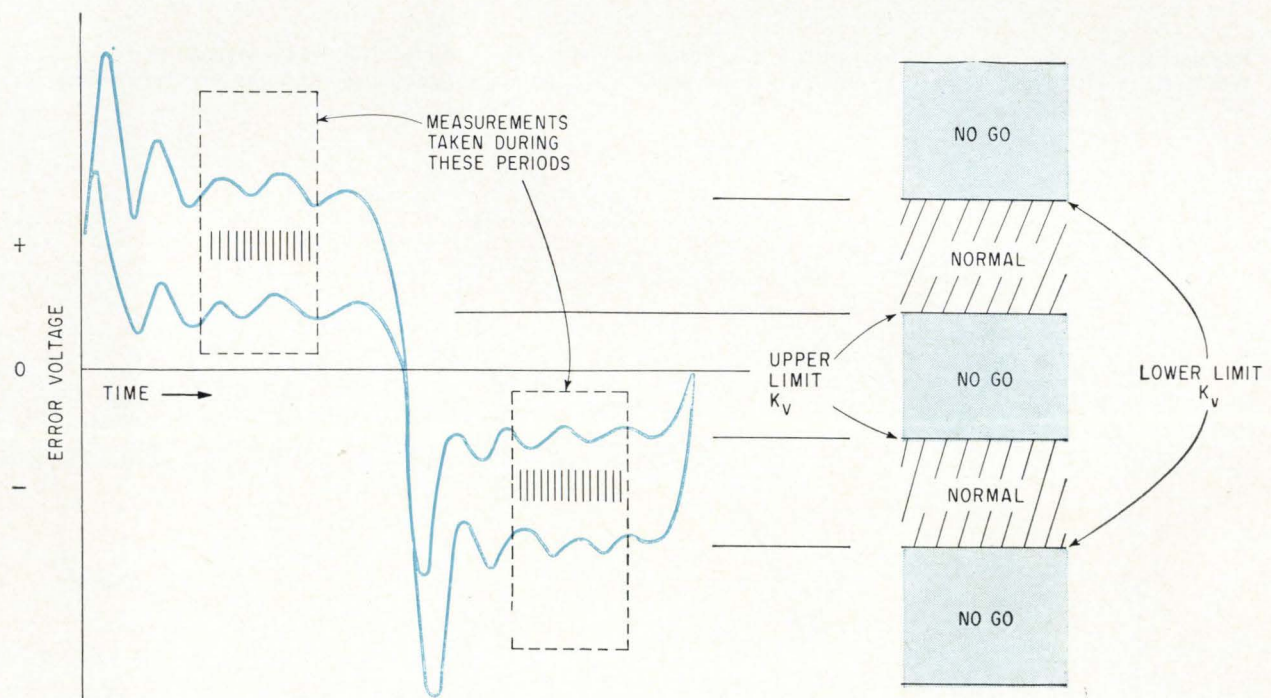

**Pass and fail limits** in an antenna servo signal. If the error signal during the measurement period is too low, the antenna may jitter; if the signal level is too high, the antenna will have a sluggish response to command inputs.



iod, slope, symmetry, time-to-null, overshoot and many other characteristics of complex waveforms may be analyzed by a computer with accuracies of 0.1% to 1.0%. The computer can also be a function generator. It can generate sine waves, triangular waves, square waves and combinations of wave shapes at frequencies up to 100 kilohertz. These output waveforms may be used as test stimuli.

The digital computer's memory bank has a special advantage in testing operations. Test procedures, voltage readings, fault isolation instructions and other information usually contained in handbooks can be recorded in the computer memory. The test operator needn't consult a manual to determine what a voltage reading should be; the computer simply extracts the correct value from

memory, compares it with the test reading and displays the result as a percentage of normality, magnitude or in any units desired.

### Fault locator

Fault isolation has always been a very difficult, time consuming problem. Manuals on fault isolation procedures contain endless isolation trees. If the symptoms match those in the manuals, maintenance personnel are in luck; if not, they must revert to trial and error methods. A digital computer readily isolates faults. At every decision point in a computer's automatic sequencing program, the computer knows which functional element is under test. An abnormal indication or reading is readily resolvable to that element—that's fault isolation.

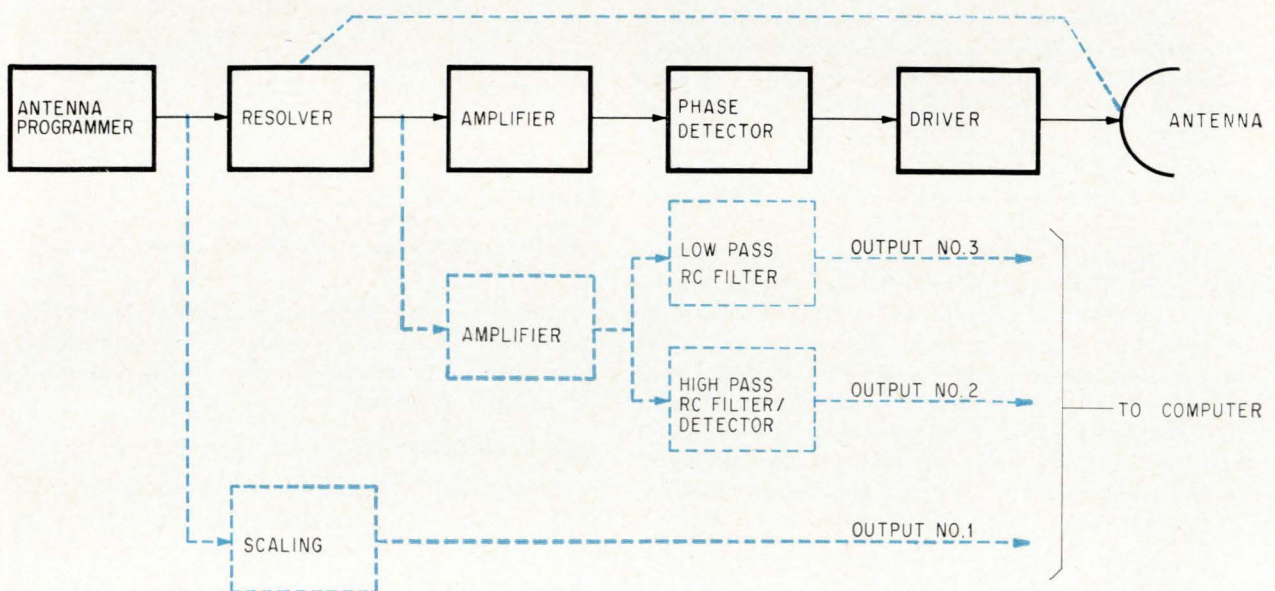

**Radar antenna servo functional diagram.** The test configuration is shown in color and by the dashed lines. Test outputs 1, 2 and 3 show the antenna's response to scan commands, search programmer and servo error.

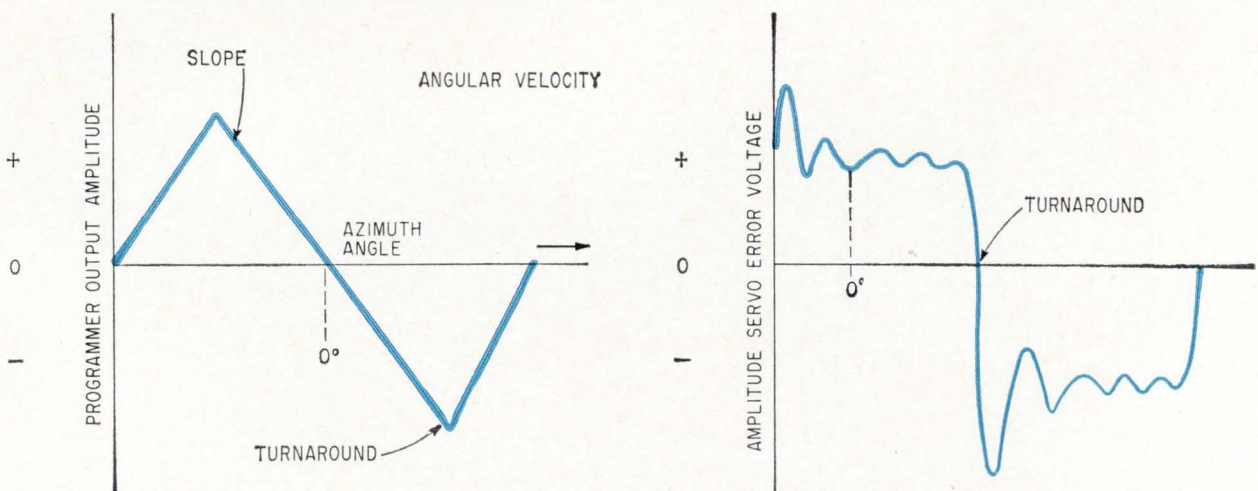

**Test waveforms** into and out of an antenna servo. The triangular waveform is the servo input and the approximately square wave at the right shows the antenna response. The spikes are turnaround transients.



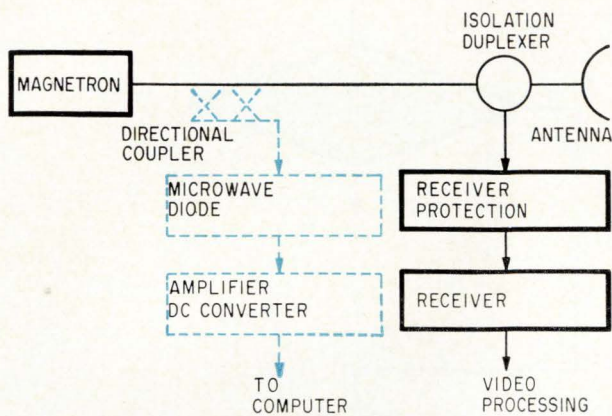

**Output section** of a radar transmitter with test configuration in color. A directional coupler samples the output pulse energy and feeds it to a detector and amplifier. A converter changes the energy into a form suitable for use by the computer.

A digital computer's memory can also help determine the tactical capability of a system. A system's tactical modes depend on functional elements, so modes lost through failures can be identified by measuring electrical parameters that represent the functions. Constructing a matrix of the functions tested versus system modes lost can assess the degradation in mission capability. Once such a matrix is recorded in the memory, the computer logic can decide the modes lost through failures.

### Signal monitoring, continuously

Two additional contributions of a computer to the built-in test concept are as a continuous monitor and a preventive maintenance aid. Usually, a continuous monitor is a group of comparison gates or thresholds that establish regions of allegedly normal operation. These mechanizations, however, are not satisfactory for time variable functions. For example, the voltage levels of an aircraft's steering signals can be anywhere between two extremes, depending on whether the plane is climbing, diving, landing or performing other tactical maneuvers.

During continuous monitoring static comparison must be supplemented by arithmetic comparison of the changes in signals with time to establish reasonable information on the signal changes. The digital computer handles both the static and changing data well. An iterative sampling by the computer of signals in strategic locations in the system adds to confidence that the system is operational.

The sampling would be an integral part of the computer's tactical program. It would occur many times during the wait or dead time of the tactical

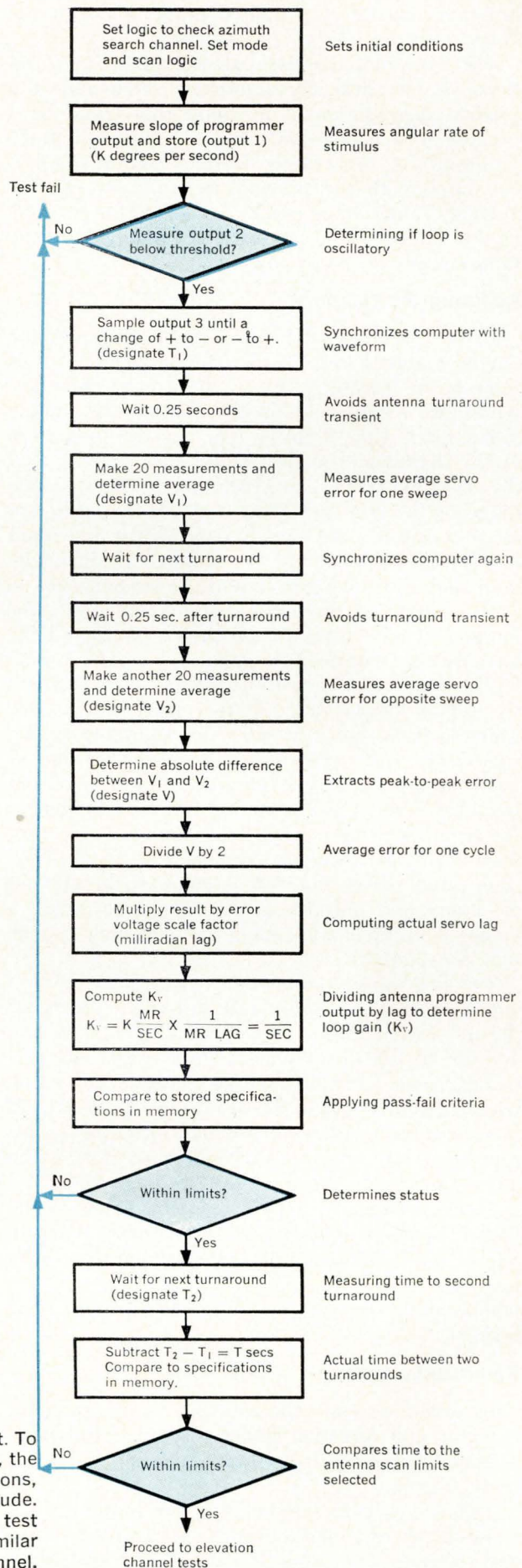

**Computer flow diagram** for a radar antenna test. To test antenna gain and azimuth scan limits, the computer is programmed to check for oscillations, excessive transients and error signal amplitude. Failures are indicated by "no" outputs. This test takes 3 seconds under computer control. Similar tests check the elevation channel.



program, making it virtually continuous during the entire mission.

The computer can also predict failures. Variations in electrical characteristics often reflect a gradual degradation of a circuit that could be a prelude to a catastrophic failure. The computer's program can be written so that each reading is compared with the previous reading or with the average values of a number of samples. So long as the number of variations is not unwieldy, many failure predictions can be made.

### Adapting the computer

Before the automatic tests can be designed, the engineer must know the computer's characteristics relevant to testing. Most of these characteristics, which are established by the computer's original role as part of the flight system, concern the nature of the digital and analog inputs and outputs that the computer will accept. Included are the dynamic range of the analog signals and whether they are a-c, d-c or both; the signals bandwidths and input and output impedances; the number of analog inputs and the analog-to-digital conversion rate in each. In addition, the number of discrete inputs, the number of data bits in each digital word and the memory capacity must be known.

The input and output dynamic range restricts the actual voltage range of the measurements; for example, it may be  $\pm 10$  volts. The digital-to-analog conversion rate sets the rate for observing or measuring a signal, provided each input or output is addressable. The conversion rate also influences the accuracy of measuring time-varying waveforms, since it may be necessary to make a series of measurements to determine a peak value. If the number of inputs and outputs is restricted and small, a complex multiplexing, coding and decoding scheme may be required.

Too low an input impedance may load down a signal monitoring point and introduce errors. If the test signal source impedance is not taken into account, it can upset scale factors in the system's tactical loops and cause wrong answers. The bandwidth of signals fed to the input must be restricted to at least three octaves below the corner frequency, represented by the resistor and capacitor in the analog-input equivalent circuit on page 109.

Memory capacity determines how much of the test information is useful. If the memory is small, only a simple read-comparison mechanization may be used. If the memory is not restricted, active computations of system parameters can be performed.

### Radar servo tests

In radar systems, the antenna is the radiator, receptor and direction finder, posing a test complexity that makes it a prime candidate for automatic testing.

Two servo characteristics that can represent reasonable antenna operation are the servo gain ( $K_v$ ) and the noise content of the servo loop. An abbrev-

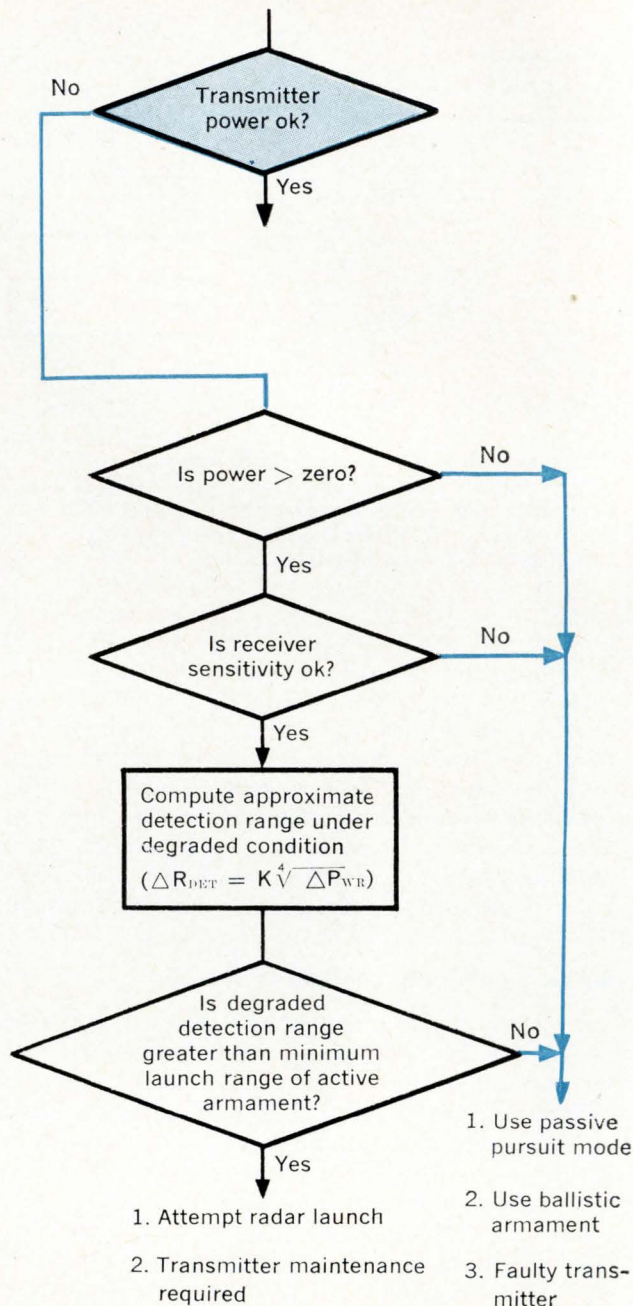

$\Delta P_{WR}$  = Power output change

**Computer setup** for degraded mission assessment. Each measured parameter indicates system performance. The computer evaluates changes in detection range with changes in radar power output.

**Computer program** for continuous monitoring. Test points shown in color at the output of each avionic subsystem instantly warn the operator of subsystem failures. The operator is then able to choose alternate subsystems to complete his mission and to diagnose faults.



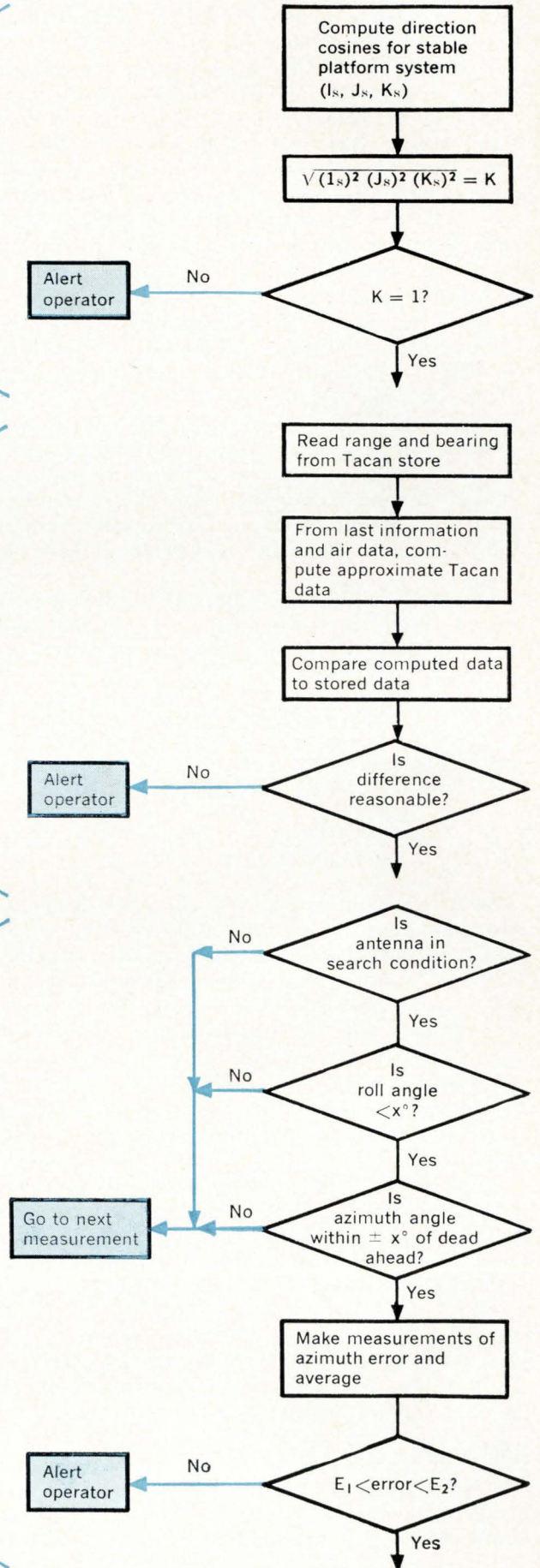
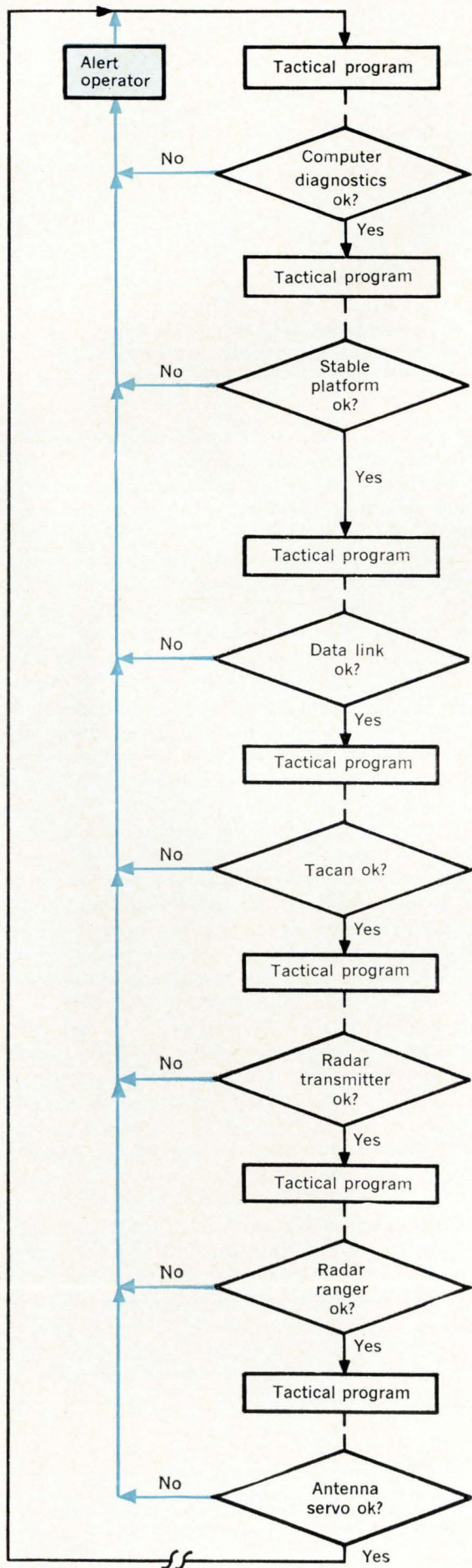



viated functional block diagram for a possible radar antenna servo is shown on page 110. Two outputs are to be tested, the antenna search programmer output (output 1) and the servo error (2 and 3).

Waveforms fed to the computer for analysis are shown on page 110. The triangular waveform is the amplitude of the servo input; it represents a constant angular velocity for both left and right antenna scan. The servo error waveform is an approximate square wave; a steady state error exists during the constant velocity part of the scan pattern. Considerable noise may be present on the error waveform. The large spike at the beginning of each scan is a turnaround transient.

Since this waveform will vary with time, the computer must be synchronized to it. If the loop oscillates, the computer cannot measure gain, but it can determine the oscillatory condition through low-pass and high-pass filtering. The signal components can be separated by establishing a corner frequency about three octaves above the antenna rotation frequency. Output below the corner frequency represents the average servo error; output above the corner frequency represents a loop noise content.

Amplitude of the error output from the low-pass filter is a function of the angular velocity input and the servo gain. The error equals the servo lag, or:

$$\omega/K_v = \frac{\text{angular velocity}}{\text{servo gain}}$$

$K_v$  is computed by measuring the search programmer output and the servo error. So:

$$K_v = \frac{\text{angular velocity}}{\text{servo lag}}$$

Radar transmitters may also be tested in flight. The simplest parameter to measure, one that represents nominal operation, is output power. Depending on the type of system, different power measurements must be made. For example, in ordinary pulsed radars and in pulsed doppler radars with a low pulse repetition rate (prf), average power output can be measured; while in pulsed doppler radars with a high repetition rate, the power at the center line of transmitter's output spectrum must be evaluated.

A directional coupler samples the energy transmitted by the output section of a conventional pulsed radar as shown on page 111. The sampled pulse train is fed to an amplifier-detector that indicates either peak or average power. The d-c output voltage is proportional to the square root of the scaled transmitter power. To determine the actual power, the output voltage must be squared and multiplied by the detector characteristic in watts per volts squared. This is the computer's job.

#### Pilot knows plane's limitations

It is important to measure actual spectral fidelity of a high-prf pulsed doppler system. Relative amplitudes of each spectral line in the transmitted

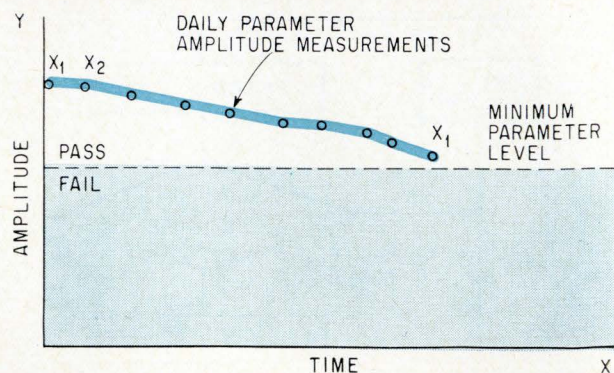

**Avionics performance chart.** If the measurements are taken daily, it is possible to detect failure trends and forestall failure with preventive maintenance.

pulse can be measured through doppler filtering and automatic gain control processing.

Aside from such basic fault isolation tests, larger systems should be provided with continuous monitoring to assess degradation in mission capability. The computer program would probably be of the iterative type; sampling each signal or group of signals at a specified rate. The measurement iteration rate is usually of the order of 1-to-4 seconds. This means that the measurements are updated at least once every 4 seconds and therefore can be treated statistically as though they were continuous.

A computer-controlled continuous monitoring test is diagramed on page 113. Only one measurement per test point is shown, but more measurements can be made at each point if the tactical program leaves more time free in the computer. The flow diagram on page 112 indicates one way to assess degradation in mission capability. Each measured value in the system is related to an appropriate system performance parameter; thus in the example shown, the pilot is continually aware of his operational limitations. Knowing his plane's limitations, the pilot is better armed to fulfill his mission.

Finally, the computer helps prevent breakdowns. If daily measurements are made, as in the graph shown above, and the time between the measurements represents the average mission length, then failure trends can be detected. For any given parameter  $Y$ , shown plotted as a function of time, a trend to failure can be detected if the expression  $\sum |Y - (a \pm bx)|^2$  is not a minimum. After each measurement is taken, new values of  $a$  and  $b$  are computed so that the resulting line best fits the measurement history. A projection is then made to predict whether the measured parameter will fall below the minimum level before the conclusion of the next system operating cycle. This process, however, requires the computer to accept new data in its permanent memory.

#### Acknowledgment

Research on this paper was supported by the Naval Bureau of Weapons under Contract No. NOW-63-0379-di. The author is grateful to the Bureau and to the Hughes Aircraft Co. for permission to publish this work.



# New Epoxy Packages make Amelco FET's more economical than ever before!

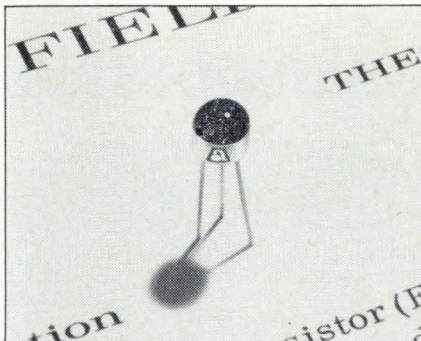

## KEY SPECIFICATIONS

	2N4302	2N4303	2N4304
$I_{DSS}$ (max. mA)	5.0	10	15
$g_m$ (min. $\mu$ mhos)	1000	2000	1000
$V_p$ (max. volts)	4.0	6.0	10
$C_{DG}$ (max. pf)	2.0	2.0	2.0
$I_{GSS}$ (max. nA)	1.0	1.0	1.0
Price ea. (1000 qty.)	\$1.45	\$1.75	\$1.15

WRITE FOR COMPLETE SPECIFICATIONS

Amelco Semiconductor, world's largest manufacturer of N Channel Field Effect Transistors, has just reduced prices drastically by offering several types in moisture resistant, high quality epoxy packages. These epoxy FET's will do virtually everything the Amelco metal can line does except fly classified missions. Don't let that bother you, though — Amelco Epoxy FET's will meet all requirements of MIL-S-19500.

So, if the cost of converting your circuits to the advantages of Field Effect Transistors has been a problem, forget it. Once again, Amelco has found the answer!

## AMELCO SEMICONDUCTOR

DIVISION OF TELEDYNE, INC.

1300 TERRA BELLA AVENUE • MOUNTAIN VIEW, CALIFORNIA

Mail Address: P. O. Box 1030, Mountain View, California

Phone: (415) 968-9241 / TWX: (415) 969-9112 / Telex: 34-8416

### REGIONAL OFFICES

**Southwest**—Suite 213, 8621 Bellanca Ave., Los Angeles, California 90045, (213) 678-3146 • **Northwest**—1300 Terra Bella Avenue, Mountain View, California, (415) 968-9241 • **East**—P. O. Box 2091, Paterson, New Jersey 07509, (201) 696-4747; P. O. Box 366, Kimberton, Pennsylvania 19442, (215) 885-1755 • **Northeast**—805 High Street, Westwood, Massachusetts (617) 326-6600; 60 Broad Hollow Rd., Melville, L. I., N. Y., 11749, (516) 692-4070 • **Southeast**—711 Magnolia Avenue, Orlando, Florida, (305) 423-5833 • **Midwest**—650 West Algonquin Road, Des Plaines, Illinois, (312) 439-3250; 3020 Woodlark Lane, St. Paul, Minnesota, (612) 646-1161 • **Canada**—Deskin Sales, Montreal, Quebec, (514) 384-1420.



# Logic Prices Drop 32 to 40%!

Latest dual in-line ICs make possible

new **EECoLogIC**®



DI Series Cards,

with 2 week delivery

starting **November.**

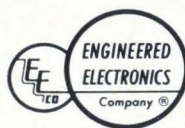
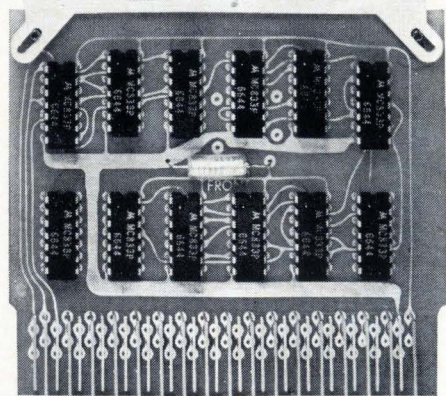

**ENGINEERED ELECTRONICS Company**

1441 East Chestnut Ave., Santa Ana, Calif. 92702 Phone: (714) 547-5651

Ask for 20-page catalog.

## Sixteen examples:

	DI Series (1-24 Qty)	Flat-Pack Equivalent
Eight 2-Input NAND Gates	\$26.00	\$38.00
Six 4-Input NAND Gates	31.00	45.00
Dual BCD Decade Counter, 1248 Code	65.00	111.00
Two 4-Bit Parallel Entry Shift Registers	72.00	120.00
Sixteen Inverters	37.00	60.00
Dual 4-Stage Binary With Gated Preset	78.00	129.00
Eight 3-Input Power Drivers	33.00	54.00
Four J-K Flip Flops	42.00	65.00
10-Bit Serial Shift Register	78.00	129.00
10-Bit Gated Data Register	62.00	
4-Bit Binary 16-Line Decoder	58.00	
BCD To Decimal Decoder	49.00	
Eight AC Pulse Gates	68.00	
Six 4-Input Gate Extenders	31.00	
Mixed NAND Gates	31.00	
Eight 3-Input Capacity Drivers	33.00	



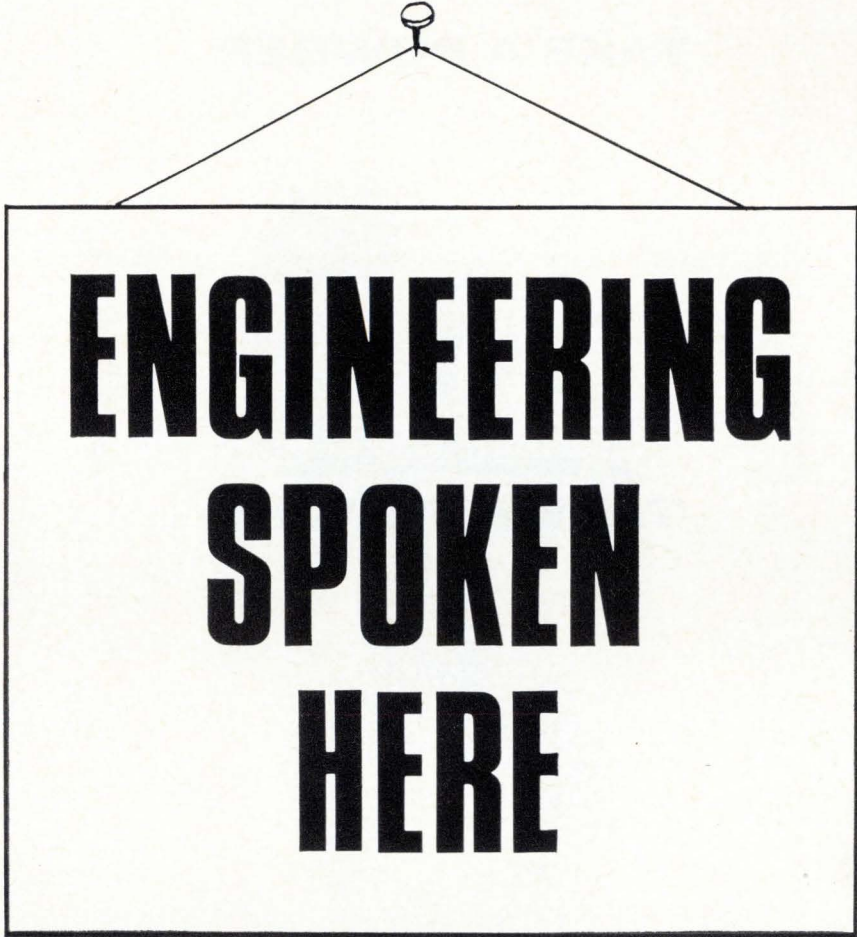

# ENGINEERING SPOKEN HERE

(WITH A PHOTOGRAPHIC ACCENT)

Many an engineer who has a need to record data is not a photographic engineer. This is why we have a *Special Applications Department*. In it are photographic specialists who have a speaking acquaintance with the various other kinds of engineering. Backing them up are some 35,000 people whose work is photography.

With one or more of these people to talk to, you may be able to solve the stickiest of data-recording

problems—through the application of materials and techniques you may not have heard about, or by collaboration in the development of new ones.

If you dial (716) 325-2000 and ask for Ext. 5129, the man who answers will connect you with the particular specialist who speaks your language best. Or you can write him by addressing **Special Applications, Eastman Kodak Company, Rochester, N. Y. 14650.**

**Kodak**





**TAKE A POWDER**

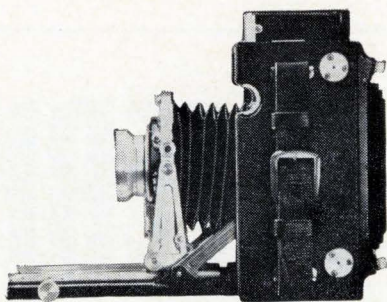

**TAKE A PICTURE**

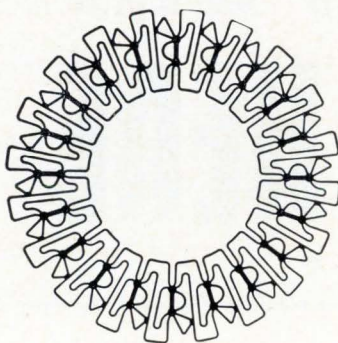

**MAKE A PART**

**Photofab<sup>®</sup> process holds tolerances  
on intricate parts to  $\pm 0.0005''$**

Flat components with oddball configurations and close tolerances are no longer production bugaboos, thanks to Magnetics' new photoetching process, Photofab<sup>®</sup>. This process delivers precision replicas in pilot or production quantities from nearly any magnetic or specialty alloy.

First, Magnetics' powder metallurgy capability develops an alloy strip with uniform magnetic and electrical properties from an exact blend of powdered metals. After the strip has been cold rolled to the specified thickness, it is then photoetched into any configuration that can be drawn on paper.

Frets, rotors, stators and head laminations are just a few of the parts which can be produced by this process—especially effective when material thicknesses of less than 0.001" are involved.

Consistent high quality in metallic properties, and reproducibility that meets your most exacting specifications are guaranteed by Magnetics Inc. The savings in days and dollars invested are, of course, tremendous.

Write Magnetics Inc., Butler, Pa. 16001, for more information on Photofab<sup>®</sup> (Dept. EL-103), or for data on custom blended alloys (Dept. EL-104).





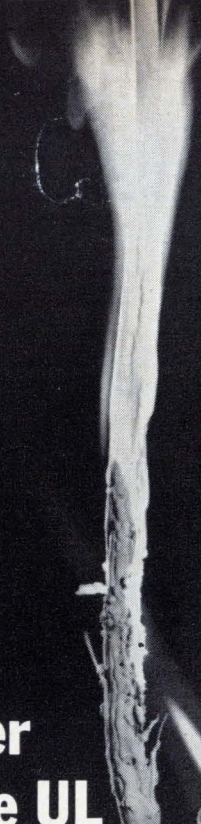

**No ordinary  
silicone rubber  
could pass the UL  
vertical flame test**



**until G.E. developed  
SE-9041**

Ordinary silicone rubber wire insulation was only half-safe. It met Underwriters' Laboratories requirements when held *horizontally* over a flame, but flunked UL's *vertical* flame test. That's why General Electric developed SE-9041—the first economical silicone rubber insulation to pass *both* UL flame tests. New SE-9041 meets UL specifications as insulation for any size conductors without flame-retardant exterior braids or saturants.

**SE-9041 is versatile too.** Although it was originally developed specifically for television wiring, this new

silicone compound can be used in any high voltage circuit from ignition wiring to klystron wiring. In electrostatic precipitators or magnetrons, for example.

**But that's only part of the story.** SE-9041 is also superior in dielectric strength. A No. 22 AWG conductor insulated with a 75 mil wall of SE-9041 would have a typical breakdown voltage of 500 volts/mil a-c. About 50% higher than values obtained with previous silicone rubber compounds! We especially formulated this new silicone rubber insulation to hold high-voltage stresses for prolonged periods of time.

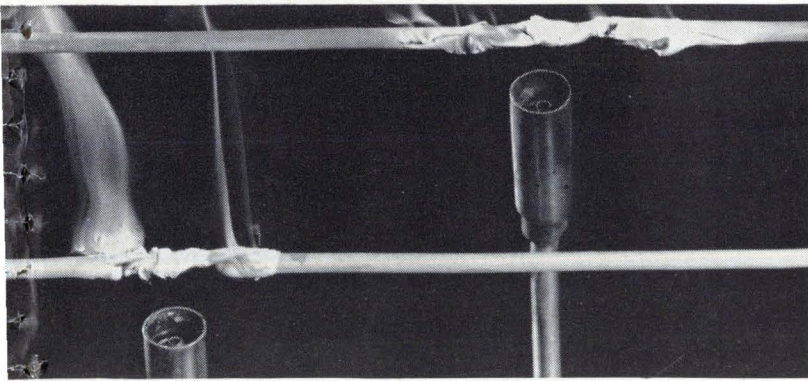

For horizontal wiring requirements, any silicone rubber insulation provides superior resistance to flame propagation. It's on the vertical jobs that SE-9041 built a reputation as a firefighter. First among lower-priced silicone insulations to pass the demanding UL vertical flame test.

**Want a sample for evaluation? Be our guest.**

**Section N10236, Silicone Products Dept.  
General Electric Co., Waterford, N. Y. 12188**

Send me a free sample of SE-9041, plus all the literature you can put your hands on.

Name \_\_\_\_\_

Title \_\_\_\_\_

Company \_\_\_\_\_

Address \_\_\_\_\_

City \_\_\_\_\_ State \_\_\_\_\_ Zip \_\_\_\_\_

Circle 119 on reader service card

**GENERAL**  **ELECTRIC**



# MIL-T SPEC LACING TAPE isn't right for every harness job!

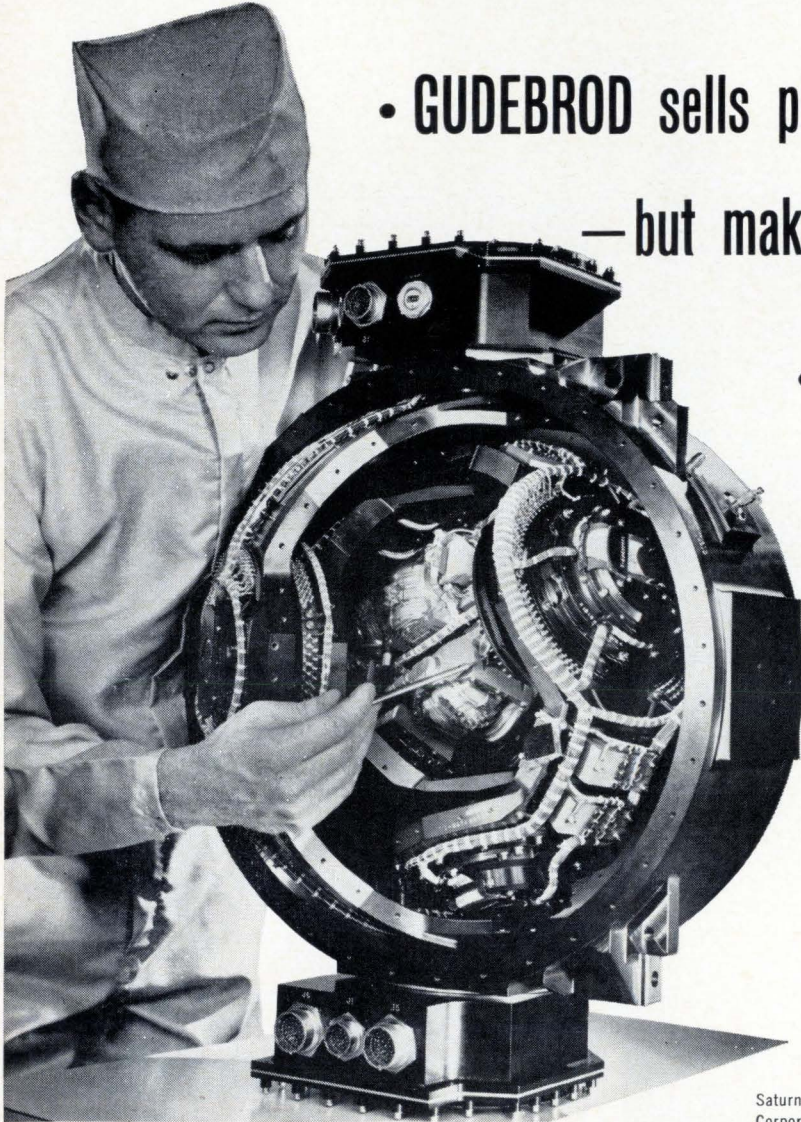

• GUDEBROD sells plenty of it (Gudelace 18)  
—but makes 172 other\* tapes too!

- Tapes for high temperatures, burnproof tapes, tapes for outer space and vacuum use.
- Tapes for heavy cabling and for small units, color coded tapes.
- They all tie tight.  
Ask about them.

\*And they all exceed MIL-T performance requirements

Saturn rocket inertial guidance stabilized platform produced at The Bendix Corporation's Eclipse-Pioneer Division. Wiring laced with Gudebrod Tape.

With every advancement in electronic technology, for every new electronic application there is need to review your harnessing practices and materials. If your harness department is struggling to make-do with the lacing tape they have always used—they may be wasting time and money as well as heading for rejects. Gudebrod has pioneered in producing special tapes—for particular applications, and to meet customer's specifications. Available at Gudebrod is a stock of 173 types of lacing tape—and a wealth of harnessing information. Why not consult with Gudebrod!

#### GUDEBROD CABLE-LACER

The first hand tool engineered for wire harnessing. Handle holds bobbins, feeds tape as needed, grips tape for knotting. Speeds, eases harnessing. Pays for itself in time saving.

Area Code 215, WA 2-1122



## GUDEBROD BROS. SILK CO., INC.

FOUNDED IN 1870

*Electronics Division*

12 SOUTH 12th STREET, PHILADELPHIA, PENNSYLVANIA 19107



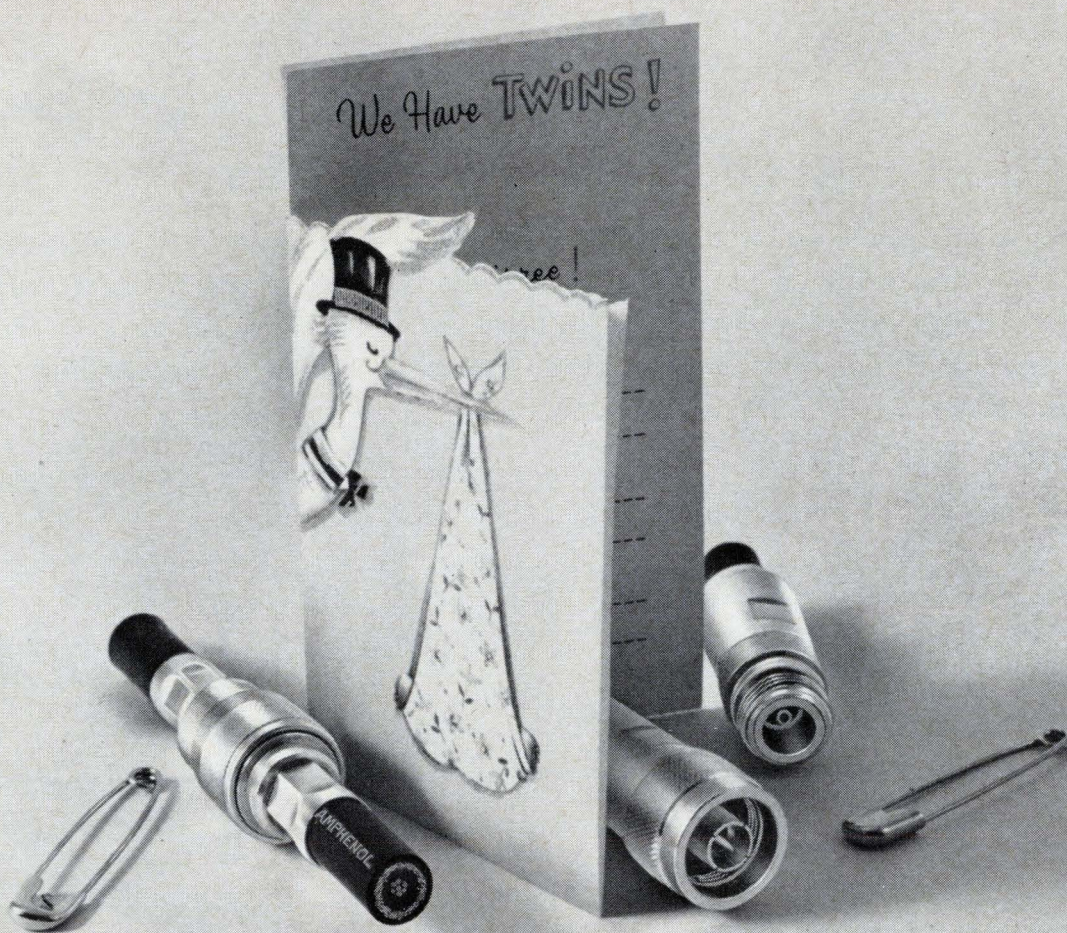

## Meet Amphenol MIL-Crimp\* and MIL-Clamp\* — new electrically identical "N" connectors

Now you can specify a crimp or field-serviceable connector and get the same superior electrical performance.

**INTERCHANGEABLE.** Amphenol MIL-Crimp (crimp version) and MIL-Clamp (field-serviceable version) have identical electrical characteristics and cable stripping dimensions. They can be used interchangeably in prototype, production or field applications. Now you can obtain well-known crimp assembly cost savings and if necessary, replace a MIL-Crimp with a MIL-Clamp connector without special tools.

**EASY TO ASSEMBLE.** No combing of the braid is required.

(MIL-Clamp is the first field-serviceable "N" connector to eliminate this step.) One tool performs all crimps on Amphenol MIL-Crimp "N" connectors.

**COMPLETE SELECTION.** Amphenol MIL-Crimp and MIL-Clamp come in the following configurations: plug, angle plug, jack, panel jack and bulkhead jack . . . panel and bulkhead receptacles, too. All competitively priced and sized to match a broad range of cable diameters.

**MIL-C-39012.** Tests conducted in Amphenol's laboratory indicate that these connectors comply fully with the performance requirements of MIL-C-39012, for

Class II type "N" connectors. Test data is available upon request.

Military specification	MIL-C-39012 Class II
VSWR	1.35 max from 0.5 to 10 GHz
Insertion loss	.05 db maximum at 10 GHz
RF leakage	at least 90 db down at 3 GHz
Dielectric with- standing voltage	2,500 volts rms at sea level

For complete technical data on MIL-Crimp and MIL-Clamp "N" connectors, call an Amphenol Sales Engineer. Or write Amphenol RF Division, 33 E. Franklin St., Danbury, Conn. 06810

\* Trademark



**AMPHENOL RF DIVISION**  
AMPHENOL CORPORATION





## difficult installations made easy

The long continuous lengths of HELIAX® coaxial cable make any type of installation possible. Whether across a vast ravine or up the tallest tower, the installed cost is less. Corrugated inner and outer conductors absorb all stress. Andrew connectors firmly anchor both conductors to eliminate electrical problems. Consult your Andrew sales engineer or write Andrew Corporation, P. O. Box 807, Chicago, Illinois, U.S.A. 60642.

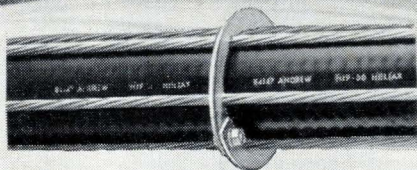

870-foot self-supporting catenary installation of 5-inch HELIAX air dielectric coaxial cable (Type HJ9-50) at mountain top site of Station KBYU-TV, Provo, Utah.

**Andrew**  
CORPORATION

29 YEARS OF ENGINEERING INTEGRITY

10-66



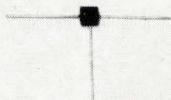

**from the smallest  
to the largest...**

(micropower to 150 watts)

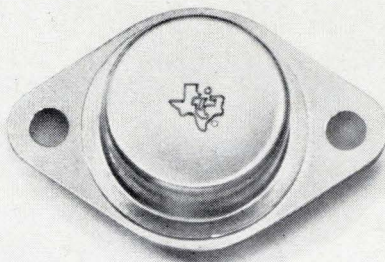

**from the slowest  
to the fastest...**

(d-c to 3000 MHz)

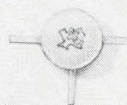

**from the oldest  
to the newest**

(2N250 to TIXM12)



**...and 7103 choices in between**

**Get the TI germanium transistors you require  
— one piece or 100,000 —  
from EW**

Your germanium transistor procurement is simplified the minute you call us. We're prepared to make prompt delivery on the full Texas Instruments line of more than 7,000 types.

Whether you need older devices to feed long-established production lines or newest units for advanced designs...100,000 pieces or evaluation samples — call us.



*"SERVING THE ENTIRE SOUTHEASTERN U.S."*

**ELECTRONIC WHOLESALERS INC.**

<b>WASHINGTON, D. C.</b> 2345 Sherman Ave., N.W. Phone 202-483-5200	<b>BALTIMORE, MARYLAND</b> 3200 Wilkens Avenue Phone 301-646-3600	<b>WINSTON-SALEM, N. C.</b> 938 Burke Street Phone 919-725-8711	<b>MIAMI, FLORIDA</b> 9390 N.W. 27th Avenue Phone 305-696-1620	<b>ORLANDO, FLORIDA</b> 345 N. Graham Avenue Phone 305-841-1550
---	---	---	--	---



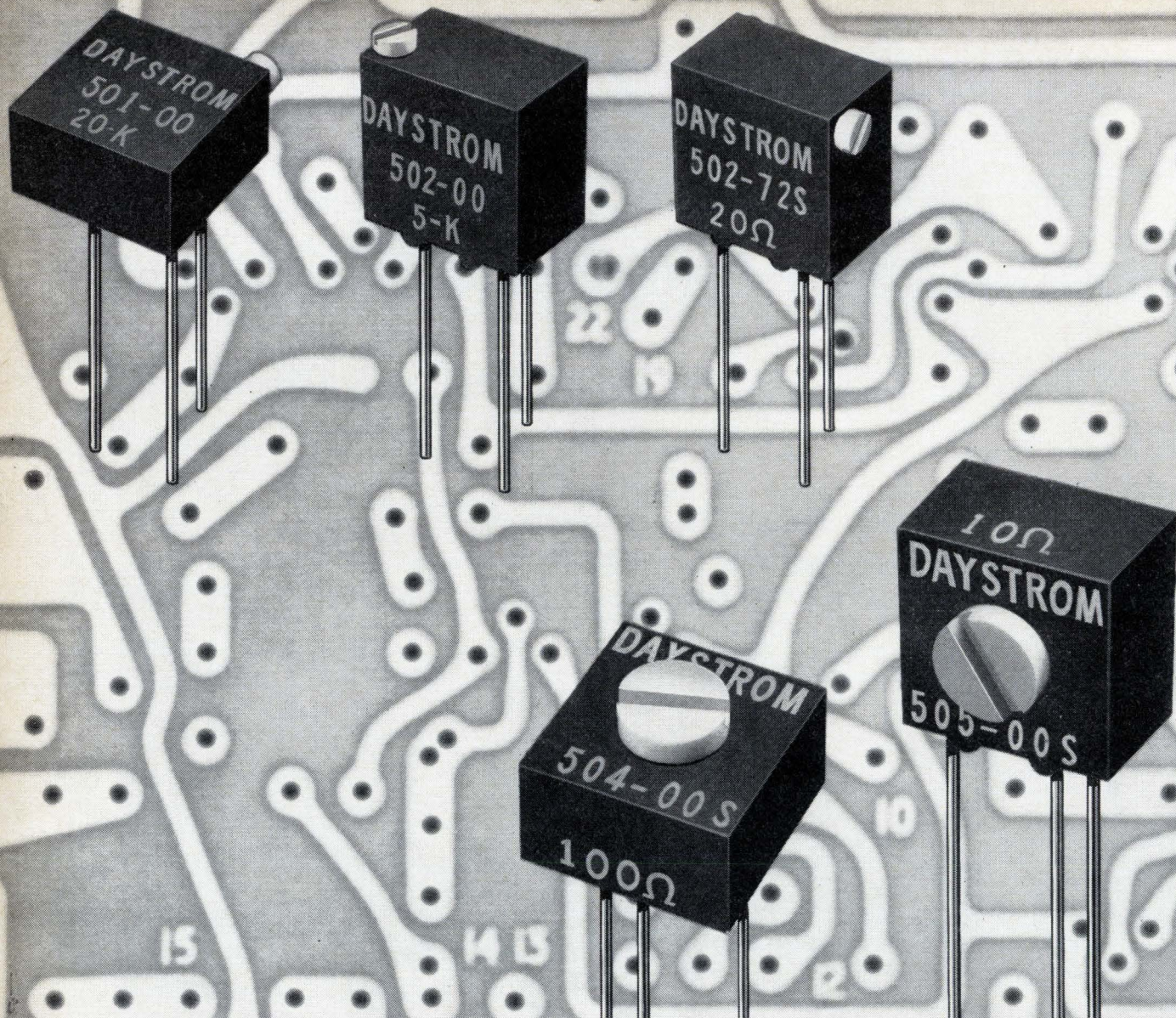

## Savings across the board just took a new turn

Single turn potentiometers have just been added to the Daystrom Squaretrim® family. New models 504 and 505 are fully adjustable with just one turn. Models 501 and 502 are 15-turn types. They all clear up to 80% more PC board space—at no extra cost. But the trim .02 cubic inch size is only one reason why these commercial 500 Series pots are proving so popular. They also feature Weston's exclusive wire-in-the-groove design, and all these performance extras:

**Convenience** 5 different configurations with adjusting screw on top, side or end • **Tolerance**  $\pm 5\%$  • **Adjustability** 15 turns or single turn • **Slip Clutch** eliminates wiper damage, cuts production delays • **Suregard™ Terminations** (controlled solder) for better protection against vibration, shock and humidity—no pressure taps • **Superior Resolution** 0.125% or less • **Wide Range**  $10\Omega$  to  $20K$  • **High Power** 0.6 watt in still air at  $70^\circ C$  • **Wide Temperature Range**  $-55^\circ C$  to  $150^\circ C$  • **Low Temperature Coefficient** 70 ppm max. • **Low Noise**  $100\Omega$  max. ENR • **Small Size**  $\frac{5}{16}$ " x  $\frac{5}{16}$ " x  $\frac{3}{16}$ ".

Weston Instruments, Inc. • Weston-Archbald • Archbald, Pa. 18403

**WESTON®** prime source for precision... since 1888

Circle 124 on reader service card



# Probing the News

Electron Devices Meeting

## Semiconductor technology steps up

Electron-beam etching, better isolation and variable resistors for integrated circuits and red-hot transistors are fruits of new techniques

A quicker, cleaner, more precise method of producing semiconductor devices may be the most valuable payoff to date from years of research on electron-beam processing of semiconductors. Electron-beam activation of the oxide coating on a silicon wafer allows diffusion windows and contact holes to be etched in the oxide without photoresist. Etching of the oxide is a key step in planar processing—the technique for making monolithic integrated circuits and most types of silicon transistors and diodes.

Details of the process will be reported by two scientists from the Westinghouse Electric Corp. Research Laboratories, T.W. O'Keeffe and R.M. Handy, at the Electron Devices Meeting in Washington, Oct. 26 to 28. In their lab, they have already made power transistors, one of which is shown in the photograph on page 126.

Several other advances in semiconductor processing will be reported by other researchers. One new method allows metal-oxide-semiconductor devices to be made along with conventional transistors in monolithic IC's. Two new ways of isolating IC devices—with air and with ceramic—will also be discussed. And a variation of planar processing has produced transistors that operate at 500°C.

### I. A flood of electrons

The electron-beam process, under development at Westinghouse, is more than a shortcut. The etching resolution is better than that attainable with ordinary photoetching methods, indicating that the process will aid in the development of smaller, higher-frequency devices and more complex IC's.

Although laboratory techniques for processing semiconductors with electron beams have existed for several years [Electronics, Nov. 16, 1964, p. 82], manufacturers have shied away from them because they have been costly compared with conventional photoetching. Researchers have generally programmed a slim beam of electrons to trace etching patterns in etching resist.

Handy and O'Keeffe found that neither programming nor resist are needed. When a flood beam of electrons bombards the silicon wafer through openings in a mask, the electrons passing through openings in the mask increase the chemical activity of the oxide under the openings. The electrons, ranging in energy from 1,000 to 15,000 electron volts, aren't energetic enough to damage or crystallize the oxide

which is a thermally grown silicon dioxide.

Chemical etchants eat away the bombarded areas faster than the areas not bombarded—typically, three times as fast. After the silicon crystal under the bombarded areas is bared by the etching, the remaining oxide is still thick enough to mask the remainder of the wafer during device diffusion or contact metallization.

**Swift and safe.** Conversion of the oxide coating into its own etching mask, in essentially one step, is what makes the technique feasible for mass production. Oxide layers may have to be grown and etched several times during the production of IC's and complex devices. Each photoetching cycle now requires resist application, exposure, development and—after the windows are etched—cleaning the re-

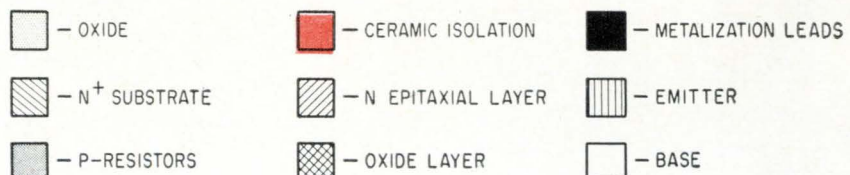
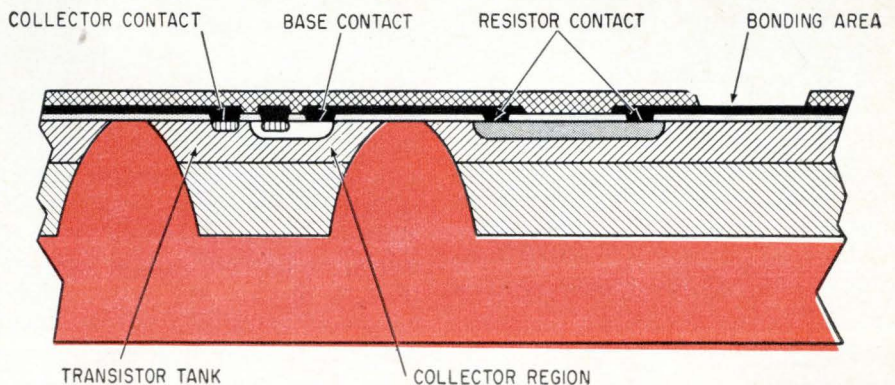

Ceramic-isolated integrated circuits with cross sections like this are being produced by Texas Instruments. The process allows IC devices to compete in performance with discrete components.



sist from the silicon wafer.

The Westinghouse technique also avoids the possibility of bombardment damage. Handy says the beam energies are too low for that. Any residual effects are erased by the annealing that occurs when the wafers are heated during the diffusion cycle following bombardment and etching of the oxide.

**Tinier holes.** O'Keeffe and Handy have etched windows as small as 0.6 by 5 microns in oxide films 6,000 angstroms thick. The window edge slope was 55°. For extra precision a steered or scanned electron beam can be used, rather than a masked flood beam, to activate the oxide.

Westinghouse and other laboratories have used such discrete beams to expose photoresist, to etch diffusion windows for extremely small devices and to etch metal films, for tailor-made device electrodes and IC wiring. At the conference in Washington, M.W. Larkin and R.K. Matta, of the Westinghouse Labs, will tell how they used this alternative technique to make transistors with emitter contacts only 1-micron square. The entire active area of the transistors measures 0.0002 by 0.006 inch. The small sizes result from defining geometries with narrow, intersecting stripes and by isolating the devices with lateral diffusion under the oxide around the windows.

## II. Double-duty process

A way of getting high-value, adjustable resistors in IC's will be described by John E. Price, of Fairchild Semiconductor Research and Development Laboratory. Fairchild is a subsidiary of the Fairchild Camera & Instrument Corp. Price makes IC's that operate on very low currents by adding metal-oxide-semiconductor resistors to IC's with bipolar transistors. The

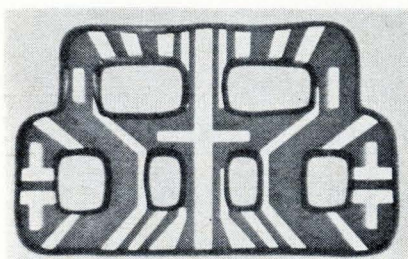

After etching, the Texas Instruments circuits look like this.

MOS resistors are made by varying the techniques used to make MOS transistors.

IC's with bipolar transistors usually have diffused resistors, which are relatively large, lack precision and have fixed values. The MOS resistors are tiny devices whose resistance value can be changed by varying the control voltage on their gates.

The thin, insulating-gate oxide for the MOS resistors is grown after the base and emitter junctions of the npn transistors are formed. This prevents the junction diffusers from contaminating the oxide. The oxide is formed by a room-temperature method, instead of high-temperature oxidation, to avoid heat that might cause the diffused junctions to move.

The oxide is grown by anodic oxidation. The anode—the silicon wafer—and a cathode are immersed in an electrolytic solution. Passing a constant current between the anode and the cathode converts the silicon surface to silicon dioxide. The thickness of the oxide, Price says, can easily be controlled to within 50 angstroms. It is proportional to the voltage drop from anode to cathode.

## III. Substitute for SOS

Another clever Fairchild technique will be reported by Bert L. Frescura, Roger Rusert and Jon Schroeder. It provides the isolation of devices needed in IC's.

Instead of diffusing isolation regions in the silicon wafer while making the IC's, the Fairchild team does it afterwards by a method called mesa isolation. Only the devices are diffused in the silicon. After the devices are interconnected, the wafer is coated with glass and bonded face-down to a substrate. Excess silicon is removed from the back of the wafer by lapping and the silicon between the devices is etched away.

In feasibility demonstrations, diode-transistor logic gates, with thin-film, nickel-chromium resistors, have been made. Fairchild thinks the technique is better than conventional isolation in three respects.

- The surface of the wafer is not made bumpy by isolation processing. A smooth surface is ideal for precision photoresist masking,

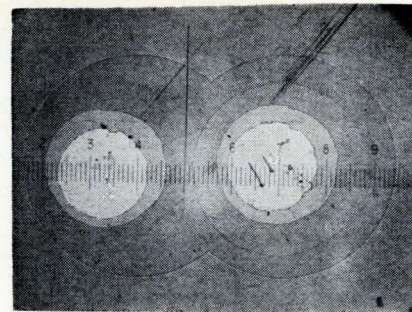

Transistor made by electron-aided etching. The smallest circle is 13 mils in diameter. Areas as small as 0.6 by 5 microns have been etched.

needed to make small devices.

- The high temperatures of conventional isolation processes are avoided, so there is no alteration of the thickness of epitaxial layers of silicon or change in device diffusion profiles. This results in better control of device characteristics.

- Because the devices end up protected by glass and a substrate packaging costs might be lowered.

The resulting circuit resembles one made by the silicon-on-sapphire process, with air isolating the devices [Electronics, May 30, 1966, p. 152A]. A year ago, the Hughes Aircraft Co. proposed a similar technique as a substitute for etching around the devices in a silicon-on-sapphire circuit, but Hughes has not yet disclosed what progress it has made. Bell Telephone Laboratories, Inc., also isolates devices in its beam-lead circuits by etching away excess silicon, but the devices are held together by gold connecting bars.

**Ceramic isolation.** Early this year, the Radio Corp. of America disclosed a method of binding small silicon crystals together with ceramic. After the crystals in the mosaic were processed, RCA would up with devices isolated by the ceramic [Electronics, March 7, 1966, p. 33].

At the conference, Texas Instruments Incorporated will disclose that it is already selling circuits with ceramic isolation. TI, however, isn't making them the way RCA does. Texas Instruments processes the silicon wafer in the usual way, except that it omits isolation diffusion and coats the wafer with glass.

Like Fairchild, TI glues the wafer to a glass plate and etches away the silicon, producing IC's



that look like the ones in the photo at the left. Then TI fills in the etched holes with ceramic and takes away the supporting plate, resulting in the structure diagrammed on page 125.

This kind of isolation allows IC components to perform like discrete components in circuits such as high-gain amplifiers, according to T.H. Ramsey and Tim Smith, of TI's circuit development and application group. Device processing is simplified, so that both pnp and npn transistors can be made and yields are as high as 75% good IC's on a wafer. The circuits are very rugged, Ramsey and Smith report, and withstand high temperatures and radiation. One group of circuits was still operating within specifications after 2,000 hours at 200°C.

#### IV. High-temperature transistors

After a decade of effort, the Westinghouse Research Laboratories are cooking up some good silicon-carbide transistors. N. Formigoni, J.S. Roberts and H.C. Chang have built SiC field-effect transistors that show an average power gain of 10 at a temperature of 500°C.

A new version of planar processing allows as many as 25 FET's measuring 0.030 by 0.040 inch to be made in a single platelet of SiC. Aluminum is diffused into the platelet to a depth of about 1.3 mils, forming the lower gate of each FET. The p layer on the "carbon" face of the crystal (the opposite face is called the silicon face) is lapped off and that face is polished.

Next, the planar structure of the upper gate region is formed by a unique, self-masked diffusion process. The polished surface is oxidized and windows are etched in the silicon dioxide. The gate pattern is etched into the crystal with a chlorine etchant. The upper gate junction is formed by aluminum diffusion to a depth of about 0.5 mil. Channel thickness is 1 to 2 microns.

During diffusion, the unetched SiC acts as the diffusion mask. After diffusion, the SiC is lapped again to make the carbon face planar and to expose the source and drain regions of the FET. Tantalum-gold ohmic contacts are applied.

## MOL Resistors

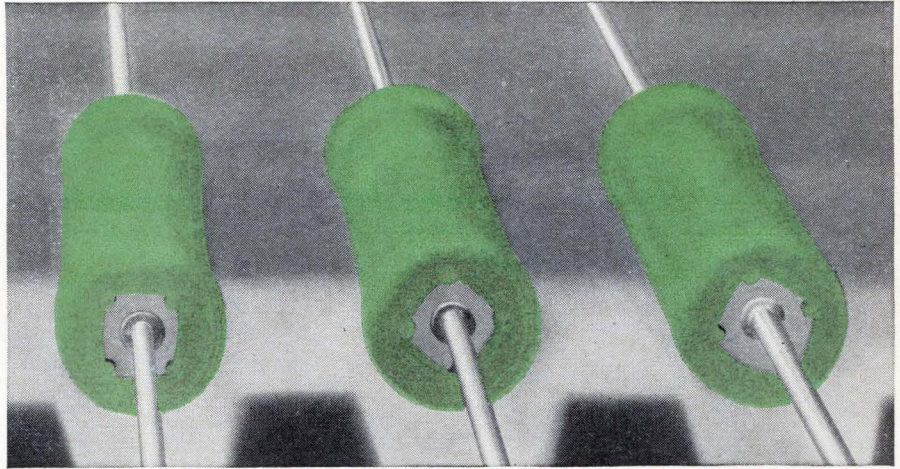

# Consistently high QUALITY

... is one of many reasons why every major TV manufacturer uses Mallory MOL film resistors. Out of millions made in the past two years, customer rejections have been practically nil. Reason: automated production backed by tight quality control. There are other reasons, too: temperature coefficient only 250 PPM/°C; proved flame resistance; less than 5% resistance change after 10,000-hour load-life tests; high stability in humidity. *And* prompt shipment of orders. Write for data and quotation. Mallory Controls Company, a division of P. R. Mallory & Co. Inc., Frankfort, Indiana 46041.

50<sup>th</sup>  
ANNIVERSARY

MALLORY



# SIGNETICS- FOR ONE-STOP SHOPPING IN DTL OR TTL CIRCUITS IN DUAL IN-LINE PLASTIC PACKAGES



for military GSE and Industrial/Commercial applications.

Now you can choose from four circuit families in two temperature ranges for military ground systems, industrial and commercial systems. Only Signetics offers this wide a selection of trade-offs in speed, power, overall performance and price.

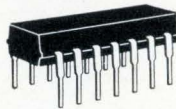

Fill your needs from these four circuit families — all available in Signetics low cost Plastic Package.

MILITARY GSE	NE 100 A DTL 0-70° C	NE 400 A Low Power TTL 0-70° C	NE 800 A High Speed TTL 0-70° C
INDUSTRIAL	ST 600 A DTL 0-70° C	ST 400 A Low Power TTL 0-70° C	ST 800 A High Speed TTL 0-70° C
COMMERCIAL	SP 600 A DTL 15°-55° C	SP 400 A Low Power TTL 15°-55° C	SP 800 A High Speed TTL 15°-55° C

**SIGNETICS  
INTEGRATED  
CIRCUITS**



A subsidiary of Corning Glass Works, 811 East Arques Avenue, Sunnyvale, California. Tel: (415) 739-7700 TWX: (910) 339-9220



# Laser may light ocean depths to allow precise positioning and mapping

Hydrographic survey system using automatic laser is latest of several electronic positioning techniques being weighed by marine geodesists who seek to chart the ocean bottom

By Robert W. Henkel

Electronics Washington Bureau

A hydrofoil craft skims the waves at 80 knots dodging enemy shells as it sweeps up a seacoast on a hydrographic survey mission. Next day detailed information on the coastal sea bottom is culled from the quick run. And in just seven days a chart of the area is ready.

The mission will sound like fantasy to anyone familiar with the problems of mapping the sea bottom. But the Naval Oceanographic Office intends to build a hydrographic survey system, HySearch, capable of such mapping—and may use an automatic laser to obtain the fast, accurate positioning data the system needs.

The laser is one of many electronic positioning devices geodesists are considering to help them expand their knowledge. Without an accurate position reading, mapping is futile. Yet the sextant, in use since 1731, is still the best instrument for determining position in many parts of the world, as marine geodesists admitted at the first symposium for their specialty, held recently in Columbus, Ohio. There, they heard both sides of the question of using active and passive underwater "benchmarks," hyperbolic radio positioning systems such as loran C, satellite and airborne systems—and lasers.

The turnout of 400 marine geodesists—more than expected—reflects the growing interest in the ocean floor. And as the military and industry look to the sea, mapping becomes more urgent.

Knowledge of the ocean floor with precision positioning is necessary in exploring for petroleum and hard minerals, for underwater search, fishing, mining, recovery and salvage operations. Lack of

Jones of the Coast and Geodetic Survey. He urged that the survey be authorized to establish basic marine geodetic networks as recommended in a report made by the President's Science Advisory Committee's Panel on Oceanography in July, 1966 [Electronics, Aug. 8, p. 50]. If it gets the money the group will carry out plans now being made to establish networks on the continental shelf.

Sometime in the year ahead, a passive marker will be located off the coast of Maine—a 2,000-pound anchor and a subsurface buoy moored 150 feet below the surface. It will be used by ships with echosounding equipment in a geodesy pilot project. The geodetic group is considering placing a number of markers about 25 miles apart along the Maine-Massachusetts coast in fiscal 1968. A study will be made of the accuracy in locating the markers, the cost and their stability.

The accuracy needed in marine geodesy is  $\pm 50$  feet in the open seas from 300 to 1,000 miles from shore and  $\pm 100$  feet in the deep portions of the ocean.

## The security risk

Everyone agrees that better marine geodetic tools such as navigational satellites and geodetic networks on the sea bottom are needed now to aid in precise ship positioning and surveying. However, the Pentagon is hedging a bit. It worries that such navigational and positioning aids could benefit a potential aggressor. An enemy submarine carrying missiles, for example, could use a geodetic network off the coast of the United States to position itself.

A hint of the problem came at the Marine Geodesy Symposium in Columbus, Ohio, when Capt. D.A. Jones of the Coast and Geodetic Survey cautioned that "our national security could be affected by the dissemination of data by these geodetic nets." This must be considered by geodesists, in their planning, he maintained.

"There's a good chance that the Russians are using the Navy's navigational satellite system, formerly called Transit, for positioning and navigating some ships," a Pentagon source says. The Russians have given technical papers based on the use of an unnamed navigational satellite that could very well be the Navy system.

The shipboard equipment needed to acquire and process the satellite signal and obtain usable position data is unclassified and can be put together for as little as \$35,000, excluding the data processor. A typical system would include two phased-locked receivers, which send the signals to an ionosphere refraction correction unit. The signal then goes to a mixer which then feeds a data recorder.

maps has handicapped companies seeking drilling sites and selecting pipeline and cable routes.

Actual marine geodetic activity to date has amounted only to a "drop in the ocean," said Captain D.A.

## I. The alternatives

Active bench marks (sonar-beacon positioning systems anchored to the bottom) will play a role in



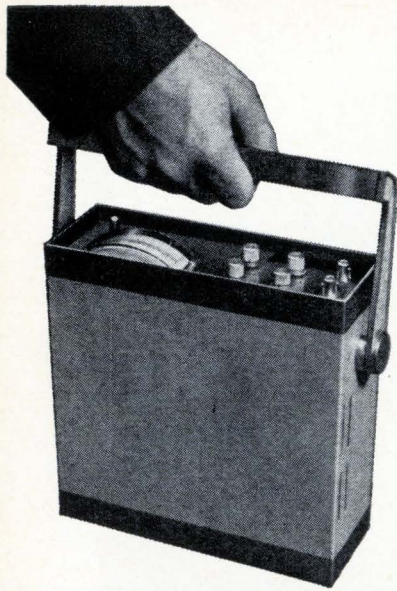

## Portable SOLID STATE PHASE METER

MODEL PM-720

ISA SHOW BOOTH 1500

Provides exacting accuracy with compact portability at low price. Advantages: Light weight (5 lbs.) ...3 1/8" height...Absolute panel meter accuracy of  $\pm 1^\circ$  or 2%... External output relative accuracy of  $\pm 0.20\%$ ...Equal accuracy for symmetrical waveforms of any shape...Two inputs can have amplitude differences of 1,000 to 1 without affecting phase reading... Direct phase angle readings between  $0^\circ$  and  $360^\circ$  without adjustments or phase shift insertion instruments. Price: \$950.

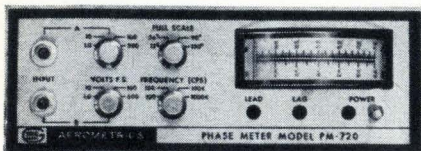

For complete specifications write to:  
R. H. DOW, MGR., AEROMETRICS,  
AEROJET-GENERAL CORPORATION,  
P. O. Box 216-F5, SAN RAMON, CALIF.

# AEROMETRICS



marine geodesy, in the opinion of Warren A. Tyrrell of Bell Telephone Laboratories. "It will take no technical breakthroughs," he said. "With great care in system design and careful operation, accuracies of 10 feet can be obtained," Tyrrell believes.

A more practical accuracy for the network is about 100 feet, he added, although others said 300 feet is more like it; inherent limitations include equipment losses and bandwidth. If a wide bandwidth is used for more accuracy, more noise develops. Practical limitations include power requirements, hardware design and the high cost of installing the network.

Walter N. Dean, one of the developers of loran C at the Sperry Gyroscope Co., a division of the Sperry Rand Corp., described some of the problems in using hyperbolic radio positioning systems for geodesy. He said the accuracy of loran C, operating at 100 kilohertz, is affected by noise and interference, adding that synchronization and propagation errors are inherent in the system.

Decca, also operating at 100 kilohertz is a ground-wave system that depends on the stability of the waves. Because of its short range, particularly at night when the range is below 100 miles, Decca is not applicable to geodesy, he said.

He noted that the Omega system, a long-range network of worldwide stations operating at 10 kilohertz, is still experimental. "I'll bet we'll have a man on the moon before there's an eight-station Omega," said Dean. Data taken from Omega so far has been during the quiet time on the sunspot cycle. Solar flares, which are now increasing, will disturb the Omega very-low-frequency phase signal more and more. "Omega propagation data now coming up will be less stable than you're getting now," he maintained.

Few shore-based navigation systems are suitable for marine geodetic surveying in ranges beyond the line of sight, said Angelo A. Ferrara of the geodetic survey. Speaking as an electrical engineer and not as a geodesist, he said, "I'm skeptical about the long-range accuracies claimed by people for this equipment."

The Navy's navigational satel-

lite system, formerly Transit, shows promise for precise positioning using doppler-shift measurements. Accuracy is affected, however, by the "ability to track the satellite, which is now accurate only to 50 to 75 meters because we don't know enough about the gravitational field of the earth," acknowledged Robert R. Newton, Johns Hopkins University's Applied Physics Laboratory, the developer of the system. This error is in addition to another 10 meters from instrument errors.

## II. The laser

The Naval Oceanographic Office is considering the possibility of using the coherent-light properties of the laser for the short-range, precise navigation needed for inshore hydrographic and oceanographic survey control. Other efforts to apply lasers to geodesy have been in range measurement only; the Navy seeks an automatic instrument capable of measuring direction as well.

The feasibility of using the laser for direction measurement has been demonstrated in tests on an automatic laser ranging and direction instrument—or Alradi for short. It is a single-unit, dual-purpose instrument with automatic readout. Results so far indicate that it can be used to make direction measurements, said Leslie L. Cunningham of the Precise Positioning Branch of the Naval Oceanographic Office. He believes that with better optics for collimating the laser output and a good light receiver, the system should make first-order, geodetic measurements in both range and direction.

Only one instrument would be needed for trilateration, triangulation and high-speed traversing. Marine geodesists could use Alradi as both a range and direction theodolite and as a precise positioning system for high-speed, inshore hydrographic survey vehicles, he said.

Studies will begin on the hydrographic survey system, or Hy-Search sometime in the next year or two, but the Oceanographic Office will probably put out a request for proposals to industry in the next few months on a first generation, demonstration model of the laser system. About \$100,000 has been allocated. Several companies



including Sanders Associates, Inc., Lear Siegler, Inc., and the Radio Corp. of America, are said to be interested. One company has already told the Navy it could provide a breadboard model of the unit primarily from off-the-shelf components six months after getting the order. Specifications aren't firm, but the Navy wants the portable system "as small and as light as possible." It would be carried on anything from a hydrofoil craft and a ground-effect machine, which rides over water and land on a cushion of air, to helicopters and pilotless drone aircraft. The precise positioning equipment would also be used with a new geophysical survey system intended for fast acquisition of gravity and magnetic data at sea.

**In close.** Alradi could handle this positioning job, Cunningham says, and could give continuous positions of survey vehicles running at speeds from 50 to 400 knots. Active shore-based stations would not be necessary, thus permitting the laser system to operate near an enemy shore. In such operations, it would have to use the "resection method," determining position by angle or range observations taken from the vehicle toward points of known location on shore.

The Alradi laser obtains geodetic accuracies at distances up to at least 10 miles, Cunningham says, measuring range through pulsing, time delay reading or phase comparison. Measuring direction accurately is more difficult. Azimuth readings with Alradi are obtained by swinging a fan-shaped beam in both directions about an axis perpendicular to the direction being measured. Several measurements are made to eliminate the effect of scintillation and nonsymmetry of the beam.

The laser system has one great advantage: it can be completely automatic even to the recordings—eliminating the human error factor, which Cunningham described as "one of the greatest sources of error in geodetic observations." With Alradi, the operator has little more to do than turn it on.

After completing observations, he takes out a tape, gives it a quick check and moves on to the next station.

Alradi can operate two ways on

a ship or aircraft moving at 400 knots. One mode provides high readout rate and accuracy and the other offers a wider range of applications with varying accuracy and readout rate.

**Find target.** Multiple sets of laser optics would be used in one mode with continuous readout of both range and bearing. A light-seeking unit connected to each set of optics will lock a laser beam to one target on shore. The target can be a retro-directive prism, giving the strongest return, or any outstanding landmark which reflects well. Movements of the vehicle would be reflected as the reading changes. Extremely accurate positions can be obtained by two sets of laser optics, he noted. Great accuracy can also be obtained by installing two single laser instruments.

The second mode swings a single fan-shaped beam in only one direction; beamwidth and scintillation will cause direction inaccuracies. To improve readings, a light-seeking unit can be included to center and hold the beam on target for longer sampling times—up to one or two seconds.

The more slowly the beam is swung and the longer the lock-on time, the greater the accuracy; but the readout rate will be slowed in proportion.

Cunningham demonstrated the direction-measurement capability of the system by building Alradi at Ohio State University in Columbus. He tied the components together mechanically and electrically into an integrated unit powered by a 12-volt, d-c automobile battery. With only \$2,000 to spend, he used the following components: a battered theodolite base that had seen service in the South Pacific, a 1-milliwatt-output, continuous-wave, helium-neon gas laser (it cost him only \$475), a laser power supply, photomultiplier tube, tube power supply, an optical interference filter and beam splitting and shaping optics.

Tests made at short distances were successful, but showed the need for a beam splitter to direct the returning signal from the prisms into the photomultiplier tube automatically.

A difference of only 2.4 seconds was measured between the two mean angles.

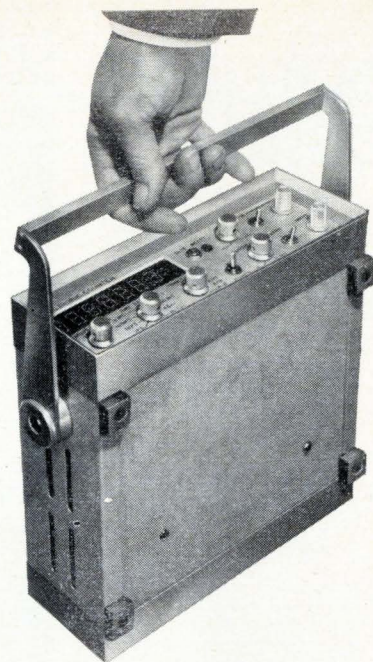

## Portable ELECTRONIC COUNTER

MODEL EC-715

A compact, high speed (10 mc—7 digit), counter-timer providing frequency, period and time interval measurement capability found only in units of greater size, weight, and cost. Unique in performing as integrating digital voltmeter with optional voltage-to-frequency converter. Light weight (7 lbs.) enables ideal utilization for field service.



For complete specifications write to:  
R. H. DOW, MGR., AEROMETRICS,  
AEROJET-GENERAL CORPORATION,  
P. O. Box 216-F5, SAN RAMON, CALIF.

## AEROMETRICS





**RCA**  
integrated  
circuits 

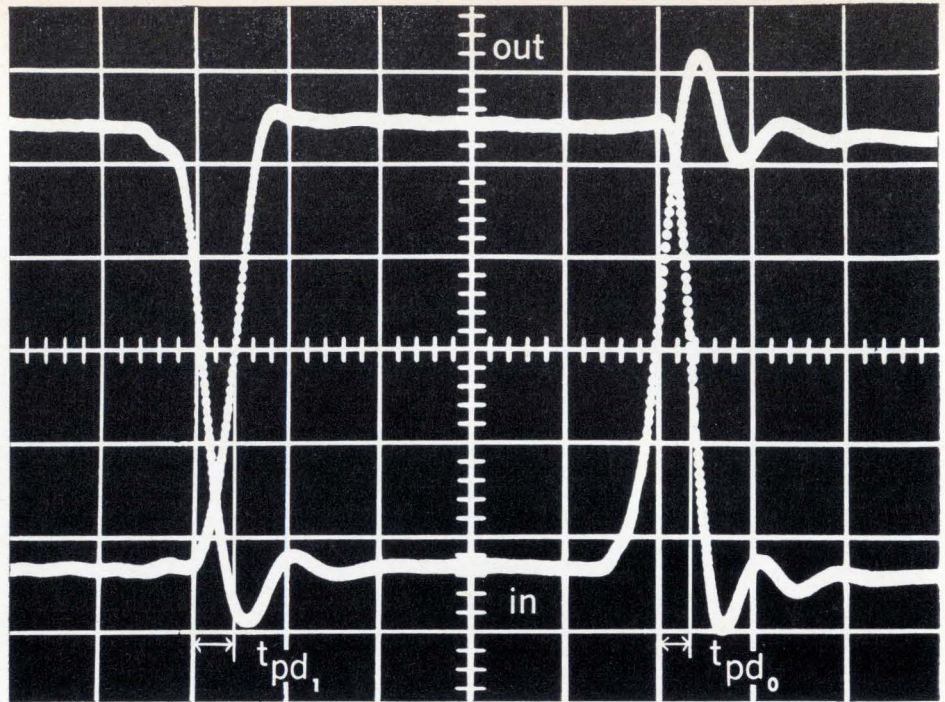

NOR Output, each division = 10 nsec.

# 3.6 NSEC LOGIC\*

- In high-volume production
- \$3.25 (1000+ price)

**RCA'S ULTRA-HIGH-SPEED ECCSL** (Emitter-Coupled Current-Steered Logic) integrated circuits—offering the speed of non-saturated switching and the flexibility of complementary OR/NOR logic—are now available immediately.

#### FEATURES

- Built-in reference voltage source. Temperature tracking of reference voltage with "0" and "1" levels provides increased noise immunity.
- Single negative 5-volt power supply.
- Constant-current differential switching—minimizes power supply noise.
- 100-ohm terminated transmission line drive capability.
- Reliable aluminum-to-aluminum ultrasonic bonding.

**RCA'S UNIQUE** 14-lead hermetically sealed, flat pack features welded top closure and exclusive brazed-lead construction. Since leads do *not* pass through body of package, lead handling and flexing put no stress on device.

#### THESE THREE TYPES FOR YOUR PRODUCTION REQUIREMENTS

- CD 2150 dual 4-input ECCSL gate.
- CD 2151 dual 4-input ECCSL gate with "wired OR" output capability.
- CD 2152 8-Input ECCSL gate with "wired OR" output capability.

For prices and availability in quantities of 1-999, contact your local RCA Distributor. For immediate engineering and volume-delivery information, call your local RCA Representative or Art Liebschutz at (201) RA 2-3200, Ext. 617.

**EXTENSIVE** technical and application information is available in RCA Technical Bulletin CD2150-CD2152 and Application Note ICAN-5025—write to: Commercial Engineering, Section 1CN 10-3 RCA Electronic Components and Devices, Harrison, N.J. 07029.



\*Typ average propagation delay 3.6 nsec for fan-out of 1+10pF/7.3 nsec for fan-out of 6+60pF

**NOW AVAILABLE FROM DISTRIBUTOR STOCK**



RCA Electronic Components and Devices

**The Most Trusted Name in Electronics**



# Changing of the guard

Offshoots of alarm systems designed to reduce number of hard-to-get plant guards enable Securitas to prosper as one of Sweden's most unusual electronics firms

By Robert Skole

Stockholm correspondent

Sweden's break-and-enter set is finding it harder and harder to make ends meet. The police and the burglars have to contend with 4,000 guards deployed by Bevkning AB Securitas, Europe's largest private security organization. But adding to the frustration is an extensive network of sophisticated alarm systems developed by AB Securitas Alarm, perhaps the country's most unusual electronics company.

As the manufacturing subsidiary of a private guard company, Securitas Alarm started out making alarm equipment. But when the firm began producing closed-circuit television systems for surveillance it uncovered a flourishing market for tv monitoring in a variety of industries.

**Out front.** Over the years, the company has turned to radar, infrared and ultrasonics in order to keep ahead of the increasing technical skills of criminals. Because of its constantly sharpened electronics talents, Securitas now is looked upon as a "problem-solver" by Swedish businessmen.

When Svenska Esso wanted an automatic self-service gasoline pump, it turned to Metior AB, a subsidiary Securitas set up jointly with a packaging company to exploit an electronic system Securitas originally developed for plant gates. And when Swedish road authorities needed a system to warn truck drivers of low bridges ahead, they too turned to Metior.

With its alarm equipment and the electronic offshoots it has spawned in other fields, Securitas Alarm sees some heady growth in sight. Last year, sales were up 50% to \$2 million, out of a total of \$24 million turnover for the guard com-

pany group. Nils Trollstad, a vice president of the parent company and managing director of Metior, expects the group's electronic business to grow about 30% annually over the next few years.

In electronics, Securitas plans to stick pretty closely to what it's doing now—closed-circuit tv, security

cards punched with a code that is read out optically. At the same time he slips his card in the reader, the card holder adds a checking code number by means of pushbuttons on the reader. Both the optical readout and the checking code are fed to a computer, which sends back a signal that opens the

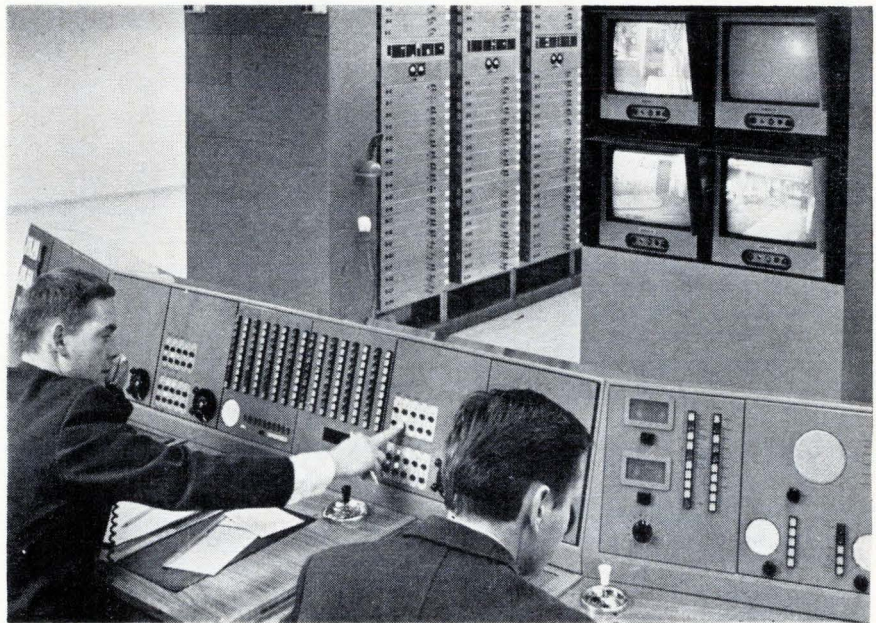

Securitas' central alarm station in Stockholm, largest in Europe, is tied by telephone lines to 4,000 surveillance systems in the city.

systems, and specialized data-processing applications.

## I. Through the gate

One of the specialties Trollstad counts on heavily is Metior's automatic credit-card reading system. It evolved out of the gate-security system the company unveiled two years ago and was developed to cut down the number of guards—hard to recruit in labor-short Sweden—at plant gates. People authorized to enter a facility get identi-

gate if the two inputs match. If they don't, an alarm sounds at the central security station where the computer is located. So there's no chance—collusion excepted—that an unauthorized person can get through with someone else's card.

**Pumped up.** When Securitas first showed its gate-security system at a Stockholm fair, engineers from AB Tetra Pak, a Swedish packaging company, saw in it the answer to a problem they were trying to solve. Tetra Pak, which at the time





**this  
DIMCO  
snapslide  
fastener...**

**holds assemblies  
securely...**

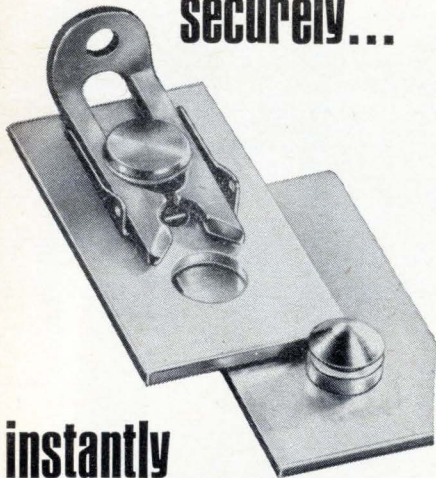

**instantly  
engages/releases...**

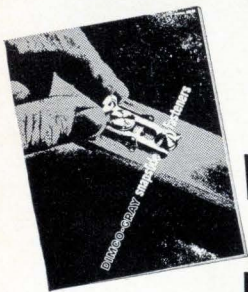

**write for  
new  
handbook**

Dimco-Gray Snapslide Fasteners hold assemblies firmly despite shock or vibration... never need adjustment, even with repeated use. Instant snap action engages or releases fastener... no tools required. Approved under Military Standards. Handbook illustrates typical applications, stimulates design ideas, describes attachment methods. Write for free copy today.

DIMCO-GRAY CO., 204 E. SIXTH ST., DAYTON, OHIO 45402

## ... 3 men control 4,000 Stockholm alarm systems with an arsenal of hardware at a central station ...

had a subsidiary that made coin-counting machines, wanted to develop a "moneymat" that would dispense cash to checking-account holders after banking hours. As a result, the two companies formed Metior to adapt the system to uses other than security. Although still not a year old, Metior expects to do about \$1 million in business during its first year.

Metior's first customer, Svenska Esso, wanted to explore the marketing possibilities of a round-the-clock, self-service gas pump. For the plant gate, credit card holders use a punched identification card and a code number that doesn't appear on the card. At the service station a match of the readout and the checking code number in the computer (located in the station) turns on the gasoline pump. The motorist fills his tank and the computer calculates the sale and records the amount and account number on punched tape.

Esso first tried the automatic self-service pump in Stockholm last year. Now the company has added a second test station in the industrial city of Vasteras.

**Quick cash.** The first of the "moneymats" will go into operation next January. It will operate almost like the automatic gas pumps. But in addition to the match in the credit-card reading system computer, there'll be an additional check by the bank's computer. The local computer will not put out an actuating signal to release cash until it receives a signal from the bank computer that the account has a balance big enough to cover the withdrawal. At the same time, the withdrawal will be "entered" in the bank computer.

Metior's skill at developing variants won it a contract to work up a system that lets a single operator control a 4,000-car parking garage. Coded discs control entries and exits plus a computer to calculate parking charges [Electronics, May 16, p. 211].

Another recent effort was a system to warn truck drivers and bus drivers when they're approaching a bridge their vehicles won't clear. The system uses photocells,

mounted on roadside poles, to spot over-height vehicles and turn on stop lights when necessary.

### II. Sense of security

Although its Metior subsidiary ranges wide, Securitas Alarm sticks to security in its electronics work. Understandably enough, Trollstad won't go into details about Securitas' detection equipment but says they use radar, ultrasonics, photocells, temperature-sensitive contacts and magnetic contacts as well as tv monitors and conventional electromechanical contacts.

Securitas has, for example, a detector that senses changes in an object's natural frequency; any tampering with the object triggers the alarm. Another component now going into Securitas systems is a special microphone that picks up vibrations in the walls of a safe only when the walls themselves are touched.

**Elaborate.** Recently, Securitas has tended toward complex systems in its fight to protect customers from miscreants or just plain misfortune. One of the latest is the so-called Securiphone. It ties an alarm system into the telephone network and signals a central station whenever an intruder sets off the local alarm.

Another elaborate system that Securitas has developed has become a best seller to European banks. The system monitors by remote control the opening and closing of safe-deposit boxes.

For itself, Securitas has built in the heart of Stockholm Europe's largest "central alarm" station. The station is hooked by telephone lines into some 4,000 alarm systems throughout the city and is designed to handle up to 20,000.

For each system, there's a chart recorder that shows when the system was turned on and off and when alarms were signaled. In addition, there's a battery of monitors for checking locations equipped with tv surveillance systems plus automatic tape recorders that log every incoming call to the station. Backed up by all this hardware, it takes just three men to run the station.





# new disciplines in DC

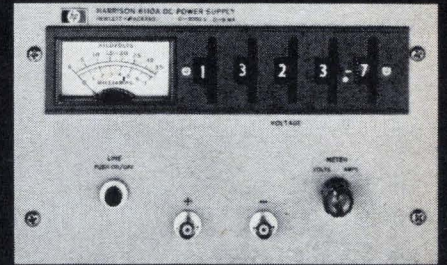

## take the high voltage models with all-silicon circuitry

### 3 Power Supplies Offer Choice of Voltage, Performance, Price

#### High Voltage

Select the model with 0 to 1600 volts DC output at 0 to 5ma. Regulation, less than 0.01%, and less than 5mv p-p ripple and noise. Stability better than 0.05%.

**Model 6515A** — 3½" High, Half-Rack Width. Price ..... \$235.

#### Higher Voltage + 4-Digit Voltage Programmer

Add 1400 volts and get 0 to 3000 volts at 0 to 6ma, plus a 4-digit front panel programmer for selecting the output voltage. Ripple and noise less than 5mv p-p, stability better than 0.05%.

**Model 6516A** — 5¼" High, Half-Rack Width. Price ..... \$295.

#### 5-Digit Voltage Programmer + Better Regulation, Stability

Add an all solid-state temperature-controlled oven and sophisticated circuit refinements, plus another digit of resolution to the output programmer, and achieve stability and resettability of 0.01%, regulation of 0.001%, and less than 1mv p-p ripple. Output is 0 to 3000v DC at 0 to 6ma.

**Model 6110A** — 5¼" High, Half-Rack Width. Price ..... \$495.

Low p-p Ripple and Noise • Line and Load Regulation An Order of Magnitude Better Than High Quality Laboratory Supplies • Output Continuously Adjustable Down to Zero • Self-Protecting — Current Limit Circuit • Low Output Impedance • Less Than 100 µsec Load Transient Recovery • No Overshoot on Turn-On, Turn-Off or AC Power Removal Floating Output — Ground Either Positive or Negative Terminal • Half-Rack Width — Rack Mounting Hardware Available.

Contact your nearest Hewlett-Packard Sales Office for full specifications





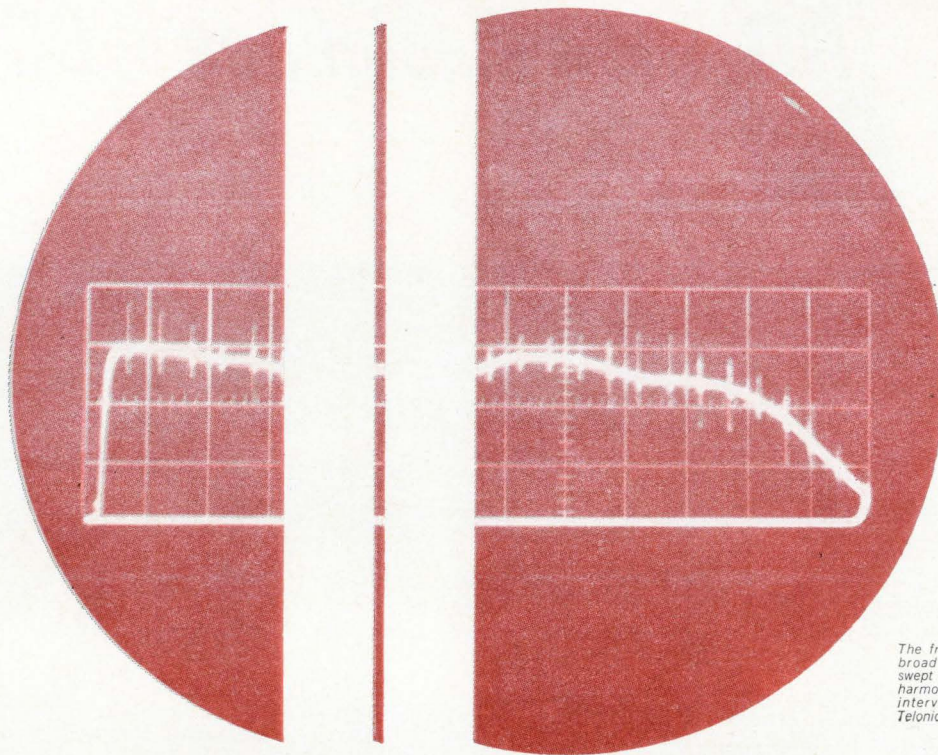

The frequency response of a broad-band video amplifier swept from .5 to 20 MHz, with harmonic markers at 1 MHz intervals. Instrument used: Telonic 1001 Sweep Generator.

# FREQUENCY RESPONSE IS A FULL SWEEP

Why settle for a point of response when you can see the entire picture? From DC to 3000 MHz there is no area of the spectrum that can't be reached, spread, shrunk, calibrated, or exhibited by a Telonic Sweep Generator. There are over 30 instruments available to cover your specific and general areas of interest—instruments that provide more pre-

cise data, faster, and with a higher degree of reliability. See them all in detail in Telonic's Catalog No. 70 — also containing an entire section on sweep generator applications and techniques. It is yours on request.

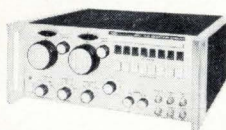
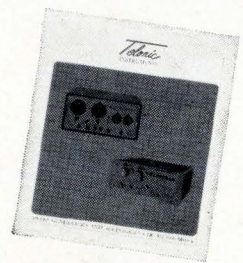

**1001** — SOLID-STATE SWEEPER WITH HIGH STABILITY, 100,000:1 RANGE, AND UNPRECEDENTED MARKING SYSTEMS - 10 kHz TO 20 MHz



**SM-2000**—A BASIC CHASSIS FOR SWEEP AND CW, ACCEPTING OVER 20 PLUG IN OSCILLATORS COVERING 20 Hz TO 3 GHz

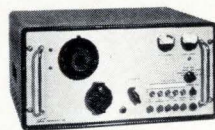

**PD-SERIES** — WHEN A HIGH POWER (4 WATTS) OUTPUT IS NEEDED FOR APPLICATION SIMULATION — 4 MODELS RANGING FROM 20 TO 1000 MHz



**HD-SERIES** — FOR ECONOMY AND FLEXIBILITY IN THE LAB OR ON THE PRODUCTION LINE, 4 INSTRUMENTS COVERING 10 kHz TO 900 MHz



**SV AND SD-SERIES** — SPECIFICALLY DESIGNED FOR TV-FM-AM CIRCUIT DESIGN AND TEST. 6 MODELS WITH OPTIONS TO FACILITATE PRODUCTION CHECK OUT, THEY COVER 20 TO 920 MHz.

Representatives throughout the U.S., Canada and Overseas. Branch offices in Maidenhead England and Frankfurt, Germany.

**Telonic** INSTRUMENTS  
A Division of Telonic Industries, Inc.

60 N. First Ave., Beech Grove, Indiana 46107 • TEL (317) 787-3231 TWX-810-341-3202

ENGINEERING CAREER OPPORTUNITIES AVAILABLE.



# U.S. invites NATO to share a satellite

French leave intensifies North Atlantic Treaty Organization's need for communications network that will bypass France

**Charles de Gaulle's** withdrawal from the North Atlantic Treaty Organization may introduce satellites into NATO's nearly completed ground communications network sooner than planned.

To bypass the portions of the ground system that went through France, the United States has invited NATO countries to use the existing American military communications satellite system now, and to join in development of a new satellite system specifically for NATO. The satellite will hover over the mid-Atlantic near the equator. Such a satellite was also recommended in a recent Air Force study.

## I. Two routes remain

The Mediterranean communications system, known as Medcom, which is three-quarters finished, never had terminals in France but did feed into communications routes through France to Northern Europe and the United States. The system, which was designated 486L at the Air Force Systems Command's Electronic Systems division, Hanscom Field, Mass., where it was developed, is a wideband tropospheric scatter and microwave network consisting of 100 sites. It hops across the Mediterranean from the center of Spain to eastern Turkey, covering 6,000 miles and five nations.

De Gaulle's order also disrupts a 7,000-mile tropo network from Turkey to Norway, called Ace High, for which Paris is a nerve center. Paris was also to have been the European terminal of Autosevocom, an automatically switched, secure voice communications link with top military officials in Washington and with the North American Air Defense Command at Colorado Springs.

**Getting around.** The network is left with two northern exit routes which bypass France. Near Madrid, it connects with the north-south

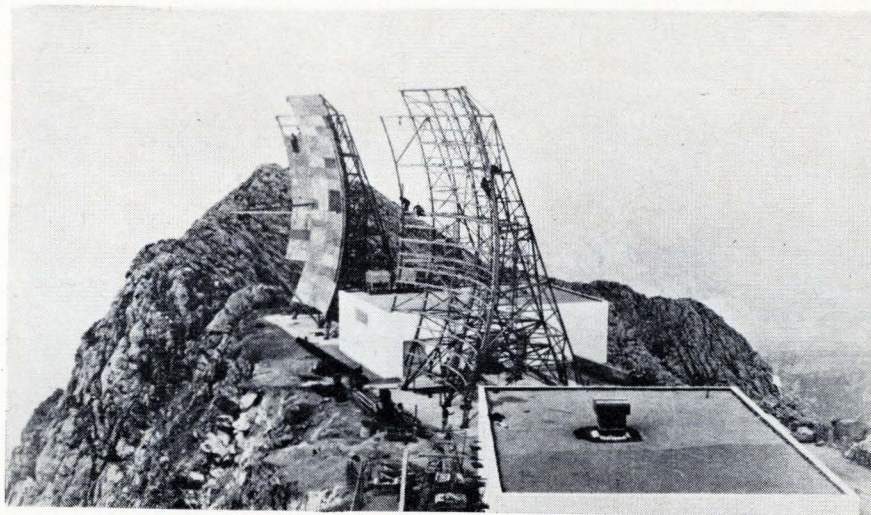

**Tropo antennas** being built on a mountain on Majorca in the Balearic Islands as part of Medcom will beam signals to Spain in a 200-mile hop.

tropo system linking Britain and Spain. In northern Italy, Medcom can plug into the U.S. Armed Forces Europe (Usafe) Microwave System and cross the Alps into Germany.

Medcom includes a non-Mediterranean link, still under construction. Called Project Tea Bag, this 178-mile tropo hop will connect Flyingsdales Moor, a ballistic missile early warning radar site in northeastern England, to Martlesham Heath in southern England. Tea Bag will tie into Medcom through the north-south tropo system.

## II. Mediterranean melange

Medcom is a consolidation of many systems, some in the planning stage since 1960. In 1962, the system program office was set up at the Air Force Electronic Systems division, Hanscom Field, Mass., to incorporate all the wideband links being built in southern Europe under one management.

About \$140 million has been committed to the project. This will reach \$150 million by October, 1967, the target date for turning the entire network over to the Air

Force Communications Service. Managing the project are Colonel G. Bruce Hilton, director of long-lines systems for the Electronic Systems division, and Major Lester Glew, program manager.

Earliest of the individual Mediterranean links to be completed, though not the first planned, was Big Rally 2, built under a crash program in 1961-1962 because the joint chiefs of staff wanted to get a wideband communications line into Turkey in a hurry.

Big Rally 2 furnished channels from northern Italy into the Turkish tropo network, which was completed in 1962. A subsystem connecting eastern Turkey, northern Italy and Crete is still under construction.

The European Mediterranean tropo, EMT, is the main artery of Medcom. This was conceived in 1961, but construction was delayed for the big push on Big Rally 2. The final site for EMT, at Martina Franca, Italy, was the scene this month of the formal commissioning ceremony for Medcom.

**Strongest link.** EMT, the major network in Europe for the Defense Communications System is the



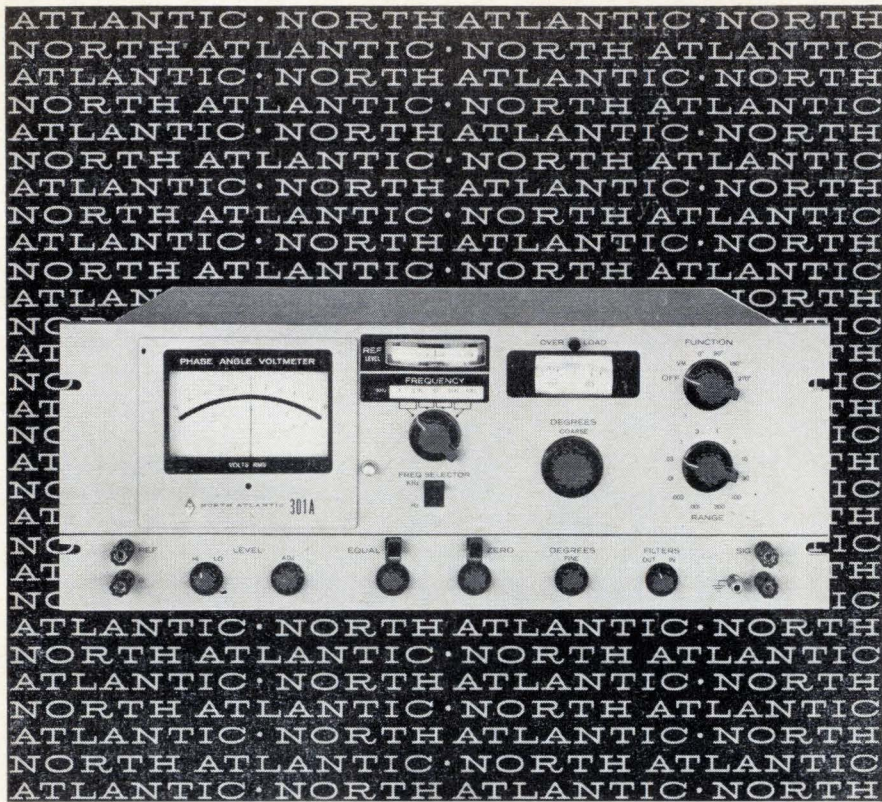

## how to measure phase angle to .25° from 10Hz to 100KHz (plus in-phase and quadrature!)

North Atlantic's Model 301A adds a new dimension to AC by enabling you to make measurements while frequency is varying over half-decades...without recalibration. The 301A **Broadband Phase Angle Voltmeter\*** provides complete coverage from 10Hz to 100KHz, and incorporates plug-in filters to reduce the effects of harmonics in the range of 27Hz to 28KHz with only 11 sets of filters. Vibration analysis and servo analysis are only two of the many applications for this unit. Selected specifications are listed below:

Voltage Range.....	1 mv to 300 volts full scale
Voltage Accuracy.....	2% full scale
Phase Dial Range.....	0° to 90° with 0.1° resolution (plus 4 quadrants)
Phase Accuracy.....	0.25°
Input Impedance.....	10 megohms, 30 $\mu$ f for all ranges (signal and reference inputs)
Reference Level Range.....	0.15 to 130 volts
Harmonic Rejection.....	50 db
Nulling Sensitivity.....	less than 2 microvolts
Size.....	19" x 7" x 13½" deep
Price.....	\$2290.00 plus \$160.00 per set of filters

North Atlantic's sales representative in your area can tell you all about this unit as well as other Phase Angle Voltmeters\* for both production test and ground support applications. Send for our data sheet today.

\*Trademark



**NORTH ATLANTIC** industries, inc.  
TERMINAL DRIVE, PLAINVIEW, NEW YORK 11803 • 516-681-8600

longest and most sophisticated part of Medcom. It provides high quality channels between Spain and Turkey via Italy and Greece, connecting the Spain-United Kingdom tropo network with the middle east and with the Usafe microwave system terminal in northern Italy.

The EMT consists of AN/FRC-96 and 97 troposcatter transmitters and receivers made by Radio Engineering Laboratories, a division of the Dynamics Corporation of America, microwave communications equipment built by Collins Radio Co., and multiplexers made by Raytheon Co. The prime system installer is Federal Electric Corp., a subsidiary of International Telephone and Telegraph Co.

The wideband channels of Medcom can accommodate digital data, voice, teletype and facsimile circuits. The microwave signals are radiated and collected by 30-foot parabolic antennas, and the tropo routes use 60-foot billboard antennas. At some of the stations in Turkey, the tropo paths require 120-foot billboards. Antennas for the consolidated system were supplied by Blaw-Knox Co.

### III. Room at the top

Suitable land is so scarce at some sites that a new technique of vertical space diversity had to be designed for the microwave terminals. Medcom uses quadruple diversity—two antennas per terminal, each transmitting and receiving and each capable of handling horizontally and vertically polarized signals. Ordinarily, the two antennas would be placed side by side, 100 wavelengths apart. To cut down on the requirement, two parabolic reflectors are mounted vertically on the same tower, 100 wavelengths apart, at several locations.

Medcom is also the first to use the 2,550-2,700 Mhz band, highest frequency to date in an operating tropo system. The FRC-96 transmitter puts out 10 kilowatts; and the FRC-97, 1 kw.

Because it was the first system in the 2,700 Mhz region, the project required a tropo equipment redesign effort by Radio Engineering Laboratories, including development of a performance monitor to test and adjust the multi-channel transmitters and receivers without taking the system off the air.





when  
you're  
tied  
down  
by  
promises...

**REMEMBER - CLAROSTAT CAN DELIVER ALL  
OF YOUR POWER RESISTOR REQUIREMENTS**

Everything is in your favor when you do business with Clarostat . . . dependable quality . . . dependable performance . . . and dependable delivery schedules. For all your power resistor and rheostat requirements Clarostat can provide *instant delivery* on most standard units and better than average cycles on *specials*. What's more, this includes MIL-R-26C, MIL-R-22A and MIL-R-6749 types. Only Clarostat gives you that "across-the-board" completeness of line for all industrial, military and commercial applications. And when you need small orders in a hurry there's a Clarostat stocking distributor just a phone call away with just the resistors you need. Don't be bugged by delivery failures and bum promises . . . CALL CLAROSTAT!

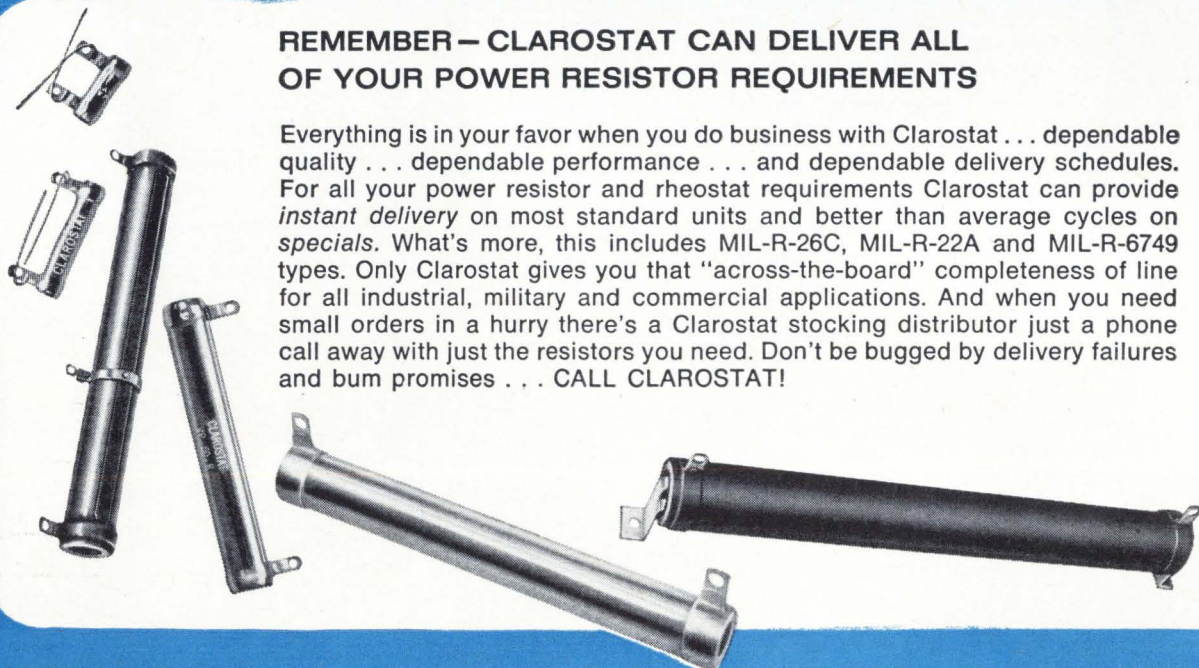

**CLAROSTAT**

CLAROSTAT MFG. CO., INC. DOVER, NEW HAMPSHIRE



# EXTERNAL PACKAGING OF COILS NOW OBSOLETE WITH DELEVAN'S NEW:

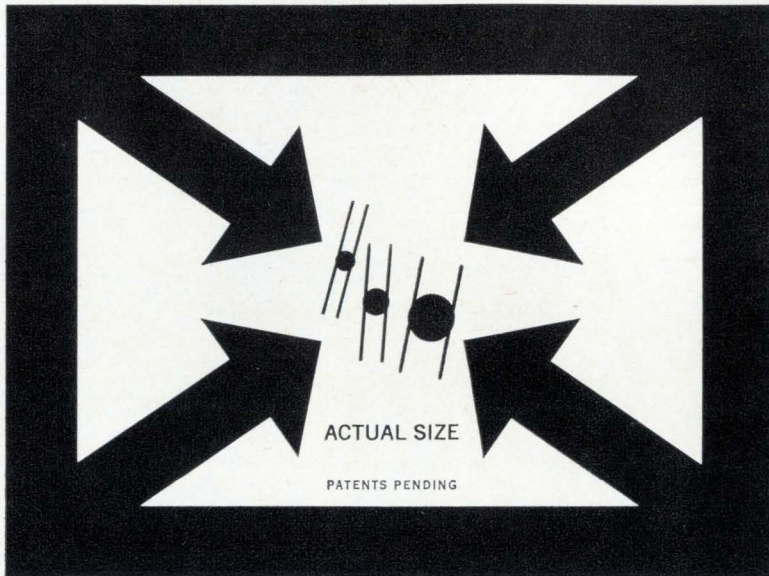

# MICRO

Micro i Inductors are physically compatible with integrated and hybrid circuit packaging. Because of their small size they can be included in miniaturized packages along with other components such as transistors and capacitors eliminating the need for placing the inductor external to the miniaturized package.

These inductors are magnetically shielded to prevent interaction with other components in a small package and have current carrying capabilities which are compatible with normal transistorized circuits. The units are epoxy encapsulated for environmental protection and use powdered iron core materials only.



Excellent inductance stability is provided under the following variable operating conditions:

1. 0 to 100% rated current (AC or DC)
2. Temperature range of  $-55^{\circ}$  to  $+125^{\circ}\text{C}$ .

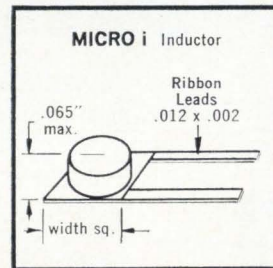
Preferred values as noted in the chart below are available immediately from stock.



ACTUAL SIZE

MICRO i	SIZE	L RANGE	L(uh)	Q	SRF(mc)	DCR( $\Omega$ )	DC(ma)
	.065 Height x .100 Square	.1 uh to 10.0 uh	1.0 $\pm 20\%$	40	125	1.0	266
			4.7 $\pm 20\%$	40	100	1.8	190
			10 $\pm 20\%$	40	40	3.8	133
	.065 Height x .150 Square	12 uh to 100 uh	12 $\pm 10\%$	50	38	4.0	100
			47 $\pm 10\%$	50	19	8.0	85
			100 $\pm 10\%$	50	10	15.0	55
	.065 Height x .250 Square	120 uh to 1000 uh	120 $\pm 10\%$	50	7.5	8.0	40
			470 $\pm 10\%$	45	3.5	20.0	38
			1000 $\pm 10\%$	45	3.0	40.0	34

L and Q Values at Standard Q Meter Test Frequencies.

**MICRO **  
DIVISION

**Delevan Electronics  
Corporation / Division**



**AMERICAN  
PRECISION  
INDUSTRIES INC.**

270 QUAKER RD. / EAST AURORA, N. Y. / 14052  
TELEPHONE 716/652-3600 TELEEX 091-293



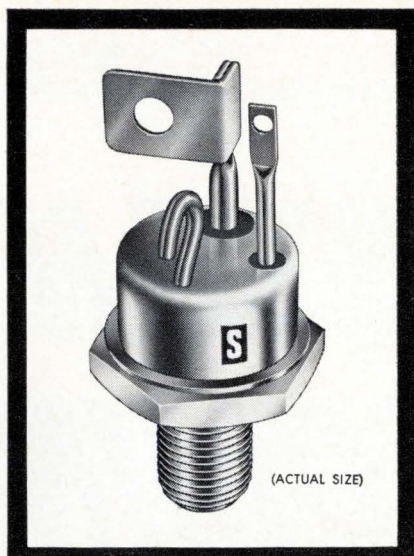

# **S**olitron

*announces a family of  
90 Amp NPN Silicon Planar  
Power Transistors featuring  
fast switching, high voltage  
capabilities with  
 $P_T = 350W @ 25^\circ C!$*

Type Number	DESIGN LIMITS				PERFORMANCE SPECIFICATIONS					
	$P_T$	$BV_{CBO}$	$V_{CE0}$ (SUS)	$BV_{EBO}$	$h_{FE}$		$V_{BE}$ (sat)	$V_{CE}$ (sat)	$I_{CBO}$	$f_T$
	Watts	Volts	Volts	Volts	$I_C = 75A$	$I_C = 90A$	Volts	Volts	$\mu A$	MH <sub>z</sub>
	25° C Case	$I_C = 1mA$	$I_C = 0.2A$	$I_E = 1mA$			$I_C = 50A, I_B = 5A$		$V_{CB} = 60V$	
Max.	Min.	Min.	Min.	Min.	Min.	Max.	Max.	Max.	Typ.	
MHT8920	350	80	60	8	10	5	2.0	1.5	10	20
MHT8921	350	100	80	8	10	5	2.0	1.5	10	20
MHT8922	350	120	100	8	10	5	2.0	1.5	10	20
MHT8923	350	140	120	8	10	5	2.0	1.5	10	20
	50° C Case	$I_C = 2mA$			$I_C = 50A$		$I_C = 50A, I_B = 10A$		$V_{CB} = RATED$	MIN.
2N3149	300	80	80	10	10	—	2.5	1.5	2000	0.1
2N3150	300	100	100	10	10	—	2.5	1.5	2000	0.1
2N3151	300	150	150	10	10	—	2.5	1.5	2000	0.1

**S**olitron TRANSISTOR DIVISION  
**DEVICES, INC.**

1177 BLUE HERON BLVD. / RIVIERA BEACH, FLORIDA / (305) 848-4311 / TWX: (510) 952-6676

Leader in Germanium and Silicon Power Transistors, Cryogenic Thermometers, High Voltage Rectifiers, Hot Carrier Diodes, Temperature Compensated Zeners, Voltage Variable Capacitors, Random/White Noise Components, Microelectronic Circuits, and High-Pac Interconnection Systems.



# CELANESE NYLON IS COMING.



Rather big.

We're starting construction of a new plant in Houston, Texas, with a yearly capacity of 12-million pounds of nylon molding resins—based on a new polymerization process. When the plant is on stream, by mid-1967, Celanese will be one of the two leading producers of nylon molding materials in the United States.

As we said, Celanese Nylon *is* coming.

Celanese benefits from twenty-five years of nylon technology. I.C.I., Ltd. and Celanese jointly own Fiber Industries, Inc., which produces nylon fiber at Greenville, S. C. Nylon salt for the new Celanese Nylon plant at Houston will be supplied from the Bay City, Texas, facility of Celanese Chemical Company which is now undergoing major expansion.

Production of a competitive high-quality Celanese Nylon, prior to start-up of the Houston plant, is possible due to existing Celanese facilities and completely integrated technology. New Celanese Nylon 66 and Celanese Nylon 610 molding and extrusion resins, plus a full range of copolymers and terpolymers, will be produced under the Celanese-developed process within a year's time.

We are also boosting production of our other major

engineering plastics: Celcon acetal copolymer, regular and glass-reinforced grades. Forticel cellulose propionate. Cellulose Acetate. Fortiflex polyethylenes. So we can offer a most complete line of engineering plastics. Included in this family of engineering plastics will be glass-reinforced nylon molding compounds.

While we obviously didn't invent nylon, the addition of Celanese Nylon resins is a logical extension of Celanese Corporation's diversified line of over 100 basic products. A line which includes petrochemicals, fibers, plastics, forest products, paints and coatings, and petroleum products. The Celanese Plastics Company, alone, operates eleven plants in the United States, four more abroad, which produce high-performance plastic resins and fabricated plastic products.

We welcome the opportunity to tell you more about Celanese Nylon—now available in development quantities for your evaluation. Write Celanese Plastics Company, Dept. 133-J, P.O. Box 629, Linden, New Jersey.



**CELANESE**  
PLASTICS COMPANY

Celanese Plastics Company is a division of Celanese Corporation.  
Canadian Affiliate: Canadian Chemical Company, a division of Chemcell (1963), Limited.  
Export Sales: Amcel Co., Inc., and Pan Amcel Co., Inc., 522 Fifth Ave., New York 10036.  
Celanese® Celcon® Forticel® Fortiflex®



# Our remarkably versatile Series JA circuit breaker comes with five different circuits inside

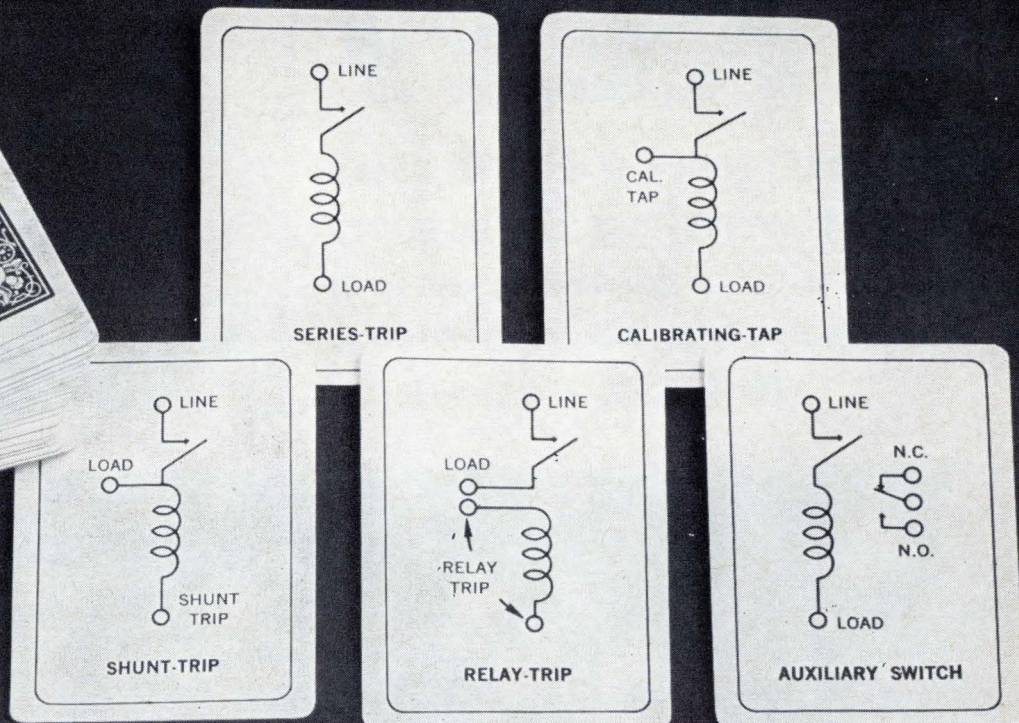

and nine colors outside.

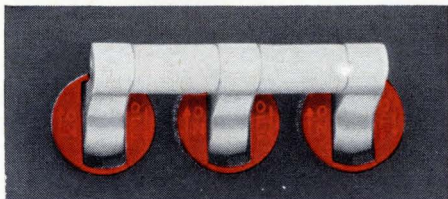

At a very modest price.

In the plain-jane world of circuit breakers, the new little Heinemann Series JA is something of a surprise package. There's that snappy white handle, for one thing. And 'instant color' caps that convert the mounting boss from hum-drum black to an attractive and functional bit of p'zazz.

The five internal circuit options, though, are old standbys in the Heinemann line of hydraulic-magnetic circuit breakers. Many of you alert fellows out there have been using them ingeniously for years.

For the uninitiated, we offer herewith a brief description of each.

Series-trip is our standard construction. You use it wherever you want simple—and precisely calibrated—in-series overload protection.

Calibrating-tap construction lets you

control two loads with one breaker. But overcurrent tripping occurs only in the main circuit through the breaker coil.

The shunt-trip circuit provides a convenient means of obtaining remote tripping through appropriate circuit-closing contacts in an associated control or safety device.

Relay-trip construction is similar to shunt-trip, except that you can use different voltages or currents in the coil and contact circuits, which are electrically isolated from one another.

The auxiliary switch is a miniature snap-action SPDT switch enclosed within the breaker case. You can use it to operate a pilot light, a fan, or any other sort of gadget that doesn't draw more than 5 amps (at 125 or 250 VAC).

The foregoing internal circuits, interestingly enough, can be combined in endless variety in multi-pole breaker configurations. If we have piqued your curiosity, we hasten to offer our Bulletin 3350, which is yours for the asking. We might first point out that the JA is available with any integral or fractional current rating from 0.100 to 20 amps, with or without time-delay, for operation at voltages up to 250 VAC (60 or 400 Hz) or 50 VDC.

Oh yes, we almost forgot—the price.

That, too, is something of a surprise. A very pleasant one. Heinemann Electric Company, 2600 Brunswick Pike, Trenton, N.J. 08602.



**HEINEMANN**



# NEW

**Airbrasive® Resistor  
Trimming System:  
a complete system  
that adjusts IC resistors  
to 0.5% accuracy**

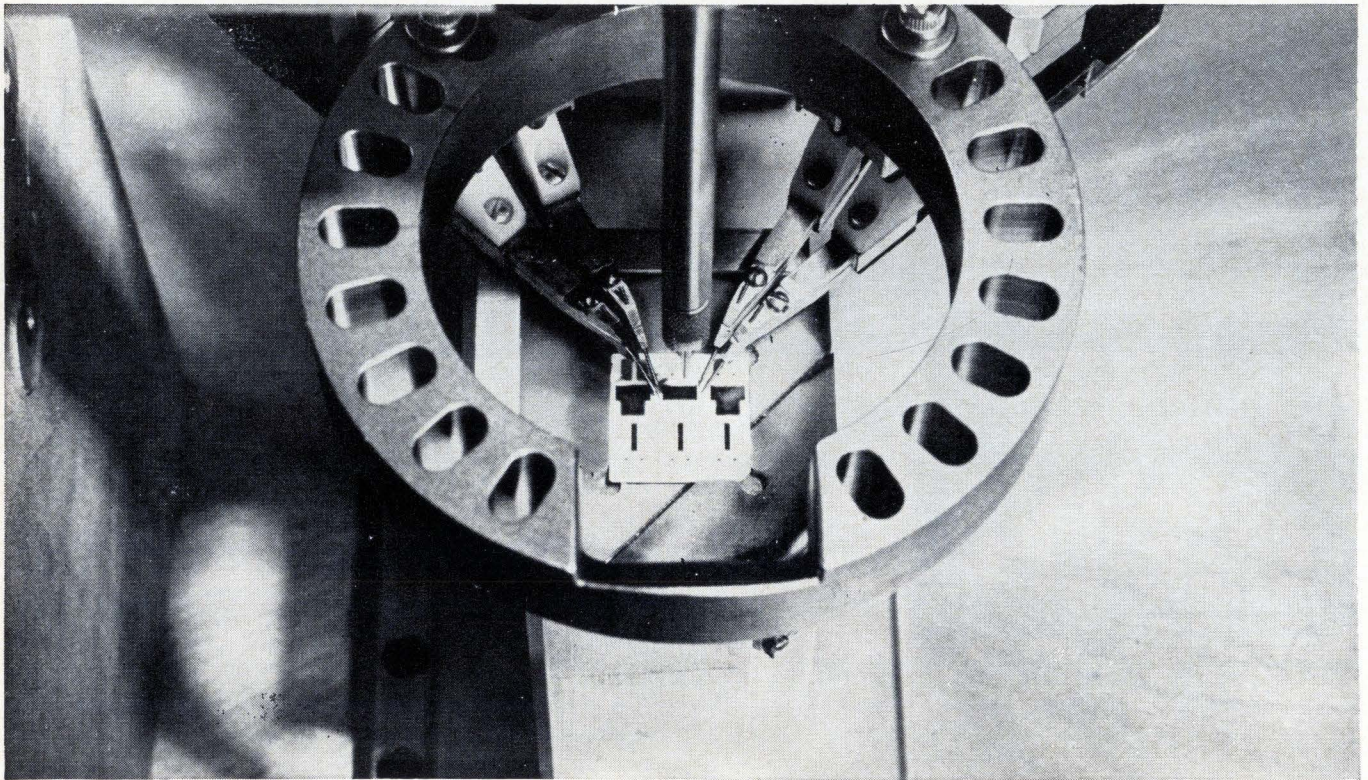
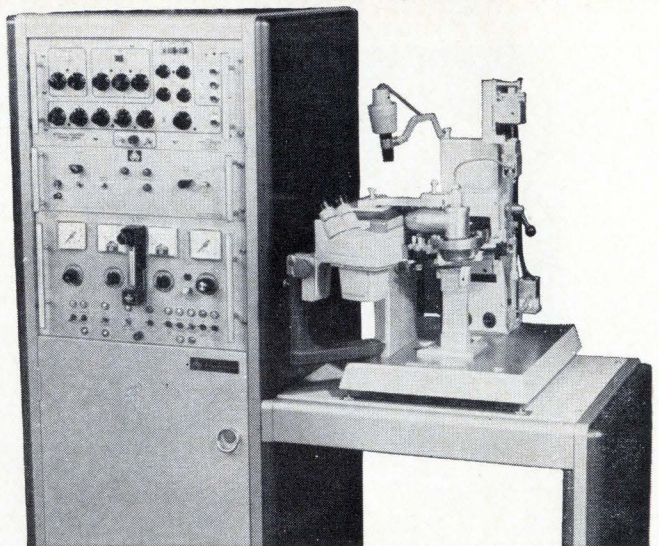

Production rates of 1000 trims per hour are attainable with this new, complete system which automatically trims and tests resistors to any specified value within 0.5%. Once operator has placed module in position, checking, trimming, and inspection are automatic. Complete cycle requires from one to three seconds, depending on programmed tolerance and the amount of material to be removed.

Final value tolerance limits may be programmed from 0% to 11% in increments of 0.1%. The machine increases production yield by holding programmed tolerance with great accuracy. Modules which cannot be trimmed to required value are rejected before further processing is done.

Trimming is accomplished by the proven Airbrasive method—a miniature abrasive jet of 27- $\mu$  aluminum oxide

provides precise, cool, shockless abrading which does not affect substrates or electrical properties of resistance material. Machine may be programmed for a wide range of values, will trim resistors in any position, on any size module, with thick or thin film substrate.

**Write for Bulletin 6610-A for detailed information.**

**SEE THE AIRBRASIVE RESISTOR TRIMMING SYSTEM IN ACTION AT NEREM, BOSTON, NOV. 2, 3, 4, BOOTH NO. 2F19-20**

**S. S. WHITE INDUSTRIAL DIVISION**  
Dept. EU, 201 East 42nd Street, N.Y., N.Y. 10017  
Telephone 212-661-3320



**S.S. WHITE COMPANY Industrial Division**



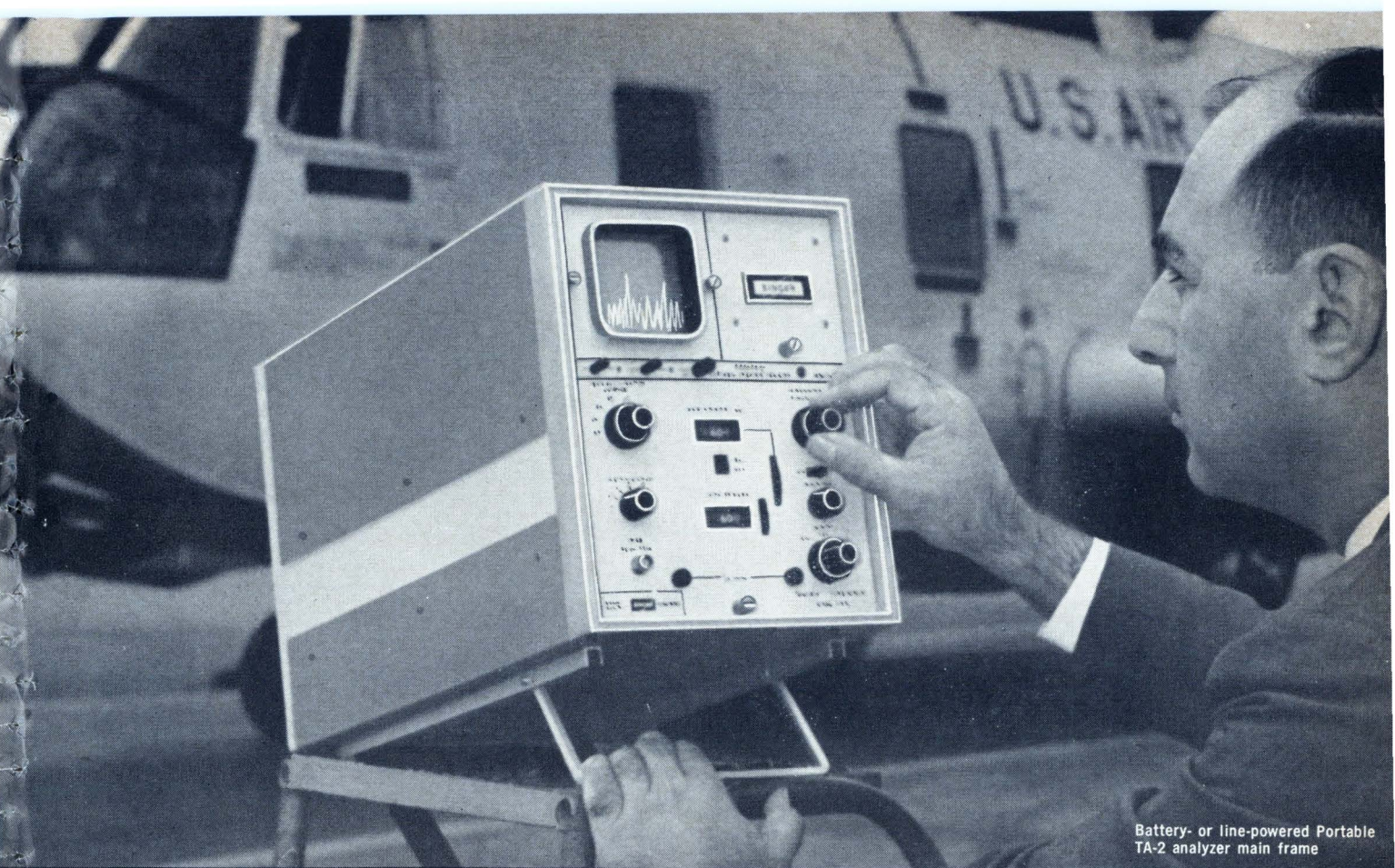

Battery- or line-powered Portable TA-2 analyzer main frame

# THE STANDARDS

## Panoramic\* UNIVERSAL SPECTRUM ANALYZERS 20 cps to 27.5 Mc

### Portable TA-2 and Rack or Bench Mount RTA-5 with 4 Solid State Interchangeable Modules

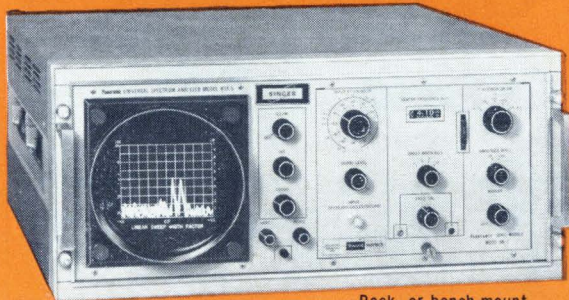

Rack- or bench-mount RTA-5 Analyzer main frame

Make precise, rapid swept band analyses anywhere! Check out and pinpoint troubles in communications signals, sound, vibration, noise and RFI.

The standard—feature-by-feature  AC/DC or internal battery operation  Bright, easily read calibrated spectrum displays  Digital frequency readout of scanned band  Calibrated linear and 40 db log level scales  Built-in Xtal markers for self-checking  Simplified — few controls, many preset for optimum results.

4 solid state plug-in modules feature digital center frequency and sweep width controls  "Quick-look" overall analysis and highly resolved narrow scans are quickly set up  Advanced design provides excellent dynamic range, sensitivity, resolution and sweep repeatability.

Choice of analyzer main frames for all modules  Compact RTA-5 main frame is only 19" wide, 7" high, and 18½" deep — ideal for space saving, rack- or bench-mounting  Portable, solid-state TA-2 weighs only 40 pounds, complete with module and internal rechargeable battery pack — also operates from almost any AC or DC source.

Modules For TA-2 & RTA-5 Main Frames	OFF SHELF DELIVERY			NEW
	AR-1 (Sonic)	AL-2 (log-scan sonic)	UR-3 (Ultrasonic)	VR-4 (Video)
Frequency Range	20-35,000 cps	20-35,000 cps	100 cps-700 kc	1 kc-27.5 mc
Sweep Widths	0.2, 1, 5, 20 kc	0.2, 1, 5, 20 kc; 25-25,000 cps log	adjust. to 0-400 kc	adjust. to 0-5 mc
Resolution	Automatic optimum to 25 cps		adjust. to 100 cps	adjust. to 200 cps
Residual distortion	All unwanted products at least 60 db down			-50 db
Sensitivity	30 μv full scale deflection			
Marker Spacing	0.02% Accuracy-Fundamentals shown-Harmonics Usable			
	2.5 kc	2.5 kc	25 kc	25 kc, 500 kc, 100 Mc

Write for brochure, or contact your local Singer Instrumentation representative



\*A Trademark of THE SINGER COMPANY

EMPIRE • GERTSCH • PANORAMIC • SENSITIVE RESEARCH

**SINGER**  
INSTRUMENTATION



# small



## smaller



## smallest



# G.E.'s new wet slug tantalum capacitor gives you the performance of the CL64 in only 1/2 the case size

Get the highest volt-microfarad product per unit weight and volume of any capacitor you can buy with General Electric's new 69F900 wet slug tantalum capacitor. How? General Electric reduced the case size of the military type (CL64) wet slugs by 1/2 (it's even smaller when compared to solids). Electrical characteristics and performance remain essentially the same. G.E.'s new 69F900 answers the need for a commercial wet slug capacitor with the high volumetric efficiency demanded by modern high density applications.

G.E.'s new addition to its complete line of tantalum wet slug capacitors has excellent high capacitance retention at low temperatures and can be

RATING	CASE SIZE	VOLUME
<b>50V, 50<math>\mu</math>f</b>		
solid (CS12)	.341 x .750	100%
wet slug (CL64)	.281 x .681	58%
<b>69F900</b>	<b>.145 x .600</b>	<b>15%</b>
<b>15V, 80<math>\mu</math>f</b>		
solid (CS12)	.341 x .750	100%
wet slug (CL64)	.281 x .681	58%
<b>69F900</b>	<b>.145 x .600</b>	<b>15%</b>
<b>6V, 180<math>\mu</math>f</b>		
solid (CS12)	.279 x .650	100%
wet slug (CL64)	.281 x .641	100%
<b>69F900</b>	<b>.145 x .600</b>	<b>25%</b>

stored to  $-65^{\circ}\text{C}$ . Its wide operating range is  $-55^{\circ}\text{C}$  to  $+85^{\circ}\text{C}$ . And it meets the parameters of larger military wet slugs: vibration to 2000 Hz, 15g acceleration!

The new sub-miniature 69F900 capacitor is fully insulated and has a low, stable leakage current. Voltage ratings are available from 6-60 volts; capacitance ranges from 3.3-450 microfarads.

Choose from a complete line of G-E wet slug tantalum capacitors to fill your slim, trim circuit needs. Write for GEA-8369 for details about the 69F900 and the other capacitors in General Electric's complete wet slug tantalum line, or ask your G-E sales engineer. **Capacitor Department, Irmo, South Carolina.**

ELECTRONIC COMPONENTS DIVISION

**GENERAL**  **ELECTRIC**

430-28



# If you make **ELECTRONIC** products...you'll really "make it" in **WISCONSIN!**

This is no "secret" to the electronic firms already in Wisconsin. From computer development and guidance systems, to tuner assemblies and switches, these products are made for growing markets.

We're taking this opportunity to encourage firms allied with consumer electronic products — specifically those involved with radio and television — to look us over.

Why? Projected market demand for TV set production will hit 7 million sets by 1970. That's hardly news — and yet the "scare" part of that statistic is that *there are not enough production facilities available*—to keep up with the demand. (Color TV manufacturers don't expect to catch up with present demand until 1967.)

With a high rating in available female workers, plus tremendous scientific / engineering / research back-up from the University of Wisconsin, electronic firms should realize that we're all here to help you make more profits — and enjoy the bountiful Wisconsin atmosphere while doing so.

How about you?

*We'll send you a special report on why the electronics industry LIKES IT HERE — and why "YOU'LL LIKE IT HERE" — too!*

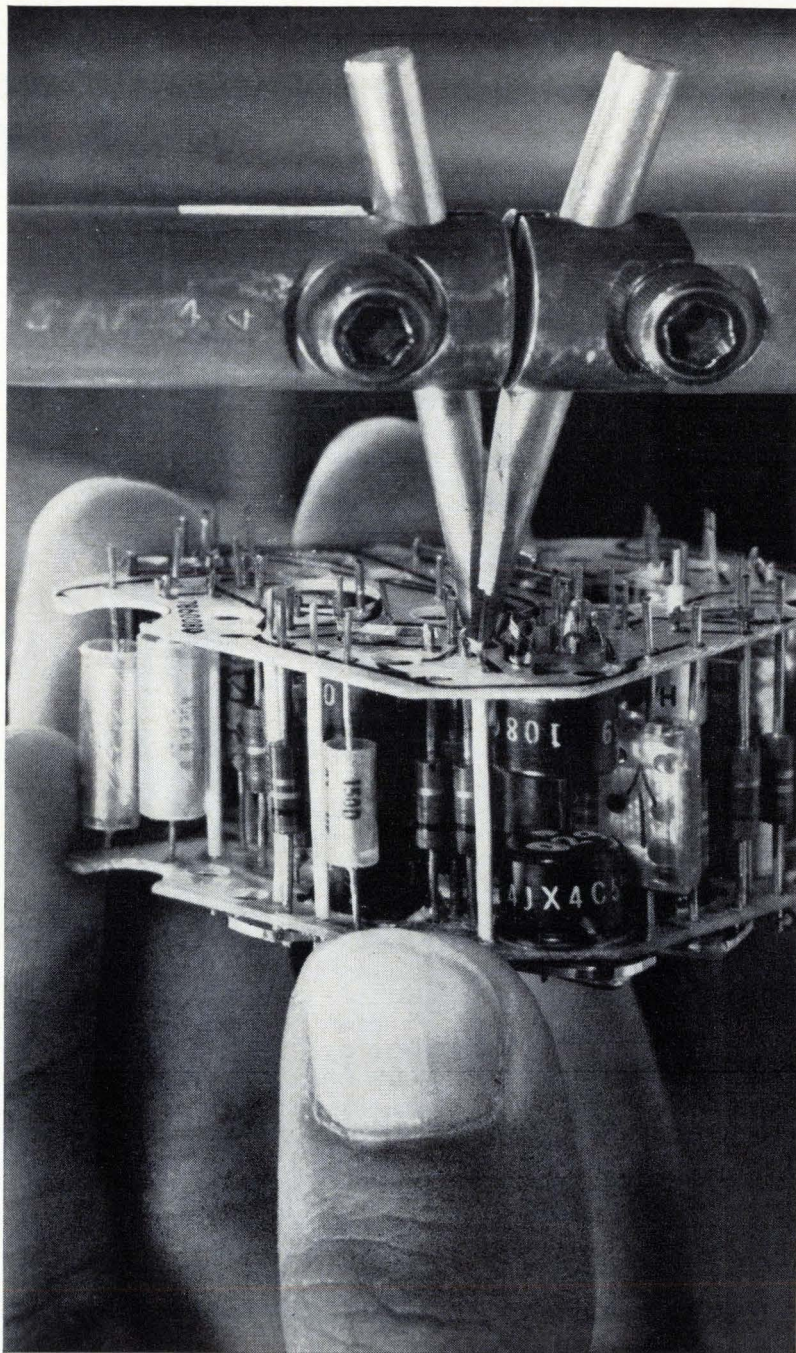

write:  
**GOVERNOR  
WARREN P. KNOWLES**  
State Capitol, Madison, Wisconsin 53702

# WISCONSIN





*Ask not who  
sounds the bugle,  
but, rather,  
what it plays.*

Once the errant bugle blows, you can't call back the sound — or even sound recall. For the countermand is buried in the fury that is summoned. The error, played. The damage, done. In today's world, there can be no errant bugle. And at MITRE it is our job to provide information to help prevent it. We deal in information systems to intercept, interpret, analyze, advise. In short, we work on the means that enable our military commanders to make and carry out command decisions — the *correct* command decisions, for either a complete or measured response.

In this capacity, MITRE is breaking new ground in information systems planning and engineering including data processing technology, programming techniques, programming languages, resource allocation and control. Paradoxically — and fortunately — the greater the success in balancing deterrent systems to offensive threat, the less the possibility of their being summoned at all.

Would you like to help us in this important work? If you have at least three years' experience and a degree, preferably advanced, in electronics, mathematics or physics, write in confidence to: Vice President, Technical Operations, The MITRE Corporation, Box 208BC, Bedford, Massachusetts.

MITRE also maintains facilities in Washington, D.C., Patrick Air Force Base and Tampa, Florida, Houston, Texas and Colorado Springs. MITRE's overseas facilities are in Paris and Tokyo.



*An Equal Opportunity Employer (M&F)*

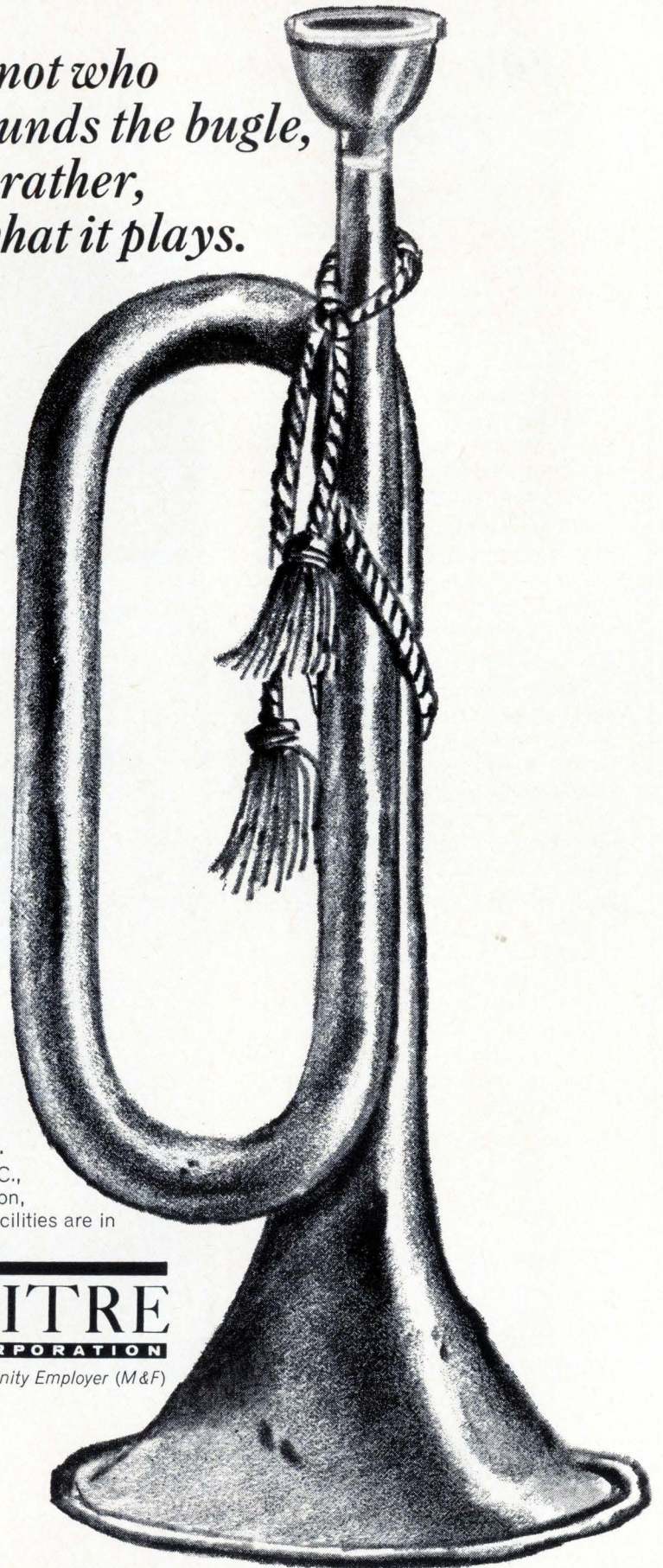

Pioneer in the design and development of command and control systems, MITRE was formed in 1958 to provide technical support to agencies of the United States Government. MITRE's major responsibilities include serving as technical advisor and systems engineer for the Electronic Systems Division of the Air Force Systems Command and providing technical assistance to the Federal Aviation Agency and the Department of Defense.



# Second breakdown? Old Reliable laughs it off.

With the Westinghouse 2N1016 series silicon power transistor, you'll never have cause to get neurotic about second breakdown. Long experience has proved the reliability of this device when operated within established ratings. Check the curve! What other 7.5 amp. power transistor can withstand such conditions without fear of second breakdown? And Westinghouse backs this series with its lifetime guarantee† by putting this symbol  on the case.

Behind this unique lifetime guarantee stand the 2N1016's special construction features that foil second breakdown. Large cross-section wide-

base junctions eliminate high energy concentration. Heavy gold-metallized contacts provide rapid heat conduction, cutting thermal stresses at elevated junction temperatures. And each transistor is tested to MIL-S-19500.

Put 2N1016 series to work in your regulators, power supplies, and inverters now. Its low saturation resistance, high collector voltages, and reliability at elevated temperatures are just what you want.

Get all the data now. Call your Westinghouse salesman or distributor and ask for Technical Data 54-661. Westinghouse Semiconductor Division, Youngwood, Pennsylvania 15697.

†Westinghouse warrants to the original purchaser that it will correct any defect or defects in workmanship, by repair or replacement f.o.b. factory, for any silicon power semiconductor bearing this symbol  during the life of the equipment in which it is originally installed, provided said device is used within manufacturer's published ratings and applied in accordance with good engineering practice. This warranty shall constitute a fulfillment of all Westinghouse liabilities in respect to said products. This warranty is in lieu of all other warranties expressed or implied. Westinghouse shall not be liable for any consequential damages.

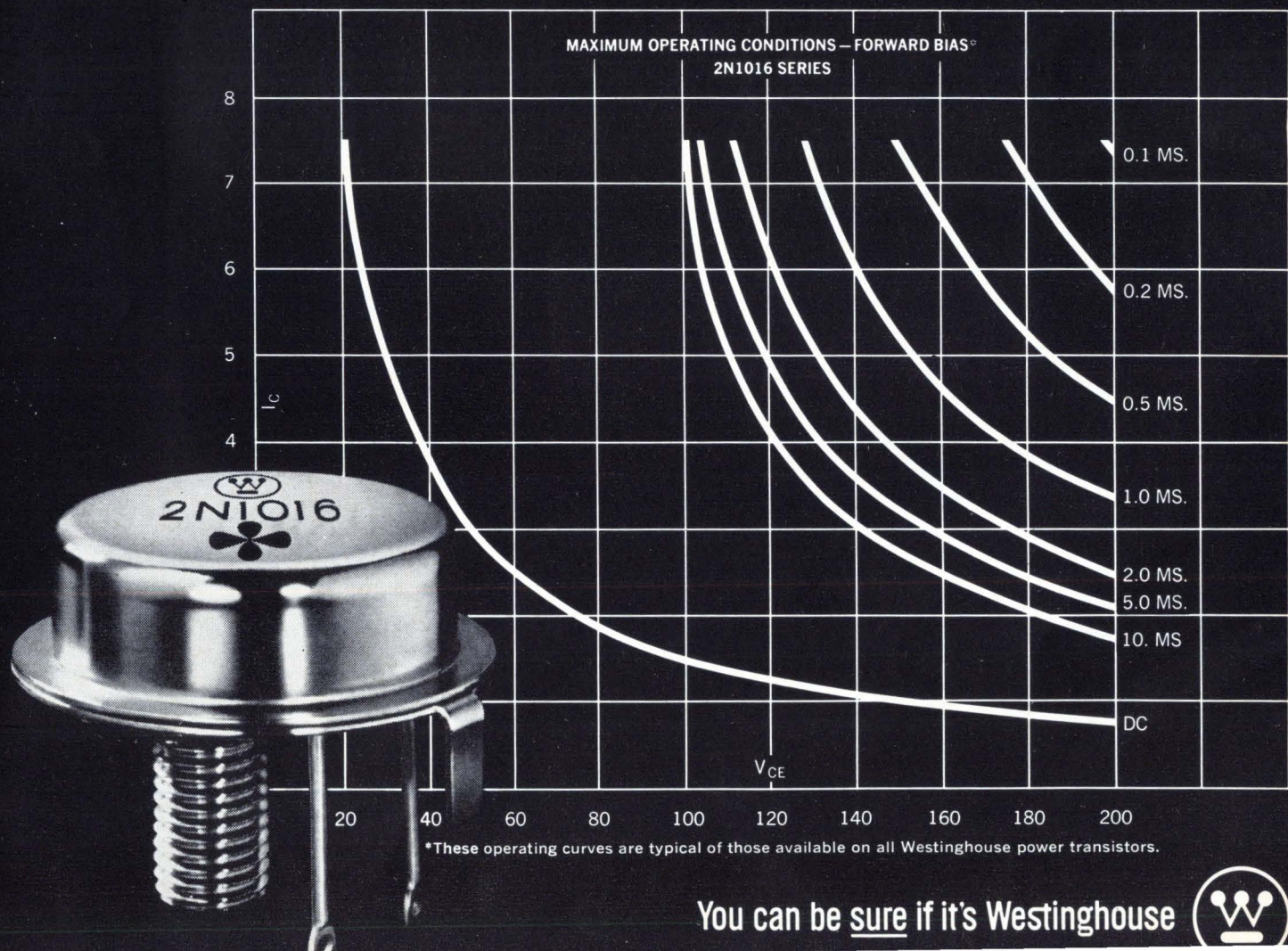

You can be sure if it's Westinghouse





# When stepper motors or brakes and clutches can't do the job— try Printed Motors!

In many incremental motion servo applications, Printed Motors are used when stepper motors or brakes and clutches can't meet system requirements.

The very high torque to inertia ratio of the Printed Motor, with no preferred armature positions, allows variable rate start-stop operation with very high position accuracy.

With appropriate servo controls, the Printed Motor can increment bidirectionally over a wide frequency range. This motor will slew bidirectionally at any required speed from less than

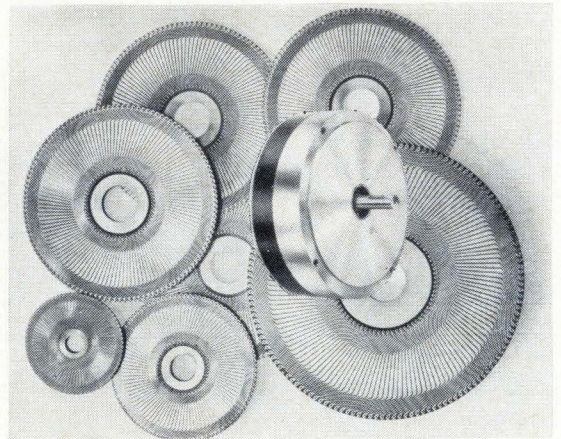

1 rpm to over 3000 rpm. This flexibility permits replacement of dual transport capstans, clutches, brakes, pulleys and other expensive, high-maintenance hardware with a single, electronically controlled capstan.

For additional information on the use of Printed Motors when stepper motors, brakes and clutches, synchronous motors, torque motors, conventional servos or hydraulics can't do the job, write or call: Printed Motors, Inc., Glen Cove, New York. 516-676-8000.

**PRINTED MOTORS, INC.**  
GLEN COVE, NEW YORK 11542



Engineering  
Manufacturing  
and Sales by:

**Photocircuits**  
CORPORATION



# new from RADIATION: IC Operational amplifiers

...eliminate stabilizing networks

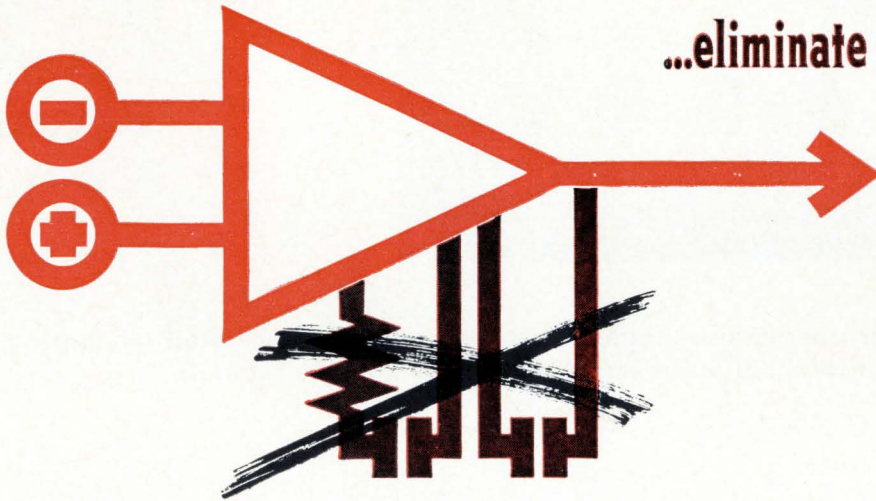

Radiation announces a new line of universal building blocks for integrated analog circuitry. Three different types of operational amplifiers are available to serve your individual needs: general-purpose, broadband, and high-gain circuits.

These highly-stable wide band amplifiers operate at unity gain *without* external stabilization. Thus, design cost and packaging space are reduced.

Further, superior design provides outstanding performance: Parasitics are eliminated, thanks to Radiation's unique dielectric isolation technique. Tighter tolerances and improved temperature coefficients are achieved through use of thin film resistors over the oxide.

Radiation operational amplifiers are ready for *immediate* shipment. Write or phone for data sheets which include worst-case limits, and contain all information required by design engineers. Radiation Incorporated, Physical Electronics, Department EL-08, Melbourne, Florida 32901, Phone: (305) 723-1511, extension 554.

## Typical electrical characteristics

PARAMETER	UNIT	General Purpose	Broad Band	High Gain
		RA-238	RA-239	RA-240
Phase margin		60°	45°	60°
Bandwidth (unity gain)	MHz	7	15	6
Voltage gain		2,700	2,700	50,000
Offset voltage	mV	2.0	2.0	2.0
Offset current	nA	80	400	80
Thermal drift	$\mu\text{V}/^\circ\text{C}$	5	5	5
Output swing	V <sub>P-P</sub>	21	21	9
Power consumption	mW	90	160	90
Common mode rejection	db	100	100	100
Power supply rejection	db	80	80	80
Input bias current	$\mu\text{A}$	0.4	1.2	0.4

Standard temperature range:  $-55^\circ\text{C}$  to  $+125^\circ\text{C}$

All Radiation integrated circuits are dielectrically isolated.



**RADIATION**  
INCORPORATED

Sales offices: Suite 622, 650 North Sepulveda Blvd., El Segundo, Calif. (213) 772-6371 ■ Suite 232, 600 Old Country Road, Garden City, N. Y. (516) 747-3730 ■ P.O. Box 37, Melbourne, Florida (305) 723-1511, extension 554.



# Our new toy.



(A fun-to-use Dialamatic voltmeter for serious-minded engineers who are frustrated by turning all those knobs on a differential voltmeter just to advance one decade.)

We figured it was about time somebody put an end to all this knob-twisting nonsense. So we invented the Wavetek Dialamatic Voltmeter.

What gives this instrument the edge over conventional differential voltmeters is its transfermatic dial\*. This device couples the switch being adjusted to all switches to the left. And you can still operate all switches

independently.

Let's say the voltage you want to measure is 5.001 and you've reached 4.999. Just advance the right-hand knob one click and all the digits automatically go to 5.000 and on to 5.001. What's more, you can switch right back through the transfer point to 4.999 still by turning just one knob.

Fast null seeking can be done from any previous dial setting to any unknown input without first setting up all zeros.

With the Dialamatic, you're getting close to the speed of the expensive, fully automatic models. But prices are like those of accurate manual instruments.

Except for its meter, the Dialamatic looks a lot like our familiar portable function generators. Same rugged, compact little box.

Inside, the Dialamatic is all solid state. And maintenance

is easy because of the clean, modular construction.

The Model 201 measures dc and sells for \$595. The Model 202 measures ac and dc for \$795. Ni-cad battery versions are available at slightly higher prices.\* \*

DC Accuracy: 0.01% + 0.001% of range setting  
 Resolution: 10 $\mu$ v  
 Input: 0 to 1,000v in 4 ranges  
 DC Input R: Infinite at null to 10v, 10 megohms 10v to 1,000v  
 AC Input Z: 1 megohm at 40 pf.  
 AC Accuracy: 0.2% + 25 $\mu$ v, 20 Hz to 10 KHz  
 Maximum Null Sensitivity: 0.001% of range setting.  
 \* \* U. S. prices.

So if you've had it with all that knob-twisting jazz, just order one of our Dialamatics. After that, it's child's play.

**WAVETEK**<sup>®</sup>  
 8159 Engineer Rd., San Diego, Calif., Tel. 279-2200  
 European Sales: 3000 Bern 9, Seidenweg 17, Switzerland

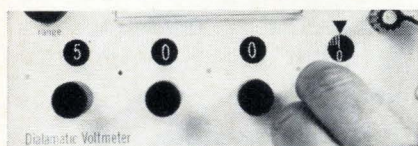
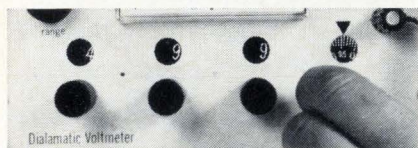
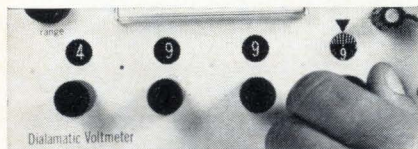

Flip one knob and go from 4.999 to 5.000 and back again.

\* Patent applied for





## Some things to discuss with your wife before you apply at Martin in Florida

A move up with Martin Company in Orlando, Florida presents some serious considerations for you and your family. But four points are particularly meaningful.

- 1. Steady advancement** on a team of top-flight engineers now designing and producing Sprint, Walleye, RADA, Shillelagh, Pershing and many other advanced systems.
- 2. Long-term professional opportunities** with a company that puts its faith in the future on the line by investing eight million dollars in new R&D facilities in the last three years alone. And Martin is maintaining more than 150 special projects aimed at future business development.
- 3. Personal rewards and recognition** from a company managed by engineers who

understand what it takes to achieve engineering excellence.

- 4. A bonus of good Florida living** that offers special advantages when it comes to rearing a family in the clean and beautiful environment of Florida's lake country.

Capture this ground floor opportunity by showing how your talent can contribute to the high standard of technical excellence that characterizes Martin Company.

A collect phone call will start things happening. Phone 305/855-6100 and talk with Don Parsons, Manager, Professional Staffing.

**MOVE  
UP**  
WITH MARTIN  
IN FLORIDA!

**MARTIN COMPANY**  
ORLANDO FLORIDA

An Equal Opportunity Employer.



# PART 8 of a series on THE STATE OF THE CHOPPER ART

## INPUT CIRCUIT IMPEDANCE ABOVE 1000 MEGOHMS

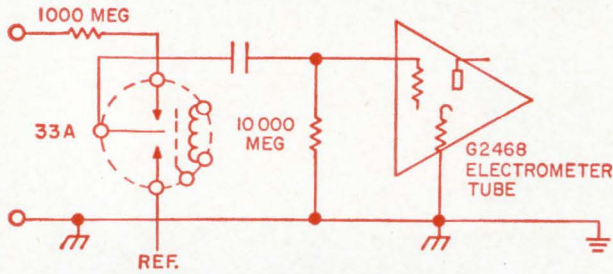

AT 1000 MEGOHMS USE A 33A . . . . .

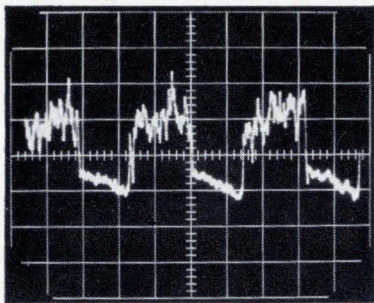

150 MICROVOLT SIGNAL, 10,000 MEGOHMS

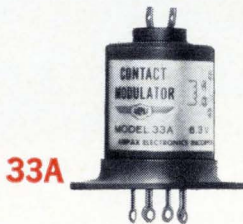

33A

We do feel awfully apologetic about using a tube. Maybe if we just kept at it we could get a MOS FET with INSULATED GATE working, and we do know how much better SOLID STATE is. But our Chief Engineer has a mighty small appreciation for creative art. He said meet the budget. So we're sorry, but a G2468 electrometer tube works at 10,000 megohms but only costs a couple bucks. Same reason we used a 33A chopper. No romance. No fun developing new circuits. It just works. Noise and offset? Down around  $\frac{1}{4}$  uv.

## OFFSET VALUES BELOW 10 NANOVOLTS

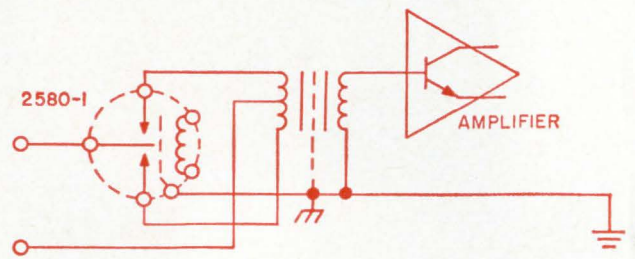

AT 10 NANOVOLTS USE A 2580-1 . . . . .

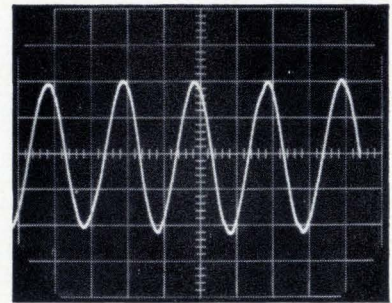

$\frac{1}{2}$  MICROVOLT SIGNAL, 10,000 OHMS



2580-1

We have been deluding our faithful readers. The Airpax choppers we have foisted off all these years were **not** completely free of noise. In fact some of them, like the 33A next door, were **loaded**. They run upwards of 200 or 300 nanovolts—0.2 of a microvolt. But perhaps we can make it up to you with the 2580-1. It doesn't seem to have any hum pickup or fixed offset or variable offset. A most rash and unscientific statement. Interpreted, means we don't know how to measure below 10 nanovolts.

Should you use the same chopper at 10,000 ohms or 10,000 megohms? You can. It might be more expensive. Mechanical choppers perform for three reasons. The open contact approaches infinite resistance. The closed contact approaches zero resistance. And the transit between zero and infinity approaches zero time. Reliability? We have photo choppers and transistor choppers to sell you, when you need not save money. Or when you need over 25,000 hours life.

**AIRPAX ELECTRONICS** incorporated Cambridge, Maryland (301) 228-4600



# Strain gauge made of single wafer

Combining sensing and transducer elements produces extremely accurate pressure sensor

By forming the pressure-sensing and energy-conversion elements as a single wafer, the Giannini Controls Corp. has devised the first monolithic solid-state pressure sensor and the first diaphragm-type gauge, the company says, to achieve an accuracy of  $\pm 0.4\%$  of its full scale. Comparable high-precision strain gauges have an accuracy of about  $\pm 1\%$ .

Usually a metal diaphragm is bonded or mechanically coupled to a piezoresistive element. But Giannini uses only a single wafer of silicon and diffuses four piezoresistive elements directly into its surface. The silicon wafer itself then acts as the sensing element by deforming under pressure. The piezoelectric elements are connected in a Wheatstone bridge configuration to provide the output signal.

Giannini's semiconductor transducer — called Semiducer — can sense pressures ranging from 0 to 10 pounds per square inch to 0 to 500 psi, measured on either the absolute scale or the gauge scale (which uses atmospheric pressure as the reference). The output level can also vary, from 0 to 30, 40, 50 or 100 millivolts.

And the sensor will maintain its accuracy, Giannini promises, because it is relatively insensitive to temperature changes. The thermal zero shift is 0.01% per degree C; the thermal sensitivity shift is 0.005% per degree C.

Applications are expected primarily in aerospace instrumentation, where the sensor's ability to withstand vibrations of 25 g up to 2 kilohertz with no calibration shift is an advantage.

The single silicon wafer, shown tilted in its package before the top is welded on, is slightly larger than a nickel. Its thickness varies with the amount of pressure to be meas-

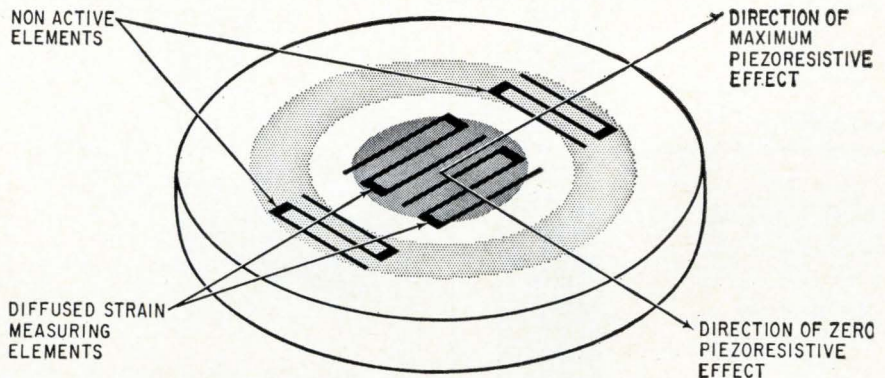

ured. For a range of 0 to 100 psi, the wafer is approximately 1/8-in. thick. Giannini declines to explain just how so thick a wafer can act as a sensitive diaphragm. Another secret is just how Giannini manages to place the wafer into the can and hold it tightly without inducing any strain in the material.

Only two arms of the Wheatstone bridge can be considered active elements, product manager Ed Yurcisin explains. They are diffused into the center of the wafer, the area of greatest mechanical strain, and are oriented in the direction of greatest maximum piezoresistance, as shown in the line drawing. The other arms are toward the wafer's edges, oriented in the direction of zero piezoresistance.

Though not sensitive to pressure, the side arms, like the center arms are sensitive to temperature. So voltage due to temperature can be distinguished from voltage due to pressure. Trimming resistors near the two side arms, with connecting wires attached, give the desired amount of resistance. Wires from the bridge pass through the can to the electrical connectors attached to the welded cap.

The output level can be raised to as much as 5 volts d-c, by adding an all solid-state electronics package that quadruples the unit's length (from 3/4 inch to 3 inches) and more than doubles the cost. In quantities of 100, the unit alone sells for about \$400, the exact price depending on the output and pressure ranges chosen; with the options the cost is about \$1,000.

Giannini is also prepared to build Semiducers to specifications. The sensor announced, model 4715, is the first in a family.

## Specifications

Pressure ranges	From 0 to 10 psi to 0 to 500 psi
Output voltage	0 to 30, 40, 50 or 100 mv
Dimensions	3/4 in. long, 1 in. diameter
Resolution	Continuous
Zero balance at ambient	$\pm 0.5$ mv

Giannini Controls Corp., 330 Madison Ave., New York, N.Y. 10017 Circle 350 on reader service card.





# GOOF-PROOF INTER-WIRING

Garlock Free-Flex® circuits minimize rework and trouble-shooting because it's impossible to hook them up wrong.

## LOOK

All Garlock Free-Flex circuits are flexible circuit assemblies . . . pre-engineered mechanically and electrically so all terminations naturally go on the right terminals . . . make it impossible to miss a connection.

■ Materials and configurations to meet your specifications and the Government's.

■ Write us for your copy of *Flexible Circuits in "Teflon" FEP Have Come of Age* reprinted from *The Journal of Teflon*, published by E. I. du Pont de Nemours and Company . . . and for the FREE-FLEX Circuitry Manual.

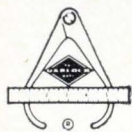

In Europe: Europélec S.A.,  
Les Clayes-Sous-Bois, France  
In the United Kingdom:  
Lectrotron, Ltd., Slough, England

**GARLOCK**  
ELECTRONIC PRODUCTS  
GARLOCK INC.  
CHERRY HILL, N.J. 08034

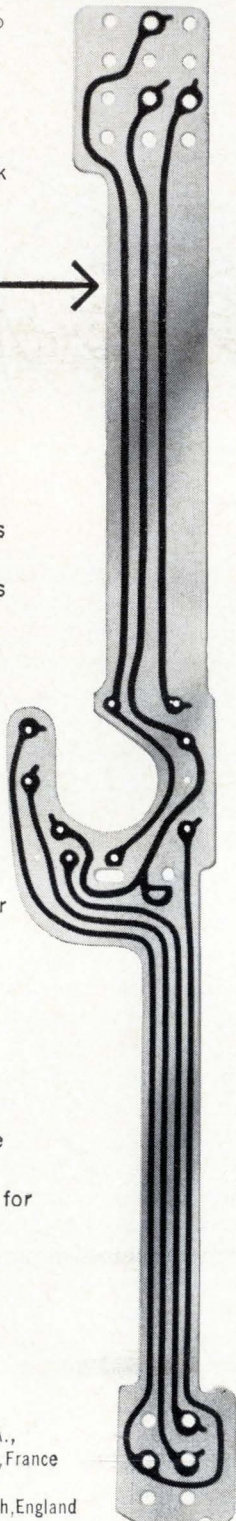

## New Components and Hardware

### Surge arresters use new bypass design

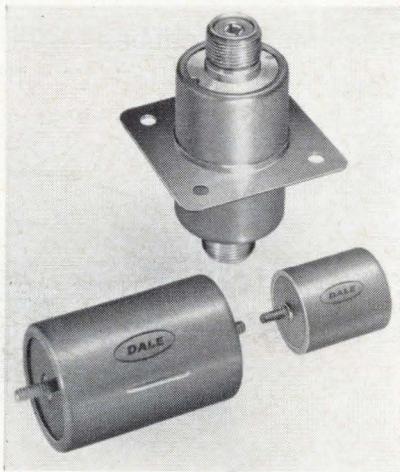

To facilitate integration of surge protection into circuit design, a number of new case styles and terminal configurations have been added to lines LA8 and LA9 of miniature magnetic surge arresters. Both series can now be mounted with either conductive or insulated clips or secured directly to the chassis with an integral flange.

In the LA8 series, both stud terminals and uhf connectors are available. In the LA9 series, stud terminals and stranded wire terminals are standard. In addition, a new electrical configuration in the LA9 series permits the use of a 1-terminal, single-ended model instead of the standard 2-terminal, feed-through type.

Both series use the company's exclusive surge bypass design. According to the manufacturer this patented mechanism improves on the basic spark gap technique by using a surge-charged coil with a tapered spiral electrode. When a transient over-voltage creates an arc across the spark gap, the coil is energized. This produces a magnetic field that causes the arc to rotate down the electrode lengthening it to the breaking point before excess current is drawn. This technique allows the arrester to bypass repeated surge currents without materially affecting its breakdown voltage level.

The LA8 surge arresters have a dustproof case with basic dimen-

sions of 1.859 in. long x 1.250 in. in diameter. They will bypass 10 current surges peaking at 15,000 amps in 5  $\mu$ sec and containing a total charge of 21 coulombs without damage to the arrester or the equipment attached and with less than 20% change in original d-c breakdown voltage.

LA9 surge arresters have a hermetically sealed case, 1 in. long x 0.875 in. in diameter. The spark gap atmosphere is pre-ionized with a radioactive isotope to stabilize breakdown voltage level. These arresters will bypass approximately 100 current surges of 300 amps peak without more than 20% change in initial d-c breakdown voltage. Current peaks in 2 msec and slows to half its peak in 4 msec.

Dale Electronics, Inc., Box 609, Columbus, Neb., 68601. [351]

### Time delay relay exhibits high accuracy



Time delays ranging from 10 msec to 60 sec over a 20 to 32 v d-c range are available with a half-size, solid-state, time delay relay. Type QR has a built-in regulator and filter to assure a timing accuracy of  $\pm 10\%$  over a wide range of temperature and voltages.

A high-speed recovery circuit permits the relay to be used where exceptional high-speed recycling is necessary. Other features include elimination of triggering errors caused by normal line transients, and diode protection against polarity reversal.

Designed to meet environmental military specifications, the hermetically sealed relay will operate in a



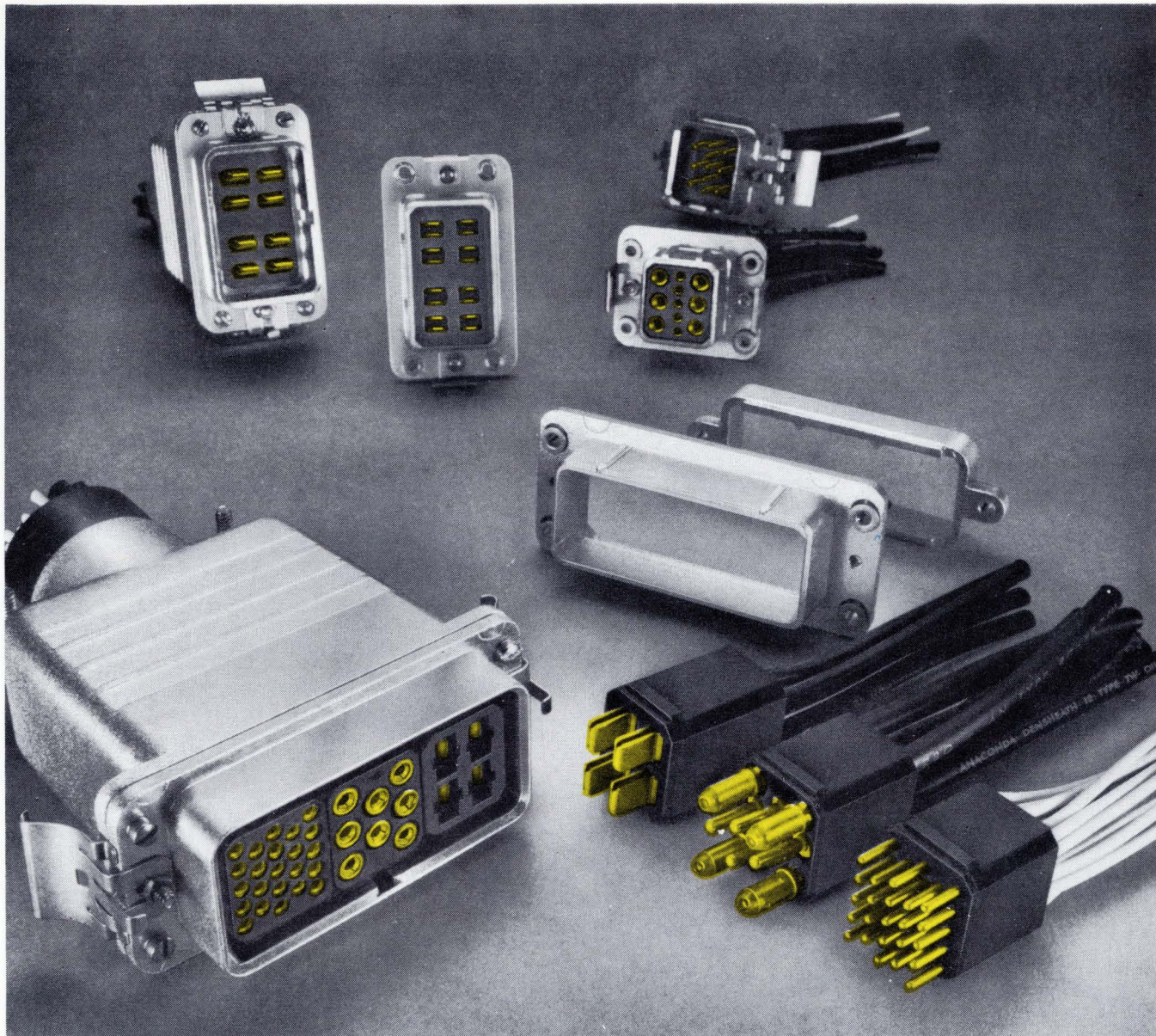

## Go 1, Go 2, Go 3 . . . with Series "G"!

As you can see, something new has been added to our connector line. They've gone modular. Now you can stylize your electronic equipment from front to back, get all three kinds of service—signal, power, coaxial—from one basic housing style.

You no longer need a different connector for each type of circuit in your product. AMP's Series "G" Connectors are designed so you can "go" with one, two, or three modular inserts for the exact combination of contact types you want. Inserts are available in either diallyl phthalate or general purpose phenolic with numbered cavities for one or more of these types:

- Type I—#12 screw machine pin and socket power contact
- Type II, III and III(+)—regular signal circuit pin and socket contacts
- Type IV—miniature coaxial contact
- Type XII—new 35-amp stamped and formed power contact
- New subminiature COAXICON\* contact

Designed for rugged, dependable performance as well as flexibility, Series "G" Connector shells are two-piece cast aluminum. They consist of a polarized two-piece shell and retainer plate for easy, drop-in assembly of the modules. And, they're available with floating bushings or locking springs, so you can use them equally well for rack-and-panel mounting, service drops, and in-line hook-up applications.

Try this new connector concept in your engineering designs. You'll get all kinds of service . . . with style! It's the practical way to cut inventory costs, too. Write today for complete details.

★Trademark of AMP INCORPORATED

**AMP**  
**INCORPORATED**  
 Harrisburg, Pennsylvania

A-MP\* products and engineering assistance are available through subsidiary companies in: Australia • Canada • England • France • Holland • Italy • Japan • Mexico • Spain • West Germany







**The Fairchild 6200  
shows what happens  
inside a MOS-FET,  
Bipolar, SCR, or that new  
device you're working on.**

**It used to be the best curve  
tracer on the market. Now  
there is a better one.**

**The Fairchild 6200B.**

**Write for information:**

**FAIRCHILD**  
INSTRUMENTATION



# Who is the leader in . . .

## High Temperature Wire/Cable

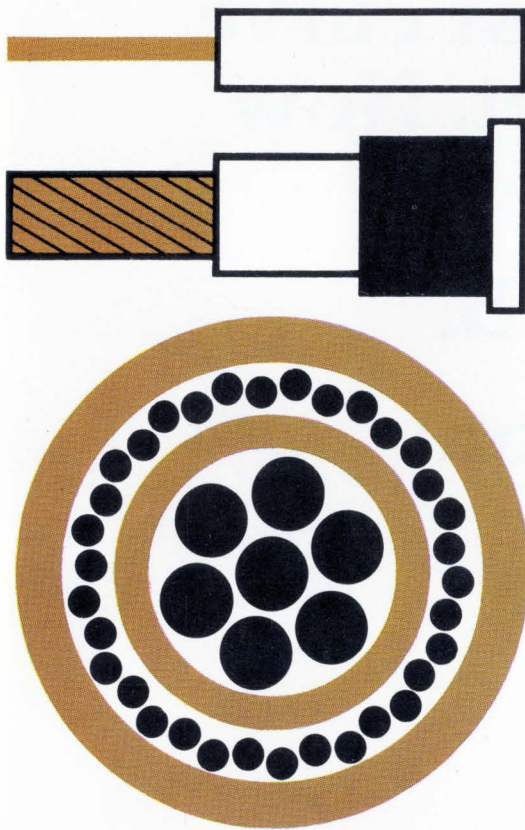

**SUPER TEMP WIRE**—Specialized high-temperature insulated wire/cable designs . . . from film coated wires, finer than a human hair, to complex multi-conductor and coaxial cables . . . for critical electrical/electronic applications, mark Haveg contributions to wiring projects on Gemini and Apollo man-on-the-moon programs, as well as on the Polaris, Saturn and Titan missile and rocket programs.

## Custom Molded Plastics



**PRECISION MOLDING**—Versatility of materials technology, die making, and quality-controlled processing allow Haveg engineers to design and manufacture critical components from thermosets, thermoplastics, and HAVELEX®—the inorganic plastic with superior dimensional stability and high dielectric strength. Precision Molding specializes in electrical/electronic components molded to fine tolerances.

©Trademark of Haveg Industries Inc.



# Haveg is

Haveg Industries, Inc. has been an innovator in the development and fabrication of custom-engineered plastics since 1929. Today, Haveg maintains numerous plant operations and divisions in both the eastern and western United States, with product technology as diversified and unique as . . . corrosion resistant chemical process equipment . . . precision molded plastics for electrical/electronic applications . . . aircraft seals and aerospace vehicle components . . . corrugated plastic conduit for underground cabling . . . specialized high-temperature wire and cable . . . high-strength, filament-wound fiberglass structures . . . extruded plastic pipe for water distribution service . . . proprietary foamed plastics for consumer and industrial markets . . . high-temperature silica fabric insulations for missiles and industry.

In all of these areas Haveg offers a unique combination of engineering skills, craftsmanship, and experience in depth. Every Haveg division is a specialist in its field, oriented toward product development and backed by the latest in fabricating and manufacturing facilities.

Haveg's divisions, with their specialized capabilities, welcome the opportunity to apply their knowledge to solving your out-of-the-ordinary problems in plastics engineering and processing . . .

- Aircraft Products
- Amco Pipe
- American Molding
- Chemical Equipment
- Commercial Products
- Corflo Products
- Precision Molding
- Reinhold Aerospace
- Sil-Temp Materials
- Spiralloy Structures
- Super Temp Wire

For prompt assistance from any of these divisions, write today. If you would like more information about Haveg's diversification and exclusive manufacturing techniques, send for our new corporate capabilities brochure or specific divisional brochures.

**HAVEG INDUSTRIES INC** 

Subsidiary Hercules Incorporated

918 Greenbank Road, Wilmington, Delaware 19808

## New Components

temperature range of  $-55^{\circ}\text{C}$  to  $+100^{\circ}\text{C}$ , will withstand 10 to 2,000 hz vibration at 20 g, and is unaffected by 50 g, 11 msec shock. It weighs less than 10 grams and has a volume of 0.13 cu in. The unit may be obtained with mounting brackets, and three header styles permit plug-in or soldered connection.

Branson Corp., Vanderhoof Ave., Denville, N.J. [352]

## Chopper exhibits low noise level

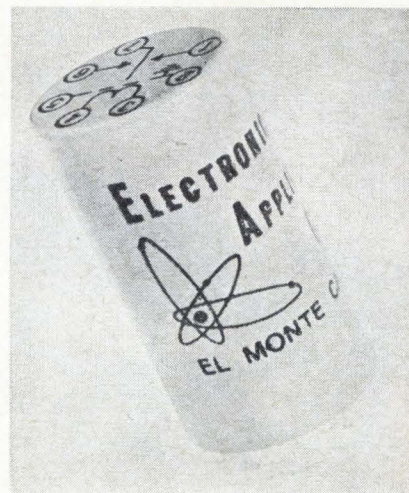

A chopper has been developed that virtually eliminates thermal noise by using copper-cored header pins and gold contacts mounted to these pins.

Magnetic coupling noise is less than  $1\ \mu\text{v}$ , which is easily achieved by shielding the drive coil from the contacts. This design method, using the hard gold contacts, makes a superior unit for dry circuit application, according to the manufacturer.

Model 600, with a standard 7-pin plug-in header, is a direct replacement for many units now in the field. It has a standard drive voltage of 6.3 v, 160 ohm coil with an impedance of 200 ohms and exceeds the requirements of MIL-E-5400.

All units have various mounting options and terminations and top drive is available. They are unconditionally warranted for 2 years or



# Make a Few Gallons of hot, Pure Water do the work of thousands

## ... with Barnstead microelectronic cleaning equipment

You cut rejects of integrated circuits, transistors, diodes and other semiconductor materials with hot rinses of particle-free, ultra-pure water. You minimize purification expense and usage of heat and water — at the same time!

Instead of dumping used hot, pure water down the drain, Barnstead equipment continually re-purifies it, to be used over and over again.

Barnstead makes a variety of microelectronic cleaning stations, including open or cabinetized, dust-free types, and built-ins for clean rooms. They incorporate rinses of 18-megohm water, often combined with chemical baths, ultrasonic cleaners and Freon rinses.

Ask us about this or *any* pure-water need, including stills, demineralizers and associated equipment.

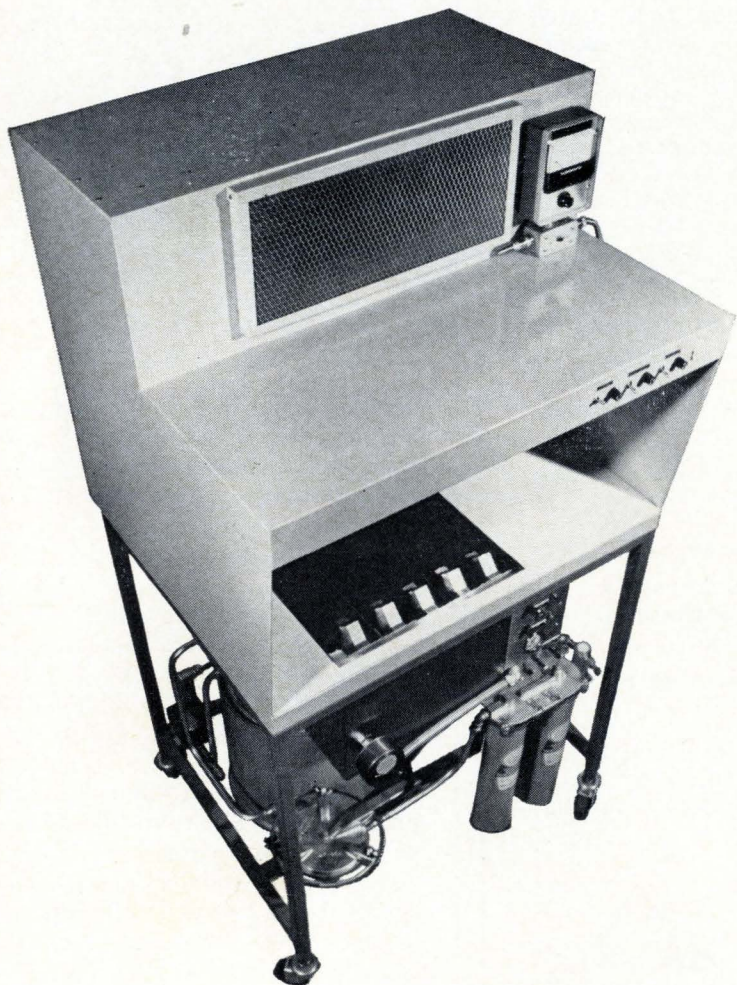

Helping you get more out of water!

# Barnstead

Still and Sterilizer Co.  
326 Lanesville Terrace, Boston, Mass. 02131

## New Components

15,000 hours of operation. Prices start as low as \$6.95.

Electronic Applications Co., 10916 Basye St., El Monte, Calif. [353]

## Switch serves as time integrator

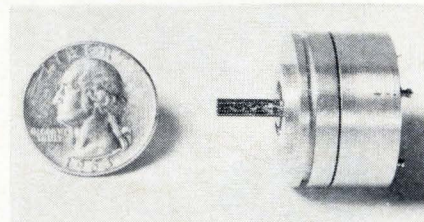

A miniature, high-speed Poly-Coder switch has been announced for use as a time integrating device in alignment amplifiers. The BB-1670SO24 switch is noise-free throughout its long operating life because of its brush design and dielectric material.

The device weighs 0.9 oz. and measures 1 in. in diameter. Operating voltage is 28 v d-c, and current capacity is 100 ma resistive load.

Other specs include: starting torque, 0.3 in. oz max.; insulation resistance, 1,000 megohms at 200 v d-c; life,  $10 \times 10^6$  minimum revolutions at 3,600 rpm with rated load either direction. Environmental capability of the Poly-Coder switch is MIL-E-5400, Class 2.

Litton Industries, Poly-Scientific division, Blacksburg, Va. [354]

## Reliable trimmers at industrial prices

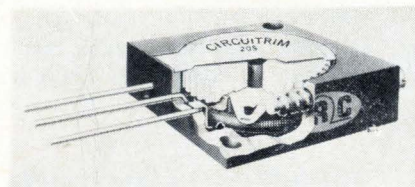

Wire-wound, trimmer potentiometers, at industrial prices, offer performance characteristics identical to those of military specification MIL-R-27208. The type 205-10



# EIMAC

## advanced traveling wave tube amplifiers drive military communications satellite system

Aerospace history was made on June 16, 1966, when the Space Systems Division, USAF, launched seven advanced military communications satellites from a single Titan III-C booster.

The satellites are in near-synchronous equatorial orbit at an altitude of more than 18,000 miles, and are reported to be functioning to specification.

EIMAC developed a new traveling wave tube amplifier for the satellites under USAF contract, for use in the three-phase launch feasibility demonstration of the system. Philco Corporation's Western Development Laboratories is prime contractor for the satellites.

The Philco WDL launch concept pioneers a unique satellite dispenser which provides great economy by substantially reducing the number of high-cost boosters required to establish the necessary communications capability. The simple and highly-reliable satellite design contains no moving parts, and is expected to operate in orbit for several years.

The hermetically-sealed EIMAC TWTA package includes a solid state power supply, and is optimized for operation in the X-band satellite-to-ground frequency band. In typical operation, the TWTA package has an overall efficiency of 26%, with saturated gain

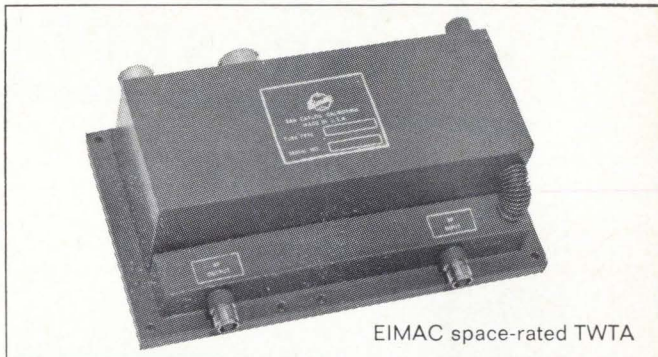

EIMAC space-rated TWTA

of 39db. Weight of the unit, including base plate, is 3.35 pounds, and volume is less than 75 cubic inches. The unit is rated for 50,000 hours mean time operation before failure.

EIMAC has other space-rated satellite tube development programs underway. For additional information, contact Microwave Marketing.

**EIMAC**

Division of Varian

San Carlos, California 94070



*Artist's concept of military satellite system courtesy of Philco Corporation*

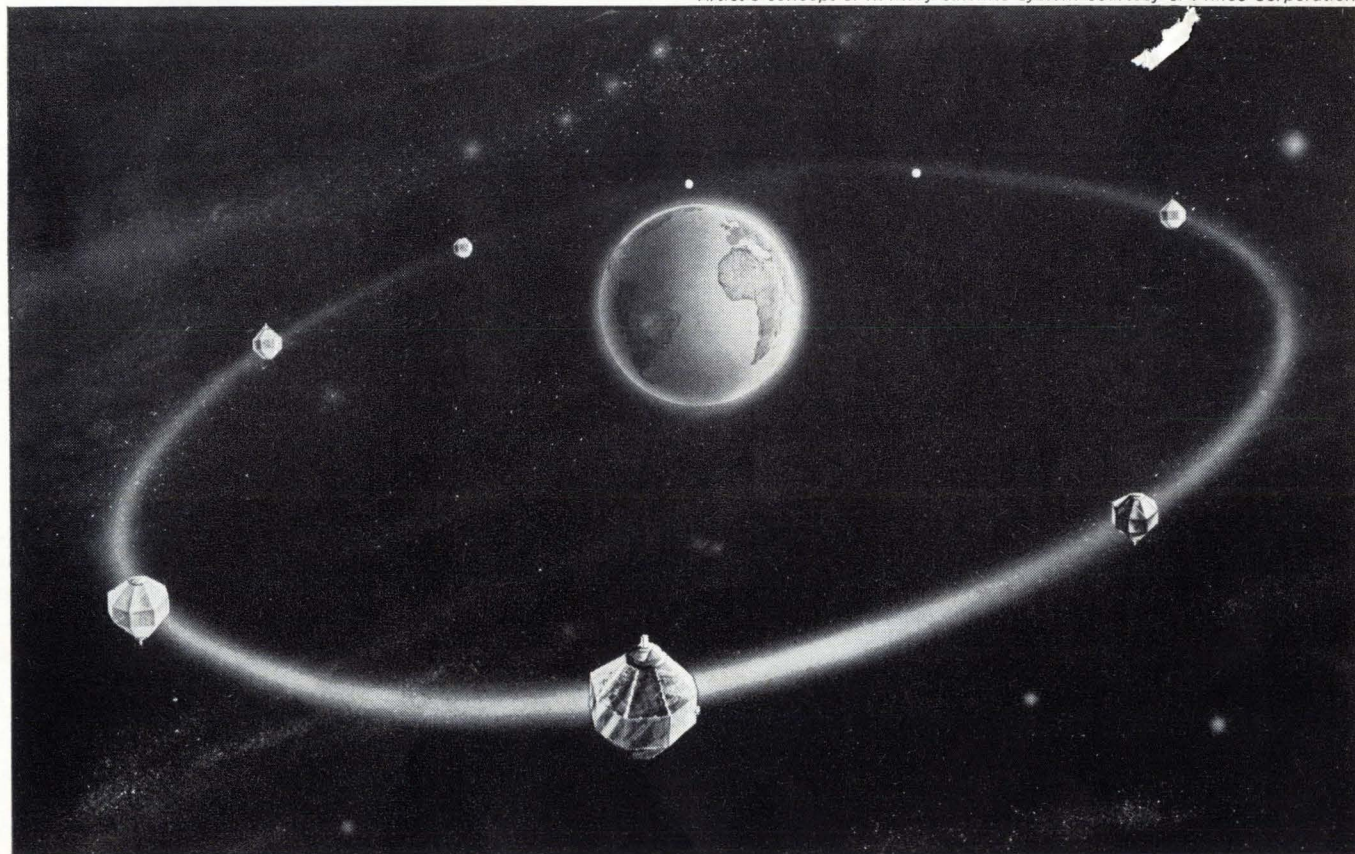



# Ame Electric SHOULD BE YOUR BEST SOURCE

## FOR REGULATED D. C. POWER SUPPLIES

If design experience and performance reliability are factors to be considered in your buying, then Acme Electric should be your first-choice source for D. C. Power Supplies. Converting alternating current to direct current is an old Acme Electric specialty. In over 35 years we have produced millions of low-voltage power supplies for battery charging and thousands of high voltage power supplies for electrostatic precipitrons. We've had our hand in the "state-of-the-art" for a long time and know the limits of each component for each application.

The standard stock model "off-the-shelf" D. C. Power Supplies listed below were designed to provide reliable performance at an economical price.

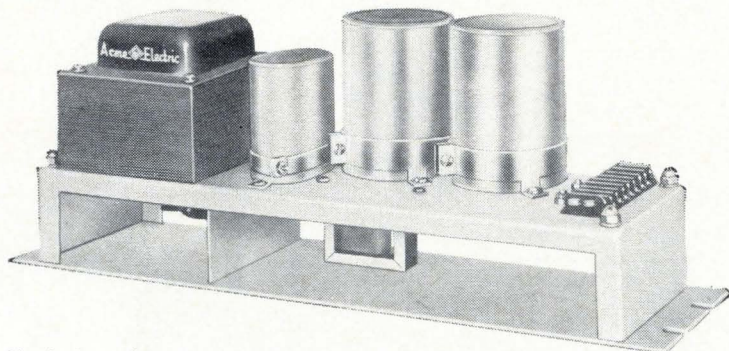

Check these features:

- ✓ All solid state components are rated for continuous duty.
- ✓ Convection cooled — no fan or other moving parts.
- ✓ May be paralleled for multiplying ampacity.
- ✓ Fast response to line and load changes.
- ✓ Line regulation,  $\pm 1\%$ .
- ✓ Load regulation  $\pm 2\%$ .
- ✓ Ripple, 1% RMS maximum.
- ✓ Operating temperature range, 0°C. to 50°C.

### PARTIAL LISTING OF STOCK MODELS AVAILABLE SINGLE PHASE, 100-130 Volts; Input 50 or 60 Cycles

Catalog Number	D. C. OUTPUT			Catalog Number	D. C. OUTPUT		
	Volts	Amps	Watts		Volts	Amps	Watts
PS-47509	10	4	40	PS-1-47461	24	75	1800
PS-47623	12	3	36	PS-1-47200	24	100	2400
PS-47508	15	2	30	PS-47202	26	4	104
PS-57352	22	25	550	PS-47638	28	8	224
+PS-41422	24	2	48	PS-47712	28	25	700
+PS-41423	24	6	144	PS-57355	28	30	840
PS-57353	24	10	240	PS-57356	44	25	1100
+PS-47125	24	15	360	PS-41424	38	4	192
PS-57354	24	20	480	PS-57357	48	6	288
+PS-47173	24	25	600	PS-47519	48	10	480
PS-1-47127	24	50	1200	PS-57358	48	15	720

+ 24 volt output units of same current rating can be paralleled to multiply current capacity.

Write for catalog 175 and full list of "off-the-shelf" D. C. Power Supplies.

**Ame  Electric**  
**Engineers and Builders of...**

3110 WATER STREET, CUBA, NEW YORK  
Canadian Representative: Polygon Services, Ltd.  
50 Northline Rd., Toronto 16, Ont.

SAA-3932-3220

REGULATED POWER SUPPLIES  
STATIC POWER RECTIFIERS  
VOLTAGE STABILIZERS  
VOLTAGE REGULATORS

## New Components

units, military specification style RT22, are a half-inch square.

They have molded-in printed circuit board pins. Epoxy seals provide humidity protection and the high temperature, thermosetting-plastic cases resist the adverse effects of automatic soldering and subsequent cleaning.

Rated 1 watt at 70°C, the units are available with resistance values from 10 ohms to 50,000 ohms,  $\pm 5\%$  tolerance. Price is \$3.81 each in lots of 100; delivery, 3 to 4 weeks.

IRC, Inc., 401 N. Broad St., Philadelphia, Pa., 19108 [355]

## Contactors help testing flatpack IC's

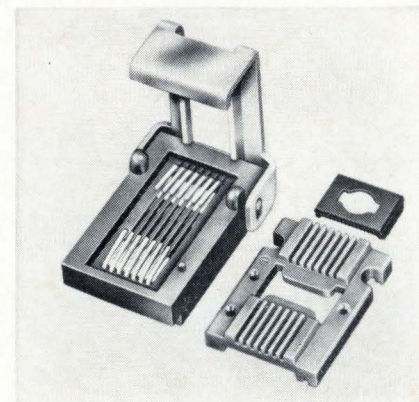

A compact contactor has been developed for use in production, life and acceptance tests as well as for aging and breadboarding carrier held, 14-lead flatpack integrated circuits.

Loading and unloading of the 029-190 contactor is fast, featuring one-hand operation with the manufacturer's push-pull, stainless steel latch. Sturdy polarization pins assure correct orientation of carrier in the contactor. With body molded of Polysulfone for operation at temperatures from  $-65^{\circ}$  to  $150^{\circ}$ C, the unit has excellent electrical characteristics. Materials and design qualify the 029-190 for vibration, shock and environmental stresses. Contacts are precision formed of beryllium copper, full spring tempered, then hard gold-over-nickel plated.

Wiring type contacts do not dam-



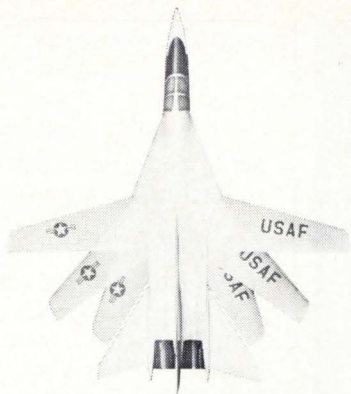

F-111A • F-111B • FB-111  
RF-111 • F-111K • MARK II  
BORON FILAMENT

*and other advanced  
aircraft and space programs*

**Spread your wings.**

Make full use of your creative energy on a responsible assignment in General Dynamics' highly diversified Research and Engineering Departments. Contribute to the F-111 or other advanced aircraft projects; missile assignments; space systems and mission analysis or other challenging R&D requirements.

Enjoy living in 1965's All-America City, where superior housing, schools, sports and recreation, graduate studies and mild weather are all part of the package.

Call collect—817-PE 2-4811 extension 3551 or send a resume of your education and experience to J. B. Ellis, Industrial Relations Administrator, Engineering, General Dynamics, Fort Worth Division, P. O. Box 748E, Fort Worth, Texas. An equal opportunity employer.

**Information Technology**

- Mission Simulation, Display Technology

**Navigation, Stability, Guidance & Control**

- Stability and Control, Computer Design, Servo Analysis

**Electronic Systems**

- ECM, Penetration Aids

**Electronic Age**

- Microwave and Computer Design

**Electronics Laboratories**

- Circuit Design, Flight Test Instrumentation

**Electrical Installation Design**

**GENERAL DYNAMICS**

*Fort Worth Division*



for maximum **SOLID CARBIDE** drilling precision

## **SERIES 125 - 1/8" SHANK SOLID CARBIDE CIRCUIT BOARD DRILLS**

**the rigid stability  
of 1/8" shanks  
with EVERY size drill**

Series 125 Circuit Board Drills are made with Metal Removal Company specifications of point configuration (Four Facet Point), helix angle, very fine flute finish and exacting size tolerances.

**The Series 125 Circuit Board Drill is an advancement of drill design to its present optimum. Among many features, it offers:**

- Strength and rigidity of the 1/8" shank permits location and hole size tolerance to close limits.
- Drill bushings completely eliminated where used with precision spindles and collets.
- Also available in double end style with 1/8" shanks.
- 1/8" common shank size for all drill diameters eliminates inventory of collets for each size drill.
- Drill point is concentric to drill diameter within .0005"; drill diameter to shank concentricity is within .0003".
- Permits ultra high speed drilling at rates up to 150,000 RPM and 5 feet per second feed.
- Can be manufactured with geometry variation for clearances required for fast feed, high RPM operation.

For complete information write for Bulletin CB66.

### **THE METAL REMOVAL COMPANY**

1859 West Columbia Avenue  
Chicago, Illinois 60626

Plants Located in CHICAGO • LOS ANGELES • SAN JUAN

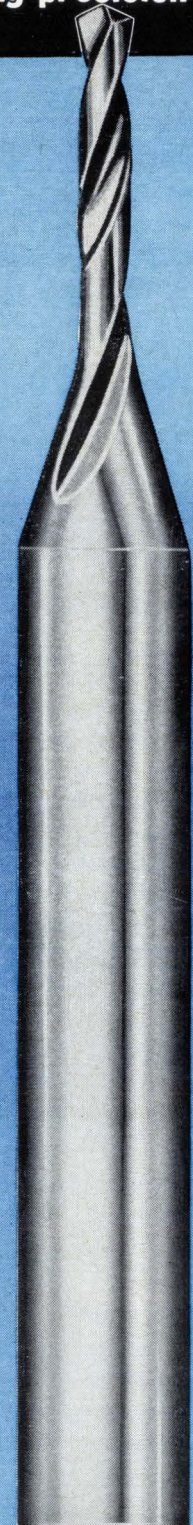

**MASTER TOOL AND WHEEL MAKERS FOR THE WORLD**

## **New Components**

age leads and exert a uniform 50-gram contact pressure maintaining contact resistance of less than 0.010 ohm. Base terminals can be dip-soldered, hand-wired or connected by miniature wire wrap.

Price is \$1.75 to \$5 depending on features and quantity; availability, stock to two weeks.

Barnes Development Co., Lansdowne, Pa., 19050. [356]

## **Variable capacitors for h-f application**

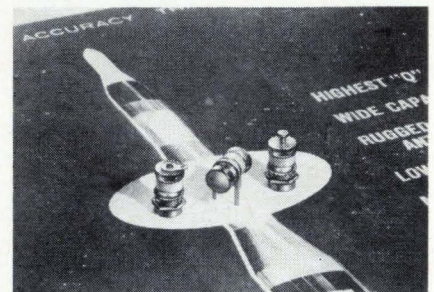

Variable air capacitors, known as the 5200 series, provide improved rotational life, noiseless contact while adjusting, greater stability under shock and vibration, broader operating temperature range and greater soldering ease. These advantages are the result of a patent-pending, one-piece rotor construction.

Capacitance is 0.8 to 10 pf; working voltage, 250 v d-c (test voltage 500 v d-c); temperature coefficient,  $0 \pm 30$  ppm/ $^{\circ}$ C; Q at 100 Mhz, greater than 3,000; sinusoidal vibration, greater than 60 g; random vibration, greater than 2.0 g<sup>2</sup>/hz; shock, greater than 275 g (6 msec). The unit is constructed with 570 $^{\circ}$  solder.

Johanson Mfg. Corp., 400 Rockaway Valley Rd., Boonton, N.J. [357]

## **Transformer withstands environmental changes**

A high-voltage, low-current transformer has been designed for application in photomultipliers and related equipment.

Made rugged to withstand a wide



# Heat Dissipation Bonus of Beryllia Worth An Extra Two Cents?



Coors Beryllium Oxide Ceramic offers you the bonus of 10 times the thermal conductivity of aluminum oxide ceramic—approximately the heat transfer qualities of aluminum metal. Ordinarily, beryllia is thought to be too expensive, except for designs where maximum heat dissipation is an essential. However, we find the additional cost of using beryllia in small metallized assemblies adds only a few cents to the total cost of the completed part. For an “extra two-cents worth” Coors offers a beryllia-to-metal assembly that allows you to use more power . . . or allows you even further miniaturization than with alumina . . . or gives you longer component life—or a combination of all three. When you design micro-substrate assemblies—Consider Coors Metallized Ceramics—and get the bonus of beryllia’s thermal conductivity. Write for Coors Metallizing Data Sheet 9502, or call the Coors “hot line”—303/279-4533, Ext. 351.

*consider  
Coors metallized  
ceramics*

# Coors CERAMICS

ALUMINAS • BERYLLIAS • MAGNESIAS • SPECIAL OXIDES

Coors Porcelain Co., Golden, Colo.

Circle 167 on reader service card



THIS COORS  
METALLIZED BERYLLIA  
MICRO-COMPONENT  
DISSIPATES THE SAME  
QUANTITIES OF HEAT

AS THIS COORS  
METALLIZED ALUMINA  
MICRO-COMPONENT

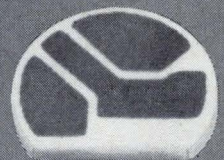



# SCHOOL DROPOUTS

(Wisconsin  
style)

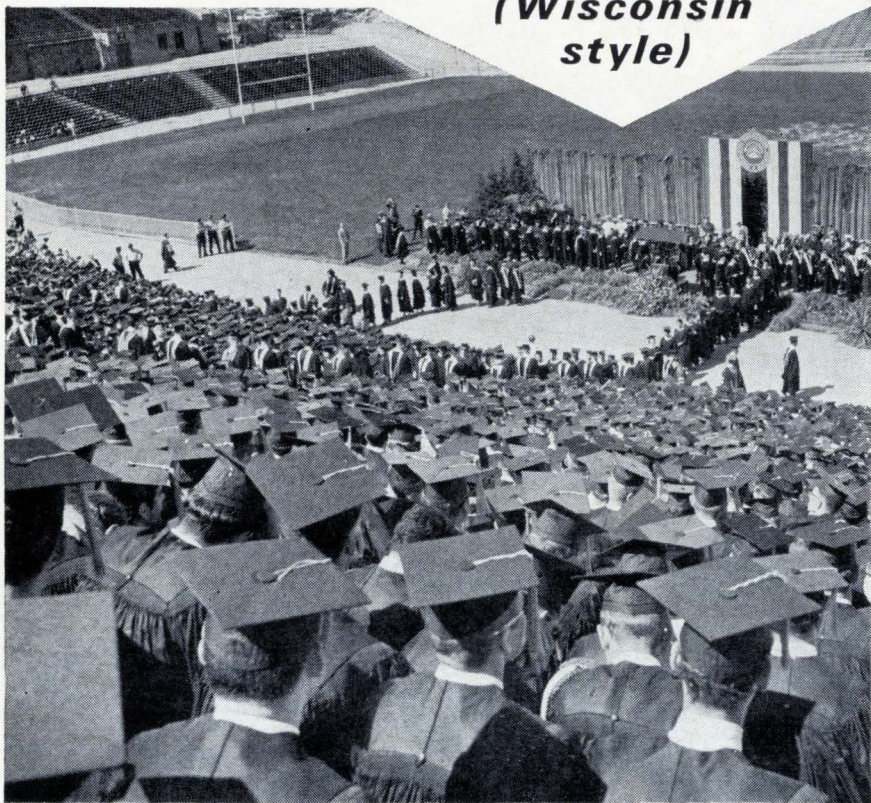

Wisconsin has one of the nation's lowest school drop-out rates. Industry, therefore, has more new talent available each year from skilled labor on up through top management in the fields of administration, engineering, chemistry, biology, and related fields. The number of students graduated from Wisconsin schools and colleges at all levels is impressive . . . 15,000 bachelor and advance degrees were awarded in 1965. But of even more importance is that Wisconsin's educational facilities are industry oriented—64 vocational and adult education schools are located strategically throughout the state, a valuable asset to any industry anxious to train new employees. Yes, in Wisconsin there is excellent opportunity for employees and school drop-outs to complete and further their education and training. Let us tell you more.

Write Industry Development Department, Dept. H, Wisconsin Power and Light Company, P.O. Box 192, Madison, Wisconsin 53701.

*Take the profitable leap to better living*



## WISCONSIN POWER & LIGHT

... investor owned

### New Components

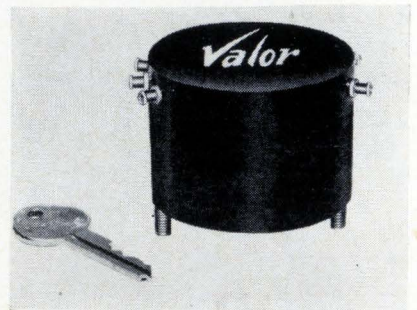

range of environmental temperatures and conditions, the new transformer is potted with a corona-resistant silicone compound in a diallyl phthalate case. It will operate in temperatures up to 130°C, at altitudes up to 200,000 ft.

Price is approximately \$20; delivery, one to eight weeks, depending on quantity.

Valor Electronics, Inc., 13214 Crenshaw Blvd., Gardena, Calif. [358]

### Resistor designed for tv circuitry

A tin-oxide, low-power resistor, to be available in November, will not burn when overloaded up to 100 times rated power. Designed for television circuitry, the FP style resistors will open instead of burning at such drastic overload, according to the manufacturer. These resistors are coated with an inorganic, passive substance that is nonflammable. The units continue operating under overloads up to 10 times rated power for up to 10 seconds.

The six FP styles—2, 3, 4, 5, 7 and 10 watts—have tolerances of 1, 2, 5, or 10%. The  $\pm 200$  ppm temperature coefficient of the new resistors is guaranteed over a range of  $-55^{\circ}\text{C}$  to  $+150^{\circ}\text{C}$ . Load life change is guaranteed to be less than 5% under tests specified in Mil-R-22684B. Resistance change is less than 0.5% under low temperature operation. Maximum resistance change under temperature is 1%. A short time overload of 10 times rated power, applied for 5 seconds, results in a resistance change of only 0.5%.

Corning Glass Works, Corning, N.Y. [359]



# Engineers:

1. If you're looking for money, our \$470,000,000 backlog of orders tells its own story.
2. If you're looking for challenge, we offer you pioneering in a brand-new ocean.
3. If you're looking for a career, we offer you stability and rapidly expanding opportunities for growth.

## If you're looking for all three, we're looking for you.

We need qualified engineers for responsible jobs—challenging positions with commensurate pay—in all eight categories listed below.

Money? If you're a capable and imaginative engineer who is willing to take responsibility, we'll offer you a high starting salary plus wide-open promotional opportunities and liberal fringe benefits.

Challenge? We're in the forefront of revolutionary technological advances that are taking place in, under, and on the ocean. Nuclear submarine building. Oceanography. Engine room automation. Aircraft carrier design. You name it—we're in it. And we'll give you a chance to put your abilities to work—all your abilities.

Career? Newport News offers you permanence and a solid future. With us, you can build a lifetime career in your chosen field of engineering—and you can build it to any size. We want you to move ahead. How high you climb is entirely up to you.

If you're interested in advanced study, we are close to some outstanding institutions. Next door is Virginia Associated Research Center with one of the world's largest synchrotrons, where you can study in high-energy physics. Across the harbor is Old Dominion College, offering gradu-

ate courses in such subjects as Microwave Theory, Solid State Electronics and Nuclear Engineering. Within easy driving range are Virginia Institute for Scientific Research—a world leader in solid state physics—and the University of Virginia, with its new nuclear laboratory.

Sound interesting? Then act now to get details on immediate, specific career openings in your field. Our \$470,000,000 order backlog, up \$50,000,000 in three months, makes our need for qualified engineers urgent. Write or phone John J. Gaughan, employment manager. You'll get fast action.

IMMEDIATE OPENINGS IN THESE ENGINEERING CATEGORIES

Mechanical Engineers	Naval Architects
Electrical Engineers	Nuclear Engineers
Marine Engineers	Civil Engineers
Industrial Engineers	Metallurgical Engineers
Systems Analysts	

### Newport News



NEWPORT NEWS SHIPBUILDING AND DRY DOCK COMPANY  
Newport News, Virginia 23607 Phone: (703) 247-1211

Write or phone for illustrated, fact-packed booklet, "Blueprint of Your Future."

An Equal Opportunity Employer



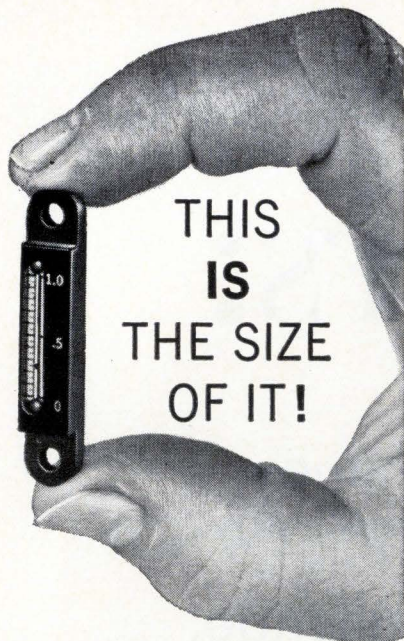

THIS  
IS  
THE SIZE  
OF IT!

## CURTIS MIL-I-81219(WP) ELAPSED TIME METER

- 50 MW POWER
- 2 GRAMS WEIGHT
- $\pm 3\%$  ACCURACY
- DIRECT READING  
(without removal)
- AC OR DC
- OFF-THE-SHELF-DELIVERY

Curtis' new subminiature elapsed time meter, Model 620-N, meets or exceeds MIL-I-81219(WP) and Military Standard MS-90386(WP). Yet it weighs 1/10 of and costs 1/3 of competitive MIL type electro-mechanical timers. The unit is epoxy encapsulated and meets MIL-STD-202 for shock and vibration.

Write for complete details and prices on the entire line of Curtis Elapsed Time Meters, Integrators, and Ampere Hour Meters.

**Curtis Instruments, Inc.**  
351 Lexington Avenue, Mt. Kisco, N. Y.

## New Semiconductors

### Parabola increases infrared intensity

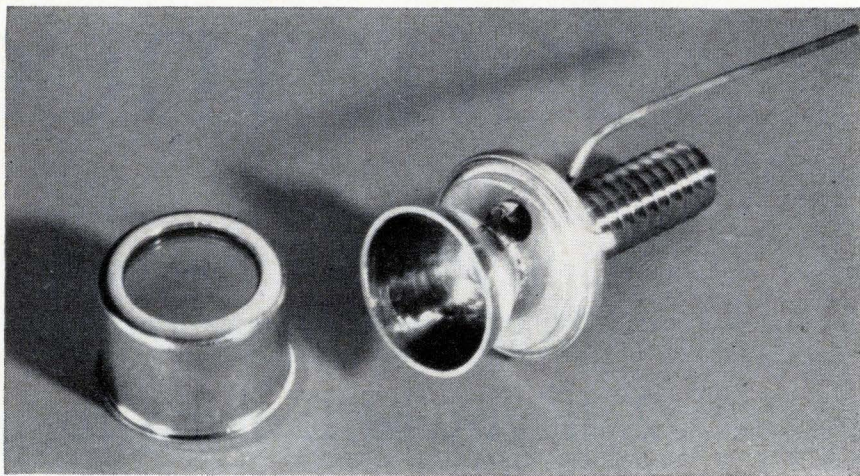

Improved design of a gallium-arsenide diode infrared source and the addition of a parabolic reflector result in more intense radiation in a narrow beam. The manufacturer, the Philco Corp., Spring City, Pa., a subsidiary of the Ford Motor Co., believes this to be the first commercial GaAs source offered with a parabolic reflector.

Operating at a wavelength of 0.92 micron, the unit radiates 40 milliwatts of continuous power in a beam whose half power points are  $15^\circ$  apart. John Roschen, Philco's product manager for the sensor and transducer department, says the beam angle is one half to one fourth the value obtained without a reflector. The diode also radiates more power, about 25% higher than previous outputs, Roschen estimates.

Roschen says that infrared immersion optics in the package reduces the amount of energy reflected back to the GaAs source and consequently increases output power. The parabolic reflector concentrates radiated energy into a narrower beam, increasing beam intensity.

Designed for operation at room temperature, the source, type GAE-406, requires a 2-ampere d-c input to produce the 40-milliwatt output. Conversion efficiencies are slightly greater than 1%. The diode will continue to emit, although at lower outputs, down to a threshold cur-

#### Specifications

Unit	Type GAE-406 infrared source
Material	GaAs
Radiating wavelength	0.92 micron
Continuous-wave operation	
Output	40 mw
Input	2 amps d-c
Efficiency	Greater than 1%
Pulse Operation	
Output	200 mw peak
Input	15 to 20 amps d-c
Threshold current	2 ma
External cooling	Heat sink
Price	
1-9	\$135
10-99	\$115

rent of 2 milliamperes. Roschen says that at this threshold the output is less than  $100 \mu\text{w}$ .

Power as high as 200 milliwatts peak is produced when the diode is pulsed with a 15- to 20-ampere d-c source. These values correspond to a 10-microsecond pulse width and a 10-kilohertz pulse repetition frequency.

The infrared diode can be used for communications, as a card reader in optical data processors and as a photoelectronic control head. Another possible application is to combine many elements in an array and use the device as a terrain illuminator. Roschen says it might be possible to combine 150 such devices to obtain about 6 watts output. If the array was designed to function in a cooled environment, it might be possible to get an output of 30 to 60 watts.

The diode is packaged in a modified TO-5 transistor case that has a 6-32 stud attached for heat sinking. The diode may be used in



Immediate openings for circuit design and sales engineers.



## another ZELTEX FIRST...

### Model 145 Operational Amplifier with 0.5 $\mu\text{V}/^\circ\text{C}$ and 1 $\text{pa}/^\circ\text{C}$ drift!

More amplifier news from Zeltex... announcing a miniature chopper stabilized amplifier in a rugged die cast aluminum case with exceptional drift and speed.

Use the new Model 145 for D/A conversion, precise integration, low level amplification—you name it! Write for full technical data today.

#### KEY SPECIFICATIONS

Voltage drift	..... 0.5 $\mu\text{V}/^\circ\text{C}$
Current drift	..... 1.0 $\text{pa}/^\circ\text{C}$
Gain B.W.	..... 100 MHz
Slew rate	..... 100 $\text{V}/\mu\text{sec}$
DC gain	..... $10^8$
Output	..... $\pm 10\text{ V}$ @ 20 ma

SPECIALISTS IN AMPLIFIERS AND COMPUTER ELEMENTS



**ZELTEX, INC.**

1000 Chalomar Road  
Concord, California 94520  
Phone (415) 686-6660

Circle 233 on reader service card

5 of a series

TRANSICOIL SOLVES  
SERVO PROBLEMS

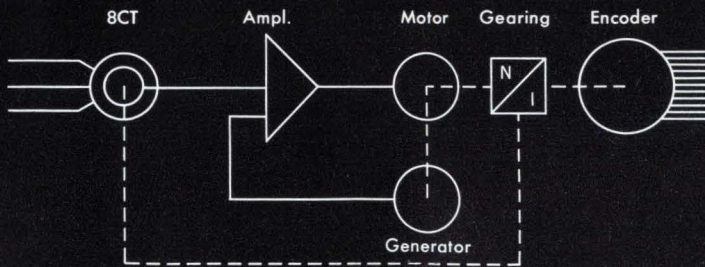

## New Transicoil synchro-to-digital converter

This particular servo package provides synchro-to-digital conversion of airborne test data for telemetering to a ground station. Synchro input is fed to a size 8 control transformer which is nulled by an 11 motor generator driven from a transistorized servo amplifier. An 11-bit V-scan encoder is precision geared to the synchro and provides output in natural binary form. Careful packaging design facilitates side-by-side stacking for multi-channel applications in a confined space. ■ Let Weston-Transicoil convert your system requirements into a sophisticated assembly... test our response time!

**PERFORMANCE:** Input: 11.8V, 400 CPS, 3 wire synchro ■ Output: 11 bit natural binary from V-Scan encoder ■ Static Accuracy:  $\pm 2$  bits at encoder ■ Dynamic Accuracy:  $1^\circ$  at 16 RPM ■ Slew Speed: 16 RPM ■ Power Required: 115V, 400 CPS, 15 watts; 28V d.c., 250 ma. ■ Weight: 30 oz. ■ Size: 1.8 x 4.75 x 5.0"

Weston Instruments, Inc. Transicoil Division, Worcester, Pa. 19490.

**WESTON**<sup>®</sup> prime source for precision . . . since 1888



# NO MATTER WHERE YOU'RE GETTING THESE MIL & INDUSTRIAL TRIMMERS AND POTS



## WE CAN SUPPLY THE IDENTICAL ITEMS AT LOWER COST... FROM STOCK!

**WE'LL PROVE IT! MAIL THIS COUPON.**

**FAIRCHILD** A DIVISION OF FAIRCHILD CAMERA AND INSTRUMENT CORPORATION  
**CONTROLS** 225 PARK AVENUE, HICKSVILLE, L. I., NEW YORK  
TELEPHONE: (516) 938-5600 • TWX: (510) 231 1854  
CABLE: FAIRCON-HICKSVILLE, NEW YORK, U. S. A.

Please quote me on the following items:

Type Number \_\_\_\_\_ Quantity \_\_\_\_\_

Type Number \_\_\_\_\_ Quantity \_\_\_\_\_

Type Number \_\_\_\_\_ Quantity \_\_\_\_\_

Name \_\_\_\_\_ Title \_\_\_\_\_

Company \_\_\_\_\_

Address \_\_\_\_\_

City \_\_\_\_\_ State/Zip \_\_\_\_\_

### New Semiconductors

combination with Philco's L-4504 silicon diode detector.

Philco Corp., Spring City, Pa. [361]

### Mixer diodes feature low noise figure

The 345R mixer diode is a hot carrier, silicon device that offers great improvements in noise figure, reliability and sensitivity compared with silicon point contact diodes. The microwave diodes are lower impedance than point contact diodes but are generally interchangeable wherever the IN21-IN23 diodes are employed. At S band the noise figure of the hot carriers is at least 1 db lower than the best silicon point contacts available with a typical noise figure of 7 db, according to the manufacturer. MSI Electronics Inc., 34-32 57th St., Woodside, N.Y., 11377 [362]

### High-voltage transistors used in color tv

High-voltage silicon transistors have been announced for horizontal output circuits of 25-inch color tv receivers. Two of the DTS-402 transistors are connected in series to the flyback transformer primary with center tap. The circuit features off-line operation, B+ regulation and individual peak detector clamps for each transistor. The circuit eliminates the large power transformer previously needed.

The transistors switch 120 v, producing a retrace pulse up to 1,200 v. Peak current switched is 3.5 amps, while the high-voltage circuit provides 24 kv at 1.3 ma with 3 kv regulation. Known high-voltage fault conditions are endured safely by the two DTS-402 transistors.

The DTS-402 transistor is a version of the manufacturer's DTS-423 silicon power transistor presently being offered to industry. The DTS-402 has a maximum fall time specification and a collector-emitter breakdown voltage rating of 700 v. Delco Radio, division of General Motors Corp., Kokomo, Ind., 46901 [363]



# HERE'S HOW...

THE ELECTRONIC INDUSTRY IS USING THESE TWO FAMOUS ULANO FILMS IN ULTRAMINIATURE MASK TECHNOLOGY AND COMPLEX PRINTED CIRCUITRY

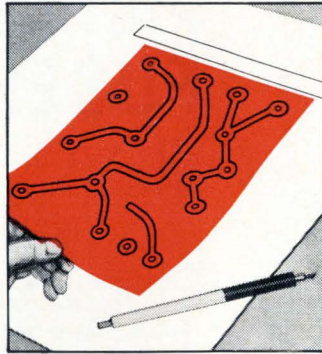

Cut a piece of the desired film large enough to cover area to be masked. Tape it down firmly at the top with dull-side up.

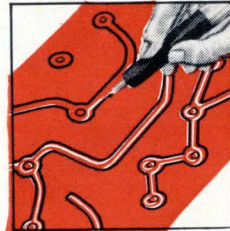

With sharp blade, outline the areas to be masked. Do not cut through the backing sheet. The Ulano Swivel Knife does the job quickly, easily.

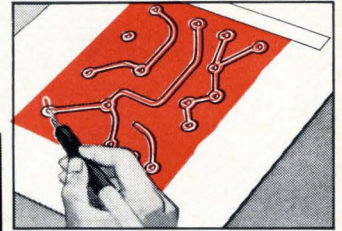

Using the tip of the blade, lift up a corner of the film thus separating it from the backing sheet.

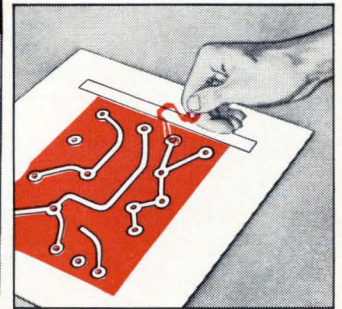

Now carefully peel off the film as outlined leaving a completed mask, positive or negative, that corresponds exactly to the desired pattern.

# Ulano

T.M.

## RUBYLITH<sup>T.M.</sup> • AMBERLITH<sup>T.M.</sup>

HAND CUT MASKING FILMS FOR THE GRAPHIC ARTS

**ULANO RUBYLITH**... a revolutionary knife cut red film is laminated to a stable transparent plastic backing sheet. The red film is "light safe" so that when contacted to a sensitized emulsion and exposed to a suitable light source, light passes through the cut-out portions only... not through the red film. ■ The polyester backing is absolutely stable... insures perfect register. ■ Special effects such

as crayon tones, paste ups, benday sheets, and opaquing are easily combined with versatile ULANO RUBYLITH.

**ULANO AMBERLITH**... a companion to Rubyolith serves as a color separation medium used as the master on camera copy board to secure negatives or positives.

A wide variety of Ulano films—in rolls and sheets—is readily available

ulano

NEW YORK • CHICAGO • ZÜRICH

610 DEAN ST., BROOKLYN, N. Y. 11238  
In Europe: ULANO A. G., Untere, Heselbachstrasse No. 22  
Kusnacht, Zurich, Switzerland

Ulano - Rubyolith - Amberlith are registered trade marks of the Ulano Companies.



WRITE TODAY

on your letterhead for free special sample kit 1848

## New plant site?

# JOIN THE SUCCESSFULS on the Niagara Frontier

SIZE DOESN'T COUNT. Of 66 electronics and electrical producers in Erie County, 45 employ under 50. Big and small benefit from ample supplies of skilled talent... raw material... cheap power... and easy access to both U.S. and Canadian markets. For full details write Erie County Executive Edward Rath, Erie County Hall, Dept. E-1, Buffalo, N. Y. 14201. He'll send the new book that tells why Erie County offers the best profit opportunities for your new plant.

## The future is here on the Niagara Frontier

(Buffalo and Erie County)

## Only From HEATH Can You Get A Laboratory - Quality Transistor Analyzer For Just \$54.88

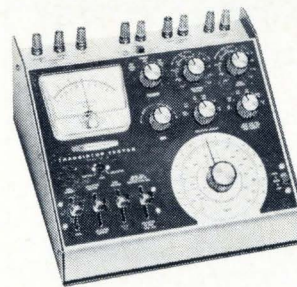

- Unmatched in quality, performance and price! • Ideal for servicing, design work, incoming inspection, production testing, etc.
- Provides complete DC analysis of PNP & NPN transistors • DC gain (Beta, Alpha) read direct on calibrated scales • 15 uA basic range for leakage (Icbo, Iceso) tests • Four lever switches for fast, easy test selection • Provisions for checking high voltage & high current transistors through external supplies

Now In Kit Or Assembled Form

Kit IM-30, 9 lbs. \$54.88  
Assembled IMW-30, 10 lbs. \$84.95

**IM-30 SPECIFICATIONS**— Checks: Transistors up to 15 amps and diodes up to 1.5 amps. Tests: Shorts, DC Gain (Beta 0.300) (Alpha 0.9967), Leakage (Icbo, Iceso), Diode Forward & Reverse Current. **Power supply:** Internal, seven 1.5 volt size D batteries provide 1.5, 3, 4.5, 6, 7.5, 9 volts collector supply for gain or leakage and 1.5 volts for bias; external, 0-50 volts for gain, 0-150 volts for leakage and 0-5 volts for bias. **Bias control:** Permits any collector current from 10 uA to 15 amps for gain tests. **Gain control:** 3% wire-wound potentiometer has calibrated scales to give DC Beta and DC Alpha directly when meter is at null. **Transistor & diode connections:** Universal transistor socket and binding posts.

HEATH COMPANY, Dept. 67-10  
Benton Harbor, Michigan 49022



- Please send FREE Heathkit Catalog.  
 Enclosed is \$ \_\_\_\_\_, plus shipping.  
Please send model \_\_\_\_\_

Name \_\_\_\_\_  
Address \_\_\_\_\_  
City \_\_\_\_\_ State \_\_\_\_\_ Zip \_\_\_\_\_

Prices & specifications subject to change without notice. TE-149



## FUSEHOLDERS For BUSS FUSES

AVAILABLE FOR ALL  
TYPES OF APPLICATIONS

Panel mounted, in-the-line, lamp indicating, signal activating, visual indicating — with solder terminals or quick-connect terminals — for fuses from 1/4 x 5/8 inches and larger.

Fuseholders to meet Commercial and Military specifications.

Write for BUSS Bulletin SFB.

INSIST ON

**BUSS  
QUALITY**

BUSSMANN MFG. DIVISION, McGraw Edison Co., St. Louis, Mo. 63107  
Circle 175 on reader service card

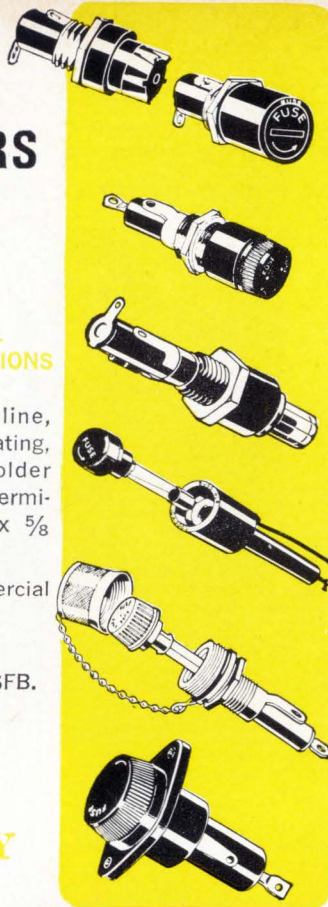

## TRON SUB-MINIATURE PIGTAIL FUSES

BODY SIZE ONLY  
.145 x .300 INCHES

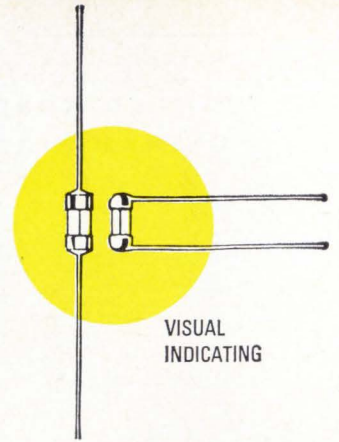

For use on miniaturized devices, or on gigantic space tight multi-circuit electronic devices.

Glass tube construction permits visual inspection of element.

Smallest fuses available with wide ampere range. Twenty-three ampere sizes from 1/100 thru 15 amps.

Hermetically sealed for potting without danger of sealing material affecting operation. Extremely high resistance to shock or vibration. Operate without exterior venting.

Tell us what you need or . . .

Write for Buss Bulletin SFB

INSIST ON **BUSS  
QUALITY**

BUSSMANN MFG. DIVISION McGraw-Edison Co., St. Louis, Mo. 63107  
Circle 175 on reader service card

## BUSS: The Complete Line of Fuses and . . .

### NEW BLUE M FULL-RANGE CONSTANT TEMPERATURE/ HUMIDITY CABINET



MEETS ANY  
CURRENT MIL  
HUMIDITY SPEC!  
—20°C. to +93°C. Range

Convenient and compact top loading cabinet; 18" W. x 16" H. x 16" D. I.D. Features patented Dual Wet and Dry Bulb POWER-O-MATIC 60® Saturable Reactor Control Systems, programming, separate recorder. Only 29" W. x 63" H. x

30" D. overall. 1/2" thick removable Plexi-Glass panel top permits many fixturing capabilities . . . unit accessories greatly extend operational flexibility. Unmatched for reliability and dependability. 120 V./1 Ph./60 Cy. A.C. Competitively priced.

SEND FOR FULL INFORMATION



**BLUE M** Engineering Company

A DIVISION OF BLUE M ELECTRIC COMPANY

Corporate Headquarters: BLUE ISLAND, ILLINOIS 60406



give...so more will live

# HEART FUND







# Ballantine Announces a New Solid State DC Digital Voltmeter

## New Instruments

range and in the c-w mode. External frequency-modulation is also possible, so the unit can be phase-locked during c-w operation.

A key to the unit's low price is the elimination of a meter for visually checking the output's calibration. Jerrold says a meter is unnecessary because the unit contains a proprietary circuit that keeps the output calibrated despite frequency changes.

The output's amplitude can be adjusted without affecting output frequency because of a current-operated variable attenuator with a leveler correction feedback signal. So the frequency need not be readjusted as in instruments where a correction signal is applied to an oscillator stage.

Output attenuation is controlled by five toggle switches which, when used with the calibrated 6-decibel output level control, allow an attenuation range of 65 db in increments of 0.5 db. Toggle switches replace the usual slide switches to eliminate radiation problems.

In the instrument is a detection system that uses a half-wave peak-to-peak feed-through detector.

Jerrold anticipates use of the unit in the field as well as in the shop. The instrument can operate off a 12-volt battery coupled to an a-c inverter.



Model 353

## Gives you fast, accurate readings to 0.02% ± 0.01% f.s. and at a low cost of just \$490

Ballantine's new Model 353 enables you to speed up dc measurements materially over those made on multi-knob differential voltmeters. And with laboratory accuracy from 0 to 1000 volts dc.

It requires just two steps: (1) Set knob to **NORMAL** mode and read voltage; (2) dial in the first digit in **EXPAND** mode and read voltage to four places with overrange to five; and, in addition, interpolate to another digit.

The **NORMAL** mode error becomes submerged by more than ten to one, and the operation is fast and accurate to 0.02% of reading ± 0.01% f.s. If the input signal is varying, the last digit may be followed visually, thus providing the advantage of analog display.

Note these other interesting features of the new 353: a left-to-right digital readout; an automatic display of "mV" or "V"; proper placement of the decimal point; 10 megohms input resistance; an automatic disabling of the motor during the "expand" dialing; a red light to indicate overrange or wrong polarity; and provision for a foot-operated switch for a "read" or "hold" function.

Write for brochure giving many more details

Step 1.  
**NORMAL**  
Mode  
8.342 V



Step 2.  
**EXPAND**  
Mode  
8.3420 V



Example of  
"Overrange"  
presentation  
108.340 V



### Specifications

<b>Frequency range</b>	500 khz to 300 Mhz
<b>Sweep rates</b>	0.2 per minute to 60 per sec
<b>Output voltage</b>	+2 dbmv
<b>Flatness</b>	±0.25 db at 0 dbm
<b>Source impedance</b>	50 ohms
<b>Power consumption</b>	19 w
<b>Size</b>	17.5 by 7 by 12.5 in.
<b>Weight</b>	20.5 lbs
<b>Operating temperature range</b>	50° to 125° F
<b>Cost</b>	About \$1,100
<b>Available</b>	January, 1967

Jerrold Electronics Corp., 401 Walnut St., Philadelphia, Pa. 19105 [371]

## High-speed, automatic transistor tester

More than 4,000 transistors can be tested per hour with a go, no-go test instrument for production-line testing and classification and incoming inspection of semiconduc-



— Since 1932 —  
**BALLANTINE LABORATORIES INC.**  
Boonton, New Jersey

CHECK WITH BALLANTINE FIRST FOR DC AND AC ELECTRONIC VOLTMETERS/AMMETERS/OHMMETERS, REGARDLESS OF YOUR REQUIREMENTS. WE HAVE A LARGE LINE, WITH ADDITIONS EACH YEAR. ALSO AC/DC LINEAR CONVERTERS, AC/DC CALIBRATORS, WIDE BAND AMPLIFIERS, DIRECT-READING CAPACITANCE METERS, AND A LINE OF LABORATORY VOLTAGE STANDARDS FOR 0 TO 1,000 MHZ.



# JFD Modutrim microminiature Ceramic Variable Capacitors...

## Widest $\Delta$ Cs, highest stability and smallest size

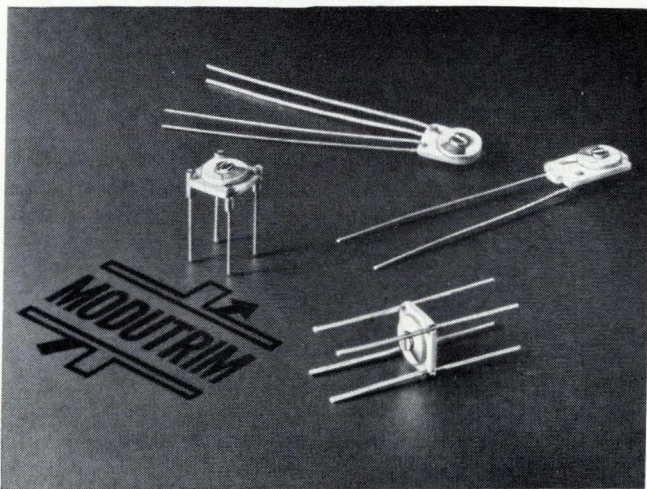

Capacitors shown enlarged 25%

Modutrim microminiature ceramic variable capacitors offer micromodule and hybrid circuit designers a choice of wide  $\Delta$  Cs in extremely small and stable units.

A unique rotor design utilizing a special proprietary ceramic material in a monolithic structure gives excellent stability. Q is in excess of 500 measured at 1 MC for those values under 50.0 pf.

MT 100 Series' design is specifically for channel-mount and cordwood applications, as well as many other micro-module packages.

MT 200 Series offers still further miniaturization, as an ideal answer to high component density problems and various LC networks packaged in TO-5 cans.

MT 300 Series' 4 terminal lead configuration provides optimum mechanical support and is specifically designed for printed, microminiature and module circuits.

MT 400 Series is designed for cordwood and module applications. This configuration has 8 terminations for easy connection above and below the capacitor substrate.

Write for Bulletin MT-65-2.

**JFD** "TODAY'S COMPONENTS BUILT FOR TOMORROW'S CHALLENGES"

JFD ELECTRONICS CO. / COMPONENTS DIVISION 15th Avenue at 62nd Street  
Brooklyn, N. Y. 11219 / Phone 212-331-1000 • Sales Offices—Arcadia, Calif.  
Chi., Ill. / Balt., Md. / Saxonville, Mass. / Bklyn., N. Y. / New Hartford, N. Y.  
Cinn., Ohio / Phila., Pa. / Pitts., Pa. / Paris, France / Azor, Israel

# See, there's a Blackstone ultrasonic unit for every precision cleaning need:

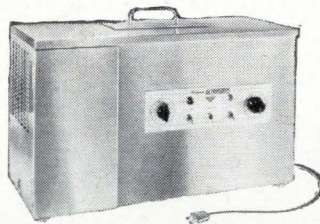

**1. Blackstone VRO.** Makes it easy to put vapor rinse and ultrasonic cleaning at every work-station. Requiring no water, drains or hood because of a built-in refrigeration system, the VRO runs on 110 volts, delivers 21,000 cycles,  $\pm$  1 Kc., controls particulate matter to 1 micron, and has jet spray plus solvent vapor rinsing. To assure long, trouble-free life, the lead zirconate titanate transducer is mechanically held by a retainer which is silver-brazed to the bottom of the 4" x 4" x 3" deep 316L stainless steel tank.

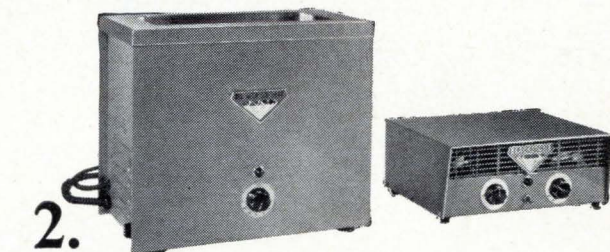

**2. Blackstone HT Series.** Provides the right combination of tank size, power output and temperature to meet daily "on-the-bench" cleaning needs. Tank sizes can be furnished with 72, 144 and 216 square inch cleaning area capacities. Power outputs can be 100, 200, 300 and 500 watts and can be controlled from 0 to 100% for maximum cleaning efficiency without affecting the part to be cleaned. Temperature is thermostatically controlled from ambient to 190°F.

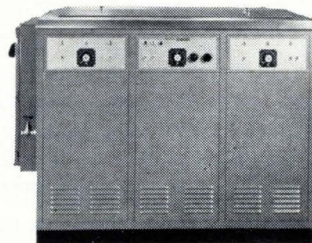

**3. Blackstone VR Series.** Great where cleaning needs vary from day-to-day. Available with two ultrasonic tanks of either 5, 10 or 20 nominal gallon capacities, you can attack contami-

nants with a combination of solvents such as DuPont "Freon"® TF and "Freon"® T-WD602. Includes a third tank for vapor and spray rinsing. By changing sequences and solvent combinations, you can handle almost any cleaning problem on a moment's notice.

Give us a sample of your work. We'll process anything you're cleaning and make recommendations — at no charge, of course.



**BLACKSTONE ULTRASONICS, INC.**

1400 Howard Street • Sheffield, Pa.



**CONTINUOUS  
PERFORMANCE** | **POPULAR  
PRICES**

**PRESS-FIT<sup>®</sup> TEFLON\* TERMINALS**

You can depend on Sealectro "Press-Fit" Teflon\* insulated terminals for superior continuous performance at popular prices. "Press-Fit" Teflon terminals are designed for maximum operating efficiency minus hardware props such as nuts, washers and lockwashers. Tolerances of .001" ensure a positive fit. To make substantial savings in your next military or commercial production, send for the catalogue of stock Sealectro "Press-Fit" Teflon terminal performers. They include more than 10,000 Feed-Thrus, Stand-Offs, Jacks, Transistor Sockets and Holders, Probes, Bushings, and Taper-Pin receptacles. All available at popular prices and all available in the 10 EIA colors.



CIRCUIT HARDWARE DIVISION  
**SEAELECTRO**  
 CORPORATION  
 HOYT STREET • MAMARONECK • NEW YORK  
 PHONE: 914-698-5600 TWX: 710-566-1110  
 Sealectro Ltd., Portsmouth, Hants, England

\*Registered Trademark E. I. DuPont De Nemours & Co.

**New Instruments**

tor devices. With automatic handlers, the T207 performs all the standard industrial d-c tests in 35 nsec each, handling 4,000 transistors an hour.

Programing all conditions of each test is done at a single test position on the front panel. A mode switch at this test position provides wide flexibility. Any test may be performed at any position in any sequence of eight to 20 tests.

Absolute protection has been provided for component, test instrument and operator under all conditions. Oscillation suppression



and detection circuits are built in. A simple front-panel pin-board matrix translates test results into single-bin decisions.

For complex classification and data logging, the T207 tester is readily modified for operation by a digital computer.

With manual operation, a trained operator can test 1,000 to 1,200 transistors per hour. By time-sharing the T207 between four operators with the company's multiplexer, 5,000 to 6,000 transistors per hour can be tested. Range of the T207 covers the low and medium power transistors and diodes up to 600 v and 1 amp. Cutoff and leakage tests can be made at currents down to 100 picoamps.

The manufacturer guarantees for 10 years the performance of critical circuits such as forcing power supplies, comparators and sequencing circuits contained in sealed electronic modules. The entire T207



# New! Free!

# 1967

# Newark

# Industrial Electronics

# Catalog

- Industry's Most Complete Catalog
- Over 70,000 items
- 700 Pages
- Over \$8,000,000 Industrial Electronics Inventory including over 600 Standard Brand Lines

LISTING

TEXAS INSTRUMENTS

TTL Complex Function  
Integrated Circuits



**SN5491/SN7491** 8-bit Shift Register replaces nine standard TTL units. 144 component elements perform 11 circuit functions.

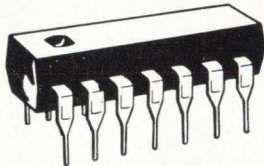

**SN5480/SN7480** Gated Full Adder provides better performance than 5 standard TTL units, at less than half the price of the equivalent units.

**SN7490** BCD Decade Counter with binary-coded decimal output. Can be used as a divide-by-five, divide-by-two or a divide-by-ten circuit.

**IMMEDIATE DELIVERY FROM STOCK • FACTORY OEM PRICES  
FAST EFFICIENT SERVICE FROM 7 NEWARK WAREHOUSES**

**New** MAIN OFFICE AND WAREHOUSE  
TO SERVE YOU BETTER

- ALL-ON-ONE FLOOR EFFICIENCY
- SPEEDY AUTOMATED ORDER HANDLING
- CONVENIENTLY LOCATED
- PLENTY OF FREE PARKING



**NEWARK ELECTRONICS CORPORATION**

500 North Pulaski—Chicago, Illinois 60624

AUTHORIZED TEXAS INSTRUMENTS WAREHOUSES IN

Chicago, Illinois  
(312) 638-4411  
Cincinnati, Ohio  
(513) 421-5282  
Denver, Colorado  
(303) 757-3351

Detroit, Michigan  
(313) 548-0250  
Los Angeles Area  
(213) OR 8-0441  
Grand Rapids, Michigan  
(616) 452-1411

Other Newark Warehouses in:  
New York City (212) 255-4600

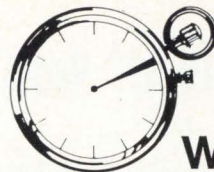

**WHAT IS  
MOTOROLA OSCILLATOR  
STABILITY?**

*Accurate within a second  
in 300 years. Stabilities to  
1 part in 10<sup>-10</sup>*



**WHAT IS  
MOTOROLA OSCILLATOR  
WARM-UP TIME?**

*Down to ten minutes.  
The industry's fastest.*



**HOW WELL DO  
MOTOROLA OSCILLATORS  
PERFORM?**

*Specifications are guaranteed.*



*Get the full story from your  
Motorola Representative. Or write for  
details to: Motorola Communications  
& Electronics Inc., 4900 West Flournoy,  
Chicago, Illinois 60644. A Subsidiary  
of Motorola Inc.*



**MOTOROLA**  
Precision Instrument Products



# Throw this at trio/lab.®

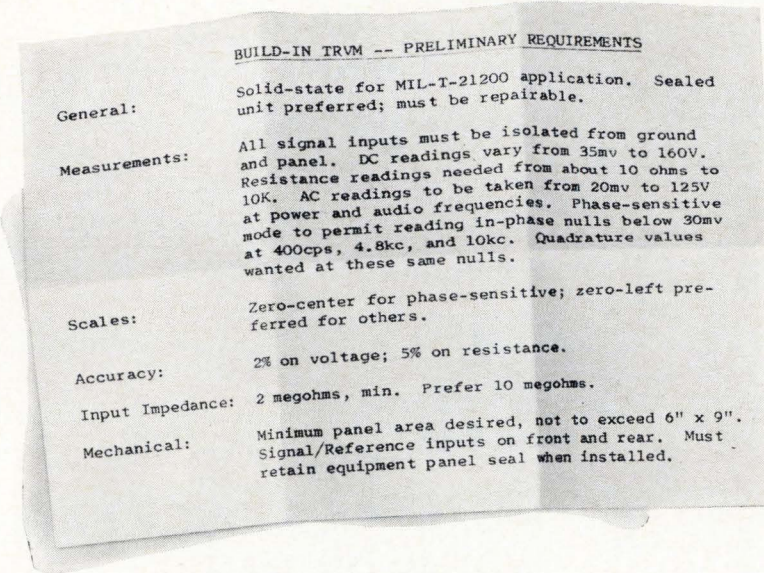

## Here's what you get back.

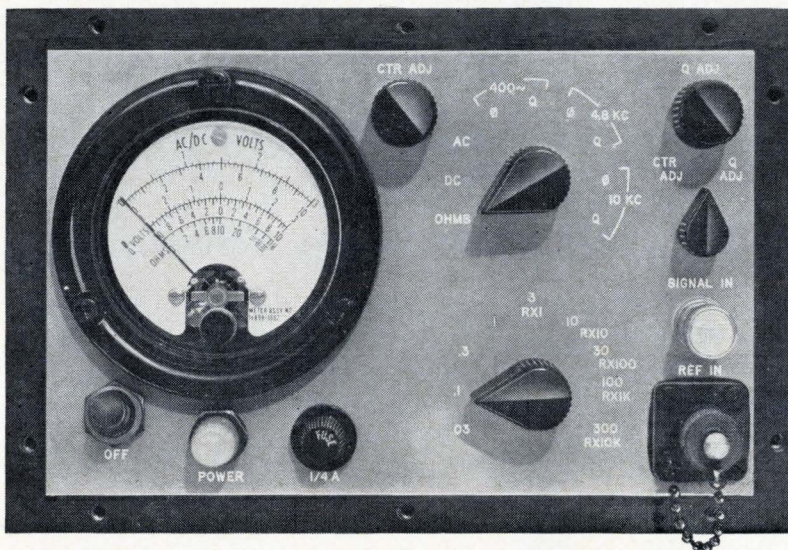

A custom build-in TRVM.

As simple or as complex as you need it. We make it for you at production price and delivery, from a stock of thousands of Build-in-Bloc modules, all solid-state: AC preamp and ranging network, AC amplifier, DC-to-AC converter, resistance scaler, current shunt, bridge rectifier, ring demodulator, phase shifter, power supply.

You enjoy state-of-the-art developments; known characteristics; field-

proven, factory-tested reliability; avoidance of variations inherent in unproven designs; MIL performance at industrial prices.

You also enjoy peace of mind: We pioneered the build-in electronic panel meter. 90% of all build-ins are made by trio/lab.

Write or call for design help or a free copy of our handbook/catalog.

Trio Laboratories, Inc., Plainview, L.I., New York. (516) OV-1-0400. TWX: (510) 221-1861.



© 1966, TRIO LABORATORIES, INC. • ORIGINAL CONCEPTS IN INSTRUMENTATION

## New Instruments

test instrument is warranted for one year.

The eight-test T207 is 24 in. wide x 26 in. high x 24 in. deep and weighs 97 lbs. Power input is 105/115/130 v, 60 hz a-c or 220 v, 50 hz a-c at 50 v.

Price of the standard T207 without options is \$16,500.

Teradyne, Inc., 183 Essex St., Boston, Mass. [372]

## Plug-in oscilloscope for lab and industry

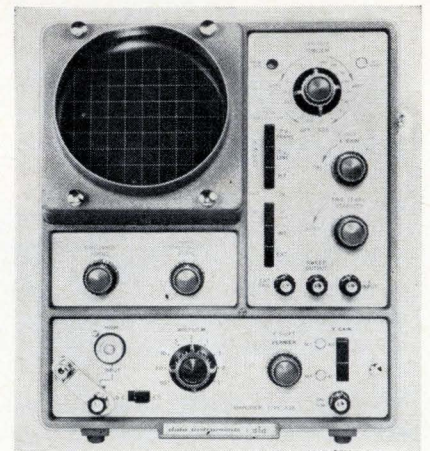

A plug-in oscilloscope designed for both laboratory and production line applications has been added to the series 43. The S43a is a single-beam, four-inch scope that extends the range of the series to the 25-Mhz region. The scope uses a precision, flat face, post-deflection-acceleration crt with an edge-lit graticule. It employs the same design and construction features of the S43 and will accept all the company's standard amplifiers.

The main feature of the S43a is its time base and horizontal amplifier section. Using a Miller run down type sweep generator to achieve precise linearity, the scope provides a horizontal deflection of the beam at speeds up to 0.5  $\mu$ sec/cm in 22 calibrated ranges with an over-all accuracy of  $\pm 5\%$ . Time and voltage controls are standardized by a 2% internal calibrator.

The trigger signal can be derived from the amplifier, the supply frequency or externally. In the h-f triggering mode the unit will lock





**WHEN THIS PARCEL ARRIVES...**  
**your entire office procedure**  
**will be revolutionized.**

COMPET MODEL CS-30A fulfills a multitude of purposes in the office, factory, laboratory or study. CS-30A is equipped with a "memory" register which automatically stores intermediate answers for continuing calculations. It has a fractional number device which is unique in desk-type calculators. By a slight touch of the R key it counts fractions over  $\frac{1}{2}$  as one and rounds off others. There is a special mechanism to ensure that no two keys can be pressed simultaneously. And it has the ability to calculate instantly up to 14 digits. Yet, even under misuse it will not break down. Plug-in circuits facilitate easy maintenance.



**COMPET Model CS-30A**

**SHARP**

... to the point of perfection

**HAYAKAWA ELECTRIC CO., LTD.**

OSAKA, JAPAN

U.S. Subsidiary: Sharp Electronic Corp.

178 Commerce Rd., Carlstadt, New Jersey, U.S.A.



If you thought  
our "Compact" was  
great @ \$17.50...

look what we have  
for \$9\*.

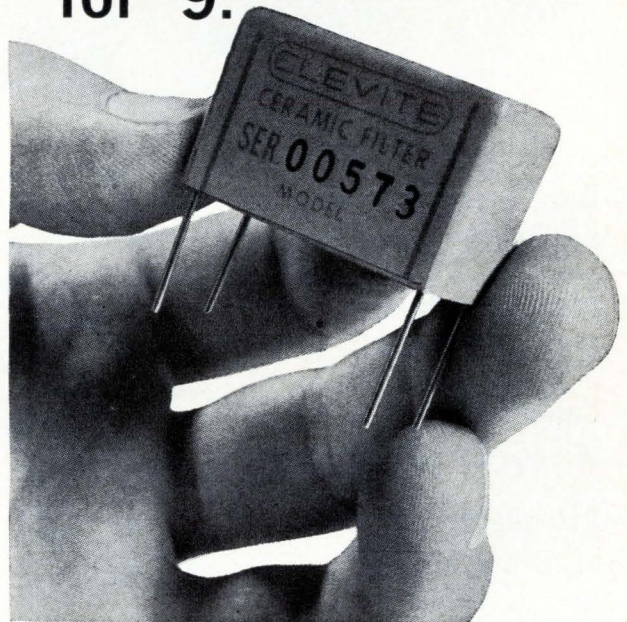

It's our new TCD filter. And for the money, it's the finest filter around. Bandwidth @ 6 db is 8 kc (minimum); at 60 db—20 kc (maximum). Transformer input provides a DC path and an input impedance of 40 K ohms, suitable for transistor and vacuum tube circuits. We designed it specifically for CB, mobile, aircraft and marine radios... put it in a package that's less than .6 cu. in. The following specs are for our standard model (but say the word and we'll custom design to your special requirements):

TCD-4-8D20A	@ 27°C		Impedance	
Center Freq: 455 ± 1kc Temp. Stability: less than 800 cps variation -20 to +60°C	B/W @ 6db 8kc min. @ 60db 20kc max.	Insertion loss 6db max.	In 40 K ohms	Out 1.5 K ohms

\*For orders of 100 to 499. Complete TCD Prices: 1-24 — \$15 ea.; 25-99 — \$12 ea.; 100-499 — \$9 ea.; 500-1999 — \$7.50 ea.; 2000-4999 — \$6.50 ea. (Prices subject to change without notice.)

Send order or request for free Technical Brochure to:  
Clevite Corporation, Piezoelectric Division, 232 Forbes Road,  
Bedford, Ohio 44014.

**CLEVITE**



# GREAT BUY FROM BENRUS!

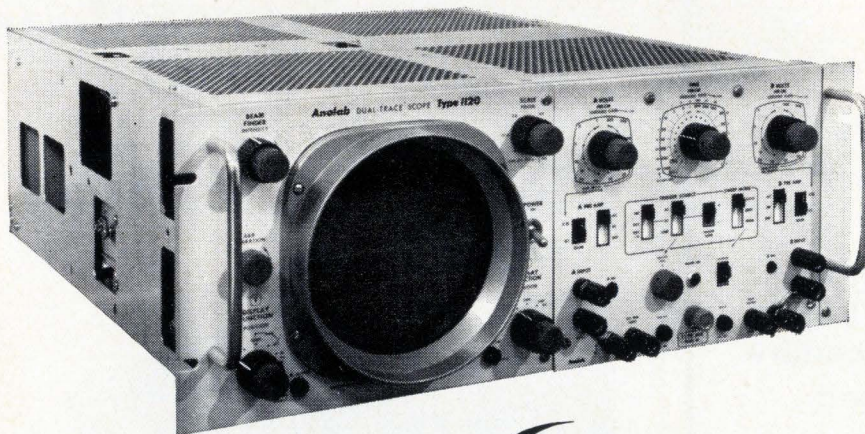

- Dual trace DC-500KHz precision oscilloscope
- Identical channels — high sensitivity
- Calibrated sweeps — .5 sec/cm to 1  $\mu$ sec/cm
- Attenuator ranges accurate to  $\pm 1\%$

SCOPE  
WITH  
PLUG-IN  
\$710.

The Type 1120 dual trace oscilloscope main frame, and the Type 300 1 mv/cm sensitivity A & B channels, trigger & sweep plug-in, comprise a versatile instrument for incorporation in systems as well as for lab and production line applications. As shown, it is designed for rack mounting. A portable bench model is available at the same low price.

Also available are a variety of interchangeable plug-ins that extend the capability of the main frame to include precision null readout with 100  $\mu$ v/cm sensitivity, sampling & sweep, and spectrum analysis.

Write for information today! We'll rush you our latest catalog, giving descriptions, specifications, installation data, and prices of the full Benrus line of oscilloscopes, data recording camera systems, and other panel-mounting instrumentation.



## BENRUS

TECHNICAL PRODUCTS DIVISION

30 CHERRY AVE. • WATERBURY, CONN. 06720 • PHONE (203) 756-4621

## New Instruments

in any incoming signal between 500 khz and 25 Mhz. Price of the main frame of the S43a is \$420. Six vertical amplifiers are available including the new H model with a bandwidth of d-c to 25 Mhz. and a rise time of 14 nsec. Amplifiers range in price from \$85 to \$170. Data Instrument division, IEH, 7300 Crescent Blvd., Pennsauken, N.J., 08110. [373]

## Pushbutton bridge measures rapidly



Batch testing of components or the observation of changing values under laboratory conditions are made simply and quickly by the B641 universal impedance bridge.

Designed for the continuous measurement of any type of impedance or admittance, at audio frequencies, as low as 1 pf—to an accuracy of 0.1%—the B641 eliminates manual balancing and makes readout virtually automatic, according to the manufacturer.

Operation is easy. Once the bridge is trimmed, it is necessary only to depress a series of front-panel range pushbuttons in sequence until a reading is obtained on the electronically-balanced meters. Setting up the first one or two digits of this reading on pushbutton decade controls makes the balancing automatic; the meters can read the first, second, third or fourth digits.

The bridge produces analog voltage proportional to the meter readings and BCD (in a 1248 code), for the Nixie readout.

The B641 is based on the transformer-ratio-arm principle, giving stable performance even when com-





# Great editorial is something he takes home

(What a climate for selling!)

## Electronics

A McGraw-Hill Market-Directed Publication  
330 West 42nd Street, New York, N.Y. 10036

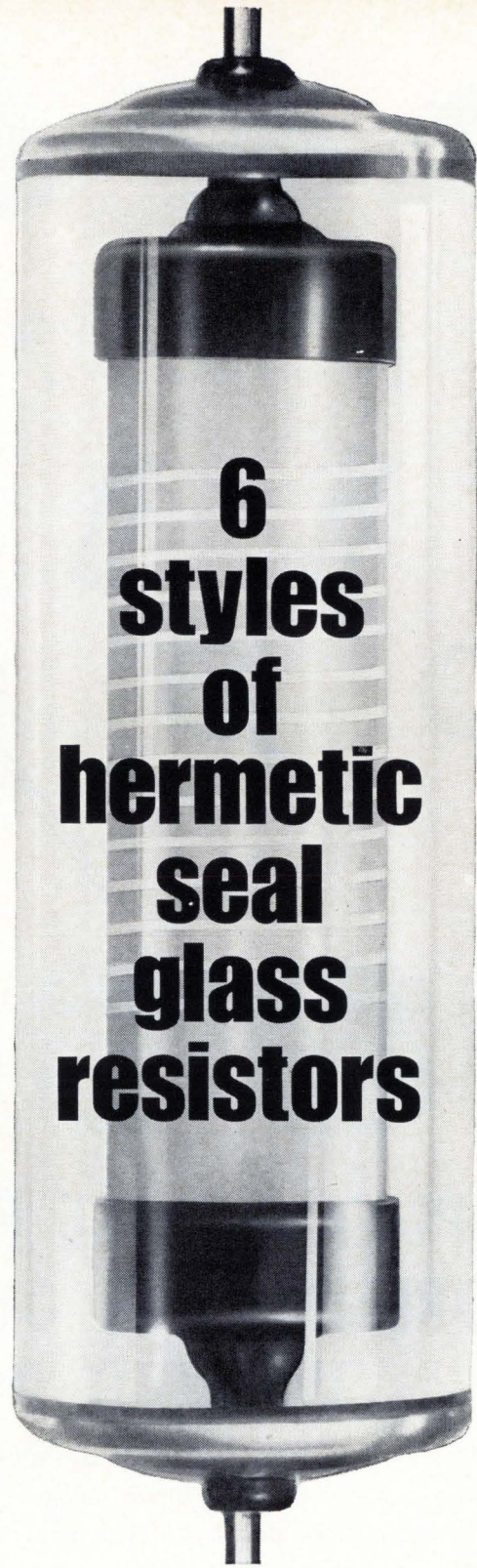

**RNR 55 through RNR 70**  
(characteristics C and E)

Mepeco is the one source for all six styles (RNR 55, 57, 60, 63, 65, 70) of established reliability Metal Film Resistors to MIL-R-55182.



### MEPCO, INC.

Columbia Road, Morristown,  
New Jersey 07960  
(201) 539-2000  
TWX (201) 538-6709



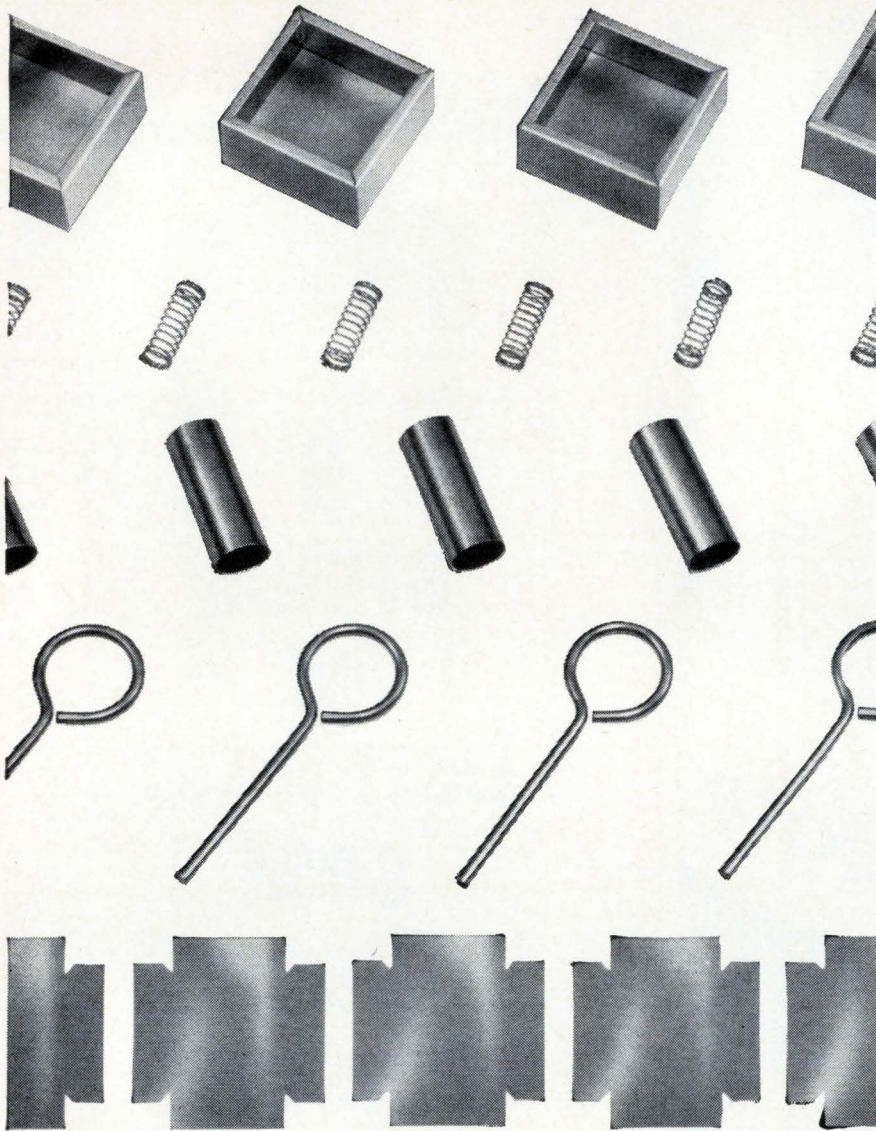

## DUPLICATE THESE PARTS AND MORE IN YOUR OWN PLANT WITHOUT DIES!

Here's a way to produce short runs of simple parts quicker than an order can be processed to get them "outside." Versatile Di-Acro "Die-less Duplicating" equipment sets up quickly for cutting stock to size and forming it to die accuracy — without costly dies. Get full information in the new "Die-less Duplicating" catalog. See your distributor or write us.

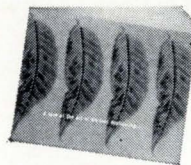

### DI-ACRO

A Division of Houdaille Industries, Inc.  
4310 Eighth Ave., Lake City, Minn. 55041

## New Instruments

ponents under test form part of a subassembly (such as a printed board or an encapsulated unit) or when long measurement leads must be used.

Wayne Kerr Corp., 22 Frink St., Montclair, N.J. [374]

## Test oscillator spans 10 hz to 10 Mhz

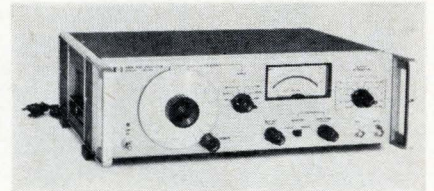

Frequency-response measurements can be made with 0.25% resolution over the range 10 hz to 10 Mhz with the model 652A test oscillator.

Equipped with a times-20 expanded-scale output meter for maximum output voltage resolution, the 652A test oscillator may easily be adjusted exactly to match the amplitude of a precision reference signal. The 652A output monitor will show actual output to the attenuator with  $\pm 0.25\%$  accuracy over the entire frequency range. For fast reading, the uppermost scale is the expanded range, centered on zero, calibrated  $\pm 2\%$ .

Model 652A is aimed at solving the problem of making very accurate wideband measurements rapidly. Its special usefulness is in testing a-c voltmeters, tv amplifiers, audio amplifiers, filter networks, tuned circuits and telephone and telegraph carrier equipment.

The 652A test oscillator uses the same resistance-capacitance solid state circuit as the company's testing a-c voltmeters, tv amplitude stability (typically 10 parts per million per minute, in ordinary environments). One output delivers up to 200 mw (3.16 v) into 50 ohms; another delivers up to 16 mw (3.16 v) into 600 ohms. A decade output attenuator is included.

Model 652A costs \$725. Current delivery estimate is 4 to 12 weeks. Hewlett-Packard Co., 1501 Page Mill Road, Palo Alto, Calif., 94304. [375]





## ULANO EUROPEAN TECHNICAL CENTER FOR GRAPHIC ARTS

Ulano's technical center in Switzerland is headed by the very capable Mr. Henri Kunz. He is qualified by his many years of experience in the Screen Process and Graphic Arts fields. Demonstrations and technical seminars are held in many languages throughout the year. Complete laboratory facilities have been installed to provide demonstrations of the complete Ulano line. Large stocks of all famous Ulano films are available for immediate delivery to all parts of the world.

You are invited to contact Mr. Henri Kunz at ULANO A.G., Untere, Heslibachstrasse No. 22, Kusnacht 8700, Switzerland, Telephone 905959. It is our pleasure to serve you.



**DO YOU USE  
SCREEN PROCESSING  
IN THE PRODUCTION OF  
COMPLEX  
PRINTED  
CIRCUITRY?**

**TWO NEW PRESENSITIZED FILMS TO  
SPEED PRODUCTION — LOWER COSTS**

**Ulano**  
T.M.



**WRITE TODAY**  
on your letterhead  
for free special  
sample kit  
number 5448

### HI-FI RED

#### HEAVY-DUTY INDUSTRY PROVED

Presensitized photo film used by many leading electronic firms for clean, sharp, tough, durable, almost indestructible screens of unmatched quality. Adheres tightly to wire, silk, nylon and dacron.

### PREP®

#### PRESENSITIZED FOTO FILM

.002 Polyester support guarantees good register. Does not require a dark room. Very good resolution—suitable for halftones. Excellent adhesion to silk, nylon, dacron and metal mesh. Tough, strong emulsion—good for machine printing and long runs.

## J. ULANO & COMPANY, INC.

610 Dean Street, Brooklyn, N. Y. 11238, U.S.A.  
Cable address: "UlanoFilm"  
In Europe: ULANO A. G., Untere, Heslibachstrasse No. 22  
Kusnacht, Zurich, Switzerland

$\Phi_{th}$   $e^+$   $\gamma$  dose  $\beta^-$   
 $n$  rads  
 $n/cm^2$  fluence ms

## Radiation Simulation Problems?

Get help with PULSE RADIATION SOURCES providing pulse widths from nanoseconds to milliseconds. Our facilities at your service include:

- TRIGA Reactors
- Accelerator Pulsed Fast Assembly
- Linear Accelerators
- Flash X-ray
- 14 Mev Neutron Generators

For information write or call now! Pulse Radiation Services, Dept. 401, General Atomic Division, General Dynamics, P.O. Box 608, San Diego, California 92112. Phone (714) 453-1000, Ext. 288.

**GENERAL DYNAMICS**  
General Atomic Division



**microbial  
contamination  
product spoilage,  
downtime,  
need for excessive  
additives**

**for use in DEIONIZED WATER SYSTEMS**

Steroline's Aquafine Ultraviolet purification systems are designed to produce unlimited quantities of 99+% of safe, pure water and other liquids.

Skilled Steroline specialists will design the most economical purification system for you...reducing bacterial build-up...eliminating downtime...ending product spoilage...reducing maintenance costs. And, Steroline purification systems are available with special warning device and/or automatic shut off. Whether you select a portable or permanent system, you'll find that your over-all savings quickly exceed your capital investment.

Get the facts on liquid purification. Write:

*Steroline Systems Corporation*

11809 (J) East Slauson Avenue  
Santa Fe Springs, California 90670  
Telephone: (213) 698-8157 Cable: Sterline

DISTRIBUTORS! Valuable territories open. Write for full information.



## Rotron brings a new DIMENSION for LOW PROFILE cooling applications

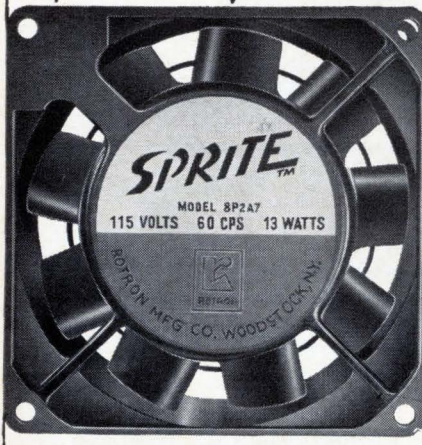

3 1/8"

A fan that's just 3 1/8" square — fits standard 3 1/2" rack panel. Delivers big 35 CFM of air at free delivery.

- Pressure characteristics better than larger conventional fan designs.
- Optimum performance. .05 to .075 inch water at 25-30 CFM.
- Double flange construction for universal flush mounting.
- Low maintenance.
- Costs as low as \$5.85 in quantity.

**Aerodynamic design provides high pressure in range approaching free delivery.**

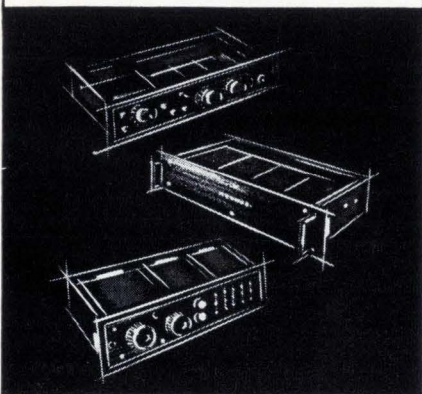
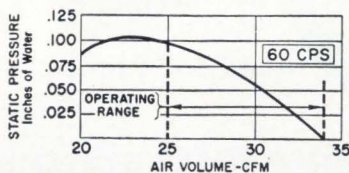

**ROTRON MANUFACTURING COMPANY, INC.**  
WOODSTOCK, NEW YORK  
West Coast: ROTRON PACIFIC, Glendale, California  
Rotron-Vacvac Europe (R.V.) Breda, The Netherlands  
Export Sales: AURIEMA INTERNATIONAL GROUP

## New Subassemblies and Systems

### Laser detector lines up machinery

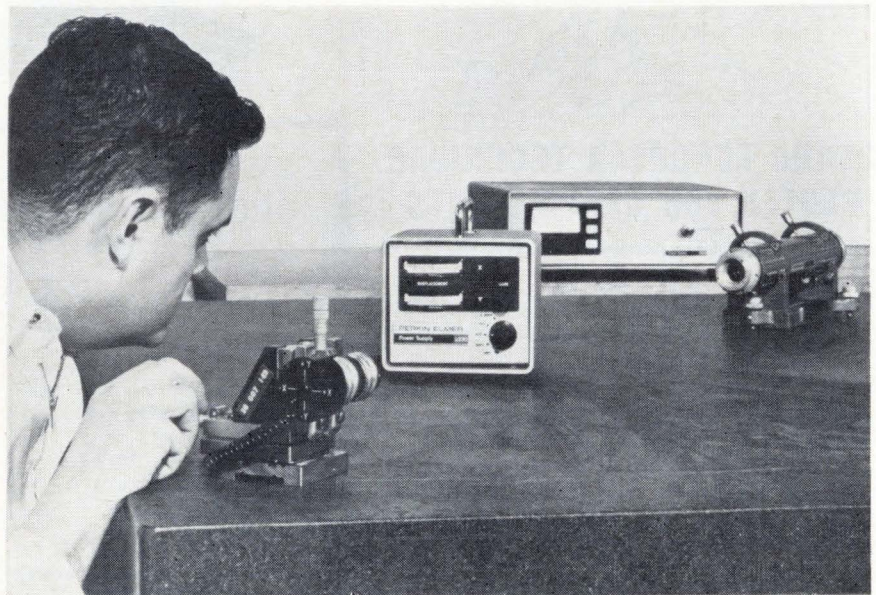

**A laser centering detector**, run by a single operator, precisely aligns industrial equipment 10 times faster than optical alignment methods.

It can align such equipment as machine tools, turbine bearings and aircraft tooling dies to an accuracy of 10 microinches per foot. The manufacturer, the Perkin-Elmer Corp., notes this is about five times more accurate than is possible with an alignment telescope. For checking angles, the detector possesses the same accuracy as an autocollimator—0.2 arc second.

The new unit, the model CD-1, homes in on the center of the light beam from a continuous-wave gas laser by sensing the centroid of light intensity around two orthogonal axes. A standard helium-neon gas laser, such as the Perkin-Elmer model 5200 (1.3 milliwatt, visible red output), supplies the light. The maximum alignment range of the laser and the battery operated detector is 75 feet. Two meters read out alignment error along the axes.

The unit's detector consists of four silicon photocells arranged in a 2 by 2 array. They are mounted in a circular 1.25-inch diameter aluminum head that is also available with a 2.25-inch adapter ring

—standard size for optical tooling. Similarly, the model 5200 laser fits a standard collimator holder. A 10-foot cable connects the detector head to the readout meter box that also contains two recorder jacks.

Diagonally opposite photocells in the detector head connect in a bridge circuit. In operation, the laser mounted at one end of the equipment being aligned is pointed at the detector head mounted at the other. Any offset between the centroid of the laser beam and the center of the photocell array generates a differential signal that is amplified and fed to the indicating meters. The meters read out the offset as a linear displacement on the two axes perpendicular to the beam's axis. Three sensitivity ranges can read the displacement down to  $\pm 0.0005$  inch.

In a typical demonstration, the detector is attached to the tool post of a machine lathe. The laser is mounted on the lathe's tail stock and the carriage moves slowly toward the tail stock. Detector output goes into a dual-channel recorder that plots a profile of carriage misalignment in the horizontal X and Y planes. Errors as small as 100 microinches can be observed on the plot—a process repeatable to within 50 microinches.



Two 12-volt mercury batteries in the detector have a life of over 50 hours. The detector itself weighs only one-half pound and the separate meter box, measuring 5 by 5.5 by 6 inches, weighs two pounds. Both the model 5200 helium-neon gas laser and the model CD-1 centering detector are available in combination at \$2,925. The centering detector alone costs \$950. Electronic Products Div., Perkin-Elmer Corp., Main Avenue, Norwalk, Conn. [381]

## Traffic detector is completely automatic



A detector registers a moving or stationary vehicle using a basic inductance principle — a metallic mass passing over a loop of wire. The AT-100 will indicate, by output relay changeover contacts, either of two occupancy conditions — presence or pulse output. Among other applications, the AT-100 output can activate a traffic-signal controller or traffic counter.

Because the loop is buried in the roadway, it is unaffected by road maintenance such as repaving or snow removal. The loop size can be varied to cover one or several lanes of traffic.

The electronic unit is compact, of silicon solid-state design, and features low power consumption. Because of design simplicity, it is said to be extremely reliable and comparatively inexpensive.

Unlike previous loop detectors, according to the manufacturer, the AT-100 automatically tunes and adjusts itself to all environmental changes, standard road loops, combination of loops, and combinations of lead-in wire, which can be up to 750 feet long. Because it tunes itself, it is unaffected by tem-

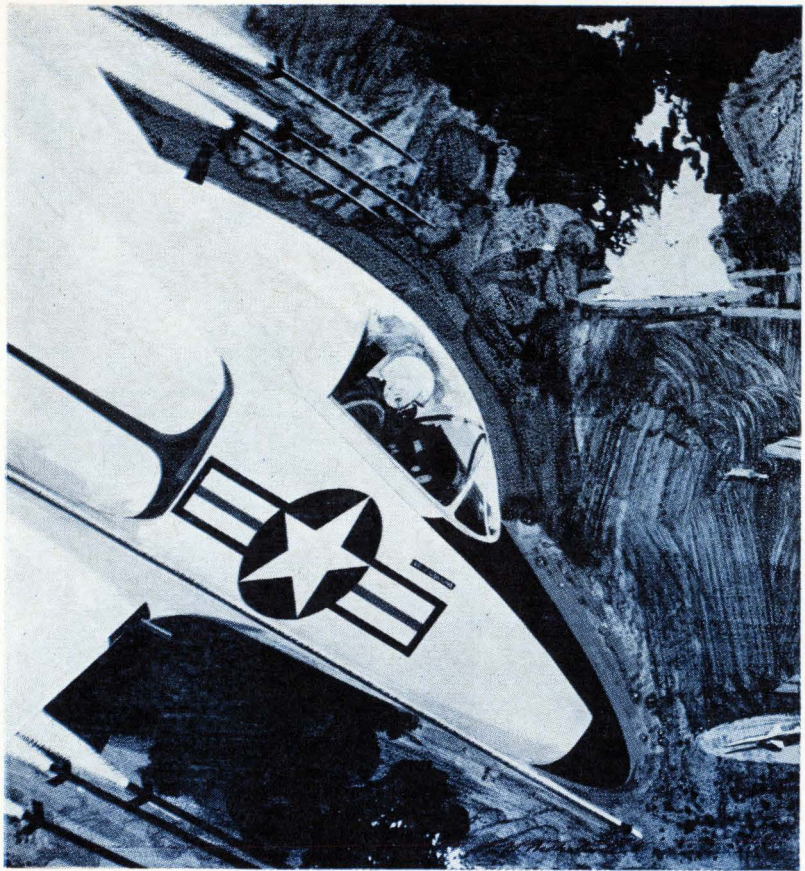

## High Power TWTs for Hostile Environments

When you specify high power TWTs to work against improved radar, fire control, or guidance complexes, tube performance must be dependable, repeatable, and efficient.

MEC's militarized high power tubes were developed to meet every one of these requirements. Octave and special band TWTs from L through X band have been designed and delivered for systems operating up to 70,000 feet. Conduction cooling with heat sink temperatures of 100°C, and full MIL-spec compliances are standard. Operating efficiency normally exceeds 20%. These tubes not only combine light weight and small size as individual components, but when mated with MEC's solid state power supplies, make a combination that is ideal for systems where space and weight are at a premium.

Check the table below. There's probably a tube to satisfy your requirements for electronic warfare, communications, or telemetry systems. For complete information on standard and special tubes, please address Microwave Electronics, a Division of Teledyne, Inc., 3165 Porter Drive, Palo Alto, California.

Exceptional opportunities exist on our technical staff for qualified scientists and engineers. An equal opportunity employer.

Type	Freq. (GHz)	Min. Psat (Watts)	Min. Gain @ Psat (db)	Focus	Cooling
M5311	1-2	100	30	PPM	Conduction
M5312	2-4	100	30	PPM	Conduction
M5313	4-8	100	30	PPM	Conduction
M5462	4-8	200	30	PPM	Conduction
M5314	7-11	100	30	PPM	Conduction

All tubes will operate with heat sink of 100° C max.  
All tubes meet full MIL-E-5400 Cl. II environment.  
Alternate cooling methods available.

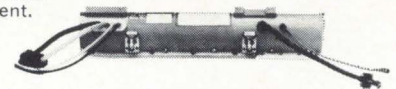

**Microwave Electronics**  
3165 Porter Drive, Palo Alto, California  
a division of Teledyne, Inc.



# ANOTHER OSCILLATOR?



**Yes.** But this time with a different kind of difference. This one saves you money.

**How?** You don't have to measure the test signal distortion, or pre-filter it out. There isn't any.

You can save the cost of ac voltmeters to monitor changes in amplitude with frequency. It doesn't change.

You can run tests for days on end without checking for amplitude drift. You wouldn't find any.

You can calibrate near line frequency, or its harmonics, as perfectly as you can anywhere else. There's no hum bounce.

Your fastest peak-reading digitizers won't dance the Last Place Jump. Every cycle peak stops at the same level as the one before it.

When you switch frequency, your connected gear can stay connected without blowing its top. There aren't any switching transients.

There are lots more ways in which the new K-H 4000 saves you time, equipment, headaches, and uncertainty. Which are only other words for money. Which is why the K-H 4000 costs less to own than any other oscillator.

**Where?** Anywhere from 0.001 Hz to 100 kHz.

**Details?** Bingo, or write. You won't be disappointed.

**KH KROHN-HITE CORPORATION**  
580 Massachusetts Avenue, Cambridge, Mass. 02139  
Telephone: 617/491-3211

## New Subassemblies

perature or moisture changes. Once the unit has "locked on" to a particular loop configuration, it cannot be detuned.

The unit contains up to six protected detector modules which can be plugged into one power supply without cable interconnection. The power supply packages are designed to accommodate up to three or six units.

In counting, the AT-100 is 98+ % accurate at speeds up to 100 miles per hour on single-lane loops and can be operated from a 12-v d-c power source. Unlike certain devices in use, the detector is equally sensitive to motorcycles or multi-axle trucks.

Link Group, General Precision Inc., 670 Arques Ave., Sunnyvale, Calif. 94086. [382]

## Power supplies programed remotely

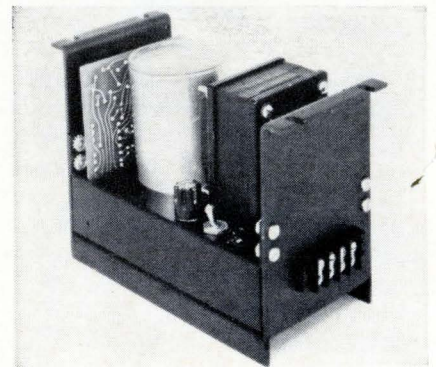

Two power supplies, designed to power integrated circuits, feature remote programming and sensing capability, convection cooling, adjustable current limit, and short circuit protection. Models 505 and 507 operate at 45 to 440 hz, 105-130 v a-c input, over a temperature range of -20°C to 70°C. Ripple is less than 0.005%. Both models also have output voltage adjustable from 3 to 6 v d-c, to meet the varying voltage requirements of different integrated-circuit manufacturers and to allow optimization of the operating voltage of the over-all integrated-circuit system.

Model 505 has 0.02% regulation with line or load and an output current of 8 amps. The 507 has a



0.015% regulation with line or load and an output current of 5 amps.

Dimensions for both supplies are  $3\frac{1}{8}$  in. x  $5\frac{1}{2}$  in. x 8 in., and each model can be mounted on an  $8\frac{3}{4}$ -in. rack panel, a  $5\frac{1}{4}$ -in. rack panel or in a mounting drawer.

Price of the 505 is \$199 complete; the 507, \$190 complete. Delivery is stock to two weeks.

RO Associates, 917 Terminal Way, San Carlos, Calif. [383]

## Multiple purpose time generator

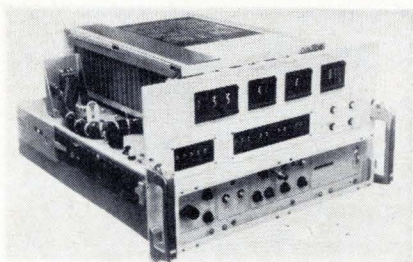

Time generator model 173 is designed for use in tracking and data processing systems where phases of the operation must be either time-controlled or time-tagged. Typical applications include its use as a time base for tracking and telemetry systems, a time reference source for computer or data-processing systems, a time correlator of data acquired from remote sites, a time reference for astronomical observations, and a time reference for operational simulators or checkout sets. The customer can specify time code outputs.

Time-of-year data is generated for local display on the time generator as well as for remote display. Buffered pulse rates from 0.1 pps to 500,000 pps can be provided. Binary and serial time codes specified by the National Aeronautics and Space Administration are provided. Other features include integrated circuits used in clock and divider chains, automatic reference switching and built-in battery pack.

Model 173 is an integrated-circuit multipurpose unit. Two time codes—a NASA 1/sec binary time code and a NASA serial decimal time code—are provided. Time-of-year information of 30 bits of binary coded decimal (BCD) representing days (10), hours (6), minutes (7), and seconds (7) is offered. Information is derived from a sta-

# BARRIER BREAKTHROUGH

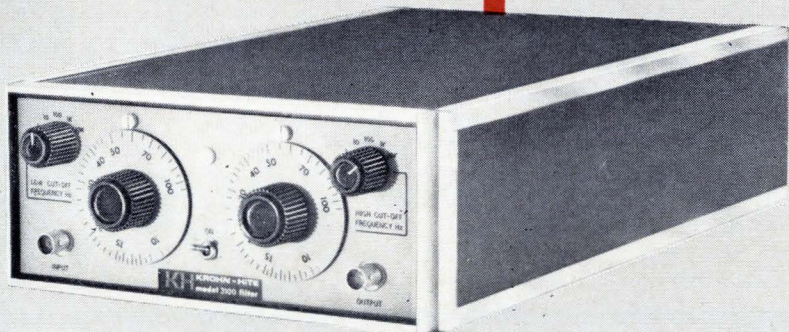

## A NEW KROHN-HITE FILTER THAT TUNES CONTINUOUSLY FROM 10 Hz TO 1 MHz

No longer do you have to switch to fixed bandpass filters to get past the famous "200 kHz barrier". Because here is an active filter that goes the whole way from 10 Hz to 1 MHz, with independent and continuous tuning of high and low cutoff frequencies.

The new K-H 3100 is a multipurpose instrument in more ways than just covering audio, ultrasonic, and RF work. For frequency-domain filtering, you have the flat gain characteristic of Butterworth response, eliminating any need for compensating amplitude distortion due to cutoff peaking. And for time-domain work, where waveform fidelity is essential, a switch lets you select the unmodified R-C response for its superior transient performance.

Add to these features the advantages of all-silicon solid state construction, plus the security of Krohn-Hite design and manufacturing care, and you'd expect a premium price. No such thing: the best electronic bandpass filter costs just \$525. Details? Bingo, or write . . . you won't be disappointed.



**KROHN-HITE  
CORPORATION**

580 Massachusetts Avenue, Cambridge, Mass. 02139

Telephone: 617/491-3211



# MAGNETIC SHIELDING MADE EASY

**APPLIED IN SECONDS**

**Cut to any size or outline  
with ordinary scissors**



Co-Netic and Netic foils are ideal for initial laboratory or experimental evaluation... also for production applications and automated operations. Dramatically enhance component performance by stopping degradation from unpredictable magnetic fields. When grounded, foils also shield electrostatically. They are not significantly affected by dropping, vibration or shock, and do not require periodic annealing. Available in thicknesses from .002" in rolls 4", 15", and 19-3/8" wide. High attenuation to weight ratio possibilities. Every satellite and virtually all guidance devices increase reliability with Netic and Co-Netic alloys, saving valuable space, weight, time, and money.

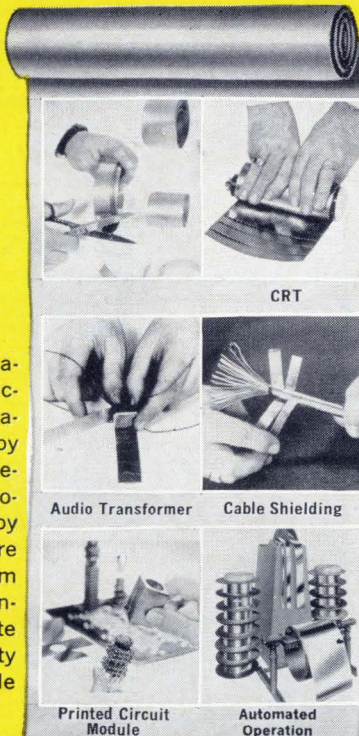

Audio Transformer

Cable Shielding

Printed Circuit Module

Automated Operation

## MAGNETIC SHIELD DIVISION

Perfection Mica Company

1322 N. ELSTON AVENUE, CHICAGO 22, ILLINOIS

ORIGINATORS OF PERMANENTLY EFFECTIVE NETIC CO-NETIC MAGNETIC SHIELDING

Circle 239 on reader service card

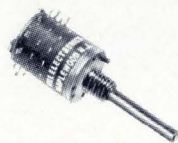

so  
precise  
each  
switch  
element  
is a  
"JEWEL"!

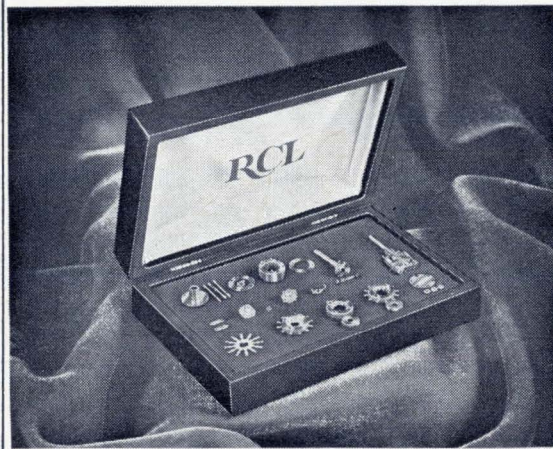

## RCL 1/2" ROTARY SWITCHES

- Up to 12 positions per deck with stops.
- As many as 6 poles per deck.
- Shorting and non-shorting poles may be grouped on one deck in any combination.

"Off-The-Shelf" Delivery - Write for complete engineering information

# RCL

**ELECTRONICS, INC.**

General Sales Office: One Hixon Place,  
Maplewood, New Jersey 07040

## New Subassemblies

ble, externally-provided, 1-Mhz reference frequency source.

The unit is completely self-contained and requires only a reference frequency source and a 115 v a-c, 60-hz power source. A built-in emergency power supply provides more than five hours of operation in the event of external power failure.

The time generator is constructed on a 17 x 22 x 4-in. aluminum chassis, and is provided with slides for mounting in a standard 19-in. cabinet, and requires 10 1/2 in. of vertical panel space. It is locked in a cabinet by lever-action handles and keepers.

Space is provided for 96 module cards. In the present configuration, 60 card slots are used and 36 slots are for expansion. All controls and displays are functionally grouped for convenience, with a clear protective cover provided to isolate all primary controls thus preventing accidental loss of synchronization. General Dynamics, Electronics division, 1400 N. Goodman St., Rochester N.Y., 14601. [384]

## IC clock oscillator with digital output

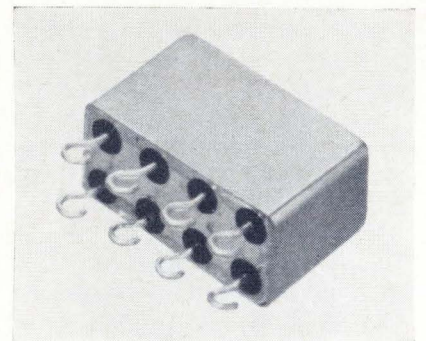

An integrated-circuit clock oscillator occupies only 0.16-cu-in. and has a digital output for computer, missile guidance and other digital applications. The model 716 features a low aging, high reliability Koldweld crystal combined with integrated circuitry for 450 ppm stability over -55°C to +90°C in frequencies from 701 to 1,000 khz. Output voltage at load is logic zero +0.2 ±0.2 v d-c, logic one +2.8 v d-c minimum. Waveform is square



with 50/50  $\pm 15\%$  symmetry and 20-nsec typical rise time. Current drain is 15 ma.

The unit measures  $0.5 \times 0.625 \times 0.5$  in., is encapsulated and is available with pin or cane hook header. It meets Mil-Std-202 Method 204D (20 g, 2,000 hz) vibration, Method 202B (100 g, 11 nsec) shock, and Method 212A (100 g) acceleration. Monitor Products Co., Inc., 815 Fremont, South Pasadena, Calif. [385]

### Rugged tape reader offers variable speed

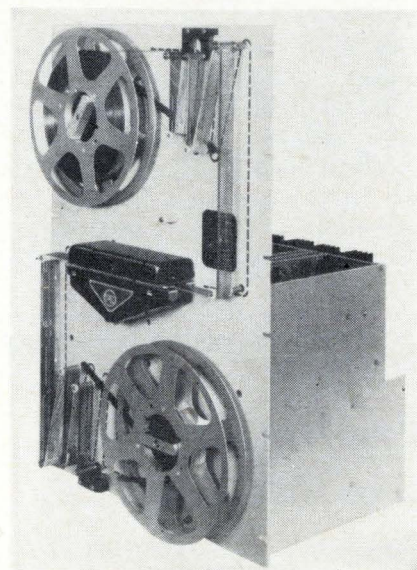

Where environmental conditions are not severe, yet high performance and reliability must be maintained, a bidirectional, photoelectric commercial tape reader can be useful.

Model 500RF/10 is intended for military use such as nonportable checkout and test equipment or for commercial requirements such as numerical control applications where the reliability required is higher than standard readers provide.

Features of the reader include: tape movement controlled by closed loop servo utilizing single capstan printed motor; variable speed capability (from 100 to 500 characters per sec); proportional reel servos; mounting of two 10½-in. spoolers within the frame of a standard 19-in. rack, and minimum maintenance with no adjustments required.

Photocircuits Corp., Glen Cove, N.Y., 11542. [386]

## In the face of rising costs, these new power modules bring the cost per watt of 0.05% regulated DC to an all-time low!

**MC-65 SERIES** is a new line of **all-silicon AC-DC** power modules — specifically designed to give you more watts per dollar. A wide range of different voltage and current models is available. So, if you're interested in better power supplies at budget prices — and who isn't — write for information on these new Technipower modules today!

- 314 models, outputs 3 to 152VDC, up to 750 watts.
- Regulation  $\pm 0.05\%$ .
- Temperature coefficient 0.015%/°C typical.
- Ripple 2mV RMS.
- Temperature rating 65°C.
- Not damaged by output shorts or overloads.
- No turn-on/turn-off overshoot.
- Designed to meet MIL specifications.

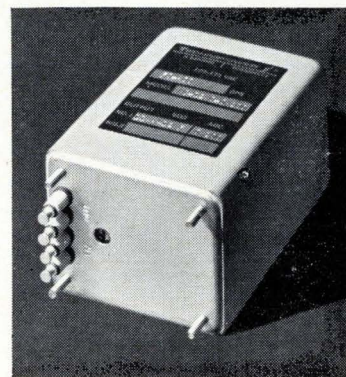

Portrait of a Hero

Your inquiry will also bring you a copy of the latest Technipower catalog, giving complete data and prices for more than 4000 power modules and lab supplies.



# TECHNIPOWER

A BENRUS SUBSIDIARY

18 MARSHALL STREET • NORWALK, CONNECTICUT 06854 • PHONE (203) 866-9244  
TWX (203) 866-2081



# Ebert Guaranteed\* Reliability

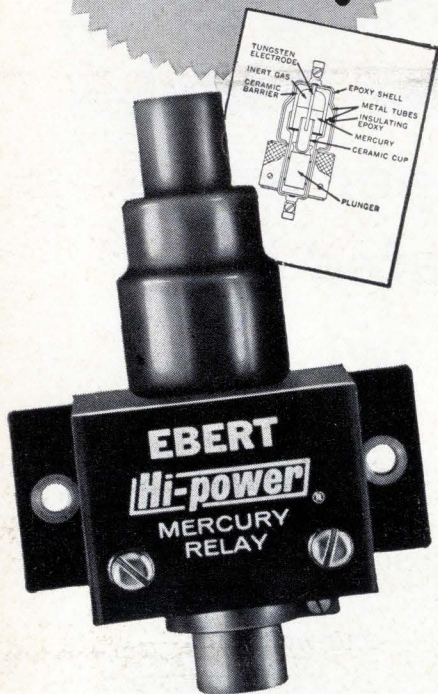

**NEW EBERT *Hi-power*® METAL TUBE MERCURY RELAYS ARE GUARANTEED TO PROVIDE LONG, MAINTENANCE-FREE LIFE EVEN IN PROBLEM ENVIRONMENTS**

**FACT:** Ebert *Hi-Power* Mercury Relays are available in 1, 2 and 3-pole units. Load ratings up to 40KW or 100 Amps. Load voltages up to 550 V.A.C. They are *unmatched* for continuous in-use reliability, durability, compactness and ease of installation.

**FACT:** Their *hermetically sealed, mercury-to-mercury* action eliminates contact problems.

**FACT:** Their epoxy-clad, *metal tube* construction withstands physical shock or rough handling.

**FACT:** Once you've tried an Ebert *Hi-Power* Relay you won't be satisfied with any other!

WRITE FOR FREE MANUAL AND 30-DAY FREE TEST DETAILS

Also available in solid state time delay and solid state hi-sensitive models

\*Guaranteed for one year against defects in materials and workmanship.



**EBERT ELECTRONICS CORP.**  
130-12 JERICHO TURNPIKE  
FLORAL PARK, NEW YORK 11002

## New Microwave

### K-band doubler offers high efficiency

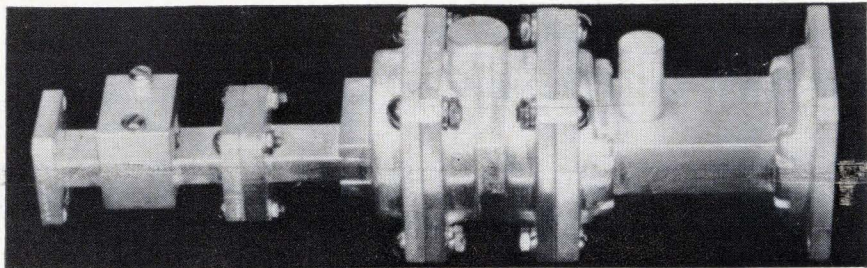

The combination of a high Q input circuit and a gallium-arsenide variable capacitance diode with high cutoff frequency produces efficiencies that at times surpass 40%. The K-band doubler, originally built for the U.S. Naval Research Laboratories, was developed by L.P. Associates Inc. The unit furnishes this high efficiency while keeping spurious harmonic outbursts more than 30 db below signal level. Efficiencies vary from 30% to 40% over a 3-db bandwidth centered around an input frequency of 12 gigahertz and covering an input power range of 75 to 150 milliwatts. Efficiency drops rapidly but smoothly as the input power falls below these levels. There are no inflections in the characteristics. In addition, the output power follows the same characteristics for either increasing or decreasing input power. The company claims that doubler efficiency outstrips any comparable doubler on the market in the same input power range.

The model 1037 doubler is useful in laboratory or systems applications where a 24-Ghz klystron is not available. Klystrons transmitting at 12 Ghz are much cheaper than 24-Ghz klystrons—power costs rise with frequency. The equivalent power output can be obtained a lot cheaper by using a 12-

Ghz device and doubling the frequency.

In addition to the model 1037, units accommodating input power levels as high as 0.5 watt and output frequencies up to 70 Ghz can be supplied. The waveguide input and output use standard flat cover flanges.

L.P. Associates, Inc., 11830 West Pico Boulevard, Los Angeles, Calif. 90064 [391]

### Power twt amplifiers cover wide area

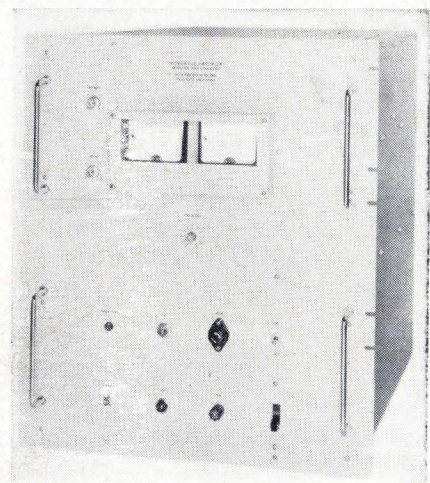

A complete line of twelve self-contained microwave amplifiers cover from 250 Mhz to 12.4 Ghz. Power output ranges from 100 w to 300 w e-w depending upon the band. Typical small signal gain is 30 db and typical noise figure is 35 db.

Standard power input is 210-230 v a-c, 60 hz, single phase; however, 400 hz and 3-phase options are available. The 300-w amplifiers are liquid cooled; all other amplifiers

#### Specifications

Input frequency	12 Ghz 5-35 Ghz can be supplied
Input power	75-150 mw
Efficiency	70-500 mw can be supplied 30%-40% + within 3 db bandwidth
Harmonic attenuation	More than 30 db
Size	5 in. long; standard UG-39/u X-band covers
Price	\$1,000/unit
Delivery	6 weeks



are air cooled by integral blowers. All power supplies are electronically regulated.

Protective circuits include sequenced element turn on, helix overload, over-temperature cutouts and conventional primary protection.

Size varies with the particular amplifier, but is typically 19 in. wide x 22.75 in. high x 24 in. deep for rack mount. Bench mount adapters are available.

Delivery is 60 to 75 days after receipt of order. Prices are available upon request.

Alto Scientific Co., Inc., 4083 Transport St., Palo Alto, Calif., 94303. [392]

## Diversity system has automatic switching

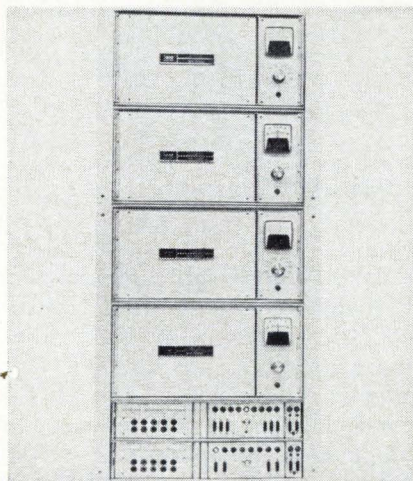

A solid-state, 2-GHz microwave system features high-speed, all-electronic switching, continuous monitoring of both transmitters and automatic combining of receiver outputs. Baseband options provide for transmitting up to 60 or 120 channels.

Each terminal is equipped with two type SS2000 transmitters, two receivers and two shelves of monitor, logic, control and combining circuitry. A diode switch, antenna circulator and receiver hybrid are included on the rear of the assembly. The true hot standby system provides maximum protection against equipment failure with logic circuits that prevent transfer to an inoperative transmitter.

A ratio square combiner for the receiver outputs automatically provides optimum performance. When receivers are operated in space

# Nine AUTOMATIC operations with this Cat-Whisker Welding Machine

by **KÄHLE**

This KAHLE machine is fully automatic. It flattens the lead wire; then the whisker wire is fed, cut, transferred and welded to the flat with a synchronous electronic timer insuring a uniform weld. Finally, it forms to the required configuration . . . PRODUCTION RATE 3,000 TO 4,000 PER HOUR!

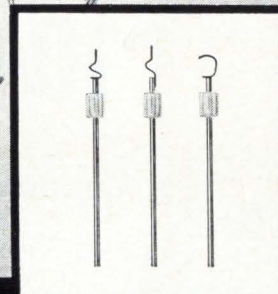
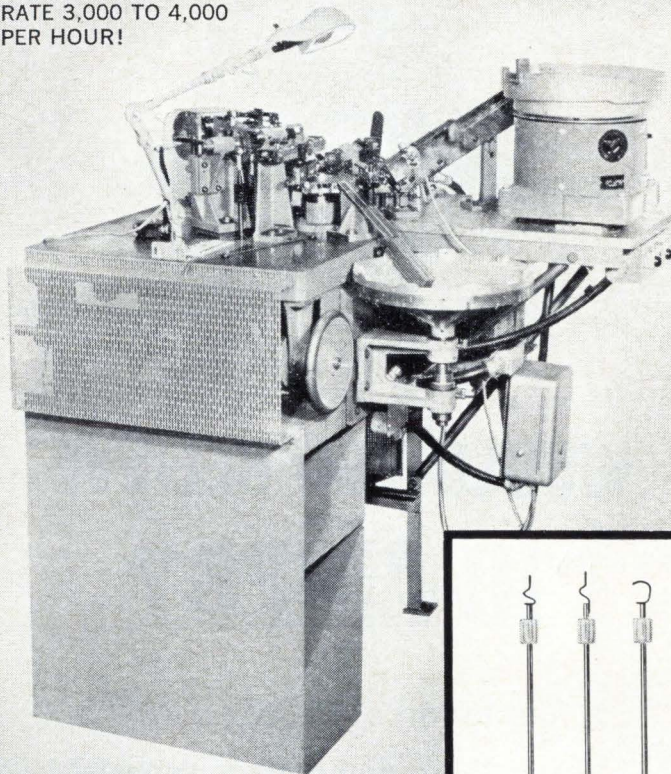

**Let KAHLE automate your Production, Assembly, Control, Inspection, Testing!**

**KAHLE Servos and Feedbacks detect rejects prior to completion of assembly**

Instrumentation feedbacks and servos can be supplied that will reject faulty parts prior to assembly and product finishing . . . saving materials and time in production.

**KAHLE Machines are Customer-approved under actual operating conditions**

Your equipment is run in our factory, using your materials in the presence of your engineers; the machine is not shipped to you unless you approve it!

**CONSULT KAHLE**—Save time and money by letting professionals build your specialty production equipment for automation!

**Kahle Engineering Company**

3324 HUDSON AVE., UNION CITY, N. J. 07087

Telephone: (201) 867-6500

KAHLE EUROPEA—Via Spartaco 16, Caravaggio (Bergamo), Italy

**KÄHLE**

Designers and Builders of Automatic Equipment for High Speed Production for Over 30 Years



# IN THIS SIZE

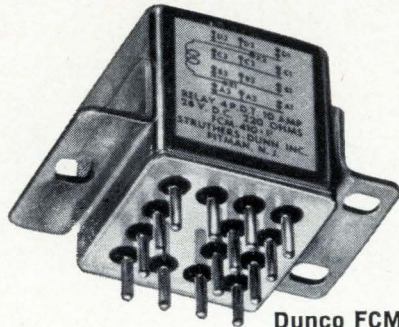

Dunco FCM-410  
"1-inch cube"  
AEROSPACE RELAYS

## WOULD YOU BELIEVE 10-AMPS?

- ...and to MIL-R-6106E
- ...and thoroughly space-proven?
- ...and available **now?**

Be convinced that there really is a reliable, 4P-DT power relay that's far smaller than conventional MIL-R-6106E relays with 10-amp contacts! Pick up the phone and call any of the Dunco sales offices listed below, or write for Data Bulletin A/2460 to: Struthers-Dunn, Inc., Pitman, N. J. 08071.

## STRUTHERS-DUNN, Inc.

tel: 609-589-7500

twx: 609-589-1548



SALES ENGINEERING OFFICES IN: Albuquerque • Atlanta • Belmont, Calif. • Birmingham, Ala. • Boston  
Buffalo • Cedar Rapids • Charlotte • Cincinnati • Clearwater, Fla. • Cleveland • Clifton • Dallas  
Encino • Englewood • Glen Ellyn, Ill. • Houston • Kansas City • Las Vegas • Memphis • New York • Phoenix  
Pittsburgh • Richardson, Tex. • Rome, N.Y. • St. Louis • St. Paul • Salt Lake City • Seattle • Southfield  
Towson, Md. • Wichita • Wilmette. Canadian Licensee: Renfrew Electric Co., Ltd. Export Dept.:  
1505 Race St., Philadelphia, Pennsylvania 19102, U.S.A.

### New Microwave

diversity, a 3-db noise improvement can be obtained.

With diode switching, the maximum signal interruption due to transmitter failure is typically only 2 to 3 msec, less than a tenth the interval normally expected with relay-type automatic transfer equipment.

Farinon Electric, 935 Washington St., San Carlos, Calif., 94070 [393]

### Lightweight antenna For S-band telemetry

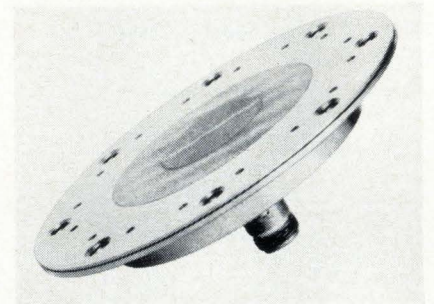

A small, lightweight antenna has been announced for airborne, flush-mounting applications. The radiation pattern of this annular slot antenna is similar to a dipole with linear polarization perpendicular to the plane of the aperture.

Characteristics are as follows: frequency, 2.15 to 2.35 Ghz; vswr, 1.5 to 1 (max); r-f connector, type N; weight, 14 oz; temperature range, -65°F to 350°F.

L.P. Associates, Inc., 11830 West Pico Blvd., Los Angeles, Calif., 90064. [394]

### Waveguide tee covers 8.2 to 12.4 Ghz

The X-band series waveguide E-plane tee has been improved through a design change to solid aluminum construction. This reduces size and weight and permits the tee to be readily adapted as a holder for oscillating, limiting, and spst and spdt switching microwave diodes. Elimination of the usual multiple brazing operations also results in a substantial cost reduction. The model X160 tee weighs less than 7 oz. It measures 2.36 x



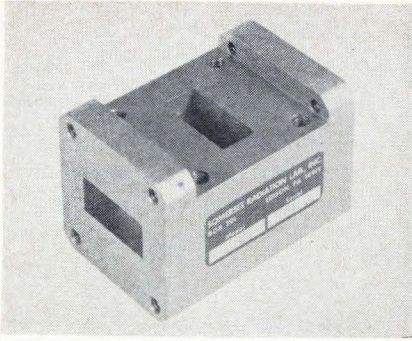

1.63 x 1.63 in. with three cover-type flanges that mate with UG-39/U waveguide flanges. Frequency range is 8.2 to 12.4 Ghz.

Price is \$66 each; delivery, immediately from stock. Somerset Radiation Laboratory, Inc., P.O. Box 201, Edison, Pa. [395]

### Mixer duplexer for airborne radar

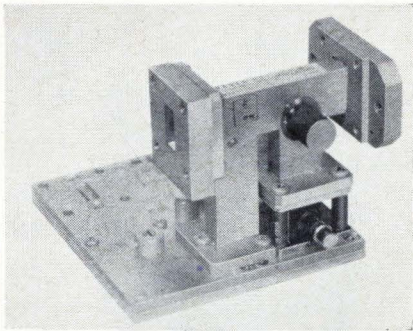

A miniature Ku-band, mixer-duplexer configuration has been developed for use in airborne radar. The lightweight (9.25 oz) assembly uses the Air-Strip transmission technique to provide highly efficient operation in a size considerably smaller than standard microwave components.

The Air-Strip portion of the unit contains a balanced signal mixer and a single-ended automatic-frequency-control mixer. Local oscillator power is controlled by a 5-db pad attenuator, a power divider, and separate variable attenuators (0 to 10 db) for each mixer. All microwave inputs are standard Ku-band waveguide and i-f outputs are BNC female connectors. The noise figure of the balanced signal mixer is less than 11 db when measured with an i-f receiver that has a noise figure of 3 db.

Micro-Radionics, Inc., 14844 Oxnard St., Van Nuys, Calif. [396]

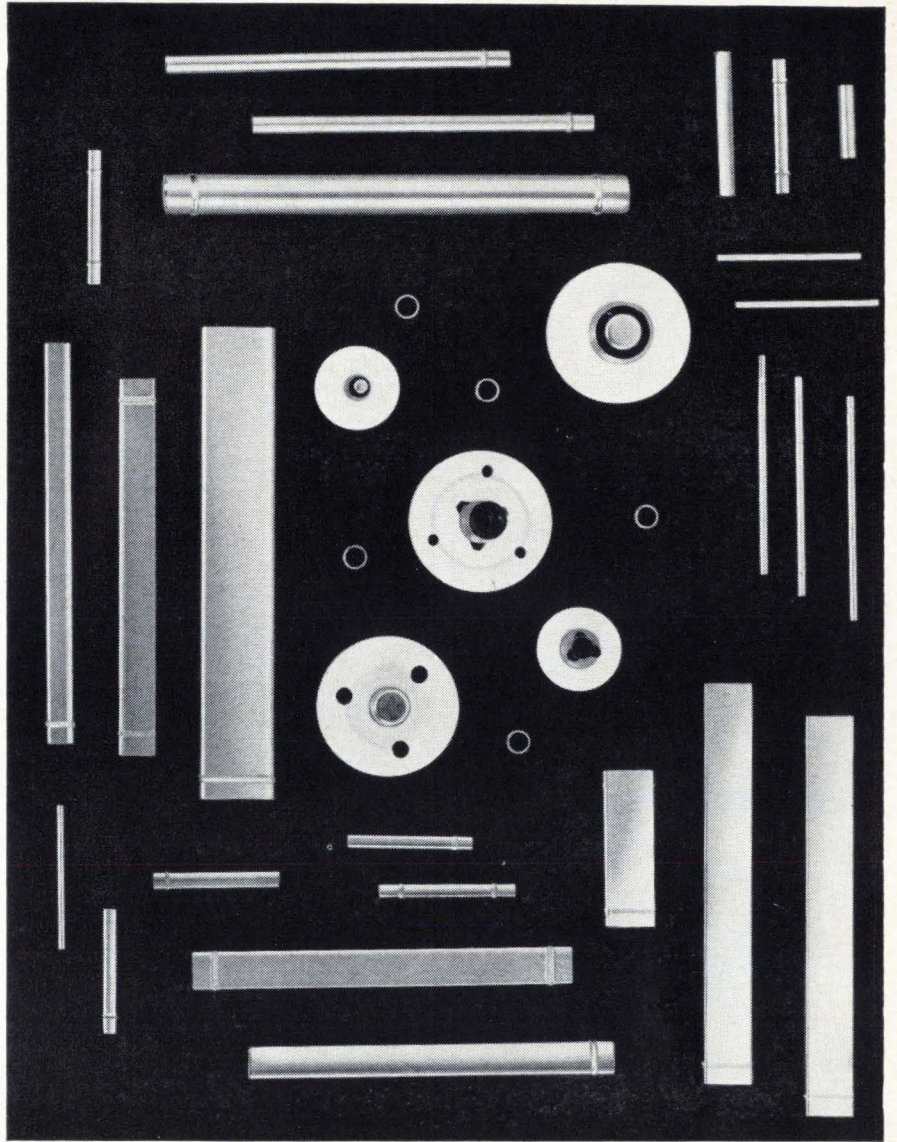

## YES, WE ARE INDEPENDENT!

We Are The World's Leading Independent Maker of Nickel Cathodes.

Every cathode that we fabricate is for our customers. And we have two large plants that are producing a variety of cathodes including seamless, Weldrawn, disc, lockseam and lapseam.

Superior offers you cathodes in a wide choice of materials for your most exacting requirement. We are pioneers in creating new designs and in developing and using new materials for improved performance.

Do you have a copy of Superior Catalog No. 51? Send for it today. Dept. 2500.

**Superior Tube** 

The big name in small tubing

NORRISTOWN, PA. 19404

West Coast: Pacific Tube Company, Los Angeles, California

Johnson & Hoffman Mfg. Corp., Carle Place, N. Y.—an affiliated company making precision metal stampings and deep-drawn parts



**rugged**



CDS-5 (To-5)

**reliable**

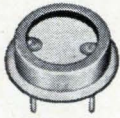

CDS-7

**top performance**

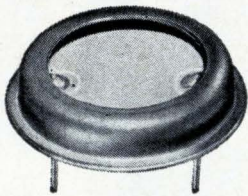

CDS-9

## POWERMASTER PHOTOCELLS

Outstanding construction and design of Pioneer Photocells assure long-life and top performance. New heavy base (.080) allows compression glass to metal seal on leads, eliminates danger of air leakage and cell deterioration.

Available in one inch, half inch and To-5 sizes over a wide sensitivity range.

Consult us on special applications of photo sensitive layers.

*Photocells pictured are actual size.*

**The Pioneer  
Electric & Research Corp.**

Subsidiary of **PENN** Controls, Inc.  
725 Circle Avenue • Forest Park, Ill.

## New Production Equipment

### Machine feeds, sets Teflon terminals

A semiautomatic machine feeds and sets Teflon insulated terminals semiautomatically. The model FST-2 Electroset handles Teflon insulated terminals in various shapes including standoffs, feed-throughs and split lugs. Complicated chassis, cans and panels with deep recesses, as well as flatboards, can be accommodated.

Terminals are placed in an 8-in.-diameter vibratory feeder, capable of holding about 2,000 pieces. Orientation takes place either within the bowl or just beyond. From the orienting station, terminals drop down a feed tube or raceway, past a photoelectric cell to an escapement. At this point, the terminal drops into a nest in the end of an air-actuated shuttle. The terminal is then transferred from the shuttle into the inserting tool and held under vacuum. The operator locates the hole in the chassis or board over a locating pin in the end of an anvil and steps on a foot switch. The switch actuates the air head which drives the inserting tool down, pressing the Teflon insulated terminal into the chassis or board. On the return stroke, a switch is closed, actuating the shuttle that advances under the inserting tool, transfers the next terminal to the tool and retracts.

The transfer can be accomplished in several ways, depending

on the shape of the terminal. In some cases, the inserting tool is lowered allowing it to grip the terminal and hold it under vacuum. In others, an air jet in the shuttle gives the terminal an upward thrust into the orifice of the inserting tool where it is held by vacuum.

After the terminal is in the inserting tool, the shuttle returns to its loading station, receives the next terminal and waits for the next cycle. The elapsed time for feeding, transferring and inserting the terminal is about 1/2 second.

Black & Webster, Inc., 570 Pleasant St., Watertown, Mass. [401]

### Machining tool polishes wafers

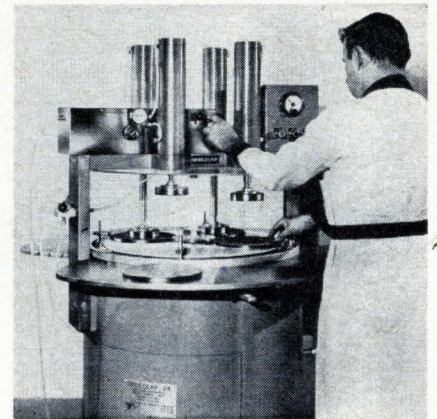

A free-abrasive machining tool has been specially modified for mass polishing of semiconductors. The modifications were developed in conjunction with engineers of a leading integrated-circuit manufacturer. The customer's specifications call for hourly production of 350 polished 1 1/4-in. wafers.

The modified model 24 incorporates a polishing cloth held in place on the backup wheel by a worm drive clamp. The abrasive slurry is then metered onto the polishing surface.

In addition, the company has added a Plexiglas shield over the polishing surface to minimize effects of fallout of dust and dirt. Even though it is expected the modified machine will normally be operated in a semiclean room, it

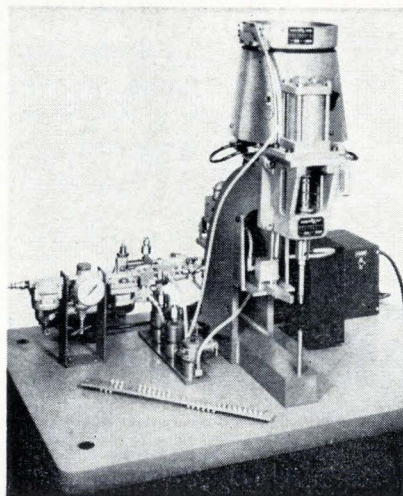



was felt the protective shield would be further insurance against contamination. All air lines are vented outward.

The 24BTAW (M) combines the important free-abrasive machining features of positive ring drive and patented water cooling of the back-up wheel. The positive ring drive insures the required wafer rotation with reference to the polishing plate. Without such positive drive, the polishing friction prevents mounting plate rotation with the expected serious results.

Water cooling insures against wax melting which, in turn, simplifies the mounting procedure. By reducing the amount of heat generated in the polishing process, heat distortion of the wafers is also eliminated. Further, water cooling maintains constant polishing temperature, thereby eliminating an important variable from the process.

Speedlap Corp., 3620 Oakton St., Skokie, Ill., 60076. [402]

## Compact, water-cooled electron beam gun

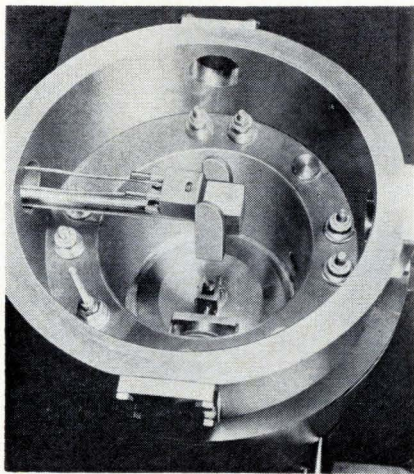

An electron beam gun melts, vaporizes and deposits high-purity thin films of any known material including oxides and refractory materials such as tungsten, tantalum, molybdenum, platinum, rhodium and silicon. Even refractory dielectric materials such as quartz, aluminum oxide, cerium dioxide, zirconium oxide and thorium oxide are easily vaporized.

Known as the Minigun, the miniaturized device is suitable for use with any standard vacuum cham-

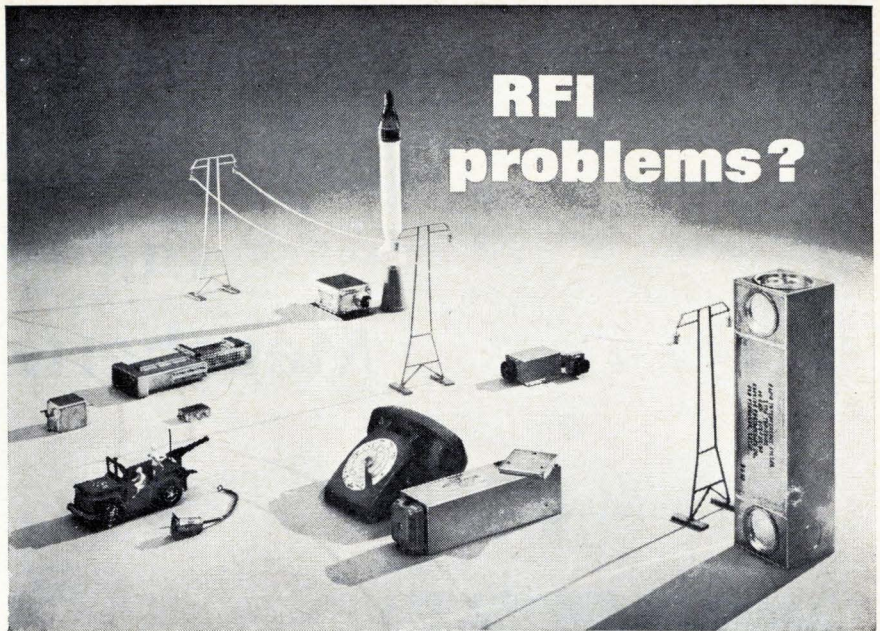

## SOLUTIONS—HOPKINS FILTERS! OBVIOUSLY IN ALL SIZES AND SHAPES!

Where components and equipment generate conducted or radiated RFI, control measures must be taken to produce a compatible environment. Hopkins has in excess of 2,000 solutions to problems in RF Interference and designed proper filters for maximum noise suppression. When you are plagued with an RFI problem, Hopkins will solve it—and provide the engineering, design, prototype, testing and production of custom filters to specification.

Our service includes complete RFI testing to a wide variety of military specifications in our certified shielded enclosures.

We are here to solve your RFI filter problems and welcome your contact.

*Our literature is as close as your telephone or letter.*



**SINGLE & DUAL CIRCUIT FILTERS FOR POWER LINES**  
Data-Log Series 1960



**FILTERS FOR COMMUNICATION CIRCUITS**  
Data-Log 258B



**GENERAL PURPOSE RFI FILTERS**  
Data-Log RFI 2000

**HOPKINS**  
Engineering Company

12900 Foothill Blvd., P.O. Box 191 • San Fernando, Calif. 91341  
Telephone: (213) 361-8691 • TWX 213-764-5998 • Cable: HOP

*A Subsidiary of Maxson Electronics Corporation*



# Takes what hurts out of Megahertz

\$23 a MHz\*

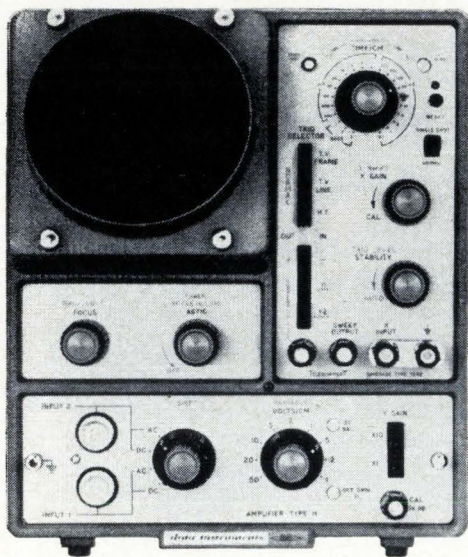

\*  
Main Frame \$420  
25MHz Amplifier \$160

Is your budget too tight for your bandwidth? Here's quick and permanent relief—Data Instruments S43A. Everything about this instrument is designed for sophisticated requirements—except the price. The main frame including the time base and horizontal amplifier is \$420. Six vertical amplifiers ranging in price from \$85 to \$170 give the unit broad operating capabilities—Bandwidths to 25MHz with a risetime of 14 nsec. And sensitivities to 100 $\mu$ v/cm. Narrow band and wide band amplifiers are also available as well as an envelope monitor with a tuned bandwidth to 32MHz.

The 4 inch, flat-faced PDA tube provides accurate and unambiguous viewing. It is available in a variety of phosphors and has a removable graticule with controlled edge lighting. An extremely reliable time base provides sweep speeds to .5 $\mu$ sec/cm in 22 precisely calibrated ranges with single shot and lockout. It also has neon indication when the time base is armed. It features rock steady triggering in a number of modes and the horizontal amplifier provides 10X expansion to 500KHz.

For those who want even more performance there is the D43A. This is a double beam scope giving two simultaneous 25MHz traces on a 4 inch tube. The main frame is \$515, and it accepts the same vertical amplifiers as the S43A. Each instrument is fully guaranteed for one year, and field and factory servicing are provided.

If your budget is pinching you (and even if it isn't) why not arrange for a demonstration of the S43A? We have a man in your area and it doesn't hurt to look. At \$23 a MHz it doesn't hurt at all.

**data instruments**

Data Instruments Division • 7300 Crescent Boulevard, Pennsauken, N.J. 08110

## Production Equipment

ber and can be used in bell jars as small as 10 inches in diameter. It is especially suitable for shadow casting with refractory metals and the deposition of refractory materials where thin films of the highest purity are required. Since the heat goes directly into the evaporant and the evaporant itself is the hottest point in the system, the purity of the deposited film is assured.

The Minigun is a fixed position, bent-beam electron gun and is rated at 5,000 v at 400 ma or 2 kva maximum. It is water-cooled. Suitable for many types of high-purity thin-film work, the compact Minigun is supplied complete, ready for field installation in existing vacuum systems.

Many accessories are available including the company's standard collars for mounting, shutters, collimating fixtures, cooled rotatable substrate holders, and a choice of power supplies.

Denton Vacuum, Inc., 802 Fellowship Road, Cherry Hill, N.J., 08034. [403]

## Dispenser fills void quickly

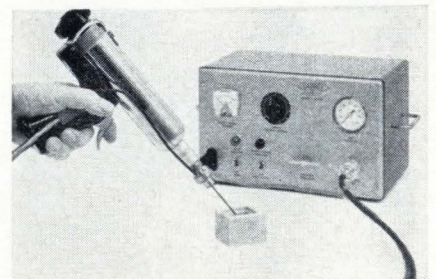

A resin dispenser assures rapid filling of molds or housings with a minimum of voids. This is true even when assemblies are so complex that there is little space for material to flow. The unit provides easily adjustable temperature and pressure control as well as a wide selection of needle sizes.

The system comprises a control unit for needle temperature and air pressure, and a lightweight, hand-held dispensing gun in which pre-mixed, degassed, frozen or pre-loaded cartridges of epoxy resin are inserted. Interchangeable stain-



less-steel needles permit choice of discharge-orifice from 0.008 to 0.135 in. An electric heating element at the base of the dispensing needle maintains the resin temperature so that its viscosity is suited to the desired rate of flow. Temperature of this element can be set at any level up to 450°F by the regulating knob on the power-control unit.

Force feed of the resin is obtained by applying air pressure behind the plunger of the cartridge. A pressure-regulating valve and gauge on the front of the control unit permit close adjustment of feed pressure. The air pressure can be obtained from an industrial compressed-air system or from bottled air or other noncombustible gas.

The dispensing gun, which weighs about 1½ lbs, is connected to the control unit by cables 10 ft long. The control unit is contained in a metal cabinet 12x7x7½ in. All switches, connections and adjustable controls are on the front panel. The system operates at 115 v a-c. Castall Research Laboratories, Inc., 18 Court St., Brockton, Mass., 02401. [404]

### Evaporation source is bakeable to 250° C

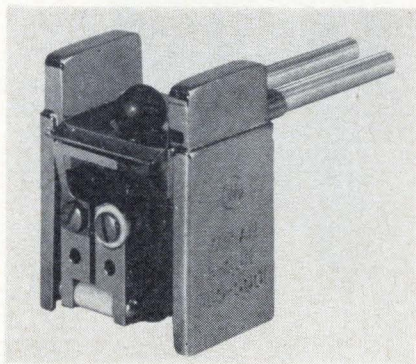

The e-Gun evaporation source for deposition of high-purity thin films is suitable for either laboratory or production work. It is particularly valuable in optical or integrated-circuit projects.

The electron beam creates temperatures up to 3,500°C so that virtually any material can be evaporated. Since the crucible is shielded from the filament and the beam is tightly focused, the evap-

# LAPP GAS FILLED CAPACITORS ARE DESIGNED FOR

HIGH  
VOLTAGE

HIGH  
CURRENT

HIGH  
CAPACITANCE

APPLICATIONS

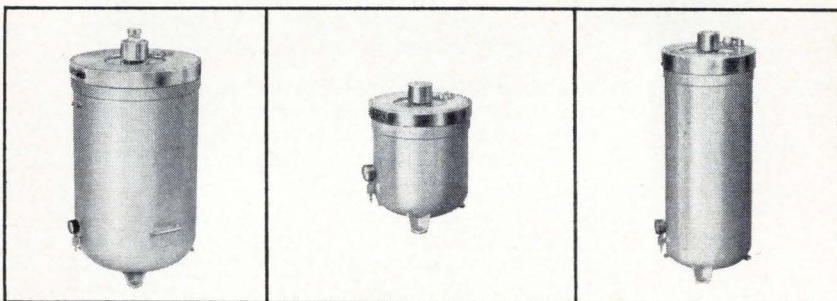

These uniquely designed Lapp Gas-Filled Capacitors are completely unaffected by atmospheric or dust conditions. They are precision built and of extra strong construction to assure years of accurate, trouble-free operation. ■ Lapp Gas-Filled Capacitors are available in either fixed or variable models. All are equipped with an external safety gap to protect against internal flashover on excess voltage peaks. Capacitance available up to 30,000 mmf, safety gap settings up to 85 kv peak and current ratings up to 400 amps at 1 mc. ■ Write for Bulletin 302... get our complete Gas-Filled Capacitor story. Lapp Insulator Co., Inc., Radio Specialties Division, 210 Sumner St., LeRoy, N.Y. 14482.

# Lapp



NOW from **SAGE**

Two new Smaller Sizes in  
METAL SLEEVED TYPE C

*Clipper* RESISTORS

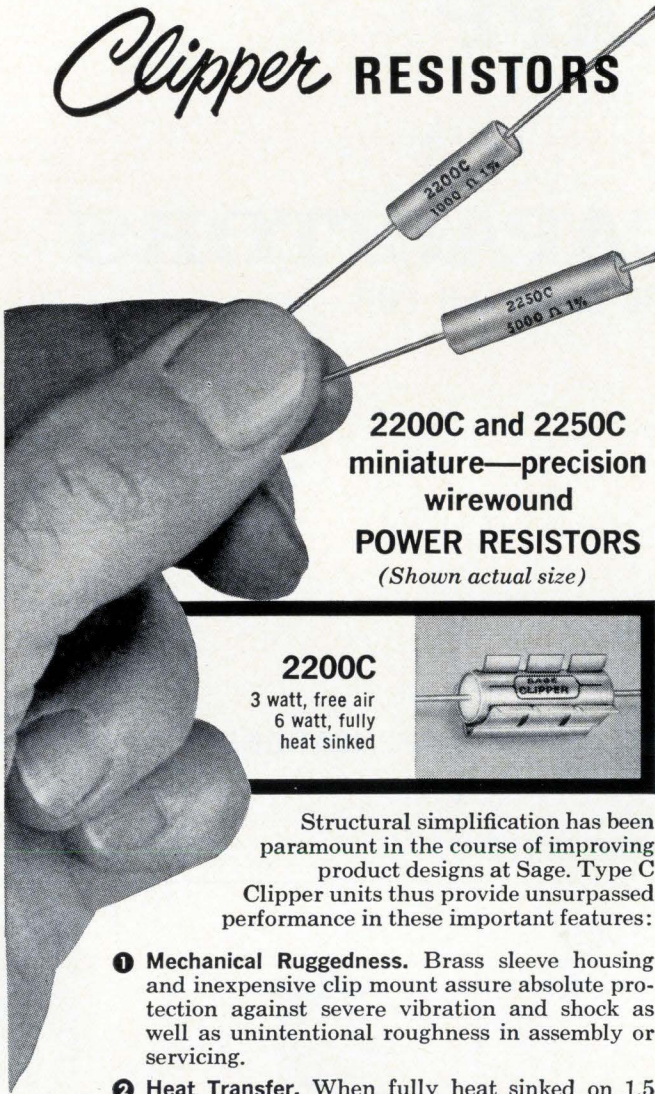

**2200C and 2250C**  
miniature—precision  
wirewound  
**POWER RESISTORS**  
(Shown actual size)

**2200C**  
3 watt, free air  
6 watt, fully  
heat sunked

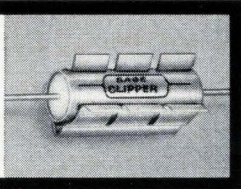

Structural simplification has been paramount in the course of improving product designs at Sage. Type C Clipper units thus provide unsurpassed performance in these important features:

- Mechanical Ruggedness.** Brass sleeve housing and inexpensive clip mount assure absolute protection against severe vibration and shock as well as unintentional roughness in assembly or servicing.
- Heat Transfer.** When fully heat sunked on 1.5 square inches .040" aluminum per watt, power rating is increased **2 for 1** over the free air rating.
- Reliability.** Construction is fully welded; IMPERVOHM® insulation rated for 350°C operation and 1000 volt rms dielectric strength.

SEE OUR SPECIFICATIONS IN  
**VSMF**  
THE MICROFILM CATALOG FILE



STYLE	POWER RATING		RESISTANCE .05 Ω to
	Free Air	Body Mounted	
*2200C	3	6	20 K Ω
*2250C	3	6	40 K Ω
2400C	3.5	7	42 K Ω
2550C	5.5	11	88 K Ω
2600C	7	14	114 K Ω
2650C	8	16	170 K Ω
2750C	10	20	257 K Ω

\*new  
Ask for Catalog R-62 giving full details

**SAGE**

**SAGE ELECTRONICS CORP.**  
BOX 3926 • ROCHESTER, N. Y. 14610

## Production Equipment

orant cannot become contaminated.

The e-Gun source is bakeable to 250°C and is entirely compatible with vacuum pressures down to  $1 \times 10^{-11}$  torr. It is said to be remarkably efficient (over 97% of the electrons from the filament strike the evaporant). The source is easy to maintain and service, can be operated manually from its control unit or automatically with a rate monitor. Only minimal training is needed for excellent results.

The unit comes in three models: the single-crucible source, for general use; the multiple-crucible source, for deposition of more evaporant or different materials in a single cycle; and the universal-position source for still larger amounts of evaporant and evaporation in any direction.

Varian Associates, Vacuum division, 611 Hansen Way, Palo Alto, Calif., 94303. [405]

## Circular welder features scr drive

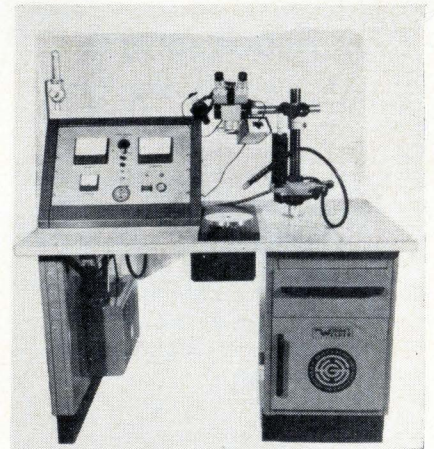

The Widge II circular welder is available for the production welding of instrument cases, gyro and accelerometer cases, component cans and other precision requirements. This equipment is used for structural joining and hermetic sealing requirements and especially where heat and weld penetration must be controlled.

The scr drive gives infinite speed control between 0 and 30 rpm, with nonstop direction reversing and jogging capability. The drive sys-



tem is equipped with a tachometer so that rotational speed may be monitored.

The power supply may be a part of the work station or it may be separate. Current range is 0.5 to 17 amps d-c with automatic weld sequence control.

The weld station has a 6-in. diameter aluminum worktable for accepting the weld fixturing that is located by a centering pin. Because this unit is used to edge weld stock as thin as 0.002 in., a microscope is provided to aid with setting up and to observe the actual welding operation.

Widge II is available as a complete package, including torch, hose regulators and so forth, ready for welding.

G.H. Silver & Associates, Inc., P.O. Box 21, Newtonville, Mass., 02160. [406]

## System automates film deposition

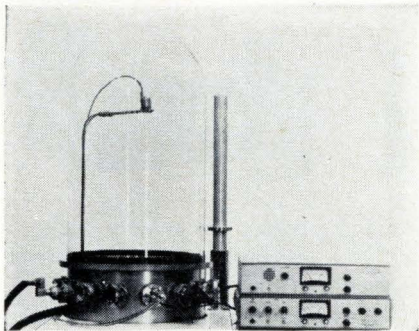

A control system provides complete automation of any vacuum deposition process. It monitors and controls the thickness of all types of vacuum deposited films. It also measures and regulates the rate at which an evaporated material is deposited on a substrate.

The new system incorporates three sensitive, precision instruments: a water-cooled sensor head; a simple, accurately calibrated deposit thickness monitor; and a deposit rate control with three-range rate control. Optional equipment includes an scr power control module. The sensor head, connectors, cable and feedthroughs are made of 304 stainless steel, OFHC copper or high-density ceramic for high vacuum compatibility.

Both the thickness monitor and the rate controller incorporate dou-

# NEW OPTIONS EXTEND DA410 FREQUENCY RESPONSE ANALYZER APPLICATIONS

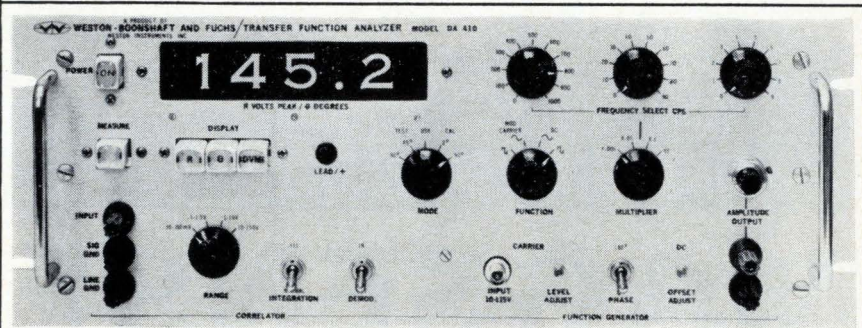

The Weston-Boonshaft and Fuchs Standard DA410 Frequency Response Analyzer performs frequency response tests with:

- Frequency range—.001 to 1000 Hz
- Accuracy—1% amplitude, 1° phase
- Noise and harmonic rejection—>40 db
- For DC and carrier signals
- Is self-checking and self-calibrating
- All solid state—7" high
- Direct digital readout

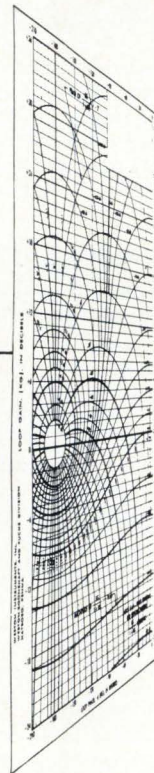

## OPTIONS

- Extend frequency range to 10K Hz, 50K Hz (carrier)
- Add adjustable  $\pm 10$  volt output bias
- Reject  $\pm 10$  ( $\pm 100$ ) volt DC on all ranges
- Permit operation from magnetic tape
- Remote programmable in frequency, range and output amplitude
- Accept floating input
- Provide BCD output of phase and amplitude to printer

The DA410 Frequency Response Analyzer with its wide range of options and accessories can perform your frequency response tests. Write for Option bulletins.

Weston Instruments Inc., Boonshaft & Fuchs Division, Hatboro, Pa. 19040

# WESTON®

prime source for precision... since 1888



# SHORT-CUT TO CONTROL

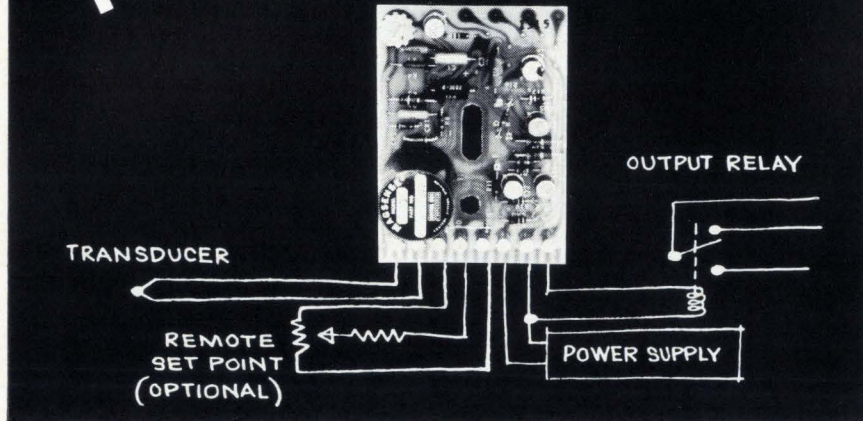

# MAGSENSE®

## Control/Alarm for Temperature, Pressure, Speed, Flow

Save time and money solving control problems with this proven short-cut. Just connect your thermocouple, tach generator, thermistor or other input to the isolated input of a MAGSENSE unit, and a relay or power contactor to the other. It's about that simple to control accurately and reliably. Solid-state MAGSENSE units have 100-billion power gain and accept the output of transducers directly *without amplifiers*.

### NO MORE WORRIES ABOUT OVERLOAD OR COMMON MODE VOLTAGE

Continuous overload capability is 1000 times nominal full-scale input *without damage*. Common mode voltages as high as 110 AC can be present without affecting trip point.

### SPECIFY YOUR NEEDS

Set point or dual set point  
Remote set point  
Solid state ground leg switching  
or pulse outputs for SCR's

Transducer excitation voltage  
Latching, non-latching, proportional  
or differential gap control  
Cold junction, copper compensation

### BRIEF SPECIFICATIONS

INPUTS:	Will reliably alarm and/or control with signal levels as low as 1 microamp or 10 microvolts.
POWER REQUIRED:	12V DC or 28V DC $\pm 10\%$ at 30 milliamps.
REPEATABILITY:	$\pm 0.8\%$ of full scale input (typical) for temperature variation of 0 to 50° C and line voltage variation of $\pm 10\%$ from nominal.
SIZE:	3" x 4" x 1 1/4"
WEIGHT:	3 oz. maximum
PRICE:	From \$35 to \$175. Quantity discounts.

CONTACT: MAGSENSE PRODUCTS, Dept. 804, La Jolla Division, Control Data Corporation, 4455 Miramar Road, La Jolla, Calif. 92037. For immediate action, phone (714) 453-2500.

**CONTROL DATA**  
**CORPORATION**

4455 Miramar Road, La Jolla, Calif.

"See us at Booth 2308, ISA SHOW"

## Production Equipment

ble meter relay set points and feature all-solid-state silicon transistor construction. Either unit can be rack mounted or portable.

The thickness monitor has an accuracy of 100 khz in 3-, 10-, or 30-khz steps and the rate controller has a rate response range of 0 to 300 hz per sec in three ranges.

Each unit measures 16 in. wide, 11 in. long and 3 1/2 in. high and weighs 16 lbs. Price for the complete system is \$2,500.

Utek Corp., Box 10920, Palo Alto, Calif. [407]

## Semiconductor oven operates at 50° to 350° C



An industrial oven with a range of 50° to 350°C processes semiconductor materials and devices. Time-proportional instrumentation precisely controls process temperatures within these limits.

The unit's multiwell construction and improved insulation combine to reduce outer wall temperature sufficiently to permit the operator to work in comfort and safety. The inner wall surrounding the work chamber is available either in aluminum or stainless steel, depending upon process requirements. The oven door is constructed to permit gravity flow of ambient air.

A squirrel-cage blower wheel provides mechanical convection of heated air in the semiconductor oven. Air circulates horizontally and there is no radiant heat. Blower, controls and other functional parts are readily accessible from the oven's front for easy service.

Lindberg Hevi-Duty, division of Sola Basic Industries, 2450 W. Hubbard St., Chicago, Ill., 60612. [408]



## New Books

### Motivation

Zero Defects: A New Dimension in Quality Assurance  
James F. Halpin  
McGraw-Hill Book Co., 228 pp., \$10.50

Although the author at times shows great ability both as historian and salesman, this is not a history of zero defects at the Martin Co.'s Orlando division nor is it a sales pitch to promote such an undertaking elsewhere. It is a how-to-do-it manual by a firm believer [Halpin developed the ZD program at Martin Orlando] to assist individuals or organizations already committed to a ZD program or about to take the plunge. But whether or not you happen to be one of Halpin's intended targets, this is a refreshing, skillfully written discussion of a major modern problem with a nostalgically old-fashioned solution.

Raymond Loewy, the noted industrial designer, recently told a national conference on standards: "I am dismayed by the diminishing quality of some of our most popular products. Good old goods-hungry United States, nation of gadget-lovers, is developing a mild case of indigestion. For a great creeping nausea is rising over products that fall apart in the hand, that buzz and rattle and fail and fail and fail again, and generally make themselves unpalatable."

If you consider Loewy the diagnostician who identified the illness, then Halpin is the internist who prescribes a convincing though somehow familiar cure for the malady—and submits some impressive testimonials along with his obvious qualifications as a keen human and industrial psychologist.

Perhaps he treats his individual (never plural) as just a bit more compliant and predictable than has been our experience, but then self-confidence and the power of positive thinking have long been favorites rather than long-shots in the human race.

The secret of success in zero defects is a return to craftsmanship. The key to this—not revealed until chapter 14—is job awareness. It is essential to human dignity that someone cares. It is essential to em-

ployee motivation that he know his job is important and someone cares about it. Halpin provides a technique through which management can show that it cares and be constantly reminded of the need for and value of doing so.

Don't be misled by the author's detailed plan in chapter 3 for a ZD campaign complete with PERT chart. As he makes plain, ZD is a crusade, not just another magic management procedure, and without individual motivation will do more harm than good. The procedures can be common to all departments in any organization but their actual implementation must be tailored to each department, product line, work crew, shift and individual. This places the heaviest load and the most critical responsibilities on the first-line supervisor, and Halpin does little to help this fellow except to portray convincingly the importance of his role and the probability that his labors will be rewarded by a general reduction in future problems.

Chapter 12 gives some creative ideas on ZD measurement criteria in clerical, administrative and non-production areas. Scientific and professional employees are treated to somewhat less sympathetic scrutiny. Their creative endeavors are to be reflected in a percent defective ratio:  $s/p \times 100$ , where  $s$  is the number of errors and  $p$ , the number of projects or opportunities for error. The production worker, however, is rated by the number of defects divided by the number of hours worked. It is doubtful that either of the author's two ventures into the mathematical realm would satisfy any two employees in a single department.

Halpin also waits until chapter 11, by which time the reader is firmly hooked, to admit that "ZD is a motivational symbol and not an economically feasible and attainable objective per se." In keeping with the positive approach he attacks the employee's double standard as the target for the ZD treatment (don't give your employer less than you demand from your wife or the plumber), but doesn't

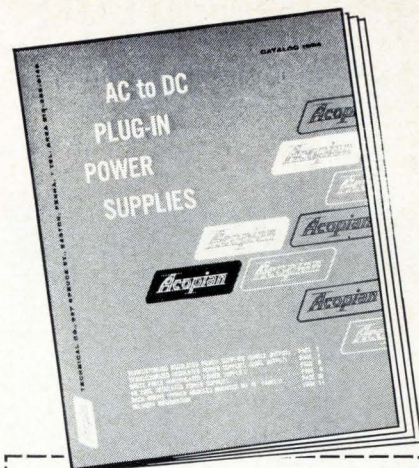

Please send me the latest Acopian catalog that lists

**62,000  
DIFFERENT  
POWER  
SUPPLIES**  
available  
for shipment  
in 3 days.

Name \_\_\_\_\_

Title \_\_\_\_\_

Company \_\_\_\_\_

Address \_\_\_\_\_

City \_\_\_\_\_

State \_\_\_\_\_

ZIP \_\_\_\_\_

ACOPIAN CORP.  
EASTON, PENNSYLVANIA  
TEL: (215) 258-5441





# IF YOU DON'T RECOGNIZE THIS

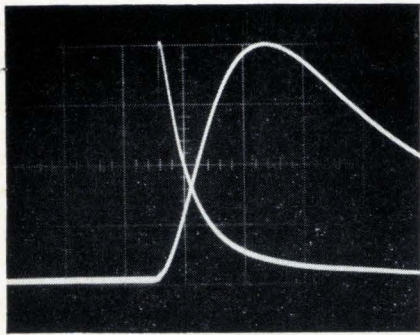

## IT'S NO WONDER,

because you've probably never seen 2940 feet of coaxial cable measured this way before.

## HOW COULD YOU?

We used the TRW Model 46A Trigger Delay Generator, just coming on the market. It's brand new, with some inherited virtues of its predecessor, TRW Model 2A—**nanosecond accuracy**, high power trigger to override random noise, clear digital display, selectable triggering threshold—**plus plug-in capability** so you buy exactly the triggering input you need, exactly the sensitivity and spectral range your application calls for.

### ASK US FOR A TECHNICAL DATA BULLETIN AND APPLICATION NOTES

giving the characteristics of the TRW Model 46A and the plug-ins, and illustrating how you can use the TRW Trigger Delay Generator, as we did, to make direct measurement of delay lines, to generate fiducial marks, calibrate oscilloscopes, and trigger the TRW Image Converter Camera or countless other laboratory instruments.

### **TRW**INSTRUMENTS

139 Illinois Street, El Segundo, California  
AC 213, 679-9101 Extension 22884.

*Developers and manufacturers of state of the art diagnostic instruments for basic and applied research.*

## New Books

stress the potential double standard of the employer who is depending on profit, delivery schedules, production quotas or calculated obsolescence of the product.

This reviewer disagrees with Halpin's claim that "ZD, like motherhood, apple pie and John Wayne, cannot be ignored." Not only can it be, it has been ignored to the point where the quality assurance department in many organizations should be renamed the disaster prevention department. The cynic won't be moved, the idealist doesn't need it, but there are a lot of neutrals around and the \$35 billion annual cost to United States industry for finding and correcting defects makes it a high-stakes poker game. It is certainly an extremely high-stakes game in the Department of Defense where we trade primarily with lives rather than with dollars.

Automation cannot be expected to reduce the effect of human aberrations on product quality. Somewhere there is always a button-pusher, growing ever more remote and incapable of identifying with his product. As the points of human intervention become less and less frequent, it seems that every push of the button becomes more critical, for we have not seen the expected breakthrough in quality through automation.

For the reader who is going the ZD route, this book will provide a complete guide to all the procedures, timing and details right down to the slogan writing. It is doubtful that even the most casual of Halpin's readers could ever again feel completely comfortable if he failed to strike some small blow for the revival of craftsmanship.

Joseph B. Brauer  
Rome Air Development Center  
Griffiss Air Force Base, N.Y.

### Microscopy

Electron Optics  
P. Grivet with the collaboration of  
M.Y. Bernard, F. Bertein, R. Castaing,  
M. Gauzit and A. Septier  
Pergamon Press, 781 pp., \$30

Had the English edition been published soon after the French origi-

## Engineers:

*GO Forward . . .*

*GO Fast . . .*

*GO Far . . .*

at

# HUGHES AIRCRAFT COMPANY!

Immediate openings are  
available for:

#### DESIGN ENGINEERS

Assignments are available for Electronic and Mechanical Design Engineers in the development of Trainers & Simulators and in the design of checkout and test equipment for large missile and aerospace systems. These, responsible positions require interest and/or experience in such design areas as: analog circuits, digital logic, switch/relay logic, electromechanical packaging, infrared testing, inertial guidance and Command/Control systems. Responsibilities will include all phases of development from concept to final fabrication and evaluation. B.S. degree is required in E.E., M.E. or Physics.

#### SYSTEMS ENGINEERS

(Polaris Project)

Immediate openings exist for well-qualified Systems Engineers on our Polaris Project Team. Desirable background for these positions would include experience on Guidance, Flight or Fire Control aspects of major weapon systems or subsystems and some experience on the Polaris Weapon System (preferably on the MK 84, MK II and/or missile subsystems). B.S. degree is required in E.E., Mathematics or Physics.

#### U.S. CITIZENSHIP IS REQUIRED

For immediate consideration and to arrange for an interview appointment in your area in the near future, please airmail confidential resume to:

MR. B. P. RAMSTACK

**HUGHES**

HUGHES AIRCRAFT COMPANY

P. O. Box 90515,  
Los Angeles, Calif. 90009

An equal opportunity employer—M & F



nal, 11 years ago, it could have been highly recommended as a reference for electron lenses and their applications in microscopy. Unfortunately, the book is no longer up-to-date. No bibliographic entry is dated later than 1961, and only a few are later than the mid-1950's.

The introductory 10 chapters describe the basic properties of electron lenses in terms of geometric optics, but no underlying thesis is given.

The rest of the book covers a wide range of applications, including the cathode-ray tube, the mass spectrograph and the beta-ray spectrograph. The material gives an adequate introductory review of these instruments but, here again, there is much obsolescence. For example, the section on preparing biological specimens, an important application of electron microscopy, doesn't mention the negative staining techniques discovered by Hall and Huxley about 10 years ago, which have proved to be of great value in showing fine detail.

One would expect that the chapter on electron-probe devices would be timely, since Castaing, inventor of the electron-probe microanalyzer, is one of the authors. Alas, this is not so—references later than 1960 are missing.

No account of diffraction theory could be found—another serious omission, especially since phenomena readily interpreted in terms of diffraction theory are frequently mentioned. These topics are image formation and resolving power, Fresnel fringes, moire patterns and interference fringes obtained with an electron interferometer.

C.R. Worthington

The University of Michigan  
Ann Arbor, Mich.

#### Recently published

Introduction to Dynamic Programming,  
George L. Nemhauser, John Wiley & Sons,  
256 pp., \$7.95

Modern Electronics, Hendrik De Waard and  
David Lazarus, Addison-Wesley Publishing  
Co., 358 pp., \$9.75

Effective Writing for Engineers, Managers,  
Scientists, H.J. Tichy, John Wiley & Sons  
337 pp., \$5.95

Design and Construction of Electronic  
Equipment, George Shiers, Prentice-Hall,  
Inc., 362 pp., \$14

Pratique des Televiseurs a Transistors,  
F. Juster, Editions Chiron, Paris, 548 pp.,  
58 Francs, (\$11.70)



### POTTING COMPONENTS CONDUCTS HEAT

Improved component life and performance of transformers, resistors and other heat generating components is assisted by potting them with Astrodyne Compound 166. Very high thermal conductivity (7.4 BTU/hr-ft<sup>2</sup>-°F/inch) plus high dielectric strength (626 volts/mil) and excellent physical characteristics when cured

are provided by Potting Compound 166. It offers an effective conducting path from components to heat sink or outer case. Compound 166 is supplied in mix-and-use boxes (12/carton—\$42.00, or \$4.25 each. Lower price in bulk quantity). Complete technical specifications on request.



**astrodyne, inc.**

SUBSIDIARY OF ROANWELL CORP.  
207 CAMBRIDGE ST., BURLINGTON, MASS. (617) 272-3850

Circle 240 on reader service card

# Photocell Decay Problems?

## Try Type 7H

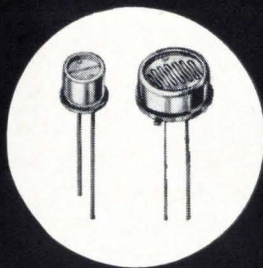

Clairex Type 7H Photocells now offer decay times of .006 sec @ 100 ft-c. Couple this with 240 ohms @ 100 ft-c, CdS stability, and your problems are solved. Available in TO-18 and TO-5 cases. And 6 resistance ranges.

# CLAIREX

"The LIGHT Touch in Automation and Control"  
1239 Broadway, New York, N.Y. 10001  
212 MU 4-0940



## VECTOR PLUGBORDS CUT CONSTRUCTION TIME

### MAKE CARD CIRCUITRY FASTER, EASIER, AND CHEAPER WITH VECTOR PLUGBORDS

1. Pick a plugbord from over 50 stock models featuring
  - Vector Edge Pins
  - Elco Varicons\*
  - Etched contacts
2. Push in Vector Mini-Klip Terminals or Inbord pins into prepunched holes.
3. Snap in or wrap leads, solder cross connections, and a finished plug-in circuit card is ready for operation.

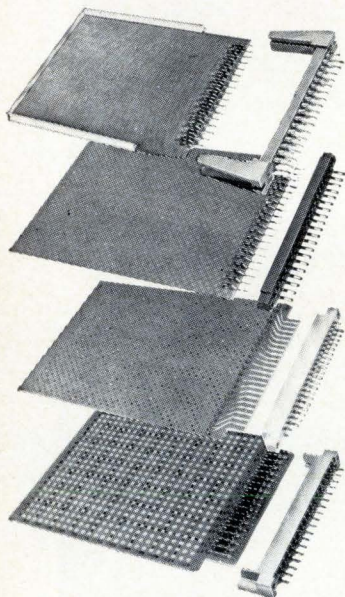

■ **MICRO PLUGBORD WITH KARDEJ AND VECTOR EDGE PINS** — Holes .025 or .042 diameter spaced .05 or .1 centers in G-10 epoxy glass with strengthening aluminum KARDEJ accommodates "FLATPAKS." New VECTOR-CONN\* Receptacles.

■ **EDGE PIN PLUGBORD**—Full line of Plugboards for new VECTOR-CONN\* Receptacles with 8-41 pins, block ends, or card guides. Or make your own Plugboards with Vectorbord and Edge Pins.

■ **ETCHED PLUGBORDS** — Standard spaced etched P.C. "fingers" on one or both sides of epoxy paper or epoxy glass pre-punched plugboards.

■ **VECTOR-ELCO VARICON\* PLUGBORDS** — Many standard sizes, 12 to 41 contacts. Pre-punched with .062" or .093" holes in epoxy glass and epoxy paper material.

\*Trademark

For full information contact:

**Vector** 

ELECTRONIC COMPANY, INC.  
1100 Flower Street, Glendale, California

## Technical Abstracts

### Network synthesis

Inductorless filters  
H.J. Orchard  
Lenkurt Electric Co.,  
San Carlos, Calif.

Gyrator-capacitor combinations are fast becoming a widely used approach for replacing inductors in LC-active filter networks. This technique's main advantage is that over-all sensitivity of component tolerances can be controlled.

Elimination of the inductor helps reduce equipment size, weight and cost and avoids losses produced by this component. However, substitutes such as RC-active filter networks have resulted in circuits much more sensitive to component tolerances than conventional LC filters.

Much of the enthusiasm for RC-active filters, as a replacement for LC filters, arises from a misunderstanding of the sensitivity to component tolerances that exist in conventional LC filters.

An engineer designs a reactance ladder filter that operates in a flat passband from a resistive source into a resistive load. He arranges for the source to deliver its maximum available power into the load at frequencies of minimum loss over the passband. He finds, to a first order of approximation, that at every frequency in the passband and for every component, the sensitivity of the loss to component tolerances is zero. This is verified by noting that for a zero loss in a reactance network, a component change, either up or down, increases the loss. Near the correct value, the curve relating loss to any component value must be quadratic and consequently the derivative of the curve at that point must be zero.

An engineer's ability to make high-quality filters meet stringent specifications relies heavily on this desensitizing property that occurs at zero loss in a doubly loaded reactance network. This property does not occur in singly loaded or predistorted, dissipation-compensated filters, which explains why such networks are not widely used.

The sensitivity of an RC-active filter increases rapidly with the de-

gree and sharpness of the filter characteristic, whereas in an LC filter it gets worse only by virtue of second-order effects becoming noticeable. In LC equivalents to bandpass filters, component tolerances for the same quality of passband are about 100 times greater than RC filters; for complex filters tolerances may be 1,000 times greater.

In this respect the LC filter possesses a valuable property that familiarity tends to obscure. The solution is to design a conventional, doubly loaded LC ladder filter to meet the specification and simply replace each inductor in the filter with a gyrator terminated by a capacitor. (The gyrator, when loaded by a capacitor, simulates an inductor at its input terminals.) This gyrator-capacitor network, like the LC network, is lossless and passive and has precisely the same low sensitivity.

The basic component available to eliminate inductors is the transistor, which is both active and a nonreciprocal device. When used as a gyrator, the active property must be eliminated and the nonreciprocal property retained. First experiments in this direction have been successful.

Presented at the Institute on Modern Solid-State Circuit Design, University of Santa Clara, Santa Clara, Calif., Sept. 14-15

### Computer-aided design

Algorithms for a dichotomous evaluation of microcircuits  
R.M. Carpenter  
National Aeronautics and Space Administration  
Cambridge, Mass.

A computer program to aid in circuit design is available for networks with a large number of components, typically 30 to 100. Based on theorems for oriented, weighted graphs, the program is intended to meet circuit design requirements that exceed the memory capacity of medium-size computers when programs based on node or loop analysis are employed.

Since worst-case design imposes large limitations on the best circuit design, Monte-Carlo routines and similar reliability techniques are in-



roduced. The resultant procedure is particularly useful to circuit designers and reliability analysts with access to a medium-size, desk-top computer or a time-sharing outlet.

The program performs a dichotomy of a signal-flow graph associated with any active network. Algorithms are established to:

- divide the network into voltage and current generators
- examine separately each set and the associated system of controls interrelating both sets
- derive network characteristics and design criteria
- establish an optimum model for a preassigned level of accuracy.

Although the algorithms were developed for active networks, the dividing procedures provide an effective approach to other matrix manipulations.

Presented at the Institute on Modern Solid-State Circuit Design, University of Santa Clara, Santa Clara, Calif., Sept. 14-15

### Boosting frequencies

Microwave power transistors  
By H.C. Lee  
Radio Corp. of America  
Somerville, N.J.

Continued advances in the design of overlay transistors has extended operation into the microwave region. Overlay transistors operate efficiently and produce gain at high frequencies because their design permits a substantial increase in the ratio of emitter periphery to emitter area. This high ratio results in high current-handling capability without the expected decrease in frequency response [Electronics, Aug. 23, 1965, p. 70].

In amplifier circuits, overlay transistors now under development produce 7 watts of continuous-wave power at 1 gigahertz and 1 watt at 2 Ghz. As oscillators the devices have developed 450-milliwatt output at 1.68 Ghz. When they are used as harmonic multipliers which also provide gain, an input power of 1 watt at 36 Mhz produces 3 watts at 1.1 Ghz.

In an amplifier for large-signal operation, high power gain requires high current gain as well as constant gain with varying current level. Current gain is an intrinsic parameter in the overlay transistor; constant current gain is achieved by using shallow diffusion manu-

## NEON or INCANDESCENT SUB-MINIATURE INDICATOR LIGHTS

MEET OR EXCEED ENVIRONMENTAL  
AND OPERATIONAL REQUIREMENTS  
OF MIL-L-6723 AND MIL-L-3661

**Miniaturization** is made possible by the wide selection of Dialco Sub-Miniature Indicator Lights for mounting in 15/32" or 17/32" clearance hole. Among the features offered are: Watertight construction; resistance to vibration and corrosion; high-heat plastic or glass lenses; anti-rotation (locked) construction; phenolic insulation of military specification grade.

**Neon** assemblies accommodate T-2 lamps in two types: NE-2D (MS25252) for 105-125V AC-DC; and High Brightness NE-2J for 110-125V AC only. In DIALCO units, the current limiting resistor is built in (U.S. Pat. No. 2,421,321).

**Incandescent** assemblies accommodate T-1¼ lamps in voltages from 1.35 to 28V—with life ratings to 50,000 hours.

SAMPLES ON REQUEST—AT ONCE—NO CHARGE.

(Illus. approx. actual size)

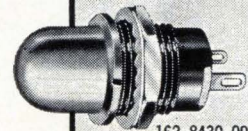

162-8430-0931-502



134-3830-0375-201

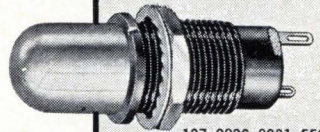

137-8836-0931-552



174-8430-0131-203

WRITE FOR CURRENT CATALOG

**DIALCO**®

Foremost Manufacturer of Indicator Lights

**DIALIGHT** CORPORATION

60 STEWART AVENUE, BROOKLYN, N.Y. 11237 212 HYACINTH 7-7600

Circle 207 on reader service card

# RELIABILITY ENGINEERS

### BSEE or BSME-Reliability design review:

Experienced with small electrical components and semiconductors. Prepare procurement, test and design specifications.

### BSEE-Reliability analysis:

Experienced in circuit design and analysis. Perform detailed reliability analyses of complex electronic parts and circuits and recommend improvements in design reliability.

### BSEE-Reliability test engineering:

Prepare test procedures for electrical and electronic packages and coordinate procedures with test laboratories, conduct proofing of test procedures and test equipment.

### BSME-Reliability and inspection:

Perform mechanical and structural reliability analyses. Provide for inspection planning and review prints to determine inspection attributes. Experience in metallurgy and NDT helpful.

### Non-destructive testing:

Background in electronics and applied physics plus knowledge of instrumentation related to the use of X-rays, sound waves, electrical fields and optics.

Write Mr. K. R. Kiddoo, Professional Placement Manager, Lockheed Missiles & Space Company, P.O. Box 504, Sunnyvale, California. An equal opportunity employer.

**LOCKHEED**

**MISSILES & SPACE COMPANY**

A GROUP DIVISION OF LOCKHEED AIRCRAFT CORPORATION







## New Literature

**Random vibration testing.** B&K Instruments, Inc., 5111 W. 164th St., Cleveland, Ohio. A 34-page booklet compares sine wave, wideband random, and narrow-band random vibration testing. Circle 420 on reader service card.

**Balanced modulators.** Spectran Electronics, P.O. Box 878, Pompano Beach, Fla. A specification and price sheet covers a line of balanced ring modulators that provides frequencies from 0 to 30 Mhz. [421]

**Rotating drum switches.** Sealectro Corp., Mamaroneck, N.Y., 10543, has released a six-page catalog giving design and specifying information on the expanded line of Actan rotating drum switches. [422]

**Resistors.** Texas Instruments Incorporated, 13500 North Central Expressway, Dallas, Texas. A 12-page brochure details the company's lines of precision metal- and carbon-film resistors for severe applications. [423]

**Frequency converters.** Lorch Electronics Corp., 105 Cedar Lane, Englewood, N.J. Catalog FC-668 describes and illustrates two new series of wideband frequency converters. [424]

**Diode switch.** Microwave Associates, Inc., Burlington, Mass., has available bulletin 7035 describing a high-performance diode switch that provides isolation of 90 db for use in microwave communications systems. [425]

**Potentiometers.** Duncan Electronics, Inc., 2865 Fairview Road, Costa Mesa, Calif., 92626. A four-page catalog details wirewound single- and multi-turn precision potentiometers and turn-counting dials. [426]

**Slide switches.** Switchcraft, Inc., 5555 N. Elston Ave., Chicago, Ill., 60630, has published the eight-page catalog No. S-330 describing a versatile line of double-wipe slide switches. [427]

**D-c relays.** Sigma Instruments Inc., 170 Pearl St., Braintree, Mass., 02185, has issued a bulletin on telephone-type, general-purpose d-c relays (the dpdt and 4pdt series 63) for high-fidelity transmission of audio signals and use in logic circuitry. [428]

**Wideband amplifiers.** Dana Laboratories, Inc., Irvine, Calif., 92664. Data sheet 597 covers the series 3400 amplifiers—eight direct-coupled, wideband, differential amplifiers designed for research instrumentation and data acquisition. [429]

**Precision switches.** Cherry Electrical Products Corp., 1650 Old Deerfield Road, Highland Park, Ill., 60035. Catalog C-67 contains detailed illustra-

tions of 19 different series of precision switches, accompanied by information on special features, button and terminal variations and operating characteristics. [430]

**Digital circuit modules.** Engineered Electronics Co., 1441 E. Chestnut Ave., Santa Ana, Calif. A 48-page technical catalog describes the Q series of low-cost, low-noise digital circuit modules. [431]

**Magnetic-component design.** Ferro-cube Corp. of America, Saugerties, N.Y. A 32-page booklet (bulletin 330) tells how to apply the manufacturer's ferrite cores to the design of power magnetics. [432]

**Connector potting boots.** Pli-O-Seal Mfg. Co., 1121 Chestnut St., Burbank, Calif., 91503, offers catalog N66 describing three styles of nylon potting boots for potting standard, pygmy and sub-miniature electrical connectors. [433]

**Crt display modules.** Beta Instrument Corp., 377 Elliot St., Newton Upper Falls, Mass., 02164. A short-form catalog contains a full-page block diagram of a typical art display system using the company's modular building blocks. [434]

**Power dividers.** Elpac, Inc., 3760 Campus Drive, Newport Beach, Calif. A two-page data sheet covers the models P240 and P340 power dividers, both of which provide an 8-to-1 bandwidth through the 500 Mhz to 4 Ghz frequency spectrum. [435]

**Casting resins.** Emerson & Cuming, Inc., Canton, Mass. A revised quick-reference chart for notebook or wall mounting describes the more important members of the Stycast line of potting and encapsulating resins. [436]

**Piston trimmer capacitors.** Roanwell Corp., 180 Varick St., New York, N.Y., 10014. Data sheet EDS-2 deals with the Little Ones, said to be the smallest glass trimmer capacitors available in the 1.0 to 10.0 pf range. [437]

**Time delay relays.** The A.W. Haydon Co., 232 North Elm St., Waterbury, Conn., 06720. Product information sheet No. 130 provides data on the series K42300 electromechanical time delay relays. [438]

**IC digital assemblies.** Cambridge Thermionic Corp., 445 Concord Ave., Cambridge, Mass., 02138, offers a new literature portfolio covering its highly flexible and economical line of integrated-circuit logic assemblies. [439]

**Electronic enclosures.** Zero Manufacturing Co., 1121 Chestnut St., Burbank, Calif., 91503. Catalog SS66 describes a



NEW BOOKS  
FROM  
McGRAW-HILL

McGRAW-HILL

### RELIABILITY HANDBOOK. By W. GRANT IRESON.

This all-inclusive handbook provides you at once with the basic guidelines for determination and application of suitable performance patterns, selection of test plans, use of mathematics and statistics, organization of reliability data, and estimation of reliability. Reliability in design and development, fruitful analysis and correction of malfunctions and failures, the concept of maintainability, human factors, relationship between reliability and quality control and costs—all are explained in complete, authoritative detail. 700 pp., \$22.50

### MODERN OPTICAL ENGINEERING. By WARREN J. SMITH.

This book will help the engineer or scientist apply the principles and theory pertinent to the design of optical systems. It thoroughly covers the fundamentals of geometrical optics and optical system design, emphasizing the techniques required for modern applications. Background material—such as that relating to vision, materials, and radiometry—is clearly developed in direct relation to the overall subject. The book avoids advanced or difficult mathematics, and is an ideal guide for self-study. 452 pp., \$15.00

### DIRECT ENERGY CONVERSION. By GEORGE W. SUTTON.

The fundamentals, potential, techniques, and recent developments in solar photovoltaic cells, fuel cells, thermoelectric power generation, thermionic power generation, and MHD power generation are presented, explained and correlated in this authoritative new text for graduate students and practicing engineers. 336 pp., \$14.50.

At your bookstore or direct from publisher for

### 10 DAYS FREE EXAMINATION

McGRAW-HILL BOOK CO., Dept. 23-L 1017  
330 West 42 Street, New York, N. Y. 10036  
Send me book(s) checked below for 10 days' examination on approval. In 10 days I will remit for book(s) I keep plus a few cents for delivery costs and return unwanted book(s) postpaid. (We pay delivery costs if you remit with this coupon—same return privilege.) Include sales tax if applicable.

- Ireson, RELIABILITY HANDBOOK, \$22.50.
- Smith, MODERN OPTICAL ENGINEERING \$15.00.
- Sutton, DIRECT ENERGY CONVERSION, \$14.50.

Name (print) .....

Address .....

City..... State..... Zip Code.....

For prices and terms outside U. S. write McGraw-Hill Int'l. NYC 23-L 1017



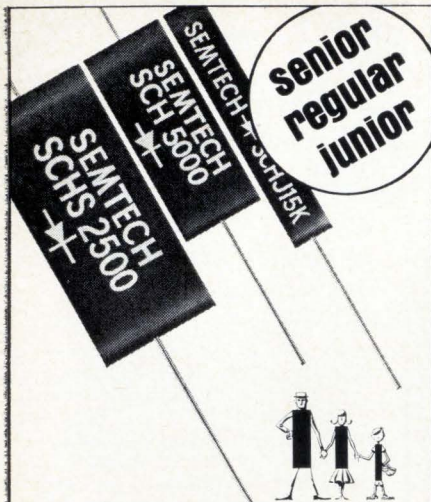

## Introducing the "Sлимпac" family

high voltage — high current silicon rectifier series.

Semtech Corporation is proud to introduce a new "family" of high voltage high current low cost silicon rectifiers... "Sлимпac." The entire "Sлимпac Family" has corona free construction and meets the most stringent life and environmental requirements. For use on commercial, industrial and military applications.

Now being produced in quantities for off-the-shelf delivery the series is available in three basic current ratings:

"Sлимпac" Senior — PIV: 2,500 to 15,000V (Low leakage 10 UA @ PIV, 25°C)

\*Average Rectified Current: 2 amps @ 55°C / free air, 1.2 amps @ 100°C / free air  
Case Sizes: .687" H, .375" W, 1.5" to 6.5" L

"Sлимпac" Regular — PIV: 5,000 to 25,000V (Low leakage 0.1 UA @ PIV, 25°C)

\*Average Rectified Current: 0.5 amps @ 55°C / free air, .33 amps @ 100°C / free air  
Case Sizes: 50" H, .25" W, 1.125" to 4.25" L  
Also available: "Sлимпac" Fast Recovery (Tr 150 ns max.)

"Sлимпac" Junior — PIV: 15,000 to 45,000V (Low leakage 0.1 UA @ PIV, 25°C)

\*Average Rectified Current: .050 amp at 55°C / free air, .030 amp @ 100°C / free air  
Case Sizes: .25" H, .25" W, 1.5" to 3.5" L



Write for technical literature or contact your nearest representative.

\* Average Rectified Current rating can be doubled in oil environment.

## SEMTECH CORPORATION

WESTERN: 652 Mitchell Rd., Newbury Park, Calif., (805) 498-2111 / (213) 628-5392 / TWX 805-499-7137

CENTRAL: 140 N. La Grange Rd., La Grange, Ill. (312) 323-4745

EASTERN: 71 WEST 23rd St., N.Y., N.Y. (212) 989-7550 / TWX 212-640-5060

EUROPEAN SALES: Bourns A G, Alpenstrasse 1, Zug, Switzerland (042) 4 82 72/73

## New Literature

complete line of rfi shielded vertical, slope front and low silhouette aluminum electronic enclosures and accessories. [440]

**Amplifier catalog.** Optical Electronics, Inc., P.O. Box 11140, Tucson, Ariz., 85706, has released a comprehensive catalog covering 32 logarithmic amplifier models, nine operational amplifier models, 46 analog function module models and nine power supplies and current sources. [441]

**Sockets for flatpack IC's.** Barnes Development Co., Lansdowne, Pa., 19050. Bulletin 125 describes and illustrates the series MD-108 flip-top test sockets for test, aging and breadboarding of flatpack integrated circuits. [442]

**Million-bit memory.** Electronic Memories, 12621 Chadron Ave., Hawthorne, Calif., 90250, has published a brochure on the Nanomemory 900, a high-speed, large-scale memory with a capacity of 16,384 words of up to 84 bits, and an access time of only 650 nsec. [443]

**Dual-channel receiver.** Defense Electronics, Inc., Rockville, Md. Bulletin TR-109 contains engineering features, performance specifications, block diagram and outline data on a solid-state, dual-channel telemetry/voice receiver. [444]

**GaAs hot carrier test data.** International Semiconductor, Inc., 1 Charles St., Newburyport, Mass., 01950. A four-page report gives the reliability results of GaAs hot carrier diodes operated for 2,000 hours at 150°C. [445]

**Control computer system.** Westinghouse Electric Corp., Box 868, Pittsburgh, Pa., 15230. Booklet B-9256 describes the Prodac 250 intermediate-size process control computer system. [446]

**Etch resist and protective coating.** Alpha Metals, Inc., 56 Water St., Jersey City, N.J., 07304, has released technical bulletin 5b-34 on Etchcoat No. 934, a rosin-base combination etch resist and protective coating designed to provide faster, more economical p-c board manufacture. [447]

**Instrumentation.** The John Fluke Manufacturing Co., Inc., Box 7428, Seattle, Wash., 98133. Eighteen new instruments are illustrated and described in a four-page brochure. [448]

**Dual slope digital meter.** Fairchild Instrumentation, a division of Fairchild Camera & Instrument Corp., 475 Ellis St., Mountain View, Calif., has published a brochure on the 7100 series dual slope integrating digital meters for measuring voltage, resistance and ratio. [449]

See GRC at the DIE CASTING SHOW: Booth #420

# GRC®



die cast  
ZINC ALLOY



molded  
PLASTICS



Coil Bobbins  
Gears & Pinions

**GRIES REPRODUCER CO.**

Division of Coats & Clark Inc.  
World's Foremost Producer of Small Die Castings  
151 Beechwood Ave., New Rochelle, N. Y.  
(914) 633-8600

## GET THIS SAMPLE KIT

### OF GRC TINY ZINC ALLOY DIE CASTINGS

Gries' special methods and Value Engineering are combined to give highest functional value. Imaginative engineering ideas are turned into precise, uniform tiny parts. You save every step of the way... basic part thru final assembly.

**NO SIZE TOO SMALL!**  
MAXIMUM SIZE FOR DIE CASTINGS: 2", 1/2 oz.

Write today on company letterhead for your kit.



Circle 243 on reader service card

## STYCAST® CASTING RESINS CHART COMPLETELY REVISED



This chart for notebook or wall mounting has just been brought up to date. It contains comparative property data on over 20 Stycast® epoxies and urethanes.

This valuable Folder is Yours.  
Write or Use Reader Service Card

**EMERSON & CUMING, INC.**

CANTON, MASS.  
604 W. 182nd St.  
Gardena, Calif.

3450 Commercial Ave.  
Northbrook, Ill.



Emerson & Cuming Europe N.V.  
Oevel, Belgium



# Some organizations cut R&D funds first when costs must be reduced.

## We don't.

With us R&D isn't a luxury; it's our only reason for existence. Engineers and scientists at our eight laboratories work in basic or applied R&D on projects of great national significance. That's why they are backed by the full resources of the Navy and the Federal government and provided with all the facilities and equipment they need to do the job.

If you feel your professional development has been impeded by

half-hearted management support of research, we invite you to consider a career with us. To explore the possibilities, get in touch with the Employment Officer (Dept. C) of the particular laboratory which interests you. He'll bring you up-to-date on the benefits of career Civil Service and the unique recreational and educational opportunities you and your family will find in the Washington, D. C. area.

### Naval Laboratories of the Washington, D.C. Area\*

#### 1. Naval Research Laboratory Washington, D. C. 20390

—places heavy emphasis on pure and basic research in the physical sciences to increase the store of knowledge of the sciences, as well as on applied problem-solving research under the sponsorship of various government activities to improve materials, techniques and systems.

#### 2. Naval Ordnance Laboratory White Oak, Maryland 20910

In addition to being one of the nation's leading establishments for research and development in undersea warfare, NOL is the Navy's principal aeroballistic activity and a leader in the development of air and surface weapons, with a broad research program including explosives, electrochemistry, polymers, magnetism, acoustics, materials, solid state and nuclear phenomena.

#### 3. Naval Oceanographic Office Washington, D. C. 20390

—engaged in long range technical and scientific research in general oceanography, geophysical and geodetic surveys, bathymetry, oceanographic instrumentation, information processing, cartography and other important areas.

#### 4. David Taylor Model Basin Washington, D. C. 20007

—fundamental and applied research leading to the development of advanced ship design concepts and related to the resistance, stability, and propulsion of ships and aircraft; the strength of ship structures and the survivability of ships under attack; hydro-structural acoustics and mechanical vibration, as applied particularly to silent operation of ships; the application of mathematics and high-speed computer techniques to engineering and logistics problems of the Navy; and development of new ship types such as surface-effects ships and hydrofoils.

#### 5. Naval Weapons Laboratory Dahlgren, Virginia 22448

—engaged, first, in studying and analyzing advanced weapons systems, ballistics, and astronautics through basic and applied research in mathematics, physics, and engineering . . . and, second, in achieving maximum degree of competence in various sophisticated DOD projects utilizing the most advanced computer technology and systems available.

#### 6. Marine Engineering Laboratory Annapolis, Maryland 21402

—R&D in naval shipboard and submarine machinery and auxiliary systems (electrical, propulsion, control, etc.). Emphasis on ship silencing, new concepts in energy conversion and control, ways to minimize friction and wear, special operating machinery for deep diving vessels; naval alloys to meet all ocean environmental conditions; minimization of ships' magnetic signatures; and systems engineering.

#### 7. Naval Propellant Plant Indian Head, Maryland 20640

—develops and maintains the Navy's technical competence in missile, gun and rocket propellants. Conducts R&D in chemistry, propellants, propellant ingredients, propellant processing; performs product and production engineering, chemical engineering, chemical process development and pilot plant operations in the field of solid and liquid propellants and explosives.

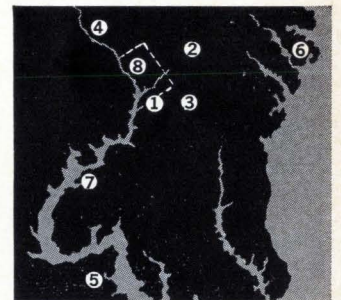

#### 8. Naval Observatory Washington, D. C. 20390

—continued fundamental observations of positions and motions of celestial bodies . . . basic research in positional astronomy, astrophysics and celestial mechanics . . . determination of precise times and frequencies . . . control of world-wide Department of Defense distribution systems for time and frequency . . . computing and publishing astronomical ephemerides and catalogs.

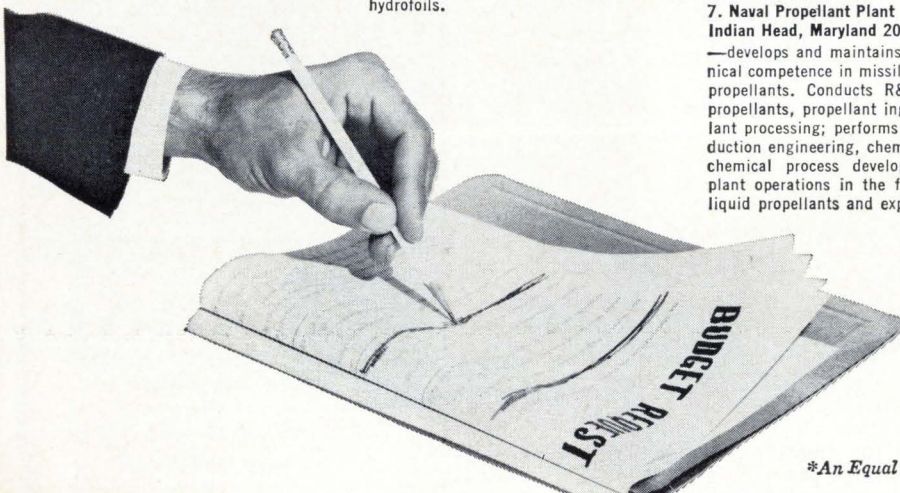

\*An Equal Opportunity Employer



# design engineers

NAVAL ARCHITECT • MARINE • MECHANICAL  
STRUCTURAL • ELECTRICAL • ELECTRONICS  
ARCHITECTURAL • CIVIL

## Investigate your opportunities in the world's largest ship- building complex

The San Francisco Bay Naval Shipyard provides service to surface and underwater ships and deep submersibles. Assignments include new construction of Polaris nuclear submarines and guided missile frigates; and the repair, overhaul and conversion of all classes of ships. Other projects include research on noise reduction, ASW, replenishment-at-sea, Trieste II and Sea Lab II and III.

*Openings exist at all levels in these program areas:*

Ship Structure Development	Naval Tactical Data Systems
Ship Weight Control	Shipboard Mechanization
Structural Mechanics	Plant Facilities
Nuclear and Conventional Propulsion Systems	Ordnance, Guided Missile, Fleet Ballistic Missile and Electronic Systems
Navigation and Communication Systems	Shipboard Aeronautical Material and Equipment
Sound and Vibration Control	Shipboard Electrical and Power Systems
Cargo Replenishment-at-Sea Development	

Job Locations: San Francisco Bay Naval Shipyard has two work sites located 40 miles apart: San Francisco and Vallejo, California. Each location has ready access to the full cultural advantages of San Francisco and the mild year-round climate of the "Bay Area." All types of recreation from ocean surfing to skiing on the slopes of the Sierras are within easy driving distance.

Send your resume or Standard Form 57, Application for Federal Employment, to:

Coordinator, Professional and Technical Recruitment (Code 174A5)  
Employment Division  
San Francisco Bay Naval Shipyard  
Vallejo, California 94592

AN EQUAL OPPORTUNITY EMPLOYER

MUST BE A U.S. CITIZEN

## ENGINEERS & SCIENTISTS *Advancing the Art of* ELECTRO-OPTICAL SYSTEMS IS A CAREER IN ITSELF AT **SERVO**

Servo's leadership for today's IR uses in aerospace programs for navigation and military reconnaissance, and in many industrial applications, is well recognized. Combining advanced communications, electronic control, logic, programming and display techniques with a mastery of electromagnetic phenomena in the microwave, infrared and ultraviolet spectra, Servo continues to create new products and new systems.

Applications of optical sensors—designing electronic systems that convert sensed information into meaningful images, signals, corrective actions or situation analysis is an art at Servo that penetrates all echelons of the company. Engineers and Scientists who can see their own careers advancing in this stimulating center of electro-optical activity are urged to investigate the following immediate positions.

### OPTICAL ENGINEER

Minimum M.S., with background knowledge of techniques and methods of optical component fabrication, to design optical elements and systems working from broad customer/system needs and/or specifications. Should have the ability to meet and converse with customers to help them decide what they need. Supervisory experience helpful but not necessary. Ability to work with EEs and MEs is required.

### INFRARED ENGINEER

Degree Electronics or Physics. Minimum 5 years experience infrared equipment technology, IR Systems Analysis, Transistor Circuit Design. Knowledge Optics and IR detectors.

### ELECTRICAL ENGINEERS

With ability to do circuit design, to evaluate designs of others, to translate customer/systems needs into working hardware, to supervise technicians and other engineers, and to plan and implement a project without straying from the budget. Capability to conceive and write proposals, make presentations to customers and corporate personnel, and the ability to communicate with customers and potential customers is desirable.

### PRODUCT DEVELOPMENT ENGINEERS

BSEE, Minimum 5 years experience in transistor HF Pulse and digital circuit design with broad background encompassing vacuum tube and analog techniques.

### NEW ADVANCED DEVELOPMENT GROUP

Offers ground floor opportunities in a wide diversity of projects. We want self-starters who can initiate projects and follow through for the following positions:

### SOLID STATE PHYSICISTS-EXPERIMENTALISTS

B.S. or M.Sc. level with some knowledge of theory and strong lab background. Additional background in microwave helpful but not necessary. Familiarity with measuring techniques and instrumentation required.

### OPTICAL PHYSICISTS-EXPERIMENTALISTS

B.S. or M.Sc. level with knowledge of classical and modern (linear) physical optics and strong lab background. Knowledge of modulation techniques helpful but not necessary. Acquaintance with instrumentation techniques required.

For an interview at your convenience, send resume in confidence to: Arthur E. Levine, or call (516) 938-9700.



**SERVO**  
CORPORATION  
OF AMERICA

111 New South Road, Hicksville, L.I., N.Y.

An Equal Opportunity Employer



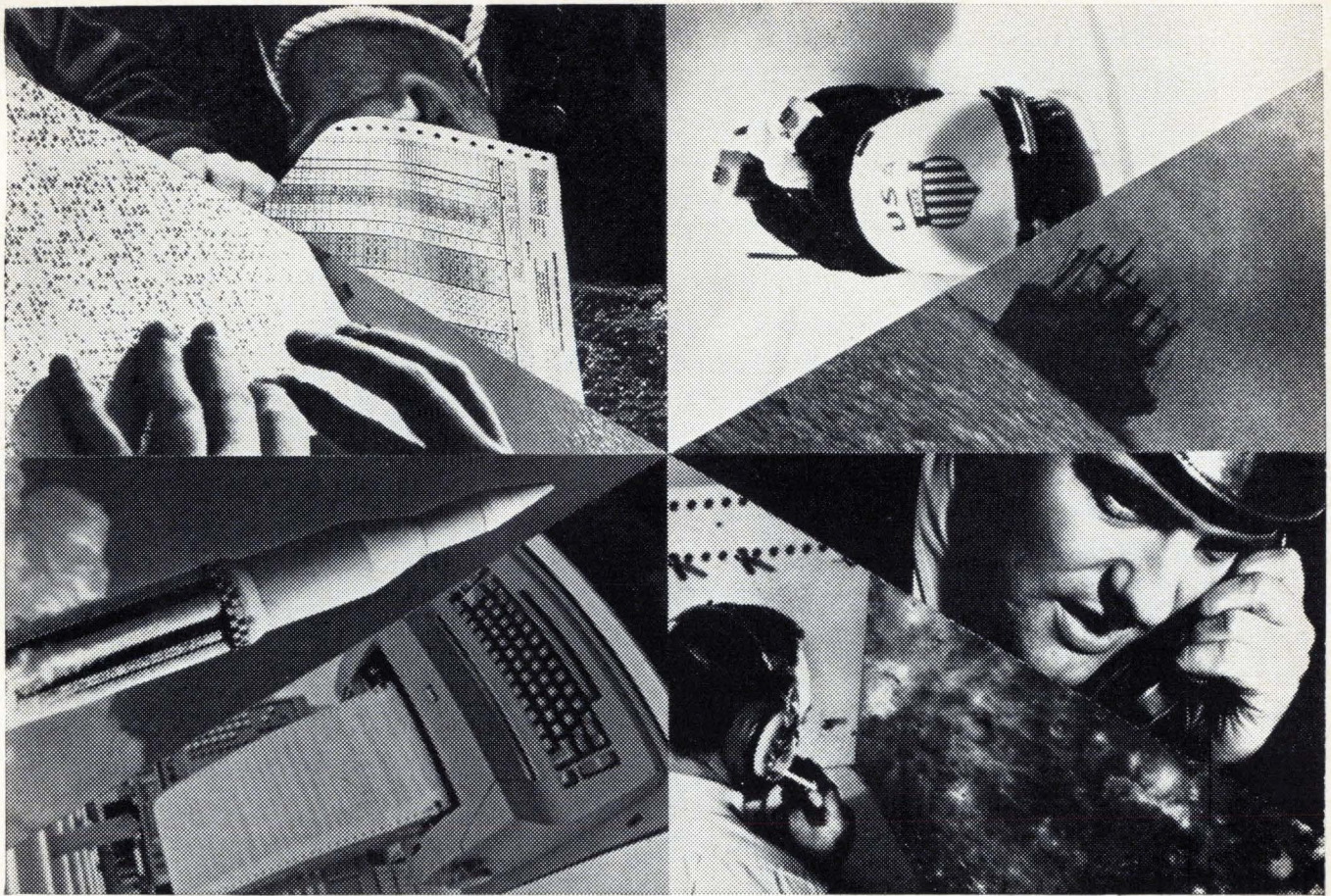

## The Spirit of '66 at IBM.

### It's revolutionary.

Why? Because in less than 20 years, IBM's Data Processing Systems have helped business, science, education, government and defense become more effective. And today's pace of development at IBM continues to be one of the most rapid in all industry.

Right now IBM needs engineers and programmers for the Federal Systems Division Engineering Laboratory in Gaithersburg, Maryland. It will be their job to develop special data handling systems—featuring custom hardware and software to satisfy far-ranging needs of government programs.

Programs such as: ground- and marine-based tactical defense systems; ground-based satellite communications systems; specialized data acquisition and display systems; development of standard system integration modules; and development of special subsystem hardware.

These programs demand creativity. They also provide the opportunity for you to be actively exposed to the complete project—from start to finish.

There are openings for engineering graduates with at least 2 years' experience in the following areas:

- Digital Systems Logic Design
- Digital/Analog Circuit Design
- Systems Engineering
- Sonar Systems Design
- Advanced Communications Design
- Mechanical Packaging Design
- Machine Architecture
- Programming Design

If you feel you're qualified, send your resume in complete confidence to:

Mr. J. Martone, Dept. 554-X3M  
IBM Federal Systems Division  
18100 Frederick Pike  
Gaithersburg, Maryland

An Equal Opportunity Employer

**IBM®**



# ENGINEERS-TECHNICIANS NOTHING-BUT-THE-FACTS

We are in the Display Indicator business.

We engineer entire systems including the required data processing circuitry.

We are leaders in Vertical Scale Indicators, Warning Tone Generator Systems, Tactical Navigation Systems & Electroluminescent Indicators.

We are engineering a highly diversified product line AND . . . HUYCK is a nice place to work if you're a creative and capable individual.

Our current personnel needs are:

## ADVANCED DEVELOPMENT ENGINEERS

Degree in engineering, physics, or chemistry with experience in solid-state physics. In particular, we require creative people to develop techniques which will subsequently lead to solid-state, multi-color display devices. Working knowledge of electro-luminescence, electro-optics or lasers is highly desirable.

## CIRCUIT DESIGN ENGINEERS

Degree in Electrical Engineering and experience in design and development of solid-state circuitry for both analog and digital special purpose computers. Electro-mechanical and optical knowledge and/or project leadership experience are highly desired additional skills.

Send resume in confidence to  
Mr. S. R. Kase—Employment Manager  
Appointments Will Be Arranged  
With Members of Our Technical Staff



## HUYCK SYSTEMS COMPANY

360 Wolf Hill Road, Huntington Station, Long Island

An Equal Opportunity Employer

## PRELIMINARY DESIGN ENGINEERS

Degree in Electrical Engineering or Applied Physics with a minimum of 6 years experience. Personnel are required to perform system studies in the following areas: Advanced ASW Displays, and integrated Cockpit Displays. Individuals should be capable of extrapolating these study efforts into technical presentations and assuming project leadership.

## TECHNICIANS

1 to 8 years experience in the development of highly reliable electronic devices. Will work in the advanced development area on advanced display devices & controls circuitry. Desired experience in: digital circuitry, electro-luminescence or temperature stabilized circuitry.

## LEGAL NOTICE

STATEMENT OF OWNERSHIP, MANAGEMENT AND CIRCULATION  
(Act of October 23, 1962, Section 4369, Title 39, United States Code)

- Date of filing: October 1, 1966.
- Title of publication: ELECTRONICS.
- Frequency of issue: Biweekly—330 West 42nd St., City, County and State of New York—10036.
- Location of known office of publication: 330 West 42nd St., City, County and State of New York—10036.
- Location of the headquarters or general business offices of the publishers: 330 West 42nd St., City, County and State of New York—10036.
- Names and addresses of publisher, editor, and managing editor: Publisher: Gordon Jones—330 West 42nd St., New York, N. Y.—10036; Editor: Lewis H. Young—330 West 42nd St., New York, N. Y.—10036; Managing Editor: None.
- The owner is McGraw-Hill, Inc., 330 West 42nd St., New York, N. Y. 10036. Stockholders holding 1% or more of stock are: Paul T. Babson, 330 Beacon Street, Boston, Massachusetts; Donald C. McGraw, Elizabeth McGraw Webster, Donald C. McGraw, Jr. & Harold W. McGraw, Jr., Trustees under Indenture of Trust m/b James H. McGraw, dated 1/14/21 as modified; Donald C. McGraw & Harold W. McGraw, Trustees under an Indenture of Trust m/b James H. McGraw, dated 7/1/37 as amended; Donald C. McGraw, individually; Donald C. McGraw and Catharine McGraw, as Trustees of the Estate of Mildred W. McGraw, all of 330 West 42nd St., New York, N. Y. 10036.
- Known bondholders, mortgages, and other security holders owning or holding 1 percent or more of total amount of bonds, mortgages or other securities: None.
- Paragraphs 7 and 8 include, in cases where the stockholder or security holder appears upon the books of the company as trustee or in any other fiduciary relation, the name of the person or corporation for whom such trustee is acting, also the statements in the two paragraphs show the affiant's full knowledge and belief as to the circumstances and conditions under which stockholders and security holders who do not appear upon the books of the company as trustees, hold stock and securities in a capacity other than that of a bona fide owner. Names and addresses of individuals who are stockholders of a corporation which itself is a stockholder or holder of bonds, mortgages or other securities of the publishing corporation have been included in paragraphs 7 and 8 when the interests of such individuals are equivalent to 1 percent or more of the total amount of the stock or securities of the publishing corporation.
- This item must be completed for all publications except those which do not carry advertising other than the publisher's own and which are named in Sections 132.231, 132.232 and 132.233, Postal Manual (Sections 4355a, 4355b, and 4356 of Title 39, United States Code).

Average No. Copies Each Issue During Preceding 12 Months	Single Issue Nearest to Filing Date
A. Total No. Copies Printed . . . . .	73,761
B. Paid Circulation . . . . .	75,698
1. Sales through dealers and carriers, street vendors and counter sales . . . . .	67,934
2. Mail subscriptions . . . . .	70,000
C. Total Paid Circulation . . . . .	67,934
D. Free distribution by mail, carrier or other means . . . . .	4,551
E. Total Distribution . . . . .	72,485
F. Office use, left-over, unaccounted, spoiled after printing . . . . .	1,276
G. Total . . . . .	73,761
H. Corrected statements made by me above are correct and complete.	75,698

McGRAW-HILL, INC.  
By JOHN J. COOKE,  
Vice President & Secretary

### REFURBISHED LAB EQUIPMENT

HEWLETT PACKARD	
450A Amplifier, 10 Hz-1MHz @ 40 db gain	\$75.00
460A Amplifier, 3KHz-200MHz @ 20 db gain	95.00
523B Counter, 10 Hz-1.1MHz on f, 1 usec-10 sec time	395.00
Dymec 2503 RDB Subcarrier FM/FM telemetry direct digital read, 100 KHz count	295.00
Dymec Scanner Coupler, Binary Decimal Klystron Ps, 717A, 800-100V Beam @ 25 ma, 600V reflector	145.00
616A Generator, 1.8-4.0 GHz	495.00
150 Scope, 152A dual trace PI, DC-10 MHz	495.00
400C VTVM, 5Hz-600 KHz, 1mv-300v	90.00
410A VTVM, DC, Ohms, AC to 700 MHz	95.00
212A Pulser, 0.07-10 usec, 50 v into 50 ohms	175.00
Ballentine 700 Sensitive Inverter	95.00
Millivac MV 19A, 20 Hz-200KHz VTVM	95.00
MV 73B, AC-DC 1ua-10A, 10uv-1Kv 10 ohm/v	125.00
GR 1231B Amp & Null Det., sens. to 25 uv	95.00
1231PS Filter, variable f, 50 Hz-100KHz	75.00
1214A Unit Osc. 400 & 1000 Hz	45.00
Greibach 500, 30 & 75 vdc fs @ 30 K ohm/v	75.00
Boonton Q meter 170A, 30-200 MHz	295.00
4 N Speedmax 12" strip chart	245.00
1 Measurements 80 Generator, 2-400 MHz	295.00
1 Measurements 71 sq. Wave, 6Hz-100KHz	85.00
Brush 202, 2 channel strip chart	125.00
Amplex FRA00 Digital Tape, 7 level heads IBM format	1500.00
Tektronix 511A, 512B, 513D, 514AD, 535	PUR
Dumont 304A, H, DC-300Kc scopes	95.00
EG&G 2236A TWT Scope, 3000MHz Band-pass	1200.00
Miller H, 2 channel valve preamplifier	195.00
Moseley XY Model 1, 5mv-10Vfs, 8x11 paper	195.00

HARLAN LABS  
7917 Balboa Avenue, San Diego, Calif. 92111  
Phone 714-278-1700

### CIRCLE 966 ON READER SERVICE CARD

RADAR AUTO-TRACK & TELEMETRY ANTENNA PEDESTALS. 3 & 10 CM. SCR 584 AUTOTRACK RADARS. M-33 RADAR TPS-1D SEARCH. APS-45 TPS-10D HT. FINDERS. WX RADARS. FPN-32GA. APS-15B APS-27 (AMTI) SEARCH. APN-102 DOPPLER DOZENS MORE CARCINOTRONS. PFM-25. S-1-2-3-6 MEGAWATT PULSE MODULATORS. CAVITIES. PULSE TRANSFORMERS. IF STRIPS. WAVEGUIDE. BENDS. 200 MC. 1 KMC. 3 KMC. 6 KMC. 9 KMC. 24 KMC. RF PGDS.

### RADIO RESEARCH INSTRUMENT CO.

550 5TH AVE., NEW YORK 36, N. Y. JU 4-6491

CIRCLE 967 ON READER SERVICE CARD

## INSTRUMENT TECHNICIANS

### THE OAK RIDGE NATIONAL LABORATORY

Highly skilled instrument technicians to assist in the installation and maintenance of process control instrumentation systems and devices for chemical pilot plants, nuclear reactors and other large experimental installations.

High school education, plus additional training in either the physical sciences, instrumentation, or electronics, and at least 4 years experience in installation and maintenance of complex instrumentation and control systems. Entrance rate \$3.39 per hour; \$3.45 per hour after six months. Reasonable interview and relocation expenses paid by Company.

Excellent Working Conditions  
and  
Employee Benefit Plans  
An Equal Opportunity Employer

Send detailed resume to:  
Central Employment Office  
UNION CARBIDE CORPORATION  
Nuclear Division  
P. O. Box M  
Oak Ridge, Tennessee 37830



## E.E.'s

For FEE PAID positions throughout U.S.

Send Coupon Today  
ATOMIC PERSONNEL, INC.

Suite L, 1518 Walnut St., Phila., Pa.

Experienced Engineers... Working "Full Time"... For You!

Send resume today. (If none, send coupon for confidential application.)

Name \_\_\_\_\_  
Address \_\_\_\_\_  
City \_\_\_\_\_ State \_\_\_\_\_

## ENGINEERING OPPORTUNITIES

Write Personnel  
V-M CORPORATION

Voice of Music Benton Harbor, Mich.

## SEARCHLIGHT SECTION

FOR SALE:

### ELECTRIC, GAS, and VACUUM FURNACES

Forming Gas Generators. Nitrogen Generators. Endothermic Generators. Ammonia Dissociators. Induction Heaters. Vacuum Metallizers. Strip Chart Recorders. Temperature Controllers. Programmers. Mass Spectrometers. Spectrophotometers. Refractometers. Gas Purifiers. Electron Tube Manufacturing, Aging, and Testing Equipment.

### INSTRUMENTS & MACHINES INC.

1200 Grove Street Irvington, N.J.  
201-371-7900

CIRCLE 968 ON READER SERVICE CARD

### MINI-FLUID DISPENSER

AIR OPERATED  
for miniature potting and encapsulating  
Available in 3 sizes  
6cc - 12cc - 30cc



PHILIP FISHMAN COMPANY  
7 CAMERON ST., WELLESLEY, MASSACHUSETTS 02181

CIRCLE 969 ON READER SERVICE CARD

### EMPLOYMENT SERVICES

Your Resume—Make it sell You! Instructions, samples: \$2. Executive, Box 246EL, Montclair, N.J. 07042.



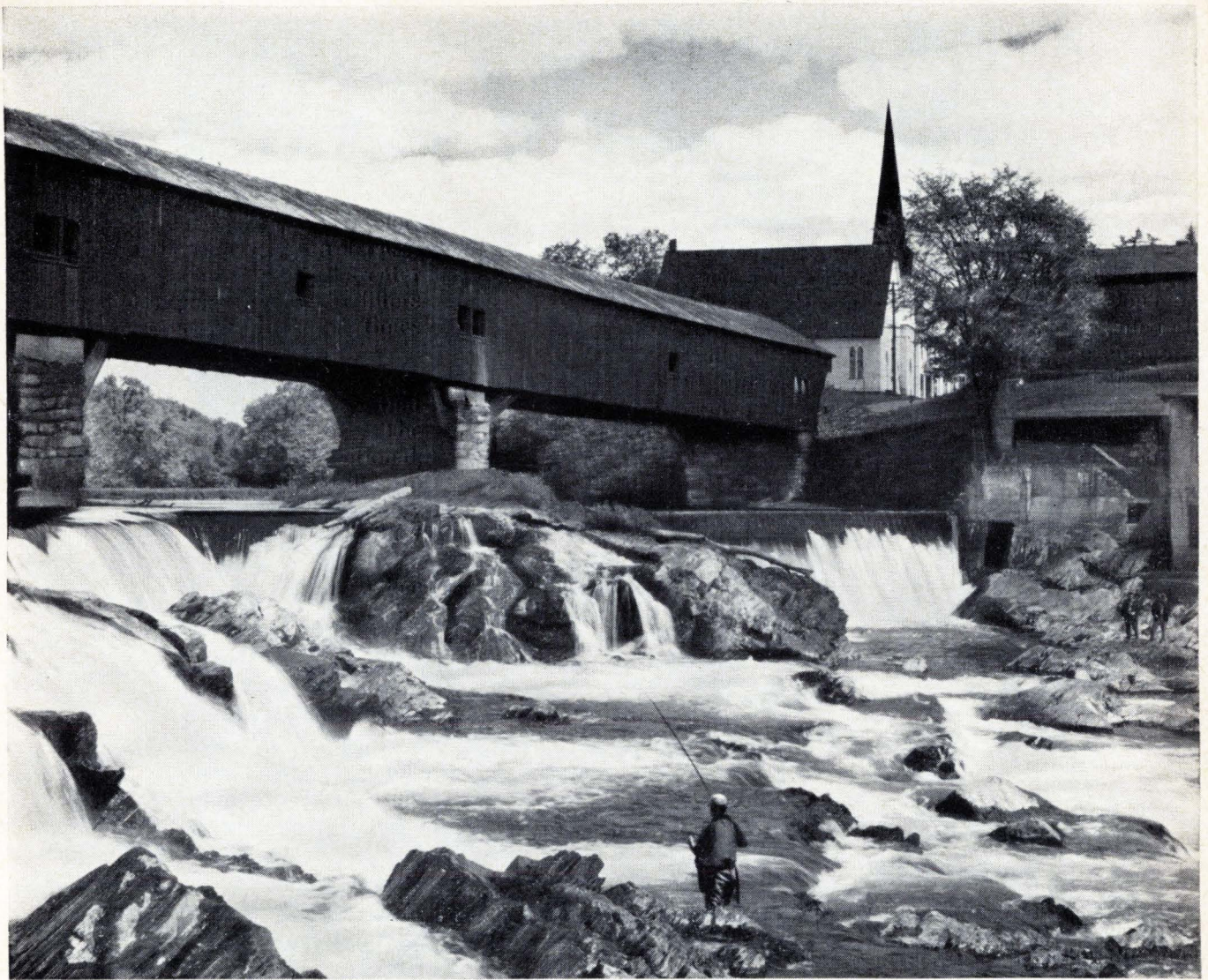

## decompression chamber

Around Nashua, New Hampshire, where we are located, the living is easy. No traffic jams. No housing problems. No worries about the quality of public education. Plenty of lakes, seashore and mountains close at hand. And for pleasure more urbane, Boston is no great distance away.

The economic pressure is off, too. There's no state income tax, and skills and services can be come by quite inexpensively.

About the job. You'll be working in depth; probably helping to evolve an advanced systems technology. The working atmosphere is free. (Should you ever find it especially heady, top management's door is always open.)

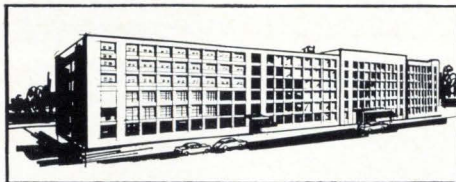

We're one of the top defense contractors in the country. Our electronics technology leads the field in many areas. We're heavy in: phased arrays and other radar; information handling and display; long range communications; oceanographic telemetering; electro-optics; lasers; instrumentation and control, microwaves, flexible printed circuits and systems-oriented, special-purpose hardware. Send us your resume. We'll show you what we mean about

pressure-safe living and working at Sanders.

Immediate senior level openings exist in research, development, product design and manufacturing engineering. Write in confidence to Mr. Lloyd Ware, Staff Engineer.

**sanders associates, inc.**

Nashua, New Hampshire



**NEW DIRECTIONS IN  
ELECTRONICS SYSTEMS**

**An Equal Opportunity Employer**



# SOLVENT IOWA

**offers more profit potential  
for electronics firms**

Before you select your next plant location, investigate SOLVENT IOWA, where there is no state debt and where tax rates are equitable. State revenue is spent in a business-like way . . . on projects that foster present growth and provide for future progress. Iowa's workers, both men and women, are easily trainable. Many were educated by leading space-age scientists in state universities and private colleges. Others are trained through an area system of vocational schools and community colleges. It's a profitable climate, geared to the nation's sophisticated industries. Let us provide you, in confidence, with detailed information on the other site selection factors which SOLVENT IOWA can offer you . . . for greater profit.

**115 OF FORTUNE'S TOP 500 FIRMS HAVE IOWA LOCATIONS**

CONFIDENTIAL

IOWA DEVELOPMENT COMMISSION  
Dept. 5106, 250 Jewett Bldg.  
Des Moines, Iowa

  
AN  
IOWA LOCATION  
FOR YOU

Name \_\_\_\_\_

Firm \_\_\_\_\_

Address \_\_\_\_\_

City \_\_\_\_\_ State \_\_\_\_\_ Zip \_\_\_\_\_



The Switch to IC's:

## Are Circuit Designers Obsolete?

More and more electronic and electrical equipment is being designed with integrated circuits. The reasons for this are simple: integrated circuits cost less, are cheaper to use, are more reliable, and result in a better, more competitive product. But many circuit designers view the switch to IC's with apprehension. They feel that the device manufacturers have pre-empted part of their function, and they are afraid, to put it bluntly, that integrated circuits will put them out of a job. Such fears are based on an extremely narrow view of the designer's function. For, while integrated circuits most certainly do not replace the design engineer, they do change his role radically.

**DESIGNING WITH IC's:** When you design with integrated circuits, you are freed from the necessity of specifying every last transistor, resistor, capacitor, and diode. You have instead a number of basic units such as flip-flops, gates, and buffers with which to build your functional blocks. The fitting of the integrated circuits into larger units is a much simpler task than designing with discrete components. You can be guided by a few simple rules regarding acceptable levels of input and output, impedance, fan-out, etc. This kind of design requires no involved calculations or knowledge of calculus. Once you select the basic elements of your circuit, you can safely turn over the detail work to a competent senior technician. This leaves you free to concentrate on the design of the unit as a whole. You design the operating system instead of one of its parts. Far from making you useless, integrated circuits upgrade your job to that of the system engineer, just as they upgrade the technician's job to the level of the circuit designer. And if you have any doubts about the demand for design engineers, simply look in the classified section of your newspaper.

**WHAT ABOUT CONTROL?** It is true that you lose control of what goes into the basic circuit, the building-block element you use. This control can be important to you from the standpoint of both function (what the circuit does) and quality (how well it does it). By combining the various available elements you can build virtually any digital and most analog functions you need (and here's where you have a chance to exercise your real skills as a designer). As for quality, consider the pains you go through to design, breadboard, test, modify, and prove a circuit which will be used by your company hundreds or maybe even thousands of times. The manufacturer who makes an integrated circuit expects to sell millions of units. His entire reputation and livelihood are dependent on the quality and performance of his devices. You can depend on it that the care taken in the proving of new circuit designs and manufacturing methods is even greater than that which you exercise.

**REDUCE DESIGN COSTS:** In summary, integrated circuits can save expensive design time which you now spend computing component values. They save breadboarding individual components and testing and modifying basic circuit elements. They allow you to work in areas for which your education and experience have prepared you: overall system design. All these things mean money saved for your employer. If he gets the message, he'll be asking you questions about integrated circuits, soon. Do you have the answers? We do. We'll send them to you in return for the attached post card.



# Integrated Sync Generator

High resolution television cameras use big-count digital circuits as line counters within the sync generator area. The longer the count, the greater the length of the counter circuits. Using integrated circuits, however, it is possible to reduce the complexity of such counter circuits, by replacing shift registers or large binary counters with small moduli counters in "divide-by" configurations.

For example, a count of 729 can be achieved by combining six modulo 3 binary counters:  $3 \cdot 3 \cdot 3 \cdot 3 \cdot 3 \cdot 3 = 729$ . Or, you can combine four small counters to get a line count of 525:  $3 \cdot 5 \cdot 7 \cdot 5 = 525$ .

Modulos 3, 5, and 7 counters (shown here) are the most frequently used integrated counting circuits. They are easily implemented with Fairchild  $\mu$ L9923 or  $\mu$ L9926 high yield J-K flip-flops. For more detailed information on these and other moduli counters, send for "Circuit Notes RTL-1." Simply return the attached post card.

The technique of using the modulo circuit in high resolution systems results in drastic cost reductions and greater circuit reliability. The higher the count required, the greater the potential savings.

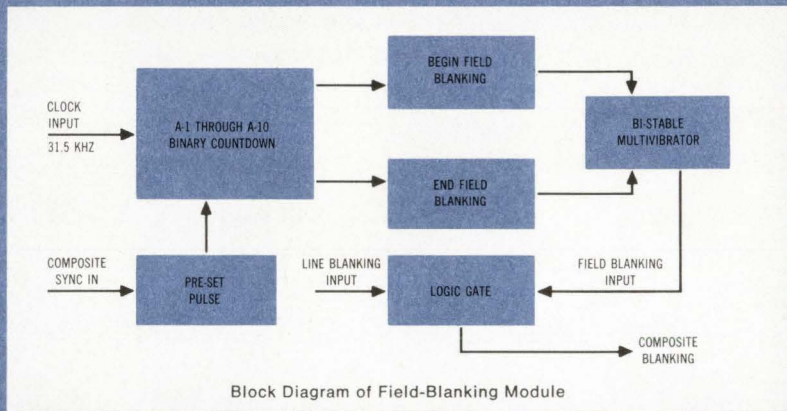
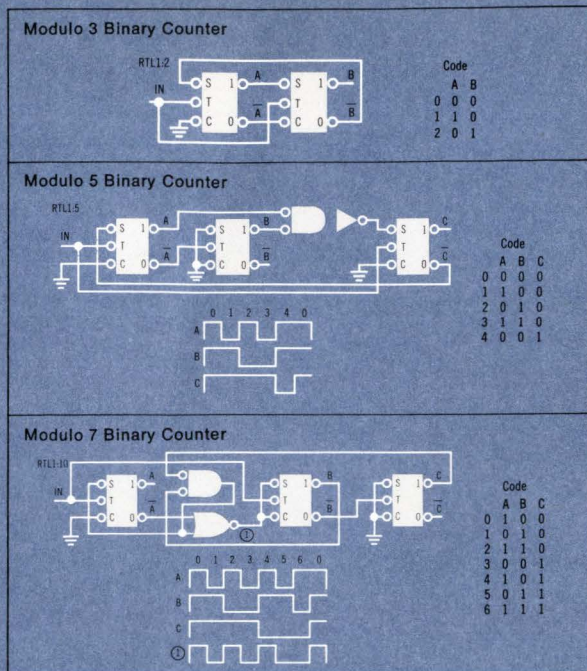

**CASE HISTORY:** Fairchild integrated circuits are used in the sync generator portion of a new video amplifier made by Ball Brothers Research Corporation, Boulder Industrial Park, Boulder, Colorado.

The unit, designated the Mark VIII Automatic Gain Control (AGC) Video Amplifier, is used by television studios to maintain a constant video signal level from the various cameras and film chains used in a broadcast. In addition to locally generated signals, most stations receive signals originating at the network level. Such signals usually include timing information which must be recovered for subsequent video processing. The sync generator, built with Fairchild IC's, derives field blanking pulses, and so allows the video signals to be processed by the AGC Video Amplifier.

In essence, the sync generator accepts the composite sync signal and channels it through 10 binary modulo counters controlled by a system clock running at 31.5 KHz. From the counter output the beginning and end field blanking signals are derived and fed through a bi-stable multivibrator into a logic gate. The logic gate uses the line blanking signal as its second input, and produces the composite blanking signal (see logic diagram).

18 Fairchild integrated circuits are used to implement this circuit, of which 7 are  $\mu$ L9914 Dual 2-input gates, and 11 are  $\mu$ L9923 J-K flip-flops.

The Mark VIII AGC Video Amplifier is a newly designed unit, and no exact comparative figures on the savings effected by the integrated circuits are therefore available. According to the Ball Brothers Research Corporation, integrated circuits were selected for this design because the use of discrete components would have required much more space and considerably more power. This would have created a severe packaging problem. By using integrated circuits, BBRC designers were able to implement the entire field blanking circuitry on a single plug-in board which fits neatly into the modular design of the equipment. Additionally, the reduction in the number of components on the circuit board has resulted in savings in assembly time. BBRC estimates that the assembly time of the integrated circuit board is one third less than the time required to assemble a discrete component board of comparable complexity.

**FAIRCHILD**  
SEMICONDUCTOR



---

# Newsletter from Abroad

---

October 17, 1966

## Japan to produce her own missiles

Some \$400 million worth of missile business may be the offing for Japanese electronics companies over the next five years. In a major switch of missile-procurement policy, Eikichi Kambayashiyama, head of Japan's Self-Defense Agency, this month ordered his secretariat to start selecting contractors for domestic production of Hawk and Nike-Hercules missiles. So far, the agency has obtained its ground-to-air missiles from United States manufacturers under the U.S. military assistance program.

The agency's timetable calls for formation of the first Hawk and Nike battalions using Japanese-made missiles in 1969. To make the date, contracts will have to be let next year and the agency will ask for \$54 million for missile production in its 1967 budget. The agency still has to sell the domestic missile program to the Ministry of Finance. The Japanese missiles will cost slightly more than U.S. ones but the agency maintains the difference would be more than made up by the know-how Japanese companies would acquire with the program.

Competition for the missile business will be fierce. The Japan Radio Co. has the inside track for the Hawk prime contract. The Raytheon Co., which developed the missile, has a minority holding in JRC. However, the Self-Defense Agency intends to see that the missile work is spread out. Tokyo Shibaura Electric Co. (Toshiba) and Mitsubishi Electric Corp. are expected to get a substantial part of the Hawk contract. Mitsubishi Heavy Industries Ltd. and the Nippon Electric Co. Ltd. most likely will split the Nike contract.

Over the next five years, the agency expects to add four Hawk battalions and five Nike-Hercules battalions. It now has two of each armed with U.S. missiles.

## Swedes try laser to check ceiling at airport

Sweden's civil aviation agency, the Royal Swedish Air Board, may switch to lasers to measure the ceiling at the country's major airports. The board has ordered a prototype laser "ceilometer" from Allmann Svenska Elektriska Aktiebolaget (ASEA) and will start testing it next spring at a military airport, probably near Stockholm. If the tests are successful, the Air Board presumably will order 10. It has an option for that many from ASEA.

ASEA's airport unit uses a Q-switched ruby laser that puts out pulses of 25-nanosecond duration. The reflected laser-light pulses are picked up on the airfield and sent by a data transmission system to the control tower. Along with a readout of ceiling height once a minute, the system displays the reflected pulses on an oscilloscope screen for analysis of cloud formations.

## Down to the sea with Siemens?

West Germany's largest electronics company, Siemens AG, may soon make a strong move into automatic ship controls. Siemens is trying to work out an arrangement for close technical cooperation with a major Hamburg shipbuilder, Blohm and Voss AG. Eventually the two firms may tie up financially.

Siemens already does substantial business with German shipbuilders, but a deal with Blohm and Voss would give it an inside look at systems designs for ship controls and strengthen its competitive position. The



---

# Newsletter from Abroad

---

AEG-Telefunken group, the second-ranking German electronics producer, already is cooperating closely with another large German ship-builder.

## **Tv independents want color lines changed in Britain**

As Harold Wilson's Labor government nears completion of a white paper on broadcasting policy, **Britain's independent television networks are clamoring for the right to broadcast color without changing standards.** Like the government-owned British Broadcasting Corp.'s first program, the independents broadcast black-and-white in the very-high-frequency band on a 405-line standard.

**The independents' outcry runs counter to the government's long-range plan to switch the entire country over eventually to 625 lines in the ultra-high-frequency band.** For color, the only plans so far are for BBC's second program in the uhf band on a 625-line standard. Pointing to the lukewarm reception BBC-2 has had among Britain's mass audience in its first two years, the independents claim that color sets would catch on more quickly if there were color programs on the vhf standard as well as the uhf standard.

**The controversy puts receiver manufacturers in a dilemma. They are counting on color to bring new life to a listless market for tv sets and so they're for almost anything that would boost color-set sales.** On the other hand, they'd prefer making sets with just one standard—625 lines and uhf—in order to take advantage of the export markets on the Continent, where most countries use the uhf standard.

## **Portable tv's and car radios buoy French market . . .**

Portable television sets and auto radios are bringing a lift to an otherwise sagging entertainment market in France. Some retailers report that about half their tv sales this summer came from portable sets. **The surge in small sets, however, caught domestic producers off guard. They were looking forward to the start of color tv broadcasts late next year to lift them out of the doldrums. Meanwhile, importers captured most of the gain in portable sales.**

Car-radio producers, to their delight, are now riding high after a five-year slump. Radiomatic S.A., France's largest manufacturer of car radios, says the market is skyrocketing. Philips S.A., a French sales organization of Philips Gloeilampenfabrieken NV of the Netherlands, **predicts car-radio sales will be double this year in Paris, the prime market in the country. Still another doubling is in sight for 1967.** Marketing men attribute the boom in large part to Paris' harrowing traffic jams, which have turned stalled motorists into a captive radio audience.

## **. . . and Swedes see boom in car radios**

A year-end reshuffling of programs on the government-owned Swedish Broadcasting Corp. has manufacturers of auto radios ecstatic. After Dec. 12, only talk programs and serious music will be broadcast by SBC's amplitude-modulation stations. Popular music, the usual motoring fare, will be aired exclusively by frequency-modulation stations. **It's estimated that at least 300,000 auto radios in Sweden can receive only a-m broadcasts. Those radios will become obsolete overnight when the new schedule goes into effect.** Manufacturers expect the boom to start around Christmas.



## Italy

### Soviet excursion

So far, the flow of technological know-how between the Soviet Union and the countries of Western Europe has been essentially one way—into the USSR. Now there are signs that at least a trickle may be coming the other way.

Last month in Turin, Italy, the Russians astounded Italian industrialists at the 16th International Technical Salon with a display of production equipment for thin-film integrated circuits. Before the show ended, Techmashexport, the Russian production-equipment export agency, had a pair of hot prospects—the auto-industry giant Fiat and Ing. C. Olivetti & Co., Italy's dominant business-machine producer.

Neither firm will confirm or deny it plans to buy from the Russians, but Fiat engineers had a long session with Techmashexport officials and the head of the Russian delegation huddled with Olivetti executives for a whole day during the show. And on the Russian stand at Turin a beaming Techmashexport official reported, "it wasn't only that they wanted to look, they wanted to buy."

**Laser welder.** The Russians displayed three basic units for thin-film production: a vacuum-depositing unit, a micro spark-erosion unit and a laser microwelder. Along with the basic equipment there was a line of test instruments to check out thickness of films and their quality.

Particularly interesting to the Italians was the laser microwelder. The Russians had it set up with a microscope to show the intricate welding patterns possible. In addition to making connections on thin-film circuits, the ruby-laser welder is used to produce carburetor jets in the USSR, the Russians say. It can pierce holes from 0.001 to 0.5

millimeter in metals up to 1 mm thick.

Another insight into Russian thin-film capability came from a matchbox-size two-band receiver shown at Turin. The set receives both the standard amplitude-modulation 525 to 1605 kilohertz band and a long-wave band, 150 to 408 khz. The circuitry is thin-film, with microwelded connections. The tiny set uses an earpiece rather than a loudspeaker.

## Japan

### Brighter future

In the quest for large and fast electronic displays, researchers around the world are taking a hard look at light-emitting diodes.

At the International Electron Devices Meeting at Washington later this month, for example, Bell Telephone Laboratories will report on a gallium arsenide diode-matrix display it has developed. And at this week's Symposium on Information Display at Boston, a research team from the Nippon Electric Co., will describe a display built of discrete gallium phosphide diodes.

The NEC team expects its GaP diode matrix will find applications

before long in small displays and in high-speed writing on photographic film. Even more promising for the long run, it feels, is a gallium arsenide matrix it has fabricated with integrated circuit techniques. Like every one else, NEC has its sights set on large panel displays for television and radar.

**Seeing red.** Masayoshi Ozawa, Takao Ando and Akira Kawaji head the NEC team. The GaP matrix it has developed emits a bright red light. The diodes, about 1 millimeter in diameter, are laid out in five rows, each with four diodes. Center-to-center spacing is 2 mm. For the experimental displays, NEC cements the diodes to plastic sheets with holes drilled in the matrix pattern to let light through.

In its discrete display, NEC switches on selected diodes to obtain digits or letters by scanning them sequentially, very much like a tv scan. The pulses that turn on the diodes have a duration of about 2 microseconds so the complete scan for the 20-diode matrix lasts 40 microseconds.

Although the diodes can handle continuous current up to 100 milliamperes, the scanning circuits apply only 20-ma pulses. At that level, the diodes emit on the average 30 foot-lamberts of red light.

**Forward.** The diodes show a cur-

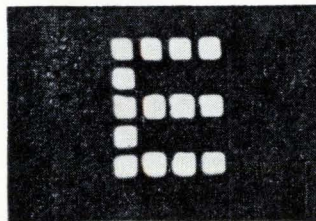

**Integrated circuit display** developed by Nippon Electric Co. has 100 GaAs diodes in a 10-by-10 array. The diodes emit infrared light.

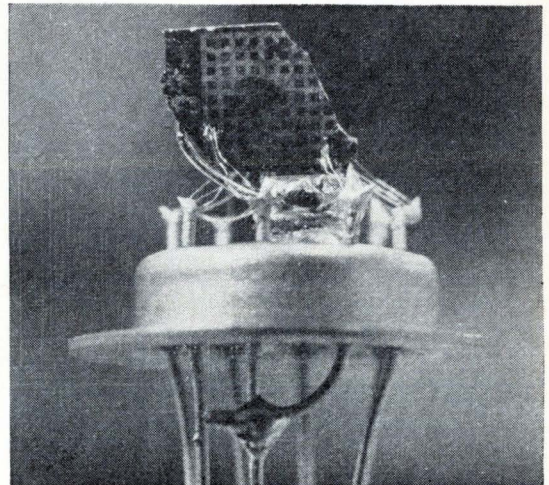



rent-voltage curve very much like that of an ordinary diode although the absolute values are slightly different. The reverse characteristic resembles a high-quality zener diode, with practically no current flow until a sharp avalanche at 8 volts. The forward curve is not quite as steep as a run-of-the-mill diode: for 20 ma forward current the drop is about 4 volts. Although the diode emits light either with forward current or reverse avalanche current, in its display NEC uses forward current. The scanning circuits switch the diodes from a reverse bias of 4 volts—a no-light condition—to a forward bias of 4 volts. Thus, there's no need for a switching element in series with each diode and the scanning circuits are simpler. All the p-sides of the diodes are connected to a common terminal. There are individual leads for the n-sides so that the diodes can be selected.

NEC fabricates the discrete GaP diodes by an alloying process. The acceptor added to the basic chip to form the p-side of the junction is zinc. The emitted light passes through the p-layer, which is about 200 microns thick.

By changing the donor impurity that forms the n-side, the color of the light can be changed. An oxygen impurity gives a bright red light and the most luminous energy. Sulphur or tellurium gives a green or yellowish green, depending on the impurity concentration.

The green light looks brightest to the naked eye. With a sulphur impurity from green light, the display puts out enough light at a 20-ma scan level to expose film with an ASA 100 speed rating in 10 microseconds.

**By the wafer.** Of greater potential than the discrete GaP diodes are gallium arsenide diodes, which NEC has fabricated on integrated-circuit chips in 10 by 10 arrays. The display emits infrared light, invisible to the naked eye, but easily recorded on film.

In the IC display, the light emitting junction lies about 100 angstroms beneath the rear surface of the GaAs wafer, 0.2 mm thick. The infrared emission passes out

through the front side with practically no attenuation.

The individual diodes on the wafer measure about 300 microns on a side and are spaced 200 microns apart. The basic wafer is n-type GaAs. The acceptor diffused into unmasked areas of the wafer to form the diodes is zinc.

### Sony's chipper

As he made his rounds during a visit to London late last month, Sony Corp. president Masaru Ibuka carried in his pocket a surprise—a miniature radio built around a monolithic integrated circuit.

It was the first showing to outsiders of the IC radio which Sony plans to have on the United States market not later than next spring. In so doing, the Japanese company will follow by about six months the General Electric Co. and the Philco-Ford Corp. Both plan to start selling IC radios this fall.

**Discrete trio.** Sony packed nine npn transistors, four diodes and 14 resistors on the silicon chip used in the radio. All the same, Sony didn't go all the way. Along with the IC, there are three discrete transistors—an npn silicon transistor for the converter stage and a pair of complementary symmetry germanium transistors for the push-pull output stage. Sony maintains that adding the circuit functions of this trio of transistors to the chip would have increased its cost without bringing any particular advantage—except perhaps the sales pitch of an all-IC radio.

Although they won't be able to set up the all-IC clamor, Sony's hucksters presumably will make much ado about the radio's small size—a stack of three would almost fit inside a king-size cigarette package. Sony says discrete components couldn't be squeezed into a receiver this small, especially one with a rechargeable battery as Sony's has. Output is 50 milliwatts undistorted, 70 milliwatts maximum. The set plays six hours after recharging.

**On the chip.** Sony's IC, developed specifically for the small receiver, uses a chip 1.5 millimeters

by 2.25 mm. The chip mounts on a metal plate and is encapsulated in epoxy. The IC package measures 6.5 mm by 8.5 mm by 4 mm; there are 16 external leads.

Five of the nine transistors are used in the intermediate-frequency amplifier, four for the audio amplifier. One diode serves as the second detector, the other three as forward-biased voltage regulators.

At first glance, the number of transistors seems high; conventional pocket radios generally have two stages of i-f amplification and two audio stages. However, in its IC circuitry, Sony had to cope with an

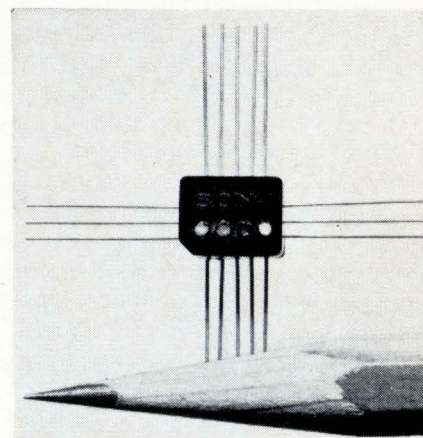

**Sony integrated circuit** for pocket receiver comes in plastic package. Leads extend straight down from bottom of epoxy mount but were bent out for purposes of this photo.

unusually low power supply voltage—the 2.44 volts from a pair of nickel-cadmium cells. Most likely, Sony had to add an extra stage both in the i-f and audio circuits to obtain the necessary gain and use emitter followers in both to keep voltage levels compatible throughout the circuits. Sony won't give details about its IC circuitry except to say that most of the stages are direct-coupled and that there are no differential amplifiers.

The low supply voltage also was a major factor in the decision to use two discrete germanium transistors for the push-pull output stage. The lower emitter-to-base voltage compared to a silicon transistor means a higher power output from the germanium pair. At the same time, Sony avoided having to



lay down a pnp transistor on the IC chip and freed itself from the dissipation problem that output transistors on an IC chip bring.

The converter transistor was kept off the chip largely because it would have meant three more external connections for the IC package.

## West Germany

### Uncoiled

Last March the Radio Corp. of America scored an important first in the television industry when it introduced a production-line receiver with an integrated circuit in it. RCA's landmark receiver, a 12-inch black and white set, uses a single monolithic chip that replaces some 30 discrete components in the intercarrier sound circuitry [Electronics, March 21, p. 137].

For all its merits, RCA's IC circuit has a big drawback. An external phase-shift transformer and a tuned circuit are needed along with the IC, and the coils involved have to be adjustable to compensate for variations in IC parameters.

**Fixed.** Now a West German designer has come up with a circuit that does away with coils in the intermediate-frequency and discriminator stages of tv sound channels. The mixer stage, to be sure,

needs a coil; but it doesn't have to be adjustable. The circuit thus can be fabricated completely on a thin-film hybrid circuit and on a monolithic chip would require only a single fixed external coil.

The designer, Hansjeurgen Mosel, developed the circuit at the Stuttgart applications laboratory of Standard Elektrik Lorenz AG, a subsidiary of the International Telephone and Telegraph Corp. Although SEL has yet to incorporate the IC circuit in a production-line tv receiver, Mosel says a thick-film circuit with the same basic principles was used in an frequency-modulation receiver SEL introduced last spring.

**Mixer.** In the circuit, the f-m signal of 5.5 megahertz (the standard intercarrier frequency in Europe) is converted to a sound i-f frequency of about 250 kilohertz in the mixer stage ( $Q_1$ ,  $C_1$ ,  $C_2$  and  $L_1$ ). The Hartley oscillator in the stage has a nominal frequency of 5.75 Mhz, but it can deviate as much as 150 khz from the nominal value without noticeable effect on the mixer's performance. For that reason, a fixed coil can be used.

Neither the i-f amplifier nor the discriminator that follows the mixer stage has a coil. The 250-khz signal from the mixer is amplified and limited by three direct-coupled transistor stages ( $Q_2$ ,  $Q_3$  and  $Q_4$ ). The first of the three acts as an impedance transformer; the other two provide i-f amplification. Over-

all gain is about 60 decibels over a range of 50 to 450 khz for an output of some 12 volts for input voltages between 2 and 7 millivolts.

In the no-coil discriminator, positive voltage swings of the i-f output charge capacitor  $C_8$ . On negative swings, the capacitor discharges through the emitter of  $Q_5$ . The average collector current of the transistor, which appears across  $R_9$ , then is the demodulated sound signal with a sawtooth i-f voltage superimposed on it. A low-pass filter ( $R_{10}$ ,  $R_{11}$ ,  $C_{10}$  and  $C_{11}$ ) separates the two. The low-frequency output signal, about 0.5 volt, is large enough to drive even vacuum tube amplifiers in succeeding sound-channel stages.

## France

### Computer czar

President Charles de Gaulle made it clear this month that he's doggedly determined to build a strong French computer industry. He's turned the job over to 45-year-old Robert Galley, who's been directing France's largest postwar industrial effort—the \$1-billion enriched uranium plant now nearing completion at Pierrelatte.

Galley's appointment as "Délégué à l'Informatique" makes him the head of a new government

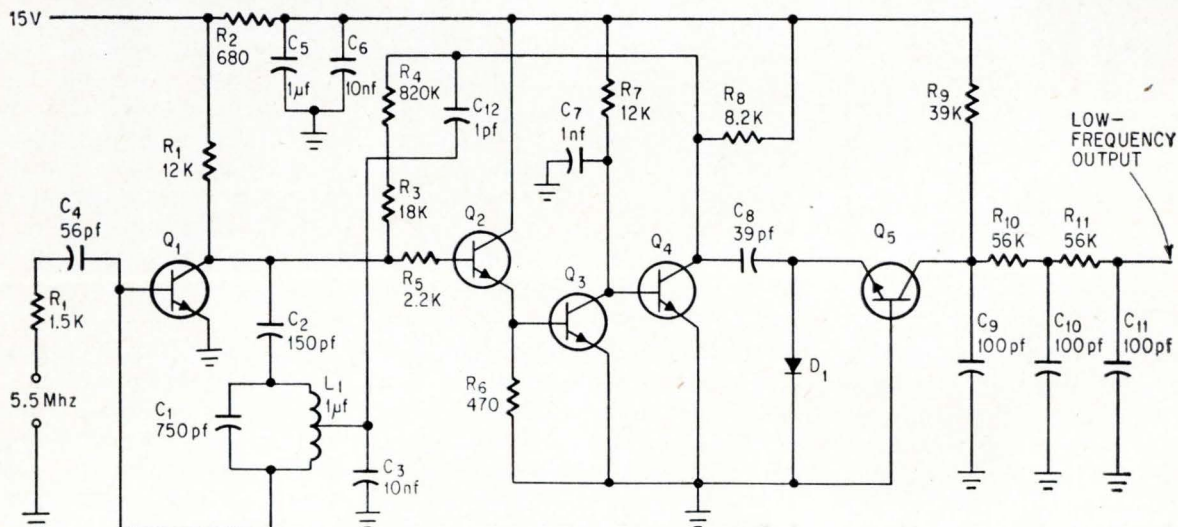

Designed with an IC in mind. Standard Elektrik Lorenz's i-f section for tv sound channels has just one coil—in the mixer stage—and it doesn't have to be adjustable.



agency set up this summer under the so-called "Plan-Calcul" [Electronics, Aug. 8, p. 301]. Galley will report directly to the Prime Minister and he'll have considerable power. Along with development funds to spur joint efforts by computer companies, he'll have a decisive voice whenever the government buys computers and he'll have under his wing a training program whose goal is to turn out 7,500 computer engineers by 1970.

**Damn Yankees.** In a sense, Galley's job boils down to doing for computers what he's done for enriched uranium—free France from dependence on the United States. More than anything else, the decision to build the costly Pierrelatte plant was made because France wanted nuclear armaments with no United States controls on them. Now that the U.S. government has embargoed exports of the large computers De Gaulle needs for his military program, he's moved to give France Pierrelatte-like independence in computers.

Galley's immediate goal, though, won't be to develop a computer like the Control Data Corp. 6600 that De Gaulle wanted but couldn't get. Work on a giant computer probably won't start until the early 1970's. Instead, Plan-Calcul calls for development by late 1968 or early 1969 of a medium-range line of computers for scientific and industrial use. In business computers, France plans to put up with the domination of the International Business Machines Corp. and Bull-General Electric.

Central processors for the French medium computers will be developed by a still unnamed company formed by the two largest French-controlled computer makers, Compagnie Européenne d'Automatisme Electronique and Société d'Electronique et d'Automatisme [Electronics, June 5, p. 198]. Another new joint company, Systèmes et Périphériques Associés aux Calculateurs (Sperac), will develop the peripheral equipment. Sperac is jointly owned by Compagnie Française Thomson Houston-Hotchkiss Brandt and the Compagnie des Compteurs.

Galley thus goes into the com-

puter czar job with the industry essentially narrowed down to two companies backed by major electronics companies. And Galley has the industry solidly behind him. An executive at CSF-Compagnie Générale de Télégraphie sans Fil summed up the industry's reaction when the appointment was announced. "We're all enchanted by the nomination," he said.

---

## Sweden

---

### Wave of affluence

Among swank Swedes, a peek in the kitchen is all that's needed to tell how assiduously one is keeping up with the Ericssons. The fashionable status symbol is an \$800 microwave oven.

For Swedish microwave oven producers, though, the vogue for home ovens is just a minor factor in a booming market. There are today some 4,500 commercial ovens operating in the country, making Sweden—with a population of about 8 million—the nation with the most microwave ovens per capita. And there's lusty growth in sight. Says Kjell-Ake Kack, marketing manager for Husqvarna Vapenfabriks AB, which has about 70% of the market, "We expect to more than double the number of commercial installations within several years."

Husqvarna's basic oven uses a single air-cooled magnetron that puts out 1,250 watts of power at a frequency of 2,450 megahertz. But the company sees as its upcoming best-seller a two-magnetron oven that can heat deep-frozen foods to piping hot in just two minutes. With restaurant help hard to come by in affluent Sweden, there's a trend to mass preparation of frozen meals in central kitchens. Restaurant chains already are doing this and the government actually is investigating whether it should set up a mammoth frozen-food factory to supply precooked foods to all public institutions. Wherever the meals are served, of course, there would be a microwave oven.

Husqvarna has prepared for the development with a conveyor belt tunnel oven that can heat 1,000 portions an hour. The unit will be on the market about the middle of next year. Meanwhile, the two-magnetron oven is going into "cook-it-yourself" cafeterias.

**Cold hot dogs.** Another Husqvarna development is an electronic hot-dog vending machine that may put out of business the white-jacketed vendors who ply Stockholm's streets during the winter. The vending machine holds 200 frozen frankfurters and can heat one to 70°C by microwaves in 12 to 15 seconds and then dispense a hot dog each time a coin is inserted.

Although it has a booming domestic market and its doing well throughout Europe, Husqvarna plans to take a crack at the United States market for commercial ovens. It currently is negotiating with an American company to handle sales and service.

---

## New Zealand

---

### Static on network

Pressure is building up on the state-owned New Zealand Broadcasting Corp. and its long-standing monopoly seems in jeopardy.

Convinced that commercial television isn't far off, a group of business men in the country's capital, Wellington, has formed a company called the New Zealand Television Corp. and is clamoring for independent tv stations. G.A. Wooler, chairman of NZTVC, says three major United States broadcasting companies want a piece of the action. NZTVC will initially invest \$7 million, \$2.8 million of it from the U.S., if it gets a government go-ahead.

**Jolly Roger.** NZTVC, though, is just one challenger of the state-broadcasting monopoly. This month the network got a first taste of competition when a "pirate" radio station began broadcasting from a ship in the Mauraki Gulf, off the north coast. Radio Mauraki, as it's known, faces some competition it-



self. Two other pirate operations, Radio Southern Cross and Radio Ventura, plan broadcasts from ships.

So far the government has made no move against the pirates. Rather than the marines, the government looks to Pacific storms to silence the renegade transmitters.

But more than NZTVC and the pirate stations, what threatens the broadcasting monopoly is the position of the ruling liberal-conservative National Party. At its congress this summer the party backed establishment of an independent tv network and has been agitating for action ever since. The feeling in Wellington is that the government will be forced to decide soon.

## Around the world

**Great Britain.** The Marconi Co. will introduce a low-cost version of its highly successful Myriad 1 real-time computer at the Electronica 66 show in Munich, Germany, this week. The new Myriad 2 uses the same diode-transistor-logic integrated circuits as its bigger brother but is slightly slower as well as smaller. Price of the Myriad 2 is \$56,840, about \$30,000 less than Myriad 1.

**Japan.** Hitachi Ltd. has developed a hybrid computer that draws animated cartoons with an x-y plotter. Hitachi claims its analog-digital approach works with a much smaller memory than is needed for digital animation. However, the hybrid system is inherently much slower than digital animation with writeout on a cathode-ray tube, which has been demonstrated by several American companies.

**United Arab Republic.** Egypt plans to boost its television set output to 150,000 units annually in the next two years. The industry currently produces 60,000. Most of the sets will be absorbed by the domestic market; but Salah Amer, chairman of the U.A.R.'s electronics industry board, says Egypt will export to other Arab countries and has assured markets in India, Czechoslovakia, Greece and Sudan.

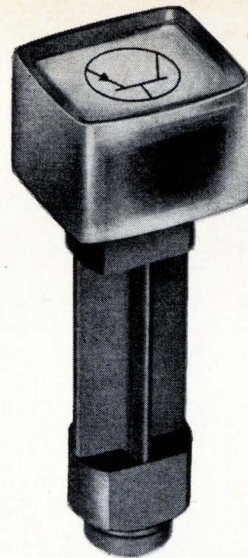

## push-button drafting?

Why not! When you try to improve drafting room production, it soon becomes apparent that yesterday's methods just aren't up to the job. They're time-consuming and costly. Mergenthaler has an answer. We call it The Diagrammer, and it's the first practical step to automated drafting. We can't begin to tell you all about it here. But if you're interested in a fast, simple, sleeves-up approach for producing schematics and diagrams photographically, The Diagrammer is for you. Just a note to us on your letterhead will bring you the full story. You have nothing to lose but the backlog in your drafting room. Mergenthaler Linotype Company, 29 Ryerson Street, Brooklyn, N. Y.

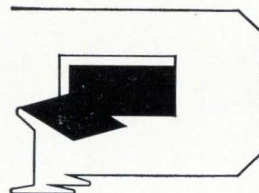

## THE DIAGRAMMER

Circle 225 on reader service card

To order reprints: Fill in, cut out coupon below, insert in envelope and mail to: **Electronics Reprint Dept., 330 W. 42nd Street, New York, N.Y. 10036**

### Reprint order form

For listing of reprints available see the Reader Service Card.

Communications Satellites Part I

Send me ..... reprints of Key no. R-89 at 50¢ each.

For reprints of previous special reports fill in below:

Send me ..... reprints of Key No.(s) ..... @ ..... ¢ each.  
(For prices, see Reader Service Card)

Name .....

Number of street .....

City, State, Zip code .....





■ <b>AMP Incorporated</b> Garceau, Hargrave & McCullough Inc.	14, 157	<b>Di-Acro Corporation</b> Charles E. Brown Advertising Agency	184	<b>Honeywell Test Instruments Corporation</b> Campbell-Mithun Incorporated	64
■ <b>Acme Electric Corporation</b> Scheel Advertising Agency Inc.	164	<b>Dialight Corporation</b> H. J. Gold Company	207	<b>Hopkins Engineering Company</b> Philip J. Meany Company	197
<b>Acopian Corporation</b> Mort Barish Associates Inc.	203	■ <b>Dimco-Gray Company</b> Weber, Geiger & Kalat Inc.	134	■ <b>Houston Omnigraphic Corporation</b> Ray Cooley & Associates	92
<b>Aerojet General Corporation</b> D'Arcy Advertising Company	130, 131	■ <b>DuPont de Nemours &amp; Company, Freon Division</b> Batten Barton Durstine & Osborn Inc.	51	■ <b>Hughes Aircraft Company</b> Foote, Cone & Belding Inc.	204
<b>Aerovox Corporation Hi, Q Division</b> Lescarboursa Advertising Inc.	63	■ <b>Dynamics Instrumentation Company</b> Burruss Advertising Inc.	227	<b>IRC Incorporated</b> Gray & Rogers Inc.	65
<b>Airpax Electronics Inc.</b> Welch, Mirabile & Company Inc.	154	<b>Eastman Kodak Company</b> Rumrill Hoyt Incorporated	117	<b>Iowa Development Commission</b> L. W. Ramsey Advertising Agency	216
<b>Allen Bradley Company</b> Fensholt Advertising Agency Inc.	52, 53	<b>Ebert Electronics Corporation</b> Flamm Advertising	192	■ <b>J F D Electronics Corporation/Components Division</b> Michel-Cather Incorporated	177
<b>Alpha Wire Corporation</b> Campbell-Ewald Company	32	<b>Eimac Division of Varian Associates</b> Hoefler Dieterich & Brown Inc.	163	<b>Kahle Engineering Company</b> George Homer Martin Associates	193
<b>Amelco Semiconductor Corporation</b> Sturges & Associates	115	<b>Electro Tec Corporation</b> McClellan Associates Inc.	46	■ <b>Keppo Incorporated</b> Weiss Advertising	22
<b>Amphenol Corporation, RF Division</b> Marsteller Incorporated	121	<b>Emerson &amp; Cuming Incorporated</b> Edwin F. Hall Company	210	<b>Krohn-Hite Corporation</b> Stern/Frank Advertising Incorporated	188, 189
■ <b>Amperex Electronics Corporation</b> Sam Groden Incorporated	31	<b>Engineered Electronics</b> Jansen Associates Inc.	116	■ <b>Lapp Insulator Company Inc.</b> Wolff Associates Incorporated	199
■ <b>Andrew Corporation</b> Fensholt Advertising Inc.	122	<b>Erie, County of</b> Comstock & Company	173	<b>Lockheed California</b> McCann Erickson Company	208
<b>Astrodyne Incorporated</b> Tech/Reps	205	■ <b>Fairchild Controls Company</b> Dunwoodie Associates Inc.	172	<b>Lockheed Missiles &amp; Space Company</b> McCann Erickson Company	207
<b>Baldwin Lima Hamilton Corporation</b> Gray & Rogers Inc.	27	■ <b>Fairchild Instrumentation</b> Faust/Day Incorporated	158, 159	<b>Louisiana, State of Department of Commerce</b> Bauerlein Incorporated	228
■ <b>Ballantine Laboratories</b> Lang-Lawrence Advertising Inc.	176	■ <b>Fairchild Semiconductor Incorporated</b> Faust/Day Incorporated	12, 13, 217, 218	<b>McGraw Hill Book Company</b>	209
<b>Barnstead Still &amp; Sterilizer Company</b> Creamer, Trowbridge & Case Inc.	162	<b>Fansteel Metallurgical Corporation</b> Reincke, Meyer & Finn Inc.	17	<b>Machlett Laboratories Inc.</b> Fuller & Smith & Ross Inc.	11
<b>Bendix Semiconductor Corporation</b> MacManus, John & Adams Inc.	18, 19	<b>Garlock Company Incorporated</b> Richardson Thomas Bushman Inc.	156	<b>Magnetics Incorporated</b> Lando Advertising Agency Inc.	118
■ <b>Benrus Watch Company, Technical Products Division</b> S & S Creative Services	182	<b>General Atomic Division, of General Dynamics Corporation</b> Barnes Champ Advertising	185	■ <b>Mallory Controls Company, a division of P.R. Mallory &amp; Co. Inc.</b> Aitkin-Kynett & Company Incorporated	127
<b>Binary Electronics of California</b>	208	<b>General Dynamics Fort/Worth Division</b> Glenn Advertising Inc.	165	<b>Martin Company</b> Shattack Roether Advertising	153
<b>Blackstone Corporation, Ultrasonics Division</b> Carr Liggett Advertising Inc.	177	■ <b>General Electric Capacitor Division</b> George R. Nelson Incorporated	146		
■ <b>Blue M Electric Company</b> South Suburban Advertising Inc.	174	■ <b>General Electric Silicone Products Division</b> Ross Roy Incorporated	119		
■ <b>Bourns Incorporated Trimpot Division</b> The Lester Company	15	<b>General Radio Company</b> K.E. Morang Company	6		
■ <b>Brush Instruments Division of Clevite Corporation</b> Carr Liggett Advertising Inc.	54, 55	<b>Gries Reproducer Company</b> Harold Marshall Advertising Company Inc.	210		
<b>Eurroughs Corporation, Electronic Components Division</b> Conti Advertising Agency Inc.	66	<b>Gudebrod Brothers Silk Company</b> Ramsdell-Buckley & Company	120		
■ <b>Bussmann Mfg. Division, McGraw Edison Company</b> Henderson Advertising Company	174, 175	<b>Haveg Industries Incorporated</b> Garceau, Hargrave & McCullough Inc.	160, 161		
<b>Celanese Corporation of America</b> West, Weir & Bartel Inc.	142	<b>Hayakawa Electronics Company Ltd.</b> Dai-Ichi International Incorporated	181		
■ <b>Clairix Corporation</b> Michel-Cather Inc.	205	■ <b>Heath Company</b> Advance Advertising Service Inc.	173		
<b>Clarostat Mfg. Company Inc.</b> Lescarboursa Advertising	139	<b>Heinemann Electric Company</b> Thomas R. Sumdheim Advertising Agency	143		
■ <b>Clevite Corporation, Piezoelectric Division</b> Carr Liggett Advertising Inc.	181	■ <b>Hewlett Packard Colorado Springs Division</b> Tallant/Yates Incorporated	3rd Cover		
<b>Consolidated Electrodynamics Corporation</b> Hixon & Jorgensen Inc.	60, 61	■ <b>Hewlett Packard Dymec Division</b> Lennen & Newell Incorporated	1		
<b>Control Data Corporation</b> Barnes Champ Advertising	202	■ <b>Hewlett Packard Harrison Division</b> Healy Advertising Agency	135		
<b>Coors Procelain Company</b> Tallant/Yates Advertising	167	■ <b>Hewlett Packard Rockaway Division</b> George Homer Martin Associates	30		
<b>Curtis Instruments Inc.</b> Lescarboursa Advertising Inc.	170	■ <b>Hewlett Packard Sanborn Division</b> Culver Advertising Incorporated	2		
<b>Data Instruments Division</b> Technical Marketing Inc.	198	<b>Honeywell Commercial Division</b> Campbell-Mithun Incorporated	56, 57		
<b>Delevan Electronics Corporation</b> Stahlka, Faller & Klenk Inc.	140				

## Classified Advertising

F.J. Eberle, Business Mgr.

**EMPLOYMENT OPPORTUNITIES** 211-215

**NOTICES**

Legal 214

**EQUIPMENT**

(Used or Surplus New)

For Sale 214

## ADVERTISERS INDEX

<b>Atomic Personnel</b>	214
<b>Fishman Co., Philip</b>	214
<b>Harlan Labs</b>	214
<b>Instruments &amp; Machines Inc.</b>	214
<b>International Business Machines</b>	213
<b>Radio Research Instrument Co.</b>	214
<b>Sanders Associates Inc.</b>	215
<b>Servo Corp. of America</b>	212
<b>Union Carbide Corp.</b>	214
<b>U.S. Navy</b>	211, 212
<b>V-M-Corp.</b>	214

■ For more information on complete product line see advertisement in the latest Electronics Buyers' Guide



# Electronics advertisers

October 17, 1966

<b>Mepco Incorporated</b> Ray Ellis Advertising Corporation	183	<b>Steroline Systems Corporation</b> Clinton E. Frank Inc.	185
<b>Mergenthaler Linotype Company</b> Merlin Advertising	225	<b>Struthers-Dunn Incorporated</b> Harry P. Bridge Company	194
■ <b>Metal Removal Company</b> Advertising Producers Associated	166	■ <b>Superior Tube Company</b> Gray & Rogers Incorporated	195
<b>Microwave Electronics Corporation</b> Bonfield Associates	187		
<b>Mitre Corporation</b> The Bresnick Company	148	<b>TRW Instruments Company</b> Fuller & Smith & Ross Incorporated	204
<b>Monsanto Company</b> Inorganic Division Foote, Cone & Belding	28, 29	<b>TRW Semiconductor</b> Fuller & Smith & Ross Incorporated	39
<b>Motorola Communications &amp; Electronics Incorporated</b> K & A Incorporated	179	■ <b>Technipower Incorporated</b> S & S Creative Services	191
<b>Motorola Semiconductor Products Incorporated</b> Lane & Bird Advertising Incorporated	45	■ <b>Tektronix Incorporated</b> Hugh Dwight Advertising Incorporated	41
		<b>Telrex Laboratories</b> George Homer Martin Associates	208
		■ <b>Telonic Instruments Incorporated</b> Jansen Associates	136
<b>Newark Electronics Corporation</b> Stral Advertising Company	179	<b>Texas Instruments Incorporated</b> Marsteller Incorporated	58, 59
<b>Newport News Shipbuilding &amp; Dry Dock</b> Cargrill Wilson Acree Company	169	<b>Texas Instruments Incorporated, Semiconductor Components Division</b> Don L. Baxter Incorporated	123
<b>North Atlantic Industries Incorporated</b> Murray Heyert Associates	138	<b>Triplet Electrical Instrument Company</b> Burton Browne Advertising	33
		<b>Trio Laboratories Incorporated</b> Zam & Kirshner Incorporated	180
<b>Pamotor Incorporated</b> Harry P. Bridge Company			
■ <b>Perfection Mica Company, Magnetic Shield Division</b> Burton Browne Advertising	190	<b>Ulano Company, J.</b> Byrde, Richard & Pound Incorporated	173, 185
<b>Philco/Ford Company, Microelectronics Division</b> Hoefler, Dieterich & Brown Inc.	9	■ <b>United Transformer Company</b> Philip Stogel Company	2nd Cover
<b>Pioneer Electric &amp; Research Corporation</b> K & A Incorporated	196	<b>Unirode Corporation</b> Silton, Callaway & Hoffman Inc.	20, 21
<b>Photocircuits Corporation</b> Duncan-Brooks Incorporated	150	■ <b>Universal Instruments Corporation</b> Caroe Marketing Incorporated	62
<b>Polaroid Corporation</b> Doyle, Dane, Bernbach Incorporated	47		
■ <b>Potter &amp; Brumfield Division of American Machine &amp; Foundry</b> Grant, Schwenck & Baker Incorporated	24	<b>Varian Associates, Tube Division</b> Hoefler, Dieterich & Brown Incorporated	43
<b>Princeton Applied Research Corporation</b> Mort Barish Associates Inc.	34	<b>Vector Electronics Company</b> Van Der Boom, McCarron Inc.	206
		<b>Vishay Instruments Incorporated</b> Alpern Communications	16
<b>RCL Electronics Inc.</b> Morvay Advertising Agency	190	<b>Wavetek Incorporated</b> Chapman, McQuiston, Suzuki & Wright Advertising	152
<b>RHG Electronics Laboratories Inc.</b> S.M. Sachs & Associates Inc.	8	<b>Westinghouse Semiconductor Division</b> ITSM Division of McCann Erickson	149
<b>Radiation Incorporated</b> Basford Incorporated	151	<b>Weston Instruments Archbald Division</b> Arndt, Preston, Chapin, Lamb & Keen Incorporated	124
<b>Radio Corporation of America</b> Al Paul Lefton Company	132, 4th Cover	<b>Weston Instruments Incorporated</b> Boonshaft & Fuchs Division Arndt, Preston, Chapin, Lamb & Keen Incorporated	201
■ <b>Rotron Mfg. Company Inc.</b> Lescarbourea Advertising Incorporated	186	■ <b>Weston Instruments Incorporated</b> Transicoil Division Arndt, Preston, Chapin, Lamb & Keen Incorporated	171
■ <b>Sage Electronics Corporation</b> Mathison Advertising Incorporated	200	<b>White Company, S.S.</b> W.L. Towne Company Incorporated	144
<b>Sealectro Corporation</b> Lescarbourea Advertising Incorporated	178	<b>Wisconsin Power &amp; Light Company</b> Ralph Timmons Company	168
<b>Semtech Corporation</b> Burruss Advertising	210	<b>Wisconsin, State of Department of Resource &amp; Development</b> The Cramer-Krasselt Company	147
<b>Signetics Corporation</b> Cunningham & Walsh Incorporated	128		
■ <b>Singer Company Metrics Division</b> Hepler & Gibney Incorporated	145	■ <b>Zeltex Incorporated</b> Sturges & Associates	171
<b>Solitron Devices Incorporated</b> Haselmire Pearson Advertising	141		
<b>Sperry Electronic Tube Division</b> Neals & Hickok Incorporated	48		
<b>Sprague Electric Company, The</b> Harry P. Bridge Company	5, 10		
<b>Stackpole Carbon Company</b> Electronic Components Division Meek and Thomas Inc.	102	■ <b>For more information on complete product line see advertisement in the latest Electronics Buyers' Guide</b>	

# NEW

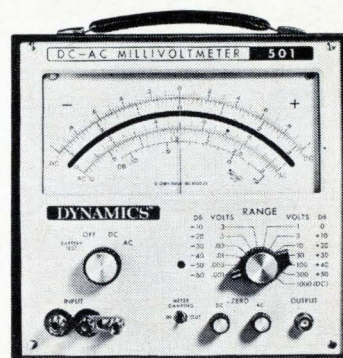

Portable - 6 "D" Cells

## DC-AC

millivoltmeter

1mV-1kV

1 Hz - 100 kHz

Dynamics™ new Model 501 DC-AC Millivoltmeter now provides two fully-portable laboratory-precision instruments in one package. It is the only portable instrument that permits 1 Hz measurements while operating on six (6) ordinary D cells featuring guarded and isolated operation from 1mV to 1kV.

In addition to its superior measurement capabilities, the Model 501 is equipped with output terminals for driving external recorders. "Box-within-a-box" construction permits both floating and differential measurements. Added features include the big 7.2 inch mirror-backed, taut-band meter with dB scale for ac measurements.

Check full specifications and compare. Write for Product Bulletin PD5-761.

**DYNAMICS™**  
INSTRUMENTATION COMPANY

583 MONTEREY PASS ROAD  
MONTEREY PARK, CALIFORNIA  
(213) 283-7773



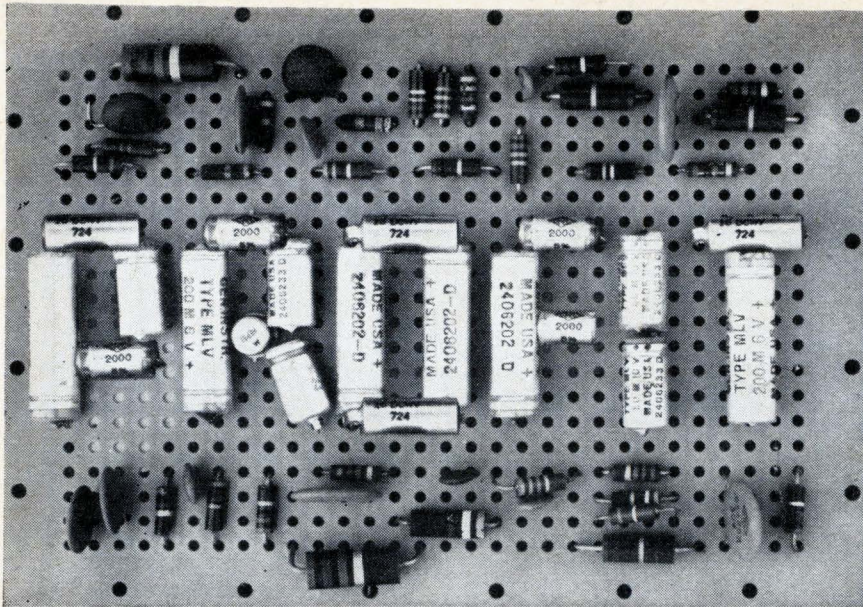

*where industry is never short-circuited...*

Plug-in anywhere in Louisiana and you'll be able to take advantage of:

Louisiana's revolutionary **Right-To-Profit Laws**, which protect industry, large and small, from unfair taxation and excessive government regulation.

Louisiana's money-saving **plant financing programs**. Build the exact production facility you require, without tying up your capital in brick and mortar.

Louisiana's **manpower training program**. Louisiana offers industry a substantial pool of labor, both trained and trainable. Where training is necessary, we'll provide it at no cost to you.

For full information on these and other ways to profit in Louisiana, write to William T. Hackett, Department of Commerce and Industry, Room 214, Capitol Annex, Baton Rouge, Louisiana 70804.

# LOUISIANA

The Right-To-Profit State



## Advertising sales staff

**Frank E. LeBeau [212] 971-6464**

Advertising sales manager

**Atlanta, Ga. 30309:** Michael H. Miller, 1375 Peachtree St., N.E., [404] TR 5-0523

**Boston, Mass. 02116:** William S. Hodgkinson McGraw-Hill Building, Copley Square, [617] CO 2-1160

**Chicago, Ill. 60611:** Robert M. Denmead, J. Bradley MacKimm, 645 North Michigan Avenue, [312] MO 4-5800

**Cleveland, Ohio 44113:** William J. Boyle, 55 Public Square, [216] SU 1-7000

**Dallas, Texas 75201:** Richard P. Poole, 1800 Republic National Bank Tower, [214] RI 7-9721

**Denver, Colo. 80202:** Joseph C. Page, David M. Watson, Tower Bldg., 1700 Broadway, [303] 255-5484

**Detroit, Michigan 48226:** J. Bradley MacKimm, 856 Penobscot Building [313] 962-1793

**Houston, Texas 77002:** Kenneth George, 2270 Humble Bldg., [713] CA 4-8381

**Los Angeles, Calif. 90017:** Ian C. Hill, John G. Zisch, 1125 W. 6th St., [213] HU 2-5450

**Minneapolis, Minn. 55402:** J. Bradley MacKimm, 1104 Northstar Center [612] 332-7425

**New York, N. Y. 10036:** Donald R. Furth [212] 971-3615  
James R. Pierce [212] 971-3615  
George F. Werner [212] 971-3615  
500 Fifth Avenue

**Philadelphia, Pa. 19103:** William J. Boyle, Warren H. Gardner, Jeffrey M. Preston, 6 Penn Center Plaza, [215] LO 8-6161

**Pittsburgh, Pa. 15222:** Warren H. Gardner, 4 Gateway Center, [412] 391-1314

**Portland, Ore. 97204:** James T. Hauptli, 218 Mohawk Building, 222 S.W. Morrison Street, Phone [503] 223-5118

**St. Louis, Mo. 63105:** Robert M. Denmead The Clayton Tower, 7751 Carondelet Ave. [314] PA 5-7285

**San Francisco, Calif. 94111:** James T. Hauptli, 255 California Street, [415] DO 2-4600

**London W1:** John W. Patten, Edwin S. Murphy Jr., 34 Dover Street, Hyde Park 1451

**Milan: 1, via** Baracchini Phone: 86-90-617  
86-90-656

**Frankfurt/Main:** Gerd Hinske, Dieter Rothenbach, Elsa-Brandstroem Str. 2  
Phone: 72 01 81

**Geneva:** Michael R. Zeynel, 1, rue du Temple  
Phone: 31 95 60

**Paris VIII:** Denis Jacob, Kenneth Davey, 17 Avenue Matignon Phone: 359 6637

**Tokyo:** Nobuyuki Sato, 1, Kotohiracho Shiba, Minato-Ku [502] 0656

**Osaka:** Ryosi Kobayashi, 163, Umegee-cho, Kita-ku [362] 8771

**Wallace C. Carmichael [212] 971-3191**  
Manager Electronics Buyers' Guide

**David M. Tempest [212] 971-3139**  
Promotion manager

**Milton Drake [212] 971-3485**  
Research and circulation manager

**Wallis Clarke [212] 971-2187**  
Assistant to sales manager

**Wallace C. Carmichael [212] 971-3191**  
Business manager

**Stephen R. Weiss [212] 971-2044**  
Production manager

**Thomas M. Egan [212] 971-3140**  
Production manager Electronics Buyers' Guide