

# Electronics®

Computer-aided design with symbols: page 92

Reducing distortion in FET amplifiers: page 99

Japanese technology in communications: page 133

December 12, 1966

75 cents

A McGraw-Hill Publication

Below: Two views of Lunar Module in simulated moon landing, page 111

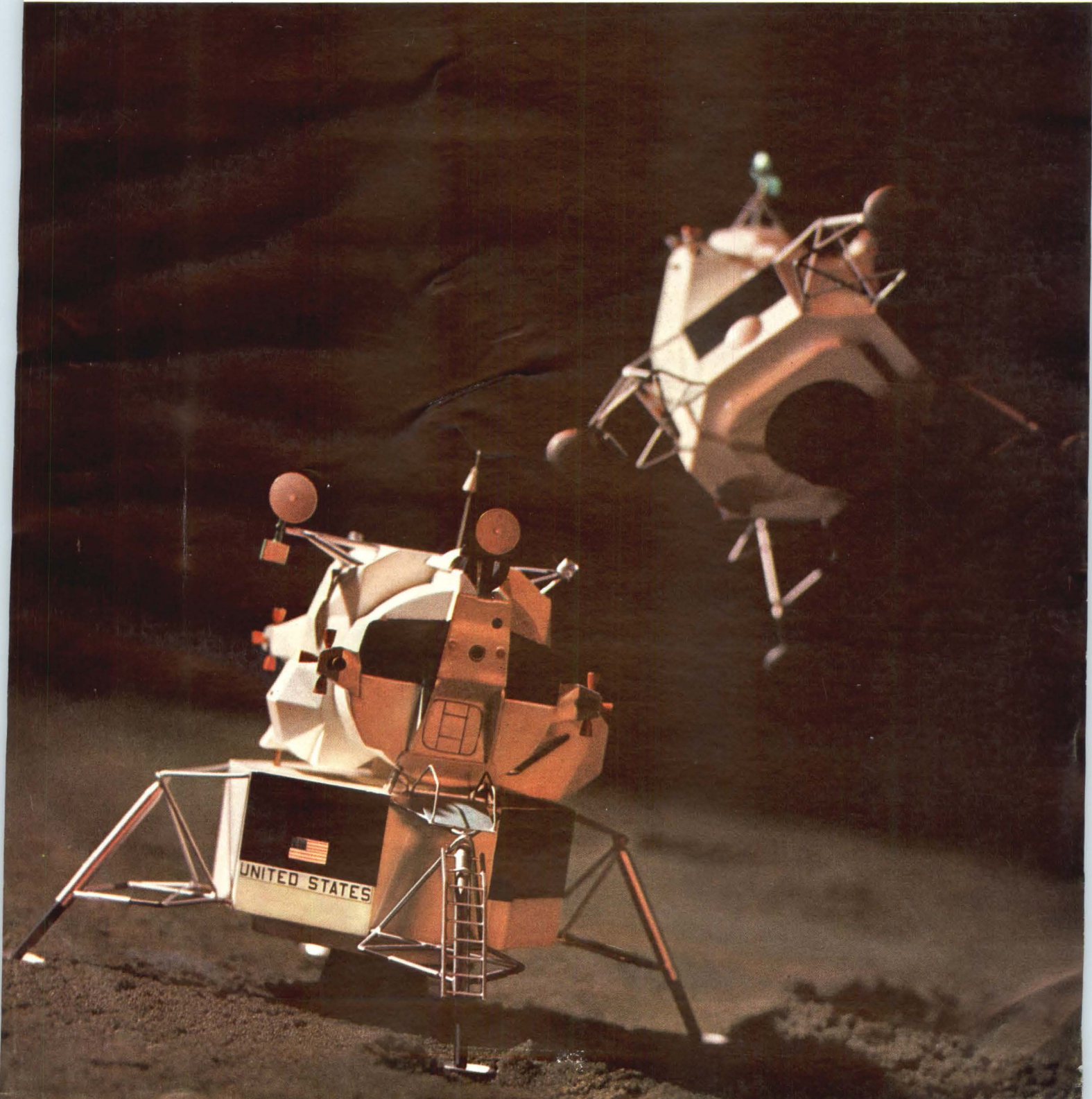



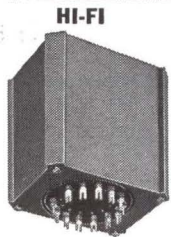

**HI-FI**  
Transistor output; matches any PP transistor to 4, 8, 16  $\Omega$  speaker. Primary 48, 36, 12  $\Omega$  C.T.; 20  $\sim$  to 20 KC; 40 watts.

**MINIATURE MIL TYPE**

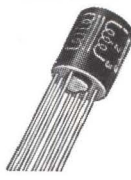

Metal case hermetically sealed to MIL-T-27B. Gold Dumet leads spaced on 0.1 radius, for printed circuit application.

**CHOPPER**

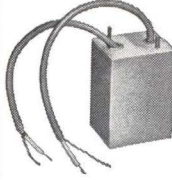

Magnetic shielded plus electrostatic shield for voltage isolation of  $2 \times 10^6$ . Primary 200K C.T. to within 0.1%. Secondary 50K.

**HIGH POWERED AUDIO**



Low distortion 2.5 KW output transformer, PP 450 TH's 18,500 ohms C.T. to 24/6 ohms, 20 KV hipot. 520 lbs.

**CATHODE FOLLOWER OUTPUT**



Provides equal voltages to 5 loads. Primary inductance maintained to 5% with 20% change in DC unbalance and 30% change in AC voltages.

# "SPECIAL" CUSTOM BUILT AUDIO TRANSFORMERS TO YOUR SPECIFICATIONS

**HI-FREQUENCY CARRIER TO MIL-T-27B**



Electrostatically shielded, humbucking, +30 dbm level. Within .5 db 250 cycles to 110 KC. 600/135: 600 centertapped to .1% tolerance.

**HYBRID TRANSFORMER**

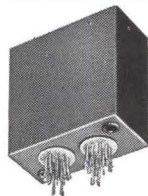

Two transformers each 600  $\Omega$  primary, 40K  $\Omega$  C.T. secondary 250 cycles to 5 KC within  $\frac{1}{4}$  db. 40 db isolation over band.

**MICROMODULE**



Life tested per micromodule specs.: no failures. 10K  $\Omega$  C.T. to 10K  $\Omega$ , 100 mw from 400  $\sim$  to 20KC.

**SUBMINIATURE MOLDED TRANSFORMER**

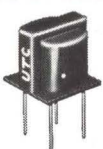

Grade 3 with printed circuit leads for transistor application. 150  $\Omega$  to 150  $\Omega$  at 10 dbm level. Size  $\frac{1}{2} \times \frac{1}{2} \times \frac{1}{2}$ "; weight 5 grams.

**BOLOMETER TRANSFORMER**



Primary 10 ohms, secondary 530K ohms, 230:1 ratio, response from  $\frac{1}{2}$  cycle to 25 cycles. 120 db magnetic shielding, plus full electrostatic shielding.

**ULTRA-MINIATURE**



Electrostatically & magnetically shielded output transformer  $\frac{3}{16}$  D. x  $\frac{1}{4}$ " H. Pri. 15K CT, Sec. 8K CT; max. level 50 mw; audio range response. To MIL-T-27B, grade 4.

Exceptional quality and reliability is provided in all UTC designs. Over 30 years of engineering knowledge and experience substantiated by extensive field performance assure the highest quality and most reliable components in the industry. Complete environmental testing facilities are incorporated to prove out new designs. Full analysis and evaluation of materials are conducted in UTC's Material and Chemical Laboratories. Rigid quality control measures coordinated with exhaustive statistical findings and latest production procedures results in the industry's highest degree of reliability. Range covered in Audio Transformers is from 0.1 cycles to 400 MC . . . microwatts to 50 KW.

**MILITARY AND COMMERCIAL TYPES FOR EVERY PHASE OF THE ELECTRONICS ART**

**POWER TRANSFORMERS • AUDIO TRANSFORMERS • INDUCTORS • PULSE TRANSFORMERS • ELECTRIC WAVE FILTERS • LUMPED CONSTANT DELAY LINES • HIGH Q COILS • MAGNETIC AMPLIFIERS • SATURABLE REACTORS • REFERENCE UNITS**

Write for catalog of over 1,300 UTC TOP QUALITY STOCK ITEMS IMMEDIATELY AVAILABLE from your local distributor.



**UNITED TRANSFORMER CO.**

DIVISION OF TRW INC. • 150 VARICK STREET, NEW YORK, N. Y. 10013



# 160 db measurement range

points to  
db resolution for sonar, acoustics,  
all audio response measurements

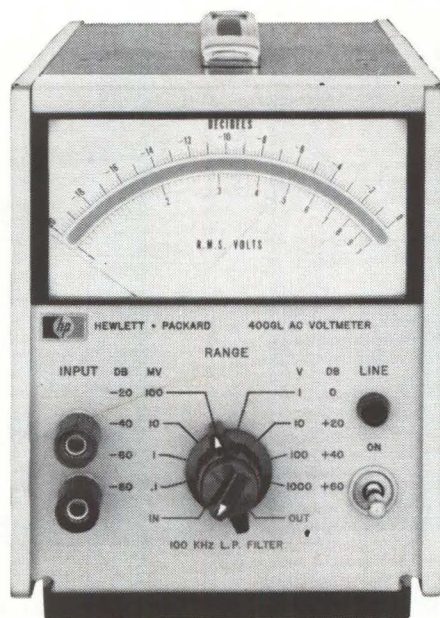

hp 400GL  
AC Voltmeter

- 20 db log linear meter scale, -100 to 60 db, for greatest range available
- 20 db step attenuator, for greater convenience
- 100  $\mu$ v to 1 kv range, 20 Hz to 4 MHz—high sensitivity, low noise
- Switchable low-pass filter at 100 kHz, for greater accuracy in audio, sonar ranges
- Fast response (read 3 sec. after turn-on), fast overload recovery
- 10 megohm input impedance, for minimum circuit loading

Here's a voltmeter designed specifically to increase the efficiency and speed of acoustic and sonar measurements, offering wide dynamic range with low noise,  $\pm 0.2$  db accuracy and the convenience of maximum resolution on a wide-range linear scale (0 db=1 v). It's a special version of the popular Hewlett-Packard 400 F/FL Voltmeter, noted for its speed of response, accuracy, high sensitivity and low noise. Use the 400GL in the calibration lab for frequency response tests or use it on board. The 400GL also can be used as a high-gain ac amplifier with 80 db amplification. Make convenient, accurate measurements without calibration or conversion, increase accuracy of audio measurements with the 100 kHz low-pass filter, especially on the more sensitive ranges, by reducing noise bandwidth.

Ask your Hewlett-Packard field engineer for a demonstration of the 400GL, priced at only \$290. Or write for complete specifications: Hewlett-Packard, Palo Alto, California 94304, Tel. (415) 326-7000; Europe: 54 Route des Acacias, Geneva.

Data subject to change without notice. Price f.o.b. factory.

HEWLETT  PACKARD  
An extra measure of quality

1926



# OUTSTANDING PERFORMANCE... AT REASONABLE COST HIGHEST ACROSS-THE-BOARD PERFORMANCE AVAILABLE FROM A WIDEBAND DIFFERENTIAL DATA AMPLIFIER

New Hewlett-Packard 2470A Differential Data Amplifier...\$585

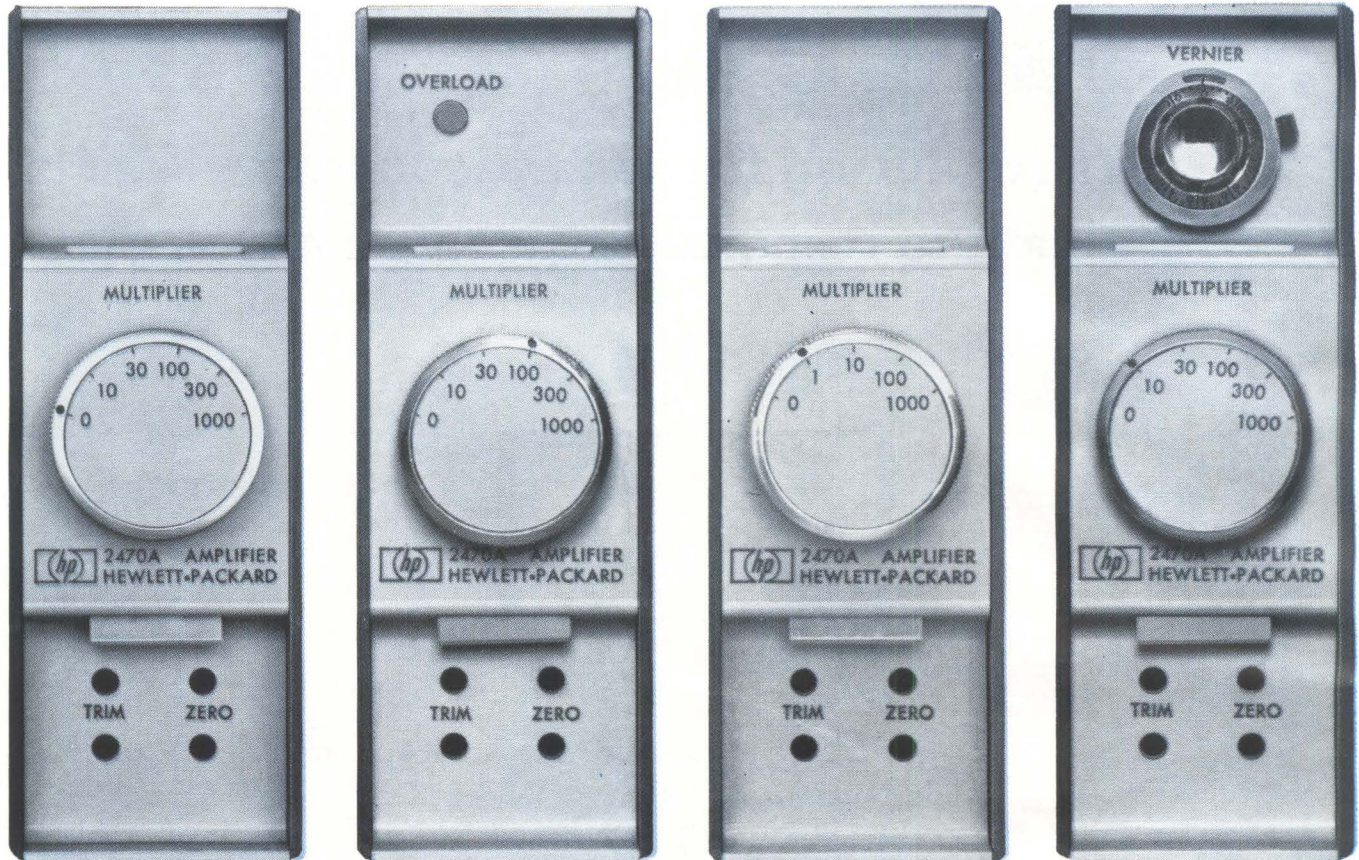

**Top electrical performance:** Compare, spec to spec—DC gain X10 to X1000 (optional precision vernier, X1 gain), output  $\pm 10$  v, 0-100 ma. Gain accuracy  $\pm 0.02\%$  range; constant 50 kHz bandwidth. Differential input for low drift, high cmr (120 db at 60 kHz on gains down to x30, 90 db at x1). Full output across full bandwidth ( $10^7$  v/sec RTO). High 1000-meg input impedance all gain settings, output impedance 0.1 ohm  $+10$   $\mu$ h. DC linearity of 0.002% on both polarities; dc gain stability of 0.005% per month achieved without chopper stabilization. Low drift and noise. Fast 100 microsecond settling, 100 microsecond overload recovery, excellent overload protection, optional overload indicator. Input and output isolated by internally driven guard shields; dual output available with fixed 2-pole filter.

**Built-in reliability:** The predicted MTBF of the 2470A is in excess of 20,000 hours. Silicon transistors are used throughout, and passive and active components are selected for dependability, as well as performance. Amplifier meets spec at 95% humidity at 40°C. Critical parameters (zero drift, full-scale accuracy, common mode rejection) are verified after 100 hours of "run-in" at elevated temperature.

**Packaging for value, compactness:** Amplifier and self-contained power supply are enclosed in a unique, rugged molded dielectric case. Combining case, bench stand, power and signal cables, plus many other accessories, are available.

**Use for:** Amplifying signals from low-level resistive transducers, such as thermocouples, strain gages. High input and low output impedance make it ideal for amplification over long transmission lines; use it, with resistive or reactive loads, such as x-y, strip-chart or oscillographic recorders, digital voltmeters, null detectors and servo systems, telemetry systems... or use it as a high-performance bench amplifier.

Call your Hewlett-Packard field engineer for complete information or write the Dymec Division of Hewlett-Packard, 395 Page Mill Road, Palo Alto, California 94306, Tel. (415) 326-1755; Europe: 54 Route des Acacias, Geneva.

**HEWLETT  
PACKARD**  **DYMEC  
DIVISION**

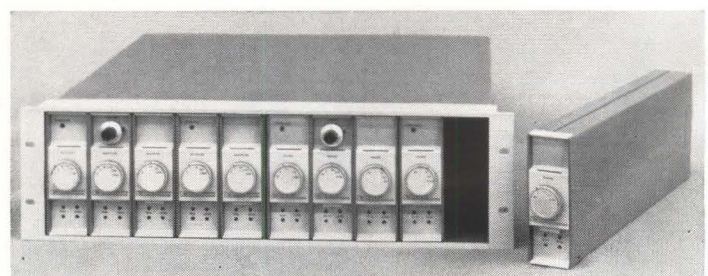



## News Features

### Probing the News

- 179 **Engineers call her boss**
- 184 **What's new with A-New**
- 189 **Higher education from satellites**
- 193 **Army enlists IC's for artillery fuzes**

### Electronics Review

- 43 **Avionics:** Quick as a wink
- 43 **Solid state:** Bridges of gold
- 44 **Space electronics:** Wanted: a multi-processor; Building-block approach
- 46 **Medical electronics:** The inside story
- 47 **Displays:** IBM's new image
- 48 **Computer:** Dropping the guard
- 48 **AIAA meeting:** Closer link; Tuned to space; Addenda
- 54 **Consumer electronics:** One for all
- 54 **Industrial electronics:** Stop gap
- 56 **Avionics:** Toward a standard
- 58 **Electronics notes**

### Electronics Abroad

- 257 **Sweden:** Soldiers' play; Hot line
- 258 **Israel:** Export expectations
- 258 **West Germany:** Pipeline under control; Electronic arm; Automatic underground
- 260 **France:** Keeping track
- 261 **Great Britain:** Iron-horse computer
- 262 **Japan:** Numbers games

### Departments

- 4 Readers Comment
- 8 People
- 14 Meetings
- 16 Meeting Preview
- 23 Editorial
- 25 Electronics Newsletter
- 73 Washington Newsletter
- 201 New Products
- 202 New Products Index
- 238 Technical Abstracts
- 240 New Books
- 244 New Literature
- 251 Newsletter from Abroad

## Technical Articles

### I. Design

- Circuit design** 92 **Computer-aided design: part 3**  
**Analyzing circuits with symbols**  
Manipulating symbols in a computer can be more helpful in design than working with numbers  
Richard Carpenter and William Happ  
National Aeronautics and Space Administration
- Solid state** 99 **Knowing the cause helps to cure distortion in FET amplifiers**  
Trouble is avoided by rules that relate device characteristics and factors causing distortion  
James S. Sherwin, Siliconix, Inc.
- Circuit design** 106 **Designer's casebook**
  - Warning lights monitor d-c supply voltage
  - Tunnel diodes lock output of servocircuit
  - Agc circuit possesses 60-decible gain
  - Transistors make voltage shifter adjustable
  - Bipolar pulse generator tests fast flip-flop
- Space electronics** 111 **Apollo: the goal is in sight (cover)**  
Electronics equipment is meeting its stiffest challenge to date, the ultrareliability needed to make the lunar landing program a success  
John Rhea, Electronics Washington Bureau
- Japanese technology** 133 **Communications technology in Japan**  
Spurred by demands to increase telephone system capacity and provide communications between computers, Japanese engineers are rapidly developing original techniques for pcm and digital data transmission

### II. Application

- 134 **Japanese stay with pcm to meet mushrooming growth in telephony**  
New ways are being found to transmit more conversations without adding more lines  
Hiroshi Inose and Hiroya Fujisaki, University of Tokyo
- 147 **Bit by bit, Japan is speeding its data communications links**  
Up to 6,000 bits a second will move over a single voice line to meet the increased demand for data communications  
Mitsuru Yokoi, Shigehiro Hirasawa and Yoshiyuki Mima, Nippon Telegraph and Telephone Public Corp.



# Electronics

**Editor-in-Chief:** Lewis H. Young

**Senior editors**

**Design:** Samuel Weber

**Application:** George Sideris

**News:** Kemp Anderson Jr.

**Assistant to the editor:** Sally Powell

**Senior associate editors:** John F. Mason, Donald Christiansen, Robert Henkel, Joseph Mittleman

**Department editors**

**Avionics:** W.J. Evezia

**Communications:** Leonard Weller

**Computers:** Wallace B. Riley

**Design theory:** Joseph Mittleman

**Electronics abroad:** Arthur Erikson

**Electronics review:** Stanley Zarowin

**Industrial electronics:** Alfred Rosenblatt

**Instrumentation:** Carl Moskowitz

**Military electronics:** John F. Mason

**New products:** William P. O'Brien

**Special projects:** Donald Christiansen

**Staff writers:** Jan Rahm, William Olcott

**Regional Bureaus**

**Domestic**

**Boston:** Thomas Maguire, manager; Robin Carlson

**Los Angeles:** William B. Wallace, manager; June Ranil

**San Francisco:** Walter Barney, manager; Mary Jo Jadin

**Washington:** Robert W. Henkel, manager; William D. Hickman, John Rhea, correspondents; Patricia C. Hoehling

**Foreign**

**Bonn:** John Gosch

**Tokyo:** Charles Cohen

**Copy editors**

David Goller, Albert Tannenbaum

**Graphic design**

**Art director:** Saul Sussman

**Assistant art directors:** Ann Mella, Valerie S. Betz

**Production editor:** Arthur C. Miller

**Editorial secretaries:** Marlene Angrist, Claire Benell, Lynn Emery, Lorraine Fabry, Kay Fontana, Patricia Gardner, Lorraine Longo

**McGraw-Hill News Service**

**Director:** John Wilhelm; **Atlanta:** Fran Ridgway; **Chicago:** James Rubenstein;

**Cleveland:** Arthur Zimmerman; **Dallas:** Marvin Reid;

**Detroit:** N. Hunter; **Houston:** Ron Lovell; **Los Angeles:** Michael Murphy, Gerald Parkinson

**San Francisco:** Margaret Drossel

**Seattle:** Ray Bloomberg; **Washington:** Arthur L. Moore, Charles Gardner, Herbert W. Cheshire, Seth Payne, Warren Burkett

**McGraw-Hill World News Service**

**Bonn:** John Johnsrud; **London:** John Shinn;

**Mexico City:** Bruce Cross; **Milan:** Ronald Taggiasco;

**Moscow:** Howard Rausch; **Paris:** Peter Kilborn;

**Rio de Janeiro:** Wes Perry; **Tokyo:** Marvin Petal

**Reprints:** Susan Nugent

**Publisher:** Gordon Jones

**Electronics:** December 12, 1966, Vol. 39, No. 25

Published every other Monday by McGraw-Hill, Inc. Founder: James H. McGraw 1860-1958.

Printed at 99 North Broadway, Albany, N.Y. 12207; second class postage paid at Albany, N.Y.

Executive, editorial, circulation and advertising addresses: McGraw-Hill Building, 330 W. 42nd Street, New York, N.Y. 10036. Telephone (212) 971-3333. Teletype TWX N.Y. 212-640-4646. Cable address: MCGRAWHILL N.Y.

Subscriptions are solicited only from those actively engaged in the field of the publication. Position and company connection must be indicated on orders. Subscription prices: United States and possessions and Canada, \$6.00 one year, \$9.00 two years, \$12.00 three years; all other countries, \$20.00 one year. Single copies: United States and possessions and Canada, 75¢; all other countries, \$1.50.

Officers of McGraw-Hill Publications: Joseph H. Allen, President; Bayard E. Sawyer, Executive Vice President; Vice Presidents: J. Elton Tuohig, Operations; John R. Callahan, Editorial; Donald C. McGraw, Jr., Marketing; John M. Holden, Marketing Services; Huber M. Gemmill, Circulation; Angelo R. Venezian, Production; Robert M. Wilhelmy, Controller.

Officers of the Corporation: Donald C. McGraw, Chairman of the Board; Shelton Fisher, President; L. Keith Goodrich, Hugh J. Kelly and Robert E. Slaughter, Executive Vice Presidents; John J. Cooke, Vice President and Secretary; John L. McGraw, Treasurer.

Title © registered in U.S. Patent Office; © Copyright 1966 by McGraw-Hill, Inc. All rights reserved. The contents of this publication may not be reproduced either in whole or in part without the consent of copyright owner.

**Subscribers:** The publisher, upon written request to our New York office from any subscriber, agrees to refund that part of the subscription price applying to copies not yet mailed. Please send change of address notices or complaints to Fulfillment Manager; subscription orders to Circulation Manager, Electronics at address below. Change of address notices should provide old as well as new address, including postal zip code number. If possible, attach address label from recent issue. Allow one month for change to become effective.

**Postmaster:** Please send form 3579 to Fulfillment Manager, Electronics, P.O. Box 430, Hightstown, New Jersey 08520

## Readers Comment

### Questioning the laser gyro . . .

To the Editor:

The story "Laser gyro comes in quartz" [Sept. 19, p. 183] mentioned possible applications of strapped-down ring lasers for aircraft and missiles to sense  $\omega$ . As in other approaches I have read about, the beat frequency  $f_b$  is explained by the change of wavelength  $\lambda$  due to Doppler effect in terms of  $\lambda' = \lambda (1 \pm v/c)$ .

While this is correct for missiles, it certainly does not apply for aircraft where the observer rotates with the device and no Doppler effect will be noticed. Instead, while  $\lambda$  remains unchanged, the speed of light becomes  $c' = c \pm \omega$  resulting in the same  $f_b$  as obtained in missiles. Both relations are complementary and should be used side by side when explaining  $f_b$ .

T. F. Heiting

Advanced Electronics  
Seattle, Wash.

### . . . In answer

To the Editor:

It is not entirely correct to say that the article explains the change in wavelength as being due to a Doppler effect. The article states only that as the gyro is rotated, the effective paths for the oppositely directed beams become different and as a result the frequencies differ.

These results are consistent with the general theory of relativity since the operation of the gyro takes place on a rotating frame, which is not an inertial frame. The theory predicts that light, whose velocity by definition is always equal to  $c$ , will take a longer time to traverse a closed contour on a rotating frame when traveling in the direction of rotation, than when traveling opposite to the direction of rotation. This lack of time synchronization results in an effective optical path difference for the two beams. A condition for laser oscillation is that an integral number of wavelengths, or the frequencies, differ for the two directions and this frequency difference is measured by an observer located on the



# Did you know Sprague makes...?

## UNICIRCUIT® RCTL INTEGRATED CIRCUITS

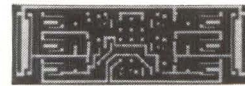

(8X actual size)

Sprague Series US-0100 . . . a complete line of monolithic digital building blocks featuring low power consumption (2 mW typ.)

Check 39 Reader Service Card

## UNICIRCUIT® mW RTL INTEGRATED CIRCUITS



Types US-0908 through US-0921 . . . Fully interchangeable mW digital building blocks featuring power consumption of 2 mW/node and propagation delay of 40 nsec

Check 40 Reader Service Card

## \*SERIES SE100, NE100, US700 DTL LOGIC (Signetics CS700)

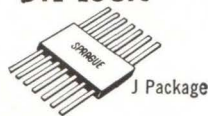

Two operating temperature ranges: -55 C to +125 C and 0 C to +70 C. NAND/NOR gates, clock and line drivers, gate expanders, RST and JK binary elements, one-shot multivibrator.

Check 41 Reader Service Card

## MULTIPLE TRANSISTORS (NPN-PNP PAIRS/QUADS)

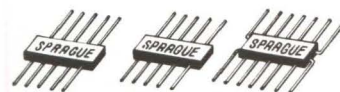

AMPLIFIERS	SWITCHES	CHOPPERS
Pairs		Quads
2 NPN		4 NPN
2 PNP		4 PNP
1 NPN-1 PNP		2 NPN-2 PNP

Check 42 Reader Service Card

## UNICIRCUIT® CUSTOM HYBRID CIRCUITS

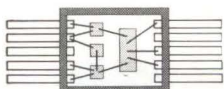

Combine monolithic silicon circuits with tantalum or Ni-Cr alloy resistors. Close resistance tolerances, low temperature coefficient. Resistor matching,  $\pm 1/2\%$ .

Check 43 Reader Service Card

## LOW-COST HERMETICALLY- SEALED PLANAR TRANSISTORS



TO-18  
CASE

TO-5  
CASE

Check 44 Reader Service Card

## DIFFERENTIAL AMPLIFIER TRANSISTOR PAIRS



NPN or PNP • Matched characteristics.  
 $h_{FE} = 10-20\%$ .  $\Delta V_{BE} = 5-20$  mV.  
 $\Delta V_{BE}/Temp = 5-20 \mu V/^{\circ}C$ .

Check 45 Reader Service Card

## DIGITAL-TO-ANALOG CONVERSION CIRCUITS



UT-1000—Four-bit ladder network  
UD-4001—Ladder switch for driving resistor ladder networks  
UD-4024—Buffer amplifier

Check 46 Reader Service Card

## TW-3000 MICROPOWER PNP SILICON HIGH-SPEED SWITCHING TRANSISTORS



TO-18  
CASE

Fastest switching transistor available in the 1 to 100  $\mu A$  range  
 $C_{ib} = 0.7$  pF typ., 1.5 pF max.  
 $C_{ob} = 1.5$  pF typ., 2.5 pF max.

Check 47 Reader Service Card

\*Available from Sprague Electric under technology interchange with Signetics Corp.

For complete technical data on any of these products, write to:  
Technical Literature Service  
Sprague Electric Company  
35 Marshall Street  
North Adams, Mass. 01247

## SPRAGUE COMPONENTS

INTEGRATED CIRCUITS  
THIN-FILM MICROCIRCUITS  
TRANSISTORS  
CAPACITORS  
RESISTORS

PULSE TRANSFORMERS  
INTERFERENCE FILTERS  
PULSE-FORMING NETWORKS  
TOROIDAL INDUCTORS  
ELECTRIC WAVE FILTERS

CERAMIC-BASE PRINTED NETWORKS  
PACKAGED COMPONENT ASSEMBLIES  
BOBBIN and TAPE WOUND MAGNETIC CORES  
SILICON RECTIFIER GATE CONTROLS  
FUNCTIONAL DIGITAL CIRCUITS

# SPRAGUE®

THE MARK OF RELIABILITY

\*Sprague and ® are registered trademarks of the Sprague Electric Co.



# With this NEW instrument you can test practically any capacitor



*... especially electrolytics to MIL or EIA Standards*

## THIS CAPACITANCE BRIDGE

- ... has a C range of  $10^{12}$ , from 1 pF to 1.1F ... with an accuracy of  $\pm 1\%$  to 0.11F and  $\pm 2\%$  from 0.11F to 1.1F.
- ... has a D range from 0 to 10 with an accuracy of approximately  $\pm 2\%$ .
- ... is completely self-contained; just plug it into a power line and start making measurements. The 120-Hz generator, tuned detector, adjustable dc polarizing voltage and bridge circuits are all contained in a GR-patented, Flip-Tilt cabinet/carrying case.
- ... has an internal, metered dc polarizing voltage that is adjustable from 0 to 600 volts.
- ... provides for 2-, 3-, 4- or 5-terminal connections; effects of residual impedances are practically eliminated.
- ... measures leakage current down to  $0.5 \mu\text{A}$ .
- ... can be used up to 1000 Hz with an external generator.
- ... has panel safety lights to indicate when bias voltage is being applied and when the charge on the unknown capacitor exceeds one volt.
- ... has ORTHONULL® balance finder, which eliminates sliding balance when high-D capacitors are measured.
- ... has a phase-reversible 120-Hz generator to reduce the effects of stray voltage; amplitude is selectable and limited to 0.2V, 0.5V, or 2V.
- ... meets or exceeds requirements of standards including MIL-C-39003 (Solid Tantalum), MIL-C-39018 (Aluminum Oxide), MIL-C-62 B (Polarized Aluminum), MIL-C-26655 B (Solid Tantalum), MIL-C-3965 C (Tantalum Foil and Sintered Slug), (EIA) RS 154 B (Dry Aluminum), (EIA) RS 205 (Electrolytic), (EIA) RE 228 (Tantalum).
- ... Price is \$1195, Type 1617-A Capacitance Bridge.



*Models are available for portable use, rack mounting, 115- or 230-V input, 50- or 60-Hz.*

*Please write for complete information.*

BOSTON • NEW YORK • CHICAGO • PHILADELPHIA • WASHINGTON, D.C.  
SYRACUSE • DALLAS • SAN FRANCISCO • LOS ANGELES • ORLANDO  
CLEVELAND • TORONTO • MONTREAL  
BOURNE END, ENGLAND • ZURICH, SWITZERLAND

**GENERAL RADIO**  
WEST CONCORD, MASSACHUSETTS



rotating frame with the gyro.

Since the results are a first order effect, classical theory may be used to give the correct answer, to first order. In using classical theory one considers the speed of light to be different for both directions and the accepted result is obtained. However, it should be emphasized that this change in the speed of light is only an apparent change. What physically changes is the time for the light (whose speed is an invariant) to traverse a closed path on the rotating frame.

No matter which technique is used, applications in missiles and aircraft are identical, since the observer in both cases is on the rotating frame.

Possibly Heiting objects to the terminology, "Doppler effect" for the laser gyro, since there is no Doppler effect when a source and observer are on the same inertial frame. However this again illustrates the distinction between a rotating frame and an inertial frame. On a rotating frame the laser gyro effect can be considered a Doppler effect. The laser will oscillate with a corresponding change in wavelength due to the change in time interval for the light to traverse a closed path on the rotating frame.

Frederick Aronowitz  
Principal Research Scientist  
Honeywell, Inc.  
Minneapolis, Minn.

### Approval for the milliday . . .

To the Editor:

The milliday sounds great, and has fewer drawbacks than you indicate [Nov. 14, pp. 43-44]. The time-zone problem can be resolved by redividing the earth into 20 fifty-

milliday or 25 forty-milliday time zones—take your pick. At the same time let's redivide the earth into 400 degrees (decents?). This will make one decent of latitude equal very nearly to 100 kilometers, and we can do away with the now very useful but then unnecessary nautical mile, 60 to a degree of latitude.

Many people would be satisfied to reset their clocks to 000.000 at New Year instead of to 001.000. This would make New Year's Day zero—an automatic holiday since numerically it wouldn't exist.

Whatever we do let's keep the second for scientific purposes. Imagine the argument on what to call the cycle per milliday!

David B. Hoisington  
Professor, Electrical Engineering  
U.S. Naval Postgraduate School  
Monterey, Calif.

### . . . ever since 1582

To the Editor:

The "Timely program" for measuring intervals in millidays worked out by Frank Cilino and his fellow engineers at Western Electric [Nov. 14, p. 43] has been in use by astronomers since 1582.

The current Julian Period began Jan. 1, 4713 B.C., and this year's Christmas, for example, is simply Julian Day 2,439,485. By the use of such a "counting" calendar no reference need be made to months or years, and a time specified is unambiguous to every astronomer, regardless of the factors of nationality or religion which often complicate calendar systems.

C.D. Geilker  
Observatory assistant  
Warner and Swasey Observatory  
East Cleveland, Ohio.

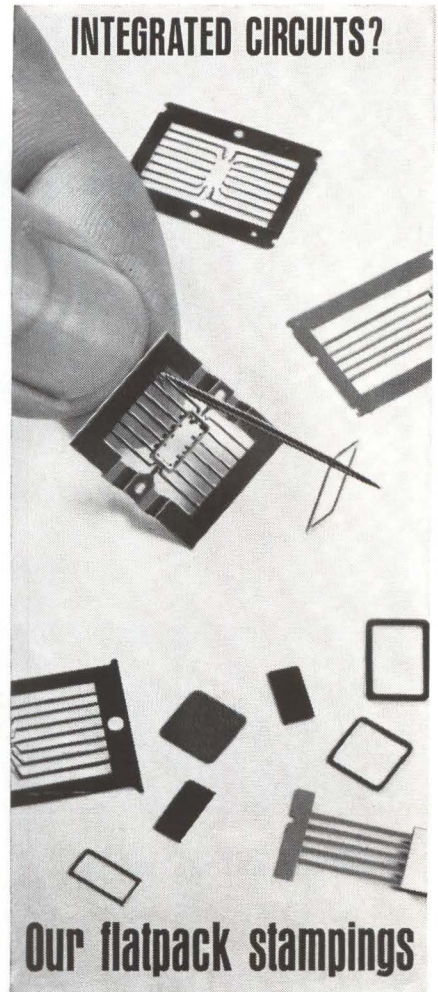

Must metal parts for integrated circuits be produced by chemical etching . . . slowly . . . expensively?

No. Volkert stamps and forms these thin, critically precise components—in high volume, and at less cost. No secondary forming is needed.

Volkert's specialized facilities meet your most exacting tolerances for lead frames, frames and bases. We are aware of your design and production requirements as to burr, flatness, finger widths and center distances. And we work with Kovar, Rodar and clad materials. Lead frames can be formed in a continuous strip for automatic assembly.

For your next big job, in flatpacks or any other microminiature electronic components, think Volkert. Where your small stampings get that critical edge. Call or write today.

**Volkert STAMPINGS, INC.**

Subsidiary of The Stanley Works

222-33 96th Avenue  
Queens Village, L.I., N.Y. 11429  
Telephone 212-464-8400

Circle 7 on reader service card 7

### SUBSCRIPTION SERVICE

Please include an Electronics Magazine address label to insure prompt service whenever you write us about your subscription.

Mail to: Fulfillment Manager  
Electronics  
P.O. Box 430  
Hightstown, N.J. 08520

To subscribe mail this form with your payment and check  new subscription  renew my present subscription

Subscription rates: in the U.S.: 1 year, \$6; two years, \$9; three years, \$12. Subscription rates for foreign countries available on request

### CHANGE OF ADDRESS

ATTACH LABEL HERE If you are moving, please let us know five weeks before changing your address. Place magazine address label here, print your new address below.

name \_\_\_\_\_

address \_\_\_\_\_

city \_\_\_\_\_ state \_\_\_\_\_ zip code \_\_\_\_\_



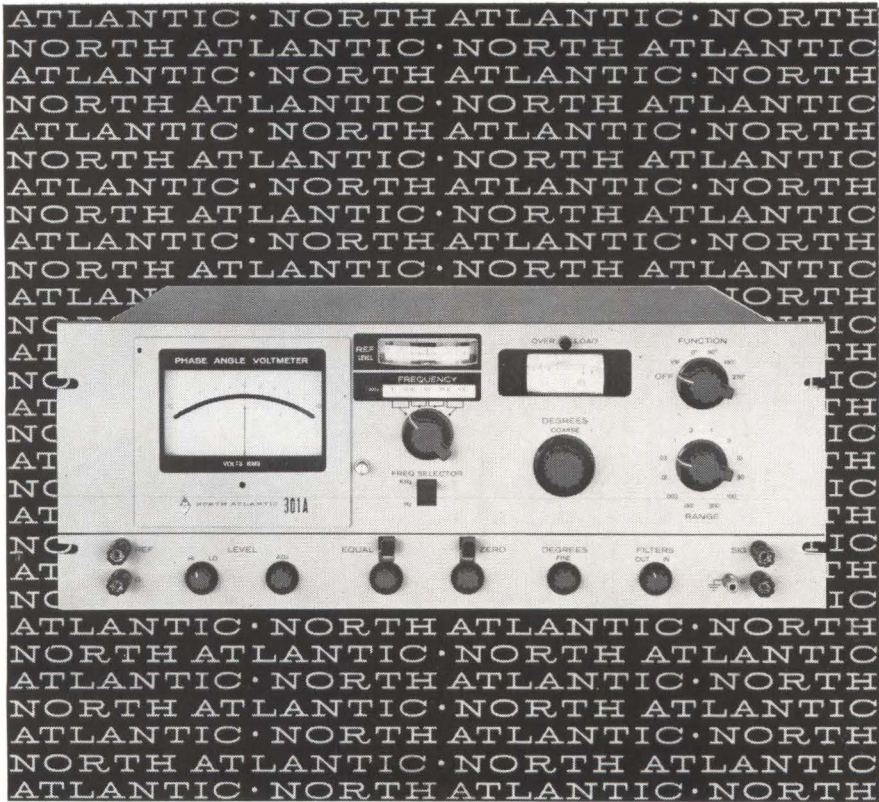

## how to measure phase angle down to .25° from 10Hz to 100KHz (plus in-phase and quadrature!)

North Atlantic's Model 301A Broadband Phase Angle Voltmeter\* adds a new dimension to AC by enabling you to measure phase angle, in-phase and quadrature while frequency is varying over half-decades...without recalibration. It provides complete coverage from 10Hz to 100KHz and incorporates plug-in filters to reduce the effects of harmonics in the range from 27Hz to 28KHz with only 11 sets of filters. Vibration analysis and servo analysis are only two of the many applications for this unit. Selected specifications are listed below:

Voltage Range.....	1 mv to 300 volts full scale
Voltage Accuracy.....	2% full scale
Phase Dial Range.....	0° to 90° with 0.1° resolution (plus 4 quadrants)
Phase Accuracy.....	0.25°, 31.6Hz to 31.6KHz (derating to .6° at 10Hz, 1° at 100KHz)
Input Impedance.....	10 megohms, 30μf for all ranges (signal and reference inputs)
Reference Level Range.....	0.15 to 130 volts
Harmonic Rejection.....	50 db
Nulling Sensitivity.....	less than 2 microvolts
Size.....	19" x 7" x 13½" deep
Price.....	\$2290.00 plus \$160.00 per set of filters

North Atlantic's sales representative in your area can tell you all about this unit as well as other Phase Angle Voltmeters\* for both production test and ground support applications. Send for our data sheet today.

\*Trademark



**NORTH ATLANTIC** industries, inc.  
TERMINAL DRIVE, PLAINVIEW, NEW YORK 11803 • 516-681-8600

## People

The Semiconductor division of the International Telephone and Telegraph Corp. is aiming to reach the third spot in industry rankings by 1971. ITT, which now ranks itself seventh, will rely heavily on automation and has already committed \$20 million to the task—\$5.3 million earmarked for integrated circuit production alone.

In addition, ITT has hired two key men who want to automate the entire production process — including the mask-making. **Jack McVickers**, 34, who worked for the General Motors Corp. in the highly automated auto industry, takes over as manager of ITT's Semiconductor plant in West Palm Beach, Fla. McVickers, who is a member of the Tau Beta Pi society, gained valuable IC experience during his six years with the Molecular Electronics division of the Westinghouse Electric Corp. **James**



**Jack McVickers**

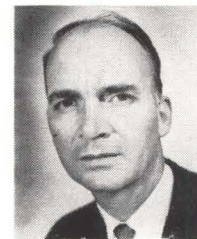

**James Nall**

**Nall**, 40, who designed a mask-making facility for the Fairchild Camera & Instrument Corp., becomes a special consultant to ITT.

Under a licensing know-how agreement, the division got its integrated circuit program off the ground by copying Fairchild's diode transistor logic (DTL) line. ITT has been producing the DTL line for the past nine months and expects to have copies of Fairchild's transistor-transistor logic (TTL) devices on the market by February.

ITT makes its own masks from drawings supplied by Fairchild. Ultimately, ITT will be making more critical TTL circuits and its own proprietary designs as well. This is where Nall, who has a master's degree in both chemistry and engineering, comes in.

Nall is designing the equipment for the intricate mask-making process and attempting to advance the



**OHMICONE®**  
**SILICONE-CERAMIC**  
**COATED** AXIAL LEAD  
RESISTORS

# two Choices from OHMITE



## 1

**MOLDED**



**SERIES 88 • MOLDED OHMICONE®**  
Coating is uniformly thick, dense and smooth. Meets 1000 VAC insulation test. Consistent form and size make these resistors highly suitable for rapid automated assembly techniques and also permit firm mounting in clips for significant heat-sink advantages. Available in commercial, military, precision, and non-inductive types. Can be provided to meet new Char. U of MIL-R-26. Solderable or weldable leads. **(Bulletin 101)**

**Wattages (Commercial):** 1.5, 2.25, 3.25, 6.5, 9, 11 watts at 25°C.  
**Resistances:** 0.1 to 226K ohms.  
**Tolerances:** To 0.05%; standard commercial, 3%.  
**Low Temperature Coefficient of Resistance:**  $0 \pm 20$  ppm/°C, 10 ohms and above.

## 2

**CONFORMAL**



**SERIES 44 • CONFORMAL OHMICONE®**  
Same basic high quality wire-wound resistor as above, but with a conformal coating (1000 VAC rating). While it does not have the uniform shape and dimensions of the molded Series 88, the Series 44 is available with the same close, standard tolerance and low TC. It is supplied in commercial and high precision types. Can also be furnished to meet MIL-R-26 requirements. **(Bulletin 109)**

**Wattages (Commercial):** 1.5, 3.25, 6.5, 11 watts at 25°C.  
**Resistances:** 0.1 to 442K ohms.  
**Tolerances:** To 0.05%; commercial, 3% for values above 1 ohm.  
**Low Temperature Coefficient of Resistance:** Standard is  $0 \pm 20$  ppm/°C for 10 ohms or more.

**OHMICONE Silicone-Ceramic**—Not just a conventional silicone coating, but rather silicone combined with a ceramic compound. Blending the two materials provides a coating which has the best characteristics of each. Developed and patented by Ohmite, *Ohmicone* envelopes a wire-wound resistor in an unusually tough, resilient jacket that has high moisture resistance and excellent dielectric properties, plus good stability and low temperature coefficients. Choose either the molded or conformal coating in accordance with your requirements.

**RHEOSTATS • POWER RESISTORS • PRECISION RESISTORS • VARIABLE TRANSFORMERS • RELAYS  
TAP SWITCHES • TANTALUM CAPACITORS • SEMICONDUCTOR CONTROLS • R.F. CHOKES**

# OHMITE

MANUFACTURING COMPANY  
3610 Howard Street • Skokie, Illinois 60076  
Phone: (312) ORchard 5-2600





# All from Sprague!

## ENERGY-STORAGE CAPACITORS for every type of discharge application

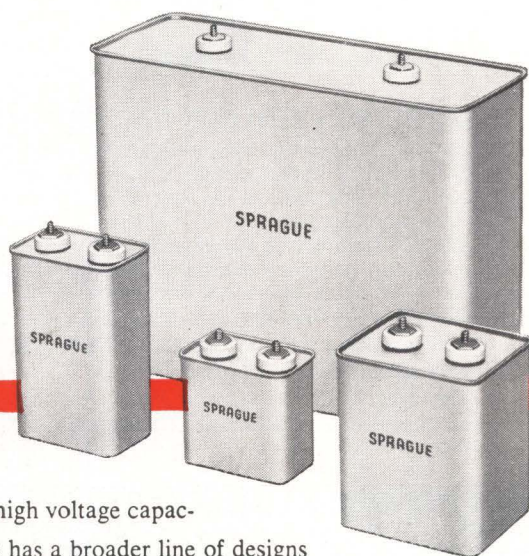

A pioneer in high voltage capacitors, Sprague has a broader line of designs for energy-storage applications than any other capacitor manufacturer. If your project involves lasers, masers, electronic photoflash, time-control circuits, exploding wire, thermonuclear fusion research, magnetization of permanent magnets, medical equipment, or similar discharge applications, Sprague can provide a capacitor to meet your specific needs.

### Light, Moderate, or Heavy Duty Capacitors

Available types range from small, light-weight units for aerospace applications such as satellites, missiles, etc., to heavy-duty capacitors for high-current/high-frequency oscillatory discharges.

### Broad Range of Electrical Ratings

Voltages from 2 kilovolts to 24 kilovolts. Energy ratings up to 6700 joules. Self-inductance as low as .0025 microhenry.

### Paper, Metallized Paper, and Paper/Film Designs

Metallized capacitors intended for light-weight, space-saving applications . . . one-half the size, one-third the weight of conventional capacitors. Other available designs include castor oil impregnation for extremely long life (assuring a high number of discharges), and non-flammable synthetic askarel impregnation for applications where non-combustibility is a prerequisite.



### Energy-Storage Electrolytic Capacitors

A selected line of cylindrical types for industrial applications requiring maximum capacitance in minimum space.

For complete information or application engineering assistance on Sprague Energy-Storage Capacitors, write to Field Engineering Department, Sprague Electric Company, 35 Marshall St., North Adams, Mass. 01248.

### SPRAGUE COMPONENTS

CAPACITORS	PACKAGED COMPONENT ASSEMBLIES
TRANSISTORS	FUNCTIONAL DIGITAL CIRCUITS
RESISTORS	MAGNETIC COMPONENTS
THIN-FILM MICROCIRCUITS	PULSE TRANSFORMERS
INTEGRATED CIRCUITS	CERAMIC-BASE PRINTED NETWORKS
INTERFERENCE FILTERS	PULSE-FORMING NETWORKS

48C-5172



'Sprague' and '®' are registered trademarks of the Sprague Electric Co.

## People

state of the art. He has the credentials; Nall founded and was the president of the Molectro Corp., known for its high-precision masks.

Nall, who spent nine years with the National Bureau of Standards doing photolithographic work, says present manufacturing processes usually are based on mechanization of laboratory methods—not the best approach to high-quantity production in Nall's view.

The next step is automation, which Nall defines as an open-loop system with no feedback. He wants to attain a new dimension in manufacturing—cybernation or advanced automation—a closed-loop system with real-time feedback to enhance yields and cut costs.

**Common carrier.** McVickers says that IRT is incorporating what he calls the common carrier system (a wafer moves through the entire process while remaining in the same holder) in the diffusion and photochemical processes. "At this time," he says, "I don't believe it would be economically justified to automate the entire wafer process." For example, he says a need to handle larger wafers could obsolete expensive equipment.

In assembly techniques, McVickers says IRT employs the most advanced die-mounting and wire-bonding machines in the industry. At present IRT produces TO-5 packages as well as ceramic dual inlines and flatpacks.

He notes that assembly techniques could be carried further but this depends on the package to be produced and its market potential. This, according to McVickers, hangs the semiconductor manufacturer squarely on the horns of a dilemma: if he commits an assembly and packaging process to advanced automation, he may not have the flexibility to make changes as new technologies, such as large-scale arrays, come in. McVickers points out that the arrival of LSI will drastically affect both packaging and the wafer assembly process.

Looking to the future, IRT is working on a new low-cost package that could be either epoxy or ceramic. Either, McVickers says, could use conventional or flip-chip technology.





## Two new ways to achieve higher power with Machlett planar triodes

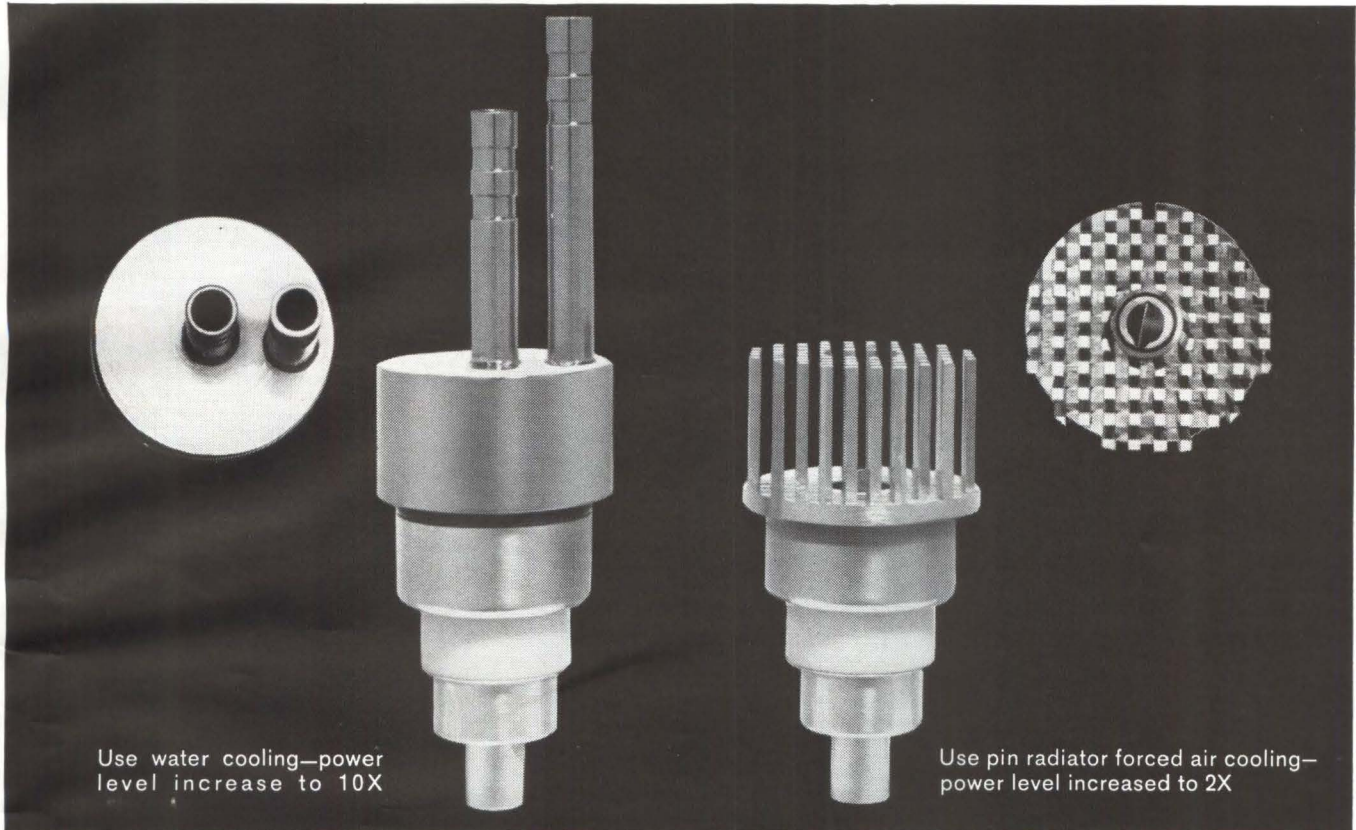

Use water cooling—power  
level increase to 10X

Use pin radiator forced air cooling—  
power level increased to 2X

Advanced cooling methods for UHF  
planar triodes now permit you to  
make full use of the high power  
range found in Machlett tubes.  
Here are two examples:



**ML-7855** with water jacket. Anode  
dissipation capability: 400 watts.  
New maximum input: 2.5kV, 300 mA.



**ML-7855** with pin radiator. Anode  
dissipation capability: 150 watts.  
An optional input: 1.75kV, 150 mA.  
For full operating details on  
Machlett tubes recommended  
for this new high-service power  
level, write to The Machlett  
Laboratories, Inc. —  
Springdale, (Stamford) Conn. 06879.

**RAYTHEON**

**THE MACHLETT LABORATORIES, INC.**

A SUBSIDIARY OF RAYTHEON COMPANY



# This NEW G-V

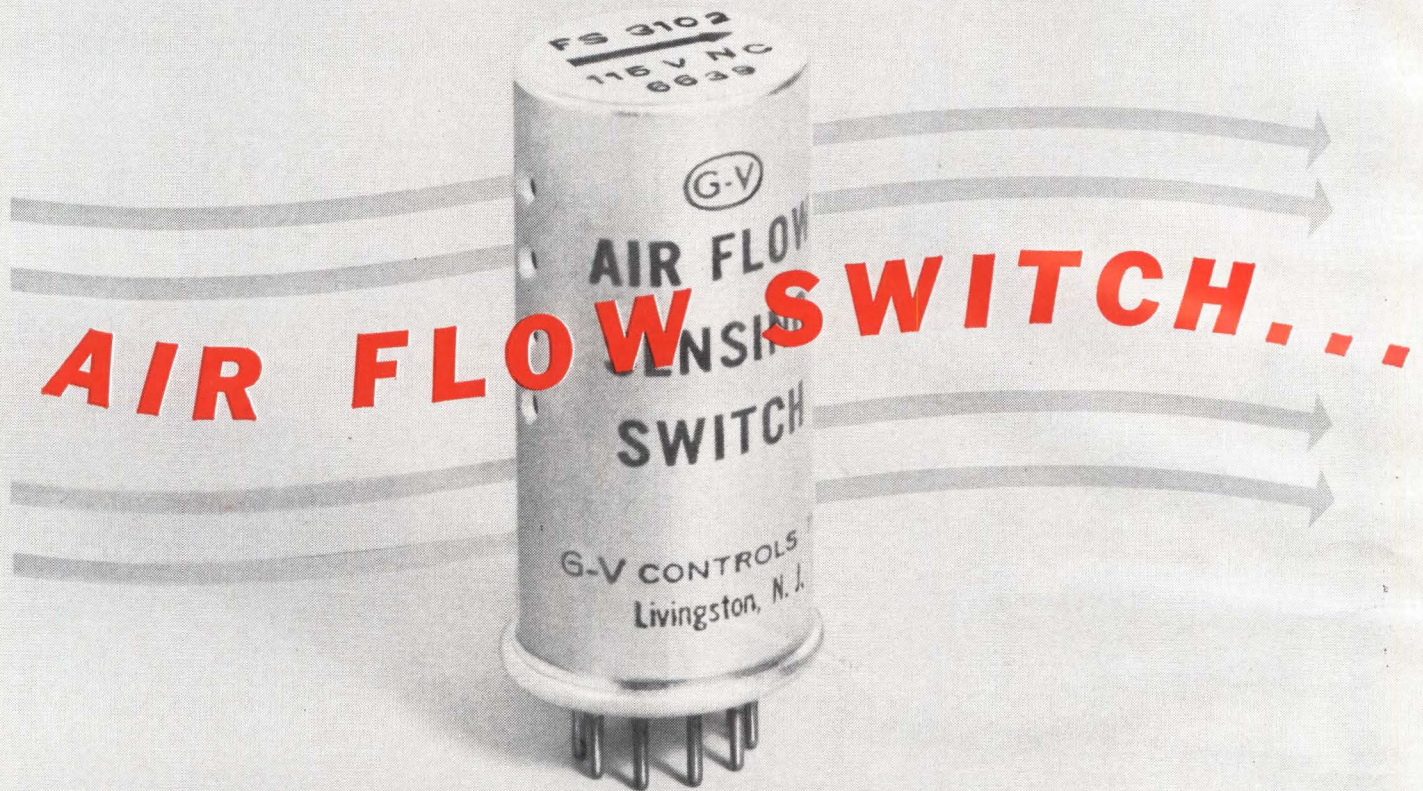

## SEALED THERMAL TIME DELAY RELAYS

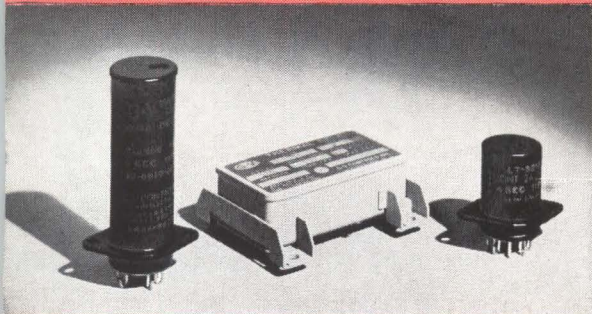

G-V is the largest source and offers the widest variety. Several types are hermetically sealed and still adjustable. All meet requirements of Mil-R-19648. Available in a wide variety including: sub-miniature, miniature, octal and missile types. **Features:** delay time, 0.1 sec. to 3 min.; heater voltages to 230 V; ambient operating temp.,  $-55^{\circ}\text{C}$  to  $+125^{\circ}\text{C}$ ; vibration to 2000 Hz; shock to 50g.

G-V

Circle 481 on reader service card

## INDUSTRIAL THERMAL TIME DELAY RELAYS



G-V industrial relays are designed and built to the quality standards of military types. They are available in miniature, octal plug-in and printed circuit board mountings. **Features:** delay time, 0.5 sec. to 3 min.; heater voltages to 230V; operation in any plane.

G-V

Circle 482 on reader service card

## INSTANT RESET THERMAL TIMING DEVICES

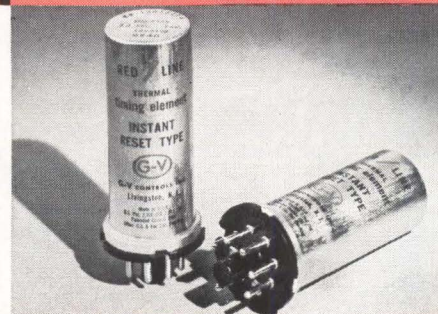

Instant reset during or after timing is available, by combining G-V's unique instant reset timing element with a magnetic relay. Widely used in communication systems and data processing equipment. **Features:** Delay time, 2 sec. to 5 min.; ambient operating temp.,  $32^{\circ}\text{F}$  to  $185^{\circ}\text{F}$ .

G-V

Circle 483 on reader service card



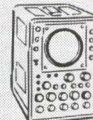
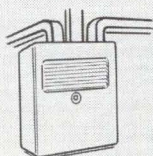

# works when airflow stops!

**UNIQUE APPROACH TO AIR FLOW SENSING OFFERS POSITIVE PROTECTION... *it's from G-V***

The G-V Air Flow Sensing Switch uses a new design concept and technique in monitoring the presence of air flow. The device utilizes a thermal principle which eliminates all moving parts, allows operation in any plane and eliminates maintenance and sensitive adjustments. It features a built-in time lag to disregard brief transient interruptions. It operates an alarm or automatic shut-down if the air flow drops below a safe level in electronic equipment, cooling packages, air conditioners, computers and wherever an air-flow cooling system is used. Military versions and mountings for industrial equipment are available.



**G-V CONTROLS INC.**

LIVINGSTON, NEW JERSEY 07039  
(201) 992-6200

Circle 487 on reader service card

## SEALED ELECTRICAL THERMOSTATS

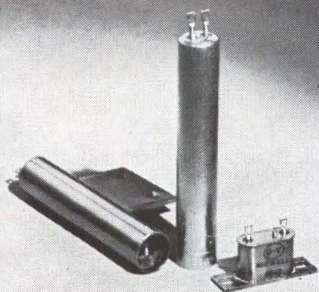

**Cartridge Type:** Series C8 hermetically sealed and still adjustable. Contact rating up to 5 amps. **Crystal Can Size:** Series VE-2 hermetically sealed. Contact rating up to 3 amps. **Features:** Rapid rate of response; minimal differential; operating range,  $-65^{\circ}$  to  $+300^{\circ}\text{F}$ ; vibration to 2000 Hz; shock to 50g.



Circle 484 on reader service card

## SOLID STATE TIME DELAY

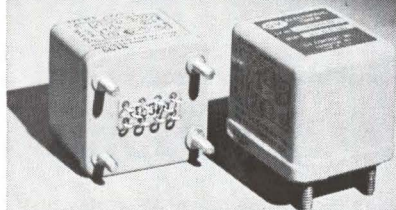

Series 900-064 has been accepted as a standard for many military and aerospace applications where high quality, reliability and cost are requirements. **Features:** hermetically sealed; fixed or adjustable time delays 0.1 to 60 sec.; solid state or relay output; vibration to 2000 Hz; shock, 50g.



Circle 485 on reader service card

## DIRECT-LINE FIELD ENGINEERING SERVICE

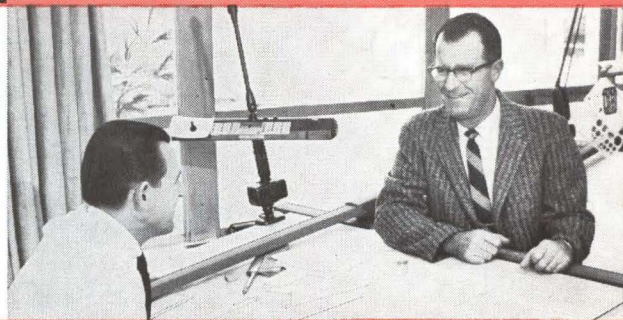

G-V assistance is always available to help you design and produce a better product. G-V Regional Field Engineers in your area will assist you and your design group in new applications and proper selection of your controls. G-V Product Engineers will help you with special applications. When you require experience, products and services in electro-mechanical and solid-state controls . . . call your man from G-V.



Circle 486 on reader service card



**"Just building a lipstick size relay that worked would have been easy."**

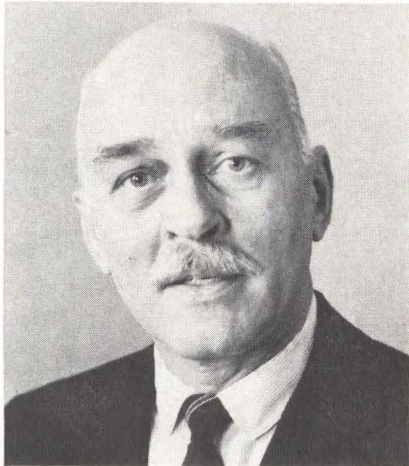

**Building one around our great high-rel idea was another story."**

Wedge-action\*, our great high-rel idea, is 9 years old. Our 2PDT lipstick-case size relay has been around for less than 2 years. But it's already a standard replacement for the competition in lots of MIL-R-5757/8 applications.



Why? Because it outperforms every spec requirement for both high and low-level loads. Like all our wedge-action relays, it combines long contact wipe with high contact force to give you continually clean precious-metal mating surfaces throughout life. Competitively priced with fast delivery.

The lipstick is just one of our family of wedge-action relays, which cover almost every dry-circuit to 2 amp application. When you need a high-rel relay that really works, test one of ours and try your darndest to prove we're wrong. You won't be able to.

\*U.S. Patent No. 2,866,046 and others pending.



**Electro-Tec Corp.**

SLIP RINGS • RELAYS • SWITCHES • OPTICS

P. O. Box 667 • Ormond Beach, Florida  
(904) 677-1771 • TWX 810-857-0305

Manufacturing Facilities:  
Ormond Beach, Fla. • Blacksburg, Va.

## Meetings

**Electrical and Electronic Measurement and Test Instrument Conference**, IEEE; Talisman Motor Inn, Ottawa, Canada, Jan. 9-11.

**Symposium on Reliability**, American Society for Quality Control, IEEE; Sheraton-Park Hotel, Washington, Jan. 10-12.

**Symposium on Computers and Communications**, IEEE; Miramar Hotel, Santa Monica, Calif., Jan. 19.

**American Society for Quality Control Meeting**, American Society for Quality Control; California State Polytechnic College, Kellogg Campus, Pomona, Calif., Jan. 21.

**Midwest Welding Conference**, Illinois Institute of Technology Research Institute; Illinois Institute of Technology, Chicago, Jan. 24-25.

**Ultrasonic Manufacturers Association Technical Symposium and Meeting**, Ultrasonic Manufacturers Association; New York, Jan. 25.

**Power Meeting**, IEEE; Statler Hilton Hotel, New York, Jan. 29-Feb. 3.

**Symposium on Nondestructive Testing of Welds**, Illinois Institute of Technology Research Institute; Illinois Institute of Technology, Chicago, Jan. 30-Feb. 2.

**American Society for Testing and Materials Meeting**, American Society for Testing and Materials; Statler Hilton Hotel, Detroit, Mich., Feb. 5-10.

**Winter Convention on Aerospace & Electronic Systems**, IEEE; International Hotel, Los Angeles, Feb. 7-9.\*

**Electronic Packaging Conference**, Society of Automated Engineers; Roosevelt Hotel, New York, Feb. 14-16.

**International Solid State Circuits Conference**, IEEE; University of Pennsylvania, Sheraton Hotel, Philadelphia, Feb. 15-17.

**Airborne Photo-Optical Instrumentation Seminar**, Society of Photo-Optical Instrumentation Engineers; Ramada Inn, Cocoa Beach, Fla., Feb. 20-21.

**National Air Meeting on Collision Avoidance**, Institute of Navigation; Dayton, Ohio, Feb. 23-24.

**Particle Accelerator Conference—Accelerator Engineering and Technology**, IEEE; Shoreham Hotel, Washington, March 1-3.

**International Symposium on Residual Gases in Electron Tubes and Sorption-/Desorption Phenomena in High Vacuum**, Italian Society of Physics; Rome, March 14-17.

**International Convention**, IEEE; New York Hilton Hotel & Coliseum, March 20-24.

**Symposium on Modern Optics**, Polytechnic Institute of Brooklyn; Waldorf-Astoria Starlight Roof, New York, March 22-24.

**Photovoltaic Specialists Conference**, IEEE; Sheraton Cape Colony Inn, Cocoa Beach, Fla., March 28-30.

**Technical Meeting and Equipment Exposition**, Institute of Environmental Sciences; Washington, April 10-12.

**International Conference on Electronics and Space**, Electronic Industries Association of France; Paris, April 10-15.

**Region III Meeting**, IEEE, Heidelberg Hotel, Jackson, Miss., April 17-19.

**American Society for Testing and Materials Symposium on Adhesion (Cold Welding) of Materials in Space Environments**, American Society for Testing and Materials; Royal York Hotel, Toronto, Canada, May 1-2.

## Call for papers

**Symposium on Electromagnetic Compatibility**, IEEE; Washington, July 18-20. Jan 1 is deadline for submission of abstracts to Frank Mitchell Jr., Technical Program chairman, Jansky and Bailey Engineering Department, Atlantic Research Corp., Alexandria, Va. 22314.

**International Symposium on Modern Optics**, Polytechnic Institute of Brooklyn; Brooklyn, N.Y., March 22-24. Jan. 15 is deadline for submission of abstracts to Symposium Committee, Polytechnic Institute of Brooklyn, 333 Jay Street, Brooklyn, N.Y. 11201.

**Intersociety Energy Conversion Engineering Conference**, IEEE; Miami Beach, Fla., Aug. 13-17. Jan. 15 is deadline for submission of abstracts to Manfred Altman, director, Institute for Direct Energy Conversion, University of Pennsylvania, Philadelphia, Pa.

\* Meeting preview on page 16



# THE Connector Thing

A periodical periodical designed, quite frankly, to further the sales of Microdot connectors and cables. Published entirely in the interest of profit.

## MICRODOT WELCOMES AMPHENOL

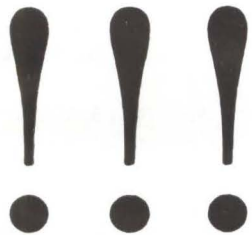

For over two years now, Microdot has had the subminiature, high density multi-pin connector market to itself. The sensational Microdot MARC 53 has been used on all the Gemini "Walks in Space" plus a multitude of military and NASA programs. Now, however, we've got competition...the brand new Amphenol Astro 348. Good to have you aboard.



### IN HONOR OF THIS GREAT EVENT, MICRODOT IS HOLDING THREE (count 'em, three)



To be able to enter these contests, you've got to know a little something about the Microdot MARC 53. It's one of the real stars in the Microdot connector line...a high density (anywhere from 7 to 91 contacts in four shell sizes), subminiature, high-performance connector. The MARC 53 can save as much as 61% in weight and 54% in panel space. *Posilock*, a push-pull lock coupling, mates easily with high density inserts with no danger of damage.

The dual locking action eliminates accidental disconnect, *Posiseal*, a multiple, environmental sealing system, *guarantees* an interfacial seal.

MARC 53 is approved to MIL C-38300A (USAF).

#### ...AND ABOUT AMPHENOL.

We wish we could also tell you all about the high density (two insert arrangements of 55 and 85 contacts in two shell sizes), subminiature, high performance, bayonet lock, bonded insulator Astro 348's but we're afraid that the Microdot officers, directors, stockholders, sales engineers and maintenance crew would hang us up by the thumbs. To find out more, write Amphenol.



#### CONTEST #1

Open only to employees of Amphenol, their families, friends, reps, distributors and advertising agencies.



#### WIN A REVELL SCALE MODEL KIT OF THE GEMINI SPACE CAPSULE

In twenty-five words or more, tell us why the Astro 348 is the best subminiature multipin on the market. Neatness does not count. TEN WINNERS...the prize is calculated to tantalize you because the Microdot MARC 53 is used on the Gemini program. So there.

#### CONTEST #2



Open only to employees, representatives and distributors of Microdot, their families, friends and advertising agencies.

WIN A REVELL SCALE MODEL KIT OF THE U.S.S. MIDWAY. In twenty-five words or more, tell us why the MARC 53 is the best subminiature multipin on the market. Neatness counts. Ten Winners.

#### CONTEST #3

Open to everybody except employees of Amphenol, Microdot, their families, friends and advertising agencies.

#### WIN A MODEL! SHE'S YOURS...

in perfect 1/8 scale, 8 x 10 glossy, perfect for your office wall, workshop or pool hall...inscribed "With Love and You Know What to

(your name here) from Marcia". All you have to do is write, in twenty five words or more a description of your application for the MARC 53. You notice how fast we forget the competition when we get down to business. Remember...everybody who enters Contest #3 wins!



## MICRODOT INC.

Microdot, Inc., 220 Pasadena Ave., So. Pasadena, Calif. 91030

- I want to enter Contest #1. My 25 words or more are attached. I am an employee of Amphenol.
- I want to enter Contest #2. Anybody who uses company postage for this one, gets docked.
- I want to enter Contest #3. My 25 words or more are attached. How does one go about getting Marcia in a slightly larger scale, say 1/1?
- I don't want to enter any contest. Just send specs on the MARC 53.

Name \_\_\_\_\_

Title \_\_\_\_\_

Company \_\_\_\_\_

Address \_\_\_\_\_

City \_\_\_\_\_

State \_\_\_\_\_ Zip \_\_\_\_\_

MARC 53, Posilock and Posiseal are trademarks of Microdot Inc. Astro 348 is not.

These contests are not valid in any locale where the local gendarmes take umbrage.



# Taylor's total reliability plan:

## Glass-Epoxy

# copper-clad

in sheets, panels or punched blanks to your specifications and reliability requirements

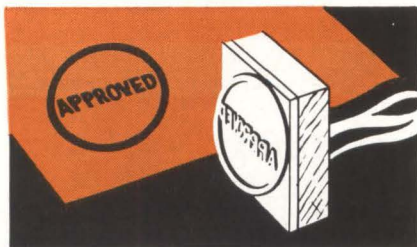

Accepted by an increasing number of major OEMs and commercial etchers who give their stamp of approval, because . . .



. . . they get highest quality level assurance from two fully-equipped copper-clad plants using white-glove techniques . . .



. . . in atmosphere-controlled white rooms, under extremely tight quality control procedures, to produce copper-clad . . .

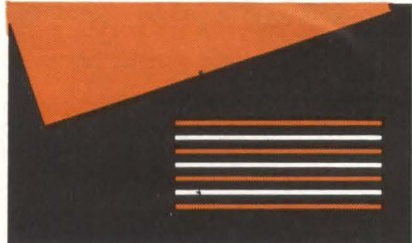

. . . to specifications and established reliability requirements in standard sheets, ultra-thin sheets and multi-layer prepregs . . .

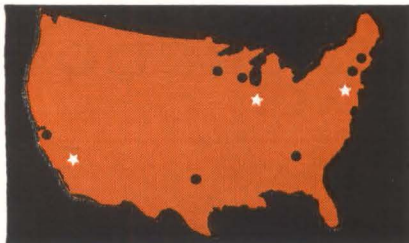

. . . then deliver when promised, or in an emergency, from plant or warehouse stocks in special packages.

Let us prove the advantages of Taylor's **TOTAL RELIABILITY PLAN** to you! Ask for a demonstration today. Write for a sample (give grade designation and copper combination) and Bulletin GB-2.



... your assurance  
of quality

## Taylor copper-clad

TAYLOR CORPORATION • Valley Forge, Pa. 19481

Phone: 215-666-0300 TWX: 215-666-0659

West Coast Plant: La Verne, Calif.

Also manufacturer of Taylor laminated plastics, Taylorite® vulcanized fibre and Tayloron® prepregs

## Meeting preview

### Broader horizons

Electrical and electronics engineers must master new subjects—metallurgy, advanced chemistry and biology—to perform today's engineering tasks and those of the future. This need to broaden horizons will be the theme of the Winter Convention on Aerospace and Electronic Systems sponsored by the Institute of Electrical and Electronics Engineers. The meeting will be held in Los Angeles, Feb. 7 to 9.

Cybernetics, bionics and the man-machine interface will be discussed at the opening session which will be devoted to the brain and its analogy to electronic systems.

Participants will include John Eccles, co-holder of the 1963 Nobel prize in physiology; Dean Wooldrige, research associate at California Institute of Technology; George M. Austin, head of the neurosurgery division at the University of Oregon and Richard Bellman, professor of mathematics at the University of Southern California School of Medicine.

**Parallels.** To demonstrate the links between electronics and biology, George E. Forsen, a research engineer in the Applied Physics Laboratories of Stanford Research Institute, will describe the artificial "eye" he is building and the data processing equipment to extract visual information. His work is based on the study of the visual patterns of a cat—an investigation which might have application in unmanned reconnaissance systems.

John L. Stewart of Santa Rita Technology, Inc., will report on his work on the sound receptor of the inner ear in developing an electronic-mechanical parallel for use in sound identification and ultimately, voice recognition in automatic systems.

Other sessions will deal with interplanetary data transmission, meteorology, computer technology, information display systems, advanced communication techniques, mass transportation and information storage and retrieval. The Air Force will sponsor classified sessions on tactical communications, reconnaissance techniques.



# It's later than you think!

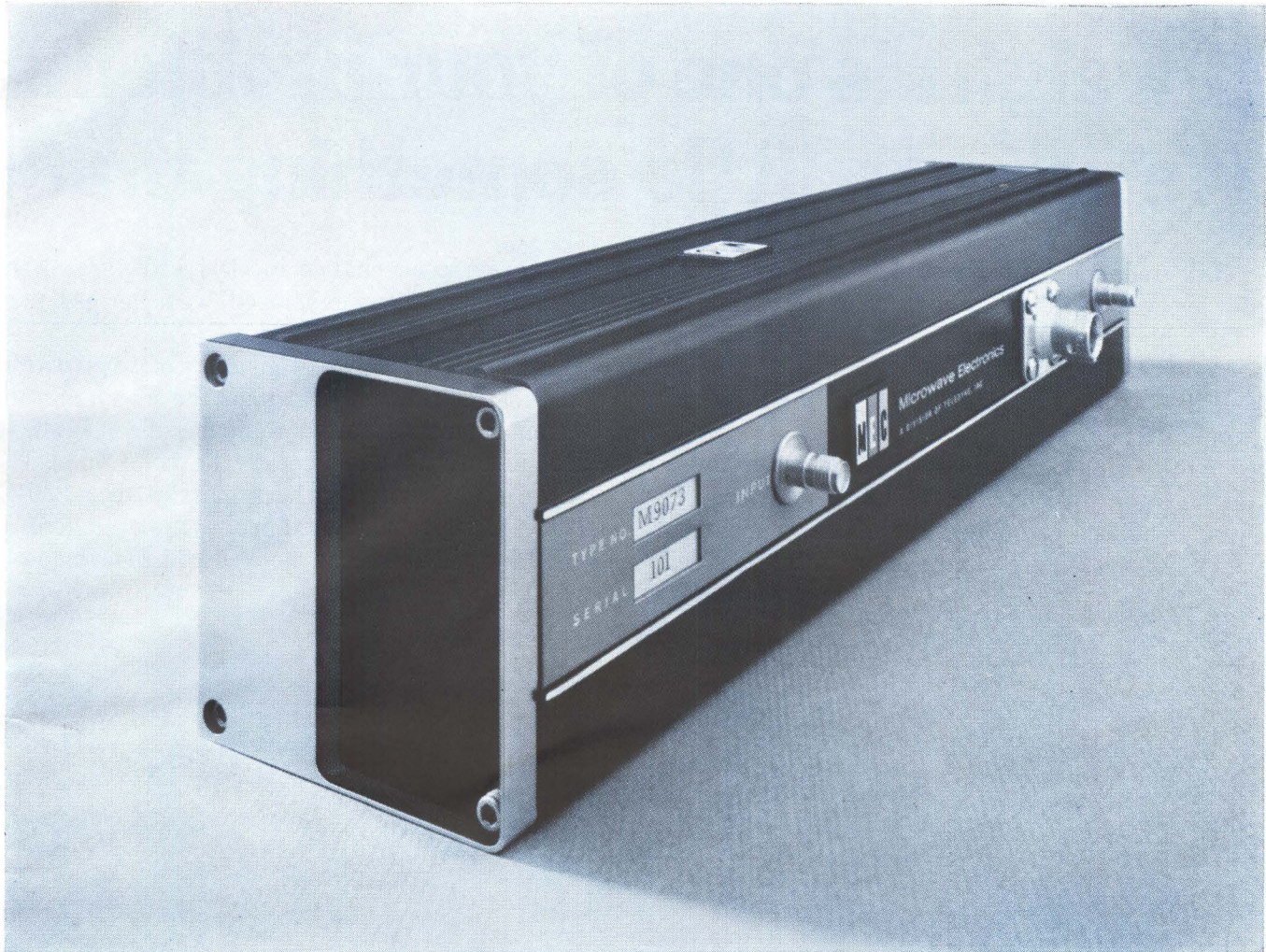

## Here's the second generation TWT amplifier.



Smaller and lighter than any other integrated TWT amplifier on the market! That's the difference—the BIG difference—between MEC's new low noise TWT amplifier and all first generation versions.

Let's be specific:

- MEC's rugged package weighs less than 4 pounds.
- It's only 11<sup>3</sup>/<sub>8</sub> inches long and is 2<sup>3</sup>/<sub>8</sub> inches square.
- It operates on *either* ac or dc.
- And, it meets MIL-E-5400 Class II requirements.

That's what makes MEC's TWT amplifier ideal for airborne and other applications where space and weight are at a premium.

The package combines MEC's proven miniature low noise TWT with an advanced power supply design. For precise, efficient, and stable performance, the all-silicon, solid-state supply features integrated circuitry and micrologic networks.



The unique primary input circuit allows you to operate from either 115 volt, 48 to 420 cycles ac, or 150 volt dc at efficiencies greater than 70%. That'll really simplify your

flight line or service area testing!

Compare the specifications of integrated TWT amplifiers—then let's hear from you.

Model	Freq. (GHz)	Gain min (db)	N.F. max (db)	P sat min (dbm)
M9071	2 - 4	35	10	10
M9072	4 - 8	35	10	10
M9073	8-12.4	35	10	10
M9080	7-11	35	10	10

Please write for complete specifications.

Exceptional opportunities exist on our technical staff for qualified scientists and engineers. MEC is an equal opportunity employer.



**Microwave Electronics** 3165 Porter Drive, Palo Alto, California

a division of Teledyne, Inc.



# If weight is one of your problems, we've got a little something that'll

Like reducing pills, Unitrode diodes aren't made for everybody. If weight, space, and reliability are no problem to you, you may very well find cheaper components that will get by.

But we didn't develop Unitrode diodes for *every* application.

We developed them for applications that *need* high power and tremendous surge capacity. That would subject components to extra punishment. That would require components lasting virtually

forever with no change in electrical parameters.

And when we say developed, we mean just that. *Developed.* From the ground up. With entirely new design. With entirely new methods of construction. The solid state bond that joins the silicon and the terminal pins is stronger than the silicon itself, so the silicon will break before the bond does. The entire unit is fused in hard glass at over 800°C. It's voidless, so all contaminants are excluded.

That's why you can hold a Unitrode diode in



# help you reduce.

liquid nitrogen, or subject it to 300°C.

That's why a Unitrode diode can handle as much energy in the avalanche as in the forward direction.

Because the pins are bonded over the full face of the silicon die, heat due to surge is carried away quickly from the silicon to the terminal pins. So even the smallest Unitrode diode can withstand a surge of 75 millijoules. The largest, which isn't much larger at that, can take 1.5 joules.

That's Unitrode reliability.

If your company's work needs diodes with these unique characteristics, why not get in touch with us? We'll be glad to send you complete information and samples.

We're at 580 Pleasant St., Watertown, Mass. 02172. Telephone (617) 926-0404.

## UNITRODE®





From the expanding line of Sigma relays...

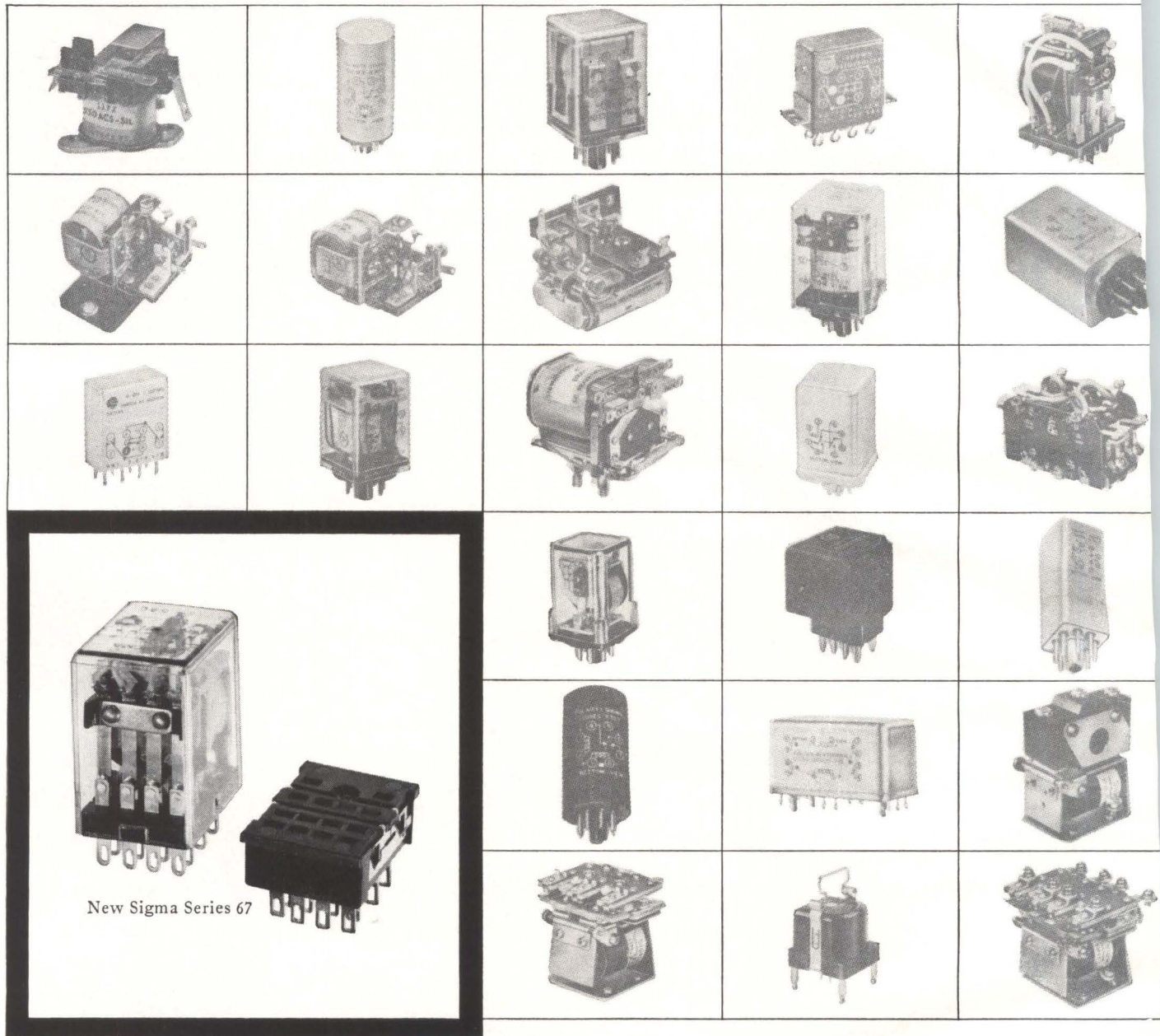

# Miniature 4PDT relay switches Try the new Series 67—or any

We'd like to give you a new Sigma Series 67—or any of our other standard relays. Test and compare it against the brand you may now be using. It's the best way we know to prove what we say about Sigma relay performance.

Test the new Series 67, for example. This rugged AC-DC relay, only slightly larger than a cubic inch, brings new reliability and versatility to precision switching. Each of its four poles can switch a low-level to 3-ampere load 100,000 times minimum.

The relay's in-line contact arrangement extends mechanical life to 100 million operations DC, and 50 million operations AC.

Completely versatile, the Series 67 is available for either direct solder-terminal installation or fast, easy, socket mounting with choice of solder or printed-circuit-terminal connections. The socket can be installed in seconds, with no need for screws or fasteners. It simply snaps into the face of the panel and four spring clips lock it.



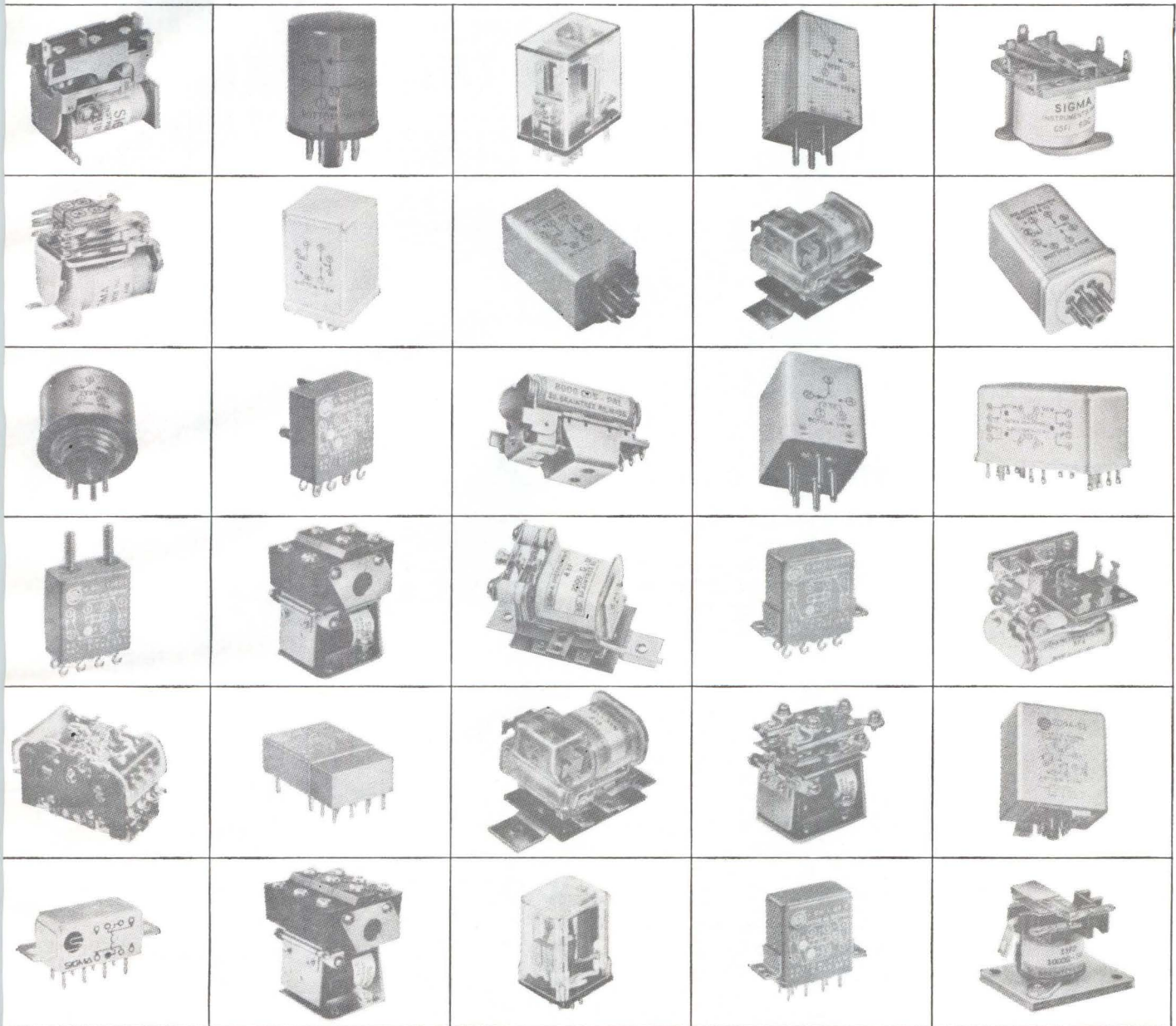

# 3 amps 100,000 times minimum. Sigma relay—absolutely free.

Put Sigma relay performance to the test yourself, free of charge. Just send for the new Preferred Standard and Stock Relay Catalog of the expanding line of Sigma relays. Then select the

relay you want to test and compare, and your Sigma representative will see that you get it. Offer limited to original equipment manufacturers having applications for relays.

SIGMA DIVISION  SIGMA INSTRUMENTS INC  
Assured Reliability With Advanced Design / Braintree, Mass. 02185

Need Sigma relays fast? Call your Sigma distributor for off-the-shelf delivery of our most popular types.



**IN DC POWER SUPPLIES**

# THE KEPCO VOLTAGE CONTROL MAKES THE DIFFERENCE!



## THE NEW KEPCO SM-A GROUP

The familiar Kepco SM Power Supply is sporting a new suffix these days, "A." The new "A" version, in the Kepco tradition, designates a product improvement, introduced without price increase. Specifically, we've redesigned the voltage control assembly of the SM Power Supplies to accommodate a precision, 10-turn potentiometer control of the type used in most other Kepco Power Supplies.

This latest improvement continues a sequence of refinements that have marked the successful six-year history of reliable SM Series Power Supplies. Last year, for example Kepco's engineers gave the SM a better reference and jacked up the loop gain to tighten its regulation from 0.1% to 0.01% line, 0.05% load. Together with a 0.05% stability spec, less than a millivolt (rms) of ripple, and the new 10-turn control, the fifteen SM models are a pretty impressive group of supplies.

The SM design employs a mechanically coupled variable autotransformer and voltage control rheostat to limit dissipation, reduce overvoltage potential and control output. The new "A" models, with an efficient, low backlash gearing assembly, couples a full 360° (10-turn) precision rheostat to the 320° variable autotransformer to improve resolution (to 0.05%).

The supplies employ Kepco's patented *Flux-O-Tran*® regulating transformer in an RFI-free (non-SCR) control circuit which includes a full feedback series transistor regulator. Plug-in circuit cards and plug-in transistors simplify maintenance (even the power transistors are "plug-in"). Front and rear output terminals are provided, with remote error sensing connections at the rear. The table on the right lists the available models.

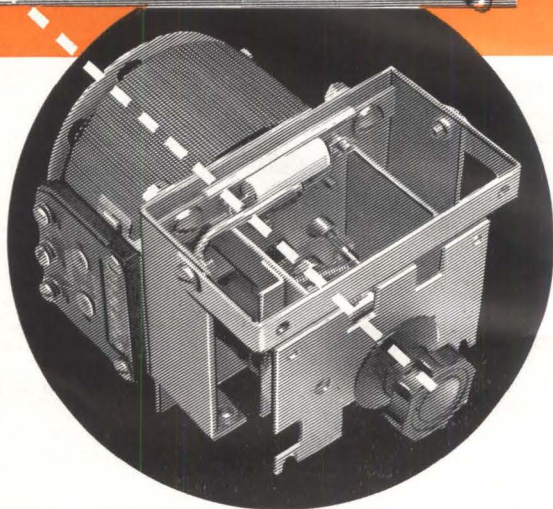

**REGULATION  
0.01% LINE — 0.05% LOAD**

MODEL	DC OUTPUT RANGE		DIMENSIONS			PRICE
	VOLTS	AMPS	H"	W"	D"	
SM 14-7AM	0-14	0-7	3½	19	13⅞	\$405.00
SM 14-15AM	0-14	0-15	5¼	19	13⅞	525.00
SM 14-30AM	0-14	0-30	8¾	19	13⅞	725.00
SM 36-5AM	0-36	0-5	3½	19	13⅞	395.00
SM 36-10AM	0-36	0-10	5¼	19	13⅞	525.00
SM 36-15AM	0-36	0-15	8¾	19	13⅞	625.00
SM 75-2AM	0-75	0-2	3½	19	13⅞	425.00
SM 75-5AM	0-75	0-5	5¼	19	13⅞	525.00
SM 75-8AM	0-75	0-8	8¾	19	13⅞	625.00
SM 160-1AM	0-160	0-1	3½	19	13⅞	425.00
SM 160-2AM	0-160	0-2	5¼	19	13⅞	525.00
SM 160-4AM	0-160	0-4	8¾	19	13⅞	625.00
SM 325-0.5AM	0-165-325	0-0.5	3½	19	13⅞	440.00
SM 325-1AM	0-325	0-1	5¼	19	13⅞	555.00
SM 325-2AM	0-325	0-2	8¾	19	13⅞	675.00



NEW 52 PAGE CATALOG  
CONTAINING COMPLETE  
SPECIFICATIONS AND  
APPLICATIONS NOTES  
IS NOW AVAILABLE  
WRITE FOR YOUR  
FREE COPY!

Applicable Patent Nos.  
furnished on request



See our complete Catalog in



KEPCO, INC. • 131-38 SANFORD AVENUE • FLUSHING, N.Y. 11352 • Phone: (212) 461-7000 • TWX #710-582-2631 • Cable: KEPCOPOWER NEWYORK



---

**Editorial**

---

## Data management is the next step

**Watching the burgeoning** electronics technology, which advances and changes direction with lightning speed—in the past two years to integrated electronics; time-shared computers; high-frequency, high power semiconductors, and laser holography—a breathless observer might well ask, “What’s next?”

Next, it is becoming increasingly clear, will be a subject that devotees are calling data management. It means assembling large volumes of data from all over the world, manipulating it automatically in a computer to distill an essence, and then displaying this end product to a military commander, government official or business executive who will then use it to make a decision.

At first breath, data management looks like little more than the next step in data processing systems. But a lot more is involved. Thousands of times as much raw data as is now encountered in data processing systems will be flowing in. The data will have to be received, processed and the end result displayed in real time. Many people will need access to the system at the same time to ask for information and receive it. And most importantly, the entire process has to be viewed, designed, installed and operated as an integrated system, not as separate pieces of hardware tied together with wires.

A prime data management system will use all of the technological developments of the past two years and a few that are still in laboratories. An essential requirement is the development of even bigger computer memories, up to billion-word capacities. And these memories have to possess very short access times and to cost even less than conventional-sized memories do today.

But probably the most significant change will take place internally in the central processor. Because it will have to manipulate so much more raw data and perform so many more kinds of operation, the computer organization and circuit design will be radically different. Conventional logic circuitry will not do because it would require far too many components, even far too many integrated circuits, to do all these operations. Instead, large scale integration—arrays of hundreds of circuits on a single silicon chip—will be used.

Since the operation of the computer has to be so complex, a lot more of the functions will be

performed by hardware—the integrated arrays—than by software. Already, in third generation computers like IBM’s system 360 and RCA’s Spectra 70, which use integrated circuits, software costs have climbed so fast that they far outweigh the costs of hardware. The way software costs have been skyrocketing, according to one computer man, if the trend doesn’t change, in a few years computer companies will be giving the machines away and selling just the software.

One of the most attractive attributes of the data management system is its scope, reaching to any part of the world. That will require some radical changes in communications equipment. Pulse code modulation is clearly the technique with the most promising future. Tremendous engineering strides have to be made to increase the capacity of pcm systems so they can handle this blizzard of data.

Peripheral equipment will be different too, allowing executives and officials who are not technically-oriented to carry on dialogues with the data management system. Three-dimensional displays, from holograms or cathode ray tv-like pictures, will be used along with conventional hard copy.

It is easy to visualize some pressing needs that the data management system will solve: automatic air traffic control, instant reservation and check-in systems for air travel, medical diagnosis, information retrieval, more efficient management of government, crime prevention and solution, traffic control and the scientific management of industry.

How far away is this data management system? Closer than most people believe. A Model-T version—though it is a wonderously sophisticated system by today’s standards—is already operating in Cheyenne Mountain as the Combat Operations Center of the North American Air Defense Command. It sifts out a change in the status of air space over an area of 10½ million square miles through which more than 100,000 aircraft fly a day and 1,000 man-made objects orbit. Any change is reported and displayed instantly to the military commander.

In New York State, a plan is being prepared for a state-wide identification and intelligence system so that all the 2,600 agencies concerned with the administration of justice can share information. The scope of the system is immense: these agencies already store 60 million forms in their active files, and every year the state has three million violators of the law to arrest and prosecute.

Information technology has already had a spectacular growth. One estimate claims there are 35,000 electronic computers at work in the United States, and the number will double by 1970. The greatest impact of information technology is still ahead. More and more people are recognizing that the essential ingredient in business and government is information.



*Tell us your precision switch problem...*  
*Is it reliability?*  
*Special characteristics?*  
*Cost-to-quality ratio?*  
*Delivery?*

Potter & Brumfield's experience in producing top rated electromechanical relays (more than a third of a century) provides an exceptional background for the design and manufacture of precision switches.

**RELIABILITY** Vibration, acceleration, shock, humidity, electrical life and many other factors are tested as standard procedure. Certification of tests is supplied on request.

**SPECIAL CHARACTERISTICS** A well staffed engineering department is at your service for almost limitless modifications, including configuration of actuators, operating force,

contact pressures, gaps, materials, terminations or performance characteristics. Any combination of these can be designed and produced to your exact specifications.

**COST-TO-QUALITY RATIO** A plant designed exclusively for switch production enables us to take advantage of all modern production techniques to provide top quality craftsmanship at competitive prices.

**DELIVERY** We can make next day shipment on most basic switches. Your local authorized P&B switch distributor has them on his shelf for immediate delivery at factory prices.

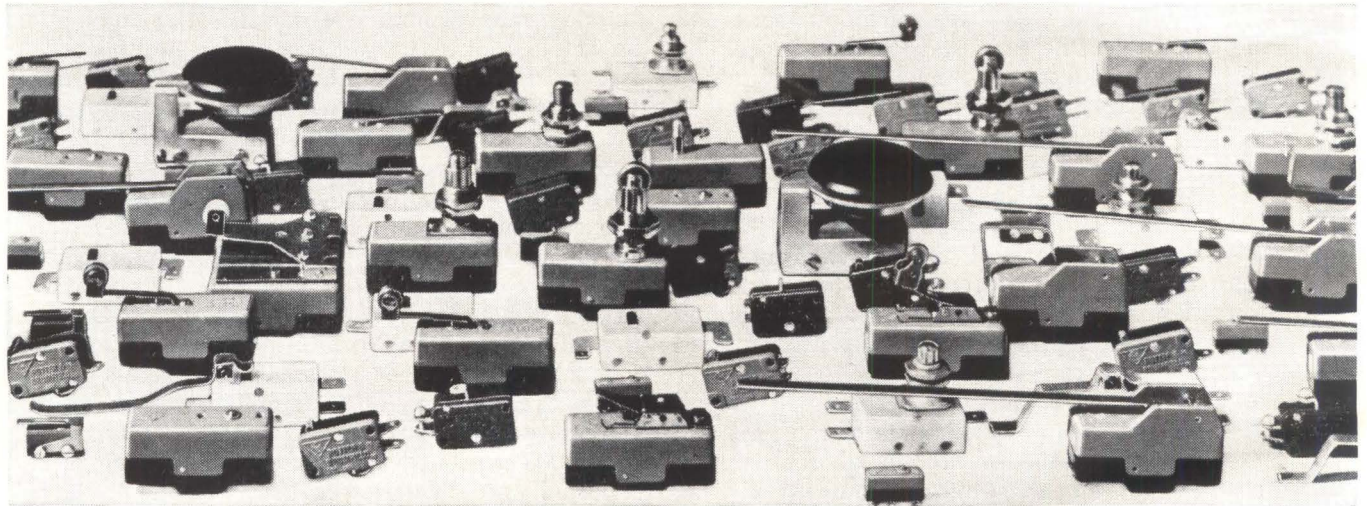

**POTTER & BRUMFIELD**

Division of American Machine & Foundry Company, Princeton, Ind. 47570  
Export: AMF International, 261 Madison Avenue, New York, N.Y. 10016

*Better check out this big new source  
for precision switches!* Write for your copy of  
P&B's Switch Catalog 1-A





# Electronics Newsletter

December 12, 1966

## Giant order for IC's?

Rumors persist that manufacturers of integrated circuits are being asked to bid on an order so large it would dwarf all existing IC contracts. Some industry observers claim that the General Electric Co. is circulating the request for bids, but spokesmen for the company deny it. The contract appears to be for a project so secret that even the IC producers won't admit its existence.

It's understood that the specifications call for circuits with a transistor-transistor logic that closely resembles the SUHL (Sylvania ultrahigh level logic). The SUHL circuit is produced by Sylvania Electric Products, Inc., a subsidiary of the General Telephone & Electronics Corp., and a competitive type is produced by Texas Instruments Incorporated. GE is said to be offering about 10 cents per logic gate for the multigate IC's. The going price for such IC's is about 25 cents per gate in large quantities and as low as 18 cents in extra-large quantities.

Although Sylvania and TI appear to have the inside track for the giant order, other producers aren't sitting on the sidelines. Motorola, Inc., and the Fairchild Camera & Instrument Corp. are understood to be applying for second-source contracts that may eventually be as large as the prime contract. Coincidentally, Sylvania is currently quadrupling its IC production facilities.

Apart from the obvious financial impact, other effects are likely if the order materializes. For example, it would undoubtedly place great economic pressure on all the IC producers to agree on common package pin positions. The byproduct of such standardization would be competition that's even keener than is currently evident.

## IBM sets sights on holography

Researchers at the International Business Machines Corp. have developed what amounts to a simple hologram camera. Although the company won't disclose details of the design for several weeks—until patent safeguards are met—the project apparently ties in with IBM's long-range plans to expand its activity in the display field. [For more on IBM's research into display products, see page 47.]

## GE eyes auto market ...

The General Electric Co. will soon enter the automobile equipment market. This week the giant producer of consumer and industrial products will show automobile producers an array of electronic items—from simple turn-indicator signals to complex laser ranging systems. GE plans to enter the lucrative auto market by developing ways to replace conventional electromechanical or mechanical equipment with solid state electronic components.

As yet GE has no finished products to sell. It plans to open an applications engineering office in Detroit and invite the Chrysler Corp. and the General Motors Corp. to consider—as one GE spokesman put it—the use of GE-conceived electronic designs as replacements for the conventional electromechanical designs. The Ford Motor Co. isn't expected to be a customer because Ford has its own electronics subsidiary.

GE's list of possible products includes: capacitive discharge ignition systems, windshield wiper controls, diagnostic equipment and warning control systems on highways. It also plans to show an electric-car control system that uses silicon controlled rectifiers.



---

# Electronics Newsletter

---

## ... and H-P debates making an entry in calculator field

Another company that may enter a new field is the Hewlett-Packard Co., which is eyeing the office-equipment market with a desk calculator using integrated circuits. The decision, according to informed sources, hinges on convincing some H-P officials that their sales organization can handle a commercial instrument.

The desk calculator, it's reported, is still on the drawing board. Engineers are working on design, production and marketing plans for presentation to Hewlett-Packard's corporate officials.

## IC's invade Scott hi-fi's

H.H. Scott, the hi-fi producer, introduced last week three f-m tuner-amplifier models containing integrated circuits. This marks the introduction of IC's in the hi-fi field.

Four identical IC's, manufactured by the Semiconductor division of the Fairchild Camera & Instrument Corp., are used in the amplifiers. Two stages act as intermediate-frequency amplifiers; the other two act as both i-f amplifiers and as limiters.

Scott says the IC models perform better than comparable models with discrete components but are priced the same—from \$440 to \$530. Scott reports that the IC tuner's capture ratio was lowered from 3 to 1.8 decibels and the stereo separation at 15 kilohertz was increased from 19 to 30 db. Interference noise (a-m rejection) was reduced to 52 db, down from 46 db. Additionally, there is some improvement in selectivity from 45 to 46 db, and in sensitivity from about 1.8 microvolts to about 1.6  $\mu$ v. The company is continuing use of field effect transistors in the front-end circuit.

## Collins will build ground terminal for Australia

The growth of the satellite communications ground terminal market is attracting an increasing number of companies. The Collins Radio Co. has won a contract, estimated at slightly more than \$3 million, to build a ground station for Australia—the company's first order for such a station. The company has designed a 90-foot diameter antenna to be built on top of a five-floor tower. Collins will build most of the electronics at its Dallas, Texas, plant.

## Chip functions in three modes

The General Instrument Corp. has delivered to a customer a complex integrated circuit that operates in three modes—as an analog-to-digital converter, as a digital-analog converter and as a multiplexer. Using metal oxide semiconductor technology, the device is built on one chip which has 470 transistors. The chip is bonded to a ceramic substrate which has 40 wire-bonded leads on 100-mil centers. It's tested before packaging. Packaged, it's 695 mils by 895 mils. General Instrument will market the device in January.

## Addendum

The International Business Machines Corp. has submitted a technical proposal on the Air Force contract for 134 electronic data processing machines. The bidding on the \$100-million order has been divided into two phases, technical and the pricing. [See earlier story on page 73.] . . . Walter Finke, a Honeywell, Inc., vice president, will take over as president of the Dictaphone Corp., a producer of dictating and recording equipment.



*now...  
new standards  
of performance and reliability  
in dielectric coolants*

# **FREON<sup>®</sup> E**

# **SERIES**

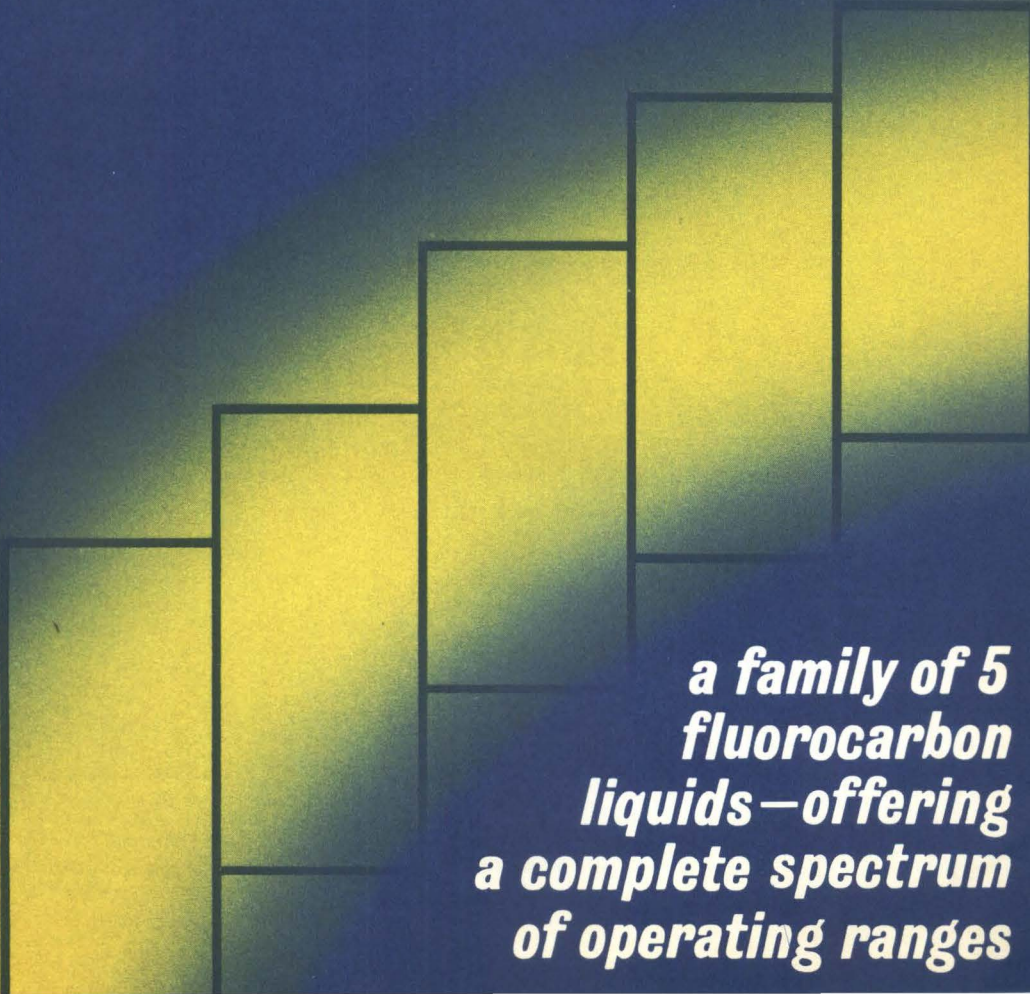

*a family of 5  
fluorocarbon  
liquids—offering  
a complete spectrum  
of operating ranges*



# **FREON<sup>®</sup> E SERIES**

## **dielectric coolants**

### **let you specify— not speculate!**

Du Pont's "FREON" E Series is a family of 5 homologous dielectric coolants setting totally new standards of performance and reliability. There's no guesswork necessary in choosing the right one for your equipment. With the

"FREON" E Series, you can choose the exact coolant that best meets your needs, and permits the customer to operate the equipment exactly as specified for the task.

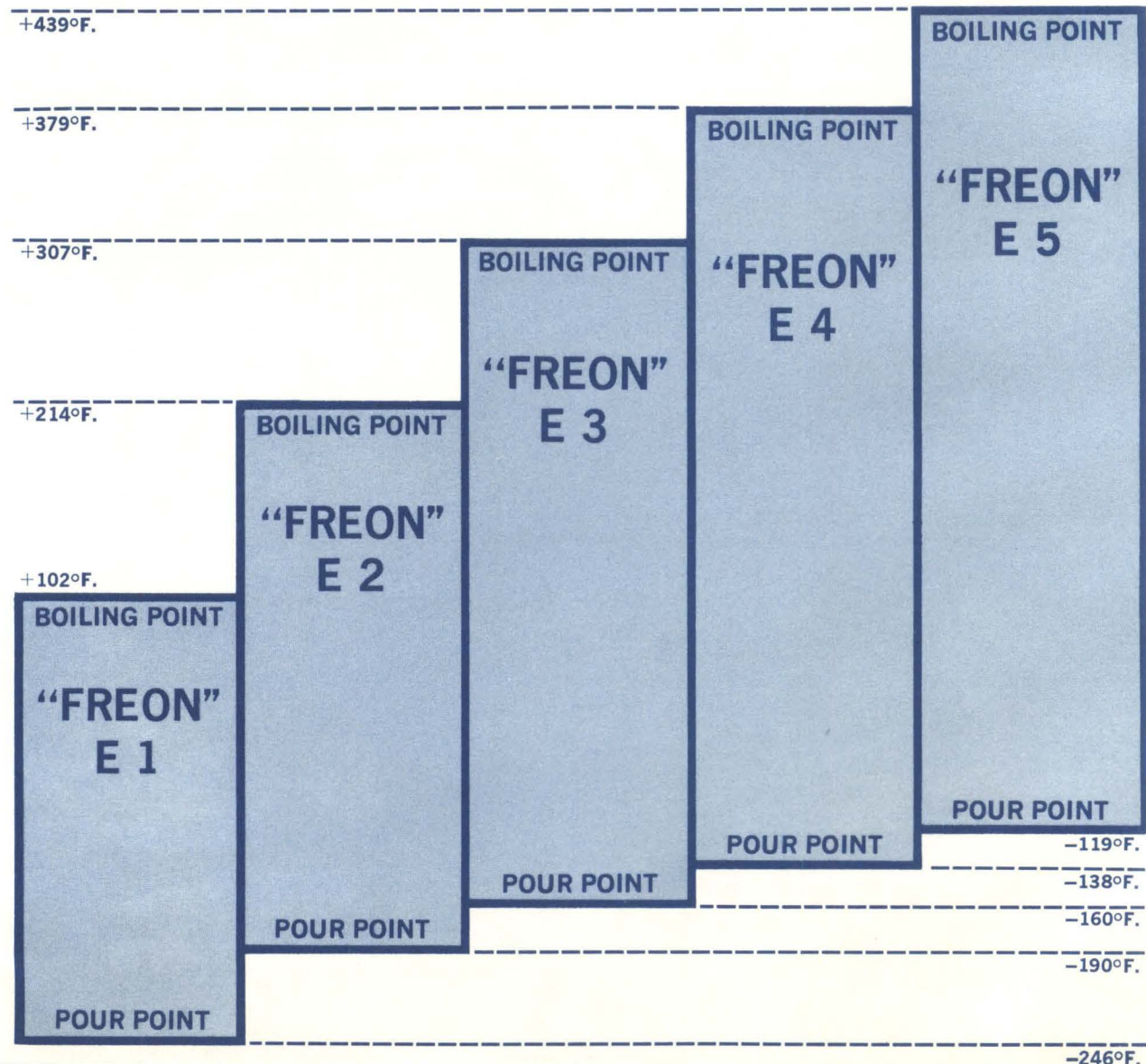



# Here's why **FREON<sup>®</sup> E SERIES** coolants will increase your equipment performance and reliability:

## 1. Stable and compatible

"FREON" E Series fluorocarbon liquids are not affected at high temperatures (over 550°F!)—are inert with metals, plastics, elastomers.

## 2. Completely safe

No special safety precautions are necessary with "FREON" E Series coolants. They are nonflammable and relatively nontoxic. Use them anywhere!

## 3. Outstanding dielectric properties

These insulating fluids provide high dielectric strength in liquid and vapor—low losses—high resistivity.

## 4. Widest temperature ranges

The "FREON" E Series offers liquid limits

from -246°F. up to +439°F. at zero psig. Each coolant has a specific, constant, and extremely wide liquid temperature range. You choose the one to meet your exact needs.

## 5. Unmatched purity and uniformity

Each coolant in the "FREON" E Series is a single, pure compound—not a mixture of several different fluids. Thus composition is always the same—lot to lot—day to day.

## 6. Precise boiling points and vapor pressures

There's no plus-or-minus factor on boiling points . . . and no "averaging." You're always sure of coolant characteristics—and operating temperatures.

If you're looking for new standards of performance in a dielectric coolant, find out more about the "FREON" E Series. Simply fill out and mail this card.

I would like to know more about "FREON" E Series coolants for use in:

\_\_\_\_\_

Name \_\_\_\_\_

Position \_\_\_\_\_

Company \_\_\_\_\_

Address \_\_\_\_\_

City \_\_\_\_\_ State \_\_\_\_\_ Zip \_\_\_\_\_



# FREON<sup>®</sup> SERIES

## fluorocarbons offer new opportunities for creative design...

The unique thermal, electrical and chemical properties of "FREON" E Series fluorocarbons provide new opportunities for electronic and space-age engineering . . . in improving reliability by outstanding temperature control . . . in miniaturizing components or systems . . . in transmitting hydraulic pressure in systems operating under conditions of extreme temperature changes . . . in optical equipment . . . or you name it. Whatever new application you can think of, just jot it down on the reply card. We'll help you investigate the new use with necessary technical assistance.

In Europe, mail card to: Du Pont de Nemours International S.A., "Freon" & "Valclene" Products Department, 81, Route de l'Aire, CH 1211 Geneva, 24 Switzerland.

### BUSINESS REPLY CARD

No postage stamp necessary if mailed in the United States

Postage will be paid by

E. I. du Pont de Nemours & Co. (Inc.)  
"Freon" Products Division  
Room 4313  
Wilmington, Delaware 19898

FIRST CLASS  
PERMIT No. 9  
Wilmington, Del.



# FREON<sup>®</sup>

fluorocarbons



REG. U. S. PAT. OFF.

BETTER THINGS FOR BETTER LIVING  
...THROUGH CHEMISTRY





## Like Popcorn.

The other day one of our engineers said, "We're turning out those Unibloc\* plastic transistors like popcorn." And, boy did we jump all over him!

Sure, it's one way of saying we're making them by the millions (by the tens of millions as a matter of fact). And, we suppose it even reflects the fact that we produce them so fast right here in Phoenix that we can compete price-wise with devices made anywhere in the world.

But, that's not the point.

The trouble with likening them to "popcorn" is that

it doesn't give you the true picture about the precision and quality that's built into each and every device we make.

As a matter of fact, we advertising guys are the ones who dubbed them "no compromise" transistors because you get the same premium performance with Unibloc devices that you've always associated with metal-can transistors.

That is the reason we were so upset.

So, on your next new design, grab a handful of popcorn and live it up.

\*Trademark of Motorola Inc.

*- where the priceless ingredient is care!*



**MOTOROLA**  
**Semiconductors**

MOTOROLA SEMICONDUCTOR PRODUCTS INC. • P. O. BOX 955 • PHOENIX, ARIZONA 85001 • (602) 273-6900 • TWX 910-951-1334

←Circle 30 on reader service card

Circle 31 on reader service card **31**



# small

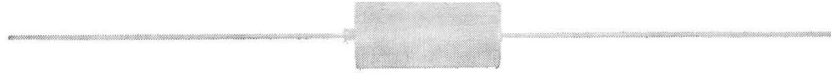

## smaller



## smallest



# G.E.'s new wet slug tantalum capacitor gives you the performance of the CL64 in only 1/2 the case size

Get the highest volt-microfarad product per unit weight and volume of any capacitor you can buy with General Electric's new 69F900 wet slug tantalum capacitor. How? General Electric reduced the case size of the military type (CL64) wet slugs by 1/2 (it's even smaller when compared to solids). Electrical characteristics and performance remain essentially the same. G.E.'s new 69F900 answers the need for a commercial wet slug capacitor with the high volumetric efficiency demanded by modern high density applications.

G.E.'s new addition to its complete line of tantalum wet slug capacitors has excellent high capacitance retention at low temperatures and can be

RATING	CASE SIZE	VOLUME
<b>50V, 30<math>\mu</math>f</b>		
solid (CS12)	.341 x .750	100%
wet slug (CL64)	.281 x .681	58%
<b>69F900</b>	<b>.145 x .600</b>	<b>15%</b>
<b>15V, 80<math>\mu</math>f</b>		
solid (CS12)	.341 x .750	100%
wet slug (CL64)	.281 x .681	58%
<b>69F900</b>	<b>.145 x .600</b>	<b>15%</b>
<b>6V, 180<math>\mu</math>f</b>		
solid (CS12)	.279 x .650	100%
wet slug (CL64)	.281 x .641	100%
<b>69F900</b>	<b>.145 x .600</b>	<b>25%</b>

stored to  $-65^{\circ}\text{C}$ . Its wide operating range is  $-55^{\circ}\text{C}$  to  $+85^{\circ}\text{C}$ . And it meets the parameters of larger military wet slugs: vibration to 2000 Hz, 15g acceleration!

The new sub-miniature 69F900 capacitor is fully insulated and has a low, stable leakage current. Voltage ratings are available from 6-60 volts; capacitance ranges from 3.3-450 microfarads.

Choose from a complete line of G-E wet slug tantalum capacitors to fill your slim, trim circuit needs. Write for GEA-8369 for details about the 69F900 and the other capacitors in General Electric's complete wet slug tantalum line, or ask your G-E sales engineer. **Capacitor Department, Irmo, South Carolina.**

ELECTRONIC COMPONENTS DIVISION

**GENERAL  ELECTRIC**

430-28A



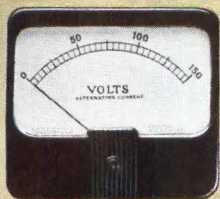

Technically speaking, men who know meters say nothing in the industry can measure up to the new Auto-Torque. It's built to take it. The

first and only band-type meter built by automated machines for reliability never before possible in conventional meters.

More reliable because Auto-Torque meters have half as

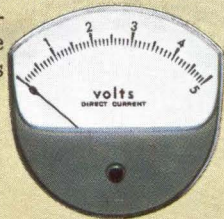

many parts. No screws. No nuts. No hairsprings. No pivots and jewels. And best of all, no "sticks". The mechanism is self-shielded, too, so it can be mounted on any panel without special calibration. Accuracy is unaffected by external fields.

Another thing. The moving system of the Auto-Torque mechanism is suspended on metal bands under tension. So there's no friction and wear.

What's more, (and this may surprise



you) new Auto-Torque meters can actually save you money! Prices to volume buyers are below those for comparable pivot and jewel meters. And there are all kinds of styles to choose from — in fact, the widest selection of band-type meters available today. And they're all a knockout. If you want more information, write to Honeywell Precision Meter Division in Manchester, New Hampshire 03105.

**Honeywell**  
**Auto-Torque Meters**

## Auto-Torque is a technical knockout.





# Why has it taken 3 years for the leader in oscillography to introduce this thermal writing instrument?

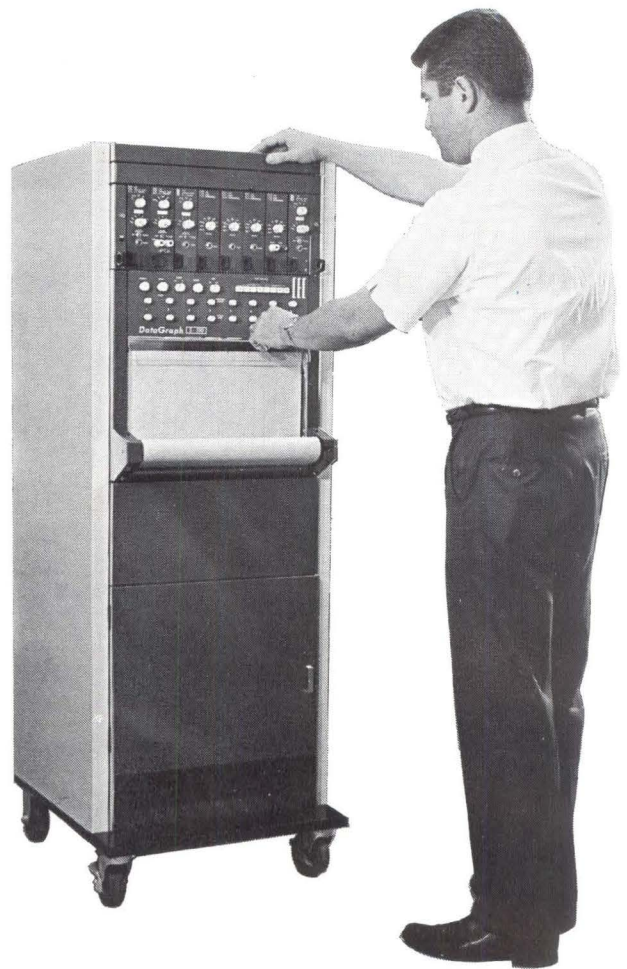

## *Because we're exacting.*

We refused to enter the field with "just another good recorder."

So we designed, tested and retested until we had perfected an instrument that was everything we wanted it to be. A thermal-writing recorder that would reflect the *highest* state-of-the-art in every important function and feature.

It's called the DG 5510. Its name may not inspire any hurrahs—but we believe its advantages will. Such as...

**Modular Design**—eight channels in a solid-state, self-contained unit with plug-in driver amplifiers and power supply capable of accepting a wide range of high-level signals.

**Unmatched frequency response**—dc to 115 Hz full scale, higher than any other thermal-writing recorder.

**Electrical Signal Limiting** to assure that the stylus motor and writing

assembly cannot be damaged by transient or other high-level signals which may occur. Each analog channel is provided with this protection built into the driver amplifiers, adjustable to 115% of full-scale deflection.

**Flexibility varying ac and dc signals**, having a wide dynamic range, can be precisely conditioned by the proper choice of the Type 1-500 series pre-amplifiers available.

**Solid-state driver amplifiers** provide compensation and damping to the stylus motors throughout the entire operating limits to assure constant instrument accuracy.

**A heated writing stylus traveling over a "knife edge"** produces exceptionally sharp contrast rectilinear traces when used with CEC DataTrace™ thermal-sensitive paper.

**Accessibility and ease of maintenance** are additional advantages of the recorder assembly. It comes with 3-position rack slides and mounts into a standard 19" rack.

**Widespread applications** include the military, aerospace and industry in general.

Now you know why we waited for the DG 5510. And why the wait was worth it.

For all the facts about this advanced new thermal-writing recorder, call or write for CEC Bulletin 5510-X22.

# CEC

Data Instruments Division

**CONSOLIDATED ELECTRODYNAMICS**  
A SUBSIDIARY OF BELL & HOWELL/PASADENA, CALIF. 91109  
INTERNATIONAL SUBSIDIARIES: WOKING, SURREY, ENGLAND  
AND FRIEDBERG (HESSEN), W. GERMANY





## Cooking up a NEW product?

*Add a dash of extra sales appeal  
(and save a little money)  
with Heinemann's good-looking  
'instant color' circuit breaker.*

For years we've been making homely circuit breakers that work beautifully.

Our new Series JA breaker has changed things a bit. It's sort of handsome. For a circuit breaker.

The pictures opposite will show you how nicely a JA with a spot of color can dress up a panel.

The functional possibilities are intriguing, too. JA breakers in color are a very practical way to indicate a specific switching sequence. Keyed to matching pilot lights, they can neatly simplify equipment operation.

It takes just one second to color the JA in any of nine different hues. Slip a cap over the breaker's mounting boss and the job's done. (The caps cost a few pennies; the white handle comes at no extra charge when you buy the rest of the breaker.)

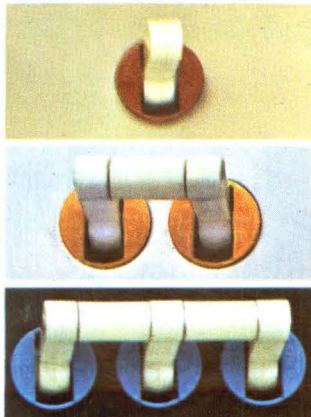

Price is another attractive feature. The JA runs about ten percent less than our Series AM12, which has long been the most popular OEM model on the market. Yet it has similar functional capabilities. It offers the same kind of precise overload response. And it can be had with all our usual options—custom current ratings, choice of time delays, special-function internal circuits.

Series JA breakers are available in one-, two-, and three-pole models, in any integral or fractional current rating from 0.100 to 20 amps. Standard maximum voltages are 250 vac, 60 or 400 cps; 50 vdc. Our Bulletin 3350 will give you full details. A copy is yours for the asking. Heinemann Electric Company, 2600 Brunswick Pike, Trenton, New Jersey 08602.



**HEINEMANN**





1.4915 V

POWER

SAMPLING RATE

VOLT

OHMS

OHMS

OVERLOAD

RATIO  
VOLTS

OHMS

FAIRCHILD

INTEGRATING DIGITAL METER MODEL 7100A

Another  
**FAIRCHILD**  
precision instrument  
made with  
silicon Planar  
solid state  
devices.



**The 7100A measures  
volts, ohms, and ratio.**

**It has 0.01% accuracy  
10 $\mu$ V resolution,  
fully guarded input,  
Dual-slope integration,  
automatic ranging  
and polarity. It's the only  
one that has everything.  
For \$2,100.**

**Our new brochure  
shows all it has.  
For free.**





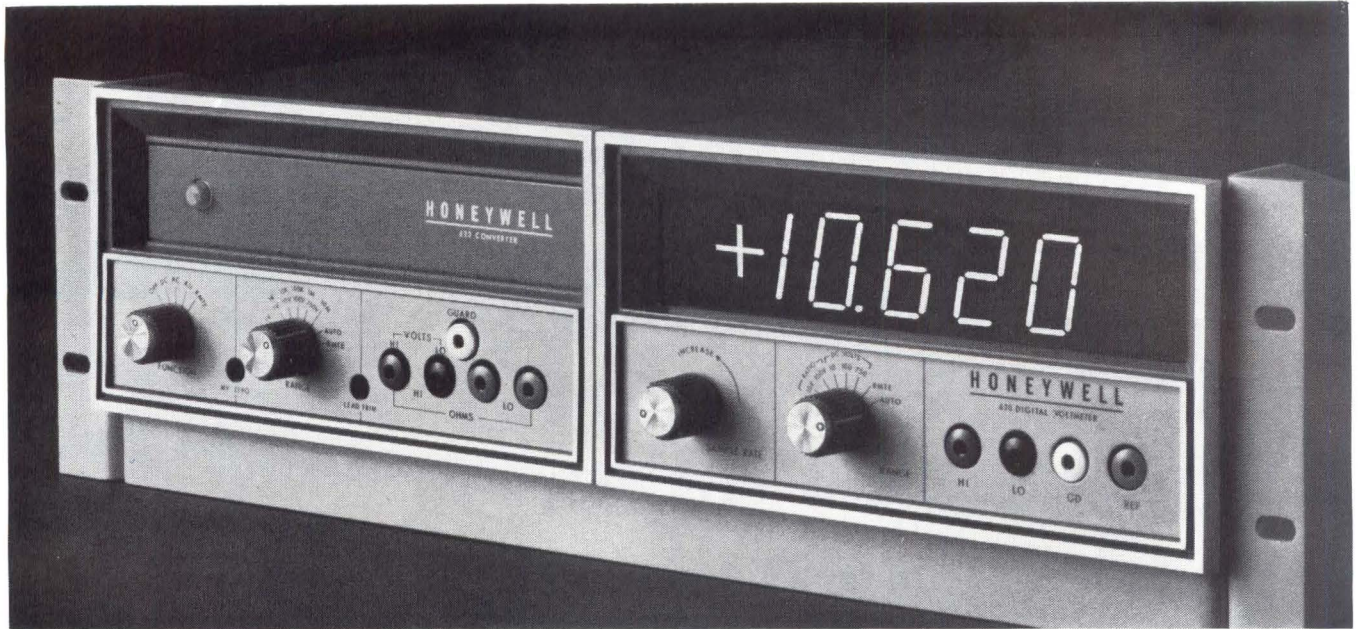

## Today's best DVM value plus AC, Resistance, and low-level DC measurements!

### Honeywell's New Autoject 620/623 package

We started with our outstanding 620 integrating DVM with Autoject — which provides greater than 60 db of normal mode rejection to noise of any frequency above 30 Hz in 250 msec!

Then we added the new companion 623 converter module with differential input to insure maintaining the 620's high CMR. Combined in a compact, fully portable cabinet for either bench use or rack mounting, the result is a highly versatile measuring instrument offering more performance per dollar than similar units.

**The 620 DVM is accurate to  $\pm .01\%$** , gives you 4 readings per second, and has 4 full digits, plus a 5th for 20% overrange. Solid-state throughout, its isolated-guarded differential input (140 db of CMR) provides foolproof operation, with ground loops, offset, or error due to noise completely eliminated. The

620's *constant* high input impedance of greater than 1000 megohms eliminates errors due to source of loading. Here are the highlights of the new 620/623 package:

- Low-level DC measurements to  $1\mu\text{v}$ .
- 3 full ranges on DC: 10, 100, and 750 volts with overrange.
- 3 full-scale ranges with DC pre-amp for 10, 100, and 1000 mv with 20% overrange. Speed: 3 rdg/sec.
- 4 full ranges on AC: 1, 10, 100, and 530 volts RMS full-scale with 20% overrange.
- 5 full-scale Resistance ranges: 1, 10, 100K, 1 megohm, and 10 megohms with 20% overrange. Speed: 3 rdg/sec.
- All full-scale values presented as 5-digit display; i.e., 1-volt range = 1.0000.

For automatic or systems use, the 620/623 provides these features:

- Automatic ranging on *all* functions, *all* ranges.
- Remote programming of all functions which include *automatic delays* to insure maximum accuracy on the first encoding.
- Electrical outputs for printer operation.

**Buy the package or add on at any time.** The 623 converter module utilizes plug-in circuit boards, one for each function desired (AC, Resistance, low-level DC). You can add measuring capability at any time, in any sequence, without field modifications. And, if you already own a 620 DVM, it's a simple matter to expand its capabilities through the addition of the 623 module!

*For full specs and price information, mail coupon today!*

*Need extra measuring capability? Add the 625 milliohm and 626 phase converters for a complete measurement system.*



Honeywell, Test Instruments Division  
Mail Station 418, Denver, Colorado 80217  
Please send 620/623 information to:

9-12B

Name \_\_\_\_\_

Company \_\_\_\_\_

Address \_\_\_\_\_

City/State/Zip \_\_\_\_\_

DATA HANDLING SYSTEMS  
**Honeywell**





Improve  
Color TV life,  
reduce costs

Multifunction G-E compactrons do the job of 2 or more ordinary tubes . . . require less wiring and simplify your circuitry. Now G.E. offers 5 new types. G.E.'s new 6AG9 is the industry's first ultra-high transconductance video output pentode to incorporate other functional elements (in this case, a triode). The 6EF4 is an improved 40-watt, high voltage regulator that protects against destructive arcing.

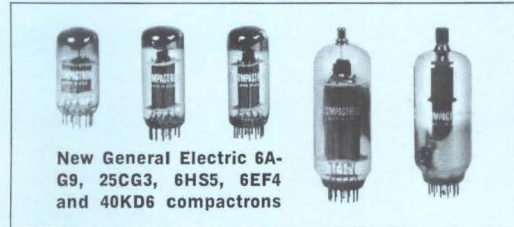

New General Electric 6A-  
G9, 25CG3, 6HS5, 6EF4  
and 40KD6 compactrons

The 6HS5 is a new type of high voltage regulator of the pulse-shunting variety. The 40KD6 and the 25CG3 are series-string versions of the 6KD6 and 6CG3 respectively, designed for 270-volt large-picture sets. Circle **Number 90** for more details.

How tiny can  
a transistor get?

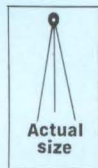

0.07 x 0.07 x 0.085 inches is all G.E.'s new microtab transistors measure. Yet each delivers precisely the same performance as its larger, conventional-sized counterpart. They're perfect for hearing aids, miniature operational amplifiers and very small instruments . . . or for your hybrid circuits, and linear and analog circuits. Equivalents to 2N930, 2N2484 and 2N918 transistors are already available for less than \$1.00 in quantities. Circle **Number 91** on the magazine inquiry card.

Designing small motors?  
Better check this  
new magnetic material.



Improved Cast Alnico 8

General Electric's new Improved Cast Alnico 8, the best material for small motor applications, is now available. Although this new material can be substituted directly for some existing designs at comparable costs, it is more economical and efficient to redesign the motor to utilize the improved properties available. Improved properties provide greater flux density, high coercive force, extreme temperature stability, and greater useful recoil energy. Circle **Number 92** for complete information.

What's new  
for peripheral  
computer equipment?

**Instant response**—inertial time constants low as 1 millisecond—is what you get with the new G-E Hyper-Servo\* motor. And it accelerates faster than any other motor ever developed by General Electric. Hyper-Servo motors greatly increase the overall capacity of peripheral data processing equipment. They're available in 3.4-, 4.6-, and 4.8-inch diameters. Performances include torque-to-inertia ratios in excess of 350,000 rad/sec<sup>2</sup> and continuous torque ratings from 32 oz-in at 2700 rpm to 326 oz-in at 2800 rpm. A wide variety of models can provide the high performance drive motor for nearly every computer peripheral application. Circle magazine inquiry card **Number 93**.



New high-response  
d-c motor

\*Trademark of the General Electric Company.

Switch to the  
lowest cost SCR



G-E C106 SCR's cost from 35 to 50¢ in volume. That's about half the price of other "low cost" SCR's. Yet you buy them at no sacrifice to performance or quality. New, planar C106's are reliable . . . give exceptional electrical uniformity and long term stability. They feature up to 200-v blocking capability, microamp triggering, and a configuration that's excellent for printed circuits, plug-in sockets, screw mounting, and point-to-point wiring. Circle **Number 94** on the magazine inquiry card.

Actual size G-E C106 SCR

**MORE**







# INNOVATION IS THE PULSE OF PROGRESS



In the early 1900's, Robert Hutchings Goddard began his first experiments with rockets in the basement of Worcester Tech. Working entirely on his own and financing his experiments from his meager salary as an instructor, Goddard laid the foundations of modern rocket research. He was the first man to launch a liquid-fuel rocket yet little was known about him until his untimely death in 1945.

In 1957 Raychem pioneered a series of innovations in the field of radiation chemistry. Among the first was heat shrinkable tubing which has since become an accepted device throughout the aerospace, communication and appliance industries. Today Raychem continues to be the world leader in the development of commercially irradiated products.

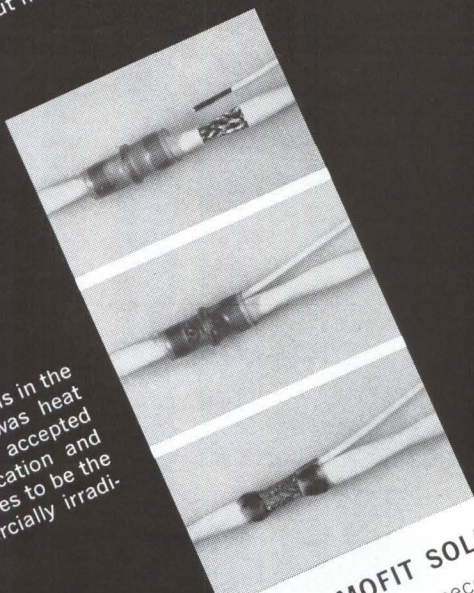

## THERMOFIT SOLDER SLEEVES<sup>1</sup>

are applied in seconds with the new, infrared heater, the Zap Gun<sup>2</sup>. The Zap Gun-Solder Sleeve system provides the lightest weight, most reliable and compact method of shield termination and wire splicing.

Thermofit Solder Sleeves are heat shrinkable sleeves containing a precise amount of solder and flux. Used in conjunction with the Zap Gun's automatically timed installation cycle, this new system assures complete reproducibility.

The Zap Gun-Solder Sleeve system solders, insulates and encapsulates in a single step.

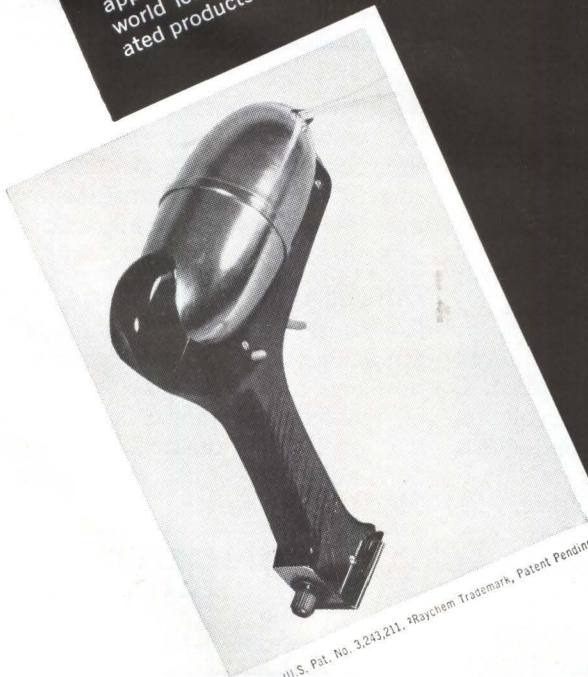

<sup>1</sup>U.S. Pat. No. 3,243,211. <sup>2</sup>Raychem Trademark, Patent Pending.

RAYCLAD TUBES INCORPORATED  
A SUBSIDIARY OF

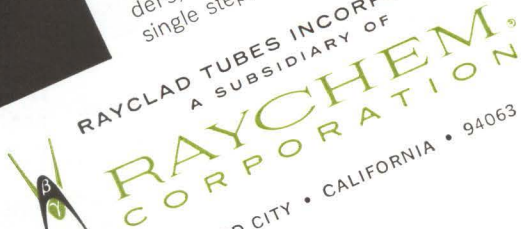

OAKSIDE AT NORTHSIDE • REDWOOD CITY • CALIFORNIA • 94063



# Now: A Fast Signal Averager

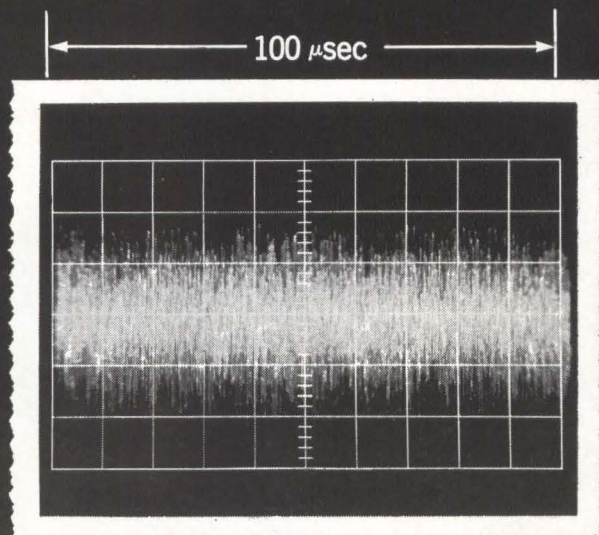

Photo #1—Input to Model TDH-9  
SENSITIVITY: 5 V/cm  
TIME: 10  $\mu$ sec/cm  
NOISE-TO-SIGNAL RATIO: 10:1

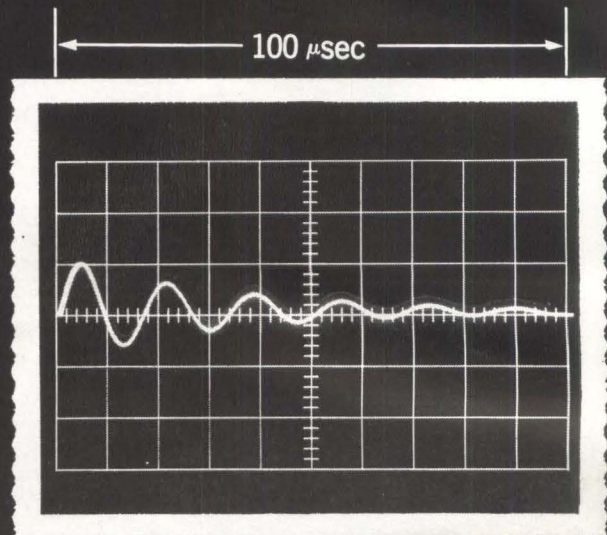
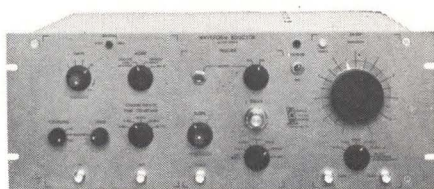

Photo #2—Output of Model TDH-9  
SENSITIVITY: 5 V/cm  
TIME: 10  $\mu$ sec/cm  
TDH-9 VOLTAGE GAIN: 10



## PAR Model TDH-9 Waveform Educator

Photo #1 is an actual oscillogram of a signal obscured by noise — a situation unfortunately prevalent in many research areas such as studies of biomedical evoked potentials, seismology, spectroscopy, fluorescent lifetime studies, and vibration analysis. Photo #2 shows the dramatic improvement in signal-to-noise ratio when the noisy signal was processed

by the PAR Model TDH-9 Waveform Educator.

This new instrument employs a highly efficient waveform-averaging technique, and at the same time offers the fastest sweep rates obtainable in signal processing equipment of the signal-averaging type. Sweep durations as short as 100 microseconds, with dwell times per channel of 1 microsecond, are obtainable. The high resolution capability of the Model TDH-9 allows observation of waveforms or transients which have heretofore been unresolvable by averaging instruments employing a greater number of channels.

Although the Model TDH-9 Waveform Educator sells for only \$4,200,

we invite functional comparison with the higher-priced digital averagers. We believe you will be pleasantly surprised. For more information about the PAR Model TDH-9, ask for Bulletin No. T-126.

### *Have a noise problem?*

PAR's technical staff, unusually knowledgeable in signal processing problems and techniques as a result of its experience in the development and application of Lock-In Amplifiers, welcomes your specific inquiries. Please call or write.





## Avionics

### Quick as a wink

The old adage notwithstanding, the eye is quicker than the hand. But when researchers have tried to apply the eye's speed advantage to some control chores performed by hand, the results generally have never moved beyond the laboratory stage. Now, Honeywell, Inc.'s Radiation Center in Watertown, Mass., has unveiled a prototype system that it says is accurate to within  $1^\circ$  of arc.

The system, called an Oculometer, looks like a telescope. The user presses his eye against the eyepiece and tracks, for example, a satellite. Each time the satellite moves, the eyeball follows. The Oculometer translates each eyeball movement into guidance commands, in the x, y and z planes.

**Eye on the target.** The work, supported by the National Aeronautics and Space Administration, is now getting attention from the Army and Navy, which are weighing adapting the Honeywell system to gun, missile and vehicle controls. And Honeywell is negotiating a contract with NASA for further development of the system for control of some extra vehicular equipment for astronauts. This system, Honeywell says, will be accurate to within  $0.25^\circ$  of arc.

The Oculometer has other advantages, apart from speed. If, for example, an astronaut were steering his spacecraft toward an orbiting satellite with conventional hand controls, he would have to translate the steering operations—in the x, y and z planes—into four separate hand movements: up, down, left and right. With the Oculometer, the natural eye movements alone perform the steering operation.

**Remote control.** The actual target needn't be in direct view; it could be an image on a television

screen. A gunner tracking an enemy craft on tv could aim his guns by following the moving target on the screen with his eyes.

To understand how the Oculometer works, consider the diagram shown below. An object (1) is spotted through the eyepiece. Simultaneously, a tiny spot of light (2), is aimed at the center of the viewer's eye. That light is reflected by the cornea—much the way a person standing eyeball to eyeball with another person is able to see his reflection in the other person's eyes—and the reflection is directed by mirrors to a scanning photomultiplier (3). The image appearing at the face of the photomultiplier is a virtual point image of the pupil. Any change in the position of the point can be translated as a movement of the eye—and a movement of the target.

The scanner views both the corneal reflection and the pupil-iris boundary of the eye. Then, the signals from the scanner are time-division multiplexed by a switch (4) into separate signals—pupil position and corneal-tracking—which are fed to the control mechanism, be it a steering wheel or a joy stick (5). Simultaneously the pupil-position signal is fed back to the light source (2) keeping the

light aimed directly at the center of the pupil. In the diagram the output signal is presented as a line image projected on a cathode-ray tube.

## Solid state

### Bridges of gold

To the growing arsenal of isolation techniques [Electronics, Oct. 17, p. 125] developed to combat parasitics in integrated circuits, add another—air-oxide isolation. The technique was devised by James A. Cunningham, a scientist at Texas Instruments Incorporated's Semiconductor Research and Development Laboratory in Dallas.

When made by the new process, the devices look like a cross between circuits produced by Bell Telephone Laboratories' beam lead techniques and Fairchild Camera & Instrument Corp.'s mesa isolation techniques.

**Building bridges.** With the  $\pi$  process, the device that's formed is a unique structure in which heavy gold interconnections form bridges between single crystal silicon islands floating on a sea of

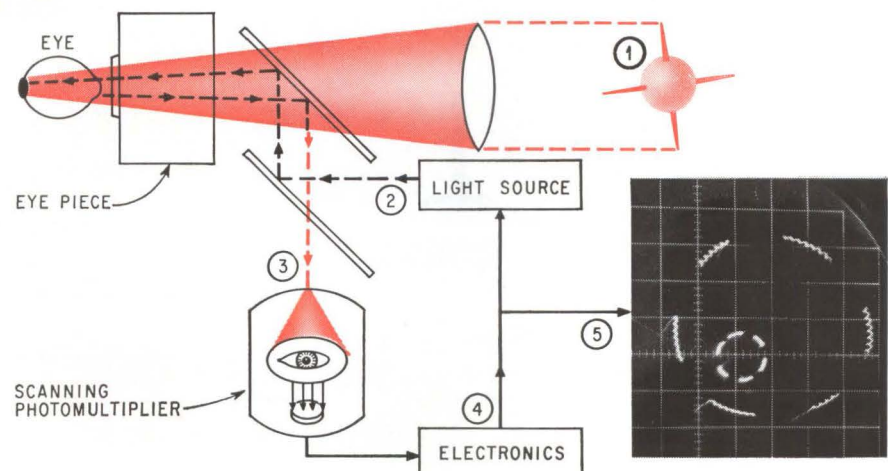

Guiding a vehicle with the Honeywell Oculometer is as easy as keeping your eyes open.



polycrystalline material

According to Cunningham, devices isolated in this fashion have been built in the laboratory and performed as well as silicon on sapphire or ceramic back-filled devices. However, TI is not presently producing IC's incorporating this or any other advanced isolation technique, so Cunningham feels it is still too early to tell which method will ultimately prevail on the basis of a performance-cost trade off.

The speed of the resultant circuit, notes Cunningham, is comparable to speeds of circuits made by other isolation techniques. In addition, the researcher says, the device dissipates heat better than those made by TI's ceramic process.

The isolation process begins with conventional wafers of n<sup>+</sup> single crystal silicon. On one side of the wafer, a moat that is 1- to 2-mils deep, is etched in a pattern that corresponds to the final scribe and break operation for the wafer. Then an oxide, 1- to 2-microns thick, is formed on both sides of the wafer.

The next step is to deposit about 8 mils of polycrystalline silicon on the etched side of the wafer by epitaxial techniques. Then the starting material is etched until the polycrystalline material is exposed in the previously etched moat. This results in an n<sup>+</sup> film of from 1- to 2-mils thick, over

which an n-type epitaxial film is deposited. Thickness and resistivity of this layer depend on the specific device requirements.

At this point the wafer is reoxidized, and the necessary device diffusions are performed conventionally, except that deep-lying isolation diffusion used in p-n junction isolation is deleted.

**Mask of gold.** When the devices are formed and the last oxide layer removed, a layer of molybdenum, followed by a layer of gold, is deposited over the surface of the wafer, forming a bimetal film. Using standard photoresist methods, the gold is etched to form the desired contact and interconnection pattern, but the underlying molybdenum is left untouched. The interconnections are thickened to about 0.2 mil by electroplating gold through a photoresist pattern. The gold interconnections then serve as a mask for the subsequent etching of the molybdenum.

In the following step air isolation is achieved by etching down to the oxide through another photoresist pattern. Unlike other isolation methods, this is done from the front of the device. When exposed to the silicon etchant, the gold is not attacked, but the etchant removes the silicon underneath it, forming a gold bridge across the moat. At the same time, the scribing land extending into the polycrystalline material is exposed.

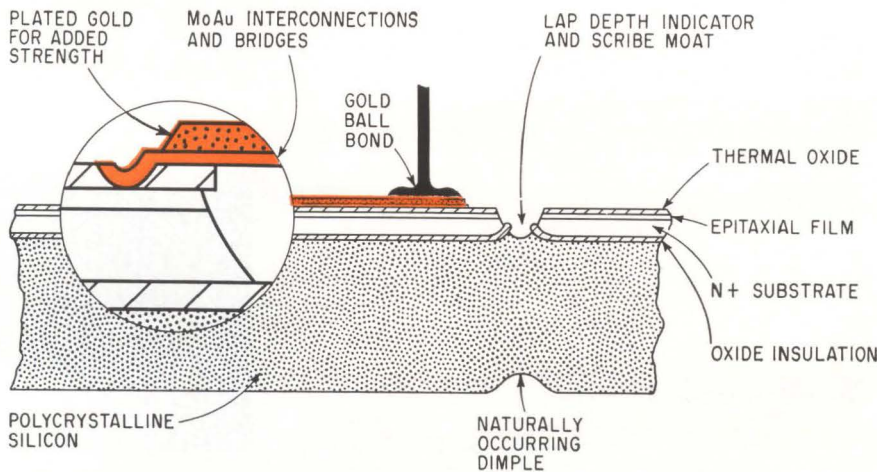

Electroplated bridges of gold interconnect are used to isolate devices in Texas Instruments' air-oxide technique.

## Space electronics

### Wanted: a multiprocessor

The greatest challenge facing the designers of space computers for the '70s is not so much to build a system that can juggle many complex problems, but to build one that could continue juggling, albeit in a limited fashion, if some of its circuits failed.

As one computer designer put it, "If it's got to fail, it has to occur gracefully."

During this "graceful" failure period, the astronauts could repair or replace burned-out parts, determine ways to reduce their reliance on the computer, or permit the computer itself to calculate ways to bypass the circuitry that failed.

Besides this, the post-Apollo space computer will have to perform navigational, scientific and other functions undreamed of five years ago.

**Start from scratch.** To assure this kind of performance, says Thomas E. Burke, assistant director of the computer research laboratory at the National Aeronautics and Space Administration's Electronics Research Center, "we can't just try to extend existing computers. We've got to take the systems approach and start from the bottom."

The Cambridge, Mass., center, focal point of NASA's long-range computer efforts, is laying the groundwork for such a system. The center is ready to move into large-scale simulation to evaluate various concepts, and plans are being made to develop experimental hardware that would be the test-bed for new memory systems and other hardware.

Some of this work, for manned flights, is already under way at North American Aviation, Inc.'s Autonetics division. And last month, the International Business Machines Corp.'s Federal Systems division won a contract to study multiprocessing techniques for unmanned flights; a team from IBM's Center for Exploratory Studies, Rockville, Md., will move to Cambridge next month for this project. Also, the Instrumentation Lab-



oratory at Massachusetts Institute of Technology is exploring for NASA the application of computer-aided design to the development of some of the next-generation hardware.

**Right the first time.** "If you want to use the technology of large-scale circuit integration, designs must be right the first time," Burke says. Further, he notes, the automated design technique would eliminate breadboarding of the system's logic.

The multiprocessor approach appears to be the dominant one in plans for spaceborne computers after the Apollo program. Alternatives include an array of independent computers for different tasks and distributed logic processors.

In the multiprocessor structure, as outlined by Ramon L. Alonso, a staff member at MIT's computer design center, each of a group of processing elements would have its own program and scratch-pad data memory. There would be no one supervisory element or processor; the combination would be truly collaborative.

A time-multiplexed bus would transfer information among the computer's units. Every unit having access to the bus would be able to receive all data appearing on it. Every unit would also be able to transmit data on the bus through a multiplexer circuit. And each multiplexer would "enable" the next in line as soon as it was through sending data. The next multiplexer could send its data or skip the enable on to the following one if it had nothing.

**Remember.** The data needed to start jobs would be stored in a common erasable memory. "This either must be infallible or else have graceful degradation properties," Alonso says. As the memory would have access to the bus, it could be interrogated by a message from a processor specifying its identity and stating that the contents of a certain memory address were desired. The memory would then place the message in a waiting stack; when its turn came, the message would trigger the start of a memory cycle, delivering both address and content to another wait-

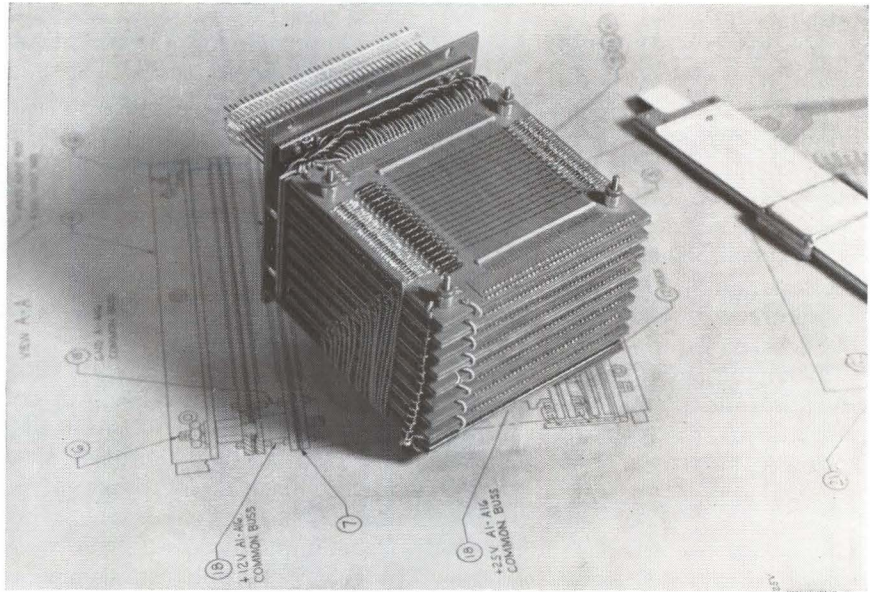

**High-speed memory stack in RCA's variable instruction computer.** The machine, developed for the military, is being proposed for use in space.

ing stack for transmission on the bus.

Based on experience with Apollo, Alonso says that within a few years a machine will have to handle a hundred programs at a time on a sampled basis, out of a total assembly of hundreds of programs in the complete multiprocessor system. Each program would periodically receive a sample update, requiring an average sample rate of about 50 per second per program. This means that 5,000 samples, or jobs, would be executed every second, an operation requiring a bit transfer rate of 14 megabits per second for common memory, input-output and messages.

Experience with the executive program structures of the Apollo guidance computer shows this to be the minimum bit rate that could serve the multiprocessor system. "But it's well within the reach of today's technology for memory and transmission systems," he says.

### Building-block approach

Not everyone is convinced that the space computer of the '70s will have to be designed from scratch. Concepts that had their origin in reliability programs are now evolving toward the multiprocessor goal. At the Radio Corp. of America and NASA's Jet Propulsion Laboratory,

for instance, computer researchers are convinced that approaches using existing designs as building blocks would effectively serve the space agency's needs.

An RCA computer that was built under military sponsorship is being proposed for the space job even though it wasn't developed specifically for such a function. This computer, developed by the concern's Aerospace Systems division in Burlington, Mass., and called vic, for variable instruction computer, will fly early next year aboard a KC-135 plane out of Wright-Patterson Air Force Base, Ohio.

**Detailed plan.** Vic is designed for airborne command posts and airborne warning and control systems. This month, RCA will submit to the Air Force Electronic Systems Division a detailed proposal for the use of vic in the 481-A program, the post-attack command-and-control system of the Strategic Air Command.

"But vic will have applications in the Manned Orbiting Laboratory and other space projects," says E.H. Miller, manager of aerospace computer applications at RCA. The military has spent about \$450,000 on the vic project.

Vic uses integrated circuits, with each functional unit as nearly independent as possible. The main



memory is expandable in 4,000 38-bit word modules to a total of 32,000 words; the variable instructions are stored in these redundant high-speed memory modules. Each module has its own independent address register, local control and power supply. Vic is an asynchronous machine and there is no central clock source, a feature critical to the operation of the separate functional units.

From the standpoint of reliability, the fundamental advantage of vic lies in its instruction repertoire. A programmer, for example, can find a great many ways to execute a particular macro-order, which may contain 12 to 15 micro-orders.

The program and variable words are combined to control the computer's step-by-step operation. The lists of the order register and variable register are decoded to generate specific data address and control operations. At least one, and sometimes four, variable words each containing three micro-orders, are required for each order.

**Detect failure.** With this flexibility, it's possible to program alternate ways to execute an order and circumvent the failure of some portion of every register and control path in the machine. A comprehensive set of diagnostics can detect failures in basic algorithms and then determine which secondary, or even tertiary, algorithms can be substituted.

Vic's 36-bit parallel arithmetic can be considered as three 12-bit sub-units. Even if two of these failed, it would still be possible to operate on the remaining sub-unit.

Another approach is being taken at the Jet Propulsion Laboratory, where an experimental computer called the STAR (self-testing and repairing) is being built.

The system organization of this machine is now being extended to include multiprocessing features according to Algirdas Avizienis, a member of the lab's staff.

**'Self-repair.'** JPL chose what it calls a selective-redundancy approach, using standby spares for replacement or "self-repair." The computer is required to survive space voyages of up to several

years and then be able to control the approach of the unmanned spacecraft to a planet. The computer in the spacecraft would be employed for onboard processing of scientific data when guidance computation isn't in progress. At the end of the voyage, the surviving spares could be reconfigured to form a multiprocessor for scientific experiments and data transmission.

A replacement or self-repair system requires diagnosis of self-test. For the STAR, concurrent diagnosis was chosen, permitting a very brief rollback of the program each time a fault is found. This would be an important time-saver in approach and reentry guidance programs, which require real-time computing.

and leave him a social outcast. And an angry chimp who has been mistreated by his jungle confreres is hardly a good subject for medical research.

Now, however, Electro-Optical Systems, Inc., Pasadena, Calif., is developing a special telemetry package for the Air Force that will do away with the backpacks and protruding wires for chimps under observation. The package—transmitter, antenna and batteries—will be implanted inside the chimp's body so researchers can monitor electrocardiogram and temperature data as the animal goes about its normal routine. Electro-Optical is a subsidiary of the Xerox Corp.

The idea is that the information obtained will make it easier to extrapolate data taken from chimps

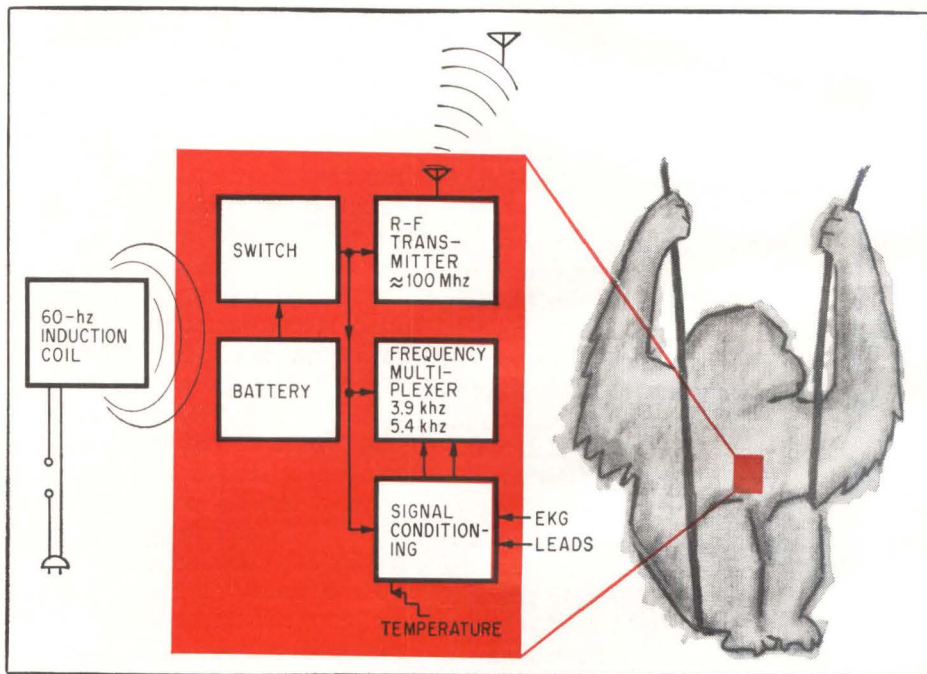

Swinging chimp can now enjoy life again. A special telemetry package, implanted within its body, does away with backpacks and protruding wires.

## Medical electronics

### The inside story

Researchers monitoring the physical reactions of chimpanzees in their natural habitat have consistently run into a problem. The electronics-crammed backpack and the electrical leads that protrude from the ape's body both irritate his skin

during space-environment tests and determine how a test would have affected an astronaut.

**Versatile.** Eventually, Electro-Optical plans to sell the device commercially for similar applications. For example, such a unit could possibly be used to monitor the operation of a pacemaker in a heart patient.

High-value resistors—up to one megohm—can be used because the



pack is inside the chimp's body where the constant temperature overcomes thermal problems. The manager of the program for Electro-Optical, Robert Russell, says this allows for a relatively high-powered output signal that can travel as far as 1,200 feet—an order of magnitude improvement over previously developed devices transmitting from inside the body.

In addition, a full-scale receiver and a directional antenna can pick up the remote signal—something portable receivers are too weak to do. Only the path the signal travels limits transmission.

**Canine check.** A model is currently operating at Electro-Optical's research laboratory, and the company will deliver within a month a prototype for implantation in a dog to check out transmission. This encapsulated pack will measure  $3\frac{3}{4}$  by 3 by  $\frac{5}{8}$  inches and weigh only two ounces. It will have a mercury cell battery putting out 500 milliamperes for continuous use for 40 days and will transmit on one channel. The prototype will also contain a subcarrier oscillator working at 3.9 and 5.4 kilohertz, a biopotential signal conditioner, a bandpass amplifier to transform the oscillator's square wave into a sine wave for transmission and the signal transmitter.

The prototype package contains discrete components, but the company intends to put thick-film hybrid circuits in the final package.

Electro-Optical has a contract to deliver four units to the Air Force, excluding the prototype, with the first to be delivered around next April. These devices will transmit two multiplexed variables—temperature and electrocardiogram data or whatever else may be desired. Russell says transmission could be expanded to as many as four or five channels.

A saturated transistor switch rather than a magnetically latching relay will enable researchers to turn the device on or off remotely. "This saves weight and we feel it is more reliable," Russell points out.

**End result.** The final units will have a second subcarrier oscillator and bandpass amplifier for the

second channel, a linear mixing amplifier for multiplexing and the circuitry for remote switching of the power.

The telemetry signals are transmitted in the f-m band at 88 to 108 megahertz.

Russell says the company first thought the package would need about 1,300 microamps. "But now," he comments, "it appears we will be able to get away with 530 microamps."

Depending on how the prototype works, the final design may be in the form of one or two packages. Russell observes that one advantage of having two packages would be that the battery could be implanted separately in an easily accessible place for simpler replacement.

## Displays

### IBM's new image

Increasingly, the International Business Machines Corp. is looking at the growing field of displays—generated by computers or by other equipment. One piece of gear that's being developed by IBM for this market is an electrostatic storage tube which is able to display bright, flicker-free, wall-size pictures. Additionally, the tube can store a picture for about a month without consuming energy or taking up computer time.

The tube was devised by Jan Engle, a researcher at IBM's Systems Development division in San Jose, Calif. With the basic work completed there, the project was moved to the division's Kingston, N.Y., facility for advanced development.

**Dual chamber.** Three basic parts make up the tube: a newly designed electron gun that boasts both high speed and high resolution, a dielectric membrane that can store a charge and an electrographic developer—a sand-like chemical with a net positive charge. The membrane divides the tube into two chambers, with the gun in one chamber and the de-

veloper in the other.

To produce a picture, the electron gun writes on the face of the dielectric membrane—much like an electron gun in a television picture tube writes on a phosphor coating. A latent image, written by the electron beam, is formed on the other side of the membrane; particles of the positively charged developer are attracted to the negative charges, which produce an image on the face of the membrane.

If the membrane is opaque, the image can be seen directly by reflected light; if it's transparent and the tube has a rear window, the image can be optically projected as a wall-size display. Both the direct-view and the rear-window tubes are currently under development.

**Flexibility.** Since the tube is sealed, it does not require vacuum equipment. And since there are no phosphors to be excited, it does not draw a high current. Further,

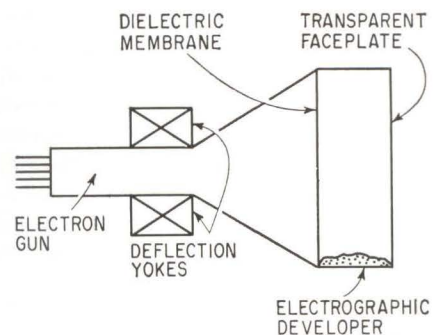

**Display tube developed by the International Business Corp. is able to store information for a month without using current or computer time.**

the optical-display system can be independently designed, permitting wide flexibility of application, ranging from high-density recording on film to the bright wall-size displays.

Tubes developed so far have a linear resolution of 2,000 television lines over a 3.4-inch diameter surface.

The principal disadvantage of the tube is the need for mechanically tipping it in order to dust the membrane with the developer. This takes less than one second,



while erase time is a second and a half.

The first order of business at the Kingston labs is to solve the tipping problem.

## Computers

### Dropping the guard

When a computer must work in an area cluttered with electromagnetic pollution, the traditional step is to protect its sensitive signals by shielding the entire machine with noise-absorbing screens. That approach is fine when the computer is being used in a factory, where space and weight are not at a premium. But in a missile or an airplane, where a few pounds and a few cubic inches count heavily, screening may be a bit of a problem. Now at the University of Illinois, a group of computer researchers has designed a series of analog computer circuits that depend on noise and therefore needn't be protected from it.

In the circuits, developed under the supervision of W.J. Poppelbaum, an electrical engineering professor, an analog quantity is represented by the average value of a sequence of randomly spaced pulses. The pulses are generated from white noise and a trigger level proportional to the analog signal.

**Shaping the noise.** The pulses are shaped and clipped so that all have the same duration and amplitude. Two or more such pulse trains applied to an ordinary diode AND gate, shown below, produce a

random pulse sequence at the output; the average value of this sequence, after again shaping and clipping, is proportional to the product of the original analog quantity.

The quotient of two analog quantities can be obtained with a feedback network, shown below. In this network a random sequence generator produces a pulse train representing a quotient. An AND gate forms the product of the quotient and the divisor; the product is then

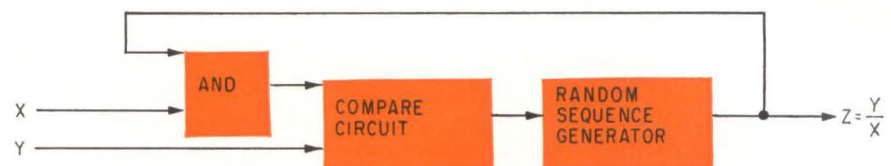

Ordinary AND gate, a comparator, and a pulse generator compute the quotient of two analog quantities.

compared with the dividend. If the two are unequal, the random sequence generator is automatically adjusted to make them equal.

The sum can be obtained just like the product, by using a diode OR gate, but a conventional adder network (a number of equal resistors with one common connection) is cheaper and works just as well. Likewise, the difference of two analog quantities is the sum of one and the logical inverse of the other; if the basic pulse train has positive-going pulses from a negative reference, the inverse would have the same voltage swing but negative-going pulses from a positive reference.

**Problem-solving.** With a sufficiently large number of units for performing the four basic arithme-

tic operations, theoretically almost any problem can be solved. The speed is limited only by the width and average frequency of the noise pulses; fractional nanosecond noise pulses can be obtained from a diode reverse-biased close to the avalanche point, providing a frequency response in the neighborhood of 500 megahertz.

The principal limitation to the circuits, as with any analog system, is in their precision. For example, a problem might be solved to a

precision of 1% by taking the average value of 1,000 noise pulses; but 10 times the precision, or 0.1%, would require an average of perhaps 100 times the number of pulses. A very complex analog computer with a limited degree of precision can be designed at a fraction of the cost of ordinary analog machines that use operational amplifiers; but the circuits cannot economically approach the precision of digital computers.

## AIAA meeting

### Closer link

The dinosaur is extinct because it couldn't respond fast enough to attacks from the rear. The communications network between brain and tail was too lossy.

The Avco Corp.'s Electronics division in Cincinnati has developed a new approach to airborne high-frequency communication in order to prevent lossy communications aboard flying behemoths. The system will go into the C-5A, a heavy logistic transport aircraft being built for the Air Force by the Lockheed Aircraft Corp.

To avoid stringing a lossy coaxial cable 260 feet from the cock-

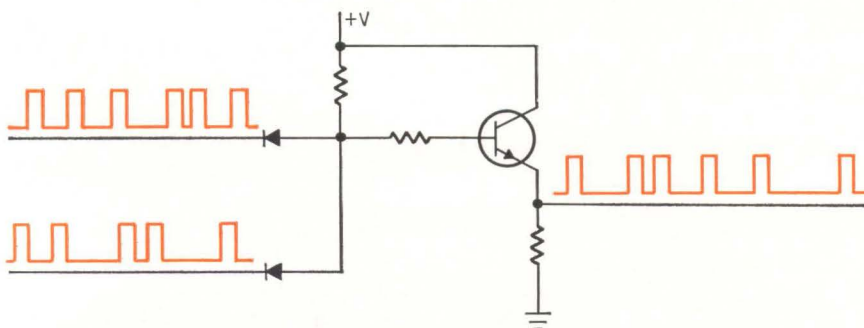

Analog multiplication, using noise, can be performed with an AND gate.





8-19

## The first JAN voltage-variable capacitor!

TRW's newest addition to the broadest line of voltage-variable capacitors...JAN 1N4801A-1N4815A Varicaps to MIL Spec 19500/329B!

Outstanding characteristics are extremely low leakage (less than 0.005  $\mu$ A at MWV) and the widest

capacitance change per volt available anywhere!

Optimum uniformity and tracking is assured by TRW proprietary alloy junction process—ideal for VCO, VCXO and delay lines. Capacitance range from 6.8 to 100 pF nominal.

Contact any TRW distributor or TRW Semiconductors Inc., 14520 Aviation Blvd., Lawndale, Calif. 90260. Phone: 679-4561. TWX 910-325-6206. *TRW Semiconductors is a subsidiary of TRW INC.*

# TRW

\*VARICAP IS THE TRADEMARK FOR SILICON VOLTAGE-VARIABLE CAPACITORS MANUFACTURED BY TRW.



pit electronics bay to the tailfin antenna, the h-f radio transceiver and antenna coupling equipment will be installed in the tail of the plane. Only wires carrying low-level control signals will traverse the distance from cockpit to tail.

The development was disclosed at the meeting of the American Institute of Aeronautics and Astronautics in Boston this month.

The new h-f system will also include binary tuning, controlled by integrated circuit logic. This will eliminate servomotors, precision gearing, sliding contacts and other mechanical techniques traditionally used to vary inductances and capacitances. The electronic tuning system is identical to one developed by Avco for the F-111 fighter-bomber now being built.

**More power.** Besides the drastic reduction in weight achieved by eliminating 260 feet of heavy coaxial cable, Avco designers say the radio-in-the-tail design will eliminate radio-frequency interference problems along the length of the fuselage and result in a higher level of radiated power.

"Putting the transmitter and re-

ceiver in the tail, with direct coupling to the antenna, effectively doubles the range of the communications system," according to applications engineer Bert Beitman.

The Avco system, called the AT-440, combines transmitter and antenna coupler in one piece of equipment called a couplifier. The plate of the power amplifier tube is matched to the antenna across a small length of coaxial cable, not more than two feet. Under present design plans for the C-5A, the shunt-type antenna will be part of the leading edge of the plane's vertical tailfin, and the radio equipment will be installed in the tail, just below the fin.

With the couplifier, says Beitman, receiver signal-to-noise performance can be improved up to 10 decibels, resulting from elimination of coaxial noise and impedance mismatch.

"You dump half of your power with the traditional cable and fittings, plus causing rfi problems," says Beitman.

**Mismatch.** There will still be a mismatch between antenna and cable, but the cable will be only

two feet, and the standing wave losses will be drastically lower.

The binary tuning system in the AT-440 is part of the AN/ARC-123 radio which Avco has designed for the F-111. The F-111 and the C-5A represent the first applications of the technique to matching and tuning in communications systems.

The complete tuning time is 300 milliseconds. Under control of the computer logic, sensors in the couplifier probe r-f levels in 10-millisecond samplings, switching inductance coils on or off at each step to refine the tuning and match impedance loads. The coils are switched by relays which operate in a vacuum to heighten reliability and provide the required voltages in a small switch area. The relays never operate while transmitter power is on, a further protection for reliability purposes. Sampling is done for 10 seconds, then the r-f energy is removed while switching is accomplished. And the procedure is repeated until optimum match is obtained.

The AT-440 control box, the only part of the system up front, contains the solid state digital syn-

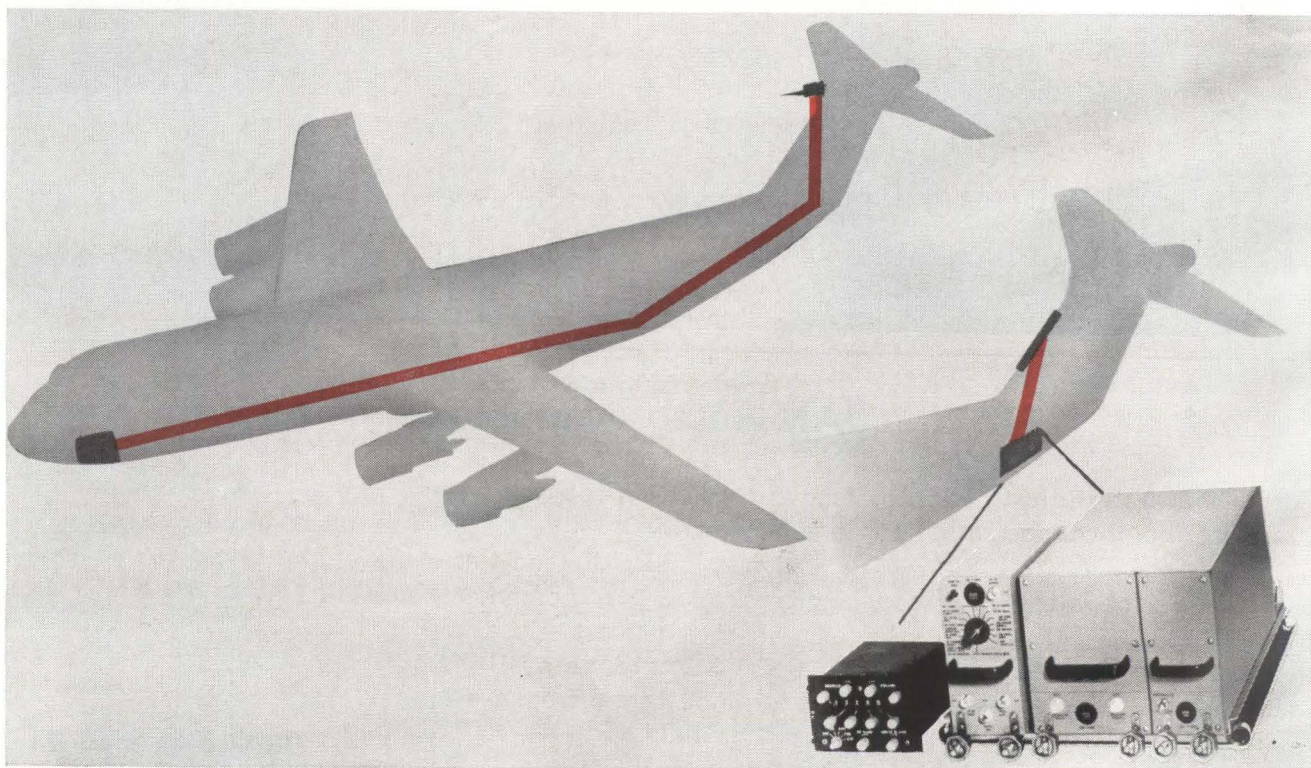

Radio-in-the-tail design shortens the transmission path between antenna and receiver. Design is for Lockheed's C-5A.





# Tektronix Type 453 portable oscilloscope

## takes the guesswork out of triggering



push all lever switches up and  
the Type 453 automatically  
gives you the most often  
used trigger logic

The Type 453 provides the following features when all lever switches are up: automatic triggering that allows discrete trigger level selection with the presence of a signal and provides a bright base line at all sweep speeds when no signal is present; + slope triggering; AC coupling that gives positive triggering regardless of vertical positioning; and internal triggering that makes full use of the vertical amplifier gain and the compact internal delay line. The Type 453 will trigger to well above 50 MHz and a green light gives a positive indication of a triggered sweep.

The Type 453 is a portable instrument with rugged environmental capabilities plus the built-in high performance normally found only in multiple plug-in instruments.

The vertical amplifier provides dual trace, DC to 50 MHz bandwidth with 7 ns risetime from 20 mV/div to 10 V/div. (DC to 40 MHz, 8.75 ns  $T_r$  at 5 mV/div.) The two included Type P6010 miniature 10X probes maintain system bandwidth and risetime performance at the probe tip—DC-50 MHz, 7 ns—with an increase in deflection factors of 10X. You can also make 5 mV/div X-Y and 1 mV/div single trace measurements.

You can operate the delayed sweep with ease. Lever control to the right and HORIZ DISPLAY switch to A INTEN DURING B gives delayed sweep operation. Setting the B TIME/DIV and the DELAY-TIME MULTIPLIER to meet your requirements and switching to DELAYED SWEEP allows  $\pm 1.5\%$  delay measurements to be made.

The Type 453 is a continuation of the Tektronix commitment to quality workmanship. Its design and layout make it easy to maintain and calibrate. Transistors plug in and are easily removed for out-of-circuit testing. An accurate time ( $\pm 0.5\%$ ) and amplitude ( $\pm 1\%$ ) calibrator permits quick field calibration.

The front panel protection cover carries all the accessories with the complete manual carried in the rain/dust cover. The Type C-30 Camera and a viewing hood that fits in the rain cover also are available.

Type 453 (complete with probes and accessories) . . .	\$2050.00
Type C-30 Camera . . . . .	\$ 350.00
Collapsible Viewing Hood . . . . .	\$ 7.50

U.S. Sales Prices, FOB Beaverton, Oregon

## Tektronix, Inc.



For complete information, contact your  
nearby Tektronix field engineer or write:  
Tektronix, Inc., P.O. Box 500, Beaverton, Oregon 97005



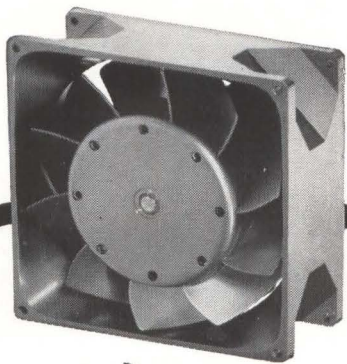

**New**  
**4 1/2"**

**SHADED-POLE**  
**Model 2500**  
**PAMOTOR**  
**Miniature**  
**Axial Fans**

- 20,000+ operational hours at 45°C
- Low-cost design
- All metal construction
- Unexcelled performance and reliability
- Universal 4 1/8" mounting for interchangeability
- 50-60 cycles at 110 or 220 vac

**IN STOCK FOR**  
**IMMEDIATE DELIVERY!**

Write for technical data on the Model 2500 and other PAMOTOR axial fans to:

**PAMOTOR, INC.**  
312 SEVENTH STREET • SAN FRANCISCO, CALIF.

## Electronics Review

thesizer. Operating frequencies may be selected in 100 hertz increments from 2 to 29,999 megahertz. Other controls include those for audio volume, r-f gain, noise blanking, squelch disable and level, and system on-off. For high reliability design, the control box uses 85% integrated circuits.

### Tuned to space

Ground-based radio telescopes, no matter how sensitive, can't detect celestial radio sources between 1 and 10 megahertz because the earth's atmosphere blocks these electromagnetic waves. At the AIAA meeting in Boston this month, the Avco Corp.'s Space Systems division proposed the orbiting of twin satellites some 6,000 miles out in space to hunt out these signals.

The twin-satellite plan stems from the need to keep the antenna system for such a project down to a workable size. With frequencies as low as 1 Mhz, the wavelengths that must be measured are 300 meters; to achieve a beamwidth resolution of about 1°, an antenna would have to be 12 miles wide.

**Far apart.** As an alternative, Avco's engineers propose the use of two satellites spaced six miles apart and acting as a single interferometer.

The antennas on each satellite would measure the relative phase and amplitude of the radio sources, and the combination of satellite relative motion and ground-data processing would be used to synthesize a large antenna aperture.

Avco selected a frequency range of 1 to 5 Mhz as one that could be used in such a space system to return information on discrete sources of radio energy, such as remnants of super novae, peculiar giant galaxies, and quasars. The company also settled for a resolution of 2° at 1 Mhz.

Each satellite would consist of a four-foot-diameter central body to house the electronic systems and a pair of 150-foot-long X-shaped antennas. Each antenna would be mounted on the end of a 37-foot boom extending from the satellite body.

**Compromise.** The trick would be to put the satellites into an orbit high enough to keep them away from the disturbing influences of the earth's atmosphere, but low enough to permit them to drift six miles apart in a reasonable time. At the 6,000 miles envisioned in the plan, Avco calculates the satellites would separate by 37.5 meters once each orbit of 5.8 hours. At this rate, they would reach the required interval of six miles in 64.3 days. During the separation process, measurements could be taken first at 5 Mhz and thereafter on down to 1 Mhz.

Once a certain portion of the sky had been studied, the satellites could be maneuvered to drift back together and the process could be repeated to study another portion. Francis W. French, an Avco engineer, estimates that the two satellites could cover 70% of the sky during their first 18 months in orbit.

**Point the way.** Proper attitude would be maintained by the antennas themselves acting as gravity gradient stabilization booms, keeping one of the antenna dipoles always pointing straight down. To maintain very accurate distances between the satellites, small cold-gas reaction jets would be fired at thrusts measured in thousandths of a pound. French estimates that 50 watts of continuous power would be adequate for each satellite and could be supplied by solar cells.

### Addenda

Also at the AIAA meeting:

■ Samuel C. Phillips, Apollo program director, said the software for the Apollo guidance and navigation computer may in the long run cost more than the hardware. More than 300 persons at the Massachusetts Institute of Technology are now programming computer subsystems for the various missions.

■ The communications blackout during the Apollo reentry maneuver apparently doesn't worry the mission managers as much as it does NASA research groups. George E. Mueller, NASA associate administrator for manned space flight, said there are no plans to incorpo-



# These are some of the relatively unexciting components that make Trygon's new Liberator power supplies possible.

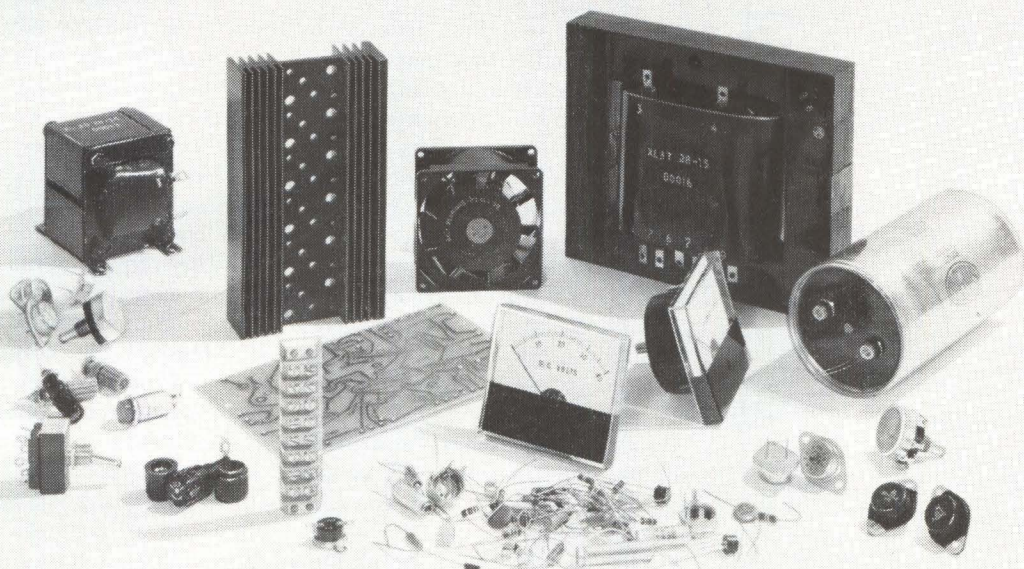

## Here's the extraordinary, almost impossible system job it can do for you.

Trygon's Liberator Series is engineered to provide the ultimate in high power system performance, in a minimum size, at lowest possible cost.

Output current levels of 40 amperes (3½"), 70 amperes (5¼"). .005% regulation/.5mv ripple/3mv peak to peak noise/.01% stability/extremely low output impedance/MIL Spec. performance compliance/integral slide mounting/automatic load share paralleling/overvoltage protection/wide adjustable voltage range.

3½" units: 2.5-4.5V/40A; 4.8-6.8V/40A; 6.5-9.5V/25A; 8.5-11.5V/25A; 11-14V/25A; 13.5-19.5V/20A; 18.5-26.5V/15A; 24-32V/15A. Priced from \$420 to \$445.

5¼" units: 2.5-4.5V/70A; 4.8-6.8V/70A; 6.5-9.5V/50A; 8.5-11.5V/50A; 11-14V/50A; 13.5-19.5V/40A; 18.5-26.5V/30A; 24-32V/30A. Priced from \$535 to \$550.

LIBERATOR: the most precise system power supply available—at the highest possible power output—in the smallest possible package—at the lowest possible price. MAKE US PROVE IT!

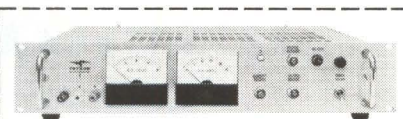

TRYGON POWER SUPPLIES  
PLEASANT AVE., ROOSEVELT, L.I., N.Y.

SEND ME PROOF OF LIBERATOR PERFORMANCE

NAME \_\_\_\_\_

COMPANY \_\_\_\_\_

ADDRESS \_\_\_\_\_

CITY \_\_\_\_\_ STATE \_\_\_\_\_ ZIP \_\_\_\_\_

 **TRYGON**  
ELECTRONICS, INC.,  
Roosevelt, N.Y. 11575



# At last!

## *a High Speed*

### FLAT PACK SEALER

- Welds up to 1000 lids per hour to metal or ceramic cases.
- Automatic lid positioning
- Rapid weld cycle provides low internal temperature rise
- No optics required
- Complete system with stainless steel dry box means simple, rapid installation

For additional information or sample welding of your part, write to

Dept. 90

The Sippican Corporation

Industrial Products Division

Mattapoisett, Massachusetts 02739

## sippican

rate a fluid injection system [Electronics, Nov. 14, p. 54] or any other technique to get signals through the plasma sheath that will envelop the vehicle. A fluid injection system would require structural changes in the spacecraft, and this undoubtedly is one reason why it isn't being considered at this late date.

▪ The space agency has decided to seek competitive proposals for flight models of an auxiliary memory system developed for the Apollo computer by the Raytheon Co. [Electronics, Oct. 31, p. 26]. The memory was first ordered by NASA in the belief that the standard Apollo guidance and control computer wouldn't be adequate for the moon trip; but NASA has decided to use the unit only in the follow-on Apollo Applications Program. The memory consists of 16,000 words stored on digital transistor logic (DTL) flatpacks and another 1.5 million words in the triple redundant mode stored in a tape unit. Each word consists of 15 bits plus a parity bit.

By using the memory unit in the simplex mode, as many as 4.5 million words can be stored, the company said.

▪ The electronics for the nation's first satellite-borne X-ray astronomy experiment will be redesigned as a result of schedule changes in the Apollo program. Now planned sometime after the summer instead of February, the flight will be the first in which a manned vehicle has been used for a complex scientific experiment.

"Its success or failure can be a guidepost for the Apollo Applications Program," says John R. Waters, project scientist.

A change in the Apollo vehicle will improve detection instrumentation. In the original spacecraft, a shield guarded against the effects of radioactivity in the fuel gauge system. The new vehicle will jettison the shield to make room for larger and more sensitive X-ray gear. The astronaut will search for an X-ray source and when he finds it, he'll maneuver the spacecraft into the best position and hold it there.

---

## Consumer electronics

---

### One for all

The Westinghouse Electric Corp. early next year will market a phonograph in which one integrated circuit replaces all electronic components. Containing the equivalent of 39 transistors, diodes and resistors, the Westinghouse-made IC itself will also go on sale early in 1967.

The Westinghouse phonograph, to be priced at about \$50, is a one-watt battery-powered model. Because of the mechanical drive system, it's about the same size as a previous model, which contained 18 discrete components.

"Engineers have combined voltage and power amplification with this chip to unite for the first time all the requirements for an electronic consumer product," says a Westinghouse spokesman.

**Trends.** Other companies use IC's in consumer products, but the items also contain discrete components. The General Electric Co. has developed a portable radio the size of a cigarette pack, with an IC that includes all the active components and some resistors but with the remaining passive components attached to a printed-circuit board [Electronics, July 11, p. 40]. Two models of the radio will be available late this month and the prices (\$39.95 and \$29.95) compare favorably with comparable discrete-component radios.

GE has put IC's in the audio amplifiers of three other consumer products—a phonograph, a portable television set and an eight-track cartridge tape player for home use.

---

## Industrial electronics

---

### Stop gap

Engineers at the Texas Transportation Institute say they have found a way to sharply reduce the auto-traffic accordion effect—the bunch-



# Solitron

announces another **FIRST:**

*a family of high voltage 60 Amp NPN Silicon Power Planar Transistors featuring  $V_{CEO}$  ranges from 200V to 300V, capable of  $P_T=350W@25^\circ C!$*

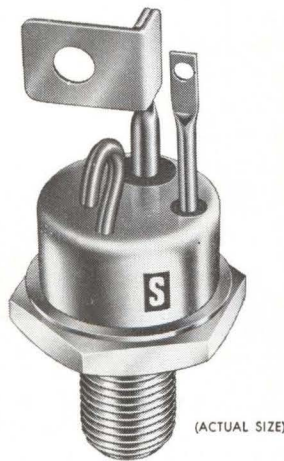

Type Number	DESIGN LIMITS				PERFORMANCE SPECIFICATIONS					
	$P_T$	$BV_{CBO}$	$V_{CEO}$ (SUS)	$BV_{EBO}$	$h_{FE}$		$V_{BE}$ (sat)	$V_{CE}$ (sat)	$I_{CBO}$	$f_T$
	Watts	Volts	Volts	Volts	$I_C = 40A$	$I_C = 60A$	Volts	Volts	$\mu A$	MHz
	25°C Case	$I_C = 1mA$	$I_C = 0.2A$	$I_E = 1mA$	Min.	Min.	$I_C = 40A$	$I_B = 6A$	$V_{CB} = 100V$	Typ.
SDT8951	350	200	200	8	10-40	5	2.0	2.0	10	20
SDT8952	350	225	225	8	10-40	5	2.0	2.0	10	20
SDT8953	350	250	250	8	10-40	5	2.0	2.0	10	20
SDT8954	350	275	275	8	10-40	5	2.0	2.0	10	20
SDT8955	350	300	300	8	10-40	5	2.0	2.0	10	20

TRANSISTOR DIVISION **Solitron** **DEVICES, INC.**

1177 BLUE HERON BLVD. / RIVIERA BEACH, FLORIDA / (305) 848-4311 / TWX: (510) 952-6676

Leader in Germanium and Silicon Power Transistors, Cryogenic Thermometers, High Voltage Rectifiers, Hot Carrier Diodes, Temperature Compensated Zeners, Voltage Variable Capacitors, Random/White Noise Components, Microelectronic Circuits, and Power-Sink Interconnection Systems.



YOU NEED A

# Multi-Vider™

IF YOU DESIGN  
PRODUCE, TEST  
REPAIR, CALIBRATE

- accelerometers
- bridges
- calibrators
- computers
- differential amplifiers
- differential voltmeters
- digital-ladder networks
- digital voltmeters
- diodes
- gyros
- Kelvin-Varley dividers
- meters
- operational amplifiers
- resistance thermometers
- potentiometers
- R-C integrators
- regulated power supplies
- resistors
- shunts
- standard cells
- synchros
- thermocouples
- torquers
- volt-boxes
- Zener diodes

OR IF YOU MEASURE:

- basic material properties
- contact resistance
- insulation efficiency
- lead-wire resistance
- resistivity of thin films
- solid-state cryogenic behaviour
- temperature
- wire uniformity

Write Dept.  
C-12

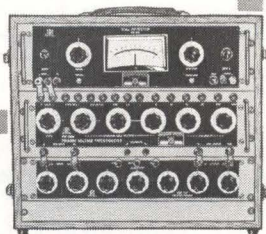

**JULIE RESEARCH LABORATORIES, INC.**  
211 West 61st Street New York, NY 10023

ing up of cars on high-speed highways. So satisfied are they with the solution—a computer-controlled traffic-light system at entrance ramps—that plans are under way to extend the system to cover a six-mile stretch of the Gulf Freeway in Houston.

A prototype designed and installed by the Taft Broadcasting Co. of Houston has been in operation at a freeway access ramp during the morning traffic rush for the past 14 months. Studies show that traffic speed during the test period increased 30% and traffic volume rose 10% while the number of accidents fell 50%.

**Flashing lights.** The system works this way: overhead sensors detect gaps in freeway traffic, send a signal to a control center and a computer controls the ramp traffic signal. If there is room the light flashes green; if traffic is too heavy, the light remains red until the sensors again detect a gap in the traffic flow. The presence or absence of cars on the access ramp is detected by sensors beneath the pavement.

## Avionics

### Toward a standard

The Airline Electronic Engineering Committee, whose job it is to set international avionics standards for all commercial planes, early this month settled on standards for a second-generation weather radar and for inertial navigation systems.

Equipment produced under these criteria will be built into such planes as the Boeing Co.'s giant 747 subsonic transport, the Anglo-French Concorde supersonic transport and the United States version of the SST. In fact, it was the rapid progress toward the design of the Concorde and the 747 that spurred the committee to speed its rulings on the standards.

**Things to come.** The committee is made up of engineers representing both U.S. and foreign carriers and is sponsored by Aeronautical Radio, Inc., (Arinc), which is jointly owned by the airlines. Working

with avionics and aircraft producers, the panel sets the Arinc equipment standards, which cover not only such factors as outside configuration, interwiring, input-output and connections, but often the operational specifications for electronic hardware.

Although the Arinc committee's aim is to achieve standardization of avionic gear—especially to make equipment interchangeable—airlines aren't committed to installing only equipment that fits the committee's standard. Realistically, the problem of redesigning an aircraft installation to accommodate a special piece of gear would be prohibitively expensive for an airline.

Approval of the weather radar specification caps nearly two years of work by the committee, according to William T. Carnes, Arinc avionics engineering manager and chairman of the group. Frank C. White, manager of communications-data processing for the Air Transport Association and head of the panel's radar subcommittee, says the panel "later will probably come out with a more sophisticated version of the radar for follow-on SST's. Later SST's may require a two-frequency weather radar, some officials believe.

**Controversy.** The standard gear was originally slated to be X-band only, but late in the game some airlines wanted it expanded to include the next generation of C-band. The frequency controversy continues.

The Arinc specification doesn't presage a big step in technology. To avoid what the airlines considered to be the high cost and complexity inherent in more advanced systems, such techniques as electrically steerable antennas weren't considered. The group did consider specifying complete interchangeability of units but decided against this because of the restrictions such a move would place on designers.

The radar standard sets forth a new way to calculate performance, White notes—a "performance index." This index relates the radar equation "to the real world—how far you'll see a storm," he explains. An airline will specify the range it wants and the builder will know



# MAKE AXIAL LEAD COMPONENTS

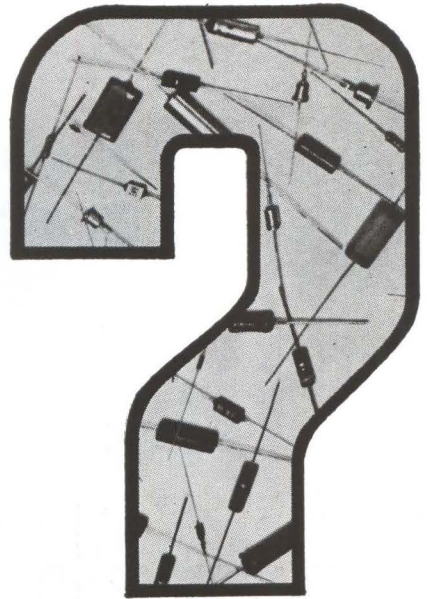

**Universal continuous process systems  
can combine almost any functions...  
with a big advantage in LABOR SAVINGS**

This new 20-page publication illustrates how to feed raw materials... assemble... coat... test... sort... code and package finished axial lead components **automatically**. By combining processing steps into complete systems, Universal enables you to maintain physical control from one function to the next.

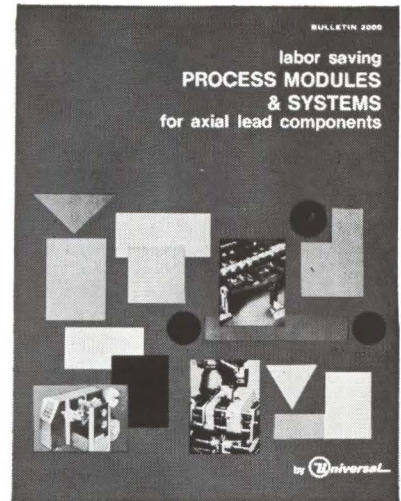

Typical process systems including bowl feed, lead straightener, line loader, multiple test, sort, orient, print and cure.

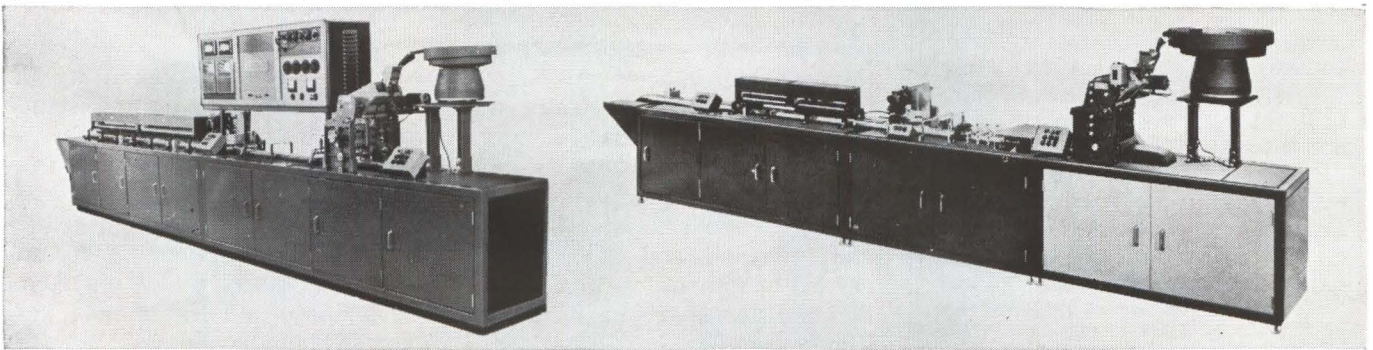

Standard modules developed by Universal are customer-proved in systems that are now producing billions of components a day. They are the building blocks for this equipment. However, these standard modules combined with customized units can be designed into systems to meet special requirements. This is an area where Universal's special technology and engineering experience can make an even greater contribution in terms of operating reliability, fail-safe design and **labor savings**.

*Send for your copy  
of bulletin 2000*

**Universal** INSTRUMENTS CORPORATION / E. FREDERICK ST., BINGHAMTON, N. Y. 13902 / 607-772-1710



# feeling the pinch

{ for qualified  
electronics  
technicians? }

New electronics equipment demands technicians with a wide range of specialized skills. Men who understand the "why" of electronics... can install, maintain, troubleshoot and repair the electronics gear you're using today and will be using in years ahead.

**Qualified** electronics technicians are scarce. But with a Cleveland Institute of Electronics Training Program you can soon develop an ample supply by up-grading your present staff of technical personnel. CIE "AUTO-PROGRAMMED" Courses are fast, economical, effective. What's more, they can be readily "tailored" to your specific training needs. Hundreds of companies use them... thousands of men are enrolled. Get free details fast. Mail coupon today. Cleveland Institute of Electronics, Dept. E-25, 1776 E. 17th St., Cleveland, Ohio 44114.

SEND COUPON TODAY

**Cleveland Institute  
of Electronics**

Dept. E-25, 1776 E. 17th St., Cleveland, Ohio

Gentlemen: I am interested in learning more about your Electronics Home Study Programs. Please send complete information.

Name \_\_\_\_\_

Title \_\_\_\_\_

Company \_\_\_\_\_

Address \_\_\_\_\_

City \_\_\_\_\_ State \_\_\_\_\_ Zip \_\_\_\_\_

Accredited Member, National Home Study Council.

what he has to do. Up until now, radar performance has been a "gambler's choice and a salesman's gambit," White says.

The index may also be applicable to the aircraft equipment needed for satellite communication, the official says.

**Display.** Although a bright display—a direct-view storage tube—is more expensive, less reliable and has less gray-scale capability than conventional tubes, it is specified for the radar to insure adequate visibility of the display in all cockpit light conditions. The antenna is restricted to a 30-inch diameter because of the tapered noses of jetliners.

The inertial navigation system characteristic doesn't include all the detailed specifications normally given in an Arinc document, but it does define the basic installation and interchangeability standards urgently needed by airlines and manufacturers. The entire specification was approved, Carnes says, subject to the working out of digital data standards at a meeting of the inertial navigation subcommittee in Washington on Dec. 15.

**Basic system.** From the beginning—despite a request by some hardware builders for a specification covering a large central digital process system to integrate the platform with other aircraft systems—airline interest has concentrated on a basic navigator that would include only the computation gear necessary for a "minimum system." The platform will supply to the computer only aircraft position and velocity data needed to compute vertical navigation and steering command signals. If more complex signals are needed, another computer could be selected without changing the basic inertial system.

Although most carriers indicated a preference for a single unit design, the committee decided to accept some restrictions and limitations in order to achieve both current "standard installation" and provide for future design trends. Specified is a navigation unit containing sensors and associated stabilization platform, plus control and computation circuitry to oper-

ate the platform and signal processing. The computer and associated circuitry can be packaged in a separate case as an option.

**Connector.** The standard significantly reduces the necessary interwiring by prescribing circuit multiplexing and direct "Y" connections to the platform and the optional electronics unit.

The airlines say it is absolutely imperative that the inertial system's digital signal be standardized wherever an interface between another system currently exists or will in the future. Two basic types of digital transmission have been proposed: two three-circuit serial data transmission systems and a two-circuit system to transmit incremental data by bipolar d-c signal on one three-wire circuit and the clock signal on the other circuit.

## Electronics notes

▪ **Hard copy.** The Xerox Corp., which specializes in the office-copying field, now has branched out to produce peripheral computer gear. Its product, naturally, has the Xerox electrostatic machine as its building block and produces hard copy of graphics generated by a computer. The product, called a Xerox Computer Adapter, ties in with the company's Long Distance Xerography (LDX) system to transmit computer graphics to any remote location via telephone lines.

▪ **New failure mode.** Investigators at the Sudbury reliability analysis laboratory of the Raytheon Co.'s Space and Information Systems division have found that catastrophic lead bond failures can be induced under pulse conditions in small signal transistors. Such failures occurred when high forward current pulses were applied at a low repetition rate to the emitter base junction of wedge bonded transistors. The Raytheon experimenters postulate that the failures resulted from thermal expansion of the wire in a section close to the bonded area. This portion, particularly in aluminum-to-aluminum wedge bonded transistors, is work-hard-



# Today, Only Motorola Offers Integrated Circuits With The Speed Potential Required For Your "Next Generation" Computers!

*Let's look at the facts.*

First of all, consider that the computer systems of tomorrow are going to require greater and greater speed. And, as you get below 5 ns, today's so-called "high-speed" logic approaches are not *practical* for driving transmission lines due to impedance mismatching problems. MECL\* integrated circuits offer the solution.

Then, remember that with most saturated logic systems internally generated "large noise spikes" become a problem as you go to higher and higher speeds. Not with MECL.

And, when you consider the need for reduced "can count" for lower system costs you'll want for the future, the "simultaneous complementary logic function at each gate" feature is a strong inducement. (In fact, our coming new multi-function MECL series will provide the lowest can count per system of any logic family.) Only MECL offers it.

When you sift through all the confusion about "best speed/power product" only one system is best at high speeds. That's MECL.

Today five of the major computer companies in the United States are designing or developing new systems utilizing MECL integrated circuitry . . . compelling evidence that MECL is indeed the direction of the future.

You can start getting familiar with tomorrow's systems *today* by designing your newest prototype from this wide selection of MECL types — the largest number of circuit functions available in *any* integrated circuit line:

TYPE ††	FUNCTION	Prop. Delay @ 25°C		Total Power Dissipation mW Typ.
		t <sub>dl</sub> ns Typ	t <sub>cl</sub>	
MC301/MC351	5-Input OR/NOR Gate	7.5	7.5	37
MC302/MC352A	R-S Flip-Flop w/Buffered Outputs	10.5**	11.5†	43
- /MC352	R-S Flip-Flop	10.5**	11.5†	40
MC303/MC353	Half-Adder	7.0	8.0	63
MC304/MC354	Bias Driver	—	—	18
MC305/MC355	Gate Expander	5.0	4.0	—
MC306/MC356	3-Input OR/NOR Gate	7.5	7.0	37
MC307/MC357	3-Input OR/NOR Gate	7.5	7.0	15
MC308/MC358A	AC-Coupled J-K Flip-Flop w/Buffered Outputs	8 **	10 †	87
- /MC358	AC-Coupled J-K Flip-Flop	8 **	10 †	50
MC309/MC359	Dual 2-Input NOR Gate	6.5	8.0	54
MC310/MC360	Dual 2-Input NOR Gate	6.5	8.0	54
MC311/MC361	Dual 2-Input NOR Gate	6.5	8.0	41
MC312A/MC362A	Dual 3-Input NOR Gate w/Buffered Outputs	7.5	7.0	70
MC312/MC362	Dual 3-Input NOR Gate	7.5	7.0	54
MC313F/MC363F	Quad 2-Input NOR Gate	6.5	8.0	125
MC314/MC364	AC-Coupled J-K Flip-Flop	12 **	13 †	118
MC315/MC365	Line Driver	14	12	270
MC316/MC366	Lamp Driver	—	—	135
MC317/MC367	Level Translator — MECL to Saturated Logic	30 **	25 †	63
MC318/MC368	Level Translator — Saturated Logic to MECL	17	16.5	105
- /MC369F	Dual 4-Input Clock Driver/High-Speed Gate	3	3	250
- /MC369G	Dual 2-Input Clock Driver/High-Speed Gate	3	3	250

†† MC300 Series — 55 to +125°C      \*\*t<sub>cl</sub>  
MC350 Series 0 to +75°C            †t<sub>cl</sub>

One other point. The new, faster multi-function types we're developing today for future integrations (we've already demonstrated a 200 MHz Frequency Counter — using our soon-to-be-announced 1.5 ns MECL series) will be completely compatible with existing types. Thus, they'll fit right in with the designs you develop using today's MECL types.

Call your Motorola semiconductor distributor and order evaluation units of the above MECL integrated circuit types. Our field representative has complete application information on use of MECL circuits in system applications. Contact him.

\*Trademark of Motorola Inc.

*— where the priceless ingredient is care!*



## MOTOROLA Semiconductors

MOTOROLA SEMICONDUCTOR PRODUCTS INC., P. O. BOX 955, PHOENIX, ARIZ. 85001 (602) 273-6900 TWX 910-951-1334



*From the Problem Solvers at Ucinite...*

***A redesigned electronic  
two-conductor patch cord  
that cut costs nearly 50%  
...met tough retrofit specs***

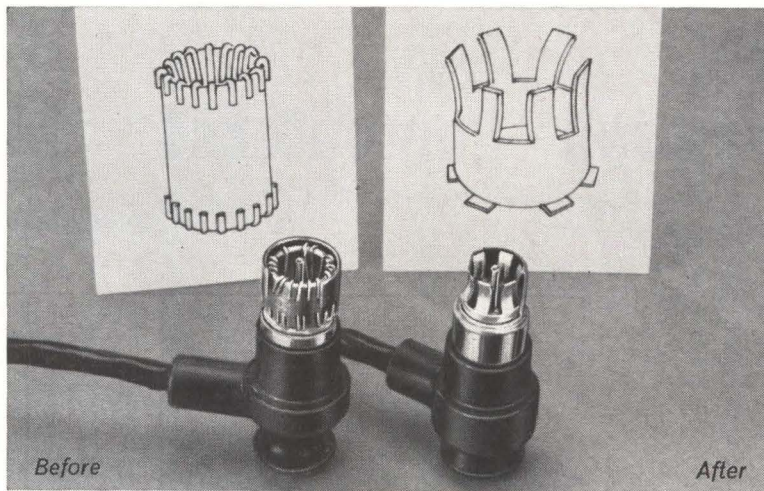

The customer using this two-conductor patch cord, which mates with jacks on printed-circuit boards, came to Ucinite for help in lowering unit production costs. Ucinite engineers were asked to redesign the parts, staying within the same envelope dimensions for retrofit with equipment in the field. Since the patch cords are used in classified communications equipment, all modifications had to meet tight military specifications. Ucinite design specialists first replaced costly machined parts with more economical stamped parts of equivalent reliability. A complex toroidal spring wound contact was replaced with a stamped six-finger contact, and a second toroidal spring wound contact replaced with a standard closed-entry napkin ring contact. By elimination of all parts that required screw-machining, and simplification of the contact design, Ucinite engineers reduced manufacturing costs nearly 50%. This is just one example of how Ucinite's unique engineering and manufacturing capabilities can work for you in the design and manufacture of electro-mechanical assemblies. Your local Ucinite field engineer will be happy to drop by for a firsthand survey of your problems . . . to show you how Ucinite Know How can help you *do it better for less*. Just call or write, outlining your needs, and we'll take it from there.

The Ucinite Company, Division of United-Carr Incorporated, Newtonville, Mass. 02160 • 617-527-8400.



ened and inflexible. The researchers suggest that the effect may be minimized using low-resistivity lead wires with a low coefficient of work-hardening. Lead movement under current pulses was also noted in gold bonded devices.

- **Frequency split.** The Federal Communications Commission has ordered land mobile stations operating in the 450- to 470-megahertz band to reduce channel spacing from 50 to 25 kilohertz [Electronics, Oct. 17, p. 40]. The order will increase the number of authorized channels to about 600 and temporarily relieve frequency congestion in metropolitan areas. Although existing stations have until Nov. 1, 1971, to change over, stations licensed after Nov. 1, 1966, must comply by June 1, 1967. The order means land mobile stations will either have to modify their transmitters or buy new ones. It costs from \$70 to \$100 to convert a transmitter.

- **Emergency radio.** The Air Force is flight testing three developmental models of emergency radios small enough for pilots to carry in their vest pockets. Designated the AN/URC-64, the radio will weigh 1 pound and operate on four channels in the ultrahigh frequency band. One channel will be the international distress frequency. Although the final design won't be approved until the device is tested, the initial models use thick-film, hybrid integrated circuits. The Magnavox Co.'s Research Laboratories at Torrance, Calif., is developing the radio under a \$334,000 contract from the Air Force Systems Command. The flight tests are being made at Wright-Patterson Air Force Base, Ohio.

- **Lay-offs.** The General Electric Co.'s computer plant in Phoenix, Ariz., will lay off 450 employees over the next few weeks. The company explained the move would bring employment levels in line with contracts.

- **Acquisition.** The Perkin-Elmer Corp. will buy the Aerospace Systems division of Scientific Data Systems, Inc. The division develops electro-optical equipment for space and defense programs.

- **Price cut.** The Admiral Corp.



has lowered the so-called fair trade minimum prices on 18 color television sets to meet competition in the New York metropolitan area. The company says the reductions apply only to the New York area, which is the only place where Admiral products are fair traded. The General Electric Co., Magnavox Co., Zenith Radio Corp. and the National Union Electric Corp. say they are not considering any price changes. National makes Emerson and DuMont sets. The Radio Corp. of America, which increased prices on some sets in September, also reported that no price changes were planned.

▪ **Chemicals from coal.** Add another application for the laser. Researchers at the Interior Department's Bureau of Mines report that lasers have been used to break down coal into its chemical components. The results also indicate that the technique—firing the beams at coal for split-second intervals—may eventually be successful in producing some chemicals for less than it would cost using conventional methods. Bureau scientists, focusing 2- to 10-joules of laser energy at the coal, generated temperatures of more than 1,000°C. The gases liberated in the process were cooled rapidly to prevent a secondary chemical reaction.

Analysis showed that the products formed contained up to 25% acetylene and lesser amounts of diacetylene vinyl-acetylene, hydrogen cyanide, ethylene and ethane. The reaction occurs in milliseconds, whereas conventional techniques for producing the chemicals, using carbonization methods, may take hours.

▪ **Electronics, too.** Johnson & Johnson, one of the largest suppliers of medical products, is entering the medical electronics field as a distributor. The company has signed an agreement with United Aircraft Corp.'s Vector division to act as the exclusive distributor of United's electrocardiogram electrode.

The EKG electrodes, called Telectrodes, are disposable sensors that are applied to a patient's body with adhesive.

# Designed for UHF APPLICATIONS

A WIDE RANGE OF

# RMC

## TEMPERATURE COMPENSATING SOLDER-INS

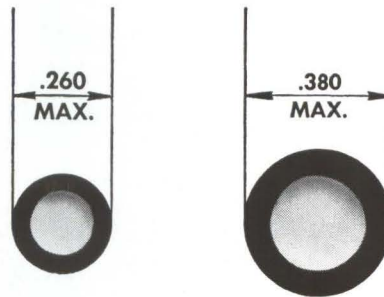

Nom. T. C.	Cap. Range	Cap. Range
NPO	1.5—10.0 pfd.	11— 22 pfd.
N-30	1.5—10.0 pfd.	11— 22 pfd.
N-75	2.2—12.0 pfd.	13— 23 pfd.
N-150	2.2—12.0 pfd.	13— 25 pfd.
N-220	2.4—15.0 pfd.	16— 27 pfd.
N-330	2.7—15.0 pfd.	16— 33 pfd.
N-470	2.7—15.0 pfd.	16— 33 pfd.
N-750	4.7—27.0 pfd.	28— 47 pfd.
N-1500	11.0—47.0 pfd.	48—105 pfd.

### SPECIFICATIONS

**CAPACITANCE:** Within tolerance @ 1 MC and 25°C

**CAPACITANCE TOLERANCES:** ±5%, ±10% or ±20% (but not less than ±.25 pf)

**WORKING VOLTAGE:** 500 VDC

**INSULATION RESISTANCE:** Greater than 7500 Megohms @ 500 VDC

**TEMPERATURE COEFFICIENT:** As noted on Capacitance chart

**FLASH TEST:** 1000 VDC for 1 second

**ELECTRODE:** Pretinned for assured solderability

These new "Solder-In" capacitors are designed for use in UHF applications requiring the absolute minimum in lead inductance effects.

If your applications require special physical or electrical characteristics, contact RMC's engineering department.

*Write today on your company letterhead for your copy of the RMC Catalog.*

DISCAP  
CERAMIC  
CAPACITORS

# RMC

**RADIO MATERIALS COMPANY**

A DIVISION OF P. R. MALLORY & CO., INC.

GENERAL OFFICE: 4242 W. Bryn Mawr Ave., Chicago 46, Ill.

Two RMC Plants Devoted Exclusively to Ceramic Capacitors





FACTORIES AT CHICAGO, ILL. AND ATTICA, IND.

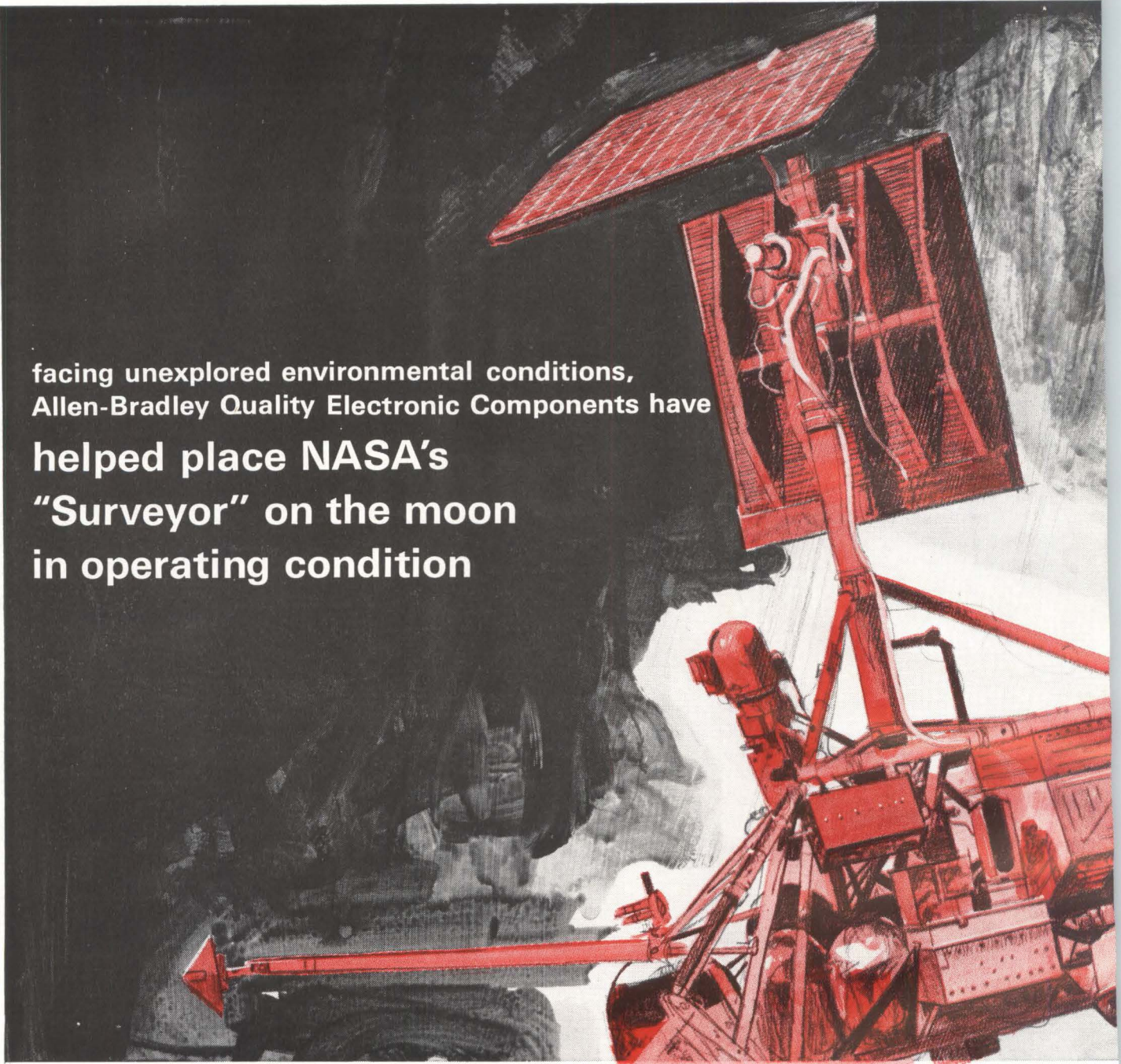

facing unexplored environmental conditions,  
 Allen-Bradley Quality Electronic Components have  
 helped place NASA's  
 "Surveyor" on the moon  
 in operating condition



**A-B QUALITY ELECTRONIC COMPONENTS THAT CONTRIBUTED TO THE "SURVEYOR'S" SUCCESS**

TYPE BB 1/8 WATT		MIL TYPE RC 05
TYPE CB 1/4 WATT		MIL TYPE RC 07
TYPE EB 1/2 WATT		MIL TYPE RC 20
TYPE GB 1 WATT		MIL TYPE RC 32
TYPE HB 2 WATTS		MIL TYPE RC 42

**ALL A-B HOT MOLDED FIXED RESISTORS**

are available in all standard EIA and MIL-R-11 resistance values and tolerances, plus values above and below standard limits. Shown actual size.



**FEED-THRU CAPACITORS**

A-B feed-thru capacitors have a discoidal design that eliminates all parallel resonance effects at 1000 MHz and less. Insulation resistance exceeds 100,000 megohms. Standard values are 470 uuf  $\pm 20\%$  and 1000 uuf GMV. Special values from 6.8 uuf to 1500 uuf. Rated to 500 v DC maximum. A-B discoidal capacitors are also available in the stand-off construction.

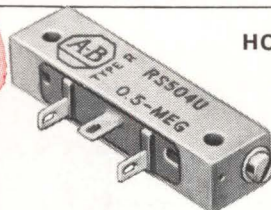

**HOT MOLDED VARIABLE RESISTORS**

Type R trimming potentiometers provide stepless adjustment and are essentially noninductive. Molded cases are dust-tight and watertight. Rated 1/4 watt at 70°C. Values from 100 ohms to 2.5 megohms. Tolerances of  $\pm 10\%$  and  $\pm 20\%$ .



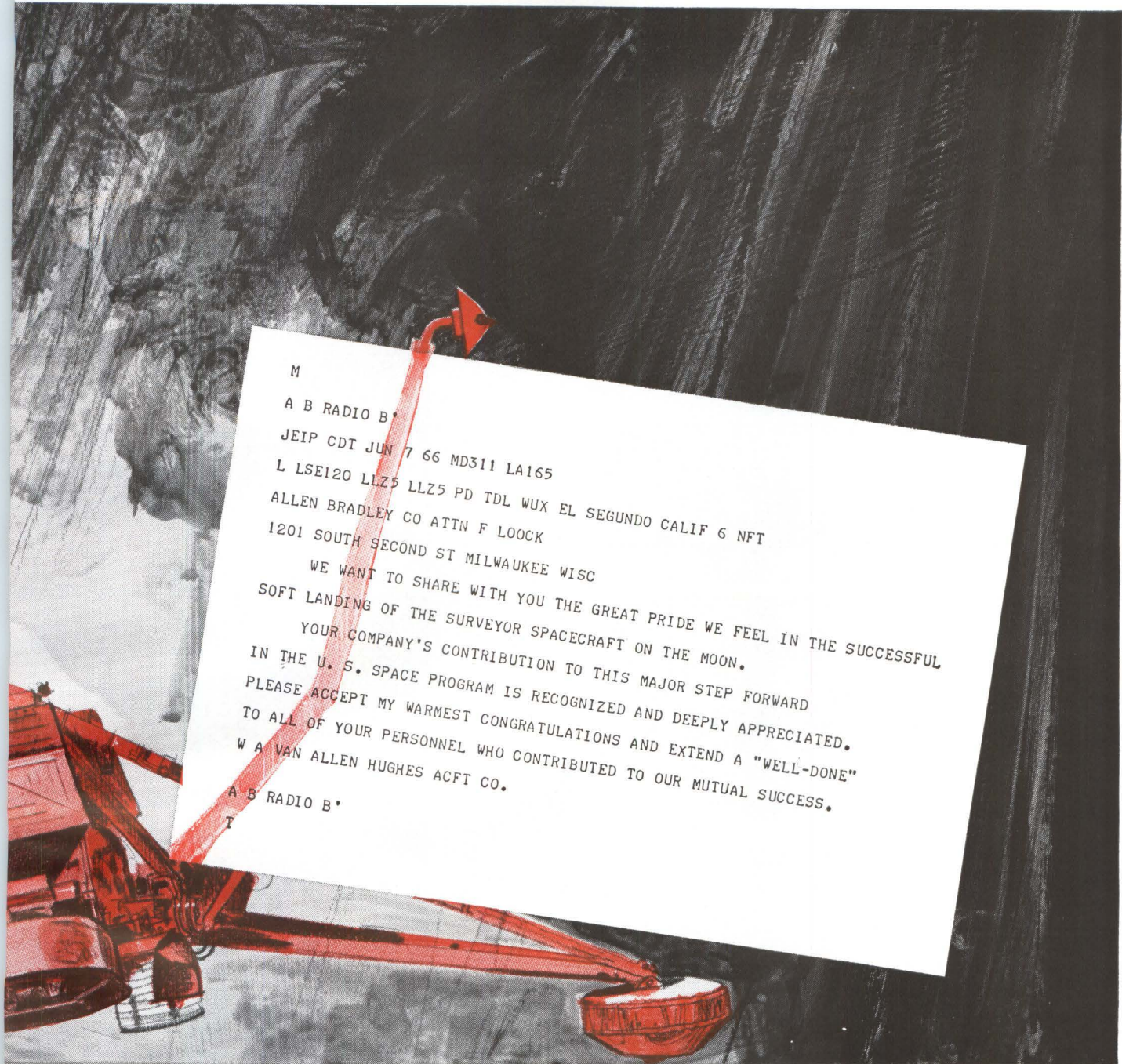

M  
A B RADIO B\*  
JEIP CDT JUN 7 66 MD311 LA165  
L LSE120 LLZ5 LLZ5 PD TDL WUX EL SEGUNDO CALIF 6 NFT  
ALLEN BRADLEY CO ATTN F LOOCK  
1201 SOUTH SECOND ST MILWAUKEE WISC

WE WANT TO SHARE WITH YOU THE GREAT PRIDE WE FEEL IN THE SUCCESSFUL  
SOFT LANDING OF THE SURVEYOR SPACECRAFT ON THE MOON.  
YOUR COMPANY'S CONTRIBUTION TO THIS MAJOR STEP FORWARD  
IN THE U. S. SPACE PROGRAM IS RECOGNIZED AND DEEPLY APPRECIATED.  
PLEASE ACCEPT MY WARMEST CONGRATULATIONS AND EXTEND A "WELL-DONE"  
TO ALL OF YOUR PERSONNEL WHO CONTRIBUTED TO OUR MUTUAL SUCCESS.  
W A VAN ALLEN HUGHES ACFT CO.

A B RADIO B\*  
T

Why were these A-B hot molded fixed and variable resistors selected for such critical service as in the "Surveyor"? First, because no A-B hot molded resistor component has ever been known to fail catastrophically under rated load—either mechanically or electrically. Second, due to the method of manufacture, you can select one A-B resistor from among ten or from ten million, and be confident there will be no variation in electrical characteristics. Incidentally, this is *not* the first "shipment" of Allen-Bradley resistors delivered to the moon—they are "standard equipment" in "space mission" service.

There are sound economic advantages to standardizing on A-B hot molded fixed and variable resistors for use here on Earth as well! As many electronic equipment manufacturers have learned—sometimes through sad experience—no other resistors will provide the consistently high reliability of Allen-Bradley hot molded resistors. They may cost a bit more, but—you must not expect to obtain "equivalent quality" at a lower price! Allen-Bradley Co., 110 W. Greenfield Ave., Milwaukee, Wisconsin 53204. In Canada: Allen-Bradley Canada Limited. Export Office: 630 Third Avenue, New York, New York, U.S.A. 10017.



**ALLEN-BRADLEY**  
QUALITY ELECTRONIC COMPONENTS



# State of the design art

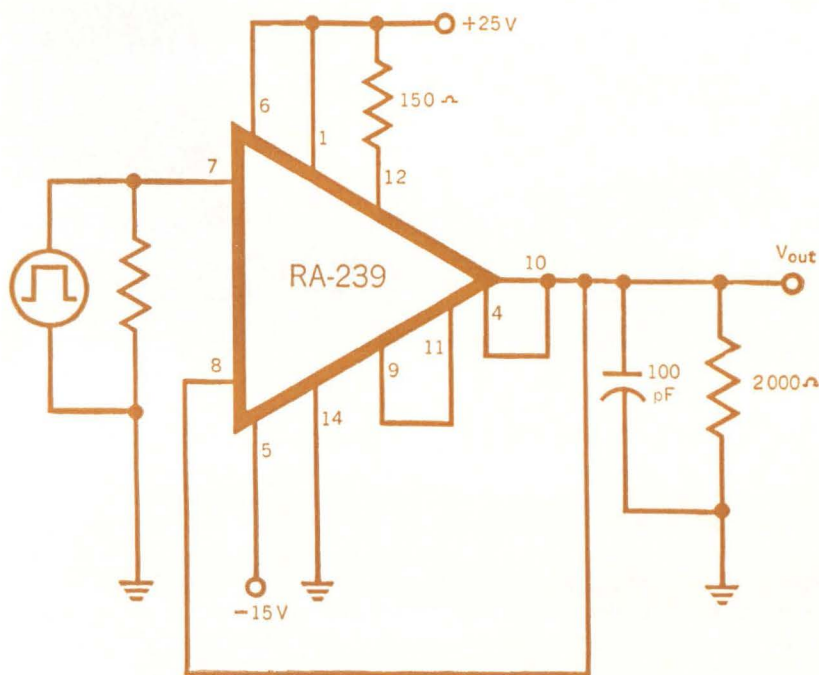

Stability without compensation . . .  
New approach to  
unity-gain, broadband  
operational amplifiers

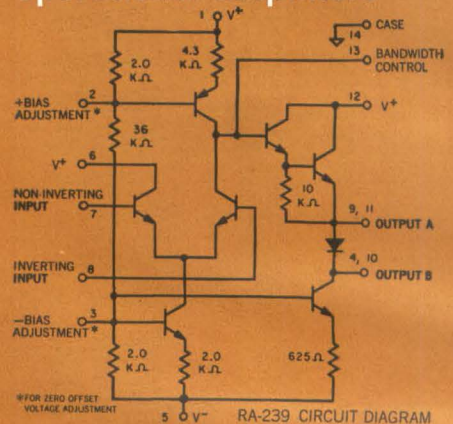

The application of Radiation's RA-239 IC Broadband Operational Amplifier, illustrates the outstanding performance characteristics of this unique circuit. It provides the 6 dB/octave high-frequency rolloff required for unconditional stability in operational feedback connections *without* use of external compensation . . . even for the critical unity gain configuration. This amplifier was made possible through Radiation's advanced technology and circuit design capability.

Performance characteristics:

$V_{in} = V_{out}$ :	1.0 V
Rise time:	30 ns
Overshoot:	15%
Slew rate:	30 V/ $\mu$ s
Bandwidth:	15 MHz
Phase margin:	60°

Unity gain transient response for the application shown at left.  
Vertical scale: 0.25 V/div;  
Horizontal scale: 50 ns/div.

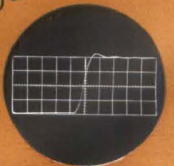



# State of the monolithic art

A new line of universal building blocks for integrated analog circuitry is now available to design engineers. Radiation Incorporated supplies three different types of IC operational amplifiers to serve your individual requirements: general-purpose, broadband, and high-gain amplifiers.

These amplifiers provide outstanding performance. Parasitics are eliminated, thanks to our unique dielectric isolation technique. Tighter tolerances and improved temperature coefficients are achieved through use of precision thin film resistors over the oxide.

Thus, Radiation's technology simplifies system designs which

were hampered by limitations imposed by conventional integrated circuit fabrication techniques.

Only Radiation can provide production quantities of inherently stable IC operational amplifiers. These circuits are stocked for immediate shipment in TO-84 flat packages.

Write or phone for our data sheets which include *worst-case limits* as well as all information required by design engineers. We'll also be glad to send you a copy of our new manual entitled: Operational Amplifier Technical Information and Applications. For your copy, request publication number ROA-T01/A01 from our Melbourne, Florida office.



Radiation IC Operational Amplifiers\*

Typical characteristics ( $T_A = +25^\circ\text{C}$ )	GENERAL PURPOSE RA-238	BROADBAND RA-239	HIGH GAIN RA-240	UNIT
Phase margin	60	60	45	Degrees
Bandwidth (unity gain)	7	15	6	MHz
Slew rate	3.2	30	3.2	V/ $\mu\text{s}$
Voltage gain	2,700	2,700	50,000	
Offset voltage	2.0	2.0	2.0	mV
Offset current	80	400	80	nA
Thermal drift	$\pm 5$	$\pm 5$	$\pm 5$	$\mu\text{V}/^\circ\text{C}$
	$\pm 1$	$\pm 5$	$\pm 1$	nA/ $^\circ\text{C}$
Undistorted output swing	21	21	9 (11.6) <sup>†</sup>	$V_{p-p}$
Power dissipation	90	160	90	mW
Common mode rejection	100	100	100	dB
Power supply rejection	100	100	100	dB
Input bias current	0.4	1.0	0.4	$\mu\text{A}$

\*Standard temperature range:  $-55^\circ\text{C}$  to  $+125^\circ\text{C}$ .  $V^+ = +25\text{V}$ ;  $V^- = -15\text{V}$ .

<sup>†</sup> $V^+ = +20\text{V}$ ;  $V^- = -20\text{V}$ .

All Radiation integrated circuits are dielectrically isolated.

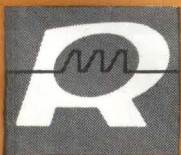

**RADIATION  
INCORPORATED**

MICROELECTRONICS DIVISION

Sales offices: Suite 622, 650 North Sepulveda Blvd., El Segundo, Calif. (213) 772-6371—Suite 232, 600 Old Country Road, Garden City, N. Y. (516) 747-3730—Suite 201, 1725 Eye Street, N. W., Washington, D. C. (202) 337-4914—P.O. Box 37, Dept. E-12, Melbourne, Florida (305) 723-1511, ext. 554

More IC developments from Radiation! Our line of monolithic diode matrices continues to grow. For example, a new low-cost 6 x 8 RM-34 Diode Matrix is immediately available in volume, at a unit price of less than \$5.00—and can be supplied to any code configuration you may want.

Many IC applications are now possible, using Radiation Matrices. For example, design of logic function generators for data transfer and operational control is simplified with 6 x 8 diode matrices. This application allows engineers to: Eliminate unnecessary logic gates—Reduce delay time—Save space by reducing package count—Increase speed of performance—Boost fan-out capability through duplicate function generation—Combine matrices to produce many AND/OR logic circuits.

Radiation's popular line of dielectrically isolated matrices offers an unusual degree of flexibility. (1) They contain all active devices within a single chip. (2) A fusible link in series with each diode permits unlimited matrix patterns to be formed. And (3), matrices can be combined to produce an infinite variety of configurations.

For further information, refer to our ELECTRONIC DESIGN advertisement of November 22. We'll be glad to send data sheets which include *worst-case limits*, and a copy of our manual, Monolithic Diode Matrix Technical Information and Applications. RDM-T01/A01. Write or call our Melbourne, Florida office.

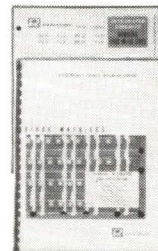

Circle 65 on reader service card



**ONLY HONEYWELL OFFERS**

# **TOMORROW'S BREED OF I/C COMPUTER TODAY...AND AT OFF-THE-SHELF PRICE**

**... $\mu$ -COMP DDP-416**

**\$15,000**

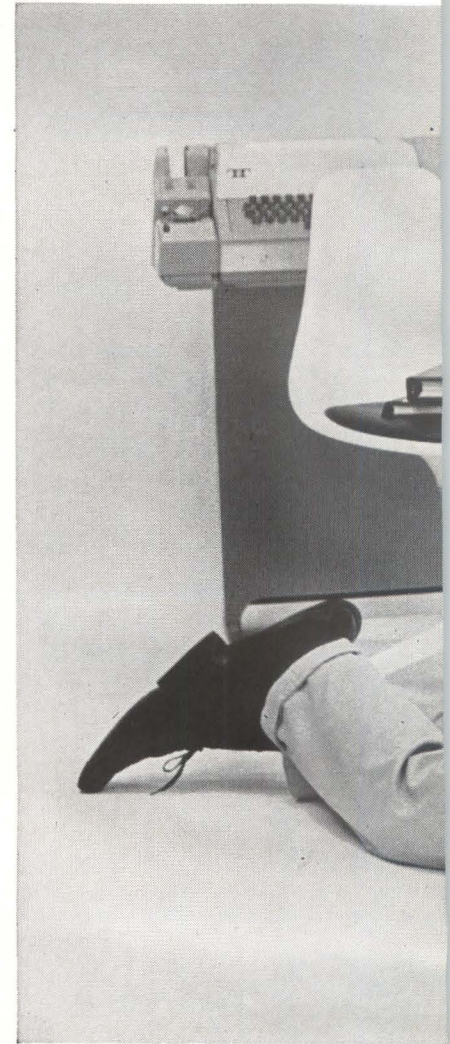

## **SPECIFICATION SUMMARY**

Type	16-bit parallel, binary
Console	Movable
Addressing	Indirect
Memory Size	Up to 16,384
Cycle Time	960 nanoseconds
Add	1.92 $\mu$ secs
Single word I/O transfer	1.92 $\mu$ secs
Automatic (cycle stealing) I/O transfer	Over 1 mc (16 bit words)
Weight	250 lbs.
Temperature	0° to 45°C

BY ANY STANDARDS . . . the NEW  $\mu$ -COMP DDP-416 on-line, real-time computer gives you a price/performance ratio that can't be beat: full size 16-bit capability, nanosecond speeds, plus I/C size and reliability. Only \$15,000.

TAKE RELIABILITY . . . most manufacturers are just now planning their first I/C computer. Honeywell, Computer Control Division announced the first commercial I/C computer a year ago . . . DDP-124, the second last month . . . DDP-516, the third today. Result! Field proven reliability and a thorough knowledge of how to work with I/C's. Example . . . DDP-416 MTBF: 4,000 hours or two years under normal 40-hour week operation.

UNPRECEDENTED EFFICIENCY . . . quick response to external conditions . . . ability to process several inputs and outputs simultaneously . . . service I/O requirements in order of priority without hold conditions. This kind of efficiency is expected only in higher priced computers.

The DDP-416 is directly compatible with ASCII 8-bit character codes. And the 30-command repertoire includes many "big-machine" functions like memory reference instructions: Load, Store, Add,



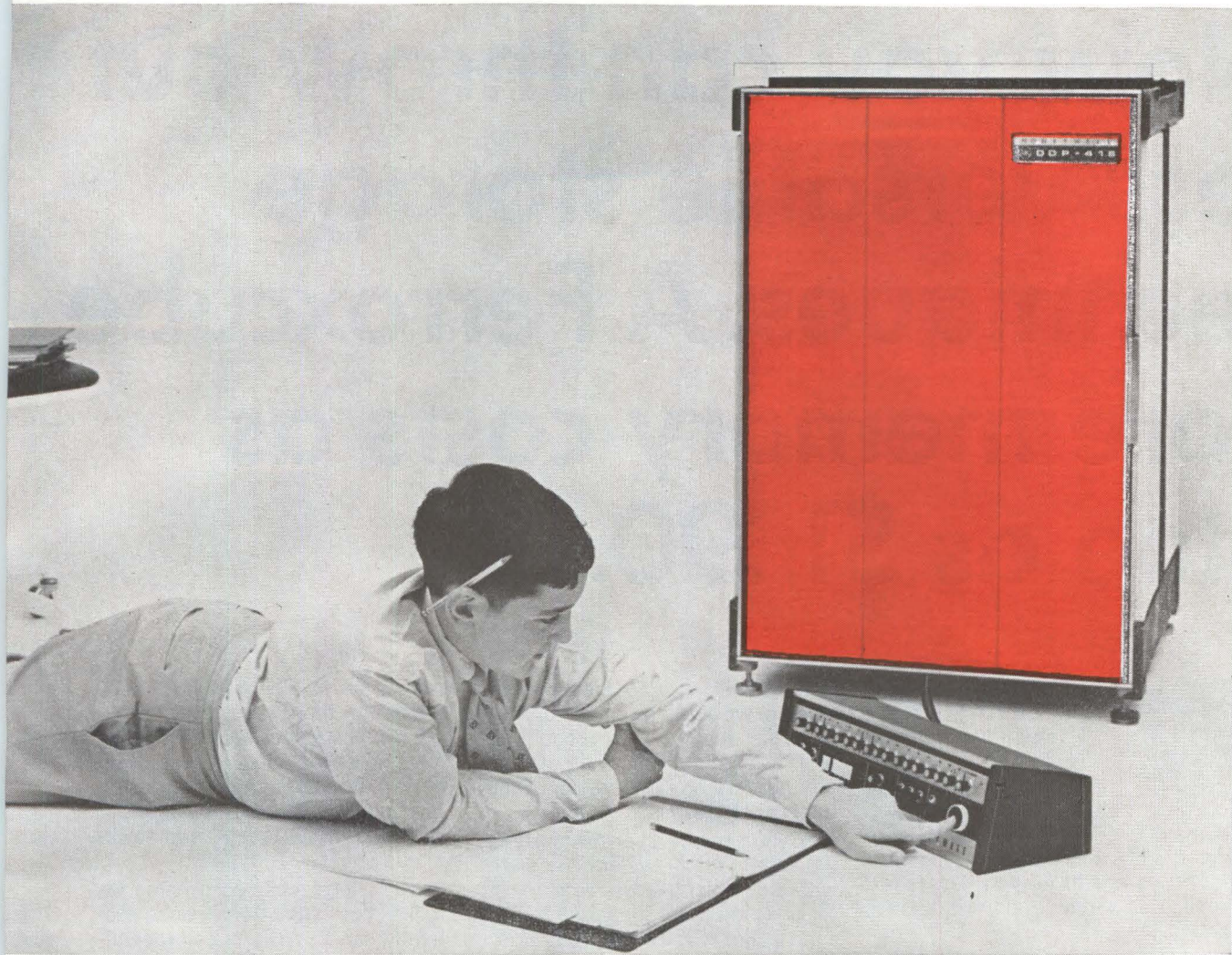

Donald, 12-year-old son of DDP-416 logic design engineer Bill Woods, writing software demonstration program for new  $\mu$ -COMP computer.

Subtract, Logical AND, Exclusive OR, Increment Memory and Skip, Jump, Jump-Skip. And two-cycle I/O commands that select device, test status, and transfer data without I/O hold-off. Priority interrupt and power-failure protection are standard.

**MODULAR CONSTRUCTION . . .** system power supply, central processor and a 4,096 word memory (expandable to 16,384 words) are mounted in a single 24" x 24" x 38" cabinet. Tilt out construction gives you easy front access to both modules and interwiring. The control console is moveable and the entire computer may be mounted in a standard 19" rack.

**EXPANSION CAPABILITY . . .** memory parity, memory lockout, real-time clock and multiplexed channel for multi-station time-shared I/O capability are all easy to add as plug-in options.

And if your problem is too big for the DDP-416, or if you think you'll grow out of it too fast, you may want the more powerful  $\mu$ -COMP DDP-516 for \$25,000.

**SIMPLIFIED SOFTWARE . . .** it may take a bright 12-year-old to work with the DDP-416, but you'll find it a snap to program. The package of 50 programs

is written in a simple format to give the real-time systems builder extended flexibility. You get mathematical and I/O subroutines, complete diagnostics, DESECTORIZING that lets you ignore memory addressing restrictions, a debug program, plus participation in our active users' group.

Best of all, if you decide to get the more powerful DDP-516 in the future, you can continue to use your DDP-416 programs because of direct compatibility.

**DELIVERY . . .** both hardware and software, second quarter of 1967.

### IMMEDIATE DELIVERY RESERVATION FILL OUT AND RETURN COUPON NOW

- Please reserve a DDP-416 and confirm approximate delivery date. Send more information by return mail. Hold this delivery date for me for 15-days so I can make a final decision and get my P.O. to you.
- Don't reserve a DDP-416 for me yet. I need more facts. Send me your DDP-416 summary brochure.
- I think I need a more powerful computer. Send me your DDP-516 summary brochure.

Name \_\_\_\_\_ Title \_\_\_\_\_  
 Company \_\_\_\_\_  
 Address \_\_\_\_\_  
 City \_\_\_\_\_ State \_\_\_\_\_ Zip \_\_\_\_\_

Please attach this coupon to your letterhead — we'll take it from there.  
 Honeywell, Computer Control Division  
 Customer Services  
 Old Connecticut Path  
 Framingham, Mass. 01701

# Honeywell

 **COMPUTER CONTROL DIVISION**



# Now you can throw out less versatile storage techniques. A Ferroxcube core memory costs as little as \$1,190.



We haven't been a leading core memory manufacturer all these years for nothing. We learned how to mass produce core memories and thereby sell them to you at prices competitive with less reliable, less versatile storage techniques.

Aside from price (we'll get back to that in a moment), consider the advantages of core memory systems. Speed. Random access.

Non-dissipative. And they're non-volatile. We could go on and on. We won't because you've probably always wanted to design your system around core storage anyway. Only the cost stopped you.

Now you can buy a Ferroxcube 128 x 8 core memory system complete with stack electronics, data register and timing for a paltry \$1,190. That's our FX-12. Its capacity

ranges up to 512 x 8. The FX-14 picks up there and goes on to 4,096 x 32. Prices are comparably low. Moreover, the FX-14 is available with almost any choice of interfacing elements. Buy only what you need to interface with what you already have.

In brief, Ferroxcube core memories make both functional and economic sense. Write or call for Bulletin M661.

**Ferroxcube** 



FERROXCUBE  
CORPORATION  
OF AMERICA  
Saugerties, New York  
914-246-2811

Boston  
617-899-3110

Chicago  
312-261-7880

Dallas  
214-255-0441

Los Angeles  
213-837-1484

Minneapolis  
612-888-4681

New York Area  
201-267-5888

Phoenix  
602-265-1792

Philadelphia  
215-927-6262

Washington, D.C.  
703-893-4900





Put the  
Blame  
on Mame, boys

Donna Dinkler is a final inspector on one of our series 1220 relay production lines. The little picture below shows her doing her job. We only called her "Mame" up above because—well, we had trouble trying to rhyme Donna Dinkler.

Anyway, you'll look a long time before you find an inspector that's fussier than Donna. A 1220 doesn't measure up in every way and ZAP! Into the reject pile.

Now this kind of painstaking inspection doesn't speed up the production of 1220's one single bit. But it's the only way to assure that the 1220's you get are no less than perfect.

Multiply Donna by the other inspectors on the series 1220 lines and their fussiness and you see why we occasionally have sales running ahead of delivery. So many engineers have found these versatile, enclosed 10 amp. DPDT or

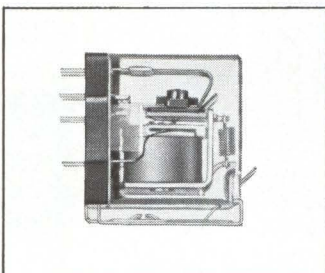

3PDT relays to be so reliable and long lived that we're hard pressed at times to keep up with the demand. The 1220 is a U/L listed relay with terminals that can be used as solder lug, AMP Faston 110 series quick connect or socket plug-in that comes complete with mounting bracket.

So, if you need 1220's in quantities up to 399, see your Guardian distributor. If you need larger quantities order direct from factory production. If you want more information, send for bulletin B2.



**GUARDIAN  
ELECTRIC**

1550 W. Carroll Avenue, Chicago, Ill. 60607  
Guardian Electric Manufacturing Company,

Circle 69 on reader service card





TYPE 209

# WIDEBAND PRIMARY PHASE STANDARD

## FEATURES:

Accuracy  $0.015^\circ$ , resolution 10 micro-degrees ( $10^{-5}$ ).

Self-calibration, self-checking by means of fundamental bridge balancing, without the use of an external standard.

Directly traceable to National Bureau of Standards.



- As a primary wide-band phase standard in any standard laboratories.
- For accurate measurement of phase shift of an unknown network.
- For calibration of phase meters, complex ratio bridges and phase sensitive equipment.
- As a precision phase meter, measures phase shift between two voltages.

## SPECIFICATIONS:

**FREQUENCY** — Continuous coverage from 50 cps to 10 kc with rated accuracy.

**PHASE RANGE** — Can be set for any phase angle from  $0^\circ$  to  $360^\circ$  with 7-digit resolution.

**ACCURACY** —  $\pm 0.015^\circ$  for 50 cps to 1 kc;  $\pm 0.02^\circ$  from 1 kc to 2 kc;  $\pm 0.03^\circ$  from 2 kc up to 3 kc;  $\pm 0.04^\circ$  from 3 kc up to 5 kc;  $\pm 0.07^\circ$  up to 10 kc.

**RESOLUTION** — 0.00001 degree (10 micro-degrees).

**MAXIMUM INPUT** — 70 volts rms above 200 cps; 0.35 x signal frequency below 200 cps.

**REQUIREMENT FOR INPUT SIGNAL:** Percentage of Frequency Stability — Less than 0.14 x maximum tolerance of phase error in degree. Waveform Distortion — Less than 0.2% desirable; Source Impedance — 600 ohms or less.

**MAXIMUM OUTPUT SIGNALS** — 50 volts above 200 cps; decreases to 0.25 x signal frequency below 200 cps.

Measure phase shift of unknown network with accuracy better than  $0.02^\circ$

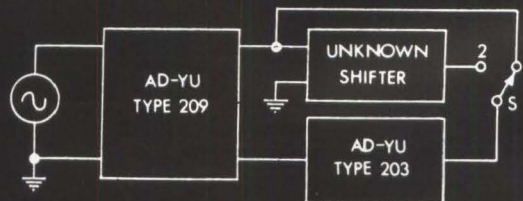

Measure phase between two signals,  $E_a$  and  $E_b$  with AD-YU Type 203 as null detector. Phase angle between  $E_a$  and  $E_b$  is read directly on the 7-digit dial of Type 209.

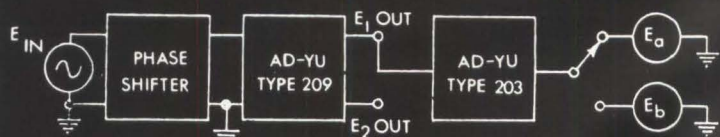

# ADYU

**ELECTRONICS INC.**  
249-259 TERHUNE AVENUE, PASSAIC, N. J.  
Phone (201) 472-5622 • CABLE: ADYU PASSAIC

**WORLD FAMOUS  
IN PHASE AND  
TIME MEASUREMENT.**



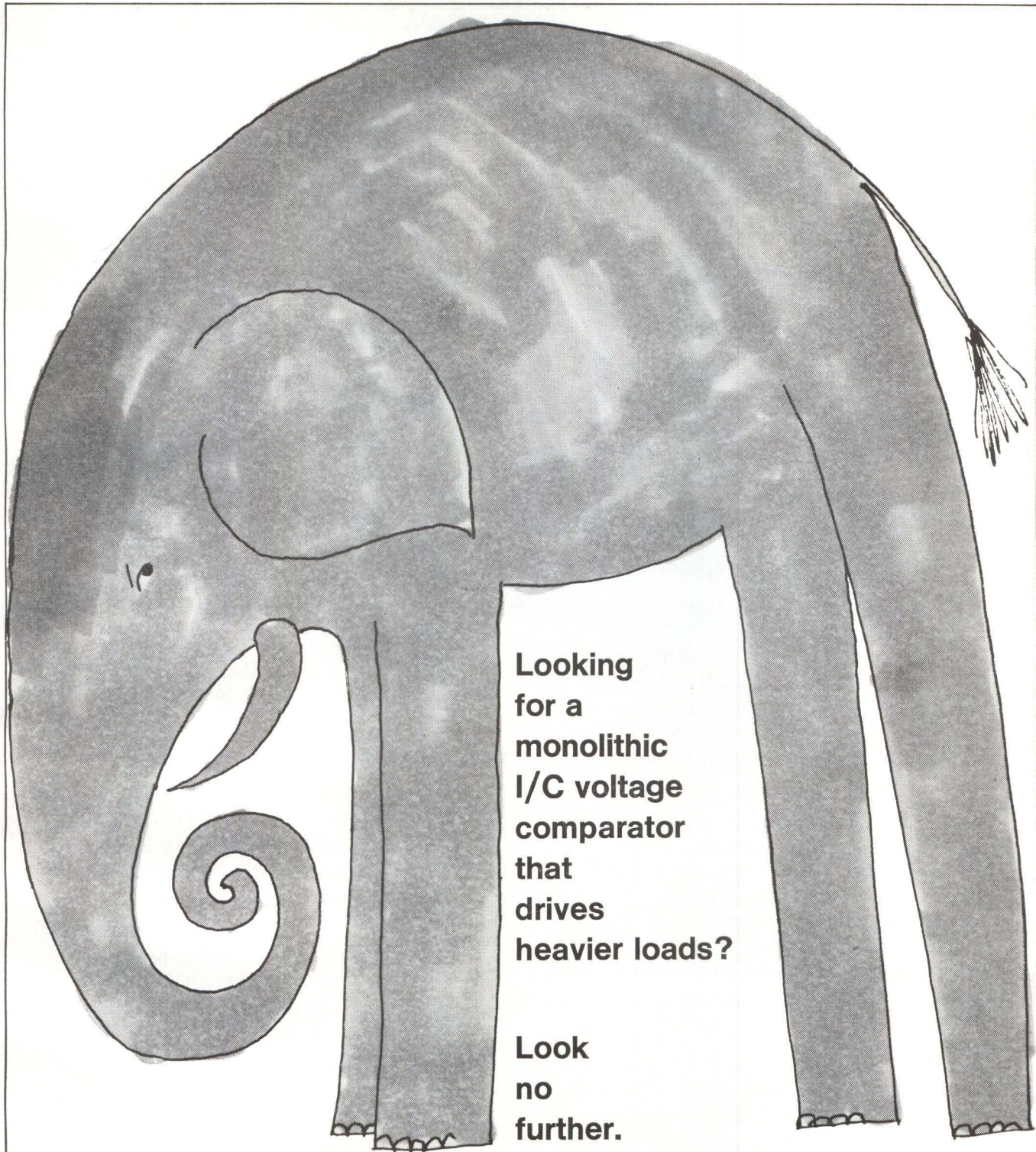

Looking  
for a  
monolithic  
I/C voltage  
comparator  
that  
drives  
heavier loads?

Look  
no  
further.

Signetics SE518\* provides much more than an unusual load-driving capability. It interfaces directly with all popular logic circuits—DTL, TTL, RTL, or any of several types of CML. For application ease and flexibility, the SE518 operates from standard logic power supplies, and provides a strobe control. No other I/C voltage comparator offers all these advantages in one package. We'd be happy to show you how to use it as a Schmitt Trigger, a Sense Amplifier, a Line Receiver, a Window Detector, or in dozens of other applications. Send for our application notes and data sheet today. Write Signetics, 811 E. Arques Ave., Sunnyvale, California.

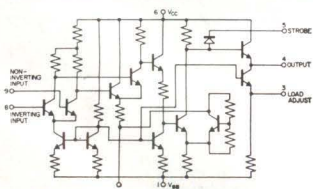

\*Just one of the Signetics product family that is also available from Sprague Electric Co. under a technology interchange agreement.

**SIGNETICS  
INTEGRATED  
CIRCUITS**



A SUBSIDIARY OF CORNING GLASS WORKS



# E PLURIBUS UNUM

Unitized approach to  
microwave source solves  
multiple system problems

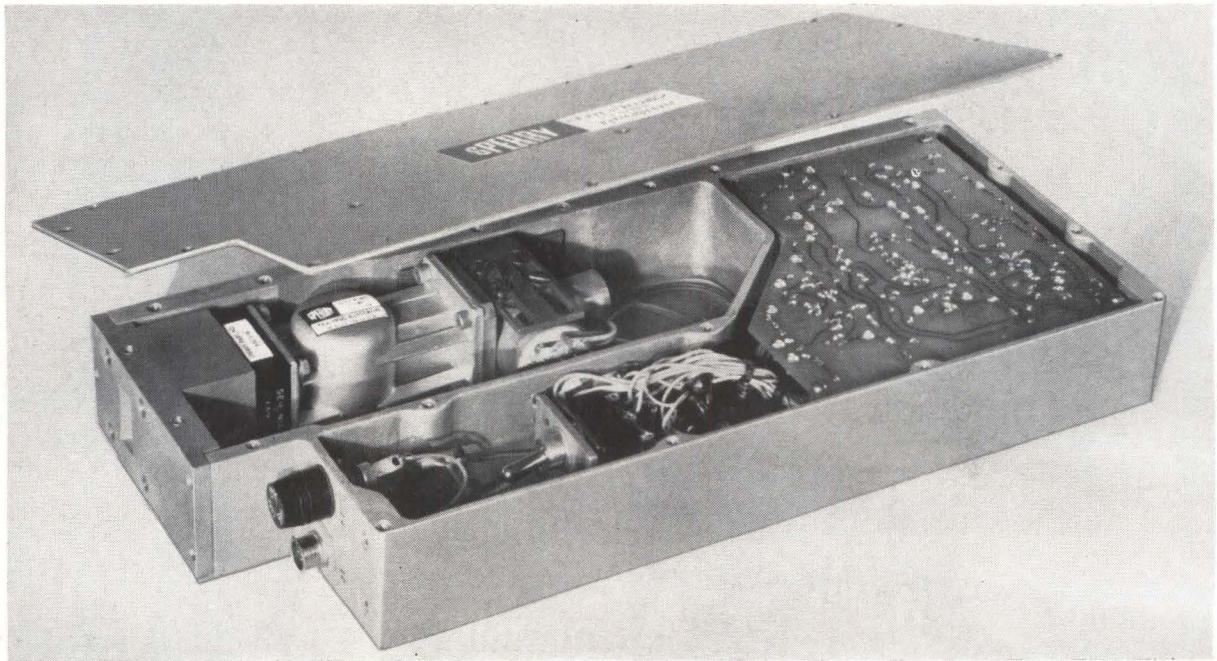

Microwave system designers are discovering a remarkable new work-saving technique — a way to get a lot of answers by asking just one question. They are asking Sperry to supply a microwave oscillator, its solid-state power supply, and associated stalo cavities and isolators (as required), in a single, fully-integrated package.

System designers simply specify a single voltage input and the microwave output characteristics they desire. Sperry does the rest.

Sperry accomplishes this by starting with a fixed reflector voltage reflex klystron. They add "instant" temperature compensation and hook up a solid-state power supply that has been specially designed to match

Don't fight the interface problems inherent in microwave source design — let Sperry solve them for you. Put the Sperry "Storehouse of Knowledge" to work on your system. It will give you predictable source performance at predictable cost, while freeing you to concentrate on other aspects of the system design.

the characteristics of the tube. Next the required stalos and isolators are added, and the entire microwave source is packaged as a unit.

With the proper mix of solid-state and tube techniques, Sperry is able to produce desirable secondary characteristics—such as outstanding frequency stability, low FM noise level and precise RFI control—that are beyond the reach of either technology alone.

Learn how Sperry's unitized approach to microwave sources can simplify your design problem. For your free copy of a new technical paper on the subject, contact your Cain & Co. man or write Sperry, Gainesville, Florida.

## SPERRY

DIVISION OF  
SPERRY RAND  
CORPORATION

## SPERRY ELECTRONIC TUBE DIVISION, Gainesville, Fla.

National Representatives: Cain & Co., Los Angeles, 783-4700; Boston, 665-8600; Arlington Heights, 253-3578; Dallas, 369-2897; Dayton, 228-2433; Eastchester, 337-3445; Philadelphia, 828-3861; San Francisco, 948-6533; Syracuse, 437-2933; Washington, 296-8265; South Amboy, 727-1900; Huntsville, 859-3410; Orlando, 422-3460; Montreal, 844-0089.



---

# Washington Newsletter

---

December 12, 1966

## Navy faces battle over FDL program

Despite powerful opposition from merchant ship operators and shipyard builders, the Navy expects to win its battle for the billion-dollar Fast Deployment Logistics ships program when Congress convenes in January. Instead of the highly automated floating warehouses that would form the FDL fleet, its opponents want 100 ships subsidized by the Navy that could be used in peacetime or adapted to military use when needed.

Builders of conventional shipyards are backing the merchant ship lobby because they've been shut out of bidding for the construction of the country's first fully automated shipyard. Only aerospace firms with shipbuilding operations have the systems design and engineering capability needed. In the running for the automated shipyard contract are the Lockheed Shipbuilding and Construction Co., a subsidiary of the Lockheed Aircraft Corp.; Litton Industries, Inc. and the General Dynamics Corp.

## NASA cancels advanced Surveyor

The National Aeronautics and Space Administration has decided not to build the second model of the Surveyor spacecraft. It had planned to buy three of the heavier, more complex lunar soft landers from the Hughes Aircraft Co. at a total cost of \$150 million. However, the advanced versions have been looking less desirable in recent months because they couldn't have been launched early enough to provide lunar surface information for the Apollo program—their primary mission requirement.

## Comsat proceeds with Intelsat 2

Comsat will launch its second Intelsat 2 satellite on Jan. 11 now that it knows for sure why the first satellite failed to go into proper orbit over the Pacific Ocean. Ground tests confirm that the apogee engine was exposed to colder temperatures than it was designed for [Electronics, Nov. 14, p. 74] so it shut off prematurely.

For the January launch, also over the Pacific, Hughes Aircraft Co., the builder, will insulate the motor. If Comsat succeeds in achieving a synchronous orbit, a third Intelsat 2 satellite will be launched over the Atlantic Ocean three weeks later to give Comsat a worldwide network.

Meanwhile, the Communications Satellite Corp. will make money from the first Intelsat 2 (called Lani Bird) even with its nonsynchronous elliptical orbit. Eight-hour a day commercial service began on Dec. 2 between Hawaii and San Francisco. More than 40 of its 240 circuits have been leased, 10 by the Defense Department, so Comsat should earn from \$75,000 to \$100,000 a month with Lani Bird.

## Air Force demand for fixed prices irks computer firms

Computer companies are bristling at a demand by the Air Force that they quote firm prices over a 2½ year period on 134 electronic data processing systems. Some companies, including the International Business Machines Corp., may decline to submit bids.

The Air Force won't guarantee that it will use or accept the systems and the companies consider this a one-sided deal. An added source of irritation to many of the 15 computer makers invited to bid on the giant order is that the Air Force waited until Nov. 25, only five days before the original deadline for bids, to spring its surprise request. The



---

# Washington Newsletter

---

deadline for the pricing portion of the proposal has been extended one month to Dec. 30.

The systems are being sought for the second phase of the Air Force's Base Level Automation Standardization program. Despite the rumblings from the computer makers, the Air Force says it is studying the feasibility and desirability of continuing to seek firm prices on future data-processing-systems orders.

## Avionics systems being weighed for new VTOL

Two integrated avionics systems are likely candidates for the supersonic fighter bomber with vertical takeoff and landing capability under joint United States-German development. They are the Mark-2 system now being developed by North American Aviation, Inc. and the Integrated Light Attack Avionics System (Ilaas) developed by the Sperry Rand Corp.

The Republic Aviation division of Fairchild Hiller Corp. and the German combine of Entwicklungsring-Sud are to conduct a prototype definition on the VTOL. Early in 1968, a decision on whether or not to produce prototypes for testing will be made.

## NASA announces space lab launch for 1968

The National Aeronautics and Space Administration isn't letting the refusal of the White House to provide funds stop it from putting up a manned orbiting space station. The agency has announced plans for a 1968 launch of a station using hardware left over from the Apollo moon program.

NASA will orbit equipment for the station over a period of several months. First, it will use the top stage of a Saturn rocket as a workshop for astronauts [Electronics, Nov. 14, p. 73]. After they've conducted experiments, the astronauts will be returned to earth and the workshop will remain in orbit. A few months later, a telescope will be put up in an unmanned craft. Finally, a manned Apollo ship will be launched. The three systems will be docked together for up to two months of experiments before the astronauts return to earth.

The station would put NASA ahead of the Air Force, which plans to launch its manned orbiting laboratory in 1969. The Air Force program, with the strong support of the Pentagon and the Administration, seems likely to survive any attempt to cut back its funds.

## Addenda

Seven airlines will participate in very-high-frequency communication experiments [Electronics, Nov. 14, p. 73] during their regular Pacific flights via the space agency's Applications Technology Satellite. Equipment for the tests beginning in mid-December came from the Bendix Corp; the Collins Radio Co; and Dorne and Margolin, Inc. . . . The Federal Communications Commission has ordered the international communications carriers, the broadcasting networks and the Communications Satellite Corp., to settle their differences and decide what the charges will be for future satellite services by Jan. 16, or face a formal investigation. . . . Negotiations between the Hughes Aircraft Co., and the Air Force on the contract to build a demonstration tactical communications satellite have run more than 15 days, making it appear stronger than ever that Hughes has won [Electronics, Nov. 28, p. 52]. The first satellite of two the Air Force is ordering is scheduled for delivery 16 months after the contract is signed.



**NEW!**

**IMMEDIATE DELIVERY  
FROM STOCK  
\$1,380**

**100kΩ to 10,000 TΩ**

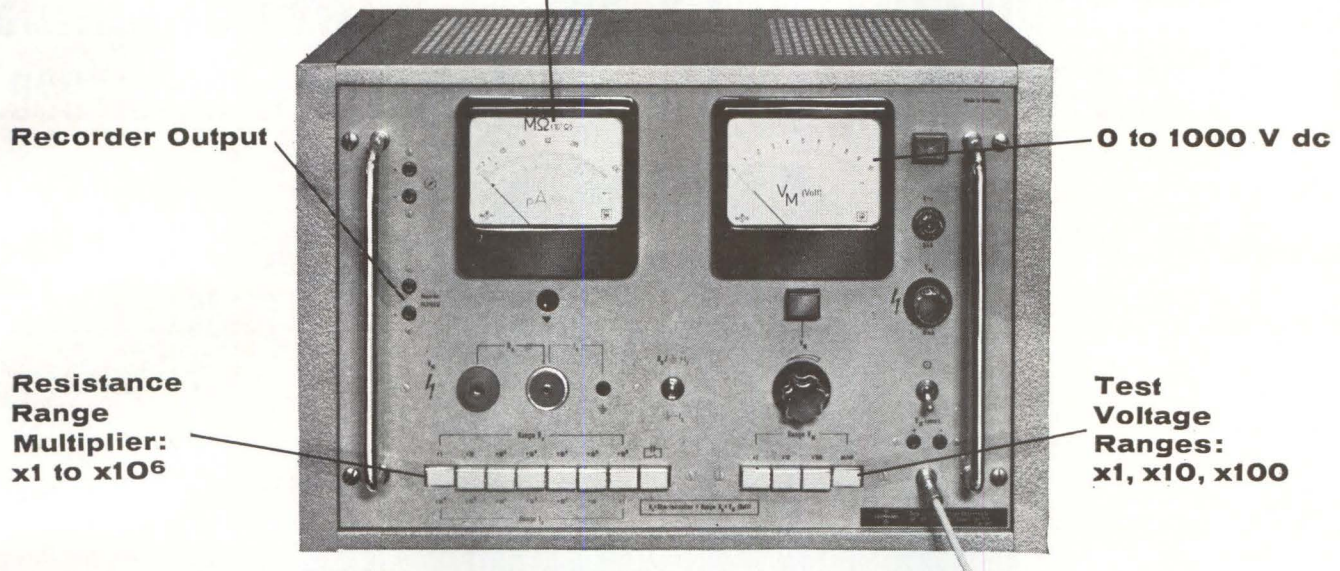

**TYPE T07a**

**TERA-OHMMETER®  
FOR INSULATION MEASUREMENTS**

**FEATURES**

- Resistance Range: 100kΩ to 10,000TΩ (10<sup>5</sup>Ω to 10<sup>16</sup>Ω)
- Current Range: 0.1 pA to 10 μA
- Test Voltage: 0 to 1000 V dc
- High Speed: less than 4 sec. for measurement
- High Accuracy: ±3% of f.s.d
- All Silicon Solid State Design

**APPLICATIONS**

- Measure Insulation Resistance and Leakage Current of Components, including: Capacitors, Transformers, Switches, Cables, Wires, Pots, etc. Semiconductors Insulating Materials and Lacquers, including: plastics, glass, rubber, oils, varnishes, mica, paper, etc.
- Determine Volume and Surface Resistivity
- Measure Voltage Coefficients
- Measure Purity of Liquids

Type T07a Tera-Ohmmeter® offers highly accurate resistance measurements. Analyze the many factors affecting insulation resistance: humidity, temperature, impurities, voltage coefficient, surface conditions, etc. The Tera-Ohmmeter finds unlimited application in both R&D and production use. It is unique in offering an extremely wide resistance and current measurement range, at accurate test voltages from 1 V to 1000V, high measuring speed, recorder output, high stability and provision for charge and discharge of test item. Accessories available include: comparison resistors, sample holders, and shielded cables.



**RESISTANCE / CURRENT  
Measuring Scale**

Get The Extra Capability,  
Greater Reliability, and  
Longer Useful Life Of ...



**ROHDE & SCHWARZ**

111 LEXINGTON AVENUE, PASSAIC, N. J. 07055 • (201) 773-8010



# NEW

## Lambda high current LK Series power supplies 0-20, 0-36, 0-60 VDC • up to 35 amps • 5¼" height • starting at \$330.

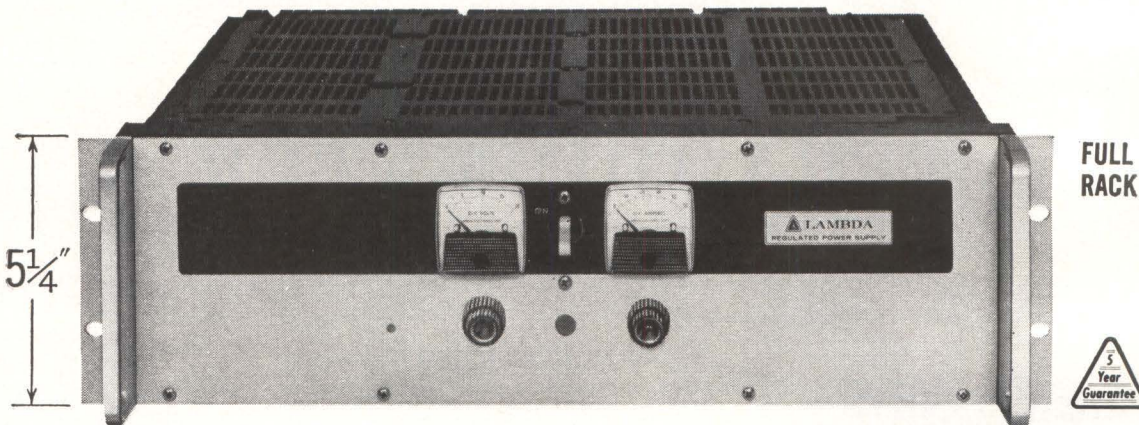

### Features

- All Silicon
- Convection cooled
- Remotely programmable
- Meet Mil-Environment specs
- Vibration: MIL-T-4807A
- Shock: MIL-E-4970A
- Proc. 1 & 2
- Humidity: MIL-STD-810
- Meth. 507
- Temp. Shock: MIL-E-5272C
- (ASG) Proc. 1
- Altitude: MIL-E-4970A
- (ASG) Proc. 1
- Marking: MIL-STD-130
- Quality: MIL-Q-9858
- Remote Sensing

- Series/Parallel Operation
- Regulation—.015% or 1 MV (Line or Load)
- Ripple—500 uV RMS.
- Temp. Coef. .015%/°C
- Transformer—designed to MIL-T-27 Grade 6
- Completely Protected—Short Circuit Proof—Continuously Adjustable Automatic Current Limiting
- Constant I./Constant V. by automatic crossover
- No Voltage Spikes or Overshoot on "turn on, turn off" or power failure
- Wide Input Voltage and Frequency Range—105-132 VAC, 47-63 cps

Rack or Bench use—rubber feet included for bench use.

3 full-rack models — Size 5¼" x 19" x 16½"

Model <sup>2</sup>	Voltage Range	CURRENT RANGE AT AMBIENT OF: <sup>1</sup>				Price <sup>2</sup>
		40°C	50°C	60°C	71°C	
LK 350	0-20VDC	0-35A	0-31A	0-26A	0-20A	\$675
LK 351	0-36VDC	0-25A	0-23A	0-20A	0-15A	640
LK 352	0-60VDC	0-15A	0-14A	0-12.5A	0-10A	650

6 half-rack models — Size 5¾" x 8¾" x 16½"

Model <sup>2</sup>	Voltage Range	CURRENT RANGE AT AMBIENT OF: <sup>1</sup>				Price <sup>2</sup>
		40°C	50°C	60°C	71°C	
LK 340	0-20VDC	0- 8.0A	0- 7.0A	0- 6.1A	0-4.9A	\$330
LK 341	0-20VDC	0-13.5A	0-11.0A	0-10.0A	0-7.7A	385
LK 342	0-36VDC	0- 5.2A	0- 5.0A	0- 4.5A	0-3.7A	335
LK 343	0-36VDC	0- 9.0A	0- 8.5A	0- 7.6A	0-6.1A	395
LK 344	0-60VDC	0- 4.0A	0- 3.5A	0- 3.0A	0-2.5A	340
LK 345	0-60VDC	0- 6.0A	0- 5.2A	0- 4.5A	0-4.0A	395

<sup>1</sup> Current rating applies over entire voltage range.

<sup>2</sup> Prices are for non-metered models. For metered models add suffix (FM) to model number and add \$30.00 to price.

<sup>3</sup> Overvoltage Protection: Add suffix (OV) to model number and add \$70.00 to the price for half-rack models; \$90.00 for full-rack models.



**LAMBDA ELECTRONICS CORP.**  
515 BROAD HOLLOW ROAD • MELVILLE, L. I., NEW YORK • 516 MYRTLE 4-4200

A **Voeco** SUBSIDIARY

LA-173





# servo is microwaves

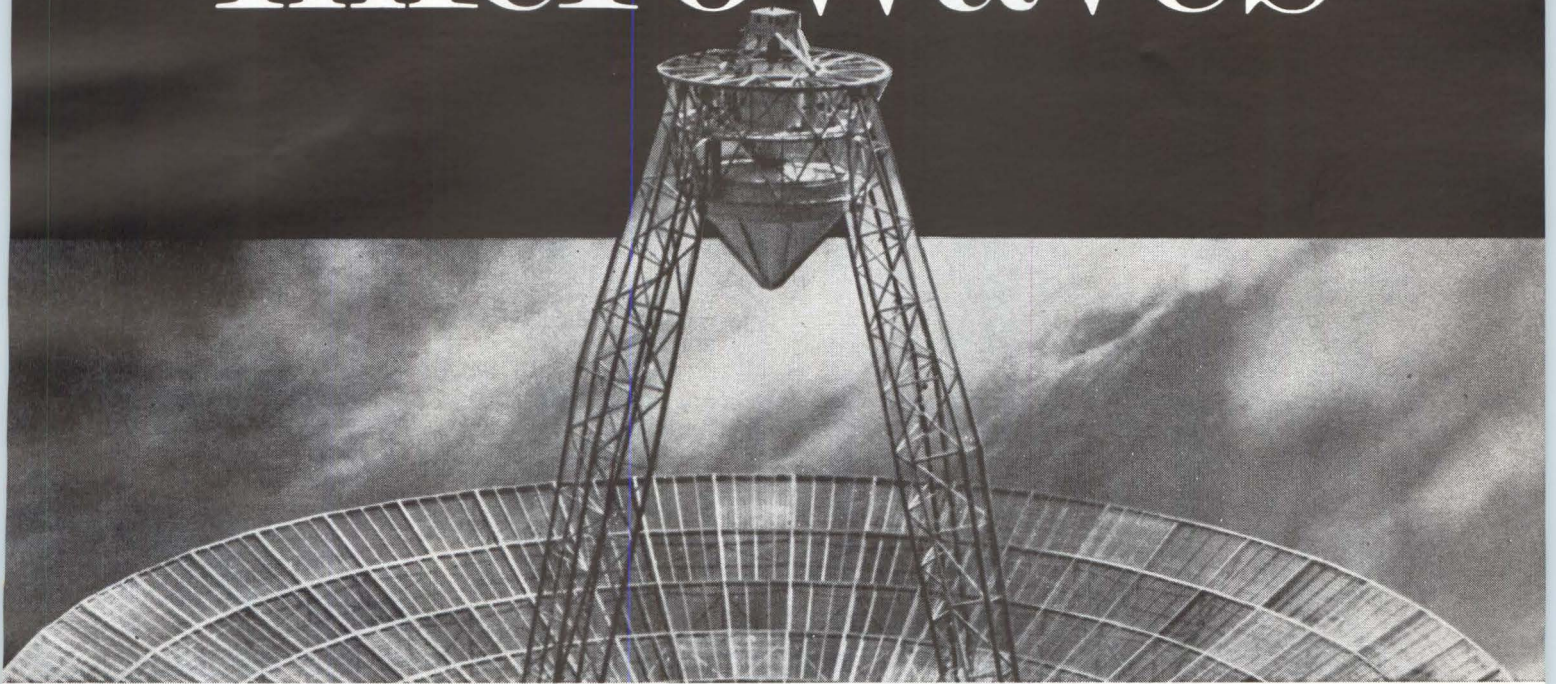

Want to generate a signal in the Ka band, test electronic gear on an aircraft, or check out the guidance system of a missile? Servo designs and manufactures instruments for these applications. And many others.

Our engineers are expert in producing microwave pulse-swept systems, microwave signal generators, microwave amplifiers and high voltage power supplies. Take the unit pictured above, for example. It's the first 20-watt TWT amplifier available...and industry's most compact, too. Servo's amplifiers have many unusual features, and are

supplied in models for operation from 1 to 18 GHz in octave bandwidths.

Our Servodynamics Division also supplies special synchro-to-digital and digital-to-synchro conversion equipment and servo analyzers, digitally programmable function generators, and phase meters.

Other Servo divisions design systems and products which serve safety through science: the Railroad Products Division, the Infrared & Electro-Optics Division, and the Communications & Navigation Division.

servo corporation of america

# servo

111 new south road  
hicksville, l.i., new york 11802  
516 938-9700

Circle 77 on reader service card



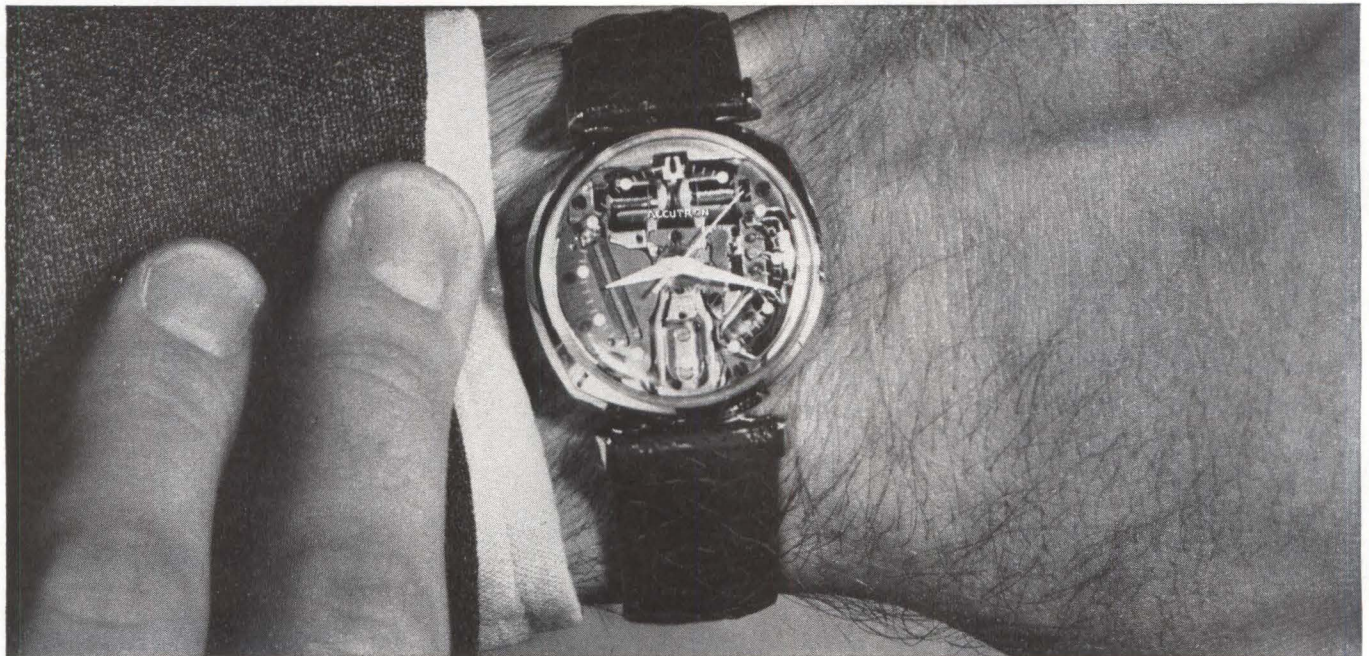

**Bulova needed a battery smaller than a button to power its Accutron<sup>\*</sup> timepiece for 15 months.**

**Mallory made it.**

## What can we do for you?

The Mallory people pride themselves on solving specialized problems. What they did for Bulova, they can do for you. Mallory's skilled engineers lead the way in miniaturized power sources for every power need. From hearing aids to Bulova electronic clocks for Gemini spacecraft, Mallory has solved the problem of packaging long-lasting power in button-size batteries. Quality manufacturers are willing to spend more to bring their customers the best batteries in the business. They come to Mallory.

### BATTERY ENERGY PER OUNCE

<b>MALLORY MERCURY</b>
MALLORY ALKALINE MANGANESE
ORDINARY

**High Energy.** The secret of Mallory batteries long-lasting life is high energy. More energy per ounce squeezed into each battery reduces battery changing to a minimum. Mallory high-energy battery systems offer the longest life—more maximum hours of service than any other battery commercially available. Mallory Mercury batteries for electronic circuits have about 4 times more energy per unit volume than ordinary zinc carbon batteries.

Mallory heavy-duty Alkaline batteries have about 3 times more energy than conventional zinc carbon batteries. All this adds up to peak power at a lower cost per hour usage.

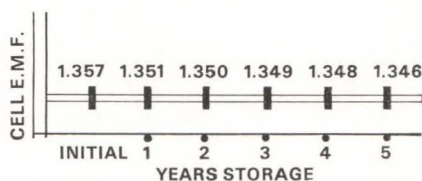

**Higher Stability.** Mallory high-energy Mercury batteries have the unique property of staying exactly at the same operating range throughout long life. Their output is so exact, they are used as laboratory voltage standards. This stability is most useful and often essential in powering products which remain idle for months but must operate perfectly when the occasion arises. This also means that Mallory battery systems have exceptional shelf stability. In fact, Mallory has had cells in storage for 12 years and more which still maintain useful capacity.

The reason for this higher stability is that the Mallory Mercury system is inherently inactive when not being discharged; and is, in effect, hermetically sealed, preventing evaporation of the electrolyte.

Of course, Mallory high-energy batteries cost more, but they're worth more because of the superior performance they give your product.

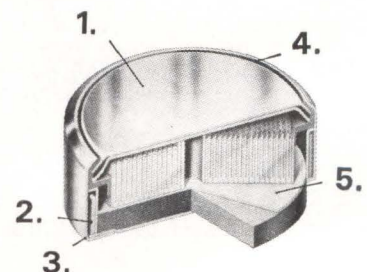

1. Double top seal. 2. Sealing grommet. 3. Self-venting structure. 4. Non-corroding metal structure. 5. Long-life barrier.

If you're thinking of an energy system for your new product, call in the Mallory people. They're constantly looking for new problems to solve. Find out what they can do for you. For a consultation on your specific requirements, write Mallory Battery Company, a division of P. R. Mallory & Co. Inc., S. Broadway, Tarrytown, New York 10591. Tel.: 914-591-7000. (In Canada: Mallory Battery Company of Canada Limited, Sheridan Park, Ontario.)

\*T/M Bulova Watch Company, Inc.

**MALLORY** It's good business to do business with Mallory



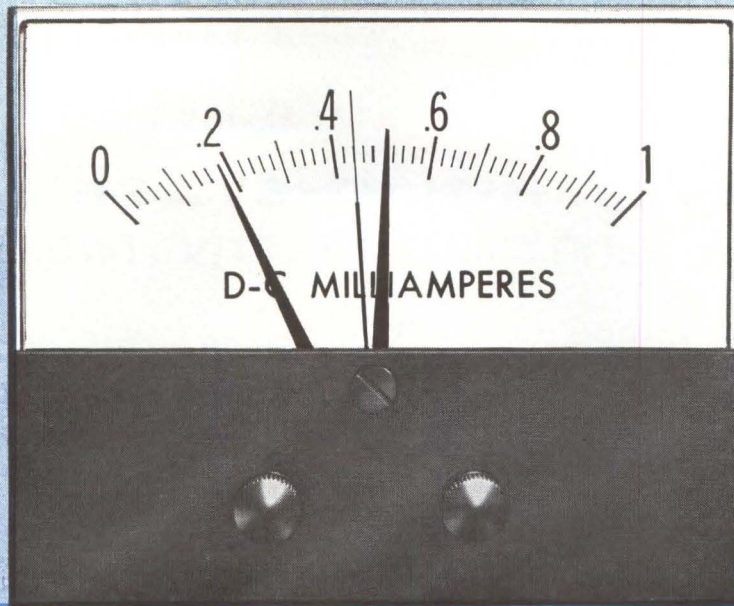

# ANNOUNCING

## A GENERAL ELECTRIC METER RELAY IN THE CLASSIC HORIZON LINE STYLING

Here's the newest addition to G.E.'s panel meter family . . . the Type 196 HORIZON LINE® meter relay and controlling pyrometer. You get the same features and high reliability that made the BIG LOOK® meter relay so popular.

The new Type 196 has solid state, light-sensitive switching for direct control of load relay. Choose from 3½- and 4½-inch models with single or double setpoints.

G.E.'s unique "piggyback" control module plugs directly into rear of the meter, eliminating separate mounting of wire and components.

The new Type 196 can be front mounted for a crisp, classic look or back of panel mounted for a trim, built-in appearance.

Learn more about G.E.'s new HORIZON LINE meter relays. Write: Section 592-32, General Electric Co., Schenectady, N. Y. 12305, for bulletin GEA-8014, or contact your G-E sales representative.

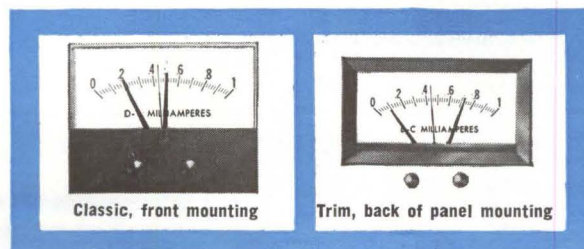

GENERAL  ELECTRIC



# THE ONLY SOLID-STATE AM/FM MODULATION METER

MODEL 2300

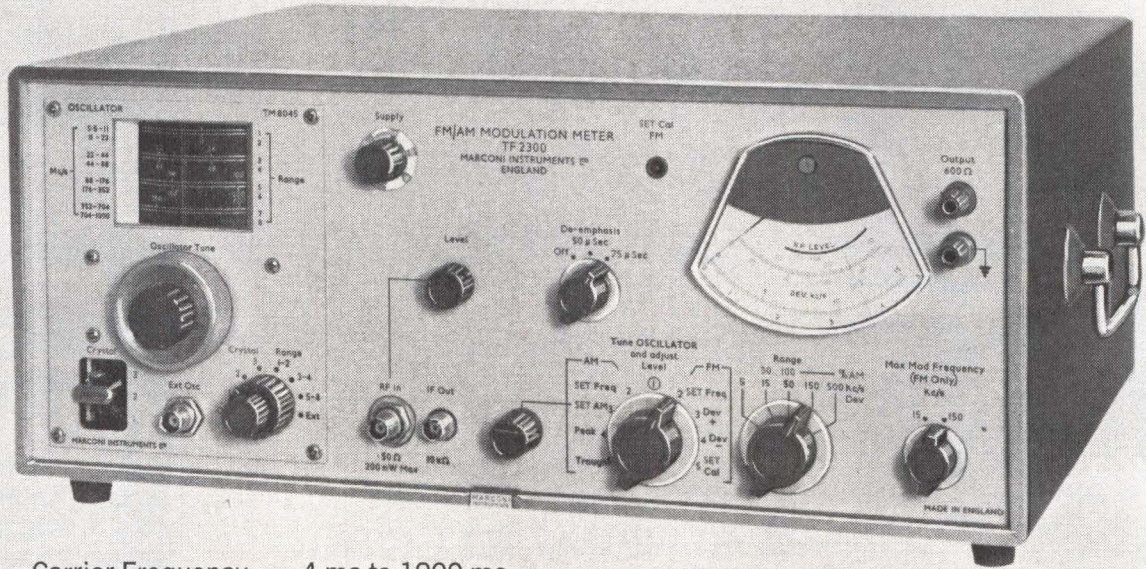

Carrier Frequency: 4 mc to 1000 mc

Sensitivity: 20 mV to 250 mc  
50 mV to 500 mc  
100 mV to 1000 mc

need we say more?

	<p><b>FM MEASUREMENT</b> Peak deviation in five ranges of 5, 15, 50, 150 and 500 kc. Modulating frequencies 30 cps to 150 kc. Suitable for AM or FM broadcast (mono or stereo) TV Sound, telemetry and communications.</p>		<p><b>AM REJECTION.</b> Less than <math>\pm 1</math> kc additional deviation error with 80% amplitude modulation superimposed at 1 kc using a 15 kc audio bandwidth.</p>
	<p><b>AM MEASUREMENT</b> for carriers to 500 Mc. Two ranges of 30% and 100% (usable to 95%). Peaks or troughs switch selected. Modulating frequencies 30 cps to 15 kc.</p>		<p><b>L. F. OUTPUT</b> Low distortion, low noise de-modulated signal derived from FM or AM carrier. Switchable de-emphasis 50 <math>\mu</math>sec and 75 <math>\mu</math>sec. Level 0dB into 600<math>\Omega</math> feeds distortion or wave analyser.</p>

WRITE FOR DETAILED CATALOG SHEET

## MARCONI INSTRUMENTS

DIVISION OF ENGLISH ELECTRIC CORPORATION

111 CEDAR LANE

ENGLEWOOD, NEW JERSEY

(201) 567-0706



NEW family  
of medium-  
power  
silicon NPN  
transistors  
packs BIG  
performance  
at mass  
production  
prices

Here's A Typical Value: RCA 40458

$h_{FE}$ ..... 50 min. at 300 mA

$V_{CEO}$  (SUS)..... 40 V min. at 100 mA

$V_{CE}$  (sat)..... 0.3 V max. at 300 mA

$f_T$ ..... 150 MHz min.

$I_C$ ..... 1A

Dissipation: 2 W at 75°C Case Temp.

only 47¢\*

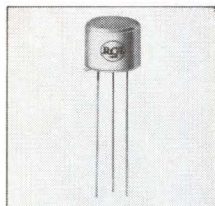

Hermetically sealed  
in a metal case

now examine the entire family of value-packed industrial types

RCA 2N3241A Silicon Epitaxial Planar Transistor Family Characteristics									
	2N3241A	2N3242A	2N4074	40397	40398	40399	40400	40458	
$BV_{CEO}$	25	40	40	25	25	18	18	40	max. volts
$h_{FE}$ 10V, 10mA	100-200	125-300	75-300	165-600	75-300	165-600	75-300	100-300 (50 min. @ 300mA)	
$f_T$ typ.	175	175	80	80	80	80	80	150 min.	MHz
$V_{CE}$ (SAT)	0.25 at 200mA $I_C$	0.3 at 300mA $I_C$	0.3 at 300mA $I_C$	0.25 at 200mA $I_C$	0.25 at 200mA $I_C$	0.2 at 100mA $I_C$	0.2 at 100mA $I_C$	0.3 at 300mA $I_C$	max. volts
Turn-on $I_C = 150mA$	75	75	—	—	—	—	—	75	max. nanoseconds
Dissipation** at 25°C Ambient	0.5	0.5	0.5	0.5	0.5	0.5	0.5	0.5	max. watts
$I_C$	Limited by $P_T$	Limited by $P_T$	0.3	0.2	0.2	0.2	0.2	1.0	max. amperes
Price*	\$0.44	\$0.50	\$0.44	\$0.40	\$0.36	\$0.33	\$0.30	\$0.47	

\* In quantities of 1,000 and up.      \*\*All types available with integral heat radiator for 1 watt dissipation at  $T_A = 25^\circ C$ . Add 4¢ per unit for these versions.

The new RCA 2N3241A family of NPN epitaxial planar transistors, designed for amplifier and switching service in audio and video frequency ranges, is as versatile as it is reliable. Applications include • relay drivers • video amplifiers • high current audio drivers • saturated switches • TV deflection drivers • medium power audio output amplifiers. All devices offer exceptionally low leakage, low saturation voltages, and high minimum beta. Check the chart for specifications...and note the low prices!

See your RCA Distributor for his price and delivery

Double the 25°C free air dissipation capability from ½ watt to 1 watt by specifying integral heat radiator versions of the devices listed above.

You won't find another family of medium-power silicon transistors with so much performance, at so little cost, available immediately in production quantities. Call your local RCA Field Office for complete information. For technical data sheets write: RCA Commercial Engineering, Section EN12-2, Harrison, N.J. 07029.

RCA Electronic Components and Devices



The Most Trusted Name in Electronics



It has a circuit of dependable FORMICA® brand copper clad . . .

## They designed an emergency landing light knowing it couldn't be babied in Arctic snow or jungle rainstorm.

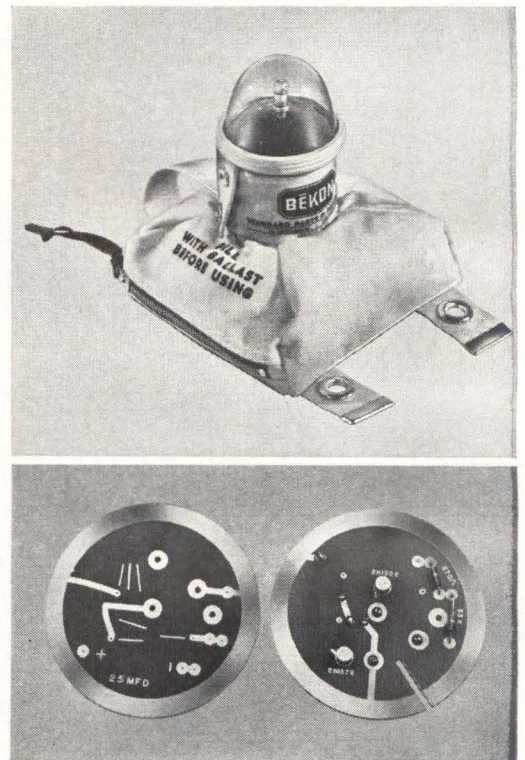
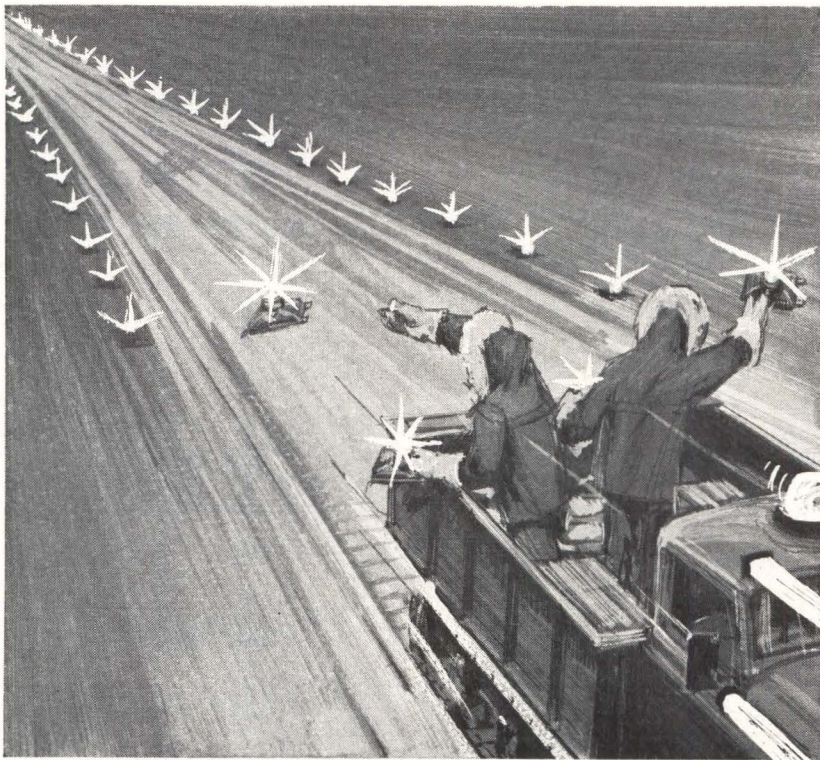

Power failure puts an airfield out of business—or rather it used to. Today, airfields throughout the world depend on Bekon\* lights for such emergencies. These rugged little life-savers, thrown quickly from moving trucks, to serve as emergency runway markers, keep working in any climate, under any weather condition. The Bekon Light nerve center is a printed circuit, made of a FORMICA® brand copper clad laminate. If the dependability of the p. c. in your product is also important, write Dept. ID-7 for data on FORMICA® brand copper clad laminates. Look for the FORMICA® brand, your assurance of quality.

There are many brands of industrial plastics but only one



Leadership through innovation Formica Corporation • Cincinnati, Ohio 45232 • subsidiary of 

\*Made by Standard Parts & Equipment Corp., Ft. Worth



# Sensitivity that counts

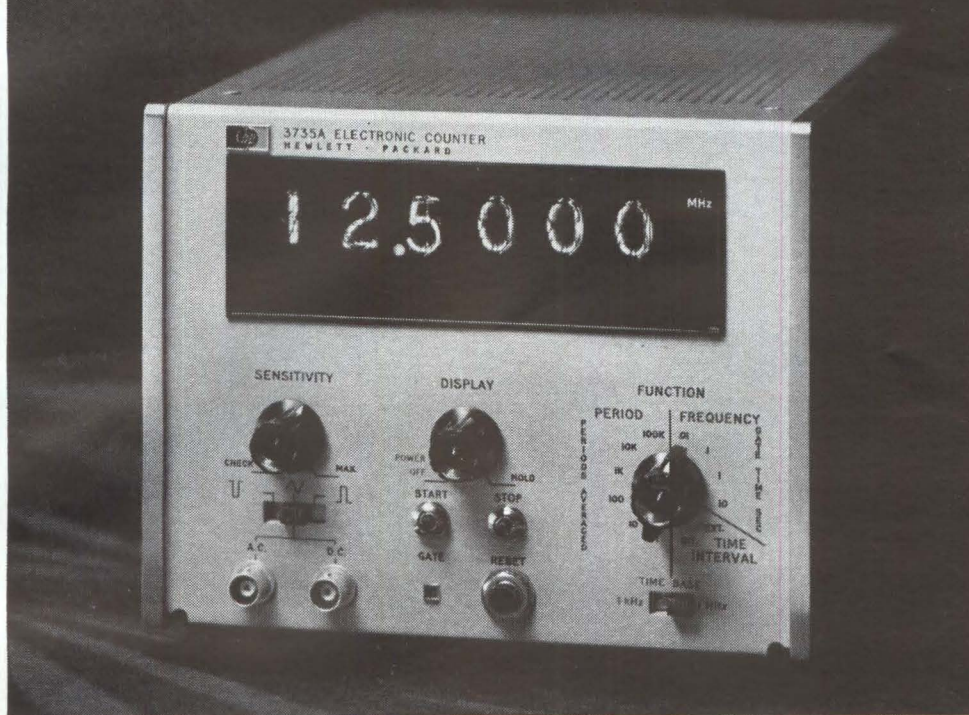

## New HP Counter with 10 mV sensitivity

Here's a 12.5 MHz multi-function counter with a 10 mV input sensitivity. It offers all the versatility of a multi-purpose counter—measures frequency, period, multiple period average, ratio and time interval. It totalizes, too.

A front-panel switch offers finger-tip control for optimum response to sine or pulse (+ or -) inputs—ac- or dc-coupled. Sensitivity is 10 mV rms sine, 100 mV peak pulse. Gate times are 0.01, 0.1, 1 and 10 seconds, derived from a stable internal 1 MHz time base or from an

external frequency standard. The counter also features a high-resolution 6-digit readout with automatic decimal and units indicators. It offers broadband versatility and sensitive, low-level signal handling capability at a reasonable price. Model 3735A, \$1650.

To check out performance details against your needs for a multi-function counter, why not call your local Hewlett-Packard field engineer. Or write Hewlett-Packard, Palo Alto, California 94304, Telephone (415) 326-7000.

**HEWLETT**  **PACKARD**  
An extra measure of quality

2329



# It's a bargain, no matter how you trim it

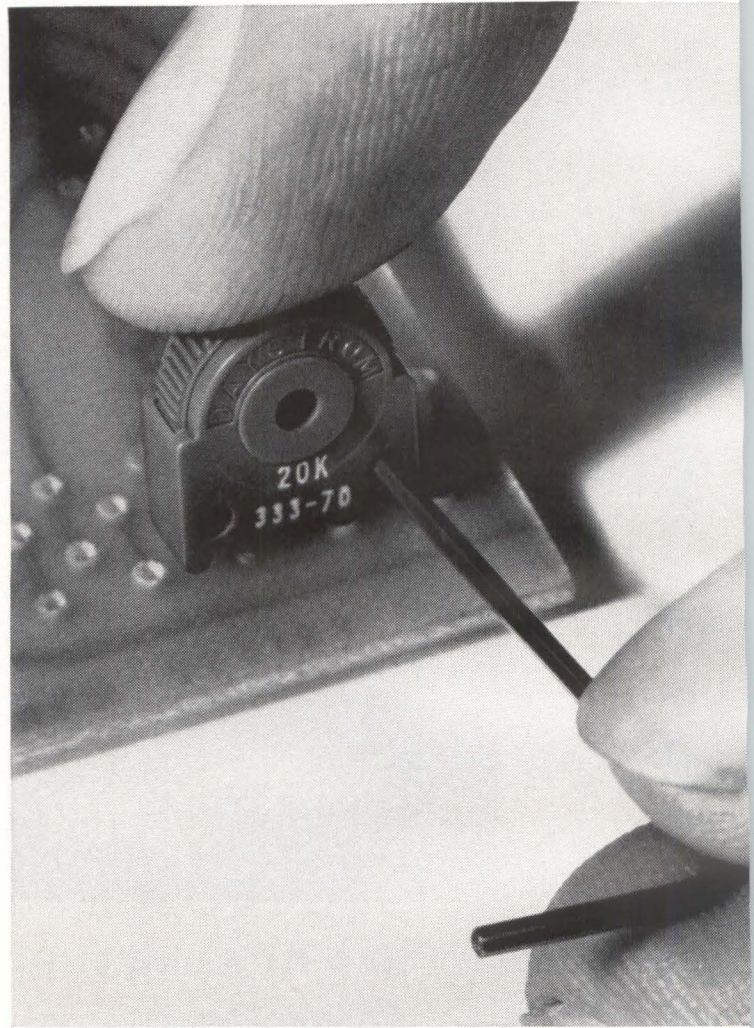
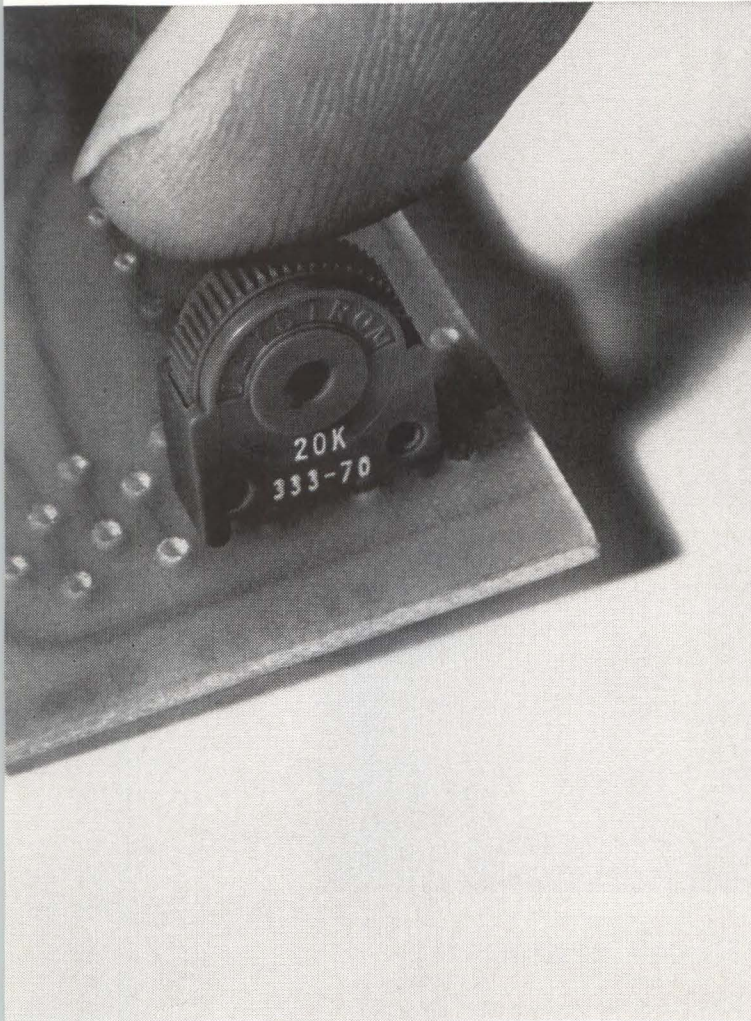

with the flick of a finger...

or the turn of a key.

*You can trim the Daystrom Model 333 pot with your thumb on the convenient knurled knob. Or, use a hex-key on the Allenhead vernier for finer (4:1) settings.*

*But dual adjust is just one of the design features that make this low-cost commercial trimmer a bargain. Others are Weston's exclusive wire-in-the-groove construction which locks linearity in and contact noise out—even under shock and vibration... a slip clutch stop that protects the wiper at the end of rotation... Suregard™ terminations for long-life reliability.*

*You'll recognize these features as the same used in Weston's rugged MIL-type Squaretrim® pots.*

*In addition, compact 333 series pots take up less than 1/10 square inch on your PC boards. They're designed for edge mounting, with provision for dip soldering, so they're ideal for automated production techniques. And they'll handle 0.25 watt comfortably—in still air.*

*The price is a trim \$1.25 in lots of 500. Standard values range from 50Ω to 50K. For complete details or evaluation samples, contact your Weston distributor or call:*

**Weston Instruments, Inc., Weston-Archbald Division  
Archbald, Pennsylvania 18403. Phone 717-876-1500**

**WESTON®** prime source for precision...since 1888

Circle 84 on reader service card



FROM SILICON TRANSISTOR CORPORATION

# POWER

# 150 WATTS AT 45°C

# V<sub>CEO</sub> (SUS) 30 TO 250 VOLTS



These high power diffused silicon transistors in the TO-82 package are also available as JAN devices for your military requirements.

### ELECTRICAL CHARACTERISTICS

(T<sub>c</sub>=25°C, unless otherwise noted)

CHARACTERISTIC	TEST CONDITIONS	2N1015 SERIES		2N1016 SERIES		UNITS
		MIN.	MAX.	MIN.	MAX.	
Breakdown Voltage, Collector to Emitter, BV <sub>CEO</sub> (SUS)	*I <sub>c</sub> =100mA, I <sub>B</sub> =0	30 A-60 B-100 C-150 D-200 E-250		30 A-60 B-100 C-150 D-200 E-250		Volts Volts Volts Volts Volts Volts
Collector Cutoff Current, I <sub>CX</sub>	V <sub>CE</sub> =rated voltage V <sub>BE</sub> =1.5V, T <sub>c</sub> =150°C		20		20	mA
Emitter Cutoff Current I <sub>EBO</sub>	V <sub>EB</sub> =25V, I <sub>c</sub> =0, T <sub>c</sub> =150°C		20		20	mA
D.C. Forward Current Gain, h <sub>FE</sub>	*I <sub>c</sub> =2 Amps, V <sub>CE</sub> =4V *I <sub>c</sub> =5 Amps, V <sub>CE</sub> =4V	10		10		
Saturation Resistance, r <sub>CE</sub> (sat)	*I <sub>c</sub> =2 Amps, I <sub>B</sub> =300mA	0.3	0.75			Ohms
	*I <sub>c</sub> =5 Amps, I <sub>B</sub> =750mA	Typical		0.2 Typical	0.5	Ohms
Base to Emitter Voltage, V <sub>BE</sub>	*I <sub>c</sub> =2 Amps V <sub>CE</sub> =4V	1.5	2.5			Volts
	*I <sub>c</sub> =5 Amps, V <sub>CE</sub> =4V	Typical		1.7 Typical	3.5	Volts

\*Pulse Cond. 300 μ sec., 2% duty cycle.

Available from stock.  
For further information contact your local representative, distributor or

## SILICON TRANSISTOR CORPORATION



EAST GATE BLVD., GARDEN CITY, N.Y. 11532 (516) Pioneer 2-4100, TWX 510-222-8258



# now--a 24 channel solid state multicoupler

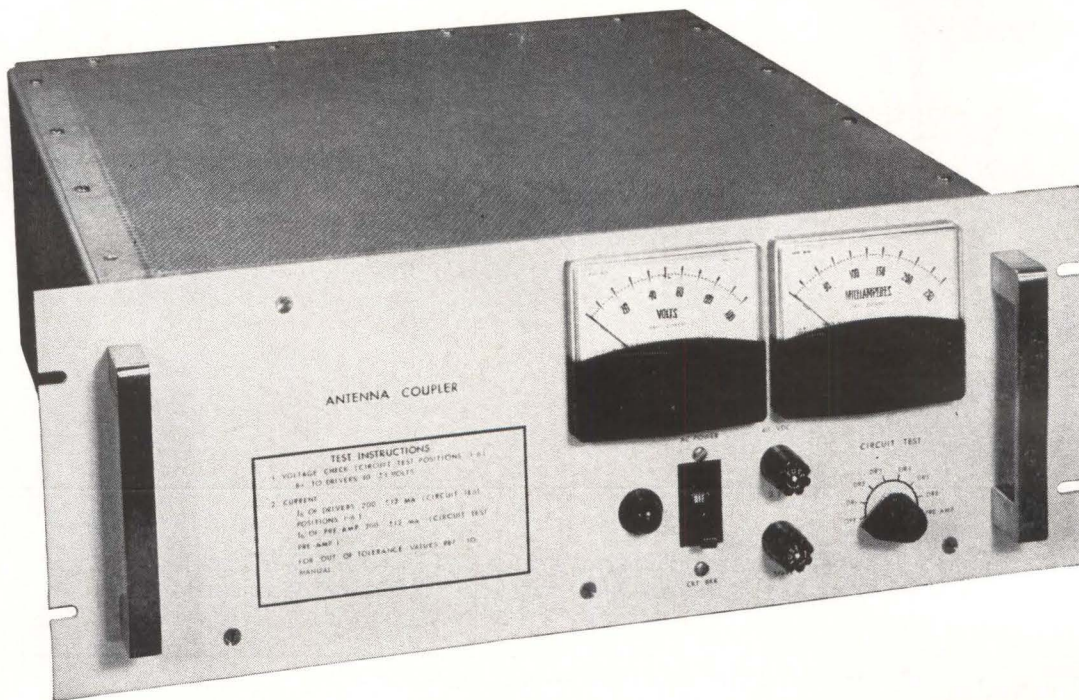

only from Conductron-MRC

MODEL	C 325-24	Outputs	24
Bandwidth	2 MHz—30 MHz	VSWR	< 1.25:1
Gain	2 dB $\pm$ 1 dB	Impedance—In	50 ohms
Noise Figure	7.5 dB: 20 MHz—30 MHz, 6.5 dB: 10 MHz—20 MHz, 6 dB: 2 MHz—10 MHz	Impedance—Out	50 ohms
Intermodulation Distortion	— 56.5 dB, 2nd order — 60 dB, 3rd order	Power Required	115 V $\pm$ 10%, 50—60 cps or 48 V $\pm$ 3V, DC
Phase Tracking	2 degrees $\pm$ 1 degree	Dimensions	19" wide x 20" deep x 7" high
Amplitude Tracking	1 dB	Mounting	Standard 19" rack
Isolation, Back to Front	> 52 dB	Connectors	BNC
Isolation, Output to Output	> 40 dB	MTTR	< 30 min.
Gain Reduction (Overload)	< 2.5 dB for .8 volt signal	MTBF	> 30,000 hours
Inputs	1	Fault Isolation	Internal
		MIL Qualified To	MIL-E-4158C, MIL-Q-9858A

If 24 for 1 sounds like good odds for your antenna coupling requirements, check the specifications above, then write Conductron—MRC Division, 2311 Green Rd., Box 614, Ann Arbor, Michigan 48107. Ask for Bulletin 11C.



**CONDUCTRON - MRC Division**

ANN ARBOR, MICHIGAN





## Which vacuum deposition method is best for you?

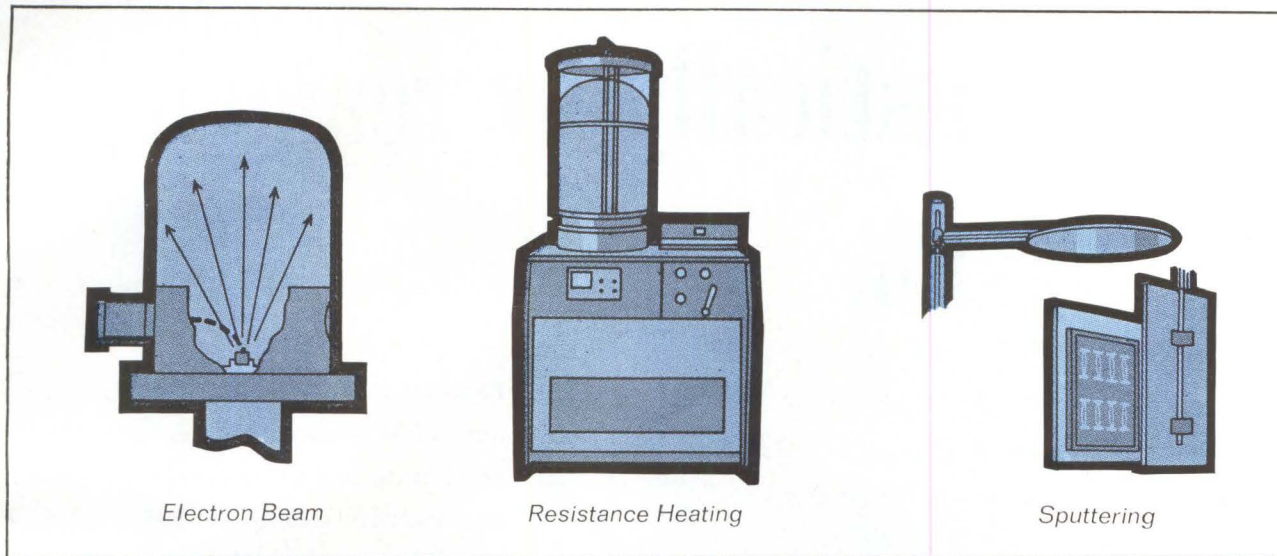

Electron Beam

Resistance Heating

Sputtering

## CVC can demonstrate the advantages of each.

Resistance heating, electron beam evaporation, advanced low-energy sputtering—each has its distinct advantages for thin-film applications. CVC has the techniques and the Application Laboratory to help you select the right method. CVC has the equipment to help you do the job.

**GUARANTEED PERFORMANCE CV-18 TYPE VACUUM COATERS** come completely equipped for resistance heating. Pumpdown to  $8 \times 10^{-7}$  torr in 9 minutes (with standard CV-18) is guaranteed for your laboratory or production line. These vacuum chamber systems are the basis of any vacuum coating operation — electron beam evaporation and sputtering, as well as resistance heating.

**ELECTRON BEAM GUN EVAPORATORS** with the new CVC deflection system give you high purity films of many metals, insulating materials and ceramics too difficult to handle by resistance heating. The new deflection system permits external mounting of the gun on a baseplate feedthrough ring. The beam enters the chamber and is deflected down to

the evaporant. The advantages of this system are many: easy mounting, greater flexibility in substrate location, longer filament life, greater control over evaporation location, and more working room within the chamber.

**PlasmaVac® LOW-ENERGY SPUTTERING with RF SPUTTERING CAPABILITY.** The most versatile thin-film deposition tool ever developed! Will deposit almost any material (including metals, alloys, semi-conductors, and insulators) on almost any surface. Gives precision control of deposition rate and film thickness. Adapts easily to laboratory or production line set-ups. Because it increases quality and yields, PlasmaVac is a valuable new tool in the fields of electronics, ceramics, optics, and metallurgy. With PlasmaVac, you have an almost limitless capability for thin-film deposition.

Please write us with details on what you'd like to do in the thin film field. We'll be glad to make recommendations. Dept. J.



**Consolidated Vacuum Corporation**

ROCHESTER, N. Y. 14603 • A SUBSIDIARY OF BELL & HOWELL  
International Subsidiaries: Woking, Surrey, England  
& Friedberg, West Germany



# 3M Brand Inert Fluorochemical Liquids cut component failure rates drastically by removing heat faster.

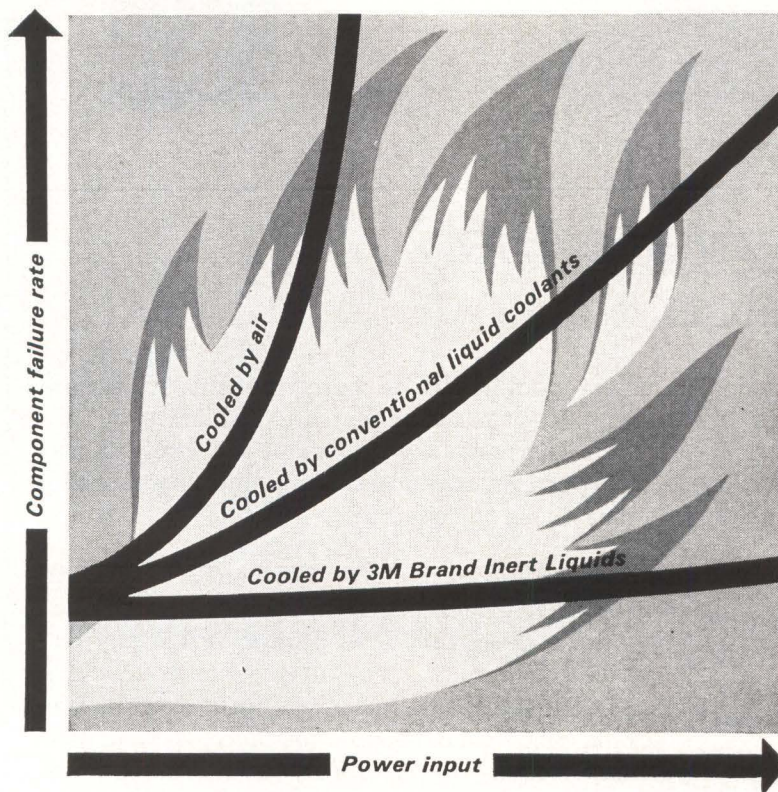

**PRACTICALLY EVERYTHING** we can say about 3M Fluorochemical Inert Liquids adds up to one thing for the designer and engineer: **INCREASED RELIABILITY.** Why? Because component failure rates increase sharply as component temperatures increase. Efficient heat removal lowers the temperature and increases reliability.

3M Inert Liquids are far more efficient at removing heat than air or other conventional dielectric coolants. Results: **LOWER COMPONENT TEMPERATURES, LOWER FAILURE RATES, HIGHER RELIABILITY.**

**FOR THE FULL STORY:** chemical inertness, non-flammability, high temperature stability, compatibility, high electric strength, low dissipation factors, write: 3M Company, Dept. KAX-126, St. Paul, Minn. 55119.



# Announcing the Brush Mark 250, first strip chart recorder for the perfectionists of the world.

Shown with 1  $\mu$ v preamplifier RD 4215-70; event markers optional.

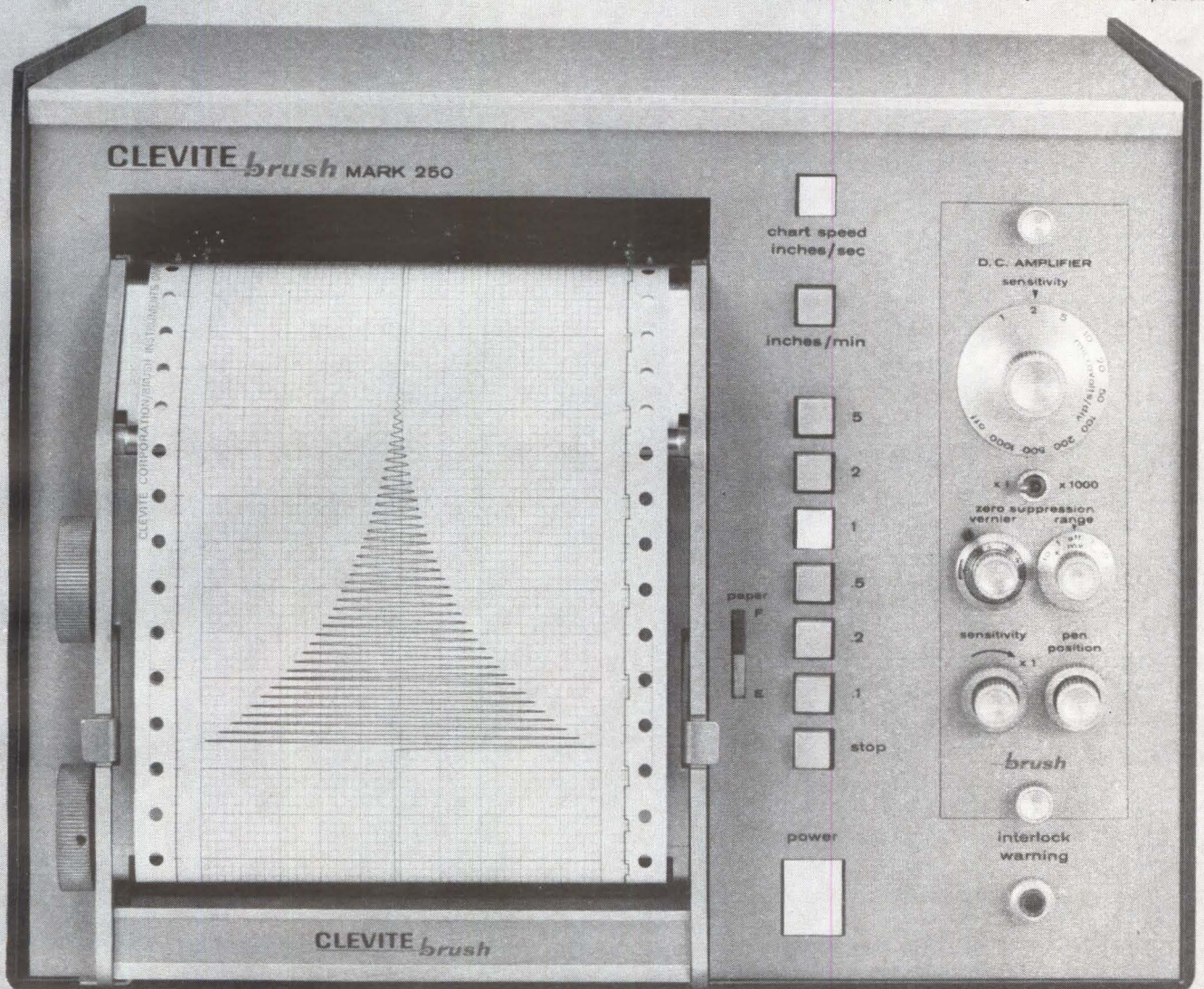

Meet the fastest, most accurate strip chart recorder on record: The new Brush Mark 250. When you read about all the features you'll know why we call it the first recorder for the perfectionists of the world!

**1 Unmatched frequency response.** Flat to 10 cycles on full 4½" span! Useful response to 100 cycles. Nobody has a strip chart recorder in the same league.

**2 Wide selection of signal conditioners.** Choose from 21 interchangeable preamps. Use one today; plug in a different one when your recording requirements change.

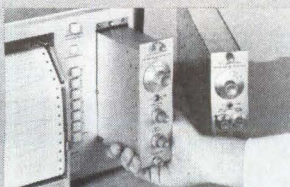

**3 Crisp, clean rectilinear writing.** Patented, pressurized inking system puts smudge-proof trace *into* the paper not just on it.

**4 Contactless, non-wearing feedback system.** Same one used in our multi-channel Mark 200 recorders. (No slide wires!) Accuracy? Better than ½%!

**5 Multiple chart speeds.** Pushbutton choice of twelve . . . from 5 inches/second to 1/10 of an inch/minute (up to 8 days of continuous recording).

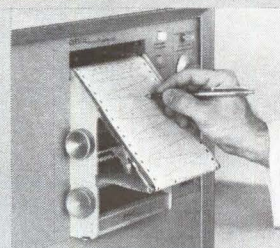

**6 Portable or Rack mounting.** And either way you get the exclusive new dual position writing table.

**7 Removable chart paper magazine.** Great for desk top record reviews. Man-sized manual winding knobs let you roll chart forward *and* back. Chart reloading is a cinch.



See what we mean? The Mark 250 is for the perfectionists of the world. Ask your Brush Sales Engineer for a demonstration. Or, write for chart sample and specifications. Clevite Corporation, Brush Instruments Division, 37th & Perkins, Cleveland, Ohio 44114.

**CLEVITE**

**brush** INSTRUMENTS DIVISION  
The Brush Mark 250 First recorder for perfectionists



# think faster think Burroughs memory systems

IN MEMORY SYSTEMS THE FASTEST BIT  
MAKES THE DIFFERENCE . . . AND  
BURROUGHS MAKES ITS OWN BITS  
(BOTH CORE AND THIN FILM).

The new Burroughs line of core Memory Systems is fast . . . as fast as 0.6  $\mu$ sec. full cycle time. You can also have a "not-so-fast" model at lower cost if you don't need the speed.

Now, Burroughs 14 years of experience is available to provide you with the Memory System you need for your data handling equipment.

- System cycle times of 0.6 and 1.0  $\mu$ sec.
- Modular building block construction—basic module is 8192 words by 20 bits and contains the core-memory, sense amplifiers, driver circuits and information registers.
- Associated memory control module includes timing circuits, address register and decode logic.

## FEATURES:

1. 20 mil, 2-1/2D ferrite core memory—manufactured by Burroughs.
2. Driver Circuits and sense amplifiers use Burroughs hybrid microcircuits.
3. Monolithic integrated circuits used for all logic and registers.

*If you would like your system to think faster write or call for further information on Burroughs memory systems.*

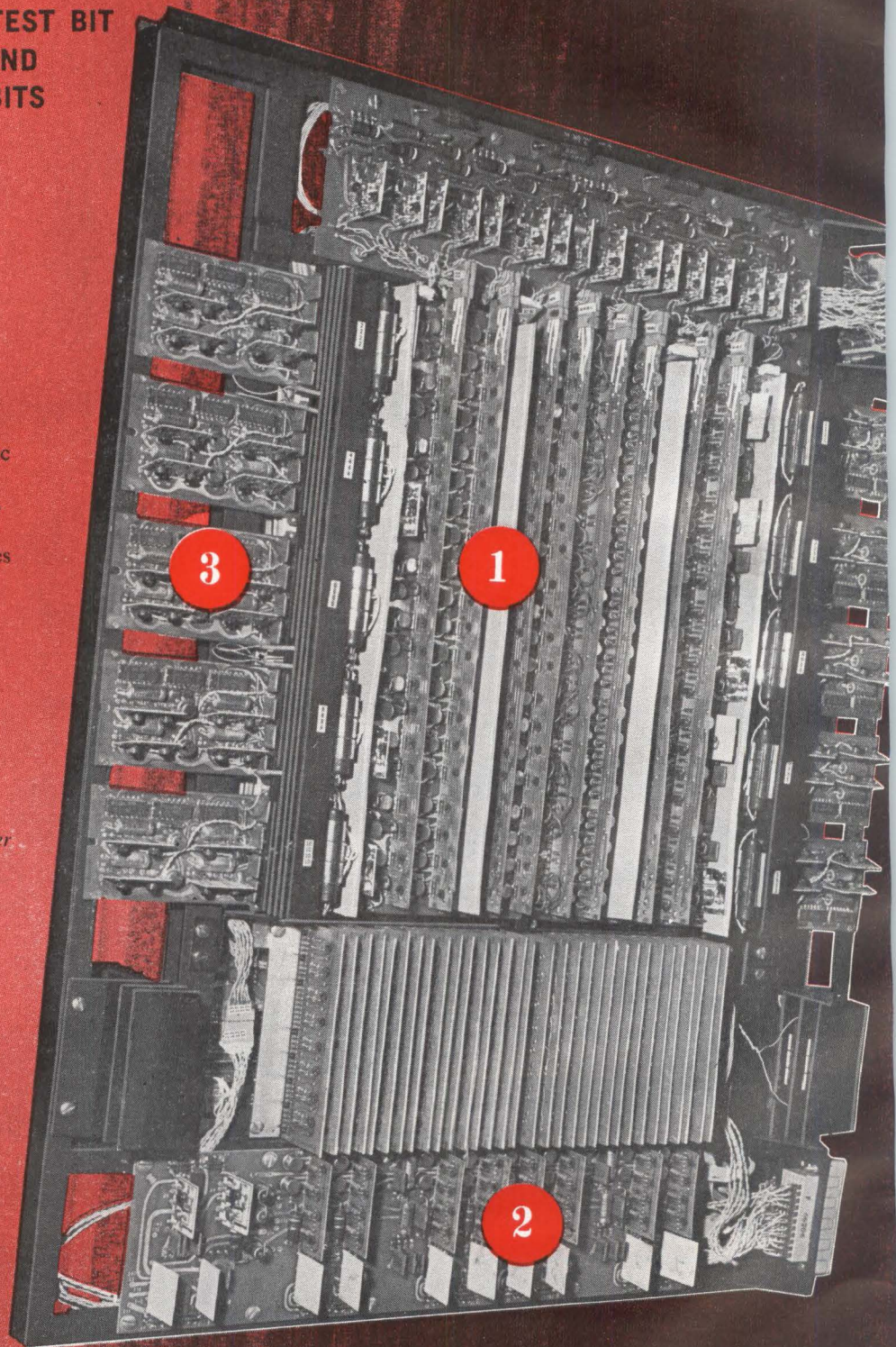
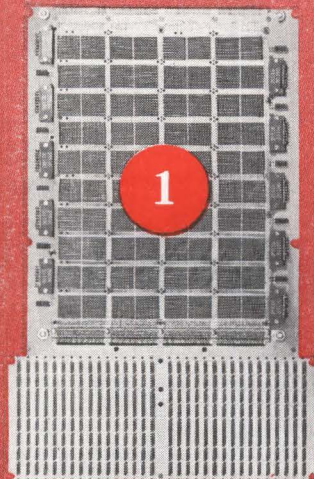



# Technical Articles

---

**Computer-aided design,  
part 3; symbol analysis:  
page 92**

Manipulating letter symbols in a computer is easier than performing calculations with actual component values when a circuit is being analyzed because the numbers can hide relationships among components. With symbols, the engineer can visualize such relationships and obtain a deeper feeling for how the circuit works.

**Knowing the cause  
helps to cure distortion  
in FET amplifiers:  
page 99**

To engineers, the field effect transistor offers the advantages of high gain and low noise in an amplifier. But, because the FET is a relatively new device, many engineers still do not understand how distortion affects its performance. Here are some rules for operating an FET amplifier at maximum effectiveness.

**Apollo: the goal  
is in sight:  
page 111**



Now that the Gemini program has been completed, space technologists are in the full glare of publicity on the next step, putting men on the moon. The Apollo mission will give space electronic equipment the toughest test to date. This overview of the electronics for Apollo describes the mission and how it affects the major electronics systems. Future articles will dissect the Apollo electronic equipment. For the cover, Richard Saunders made a double exposure of a model of the lunar module as it was landing and after it had settled on a simulated moon surface built at the Grumman Aircraft Corp.

**Communication technology  
in Japan:  
page 133**

Of all aspects of technology, the Japanese are probably doing more original development work in communications than in any other. One reason is the explosive growth of telephony inside Japan. Another is Japanese determination to supply equipment to fill the vacuum in communications that exists in Asia and in Africa. The Japanese want to be competitive with hardware and techniques everywhere in the world.

- Japan stays with pcm to meet mushrooming growth in telephony
- Bit-by-bit, Japan speeds its data communications

---

**Coming  
December 26**

- Second annual European market report
- Integrated circuits in action: reliability tests
- Using the state variable in circuit analysis



# Computer-aided design: part 3

## Analyzing circuits with symbols

Manipulating symbols instead of numbers offers many advantages, especially in determining the sensitivity of circuit performance to parameter changes and component tolerances

By Richard Carpenter and William Happ

Electronic Research Center, National Aeronautics and Space Administration, Cambridge, Mass.

**Manipulating letter symbols** in a computer is an easier way to analyze a circuit than performing the calculations with actual component values. If the numerical values of the components are inserted at the start of a computer-aided design, the numbers hide the relationships among components. Also the designer can lose sight of how the component variables affect the circuit's operation.

By substituting symbols for the component values, the relationships between circuit parameters are easier to visualize and the designer gains insight into the circuit's operation. In addition, the formula of letters can be manipulated faster by the computer than the actual numbers. And since the numerical component values are not substituted until the last step in the process, the technique

avoids the inaccuracies of cumulative rounding out of numbers that are entered into the program at an early stage [see "Advantages of symbolic analysis," p. 93].

Symbolic analysis establishes the desired relationships among components from a topological study of the network; that is by graphing the circuit. To do this the network is divided into branches by a graphic procedure and all of the variables associated with each branch are coded for a computer. In contrast, numerical analysis requires a matrix of numbers derived from the circuit node voltages.

Because of its advantages, the symbolic technique is a good candidate for performing both sensitivity and tolerance analysis—two major design problems that require computing partial derivatives. The symbolic approach can obtain the partial derivatives in terms of letters and thus avoids tedious numerical calculation.

Sensitivity analysis determines how aware a network is to changes in element values. Tolerance analysis measures the total circuit change caused by various combinations of element value deviations. The components, of course, change in value because of temperature variations and normal deviations from a mean manufacturing value.

### Finding partial derivatives

Most engineers are experienced in deriving circuit responses from transfer functions. The transfer function, the ratio of an output to an input function, is usually expressed in letters related to the complex frequency variable,  $s$ . Both the sensitivity and tolerance analyses are evaluated from a transfer function; thus, the engineer works with terms

### The authors



Richard Carpenter is studying toward a doctorate with a thesis topic in the area of computer-aided circuit design. His experience with NASA includes circuit design on the Nimbus meteorological satellite and applied research in computer-aided design of standard reliable circuits for space missions.



William W. Happ received a doctorate in theoretical physics from Boston University in 1949. He taught in Canada for nine years and has worked for several electronics and aerospace firms since returning to the United States in 1952. He is now chief of the design criteria branch at NASA's electronics facility.



that are familiar to him. Both analyses are further aided by indicators that are called tagging parameters. These indicators, when programed into a computer, isolate certain terms in a transfer function with a 1 when they appear and with a 0 when they don't. Here is a simplified illustration of the tagging procedure:

Suppose P is represented by an equation for a variable in a given circuit. It is desired to have the computer tag the letter "a" whenever it appears in the equation. So the tag 1 is assigned to the letter a and the tag 0 is associated with all other letters. The computer results are tabulated as follows

$$P = abc + bcd + acd + abd$$

Tag	Equation terms
1	abc
0	bcd
1	acd
1	abd

By removing a from all terms tagged and summing these terms, the partial derivative of P with respect to a is obtained.

$$\frac{\partial P}{\partial a} = bc + cd + bd$$

### Sensitivity analysis

Sensitivity analysis allows the engineer to observe the effects of changes in circuit functions caused by changes in element values. These observations are based on the output expressions for the circuit that result from the symbolic technique. One definition of sensitivity is given by

$$S = \frac{\partial (L_n P)}{\partial (L_n Q)}$$

where S = sensitivity,  
P = the transfer function  
Q = a circuit parameter  
L<sub>n</sub> = the natural logarithm

Sensitivity is a dimensionless quantity that repre-

sents a percentage change in the transfer function of the circuit or system. It corresponds to a percentage change in a parameter of the system. For example, if P represents a circuit's voltage gain and Q represents the beta of a transistor in the circuit, then S represents the percentage of change in the voltage gain due to the change in beta.

Previously, the manual calculation of sensitivity required the engineer to derive the equation that contained the parameter and then either to take a derivative of the equation and evaluate the derivative, or to solve the equation for the value of the transfer function each time the value of a component changed.

The following equation calculates sensitivity with the symbolic method:

$$S = - \frac{H(\bar{Q})}{H(\bar{P})} \quad (1)$$

where H( $\bar{Q}$ ) is that part of the topology equation devoid of the parameter Q, and H( $\bar{P}$ ) is that part without P.

An alternate for equation 1 is the following expression for the sensitivity:

$$S = - \frac{H(\bar{Q}, \bar{P})}{H(\bar{P})} + \frac{H(\bar{Q}, P')}{H(P')} \quad (2)$$

where

H( $\bar{Q}, \bar{P}$ ) = that part of the topology equation that is simultaneously devoid of both P and Q;

H( $\bar{Q}, P'$ ) = that part that contains P devoid of Q;  
H(P') = that part that contains P;

H( $\bar{P}$ ) = that part devoid of P.

Since all of these terms can be obtained easily by tagging the appropriate parts of H, the solution is obtained easily by computer analysis.

Evaluating sensitivity by tagging is part of a subroutine of a computer program developed at the National Aeronautics and Space Administration's Electronics Research Center.

### Sample sensitivity problem

The program produces the system response of a circuit from a coded signal flow graph that is obtained with an equivalent schematic of the circuit. Once the representation is formed, each of the N elements (or components) in the schematic of the circuit is numbered consecutively. The computer program uses a nine-digit code for specifying each component of the circuit. A tenth entry is given for the numerical value associated with the element.

Since each element is dependent on a voltage or current that produces a voltage or current, the problem is in two parts: one part contains the voltage generators and the other part contains the current generators. These two are then interrelated via the network's immittances.

### Finding impedance sensitivity

To illustrate how the program computes sensitivity analysis consider this problem: find the sensi-

#### Advantages of symbolic analysis

- The symbolic technique highlights those parameters that are most critical in a desired function.
- All circuit functions are presented in terms of the complex frequency variable, s. (Small s should not be confused with capital S, which means sensitivity.)
- Partial derivatives can be computed as symbolic functions, thus avoiding tedious numerical calculations.
- The technique is inherently faster than the numerical technique because no numbers are calculated until the last step.
- Since no numbers are required, no numerical round-off error occurs due to matrix inversion.
- The technique is easily adapted to a small or medium size computer or time-sharing console.
- Only one coded description of the circuit is need for listing in the computer.



tivity of the input impedance to changes in the two inductors,  $L_2$  and  $L_4$  for the circuit at the right.

Step 1. An imaginary element is required by the program to relate the current  $I$  and the terminal voltage  $V$ . This imaginary element is drawn across the driving-point terminals and labeled 1. Then each of the remaining elements and nodes is numbered consecutively as shown in the colored diagram. The node numbers appear in circles, the element numbers are not circled.

Step 2. Code each element in the circuit as either a voltage generator, shown by double arrows, or a current generator, shown by a single arrow and a horizontal bar. To do this, a current source is drawn as a voltage generator controlled by current,  $I$ , and a voltage source is drawn as a current generator controlled by voltage,  $V$ . For the imaginary element a current generator is needed because it represents a voltage source. The direction of the arrows specifies the direction assumed for positive current flow.

Element  $L_2$  is arbitrarily chosen as a voltage generator. Therefore, the engineer must draw element  $C_3$  as a current source. Two voltage sources are not allowed in parallel because this would violate Kirchhoff's voltage law. Current sources in parallel are permitted.

Also, element  $L_4$  is a current generator and  $C_5$  is a voltage generator. This is required since no two current generators may be connected in series because this would violate Kirchhoff's current law.

Step 3. Form table 1 from the coded schematic diagram, with the tagging procedure detailed below. The nine columns, A through K, represent the inputs needed for the computer program. Column E, shown with the numerals in color, should be determined first. It lists the number that corresponds to the element.

Columns A and B are obtained from the direction of current flow between any two nodes connected to an element, with A the starting point (circled numerals in the schematic) and B the terminating point. Thus, for element 1 a value of 1 is entered in column A because the current flows from node 1. In column B a 2 is entered because the current from node 1 terminates at node 2. The same entries are recorded for elements 2 and 3. Since the current in element 4 flows from node 1 to 3, a 1 is entered in column A and a 3 in column B. Finally for element 5, a 3 is entered in column A and a 2 in column B.

Column C indicates the controlling variables, 0 for voltage, 1 for current. Column G represents the generator function and is coded in the same binary manner as for column C. For example, element 1 is a voltage-controlled current generator. Hence, it is coded 0 in column C and 1 in column G. Likewise, element 2 is a current-controlled voltage generator. It is coded with a 1 in column C and a 0 in column G. Note that column C entries are always the reverse of the entries in column G for passive elements, and the same for active elements.

Column D indicates the variable that performs the controlling function. In all passive elements

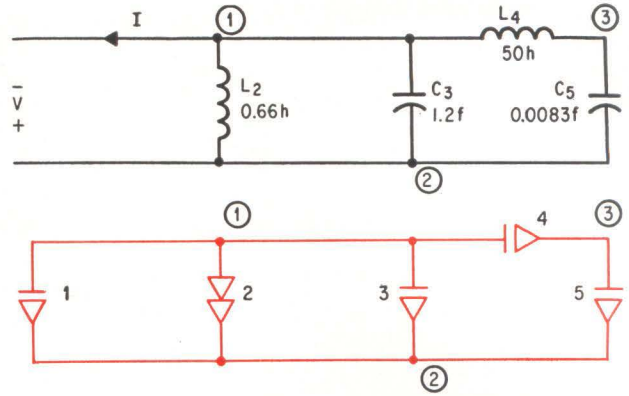

Analysis of the sensitivity of the circuit above, a passive one-port network, to changes in the component values, is made with a coded circuit, in color. The elements are numbered consecutively and the node numbers are circled. Element 1 is an imaginary element needed to relate the terminal voltage,  $V$ , with the input current,  $I$ . Single arrows with a bar above are current sources and double arrows represent voltage sources.

the entry for column D will be the same as in column E since a passive element cannot create current or voltage. This is true for elements 2 through 5 in this example. However, the current in element 1 is controlled by the voltage generated by element 2; hence, a 2 is entered in column D.

Column F specifies frequency dependence in terms of the complex variable  $s$ , 0 for no frequency dependence, 1 for frequency dependence of  $s^1$ , 2 for  $s^2$ , etc. For most networks the power of  $s$  will not be greater than  $s^2$ . For example, element 2 is a current-controlled voltage generator (an impedance); hence, its frequency dependence is  $s^1$ . Therefore, a 1 is entered in column F.

Column H indicates the presence of the imaginary element by a 1 for the element and a 0 for all other elements.

Column K indicates the elements for which the sensitivity is desired, coding a 1 for those elements and a 0 for all others.

The column at the far right of table 1 corresponds to the component values in a numerical form suitable for input to the computer. The imaginary element is listed as a 1 and is indicated by  $.100E + 1$ . This term  $.100E + 1$  for the imaginary element, 1, means that it has a value of  $.100$  times  $10$  with an exponent  $+1$ , or  $.100 \times 10^{+1}$ . Element 2 is an inductance of  $.666$  henry and is considered here as an impedance. Hence, its coded entry  $.666E + 0$  and is read as  $.66 \times 10^0$  henry. Element 4 is an inductance of  $50$  henrys and is considered here as

Table 1: Computer inputs, first example

A	B	C	D	E	F	G	H	K	Numerical Value
1	2	0	2	1	0	1	1	0	.100E+1
1	2	1	2	2	1	0	0	1	.666E+0
1	2	0	3	3	1	1	0	0	.120E+1
1	3	0	4	4	-1	1	0	1	.200E-1
3	2	1	5	5	-1	0	0	0	.120E+3



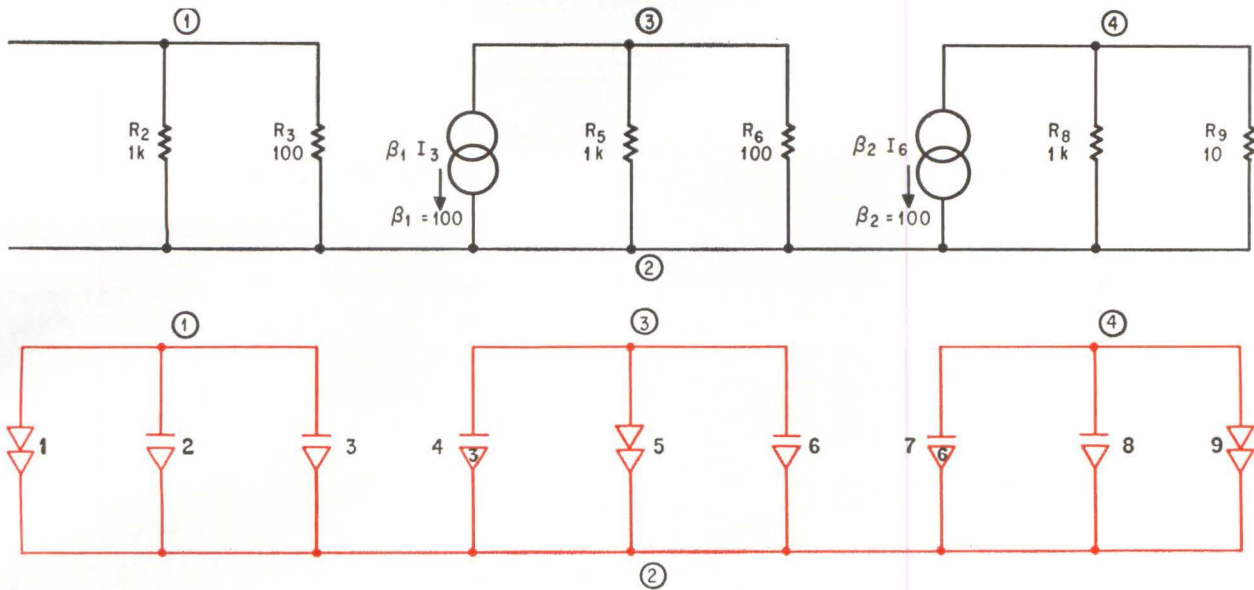

Equivalent of a transistor circuit contains both passive and active elements. Coded model, in color, is used to analyze the circuit's sensitivity to the voltage gain due to changes in the load resistor, input impedance and current gain of the transistors. The double circles represent transistor current sources. The numbers 3 and 6 inside the arrows indicate that elements 4 and 7 are dependent on currents 3 and 6 respectively.

an admittance. Hence, its numerical entry is  $1/50$  or  $.200 \text{ E-1}$ , read a  $.200 \times 10^{-1}$ , and so on.

Step 4. The computer performs the necessary calculations with the NASA program and prints out the information listed in table 2.

Step 5. Determine the sensitivities of the input impedance due to changes in  $L_2$  and  $L_4$ . To do this relate the data in table 2 to the terms in equations 1 and 2. The sensitivity can be computed both symbolically and numerically. For example, the sensitivity of the input impedance caused by  $L_2$  is determined from

$$\begin{aligned}
 S &= -\frac{H(\bar{Q})}{H(\bar{P})} = -\frac{H(\bar{L}_2)}{H(\bar{P})} \\
 &= -\frac{1 + 1/(L_4 C_5 s^2)}{1 + 1/L_4 C_5 s^2 + L_2/L_4 + L_2 C_3/L_4 C_5} \\
 &= -\frac{(1 + 2.4s^{-2})}{2.4s^{-2} + 2.9 + 8s^2}
 \end{aligned}$$

And, for changes caused by  $L_4$ , the sensitivity is found to be,

$$\begin{aligned}
 S &= -\frac{H(\bar{Q}, \bar{P})}{H(\bar{P})} + \frac{H(\bar{Q}, P')}{H(P')} \\
 &= -\frac{H(\bar{L}_4, \bar{P})}{H(\bar{P})} + \frac{H(\bar{L}_4, P')}{H(P')} \\
 &= -\frac{(1 + L_2 C_3 s^2)}{1 + L_2/L_4 + L_2 C_3/L_4 C_5 + 1/L_4 C_5 s^2} + \\
 &\quad \frac{L_2 s}{L_2 s + L_2/(L_4 C_5 s)} \\
 &= -\frac{(1 + .8s^2)}{2.4s^{-2} + 2.9 + .8s^2} + \frac{.66s}{.66s + 1.6s^{-1}}
 \end{aligned}$$

A study of the sensitivities will show that sys-

tem sensitivity is fairly constant over part of the frequency spectrum. At zero frequency or d-c,  $L_2$  has a direct 1-to-1 relationship to the impedance but  $L_4$  has no effect because it is in series with an infinite impedance. At very high frequencies the value of  $L_2$  has almost no effect because it is an open circuit and  $L_4$  has a 1-to-1 effect on the impedance.

### Analyzing an active circuit

As a second example of the technique, determine the sensitivity of the voltage gain for the circuit shown above due to changes in the load resistor  $R_9$ , the input impedance  $R_2$  and in the betas,  $\beta$  (transistor current gain) of the two transistors.

Step 1. Draw the schematic of the circuit following the method of the previous problem. Remember to add an imaginary element at the input terminals and label it 1. For this problem element 1 was arbitrarily chosen as a voltage generator.

Step 2. Number all nodes and all elements con-

Table 2: Computer outputs, first example

Tags	Symbolic value	Numerical value
$H(P')$	$\frac{L_2}{(L_4 C_5 s)} + L_2 s$	$.66s + 1.6s^{-1}$
$H(\bar{P})$	$\frac{1}{(L_4 C_5 s^2)} + 1 + \frac{L_2}{L_4} + \frac{L_2 C_3}{L_4 C_5} + L_2 C_3 s^2$	$2.4s^{-2} + 2.9 + .8s^2$
$H(\bar{L}_4 \bar{P})$	$1 + L_2 C_3 s^2$	$1 + .8s^2$
$H(\bar{L}_4 P')$	$L_2 s$	$.66s$
$H(\bar{L}_2)$	$1 + \frac{1}{(L_4 C_5 s^2)}$	$1 + 2.4s^{-2}$



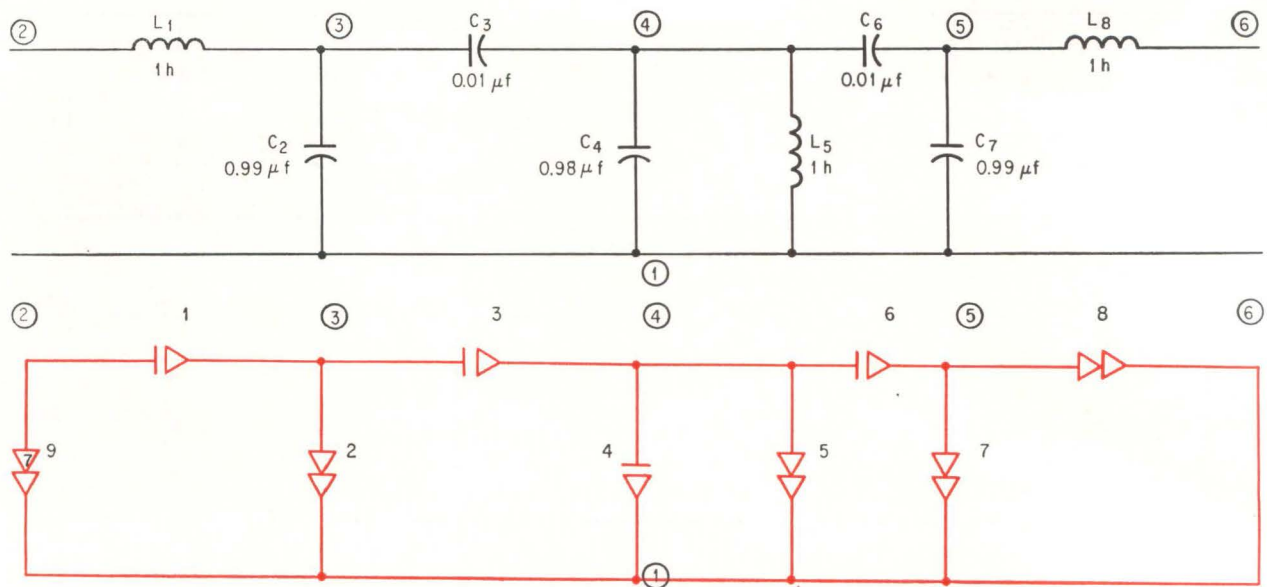

**Bandpass filter network** and its coded form, in color, serve to analyze a circuit's sensitivity to the voltage transfer function caused by changes in  $L_5$ . Element 9 is dependent on the current through element 7.

secutively as in the diagram on page 95.

Step 3. Enter the coded inputs in table 3, as in the first example. Hence, elements 2 and 3 are coded as admittances and have no frequency dependence. Element 4 is coded as a current generator dependent on the current in element 3. This is actually the  $\beta_1$  of the circuit. Element 5 is a current-controlled voltage generator (impedance) and is not frequency dependent. Element 6 is a voltage-controlled current generator and is not frequency dependent. Element 7 is also a current generator controlled by the  $\beta_2$  of the circuit, and depends

upon the current through element 6. Element 8 is a voltage-controlled current generator and is not frequency dependent. Element 9 is a current-controlled voltage source and is not frequency dependent.

Step 4. Obtain table 4 from the NASA computer program.

Step 5. Form the sensitivity relationships defined in equations 1 and 2. Hence, the sensitivity of the voltage gain due to  $\beta_1$  is,

$$S = \frac{1 + R_5 G_6 + G_8 R_9 + R_5 G_6 G_8 R_9}{1 + R_5 G_6 + G_8 R_9 + R_5 G_6 G_8 R_9} = \frac{.111 E + 1}{.111 E + 1} = 1$$

For this example the sensitivity due to  $\beta_2$  is the same as that due to  $\beta_1$ ; thus, the voltage gain is directly affected by either  $\beta$ .

The sensitivity of the voltage gain due to  $R_9$  is determined from,

$$S = - \frac{.110 E + 2}{.111 E + 2} = -.99$$

The output load directly affects the voltage gain of the circuit; in the example there is almost a 1-to-1 relationship.

By checking the sensitivity of the voltage gain to the input impedance,  $R_2$  (element number 2), the engineer will find that  $R_2$  has extremely little effect on the gain of this transistor circuit. The numerical value of the sensitivity is computed from equation 2 and the appropriate values from table 4.

$$S = - \frac{.110 E + 2}{.111 E + 2} + \frac{-.100 E + 5}{-.100 E + 5} = 10^{-2}$$

#### Analyzing a bandpass filter

Determine the sensitivity of the voltage transfer function caused by changes in  $L_5$  for the bandpass

**Table 3: Input data, second example**

A	B	C	D	E	F	G	H	Numerical Value
1	2	0	9	1	0	0	1	.100E+1
1	2	0	2	2	0	1	0	.100E-2
1	2	0	3	3	0	1	0	.100E-1
3	2	1	3	4	0	1	0	.100E+2
3	2	1	5	5	0	0	0	.100E+4
3	2	0	6	6	0	1	0	.100E-1
4	2	1	6	7	0	1	0	.100E+2
4	2	0	8	8	0	1	0	.100E-2
4	2	1	9	9	0	0	0	.100E+2

**Table 4. Output data, second example**

Tags	Symbolic value	Numerical value
$H(P')$	$-\beta_1 \beta_2 G_3 R_5 G_6 R_9$	$-.100E+5$
$H(\bar{P})$	$1 + R_5 G_6 + G_8 R_9 + R_5 G_6 G_8 R_9$	$.111E+2$
$H(\bar{\beta}_1)$	$1 + R_5 G_6 + G_8 R_9 + R_5 G_6 G_8 R_9$	$.111E+2$
$H(\bar{R}_9)$	$1 + R_5 G_6$	$.110E+2$
$H(\bar{R}_2, \bar{P})$	$1 + R_5 G_6$	$.110E+2$
$H(\bar{R}_2, \bar{P})$	$-\beta_1 \beta_2 G_3 R_5 G_6 R_9$	$-.100E+5$



filter network that is shown on page 96.

The solution is found with the same procedure outlined in the earlier examples. [Table 5] represents the coded inputs obtained from the coded schematic. Element 9 is added to the circuit to close the system.

Element 1 is coded as a voltage-controlled current source (admittance) and has a frequency dependence of  $-1$ . Element 2 is coded as a current-controlled voltage source and has a frequency dependence of  $-1$ .

Elements 3, 4 and 6 are all coded as voltage-controlled current sources (admittances) and, since they are all capacitors, their frequency dependence is  $+1$ . Elements 5, 7 and 8 are coded as current-controlled voltage sources (admittances).

Elements 5 and 8 have a frequency dependence of  $+1$ ; element 7 has a frequency dependence of  $-1$ , element 9 has no frequency dependence and is coded as 0.

Table 6 shows the data necessary for the determining of the sensitivity of the network due to  $L_5$ . The sensitivity is computed from equation 2 and is

$$S = \frac{.201E + 7s^{-2} + 3.96}{.201E + 7s^{-3} + 3.98 + .199E + 7s^2}$$

Thus, at high frequencies the sensitivity to  $L_5$  is practically zero.

### Changing theoretical to practical

To sketch a preliminary model of a circuit, a designer can assume that perfect components, with exact values, are available. However, actual components fluctuate in tolerance; the current gain of transistors for example, can vary from 10% to 300%. The designer therefore needs a technique for determining how changes in component values around the nominal value can affect total circuit performance. The technique: tolerance analysis.

The computer program for tolerance analysis is based on the following equation:

$$Y = f(P_1, P_2, P_3, \dots, P_n)$$

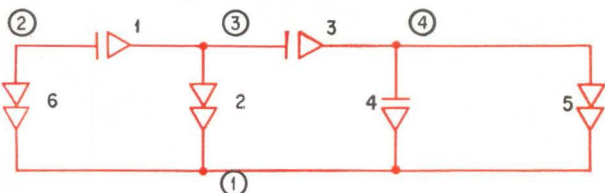
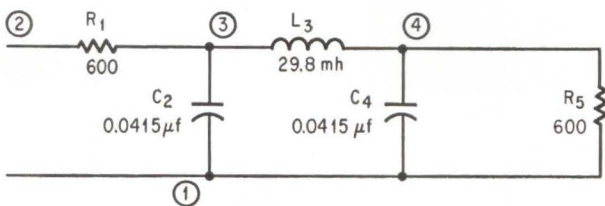

TOLERANCES  $R_1 = R_5 = 10\%$   $L_3 = 20\%$   
 $C_2 = C_4 = 20\%$

**Effect of component tolerances** (shown in percent) on the sensitivity of the network's input impedance is computed from a tolerance analysis.

**Table 5: Inputs, third example**

A	B	C	D	E	F	G	H	Numerical Value
2	3	0	1	1	-1	1	0	.100E+1
3	1	1	2	2	-1	0	0	.101E+7
3	4	0	3	3	1	1	0	.100E-7
4	1	0	4	4	1	1	0	.980E-6
4	1	1	5	5	1	0	0	.100E+1
4	5	0	6	6	1	1	0	.100E+7
5	1	1	7	7	-1	0	0	.101E+7
5	6	1	8	8	1	0	0	.100E+1
2	1	0	5	9	0	0	1	.100E+1

**Table 6: Outputs, third example**

Tags	Symbolic value	Numerical value
$H(P')$	$\frac{C_3}{C_2} + \frac{C_3 L_5}{(L_1 C_2)}$	.980
$H(\bar{P})$	$\frac{1}{(L_1 C_2 s^2)} + \frac{C_6}{(L_1 C_2 C_7 s^2)}$ $+ \frac{(C_3 L_5 + C_4 L_5 + L_5 C_6)}{(L_1 C_2)} + \frac{C_3 C_6}{(C_2 C_7)}$ $+ \frac{C_3 L_5 C_6}{L_1 C_2 C_7} + \frac{C_4 L_5 C_6}{L_1 C_2 C_7} + 1.00$ $+ \left( C_3 L_5 + C_4 L_5 + L_5 C_6 + \frac{C_3 C_4 L_5}{C_2} \right.$ $\left. + \frac{C_3 C_4 L_5}{C_2} + \frac{C_6 C_3 L_5}{C_2} + \frac{C_6 C_3 L_5}{C_7} \right.$ $\left. + \frac{C_3 C_4 L_5 C_6}{(C_2 C_7)} \right) s^2$	.201E+7 s <sup>-2</sup> +3.98 +.199E+7 s <sup>2</sup>
$H(\bar{L}_5)$	$\frac{1}{(L_1 C_2 s^2)} + \frac{C_3}{C_2} + \frac{C_6}{C_7}$ $\frac{C_6}{(C_7 L_1 C_2 s^2)} + \frac{C_3 C_6}{(C_2 C_7)} + 1.00$	.201E+7 s <sup>-2</sup> +3.96

where Y is a function of the independent variables  $P_1, P_2, P_3, \dots, P_n$  (Y in this case does not mean admittance). For small changes in each of the independent variables the statistical tolerance  $T_Y$  of Y is defined as:

$$T_Y = \left[ \left( \frac{\partial Y}{\partial P_1} \Delta P_1 \right)^2 + \dots + \left( \frac{\partial Y}{\partial P_2} \Delta P_2 \right)^2 \right]^{1/2}$$

If the dependent variable Y represents a circuit function such as input impedance, voltage gain or transfer impedance and if the independent variables represent the circuit components, then the statistical tolerance of Y represents a measure of the deviation of Y from its mean or nominal value because of deviations of the components from their respective means or nominal values.

To evaluate statistical tolerance the engineer must perform a differentiation of performance criterion with respect to each of the elements in the circuit. The number of elements in a typical circuit can make this evaluation prohibitive and time-con-



suming if it is done manually. Although computer programs have been written in the past that incorporate numerical schemes to calculate all the partial derivatives for determining the statistical tolerance, the answers obtained were not accurate because

the nature of a digital computer prevents these integration schemes from being exact.

### Understanding the program

Another method, based on flowgraph techniques, eliminates the need to evaluate any partial derivatives explicitly and also reduces calculations.

A flowgraph is defined in this application as a topological network in which each element is identified by two variables, such as current and voltage. A functional relation specifies the direction of dependence between the variables and a symbol or number denotes its junction.

A circuit analysis program based on this dichotomy of networks has been developed at the space agency. It analyzes and evaluates the flowgraph of any active or passive electrical network that contains 30 to 100 elements. The result is a relationship of  $T_Y/Y$ , the fractional change in  $Y$  due to the fractional changes in each component value  $\Delta P_i/P_i$ .

### Select a frequency variation

If a circuit contains energy storage elements, then the sensitivity of the circuit will be a complex function of frequency. To handle these elements the sensitivity is evaluated at distinct frequencies and the magnitudes obtained are used to calculate the circuit's tolerance. This procedure provides the designer with data about the adequacy of the circuit model at different frequencies. Consequently, the model can be adjusted until it produces the desired frequency response.

An example of tolerance analysis is illustrated in the following problem: Determine the variance of the input impedance at different frequencies for the passive network on page 97. Component values are given with their tolerance in percent.

The coded electrical equivalent circuit is formed as previously outlined and each component is chosen as either a current-controlled voltage source (impedance),  $Z$  or a voltage-controlled current source (admittance),  $Y$ . From the coded circuit the input matrix of [table 7] is constructed with each row containing the input data that completely describes one element of the circuit.

A sensitivity analysis is first performed on each element of the circuit. As before, the result is a ratio of two polynomials in  $s$ . The coefficients of these two functions appear in the  $a_0$  to  $a_3$  and  $b_0$  to  $b_3$  rows in [table 8], which is the computer output. The next entries in table 8 are the magnitude of the sensitivities of each element evaluated at several frequencies ( $\omega$ ). Following this is a row,  $\Delta P/P$ , containing a fractional change in each element. The last set of rows in table 8 is simply the product of the sensitivity of each element and its fractional tolerance. With this data the engineer finds,  $T_{Z1}/Z_1$ .

The larger the magnitude of the sensitivity the more important the element is in the calculation of  $T_Y$ . [Table 9] indicates importance of elements.

[Table 10] lists  $T_{Z1}/Z_1$  in percent. The evaluation is performed at several frequencies to give the designer an indication of the range over which the model will work satisfactorily.

Table 7: Tolerance analysis inputs

A	B	C	D	E	F	G	H	K	Numerical Value
2	3	0	1	1	0	1	0	0	.167E-2
3	1	1	2	2	-1	0	0	0	.241E+8
3	4	0	3	3	-1	1	0	0	.360E+2
4	1	0	4	4	1	1	0	0	.415E-7
4	1	1	5	5	0	0	0	0	.600E+3
2	1	0	5	6	0	0	1	0	.100E+1

Table 8: Sensitivity magnitudes

	$R_A$	$C_A$	$L_A$	$C_B$	$R_B$
$a_0$	.754E+8	.000E+0	.000E+0	.000E+0	.754E+8
$a_1$	.376E+4	.188E+4	.350E+4	.188E+4	.350E+4
$a_2$	.869E-1	.869E-1	.174E+0	.871E-1	.869E-1
$a_3$	.217E-5	.217E-5	.217E-5	.217E-5	.000E+0
$b_0$	.151E+9	.151E+9	.151E+9	.151E+9	.151E+9
$b_1$	.726E+4	.726E+4	.726E+4	.726E+4	.726E+4
$b_2$	.174E+0	.174E+0	.174E+0	.174E+0	.174E+0
$b_3$	.217E-5	.217E-5	.217E-5	.217E-5	.217E-5
$ S $					
$\omega_0 = 0$	.499E+0	.000	.000	.000	.499E+0
$\omega_1 = 30k$	.340E+0	.491E+0	.102E+1	.492E+0	.660E+0
$\omega_2 = 40k$	.326E+0	.772E+0	.140E+1	.773E+0	.777E+0
$\omega_3 = 50k$	.551E+0	.939E+0	.149E+1	.940E+0	.755E+0
$\omega_4 = \infty$	.100E+1	.100E+1	.100E+1	.100E+1	.000
$\frac{\Delta P}{P}$	.1	.2	.2	.2	.1
$\omega_0 = 0$	.499E-1	.000	.000	.000	.499E-1
$\omega_1 = 20k$	.340E-1	.982E-1	.205E+0	.984E-1	.660E-1
$\omega_2 = 30k$	.326E-1	.154E+0	.281E+0	.154E+0	.777E-1
$\omega_3 = 50k$	.551E-1	.187E+0	.298E+0	.188E+0	.755E+0
$\omega_\infty = \infty$	.100E+0	.200E+0	.200E+0	.200E+0	.000

Table 9: Weighted element importance

	$R_A$	$C_A$	$L_A$	$C_B$	$R_B$
$\omega_0 = 0$	A	O	O	O	A
$\omega_1 = 30k$	B	B	A	B	B
$\omega_2 = 40k$	B	B	A	B	B
$\omega_3 = 50k$	B	B	A	B	B
$\omega_\infty = \infty$	A	A	A	A	O

A — major contributor to tolerance  
 B — minor contributor to tolerance  
 C — insignificant contributor to tolerance  
 O — no contribution to tolerance

Table 10.: Percent tolerance outputs

Frequency	% tolerance
$\omega_0 = 0$	7.06
$\omega_1 = 30k$	36.6
$\omega_2 = 40k$	41
$\omega_3 = 50k$	36
$\omega_\infty = \infty$	36



# Knowing the cause helps to cure distortion in FET amplifiers

Circuit designers can steer clear of distortion trouble by following rules that are based on the interrelation of FET characteristics and the factors that cause distortion

By James S. Sherwin

Siliconix, Inc., Sunnyvale, Calif.

In an amplifier, the field effect transistor offers advantages of high gain and low noise but many designers, unfamiliar with the relatively new device, are unable to cope with the effects of harmonic distortion. By knowing the types of distortion and their causes it is possible to establish rules for operating an FET amplifier at maximum effectiveness.

Harmonic distortion in an FET amplifier is determined by many elements in the circuit—bias, operating voltage, load impedance, signal level, device characteristics and variations in input impedance. It is a function of the extent to which the device transfer curve departs from a straight line. Assuming neither load current cut-off nor saturation and neglecting the effect of supply voltage the transfer curve for an FET and other amplifying devices are closely approximated by the following: <sup>1,2,3,4</sup>

$$\begin{aligned} \text{FET} \quad I_D &= K \left[ 1 - \frac{V_{GS}}{V_P} \right]^2 \\ g_m &= \frac{2K}{V_P} \left[ 1 - \frac{V_{GS}}{V_P} \right] \end{aligned} \quad (1)$$

## The author



James S. Sherwin is manager of the FET applications section at Siliconix. He has a master's degree in electrical engineering from the University of California.

## TRIODE

$$I_P = K_1 \left[ V_G + \frac{V_P}{\mu} \right]^{3/2} \quad g_m = \frac{3}{2} K_1 \left[ V_G + \frac{V_P}{\mu} \right]^{1/2}$$

## PENTODE

$$I_P = K_2 \left[ V_G + \frac{V_{G2}}{\mu_{G2}} \right]^{3/2} \quad g_m = \frac{3}{2} K_2 \left[ V_G + \frac{V_{G2}}{\mu_{G2}} \right]^{1/2}$$

## BIPOLAR TRANSISTOR

$$I_C = K_3 [e^{\lambda V_{BE}} - 1] \quad g_m = K_3 \lambda e^{\lambda V_{BE}}$$

Definitions of the terms in the FET relations and others used below are in the table on page 101.

In determining the degree of distortion, the transfer curve may be expressed as a power series in which each term represents a fundamental and distortion component. For example, the small signal transfer function for a triode tube evaluated at a given set of d-c conditions may be written:<sup>5</sup>

$$\begin{aligned} i_p &= g_m e_{sig} + \frac{1}{2!} \frac{\partial g_m}{\partial V_G} e_{sig}^2 \\ &+ \dots + \frac{1}{3!} \frac{\partial^2 g_m}{\partial V_G^2} e_{sig}^3 + \dots + \frac{1}{n!} \frac{\partial^{n-1} g_m}{\partial V_G^{n-1}} e_{sig}^n \end{aligned} \quad (2)$$

Each term, except the first, includes a partial derivative of the transconductance term  $g_m$ . The first term represents the desired fundamental. Because the input signal voltage,  $e_{sig}$ , is a sinusoidal function [(and  $\sin^2 \omega t = \frac{1}{2}(1 - \cos 2\omega t)$ ], the second term represents a constant plus a second harmonic. The third term contains first and third harmonics. [For brevity, these terms have not been multiplied out in equation 2.]



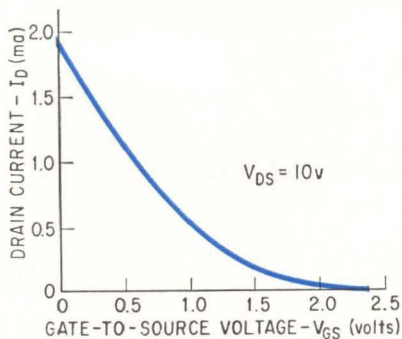

**D-c transfer curve** normally plotted for an FET at a constant drain-to-source voltage may not tell entire distortion story. Curve does not show effect of  $V_{DS}$  varying with input signal nor of the common-source output conductance varying with drain current.

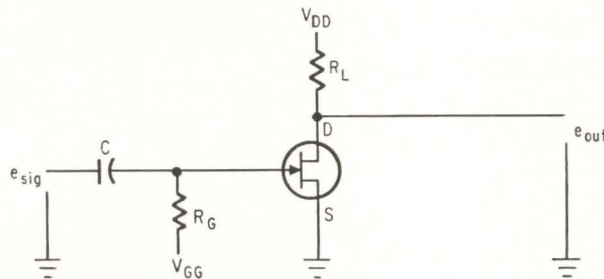

**Single-stage FET amplifier circuit** is used to determine the effect on distortion of various device and circuit parameters.

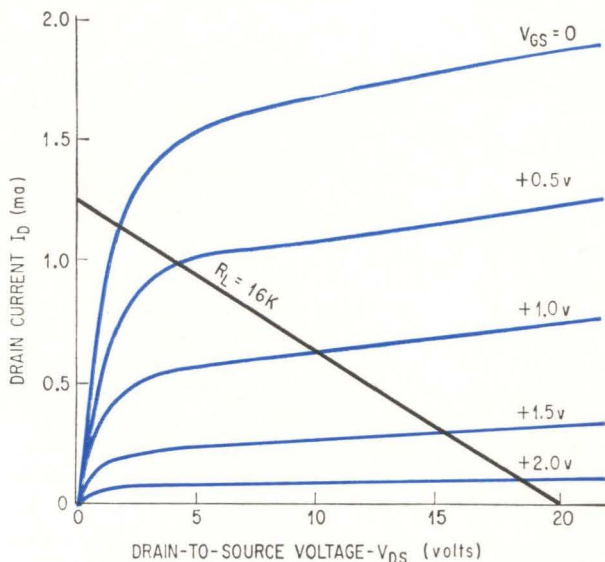

**Forward transconductance,  $g_{fs}$** , a function of the output characteristics, increases as  $V_{GS}$  goes to zero and operating point moves up and to the left along load line. This causes second harmonic distortion. However, as drain current,  $I_D$ , decreases, so does common-source output conductance,  $g_{oss}$ , also a function of the characteristics, introducing more distortion.

The first harmonic component of the third term adds to the fundamental causing a loss in proportionality between input and output. The third harmonic component causes cross-modulation and intermodulation distortion when two or more signals are present at the input.

Because the second term of the series is proportional to curvature in the transfer characteristic, second harmonic distortion may be minimized by operating on the most linear portion of the transfer

curve. The third term is proportional to rate-of-change of curvature. Therefore, the third harmonic and cross-modulation may also be minimized by operating in the most linear portion.

With field effect transistors, the transfer curve is shaped so that the second and higher order derivatives of transconductance,  $g_m$ , are zero. Only a second harmonic is present. Cross modulation products are extremely low. In the case of vacuum tubes, fourth and higher order terms are negligible. However, the series does not converge so rapidly for the transistor. Hence, fourth and higher order harmonic distortion may be significant and cross modulation is more serious in a transistor than in a vacuum tube.

Although FET's promise to generate only second harmonic distortion, the operating point must be carefully controlled for minimum distortion. Calculations made from an idealized or even a measured transfer curve may not tell the entire story. For example, a d-c transfer curve (top, left) normally plotted at a constant drain voltage  $V_{DS}$ , does not take into account the effect of  $V_{DS}$  varying with the input signal or of the common source output conductance  $g_{oss}$  varying with drain current,  $I_D$ .

The single-stage amplifier circuit (center, left) may be used to determine the effect on distortion of variations in  $e_{sig}$ ,  $V_{GS}$ ,  $R_L$  and FET characteristics  $V_P$ ,  $g_{oss}$ , and  $g_{fs}$ . It will be shown that, for low distortion, it is desirable to operate with a small input signal near zero bias. Both  $R_L$  and  $V_{DD}$  should be high and  $V_{DS}$  should be sufficiently above the knee of the output-characteristic curves of the FET but no more than necessary. Also the region near drain-to-gate breakdown should be avoided to prevent the flow of gate current on signal peaks. And, certain field effect transistor geometries are preferred over others.

### Transfer curve and conductances

The transfer curve alone, at top, left, will not yield a completely correct picture of the harmonic distortion introduced by the FET amplifier. As the input signal varies, so do the two conductances,  $g_{fs}$  and  $g_{oss}$ , which affect the gain of the stage.

Follow the instantaneous operating point up and left along the load line drawn on the FET output characteristics curves at the left.

Transconductance  $g_{fs}$  (which is the ratio of the change in output current,  $I_D$ , to the change in input voltage,  $V_{GS}$ , for a constant output voltage,  $V_{DS}$ ) increases as  $V_{GS}$  approaches zero. This variation in  $g_{fs}$  is reflected in the curvature of the transfer curve for the FET. The curvature causes second harmonic distortion.

What is not so apparent is that nonlinearities also exist because  $g_{oss}$ , the ratio of the change in output current  $I_D$  to the change in output voltage,  $V_{DS}$ , for a constant bias voltage,  $V_{GS}$ , also varies with the instantaneous operating output current— $g_{oss}$  increases as  $V_{GS}$  approaches zero, and as  $I_D$  increases.

These two effects become more visible by refer-



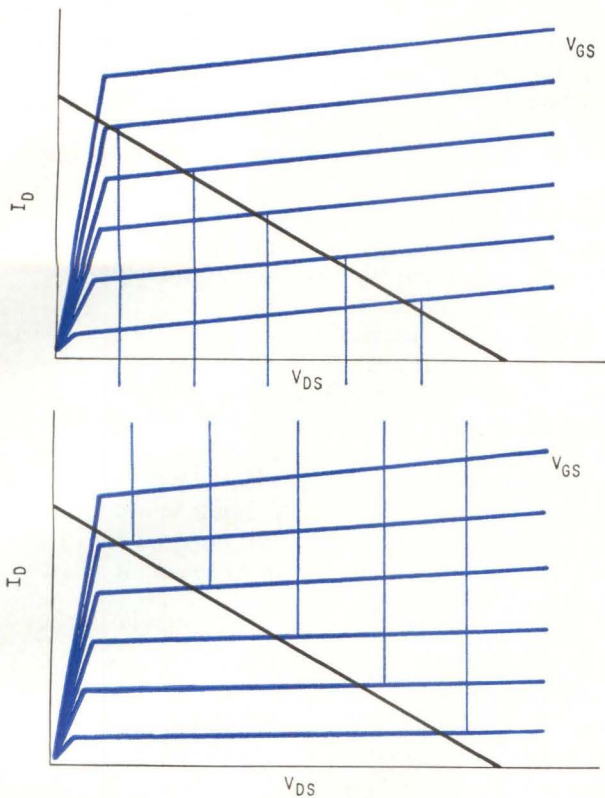

**Idealized FET output characteristics** are drawn to show (top) constant  $g_{fs}$ , constant  $g_{oss}$  and (bottom) constant  $g_{fs}$  and nonconstant  $g_{oss}$ . Transconductance  $g_{fs}$  is constant because for a given value of  $V_{DS}$  distances between  $V_{GS}$  curves are constant. Transconductance  $g_{oss}$  varies when slopes of  $V_{GS}$  curves vary.

ring to the stylized sets of constant  $g_{fs}$  output characteristics shown above. Both sets of curves exhibit a constant  $g_{fs}$ , that is, for a given value of  $V_{DS}$  the distances between the curves for constant  $V_{GS}$  are the same.

However, the top set has constant  $g_{oss}$ —the slopes of the constant  $V_{GS}$  curves are identical—while the bottom set has a varying  $g_{oss}$ —as  $I_D$  increases, the slopes of the constant  $V_{GS}$  also increase and  $g_{oss}$  increases. In effect, the bottom set of curves indicates an increase in gain as the operating point moves down and right along the load line.

#### Definition of terms

$E_n$	peak signal amplitude
$e_o$	output signal voltage
$e_{sig}$	input signal voltage
$g_{fs}$	common-source forward transfer conductance
$g_m$	mutual conductance (in FET's, $g_{fs}$ is identically equal)
$g_{oss}$	common-source output conductance (input shorted)
$i_D$	instantaneous drain current
$I_D$	drain current
$I_{DSS}$	drain saturation current
$V_{DD}$	drain supply voltage
$V_{DS}$	drain-to-source voltage
$V_{DS}$	instantaneous drain-to-source voltage
$V_{GG}$	gate supply voltage
$V_{GS}$	gate-to-source voltage
$V_P$	gate-source pinch-off voltage

From the gain equation for the FET:

$$\frac{e_o}{e_{sig}} = \frac{g_{fs}}{G_L + g_{oss}} \quad (3)$$

it is apparent that the effect of a change in  $g_{oss}$  is less for large  $G_L$ , reciprocal of load resistance. As  $V_{GS}$  increases, the decrease in  $g_{fs}$  is partially offset by a corresponding decrease in  $g_{oss}$ . In effect, the degree of distortion produced by a nonlinear transfer curve is diminished. At a certain operating point the two distortion sources will most nearly cancel to produce a point of minimum distortion.

Expanding the power series transfer function of equation 1 for the a-c terms for the FET gives the expression:

$$i_d = \frac{2I_{DSS}}{V_P^2} (V_P - V_{GS}) E_n \sin \omega t - \frac{I_{DSS}}{V_P^2} E_n^2 \left( \frac{\cos 2\omega t}{2} \right) \quad (4)$$

where  $E_n$  is the peak signal amplitude

Taking the ratio of the amplitudes of the second harmonic and the fundamental, the expression for percent second harmonic distortion is:

$$\% \text{ second harmonic distortion} = \frac{25 E_n}{(V_P - V_{GS})} \quad (5)$$

This expression is valid for small-signal distortion due only to curvature of the transfer characteristic. Required conditions are that the drain voltage saturation region is avoided and that drain current flows during all portions of the cycle.

#### Gate bias and signal level

According to equation 5, small-signal distortion is directly proportional to the input signal level. However, the distortion also depends upon the difference between the pinch-off voltage and the voltage on the gate.

The plot of total harmonic distortion vs input signal in the figure top, page 102 bears this out. This curve was plotted from data taken at zero gate bias. However, the distortion level is unaffected by the slight forward gate biasing on negative signal peaks because the transition of the gate diode of the FET from reverse bias to forward bias is gradual.

Input circuit distortion is not measurable until the rms input signal level exceeds 100 millivolts. This is apparent in the figure bottom, page 102 which plots input distortion vs input signal for gate-circuit time constants, RC, of 10 milliseconds to 1 second. The reason the distortion increases with the input signal is that the gate draws current from the signal source on input peaks; distortion is reduced by adding the equivalent of grid-leak bias.

In this manner, the d-c current drawn through the gate-return resistor, shown in the amplifier circuit on page 100, develops a gate bias approximately equal to the peak forward signal voltage. So long as the input capacitor remains charged, the gate ceases to draw current on signal peaks.



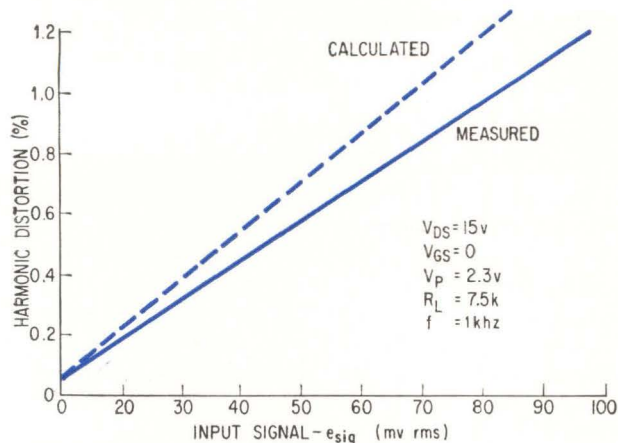

Harmonic distortion is directly proportional to input signal level. Calculated curve is plotted from equation 5.

Thus, distortion becomes a function of frequency. Reducing the frequency to 100 hertz will have the same effect as reducing the time constant by a factor of 10.

This means that for low distortion when the gate conducts on signal peaks, RC must be about 1,000 times the period of the lowest frequency to be handled. If the generator impedance is quite low, say a few hundred ohms, the input distortion will be reduced considerably. However, because this is not a normal operating condition, the gate should be operated at a bias level that insures signal peaks will not forward-bias the gate by more than 100 to 200 millivolts.

Equation 5 indicates also that distortion increases as  $V_{GS}$  approaches  $V_P$ ; for  $V_{GS} = 0$ , distortion is inversely proportional to  $V_P$ . Distortion vs  $V_{GS}$  is plotted in the figure on page 103 for two values of input signal for a device with  $V_P = 2.3$  volts. The figure below it plots distortion against  $V_P$  for  $V_{GS} = 0$ . The calculated and measured values agree closely in both plots. However, as  $(V_P - V_{GS})$  approaches zero, the measured distortion significantly exceeds the calculated value, possibly because the signal level may no longer be considered as small signal or the true transfer curve departs from the mathematically ideal parabola of equation 1.

### Drain voltage

The effects of  $V_{DS}$  and  $g_{oss}$  on distortion are illustrated in curves on page 104. The  $V_{DS}$  effect is in reality a  $g_{oss}$  effect as may be seen from the  $g_{oss}$  vs  $V_{DS}$  curves. Distortion due to  $g_{oss}$  becomes large at low  $V_{DS}$  due to the very high value of  $g_{oss}$ , while the distortion at high  $V_{DS}$  is due principally to the variation in  $g_{fs}$ . As  $V_{DS}$  is decreased, the  $g_{oss}$ -induced distortion increases and counteracts the  $g_{fs}$ -induced distortion. At a specific and fairly low  $V_{DS}$  the two distortions nearly cancel to produce a minimum in the distortion curve.

Unfortunately, operation at the point of minimum distortion is not particularly recommended. Its location is uncertain and, as can be seen from

the figure on page 104, very near a region of excessive distortion.

Operation below the point of minimum distortion at low  $V_{DS}$  results in a significant increase in nonlinear distortion due to drain saturation. This is reflected in the rapidly increasing  $g_{oss}$ . This effect is also visible on the FET output characteristic on page 101 as the operating point moves up and to the left along the load line approaching the knee of the output curves.

The effect may be further described by the saturation of the transfer curve that can be plotted for the condition of insufficient  $V_{DS}$ .

Operating a FET with the drain voltage at or near breakdown has been reported as one method for improving bias stability.<sup>6</sup> The idea, apparently, was that with the FET biased to the point where drain-gate breakdown occurs, any FET plugged into the socket will find a stable operating point at breakdown even though  $V_{GS}$  may vary somewhat from one unit to another. As signal is applied, voltage peaks at the gate drive the device further into breakdown. Zener breakdown current then flows from the drain to the gate developing a gate-leak bias in much the same manner as already described on page 101.

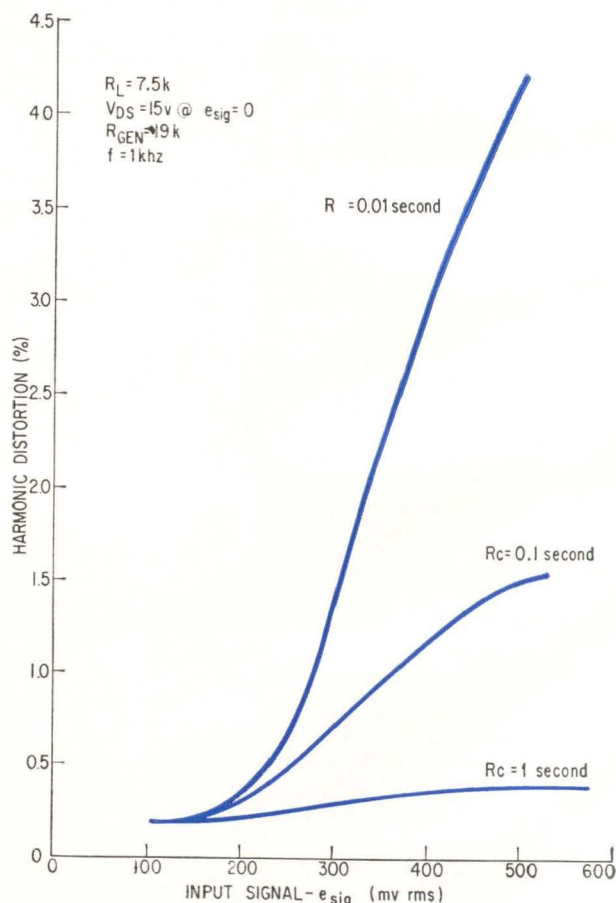

Input circuit distortion is negligible until the input signal reaches 100 mv. The larger the input circuit time constant, the lower the distortion.



The result is effective in stabilizing the operating point; however input circuit distortion becomes significant with normal generator resistances, a fact overlooked by the author. In fact, distortion of up to 44% was measured with an FET operating from a 20-kilohm/100-millivolt source under the other conditions reported in reference 6.

### Long, short and medium gates

The physical geometry of the FET also has an effect on distortion, as shown by the three curves in the figures on page 104. Three devices of approximately equal pinch-off voltage generate significantly different distortion levels. These distortion levels are due to different gate lengths, which affect the value of  $g_{oss}$  and the rapidity with which the device output characteristics shift from triode to pentode type as  $V_{DS}$  increases. The three photos on page 105 show the output characteristics of the three devices. That the values of  $g_{oss}$  differ is apparent from the slopes of the characteristics.

The 2N3578 is a very long gate FET, top photo, and has the lowest value of  $g_{oss}$ . The transition from the triode- to pentode-like characteristic is also quite rapid. Distortion is high because  $g_{oss}$  is low and the  $g_{oss}$ -induced distortion only slightly reduces that induced by  $g_{fs}$ .

On the other hand, excessive distortion at drain saturation decreases rapidly as  $V_{DS}$  increases because of the rapid shift from the triode to pentode character. Where drain supply voltage is limited, the long gate device is perhaps preferred over other types because the operating point may be closer to the knee of the output curves.

The 2N3376 is a short-gate device, middle photo, with rather high  $g_{oss}$  and a poorly defined transition region from triode to pentode character. The high  $g_{oss}$  causes a fairly low distortion as long as adequate drain voltage is available. A short-gate device is probably the best choice where minimum distortion is required and the supply voltage is not severely limited.

The 2N2608, bottom photo, is a medium gate-length device. It is a compromise between the low distortion and low saturation voltage characteristics of the long and short gate devices.

### Load resistance

Load resistance also affects distortion level. The effect is, again, a function of  $g_{oss}$ . Distortion decreases with increasing  $R_L$ . Distortion is less with devices having short gates because  $g_{oss}$  is greater than it is for FETs with much longer gates. The reason for the improvement with increasing  $R_L$  is that the  $g_{oss}$ -induced distortion has a greater opportunity to counteract  $g_{fs}$  distortion as the load line becomes more nearly horizontal.

Consider, for example, that  $g_{oss}$  effects are zero when  $R_L = 0$  and the load line is vertical. Conversely  $g_{fs}$  effects are near zero when  $R_L = \infty$  and the load line is horizontal. At some point with high  $R_L$ , a distortion minimum will occur beyond which  $g_{oss}$  distortion is greater than  $g_{fs}$  distortion.

A particularly effective way of operating with

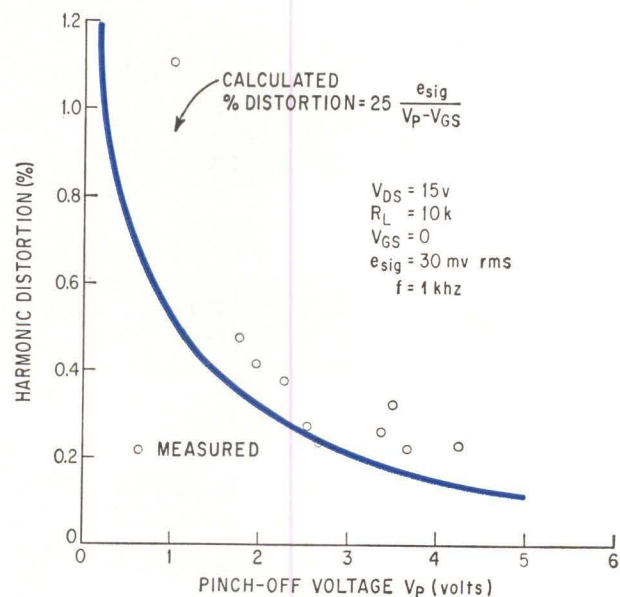
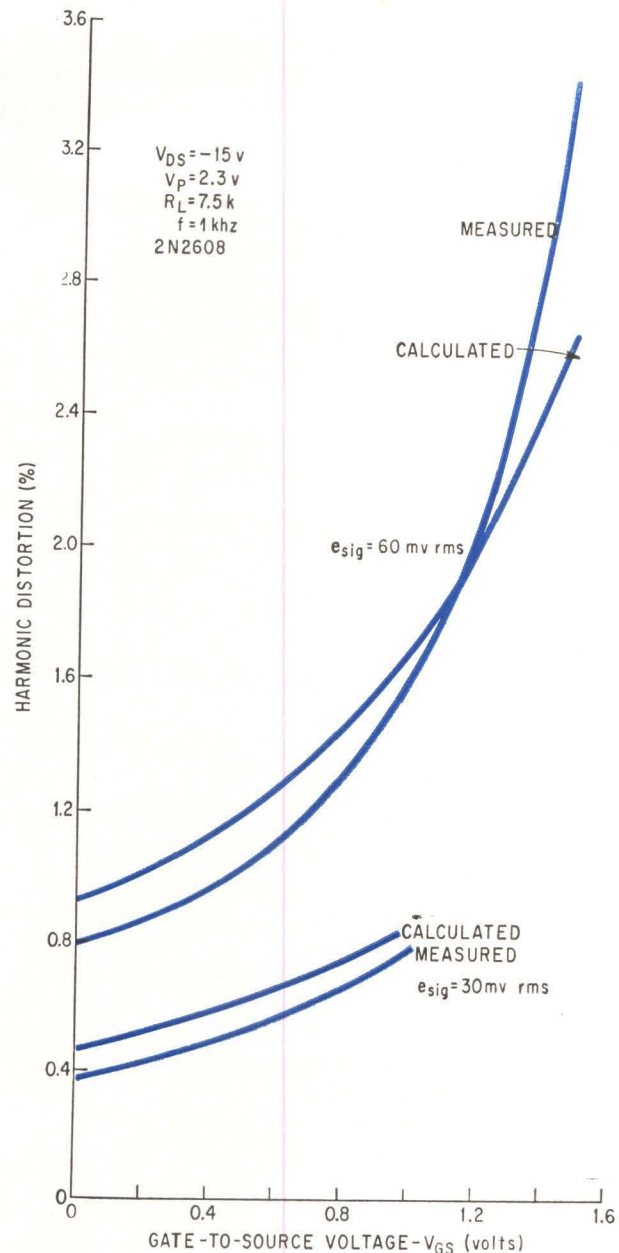

Distortion increases as the gate-to-source voltage,  $V_{GS}$  approaches the pinch-off voltage,  $V_P$ .



high  $R_L$  for low distortion and high gain is shown in the circuit next page. A second FET is used here as the load resistor. The load line is one of the constant  $V_{GS}$ -output curves of  $Q_2$  superimposed upon the output characteristics of  $Q_1$ . The load FET should have  $I_{DSS}$  greater than that of the amplifier

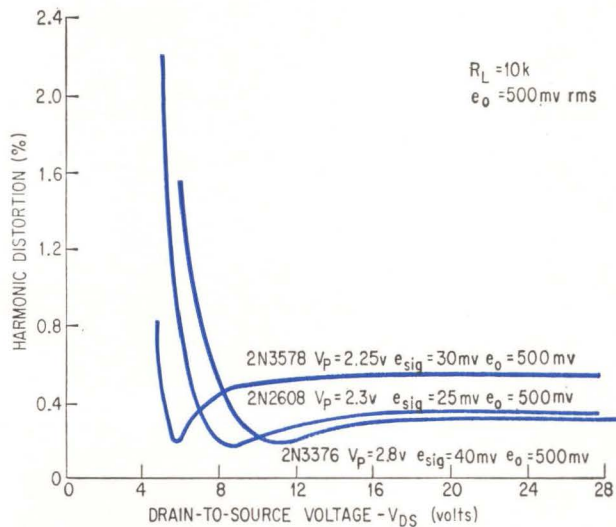

Drain-to-source voltage,  $V_{DS}$ , must remain well above the pinch-off voltage for the FET or the distortion increases sharply.

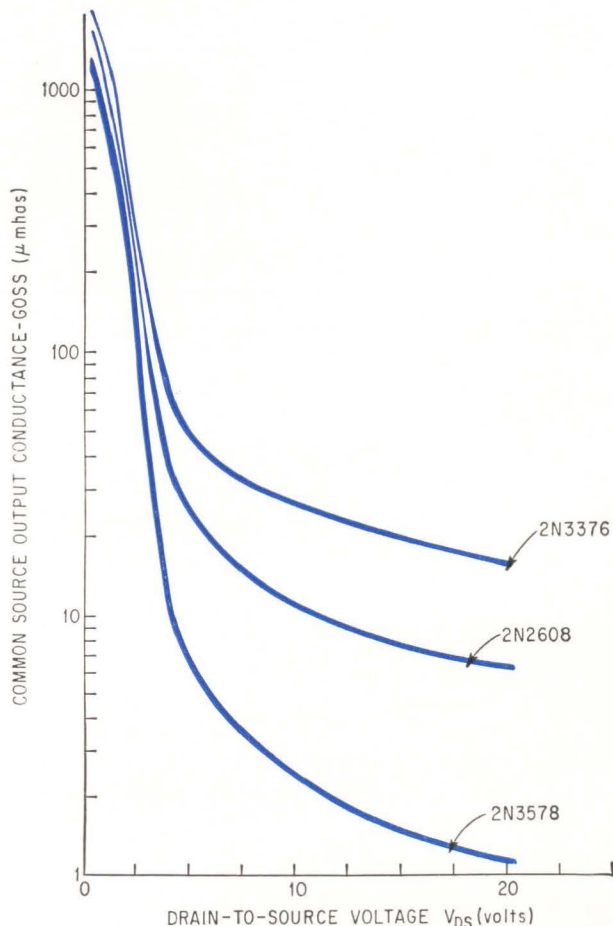

Output transconductance  $g_{oss}$  goes up for three types of FET's with varying gate lengths as drain-to-source voltage,  $V_{DS}$ , goes down.

field effect transistor used in the circuit.

Load resistor  $R_L$  is adjusted for an operating point A, at  $V_{DS} \approx V_{DD}/2$ . It is important to use devices with high  $g_{oss}$ , otherwise  $V_{DS}$  will be unstable because of device heating and the consequent decrease in  $I_D$ . The operating point then shifts from  $V_{DS} \approx V_{DD}/2$ . Low  $I_{DSS}$  is also desirable to maintain low power dissipation and, hence, good temperature stability.

### Rules for low distortion

To attain the lowest possible distortion with an FET amplifier close attention must be given to d-c operating point, bias level, load resistance and, of course, the FET characteristics. The rules to follow, listed in descending order of importance, are:

1. Maintain  $V_{DS}$  high enough so that peak output signal swing will not reduce  $V_{DS}$  below two to four times  $V_P$ . Distortion increases sharply for drain-to-source voltages approaching the pinch-off voltage.
2. Maintain  $V_{GS}$  at such a point that peak input signal swing will not forward-bias the FET gate junction by more than 200 mv.
3. Do not operate near drain-gate breakdown voltage unless the signal source impedance is low.
4. Maintain a minimum  $V_{GS}$  consistent with other circuit requirements. More properly, maximize  $(V_P - V_{GS})$ . Distortion increases with bias voltage.
5. Minimize input signal level.
6. Use a high value of load impedance. Distortion decreases with  $R_L$ .
7. Maintain  $V_{DS}$  at the lowest value consistent with rules 1 and 3.

Note that rules 4 and 6 indicate operation at the highest practical gain commensurate with power supply and frequency response limitations.

### Distortion redefined

A particularly practical viewpoint is to consider distortion as a percentage of output voltage rather than of signal voltage as represented by equation 5. The combined effects of FET parameters  $V_P$ ,  $I_{DSS}$ ,  $g_{fs}$  and stage gain may then be determined. It is also reasonable to assume that prime interest lies in the output distortion level regardless of what input signal level is required.

Consider the stage gain expressed in equation 3 simplified to

$$\frac{e_o}{e_{sig}} = g_{fs} R_L \quad (6)$$

Combine this with equation 5 to obtain distortion in terms of peak value of rms output voltage.

$$\% \text{ Distortion} = \frac{25 e_o}{g_{fs} R_L (V_P - V_{GS})} \quad (7)$$

If  $R_L$  is related to supply voltage and FET characteristics as follows:

$$R_L = \frac{V_{DD} - 2V_P}{2I_D} \quad (8)$$



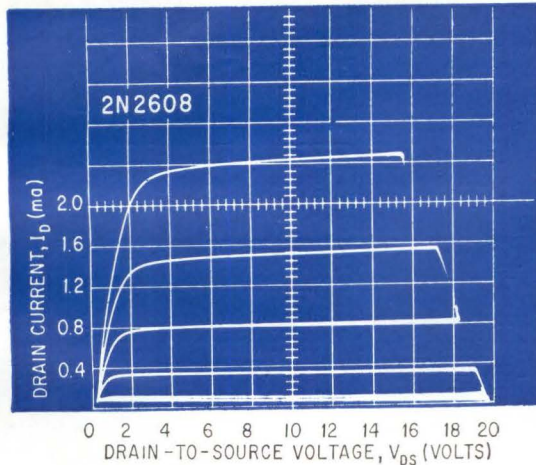
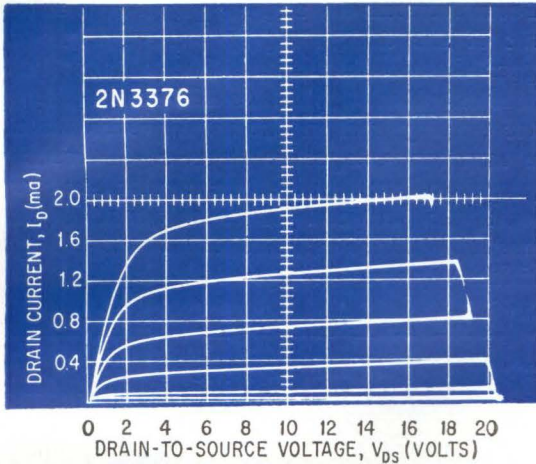
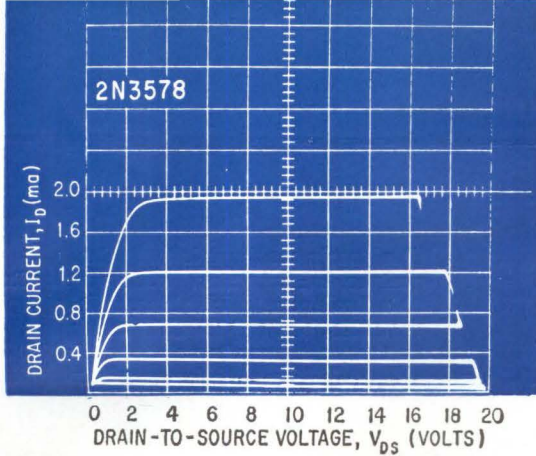

Different gate lengths of the FET's affect the distortion levels because they also affect the value of common-source output conductance,  $g_{oss}$ , or the slope of the curves. Very long gate 2N3578 has lowest slope and lowest  $g_{oss}$  (top). Short gate 2N3376 has rather high  $g_{oss}$  (middle). Median gate 2N2608 is compromise between the other two FET's (bottom).

for maximum output signal swing, then the FET characteristic equations

$$I_D = \frac{I_{DSS}}{V_P^2} (V_P - V_{GS})^2 \quad (9)$$

$$g_{fs} = \frac{2I_{DSS}}{V_P^2} (V_P - V_{GS}) \quad (10)$$

may be used with equations 7 and 8 to find output distortion (again, at peak out voltage).

$$\% \text{ Distortion} = \frac{25 e_o}{V_{DD} - 2V_P} \quad (11)$$

From equation 11, it is apparent that FET ampli-

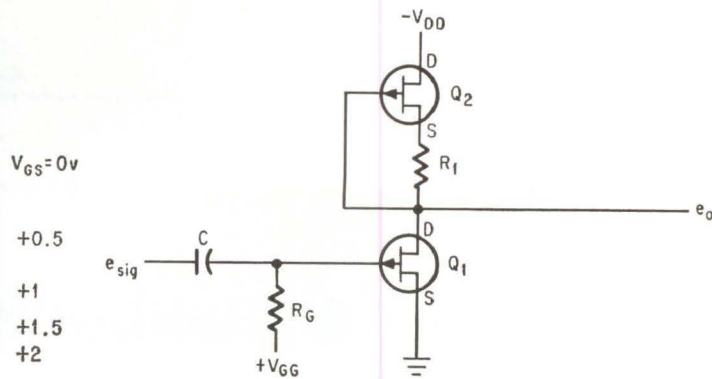

FET used as load resistor is effective way of operating for low distortion and high gain. Load line is a constant  $V_{GS}$  characteristic curve for  $Q_1$  superimposed on the output characteristics of  $Q_2$ .

fier distortion for a given output voltage is independent of  $I_{DSS}$  and  $g_{fs}$ . Rules 4 and 5 become of little importance for the case where  $e_{sig}$  is small and  $R_L$  may be increased without regard to bandwidth or other design considerations.<sup>7</sup> High  $V_{DD}$  and low  $V_P$  allow high  $R_L$ , high gain, and thus low  $e_{sig}$  to produce a given  $e_o$ . Distortion is minimized not only because of the low signal required, but also because of the advantages of high  $R_L$ , already discussed (but not expressed in equation 11).

### Transistor selection

The FET to be selected for lowest distortion will depend upon the available input signal, supply voltage, and required bandwidth. For large input signal and large bandwidth, a high  $V_P$  is desired unless source degeneration is applied. For small input signal or low  $V_{DD}$ , a low  $V_P$  unit is desired. The choice will depend upon the specific conditions of application. In any case, an FET exhibiting high  $g_{oss}$  is desired. This characteristic may be evaluated by referring to the output characteristic curves for any particular FET. Output characteristic curves with large slope mean high  $g_{oss}$ .

No attempt has been made to play off one characteristic against another. For example, a low  $V_P$  unit from any one given geometry will exhibit a slightly higher  $g_{fs}$  at a given drain current than will the high  $V_P$  unit of the same family. This means that the device may be operated at low  $I_D$  for higher gain ( $g_{fs}R_L$ ) than is attainable with high  $V_P$  units.

The author believes that few, if any, of these trade offs can significantly improve the distortion level.

### References

1. F.E. Terman, "Radio Engineering," McGraw-Hill Book Co. 1947, p. 162
2. Ibid, p. 170
3. R.D. Middlebrook, "A Simple Derivation of Field Effect Transistor Characteristics," Proceedings of the IEEE, August 1963, p. 1146.
4. J.G. Linvill, "Models of Transistors and Diodes," McGraw-Hill Book Co. 1963, p. 17.
5. Terman, op. cit., p. 185
6. W.A. Rhinefelder, "FET's Outperform Bipolars, Pentodes in Linear Voltage Amplifiers," Electronic Design, December 20, 1965, p. 24.
7. J.S. Sherwin, "Take the Fog Out of Field-Effect Design," Electronic Design, May 24, 1966, p. 38.



# Designer's casebook

Designer's casebook is a regular feature in Electronics. Readers are invited to submit novel circuit ideas, packaging schemes, or other unusual solutions to design problems. Descriptions should be short. We'll pay \$50 for each item published.

## Warning lights monitor d-c supply voltage

by Robert L. Nuckolls III

Electronic Designs Development,  
Wichita, Kan.

**Overvoltages in an aircraft's** d-c supply can ruin expensive radio equipment. A pilot confronted by a myriad of dials may not notice supply voltage changes on a voltmeter dial in time to take corrective action. The circuit at the right, replaces the voltmeter with warning lights that display overvoltage or undervoltage conditions. Installed in an automobile, the circuit warns of voltage regulator malfunctions so that repairs can be made before the battery is destroyed.

When the 28-volt supply voltage rises to 32 volts, it back biases zener diode  $D_1$  into conduction; current flows through  $R_1$  and  $D_1$ , triggering  $SCR_1$  and turning on the red overvoltage warning lamp. Although the cathode of  $SCR_1$  is clamped at 0.6 volt by diode  $D_3$ , the voltage at the anode of zener  $D_1$  is 1.1 volts; the 0.5-volt difference is enough to turn on the scr which requires only 0.2 volt for triggering. Once turned on, the scr continues to conduct and the lamp remains lit. It can be extinguished by pressing the lamp's press-to-test mounting fixture. This opens the circuit.

To control the yellow undervoltage warning lamp, zener diode  $D_2$  is chosen so that it is back biased into conduction as long as the supply voltage stays above 24 volts. The current through  $D_2$  holds transistor  $Q_1$  in saturation by making the base of  $Q_1$  positive with respect to its grounded emitter. With  $Q_1$  in saturation, the gate of  $SCR_2$  is held 0.2 volt above ground by the voltage drop across  $Q_1$ . Since the cathode of  $SCR_2$  is fixed at 0.6 volts by diode  $D_3$ , the reverse bias from gate to cathode on  $SCR_2$  is 0.4 volt, maintaining  $SCR_2$  and the lamp in a normally off condition.

When the supply voltage drops below 24 volts, zener diode  $D_2$  cuts off; this drops the base voltage on transistor  $Q_1$  to ground and shuts it off. With  $Q_1$  an open circuit, the gate of  $SCR_2$  is switched to the supply voltage and  $SCR_2$  conducts, turning on the yellow lamp.

Potentiometers  $R_2$  and  $R_3$  provide some adjustment of the critical supply voltage levels which trigger the warning lamps. The voltages handled by the circuit are typical for a 28-volt battery/alternator d-c supply in an aircraft; however, the circuit can monitor voltages as large as 600 volts with appropriate lamps and semiconductor devices. This circuit was designed for cockpit installation and is not temperature compensated, but it will operate satisfactorily over a range of 50° to 90°F.

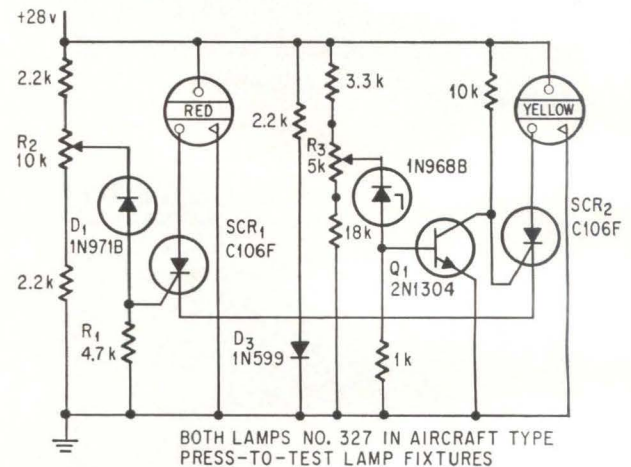

An increase in supply voltage to 32 volts brings zener diode  $D_1$  into conduction firing  $SCR_1$ , and turning on the red overvoltage warning lamp.

## Tunnel diodes lock output of servocircuit

By John C. McKechnie

Martin Co., Orlando, Fla

**An often-ignored property** of tunnel diodes, the reverse current-voltage curve, can be the basis for a family of circuits that delivers a nearly constant output when the input voltage is between two specified levels. This form of response, provided by an offset hysteresis transfer function, is particularly useful in servosystems.

Features of the offset hysteresis transfer function [the top curve in the diagram at the right] are:



- Output is delayed until the input signal,  $e_i$ , reaches a minimum level,  $e_{on}$ .

- There are only two response states, full on (plus or minus) and off.

- Once the function is on, an overshoot voltage in the opposite direction—to  $e_{off}$ —is necessary to turn it off.

- An increase in the input signal will not change the output when the function is on.

Among the circuit types that can exploit these actions are analog computing elements, absolute value threshold detectors, bang-bang elements of nonlinear servosystems and servofeedback loop elements. A circuit built with radiation-hard tunnel diodes has been developed at the Martin Co. to produce a dead band and gated response in the feedback of a missile servosystem.

The basic form of the circuit is shown and the reverse current-voltage characteristic of the tunnel diodes is displayed in the lower section of the diagram. The forward current-voltage characteristic is similar to that of a conventional diode; that is, it presents essentially zero impedance.

The circuit consists of two loops, each containing a tunnel diode, a current-limiting resistor, an output resistor and a ground reference. The upper loop ( $e_i, R_1, R_3, e_o$ ) provides the hysteresis characteristic when the input voltage,  $e_i$ , is positive. When the input is negative, the loops work in reverse.

As  $e_i$  rises until it equals  $e_{on}$ , the reverse current in the upper loop through  $D_1$  increases to a value  $i_p$ , at point A on the characteristic curve. At this point,  $D_1$  switches to its higher voltage state,  $e_2$ , as determined by the intersection of the curve and the load line of the current-limiting resistor,  $R_1$ , at point B. Since the curve's slope is quite steep at

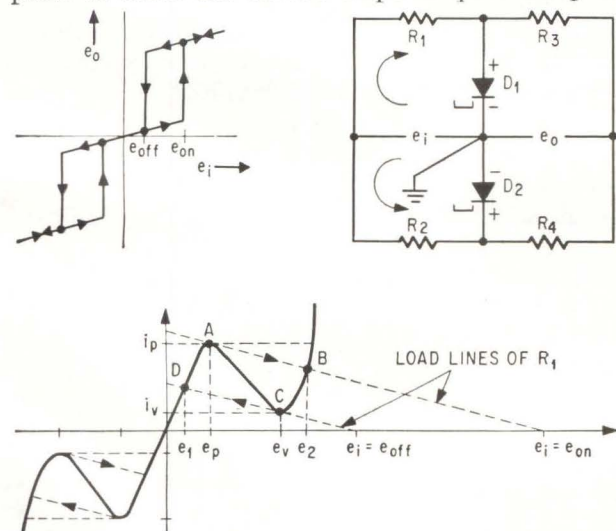

Offset hysteresis transfer function, shown at top, is achieved in the circuit by exploiting the reverse current-voltage characteristic of tunnel diode, seen in bottom curve.

point B, any further increase in  $e_i$  is mostly absorbed across  $R_1$  and the output voltage,  $e_o$ , remains nearly constant.

Then, as  $e_i$  decreases to a value that equals  $e_{off}$ , the reverse current through  $D_1$  also decreases. When the current falls to  $i_v$ , at point C of the curve,  $D_1$  switches to its lower voltage state. This state,  $e_1$ , is determined by the intersection at point D of  $D_1$ 's characteristic curve and the load line of  $R_1$ . It is apparent from the curve that  $e_{off}$  is less than  $e_{on}$ , accomplishing the desired hysteresis characteristic.

Meanwhile,  $D_2$  in the lower loop is virtually a short circuit. As the positive  $e_i$  gradually increases from zero, a forward current flows through  $D_2$  and  $R_2$ . As long as  $e_i$  is positive, forward conduction is maintained and essentially all of  $E_i$  in the lower loop is dropped across  $R_2$ .

The switching point of the output with respect to the input voltage level depends upon the values selected for  $R_1$  and  $R_2$ . The output voltage in the on state is varied with output resistors  $R_3$  and  $R_4$ , which combine with the output load resistance to make a voltage divider.

## Agc circuit possesses 60-decibel gain

By William H. Ellis Jr.

Page Communications Engineers, Inc., Washington, D.C.

Integrated circuits, diodes and a single transistor form an automatic gain control circuit that provides an output change of less than 6 decibels for an input change of greater than 60 db. Frequencies can range from 20 hertz to over 10 khz [See Electronics, p. 81, Nov. 28, 1966 for an alternate circuit.]

Resistor  $R_1$  and diodes  $D_1$ ,  $D_2$ ,  $D_3$  and  $D_4$  form a voltage divider in the circuit [at top p. 108]. Current through the diodes establishes the voltage division ratio because it changes the effective resistance of the diodes. The signal at the voltage divider is amplified by the integrated circuit at the left of the diagram on the next page, an operational amplifier with a gain of 100. The output of this amplifier is rectified by  $D_5$  and  $D_6$ .

Effective full-wave rectification—which improves the low frequency performance of the circuit—is achieved without a transformer by the second operational amplifier. The control signal at the output of the second amplifier is buffered by the emitter follower,  $Q_1$ , that drives the input diodes.

For manual control the feedback loop is broken



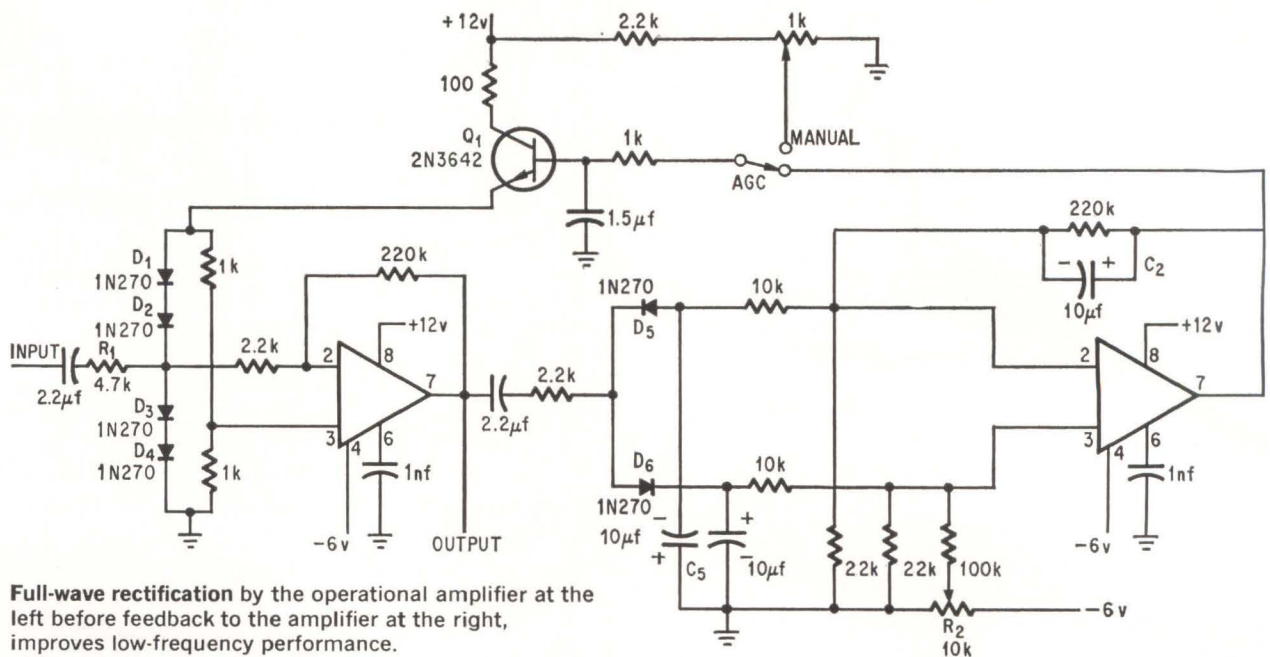

Full-wave rectification by the operational amplifier at the left before feedback to the amplifier at the right, improves low-frequency performance.

and a potentiometer inserted to control current flow through the diode voltage divider. Adjusting  $R_2$  varies agc delay. Capacitor  $C_1$  controls agc delay.

The circuit exhibits good d-c stability at a temperature of  $70^\circ\text{C}$ .

Variable voltage division requires several volts of input signal for maximum agc range under maximum signal conditions. Consequently, one or more stages of linear amplification may be required ahead of the agc circuit.

## Adding transistors makes voltage shifter adjustable

By James E. Walters

Light Military Electronics Division,  
General Electric Co., Utica, N.Y.

**Single-transistor circuits** for shifting voltage levels have been the rule in digital systems that require two or more driving voltages. In contrast, the circuit at the right is more complex but offers several advantages over the usual logic-level shifter: it has high input impedance, has good thermal stability and provides accurate control and adjustment of the output level.

These advantages are frequently desirable in interfacing, where the amount of shift must be adjustable, or the amount of shift must be more precise than that of the zener shifter. The circuit, as shown, is capable of shifting signals over approximately an 18-volt range.

As the input voltage  $V_1$  goes from  $Q_1$  through  $Q_3$  its level is shifted downward by the voltage drop across potentiometer  $R_1$ . Transistor  $Q_2$  is a constant-

current source that preserves the preset voltage drop across  $R_1$ , regardless of input. If the shift desired is a fixed one, the potentiometer can be replaced by a fixed resistor.

Output transistor,  $Q_3$  is an emitter follower, which buffers the effect of the load on the amount of shift. Resistor  $R_1$  clamps the base of  $Q_3$ , a fixed voltage drop below  $V_1$ . The level shift is due only to changes made to variable resistor,  $R_1$ .

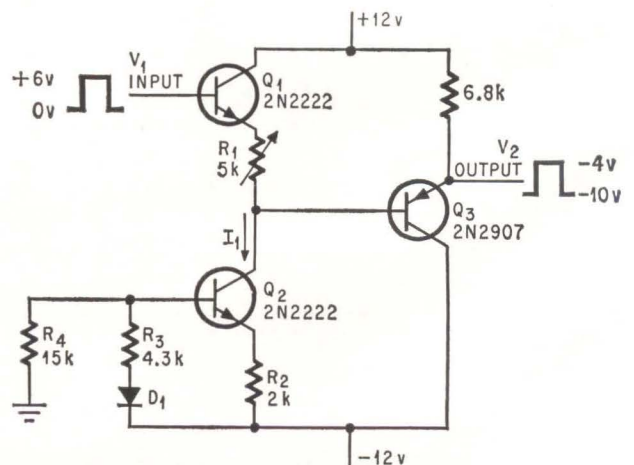

Potentiometer  $R_1$  combines with constant current generator  $Q_2$  to form an adjustable zener diode.



Because  $Q_1$  and  $Q_3$  are complementary npn and pnp transistors, the voltage drop across their base-emitter junctions cancel out and these thermal drifts nullify each other. Diode  $D_1$  compensates for the  $-1.8$  millivolt per  $^{\circ}\text{C}$  drift of  $Q_2$  base to emitter drop.

Selection of component values for different

amounts of voltage drop can be made from the following current-voltage relationships:

$$I_1 = \frac{(V_{cc} - 0.6) \cdot \alpha R_3}{(R_3 + R_4) \cdot R_2}$$

$$V_e \approx V_1 - I_1 R_1 \text{ for } I_1 > i_{b3} \text{ and } V_{be1} = V_{be2}$$

## Bipolar pulse generator tests fast flip-flops

By Otakar A. Horna

Research Institute for Mathematical Machines, Prague, Czechoslovakia

**Fast flip-flop circuits** are easily tested with a bipolar pulse generator whose pulse repetition frequency goes up to 50 megahertz. The high prf is achieved with a gallium-arsenide tunnel diode that functions as a relaxation oscillator.

The pulse driver shown below is formed by the tunnel diode,  $D_1$ , a developmental type, with a peak current of 10 milliamperes, that is similar to the RCA 40062. The frequency of oscillation is changed by varying inductance  $L_1$ . When  $L_1$  is 0.5 microhenry, the prf is 25 mhz. When  $L_1$  is increased, the frequency goes up.

The ratio of the pulse width to the repetition period can be adjusted continuously by varying resistor  $R_1$ . This essentially shifts the operating

point of the tunnel diode from point A on the  $I_d$  versus  $V_d$  curve where the ratio is 1 to 7, to point B, where the ratio is 1 to 1. In addition, this adjustment changes the prf slightly.

The bases of transistor  $Q_1$  and  $Q_2$  act as a current switch. The bases are connected between the tunnel diode,  $D_1$ , and the d-c level shifting network  $R_3R_4C_3$ . Thus,  $Q_1$  and  $Q_2$  are driven from a source with a very low internal resistance and do not saturate. Hence, the rise and fall times are less than 5 nanoseconds, and the delay between both pulses is less than 0.5 nsec.

Isolating network,  $R_2C_2$ , receives the 1-volt pulse signal from  $D_1$  and applies it directly to output terminal 1 where a signal for time-base synchronization can be taken for an oscilloscope. A positive pulse can be taken for terminal 2 and a negative pulse for terminal 3.

With the given values of resistors  $R_5$  and  $R_6$  and a supply voltage of 2 volts the amplitude of the output pulse is 1.8 volts and the output impedance is 100 ohms. This impedance terminates a 100-ohm coaxial cable. The terminals are miniature coaxial connectors. Terminals 2 and 3 are short-circuit proof.

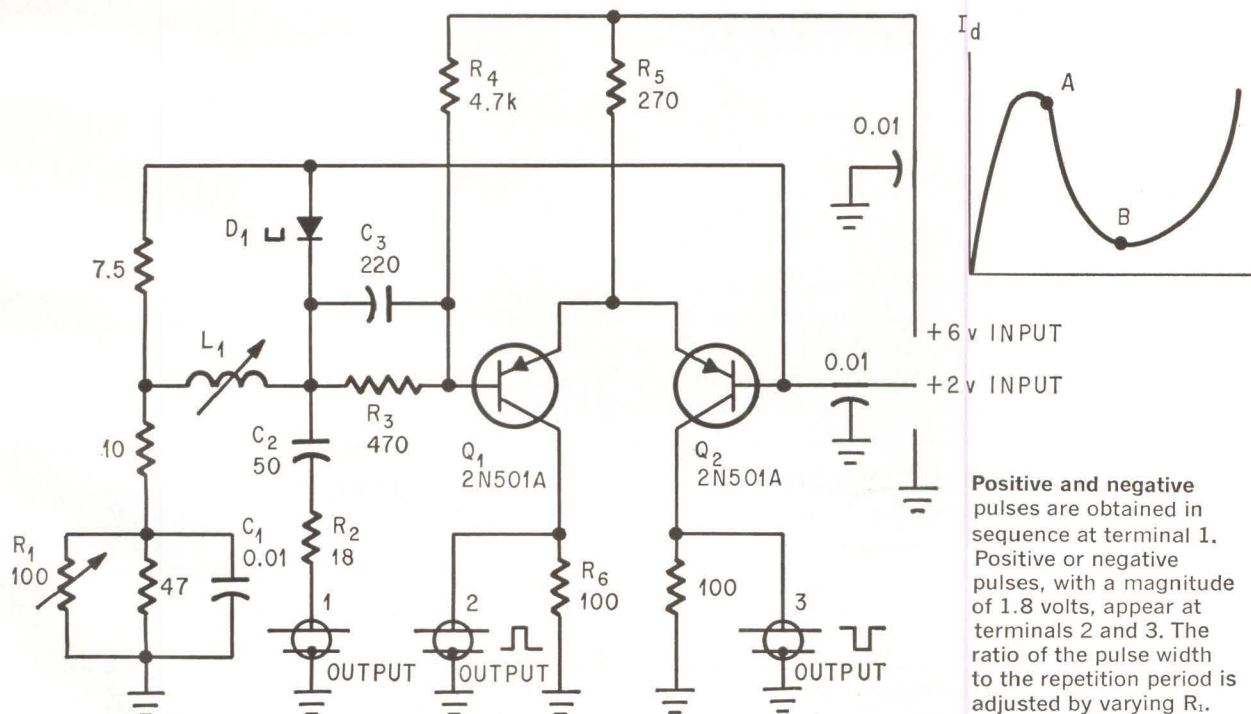

**Positive and negative pulses** are obtained in sequence at terminal 1. Positive or negative pulses, with a magnitude of 1.8 volts, appear at terminals 2 and 3. The ratio of the pulse width to the repetition period is adjusted by varying  $R_1$ .



# New MOS hybrid microcircuits

An industry first. General Instrument, the leading producer of both hybrid and MOS ICs, has combined both technologies to create the most advanced line of hybrid ICs yet produced. The PC-250 is the result of this marriage of high performance MOS transistors and high performance bi-polar transistors used in conjunction with GI's proven hybrid assembly techniques.

The PC-250 is an ultra-high input impedance amplifier which can be used not only as a general purpose amplifier, but is designed for use wherever electrometer type high input impedance circuits are required—as in infrared detectors, high impedance transducers and crystal cartridges—thereby eliminating the need for the much larger, more complex, less reliable electrometer tube. The PC-250 and the PC-251 (the short-circuit-proof version of the PC-250) are immediately available in hermetically sealed ceramic-metal flatpacks from your authorized General Instrument Distributor. Write for full information.

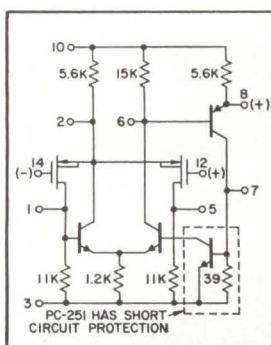

#### CIRCUIT DIAGRAM:

- The high impedance MOSFETs matched in a differential pair form the front end of the amplifier—resulting in an electrometer type performance input circuit.
- No external frequency stabilization is required in most normal closed loop amplifier configurations.
- This circuit is indicative of the many types possible with this new combined technology.

#### FEATURES:

Input resistance . . .  $10^{14}$  typical  
Voltage Gain . . . 50dB, 44dB min.  
Input Leakage Current . . . 3 pA



GENERAL INSTRUMENT CORPORATION • 600 WEST JOHN STREET, HICKSVILLE, L. I., NEW YORK



# Apollo: the goal is in sight

The lunar landing mission will provide the stiffest challenge to date for electronics equipment. Ultrareliability is the aim of the engineers and test performances thus far have been outstanding

By John Rhea

Electronics Washington Bureau

Now that the Gemini project has been completed, the engineers working on space technology have turned their attention to the next step in space exploration: Apollo, landing men on the moon. The exacting requirements of this mission will pose the toughest test yet for electronics equipment. In pre-flight tests so far the electronic gear has performed spectacularly. A sliding of the launch date of the first vehicle, from December 1966 to March 1967 and then April 1967, is due to mechanical difficulties not electronic.

Apollo electronics hardware is the best yet, says George Mueller, the former professor, Bell Telephone Laboratories scientist and TRW, Inc. executive who runs the entire manned space program. There are exceptions, he adds, but "we can solve a finite number of problems."

Maj. Gen. Samuel Phillips, Mueller's top aide, agrees that Apollo is over the hump on technical problems. "We are almost complacent about the lunar landing," says Phillips, who was loaned to the space agency after ramrodding the Air Force's Minuteman missile program to success ahead of schedule.

In 1961, when President John F. Kennedy announced the national goal of sending men to the moon during this decade, the challenge was not to invent radical new electronics equipment as much as using existing technology to develop an ultra-reliable system that would ensure the safety of the astronauts.

The National Aeronautics and Space Administration has used this philosophy in its own planning and has applied it to industry, insisting that electronic devices be limited to the 1962-63 technology. As a result, for example, integrated circuits were limited to only a few applications where it was essential to save weight without sacrificing reli-

ability, most notably in the spacecraft's guidance computer.

Reliability was achieved through a combination of redundancy in circuits and systems, careful screening of all parts and torturous qualifications testing. Apollo is unlike previous space efforts in that the bulk of the testing is being done before anything flies. Although an astronaut has yet to make an Apollo flight, more than half of the \$22.7 billion to be invested in the manned flight program has already been spent. "The cardinal rule is that we do everything that can be done to develop reliable systems through ground testing," says Phillips, comparing Apollo to early missile programs in which the bugs were ironed out in test flights—many of them spectacularly unsuccessful.

In the mission, an Apollo capsule containing three men will be launched from Cape Kennedy into an orbit around the moon. While the Apollo vehicle circles, two explorers will climb into the lunar module for the trip from capsule to moon. After exploring the surface, they'll fly the module to the Apollo vehicle for the return trip to earth. The trickiest part is the rendezvous between the capsule and the lunar module for the return.

The three basic elements in the Apollo system are the spacecraft (the Apollo capsule and the lunar module), launch vehicle and ground support equipment. All depend heavily upon electronics technology. Electronic systems will guide the spacecraft throughout its journey, maintain communications and record volumes of data. The Instrument Unit serves as the "brains" of the Saturn launch vehicle while it is being boosted out of the earth's atmosphere. On the ground, simulators are preparing the astronauts for their complex tasks. Checkout equipment at spacecraft manufacturers' plants and NASA centers verify that all hardware is



ready for the mission. Finally, a global tracking network and control center will monitor every aspect of the flight.

### Two to make ready

There are really two sets of launch vehicles and spacecraft, and consequently, two categories of electronic equipment. The early flight tests, such as the upcoming manned flight, use the so-called Block 1 Apollo spacecraft and the uprated Saturn 1 launch vehicle, a two-stage rocket that develops 1.6 million pounds of thrust in its booster stage.

The "lunar capable configuration," NASA jargon for spacecraft-launch vehicle combination able to take men to the moon and back, will use the three-stage Saturn 5 launch vehicle, which has a 7.5-million-pound thrust booster. Instead of one spacecraft, there are two in this configuration: a more advanced Block 2 Apollo consisting of Command and Service Modules and a two-man spacecraft known as the Lunar Module [formerly the Lunar Excursion Module].

These differences stem from the original plan to use two Saturn 5's to assemble a lunar landing spacecraft in orbit around the earth and fly directly to the moon and directly back. Then, in early 1962, NASA studies showed that it would be safer to fly from an earth orbit to an orbit around the moon and send a landing module to the moon. The Apollo, still orbiting the moon, is to rendezvous with the returning Lunar Module and come back to earth. This approach required only one Saturn 5 launch vehicle, another point in its favor.

While NASA began developing the lunar landing spacecraft and the more advanced Apollo spacecraft needed for the new mission, work continued on the original Apollo for use in earth orbital test flights. Officials reasoned that if they held up these early flights while waiting for the Block 2 version they would lose too much time in an already tight schedule.

## I. Freeze it if you can

The major problems facing Apollo now are more structural than electronic. Saturn 5's second stage, the S-2, has generally been considered the "pacing item," or single element that is delaying the program. The stage's propellant tank walls have cracked at joints in pre-firing tests, thus delaying flight qualification. Every day lost in test-firing the stage at NASA's Mississippi test facility delays the first Saturn 5 flight by a day. Other delays have been caused by problems with the spacecraft environmental control system used to cool equipment and the rupture of a fuel tank in the Service Module during a recent test at the North American Aviation, Inc. plant in Downey, Calif.

Weight has been bothersome throughout the program, but NASA officials believe they have it under control. The problem centers in the Lunar Module since it was the last major element of the Apollo-

Saturn system to be placed under contract and hence is going through the early development problems that have been met and solved in the Command and Service Modules. The Lunar Module is a separate spacecraft—the first ever designed to operate entirely outside the earth's atmosphere.

This weight problem translates into more stringent design requirements for the electronics in the module—and an unanticipated entry for integrated circuits as a means of slimming the module. The Aerospace Systems division of the Radio Corp. of America, Grumman Aircraft Engineering Corp's electronics subcontractor on the lunar module, has consequently used integrated circuits in such subsystems as the descent engine control assembly and the rendezvous radar range tracker. This approach would not have been possible had the design of the Lunar Module been frozen as early as the Command and Service Modules.

### Late start for IC's

One problem that was solved conclusively in 1966 was whether the moon's surface had sufficient bearing strength to support the Landing Module. This conclusion, based on the successful Surveyor I landing June 2, was particularly important since the landing structure and radar system had already been designed on the assumption that the astronauts could safely guide the lunar module to a suitable landing site with the aid of landing radar. Many landing systems had been considered—monopulse terrain avoidance radar, laser range finders and systems for tracking a transponder previously placed on the moon—but a multibeam, doppler radar altimeter was chosen.

RCA explains that this approach was taken because it permits day or night landings, does not depend on prelocated landing aids, allows unmanned landings and supplies data directly to displays to permit the crew to land entirely under manual control. Also, since the radar equipment is on the lunar module's descent stage, it can be left on the moon when the Lunar Module returns to the Command Module. It's weight does not penalize the performance of the ascent stage. RCA also is subcontractor to Grumman for the rendezvous radar that will be used to guide the Lunar Module's linkup with the Command Module.

The attitude and translation control assembly (ATCA) and the descent engine control assembly (DECA) on the lunar module are also being built by RCA. The DECA controls engine gimbals to the correct pitch and roll trim positions in response to trim error signals from the ATCA and position commands from the computer. It also provides throttle control signals and actuates the start solenoid of the descent engine, both in response to commands from the astronaut control panel and from the guidance system. It performs the logic functions necessary to determine the proper firing combination of attitude jets and provides modulated trains of pulses to the 16 jet-solenoid drivers.

Between 25% and 35% of the functions per-



formed by ATCA and DECA are done by integrated circuitry, both digital and analog. The digital IC's are principally gates and flip-flops. The analog units are used principally in operational amplifiers and preamplifier circuitry. Digital and analog IC's are also used in the rendezvous radar, notably in the three-tone range tracker which measures the phase angle between the transmitted tones and those received back from the Command Module transponder.

The project leaders at RCA say they used IC's wherever it was possible to replace discrete components with qualified, proven IC's. In some cases, IC's were not available at the required frequencies and in other instances it would have been necessary to change the basic design in order to incorporate integrated circuitry.

Digital IC's presented no particular problem as far as approval is concerned, but, at the time that the RCA project engineers wanted to use analog integrated circuitry, the analog IC's offered by vendors did not have the required life-time tests behind them. Grumman insisted that 500 of the  $\mu$ A702's, made by the Fairchild Camera & Instrument Corp., undergo 2,000-hour tests. This was done at Fairchild under a special contract.

#### Lasers squeezed out

Weight and the desire to freeze designs also decided the 18-month competition between radar and optics in 1965-66. The Hughes Aircraft Co. was studying an optical rendezvous system with the idea of comparing it with radar for operational capability, simplicity, size, weight and power drain [Electronics, Jan. 24, 1966 p 123]. NASA decided in 1966 to go with the radar technique. Radar enthusiasts generally concede that if the competition were to take place in a few years—when the right kind of laser will probably be available—coherent optical techniques could win the battle.

One of the few areas in which NASA is pushing the state of the art is the fuel cells used to power the spacecraft's electrical and electronic equipment. A major reason for selecting cells powered by liquid hydrogen and liquid oxygen was that they could produce water for the astronauts as a byproduct and thus reduce the weight of water to be carried on the spacecraft. However, the fuel cells developed by the Pratt & Whitney Division of United Aircraft Corp. fell behind schedule early in the program and bothered the North American Aviation, Inc. and NASA project managers to the point where they seriously considered developing a backup power system.

One company, Hoffman Electronics Corp., sub-

**The Saturn-Apollo assembly and its 39-story service structure at the Merritt Island launch facility. This dizzying view was photographed from the 52-story building where the Apollo system is assembled. The slim tower atop the spacecraft is the launch escape rocket.**

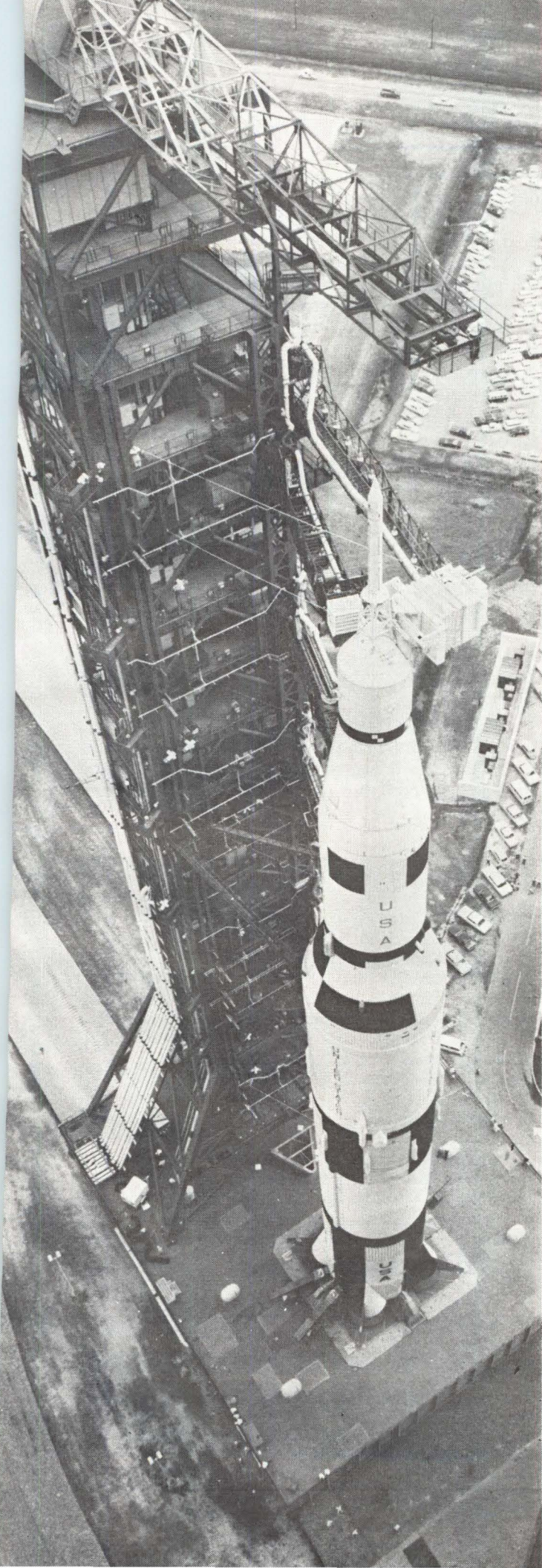



mitted an unsolicited proposal to build a backup system consisting of solar cells mounted on panels extending from the side of the spacecraft. For various reasons—including Pratt & Whitney's ability to solve some of its critical problems in the fuel cells and a lack of money to develop a backup—NASA decided to gamble on the fuel cells. The wisdom of this decision still has to be proven in the flight tests.

## II. The seven phases of Apollo

Program chief Mueller divides the Apollo program into seven major phases. Only the first has been completed—three unmanned Saturn 1 launches this year to verify that the spacecraft and launch vehicle work in space as well as they did in test facilities on earth. Attention was focused on such potentially troublesome items as the heat shield, guidance system and on-board propulsion systems. NASA was satisfied that all systems were safe enough for the astronauts—manrated in space-talk.

On the next Apollo-Saturn flight, astronauts Virgil (Gus) Grissom, Edward White 2d, and Roger Chaffee will usher in the second phase—long, manned missions. The first manned Apollo flight may last up to 14 days, or twice the time it will take to go to the moon and back. The Gemini flights have made space agency engineers confident that man and equipment can function that long in space.

The first manned flight is designated 204. A

second two-week mission, flight 205, was canceled last month in a schedule shuffle. The realignment was made in an attempt to circumvent the problems in the Service Module's fuel tanks and in the environmental control system.

The third phase begins with flight 206 later next year, an unmanned test flight of the Lunar Module. If the results are negative, the flight will be repeated until the module is manrated. If the module qualifies in one flight, a dual rendezvous mission will be performed next fall with flights 205 and 208. A three-man crew in an Apollo spacecraft would rendezvous with an unmanned Lunar Module.

The Apollo timetable allows three attempts to master rendezvous, but there are compelling reasons why NASA wants to do it with only one mission: the Dec. 31, 1969 deadline and the limited number of launch vehicles available—12 Saturn 1's and 15 Saturn 5's. If rendezvous can be mastered in one mission, four launch vehicles and two Apollo spacecraft would become available for earth orbital scientific experiments of the Apollo Applications Program [see "Science on the moon," p. 122]. This program is considered the essential bridge between the moon trip and the more advanced space missions expected to follow, but NASA ground rules forbid them from interfering with the mainline Apollo program.

The first four phases all use the smaller Saturn 1 vehicle. The first Saturn 5 flight, designated 501, is planned for early next year. This fifth phase is flight qualification of Saturn 5 and proof that it is compatible with the Block II Apollo spacecraft.

### The millions add up to billions

One measure of how deeply electronics is involved in Apollo is the amount of money the program has meant to the industry since the lunar landing goal was established in 1961. The price tag for putting a man on the moon is estimated at \$22.7 billion, including the earlier Mercury and Gemini programs and the construction of facilities. Using the standard yardstick that 50 cents out of every space dollar is spent with the electronics industry, this represents a market of more than \$11 billion over the scheduled eight-year life of the program.

Although most of this money is channeled through the airframe companies making the Apollo spacecraft and Saturn launch vehicles, several electronics firms are major contractors in their own right. Chief among these is the General Electric Co., which established a special department at Daytona Beach, Fla., to perform over-all integration, checkout and reliability of the entire Saturn-Apollo system. GE received \$411 million for this work through the end of the last Federal fiscal year, which ended June 30, and stood fifth among National Aeronautics and Space Administration contractors for that year.

Ranking behind GE last year was the AC Electronics division of the General Motors Corp. in Milwaukee, which is the prime contractor for the guidance and navigation system to be used in

Apollo. This program has meant \$230 million for the AC division. The Raytheon Co. is building the guidance computer for the AC division at Lexington, Mass. A related system, the stabilization and control equipment, is built by Honeywell, Inc., Minneapolis, under a \$114 million subcontract to North American Aviation, Inc., which was given \$2.2 billion to build Apollo spacecraft. Subcontractors received more than \$847 million of that money and most of them are in the electronics industry.

International Business Machines Corp., seventh largest NASA contractor in fiscal 1966, has received \$93 million for the instrument units used to control the Saturn launch vehicles. The firm is assembling the units at its new plant in Huntsville, Ala. IBM also provides a variety of the instrument unit's digital computers, data adapters and associated hardware and has received \$37 million for those jobs.

Other major Apollo electronics contractors include Radio Corp. of America, partner to the Grumman Aircraft Engineering Corp. on Apollo's Lunar Module; Bendix Corp., which runs the Manned Space Flight Network used to track Gemini and Apollo; and Collins Radio Co., subcontractor to North American for Apollo communications and data subsystems. All have received more than \$100 million in space contracts.



Aiming for the moon...

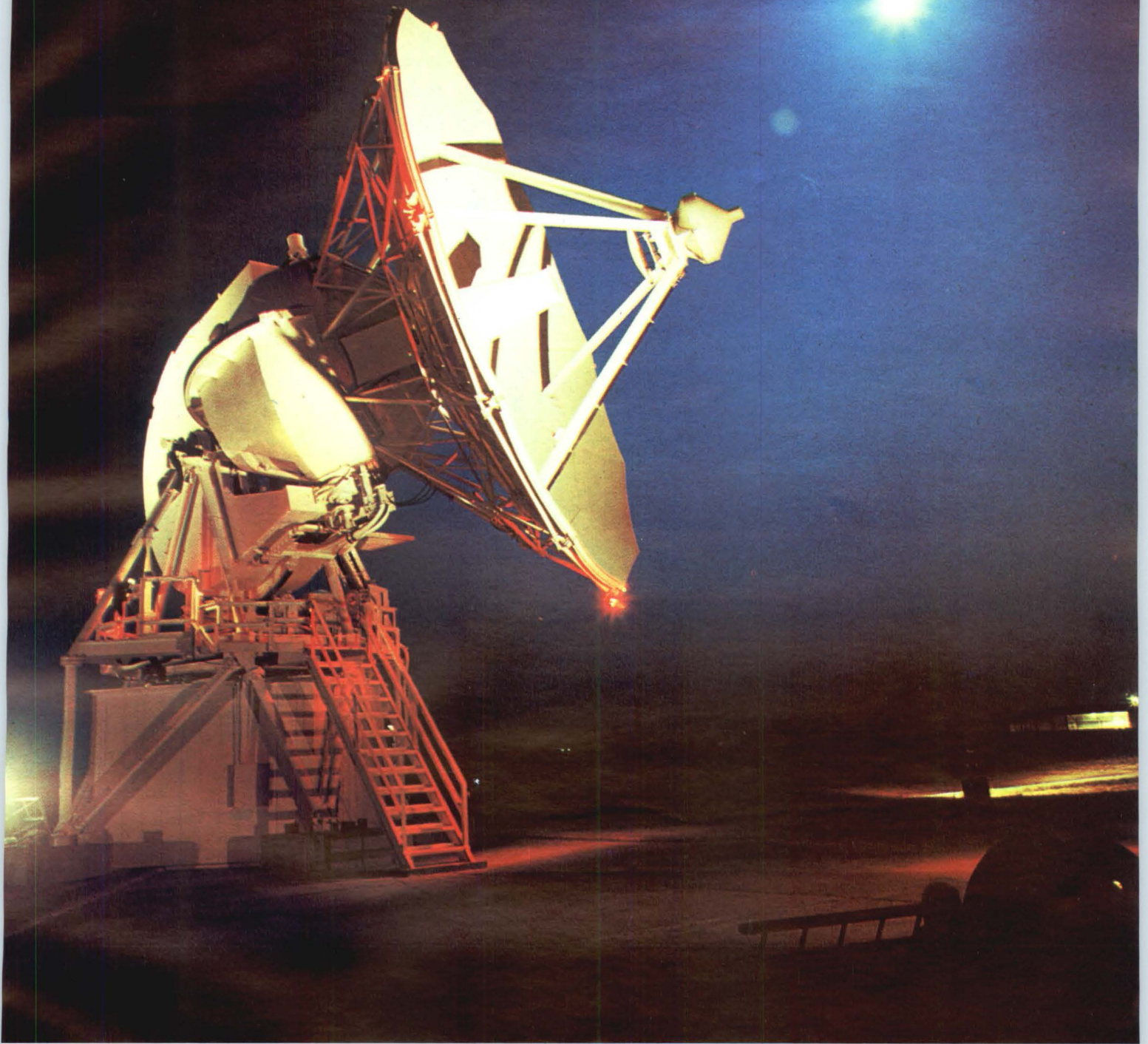

**Pointing symbolically** at the moon, a 30-foot antenna for the unified S-band system is readied by Collins Radio for a tracking station near Corpus Christi, Texas. Tracking signals, voice communications and digital data transmission from ground stations to the Apollo spacecraft will all be beamed over a single carrier by this antenna and others like it in the ground tracking network.



...with complex assemblies...



A closeup of the antenna built by the Radio Corp. of America. The microwave circuitry is mounted on the rear of the antenna. Intermediate frequency signals are carried to supporting equipment inside the module by flexible coaxial cable.

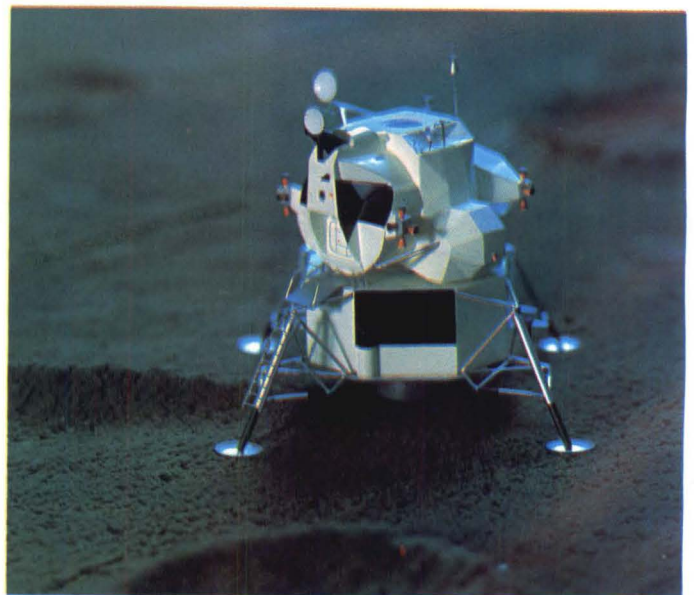

Scale model of the Lunar Module sits on a mockup of the moon at Grumman Aircraft Engineering Corp. The small parabolic antenna above the ladder is part of the rendezvous radar system that will guide the Lunar Module to the Command Service Module.



**Apollo spacecraft** is prepared for altitude chamber tests. The cone-shaped section is the Command Module, in which the astronauts will live and work during the round trip to the moon. Under it is the cylindrical Service Module, which will be jettisoned after it propels the command section home.

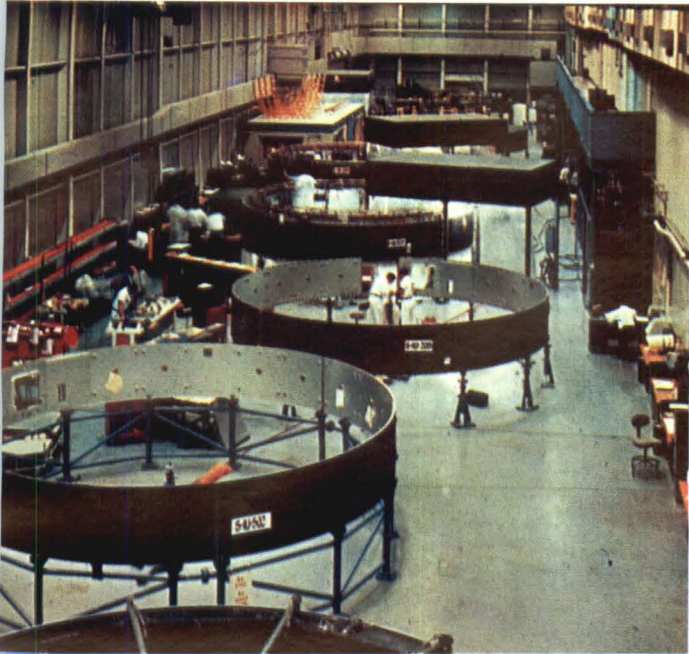

On a production line in a special plant in Huntsville, Ala., IBM turns out the ring-shaped instrumentation units that control the vehicle during takeoff.

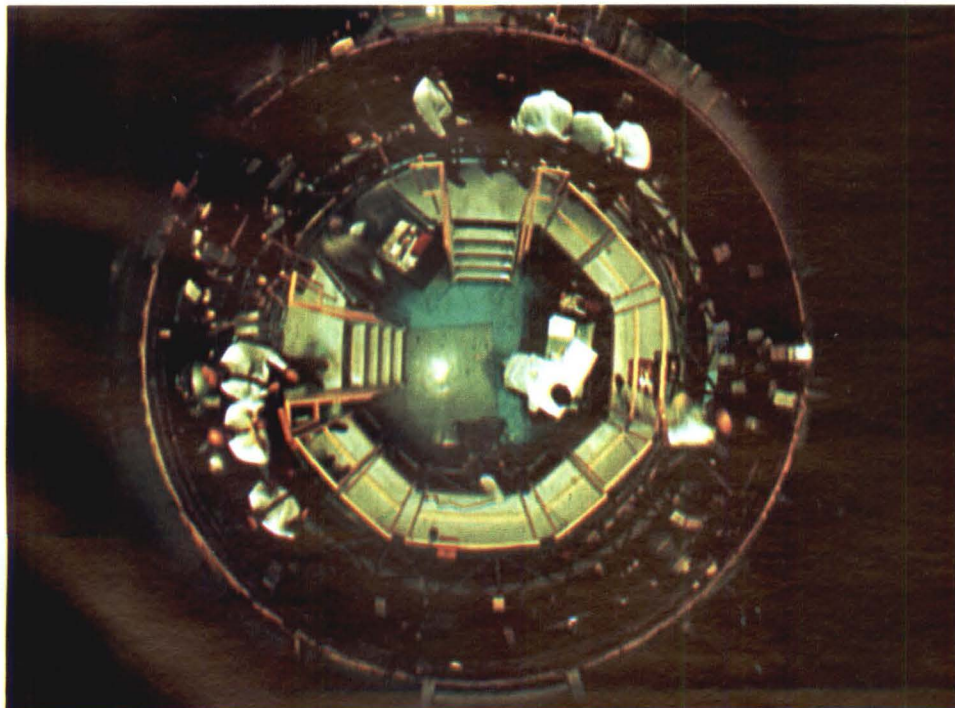
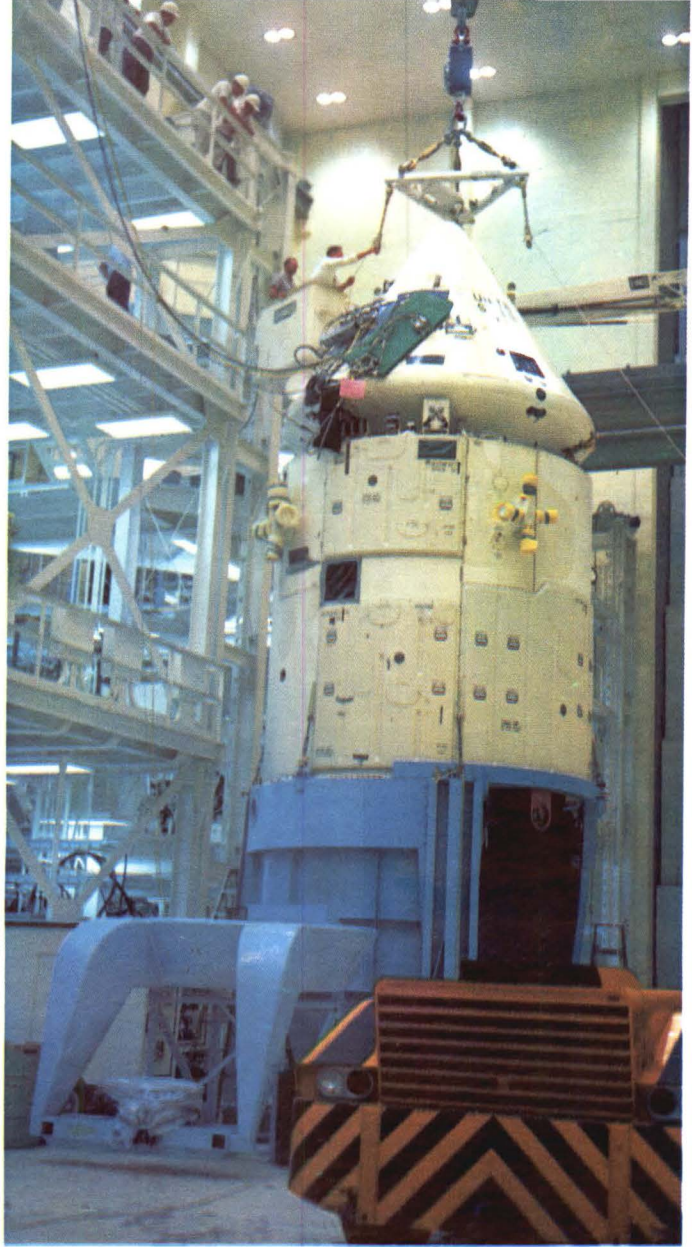

**Brains of the Saturn** launch vehicle and the underpinning of the spacecraft during takeoff, is this big Instrument Unit. This bird's-eye view of the 22-foot diameter ring shows the booster guidance and control subsystems being installed.



## ... and failure-free guidance

The Apollo guidance and navigation system being "flown" by C. Stark Draper, inertial guidance pioneer and founder-director of the Massachusetts Institute of Technology's Instrumentation Laboratory. The system is identical to an Apollo spacecraft installation except for its structural support. Tests are run regularly from the roof of an MIT laboratory building by institute engineers and sometimes by astronauts, using the edge of the moon as a landmark and measuring the angle between the moon and known navigational stars.

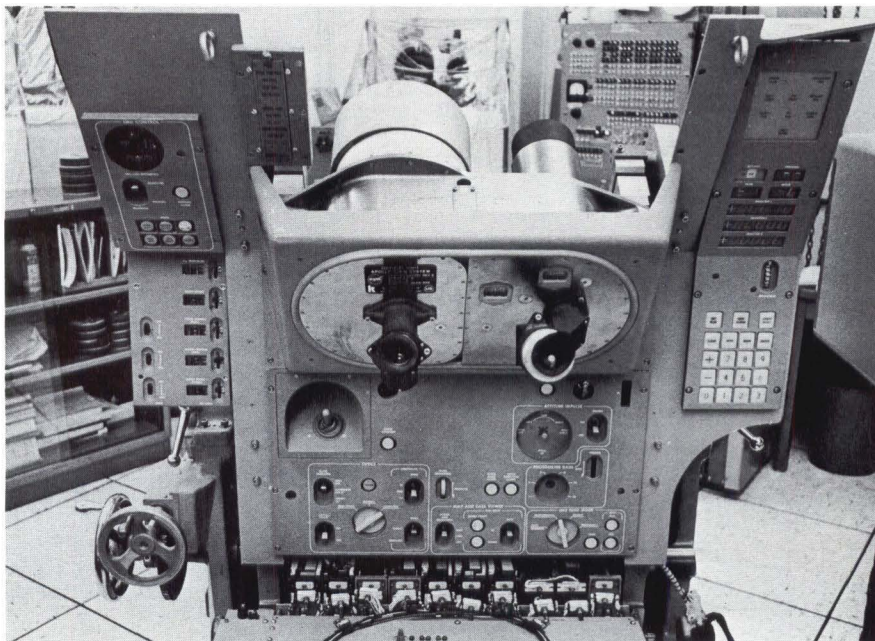
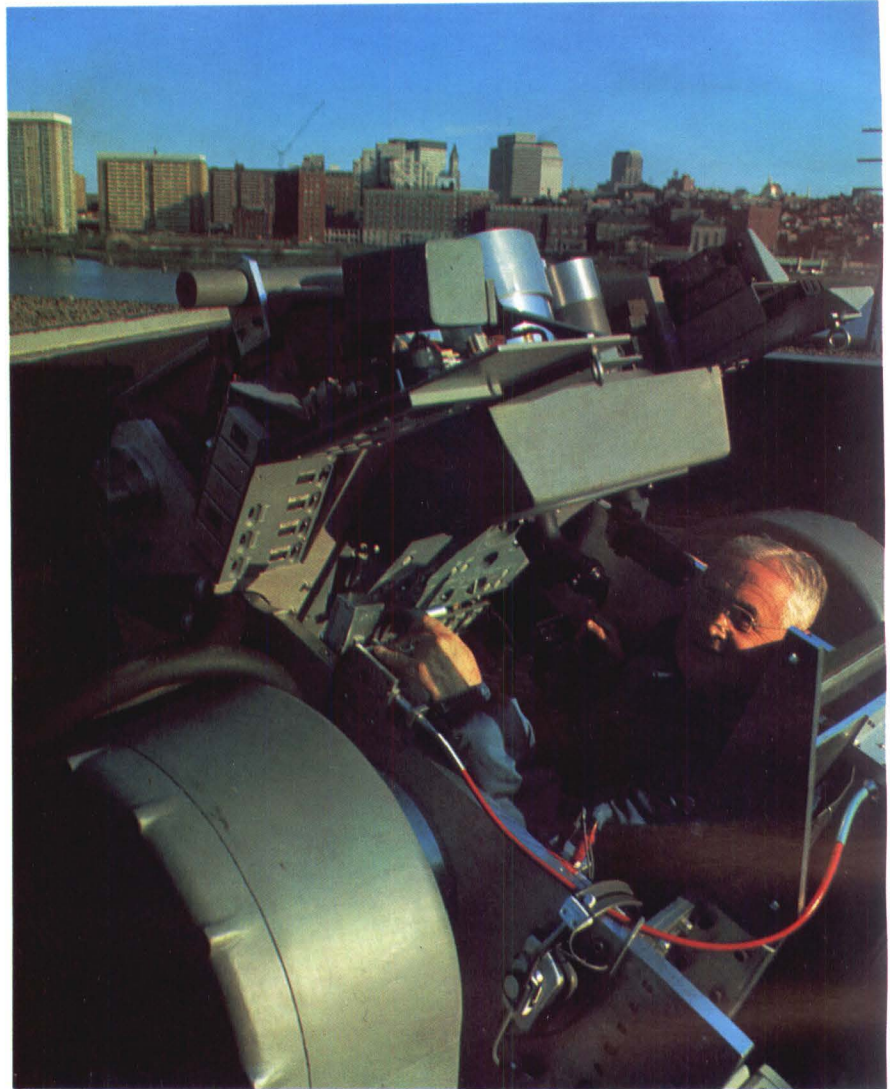

An astronaut's-eye view of the guidance and navigation system in the lower bay of the command module. The left eyepiece is a sextant and the right one a scanning telescope. Immediately below are navigation optics controls, spacecraft attitude controls and servoassembly. At the bottom is the guidance and navigation computer. The focal point of the entire system is the computer display at the upper right, called DSKY, for display and keyboard.



Mueller's conservative timetable calls for as many as five unmanned flights. However, many people in the space program hope to qualify the Apollo-Saturn 5 combination after two shots. If so, flight 503 will be manned.

Plans are to man a Saturn 5 flight in 1968, but it could occur late in 1967. In this, the sixth phase, the astronauts will run through a dress rehearsal of every step of the lunar journey except time spent on the moon. There is a chance, a very slim one, that they would go take a look at the moon. Finally, phase seven will be the culmination of nearly a decade of work: the landing on the moon.

### **Nine steps to the moon**

The lunar mission will consist of nine steps, or decision points, separated by mission "plateaus." At each point the ground controllers and astronauts will assess the spacecraft's condition before deciding to go on to the next plateau. If the spacecraft is not ready they may take an alternate step, such as returning to earth, or tolerate a short delay until the spacecraft is ready. This approach is known as open-ended mission planning.

The first step, prelaunch preparations, is conducted in the sprawling Launch Complex 39 at Merritt Island just north of Cape Kennedy proper. The entire system is checked out in the world's most voluminous structure, the 52-story vehicle assembly building. Then, the entire vehicle, or stack in spacetalk, is rolled to the launch pad along with its Mobile Service Structure. This 39-story structure stays with the vehicle until the final countdown for the moon flight.

Other ground-based electronics equipment checks out the spacecraft and launch vehicles prior to flight. High-speed digital computers generate simulated conditions and measure the response of the vehicles. The automatic checkout system at the North American plant, for example, can monitor more than 25,600 samples per second. Similar equipment is installed at other prime contractor facilities and at the NASA centers in Houston, Huntsville and Cape Kennedy.

Two mission simulators produced by General Precision's Link Group and located at Houston and Cape Kennedy, and five system trainers produced by North American's Los Angeles division, familiarize astronauts with operating procedures. The two Apollo mission simulators are used by the astronauts to practice their flights and are programmed with all possible emergencies the crew might face on the actual mission.

Before the astronauts proceed to the moon on a real flight, they must again check out all systems at a way station in space, a parking orbit around the earth. If all systems are go, the next plateau is translunar coast. During this step, the astronauts jettison a launch escape rocket atop the command module and dock the Command Module nose-to-nose with the Lunar Module. The Command and Service Modules are turned around by small reaction-control rockets.

During the three-day coast to the moon, course corrections are made two or three times under control of the guidance system. Proper temperature is maintained by a technique known as barbecuing. The spacecraft slowly rotates like meat on a spit so that one side does not face the sun too long.

### **On the moon**

Near the moon, one astronaut checks the equipment in the Lunar Module. If everything is in order, the fourth plateau, lunar orbit, begins. After three orbits, 80 miles high, two astronauts get into the Lunar Module, detach it from the Command Module and coast down to 50,000 feet above the moon. Ten minutes later, after a manually controlled engine has braked the descent, the module lands.

The lunar surface stay, the sixth plateau, will last 18 hours and 22 minutes. After about two hours spent in checking the spacecraft for damage and preparing it for the return trip, the two men will put on their space suits and walk down the ladder to the moon's surface. They'll explore the moon for three hours, collect samples of rocks, photograph the barren landscape—including live television beamed back to earth—and set up experimental equipment that will send data to earth after they leave [See "Science on the moon," p. 122]. Then, after six hours of sleep and a meal in the Lunar Module, and another three hours of exploration, the astronauts will check out Lunar Module systems again and take off.

When the two spacecraft have rendezvoused and docked, the Lunar Module crew returns to the mother ship, bringing along their lunar samples. The Lunar Module is then jettisoned and the Service Module's propulsion engine is ignited to send the spacecraft home. Shortly before it reaches the earth's atmosphere, the Service Module is also jettisoned and only the Command Module returns to earth.

### **Reentry blackout**

Earth reentry is regarded as the most critical phase of the entire trip. When reentry begins 400,000 feet over the western Pacific, the spacecraft will appear like a glowing fireball in the sky as it enters the atmosphere at 25,000 mph, faster than any other spacecraft. At 24,000 feet, parachutes will begin slowing the spacecraft to 25 feet per second at splashdown. The astronauts will then be recovered in much the same manner used in the Mercury and Gemini programs.

An unsolved electronics problem is the communications blackout period caused when an Apollo spacecraft returning from the moon penetrates the earth's atmosphere at 25,000 mph and heats the surrounding gases into a plasma that prevents communications for as much as ten minutes. Losing contact with the tracking network during this critical phase of the mission is expected to hamper recovery operations. A possible solution is in sight with the development of techniques to inject water



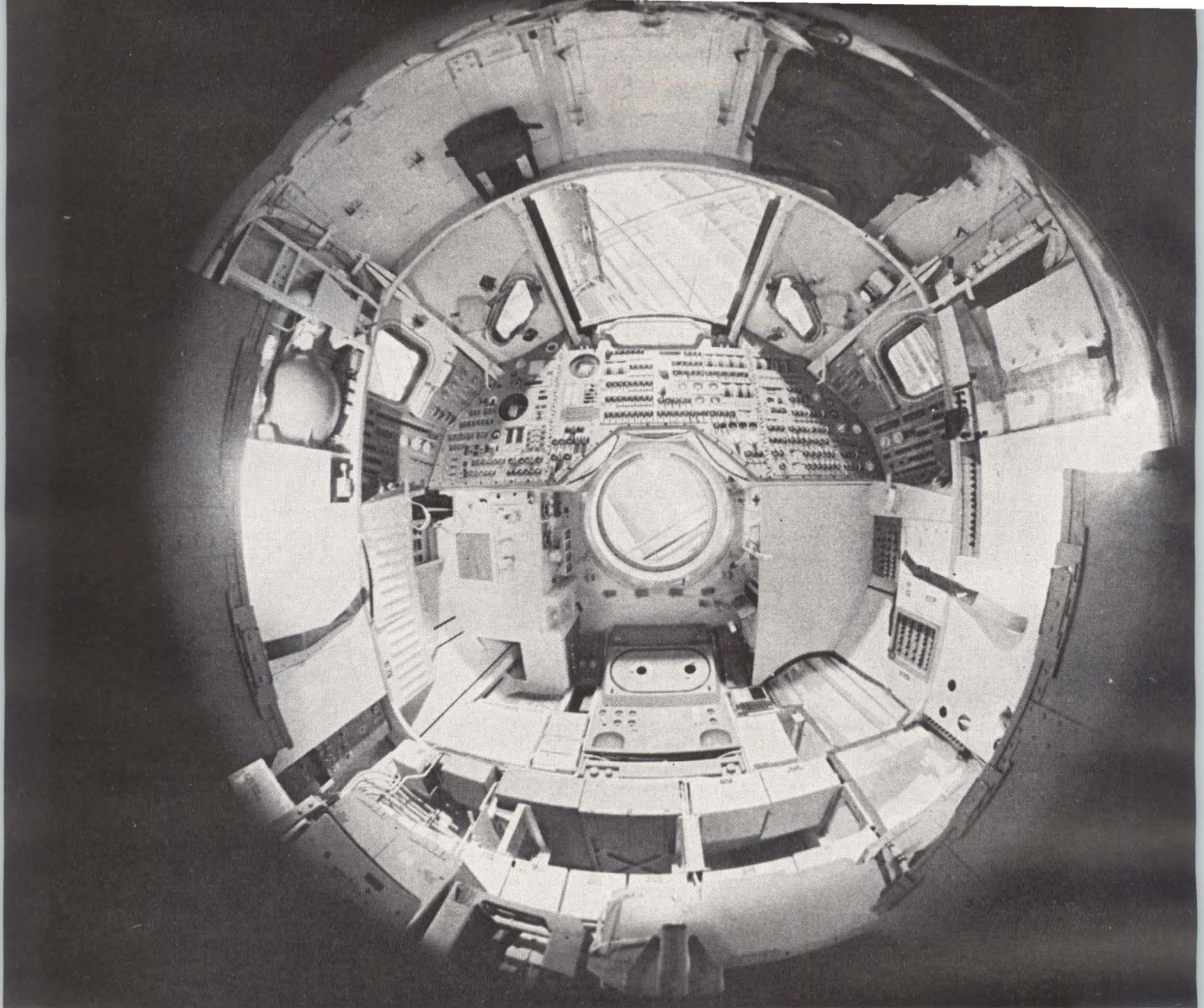

All the controls in the spacecraft are displayed in this 360-degree view of the Command Module's interior.

into the plasma and thus cool it sufficiently to permit limited communications. Questions still to be answered are whether the technique can be perfected in time for the moon mission and whether total spacecraft weight can be held to a level that will permit carrying extra water.

### III. Flight electronics systems

The electronic equipment that controls the Saturn launch vehicles has its antecedents in early missile programs. The inertial guidance platform can be traced from the earlier Pershing, Jupiter and Redstone programs. The telemetry system evolved from a design first used in Redstone.

To meet manned flight needs, NASA's Marshall Space Flight Center designed—and asked International Business Machines Corp. to build—a separate stage of the Saturn vehicle called the Instrument

Unit. The unit, shown on page 116, is nearly 22 feet in diameter and three feet high. It fits between the S-4B propulsive stage and the spacecraft. Besides carrying the launch vehicle electronics, this unit structurally supports the nearly 50 tons of spacecraft above it. The system performed successfully in 10 unmanned flights of a smaller version of the Saturn I.

The Instrument Unit goes into operation about five seconds before liftoff, when the inertial guidance platform and the general-purpose launch vehicle digital computer are released from ground control. The guidance platform, previously aligned to the desired launch angle, measures the vehicle's acceleration and attitude as the vehicle ascends. The digital computer integrates these measurements with the time since launch to determine vehicle position relative to starting point and destination. It then computes attitude correction signals.

At first the vehicle is buffeted by the thick atmosphere and the guidance system's principal job is



to keep the vehicle's nose up. After the booster stage has done its job and is jettisoned, the guidance system tries to find the best path to achieve the mission.

During the boost phase, guidance is accomplished by a series of repetitive computations known as iterative, or closed-loop, guidance. About once every two seconds the guidance computer determines vehicle position and vehicle conditions required at the end of power flight such as velocity and attitude. Based on the most recent solution to the guidance problem, the digital computer generates attitude correction signals 25 times a second.

These signals, rate gyro outputs and control accelerometer outputs go to the analog flight-control computer, which issues control commands. These commands swivel the rocket engines to keep the vehicle pointed in the right direction.

To ensure reliability, all critical circuits of the digital computer and data adapter that links the analog and digital equipment are triplicated. The outputs of the three identical circuits are compared, or voted upon. The majority rules so that a random failure is ignored. Also, the computer memory is duplexed so that if an error is generated in one part of the memory, the output is obtained from the other memory. Correct information is then read back into both memories to correct the error.

### Spacecraft guidance

The spacecraft guidance evolved from work done by the Massachusetts Institute of Technology for the Navy's Polaris submarine program. This system combines what man can do best, pattern recognition in sighting stars and landmarks, with what machines can do best, tedious and repetitive computation and high-speed switching. It has three subsystems: inertial guidance, optical equipment and digital computer.

Heart of the inertial system is the Inertial Measurement Unit (IMU), a spherical structure that establishes a stable onboard frame of reference for measuring spacecraft acceleration. The IMU consists of three gyroscopes and three accelerometers mounted on a stabilized structure that, in turn, is suspended inside three concentric spherical gimbals connected to each other by drive motors and angle resolvers. Gyro signals drive gimbal motors to hold the inner member in a fixed spatial orientation despite spacecraft movements. The gyro design is the MIT 25 IRIC (for 2.5-inch-diameter inertial reference integrating gyroscope) and the accelerometer is the MIT 16 PIPA (for 1.6-inch-diameter pulsed integrating pendulous accelerometer). Inertial unit data flows to the guidance computer, which generates steering signals for the small thrusters mounted around the craft. Position information is also transmitted directly to the computer from ground-based tracking stations. The ground commands were originally planned as a backup to the spacecraft systems, but were applied as the primary mode of guidance because of the greater accuracies possible with the ground equipment.

## Apollo earth orbital experiments

**In-flight exerciser. (M)** A bungee cord is held between the feet and stretched to measure an astronaut's reactions to physical exertion in flight. (Gemini)

**In-flight phonocardiogram. (M)** Piezoelectric transducers are attached to an astronaut's chest to record the sound of his heart beats for comparison with electrocardiogram data. (Gemini)

**Bone demineralization. (M)** Pre- and post-flight X-rays are taken of the heel bone to find occurrence and degree of bone demineralization. (Gemini)

**Human otolith function. (M)** A 16 mm. sequence camera is used to determine the degree of counter-rolling of astronauts' eyes, or movement in the opposite direction from that of the spacecraft.

**Cardiovascular reflex conditioning. (M)** This involves one of the astronaut's donning a pair of space leotards that apply a small pressure to the lower part of his body. The purpose is to prevent blood pooling at the lower extremities.

**Cytogenetic blood studies. (M)** A count of the astronauts' red and white blood cells are taken before and after flight to assess the effects of space flight.

**Synoptic Terrain photography. (S)** A 70-mm. Hasselblad camera is used to photograph features on earth. (Gemini)

**Synoptic weather photography. (S)** The same camera is used for weather observation. (Gemini)

**Dim light photography. (S)** The camera is used again with more sensitive film to study dimly lit phenomena such as zodiacal light and the upper atmosphere air glow.

**Daylight sodium cloud photography. (S)** It involves using the Hasselblad camera to photograph sodium vapor clouds emitted from French sounding rockets launched from an Algerian launch site. The photographs are expected to add to the basic information on upper atmosphere patterns.

**In-flight nephelometer. (T)** This experiment is intended to measure the size and number of dust particles in the spacecraft cabin by shining a beam of light at a right angle from a photomultiplier.

Experiments designated **(M)** are medical, **(S)** are scientific and **(T)** technological. (Gemini) indicates that the experiment was previously conducted in Gemini flights.

The optical equipment permits the astronauts to realign the inertial unit orientation as needed by referring to the stars and to landmarks on the earth and moon. The two main units are a wide-angle scanning telescope for landmarks and a 28-power magnification space sextant to measure angles between two sighting points such as stars.

### Single-circuit computer

The application of integrated circuitry in the guidance computer, built by the Raytheon Co., has permitted a reduction in weight along with an increase in memory capacity. It has also brought problems. In the original Block 1 guidance computer, encapsulated transistors were used in the processor; in the more advanced Block 2 design for



the moon flight, these components were replaced by Texas Instruments Incorporated, and Fairchild Camera & Instrument Corp. flatpack IC's developed for the Minuteman missile program. This required a change in internal wiring from the ribbon type to multilayer boards and gave NASA some anxious moments.

The Apollo computer relies completely on one standardized integrated circuit to perform all logic functions. The only logic element in the computer—and in the digital portions of the coupling and display unit (CDU)—is a three-input NOR gate. The MIT design group specified a planar integrated circuit, sponsored a tightly-supervised competition among vendors and—more than two years ago—imposed rigid quality-control procedures to eliminate failure modes.

The designers settled on standardized dual-gate circuits in a single flatpack. Says Eldon Hall, head of the Apollo computer group: "The standardization approach to reliability is the conservative approach. But it is hard to sell to engineers. They prefer exotic circuits and variety."

There was an element of hedging in the MIT decision, made when IC's were still in their infancy. "Integrated circuit users were then being led to believe that reliable circuits would be available in great diversity, just by using different masks," says Albert L. Hopkins Jr., of the MIT computer design group. "The people here decided on a single type circuit which they were sure could be delivered by vendors. It's a good thing they did. A gated flip-flop, for example, would have been a good circuit as far as the logic design is concerned, but we never would have gotten delivery of high-reliability circuits in time."

The high level of confidence in these circuits played a key role in the MIT and NASA decisions on the over-all design of the guidance and navigation system. Originally, the plan was to use a single modular computer plus trays of spare modules. Because of the housekeeping problem this would impose on the astronauts, and because moisture-proofing requirements ruled out in-flight maintenance, it was decided instead to install two redundant computers, thus using up the space and weight gained in going to an IC logic element.

Paul Schrock, who is in charge of guidance testing at NASA headquarters, says that the packaging and connection problems have been overcome and estimates that the entire Block 2 system can be flight-qualified by next February.

The Block 1 version, to be used in the first manned Apollo flight, has been qualified. That system was rated as accurate to within one mile on the last unmanned flight on Aug. 25. The spacecraft on that flight missed its landing point by 198 miles. "The miss was caused by a very mundane thing," says Owen E. Maynard, chief of mission operations at the Manned Spacecraft Center. The aerodynamic characteristics, based on wind tunnel tests were not known precisely. "We went through our data after the flight and there is no uncertainty

## Science on the moon

On the Apollo lunar landing mission, the two astronauts to walk on the surface will scoop up some 50 pounds of samples, package them in a vacuum container and return them to earth. These samples will include two 1-foot-long core samples taken by driving small tubes into soft spots on the lunar surface.

The main experiment is known as theALSEP (for Apollo lunar surface experiment package) and will be carried on each of the three flights currently planned to land on the moon's surface.ALSEP is being developed by Bendix Corp.'s Systems division, Ann Arbor, Mich., and consists of a 170-pound package of seven experiments, geological sampling equipment and power and data transmission subsystems.

The experiments are a seismometer to measure lunar tremors; a magnetometer to search for magnetic fields, a plasma spectrometer to measure the solar wind; a suprathermal ion detector/cold cathode gauge experiment to measure the moon's ionosphere, if any; a heat flow experiment consisting of a probe that extends two feet into the lunar surface; a charged-particle lunar environment experiment and a small device to fire projectiles on the surface so that astronauts can record seismic shock tremors. TheALSEP is left on the moon after the astronauts leave and uses a nuclear power source to transmit data directly to earth for another six months to a year. Bendix has a \$20.9 million contract to produce fourALSEPs.

## Apollo applications program

More advanced studies are being planned for the Apollo Applications Program (AAP) that the space agency hopes will be the successor to the manned lunar landing. The National Aeronautics and Space Administration has \$41 million in available funds during the current fiscal year to study various sci-

about this anymore," Maynard reports. Had updated data been fed into the computer by the tracking station in Australia as planned or had a man been aboard, NASA officials believe that the landing would have been right on target.

Basic word length for both computers in all parallel operations is 15 bits with an added bit for parity check and with subroutines for double precision operations. Memory cycle is 11.7 microseconds and single addition time is 23.4 microseconds. Core ropes are used for fixed memory and the erasable memory consists of ferrite core planes. The erasable memory in the Block 2 configuration is of 2,048 words, twice as large as Block 1. The Block 2 unit also has a 36,864-word fixed memory capacity, 50% more than Block 1. The Block 2 computer at 65 pounds is also 15 pounds lighter than the Block 1 machines.

## Navigation changes

The arrangement of the guidance and navigation subsystem in the over-all control system also differs from Block 1 and Block 2. In the earlier version, the guidance and navigation system is connected



entific missions, but as yet has not approved any flight hardware. If next year's total NASA budget can be kept at this year's \$5 billion level despite the pressures of Vietnam, there should be several hundred million dollars available for AAP experiments.

Initial AAP missions could actually fly before the manned lunar landing. However, this is based on the preparatory steps being accomplished in fewer flights than planned.

The two leading candidates for AAP missions are probably the Apollo Telescope Mount (ATM) and the S-4B workshop, both in the study phase at NASA's Marshall Space Flight Center, Huntsville, Ala. ATM is a telescope similar to those used on the unmanned Orbiting Astronomical Observatories and would be carried into orbit on an unmanned Lunar Module. The astronauts would come up later in the Apollo spacecraft to set up the experiment, make studies of the sun from space and return with the film. The telescope might even continue to operate unmanned until astronauts in another spacecraft can come up later and retrieve the film.

#### Workshop in space

The S-4B workshop idea involves using the third stage of the Saturn 5 launch vehicle for experiments once it has completed its primary job: putting the Apollo spacecraft into orbit. The McDonnell Corp., St. Louis, recently won a \$9 million contract to produce an airlock necessary for the astronauts to enter the empty rocket stage. Once the stage was pressurized and furnished with oxygen, food and water, the astronauts could take off their spacesuits and conduct biological and other experiments requiring zero gravity.

A variety of other experiments have been proposed for Apollo applications, including attaching a cable between the S-4B and the Apollo spacecraft

and rotating the two to produce artificial gravity; orbiting a big piece of reflecting material that could be inflated in space to create a 2,000-foot-diameter mirror that would reflect sunlight and illuminate areas at night—such as Vietnam battle areas; erecting large antennas for radio astronomy; and carrying high resolution cameras operating in spectra ranging from infrared to ultraviolet to measure natural resources on earth.

#### Lunar exploration

Extended lunar exploration may also be part of AAP. This program was once considered the likely successor to the Apollo moon landing, but has received a much lower priority during the last two years. The Boeing Co. and Bendix have NASA contracts to study lunar jeeps capable of making short trips across the moon's surface. Other studies have looked into the possibility of establishing a semi-permanent scientific base on the moon similar to those in Antarctica.

Probably the two most important questions to be answered by the Apollo and AAP experiments are whether man can function normally for long periods in space and whether he can conduct investigations sufficiently better than automated equipment to justify the extra expense of sending him along on scientific missions.

Results of the Mercury and Gemini programs have shown that man can survive two weeks in space and that a properly trained astronaut can respond to unexpected situations as no space robot could do. But until much more is known about man's capabilities in space, top Government officials inside and out of NASA are reluctant to commit themselves to the next giant step in space: the major goal of sending a manned expedition to Mars.

in series with the stabilization and control system, which is linked directly with the spacecraft's two rocket systems: the small group of attitude control rockets around the spacecraft, known as the correction control system, and the main propulsion unit in the service module, known as the service propulsion system. In this configuration the guidance and navigation system cannot act as a backup to the stabilization control system.

In the Block 2 configuration, the guidance, navigation and control system and the stabilization control system are connected in parallel and each has direct links to the two rocket systems. Either control system can work alone if the other fails.

The Lunar Module also uses the Block 2 system, but with a few differences. An abort guidance system is added in case the astronauts have to scramble back to the Apollo orbiting the moon before they land. This system is connected to the stabilization control system and is made by TRW Systems under subcontract to Grumman. TRW also makes the computer designed specifically for this system and uses a strapped down inertial platform provided by United Aircraft Corp.

Another difference in the Lunar Module guidance system is that Grumman furnishes its own stabilization system using electronic components from RCA and a rate gyro package from General Precision's Kearfott division. The stabilization control system in the Apollo spacecraft is built for North American by Honeywell, Inc.

Astronauts communicate with the computer in a coded numerical language via a 12-digit character display and a 16-button keyboard designated DSKY, which stands for display and keyboard. There have been problems in the DSKY resulting from the use of mechanical relays, according to Schrock, but these units are considered adequate for the current missions. Development is under way at Raytheon on solid state relays, which will replace the mechanical units later in the program.

Two other subunits complete the guidance and navigation system. They are the power servoassembly and the coupling and display unit. (CDU). The servo accepts power from the spacecraft main power supply, converts it into the required currents and frequencies for different parts of the guidance system and also serves as an amplifier for servo-



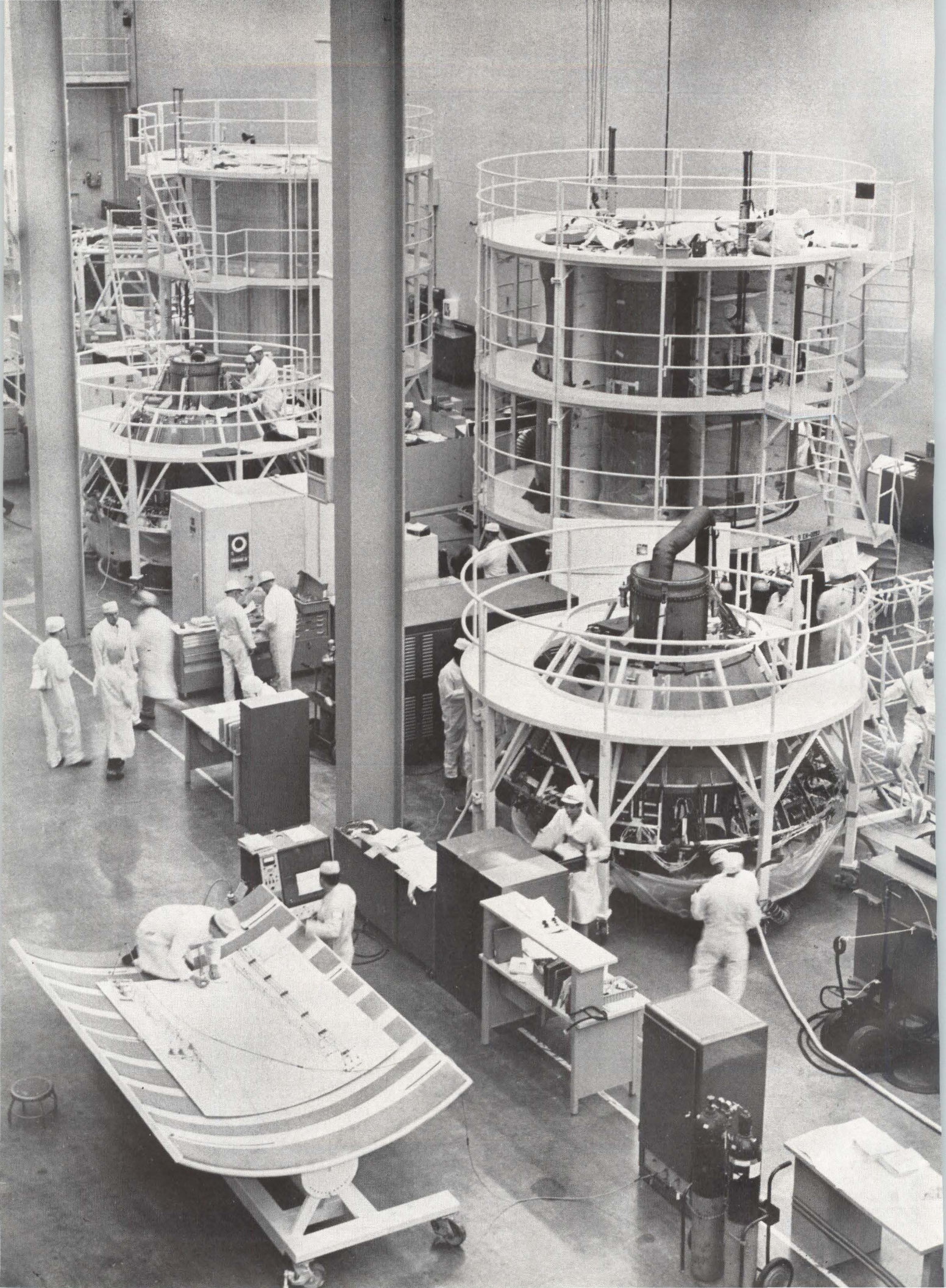



mechanism signals. The coupling and display unit is the interface between the inertial unit and optical measuring systems and the computer. The Block 1 electro-mechanical coupling unit will be replaced by an all-electronic unit in Block 2.

#### Abort guidance system

If the primary guidance system is not functioning properly, the abort guidance system (AGS) goes into action. The AGS is a strapped-down system, a type that does not require the sensors and drive for the platform of a fully stabilized inertial navigation system. To account for the differences between a stabilized platform and the strapped-down instrumentation requires a complex computer program. So, TRW Systems developed a large-scale, high-speed all-ic computer.

"If we had to use commercially available computers for the job—and there are some that could do the job—we would have had to add another spaceship just to carry the computer," reports Nathaniel Trembath, AGS program manager at TRW.

As in Block 1, TRW avoided pressing the state-of-the-art in the Block 2 design. As an example, most analog circuits are discrete instead of linear IC. TRW tried to use vendor standard designs that had been upgraded for Apollo—but was rarely able to use anything directly off the shelf.

Some failures occurred in Block 1 because of humidity corrosion. The designers decided to repackage as a solution. In the process, they changed a basic philosophy regarding system protection. In Block 1, the concept was to provide a capability for repairs in flight. This meant sliding tray-type chassis and plug-in modules. To provide better environment protection in Block 2, they decided to bolt everything in so it couldn't be removed. This meant that redundancy of circuitry had to be provided since it couldn't be repaired by replacement. Some redesign was necessary and some realignment of existing circuits so that some could take over for others in case of failure.

Instead of using an egg-crate concept [where all the component trays are tightly packed against one another], TRW is using separate bolt-down boxes with enough clearance to make connections by hand, while allowing visibility of the work being done. The new bolt-down boxes themselves are sealed. In Block 1, the trays weren't sealed, they depended upon the sealing of the individual modules for protection. Now they are multi-sealed; that is, the modules are still sealed and the box containing the modules is also sealed. The vendors were given a choice of a gasket seal or a hermetic seal—most chose the gasket seal for its obvious reparability.

In the Service Module, they were able to increase the packaging density somewhat in redesign, but

not enough to compensate to the increased cost in weight and volume of the added box seal. The net result is a slight increase in weight and increase in volume. In the Command Module, the situation is even more disadvantageous with regard to weight and volume.

One major and immediate advantage of the change (in addition to better environment protection) is the loosening of mechanical tolerances for the hardware. This doesn't mean too much in terms of fabrication costs although it does save some money), but it means a great deal in terms of schedule which is already in trouble. It avoids the problems of having to rework already-built modules to make them mate when they reach the assembly stage, or of holding up critical construction waiting for a module to make sure it is going to fit.

## IV. Unified S-band communications

The Apollo telecommunications system is a combination of equipment on the ground, in the Apollo spacecraft and the Lunar Module. Here, too, there is an evolution from the early Block 1 tracking network that grew out of the Mercury and Gemini programs to the Block 2 network for the Apollo moon landing. The most significant modification is the

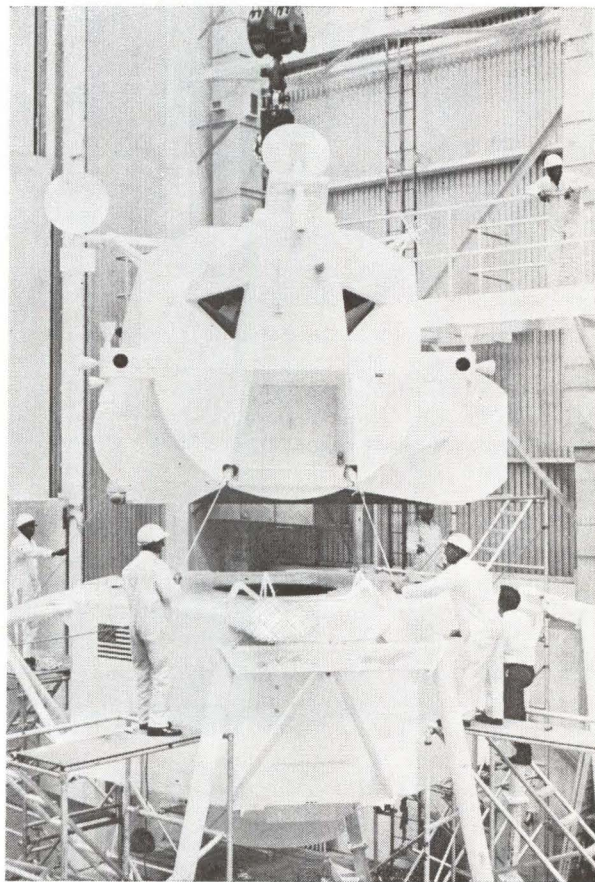

Sections of the Lunar Module are being mated during checkout procedures underway at the Kennedy Space Center. The bottom section which will serve as a launch platform when the moon explorers are ready to head back to the Apollo mothership, will remain on the moon.

Subsystems are installed in the Command Module and checked out in this huge cleanroom, at North American Aviation Inc.'s Space and Information Systems division in Downey, Calif.



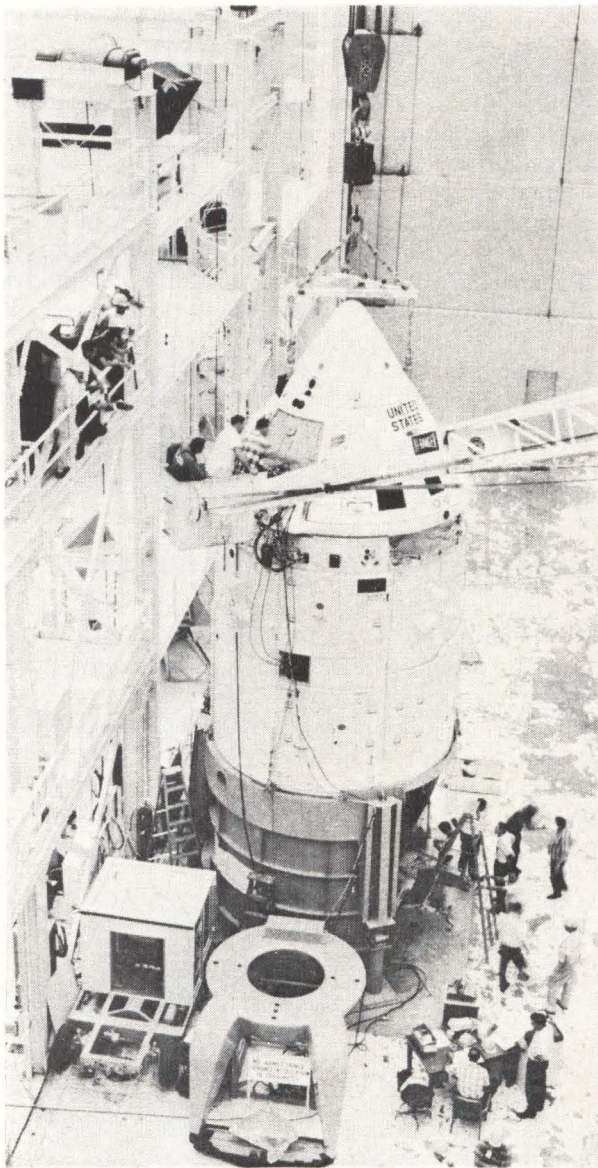

**The Apollo-Saturn Command Module** is mated to the Saturn Lunar Module Adapter in the skyscraper building constructed at the Kennedy Space Center. They will fly in the Apollo-Saturn 202 mission to verify performance of the uprated Saturn engine.

replacement of the vhf, uhf and C-band stations by what NASA calls its unified S-band system.

In the unified S-band approach, all voice and data are modulated onto the same r-f carrier used for tracking. This equipment, operating in the 2,100-2,300 megahertz band, is produced by Motorola, Inc. The unified S-band approach is based on the coherent doppler and pseudo-random range system developed by Jet Propulsion Laboratory for its deep space unmanned missions. This method was adapted for manned flight use since it reduces spacecraft equipment requirements.

Voice and digital data are modulated onto subcarriers and then combined with the ranging data for the uplink, the transmission to the spacecraft. The composite information phase-modulates the transmitted carrier frequency. The transmitted and received carrier frequencies are coherently related

to allow measurements of the carrier doppler frequency by the ground stations for precise determination of spacecraft velocity.

In the transponder the subcarriers are extracted from the radio-frequency carrier and detected to produce the voice and command information. The ranging signals, modulated directly onto the carrier, are detected by a wideband phase detector and translated to a video signal. The voice and telemetry data to be transmitted from the spacecraft are modulated onto subcarriers, combined with the video ranging signals and used to modulate the downlink carrier.

The unified S-band network, which is currently being phased into operation, consists of 85-foot antennas at Canberra, Australia, Goldstone, Calif., and Madrid, Spain; single and dual 30-foot antennas at the old Mercury and Gemini stations; three ships with 30-foot transportable antennas to track the spacecraft during orbital insertion and injection into the lunar trajectory; and two ships in the reentry area with 12-foot antennas.

NASA has completed qualification testing of all the Block 1 communications equipment, according to James Allman, who is in charge of communications and instrumentation equipment testing at NASA headquarters, and is currently trying to verify that spacecraft and ground equipment will be compatible in the Block 2 configuration. He hopes to complete these tests this year so that everything will be ready for the first Block 2 mission involving the dual launch and rendezvous between Apollo and Lunar Module in mission 205/208. These compatibility tests are being made at Houston using spacecraft equipment and a simulated ground station.

One piece of equipment currently under test is the lunar television camera built by Westinghouse Electric Corp. The preproduction model of this camera, which will be carried by astronauts to the moon's surface for live tv, was delivered last summer for integration tests at NASA's Marshall Center and North American's Apollo plant at Downey, Calif. Eighty percent of the camera's components are ic's, thus making it one of the few examples of state-of-the-art hardware in Apollo. A similar camera, built by RCA for the Block 1 flights, will provide the first live tv from a U.S. spacecraft on the initial manned Apollo flight.

As the time for the first manned Apollo flight draws near, a portion of the scientific community still doubts the merits of a trip to the moon at the price it is costing. In rebuttal, defenders of the project are pointing to some accomplishments in electronics that help justify the costs: like the perfection of ultrareliable components and circuits, and accelerated development of S-band communications. In addition, work on Apollo has clearly catapulted U.S. advanced technology far ahead of that in European countries.

Reprints of this report are available. Use the reader service card at the back of this issue.

© copyright 1966, Electronics ® a McGraw-Hill Publication



# ANALOG MONOLOGUE

On Means for Modelling, Measuring, Manipulating, & Much Else

## BUILDING BETTER BREADBOARDS

Since the days of crystal sets, the term "breadboards" has been used for the structures on which temporary or experimental electronic circuits were assembled . . . probably because the earliest experimenters, working in attics, cellars, or garages, *did* in fact raid the kitchen, for oatmeal boxes, glass jars, and — to serve as a convenient wooden "chassis" — even the household breadboard.

Although the wooden plank has long since been replaced by various mechanical schemes — some of them impressively elaborate and complex — the homely name has survived . . . along with the need to plan a layout, assemble the hardware, cut and solder wires, and (again a classic phrase) the need to "debug" the resultant lashup.

During the past twenty years, breadboards — wooden, metallic, or plastic — have cost us and our customers an unbelievable amount of wasted time and effort. Operational amplifier circuits are, when correctly built, among the most reliable, stable, and "forgiving" devices in all of electronics; but they are easily encouraged to misbehave by "haywiring," "strays," and other parasitic temptations. Now we have Built a Better Breadboard . . . and we invite you to beat a path to our door.

Because they do not retain any of the limitations and defects of older schemes, we feel that this new generation of circuit-assembly aids deserve a new generic name. We call them, therefore, *not* breadboards, but **OPERATIONAL MANIFOLDS**. Two designs are now available, as shown in figures 1 and 2. Both offer the same four features: *Speed, Convenience, Flexibility, and Logical Organization*. In essence they consist of compact bench-mounting structures of unique design — containing a well-regulated dual power supply, four or five pluggable (and therefore interchangeable) operational amplifiers, and a completely wired jack-panel. The spatial organization and marking of the panel greatly simplify rapid interconnection of the amplifiers, which is accomplished by means of pluggable components and jumper leads. Provision is also made for the addition of plug-in networks, such as linear and nonlinear Philbrick Transconductors. The wiring, shielding, grounding, dynamic-stabilization, and guarding problems normally associated with low-level, wide-band, high-gain circuits have been almost entirely eliminated in these manifolds, almost as effectively as in our single-amplifier Q3-style Universal Operational Modules in fact . . . at much lower cost per circuit, too.

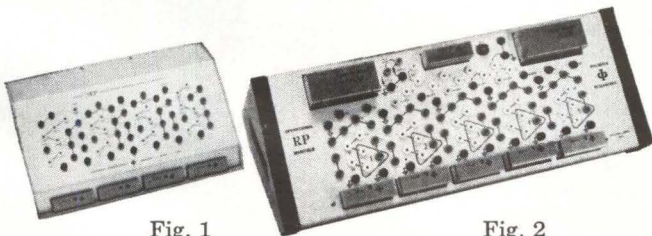

Fig. 1

Fig. 2

It takes but a few weeks of active use to recover the modest cost of either the MP (4 amplifiers, plus power supply, \$390) or the RP (5 amplifiers, plus power supply, \$495.), and you will probably notice certain extra-economic bonuses: superior circuit performance, sunnier dispositions, and greater freedom of invention, to name three. In time, you may find yourself using manifolds for semi-permanent circuits that must be built to otherwise-impossible schedules. They are

neat enough, they compete very favorably with one-shot "custom" chassis-punching and wiring, and RP is easily rack-mountable.

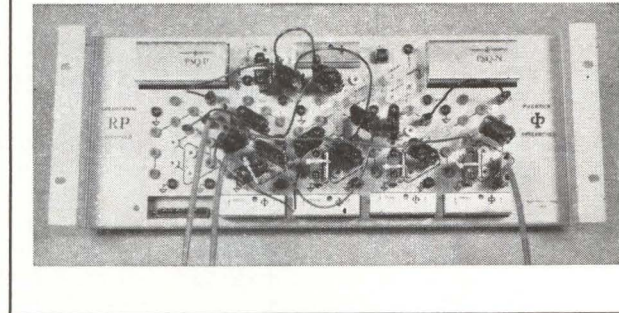
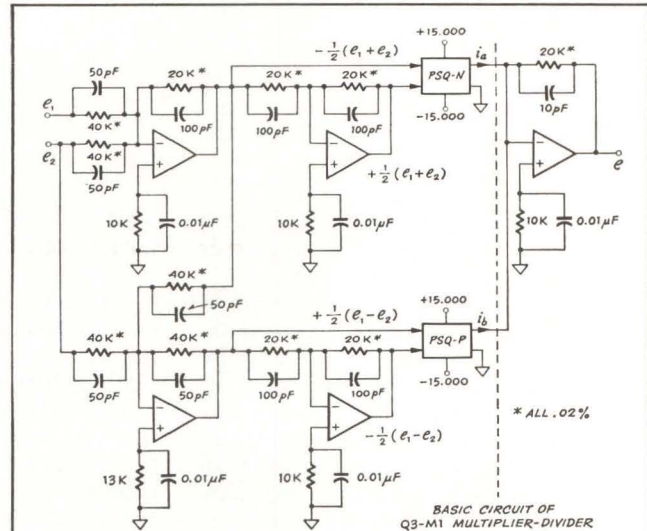

Fig. 3

As for speed and convenience, we should be content to rest our case on the schematic and photograph of Figure 3. This 5-amplifier multiplier was "constructed" in just 27 minutes, starting with the schematic. To make the test perfectly fair, we ran it in the laboratory of a customer, only 15 minutes after he first saw the RP, and with no rehearsals. We didn't help him, except to run through the instructions once, and hand him one of our standard kits of plug-in components and jumper-leads . . . informally known, by the way, as our "Bag of Worms."

Would you like to try our Better Breadboard? Call your local Philbrick field engineer (or the factory) and ask for a free demonstration. If you like, we'll leave one with you for a few days, Worm-Bag and all — but we think it only fair to tell you that you probably will not be able to resist keeping it. Even the fellow with the "non-electronic brain" can understand it. The easy-to-follow instruction book guarantees that. If you'd prefer to start off more slowly, write for free literature package MBA3. Philbrick Researches, Inc., 22D Allied Drive at Route 128, Dedham, Massachusetts 02026. Phone (617) 329-1600.



PHILBRICK



# TI takes the heat off power supplies.

Heat build-up is a serious problem in power supplies, computers and other electronic and electrical equipment.

That's why many manufacturers of these products have turned to the positive protection afforded by Texas Instruments cooling effect detectors.

The Klixon® 2ST detector is a sensor-switch combination designed to protect air-cooled electronic and electrical equipment against overheating due to the decrease of air flow and/or increase of incoming temperature. It is used in conjunction with Texas Instruments

4 MC Magnetic Circuit breaker to give warning of a dangerous condition or to cut off power.

The 2ST not only eliminates the need for vane switches and thermostats, but offers many advantages over these devices at little or no extra cost.

The 2ST functions perfectly in any position. It's rugged... can withstand the ordinary knocks of installation and maintenance. The sensor reacts to the cooling capacity of the air... it is not affected by the individual parameters of velocity and/or temperature. The sens-

ing element is a thermal analog of the equipment being protected. Its thermal characteristics can be matched to thermal limitations and requirements of the equipment. Other successful applications of the Klixon 2ST cooling effect detector include computer high-speed printers and card-reader-punch units, copying machines and projectors.

Texas Instruments and other manufacturers get together daily to solve problems. Perhaps we have the answers to help you, too. Get more information. Circle reader card 488.



## Texas Instruments makes it happen in industry.

### Electric utilities going solid state for power control and protection.

Electric power. It must be generated... controlled. There must be protection against blackouts... against damage to company and consumer equipment.

One unique electronic protective device is Escó Manufacturing Company's CM-78 inverse timer and control. It is made to sense overcurrent conditions in power lines and generate a command signal to trip circuit breakers before damage can be done.

The CM-78 is a custom-designed, solid-state electronic assembly made for Escó by Texas Instruments. All its semiconductor components are produced by TI... SCR's, silicon transistors, silicon rectifiers, and silicon diodes. Precision resistors and solid tantalum capacitors from TI are also employed. The circuits are solidly encapsulated in epoxy in a module only 5" x 4" x 1 1/8".

The advanced new

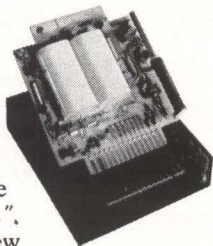

electronic module offers a multiplicity of advantages over the electromechanical devices now in general use, yet it costs no more. It's faster, more reliable, and many times smaller.

Escó came to Texas Instruments because they found that TI offers the broadest, most complete line of semiconductors in the industry and because TI can provide these products in pre-assembled, pretested electronic assemblies. This eliminated the need for large capital investments in new production facilities and extensive electronic engineering capability. Considering solid-state electronics? Send for a free packet of detailed information by circling reader service card no. 489.

### TI semiconductors help brokers read market quotations easier

Texas Instruments semiconductors will soon be in brokers' offices all over the country as part of a new stock quotation display made by Trans-Lux Corporation.

The new "Trans-Jet" display is a brokerage-size, self-contained unit that can be mounted on a wall or hung in the middle of the room for viewing

from both sides. It takes incoming signals directly from the stock exchange communications network and converts them to a moving display via a new electronic-electromechanical-pneumatic system.

The new system incorporates Texas Instruments low-cost industrial integrated circuits, Silect™ plastic-encapsulated silicon bipolar and unijunction transistors, germanium transistors, silicon diodes, SCR's and semiconductor light sensors.



In the conventional display an electromechanical tape-feeding system and film projector require a separate console. The new "Trans-Jet" built-in electronic control is only 12" x 10" x 6". And maintenance has been reduced from bi-weekly to semi-annually.

Semiconductors offer a wide range of opportunities for miniaturization reliability, efficiency and economy. For information and application assistance circle reader card 490.

TEXAS INSTRUMENTS  
INCORPORATED







# There's a G-E silicone

## Bonding

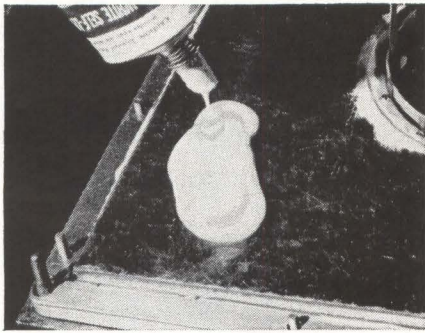

Laminated layers of mica sheeting are securely bonded with G-E RTV silicone sealant. Ready to use, it bonds to most materials.

## Insulating



G-E RTV translucent sealant provides excellent see-thru insulation instantly. UL-recognized, the sealant also comes in colors.

## Damping

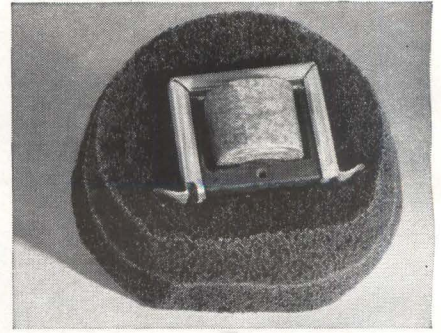

G-E RTV-7 silicone rubber foams on the spot to provide mechanical support, shock and vibration damping, and light weight electrical insulation.



Screws and drilling are eliminated by adhering identification plates with RTV sealant. It won't harden, soften, crack or shrink.

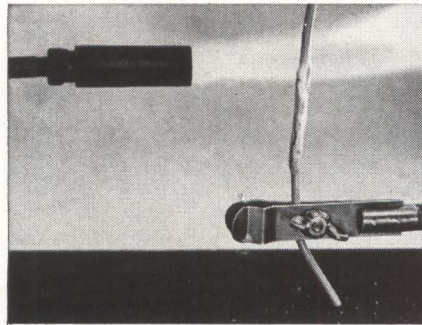

Silicone rubber wire and cable insulation passes UL vertical flame tests and is frequently used in high-voltage circuits.

## Sealing

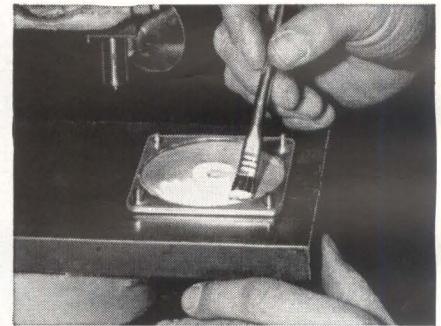

G-E two-part RTV, available in a range of viscosities, seals filament condenser plate in dielectric heater. Also protects against vibration.

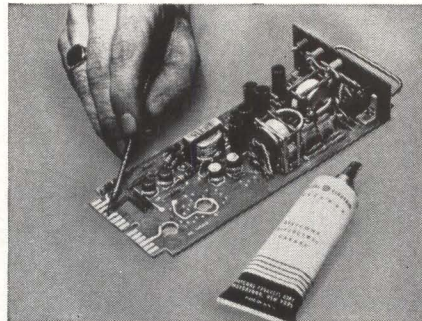

G-E silicone dielectric greases, ideal heat transfer media, are easily brushed, painted, sprayed, dip-coated or applied directly from tube.

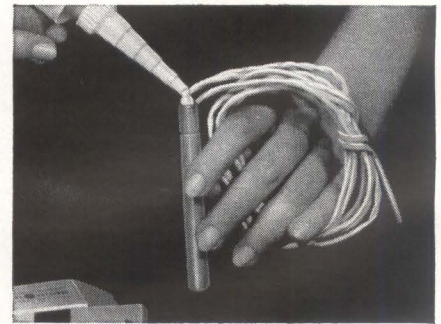

G-E RTV is ideal for high temperature moisture sealing of heating elements. It withstands temperatures as high as 600°F, as low as -75°F.



# design solution for:

## Moldmaking

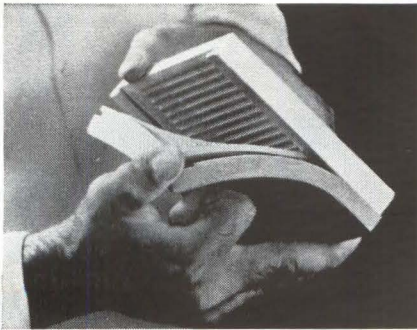

Tough, flexible G-E RTV silicone for moldmaking reproduces detail accurately and minimizes tooling costs.

## Potting and Encapsulating

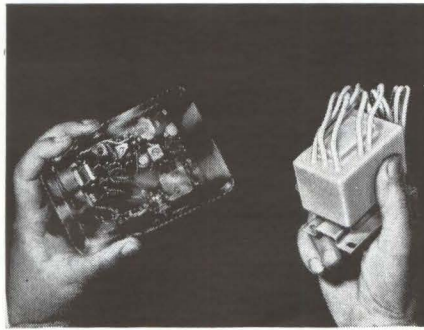

Many G-E RTV silicone compounds are available—all with good strength, outstanding electrical properties and resistance to temperature extremes.

## Fluids Applications

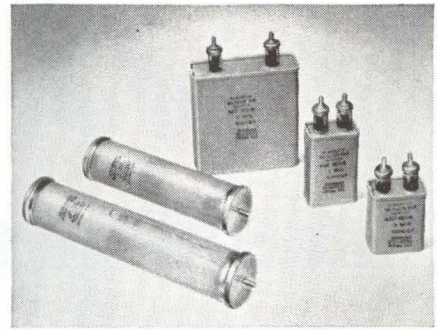

G-E silicone dielectric fluids provide excellent electrical properties and thermal stability for many types of components.

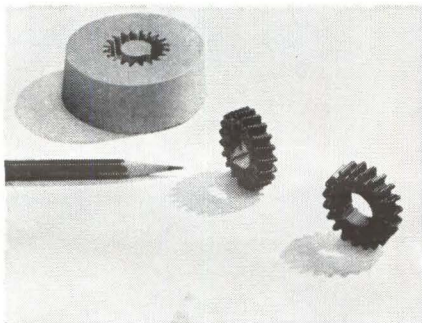

For prototypes or short-run parts production, G-E RTV is an excellent flexible moldmaking material. And it needs no release agent.

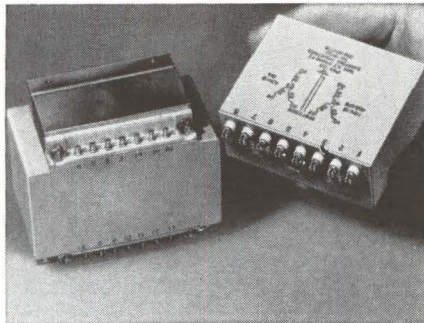

Impregnation of transformer coils with G-E RTV provides electrical insulation and environmental protection at high temperatures.

## Fabricating



G-E silicone elastomers are easily used to make numerous silicone rubber parts by standard rubber fabricating techniques.

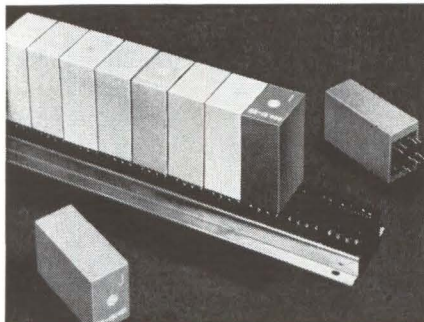

G-E RTV provides attractive, protective packaging for components. Each unit is encapsulated in a different color RTV for easy identification.

## If you can't find it here, write for our Silicone Selector Guide:

Section N12254 Silicone Products Dept., General Electric Company, Waterford, New York 12188.

GENERAL  ELECTRIC



# CELANESE NYLON IS COMING.



Rather big.

We're starting construction of a new plant in Houston, Texas, with a yearly capacity of 12-million pounds of nylon molding resins—based on a new polymerization process. When the plant is on stream, by mid-1967, Celanese will be one of the two leading producers of nylon molding materials in the United States.

As we said, Celanese Nylon *is* coming.

Celanese benefits from twenty-five years of nylon technology. I.C.I., Ltd. and Celanese jointly own Fiber Industries, Inc., which produces nylon fiber at Greenville, S. C. Nylon salt for the new Celanese Nylon plant at Houston will be supplied from the Bay City, Texas, facility of Celanese Chemical Company which is now undergoing major expansion.

Production of a competitive high-quality Celanese Nylon, prior to start-up of the Houston plant, is possible due to existing Celanese facilities and completely integrated technology. New Celanese Nylon 66 and Celanese Nylon 610 molding and extrusion resins, plus a full range of copolymers and terpolymers, will be produced under the Celanese-developed process within a year's time.

We are also boosting production of our other major

engineering plastics: Celcon acetal copolymer, regular and glass-reinforced grades. Forticel cellulose propionate. Cellulose Acetate. Fortiflex polyethylenes. So we can offer a most complete line of engineering plastics. Included in this family of engineering plastics will be glass-reinforced nylon molding compounds.

While we obviously didn't invent nylon, the addition of Celanese Nylon resins is a logical extension of Celanese Corporation's diversified line of over 100 basic products. A line which includes petrochemicals, fibers, plastics, forest products, paints and coatings, and petroleum products. The Celanese Plastics Company, alone, operates eleven plants in the United States, four more abroad, which produce high-performance plastic resins and fabricated plastic products.

We welcome the opportunity to tell you more about Celanese Nylon—now available in development quantities for your evaluation. Write Celanese Plastics Company, Dept. 133-L, P.O. Box 629, Linden, New Jersey.



**CELANESE**  
PLASTICS COMPANY

Celanese Plastics Company is a division of Celanese Corporation.  
Canadian Affiliate: Canadian Chemical Company, a division of Chemcell (1963), Limited.  
Export Sales: Amcel Co., Inc., and Pan Amcel Co., Inc., 522 Fifth Ave., New York 10036.  
Celanese® Celcon® Forticel® Fortiflex®





Japanese technology

## Communications technology in Japan

In communications, the Japanese are pressing original development work to increase their own telephony capacity and to make better use of computers. The Japanese engineer keeps an eye on the great growth in communications taking place within his own country and the vacuum in communications which exists in most other Asian countries and in Africa. The goal is to compete favorably everywhere in the world with up-to-date hardware and techniques.

p. 134 Japanese stay with pcm to meet mushrooming growth in telephony

p. 147 Bit by bit, the Japanese speed data communications



# Japanese stay with pcm to meet mushrooming growth in telephony

Communications boom in Japan is stimulating development of varied techniques of pulse-code modulation and other methods of expanding transmission networks without adding new lines

By Hiroshi Inose and Hiroya Fujisaki

University of Tokyo

**Japan's need** for short, high-capacity communications links between its densely populated areas is fostering the rapid development of pulse-code modulation techniques and installation of pcm systems.

Although Japanese communications systems designers did not begin extensive research in pcm until 1950, they are more than making up for lost time to meet the current communications boom. Japan now ranks second in the world in installation of pcm telephone systems; the United States is first. In the past year, Japan has installed seventy-three 24-channel systems and by September, 1967, more than 326 systems will be in operation.

## The authors



Hiroya Fujisaki, an associate professor at the University of Tokyo, received his doctorate degree there in 1962 and is now engaged in research on speech and digital communications. From 1951 to 1961, he was with Massachusetts Institute of Technology in the United States and the Royal Institute of Technology in Sweden.

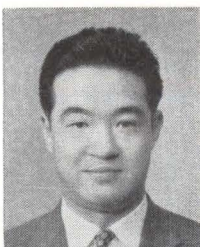

Hiroshi Inose specializes in digital transmission and exchange systems. A professor of electrical engineering at the University of Tokyo, he received his doctorate there in 1955. Between 1956 and 1961, he was associated with the University of Pennsylvania and Bell Telephone Laboratories. He is the holder of many awards from professional organizations.

The nation's telephone network is the major user of pcm because one of the main advantages of pcm is that it allows many messages, usually up to 24, to be sent over an existing telephone transmission line; thus avoiding the great expense of installing more transmission lines. In cities, and in communications between cities, pcm is an economical way to provide for the increase of telephone subscribers.

Pcm for telemetry is also becoming a favored transmission mode in science and industry. For example, modifications that will improve signal-to-noise ratios have been proposed for the space program. Government agencies, railroads, electric companies and gas suppliers have installed pcm telemetry systems.

Computers and digital data transmission systems are being put in service in large numbers by public utilities and businesses [see "Bit by bit, Japan is speeding its data communication links," p. 147]. The users of these computers and the companies making the data processing equipment see in pcm the answer to future requirements for transmission of huge volumes of digital data at high speeds.

In development or being studied at numerous Japanese companies and laboratories are such techniques as high-speed modulation, nonlinear coding, synchronization and error-correction methods, transmission of pcm signals by radio (and through waveguide at millimeter wavelengths) and the integration of telephone switching and transmission systems. Eventually, the transmission of voice, video and data communications may be unified in the integrated networks.

Since World War 2, the buildup of communications in Japan has been remarkable—more than 10,000 miles of microwave links and 1,500 miles of



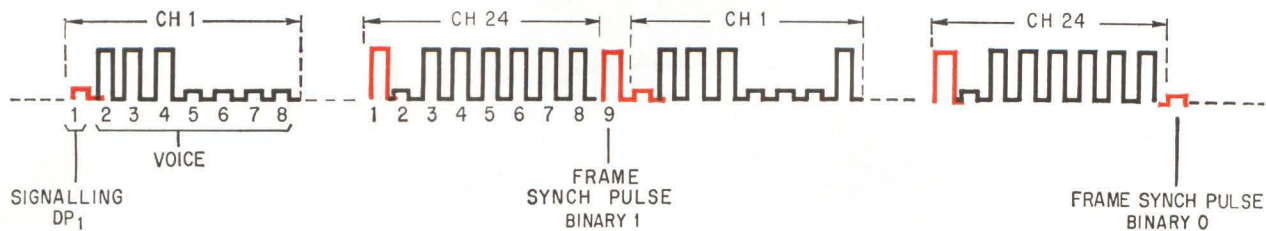

**Pulse-code modulation format** consists of coded pcm word from each of 24 voice channels. First pulse (color) in any coded channel is the signaling pulse that indicates the subset is off-hook or carries dialing information. This is followed by seven time slots for the coded voice signal. At the end of the 24th channel is a framing synchronization pulse which is 0 or 1 in alternate frames. In the PCM-24 telephone system 8,000 frames are transmitted each second.

coaxial cable now serve some 13 million subsets. But the decision to use pcm in telephone communications was not made until 1963.

One of the reasons for the delay was a lack of the silicon transistors that are required by practical pcm equipment. Although Japan ranks second in world production of semiconductor devices and is the home of such advances as the Esaki diode, until recently transistor production concentrated on germanium devices for radio and television sets.

In August, 1963, Nippon Telephone and Telegraph Public Corp. (NTT) began developing a 24-channel pcm telephone system, called the PCM-24. Nippon Electric Co. produced the equipment.<sup>1,2,3</sup> It is also being made now by Fujitsu Ltd., which recently exported 23 systems, with 200 repeaters, to the Hong Kong Telephone Co.

Test operations of the PCM-24 systems began last December with 15 systems in the Osaka, Tokyo and Mito areas. A total of 326 installations are to be in operation by September, 1967. Meanwhile, higher capacity systems are being developed.

Fujitsu is studying nonlinear coding schemes. Oki Electric Industry is working on transmission and exchange problems as well as synchronization schemes. Both Tokyo University and Osaka University and the company that handles overseas communications, Kokusai Denshin Denwa Co., are active in pcm development.

### Developing the system

The system now in production, the PCM-24, grew out of a study comparing the conventional frequency-division multiplex (fdm) type of telephone system with time-division multiplexed pcm.

Pcm systems are more economical in short-haul communications that mainly go over existing lines between exchanges that normally handle audio frequencies. Pcm requires a wider transmission bandwidth but provides more channels. Greater channel capacity is possible because pcm is more immune to interchannel interference. In addition, the pcm terminals cost less because channel separation is handled by digital circuits rather than costly band-pass filters.

In the PCM-24 system, speech signals are sampled 8,000 times a second; each channel is transmitted as an 8-bit code word. Seven bits are needed to maintain a signal-to-quantization noise ratio of commercial quality and one bit is needed for signal-

ing—off-hook, on-hook or dialing. Speech quality of the PCM-24 system is comparable to conventional fdm carrier telephony with 4-kilohertz bands. Each frame consists of 193 bits—192 for the 24 code words and one bit for the synchronization framing pulse. Since 8,000 frames are sent each second, the system clock frequency is 1.544 megahertz. These are the same basic characteristics as in the T-1 pcm system which has been used in the United States since 1962 by the American Telephone & Telegraph Co. However, the code format, shown in the diagram above, is different.

As in Bell System's unit, nonlinear quantization (compression and encoding) is mandatory to maintain a signal-to-quantization noise ratio of more than 26 decibels as the input speech levels vary over a 40-db range. For this purpose, the system compresses—that is, emphasizes—the low-level signals with a logarithmic characteristic that has a  $\mu = 100$  [Electronics, Sept. 19, pp. 142-143]. Diode components for the compressor are stabilized in an oven at  $120^\circ\text{C} \pm 0.3^\circ\text{C}$ .

### Feedback encoder

The feedback encoder in the circuit on page 136 provides the best economy, accuracy and stability. All 24 channels share one encoder and one compressor (not shown). By comparison, Bell employs one encoder for odd numbered channels and another for even numbered channels. This allows transients to die out during alternate channels and consequently reduces the circuit's speed requirements. However, the PCM-24's encoder equals the performance with less cost, less complexity, smaller size and lower power drain.

The PCM-24 encoder circuit is a digit-at-a-time encoder; it establishes the coded word by sequentially determining, in seven steps, which digits (1's or 0's) should appear in the 7-bit word.

When a sampling pulse is applied to the sample-and-hold circuit shown in the diagram, the capacitor charges or discharges to the value of the compressed signal; it remains charged until the next sample is applied.

While the capacitor is charged, the signal level is summed with the currents determined by connecting the weighting resistors R to 64R to ground or to the voltage  $-E_s$ . A binary 1 is generated when the current that the sample signal produces is greater than the currents caused by the weight-



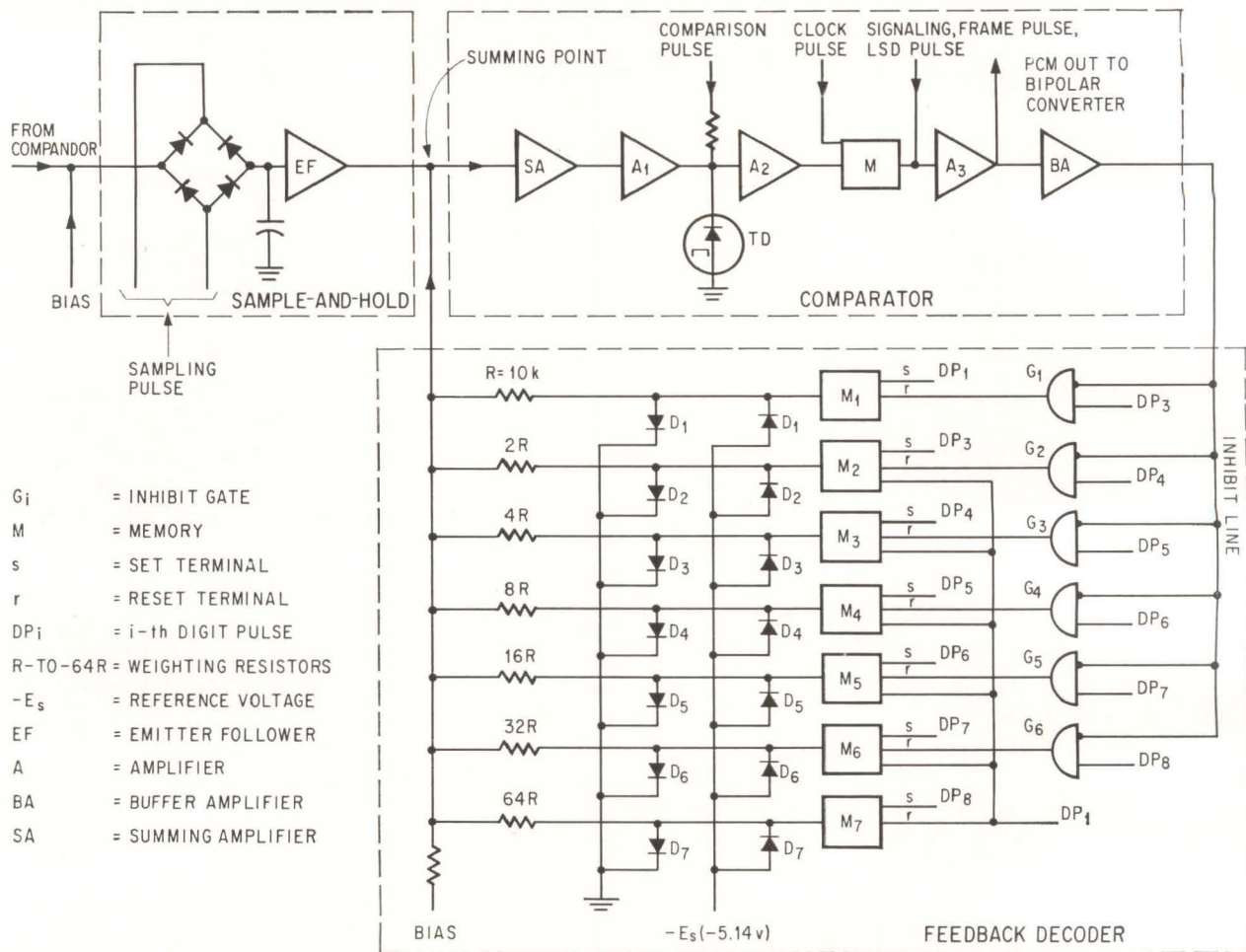

**Feedback encoder** takes compressed voice signals, samples them and then encodes them as pcm signals. Lines marked  $DP_1$  to  $DP_8$  refer to timing pulses. The sampled pulse at the comparator input is summed with a current determined by resistors  $R$  to  $64R$ . If the summed current is positive, it produces a pulse in the time slot; if it is negative, there is no pulse. Feedback decoder at the bottom essentially reconverts the pcm output signal to the analog signal that appears at the summing point.

ing resistors. Otherwise a binary 0 is generated.

For example, consider encoding a signal level equivalent to the number 84. The desired pcm output is 10101000. The first digit on the left is called the most significant digit (msd). The circuit first determines this digit and then works its way down until it has determined the least significant digit.

During the first pulse in the code word format, a clock pulse called digital pulse 1,  $DP_1$ , resets the memories  $M_2$  to  $M_7$  and sets the memory  $M_1$  so that the most significant digit can be determined. The lines,  $DP_1$  to  $DP_8$ , correspond to time slots in the channel. Because the first memory is triggered during clock pulse  $DP_1$ , there is no  $DP_2$  line, which would normally correspond to the most significant digit.

When memory  $M_1$  is set, the output of the memory goes more negative than voltage  $-E_s$  at the bottom of the diagram. Therefore, diode  $D_1$  at the right conducts, causing a reference current to flow in resistor  $R$ . This current which is equivalent to decimal number  $-64$  is summed with the current caused by the signal sample, which in this example is 84. Since the sum current is positive

$[84 + (-64) = 20]$ , the comparator generates a 1 for the most significant digit. Because a 1 is generated, diode  $D_1$  will continue to conduct for the remainder of the encoding process. If a 0 were generated for the msd (signal level less than 64), an inhibit pulse would reset memory  $M_1$  which in turn would back bias  $D_1$ .

The next clock pulse makes  $D_2$  conduct, lowering the negative reference current to  $-96$  at the comparator  $[-64 + (-32) = -96]$ . Since the input signal level is 84, the input to the summer is negative. This generates a 0 as the code word's third bit. This 0 also results in an inhibit pulse which resets  $M_2$  and turns off  $D_2$ . As a result the reference voltage returns to  $-64$  since only  $D_1$  is conducting. The other digits in the code word are generated in a similar manner by the next five clock pulses.

### Framing synchronization

Timing or clock pulses at the repeaters—pulse regenerating circuits—must coincide with the transmitted pulses. This is called bit synchronization. Also, since 8,000 frames are sent each second, the repeater must determine the start of each frame—a



group of 24 coded words. This is called "framing synchronization" or simply "framing." The terminals at the exchange use the framing signal—the 193rd bit position in the frame—as a timing reference to steer signals to their proper destinations. Repeaters appear both in terminal equipment and on the transmission line. On the lines, repeaters are spaced 2 kilometers apart except near exchanges where the higher impulse noise levels requires spacing of 1 km.

For framing, the network uses the so-called backward acting system, as does Bell's T-1 system. Once the repeater knows where the framing time slot occurs, it merely checks each subsequent frame to insure that the pulse is correct. The framing pulse must appear only on alternate frames. It can be detected because its pulse pattern is statistically unlike any other bit pattern.

If the alternate pattern is lost—system out of frame—the repeater moves to the next time slot and looks for the pattern again. It repeats this one bit shift until the correct pattern is received. The scheme is simple and economical but it requires an average of tens of milliseconds to recover synchronization. Even though the signal is noisy during recovery time, on the average only a portion of a syllable in a word is lost.

To prevent the repeater from initiating a search when only a single framing pulse is in error, or if errors are widely separated, the incorrect framing pulses are integrated. Reframing won't begin until the integrated output exceeds a threshold. For example, a steady burst of errors for 3 msec will cause an out-of-frame condition. If there is a large enough spacing between framing-pulse errors, loss of framing will not occur because the integrated level cannot build up.

### Timing and equalization

The system transmits the encoded samples as bipolar binary pulses that have a 50% duty cycle,

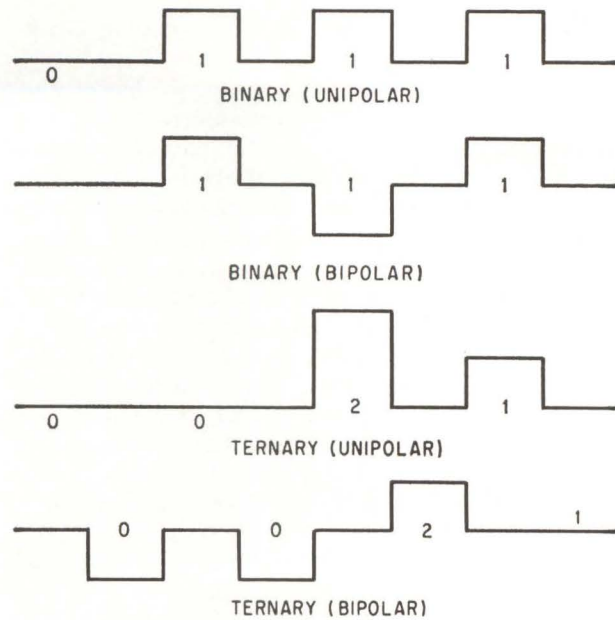

**Binary and ternary waveforms** convey digital information. All waveforms represent the decimal number 7. Unipolar binary waveform at top is encoded as 111, the binary designation for 7. In the second waveform, the polarity of each pulse—the 1's—is the negative of the preceding pulse. Bipolar binary waveforms in the PCM-24 system improve transmission characteristics. Ternary waveforms represent the code 21—the ternary designation for decimal number 7; that is  $2 \times 3^1 + 1 \times 3^0 = 7$ . In a unipolar ternary waveform, the code is represented by an obvious amplitude difference. In bipolar ternary, the negative pulse represents 0, the baseline is 1 and the positive pulse is 2.

as in the second pulse pattern from the top in the diagram shown above. Each binary 1 digit is encoded with a polarity that is the negative of the preceding binary 1 pulse. This pulse pattern places the major portion of the pcm signal's energy at a frequency of about half the bit rate. Because the bipolar component has no d-c component it is relatively easy to transmit through transformers. Also

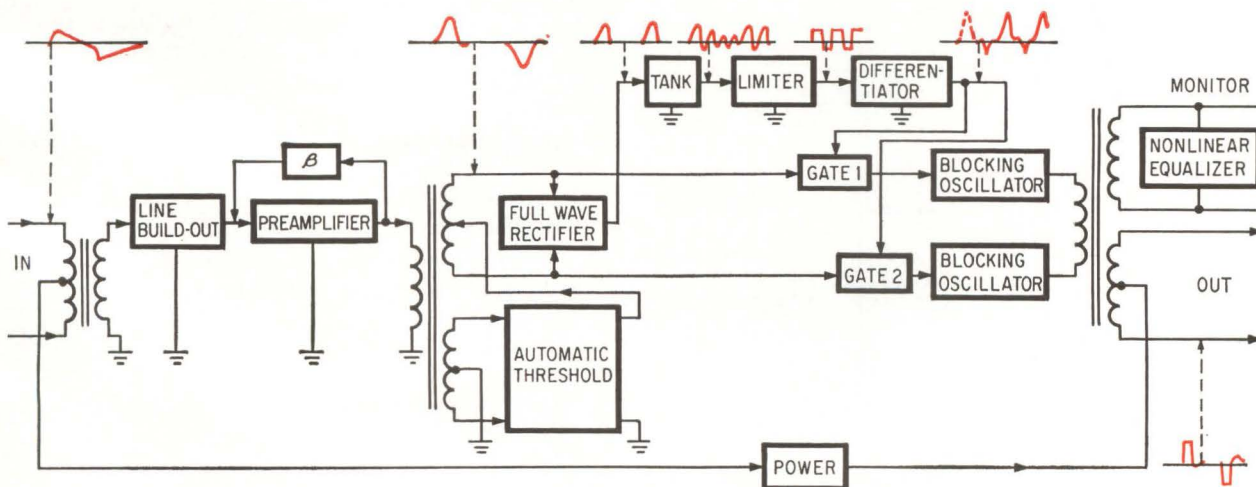

**Repeater circuit** equalizes the signal in the line build-out network and preamplifier, extracts timing information and reshapes the pulses. Waveform at input is a typical bipolar binary pulse that has been distorted and attenuated by the transmission line. At the output are two regenerated pulses that are sent farther down the line. Rectifier, tank, limiter and differentiator are parts of the timing extraction circuit. Waveforms at top indicate how circuit acts on equalized input pulses at the transformer's secondary.



the high-frequency energy is less, reducing crosstalk.

Normally, the transmission line will distort and attenuate the pulses. The repeater reshapes and retimes the input pulses as in the diagram on page 137. Measurements indicate that transmission disturbances are infrequent, so the repeaters can extract timing information from the signal pulses themselves. A separate timing signal is not needed, reducing transmission costs; and repeater costs are less because the retiming operation is simplified.

The line build-out network and the preamplifier form an equalizer that compensates for line attenuation. This input circuit has a 1.25 Mhz cutoff and has an over-all transfer function that is represented by a 6th-order rational function of frequency. Another equalizer, a load to the blocking oscillator's output, also reduces distortion by insuring that the output has a slightly nonrectangular pulse shape for greater immunity against crosstalk.

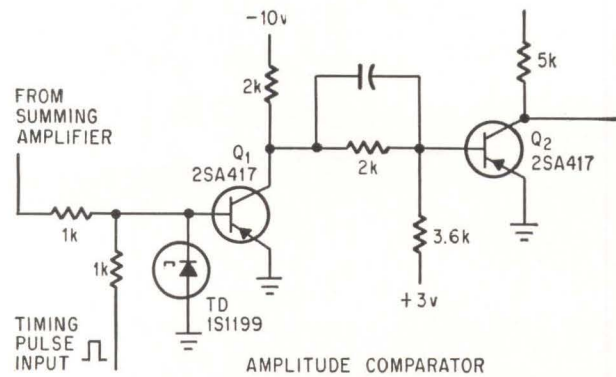
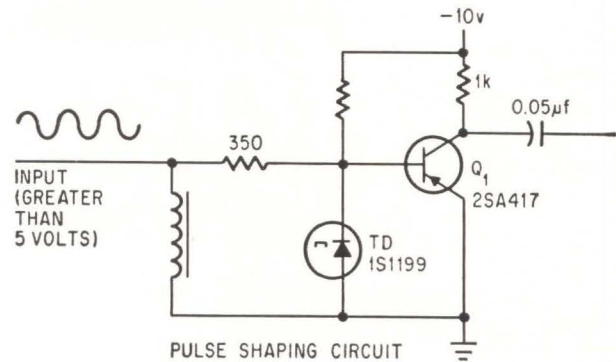
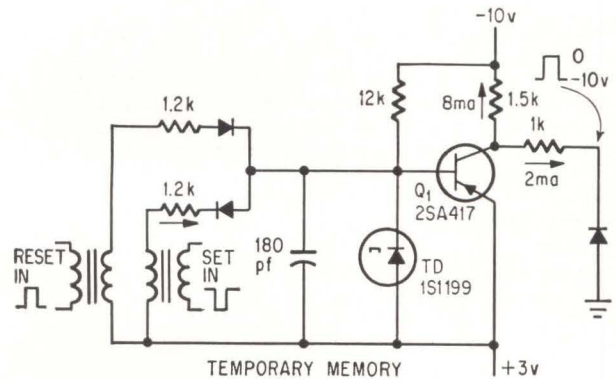

**Three circuits** in pcm terminal equipment all incorporate a tunnel (Esaki) diode and a common emitter transistor stage. Memory circuit, at top, is bistable; other two circuits are monostable.

### Driving current ( $I_b$ ) and switching times

$I_b$ (mA)	Base		Collector	
	$\tau_{sb}$ (on)	$\tau_{sb}$ (off)	$\tau_{sc}$ (on)	$\tau_{sc}$ (off)
2.0	4.0	7.0	16.0	23.0
3.0	2.5	2.5	13.0	18.0
4.0	2.0	2.0	10.0	15.0

Timing or clock information is extracted from the equalized input signal by first rectifying the input signal. Rectification converts the bipolar pulses to monopolar pulses with a fundamental frequency at the bit rate. These pulses are then fed to a tuned circuit (tank) whose output is clipped and differentiated to produce the narrow clock pulses that occur at the center of the input pulse. The differentiated pulses and the equalized signal are then "AND'ED" in gates 1 and 2. Therefore, blocking oscillator 1 or 2 will produce bipolar pulses that match the polarity of the equalized signal.

At the input to the gates the automatic threshold control circuit determines the threshold at which the blocking oscillator triggers. The circuit also establishes the clipping level at the input to the timing circuit. The threshold is approximately half the peak level of the equalized input signal. A threshold device is necessary to make the recovered clock independent of the signal amplitude and to reduce crosstalk in the regenerated pulses.

The repeaters and much of the timing and framing circuits in the terminals can be monitored by merely checking the timing of the framing pulses. However, monitoring other terminal equipment—such as companders, coders and decoders—requires a pilot signal, transmitted over one of the 24 channels when the channel is idle. Failure in synchronization or incorrect transmission of the pilot is detected at the receiving terminal and the transmitting terminal is notified.

### Tunnel-diode circuits

The PCM-24 system makes extensive use of digital circuits composed of transistors and tunnel diodes shown in the diagram at the left. These allow high-speed switching with relatively few elements and result in greater economy and reliability. In these circuits, the input of a grounded emitter amplifier is shunted by a tunnel diode whose negative resistance characteristic produces a bistable or monostable condition depending on the configuration of the circuit.

In the memory circuit, the 12-kilohm resistor and the transistor input impedance allow the tunnel diode to have either of two stable states. A set signal switches the tunnel diode to a high voltage state, where it remains after the set pulse is removed. A reset signal switches the diode to a low voltage state, where it remains after the reset pulse is removed. The pulse-shaping circuit is similar to a Schmitt trigger but is simpler, more stable and requires less power.



The bottom circuit is a comparator and AND gate that is used in the feedback encoder on page 136. The input from the summing amplifier must be above a specified level and the timing pulse must be present if a pulsed output is to result.

In all these circuits switching can be speeded by increasing the base driving current to the transistor. This is indicated in the table on page 138, which includes the switching speeds at the base,  $\tau_{sb}$ , and at the collector,  $\tau_{sc}$ .

### Orthogonal transmission

New methods of modulating and coding the information, improved repeater design and more efficient methods of transmitting signals have been developed recently in Japan. An interesting proposal for reducing transmission bandwidth is to encode the samples as a ternary pcm word and transmit the bits as orthogonal waves. Thus, all the bits in the pcm word can be transmitted simultaneously over about half the bandwidth normally needed for one channel of conventional pcm. The bits, of course, are converted from a serial format to a parallel format for simultaneous transmission.

Ternary pulses in this orthogonal transmission technique are compared with binary pulses in the diagram on page 137. The term orthogonal means that the correlation between different waveforms is zero. This, in turn, means that waveforms that are transmitted simultaneously can be separated without interference. For two sinusoidal waves,  $S_1$  and  $S_2$ , with suitable different phase or frequency, zero correlation is equivalent to saying

$$\int_0^T S_1 S_2 dt = 0$$

where  $T$  is the period of the lowest frequency waveform.

In the orthogonal modulation technique, one of the waveform sets diagramed above is chosen to transmit 5-bit ternary code words. A waveform in the set is orthogonal to any other waveform in that set. In addition, each waveform can have one of three states—the one shown, one  $180^\circ$  out of phase and one with zero amplitude. Therefore

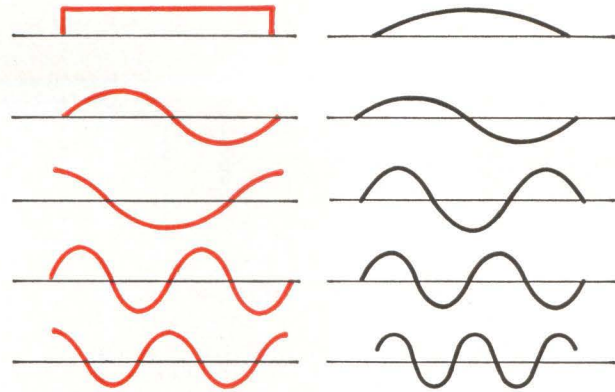

**Orthogonal waveforms** can simultaneously transmit all the bits in a 5-bit pcm word. Some orthogonal waves can have the same frequency as in the set in color. Phase and frequency differences allow separation.

there are a sufficient number of waveform combinations to transmit all possible combinations of a 5-bit ternary code word.

Orthogonal waves can also improve the threshold characteristics of pcm systems by making it possible to assign longer transmission times to the more significant digits in a code word.<sup>5</sup> Known as an orthogonal pcm with weighted bit length, this process increases the likelihood of detecting the signal correctly; so for the same speech quality, the minimum signal-to-noise ratio can be less.

An optimum assignment of bit length would improve threshold about 1 db. In conventional pcm telephone system, a 1-db improvement would require several times more bandwidth. Bandwidth economy is particularly important in long-distance transmission, such as in satellite communications.

### Hadamard transformation

Another interesting proposal for pcm transmission is similar to compression in that it reduces the number of bits needed to provide a suitable signal-to-quantization noise level.<sup>6</sup>

A set of  $n$  signals of greatly varying levels can be transformed into a new set of  $n$  signals whose levels are more equal. Consequently, less digits are needed to maintain a given signal-to-quantiza-

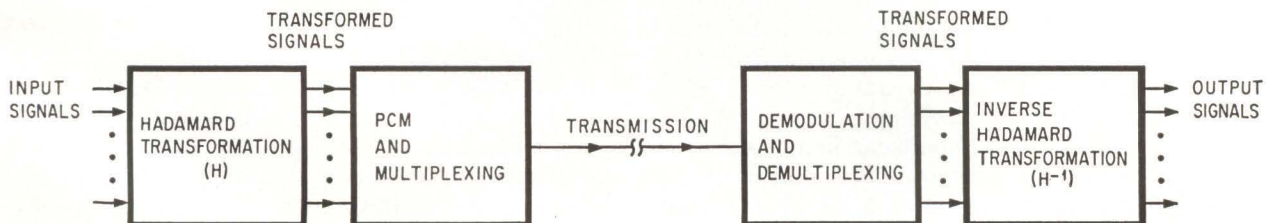

**Hadamard transformation matrix,  $H$** , in color at right, makes input voice signals more uniform. The transformation is simply implemented as a weighting network. As in the block diagram in a pcm system, it may improve the signal-to-quantization noise. Both the transformation,  $H$ , and its inverse,  $H^{-1}$ , are identical; therefore the same type of network is placed on either end of the line.

$$H_8 = H_8^{-1} = \frac{1}{\sqrt{8}} \begin{pmatrix} 1 & 1 & 1 & 1 & -1 & -1 & -1 & -1 \\ 1 & 1 & -1 & -1 & 1 & 1 & -1 & -1 \\ 1 & -1 & 1 & -1 & 1 & -1 & 1 & -1 \\ 1 & -1 & -1 & 1 & 1 & -1 & -1 & 1 \\ -1 & 1 & 1 & -1 & -1 & 1 & 1 & -1 \\ -1 & 1 & -1 & 1 & -1 & 1 & -1 & 1 \\ -1 & -1 & 1 & 1 & -1 & -1 & 1 & -1 \\ -1 & -1 & -1 & -1 & 1 & 1 & -1 & 1 \end{pmatrix}$$



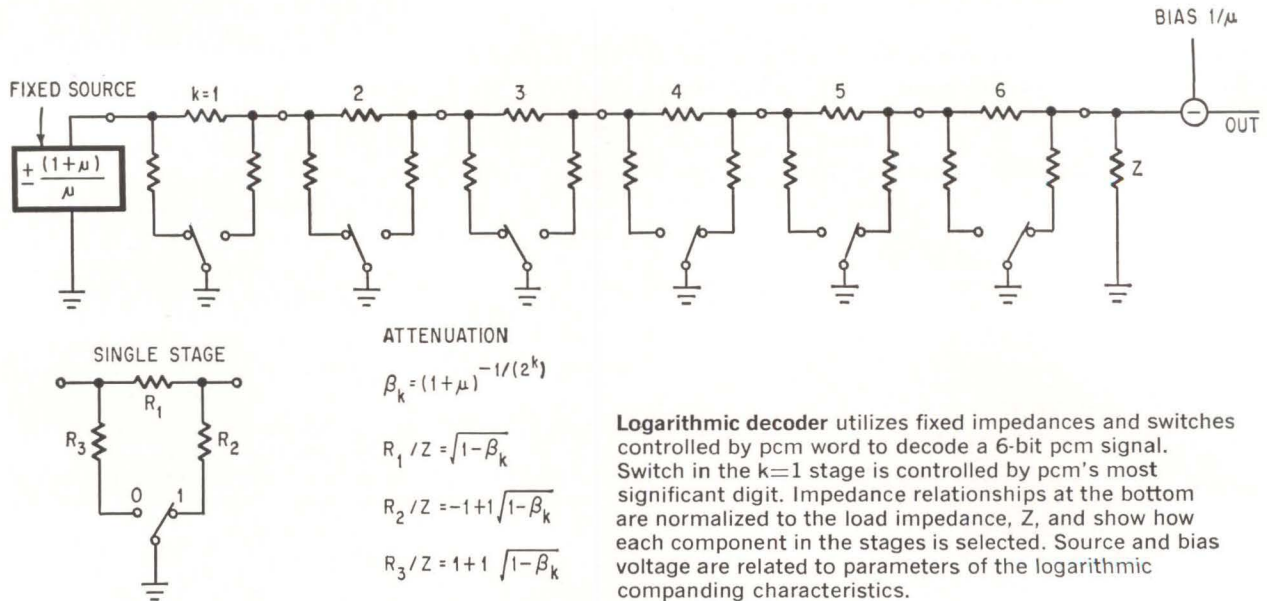

**Logarithmic decoder** utilizes fixed impedances and switches controlled by pcm word to decode a 6-bit pcm signal. Switch in the  $k=1$  stage is controlled by pcm's most significant digit. Impedance relationships at the bottom are normalized to the load impedance,  $Z$ , and show how each component in the stages is selected. Source and bias voltage are related to parameters of the logarithmic companding characteristics.

tion noise level. As in any companded system, this is also a bandwidth reducing scheme since less digits implies smaller bandwidth.

A matrix known as the Hadamard matrix in the diagram on page 139 is especially suited to serve as the transformation because it can be realized by a simple weighting network. This matrix is written for eight channels but can be set up for any integral power of 2 such as 2,4,8,16 or 32 channels. Theory and experimentation show that as the number of channels increases, the maximum increase in the signal-to-quantization noise ratio is 24 db.

### Nonlinear encoding

Since levels of speech signals may vary as much as 60 db, it is difficult for an encoder to quantize low-level signals as accurately as high-level signals, unless the quantization steps are nonuniform. That is, changes of a few millivolts in a low-level signal must be as significant as a change of tens of millivolts in a high-level signal. Speech quality will be poor after the pcm signal is decoded unless low-level signals are emphasized by nonuniform quantization or compression.

Generally, a diode's nonlinear voltage-current characteristics compress the signal at the transmitter and then expand it at the receiver. However, it is difficult to get exactly matching characteristics at the compressor and expander.

In 1963, an ingenious technique was developed to eliminate diodes from nonlinear pcm encoders.<sup>7</sup> The pcm signal controls switches that make a network's impedance or immittance proportional to the pcm code word. Combining both variable and fixed impedances or immittances makes possible many different expander characteristics. Attenuation is controlled to obtain logarithmic characteristics; immittance is controlled to obtain hyperbolic and modified (or weighted) hyperbolic curves. The latter consists of two hyperbolic curves that follow different equations for high-level and low-level signals and results in better character-

istics than a single curve. The expander may serve as an analog-to-digital converter in the feedback path of the encoder to get the desired encoding characteristic.

The circuit shown above is a simplified 6-bit logarithmic decoder that can be made of cascaded attenuators. Resistor values are given by the equations at the bottom of the diagram. In this circuit  $k$  is the bit position and  $k=1$  is the most significant bit position. The bias and source are fixed voltages.

Independent work on encoders with modified or weighted hyperbolic characteristics has extended the dynamic range of hyperbolic encoders to meet the specifications for the PCM-24 system.<sup>8,9</sup> A 7-digit pcm word will provide greater than 26-db signal-to-quantization noise level, even if the input signal varies by 40 db. Compared to a logarithmic encoder, hyperbolic encoders can be made with simpler relays, fewer transistors and fewer and less precise resistors.

### Evaluating nonlinear encoding

A basic measure of speech quality is the articulation score, the percentage of unrelated syllables correctly understood in a message. This score can disclose the effectiveness of the companding in a pcm system.

In 1962, tests of delta pcm and conventional pcm with the same companding characteristic showed that delta pcm, also called differential pcm, had a better articulation score and signal-to-noise ratio than conventional pcm.<sup>10</sup> Theoretical analysis of delta pcm led, in 1965, to the proposal of an optimum companding characteristic.<sup>11</sup>

A more plausible criterion than signal-to-noise ratio is needed to evaluate nonlinear coding characteristics for speech signals. For example, when the signal-to-quantization noise ratio is calculated using conventional theory, the results cannot be correlated with the articulation score.<sup>12</sup> The problem is that conventional theory neglects unvoiced sounds because unvoiced sounds are assumed to



have less power and contribute less to quantization noise. However, this assumption is not correct and the quantization noise must be considered separately for voiced and unvoiced sounds. The discrepancy is evident in the black curve in the graph shown at right which erroneously indicates that the signal-to-quantization noise ratio could decrease for the highest articulation scores.

To correct this anomaly, the authors related the articulation score with the information transmission rate in a speech sample, averaged over the voiced and unvoiced intervals of speech signals. The resulting curve, shown in color, indicates that signal-to-quantization noise must increase with articulation score.

### Improving delta modulation

Although the delta modulation technique is considered simpler than pcm, it was also considered inferior until recently because of its wider bandwidth requirements. However, current studies make it clear that there are many ways to improve this single-bit modulation technique.

In the basic delta modulation technique, each sample is transmitted as a single pulse which represents a change in level from the prior pulse.

A simple delta modulator as in the diagram shown below incorporates timing or clock source and therefore is a synchronous system. At the sampling time, the input signal is compared with the integrated output and, if the difference exceeds a predetermined amount, a pulse is generated. The amplitude difference and clock frequency must be chosen so that the system can follow the fastest-changing signal that is to be transmitted. To improve signal-to-noise ratios, the difference level is reduced and the clock (timing) is made correspondingly faster. If the difference between the input and integrated level is below the predetermined level, the pulse modulator delivers a negative pulse that reduces the integrated level.

The digital output is proportional to the derivative of the signal instead of the signal's amplitude; therefore, delta modulation is not suitable for transmitting d-c signals.

To recover the original signals, the receiver integrates the bits and filters the resultant integrated waveform. Because of the integrator's time constant, the effect of transmission disturbances that change the pulse pattern will be evident in the

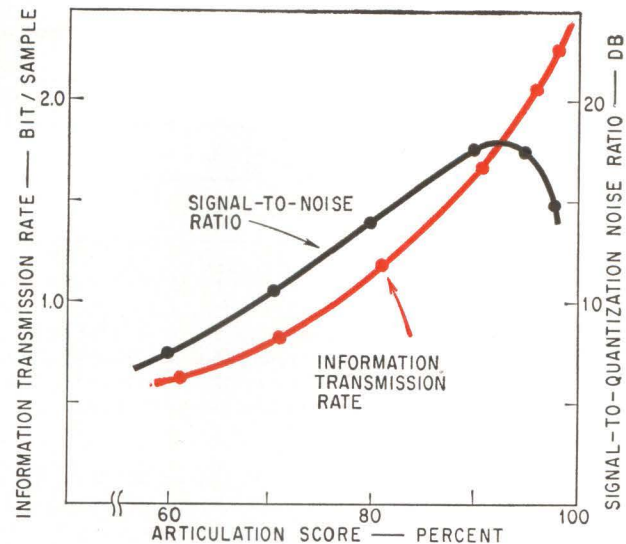

Two ways are shown to relate properties of the pcm signal to articulation scores—the percentage of unrelated syllables correctly understood in a message. Curve in black, based on conventional theory, erroneously indicates that the signal-to-quantization noise ratio decreases at the higher articulation scores. It is more meaningful to relate scores to average information and transmission rate of voice and unvoiced sounds, as in the curve in color.

recovered signal even after a relatively long time interval. That is, errors caused by transmission disturbances tend to accumulate.

In delta pcm, the comparator is replaced by a quantizer. Rather than just generating a pulse, the difference in level is quantized and transmitted with a few bits. As indicated earlier, delta pcm can produce better signal-to-noise and articulation scores than conventional pcm.

If delta modulation, delta pcm and conventional pcm are compared, it is found that conventional pcm requires the most complex equipment; but its bandwidth utilization is the most efficient of the three methods. Delta modulation requires the simplest equipment but is the least efficient in utilizing bandwidth. Delta pcm is intermediate between delta modulation and conventional pcm both in equipment complexity and efficient utilization of bandwidth.

A variation of delta modulation, called delta sigma modulation, reduces the effect of cumulative errors.<sup>13</sup> As in the diagram on page 142, the integrator is removed from the feedback path and is

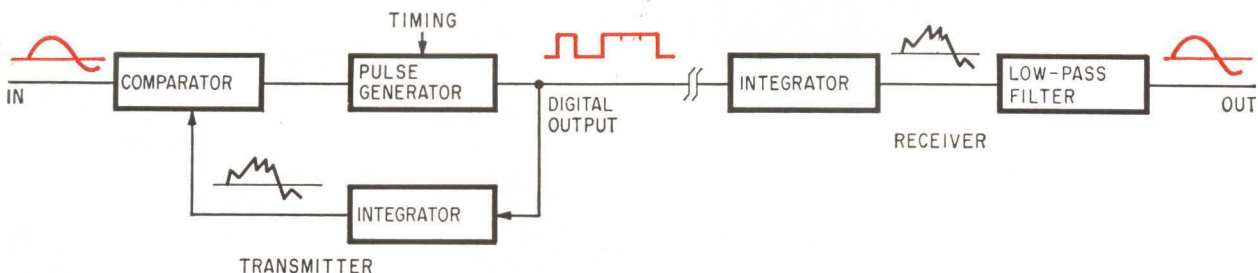

Delta modulation circuit, at left, integrates output pulses and compares resulting wave with the input signal (curve in color at the left). Output pulses, also in color, represent derivative of signal waveform—not the amplitude. In the receiver at the right, input pulses are integrated and filtered to recover original waveform.



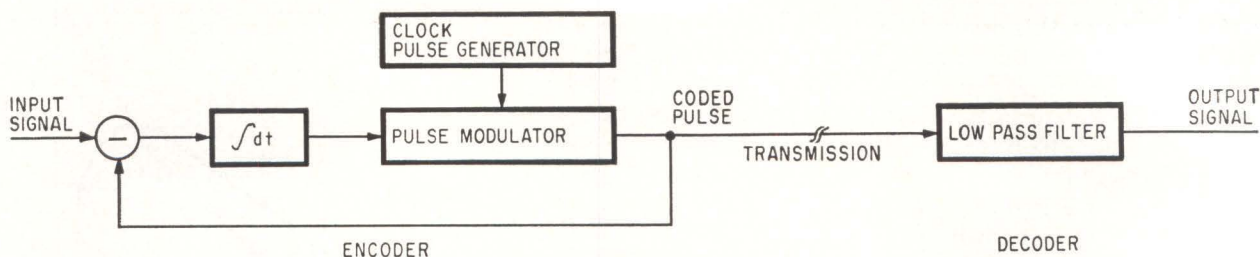

**Delta sigma modulation** places the integrator in the forward loop. In conventional delta modulators it would be in the feedback loop. The change causes output pulses to indicate the amplitude of input signal instead of the derivative, so the received signal does not have to be integrated. Signal is decoded by passing pulses through a low-pass filter. Because the delta sigma modulator has no integrator in the receiver, cumulative errors that occur in conventional delta modulation are eliminated.

inserted in the forward path of the modulator. To generate the output pulses, the output of the integrator is compared with the fixed reference.

The output pulses now represent the signal's amplitude, instead of the signal's derivative. At the receiver of the delta sigma system, the signal is recovered by merely reshaping the pulses and passing them through a low-pass filter. Since there is no integration, transmission disturbances cannot cause cumulative errors.

Furthermore, since the system's dynamic range is independent of the input frequency, delta sigma modulation can transmit d-c components with the same facility with which it transmits audio or video signals.<sup>14</sup>

Adding a compandor to the feedback path is another way of improving delta modulation. The signal-to-quantization noise ratio is improved about as much as in a conventional pcm system. If syllabic rather than conventional (instantaneous) companding is used, then delta modulation has a higher signal-to-quantization noise ratio than ordinary pcm with the same clock frequency.<sup>15</sup> A 5-db improvement was measured in one experimental system. Conventional companding is based on the instantaneous speech level; syllabic companding implies that the compandor's output depends on the average level in the voice signal.

Still another method to improve delta modulation is encoding the signals in an asynchronous ternary

code instead of a binary code with a fixed sampling frequency.<sup>16</sup> The modulation scheme, which has been under development since 1964, is illustrated in the diagram below.

The system, which has no clock, generates a pulse whenever the difference between the signal and the output of the local decoder exceeds a predetermined value; thus the output is asynchronous. Furthermore the sign of the difference determines the pulse's polarity so that the signal is coded in a ternary form.

The ternary waveform requires less bandwidth, making this scheme particularly advantageous for time-sharing and frequency-sharing systems such as random access multiplex communications. Each digit would be transmitted as two radio-frequency pulses of different frequencies and spacings. By assigning independent combinations of spacings and frequencies, the channels can be separated.

### Separating the frames

It is essential to rapidly extract framing information from the incoming pulse train and to maintain frame synchronization regardless of transmission disturbances. If the communications link is noisy, several synchronization pulses are inserted in a frame—usually either in time slots that are equally separated by information pulses (interlace framing) or in consecutive time slots (sequence framing). Two reframing procedures are possible if synchronization is lost.

In an interlace scheme, the system may first lock onto any pulses at the required interlace spacing. While maintaining the spacing between pulses, the system will shift one bit at a time until it locks onto the pulses with the proper framing code. It is also possible to shift by two or more bits if the code format allows all bit positions to be scanned.

In sequence framing, the system may lock onto the required number of pulses—say five pulses. If these pulses do not have the correct framing code, the system resets or locks onto the next five pulses and so on, until it finds the pulses with the proper framing code. One-bit or multiple-bit shifting may also be used.

In 1960, it was found that as the number of synchronization pulses per frame increases, a re-setting-sequence system will reframe faster than

### Asynchronous delta modulator

generates a pulse whenever the difference between the output of the local decoder and the input signal exceeds a predetermined value.

Therefore the pulse output is asynchronous. As waveshapes indicate, the number of pulses decreases when the waveform is not changing rapidly. Because fewer pulses are transmitted, the system is suited for asynchronous multiplexing.

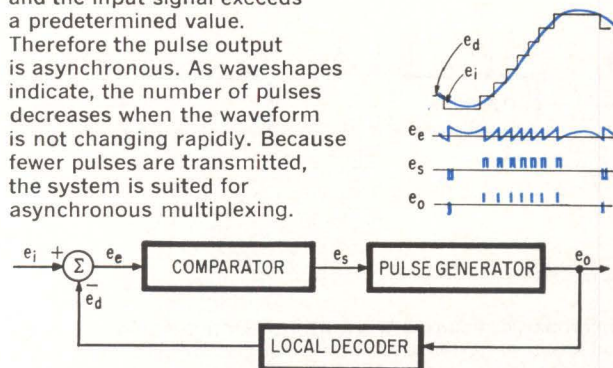



an interlace single-bit shift system. The optimum code pattern for the resetting-sequence mode is a series of bits in which the first and last bit are the same and all the intermediate bits are different. For example, a code word with the sequence 0111110 or 1000001 is suitable. Experiments with a simulator confirm the analysis.<sup>17</sup>

Maintaining synchronization with a minimum number of pulses is desirable because the fewer framing pulses the smaller the bandwidth. A technique that meets this objective was proposed for a time-division multiplexed system that employs either delta modulation or pcm.<sup>18</sup>

The system consists of logic circuits and a delay line with a delay time of one frame length. The circuit includes five main sections—a synchronism pulse extractor, a sync detector, a lost sync detector, an erroneous sync detector and a hunting initiator. The framing sync pulse is extracted by checking all channels in parallel, resulting in fast reframing. Pulse extraction is accomplished by taking the logical multiplication ("AND" operation) of the pulses in successive frames. After several frames, the result of this logical multiplication is "0" for every channel except the framing channel; only the framing pulse circulates in the delay line circuit that is in the sync extractor circuit.

The synchronization detector monitors the delay line circuit and confirms synchronization if only one pulse recirculates. Synchronization may be lost either because of faulty circuit operation or because the framing pulse is lost in the transmission line. The lost-synchronization detector detects this and initiates hunting. Similarly, hunting is also initiated if the system is erroneously synchronized.

Experiments on a simulator indicate that with a 20-bit frame containing one sync bit, frame separation is completed within six frames. With a 40-bit frame containing two sync bits, framing is completed within three frames.

The general characteristics of frame synchronization have also been analyzed.<sup>20,21</sup> Synchronization schemes that utilize information in all the pulses in the frame are superior to those that observe only a part of the frame. If all the pulses are observed, average synchronization time is proportional to the logarithm of the number of channels.<sup>22</sup> If only part of the frame is observed, synchronization times are directly proportional to the number of channels rather than to the logarithm.

### Faster repeaters

High-speed regenerative repeaters will be important in future long-distance communications systems. In areas of high density traffic, it should be economical to modulate signals onto a carrier in the millimeter wavelength region and to transmit the signal through a waveguide system. Because it is difficult to make efficient bandpass filters, frequency-division multiplex techniques would not be practical. Consequently, if the bandwidth is to be efficient, it is necessary to go to high bit rates such as 160-million or 320-million bits per second.

Repeaters will have to regenerate these bits with a minimum of error.

Studies of high-speed pulse regeneration of these high bit rates were made in 1963.<sup>23</sup> The pulses consisted of bursts of an 11 gigahertz oscillator. This 11-Ghz signal simulated the intermediate frequency of a millimeter wave system.

One part of the repeater is a partial amplitude regenerator whose main elements are two silicon diodes, in a wideband detector, and a hybrid junction. Another element is a high-speed timing gate (microwave switch) that uses silver-bonded diodes developed at the Electrical Communications Laboratory of NTT. The diodes have very favorable characteristics for switches that operate in nanoseconds.

A long chain of repeaters was simulated by placing the circuit in a loop that had a 50-nsec delay. Thermal noise and interference signals were added to simulate a practical communications link. Error rates were checked by free-running operation in which the pulses were allowed to circulate in the loop. When the ratio of the peak pulse power to the mean thermal noise power was greater than 22 db, measured error rates were less than  $0.6 \times 10^{-10}$ . The photograph (see below) is an example of 320-megabits per second pulse waveforms that have been detected after numerous regenerations. The pulses show only a small amount of intersymbol interference and the information can be extracted without an error.

### Data and telemetry systems

In many industries the demand for on-line data processing equipment—integrated with the manufacturing process or the system—is stimulating the development of pcm telemetry. In the block diagram (shown on p. 144) is a typical pcm telemetry system used by Japanese electric power utilities. Frame rates are several seconds long and the number of time slots range from 30 to 256. The higher bit rates are for quantities, such as watt-hours or the water level in the reservoir, which require four or five binary coded decimal digits to transmit accurately. Other data—such as current, voltage, power and frequency—is coded in three binary coded

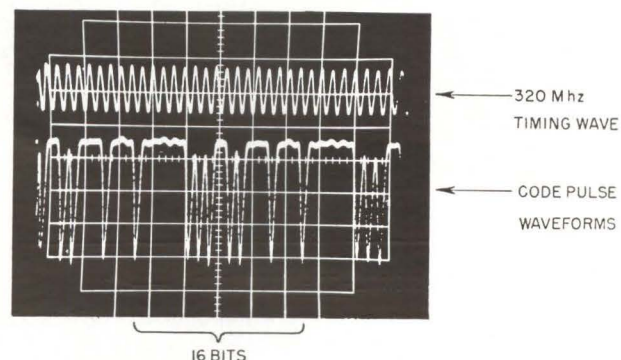

Regenerated pulse-code waveforms produced by a 320-megabit per second repeater circuit. Scope trace shows no loss of information.



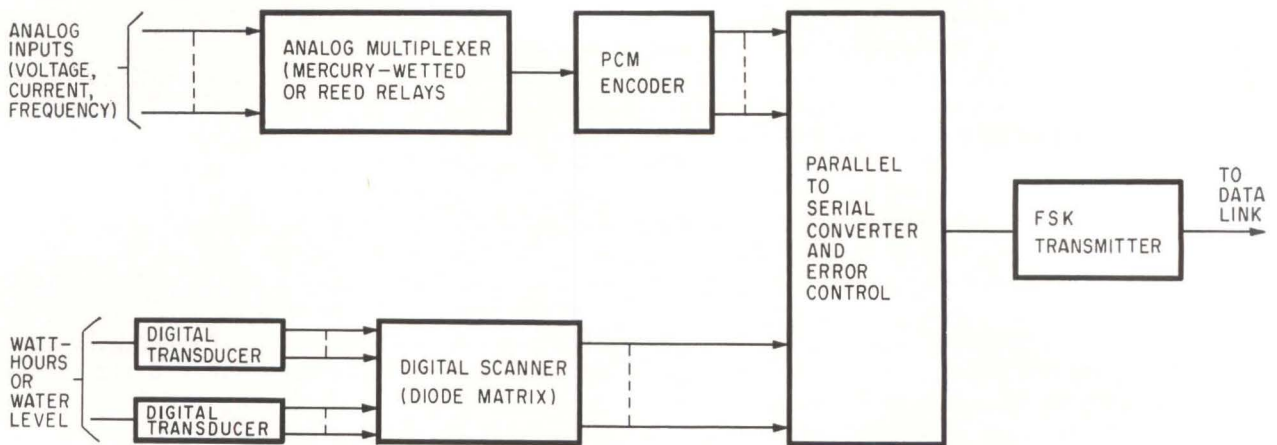

**Pcm telemetry system** gathers data in electric power system. Current, voltage or other signals that can be transmitted in a relatively few bits are time-division multiplexed as analog signals and then converted to pcm. Signals requiring more bits are converted to digital form before multiplexing. The parallel inputs are then brought out in a single line. These pulses frequency-shift key a transmitter and the modulated signal is transmitted. Essentially the reverse process occurs at the receiver.

decimal digits to which error control bits are added. Similar systems have been installed by the Ministry of Construction, gas companies and Japanese National Railways.

Since the data sources are often far apart in some of these systems, it has been proposed that digital data concentrators be added to the system to make the network more efficient. Then all the data could be transmitted at a rate fast enough to permit serial transmission to a central processor.

The Japanese National Railway maintains a pri-

vate microwave and cable network throughout the nation. In combination with a duplicated central processor, this communications link provides a nationwide reservation service [see "Bit by bit, Japan is speeding its communications links," p. 147].

Another example is a 2,000-bit per second data link that electronically controls the Tokaido Super-express train which travels between Tokyo and Osaka at 130 miles per hour. The electric power industries—including the Tokyo Electric Power Co., whose 8,100-megawatt generation capability makes it the world's largest privately owned utility—also maintain their own microwave, cable and power-line carrier networks.

### Space telemetry

A digital telemetry system, known as a pcm-pam (pulse-amplitude modulated) hybrid system, has been proposed for Japanese sounding rockets.<sup>24</sup> The system adds a pam pulse that improves the signal-to-noise characteristics of the received signal. The pulse modulation is the difference between the actual signal level and the voltage equivalent of the 5-bit pcm word; that is, the modulation is proportional to the quantizing error.

The data's signal-to-noise ratio is increased a maximum of 7 db over a pcm word with 6 bits. This improvement occurs when the rocket is at maximum distance from the ground receiver and the carrier signal is at the receiver threshold.

When the input signal is above threshold, the pam pulse is recovered more accurately. As a result as in the diagram at left, the output signal-to-noise ratio increases. Conventional pcm, in contrast, is limited by the quantization noise and therefore does not improve with higher carrier level inputs. The pam-pcm system also shows an improvement over analog transmissions—frequency modulation—represented by the curve marked FM.

The pcm-pam scheme is similar to a pcm system with a pulse-position modulation (ppm) vernier

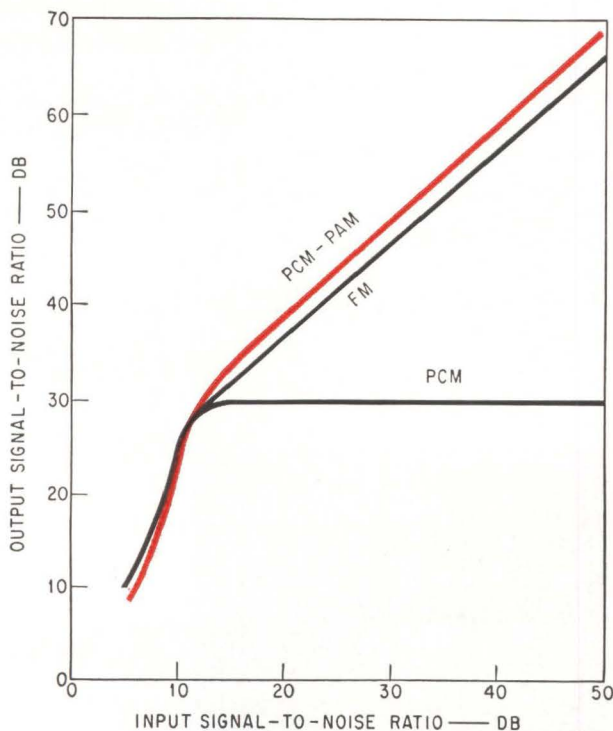

**Comparison** of pcm, pcm-pam and frequency-modulated systems that all occupy the same bandwidth. For pcm-pam and pcm systems each code word consists of 5 bits. Signal-to-noise ratio is markedly higher for pcm-pam system than for pcm. Pcm-pam also has slight improvement over f-m system.



but results in a better signal-to-noise ratio and simpler circuitry. In the ppm technique, noise makes it difficult to determine the exact time of arrival of the ppm signal.

The experimental pcm-pam system has a bit rate of 160 kilobits per second. The sampling rate is 1.25 khz and the number of time slots, including the synchronizing channel, is 16. By using supercommutation—sampling and encoding a signal more than once during a frame—it is possible to increase the sampling rate to 10 khz.

### Integrated pcm system

Japan is making an intensive effort to develop an integrated telephone system which would incorporate switching pcm signals in an exchange. It will consist of pcm central offices having a number of pcm remote line concentrators interconnected by pcm repeated lines. Since such a system would allow many more telephone subscribers to be served by present transmission lines, it is an attractive communications network for Japan—a densely populated nation with large metropolitan districts. For this reason the Electrical Communications Laboratory maintains a large research and development group on pcm integrated systems.

An integrated network is not commercially possible at present with the frequency-division multiplex (fdm) because frequency separation and conversion devices are costly. However, the rapid growth of short-haul, pcm networks, is a good basis for the marriage of the switching and transmission technique. Eliminating recurrent modulation and demodulation processes is one of the major economic advantages of the concept.

In addition to ECL, research in this field is also being conducted at the University of Tokyo and

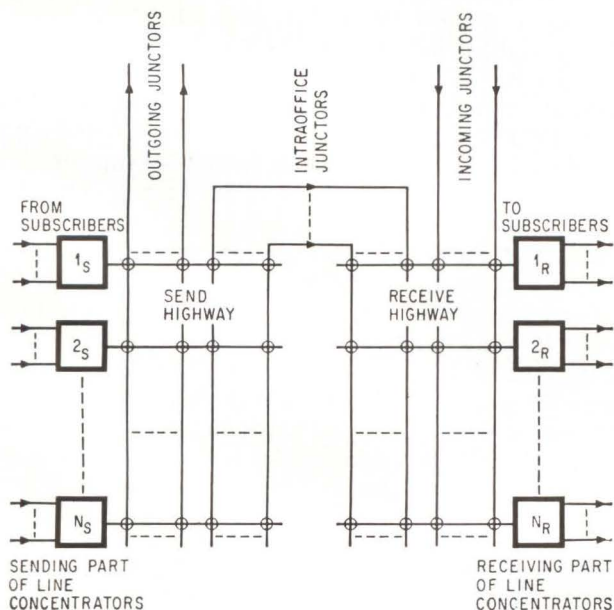

**Essex type, three-stage time-division exchange requires an unused time slot to be simultaneously available at the sending and receiving part of the line concentrators and at the junctors need for switching. As a result, connections are often blocked and exchange is inefficient.**

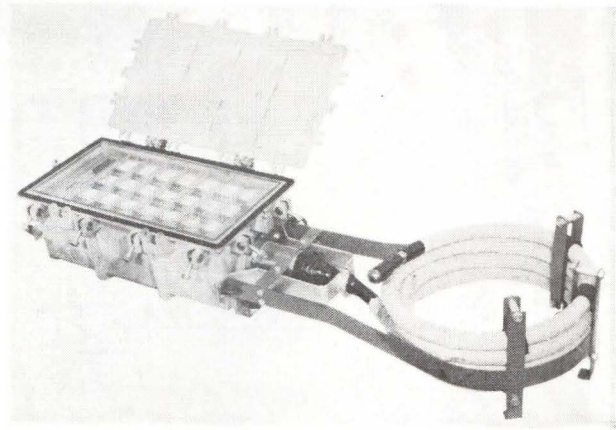

**Repeater housing** for manhole installation contains 21 repeaters to regenerate pcm signals that were attenuated and distorted by transmission line.

by the major telecommunications manufacturers—Nippon Electric, Fujitsu, Hitachi and Oki Electric companies. These manufacturers also produce the majority of the nation's electronic computers and professional quality semiconductor devices; therefore all the developments are coordinated. This is important for a complex system such as the pcm integrated communications system, which has almost every characteristic of a real-time, integrated data-processor.

Another factor favoring an integrated network is the potential capability of integrating speech, visual and data communications. Computer manufacturers are particularly interested because a pcm integrated system may provide superhighways for an enormous flow of data between remotely located data processors. However, there are many problems to be solved before effective integrated systems are practical. Most of the problems are concerned with switching networks and system synchronizing.

### Switching networks

In a nonintegrated network, speech samples are coded and decoded at each exchange; in an integrated network, speech samples pass through in coded form. For efficiency, the integrated exchange must transfer as many coded signals as possible in the time slots that are available.

When discussing an integrated exchange, time slots refer to the intervals during which the exchange can transfer a coded voice sample. For example, conventional pcm with serial pulses in 24 channels would correspond to 24 time slots per frame. Efficiency can then be defined as the ratio of the number of incoming channels per frame to the number of time slots per frame.

A prototype integrated exchange developed by Bell Telephone Laboratories is the experimental Essex exchange, represented in the diagram at the left. In it, a connection between a calling and called party was established only if an unused time slot was simultaneously available in three places: at the line from the sending concentrators, at the pairs of junctors that are needed for switch-



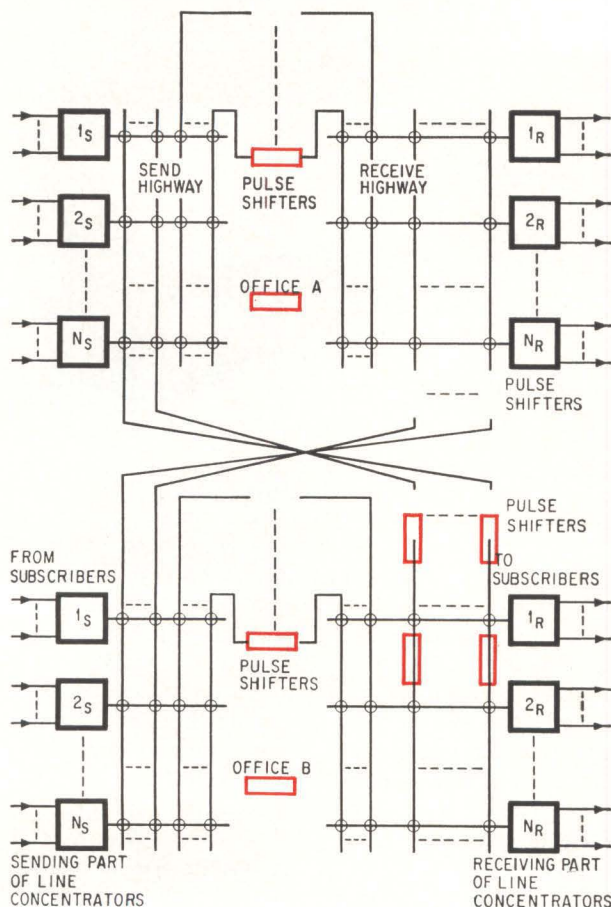

Exchange arbitrarily assigns time slots, thus reducing blocking and increasing efficiency. Pulse shifters, color, at the junctors store the incoming signal until a time slot is available on desired line. The diagram represents two offices.

ing and at the line to the receiving concentrators.

Since the input words are time-division multiplexed, all these elements are also time-division multiplexed; they may not be simultaneously available even though each may be idle at some time during the frame. When time slots are not simultaneously available (in phase), the connection is blocked.

To prevent excessive blocking in a three-stage, time-division exchange such as Essex, the efficiency of the exchange is deliberately kept below a certain limit. For example, if the blocking probability is to be less than 1%, the efficiency of a network with 24 time slots is limited to 50%.

However, efficiency can be increased if the number of time slots per frame is increased. Consequently in 1960, it was proposed to increase the number of time slots by transmitting the code words in parallel rather than in serial form.<sup>25,26</sup> Instead of the conventional serial pcm stream, the 8-bit words are transmitted in parallel through eight lines. Without increasing the clock rate (1.544 Mhz), this parallel technique increases the number of time slots to 192 per frame.

Another important concept is interchanging time slots so that information is transferred even if the

time slots are not in phase.<sup>27</sup> In this technique, incoming pulses are stored in delay devices, which may be called pulse shifters, and interchanged whenever a time slot is available. In this way arbitrary time slots may be assigned to the calling and called subscriber and blocking may be reduced or eliminated. Each device has a total delay of one frame period and provides a range of outputs that are delayed one time slot from each other.

The diagram at the left is a proposal for a time-division switching network that includes pulse shifters at all the junctors.<sup>28</sup> For a blocking probability of less than 1%, the efficiency of a network with 24 time slots is increased to about 60%.

It has been found that similar improvement is obtained by installing pulse shifters on some, but not all, of the junctors and using the junctors with pulse shifters as alternate routes.<sup>29</sup> The use of additional junctor stages (four or five) with pulse shifters increases the efficiency of the network up to 80%. In 1961, an experimental exchange demonstrated the feasibility of the time slot interchange principle.<sup>30</sup>

### System synchronization

In an integrated communications system, the clock frequency of each pcm office should be in synchronism; also each interoffice delay should be adjusted to an integral multiple of the frame period. If these conditions are satisfied, the time slots of all the pcm lines are precisely in time phase.

The traditional forced-synchronization scheme in which the offices are controlled by a master office through a hierarchical structure is apparently unrealistic. Such a system gets very complicated when it is necessary to protect the network against a possible failure in the master office.

An independent synchronization technique was proposed in 1964, in which each office maintains a very stable clock source.<sup>31</sup> Minor errors in clock frequencies are adjusted during pauses in speech so that speech information is seldom lost.

In 1964, it was proposed to establish frequency synchronism by mutual interaction of all clock sources in the system.<sup>32</sup> The clock source at each office would be a multiple-input, phase-locked oscillator. The entire system can operate at a single frequency. In comparison to other synchronism schemes, system parameters fluctuate less and there is less chance of partial failures.

A method for phase synchronization has also been proposed and the feasibility demonstrated by an experimental simulator involving three offices.<sup>33</sup> Research and development efforts on mutual synchronization are also being carried out at ECL, Oki Electric and other companies.

### References

1. Electrical Communication Laboratory Technical Journal, Vol. 14, Sept., 1965.
2. D. Kumagai, S. Matsuda, Y. Kurahashi and T. Araya, "The PCM-24 System for Short-Haul Telephone Transmission," 6th Colloquium of Electrical Communication Laboratory, Oct., 1965.
3. Special Issue of PCM, NEC (a technical house organ published by Nippon Electric Co.), No. 73, Nov., 1965.



4. T. Osatake, M. Akiyama and K. Kirisawa, "Ternary PCM Transmission on Orthogonal Waves," to be published in the Journal of the Institute of Electrical Communications Engineers of Japan (JIECEJ).
5. M. Akiyama, "Orthogonal PCM Transmission with Weighted Bit Length," JIECEJ, Vol. 49, June, 1966, pp. 1,153-1,159.
6. Y. Taki and M. Hadori, "PCM Communication System Using Hadamard Transformation," JIECEJ, Vol. 49, Nov., 1966.
7. H. Kaneko and T. Sekimoto, "Logarithmic PCM Encoding Without Diode Combandor," Transactions of the IEEE, SC-11, 3, Sept., 1963, pp. 296-307.
8. Y. Ohashi and Y. Katagiri, "Weighted Hyperbolic Encoder," JIECEJ, Vol. 48, March, 1965, pp. 410-417.
9. M. Kawashima, T. Higeta, S. Hinoshita, Y. Minejima, G. Kakehi and S. Sasaki, "Composite Hyperbolic Coders," JIECEJ, Vol. 48, June, 1965, pp. 1,063-1,072.
10. Y. Tanaka, K. Yamashita and S. Hosokawa, "Instantaneous Companding for PCM and Delta PCM," JIECEJ, Vol. 46, Jan., 1963, pp. 17-22.
11. K. Nitadori, "Statistical Analysis of Delta-PCM," JIECEJ, Vol. 48, Feb., 1965, pp. 192-199.
12. H. Fujisaki, K. Kato and H. Kobayashi, "Evaluation of Non-linear Quantization Characteristics in PCM Transmission of Speech," JIECEJ, Vol. 49, Nov., 1966.
13. H. Inose, Y. Yasuda and J. Murakami, "A Communication System by Code Modulation Delta Sigma Modulation," Proceedings of the IEEE, Vol. 51, Nov., 1963, pp. 1,524-1,535.
14. H. Inose, Y. Yasuda and H. Takano, "Video Transmission by Delta Sigma Modulation," Proceedings of the International Telemetering Conference, London, Vol. 1, 1963, p. 307.
15. A. Tomozawa and H. Kaneko, "Improvement of Delta Modulation by Syllabic Companding," JIECEJ, Vol. 49, Nov., 1966.
16. H. Inose, T. Aoki and K. Watanabe, "Asynchronous Delta Modulation," JIECEJ, Vol. 49, March, 1966, pp. 401-408.
17. Y. Nakamaru and H. Kaneko, "Synchronization System for Digital Transmission," JIECEJ, Vol. 43, Dec., 1960, p. 1,388.
18. H. Inose, M. Takagi and T. Aoki, "A Method of Synchronization in Time-Division Multiplexed Delta Modulation System," JIECEJ, Vol. 46, June, 1963, pp. 785-794.
19. H. Inose, M. Takagi and A. Imazu, "A Method of Group Synchronization in Digital Information Transmission," JIECEJ, Vol. 48, Aug., 1965, pp. 1,384-1,394.
20. O. Shimbo, "A Mathematical Analysis on Pulse Signal Synchronization," JIECEJ, Vol. 48, June, 1965, pp. 1,099-1,107.
21. O. Shimbo, "On Synchronization of PCM Communication Systems," JIECEJ, Vol. 48, June, 1965, pp. 1,108-1,116.
22. K. Nitadori, "Statistical Methods of Group Synchronization," JIECEJ, Vol. 48, Oct., 1965, pp. 1,691-1,698.
23. K. Miyauch and O. Ueda, "Experiments on High Speed Pulse Regeneration in 11-Gc Region," JIECEJ, Vol. 46, June, 1963, pp. 806-814.
24. T. Nomura and Y. Yasuda, "A PCM-PAM Hybrid Telemetry System," Proceedings of the 1964 National Telemetering Conference, paper 5-5.
25. T. Osatake and M. Akiyama, "Coded Pulses Parallel Transmission with Particular Reference to Telephone Switching," JIECEJ, Vol. 43, June, 1960, pp. 719-724.
26. T. Osatake, M. Akiyama, S. Takaba, N. Shirato and K. Kirisawa, "An Experimental Electronic Switching System on a Basis of Coded Pulse Parallel Transmission," JIECEJ, Vol. 4, Oct., 1963, pp. 1,402-1,409.
27. H. Inose, Y. Yoshida, Y. Yasuda and Z. Koono, "A Time Slot Interchange System in Time-Division Electronic Exchanges," JIECEJ, Vol. 46, March, 1963, pp. 283-290.
28. H. Inose and T. Saito, "Three Stage Time-Division Switching Networks with Time Slot Interchange Capability," JIECEJ, Vol. 49, March, 1966, pp. 409-417.
29. H. Inose and T. Saito, "Three-Stage Time-Division Switching Network with Pulse-Shifting Junctor as Alternate Route," JIECEJ, Vol. 49, Dec., 1966.
30. H. Inose, Y. Yasuda, Y. Kawai and M. Takagi, "Subscriber-Line Circuit for an Experimental Exchange System Featuring Delta Modulation Techniques," JIECEJ, Vol. 44, Sept., 1961, pp. 1,322-1,328.
31. T. Osatake, M. Akiyama and M. Nishizawa, "Repeater for Pulse Code Modulation Systems in Independent Synchronization," JIECEJ, Vol. 47, Feb., 1964, pp. 210-219.
32. H. Inose, H. Fujisaki and T. Saito, "Theory on Mutually Synchronized Systems," JIECEJ, Vol. 49, 4, April, 1966, pp. 755-762.
33. H. Inose, H. Fujisaki and T. Saito, "System Design of a Mutually Synchronized System," JIECEJ, Vol. 49, Nov., 1966.

Japanese technology

## Bit by bit, Japan is speeding its data communications links

Computers, like people, require fast, accurate communications to get along with each other and Japan is developing transmission techniques to squeeze over 100 telegraphic signals onto a voice-grade line

By Mitsuru Yokoi, Shigehiro Hirasawa and Yoshiyuki Mima

Nippon Telegraph and Telephone Public Corp., Tokyo

If speed and accuracy are the keys to new techniques of data communications, then Japan is well on the way to becoming keeper of the gate. Faster data communications links, new methods to control accuracy and more channels to transmit data are being developed in Japan to keep up with the

nation's rapidly increasing computer installations.

Japan now ranks third in computer installations, behind the United States and West Germany, and its economic boom and labor shortage are pressing computers into service in many diverse fields. Computers are recording railroad reservations and con-



trolling rail traffic, they are keeping records in banks and utilities and the machines are aiding the government's employment services.

As the volume of data communications mounts communications companies are seeking ways to increase the capacity of transmission lines by stepping up the transmission speed and the capacity of terminal equipment. Present facilities of the Nippon Telegraph and Telephone Public Corp. (NTT) can transmit data between any two locations at rates up to 1,200 bits per second. This is adequate for present demands but is only considered a first step. Among the systems being tested is one to transmit up to 6,000 bits of data a second over a single voice line—a new technique for submarine cable communications called Rectiplex. The system is too costly to use with conventional land lines but in-

tegrated circuits may make that possible too. Production of integrated circuits for third-generation computer is picking up speed as part of an engineering effort that has given Japan a thriving computer industry.<sup>1,2</sup>

Still another facet of the communications progress in Japan is the development of new and more efficient forms of pulse-code modulation. This work, described in the article that begins on page 134, has as its goal a unified communications and switching network that will be able to handle digital data at high speed, as well as voice and video transmission.

Studies of data transmission and error detection and correction began in the early 1950's and led to the standardization, in 1963, of a data-transmission equipment for 200-baud and 1,200-baud leased

### Data transmission networks in Japan<sup>1</sup>

User	Number of Channels <sup>2</sup>			Main Computer	Applications
	50	200	1,200		
	(bits per second)				
Ministry of Labor <sup>3</sup> .....	276	9	8	Facom 230-50	Employment research
Japanese National Railways <sup>4</sup> .....	210			MARS-101	Seat reservation
				MARS-102	
Kinki Nippon Railway Co.....	18			NEAC 2203	Seat reservation
Central Cooperative Bank for Agriculture and Forestry.....	47		4	Facom 230-30	Exchange control
Fuji Bank, Ltd.....		14		IBM 1440	Current deposit
Shizuoka Bank, Ltd.....		31		IBM 1440	Exchange control
Fuji Photo Film Co.....		14		IBM 1440	Inventory
Japan Air Lines Co.....	37			NAEC 2230	Seat reservation
Nikko Securities Co.....	152			Facom 323	Stock brokerage
Tokai Bank, Ltd.....	227			Hitac 3030	Exchange control
Hachijuni Bank, Ltd.....	44			Facom 230-30 <sup>5</sup>	Exchange control
Daishowa Paper Mfg. Co.....		4		IBM 1440	Inventory
All Nippon Airways Co.....	99			Hitac 3030	Seat reservation
Okamura Manufacturing Co.....		21	2	IBM 360-40	Inventory
Sumitomo Bank Ltd.....	310		65	NCR 315	Current deposit
Heiwasogo Bank Ltd.....		9		NAEC 2200	
				IBM 360-20	Current deposit
Tokyo Kogyo Co.....		13		IBM 360	Inventory
Tokyo Sangyo Shinyo Bank.....		17		IBM 360	Loan control
Mitsubishi Shoji Kaisha, Ltd.....	14	21	2	GE Data net 30	Inventory
Sanwa Bank, Ltd.....	250		2	Hitac 4010	Exchange control
National Broadcasting Association in Japan		50		.....	
Local Bankers' Association <sup>5</sup> .....	31	25		Facom 230-50	Exchange control
Japan Monopoly Corp.....	200		10	.....	
Yachiyo Bank, Ltd.....			8	NCR 315	Current deposit
Daiichi Bank, Ltd.....			100	IBM 360-50	Current deposit
Fuji Bank, Ltd.....			110	Univac 418	Current deposit
Kinki Nippon Tourist Corp.....			2	Univac 418	Seat reservation
Kawasaki Steel Corp.....			4	Univac 494	Inventory
<b>Total.....</b>	<b>1,912</b>	<b>228</b>	<b>317</b>		

1. The table includes several systems now under installation and not yet in operation.

2. More than 600 channels in point-to-point off-line data-transmission service are not included in the table.

3. This system will expand to about 620 channels before the end of the year.

4. JNR uses its own data transmission lines; all others use services supplied by NTT.

5. This system's computer is the property of NTT, and marks NTT's advance into a new service.



lines. (These lines are permanent connections between two terminals, as contrasted with ordinary switched telephone lines that are routed to their destinations through exchanges.)

### Data transmission today

In the second half of 1962 NTT began investigating data transmission over switched telephone networks. Data transmission service over these lines will probably begin soon. One problem with such service is that no time charge is made on local telephone calls in Japan. This isn't a problem with voice messages because most people will converse only for limited times. But machines transmitting data could tie up a line for days at the price of one 5-minute telephone call.

The higher-speed services have by no means made obsolete the older 50-baud data transmission circuits whose primary application is in private message services. At present more than six hundred 50-baud point-to-point data transmission circuits are in service in Japan—about 8% of the total number of private telegraph circuits. These systems generally use the same equipment as ordinary telegraph facilities, including line transmitters, reperforators and telegraphic carrier systems. Some systems include error detecting and correcting equipment. Customers install terminal equipment, transmitters and reperforators in their offices, as authorized by NTT. The service is called first regular-class private-circuit service.

The 200-baud and 1,200-baud circuits are called second regular-class and third regular-class private-circuit services respectively. Demand for these services, now occupying only a few channels, is growing rapidly; in another year about 500 channels of 200-baud service and 150 channels of 1,200-baud service should be in operation on point-to-point circuits.

Of course, these data transmission systems serve not only for point-to-point transmission but also for the central-computer on-line network services shown in the table on the preceding page.

Although data communications in Japan is still in its infancy, several significant systems are now in use, including railway and airline seat reservation systems, a government employment center, and a centralized railway traffic control system.

### Reserving a seat

One of the leaders in data communications has been Japanese National Railways, Japan's government-owned backbone railway system. The Railway Communications Committee of JNR began studies in 1956 to improve communications on then existing lines and to pave the way for even better communications on planned high-speed lines. From these studies JNR's large-scale seat reservation systems, MARS 101 and MARS 102, have arisen. Smaller-scale reservations systems have been installed by Kinki Nippon Railway Co., a private regional railways system, by Japan Air Lines Co. and by All-Nippon Airways Co.

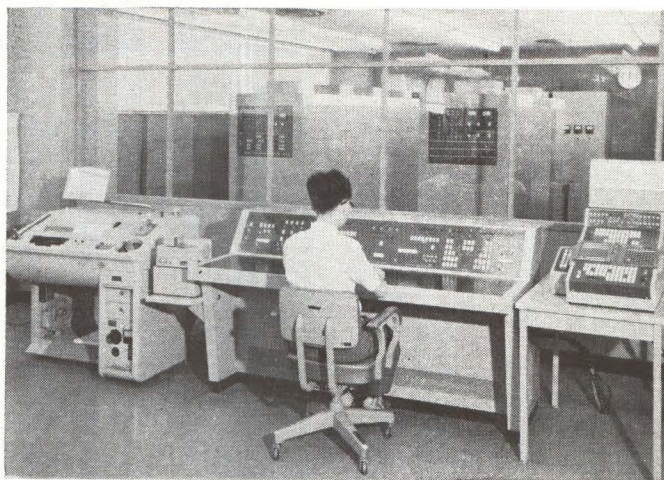

Central computer installation for JNR's seat reservation system.

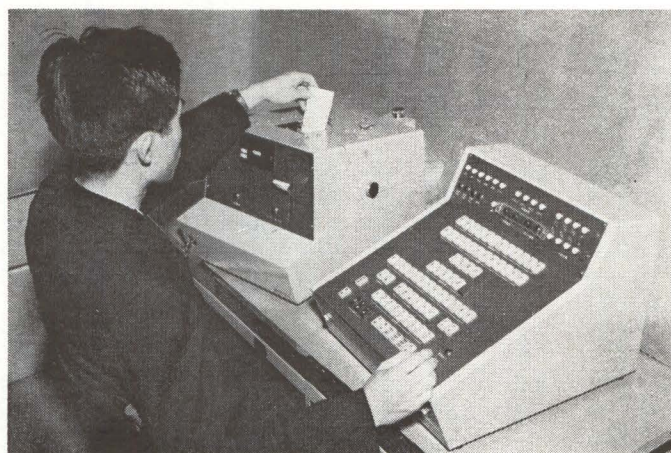

Agent set that connects the local JNR ticket office with the central computer system for reserving seats in railroad trains.

The computer systems in JNR's central reservation office in Tokyo can process 1.4 million seats each week [see block diagram on next page and photos above]. Some 467 agent sets, or consoles, are the remote input-output terminals to the central processors, which are five Hitac 3030 computers built by Hitachi, Ltd. Each agent, through his set, requests the desired number of seats, train name, date and class of travel, and specifies the stations of origin and destination. The processor searches its bulk memory, containing 16,000 words in magnetic cores and 32-million words on magnetic drums, for the requested seats; if space is available the agent's console prints out tickets while the passenger waits. Total elapsed time is about 26 seconds. With the former manual system, waiting time averaged about 2 minutes and was frequently much longer during busy periods.

### Train control

On the new Tokaido line of the Japanese National Railways between Tokyo and Osaka, a centralized traffic control system supervises all trains [see block diagram, bottom p. 150]. The positions of each train and the condition of the route are



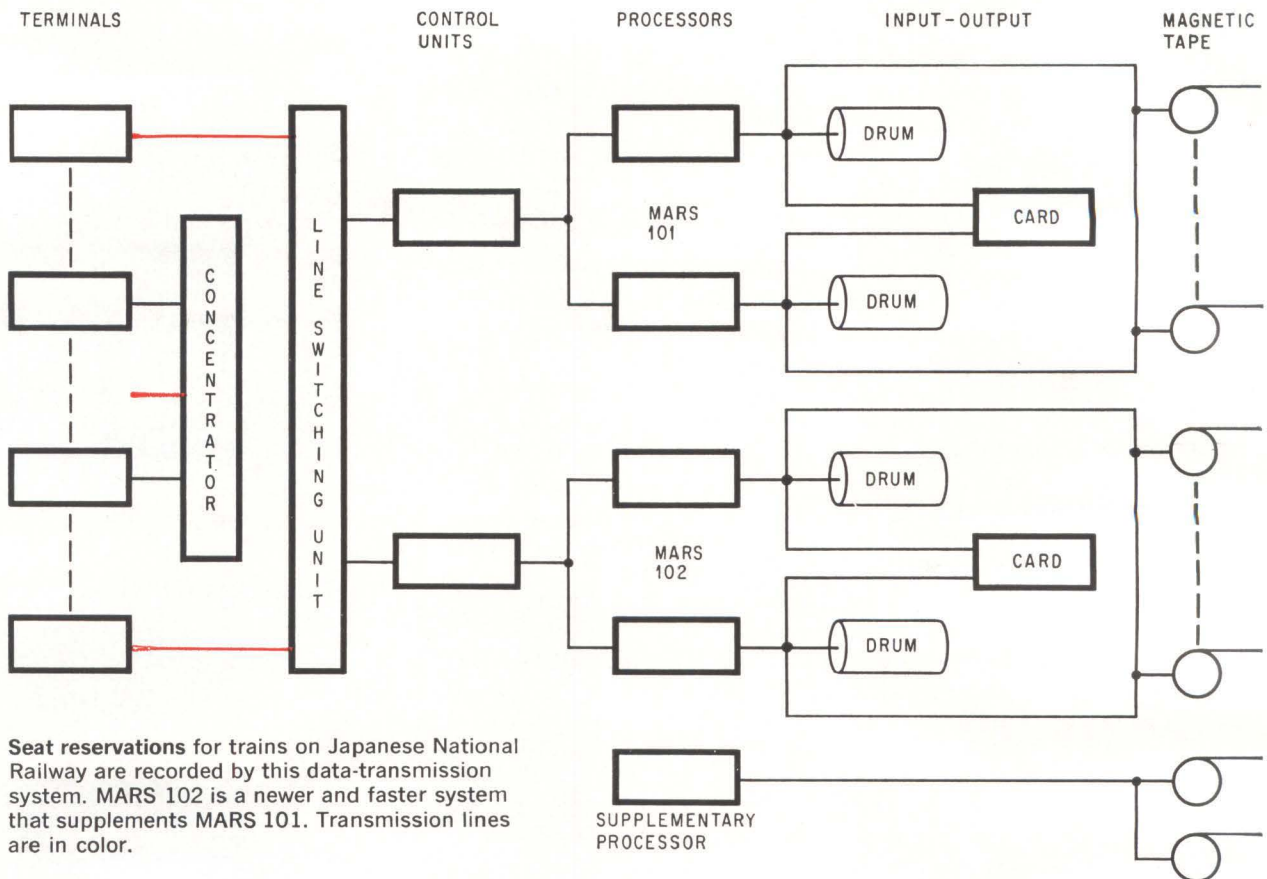

transmitted to the computer at the control center. A pencil-size coaxial cable with a capacity of 300 circuits installed between Tokyo and Osaka—a distance of 515.5 kilometers—transmits the coded data.

Coils are installed between the rails of the track on each side of every station; these coils pick up a signal from the passing train that indicates the number of the train. The signal is a 200-kilohertz carrier, modulated by five of 11 frequencies between 1.125 and 2.115 khz, and provides up to 462 different train identities. It is coupled inductively from a coil on the train to a coil on the track. The track coil relays the signal to a control terminal at the station, where it is decoded and retransmitted by cable to the central control center at 2,000 bits

per second. The control center determines from these signals when each train enters and leaves each station and how many trains are in a particular section between stations. Using this information, the center controls the speed of the trains, commands them to start and stop and sets track switches. In emergencies, the control center can communicate with the train by radio, again through the local control terminal.

The centralized traffic control system was installed on the new Tokaido line in 1965. Similar systems are scheduled for installation on other JNR lines in the near future.

Centralized traffic control should not be confused with automatic train control, another feature of trains on the new Tokaido line. Automatic train

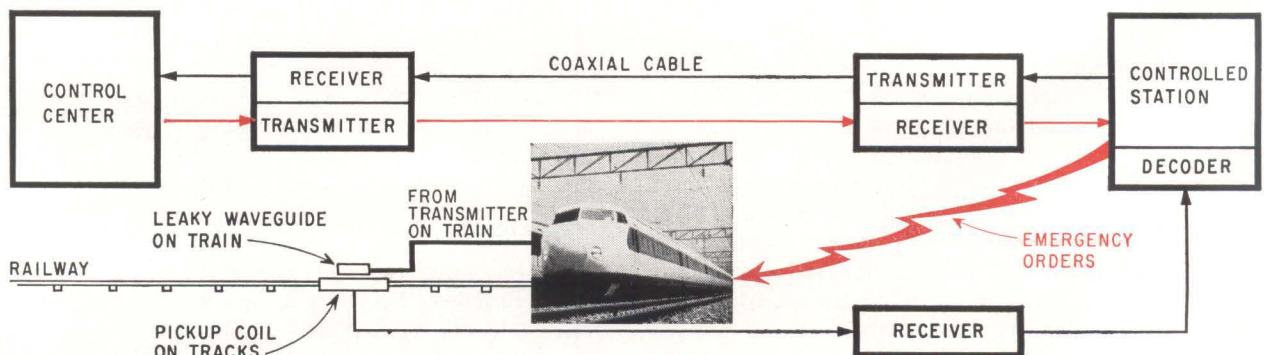



control prevents collisions between trains; it does not involve data communications.

### Labor and money

Banks and securities companies began the second round of data communications applications in the early 1960's. Other industries and government agencies followed their example, using data communications for various applications like inventory control and placement services.

The Labor Market Center was established in July, 1964, in the Ministry of Labor, to streamline employment security administration, to promote labor mobility and to foster a modern labor market as an integral part of the active employment policy.

The Labor Center's data processing equipment [photo, p. 152] is a Fujitsu Facom 230-50 electronic computer and communication control unit. The Prefectural Employment Security Offices record, on paper tape, data on jobs available and jobs wanted and various reports on unemployment insurance. The data is then transmitted at 50 bauds to the line concentrator at the prefectural office, then to the time-division multiplexer at the relay station and finally to the Labor Market Center at 1,200 bauds [see block diagram p. 152].

The central exchange equipment at the Labor Center classifies the data according to destination. All data addressed to the center is recorded on magnetic tapes for processing by the computer. This is a store-and-forward exchange, typical of systems in which signaling speed is slower than computer input-output speed. Data or messages addressed to other prefectural offices are transmitted immediately to these offices without being recorded on magnetic tapes. The electronic computer sorts, computes and collates the data recorded on the magnetic tape for permanent storage or for retransmission to the prefectural office through the central exchange's equipment.

### Transmission circuits

Although Japan has the usual problems connected with transmitting data over telephone lines, fortunately most telephone circuits in the small island nation are new and of high quality. The majority of the older circuits were destroyed during World War 2 and the circuits were rebuilt with nationwide expansion of the network in mind. The number of subscribers has been growing very rapidly in recent years.

To keep the error rate low and to standardize signals for compatibility, NTT usually supplies its subscribers with all equipment needed for first, second or third regular class data transmission.

Sometimes, however, NTT supplies only the modem (modulator-demodulator), the signal converter that connects a telephone transmission line with terminal equipment. The customer provides his other equipment under authorization from NTT. Since the modem should match the transmission line, NTT provides no data transmission lines without modems. Four standard modems are now avail-

### NTT's data transmission services

Circuits	Remarks
<b>Leased circuits</b>	<b>Private use</b>
Local line (two-wire or four-wire circuits)	Up to 1,200 bits/sec.
Toll line	
First regular class	Up to 50 bits/sec.
Second regular class	Up to 200 bits/sec.
Third regular class	Up to 1,200 bits/sec.
Wideband circuit	See note 1.
<b>Switched circuit</b>	
Telex	50 bauds only
Telephone circuit	
Semileased circuit	See note 2
Ordinary switched telephone circuit	See note 3
<b>Dedicated network service</b>	See note 4

- Note: 1) Bandwidth is 48 khz; the service is available to government agencies and enterprises. This is not a high-speed transmission system, but a telephone group of 12 voice-band channels leased as a single unit.  
 2) For private use over distant direct dialing telephone network.  
 3) Undergoing field trial and not yet generally available.  
 4) Will go into service in 1968 as a private network for a group of customers.

able, differing principally in their line frequencies.

Error rates indicate data transmission quality and are a realistic measure of how well the system and transmission network match. With NTT modems, error rates on nonswitched circuits range from 10 to 30 bits per million in telegraph circuits at 50 bauds, and 1 to 5 bits per million in 200-baud and 1,200-baud circuits. The error rate may be greater in switched telephone circuits because of the numerous exchanges through which a signal may pass. In this case the rate is specified in blocks, because error-detecting equipment causes the retransmission of entire blocks whether they contain one or 100 errors. The average block error rate on switched telephone circuits is less than 5 blocks per 1,000 for a block length of 60 characters each with 10 elements.

Modems whose data signaling rates are 2,400 bits per second on voice-band circuits have been developed cooperatively by NTT and communications equipment manufacturers and are now undergoing field tests. Commercial application may follow in the near future. Modems for 3,600 and 4,800 bits per second are now under development in the laboratory and may eventually see service. The most technologically advanced unit on the market is the Rectiplex system, developed by Fujitsu Ltd. and the Kokusai Denshin Denwa Co., Japan's overseas cable and communications system. Its speed is almost 6,000 bits per second over voice-band circuits—an information capacity five times



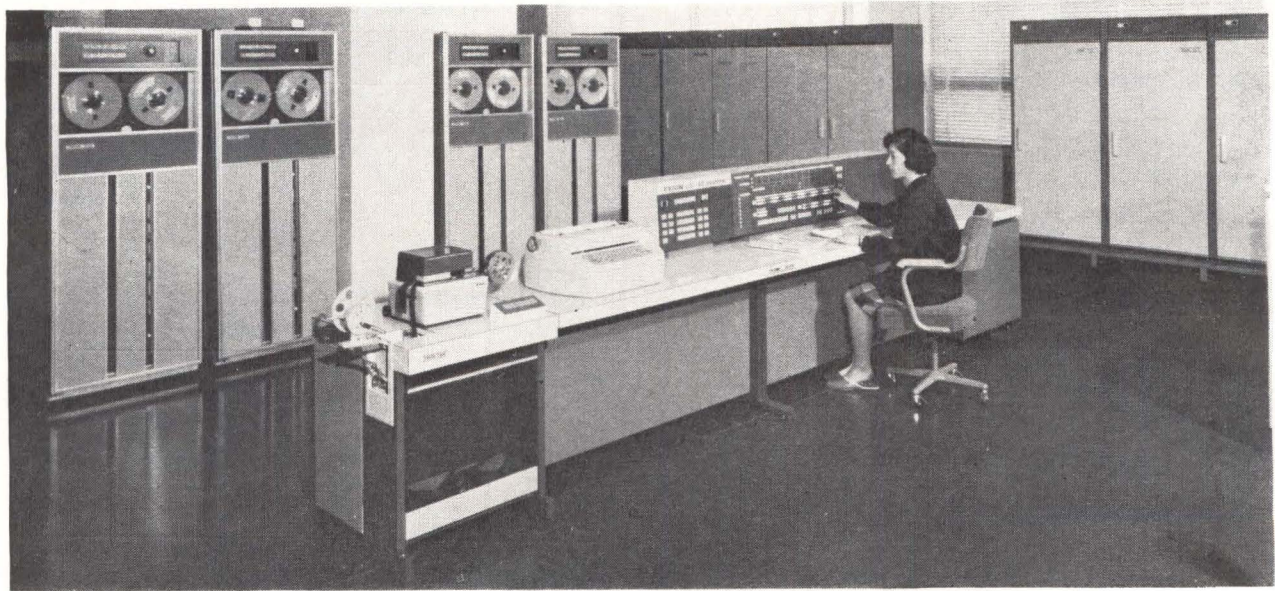

Labor Market Center's computer system links local labor offices with central bureau.

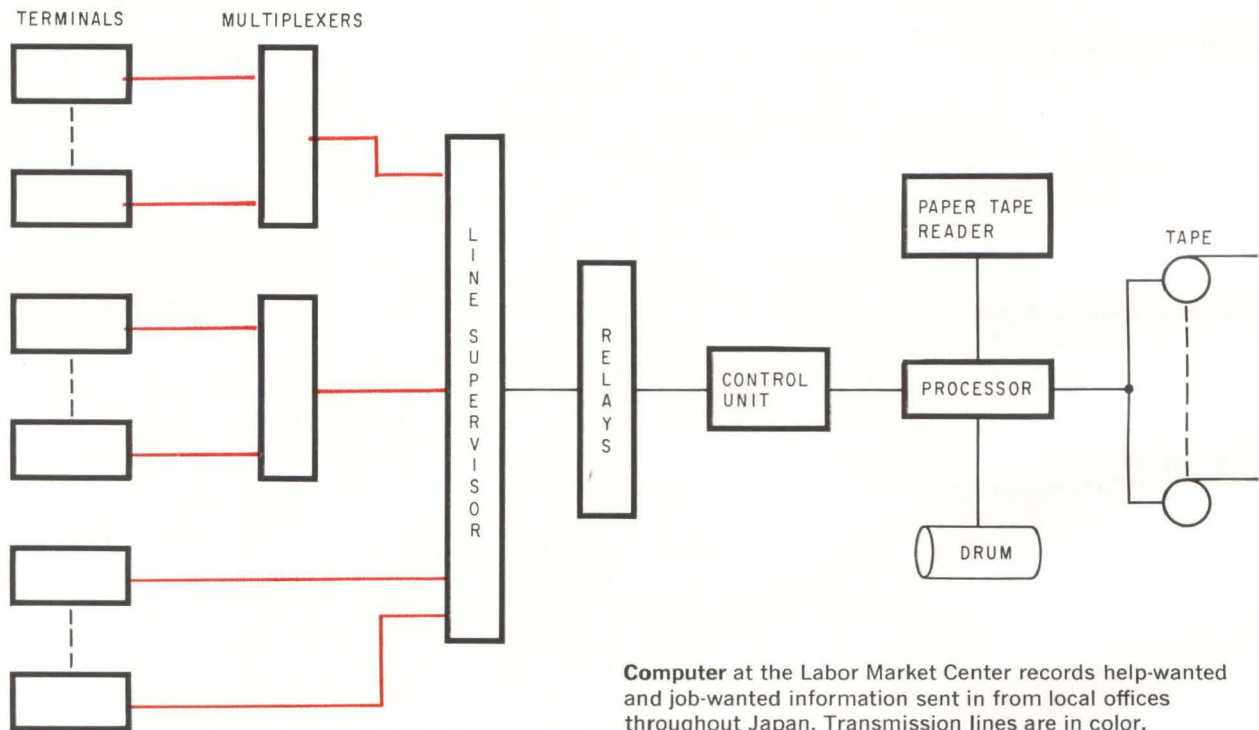

Computer at the Labor Market Center records help-wanted and job-wanted information sent in from local offices throughout Japan. Transmission lines are in color.

that of the simplest pulse-modulation circuits. Capacity equals 108 telegraph channels operating at 50 bits per second.

Tests of the Rectiplex system between Tokyo and San Francisco have been excellent. However, the highly efficient terminal equipment is very expensive—costing more than an additional overland transmission line. But the system is much cheaper than additional submarine cables for international communications.

The system has 18 carrier frequencies, ranging from 540 hertz to 2,580 hz at 120 hz intervals, for data transmission. Each carrier handles six chan-

nels. A 19th carrier, at 2,820 hertz, transmits a synchronizing signal for automatic phase-control circuits. Differential phase modulation of the individual carriers provides excellent performance with respect to noise and line interruption. Rectiplex increases the signal rate in two ways:

- First, it combines three input channels into one without increasing the modulation rate.

- Second, each of the three inputs has twice the signal rate of ordinary 50-baud channels because two such lines are combined with conventional time-division multiplexing.

Therefore the total capacity of a single carrier



in the Rectiplex system is six times the standard 50-baud line. Eighteen carriers handle a total of 108 lines.

### Data transmission equipment

Several kinds of equipment are available for data processing applications. Data transmission equipment is usually identified by a code that denotes the transmission rate; for example, series 200 data transmission terminals are designed for 200-baud data transmission.

A widely used data transmission terminal is the DT-51. It transmits and receives binary information on punched paper tape, detects errors and automatically retransmits incorrect blocks. Data input and output are on six-hole or eight-hole paper tape. The equipment can simultaneously transmit in both directions over 50-baud telegraph or telephone circuits.

A block-check method detects errors. At the receiving end, each block of 60 characters is checked for errors. When errors from transmission faults are detected, a cancel character is punched after the block to show that an error is present and the receiving terminal automatically requests the transmitter to retransmit that block.

The DT-202 data transmission terminal can handle 200 bits per second, and the DT-1202 terminal is designed for 1,200 bits per second data transmission. These terminals have photoelectric six-hole or eight-hole tape readers, asynchronous tape perforators and electronic transmission controllers. The tape reader is the input and the perforator is the output. The transmission controller is installed between the modem and the tape reader or perforator and controls both the reader and perforator. The controller also detects and corrects errors due to faulty equipment as well as transmission.

The tape reader sends a character in parallel to the transmission controller, which converts the parallel signal into serial form, adds start and stop elements to each character and sends the character in serial to the modem. Each serial character is composed of 10 pulses; dummy pulses are inserted when six-hole paper tape is the data source.

### Line switching

The DT-10 line-switching control equipment comprises an automatic calling unit, a line-connecting unit and a control unit. Data transmission terminals read the address codes punched on paper tape and transfer it to the control unit. When the code addresses a terminal station on a switched network, the automatic calling unit "dials" the receiving terminal. When the address is that of a terminal station on a point-to-point line, the line-connecting unit connects the addressed line to the data transmission equipment. Then the line is extended from the line-switching equipment to the data-transmission equipment, which reads the punched paper tapes and transmits the data until it finds the next address code.

The DT-20 communication control equipment

### Baud, bits and hertz

A binary digit—a bit—can have only two values, 0 or 1; therefore a bit can be represented on a transmission line by the presence or absence of a unipolar pulse at a specified time. Sometimes more complex waveforms are used to improve transmission characteristics [see page 137]. However, basically the shorter the pulse's duration, the higher the information transfer rate.

If  $\tau$  is the pulse duration in seconds, then the modulation rate is  $1/\tau$ , as in the diagram below. Modulation rate is measured in bauds, named after the French originator of the 5-bit teletype code, Emile Baudot. Numerically, the modulation rate in bauds equals the number of binary pulses transmitted per second.

A signal modulated at B bauds has a fundamental frequency and minimum bandwidth of  $B/2$  hertz. Transmission of both sidebands in an amplitude-modulated system requires a bandwidth of B hertz.

Recent data transmission systems have more complex transmission parameters; for example, a single pulse may not be a pure binary quantity, and the transmission system may have several parallel channels to carry data. For a system of this type, the data signaling rate is:

$$S = \sum_{i=1}^p \frac{1}{\tau_i} \log_2 m_i$$

where  $p$  = the number of channels;  $\tau_i$  = unit duration in the  $i$ -th channel in seconds; and  $m_i$  = number of possible values of the  $i$ -th channel pulse.

If  $m_i = 2$ , then the channel is binary, and  $1/\tau$  is properly measured in bauds.

The baud concept dates back to telegraphy and telegraph line ratings. Today, ratings are expressed more meaningfully in terms of the system using the transmission line; so that data transfer rate in bits per second is often used instead of the modulation rate in bauds.

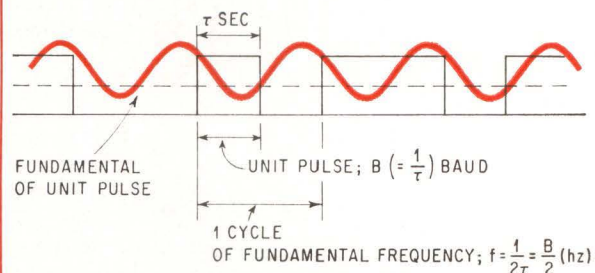

**Modulation rate in bauds** is essentially the same as signaling rate in bits per second and is half the equivalent frequency in hertz.

can perform remote data collection, storing batched input data in a central processing unit. It addresses and transmits to terminals any data that is queued in the central processing unit.

It is designed for concurrent use of switched and nonswitched networks and controls message traffic from various types of communication terminals. Its automatic calling unit enables the central processing unit to call any number in the network.

The new DT-2 tape-controlled teleprinter [lower



## Rectiplex system shifts phase for high bit capacity

To modulate three binary channels onto one carrier, the Rectiplex system shifts the phase of the carrier by some multiple of  $45^\circ$  depending on the state of the binary inputs. These binary inputs may have any one of eight possible combinations, corresponding to the eight possible  $45^\circ$  shifts in a single cycle. The phase for a particular signal combination is established relative to the phase of the preceding signal; the system therefore employs differential phase modulation, as contrasted with some systems that shift the phase relative to an absolute phase.

Conventional carrier telegraph systems also modulate only one binary channel onto a carrier; but if more than two states of the carrier are possible, multiple channels can be transmitted simultaneously.

Differential phase modulation has been studied in Japan for about a quarter of a century, but has not been used because of the difficulty of demodulating phase-modulated signals. Efficient methods have been recently developed for demodulation and for automatic phase control, and electronic components have been improved; the Rectiplex system then became feasible for high-cost data links such as the transpacific cable.

The relation between the combinations of signal polarity and the amount of phase shift from the preceding element is shown in the vector diagram below. How phase

ELEMENT NO.	m-1	m	m+1	m+2	m+3	m+4	m+5	m+6
CH 1		1	1	0	0	0	1	1
CH 2		0	1	0	0	1	0	1
CH 3		1	0	0	1	1	0	1

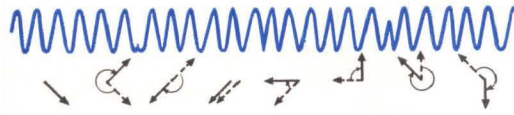

Typical string of bits on three channels shows the corresponding phase shift for each combination of three. The resulting waveform is shown in color.

shift affects a typical series of bits on three channels, and the resulting waveforms are shown above.

**Phase demodulation.** To demodulate the signal the phase difference of an element is compared with the preceding element. The principle of demodulation is shown at right. The automatic phase control circuit is actually similar to the carrier oscillator at the transmitter. It is synchronized with the transmitter by the 19th carrier mentioned on page 152. It drives a differential phase modulator that modulates a signal and compares it with the received signal. The difference between the phases of the incoming signal and the local phase modulator produces a demodulated output.

In the top diagram part of the demodulated output feeds back through a delay to the local phase modulator. The delay permits a signal element to be compared with the preceding element in the phase detector. In the bottom diagram the delay is applied to the entire demodulated output instead of just to the portion fed to the local modulator.

Four demodulating circuits demultiplex the three channels on one carrier. The phases of the reference signals of each demodulator differ by  $45^\circ$ . The vectors indicated by broken lines [top, left, page 155] are the four reference signals. The demodulated outputs of two channels are obtained by comparing the input signal with the reference phase signals  $R_1$  and  $R_2$  respectively. The demodulated output of the third channel is obtained by comparing it with both  $R_{3a}$  and  $R_{3b}$ , and taking the exclusive OR of the result—that is, the

output is a binary "1" if the  $R_{3a}$  or the  $R_{3b}$  output is 1, but not both. If both are 1 or both 0, the output is 0.

**Channel filtering.** In conventional frequency-division multiplex systems, a bandpass filter separates the various channels. Consequently the characteristics of the system depend on the characteristics of the filter. The Rectiplex system contains no bandpass filter. The filtering function is performed by

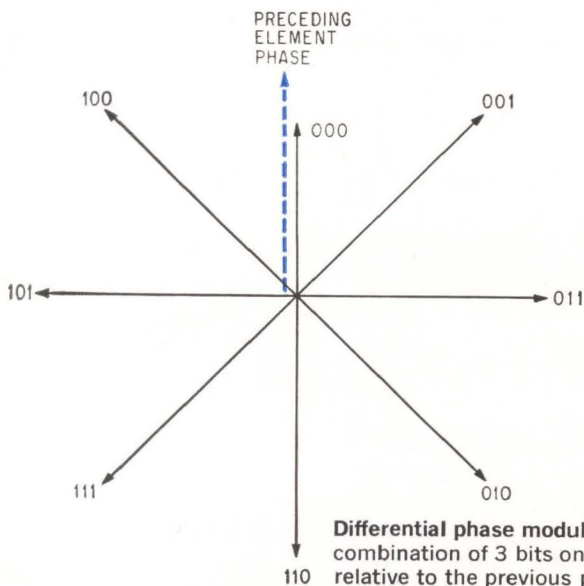

Differential phase modulation shifts the phase for each combination of 3 bits on three independent channels, relative to the previous phase, shown in color. Thus the combination of three zeros (000) repeated over and over causes no phase shift; the combination 001, if repeated, causes successive phase shifts of  $-45^\circ$ .

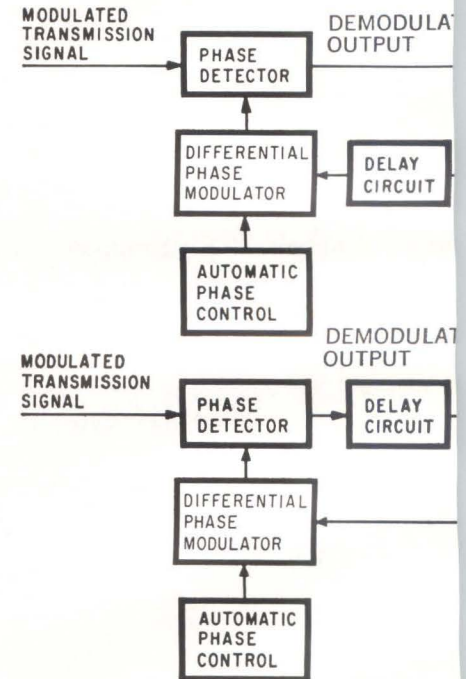

Demodulation of a differential phase modulated signal requires each element to be delayed for comparison with the following element. The demodulator's output may be connected either before or after the delay.

an integrator with a reset function, enabling efficient demodulation and utilizing the active channel bandwidth.

The carrier frequency for each of the 18 channels is allocated at intervals of 120 hertz. These multiple signals are sent together to the phase detector. Then the desired signal for any given refer-



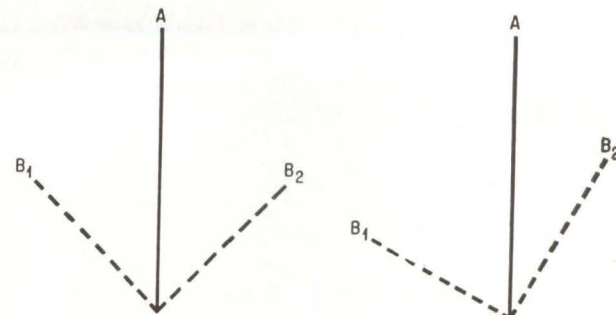
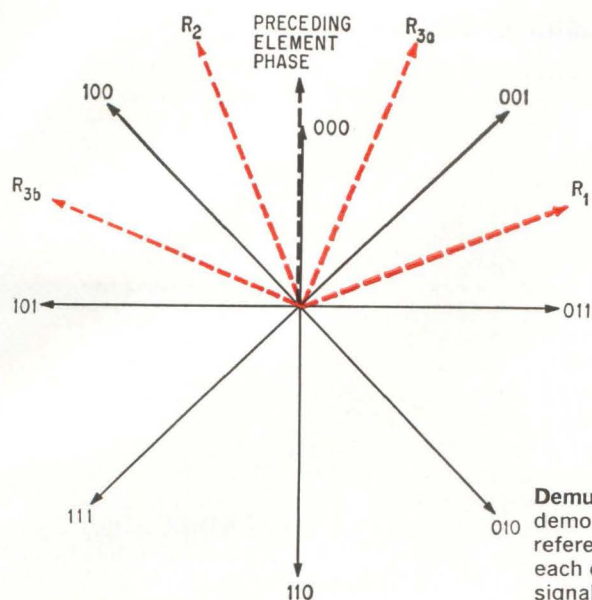

Reference signals are maintained in proper phase for demultiplexing by comparing them with the phase of a data signal that should be equally out of phase with two references.

Demultiplexing the three channels carried by the demodulated signal requires comparison with four reference signals (color) displaced in phase  $45^\circ$  from each other and  $22\frac{1}{2}^\circ$  from the possible phases of the signal.

ence is obtained as a d-c component from the phase detector, but those of the adjacent channel show up as a-c components with frequency differences of 120 hertz. These a-c components are integrated out. No influence of the adjacent channels appears at the integrator output and only the demodulated output of the desired channel is obtained.

**Automatic phase control.** The demodulating carrier producing the reference signal is regenerated from the modulated signal by the automatic phase control (APC) circuit. The demodulating carrier must have the same frequency and phase as the modulating carrier at the transmitter. In order to obtain the signal, the APC circuit supplied for all demodulating circuits maintains the demodulating carrier in normal condition.

Signal A [at right above] coming in on one of 18 carriers is phase-detected by the reference signals  $B_1$  and  $B_2$ , which differ in phase. The two d-c outputs of the detector are compared. Normally the two d-c outputs are equal. If they become unequal, the phase of  $B_1$  and  $B_2$  can be altered to equalize the two d-c outputs, bringing the phase of signals  $B_1$  and  $B_2$  into the proper relation to signal A.

As described previously, the most recently received element (corresponding to a bit in a binary system) modulated the reference signal and is compared with the next element. The phase difference between the last received element and the next element identifies the next element. But in the Rectiplex

system's demodulating circuit there are four reference signals [above, left] and eight possible last elements on each carrier, corresponding to the eight combinations of bits on three channels. Any one of these eight defines two of the four references that are  $\pm 67.5^\circ$  or  $\pm 112.5^\circ$  out of phase with the last element [table below]. These two references give two differences. The references are adjusted so that the two phase differences are equal at all times, thereby maintaining the demodulating carrier at a constant phase.

**Demodulation.** To synchronize the demodulating circuit with the modulating one, a synchronous signal is transmitted by means of phase reversal modulation of the 19th carrier. This form of modulation generates several upper and lower sidebands. Narrow bandpass filters in the receiver separate the first upper and lower sidebands from which a ring modulator de-

rives the beat frequency components—the sum and difference of the two sideband frequencies. The difference frequency is filtered and shaped, and becomes the demodulating clock pulse.

**Time-division.** The Rectiplex system transmits six independent signals by phase modulation on a single carrier frequency. These signals are brought together in pairs by a time-division multiplex circuit that also synchronizes the signals, which otherwise have no common timing reference.

The incoming signals arrive on 50-baud lines; the multiplexer interweaves two of these into one 96-baud signal containing the characters from the two channels alternately. Three 96-baud signals are then phase-modulated onto one carrier. A demultiplexer following the demodulator at the receiving end separates the incoming signal into two parts for output on 50-baud lines.

Modulated signal	Amount of phase shift	Selected signal
000	$0^\circ$	$R_1, R_{3b}$
001	$-45^\circ$	$R_{3b}, R_2$
011	$-90^\circ$	$R_2, R_{3a}$
010	$-135^\circ$	$R_{3a}, R_1$
110	$-180^\circ$	$R_1, R_{3b}$
111	$-225^\circ$	$R_{3b}, R_2$
101	$-270^\circ$	$R_2, R_{3a}$
100	$-315^\circ$	$R_{3a}, R_1$



right photo, p. 157] is an off-line unit that can read paper tape and edge cards, and punch paper tape. It uses the 7-bit coded character set for information processing interchange, as proposed by the International Organization for Standardization (iso) and other associated international organizations. In Japan, domestic communications are usually in the Japanese national character syllabary called katakana but all international traffic uses the Roman alphabet. Both of these are permitted with the iso and both, plus graphic characters up to a total of 192 characters, are available on the PR-2.

The code includes two special characters called shift-in and shift-out. The new teleprinter interprets code characters following the shift-out character as outside the standard code table. Katakana characters are printed until a shift-in character is received, then other characters are printed.

The keyboard and printing mechanisms are quite different from those of older tape-controlled teleprinters that use 6-bit coded characters on 50-baud transmission circuits; however, the PR-2 is almost identical with previous teleprinters from the operator's viewpoint.

A faster-on-line teleprinter now being developed prints 1,200 characters per minute received over a 200-baud transmission line. Its mechanism differs from both the PR-2 and older teleprinters.

Two pulse motors make the character selection mechanism relatively simple. Both motors operate at the same time, so that the time to position each character is less than 36 milliseconds. Actual printing time is less than 10 msec per character. The transmission time for a 10-bit character is 50 msec. The maximum time needed for carriage return is 500 msec, so that no data can be transmitted for ½ second following each carriage return character sent over the transmission line.

### Special terminal equipment

Several interesting types of special data terminal equipment have been developed in Japan for customer-owned business machines.

A data terminal developed by Nippon Electric Co. detects errors and, if necessary, retransmits an entire block of data so that only clear data appears on the output tape. The terminal is a remote input-output terminal connected to a computer by a telegraph or telephone circuit. To maintain clear data, a magnetostrictive delay-line buffer stores data in both the receiver and transmitter. Incoming information is stored in the memory until the acknowledge signal is received, and then the memory controls punching of the paper tape. If a negative acknowledge signal is received, the message in the memory is discarded and the block is retransmitted.

The terminal can be operated by relatively unskilled personnel. It comprises a transmission controller, tape reader, tape punch, card reader, card punch and teleprinter.

A new and unusual sprocket magnetic tape transport was designed by Oki Electric Industry Co. for data storage or conversion of signaling speed

## Checking for errors

Data-transmission equipment can include hardware to protect against disturbances that are likely to occur on any transmission line, such as interruptions and impulsive noises. These disturbances cause bursts of errors in received data; that is, a group of successive pulses is more likely to be lost or obscured than is a single pulse.

Because errors occur in bursts, any error in a block of data is considered to invalidate the entire block, which is then retransmitted as a whole. This mode of correcting errors, sometimes called block checking, is more efficient in data transmission systems than individual character checking.

Nippon Telegraph and Telephone Public Corp.'s equipment checks each block's accuracy in two ways: a vertical parity check and a longitudinal modulo-four check. Each character normally comprises seven bits and one parity bit, defined so that each character contains an even number of 1 bits. In the vertical parity check, if a character in a block is received with an odd number of 1 bits, the entire block is retransmitted.

Each of the eight parallel data channels in a block undergoes the modulo-four check. The 1 bits are counted by fours at the transmitter and the receiver, both discarding all carries. After the block is completed the transmitter sends its count and the receiver compares the two counts. If the counts do not match for all eight channels, the receiver punches a cancel character in the paper tape at the end of the block and the entire block is retransmitted.

Field trials made by NTT scientists in 1959 proved the reliability of block checking, which is based on work begun in 1951 by Zenichi Kiyasu. These tests and other work justified the present standard of 200 and 1,200 bauds for data transmission, in addition to the older 50-baud telegraphic standard.

Unfortunately the cancel mark is behind the erroneous data, not before it. For some applications this is only slightly inconvenient, because all the correct information is available and any erroneous information is marked. In off-line computer transmission the computer can store data as it comes in and discard blocks that contain errors. For on-line applications, where the presence of erroneous data may be intolerable, NTT and its manufacturers are developing a paper tape punch described at the left that does not punch erroneous data.

in high-speed data transmission circuits. A sprocket controls the tape motion in the same manner as ordinary paper tape, character by character, either forward or backward. The maximum reading and writing speed is 1,500 characters per minute. One reel of tape holds up to 140,000 characters.

Parallel transmission, rather than the conventional serial transmission, can be a useful function in some data-gathering applications. A study of parallel transmission equipment is being conducted by NTT to reduce terminal equipment cost.

The D-600 prototype equipment designed under this project to read paper tape transmits data



## New Japanese terminal equipment

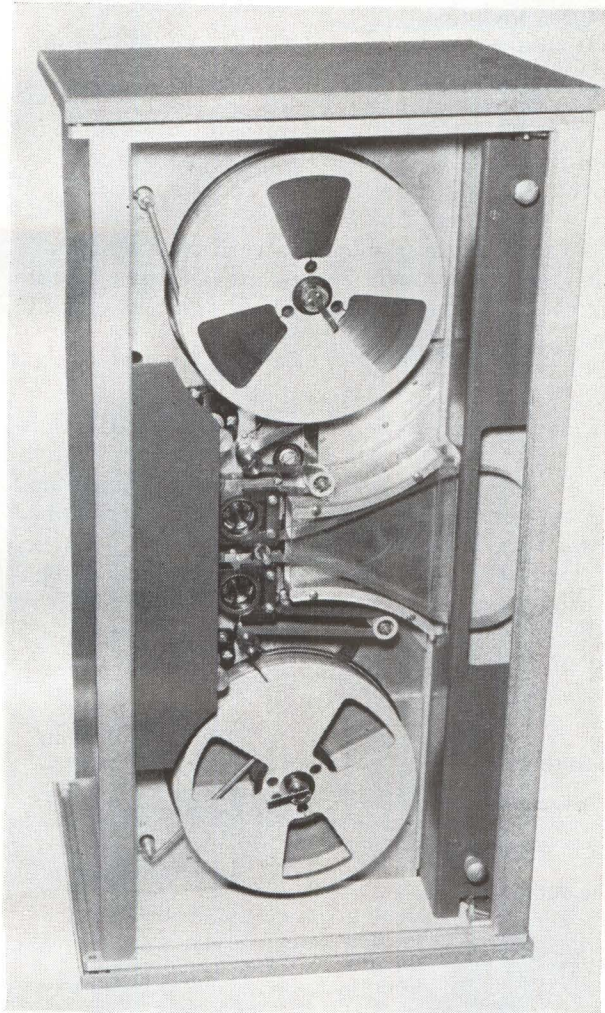

**Sprocket magnetic tape handler** reads magnetic tape in much the same way that similar machines read paper tape. It stores data or converts signaling speed.

**Tape-controlled teleprinter** is shown with an associated data tape reader at right. The machine can print data read from tape or edge-notched cards. It prints both Roman and Japanese characters.

in parallel format over switched telephone networks at 600 bits per second. A total of 10 channels are used. Eight channels correspond to the eight parallel information bits in standard eight-hole punched paper tape. The ninth and tenth channels transmit control signals, one in each direction.

Compatibility with the data processing speed of computers and the information transfer rates of input-output equipment peripheral to computers require wideband modems. A 42,000-bit-per-second wideband modem, one approach for 48-kilohertz transmission lines, has been developed at NTT's Electrical Communication Laboratory, using phase modulation techniques. The modem accepts data at arbitrary rates up to the maximum simply by setting an adjuster. The input data is converted in a series of phase shifts of the carrier, either  $0^\circ$ ,  $90^\circ$ ,  $180^\circ$  or  $270^\circ$  with respect to the preceding signal element carrier phase. The modem processes

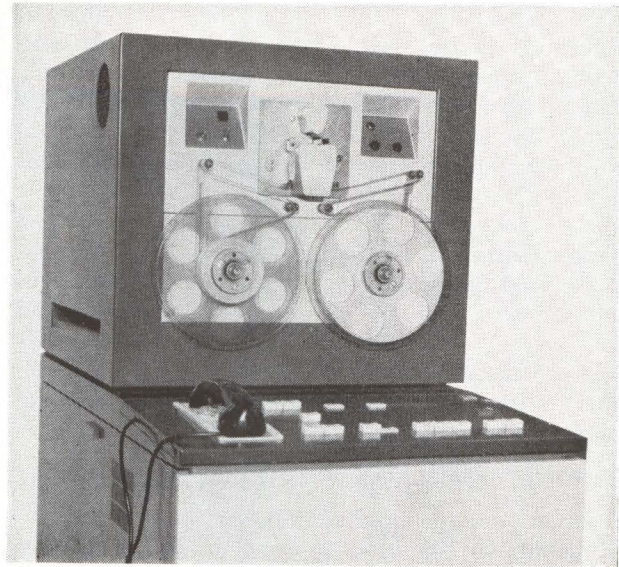

**Parallel data transmission unit** reads standard eight-hole paper tape and transmits the data in parallel over eight telephone lines. Two more telephone lines transmit control signals between the transmitter and receiver. This unit is a prototype.



bits in pairs; each of the four possible pairs of binary digits—00, 01, 11, and 10—generates a signal embodying one of the four possible carrier phase shifts. This is a quaternary phase modulation technique somewhat similar to the differential phase modulation technique in the Rectiplex.

A timing regeneration circuit keeps the timing clock in phase when no phase shift is received for a long time. The receiver has a crystal oscillator whose frequency is controlled by the received carrier only when phase variation is detected. During bursts of constant phase or short interruptions, the timing clock is regenerated by the oscillator of the receiver alone.

Another quaternary phase modulation system employs phase shifts of  $45^\circ$ ,  $135^\circ$ ,  $225^\circ$  or  $315^\circ$ , so that a phase shift occurs even for a steady burst of pairs of zeros, simplifying synchronization. The signal-to-noise ratio is the same for either method;



however, the second system is really a type of eight-phase modulation and requires logic circuits to determine phase shift. Moreover, the carrier frequency must be fixed and the modulated carrier bandwidth must be wider to regenerate the timing signal. The receiver for the modem employs synchronous detection, in which a logic circuit and two modulators identify pairs of bits and deliver them serially to the receiver data output circuit under control of a timing signal.

For two years, the NTT laboratory has been conducting series of point-to-point data transmission tests over 48-khz bandwidth lines. The modem has performed satisfactorily and will soon become available as the standard modem for wide-band data-transmission service.

### Research, development and the future

Japan's data communications services will expand tremendously soon, as more channels of greater length become available operating at higher speed and as entirely new services are offered.

Complete data communications services, including electronic computers, will be supplied by NTT—not only data transmission services. The decision to do so was based on NTT's long experience with direct distance-dialing networks. The first customer for NTT's computer services is the Local Banker's Association, which requires nation-wide communications for the exchange of drafts.

Research is continuing in other applications including remote processing systems, process control systems, information retrieval systems, open-to-the-public computers on communications networks. The demand for these services during the next five years will require an estimated tenfold increase in the capital investment for necessary equipment. Because of the magnitude of the investment, many organizations are cooperating on the needed research; these include the computer centers at several universities, the Electrotechnical Laboratory of the Ministry of International Trade and Industry, the Electrical Communication Laboratory of NTT and laboratories of several electronics firms.

The largest single research project now under way is development of a giant time-sharing computer for a nationwide data-communications network. Engineering knowhow from the leading electronics research organizations in Japan is being integrated in this government-sponsored project and the budget during the five years allocated to research, developing software and debugging is expected to reach about \$37 million.

In addition to the central and terminal equipment for the network, NTT and the communications equipment manufacturers have many problems in establishing more efficient data transmission systems. These problems include:

- Finding the best transmission medium for multiple and public-access computer services. Choices include coaxial cable, microwave, wave-guide or light beam transmission.

- Determining how to use telephone networks

most effectively for data communications. The alternatives include applying existing frequency-division multiplex telephone networks to data transmission, using pulse-code-modulation electronic switching systems jointly for telephone service and for data communication or establishing separate high-performance networks for data transmission.

- Developing new terminal equipment with a lower cost-to-performance ratio.

To solve these problems, a variety of computers, communication mode controllers, modems, remote data terminals, transmission lines and networks are being developed and studied.

In the more distant future, Japan will probably develop an integrated communication network, with an electronic switching system, in which transmission paths concurrently operate for telephone, telegraph and data-transmission. Such an integrated network could offer the cheapest service for public customers, because of multiple use and flexibility of facilities. To assure compatibility among data-transmission and data-processing equipment from different manufacturers, international standards will be prepared to define the operating features and technical specifications.

### References

1. Katsuhiko Noda, "Success story; Japanese originals," *Electronics*, June 27, 1966, p. 93.
2. *Electronics*, "Onward and upward," Oct. 3, 1966, p. 257.

### The authors



Mitsuru Yokoi is a staff engineer in the data communications engineering group at NTT. He has a doctorate from Hokkaido University and has been with NTT since 1948.



Shigehiro Hirasawa is a staff engineer for data transmission at NTT. He joined the company in 1951 and has worked on a telecommunications system for the National Defense Ministry.



Yoshiyuki Mima is a staff engineer for information processing at NTT. He has been studying telephone switching systems for the company since 1950.

Reprints of this report are available. Use the reader service card at the back of this issue.  
© copyright 1966, *Electronics* © A McGraw-Hill Publication



# we're not saying conventional shift registers are old hat...

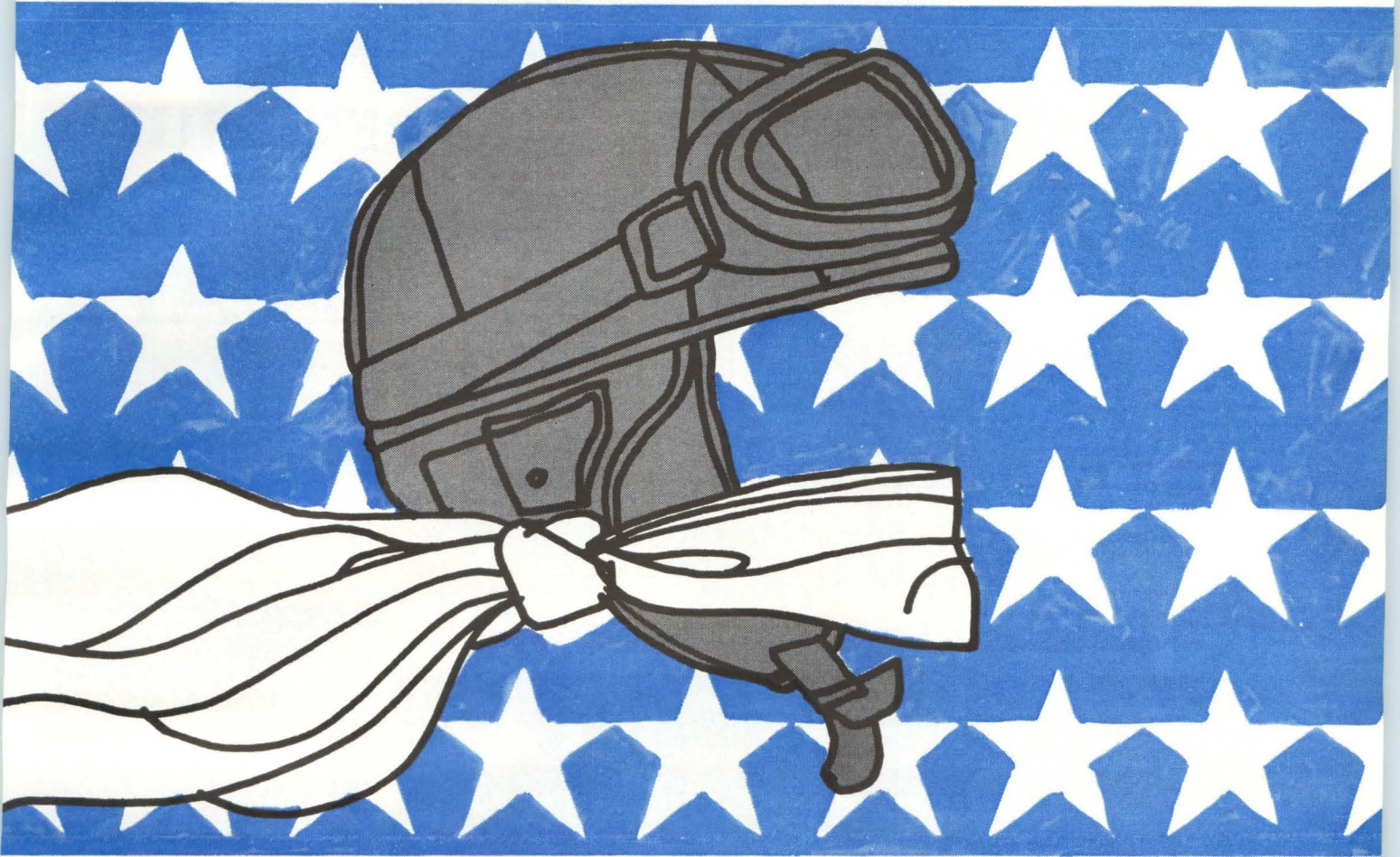

## but, you will!

(AMELCO'S NEW 20-BIT SHIFT REGISTER IN A SINGLE MEMA\* PACKAGE)

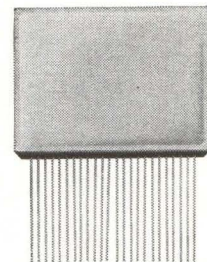

If exceptionally high packaging density, low cost, and high reliability are important considerations to you, consider the many advantages of Amelco's new Shift Register in a MEMA. The MEMA (Micro-Electronic Modular Assembly) is a hermetically sealed package offering the following advantages  275 Monolithic Circuits per cubic inch  Reduced testing and assembly cost both at the component and system level  Improved reliability as a result of reduced interconnection wiring.

The Shift Register itself is assembled using Amelco's

dual TTL Logic elements. It provides  Serial or Parallel Input and Output  1.0 MHz Clock Rate  Low Power Dissipation (190 mW for the 20 bit register).

Two types are now available — 20 bit Shift Register, Type 5551BM — 16 bit Shift Register, Type 5552BM — and the MEMA's great flexibility will be used for additional standard and custom circuits.

So don't take our word that other packages are old hat. Find out for yourself.

## AMELCO SEMICONDUCTOR

DIVISION OF TELEDYNE, INC. • 1300 TERRA BELLA AVENUE • MOUNTAIN VIEW, CALIFORNIA • Mail Address: P. O. Box 1030, Mountain View, California • Phone: (415) 968-9241 / TWX: (415) 969-9112 / Telex: 34-8416 • REGIONAL OFFICES: Southwest — Suite 213, 8621 Bellanca Ave., Los Angeles, California 90045, (213) 678-3146 • Northwest — 1300 Terra Bella Ave., Mountain View, California, (415) 968-9241 East — P. O. Box 2091, Paterson, New Jersey 07509, (201) 696-4747; P. O. Box 366, Kimberton, Pennsylvania, (215) 885-1755 • Northeast — 543 High Street, Westwood, Massachusetts, (617) 326-6600 • Southeast — 711 Magnolia Avenue, Orlando, Florida, (305) 423-5833 • Midwest — 650 West Algonquin Road, Des Plaines, Illinois, (312) 439-3250; 3020 Woodlark Lane, St. Paul, Minnesota, (612) 646-1161 • Canada — Deskin Sales, Montreal, Quebec, (514) 384-1420.

Circle 159 on reader service card



# Keystone Thermistors

...very much  
part of the picture  
for Jerrold CATV

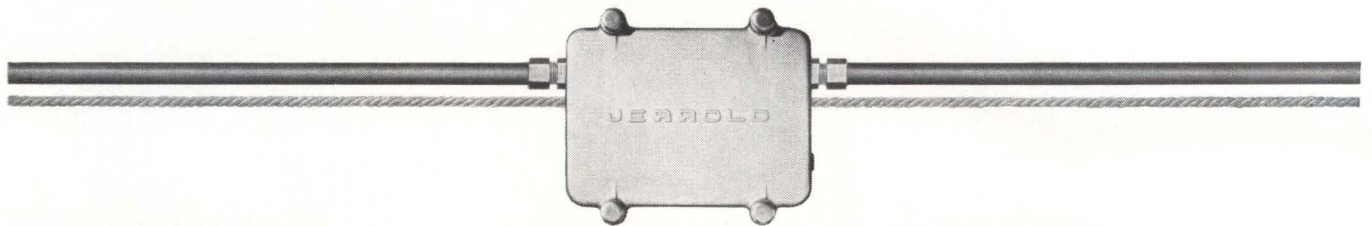

An essential element in the constant picture quality provided by Jerrold Electronics Corporation's Starline all-band solid state CATV

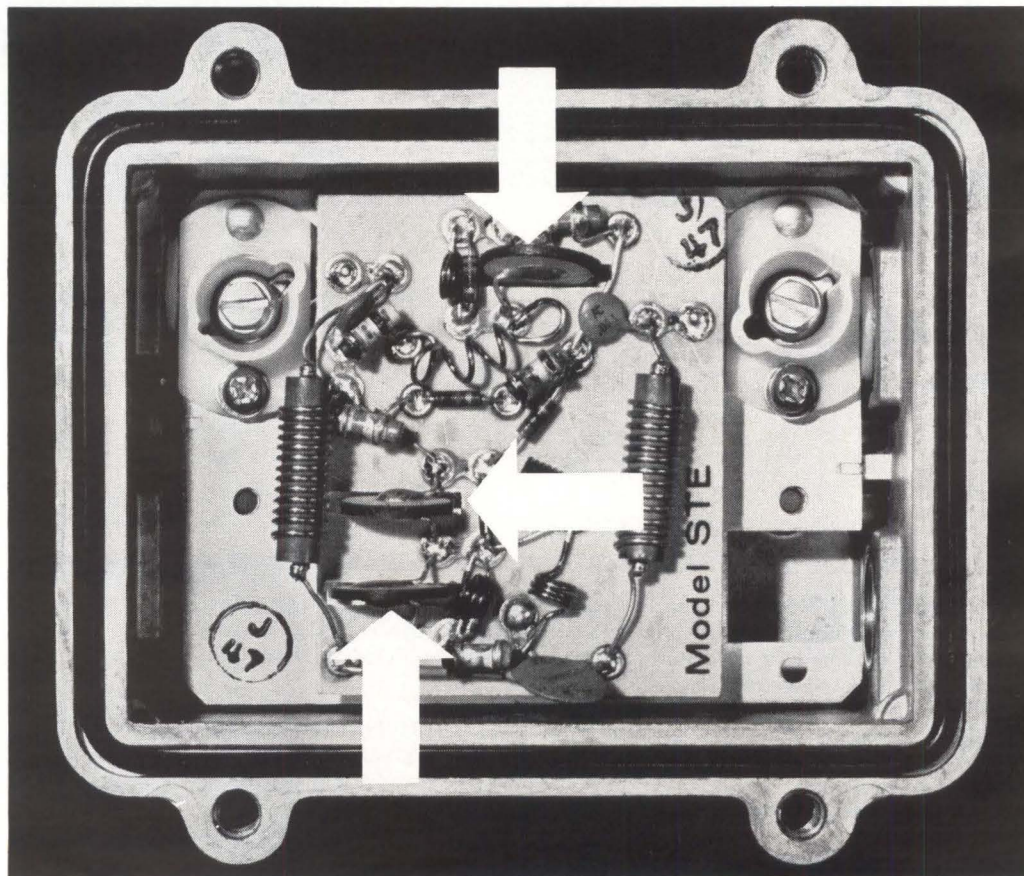

distribution system are thermal equalizers employing Keystone disc type thermistors (see arrows). Stationed at every third trunk amplifier location, each of these units, controlled by our thermistors, equalizes for 17db of cable at 216 mc at 70°F and compensates for temperature changes for 60 db of cable from a wintry low of -40°F to a summer high of 120°F. ■ We make thermistors that measure and control temperatures, provide power surge protection, sense liquid levels, etc., in over 400 standard types! Resistance values, temperature coefficients and physical sizes range widely to meet your needs. Let us have your inquiry. KEYSTONE CARBON COMPANY, St. Marys, Pa. 15857

**Keystone**  
leads

in versatile thermistor design



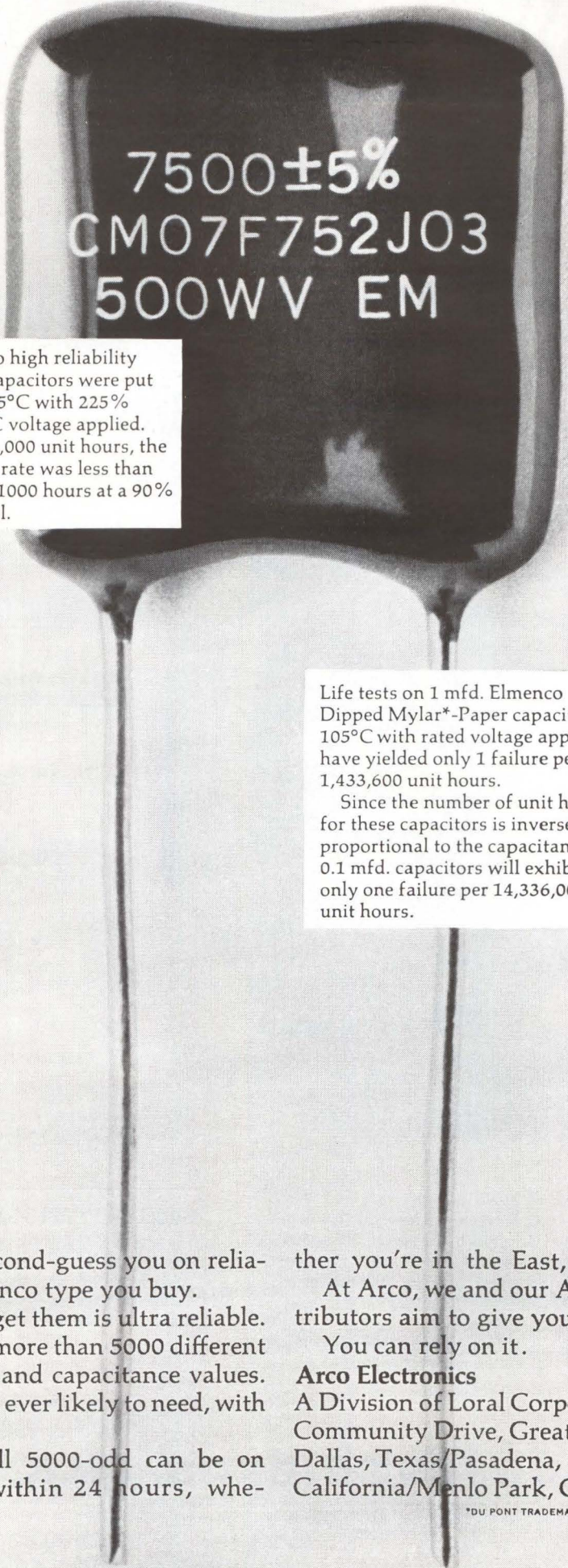

7500±5%  
CM07F752J03  
500WV EM

10,000 Elmenco high reliability Dipped Mica capacitors were put on life test at 85°C with 225% of the rated DC voltage applied.

After 26,500,000 unit hours, the verified failure rate was less than 0.00004% per 1000 hours at a 90% confidence level.

Life tests on 1 mfd. Elmenco Dipped Mylar\*-Paper capacitors at 105°C with rated voltage applied have yielded only 1 failure per 1,433,600 unit hours.

Since the number of unit hours for these capacitors is inversely proportional to the capacitance, 0.1 mfd. capacitors will exhibit only one failure per 14,336,000 unit hours.

No-one's going to second-guess you on reliability, whatever Elmenco type you buy.

Even the way you get them is ultra reliable.

At Arco, we carry more than 5000 different Elmenco types, sizes and capacitance values.

Probably all you're ever likely to need, with a few left over.

And practically all 5000-odd can be on their way to you within 24 hours, whe-

ther you're in the East, West or Mid-West.

At Arco, we and our Authorized Arco Distributors aim to give you all we've got.

You can rely on it.

**Arco Electronics**

A Division of Loral Corporation  
Community Drive, Great Neck, N. Y.  
Dallas, Texas/Pasadena,  
California/Menlo Park, California

\*DU PONT TRADEMARK.



# MIL-T-713 LACING TAPE isn't right for every harness job!



• GUDEBROD sells plenty of it (Gudelace 18)

—but makes 172 other\* tapes too!

• Tapes for high temperatures,  
burnproof tapes, tapes for  
outer space and vacuum use.

• Tapes for heavy cabling and for  
small units, color coded tapes.

• They all tie tight.  
Ask about them.

\*And they all exceed MIL-T performance requirements

Saturn rocket inertial guidance stabilized platform produced at The Bendix Corporation's Eclipse-Pioneer Division. Wiring laced with Gudebrod Tape.

With every advancement in electronic technology, for every new electronic application there is need to review your harnessing practices and materials. If your harness department is struggling to make-do with the lacing tape they have always used—they may be wasting time and money as well as heading for rejects. Gudebrod has pioneered in producing special tapes—for particular applications, and to meet customer's specifications. Available at Gudebrod is a stock of 173 types of lacing tape—and a wealth of harnessing information. Why not consult with Gudebrod!

## GUDEBROD CABLE-LACER

The first hand tool engineered for wire harnessing. Handle holds bobbins, feeds tape as needed, grips tape for knotting. Speeds, eases harnessing. Pays for itself in time saving.



Area Code 215, WA 2-1122



**GUDEBROD BROS. SILK CO., INC.**

FOUNDED IN 1870

*Electronics Division*

12 SOUTH 12th STREET, PHILADELPHIA, PENNSYLVANIA 19107



# Fast, convenient direct reading measurements of impedance and phase angle 500 kHz to 108 MHz...



## THE 4815A RF VECTOR IMPEDANCE METER

This new Vector Impedance Meter is a versatile instrument that provides fast, direct reading measurements of impedance and phase angle over the frequency range from 500 kHz to 108 MHz. It is continuous tuning over this frequency range, and does not require balancing or data interpretation. Thus, it is an extremely useful tool for the evaluation of the complex impedance of both active circuits and components. The convenience of probe measurement, ease of operation, and direct reading features make the instrument equally useful for laboratory, receiving inspection or production line measurements.

The 4815A is a convenient and powerful measuring tool for any application involving measurements over a band of frequencies or in-circuit measurements. It may be used to determine the self-resonance point of capacitors, the series and parallel resonance points of crystals, or the characteristics of high frequency transformers and transducers. Price: \$2650 f.o.b. factory. For complete specifications, contact your local Hewlett-Packard field engineer or write Hewlett-Packard, Rockaway Division, Green Pond Road, Rockaway, N. J. 07866; Europe: 54 Route des Acacias, Geneva.

### Advantages:

- Fast, continuous tuning from**  
500 kHz to 108 MHz
- Provides data directly in impedance**  
and phase angle, 1 ohm to 100K ohms  
0 to 360°
- Convenient probe for in-circuit measurements**
- Analog outputs permit permanent**  
data recording
- Self calibration check provides**  
measurement confidence
- Low-level test signal minimizes**  
circuit disturbance

**HEWLETT**  **PACKARD**  
An extra measure of quality



# “How can we scan temperatures at a rate of 10 points/second?”

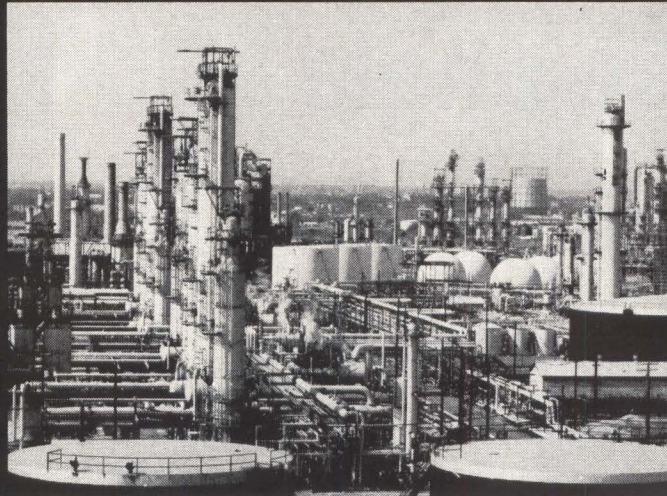

## With an EMC Scanner System!

Proven EMC temperature scanner systems are now available for countless applications in a variety of industries.

Monitoring temperatures at a rate of up to 10 points a second from 0°C to 500°C with a demonstrated accuracy of 0.1% of full scale, these systems have already saved thousands of man-hours for users in the chemical industry.

These modularly-constructed systems are simple to install, operate and maintain. Pushbutton controls provide monitoring ease and flexibility. Modular units are interchangeable.

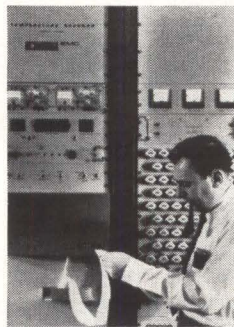

The highly reliable systems are constructed from modules with proven reliability of 4.5 million hours MTBF. This gives the typical system an MTBF in excess of 8,000 hours.

An EMC representative will be glad to provide you additional information on how EMC systems can meet your requirements for process monitoring and control.

**ELECTRONIC**  
**MODULES**  
**CORPORATION**

**Electronic Modules Corporation • SYSTEMS DIVISION**

1949 GREENSPRING DR. • TIMONIUM, MARYLAND 21093 • TEL. 301-252-2900 • TWX-301-252-0723



**This is the new Tally System 800 for verification and duplication of perforated tape. We call it the "Super Dupe".**

**It duplicates perforated tape on a bit-for-bit basis at 120 characters per second.**

**It verifies two tapes bit-for-bit.**

**It verifies two tapes and duplicates a completely error free third tape.**

**It detects perforation bit errors as they happen.**



The Tally System 800 verifies and/or duplicates perforated tapes from one through eight channels in any code structure at 120 characters per second. It uses bit echo techniques to make sure that every error is caught on the character and eliminated by comparing each perforated bit with each bit read by the master reader. Its price is remarkably low and delivery amazingly good. If it's your kind of baby and you would like the full story, please write our man Crawford. Address Tally Corporation, 1310 Mercer St., Seattle, Wash., 98109. Phone: (206) Main 4-0760. TWX 910-444-2039.

**TALLY®**



# Adage makes the fastest A-to-D converter on the market

8 bits at 1 Mc, 1  $\mu$ s conversion time (Model VT7-AB)  
14 bits at 200 Kc, 4  $\mu$ s conversion time (Model VT13-AB)

Adage has been making solid-state analog-to-digital converters, and compatible sample-and-hold amplifiers, multiplexers, and D-to-A converters, since 1957 — longer than anyone else. We like to think our record of performance is also unmatched.

May we send you literature describing our products — or an applications engineer to help you with your problem? Write Leon Dall, Product Manager, Adage, Inc., 1079 Commonwealth Ave., Boston, Mass. 02215, (617) 783-1100.

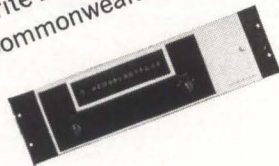

**Adage**  
INC

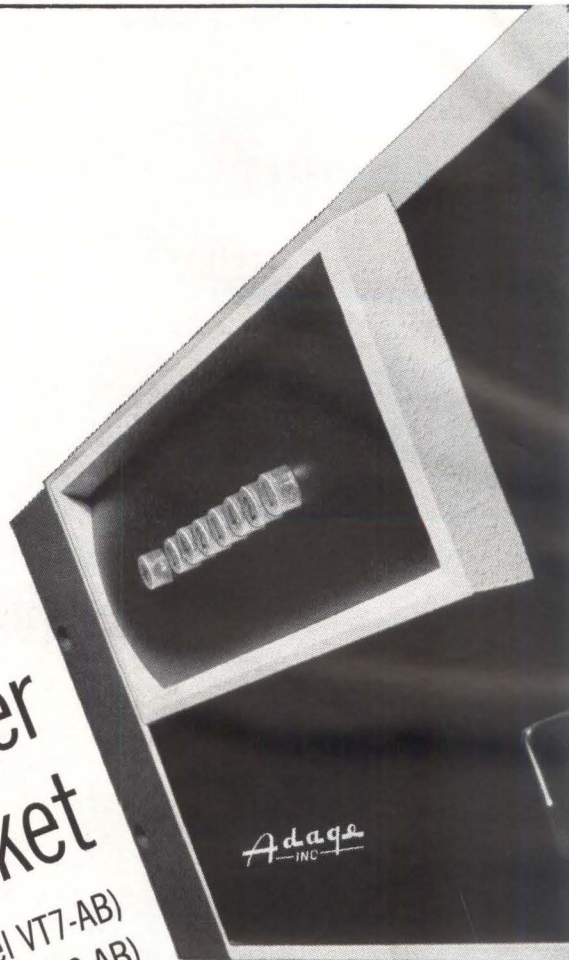



# Get tougher-than-military ruggedness with molded-package economy...

Low mounting of circuit permits uphill bonding . . . preventing internal shorts and improving reliability.

Solid molded package supports bonding wires . . . giving maximum resistance to shock, vibration and acceleration.

Leads are firmly anchored in package for mechanical strength and hermeticity.

Mounting platform extends full length of package for up to 500 mW heat dissipation.

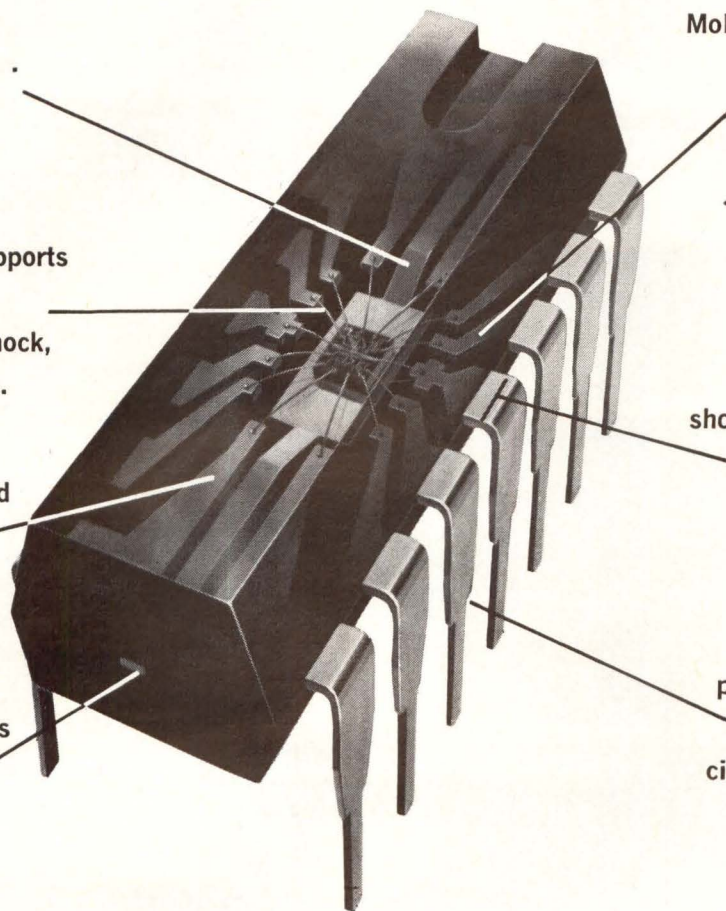

Molding compound adheres tightly to leads over temperature range of  $-55^{\circ}$  to  $+150^{\circ}\text{C}$  . . . preventing moisture intrusion in service.

Stiff leads with 0.060" shoulders give strength and stability for automatic insertion and handling.

Pin shoulders support package above PC board . . . allowing free air circulation and preventing formation of moisture pockets.

## Call **ELECTRONIC WHOLESALERS** for immediate delivery of **TI Series 74N TTL** and **Series 15830N DTL** integrated circuits in **TI's high-reliability economy molded package**

Texas Instruments has recently completed tests (many more severe than military) which clearly establish the ruggedness and reliability of TI's molded package. For your copy of the 36-page report which describes these tests in detail, circle 199 on the Reader Service card.

We carry complete stocks of both TTL and DTL integrated circuits in TI's tougher-than-military molded package. Call us for prompt service.



"SERVING THE ENTIRE SOUTHEASTERN U.S."

## **ELECTRONIC WHOLESALERS INC.**

WASHINGTON, D. C.  
2345 Sherman Ave., N.W.  
Phone 202-483-5200

BALTIMORE, MARYLAND  
3200 Wilkens Avenue  
Phone 301-646-3600

WINSTON-SALEM, N. C.  
938 Burke Street  
Phone 919-725-8711

MIAMI, FLORIDA  
9390 N.W. 27th Avenue  
Phone 305-696-1620

ORLANDO, FLORIDA  
345 N. Graham Avenue  
Phone 305-841-1550



# Who designed and constructed the world's highest power RF feed-through bushing?

## Lapp Insulator Company

Lapp? Yes, Lapp Insulator of LeRoy, N. Y. Matter of fact Lapp has been designing and producing Feed-Through Bushings for 42 years. They get bigger, *and* more intricate, all the time. Demanding, unusual specifications don't bother us. Why? Because when it comes to radio frequency insulating components we've got plenty of "know-how" . . . and ingenuity . . . and *ability* to produce the finished product.

Getting back to that "world's highest power" bushing, we designed and made three of these for Continental Electronics Manufacturing Company. They are a vital part of the U. S. Navy VLF transmitter at Northwest Cape, Australia. Each one is rated for 2545 amperes continuous duty at 140 kv RMS at 15.5 kc and is both internally and externally graded to assure uniform voltage distribution. These bushings are approximately 16 feet tall and weigh about 7000 pounds each.

Two other Feed-Through Bushings we've made are shown here. But there have been hundreds of others. Write or call us with *any* radio frequency insulating problem. Radio Specialties Division, Lapp Insulator Co., Inc., Dept. E, LeRoy, N.Y. 14482.

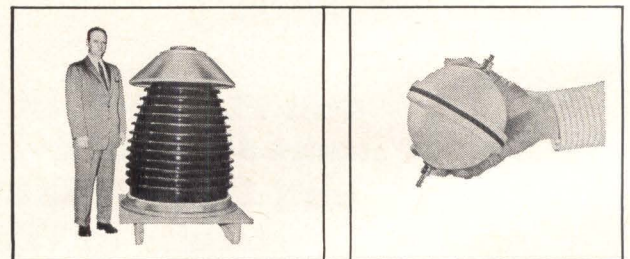
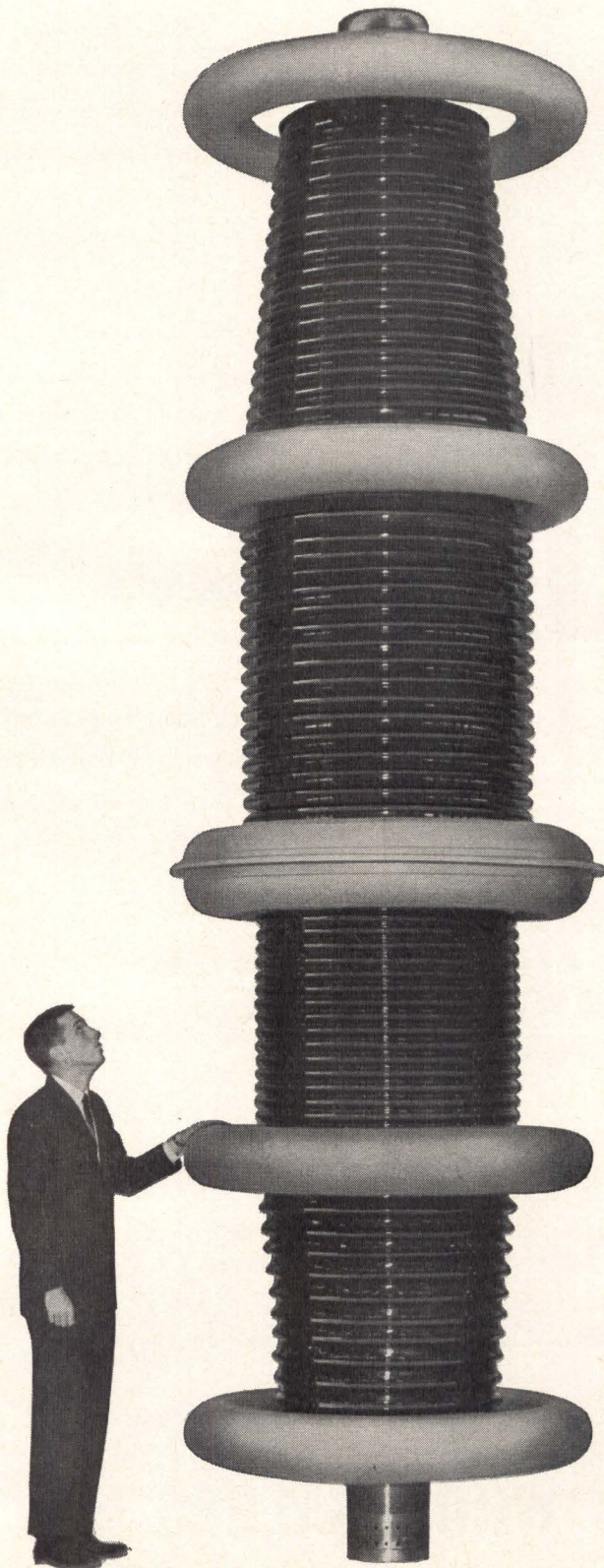





INDUSTRIAL APPLICATIONS FOR FAIRCHILD INTEGRATED CIRCUITS



The Switch to IC's:

## The Handwriting on the Wall

Integrated circuits are gaining acceptance in industry at a rate much faster than previous technological breakthroughs. It took transistors, for example, about 10 years to get from the drawing boards to electric guitars. But integrated circuits, which only two years ago were in the highly exotic, state-of-the-art category, are already making a limited appearance in home television sets, and are rapidly gaining a position of dominance in the industrial market. There are some technical reasons for this accelerated pace of acceptance, but there are also compelling marketing reasons. In the competitive electronics industry, these reasons tend to dominate.

**TECHNICAL REASONS:** When transistors started to replace vacuum tubes they brought with them a whole new manufacturing technology: printed circuit boards, flow-soldering techniques, automated insertion tools, and the like. No such change in manufacturing procedure is necessary when you switch from transistors to integrated circuits. The technology exists, and can be readily adapted, especially since most integrated circuits are available in standard transistor packaging.

Some applications made the switch because of size and performance advantages. Modern computers operate in the nanosecond range, and a nanosecond is about the length of time it takes electric current to flow through a foot of wire. The size reduction possible with integrated circuits often eliminates enough wire to have a significant effect on the speed of the computer.

**MARKETING REASONS:** In industrial electronics, where the speed of light is rarely an important criterion, the reason for the rapid changeover to integrated circuits has been an improved cost/performance ratio. A manufacturer of test equipment, for example, recently discovered that he could add a function to his instrument by simply adding one additional integrated circuit. Previously the same function required a board which was offered as a \$100.00 option. Now the instrument includes it in its base price, which is still below what the discrete component equivalent sold for. This case is typical. Obviously, more performance at less cost is a sales story every manufacturer is eager to make his own. And so the switch to IC's is on.

**CUSTOMER DEMANDS:** Most important, the word has reached many customers that integrated circuits are more reliable, perform better, and cost less than discrete component equipment and systems. Consumer appliance manufacturers who include even a single integrated circuit in their electronics are quick to advertise their more advanced, more reliable equipment to the public. And so both industrial and consumer manufacturers find that they must switch to integrated circuits to give their customers what they want.

**THE MORAL:** The question for a company making equipment containing electronics is therefore not whether to switch to integrated circuits, but when and how. The when is simply answered. If you're not already planning the changeover, start now, while you may still get a jump on competition, or at least keep up. The how is not so simple: you'll need some basic information. The enclosed postcard will bring you an abundance.



# Integrated Cycloconverter

A cycloconverter is a step-down static frequency converter that produces a constant or a precisely controllable output frequency from a variable frequency AC power input. The device is not new in concept. In the past mercury arc rectifiers were used to implement cycloconverters, resulting in severe shortcomings: mercury arc cycloconverters were large and heavy, relatively inefficient, and sensitive to shock, vibration, and operating position. They generated a lot of heat, and required constant maintenance and tube replacements. They also required complex and cumbersome control circuitry. For these reasons cycloconverters were considered a lab curiosity, unsuitable to practical applications.

The Power Equipment Division of Lear Siegler, Inc., Cleveland, has overcome these limitations by building a lightweight, compact cycloconverter utilizing silicon controlled rectifiers (SCRs) in place of the mercury arc

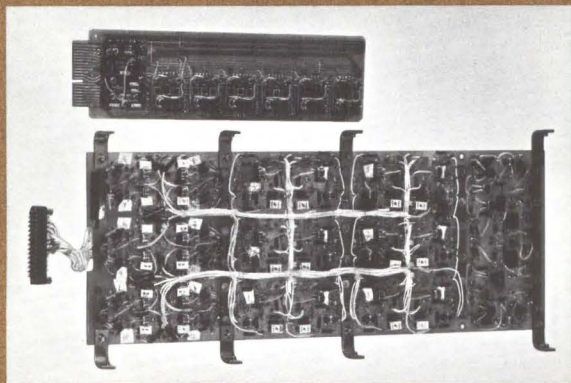

Comparison of firing and blanking control logic boards as implemented with IC's and with discrete components.

tubes, and using integrated circuits for control purposes. The resulting cycloconverter has an efficiency of up to 98.5% at full load, provides frequency control with accuracy as high as 0.00001%, and has improved reliability by an order of magnitude. The development of this unit has made practical the use of AC power in such applications as aircraft generating systems, variable speed squirrel cage motors, and many others (see below). The Lear Siegler cycloconverter consists of two groups of SCR's mounted in a full-wave configuration, on high efficiency aluminum heat sinks. A three-phase AC power supply provides the input frequency. Monolithic integrated circuits mounted on top of the unit provide firing and blanking control. The blanking control inhibits firing signals to the positive group of SCR's while the negative group is conducting, and vice versa. This eliminates the need for interphase chokes, and considerably improves the efficiency of the unit. The output frequency can be precisely varied from dc to one half of the input frequency. A total of 185 components, of which 30 are integrated circuits, are used for firing and blanking control, compared to 1324 discrete components previously required, a saving of 7 to 1. Furthermore, only three circuit types of the DTL family and one linear circuit type are used. Cost data developed to date indicates a reduction in fabrication costs of frequency converter board assemblies by a factor of 2.5 to 1. The unit has been subjected to severe reliability tests, and has operated without interruption for 4200 hours at 100kW from a plant power line with a 100 volt transient.

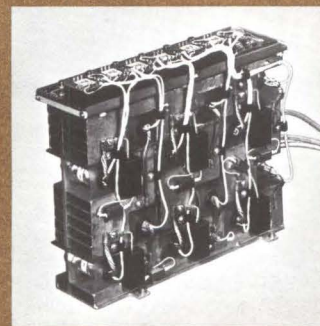

Cycloconverter module made by Power Equipment Division, Lear Siegler, Inc.

## Cycloconverter Applications

**VSCF GENERATING SYSTEM FOR AIRCRAFT:** A variable speed constant frequency (VSCF) generating system for helicopter and fixed wing aircraft using the integrated cycloconverter has been built by Lear Siegler (see block diagram). Power is provided to the system from a high speed alternator driven by the aircraft engine. The alternator speed can vary over a 3:1 or 2:1 speed ratio without affecting the quality of power delivered to the load bus, so long as the alternator frequency remains above 800 Hz for a 400 Hz system. A full wave bridge configuration is used for the cycloconverter, to give the unit improved performance characteristics. This configuration is possible because of size and cost economies achieved through integrated circuit firing controls. The single phase frequency converter module is less than 8 pounds, and it supplies a 100 KVA load in a 50°C ambient, and a 50 KVA load in an 85°C ambient.

**VARIABLE SPEED SQUIRREL CAGE DRIVE:** The availability of a practical solid-state frequency converter has made possible the use of a polyphase squirrel cage motor as an adjustable speed drive. Such a system provides superior weight to horsepower ratios of less than one pound per horsepower. It has the added advantage, when applied to multi-wheel land vehicles, of automatic torque control. This is accomplished by means of a tachometer signal which is fed back into the firing control circuitry. The effect is to transfer any excess power from a wheel which is slipping to the wheel with the surest footing. A similar system can also be used to furnish power to locomotive drive systems such as rapid transit railways and diesel locomotives.

**OTHER APPLICATIONS:** The cycloconverter opens the door for utilization of AC power drives in a wide variety of applications. Wheeled vehicle drives, tracked vehicle drives, antenna drive systems, industrial process drives, and rapid transit railway drives are currently being built by the Power Equipment Division of Lear Siegler. Many other applications are under investigation and in various stages of completion.

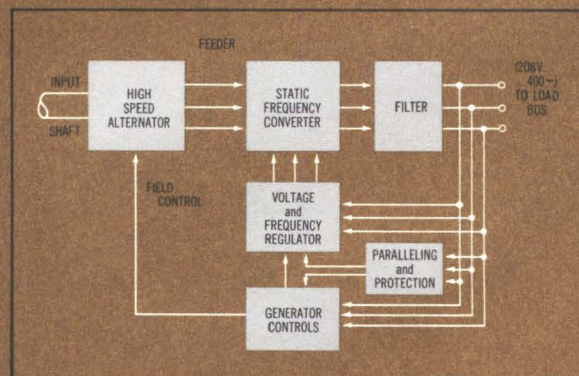

Variable speed constant frequency generating system block diagram.

**FAIRCHILD**  
SEMICONDUCTOR



# want a custom-designed electronic power supply?

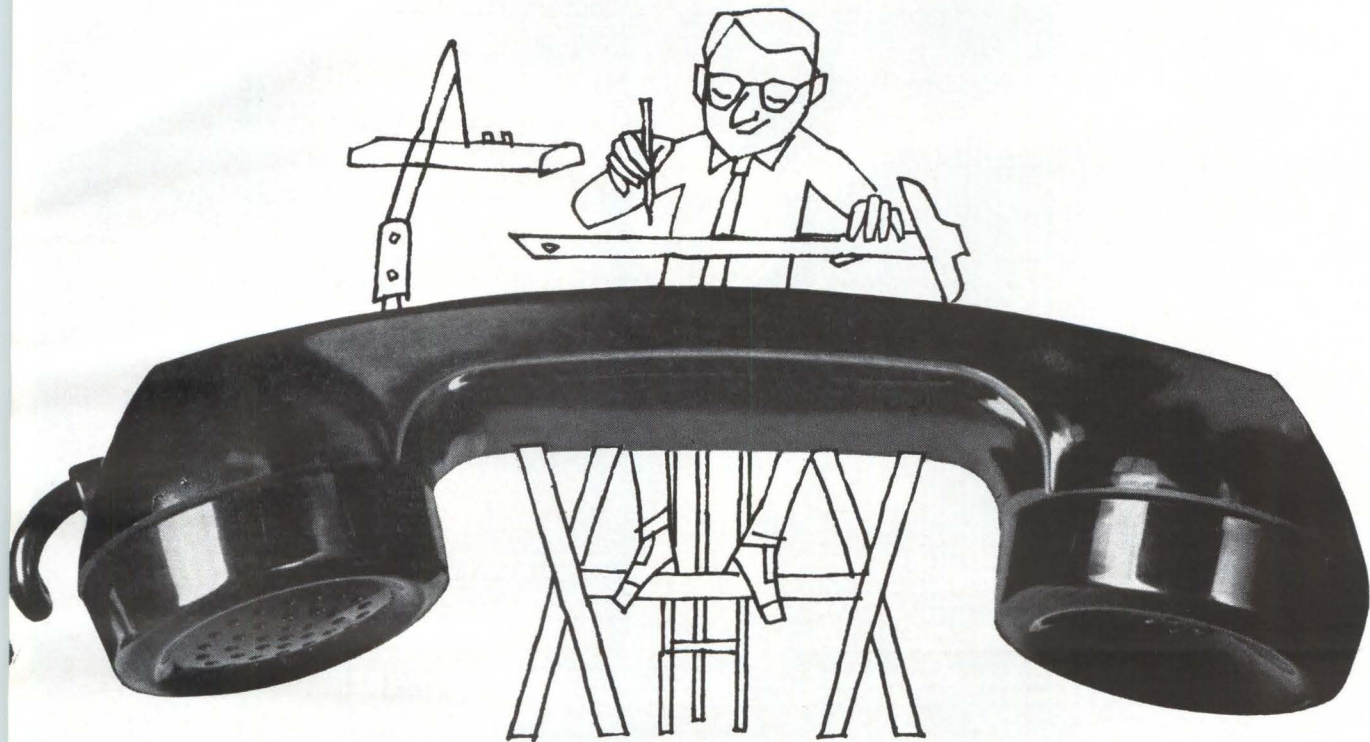

**call 312 439-2800**

Sola answers your tough ones.

We're geared to handle them with a team of electronic engineers and volume production facilities. High- and low-voltage transistorized power supplies, or entire power systems. For electrostatic copiers to process control,

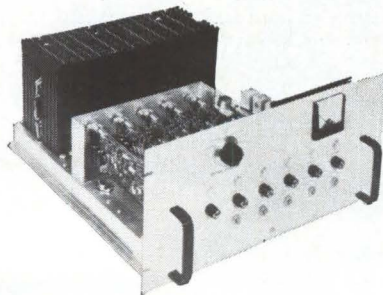

optical readers to radar.

Tell us your specs; we'll design to meet them.

Want to know more? Call Phil Snyder at 312/439-2800, or write him for catalog PS-100: 1717 Busse Road, Elk Grove Village, Illinois 60007.

**SOLA ELECTRIC**



DIVISION OF SOLA BASIC INDUSTRIES

OTHER DIVISIONS: ANCHOR ELECTRIC • ENGINEERED CERAMICS • HEVI-DUTY ELECTRIC • LINDBERG HEVI-DUTY • NELSON ELECTRIC



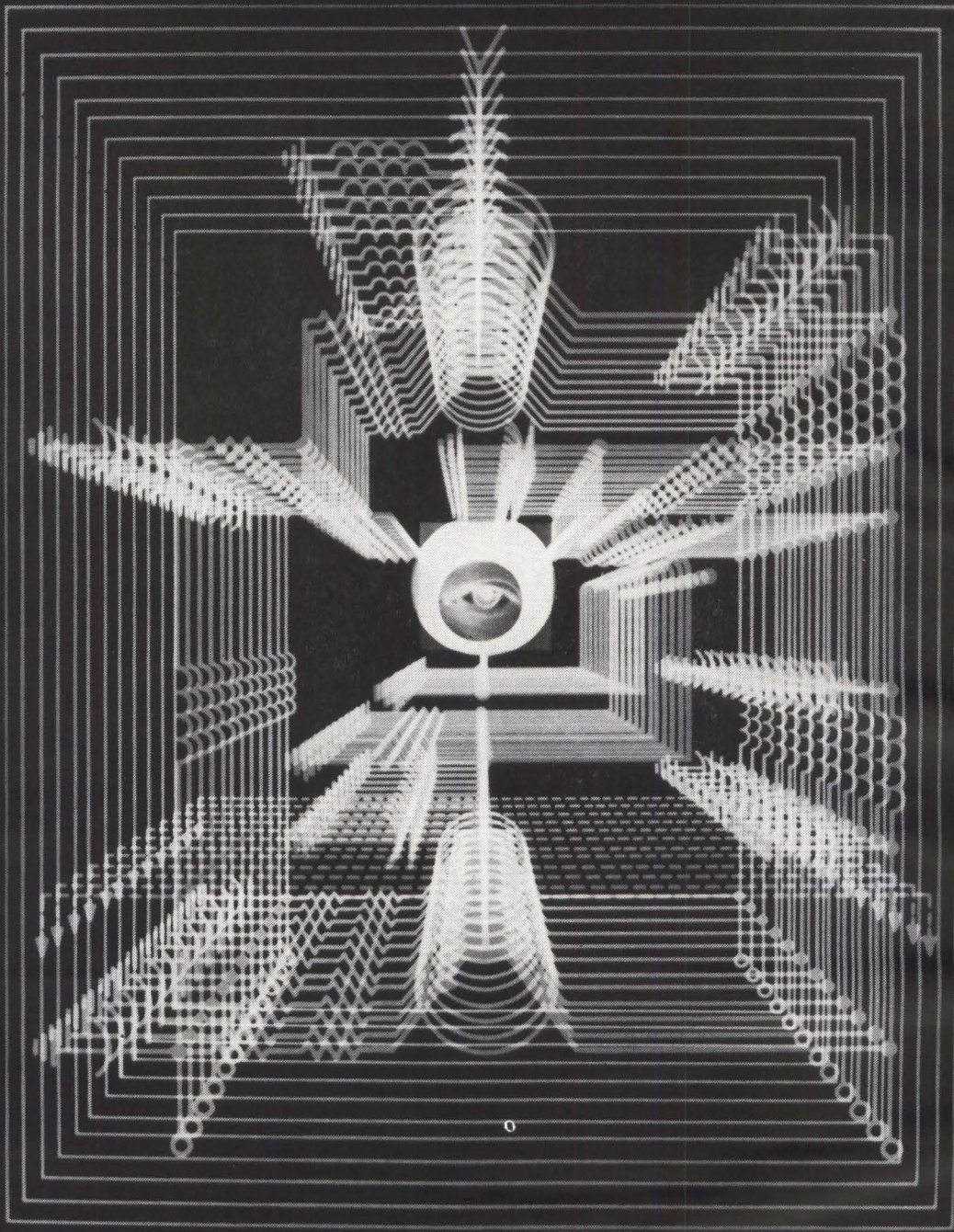

*Look into the vehicles of opportunity at Lockheed...for circuit designers.*

Opportunity broad enough to interest every circuit designer, that's the sweep of electronics assignments at Lockheed. Big, wide-ranging programs that extend from deep sea to deep space. And with ever-growing commitments comes an increasing need for new concepts and major technical advances in flight controls, communications, antennas and state-of-the-art electronics checkout equipment in both spacecraft and fleet ballistic missiles. In addition to its major vehicle programs... Agena, Poseidon, and Polaris, Lockheed is involved in deep submersibles; unique advanced land vehicles; information systems for states and hospitals; and many other technically alluring programs. For complete information, write Mr. R. C. Birdsall, Professional Placement Manager, P.O. Box 504, Sunnyvale, California. Lockheed is an equal opportunity employer.

**LOCKHEED**  
MISSILES & SPACE COMPANY  
A GROUP DIVISION OF LOCKHEED AIRCRAFT CORPORATION



# 200,000

# OHMS PER VOLT



**Model 630-NS**  
**VOLT-OHM-MICROAMMETER**

### TRIPLET SUSPENSION MOVEMENT

*no pivots... no jewels...  
no hair springs... thus NO FRICTION.*

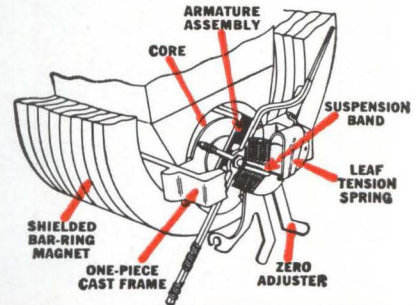

**\$100.00**  
SUGGESTED  
U.S.A. USER NET

## FACTS MAKE FEATURES

- 1** 200,000 OHMS PER VOLT D.C. for greater accuracy on high resistance circuits. 20,000 OHMS PER VOLT A.C.
- 2**  $5\mu\text{a}$  SUSPENSION METER MOVEMENT. No pivots, bearings, hair-springs, or rolling friction. Extremely RUGGED. Greater sensitivity and repeatability.
- 3** 62 Ranges, usable with frequencies through 100 Kc. Temperature compensated.  $1\frac{1}{2}\%$  D.C. ACCURACY, 3% A.C.

Low voltage ranges and high input impedance make the 630-NS especially useful in transistor circuit measurement and testing. Input impedance, at 55 volts D.C. and above, is *higher than most vacuum tube voltmeters.*

The unit is designed to withstand overloads and offers greater reading accuracy. Reads from  $0.1\mu\text{a}$  on  $5\mu\text{a}$  range. Special resistors are rigidly mounted and directly connected to the switch to form a simplified unit. Carrying cases with stands are priced from \$11.00.

**TRIPLET ELECTRICAL INSTRUMENT COMPANY, BLUFFTON, OHIO**

### 62 RANGES

D.C. VOLTS	0-0.6-3-12-60-300-1200 at 100,000 Ohms/Volt. 0-0.3-1.5-6-30-150-600 at 200,000 Ohms/Volt. 0-0.150 at $60\mu\text{a}$
A.C. VOLTS	0-3-12-60-300-1200 at 10,000 Ohms/Volt. 0-1.5-6-30-150-600 at 20,000 Ohms/Volt.
DB	-20 to 77 in 10 ranges.
D.C. MICRO-AMPERES	0-5 at 300 MV. 0-60-600 at 150 MV. 0-120 at 300 MV.
D.C. MILLI-AMPERES	0-6-60-600 at 150 MV. 0-1.2-12-120-1200 at 300 MV.
D.C. AMPERES	0-6 at 150 MV. 0-12 at 300 MV.
OHMS	0-1K-10K-100K (4.4-44-440 at center scale)
MEG OHMS	0-1-10-100 (4400-44,000-440,000 Ohms center scale)

OUTPUT: Condenser in series with A.C. Volt. ranges.

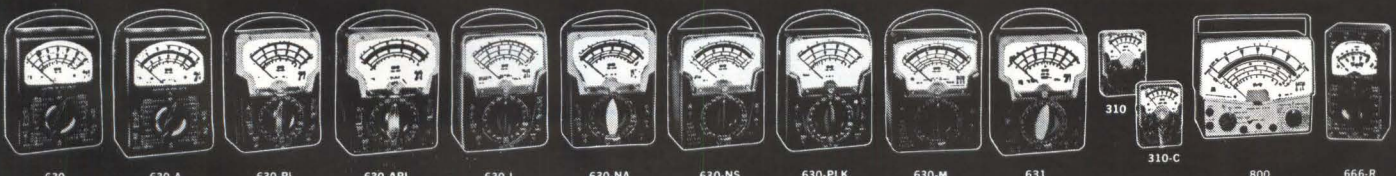

THE WORLD'S MOST COMPLETE LINE OF V-O-M'S. AVAILABLE FROM YOUR TRIPLET DISTRIBUTOR'S STOCK.



# 0.0004 seconds

**A breakthrough  
in torque  
response**

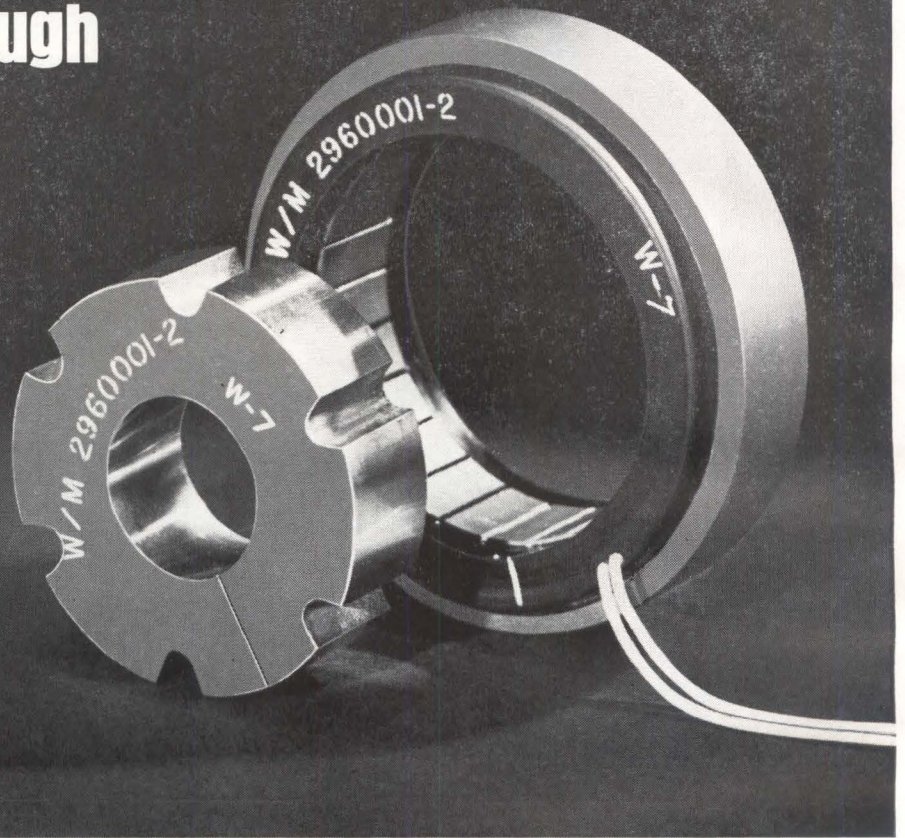

*Torque motors with a response of four hundred millionths of a second are now a reality. And this breakthrough is only one of several benefits offered you in a new line of torquers by Wright Division of Sperry Rand.*

## Reliability

No contacts. No brushes. No commutation bars. Simplified winding. Permanent magnet.

## Better Performance

Direct Drive. No friction. No ripple torque.

## What does a Wright torque motor do?

It holds, clamps, stabilizes, drives, opens, closes, cracks, shuts, pushes, picks up, moves, rotates, nulls, controls, actuates.

Design engineers are invited to write or telephone for details. Comparison will show you that on applications where incremental rotation is needed, this new Wright concept in torquers offers substantial advantages.

SIZE	O.D.	Watts at Peak Torque	Design					
			2 Pole 180°		4 Pole 90°		6 Pole 60°	
			Peak Torque Oz.-In.	Electrical Time Constant L/R (Secs.)	Peak Torque Oz.-In.	Electrical Time Constant L/R (Secs.)	Peak Torque Oz.-In.	Electrical Time Constant L/R (Secs.)
10C	.9650	9.5	6.5	.0004	—	—	—	—
14C	1.3400	19	12	.0007	24	.0004	—	—
18C	1.8000	35	23	.0013	46	.0007	—	—
23C	2.3000	60	40	.0022	80	.0011	—	—
27C	2.6093	71	47	.0026	94	.0013	140	.0007
40C	4.000	180	100	.0055	200	.0028	300	.0019
50C	5.000	183	120	.007	240	.004	360	.0025
70C	7.000	377	250	.015	500	.0075	750	.005
100C	10.000	545	360	.020	720	.010	—	—

**WRIGHT**   
Division of Sperry Rand Corporation

Durham, North Carolina ■ Telephone 919-682-8161 ■ TWX 919-682-8931



**Last month there were four good high-frequency counters on the market. Now there are five and four of them are obsolete**



**TSI's new Model 600 is the newest and most versatile solid-state counter from the oldest manufacturer of solid-state counters**



**Here's what the basic counter offers you:**

- All silicon solid state circuitry
- Frequency measurements from zero to 100 MHz without prescaling
- Full plug-in capability
- Period measurements to 1 MHz and multiple period measurements to 20 MHz
- Ratio measurements to 100 MHz/1 MHz and multiple ratio measurements to 100 MHz/20 MHz
- Totalizing to 100 MHz
- Scaling of zero to 100 MHz by decades to  $10^9$
- Time base stability of one, two or five parts in  $10^9$  per 24 hours.

Interested? Don't test the specs, test the instrument itself! Call or write us and we'll send a representative to demonstrate the 600 right in your lab.

*When Reliability Counts*



Transistor Specialties, Inc.  
120 Terminal Drive  
Plainview, Long Island, N. Y. 11803  
Phone (516) 935-8700



# The best move for Electronic Engineers

The Electronic Engineer considering a move, should give serious consideration to Hamilton Standard. The progressive expansion of our autonomous Electronics Department has resulted in an average annual growth rate of over 15% the last two years. Early in 1967, the group will move into a new, fully air conditioned 200,000 square foot building, depicted below. And there's great coun-

tryside living just minutes from the plant. HSD electronics product line is wide and varied—found in such installations as a utility power plant in New Jersey, a generating station in Belgium, a submarine-seeking helicopter, commercial airliners, radar picket ships, and countless others. Increased business and bright prospects have created very attractive positions for:

## PRODUCT DEVELOPMENT ENGINEERS

**Airborne Controls**—develop precision electromechanical airborne control components and systems utilizing digital or analog control techniques.

**Power Supplies**—static power conversion equipment and generating systems.

## DESIGN AND ANALYTICAL ENGINEERS

**Electronic Designers**—circuit design, airborne control component equipment and data systems (analog and digital)

**Mechanical Designers**—precision electromechanical components, transducers, torque motors et al.

**Systems Designer**—digital control/data systems—system timing, accuracy and implementation.

## MICROCIRCUIT ENGINEERING, MATERIALS AND COMPONENTS DEVELOPMENT, MICROCIRCUIT PACKAGING

Metallurgist, Physicist, Chemical, Electrical or Mechanical Engineers for:

- Microcircuit electron beam welding techniques.
- Fine particle technology.
- Materials and process semiconductor device fabrication.
- Bonding techniques, semiconductor devices.
- Silk screening, photoengraving microcircuits.
- Semiconductor OR electronic component package design.
- Microcircuit for Semiconductor.
- Low power/low frequency control OR digital microcircuit design and development.

## LET'S SET UP AN INTERVIEW

so we can give you the complete details. Please forward your resume, stating present salary, to Mr. Robert E. Harris, Personnel Department, Hamilton Standard, Windsor Locks, Connecticut.

*An Equal Opportunity Employer*

**Hamilton  
Standard**

**U**  
DIVISION OF UNITED AIRCRAFT CORPORATION  
**A®**

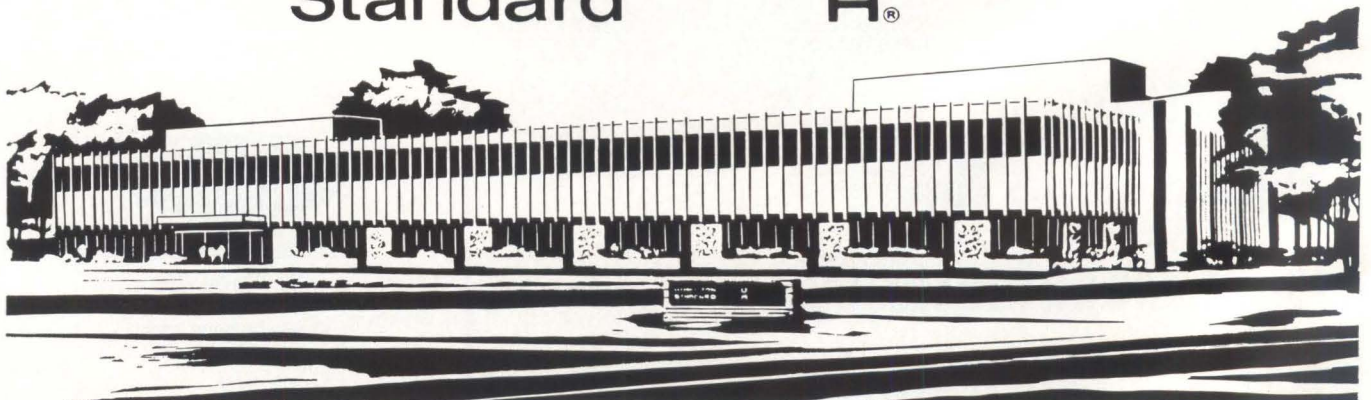



# WE MAKE EPOXIES FOR JUST ABOUT ANYTHING YOU CAN THINK OF.

Critical electronic parts often require epoxies for low outgassing and outstanding heat resist-

ance. Plaskon® epoxies are currently being specified in a wide range of parts, including some that have been designed to meet or exceed

the proposed military specifications.

However, if epoxies are not what you need, we have a complete line of other thermosets to provide the right product for the job: Diallyl®, Phenolics, Alkyd, Urea and Melamine. But all you have to worry about is a good idea. It's our job to find the right epoxy or other thermoset to make it a reality.

PLASTICS  
DIVISION  
POST OFFICE BOX 365  
MORRISTOWN, N. J.

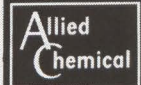

Please send me complete information on the right epoxy for \_\_\_\_\_ application.

Name \_\_\_\_\_

Address \_\_\_\_\_

Company \_\_\_\_\_

City \_\_\_\_\_ State \_\_\_\_\_ Zip Code \_\_\_\_\_

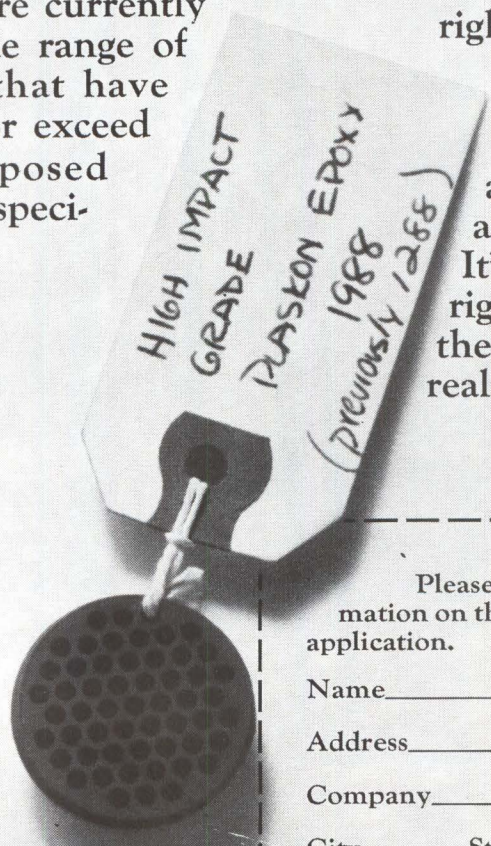
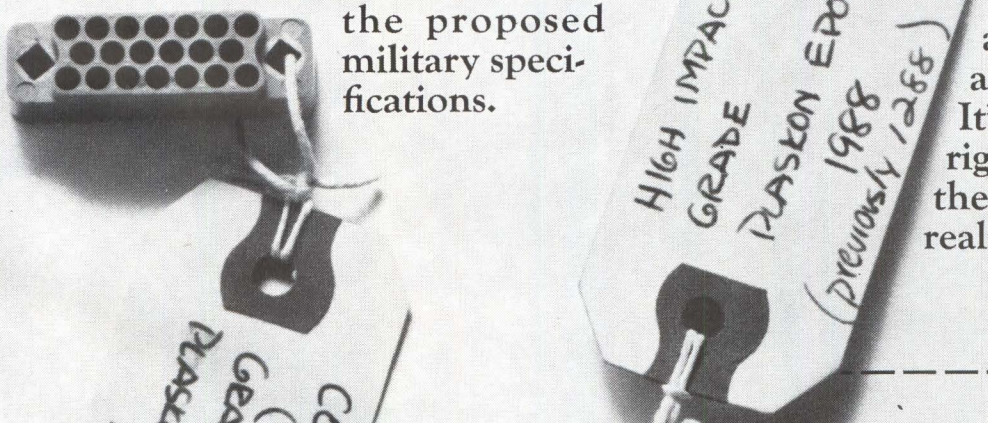
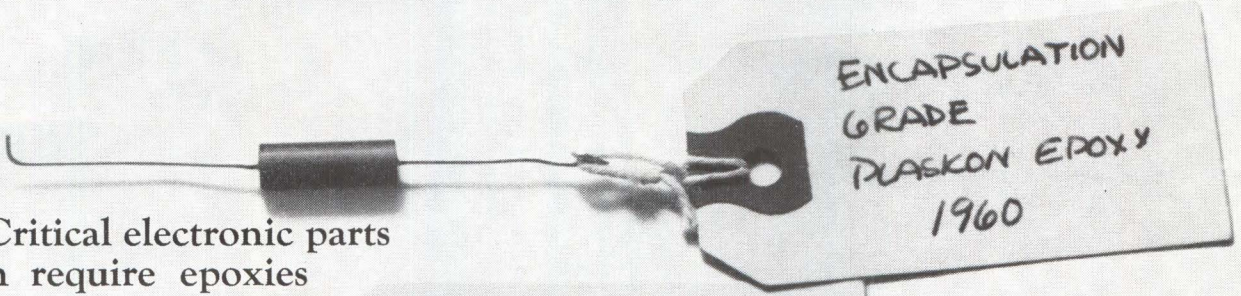



### This is the $\mu$ A703 radio R-F amplifier.

(cost: \$2.75)

As a basic power amplifier the  $\mu$ A703 operates to 150MHz, delivers 20db gain at 100MHz, and has a noise figure of only 7db. As a single component monolithic I-F stage for FM tuners, the  $\mu$ A703 provides superior isolation between stages due to its low reverse transadmittance (0.001 millimhos). It provides excellent phase distortion characteristics because it limits without saturation. You can also use it as a local oscillator to 150MHz.

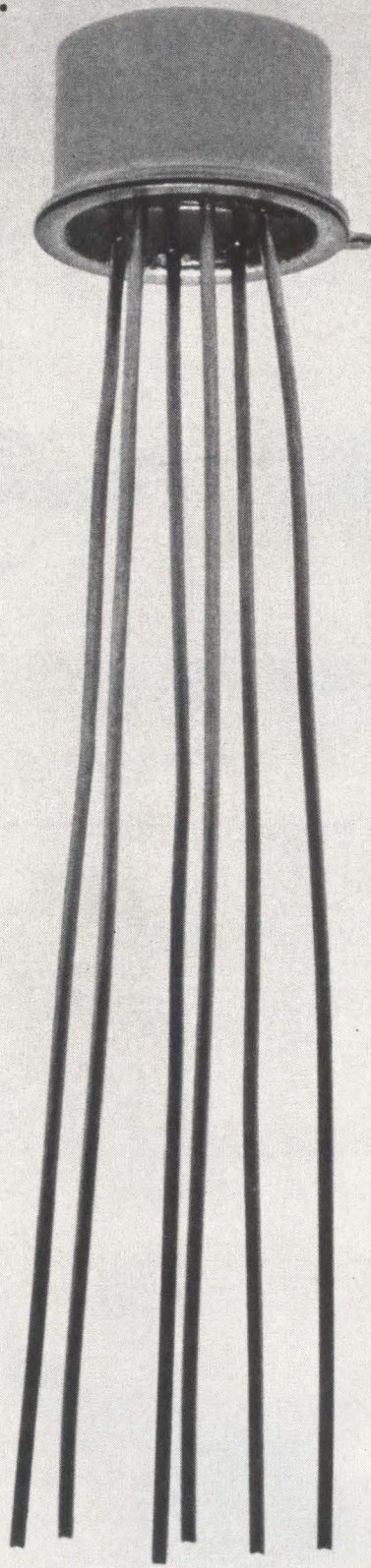

### This is the $\mu$ A703 TV I-F amplifier.

(cost: \$2.75)

Use it in the audio stages of your TV receivers or as a voltage controlled oscillator for color sets.

### This is the $\mu$ A703 radar I-F amplifier.

(cost: \$2.75)

Cascade several units and use as a logarithmic amplifier. It minimizes overdrive recovery and pulse distortion, and gives you improved dynamic range, because it limits without saturation.

For complete details on the  $\mu$ A703, the  $\mu$ A703, or the  $\mu$ A703, call any Fairchild distributor or write.



TO ORDER:  $\mu$ A703A -55°C to +125°C / U5D770331X ■  $\mu$ A703C 0°C to +70°C / U5D770339X  
FAIRCHILD SEMICONDUCTOR / A Division of Fairchild Camera and Instrument Corporation ■ 313 Fairchild Drive, Mountain View, California (415) 962-5011 ■ TWX: 910-379-6435



# Probing the News

---



Chief of an electronics laboratory, Rima V. Vasilyeva walks through machinery hall of institute building in Moscow.

## People

# Engineers call her boss

Rima V. Vasilyeva supervises a key electronics instrument lab doing research for Soviet machine-building plants

By Howard Rausch

Moscow News Bureau

**When the chief arrives** for work at one of the Soviet Union's leading electronics instrument laboratories she has already prepared breakfast for her family and tidied up her three-room Moscow apartment.

Rima V. Vasilyeva walks briskly through the machinery hall of the

Central Research Institute of Technology and Machine Building, up a narrow flight of stairs and toward one of her two desks. They symbolize her dual roles as administra-

**Engineer Vasilyeva** checks reports in her office at the laboratory.







**Mrs. Vasilyeva keeps up with technology** by reading American and British journals that are translated and sent to institute.



tor and as technical supervisor of the institute's electronics instrument laboratory.

As administrator she studies research problems and decides on instrumentation that may help to solve them. As electronics specialist she supervises the work of 16 engineers and technicians—all but three are men—who design, build and test the new instruments.

The electronics lab is one of four at the institute which conducts research for about 500 machine-building enterprises throughout the country. The other labs specialize in materials, technical processes, and machine construction. Frequently two or more labs cooperate on a project.

"If an enterprise needs an instrument for machine design," she says, "we consult with the plant's design people, find out which parameters of the new machine are to be measured or controlled, then formulate technical plans for doing the job."

The institute and the enterprise

sign an agreement based on these plans; the agreement then must be approved by the Ministry of Heavy Machine Building. The research and development typically takes 18 months.

**Academy function.** No research and little development is done at the enterprises themselves. Basic research is concentrated at research institutes operated by the Soviet Academy of Sciences and by various science academies run by the 15 Soviet republics. The industrial research institutes, including the Moscow facility, emphasize applied research and development, including construction of prototypes and even of pilot plants.

From the quiet administrative office which she shares with a senior engineer, Mrs. Vasilyeva often takes visitors to the electronics laboratory where seven engineers and nine technicians design instruments for testing and controlling the machinery of the future.

The two rooms are connected by a long walkway lined with a gallery of posters: big, colorful safety posters, the closest Soviet counterpart to Pop Art; bold exhortations to

**She assists** a lab technician doing a sensitivity test on a pickup.



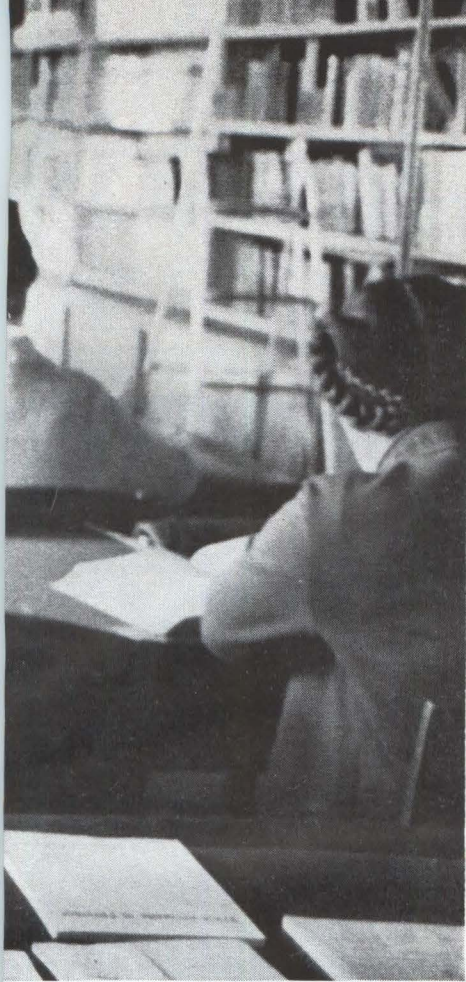

work better and harder, citing goals of the one-year and five-year plans; and international slogans such as "Peace" and "Hands off Vietnam."

The lab, about 22 by 16 feet, is cluttered and cramped. Most of the instruments are Soviet-made, but there are several from Britain (a Pye amplifier was noted), Denmark (a millivoltmeter made by Bruel and Kjaer), Japan, East and West Germany, and Czechoslovakia.

Mrs. Vasilyeva, who helped to found the electronics lab in 1948, is particularly proud of a stationary gauge, now in mass production, that automatically measures and records vibrations of turbine bearings and shafts. In case of excessive vibration it can sound a warning or halt the turbine altogether.

It employs a 4.8-pound induction-type vibration pickup 4.9 by 4.9 by 3.3 inches, with a seismic mass whose natural frequency is 6.5 to 8.5 hertz. At 100 hz the instrument measures maximum amplitude accurately to 300 microns; at 150 hz, accuracy is up to 100 microns.

Components include eight 2-vibration pickups for each measurement point, up to eight points; a

## What puts the flash in flash bulbs?

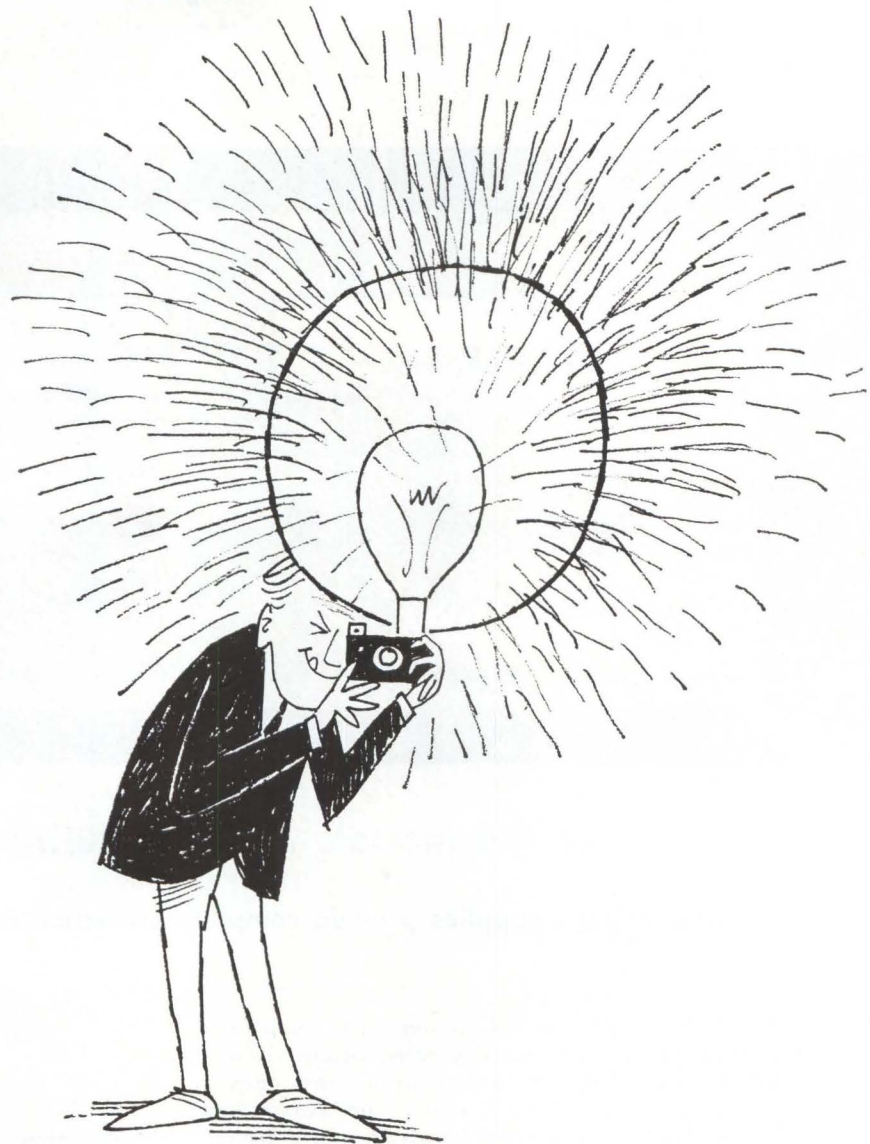

One of the big reasons for the dependable performance of many of today's flash bulbs is the Zirconium foil you see inside the bulb. Zirconium foil, Hamilton's Zircoflash®—only .0008" thick—is delivered in quantity and on time by Hamilton Precision Metals.

There are 7 proprietary metals, 112 commercial alloys and 12 pure metals now available. With expanded production facilities, Hamilton Precision Metals is now producing these metals *in quantity*. Strip and foil are available from 0.10" thick down to 0.000080" thin, and from 1/32" to 12" in width—wire in diameters from 0.1870" to as fine as 0.0010".

Check with Hamilton Precision Metals on your electronic metals requirements of precision strip, foil or wire. Write today for completely new brochure. It gives you complete information on our capabilities as well as detailed properties on over 100 metals.

### HAMILTON PRECISION METALS

division of Hamilton Watch Company ■ Lancaster, Pa.





# new disciplines in DC

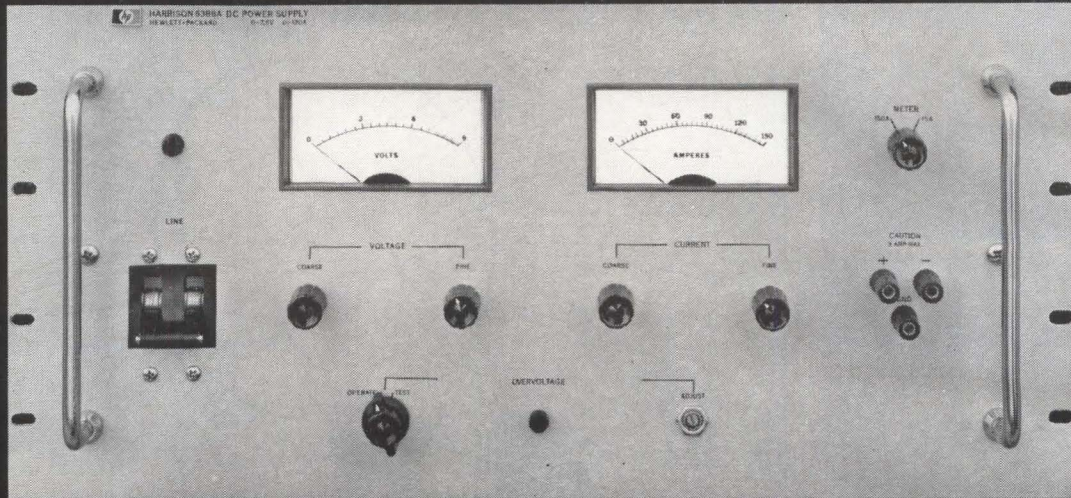

## take the models with the built-in "Crowbar"

Low voltage supplies provide complete protection for integrated circuits

This series of Hewlett-Packard 0.01% regulated supplies has been designed for use with integrated circuits. If a higher than normal DC output voltage results from open sensing leads, open circuit voltage control, an extremely large AC input surge, shorted series transistor, etc., a completely independent circuit inside the instrument initiates the conduction of an SCR "Crowbar" across the output terminals within 10  $\mu$ s.

All supplies have been designed for low output impedance and minimum Peak-to-Peak ripple to avoid false triggering of low level integrated circuits. For example, Model 6384A has less than 2 MV P-P, 1 MV RMS ripple, even at 8A output. All models employ all-silicon circuitry and conform to RFI specification MIL-I-6181D for conducted and radiated interference.

Compact — Minimum Space, High Output Current Rating • Low Output Drift Assured by Front-End "Diff-Amps" • Short-Circuit-Proof • Constant Voltage/Constant Current Operation with Automatic Crossover, except Model 6384A Constant Voltage/Current Limiting • No Overshoot for Turn-On, Turn-Off, or AC Power Removal • Floating Output, Can be used as Positive or Negative Source • Adjustable Crowbar Threshold Voltage • Compact Model 6384A Front Panel includes Fuse, Combined Line Switch/Pilot Light, Single Meter with 6V and 10A Meter Switch, and Output Voltage Control

DC Output	Size	Model	Price
4-5.5V, 0-8A	3½"H x 8½"W	6384A	\$220.
0-7.5V, 0-15A	5¼"H x 19"W	6385A	\$450.
0-7.5V, 0-30A	5¼"H x 19"W	6386A	700.
0-7.5V, 0-60A	8¾"H x 19"W	6387A	825.
0-7.5V, 0-120A	8¾"H x 19"W	6388A	1,050

Contact your nearest Hewlett-Packard Sales Office for full specifications.

HEWLETT  
PACKARD  HARRISON  
DIVISION

100 Locust Ave., Berkeley Heights, New Jersey 07922 AREA CODE (201) 464-1234 TWX 710-984-7972

H07A

Circle 182 on reader service card





The electronics specialist is also a domestic engineer. She serves breakfast to her daughter, Olga, 14, before going to work.

two-channel amplifier; a choice of two potentiometers for recording vibration amplitudes, one weighing 101 pounds the other only 48.4; also an indicator for measuring all vibration amplitudes. The indicator is fitted with a brush-type switch.

**Foreign influence.** Although she speaks almost no English, Mrs. Vasilyeva reads British and American technical publications regularly. These are reproduced in Moscow and circulated to technical institutions about three months after original publication.

Under the glass top of her desk Mrs. Vasilyeva has a list of 16 management tips translated from an American magazine. One suggestion is: "Never do yourself what your assistant is able to do."

Her lab is divided into four groups of vaguely defined specialties, and Mrs. Vasilyeva generally works only with the group leaders. Most of her attention goes to groups specializing in transducers and in amplifiers.

Mrs. Vasilyeva also works closely with the institute's design bureau, where six engineers and 12 draftsmen transform ideas into working drawings.

Work at the lab starts at 8:30 a.m. for the director, who finishes at 4:30 on weekdays and a bit earlier on Saturday. "Next year we hope to go to a five-day week," she declares. For running the lab she is paid 400 rubles a month—\$440

at the official, inflated rate of exchange. Senior engineers receive \$200 a month, ordinary engineers \$122 to \$133, senior technicians \$111, junior technicians \$90, and lab assistants \$67.

**Comfort and convenience.** The Vasilyeva home is a comfortable, tastefully furnished apartment five minutes' walk from the lab.

Mornings she cooks and serves breakfast for her husband, a radio engineer, and for their 14-year-old daughter, Olga, an aspiring artist. The Vasilyevas also have a married son of 26, also a radio engineer, and a two-year-old grandson.

There are many signs that the Vasilyevas are well-to-do by Moscow standards. Outside the apartment house is a Moskvitch, a Soviet compact car that costs \$5,000 in rubles; inside are a quality radio and a television set beside a glass-doored case in which is displayed, among other things, a medal for successful labor earned recently by Mrs. Vasilyeva.

As Olga gets ready for school at 8:15, Mrs. Vasilyeva gives her "directives" for the day: what to eat for lunch and supper, where to go after school, and so on. After Olga has dashed out the door her mother says: "She goes to an English-language school. Classes are conducted in English, and she should speak only English there; I stress 'should' because I suspect they don't always do it."



Fluorocarbon polymers are made easily bondable to other materials when you apply MC&B Poly-Etch. This new product is an activated form of sodium in solution. Poly-Etch reacts with the fluorocarbon resin, extracting fluorine atoms at the surface, forming a carbonaceous film which is compatible with most adhesives.

Poly-Etch is easily applied by dipping, spraying, brushing or spotting. It can be used with conventional adhesives and provides the only sure way to bond other materials to fluorocarbon plastic.

Prices: 6 ounce can \$15  
1 pint bottle 12  
1 qt. container 20

Poly-Etch is available from MC&B distributors. For literature, write

**MC&B**

P.O. Box 85, East Rutherford, N. J. 07073  
TEFLON® is a registered trademark of Du Pont Co.



# What's new with A-New

The Navy's totally integrated airborne ASW system gives battle commander coordinated information from his sensors

By W.J. Evezia

Avionics editor

**A number of** advances—including a pint-sized digital computer, multi-purpose display consoles, a data processing system, and a sonic analyzer—are bringing a totally integrated airborne antisubmarine warfare (ASW) system closer to operational status for the Navy.

Some of the improvements are incorporated in the engineering prototype of the new system called A-New on which flight tests began in October. Others will be installed in time for the service acceptance tests scheduled for 1969.

The Navy has already invested more than four years and over \$20 million in the A-New project which is intended to ease the lot of the battle commander of an ASW aircraft. The system is designed to give him quick access to information. Because of the deluge of data from a number of different sensors the battle commander, or tactical coordinator, has had the almost impossible job of working rapidly and accurately. But with an assist from A-New, he will be in a stronger position to hunt and kill enemy submarines.

**Checkout.** After having passed feasibility and simulation tests, the A-New system [officially designated Mod. III at this stage of its development] was installed aboard a Lockheed P3A. It is being put through its paces at the Weapons System Test Facility, Naval Air Test Center, Patuxent River, Md. These checks will form the basis for the service acceptance tests of the production A-New system which will be installed in a new version of the Orion—the P3C.

The A-New system, Navy officials say, is doing an impressive job in furnishing the battle commander with more usable data and achiev-

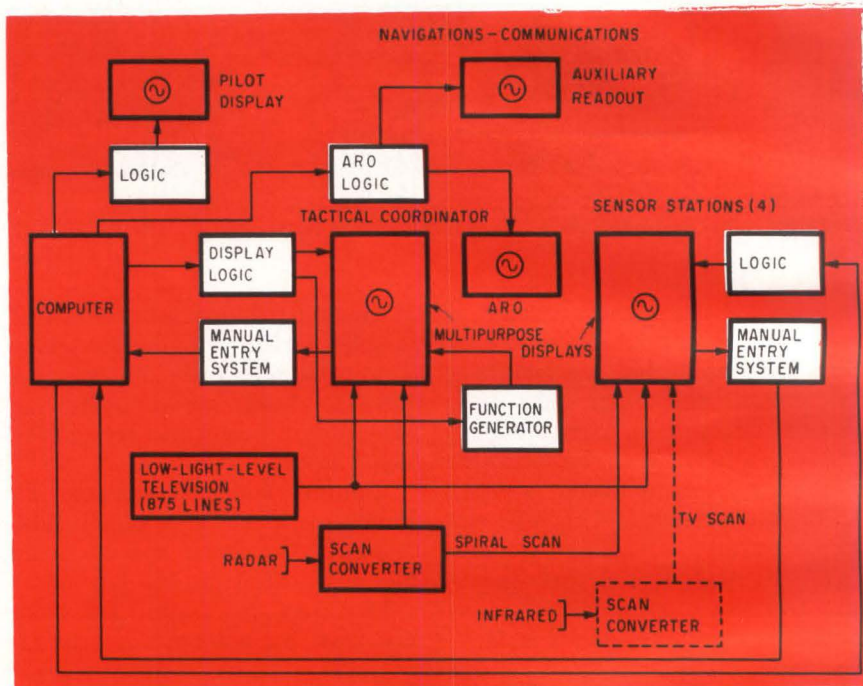

In the A-New system now being evaluated, computer-generated commands and data are transmitted through logic boxes to cathode-ray tube displays. In the production model the interface hardware, shown in white, will be replaced by a single unit. The infrared system is still being evaluated.

ing greater accuracy in target identification during the present tests.

Although A-New is not intended to advance the state of the art, it incorporates some entirely new elements. The most notable is general-purpose digital data processing.

**Computer key.** Early in the program, the Navy decided that a digital computer processor was needed to correlate and display data from the surveillance, navigation and communication equipment carried aboard the ASW aircraft. The development job was turned over to the Univac division of the Sperry Rand Corp., which came up with the small, fast and versatile Univac 1830. This unit is installed in the current test bed. It will, however, be replaced by an

advanced version incorporating integrated circuits—the 1830A—in the production A-New system.

The 1830A occupies only about three cubic feet of space, weighs less than 300 pounds and operates in real time. A general-purpose, stored-program computer with performance characteristics exceeding those of many large ground machines, it has a 2-microsecond cycle time [1 usec with overlap]. The 1830A's 48,000-word memory is expandable to 131,072 30-bit words.

In the Mod. III system now under evaluation, the computer is connected through logic boxes to four sensor stations. [See block diagram]. Among other things, the operators at these stations collect data on low light level television,



# Does AE make the world's prettiest dry-reed switches?

Some of our customers think so. They go for the chic look of our PC Correeds on a printed circuit board.

Our designers are flattered. But they point out that the beauty of a PC Correed is more than skin-deep.

Take the contact leads. We keep them separate from the terminals—to eliminate strain. The terminals themselves have "I-beam" strength. They are longitudinally ribbed for extra rigidity—for easy insertion in PC boards.

The contact terminals are *welded*, not soldered. This makes a better electrical connection.

We filled the plastic bobbins with glass, to prevent moisture absorption. And to boost structural

strength. You can pack these smart-looking switches as densely as you like. Because of their low profiles, magnetic shielding, and standard PC terminal spacing (multiples of 0.200").

PC Correeds are available with 1, 2, 3 and 5 reedcapsules, in contact forms A, B, C and magnetic latching. You can get many of these modules right from stock. So it's easy to put a little beauty in your life.

Want some helpful new design information? Ask your nearest AE representative for Circular 1070-B. Or drop a line to the Director, Electronic Control Equipment Sales, Automatic Electric Company, Northlake, Illinois 60164.



**AUTOMATIC ELECTRIC**  
SUBSIDIARY OF  
GENERAL TELEPHONE & ELECTRONICS **GTE**



# NEW... FREE...



## VITREOSIL® PURE FUSED QUARTZ CATALOG

From Thermal American Fused Quartz Company . . . A comprehensive 48 page catalog describing the latest in **VITREOSIL** pure fused quartz laboratory ware, industrial ware, tubing, fabrication and special quartz products.

Also included are informative sections giving technical and application data.

Price information is included with each catalog — see separate price list.

Ask for your copy today. 46



## . . . one input-output channel of the A-New computer services 16 peripheral units . . .

sonobuoys, radar, electronic countermeasures equipment, magnetic anomaly detectors and photographic reconnaissance gear. They furnish information inputs to the computer.

**Less talk, more action.** However, there will be some changes in the production model A-New for the P3C. For instance, it will require only three sensor stations, as against four in the Mod. III version.

The ASW battle commander can present a variety of stored information on his display console at will. Cathode-ray tube displays largely eliminate the need for vocal coordination between the commander and sensor station operators.

Included are:

- Multipurpose displays at the battle commander and sensor stations. These units along with their Charactron beam tubes were made by the Stromberg-Carlson Corp., a division of the General Dynamics Corp. Computer-controlled digital data, tactical and geographic vectors, low light level television, scan-converted radar and infrared video as well as computer-generated circles and ellipses are presented.

- Auxiliary readout (ARO) units at both the commander and navigation-communication stations. The 5½-inch crt display, which incorporates a Charactron, was also manufactured by Stromberg-Carlson. A 256-word buffer, the ARO is used to amplify target data as well as weapons and stores status. In addition, it indicates data link messages, Teletype and computer-generated information automatically or on demand.

- A pilot display, an 9-inch crt unit made by the Electronics Systems division of the Loral Corp. Limited tactical data in the form of 36 computer-generated alphanumeric numbers and symbols—fly-to points, sonobuoys, action cues and aircraft position—are presented. In the P3C configuration, the pilot will also have access to low light level television and radar pictures on his display.

**Consolidating gains.** Interface hardware [shown in white in the block diagram] between displays,

computer and sensors, including display controls, was supplied by Loral. On the P3C, these subsystems will be replaced by a single piece of equipment called the data processing system, incorporating a digital multiplexer that will enable a single input-output channel of the A-New computer to service 16 peripheral units. The Navy believes this arrangement may be the first in a series of A-New subsystems to be consolidated. As yet, no contract has been let for the system.

The P3C, which carries the production A-New, will also be equipped with a new sonic analyzer that will use sophisticated correlation techniques to extract signals from noise. It will be used with sonobuoys to enhance their detection capabilities. Loral supplied the dark tube display on which information is presented in the form of high-contrast black lines and up to 10 shades of gray on a green background for the Mod. III version of A-New. Proposals for the new system which will have a dark trace tube, logic driver, frequency translator and spectrum analyzer are being evaluated.

In addition to its other functions, the Univac computer serves as a navigation aid, enabling the A-New aircraft to maintain course even when a smooth sea gives poor doppler radar returns. Moreover, with A-New, the position of a sonobuoy is automatically fed into the computer the minute it is dropped. This information, together with sea condition and wind velocity inputs, allows the computer to make an accurate plot of the buoy pattern and guide aircraft around the station.

A modified Collins Radio Co. FD-108 flight-director unit will further improve the teamwork between pilot and battle commander in the A-New-equipped P3C. During tactical maneuvers, for instance, the commander will no longer have to check the position of his aircraft and fly-to-point before ordering a change of course. The maneuver itself will automatically order the computer to calculate the bearing and distance. The commander simply observes the computer-generated information on his



multipurpose display console.

**Serviceability.** While the A-New aircraft is on station, the Univac computer will diagnose faults in the avionics digital circuitry. Analog circuits will be checked with separate manual test equipment that is built in. The A-New system gear will be easy to get to and maintain on board the aircraft. It will be mounted on open racks and the equipment packages will have removable side panels so modules can be easily replaced.

The Navy hopes that real-time, computer-to-computer communications will eventually permit A-New aircraft coming on station to absorb, in seconds, all of the information it took hours of submarine hunting to gather. The means of communication—the Naval Tactical Data System—is already available as are most of the equipment and modulation techniques. But the language is not, and the Navy is undertaking to devise one. Software engineers are also seeking to develop new tactical algorithms for the A-New system to abet the battle commander's decision-making.

**Development.** Since the conventional sensors proposed for A-New had never before worked together, no one really knew at the outset whether such a system would be effective under combat conditions. This prompted a deliberate, three-stage approach. During the first phase, a flying breadboard established the feasibility of the A-New concept. The second stage concentrated on down-to-earth laboratory simulation. Finally, the Navy began flight testing the Mod. III prototype system.

Simulation studies, with a large assist from a real-world-problem generator supplied by Sylvania Electric Products Inc., a subsidiary of the General Telephone & Electronics Corp., are continuing on the A-New configuration for the P3C as well as for carrier aircraft and helicopters. The generator is pre-programmed so the authentic problems and tactics that have been created can be repeated in identical formats to assess changes in the A-New system as it evolves.

Carrier-based planes will probably have to wait until after 1970 for A-New gear and it appears likely that helicopters will have an even longer wait.

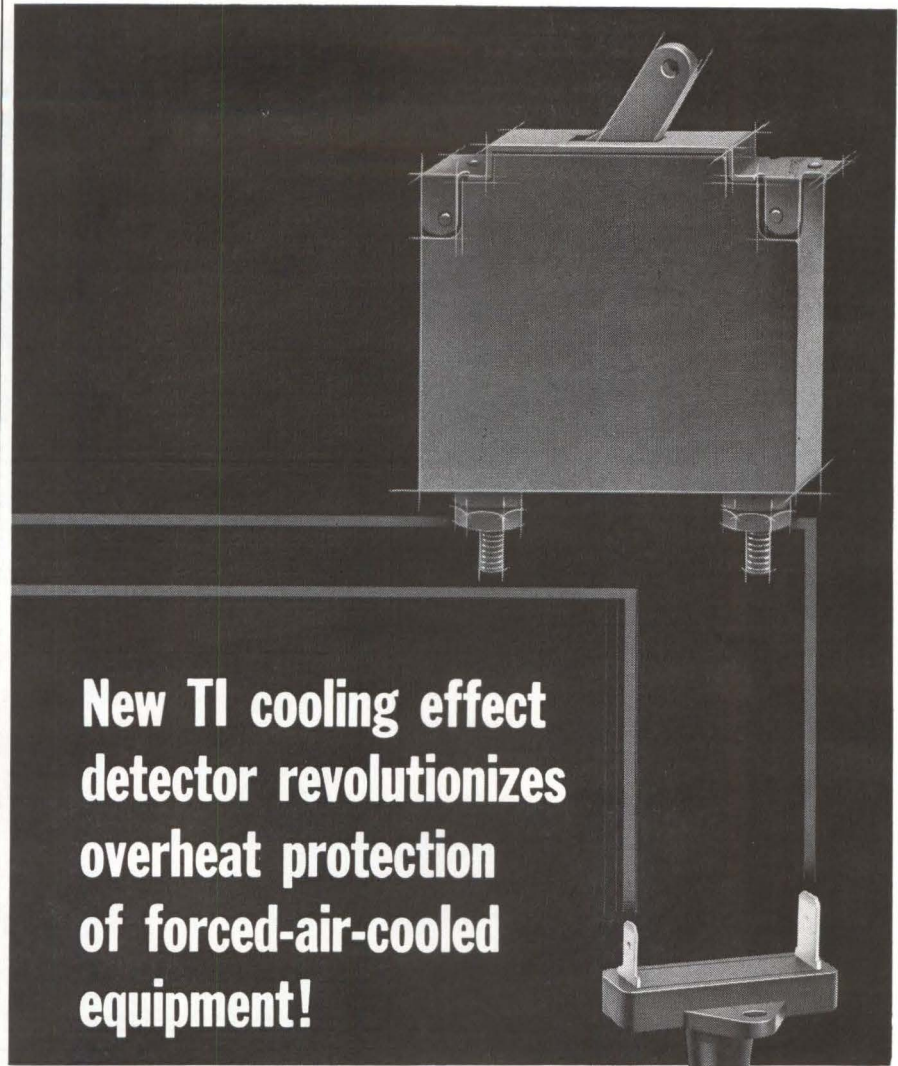

## New TI cooling effect detector revolutionizes overheat protection of forced-air-cooled equipment!

**KLIXON® 2ST Cooling Effect Detectors** combine unprecedented sensitivity, reliability, simplicity and economy to prevent harmful overheating in computers, radar and microwave systems, copying machines, film projectors and other fan-cooled equipment. They completely eliminate the need for vane switches and thermostats.

**Reliable solid-state sensing makes the difference!** The sensor is a self-heated NTC (negative temperature coefficient) resistor. Mounted in the air stream and connected in series with a special rating of the KLIXON 4MC magnetic circuit breaker, it monitors the cooling capacity of the air stream. Loss of cooling effect as a result of clogged inlets, fan failure, air conditioner loss, or any combination of these causes a sharp drop in sensor resistance. The resultant increased current will trip the circuit breaker.

**Unlike conventional thermistors,** KLIXON 2ST Detectors sense over their entire surface, instead of only one point. This simplifies installation and mounting. Moreover, they can handle directly a current large enough to actuate a circuit breaker without intermediate amplification. They can be designed to operate at any voltage between 3 and 24 v-dc/60 cycle ac.



**Bulletin PRET-16** gives you all the facts you need to evaluate these exclusive TI developments. Write for your copy. TI Control Products Group, Attleboro, Mass., 02703.

# TEXAS INSTRUMENTS

INCORPORATED



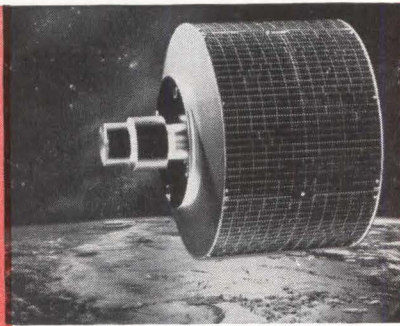

*De-spun Antenna System  
for Global Communication*

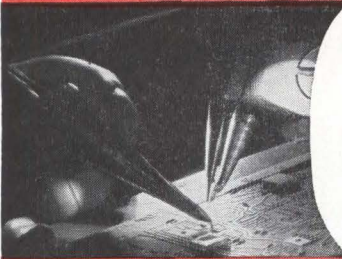

*Microminaturization Circuit Techniques*

## GET THE MESSAGE THROUGH . . .

... the depths of space, through jungle brush and canopy, through intricate computer networks. Use VHF, microwaves, lasers. Across the complete spectrum of communications, Sylvania Electronic Systems gets the message through.

Doing this job demands the best of scientists, engineers, and technical managers of many disciplines, working in the best of facilities, where the climate is strictly professional and optimal toward new ideas and advancement.

With locations in suburban Boston, Buffalo, and San Francisco — close to major universities where you can further your education — Sylvania Electronic Systems offers the complete spectrum of job opportunities.

Got the message? Then get through to the Manager, Professional Staffing, Sylvania Electronic Systems, Division of Sylvania Electric Products Inc., 59 Sylvan Road, Waltham, Mass. 02154.

*The complete spectrum of opportunity — job diversification, geographic location, professional satisfaction — is awaiting you at Sylvania Electronic Systems.*



*Laser Acquisition and Tracking System*

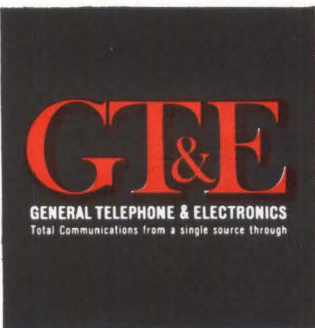

# SYLVANIA ELECTRONIC SYSTEMS

RESEARCH • SYSTEMS DEVELOPMENT • PRODUCT & FIELD ENGINEERING

*An equal opportunity employer*

52  
59  
68  
74  
84  
89



# Higher education from satellites

Space agency sponsors satellite-building program to train new scientists by giving budding Ph.D.'s responsibility for their own spacecraft

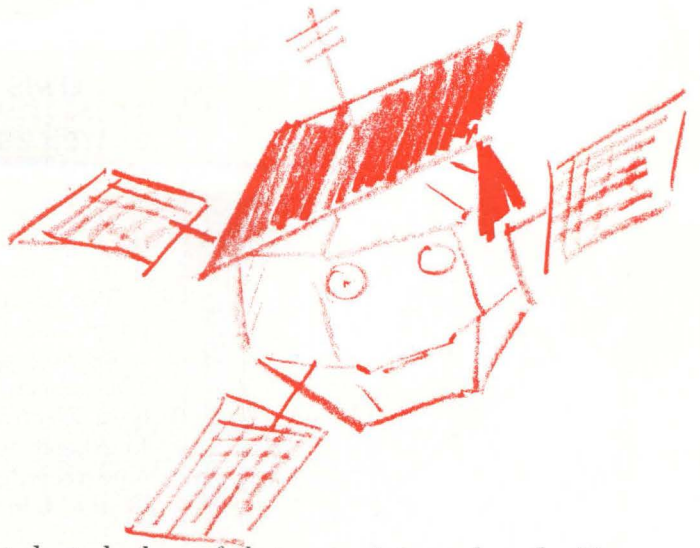

**A winning football team**, a nuclear reactor and a large-scale computer no longer guarantee prestige to a major university. These days a school must have its own satellite.

But there's much more than prestige at stake. The National Aeronautics and Space Administration is now financing satellite-building projects to train the next generation of space scientists.

Many institutions already participate in space experiments. But having complete responsibility for their own satellites gives them, and their graduate students, experience over a broader range of space science. Since universities lack the facilities to produce and test spacecraft, they are going to electronics and aerospace companies for their hardware.

The academic space club is currently more exclusive than the Ivy League. Only one school, the University of Iowa, has orbited a satellite. Rice University has launched a program but no spacecraft. Four others have study contracts: Harvard University, the Massachusetts Institute of Technology, the University of Michigan and the University of California at Los Angeles.

Preliminary studies are under way at the University of California campuses at Berkeley and San Diego, at Stanford University and at the University of Southern California.

The satellites are designed to do a variety of scientific jobs in space, depending on the universities' interests. All, however, are relatively cheap—around \$3 million—and use the Scout launch vehicle. Scout is considered too small for all but a few of NASA's projects, but has proved ideal for newcomers to space.

At all the schools, students do the work and faculty members supervise. Four doctoral candidates at Rice will base their work on the satellites, which are nicknamed Owls for the school's mascot. "They'll get a feel for the spacecraft rather than just the individual experiment," says Brian J. O'Brien, the project manager. "Before a graduate student publishes a scientific paper or conducts a discussion, he has to know how well he can trust a spacecraft. He'll have to worry about weight, power—the whole engineering facet."

Alexander J. Dessler, chairman of Rice's new Department of Space Science, stresses the need for training future space scientists. "This is a critical time," he says. "Just as the major space programs are whipping along on Apollo and beyond, we will be turning out a significant number of graduates to help direct and work on them. There's a real shortage now."

Paul J. Coleman Jr., director of UCLA's satellite project, agrees with his colleagues at Rice University that a satellite is an ideal way for students to become involved in every phase of space science. He hopes the UCLA project will swell graduate enrollment and produce as many as 10 Ph.D.'s.

**A helping hand.** Since it was established in 1958, NASA has encouraged universities to participate in space projects and has flown a number of their experiments on its spacecraft. James Van Allen of the University of Iowa developed radiation counters for the nation's first successful satellite—Explorer 1, launched Jan. 31, 1958—that discovered the radiation belts bearing his name. Van Allen and his colleagues were working on a satellite

of their own, Injun, when the National Academy of Sciences met on the Iowa campus in the summer of 1962 to plan space goals. On the basis of the Iowa work, the academy recommended that other universities have their own satellites and that NASA provide them with the launch vehicles as well as support equipment.

The Iowa satellite was a joint project of the university and the space agency's Langley Research Center, Hampton, Va. It was designated Explorer 25 and went into orbit Nov. 21, 1964 carrying a magnetometer and 16 radiation sensors to conduct further studies of the Van Allen belt.

## 1. Ground rules

Shortly after the 1962 planning conference NASA set up a small university satellite organization within its Office of Space Science and Application. The group is far down the agency's organizational chart, falling under the Explorers and Sounding Rockets branch of the Physics and Astronomy division.

A university proposing a satellite first talks to the NASA scientific discipline branches to see how the project would fit into the over-all space program. After discussions on the merits of the project and the budgetary outlook, the university submits a formal proposal the way any industrial company would. If it is accepted, the school receives its money from the Grants and Research Contracts division and begins working out the details of schedules and subcontracts with NASA's university satellite group.

Rice was the first university to get its satellite project officially approved and funded under the new program. Two Owls will study the



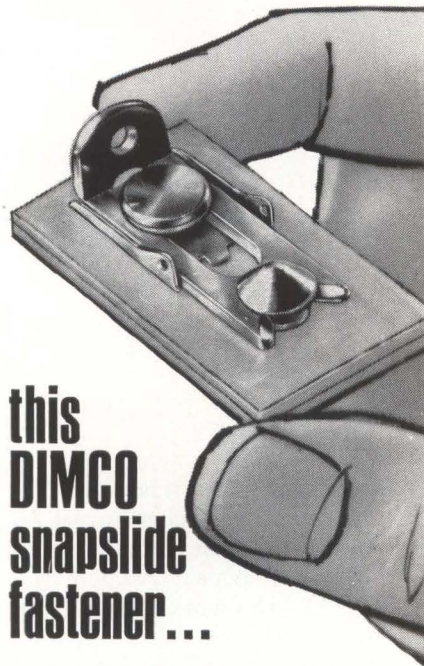

**this  
DIMCO  
snapslide  
fastener...**

**holds assemblies  
securely...**



**instantly  
engages/releases...**

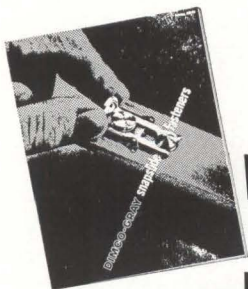

**write for  
new  
handbook**

Dimco-Gray Snapslide Fasteners hold assemblies firmly despite shock or vibration... never need adjustment, even with repeated use. Instant snap action engages or releases fastener... no tools required. Approved under Military Standards. Handbook illustrates typical applications, stimulates design ideas, describes attachment methods. Write for free copy today.

DIMCO-GRAY CO., 204 E. SIXTH ST., DAYTON, OHIO 45402

## ... Owls will keep watch over auroras as well as Van Allen radiation belt...

auroras and their relationship to the Van Allen belt and energetic space particles hitting the earth.

Rice has a \$3.6-million cost-reimbursement contract from NASA and is serving as a prime contractor. The subcontractors are: the Lockheed Electronics Co., a division of Lockheed Aircraft Corp., for the tape recorders and the electronics in the television camera system; Westinghouse Electric Corp. for the vidicon; the Space-General Corp., a division of Aerojet-General Corp., for the data distribution system; and the Northrop Corp. for spacecraft chassis and the antenna.

**East of the sun.** Two Owl satellites will be launched about a month apart early in 1968 during a period of peak solar activity. Each 175-pound satellite will be oriented by a permanent bar magnet so that one axis is continually aligned with the earth's magnetic lines of force. A television camera will photograph the auroras below while Geiger counters on the upper side of each satellite measure particles on their way to earth. Other detectors on the lower side of the satellite will measure Van Allen radiation.

Power will be supplied by the 9,000 solar cells that cover the spacecraft. Their output will average 30 watts while the satellite is in the sunlight and will be fed into two nickel-cadmium batteries.

### II. Western branch

The UCLA project, as yet unnamed, got under way in October with a \$55,000 grant from NASA. The university has issued 60-day study contracts to three aerospace firms: the Hughes Aircraft Co.'s Space Systems division; the General Dynamics Corp.'s Convair division; and the Philco-Ford Corp.'s Western Development Laboratories.

The proposed satellite will carry 20 pounds of scientific equipment grouped into four experiments. An energized particle detector will determine direction and density of protons and electrons. Dual magnetometers, one a flux gate for direct current and low frequency and the other for d-c up to 1 kilohertz, will measure magnetic fields. A plasma detector will measure the

direction and density of ions. The fourth experiment is an electric field meter. UCLA is aiming for a launch in 1968 from the Vandenberg Air Force Base in California.

**Another redskin.** Meanwhile, Iowa is preparing a more sophisticated version of its earlier Injun for a launch late next year at Vandenberg Air Force Base. And the university is again working with the Langley center. The satellite, called Injun 5, will carry three Langley experiments and one from

### University satellites

School	Satellites
Iowa	Injuns
Rice	Owls
Harvard	Pilgrims
Michigan	Michaels
MIT	Sunblazers
UCLA	Unnamed

the Air Force Cambridge Research Laboratories, Bedford, Mass.

One of the Langley experiments consists of two low-energy proton-electron differential energy analyzers to measure trapped particles in the range of 75 electron volts to 75 kiloelectronvolts (kev). Another consists of two 20-foot-long dipole antennas to measure very low frequency emissions, the so-called "whistlers" and other radio noises, at three frequencies: 30 to 750 hertz, 750 hz to 4 kilohertz and 4 to 16 khz. The third is an array of solid-state detectors to measure protons at 250 kev to 21 megelectronvolts (mev), alpha particles at 1.5 to 10 mev and electrons at 200 kev to 1.2 mev. The Air Force experiment consists of a low-energy electron detector.

The Iowa satellite will weigh about 150 pounds and be launched from Vandenberg. Once in orbit, Injun will be magnetically stabilized like the Owls and will receive an Explorer designation. Cost of the program, excluding the launch vehicle is about \$2 million.

### III. Cambridge contingent

Harvard College Observatory professor Richard Huguenin is in charge of a study project aimed at



orbiting a satellite, dubbed Pilgrim, to observe solar radio bursts at frequencies from 250 khz to 16 megahertz. "It will enable us to see a portion of the radio spectrum that is not observable from the ground," says Huguenin. "There is no window in this range."

Pilgrim will use proven components—principally recorders and telemetry equipment. It will carry devices to keep it pointed toward the sun within a few degrees, says Huguenin. The sun is a sporadic emitter. But Pilgrim is expected to stay up one year, taking data continuously, so it will probably gather a fantastic amount of data for processing here on earth, he adds.

MIT's Center for Space Research has a NASA grant to design a satellite called Sunblazer to explore the interplanetary plasma and its influence on deep-space communications. This project is to be conducted with the interplanetary and solar probes branch of NASA and the Pioneer spacecraft program management office, rather than with the university satellite office.

Sunblazer is intended to carry a radio transmitter into an orbit around the sun so that scientists can observe the effect of the interplanetary medium on signals transmitted to earth as the spacecraft passes behind the sun.

**Bantam rooster.** The spacecraft will weigh only 10 to 15 pounds and will be just large enough for a solid-state two-channel transmitter and a solar-cell power source. Because signals will be coherent, observers can detect the relative delay between pulses on different frequencies and thus determine the electron densities along the path of transmission. The transmitter will emit pulses 26 milliseconds long on carrier frequencies of 100 to 300 Mhz. Several shots a year are planned to get a continuously operating network of Sunblazers.

The University of Michigan project, called Michael for Michigan Aeronomy Experimental Laboratory, is also covered by a NASA study contract. Michigan took an informal approach and has been asked to restudy the satellite and submit a formal proposal. The Michael would conduct aeronomy studies—ionization, dissociation and chemical reactions.

## ADAMS-RUSSELL ISOLATED CONVERTERS

(DOUBLE BALANCED MIXERS) are immediately available for frequency conversion, phase detection, modulation and phase reversing switching. Three models (BNC/TNC, OSM, or plug-in lead connectors) provide low-noise and high dynamic range frequency conversion for critical receiver, synthesizer and transmitter applications.

From DC to 400 Mc, these isolated converters can be used with freedom of interchangeability from one application to another and assured adherence to specifications over their range... without need for diddling. Other miniaturized hybrid devices including isolated converters for use at LF, HF and UHF frequencies as well as power dividers and other hybrid junctions will soon complement this Adams-Russell family.

Typical performance of these ICH-50-series converters includes an RF range from 500 Kc to 400 Mc; L. O. range from DC to 460 Mc; Conversion Loss of 7 db and a Noise Figure of 7.5 db. The units are completely RF shielded, designed for operation under extreme military environmental conditions of shock and vibration. Complete details, including price, sent by return mail.



**ADAMS - RUSSELL**

280 Bear Hill Road Waltham, Massachusetts  
(617) 899-3145 TWX: (710) 324-0618





# MATREX<sup>®</sup>

## PROGRAMMING BOARDS

**EXTREMELY COMPACT**

*brand new possibilities*

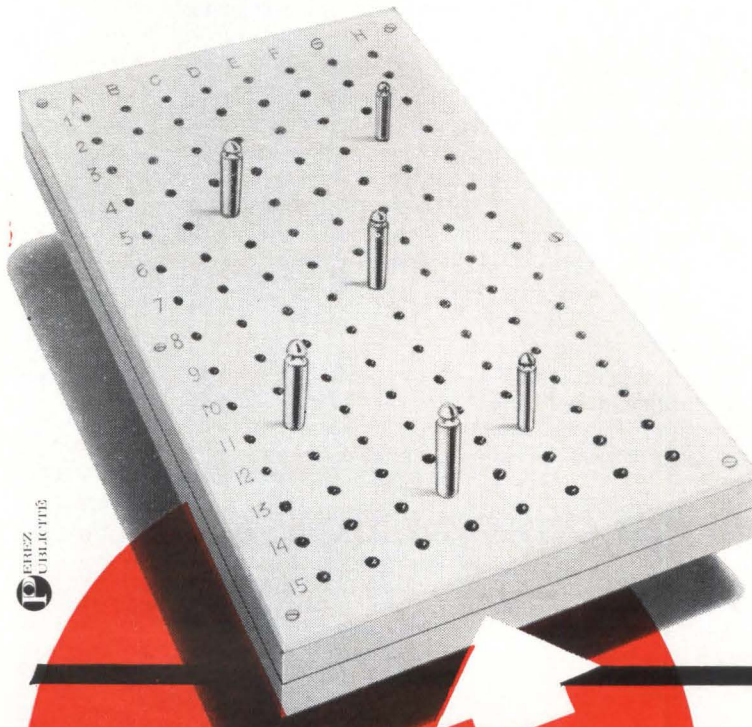

PEREZ  
ELECTRIC

*It's inside  
they are not like  
the others!  
1, 2, 3 contact planes  
or more...*

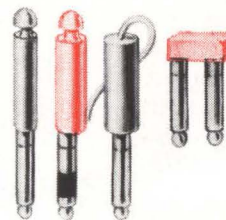

**WIDE CHOICE OF  
PLUGS  
AND TOP PANELS  
IN A VARIETY OF  
COLORS**

- HIGH SWITCHING DENSITY
- ANY CONFIGURATION AND SIZE AVAILABLE
- GREAT SHOCK AND VIBRATION OUSTANDING
- SINGLE OR BUSSED SOCKETS
- HIGH RELIABILITY

**J. MAUREL** MANUFACTURER

113 AVENUE JEAN-BAPTISTE CLEMENT - 92 - BOULOGNE sur SEINE / FRANCE - TEL. VAL. 96.20 +

*WE ARE LOOKING FOR A LICENSEE MANUFACTURER*



# Army enlists IC's for artillery fuzes

It has asked electronics companies to help in a crash program to develop cheap proximity fuzes using integrated circuits

By William D. Hickman

Electronics Washington Bureau

If the Army could make cheaper proximity fuzes for ordnance, artillery batteries in Vietnam would have two to five times more effective firepower at their disposal than they do with conventional ammunition. Proximity fuzed rounds will never completely supplant their impact-fuzed counterparts, but they have proved their mettle in countless barrages. Unfortunately, cost has been the biggest obstacle to employing them more widely. So a crash program is under way to get the price down by using integrated circuitry.

The Harry Diamond Laboratories, a division of the Army Material Command, is spearheading the research and coordinating the efforts of electronics and aerospace companies to apply ic technology to ordnance.

**The mother of invention.** Although, as one Diamond Labs official puts it, "no one expects the war in Vietnam to go on forever," the added punch of artillery with proximity fuzes against dug-in enemy troops gives the undertaking particular urgency.

So far, the Army has committed about \$750,000 to the project which it hopes will provide an economical hybrid proximity fuze—incorporating both ic's and discrete components—within 21 months. The ic development will be complete in 11 months and production-model fuzes will be coming off the line 10 months later.

The meeting of such a tight schedule would represent a signal accomplishment since the normal lead time from laboratory to battlefield for the ic work alone would have been three years or more.

**One-chip ante.** The unit cost of the vintage printed-circuit, vac-

uum-tube fuzes now available is about \$10—even in quantity—and no reduction is in store. Their high cost limits them to large shells for crucial Vietnam targets. Although bulky, the fuzes could be adapted for the Army's smaller shells. But the cost is prohibitive.

Proximity fuzes could be built with discrete transistors similar to the conventional, epoxy encapsulated types used in audio-frequency equipment for about \$5 apiece. But the Army, going all out to reduce cost, does not find this saving sufficiently appealing. Accordingly, discrete semiconductors have been passed over for promotion.

Diamond Labs has blocked out timetables and cost calculations of circuit development as follows:

- The hybrid configuration, with ic's as well as vacuum tubes and other discrete components, should be ready in less than a year at a cost of \$4 or less a unit.

- A single-chip assembly on

which the entire fuze circuit—including transmitter, receiver and switching gear—will be integrated should be within reach in two years. The relatively low outputs that are anticipated will probably keep the price at about \$2 apiece.

- Greater technical savvy and larger production runs should give the Army single-chip ic assemblies priced at 50¢ each by 1971.

## I. On and off the line

Diamond Labs is overseeing pilot production of ic's for the hybrid proximity fuze from its Washington, D.C. base. Pilot production is under way at the Westinghouse Electric Corp.'s Molecular Electronics division in Baltimore and Motorola, Inc.'s Military Electronics division in Phoenix, Ariz. Westinghouse is investigating equipment and processes while Motorola is concentrating on how to design the fuze mechanism to introduce ic components.

To date, the two companies have each delivered 12,000 ic units for evaluation and demonstration purposes. The deliveries were made under \$400,000 worth of contracts, awarded to answer engineering and cost questions. The Army is, for example, vitally concerned about the expense involved in turning out the amplifier firing-circuit switch in quantity. Westinghouse and Motorola are supplying assemblies with slightly different installation characteristics. The units incorporate a temperature-sensitive gain control to keep them stable over a broad environmental range. They also have a differential analyzer, a signal detector and a 4-layer, silicon-controlled-rectifier switch.

The ic's now coming off the line will go into the hybrid proximity

### Bursting in air

The proximity fuze, a product of a top-priority World War 2 project, was perfected in time to give Allied forces highly effective new ordnance.

It detonates a shell's warhead before impact, spewing lethal shrapnel over a wider target area than can be covered with conventionally fuzed ordnance.

A proximity fuze assembly is simply a tiny transceiver that measures the doppler shift between shell and target. At a preset distance—generally 10 to 50 feet from the target—its detector circuit trips the detonator.



# ALSiMAG<sup>®</sup> DICED CHIP CAPACITORS

Parts illustrated  
approximately actual size.

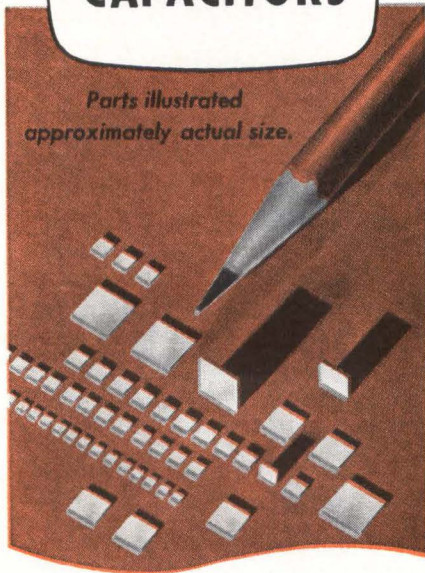

## Small and Reliable

New, unencapsulated chips, diced from thin sheets of ALSiMag dielectric, are now available using dielectric constants from 6 to 9000 with properties as outlined in ALSiMag Dielectric Ceramic Bulletin No. 644. Small .075" squares produce 5.0 pf NPO to .0015 mf Y5V. Smaller sizes available in limited quantities. Capacitance controlled from GMV to  $\pm 5\%$ . Electrodes are available using silver, gold, palladium-gold or platinum-gold.

If you will outline your requirements, we will design ALSiMag diced chip capacitors to meet your needs. ALSiMag Capacitor Bulletin 642 sent on request.

American Lava Corporation **3M**  
A SUBSIDIARY OF COMPANY  
Titania Division  
Chattanooga, Tennessee 37405  
Sixty-Fifth Year of Ceramic Leadership

## ... discharge capacitor and other discrete units will have to wait for a berth on the chip ...

fuzes for 81-millimeter mortar rounds. The ic's may subsequently take their last rides on such Vietnam workhorses as 2.75-inch rockets, 40-mm artillery shells and ammunition for the 40-mm cannon on helicopters. Diamond Labs has proved the feasibility of equipping 20-mm rounds with proximity fuzes, although the Army has not yet established an operational requirement for such relatively small-bore ammunition. Once costs are brought down to the desired levels, consideration will be given to equipping the smaller, and less expensive, rounds with proximity fuzes.

**Cost conscious.** Price is the Army's principal preoccupation and the cost of the Westinghouse ic is now being negotiated. Diamond Labs is shooting for an eventual cost of \$3 or possibly much less per unit.

Westinghouse already has another contract with Diamond to develop a more advanced scr amplifier switch. Specifications call for it to have some bandpass control-frequency capability.

While Westinghouse and Motorola are now the most important

parties in the crash effort, they are by no means the only companies to which Diamond Labs has turned. Philco-Ford Corp.'s Lansdale division is working on a new type of amplifier and an electronic timer, involving metal-oxide-silicon techniques, for proximity fuzes. The General Electric Co.'s Electronics Laboratory, also at work on a timer, has elected to approach the problem through bipolar technology. Finally, Texas Instruments Incorporated, which submitted an unsolicited proposal, has been rewarded with a token \$1,000 contract. The company will tackle basic ic problems with an approach that is different from the ones taken at Westinghouse and Motorola. Additionally Diamond Labs is itself working on some of the problems.

### II. Blocks off the chip

Army engineers still have a way to go before they get all the discrete components they would like on a single chip; for instance, a bandpass frequency-control unit, radio-frequency detector, discharge capacitor and radio-frequency oscillator. It is now impossible to put the discharge capacitor on the

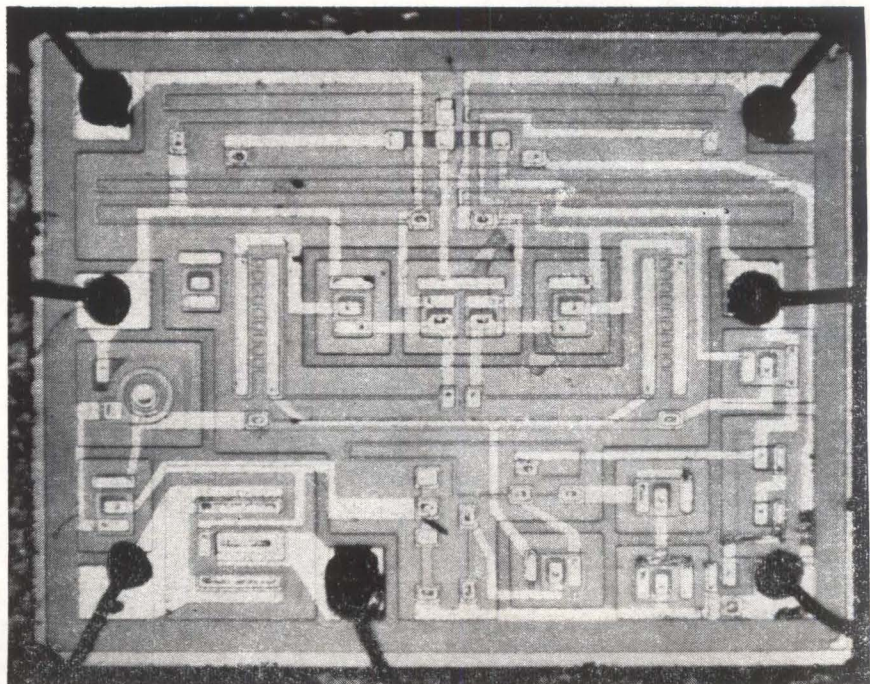

First IC for proximity fuzes will be installed on 81-millimeter mortar shells and later on 2.75-inch rockets. This circuit is being made by the Molecular Electronics division of the Westinghouse Electric Corp.



# If your blip is a blooper, you'll know it in 10 seconds.

Once you start using Polaroid Land film, you'll wonder how you and your oscilloscope ever got along without it.

In 10 seconds, you get an on-the-spot record. You can study it, attach it to a report, send it as a test record along with a product shipment, or file it for future reference.

You have a choice of 5 films for oscilloscope recording.

The standard film has an A.S.A. equivalent rating of 3000. You can get it both in pack film [Type 107] and roll film [Type 47]. They both give you 8 pictures  $3\frac{1}{4} \times 4\frac{1}{4}$  inches. This emulsion is also available in 4 x 5 sheets [Type 57].

And for extremely high-speed oscilloscope recording, there's Polaroid PolaScope Land film [a roll film, Type 410].

It has an A.S.A. equivalent rating of 10,000. It can discover traces too

fleeting for the human eye: such as a scintillation pulse with a rise time of less than 3 nanoseconds.

Because these films are so sensitive, you can use small camera apertures and low-intensity settings. Every shot is a sharp, high-contrast image that's easy to read.

To put these films to work on your scope, you need a camera equipped with a Polaroid Land Camera Back.

Most oscilloscope camera manufacturers have one.

For instance: Anclab, BNK Associates, Coleman Engineering, EG&G, Fairchild, General Atronics, Hewlett-Packard and Tektronix.

You can get the full story by writing to Polaroid Corporation, Technical Sales Department, Cambridge, Massachusetts 02139 [or directly to the manufacturers mentioned above].

About the only thing we can't tell you is how to keep your blips from being bloopers.

"Polaroid" and "PolaScope"®

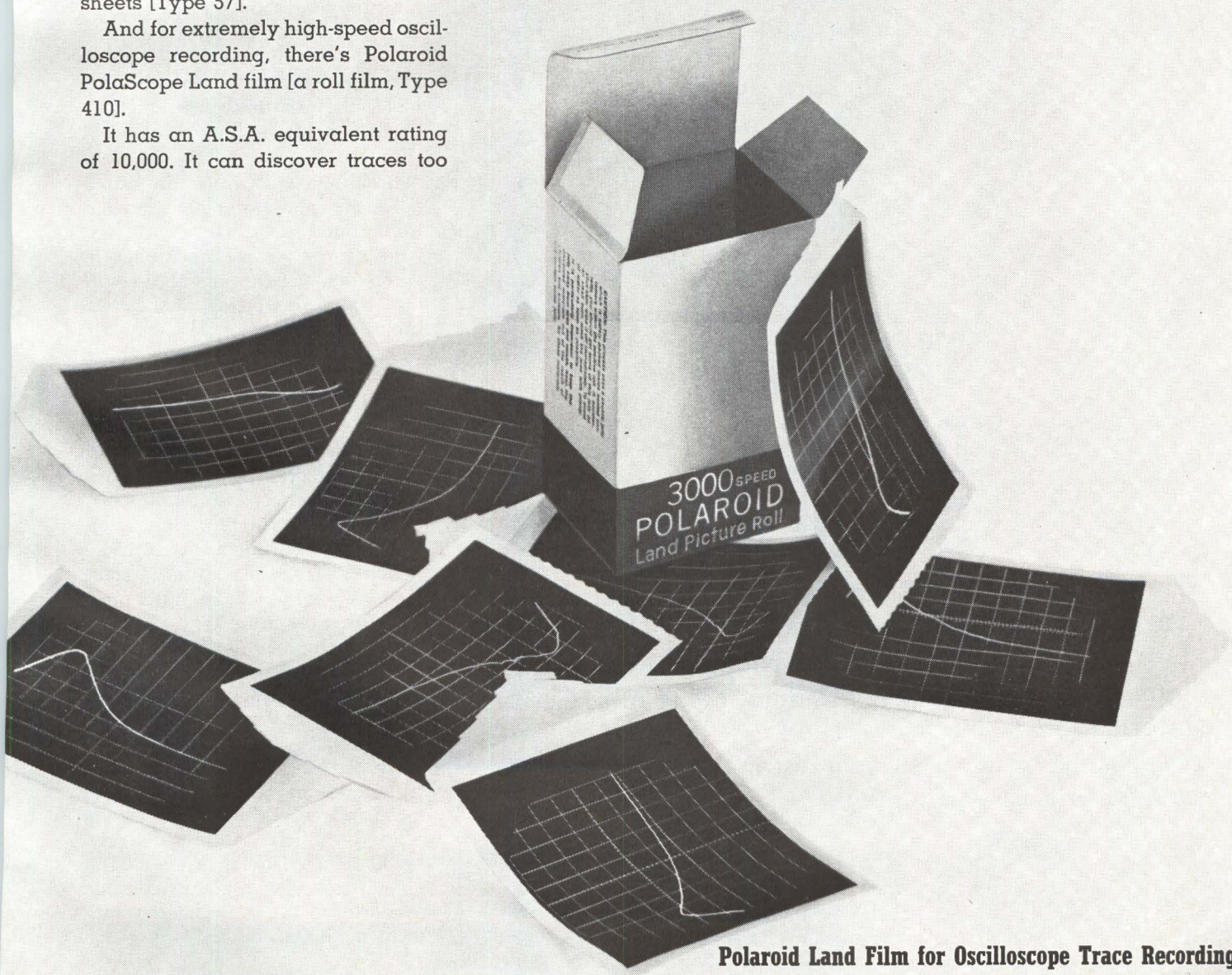

**Polaroid Land Film for Oscilloscope Trace Recording.**



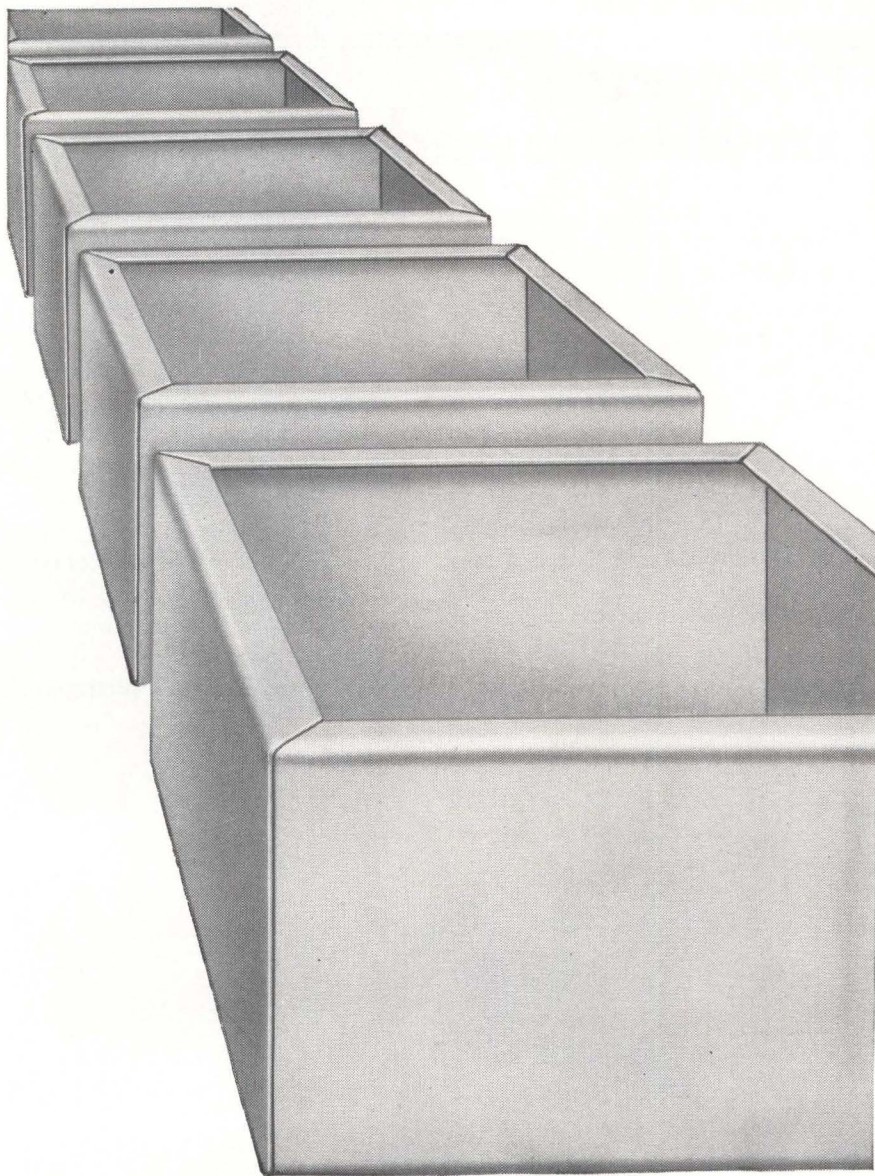

## THIS IS "DIE-LESS DUPLICATING"!

Produce short runs of simple parts quicker than an order can be processed to get them "outside." Use Di-Acro "Die-Less Duplicating" equipment to cut stock to size and to form it with die-accuracy — without costly dies. Get full information in our new "Die-Less Duplicating" catalog. See your distributor, or write us — naturally!

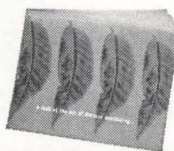

### DI-ACRO

A Division of Houdaille Industries, Inc.  
4312 Eighth Ave., Lake City, Minn. 55041

chip that stores the power to trigger the detonator. This is because the wattage available from the long-life storage batteries, which are not activated until the ordnance is fired, is still insufficient for such an application.

In addition, a debate is shaping up over the building block. There are currently two types in the running: the Westinghouse and Motorola prototypes and one that was developed in-house at Diamond Labs. Since the Westinghouse and Motorola assemblies are being built into the first hybrid proximity fuzes for 81-mm ammunition, they appear to have at least a temporary edge.

Diamond Labs built its chip on a pilot basis only to stockpile some design data against a possible future need. Critics of the simpler Army-developed chip note that it experiences frequency shifts that can trigger detonation before or after the preset distance is reached. But an official at Diamond Lab says the variations are tolerable in an operational fuze. On the other hand, the Westinghouse and Motorola entries permit virtually no variation in gain.

In addition to proximity fuzes, the Army is developing ic's for electronic timer fuzes. These fuzes will have a variety of uses, including the detonation of flares and antipersonal ordnance. Officials at the Picatinny Arsenal, Dover, N.J., which is handling most of the development work, are interested in electronic fuzes that will be more precise and accurate than the mechanical clocks now in use. Among the companies at work on this project are Radio Corp. of America, Litton Industries, Philco-Ford Corp., Burroughs Corp. and Texas Instruments.

**Bonus.** There may well be some technological fallout from the proximity fuze venture. The development pace of analog ic's has trailed that of digital assemblies, largely because the former have lacked a volume outlet. With the Army turning to analog assemblies for proximity fuzes, however, production techniques may be refined to where lower prices permit an expansion of both military and commercial applications. The Air Force's Minuteman missile program had such a salutary effect on the development of digital ic's.





**These  
new  
heat shrinkables  
devour vinyl  
spec  
by spec.**

E. C. C. heat shrinkables are recognized under UL component file E39100.

Yet cost no more. That's because new Insultite CP-150 and Insultite SRT are polyolefins. Heat shrinkable, irradiated polyolefins that provide polyolefin protection at a polyvinyl price.

**Take new CP-150.** It insulates and encapsulates any subject. Quickly. Tightly. Permanently. Won't split or rupture. Even over the most irregular surfaces. And it's particularly ideal for commercial, automotive, appliance, and computer applications.

**As for new SRT?** Wrap up your capacitor insulation problems once and for all. This clear, tough, thin-wall polyolefin is perfect for components that are subject to shock and strain, and where space and visual identification are considerations.

Both CP-150 and SRT devour vinyl specs. Like low temperature flexibility, abrasion resistance, structural strength, voltage standoff, and dielectric characteristics. And they shrink at a better than 2 to 1 shrink ratio. Come in a variety of printable colors and sizes. From  $\frac{3}{4}$ " to 2" ID.

Think shrink with the Insultites. We offer commercial, military grade, flexible and semi-rigid tubing, heat-shrinkable end caps, and exclusive meltable inner-wall tape. Write for free samples today. (Specify diameters, please.)



**ELECTRONIZED CHEMICALS CORPORATION**

A subsidiary of High Voltage Engineering Corporation

Box 57, Burlington, Massachusetts, Area Code 617-272-2850



## **NEW LOW PRICES**

### **High Voltage Silicon Power Transistors**



**The new  
DTS 410  
(200v., 3.5a)  
\$1.95 each\***



**DTS 411  
(300v., 3.5a)  
Were \$5.75 ea.,  
now \$3.15 ea.\***



**DTS 413  
(400v., 2.0a)  
Were \$6.50 ea.,  
now \$3.95 ea.\***



**DTS 423  
(400v., 3.5a)  
Were \$7.16 ea.,  
now \$4.95 ea.\***



# We just lowered the cost of lowering the cost of high-energy circuits.

From now on, the cost-cutting advantages of Delco NPN high voltage silicon power transistors cost even less. Look over the new low prices on the opposite page.

You can use these transistors in applications ranging from large screen video deflection and line operated class A audio output to high voltage, high efficiency regulators, converters and (VLF) amplifiers.

By using Delco high voltage silicon power transistors, you can reduce the number and complexity of input, output and filtering components. Fewer components mean lower assembly cost, shorter assembly time. There's less chance for breakdown—lower maintenance costs. Circuitry can be more compact, lighter and easier to keep cool.

\*Prices shown are for quantities of 1,000 or more.

**FIELD SALES OFFICES**  
 UNION, NEW JERSEY\*\* Box 1018 Chestnut Station (201) 687-3770  
 DETROIT, MICHIGAN 57 Harper Avenue (313) 873-6560  
 SANTA MONICA, CALIF.\*\* 726 Santa Monica Blvd. (213) 393-1465  
 SYRACUSE, NEW YORK 1054 James Street (315) 472-2668  
 CHICAGO, ILLINOIS\*\* 5151 N. Harlem Avenue (312) 775-5411  
 General Sales Office: 700 E. Firmin, Kokomo, Ind. (317) 459-2175

\*\*Office includes field lab and resident engineer for applications assistance

These NPN silicon transistors are fabricated by our unique Delco 3-D process that provides high voltage protection, high frequency response and low saturation resistance. Each is packaged in a solid copper coldweld Delco TO3 case for low thermal resistance. Inside, they are ruggedly mounted to withstand mechanical and thermal shock due to special bonding of the emitter to base contacts.

Contact your nearest Delco sales office or distributor for complete data, application assistance or immediate delivery.

TYPE	V <sub>CEO</sub>	V <sub>CEO</sub> (sus)	I <sub>C</sub> Max	h <sub>FE</sub> Min V <sub>CE</sub> =5V @ I <sub>C</sub>	Power Diss Max
DTS 410	200V	200V (min)	3.5A	10 @ 2.5A	80W
DTS 411	300V	300V (min)	3.5A	10 @ 2.5A	100W
DTS 413	400V	325V (min)	2.0A	15 @ 1.0A	75W
DTS 423	400V	325V (min)	3.5A	10 @ 2.5A	100W

## DELCO RADIO

Division of General Motors, Kokomo, Indiana





# CIRCUIT CONTROL AND PROTECTION BY AIRPAX

## SERIES 50 APL



APL 1 SERIES TYPE

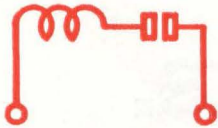

APL 3 SHUNT TYPE

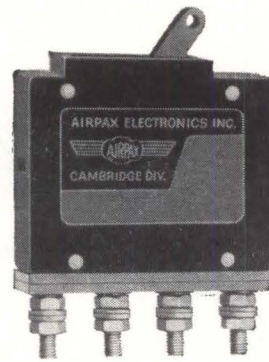
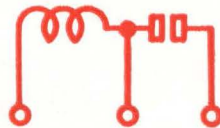

APL 4 RELAY TYPE

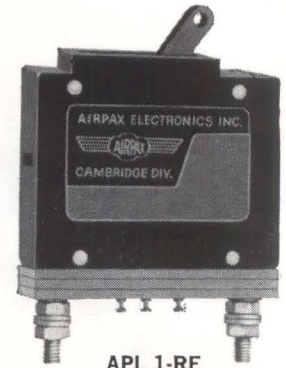
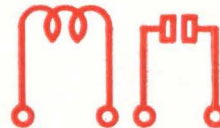

APL 1-RE  
SERIES WITH REMOTE

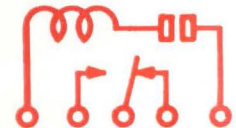

APL 1111 FOUR POLE

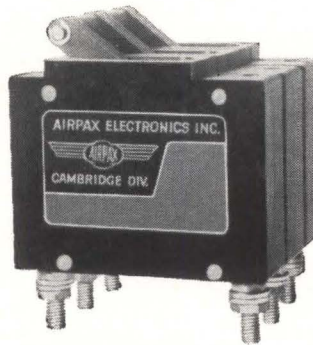
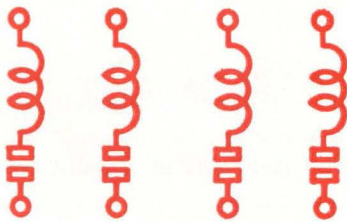

APL 111 THREE POLE

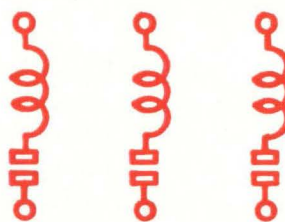

APL 11 TWO POLE

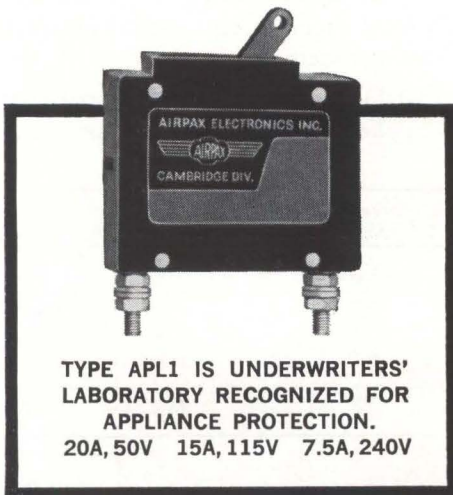
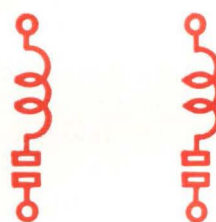

TYPE APL1 IS UNDERWRITERS' LABORATORY RECOGNIZED FOR APPLIANCE PROTECTION.  
20A, 50V 15A, 115V 7.5A, 240V

COMPLETELY MAGNETIC TIME DELAY AND TRIP. CONTAINS NO HEATING ELEMENTS.

AVAILABLE 50 MA TO 50 AMPERES AC OR DC. 50, 60 AND 400 CYCLES.

TRIP TIME IN SECONDS vs. PERCENT OF RATED CURRENT

	100%	125%	200%	400%	800%	1000%
Delay 60	No Trip	May Trip	.035 max.	.030 max.	.020 max.	.018 max.
Delay 61	No Trip	1.0 - 6.0	.240 - .800	.040 - .180	.012 - .050	.010 - .040
Delay 62	No Trip	15.0 - 70.0	3.0 - 9.0	.30 - 1.50	.018 - .080	.010 - .040

AIRPAX ELECTRONICS  
incorporated  
Cambridge, Maryland  
(301) 228-4600

AIRPAX ELECTRONICS  
incorporated  
Ft. Lauderdale, Fla.  
(305) 587-1100

AIRPAX ELECTRONICS  
incorporated  
Van Nuys, Calif.  
(213) 781-2821

**AIRPAX ELECTRONICS** incorporated Cambridge Division, Cambridge, Maryland



# Solid state devices improve electrometer

Vibrating reed electrometer uses field effect transistor as replacement of input tube to increase reliability

A solid state vibrating reed electrometer (VRE) that has a sensitivity of  $10^{-17}$  amperes is now available from Cary Instruments, a subsidiary of Varian Associates. Model 401 is a solid state version of the company's successful model 31 VRE. "Both instruments," says Don Parker, manager of Cary's electronic products section, "are at least 50 times more sensitive than any competitive vibrating reed device and about 1,000 times more sensitive than electrometers that use only tubes."

A VRE is primarily used to measure very minute electric currents and charge density, in such applications as determining Hall effect in organic and inorganic semiconductors and photoconductors; transistor leakage, the gate resistances of metal-oxide-semiconductor field effect transistors, and the electrical and electrochemical properties of materials. The instruments are also used to amplify the outputs of mass spectroscopes for easier reading.

In addition to its extremely high current sensitivity, the model 401 can detect charges as small as  $5 \times 10^{-16}$  coulombs, potentials down to  $2 \times 10^{-15}$  volts and resistances as high as  $10^{16}$  ohms. A single switch on the instrument's front panel automatically makes the necessary circuitry changes for measuring current, charge and voltage.

The instrument detects current by measuring the electrons (charge) collected on a gas dielectric three-terminal capacitor. A small portion of the d-c voltage across this capacitor is converted to a-c by the vibrating-reed capacitor. The a-c signal produced is proportional to the collected charge. This signal is passed through an a-c amplifier, synchronously rectified, filtered and used to drive the indicating meter. A portion of the d-c output is applied as negative feedback to



null the input signal and provide very high gain stability, low insulation leakage and rapid response.

Since voltage measurements are read directly on the instrument's meter, the amount of current can also be determined by reading the voltage across one of the three built-in calibrated input resistors. Resistance is measured by applying a known potential across the unknown resistance and measuring the resulting current.

Charge measurements are obtained by multiplying the meter reading by the value of the capacitor, which is  $2 \times 10^{-11}$  farads.

Cary reports that the key solid state device in its new model is a field effect transistor that replaces the input tube of conventional VRE's. The input tube is generally the hardest-worked component and tends to be the least reliable because of microphonic problems. The FET's noise level remains constant even with rough handling.

The 401 has five different recorder and digital voltmeter outputs (10, 25 and 100 microvolts, and 1 and 30 volts) and three power options: 117 v, 60 hertz; 220 v, 50 hz; and a 12 v, d-c battery.

Zero stability is rated within 100 microvolts for 24 hours with the

input shorted and less than  $10^{-17}$  amperes with the input open. The instrument has an inherent accuracy of  $\pm 0.1\%$ ,  $\pm 10$  microvolts, and a meter accuracy of  $\pm 1\%$  of full scale. These specifications remain constant while operating at temperatures ranging from  $4^{\circ}\text{C}$  to  $40^{\circ}\text{C}$ .

Included as standard equipment in the model 401 are a number of features which are available only as options for the earlier model 31, including remote resistor switching with three input resistors, remote input shorting, critical damping for faster response and a master-slave capability. The 401 is priced at \$1,950, which is \$300 more than the basic price, without options, of the model 31.

A high-voltage probe that extends the voltage range up to 30 kilovolts is available as an accessory. The probe is essentially a 0.02-picofarad capacitor that is isolated by an optically polished sapphire.

In addition to its primary use in electrical measurement, the 401 can measure soft beta radiation from such sources as carbon-14, tritium and sulphur-35; and it can make alpha particle counts even in the presence of substantial beta



## New Products

and gamma background radiation. Because of its high sensitivity, it should be useful in gas chromatography, where it could measure small amounts of carbon-14 in doped compounds. The instrument could also be used in biomedical research to measure ion transfer, skin potential and resistance across membranes.

### Specifications

<b>Voltage range</b>	From $2 \times 10^{-5}$ to 30 v
<b>Current range</b>	From $10^{-17}$ to $10^{-5}$ amps
<b>Resistance range</b>	From $10^6$ to $10^{16}$ ohms
<b>Charge range</b>	From $5 \times 10^{-16}$ to $6 \times 10^{-10}$ ohms
<b>Zero stability</b>	
with shorted input	100 $\mu$ v for 24 hours
with open input	$10^{-17}$ amps
<b>Accuracy</b>	$\pm 0.1\%$ , $\pm 10 \mu$ v
<b>Operating temperature range</b>	4°C to 40°C
<b>Price</b>	\$1,950
<b>Available</b>	February, 1967

Cary Instruments, subsidiary of Varian Associates, 2474 S. Peck Road, Monrovia, Calif. 91016.  
Circle 348 on reader service card.

## Glass-encapsulated precision crystals

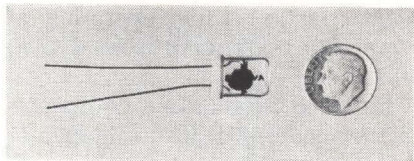

Higher Q, greater reliability and better frequency stability are offered by a series of miniature glass-

sealed crystals than are obtained from crystal units in soldered containers.

The 76AX series units, measuring  $\frac{1}{2} \times \frac{3}{8} \times \frac{5}{32}$  in., have aging rates of less than 1 part in  $10^8$  per day after initial stabilization, and are available in frequency ranges of 7.5 to 200 Mhz. They meet tolerances of 0.0025% over a temperature range of  $-55^\circ$  to  $+105^\circ$  C.

The new series is the equivalent of the HC-26/U leads and the HC-29/U pins.

Bulova Watch Co., Inc., 61-20 Woodside Ave., Woodside, N.Y., 11377 [349]

## Vacuum relay offers variety of applications

A vacuum relay that, according to its manufacturer, is both tough and versatile—and a midget too—has a number of applications such as communication multicouplers and transmitters, laser power supplies, microwave-power, tube test equipment and high-voltage power supplies.

The unit is a single-pole, double-throw Kilovac relay with a rated operating voltage of 8 kv in air and 12 kv in oil. It will carry up to 15 amps rms continuous current at rated voltage. The relay has a maximum operating time of 18 msec and a maximum contact resistance of 0.015 ohm. It applies a

standard 26.5-v d-c coil with resistance of 250 ohms. Other coil operating voltages are available upon special order.

The relay is compact and can withstand a 4,000-g shock for a

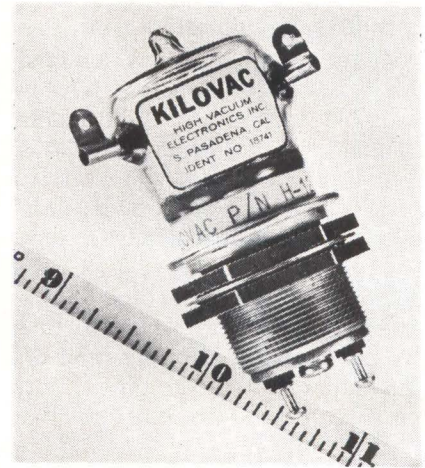

0.3-msec pulse. This makes it particularly advantageous in airborne communications systems and other severe environments. Reliability is enhanced because of operation in a high vacuum dielectric.

Other advantages are short contact travel, low contact mass, contacts free of oxides and pitting and minimum contact bounce.

Delivery of the H-12/S4 is 30 days after receipt of order. Price of the unit is \$110 each in quantities of 1 to 9.

High Vacuum Electronics, 538 Mission St., South Pasadena, Calif. [350]

## New products in this issue

- 201 Solid state electrometer
- 202 Glass-encapsulated crystals
- 202 Vacuum relay

### Components and hardware

- 205 Relays fit in flatpacs
- 205 Patch panel
- 208 Crystal oscillators

### Semiconductors

- 210 Low-cost tunnel diode
- 210 Npn, pnp transistors
- 212 Safe area transistors

### Instruments

- 214 X-Y recorder for OEM's
- 214 Precision phasemeter

- 215 Frequency divider
- 215 Linear transducer
- 216 Digital voltmeter
- 217 Sweeper divider
- 217 Capacitance probes
- 218 X-Y plotter
- 219 Universal multiplier

### Subassemblies and systems

- 220 Digital recorder
- 220 Peak selector memorizer
- 222 Decade counter
- 222 Static inverters
- 223 L-v, d-c supplies
- 224 Miniature r-f filters

### Microwave

- 226 Co-ax transfer switch

- 226 Step-recovery multiplier
- 226 Klystron power supply
- 228 Coaxial termination

### Production equipment

- 230 Reusing etching liquid
- 230 Core thickness grader
- 232 Component work station

### Materials

- 234 Glass seals diodes safely
- 234 Two-part resin for cables
- 236 Alumina standard substrates
- 237 Narrow line garnet
- 237 Selective-etch sheets



# EIMAC

**offers new 1 kW PEP  
tetrode for SSB with  
highest linearity—at least  
-40 db in typical operation**

EIMAC's new 4CX1500B power tetrode is the most linear tube on the market; intermodulation distortion characteristics under typical operating conditions are at least -40db at all drive power levels from zero to maximum. The new tube is ideal for advanced single sideband transmitters demanding high linearity to avoid channel-to-channel interference. The 4CX1500B is the product of a four-year development study which included optimization of internal tube geometry by computer techniques. Rated maximum plate dissipation of this radial beam tetrode is 1500 watts, and control grid dissipation rating is 1 watt maximum. Because the 4CX1500B has very low grid interception (typically less than 1.5 mA grid current), it is possible to drive the grid positive without adverse effects upon the distortion level; the tube is therefore recommended for Class AB<sub>2</sub> linear amplifier service. For further information, write Product Manager, Power Grid Tubes, or contact your nearest EIMAC distributor.

#### TYPICAL OPERATION (Frequencies Below 30 MHz)

DC Plate Voltage	2500	2750	2900 volts
DC Screen Voltage	225	225	225 volts
DC Grid Voltage	-34	-34	-34 volts
Zero-Signal DC Plate Current	300	300	300 mA
Single-Tone DC Plate Current	720	755	710 mA
Two-Tone DC Plate Current	530	555	542 mA
Driving Power	1.5	1.5	1.5 watts
Useful Output Power	900	1100	1100 watts
Intermodulation Distortion Products			
3rd Order	-38	-40	-40 db
5th Order	-47	-48	-48 db

**EIMAC**  
Division of Varian  
San Carlos, California 94070

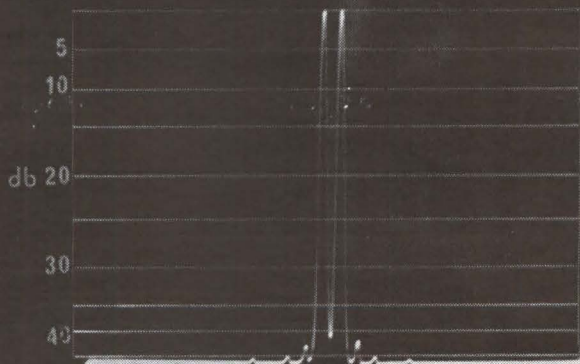
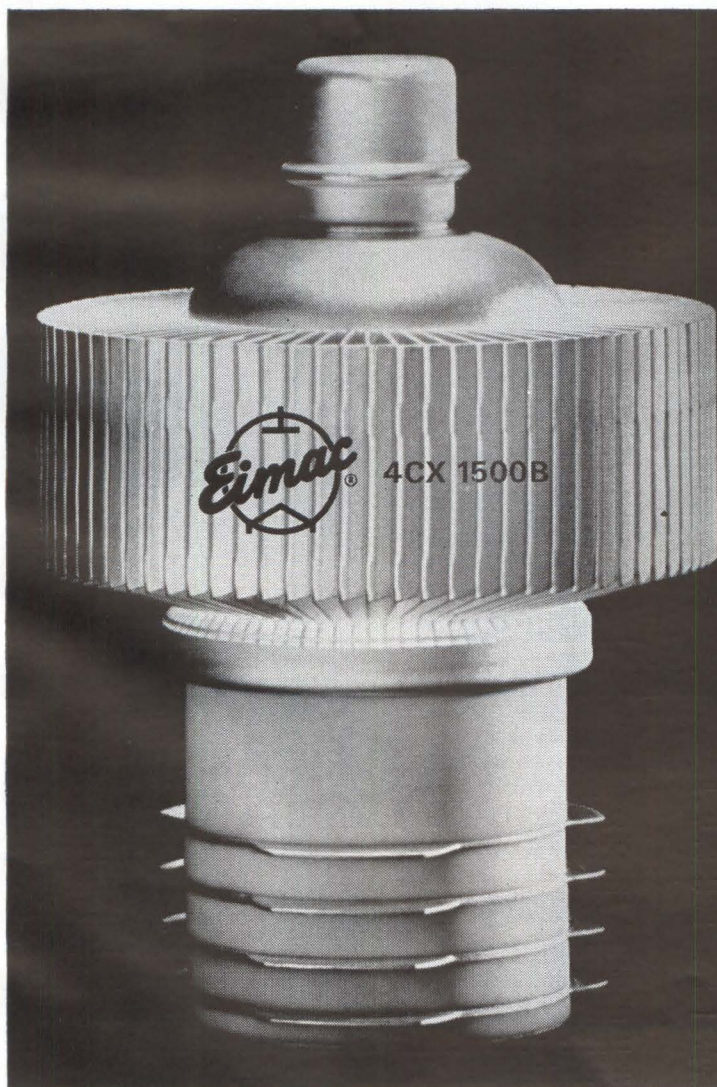

We have a new brochure  
entitled "Single Sideband."  
Write for your copy.





**ENGELHARD** gold and silver on relay contacts  
assure only one miss in ten million cycles!

Electro-Tec Corp. faced one of its toughest problems — develop electromechanical relays to meet the extraordinary reliability requirements of missiles, manned aircraft and space craft, and computers. The solution: new Wedge-Action relays using Engelhard 24K gold and fine silver for contacts.

These remarkable relays have the highest confidence level ever achieved in any electromechanical relay — only one miss in 10 million cycles. Engelhard impurity-free gold and silver, electrodeposited to both moving

and stationary switching contacts, helped do the trick. Contact resistance is an extremely low 0.012 ohms to 0.015 ohms. And remains constant to within 15 milliohms for more than 100,000 operations.

This is just one more example of the problem-solving capabilities of Engelhard precious metals — capabilities that result from our constant search and development of the precious metals. When you have a precious metals problem, call on Engelhard: *the company that is working wonders with wonder-working metals!* ESD



## Some other **ENGELHARD** products

**PRECISION-DRAWN TAPE** is supplied to specification in bimetals or solid precious metals. **ECON-O-TAPE** is available in any thickness, length or width (from .0095"). Shaped or rectangular sections. Excellent material for electrical contacts subject to corrosion.

**E-70 BRIGHT GOLD PROCESS** produces mirror bright electroplates from flash deposits to 500 microinches in thickness. This highly efficient, neutral bath produces hard, wear resistant finishes suitable for the complete range of decorative applications.

**CLAD CONTACT PARTS** provide a precious metal layer essentially pore free and durable, with an extremely strong bond to the base metal. These parts are supplied usually in the form of blades and spring assemblies.

**ACID GOLD PLATING PROCESS** provides high purity gold electrodeposits (24 Karat) that are smooth, lustrous, free from porosity, highly ductile, relatively hard. Excellent deposits up to several mils in either still or barrel plating. Highly stable and simple to handle over long periods. Adaptable to plating wide variety of electronic components.

**SEMICONDUCTOR MATERIALS** are supplied in a wide range of precious and base metals and their alloys. These include solid sheet, wire, tape, base tab materials and clad products, fine gold wire, and ribbon. New materials are constantly under development. Technical assistance is available.

**PRECIOUS METAL CONTACTS** in pure or alloyed forms of silver, platinum, palladium and gold provide unmatched resistance to atmospheric corrosion and electrical pitting. Engelhard will manufacture to specifications or provide material in wire, rod or sheet form.

**THIN WIRE AND FOIL** are produced by Engelhard's Baker Platinum Division to meet rigid electronic design requirements. Both extruded and Taylor Process thin wire are available in diameters as small as .001". Thin-gauge foil is supplied in sheets up to 8" x 18".



## New Components and Hardware

### Fitting relays into flatpacks

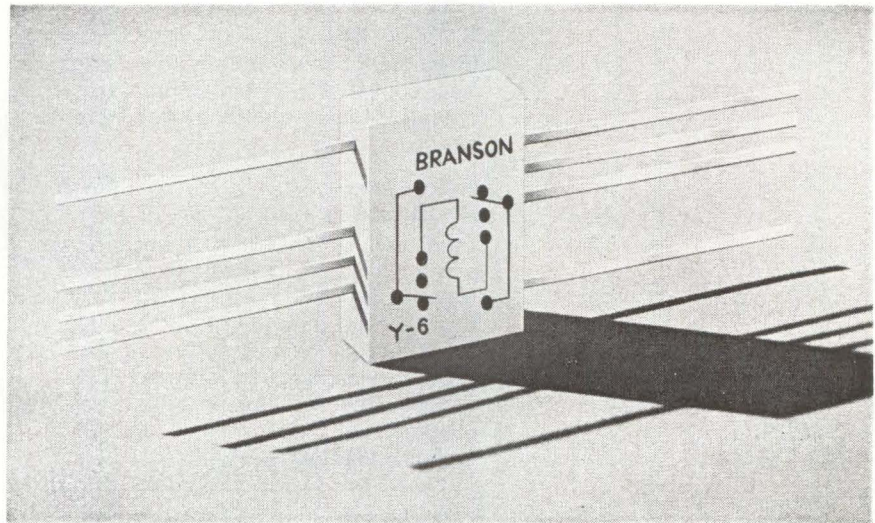

Relays that are compatible with integrated flatpack circuitry are the latest offering from the Branson Corp. The devices have been squeezed into TO-87 flatpacks,  $\frac{3}{8}$  by  $\frac{1}{4}$  by  $\frac{1}{10}$  inch, with  $\frac{1}{2}$ -inch long ribbon leads.

Branson believes its relays are the first to be packaged this way, and reports that the packages are a third to a half the size of conventional crystal can relays. The company sees initial applications in portable communications systems, weapons delivery equipment and high-density printed circuit boards in aircraft and missile control systems, where small size is mandatory.

The relay is entirely contained within an alumina case that is insulated from ground, and provides the thermal conductivity needed to dissipate any heat from the coil. The coil itself is wound directly on the one-piece, soft iron core over an insulating film. The ends of the core are the magnetic poles which mate with the center-pivoted balanced armature.

As the actuating voltage, either 6, 12 or 24 volts, is applied to the

coil, glass-tipped actuators move the gold-plated contacts, made of silver, magnesium and nickel, within each pole of the relay. Only 250 milliwatts of coil power is required. The unit operates and releases in one millisecond.

The small relay, Branson says, is extremely rugged. The armature itself can withstand vibrations of up to 3,000 hertz at levels of 50 gravities. The shock rating for the entire relay is 50 g's for 11 milliseconds. The devices will work at class B military temperatures—

from  $-65^{\circ}$  to  $+125^{\circ}$  C.  
Branson Corp., P.O. Box 845, Denville, N.J., 07834 [351]

### Patch panel features high contact density

A patch panel, accommodating 800 pin and socket contacts in a space approximately 12x8x5 in., has been developed for telemetry and missile and spacecraft instrumentation systems as well as for data processing applications. The same design principle can provide 1,200 circuits in a single unit.

Previously, contact densities of this magnitude have presented problems due to the excessive mating forces required, contact bending, misalignment, molding and

#### Specifications

Coil voltage	6, 12 or 24 volts
Contact resistance	About 50 milliohms
Contact and lead resistance	Less than 100 milliohms
Rated contact life	100,000 operations
Price	\$45
Delivery	60 days for sample quantities



# Short course

## on how to choose a demineralizer...

### 1. It's not easy.

Every plant has different pure-water needs. Your company's raw water, processes and equipment usually differ sharply from the next company's.

### 2. Look for a demineralizer manufacturer who can advise you with total objectivity.

Barnstead is a good choice, because we make over 100 types of demineralizers, from midgets to monsters. And if a still is called for, you'll find we make a huge line of these, too — plus a broad range of accessory equipment.

Check the chart below, to see where your demineralizer requirements might fit. Then contact Barnstead for a no-obligation recommendation.

THE PROBLEM	THE SOLUTION
Take 10 common minerals out of "average" water.	Barnstead 2-Bed Demineralizers, 50 to 2500 gph and larger.
Get extra removal power for silica, CO <sub>2</sub> ; ultra-high electrical resistance; constant pH.	Barnstead Mixed-Bed Demineralizers, 30 to 3,000 gph.
Purify water with unusually heavy mineral concentrations; lengthen operating cycles; minimize per-gallon operating costs.	Barnstead 4-Bed Demineralizers, 30 to 3,000 gph.
Eliminate full shutdowns for regeneration.	Two Barnstead 2-Bed Demineralizers, in parallel.
Eliminate manual labor involved in regeneration.	Barnstead demineralizers that automatically regenerate themselves.
Reduce maintenance and equipment investment to absolute minimum.	Barnstead throw-away or regenerable Cartridge Type Demineralizers, 5 to 3,000 gph.
Pretreat water loaded with sediment, organics, coloring, odors.	Barnstead sand, carbon, organic removal filters; coagulant feeders; water softeners; stills.



## Barnstead

Still and Sterilizer Co.  
337 Lanesville Terrace, Boston, Mass. 02131

## New Components

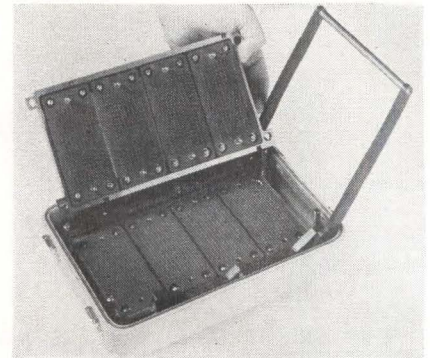

manufacturing tolerances. In this patch panel excessive mating and unmating forces are overcome with a cam-type engaging device that converts rotary motion into axial motion and provides a mechanical advantage to allow easy manual mating and unmating.

Misalignment, contact bending, molding and tolerance difficulties are solved by dividing the contacts into smaller groups. Multiple insulation blocks contain independent guide-pin systems that automatically align the individual groups of contacts. Socket inserts are held firm while pin inserts float for proper contact alignment. Inserts have closed entry to prevent marginal continuity problems.

The patch panel is claimed to be the first of its size with pin and socket contacts that offer an inherent reliability and low millivolt drop (1 mv maximum at 1 amp d-c). This drop is less than the maximum mv drop specified by MIL-C-26500 for connectors. The crimp type removable contacts employ a standard MS3191 crimping tool.

Versatility in design allows many combinations of circuitry to be pre-programmed and sealed, permitting permanent, removable programming to coincide with data processing tapes. The unit also functions as an in-work patch panel since the inserts can be reprogrammed while mated or unmated.

The plug and receptacle inserts are identical and can be inserted in either position allowing maximum freedom in combining pin and socket applications and reducing spares and logistics problems. Inserts can also be mounted indi-



The Hughes/NASA Syncom stands still at 6875 mph to talk to a billion people.



## **CIRCUIT DESIGNERS... is your appointment in space with Hughes?**

Today, Hughes is one of the nation's most active aerospace/electronics firms: Projects include: F-111B PHOENIX Guided Missile System, TOW Anti-Tank Missile, SURVEYOR Lunar Spacecraft, SYNCOM, POLARIS, VATE, Hard Point Defense and others.

This vigor will assist the qualified engineers and scientists towards more and better opportunities for both professional and personal growth.

Many immediate openings exist. The engineers selected for these positions will be assigned to the following design tasks: the development of high power airborne radar transmitters, the design of which involves use

of the most advanced components; the design of low noise radar receivers using parametric amplifiers; solid state masers and other advanced microwave components; radar data processing circuit design, including range and speed trackers, crystal filter circuitry and a variety of display circuits; high efficiency power supplies for airborne and space electronic systems; telemetering and command circuits for space vehicles, timing, control and display circuits for the Hughes COLIDAR (Coherent Light Detection and Ranging).

**If you are interested and believe that you can contribute, make your appointment today.**

For immediate consideration, please airmail your resume to:

**Mr. Robert A. Martin**  
**Head of Employment**  
**Hughes Aerospace Divisions**  
**11940 W. Jefferson Blvd.**  
**Culver City 20, California**

*Creating a new world with electronics*

**HUGHES**

HUGHES AIRCRAFT COMPANY  
**AEROSPACE DIVISIONS**

An equal opportunity employer.

U. S. CITIZENSHIP REQUIRED



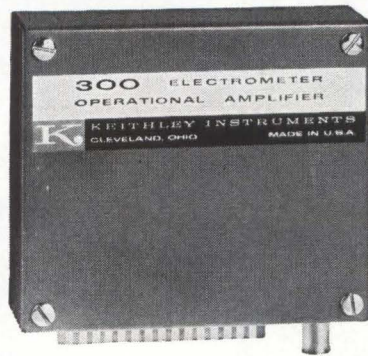

## NEW OPERATIONAL AMPLIFIER ...COMPACT ELECTROMETER, TOO!

### Keithley Model 300

This economical little package is a true electrometer operational amplifier. It combines more than  $10^{14}$  ohms input resistance, less than  $5 \times 10^{-14}$  ampere offset current and ultra-low current drift of  $10^{-15}$  ampere per day into a precise single-ended output design that meets demands in conditioning signals as low as  $10^{-14}$  ampere.  Completely shielded, the 300 is a simple-to-use, easy mounting plug-in module. An output voltage of 11 volts at 11 ma is provided. Works to specs on unregulated supplies from  $\pm 16$  to  $\pm 25$  volts, at +25 ma or -8 ma.  For experiments or systems requiring extraordinary conditioning of small current signals, the Model 300 is the finest operational amplifier on the commercial market. Particularly for researchers in automated R & D, designers and producers of process or production control equipment.  Ask your Keithley engineer for a demonstration. But read our technical engineering note first. It's yours by dropping us a line.

#### CHARACTERISTICS

Voltage Gain dc open loop: >20,000	Voltage Offset adjustable to zero
Input Resistance: > $10^{14}$ ohms	Voltage Drift <500 uv/hr.
Capacitance: <10 pf	Overload Limit $\pm 400V$
Current Offset: < $5 \times 10^{-14}$ amp	Output Voltage: $\pm 11V$
Current Drift: < $10^{-15}$ amp/day	Current: $\pm 11ma$

**SINGLE UNIT \$200... LESS IN QUANTITIES**

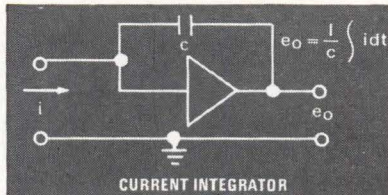
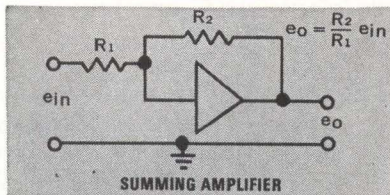
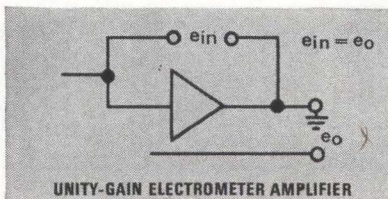
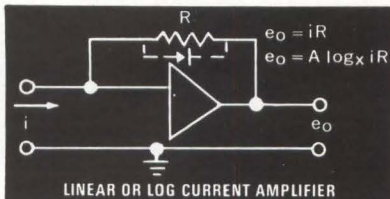

# K

**KEITHLEY  
INSTRUMENTS**

12415 Euclid Ave. • Cleveland, Ohio 44106  
EUROPE: 14 Ave. Villardin, 1009 Pully, Suisse

## New Components

vidually with a single engaging mechanism for stationary data processing applications where substantial quantities of inserts would be required.

The stainless steel patch panel box contains a seal for r-f interference shielding and an environmental seal. A pressure relief valve compensates for sudden changes in altitude during environmental testing. Weight of the unit is 15 lbs. Amphenol Space & Missile Systems, a division of Amphenol Corp., 9201 Independence Ave., Chatsworth, Calif. [352]

## Crystal oscillators offer high stability

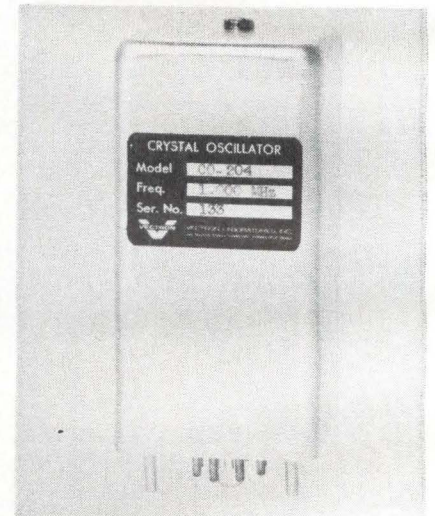

With the help of an integrated-circuit, proportionally-controlled oven, the model CO-204 crystal oscillator provides a mean-time-between-failures exceeding 100,000 hours. The 2x2x4-in. plug-in module offers a stability (aging rate) better than  $1 \times 10^{-9}$  per day, and operates over  $-20^\circ$  to  $+71^\circ$  C, with  $-54^\circ$  to  $+75^\circ$  C operation optional.

Despite low power drain, the CO-204 has fast warm-up characteristics. Within 60 minutes after turn-on, the output frequency is typically within  $1 \times 10^{-9}$  of its output several hours thereafter.

Other units in the company's newly announced line range in stability from  $1 \times 10^{-8}$  per day through  $3 \times 10^{-9}$  per day.

Vectron Laboratories, Inc., 146 Selleck St., Stamford, Conn., 06902. [353]



# CONSIDER COLORADO / INDUSTRIAL COLORADO

*...where everything's closer than you think...* From raw materials to markets. In miles and in minutes. Coming and going.

Consider Colorado's location. Near the geographic center of the nation. Distribution center of a 10-state area populated by 10 million people. Strategically located on transcontinental shipping routes that speed goods to the nation's markets.

Consider transportation facilities that move products and people quickly and economically. North-South and East-West Interstate highways crisscrossing the State. 75 common carrier interstate truck lines, 5 major lines headquartered in the State. 62% east-bound truck capacity available for backhaul. Savings up to 50% or more for east-bound shipments of selected commodities over west-bound rates. 7 Class 1 Railroads. Denver's Stapleton International Airport, consistently among the nation's ten busiest commercial airports, with 322 flights per day scheduled by 8 commercial airlines. 75% west-bound air freight capacity available.

If transporting products and people efficiently and economically is an important factor in your business, consider Industrial Colorado for your expansion or relocation.

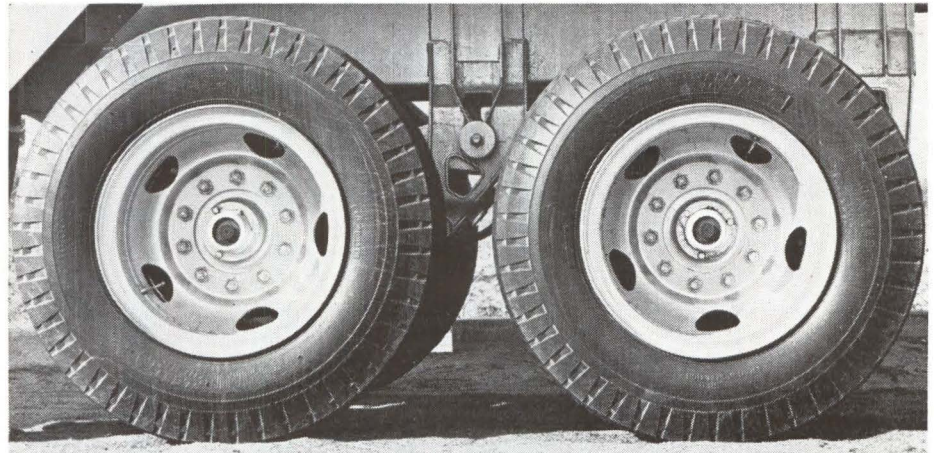

*Traffic to and from national markets flows quickly by truck, plane and train in and out of Colorado, transportation hub of the West. Write for a complimentary copy of Industrial Colorado, a revised-to-the-minute, factual, 74-page spiral-bound portfolio. It covers 11 important considerations pertinent to plant expansion or relocation in any part of the State. Address inquiries to Dwight E. Neill, Director, Division of Commerce and Development, 10 State Services Building, Denver, Colorado 80203.*

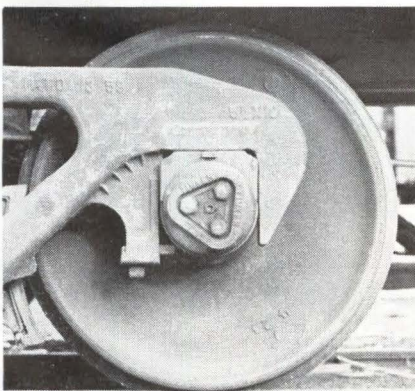

D-487

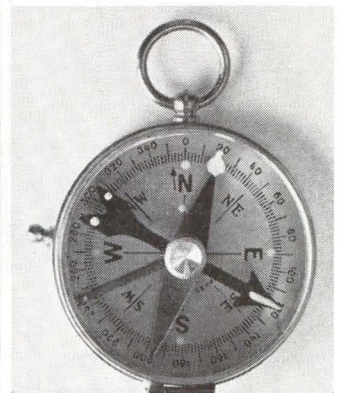
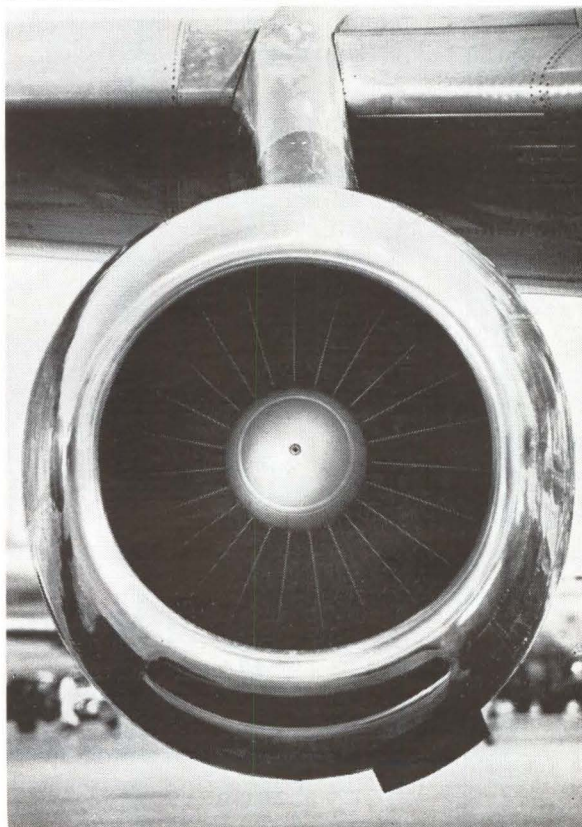



SYSTEMS FORMULATION & ANALYSIS ENGINEERS

For assignments in commercial on-line computer applications with emphasis on communications interface. Extensive experience required in hardware specifications and advanced systems, including multiprogramming and list processing. Requires B.S. in engineering, business or related field.

- SR. SOFTWARE PROGRAMMERS
- PROJECT ENGINEERS  
Computing Systems  
Peripheral Equipment  
Discs & Controllers
- COMMUNICATIONS SPECIALIST
- CIRCUIT DESIGN ENGINEERS
- ELECTRICAL SYSTEMS LIAISON ENGINEERS
- PACKAGING ENGINEERS (ALL LEVELS)
- MECHANICAL DEVELOPMENT ENGINEER
- RELIABILITY ENGINEERS
- QUALITY CONTROL ENGINEERS
- INDUSTRIAL ENGINEERS
- EDP ANALYST
- TEST EQUIPMENT DESIGN ENGINEERS
- MEMORY DESIGN—RESEARCH
- COMPONENT ENGINEERS
- COMPUTER TECHNICIANS
- SR. PRODUCT DESIGN ENGINEER

ARRANGE NOW FOR AN INTERVIEW IN YOUR AREA

Confidential interviews will be held soon in various parts of the country. To arrange an appointment, please send your resume, including experience, training and salary history, to Bill Holloway, Technical Placement.

# digital systems

opportunities at NCR electronics division in los angeles

The National Cash Register Company



ELECTRONICS DIVISION  
2816 W. El Segundo Blvd., Hawthorne, Calif.  
Telephone: Area Code (213) 757-5111  
*An equal-opportunity employer*

## New Semiconductors

### Low-cost, high-speed tunnel diode

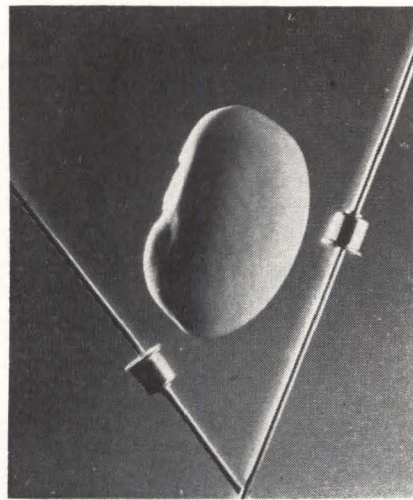

A new batch manufacturing technique, developed by the Semiconductor Products department of the General Electric Co. has broken the price barrier for tunnel diodes in high speed logic circuits. Prices are as low as 50 cents in quantities of 100,000 and clock rates are typically 100 megahertz, with rates as high as 400 Mhz being reported for the devices in some hybrid logic circuits.

The new diodes are the latest link in a chain of tunnel diode developments. Early tunnel diode structures were extremely fragile, looking much like a golf ball placed on an inverted tee. Also they had to be made one at a time, a requirement not conducive to low costs.

About a year ago the Semiconductor division of Sylvania Electric Products, Inc. developed a batch process for making tunnel diodes in what it termed a "solid structure." The structure was rugged and opened the way to low-cost manufacture of tunnel diodes. But the Sylvania devices were designed chiefly for the microwave market, and their prices range from \$10 to \$75.

There are five diodes in the GE's TD 700 line, with peak currents of 0.5, 1.0, 2.2, 4.7 and 10.0 milliamperes. Their military counterparts, the TD700-H line, are identical but will operate at temperatures up to 125°C. Power dissipation is about 40 microwatts.

General Electric's batch process technique starts with wafers of germanium. Using conventional photomasking, a thin film of silicon oxide is first laid down, then a thin film of chromium. The junction-forming metal is deposited next; it overlays the chromium and the exposed germanium. The wafers then go through an oven where all the junctions are alloyed. After dicing of the wafers, the resulting pellets are mounted to headers and the leads are attached. Finally the germanium is etched away to provide the proper peak current value and a cap is welded to the header.

The diodes are available either in the axial lead package shown at the left (with a navy bean for size comparison) for conventional circuits or in pellets for use in hybrid ic's.

#### Specifications

Peak currents	0.5, 1.0, 2.2, 4.7 and 10.0 ma
Current rate	100 Mhz, typical
Peak voltage	90 mv, max.
Power dissipation	40 $\mu$ w, typical
Price range	50¢ to 90¢ in 100,000 lots
Availability	Sample quantities from stock

General Electric Co., Semiconductor Products department, Schenectady, N.Y. [361]

### Npn, pnp transistors come in 10 models

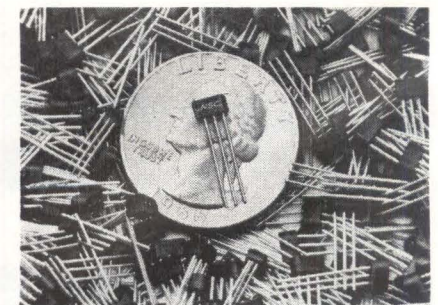

New materials, assembly techniques and automated testing have made possible a line of 10 npn and pnp general-purpose transistors priced at about 25 cents each.

The transistors have the usual inherent performance and stability characteristics of silicon devices.



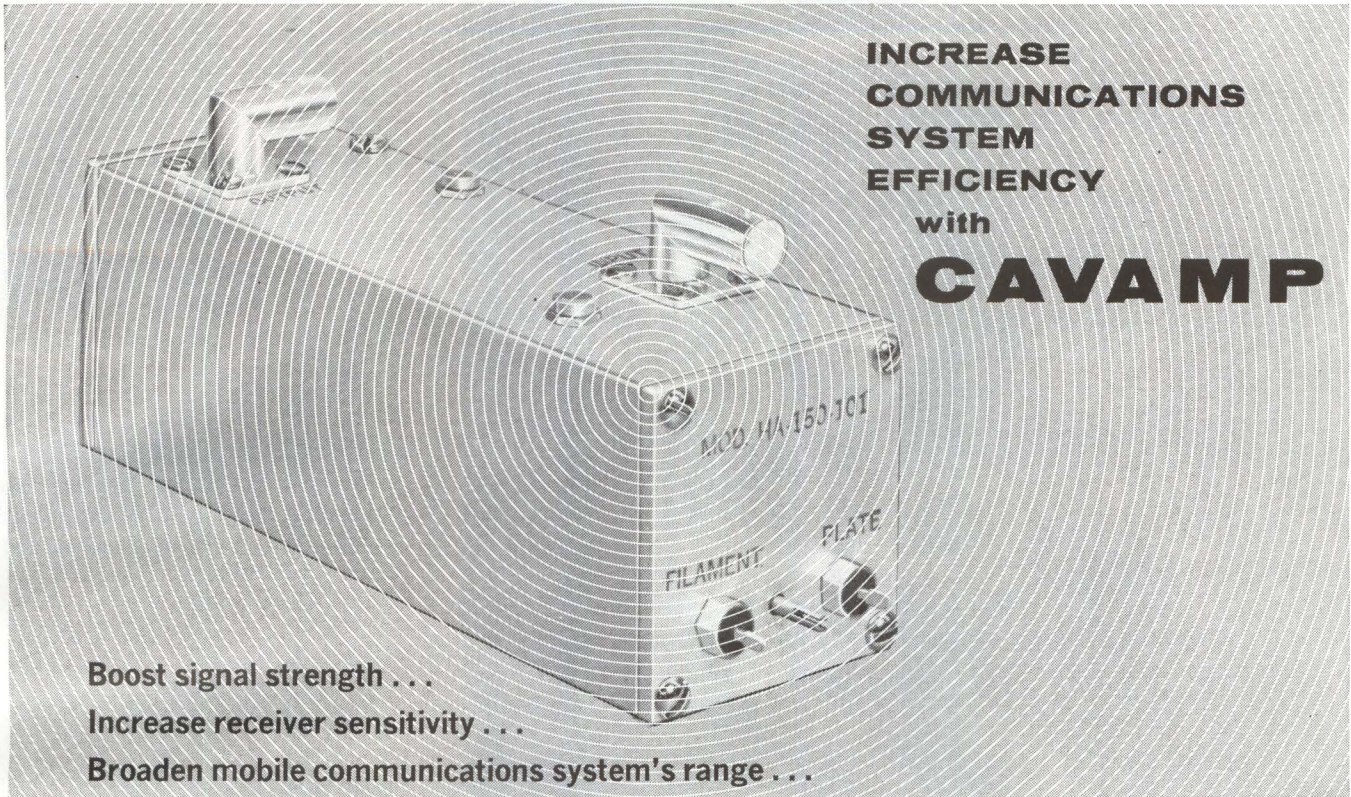

**INCREASE  
COMMUNICATIONS  
SYSTEM  
EFFICIENCY**  
with  
**CAVAMP**

**Boost signal strength . . .  
Increase receiver sensitivity . . .  
Broaden mobile communications system's range . . .**

How? With Sinclair's Cavamp. For use in compact duplex or multicoupler systems, Cavamp combines amplifier with filter to reduce noise while boosting signal strength.

Cavamp is capable of quieting receivers of .6 microvolt sensitivity with less than .2 microvolt signals, supplying gains of up to 14 Db at a 5Db noise figure. It incorporates a double-ended 8058 nuvistor that insures greater overload protection (1 milliwatt maximum input) and lower intermodulation product levels.

Cavamp incorporates a narrow band pass filter to increase receiver selectivity.

Transmission line losses are offset, or receiver front end sensitivity is increased, improving system performance.

Designed for the 150 and 450 MHz range, Cavamp is factory tuned to your specific frequency, however, can be easily field retuned to any frequency in the band by making two screwdriver adjustments.

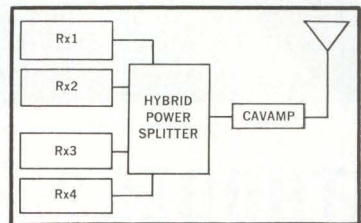

**Receiver multicoupling for closely spaced receivers:**  
Four receivers, separated by 50 KHz, connected to a hybrid power splitter providing each with 25 Db isolation: power splitter loss of 6.5 Db offset by Cavamp with 12 Db gain. Band pass filter characteristic also protects receivers from nearby transmitters.

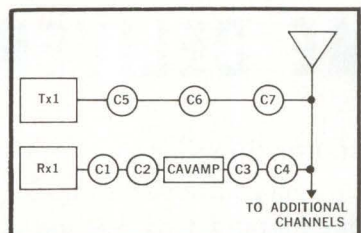

**Receivers and transmitters connected to a common antenna with a passive multicoupler for an expandable system:**  
Transmitter, Tx1, separated from receiver, Rx1, by 500 KHz. Cavities C1,2,3,4 insert 6 Db loss at Rx1 frequency, 80 Db attenuation against Tx1. Cavities 5,6,7 insert 1.5 Db loss at Tx1 frequency, attenuate Tx1 noise at Rx1 frequency by 35 Db or more. 6 Db insertion loss not degrading to receiver operation: Cavamp offsets filter losses, provides 6.0 Db gain on Rx1.

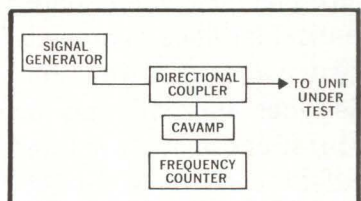

**Increasing sensitivity of frequency measuring system:**  
Where frequency counter is used, high signal strength is often required to drive the counter. Cavamp increases counter sensitivity while the selectivity reduces false triggering from unwanted signals.

Clip the coupon and attach to your letterhead for full details and prices.

**SINCLAIR RADIO LABORATORIES, INC.**  
523 FILLMORE AVE. DEPT. 101-P TONAWANDA, NEW YORK

**FREE LITERATURE**

TO: SINCLAIR RADIO LABORATORIES, INC.  
Dept. 101-P 523 Fillmore Avenue  
Tonawanda, New York 14152

Name: \_\_\_\_\_  
Title: \_\_\_\_\_  
Company: \_\_\_\_\_  
Address: \_\_\_\_\_  
City: \_\_\_\_\_  
State: \_\_\_\_\_ Zip: \_\_\_\_\_



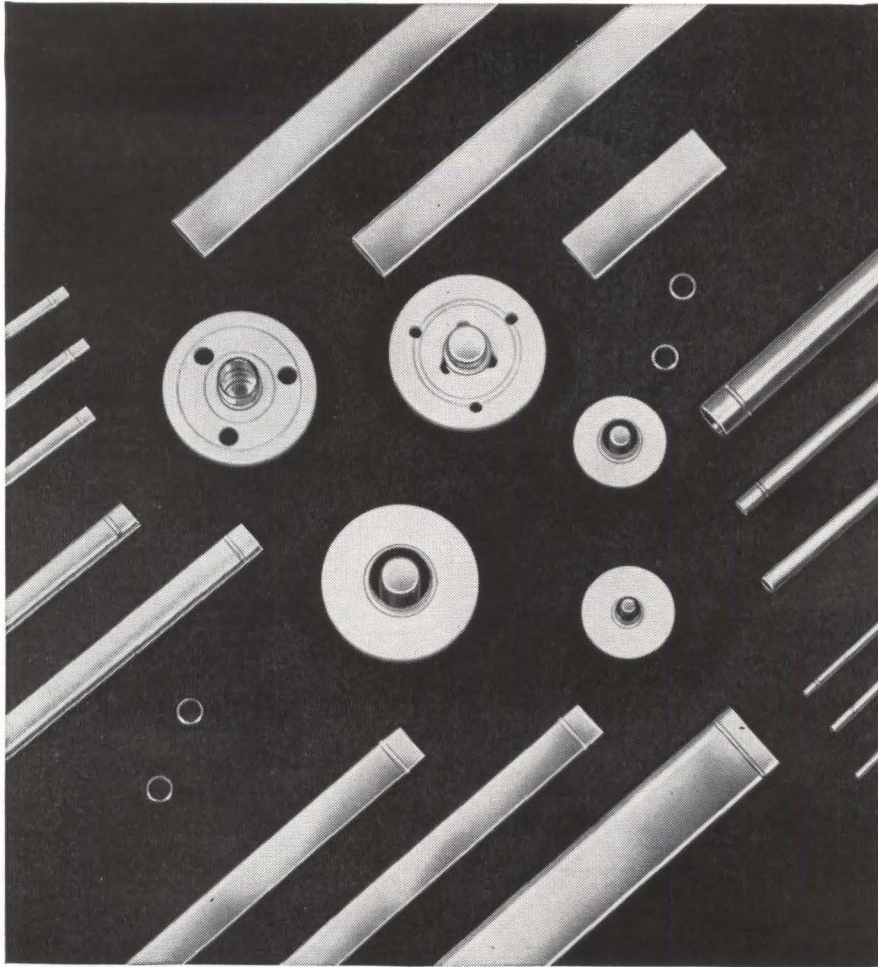

## NEED CATHODES? WANT ON-TIME DELIVERY?

It's a reasonable request. And Superior gives you tangible assurances. First, every cathode we make is for our customers—none for ourselves. Second, we have two large, modern plants, located about 600 miles apart, with identical facilities to protect you against delays. And you can choose from the widest variety of cathode types and materials in the field. So why do you suppose we are the world's leading independent cathode supplier? Send for our Catalog 51. Dept. 2500.

**Superior Tube** 

The big name in small tubing

**NORRISTOWN, PA. 19404**

*West Coast: Pacific Tube Company, Los Angeles, California*

Johnson & Hoffman Mfg. Corp., Carle Place, N. Y.—an affiliated company making precision metal stampings and deep-drawn parts

### New Semiconductors

The line includes low-level, high-gain units, uhf transistors and diffused epitaxial types. Applications include data processing, communications, radio, television, and home entertainment products.

Type numbers for the GEM transistors are 2N3793, 3794, 4284, 4285, 4286, 4288, 4290, 4291, 4292 and 4293. Power dissipation is typically 250 mw.

Additionally, the construction of the units permits access to the transistor connections from the top of the p-c board for testing and troubleshooting. Standard lead configuration is in-line (E-C-B). The leads can be bent to standard TO-18 or TO-5 configurations at a nominal cost.

National Semiconductor Corp., Danbury, Conn., 06810. [362]

### Npn transistors offer large d-c safe area

Two silicon npn transistors of planar epitaxial construction offer 30-w d-c safe area at 100°C case temperature with a 5-amp capability.

The 2N4115 and 2N4116 link Nichrome resistors in series with the emitter to provide a larger d-c safe area than previously possible; this in turn broadens the applications of planar devices in military and aerospace systems.

The devices have a breakdown voltage ( $BV_{CEO}$ ) of 80 v minimum and a low 5-amp collector-saturation voltage of 1.5 maximum. The 2N4115 offers a beta of 40 to 120 at 2 amps and a high gain bandwidth product of 70 Mhz; the 2N4116 offers a 100 to 300 beta at 2 amps and a high gain bandwidth product of 80 Mhz.

Available in the isolated collector TO-59 package, the transistors are guaranteed over the full military temperature range. Prices for the 2N4115 are \$36 for 1 to 99, \$24 for 100 to 999; for the 2N4116, \$48 for 1 to 99 and \$36 for 100 to 999.

Fairchild Semiconductor, a division of Fairchild Camera and Instrument Corp., 313 Fairchild Drive, Mountain View, Calif. [363]



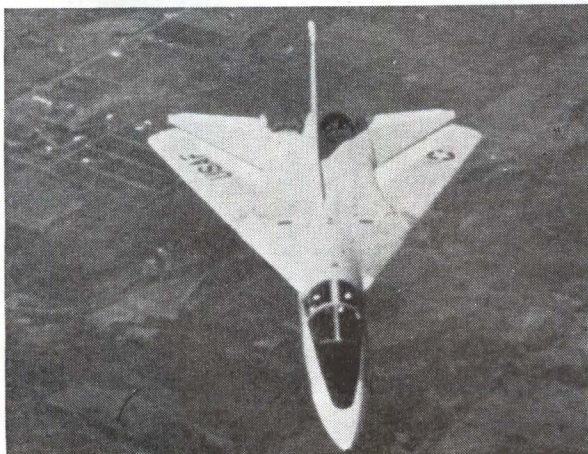
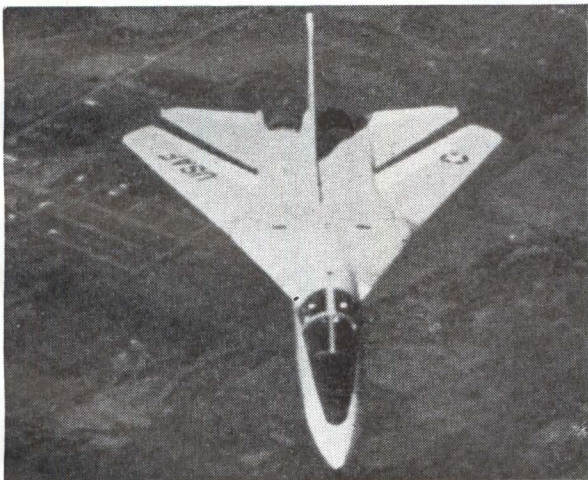
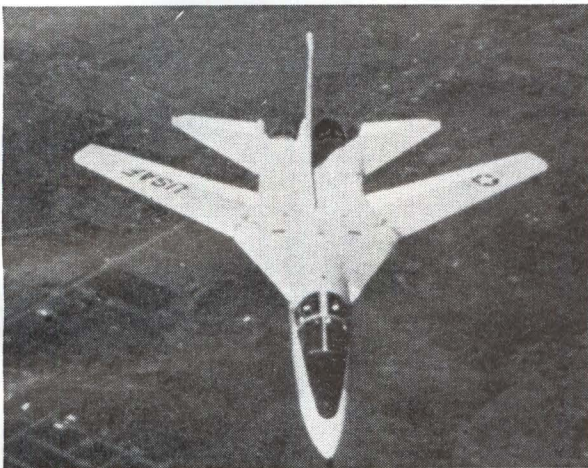
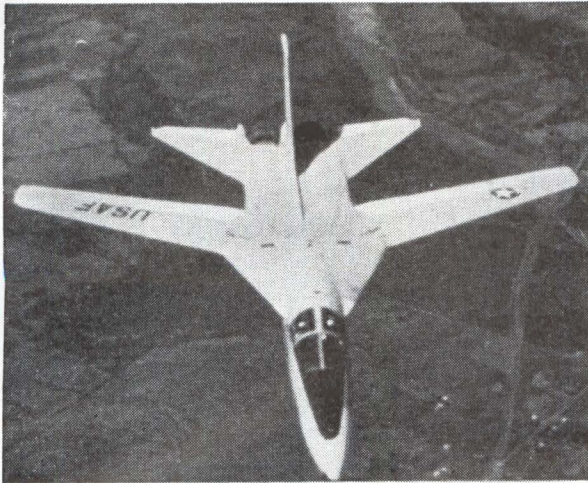

# F-111A • F-111B • FB-111 F-111K • RF-111 • MARK II BORON FILAMENT

AND OTHER ADVANCED  
AIRCRAFT AND SPACE PROGRAMS

These are a few of the long range programs at the Fort Worth Division of General Dynamics. Here you will find a highly diversified engineering and research organization assigned to the above 111 programs or other advanced aircraft projects; missile assignments, space systems, mission analysis, or other R&D.

You'll enjoy living in modern, metropolitan Fort Worth where superior housing, cultural advantages, a variety of sports and other recreation, graduate studies at one of three major universities, and mild weather are all part of an attractive package.

Call collect—817-PE 2-4811 extension 3551 or send a resume of your education and experience to J. B. Ellis, Industrial Relations Administrator, Engineering, General Dynamics, Fort Worth Division, P. O. Box 748E, Fort Worth, Texas. An equal opportunity employer.

## Information Technology

- Mission Simulation, Display Technology

## Radar and Fire Control

- Airborne Systems and Simulators

## Navigation, Stability, Guidance & Control

- Stability and Control, Computer Design, Servo Analysis

## Electronic Systems

- ECM, Penetration Aids

## Electronic AGE

- Microwave and Computer Design

## Electronic Laboratories

- Circuit Design, Flight Test Instrumentation

## Electrical Installation Design

**GENERAL DYNAMICS**

*Fort Worth Division*



## New Instruments

### X-y recorder priced for equipment market

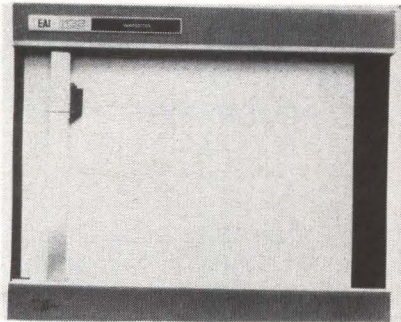

A single-range, 11x17-in. x-y recording system has been introduced for the original equipment manufacturers' market. The Variplotter is particularly suited for displaying outputs from special-purpose systems, such as material and engine-testing machines and aircraft simulators, says the manufacturer. Access to data input connec-

tions and some controls is from the rear to facilitate system application. All primary controls are accessible from the front.

Features of the plotter include a  $\pm 0.1\%$  of full-scale static accuracy, a 10 x 15-in. plotting area, 20 in. per sec slewing speed on each axis. Any sensitivity between 1 mv per in. and 20 v per in. may be specified by the customer for each axis; 100 mv per in. is standard.

The series 1132 Variplotter is priced at \$1,190, a cost normally associated with smaller units the company says. Delivery is 30 days from receipt of order.

Electronic Associates, Inc., West Long Branch, N.J. [371]

### Precision phasemeter covers 30 hz to 20 khz

A wideband primary precision phasemeter is accurate enough for

laboratory work and is also suitable for more general applications or in production testing.

Specifications include an accuracy of  $\pm 0.1^\circ$  absolute; frequency



range, 30 hz to 20 khz continuous coverage; phase range, 0 to  $360^\circ$ ; resolution,  $0.01^\circ$ ; input voltage, 0.5 v rms to 10 v rms for the basic unit; permissible harmonic distortion, 1% second,  $\frac{1}{2}\%$  third; input impedance, 10 megohms shunted by 25 pf; recorder output, 50  $\mu$ a per degree on 600 ohms (approx.); power supply, 105 to 125 v, 60 hz, 250 w.

The unit, model 910, measures

### UNEXCELLED QUALITY FOR LESS THAN 4¢

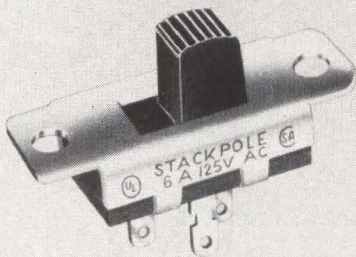

- Rated from 1 to 10 amps with full UL AND CSA approval.
- 7960 slide switch combinations — 23 basic types.
- New rugged solder lug terminal, designed for use with quick connectors.
- Uniform quality assured by automated assembly.
- Electro-silver plated terminals and contacts—shorting and non-shorting.
- Phenolic or nylon triggers in a variety of colors.
- Write for engineering bulletin.



**STACKPOLE**  
CARBON COMPANY  
Electro-Mechanical Products Division  
Johnsburg, Pa. 15845

Circle 214 on reader service card

### UNIQUE DESIGN ADDS VALUE AND APPEAL

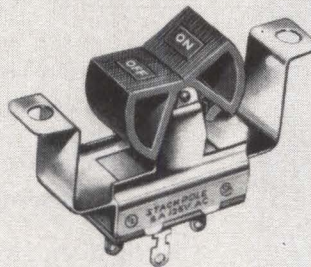

- 23 rocker switch configurations, including 2-3 positions, spring return and center-off.
- Variety of rocker designs available in a spectrum of colors and hot-stamped lettering.
- 1 to 10 amp UL AND CSA ratings at 125V and 250V.
- Solder lug, space saver, quick-connect or printed circuit terminals.
- Field-proven quality same as famous Stackpole slide switches.
- Prices start at less than 15¢.
- Write for engineering literature.



**STACKPOLE**  
CARBON COMPANY  
Electro-Mechanical Products Division  
Johnsburg, Pa. 15845

Circle 276 on reader service card

### DUST-FREE CONSTRUCTION AT NEW LOW COST

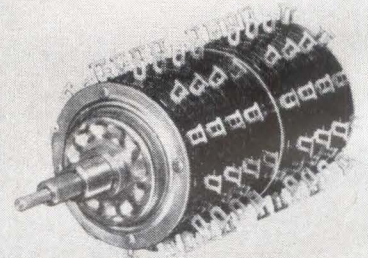

- Environment-proof rotary switch design guards against contact contamination.
- Four struts guarantee rigidity and contact alignment.
- $15^\circ$ ,  $30^\circ$ ,  $60^\circ$ , and  $90^\circ$  indexing angles available as standards.
- Solder or quick-connect terminals molded permanently into position minimize production damage.
- Free-floating, solid silver alloy wiper underwrites uniform low contact resistance.
- A pole can be made shorting, non-shorting, or both shorting and non-shorting all on the same deck.
- Write for bulletin.



**STACKPOLE**  
CARBON COMPANY  
Electro-Mechanical Products Division  
St. Marys, Pa. 15857

Circle 277 on reader service card



20x15x15½ in. and weighs approximately 90 lbs.

Bramson Instrument Co., 176 Federal St., Boston, Mass., 02110. [372]

## Frequency divider gives direct display



An automatic frequency divider enables high-frequency electronic counters to measure microwave frequencies through X band. The display is direct and complete, requiring no further calculations.

Model 5260A operates over all of the most used portion of the microwave region, 0.3 to 12.4 Ghz. It accurately divides input frequencies up to 1.2 Ghz by a factor of 100 or, when the input is within the range of 1.0 to 12.4 Ghz, by a

factor of 1,000. The divided-down frequency (1 to 12.4 Mhz) is supplied to the counter. The divider introduces no error of its own and measurements thus are as accurate as the electronic counter, according to the manufacturer.

The new frequency divider is, in a sense, an automated transfer oscillator but contains elements of both heterodyne converters and transfer oscillators. An internal oscillator is phase locked to a sub-multiple of the input frequency. A second oscillator is phase locked to the first one in such a way that exactly 1/100 or 1/1,000 of the input frequency can be derived. No frequency error is introduced and measurements are made with the basic accuracy of the associated counter.

The frequency divider works with input signal amplitudes greater than 100 mv and a front panel meter indicates when the signal level is within the proper amplitude range (-7 dbm to +10 dbm). Input impedance is 50 ohms and the vswr is relatively constant and less than 1.6:1 up to 10 Ghz.

Vswr is less than 2:1 up to 12.4 Ghz. Price of the divider is \$3,250. Hewlett-Packard Co., 1501 Page Mill Rd., Palo Alto, Calif., 94304. [373]

## Linear transducer features long life

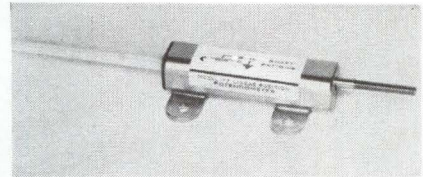

A linear position transducer, with the Infinitron resistance element providing continuous resolution, has a much longer life than an equivalent wirewound unit, the company claims, and retains many of the desirable qualities of wirewound elements.

Specifications of the model 177 include: resistances, 250 to 15,000 ohms; resistance tolerances, ±5%; noise, 100 ohms; power rating (40°C), 1.5 watts per inch; temperature coefficient, 300 ppm/°C

### CERAMIC CAPACITORS WITH SUPERIOR TEMPERATURE COEFFICIENT

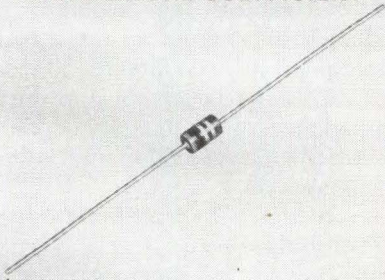

- Available in range of 0.1 to 10 picofarads.
- Tolerances of 5%-10%-20%, at rated working voltage of 500V DC.
- Temperature coefficient is ± 2% for values of 0.1 to 5.1 pf over a temperature range of -55° C to +85° C.
- Only ± 3% temperature coefficient for values of 5.1 to 10.0 for temperatures ranging from -55° C to +85° C.
- Power factor less than 1% at 1 megacycle at less than 80% RH.
- Write for bulletin.



**STACKPOLE**  
CARBON COMPANY  
Electronic Components Division  
St. Marys, Pa. 15857

Circle 278 on reader service card  
Electronics | December 12, 1966

### CERAMAG® FERRITE MATERIALS CONSISTENT IN PERFORMANCE, QUALITY

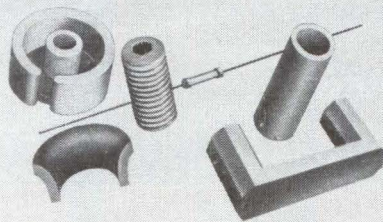

- Select from over 30 grades.
- Available in toroids; cup, insert and thread cores; bobbins; sleeves; transformer cores; deflection yokes; and rectangular solids.
- A wide range of sizes held to exact tolerances.
- Maximum permeability and high Q.
- Tooling available for hundreds of parts.
- Offers the advantage of complete moldability.
- Write for bulletin.



**STACKPOLE**  
CARBON COMPANY  
Electronic Components Division  
St. Marys, Pa. 15857

Circle 279 on reader service card

### GUARANTEED UNIFORMITY IN ELECTRICAL, PHYSICAL CHARACTERISTICS

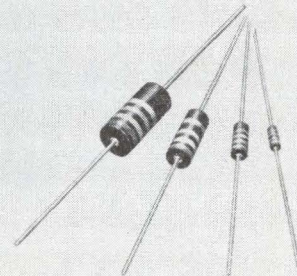

- Available in 2, 1, ½ and ¼ watt sizes.
- Uniform from resistor to resistor, order to order.
- 100% tested for resistance value.
- Same day shipment on 9 orders out of 10.
- Solderability, load life and humidity-temperature characteristic checked.
- Impregnated to assure moisture resistance.
- Write for literature.



**STACKPOLE**  
CARBON COMPANY  
Electronic Components Division  
Kane, Pa. 16735

Circle 215 on reader service card  
215



# VITRO

## Micro Modules

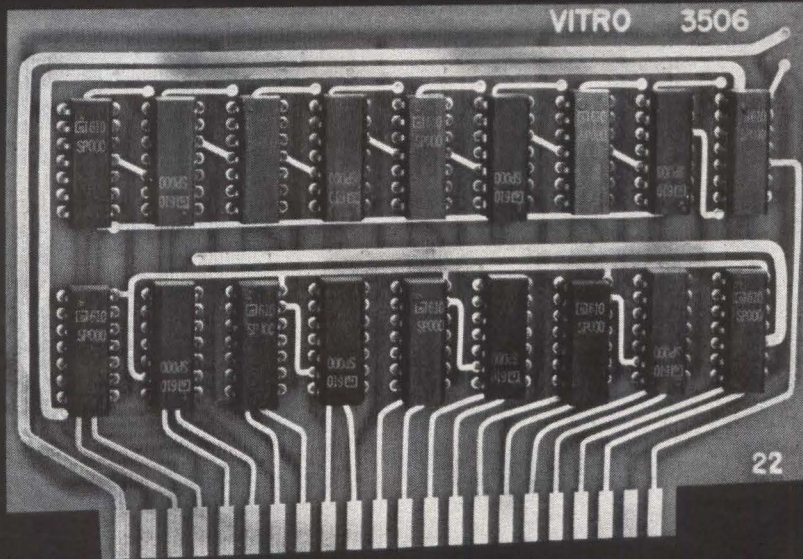

- all-new, highly competitive prices
- built-in drivers, inverters and buffers eliminate most interconnecting wiring
- up to 18 microcircuits per card enable high density and lower costs
- boards designed to meet MIL- and NASA standards
- boards keyed to assure proper mounting
- dual in-line packages easily replaced for ease of maintenance
- off-the-shelf delivery

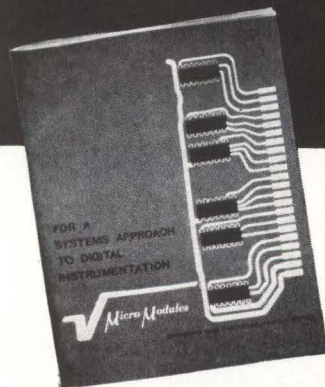

WRITE for this FREE 36 page catalog describing our complete line of card-mounted digital microcircuits. Brochure contains logic diagrams, connections, performance data, power supplies and card drawers. NEW price sheet is also included.

V-31

# Vitro ELECTRONICS

Producers of NEMS-CLARKE Equipment  
A Division of Vitro Corporation of America

919 Jesup-Blair Drive · Silver Spring, Maryland (301) 585-1000  
2301 Pontius Avenue · Los Angeles 64, California (213) 477-6717

## New Instruments

maximum; insulation resistance, 50 megohms; independent linearity, 0.75%.

In addition, the model is designed with a self-aligning shaft and is rated at 40 g for vibration, 100 g for acceleration and 50 g for shock. It has a resistance change with humidity of less than  $\pm 5\%$  and meets environmental conditions of MIL-E-5272. The transducer ranges from 0.5 in to 1 in. and is available with single or dual potentiometric output.

Bourns, Inc., Instrument division, 6135 Magnolia Ave., Riverside, Calif., 92506. [374]

## Digital voltmeter provides BCD output



A low cost, solid-state digital voltmeter features an accuracy of  $\pm 0.05\%$  of reading  $\pm 1$  digit; reading time of 0.6 sec filtered, 20 msec with filter bypassed; constant input impedance of 10 megohms; automatic polarity selection and indications and BCD output.

A reading storage feature provides bidirectional tracking without blinking. The meter is of modular construction and consists of a basic unit and plug-ins specific to the measured parameter.

Models 251 and 252 with their applicable plug-ins are multirange digital voltmeters. The 251 is characterized by resolution to 1 part in 10,000 (0.01%) and three ranges, 9.999, 99.99 and 999.9 v. Resolution to 1 part in 3,000 and ranges of 2.000, 20.00, 200.0 and 1,000 v are basic to the model 252. Because of its fast reading time (20 msec) the model 252 is well suited for systems applications.

Basic model 251 lists for \$525



and model 252 lists for \$435. The plug-in units, 251-1 and 252-1, list for \$150 each.

United Systems Corp., 918 Woodley Rd., Dayton, Ohio, 45403. [375]

## Sweeper divider occupies small space



A sweeper divider, model SD-10, accepts input from any standard h-f sweeper or signal generator and provides output at either 1/10, 1/100, or 1/1000 of the drive frequency. This frequency division not only translates the range of a sweeper to the lower frequencies, but also multiplies the effective stability so that narrow band measurements are feasible. Marker generators within the h-f sweeper are useful at their divided frequencies using this technique.

The SD-10 is housed in an enclosure 5½ in. long x 1½ in. wide x 4¼ in. deep, occupying very little bench space. All connectors are BNC, except for the power input which uses a standard banana plug.

A d-c supply of 3.6 v is required. Other models are available with internal a-c supply.

The sweeper divider is priced at \$99.50. Delivery is from stock. Aerospace Research, Inc., 130 Lincoln St., Boston, Mass., 02135. [376]

## Capacitance probes measure precisely

A series of capacitance probes, capable of measuring to 20 billionths of an inch, have been developed for industrial and laboratory use. The largest (shown at top of p. 218) is rectangular in cross section, 6 in. long, and is used for measurement in nuclear reactors. The two smallest probes (with different terminations) can measure to 0.1% of their

# MOL Resistors

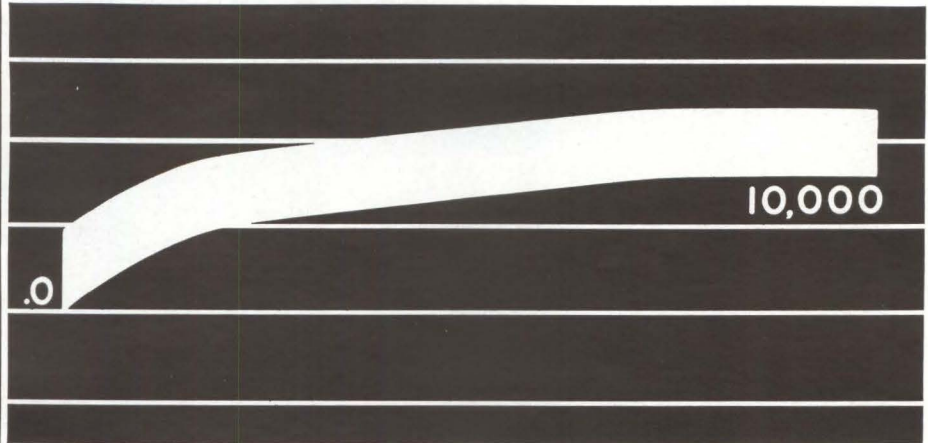

# STABILITY

... is just one reason why all major TV manufacturers use Mallory MOL film resistors. On 10,000-hour load-life test, resistance changed less than 5%. Other reasons: temperature coefficient of 250 PPM/°C; proved flame resistance, stability in humidity. *Plus* prompt delivery from expanded production capacity. Write for data and quotation. Mallory Controls Company, a division of P. R. Mallory & Co. Inc., Frankfort, Indiana 46041.





**SHORT-CUT  
TO CONTROL**

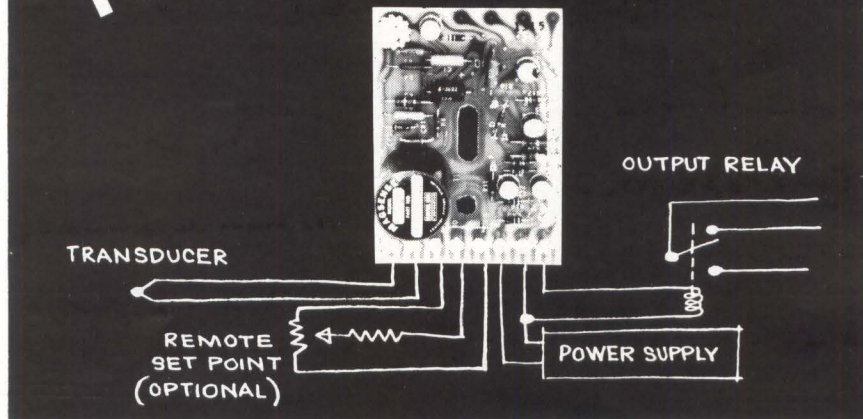

# MAGSENSE®

## Control/Alarm for Temperature, Pressure, Speed, Flow

Save time and money solving control problems with this proven short-cut. Just connect your thermocouple, tach generator, thermistor or other input to the isolated input of a MAGSENSE unit, and a relay or power contactor to the other. It's about that simple to control accurately and reliably. Solid-state MAGSENSE units have 100-billion power gain and accept the output of transducers directly *without amplifiers*.

### NO MORE WORRIES ABOUT OVERLOAD OR COMMON MODE VOLTAGE

Continuous overload capability is 1000 times nominal full-scale input *without damage*. Common mode voltages as high as 110 AC can be present without affecting trip point.

#### SPECIFY YOUR NEEDS

Set point or dual set point	Transducer excitation voltage
Remote set point	Latching, non-latching, proportional or differential gap control
Solid state ground leg switching or pulse outputs for SCR's	Cold junction, copper compensation

#### BRIEF SPECIFICATIONS

INPUTS:	Will reliably alarm and/or control with signal levels as low as 1 microamp or 10 microvolts.
POWER REQUIRED:	12V DC or 28V DC $\pm 10\%$ at 30 milliamps.
REPEATABILITY:	$\pm 0.8\%$ of full scale input (typical) for temperature variation of 0 to 50 C and line voltage variation of $\pm 10\%$ from nominal.
SIZE:	3" x 4" x 1 1/4"
WEIGHT:	3 oz. maximum
PRICE:	From \$35 to \$175. Quantity discounts.

CONTACT: MAGSENSE PRODUCTS, Dept. 806, La Jolla Division, Control Data Corporation, 4455 Miramar Road, La Jolla, Calif. 92037. For immediate action, phone (714) 453-2500.

**CONTROL DATA  
CORPORATION**

4455 Miramar Road, La Jolla, Calif.

## New Instruments

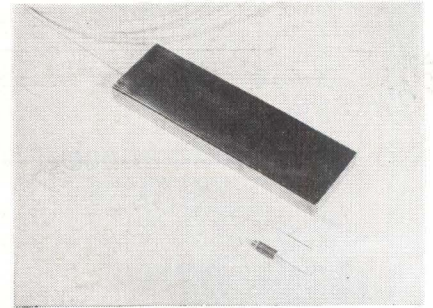

total displacement range, which can be as small as 20 millionths of an inch, and were developed to measure within gas bearings. They have a diameter of less than 20 mils and are part of a complete system which has a long-term stability of less than 0.25% and a frequency response of 10 khz or over.

The probes have a linearity of 0.2% and can measure significantly less. Probes and leads are available for temperatures to 1,900°F. The manufacturer has experience in applying these probes to measurements in almost all environments. Leads of up to 50 ft have been used. MTI Instruments division, 968 Albany-Shaker Road, Latham, N.Y., 12110. [377]

## X-y plotter designed for flight applications

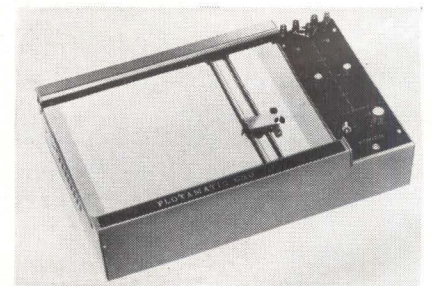

An 8 1/2- by 11-in. low-cost analog x-y plotter operates from 400 hz a-c power. The transistorized Plotamatic Model 680-400 is suited to aircraft ground-support and flight applications, operating directly from the aircraft power supply.

Model 680-400 incorporates a new servo amplifier design which improves reliability and frequency response, with full-scale accuracies of 0.2% (both axes) and repeatability of 0.1%. Increased stability is



assured by a temperature-compensated zener bridge voltage reference circuit. A voltage range of 100 mv/in. is standard; other ranges are available on order. Operating temperature range is 0° to 50°C, and input impedance is constant at 1 megohm.

Other standard features include full-scale zero adjust plus 100% offset, sealed follow-up potentiometers, new nonclog vacuum paper hold-down and easily replaceable ink cartridge.

Data Equipment division, Bolt Beranek and Newman, Inc., Santa Ana, Calif. [378]

### Universal multiplier covers 0 to 10 Ghz

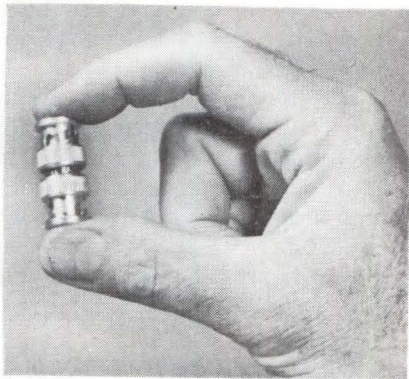

A universal, step-recovery diode multiplier has been designed to meet the need for a single harmonic generator and pulser that covers the entire 0-to-10 Ghz spectrum from audio frequencies through radio frequencies to vhf, uhf and shf. Model B830 also is extremely light weight, 0.5 oz, and features very high conversion efficiency, approaching 200% divided by the harmonic number, and relatively high power output (10 mw at 500 Mhz produces 7.0 mw at 1,000 Mhz).

For high efficiency output at a single frequency, an external cavity, tuning stub or tank circuit is used. Conversely, for a comb of harmonics, the external output circuit should have a low Q.

As the basis of a pulse generator, the instrument provides pulses with less than 1-nsec rise and fall times and pulse amplitude in excess of 10 v into 50 ohms.

Somerset Radiation Laboratory, Inc., 2060 North 14th St., Arlington, Va., 22216. [379]

# IN THIS SIZE

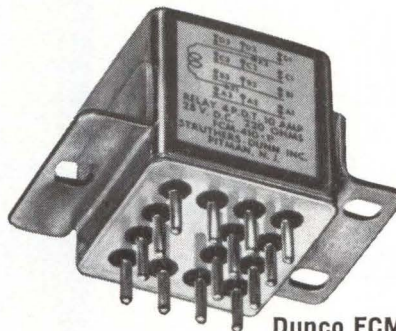

Dunco FCM-410  
"1-inch cube"  
AEROSPACE RELAYS

## WOULD YOU BELIEVE 10-AMPS?

- ...and to MIL-R-6106E
- ...and thoroughly space-proven?
- ...and available now?

Be convinced that there really is a reliable, 4P-DT power relay that's far smaller than conventional MIL-R-6106E relays with 10-amp contacts! Pick up the phone and call any of the Dunco sales offices listed below, or write for Data Bulletin A/2460 to: Struthers-Dunn, Inc., Pitman, N. J. 08071.

## STRUTHERS-DUNN, Inc.

tel: 609-589-7500

twx: 609-589-1548



SALES ENGINEERING OFFICES IN: Albuquerque • Atlanta • Belmont, Calif. • Birmingham, Ala. • Boston Buffalo • Cedar Rapids • Charlotte • Cincinnati • Clearwater, Fla. • Cleveland • Clifton • Dallas Encino • Englewood • Glen Ellyn, Ill. • Houston • Kansas City • Las Vegas • Memphis • New York • Phoenix Pittsburgh • Richardson, Tex. • Rome, N.Y. • St. Louis • St. Paul • Salt Lake City • Seattle • Southfield Towson, Md. • Wichita • Wilmette. Canadian Licensee: Renfrew Electric Co., Ltd. Export Dept.: 1505 Race St., Philadelphia, Pennsylvania 19102, U.S.A.



# RADITE from RDC

FOR DEPENDABILITY IN MICROWAVE  
ABSORPTION STOCK AND  
FUNCTIONAL PARTS

Prompt delivery on standard or  
engineered Radite products.



Bar and Plate Stock

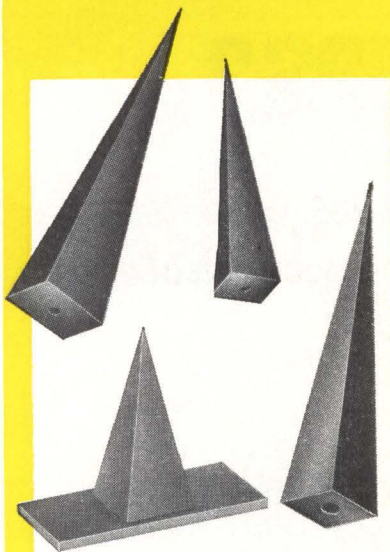

Broadband Load Inserts



**5-YEAR WARRANTY** on every RDC product! For the first time in the microwave industry, this additional assurance of reliability.

A Complete Source for Microwave Components.



Send for complete information...  
**RADAR DESIGN CORPORATION**  
510 PICKARD DR. ■ SYRACUSE, N. Y. 13211  
PHONE: 315-454-4418

## New Subassemblies and Systems

### Digital recorder handles data bursts

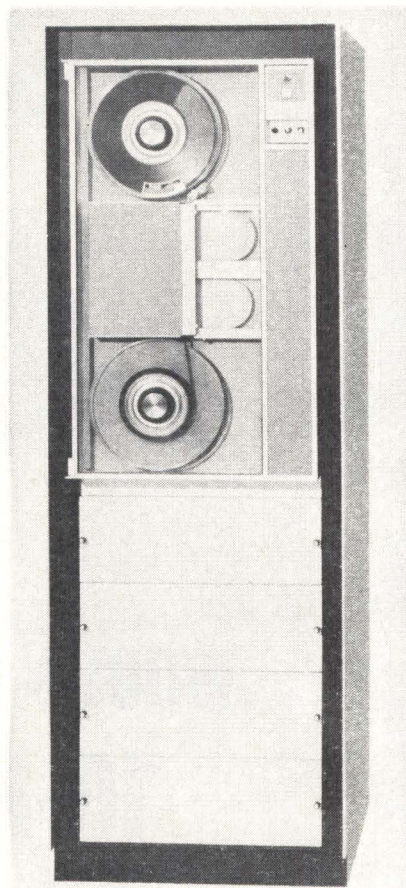

The **ADR-100** Asynchronous Digital Recorder with four times the acquisition speed of presently available equipment for the same purpose, marks the entry of the 3M Co. into the computer equipment field. The ADR-100, developed by 3M's Revere-Mincom plant at Camarillo, Calif. is a data processor, designed to allow more efficient use of expensive computer time, without loss of even random data. It's claimed to be adaptable to nearly 90% of the computers now on the market.

Basic advantage of the ADR-100 is its ability to handle information in random bursts at irregular rates. Typical inputs can be temperature, pressure and flow signals, light intensities, or accelerations. In addition to engineering and scientific data, it can also process stock control records and other business information, and can be incorporated into computer systems for

warehouses, banks and credit systems. The unit organizes input information and records it on magnetic tape for a standard output, making maximum use of computer running time. Such tapes remove certain performance burdens from the computer, and eliminate time delays between data groupings.

Design of the ADR-100 has eliminated the need for an internal core memory, which with extensive use of integrated circuits has brought the price of the unit down to the \$10,000 to 15,000 range. Reliability of IC's is also expected to reduce downtime and maintenance, providing further savings.

The recorder provides another important service as an information converter: punched tape to magnetic, cards to tape, and optical inputs to tape. Data conversion rates are estimated to be up to six times those of present units, and foreseeable improvements could increase the ratio to 100 to one.

The unit will be available early in 1967, either in standard 19-inch equipment rack form, 69 inches high, or in a castored console with horizontal tape deck.

#### Specifications

<b>Format</b>	IBM-compatible 7- or 9-channel
<b>Write mode</b>	Asynchronous, 0-2000 characters per second
<b>Read mode</b>	Continuous at 12.5 inches per second $\pm 2\%$ forward
<b>Packing density</b>	Up to 800 bits per inch
<b>Improved skew</b>	Less than 250 micro-inches
<b>Start time</b>	Less than 5 milliseconds
<b>Stop time</b>	Less than 5 milliseconds
<b>Tape</b>	1/2-inch, 10 1/2- or 8-inch plastic reels

3M Co., Revere-Mincom division, 300 South Lewis Road, Camarillo, Calif. 93010 [381]

### System selects peaks, then memorizes them

A solid state electronic peak selector and memory (PSM) system uses noncontinuous signals for closed-





loop process control. The system, consisting of the model 91-100P peak selector unit and one or more model 91-100 M memory units, is designed primarily for chromatographic readout, but it may be used in rapid rise industrial processes requiring peak picking and electronic memory storage. A memory unit is required for each signal that must be memorized.

The system senses the momentary peak value of a standard non-continuous 10 to 50 ma d-c signal, locks onto the peak and continuously transmits it to a receiving device. The peak picker holds the maximum peak, or input, value until the peak selector encounters a new peak with a positive slope. The new peak can occur at the elution of the next component in chromatography or it can be a programmed signal in an industrial process. Storage loss of the locked signal is less than 0.25% per hour, permitting long delays between input signals.

The PSM system converts the chromatograph's pulse signal into a continuous signal for trend recording and for analog or digital control. It also converts the peaks of a flash-point analyzer saw-tooth record into a continuous signal.

In digital control, the non-continuous milliamp output signal from a chromatograph is transmitted to a peak selector. As the peak signals appear at the peak selector output, the chromatograph programmer sends a "come read" signal to the digital computer. The computer scans the output and locks onto the peak signal.

Units in the system are virtually identical. The peak selector can be changed to a memory unit by removing a jumper, across two easily accessible terminals on a board, at the front of the instrument.

The system has a wide range. Peaking time of the input signal

## What's your angle? An IMC synchro or resolver could tell you.

We could also help you resolve Indicating, Measuring and Control problems using flag and remote angle indicators, steppers, or solenoids. They are in stock at IMC Magnetics Corp., Western Division.

For quick service contact the Applications Section at Western Division, 6058 Walker Ave., Maywood, Calif. 90270. Phone 213 583 4785 or TWX 910 321 3089.

If you need data sheets for reference or consideration for future projects, write IMC's Marketing Division at 570 Main Street, Westbury, N.Y. 11591.

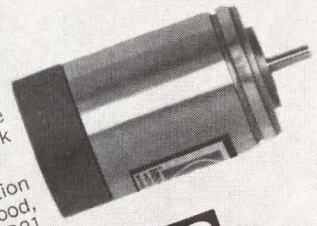

Circle 280 on reader service card

## This was the result of an IMC reducing plan.

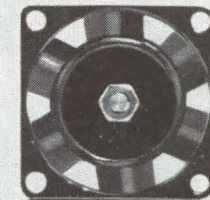

It moves  
10,000 times its own volume  
of air every minute.

Reduces your problems in designing miniaturized equipment, the IMC Cube fits within a one-inch cube and delivers 4½ cubic feet per minute of cooling air. For microcircuits, transistor heat sinks, airborne computers and instrumentation, and other systems that require a small airmover to increase system life

and reliability. Many airmovers are in stock at IMC's Eastern Division. For quick service contact the Sales Dept. at 570 Main Street, Westbury, N.Y. 11591. Or phone (516) 334-7070. If you need data sheets for reference or future projects, write Marketing Div. at the same address, or circle the inquiry number below.





# Service...Engineering...Experience

MAKE THE **BIG** DIFFERENCE  
BETWEEN A YOKE SPECIALIST  
AND A YOKE SUPPLIER

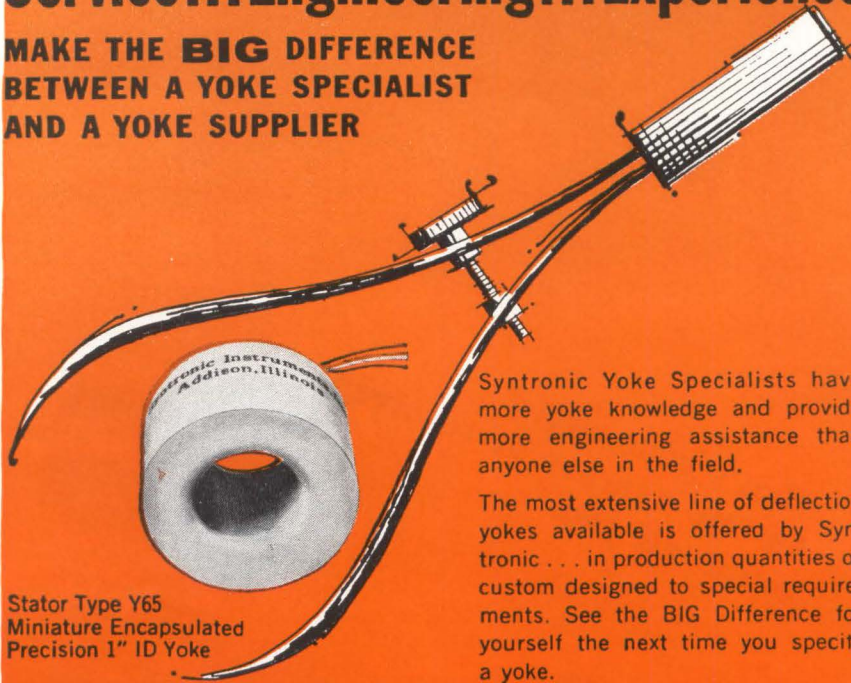

Stator Type Y65  
Miniature Encapsulated  
Precision 1" ID Yoke

Syntronic Yoke Specialists have more yoke knowledge and provide more engineering assistance than anyone else in the field.

The most extensive line of deflection yokes available is offered by Syntronic . . . in production quantities or custom designed to special requirements. See the BIG Difference for yourself the next time you specify a yoke.

*Syntronic* INSTRUMENTS, INC.  
100 Industrial Road, Addison, Illinois Phone 312, 543-6444

Circle 281 on reader service card

## New Subassemblies

may vary from a minimum of 1/2 second to a maximum of 5 minutes.

Repeatability is 0.25% of span. Accuracy is  $\pm 0.5\%$  of span. Dead-band is  $\pm 0.5\%$  of span.

The Foxboro Co., Foxboro, Mass., 02035. [382]

## Decade counter goes forward, backwards

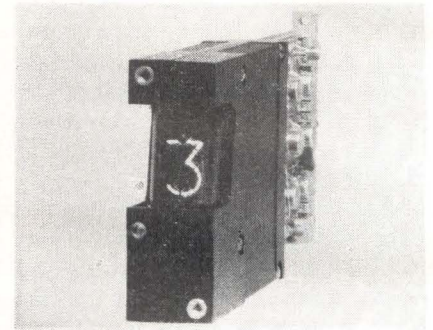

A bright, clear in-line numerical display (plus decimal point), base preset and 8-4-2-1 bipolar binary-coded decimal outputs are some of the features of a high-speed, forward-backward decade counter. Model IC-803 will accept forward, backward and reversing signals, either periodic or aperiodic, over the range of 0 to 3 Mhz and requires no additional circuitry or modules for reversing. Since the unit has no reversing delay, it will change count directions at the full 3-Mhz counting rate.

Packaged in modular form, the 3x1x6<sup>3</sup>/<sub>4</sub> in. unit is available individually or mounted, with other similar units, in complete modular packages for original equipment manufacturer instrumentation applications.

The BCD output is 0.3 v for a binary 0 and 4.5 v nominal for a 1.

Price in quantities of 100 is \$96.90 each; delivery, from stock. Janus Control Corp., 296 Newton St., Waltham, Mass. [383]

## Static inverters power 400-hz devices

A Hi-Temp static inverter, model S6D, converts 28 v d-c to 400 hertz sine wave voltages of 115 or 26 v

# Photocell Decay Problems?

*Typesetter lost a zero. This should be .0006*

Try Type 7H

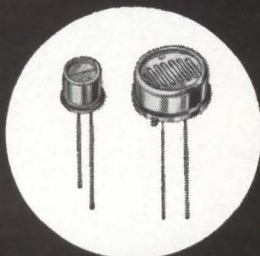

Clairex Type 7H Photocells now offer decay times of .006 sec @ 100 ft-c. Couple this with 240 ohms @ 100 ft-c, CdS stability, and your problems are solved. Available in TO-18 and TO-5 cases. And 6 resistance ranges.

**CLAIREX**

"The LIGHT Touch in Automation and Control"  
1239 Broadway, New York, N.Y. 10001  
212 MU 4-0940



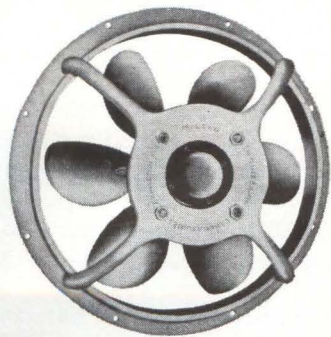

## CUT COOLING COSTS!

Save money with McLean Propeller Fans! Reliable, rugged, self-contained, easy to mount. Quiet, vibrationless. Choose from 275, 300, or 390 CFM push or pull models. McLean motors give long, service-free life under toughest conditions. Fast delivery.

McLean Engineering Laboratories,  
P. O. Box 228, Princeton, N. J. 08540  
Phone 609-799-0100,  
TWX 609-799-0245, TELEX 083-4345.

Send for 44-Page Catalog

Circle 300 on reader service card

### Reprint order form

Send to: **Electronics Reprint Dept.**  
330 West 42nd Street  
New York, N. Y. 10036

For listing of reprints available see the reader service card.

To help expedite mailing of your reprints please send cash, check or money order with your order.

For reprints of the latest special report:

### Communications Satellites Part I

Send me . . . reprints of key no R-89 at 75¢ each.

For reprints of previous special reports fill in below:

Send me . . . reprints of key no.(s) . . . at . . . ¢ each.

For prices see the reader service card.

Name . . . . .

Number & Street . . . . .

City, State . . . . .

Zip code . . . . .



a-c. With continuous full-load operation at 212°F, it supplies an output power of 60 volt-amps.

Modular design techniques are used to provide a package as small as 3x5½x4 in. which weighs less than 4.2 lbs. Components include all silicon semiconductors assembled with thermal design to produce a highly reliable inverter, according to the manufacturer. True hermetic sealing and full encapsulation enable the unit to meet the environment of MIL-E-5272C at the higher temperature of 100°C.

Regulation is 0.2% for input variations of 24 to 30 v d-c. Frequency stability is less than 1%. Other features include complete isolation of inputs and outputs and an output voltage adjustment range of 12% from the nominal output voltage. The module is also protected against short circuit conditions, input voltage transients and reverse polarity damage. These inverters can power 400-hz motors, gyros or any other 400-hz devices.

Price is as low as \$675 each.  
Abbott Transistor Laboratories, Inc.,  
3055 Buckingham Road, Los Angeles, Calif., 90016. [384]

## L-v supplies protect against overloads

All-silicon, well-regulated d-c power supplies are designed for use with integrated circuits, micro-modular circuits and other low-voltage semiconductor circuitry. An over-voltage crowbar protection circuit monitors the voltage and shorts the output terminals within 10 μsec in the event of an incipient overload condition. No damage can occur regardless of how long the overload is imposed.

Five compact models are offered in half and full rack widths. The model 6384A, with output of 4 to

## Why the most readable readouts have a new lens system.



We've just designed a totally new lens system for our miniature rear-projection readouts, the Series 120 and the Series 220 (front plug-in model). Since we already had the most readable readouts made—even with the old lens system—why all the effort?

Frankly, the most important thing we (or any other readout manufacturer) have to sell is readability. That's why we keep on working to make the best just a little bit better. This time it really paid off. Our new lens system delivers a significant increase in character sharpness and a 50% increase in brightness! Here's what we did:

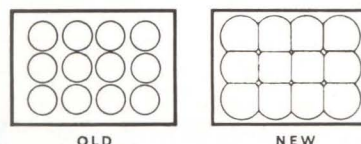

First we squared our circular lenses. That gives us greater usable lens area for a two-fold effect: the new larger lenses collect more light; magnification required is reduced. Both factors increase brightness and sharpness.

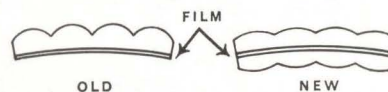

Second, we split the old single condenser lens and made a lens-film-lens sandwich. The old lens refracted light rays toward the projection lens before the rays passed through the film. Of necessity, the lens had steep curvature which limited the usable size of film. The new split-lens condenser refracts light in two stages: before it passes through film and after. By comparison, the new lenses are practically flat, permitting use of larger film and reducing aberration associated with thick lenses. The effect builds up: larger film means less magnification which in turn means greater brightness and sharpness.

So that's why the most readable readouts have their new lens system. Frankly, this new lens system may not seem earthshaking to you, unless you happen to be using readouts. In any case, send us your inquiry. We'll give you the reading on readability!

**IEE INDUSTRIAL ELECTRONIC ENGINEERS, INC.**

7720 LEMONA AVENUE, VAN NUYS, CALIFORNIA  
PHONE: (213) 787-0311 • TWX: (910) 495-1707  
© 1966 IEE Representatives in Principal Cities



*To the microwave engineer  
who needs a low cost,  
solid state oscillator right now...*

**Sanders has it in stock**

Take your choice from Sanders complete line of solid state oscillators... 21 standard models... 4 different series... available from stock.

Covering the frequency range from 50 MHz to 4.0 GHz, these high performance oscillators provide stable operation over a wide range of temperatures.

Our new Catalog TC-183 gives you the complete story, including information on solid state transmitters. Ask for it.

Sanders Associates, Inc., Microwave Division, 95 Canal Street, Nashua, New Hampshire 03060. Phone: (603) 883-3321. TWX: 228-1887 SA Microwave.

\*T.M., Sanders Associates, Inc.

**SANDERS ASSOCIATES, INC.**  
MICROWAVE DIVISION  
*Creating New Directions in Electronics*

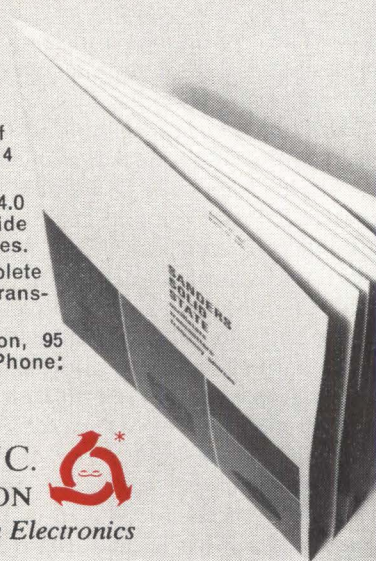

Circle 282 on reader service card

# MODULAR HEAT SINKS

Around corners or in straight sections, these modular heat sinks are easily joined into a rigid mechanical assembly with interlocking "H" extrusion bars. Unique Astrodyne design allows custom assemblies which provide excellent heat dissipation plus packaging versatility. Assemblies may be epoxy-bonded or permanently brazed if desired. Components mount easily on the wide shelves which may be located inside or outside the assembly. Efficient T-fin heat radiators provide greater dissipation per inch of length. Corner construction permits assembly of heat sinks around a central chassis.

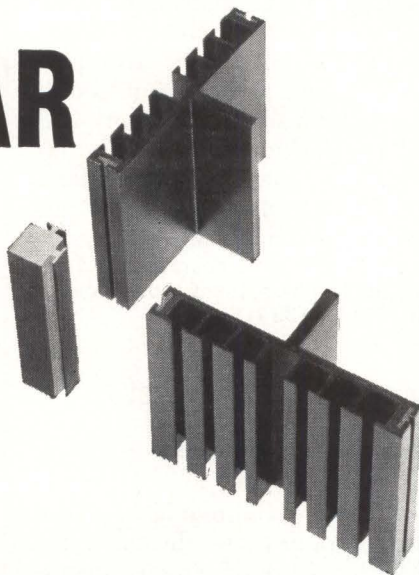

Standard or custom mounting hole patterns may be specified. Model 2520 units are normally supplied in 6" lengths with black anodize, but other lengths and finishes may be ordered.

Technical Bulletin on the 2520 units plus our new Short Form Catalog on **NATURAL CONVECTION HEAT SINKS** will be sent by return mail.



**astrodyne, inc.**

SUBSIDIARY OF ROANWELL CORP.  
207 CAMBRIDGE ST., BURLINGTON, MASS. (617) 272-3850

224 Circle 224 on reader service card

## New Subassemblies

5.5 v at 0 to 8 amps is available for immediate delivery. Price is \$220. Four other models with outputs of 0 to 7.5 v at 0 to 15 amps, 0 to 30 amps, 0 to 60 amps, and 0 to 120 amps respectively, will be available later in the year.

Hewlett-Packard/Harrison division, 100 Locust Ave., Berkeley Heights, N.J., 07922. [385]

## Miniature r-f filters meet military specs

Low-pass, high-pass and bandpass r-f filters are maximally flat and meet or exceed requirements of MIL-F-18327. With a frequency range of from 20 khz to 100 Mhz, source and load impedance is 50 ohms.

The completely shielded units are available in a 3 to 40 db shape factors of 10.2, 4.8, 3.3, 2.6 and 2.2.

Other specifications of the series F-11 include: bandwidth (bandpass only), 5% of center frequency minimum and 100% maximum; mounting, 4-40 screw inserts; terminals, 0.031 p-c type, 3/8 in. long and minimum insertion loss, 0.5 db for the low-pass filter.

Vanguard Electronics Co., 930 West Hyde Park Blvd., Inglewood, Calif., 90302. [386]

## Reference source boasts high stability

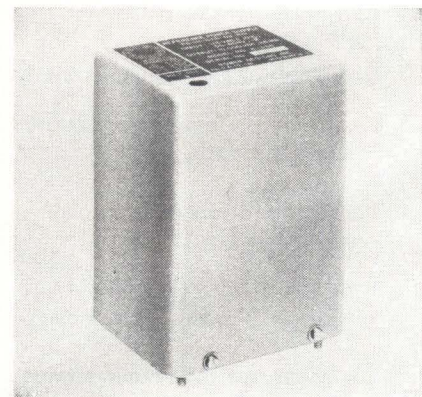

The description of this reference source, which appeared in the Oct. 31 issue, page 133, contained a typographical error. The output voltage of the model X-336 is nominally 10 volts, not 10,000 v d-c. Power Designs Inc., 1700 Shames Drive, Westbury, N.Y.

Electronics | December 12, 1966





**WHEN THIS PARCEL ARRIVES...**  
**your entire office procedure**  
**will be revolutionized.**

COMPET MODEL CS-30A fulfills a multitude of purposes in the office, factory, laboratory or study. CS-30A is equipped with a "memory" register which automatically stores intermediate answers for continuing calculations. It has a fractional number device which is unique in desk-type calculators. By a slight touch of the R key it counts fractions over  $\frac{1}{2}$  as one and rounds off others. There is a special mechanism to ensure that no two keys can be pressed simultaneously. And it has the ability to calculate instantly up to 14 digits. Yet, even under misuse it will not break down. Plug-in circuits facilitate easy maintenance.



**COMPET Model CS-30A**

**Sharp SHARP**

...to the point of perfection  
**HAYAKAWA ELECTRIC CO., LTD.**  
 OSAKA, JAPAN

U.S. Subsidiary: Sharp Electronic Corp.  
 178 Commerce Rd., Carlstadt, New Jersey, U.S.A.

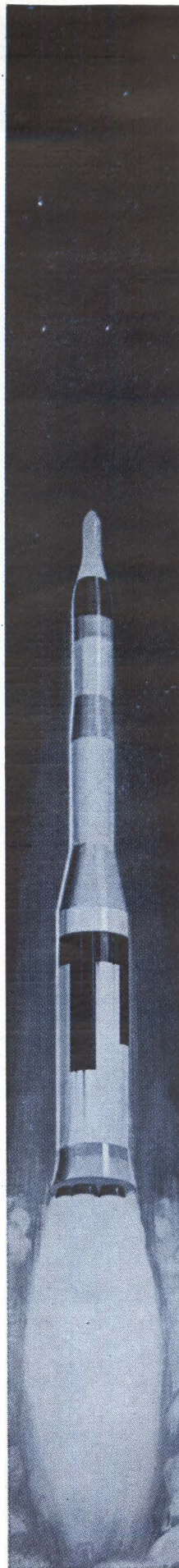

# High Q with Assured Reliability!

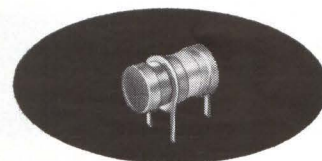

ACTUAL SIZE

The Johanson 3955 Series  
**Variable Air Capacitors**  
 are backed by  
 these special  
**RELIABILITY ASSURANCE  
 PROVISIONS**

1. Parts examined and assembled in accordance with special Johanson high reliability inspection and assembly procedures.
2. All sub-assemblies inspected under magnification to assure highest quality components prior to final assembly.
3. Final assemblies subjected to 100% burn-in and screening tests.
4. Samples taken from each lot and subjected to life tests.
5. Test data supplied on request.

**SPECIFICATIONS**

**Capacity Range:** 0-8 - 10 pf  
**Working Voltage:** 250 VDC  
**Q** >2000 @ 100 MC  
**Temperature Coefficient:** 0±20.0 ppm/°C

*Write Today for Full Data*

**Johanson**

**MANUFACTURING  
 CORPORATION**

400 Rockaway Valley Road,  
 Boonton, N. J. 07005 (201) 334-2676



Your local  
**ELECTRONIC  
DISTRIBUTOR**  
has it!

**SHIELDFLEX®**

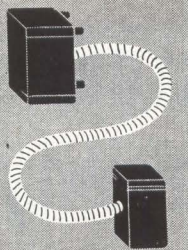

flexible  
tubing

**STOPS  
ELECTROMAGNETIC  
INTERFERENCE**

SHIELDFLEX is especially designed to: isolate conductors from external magnetic fields; contain the magnetic field generated by current carrying conductors; provide electrostatic shielding.

**BENEFITS:**

- production economy—cable can be run through a length of Shieldflex for both magnetic and mechanical protection
- optimum shielding efficiency equivalent to that expected from high permeability shield structures
- typically 39 db attenuation in a 1 oersted, 60 cps field
- space economy since conductors can be routed very close to components or other conductors

**AND:**

- it is now available at your local electronic distributors
- packaged, ready for use in random lengths; 1/2" to 2" I.D.

Distributed nationally through local electronic distributors by:

*Russell Industries, Inc.*

Write, wire or call 96 Station Plaza, Lynbrook, N. Y. 11563. Phone: (516) 887-9000.

Product of **MAGNETIC METALS COMPANY**; also manufacturers of: • Transformer Laminations • Motor Laminations • Tape Wound Cores • Powdered Molybdenum Permalloy Cores • Electromagnetic Shielding • Metallurgical Services • Custom Heat Treating • Photo Etched Precision Parts

**New Microwave**

**Co-ax transfer switch  
operates remotely**

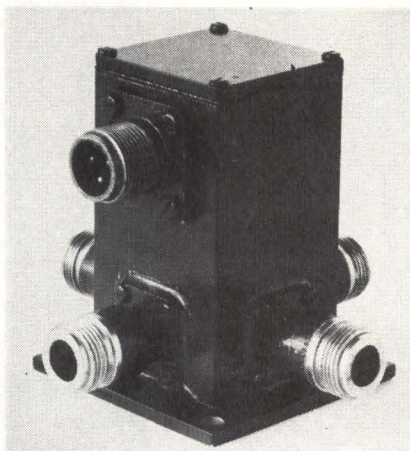

**A four-port, fail-safe** coaxial transfer switch provides 50-db isolation minimum from d-c to 1.4 Ghz. A solenoid operates the switch with a maximum switching time of 10 nanoseconds. The vswr is less than 1.2 and insertion loss is less than 0.2 db. This switch meets all applicable environmental requirements of MIL-STD-202B.

Model F7223 (N connectors and 28 v d-c solenoid) is priced at \$270 in quantities of 1 to 9. Orders can be filled in 30 to 60 days.

Alternative requirements, such as other connectors, other solenoid voltages, different electrical specifications, etc., can be met upon request.

Sage Laboratories, Inc., 3 Huron Drive, Natick, Mass. [391]

**Step-recovery multiplier  
covers 0 to 10 Ghz**

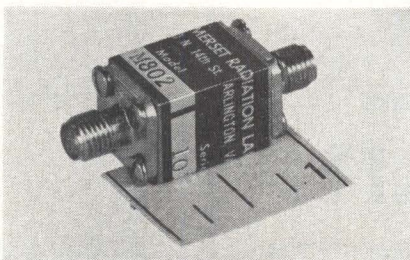

A step-recovery diode multiplier meets the need for a single harmonic generator and pulser that

covers the entire 0-to-10-Ghz spectrum. Called model M802, it features a very high conversion efficiency approaching 200% divided by the harmonic number and relatively high power output. Volume is less than 0.3 cu in. and weight is only 5 oz.

For high efficiency at a single frequency, an external cavity, tuning stub or tank circuit that has high Q is used. Conversely, for a comb of harmonics, the external output circuit should have a low Q. Model M802 can also produce pulses with less than 1 nsec rise time and fall time and pulse amplitude in excess of 10 v into 50 ohms.

Specifications include a diode transition time of 100 picoseconds; input voltage 15 v peak and a maximum input power 250 mw average. In typical operation, 10 mw at 500 Mhz produces 7 mw at 1,000 Mhz and conversion efficiency is about 70%. Connectors are OSM female 50 ohms; operating temperature range -65° to +175°C.

Price is \$160 each with availability five days from receipt of order.

Somerset Radiation Laboratory, Inc., 2060 North 14th St., Arlington, Va., 22216. [392]

**Klystron power supply  
takes little space**



A universal, solid state klystron power supply is only one-fourth the size of its predecessor. Model 819 is a primary klystron power source for laboratory, production and field operation. It features versatility of available voltages and currents, as well as choices of either amplitude or frequency modulation.

Variable beam voltages from 200 to 3,600 d-c can be obtained at up



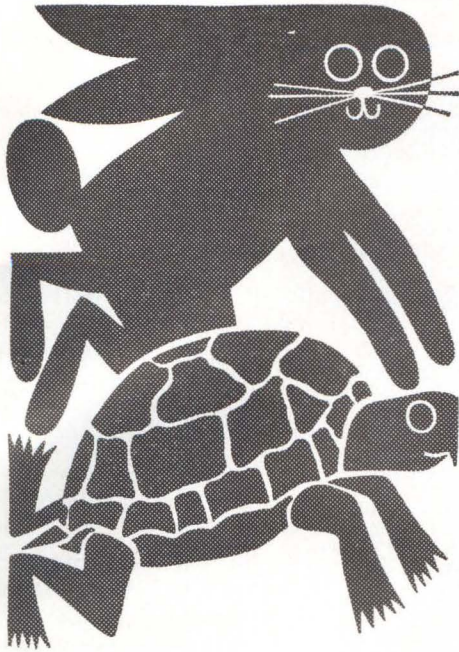

**if you don't join us,  
you'll be 10 years behind  
your field—  
6 months from now**

**PHILCO-FORD MICROELECTRONICS DIVISION**

Philco-Ford has pioneered the exciting, exploding field of microelectronics—and you can get in on the ground floor. As a subsidiary of the Ford Motor Company, we have the resources to conquer this brave, new world, but we need your help. If you are experienced in integrated or hybrid circuits or microwave components . . . or if you are a process and device development engineer . . . or if you are interested in MOS and are challenged by it, Philco-Ford has an exciting career for you. You will work either in the San Francisco Bay area or in the suburbs of Philadelphia.

**FOR CALIFORNIA INTERVIEWS**

Send your resume to Mr. Richard C. Gardner Supervisor, Employment, Philco-Ford Microelectronics Division, Dept. 50 2920 San Ysidro Way Santa Clara, California 95051.

**FOR PHILADELPHIA INTERVIEWS**

Send your resume to Mr. L. L. Baldwin Supervisor, Salaried Personnel, Philco-Ford Microelectronics Division, Dept 50 Blue Bell, Pa. 19422



MICROELECTRONICS DIVISION  
An Equal Opportunity Employer M/F

**24  
STANDARD  
MODELS...**

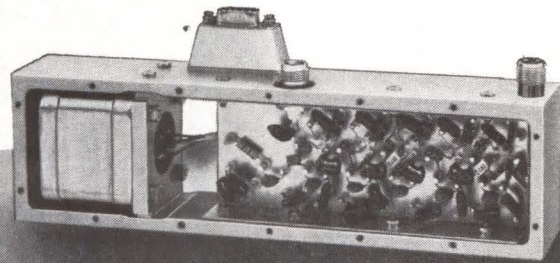

**RHG OCTAVE  
AMPLIFIERS**

**FEATURING**

- Noise figures to 2.5 db
- Solid State Reliability
- Low input and output VSWR
- RFI and Weatherproof housing
- Octave coverage to 1000 MHz
- With or without power supply

**FOR EXAMPLE**

<b>Model B505</b>	
Frequency:	200 - 400 MHz
Gain:	20 db (min.)
Noise Figure:	< 4 db over band
Input and Output Impedance:	50 ohms
Input and Output VSWR:	2:1 typical over band
Price:	\$495

Utilizing RHG's broad background in low noise pre-amplification, an additional **43 CUSTOM DESIGNS** have been produced. The solution to your problem may be on file in our library now.

For specials, test our **ONE-DAY-QUOTE** Service. For standards, see complete listing in EEM Section 3400.

**RHG**

**RHG ELECTRONICS LABORATORY, INC.**

94 Milbar Blvd., Farmingdale, L.I., N.Y. 11735 • (516) 694-3100

MICROWAVE FM and AM RECEIVERS ■ MICROWAVE MIXER PREAMPS  
LINEAR and LOG IF AMPLIFIERS ■ RF and OCTAVE AMPLIFIERS



**IT'S  
A  
FACT**

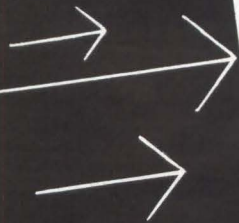

America's principal  
defense contractors,  
computer builders,  
instrumentation  
manufacturers and  
electronic systems  
developers use more  
Metal Removal Company  
solid carbide circuit  
board drills and  
routers than all other  
makes combined.

For more information,  
may we send you our  
Catalogs D63 and E65  
... and name of  
nearest distributor?

**SOLID CARBIDE  
CIRCUIT BOARD  
TOOLING**

**THE METAL REMOVAL COMPANY**  
1859 West Columbia Avenue • Chicago, Illinois 60626

Plants Located in CHICAGO • LOS ANGELES • SAN JUAN

**MASTER TOOL AND WHEEL MAKERS  
FOR THE WORLD**

Circle 228 on reader service card

To order reprints: Fill in, cut out coupon below, insert in envelope and mail to: **Electronics Reprint Dept., 330 W. 42nd Street, New York, N.Y. 10036**

**Reprint order form**

For listing of reprints available see the Reader Service Card.

Communications Satellites. Parts I and II.

Send me . . . . . reprints of Key no. R-90a at \$1.25 each.

For reprints of previous special reports fill in below:

Send me . . . . . reprints of Key No.(s) . . . . . @ . . . . .¢ each.  
(For prices, see Reader Service Card)

Name . . . . .

Number of street . . . . .

City, State, Zip code . . . . .

**New Microwave**

to 360 w. Also available are well-regulated low-ripple reflector, grid and d-c filament supplies, all variable and referenced to the high voltage. A modulator for use with internal square, sawtooth or sine-wave and external signals can apply up to 200 v peak-to-peak to the reflector circuit. Also, the current-limit setting on the beam supply is continuously variable.

Single range tuning is provided for the beam and reflector voltages, and these voltages can be read out either on meters or on digital counters as desired. Beam voltage and current, filament, reflector and calibration voltages may be monitored on front-panel meters.

PRD Electronics, Inc., 1200 Prospect Ave., Westbury, L.I., N.Y., 11590 [393]

**Coaxial termination  
rated at 20 watts**



Coaxial terminations, series TB-6, that operate from d-c to 6 Ghz, have an average power rating of 20 watts; peak power handling capability is 5 kw.

The terminations contain a beryllium oxide element within a carefully matched coaxial housing. As a result, maximum vswr is only 1.15 up to 5.5 Ghz, and 1.20 from 5.5 to 6 Ghz.

Cooling fins minimize the temperature rise of the terminating element, and the units operate over a temperature range from -55° to +125° C. They are available with type N connectors at \$60 each, and with type BNC or TNC connectors at \$65 each. All are in stock for immediate delivery.

Microlab/FXR, 10 Microlab Road Livingston, N.J., 07039. [394]





## ULANO EUROPEAN TECHNICAL CENTER FOR GRAPHIC ARTS

Ulano's technical center in Switzerland is headed by the very capable Mr. Henri Kunz. He is qualified by his many years of experience in the Screen Process and Graphic Arts fields. Demonstrations and technical seminars are held in many languages throughout the year. Complete laboratory facilities have been installed to provide demonstrations of the complete Ulano line. Large stocks of all famous Ulano films are available for immediate delivery to all parts of the world.

You are invited to contact Mr. Henri Kunz at ULANO A.G., Untere, Heslibachstrasse No. 22, Kusnacht 8700, Switzerland, Telephone 905959. It is our pleasure to serve you.



**DO YOU USE  
SCREEN PROCESSING  
IN THE PRODUCTION OF  
COMPLEX  
PRINTED  
CIRCUITRY?**

**TWO NEW PRESENSITIZED FILMS TO  
SPEED PRODUCTION — LOWER COSTS**

**Ulano**  
T.M.



**WRITE TODAY**  
on your letterhead  
for free special  
sample kit  
number 5448

### HI-FI RED

#### HEAVY-DUTY INDUSTRY PROVED

Presensitized photo film used by many leading electronic firms for clean, sharp, tough, durable, almost indestructible screens of unmatched quality. Adheres tightly to wire, silk, nylon and dacron.

### PREP®

#### PRESENSITIZED FOTO FILM

.002 Polyester support guarantees good register. Does not require a dark room. Very good resolution—suitable for halftones. Excellent adhesion to silk, nylon, dacron and metal mesh. Tough, strong emulsion—good for machine printing and long runs.

## J. ULANO & COMPANY, INC.

610 Dean Street, Brooklyn, N. Y. 11238, U.S.A.

Cable address: "UlanoFilm"

In Europe: ULANO A. G., Untere, Heslibachstrasse No. 22  
Kusnacht, Zurich, Switzerland

**2** of a series

**TRANSICOIL SOLVES  
SERVO PROBLEMS**

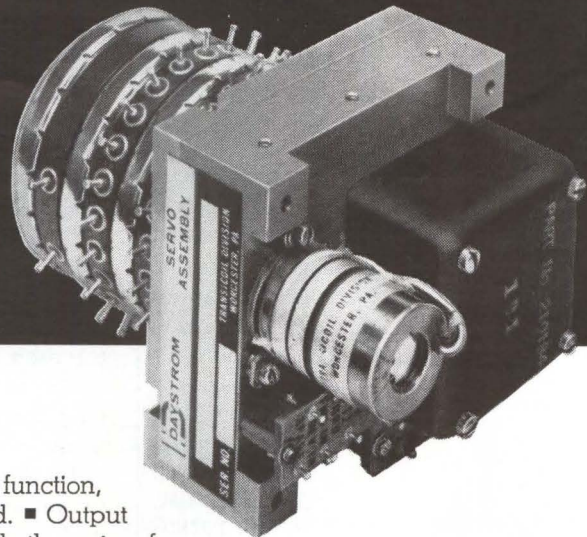
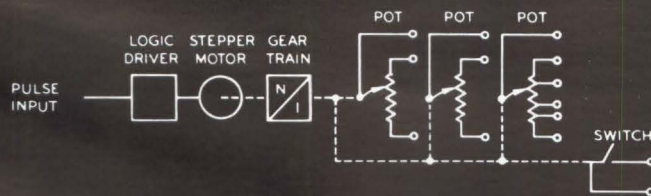

## Transicoil digital pot drive

Transicoil incremental servos effectively perform an integration function, since they produce a finite shaft motion for each input command. ■ Output of this servo package is an analog function synchronous with the rate of input pulses to the stepper motor. Extremely low time constant is assured because the unit accelerates to full speed in less than one pulse. Stopping time is equally short. ■ This compact unit includes a size 8 stepper motor, precision gear reduction, solid state logic driver, and 3 gang tapped pots with internal limit switch. ■ The assembly, except for pots, is manufactured by Transicoil. It offers the quality and reliability typical of Transicoil's broad line of standard and special-purpose servo assemblies. ■ Write for our 16-page brochure, SERVO ASSEMBLIES. It describes Transicoil products and design capabilities.

**Weston Instruments, Inc., Transicoil Division, Worcester, Pa. 19490.**

**WESTON®** prime source for precision . . . since 1888



# \*NEW FROM HATHAWAY



MINIATURE  
FORM

\*  
C  
RELAY

**SIGNIFICANT  
PERFORMANCE  
GAINS ESTABLISHED BY  
HATHAWAY'S CONTROLLED  
REED PROCESS ARE:**

- A pure, inert contact environment resulting in no "film" buildup on contacts eliminating contact resistance irregularities and recurring infant mortality on dry circuit loading.
- The Direed actuation avoids failure mechanisms characteristic of electromechanical devices.
- Whatever the switching assignment, Hathaway Double Throw relays will do it better and more economically.

Hathaway Form C Relays are available in all Series—"J" AXIAL, "K" PRINTED CIRCUIT, "R" COMPUTER GRADE, "GP" GENERAL PURPOSE

For detail information call or write

**HATHAWAY INSTRUMENTS, INC.**  
5250 EAST EVANS AVENUE  
DENVER, COLORADO 80222  
(303) 756-8301 • TWX 292-2935  
Distributed Nationally by  
**COMPAR CORPORATION**

## New Production Equipment

### Getting the most out of an etchant

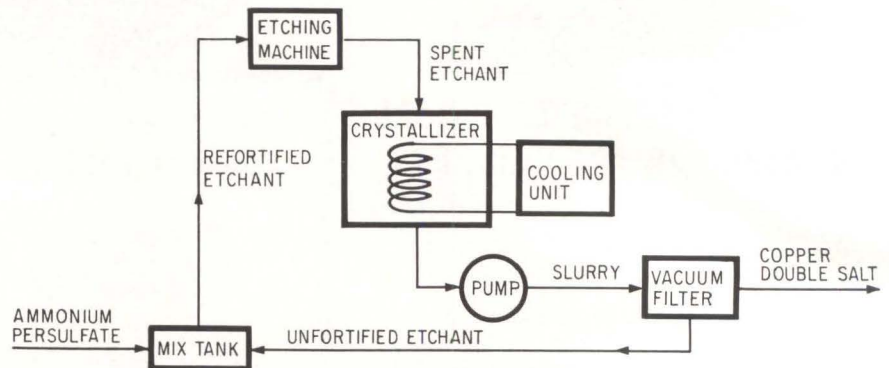

**Etching liquid**, once it has served its purpose in the manufacture of printed circuit boards, is usually dumped. However, the FMC Corp.'s Inorganic Chemicals division has developed a new process that allows the spent etchant to be continuously recovered and reused while the printed circuit boards are made. It is designed for manufacturers who use ammonium persulfate etching solutions. In addition to eliminating entirely any waste liquid, which FMC says is being done for the first time, the process recovers a double copper salt—copper ammonium sulfate hexahydrate—which can be sold.

Just before the ammonium persulfate etching solution is completely spent, the FMC process transfers it to a crystallizer. Although this occurs when there is about half of the persulfate still in the etch the etching reaction slows down to the point where, in the past, the entire solution was thrown away.

In the crystallizer, the products of the etching reaction are cooled and the copper salt crystallizes out of the solution. Next, the slurry, which consists of the crystallized salt and the remaining liquid, or liquor, is filtered. The liquor, still containing some ammonium persulfate, is fed back to mixing tanks where more of the persulfate is added. This brings the liquor back up to its original etching strength and it is ready to be used again in the etching machine.

After the process has cycled through a few times, a stable amount of copper sulfate remains permanently in the solution. But there is not enough of it to affect the etching reaction, according to FMC. The company has also developed a control method for the process which assures that the solution is etching the circuit boards at a constant rate.

FMC says that the new process increases the persulfate use efficiency from the present 50% to 95%. Thus it can substantially reduce the amount of persulfate required to etch a given number of circuit boards.

For manufacturers who etch about 10 pounds of copper per hour, installation of the process equipment would cost about as much as an etching machine—about \$15,000—according to FMC. FMC Corp., Inorganic Chemicals Div., 633 Third Ave., New York, N.Y. 10017 [401]

### Thickness grader for memory cores

The Ramsey Engineering model MR-301 Mike-O-Roll is a roller type grading micrometer developed for automatic height grading of ferrite memory cores at high speed production rates. Sorting rate is 120,000 cores per hour for core sizes ranging from 0.012 in. to 0.080 in. outside diameter. The ma-



**Leadership is  
no accident!**

in sports  
or in  
industry

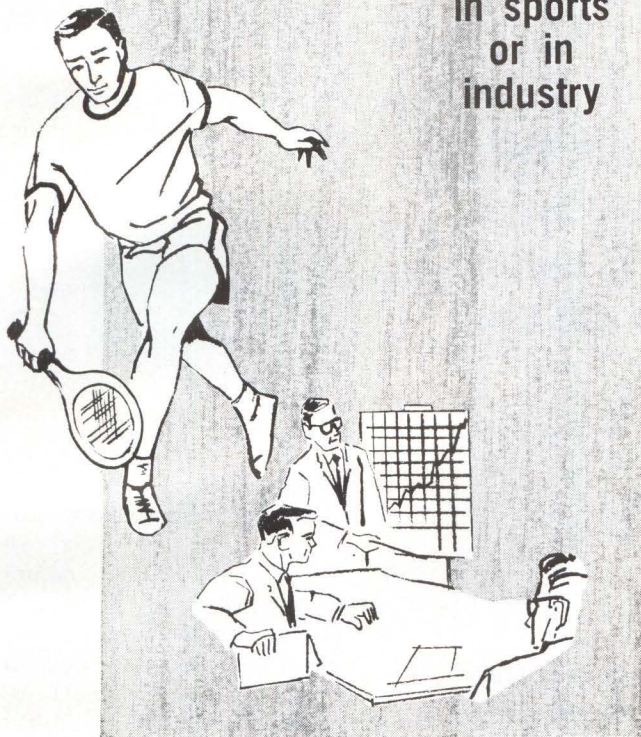

**QUALITY PRODUCTS**  
are one of the  
reasons for **ALPHA'S**  
**LEADERSHIP**

The extensiveness of Alpha's quality product line is unmatched anywhere. Alpha offers a complete system of solders, fluxes, soldering chemicals, special alloys, lead and tin products, solder preforms and ultra high purity metal fabrications for semi-conductor devices. There is an Alpha product for every soldering requirement in industry . . . electronic, electrical, automotive, aerospace. Additional reasons for Alpha Leadership include authoritative Soldering Technology Seminars; an outstanding Research and Development Department geared to problem solving; prompt, reliable service; and unequalled know-how and experience.

BULLETIN A103 TELLS THE ALPHA STORY.  
WRITE FOR YOUR FREE COPY TODAY.

**alpha**® **alpha metals, inc.**

56 WATER STREET, JERSEY CITY, N. J. 07304 201-434-6778

Los Angeles, Calif. • Alpaloy Corp. (Div.), Chicago, Ill.  
Alpha Metals, Inc. (U.K.) Ltd., Hounslow, Middlesex, Eng.

J-6826

Circle 284 on reader service card

**NEW.**  
**Low  
Frequency  
Ceramic  
Band Pass  
Filter.**

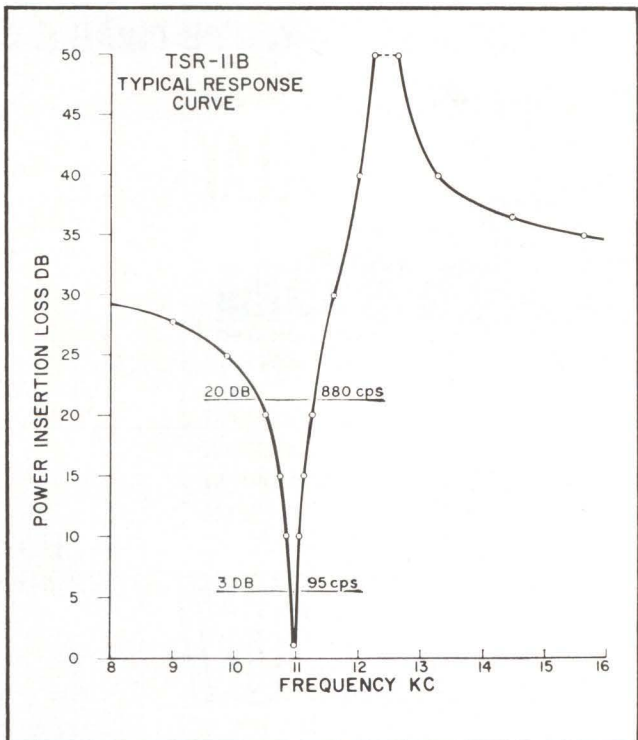
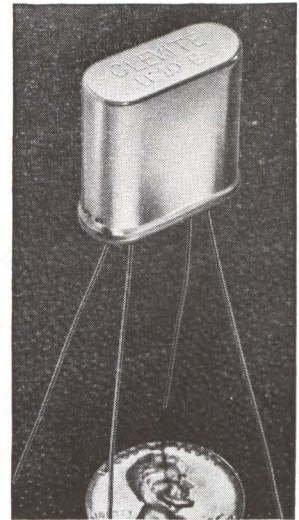

**Big performance in a  
quarter ounce package.**

Looking for something better in a low frequency filter? Look no more. Clevite's new generation of fixed-tuned ceramic band pass filters combine narrow bandwidths and high performance with surprisingly small size and low weight.

Check the specs and see for yourself:

**Center Frequency** — from 9kc to 50kc

**Bandwidth (% fo)** — @ 3db-1%; @ 20db-13%

**Stability** — Within 0.2% for 5 years

Within 0.2% from -40°C to +85°C

**Dimensions**—HC-6/U case 3/4" x 3/4" x .34" (hermetically sealed)

**Shock** — 20g any axis 20-2000 cps per mil std. 202B.

As we said, look no more for a high performance, low frequency filter. This new one from Clevite is the perfect choice. Write for free Technical Bulletin 94023. Clevite Corporation, Piezoelectric Division, 232 Forbes Road, Bedford, Ohio 44014.

**CLEVITE**

Circle 231 on reader service card

231



**TRYLON HLP T-45 LOG PERIODIC ANTENNA**  
 Single-layer, horizontally-polarized,  
 for 3 to 30 mc. 45° take-off angle;  
 11 db/iso gain; VSWR: less than 2:1;  
 power to 100 kw.

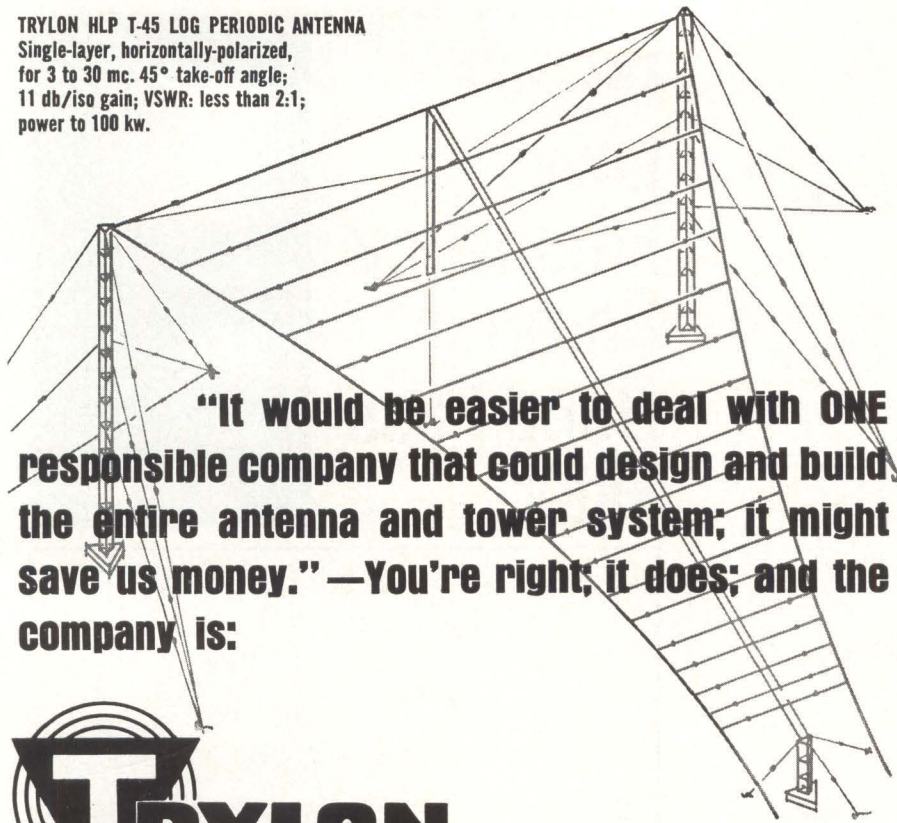

**"It would be easier to deal with ONE responsible company that could design and build the entire antenna and tower system; it might save us money." —You're right; it does; and the company is:**



Circle 285 on reader service card

## Production Equipment

chine grades the cores into five different size classifications plus undersize and oversize grades.

The MR-301 offers a low cost mechanical technique for presorting large production quantities of cores, eliminating those which are too thick, too thin or which have manufacturing defects, such as firing flash or die fins. This prelimi-

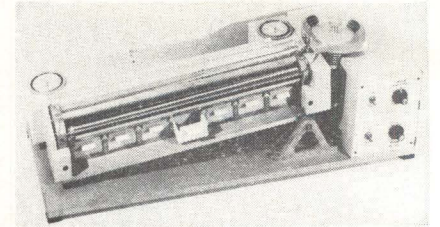

nary test for physical rejects helps reduce over-all memory core production costs by speeding up "throughput" on electrical parameter test systems.

In operation, cores placed in the feeder bowl pass down an inclined "V", formed by two counter rotating chrome-plated cylinders which are separated by a progressively widening air gap. Individual cores advance along the rollers until they reach a suitable opening for their particular thickness. They then drop through the air gap and into the proper grading drawer. Computer Test Corp., 3 Computer Drive, Cherry Hill, N.J. [402]

## Work station uses 3-plane manipulators

A work station serves as a platform to hold a component in place when very fine manipulation is required. Magnifiers or stereo microscopes can be used with the work station.

The manipulators have rack and pinion movements with 2-in. travel in all three planes. The section holding the pin vise can be tilted to approach the work piece at an angle. The table can be adjusted to various heights. Electrical insulation can be provided between the base, work table and platform.

Price of the unit is \$425. C.H. Stoelting Co., 424 North Homan Ave., Chicago, Ill., 60624. [403]

ACHIEVEMENT  
  
 '67  
 IN  
 ELECTRICAL/  
 ELECTRONICS  
 ENGINEERING

**EXHIBITS**  
**NEW YORK**  
**COLISEUM**

**TECHNICAL**  
**SESSIONS**  
**NEW YORK HILTON**

Monday through Thursday  
**MARCH 20-23 1967**

- 69 Technical Sessions at the New York Hilton. Hours: Mon. 9:30-12:00 a.m.; 2:00-4:30 p.m. — other days 9:00-11:30 a.m.; 2:00-4:30 p.m.
- FOUR COMPLETE FLOORS OF EXHIBITS at the New York Coliseum including over 700 firms. Hours: 10 a.m.-8 p.m. 4 Days.
- Gala Annual Banquet — Wednesday 7:15 p.m. New York Hilton Grand Ballroom — \$15.00

- Free shuttle busses between the Hilton and the Coliseum — every few minutes.
- Registration — IEEE Members \$2.00 Non-members \$5.00 Ladies \$1.00 High School Students \$2.00 if accompanied by an adult. One student per adult Monday through Wednesday, Thursday only — limit of 3 students per adult. Good for all days — Technical Sessions and exhibits. In and out privileges.



**'67 International**  
**IEEE CONVENTION / EXHIBITION**



# DELAYS

FROM 10 TO  10,000  $\mu$ S

## *delttime* MAGNETOSTRICTIVE DELAY LINES

Delttime, with over a decade of experience in precision magnetostrictive delay line technology, offers models to fill virtually every delay requirement. Complete input-output circuit modules for carrier and RZ or NRZ digital systems... torsional, longitudinal, tapped and adjustable models as well as high vibration and shock withstanding delay lines for airborne applications are included in the standard line.

If your application requires a signal delay or extremely economical delay line memory element, contact us, our application engineers are at your service... or write for our complete technical catalog.



SUB-SYSTEMS DIVISION  
**SEAELECTRO**  
CORPORATION

HOYT STREET • MAMARONECK • NEW YORK  
PHONE 914 698-5600 TWX: 710-566-1110

Sealectro Ltd., Portsmouth, Hants, England

Circle 286 on reader service card

Because there's a  
**BIG DIFFERENCE**  
in our techniques  
and skills, you get  
more uniformity and  
precision with...

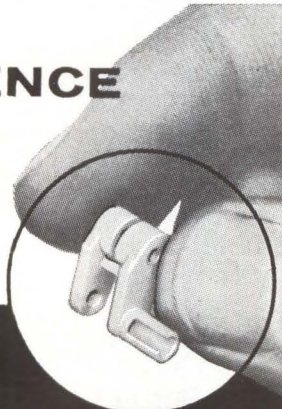

**small  
plastic molded parts**

engineered by **GRC**<sup>®</sup>

Your products—and your profits—benefit when you specify GRC tiny plastic moldings. The 30 years we've been specializing in these significant small parts have been a time of continuous development and perfection of our special, patented, automatic, injection molding machines—and our skills in tooling and production. Your very next small part might very well need the kind of uniformity and precision only GRC can deliver; get to know us now.

NO MINIMUM SIZE—MAX. SIZE: .05 oz.; 1 3/4" long

Write today for helpful engineering literature and samples

**GRIES REPRODUCER CO.**

Division of Coats & Clark Inc.

151 Beechwood Ave., New Rochelle, N.Y. 10802 • (914) 633-8600

Plants in: NEW ROCHELLE, N.Y.; WARREN, R.I.; TOCCOA, GA.

Handbook of  
value engineering  
small part ideas



World's foremost  
producer of small  
die castings and  
plastic moldings.

## Designed for Advanced Data Systems...

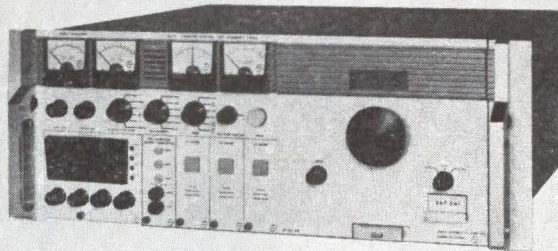

## The Series 400 TELCOM Receiver

### Look at these features...

- All solid state design
- Superior performance
- Completely modular, plug-in construction
- RF heads for VHF and S-Band telemetry, sweep tuned and wide band heads for surveillance applications
- Plug-in pre-detection recording converter, spectrum display, electrically switchable IF Filters

Interested? Get the detailed specifications. Write for your free copy of the DCS Series 400 TELCOM Receiver brochure.

Would you like an appointment to see a TELCOM Receiver for yourself? Just call the DCS office below nearest you...

Dept. E, 12-66, East Liberty Street, Danbury, Conn. 06813

Telephone: 203-743-9241 • TWX 744-1990



**DATA-CONTROL SYSTEMS INC.**  
*Instrumentation for Research*

Sales Offices  
Silver Spring, Md., Huntsville, Winter Park, Long Beach, Santa Clara,  
Albuquerque

Copenhagen London Rome Paris Munich Amsterdam



# OFF-THE-SHELF INTER-WIRING

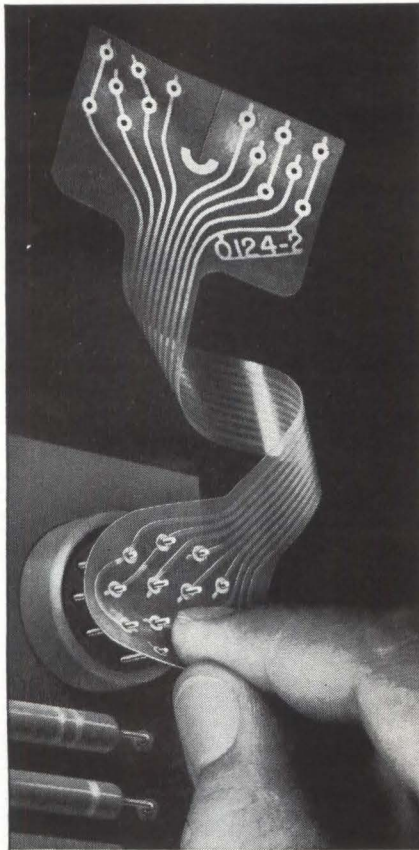

With a Garlock Free-Flex® circuit, interwiring becomes an off-the-shelf item, as easy to use as any other electronic component. ■ Order a quantity of Free-Flex circuits . . . pre-engineered mechanically and electrically especially to fit your product, making connections between components and sub-assemblies *in one piece* . . . and from that point on, interwiring will be as simple as reaching into *your* stock for the right component, as you need it. ■ Free-Flex circuits take the headache out of interwiring because it's impossible to hook them up wrong or use the wrong one . . . they're goof-proof. And they take less time to assemble, are more reliable, and more economical than conventional interwiring. ■ Write us for your copy of *Flexible Circuits in "Teflon" FEP Have Come of Age* reprinted from *The Journal of Teflon*, published by E. I. du Pont de Nemours and Company . . . and for the FREE-FLEX Circuitry Manual.

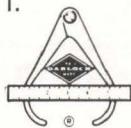

**GARLOCK**  
ELECTRONIC PRODUCTS  
GARLOCK INC.

Cherry Hill, N.J. 08034 • Phone (609) 424-1470

In Europe: Europélec S.A., Les Clayes-Sous-Bois, France  
In the United Kingdom: Lectropon, Ltd., Slough, England

## New Materials

### Glass seals diodes safely

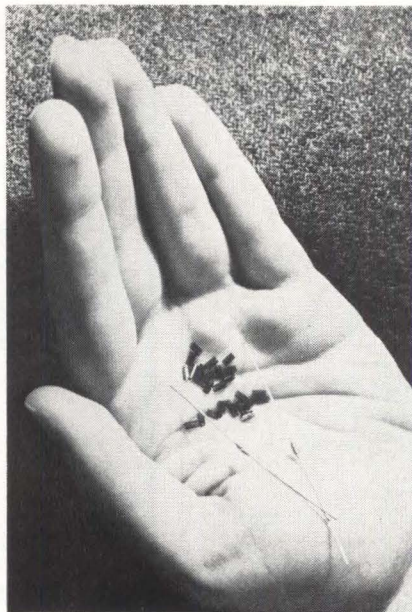

Sealing miniature diodes with glass wouldn't be much of a problem if the glass would only behave. But often it doesn't, spreading unwanted contaminating materials that affect the properties of the diode the glass is supposed to protect or changing its own properties so that the seal itself degrades.

A new sealing glass developed by Corning Glass Works reportedly combines in the same glass for the first time two desirable properties—low alkali content and no lead—which should make for more reliable, longer-lasting seals. Coupled with this is another advantage—it can be sealed quickly with infrared energy. The glass is used to seal both molybdenum and tungsten.

For Corning's new code 4070 glass, maximum alkali content is limited to 0.05% for both sodium oxide and potassium oxide and to 0.01% for lithium oxide. Alkali content in a sealing glass should be kept low because the alkali tends to migrate from the glass and onto the semiconductor chip, changing its characteristics. This could cause the maximum peak inverse voltage the diode can withstand to decrease, for example. The voltage also would tend to be unstable at higher temperatures.

Lead content is important in a sealing glass because when heat is applied during the sealing operation, any lead oxide the glass may contain is reduced to lead. This, unfortunately, makes for a much poorer seal. It is an advantage, then, that the new glass is lead free.

Any infrared radiation source—a quartz-iodine lamp, for example—can be used to seal the glass which absorbs radiation from 0.75 to 4.75 microns. Although the sealing temperature is higher than for other low-alkali glasses Corning had previously developed, the infrared heat can be focused onto a small area. Heat sensitive devices can be sealed quicker and safer than if encapsulation was made with a direct flame or in a furnace.

Code 4070 glass is available in cut tubing with an outer diameter of up to 150 mils. In high volume the cost is \$5 per 1000 pieces, with sampling quantities also available.

#### Properties

Softening point	816° C
Annealing point	622° C
Strain point	582° C
Expansion 0-300°C (in/in/°C)	47 x 10 <sup>-7</sup>
Density (gr/cc)	2.76
Transmission	
1.1 microns	5.0%
0.56 micron	17%

Communications Products Sales, Corning Glass Works, Corning, N.Y. [406]

### Two-part resin seals communications cables

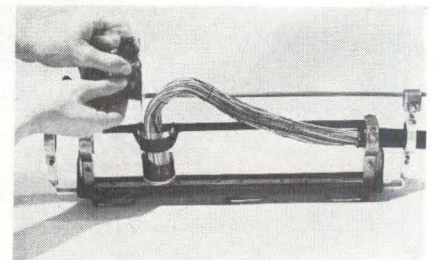

A two-part resin is designed for capping and sealing communications cables and for capping drop-wire stubs in direct burial splices. Known as Scotchcast-brand elec-



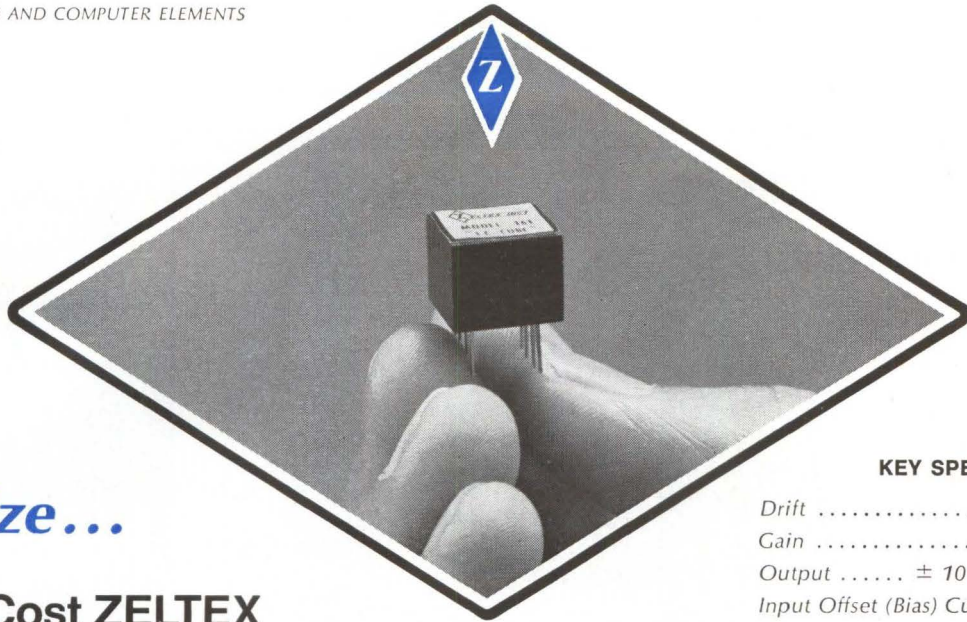

**Try this  
on for size...**

**New, Low-Cost ZELTEX  
"IC CUBE"\* High-Performance Diff Amps!**

First of a family of Hybrid Integrated Circuit Differential Amplifiers, ZELTEX's new Model 161 is an exceptionally stable device in a new, easy to mount epoxy package at a price you'll find hard to resist. In addition to the low initial cost of only \$47.00 (100 lots), Model 161 offers savings in engineering and assembly time. All internal resistors and capacitors are built into the 161. And, the new ZELTEX (0.5" x 0.5" x 0.4") IC Cube package fits flush to the board without time consuming lead soldering.

Units for evaluation are available immediately. Order yours today!

\*IC CUBE is a tradename of ZELTEX, Inc.

**KEY SPECIFICATIONS**

Drift .....25  $\mu$ V/ $^{\circ}$ C  
Gain ..... 80,000  
Output .....  $\pm$  10 Volts at 4 mils  
Input Offset (Bias) Current..150 nA  
Input Impedance ..... 20 meg $\Omega$   
Short Circuit Proof



**ZELTEX, INC.**

1000 Chalomar Road  
Concord, California 94520  
Phone (415) 686-6660

Circle 288 on reader service card



**New Free Handbook  
on Servo Packages**

Getting our new Servo Package catalog is almost like getting a servo design engineer through the mail. It gives you details about integrators, in-line servos, geared assemblies, data converters, synchronizers, and custom units, *pre-engineered* by Cedar. Write or call us for your free copy.

**CEDAR CONTROL DATA**  
ENGINEERING DIVISION CORPORATION

5806 West 36th Street, Minneapolis, Minn. 55416  
Phone: (612) 929-1681

**Who Said Precision Scopes  
Have To Be Expensive?**

Compare the  
new HEATHKIT<sup>®</sup>  
DC-8 MHz  
triggered-sweep  
scope kit  
10-14 \$299.00  
wired  
10W-14 \$399.00

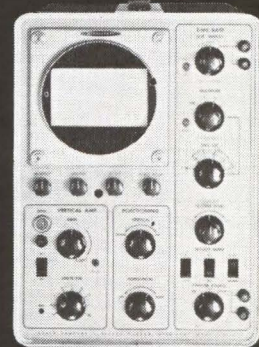

• DC to 8 mc bandwidth — 0.04 usec rise time • Triggered sweep — 18 calibrated rates • Delay-line vertical amplifiers for fast-rise signal analysis • 3% calibrated vertical attenuator — 0.05 v/cm to 20 v/cm, 600 v. (max.) input • Electronically regulated power supplies • Forced air ventilation • Built for continuous-duty industrial & lab use

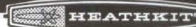

**FREE  
CATALOG**

Describes this and over 250 other Heathkits. Save up to 50%. Use this coupon for your free copy.

**Heath Company, Dept. 67-12**  
Benton Harbor, Michigan 49022

Please send FREE Heathkit Catalog & Information describing the New Heathkit 10-14 Oscilloscope  
 Enclosed is \$\_\_\_\_\_, plus shipping.  
Please send model\_\_\_\_\_.

Name \_\_\_\_\_  
Address \_\_\_\_\_  
City \_\_\_\_\_ State \_\_\_\_\_ Zip \_\_\_\_\_

Prices & specifications subject to change without notice. TE-146R



# SUBSONIC SUPERSONIC HYPERSONIC

## What's your Speed?

Lockheed has a program to match your interests, your background, and your drive.

A wide range of important programs are in progress, such as the Army's AAFSS compound helicopter, STOL and V/STOL short-haul transports, extremely advanced fighters, supersonic transports, SCRAM-JET hypersonic test vehicles.

And the variety that Southern California offers can match your style of living—whatever it is.

On your left, the ocean. On your right, the desert. Up, the mountains. Down, the surf. All within hours. And there's everything in between. Educational opportunities at numerous universities. Theatre, art, music. Major league baseball, football, and basketball. Pools and patios. Palms and pine trees.

For more information, write Mr. E. W. Des Lauriers, Professional Placement Manager, Dept. 1512, 2402 North Hollywood Way, Burbank, California. Lockheed is an equal opportunity employer.

**LOCKHEED-CALIFORNIA COMPANY**  
A DIVISION OF LOCKHEED AIRCRAFT CORPORATION

## New Materials

trical insulating resin No. X3598, it is a fast curing, flexible polyurethane material especially designed for telephone and other communications applications where low-voltage systems are used.

The resin cures within 2 to 5 minutes at 75°F; low enough not to harm sensitive plastic wire insulation. It comes packaged in a Unipak container for easy handling and mixing and is available from stock.

3M Co., 2501 Hudson Road, St. Paul, Minn., 55119. [407]

## Standard substrates made of alumina

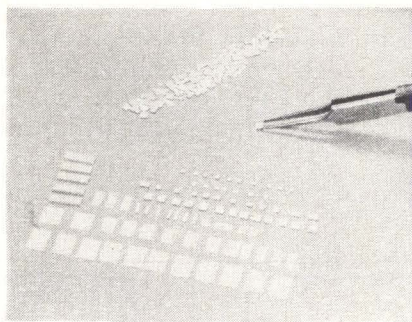

Alumina has been finding wider use as an IC substrate material because of its high thermal conductivity, excellent dielectric properties, mechanical strength and fine finish. However, important IC research is often delayed by lack of immediate availability of alumina substrates. Hence this new series of standard substrates in over 600 different combinations available within a few days from receipt of order.

The C-100 standard substrates are offered in sizes from 0.007-in. thickness to 0.050-in. thick in square areas up to 2 sq in. They are available to the integrated circuit engineer with three finishes: bare (unmetalized), metalized and gold plated on one side and metalized and gold plated on both sides. The gold plating, 0.000150 in. minimum thickness, is directly on the moly metalizing, with no nickel interlayer, thus permitting direct die attach.

Prices on the C-100 series will

# Telrex

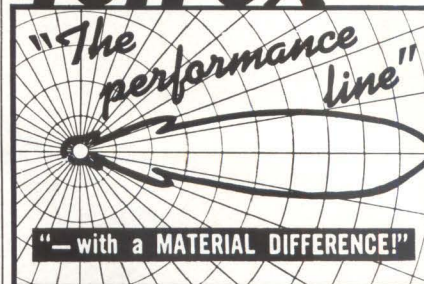

Telrex Communication Engineering Laboratories provides the Most Technically-Perfect, Finest Communication Arrays — Precision Engineered, Manufactured, Tuned, Matched, Calibrated and "Balun" Fed for "Balanced-Pattern" and Maximum S/N Ratio.

**Telrex "Beamed-Power"  
"Balanced-Pattern"**

**ANTENNAS AND  
ANTENNA SYSTEMS**

The Standard of Comparison, and the Choice of the Discriminating, Successful, Communication Engineer.

Telrex Antennas and Antenna Systems provide Optimum Performance and Reliability per element, per dollar, from 500 Kc to 1500 Mc.

Send for free Military, Commercial Tech Catalog CMS67, illustrating Antennas and Systems, Rotator-Selsyn-Indicator Systems, "Baluns," Towers, Masts and Accessories.

COMMUNICATION SYSTEMS SINCE 1921 **telrex** Laboratories  
ASBURY PARK, N.J. 07712, U.S.A.

Circle 297 on reader service card

# San-Esu

## poly varicon

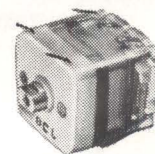

4X-20 BET

### CONTRIBUTING...

To cut the production costs!  
To make highly reliable quality!  
To rationalize the production line!



For catalog, write to:

**SAN-ESU ELECTRONICS CO., LTD.**  
1-2, 6-chome Nishiōi, Shinagawa-ku,  
Tokyo, Japan Tel. Tokyo (783) 7311  
Cable: SANESVARICON TOKYO

Circle 236 on reader service card  
**Electronics** | December 12, 1966



vary with square area, thickness, and metalizing specifications. A typical 0.250 x 0.275 substrate, 0.007-in. thick, metalized on both sides, is priced at 12 cents each for a minimum lot of 500.

Glass Beads Co., P.O. Box 266, Latrobe, Pa., 15650. [408]

### Narrow line garnet at low temperatures

An aluminum doped yttrium iron garnet material is offered with narrow line widths at low temperatures. Line widths at 6.2 Ghz are approximately 33 oersteds at 300°K, 280 oersteds at 77°K, and 340 oersteds at 4°K. Other features include: saturation magnetization, 560 gauss  $\pm 5\%$ ; X-band loss tangent, 0.002; Curie point, 150°C.

YAF-17 is useful in low temperature applications including circulators used with masers and parametric amplifiers.

The bars measure  $\frac{1}{2}$  x 1 x 6 in. and are priced at \$245 each. However, other sizes and shapes are available to customer specifications.

Airtron, a division of Litton Industries, 200 E. Hanover Ave., Morris Plains, N.J. [409]

### Sheet deposition for selective-etch use

Sheets of conductive materials are available for the selective etch of resistor-conductor patterns. Standard vacuum-deposited resistor materials are overcoated with aluminum, gold, copper or a manufacturer's typical conductive layer which is easily etched, highly solderable and can be used in eutectic chip bonding.

Stock sizes include 1 x 1 in., 2 x 2 in., 3 x 3 in. ceramic or glass substrates nominally 0.03 in. thick.

Basic film specifications are: sheet resistance, 50, 100, 200, and 400 ohms per square; tolerances,  $\pm 10\%$  and  $\pm 20\%$ ; noise level, matching and tracking comparable to high-quality discrete-metal film resistors. Conductor resistance is less than 0.1 ohm per square.

Alpha MicroElectronics Co., Inc., 10501 Rhode Island Ave., Beltsville, Md., 20705. [410]

**Where can you  
get a power supply  
designed to furnish the  
EXACT CURRENT  
& VOLTAGE  
you need for that  
beautiful system you  
are designing?**

**CAL POWER  
CORPORATION**

Formerly Perkin Electronics Corp. & Power Instruments Corp.

**delivered  
when you  
need it**

To provide your electronic power package, select a successful organization that puts technical integrity first — an organization with a solid history of performance.

Select Cal-Power. Our power supplies are riding in space, probing the oceans, performing in laboratories, assisting in automatic checkouts, keeping production lines humming. Precision power packages — from milliwatts to megawatts — standard lab supplies or custom-packaged to fit your specific requirements. Whether it's a 28-volt dc bench supply or an exotic multiple-output power package, we can design, develop and manufacture the power sources you need. Toss us your challenges.

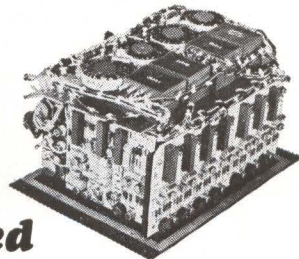
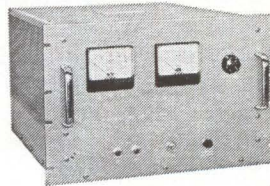

**try this  
experienced  
solid state  
organization**



**Cal-Power Corporation**

140 Kansas • El Segundo, California • Tel. (213) 772-2171 / 322-5320 • TWX 322-4604



# PENNTUBE V<sup>†</sup>

IRRADIATED POLYOLEFIN

## SHRINK-FIT TUBING

most versatile,  
easy-to-apply shrinkable  
tubing you can buy

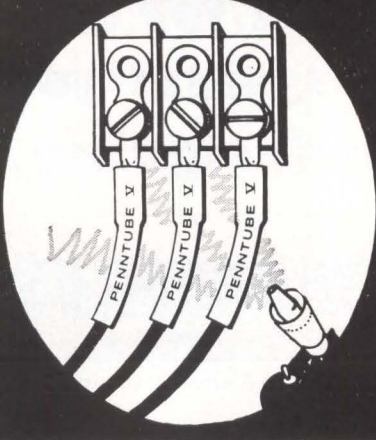

- 2:1 Shrink Ratio
- offers high dielectric and mechanical strength
- won't split, melt or cold flow — resists corrosion and chemicals
- wide service and temperature range —67°F to 275°F continuous duty

Shrinks to half its diameter enabling tight encapsulation and provides the added benefits of excellent electrical insulation, resistance to solvents, fungi, rocket fuels, oxidizers and other corrosive agents. Color on special order.

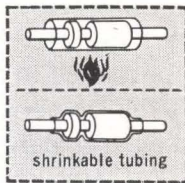

MEETS or EXCEEDS  
MIL-1-23053A, CLASSES 1 AND 2

**One source for:**

- Teflon<sup>®</sup> TFE Shrinkable (Penntube I-E)
- Teflon FEP Shrinkable (Penntube IISMT)
- Irradiated Polyolefin Shrinkable (Penntube V)



## PENNTube Plastics Co.

DIVISION OF  
PENNSYLVANIA FLUOROCARBON COMPANY, INC.  
Holley Street and Madison Avenue  
Clifton Heights, Pa. 19018  
(215) MADison 2-2300 • TWX: 215-623-1577

EXPORT DIVISION  
Empire State Building, New York, N. Y.

\*DuPont Reg. TM. †Penna. Fluorocarbon Reg. TM.

**WRITE FOR PRODUCT  
DATA SHEET AND SAMPLES**

## Technical Abstracts

### Semiconductor testing

Optical scanning techniques for semiconductor device screening and identification of surface and junction phenomena  
C.N. Potter  
Sperry Rand Research Center  
Sudbury, Mass.,  
and D.E. Sawyer  
National Aeronautics and  
Space Administration  
Electronics Research Center  
Cambridge, Mass.

A flying-spot light beam tracing a raster pattern on the surface of a semiconductor device can provide a minutely detailed record of its electrical behavior, directly related to its physical structure. As a non-destructive testing system, it can be used between successive steps in manufacturing integrated circuits, to isolate the causes of failures or substandard performance.

The light source is a helium-neon laser. Sinusoidal scanning of the beam is accomplished by two mirrors mounted on magnetically-driven vibrating reeds. The light pattern is optically demagnified and projected on the surface of the device under test. The electrical output stimulated by the light beam is amplified and used to modulate the intensity of a cathode-ray tube electron beam. Reflection of the electron beam is synchronized with the light raster to correlate the electrical output trace with the light-spot position. This produces a response map that can be directly compared with a photomicrograph of the device for interpretation. Device phenomena that have been identified and studied by means of this technique include localized surface and junction breakdown, channeling and uniformity of avalanche photodiodes.

A different presentation can be obtained by feeding part of the device output to the vertical input of the crt, resulting in a topological map of the photoresponse of the sample. Or if the vertical deflection mirror is stopped, the light spot continuously retraces the same path. This allows observation of a single cross section of the device.

Additional information can be obtained by using microwave mod-

ulation of the laser beam. A mixer, local oscillator, i-f amplifier and a second detector are inserted in the circuit between the sample output and the oscilloscope amplifiers, and tuned to a laser mode beat. The amplitude of the detached signal is proportional to the microwave response of the device to the modulated scanning spot.

Presented at the Fifth Annual Symposium on Physics of Failure in Electronics, Columbus, Ohio, Nov. 15-17.

### Storing on MOS FET's

A micron bit-size charge storage device  
N.C. MacDonald and T.E. Everhart  
Department of Electrical Engineering  
University of California, Berkeley

A new potential for MOS FET's lies in providing storage for as many as  $10^{10}$  bits of information per square centimeter. A scanning electron microscope with a small beam (2 to 5 microns in diameter) stores and reads the information. Storage is possible in a metal-oxide-semiconductor structure because the amount of fixed charge introduced in the insulator controls the surface conductance of the semiconductor. The change in the surface conductance is monitored by incorporating two electrodes in the familiar field effect transistor structure.

If an 0 is stored, a subsequent scan of the adjacent area results in a negligible increase in the surface conductance. If a 1 is stored, however, the subsequent read cycle will produce a large increase in conductance.

With present silicon technology, electron bombardment of the gate electrode, an area typically 5 by 5 microns, permits storing  $10^7$  bits per square centimeter on a single, three-terminal MOS FET. With advances in thin films, particularly in stabilizing insulating layers,  $10^{10}$  bits per square centimeter could possibly be stored.

For computers, the device provides a large storage capacity, random access and an erasable memory with nondestructive readout. Information will remain stored for months even without power.

Presented at the International Electron Devices Meeting, Washington, Oct. 26-28



# HERE'S HOW...

THE ELECTRONIC INDUSTRY IS USING THESE TWO FAMOUS ULANO FILMS IN ULTRAMINIATURE MASK TECHNOLOGY AND COMPLEX PRINTED CIRCUITRY

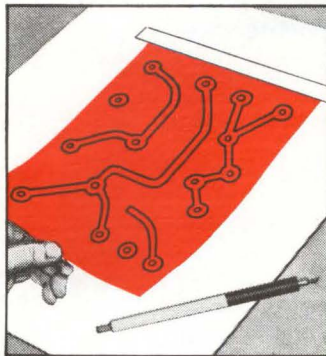

Cut a piece of the desired film large enough to cover area to be masked. Tape it down firmly at the top with dull-side up.



With sharp blade, outline the areas to be masked. Do not cut through the backing sheet. The Ulano Swivel Knife does the job quickly, easily.

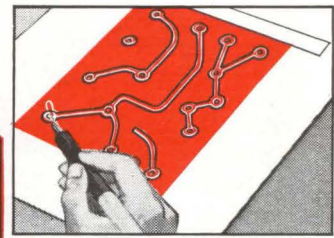

Using the tip of the blade, lift up a corner of the film thus separating it from the backing sheet.

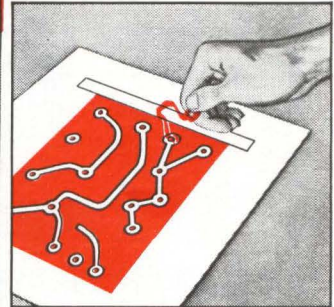

Now carefully peel off the film as outlined leaving a completed mask, positive or negative, that corresponds exactly to the desired pattern.

# Ulano<sup>TM</sup>

## RUBYLITH<sup>TM</sup> • AMBERLITH<sup>TM</sup>

HAND CUT MASKING FILMS FOR THE GRAPHIC ARTS

**ULANO RUBYLITH**... a revolutionary knife cut red film is laminated to a stable transparent plastic backing sheet. The red film is "light safe" so that when contacted to a sensitized emulsion and exposed to a suitable light source, light passes through the cut-out portions only... not through the red film. ■ The polyester backing is absolutely stable... insures perfect register. ■ Special effects such

as crayon tones, paste ups, benday sheets, and opaques are easily combined with versatile ULANO RUBYLITH.

**ULANO AMBERLITH**... a companion to Rubyolith serves as a color separation medium used as the master on camera copy board to secure negatives or positives.

A wide variety of Ulano films—in rolls and sheets—is readily available

# ulano

NEW YORK • CHICAGO • ZURICH

610 DEAN ST., BROOKLYN, N. Y. 11238

In Europe: ULANO A. G., Untere, Heselbachstrasse No. 22  
Kusnacht, Zurich, Switzerland

"Ulano," "Rubyolith," "Amberlith" are registered trade marks of the Ulano Companies.



**WRITE TODAY**

on your letterhead for free special sample kit 1848

## print electronic components ... efficiently

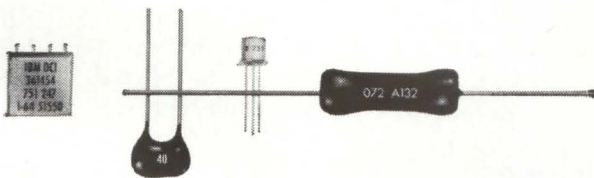

Clear, easy to read identification on small parts can be applied efficiently at speeds equal to your production with a Matthews Off-set "In-Line" Rotary Printer.

Standard printers work equally well on round, flat, or contoured surfaces, with the parts handling section designed for each part. Special inks available for various surface conditions. Inquire today for photos with sample.



**JAS. H. MATTHEWS & CO.**  
Industrial Marking Products Division  
6516 PENN AVENUE • PITTSBURGH, PA. 15206  
MARKING METHODS SINCE 1850

## What's NEW in laminated plastics? Synthane FR-16!

### It's a lower-cost flame-retardant, glass epoxy laminate Designed specifically for printed circuits used in computers

Write for FR-16 Engineering Bulletin to Synthane Corporation 36 River Road, Oaks, Pa. 19456.



Laminated Plastic Sheets, Rods, Tubes and Fabricated Parts



# AMPERITE

## Thermostatic DELAY RELAYS

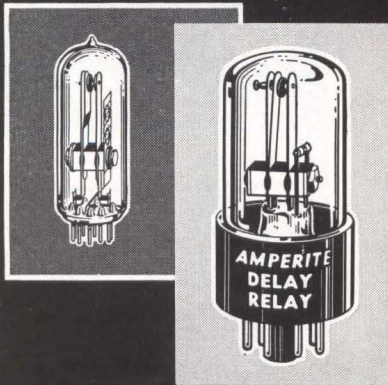

**Only a glass seal**  
offers true hermetic sealing  
... assuring maximum stability and life!

**Delays: 2 to 180 seconds** . . . Actuated by a heater, they operate on A.C., D.C., or Pulsating Current . . . Being hermetically sealed, they are not affected by altitude, moisture, or climate changes . . . SPST only—normally open or normally closed . . . Compensated for ambient temperature changes from  $-55^{\circ}$  to  $+80^{\circ}$  C. . . Heaters consume approximately 2 W. and may be operated continuously . . . The units are rugged, explosion-proof, long-lived, and—inexpensive!

**TYPES:** Standard Radio Octal, and 9-Pin Miniature.  
List Price, \$4.00

**PROBLEM? Send for Bulletin No. TR-81**

# AMPERITE

## BALLAST REGULATORS

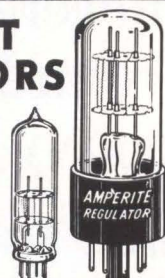
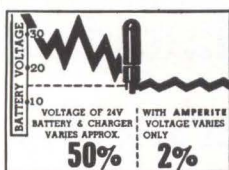

Hermetically sealed, they are not affected by changes in altitude, ambient temperature ( $-50^{\circ}$  to  $+70^{\circ}$  C.), or humidity . . . Rugged, light, compact, most inexpensive . . . List Price, \$3.00.

Write for 4-page Technical Bulletin No. AB-51

# AMPERITE

600 PALISADE AVE., UNION CITY, N.J.

Telephone: 201 UNion 4-9503

In Canada: Atlas Radio Corp., Ltd.,  
50 Wingold Ave., Toronto 10

## New Books

### To whet the appetite

System Analysis by Digital Computer  
Edited by F.F. Kuo and J.F. Kaiser  
John Wiley & Sons, Inc., 438 pp., \$8.95

Much of today's computer programming is aimed at teaching computers how to design components, devices and systems. This activity has not yet fathered completely robot-run industries, or even totally automated design procedures; but it has led to a searching and continuing analysis of the design process and to computer-aided design algorithms.

Although the computer cannot yet do the whole job, programs for analysis and optimization are widely available and used. Most design work, of course, is done in industry. As a result, computer-aided design algorithms often do not lead to documented publication.

To disseminate some of this eagerly sought information, Princeton University and the Cosine (Computer Science in Electrical Engineering) Committee of the Commission on Engineering Education cosponsored a conference at Princeton in August, 1966. This book is a somewhat edited version of the papers presented at that conference and is, unfortunately, more apt to whet appetites than to satisfy desires.

All the authors but two are with the Bell Telephone Laboratories. The exceptions are F.F. Kuo, who this fall left Bell Labs to go to the University of Hawaii, and C. Pottle of Cornell University.

The lead paper is Kuo's introductory survey, "Network Analysis by Digital Computer." Reprinted from the June 1966 Proceedings of the IEEE, the paper provides a comparison among several available programs such as Deuce, ECAP, and NET-1. The author then reviews state-space and frequency domain analysis programs, and fortifies his paper with a list of 63 references. Omitted in this discussion are important electronic circuit design programs based on flow-graph methods of analysis, which show unique capabilities in model simplification.

In the second paper, H.C. So dis-

cusses the iterative design of an n-port, using hybrid analysis, and specifically the Bell Labs program, Hybrid.

Pottle's paper presents a general state-space active network analysis technique. The author develops necessary concepts and defines terms carefully so that the reader unfamiliar with state-space techniques should be able to follow the discussion. A related computer algorithm is described in the appendix.

The book's analysis portion ends with a paper by M.L. Liou on numerical analysis of linear time invariant equations in the time domain (state-space equations) and frequency domain (Fourier and inverse Fourier transforms).

Two papers on design follow. The first, a specific example of a design program, is an article by G. Szentirmai on a general purpose filter synthesis program. Only limited familiarity with insertion loss filter design is expected of the reader. The second is a tutorial review paper by P.E. Fleischer on optimization techniques.

Analysis, synthesis, or design of a system with a computer requires that the system's salient characteristics be represented within the computer. This is the essence of simulation, without which there cannot be much computer-aided design. Ergo, the next three papers are concerned with various aspects of simulation. In the first, J.F. Kaiser defines, explains and classifies digital filters. He develops the sampling process before going into various design methods and realization schemes. The article is heavily referenced (82 listings, most of them recent) and should be useful for engineers interested in this field.

Next, B.J. Karafin reports on Blodi, a sampled data system simulation language for use in conjunction with a block diagram compiler developed by Bell Labs. The last paper in this section is a very brief discussion of hybrid computers and techniques, followed by sample applications. The author is J. Chernak.

The final three papers are concerned with non-numeric computer



# Helipot® Industrial Servo System

## \$169.95

... all you need is a cord

With standard Helipot servo components, you can build a complete, reliable servo system that will satisfy most industrial control applications. Components include: 1) *motor-pots*, compact models which combine a precision potentiometer with a small d-c gearhead motor; 2) *power supply*, which operates from 115v, 60 Hz input and provides d-c output for amplifier; 3) *amplifier*, solid-state d-c unit with gain of 300 volts per volt; 4) *command pot*, any standard Helipot precision pot (there are hundreds) to supply system input; and 5) *turns-counting dial* from Helipot's wide selection. Typical price for the whole works: just \$169.95. Contact your Helipot sales rep for information.

**Beckman®** INSTRUMENTS, INC.

**HELIPOT DIVISION**  
FULLERTON, CALIFORNIA • 92634

INTERNATIONAL SUBSIDIARIES: GENEVA; MUNICH; GLENROTHES, SCOTLAND; TOKYO; PARIS; CAPE TOWN; LONDON; MEXICO CITY



Circle 293 on reader service card

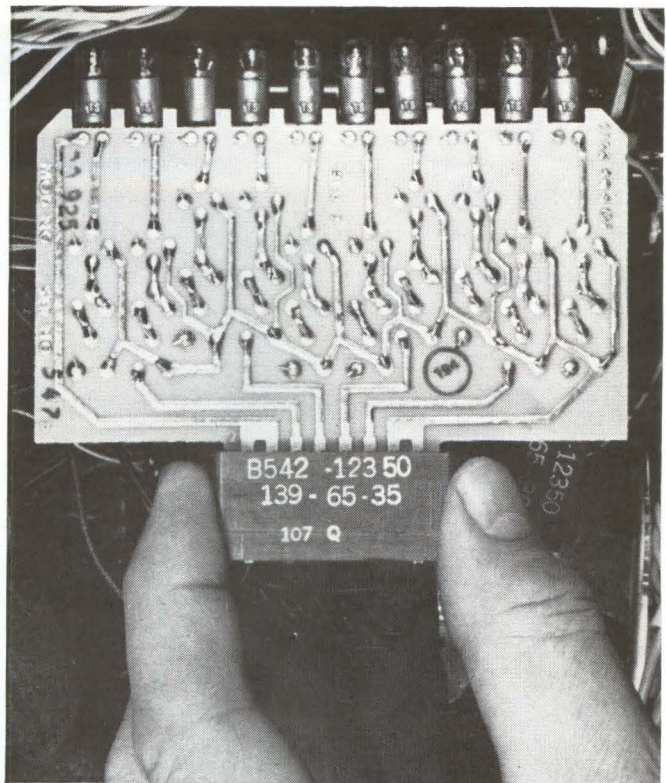

Lamps in this Electronic Associates, Inc., computer circuit board are the Tung-Sol Tu-Pin molded base types.

## Computer-Inspired, Molded Base Subminiature Lamps are Self-Mounting

Requirements of the computer industry for a compact subminiature lamp assembly, led to the development of the Tung-Sol integrally molded base lamp.

A molded nylon encapsulation replaces the conventional cemented-on metal base. This permits direct mounting of the lamp without need for the usual mated socket. Greater reliability is achieved, with obvious simplification of installation procedures.

The molded-base lamp lends itself to automated assembly and molding permits extreme flexibility of base configuration. Bases may be color-coded for accurate identification.

Tung-Sol integrally molded base subminiature lamps are available in Tu-Pin form or with special harnessing to your specifications.

Describe your requirements for more specific information.

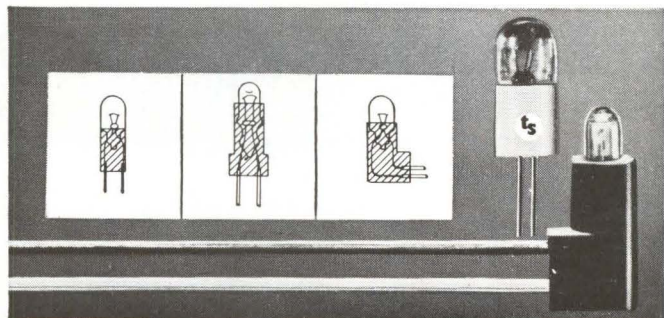

Molding permits extreme flexibility of base configuration.

## TUNG-SOL® MOLDED BASE SUBMINIATURE LAMPS

WAGNER ELECTRIC CORPORATION, TUNG-SOL DIVISION  
One Summer Avenue, Newark, N. J. 07104

Circle 241 on reader service card 241

# NCC to be Sure

### POLYESTER FILM CAPACITORS

#### Type MXT



In Plastic Tube.  
Capacitance  
Range : .001 MFD to .22 MFD.  
Voltages : 100v, 200v, 400v, 600v DC.

#### Type MFL

dipped Flat Shape.  
Capacitance  
Range : .001 MFD to .47 MFD.  
Voltages : 35v, 50v, 100v, 200v DC.

#### Type MFK

dipped Flat Shape.  
Non-Inductive Construction.  
Capacitance  
Range : .01 MFD to .22 MFD.  
Voltages : 100v, 200v, 400v, 600v DC.

### METALLIZED POLYESTER FILM CAPACITORS

#### Type FNX-H

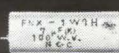

Mylar Wrapped Semicol  
With Epoxy End Seal.  
Capacitance  
Range : 1 MFD to 10 MFD.  
Voltages : 50v DC.

### SOLID TANTALUM CAPACITORS

#### Type TSL

Sealed with Epoxy Resin.



Capacitance  
Range: 1 MFD to 220 MFD.  
Voltages: 3v, 6v, 10v, 15v, 20v, 25v, 35v DC.

#### Type TAX

MIL-C-28655A Hermetically Sealed.

## MATSUO ELECTRIC CO., LTD.

HEAD OFFICE: 3-chome, Sennari-cho, Toyonaka-shi, Osaka, Japan.  
Cable Address "NCC MATSUO" OSAKA

Circle 294 on reader service card



# for KV pulses...

time to switch  
to solid-state  
h-v switching

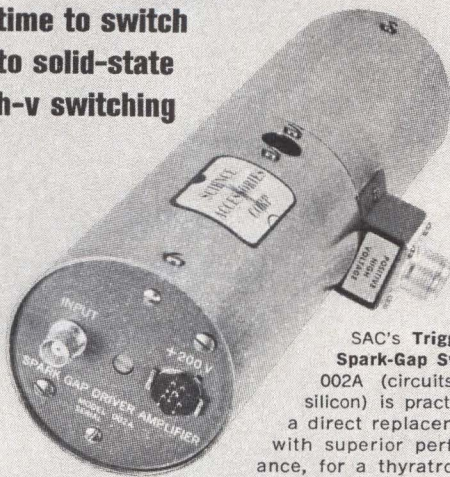

SAC's Triggered Spark-Gap Switch 002A (circuits all-silicon) is practically a direct replacement, with superior performance, for a thyratron in switching 2 to 14 KV. It excels in: **Short Delay, Jitter, Risetime, Current Handling, Output Adjustability, Recovery Time, and Dependability.**

Model 022 integrates 002A with power supplies, operates off 110V/60Hz (also 220V/50Hz). Bulletins 002A and 022.



tame your kilovolts  
for oscilloscopy  
with high-voltage  
probe model 003



1000:1 attenuation of pulses up to 80 KV with 1-ns risetime. 50K-ohm input; 50-ohm GR-connector output. **Bulletin 003.**

**SAC SCIENCE ACCESSORIES CORPORATION**  
69 STATION PLAZA / SOUTHPORT / CONNECTICUT / 06490 / USA / PHONE 203-259-8329

Circle 295 on reader service card

## WHO'S STRONG ON MAGNETS?



## CALL PERMAG

We stock all sizes, all shapes, all grades, for all uses . . . all ready for 24-HOUR DELIVERY. Including soft magnetic materials—now available for the first time in small, less-than-mill-run quantities. Also, magnets engineered and fabricated to your needs. Write for catalog and data sheets.

**PERMAG PACIFIC CORP.** 5441 W. 104th St. Los Angeles, Calif. 90045 / Phones: Area Code 213 776-5656, 213 670-7060 / TWX: 213 670-0408

**PERMAG CENTRAL CORP.** 5301 D. Otto Ave. Rosemont, Des Plaines, Illinois 60018 / Phone: Area Code 312 678-1120

**PERMAG CORP.** 88-06 Van Wyck Expressway Jamaica, New York 11418 / Phone: Area Code 212 OLYMPIA 7-1818 / TWX: 212 479-3654

Circle 242 on reader service card

## DIELECTRIC MATERIALS SUPPLEMENT

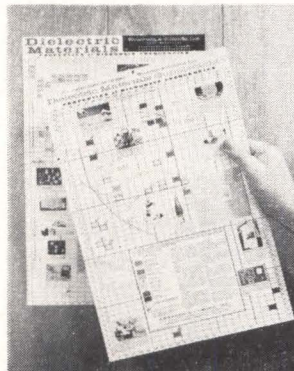

This brand new chart in full color for wall mounting or notebook contains data on all important materials developed since the original DIELECTRIC MATERIALS chart. The original is shown in the background.

This valuable chart is yours. Write or use the Reader Service Card.

**EMERSON & CUMING, Inc.**  
CANTON, MASS.



604 W. 182nd St.  
Gardena, Calif.

3450 Commercial Ave.  
Northbrook, Ill.

**Emerson & Cuming Europe N.V.**  
Oevel, Belgium

Circle 296 on reader service card

## New Books

topics. W.S. Brown discusses Altran, a language for handling symbolic algebra on the digital computer. This is followed by a short paper on computer produced movies by K.C. Knowlton and one on graphic input-output devices by W.H. Ninke.

Because the book is only a collection of papers grouped around a common theme, it will sorely disappoint those who are looking for a systematic, logical and evenly paced development of the subject. In fact, there is little cohesion—in spite of the editors' efforts—and the only noticeable perspective is supplied in the surveys by Kuo and Fleischer.

The book, then, is not an introductory text, an advanced text, or a handbook. It is a compact set of conference proceedings, relatively inexpensive and readily available for all those who think they would have liked to attend the conference but couldn't.

G.F. Paskusz

University of Houston  
Houston, Texas

## Recently published

**Handbook of Basic Transistor Circuits and Measurements, R.D. Thornton et al, John Wiley & Sons, Inc., 156 pp., \$4.50 clothbound, \$2.65 paperbound**

A presentation of specific circuits illustrating both the theoretical and practical aspects of transistors. This is the seventh in a series of laboratory-oriented volume, published by the Semiconductor Electronics Education Committee which was formed in 1960 to prepare educational material on semiconductors.

**Dielectrics and Waves, Arthur R. von Hippel, The M.I.T. Press, 284 pp., \$5.95**

An excellent reference for microwave engineers concerned with the properties of ferromagnetic materials and dielectrics. Also includes discussion of crystalline structures now used in laser research. First published in 1954.

**Communication Systems and Techniques, Mischa Schwartz, William R. Bennett and Seymour Stein, McGraw-Hill Book Co., 618 pp., \$16.50**

Each author wrote one section of this graduate text and reference book. The sections cover fundamental aspects of communications in the presence of noise, continuous-wave and pulse-modulation in modern communications systems and digital communications theory and principles.

**Introduction to Nonlinear Automatic Control Systems, Rajko Tomovic, John Wiley & Sons 172 pp., \$7.50**

An undergraduate text by a professor of electrical engineering at the University of Belgrade, Yugoslavia. Simulation models are stressed.



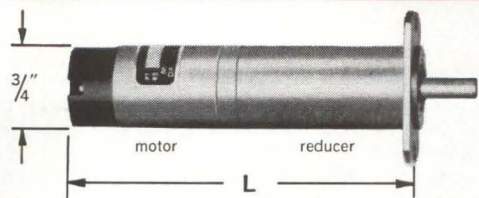

### 3/4" GEARHEAD MOTOR

Now you can get up to 300 oz. in. torque from a precision miniature gearmotor only 3/4" in diameter. Globe's Type SD permanent magnet d.c. motor with integral planetary gearhead provides 19 standard ratios, wound for 4 to 50 volts. Armatures can be wound to produce any speed-torque combination within the capacity of the motor. Can meet environmental and other applicable portions of MIL-M-8609. Request Bulletin SDG.

Speed Reduc. Ratio	Max. Cont. Torque Oz. In.	L	Speed Reduc. Ratio	Max. Cont. Torque Oz. In.	L
14.58	3.0	2 <sup>3</sup> / <sub>4</sub>	733	100	2 <sup>6</sup> / <sub>16</sub>
22.08	4.5		1108	150	
33.28	7.0		1853	200	
55.66	10	2 <sup>5</sup> / <sub>32</sub>	2799	300	3 <sup>1</sup> / <sub>8</sub>
84.11	14		4230	300	
127.1	21		6391	300	
192	30	2 <sup>6</sup> / <sub>16</sub>	10689	300	3 <sup>1</sup> / <sub>4</sub>
321	45		16150	300	
485	70		24403	300	
			36873	300	

**GLOBE**

Globe Industries, Inc., 2275 Stanley Ave.  
Dayton, Ohio 45404, Tel.: Area 513 222-3741



Circle 290 on reader service card

## Lighted Pushbutton Switches

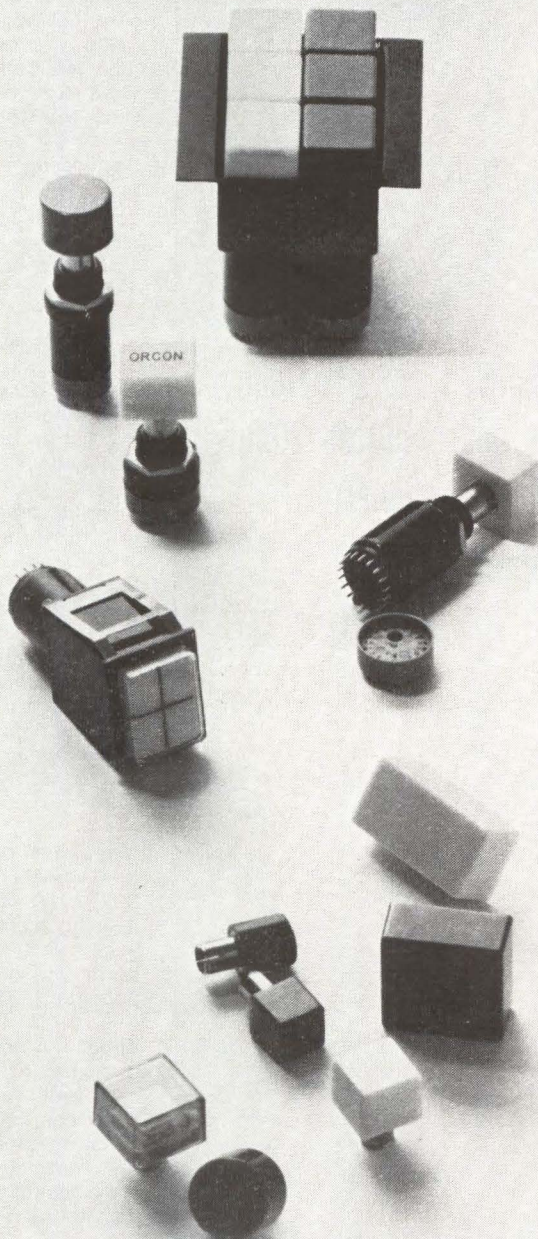

### USECO offers greatest capacities, smallest sizes.

USECO'S ORCON switches combine exclusive multi-circuit capacity, isolated contacts, sliding-wiping action, independent light circuit and connector convenience in 3/4" and 11/16" diameter sizes. Standard and custom available. Plus indicator lights, ganged assemblies, multi-light units, adapters and accessories. For brochure, contact USECO, 13536 Saticoy Street, Van Nuys, Calif. 91409. (213) 873-3520.



Division of Litton Industries

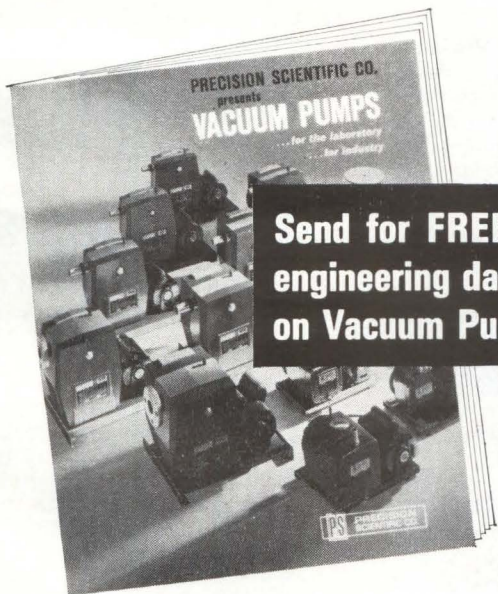

Send for **FREE** engineering data on Vacuum Pumps

### Precision High Vacuum Pumps are job-rated

From this newest, most complete line of internal vane mechanical vacuum pumps you can select a model with guaranteed performance matched to your requirements. For lab use, for roughing or backing a system, or for integral use in your product—take your choice of both single and two stage models in capacities from 25 to 1500 liters/minute (free air) at prices from \$100 to \$1500. Guaranteed ultimate vacuum runs to 0.1 micron of mercury. And these pumps are quieter, smaller and more efficient than any on the market today. Consult your Precision Scientific distributor, or send for 24-page Bulletin 650.

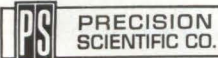

3737 W. Cortland St., Chicago, Ill. 60647  
Local Offices: New York • Chicago • Los Angeles

Circle 291 on reader service card

Circle 243 on reader service card



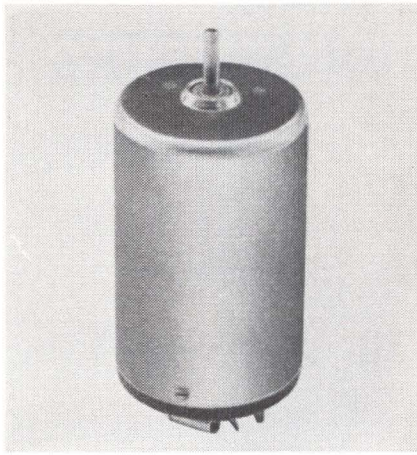

**Who needs 55% efficiency in a micro motor 20mm or less in diameter?**

**No one.**

But it is a testimony to Mitsumi's ability to meet unusual speciality micro-electronics requirements. Micro motor efficiency over 50% has been considered impossible for a motor as small as 20mm in diameter. Adoption of a new system in the magnetic circuit has upset this common concept.

Both electrical and mechanical noises have practically been eliminated by a built-in noise suppressor, and a specially constructed brush which has improved the rectifying capacity.

Ask for Mitsumi when you need a reliable, quality micro motor for portable tape-recorders, record-players, measuring instruments and 8mm 2-speed movie cameras. Over 30 types of AC or DC micro motors are immediately available.

Mitsumi is the world's leading maker of polyethylene variable capacitors, I-F transformers, synchronous motors, front-end FM tuners, UHF & VHF TV tuners, CdS photoconductive cells, trimming potentiometers, coils, sockets, trimmer capacitors, terminals, and fuse holders.



**MITSUMI**

**MITSUMI ELECTRIC COMPANY, LIMITED**  
1056 Koadachi, Komae-machi, Tokyo. 415-6211  
302, Cheong Hing Bldg., 72 Nathan Road,  
Kowloon, Hong Kong. 666-925  
Marienstrasse 12, Düsseldorf, W. Germany.  
**MITSUMI ELECTRONICS CORPORATION**  
11 Broadway, New York 4, N.Y. 10004. HA5-3085  
333 N. Michigan Avenue, Chicago, Ill. 60601  
263-6007

## New Literature

**Memory products capability.** Indiana General Corp., Electronics division, Keasby, N.J. A brief history of memory core development, plus highlights of memory product manufacturing facilities and capabilities are available in an eight-page booklet.

Circle 420 on reader service card.

**Oscilloscopes.** Data Instruments division, IEH, 7300 Crescent Blvd., Pennsauken, N.J., 08110. A six-page brochure describes two broad classes of oscilloscopes: plug-in amplifier types and built-in amplifier types. [421]

**Silicon transistors.** RCA Electronic Components and Devices, Harrison, N.J., 07029. "Specs in Brief" booklet (form number 2L1066) covers silicon transistors for a-f, r-f and switching applications. [422]

**Interval timer.** Automatic Timing & Controls, Inc., King of Prussia, Pa., 19406. Bulletin 309 describes a push-button-start interval timer with 0.2% repeat accuracy. [423]

**Flexible couplings.** Theta Instrument Corp., Saddle Brook, N.J., 07662, has released an engineering bulletin discussing flexible couplings designed to drive synchros, pots, and shaft encoders with unusual angular accuracy. [424]

**Microwave catalog.** Transco Products, Inc., 4241 Glenco Ave., Venice, Calif., 90291. A 57-page catalog contains specifications and dimensions of coaxial switches, waveguide switches, airborne antennas, and microwave components. [425]

**Zirconium copper.** American Metal Climax, Inc., 1270 Avenue of the Americas, New York, N.Y., 10020, offers a technical data booklet on Amzirc zirconium copper, a heat-treatable copper alloy developed for applications requiring conductivity and good strength at high temperature. [426]

**P-c board production.** Epec Industries, Inc., Industrial Park, New Bedford, Mass., 02745, a four-page brochure describes Protomaka, the laboratory equipment for making p-c boards, and its companion piece, Proto-plata, for precious metals electroplating. [427]

**Test equipment.** Wiltron Co., 930 East Meadow Drive, Palo Alto, Calif., A 12-page catalog provides specifications, technical information and photographs of the latest in test and measurement equipment available from the company. A section is devoted entirely to new communications test equipment. [428]

**Transfer function analyzer.** Canoga Electronics Corp., 8966 Comanche Ave., Chatsworth, Calif., 91311. Model 950 Servodyne, an automatic transfer func-

tion analyzer, is described in a two-page data sheet. [429]

**Nonlinear potentiometers.** Duncan Electronics, Inc., 2865 Fairview Road, Costa Mesa, Calif., 92626. A four-page brochure details functions, output equations and circuit diagrams for a line of precision, wire-wound nonlinear potentiometers. [430]

**Printing impulse counter.** Landis & Gyr, Inc., 45 W. 45th St., New York, N.Y., 10036. Bulletin 361 contains specifications, operating characteristics, electrical and mechanical data, dimensions and wiring diagrams of typical circuits for a high capacity, 20-column printing impulse counter. [431]

**Broad-band couplers.** Alford Manufacturing Co., 120 Cross St., Winchester, Mass., 01890, has issued bulletin 608 on the Quadrids, which are broad-band, hybrid-like, 3-db couplers for use in applications requiring two signals of equal amplitude but one shifted 90° in phase with respect to the other. [432]

**Microwave diodes.** Alpha Industries, Inc., 381 Elliot St., Newton Upper Falls, Mass., 02164. Catalog D-1 provides tabulated electrical and mechanical data on more than 100 models of microwave diodes. [433]

**Silicon controlled rectifiers.** International Rectifier Corp., 233 Kansas St., El Segundo, Calif., 90245, lists a complete line of silicon controlled rectifiers in a new catalog, designated A-66, for easy evaluation and simplified ordering. [434]

**Platinum transducers.** The Lewis Engineering Co., Naugatuck, Conn., 06771. Low-cost resistance temperature detectors with platinum elements for industrial use are covered in bulletin I-402. [435]

**Tape recorder/reproducer.** Leach Corp., 1123 Wilshire Blvd., Los Angeles, Calif., 90017. An eight-page brochure details data on a 54-lb portable tape recorder/reproducer which provides instrumentation-quality recording, storage and reproduction of direct, f-m and digital data. [436]

**Printed-circuit manufacture.** Komak, Inc., Southwest Corner 9th & Ontario Sts., Philadelphia, Pa., 19140, has released a 16-page booklet showing the quality control exercised, from design to finished product, in the manufacture of its printed circuits. [437].

**Tool for electronics.** Henry Mann Co., Box 104, Cornwells Heights, Pa., 19020. A 48-page catalog features a complete selection of specialized micro-miniature tools for electronics. Copies may be obtained by writing on company letterhead.



# ELECTRONICS

Qualification Form  
for Positions Available

## ATTENTION: ENGINEERS, SCIENTISTS, PHYSICISTS

This Qualification Form is designed to help you advance in the electronics industry. It is unique and compact. Designed with the assistance of professional personnel management, it isolates specific experience in electronics and deals only in essential background information. The advertisers listed here are seeking professional experience. Fill in the Qualification Form below. **STRICTLY CONFIDENTIAL:** Your Qualification Form will be handled as "Strictly Confidential" by Electronics. Our processing system is such that your form will be forwarded within 24 hours to the proper executives in the companies you select. You will be contacted at your home by the interested companies.

**WHAT TO DO.** (1.) Review the positions in the advertisements. (2.) Select those for which you qualify. (3.) Notice the key numbers. (4.) Circle the corresponding key number below the Qualification Form. (5.) Fill out the form completely. Please print clearly. (6.) Mail to: Classified Advtg. Div., Electronics, Box 12, N. Y. 10036.

COMPANY	PAGE	KEY #
ATOMIC PERSONNEL, INC.	249	1
COLLEGE PLACEMENT COUNCIL	177*	2
GENERAL DYNAMICS Electronics Div.	246	3
GENERAL DYNAMICS Fort Worth	213	4
GENERAL ELECTRIC	245	5
HAMILTON STANDARD Div. of United Aircraft Corp.	176	6
IBM CORP.	247	7
JARRELL-ASH CO.	190*	8
LEAR SIEGLER, INC.	191*	9
LOCKHEED-CALIFORNIA CO.	236	10
LOCKHEED MISSILES & SPACE CO.	172	11
MOSLER RESEARCH PRODUCT, INC.	190*	12
NATIONAL CASH REGISTER CO.	210	13
PHILCO TECH. REP.	227	14
SANDERS ASSOCIATES, INC.	248	15
SERVO CORP. OF AMERICA	190*	16
SYLVANIA ELECTRONIC SYSTEMS	188	17
U. S. NAVY, NAVAL RESEARCH LAB.	189*	18
U. S. NAVAL SHIP SYSTEMS COMMAND	191*	19

\*These advertisements appeared in the November 28th issue.

### PERSONAL BACKGROUND

Name .....  
Home Address .....  
City ..... Zone ..... State .....  
Home Telephone .....

### EDUCATION

Professional Degree(s) .....  
Major(s) .....  
University .....  
Date(s) .....

### FIELDS OF EXPERIENCE (Please Check) 12/12/66

<input type="checkbox"/> Aerospace	<input type="checkbox"/> Medicine
<input type="checkbox"/> Antennas	<input type="checkbox"/> Microwave
<input type="checkbox"/> ASW	<input type="checkbox"/> Navigation
<input type="checkbox"/> Circuits	<input type="checkbox"/> Operations Research
<input type="checkbox"/> Communications	<input type="checkbox"/> Optics
<input type="checkbox"/> Components	<input type="checkbox"/> Packaging
<input type="checkbox"/> Computers	<input type="checkbox"/> Radar
<input type="checkbox"/> ECM	<input type="checkbox"/> Radio-TV
<input type="checkbox"/> Electron Tubes	<input type="checkbox"/> Simulators
<input type="checkbox"/> Engineering Writing	<input type="checkbox"/> Solid State
<input type="checkbox"/> Fire Control	<input type="checkbox"/> Telemetry
<input type="checkbox"/> Human Factors	<input type="checkbox"/> Transformers
<input type="checkbox"/> Infrared	<input type="checkbox"/> Other .....
<input type="checkbox"/> Instrumentation	

### CATEGORY OF SPECIALIZATION

Please indicate number of months experience on proper lines.

	Technical Experience (Months)	Supervisory Experience (Months)
RESEARCH (pure, fundamental, basic)	.....	.....
RESEARCH (Applied)	.....	.....
SYSTEMS (New Concepts)	.....	.....
DEVELOPMENT (Model)	.....	.....
DESIGN (Product)	.....	.....
MANUFACTURING (Product)	.....	.....
FIELD (Service)	.....	.....
SALES (Proposals & Products)	.....	.....

CIRCLE KEY NUMBERS OF ABOVE COMPANIES' POSITIONS THAT INTEREST YOU

1	2	3
4	5	6
7	8	9
10	11	12
13	14	15
16	17	18
19		

## TV/CRT: Engineering and Manufacturing

Want to be part  
of our next innovation?  
We're going places.  
We can get you growing,  
too.

Innovation means growth in this business. And our engineers—in circuit, set, CRT design and manufacturing engineering—work in a climate that's aimed at producing the new and different approach *right now*. Successful designs like the 12" personal portable; the 9" battery set, and our sensational low-cost Porta-color set are putting a steep pitch in our growth curve. Further growth examples: expansion in our Electronics Park Headquarters Operation plus a brand new facility now expanding in Portsmouth, Va. We have other plans, too. You can figure in them—to your long-range personal profit. You can expect a full package of G.E. benefits, including our Savings and Security Plan; efficient work surroundings; a place in a diversified company with a history of 37 years in television research, design and production; and excellent local living conditions in Upstate New York or Eastern Virginia. Interested in our kind of growth? Investigate this partial list of openings now:

**CRT DESIGN, MFG., PROCESS AND QUALITY CONTROL ENGINEERING:** design, develop and manufacture cathode ray tube products for both monochrome and color, including element, materials application, mfg. techniques, and QC. BS degree plus 2-10 years' related experience desired.

**TV MANUFACTURING, PROCESS AND QUALITY CONTROL ENGINEERING:** establish, plan and attain quality control programs. Apply producibility, manufacturability and quality control principles to engineering designs. Requires BS degree plus 2-10 years' related manufacturing, QC or reliability experience.

**CIRCUIT DESIGN ENGINEERING (BOTH SIGNAL AND DEFLECTION):** to conceive, develop and apply TV signal processing circuits, deflection yokes and related components. BS degree plus 2 or more years' related experience.

**MECHANICAL PRODUCT DESIGN:** requires BS degree plus 2-10 years' experience or equivalent in consumer electro-mechanical product design and packaging.

**COMPONENT DESIGN AND/OR APPLICATION:** conceive, design and apply electronic components for monochrome and color TV receivers. Needs 2-4 years' component design or application experience.

For more information, or to arrange a personal interview, send a resume of your experience in confidence to M. H. FitzGibbons, Manager, Professional Relations, Television Receiver Dept., Section M, General Electric Co., Electronics Park, Syracuse, N.Y. 13201.

GENERAL  ELECTRIC

An Equal Opportunity Employer





# **AGE engineering is the art of anticipation**

## **Keeping ahead of this one requires a special sophistication**

The F-111 places heavy demands on the foresight of an AGE engineer. This—the most advanced combat aircraft in the U.S. arsenal—has already been extended to several versions. Ground- and carrier-based fighters. Attack bomber. Reconnaissance craft. Our AGE engineers, who pioneered and developed AGE for the original F-111, are now committed to a still more challenging task: developing equipment to test all aircraft configurations—present and future—so that as new avionics systems and aircraft missions are defined, the additional test needs can be met without major redesign. Necessarily, the equipment will require an expanded depth of testing capability, combined with a high degree of compactness and rugged construction for deployment and usage in all areas of the world.

The magnitude of the systems and design problems to be encountered really comes into focus when you consider the complexity of Aerospace Ground Equipment: it's a highly-automated test and fault-location system which includes a video station, radar/receiver/transmitter modulator station, indicator/controls station, central air data computer station, radar servo and indicator station, computer station, penetration aids station, attitude and rate station, UHF communications station, HF communications station, TACAN station, HF communications flight-line tester, IR station, UHF guidance station and digital station—each sophisticated enough to test state-of-the-art equipment.

And this is only one of the programs our AGE laboratory is "writing the book" on. Other programs include internal and external checkout systems for missiles such as Atlas, Nike-Zeus and Polaris . . . flight-line and depot systems for terrain-following radar . . . SSB equipment . . . automated vehicular trouble-shooting systems, and many more.

Obviously, if any of these areas dovetails with your interests, we have a lot to talk about. (You'll quickly see why so many engineers like the growth atmosphere of the Electronics Division.)

If you'd prefer to move in another direction, send us your resume anyway. We have rapidly expanding study and development programs going in ASW, radio communications, data equipment, navigational aids, tracking equipment and countermeasures. Opportunities are wide open. Direct your resume, in confidence, to Mr. L. A. Corwin, Dept. 174.

### **GENERAL DYNAMICS**

#### ***Electronics Division***

1400 N. Goodman Street, Rochester, New York 14601  
An Equal Opportunity Employer (M&F)



# Look closely.

That position  
you've been looking for  
may be listed here.

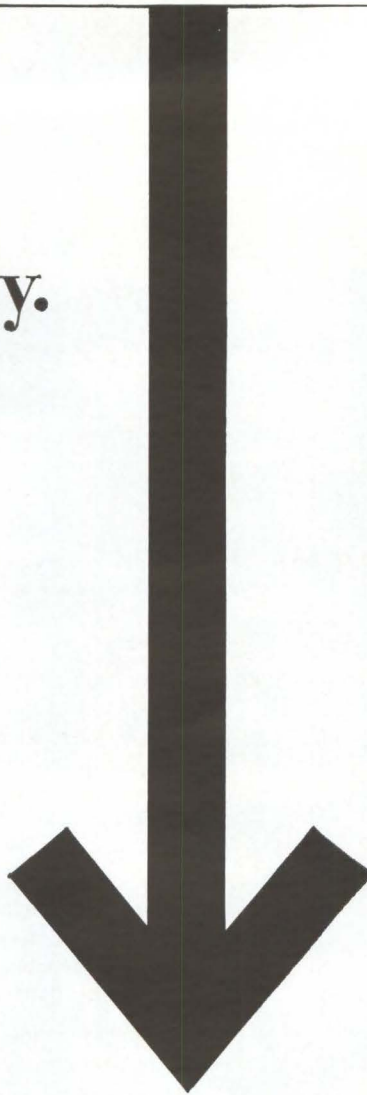

If you've been searching for a position offering personal and professional advancement with a growth company, take a closer look at IBM's facility in East Fishkill, New York. Here you can enjoy an exceptional scientific environment with a growing division of IBM—THE leader in THE major growth industry: information handling and control. Read on! Your new career may be here.

#### **Component Application Engineers:**

Match components to circuit applications, considering component quality, reliability and cost. Design and implement evaluation testing to analyze component design. Aid circuit designer in selection of component parameters to achieve best compromise between component and circuit performance. Background in electrochemical or circuits design required. Position will encompass work in transistors, diodes, integrated circuits, pulse transformers, delay lines, capacitors and resistors.

**Industrial Engineers:** Experienced in one or more of the following areas: estimating labor, materials and tooling cost of small components and assemblies, MTM,

budgets, learning curves, manufacturing processes and methods, manpower planning, plant layout, space planning, packaging and materials handling.

**Quality Engineers:** For final test quality control, failure analysis, reliability analysis, chemical laboratory, standards laboratory and test equipment maintenance and calibration.

**Process Engineers:** Opportunities exist in semiconductor device development, semiconductor manufacturing vendor liaison, pilot line or manufacturing engineering. Includes development of individual components, device design, diffusion, silk screening, printed circuits, plastic encapsulants, X-ray fluorescent analysis, instrumentation methods, photo resist, etching and materials processing.

These positions require a B.S. or advanced degree in Electrical Engineering, Mechanical Engineering, Chemical Engineering, Industrial Engineering, Physics or Metallurgy, plus one to five years' experience.

**Systems Analysts/Programmers:** Development and installation of information and process control data systems in

manufacturing. Candidates must have one to five years' industrial experience. Job training in programming or systems planning will be provided.

**Materials Engineers:** Experience in epitaxial deposition of semiconductor materials related to device-oriented laboratory. Positions are also available in developing diffusion processes and investigating related phenomena for device applications.

**Cost Engineers:** Cover the full spectrum of programs from conception through manufacturing. Help optimize the cost of component designs and the implementation of new manufacturing processes. Establish cost targeting and cost control tools. Apply new cost engineering techniques such as parametrics, simulation, mathematical cost models, fixed variable approaches and computer applications.

Please write, outlining your qualifications and interests, to: J. P. Cardarelli, Department 554-Z2M, IBM Corporation, East Fishkill Facility, Route 52, Hopewell Junction, N.Y. 12533. IBM is an Equal Opportunity Employer.

# IBM®



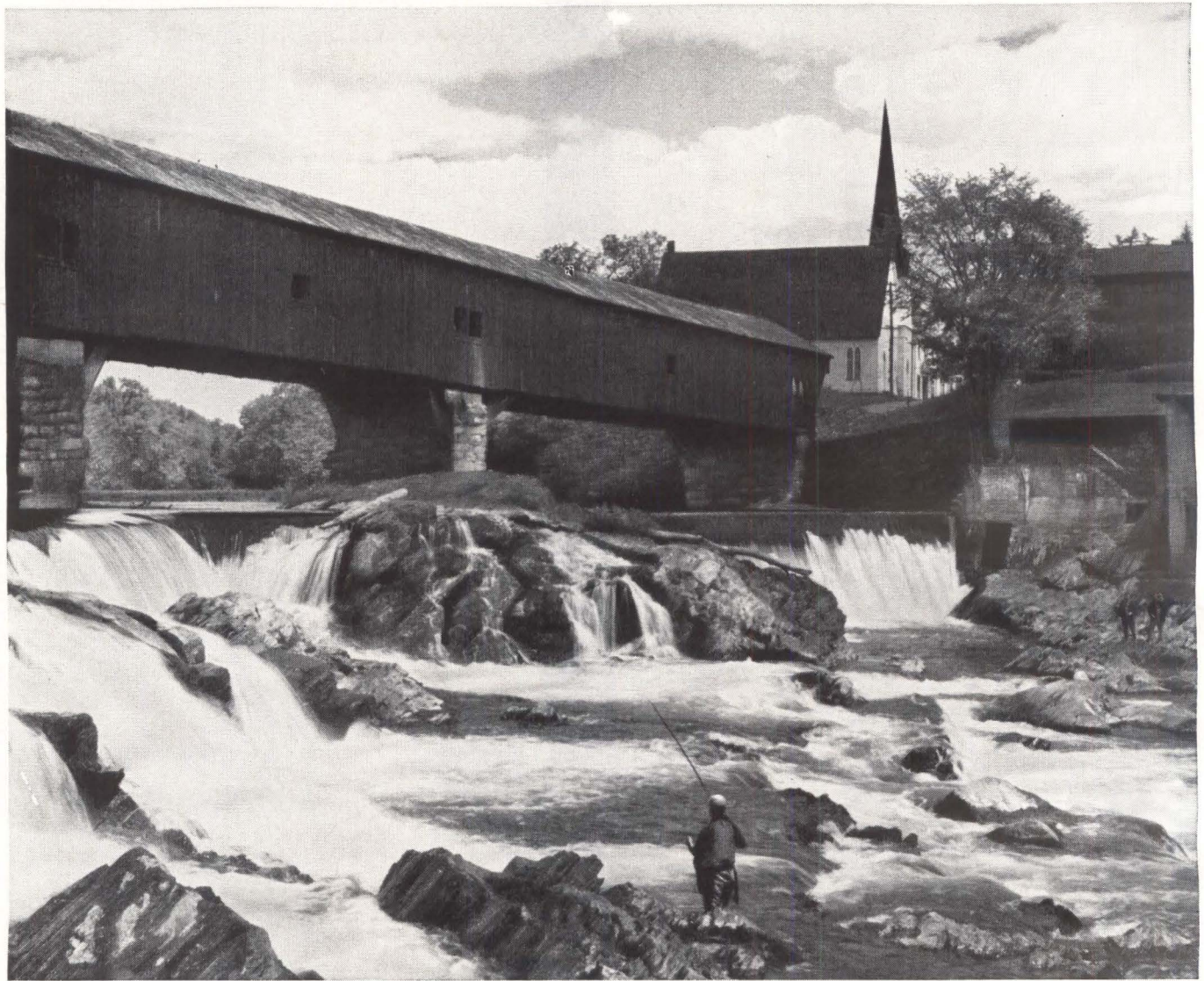

## decompression chamber

Around Nashua, New Hampshire, where we are located, the living is easy. No traffic jams. No housing problems. No worries about the quality of public education. Plenty of lakes, seashore and mountains close at hand. And for pleasure more urbane, Boston is no great distance away.

The economic pressure is off, too. There's no state income tax, and skills and services can be come by quite inexpensively.

About the job. You'll be working in depth; probably helping to evolve an advanced systems technology. The working atmosphere is free. (Should you ever find it especially heady, top management's door is always open.)

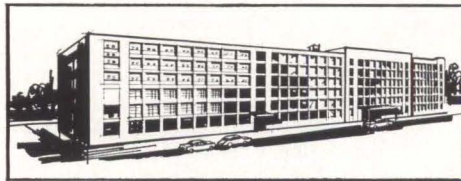

We're one of the top defense contractors in the country. Our electronics technology leads the field in many areas. We're heavy in: phased arrays and other radar; information handling and display; long range communications; oceanographic telemetering; electro-optics; lasers; instrumentation and control, microwaves, flexible printed circuits and systems-oriented, special-purpose hardware. Send us your resume. We'll show you what we mean about

pressure-safe living and working at Sanders.

Immediate senior level openings exist in research, development, product design and manufacturing engineering. Write in confidence to Mr. Lloyd Ware, Staff Engineer.

# sanders associates, inc.

Nashua, New Hampshire



**NEW DIRECTIONS IN  
ELECTRONICS SYSTEMS**

**An Equal Opportunity Employer**





## EMPLOYMENT OPPORTUNITIES

THE MARKET-PLACE FOR ALL EMPLOYMENT NEEDS

Send new ads or inquiries to:

### ELECTRONICS

Class. Adv. Div., P.O. Box 12, N.Y., N.Y. 10036



## E.E.'s

For FEE PAID positions throughout U.S.

Send Coupon Today

ATOMIC PERSONNEL, INC.

Suite L, 1518 Walnut St., Phila., Pa.

Experienced Engineers... Working "Full Time"... For You!

Send resume today. (If none, send coupon for confidential application.)

Name \_\_\_\_\_

Address \_\_\_\_\_

City \_\_\_\_\_

State \_\_\_\_\_

# YOU'RE H!RED

Do you need electronics engineers or technical management men? Electronics magazine is the way to recruit them. Electronics is designed specifically for the working engineer. 68,000 subscribers and an additional 133,000 pass-along readers turn to it to keep up with their industry. You can find the man that meets your qualifications with an advertisement in the Employment Opportunities Section.

For rates & information write: Electronics, a McGraw-Hill Publication. Classified Advertising Division, Post Office Box 12, New York 10036.

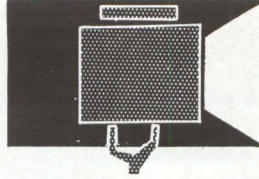

## SEARCHLIGHT SECTION

- CLASSIFIED ADVERTISING • BUSINESS OPPORTUNITIES
- USED OR SURPLUS EQUIPMENT

### AUTOTRACK ANTENNA MOUNT

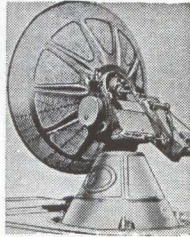

360 degree azimuth, 210 degree elevation sweep with better than 1 mil. accuracy. Missile velocity acceleration and slewing rates. Amplidyne and servo control. Will handle up to 20 ft. dish. Supplied complete with control chassis. In stock—immediate delivery. Used world over by NASA, USAF, MP-61-B. Type SCR-584. Nike Ajax mounts also in stock.

### PULSE MODULATORS

#### MIT MODEL 9 PULSER 1 MW—HARD TUBE

Output 25kv 40 amp. Duty cycle .002. Pulse lengths .25 to 2 microsec. Also .5 to 5 microsec. and .1 to .5 microsec. Uses 6C21. Input 115v 60 cycle AC. Mfg. GE. Complete with driver and high voltage power supply. Ref: MIT Rad. Lab. Series, Vol. 5, p. 152.

#### 2 MEGAWATT PULSER

Output 30 kv at 70 amp. Duty cycle .001. Rep rates. 1 microsec 600 pps. 1 or 2 msec 300 pps. Uses 5948 hydrogen thyratron. Input 120/208 VAC 60 cycle. Mfr. GE. Complete with high voltage power supply.

#### 15 KW PULSER—DRIVER

Biased multivibrator type pulse generator using 3E20 Output 3kv at 5 amp. Pulse lgths .5 to 5 microsec. easily adj. to .1 to .5 msec. Input 115v 60 cy AC. \$575. Ref. MIT Rad. Lab. Series, Vol. 5, pps. 157-160.

#### MIT MODEL 3 PULSER

Output: 144 kw (12 kv at 12 amp.) Duty ratio: .001 max. Pulse duration: 5, 1 and 2 microsec. Input: 115 v 400 to 2000 cps and 24 vdc. \$325 ea. Full desc. Vol. 5, MIT Rad. Lab. series, pg. 140.

#### 250 KW HARD TUBE PULSER

Output 16 kv 16 amp. Duty cycle .002. Pulses can be coded. Uses 5D21, 715C or 4PR60A. Input 115 v 60 cy. AC \$1200 ea.

#### PLAN POSITION INDICATOR CONSOLE

Complete PPI console operating from 115 volt 60 cycle AC. 10" CRT range 4 to 250 miles. Digital height readout. Complete AN/UPA-25. Price \$1200.

#### SCR 584 AUTOTRACK RADARS

Our 584s in like new condition, ready to go, and in stock for immediate delivery. Ideal for telemetry research and development, missile tracking, satellite tracking. Fully Desc. MIT Rad. Lab. Series, Vol. 1, pps. 207-210, 228, 284-286. Comp. Inst. Bk available \$25.00 each.

### MICROWAVE SYSTEMS

#### L BAND RF PKG.

20 KW peak 990 to 1040 MC. Pulse width .7 to 1.2 micro sec. Rep. rate 180 to 420 pps. Input 115 vac. incl. Receiver \$1200.

#### 200-225 mc RADAR SYSTEM

1 Megawatt output, 200 nautical mile range for long range detection of medium and high altitude jet aircraft as well as general search. Complete system in stock. Input 120/208 V, 60 cy. Type TPS-28. Mfg. Hazeltine.

#### C-BAND RADAR

250 KW output. C-band. PPI indicator. 5C22 thyratron modulator. Antenna hi gain parabolic section. Input 115 volts 60 cycle AC. complete \$2750.00.

#### 200 TO 2400 MC RF PKG.

200 to 2400 MC CW. Tunable. Transmitter 10 to 30 Watts. Output. As new \$475.

#### 500 KW L BAND RADAR

500 kw 1220-1350 msc. 160 nautical mile search range P.P.I. and A scopes. MTI. thyratron mod 5J26 magnetron. Complete system.

#### 100 KW X BAND RADAR

Complete 100 kw output airborne system with AMTI. 5C22 thyr. mod. 4J52 magnetron. PPI. 360 deg az sweep. 60 deg. elev. sweep. gyro stabilizer, hi-gain revr. Complete with all plugs and cables

#### AN/GPG-1 SKY-SWEEP TRACKER

3 cm. automatic tracking radar system. Complete package with indicator system. Full target acquisition and automatic tracking. Input 115 volts 60 cycle. New. In stock for immediate delivery. Entire System 8' long, 3' wide, 10' high. Ideal for Infrared Tracker, Drone Tracker, Missile Tracker, R. & D.

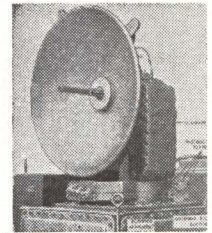

#### 500KW S BAND RADAR

250 miles search 115V 60 cy AC. Mfg. G.E.

RADAR AUTO-TRACK & TELEMETRY ANTENNA PEDESTALS 3 & 10 CM. SCR 584 AUTOTRACK RADARS. M-33 RADAR TPS-1D SEARCH. APS-45 TPS-10D HT. FINDERS. WX RADARS. FPN-32GCA. APS-10 APS-15B APS-27 (AMTI) SEARCH. APN-102 DOPPLER. DOZENS MORE. CARCINOTRONS. PFN'S. 25-5-1-2-3-6 MEGAWATT PULSE MODULATORS. CAVITIES. PULSE TRANSFORMERS. IF STRIPS. WAVEGUIDE. BENDS 200 MC. 1 KMC. 3 KMC. 6 KMC. 9 KMC. 24 KMC. RF PKGS.

RADIO RESEARCH INSTRUMENT CO. 550 5TH AVE., NEW YORK 36, N. Y. JU 6-4691

# FOR SALE

When you have used electronics equipment to sell, advertise in Electronics Searchlight Section for fastest results.

For information: Searchlight Section Classified Advertising Division Post Office Box 12 New York 10036

### CIRCLE 966 ON READER SERVICE CARD

#### TEST EQUIPMENT

For over 20 years specializing in top brands only. Write for our latest listing. We buy complete inventories.



#### ELECTRONIC SALES

1413 Howard Street, Chicago, Illinois 60626 Telephone ROgers Park 4-0600

### CIRCLE 967 ON READER SERVICE CARD

#### ELECTRON TUBES

KLYSTRONS • ATR & TR • MAGNETRONS SUBMINIATURES • C.R.T. • T.W.T. • 5000-6000 SERIES • SEND FOR NEW CATALOG A2 • A & A ELECTRONICS CORP. 1063 PERRY ANNEX WHITTIER, CALIF. 696-7544

### CIRCLE 968 ON READER SERVICE CARD

#### MINI-FLUID DISPENSER

AIR OPERATED for miniature potting and encapsulating

Available in 3 sizes 6cc - 12cc - 30cc

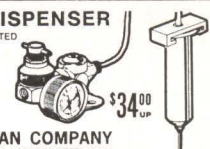

PHILIP FISHERMAN COMPANY 7 CAMERON ST., WELLESLEY, MASSACHUSETTS 02181

### CIRCLE 969 ON READER SERVICE CARD

#### Patent Rights Offered

Pulse Series Extenders US Pat. #3,267,448 Use a single transmission channel to sample many signals from RC or similar circuits just long enough to pick up 2 or more pulses from each; then obtain sustained series for readout by vibrating reed frequency meters.

R. E. GUNTHER Princeton Jct., N.J.

### CIRCLE 970 ON READER SERVICE CARD





The World's Most Complete Line of...

# PRECISION TRIMMER CAPACITORS

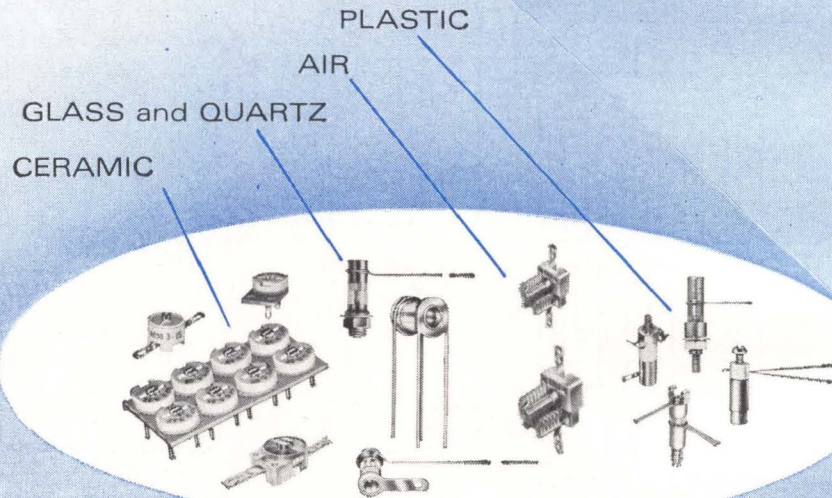

## MINIATURIZED ERIE TRIMMER CAPACITORS FOR PRINTED CIRCUIT BOARD... OR PANEL MOUNT APPLICATIONS—MILITARY OR COMMERCIAL TYPES

When knowledgeable engineers discuss quality Precision Trimmer Capacitors... ERIE is the name most often mentioned as the best single-source in the industry.

Today, miniaturized ERIE Trimmer Capacitors are available in a wide selection of dielectrics for virtually any circuit application... Ceramic, Glass, Quartz, Air and Plastic.

For more than 20 years ERIE has earned an enviable reputation for quality components. Quality, however, is a by-product of experience and advanced engineering capability. At ERIE, Precision Trimmer Capacitors are smaller than ever with better than ever quality.

If you have a specific Trimmer Capacitor problem... we suggest ERIE as your one-stop source. One of our standard units will probably fulfill your requirements. If not, our Trimmer Engineering Department will welcome the opportunity to discuss your circuit needs.

Write TODAY for new Precision Trimmer Capacitor catalog.

Another Series of Components in ERIE's Project "ACTIVE"  
Advanced Components Through Increased Volumetric Efficiency

ERIE

TECHNOLOGICAL

PRODUCTS, INC.



Formerly  
Erie Resistor  
Corporation

Erie, Pennsylvania



---

# Newsletter from Abroad

---

December 12, 1966

## **Kita diode shows continuous output at 50 Ghz**

Japanese researchers continue to show a flair for diodes. Shoichi Kita, who developed the silver-bonded germanium diode named for him, reports he's discovered that Kita diodes—originally developed for parametric amplifiers—will also work as millimeter-wave oscillators.

In experiments at the government-owned Nippon Telegraph and Telephone Public Corp., Kita has operated diodes at frequencies up to 50 gigahertz with continuous-wave output. Bell Telephone Laboratories has pushed silicon diodes to considerably higher frequencies—85 Ghz—but only for pulse outputs.

Kita stumbled upon the "new" oscillator while checking the impedance of Nippon Electric Co. GSB-3 diodes intended for a parametric amplifier. At 11.75 Ghz he noticed a sharp rise in the figure of merit when the reverse bias reached about 7 volts. Then he boosted the frequency to 47 Ghz and found the diode oscillated.

Later Kita obtained c-w outputs of about 2.5 milliwatts at 40 Ghz and about 0.7 mw at 50 Ghz. The diode's behavior is very similar to that of a klystron. The diode frequency can be pushed by changing power supply voltage and pulled by changing tuning of the cavity in which the diode operates.

## **R&D reshuffle by Britain aids electronics**

Britain's electronics industry should benefit from a reshuffling of government research and development facilities early next year. Under the new R&D alignment, the Ministry of Aviation will hand over its research establishments to the Ministry of Technology, the government's godfather to the electronics industry.

The shift will put under the technology ministry's wing two major British electronics research centers, the Royal Radar Establishment at Malvern and the Royal Aircraft Establishment at Farnborough. Both are now oriented heavily to aerospace applications but will diversify under the new setup. More important, a strong effort will be mounted to get out to the industry research and development results that point to marketable products. One main assignment of the technology ministry is to inject new technology into the electronics industry. But since the ministry took on the job a year ago little has been done, partly because of the ministry's limited research in electronics.

## **More Japanese sets with IC's on way**

A scramble to get radio and television receivers with integrated circuits on the market has started among Japanese set producers.

The Sony Corp. was first with a miniature radio this fall [Electronics, Oct. 17, p. 22]. Late in November the Matsushita Electronics Corp. showed a pair of IC radios and a tv set well along in development. Early this month, the Victor Co. of Japan Ltd. started selling a 25-inch color set with a hybrid IC in the sound channel.

Victor's IC isn't as complex as the monolithic circuit the Radio Corp. of America uses in its 12-inch black-and-white receiver, first production-line set ever to have an IC. Victor's circuit serves only as the sound intermediate-frequency amplifier and limiter. RCA's IC has in addition a frequency-modulation discriminator and a first stage of audio amplification [Electronics, March 21, p. 137].

The Victor IC contains three transistors and six resistors. It replaces



---

# Newsletter from Abroad

---

two tubes, five resistors and three capacitors. Although the IC—supplied by Kyodo Electronic Laboratories Inc.—costs more than the components it replaces, Victor says the IC set is cheaper to fabricate. The main saving is in the power supply. Because of the IC's low consumption, Victor is using the same supply for the 25-inch set that it normally puts into 19-inch sets.

The IC radios Matsushita has on the way will have a monolithic circuit based on a linear circuit for hearing aids developed by Philips Gloeilampenfabrieken NV of the Netherlands. Matsushita Electronics is a joint venture of Philips and the Matsushita Electric Industrial Co.

## Marconi expands MOS development

The resurgence of metal oxide semiconductors has spread to Great Britain. After four-and-a-half years of small-scale development work in MOS, the Marconi Co. this year stepped up its efforts considerably and now has devices about ready for the market. Marconi, the electronics subsidiary of the English Electric group, already produces hybrid integrated circuits with silicon transistors for its Myriad computers.

Marconi won't disclose how much it is spending on MOS development but I.G. Cressell, manager of the company's microelectronics division, says a sizeable chunk of Marconi's \$450,000 yearly R&D budget is tagged for MOS. In pilot production, Marconi has been getting "reasonably high yields" on a J-K flip-flop and will soon be ready with a 56-element eight-bit shift register.

## Russians detect laser pulses with radio antenna

Soviet physicists have found a way to pick up laser light beams directly with a radio antenna. In the Russian technique, the radio antenna is fed a negative potential; the antenna field then interacts with the laser beam to develop electrical impulses. Length of the output pulses exactly matches the pulse length of the laser beam. The Russian researchers—led by Gurgun Askaryan of the Physics Institute of the Soviet Academy of Sciences—used 300-microsecond laser pulses in their experiment.

Although Askaryan sees high promise in the technique, he says there's much more work to be done before data can be transmitted effectively to radio antennas via laser beams.

## IBM bearish on Zurich lab's double thin films

The International Business Machines Corp. has written off double magnetic thin films as a candidate for the next generation of computer memories despite the films' interesting magnetic properties. The films—originated at IBM's Zurich research facility—are too difficult to fabricate. IBM is pushing development, though, of coupled films which have much thicker nonmagnetic separating layers than the double films.

The double thin films have separating layers in the range of 350 angstroms compared with some 10,000 angstroms for the coupled films. Coercive force of the double films with a separating layer of silicon oxide is about one-tenth the value for a single magnetic film. The coercive force for a double film with a metal separating layer, however, is higher than for a single film. Zurich apparently will continue some experimental work in double films, but the effort will be played down. Device development of coupled films is being done at IBM's Burlington, Vt., plant.



**courting  
capacitor  
disaster?**



## **ONLY Hi-Q CERALAM® CAPACITORS OFFER YOU PROVEN HIGH PERFORMANCE & ESTABLISHED HIGH RELIABILITY**



With so much current talk about jamming more and more performance into smaller and smaller packages, we think it's about time attention was called to this kind of "brinkmanship." These claims are okay—usually—as far as they go. But how often do you see them underscored with a promise of tops in reliability? Not often? Never! (Unless the reference is to a CERALAM capacitor.) It's simply a fact that you can't jam a conventional capacitor construction into a smaller package without sacrificing reliability. And you can't put one of these "wonder" capacitors into your equipment without risking its reliability.

There's just one way to cram more performance into a smaller package and still provide the kind of reliability that's demanded in a probe going millions of miles into space. That's with CERALAM construction... a lamination so dense it becomes a rugged monolithic block. Hi-Q developed the technique, and *proved it in performance* so we could guarantee reliability. That's something you can't buy anywhere else. So don't mess around, call us and be sure.



**AEROVOX**  
CORPORATION  
OLEAN, NEW YORK  
MYRTLE BEACH, SOUTH CAROLINA



# CORNING®

## New CORNING® FP Resistor won't burn under extreme overload

Now you've got a low-power resistor you can trust in circuits where it can get socked with 100X rated overloads and more.

The new CORNING FP Resistor will open up . . . but it won't burn!

You'll also enjoy all the 5%/1000 hours stability, and reliability, that are yours in CORNING® Glass Tin Oxide Film Resistors.

The FP Resistor is available in 2, 3, 4, 5, 7, and 10 watt sizes that cover the resistance range from 9 ohms up to 90 K.

The FP is strip-packed for handling convenience.

Test the new, blue FP Resistor for a new measure of protection for your equipment. Test them as fuse-resistors, without modification.

Test the new, blue FP Resistor—backed by Corning for performance and for service.

Corning Glass Works, 3913 Electronics Dr., Raleigh, N. C.

**CORNING**  
ELECTRONICS



# FP Resistors

new,  
blue,  
and

flameproof!

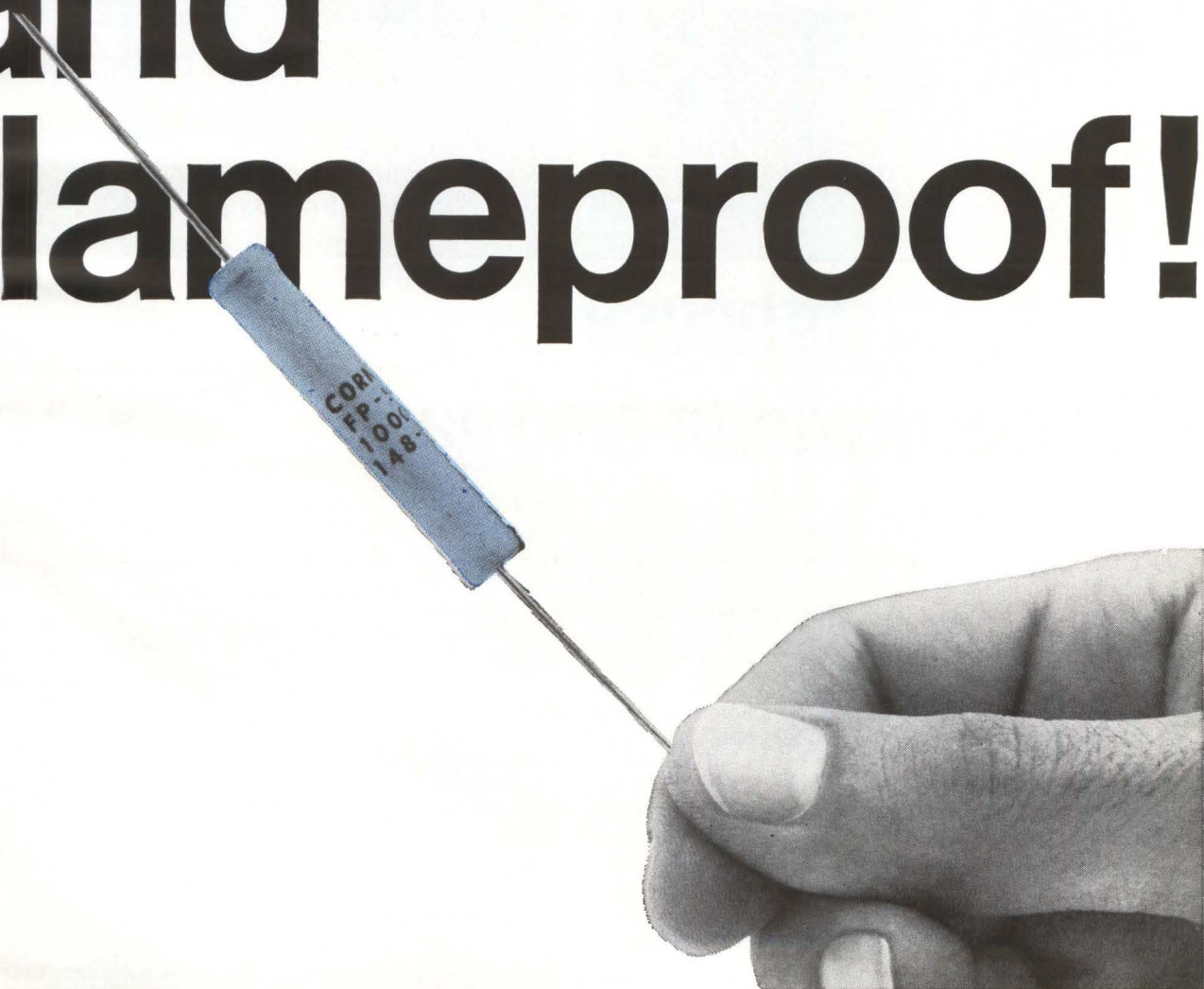



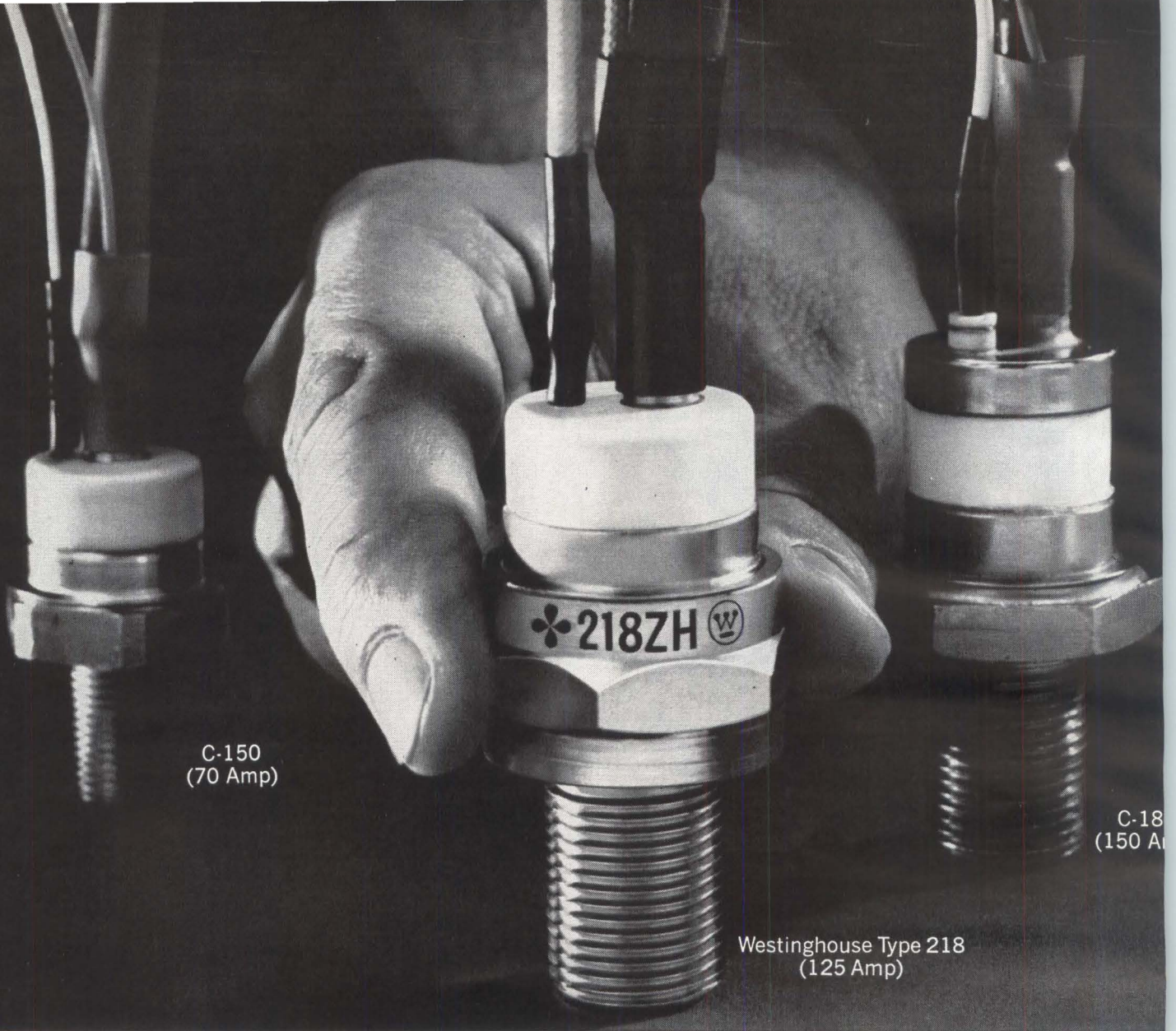

C-150  
(70 Amp)

C-18  
(150 Amp)

Westinghouse Type 218  
(125 Amp)

# Now Westinghouse fills the thyristor amp gap

With the new Westinghouse 125 amp thyristor — Type 218 — you can stop paying for 150 amps just to fill 70 to 125 amp applications.

What's more, the Type 218 gives you a 3,300 amp surge rating—45,000 ampere<sup>2</sup> seconds — even better than many 150 amp thyristors! Voltage ratings through 1400 volts, dv/dt rating of 100 volts per microsecond, and a typical turn off time of 40 microseconds offer greater design flexibility. 20 microseconds turn-off

time available by request.

Key to this unusual performance is the exclusive Westinghouse C. B. E. design (Compression-Bonded Encapsulation). By eliminating solder joints, this construction ends thermal fatigue, greatly reduces thermal impedance.

Such features make possible the unique Westinghouse lifetime guarantee. On the Type 218, and other semiconductors, this symbol  on the case means that the guarantee applies.

For immediate delivery on Type 218,

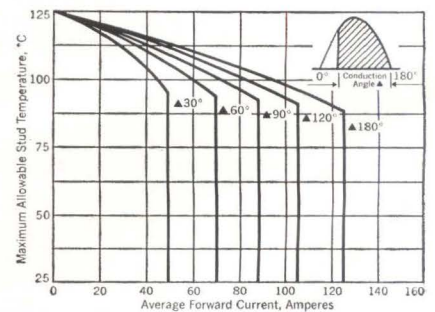

Current capability of Westinghouse  
Type 218 Thyristor

just call your local Westinghouse distributor. For detailed technical data, write: Westinghouse Semiconductor Division, Youngwood, Pa. 15697.

You can be sure if it's Westinghouse



SC 2077



Westinghouse warrants to the original purchaser that it will correct any defect or defects in workmanship, by repair or replacement f.o.b. factory, for any silicon power semiconductor bearing this symbol  during the life of the equipment in which it is originally installed, provided said device is used within manufacturer's published ratings and applied in accordance with good engineering practice. This warranty shall constitute a fulfillment of all Westinghouse liabilities in respect to said products. This warranty is in lieu of all other warranties expressed or implied. Westinghouse shall not be liable for any consequential damages.



# Electronics Abroad

Volume 39

Number 25

## Sweden

### Soldiers' play

Except during some United Nations peacekeeping missions in the Congo during the early 1960's, Swedish soldiers haven't fired shots in anger since 1812. But Swedish conscripts nonetheless now are getting some idea of battlefield action



Infantry instructor pushes a button on his control transmitter . . .

during training. It's coming from \$1.5 million worth of electronic land warfare training equipment that the Royal Army Ordnance Administration is putting into the field.

Developed by the aircraft-auto-electronics company SAAB Aktiebolag, the main battlefield props are infantry and tank targets that pop up under radio control. A hit infantry target drops at once; a hit tank target flashes a light or belches a puff of smoke. Although the "enemy" doesn't fire back at the attacking conscripts, his mock infantry sets up a racket of machine-gun rattling and his tanks menace the trainees with muzzle flames and sounds of cannon shots.

**No strings.** Armies around the world use battlefield simulation equipment, but most systems use cables and levers to pop up targets. Others have electrical actuation, which means stringing out wires and bringing in a field generator set to play a land war game. The SAAB targets are self-contained, with compressed-air bottles as the energy source to raise and lower targets under remote radio control.

Largely because of the target autonomy and the resulting ease of setting up a mock battle, SAAB has sold its targets to the Norwegian and Danish armies as well as Sweden's. And the company says it has negotiations under way with eight other European armies. Early next year, SAAB will demonstrate its equipment in the United States and Canada.

**Through channels.** The SAAB targets are controlled by a portable transmitter, about the size of an attaché case, that puts out about 1 watt—enough to actuate receivers on targets up to 3,300 yards distant. The transmitter operates in the 30 megahertz band and has 36 tone-frequency channels. Channel-selection is by pushbutton.

Each transmitter controls up to 12 battlefield receivers and each receiver is tuned to pick up only three tone-frequencies assigned to it. One receiver channel controls raising the associated targets (as many as 10 targets can be hooked up to one receiver), a second controls lowering, the third turns on and off the machine-gun sound simulator or gun-fire simulator.

The targets have sensors that pick up vibrations set up when a bullet passes through the target. On the infantry targets, an output from the sensor actuates a solenoid valve that ports compressed air to the target-lowering mechanism. The targets also can be lowered by a signal from the transmitter. On the tank targets, the sensor signal flashes an off-target

lamp or triggers a smoke-puff unit that shows a hit has been scored.

**Tougher enemies.** SAAB is working on an improvement that will make it harder to put its targets out of action. Although the sensors on the present targets won't develop an output when short shots knock pebbles against the targets, they do score hits by ricocheted bullets. SAAB is developing a sensor that will distinguish between true hits and ricochets.

And SAAB has about ready for market an instant-scoring system for air force strafing practice. Sensors on the ground targets will be linked to a central remote scoring device and pilots will get their scores by radio immediately after their runs. On most strafing ranges, ground crews have to check the targets for hits after each pass by a strafing plane.

### Hot line

The L.M. Ericsson Telephone Co. has moved into a commanding position in the scramble to stake out

. . . Up pops a radio-controlled target.





shares in the lucrative West European market for electronic telephone-exchange equipment. The company this month reported three new orders for computerized exchanges: one for Rotterdam, one for Helsinki and one for the Swedish Air Board.

The Rotterdam exchange will be built for the government-run Dutch telephone system at a cost of \$2 million. It will handle switching between Dutch cities and some 18 district telephone centers, plus international traffic in the southern part of the nation. The station will be in operation by mid-1968 and will have a capacity of 30,000 lines.

Along with computer-controlled switching, the Rotterdam system will make possible such special services as automatic transfer of calls from one number to another number, one-digit dialing for frequently called numbers, push-button dialing, wake-up service, conference calls and the like.

**Space division.** The Dutch installation will be similar to an Ericsson 4,800-subscriber, computerized exchange about to go into operation in the town of Tumba, outside Stockholm. The Ericsson electronic exchange, like those in service in the Bell System in the United States, uses space division with a separate wire path for each conversation. For the electronic exchanges Ericsson developed a special-purpose digital computer and a compact code switch containing 2,000 contacts that is smaller than a conventional 1,000-contact crossbar switch [Electronics, Oct. 4, 1965, p. 213].

The Helsinki exchange, ordered by the privately owned Helsinki Telephone Co., will have an initial capacity of 4,000 lines and is scheduled to go into service in mid-1969. It is designed for fully automatic and semiautomatic traffic, both domestic and international.

Ericsson has not released technical details on the computerized exchange ordered by the Air Board, the Swedish Air Force's highest authority. The value of this contract is about \$2-million. The equipment will be used in the board's own nationwide communications network.

## Israel

### Export expectations

Signs point to a dramatic rise in exports of electronic and electrical equipment from Israel over the next few years. The prospects are so bright that although exports for the electronic-electrical industry reached \$1 million only two years ago, the Israeli Ministry of Commerce and Industry now predicts exports will exceed \$18 million within the next four years.

Ministry officials offer substantial evidence to back up their prediction. Despite the ups and downs of the Israeli economy in recent years, foreign technology-oriented companies have found a stable climate for investments. Of the 30 major Israeli electronics companies, about 20 have some foreign interest. And there's been a trend recently to know-how or coproduction arrangements between Israeli electronics companies and technically strong companies in the United States, Britain, France, Germany and Switzerland. These ventures are aimed primarily at exports, since Israel, with 2.6 million people, is a small market.

What's more, the government this fall started a drive to diversify the country's exports. Israel's kingpin export products currently are polished diamonds and citrus fruits, but rising production costs are making them increasingly harder to sell in world markets. To broaden the country's export base, the government offers extra tax rebates to manufacturers who produce new products for export. The rebates range from 3.5% to 8.5% and they also apply to products that replace imports. The government is fighting a rising tide of imports.

**Selective.** In their export effort, Israeli electronics companies are concentrating on the gaps in the world-market product lines of the major international companies. The Israelis already are selling abroad small custom-built computers and peripheral equipment, electromedical equipment and some test instruments. Elron Electronic indus-

tries, for instance, a partner with the government in the new Elbit Computers group, forecasts its exports will run about \$250,000 for the 1966-1967 fiscal year, compared to \$150,000 for the previous year.

Along with its rising exports, the industry will get a lift next year when Israel establishes a television network. According to William E. Robinson, managing director of the Jerusalem-based Overseas Radio Corp., the potential market for tv sets is more than 350,000 units. Most of the market should go to Overseas Radio, in which the Zenith Radio Corp. has a minority holding.

## West Germany

### Pipeline under control

The dozen international oil companies that are spending \$185 million for a transalpine crude-oil pipeline are going to great lengths to make sure that everything will be under control when the 286-mile line goes into service next year.

The pipeline starts on the Adriatic coast south of Trieste, Italy, and stretches to Ingolstadt in southern Germany. En route, it crosses 150 rivers and cuts through the Italian and Austrian Alps in tunnels at altitudes up to 5,000 feet. Because much of the pipeline will be practically inaccessible once it's laid, its owners are making it the most closely controlled pipeline yet built.

Instead of a single main control station, the transalpine pipeline will have two, one near Trieste and the other at Ingolstadt. From these stations, operators can set the positions of 30 main slide-valves and control dozens of pumps and motors at pumping stations along the line. All in all, the main stations can send out a total of 135 remote commands to control equipment at pumping and transfer stations. And operators can keep an eye on some 50 different crude-oil parameters like pressure, flow rate, temperature and density.



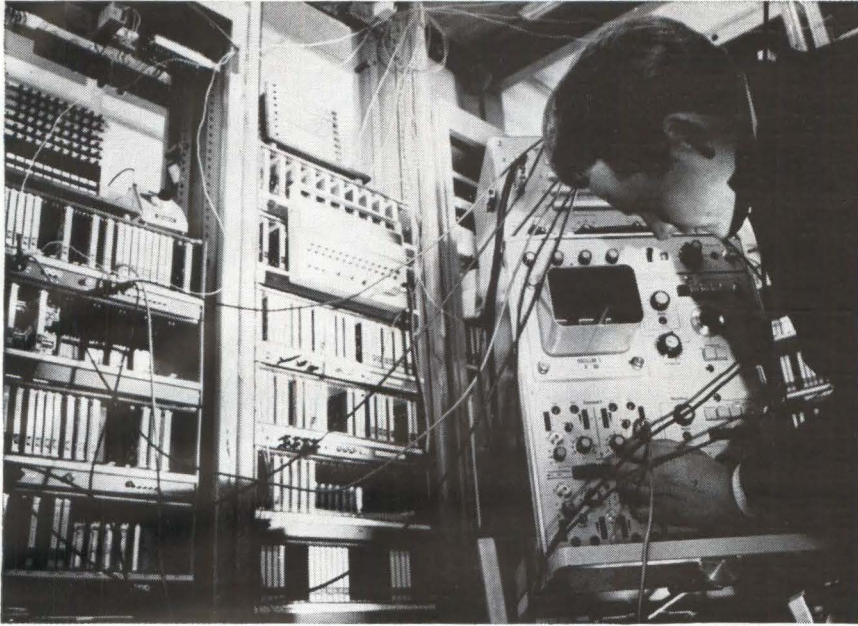

Remote-control station for transalpine pipeline is built up by Siemens from some 3,000 Simatic N plug-in NOR gate circuits.

**Private line.** The oil data, plus valve and pump information, will be fed in from 29 telemetering stations installed along the pipeline. Part of the data sent to the two main stations will also be transmitted to a control substation in Austria for monitoring.

Because the Italian, Austrian and West German telephone networks would have been involved were the remote-control and telemetering system tied into regular telephone lines, the pipeline operators laid their own cable alongside the pipeline.

A pair of four-wire lines in the cable will handle the flow of data and control signals. Time-division multiplex and pulse-code-modulation techniques will be used to squeeze 25 narrow-band channels with 50 baud transmission speed into a normal 3 kilohertz voice channel. Each station along the line will have one channel, frequency keyed by the remote-control equipment. The main stations will interrogate the telemetering stations once every five seconds.

At the main stations, incoming data will be decoded and fed to analog displays or recorders. However, both the main station at Trieste and the Austrian substation will have digital data-loggers as well. The main stations and the

substation will have limit monitors for pipeline pressure and oil flow and any of them will be able to transmit an emergency stop signal if pressure or flow starts to get out of hand.

West German's Siemens AG is supplying the control equipment. Basic building block of the system is the company's Simatic N low-frequency NOR gate.

### Electronic arm

Help is in sight for the hundreds of West German children born several years ago with limb deformities caused by tranquilizers their mothers took while pregnant.

In a project financed by the Ministry of Health, the Ferdinand von Artl Academy for Psychophysiology has developed an electronic lower arm with a hand that can grasp and release objects. The lower arm is the first step toward a prosthetic device that can duplicate the movements of a complete arm. No timetable has been laid down for developing the complete arm, but work will start next year on a feedback system that will let users of the arm sense how firmly they grasp an object. The next logical step is to develop wrist rotation and, finally, an upper arm.

The research was triggered by

the birth of many deformed babies in the early 1960's, later traced to the use of the drug thalidamide by expectant mothers.

**Muscle control.** Dieter Born, an electronics engineer at the Von Artl Academy, designed and built the arm. Called a Bioelektronikon, it can apply grasping pressure up to 11 pounds. Like the prosthetic sleeve developed in Russia [Electronics, Dec. 28, 1964, p. 111] and the experimental artificial arm of the Philco-Ford Corp. [Electronics, Sept. 20, 1965, p. 42], Born's limb responds to electromyographic (EMG) potentials. These are the tiny voltage signals transmitted when the brain orders a muscle to contract. An electrode attached to the skin picks up the potentials and feeds them to a 13-transistor amplifier whose output controls a relay. The relay, in turn, controls a 12-volt motor that actuates the hand.

The EMG voltages produced by muscle contraction have an amplitude of about 1 millivolt. However, the resistance of the layers of fat and the skin between the muscle and the electrode causes the amplitude at the electrode to drop to a level between 30 and 100 microvolts. The electrodes—one to control grasping, the other to control releasing—are foam rubber pads wetted with a low-resistivity solution.

The EMG voltages are amplified in a two-stage amplifier with a power gain of 75 decibels. The amplifier's output is fed to a pulse generator and then to a delay network. Thus, the motor relay stays closed so long as there is a pulse train triggered by an EMG voltage input from either of the two electrodes. The circuitry and the power supply, a rechargeable 12-volt nickel-cadmium battery, are packaged in an external pocket-size unit.

**Adding functions.** Born says that the basic circuits of the Bioelektronikon could be duplicated in parallel to build a complete artificial limb that could execute almost all the functions of a normal arm. The trick is finding enough control muscles that aren't used during normal body functions. Theoretically, even eyebrow muscles could generate the EMG voltages to con-



trol artificial arm movements. A complete artificial arm would need nine electrode-amplifier sets, each with a distinct control muscle.

Before he tackles additional functions, though, Born plans to perfect the grasping of the artificial hand. Early next year, he'll start work on a feedback network that will transmit pulses back to the brain so the limb-user can "feel" how firmly he is grasping something. The West German Ministry of Health earmarked funds for this development a fortnight ago.

### Automatic underground

Add Hamburg to the list of cities like Paris and Montreal that are turning to electronics for mass-transit control. Under test now in the Hamburg subway is a system designed to stop trains at station platforms with an accuracy of three feet; the system also allows headway between trains as short as 60 seconds, about one-third the current interval between trains.

Like the automatic control complex on trial in Paris, the Hamburg experimental system uses inductive loops laid between the subway tracks as the basis of its control. The loop triggers a pulse output from a transmitter-receiver located on the train's undercarriage. The loops are installed at fixed intervals of about 100 feet so the pulse interval reflects the train's speed.

A trackside pickup logs the pulses, and through them keeps track of the train's position and its speed. When the train should speed up for a straight stretch or slow down to approach a station, the computer-like trackside equipment feeds back control pulses to the transmitter-receiver on the train's undercarriage. For the trial, the pulses are converted into a speed-indication for the train operator; later they will serve as the basis for automatic train control.

Both Siemens AG and Allgemeine Elektrizitäts-Gesellschaft are supplying the hardware for the test systems.

The Hamburg public transport company is running the trial on a 3.6-mile regular subway line. Unless unforeseen difficulties cause

delays, the company plans to extend automatic control to all the city's subway lines at the end of 1967. The full-fledged system will have a central train describer that will display locations of all subway trains with an accuracy within 30 feet.

## France

### Keeping track

The de Gaulle government, now developing its own nuclear missiles and space boosters, is depending on the French electronics industry to outfit the top-secret missile test center under construction near Bordeaux. Although the Centre d'Essais des Landes is not due to be completed until late 1969 or early 1970, testing has been under way since February.

The site lies between Biscarosse and Mimizan on the Atlantic coast some 40 miles south of Bordeaux, and covers an area 15 miles long and three miles wide. It succeeds the Colomb-Bechar-Hammaguir test site in the Algerian Sahara that the French have agreed to vacate by July, 1967.

Primary mission of the new site is testing tactical and intermediate-range missiles and some air-to-ground and ground-to-air weapons. But it will also be used for tests

of the "Cora" rocket, the French second-stage contribution to the Europa-1 launcher being developed by the European Launcher Development Organization (ELDO).

The Landes center is equipped for both optical and microwave tracking. The optical system consists of five stations equipped both for television and film recording. Cinetelescopes are used to measure altitude changes of a missile up to 60 miles. Electronic tracking and telemetry are directed from a control center, using a CAE 90.8 computer. This is the largest digital computer made by Compagnie Européenne d'Automatisme Electronique, a major member of the new all-French computer company [Electronics, Aug. 8, p. 301].

**Message center.** The computer has a cycle time of less than two microseconds to permit it to receive up to 20 messages a second from supporting stations. The memory has 30,000 24-bit words. Working in real time, the 90.8 compares data, provides instantaneous information on the position and speed of the missile, calculates its probable impact point and sends the data to tracking and observation stations. The computer also prints out data for each flight for later analysis.

Other Landes electronic equipment includes the Aquitaine radar supplied by Compagnie Française Thomson-Houston-Hotchkiss Brandt. This system can follow a transponder-loaded missile about 1,500 miles with an accuracy to within 33 feet. It has a peak power of one megawatt and operates in the C band. Its 10-foot-diameter Cassegrain antenna has a gain of 41 decibels. One Aquitaine radar is already in service. Another will be installed at Hourtin, some 30 miles northwest of Bordeaux, and a third at a down-range tracking station on the island of Flores in the Azores.

The Hourtin Aquitaine is linked to an L-shaped trajectory determination system designed for tracking both missiles and Cora rockets.

The Aquitaine radar at Landes is supplemented by two smaller radars, known as Cotal and Supercotal, which have ranges of about

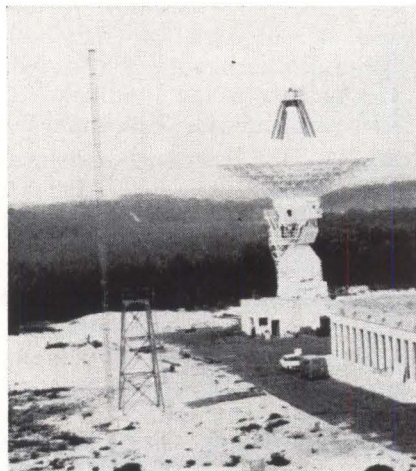

Cyclope 2 precision antenna at Landes tracking center covers frequency range from 216 Mhz to 2,300 Mhz. Gain is 45 db at 2,300 Mhz.



400 miles. They also pick up data from the transponder. Both do more than just back up the Aquitaine; they aid it during multiple missile firings.

**Signal scoop.** Also at the new center is the Cyclope 2 precision antenna, successor to Hammaguir's Cyclope 1. Builder is Elecma, the electronics division of the government-controlled aircraft engine company, Société Nationale d'Etude et de Construction de Moteurs d'Aviation. The Cyclope's 39-foot diameter dish picks up telemetry signals by conical scanning at a frequency of 15 megahertz and has a range of about 1,500 miles. It covers the entire 216-2,300 Mhz band and has a gain of 26 decibels at 250 Mhz and 45 db at 2,300 Mhz.

In addition to its Aquitaine, the Flores station is now getting equipment to follow the return to the atmosphere and impact of the 1,500-mile-range weapons. This gear includes instruments for optical, infrared, photographic and spectrographic measurements. The Flores installations will also be called on to follow satellite launchings from France's new space center in French Guiana, where launchings should begin in 1969 [Electronics, Nov. 1, 1965, p. 159].

Rounding out the new equipment at Landes are three instrument-packed dc-7 aircraft to track short-range missiles. Then, in 1968, a tracking ship, the Henri-Poincaré, will complete the network. The vessel will carry Thomson Houston's newest radar, the Béarn. Somewhat smaller than the Aquitaine, the Béarn can automatically track transponder-loaded missiles traveling 18,000 meters a second at distances up to 2,500 miles with an accuracy of 10 feet.

## Great Britain

### Iron-horse computer

As with most railroads, British Railways expects to one day have computers controlling its train runs. That day is far off, but the government-owned line will take a first step in that direction early next

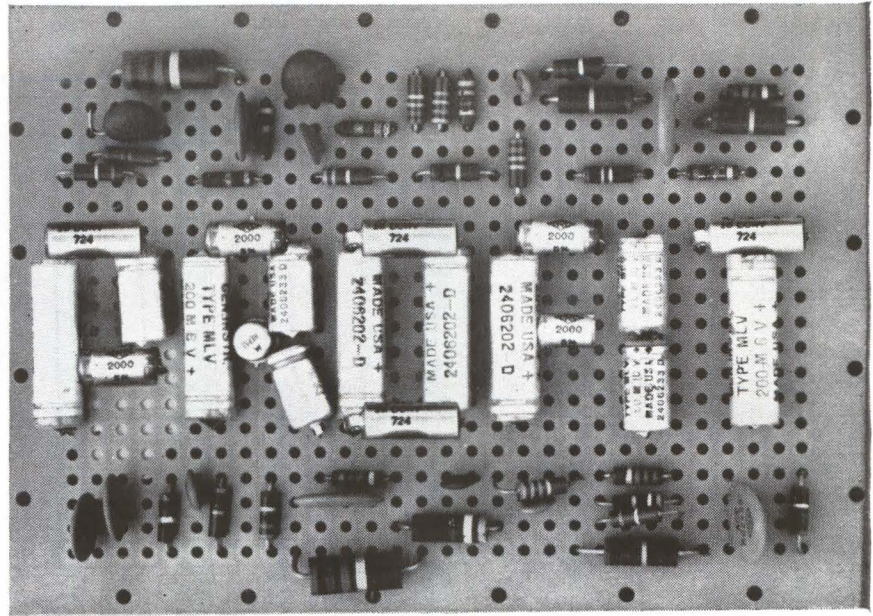

*where industry is never short-circuited...*

Plug-in anywhere in Louisiana and you'll be able to take advantage of:

Louisiana's revolutionary **Right-To-Profit Laws**, which protect industry, large and small, from unfair taxation and excessive government regulation.

Louisiana's money-saving **plant financing programs**. Build the exact production facility you require, without tying up your capital in brick and mortar.

Louisiana's **manpower training program**. Louisiana offers industry a substantial pool of labor, both trained and trainable. Where training is necessary, we'll provide it at no cost to you.

For full information on these and other ways to profit in Louisiana, write to William T. Hackett, Department of Commerce and Industry, Room 214, Capitol Annex, Baton Rouge, Louisiana 70804.

# LOUISIANA

## The Right-To-Profit State



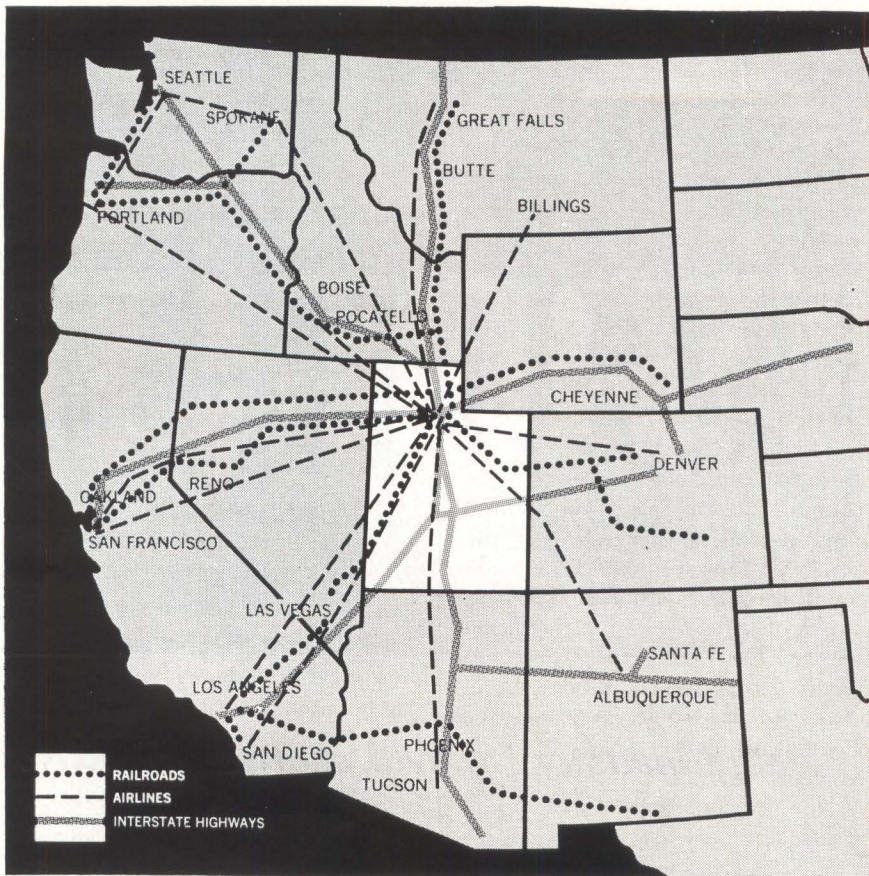

## Western distribution problems? Call us, we've got connections.

The shortest distance to ALL major markets of the West is from UTAH... because it's right in the middle. • Locating your plant or distribution center in Utah puts you just a day away from the major cities in a market of 30 million people. This market is growing 30% faster than all America for both population and industry. It's the area of the future. • **FREE:** Write for information on "The New Industrial Utah" to Utah Industrial Promotion Commission, Dept. 119, 167 Social Hall Ave., Salt Lake City, Utah 84111.

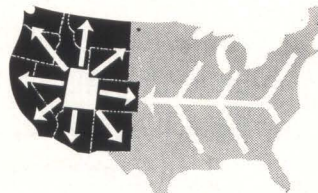

Win the WEST .. from  
**Utah**

Circle 262 on reader service card

To order reprints: Fill in, cut out coupon below, insert in envelope and mail to: **Electronics Reprint Dept., 330 W. 42nd Street, New York, N.Y. 10036**

### Reprint order form

For listing of reprints available see the Reader Service Card.

**Computer-aided Design: Part I, The Man-machine Merger.**

Send me ..... reprints of Key no. **R-01** at \$1.25 each.

For reprints of previous special reports fill in below:

Send me ..... reprints of Key No.(s) ..... @ ..... ¢ each.  
(For prices, see Reader Service Card)

Name .....

Number of street .....

City, State, Zip code .....

year when it puts a group of computerized signal boxes into service.

The group—three main boxes and six smaller ones—is now being installed on a section of track west of London on the heavily traveled Bournemouth-London line. A second group of eight boxes has been ordered by British Rail for the Leeds area in the north, with Elliott-Automation, Ltd., supplying the equipment.

**In sight.** The central train describer for each group of boxes will be fed the signals currently used to show which trains occupy which blocks of track. The signal-tower describer will register the inputs in a core memory with a capacity of 8,000 words of 18 bits. The computer unit will process the incoming data—the logic circuits are monolithic integrated circuits—and display it on a cathode-ray tube. Each train will show up on the display as a four-character alphanumeric code that will advance across the crt as the train progresses from block to block.

British Rail's investment in the two systems is slightly more than \$360,000. For the money the railroad is getting equipment that at first glance does little more than the existing gear, although it's much smaller. But the computerized signal-box setup with crt display represents a tryout of the first half of a computer system to control the signal lights themselves. The computer outputs that control the display could be the inputs to a computer that would generate signals to switch signal lights.

## Japan

### Numbers games

As Japan's computer industry enters the age of integrated circuits everything about the industry seems headed up—except the number of computer makers.

At the Japan Electronic Computer Show late last month, all six of the country's native data-processing producers turned up. Four had hardware with ic central processors



WITH **KH** ALL-SILICON  
R-C OSCILLATORS  
YOU GET MORE  
THAN ADJUSTABLE  
FREQUENCY!



**MODEL 4004**, one of the new K-H all-silicon Variable R-C Oscillators, provides continuously adjustable frequency over the range of 0.001 Hz to 100 kHz. Programmed units also available.

A stable low-distortion signal source is essential for today's complex electronic measurements. You get unsurpassed signal stability and purity in K-H's new line of all-silicon broad band variable R-C Oscillators. Amplitude stability is described, below. Distortion is plotted.

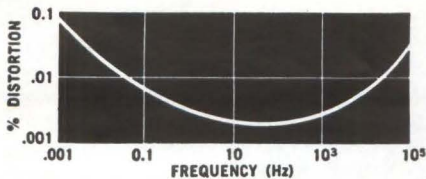

**TYPICAL HARMONIC DISTORTION PLOT** of K-H Series 4000 R-C Variable Frequency Oscillators.

Stability and signal purity are only two examples of the extra value you get from these modern Krohn-Hite electronic instruments. Other values increase user confidence further by providing simpler, faster and lower-cost operation.

**Excellent Amplitude Stability:** 0.01%, cycle-to-cycle; 0.01% per hour.

**Sine- and Square-Wave Outputs:** Pure sine-wave output — no diode-shaped approximations to produce step-function or waveform discontinuities. Square-wave rise and fall times less than 20 nanoseconds.

**Quadrature Outputs:** Sine and cosine outputs remain within  $\pm 1^\circ$  of quadrature. Ideal as driver for polyphase variable power sources or simulators for rotary or linear encoders.

There's more in K-H Data Sheet 4000.

Write for a copy.

**KH KROHN-HITE CORPORATION**  
580 Massachusetts Avenue, Cambridge, Mass. 02139  
Telephone: 617/491-3211

WITH **KH** ALL-SILICON  
VARIABLE FILTERS  
YOU GET MORE  
THAN ADJUSTABLE  
BANDWIDTH!

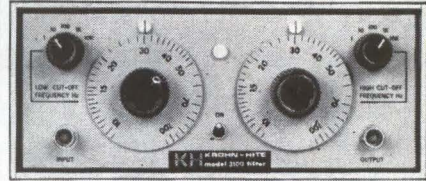

**MODEL 3100**, one of the new K-H all-silicon Broad Band Variable Electronic Filters providing continuously adjustable bandwidth over the range of 10 Hz to 3 MHz maximum bandwidth.

Frequency- or time-domain filter response is essential for today's complex electronic measurements. You get both, at the flip of a switch in K-H's new line of all-silicon Broad Band variable electronic filters. The frequency-domain characteristics are described, below. Time-domain response is illustrated.

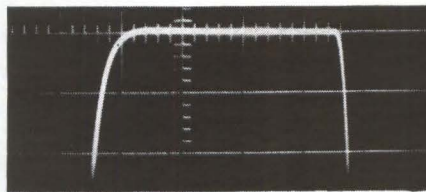

**TRANSIENT-FREE RESPONSE** to impulse signals demonstrates value of K-H Broad Band Filters for Time-Domain applications.

These responses are typical of the extra value you get from modern Krohn-Hite electronic instruments. Other values increase user confidence further by providing simpler, faster and lower-cost operation.

**Frequency-Domain Characteristics:** Fourth-order Butterworth with maximal flatness in the passband.

**Zero-db Insertion Loss:** All silicon amplifiers provide "lossless" passband response. Steep (24 db per octave) attenuation slopes extend to at least 80 db.

**90-db Dynamic Range:** Low hum and noise (100 microvolts) eliminates costly preamplifiers.

**No Impedance Matching Problems:** 100 k-ohms input impedance; 50 ohms output impedance (lower when specified).

There's more in K-H Data Sheet 3100/3103.

Write for a copy.

**KH KROHN-HITE CORPORATION**  
580 Massachusetts Avenue, Cambridge, Mass. 02139  
Telephone: 617/491-3211

on their stands and the other two said they'd have  $\mu$  processors on the market next year. Along with the new hardware, the show brought estimates of from \$85 million to \$100-million—a strong gain—for deliveries of domestic computers during the fiscal year that will end next April. Deliveries of imported machines are expected to run at about the same level as domestic machines.

For all the brisk business in the offing, there's speculation that the number of Japanese computer makers will drop to five before too long. A trio of producers—the Nippon Electric Co., Hitachi Ltd. and Fujitsu Ltd.—holds about three-fourths of the market. All three are shooting for sales of \$28 million this year, leaving fairly slim pickings for the remaining three.

**Behind.** Of the three companies in the lower half of the standings, only Tokyo Shibaura Electric Co. (Toshiba) remains in the same race as the first division companies. Toshiba has about an eighth of the domestic-computer market.

Oki Univac Kaisha Ltd., a joint venture of Oki Electric Manufacturing Co. and the Univac Div. of the Sperry Rand Corp., has almost an eighth of the market. But Oki has settled into a role of an assembly plant—using both imported and domestic components—of Univac-designed machines.

Mitsubishi Electric Corp. holds only 2% of the market for domestic computers and seemingly is hanging on only to strengthen its hand in negotiations to team with the General Electric Co. and Toshiba for a computer joint venture. Talks between the three companies are now underway with GE and Mitsubishi pressing while Toshiba holds back. One stumbling block in the negotiations is Mitsubishi's ties with the Westinghouse Electric Corp. Then, too, Mitsubishi and Toshiba are allied with different industrial groups in Japan.

Toshiba, though, may come around even though the company did manage to increase its market penetration this year. Compared to the leaders, Toshiba has the handicap of a mixed bag of computers—



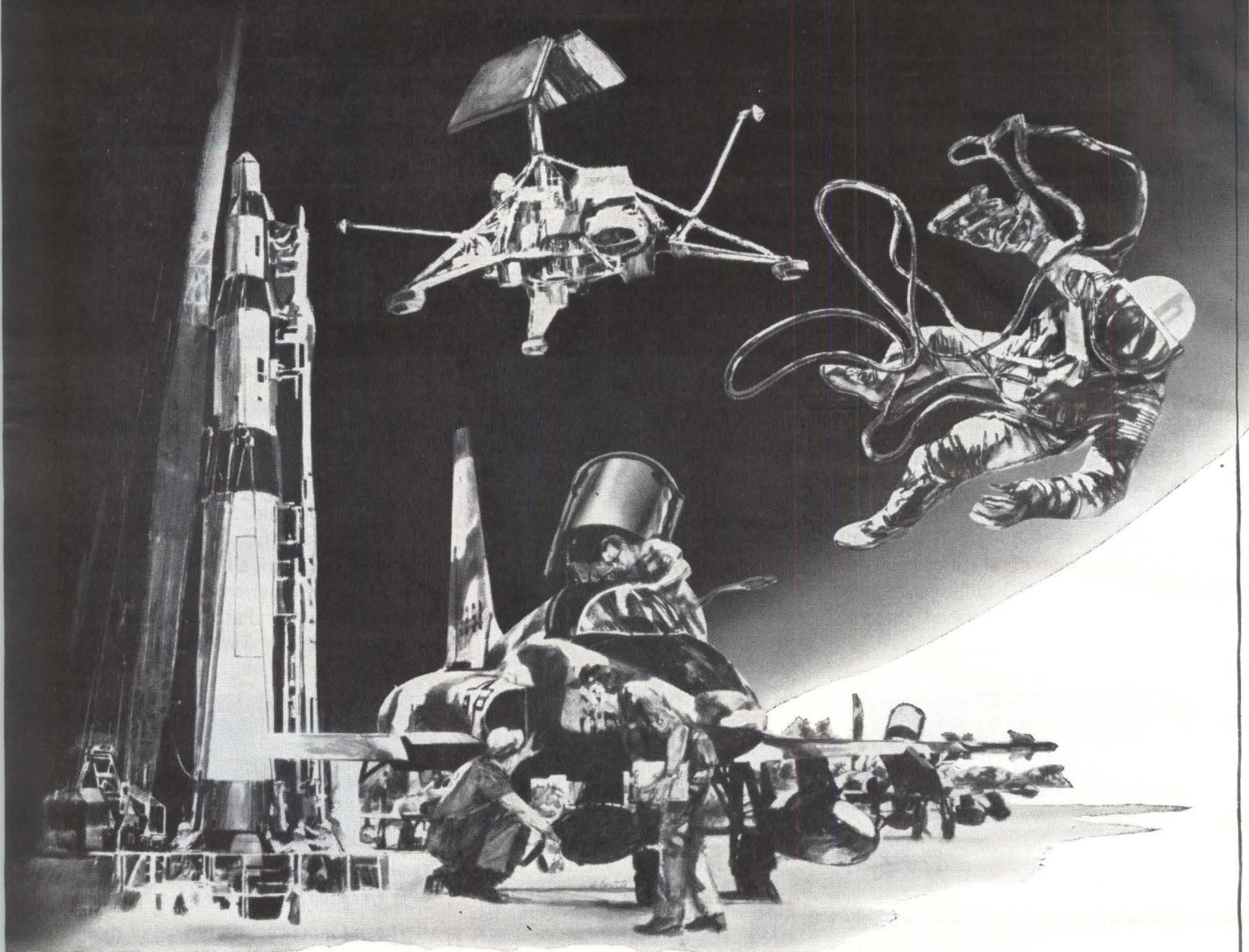

Some connectors will go to any extreme.  
Like our MIL-C-26482 plugs.

You name the commercial, industrial or military, aerospace/aircraft/ground support equipment application ... ITT Cannon Electric probably makes a bayonet-coupling plug for it that meets or exceeds the performance requirements of MIL-C-26482. ITT Cannon, backed by 50 years of experience in connector manufacture and a vast network of distributors, offers the widest range of MIL-C-26482 type plugs

... all competitively priced ... all stocked by distributors ... all immediately available in countless shell sizes and insert arrangements. Call your ITT Cannon Distributor for circular miniatures or subminiatures ... solder or crimp termination ... front or rear release contacts. Specify KPSE, KPT, KPTM, PV or CENTI-K™ connectors. Or just tell your distributor the performance level you require. He'll meet your need.

ITT Cannon Electric, 3208 Humboldt Street, Los Angeles, California 90031. A division of International Telephone and Telegraph Corporation.

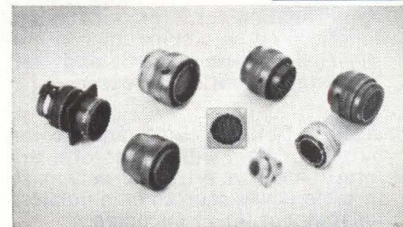

**CANNON** **ITT**



## Electronics Abroad

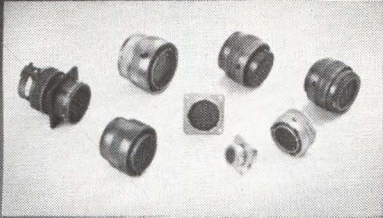

### HERE ARE YOUR AUTHORIZED CANNON DISTRIBUTORS

#### ALABAMA

Nelson Radio & Supply Company, Inc.  
Mobile  
Phone: (205) 479-1471

#### ARIZONA

Kimball Electronics, Inc.  
Phoenix  
Phone: (602) 264-4438

#### CALIFORNIA

ABC Connectors, Inc.  
North Hollywood  
Phone: (213) 875-0665,  
765-8881, 983-1738

#### K-Tronics

Los Angeles  
Phone: (213) 685-5888  
Kieruff Electronics, Inc.  
Palo Alto 94303  
Phone: (415) 968-6292

Liberty Electronics Corp.  
Ingewood  
Phone: (213) OR 8-8111

Richey Electronics, Inc.  
North Hollywood  
Phone: (213) 761-6133  
or 877-2651

San Delcor, Inc.  
San Diego  
Phone: (714) BR 4-3131,  
276-2653

#### COLORADO

Waco Electronics  
Denver  
Phone: (303) 322-7708

#### CONNECTICUT

Connector Corporation  
of America  
New Haven  
Phone: (203) MA 4-0127

#### FLORIDA

Electro Air of Florida, Inc.  
Orlando  
Phone: (305) 241-5461  
Industrial Electronics  
Associates, Inc.  
Palm Beach Gardens  
Phone: (305) 848-8686,  
WX-8686

#### GEORGIA

Electro Air Corp.  
Atlanta  
Phone: (404) 351-3545

#### ILLINOIS

Merqup Electronics, Inc.  
Chicago  
Phone: (312) AV 2-5400  
Radio Distributing  
Company, Inc.  
Chicago  
Phone: (312) 379-2121

#### INDIANA

Radio Distributing  
Company  
Indianapolis  
Phone: (317) ME 7-5571  
Radio Distributing Co., Inc.  
South Bend  
Phone: (219) 287-2911

#### KANSAS

Radio Supply Company, Inc.  
Wichita  
Phone: (316) AM 7-5214

#### LOUISIANA

Southern Radio Supply  
Company, Inc.  
New Orleans  
Phone: (504) 524-2345

#### MARYLAND

Radio Distributing Co.  
Baltimore  
Phone: (301) 377-6402  
or 377-4616

#### MASSACHUSETTS

Lafayette Industrial  
Electronics  
Natick 01762  
Phone: Boston  
(617) 969-6100  
Natick  
(617) 875-1358  
Schweber Electronics  
Waltham  
Phone: (617) 891-8484

#### MICHIGAN

Newark-Detroit  
Electronics, Inc.  
Detroit  
Phone: (313) 548-0250

#### MINNESOTA

LeW Bonn Co.  
(Industrial Sales Division)  
Minneapolis  
Phone: (612) 339-9461

#### MISSISSIPPI

Elliington Electric  
Supply, Inc.  
Jackson  
Phone: (601) 355-0561

#### MISSOURI

Electronic Components  
for Industry Co.  
St. Louis  
Phone: (314) MI 7-5505

Radiolab, Inc.  
Kansas City  
Phone: (816) LO 1-9935

#### MONTANA

Electronic Supply Company  
Billings  
Phone: (406) 252-2197

#### NEW MEXICO

Waco Electronics, Inc.  
Albuquerque  
Phone: (505) 268-2409

#### NEW YORK

Progress Electronics, Inc.  
Plainview, L. I.  
Phone: (516) GE 3-1700  
Schweber Electronics  
Westbury  
Phone: (516) ED 4-7474

Stack Industrial  
Electronics, Inc.  
Binghamton  
Phone: (607) 723-6326

Summit Distributors, Inc.  
Buffalo  
Phone: (716) 884-3450

Time Electronic Sales  
Great Neck, L. I.  
Phone: (516) HU 7-0100

#### NORTH CAROLINA

Kirkman Electronics, Inc.  
Winston-Salem  
Phone: (919) 724-0541

#### OHIO

Hughes Peters, Inc.  
Cincinnati  
Phone: (513) 381-7625

Hughes Peters, Inc.  
Columbus  
Phone: (614) 294-5351  
Radio Distributing  
Company, Inc.  
Cleveland  
Phone: (216) 475-4770

#### OKLAHOMA

Oil Capitol  
Electronics Corp  
Tulsa  
Phone: (918) TE 6-2541

Van Dusen  
Aircraft Supplies, Inc.  
Oklahoma City  
Phone: (405) MU 5-5577

#### PENNSYLVANIA

Aercon, Inc.  
Clifton Heights  
Phone: (215) MA 2-2500

Philadelphia  
Electronics, Inc.  
Philadelphia  
Phone: (215) LO 8-7444

Radio Parts Co., Inc.  
Pittsburgh  
Phone: (412) 361-4600

#### TENNESSEE

Lavender Radio &  
TV Supply, Inc.  
Memphis  
Phone: (901) BR 6-2756

#### TEXAS

Hall-Mark Electronics Corp.  
Garland  
Phone: (214) BR 6-8531  
Harrison Equipment  
Co., Inc.  
Houston  
Phone: (713) CA 4-9131

McNicol, Inc.  
El Paso  
Phone: (915) 566-2936

Sterling Electronics, Inc.  
Dallas  
Phone: (214) FL 7-9131

Wholesale Electronic  
Supply, Inc.  
Dallas  
Phone: (214) TA 4-3001

#### UTAH

Kimball Electronics, Inc.  
Salt Lake City  
Phone: (801) 328-2075

some are Toshiba designs, others are GE designs — rather than a homogeneous family of machines.

**Accent on IC's.** All three of the leaders now have third-generation computers in production. Nippon Electric Co. is putting most of its effort into its NEAC 2200 series, based on the Model 200 computer of Honeywell Inc. Most NEAC 2200 computers have discrete components, but NEC has rounded out the family with two IC machines. At the bottom of the line is the NEAC 2200 Model 50, smaller than anything Honeywell produces in the series. The top of the line is extended with the Model 500.

The Model 50 uses monolithic diode-transistor-logic circuits that NEC produces itself and the company may switch to IC processors for larger models when its output of circuits is sufficient. NEC maintains the redesign for IC's wouldn't be difficult.

For its new large computer, the 2200 Model 500, NEC opted for complementary transistor logic circuits supplied by the Fairchild Camera & Instrument Corp. The first Model 500 was delivered last month to the University of Osaka where it will be used in a time-sharing system similar to Project MAC at the Massachusetts Institute of Technology.

NEC has even larger computers in mind, but they will be built around the current-mode-logic circuits the company has in the works.

**Home made.** Fujitsu's bread-and-butter line is the Series 230 computers it designed itself. The four models currently on the market have discrete components, but three IC machines are in the offing. Fujitsu introduced at the show a scientific and process-control computer—the Series 270 Model 30—with Fujitsu transistor-transistor-logic circuits. Fujitsu makes the IC's itself, but its circuits are interchangeable with the TTL line of Texas Instruments Incorporated.

Hitachi's IC machine is its Series 8000, a version of the Spectra 70 of the Radio Corp. of America. Hitachi currently imports most of the IC's it needs for the computer but eventually will supply its own.

# FREE 16-PAGE SHORT COURSE

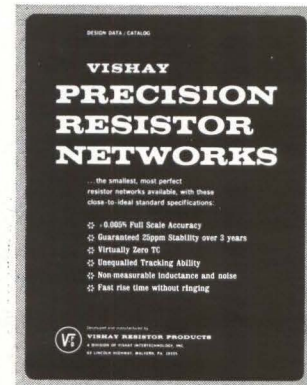

The standard specs on the cover above tell you these are networks with total performance never before available. The other pages tell you the how and where . . . how and where this performance is needed and important...how and where Vishay (and only Vishay) achieves it...how simple network design can be and where you can get experienced assistance. There's even a streamlined Design Check List that'll bring you an immediate quote.

About the only thing we've left out it just how much less this total performance can cost . . . and how much time you'll save (in design and delivery).

To find out, send for your copy of this Design Data/Catalog today. Return the Checklist with your application's specs (we're used to meeting the tightest). We promise a quick response (and quick delivery when you order).

Write to Vishay Resistor Products, 65  
Lincoln Highway, Malvern, Pa. 19355

## VISHAY RESISTOR PRODUCTS



a division of  
Vishay  
Intertechnology, Inc.





■ Ad-Yu Electronics Incorporated P & G Advertising Agency	70	Electronic Modules Corporation Ray Thompson & Associates	164	■ IMC Magnetics Corporation Monad Advertising Design	221
Adage Incorporated Horton Church & Goff Incorporated	166	Electronic Chemicals Corporation Kenyon & Eckhardt Incorporated Advertising	197	IEEE Advertising Alpaugh Advertising	232
Adams-Russell Incorporated Tech/Reps	191	Emerson & Cuming Incorporated Edwin F. Hall Associates	242	Industrial Electronic Engineers Inc. Gumpertz, Bentley & Dolan Inc.	223
Aerovox Corporation, Hi-Q Division Lescarboura Advertising Inc.	253	Engelhard Industries Incorporated Keyes, Martin & Company	204, 205	■ ITT Cannon Electric Incorporated	264, 265
Airpax Electronics Inc. Welch, Mirabile & Company Inc.	200	Electro Tec Corporation McClellan Associates Inc.	14	West, Weir & Bartel Incorporated	
Allen Bradley Company Fenshold Advertising Agency Inc.	62, 63	Erie Technological Products Company Incorporated	250	ITT Semiconductor Neals & Hickok Incorporated	268
Allied Chemical Corporation, Plastics Division McCann Erickson Incorporated	177	Fairchild Instrumentation Faust/Day Incorporated	36, 37	Johanson Mfg. Corporation Josephson, Cuffari & Company	225
Alpha Metals Incorporated Black Russell Morris Inc.	231	Fairchild Semiconductor Incorporated	169, 170, 178	Julie Research Laboratories Incorporated	56
■ Amelco Semiconductor Division of Teledyne Incorporated Sturges & Associates	159	Ferrocube Corporation of America Solow/Wexton Incorporated	68	Keithley Instruments Incorporated Bayless-Kerr Company	208
■ American Lava Corporation Designers Incorporated	194	■ Formica Corporation Division of American Cyanamid Company Clinton E. Frank Incorporated	82	■ Keppo Incorporated Weiss Advertising	22
Amperite Company H.J. Gold Company	240	G-V Controls Armand Richards Advertising Agency	12, 13	Keystone Carbon Company Downing Industrial Advertising	160
Arco Electronics Division of Loral Corporation Campbell Ewald Company	161	Garlock Company Incorporated Richardson, Thomas & Bushman Inc.	234	Krohn-Hite Corporation Stern/Frank Advertising Inc.	263
■ Astrodyne Incorporated Tech/Reps	224	General Dynamics Fort Worth Division Glenn Advertising Inc.	213	■ Lambda Electronics Corporation Michel-Cather Incorporated	76
Automatic Electric Company Tatham-Laird & Kudner Incorporated	185	■ General Electric Components Division George R. Nelson Inc.	32	■ Lapp Insulator Company Incorporated Wolff Associates Incorporated	168
■ Barnstead Still & Sterilizer Company Creamer, Trowbridge & Case Incorporated	206	■ General Electric Company, Equipment Sales, Tube Dept. Doe-Anderson Advertising Agency	39, 40	Litton Industries Useco Division West, Weir & Bartel Incorporated	243
■ Beckman Instruments Incorporated Helipot Division Hixson & Jorgensen Incorporated	241	■ General Electric Meter Division George R. Nelson Incorporated	79	Lockheed California McCann Erickson Company	236
■ Brush Instruments Division of Clevite Corporation Carr Liggett Advertising Incorporated	89	■ General Electric Silicon Products Dept. Ross Roy Incorporated	130, 131	Lockheed Missiles & Space Company McCann Erickson Company	172
Burroughs Corporation, Electronic Components Division Conti Advertising Agency Incorporated	90	General Instrument Corporation, Semiconductor Products Group Norman Allen Associates Incorporated	110	Louisiana State of, Dept. of Commerce & Industry Bauerlein Incorporated	261
Cal Power Corporation Jordan Farrell Incorporated	237	General Radio Company K.E. Morang Company	6	■ McLean Engineering Laboratories Healy Advertising Agency	223
Cedar Engineering Division of Control Data Corporation Colle & McVoy Advertising	235	Globe Industries, Inc. Odiorne Industrial Advertising	243	■ Machlett Laboratories Inc. Fuller & Smith & Ross Incorporated	11
Celanese Corporation of America, Celanese Plastics Division West, Weir & Bartel Incorporated	132	Gries Reproducer Company Harold Marshall Advertising Company Inc.	233	■ Magnetic Metals Company Inc. J.B. Ferguson Jr. Advertising	226
■ Clairex Corporation Michel-Cather Incorporated	222	■ Guardian Electric Mfg. Company K & A Advertising	69	Mallory Control Company a Div. of P.R. Mallory Company	217
■ Clevite Corporation Piezoelectric Division Carr Liggett Advertising Inc.	231	■ Gudebrod Brothers Silk Company Ramsdell-Buckley & Company	162	Aitkin-Kynett Company Incorporated	
Cleveland Institute of Electronics Foote, Cone & Belding, Rapp & Collins Division	58	Hamilton Standard Division of United Aircraft Corporation Cunningham & Walsh Incorporated	176	■ P.R. Mallory & Company Battery Division Aitkin-Kynett Company Incorporated	78
Colorado State of, Industrial Development Division Buchen Advertising Incorporated	209	Hamilton Watch Company Precision Metal Div. Beaumont, Heller & Sperling Inc.	181	Marconi Instruments Armand Richards Advertising Agency	80
Conductron-MRC Division Gray & Kilgore Incorporated	86	Hathaway Instruments Incorporated Eby & Everson Incorporated	230	Matheson Coleman & Bell Leonard M. Sive and Associates	183
Consolidated Electroynamics Corporation, Sub. of Bell & Howell Hixson & Jorgensen Incorporated	34	■ Hayakawa Electronics Company Ltd. Dai-Ichi International Inc.	225	■ Matsuo Electric Company Ltd. Fuji Agency	241
Consolidated Vacuum Corporation Sub. of Bell & Howell Wolff Associates Incorporated	87	■ Heath Company Advance Advertising Service Inc.	235	Mathews & Company, Jas. H. W.S. Hill Company	239
Control Data Corporation Barnes Champ Advertising	218	Heinemann Electric Company Thomas R. Sumdheim Inc.	35		
Corning Glass Works, Electronics Division Rumrill-Hoyt Incorporated	254, 255	Hewlett Packard Colorado Springs Division Tallant/Yates Incorporated	3rd Cover		
Data Control Systems Bodge-Eade Incorporated	233	■ Hewlett Packard Dymec Division Lennen & Newell Incorporated	2		
■ Delco Radio Division of General Motors Corporation Campbell-Ewald Company	198, 199	Hewlett Packard Harrison Division Healy Advertising Agency	182		
Di-Acro Corporation Division of Houdaille Industries Inc. Charles E. Brown Advertising Agency	196	■ Hewlett Packard International Lennen & Newell Incorporated	83		
■ Dimco-Gray Company Weber, Geiger & Kalat Incorporated	190	Hewlett Packard Loveland Division Tallant/Yates Incorporated	1		
■ DuPont de Nemours & Company, Freon Division Batten, Barton, Durstine & Osborn Incorporated	27 to 30	Hewlett Packard Rockaway Division George Homer Martin Associates	163		
Eimac Division of Varian Associates Hofer Dieterich & Brown Inc.	203	Honeywell Computer Control Division Franklin P. Folts Incorporated	66, 67		

## Classified Advertising

F.J. Eberle, Business Mgr.

EMPLOYMENT OPPORTUNITIES 245-249

EQUIPMENT  
(Used or Surplus New)  
For Sale 249

## ADVERTISERS INDEX

A & A Electronics Corp	249
Atomic Personnel, Inc.	249
Fishman, Philip	249
General Dynamics Corp.	246
General Electric Co.	245
Gunther, R.E.	249
IBM Corp.	247
Norman Electronic Sales	249
Radio Research Instrument Co.	249
Sanders Associates, Inc.	248

■ For more information on complete product line see advertisement in the latest Electronics Buyers' Guide





<b>Maurel Manufacturer J.</b> S. P. F. D.	192	<b>Sprague Electric Company, The</b> Harry P. Bridge Company, The	5, 10
<b>Metal Removal Company, The</b> Advertising Producers Associates	228	<b>Stackpole Carbon Company</b> <b>Electronic Components Div</b> Meek & Thomas Incorporated	214, 215
<b>Microdot Incorporated</b> Gumpertz, Bentley & Dolan Advertising	15	<b>Struthers-Dunn Incorporated</b> Harry P. Bridge Company, The	219
<b>Microwave Electronics Corporation</b> Sub. of Teledyne Bonfield Associates	17	<b>Superior Tube Company</b> Gray & Rogers Advertising	212
<b>Minnesota Mining &amp; Manufacturing Company, Chemical Division</b> Young & Rubicam Incorporated	88	<b>Sylvania Electronics Systems</b> Briant Advertising	188
<b>Mitsumi Electric Company Ltd.</b> Dentsu Advertising Ltd.	244	<b>Synthane Corporation</b> Arndt, Preston, Chapin, Lamb & Keen Inc.	239
<b>Motorola Semiconductor Products Incorporated</b> Lane & Bird Advertising Inc.	31, 59	<b>Syntronic Instruments Incorporated</b> Burton Browne Advertising	222
<b>National Cash Register Company</b> Allen Dorsey & Hatfield Incorporated	210	<b>TRW Semiconductor Division</b> Fuller & Smith & Ross Incorporated	49
<b>North Atlantic Industries Inc.</b> Murray Heyert Associates	8	<b>Tally Corporation</b> Bonfield Associates Inc.	165
<b>Ohmite Mfg. Company</b> Fensholt Advertising Agency Inc.	9	<b>Taylor Corporation</b> Gray & Rogers Incorporated	16
<b>Pamotor Incorporated</b> Harry P. Bridge Company	52	<b>Tektronix Incorporated</b> Hugh Dwight Advertising Incorporated	51
<b>Penntube Plastics Company</b> Ernest William Greenfield Inc.	238	<b>Telrex Communication Engineering Laboratories</b> George Homer Martin Associates	236
<b>Permag Corporation</b> Schneider Allen Walsh Incorporated	242	<b>Texas Instruments Incorporated</b> Marsteller Incorporated	128, 129
<b>Philbrick Researches Incorporated</b> Culver Advertising Incorporated	127	<b>Texas Instruments Incorporated</b> Horton, Church & Goff Incorporated	187
<b>Polaroid Corporation</b> Doyle, Dane & Bernbach Incorporated	195	<b>Texas Instruments Incorporated</b> Semiconductor Components Division Don L. Baxter Incorporated	167
<b>Potter &amp; Brumfield Div. of American Machine &amp; Foundry Inc.</b> Grant, Schwenck & Baker Incorporated	24	<b>Thermal American Fused Quartz Incorporated</b> Kniep Associates	186
<b>Precision Scientific Company</b> Tri-State Advertising Company Inc.	243	<b>Transistor Specialties Incorporated</b> Reever Advertising Incorporated	175
<b>Princeton Applied Research Corporation</b> Mort Barish Associates Incorporated	42	<b>Triplet Electrical Instrument Company</b> Burton Browne Advertising	173
<b>Philco Microelectronic Division of Philco Ford Company</b> Hofer, Dieterich & Brown Inc.	227	<b>Trygon Electronics</b> Solow/Wexton Company Inc.	53
<b>RHG Electronics Laboratories Incorporated</b> Samuel H. Goldstein Inc.	227	<b>Trylon Incorporated</b> George Moll Advertising Incorporated	232
<b>Radar Design Corporation</b> Barlow/Johnson Incorporated	220	<b>Tung Sol Electric Company, Division of Wagner Electric Company</b> E.M. Freystadt Associates	241
<b>Radiation Incorporated</b> Basford Incorporated	64, 65	<b>Ucinite Company, The</b> Loudon Advertising Incorporated	60
<b>Radio Corporation of America</b> Al Paul Lefton Company	81, 4th Cover	<b>Ulano &amp; Company, J.</b> Byrde, Richard & Pound Incorporated	229, 239
<b>Radio Materials Company</b> Division of P.R. Mallory Inc. Gallay Advertising Incorporated	61	<b>United Transformer Company</b> Philip Stogel Company	2nd Cover
<b>Rayclad Tubes Incorporated</b> Shafer Associates	41	<b>Unirode Corporation</b> Silton, Callaway & Hoffman Incorporated	18, 19
<b>Rohde &amp; Schwarz Incorporated</b> Armand Richards Advertising Agency	75	<b>Universal Instruments Corporation</b> Caroe Marketing Incorporated	57
<b>San Esu Electronics Company Ltd.</b> General Advertising Agency	236	<b>Utah Industrial Promotion Commission</b> David W. Evans & Associates	262
<b>Sanders Associates</b> Chirurg & Cairns Inc.	224	<b>Vishay Instruments Incorporated</b> Alpern Communications	265
<b>Science Accessories Corporation</b> William Hill Field Advertising	242	<b>Vitro Corporation of America</b> Buchen Advertising Incorporated	216
<b>Seaelectro Corporation</b> Lescarboura Advertising Inc.	233	<b>Volkert Stampings</b> Fred Wittner Company	7
<b>Servo Corporation of America</b> Basford Incorporated	77	<b>Westinghouse Semiconductor</b> ITSM Div. of McCann-Erickson Inc.	256
<b>Sigma Instruments Corporation</b> Marschalk Company Inc.	20, 21	<b>Weston Instruments Archbald Division</b> Arndt, Preston, Chapin, Lamb & Keen Incorporated	84
<b>Signetics Corporation</b> Cunningham & Walsh Incorporated	71	<b>Weston Instruments Incorporated, Transicoil Division</b> Arndt, Preston, Chapin, Lamb & Keen Incorporated	229
<b>Silicon Transistor Corporation</b> A.D. Adams Advertising	85	<b>Wright Machinery Company Division of Sperry Rand Corporation</b> C. Knox Massey and Associates Inc.	174
<b>Sinclair Radio Laboratories Inc.</b> John E. Hayes Company Inc.	211	<b>Zeltex Incorporated</b> Sturges & Associates	235
<b>Sippican Company</b> Electronic Marketing Assistance	54		
<b>Sola Basic Industries, Sola Electric Division</b> Marsteller Inc.	171		
<b>Solitron Devices Incorporated</b> Transistor Division Haselmire Pearson Advertising	55		
<b>Sperry Electronic Tube Division</b> Neals & Hickok Incorporated	72		

## Advertising sales staff

**Frank E. LeBeau [212] 971-6464**

Advertising sales manager

**Walls Clarke [212] 971-2187**  
Assistant to sales manager

**Atlanta, Ga. 30309: Michael H. Miller, 1375**  
Peachtree St., N.E.,  
[404] TR 5-0523

**Boston, Mass. 02116: William S. Hodgkinson**  
McGraw-Hill Building, Copley Square,  
[617] CO 2-1160

**Chicago, Ill. 60611: Robert M. Denmead,**  
J. Bradley MacKimm, Ralph Hanning,  
645 North Michigan Avenue,  
[312] MO 4-5800

**Cleveland, Ohio 44113: William J. Boyle, 55**  
Public Square, [216] SU 1-7000

**Dallas, Texas 75201: Richard P. Poole, 1800**  
Republic National Bank Tower,  
[214] RI 7-9721

**Denver, Colo. 80202: Joseph C. Page, David**  
M. Watson, Tower Bldg., 1700 Broadway,  
[303] 255-5484

**Detroit, Michigan 48226: J. Bradley**  
MacKimm, 856 Penobscot Building  
[313] 962-1793

**Houston, Texas 77002: Kenneth George,**  
2270 Humble Bldg.,  
[713] CA 4-8381

**Los Angeles, Calif. 90017: Ian C. Hill,**  
John G. Zisch, 1125 W. 6th St.,  
[213] HU 2-5450

**Minneapolis, Minn. 55402: J. Bradley**  
MacKimm, 1104 Northstar Center  
[612] 332-7425

**New York, N. Y. 10036:**  
Donald R. Furth [212] 971-3615  
James R. Pierce [212] 971-3615  
George F. Werner [212] 971-3615  
500 Fifth Avenue

**Philadelphia, Pa. 19103:**  
Warren H. Gardner, Jeffrey M. Preston,  
6 Penn Center Plaza,  
[215] LO 8-6161

**Pittsburgh, Pa. 15222: Warren H. Gardner,**  
4 Gateway Center, [412] 391-1314

**Portland, Ore. 97204: James T. Hauptli,**  
218 Mohawk Building, 222 S.W. Morrison  
Street, Phone [503] 223-5118

**Rochester, N.Y. 14534: William J. Boyle,**  
9 Greylock Ridge, Pittsford, N.Y.,  
[716] 586-5040

**St. Louis, Mo. 63105: Robert M. Denmead**  
The Clayton Tower, 7751 Carondelet Ave.  
[314] PA 5-7285

**San Francisco, Calif. 94111:**  
James T. Hauptli, 255 California Street,  
[415] DO 2-4600

**London W1: John W. Patten, Edwin S.**  
Murphy Jr., 34 Dover Street,  
Hyde Park 1451

**Milan: I, via**  
Baracchini Phone: 86-90-617  
86-90-656

**Frankfurt/Main: Gerd Hinske, Dieter**  
Rothenbach, Elsa-Brandstroem Str. 2  
Phone: 72 01 81

**Geneva: Michael R. Zeynel,**  
1, rue du Temple  
Phone: 31 95 60

**Paris VIII: Denis Jacob, Kenneth Davey,**  
17 Avenue Matignon Phone: 359 6637

**Tokyo: Nobuyuki Sato, 1, Kotohiracho**  
Shiba, Minato-Ku [502] 0656

**Osaka: Ryosi Kobayashi, 163, Umegee-cho,**  
Kilta-ku [362] 8771

**George F. Werner [212] 971-2310**  
Manager Electronics Buyers' Guide

**Milton Drake [212] 971-3485**  
Research and circulation manager

**Wallace C. Carmichael [212] 971-3191**  
Business manager

**Stephen R. Weiss [212] 971-2044**  
Production manager

**Thomas M. Egan [212] 971-3140**  
Production manager Electronics Buyers' Guide

**For more information on complete product line see advertisement in the latest Electronics Buyers' Guide**



# Simplify your source selection for 930 DTL

## Specify

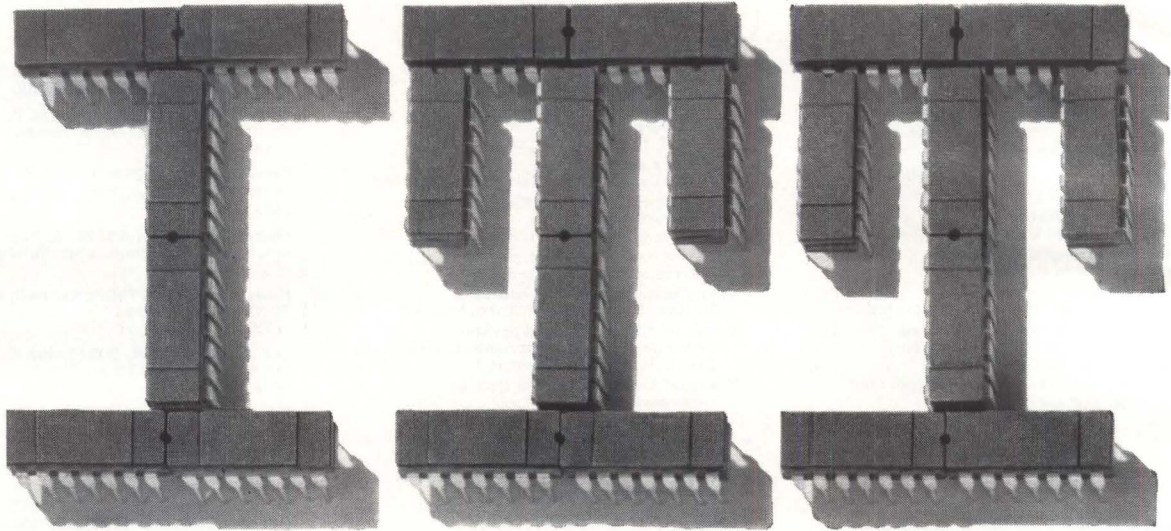

You eliminate series 930 DTL evaluation, delivery, packaging and single source troubles. Here's why:

**Evaluation** — Our 930 DTL circuits and test limits are identical to those of the other leading manufacturer.

**Delivery** — Our on-time delivery helps you eliminate manufacturing scheduling headaches.

**Packaging** — Your choice of dual in-line, flat pack, or TO-5 packages.

**Alternate Source** — With ITT added to your print, you eliminate the potential headaches of single source procurement.

Let us prove it to you. A phone call will get you off-the-shelf 930 DTL delivery from your ITT distributor. For volume procurement, ask your ITT field salesman for a quotation.

ITT SEMICONDUCTORS  
3301 Electronics Way  
West Palm Beach, Florida

Please send me a copy of "ITT's New Unabridged DTL Design Data Book" containing complete information and specifications on all ITT 930 DTL circuits.

NAME \_\_\_\_\_

TITLE \_\_\_\_\_

COMPANY \_\_\_\_\_

ADDRESS \_\_\_\_\_

CITY \_\_\_\_\_ STATE \_\_\_\_\_ ZIP \_\_\_\_\_

**ITT**  
SEMICONDUCTORS

ITT SEMICONDUCTORS IS A DIVISION OF INTERNATIONAL TELEPHONE AND TELEGRAPH CORPORATION, 3301 ELECTRONICS WAY, WEST PALM BEACH, FLORIDA. FACTORIES IN WEST PALM BEACH, FLORIDA; PALO ALTO, CALIFORNIA; LAWRENCE, MASSACHUSETTS; HARLOW AND FOOTSCRAY, ENGLAND; FREIBURG AND NURENBERG, GERMANY



# PRESS!

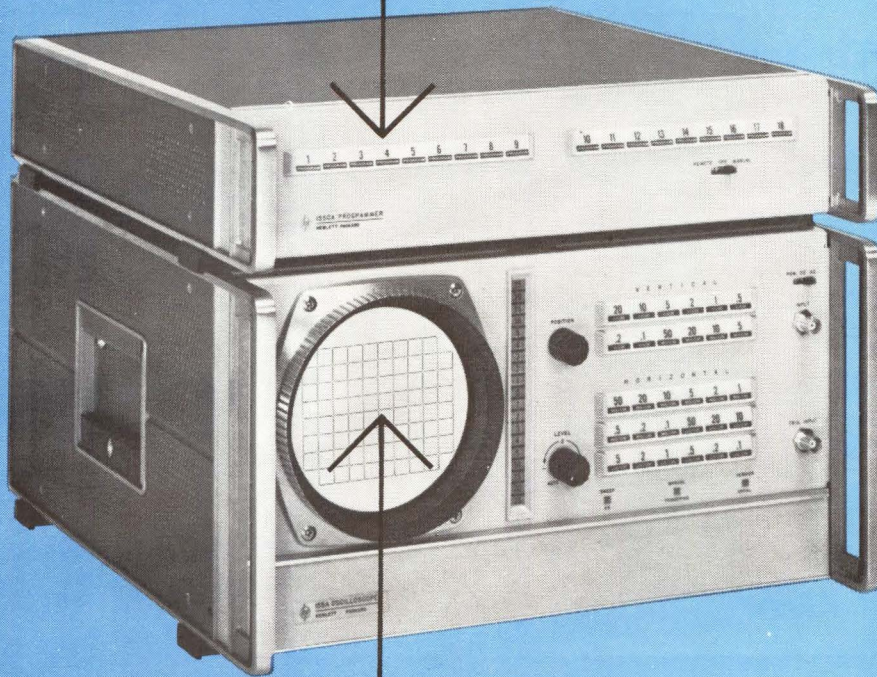

# READ!



## SPEED TESTING & INCREASE PRODUCTION OUTPUT *New hp Model 155A/1550A Push-Button, Programmable Oscilloscope*

Speed production line testing of circuits and components with an easy, fast press / read on the new hp Model 155A/1550A Push-Button Programmable Oscilloscope! This 5 mv/cm, 25 MHz scope—the first designed specifically for production and automatic systems applications—increases production output by reducing test time per unit, simplifying test procedures, minimizing operator errors and fatigue, and shortening training time.

You can insert up to 18 test programs in each 1550A digital programmer, or cascade programmers for additional capability. Each test program can control any or all major scope functions—including calibrated vertical positioning, sensitivity, input coupling, sweep time, trigger source, and trigger slope. Change test programs in only a few minutes by changing diode pin settings or by interchanging programmers. Diode-controlled, digital programming makes the 155A / 1550A fully compatible with any contact-closure-to-ground programmer for high speed, automatic check-out systems.

Confidence in measurements is substantially increased because the unique DC stabilizer circuitry eliminates DC drift. The trace stays where it is positioned, regardless of

sensitivity or sweep. Calibrated vertical positioning over  $\pm 25$  cm dynamic range allows waveform to be accurately offset, magnified, and viewed in detail. Magnification with accurate offset gives big display for ease of reading and greater accuracy.

Confidence in test results is increased by push-button programming because it makes complex tests easier to make. Tests are complete—you have full confidence that you are shipping only good units and rejecting only bad units.

Find out how the new hp Model 155A/1550A Push-Button, Programmable Oscilloscope can increase your production output. Call your nearest hp sales office for a demonstration. Or, write to Hewlett-Packard, Palo Alto, California 94304, Tel. (415) 326-7000; Europe: 54 Route des Acacias, Geneva. Price: hp Model 155A Oscilloscope, \$2450.00; hp Model 1550A Programmer, \$600.00, f.o.b. factory.

**HEWLETT**  **PACKARD**  
An extra measure of quality



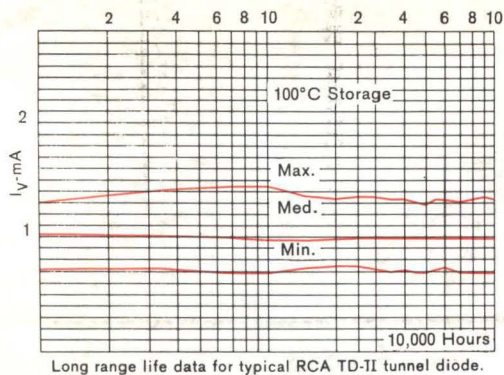

# Unexcelled tunnel- diode reliability assured by **RCA** **TD-II** technology

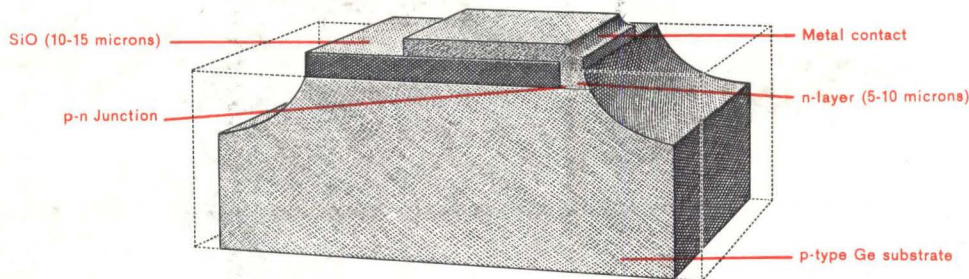

Cross-sectional view of RCA TD-II pellet before and after etching

RCA TD-II technology introduces a new standard of tunnel-diode reliability. Life tests exceeding one-million device hours have demonstrated the unprecedented stability of this epitaxial planar structure, an RCA-pioneered first for tunnel diodes.

In the TD-II process, a SiO layer is initially used to mask the surface of a p-type germanium wafer. Then an n-layer is epitaxially grown over all unmasked or inert areas to form many device junctions simultaneously. Even after individual etching, the diode retains the support of a massive stable substrate—without the “neck” structure found on earlier, less reliable tunnel diodes. Thermal resistance is improved. And, unlike previous designs, connection to a metallized contact can be easily made without placing all force di-

rectly on the junction. Because TD-II is a batch process, you benefit further from low cost and uniform characteristics. Other advantages include:

**Wide Applications**—With over 15 types having  $I_P$  of 5 to 100 mA and  $t_r$  of 100 to 1800 ps, RCA TD-II devices are ideal for high-speed switching and small-signal applications.

**MIL-Tested**—RCA TD-II units are designed to meet MIL-STD-750 including 1500 g shock and 20 g vibration.

**Immediate Availability**—Call your RCA representative today for off-the-shelf delivery. For data sheet and detailed reliability information, write RCA Commercial Engineering, Section I-N-12-2, Harrison, N. J. 07029.



RCA Electronic Components and Devices

**The Most Trusted Name in Electronics**

Circle 902 on reader service card