

v.l. #14

LIBRARY UNIVERSITY OF TENN. MED. UNITS MEMPHIS

Electronics

NO LONGER

Designing the probability computer: page 72
Putting an amplifier design on computer: page 85
What doctors want from technology: page 96

LIBRARY STATE TECHNICAL INSTITUTE AT MEMPHIS July 10, 1967 JUL 10 1967 \$1.00

A McGraw-Hill Publication

Below: Can electronics change the look of the operating room? page 95

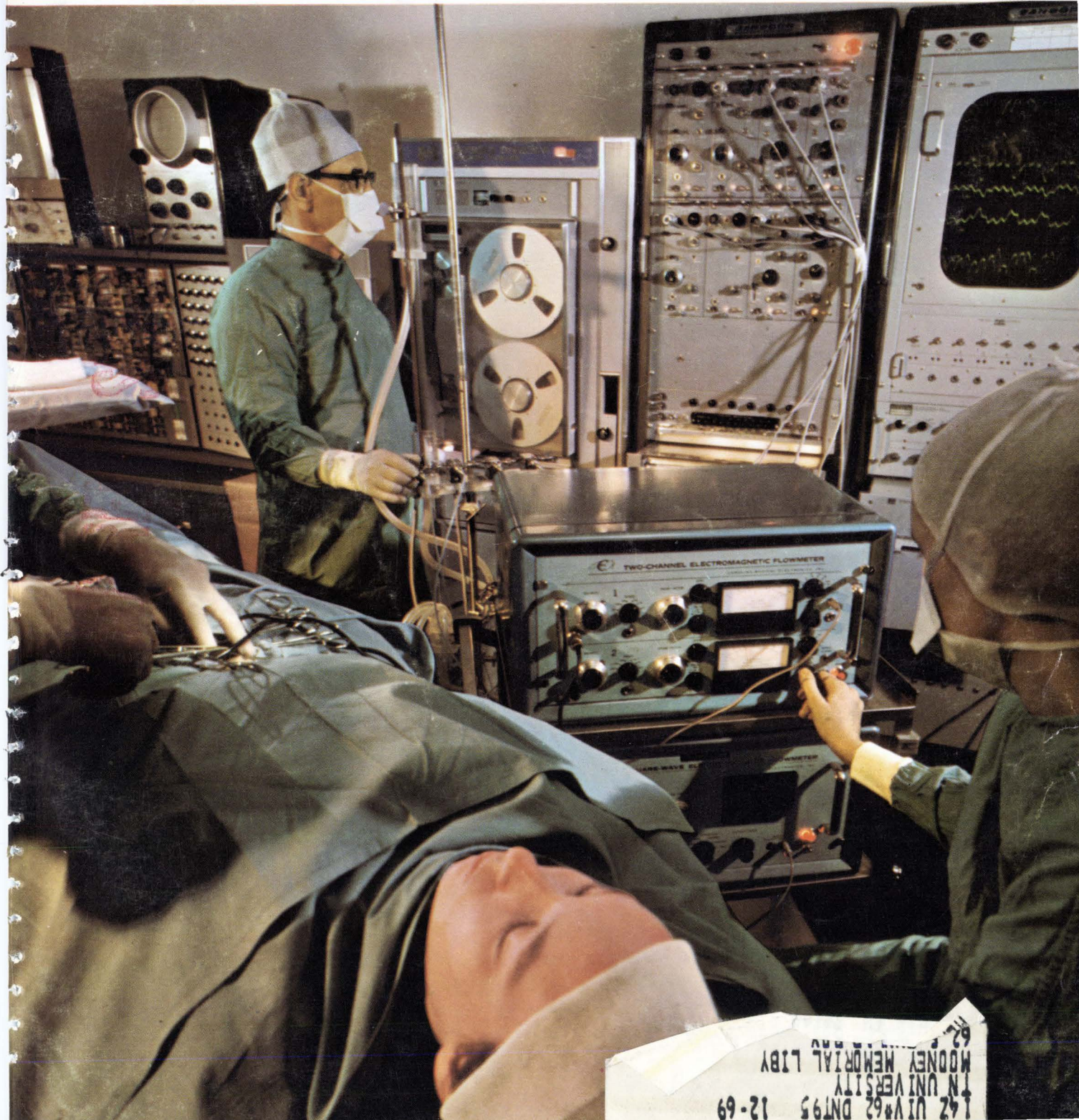

142 UNIV 62 DNT 95 12-69
MOONEY MEMORIAL LIBRY
UNIVERSITY

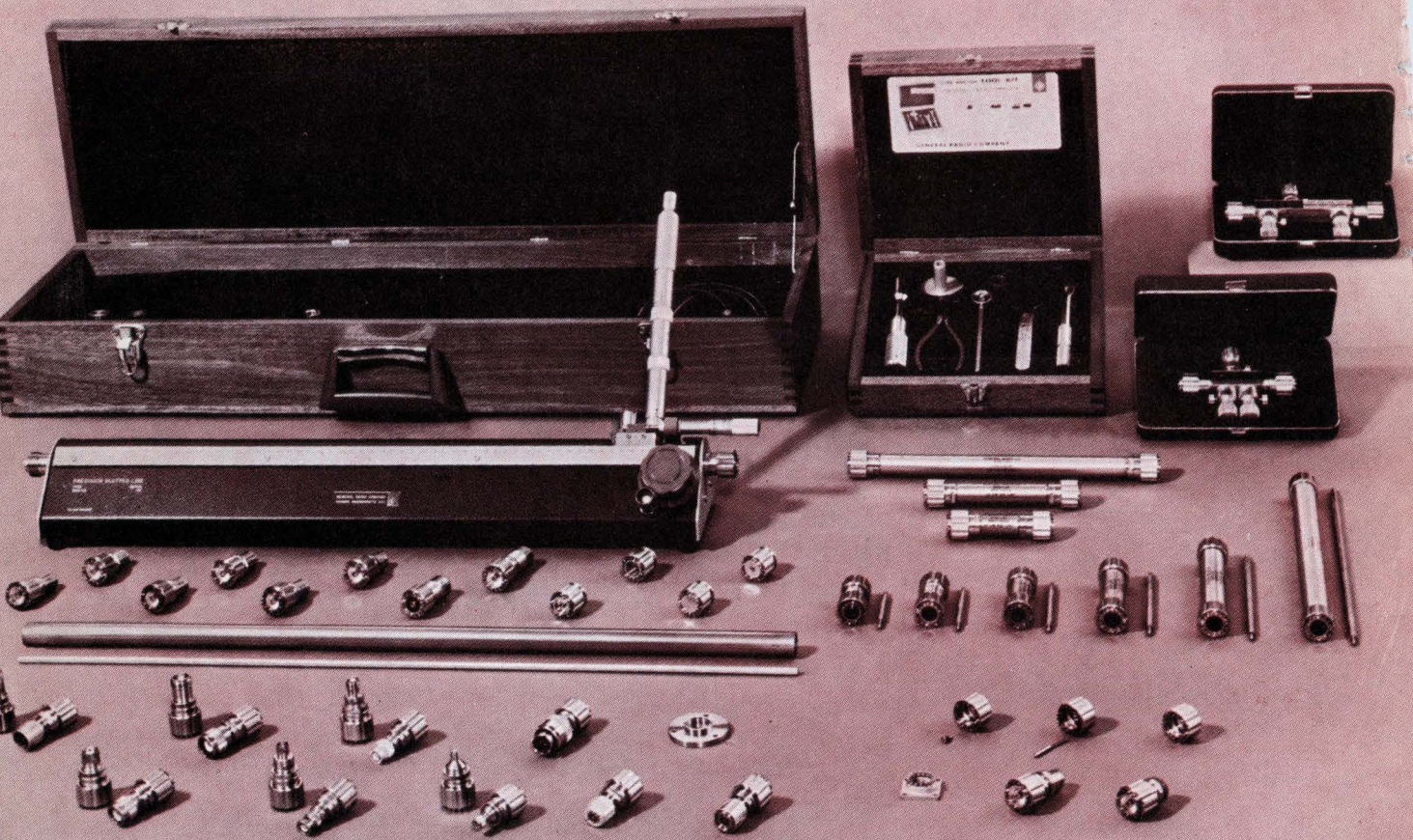

Today's standards for precision coaxial measurements

The GR900 connector gives new meaning to accuracy in microwave measurements. With VSWR less than $1.001 + 0.001 f_{\text{GHz}}$ to 8.5 GHz, characteristic impedance accurate to 0.1%, shielding better than 130 dB, and repeatability within 0.03%, the 14-mm GR900 has become a recognized industry standard.

Today the GR900 line of coaxial components contains air lines, standards, terminations, a slotted line, tuners, elbow, and adaptors to most other popular coaxial connectors (N, TNC, BNC, C, SC, OSM/BRM, GR874, Amphenol APC-7, and 7-mm Precifix). And the GR900 product line is still growing.

Circle 900 on reader service card

For high-accuracy microwave measurements, you won't find anything that will outperform the GR900. For complete information, write General Radio Company, W. Concord, Massachusetts 01781; telephone (617) 369-4400; TWX (710) 347-1051.

GENERAL RADIO

Data acquisition, computation and answers

LIBRARY
UNIVERSITY of TENN. MED. UNITS
MEMPHIS

JUL 10 1967

while you wait.



Only you don't have to wait.

Solutions to your problems come faster with the new Hewlett-Packard 2018 Computerized Data Acquisition System. The system's on-line processor—the 2116A Instrumentation Computer—eliminates any frustrating wait for access time at a central processor, leaving you in full control of your own measurements... with on-line, real-time answers.

Measuring capabilities comprise 200 or more mixed analog inputs which may include dc and ac voltages, resistances and frequencies. Computations are as various as your needs: involving single or multiple inputs, converting readings to engineering units, comparing against limits, solving equations, etc. And you can read out on the medium of your choice—printed sheet, paper tape or magnetic tape.

The big difference is the personal control the 2018 software gives you. Data acquisition "tasks" are written in standard ASA Basic FORTRAN. An exclusive HP Executive Program correlates system operation with time-of-day and allows you to change task constants—channel lists, comparison limits, computation constants, etc.—through the keyboard. The system can then be switched immediately back to automatic operation—without reprogramming.

Cost, including the instrumentation computer, is under \$50,000 installed. Programming training is provided. And—the 2018 system is deliverable immediately.

Don't wait. For more information call your local field engineer or write Hewlett-Packard, Palo Alto, California 94304, Europe: 54 Route des Acacias, Geneva.

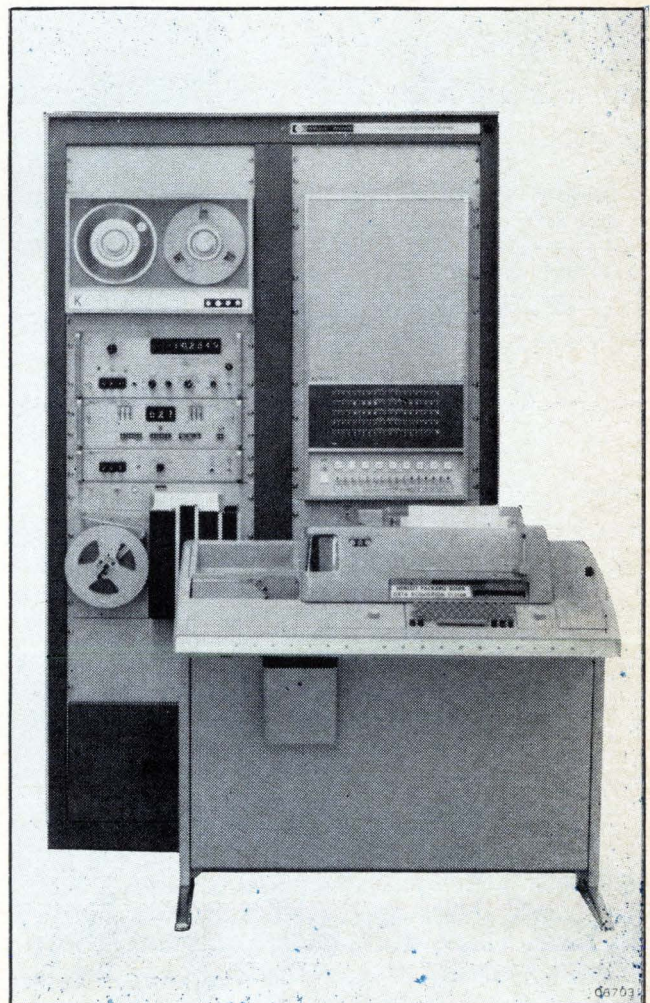

HEWLETT  PACKARD

MEASURING SYSTEMS

How to compare spectrum analyzers:

look at the price tags.

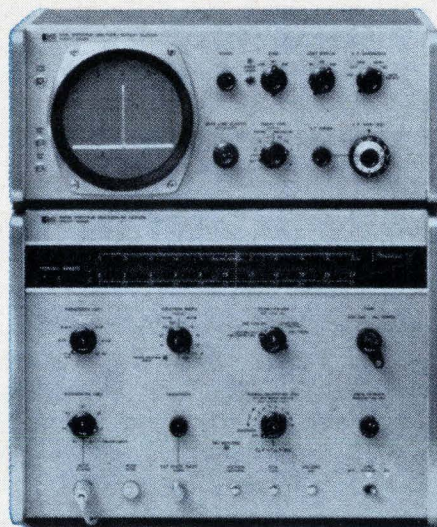

This one costs about \$10,000.

Others cost as little as \$5,000.

The prices are right.

The Hewlett-Packard 8551B/851B, the \$10,000 model, is the only one that gives you 1967 performance . . . RF attenuator for detecting overdriven input and setting level; 60 dB calibrated display range for comparing signals of widely different amplitudes; swept front end, high-frequency IF to see through the clutter of intermodulation, images, spurious and multiple responses; 2 GHz spectrum widths in one

display with exceptionally flat response (± 1 dB with fundamental mixing, $< \pm 3$ dB for harmonic mixing). Some lesser analyzers outclass others. None comes close to the 8551B/851B for performance . . . and for your money's worth. Get all the information with a call to your Hewlett-Packard field engineer. Or write Hewlett-Packard, Palo Alto, California 94304; Europe: 54 Route des Acacias, Geneva.

HEWLETT  PACKARD

News Features

Probing the News

- 125 **Resourcefulness brings linear IC's from obscurity into the marketplace**
131 **\$25,000 inertial system still a will-o-the-wisp**

Electronics Review

- 43 **Companies:** LSI for sale
44 **Medical electronics:** Touching scene
45 **Consumer electronics:** Quick fix
45 **Military electronics:** Just in case; Over and out; On display; The slim look
48 **Communications:** Showing them the way
48 **Solid state:** More complex
50 **Industrial electronics:** Wanted by the FBI; Success stories
54 **Oceanography:** Burrup, burrap
55 **For the record**

Electronics Abroad

- 193 **Soviet Union:** Cold calculation
193 **Japan:** Colorful one; Small talk; Reel time
195 **France:** The miracle worker
195 **West Germany:** Keep it clean
196 **Great Britain:** Sensitive soles; Corporate giant
197 **Around the world**

Departments

- 4 Readers Comment
8 People
14 Meetings
16 Meeting Preview
23 Editorial
25 Electronics Newsletter
57 Washington Newsletter
141 New Products
142 New Products Index
178 New Books
180 Technical Abstracts
182 New Literature
189 Newsletter from Abroad

Technical Articles

I. Design

- Advanced technology** 72 **Stochastic computer thrives on noise**
A new approach to computer organization solves problems that can't be handled now by analog, digital, or hybrid machines
Brian R. Gaines, Standard Telecommunications Laboratories

- Circuit design** 80 **Designer's casebook**
■ Scr ring circuit replaces stepping relays
■ Multivibrator replaces reactor in d-c converter
■ Single control adjusts outputs of several pulse generators
■ Zener diodes control amplitude stretching

- Circuit design** 85 **Computer-aided design: part 10**
Making a video amplifier to measure
Even a well-known circuit can be improved with the aid of a computer
John Pilcicki, Arinc Research Corp. and Richard Hughes, Naval Ordnance Test Station

II. Application

- Medical electronics** 95 **Special report: Medical electronics**
96 **Prescription for medical instrumentation: realism, patience, communications (cover)**
A doctor asks for practical equipment rather than exotic engineering gear that is imaginative but of little use
Robert F. Shaw, Presbyterian Medical Center

- 103 **Collecting the body's signals**
One of the major medical jobs of electronic instrumentation is to measure and record biopotentials. A lot more could be done with this information if the equipment were available
Allan F. Pacela, Beckman Instruments Inc.

Electronics

Editor-in-Chief: Lewis H. Young

Associate managing editors

Design: Samuel Weber

Application: George Sideris

News: Robert Henkel

Copy: Sally Powell

Senior editor

Special projects: Donald Christiansen

Senior associate editors

John F. Mason, Joseph Mittleman, Stephen E. Scrupski

Department editors

Advanced technology: Stephen E. Scrupski

Avionics: W. J. Evanzia

Communications: Leonard Weller

Computers: Wallace B. Riley

Design theory: Joseph Mittleman, Edward Fearon

Industrial electronics: Alfred Rosenblatt

Instrumentation: Carl Moskowitz

Military electronics: John F. Mason

New products: William P. O'Brien, John Drummond, Stephen Fields

Solid State: Mark B. Leeds

Staff writers: James Brinton, Kay Sloman

Section editors

Electronics abroad: Arthur Erikson

Electronics review: Stanley Zarowin

Probing the news: Eric Aiken

Regional bureaus

Domestic

Boston: H. Thomas Maguire, manager; Robin Carlson

Los Angeles: Lawrence Curran, manager; June Ranill

San Francisco: Walter Barney, manager; Mary Jo Jadin

Washington: William D. Hickman, Paul Dickson, Patricia C. Hoehling

Foreign

Bonn: John Gosch

London: Michael Payne

Tokyo: Charles Cohen

Copy editors

Albert Tannenbaum, James Chang, Frederick Corey

Graphic design

Art director: Saul Sussman

Assistant art directors: Ann Mella, Valerie Betz

Production editor: Arthur C. Miller

Editorial secretaries: Claire Benell, Lynn Emery, Kay Fontana, Patricia Gardner, Lorraine Longo

McGraw-Hill News Service

Director: John Wilhelm; Atlanta: Fran Ridgway; Chicago: James Rubenstein;

Cleveland: Arthur Zimmerman; Dallas: Marvin Reid;

Detroit: N. Hunter; Houston: Robert E. Lee; Los Angeles: Michael Murphy, Gerald Parkinson

Pittsburgh: Louis Gomolak

San Francisco: William F. Arnold

Seattle: Ray Bloomberg; Washington: Arthur L. Moore, Charles Gardner,

Herbert W. Cheshire, Seth Payne, Warren Burkett, James Canan, William Small

McGraw-Hill World News Service

Bonn: John Johnsrud; London: John Shinn;

Mexico City: Bruce Cross; Milan: Ronald Taggiasco;

Moscow: Howard Rausch; Paris: Peter Kilborn;

Rio de Janeiro: Wes Perry; Tokyo: Marvin Petal

Reprints: Susan Nugent

Circulation: Milton Drake

Publisher: Gordon Jones

Electronics: July 10, 1967, Vol. 40, No. 14

Published every other Monday by McGraw-Hill, Inc. Founder: James H. McGraw 1860-1958.

Printed at 99 North Broadway, Albany, N.Y. 12207; second class postage paid at Albany, N.Y.

Executive, editorial, circulation and advertising addresses: McGraw-Hill Building, 330 W. 42nd Street, New York, N.Y. 10036. Telephone (212) 971-3333. Teletype TWX N.Y. 212-640-4646. Cable address: MCGRAWHILL N.Y.

Subscriptions are solicited only from those actively engaged in the field of the publication. Position and company connection must be indicated on orders. Subscription prices: United States and possessions and Canada, \$8.00 one year, \$12.00 two years, \$16.00 three years; all other countries, \$25.00 one year. Single copies: United States and possessions and Canada, \$1.00; all other countries, \$1.75.

Officers of McGraw-Hill Publications: Joseph H. Allen, President; Bayard E. Sawyer, Executive Vice President; Vice Presidents: J. Elton Tuohig, Operations; John R. Callahan, Editorial; John M. Holden, Marketing; Huber M. Gemmill, Circulation; Angelo R. Venezian, Production; Robert M. Wilhelmy, Controller.

Officers of the Corporation: Donald C. McGraw, Chairman of the Board; Shelton Fisher, President; L. Keith Goodrich, Donald C. McGraw, Jr. and Robert E. Slaughter, Executive Vice Presidents; John J. Cooke, Vice President and Secretary; John L. McGraw, Treasurer.

Title © registered in U.S. Patent Office: © Copyright 1967 by McGraw-Hill, Inc. All rights reserved. The contents of this publication may not be reproduced either in whole or in part without the consent of copyright owner.

Subscribers: The publisher, upon written request to our New York office from any subscriber, agrees to refund that part of the subscription price applying to copies not yet mailed.

Please send change of address notices or complaints to Fulfillment Manager; subscription orders to Circulation Manager, Electronics at address below. Change of address notices should provide old as well as new address, including postal zip code number. If possible, attach address label from recent issue. Allow one month for change to become effective.

Postmaster: Please send form 3579 to Fulfillment Manager, Electronics,

P.O. Box 430, Hightstown, New Jersey 08520

Readers Comment

Is Einstein wrong?

To the Editor:

The radar doppler technique that furnished the velocity and range data for landing Survey 3 on the moon [May 15, p. 110] is impossible under Einstein's theory. Notice that the range,

$$R = (\Delta F \pm F_d) c / 2M$$

is actually determined by directly comparing the phase of the out-and-back signal with that of the vehicle-borne transmitter. There are two components, ΔF , the phase delay due to the altitude above the moon's reflective surface, and F_d , a doppler phase shift, due to the relative velocity of the ship with respect to the moon.

Under Einstein's special theory, however, it is recognized by all authorities that the phase of a light signal is independent of velocity (invariant under a transformation of coordinates). Hence, the doppler shift, F_d , cannot possibly affect the range measurement.

Consequently, either the above equation is wrong and will yield wrong range measurements, or else Einstein's principles of Lorentz covariance is false. And so we have

Expanded new product coverage

Starting in this issue, on page 141, Electronics expands its coverage of new product developments. In the new format there are two kinds of stories:

1. Comprehensive stories about new products that represent a significant design change, or a radical new application, or a marketing diversification or an unusual product evolution; in this issue there are 12 such stories.

2. Brief stories about new products which represent important improvements in performance or cost. These are collected into categories and appear in review sections; in this issue, 72 such new products are reported.

An index of this new New Products section appears on page 142.

Only from Sprague!

DIGITAL-TO-ANALOG

HYBRID D to A CIRCUITS

with precision components not found in monolithic integrated microcircuits

FOUR BIT SERIES

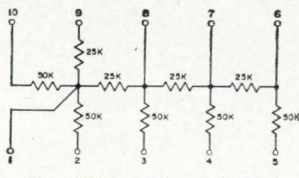

UT-1000 LADDER NETWORK

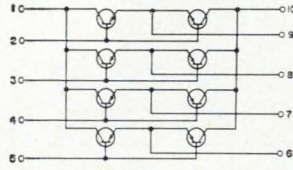

UD-4001 LADDER SWITCH

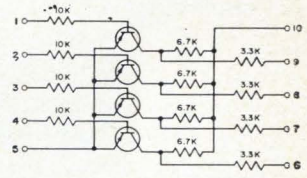

UD-4024 BUFFER AMPLIFIER

FIVE BIT SERIES

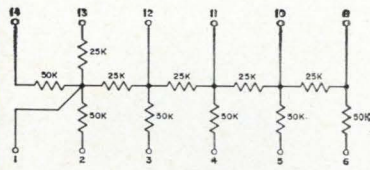

UT-1001 LADDER NETWORK

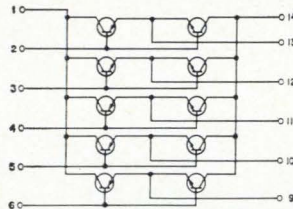

UD-4036 LADDER SWITCH

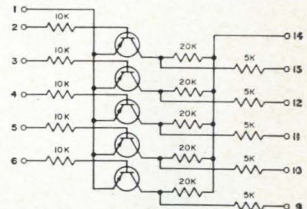

UD-4037 BUFFER AMPLIFIER

Up to 12 bits with less than 1/2 bit error!

- Improved tracking over temperature range of -55 C to +125 C.
- 3 to 1 size reduction over conventional converters using discrete components.
- Reduced handling of components... fewer external connections... lower assembly costs.
- 4-bit series expandable to 8 or 12 bits... 5-bit series expandable to 10 bits.
- Silicon-base hybrid microcircuits in hermetically-sealed flat packs.

- Combination of precision thin-film tantalum nitride resistors, nickel-chromium resistors, and active devices of planar construction.

- Packaged for compatibility with monolithic circuits.



For complete technical data on D-to-A microcircuits, write to Technical Literature Service, Sprague Electric Company, 35 Marshall Street, North Adams, Massachusetts 01247.

SPRAGUE COMPONENTS

THIN-FILM MICROCIRCUITS
INTEGRATED CIRCUITS
TRANSISTORS
CAPACITORS
RESISTORS

PULSE TRANSFORMERS
INTERFERENCE FILTERS
PULSE-FORMING NETWORKS
TOROIDAL INDUCTORS
ELECTRIC WAVE FILTERS

CERAMIC-BASE PRINTED NETWORKS
PACKAGED COMPONENT ASSEMBLIES
BOBBIN and TAPE WOUND MAGNETIC CORES
SILICON RECTIFIER GATE CONTROLS
FUNCTIONAL DIGITAL CIRCUITS



'Sprague' and '®' are registered trademarks of the Sprague Electric Co.

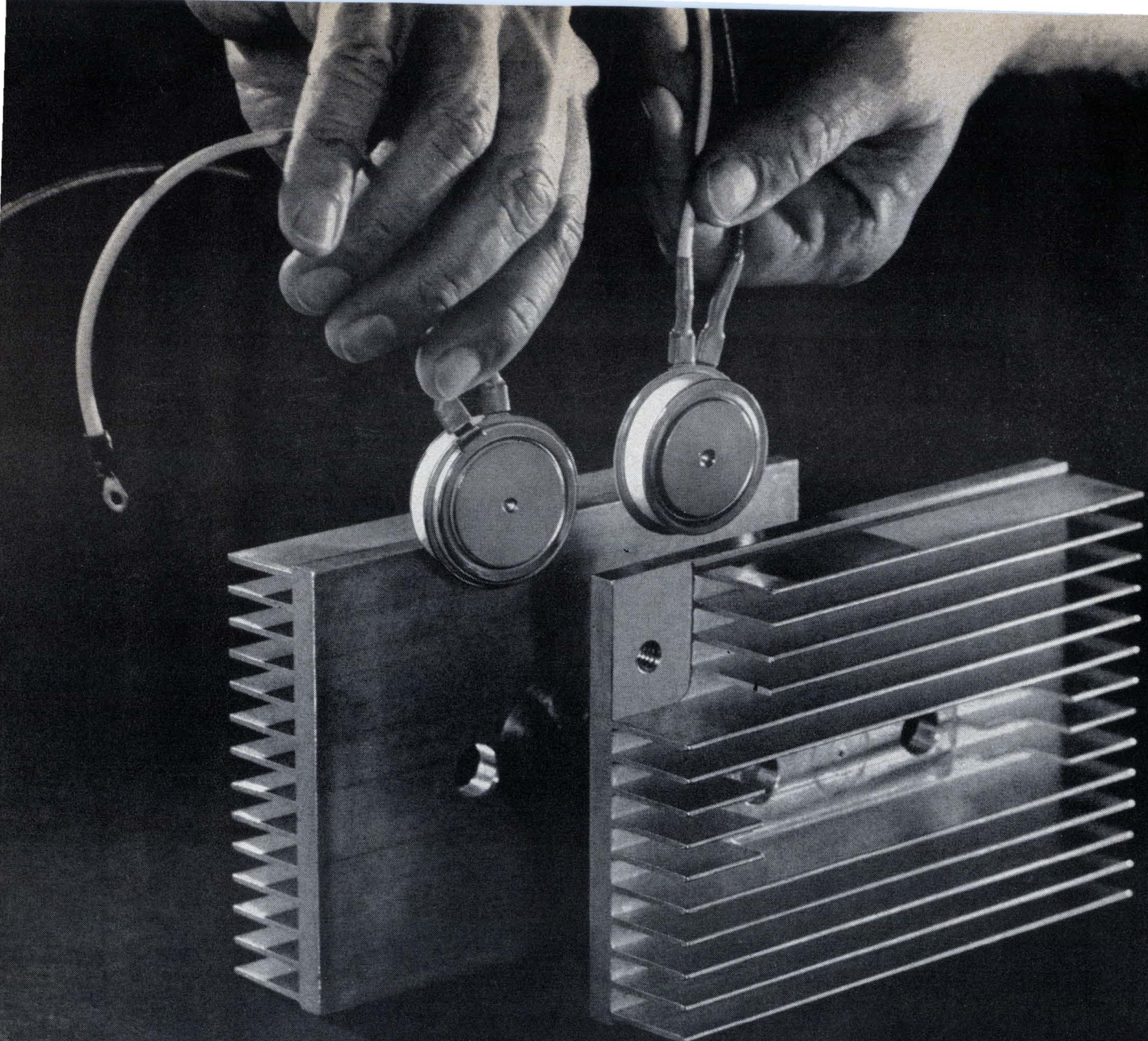

Some day most thyristors will look like the new Westinghouse reversible Pow-R-Disc.™

Reason: 75% more amps per dollar.

Here's the new direction in thyristor design that can help keep your products competitive into the 1970's. Westinghouse Pow-R-Disc thyristors with "two-sided" heat sinking make possible a radical improvement in heat transfer and current handling capability.

For example, the same basic silicon chip that controls 110 amps RMS in a conventional stud mount device can control 180 amps RMS in the Pow-R-Disc thyristor. In addition the Pow-R-Disc thyristor costs about 10% less! Result: 75% more amps per device dollar. Surge ratings and voltages are equally impressive... up to 5000 amps and 1500 volts.

Flexibility of mounting is unequalled—a

amps RMS—and merely flip the device over to change from forward to reverse polarity.

Pow-R-Disc thyristors have the unique Westinghouse Lifetime Guarantee* marked by this symbol ♣ on the package. Reason: High quality coupled with original Westinghouse CBE construction that eliminates solder joints and ends thermal fatigue.

Three current ratings are available now: Type 227—180 amp, Type 228—275 amp, and Type 229—400 amp. Voltage rating on all three is up to 1500V.

For data, call your Westinghouse distributor. Or write Westinghouse Semiconductor Division, Youngwood, Pennsylvania 15697.

♣ Westinghouse warrants to the original purchaser that it will correct any defects in workmanship, by repair or replacement f.o.b. factory, for any silicon power semiconductor bearing this symbol ♣ during the life of the equipment in which it is originally installed, provided said device is used within manufacturer's published ratings and applied in accordance with good engineering practice. The foregoing warranty is exclusive and in lieu of all other warranties of quality whether written, oral, or implied (including any warranty of merchantability of fitness for purpose).

You can be sure
if it's Westinghouse



two alternatives from which to choose:

Is Einstein's theory wrong, or have the lunar soft landings been fakes?

Pascal M. Rapier

Director
Newtonian Science Foundation
Rivervale, N. J.

The author replies:

Ryan Aeronautical Co. engineers say their understanding of Einstein's theory is that it gives a doppler shift differing from that of classical theory by the factor $1/\sqrt{1-\beta^2}$, where β is the ratio of the vehicle velocity to the speed of light. For Surveyor approach velocities, this factor differs from unity by one part in 10^{-11} at most. The lunar landings do not appear, therefore, to shed any light on the question of the validity of relativity theory.

C.J. Badewitz

Director
Electronics and Space System
Ryan Aeronautical Co.
San Diego, Calif.

Historical postscript

To the Editor:

In the story "Out of the past" [June 12, p. 33], your historical account of the color-system activities before the Federal Communications Commission is not very accurate. CBS first proposed a field-sequential color system in 1946 and received a negative decision from the FCC. At that time, CBS was proposing color in the uhf region.

In the hearings begun in 1949, CBS proposed a field-sequential color system in six-megahertz channels for broadcasting of television

by all stations, not just for network broadcasting. While CBS chose to use a rotating filter in front of a single camera tube, a camera with three camera tubes such as the RCA TK-41 could certainly be operated in the field-sequential mode without a rotating filter. Likewise, CBS chose to use a rotating filter in front of a conventional black-and-white kinescope in the receiver. During this same period, we operated a field-sequential receiver in RCA Laboratories using an RCA's shadow-mask kinescope.

Actually, the issue that caused the FCC to adopt the presently used system was that of compatibility.

The present system can hardly be called "the three-vidicon compatible-color system" for the RCA TK-41 used three image orthicons, and now we have the RCA TK-42 with one image orthicon and three vidicons.

Further, the cameras used by CBS in the 1949-1950 hearings used an image orthicon and a whirling disc while the cameras used by RCA and the rest of the industry have contained three image orthicons until quite recently. Vidicons could hardly have played a part in FCC deliberations since the first RCA Type 6198 vidicons were first made commercially available in March, 1952.

George H. Brown

Executive vice president
Research and Engineering
Radio Corp. of America
Princeton, N.J.

▪ This short news story did not intend a comprehensive review of the history of color tv. But reader Brown is right about our confusing vidicon with orthicon in the part about the early FCC deliberations.

...now
5 MHz
capable
to your
digital
voltmeter

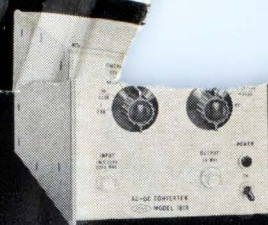

with PM's new AC/DC Converter

A unique rectifying detector circuit* employing MOS FETs provides a frequency range of 5 Hz to 5 MHz, 70 dB dynamic range and 300 microvolt sensitivity.

DC output is the RMS value of the AC signal.

In addition to its usefulness with DVMS, the analog output is ideal for swept frequency measurements where plots of filter characteristics are needed.

Add the companion PM Logarithmic Converter for direct measurements in dB.

PM 1008 AC/DC Converter: \$900

*PATENT PENDING

For details on this and other intriguing new PM instruments, write or call:

PM PACIFIC
MEASUREMENTS
INCORPORATED

940 INDUSTRIAL AVENUE,
PALO ALTO, CALIFORNIA
(415) 328-0300

SUBSCRIPTION SERVICE

Please include an Electronics Magazine address label to insure prompt service whenever you write us about your subscription.

Mail to: Fulfillment Manager
Electronics
P.O. Box 430
Hightstown, N.J. 08520

To subscribe mail this form with your payment and check new subscription renew my present subscription

Subscription rates: in the U.S.: 1 year \$8; two years, \$12; three years, \$16. Subscription rates for foreign countries available on request

CHANGE OF ADDRESS

ATTACH
LABEL
HERE

If you are moving, please let us know five weeks before changing your address. Place magazine address label here, print your new address below.

name

address

city

state

zip code

Did You Know Sprague Makes 32 Types of Foil Tantalum Capacitors?

POLARIZED CAPACITORS



plain-foil
Type 121D non-polarized plain-foil
Type 122D polarized etched-foil
Type 123D non-polarized etched-foil

ASK FOR BULLETIN 3602C

Circle 332 on readers
service card

85 C TUBULAR TANTALEX® CAPACITORS



Type 110D polarized plain-foil
Type 111D non-polarized plain-foil
Type 112D polarized etched-foil
Type 113D non-polarized etched-foil

ASK FOR BULLETIN 3601C

Circle 333 on readers
service card

RECTANGULAR TANTALEX® CAPACITORS



Type 300D polarized
plain-foil
Type 301D non-polarized
plain-foil
Type 302D polarized
etched-foil
Type 303D non-polarized
etched-foil

ASK FOR BULLETIN 3650

Circle 334 on readers
service card

TUBULAR TANTALUM CAPACITORS TO MIL-C-3965C



CL20, CL21 125 C polarized etched-foil
CL22, CL23 125 C non-polarized etched-foil
CL24, CL25 85 C polarized etched-foil
CL26, CL27 85 C non-polarized etched-foil
CL30, CL31 125 C polarized plain-foil
CL32, CL33 125 C non-polarized plain-foil
CL34, CL35 85 C polarized plain-foil
CL36, CL37 85 C non-polarized plain-foil

Circle 335 on Readers
service card

RECTANGULAR TANTALUM CAPACITORS TO MIL-C-3965C



CL51 polarized plain-foil
CL52 non-polarized plain-foil
CL53 polarized etched-foil
CL54 non-polarized etched-foil

Circle 336 on readers
service card

For comprehensive engineering bulletins on the capacitor types in which you are interested, write to:
Technical Literature Service
Sprague Electric Company
35 Marshall Street
North Adams, Mass. 01248

45C-5161 R1

SPRAGUE®

THE MARK OF RELIABILITY

Sprague and ® are registered trademarks of the Sprague Electric Co.

People

The research aims of the Avionics Laboratory at Wright-Patterson Air Force Base, Ohio, may shift as a result of the appointment of a new director, **Col. James L. Dick**. Although the Avionics Lab is primarily associated with electronics, Dick's experience and interests are primarily concentrated on the effects of nuclear radiation on men and equipment. This is an indication that the Air Force may place more emphasis on the problems of radiation-resistant electronic hardware.



Col. James L. Dick

Holder of a doctorate in nuclear chemistry, Dick won the Department of Defense Commendation Medal for his management of Project Roller Coaster, a study of radiation hazards associated with nuclear weapons.

Formerly vice commander of the Air Force Cambridge Research Laboratories, Bedford, Mass., Dick replaces a civilian, Peter R. Murray, at Wright-Patterson.

A \$50,000 inertial navigation system could be flying in the early 1970's, according to **Robert E.**

Honer of Litton Industries Inc.'s Guidance and Control Systems division. Like others in the industry, Honer isn't as optimistic as the Air Force, which is preparing to test an inertial navigator that it claims could cost about \$45,000 in production quantities. [For more on the Air Force project, see page 131.]



Robert E. Honer

Honer, 46, who just joined the division as vice president and director of planning, hopes to make Litton "as dominant in commercial navigation systems as it is in the military market." He claims that Litton now sells 90% of the country's military inertial navigators, and sees an immediate market for sev-

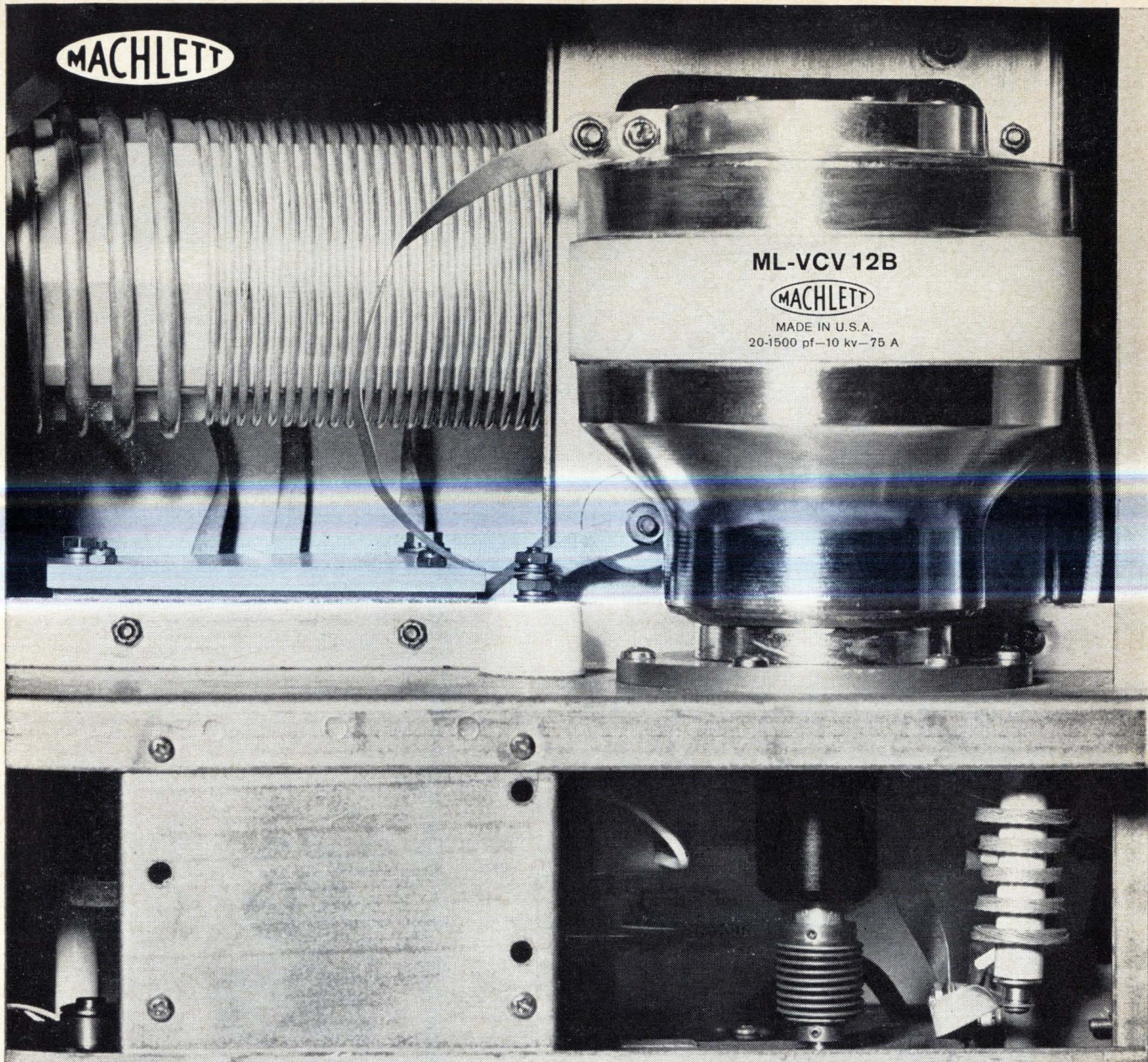

TRW's T-368/URT transmitters* use Machlett variable vacuum capacitors

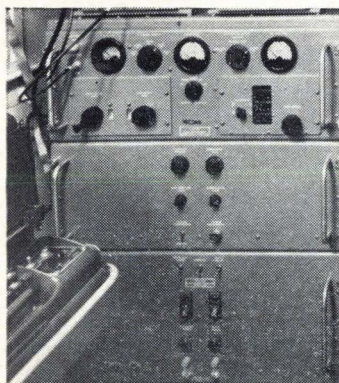

For peak performance under adverse temperature and humidity conditions, TRW's rugged field transmitters for military teletypewriter communications use ML-VCV 12B ceramic variable vacuum capacitors.

The ML-VCV 12 series: 20-1500 pF; 7.5; 10, 15 kV and 75A RMS.

Direct replacements for previously used glass capacitors, these ceramic units provide great structural rigidity and low capacitance change with temperature variation.

Send for "Vacuum Variable Capacitors—An Introduction to their Design, Ratings and Installation," printed in the Machlett *Cathode Press: The Machlett Laboratories, Inc., 1063 Hope St., Stamford, Conn. 06907.*

*Used in Radio Set AN/GRC-26D, Frequency Range: 1.5-20 mc
Power levels: AM voice or FSK/AM 400 watts, CW or FSK 450 watts.

The Machlett Laboratories, Inc., welcomes resumes from engineers and scientists.

RAYTHEON

THE MACHLETT LABORATORIES, INC.

A SUBSIDIARY OF RAYTHEON COMPANY

ECONOTAN[®]

MINIATURE SOLID TANTALUM CAPACITORS

UP TO 35 WVDC

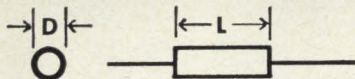

CASE SIZE	CT	CM	CL
DIAMETER	.095	.133	.180
LENGTH	.260	.320	.345
CUBIC INCHES	.00184	.00444	.00877

- Metal can/epoxy construction
- 2 to 35 WVDC voltage ratings
- .0047 to 68 mfd capacitance range
- $\pm 20\%$ and $\pm 10\%$ standard tolerances
- -55°C to $+85^{\circ}\text{C}$ temperature range
- 6% max. DF most values
- .5 to 2.0 μA max. leakage
- 130% surge voltage specification
- 20,000G's, 10 msec shock specification
- 2,000 hour life test
- Mylar sleeves

BEST DELIVERY IN THE INDUSTRY

AVAILABLE ON REQUEST:

- TECHNICAL LITERATURE
- RELIABILITY DATA
- SAMPLE ECONOTAN[®] UNITS



COMPONENTS, INC.

MAINE DIVISION



SMITH STREET / BIDDEFORD, MAINE / 207-284-5956

People

eral thousand nonmilitary systems.

Litton's latest commercial unit, the LTN-51, is to be delivered to American Airlines in October. A prototype begins flight tests this month and Litton hopes it will be the first such navigator to be certified by the FAA.

Systems selling for \$100,000 to \$125,000 are attractive now for commercial users, says Honer. But, he points out, systems priced at \$50,000 would open up a wider market with sales to owners of corporate and private planes.

Litton might use large-scale arrays of metal oxide semiconductor integrated circuits to reduce system size, cost, and power requirements. Two programs are under way to exploit mos technology in computers [Electronics, March 6, p. 25].

"My five years with Litton Industries," says **Frederick T.C. Bartels**, "gave me an understanding of the



problems users have with the changing integrated circuit field. But I was anxious to get closer to research and development." So the 34-year-old Bartels switched from customer—the role he filled as technical director of Litton's Guidance and Control division—to developer. He becomes director of technology for the semiconductor operation of the Union Carbide Corp.'s Electronics division as it prepares to plunge into the ic business.

The first step will take place in San Diego, Calif., in October with the opening of an ic plant.

The San Diego plant will turn out homegrown metal-oxide-silicon digital and linear bipolar devices. A number of single transistors and a dual transistor pair are in pilot production. Bartels' department also is developing dielectric isolation approaches. Slated for introduction later this year is a linear bipolar wideband video amplifier.

Model QRE 7.5-10



Model QRE 10-3.7

Sorensen Off-the-Shelf Power Supplies Designed for Integrated Circuits:

Sorensen has provided stock availability of the new QRE Series. This series was designed specifically for use with integrated circuits, micro miniature chips, and digital logic circuitry. QRE provides overvoltage protection within 10 microseconds, voltage regulation, line and load combined, is $\pm 0.005\%$ or $\pm 0.01\%$.

All QRE units include these Sorensen features, series/parallel operation, remote sensing, remote programming and high stability. Designed as a space saving system the QRE Series may be selected from either modular or 3 1/2" high rack units.

MODEL	V/A RANGES	PRICES
QRE 10-2.2	0-10V, 0-2.2A	\$135
QRE 10-3.7	0-10V, 0-3.7A	155
QRE 7.5-10	0-7.5V, 0-10A	.295
QRE 7.5-20	0-7.5V, 0-20A	465
QRE 7.5-50	0-7.5V, 0-50A	595



For QRE details, or for information on other stock or custom DC power supplies, AC line regulators, frequency changers, or for our free catalog #662A, contact your Sorensen rep., or Raytheon Company, Sorensen Operation, Richards Ave., Norwalk, Conn. 06856. Tel: 203-838-6571.

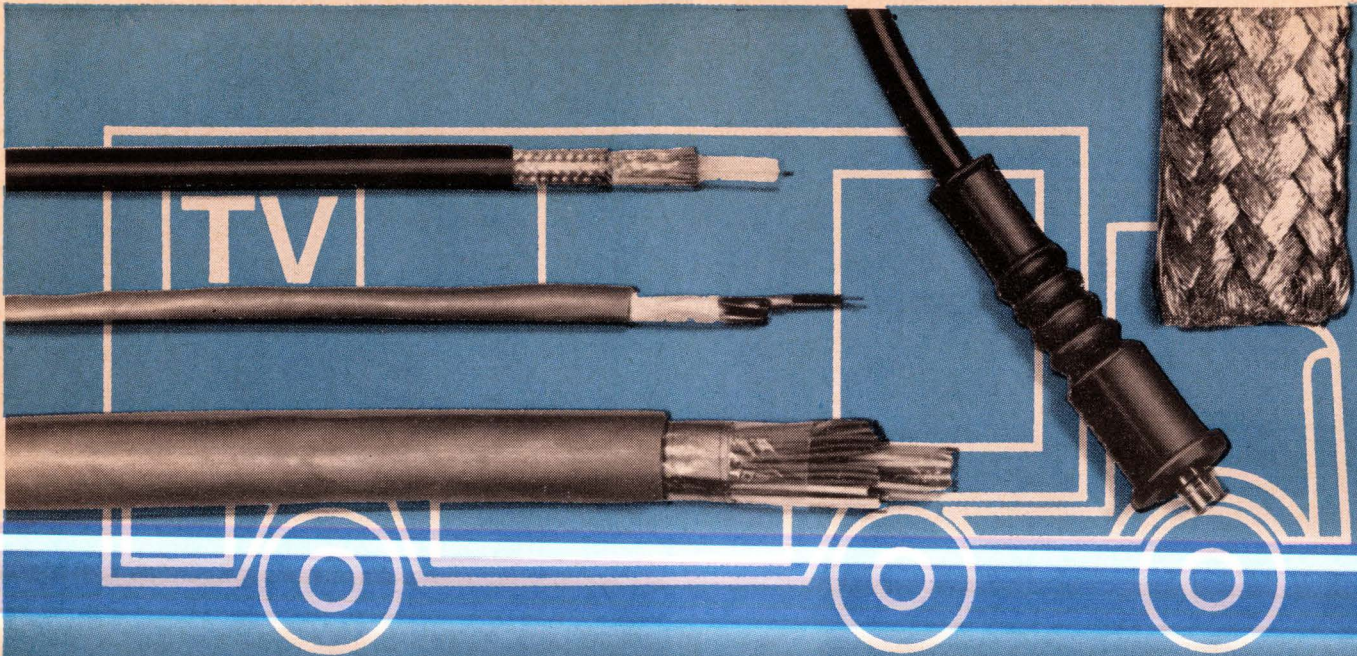

talk about systems...

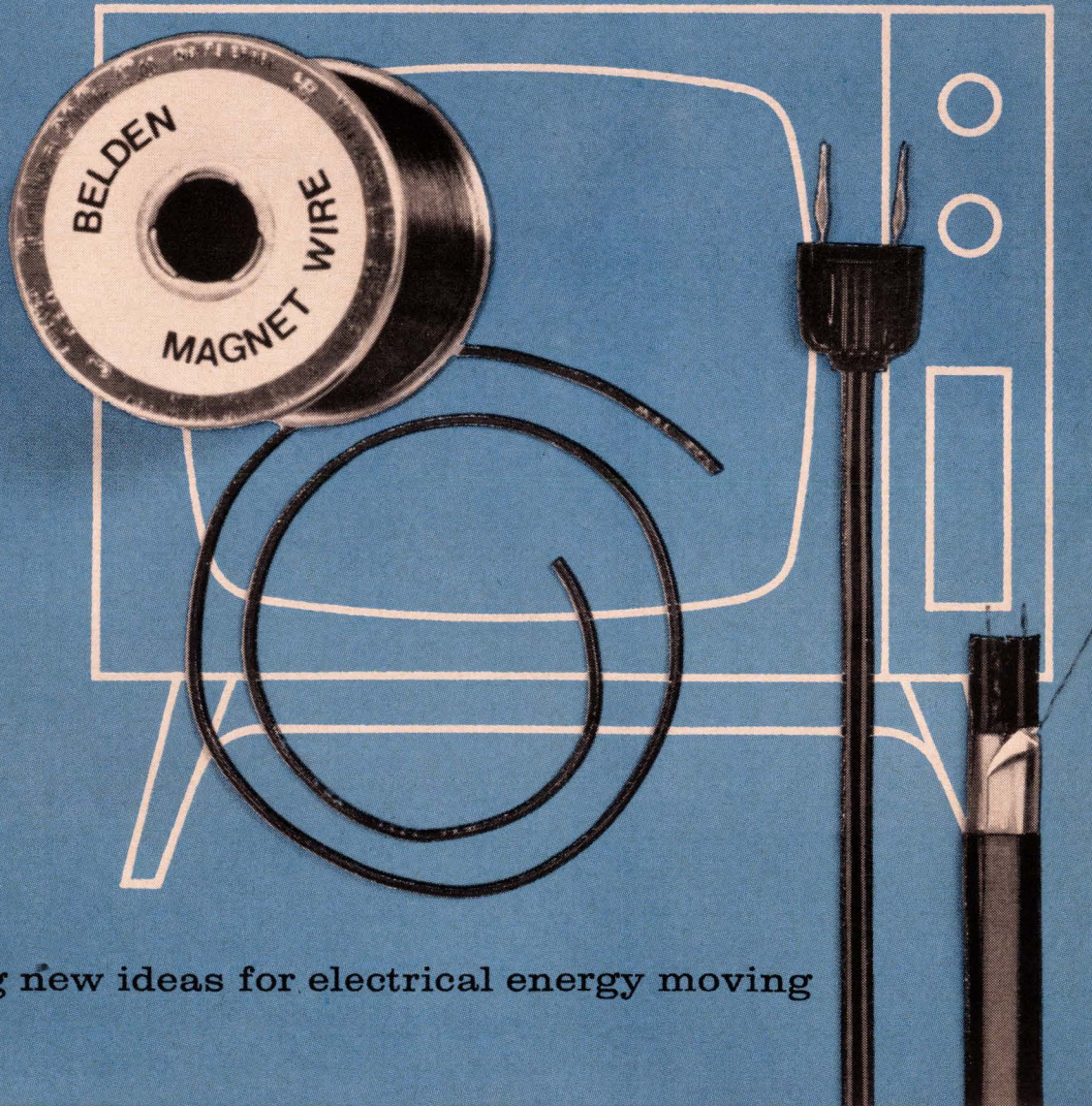

keeping new ideas for electrical energy moving

G-2-7

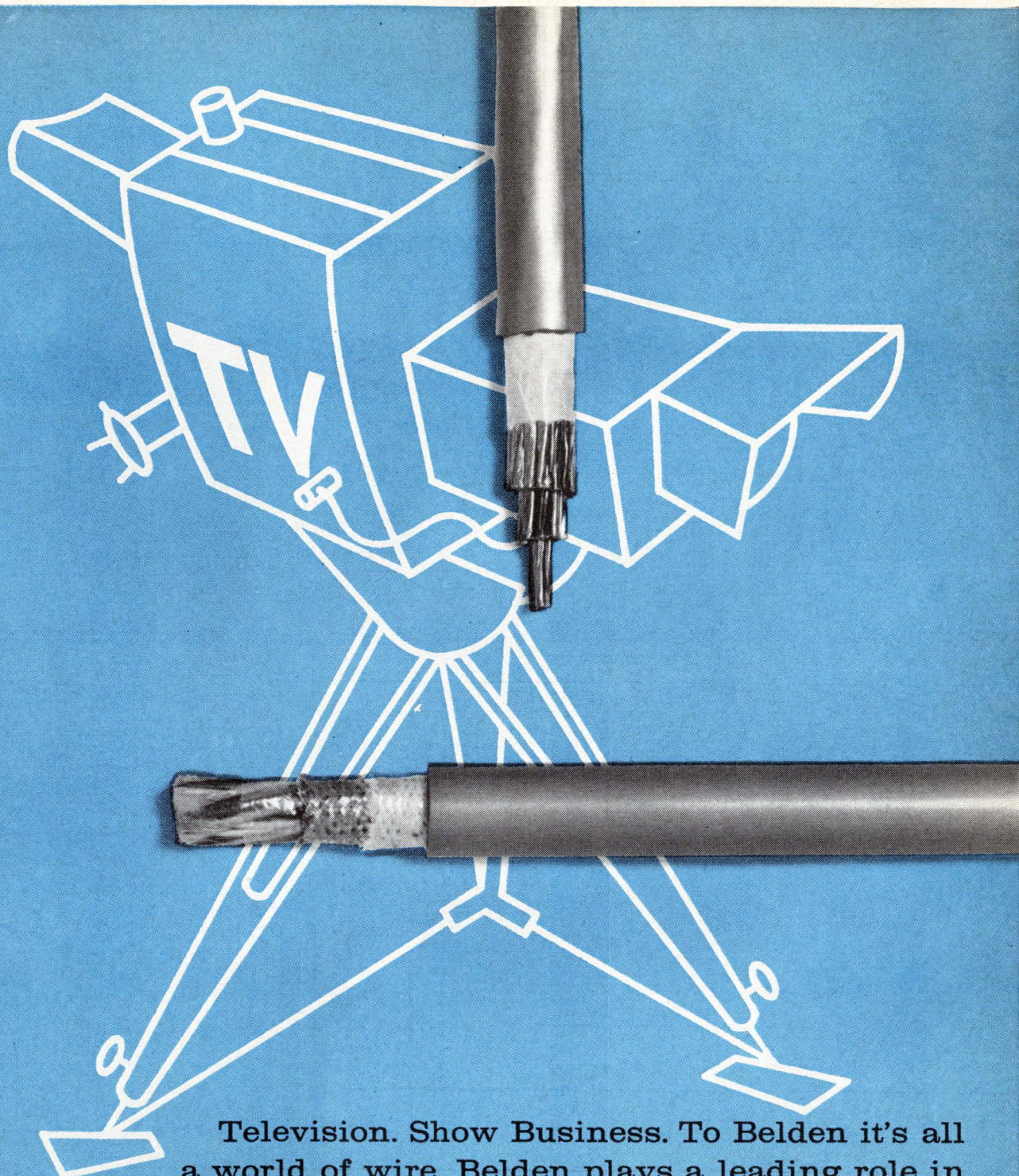

Television. Show Business. To Belden it's all a world of wire. Belden plays a leading role in many complex systems of sight and sound communication. By delving into design, processing, packaging and a host of factors, Belden's team of wire specialists have helped many people wring out hidden costs. Success takes a supplier that is really perceptive — one who makes all kinds of wire for all kinds of systems. Want to join us in wringing out values and costs? Just call us in . . . Belden Corporation, P.O. Box 5070-A, Chicago, Illinois 60680.

Belden

there's a better way to do it!

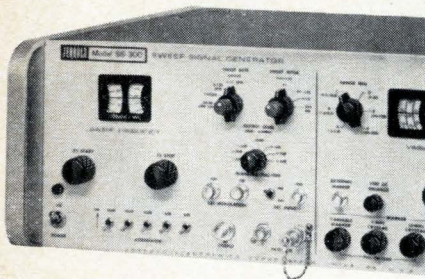

JERROLD SS-300 Sweep System

Jerrold has come up with a **new idea** — a solid-state sweep frequency **system** that does it all — in one compact unit. The extraordinary SS-300 incorporates a sweep generator (500 kHz to 300 MHz), plus a variable frequency **marker generator** and a **detector** system.

Features include:

- Remote Programming
- Start-Stop Frequency Tuning
- Exceptional Sweep Frequency Linearity
- Automatic Leveling Without Frequency Shift.

There's a brochure detailing every exciting feature . . . and we'll be happy to send it to you on request.



MEASUREMENT AND
TEST INSTRUMENTATION

JERROLD ELECTRONICS CORPORATION
Government and Industrial Division
Philadelphia, Pa. 19105

there's a better way to do it!

Jerrold TECH/NOTE No. 5001 details "a better way to do it" than the static point-to-point technique of determining AM rejection of limiter design. Request your copy.

Meetings

Symposium on Electromagnetic Compatibility, IEEE; Shoreham Hotel, Washington, July 18-20.

Medac Symposium and Exhibition, Association for the Advancement of Medical Instrumentation; Hilton Hotel, San Francisco, July 31-Aug. 4.

Technical Symposium, Society of Photo-Optical Instrumentation Engineers; International Hotel, Los Angeles, Aug. 7-11.

Electromagnetic Measurement and Standards, National Bureau of Standards; University of Colorado, Boulder, Colo., Aug. 7-18.

Conference on Energy Conversion Engineering, American Society of Mechanical Engineers; Miami Beach, Aug. 13-17.

Guidance, Control, and Flight Dynamics Conference, American Institute of Aeronautics and Astronautics; Sheraton Motor Inn, Huntsville, Ala., Aug. 14-16.

Conference on Medical and Biological Engineering, Royal Swedish Academy of Engineering Sciences; Stockholm, Aug. 14-19.

Cryogenic Exposition, Cryogenic Society of America; Cabana Motor Hotel, Palo Alto, Calif, Aug. 20-23.

Cryogenic Engineering Conference, Cryogenic Engineers; Stanford University, San Francisco, Aug. 21-23.

International Conference on Phenomena in Ionized Gases, International Atomic Energy Agency; Vienna, Austria, Aug. 27-Sept. 2.

Association for Computing Machinery Conference, Association for Computing Machinery; Sheraton Park Hotel, Washington, Aug. 29-31.

Cornell Conference on Engineering Applications of Electronic Phenomena, Cornell University and Office of Naval Research; Cornell University, Ithaca, N.Y., Aug. 29-31.*

Technical Meeting on Space Simulation, American Society for Testing and Materials, Sheraton Hotel, Philadelphia, Sept. 11-13.

Symposium on Computer Control of Natural Resources and Public Utilities, International Federation of Automatic Control, Haifa, Israel, Sept. 11-14.

Instrument Society of America Conference & Exhibit, Instrument Society of America; International Amphitheater, Chicago, Ill., Sept. 11-14.

Short Courses

Physiological systems analysis for engineers; University of Michigan, Ann Arbor, Mich.; July 10-21; \$300 fee.

Applied ferromagnetism; University of Wisconsin's College of Engineering, Madison, Wis.; July 17-21; \$150 fee.

Integrated circuits engineering, University of Arizona and Semiconductor Products division of Motorola, Inc., Tucson, Ariz., July 17-Aug. 18; \$500 fee.

Course in biotelemetry, Boston University, Boston, Sept. 27-30; \$125 fee.

Calls for papers

Meeting of the Users of Automatic Information Display Equipment; Statler Hilton Hotel, Washington, Oct. 16-19. **July 15** is deadline for submission of abstracts to George E. Perez, program chairman, P. O. Box 6749, Fort Davis Station, Washington, D. C. 20020.

Symposium on Theory and Measurement of Atmospheric Turbulence and Diffusion in the Planetary Boundary Layer, Sandia Corp. and the Atmospheric Sciences Laboratory of the Army Electronics Command; Sandia Base, Albuquerque, N. M., Dec. 5-7. **Aug. 1** is deadline for submission of abstracts to J. D. Shreve, Aerospace Sciences Division, Sandia Corp., Box 5800, Albuquerque, N. M.

* Meeting preview on page 16.

What you can now do about voltage calibration problems:

Tell your Fluke Sales Engineer to hurry on out with his two new Fluke Kelvin-Varley Dividers, new Fluke Lead Compensator, and new Fluke Reference Divider. Use them for NBS traceable calibration.

End of problems!

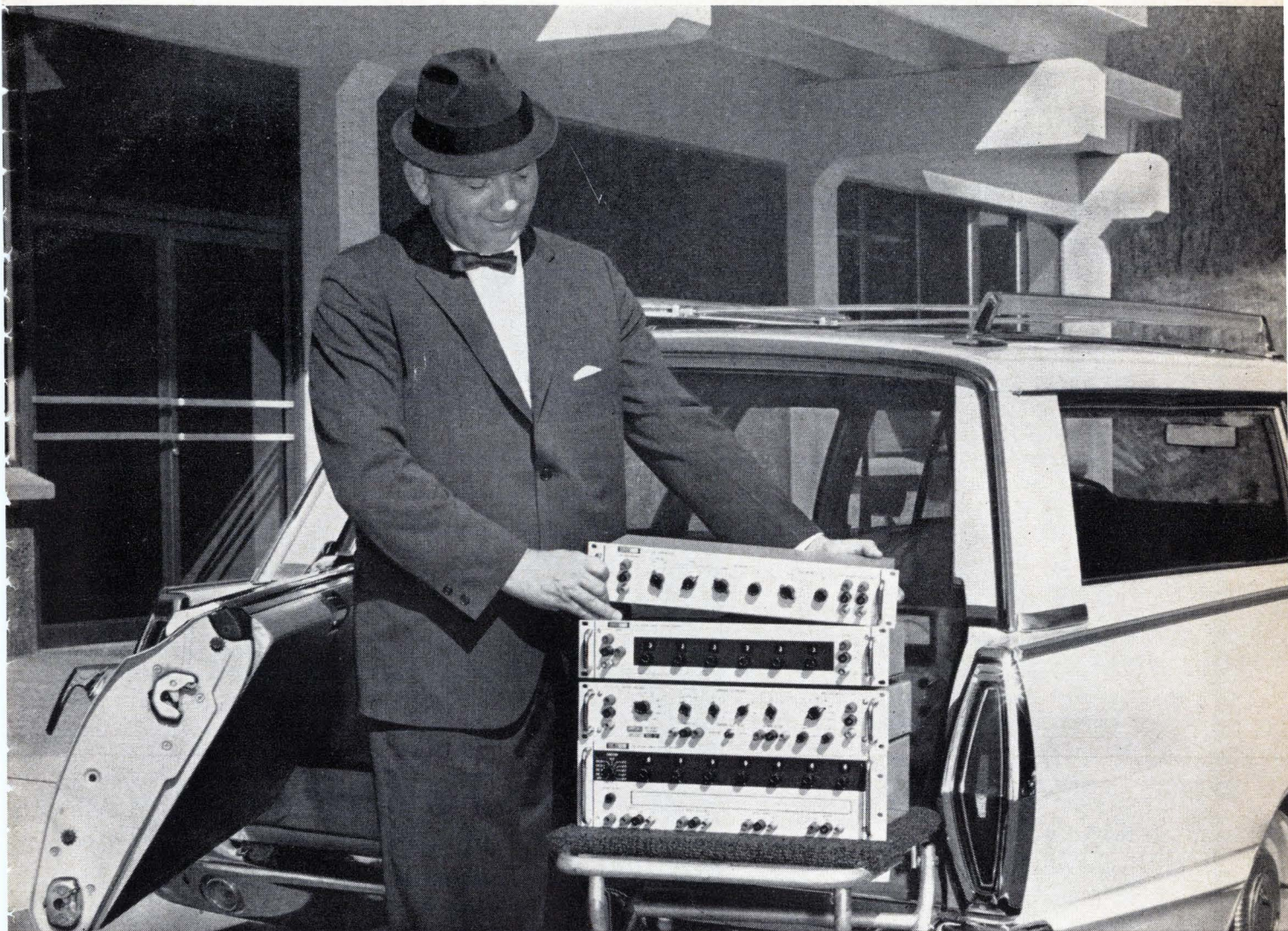

Four new pieces of gear are now ready to help you solve voltage calibration problems with little fuss and no muss.

Basic unit is the Model 750A Reference Divider which can be used with either the seven dial Model 720A Kelvin-Varley Voltage Divider or the six dial Model 725A. The Model 721A Lead Compensator is a vital accessory for the precise comparison of voltage dividers.

Model 750A Reference Divider. The Model 750A is an adjustable resistive divider with a ratio accuracy of $\pm 0.001\%$ of output ± 5 microvolts for one year. Because its accuracy is related to saturated standard cells, the output is considered traceable to the National Bureau of Standards. Calibration can be maintained at better than ± 5 ppm of output. Price: \$995.

Model 720A Kelvin-Varley Divider. The Model 720A in-

corporates an internal Wheatstone bridge and adjustable resistors on the first three decades, making it a "self-calibrating" ratio standard with ± 0.1 ppm absolute linearity. Price: \$1,195.

Model 725A Kelvin-Varley Voltage Divider. A low cost high accuracy 1100 volt divider, the 725A offers four times the linearity of competitively priced models. It essentially has a "zero" power coefficient derating spec. Price is \$390.

Model 721A Lead Compensator. Lead compensation, where ratios between standard and test divider are as great as 4000:1, is possible with the Model 721A. Mode selection for electrically interchanging standard and test divider, as well as voltage ON-OFF for operator protection, is provided. Price: \$245.

Fluke, Box 7428, Seattle, Washington 98133 • Phone: (206) 774-2211
TWX: (910) 449-2850 • In Europe, address Fluke International Corporation •
Sophialaan 2, The Hague, The Netherlands • TELEX: 845-31469
See us at WESCON Booths 3209, 3210, 3211.

FLUKE

for maximum **SOLID CARBIDE** drilling precision

**SERIES 125 - 1/8" SHANK
SOLID CARBIDE
CIRCUIT BOARD DRILLS**

**the rigid stability
of 1/8" shanks
with EVERY size drill**

Series 125 Circuit Board Drills are made with Metal Removal Company specifications of point configuration (Four Facet Point), helix angle, very fine flute finish and exacting size tolerances.

The Series 125 Circuit Board Drill is an advancement of drill design to its present optimum. Among many features, it offers:

- Strength and rigidity of the 1/8" shank permits location and hole size tolerance to close limits.
- Drill bushings completely eliminated where used with precision spindles and collets.
- Also available in double end style with 1/8" shanks.
- 1/8" common shank size for all drill diameters eliminates inventory of collets for each size drill.
- Drill point is concentric to drill diameter within .0005"; drill diameter to shank concentricity is within .0003".
- Permits ultra high speed drilling at rates up to 150,000 RPM and 15 feet per minute feed.
- Can be manufactured with geometry variation for clearances required for fast feed, high RPM operation.

For complete information write for Bulletin CB66.

THE METAL REMOVAL COMPANY

1859 West Columbia Avenue
Chicago, Illinois 60626

Plants Located in CHICAGO • LOS ANGELES • SAN JUAN



MASTER TOOL AND WHEEL MAKERS FOR THE WORLD

Meeting preview

Microwave review

New levels of operation and new applications for microwave bulk effect devices—Gunn and limited space-charge accumulation (LSA) diodes—will be among the highlights of the meeting on Engineering Applications of Electronic Phenomena at Cornell University, Ithaca, N. Y., set for Aug. 29 to 31. Other topics under this year's theme of high-frequency generation and amplification are laser-acoustic interactions, fundamental limitations of semiconductor devices, and new parametric amplifiers.

The meeting, cosponsored by Cornell, the Office of Naval Research, and the IEEE, leads off with a perspective-setting session on the state of the high-frequency art. The author of one of the most widely used texts on modern physics for engineers, Robert L. Sproull of Cornell, will discuss applicable solid state physics; John Copeland, a researcher at Bell Telephone Laboratories, will describe the LSA diode; E.O. Johnson, of Radio Corp. of America's Electronic Components and Devices division, Harrison, N.J., will review his analysis of the physical limitations on frequency and power parameters for semiconductor devices.

Other papers on the Gunn and LSA diodes include one from a group headed by L.F. Eastman and W.K. Kennedy Jr. of Cornell, who share with Copeland much of the credit for early work on LSA diodes. They will describe LSA operation of long bulk gallium-arsenide samples. Nanosecond radar using Gunn oscillators—one of the first applications of the Gunn diode in working hardware—will be discussed by designers from the Royal Radar Establishment, Malvern, England.

Paul Bura of RCA's Advanced Communication Technology Laboratory, New York, will describe superconducting parametric amplifiers. These differ fundamentally from the conventional cooled parametric amplifier by using inductance as the variable reactance instead of capacitance. Gains of about 20 decibels have been measured between 2.0 and 2.5 gigahertz.

There's a Tektronix Field Engineer in your area

His business is helping you solve measurement problems

When you set out to solve a measurement problem, the man you can depend on for help from beginning to end is your nearby Tektronix Field Engineer.

His business is the technology of measurement, and he's trained to help people make measurements. His specialty, of course, is oscilloscopes and how oscilloscopes can best be used to solve your particular measurement problem.

The Tektronix Field Engineer can assist you in selecting the proper oscilloscope for the measurement job at hand. He can give you many helpful suggestions on operating your oscilloscope to get the most out of it. And he can help you with application and maintenance problems.

His service is part of the package you get when you buy a Tektronix oscilloscope. There's a Tektronix Field Engineer in your area. Call him when you have a measurement problem.

Tektronix, Inc.

P.O. Box 500
Beaverton, Oregon
97005



*Tony H. Bryan of Walnut Creek, California—
One of the Tektronix Field Engineers
serving you from 42 U.S. Field Offices
and in more than 20 countries
around the world.*

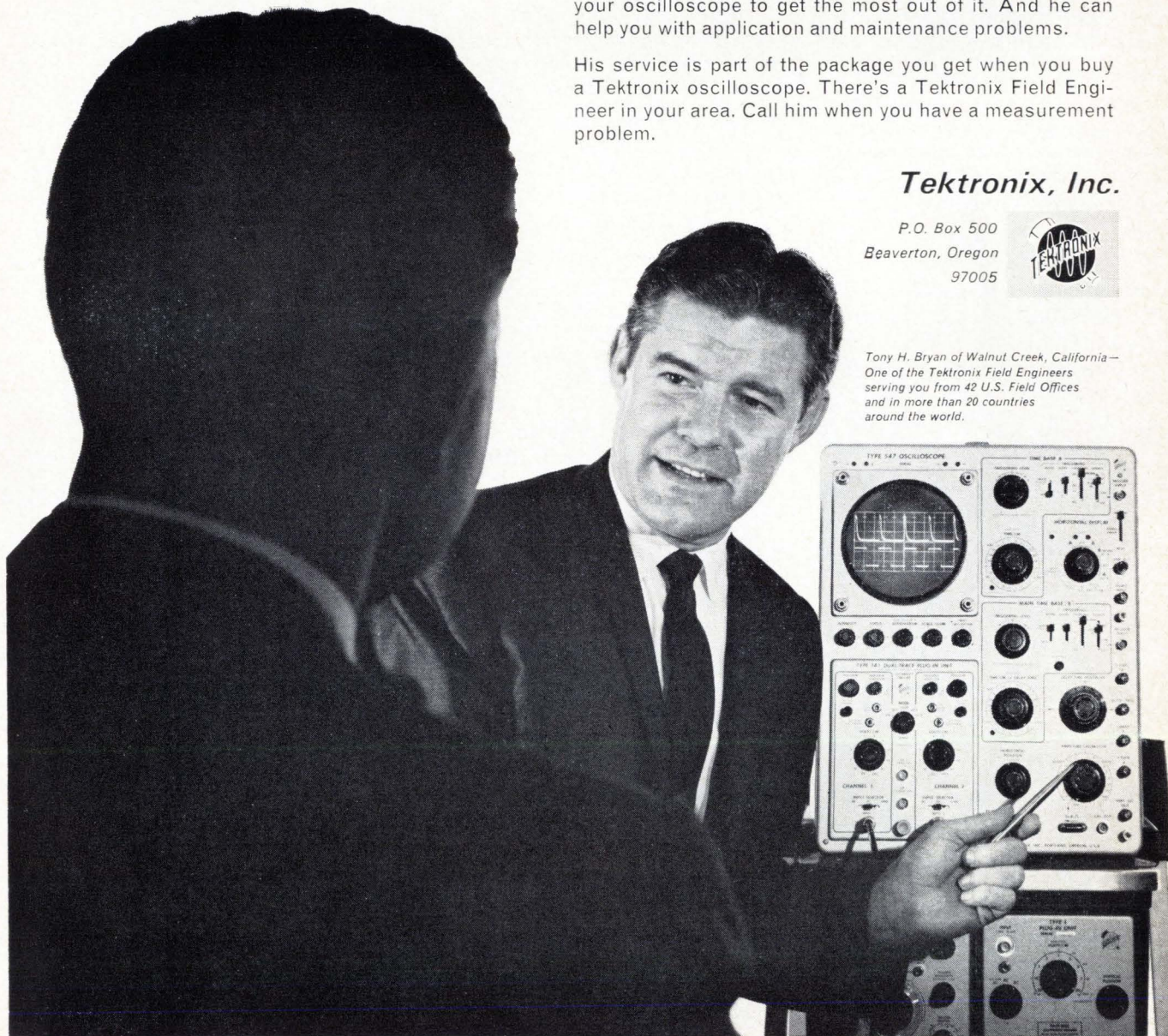

IBM[®] Circuit Design and Packaging Topics

□ General Radio relies on IBM reed switches

□ Suppression circuits extend reed switch life

□ General Radio relies on IBM reed switches

General Radio Company, West Concord, Mass., maker of test instruments, demands the best for their customers knowing that they can't tolerate equipment failure that will interrupt inspection or production routines.

That's why IBM reed switches go into General Radio's instruments.

General Radio uses reed switches in test instruments because they offer lower contact resistance than transistors, are smaller and more reliable than conventional relays.

General Radio confirms through its own vendor-component evaluation program that IBM reed switches show zero failures after 25 million operations.

GR's Service Department claims they can't afford anything less since tests prove that the IBM switch "just keeps on going."

As a result, General Radio relies on IBM reeds in nine varieties of instruments, including the GR 1680-A Automatic Capacitance Measuring Assembly, the 1770 Scanner Systems and four different models of Coherent Decade Frequency Synthesizers.

□ Suppression circuits extend reed switch life

The miniature dry reed switch possesses characteristics which make it applicable to an extremely wide range of low power switching applications.

The reed offers rapid response, low actuate power, small size and a contaminant-free, adjustment-free contact arrangement. All of this provides the switching circuit designer with a highly adaptable device for modern, low-power, high density applications.

However, the construction of the miniature reed, with its small air gap and low-release spring force, makes it more susceptible to failure from contact degradation than any previous common contact switching device. Ac-

cordingly, special precautions must be taken when applying the miniature reed switch.

IBM conducts a continuing study to learn as much as possible about the reasons for contact degradation. Once we know why, we can take steps to prevent it—and, in some cases, prolong switch life by a factor of 10 or more.

What causes a reed switch to fail after 20-million cycles in one application yet continue to function after several hundred million cycles in another?

Failure in the reed switch can be caused by material transfer which occurs each time the contact makes or breaks current. This material transfer, plus any magnetic particles caused by wear, form a mound in the contact area. The mound eventually causes failure by increasing the contact resistance or bridging the air gap.

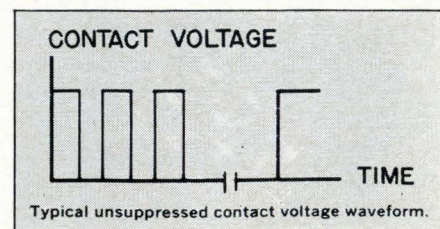

Bridge transfer occurs whenever two current-carrying conductors start to separate. The cross section of the contact point becomes increasingly smaller, giv-

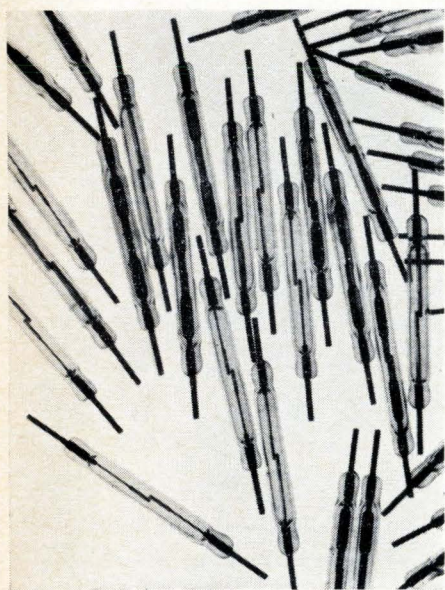

ing rise to a constriction resistance that serves to heat the area. This heating effect first causes the metal to melt forming a bridge; then with further lever separation, to boil causing the bridge to rupture by vaporization.

fallacy to rely exclusively on volt-ampere ratings in estimating contact life. For any particular load condition, contact life can be considerably extended through the use of suppressive techniques.

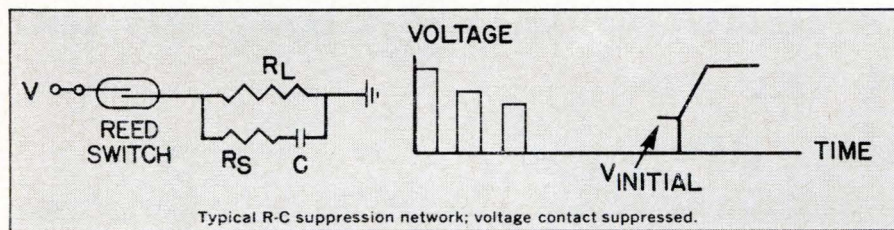

Another major process which causes material transfer in reed switches is arcing.

Arcing can occur both at the time the levers are first closing and at the time of the initial lever separation.

The arc on break is essentially the result of thermionic emission. It is caused by the heating of the levers, which in turn causes increasing constriction resistance at the time of lever separation.

The arc on make is caused solely by field emission and does not necessarily entail lever preheating. With open circuit voltages as low as 15 volts an arc can occur.

IBM studies to date indicate that major causes of contact degradation are a function of load conditions. It is a

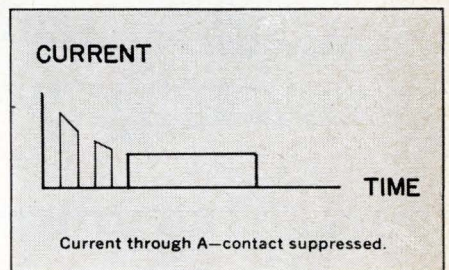

maximize the life of your reed switches. Proper suppression techniques create new possibilities for circuit designers where speed, size and power are increasingly important.

On request, we will send you a detailed report on the design of typical R-C suppression circuits which can

Send in the coupon. IBM Industrial Products Marketing, 1000 Westchester Avenue, White Plains, New York 10604

**IBM Industrial Products Marketing Dept. T2
1000 Westchester Avenue
White Plains, New York 10604**

- IBM reed switch specifications
- Suppression circuits extend reed switch life

name _____

position _____

company _____

address _____

city _____ state _____ zip _____



The end of the non-portable portable

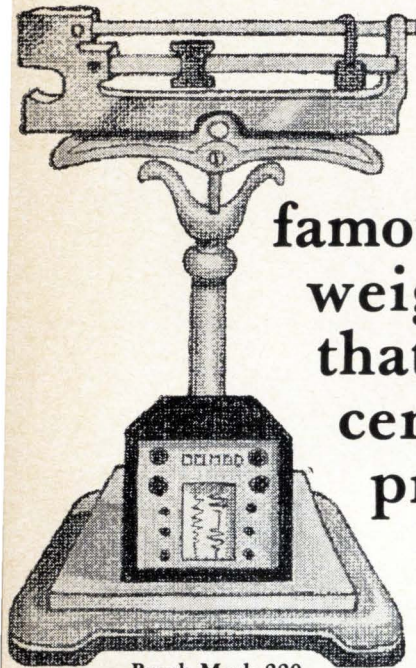

Brush Mark 220 weighs in at 25 pounds.

Mark 220 by Brush . . . a brand new recorder with a 25,000-channel pedigree. Behaves like its famous granddaddy, the Mark 200, but weighs only 25 pounds. Delivers traces that are unbelievably sharp, 99½ percent accurate. Solid state electronics provide position feedback pen control . . . no springs, no strings. The new Mark 220 has two channels for analog recording, two for

events. Maximum sensitivity is one millivolt per chart division, but the recorder is electrically protected from overloads as high as 500 volts. Pressurized writing puts smudge-proof traces into paper, and there's

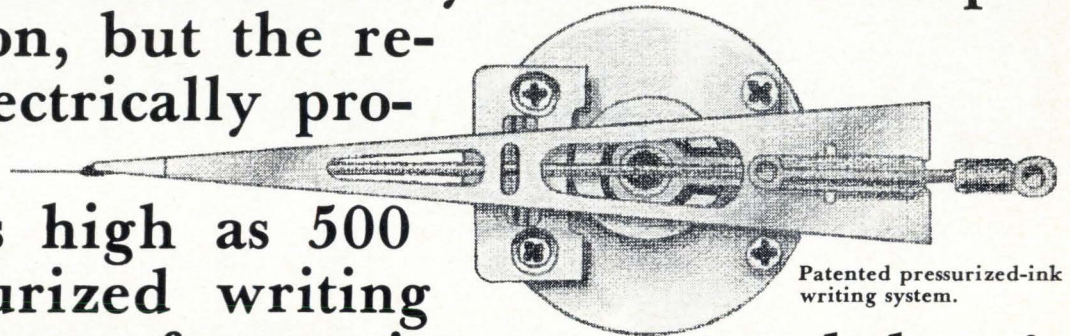

Patented pressurized-ink writing system.

enough ink in the throw-away cartridge to last for about a thousand miles. Less than \$1700 will put you in business with this fine instrument. Call for a demonstration of the remarkable Mark 220,

Throw-away ink cartridge—1000 miles between changes.

and if you wish to keep the unit . . . we'll swap it for a P.O. number. Clevite Corp., Brush Instruments Division, 37th & Perkins, Cleveland, Ohio 44114.

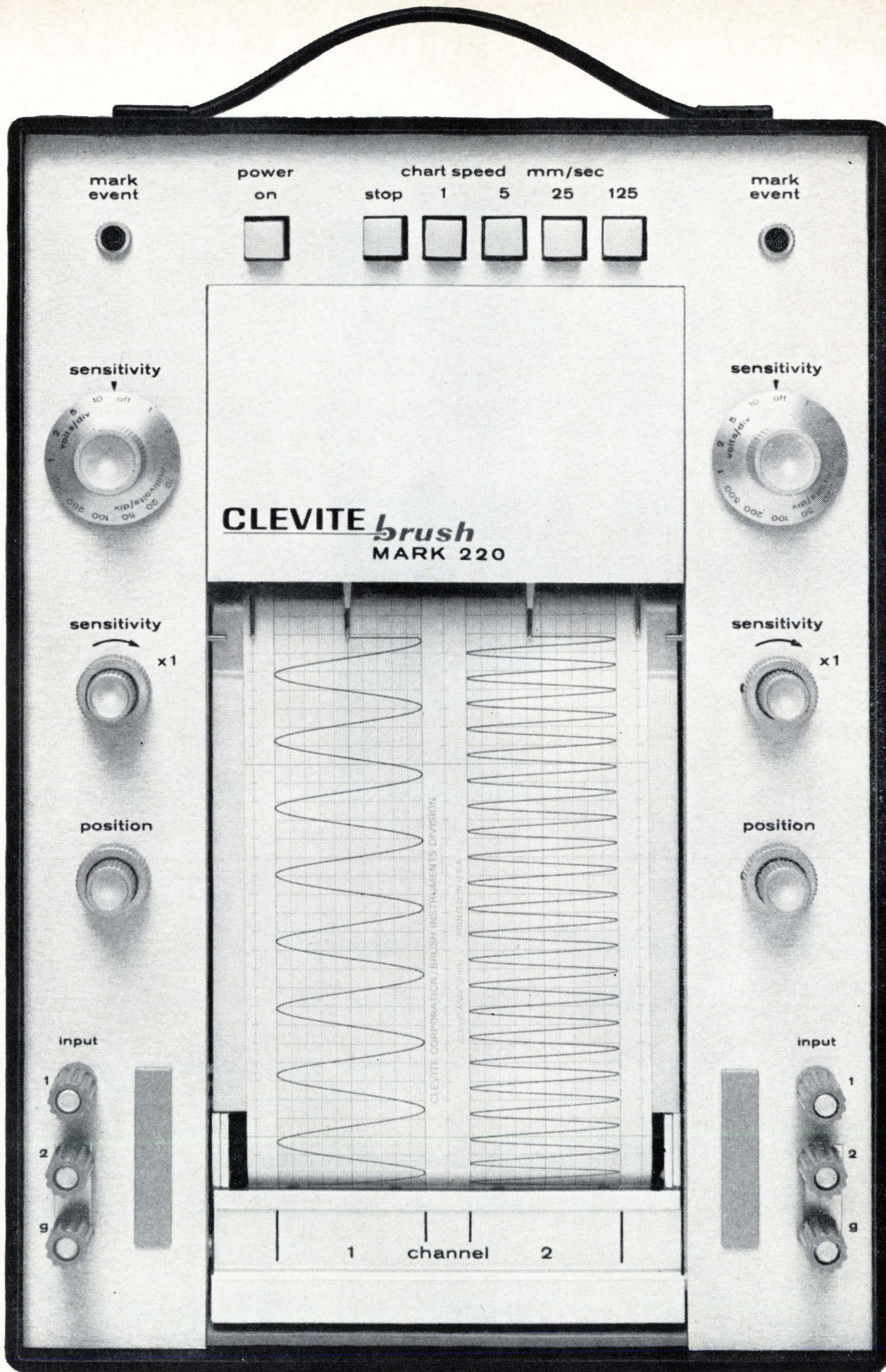

Shown 71% of actual size.

1967
AUGUST
1
TUESDAY

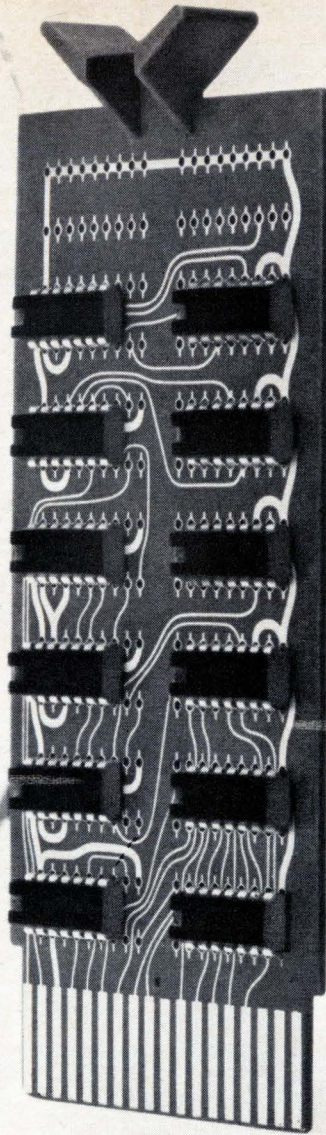

Better monolithic I. C. modules: Sometimes it pays to wait.

Even DIGITAL waited. Until now, despite the technological accomplishment, there was just no way to get the cost and performance of I.C. modules significantly less than the cost and performance of discrete component modules.

But things have changed. DIGITAL will deliver, in August, a new line of integrated circuit modules — functional logic arrays of high speed TTL's in dual in-line packages, designed to operate from dc to 10 MHz. The module line encompasses every basic system function, and features high fan out, high capacitance drive capabilities, and excellent noise margins.

Waiting has had these advantages: the I.C.'s are the latest,

best, least expensive. Cost vs. performance are now vastly improved for the first time. Lowest cost per gate, for example. The technology of dual in-line TTL's has assets not available in previous I.C. modules.

The boards are identical in size to the FLIP CHIP™ modules, but with 36, rather than 18, pins. Pin sockets and mounting panels, as well as other standardized hardware, are available. All new hardware is compatible with the other FLIP CHIPS™.

We call the new line: M series. Write for further details now. Delivery in August.

digital
MODULES • COMPUTERS

Editorial

Partners in progress: doctor and engineer

A doctor pleads for practical electronic equipment that a medical man can use, instead of fanciful gadgetry he cannot, in the article on page 96. The author laments that in an era of exploding technology, the art of healing has been almost completely bypassed by advancing technical progress. Finally, he points the finger of blame straight at engineers and technically oriented companies. They, he complains, have not tried to learn the doctor's problems, objectives, or modus operandi before they jump into creating products for the medical world. Almost predictably, the products fail.

His criticisms have a nagging ring of truth. Sometimes a case of enthusiasm running wild can cause mistakes in judgment. For example, a technique or piece of equipment developed for the space program seems, to an engineer, to have wide medical applications because it measures or records a variable from an astronaut's body. Since the medical electronics market runs about \$500 million a year, he reasons, such a product must have a big potential. His company puts it into production only to find it can't be sold because it costs too much or doesn't do anything a practicing doctor wants done.

The answer, says Dr. Shaw, lies in having engineers work more closely with doctors to learn more about the doctor's medical problems.

Such an answer is easy to give but not so easy to implement.

For, although electronics engineers and companies have been guilty of the practices Dr. Shaw itemizes, the medical profession can share a large chunk of the blame for the lack of technical progress.

Too often doctors have laid insurmountable obstacles in the path of any nonmedical man who would work with them. What the doctors frequently want are technicians to wire bread-

boards and chassis for them, not engineers to design equipment that solves problems.

Doctors are jealous of their prerogatives in diagnosing bodily ills and curing them. And rightly so. In the 18th century the world went through a period of quackery that nobody wants to repeat. But the doctors are still reluctant to listen to anybody outside the charmed circle of medicine who might contribute heavily to medical progress, lest the outsiders invade the doctor's traditional prerogatives.

This doesn't mean that doctors hate progress. Clearly they don't. The treatment of illnesses in 1967 is far different from what it was in 1957, only 10 years ago. Doctors are unquestionably receptive to change but only if the change is dictated by another doctor.

Although the medical electronics market has been estimated by many people to add up to nearly half a billion dollars a year, it still is not a business. And doctors keep it from becoming one.

If a company designs, say an electronic monitoring system for heart patients for Doctor Cronkhite at the Absurd General Hospital, no matter how well it works, some doctors will say, "Doctor Cronkhite's a promoter. We wouldn't use anything he suggested."

Some doctors, unless the Mayo Clinic has put its stamp of approval on a piece of equipment, won't use it. Still other doctors have their own pet recommending sources: Johns Hopkins Medical School or the University of Michigan's medical school, or Massachusetts General Hospital, or Dr. Michael DeBakey's heart clinic in Houston. And the list goes on and on.

To please all the doctors in the United States, the unhappy company with the heart-monitoring system would need almost as many different models as there are doctors.

Under such conditions, progress is hard to arrange.

If Dr. Shaw's proposal that engineers work more closely with doctors is to work, the doctors will have to meet the engineers halfway. The MD's will have to treat the EE's as equal contributing partners, not as maintenance men.

Both the doctor and the engineer have a contribution to make to medical electronics. The record shows that neither can make any progress in this field alone.

Can This Motor Run 5000 Hours

?



No, we can't guarantee it; but it may run longer! For example, a customer used a Clifton motor almost continuously for a year (8760 hrs.) and it still ran, though not up to specification.

Industry standard for servo motors is 1000 hours and all Clifton motors meet it. In addition, we are delivering motors to a 2000 hour life specification. Trade off on some parameters, and Clifton can develop a motor for you which will exceed by far normal life expectancy. Incidentally, when a guaranteed 5000 hour life motor *is* built, we feel Clifton "state-of-the-art" engineers will build it.

Why not have CLIFTON quality for your motor, generator, tachometer needs! Gearheads available also. Call your local Clifton Sales Office or 215-622-1000; TWX 510 669-8217.

CLIFTON 
DIVISION OF LITTON INDUSTRIES

Electronics Newsletter

July 10, 1967

50-cent IC for video i-f

Motorola will soon start selling a 50-cent integrated circuit that can be used in the video i-f circuits on both black-and-white and color television sets. The IC, called a dual MC1550, will be a dual in-line plastic encapsulated device incorporating two present MC1550's on a single chip.

Although all major semiconductor manufacturers are embarked on crash programs to produce similar devices at competitive prices with junction transistors and associated discrete circuitry, Motorola seems to have a head start.

Plasma antenna to blaze new path

The Air Force is considering plasma-jet columns as antennas. They could be used in the event of a nuclear attack when conventional communications are knocked out. Researchers at the Rome Air Development Center say they have proved the feasibility of coupling radio frequency to a plasma column.

The high-power columns would serve a dual purpose: first, by burying the plasma generators under ground, the high-power torches could quickly burn through debris caused by nuclear blasts; then, once free to shoot into the air, they would function like antennas.

TRW, GE to make tv satellite study

NASA's Lewis Research Center should complete negotiations this week with General Electric and TRW Systems for parallel nine-month feasibility studies of a television-distribution broadcast satellite. Development of such a system, which could be operational by 1973, would result in a satellite relay powerful enough to broadcast directly to medium-size antennas, such as those used by CATV systems or schools.

In another month or so, study contracts are expected for much larger tv broadcast satellites that would be powerful enough to transmit directly into home receivers. These studies will be made for Marshall Space Flight Center and may include manned satellites and the use of the Saturn 5 booster—America's largest.

First laser-equipped operating room

An operating room equipped for laser surgery has just become operational at the University of Cincinnati Medical Center. The only comparable system is being built at the National Institutes of Health, Bethesda, Md.; the laser for that installation had been delayed by design problems.

The ruby laser for Cincinnati was built and donated by the Applied Lasers division of Spacerays Inc. of Burlington, Mass. It produces 1.3- to 4.0-millisecond pulses with energy ranging from 10 to 50 joules using a 13-inch rod and 48-kilojoule power supply. Focusing optics bring energy density up to a maximum of 50 kilojoules per square centimeter.

Radar doubles in communications

The Air Force has developed a 3-D radar that doubles as a tropospheric scatter communications terminal. The 3,500-pound unit is designed to be flown to an airstrip where it will detect, track, and scan aircraft at long range; it can be switched to its communications mode when there are no planes to monitor.

The communications, says the Air Force, have been successfully tested

Electronics Newsletter

at ranges of 150 miles by the Rome Air Development Center. Tests will continue for a year.

GE improving mortar locator

The enemy's stepped-up use of mortar fire in the Vietnam war has intensified the need for an effective mortar locator that can scan in all directions. The Army has one 360° design in the works, the AN/TPQ-28, but that's not yet ready for delivery. **As a stopgap, the Army has given General Electric a contract to improve its 22.5° scan AN/MPQ-4A, which is already in Vietnam, and build 19 new ones.**

Under this \$4.9 million contract, GE will redesign the unit's cathode-ray tube to provide a brighter, longer-lasting signal, and the receiver's sensitivity will be boosted. In addition, GE will develop a moving-target indicator for later models.

The TPQ-28 is being developed by ITT-Gilfillan under a \$5 million order; **a prototype has already passed tests.**

Three-job laser

A compact laser package that combines three functions—**secure, two-way voice communications, target location, and intrusion detection**—will undergo acceptance tests in Vietnam during the next few months. The neodymium-doped yttrium aluminum garnet laser was developed at RCA's Burlington, Mass., facility under an Air Force contract.

Air Force to get its first microwave manpack sets

The Air Force will fill a gap in its communications equipment arsenal: **a family of manpack microwave communications sets will be developed.** The units will be based on two 45-pound transceivers built for the Rome Air Development Center by ITT.

One transceiver might be used to relay information from a remote radar to a headquarters display many miles away; another might be used to provide voice channels to extend a troposcatter link. **The first application of the transceiver family could be in the 407L air defense and air control system.**

The experimental all solid state sets, which just passed field tests, have four pulse-code-modulated voice channels, expandable to 12. The units, using crystal oscillators followed by a chain of broadband varactor multipliers, are tunable across 7.125-8.40 gigahertz. The built-in parabolic antenna has a gain of 26 decibels, and the transmitter output is 125 milliwatts.

Competition grows for next-generation radio telescope

The battle for Government funds to build the next-generation radio astronomy observatory and the world's largest antenna begins in earnest this month. **At least four university-research groups are submitting their proposals to the National Science Foundation.**

A New England-New York combine has formed Neroc, the Northeast Radio Observatory Corp., a nonprofit organization. Neroc proposes construction of a fully-steerable 440-foot-wide radome-covered antenna in the Northeast [Electronics, Jan. 24, 1966, p. 25].

Other proposals will include one by the National Radio Astronomy Observatory for 36 dishes in a Y-shaped array whose segments would be 13 miles long. A Michigan-California consortium suggests a 330-foot parabola, and California's Owens Valley Radio Observatory wants to build an array of seven dishes, each 130 feet in diameter.

WHAT IS O/E/N?

O/E/N IS QUALITY COMPONENTS

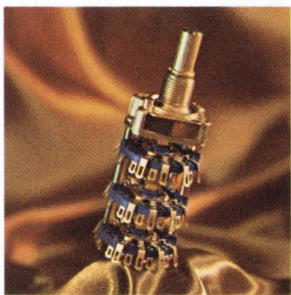

OAK MANUFACTURING CO.

...for over 35 years the leader in rotary switches, pioneer of many new advances including double-wiping contacts. Oak is also a leader in pushbutton, lever, slide and snap switches; rotary solenoids and choppers. Oak FM, VHF & UHF television tuners can be found in most major brand name sets.



MARCO-OAK

...serves our pushbutton world by showing "what's going on." Customers rely on Marco-Oak lighted pushbutton and matching indicator lights for applications far more complex than car radios. They're used in such applications as computers, missile ground controls, aircraft, utility and industrial instrument panels, TV broadcasting.

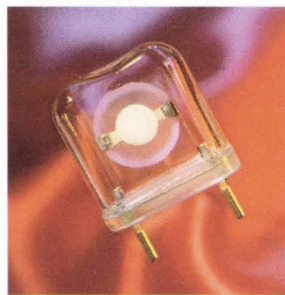

MCCOY ELECTRONICS CO.

...makes quartz crystals and assemblies to keep radio transmitters and receivers "on the beam." Such precise frequency control requires exacting manufacturing techniques—thickness accurate to .000001", cutting to 1/300 of 1° of angle accuracy, hermetic seals for protection. McCoy crystals are the highest quality available and perform in severe environments.



HART MANUFACTURING CO.

... "turns things on" with relays for household and commercial appliances, high-current relays for industry, and miniaturized relays for missiles and computers. Also thermostats, rotary and snap-in toggle switches, pilot lights. The complementary Phillips-Advance line of relays serves the electronics and communications industries.

O/E/N produces quality components...our customers build them into circuitry. We're their main source for an ever-widening variety of products. The one common denominator is engineering excellence, built into components produced by every O/E/N subsidiary or division described here. Write for Facilities and Capabilities brochure.

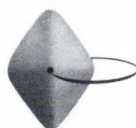

O/E/N

OAK ELECTRO/NETICS CORP
CORPORATE OFFICE
CRYSTAL LAKE, ILLINOIS 60014

Need Air Strike Immediately. RSVP

An unusual request? No longer. For success on the ground in battle often depends on success in the skies — the ability to call and receive immediate response . . . to get accurately pinpointed fire power from the air in the shortest possible time. Helping to provide that capability is the mission of MITRE.

TACTICAL SYSTEMS

These systems encompass mobile communications systems, electronics systems and operating facilities required for the command and control of deployed USAF tactical forces. Major emphasis is placed on detailing overall system design and performance to obtain increased improvements in operating capability. Immediate openings exist for programmers and analysts and systems engineers with development experience in: electromagnetic compatibility/countermeasures; airborne radar; radio frequency interference; communications and data processing; digital computers. Particularly important is experience with lightweight, compact, extremely reliable devices for use in mobile remote situations.

NATIONAL AIRSPACE SYSTEM

MITRE is currently augmenting its top-flight team of systems men in the suburban Washington, D.C. and Atlantic City, N.J. areas where FAA's prototype Air Traffic Control systems are now under development. Their mission: to provide the system engineering to the Federal Aviation Agency on the new National Airspace System — an

air traffic control system for the 1970's. Their job encompasses such technical areas as broad level system analysis, computer program analysis, system specifications, system logical design and system test planning for design verification.

Working on this project you would engage in such activities as: translating system operational objectives into technical requirements for the system's subsystems; synthesizing the technical characteristics of equipment subsystems of balanced reliability, and analyzing alternatives; reviewing and analyzing, at the logic level, design submissions of system hardware contractors; conducting design optimization studies with respect to cost, reliability, and technical suitability; or synthesizing software designs for a multi-processing computer environment.

COMMUNICATIONS SYSTEMS PLANNING AND DEVELOPMENT

Among MITRE's current communications activities are included: conceptual design of new communications systems and analysis of their performance; analysis, investigation and development of advanced communication techniques; analysis and projection of Air Force tactical communications needs; and development of sophisticated simulation techniques for communications systems synthesis and evaluation.

Immediate staff and management level openings exist for: Communications Engi-

neers and System Analysts experienced in the systems analysis and design of communications networks, modulation and signal processing techniques, switching systems and voice and data transmission; Operations Analysts with experience in simulation techniques and capable of establishing communications requirements and performing cost effectiveness trade-offs; Project Engineers for detailed engineering and specification of satellite communications systems; and specialists in airborne antenna and multiple access signal processing techniques.

MITRE now has openings in Bedford, Massachusetts; Washington, D.C.; Atlantic City, New Jersey; Houston, Texas; Eglin and Patrick Air Force Bases and Tampa, Florida. If you have two or more years' experience and a degree in electronics, mathematics or physics, write in confidence to Vice President — Technical Operations, The MITRE Corporation, Box 208 BC, Bedford, Massachusetts. Persons interested in Washington openings should write directly to Vice President — Washington Operations, The MITRE Corporation, P.O. Box 1202 BC, Bailey's Crossroads, Va. 22041.



THE
MITRE
CORPORATION

An Equal Opportunity Employer (M & F)

Formed in 1958 . . . pioneer in the design and development of command and control systems . . . MITRE serves as technical advisor and systems engineer for the Electronic Systems Division of the Air Force Systems Command and provides technical assistance to the Federal Aviation Administration, the Department of Defense, the Department of Transportation and the National Aeronautics and Space Administration.

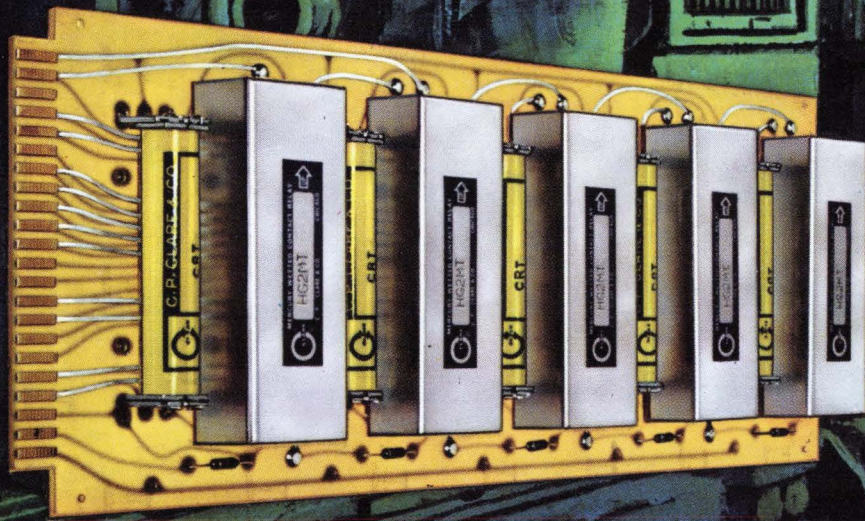

In industrial process systems Clare puts you in control

In any sector of industrial/electronic applications, Clare capability can put you in control. In cost-conscious industrial process control, or high-speed data processing systems. In demanding communications networks, or instruments of utmost accuracy. In aerospace or ground support systems, where perfection is expected—and delivered.

Everywhere contact switching can optimize control systems—wherever long life, high reliability, advanced capability, and maximum economy are needed—let Clare put you in control.

C. P. Clare & Co.—worldwide.

Clare contact switching...for optimity in

Industrial Process Control Electronic Data Processing Aerospace and Ground Support Communications Instrumentation



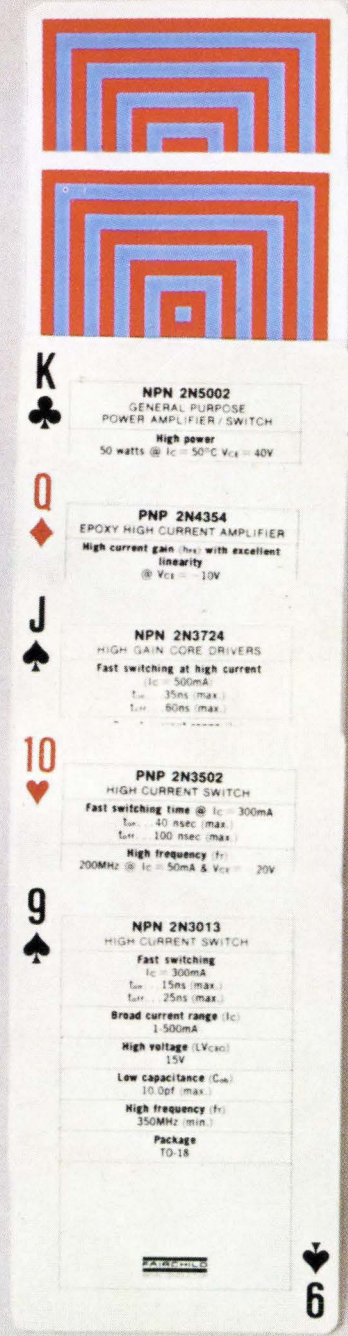
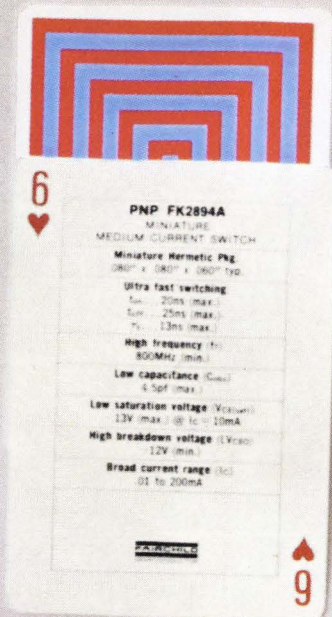
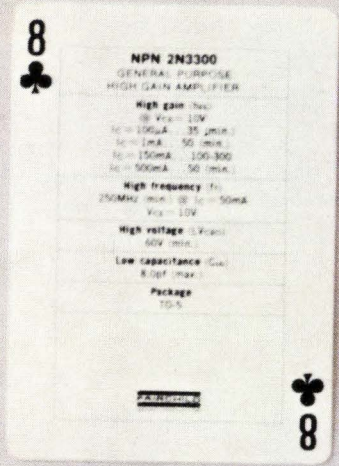

Get a whole new deck from Fairchild.

We now make silicon PNP complements for Fairchild NPN transistors. If you design complementary circuits, start fresh: you no longer have to use NPN's exclusively or settle for germanium PNP's. Fairchild now makes silicon PNP complements for the Fairchild NPN transistors you commonly use. And when we say complement we mean same performance specs, same silicon reliability, same low prices, same quick delivery. Everything matches except the polarity. To help you pick matching transistors we created a deck of attractive playing cards with our most popular complementary devices in complementary suits. We've even included abbreviated specs for each transistor. It's yours free for the coupon with our compliments. Or ask your Fairchild Distributor.



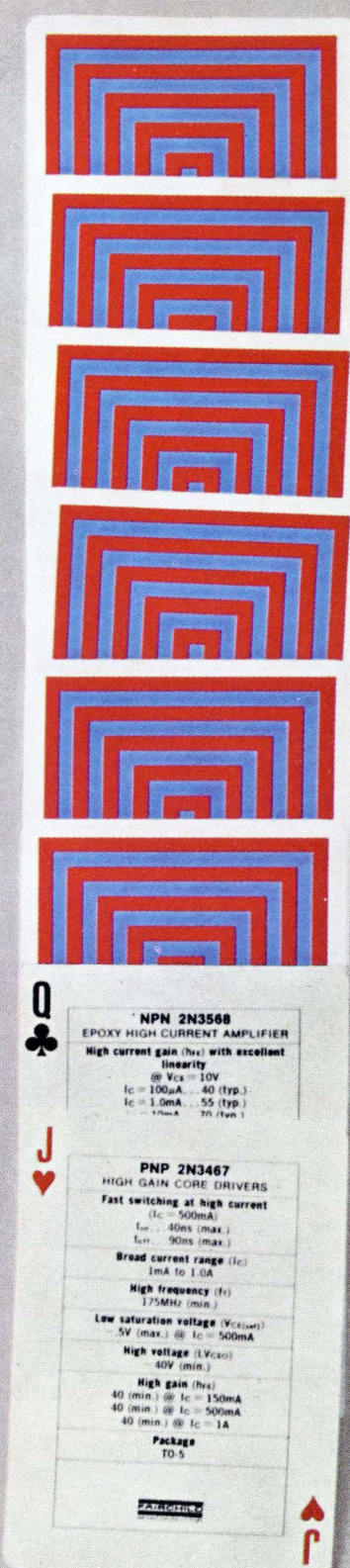
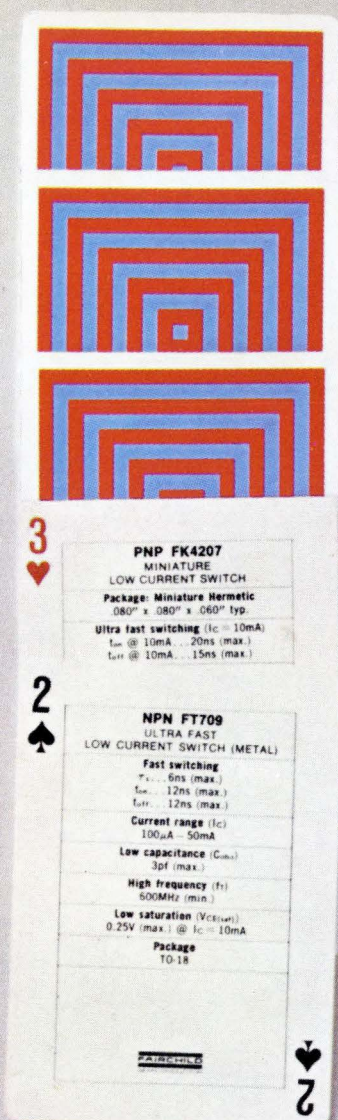
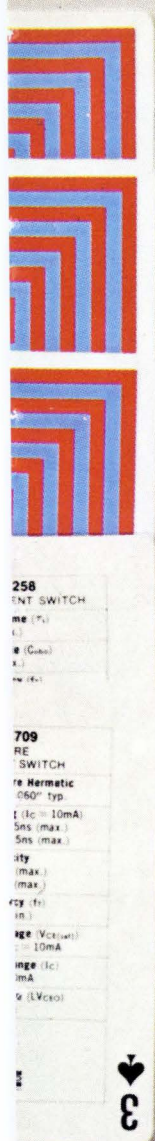

Gentlemen: I am involved in complementary circuits design and want to get your new deck along with complete information on your PNP complements to NPN transistors.

Name _____

Title _____

Company _____

Address _____

City _____ State _____ Zip _____

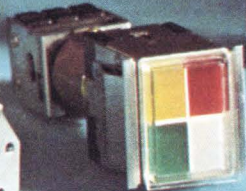
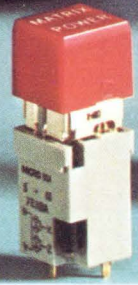
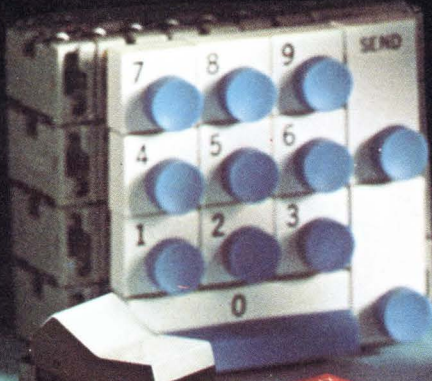



Enjoy a nice slice of freedom in panel design

Slice the apple anyway you like, you get complete freedom in every phase of panel design when you call MICRO SWITCH. From problems involving straight eye appeal to scientific visual principles. You name it! We'll share our experience in other human factors considerations, too, such as sound and tactile feedback.

The simple fact is, the MICRO SWITCH line is the world's most complete. Including all the components you need to translate your ideas into practical man/machine interface arrangements.

You will find new ideas as well. Because MICRO SWITCH offers many innovations. For example: the simplified modular construction of lighted pushbutton devices; the space-saving combination of multi-light display and multi-function control in a single compact unit; the new modular-matrix method of keyboard construction—and many others.

For your free copy of the booklet, "Switch Guide for Panel Design," call a Branch Office. (Yellow Pages: "Switches, Electric.") Or write:

MICRO SWITCH

FREEPORT, ILLINOIS 61032

A DIVISION OF HONEYWELL

HONEYWELL INTERNATIONAL—Sales and service offices in all principal cities of the world. Manufacturing in United States, United Kingdom, Canada, Netherlands, Germany, France, Japan.

Circle 33 on reader service card

Classify DIPs automatically

The TAC IC-500's are in-line transfer machines which will classify DIPs and other multi-lead devices when interfaced to an automatic test set. The machines are modular in construction, and offer a selection of add-on features, including: up to 5 test stations with Kelvin-type DC or high-frequency AC contact blocks; four different device-input modules; three different sorting modules. The IC-500's will automatically re-insert the devices into a variety of magazines. Current applications include DIPs, Flat-packs in various carriers, Multi-lead TO-5's, Resistor networks, and Flat substrates. For additional information, write, phone or wire Transistor Automation, 18 Moulton Street, Cambridge, Mass. 02138 (617) 547-1590.

TAC

RELIABILITY IN AUTOMATION



A TELEDYNE COMPANY

NASA turned to Airco for helium and...

& reliability. To pre-cool Centaur rocket engines, Airco delivered 5,500 gallons of liquid helium. The largest single commercial delivery of helium ever made. **&** it took only 42 hours, in one of Airco's 10,000 gallon trailers, from Kansas to Cape Kennedy.

That's the way Airco works. **&** from 25 points spotted across the country. We're the number one helium supplier **&** we perform for all our customers — large **&** small. For more information write us at 150 East 42nd Street, New York, N. Y. 10017.

AIRCO
Industrial Gases



When it comes to buying silicon power transistors and rectifiers, do you have to act like a tough pistol-packin' persuader?

From past experience, you may believe that's the only way of keeping your semiconductor supplier in line to avoid broken delivery promises, unexplained delays, constant expediting, rising costs, technical problems and quality control lapses.

Not anymore! Now you can lay that pistol down, because there is a new, easier way! The Slater way, of course. We've combined the idea of old-fashioned customer service with unique break-throughs in semiconductor technology that give us the highest quality yield rates in the industry. Our semiconductor lines are now in full production on:

POWER TRANSISTORS with ratings from 5 watts to 85 watts in TO-5, TO-53, and TO-57 packages, including the following types:

2N389	2N1047	2N1048A	2N1049B	2N1116	2N1768	2N2034
2N389A	2N1047A	2N1048B	2N1050	2N1117	2N1769	2N2858
2N424	2N1047B	2N1049	2N1050A	2N1690	2N2032	2N2859
2N424A	2N1048	2N1049A	2N1050B	2N1691	2N2033	2N2911

POWER RECTIFIERS with Slater's "controlled avalanche" process which eliminates need for matching—types 1N1183 thru 1N1190 (35 amp); 1N1191 thru 1N1198 (18 amp); 1N2128 thru 1N2138 (65 amp); 1N3765 thru 1N3768 (35 amp).

JAN and TX RECTIFIERS types 1N3189 thru 1N3191 to MIL-S-19500/155.

When you buy the Slater way, you won't have to point a pistol to get the kind of service you deserve. You'll get immediate delivery on any of the types listed — and the price quotes will convince you that we really mean business! Prove it to yourself—give us a call today. And just to make it easy, make that call collect.

SEMICONDUCTOR DIVISION, SLATER ELECTRIC INC., 45 SEA CLIFF AVE., GLEN COVE, N.Y., 516-671-7000

 **Slater Semiconductors**

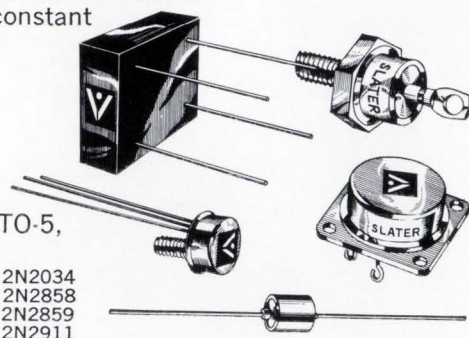

**There must be
an easier way to buy
silicon power transistors.
(and rectifiers too.)**



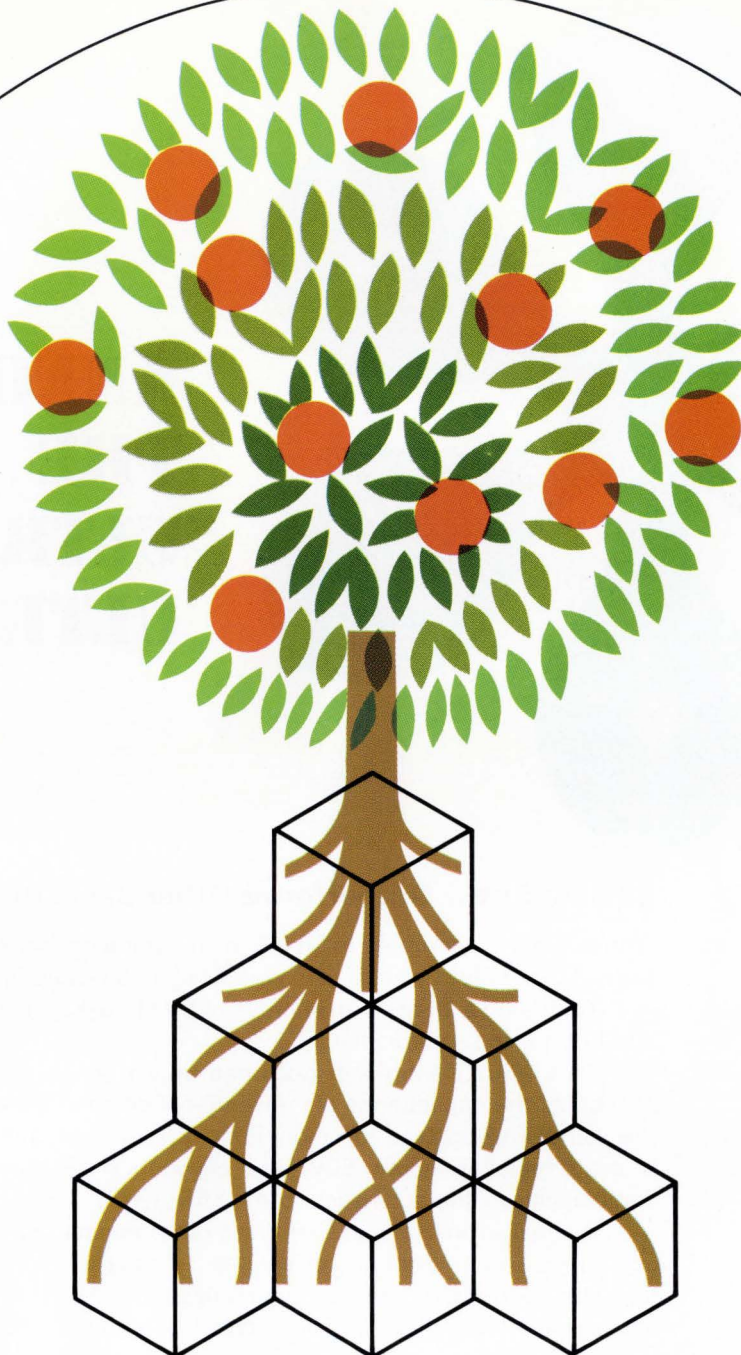

“Our ideas, like orange-plants, spread out in proportion to the size of the box which imprisons the roots.” – Bulwer

Engineering Section Manager: Requires at least BSEE degree with minimum of 8 years experience. Should have thorough knowledge of broadband and instrumentation magnetic recording systems. Position requires the ability to develop new state-of-the-art technologies and techniques in the recording performance of magnetic tape.

Electronic Engineers: (Solid State Circuit Design). Individuals to design solid state digital and analog circuits. The digital circuits range from DC to 5MHz. The analog circuits include servos from DC to 2KHz and linear amplifiers from 100Hz to 10MHz. 2-5 years solid state circuit design experience since BSEE degree.

Do you feel that in your present position you are boxed in? That you are not given enough freedom to put those good ideas to work? At Memorex we give you the wide open spaces where creativity can flourish, and where your ideas can develop and grow. Because we have given our employees this freedom our company has been able to grow...to a multi-million dollar corporation in just six years. We need men who through their ideas can help us continue to grow, and who have the ability to grow with us.

MEMOREX
CORPORATION

Memorex is an equal opportunity employer.

Video Recording Specialist: Position for a competent video recording specialist with ability to deal with senior level engineers and management. Work will involve the supervision and design of experimental video systems and the training of test technicians to evaluate tape and machine performance. Requires 10 years electronic experience including 5 years of magnetic recording background.

Electronic Engineer: Requires a BSEE with five years experience. Must have 2-3 years video circuit experience. Video tape recording background also desired. Must be capable of solving both analytical and tape systems operations problems.

Interested applicants should direct their resume to: Mr. Don Newton, Dept. S, 1180 Shulman Avenue, Santa Clara, California.

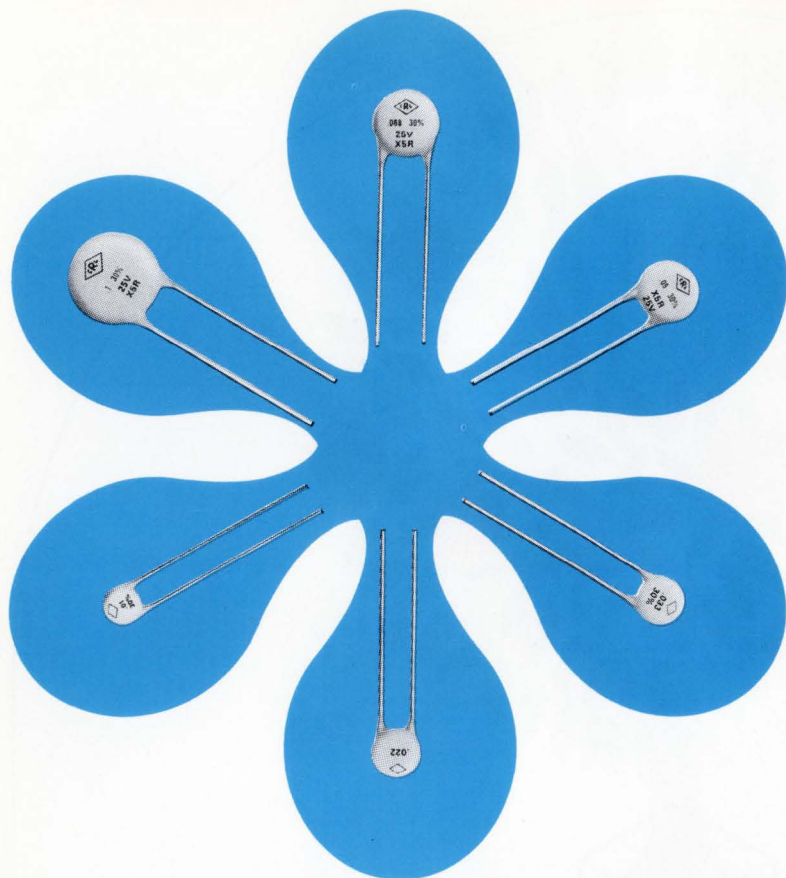

ANNOUNCING: THE "ULTRA" ULTRA-KAP[®]

Smaller Size... Outperforms Other Capacitors... Costs Less, Too!

"Inner space" continues to shrink in this trend to transistorization... but not the capacitance values you need in your design applications.

Centralab's answer: an improved 25V Ultra-Kap Disc Capacitor... smaller in size but not in performance.

This "ultra" Ultra-Kap goes one-up on previous Ultra-Kaps (which feature 100 times the capacitance of conventional ceramic dielectrics). Now you can use the Ultra-Kap instead of monolithic ceramic capacitors or mylar capacitors. It even replaces many 50V disc capacitors! Features improved temperature compensation characteristics, too—X5R (-55° to $+85^{\circ}\text{C} \pm 15\%$ from 25°C).

All this at lower cost than with other capacitors, adding an extra touch of economy to your design applications... whether for consumer entertainment, communications, the military—or for medical, instrumentation and computer markets.

Get full details about the new "ultra" Ultra-Kap... and the complete Ultra-Kap line of ceramic disc capacitors... from your Centralab representative or drop us a line.



CENTRALAB

Electronics Division

GLOBE-UNION INC.

5757 NORTH GREEN BAY AVENUE
MILWAUKEE, WISCONSIN 53201



Here's why they're "Ultra" Ultra-Kaps!

RANGE CHART				Minimum Insulation Resistance At Rated Voltage
Nominal Lead Spacing	Capacitance MFD	Maximum Diameter*	Tolerance	
.250	.01	.290	IMPROVED ULTRA-KAPS	10 MEGS
.250	.022	.405	16 Volt 25 Volt	10 MEGS
.250	.033	.405	+80-20% (Z) ±30%	10 MEGS
.250	.05	.515	or	10 MEGS
.375	.068	.590	±20% (M)	10 MEGS
.375	.1	.760		10 MEGS

*All Ultra-Kaps have a maximum thickness of .156 inches.

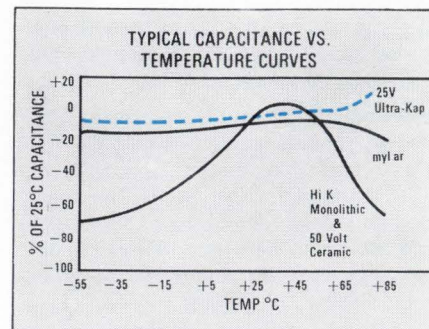

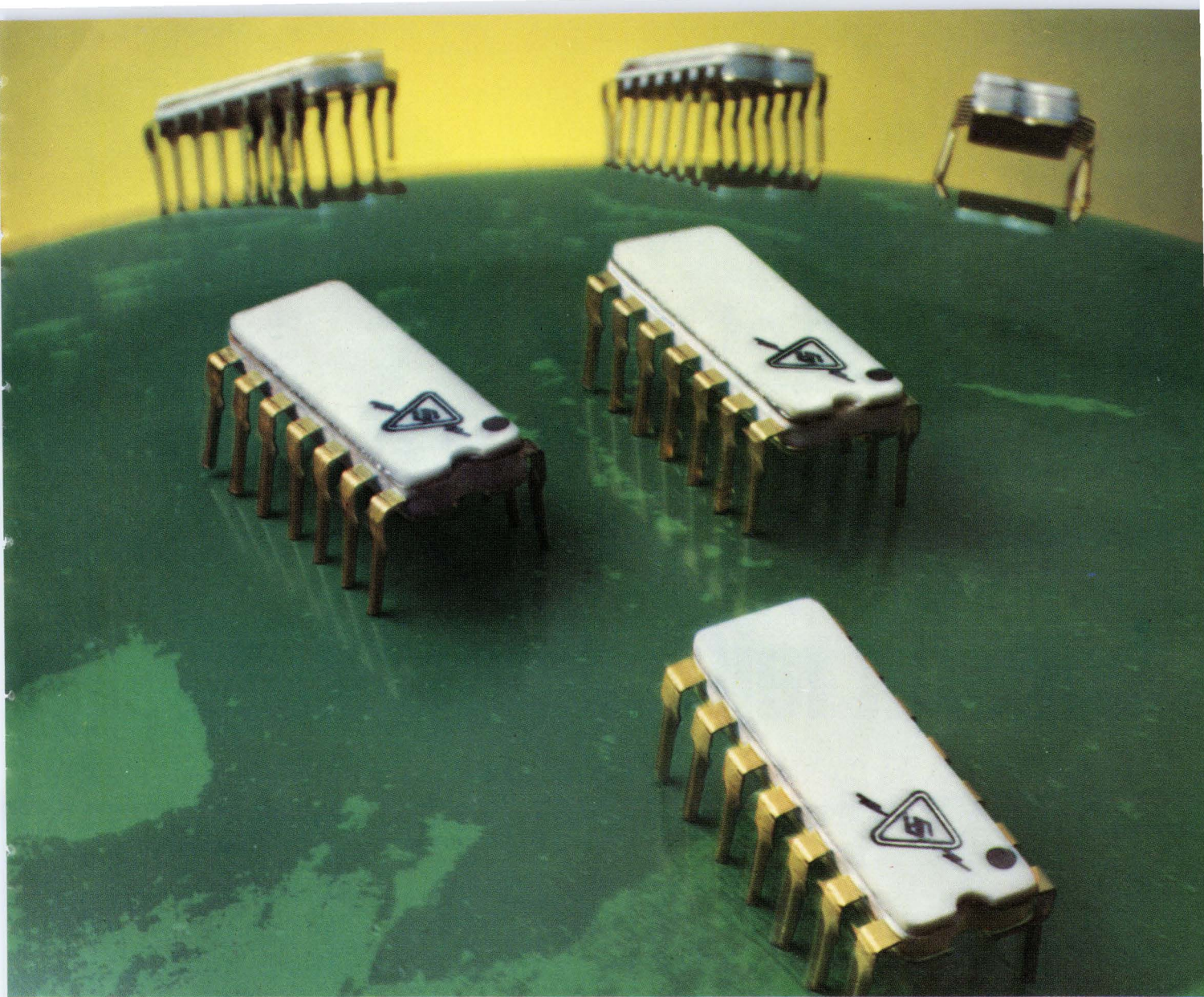

It pays to pick the fastest... in the computer race, it's SUHL/TTL.

We became deeply involved in TTL before anyone. That's why in TTL we're way ahead with SUHL™ ICs, the fastest IC line in the industry.

Our SUHL line keeps breaking speed records—now down to 5 nsec—without compromising noise immunity and power dissipation. That's why we're the prime source for TTL and why Sylvania Universal High-level Logic ICs are being second-sourced. In fact, several of the largest electronic manufacturers standardized on SUHL ICs,

even though Sylvania was their only source.

We have the most modern manufacturing facilities in the industry. All our ICs are made with one optimum process to maximize performance characteristics of every unit. Automated test equipment insures the ultimate in production monitoring, final testing, and quality control. So get SUHL's speed and reliability.

Sylvania Semiconductor Division, Electronic Components Group, Woburn, Massachusetts 01801.

SYLVANIA
SUBSIDIARY OF
GENERAL TELEPHONE & ELECTRONICS **GTE**

Circle 39 on reader service card

Helipot's new Model 77 trimmer comes clean without fail.





First \$1.10 cermet trimmer that's sealed for board washing!

The new Model 77 is an inexpensive wash-and-wear trimmer that's sealed for solvent washing on the board without failure. The cermet element gives wider performance parameters than any other adjustment potentiometer now on the market. Its pin spacing also makes it directly interchangeable with competitive models 3067 and 3068.

In the low price field, only Model 77 offers essentially infinite resolution, wide resistance range (10 ohm to 2 megohm), and other spec advantages shown at right. Quantity prices are as low as \$1.10.

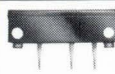
Call your Helipot rep now for a free evaluation sample. Compare Model 77 with unsealed trimmers . . . you'll see there's really no comparison.

	 Helipot Model 77	 Competitive Model 3067 Wirewound	 Competitive Model 3068 Carbon
Resistance Range, ohms	10-2 meg	50-20 K	20 K-1 meg
Resistance Tolerance	10%	10%	20%
Resolution	Essentially infinite	1.7 (100Ω) to 0.3 (20 K)	Essentially infinite
Sealing	Yes	No	No
Power Rating, watts	0.75	0.5	0.2
Maximum Operating Temp. °C	105	85	85

Beckman® INSTRUMENTS, INC.
HELIPOT DIVISION
FULLERTON, CALIFORNIA • 92634

IMMEDIATELY AVAILABLE

SMALL SIGNAL TRANSISTORS from Solitron!

Solitron now provides one of the broadest selections of devices in the industry with the purchase of Sperry Rand's silicon transistor operation. These low power units include Differential and Darlington Amplifiers and Silicon Transistors manufactured by alloy and diffused techniques. All have the same high reliability standards of quality and performance associated with Solitron. Some of these more popular devices include:



**NPN SILICON
DIFFUSED
TO - 46
2N2524**

h_{FE} 100 min @ 10 μA
 I_{CBO} <1NA @ 45V
 NF 3db max @ 10 μA
 f_t 45 MC @ 500 μA
 C_{OB} 6 pf @ 5V



**NPN DIFFERENTIAL
AMPLIFIER
TO - 78
2N2920**

h_{FE} 150 min @ 10 μA
 I_{CBO} <1 NA @ 45V
 h_{FE1}/h_{FE2} .9 @ 100 μA
 V_{BE1}/V_{BE2} 3 MV @ 100 μA
 $\frac{\Delta V_{BE1}/V_{BE2}}{T_A}$ 10 $\mu V/^{\circ}C$

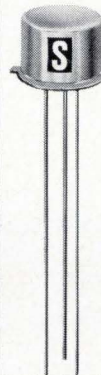

**PNP SILICON ALLOY
AMPLIFIER
TO - 5
2N1234**

BV_{CBO} 110V
 BV_{CEO} 110V
 BV_{EBO} 110V
 I_{CBO} 10 NA @ 90V
 h_{FE} 14-32 @ 1MA, 1KC



**PNP SILICON
DIFFUSED
TO - 46
2N2605**

h_{FE} 100min @ 10 μA
 I_{CBO} <1 NA @ 45V
 NF 3 db max @ 10 μA
 f_t 45 MC @ 500 μA
 C_{OB} 6 pf @ 5V



**PNP DIFFERENTIAL
AMPLIFIER
TO - 78
SMT 105**

h_{FE} 100 min @ 10 μA
 I_{CBO} <1 NA @ 45V
 h_{FE1}/h_{FE2} .9 @ 10 μA
 V_{BE1}/V_{BE2} 5 MV @ 10 μA
 $\frac{\Delta V_{BE1}-V_{BE2}}{T_A}$ 10 $\mu V/^{\circ}C$



**PNP SILICON ALLOY
CHOPPER*
TO - 5 TO - 18
2N1917 2N941
SERIES SERIES**

BV_{CBO} up to 80V
 BV_{CEO} up to 80V
 BV_{EBO} up to 80V
 I_{PI} 2NA @ 1.0V
 V_{PI} 2MV @ 500 μA (1B)



*These devices also available with Epitaxial base construction.

DIAL 1- 800-327-3243 FOR A NO CHARGE
 TELEPHONE CALL FOR FURTHER INFORMATION . . .

Solitron

DEVICES, INC.

1177 BLUE HERON BLVD./RIVIERA BEACH, FLA./TWX: (510) 952-6676

Leader in Germanium and Silicon Transistors, Cryogenic Thermometers, High Voltage Rectifiers, Hot Carrier Diodes, Temperature Compensated Zeners, Voltage Variable Capacitors, Random/White Noise Components, Microelectronic Circuits, and Power-Sink Interconnection Systems.

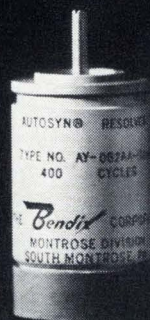

(Actual Size)

Weight-conscious engineers like what they don't see here.

Bendix® size 08 Autosyn® Synchronizers average only 1.3 ounces. And their maximum diameter is 0.750 inch.

It's this combination that explains the success of the 08 models in such a wide range of applications. In addition, all 16 standard 08 units feature 12-inch flexible leads, aluminum housings and corrosion-resistant construction. They're also available with stainless steel housings.

Some models are accurate and stable at operating

temperatures up to 800° F. Others are radiation-resistant. And if you can't find the 08 that's just right, we can build one to meet your needs exactly.

Need a larger size? Check our sizes 10, 11, 15 and 22.

Of course, the performance and reliability of every Bendix Autosyn Synchronizer are backed by one of the best names in the business. Write for our 42-pg. catalog. Flight & Engine Instruments Division, Montrose, Pa.

Bendix
**Aerospace
Products**

Electronics Review

Volume 40
Number 14

Companies

LSI for sale

Ever since the Autonetics division of North American Aviation Inc. set up a pilot microelectronics line in its research and engineering group in 1964, semiconductor manufacturers worried that the division, a systems manufacturer and one of the biggest consumers of integrated circuits in the U.S., was moving toward establishment of its own production facility.

And now Autonetics has done

just that, but officials say they have no intention of competing with their suppliers on off-the-shelf semiconductor devices.

The advent of large-scale integration (LSI) was a strong incentive at Autonetics. LSI was also cited as the stimulus when Collins Radio Co. decided to set up its own IC capability at Newport Beach, Calif. [Electronics, June 26, p. 25]. But while Collins has no plans to sell circuits for outside consumption, Autonetics will offer custom metal-oxide-semiconductor and silicon-on-sapphire devices to other users.

Custom work only. Autonetics'

president, S. F. Eyestone, stressed that the production facility will be for "custom second-generation microelectronic devices required for Autonetics' advanced avionics, data-processing, and other systems." He plays down the fact that the company would be selling custom devices to outside customers and added that "production and marketing of standard microelectronic devices is not planned."

More than 100 persons are now engaged in all phases of design, development, and manufacture in the microelectronics laboratories. The unit is headed by Earl H.

The man to watch: Autonetic's new LSI production chief

When Autonetics decided to establish a production facility for large-scale integrated arrays management chose **Earl H. Schaefer**, a manufacturing methods specialist, to head the North American Aviation group.

Schaefer is an innovator. He came to Autonetics in 1958 after 17 years with the Elgin National Watch Co. where he set up the first mass-production assembly line for precision watch manufacture in the U.S. He also developed machines to automatically drill, lap, and polish the tiny sapphire bearings for the company's time-pieces. So it is no accident that he was selected to initiate Autonetics new metal-oxide-semiconductor and silicon-on-sapphire custom device production line.

Precision work. Schaefer sees a strong parallel between the work he was doing at Elgin and the manufacture of electronic devices. His first job at Autonetics was in manufacturing methods development for circuit boards. He was director of research and engineering before his most recent assignment as Autonetics program director for the Mark 2 avionics system for the F-111.

The primary task facing him

as general manager of microelectronics, Schaefer says, is to find ways to improve the manufacture of LSI arrays. One of the major bottlenecks in the process is controlling oxide thickness, says Schaefer. Certainly the best guide to thickness is the oxide's color, and Schaefer's group is using a master material color and microcomparator technique to make tests.

"It's nothing revolutionary," he explains, "but it's typical of the sort of things that we will be concentrating on."

Schaefer agrees with predictions that the LSI state of the art will allow 1,000 devices per chip by 1970, "but after that, it's open-ended," he says.

Wages of fear. The executive believes his firm's long-rumored move into semiconductor manufacture will probably disturb Autonetics' IC suppliers initially but feels that "a bit of fear will be good for them," spurring them to improve their own ability to meet the demands of LSI. Schaefer is quick to add that Autonetics suppliers won't be hurt in the long run because the firm has no intention of competing with them for the off-the-shelf IC business.



Earl H. Schaefer

Schaefer, whose title is general manager of microelectronics.

No formal study has been conducted by Autonetics on the size of the market outside North American, but Schaefer says that as one of the biggest consumers of integrated circuits "we know the needs of the industry," and asserts that LSI production capability exists at Autonetics right now.

No sales force. The Anaheim, Calif., company does not have any orders yet for custom devices, and doesn't expect any significant realignment of its marketing force to accommodate outside orders. Schaefer feels that a good portion of the outside business will be unsolicited.

He says that, in addition to the spur provided by LSI, the desire to protect its proprietary designs was a major factor in the Autonetics decision to establish a production facility. He adds, straight-faced, that Autonetics' own in-house capability will ultimately lead to additional business for its suppliers because Autonetics will win more contracts, generating more orders for off-the-shelf semiconductor devices.

Medical electronics

Touching scene

Two California research groups are experimenting with systems that may eventually tell blind people of their immediate environments by electronically converting visual images to rough outlines on areas of their skin.

With the technique, called tactile image conversion, pictures from either a vidicon camera or a bank of photocells are reduced to a simplified dot-by-dot sketch on a selected area of skin. The dots are electrically triggered reed-like "ticklers," about the size of pencil points, whose vibrations indicate the outlines of the image.

Though the technique is several years away from development even as an aid to the blind, it also promises to help busy people with sight. For example, airline

pilots, whose eyes must already scan an awesome array of dials while landing a plane, could receive such check-off information as engine condition and fuel level tactilely, thus freeing their eyes for other concerns.

The skin can't match the eye for resolution, but its input capacity of some 2 megahertz is comparable to the eye's. Through point-for-point reception, the skin can sense two-dimensional surface images without complex coding but with reasonable recognition of shapes.

Problems. Researchers at Stanford Research Institute in Menlo Park and the Presbyterian Medical Center in San Francisco face two major problems: they don't know the actual bandwidth of the skin, and they can't be sure that a blind person's ability to move his camera in order to "range" an object can make up for the loss of three-dimensional representation.

Preliminary results, however, indicate that a blind person equipped with such a system will have to do a great deal of interpolation of all his sensory inputs. He will be limited by the devices, not by his own sensory ability, but he should be able to spatially connect objects that confront him, the researchers contend.

The two research groups differ on which areas of the skin to use. Stanford, under a new two-year grant from the Vocational Rehabilitation Administration of the Department of Health, Education, and Welfare, has opted for the fingertips. Its device is made up of a bank of photocells that activate a 1-by-1¼-inch, 8-by-12 array of piezoelectric two-layer crystal reeds.

The array was originally developed by John Linville of Stanford University's electrical engineering department to enable his blind daughter, Candy, to read ordinary printed matter [Electronics, Jan. 25, 1965, p. 35].

Stanford Research Institute hopes to increase the number of photocells and to use computer-generated images in further testing. "We will try to see what makes sense in the way of a process between the photocells and the tactile stimulators," says James C. Bliss, head of the institute's bioinformation department. Ultimately, the researchers would like to produce a portable "seeing eye" system that uses integrated circuits.

Front to back. Presbyterian's Smith-Kettlewell Institute of Visual Sciences, however, is using the subject's back as the tactile center. Also working under a Rehabil-

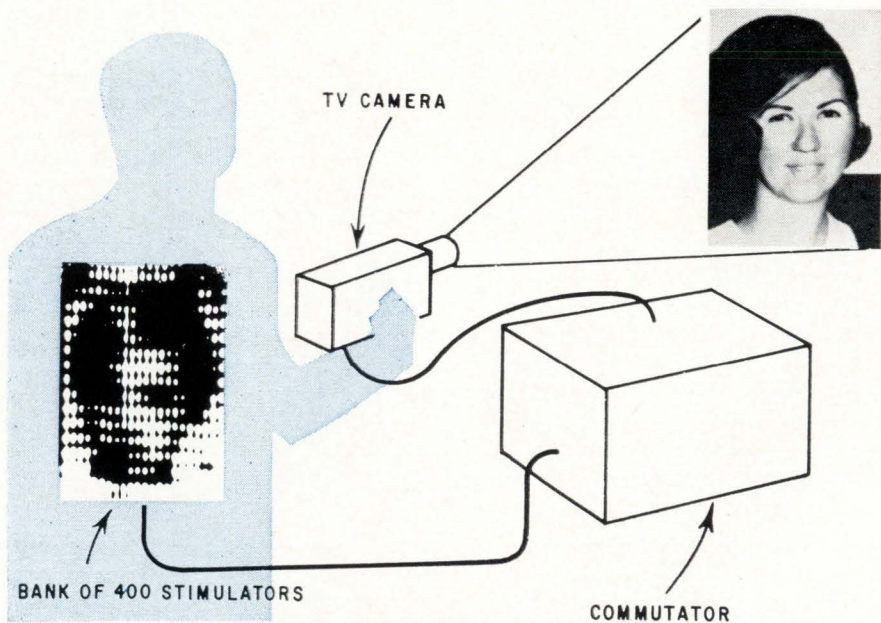

Blind spot. Visual image is transformed into a tactile "image" by converting tv camera's output into vibrations that sketch an outline on a blind man's back.

itation Administration grant, it has developed a system that works much like the old beach game, where one child tries to guess what word is being written on his back.

This system consists of a quasi-random, hand-held vidicon camera tube with a fish-eye lens, and an orthogonal logical switching matrix. It connects sequentially each element of the vidicon photocathode surface to the corresponding element of a polarized solenoid stimulator matrix with tips, 1 millimeter in diameter, in contact with the skin.

According to one researcher, Carter C. Collins, this matrix acts as a mechanical image projector that impresses a two-dimensional vibrating facsimile of the outlines of an object seen by the camera tube onto a 10-inch-square area of the blind person's back. Collins said they chose the back because they needed a large area that didn't interfere with movement of the head or hands. Although the skin on the back lacks the acuity of the fingertips or lips, it seems to give acceptable results, he says.

With a chair-mounted 3-by-3-point matrix, Collins reports, test subjects have been able to distinguish squares, rectangles, and the general size of objects. And the medical center is now building a 400-line (20 points across) array to improve resolution.

Limits on array. The skin appears to behave like the eye, Collins says. By shifting the image on the skin back and forth, researchers discovered that tactile acuity could be increased much as moving the eyeball back and forth improves its vernier acuity. They also found that experienced subjects couldn't distinguish between stimulators spaced closer than 10 millimeters apart, while the average was 20 millimeters.

The reduced number of possible skin stimulators aids such systems in a practical way: it conveniently filters out the complexity of real-world images and produces easily comprehensible shapes.

Limited as they are, the devices offer the blind a brighter future. Bliss predicts that Stanford could develop an operable reading aid within two years.

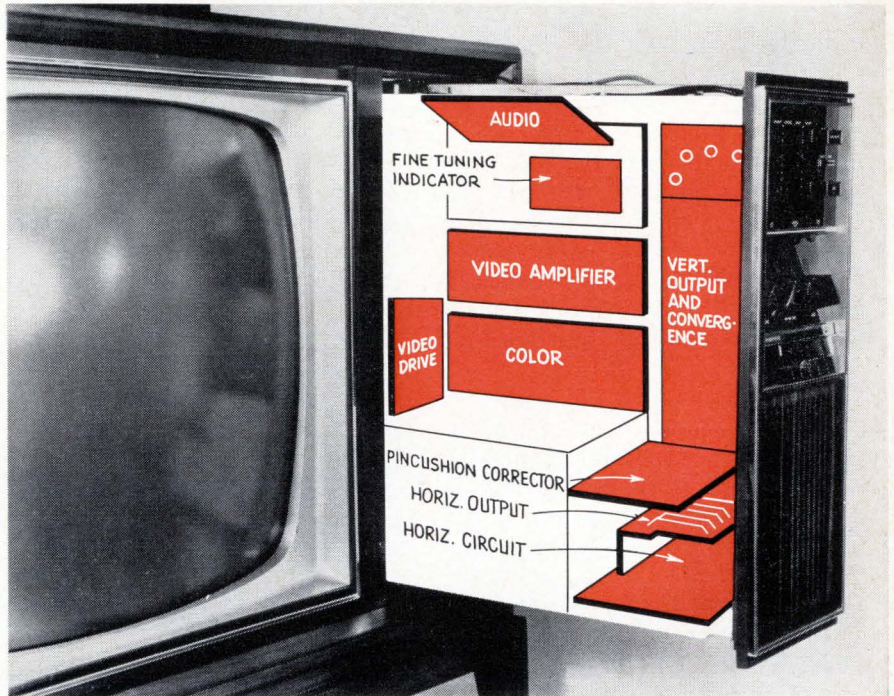

Slide out. All the electronics in Motorola's new line of color-tv sets are packaged in plug-in modules that can be slid out on a pull-out drawer.

Consumer electronics

Quick fix

A good color-television repairman is hard to find. So when a manufacturer comes up with a packaging concept that permits a relatively unskilled technician to make repairs, the industry sits up and listens.

The manufacturer, Motorola Inc., has taken a leaf from the military and heavy-industry notebook by placing the chassis of its 1968 color sets in a slide-out frame. And the chassis contains plug-in modules that can be replaced without soldering or unsolder a single lead.

Pull, look, fix. When something goes wrong, the serviceman pulls out the chassis, does a few tests to pinpoint the faulty module, and replaces it. He then sends the defective module back to Motorola, which repairs it or sends him a new one.

There is a catch. Independent repairmen will, in effect, be shut out of the Motorola market because of the high cost of stocking a complete line of modules.

Industry spokesmen, while conceding that the concept is practical, predict that the expense of producing the modular chassis will force Motorola to raise its retail prices or face deficits. But the company, which admits that such construction is more expensive, says it's confident that increased sales will make up for reduced profit margin.

Motorola is the first U.S. manufacturer to produce a color receiver that's solid state except for the high-voltage and the picture tube. Also, the audio section employs an integrated circuit.

In England, Thorn Electrical Industries Ltd. will soon introduce an all-transistor color-tv set that also has plug-in modules.

Military electronics

Just in case

A top-priority torpedo project has encountered technical and managerial problems so severe that the Navy has taken the unusual step of naming a second company to de-

velop an alternative model. The original company, the Westinghouse Electric Corp., could lose the lucrative production contract, which will follow development.

Westinghouse's Underseas division, the prime contractor on the Mark 48 wire-guided torpedo since 1964, underwent a management shakeup early this year in hopes of correcting the difficulties which have cropped up in the development work.

The Clevite Corp. will build the alternative model, which will be similar to the Westinghouse weapon. The Mark 48 is listed by the Navy as one of the eight highest-priority antisubmarine warfare projects.

On the right track. The situation came to light last month when Congressional testimony was released. Both the Navy and Westinghouse now feel that the company has gotten on the right track in the Mark 48 development.

Westinghouse officials blame the difficulties on a lack of communication between the division's top management and the project engineers. They also put some of the blame on the Navy, saying there was an insufficient exchange of ideas between Navy and management. One industry official who has followed Westinghouse's difficulties says the root of the problem was "a brilliant scholar" whose forte was books, not management.

Slow going. How much time has been lost isn't known. The Navy started studying the Mark 48 in the late 1950's. Even if the scheduling requirements had been met, the weapons systems would not have gone into production until 1969. This long development and the \$50 million spent thus far has stirred some Congressional criticism. New York's Democratic Rep. Otis Pike calls the the Mark 48 a "tremendously expensive and tremendously slow development."

The Navy agrees but contends it needs the weapon. The torpedo will be useful against both high- and low-speeds targets; it will travel faster, dive deeper, and provide longer acquisition range than its predecessors.

And although the Navy isn't say-

ing so, an obvious advantage of the wire-guided model is that it will be less susceptible to electronic countermeasures than torpedoes with active electronic guidance.

Clevite is no newcomer to the project. Westinghouse, in 1965, selected Clevite as a subcontractor for the guidance and homing control development on the Mark 48.

Over and out

Tailoring lightweight, rugged gear for ground forward air controllers in Vietnam hasn't been a complete success for the military. One loser that just came to light is the AN/PRC-65, a very-high-frequency amplitude-modulated transceiver, designed exclusively with integrated circuits.

Simmonds Precision Products Inc. of Tarrytown, N.Y., won an Air Force contract to produce the unit in 1964, but found subsequently that the job was too difficult. The Air Force recently scrubbed the contract and so far has not made an attempt to award the order to another company.

A spokesman for the company concedes: "The contract was underbid. . . . The specifications were so stringent, we just couldn't see how to meet them."

Winners. But there have been some victories. Two new lightweight radios have just been delivered to the Rome, N.Y., Air Development Center. The AN/PRC-72, built by the Bendix Corp. to replace the AN/PRC-71, is headed for tests at the Tactical Air Warfare Center at Eglin Air Force Base, Fla. It has a crystal synthesizer in its high-frequency/single sideband radio, providing channels in all frequencies in this band. The PRC-71 has individual crystals for each channel, limiting the number of channels to the number of crystals used. Besides h-f/ssb, both radios provide communications in vhf/f-m, vhf/a-m, and uhf. At 35 pounds the PRC-72 is 20 pounds lighter than the older model.

The other transceiver, the AN/PRC-66 built by the Collins Radio Co. of Canada Ltd., a subsidiary of the Collins Radio Co., is designed to replace the AN/PRC-41. It, too,

is going to Eglin for tests.

Built with ic's and equipped with a crystal synthesizer, the PRC-66 weighs only 4 pounds plus 6.2 pounds for a rechargeable battery. It measures 5 by 8 by 1½ inches, about the size of a book. The PRC-41 weighs 41 pounds. Also, the newer model is more reliable, with a mean time between failures of 5,000 hours compared with the 500 hours of the PRC-41 and has 3,500 channels instead of 1,750. Although the PRC-66 is limited to uhf, this band is compatible with radios used by fighter pilots and airborne forward air controllers in O1-E Cessnas. The PRC-66 could be used instead of the heavier PRC-72 when uhf alone is needed.

On display

Until recently, the Air Force gave lasers and other exotic devices about an even chance of becoming the basic building blocks for its next-generation equipment for multicolored wall-size displays.

But the Air Force has now decided that, as good as their potential might be, new devices aren't at that stage of development which would make them suitable for operational equipment. The next generation of display gear will be designed around the standard Ediphor projector, an old standby.

A contract for a prototype was awarded by the Air Force Systems Command last week to the CBS Laboratories division of the Columbia Broadcasting System. The equipment, which will take from 18 to 24 months to build, will project full-color pictures on screens 10 by 10 feet or bigger in command and control centers.

Long life. The new generation Ediphor display will be certainly better than versions in current use. The CBS contract calls for an improvement in mean time between failure to 500 hours from 50. Further, the new system won't use film or a glass-etching technique, both of which preclude real-time displays. The CBS unit will project its images through an oil film; by scanning the film with a modulated electron beam, in the shape of the image, depressions are formed on



Automated testing...

**...helps make μ -PACS
the most reliable
I/C modules in the
industry**

μ -PACS are 100% tested. We test the components, test the circuit boards, and test every finished PAC against stringent QC standards. In fact, we designed our own automatic PAC test system to perform more tests faster . . . like 85 static and dynamic electrical tests in less than 20 seconds. All to make sure the reliability we achieve in design is passed on to you in production.

Whether you face design of a one-shot black box, or an entire product line, why not rely on μ -PACS. You'll never have to worry about reliability. They've been proven in hundreds of systems — and in test after test. And you get the best price/performance ratio available today. Write for our new brochure. It sums up all the facts. Honeywell, Computer Control Division, Old Connecticut Path, Framingham, Massachusetts 01701.

Honeywell

 **COMPUTER CONTROL
DIVISION**

Circle 47 on reader service card

the film's surface. The image is projected when a flood beam of light is passed through the oil film.

Even beyond this project, Air Force officials are planning further improvements. One problem to be solved is the cathode damage caused by hydrocarbon ions created by interaction between the electron beam and the oil film.

Pin cushion. The Air Force is working on two techniques to circumvent this. One would separate the oil film from the electron gun by a dielectric barrier containing embedded metal conducting pins. Instead of releasing destructive ions from the oil and damaging the cathode, the electron beam would be transmitted safely to the oil film via the pins in the barrier.

The other approach would replace the oil film with a transparent crystal that could be electronically scanned and made to project the image as the oil film does.

The slim look

The old familiar 600-pound plan-position-indicator (ppi) scope for search radars is fading out of the picture. Taking its place will be a trimmed-down version, weighing only 70 pounds, from the General Electric Co.'s heavy military electronics department. The slim look stems from very extensive use of

integrated circuits.

Designated the AN/UPA-56 by the Air Force, the \$25,000 unit is called Mirage (microelectronic indicator for radar ground equipment). It will replace most of the old ppi's in Air Force ground search radars, and in aircraft used for command and control. It can also be used aboard ships.

Mirage uses 80 ic boards and four transistorized boards. It occupies 2 cubic feet compared with 21.6 cubic feet for the older unit.

Communications

Showing them the way

Officials at the Nortronics division of the Northrop Corp. believe they have established themselves as the principal contender for the Navy's potential multimillion-dollar Omega navigation receiver procurement by winning the Electronic Systems Command's contract to supply 140 production models. Nortronics was low bidder among six companies competing for the AN/SRN-12 award [Electronics, June 26, p. 60].

The \$1.68-million contract calls for delivery of the first receiver within a year.

In addition to the Navy potential, a Nortronics market forecast cites some 1,500 merchant ships of 100 tons or more that are candidates for the Omega receiver. This market is still up for grabs, which is why Nortronics is stingy with design details on its winning entry.

The Omega unit consists of the receiver plus a three-channel strip chart recorder and an oscilloscope. The basic receiver weighs 45 pounds. Total weight won't be determined until the chart recorder has been selected. The three elements fit in a package that is 23 inches wide, 21 inches high and 21 inches deep. Mean time between failure is specified at 2,000 hours.

The firm anticipates a separate request for proposals from the Navy in the next few months for an airborne version of the Omega receiver.

The Nortronics bid was just a

little more than \$42,000 under Pickard & Burns Electronics' figure of \$1.72 million. Next came Tracor Inc. at \$1.99 million, Decca Radar Inc. at \$2.06 million, the Ryan Aeronautical Co. at \$2.49 million, and the International Telephone and Telegraph Corp. at \$2.66 million.

Positioning. With Omega, ship captains will know their position to within one mile during the day and to within two miles at night. If they can compare their own position with another Omega-equipped vessel, skippers will be able to fix their own position to within 200 to 300 yards.

Four Omega transmitters are now on the air—at Haiku, Hawaii; Forestport, N.Y.; Aldro, Norway; and on Trinidad. They operate at 10.2 kilohertz. Four more Omega transmitters are planned to assure worldwide coverage. The globe is partitioned into 8-mile-wide lanes, or parabolic wavefronts, on Omega charts supplied by the Navy. The 8-mile figure is approximately half the wavelength of a signal at 10.2 khz. Lanes have three-digit identification numbers that are displayed in the first three places of a five-digit display tube readout. The last two places indicate the percent of a lane a ship has traversed.

Superior design. The display tubes are driven by logic circuitry on 22 two-sided plug-in receiver circuit boards that make wide use of dual in-line flatpack digital ic's.

According to the Navy's present plans, Omega transmitters will eventually broadcast at frequencies ranging from 10.2 to 13.6 khz. But for the next several years only the lower frequency will be used. With the lower frequency, fixes adequate for most ships can be obtained. The variety of frequencies will be used to provide more precise fixes.

Solid state

More complex

As the linear integrated circuit market grows, makers are turning out more complex designs that ap-

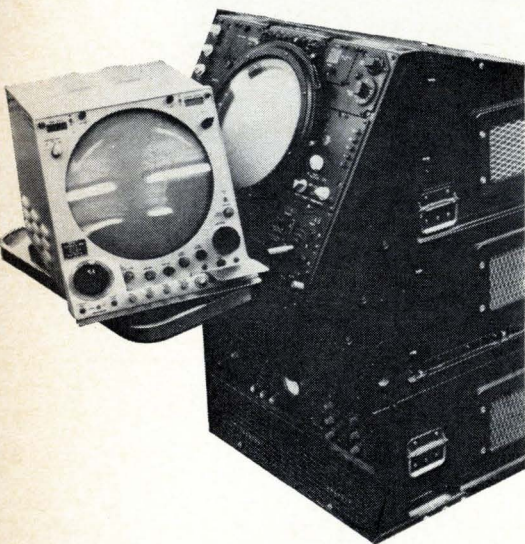

Space-saver. Lightweight radar scope compared with old model.

SPEER COMPONENT COMMENTS

Are our new custom resistor networks the missing link your precision circuits have been waiting for?

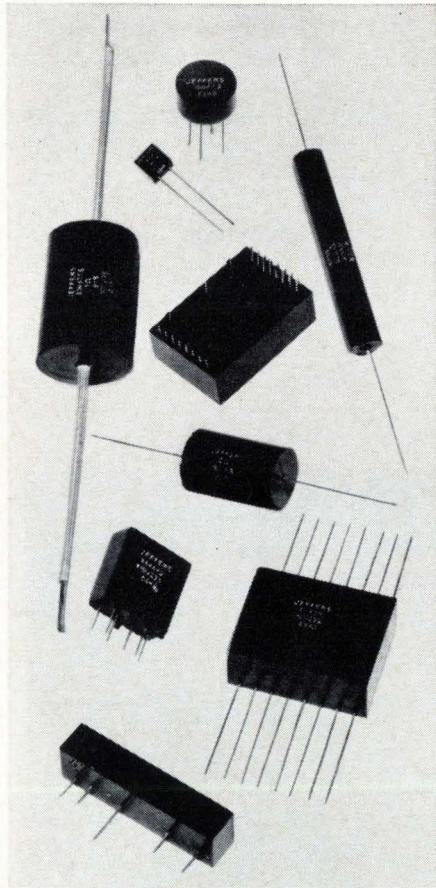

We suspect that they are—since they're a direct descendant of our Jeffers Electronics Division's *standard* JXP resistor.

What we did first was to recognize that the advantages (price, delivery, and performance) of the highly stable

JXP metal film resistive elements used in the standard line were also applicable to custom network and packaging assemblies. Therefore, we established an engineering staff and production facilities to handle design and manufacture of complex resistive element combinations and to package them according to your custom requirements.

In the meantime, the state of the art of producing the JXP type of metal film resistive element advanced. Specifically, we developed the ability to calibrate resistive elements to tolerances as low as 0.01% with characteristics of very low temperature coefficient of resistance and compatible stability.

What's more, we can design these packages to meet any network application—ladder, analog-digital, voltage divider, function generation, summing amplifier, pulse sampling—you name it.

Our custom packaged networks and assemblies offer broad environmental capabilities. And thanks to the marvels of modern technology performance, they will meet all your requirements at the lowest possible cost on the shortest delivery schedule known for this type of product.

Doesn't this indicate that our new custom packaged resistor networks are worth investigating further? You can do this at the Wescon Show. Or you can get more information by merely mailing us the coupon.

Explore our new custom resistor networks at the Wescon Show

Come to the Jeffers/Speer Booth (5327 & 8) at the Cow Palace in San

Francisco. You'll see both our new networks and our standard JXP. (Not to mention that work horse of the electronics industry—the Speer carbon composition resistor.)

If you can't make it to the Show, send us the coupon and we'll tell you more about our new networks. You'll find that they make quite a package!

Visit with our Technical Service Engineers

Take a little time out to visit our Technical Service Engineers at Booth 5327 & 8 at the Cow Palace. They are well acquainted with this subject, especially in regard to resistors (as they should be), because of contributions made by them and other members of our technical staff to these specifications during their development.

SPEER® Speer Carbon
A Division of AIRCO

JEFFERS ELECTRONICS DIVISION
SPEER CARBON COMPANY
DuBois, Pennsylvania 15801

Speer Carbon Co. is a Division of
Air Reduction Company, Inc.

Rush more information on your new custom resistor networks.

Name _____

Title _____

Company _____

Address _____

City _____ State _____ Zip _____

proach the complexity of complete analog subsystems. Engineers at the Philco-Ford Corp.'s Microelectronics division have developed an IC radio receiver that contains two of the most complicated monolithic linear circuits yet exhibited. Each performs five separate functions. [For more on linear IC's see page 125.]

One IC contains an r-f amplifier, a local oscillator, a mixer, a voltage regulator, and the first i-f stage of the radio. The second IC has a detector, another voltage regulator, the second i-f stage, an audio driver, and an audio output stage. Automatic gain control (agc) is taken from the detector, processed by an external agc network, then fed into the r-f and first i-f stages.

More functions. The nearest monolithic rivals are the μ A717 [Electronics, June 12, p. 38] made by the Semiconductor division of the Fairchild Camera & Instrument Corp., and the 915 i-f unit of Tele-dyne Inc.'s Amelco Semiconductor division; both IC's are intended for entertainment equipment. Fairchild's IC has i-f gain and limiting stages, a quad detector, and an audio stage; Amelco's unit contains three i-f amplifying stages, an agc amplifier, and an output buffer amplifier. Compared with a standard eight-transistor radio, the IC version has twice the sensitivity

and double the agc capability; other performance indexes, such as distortion content and output power, are equivalent.

Philco-Ford's IC's were custom-developed for an entertainment equipment manufacturer. They were displayed in an experimental a-m radio at the Chicago IEEE Conference on Television and Broadcast Receivers last month. Philco does not intend to offer the IC's on an off-the-shelf basis because of proprietary design obligations to the consumer firm.

But Philco will soon be offering a single IC, combining the functions of the two already developed and possessing broader characteristics, for use in a variety of communications applications.

Industrial electronics

Wanted by the FBI

Identifying a person by the whorls and loops of his fingerprints is still the arduous, time-consuming task it was in 1903 when Sir Edward Henry developed the process. But in the next year, two electronics firms will demonstrate hardware to the Federal Bureau of Investigation that will automatically read,

classify, and sort the minute differences in fingerprints.

Cornell Aeronautical Laboratory and the Autonetics division of North American Aviation Inc. have been selected to provide and demonstrate the engineering-model reading devices. Each proposes to develop a different technique. From the two devices, the FBI will select one that will be the first move toward a large central data-processing center for fingerprints. The center eventually will be able to handle more than 500,000 prints a day. Presently, the FBI must manually process some 30,000 new fingerprints daily and compare them with a central file of more than 180 million.

Scanner. M.G. Spooner, head of Cornell's computer research department, says his group will demonstrate a flying-spot scanner capable of reading prints from opaque forms. The scanner operates with a small, standard digital computer and a special-purpose, pattern-recognition computer developed by Cornell. Spooner says that the information is digitized by the scanner and subjected to image-processing techniques in the special computer. He credits two processes with helping the group win in competition with more than 30 others: a dynamic threshold scan to reduce the effect of the varia-

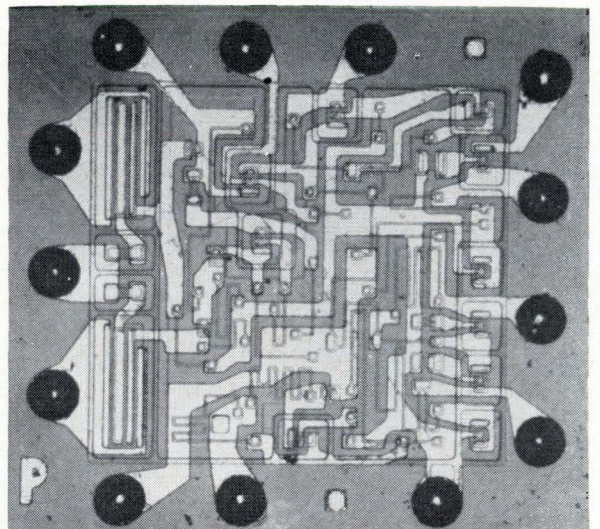
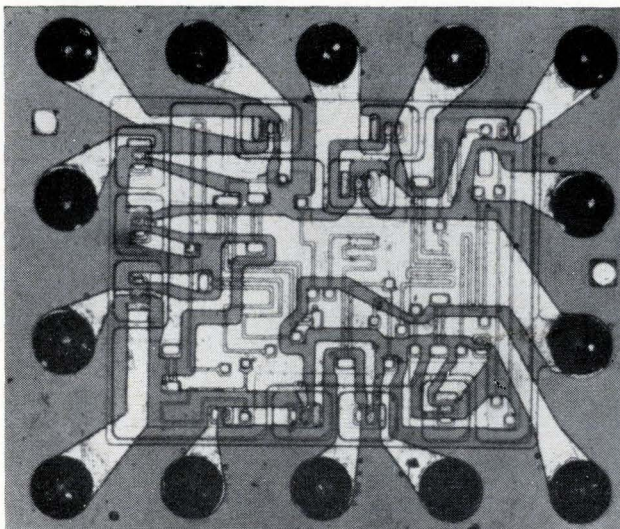

Complex linear IC's. Five functions in a monolithic linear chip highlight these Philco-Ford IC's. Circuit on left contains 12 transistors and 116 K-ohms of resistance; it provides r-f and i-f amplifying functions, voltage regulation, mixing, and a local oscillator action. Unit on right has 16 transistors and 120 K-ohms, provides detection, i-f amplification, voltage regulation, audio driving, and audio output.

Design a new circuit? It only takes 10 seconds to find out that maybe you didn't.

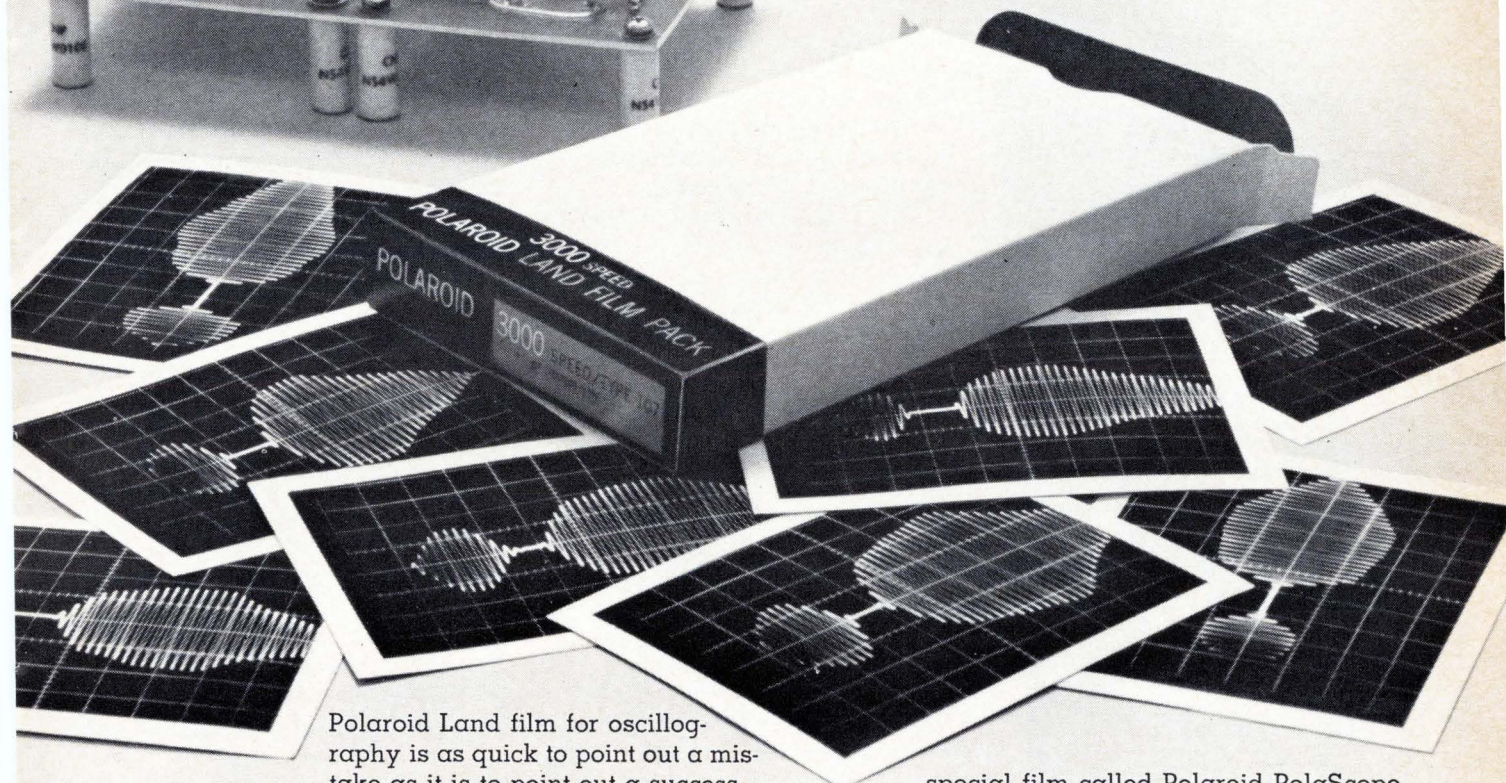
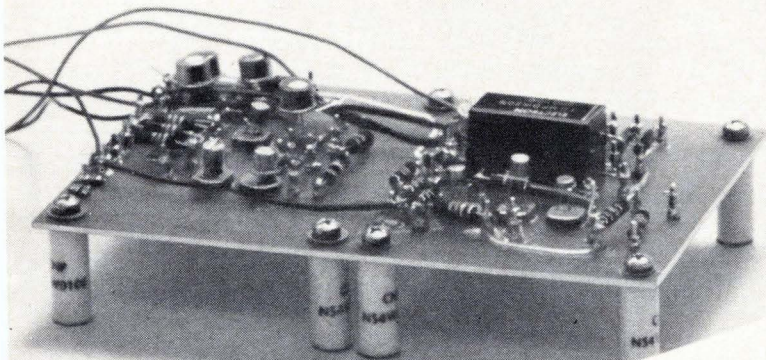

Polaroid Land film for oscillography is as quick to point out a mistake as it is to point out a success.

You never have to wait for darkroom development only to find out that your new breadboard needs more work.

You get your results in 10 seconds flat. And it's always a sharply detailed, high-contrast trace recording.

You can study it, attach it to a report, send it as a test record along with a product shipment, or file it for future use.

Choice of films? Yes. There are four different films for oscilloscope recording in pack, roll, and 4 x 5 formats.

The standard film speed has an ASA equivalent rating of 3000.

If you want to take a picture of a trace so fast you can't even see it, we've got a

special film called Polaroid PolaScope Land film with an ASA equivalent rating of 10,000. It's the fastest film around. It will actually record a scintillation pulse with a rise time of less than 3 nanoseconds.

To use these films on your scope, you need a camera with a Polaroid Land Camera Back. Most manufacturers have them (Analab, BNK Associates, Coleman Engineering, EG & G, Fairchild, General Atronics, Hewlett-Packard, Tektronix).

You can get complete details from one of these manufacturers, or by writing to Polaroid Corporation, Technical Sales, Dept. 30, Cambridge, Massachusetts 02139.

Polaroid Land Film for Oscilloscope Trace Recording

Solve Your
Special Purpose
Filter,
Transformer,
Inductor and
other Wire
Wound
Component
Problems
at SIE!



Dresser SIE now offers a complete engineering and manufacturing service to fill all your needs for special purpose wire wound components for your ordnance, aircraft, aero space and seismic applications.

Send your specifications today to the address below for complete information.

DRESSER



INC.

INDUSTRIAL PRODUCTS GROUP
P.O. Box 2928/Houston, Texas 77001
one of the **DRESSER** Industries

tions of gray in inked prints, and a scanning retina to identify minute variations. Spooner says a large file of prints could be automatically searched for a specific "wanted" print and that a half-dozen or so prints closest to the one sought would be culled for the experts to examine. Cornell has 10 months and \$89,000 to produce an engineering model.

Autonetics' officials, taking a clue from their secretive sponsors at the FBI, are not talking about their technique. However, a source close to recent contract negotiations indicates that the 13-month, \$111,000 contract is for the development of a reader employing holographic techniques and constructed with off-the-shelf components.

Other firms, including the General Electric Co. and the Bendix Corp., have described holographic schemes for automatic reading of fingerprints [Electronics, March 20, p. 52].

Filter. In both the GE and Bendix experiments, a spatial filter was used to compare prints and determine if matching had occurred. Major differences in the systems were in the way the print was viewed: in the GE system a stationary print on a transparency was compared with a transparency file; the Bendix system compared rotated prints. The rotation of prints produced a bull's-eye pattern of concentric circles in which the characteristics of the print appeared as irregularly spaced circles. It is believed that Autonetics, too, is using a spatial filtering scheme.

Another law enforcement agency that will shortly announce one or more contractors for research and development of automated fingerprinting equipment is the New York State Police identification and intelligence system. J.E. Gaffney Jr., a development engineer working on machine methods of fingerprint identification for the International Business Machines Corp.'s Center for Exploratory Studies, Rockville, Md., indicates that his company will be announcing a contract in the fingerprinting area in the next few weeks. IBM is one of the nine firms being considered by New York.

Success stories

Direct digital control (DDC) is probably the most hush-hush area of industrial electronics because the processes it controls are the most keenly competitive — petrochemicals, glass, cement, and steel. A peek under this security blanket was provided when several companies told of operating experience. All reported exceptionally good results.

In fact, one firm—Owens-Corning Fiberglass Corp. of Newark, Ohio—has become so proficient with DDC that it has installed six systems on its production lines in just one year. And now, according to W.C. Tretheway, who heads the installation of the system, management wants DDC in all its plants. He was speaking at last month's Joint Automatic Control Conference in Philadelphia.

The firm has designed its systems so that the computer is independent of the process. This made it possible to switch at one plant from an IBM 1710 to an 1800 computer while the process was on-line, Tretheway said.

Work load. A West German chemical company, Chemische Werke-Huls of Huls is another that has successfully applied DDC, says Paul von Loescke, manager of the Foxboro Co.'s Digital Systems division, which installed the system. Production from batch chemical reactors has been increased by as much as 20%, he said, and supervisory personnel may be reduced from six to two. Foxboro has applied its dual-computer PCP-88 DDC system to 29 reactors; eventually it will be extended to 80.

Another successful installation is the one designed by the Leeds & Northrup Co. for the Ideal Cement Co. in Tijeras, N.M. Otto V. Kuehrmann, Leeds & Northrup's digital applications manager, reported the system was down for only 17 hours in more than 6,000 hours of operation, and most of this downtime occurred just after the system began operating.

The most important factor affecting the acceptance of DDC is the computers' reliability. Process con-

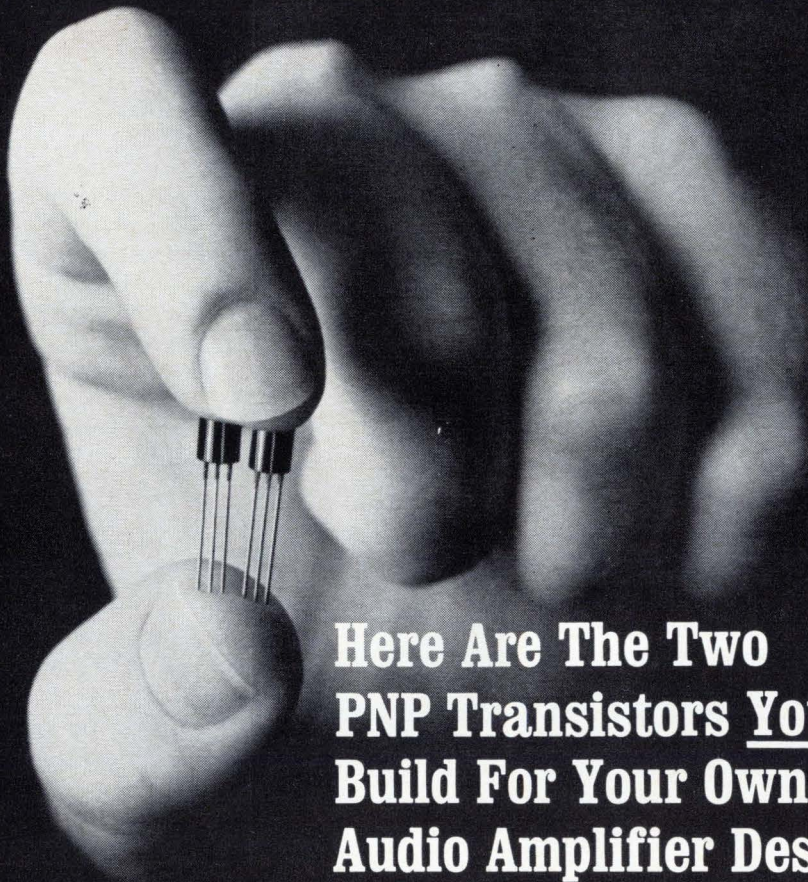

Here Are The Two PNP Transistors You Would Build For Your Own Audio Amplifier Designs! (and the 2N5086-87 are available in quantity)

Maybe you can't find transistors that have *all* the features you want for a design. But the new Motorola PNP 2N5086 and 2N5087 plastic packaged devices for audio amplifier applications come about as close as you can get to all-around versatility and performance perfection . . . just like *you* would build for yourself!

These devices offer such features as:

	2N5086	2N5087
High Voltage (BV_{CE0})	50 V (min)	50 V (min)
High, Stable Gain (h_{FE} @ $I_C = 100 \mu A$)	150 (min)	250 (min)
Low Wideband Noise Figure ($I_C = 20 \mu A$, $V_{CE} = 5$ Volts)	3 dB (max)	2 dB (max)
Low Current-Gain Bandwidth Product (f_T)	120 MHz (typ)	150 MHz (typ)
Prices (5,000-up)	\$0.35	\$0.38

In addition, then, the 2N5086-87 transistors give you good gain linearity at low currents . . . excellent signal-to-noise ratio . . . good amplification of the wanted signal . . . extra flexibility in your choice of supply voltage . . . and less chance of parasitic oscillations — due to low f_T .

PLUS, you get additional benefits like low leakage current for good bias stability ($I_{CBO} = 10$ nA (max) at 10 V) . . . rugged TO-92 UNIBLOC* plastic package

. . . and patented Annular device structure for extra stability and reliability.

AVAILABILITY UNLIMITED!. Production quantities of both devices are available, immediately. Contact your Motorola field representative or franchised Motorola distributor to fill your order — with no waiting. For detailed data, write Dept. TIC, Box 955, Phoenix, Arizona 85001.

*Trademark of Motorola Inc.

Excellent Noise Characteristics At Four Current Levels!

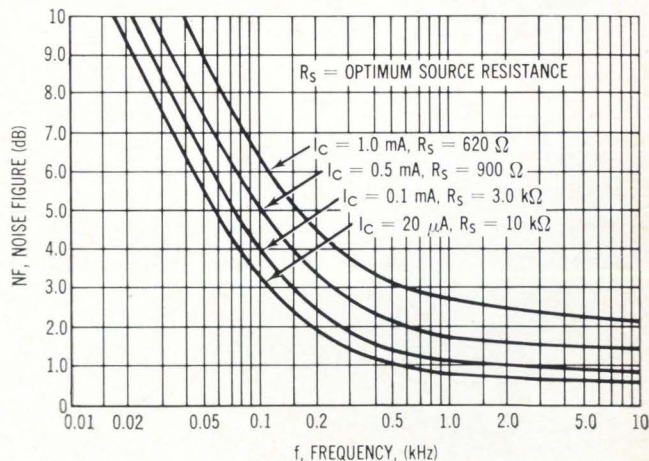

-where the priceless ingredient is care!



MOTOROLA
Semiconductors

Compact electronics package?

COOL IT...

...with a small size, long life, high output AiResearch fan.

Garrett-AiResearch special purpose fans are individually designed and custom built to deliver more flow and greater pressure rise with a minimum envelope size.

Take a typical AiResearch small size fan: computer-optimized for required performance under all operating environments; our own motor, engineered and manufactured for a perfect match to its fan; and up to 40 percent more airflow than any other ventilating fan of similar input, size, and weight.

Next time you need a ventilating fan for a very special airborne or ground electronics enclosure specify AiResearch. Available for high temperature and cryogenic applications, with flow rates and power requirements as specified. AiResearch Manufacturing Division, Torrance Facility, 2525 190th Street, Torrance, California 90509.

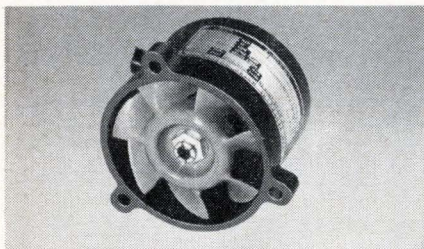
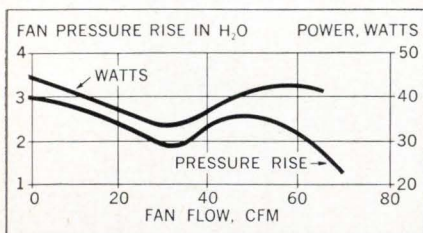

AIRESEARCH SPECIAL PURPOSE FANS



Electronics Review

Control people, who oversee their processes manually, have been loathe to turn it all over to a computer. But the computers have had so little downtime that this reluctance is rapidly fading.

Oceanography

Burrap, burrap

Man has been talking to dolphins for years. Now the Navy would like to find out if the dolphins can talk back.

The possibility of two-way communications is being explored by Listening Inc. of Arlington, Mass. Dwight W. Batteau, president of the research company, initiated the experimental work at the Navy's marine biological facility at Point Mugu, Calif., and is now continuing the project at a lagoon near the University of Hawaii's Oceanic Institute on Coconut Island, off Oahu. "Maybe in another year," says Batteau, "we will know if dolphins can be taught to convey information to man."

What might make communication possible is a dolphin-to-man translator now in the breadboard stage. Fully developed is a man-to-dolphin translator incorporating circuitry refined by three years of experimentation at Point Mugu.

Courier and scout. The dolphin, a seagoing mammal, has fascinated man since ancient times because of its friendliness and intelligence, and the indications it has given of communicability. These traits interest the Navy for many reasons. The dolphin is already being used as to carry tools and messages to and from submerged research vehicles. What the Navy will like to know is whether the creature can survey enemy waters and return with "reports," listen for the approach of underwater vessels, and go on scouting patrols.

Unlike researchers who have tried to teach English words to dolphins, Batteau uses an intermediate language that can be translated by electronic circuitry into dolphin-like whistles.

Commands. The two dolphins now in training respond to 18 "words." These include "baiep," meaning go through the hoop; "bip," hit the ball; "unweiap," roll over; "baep," make sounds; "burrap," go out and wait. The dolphins are also being taught to respond to a clicking sound made with a mechanical device and meaning "go ahead and do it."

The dolphin, which may well be congratulating himself for having taught humans 18 words, has a vocabulary of whistles in a frequency range from 5 to 20 kilohertz and with a duration of about a second. The whistles can be reduced to a frequency contour—frequency as a function of time—without loss of information.

The words and their meanings are developed by training. The sounds b and p, and sometimes an exaggerated w, are used to provide a distinct beginning and ending. The other sounds correspond to definite whistle frequencies: "ai" as in bait is 10 khz, "oo" as in boot is 12 khz, "ee" as in beet is 14 khz.

Three electronic devices are used in the program. The man-to-dolphin translator transforms human speech into a whistle language, the dolphin-to-man translator transforms dolphin whistle inputs into synthetic speech sounds, and a multifilter spectrum analyzer records the frequency contours on electrosensitive facsimile paper.

Tweeter. A word spoken into the microphone of the man-to-dolphin translator is turned into a frequency-modulated whistle that is transmitted through the water by a hydrophone. The translator itself consists of a vocal pulse detector, a voice-to-direct-current converter, and a whistle generator. The latter unit is a voltage-controlled oscillator using field effect transistors as frequency-control elements. The oscillator takes the d-c voltage from the speech-processing circuits and generates a signal whose frequency is proportional to this voltage. Logic circuitry gates the signal on and off, culling out sounds other than human speech.

The dolphin-to-man translator,

generates a d-c voltage proportional to the frequency of the dolphin's whistles, as measured by a zero-crossing detector. The voltage is converted to a string of double pulses, and the separation, or time delay, between pulses is varied to produce a synthetic speech approximating the vocabulary of the intermediate language.

For the record

Rough going. Although a pulsed ruby laser aboard a jet trainer failed to detect clear-air turbulence, NASA is hoping for better news from an agency-funded airborne experiment at William and Mary College. Moreover, the space agency is looking at crossbeam correlation techniques, already demonstrated in the laboratory, to detect jet exhausts because the exhausts are similar to turbulence. Tests on a tower are next. If they work, NASA will repeat the experiment on a plane.

Sky reader. The major components of an improved satellite infrared spectrometer for weather-forecasting data will be designed and built at the Hughes Aircraft Co.'s Santa Barbara (Calif.) Research Center under a \$1 million contract from the U.S. Department of Commerce.

Insulation. Studies for the Office of Naval Research have turned up rubbery new insulating materials that could protect electronics in space and ocean environments. Formed from carbon and boron polymers, the new materials provide more resistance to heat and corrosion than rubbers, silicones, and plastics now in use. They can withstand temperatures of 600° to 700° F for prolonged periods, while rubber breaks down at about 200° and silicones at 350° F.

Boom. The Army Materiel Command has awarded three \$6 million contracts for the production of artillery proximity fuses incorporating integrated circuits. The contracts went to Texas Instruments, the Fairchild Camera & Instrument Corp., and the Raytheon Co.

RECONNAISSANCE ...a very special ART

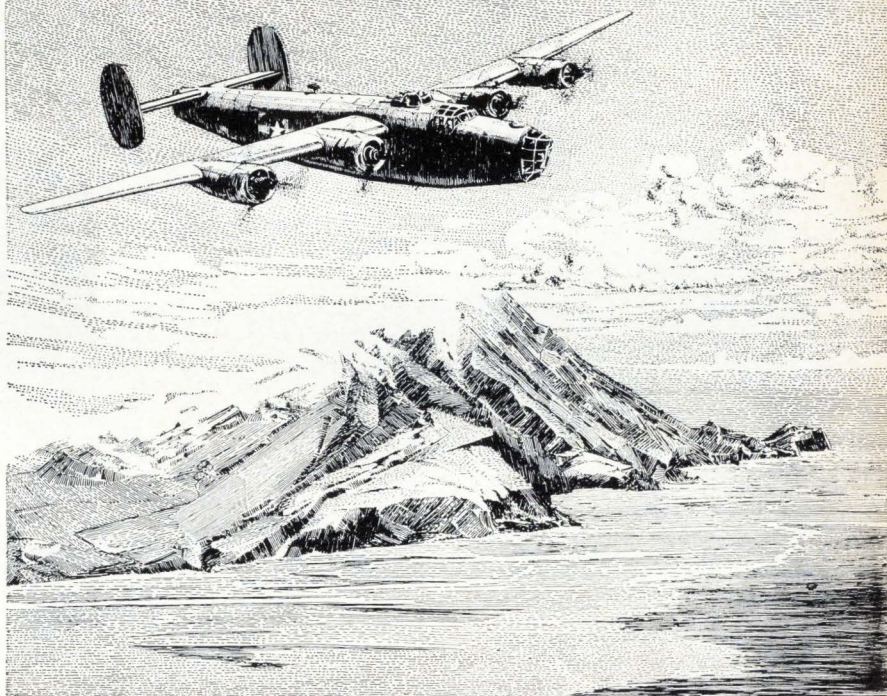

In the early days of World War II there was evidence of an enemy radar on Kiska. A B-24D containing radar investigation equipment began a series of solitary missions. The ferret found the signal, homed in on it, and set in motion plans to eliminate the radar.

"The Wizard War," as Winston Churchill called it, has stepped up its pace since then. Measures and countermeasures never rest on today's breakthroughs.

Applied Technology Incorporated is an innovator and quick-reaction supplier of advanced electronic systems and equipment. Our product line is broad.

Illustrated: RASP-1. A broadband, electronically-swept, airborne panoramic receiver. Designed for use with specialized display and analyzing equipment.

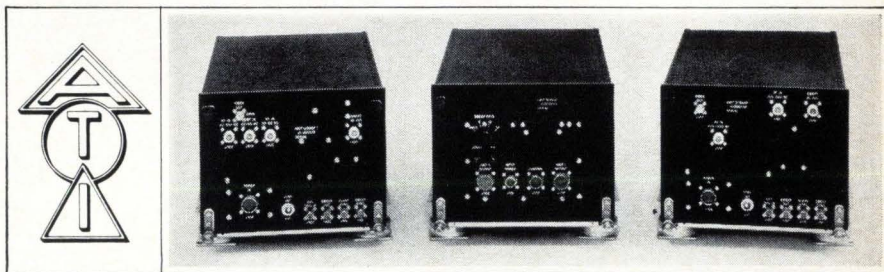

• Engineers • Designers

Join the Growing One. ATI has positions in many disciplines and on all levels.

APPLIED TECHNOLOGY INCORPORATED

3410 HILLVIEW AVENUE • STANFORD INDUSTRIAL PARK • PALO ALTO, CALIFORNIA 94304
TELEPHONE: (415) 321-5135 • TWX: 492-9370 • WASHINGTON, D. C. (703) 432-8188

ATI is an equal opportunity employer

RECONNAISSANCE & SURVEILLANCE • ACTIVE COUNTERMEASURES • SPECIAL COMMUNICATIONS TECHNIQUES

A circuit design "first"

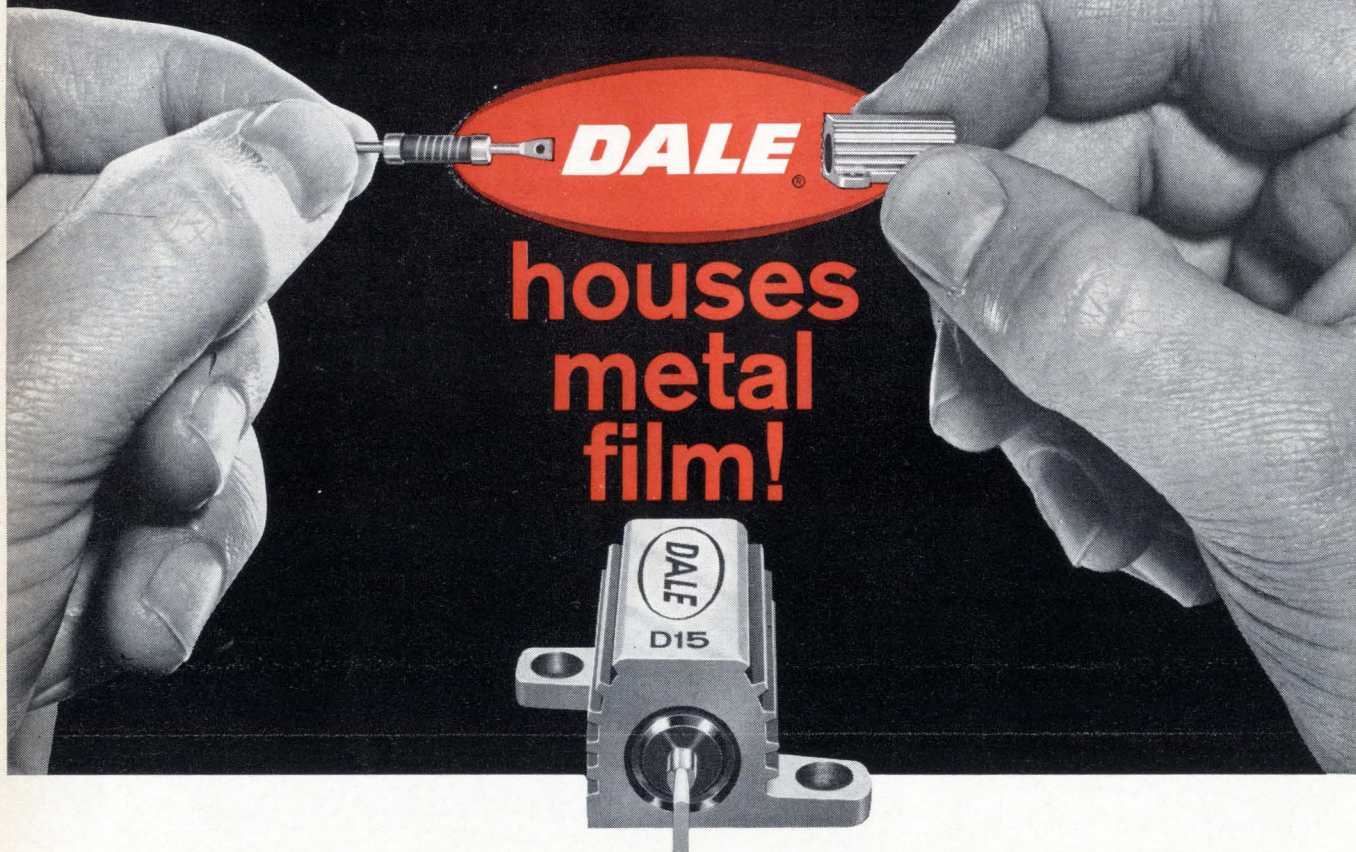

houses
metal
film!

Expanded housed D series opens new design areas for precision power metal film resistors

Dale's expanded D Series combines heat sink housings already proven by Dale Wirewounds with precision power metal film elements. The result:

1. As FILM RESISTORS, Dale's D Series offer power/size ratio unmatched by conventional parts (see chart).

2. As HOUSED RESISTORS, Dale's D Series offer higher maximum resistance values and low reactance at high frequencies.

D SERIES SPECIFICATIONS

■ **Resistance Range:** 50 Ω to 1 Megohm (D5), 50 Ω to 2 Megohms (D10), 50 Ω to 2.6 Megohms (D15)

■ **Tolerance:** $\pm 0.1\%$, 0.25%, 0.5%, 1% and 2%

■ **Power Rating:** D5=4 watts, D10=8 watts (mounted on 4"x6"x.040" aluminum chassis) D15=12 watts (mounted on 5"x7"x.040" aluminum chassis).

■ **Temperature Coefficient:** ± 25 and ± 50 ppm/ $^{\circ}$ C (-55° C to $+175^{\circ}$ C). Higher T.C.'s on request.

FILM RESISTOR POWER/SIZE COMPARISON

CHARACTERISTIC	D SERIES			2-WATT METAL FILM	5-WATT CARBON FILM	4-WATT TIN OXIDE
SIZE						
	D5	D10	D15			
	.334 W X .600 L	.420 W X .750 L	.550 W X 1.062 L			
Power Rating	4 Watts	8 Watts	12 Watts	2 Watts	5 Watts	4 Watts
Volume	0.064 in. ³	0.123 in. ³	0.320 in. ³	0.242 in. ³	0.600 in. ³	0.145 in. ³
Power Density (25 $^{\circ}$ C)	62.0 w/in. ³	65.0 w/in. ³	37.5 w/in. ³	8.3 w/in. ³	8.3 w/in. ³	27.6 w/in. ³
Power Density (125 $^{\circ}$ C)	20.4 w/in. ³	21.4 w/in. ³	12.4 w/in. ³	8.3 w/in. ³	2.1 w/in. ³	13.8 w/in. ³
Life Stability (Typical)*	.1%	.1%	.1%	0.5%	0.5%	3%
Temp. Coefficient	25 or 50 ppm/ $^{\circ}$ C			50 ppm/ $^{\circ}$ C	500 ppm/ $^{\circ}$ C	300 ppm/ $^{\circ}$ C
Max. Operating Temp.	175 $^{\circ}$ C	175 $^{\circ}$ C	175 $^{\circ}$ C	175 $^{\circ}$ C	150 $^{\circ}$ C	200 $^{\circ}$ C

*Maximum resistance shift in 1000 hours of operation at rated power.

■ **Maximum Working Voltage:** 500 (D5), 600 (D10), 700 (D15)

■ **Dielectric Strength:** 1000 VAC (D5), 1500 VAC (D10), 2000 VAC (D15)

■ **Construction:** Aluminum screw-mount radiator housing with resistance element molded inside for complete environmental protection. Meets all applicable requirements of MIL-R-18546C and MIL-R-10509E.

For complete details, write today
or phone 402-564-3131



DALE ELECTRONICS, INC.
1300 28th Avenue, Columbus, Nebr.
In Canada: Dale Electronics Canada Ltd.



Washington Newsletter

July 10, 1967

Navigation satellite seeks a partner; preferably monied

If the Navy can find someone to share the cost, it will build an improved Navigation Satellite system that will also provide accurate low-cost navigation for commercial vessels. With the help of stationkeeping thrusters, the satellites would travel a more precise, predictable orbit. This would eliminate the need for the computer now used aboard Navy ships to compensate for orbit error in the present three-satellite system. **Any ship could obtain accurate fixes with a set of tables and a doppler-rate measuring receiver costing only \$2,000 to \$3,000 instead of using the present \$60,000 computer-receiver;** the Navy has many support vessels not equipped with the expensive gear.

Applied Physics Laboratory, now working on the system, is about to seek support for the program outside the Navy; civilian Government agencies are on its list. If support can be mustered, says APL's Richard B. Kershner, the low-cost system could be in operation within five years.

Medlars slated for updating

The Public Health Service wants to enlarge and speed up its already-advanced computer-based medical library. **By early August, it will request proposals from industry to improve the National Library of Medicine's Medlars** (medical literature analysis and retrieval system). The giant system, which prints out such things as a monthly index of medical literature and demand searches, pioneered the use of computer-driven phototypesetting in 1964 when it put in the first Photon Zip 900.

Although the Public Health Service isn't saying yet what it wants in the way of a new system under the estimated \$1 million improvement program, **a strong possibility is a cathode-ray-tube typesetter** [Electronics, May 29, p. 137]. The Government agency wants to hear from companies with experience in crt data collection, time-sharing, photo-composing, and graphic image storage and retrieval.

Philco-Ford, Raytheon may split giant Comsat award

The biggest satellite communications ground station contract ever awarded is coming up soon. **And insiders expect Comsat to split the four-station procurement—estimated to run between \$12 million and \$15 million—between Philco-Ford's WDL division and Raytheon's Equipment division.** Eleven companies bid; one of them says the competition was decided by price.

Raytheon seems to be in line for eight low-noise receivers, two per station, and four communications subsystems; Philco-Ford would build the four 90-to-100-foot antennas. Proposals for the multiplex subsystem at each site won't be issued for several months, but Comsat may decide on direct procurement from Nippon Electric Co. of Japan. Nippon built the multiplexing gear for two other Comsat stations at a price of about \$500,000.

Varian's twt could replace klystrons in ground stations

If a new traveling-wave tube now in development works as planned, Comsat will install the 8-kilowatt twt amplifier in its four new ground stations. Comsat probably would also retrofit its present ground stations, replacing 10-kw klystron tubes. The klystrons have only a 70-megahertz bandwidth, which forces Comsat to use from three to five klystrons in each of its present terminals. **One of the new twt's would cover the entire commercial band with its 500-Mhz bandwidth.** Varian Associates is

Washington Newsletter

building a development model for Comsat under a \$92,500 contract and expects to deliver it by the end of the year. The need for a wider bandwidth amplifier becomes even more important next year when the Intelsat-3 satellite, with its 1,200-channel capacity, goes aloft.

GAO seen backing Air Force award on IBM's high bid

The General Accounting Office is expected to uphold the legality of the Air Force's selection of IBM to build 150 computers for housekeeping chores at air bases. **However, the GAO report, due in about two weeks, will criticize the Air Force's handling of the award.** The GAO has been probing the award at the insistence of Honeywell, which contends it could have supplied the machines at roughly half the \$114 million price bid by IBM. Burroughs and RCA, other losers in the competition, also question the selection.

At issue is the Air Force's one-step contract policy. The GAO still wants to know whether the Air Force was obligated to negotiate with the low bidder—in this case, Honeywell—to determine whether that company's equipment could have been brought up to performance standards at minor added cost.

How costly is free information?

Companies doing business with the government fear the "freedom of information" law that went into effect last week may offer competitors a pipeline to information given to Federal agencies in confidence.

Though proprietary information and trade secrets are exempted, attorneys are girding themselves for the legal battles they feel are certain because of the law's hazy language. To add to the confusion, government agencies have been issuing their own ground rules. **But one thing seems certain: bid prices and company evaluation data will be available to everyone from now on.**

Labor mounts united drive to enroll engineers

Unions—notably the United Auto Workers and Communications Workers of America—never have been very successful in organizing scientists and engineers. **But labor officials feel the time is ripe now because boredom, loss of identity at large corporations, and the need to change jobs often for advancement, is causing unhappiness in the professions.**

To coordinate organizing efforts and enable the unions with professional and white collar members to speak with a common voice, the AFL-CIO will open offices in Washington this fall for a new labor council called Space, for Scientific, Professional, and Cultural Employees. Space will not do any organizing itself.

FCC's Hyde isn't rocking the boat

Don't look to FCC chairman Rosel H. Hyde to push significant new programs affecting the electronics industry. During a year in office he hasn't made any waves. The only inquiry launched in this time has been the formal investigation of common carrier involvement in time-shared computer system services. But even this had been watched informally for two years before Hyde took over.

If President Johnson, criticized for his family's broadcast holdings in Texas, wanted a noncontroversial figure to follow the outspoken Newton Minow and E. William Henry as chairman, he chose well. **The 67-year-old Hyde undoubtedly will hold the reins as long as Johnson stays in the White House.**

CIRCUIT CONTROL AND PROTECTION BY AIRPAX



APL 1 SERIES TYPE

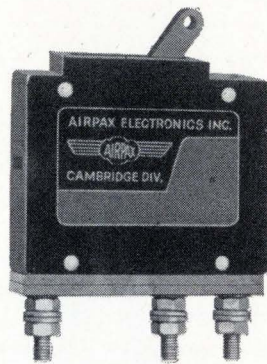

APL 3 SHUNT TYPE

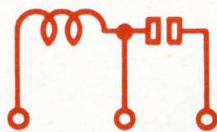

APL 4 RELAY TYPE

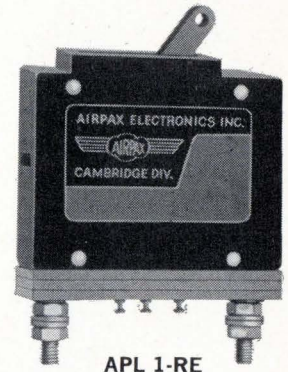
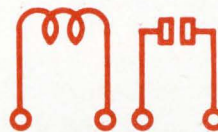

APL 1-RE
SERIES WITH REMOTE

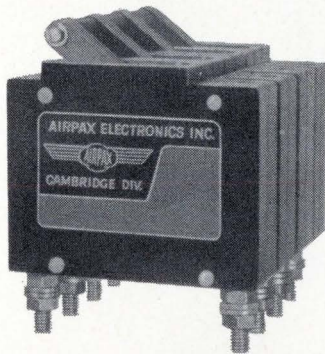
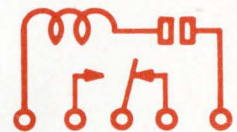

APL 1111 FOUR POLE

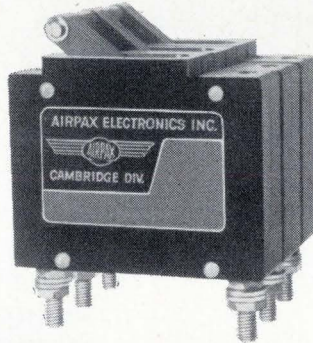
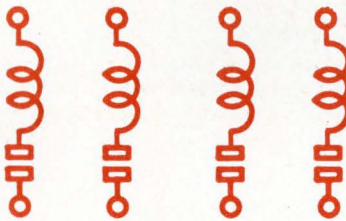

APL 111 THREE POLE

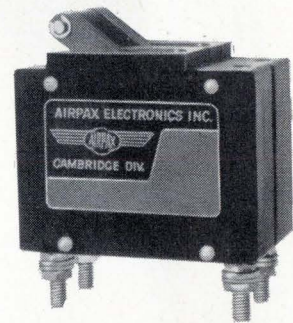
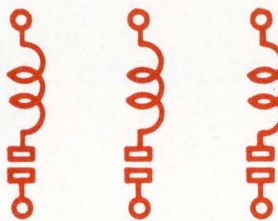

APL 11 TWO POLE

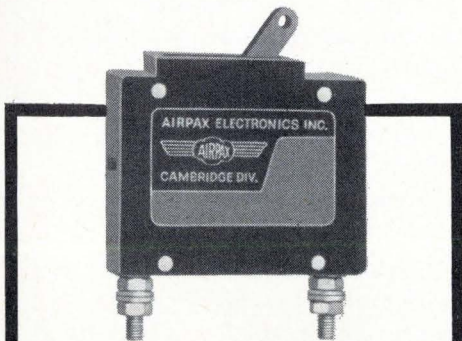
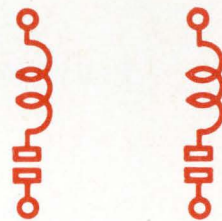

TYPE APL1 IS UNDERWRITERS' LABORATORY RECOGNIZED FOR APPLIANCE PROTECTION.
20A, 50V 15A, 115V 7.5A, 240V

COMPLETELY MAGNETIC TIME DELAY AND TRIP. CONTAINS NO HEATING ELEMENTS.

AVAILABLE 50 MA TO 50 AMPERES AC OR DC. 50, 60 AND 400 CYCLES.

TRIP TIME IN SECONDS vs. PERCENT OF RATED CURRENT

	100%	125%	200%	400%	800%	1000%
Delay 60	No Trip	May Trip	.035 max.	.030 max.	.020 max.	.018 max.
Delay 61	No Trip	1.0 - 6.0	.240 - .800	.040 - .180	.012 - .050	.010 - .040
Delay 62	No Trip	15.0 - 70.0	3.0 - 9.0	.30 - 1.50	.018 - .080	.010 - .040

AIRPAX ELECTRONICS
incorporated
Cambridge, Maryland
(301) 228-4600

AIRPAX ELECTRONICS
incorporated
Ft. Lauderdale, Fla.
(305) 587-1100

AIRPAX ELECTRONICS
incorporated
Van Nuys, Calif.
(213) 781-2821

AIRPAX ELECTRONICS incorporated Cambridge Division, Cambridge, Maryland

SOLID STATE TIMERS

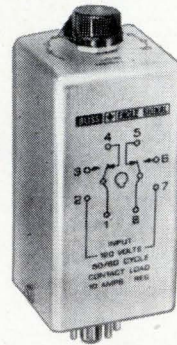

NEW
CG Timer:
Range: 50 MLS
to 60 Sec.

YOUR WIDEST RANGE

ELECTROMECHANICAL TIMERS

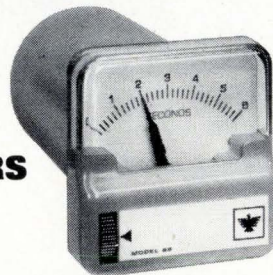

NEW
Model 88 Timer:
Range: 6 Sec.
to 48 Hrs.

The Man from E.A.G.I.E. offers virtually unlimited product/performance scope: from solid state timers such as the CG (upper)—created for short, accurate, highly-repetitive time cycles—to motor-driven electromechanical timers such as the Model 88 (lower)...and everything known to be in between. CG's qualifications: compensates for voltage changes; plugs into standard octal relay socket; quality componentry—tantalum timing capacitor; SCR control of 10 amp output relay; protection against load or output contacts being inadvertently actuated by transients or power cutoff; perfect replacement for pneumatic timers.

Accuracy, economy and reliability are hallmarks of the Eagle line...industry's most complete! Put us to the only test that counts, your most demanding time/count application. Write for CG Bulletin 158 and Model 88 Bulletin 1615, Eagle Signal Division, E. W. Bliss Company, 736 Federal St., Davenport, Iowa 52808.

BLISS



EAGLE SIGNAL

A DIVISION OF THE E. W. BLISS COMPANY

Protects delicate electronic equipment in shipment.

PELASPAN-PAC® loose fill packing will absorb the shock. Unlike other loose fill, dunnage material, it doesn't settle or mat. It's resilient and highly shock absorbent. These curled strands of foamed polystyrene interlock to protect your product no matter how it's

bounced around.

And how PELASPAN-PAC can lighten your shipping problem! A cubic foot of it weighs only 8 oz., eight times lighter than other packing materials. What that does for shipping costs!

PELASPAN-PAC has other advan-



tages. It's clean and dust free. So easy to work with you'll get major savings in labor time and cost. Does your equipment get a boot out of shipping?

Get PELASPAN-PAC from your distributor. Write for his name.

The Dow Chemical Company, Plastics Sales, Department 71231, Midland, Michigan 48640.

PELASPAN-PAC is just for kicks.



You need a pushbutton switch.



Bill, at the next board, needs a toggle switch.



Sam's looking for placard indicators.

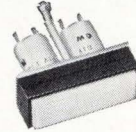

Joe wants a switchlite.



Harry wants a hermetically-sealed switch.



Here's the easy way to get all the answers at once!

Just check the bingo card in this book for any or all of the Control Switch catalogs listed below. Or send us a card of your own.

If you get all of our catalogs you'll have it made.

First, because these catalogs cover a combination of switch types and switchlites that no other manufacturer can offer. So you get a concentrated reference.

Second, because some switch manufacturers don't make *any* of the switches we make. So Control Switch catalogs save wild goose chases.

Third, because we make only quality switches. For computers, aircraft, missiles, control panels, and such. So our catalogs (and your nearest Control Switch distributor) save time screening out switches that haven't got it.



**CONTROLS
COMPANY
OF AMERICA**
CONTROL SWITCH DIVISION
1420 Delmar Drive, Folcroft, Pennsylvania 19032
A Subsidiary of
 General Precision Equipment Corp.

Here's the list. Check the Reader Service Card number at the left for the catalogs you want.

- #512 *Condensed Switch Catalog 100*
- #513 *Basic Snap-Action Switch Catalog 110*
- #514 *Toggle Catalog 180*
- #515 *Indicator Light Catalog 120*
- #516 *Hermetic Switch Catalog 130*
- #517 *Switchlite Catalog 220*
- #518 *Pushbutton Catalog 190*

World's only gas lasers with just 1 control: an on-off switch

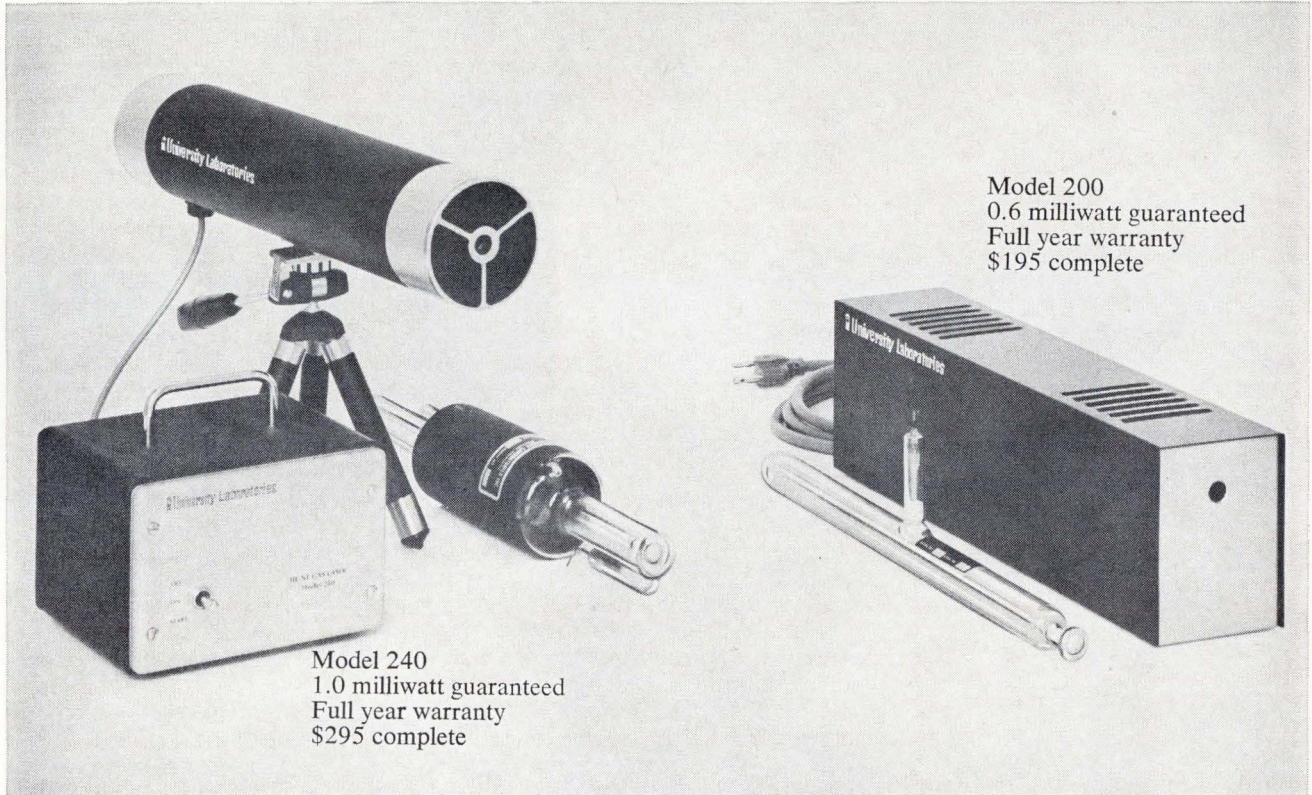

Model 200
0.6 milliwatt guaranteed
Full year warranty
\$195 complete

Model 240
1.0 milliwatt guaranteed
Full year warranty
\$295 complete

Never need adjustment, alignment, or maintenance

As simple to work as a light switch, these new, rugged He-Ne continuous gas lasers are operated by a single on-off control. Nothing more is necessary, because ULI's Lasertron™ plasma tubes have permanently aligned and sealed internal reflectors. Their proprietary design completely eliminates the need for adjusting mechanisms commonly found in other lasers of this type.

The tubes are long-lived and foolproof —will operate even under water! (They are practically complete instruments in

themselves and are available separately to OEMs.)

Since they have no mechanisms to get out of order or out of adjustment, these lasers are excellent performers in tough environments. The solid-state power supplies are simple and thoroughly reliable, assuring immediate, continuing output to specification.

Use the coupon to order now from University Laboratories, Inc./733 Allston Way, Berkeley, California 94710/Telephone: (415) 848-0491.

MODEL 200 \$195 complete
• Power over 0.6 milliwatt • Wavelength: 6328 Å • Uniphase (TEM₀₀) wavefront • Alignment stability guaranteed • Built-in collimator • Low ripple DC supply • Full year warranty.

MODEL 240 \$295 complete
• Power over 1.0 milliwatt • Wavelength: 6328 Å • Uniphase (TEM₀₀) wavefront • Alignment stability guaranteed • Built-in collimator • Adjustable tripod mount • Rugged design • Low ripple DC supply • Full year warranty.

UNIVERSITY LABORATORIES, INC., 733 ALLSTON WAY
BERKELEY, CALIFORNIA 94710

Please send technical data on ULI lasers.
 Please reserve a Model 200 a Model 240 from your current production. My official purchase order and shipping instructions will follow.

Name _____

Organization _____

Address _____

City _____ State _____ Zip _____

Terms: 2% discount 10 days, net 30 days. ULI products returned for any reason, prepaid and undamaged, within 30 days will receive full credit.

University Laboratories

NEW RELAY

+ 100,000 OPERATIONS

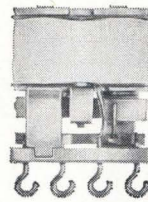

AT 5 AMPS

The completely **NEW** Hi-G BN series meets all applicable requirements of Mil-R-5757, weighs .95 oz. in a .875" x .800" x .400" crystal can. All standard configurations and header styles are available for fast delivery.

Write or call Hi-G for new bulletins which provide full details on this high quality line of 5 amp. crystal-can relays. Test data and performance capabilities are available on request. Tel: 203-623-2481

**Hi
G**

INCORPORATED

SPRING STREET & ROUTE 75 / WINDSOR LOCKS, CONNECTICUT 06096

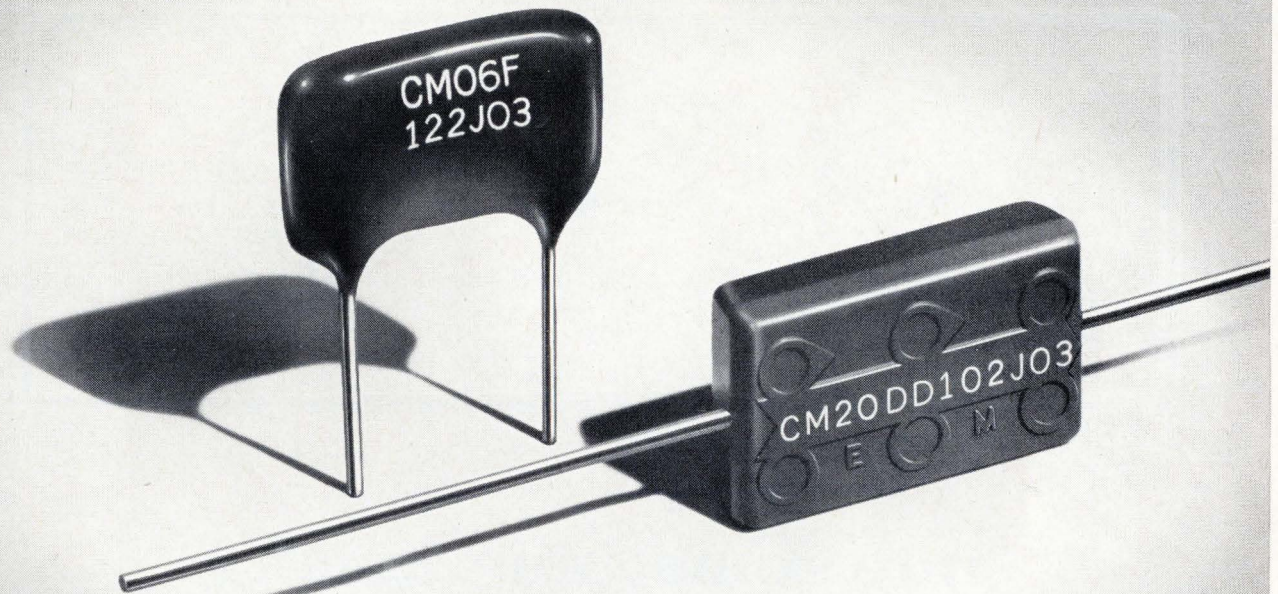

Shown 2½ x Actual Size

Capacitor Problems That Require A Lot Of Self-Control...Chemically Speaking

Problem 1: How to make sure the silver paste composition used for electrodes provides the best results for each electrical parameter in a given capacitor design?

Problem 2: How to improve the recognized moisture reliability of our dipped mica capacitors without adversely affecting life reliability?

Problem 3: How to upgrade the reliability of molded mica capacitors to equal that of dipped mica capacitors so designers can take advantage of body uniformity and axial lead design?

Solution: Chemical self-control! To do this we operate our own chemical manufacturing plant where we formulate silver pastes, phenolic dipping compounds, and epoxy molding compounds — all under strict controls.

Result: Dipped mica capacitors and molded mica capacitors of equally high reliability that operate up to 150°C. Send for technical literature and always insist on El-Menco brand capacitors . . . your assurance of better quality and reliability through control.

THE ELECTRO MOTIVE MFG. CO., INC.

WILLIMANTIC, CONNECTICUT 06226

Dipped Mica • Molded Mica • Silvered Mica Films • Mica Trimmers & Padders
Mylar-Paper Dipped • Paper Dipped • Mylar Dipped • Tubular Paper

Exclusive Supplier to Jobbers and Distributors
in the U. S. and Canada:
ARCO ELECTRONICS, INC., Community Drive,
Great Neck, L. I., New York

West Coast Manufacturers contact:
COLLINS & HYDE CO., 900 N. San Antonio Rd.,
Los Altos, California 94022
5380 Whittier Blvd., Los Angeles, California.

Want to make something BIG

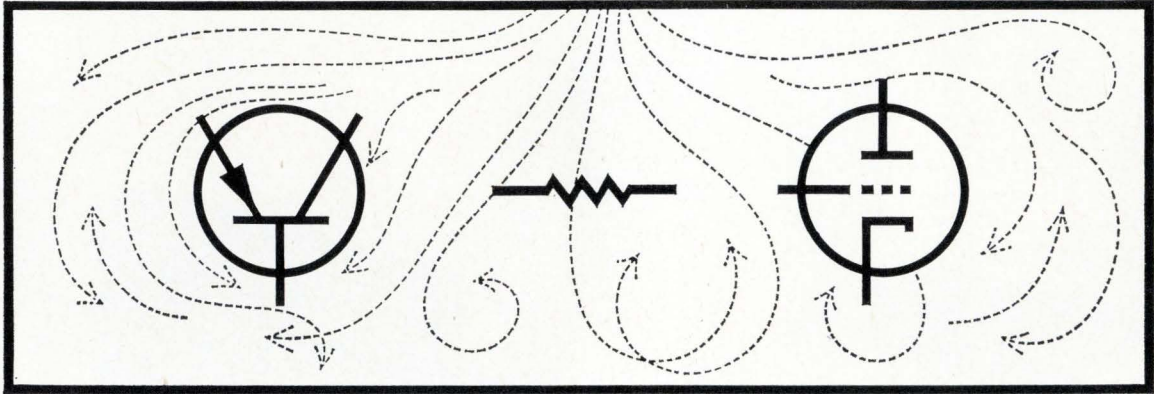

into something Small?

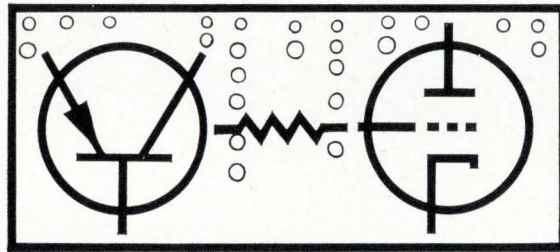

A new technical report on Evaporative Cooling with FREON® tells you How!

When miniaturization is your objective, FREON dielectric coolants can solve a lot of design problems. They are the ultimate in heat-transfer effectiveness (1,000 times as effective as air; 100 times as effective as oil) and they have a dielectric strength in both liquid and vapor phase that equals or exceeds oil.

Our new technical report describes evaporative cooling systems and makes recommendations for best heat-transfer results. Just fill in the coupon on the right and we will be glad to send you this report. We're pretty proud of it.



FREON®
dielectric coolants

BETTER THINGS FOR BETTER LIVING... THROUGH CHEMISTRY

E. I. du Pont de Nemours & Co. (Inc.)
FREON Products Laboratory
Development Section
Chestnut Run
Wilmington, Delaware 19898

Please send me the 24-page Technical Report "Evaporative Cooling with FREON Dielectric Liquids".



I'm interested in cooling: _____

Name _____ Title _____

Company _____ Address _____

City & State _____ Zip _____

B



Photo courtesy of Musée de l'Homme

Greatest trouble-shooting development

... since the Magdalenian
bone sling

Just as the bone sling gave Magdalenian man an added measure of mastery over his world, so will Sierra's Model 305 increase your control over today's high-density carrier systems. Containing the modular functions of a frequency selective levelmeter and a signal generator, served by a common tuning unit, Model 305 delivers to hand the most powerful combination of signal monitoring capabilities ever assembled.

Model 305 spans an enormous spectrum of frequencies, 10 kHz to 32.1 MHz, in a single tuning range, placing up to 32,400 voice channels within your purview. Electronic digital readout resolves frequencies to 10 Hz. Dynamic range extends from -110 to +22 dbm, with better than 0.05 db measurement accuracy. Projection-type meter scales with moving pointers indicate input-signal and generator-output levels. Projection-type digital displays show input- and output-level attenuation settings. And, for good measure, it provides frequency phase-locked tuning at 100-kHz increments, dual selective bandwidths of 250 and 3100 Hz, and compatibility with Sierra's Model 360 Spectrum Display Unit. You can add Model 305 to your collection for \$7,200, considerably less than the going rate for Paleolithic slings.

Our newly published bulletin will give you an opportunity to bone up on the finer details. Write Sierra, 3885 Bohannon Drive, Menlo Park, California 94025.



PHILCO-FORD CORPORATION
Sierra Electronic Operation
Menlo Park, California • 94025

Circle 67 on reader service card

why should you buy a relay that promises less ?

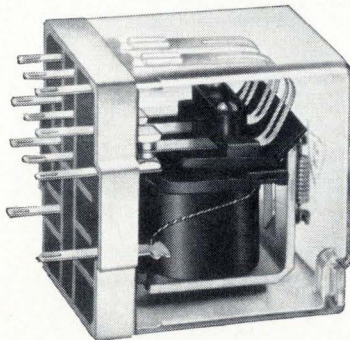

Because this one—the Guardian 1220—promises less of the things you *don't* want. Like wasted space, breakdowns, and high cost. The

1220 is an extremely compact relay. It has a new “Uni-Guard” one-piece switch that eliminates many internal solder connections.

The terminal panel is used as the male plug, dispensing with radio-type plug, extra wiring, and sub-assembly. This advanced design boosts dependability, because with fewer parts, there are fewer reasons for breakdown. The U.L. recognized, 10 amp. DPDT or 3PDT 1220 is tightly enclosed (so, no problems from dust or moisture), and it's available from stock. Price? Only \$1.85 in quantities. Write today for our free Bulletin B4—it includes full technical specs, dimensions, mounting variations.

GUARDIAN  **ELECTRIC**

1550 West Carroll Avenue, Chicago, Illinois 60607

you get a choice,

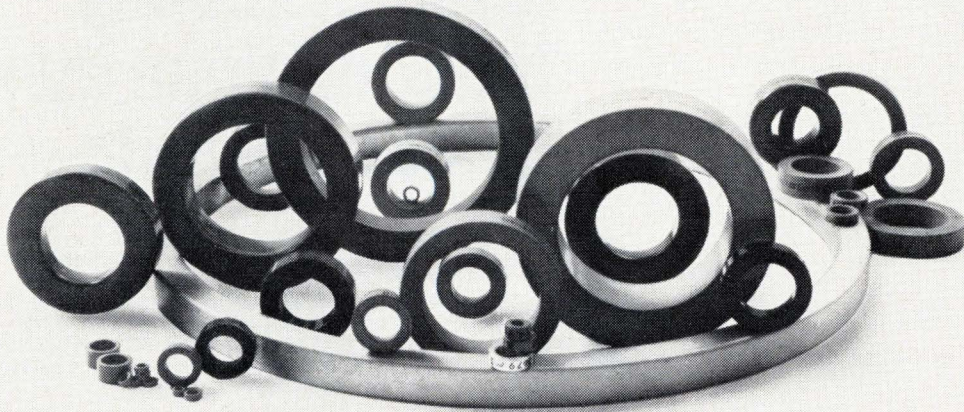

not a challenge



Most complete line of high quality tape wound cores available from any manufacturer

Magnetics' selection of tape wound cores encompasses eight material types, in a range of sizes from 0.050" to 12" inside diameter. For frequencies from DC through 500 kc, materials are produced in thicknesses ranging from 1/8 mil through 14 mils. All core sizes are available boxed in phenolic or plastic, aluminum or GVB-coated

aluminum. Magnesil®, less sensitive to external stresses, is also available unboxed or epoxy encapsulated.

In addition to offering this broad range of tape wound cores, Magnetics has improved its production of raw materials, using the most advanced testing devices to control quality in metals, winding, annealing, potting compounds, boxing processes and the application of encapsulating

materials. This across-the-board control assures you of getting what you pay for in performance.

If you have an application for tape wound cores, why settle for an approximation of your specifications? With Magnetics, you don't have to "make do"—you get a choice, not a challenge. For further information on our complete line of tape wound cores, write for Catalog TWC-300, Magnetics Inc., Butler, Pennsylvania 16001

MAGNETICS inc.
®

Here's how to save a ton of money building your own Linear Circuit:

- 1** Start with Fairchild's μ A709C monolithic, high-performance, high-gain, differential amplifier. It's an off-the-shelf integrated circuit especially designed for industrial applications. It costs less than \$5.00 in quantities of 10,000, less than \$6.00 in 1,000 quantities, and only \$6.60 if you buy 100. Yet it offers high performance to a degree which allows you to use it in instrumentation applications.
- 2** Modify the μ A709C to meet your exact requirements. It's simple. Just add a capacitor or a resistor or two. With every order of 25 units or more* we'll include a free Linear Applications Handbook that shows you exactly how. And the μ A709C is versatile enough to perform virtually any function. (For a partial list of what you can use it for, see below.)
- 3** Count your savings. Even if you spend another \$5.00 on auxiliary parts and assembly (and in most cases you'll spend far less) your total cost will be about half of what you'd pay for a ready-made circuit. Multiplied by 10,000 units that adds up to a ton of money.
- 4** Get started. Get the μ A709C. It's readily available from shelf stock. Just call your Fairchild Distributor or the nearest Fairchild Sales Office.

*In fact, this offer is good for orders of 25 or more of any Fairchild linear integrated circuit.

Typical Characteristics

μ A709C

(@ $T_A = 25^\circ\text{C}$; $V = \pm 15\text{V}$)

Open Loop Voltage Gain	45,000
Output Voltage Swing	$\pm 14\text{V}$ @ $R_L = 10\text{k}\Omega$
Input Voltage Range	$\pm 10\text{V}$
Input Resistance	250k Ω
Input Offset Voltage	2mV
Input Offset Current	200nA

Typical Applications:

PRECISION VOLTAGE SUPPLIES	HIGH Z_{IN} TRANSDUCER AMPLIFIER
TEMPERATURE CONTROLLER	DELAY EQUALIZER
DIFFERENTIAL THRESHOLD COMPARATOR	CONSTANT CURRENT SOURCE
PREAMPLIFIERS	ADDER/SUBTRACTOR
HIGH GAIN, LOW DRIFT DC AMPLIFIER	METER AMPLIFIER
LOGARITHMIC AMPLIFIER	SAMPLE AND HOLD AMPLIFIER
MULTIPLIER	SWEEP GENERATOR
QUADRATURE OSCILLATOR	CURRENT TO VOLTAGE CONVERTER
PRECISION ANALOG GATE	NULL DETECTOR
SOLID STATE MOD/DEMODO	SIGNAL POLARITY SEPARATOR
PHASE DETECTOR	CLIPPER
ONE-SHOT MULTIVIBRATOR	SAWTOOTH GENERATOR
ASTABLE MULTIVIBRATOR	FREQUENCY METER
SINE WAVE OSCILLATOR	A TO D CONVERTERS
HALFWAVE RECTIFIER	GAIN CONTROL AMPLIFIERS
PEAK DETECTOR	HYSTERESIS COMPARATOR
FULLWAVE RECTIFIER	INTEGRATOR (DC OR AC)
PEAK TO PEAK DETECTOR	LEAD AMPLIFIER
BRIDGE AMPLIFIER	
DIFFERENTIATOR	
ACTIVE FILTER	
UNITY-GAIN BUFFER	

FAIRCHILD
SEMICONDUCTOR

Write for detailed applications information.

Technical Articles

**Stochastic computer
thrives on noise**
page 72

Many of today's computer control applications cannot be handled by conventional analog or digital machines, or even hybrid machines. A new approach, in which probability as an analog quantity switches a digital circuit, offers interesting promise. In this kind of machine, digital integrated circuits are randomly switched to simulate analog computer elements. Although slower than an analog machine and not as accurate as a digital one, the stochastic computer has a speed-size-economy combination that cannot be matched by either.

**Computer-aided design:
part 10, Making a video
amplifier to measure**
page 85

Even the performance of circuits that an engineer is very familiar with can be improved by using a computer to help in the design. For one thing, the computer can tailor the design to meet a wide range of operational requirements. Then too, a circuit can be refined for optimal operation plus easy and inexpensive construction. Here computer-aided design is applied to a well-known circuit, the video amplifier.

**Special report
Medical electronics:
part I**
page 95

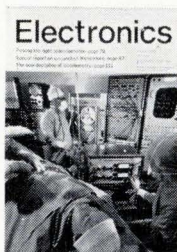

The start of a comprehensive examination of medical electronics.

1. Prescription for medical instrumentation

A doctor finds the electronics industry so intrigued by gadgets that it isn't developing the kind of equipment doctors want. He urges engineers to help doctors find practical solutions to diagnostic and therapeutic problems.

2. Collecting body signals

What doctors most need are measurements of key body parameters. Present technology can produce equipment extracting far more information from such traditional diagnostic aids as electrocardiogram traces, electroencephalograms and electromyograms if engineers aim their designs at specific body signals. For the cover, Vincent Pollizzotto took his camera inside a big metropolitan hospital to show electronics in an advanced operating room.

**Coming
July 24**

- Replacing inductors with digital filters
- Glass devices for computer memories
- Special report: Medical electronics, part II, Computers in medicine

Stochastic computer thrives on noise

Standard integrated circuits in a computer that applies probability as an analog quantity will economically increase speeds of computing for complex control problems

By Brian R. Gaines

Standard Telecommunications Laboratories Ltd., Harlow, Essex, England

A large segment of today's computer control applications—on-line control of chemical plants, aerospace navigation controls, and other large, complex systems—cannot be handled by conventional digital, analog, or hybrid computing systems. Even an order of magnitude increase in the capability of these systems would leave many computing needs unfilled. Therefore, instead of chipping away at the limitations of present systems, a new approach was taken to determine how today's computing elements—in particular, large-scale integrated digital circuits—could be used to fill these needs. The stochastic computer is the result of this new approach.

The stochastic computer differs from other computers in that it uses probability as an analog quantity—the probability of switching a digital circuit. It thus uses digital IC's that are randomly switched to simulate analog computer elements—multipliers, summers, inverters, integrators, and analog memories. Still in an early development stage, it is not quite as accurate as a digital computer, and it is not quite as fast as an analog computer, but because it uses low-cost elements in an analog configuration, it gives a speed-size-economy combination that cannot be matched by either conventional computer type.

Although the stochastic computer uses digital IC's, it is programmed as an analog computer. Initial conditions are set with digital counters, which also serve as stochastic integrators. The use of digital IC's means that the analog-type circuits are made smaller and cost less and, with large-scale integration techniques, many functions will be combined in a single package.

The bandwidth of a digital computer is limited because it computes sequentially. Thus, on problems with many equations and variables, the total

time per computation quickly becomes excessive. Analog computers are not suitable for large problems because many operational amplifiers are required and because accurate computing elements are high priced.

Attempts to capitalize on the best features of digital and analog computers have only resulted in new systems which are just as complex and as economically unfeasible as the individual computers.

Stochastic computers are most useful where the availability of low-cost computing elements is more important than the speed and accuracy of computation. In many computer-controlled processes, a 10-hz bandwidth and an over-all accuracy of 1% is adequate, and where feedback is applied, even 10% accuracy may be acceptable.

Stochastic counting

The concept of representing a quantity by a probability, a stochastic representation, is basically simple. Consider a man counting the number of bales of straw coming along a conveyor belt by incrementing a counter one step as each bale passes him. What does he do if only half a bale passes by? If he neglects it and several other half-bales pass by, then he will underestimate the total amount of straw; if instead he counts it as one bale and increments the counter, then the more half-bales that come along, the more he overestimates the quantity of straw.

One solution would be to note that there was a half-bale and, when another comes along, increment the counter by unity. But this defeats the object of having a counter in the first place since the man now has to remember the data.

Another alternative is to count in units of half a bale (if it is a binary counter, add another flip-

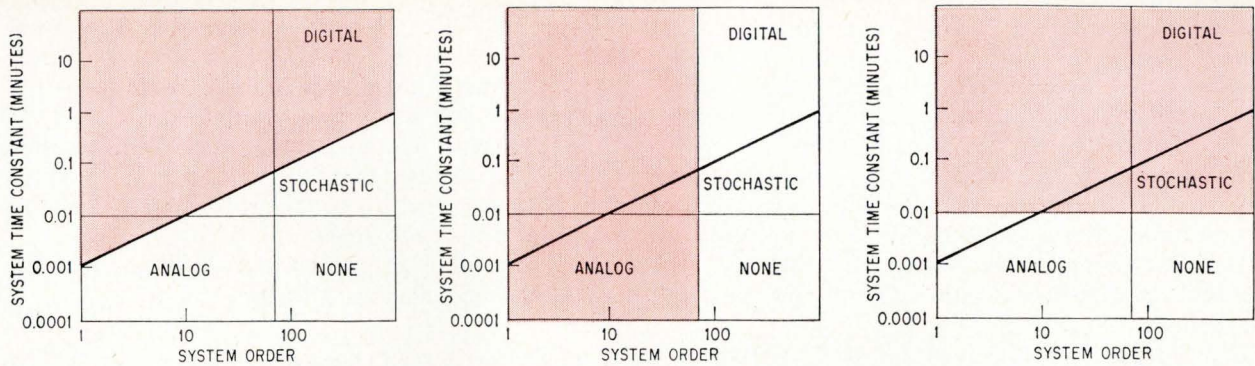

Approximate regions of application for digital (left), analog (center), and stochastic (right) computers. Analog computers are limited mainly by system order (number of differential equations), while digital computers are limited in both size and speed. Stochastic computers are limited by speed but not by size. Advances in digital computers are steadily shifting the diagonal line toward the right, but a large area remains uncovered.

flop). This method is fine, (although it involves a slightly larger counter) until the bales begin arriving in less convenient fractions: a quarter-bale—two extra bits; an eighth-bale—three extra bits; and so it goes. Any form of rounding off is liable to lead to cumulative errors which may become appreciable in the long run.

Suppose now the man adopts an alternative technique. When half a bale comes along he tosses a coin and if it comes down heads, he increments the counter; if tails, then he does not. There is then a 50% probability that when half a bale comes along he will increment the counter.

This trick has some of the advantages gained by making the counter count in half units—in the long run there will be no bias towards underestimation or overestimation; the expected count will be exactly the number of bales that have passed. This trick can be extended to other fractions of a bale—if three-eighths of a bale passed, the man could toss three coins and increment the counter if two, and only two, of them were face up.

But note that although probability is a continuous variable not subject to round-off and cumulative errors, it is subject to another form of error—random variance.

To have correctly recorded the number of bales that passed, the man's counter should display a number equal to the mean value of all the counts that could have arisen. But he tossed the coin only a finite number of times, so the counter will display a count that varies from the mean. It will be one of the many probable counts clustering around the mean. Thus, with the coin-tossing scheme, the man has eliminated round-off error but has incurred a random variance error instead. But he has eliminated the need for memory and this basic advantage in hardware carries over to the stochastic computer.

Stochastic computing

A quantity within the stochastic computer is represented by the probability that a logic level in a clocked sequence will be ON. If many clock pulse positions are taken, then the quantity can be considered to be the fraction of ON logic levels in

a clocked sequence of binary ON and OFF logic levels, with no pattern in the sequences of logic levels.

The probability that a logic level will be ON is an analog variable whose value ranges continuously from 0 to 1. In some computations, this is a convenient range to use, but generally the physical variables in a problem (length, etc.) have to be scaled into the allowable range of computer variables. This is similar to the scaling operation in the analog computer, where the physical variables are related to voltages. The actual mapping will determine the hardware required to perform a particular computation, and although many mapping schemes are possible, three examples will be considered: unipolar, two-line bipolar, and single-line bipolar.

In the unipolar representation, if the quantities are always positive (or always negative), simple scaling is all that is required to bring them within range. Given a quantity E in the range $0 \leq E \leq V$, it can be represented by the probability:

$$p(\text{ON}) = \frac{E}{V}$$

so that the maximum value of the range, $E = V$, is represented by a logic level always ON, $p(\text{ON}) = 1$, zero value by its being always OFF, $p(\text{ON}) = 0$, and an intermediate value by its fluctuating randomly, but with a certain probability that it will be ON at any particular instant.

For example, though the pulse sequence below is not infinite, we can grossly say that it has $p(\text{ON}) = 4/10$. If it represented a physical variable whose maximum value was, say, 17, then the value

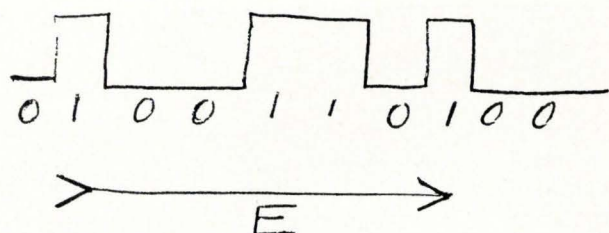

represented here would be $17 \times 4/10$ or 6.8. Note that the wire that carries these pulses is always

associated with this particular variable, as in an analog computer. Different quantities do not appear serially on common, time-shared wires, as they do in digital computers; the stochastic computer has no word length. To determine the value of a variable exactly, we would have to monitor a line for an infinite time to calculate the probability of its being ON. But as variables change, the probabilities must change. Thus, the clock frequency must be high enough to accommodate quickly changing variables.

Stochastic quantities can be generated from a binary quantity with a comparator and a digital noise source. The comparator will provide an output pulse if, at a particular clock-pulse time, the

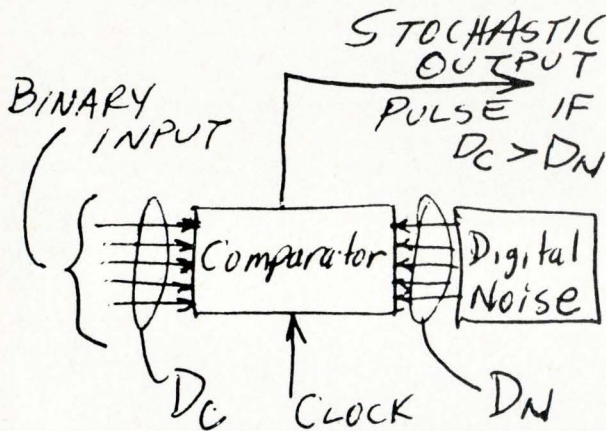

binary input is a larger number than the number represented by the digital noise pulses. For example, if all binary digits are 0, then the digital noise source will always be greater and no pulses will appear on the output line, so that $p(\text{ON}) = 0$. Similarly, if all binary digits are 1, then the comparator will deliver a continuous stream of output pulses. Thus, for a high value of the binary number, the probability is that it will often be greater than the randomly generated digital noise number and many ON output pulses will be generated. The probability of an output pulse thus is directly proportional to the magnitude of the binary number.

Besides serving as a means of inserting data in the computer, this scheme also is used to produce a stochastic output from a stochastic integrator.

The unipolar representation can be simply extended to bipolar quantities (both negative and positive values) by using two sequences of logic levels on separate lines, one representing positive values and the other negative. We call the line

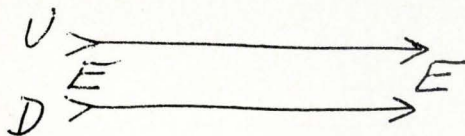

whose probability is weighted positively the UP line, and the line whose probability is weighted negatively the DOWN line. Then for a quantity E in the range, $-V \leq E \leq +V$, we let:

$$p(\text{UP} = \text{ON}) - p(\text{DOWN} = \text{ON}) = \frac{E}{V}$$

so that maximum positive quantity is represented by the UP line always ON and the DOWN line always OFF, maximum negative quantity by the UP line always OFF and DOWN line always ON.

For intermediate quantities there will be stochastic sequences on one or both lines. Zero quantity is represented by equal probabilities of an ON logic level for both lines.

It is possible to represent a bipolar quantity using a single line by setting:

$$p(\text{ON}) = \frac{1}{2} + \frac{1}{2} \frac{E}{V}$$

so that maximum positive quantity is represented by a logic level always ON, maximum negative quantity by a logic level always OFF, and zero by a logic level fluctuating randomly with equal probability of being ON and OFF.

This is the stochastic representation most studied to date since it allows the simplest logical elements to carry out all the normal analog computing operations with both positive and negative quantities.

Comparison of various computers

Although the stochastic representation of quantity leads to economy in computer hardware, the price paid for this economy is a low computing efficiency. Since probability cannot be measured exactly, it must be estimated with an error that decreases with the number of samples taken. Hence, high accuracy means low bandwidth.

The effect of this variance on the efficiency of representation may be seen by comparing the number of levels of voltages or states required to carry analog data with a precision of one part in N :

- The analog computer requires one continuous level.
- The digital computer requires $\log_2 mN$ ordered binary levels.
- The digital differential analyzer requires mN unordered binary levels.
- The stochastic computer requires mN^2 unordered binary levels.

The constant m is taken large enough to minimize the effects of round-off error or variance, say $m = 10$. The N^2 term is a result of the error being inversely proportional to the square root of the length of pulse sequence.

This comparison is a little unfair to the stochastic computer where operations such as integration are concerned, since the digital computer requires complex routines and additional precision to maintain this accuracy, whereas the redundancy of the stochastic representation enables the use of simple counting techniques for integration. However, this by no means compensates for the loss of efficiency in stochastic computing, which may be regained only in computations requiring parallel data-processing unsuited to the digital computer.

Stochastic computing elements

Inverters: to multiply a two-line bipolar quantity by -1 requires only the interchange of UP and

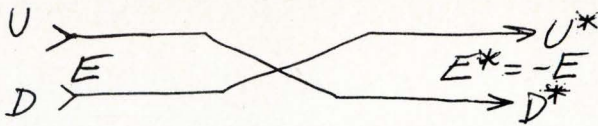

DOWN lines. The unipolar representation, of course, has no inversion operations.

In the single-line bipolar case, a conventional logical inverter, with an output that is the complement of its input, performs the same function when used as a stochastic element. Consider the

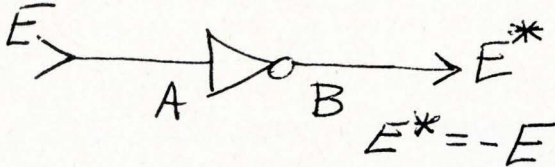

relationship between the probability that its output (E^*) will be ON, $p(B)$, and the probability that its input (E) will be ON, $p(A)$; since the two cases are mutually exclusive, the sum of the probabilities is 1, or:

$$p(B) = 1 - p(A)$$

Thus the probabilities and the quantities they represent are:

$$p(A) = \frac{1}{2} \frac{E}{V} + \frac{1}{2}$$

$$p(B) = \frac{1}{2} \frac{E^*}{V} + \frac{1}{2}$$

hence

$$E^* = -E$$

Multipliers: a simple two-input AND gate, whose output is ON if, and only if, both its inputs are ON, acts as a multiplier for quantities in the unipolar

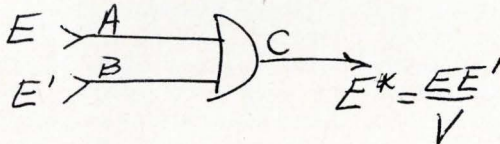

representation. The relationship between the probability that its output will be ON, $p(C)$, and the probability that its two inputs will be ON, $p(A)$ and $p(B)$, is:

$$p(C) = p(A) p(B)$$

These probabilities and the quantities they represent are:

$$p(A) = \frac{E}{V}$$

$$p(B) = \frac{E'}{V}$$

$$p(C) = \frac{E^x}{V}$$

Hence:

$$E^x = \frac{EE'}{V}$$

The product thus is normalized to lie within the range $0 \leq E^x \leq V$.

Multiplication in single-line bipolar representation is performed by an inverted exclusive-OR gate.

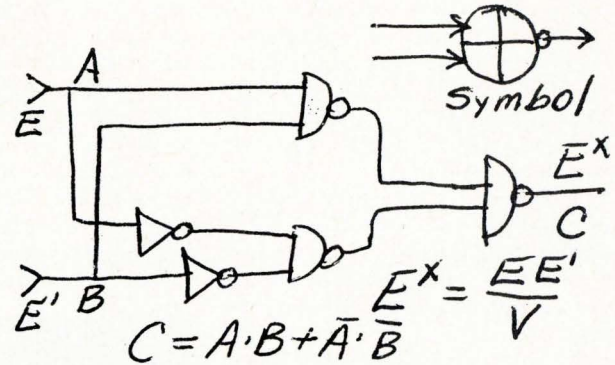

Its output is ON when its two inputs are the same, so that two positive quantities at the inputs, or two negative quantities at the inputs, represent a positive quantity at the output.

That multiplication does occur may be confirmed by examining the relationship between input and output probabilities for the gates shown.

$$p(C) = p(A) p(B) + [1 - p(A)][1 - p(B)]$$

and

$$p(A) = \frac{1}{2} + \frac{1}{2} \frac{E}{V}$$

$$p(B) = \frac{1}{2} + \frac{1}{2} \frac{E'}{V}$$

so that:

$$p(C) = \frac{1}{2} + \frac{1}{2} \frac{EE'}{V^2}$$

which is normalized multiplication of E by E' .

Two similar gates are required for multiplication

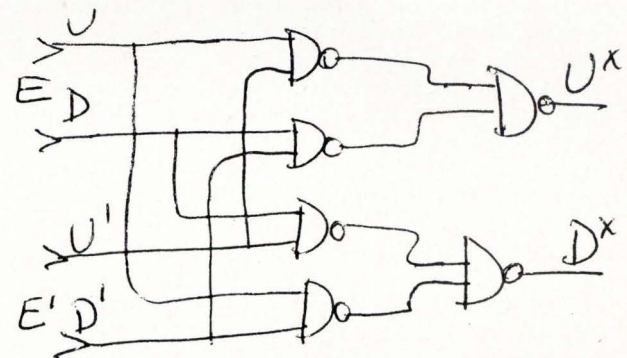

in two-line bipolar representation; these stochastic multipliers can be realized with NAND logic.

Squarers: an important phenomenon is illustrated by the use of a stochastic multiplier as a squarer. Unlike conventional analog multipliers, it is not sufficient to short-circuit the inputs of the gate in a stochastic multiplier, for its output will then be the same as its input. This difficulty arises because the input sequences must be statistically independent. Fortunately, because the sequences are

Learning machines sparked the project

Author Brian R. Gaines, who divides his time between the academic world of England's Cambridge University and the engineering world of the Standard Telecommunication Laboratories, traces the development of his stochastic computer:

"The need for a new type of computer became apparent at STL during research on the structure, realization, and application of advanced automatic controllers in the form of learning machines. Our preliminary investigations of algorithms for machine learning were hampered by the time and expense of simulating even a small learning system on a conventional digital computer. Although we were successful in demonstrating that certain general algorithms could form the basis for machine learning in a wide variety of control and problem-solving environments, it was obvious that no conventional computing system was capable of realizing these algorithms in real time at an economic price.

"An adaptive controller is, by definition, a variable parameter system. This implies a minimum hardware complement of the following: stores to hold the parameters; multipliers to enable the parameters to weigh other variables in the system; and parameter-adjustment logic to allow learning to take place.

Digital too slow. "In the digital computer these parameters would be held in magnetic core storage and fetched each time one was required to multiply a system variable or to be updated. The operations involved would take about 50 core cycles and might take place 20 or more times in one sampling interval. Even our smallest machine with a 10-bit input and 2-bit output had about 1,000 parameters, so that its maximum sampling rate with a 1-microsecond cycle time would be about 1 per second—10 times slower than a human operator.

"These figures can only be rough guides to the problems involved, but they indicate the difficulties in realizing a machine with even a fraction of the speed and adaptability of man—and eventually we must aim to surpass him.

"The computations involved in

machine-learning were obviously more suited to the parallel, multi-processor operation of the analog computer, than to the sequential, multiplexed single-processor operation of the digital computer. Matrix inversion, for example, is performed simply and rapidly by nets of resistors, whereas it is a long and difficult computation on the digital computer.

"In the course of our research

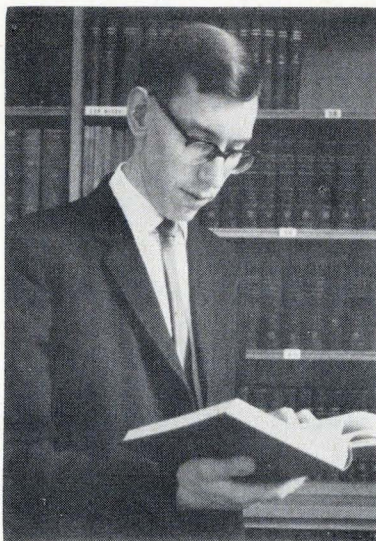

Brian R. Gaines

we investigated many forms of analog storage which might be used to hold the parameters of a learning machine. Capacitor, electroplating, electrolytic, transfluxor—they all had their individual defects in cost, size, and reliability, but the general deficiency was in the difficulty of integration into the over-all system. The external circuitry required to adjust the stored value and use it to multiply other variables exceeded the original device in complexity, size and cost.

Build around IC's. "It became obvious that the only device technology advancing rapidly enough to satisfy our requirements for large numbers of computing elements at low cost was that of integrated circuits. And it was decided to concentrate on new methods of computing with standard digital devices—gates and flip-flops—rather than develop new forms of devices. In particular we wish to be in the position to take full advantage of large-scale integration.

"Eight years ago we would have built a learning machine with vacuum tubes and relays, and it would have been massive, unreliable and useless. Four years ago we would have built it with discrete semiconductor devices and it would have served as a demonstration of principle—but the cost and size of a powerful machine would have been prohibitive. Today's integrated circuits make stochastic computing elements the most economical means of realizing learning algorithms, but are not yet sufficiently low in cost for commercial production of a learning system. In a few years time we shall have complex arrays containing hundreds of gates and flip-flops interconnected as a complete system."

At STL, Gaines and others developed a family of stochastic computing elements and studied applications to problems of data-processing, automatic control, radar and pattern recognition. He points out that the only commercial data-processing device that now uses a stochastic representation of analog data is the Enhance-tron made by Nuclear Data Inc. of Palatine, Ill. This unit is used in the study of biological responses to stimuli and replaces an analog-to-digital converter and a digital adder with a stochastic comparator and digital counter.

Gaines also reports that another type of stochastic computer has been developed independently at the University of Illinois under J.W. Poppelbaum as part of a program on optical data processing. The report of that work in *Electronics*, Dec. 12, 1966, spurred Gaines to write his article.

As a consultant to STL's New Systems division, Gaines, who recently completed his doctoral research on the human adaptive controller at the Cambridge psychological laboratory, developed the stochastic computer described in this article in close collaboration with J.H. Andreae, who is now at the University of Canterbury, Christchurch, New Zealand. It was constructed by P.L. Joyce of STL. It is the first computer to be developed as a result of this research, and is particularly fascinating because it uses what is normally regarded as a nuisance or waste product—random noise.

not patterned, a statistically independent sequence is obtained by delaying the input for one clock pulse.

A unipolar multiplier may be used as a squarer by interposing a delay flip-flop in one input. The

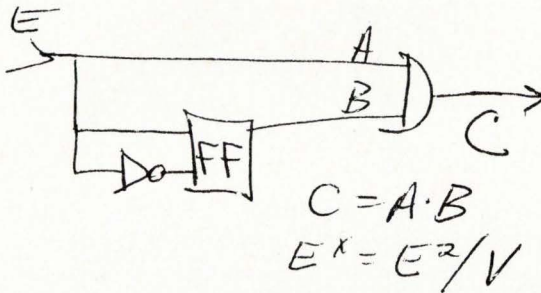

same may be done with the other multipliers, a delay in both UP and DOWN lines being required for the two-line representation.

Flip-flops used in this way perform as stochastic isolators, acting to remove the correlation between two sequences with a similar pattern.

Summers: having seen how readily inversion and multiplication is performed by simple gates, one is tempted to assume that similar gates are used to perform addition. However this is not so—stochastic logic elements must be introduced to sum the quantities represented by two stochastic sequences.

For example, consider two sequences in single-line bipolar representation, one representing maximum positive quantity and hence always ON, the other representing maximum negative quantity and hence always OFF. The sum of these quantities is zero and should be represented by the stochastic sequence with equal probabilities of being ON or OFF. But a probabilistic output cannot be obtained from a deterministic gate with constant inputs; stochastic behavior therefore must be built into the summing gates of the computer.

Stochastic summers may be regarded as switches which, at a clock pulse, randomly select one of the input lines and connect it to the output. The output line denotes the sum of the quantities represented by the input lines. The sum is weighted according to the probability ($\frac{1}{2}$ in the schematic below) that a particular input line will be selected. The random

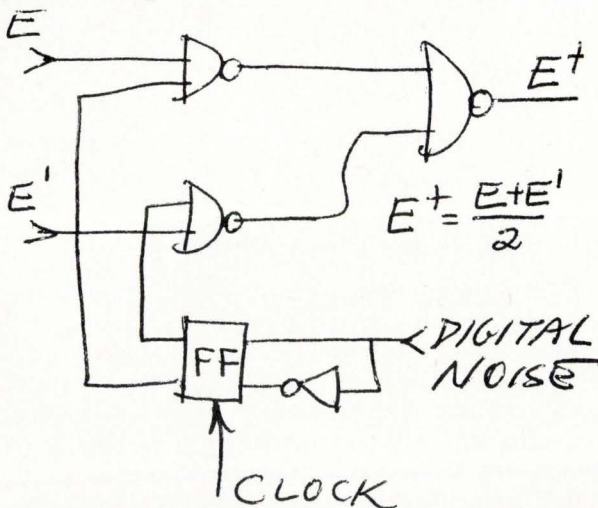

selection is performed by internally generated stochastic sequences, obtained either by sampling flip-flops triggered by a high bandwidth noise source, or from a delayed sequence of a central pseudo-random shift register; these sequences are called digital noise.

Two-input stochastic summers with equal weighting are shown. Identical circuits are used for unipolar and single-line bipolar quantities while for two-line bipolar representations, an additional inhibitory gate reduces the variance of the output.

That addition does occur may be confirmed by examining the relationship between input and output probabilities for the gates below. Assuming symmetrically distributed digital noise, we have:

$$p(C) = \frac{1}{2} p(A) + \frac{1}{2} p(B)$$

and hence

$$\frac{E^+}{V} = \frac{1}{2} \frac{E}{V} + \frac{1}{2} \frac{E'}{V}$$

so that

$$E^+ = \frac{1}{2} (E + E')$$

which is normalized addition in the unipolar case and for the single-line bipolar case, too.

Integrators: The basic integrator in a stochastic computer is a digital counter. In the unipolar representation the counter is incremented by one if the input line representing the quantity to be integrated is ON and not incremented if it is OFF. If the counter has $N + 1$ states, corresponding to an output range of 0 to $+V$, then the value of the integral when it is in its k 'th state is k/N .

In the bipolar cases, a reversible counter is required since both positive and negative quantities occur. In the bipolar single-line representation, the counter is incremented by one if the input line is ON and decremented by one if it is OFF. In the bipolar two-line representation, the counter is incremented by one if the UP line at the input is

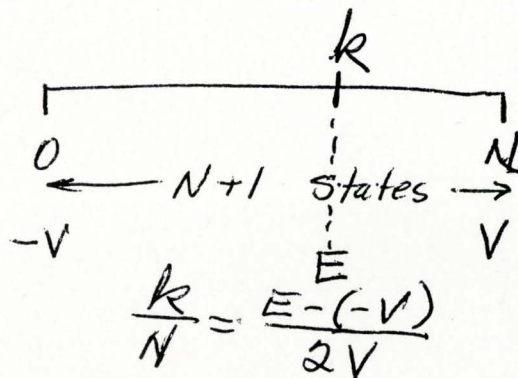

ON, decremented by one if the DOWN line is ON and does not change its count if the two lines are both ON or both OFF. If the counter has $N + 1$

states, corresponding to an output range of $-V$ to $+V$, then the value of the integral when it is in its k 'th state is

$$\int E d\tau = \left(\frac{2k}{N} - 1 \right) V$$

This quantity, to be used in further computations, must be made available as a stochastic sequence. The sequence is generated by comparing the binary number of the counter with a uniformly distributed, binary random number obtained from a central pseudo-random shift register or a sampled cycling counter.

In the unipolar and single-line bipolar representations, the comparator output line is ON if the stored count is greater than the random number.

Two-input stochastic integrators with gating at the input of the counters, form the integral of the sum of the input lines. A HOLD line prevents the

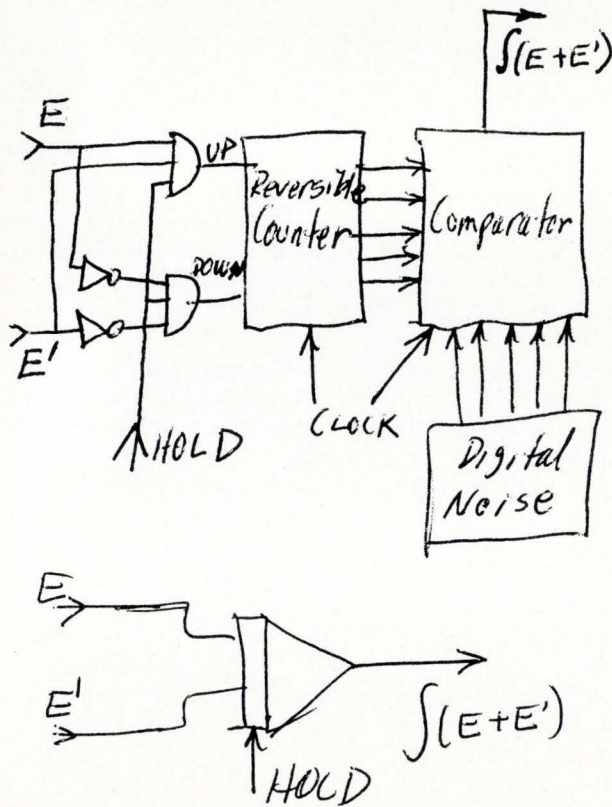

input lines from affecting the counter and an integrate or hold mode. The normal integrator symbol is used for the over-all device.

Readout with addies

An integrator with unity feedback is called an addie (adaptive digital element). It averages the quantity represented at its input, weighted by a decaying exponential term, so that past values have progressively decreasing effect on the integral. The analog equivalent of an addie is a leaky integrator (an integrator with resistive negative feedback) with the transfer function $1/(s + 1)$.

In terms of the stochastic sequences the fractional count in the addie tends to an unbiased

estimate of the probability that the input line will be ON at a clock pulse. The time taken by an addie

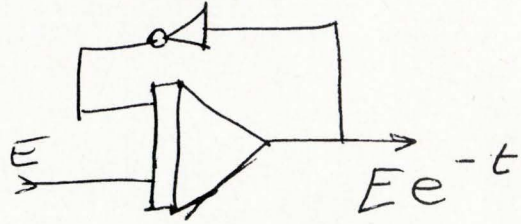

to form an estimate of this probability is directly proportional to the number of states of its counter. The probable error in the estimate, however, is inversely proportional to the square root of the number of states. Thus any quantity represented by a probability in the stochastic computer may be read out with an addie but the more states, the longer the time constant of smoothing and the lower the bandwidth of the computer.

Integrators or addies have binary representation of quantity in their counters and form the natural output interface of the stochastic computer. Integrators with HOLD lines OFF also form the input interface for digital or analog data, since binary numbers may be transferred directly into the counter to generate a stochastic output sequence, and analog quantities may be easily converted to binary form.

Similarly an integrator may be used to hold a multiplying constant, and thus act as an analog potentiometer if coupled to a multiplier. Arbitrary functional relationships may be realized by imposing a suitable nonlinear relationship between the stored count and the stochastic output; for example, to represent a switching function in the single-line bipolar case, use an integrator whose output is on when the count is equal to or above mid-value, and off when it is below mid-value. A pair of integrators coupled with appropriate stabilization can be used to generate sine and cosine functions. The generation of damped harmonic waveforms with two stochastic integrators is below.

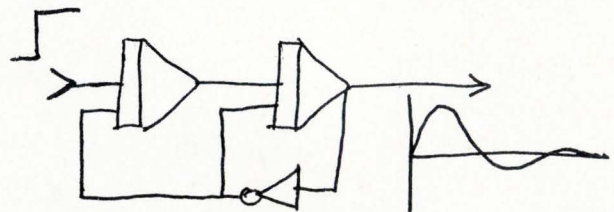

Generation of stochastic sequences

The central problem in constructing a stochastic computer is the generation of many random sequences. Each integrator requires as many separate sequences as there are flip-flops in the integrator counter. The sequences must be neither crosscorrelated nor autocorrelated, and must have known, stable generating probabilities.

The independent sequences, however, need only

Designer's casebook

Designer's casebook is a regular feature in Electronics. Readers are invited to submit novel circuit ideas, packaging schemes, or other unusual solutions to design problems. Descriptions should be short. We'll pay \$50 for each item published.

Scr ring circuit replaces stepping relays

By Charles H. Harris

Micro Tech Manufacturing Inc., Worcester, Mass.

Silicon controlled rectifiers connected in cascade provide a four-step actuating sequence for a group of solenoids. Because stepping relays—subject to wear and mechanical failure—aren't used, long-term reliability is assured. The circuit was developed to control a semiconductor bonding process, but it can be applied to any process requiring a cyclical control sequence.

Operation is started by closing momentary switch S_1 , energizing solenoid L_2 directly and triggering

SCR_1 . When SCR_1 conducts, solenoid L_1 is energized. All following operations are now controlled by lever switch S_2 , which is alternately closed in the S_{2a} and S_{2b} positions.

Closing contact S_{2b} triggers SCR_2 through diode D_1 , which is forward-biased when SCR_1 is conducting. The states of the solenoids and of the scr's at the end of the first step are indicated in the table.

Contact S_{2a} is closed in the second step. This triggers SCR_3 , energizing solenoids L_2 and L_3 . Solenoid L_1 is then deenergized by diverting SCR_1 's anode current through capacitor C_1 long enough to turn off SCR_1 .

In the third step, contact S_{2b} is closed again. This triggers SCR_4 , energizing solenoid L_4 and turning off SCR_2 by diverting its anode current through capacitor C_2 .

In the fourth step, contact S_{2a} is closed, trigger-

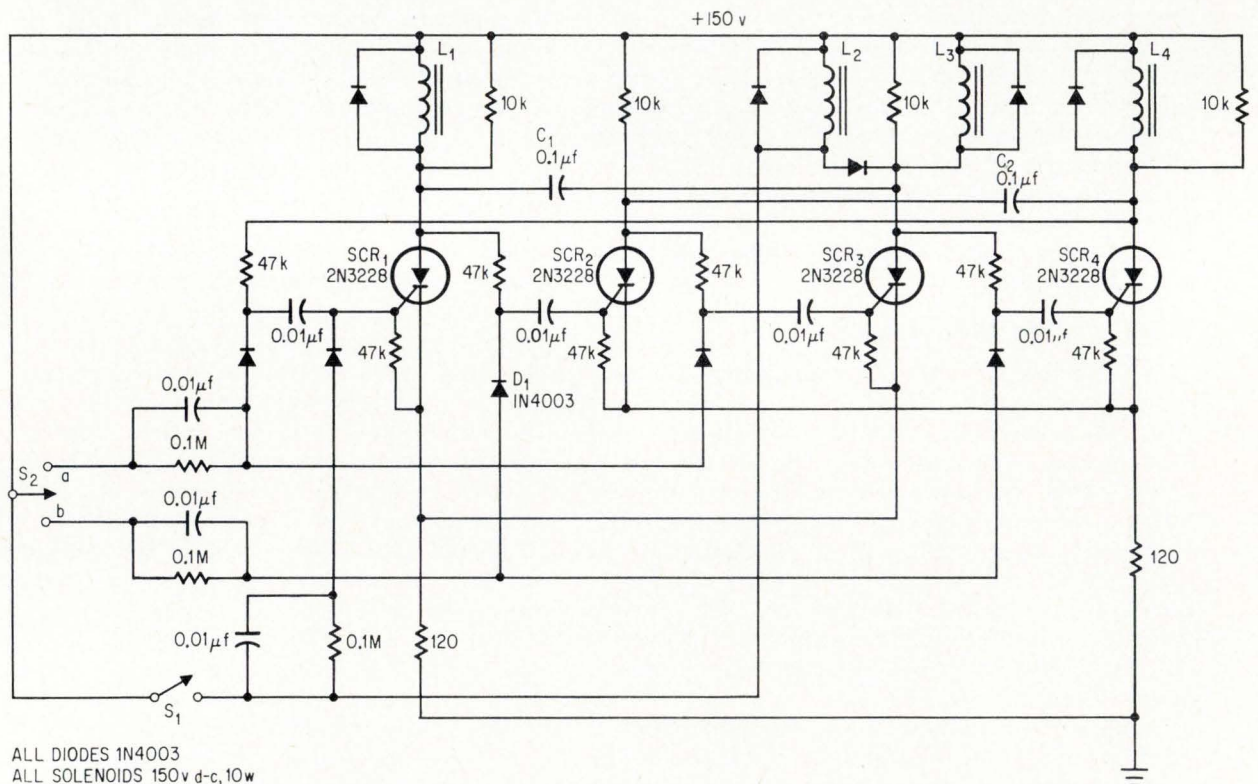

ALL DIODES 1N4003
ALL SOLENOIDS 150v d-c, 10w

Alternately closing switch contacts S_{2a} and S_{2b} causes the silicon controlled rectifiers to turn on and off in a stepped pattern that sequences solenoids L_1 through L_4 .

Operating sequence

Switch contact closure	SCR state				Solenoid state			
	SCR ₁	SCR ₂	SCR ₃	SCR ₄	L ₁	L ₂	L ₃	L ₄
S ₁ (momentary).....	on	off	off	off	on	off	off	off
(step 1) S _{2b}	on	on	off	off	on	off	off	off
(step 2) S _{2a}	off	on	on	off	off	on	on	off
(step 3) S _{2b}	off	off	on	on	off	on	on	on
(step 4) S _{2a}	on	off	off	on	on	off	off	on
S _{2b}	on	on	off	off	on	off	off	off

ing SCR₁ and turning off SCR₃ via capacitor C₁. This deenergizes solenoids L₂ and L₃ and energizes solenoid L₁.

Closing contact S_{2b} again triggers SCR₂, turning off SCR₁ and deenergizing solenoid L₄. The scr's and solenoids are now in the same state as in step 1,

and a new cycle begins. Continued operation of switch S₂ repeats the cycle.

Power is obtained from rectified line voltage with a maximum drain of about 200 milliamperes. Circuit cost, exclusive of solenoids and switches, is about \$22.

Multivibrator replaces reactor in d-c converter

By Gilbert Marosi* and Frans Ludding**

General Precision Inc., Sunnyvale, Calif.

The square-wave signal required by a d-c converter can be generated by an astable multivibrator. The multivibrator provides an operating efficiency that

*Now with CMC Systems, Sunnyvale, Calif.

**Now with Philco Corp., Palo Alto, Calif.

is 15% higher than the saturable reactor circuit sometimes used in d-c converters, and also affords a reduction in cost and size.

Transistors Q₂ and Q₃ of the multivibrator drive push-pull stages Q₁ and Q₄, whose outputs are applied to transformer T₁. Any audio transformer with a small turns ratio and low winding resistance can be applied.

The frequency, f, of the square wave is determined by the relation

$$f = \frac{1}{T_1 + T_2}$$

where $T_1 = T_2 = 0.69 R_2 C_1$. For the values shown,

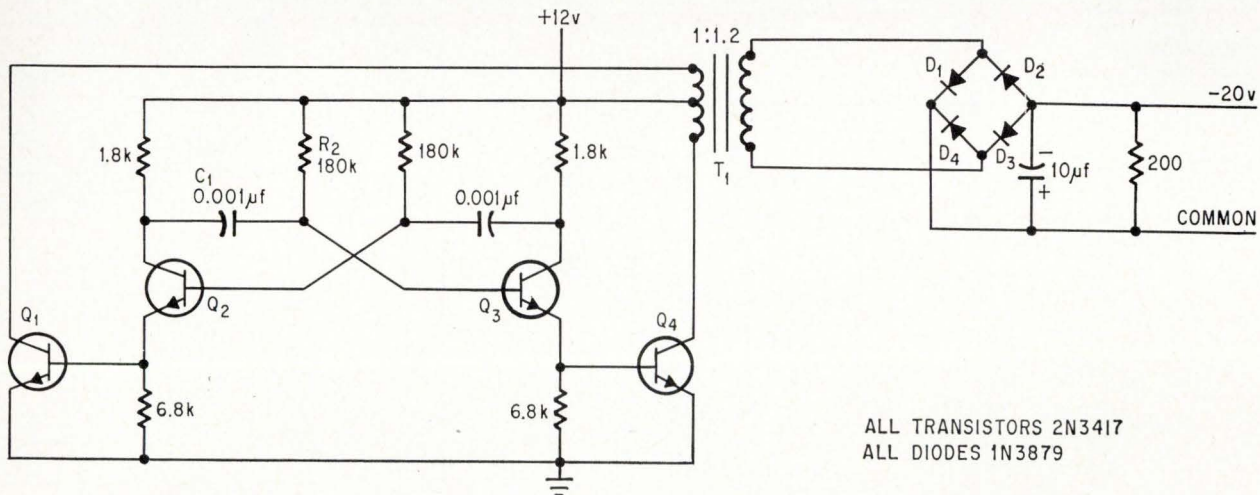

ALL TRANSISTORS 2N3417
ALL DIODES 1N3879

Square-wave signal generated by astable multivibrator Q₂ and Q₃ is fed to transformer T₁. Diodes D₁ through D₄ provide a full-wave rectified output.

$f = 4$ kilohertz. The rise and fall times of the square wave are less than 0.3 microsecond. Thus, operation at higher frequencies is possible without significantly increasing the power dissipated in the transistors.

By replacing Q_1 and Q_4 with several parallel transistors, higher power output levels can be obtained. The only requirements necessary are that the paralleled transistors should have low saturation voltages and low power dissipation characteristics.

Single control adjusts outputs of several pulse generators

By William M. Chu

International Business Machines Corp.,
Poughkeepsie, N.Y.

Single-dial amplitude control of several pulse generators is obtained by feeding their outputs through a common attenuator. In addition to simplifying

amplitude adjustment, the single control offers other advantages. There is no pulse tracking problem; pulse shape and rise time are preserved as amplitude is varied; and generators can be easily replaced, because generator modification isn't required.

This technique is applied in a circuit that supplies test pulses to measure ferrite core parameters for computer memories. Four generators supply two positive read and two negative write pulses.

The generators are first adjusted individually so that the amplitude ratio of one positive pulse to the other and one negative pulse to the other corre-

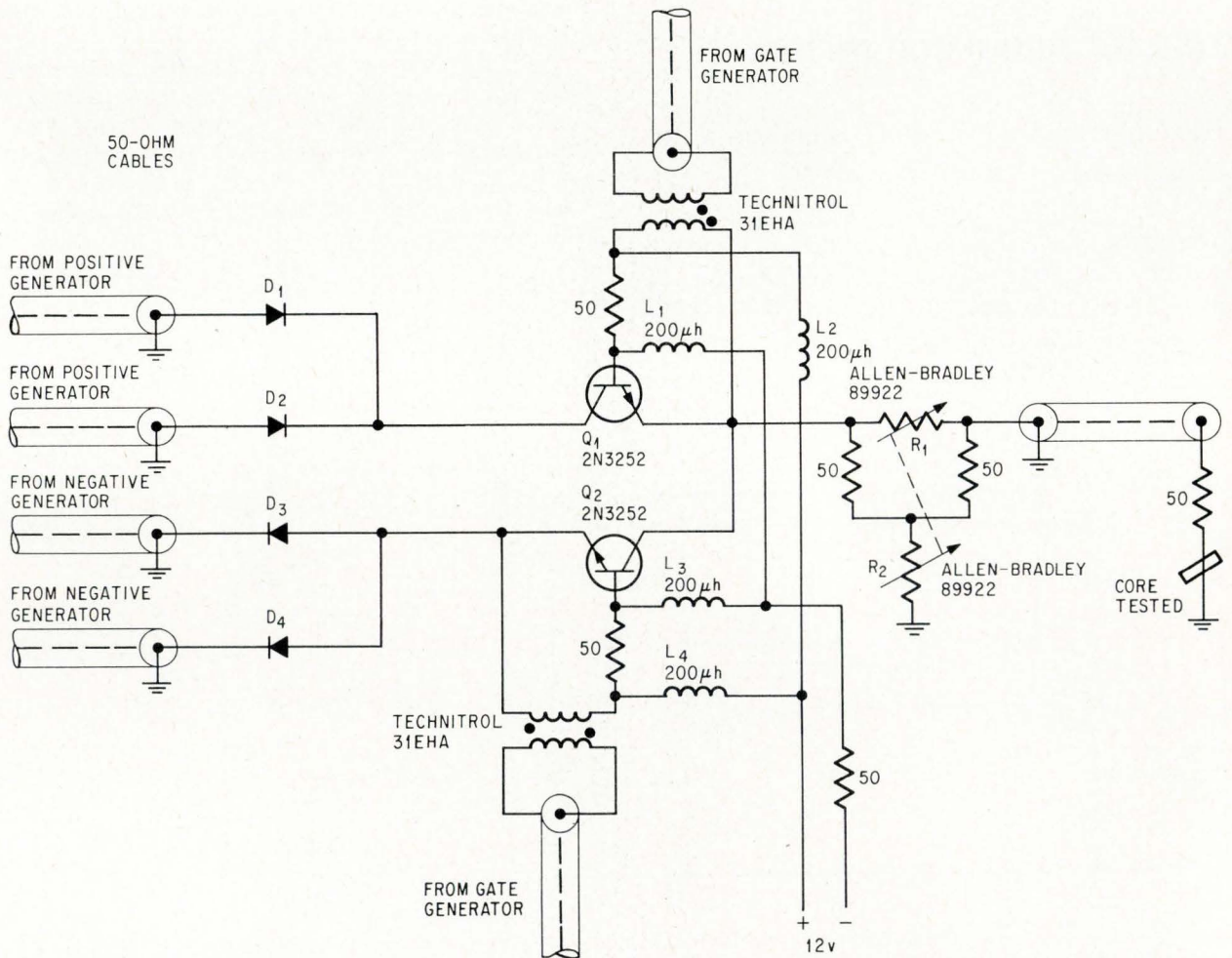

Gate-generator signals switch transistor Q_1 or Q_2 to deliver either positive or negative pulses to the core tested.

sponds to the ratio of full-select to half-select current. Once the ratio is set for each, the attenuator is adjusted to provide various pulse amplitudes with the ratio between the pulses constant. When more than four generators are to be controlled, the only additional circuitry required is one diode per generator.

Generators of the same polarity are connected via OR circuits (diodes D_1 through D_4) to transistors Q_1 and Q_2 . The transistors switch generator outputs to a single bridged-T attenuator, consisting of two fixed 50-ohm resistors and ganged variable resistors R_1 and R_2 . Switching signals are provided by two gate generators that are transformer-coupled to the emitters of Q_1 and Q_2 .

When a particular output is required, the corresponding gate generator saturates its transistor for the duration of the output pulse. Rise and fall

times of the gating pulse are slow (greater than 50 nanoseconds) so that there is minimum disturbance to the output pulse when the gate is turned on or off. The gating pulse should have an amplitude of about 200 milliamperes and a width greater than that of the output pulse. When the transistors aren't gated, they are cut off by the 12-volt supply. Inductors L_1 through L_4 are high-frequency chokes.

The maximum output current of the generators used is 1.04 amperes, when driving a 50-ohm load. Transistor and attenuator losses limit the maximum full-select current to 940 milliamperes.

Repeatability of amplitude settings is limited by attenuator backlash and generator stability. By always turning the dial (attenuator's setting) from a fixed direction, settings were repeatable to ± 1.5 ma in the 300 to 470 ma range, and to ± 2 ma in the 600 to 940 ma range.

Zener diodes control amplitude stretching

By J. Holland

Cheltenham, England

Input signals greater than a given threshold level cause the gain of the amplifier shown to increase abruptly, thus stretching the amplitude of these signals. The rise in gain results from a sudden decrease in a zener diode's reverse resistance when the voltage across it passes its critical level. One application of amplitude stretching has been to improve the signal-to-noise ratio of a keyed continuous-wave signal.

Two zener diodes are connected back-to-back across R_1 , the cathode bias resistor of the amplifier. When the voltage across D_1 is below its zener level, (3 volts), the resistance of the diode branch is very high; thus, the amplifier gain is a function of R_1 . With an R_1 of 10 kilohms, the cathode voltage swing is slightly less than the grid swing, and the gain is small.

When the input signal peaks are greater than the zener voltage, the resistance of the diode branch is the sum of the forward and backward resistances of D_2 and D_1 , respectively—about 200 ohms. Hence, the parallel combination reduces the cathode a-c feedback resistance, producing an increase in gain.

The absolute value of the amplifier gain is given as

$$G = \frac{g_m R_2}{1 + g_m R_1}$$

For the values shown, the maximum gain is 25 and the minimum gain is 50/51. Input peaks higher than the zener voltage are amplified 25.5 times more than signals below that voltage.

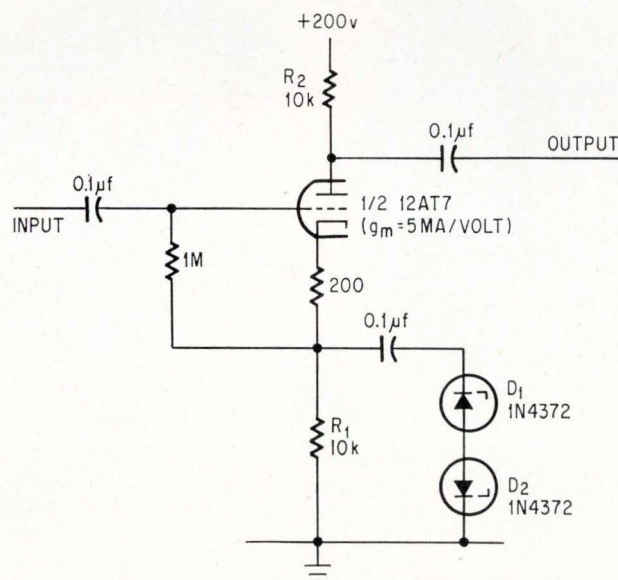

When the voltage across diodes D_1 and D_2 is greater than the zener level, the diode branch resistance drops to 200 ohms, increasing the amplifier gain 25 times.

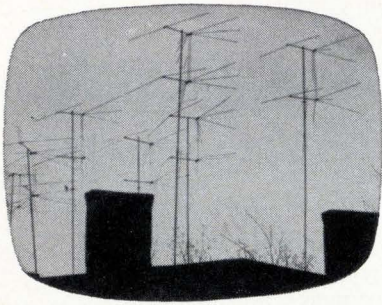

Stackpole Ceramag® ferrite components have been the accepted standard of the Television Industry for over twenty years.

In 1965, Stackpole began supplying Automatic Pincushion Correction Cores, a major advance, for color television receivers. 1964 saw the introduction of Stackpole 90° color components including Flyback, Yoke and Convergence Cores. As far back as 1954, these same components were introduced for the 70° color Deflection Systems.

The list of contributions Stackpole engineering and production know-how has made to the growth of color in television is long and varied. This same capability has been applied to the continual improvement of

black and white receiving equipment as well.

To be first with such items as Horizontal Output Transformer Cores and Automatic Pincushion Correction is not enough. Innovation must stand the test of performance. Stackpole Ceramag® components have, since 1947. Small wonder most manufacturers have come to depend so heavily on Stackpole's experience and quality. Stackpole Carbon Company, Electronic Components Division, St. Marys, Pennsylvania 15857. Phone: 814-781-8521. TWX: 510-693-4511.

Ceramag® Ferrite Components are Coloring the Entire Television Picture

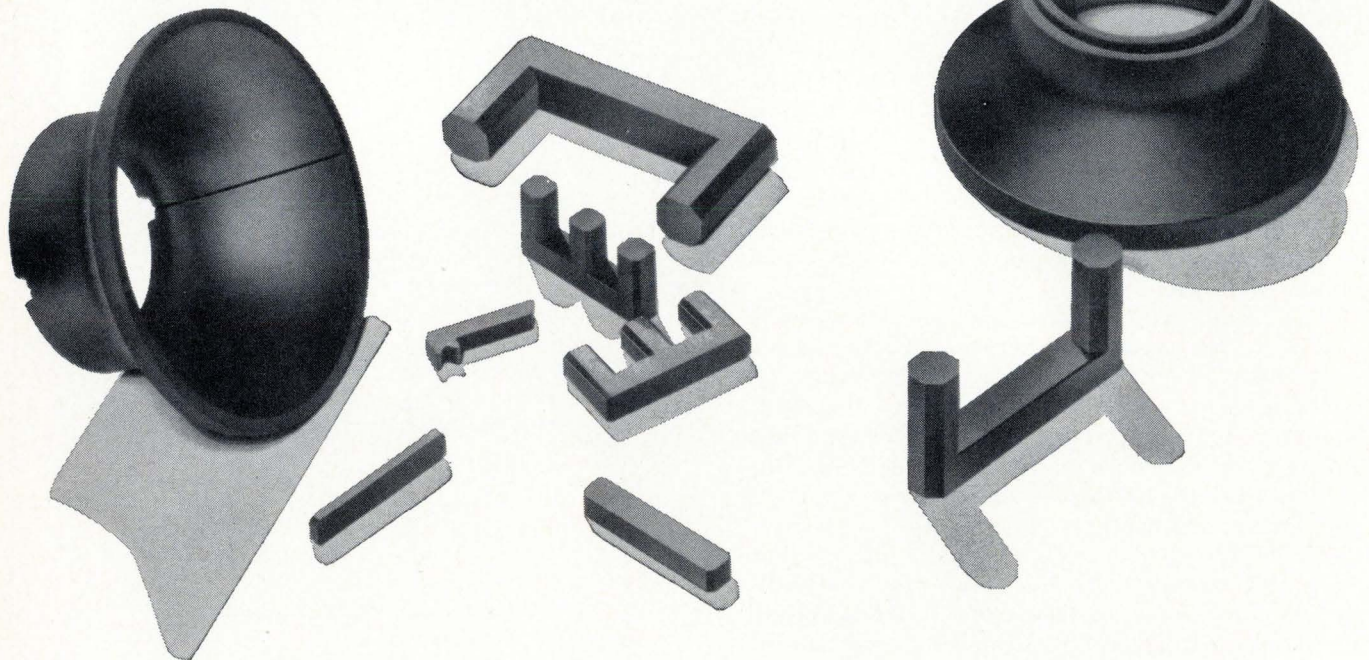

STACKPOLE
ELECTRONIC COMPONENTS DIVISION
"OUR 60th YEAR"

Computer-aided design: part 10

Making a video amplifier to measure

Starting with a basically sound circuit, the engineer can modify it to meet specific requirements. The computer helps to speed the job by calculating the qualities of critical circuit parameters

By John Pilcicki, Arinc Research Corp., Annapolis, Md.

and Richard Hughes, Naval Ordnance Test Station, China Lake, Calif.

Performance of even those circuits with which the engineer is thoroughly familiar can be sharpened with the help of the computer. A circuit such as a video amplifier can be tailored to meet a wide range of operational requirements. Further, a circuit intended for a given application can be designed for optimal operation plus easy and inexpensive construction.

The computer helps to do the job rapidly and accurately by calculating the characteristics of critical circuit parameters even before the first two leads are soldered together. The role played by the computer is threefold:

- Optimizing the circuit configuration for a particular application. Data calculated in this procedure are useful when a general-purpose circuit is applied in many different parts of a system.
- Identifying critical component parameters, particularly those of transistors, so that the best devices for the application can be selected.
- Calculating performance variations that will be encountered in production as a result of component-to-component variations.

A case in point is a general-purpose amplifier circuit suitable for broadband video applications. Since the circuit was intended to be built in integrated circuit as well as discrete component form, certain constraints were set. In particular, capacitors and complementary transistor combinations were avoided, as well as tight tolerance and high-value resistors.

At the start of the design procedure, a basic circuit is selected to meet the broad requirements

of the application—a need for good frequency and impedance characteristics. Next, an arithmetic model that simulates the active components is chosen. Then, a computer program already written to perform both d-c and a-c analysis is picked. With the model and program selected, the analyst can determine what part of the performance he wants to investigate. From the data printed, the analyst can then optimize the circuit or its configuration.

The basic circuit was picked from among four direct-coupled feedback amplifiers. All four were two-stage amplifiers. Two of them used common-emitter stages. These two, however, were rejected—the first because the d-c biasing called for a large-value feedback resistor, which made it hard to adjust the a-c gain, and the second because of its low input and high output impedances. A third circuit—common-emitter, common-base—was rejected for the latter reason and because it needed a low impedance bias path for the common-base stage, which would have required a bypass capacitor.

The circuit selected is a common-collector, common-base amplifier to which an emitter-follower stage has been added.

Circuit configuration

The circuit is thus a three-stage differential amplifier which has good frequency and impedance characteristics. The three stages are common-collector, common-base, and common-collector amplifiers. The common-base stage provides the voltage

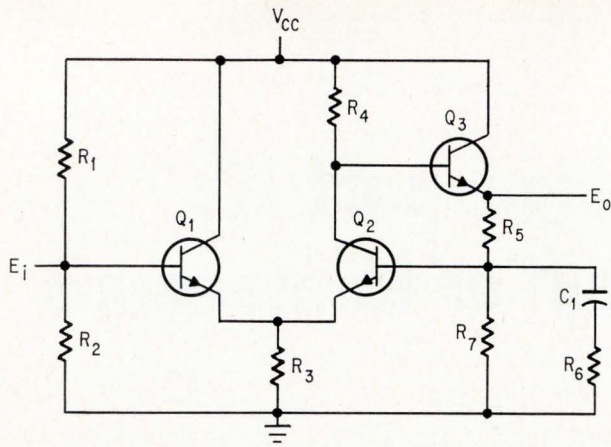

Video amplifier has common-collector, common-base, and common-emitter stages with gain determined by adjusting resistor R_6 . All-npn transistors afford ease of fabrication in IC form.

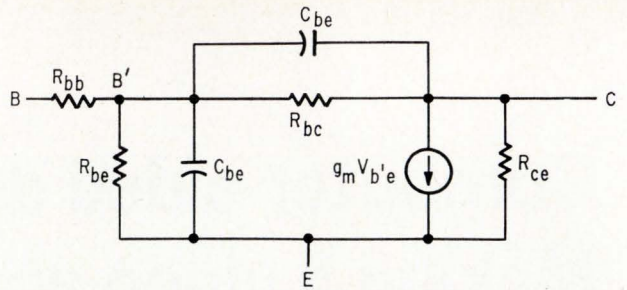

$$R_{be} = R_e (1 + h_{fe}) \quad R_{bc} = R_{be} / h_{re} \quad C_{be} = 1/2\pi R_e f_T$$

$$g_m = h_{fe} / R_{be} \quad R_{ce} = \frac{1}{h_{oe} - (h_{re} / R_e)} \quad C_{bc} = C_{ob}$$

Hybrid-pi transistor model enables accurate circuit analysis over wide frequency range. Parameters are printed by the computer in capital letters with no subscripts.

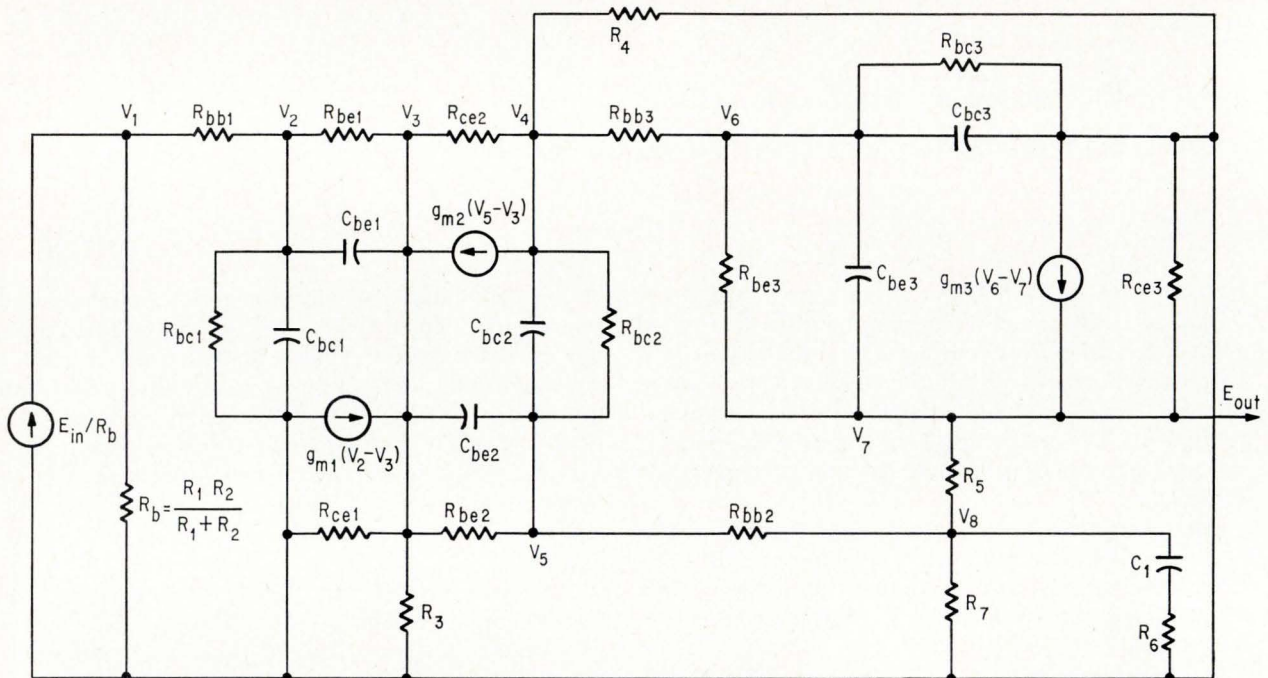

Equivalent circuit of video amplifier, too complex to handle manually, provides good accuracy.

gain and serves as a summing point for the feedback voltage, increasing the normally low common-base input impedance. Common-collector stages yield a high input impedance and a low output impedance. The circuit takes advantage of the relatively high frequency response of the common-base current gain due to the absence of Miller effect capacitance inherent in common-emitter stages. Another plus is the ease with which the gain can be changed by adjusting the value of R_6 , shown in the circuit at the top left.

Equivalent circuit

The first step in analyzing the circuit's high-frequency performance is to select a transistor model capable of representing the operation of a tran-

sistor over its entire useful frequency range in the amplifier under study. The model selected for this application is the hybrid-pi circuit at the top right. This model has these advantages:

- Its parameters are directly relatable to inherent device design and processing.
- Its parameters are easily derived from vendor data-sheet information.
- The model is valid up to the cutoff frequency of the transistors.

A detailed discussion of this and other high-frequency transistor models is available in textbooks on transistor circuit analysis.¹

One advantage of using a computer is that simplifying assumptions to make a problem tractable are often not necessary. This is fortunate, since the

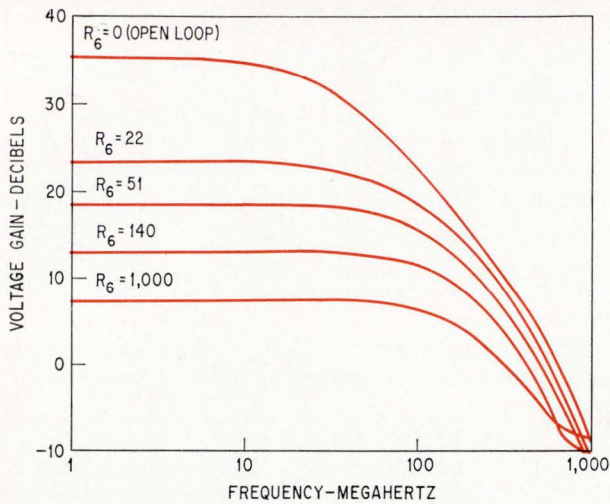

Family of gain curves at d-c bias current of 10 milliamperes per stage and with R_5 fixed at 400 ohms. R_6 is varied in steps from zero to 1K.

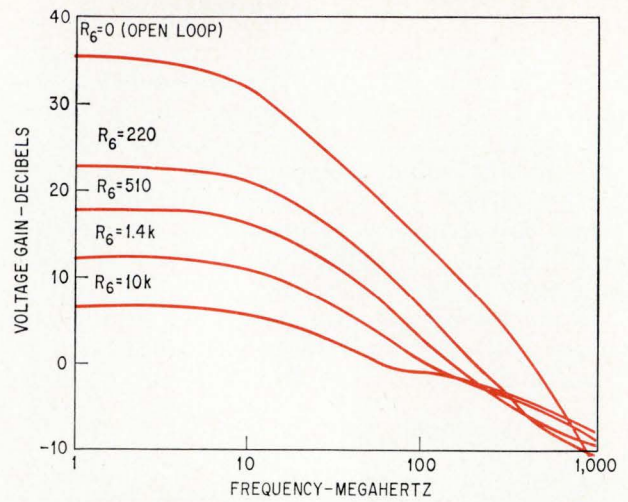

Family of gain curves at d-c bias current of 1 milliamperes per stage and with R_5 fixed at 4,000 ohms. Note that values of R_6 differ from those in curves at left.

FREQ. = 0.10000E 07

VAR. NO.	VAR. NAME	LOW VALUE OF VAR.	SOLUTION	HIGH VALUE OF VAR.	SOLUTION	DIFFERENCE OF SOLUTIONS	DIFFERENCE/NOM. SOL.
1	EIN	0.10000E 01	0.83283E 01	0.10000E 01	0.83283E 01	0.	0.
2	GM1	0.34600E-00	0.82550E 01	0.42400E-00	0.83893E 01	0.13426E-00	0.16121E-01
3	RBB1	0.27000E 02	0.83392E 01	0.33000E 02	0.83175E 01	-0.21689E-01	-0.26043E-02
4	RBE1	0.14300E 03	0.83177E 01	0.17500E 03	0.83370E 01	0.19354E-01	0.23239E-02
5	RBC1	0.90000E 05	0.83280E 01	0.11000E 06	0.83285E 01	0.49829E-03	0.59831E-04
6	RCE1	0.90000E 05	0.83283E 01	0.10000E 06	0.83283E 01	0.25153E-04	0.30202E-05
7	CBE1	0.54900E-10	0.83283E 01	0.67100E-10	0.83283E 01	-0.35763E-06	-0.42941E-07
8	CBC1	0.18000E-11	0.83283E 01	0.22000E-11	0.83283E 01	-0.26226E-05	-0.31490E-06
9	GM2	0.34600E-00	0.82513E 01	0.42400E-00	0.83922E 01	0.14085E-00	0.16913E-01
10	RBB2	0.27000E 02	0.83392E 01	0.33000E 02	0.83175E 01	-0.21686E-01	-0.26039E-02
11	RBE2	0.14300E 03	0.83041E 01	0.17500E 03	0.83482E 01	0.44058E-01	0.52902E-02
12	RBC2	0.90000E 05	0.83229E 01	0.11000E 06	0.83328E 01	0.98647E-02	0.11845E-02
13	RCE2	0.90000E 05	0.83280E 01	0.11000E 06	0.83285E 01	0.48232E-03	0.57913E-04
14	CBE2	0.54900E-10	0.83283E 01	0.67100E-10	0.83283E 01	-0.15497E-05	-0.18608E-06
15	CBC2	0.18000E-11	0.83284E 01	0.22000E-11	0.83282E 01	-0.12934E-03	-0.15530E-04
16	GM3	0.34600E-00	0.83254E 01	0.42400E-00	0.83307E 01	0.52189E-02	0.62664E-03
17	RBB3	0.27000E 02	0.83285E 01	0.33000E 02	0.83281E 01	-0.34249E-03	-0.41123E-04
18	RBE3	0.14300E 03	0.83263E 01	0.17500E 03	0.83300E 01	0.37119E-02	0.44570E-03
19	RBC3	0.90000E 05	0.83277E 01	0.11000E 06	0.83288E 01	0.10469E-02	0.12570E-03
20	RCE3	0.90000E 05	0.83283E 01	0.11000E 06	0.83283E 01	0.22054E-04	0.26480E-05
21	CBE3	0.54900E-10	0.83283E 01	0.67100E-10	0.83283E 01	0.23842E-06	0.28627E-07
22	CBC3	0.18000E-11	0.83283E 01	0.22000E-11	0.83283E 01	0.10967E-04	0.13169E-05
23	RB	0.13500E 03	0.83283E 01	0.16500E 03	0.83283E 01	0.71526E-06	0.85882E-07
24	R3	0.18000E 03	0.83154E 01	0.22000E 03	0.83389E 01	0.23499E-01	0.26216E-02
25	R4	0.3600E 03	0.81968E 01	0.44000E 03	0.84391E 01	0.24234E-00	0.29098E-01
26	R5	0.36000E 03	0.76846E 01	0.44000E 03	0.89546E 01	0.12700E 01	0.15249E-00
27	R6	0.40000E 02	0.90460E 01	0.49000E 02	0.77275E 01	-0.13185E 01	-0.15831E-00
28	R7	0.32000E 03	0.83283E 01	0.39000E 03	0.83283E 01	0.	0.
29	C1	0.90000E-05	0.83283E 01	0.11000E-04	0.83283E 01	-0.25034E-05	0.30059E-06

Parameter sensitivity test for the circuit on page 86, at 1 megahertz and R_6 of 44.5 ohms. Solutions for gain are in volts per volt.

Program is a SNAP

The Simulated Network Analysis Program (SNAP) stems from a project started by the Arinc Research Corp. under a pair of contracts with the Naval Ordnance Test Station and completed as a company sponsored research project.

Author John Pilcicki, a circuit design engineer at the Eastern division of Arinc, Annapolis, Md., used SNAP for improving circuitry in a variety of weapons guidance systems, including the Navy's Shrike and Sidewinder missiles. His coauthor, Richard Hughes, was the senior design engineer on the Shrike guidance computer and is now a section head in the weapons development department of the Naval Ordnance Test Station, China Lake, Calif.

Designed for use with the IBM 7090 or 7094 computer, SNAP applies to all circuits which can be described by a set of first-order polynomials with constant coefficients. The chief restriction is that a circuit or system must be capable of representation by a linear equivalent circuit for which n simultaneous equations in n unknowns may be derived. The equations, which may have real or complex coefficients, are written in standard matrix notation. Together with the equations describing the desired output solutions, they make up the material from which a source deck of cards is prepared. The source deck defines the circuit for the computer and can be used for many kinds of analysis as long as the general circuit configuration is not changed.

SNAP can generate up to 10 output solutions. As many as 50 input variables may be considered for a circuit described by a maximum of 20 equations and 20 unknowns at 20 different frequencies.

Expansion plan. The limitations on circuit size will be expanded to 200 input variables and 50 circuit nodes at the completion of a development program currently underway at Arinc. Additional improvements being incorporated include a topological routine to eliminate the need for circuit equations and the capability for running on the more modern computers.

The analysis options will continue to include the following:

- One-at-a-time parameter variation. When each of the specified

input variables is set first at its lower and then at its upper tolerance limits, while all other input variables are held at their nominal values, solutions are obtained for all output variables.

- Two-at-a-time parameter variation. When each of the input variables is varied, in pairs, to high and then to low tolerance values, while all other input variables are held at their nominal values, solutions are obtained for all output variables.

- Sensitivity. This test is performed only for specified output variables, and the user must spec-

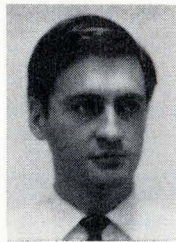

John Pilcicki



Richard Hughes

ify whether the output is to be in terms of magnitude or phase. Each input variable is set to its low and then to its high value, and the solutions for the specified output variable are computed. The difference between the output solutions given by the low and high values of each input is computed and divided by the nominal value of the output variable. The result is a percent change in output corresponding to the range of each input variable. The input variables are then listed in decreasing order of the magnitude of this percent output change. The ratio of the percent change of the specified output variable to the percent change for each input variable is also computed.

- Specified combinations. Any combination of values for input variables may be selected to obtain a set of output solutions. Both magnitude and phase for all output variables are computed for all frequencies.

- Monte Carlo analysis. This determines what the spread of circuit performance might be for circuits in production. Either the magnitude or phase of a particular output variable at a particular frequency must be specified. Many solutions are then generated, with each representing a unique combi-

nation of input variables randomly selected according to specified distributions. Values computed for the output variables that fall outside specified limits are printed, together with the input variables that gave that particular solution. A sample distribution and histogram plot are printed to show the over-all distribution of the output solution. Also, the mean value, standard deviation, and variance are computed.

Exercising options. Regardless of the option, selected solutions of output variables are computed for all specified frequencies with the input variables at nominal values. Individual options may be performed at any specific frequency, or at all listed frequencies.

The source deck for SNAP describes the equivalent circuit in standard matrix notation, specifies necessary combinations of input variables, and provides equations for the desired output variables.

The source deck contains a title card and several operational cards. Matrix coefficients are defined on separate cards, with individual real and imaginary parts. Matrix inversion is specified by a separate card.

The cards completely define the circuit under consideration. The first time the problem is compiled, a deck of binary cards is obtained and can replace the original source deck for all further analysis, as long as the configuration does not change.

The program can also perform all of the analysis options on a single algebraic equation by defining the equation as a polar output and eliminating the card that calls for inversion of the matrix.

The data deck serves two purposes: it lists all of the input-variable information needed for the various types of analyses, and includes the control information which directs the main program to perform a specific analysis.

SNAP provides high program efficiency, the authors note. For the average circuit, nominal and worst-case solutions and a sensitivity test might be expected to take 0.02 hour on the IBM 7094. A Monte Carlo analysis runs about the same time. If computer charges are approximately \$500 per hour, the average cost of analysis is less than \$20 per circuit.

VAR. NO.	VAR. NAME	CHANGE IN OUTPUT NOMINAL OUTPUT
27	R6	-0.11531
15	CBC2	-0.09134
26	R5	0.05661
10	RBB2	-0.04410
25	R4	0.03938
9	GM2	0.02506
2	GM1	0.02135
3	RBB1	-0.00656
14	CBE2	-0.00636
11	RBE2	0.00581
7	CBE1	-0.00408
24	R3	0.00327
17	RBB3	0.00310
22	CBC3	0.00282
4	RBE1	0.00240
16	GM3	0.00224
8	CBC1	-0.00088
18	RBE3	0.00069
21	CBE3	-0.00066
12	RBC2	0.00053
19	RBC3	0.00020
13	RCE2	0.00010
5	RBC1	0.00006
20	RCE3	0.00001
6	RCE1	0.00000
29	C1	0.00000
23	RB	0.00000
1	EIN	0.
28	R7	0.

Sensitivity test at 100 Mhz yields list of parameters in descending order of importance.

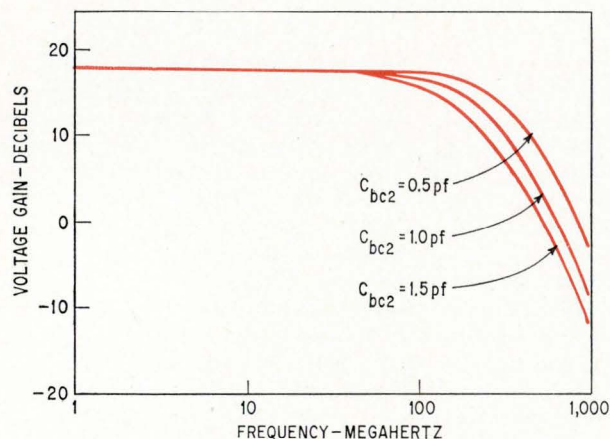

Bandwidth varies as a function of base-collector capacitance of the second transistor stage. Bias current is constant at 10 milliamperes and R_6 is 51 ohms.

A detailed description of the program, including several additional options for special calculations that do not apply to this example, is given in "The program is a SNAP," on page 89.

Frequency response

One of the advantages of SNAP is its ability to provide "quick look" frequency-response plots directly with the output printer. A typical printout describing the magnitude and phase of circuit gain as a function of frequency is on page 87. Although the resolution of this plot is limited by the matrix in which the printer can operate, the plot does provide information that helps decide whether accurate curves should be drawn from the numerical printout data.

Since the circuit under study is intended for use in a variety of applications, frequency response plots are obtained for different bias conditions and with a variety of feedback ratios. The representative families of curves on page 88 are derived from the solution of the equivalent circuit. They illustrate the gain-versus-bandwidth tradeoffs as well as the effect of changing the bias current levels.

Parameter sensitivity test

In studying parameter sensitivity, the analyst selects the portion of the frequency response curve he wishes to investigate. Two different points were selected for this study: a low frequency (1 Mhz) and a frequency at which the gain was down 3 db (100 Mhz). Initially, a tolerance of $\pm 10\%$ is assigned to each parameter, resulting in a rapid "smoking out" of the parameters having the greatest potential effect on circuit performance. Later, more realistic tolerances are tested so that performance variation as a function of expected component specification limits can be obtained. For example, the tolerances for integrated circuit elements could differ significantly from those of discrete components. Sensitivity test results at 1 Mhz are shown in the table on page 88, and a table listing the parameters in order of importance at 100 Mhz is at the left.

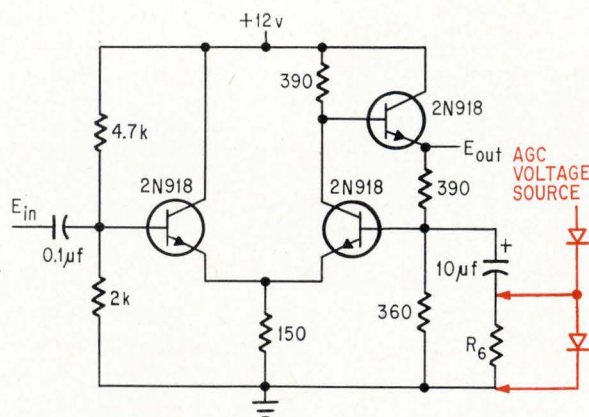

Component values for one version of the video amplifier. Using a pair of forward biased diodes (color) in place of R_6 allows amplifier gain to be varied over a range of 20 db by varying agc voltage.

In the last table the base-to-collector capacitance, C_{bc2} , had a large effect in the region of the half-power point. To gauge the possible improvement in bandwidth if a device with minimum collector capacitance were used, a special series of solutions, not shown, was calculated for a C_{bc2} range of 0.5 to 1.5 pf; the results are plotted on page 90.

Statistical analysis

In Monte Carlo statistical analysis, many solutions of circuit performance are calculated. For each solution the computer randomly selects each component parameter value according to a previously specified distribution. The types of distributions which may be selected are normal, log-normal, rectangular, or any special distribution described by the programmer.

The accuracy of the Monte Carlo representation depends partially on the accuracy of the selected component distributions, but information on actual component distribution is often difficult to obtain. Reasonable assumptions can be made, however, with the knowledge that most production-line parameter distributions are nearly normal, but that for many tight-tolerance devices manufacturers employ a selection process that renders the distribution more nearly rectangular.

Moreover, when considering tolerances, the interdependency of transistor parameters ought to be taken into account. For example, a transistor cannot exhibit both a high input impedance and a low current gain. These interdependencies can be handled in the SNAP program by including as subroutines the parameter relationships described in the hybrid- π diagram on page 86.

In the study at hand, the distributions were all considered rectangular, and the parameter tolerances in the table on this page were utilized. A histogram showing how gain would be expected to fluctuate due to that type of component distribution at a frequency of 1 Mhz is on page 92.

Test results

The data furnished by SNAP helped to optimize this circuit for several applications within a military weapon system. In all cases, agreement between the computer-predicted performance and actual laboratory measurements was very close. One practical version of this circuit is on the opposite page. At the right, laboratory tests on this configuration are compared with the analytical results. The circuit was applied where a maximum frequency response was needed. Where a lower cutoff frequency could be tolerated, the bias currents were reduced to save power.

This circuit was also employed as a variable-gain amplifier in which automatic gain control action was required. In this instance, R_6 was replaced with a pair of forward biased diodes, shown in color on the opposite page. Amplifier gain is determined by the dynamic impedance for the diodes which, in turn, is inversely proportional to the d-c current through the diodes. As a consequence, gain can be

VAR. NO.	VAR. NAME	NOMINAL VALUE	TOLERANCE	
1	EIN	0.100000E 01	-0.	TO -0.
2	GM1	0.385000E-00	0.135000E 03	TO 0.165000E 03
3	RBB1	0.300000E 02	0.150000E 02	TO 0.450000E 02
4	RBE1	0.159000E 03	0.795000E 02	TO 0.238000E 03
5	RBC1	0.100000E 06	0.900000E 05	TO 0.110000E 06
6	RCE1	0.100000E 06	0.900000E 05	TO 0.110000E 06
7	CBE1	0.610000E-10	0.305000E-10	TO 0.915000E-10
8	CBC1	0.200000E-11	0.100000E-11	TO 0.300000E-11
9	GM2	0.385000E-00	0.193000E-00	TO 0.577000E 00
10	RBB2	0.300000E 02	0.150000E 02	TO 0.450000E 02
11	RBE2	0.159000E 03	0.795000E 02	TO 0.238000E 03
12	RBC2	0.100000E 06	0.900000E 05	TO 0.110000E 06
13	RCE2	0.100000E 06	0.900000E 05	TO 0.110000E 06
14	CBE2	0.610000E-10	0.305000E-10	TO 0.915000E-10
15	CBC2	0.200000E-11	0.100000E-11	TO 0.300000E-11
16	GM3	0.385000E-00	0.193000E-00	TO 0.577000E 00
17	RBB3	0.300000E 02	0.150000E 02	TO 0.450000E 02
18	RBE3	0.159000E 03	0.795000E 02	TO 0.238000E 03
19	RBC3	0.100000E 06	0.900000E 05	TO 0.110000E 06
20	RCE3	0.100000E 06	0.900000E 05	TO 0.110000E 06
21	CBE3	0.610000E-10	0.305000E-10	TO 0.915000E-10
22	CBC3	0.200000E-11	0.100000E-11	TO 0.300000E-11
23	RB	0.150000E 03	0.135000E 03	TO 0.165000E 03
24	R3	0.200000E 03	0.180000E 03	TO 0.220000E 03
25	R4	0.400000E 03	0.360000E 03	TO 0.440000E 03
26	R5	0.400000E 03	0.360000E 03	TO 0.440000E 03
27	R6	0.445000E 02	0.400000E 02	TO 0.490000E 02
28	R7	0.355000E 03	0.320000E 03	TO 0.390000E 03
29	C1	1.000000E-05	0.900000E-05	TO 0.110000E-04

Monte Carlo analysis is based on rectangular distribution of parameters with limits given here.

varied over a 20-db range by adjusting the age voltage between approximately 0.5 and 1.5 volts.

An IC model

The amplifier design is being converted for fabrication in monolithic integrated circuit form. In ic's, the need for computer analysis is critical because changes made after the masks are fabricated are expensive. The need for accurate performance predictions is coupled with the constraints invoked by the broad ic component tolerances and parasitic elements, making computer analysis even more attractive. Analysis of this circuit, including these

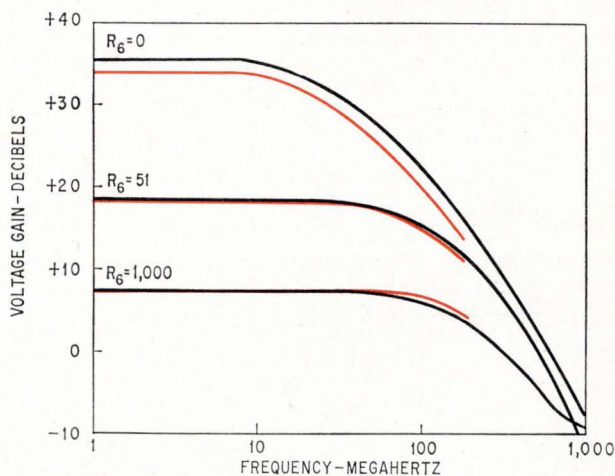

Comparison of the measured frequency response (color) of the amplifier shown on the following page and its computer-generated response curves (black).

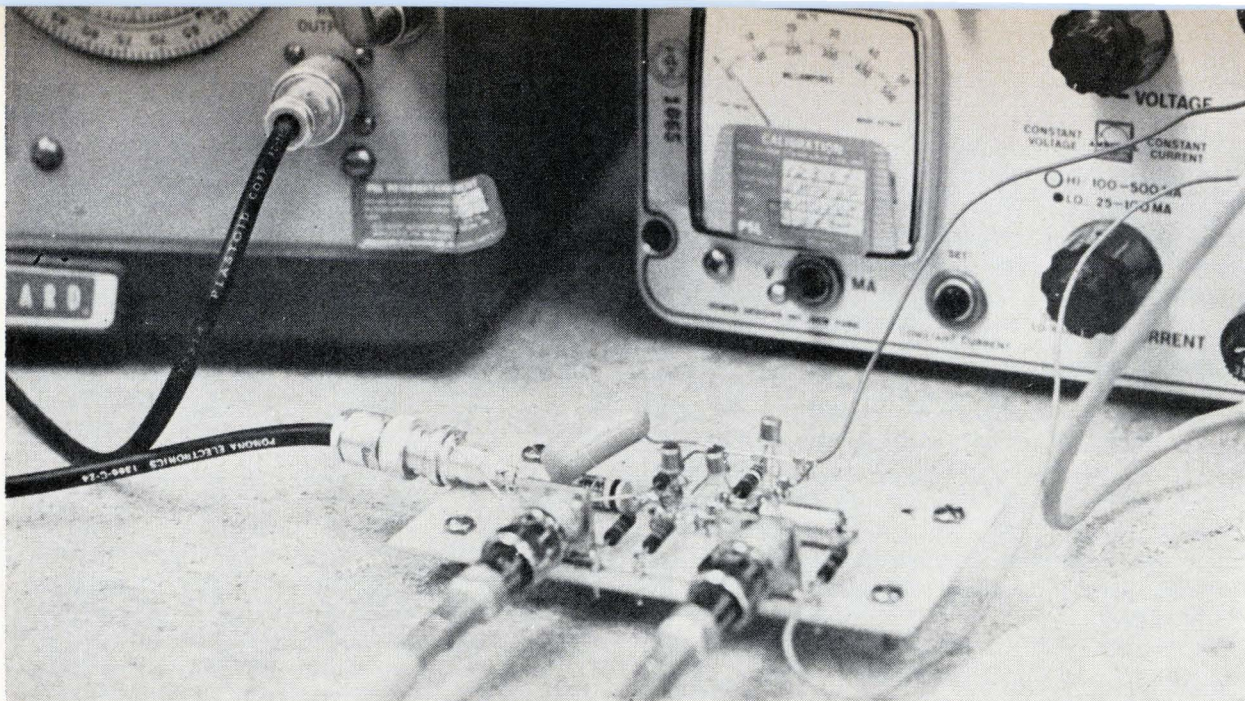

Breadboard of the video amplifier is bench tested. Both the measured breadboard results and the computer-predicted results are plotted at the bottom of page 91.

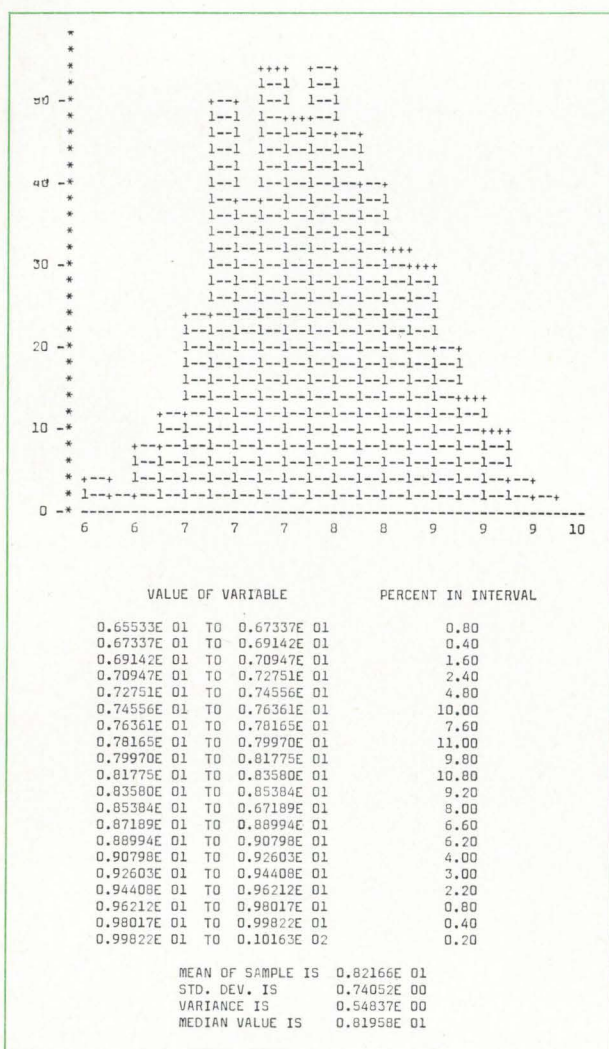

Histogram shows how gain would vary under specific conditions of component parameter distribution in production, at a frequency of 1 Mhz and with R_0 equal to 51 ohms.

additional factors, has provided the data to select the optimum component values and geometries based on a compromise between ease of fabrication and performance characteristics.

For example, when a resistor line-width of 2 mils was used, the associated parasitic capacitance was enough to cause circuit instabilities at high frequencies. A test run on the computer at the frequency of maximum instability pinpointed the particular resistor causing the problem and furnished the data necessary to redesign this component (it was made thinner).

Gain tolerance was also studied for the IC amplifier, since it was uncertain whether a ± 0.5 db gain accuracy could be met with the $\pm 20\%$ tolerance associated with diffused resistors. The parameter sensitivity test revealed that a 6% change in magnitude of the feedback resistors had about the same effect on the amplifier gain as 100% change in transistor beta. Fortunately, resistors diffused into a common substrate will hold their ratio within $\pm 3\%$ even though their absolute value varies $\pm 20\%$.

Sensitivity studies can be accommodated with a computer by representing the value of each diffused resistor as the product of its nominal value and a factor X, which is varied from 0.8 to 1.2 to account for the $\pm 20\%$ absolute tolerance common to all resistors. The $\pm 3\%$ ratio tolerance, on the other hand, is applied to the individual resistors.

The result of a worst-case calculation of amplifier gain variation using the results of the sensitivity analysis showed a gain tolerance of about 1.2 db. A Monte Carlo analysis indicated most production circuits (over 90% to a 95% confidence level) could be expected to be within ± 0.25 db.

Reference

1. P. Cutler, "Semiconductor Circuit Analysis," sections 6 to 10, McGraw-Hill Book Co., 1964.

Four ways to put the damper on component failure.

They're our 3M Brand Inert Fluorochemical Liquids —FC-43, FC-75, FC-77, FC-78—and the one whose properties are best for cooling your component will make it as reliable as a coolant can make it.

That's because our Inert Liquids are far more efficient at removing heat—a prime cause of component failure — than either air or other dielectric coolants. Now your component can operate at lower temperatures and with increased reliability.

You can also rely on our Inert Liquids for other important properties. High on the list are high dielectric strength, high temperature stability, chemical inertness, compatibility, and nonflammability.

All of which makes 3M Brand Inert Liquids as good for test bath applications as they are for cooling. You can rely on that.

3M Chemical Division
Dept. KAX-77, St. Paul, Minn. 55119
Send me all the details about 3M Brand Inert Liquids.

Name _____

Address _____

Company _____ Title _____

City _____ State _____ Zip _____

Chemical Division **3M**
COMPANY

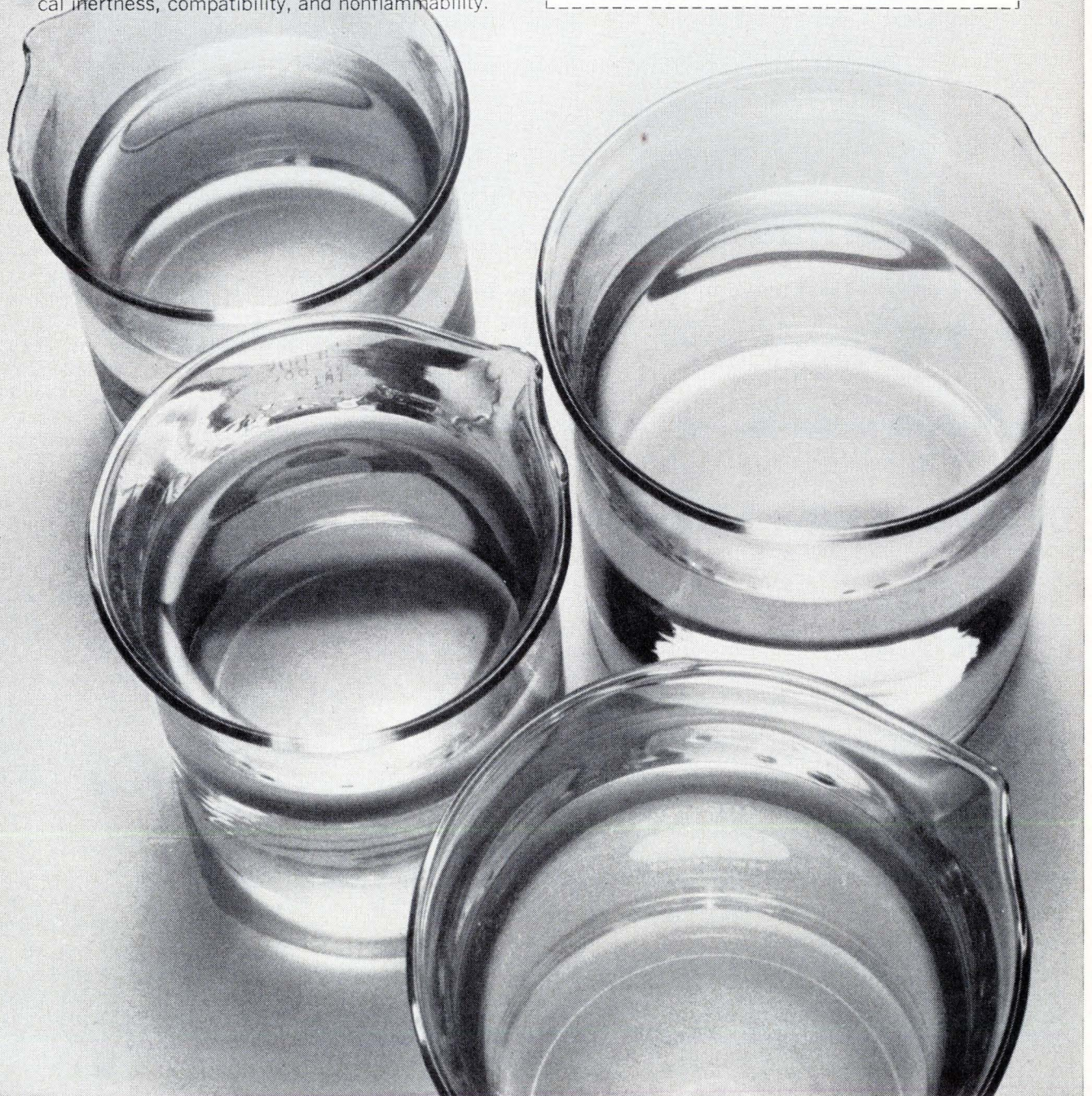

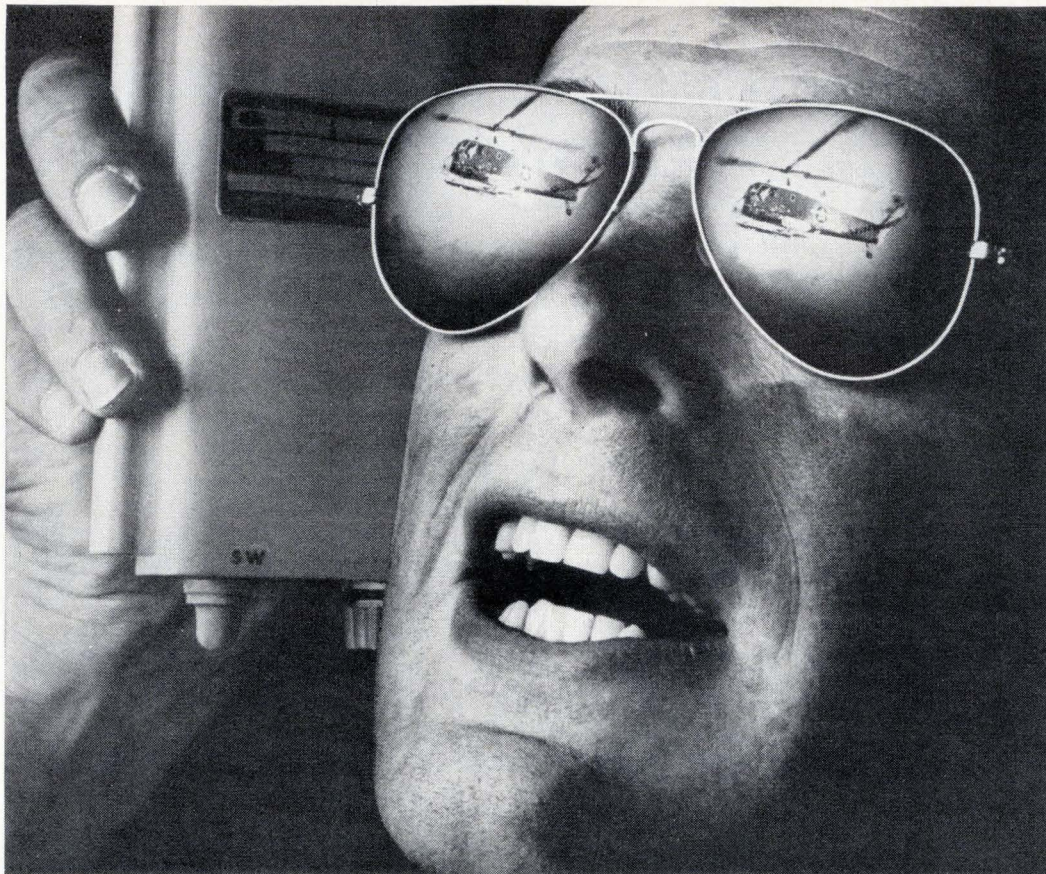

ACR Electronics needed a battery that could pack 100-mile power into a 13-oz. rescue transmitter.

Mallory made it.

What can we do for you?



ACR Electronics needed a battery. A battery to power their Personnel Survival Transmitter and Light Beacon. A battery that could put out a 750 milliwatt peak (50% duty cycle) signal throughout 8 hours of continuous operation. A battery that could flash a 100,000-lumen xenon strobe at the same time. Yet a battery that would resist extremes of temperature and environment—and hold its power for years.

Mallory made it. The battery—a Mallory mercury battery. Its high-energy density provides a maximum of power with a minimum of weight. It withstands temperatures from below zero to +160°F. And it has a shelf life of over 2 years.

USEFUL POWER YEARS LATER

Almost as important as the amount of power a battery contains is how long it holds that power. And Mallory mercury batteries are almost unique among batteries in their extraordinary shelf life. Cells casually stored for periods of more than 5 years have maintained their

original EMF to 0.5%. And capacity loss for the average mercury cell is only about 5% per year. (See graph.) This ability of Mallory mercury batteries to retain their energy makes them especially suitable for air-sea rescue units, Sonobuoys, emergency beacons and other equipment where dependable stand-by power is a must.

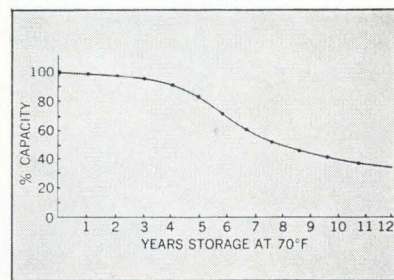

OVER 1000 DIFFERENT TYPES

Mallory currently makes over 1000 batteries of all sizes and capacities. If we're not actually producing the battery you need, we'll be glad to work with you in designing a new one. Please write the Technical Sales Department, Mallory Battery Company, a division of P. R. Mallory & Co. Inc., South Broadway, Tarrytown, New York 10591. Or call us at 914-591-7000. (In Canada: Mallory Battery Company of Canada Limited, Sheridan Park, Ontario.)

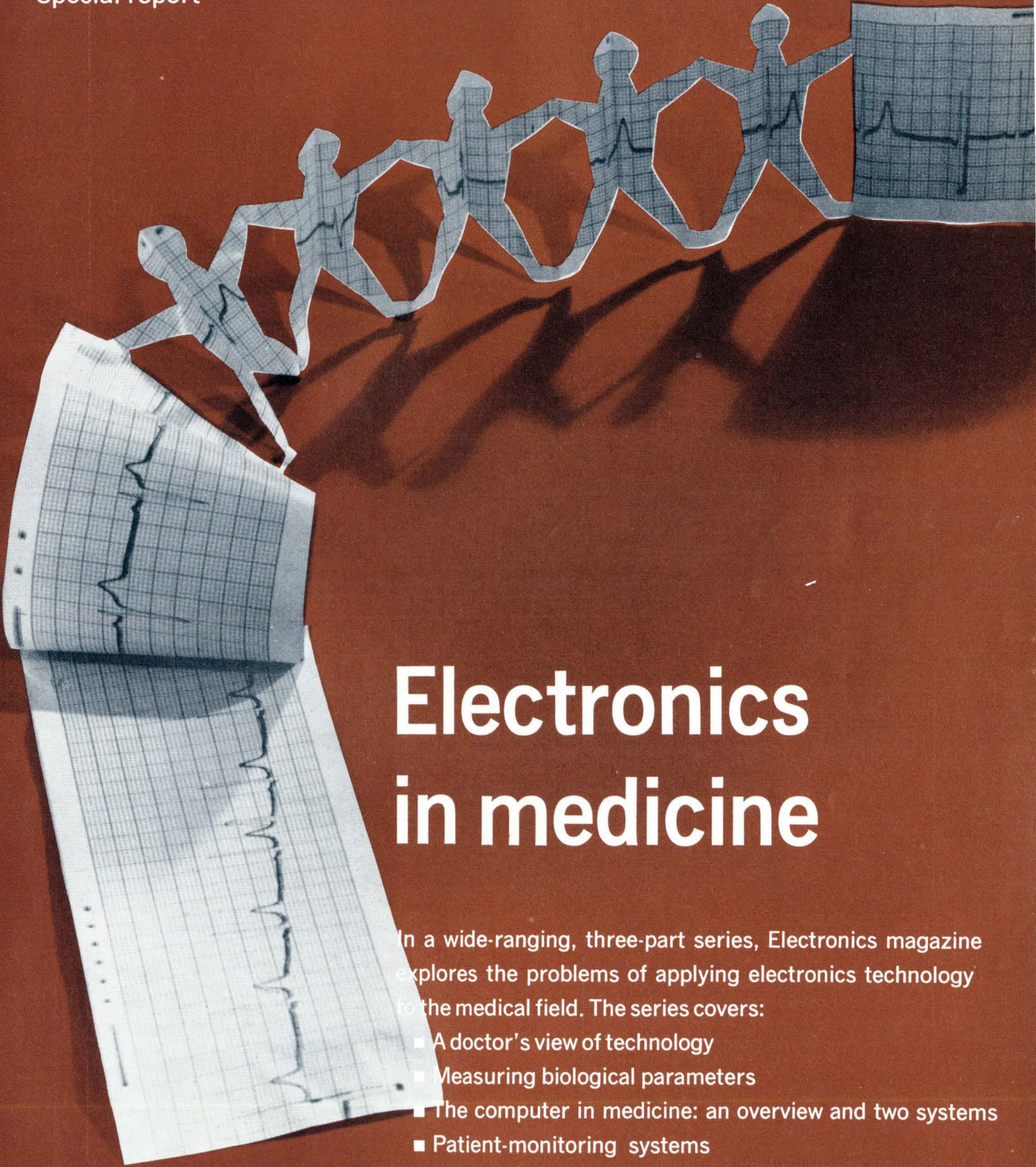

It's good business to do business with Mallory

A paper chain made of cutouts of human figures holding hands, with ECG waveforms printed on the paper. The chain is draped across the top and left side of the cover. The background is a solid dark brown color.

Electronics in medicine

In a wide-ranging, three-part series, Electronics magazine explores the problems of applying electronics technology to the medical field. The series covers:

- A doctor's view of technology
- Measuring biological parameters
- The computer in medicine: an overview and two systems
- Patient-monitoring systems
- Prosthetics made possible by electronics
- Preventive medicine with electronics



Rx for medical instrumentation: realism, patience, communication

A doctor finds the electronics industry bedazzled by gadgets at a time when the medical world wants reliable gear to handle immediate problems. As a remedy for this, he prescribes teamwork

By Robert F. Shaw, M.D.

Presbyterian Medical Center, San Francisco
Columbia University Electronic Research Laboratories, New York

Engineered devices can play a central role in man's fight against disease. Solutions to medical problems should come increasingly from the application of technology to medicine.

But it hasn't happened yet.

And it's long overdue.

Despite the technological explosion of the past two decades, electronics has contributed relatively little in this period that is both new and of practical value in diagnostic and therapeutic medicine. The problem isn't one of overcoming any conservatism or stubbornness on the part of the medical profession. It's basically a matter of bridging the gap between the electronics industry's view of medical problems and the medical world's real requirements.

Much of the instrumentation produced so far in this field has been pedestrian—and inappropriate at that. And though the industry's plans for the future appear more grandiose, there are serious questions regarding their appropriateness.

Consider a statement made last year by a Westinghouse Electric Corp. vice president on the subject of "the hospital of the future." One of the features he projected was the "remote and continuous monitoring of blood pressure, temperature, breathing rate, heart action, and other conditions" of every hospitalized and recuperating patient. But considering that only a small percentage could benefit from hourly measurements of these parameters, the usefulness of universal and continuous monitoring is questionable. Such sophisticated instrumentation is certainly not valueless. But the question the electronics industry must come to grips with is one of priorities. Physicians need practical, reliable equipment to cope with immediate problems.

Too often, industry has furnished solutions where no problems have existed. Take, for example, the chronic case of the electronic stethoscope. Every now and then some electronics company decides that doctors have too long endured the acoustical limitations of the old-fashioned stethoscope. Marketing specialists total up the more than 200,000 physicians who own conventional stethoscopes and conclude that the market is potentially lucrative.

Lead balloon

The company launches a development program, and, after many months of work and many thousands of dollars, introduces a high-fidelity instrument small enough to be considered portable and priced at perhaps \$600. But to the dismay of the designers, the medical world largely ignores this clearly superior stethoscope—perhaps the 285th such device.

This indifference doesn't reflect an unwillingness to accept technological progress. The fact is that the old-fashioned stethoscope, with all its limitations, furnishes the doctor with just about all the useful information he can garner from heart and lung sounds. Besides, it's inexpensive, requires minimal maintenance, and fits nicely into a jacket or hip pocket.

Often when companies have worked on their own to develop devices for the medical market, they have been disappointed by the reception accorded their products. As a result, the medical community has been unfairly labeled as backward about accepting new technology.

Actually, physicians are constantly adapting to change and continually updating their knowledge. They have to. Medical techniques change rapidly;

80% of the drugs prescribed today, for example, didn't exist 10 years ago.

Furthermore, physicians deal with real and often difficult problems that cannot be abandoned just because a satisfactory technical solution doesn't exist. The deaths of patients for whom treatment couldn't be found cause the doctor frustration, disappointment, and often heartache. Physicians need real solutions to their real problems, not interesting developments or creative, but useless, solutions.

Instrument designers tend to get caught up in the inventiveness of their developments, while users want simple, convenient, reliable, and economical devices. This gulf is markedly wider in the medical instrument field, where the engineer-designers and physician-users are separated by wide disparities in disciplines, technical language, and experience. In general, physicians have little appreciation for the kinds of things electronics engineers can do for them. Similarly, electronics engineers have little realistic data on physicians' practical problems. Medical people have been willing to accept a surprisingly low level of engineering in their own programs, but even more surprisingly, large industrial concerns have frequently

been willing to embark upon medical instrumentation programs with far less knowledge of the applications than they would accept in other fields of their business.

Electronic medical instruments are essentially instrumentation solutions to medical problems. Electronics companies have the technology to build the needed equipment, but lack sensible advice concerning which programs to pursue and which solutions are most consistent with real conditions. They must therefore develop in-house medical know-how and have access to the advice of working physicians.

Uncooperative subject

The development of medical instruments presents some difficult problems. Biological systems have a greater number of apparently independent variables than do physical systems, and these variables are more difficult to identify and control. Human beings don't come with convenient test points; and the measuring of living-system parameters may alter the parameters significantly. Engineers who turn their attention to medical problems after working in industry are rapidly sobered by their first brush with the perversely uncooperative nature of biological materials and processes.

The prescription for successful medical-instrumentation development calls for engineers strong in the basic physical sciences, and medical scientists accustomed to the realities of medical practice and knowledgeable in at least the fundamentals of engineering sciences. These ingredients must be brought together and thoroughly mixed, because they should interact at almost every stage of a medical-electronics project. To fill such a prescription requires a management willing to look beyond the easy short-term success, a management willing to invest its better people in the more difficult but ultimately more profitable long-range programs.

Not long ago, the physician's diagnostic repertoire was limited to analyzing a patient's account of the onset and progress of certain symptoms, and then looking, feeling, listening, and smelling for additional clues. Medical students are still introduced to the clinical phase of their professional lives with an extended course in history-taking and physical examination.

The physician's diagnostic capability was expanded dramatically when, less than three weeks after their discovery, X rays were first used to diagnose skeletal fractures. X-ray equipment and analytic chemical apparatus have become tools without which it would be impossible to practice modern medicine.

Traditionally, having arrived at a diagnosis the physician could exercise, to varying degrees, three options regarding therapy:

He could offer such advice as stay in bed, or give up cigarettes or ham hocks, or walk three miles a day.

He could introduce chemicals into the body—

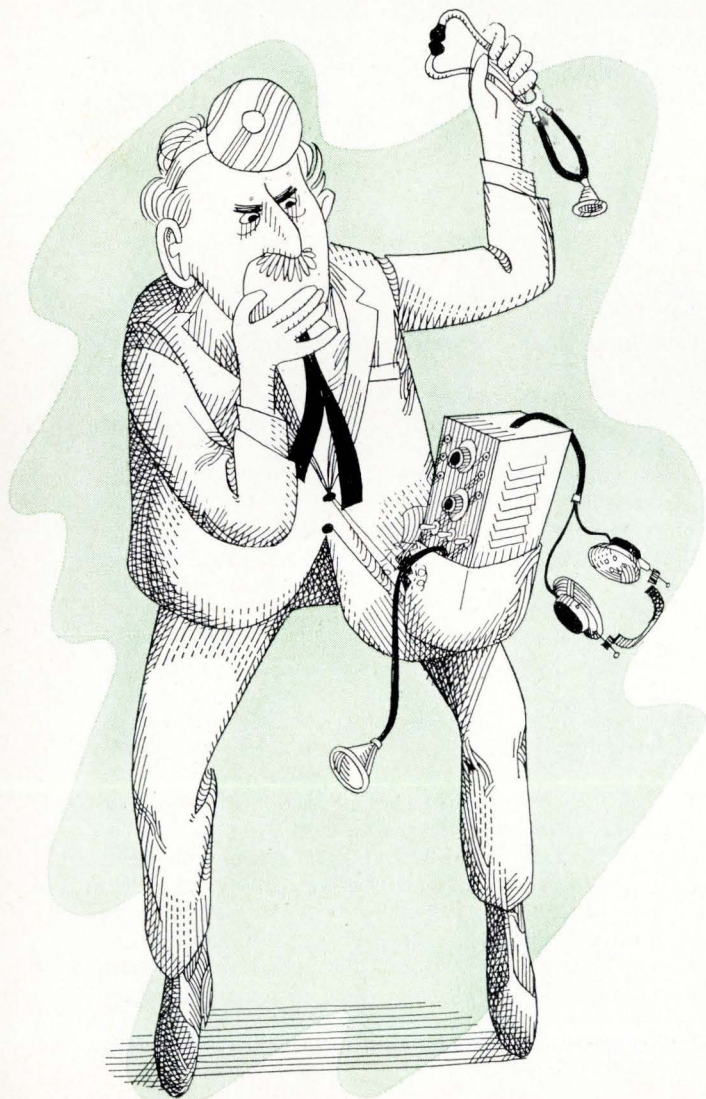

either orally or by injection—in an attempt to influence the course of a disease or its manifestations.

He could perform surgery.

Only recently has the availability of scientifically engineered devices offered a fourth and sometimes distinctly superior method of clinical treatment.

For example, heart-block, a not uncommon condition characterized by an extremely slow heart rate, has traditionally been treated with various drugs with results ranging from poor to indifferent. Heart-block can now be treated by long-term implantation in the body of electrical pulse generators that stimulate the heart to contract at a more normal rate.

Similarly, kidney failure—responsible for some 50,000 deaths a year in the U.S.—is virtually uninfluenced in its lethal course by the special diets and drugs that until recently were the only treatment available. Now, artificial kidney machines can keep patients alive, active, and productive.

The heart-lung machine is a good example of a tool that created an entirely new field of medical therapy. The machine—a simple electromechanical device that can take over the pumping function of the heart and the oxygenating function of the lungs for several hours—allows surgeons to enter the heart to repair defects. Prior to the development of the heart-lung machine, it was possible to attack only those few internal heart defects that could be repaired without interfering with the heart's function, or those that were simple enough to repair

during a few minutes of cardiac arrest. Hundreds of thousands of individuals saved by open-heart surgery owe their lives to the machine.

With these notable exceptions, plus X-ray and analytical chemistry instrumentation, however, electronic and other engineered devices have been used in the past mainly in medical research. This situation is clearly changing. Pressing diagnostic and therapeutic needs can be met by electronic techniques and devices. The number of sick and ailing humans who could benefit from new devices is large and unfortunately increasing. While the use of electronic devices in research will continue to grow and new devices will come largely from research labs, the most important contributions that electronics will make to medicine are in the areas of patient diagnosis, management, and therapy.

Ain't necessarily so

Even a casual perusal of newspapers, popular magazines, and technical journals gives the impression that large numbers of research laboratories and industrial concerns throughout the world are creating significant technical breakthroughs that are materially bolstering the fight against disease.

As indicated earlier, this isn't so. Little of our current clinical instrumentation is especially indebted to the past 20 years of electronic progress.

Consider, for example, monitoring systems—the fastest growing segment of the medical-electronics field. Electronic patient-monitoring systems can

Health is big business

Americans spent over \$40 billion on health care last year, more than 6% of the nation's gross national product. By comparison, less than \$20 billion was spent on electronics, including consumer, industrial, and military items, and instruments and components.

The U.S. population is expanding, especially in the age groups most subject to illness and hospitalization. And the past year has seen the enactment of Federal and state legislation supporting the view that top-class medical care is a citizen's right.

At this time, 22 million persons are eligible for comprehensive medical care under the Federal Government's Medicare program, and 19.5 million have already enrolled. Benefits paid in the program's first 60 days came to approximately \$500 million.

The Medicaid programs are joint Federal and state efforts to furnish comprehensive care for all needy persons regardless of age. So far, 26 states plus Puerto Rico

and the Virgin Islands have enacted Medicaid legislation. California, for one, paid more than \$500 million in benefits during the first year of its program.

Bandwagon. Further, many labor observers believe it's only a matter of time before unionized workers, seeing their parents and needy neighbors receiving funded medical care, will demand similar benefits.

Officials of the Public Health Service estimate that the country will need 3.2 million hospital beds in the next decade—nearly double the current total—and that there will have to be a comparable increase in outpatient and nursing-home facilities.

For all this projected expansion, however, the number of trained physicians, nurses, and paramedical workers is inadequate to meet even current demands. A joint study by the American Hospital Association and the Public Health Service puts the present shortage of professional and technical med-

ical personnel at 275,000—equal to approximately 20% of the total currently on the job. Moreover, the number of trained physicians, nurses, and ancillary workers isn't rising at a rate proportional to the increase in patients.

Squeeze. Consequently, the number of patients per physician is sharply increasing at a time when government funds are being made available to those previously unable to afford good medical care. To handle this expanding work load, the medical profession will have to rely increasingly on equipment that both reduces manpower requirements and increases the efficiency of available personnel. In other words, electronics faces yet another challenge.

But as imperative as the need for labor-saving devices is, the principal impact of electronics on medicine will be far broader. Electronics has the potential to extend, enhance, and, in some instances, revolutionize the medical world's diagnostic and therapeutic arsenal.

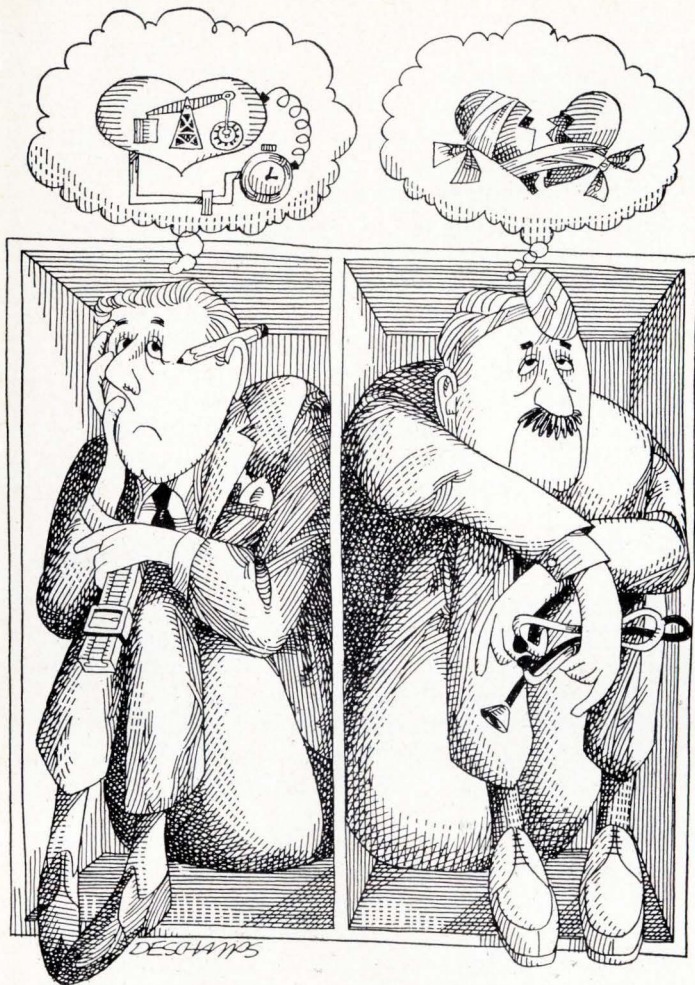

significantly diminish mortality from coronary occlusions, the leading cause of death throughout the Western world and the cause of some 600,000 deaths in the U.S. each year. Before electronic monitoring, roughly 40 of every 100 patients admitted to the hospital with coronary occlusions died, about half of these because the obstruction in their coronary blood-supply system damaged enough muscle to fatally reduce the heart's pumping capacity. In the other 20 deaths of every 100 admissions, damaged muscle served as an electrical focus that caused abnormal heart rhythms.

Deaths in hospitals from coronary occlusions have been cut in half by:

- Continuous display of electrocardiographic waveforms (the electrical potentials that accompany the depolarization and repolarization of the contracting heart muscle);
- Surveillance of the displayed waveforms to detect abnormal rhythms;
- Early treatment of these abnormal rhythms.

But even here, electronics companies can't pat themselves on the back. Neither the electrocardiograph, which became a practical on-line instrument in 1901, nor the oscilloscope commonly used for displays, are specially new devices. Moreover, except when abnormalities are so gross as to cause a change in heart rate, detection of the electrocardio-

graphic and rhythm abnormalities requiring treatment still depends upon continuous, vigilant human monitoring of oscilloscope screens.

Despite the large number of technically sophisticated firms in the medical-electronics field, hospitals can now monitor—outside the EKG—only heart and respiratory rate, temperature, and blood pressure, all parameters a high-school girl can be taught to measure in half an hour. Besides, the high-school girl can give back rubs, fetch medicines, and alert the staff to emergencies.

What neither the girl nor the regular staff can do, but electronic gear might do, is measure the amount of blood pumped with each heartbeat, the flow of blood to certain organs, oxygen levels in the blood, and various indications of a patient's metabolic state.

Further, most deaths from coronary occlusions occur suddenly outside the hospital. The victims have had progressive occlusions in their coronary arteries for months and even years prior to their deaths, but often were never even considered for treatment because they had no apparent symptoms and displayed no abnormalities in their electrocardiograms.

Here the absence of development efforts is disturbing. We can precisely locate and measure the velocity vectors of intercontinental ballistic missiles a foot or two in cross-section at distances of 300 miles. But we cannot even begin to survey our population for obstructions to coronary flow, knowing full well that almost half of us will die of coronary occlusions, because we have never addressed ourselves to the problem of measuring velocity vectors of blood cells flowing in pencil-size vessels a few inches below the surface of the chest.

Occlusion in money flow

Why the holdup? A prime reason surely is lack of money.

Federal support for medical instrumentation, as for nearly all health-related research and development, is administered by the Public Health Service's National Institutes of Health. And, as in the past, the NIH isn't putting much money into instrumentation programs. The current NIH budget is approximately \$1.2 billion, but not much more than 0.5% of this is available to support such research. The median size of NIH research grants in the instrumentation field is about \$25,000 for a year of work, an inadequate sum.

In a 1965 report on the NIH, a Presidential committee noted that many advances in the physical sciences have been tied to the availability of instruments, and that in most cases the critical instruments were developed by the scientists who needed them. Much less often do biologists or medical scientists develop instruments, the report continued, though advances in their work are also often linked to equipment.

"The need for a relatively costly program for individual critical instruments should be high in NIH

management consideration, since it is unlikely that such an instrument idea could arise or survive the study-section system," the panel stated.¹

Priorities for the distribution of NIH funds are established by study panels made up mostly of nongovernmental scientists. Unfortunately, these individuals can devote themselves to the important consideration of priorities on only a very part-time basis. Also, they are beset with the problems inherent in competing with nonpanel scientists for NIH funds. There is little reason to believe that this pattern of piecemeal NIH support for instrumentation projects will change.

Fortunately, private foundations are an important source of funding for medical-instrument programs. For example, the John A. Hartford Foundation of New York has an outstanding record for significant contributions to this field. With an annual budget of only a little more than \$14 million, this foundation has probably been responsible for the development of more innovative and useful medical instrumentation than any other single organization.

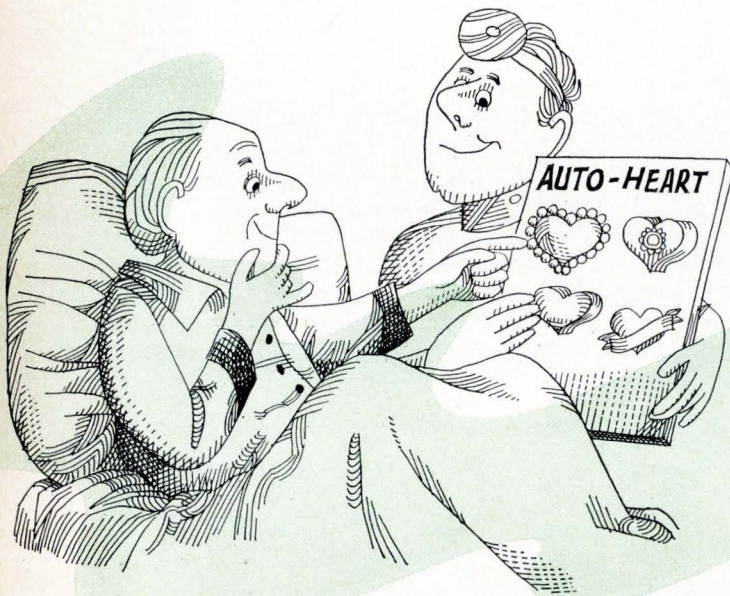

Challenges unlimited

The potential in this area is almost as wide as the field of modern medicine and almost as long as the list of diseases.

The obstruction of the flow of essential nutrients to the organs and tissues of the body by the degeneration of blood vessels is the major medical problem of our time. Besides the 600,000 Americans who die each year of coronary occlusions, 200,000 die of strokes most often caused by occlusions in the blood vessels of the brain. Similar vascular blocks are responsible for 15% of all cases of high blood pressure.

The second most important cause of death in the U.S. is cancer. Until the causes of cancer can be identified and eliminated, the only answer is

early detection and treatment. New techniques are needed to identify cancer lesions deep within the body. The introduction of X-ray image intensifiers has permitted doctors to make more continuous radiographic observations and cinoscopic studies, but little has been done to improve the quality of the images on radiographic plates.

Ultrasonic techniques are being developed as another approach to anatomical evaluation. But except for locating the midline structures of the brain—helpful in the diagnosis of tumors and blood clots—no ultrasonic medical application yet established has proved both practical and important.

Delineation of the distribution of radioactive isotopes within the body is still another approach to the problem of defining anatomic structure. While present electronic scanning systems have resolutions roughly comparable to those of the mechanical scanners usually used to trace the isotopes, there is little question that improved resolution is possible.

Radioactive isotopes can be selectively distributed in the body not only to reveal anatomic structure but to permit the assessment of physiologic and biochemical functions. In-vivo radioactive isotope scanning is an exciting new field that will doubtless burgeon over the next decade.

Prosthetics

Beyond diagnosis, medical electronics has a big role to play in therapy and prosthetics. Prostheses are man-made devices that support or replace malfunctioning body parts.

Electronic cardiac pacemakers are well established, selling at a current rate of 5,000 to 10,000 a year. And recent studies made for the NIH indicate that a self-contained electromechanical device that supplements or replaces the pumping function of the heart would have a potential market of perhaps 100,000 to 400,000 a year.

One of the two as yet unmet requirements for a prosthetic heart pump is a suitable energy source and converter. A heart pump would have to deliver 1 to 4 watts for 12 to 16 hours a day before replenishment from an external source. Piezoelectric pumps, radioactive isotope power sources, and fuel cells have been proposed, but no one has yet developed a workable device.

A second and equally important requirement here is a material that won't cause blood clotting. Woven and knitted tubes of Dacron and Teflon have been used to replace diseased blood vessels in more than a 100,000 cases, and prosthetic heart valves made of steel, polypropylene, Silastic, and Dacron have been used in tens of thousands of hearts, but these materials haven't proved satisfactory for a prosthetic circulatory pump. Evidence to date suggests that anticlotting properties are closely associated with a negative surface charge. The development of anticlotting materials is vital not only for this application, but for implantable artificial kidneys, improved heart valves and blood vessels, and other implantable prosthetic devices.

Bridge builders

The Association for the Advancement of Medical Instrumentation was formed less than two years ago [Electronics, Jan. 10, 1966, p. 25] to deal with the problems described by Dr. Shaw. The organization aims to improve communications between makers and users of electronic medical instruments and to keep the two groups abreast of developments in the field.

AAMI's first job is the establishment of communications within its own ranks. The association's membership numbers approximately 1,500 individuals—two-thirds of them doctors and the rest engineers—plus more than 100 manufacturers. Links are now maintained by advisory boards of medical and industrial members; an advisory board of engineers has been formed subject to membership approval at the annual meeting in August. An administration committee implements the recommendations and programs of these panels.

One program now being pushed would establish standard terminology, performance specifications, materials, and safety regulations for medical instruments. "Government regulation is inevitable when instrumentation affects the health and lives of almost 200 million people," says one AAMI official. Rather than fight this kind of legis-

lation as some other professional groups have, AAMI is offering its services to the Food and Drug Administration. In this way, the association is attempting to ensure that any Federal legislation will reflect the thinking of both the medical and engineering professions—the two groups that will have to follow the rules. AAMI hopes to function as an impartial fact-finding organization whose suggestions will influence standardization efforts.

The association also plans to set up a technical information library to serve as a clearing house for medical-instrumentation data. Information from manufacturers on available instruments will be stored in a central computer for retrieval by physicians with special needs. The flow of information should be two-way, however. Hopefully, manufacturers will use queries from doctors as a guide to future projects.

Group think. AAMI's educational effort has as its focal point an annual symposium. Medac '67, to be held in San Francisco from July 31 to Aug. 4, will depart from the traditional symposium format centering around the presentation of papers. This meeting will take the form of a series of bull sessions. Each of the major symposium sections—pathology, cardiology, diagnostics, surgery, hospital

automation, and artificial organs—will be chaired by a physician and introduced by a review of the most significant developments in that field during the past year.

Smaller meetings will bring together panelists to compare individual experiences, and will feature audience participation. As an example of the kind of approach the group is taking, the three meetings devoted to the treatment with artificial kidneys of chronic uremia (failure of the kidneys to remove urinary constituents from the blood) will have as panelists not only medical and engineering men but at least one chronic uremia patient and one dialysis nurse or technician.

Baffer. Electronics engineers should find a session on inter-instrumentation bias enlightening. The discussion will deal with the recurrent question of why different laboratories using identical instruments and standards on the same samples will often come up with widely varying results.

Dr. Harold Laufman, director of the Institute for Surgical Studies at Montefiore Hospital and Medical Center in New York City, will chair meetings concerned with surgical facilities. One of these sessions will consider operating-room instrumentation generally, while the other will focus on operating-room monitoring, the use of television, and contamination-control instrumentation.

The average useful life of a cardiac pacemaker is less than two years. In fact, in some metropolitan medical centers the repair of defective pacemakers has become a more common surgical operation than the appendectomy. Batteries run down, wires break, transistors fail. The problem with batteries has stimulated a search for new power sources—for example, piezoelectric crystals that can be flexed by normal body motion [Electronics, Jan. 9, p. 45], or bimetallic electrodes that develop potential differences when submerged in the body's internal fluids [Electronics, March 21, 1966, p. 105].

Implantable stimulating devices similar to cardiac pacemakers may be widely applied to conditions outside the heart. For example, some 20% of the 10 million to 15 million people in the U.S. suffering from hypertension don't respond to drug treatment. Researchers are currently exploring the possibility of diminishing vascular resistance through electrical stimulation at the input of the servosystem that regulates blood pressure.

Others are exploring the use of radio-activated

implantable bladder stimulators to replace periodically introduced rubber catheters in patients paralyzed from the waist down.

Electronically controlled artificial limbs and visual aids for the blind are among the other prosthetic devices under development.

There can be little doubt that electronic prosthetic devices will provide some of medicine's most dramatic and significant breakthroughs in the next 20 years, and some of the electronics industry's most promising opportunities. These examples only scratch the surface. Other promising fields include high-energy therapeutic devices for surgery and for selective destruction of pathological lesions, and automated clinical chemistry instrumentation.

The actual practice of medicine involves very little processing of data. Diagnosis usually hinges on one or two critical findings, such as a particular shadow of an X ray or the quantitative value of a particular chemical analysis. Findings like these can be programmed, but many equally important ones, such as the way a lump feels to the examiner,

Man in the middle

Since the days of his training as a heart surgeon, Dr. Robert F. Shaw has been aware of a gap between the medical profession's instrument needs and the electronic industry's efforts to meet them. And Shaw, who is one of those rare individuals with training in both disciplines, has often admonished both his medical colleagues and the engineering fraternity for their failure to close this gap.

"The major stumbling block," he explains, "is that medical and engineering men are pulling in opposite directions. Physicians are unaware of how engineers can help them, and the electronics industry isn't responding to the instrumentation needs of the doctor."

Shaw was struck by the problem when, as a student of heart surgery in the early 1950's, he undertook research in the field of hemodynamics—the hydraulics of the blood. Already something of a physicist, having studied under Enrico Fermi at the University of Chicago, he thought his study of hemodynamic physiology would make him a better heart surgeon. He soon found that the required instrumentation was inadequate or nonexistent, and this problem dogged his two years of research. "It was one backward step after another," he says. "From heart surgery to hemodynamics to the instrumentation to facilitate the study of hemodynamics."

Pull together. Shaw believes in teamwork between doctors and engineers to improve this situation,



Robert F. Shaw, M.D.

rather than in making engineers into doctors or vice versa. "When I was at Columbia University [where in 1960 he founded the biomedical section of the electronic research laboratories], we took a hard look at what people in this [medical instrumentation] field ought to study," he says. "It turned out that engineers thought you should take mostly engineering courses, the chemists that you should concentrate on chemistry, and the doctors that you should focus on medicine. The number of proposed basic courses grew so big that no one could possibly get through them. This sort of program could keep Ph.D.'s in school for a long time and eventually qualify them for nothing.

What's needed are people who are expert in their own field and who can enhance the efforts of others equally competent in other fields.

"This arrangement bears some resemblance to song writing, where the lyricist and composer have to work together. The design has to be adapted to the applications, and the applications have to accommodate the design." At San Francisco's Presbyterian Medical Center, where he founded and directs the technical development laboratory of the Institute of Medical Sciences, Shaw practices what he preaches. His staff there has included electronics engineers, mechanical engineers, heat-transfer specialists, chemists, pediatricians, internists, physicists, and physical chemists.

Priorities. Shaw's approach to medical instrumentation focuses on immediate needs, and he takes a dim view of some of the most recent sophisticated approaches to medical electronics. There is a priority of problems, he explains, and computed statistics for predictive medicine programs may not be the medical community's most pressing need right now.

The doctor has less patience with the more fanciful schemes for automated hospitals featuring continuous monitoring of every patient. "Who needs data every second?" he asks. "Maybe in the year 2084 there will be some use for a dossier that gives a person's heartbeat at every moment from birth to death—but I doubt it."

cannot. What limits the role of data processing in clinical diagnosis even further is the narrow range of biological responses specific organs and tissues display to the vast spectrum of injuries they can receive.

Similarly limited are the symptoms of organ and tissue pathology. Almost everything that afflicts the abdomen causes pain, bleeding, vomiting, or diarrhea. A computer program that lists the multitude of possible causes of such symptoms therefore has little practical usefulness.

Yet with all these limitations, the computer does have its place in the hospital, as will be shown in other articles of this series.

Doing well by doing good

Besides being a vitally important area of activity in human terms, medical electronics also promises

to be a profitable area in business terms. The field has not yet produced a giant, but the opportunities are there for companies that can come up with realistic tools for the doctor.

Many markets beckon to the electronics industry. Profits are a lure, but so is the sheer technological challenge of new problems. The field of medical instrumentation offers all this—great profits for far-sighted companies and extremely challenging problems for engineers—plus the chance for both to serve one of man's most basic and pressing needs.

References

1. Biomedical Science and its Administration, A Study of the National Institutes of Health, Report to the President, February, 1965, p. 178.



Collecting the body's signals

One of the major jobs of electronic medical instrumentation is to detect and record biopotentials—tiny voltages generated by muscles, nerves, and nervous-system sensors

By Allan F. Pacela

Beckman Instruments Inc., Fullerton, Calif.

What doctors principally want from electronics engineers are instruments to sense, record, and display the electrical activity of the human body. What the engineers need is information about the specific signals to be measured.

If superior equipment is the goal, it's reachable now. The technology is there. The problem is to match design to application, and this problem is increasing in importance as doctors put more and more electronic gear to work. An example: patterns of bioelectric activity picked up by present electrodes are often obscured by noise, but conventional recording systems operate at speeds so slow that they don't respond to the extraneous signals. However, with data from the electrodes now being fed directly into a computer for analysis, noise has to be eliminated. Doctors have had to jury-rig systems to reduce the interference, but engineers have the tools and techniques to build a noise-free electrode right now.

Key signals

Of the measurable bioelectrical variables, biopotentials have proved the most useful. Bioimpedance measurements date back only to the 1940's, and measurements of biological currents have so far been used only in certain areas of electrophysiology.

The author



Allan Pacela is chief research scientist in the Applied Medical Research department at Beckman Instruments. As a Beckman staff scientist he earlier worked on instrumentation for the Gemini electroencephalograph and phonocardiograph.

Biopotentials—minute voltages present in all living organisms—are caused in man by the activity of nervous-system sensors, muscles, or nerves. Human biopotentials can range from voltages signaling simple single-cell electrochemical events to those caused by the activity of large cell groupings such as the brain or muscle tissue.

All biopotentials originate at the cellular level, but the measurement of any one signal is related to a specific physiological subsystem. Thus the electrocardiogram (EKG) is a recording of the electrical activity of the heart, the electroencephalogram (EEG) of voltages in the brain, the electromyogram (EMG) of the muscles, the electro-oculogram (EOG) of the eyes, and the electroretinogram (ERG) of the responses of the retina to light.^{1, 2, 3}

The electrocardiogram, the most common biopotential recording, is measured between electrodes, at least one of which is fixed. The patterns of electrode connections are called leads or lead systems.

An EKG is produced by measuring the potential associated with the depolarization and repolarization of the heart muscle tissue. Depolarization on the surface of heart muscle fiber causes the fiber to become electrically negative with respect to adjacent regions of polarized fiber. Repolarization makes it electrically positive.

This electrical activity, which starts and coordinates the heart's mechanical-muscular activity, originates in the rear of the atrium, one of the heart's entrance chambers. This spot—the sinoauricular node—is where the heart's natural pacemaker is located. The electrical depolarization spreads over the cardiac muscle in a chainlike progression. As soon as depolarization starts, a current flows from the inactive region to the active, changing the polarization and initiating a response in the inactive region. The progression of changes in membrane polarization over the heart muscle is

called the cardiac action potential; its recording is the EKG.

Heart ripples

The electrocardiogram is characterized by six waves, P, Q, R, S, T, and occasionally U—during each heart cycle [figure at the right]. The P wave is a small, low-voltage deflection caused by the depolarization of the atria as blood is pumped from this chamber into the ventricles. The P wave is followed by an interval of rest—called the PR interval—marking the passage of the electrical impulses from atria to ventricles. A rather marked deflection, the QRS complex, then signals the depolarization of the ventricles and the pumping of blood into the aorta.

A component of the QRS indicates that the atria has been repolarized and is ready for the next heart beat, and the T wave marks ventricular recovery. The U wave sometimes follows the T, or recovery wave, but doctors aren't certain of its significance.

The placement of the measuring electrodes affects the waveshape of the recording, a problem recognized as early as 1903 by Willem Einthoven, the developer of the electrocardiograph. It was Einthoven who established the standard EKG-recording conventions known as limb leads [figure on page 104].⁴ The term "leads" indicates the arrangement of electrodes and their connection between the body and an amplifier or summing network.

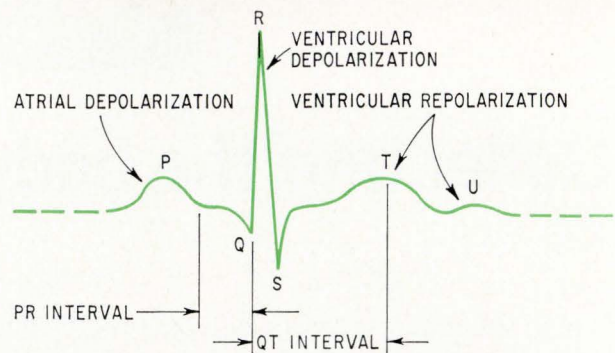

From the heart. Typical electrocardiographic tracing shows the P, QRS, T, and U waves. These phases of the heart signal represent manifestations of excitation and recovery of the heart muscles. The PR interval is the time it takes for the electrical pulse to reach the ventricle from the atria, and the QT interval represents the total excitation time of the ventricle muscles. Heart abnormalities are indicated by alterations in these waves. For example, a decrease in the size of the QRS complex and a deformed T wave indicate that cardiac failure has resulted from an occlusion in an artery.

Other common arrangements besides the standard leads include bipolar chest leads (CF, CR, and CL), which measure the potential between a chest electrode and an electrode on either arm or the left leg; unipolar chest leads (precordial or V leads), which measure from an electrode moving on the chest to a summing point, V, that functions as zero-potential reference; and augmented limb leads (aVR, aVL, and aVF), which measure the potential of an arm or leg with respect to the common connection of two other limbs. The sternal lead, with electrodes fixed at the top and bottom of the breastbone, is used in aerospace programs to measure the effects of acceleration on the heart, but isn't often used in clinical medicine because the electrodes are so close to the heart resulting in an electrocardiogram that is much more difficult to interpret.

A subject of much current work and discussion is vectorcardiography.^{5,6} This approach assumes that the resultant of all electrical occurrences of the heartbeat is equivalent to a single dipole, a positive point source and a negative point sink. If the electrocardiographic leads are considered as vector components, the size and direction of the cardiac vector forces can be calculated. The technique hasn't yet advanced the diagnostic capabilities of electrocardiography, but it has helped clarify the interrelationship of lead connections and has yielded a remarkably simple way to understand the complicated electrical activity of the heart.

Brain waves

The electroencephalogram, usually taken with scalp electrodes, has been used to gauge responses to various stimuli. In aerospace medicine, the decrease of alpha-wave activity—the dominant rhythm of the adult cortex—with the opening of the eyes has served, with computer analysis, as an

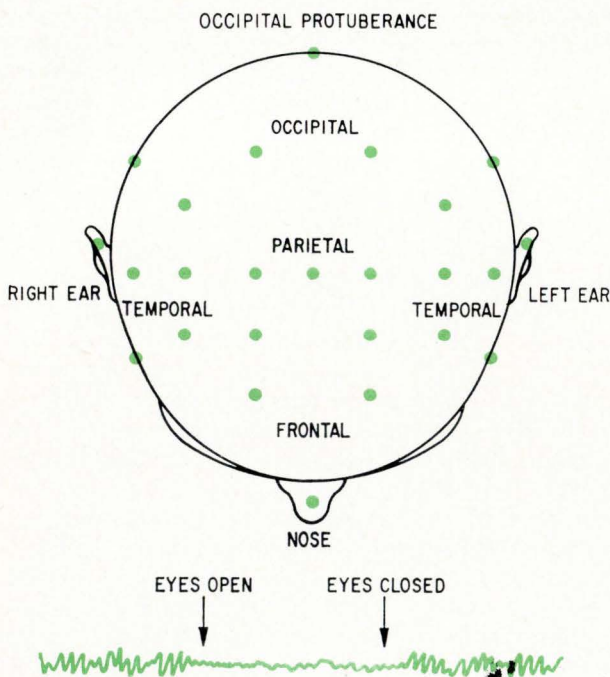

Scalp electrodes. Brain waves can be measured from these standard locations. Typical EEG signal shows the change that occurs when the eyes are opened and closed. The presence of a dominant rhythm and the frequency distribution of the EEG signal can be used to determine a subject's state of alertness.

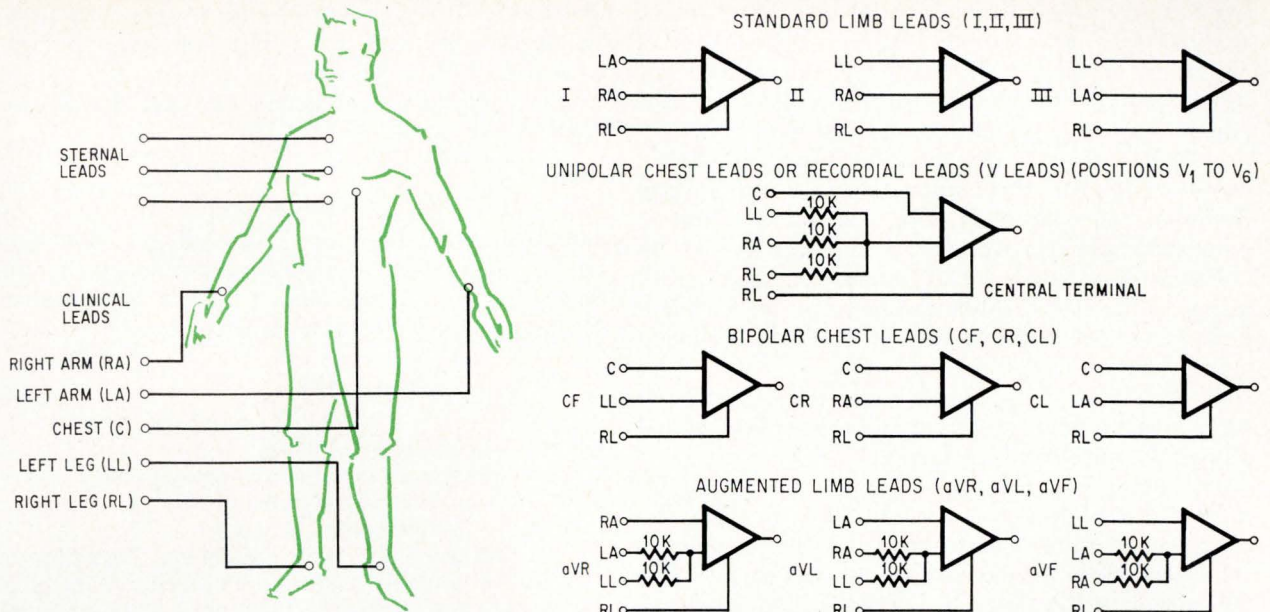

Lead arrangements. For the unipolar electrocardiographic chest lead, the exploring electrode is moved to six positions on the chest, resulting in the V_1 to V_6 designation. In more recent electrocardiograph setups, lead arrangements can be switched without moving the electrodes around.

index of "state of vigilance." And attempts have been made to use the electroencephalogram to measure long-term effects of weightlessness.^{7,8}

Researchers are experimenting with a variety of EEG clinical techniques. At Rockland State Hospital in Orangeburg, N.Y., for example, EEG's are being recorded on tape as mental patients are subjected to such stimuli as changing patterns of dots and squares or flashing colors. The signals are fed to a computer that compares them to "normal" EEG patterns.

Four bands

However, the EEG is hard to analyze because of the very nature of the available signal.^{9,10} The signal is divided into four almost overlapping frequency bands or components: alpha (8 to 13 hz), beta (14 to 100 hz), theta (4 to 7 hz), and delta (0.2 to 3.5 hz). The amplitude of signals measured on the scalp varies from 10 to 300 microvolts peak to peak, but typically is around 50 microvolts. Because the waveform is complex and not periodic, it's difficult to boost signal-to-noise ratios. Like the EKG, the EEG is obtained by connecting two fixed electrodes, or an exploring electrode to a terminal.

Analysis of the EEG spectrum is usually confined to the range from 0.2 to 100 hz, but measurements can be made from d-c to several hundred hertz. A low-frequency, 3-decibel cutoff at 0.1 or 0.2 hz will usually suffice to reject baseline drift and block low-frequency noise (extraneous signals). For specific recording of alpha-wave response, this point can be increased to 2 hz.

Noise produced by movements of the jaw, eye, neck, and scalp muscles usually appears as common-mode signals, and can be reduced by amplifiers

with high common-mode rejection ratios, by restricting the high-frequency response, and by careful placement of the electrodes.

Twitch and blink

Groups of skeletal muscle fibers are controlled by single motor neurons that generate an action potential to cause the fibers to contract or relax. The electromyogram—the recording of these signals—is produced either with needle electrodes inserted in the muscle fibers, or surface electrodes. Action potentials are often obscured by noise when surface electrodes are applied, but the method is extensively used by psychologists and aerospace doctors to measure muscular reaction to stress.¹¹ The potentials are also being used to drive electronic controls for some advanced types of artificial limbs.

The myoelectric signal from a single motor neuron is an easily recognized sharp spike, usually characterized by two or three potential reversals about a stable baseline. A surface EMG is the sum of many of these individual responses from the many motor units beneath and near the electrodes. The spikes vary in duration from about 2 to 15 milliseconds. Amplitudes are as large as 10 millivolts, but typically are 0.1 to 0.5 millivolts peak to peak. The frequency spectrum of the EMG runs between 20 and 5,000 hz.

Extraneous signals are again a problem. Brain biopotentials may interfere with myoelectric signals from the head. Similarly, cardiac and eye biopotentials can be troublesome.

The eye is the source of the biopotentials charted by electro-oculograms (EOG) and electroretinograms (ERG). An EOG is a recording of a small, steady potential—on the order of 1 millivolt—exist-

ing between the cornea and retina; it's measured with surface electrodes.¹² One or more pairs of electrodes placed near the eye can monitor the movement of the eye. Although evaluation of the EOG is empirical, the technique has proved useful in psychological studies and aerospace medicine. Monitoring of the eye's position has also helped designers of spacecraft and airplane instrument panels to place frequently used instruments in positions easy to scan. The Russians say EOG's were taken on the later Vostok and more recent Voshkod flights to check cosmonauts' eye movements during certain experiments.

As with other biopotential recordings, interfering signals make high common-mode rejection essential for the amplifiers used for EOG's.¹³

The other monitored eye signal is produced by corneal-retinal response to light. For the ERG, the electrode is applied directly to the eye, usually in a contact lens. Measurements are taken between the cornea and a reference electrode on the forehead. Voltage is about 0.5 millivolts peak to peak.

ERG response depends on the state of the eye prior to the stimulus as well as on the intensity and the duration of the light. When light is flashed on an eye accustomed to the dark, the ERG wave may last as long as several seconds. The technique is now primarily used as a research tool in visual physiology.

Electrodes

Problems in any of these measurements begin at the interface of electrode and skin, and innovations here can yield the greatest benefits. Electrodes come in many shapes, sizes, and materials. They can be as simple as a silver plate and as small as an intercellular microelectrode with a sensing tip only a few microns in diameter. They can be attached with tape, straps, glue, suture, or even suction.

Despite the variety of types and techniques, some principles do apply generally to the design and use of electrodes. In every case, a metal—usually silver—or a metal and its salt—for example, silver and silver-chloride (Ag-AgCl)—makes electrical contact with the body's fluids.¹⁴ With surface electrodes, a conducting paste, or gel, is applied between electrode and skin to reduce impedance.

The electrode-gel-tissue combination forms an electrochemical half-cell battery that produces a

potential difference between electrodes and tissue usually smaller than a volt but sometimes as large as 3 volts.^{15, 16}

The chemical phenomenon here can be written theoretically as



where M^+ is the concentration of metal ions at the interface and e^- the number of electrons. The electrode potential is a logarithmic function of the concentration of metal ions in the gel, as described by the so-called Nernst equation:

$$E = E^0 + \frac{RT}{F} \log (M^+) \quad (2)$$

where E = observed potential

E^0 = standard potential for half cell

R = universal gas constant

T = temperature (absolute)

F = coulomb per equivalent [number of coulombs required for an electrochemical reaction involving a gram atomic weight of an element]

M^+ = concentration of metal ions (in moles)

For a theoretical silver electrode,

$$E = -0.800 + 0.0591 \log (Ag^+) \text{ volts, at } 25^\circ C \quad (3)$$

The voltage for this electrode would be -800 millivolts less 59 millivolts per decade increase in silver-ion concentration with respect to a standard hydrogen electrode. In actual practice, the first term in this equation, E^0 , cannot be measured by itself, since any measurement would require two connections. When two electrodes are in series, their voltages should cancel each other out. Ideally, a voltmeter would measure a zero potential difference between two identical electrodes, but many factors, including the skill of the user, can produce difference voltages ranging from a few microvolts to 20 millivolts.

The silver electrode used in this example is also unrealistic. Such an electrode couldn't reach a stable, known potential because the absence of silver ions in the body prevents the predictable reaction described by equations 2 and 3.

The electrode's potential should be determined by unknown concentrations of body salts and other foreign substances at the electrode-skin interface, but in this case, the silver oxide on the electrode's surface would be the determining factor. To avoid this, silver chloride can be deposited electrolytically on the entire electrode surface, or a pressed silver-silver chloride pellet can be used as an electrode.¹⁷ Silver chloride is only slightly soluble and remains in equilibrium with its saturated solution, thereby controlling and stabilizing the silver ion concentration. The new equation for such a chloridized silver electrode then becomes

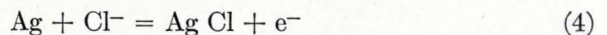

The concentration of silver is given by

$$(Ag^+) = \frac{K_s}{(Cl^+)} \quad (5)$$

where K_s is the solubility product for silver chlor-

EKG wave data

Segment	Amplitude (millivolts)	Duration (milliseconds)
P wave	0.1	90
PR interval		160
Q	0.03	
R	0.98	
S	0.01	
QRS duration		83
T	0.29	
QT interval		397

Gemini EEG

Simulated space flights can't fully reproduce the physiological and emotional responses of astronauts to the stresses of actual missions. To measure the effects on the central nervous system of long-term weightlessness, the monitoring of brain biopotentials must be done in space.

The Russians evaluated electroencephalographic tracings taken during Vostok and Voskhod flights and observed shifts in the frequency and amplitude components. In the U.S. space program, brain biopotentials were monitored in-flight for the first time during Gemini GT-7. National Aeronautics and Space Administration doctors felt that an EEG of the command pilot also would provide a relative indication of the astronaut's level of consciousness while sleeping and possibly of his alertness.

The data accumulated from the GT-7 flight was analyzed by experts at the University of California at Los Angeles and at Baylor University. The data was found to have the same clarity as any obtained on earth, even under carefully controlled laboratory conditions. The Baylor group reported that there were no definite alterations in the EEG's that could be attributed to weightlessness and that orbital flight has no apparent

deleterious effects on cerebral functions. Both groups observed increased power in the theta band—4 to 7 hertz—which corroborates the Russian observations from 5 to 7 hz. But the significance of this observation isn't fully understood.

Space applications require EEG amplifiers that are small and rugged. The one developed by Beckman Instruments Inc. for NASA has a volume of less than 1.4 cubic inches and is encapsulated in a semirigid epoxy to withstand shock and vibration.

The small amplitude of the EEG potentials makes high input impedance, high common-mode rejection, and low amplifier noise essential. In the NASA system, the project engineer, C.W. Kayser, used a differential input stage with matched 2N3460 field effect transistors [see diagram] to achieve an input impedance greater than 500 megohms. Noise referred to the input is less than 5 microvolts peak to peak and common-mode rejection is over 100 db.

Two band-pass filters shape the over-all frequency response from 0.2 to 100 hz. A design tradeoff can be made among low-end frequency response, noise, and recovery time; higher low-end cutoff frequency lowers noise and shortens recovery time.

The gain stage is a simple differential amplifier with adjustable gain from 33 to 50. Together with the input stage it provides an over-all amplifier gain of 100-150. Gain of the input stage is kept low to allow the amplifier to operate with electrode offsets as high as 0.3 volts. The output buffer amplifier is a simple unity-gain stage with a bias network to provide the 10-millivolt output offset required by the telemetry system. Because of this offset, the output signal varies from 0 to 20 millivolts.

The important features of this amplifier are:

Input characteristics

Coupling: d-c differential.
Input impedance: in excess of 500 megohms at 20 hz.
Noise: below 5 microvolts peak-to-peak referred to the input.
Common-mode rejection: above 100 db.
Input current: less than 1.0 nanoamperes.
Source impedance: 0-40 kilohms.

Transfer characteristics

Gain: 100-150, adjustable.
Frequency response: 0.2 hz to 100 hz (-3 db points.)
Recovery time: 15 seconds.
Harmonic distortion: less than 1%.
Power: ± 10 volts d-c $\pm 1\%$.

Output characteristics

Output impedance: less than 1 kilohm.
Output offset: 10 millivolts d-c $\pm 2\%$.
Output level: 0 to 20 millivolts.

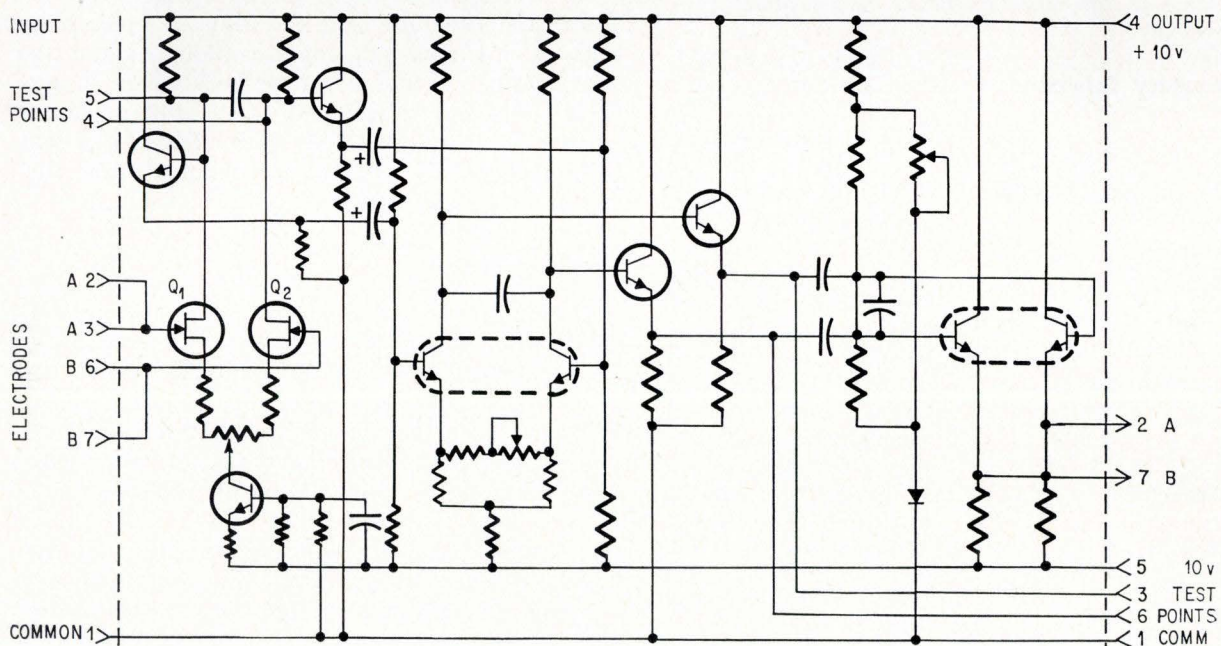

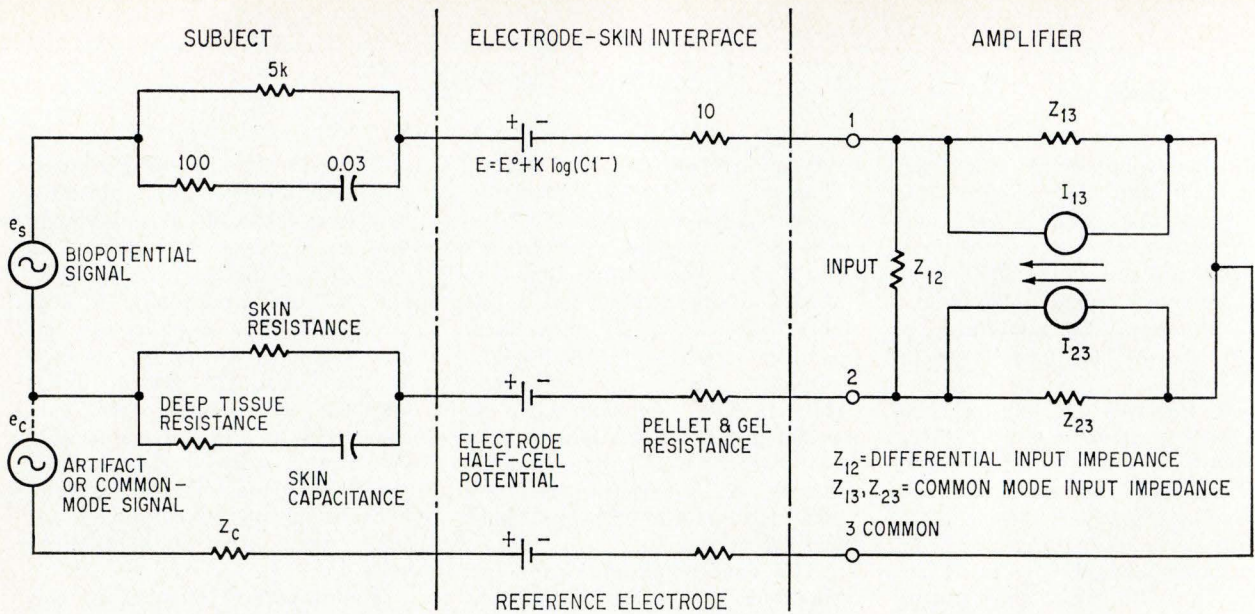

Equivalent circuit. Equipment designs for measuring a typical biopotential must consider the interactions caused by the biopotential source—the subject—and the electrode interface and amplifier characteristics. The values shown are approximate since such factors as deep-tissue and skin resistance can vary widely.

ide. The electrode-potential equation then becomes

$$E = -0.22 + 0.059 \log (Cl^-) \text{ (volts).} \quad (6)$$

With the use of AgCl, the potential is dependent on the chloride present in the body and thus is predictable and reaches a stable, known value.

Push for compatible gear

The American Heart Association this year recommended a set of standards for EKG amplifiers. The establishment of a single amplifier configuration would quickly bring electrodes into line, ending the scramble by manufacturers to build a variety of types to accommodate the different amplifiers in the field, and vastly simplifying hospital shopping lists.

Some of the more important specifications proposed are:

Gain:	200 to 2,000 in fixed steps
Frequency response:	± 0.5 db from 0.14 to 950 hz ± 3 db from 0.5 to 2,500 hz
Common-mode rejection:	60 db with a 5 kilohm input unbalance
Noise:	Less than $10 \mu v$ rms referred to the input with 100 k balanced source impedance or 25 k unbalance
Input impedance:	Differential, greater than 20 megohms Common mode, greater than 200 megohms
Linearity:	1% for outputs from 2 to 20 volts peak-to-peak
Output:	Impedance less than 100 ohms 10 ma into 1 kilohm or greater
Input ejection current:	Less than $1 \mu a$, each lead

Another electrochemical problem associated with electrodes is polarization, which manifests itself both as minute differences in the electrode potential with current flow from potential without current, and as an increased internal resistance. It can be caused by changes at the metal surface, by decomposition where metal or gaseous ions leave the surface, and by high current densities through the interface.

But noise voltages generated at the interface by body movements are the most serious hurdles. Disturbances in the ionic distribution near the metal can produce error signals as large as the biopotentials themselves. Fortunately, silver-chloride controls the ion population at the interface.

Another solution is the use of a salt bridge between the electrode and the skin. A conducting path of a known salt concentration, such as an electrode gel, creates two interfaces where the ion populations are known and the potential can be predicted accurately. Other solutions use a porous ceramic baffle or a simple mechanical baffle between the gel and skin.¹⁸

Amplifier design

Design specifications for biopotential amplifiers or signal conditioners are determined primarily by signal characteristics, electrode characteristics, and application. Signal characteristics determine such specifications as gain, noise (referred to the input), and bandwidth. Electrode characteristics determine the required input impedance, the maximum ejection current (current that flows in the source due to connection of amplifier), and the required common-mode rejection. The application influences all these specifications and imposes others—distortion, linearity, and gain stability, for instance.

Sometimes electrodes have impedances as high

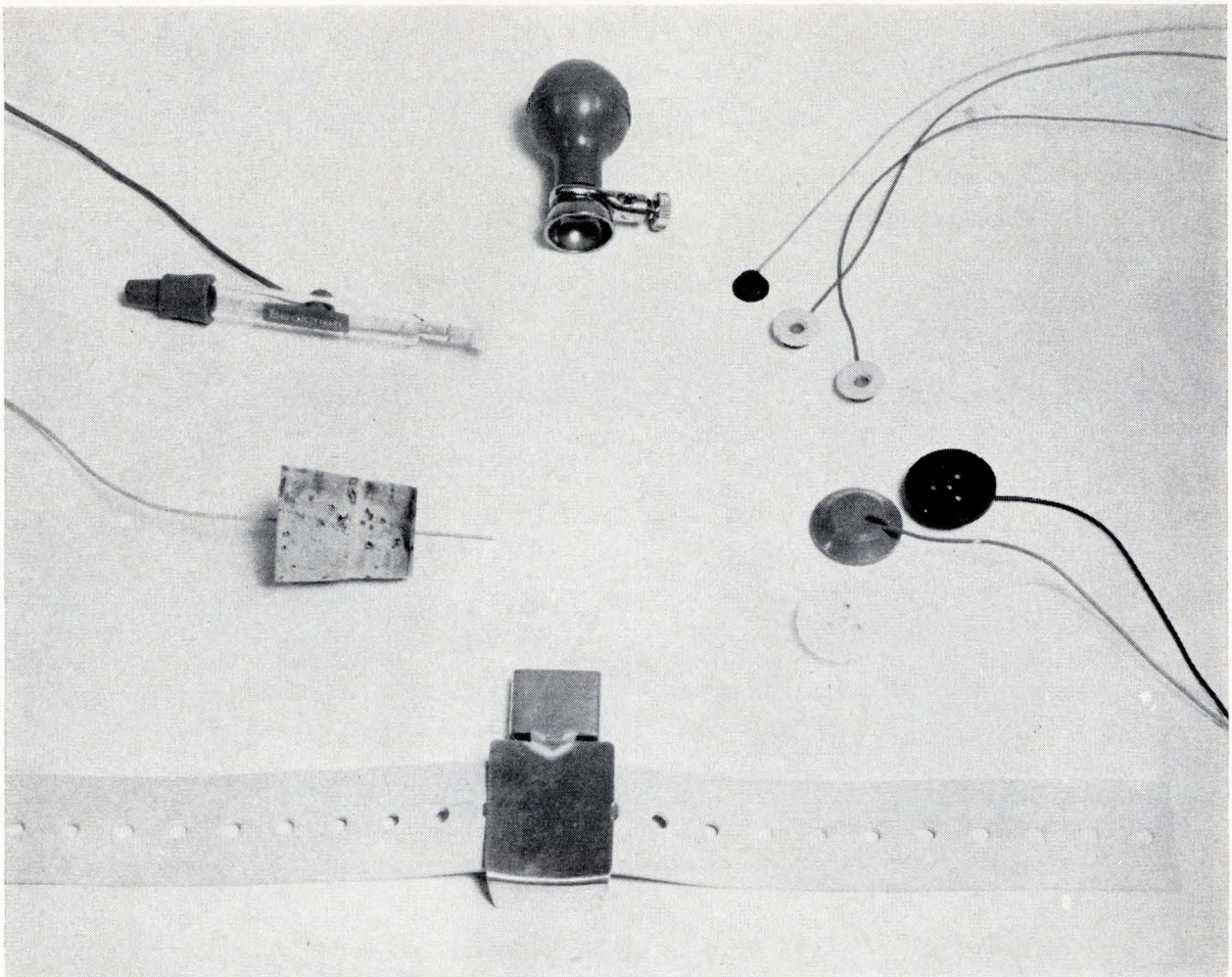

Typical electrodes. A variety of sensors are available to detect biopotentials. Clockwise from the bottom are: a standard silver plate EKG electrode with its mounting strap; a needle electrode used by researchers to record animals' EKG's or to sense myoelectric potentials, a silver-silver chloride salt bridge tissue electrode, a standard EKG suction-cup electrode, miniature silver-silver chloride electrodes for EKG's or EEG's, and low-artifact silver-silver chloride electrodes for EKG's.

as 10^{12} ohms. Such electrodes must be used with an electrometer amplifier having at least 10^{15} ohms input impedance and feedback to cancel the electrode capacitance.

The equivalent circuit on page 108 includes simple lumped, passive models representing the subject, the electrode-skin interface, and the amplifier input. The subject model consists of parallel RC elements representing skin resistance, the deeper tissue resistance, and skin capacitance.

Values shown are approximate. Skin resistance can vary from hundreds of ohms for abraded or punctured skin to a megohm for dry skin.¹⁹ While deep-tissue resistance varies less, it's still a direct function of the resistivity of blood and tissue and is proportional to the geometry and length of the path between electrodes. A value of a few hundred ohms is realistic. The value of skin capacitance, the total equivalent capacitance from the electrode to the deep tissues, depends on the electrode's surface area.

The common-mode voltage source shown represents misleading signals and noise, including

Common metal electrodes and their potentials

Electrode	Electrode reaction	Electrode potential (volts)
Potassium	$K = K^+ + e^-$	2.92
Sodium	$Na = Na^+ + e^-$	2.71
Aluminum	$Al = Al^{+++} + 3e^-$	1.67
Zinc	$Zn = Zn^{++} + 2e^-$	0.76
Iron	$Fe = Fe^{++} + 2e^-$	0.44
Cadmium	$Cd = Cd^{++} + 2e^-$	0.40
Nickel	$Ni = Ni^{++} + 2e^-$	0.25
Tin	$Sn = Sn^{++} + 2e^-$	0.14
Lead	$Pb = Pb^{++} + 2e^-$	0.13
Hydrogen	$H_2 = 2H^+ + 2e^-$	0.0000
(Standard or zero reference)		
Copper	$Cu = Cu^{++} + 2e^-$	-0.34
Silver	$Ag = Ag^{++} + 2e^-$	-0.80
Platinum	$Pt = Pt^{++} + 2e^-$	-1.20
Gold	$Au = Au^{+++} + 3e^-$	-1.42
Ag, AgCl, Cl ⁻	$Ag = Cl^- = AgCl + e^-$	-0.22

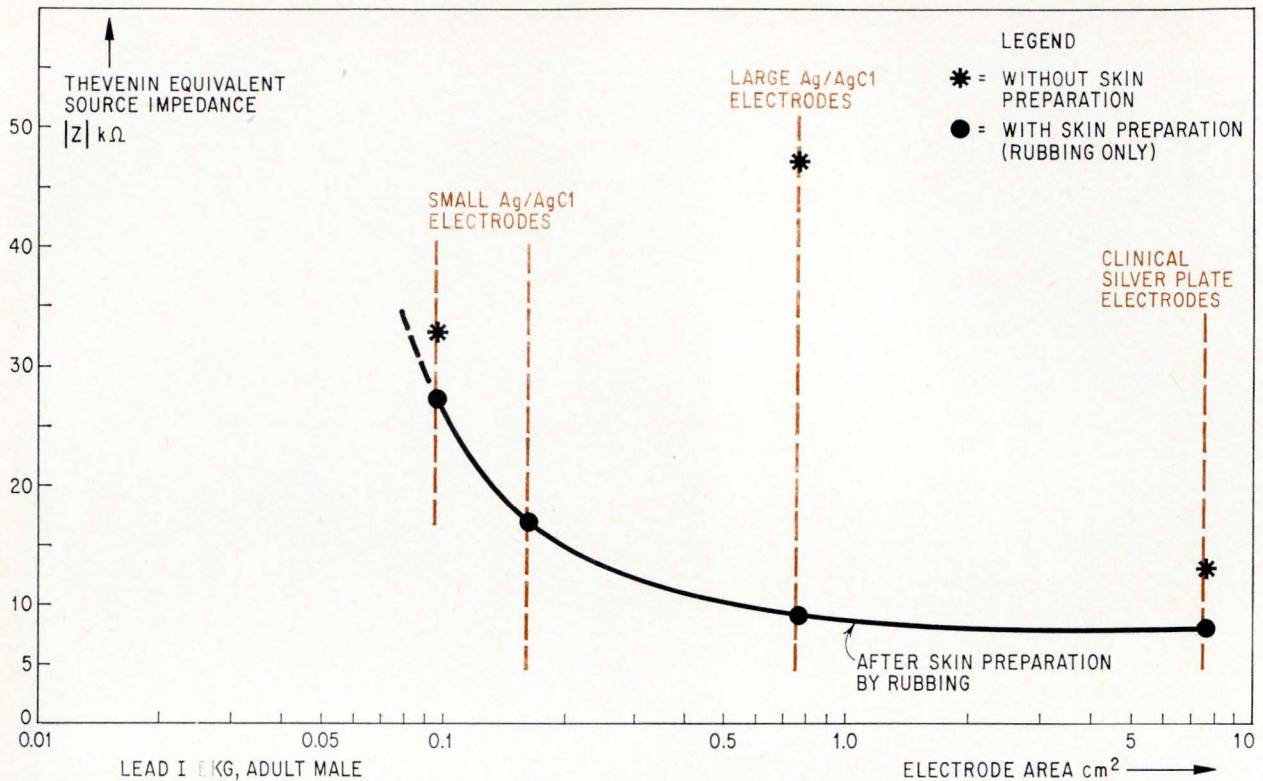

Impedance and surface. Electrode area isn't the only factor that changes electrode impedance. The curve demonstrates how surface area and the condition of the skin influence the source impedance.

power-line interference. Unfortunately, such voltages are not always completely common-mode, and can show up as differential signals at the output.

The equivalent circuit for the electrodes includes the silver-silver chloride pellet and gel resistances, and the electrode half-cell potentials. Electrode resistance usually is small enough to be ignored. Since the two half-cell potentials are in series, only the electrode-pair difference voltage is important.

The important characteristics of the amplifier in-

clude the differential and common-mode input resistance, input capacitance, and ejection currents (I_{13} and I_{23}). The input elements are shown as impedances— Z_{12} , Z_{13} , and Z_{23} .

Certain design considerations are immediately obvious. First, the input impedance must not load the source impedance, even up to the highest frequency of the input signal. Since the source impedance is complex, the input impedance shouldn't be low enough to distort the biopotential signal's waveform.²⁰ Second, the difference between the input terminal ejection currents should not produce an excessive differential input voltage. If the amplifier is direct coupled, the variation of these currents with temperature is a possible source of drift. Third, the amplifier's common-mode rejection, as noted before, should be able to handle the worst common-mode input voltage anticipated.

Less obvious is the effect of unbalanced source impedances on the common-mode rejection. Biopotential source impedances can vary greatly and 100% imbalances are possible. Also, the imbalance varies with the length of time the electrodes are attached. Although these difficulties can't be overcome, the effects of source impedance imbalances on common-mode rejection can be calculated.

Input impedance values for some common EKG electrodes in a lead I arrangement, shown above, are obtained by loading the source (resistively) to half of its open circuit voltage. Such a measurement is only an approximation of the complex, frequency-dependent source impedance, but it's still

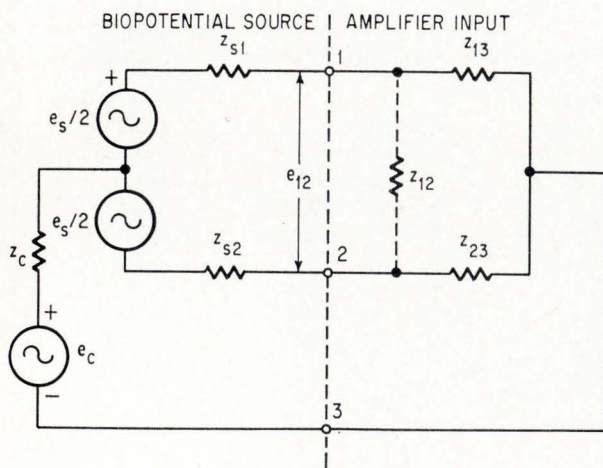

Simpler circuit. Assuming electrode pellet, gel resistance, and the electrode-difference voltage to be zero reduces equivalent circuit's complexity. This circuit permits rapid calculation of the common-mode rejection limits as a function of the source impedance imbalance.

Electrocardiographic recording instruments

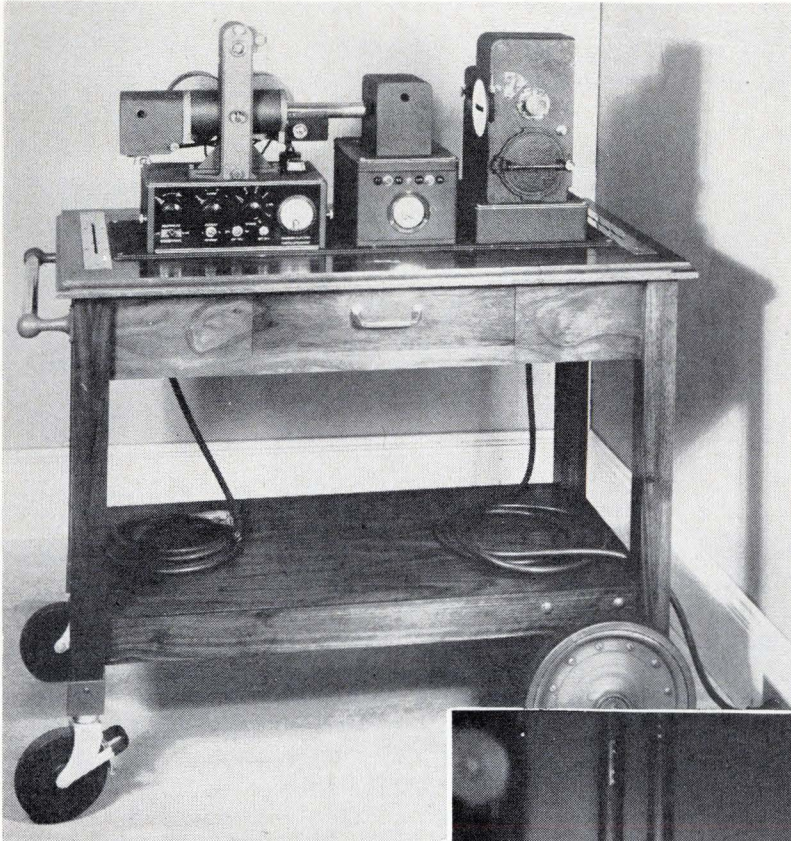

This antiquated research instrument is one of the first machines.

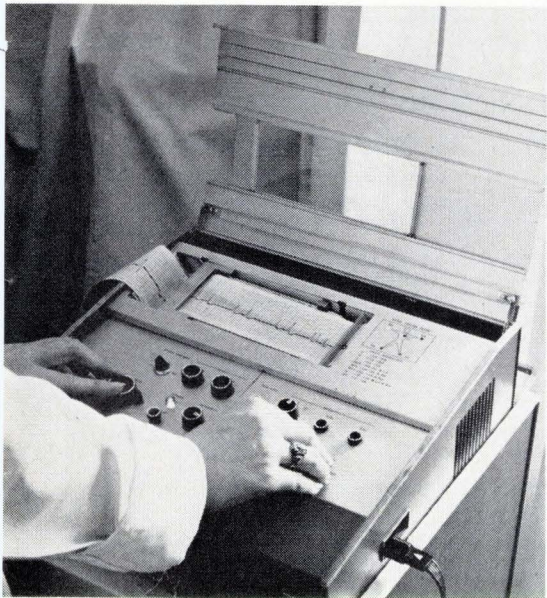

Modern recorders are flexible, easy-to-use instruments that can be brought to the patient.

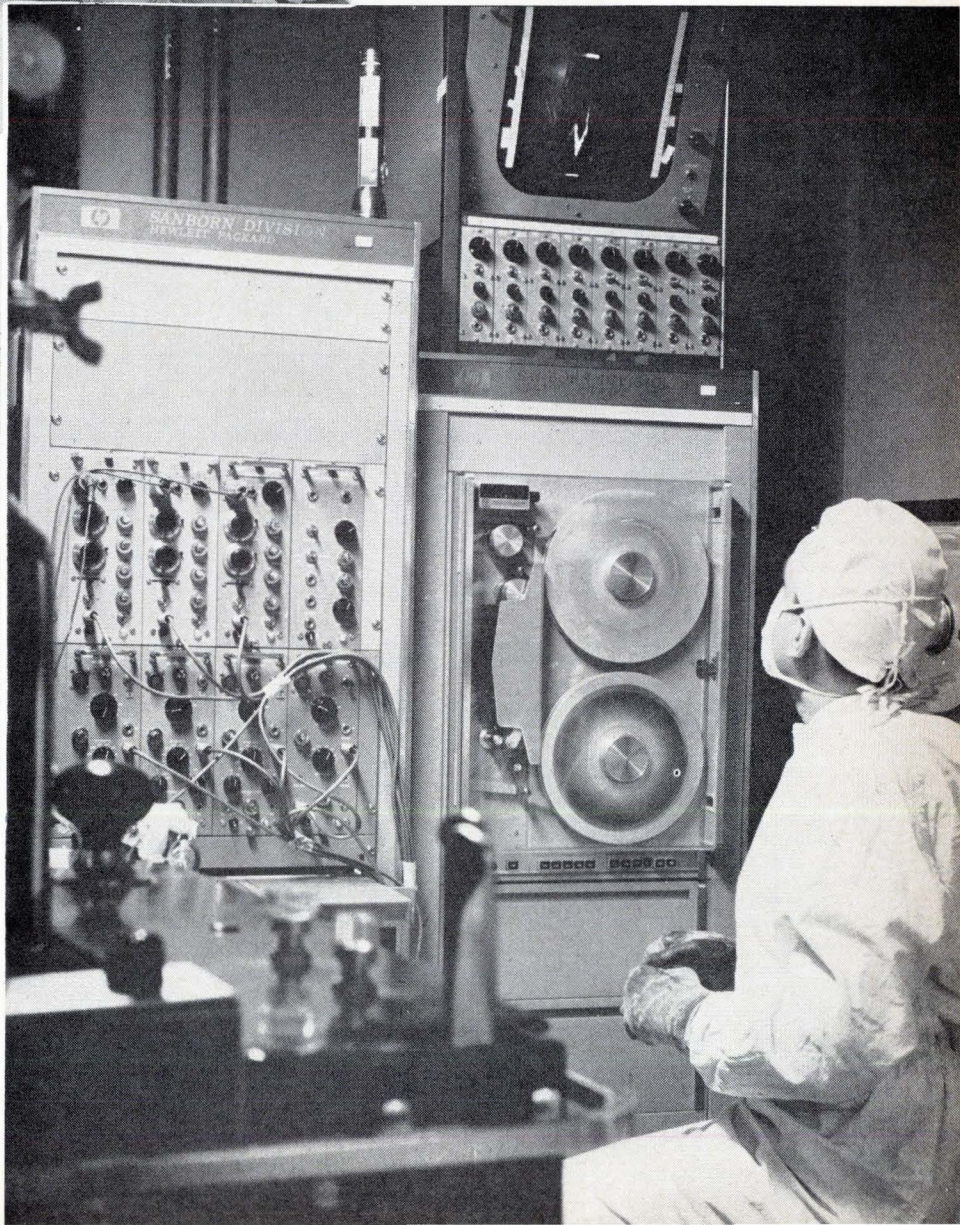

Sophisticated, computer-based monitoring systems are playing a vital role in the operating rooms of modern hospitals.

Characteristics of biopotential sources

Biopotential	Amplitude (u vp. p.)	Signal bandwidth (hz)	Other Characteristics
Body surface (EKG)	1,000 typ. (300-5,000)	Research: 0.01-2,000 Clinical: 0.2-100 Monitor: 0.5-50 Rate only: 2-20	40-240 beats/minute typical rates
Scalp (EEG)	50 typ. (10-300)	Research: d-c-250 Clinical: d-c-150 Aerospace: 0.2-100	alpha 8-13 hz beta 14-100 hz theta 4-7 hz delta 0.2-3.5 hz
Myoelectric (EMG)	100-500 typ. (100-10,000)	Research: d-c-5,000 Clinical: 20-5,000 Aerospace: 0.5-5,000	motor unit 2-15 msec.
Eye potentials (EOG) (ERG)	50-3,500 500 typ. (0-900)	Research: 0.2-15 a, b, c, d waves	5-35 uv/deg.

useful.

If the original equivalent circuit is simplified by including the lumped source impedances Z_{s1} and Z_{s2} , and the electrode-difference voltage and electrode pellet and gel resistances are assumed to be zero, as in the schematic on page 110, it's possible to calculate the effect of source impedance imbalances on common-mode rejection.

If the loading effect of Z_{12} on input voltage e_{12} is small, the circuit can be treated as two separate voltage dividers, Z_{s1} to Z_{13} and Z_{s2} to Z_{23} . A common-mode input voltage will produce a differential-input error voltage proportional to the difference between the two divider ratios, and the common-mode rejection will then be limited to:

$$\text{CMR Limit} = 20 \log_{10} \left| \left(\frac{Z_{13}}{Z_{s1} + Z_{13}} - \frac{Z_{23}}{Z_{s2} + Z_{23}} \right)^{-1} \right| \quad (7)$$

If $Z_{13} = Z_{23}$, and both Z_{s1} and $Z_{s2} \ll Z_{13}$, the CMR Limit becomes simply:

$$20 \log_{10} = \left| \frac{Z_{13}}{Z_{s1} - Z_{s2}} \right| \quad (8)$$

No matter how good the common-mode rejection of the amplifier is, therefore, the effective common-mode rejection still depends on the source impedance imbalance and still on the common-mode input impedance. Thus the specification for common-mode input impedance must take into account Z_{13} in parallel with Z_{23} .

For example, a typical EEG amplifier might have an input impedance of one megohm and a common-mode rejection of 100 decibels. But in operation, electrode imbalances of 5 kilohms are not uncommon, and the effective common-mode rejection in such cases is only 46 db.

References

- "Techniques of Physiological Monitoring, Vol. I: Fundamentals," Air Force Aerospace Medical Research Laboratories, Wright-Patterson AFB, Ohio, September 1962.
- "Techniques of Physiological Monitoring, Vol. II: Components," November 1963.
- R.W. Alnutt, et al, "Techniques of Physiological Monitoring, Vol. III: Systems," October 1964.
- Medical Physics, edit. O. Glasser, Vols. I, II, III, Chicago, 1944, 1950, 1960.
- E. Frank, "An accurate, clinically practical system for spatial vectorcardiography," *Circulation*, No. 13, 1956, pp. 737-749.
- O.H. Schmitt and E. Simonson, "The present status of vectorcardiography," *Archives of Internal Medicine*, No. 96, 1955, pp. 574-590.
- J.A. Freeman, "Monitoring Psychomotor Response to Stress by Evoked Auditory Responses," Air Force School of Aerospace Medicine, Brooks AFB, Texas, May 1965.
- J.F. Herrick, "The State-of-the-Art of Electroencephalography and its Role in Manned Space Flight," NASA, June 21, 1965.
- D.R. Bennett and R.C. Duvoisin, M.D., "The EEG in aerospace medicine; the electroencephalogram in aircrew and astronaut Selection," USAF School of Aerospace Medicine, Review 12-63, Brooks AFB, Texas, December 1963.
- E.A. Liske, Jr., M.D., "M-response in the electroencephalograms of aircrew personnel," USAF School of Aerospace Medicine, SAM-TR-65-229, Brooks AFB, Texas, September.
- R.B. Pearson, M.D., "Handbook on Clinical Electromyography, Meditron Co., El Monte, Calif., 1961.
- O.H. Mowrer, et al, "The corneo-retinal potential difference as the basis of the galvanic method of recording eye movements," *American Journal of Physiology*, No. 114, 1935, p. 423.

- W. Barry and G.M. Jones, "Influence of eyelid movement upon electro-oculographic recordings of vertical eye movements," *Aerospace Medicine*, September 1965.
- J.E. Leonard, "Electrochemistry of bioelectrodes," *Proceedings of the 17th Annual Conference on Engineering in Medicine and Biology*, Vol. 6, Nov. 16, 1964, p. 3.
- M. Sosnow and E. Ross, "Electrodes for Recording Primary Bio-Electrical Signals," USAF Aerospace Medical Laboratory, ASD Technical Report 61-437/Wright-Patterson AFB, Ohio, September 1961.
- "Medical Physics," Vols. I, II, III, edited by O Glasser, The Year Book Publisher, Chicago, 1944, 1950, 1960.
- H. Watanabe, "Molded Metal-Metal Salt Reference Electrode U.S. Patent 3, 111, 478, Nov. 19, 1963.
- R.H. Cooper, "A simple, inexpensive way to monitor electrocardiograms on an actively exercising subject," SAM-TDR-64-38, USAF School of Aerospace Medicine, Brooks AFB, Texas, August 1964.
- R.C. Burns, "Study of skin impedance," *Electronics*, April 1950, pp. 190-196.
- L.A. Geddes and L.E. Baker, "The relationship between input impedance and electrode area in recording the ECG," *Medicine and Biological Engineering*, No. 4, 1966, pp. 439-450.

The second part of this series in the July 24 issue will look at the computer's role in medicine. The Public Health Service's system for analyzing electro-physiological signals and IBM's proposed diagnostic system will be reviewed in depth. Reprints of the entire series will be available in August.

**Everything's
a filter**

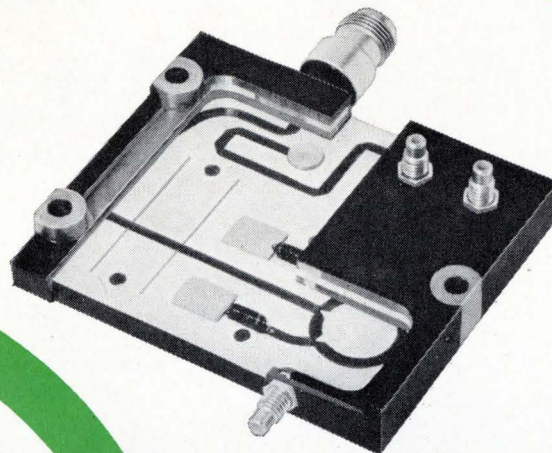

**in
microwave
sub-assemblies**

—that's why we make better sub-assemblies!

When designing a microwave sub-assembly, practically everything becomes a filtering problem. And we're not talking about just the filters themselves. Couplers, mixers, detectors—everything up to and including the launchers—interact and determine the frequency characteristics of the entire sub-assembly.

So, final sub-assembly performance starts with superior filtering knowledge. Over the years, Microlab/FXR has designed and produced more filters and other microwave components than anyone else. In the process, we've had to learn more about how these components interact—how they should be designed and packaged to minimize the effects of shock, vibration, temperature and altitude—and how to optimize the per-

formance of a sub-assembly built upon such components.

One result of this experience is the stripline sub-assembly above. It includes a mixer, two directional couplers, a filter, two terminations and a diode switch—all in a 5-ounce epoxy-encapsulated package just $3\frac{1}{2}'' \times 2\frac{1}{2}'' \times \frac{1}{2}''$. Similar sub-assemblies can be supplied for any microwave frequency and bandwidth, using these same techniques.

Let us bring our skills to your microwave sub-assembly problem. Our services can include everything from the technical proposal through value analysis, production and acceptance testing. Write today for more information, as well as a free copy of our catalog of standard microwave products. Address: Dept. E-60.



MICROLAB/FXR

Livingston, New Jersey 07039 Phones: (201) 992-7700; (212) 721-9000



all the major French
and foreign companies



and the first
public demonstrations of the
SECAM color television system



Photo Mourreau

PUBLIC SERVICE

SALON INTERNATIONAL RADIO TELEVISION ELECTROACOUSTIQUE

From 1st thru 10th September 1967
Paris (porte de Versailles - hall monumental)

RENSEIGNEMENTS : S.D.S.A. RELATIONS EXTERIEURES - 16, RUE DE PRESLES - 75 PARIS-15^e - FRANCE - TEL. 273.24.70



70% integrated circuitry. (For good measure.)

We make our Model 7000 DVM with integrated circuits to give you a better instrument at lower cost.

For example, you get an accuracy of 0.01% of reading and 100 μ V resolution in our basic, \$1150.00 instrument. You get dual-slope integration which combines integration techniques and comparison to an internal standard to achieve both noise rejection and stability. That means you don't have to calibrate the instrument daily or weekly.

No red buttons, no screwdriver adjustments. You get low power operation that requires no fan and makes no noise. And you can get it all into half of a standard rack.

When it comes to options you can get five: Auto range, AC, Resistance, DC current, and BCD output. Each option is contained on a single plug-in circuit board. You can use any or all of the options simultaneously.

You can get the instrument with the first four options for \$1550.00.

Or all five for \$1595.00.

And, of course, you can get our data sheet and brochure for free.

FAIRCHILD
INSTRUMENTATION

FAIRCHILD INSTRUMENTATION / A division of Fairchild Camera and Instrument Corporation
475 Ellis Street, Mountain View, California, (415) 962-2011 / TWX: 910-379-6944

THIS IS SIGMA'S NEW SOLID-STATE DATACEL[®]

An opto-electronic
switching device that
provides input-output
circuit isolation.

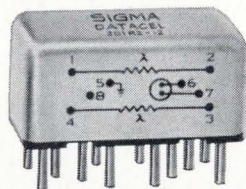

Solid-state and opto-electronic switching benefits are combined in low-cost Sigma Series 301 Databcels.

Electrically Isolated Input-Output Circuits: Light-beam coupling to 1, 2 or 4 photocells provides isolation resistance on the order of 10^9 ohms and smooth turn-on, turn-off.

AC-DC Capability: Both input and output circuits can handle either AC or DC signals. Cell loads may range from millivolt to 250-volt levels.

Application Versatility: Functions include high isolation interface switching, logic switching (and/or gate, inverter, latch circuits), audio switching, multiplexing, data sampling, feedback gain control, noiseless potentiometer.

Compact Construction: 1, 2 and 4 pole versions

all designed for high-density printed-circuit packaging. Also socket conversion to solder terminal mounting. In addition each unit visually indicates its on-off state to aid system trouble-shooting.

We'd like to give you a new solid-state Sigma Databcel—or any of our standard relays. It's the best way we know to prove what we say about Sigma performance. Just circle our reader service number on the reader service card. We'll send you the new Sigma catalog and a "free" request form. Return the form to us and your Sigma representative will see that you get the sample you need.

Need fast delivery? Opto-electronic Databcels are available off-the-shelf from your Sigma distributor. Call him today.

SIGMA DIVISION



SIGMA INSTRUMENTS INC

Assured Reliability With Advanced Design / Braintree, Mass. 02185

Sigma Instruments (Canada) Ltd., P.O. Box 43, Toronto 18



King Radio needed: capacitors that stay reliable even with extreme cold, humidity and vibration. So King Radio chose: capacitors of MYLAR.

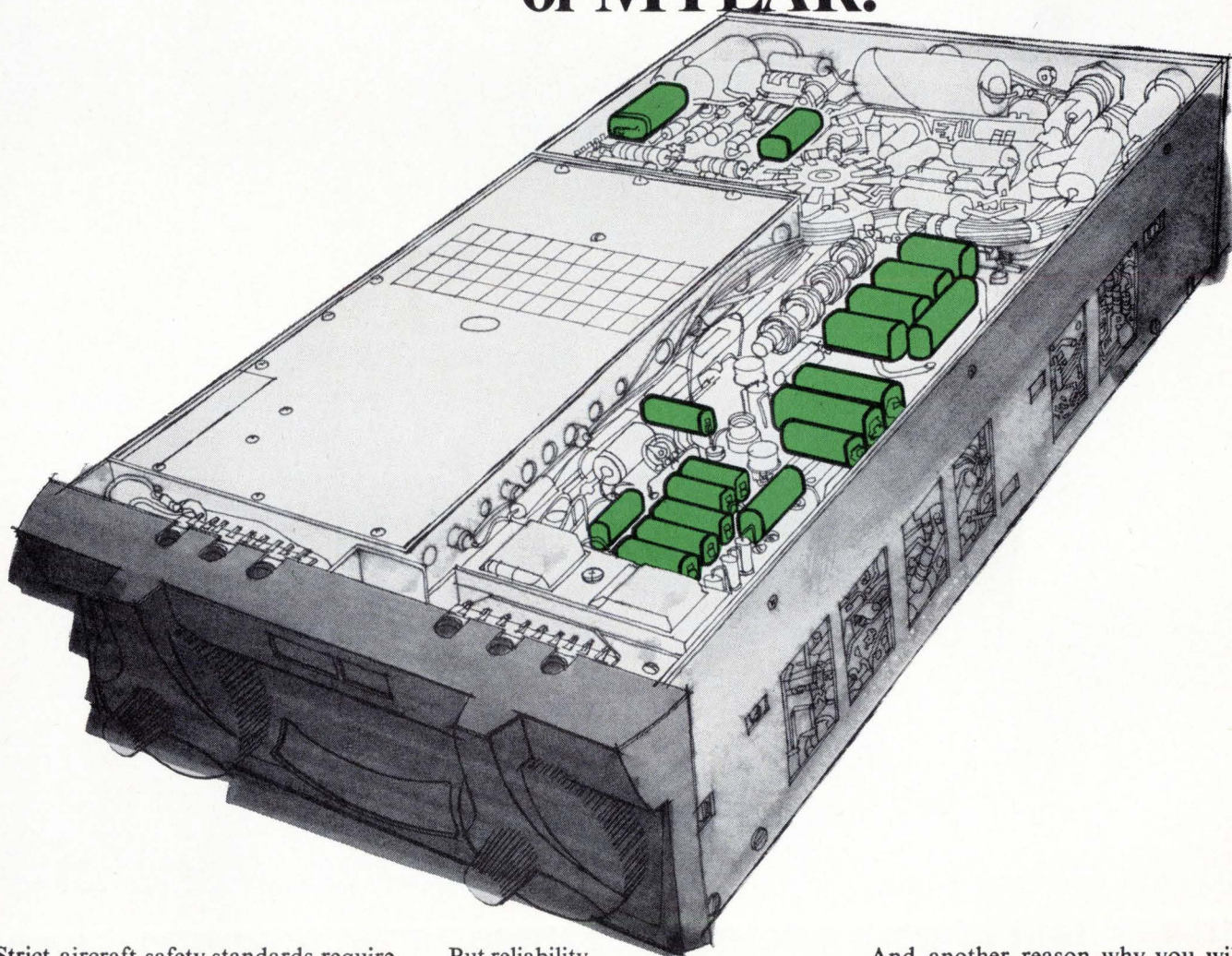

Strict aircraft safety standards require the most reliable navigation equipment available. That's why King Radio Corporation uses capacitors of MYLAR* for their Distance Measuring Equipment. MYLAR can take temperature extremes from -60° to $+150^{\circ}\text{C}$; MYLAR remains constantly stable under humid conditions.

But reliability isn't the only reason King Radio chose MYLAR. The extremely high dielectric strength of MYLAR permits its use in thinner film, thus helping King Radio to build the lightest and most compact distance measuring unit on the market. MYLAR is available in films as thin as 15 gauge.

And another reason why you will want to investigate using capacitors of MYLAR: they usually cost no more than others. Write for complete technical data to DuPont Company, Room 4960A, Wilmington, Delaware 19898. (In Canada, for information write Du Pont of Canada Ltd., Post Office Box 660, Montreal, Quebec.)



*DUPONT'S REGISTERED TRADEMARK FOR ITS POLYESTER FILM.



GTC's Hal Horwitz delivers another *portable* atomic clock

When you want to transport time, why not get the most "transportable" atomic clock? General Technology's new Portable Rubidium Standard weighs only 31 pounds *with 8-hour batteries* and is 7" x 7½" x 17½" overall. Medium-term stability: 5 x 10⁻¹² (standard deviation) for 100

second averaging. Automatic sync: less than 0.1 microsecond.

Want GTC to deliver the industry's first truly portable atomic clock to you? . . . or want more information? Call or write: Hal Horwitz, Sales Manager; General Technology Corporation, 9610 Bellanca Avenue,

Los Angeles, California 90045.
Phone 213 670-5541.

TFA-1366

TRACORTM

DIAL DANA.... BEFORE YOU BUY A DVM

See for yourself why the Model 5400 is the fastest selling digital voltmeter in the 0.01% class . . . see (plug-in)² versatility, analog output, 80/second speed . . . dial your area code number for a demonstration today.

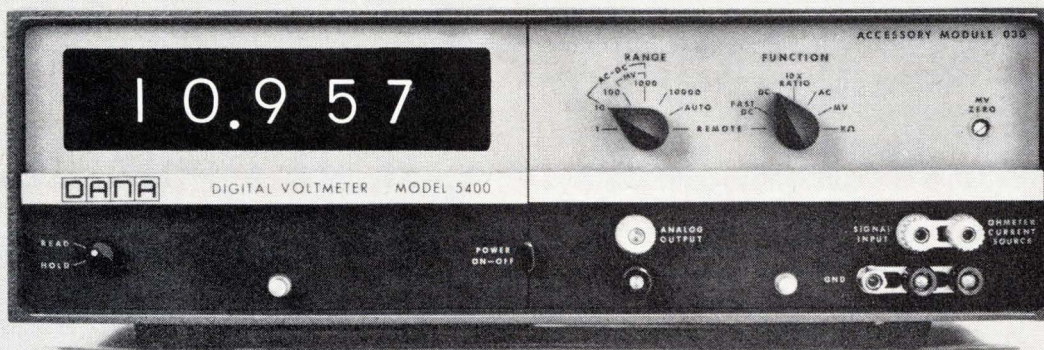
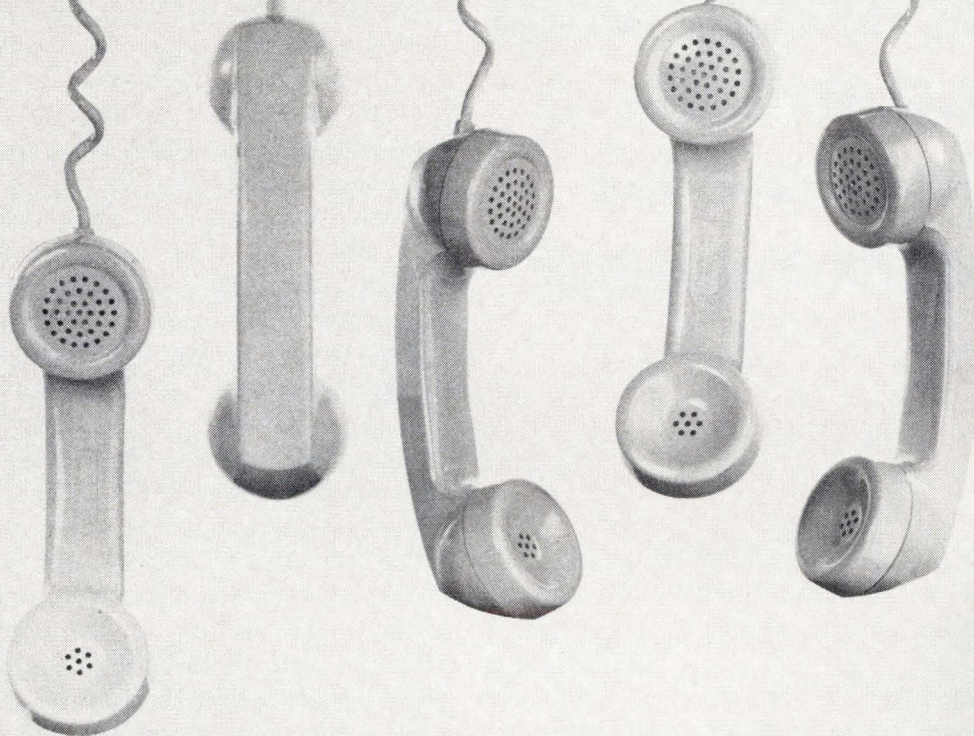

201 201: 687-8737	302 301: 946-0300	408 415: 968-7116	516 516: 433-1421	714 714: 297-4619	International Offices
201 201: 542-1441	303 303: 934-5505	412 412: 892-2953	517 313: 892-2500	714 213: 684-2840	
202 301: 946-0300	305 305: 723-6924	413 617: 648-2922	518 315: 454-9377	716 716: 271-7430	
203 203: 246-5686	309 312: 539-4838	414 414: 547-5131	602 602: 959-2115	717 717: 761-0577	
205 205: 881-3721	312 312: 539-4838	415 415: 968-7116	603 617: 648-2922	802 617: 648-2922	
206 206: 763-2755	313 313: 892-2500	417 913: 648-4173	606 513: 298-7203	805 213: 684-2840	
207 315: 454-9377	314 314: 837-0597	419 216: 885-5616	607 315: 454-9377	812 317: 253-1681	
212 201: 687-8737	315 315: 454-9377	501 214: 231-6541	609 215: 265-3250	814 412: 892-2953	
213 213: 684-2840	316 913: 648-4173	502 317: 253-1681	612 612: 537-4501	815 312: 539-4838	
214 214: 231-2573	317 317: 253-1681	503 206: 725-2700	614 216: 885-5616	816 913: 648-4173	
215 215: 265-3250	318 713: 528-6904	504 205: 881-3721	616 313: 892-2500	817 214: 231-6541	
216 216: 885-5616	319 319: 365-6635	505 505: 265-7766	617 617: 648-2922	904 305: 783-9407	
217 312: 539-4838	401 203: 246-5686	507 612: 537-4501	618 314: 837-0597	912 215: 881-3721	
218 612: 537-4501	402 913: 648-4173	512 713: 528-6904	703 301: 946-0300	913 913: 648-4173	
219 312: 539-4838	404 404: 261-5459	513 513: 298-7203	712 319: 365-6635	914 914: 769-1811	
301 301: 946-0300	405 214: 231-6541	515 319: 365-6635	713 713: 621-0040	916 415: 968-7116	

Our products keep getting smaller... so how come we need more space?

You might say that's the name of the game.

Every year we've managed to pack more power and surge capacity into a smaller package than before. And almost every year we've had to add to the size of our plant.

In fact, we've doubled it twice, and tripled it once in the last five years. This year we're doubling it still again to more than 100,000 square feet.

Now we know you couldn't care less how many bulldozers we keep busy. But to tell the truth, we're a little surprised ourselves.

You see, we didn't develop Unitrode diodes for

every application. We knew they'd simply be better than they have to be for some jobs. We developed them for applications that *need* high power and tremendous surge capacity. That would subject components to extra punishment. That would require parts lasting virtually forever with no change in electrical parameters.

And when we say developed, we mean *developed*. From the ground up. With entirely new design. With entirely new methods of construction. The metallurgical bond that joins the silicon between the two terminal pins is stronger than the silicon itself, so the silicon will break before the bond does. The entire unit is fused in hard glass at over 800°C. It's voidless, so all contaminants are excluded.

Because the pins are bonded over the full face of the silicon die, heat due to surge is carried away quickly from the silicon into the terminal pins.

That's why a Unitrode diode can handle as much energy in avalanche as in the forward direction. And *every* Unitrode diode is controlled avalanche.

After 2000 hours of life testing, our parts still meet initial specified limits. In fact, we can virtually guarantee a Unitrode will never fail. Ever.

We keep packing this kind of reliability into a smaller and smaller package and our plant keeps getting bigger and bigger. So maybe more people want the security of Unitrode reliability in their designs than we first thought.

We hope so. Can we send you samples and complete information? We're at 580 Pleasant St., Watertown, Mass. 02172. Telephone (617) 926-0404. TWX (710) 327-1296.

UNITRODE®

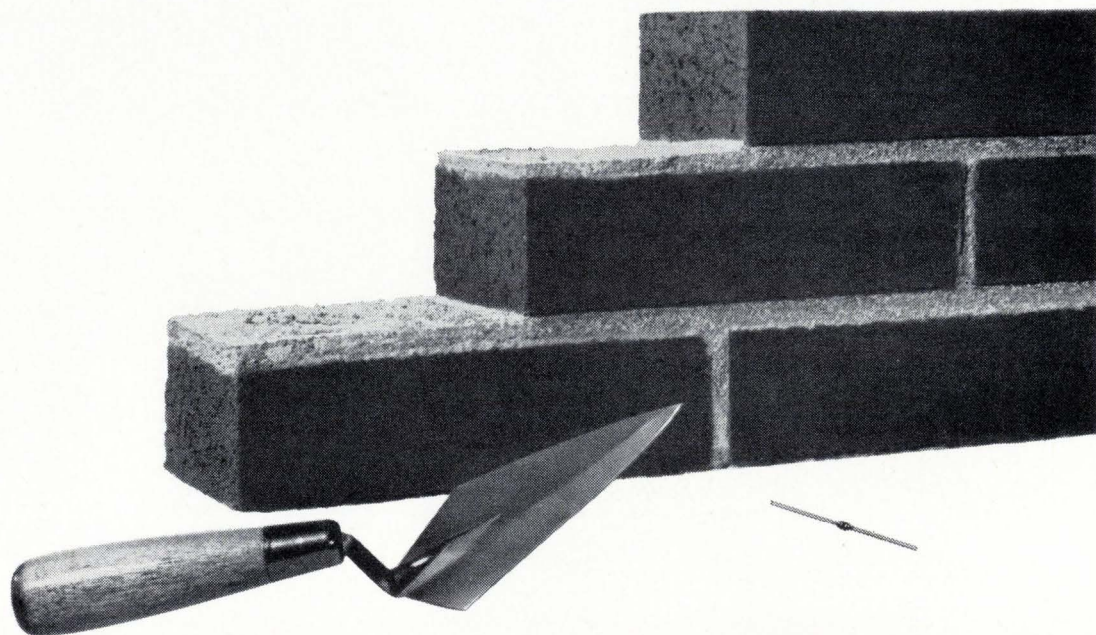



This ad is about polar relays, money, and peace of mind.

AE's Series PTW relay is a small, two-position device. But it assures positive on-off switching of a single circuit *billions* of times without readjustment.

That means you can install it and forget it. With a clean conscience, you can design the PTW into telegraph and teleprinter circuits. Digital data transmission equipment. Or any application where you need high-speed response to polarized impulse, positive circuit transfer, and a long, maintenance-free life.

The armature is mounted on a reed—there's no bearing to wear. This construction causes a small lateral wiping motion of the armature. Helps reduce contact bounce.

You can get three different plug-in mounting arrangements for the Series PTW. Type 202 provides 11 banana-type terminals. Type 203 has eight pin-type terminals.

It's a replacement for the W. E. Co. Type 255 relay. Type 204 has eight terminals in an octal arrangement. It's designed for use in carrier and microwave equipment, computers and data transmission. These relays have a current sensitivity range of two to 16 milliamps.

Get some helpful, detailed design information — for future peace of mind. Ask for Circular 1821-E. Just write to the Director, Relay Control Equipment Sales, Automatic Electric, Northlake, Illinois 60164.

AUTOMATIC ELECTRIC
SUBSIDIARY OF
GENERAL TELEPHONE & ELECTRONICS GTE

AUTOMATIC SCANNING FOR EMI MEASUREMENTS

from 20-15,000 Hz
WITH THE APPROVED ONE

**APPROVED
MIL-STD
826A**

EMPIRE® Noise and Field Intensity Meter



Solid-State, Compact and Lightweight Model NF-315A is preferred by military and civilian government agencies, and major aerospace contractors for rapid and precise EMI measurements. Here's why:

- Three scanning modes: manual, sector, and single sweep over the complete frequency range
- Three separate calibrated scales — peak, average and RMS
- 180 db signal range
- 0.005 μ v sensitivity
- 7 or 70 Hz bandwidth selection
- Reliable scanning at maximum sensitivity
- >70 db spurious response rejection
- Internal frequency and amplitude calibrators for on-the-spot checking without disconnecting signal input leads
- Highly stable circuits eliminate recalibration when tuning to new frequencies
- Excellent shock, vibration and temperature characteristics
- Six hours of continuous operation with built-in rechargeable batteries

Write for complete technical data; better yet, call for a demonstration.



® Trademark of THE SINGER COMPANY

EMC • GERTSCH • PANORAMIC • SENSITIVE RESEARCH

**SINGER
INSTRUMENTATION**

THE SINGER COMPANY, METRICS DIVISION • 915 Pembroke St., Bridgeport, Conn. 06608, U. S. A. • PHONE (203) 366-3201

E-67-1

New economy Semiconductors from TI... get 'em first from Electronic Wholesalers

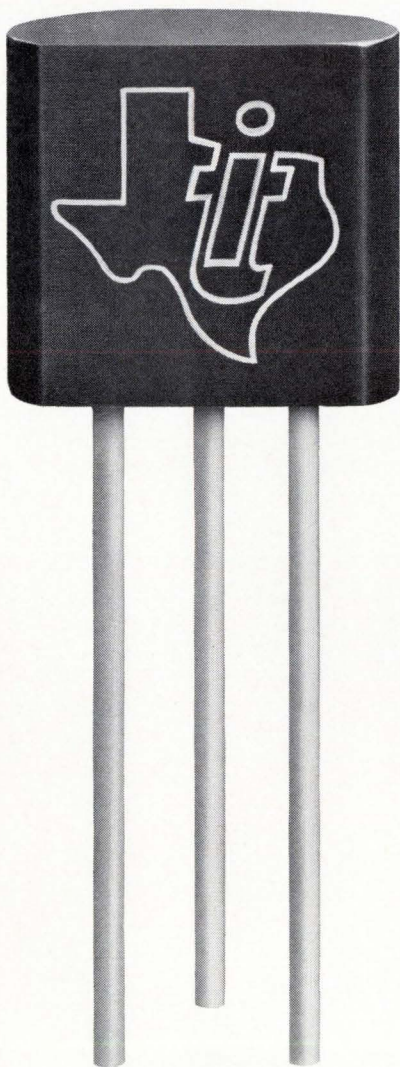

Here is a new series of TI "firsts" in SILECT™ semiconductors. Get 'em first from our complete stocks which include the entire TI line.

Industry's first plastic encapsulated MOS FET

The TIXS67 is the first p-channel silicon enhancement mode field-effect transistor to be encapsulated in plastic. Circle 290 for data sheet.

New low-cost, high-voltage FET replaces vacuum tubes

The new TIXS78 silicon N-channel FET offers a 300-volt minimum breakdown voltage, making it a one-for-one replacement for many vacuum tube applications. Circle 291 for data sheet.

New economy matched pair FETs

The TIS68 pair is matched within 5 percent for I_{DSS} and y_{fs} , yet are low in cost. Circle 293 for data sheet.

New FET switches

The TIS73-75 series are industry's first low on-resistance, low-leakage switching FETs. Circle 295 for data sheet.

New planar UJTs

The 2N4892 series of planar silicon UJTs in SILECT packages are the first such devices to be characterized for specific applications. Circle 296 for data sheet.

Smallest, lowest cost SCRs

TI's new TIC44-47 SCRs are the smallest available, yet are priced only one-third as much as metal-can equivalents. Circle 297 for data sheet.

SILECT™ package

These economy semiconductors feature TI's new SILECT molded package with TO-18 pin circle lead configuration. A recent report, covering 10 million hours of testing, concludes that SILECT transistors are as reliable as metal-can devices tested under the same conditions.



New Economy Semiconductor Designer's Kit

Save more than 75 percent on a broad assortment of economy semiconductors for evaluation. Get your kit from us. Circle 298 for information.



"SERVING THE ENTIRE SOUTHEASTERN U.S."

ELECTRONIC WHOLESALERS INC.

WASHINGTON, D. C.
2345 Sherman Ave., N.W.
Phone 202-483-5200

BALTIMORE, MARYLAND
3200 Wilkens Avenue
Phone 301-646-3600

WINSTON-SALEM, N. C.
938 Burke Street
Phone 919-725-8711

MIAMI, FLORIDA
9390 N.W. 27th Avenue
Phone 305-696-1620

ORLANDO, FLORIDA
345 N. Graham Avenue
Phone 305-841-1550

4 ways to view displays with the Tektronix Type 564

split-screen storage oscilloscope

The Tektronix Type 564 is virtually two instruments in one. It offers all the advantages of a storage oscilloscope plus those of a conventional oscilloscope.

Split-Screen Displays

An unique split-screen display area enables you to simultaneously use either half of the screen for storage and the other half for conventional displays, or use the entire area for stored or conventional displays.

Independent control of both halves of the screen permits you to take full advantage of the storage facilities. For example, you can use half the screen to store a reference waveform, the other half to display waveforms for comparison. You can erase or retain either half of the display area as you choose.

Bistable Storage Advantages

With bistable storage oscilloscopes, such as the Type 564 and Type 549, the contrast ratio and brightness of stored displays are constant and independent of the viewing time, writing and sweep speeds, or signal repetition rates. This also simplifies waveform photography. Once initial camera settings are made for photographs of one stored display, no further adjustments are needed for photographs of subsequent stored displays.

Storage time is up to one hour, and erase time is less than 250 milliseconds. An illuminated 8 cm by 10 cm graticule facilitates measurements and aids in taking photographs with well-defined graticule lines. Adding to the operating ease is a trace position locator that indicates, in a nonstore area, the vertical position of the next trace or traces.

Tektronix bistable storage cathode ray tubes are not inherently susceptible to burn-damage and require only the ordinary precautions taken in operating conventional oscilloscopes.

Plug-In Unit Adaptability

The Type 564 accepts Tektronix 2 and 3-series plug-in units for both vertical and horizontal deflection. Display capabilities of these units include single and multi-trace with normal and delayed sweep; single and multiple X-Y; low-level differential; dual-trace sampling; spectrum analysis, and many other general and special purpose measurements.

Type 564, without plug-in units	\$875
Rack-Mount RM564	\$960
Similar electrical characteristics to Type 564. 7" high.	
Type 3A6 Dual-Trace Amplifier Unit	\$525
DC to 10 MHz from 10 mV/div to 10 V/div. 5 display modes. Internal signal delay line.	
Type 3B4 Time Base Unit	\$400
Sweep speeds from 0.2 μ s/div to 5 s/div. Single sweep. Up to X50 direct-reading magnifier extends fastest sweep to 50 ns/div.	

U.S. Sales Prices FOB Beaverton, Oregon

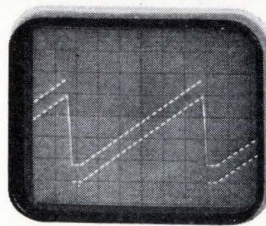

Entire screen can be used for a stored display.

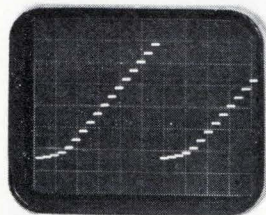

Entire screen can be used for a nonstored display.

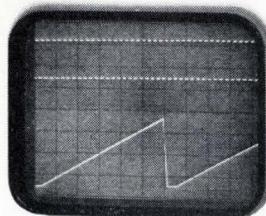

Each half of split-screen can be used independently for stored displays.

Either half of the split-screen can be used for a stored display, the other half for a nonstored display. (Shown below).

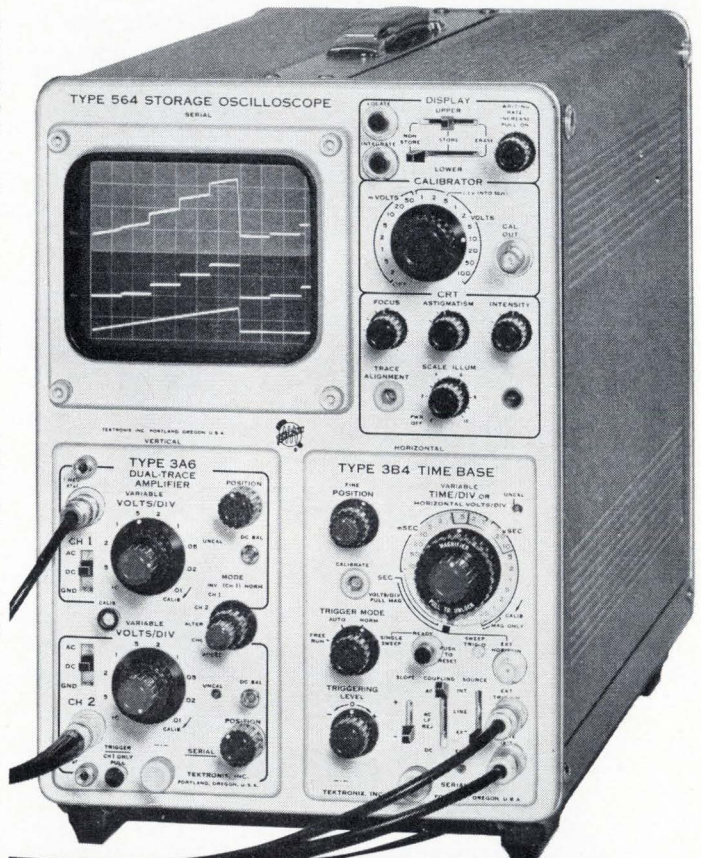

Tektronix, Inc.



For complete information, contact your nearby Tektronix field engineer or write: Tektronix, Inc., P.O. Box 500, Beaverton, Oregon 97005

Probing the News

Integrated electronics

Resourcefulness brings linear IC's from obscurity into the marketplace

With their technical limitations overcome and volume markets defined, linear IC's are invading areas long dominated by discrete semiconductors and vacuum tubes

By Mark B. Leeds

Solid state editor

Linear integrated circuits are quick-stepping into the commercial lime-light after having been outdistanced by digital devices during the last five years.

In marketing terms, linear IC's are still in an early stage. Most sales are to the Government for military and aerospace applications. But orders are now being booked in the instrument and computer fields. And within sight are untapped mass markets in the consumer field that could prove a source of exponential growth. Automobiles and home-entertainment equipment could provide volume outlets by the early 1970's.

I. The minus side

At the dawn of the microelectronics age, linear circuits faced greater problems than did digital devices. Unlike their counterparts, which have a discontinuous response, LIC's have an output directly proportional to input. This characteristic confronted semiconductor houses with several difficulties. For one thing, manufacturers had trouble fabricating equal-quality npn and pnp elements. For another, linear IC's lacked workable inductance and large capacitance values. Precision resistance values were also missing, and the required signal-handling levels of analog—or linear—systems were generally higher than those of digital equipment. Finally, alternating-

After a slow start ...

Linear integrated circuits are expected to pick up momentum ...

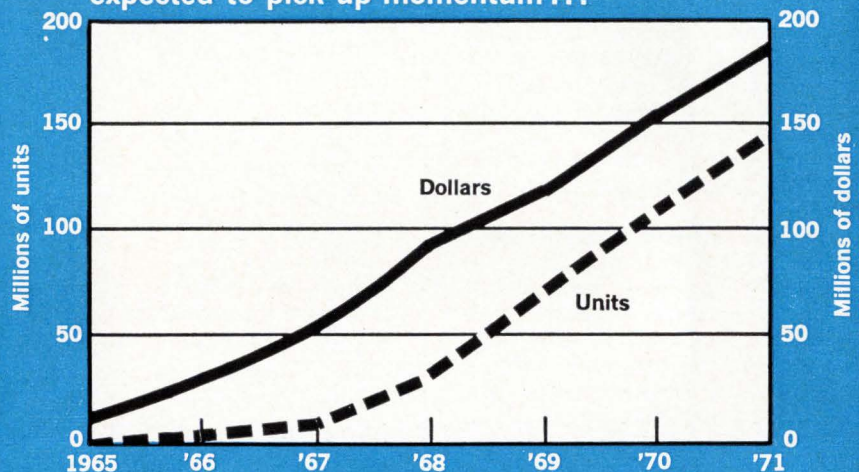

... as unit prices continue to drop rapidly

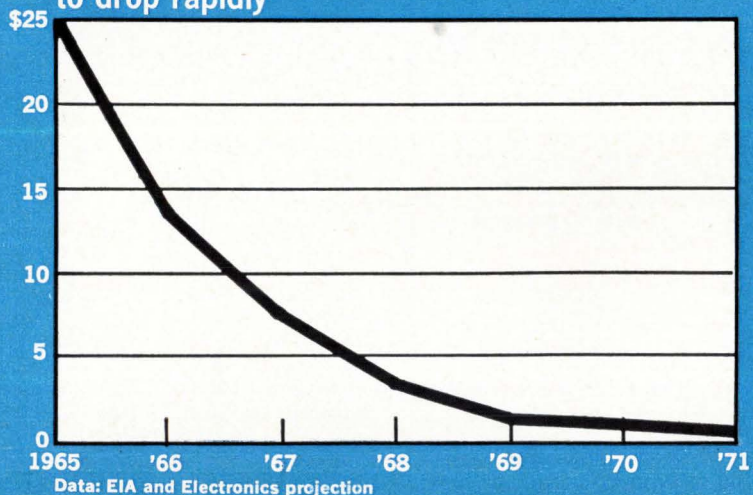

Data: EIA and Electronics projection

Clean Safe-
Clean Quick-
Clean Clean

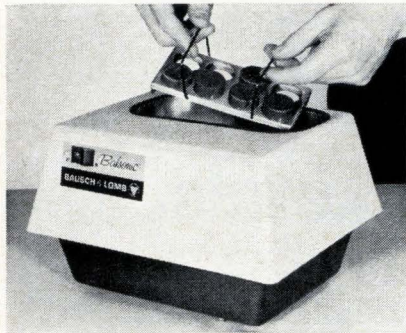

Bausch & Lomb BALSONIC ULTRASONIC CLEANERS

Different size bubbles blast
away dirt of all sizes.

Remove soils of oil, dust, dirt, grease, fingerprints, lint, jeweler's rouge, abrasive, polishing and grinding compounds, plastic residues, metal chips, tarnish, corrosion from metal, glass, plastics.

Thorough cleansing action is assured by simultaneous multi-frequency output—the only small size ultrasonic cleaner to have this feature).

Choose Balsonic wherever small part cleaning is important. Conveniently packaged with proper solvent for either Metallurgical, Precision Parts, Surgical or Contamination Control applications.

Two sizes: Balsonic I. $7\frac{3}{8} \times 3\frac{1}{2} \times 2\frac{1}{2}$ in. tank. Balsonic II. $9\frac{1}{8} \times 7\frac{1}{4} \times 3\frac{7}{8}$ in. tank.

Use the coupon for a free demonstration and our new catalog 42-2221. Bausch & Lomb, 62343 Bausch St., Rochester, N.Y. 14602.

BAUSCH & LOMB 

Bausch & Lomb
62343 Bausch St., Rochester, N. Y. 14602

- Please send me your catalog No. 42-2221 with complete information on your new Balsonic Cleaners.
- I would like a free demonstration of Balsonic Cleaners.

Name.....
Please Print

Title.....

Firm or Institution

Address.....

Zip.....

current dominated the design scene; there were also filtering, biasing, and related wave-shaping requirements apparently beyond the capacity of the linear chip.

In addition, divers self-anointed experts were predicting that everything would eventually be done by the numbers. There was little incentive for manufacturers to improve linear techniques when it appeared digital technology would undercut their achievements.

Upshot. Linear ic's, with their moderate-gain npn transistor elements, imprecise resistors, tiny capacitors, small heat sinks, inherent direct-current characteristics, and apparently blighted future, were not high on anyone's shopping list.

"A few years ago, the LIC was not given much of a chance of becoming an equal partner of the digital ic," says Robert Grimes, marketing engineer for linear ic's at Texas Instruments Incorporated.

Bonanza. But last year, semiconductor houses almost quadrupled their 1965 unit volume and more than doubled revenues. According to Electronic Industries Association figures, the sales growth of linear ic's is now far outstripping that of established digital circuitry. During the first three months of 1967, manufacturers did \$12 million worth of business, shipping 1.3 million devices—an improvement of 106% and 344%, respectively, over the comparable year-earlier levels.

Roll call. The list of firms in on the sales surge of linear ic's includes such giants of the semiconductor business as the Fairchild Camera & Instrument Corp., Motorola Inc., and TI. These companies report tenfold year-to-year increases in their production. Comparable jumps have occurred at the Radio Corp. of America; the General Electric Co; the Signetics Corp., a subsidiary of the Corning Glass Works; the Westinghouse Electric Corp.; and Teledyne Inc.'s Amelco Semiconductor division. The Philco-Ford Corp.'s Microelectronics division, aided perhaps by its close ties to concerns in the consumer goods and automotive fields, increased its output by 15 times over year-earlier levels.

In the early 1970's when the average unit price of linear ic's should be low enough for consumer markets, particularly the cost-con-

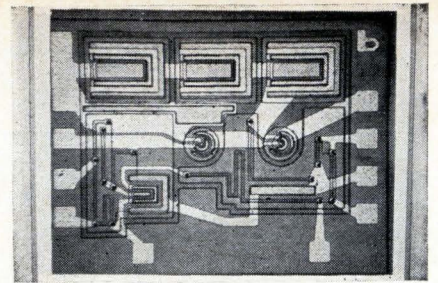

Versatility. Philco-Ford circuit can operate as three different kinds of amplifier, depending upon the choice of off-the-chip devices.

scious automotive and entertainment fields, growth could eclipse today's fast pace. Meanwhile, ic manufacturers are eyeing such industrial and commercial outlets as instrumentation, medical electronics, controls, and power supplies. Computer makers and other original-equipment manufacturers using discrete devices to interface with digital ic's are also prime marketing targets.

Among the linear wares recently introduced, or in the works, are: high-frequency amplifiers; voltage regulators; memory arrays; sense amplifiers; line receivers; comparators; communications circuits; active filters; and lower cost operational and differential amplifiers. Touchtone dialing networks and motor control and timing units are also on the product roster.

Against the odds. Drawing on their experience with digital devices, semiconductor houses have successfully applied their skills to the analog field. "Yields now approach those of digital ic's," says James Solomon, manager of ic research and development at Motorola. "And as is the case with logic units, the prime cost factors have become packaging and assembly."

But much of the credit for extending the electronic capabilities of linear ic's goes to resourceful device designers. To get high-frequency transistor elements, they developed thin collectors with high resistivity. They came up with the buried-layer technique to achieve low-saturation resistances. And for compatible design as well as simplified d-c coupling, they introduced vertical isolated pnp's, lateral pnp's and the substrate pnp. These elements permit operations comparable to those of discrete pnp and npn devices.

Better masking and etching methods have sharpened resolution and decreased resistor widths, increasing resistance values and reducing distributed capacitance. Channel effects have been used to provide higher resistance values.

Where possible, capacitors are moved off the chip or replaced by functionally equivalent active devices. "Transistors are far less costly, require less space, and can provide many of the passive functions," says Jack Gifford, marketing manager for linear IC's at Fairchild. The few capacitors kept on the die are generally for feedback. Direct-coupling is used wherever possible, so that coupling capacitor needs are eliminated. Constant-current sources and biasing arrangements that bypass the need for impractical passive elements are now almost standard practices.

Semiconductor makers have also been working on the power limitations of monolithic linear IC's. Techniques like totem-pole configurations—diode-coupled transistor cascodes—are used to accommodate larger signals in power amplifiers and regulators.

II. End runs

The hybrid approach is another favored way of extending linear capability. Thin and thick film techniques as well as a new approach, dubbed compatible, which combines film elements and monolithic chips [Electronics, June 26, p. 111], are ways of meeting high-frequency, high-voltage and high-power specifications, beyond the reach of monolithic devices. Hybrids are also used to obtain high-grade pnp's, as level-shifters, for custom IC's, and for low-volume applications where the constraint on monolithic is one of economy rather than technology.

Checkout. Hybrids can also prove valuable as prototypes of a monolithic device. The Redeye project, a venture in which the General Dynamics Corp.'s Pomona division was supplied circuitry by Motorola's Semiconductor Products division, provides a case in point [Electronics, Oct. 17, p. 77]. Hybrids proved the feasibility of a micro-electronic approach and influenced the final design of the production-model monolithic IC's that followed. This permitted both design flexi-

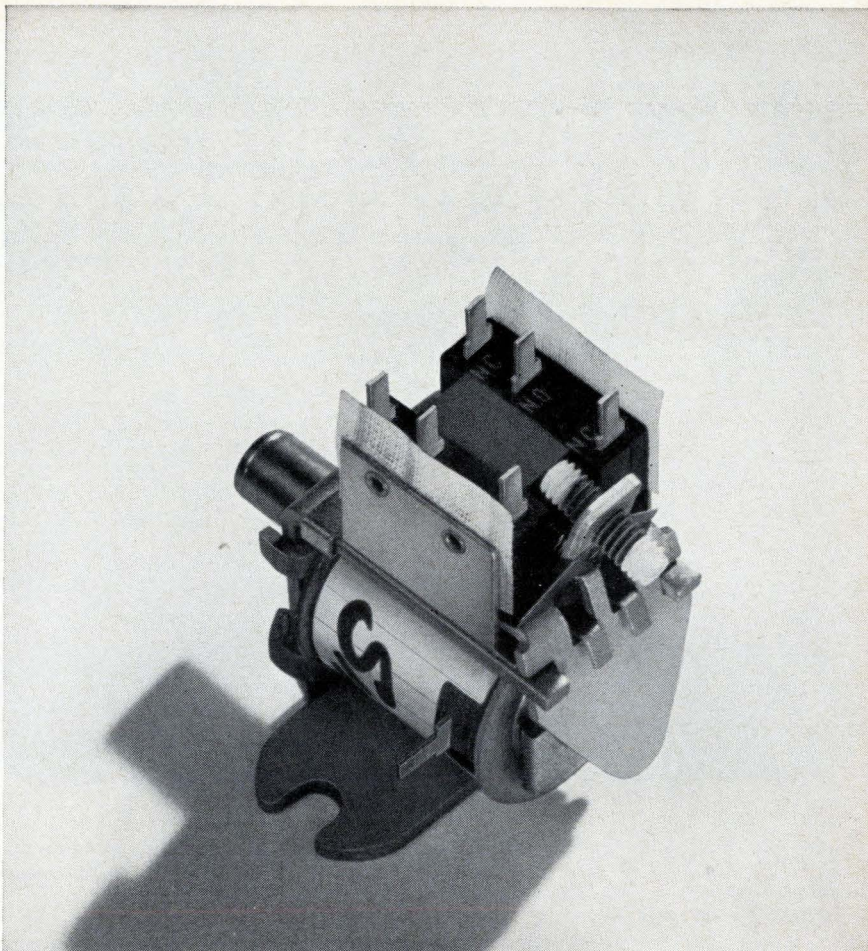

Little Emancipator

You can often do away with a separate slave relay or lock-in circuitry, simply by using a Heinemann Silic-O-Netic® time-delay relay. Its continuous-duty coil can remain energized indefinitely after actuation, and its SPDT or DPDT contacts are rated up to 5 amps (for the Type B shown). Your saving shows up not only in circuit simplicity but in the remarkably low price of the one relay that'll be doing two jobs extremely well.

The five Silic-O-Netic models offer a combination of fast recycling, good repeatability, and low power consumption—virtues inherent in their hydraulic-magnetic actuation. No thermal elements, and therefore no

"heat-loading" on frequent recycling, and only minor effect on delay from ambient-temperature changes.

We offer sixteen standard timings, $\frac{1}{4}$ to 120 seconds, with reset time about 25% of the rated delay; coil ratings (for continuous duty, mind you) up to 250 vac or 120 vdc; plug-in models, hermetic models, open-frame and enclosed-contact models. Bulletin 5006—yours for the asking—will tell you all you want to know about these versatile little t/d relays. Heinemann Electric Company, 2600 Brunswick Pike, Trenton, N. J. 08602.



HEINEMANN

3747

SOLVE YOUR VOLTAGE OR CURRENT SENSING PROBLEMS

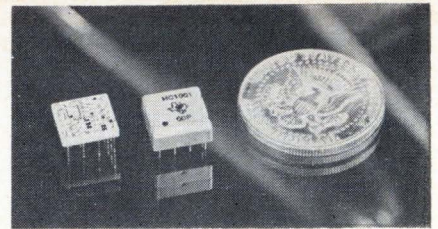

Interim item. Hybrid linear circuit may give way to monolithic devices as demand builds in consumer markets.

bility and a quick turnaround time. In addition, proprietary designs were protected.

Dollars and sense. Another interim role for hybrids has developed—one which may spell the difference between profit and loss during the early stages of manufacturers' march on consumer markets. Generally speaking, where the production volume of a linear IC is less than a few thousand a month over a period of one and one-half years or so, hybrid manufacture is more economical than monolithic. This is because development costs are lower—particularly in the case of products for a customer considering the switch from discrete semiconductor components.

III. Stopgap

One such example is TI's hybrid LIC line for home entertainment equipment [Electronics, June 12, p. 38 and June 26, p. 163]. The linear functions closely resemble those of the monolithic units concurrently introduced by the company's competitors. The hybrids' prices are about the same as those of the monolithic devices.

Texas Instruments is betting that there will be no immediate mass demand for linear IC's from manufacturers of consumer goods. The gamble seems a profitable one. The company's investment in linear devices is less than that of its rivals. In addition, the most likely eventuality is that there will be an interim period of two years or so during which customers will evaluate the IC's before introducing experimental products built around them. Thus, until such time as outlets generate orders in sufficient quantity to make monolithic fabrication a profitable proposition, TI will be able to compete at less cost than its competition. It should also have plenty of time to convert its facilities to monolithic manufacturing.



- **Current Sensing:**
from 0.15 to 5.0 amps

- **Voltage Sensing:**
from 2.0 to 230 volts

- **Differential:**
essentially no difference between contact opening and closing value

- **Response:**
disregards brief transients, responds to small changes which persist

- **Automatic Reset:**
contacts reset when current/voltage returns to normal value

With the widest selection of thermally actuated voltage/current sensing devices

...from G-V

If your component or equipment can be damaged by extended exposure to over voltage or overload . . . a G-V thermally actuated current or voltage sensing device will provide positive protection. These unique devices offer precise cut-off levels, choice of selective response times, automatic reset, and are ambient temperature compensated. Operation is independent of the frequency of the applied voltage, **AC or DC**, in any position. Available in both military and industrial versions. Typical applications include: overload protection, voltage regulation, over-voltage cut-off, under-voltage alarm, low frequency cut-off, battery charge control, and other current or voltage sensing functions.

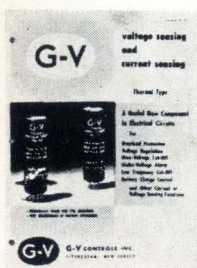

...Bulletin #70-5 includes: applications, functions, response time selection chart, types and mounting forms available, electrical, mechanical and environment specifications.



G-V CONTROLS INC.
LIVINGSTON, NEW JERSEY 07039
(201) 992-6200

The complexity of linears—the number of functions or elements per chip—is also on the rise. Among the more sophisticated monolithic units are two new devices from Philco-Ford's Microelectronics division; each IC performs five functions. [For more on these devices, see page 50.] A number of makers are about to introduce redundant forms of complexity. Such wares as dual operational amplifiers and dual sense amplifiers will typify these efforts.

New gains. In terms of parameters, the monolithic art is also on the move. Breakdown voltages, currently at 40 volts, will climb to a few hundred volts within the next two years. Current handling will rise from 750 milliamperes to several amps; cut-off frequency will go from a few hundred megahertz into the gigahertz range.

"Saturation resistances of internal transistor elements will drop below one ohm, and collector capacitances will be in the nanofarad region. For passive elements, capacitor accuracies will improve about four-fold, reaching 10%. Resistor ratios of 2% will be common," says Sam Wauchope Jr., head of the development lab at the Union Carbide Corp's Electronic division.

Marriages will occur among IC technologies as manufacturers investigate ways to combine monolithics with thin or thick film. Such packages bypass the limitations of passive components and offer a way to incorporate semiconductor elements not presently amenable to monolithic fabrication. Houses now favoring either a monolithic or a hybrid approach will gradually develop products based on both disciplines to achieve marketing flexibility. Many firms will also use metal oxide semiconductor techniques to supplement and complement their bipolar activity.

Competition will be more severe in the linear field than in the digital. Volume is lower, design skills more critical, and, with few exceptions, the products have more definition. With logic IC's, one gate resembles another, and the families that have evolved are fairly similar. With linear IC's, however, a few more decibels, a broader bandwidth, less distortion, or a lower cost, can make all the difference to customers for home performance and price are paramount.

basic measuring tools from

**HEWLETT
PACKARD**

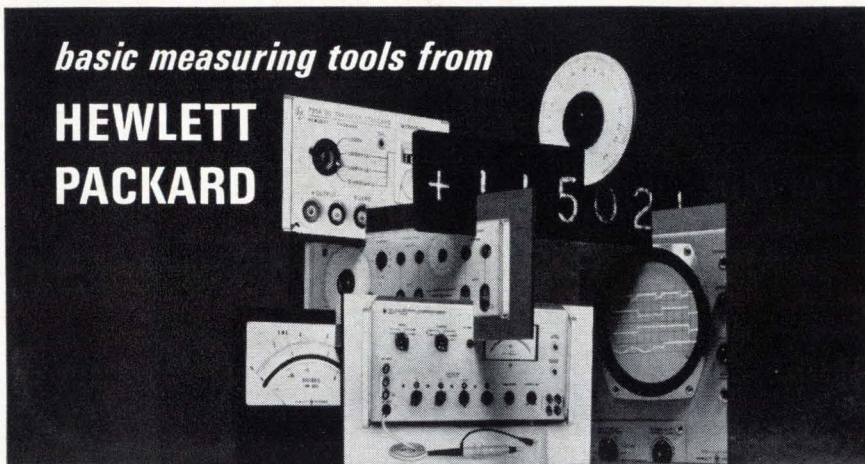

Field-proven
hp 428B Clip-on DC Milliammeters

Totally unique concept for current measurement
Measure current, 1 ma to 10 a full scale, without breaking a lead
No circuit interruption
No circuit loading
Measure dc in the presence of ac

Use it for:

Fast computer circuit testing
Combined measurements for sum of or difference between currents
Transistor circuit analysis without loading
Low-frequency ac current measurements with external metering or recording of front-panel proportional output, dc to 400 Hz

A unique concept, involving a clip-on probe, lets you measure dc currents without breaking a lead, without loading or interrupting the circuit being measured. No direct connection to the measured circuit, no effect from ac, such as common mode. Probe insulated from voltages as high as 300 v. The probe merely clips around the lead, gives a reading based on the magnetic field caused by the dc current flow. Loop several turns of the lead through the probe to increase meter sensitivity. Accuracy $\pm 3\%$, ± 0.1 ma of full scale, 0-55°C. 428B, 0.1 ma to 10 a, \$600*, offers output proportional to full-scale deflection.

Accessories include 3528A Current Probe, for measurement in conductors up to 2½", with degausser, \$450, and 3529A Magnetometer Probe 0.1 milligauss to 10 gauss, \$75.

Request a demonstration from your Hewlett-Packard field engineer or write for complete specifications to Hewlett-Packard, Palo Alto, California 94304, Tel. (415) 326-7000; Europe: 54 Route des Acacias, Geneva.

*\$5 additional for rack-mount model.
Data subject to change without notice.
Prices f.o.b. factory.

HEWLETT  **PACKARD**
An extra measure of quality

909



428B

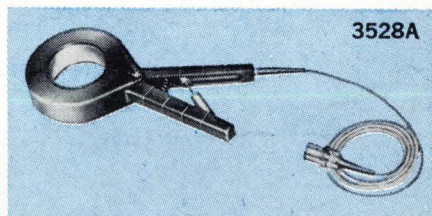

3528A

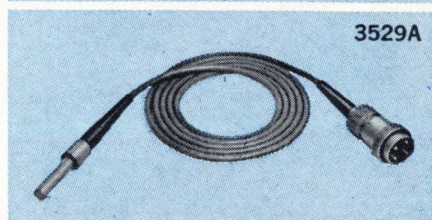

3529A

Report from

**BELL
LABORATORIES**

A fast-acting detector of infrared light

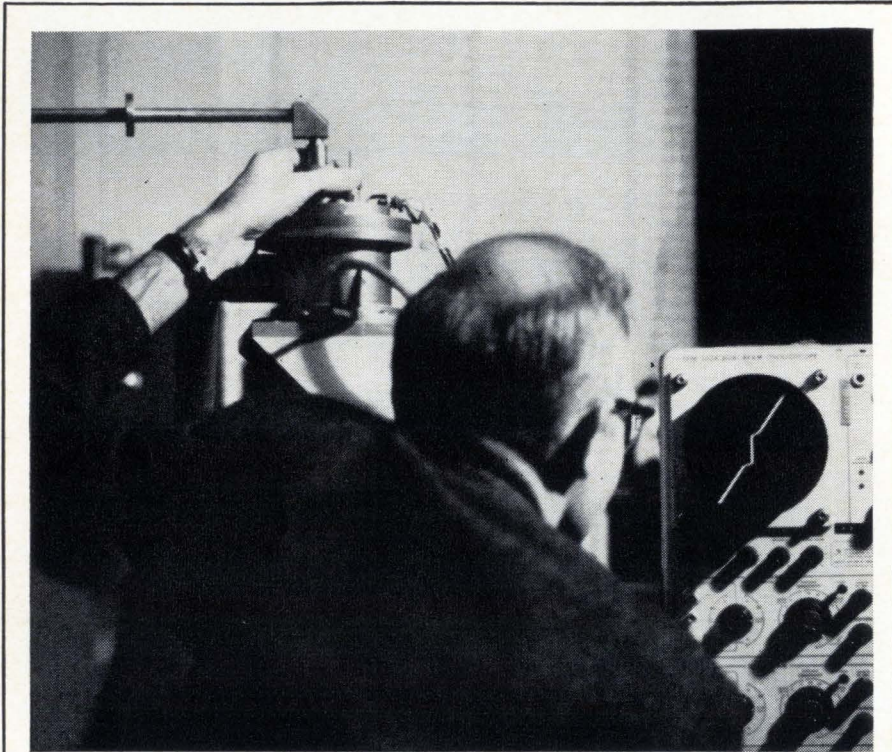

Bell Laboratories research physicist C. C. Grimes adjusts contact pressure in cryogenic apparatus in which infrared radiation is detected by a superconductor point-contact junction. Oscilloscope shows the junction's voltage/current characteristic (graph below) derived by passing a low-frequency sinusoidal current through the junction. The junction, submerged in a dewar of liquid helium, exhibits a sharp increase in voltage in the presence of electromagnetic radiation. Infrared signals enter from left through the horizontal light pipe (above left hand) and are reflected down toward the junction.

Behavior of a superconductor point-contact junction. A direct current flows at no voltage (origin O to A). After transition (A to B), the curve approximately follows Ohm's law. At a constant bias current within the transition region, the junction is sensitive to electromagnetic fields. When no field is present, the junction characteristic is the solid line. In the presence of infrared, however, the characteristic is the dashed line. The alternating voltage (square wave) is generated as the radiation shifts the operating point of the junction from X to Y.

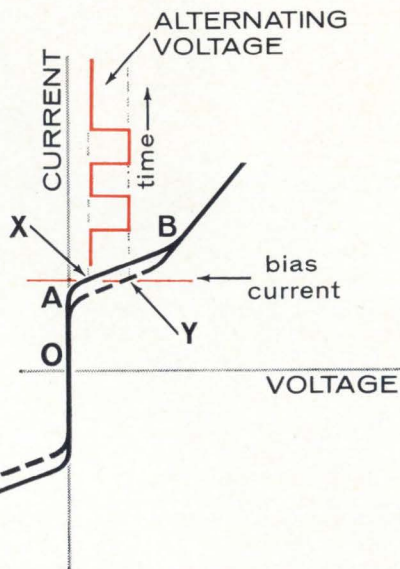

If two sharp points of superconductor are lightly pressed together, a small direct current can be made to flow between them at zero voltage . . . much as if they were a single piece of superconductor. But, if the current (controlled by external circuitry) is increased beyond a certain critical value, the contact changes electrically and a voltage appears across it.

The critical current value (A on graph) is highly sensitive to external electromagnetic fields. Such fields cause the voltage to appear at a lower current. In this instance, then, the contact is analogous to a "Josephson junction" (after Brian Josephson of Cambridge University who predicted properties of superconductor contacts), and can act as a detector of electromagnetic radiation. Some time ago, a junction composed of thin films of superconductor separated by an oxide layer was shown to work at frequencies up to 25 GHz.

Now, at Bell Telephone Laboratories, researchers Charles C. Grimes, Paul L. Richards, and Sidney Shapiro have devised and demonstrated a superconductor point-contact junction that detects infrared signals . . . up to 1500 GHz. The present experimental form responds to infrared pulses as short as 0.1 microsecond and promises to operate at 1-nanosecond intervals. This has practical importance because heretofore there have been few devices that react as rapidly and as sensitively to submillimeter or far-infrared radiation (wavelengths from 100 to 1000 microns).

The range of peak sensitivity varies with different superconductors. Indium is most sensitive at wavelengths near 2000 microns; niobium shows several peaks—at approximately 333, 500 and 1250 microns.



Bell Telephone Laboratories
Research and Development Unit of the Bell System

\$25,000 inertial system still a will-o-the-wisp

But an Air Force development team believes that flight tests will prove its prototype can provide more reliability per dollar than available units

By Lawrence Curran

Los Angeles Regional editor

When the Air Force sent a small group of officers and engineers to Holloman Air Force Base near Alamogordo, N.M., four years ago, its dream was to develop a low-cost inertial navigation system. Late this month, the detachment will begin flight-testing the first of two new "economy" models, dubbed Locating for low-cost inertial navigation. However, the dream of a bargain-priced system remains as elusive as ever: equipment would cost twice the targeted sum even on volume buys.

Inertial navigation systems are self-contained guidance packages which typically incorporate a digital computer, associated analog circuitry, controls, an inertial measurement unit, and a display. Although accurate as well as inherently interference-free and jamproof, inertial navigation systems were complex, expensive, and sometimes unreliable at the time the Holloman team began its Locating project. However, the group believes it has largely overcome these obstacles and given vendors an incentive to pare the cost of their systems.

I. Dual purpose

On the premise that no one company can supply the best of everything for an inertial system, the Holloman team went shopping for components that they could integrate. Original goals were a system that would cost \$25,000 in quantities of 200 or more; yield an accuracy of three nautical miles an hour; and have a useful life of 25,000 hours [Electronics, May 17, 1965, p. 108].

Establishing the Holloman detachment was at least as important an objective of the project as developing the inertial navigation unit. Before setting up the group, the Air Force didn't have any experts of its own who could develop and evaluate inertial navigation systems. Although based at Holloman, the 11-man team is part of the Wright-Patterson Air Force Base in Dayton, Ohio. Officially known as detachment 1 of the Avionics Laboratory, the group is under the command of Maj. Robert V. Plank; William J. Laubendorfer is technical director.

Day of reckoning. Flight tests will determine how close the detachment has come to achieving its technical goals. One original objective—2,500 hours mean time between failure—has unaccountably gone by the boards. The calculated mtbf for the first version, model A, is 1,200 hours. Laubendorfer says he doesn't know where the 2,500-hour figure came from and claims it is not accurate. In addition, the financial target has already been missed. The first system built by detachment 1 would cost almost \$45,000 per unit in quantities of 200—about double the price the group was shooting for. However, Laubendorfer says, "The important thing is that the cost of available systems is coming down and reliability is going up."

The system, which will probably never be bought in quantity, was built to demonstrate the feasibility of reliable, low-cost inertial navigation systems and to establish an inertial navigation standards group

within the Avionics Laboratory.

The detachment was recently directed to take responsibility for advanced aircraft navigation systems development. Its first assignment will be to develop an integrated system using inertial, doppler, and loran techniques.

Laubendorfer believes commercial manufacturers of inertial navigation systems regard the Holloman detachment as a friendly rival since the group is working toward an optimum low-cost unit incorporating subsystems supplied by inertial vendors.

Economy models. Laubendorfer thinks his team's work has been a factor in the downward price trend that he notes. He cites the Low-cost Inertial Platform made by the Kearfott division of General Precision Inc. and Teledyne Inc.'s Flight Reference Stabilization System. Teledyne's unit has an estimated cost of between \$25,000 and \$35,000. Kearfott equipment, now flying aboard the Navy's PC3 and Air Force's Thunderstreak II, is priced in the \$75,000-\$100,000 range, but this might be shaved to about \$50,000 for production quantities of 3,000 to 4,000, according to a company spokesman. This source is doubtful about the chances of cutting inertial navigation system prices to \$25,000. "It's a fine objective," he says, "but you can't buy accuracy cheaply."

II. Sum of the parts

Model A of the Locating system has four principal subsystems: gyro; accelerometer; computer; and gimbal. Each is a modified version of

... the logic in the main processors employs IC's almost exclusively ...

available equipment; the entire unit is built around a Holloman-developed platform electronics and power supply package.

Among the gyros considered were the G-10 and G-40 units built by the Autonetics division of North American Aviation Inc.; Litton Industries Inc.'s Vibrarotor; the Conductor Corp.'s RGG-1; the International Telephone & Telegraph Corp.'s HERO unit; and Kearfott's Gyroflex.

The Gyroflex, which edged out its competition, is a two-degree of freedom, dry, flexure-joint-suspended, free-motor gyro. Its unique feature is a rotating axial and radial suspension through which the free rotor is driven. A single-stator hysteresis-synchronous motor, inductive signal generator, and d'Arsonval torque generator are the principal subassemblies. The unit was chosen because among the newer ones considered, it seemed to be the gyro most likely to be available for use in the six systems the detachment planned to build. There are two Gyroflex assemblies in the Locating system now being readied for flight tests. Excitation frequency of the signal generator is 13.4 kilohertz in the A system and 19.2 khz in the B system.

Among the accelerometers Holloman evaluated were the Model 7 made by the Bell Aerosystems division of Textron Inc.; Kearfott's 2414; Autonetics' Electromagnetic Accelerometer (EMA); Litton's Quartz Resonator; and Teledyne's FP-1.

The Kearfott's 2414, which was picked for the horizontal axes, is a two-axis device that uses flex leads and is fluid filled. Its two torquing loops are essentially independent. The Autonetics unit got the nod as the vertical accelerometer. It is a single-axis, closed-loop, torque rebalance instrument.

In both the 2414 and EMA units, an acceleration along the input axis is sensed by the pendulous mass on which the signal generator is mounted.

Dealer's choice. Kearfott's model 2414 horizontal accelerometer was selected largely because it outperformed its competitors, but price

was also a factor. Laubendorfer believes the unit offers lower cost per velocity channel than the other accelerometers considered. The Holloman group modified the 2414 by placing some of the signal generator's electronics on the side of the accelerometer rather than on the bottom.

Autonetics' EMA vertical accelerometer had no competition. It was the only digital unit that met the detachment's requirement for small size. The team installed the unit virtually unchanged in model A.

Computer competition. Eight firms submitted proposals for the computer subsystem. A version of the Nortronics NDC 1050, designated 1050A, is installed in the first flight model Locating system. The machine, built by the Nortronics division of the Northrop Corp., is a general-purpose digital computer with a coincident core memory. The programable memory can accommodate 2,048 words of 19 bits each. There is also a parity bit for error detection. The Nortronics computer's clock rate is 268 khz, and its calculated mean time between failure is 8,082 hours.

For the B model system, Lear Siegler Inc. is supplying a computer based on its Divic line [Electronics, Feb. 20, p. 203]. The machine which has been accepted by the Holloman detachment has not yet been delivered. Its navigation program will be stored in a core rope memory, which will be virtually unalterable after it leaves the manufacturing plant. The Divic offshoot is unique in that its arithmetic section is designed to solve trigonometric problems as fast as many computers can do simple multiplication. It can handle 29 navigation problems per second, operating at a clock rate of 3 to 4 megahertz.

The logic in the main processors of both the Nortronics and Lear Siegler machines employs integrated circuits almost exclusively. Standard 14-lead flatpack diode transistor logic elements are used. The Holloman group estimates that approximately 750 ic's will be needed in each computer.

Both computers are programed

with equations developed by Autonetics for calibration alignment, course steering error, and navigation. Called unipolar equations, they are more accurate for navigation near the earth's poles than are conventional two-pole equations. In addition, less memory is required because only three direction cosines are used instead of the nine in other navigation equations.

The Sperry Gyroscope Co., a division of the Sperry Rand Corp., is furnishing the gimbal subsystem. The company's SGN-10 beat out entries from the American Bosch Arma Corp., Autonetics, Litton, and the Norden division of the United Aircraft Corp. Laubendorfer says the SGN-10 gimbal "skeleton" was chosen because it offered a bit more latitude in selection of inertial components than other systems. Its chief advantage is a greater allowable swept volume than other gimbal sets. This feature appealed to the Holloman detachment because at the time they hadn't selected the inertial components and wanted flexibility.

The SGN-10 gimbal set has been extensively modified at Holloman. The only Sperry parts remaining are the case, the outer roll and pitch gimbals, and the inner roll gimbal. The detachment designed its own azimuth cluster to mount the accelerometers, gyros, analog-to-digital electronics, redundant axis capture loop, and synchro analog-to-digital converter.

III. The mating game

"Marrying all these subsystems is a significant interface engineering job," says Laubendorfer. The Holloman detachment integrated the Locating system's major components—the computer, the platform electronics and power supply (PEPS) and the platform itself, which houses the gyros, accelerometers, gimbals, and associated electronics. With the exception of the spin motor power supply for the gyros, which was purchased from Kearfott, the platform electronics and power supply apparatus was all developed by the Holloman group.

On their own. Laubendorfer believes his team was one of the first to successfully design servos for vibratory inertial instruments—perhaps the most challenging task involved in such systems. Litton and

Kearfott are among the outfits doing similar work commercially.

About 40% of the circuitry in the PEPS is integrated, but there is no heavy IC concentration in any one area.

IV. Costs plus

To date, approximately \$3 million has been spent on developing the Locating systems. Maj. Plank breaks down costs of major subsystems in the A model this way, based on theoretical procurement quantities of 200: computer subsystem, \$16,800; gyro subsystem, \$10,000; gimbal subsystem, \$8,800; accelerometer subsystem, \$6,065; platform electronics and power supply, \$2,900.

The A model was assembled on the bench, and the detachment tested it to determine the adequacy of the computer program. The next step will be to mount the initial system in two different aircraft types—first a C-131 and then an F-106. Ten flights are scheduled; they will be conducted by a testing arm of the Air Force Missile Development Center at Holloman. The Locating system will be put through various flight profiles that accentuate certain system errors to determine whether it can do the job for which it was designed. Laubendorfer is confident the A model will meet the stringent navigation accuracy requirement of three nautical miles per flight hour—three sigma radial performance. In other words, an aircraft using the system would be within three nautical miles of its intended course 99% of the time.

Laubendorfer says the unit will calculate and display the following information to any of four destinations: time to destination; distance to destination; true course estimated time of arrival; cross-track distance; heading; bearing of the platform X-axis vs. true north; ground speed; ground track; and latitude and longitude.

Make ready. About 30 minutes are required for warmup and calibration. The system has four modes: off, standby, calibrate-align, and navigate. In the standby mode, platform temperature is brought up to the normal operating level of 150°F and the gyros are brought up to speed. Coarse leveling of the platform is also part of



financeability

(low, low interest rates)

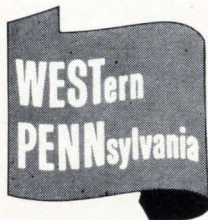

In WESTern PENNSylvania, you can obtain 100% financing of industrial plant space at average interest rates as low as 4%. This can result in savings of as much as \$106,828 on a 62,000-square-foot industrial plant. In addition, financing of industrial machinery and equipment and loans for working capital are readily available. This complete financeability . . . plus a fair tax climate . . . pre-production training of a work force, usually at no cost to you . . . four-season livability . . . gives WESTern PENNSylvania a top combination of plant-location values.

West Penn Power

Part of the Allegheny Power System 

Area Development Department, Room 761

Phone: 412-837-3000

WEST PENN POWER—Greensburg, Pa. 15601

In strict confidence, I'd like to know more about WESTern PENNSylvania's:

- Financing Plans
- Fair Tax Climate
- Pre-Production Training
- Industrial Properties and Shell Buildings
- Please have your Plant Location Specialist call.

Name _____ Title _____

Company _____

Address _____

City _____ State _____ Zip Code _____ Phone _____

the standby mode. When these operations are complete, the unit is switched manually into the calibrate-align mode, which includes a first alignment, azimuth slew, and a second alignment. Then the unit is ready to navigate.

During the early stages of the Locating program, consideration was given to a nuclear power supply to maintain operating temperatures and speeds, thus eliminating part of the 30-minute warmup. That idea has been abandoned because of a lack of manpower. The system will get its power from the 28-volt direct current of the aircraft. The model A has a backup power supply consisting of conventional C- or D-type batteries in a modular rack, which can keep the system operating for as long as five minutes in case of an interruption in aircraft power. But Laubendorfer says power interruptions longer than 50 milliseconds are rare.

V. Next step

Even before the model A has flown, the Air Force team is well into the task of assembling its successor. Model B is expected to be ready for flight tests in November. The principal changes are adoption of a Kearfott gimbal set, use of the Lear Siegler computer, and a re-designed platform electronics and power supply.

The gimbal was chosen because it now appears that Kearfott's Gyroflex gyro and its 2414 accelerometer will be available sooner than other hardware for a new generation of aircraft inertial navigation systems. "The gimbals will maximize the performance of the Gyroflex gyro and the 2414 accelerometer," Laubendorfer asserts. The new platform electronics and power supply is designed to provide more effective heat sinking for the electronic components. Laubendorfer says his group has also improved the circuit board layouts for the gyro-torquing electronics, the synchro a/d gimbal section, the accelerometer a/d function, and the d-c power supplies.

The B model will be lighter, smaller, easier to produce, and more reliable than its predecessor, which weighs 150 lbs., fills 2.5 cubic feet, and draws 520 watts of power.

Motorola's Plastic Transistor HANDYLab

the complete working tool for the initial design stage!

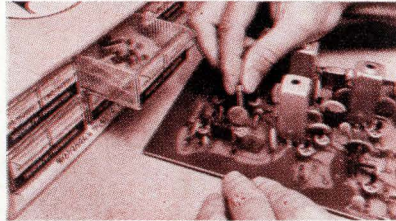

CAREFULLY-SELECTED DEVICE ASSORTMENT of twelve different general-purpose plastic anular transistors and dual switching diodes.

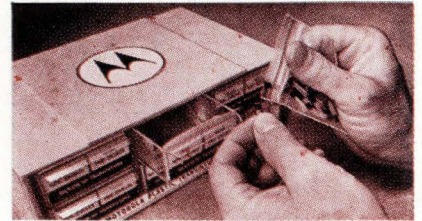

COMPACT 6-DRAWER STYRENE CABINET plus individual, snap-lid pouches for each device.

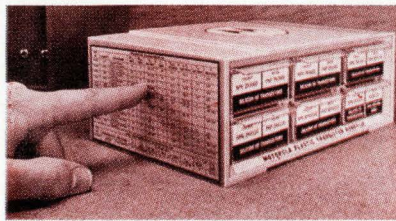

DETAILED DEVICE SELECTION CHART instantly visible on ends of cabinet.



12-PAGE HANDYLab BOOKLET containing suggestions on low-cost industrial circuits.

AVAILABLE THROUGH YOUR FRANCHISED MOTOROLA DISTRIBUTOR

EASTERN

ALABAMA, Huntsville 35805	(205) 881-7737	Gulf Semiconductors, Inc.
CONNECTICUT, Hamden 06514	(203) 288-7771	Cramer Electronics, Inc.
D.C., Washington 20001	(202) HUBon 3-5200	Electronic Wholesalers, Inc.
FLORIDA, Miami 33142	(305) 887-6541	Gulf Semiconductors, Inc.
GEORGIA, Atlanta 30318	(404) 355-2223	Jackson Electronic Supply Co., Inc.
MARYLAND, Baltimore 21230	(301) 539-6525	Pyltropic Industries, Inc.
MARYLAND, Baltimore 21229	(301) 646-3000	Electronic Wholesalers, Inc.
MASSACHUSETTS, Cambridge 02139	(617) 864-0400	R & D Electronics Supply Co., Inc.
MASSACHUSETTS, Newton 02164	(617) Woodward 9-7700	Cramer Electronics, Inc.
NEW JERSEY, Moorestown 08057	(609) 235-1900	Angus, Inc.
NEW YORK, Binghamton 13902	(607) 748-8211	Federal Electronics, Inc.
NEW YORK, Buffalo 14202	(716) TT 4-3450	Summit Distributors, Inc.
NEW YORK, Flushing 11369	(212) GR 8-4000	Cramer/Esco
NEW YORK, New York 10013	(212) YUKon 9-1600	Milgray Electronics, Inc.
NEW YORK, Syracuse 13211	(315) 454-9247	Cramer/Eastern
NEW YORK, Westbury, L.I. 11591	(516) ED 4-7474	Schwabe Electronics
NORTH CAROLINA, Winston-Salem 27102	(919) Park 5-8711	Electronic Wholesalers, Inc.
PENNSYLVANIA, Philadelphia 19109	(215) WA 5-6900	Radio Electric Service Co. of Pa.
PENNSYLVANIA, Pittsburgh 15218	(412) 351-3611	Semiconductor Specialists, Inc.

CENTRAL

ILLINOIS, Chicago 60680	(312) HA 1-6800 - TA 9-9100	Allied Electronics Corp.
ILLINOIS, Chicago 60624	(312) 638-4411	Newark Electronics Corp.
ILLINOIS, Chicago 60666	(312) 279-1000	Semiconductor Specialists, Inc.
IOWA, Cedar Rapids 52406	(319) 365-7551	Deeco, Inc.
KANSAS, Kansas City 66103	(913) AD 6-4343	Hall-Mark Electronics Corp.
LOUISIANA, New Orleans 70112	(504) 522-8726	Sterling Electronics, Inc.
MICHIGAN, Detroit 48240	(313) 255-0300	Semiconductor Specialists, Inc.
MICHIGAN, Detroit 48227	(313) Broadway 2-4212	Radio Specialists Co., Inc.
MINNESOTA, Minneapolis 55403	(612) 339-9461	The Lew Bonn Co.
MINNESOTA, Minneapolis 55423	(612) 866-3434	Semiconductor Specialists, Inc.
MISSOURI, St. Louis 63134	(314) JA 1-8866	Semiconductor Specialists, Inc.
OHIO, Cincinnati 45237	(513) 761-5432	Sheridan Sales Co.
OHIO, Cleveland 44103	(216) 432-0010	Pioneer-Standard Electronics, Inc.
OHIO, Cleveland 44133	(216) 237-9145	Sheridan Sales Co.
OKLAHOMA, Tulsa 74118	(918) TE 9-8458	Hall-Mark Electronics Corp.
TEXAS, Dallas 75220	(214) Fleetwood 7-9131	Sterling Electronics
TEXAS, El Paso 99903	(915) 533-9555	Midland Specialty Co.
TEXAS, Dallas 75231	(214) AD 1-6111	Hall-Mark Electronics Corp.
TEXAS, Houston 77042	(713) SU 1-0014	Hall-Mark Electronics Corp.
TEXAS, Houston 77001	(713) CA 5-1465	Lenert Co.

WESTERN

ARIZONA, Phoenix 85009	(602) 272-2601	Hamilton Electro of Phoenix
CALIFORNIA, Inglewood 90301	(213) ORegon 8-8111	Liberty Electronics Corp.
CALIFORNIA, Los Angeles 90230	(213) UP 0-7171	Hamilton Electro Sales
CALIFORNIA, Los Angeles 90022	(213) OV 5-5888	K-Tronics
CALIFORNIA, Oakland 94607	(415) Templebar 4-3311	Elmar Electronics
CALIFORNIA, Mountain View 94040	(415) 961-3611	Elmar Electronics
CALIFORNIA, Mountain View 94040	(415) 961-7000	Hamilton Electro Sales
CALIFORNIA, San Diego 92123	(714) BRowning 8-2112	Kieruff Electronics, Inc.
CALIFORNIA, San Diego 92109	(714) 274-3131	San Delcor, Inc.
COLORADO, Denver 80204	(303) Tabor 5-7033	Kieruff Electronics Co., Inc.
NEW MEXICO, Albuquerque 87108	(505) 268-3901	Kieruff Electronics Co., Inc.
UTAH, Salt Lake City 84110	(801) 363-5821	W. H. Bantz Company
WASHINGTON, Seattle 98121	(206) ATwater 2-3836	Hamilton Electro of the Pacific Northwest

CANADA

MONTREAL, P.Q.	(514) 861-2411	Cesco Electronics Ltd.
MONTREAL, P.Q.	(514) 735-2471	Zenitronics (Quebec) Ltd.
OTTAWA, Ont.	(613) 729-5118	Cesco Electronics Ltd.
QUEBEC CITY, P.Q.	(418) 524-3518	Cesco Electronics Ltd.
TORONTO, Ont.	(416) 638-5250	Cesco Electronics Ltd.
TORONTO 19, Ont.	(416) 787-1271	Zenitronics Ltd.
VANCOUVER, B.C.	(604) 685-4628	Bovtek Electric Co. Ltd.
VANCOUVER, B.C.	(604) 736-6411	L. A. Varah Ltd.
WINNIPEG, Man.	(204) 942-0901	Cam Gard Supply Ltd.



MOTOROLA Semiconductor Products Inc.

Box 955, Phoenix, Arizona 85001 • (602) 273-6900 . . . TWX 910-951-1334



plastic semiconductor center
of the world

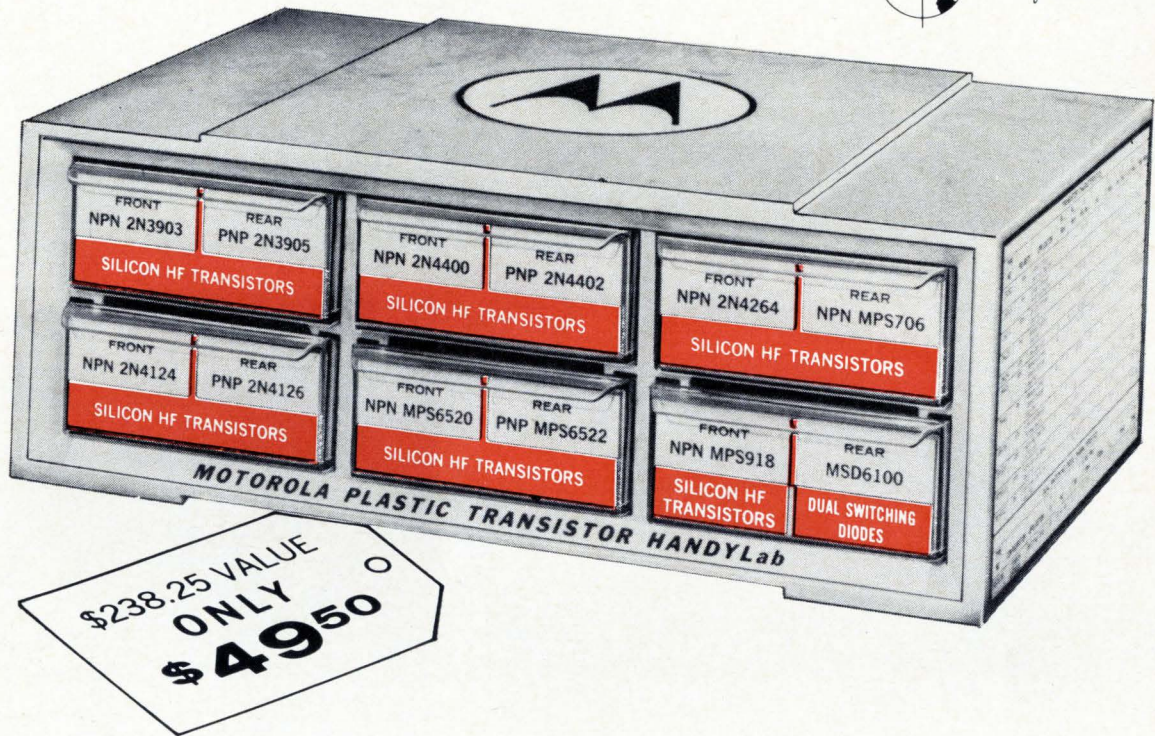

BUILD YOUR PROTOTYPE USING...

Motorola's New Plastic Transistor HANDYLab* For Low-cost Industrial Circuits

Here's a new approach to increased efficiency in your prototype designs on advanced industrial circuits. The Motorola Plastic Transistor HANDYLab contains 25 each of 12 different general-purpose, high-performance plastic transistors and dual switching diodes — or a total of 300 devices — in a handy 6-drawer, 3½ x 9¾" cabinet.

Use the HANDYLab kit as your design center and avoid time lost for lack of the device you need when you need it. The HANDYLab puts at your fingertips a broad selection of both NPN and PNP annular** devices, including units for low and medium current switching and amplifier performance, as well as the unique common-cathode dual switching diode.

- ELIMINATES SMALL-QUANTITY ORDERS
- ELIMINATES ODD-LOT INVENTORIES
- ELIMINATES DELIVERY DOWN-TIME

**300-Piece Assortment — At Less Than One-Fifth
the Cost of the Same Devices in Low Quantity Lots**

25 OF EACH DEVICE TYPE:

2N3903 (NPN)	2N4264 (NPN)	MPS918 (NPN)
2N3905 (PNP)	2N4400 (NPN)	MPS6520 (NPN)
2N4124 (NPN)	2N4402 (PNP)	MPS6522 (PNP)
2N4126 (PNP)	MPS706 (NPN)	MSD6100 (Dual Switching Diode)

For details, call your Motorola distributor or write Motorola Semiconductor Products Inc., Box 955, Phoenix, Arizona 85001.

- where the priceless ingredient is care!



MOTOROLA
Semiconductors

*Trademark of Motorola Inc. **Annular Semiconductors patented by Motorola Inc.



Greater channel capacity by existing Pacific cables

A new carrier telegraph system . . . "RECTIPLEX"

A brilliant development in multiplex telegraphy, called RECTIPLEX, will be put into Trans-Pacific telegraph service between Japan and U.S.A. in early 1968. It was developed by FUJITSU under a joint research plan with Kokusai Denshin Denwa Co., Ltd. (Japan Overseas Radio and Cable System).

The big problem was how to economically increase the speed and capacity of communication especially where cable installation or "for hire" cable is too costly . . . the trans-continental

or transoceanic, for example. The RECTIPLEX, in which unique eight-phase modulation enables carrying of three binary channels on one carrier, can transmit 108 binary channels of 50 bauds each over a single voice channel. RECTIPLEX line capacity is increased fivefold over that of the conventional 50-baud frequency modulation multiplex.

In addition, the bandpass filter is replaced by an integrator to achieve effective band utilization. An outstand-

ing demodulator eliminates noise, error and line interruption. And the RECTIPLEX handles higher speed transmission as well as standard 50-baud telegraph signals. These fine qualities promise a brilliant future in efficient data transmission as high-performance terminal equipment.

This is yet another example of innovation by FUJITSU, where brilliant initiative and mature experience are constantly focused on every problem of communications and electronics.



FUJITSU LIMITED

Communications and Electronics

Marunouchi, Tokyo, Japan

NOW...a full-sized **VOM** in a palm sized "package"

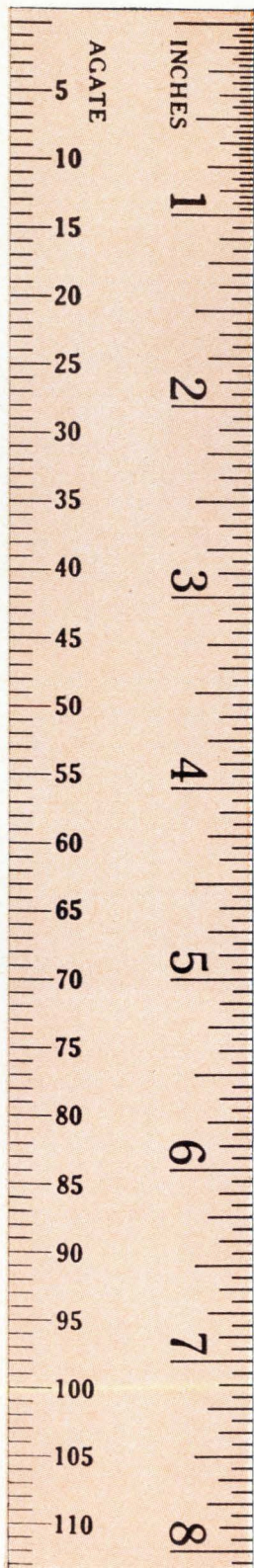

160 Volt-Ohm-Milliammeter
Complete with alligator clip
leads and operator's manual.

..... \$50.00



Carrying Case—
Cat. No. 2225..... \$ 9.50
Accessory Leads—
Probe Tip Lead—
Cat. No. 2055..... \$ 2.75

Simpson 160 Handi-VOM

Simpson Handi-VOM gives you the ranges, the time-saving conveniences and the sensitivity of a full-sized volt-ohm-milliammeter—yet it's only 3-5/16" wide, weighs a mere 12 ounces. Recessed range-selector switch never gets in the way . . . polarity-reversing switch saves fuss and fumble. Self-shielded taut band movement assures high repeatability and freedom from external magnetic fields. Diode overload protection prevents burn-out—permits safe operation by inexperienced employees and students. The demand is BIG, so get your order in to your electronic distributor, TODAY!

RANGES

ACCURACY: $\pm 3\%$ FS DC, $\pm 4\%$ FS AC
DC VOLTS: 0-0.25, 1.0, 2.5, 10, 50, 250, 500, 1000 @ 20,000 Ω/V
AC VOLTS: 0-2.5, 10, 50, 250, 500, 1000 @ 5000 Ω/V
DC MICROAMPERES: 0-50
DC MILLIAMPERES: 0-1, 10, 100, 500
DB: -20 to +10, -8 to +22, +6 to +36, +20 to +50
"0" REFERENCE: 1 MW into 600 Ω
RESISTANCE: Rx1, (30 Ω center)
Rx10, Rx100, Rx1K, Rx10K



DIVISION



SIMPSON ELECTRIC COMPANY

5200 W. Kinzie Street, Chicago, Illinois 60644

Phone: (312) 379-1121

Export Dept: 400 W. Madison Street, Chicago, Illinois 60606. Cable, Simelco

IN CANADA: Bach-Simpson Ltd., London, Ontario

IN INDIA: Ruttonsha-Simpson Private Ltd., International House, Bombay-Agra Road, Vikhroli, Bombay

WORLD'S LARGEST MANUFACTURER OF ELECTRONIC TEST EQUIPMENT

RESEARCH AND ENGINEERING

Function

The Research and Engineering organization is the principal source of all programs that originate at the Fort Worth Division of General Dynamics. R&E personnel undertake the basic and applied research which leads to the definition and design of new aerospace systems. The broad scope of the R&E functional responsibility includes the continuous development of new programs and the technical management of major hardware projects from the conceptual stage through the operational phase.

Organization

Research and Engineering is organized essentially in terms of principal engineering functions. Each of the five departments is responsible for the tasks which fall within its technical surveillance whether this task entails research, development, design or production. As a result of this functional organization structure, individual engineers have an opportunity to be familiar with a variety of programs simultaneously. The diversity of experience not only prevents overspecialization but it allows the individual to benefit from a fertile flow and interchange of ideas. When technical management activities must be coordinated across the functional departmental lines, project offices are established within the R&E organization; this project management experience provides another dimension to professional growth.

Activities

Engineering resources are being utilized on the complex tasks associated with preparing the F-111 A and B airplanes for their operational roles and with designing and developing other members of the 111 family. Engineering skills are being used, also, in the formulation of completely new aircraft product lines and space surveillance systems.

To accomplish these activities, R&E personnel research, analyze, design, integrate, test, plan, implement, manage, monitor, administer, and support. Methods and techniques have to be updated, unique capabilities have to be expanded, facility needs have to be identified and enlarged, expertise has to be enhanced, experimental and analytical data has to be added to—all a continuing set of activities. And a purposeful set of activities that an engineer finds technically rewarding.

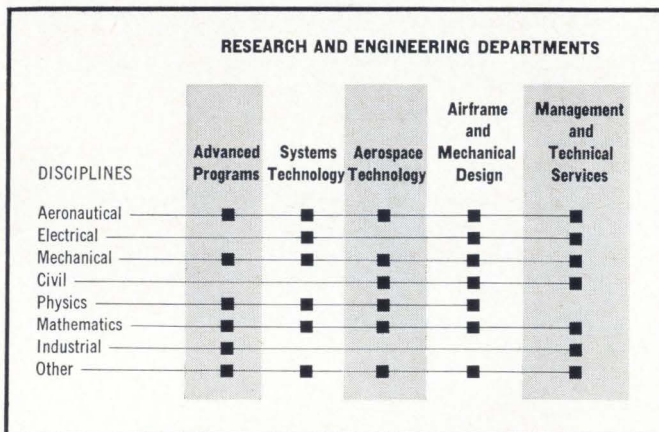
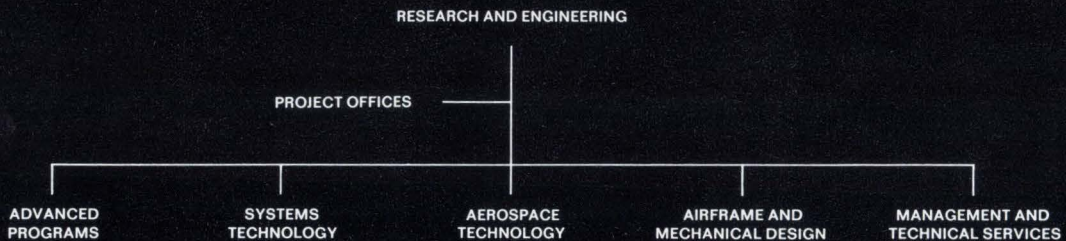

The upper levels of opportunity in research, development, design, test and evaluation await your creative engineering or scientific capabilities in the many advanced aerospace projects at the Fort Worth Division of General Dynamics. You'll live and work where there's room to grow. Fort Worth's uncongested freeways connect the plant with superior residential areas, and you'll enjoy a broad range of cultural, recreational, and upper level educational facilities. Smog-free air, a mild climate and low living costs make a further contribution to your career satisfaction. Call Collect—817-732-4811, Extension 3551; or send a résumé of your training and experience to Mr. J. B. Ellis, Industrial Relations Administrator-Engineering, General Dynamics, Fort Worth Division, P. O. Box 748E, Fort Worth, Texas 76101. An equal opportunity employer.

GENERAL DYNAMICS
Fort Worth Division

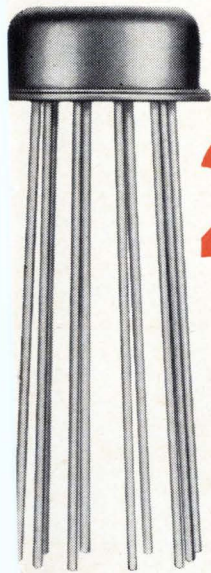

now you can test
**24 parameters of a
10-pin microcircuit
in 2 minutes flat...**

with this new semi-automatic IC analyzer

**MICA
150**

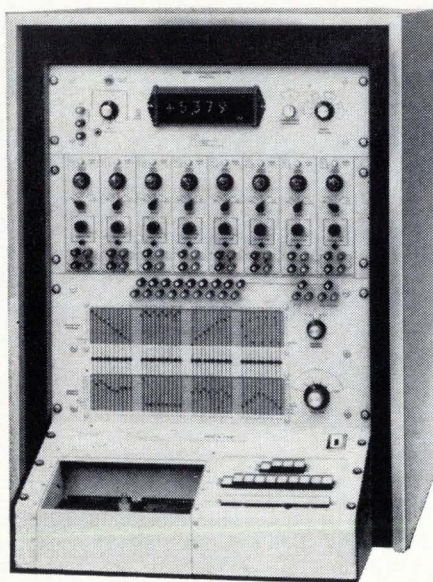

Now even a non-technical operator can speed through comprehensive DC tests on all types of IC packages with from 2 to 40 pins. Test conditions are easily set up on the programming switches of MICA-150 and pushbutton sequencing of the test from pin-to-pin of a device is simple and fast with test results indicated by direct digital readout. On a typical 10-pin, 5-input gate circuit, as many as 24 parameters of the device can be checked within two minutes without changing a single crossbar switch.

For additional information on applications of MICA-150 for DC or high frequency testing, contact W. Leo McBlain, (609) 424-2400

COMPUTER TEST CORPORATION

CHERRY HILL,



NEW JERSEY

Circle 139 on reader service card



Two words caught in the semantics squeeze.

Should you be looking for components that won't ever fail? Is failure rate the only measure of reliability? Is confidence in a supplier bred only by statistical accumulation?

Today, there's no such thing as a part that can't fail. And "statistical confidence" from millions of test hours is economically prohibitive because as failure rates decrease, the cost-of-proof increases sharply.

It comes down to plain old confidence . . . in us and in our production system.

Call it reliability. Call it confidence. We think it's both. And our Director of Reliability makes sure you get it. He's involved in everything from basic designs to final inspection to assure you of homogeneity and performance repeatability.

At IRC confidence and reliability in resistors, in potentiometers and in semiconductors are achieved by discipline, not by selection. Your questions on reliability will get top management attention by writing to our Director of Reliability.

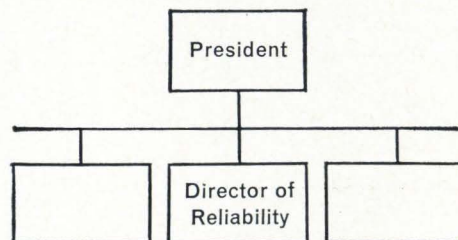

IRC, Inc., 401 N. Broad St., Philadelphia, Pa. 19108



New Products

New semiconductors

Outlook bright for dual-gate transistors

Applications of metal oxide semiconductor FET's in color tv and f-m tuners open up a new market for solid state devices

Reflecting the soft market for some consumer electronics products, sales of discrete semiconductor devices to consumer-oriented customers have been sagging for almost a year. To shore up the volume, semiconductor companies have tried several methods—including cutting prices and introducing new devices in areas that have been largely untapped by the solid state approach.

The Radio Corp. of America is

following the new market route with a new family of metal oxide semiconductor field effect transistors (MOS FET) for consumer-type applications. The new devices, with dual-insulated gates, should have wide applications in both black and white and color television sets, and in the front ends of a-m and f-m receivers.

The dual-gate device has definite advantages over the single-gate FET: better cross-modulation char-

acteristics and lower feedback capacitance. In addition to these, the high input impedance, low noise, and wide dynamic range of the FET's make the new devices attractive as r-f amplifiers with automatic gain control, burst amplifiers, i-f amplifiers, color demodulators, quadrature detectors, and other similar applications.

As a starter. For the present, RCA is offering five developmental types in evaluation quantities: the

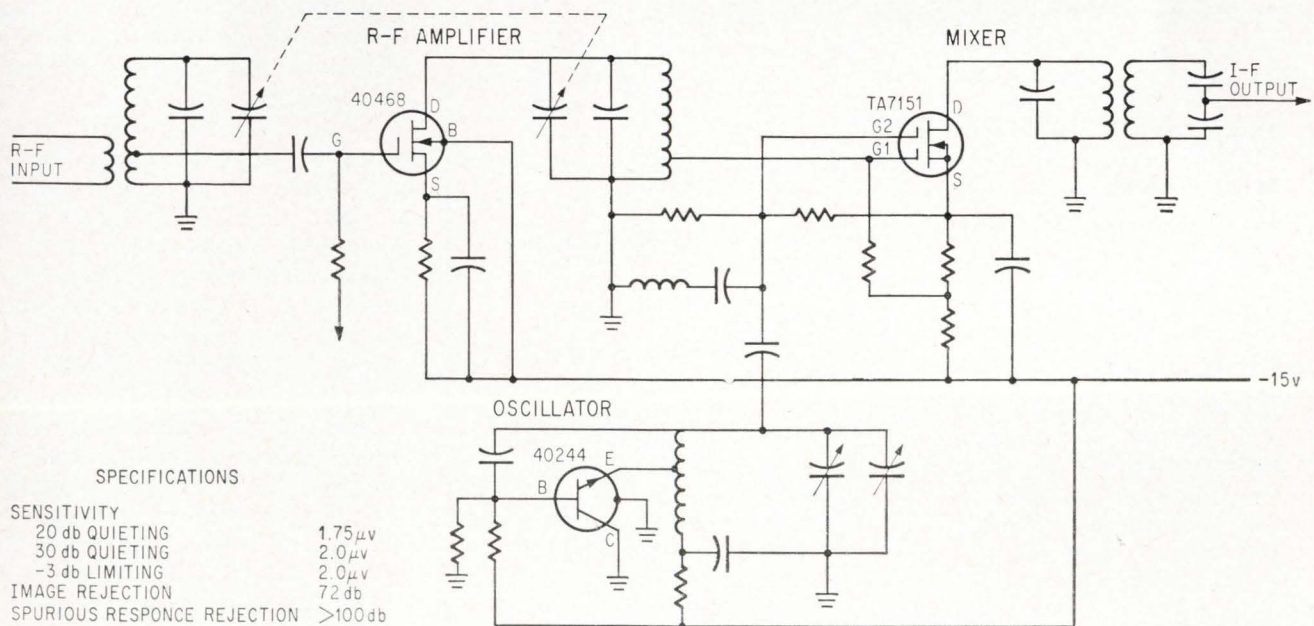

F-m mixer. The dual-gate feature of the MOS FET provides high spurious response and image rejection. Performance measurements were made across 300-ohm antenna terminals with the input frequency at 100 Mhz, modulated by a 400-hz signal with 22.5-khz deviation.

... MOS FET's make fm tuner design simple, but performance is close to excellent ...

TA7149, TA7262, TA7150, TA7151, and TA7152. These are n-channel silicon-depletion types that feature low leakage current, feedback capacitances in the order of 0.02 picofarad, typical transadmittance in the order of 10,000 micromhos at a drain current of 7 milliamperes, and square-law transfer characteristics. Unit prices range from \$2.50 to \$1.50. RCA expects the price to level off around \$1 when production quantities are available.

Types TA7149 and TA7262 have applications as r-f amplifiers or mixers in tv vhf tuners at frequencies up to 250 Mhz, as well as in receiver audio circuits. Gate-leakage currents are in the order of 11,000 micromhos, typical power gain is 20 decibels at 200 Mhz, and noise figure is 4 db at 200 Mhz.

Types TA7150 and TA7151 have special applications in f-m tuners

and receivers operating at frequencies up to 120 Mhz. Because of its cross-modulation characteristics and dynamic range, the TA7150 is suitable as an r-f amplifier. For example, it provides a typical gain of 21.5 db at 100 Mhz in an unneutralized amplifier circuit. The TA7151, designed primarily for mixer application, can approximate an ideal square-law mixer with significant spurious-response rejection.

I. Circuit applications

In a typical f-m tuner circuit with the TA7151, the dual-gate mixer is preceded by a single-gate MOS FET r-f amplifier that provides 13 db power gain at an operating current of 5 milliamperes. The TA7151 is operated with the following bias voltages: V_{DS} , +12v; V_{G2S} , +0.6v; and V_{G1S} , -0.075v. Drain current is about 6 ma. The

local oscillator output is applied to gate 2 with an injection level of 750 millivolts, while the r-f signal is applied to gate 1. Under these conditions R_{in} at 100 Mhz is 5 kilohms, R_{out} at 10.7 Mhz is 25 Kilohms, and the conversion transconductance is 2,200 μ mhos. Maximum available conversion gain is 22 db, of which 18 db are used in the tuner, providing a total tuner gain of 31 db. The tuner is used with an i-f amplifier, which provides a 94 db gain.

Although this design is exceedingly simple, its performance is excellent, close to the outstanding performance achieved in some commercial tuners that use three or more tuned circuits before the mixer stage.

Attuned to color. Type TA7152 has special application as a color demodulator since the high impedance of the dual-gate configuration permits convenient injection of both the chrominance information and the 3.58 Mhz reference signal in a demodulator circuit.

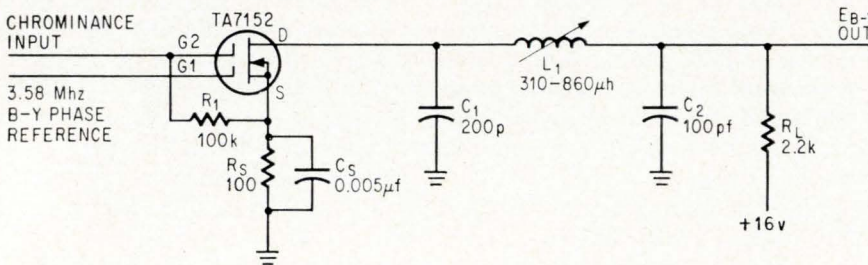

Color demodulator. With chrominance information applied to gate 2 and the 3.58-Mhz reference signal applied to gate 1, demodulation is accomplished by synchronous detection.

II. Isolation for stability

In one configuration, self-bias is used to provide regulation, and to bias gate 1 slightly negative. Operation of gate 2 at zero bias permits linear amplification of chrominance input signals up to approximately 2.5 volts. Demodulation is accomplished by synchronous detection of the two signals applied to the insulated gates. The video output at the drain is directly related to the phase of the two signal inputs.

Because the high-input impedance of the MOS transistor results in minimum feedback from output to input, there is adequate isolation which results in the device's stability. The low-pass filter, comprised of L1, C1, and C2, removes the 3.58 Mhz carrier signals and passes the demodulated video information.

Expressing confidence, F.B. Smith, Market Planning Manager confided: "RCA expects these devices to open the way for substantial improvements in performance of solid state tv and a-m and f-m receiver products."

Radio Corp. of America, Electronic Components and Devices Division, Harrison, N.J. 07029 [338]

New products in this issue

Semiconductors

141 Outlook bright for dual gate transistors

Components

144 New components review
144 Voltage regulator stays close to its output
148 Germanium stages a comeback

Instruments

152 New instrument review
152 Zeroing in on interference
156 Computer-controlled temperature testing

Subassemblies

160 New subassembly review
160 More zap from Franco

162 Transmitter boosts low-frequency use

164 Regenerative plan turns up in combiner

Microwaves

166 New microwave review
166 Four finger filter

Production equipment

171 New production equipment review
171 Squeeze play slims printer lines
173 Speedy glassing by infrared rays

Solid state

174 Trigger and trip circuits reduce bulk of scr drives

ulano is the leading manufacturer
of screen process stencil film

...any kind!

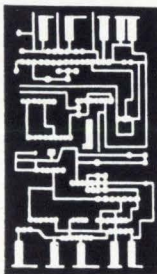

*In screen processing
of complex printed circuitry ...
there's no margin for error!
That's why Ulano offers
a complete line of
Screen Process Stencil Films
especially designed for
the Electronics Industry.*

ulano

T.M.

610 DEAN STREET, BROOKLYN, N. Y. 11238

NEW YORK • CALIFORNIA • CHICAGO • ZURICH

In Europe: ULANO A. G., Untere Heslibachstrasse 22, Kusnacht 8700, Switzerland

***For free working samples, write today
on your letterhead for Kit No..5848***

Circle 143 on reader service card

New Components Review

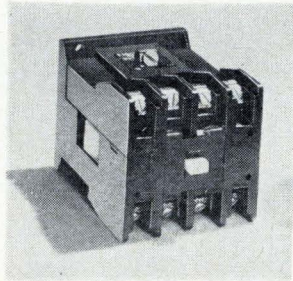

Machine tool and other control-circuit uses where panel space is limited are applications for the series 300 a-c relays. The units require a panel area of only 6.56 sq. in. Relays are available in 4- and 8-pole models, with any combination of normally-open or normally-closed contacts rated for 10 amps, 300 v a-c, 60 hz use. Ward Leonard Electric Co., Mt. Vernon, N.Y. [341]

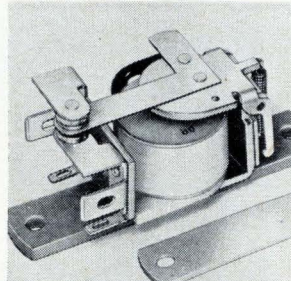

Power switching is provided by a compact 15-amp spst relay (Class 88K). A hinge-pin armature with flexible contact arm assures high contact pressure and positive wiping action throughout lifetime. Contacts and terminals are mounted on a glass-insulated board. Prices range from \$4.48 to \$5.16 each in small quantities. Magnecraft Electric Co., 5575 N. Lynch Ave., Chicago. [342]

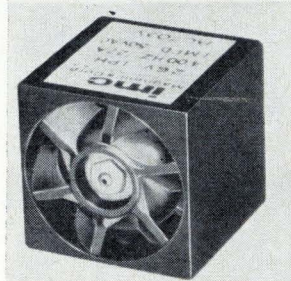

Spot cooling of IC's, transistor heat sinks, airborne computers, and instruments is accomplished by a cube fan that delivers 6.5 cfm of cooling air. The 1-in., model BC 703V vaneaxial fan weighs 1 oz. and operates efficiently for 1,000 hours at 125° C. It operates from either a 26 or a 115 v line at 400 hz. IMC Magnetics Corp., 570 Main St., Westbury, N.Y. [343]

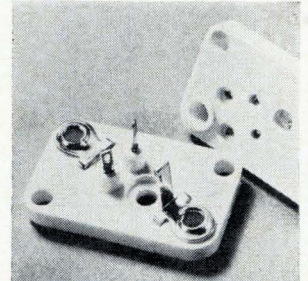

An all-molded power transistor socket for the TO-66 base features a universal mounting system, has polypropylene casting, brass cadmium-plated contacts, and steel cadmium-plated ground lug. Other materials can be supplied on request. The JST1501-1 is also available for p-c mounting. Industrial Electronic Hardware Corp., 109 Prince St., New York 10012. [344]

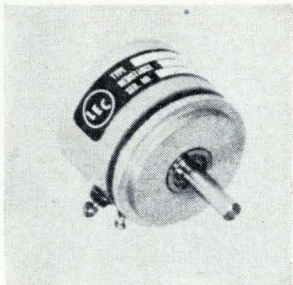

Key feature of a line of conductive-plastic pots is a temperature coefficient of 75 ppm. Models 9CP, 11CP, and 14CP are produced in bushing mount and servo types, in single or multiple gangs, with a 300° min. electrical travel. Resistance ranges from 1 to 150 kilohms; temperature, -65° to +165° C. Logan Electronic Corp., 44 Breed St., East Boston, Mass. [345]



A reserve battery for emergencies uses a 1.5-v alkaline unit that has an on-the-shelf life of 20 years or more until activated. The reserve cell is activated by turning the top terminal cap, releasing the liquid electrolyte. It is made in the standard D size for flashlights.

Price is slightly higher than that of regular batteries. Mallory Battery Co., Tarrytown, N.Y. [346]

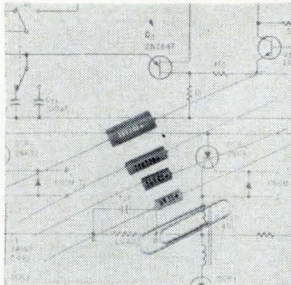

Ultraminiature, wet-slug tantalum capacitors now available, range in values up to 560 microfarads at 10 working volts d-c and 82 μ f at 60 wvdc. These space saving units have low leakage and an operating range of -55° to +85° C, and are manufactured in capacitance tolerances of standard +75% to -15%, \pm 20%, and \pm 10%. H.H. Hilton Inc., 52 Cooper St., Glens Falls, N.Y. [347]

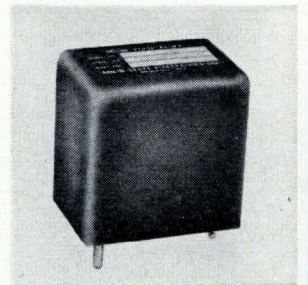

Solid state design makes the model SSR-2828-3504 a-c switching relay capable of more than 100 million operations; closing is almost instantaneous. Actuation time is 2 μ sec; dropout time, 10 μ sec. Actuation frequency can be up to 5 khz. Contacts are rated at 150 v, 4 amps rms. Solid State Electronics Corp., 15321 Rayen St., Sepulveda, Calif. 91343. [348]

New components

Voltage regulator stays close to its output

Putting in a hybrid-IC regulator close to circuit reduces line losses and transient distortions

Angrily eyeing the steady encroachment of integrated-circuit makers into their realm, many component makers have decided to fight fire with fire. The latest to reach that conclusion is the Helipot division of Beckman Instrument Inc., which this month is announc-

ing a standard line of miniature voltage regulators made of hybrid integrated electronics. The new devices, intended for highly precise regulation of d-c voltage, are made of cermet thick films and semiconductor chips.

Major application will be in

equipment in which line losses and transients that distort regulation cannot be tolerated—for example, where a central power supply and a single regulator are used. With these tiny hybrid circuits, a regulator can be placed close to the circuit to which it is supplying power, guaranteeing precise regulation.

A potentiometer maker with no semiconductor background, Helipot has built up a strong capability in thick film work over the last 10 years. The work started when Beckman wanted to produce precision potentiometers from films. Six years ago, the company began offering such components and then

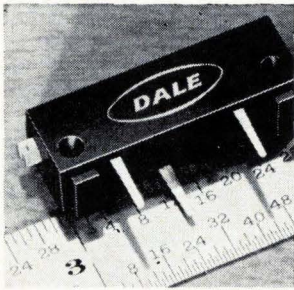

Half-watt trimmer pot is built so that settings are stable when used for balancing printed circuits. Resistance range of the 2300 series is 10 to 50,000 ohms with a standard tolerance of $\pm 10\%$. Dimensions are 1 x 0.36 x 0.28 in. Standard terminals include p-c pins and hook-type solder lugs. Cost is under \$1 each in 1,000 lots. Dale Electronics Inc., Box 488, Columbus, Neb. [349]

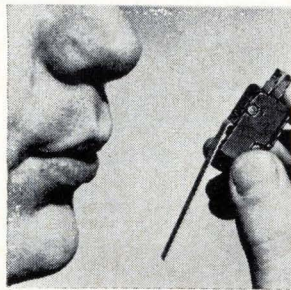

Pressure of only $1\frac{1}{4}$ grams will actuate the E22-55HLX miniature switch, because the internal actuator is free-floating on its case pivot. The actuator is made of aluminum to assure switch-button reset. Rated for 3 amps, 125 v a-c, the device has a coil-spring mechanism. Price is \$1.38. Cherry Electrical Products Corp., 1650 Old Deerfield Rd., Highland Park, Ill. [350]

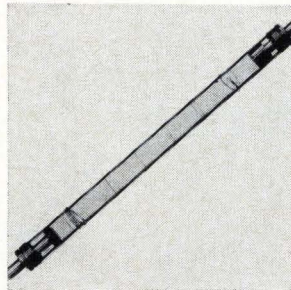

Two high-power, linear flashtubes in 3-in. and 12-in. arc lengths can handle 2,250 and 9,200 joules of energy input. Both flashtubes are constructed with 13 x 15 mm quarts. Pulse duration of the FX-47C-3 is 1.0 msec; the FX-47C-12, 1.4 msec. Prices are \$69 and \$90 respectively. Availability on both tubes is stock to 30 days. EG&G Inc., 160 Brookline Ave., Boston. [351]

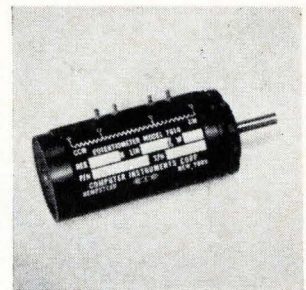

Multiturn pots, providing less than 1-sec resolution with output smoothness levels to 0.01%, operate up to 200 million revolutions. Models 7813 (rear terminals) and 7814 (radial terminals) are housed in a $\frac{7}{8}$ -in. diameter aluminum case. Resistance range is 5,000 ohms to 1.5 megohms. Computer Instruments Corp., 92 Madison Ave., Hempstead, N.Y. [352]

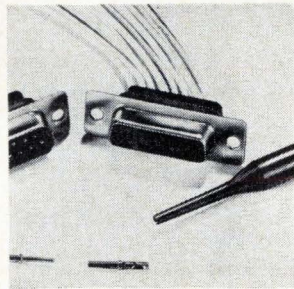

Burgun-D connectors are interchangeable with the present D sub-miniature connector series and will operate at temperatures up to $+250^\circ$ F. Five shell sizes accommodate from 9 to 50 of either size 20 or size 18 crimp removable electrical contacts. A rear-release contact retention system is included. ITT Cannon Electric, 3208 Humboldt St., Los Angeles. [353]

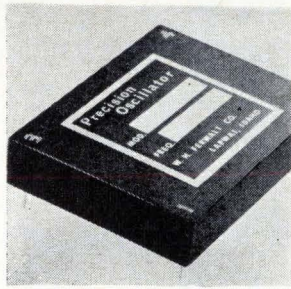

Crystal oscillators can be factory set to any frequency from 1 hz to 30 Mhz. The frequency is set to within $\pm 0.001\%$ at $+25^\circ$ C. Output levels are designed to operate directly into the latest types of IC systems. The units measure 1.9 x 2.5 x 0.50 in., and have four 0.030-in.-diameter pins for direct soldering to a p-c board. W.H. Ferwalt Co., Webb Road, Lapwal, Idaho. [354]

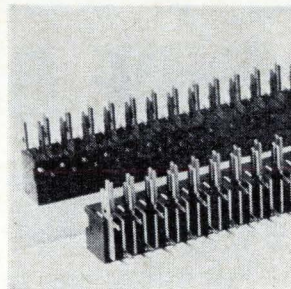

P-c connector strips have split-leg construction to save time and labor in normal assembly operations. They can be snapped directly to p-c boards, ready for dip soldering. Staking operations are eliminated and hole requirements are reduced by about 50%. Contact material is phosphor bronze with gold over nickel. Methode Electronics Inc., 7447 W. Wilson Ave., Chicago. [355]

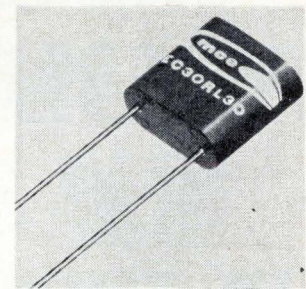

A toroidal choke for use as a noise suppressor in switching circuits features a self-shielding configuration. Inductance range is 1 to 630 mh; current, 880 to 17 ma. Packaged for p-c use, the unit is designed for plug-in on 0.1-in grid spacing. Prices range from \$3.15 to \$5.64 each in small lots. Magnetic Circuit Elements Inc., 3720 Park Pl., Monterey, Calif. [356]

moved into thin-film technology.

Its first thin-film product was a trimmer potentiometer in which the film replaced wire or carbon disk elements. The second was a family of custom microcircuits, at first using thick films and discrete components, but later using films and unpackaged semiconductor dice.

Only the beginning. With its new line of d-c voltage regulators—an extension of that development work—Beckman has its first integrated circuit product with the potential for large volume sales. It will be followed by others that also use thick films and semiconductor chips, says Helipot's manager David McNeely.

He predicts, "Eventually we will probably buy whole integrated circuits and make up many different devices by putting the ic's on thick films and adding passive components."

I. Hybrid over monolithic

McNeeley chose the hybrid approach over a monolithic one primarily because the regulators had to dissipate higher powers than monolithic circuits could handle. The rating of the new series, designated the 801, is 1.8 watts at $+25^\circ$ C in free air; and 5 watts at 25° C if mounted on an aluminum plate that serves as a heat sink. A monolithic circuit to do the same

job would require additional circuitry to dissipate power as soon as it exceeded $\frac{1}{2}$ watt.

There are five standard models with fixed outputs of 9, 12, 15, 18, and 21 volts. They occupy 0.5 sq. in. of board space and can regulate both line and load to within $\pm 0.05\%$. Output power to load can be as little as 4.5 watts for the 9-volt model and as much as 10.5 watts for the 21-volt model. Current handling capability is up to $\frac{1}{2}$ amp; resistance is stable within 0.05% over 1,000 hours at full rate loads.

Another advantage of integration is a sharp reduction in price. The new regulator costs only \$30, even

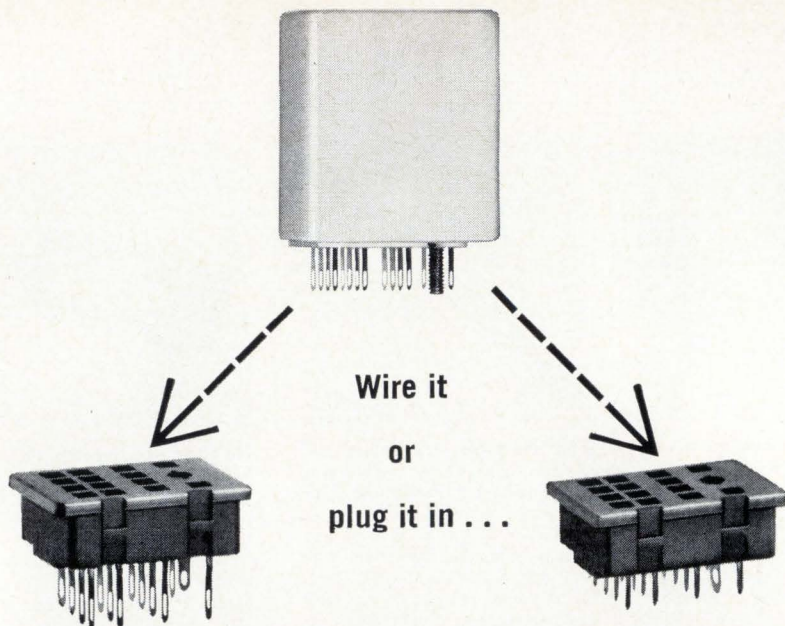

THE SPACE-SAVING PERFORMANCE OF THIS NEW 3-AMP RELAY IS YOURS EITHER WAY

New 281 Frame relays provide the high contact density, low operating power repeating accuracy and matched characteristics you need for card punchers, card sorters, addressing machines, counters, programming consoles, alarm systems and other multi-relay bank applications. Case measurements are only $1\frac{1}{2}'' \times 1\frac{1}{4}'' \times \frac{5}{16}''$.

The basic relay is a stud-mounted unit with solder tab terminals and nylon dust cover. For plug-in applications, sockets are available with solder tab or printed circuit terminals.

Gold plated 4PDT contacts are rated 3 amps resistive at 30 VDC or 115 VAC. Coils are available for all popular AC and DC voltage from 6 to 120 volts.

For complete specifications, request Data Bulletin 4121.



STRUTHERS-DUNN, INC.

PITMAN, NEW JERSEY 08071

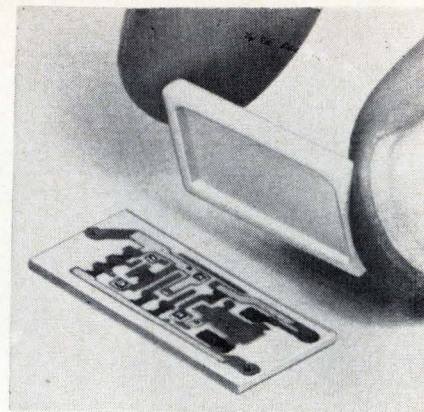

Hybrid IC. Regulating to $\pm 0.50\%$, new unit uses semiconductor chips with cermet resistors and capacitors bonded to an alumina substrate.

for a single purchase, roughly half as much as equivalent regulators made with conventional components. The price should drop even lower, possibly to \$25.50, when production increases.

Heated up. The cermet resistors and capacitors in the regulators are a mixture of glass and precious metals fused to an alumina substrate at temperatures above $1,000^{\circ}\text{F}$. The chip semiconductors are bonded to the substrate, interconnections between active and passive elements being made by thermocompression lead bonding. Sealing an alumina cover to the substrate results in a unit that may be immersion-solvent cleaned and potted.

Before year's end, Helipot will introduce more voltage regulators with fixed outputs from 3 to 9 volts and from 21 to 32 volts incorporating a small trimming potentiometer to provide an adjustable output and standard resistor-capacitor networks.

Specifications

Instantaneous input voltage	40 v d-c max, all models
Effective output voltage	9 to 21 v d-c, depending on model
Power output	4.5 to 10.5 w, depending on model
D-c load regulation	$\pm 0.05\%$
D-c input regulation	$\pm 0.05\%$ for $\pm 10\%$ input voltage change
Output impedance	0.46 ohm
Output voltage stability	0.5% shift per 1,000 hrs. at full load
Temperature coefficient	$\pm 0.02\%$ /deg C from -55° to $+125^{\circ}\text{C}$
Power dissipation	1.8 w in free air 5.0 w on 3x3x.125 in. aluminum plate
Price	\$30 each for 1 to 9 units
Beckman Instruments, Inc., Helipot Division, Fullerton, Calif. [357]	

Leadership

We developed this new Operational Amplifier for its combination of high performance and low cost.



TYPICAL SPECIFICATIONS—Model 809CE

- Offset Voltage Drift: $10 \mu\text{V}/^\circ\text{C}$
- Offset Voltage: 5 mV
- Offset Current Drift: $1.0 \text{ nA}/^\circ\text{C}$
- Offset Current: 50 nA
- Power Supplies: $\pm 15 \text{ V}$
- Power Dissipation: 90 mW
- Compensation:
 - 40 db gain—none
 - 0 db gain—two components
- Monolithic Integrated Circuit in TO-78 or dual inline package
- Common Mode Range: $\pm 13 \text{ V}$
- Common Mode Rejection Ratio: 90 db
- Power Supply Rejection Ratio: 90 db
- Gain: 40,000
- Input Impedance: $200 \text{ K } \Omega$
- Output Swing (5K load): 24 VP-P
- Output Short Circuit Protected
- Temperature Range:
 - Operating 0°C to $+100^\circ\text{C}$
 - Storage -65°C to $+150^\circ\text{C}$

Price:	1-99	100-99	1000	10,000
	6.50	5.85	5.00	4.50

Please compare the 809 with other Operational Amplifiers in the same price range, including the one you are now using, and buy the one you think is best.

AMELCO SEMICONDUCTOR

DIVISION OF TELEDYNE, INC. • 1300 TERRA BELLA AVENUE • MOUNTAIN VIEW, CALIFORNIA • Mail Address: P. O. Box 1030, Mountain View, California • Phone: (415) 968-9241 • REGIONAL OFFICES: East—Westwood, Mass., 805 High Street, (617) 326-6600; Melville, L. I., N. Y., (516) 692-4070; Syracuse, N. Y., (315) 437-8343; Paterson, N. J., (201) 696-4747; Glenside, Pa., (215) 887-0550; Towson, Md., (301) 825-3330; Orlando, Fla., (305) 423-5833 • Midwest—Des Plaines, Ill., 650 W. Algonquin Rd., (312) 439-3250; Cedar Rapids, Iowa, (319) 366-0635; St. Louis, Mo., (314) 427-7200; Farmington, Mich., (313) 474-0661; St. Paul, Minn., (612) 488-6634; Columbus, Ohio, (614) 299-4161; Dallas, Texas, (214) 631-6270 • Northwest—Home Office, Mountain View, Calif.; Los Altos, Calif., (415) 941-0336; Seattle, Washington, (206) 323-5100 • Southwest—Los Angeles, Calif., Suite 213, 8621 Bellanca Ave., (213) 678-3146; Los Angeles, Calif., (213) 870-9191; San Diego, Calif., (714) 298-4711; Phoenix, Ariz., (602) 277-9739; Albuquerque, N.M., (505) 268-0928; Littleton, Colo., (303) 798-8439 • Canada—Montreal, P.Q., (514) 384-1420.

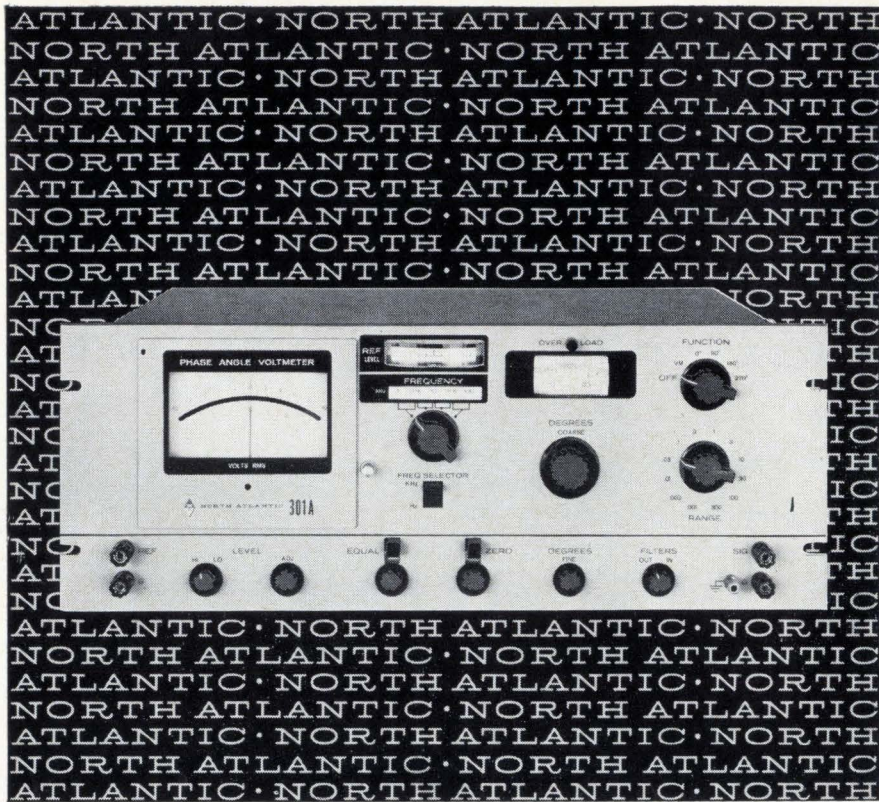

how to measure phase angle down to .25° from 10Hz to 100KHz (plus in-phase and quadrature!)

North Atlantic's Model 301A **Broadband Phase Angle Voltmeter*** adds a new dimension to AC by enabling you to measure phase angle, in-phase and quadrature while frequency is varying over half-decades...without recalibration. It provides complete coverage from 10Hz to 100KHz and incorporates plug-in filters to reduce the effects of harmonics in the range from 27Hz to 28KHz with only 11 sets of filters. Vibration analysis and servo analysis are only two of the many applications for this unit. Selected specifications are listed below:

Voltage Range.....	1 mv to 300 volts full scale
Voltage Accuracy.....	2% full scale
Phase Dial Range.....	0° to 90° with 0.1° resolution (plus 4 quadrants)
Phase Accuracy.....	0.25°, 31.6Hz to 31.6KHz (derating to .6° at 10Hz, 1° at 100KHz)
Input Impedance.....	10 megohms, 30 μ f for all ranges (signal and reference inputs)
Reference Level Range.....	0.15 to 130 volts
Harmonic Rejection.....	50 db
Nulling Sensitivity.....	less than 2 microvolts
Size.....	19" x 7" x 13½" deep
Price.....	\$2290.00 plus \$160.00 per set of filters

North Atlantic's sales representative in your area can tell you all about this unit as well as other Phase Angle Voltmeters* for both production test and ground support applications. Send for our data sheet today.

*Trademark



NORTH ATLANTIC industries, inc.
TERMINAL DRIVE, PLAINVIEW, NEW YORK 11803 • 516-681-8600

New components

Germanium stages a comeback

H-f germanium transistors have the same temperature rating as silicon devices

Although most experts are writing off germanium semiconductor devices, the material is still far from dead in high-frequency applications. That point was made clear again last month when Texas Instruments Incorporated introduced two new germanium transistors. The new devices, specifically designed for use in the 2.25-gigahertz telemetry band, offer low noise; typical noise figure is 4 decibels at 2.25 gigahertz. The gain-bandwidth product (f_T) is 2.6 Ghz covering a usable frequency range of 1 to 4 gigahertz.

Germanium won the nod over silicon because of better high-frequency characteristics. Normally, germanium is considered too difficult to work with to extract the geometries required by high-frequency transistors. However, three year ago π developed a technique for building planar structures on germanium [Electronics, April 6, 1964, p. 62], and these products are among the first commercial devices to use the process.

I. The rating game

Previously, germanium devices were rated up to 70°C, unlike silicon which is good to 125°C. These new transistors, however, are rated to 100°C, and π says that they will be rated to 125°C when life tests are completed [Electronics, March 20, p. 47].

Replacing tunnel diodes. The new devices will replace tunnel diodes and traveling-wave tubes (twt) which are more expensive, require more supporting components, and use more power. Primarily, the new transistors will be used in applications such as L- (0.90 to 1.550 Ghz) and S- (1.550 to 5.20 Ghz) band telemetry, pre-amplifiers for L- and S-band radar,

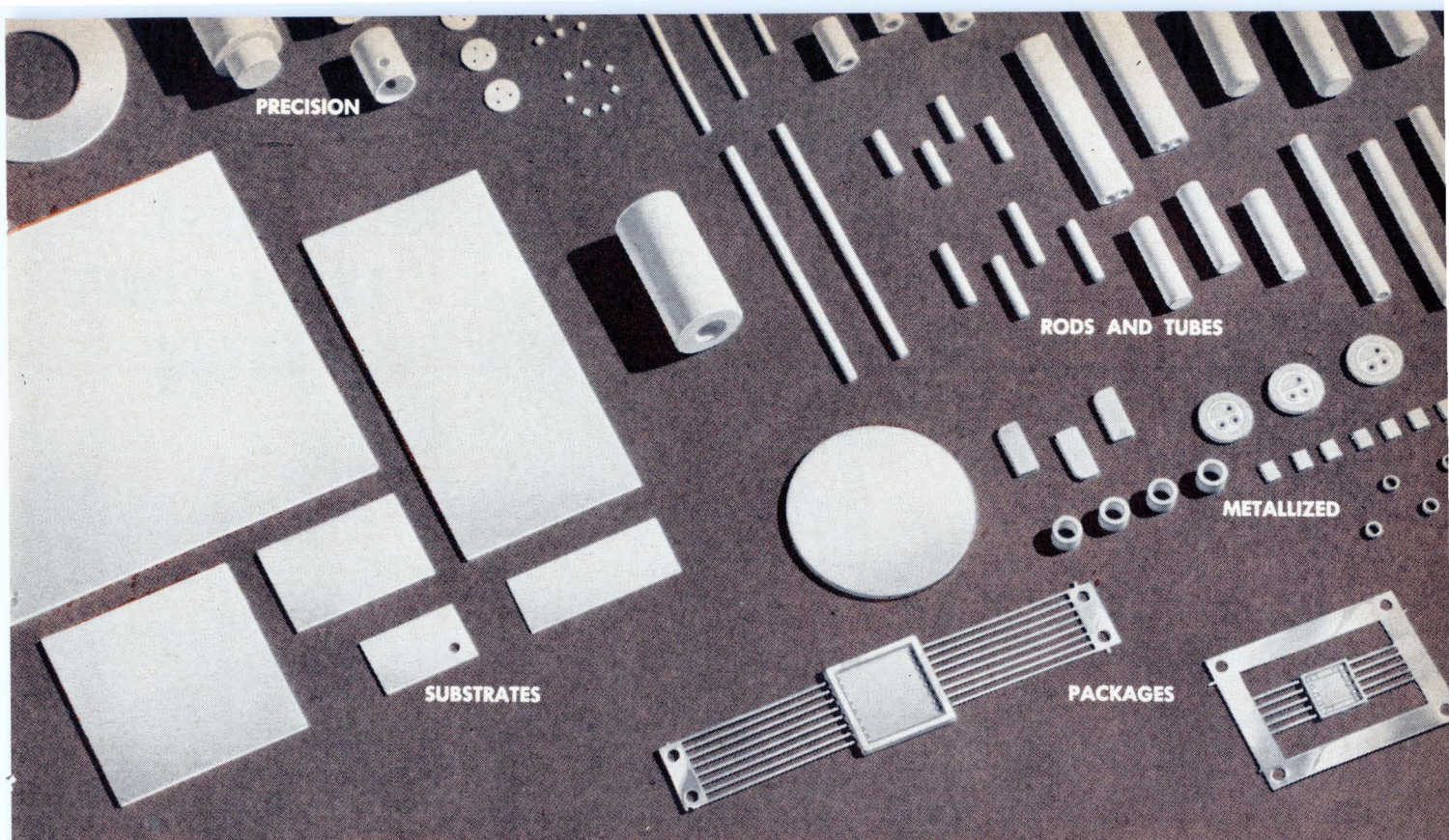

PROGRESS REPORT **ALSiMAG** BERYLLIA CERAMICS

Where heat dissipation is important, ALSiMag beryllia offers a great advantage. At low temperatures, this ceramic has the thermal conductivity of aluminum plus the favorable electrical characteristics of ALSiMag alumina ceramics.

Close Tolerances "As Fired"

It is often said that close tolerances on beryllia ceramics are difficult, if not impossible. Five years of continuous progress now permits close dimensional control of small precision "as fired" ALSiMag beryllia ceramics. They are being produced regularly and in volume to close tolerances normally associated with the finest precision metal work.

Substrates and Snap-Strates

ALSiMag beryllia substrates have an "as fired" working surface of 8 microinches CLA or better. They have controlled small crystal sizes and low internal porosity. Their electrical properties parallel those of alumina substrates and their physical properties are adequate for usual substrate requirements. ALSiMag beryllia substrates may include a plurality of precision holes, serrations or indexing notches. Prototype quantities of ALSiMag beryllia substrates are stocked

in a thickness of .025" in sizes 1/2" x 3/4", 1" x 1", 1" x 2" and 2" x 2".

ALSiMag beryllia substrates, modified to separate accurately along clean straight lines, were originated by American Lava Corporation and are called SNAP-STRATES. They offer substantial savings in the finished component in some designs. Film and circuit work can be completed on the larger SNAP-STRATE and then divided into smaller controlled individual sizes.

Rods and Tubes

The great thermal conductivity of ALSiMag beryllia has led to wide use in rod and tube form, especially for resistors. Prior consultation on sizes and tolerances of beryllia rods and tubes can be especially rewarding.

Metallized Beryllia

American Lava has broad experience in a wide range of metallized beryllia ceramics and offers single source re-

sponsibility and economy in production time. Single plane precision metallized patterns on beryllia are also available. Pattern sizes up to 3" square are practical with line widths of 7 mils on 14 mil centers and, on short length converging lines, 4 mil widths on 8 mil centers. Line resistance down to 10 milliohms per square or better is possible.

Packages

ALSiPak® packages with an ALSiMag beryllia ceramic base can solve certain problems of heat dissipation. The use of these packages has steadily increased.

Beryllia
Bulletin
675
sent on
request.

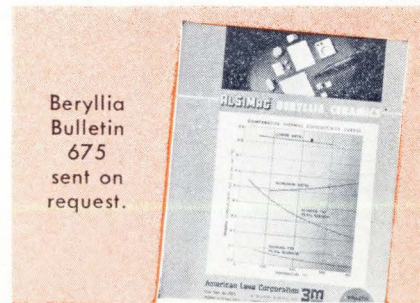

CODE IDENT. NO. 70371

American Lava Corporation **3M**
A SUBSIDIARY OF COMPANY

PHONE 615 265-3411, CHATTANOOGA, TENN. 37405

For service, contact American Lava representatives in Offices of Minnesota Mining and Manufacturing Company in these cities (see your local telephone directory): Atlanta, Ga. • Boston: Needham Heights, Mass. • Chicago: Glen Ellyn, Ill. • Cleveland, Ohio • Dallas, Texas • Laurens, S.C. • Los Angeles, Calif. • Metropolitan New York: Ridgefield, N.J. • Up-State New York and Canada: Baldwinsville, N.Y. • Orange, Conn. • Philadelphia, Penna. • Roanoke, Virginia • St. Louis: Lee's Summit, Missouri • So. San Francisco, Cal. • Troy, Mich. • 3M International: c/o American Lava Corp., Chattanooga, Tenn. 37405, U.S.A., 615/265-3411

66th
YEAR
OF
CERAMIC
LEADERSHIP

The more you need from crystal filters, the more you need Bulova!

Today's sophisticated systems call for filters with "difficult" characteristics. Difficult, that is, for everyone but Bulova! Bulova has had so much experience with crystal filters, there's hardly anything we don't know about them,

Take single side-band filters, for example: Attenuation figures alone are not enough to adequately describe today's military communication filters. More and more filters require limitations on envelope time delay, while others must follow a precise time-delay envelope curve.

Bulova has been testing for these parameters — providing measurements both in terms of phase linearity and, in many cases, directly in envelope time-delay readings. As a result,

Bulova can engineer and produce to the exact measurements you specify. And at a realistic price!

Proof: Here are the actual curves and specs for just one Bulova filter, Model 562.

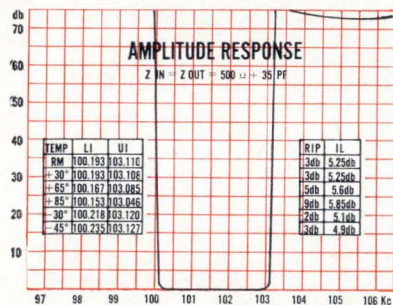
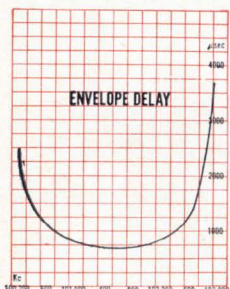

Bandwidth (1db) 100.255 to 103.035 Kc
 Bandwidth (60 db) 99.990 to 103.260 Kc
 Carrier frequency — is 100 Kc
 Loss at carrier — 55 db min.
 Ultimate attenuation — 70 db
 Max. insertion loss — 6 db
 Max. ripple — 1 db max.
 Operating temperature — -40° to +65°C
 Impedance — 500Ω (in and out)
 Differential envelope time delay — 500 μsec
 max. over 80% of pass band

With specs like these you can see why we say — the more you need from a filter, the more you need Bulova! Call or write Dept. E-21.

Try Bulova first! FREQUENCY CONTROL PRODUCTS

ELECTRONICS DIVISION
OF BULOVA WATCH COMPANY, INC.

61-20 WOODSIDE AVENUE
WOODSIDE, N.Y. 11377, (212) DE 5-6000

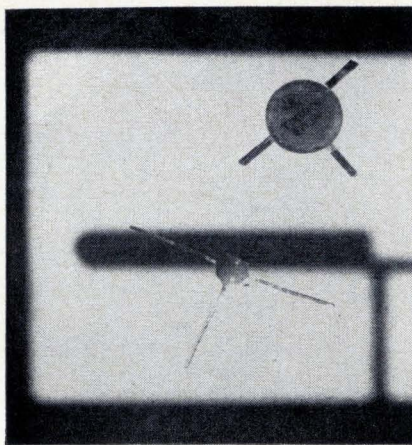

Choice items. New low-noise germanium planar transistor comes in two packages: one (top) is for strip-line applications, and the other (below) is the modified pellet-pack for hybrid IC applications.

phased-array radars, and equipment for electronic countermeasures if octave-bandwidth amplifiers are required. Unlike the tunnel diode, the new devices do not require circulators for signal isolation.

Better than a TWT. The advantages of the transistor over a traveling-wave tube are even more pronounced, although it takes three transistor amplifiers to replace a single TWT. For example, a 1- to 2-GHz low noise TWT measures about 5 x 14 inches long, weighs from 1 to 10 pounds, consumes from 1 to 10 watts, and costs more than \$1,500. Each of the germanium transistors, by comparison, measures 0.1 x 0.25 inch, weighs 0.3 gram, consumes 25 milliwatts, and is priced at \$250 each. The noise figure, which deviates less than ±0.75 db from its 25°C value over the range from -100 to +100°C, is stable with age.

The units are available in two packages. The TIXM105 is for strip-line applications, and TIXM-106 is for thick-film or thin-film hybrid-integrated circuits.

Specifications

Input and output impedance	50 ohms
Usable frequency range	1 to 4 Ghz
Gain-bandwidth product (f ₁)	2.6 Ghz
Noise figure (max)	4.5 db at 2.25 Ghz
Noise figure variation	±.75 db from its 25 deg C value between -100 and +100 deg C
Price	\$250 in quantities 1 to 99

Texas Instruments Incorporated, 13500 N. Central Expressway, Dallas [358]

Fast recovery IBR®

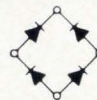

New 10-amp Integrated Bridge Rectifier from Varo.

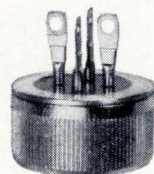

Press mount.

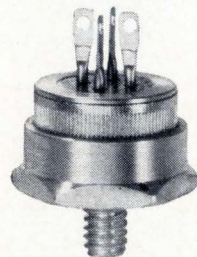

Single stud adapter.

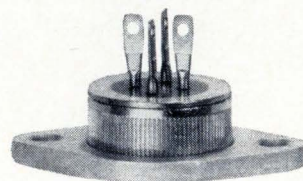

TO-3 mounting adapter.

Applications:

For better rectification efficiency at high frequencies. Also for designs where suppression of RFI is critical, or where ripple specifications are tight.

Recovery time:

200 nanoseconds.

Voltage:

100, 200, and 400 V.

Amperage:

10 amps at case temp. of 75° C.

Case:

Electrically insulated for direct mounting to chassis.

Also available:

IBRs in 10 and 25-amp standard recovery versions and epoxy bridge rectifiers from 1 to 6 amps.



VARO

SPECIAL PRODUCTS DIVISION
2203 WALNUT STREET, GARLAND, TEXAS 75040
(214) 272-3561

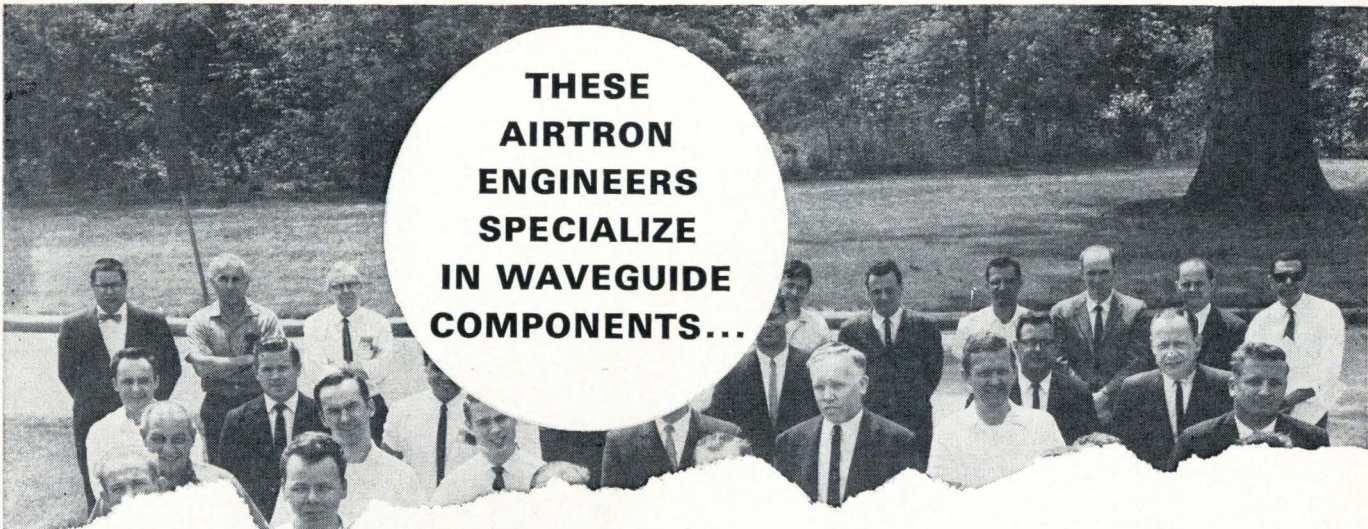

**THESE
AIRTRON
ENGINEERS
SPECIALIZE
IN WAVEGUIDE
COMPONENTS...**

How Can We Help You?

Our Application Engineering Department . . . plus 450+ production personnel are at your disposal . . . phone us . . . 201-539-5500 . . . or write for latest literature package . . . Circle No.

AIRTRON

DIVISION OF LITTON INDUSTRIES



200 EAST HANOVER AVENUE, MORRIS PLAINS, N. J. Telephone: 201 539-5500



**THESE
AIRTRON
ENGINEERS
SPECIALIZE IN...**

Stripline Devices

•
Ferrite Devices

•
Solid State Devices

•
Sub-System Assemblies

•
Microwave Materials

•
Laser Crystals

New Instrument Review



Automatic range selection is offered in an integrating digital voltmeter that has ratio and ohm options. The 4000 has an input impedance of 1,000 megohms on the 1- and 10-v ranges; sampling rate is 10 readings/sec. Accuracy is $\pm 0.01\%$. Frequency-to-voltage comparator corrects for non-linearities. Weston Instruments Inc., 614 Frelinghuysen Ave., Newark, N.J. [361]

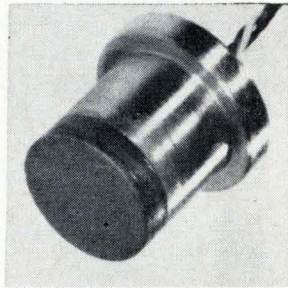

A semiconductor-type transducer that uses bonded strain gauges is suited for pressures to 5,000 psia. The SA-SAH-6G is flush mounted in a 0.290-in. housing that incorporates a positioning flange to isolate the diaphragm from strains. It provides sensitivity to 20 mv/v, and has dynamic response to 100 khz. Scientific Advances Inc., 1400 Holly Ave., Columbus, Ohio. [362]

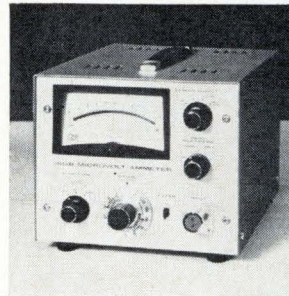

Sensitive d-c measurements are accurately made with the 150B microvolt ammeter. The unit features 14 voltage ranges from 0.3 μ v full scale to 1 v; 75-db line frequency rejection across full scale for a 2% change in meter reading, 180-db common mode rejection, and 20-nv resolution. Price is \$825. Keithley Instruments Inc., 28775 Aurora Rd., Cleveland. [363]



Plug-in converters extend to the capability of a counter-timer that measures directly to 100 Mhz. The C-1804 measures and displays frequency, period, multiple-period average, frequency ratio, frequency-ratio average, time interval with internal and external clock, and totalizes. Price is \$4,350. American Electronic Laboratories Inc., Box 552, Lansdale, Pa. [364]



A lightweight, rugged digital ohmmeter offers 0.1% accuracy and 1-milliohm resolution with 7 ranges from 0.001 to 10,000,000 ohms. Applications of the 8103 include precision resistance measurement, quality control and receiving inspection, and manufacturing checkout. Price is \$1,145. California Instruments Corp., 3511 Midway Drive, San Diego, Calif. [365]



A 4-digit counter that uses integrated circuits achieves a 10-Mhz counting rate. It measures $5\frac{1}{8} \times 6\frac{1}{8} \times 11$ in. Input impedance of the 5221A is 1 megohm shunted by 30 pf. Input sensitivity is 0.1 v rms between 5 hz and 10 Mhz. An internal control allows either positive or negative pulses to be counted. Price is \$350. Hewlett-Packard Co., 1501 Page Mill Rd., Palo Alto, Calif. [366]

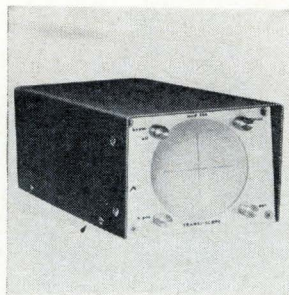

An x-y monitor that can withstand rugged environments of industry measures $3\frac{1}{2} \times 4\frac{1}{2} \times 14$ in. The Transi-Scope 350 features four simple controls, with identical d-c amplifiers to facilitate learning of monitor operation. Operating temperature range is from -40° to 131° F. Price is \$139.50. Measurement Control Devices, Inc., 2445 Emerald St., Philadelphia. [367]

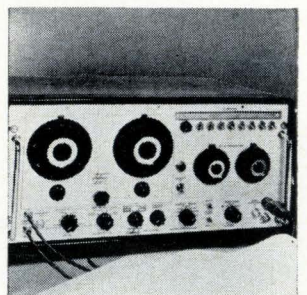

Developed for response testing of narrow-band circuits, the 3007 plug-in oscillator sweeps from 10 to 270 Mhz. It is designed to operate with the SM-2000 sweep generator chassis. Its sweep width can be as narrow as 0.2 Mhz or as wide as 70 Mhz, with a sweep rate continuously variable from 0.01 to 100 hz. Telonic Instruments, 60 N. First Ave., Beech Grove, Ind. [368]

New instruments

Zeroing in on interference

Receiver scans and displays radio frequency spectrums and provides testers with visual closeups of trouble spots

As more companies are forced to examine the contributions their products make to electrical noise and radio frequency interference, the need grows for instruments that can do the checking quickly. With a new receiver displaying any frequency spectrum from 14 kilo-

hertz to 1 gigahertz, an operator can make a quick visual check of a spectrum emitted by a design before he starts on a laborious detailed examination of the equipment. If he can see immediately that the product doesn't meet specifications, he can turn it back to

designers to redo the circuitry, or he can scrutinize the troublesome portion of the spectrum himself.

The new instrument will be introduced on July 17 in Washington, D.C., a day before the Ninth Electromagnetic Compatibility Symposium starts. Built by Fairchild Electrometrics Corp. and designated the CSR-200, the receiver is intended for RFI and electromagnetic compatibility, field strength measurements, communications site surveying, spectrum surveillance, and general design work.

Package deal. The CSR-200 is made up of two instruments, an interference analyzer (Model EMC-

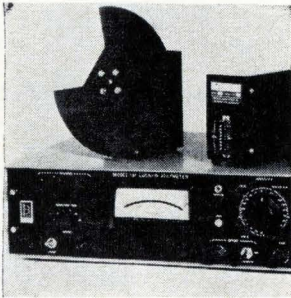

Measurement of weak radiant energy is provided by the 131 lock-in voltmeter. Depending on the detector, the unit operates across the ultraviolet to far infrared spectrum. The device is useful in laboratories and functions directly with any monochromator, light source, or detector. Price is \$1,850. Brower Laboratories Inc., Turnpike Road, Westboro, Mass. [369]

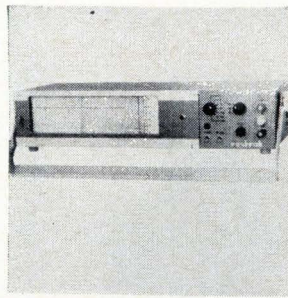

Accurate recording of data such as pH, absorbance, temperature, and pressure is possible with the 191 laboratory recorder. Twenty-one full-scale d-c ranges up to 1,000 mw, μ a, or ma can be selected by switches on the instrument panel. The unit measures $17\frac{11}{16} \times 3\frac{1}{2} \times 7\frac{5}{16}$ in. Price is \$425. Rustrak Instrument Co., Municipal Airport, Manchester, N.H. [370]

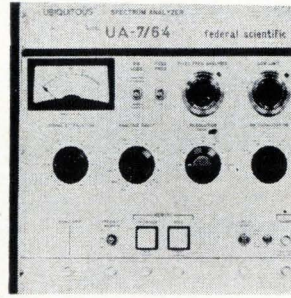

Fractional and constant bandwidth are combined in the UA $\frac{7}{64}$ octave-band spectrum analyzer. Fractional bandwidths can be selected down to 0.4% in 13 bands up to 8,192 hz. Constant-bandwidth mode provides 500-element resolution in 13 low-pass ranges. Real-time analysis is by digital delay-line techniques. Federal Scientific Corp., 615 W. 131 St., New York. [371]

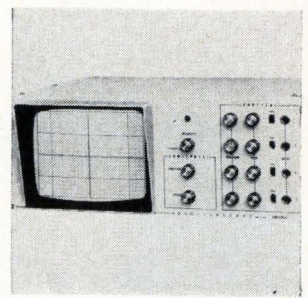

The KM-910 oscilloscope is intended for production testing, swept frequency-response tests, frequency spectrum analysis, semiconductor curve tracing, and linearity testing. It has a 9-in. rectangular tube with a viewing area of 4.7×6.3 in., and a 7-in.-/high front. IT&T Corp., Industrial Products Division, 15191 Bledsoe St., San Fernando, Calif., 91342. [372]

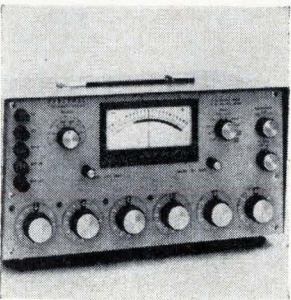

Multimeter model 1002 serves as a differential voltmeter for a-c and d-c signals, and can be used as a voltage reference source, ratiometer, decade voltage divider, and null detector. Both voltages can be measured up to 1,100 v in four ranges; and a-c/d-c ratios, using external reference voltages, up to ± 100 v. Honeywell Inc., 4800 E. Dry Creek Rd., Denver, Colo. [373]

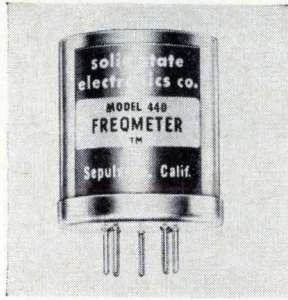

Linear conversion of frequency or repetition rate of signals to a proportional d-c voltage is accomplished with the Freqmeter. Four models span an input of 0 to 100 khz. They can be driven with sine, square or triangular waves. Outputs are insensitive to variations in supply voltage, or waveforms. Solid State Electronics Corp., 15321 Rayen St., Sepulveda, Calif. [374]



Four ranges from 1 v to 1 kv full scale, with 1-megohm input impedance, are offered in the M-550A a-c to d-c converter. Rated accuracy is within $\pm 0.25\%$ plus 50μ v from 50 to 5,000 hz. Use of FET's in the input stages provides low input-noise level. Price is \$230. Medistor Instrument Co., 1443 N. Northlake Way, Seattle, Wash. 98103. [375]

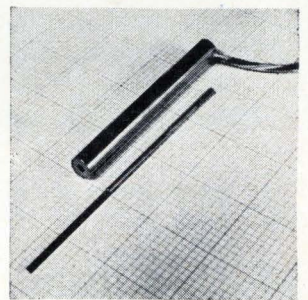

High-output and long linear range are featured in a linear variable differential transformer. Linear range of the 7131B is 0 to 2 in., and output at 2-in. displacement is 7 v nominal at 10 v, 1,000-hz excitation. Output impedance is 175 ohms. The transducer is 3.5 in. long. Prices range from \$135 down to \$39. Pickering & Co., 101 Sunnyside Blvd., Plainview, N.Y. [376]

25) and a spectrum display module (Model SPD-125). The display feature complements the sensitivity of the analyzer so that low-level signals and signal relationships normally undetectable by manual measurements can be displayed prominently. The analyzer has a sensitivity range of 0.04 microvolts (-135 decibels above 1 milliwatt) at 14 kilohertz to 1 μ volt (-107 dbm) at 1 gigahertz in the narrowband intermediate-frequency mode. But to achieve maximum sweep rate—up to 100 sweeps per second—the instrument has to be operated in a wideband if mode.

An 80-db dynamic range between

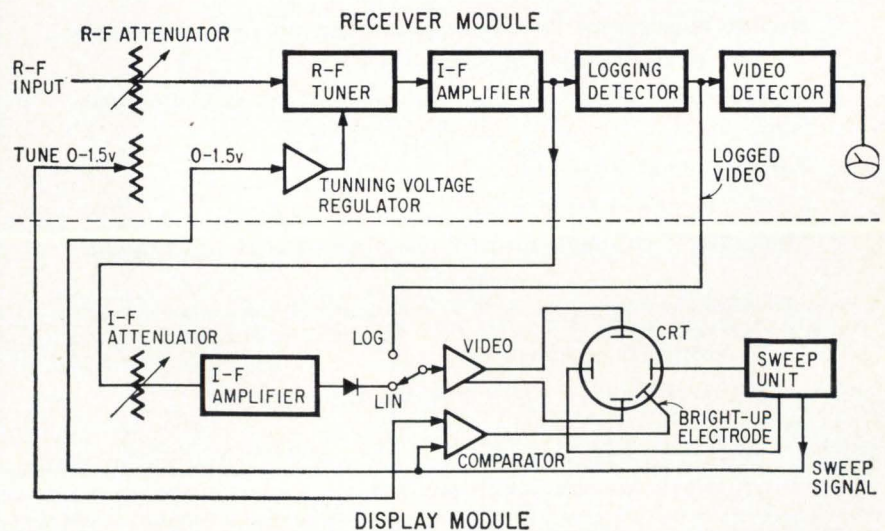

Sensitivity. Signal flow contributes to maximum sensitivity.

New! -- Ballantine Solid State AC Voltmeter



Model 303

2 Hz to 6 MHz, with 1% Accuracy at Midband -- Operates from Built-in Rechargeable Battery or Power Line

FEATURES:

- ★ Frequency range of 2 Hz to 6 MHz
- ★ Voltage range of 300 μ V to 350 V (100 μ V sensitivity, 10 Hz to 1 MHz)
- ★ Optional models with probe for voltage range 1 mV to 1000 V
- ★ 1% accuracy, 30 Hz to 1 MHz
- ★ Built-in rechargeable battery or power line operation (Optional version for power line only)
- ★ Logarithmic indicator for uniform accuracy and resolution over entire scale
- ★ Floating signal ground
- ★ 10 M Ω input resistance
- ★ Model 800 kit available for rack mounting without modifications

Prices:

Model 303: Rechargeable battery/line, \$320
 Model 303-50: Rechargeable battery/line,
 with 1 kV 20 dB Probe, \$382

Model 303-01: Line powered only, \$290
 Model 303-51: Line powered only, with
 1 kV 20 dB Probe, \$352

Write for complete technical data today



BALLANTINE LABORATORIES INC.
 Boonton, New Jersey

CHECK WITH BALLANTINE FIRST FOR DC AND AC ELECTRONIC VOLTMETERS/AMMETERS/OHM METERS, REGARDLESS OF YOUR REQUIREMENTS. WE HAVE A LARGE LINE, WITH ADDITIONS EACH YEAR. ALSO AC/DC LINEAR CONVERTERS, AC/DC CALIBRATORS, WIDE BAND AMPLIFIERS, DIRECT-READING CAPACITANCE METERS, AND A LINE OF LABORATORY VOLTAGE STANDARDS FOR 0 TO 1,000 MHZ.

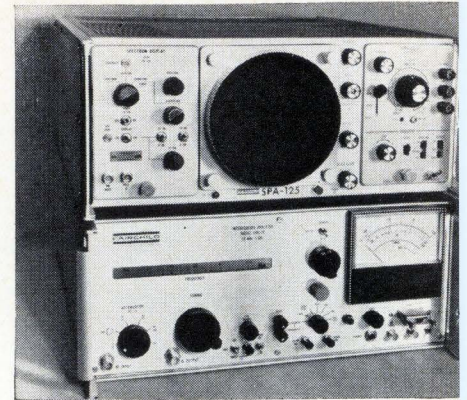

Two-in-one. New receiver to check RFI is two instruments in one: a module that displays spectrums and an analyzer of interference.

the noise floor, and the limit level is maintained throughout the unit, and a high degree of selectivity is made possible by an unusual multi-stage i-f amplifier design. The receiver is undercoupled and synchronously tuned, and has three separate dual-bandwidth channels. Intermediate frequencies of 175 kHz, 1.6 MHz, and 8.7 MHz are employed to achieve maximum image rejection. Respective pre-amplifiers for the separate i-f channels are built into the receiver tuner, and a three-transistor amplifier using a light-dependent resistor in its feedback loop supplies the automatic gain control voltage.

I. Remote control

Frequency interference tests demand that the analyzing receiver be placed outside a screen room; the CSR-200 can be operated remotely from the screen room. A motor and clutch connected to the screen room by a cable and activated by a transistor switch can operate the receiver's band-switching drum assembly. Bandwidth, calibration of impulse generators, vernier gain, and automatic frequency control can also be adjusted remotely.

R-f input is supplied by the antenna or a probe pickup device capable of operating within the frequency and dynamic range of the receiver. The rod and loop antennas employed in the 14 kHz-to-25 MHz band can be automatically switched synchronously with the EMC-25 band selector. Since antennas for frequencies between 25 MHz and 1 GHz are broadbanded, bandswitching isn't required.

A single control adjusts the input signal level to the receiver in 20-db increments, providing both r-f and i-f attenuation. The first attenuator step avoids r-f attenuation so that the instrument has maximum sensitivity. The r-f tuner assembly provides for preselection and heterodyning to the i-f and preamplification at the i-f.

Diode switching. The i-f amplifier bandwidth can be controlled both locally and remotely by diode switching a single narrowband tuned stage in series with the signal path. A portion of the amplified signal is applied to a logging detector and to a second i-f amplifier through an attenuator.

The logging detector is a seven-stage sequential system devoid of tuned circuits or delay lines. The circuit has two outputs, one a limited i-f signal, the other a d-c coupled reproduction of the logged envelope of the signal.

The video detector, located at the interface between the heavily shielded and unshielded portions of the analyzer, further detects and applies the correct time constant to the signal envelope waveform from the logging detector.

II. Display

The spectrum display module can be operated in several different modes. The spectrum mode shows the entire selected octave band with frequency and amplitude appearing on the x and y axes respectively for both linear and log display. The entire octave spectrum can then be photographed.

When a specific signal is of interest, the operator switches to the locator function to subdue or mask the over-all display and brighten the segment of interest.

Blowup. To obtain an expanded display of the brightened segment, the receiver is switched to the signature mode. A presentation of the section under observation is ballooned.

The instrument's audio amplifier provides a minimum output of 100 milliwatts to 600-ohm impedance earphones, as well as a detected output that is applied to an integral meter to indicate the level of the incoming signal modulation.

Fairchild Electro-Metrics Corporation,
88 Church Street, Amsterdam, New
York 12001 [377]

wanted: "big" insulator problems

Solving "big" insulator problems is Lapp's specialty. Wherever insulator requirements call for high strength, special electrical specifications, maximum dependability and long service . . . Lapp is the company to contact.

Lapp has been designing, testing and making insulators for communications installations for almost a half century. On many special jobs, our experience provides the basic engineering and design, which enables us to deliver the job quicker, and save you money.

How "big" are the jobs we've done? How about tower base insulators to 9 million lbs. ultimate strength with 500 kv peak wet flashover. Or, compression cone guy insulators to 620 thousand lbs. strength and in strings with grading rings giving wet flashover to 700 kv peak.

Lapp also made 3 of the world's largest RF feed through bushings with wet flashover of 600 kv peak, for continuous operation at 2545 amperes at 140 kv rms at 14-30 kc. Our double-yoked strain insulators have been made to 240 thousand lbs. ultimate strength with a wet flashover rating of 700 kv peak.

From drawing board to delivery, you can count on Lapp when it comes to "big" insulator problems. Write for additional information, Lapp Insulator Co., Inc., LeRoy, N.Y. 14482.

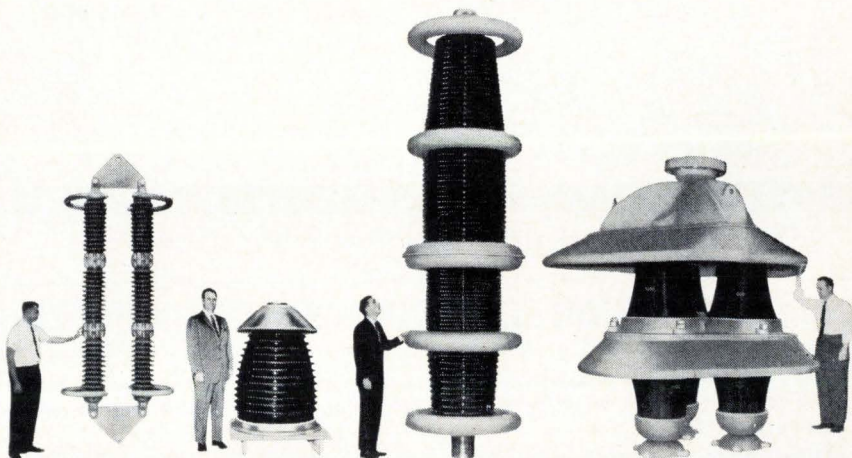

SPECTRUM MONITORING?

Check this 10-MHz to 4.5-GHz Quintet

FROM

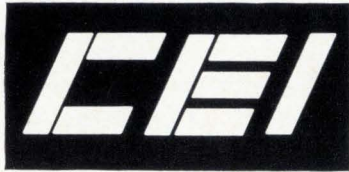

Are you interested in what's going on between 10 MHz and 4.5 GHz? If so, you can't afford to overlook this quintet of CEI receiving equipments:

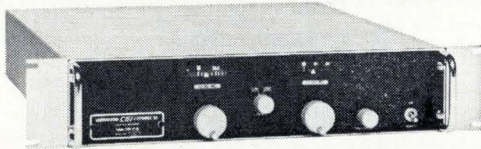

TYPE VT-10 TUNER . . .
covers the 10-MHz to 90-MHz range in two bands.

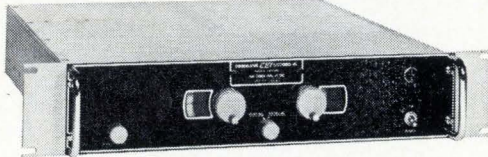

TYPE VT-30 TUNER . . .
spans the 30-260 MHz frequencies.



TYPE UT-1000 UHF TUNER . . . a companion to the VT-30, spanning 235 MHz to 1 GHz in two bands.



TYPE ST-1045 TUNER . . . covers the 1-GHz to 4.5-GHz range.

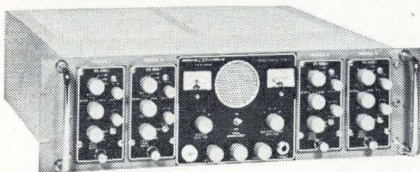

TYPE DM-4 DEMODULATOR . . . Provides demodulation of signals received by the above tuners. IF bandwidths from 5 kHz to 8 MHz are available as plug-in modules.

For complete information about these units (all are available separately) and related equipments, please contact:

COMMUNICATION ELECTRONICS INCORPORATED

6006 Executive Blvd., Rockville, Md. 20852 • Phone: (301) 933-2800 • TWX: 710-824-9603

SETTING THE PACE IN SURVEILLANCE AND SPECTRUM MONITORING. When only the highest possible performance is acceptable, look to the leader: CEI

New instruments

Computer-controlled temperature testing

Digital approach leads to further automation of environmental tests

Temperature chambers that can be completely controlled by digital computers are going to make the chore of testing electronics components and assemblies in different environments a lot less tedious. Coupled with programable signal generators and digital voltmeters, such chambers go a long way to making environmental testing as automatic as possible, cutting the cost of testing.

Adding a computer-controlled capability would boost the price of a test chamber by about 15% estimates Tenney Engineering Inc., builder of the chambers. With digital computers available at less than \$10,000, automated environmental testing is economical even for relatively small companies.

Tenney built its first models for a digitally controlled test facility being installed by a major computer manufacturer which tests a large volume of subassemblies at temperatures that range between -65°C and $+155^{\circ}\text{C}$. However, Tenney says digital-control capability can be built into any of its temperature and humidity chambers, and into pressure and vibration facilities as well.

Digitally controlled environmental testing would eliminate the need for constant supervision of the test setup—the computer could be programmed to turn off the equipment when certain preset limits are reached. In addition, the computer could handle most of the data-gathering directly. Calculations of such parameters as temperature coefficients, input impedance and gain could be made in a fraction of the time it takes to do it manually, while the data is being gathered. And the data could be processed into any desired form.

Fast cycle. One of the major features of the new chamber is that

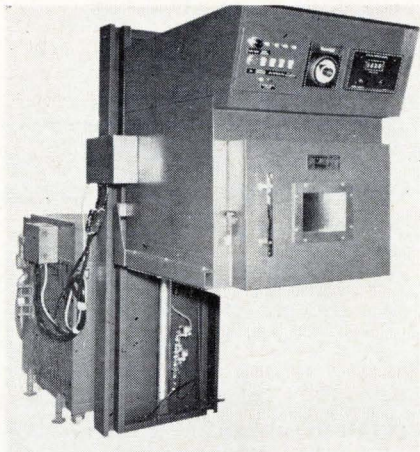

On top. Digital control instrumentation mounted atop environmental chamber cycles temperature between limits of +155°C and -65°C in 20 minutes. Temperature is read out on four-digit display.

it can cycle between its temperature extremes in only a fraction of the time required for conventional chambers.

"The temperature set point can be changed as quickly as you like because we've replaced the conventional electromechanical cam-follower control with digital control," says senior electrical engineer, John Urrutia. "Thus, the limit on how fast the temperature changes depends on the thermal capacities of the heating and cooling systems, not on the behavior of the cam-follower."

I. Versus computer control

The cam-follower in conventional environmental chambers is a flat aluminum disk or cam, 12 inches in diameter, turned by a clock motor. A wiper arm rides the periphery of the cam, which is shaped to correspond to the temperature desired within the chamber. Chamber temperature varies with the distance of the wiper arm from the cam's center because the other end of the arm is mechanically linked to the set point control of the heating and cooling system.

The speed at which chamber temperature varies depends on how fast the disk is turned and how fast the wiper arm can ride along the cam. With a typical cam motor making a complete revolution in 24 hours, the chamber would cycle once between its temperature extremes in 2½ hours, according to Urrutia. The new

HOW CAN YOU USE THIS NEW WRINKLE IN PLASTIC TUBING?

FLEXITE SHRINKDOWN TUBING is fast becoming an "indispensable" to design engineers. It shrinks 50% in diameter, upon application of moderate heat, to form a tough, tight-fitting sheath of plastic around objects of irregular shape. Primarily intended for insulation, it is also being used in many other ingenious ways. Like binding things together — adding strength and rigidity — protecting against abrasion, wear, breakage — resisting corrosion, heat, moisture — preventing vibration and noise — etc. How can **you** use it? We'll be glad to send you our "Hot Idea" experimental sample kit of all 3 types of Markel Shrinkdown. Just write for it. No cost or obligation.

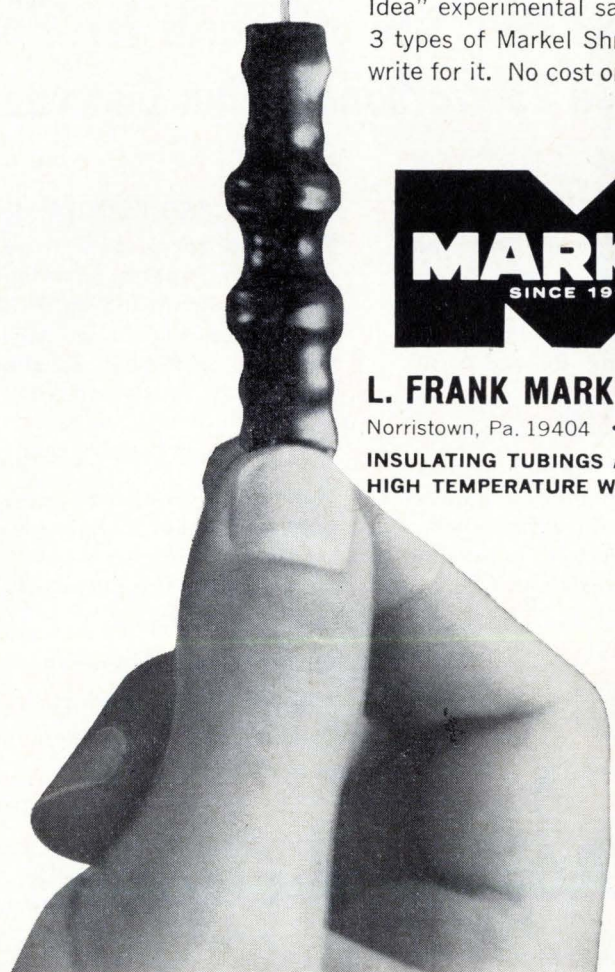

L. FRANK MARKEL & SONS

Norristown, Pa. 19404 • 215-272-8960

**INSULATING TUBINGS AND SLEEVINGS
HIGH TEMPERATURE WIRE AND CABLE**

New from Dearborn!

**World's
Smallest
1 μ F Film
Capacitor**



**STYLE LP88
DELTA FILM® 'LP'
POLYCARBONATE
CAPACITOR**

FUZ-ION* Sealed Tubular Construction Sets New Size Standards for Metallized Polycarbonate-Film Capacitors

SMALL, LIGHTWEIGHT

Heat shrinkable plastic case construction reduces weight. Super-thin dielectric permits dramatic reductions in size. Volume efficiency as high as .04 cu. in./ μ F.

UNIQUE VAPOR SEAL

Plastic case is "Fuz-ion Sealed" to epoxy ends, ensuring maximum seal efficiency. Case is nonconductive, fungus-proof, corrosion-proof, humidity-resistant.

*Trademark

OUTSTANDING PERFORMANCE

Designed for -55°C to $+125^{\circ}\text{C}$ operation. Superior operational reliability. High insulation resistance. Low dissipation factor. Low temperature coefficient. Excellent resistance to shock and vibration.

A-C AND D-C APPLICATIONS

Style LP88 Capacitors meet not only the most exacting d-c requirements, but are also ideally suited for a-c and r-f applications.

For complete technical information,
write to Dearborn Electronics, Inc.,
Box 530, Orlando, Fla. 32802.

Dearborn Electronics, Inc.
(a subsidiary of the Sprague Electric Company)
FOREMOST IN FILM CAPACITORS

**... computer instantly
selects the set point ...**

chamber will go from $+155^{\circ}\text{C}$ to -65°C in 35 minutes. With a carbon dioxide booster technique, this time is further reduced to 20 minutes.

In the digitally controlled chamber, the set point is instantly selected by computer signals that switch appropriate precision resistors into a Wheatstone bridge temperature controller. These resistors, selected from a series string, range in value from 0.1 to 204.8 ohms in binary multiples. The smallest temperature increment in the chamber is 0.1°C , says Urrutia. The computer also selects heating and cooling functions.

Chamber temperature is sensed by a digital feedback thermometer, with a calibrated platinum resistance bulb sensor, that is independent of the temperature controller. Output of the thermometer in binary-coded decimals goes directly to the computer. The thermometer also has a four-digit visual readout.

II. Time proportioning

The temperature controller also provides time proportioning of the heating cycle. This means that more heat is applied the further away the chamber temperature is from the set point. Then, as the temperature approaches the set point, the amount of heat is reduced, preventing temperature overshoot. Reset control, which also varies the amount of heat applied to the chamber, is used when the chamber temperature wanders from the control point.

The controller is all solid state, with the silicon controlled rectifiers turned on and off at those instants when the power line voltage passes through zero. This prevents the generation of unwanted transients. A temperature polarity indicator shows whether the temperature is moving above or below the set point. The controller can also be set manually; a 10-turn manual set-point potentiometer substitutes for the resistor string.

Tenney Engineering Inc., 1090 Springfield Ave., Union, New Jersey 07083.
[378]

A word to systems manufacturers

YOU CAN STOP THINKING OF US AS JUST THE BEST STORAGE TUBE MAKERS...

...and think of us as manufacturers of complete displays. It's true that our experience has included thousands upon thousands of Tonotron and Multi-Mode Tonotron halftone tubes. Typotron® shaped beam character-writing tubes, and Memotron® bi-stable display tubes. To this experience we have added scan converter and recording storage tubes employing principles unique to Hughes (i.e., no RF modulation requirement). We've worked with every conceivable application—weather and terrain avoidance radar, fire control, sonar, air traffic control, seismographic studies, ultra-sonic railroad track survey and medical diagnostic displays.

At the same time, our experience in special displays—complete equipments—includes ten-inch, 2-color consoles, 5 and 10-inch alpha-numeric displays, stor-

age tube TV displays, MTI (moving target) and scan converter video processors, and—most recently—large numbers of educational displays.

Depend on Hughes' complete engineering and production capability for display tubes and display equipment. Call or write the following:

Hughes Aircraft Company, Vacuum Tube Products, 2020 Oceanside Blvd., Oceanside, Calif. 92054. Phone: (714) 757-1200. TWX: 910-322-1380.

EAST: 1284 No. Broad Street, Hillside, N.J. 07205. Phone: (201) 289-7770. TWX: 710-741-4737.

INTERNATIONAL: Hughes International, Centinela & Teale Sts., Culver City, Calif. 90230. Phone: (213) 391-0711. Telex number: 067-222.

DATE: 2-17-67
AMT: \$1,383.00
BANK: 970-1283
ACCT: 3101-03717

HUGHES
HUGHES AIRCRAFT COMPANY
VACUUM TUBE PRODUCTS DIV.
OCEANSIDE, CALIFORNIA

New Subassemblies Review

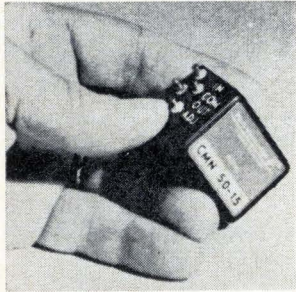

Regulated power supplies achieve one-fourth size reduction by use of h-f transformation techniques. The miniature CM-95 series is available in 18 models of d-c/d-c series regulators up to 24 v d-c and 1.5 amps. They provide local d-c regulation of 0.5% and a 200:1 input ripple reduction. Price is \$30 each. Technipower Inc., 18 Marshall St., Norwalk, Conn. [381]

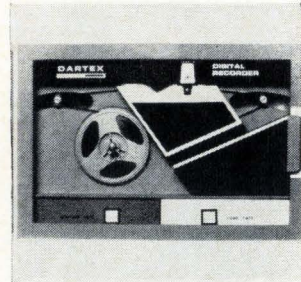

A magnetic tape, digital recorder can accept data from slow input devices for fast output. Model 1020 can asynchronously record and reproduce 8-bit parallel characters up to 120 characters/sec. It will record or read characters at a synchronous rate of 1600 characters/sec. for connection to most computers. Tally Corp., 1310 Mercer St., Seattle, Wash. [385]

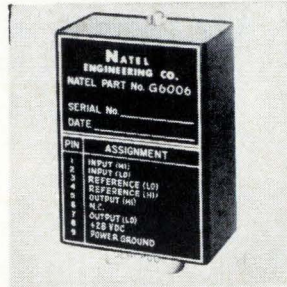

Galvanometers with load impedances of 30 to 600 ohms can be driven by the G-6006 phase-sensitive a-c/d-c converter that provides single current output. A current feedback technique enables output to remain constant within 0.02% as load varies from short circuit to maximum value. Price is \$199 in small lots. Natel Engineering Co., 7129 Gerold Ave., Van Nuys, Calif. [382]

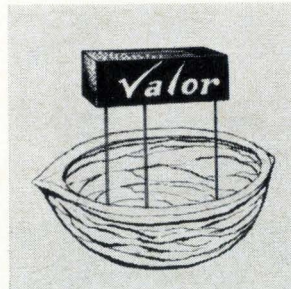

Delay time of 100 nsec, rise time of 35 nsec, and impedance of 20 ohms are features of DL1280 delay line. Unit measures 1 x 0.375 x 0.25 in. D-c resistance is 5 ohms max. With maximum attenuation of 10% and working voltage of 50 v d-c, it operates in environments of -55° to $+125^{\circ}$ C. Price is \$24. Valor Electronics Inc., 13214 Crenshaw Blvd., Gardena, Calif. [386]

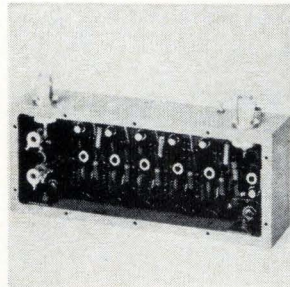

Series LL log amplifiers use a broadband untuned design and selective input filter to establish the operating frequency. Transient response is based on a turn-off technique in the summing stages. Features include ± 2 -db log accuracy; 30- and 60-Mhz center frequency; and 2-, 4-, and 10-Mhz bandwidths. RHG Electronics Laboratory Inc., 94 Milbar Blvd., Farmingdale, N.Y. [383]

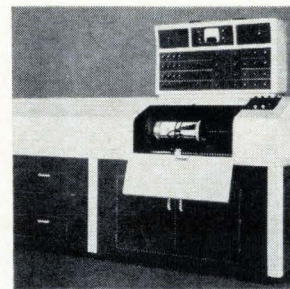

Simultaneous four-color separations are produced automatically in 20 minutes by Scan-A-Color III with built-in computer. The unit accepts flexible reflection copy or transparencies. Separations can be scanned in 340, 500, 1,000 or 1,250 lines/in. by adjusting apertures. Fairchild Graphic Equipment, 221 Fairchild Ave., Plainview, N.Y. 11803. [387]

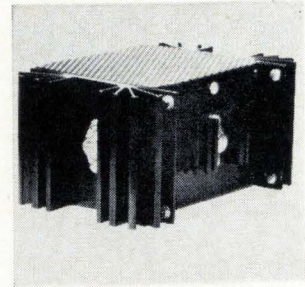

Power supply modules, models 10-400 and 10-PS, provide stable 400-hz sine waves at 1% distortion with 10 v-a power output. Regulation (no load to full load) is 1% with 115 v a-c output. Frequency can be changed by plugging in different oscillator cards with 1% accuracy or $\pm 5\%$ frequency control. Multi Phase Electronics, Box 3762, Van Nuys, Calif. [384]

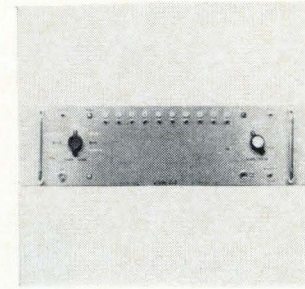

Designed as a building block for multipoint test systems, the 5800 scanner has self-contained control functions. Automatic sequential scanning is offered at calibrated rates of 60, 10, 1.0, 0.1, 0.01, and 0.002 sec/step with vernier control for intermediate settings. Basic unit has up to 50 channels. Price: \$500 up. Astro Lab, 9371-D Kramer Ave., Westminster, Calif. [388]

New systems

France produces more zap

The most powerful commercially available Q-switched infrared laser produces 50,000 megawatts

There is a new entry from France in the race for the title of most powerful commercially available laser. Last month, Compagnie Générale d'Electricité (CGE) introduced a neodymium-doped glass laser system that produces up to 50,000 megawatts with an energy

of 250 joules in a 5-nanosecond pulse, or 4×10^{16} watts/sq cm/steradian with an energy of 500 joules in a 30-nanosecond pulse in a high brightness configuration.

According to U.S. experts, the state of the art is 100,000 Mw of peak power and pulses as short as

.01 nanoseconds; however, these systems are not commercially available.

To build up such powers in its Q-switched lasers, which generate light in the infrared region, CGE uses pilot oscillators followed by a series of amplifiers. The new system is intended primarily for physics experiments. Its single elliptical cavity is water-cooled to allow a pulse repetition rate of one pulse every five minutes.

To prevent the glass rods from shattering under such powers, CGE increased the diameter in each successive amplifier stage, so that no stage can overheat.

Two Q Switches. The high-

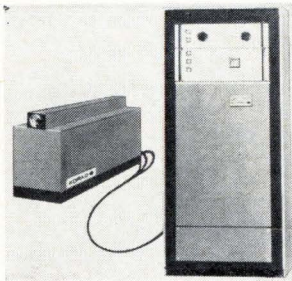

A 10-megawatt yttrium aluminum garnet laser with a repetition rate of up to 50 pps emits at 1.06 microns, in the infrared. Applications of the KY-18 include testing beam-guidance, tracking, and illumination systems. Its pulse width is less than 10 nsec; energy output is 100 millijoules per pulse. Korad Corp., 2520 Colorado Ave., Santa Monica, Calif. [389]

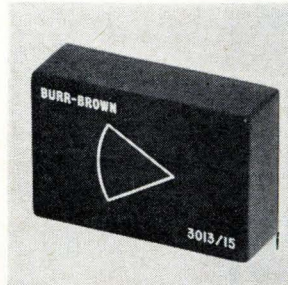

Settling time of less than 1.5 μ sec and input impedance of 10^{11} ohms are featured in a FET operational amplifier with differential input. The 3013/15 is suited for use as a buffer for a-d and d-a converters, and solid state multiplexers. It measures 1.2 x 1.8 x 0.6 in. Price is \$95. Burr-Brown Research Corp., 6730 S. Tucson Blvd., Tucson, Ariz. [390]



Adjustable between 10 and 18 μ sec, a variable delay line has a dynamic signal-to-noise ratio of 7:1 minimum. The Deltaline LG-14 produces 40 mv minimum output across 4,700 ohms when driven with 10 v at 60 ma peak current. The unit is solder sealed and meets MIL-STD-202A requirements. Sealectro Corp., 225 Hoyt St., Mamaroneck, N.Y. 10543. [391]

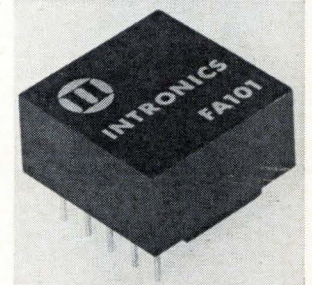

Signal buffering, instrumentation read-in and read-out, and low impedance signal transmission are among the uses for the FA-101, a 200 khz FET unity gain amplifier. Linearity is better than 0.005% for ± 10 -v input range; input impedance, over 10^{10} ohms; output impedance, under 10 milliohms. Price is under \$80. Intronics Inc., 57 Chapel St., Newton, Mass. [392]

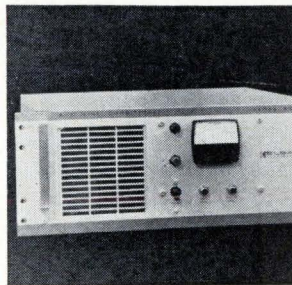

By applying high-speed regulation techniques to condition 400-hz power sources, the 6004 a-c line conditioner isolates sensitive equipment from power source disturbances. With response time of less than 50 μ sec, input-output isolation of 100 db, and regulation of $\pm 0.05\%$, the units provide 1 kva of transient-free a-c power. Elgar Corp., 8046 Engineer Rd., San Diego, Calif. [393]

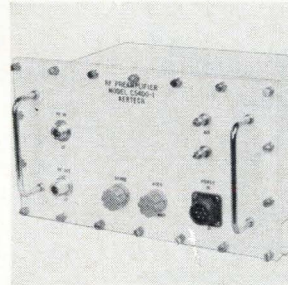

A telemetry down converter built to military specifications consists of three modules: a preamplifier (illustrated), a frequency converter, and a control panel. The C5400 converts 2.2 Ghz to vhf telemetry band. It can receive and amplify 10 or more adjacent carrier signals with various bandwidths and modulation. Aertech, 250 Polaris Ave., Mountain View, Calif. 94041. [394]



Four-quadrant operation is obtained from the 5109 analog multiplier across a 10-Mhz bandwidth with 1% full scale linearity. Input impedance is 10,000 ohms; output impedance, 100 ohms; useful dynamic range, 40 db. Applications include high-speed analog computation and data correlation. Price is \$484. Optical Electronics Inc., Box 11140, Tucson, Ariz. [395]

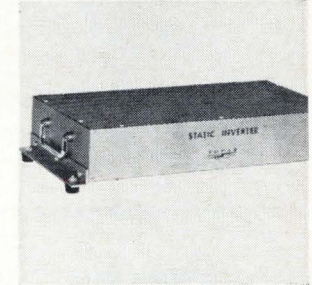

Mobile operation of instrument plotters and recording oscillographs is the function of the 290-GT-2 recorder inverter. The portable unit operates from batteries of either 12 or 24 v d-c. Output of the inverter is 295 v-a continuous and 375 v-a intermittent. Output frequency: 50 hz or 60 hz ± 2 hz. Topaz Inc., 3802 Houston St., San Diego, Calif. [396]

power laser, designated VK, is Q-switched by a Kerr cell placed after the pilot oscillator. It has up to five amplifiers in series to reach the maximum power rating of 50,000 Mw. In its pilot oscillator, the glass rod is 9.5 mm, but in the final amplifier stage, the rod is 64 mm in diameter.

I. Automated firing

In contrast, the high-brightness laser, designated VD, uses a rotating prism Q switch, and has up to four amplifier stages. In its oscillator the glass rod has a diameter of 16 mm; in the last stage of the four-stage amplifier, the rod diameter is 64 mm. The top of this line,

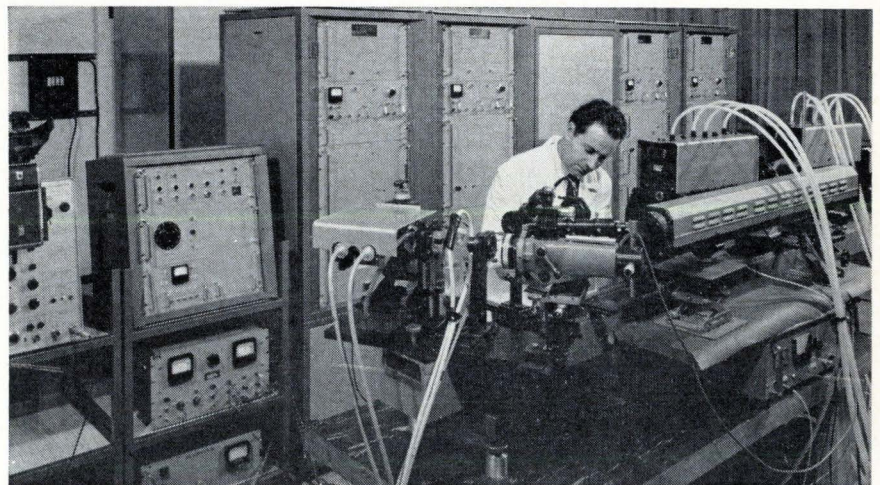

Giant laser. Powerful new system is available in two configurations: high power or high brightness.

YOKE SPECIALISTS

FOR INFORMATION DISPLAYS

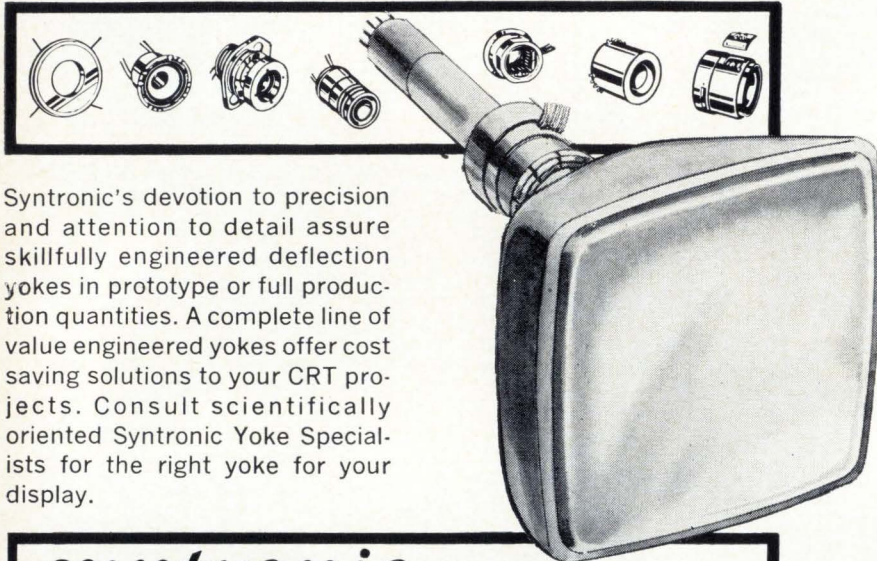

Syntronic's devotion to precision and attention to detail assure skillfully engineered deflection yokes in prototype or full production quantities. A complete line of value engineered yokes offer cost saving solutions to your CRT projects. Consult scientifically oriented Syntronic Yoke Specialists for the right yoke for your display.

Syntronic INSTRUMENTS, INC.
100 Industrial Road, Addison, Ill.
Phone: Area 312, 543-6444

Circle 204 on reader service card

Order Compack Controllers from Stock

*Save Space,
Time,
Money*

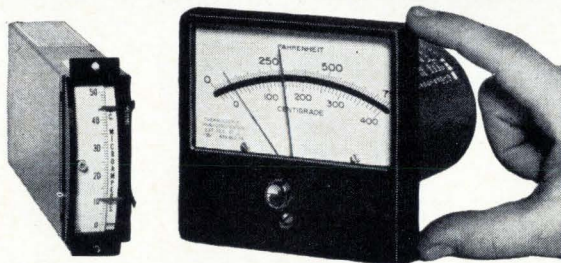

Everything about API Compacks is easy. They're space-saving controllers that simplify your design. You connect them quickly to any unamplified signal—AC, DC or temperature.

In-stock Compacks come in the following general ranges:

NON-TEMPERATURE: 0-10 to 0-100 microamperes DC, 0-1 to 0-50 milliamperes DC and AC, 0-10 and 0-50 millivolts DC. Special motor control range of 0-5 amperes AC. Single or double set point. On/Off, Cycling or Limit.

PYROMETERS: 0-300°F to 0-2500°F. Single or double set point. On/Off, Time proportioning or SCR Driver output.

Select upright-type Compack I or edge-reading Compack II, whichever suits you better.

Ask for: Bulletin 48 (non-temperature), Bulletin 49 (pyrometer models)

api INSTRUMENTS CO.
CHESTERLAND, OHIO 44026 (CLEVELAND-216) 729-1611 • TWX: 810-427-9230

called the VD 640 laser, produces 17,000-megawatt pulses with an energy of 500 joules.

Delivery of the system is from six months to one year and prices range from \$300,000 to \$400,000.

American distributor for the system is Congenel Inc., 50 Rockefeller Plaza, New York 10029 [397]

New systems

Transmitter boosts low-frequency use

Long-wave transmissions may ease traffic jam on communication channels

Crowded communications channels that are growing even more jammed have caused communications men to cast longing eyes on the low frequencies, 3 to 300 kilohertz. Although these frequencies offer reliable ground wave propagation and don't have the fading and interference problems that plague medium and short wavelengths, they are utilized by only a few government and military users.

But there's a reason these frequencies haven't found widespread use: long-wave transmission has been uneconomical. To generate efficient radiation at such wavelengths, an antenna would have to be 20 miles long and tuned at regular intervals along its length. In addition, the bandwidths are too narrow for practical use unless extremely low Q-tuned circuits are used, so a single frequency can handle only a few channels.

With a new high-power transmitter, Britain's Marconi Co. believes it can make long-wave transmission economical. Capable of operating at any fixed frequency from 40 to 160 khz and of carrying as many as five channels simultaneously, the new equipment will pioneer the transmission of teleprinter messages over long distances by long waves. Its power is 100 kilowatts. Reliability of propagation should also make the unit especially useful for marine communi-

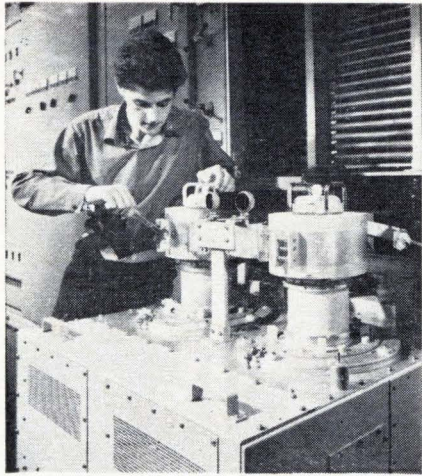

Long-wave transmitter. Two big air-cooled tetrodes provide the final amplification in new 100 kw transmitter.

cations, radio navigation, and transmission of frequency standards.

A turnaround. Although the long wave band dates from the earliest days of radio, not much effort has been applied to the design of such gear because of its apparently limited usefulness. The new design, however, includes an extension of the principle of frequency-shift keying—a method of transmitting messages by slight periodic shifts in carrier frequency—to the low-frequency band.

Use of the low frequencies is made practical by a unique wide-band linear amplifier in the final stage. It can amplify multichannel signals. Its large bandwidth is made possible by signal feedback.

Except for two air-cooled tetrodes, operated in parallel to generate an average power of 50 kw across the full frequency range, and a vacuum tube in the air-cooled driver stage, the transmitter's circuitry is solid state.

The high-power stages are fed by a separate drive circuit to avoid feedback and interference effects.

The frequency source is a 1-Mhz crystal oscillator followed by a frequency synthesizer that provides selection of any single channel in the transmitter's range. High-power oscillators, usually designed into long-wave transmitters, aren't needed because very high gain wideband amplifiers produce the final output.

Since so much of the transmitter is solid state, its physical size is 20% smaller than transmitters of similar power that have been de-

Tranquilizers

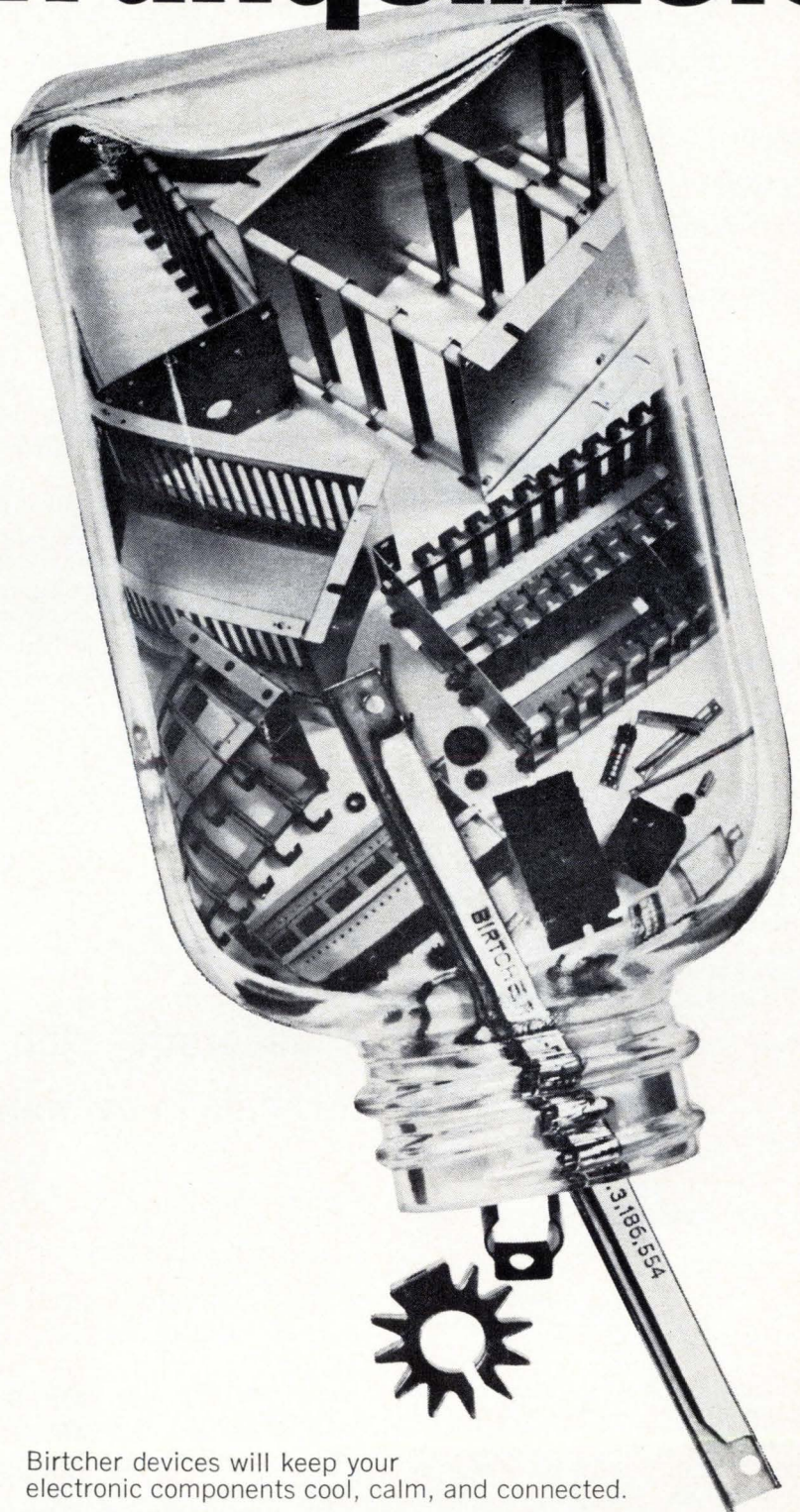

Birtcher devices will keep your electronic components cool, calm, and connected.

Write for catalog information on Birtcher's 10,000 cooling, retention, and rack devices for tubes, semiconductors, and printed circuit boards or call your Authorized Birtcher Distributor.

the BIRTCHER CORPORATION
INDUSTRIAL DIVISION

745 S. Monterey Pass Road, Monterey Park, Calif. • Tel. (213) 268-8584 • TWX 213-266-6814

FET UNITY GAIN AMPLIFIER

- Linearity:** Better than .005%
- Input impedance:** Higher than 10^{10} ohms
- Output impedance:** Lower than 10 milliohms
- Full output frequency:** Better than 200 kHz

3/4 cu. in.



Features

Voltage Gain	Unity +0, -.0005
Frequency Response	D.C. to 200 kHz, 20V p-p
Input Voltage	$\pm 10V$ to common maximum
Input Impedance	10^{10} ohms minimum
Input Offset Current	50 pA maximum
Output Voltage	$\pm 10V$ to common @ 5 mA max.
Output Impedance	10 milliohms maximum
Output Offset Voltage	$\pm 300\mu V$ maximum
Temperature Stability	$50\mu V/^\circ C$ $-25^\circ C$ to $+85^\circ C$
Operating Temperature	$-25^\circ C$ to $+85^\circ C$
Power Supply	+15 to +18 VDC -15 to -18 VDC
Package	1.12" x 1.12" x .62" Epoxy encapsulated module with 0.25" long, .040 diam. gold plated pins.
Mil Specs.	Meets MIL standards.

Applications

Signal buffering, instrumentation read in and read out, sample hold circuits, low impedance signal transmission.

The new FA101 field effect transistor amplifier includes protection against output short circuits and accidental supply voltage reversal; it requires no external zero adjustments and costs less than \$80.

Delivery: Stock to four weeks
Write or call Intronics for more information.
Phone 617-332-7350 • TWX 710-335-6835



57 CHAPEL ST. • NEWTON, MASS. 02158

veloped earlier. Still it adds up to a lot of equipment. The driver units are completely contained in an enclosure 2-feet wide and 7-feet high. The final amplifier and power supply are contained in separate cabinets, each 10 feet in length.

The transmitter can be run either manually or remotely. A single knob can turn on the entire unit. Although the transmitter is designed primarily for single-channel operation, frequency changes can be made easily—in about 30 minutes—by adjusting taps on the main tuning coils. Fine tuning is done with variable and switched banks of capacitors, although the external antenna matching unit can be adjusted to compensate for day-to-day variations.

One limitation to long wavelength transmission remains: a long antenna still has to be used for maximum efficiency during transmission. This limits applications somewhat. For example, although ships will be able to have both transmitting and receiving capability, aircraft will be able only to receive the long waves.

The Marconi Co., Chelmsford, England [398]

New subassemblies

Regenerative plan turns up in combiner

Positive feedback is used to correlate multisignals to yield maximum output

Last summer at the IEEE Communications Conference in Philadelphia, an engineer from the Bell Telephone Laboratories described a new method for combining signals from many antennas before they reach the detector in the receiver. The new method was a regenerative scheme, one using positive feedback to build up the received signal. The Bell arrangement was a laboratory setup that was never field tested.

Building on this work, the Ray-

GRC[®] tiny parts



die cast ZINC ALLOY



molded PLASTICS



Coil Bobbins Gears & Pinions



GEAR & PINION GUIDE BOOK

Gives full specs for hundreds of stock combinations of small 1-pc. die cast zinc alloy gears integral with pinions, shafts, spacers, etc., also combination to specs. GRC's exclusive techniques give you high quality in small parts of diecast zinc alloy, and engineering thermo-plastics at low cost! Write for samples and literature. Send prints for quotation.

No Minimum Size! Max: Zinc Alloy-2" long, 1/2 oz. Plastic-1 3/4" long, .05 oz.



GRIES REPRODUCER CO.

Division of Coats & Clark Inc.
World's Foremost Producer of Small Die Castings
151 Beechwood Ave., New Rochelle, N.Y. • (914) 633-8600
Plants in: New Rochelle, N.Y.; Warren, R.I.; Toccoa, Ga.

Circle 205 on reader service card

Surface Coatings

FREE ECCOCOAT[®] CHART

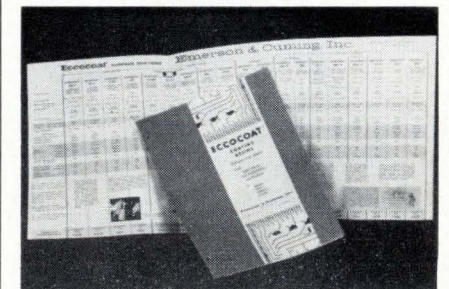

Epoxies, urethanes, alkyds, phenolics. Clear and in colors. Some are electrically conductive. Some are in aerosol cans. Electrical and physical properties are in table form. Application notes are included. Illustrated and in color for notebook or wall mounting.

This valuable chart is yours.
Write or use the Reader Service Card.

Emerson & Cuming, Inc.



CANTON, MASS.
GARDENA, CALIF.
NORTHBROOK, ILL.
Sales Offices
in Principal Cities

EMERSON & CUMING EUROPE N.V., Oevel, Belgium

Circle 206 on reader service card

theon Co. has designed equipment that also uses a regenerative approach to process the incoming signals from multiple antennas. But Raytheon is making the equipment, designated model PDC-4, commercially available.

The new unit has a novel circuit technique that produces transient-free combinations by summing up to four incoming signals in the process called maximal-ratio-squared combining. When it receives true signals, the equipment simply adds them producing a maximum output. The summing takes place only if the signals can be correlated; noise, which cannot be correlated, is eliminated.

Turning off. In previous equipment, signals were combined by what is called degenerative feedback by a phased-lock-loop technique. It's chief weakness: a noise spike, generated when one signal is lost, causes the signal-to-noise ratio to drop below the threshold level and to lose the output signal of the combiners temporarily. In Raytheon's new equipment, this kind of transient does not exist so sudden dropouts of a channel, turn off that channel. Meanwhile, the combiner operates on a maximal ratio basis for the remaining inputs.

During a 20-minute test run and using AN/MRC-98 troposcatter equipment, the PDC-4 lost the output signal for 12 seconds, while a standard postdetection system lost the output for 47.4 seconds—an improvement of nearly 400%. The tropospheric scatter system was 185 miles long and had a fourth order diversity—two frequency channels with both horizontal and vertical polarization.

The PDC-4 is a solid-state unit which is compatible with most troposcatter systems. It can provide either a combined 70 megahertz i-f signal or a demodulated output. Optional equipment is available to provide up to eight inputs and three combined outputs—redundant at i-f, redundant at baseband, or one each at i-f and at baseband.

Besides troposcatter systems, the PDC-4 can be used in line of sight diversity, high-frequency diversity, telemetry, radio astronomy, multi-element arrays, and possibly in millimeter-wave systems.

Raytheon Co., 1415 Boston-Providence Turnpike, Norwood, Mass. [399]

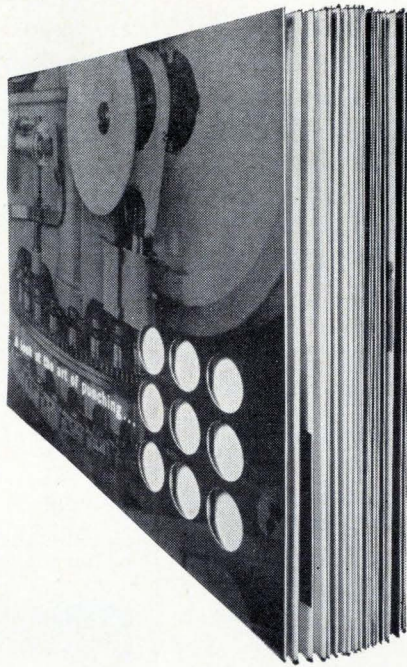

44 brand new pages of helpful punching information

- Six basic punching concepts
- Turret punch presses
- Stylus operated turret punch presses
- OBI punch presses
- Single station punch presses
- New horn punch presses
- Adjustable punch and die sets
- All shapes and sizes of punches and dies
- Template layout machines

Complete information! Illustrations, descriptions, specifications and prices. Ask your distributor for the new 44-page Di-Acro punching catalog or write us.



DI-ACRO

division of



437 EIGHTH AVENUE
LAKE CITY, MINNESOTA 55041

New Microwave Review

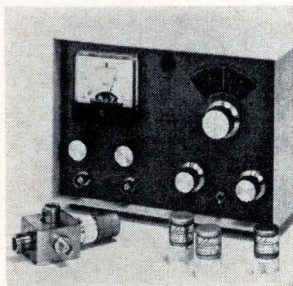

Spanning a 500-khz to 1-Ghz range, the TVS-1 vswr measuring system measures from 1.02:1 to 3.00:1 with an extended capability across any 17-db return loss range. Typical worst-case error is less than 4.1%, and accuracy of 1.77% can be expected for both fixed and swept frequency measurements. Telonic Engineering Co., Box 277, Laguna Beach, Calif. 92652. [401]

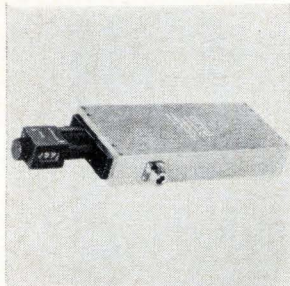

Zero insertion loss, continuously-variable attenuator, and a precision continuously-variable phase shifter capable of adjustment from 0 to 360° are combined in the Phasuator. Designed for use in phased arrays, the 2414-20B covers 2.9 to 3.6 Ghz. Maximum vswr is 1.50; maximum insertion loss, 1 db. Cost is about \$390. ARRA Inc., 27 Bond St., Westbury, N.Y. 11590. [402]

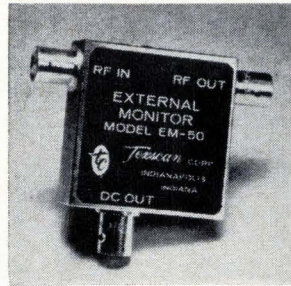

A dual-purpose device, the EM-50 is designed for externally leveling sweep signal generators and for signal monitoring. A uniform amplitude signal to remotely located test positions can be assured. Frequency range is 500 khz to 1.2 Ghz. Impedance is 50 ohms with a 3-db insertion loss. D-c output is negative. Price is \$55. Texscan Corp., 51 S. Kowebe Lane, Indianapolis. [403]

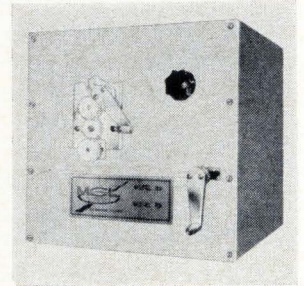

Designed for a-m, f-m, and p-m communications systems, a 1-kw output, c-w amplifier cavity covers 40 to 200 Mhz, tuned manually. The 11023 has a 13-db gain, efficiency rating of 40% and minimum bandwidth of 1 Mhz. Power input is 90 w; max vswr, 2:1. Nominal impedances are 50 ohms. Microwave Cavity Laboratories Inc., 10 N. Beach Ave., La-Grange, Ill. [404]

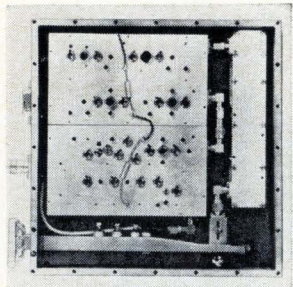

Four modules are packaged into a solid state oscillator for K_u band with 50-mw minimum output and up to 700 Mhz instantaneous bandwidth. Modules consist of X6 and X8 multipliers, amplifier, and tripler. Specifications can be customized, or modules can be purchased individually. Trak Microwave Corp., 4726 Kennedy Rd., Tampa, Fla. 33614. [405]

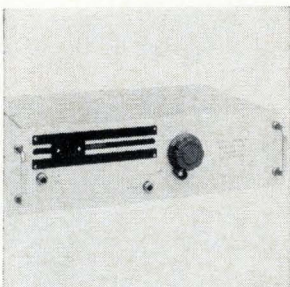

Calibrated in degrees per Ghz and millimeters of line length, a precision phase-shifter ranges from d-c through 12.4 Ghz. The 3114 line stretcher can be used for phase measurements, or as a component in a phase-sensitive bridge, and for introducing fixed line length changes into systems. Price is \$750. Wiltron Co., 930 East Meadow Drive, Palo Alto, Calif. [406]

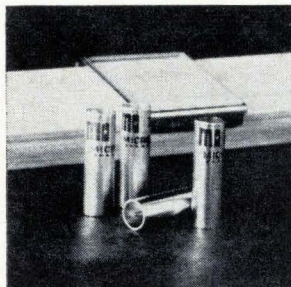

Developed for high burnout and maximum bandwidth, the MO-2703F coaxial mixer diode spans 12 to 18 Ghz. It is hermetically sealed and operates to 150° C. Noise figure is 7.5 db maximum; vswr at 16 Ghz, 1.5 maximum; i-f impedance, 400 ohms maximum; and burnout rating, 2 ergs. Alpha Industries Inc., 381 Elliot St., Newton Upper Falls, Mass. 02164. [407]

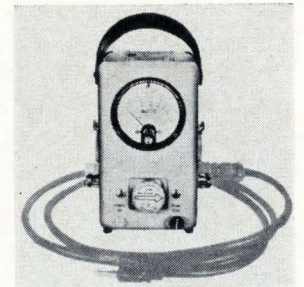

Measuring r-f power across a wide range of frequencies and power levels is achieved with the 4313 directional wattmeter. Peak and average power are measured with one instrument and a set of plug-ins. The plug-ins, for 450 khz to 2.3 Ghz, cover c-w, peak-pulse, or peak-envelope power levels from 1 w to 10 kw. Bird Electronic Corp., 30303 Aurora Rd., Cleveland. [408]

New microwave

Four-finger filter

A microwave filter with a miniskirt has the cutoff characteristics of a 20-section coaxial filter

In the research laboratories of the Bendix Corp., R.J. Wenzel has been creating filters that use elliptical functions to achieve unusual performance; in particular, a sharp attenuation after the cutoff frequency. Now Melabs, a small company in Palo Alto, Calif., has li-

censed the fruits of Menzel's work and pushed the operating frequency from megahertz to gigahertz.

Melabs' new microwave filter has a miniskirt by comparison with the broader skirts of conventional microwave filters. The "skirt" is

the spread of frequencies transmitted beyond the filter's cutoff point. In the new device there is a sharp attenuation just beyond the cutoff frequency. For a 1-gigahertz low-pass device, for example, the 40 decibel point is at only 1.05 Ghz, compared to 1.25 Ghz for other filters.

I. Getting to gigahertz

Wenzel's original work with elliptical functions produced a low-frequency device that operated from 500 kilohertz to 1.5 megahertz, with a 40 db drop at 1.75 megahertz. It was built with conventional inductors and capacitors.

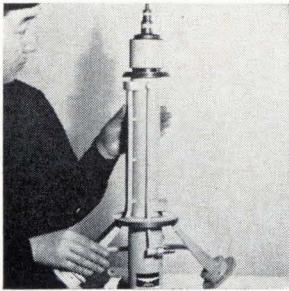

A satellite communications earth-station transmission tube, the M7864 wideband (500 Mhz) twt has a stable output of 5 kw. The metal ceramic tube is 24 in. long, weighs about 14 lbs without the focusing solenoid. The electron gun produces 1.5- to 2-amp currents at a voltage of 15 to 18 kv. Frequency is 5.9 to 6.4 Ghz. Tokyo Shibaura Electric Co., Tokyo, Japan. [409]

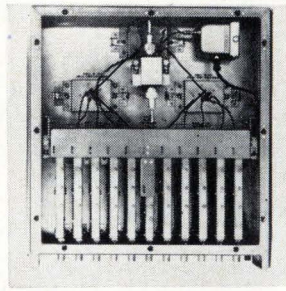

Microwave transistors in a stripline circuit are featured in a series of multicouplers covering the L- and S-band telemetry channels. Units consist of a pre-amp, 8 postamps, power dividers, and built-in power supply. Isolation between outputs is 50 db with a vswr under 2. Gain is from 2 to 5 db. Micro State Electronics Corp., 152 Floral Ave., Murray Hill, N.J. [410]

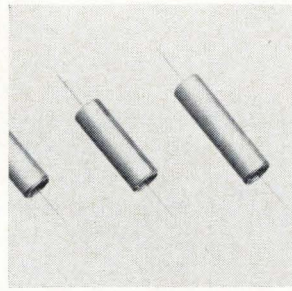

Hermetically - sealed switching modules, series 3600, are packaged for insertion as part of a co-ax line. Bandwidth is d-c to 18 Ghz; insertion loss, 0.5 to 2.2 db; and vswr, 1.5:1 to 2.3:1. Units consist of two or more silicon p-i-n diodes shunting the transmission line. Prices range from \$100 to \$175. Hewlett-Packard Co., 1501 Page Mill Rd., Palo Alto, Calif. [411]

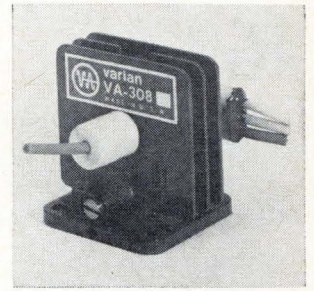

Reflex klystrons, designed for use as pump tubes in parametric amplifiers, operate between 14 and 18 Ghz. The VA-308 delivers between 200 mw and 1 w depending on the choice of beam voltage; the VA-309, from 10 to 300 mw. These powers are available for a 700-Mhz tuning range. Each tube weighs only 4 oz. Varian Associates, 611 Hansen Way, Palo Alto, Calif. [412]

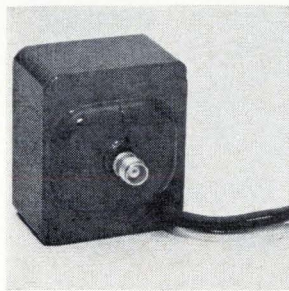

Voltage-tunable magnetron oscillators deliver 500 mw across 1.5 to 3 Ghz. The EM-1321 features flat power output (approximately ± 1 db). Linear voltage tuning is accomplished by changing the potential of the anode, which has an f-m sensitivity of 1.2 Mhz/v. Dimensions are 2.505 x 3.005 x 2.5 in. Varian Associates, Bomac Division, 8 Salem Rd., Beverly, Mass. [413]

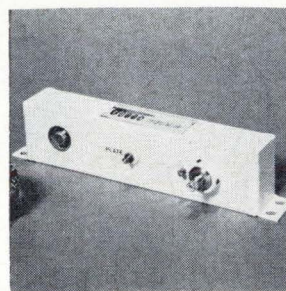

A grid-pulsed stripline oscillator meets military and commercial beacon transponder requirements. Frequency is stable with temperature, voltages and pulse repetition rates. The GLJ-3123 operates at a 0.01 maximum duty cycle continuously at 1.09 Ghz with a minimum output of +28 dbw. The compact unit weighs 4 oz. Terra Corp., 505 Wyoming Blvd., N.E., Albuquerque, N.M. 87112. [414]

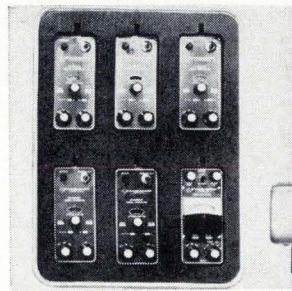

Field-installation checkout of ECM systems is provided by a portable microwave test set. The 693 includes fixed tuned signal generators—at L, S, C, X, and K_u bands—and a video amplifier that are operated by built-in rechargeable batteries. Also included are an antenna, detectors, attenuators, and other accessories. Kollmorgen Corp., 347 King St., Northampton, Mass. [415]

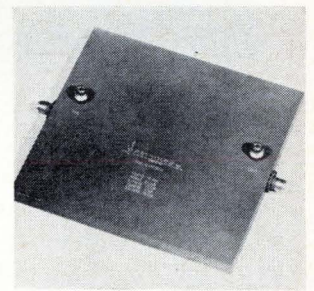

A frequency of 50 to 200 Mhz is covered by the 14040 stripline coupler. Main line vswr is 1.09; secondary line, 1.19. Coupling is 10 db ± 0.5 lb; directivity, over 25 db; power handling, 1,000 w average. It is available with type N, C, TNC, BNC, or ASM connectors. Size is 10 x 9 1/2 x 3/4 in. Price is \$575. Astrolab Inc., 4 McCandless St., Linden, N.J. 07036. [416]

Telephone companies have used the equivalent circuit with lumped constant elements. To push into the gigahertz region, Melabs has built a filter with transmission rather than lumped constant elements. It has a simple configuration that looks like four fingers connected to a very thin hand.

The filter is made by drilling a hole inside each aluminum finger and filling it with a coaxial dielectric that is shorted to an adjacent finger.

The equivalent circuit has a pi-shaped configuration with capacitive shunt arms and parallel LC series arms. The capacitance for

the series arms is supplied by the aluminum fingers of the filter. After testing the device, Melabs says its four-finger filter has the cutoff characteristics of a 20-section coaxial filter.

Ripple is about 0.1 db in the passband. Up to 2 Ghz, attenuation in the stopband is greater than 45 db below the passband. Higher, unwanted frequencies can be blocked by inserting a coaxial filter in series with the digital filter.

High cost of change. The filters do not come cheaply. "These filters will have to be more expensive than coaxial filters, which can be made with a straight lathe opera-

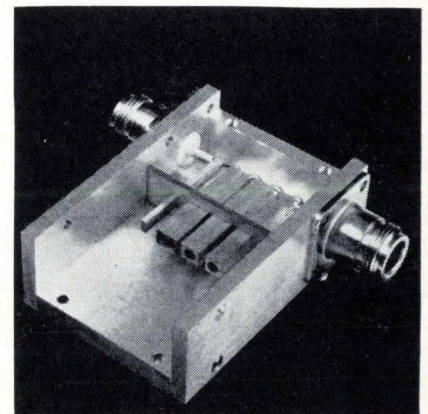

Four fingers. A 1-gigahertz low-pass filter, with four aluminum fingers, offers sharp attenuation with the 40 db point falling at 1.05 Ghz.

GIANNINI on Stepping Relays

"Why do so many engineers make sequence switching so complex and expensive, when a stepping relay is really the best answer?"

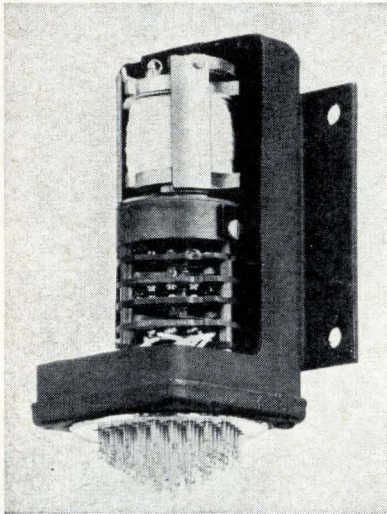

Our G-13 Series Stepping Relay shown here, for instance, is about the simplest and most reliable device for almost any sequential switching function. Vibration and shock exceed the requirements of MIL-R-6106, Class B8, and therefore are not a problem. This stepping relay is fast operating with low power consumption, and is, in fact, the only hermetically sealed stepping relay of its type designed specifically for airborne applications.

At Giannini-Voltex, we make stepping relays in a wide range of pole and contact configurations, and up to 10 Amps switching capability.

Next time you have a problem in sequence switching, get in touch with us. We'll help you find a simple way out.

Gabriel M. Giannini

GIANNINI || **VOLTEx**

12140 E. RIVERA RD., WHITTIER, CALIF. 90606
PHONE: 213-723-3371, TELETYPE: 213-685-6261
An Independent Company/An Equal Opportunity Employer

... two of the devices
are a duplex filter ...

tion," says Perry Vartanian, executive vice president of Melabs. "But we can see some applications where they will be worthwhile." Vartanian specifically mentioned the avoidance of radio-frequency interference and electronic countermeasures, where sharp cutoffs are needed to eliminate spurious signals of adjacent frequencies. Melabs found that its own sweep generator was producing third harmonics that interfered with the test. Vartanian believes that such a filter could become a common piece of lab equipment to avoid this hazard.

II. Antenna sharing

He also mentioned an application suggested by Wenzel in a paper presented at a Microwave Conference in Boston in May. If the internal shorts are opened, and the opens shorted, the inductors are changed to capacitors and vice versa—and the result is a high-pass filter. Two of these devices in series would amount to a diplexing filter, so that two receivers, one high frequency and one low frequency, could share an antenna, and the correct signals would be piped to each one.

Although Melabs calls its device a digital filter, the new product has no relation to lumped constant interdigital filters which look as if they were built of two meshed combs. Melabs first product will be a low-pass filter in the 300-Mhz to 3-Ghz range. Eventually it will make an entire line under exclusive commercial license from Bendix.

By licensing a product developed by another company which has no immediate marketing plans, Melabs is following a corporate path that is increasingly popular and should speed the introduction of new products to industry.

Specifications

Cutoff frequency for a Low pass filter	1 Ghz
Frequency range	d-c to 1 Ghz
	1 db at 0.9 Ghz
	3 db at 1 Ghz
Insertion loss	40 db beyond 1.05 Ghz
Rejection	0.1 db in the passband
Ripple	1 x 2 x 3 in.
Size	approximately 5 oz.
Weight	

Melabs, 3300 Hillview Avenue, Palo Alto, Calif. [417]

maintenance

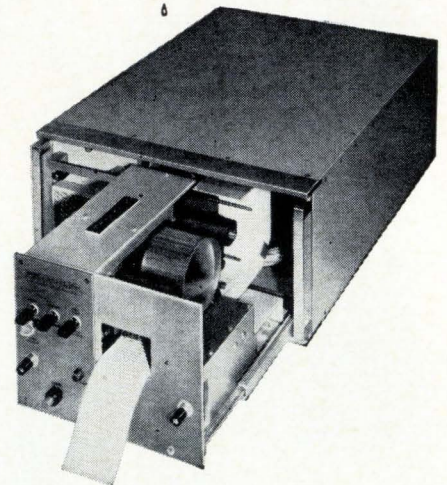
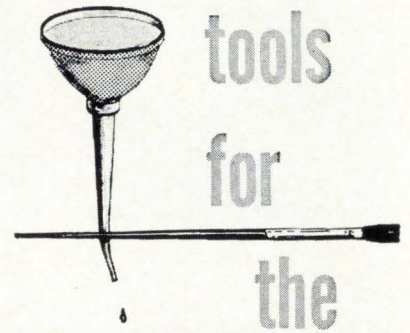

World's Fastest, Low-Cost Digital Printer

Apply several drops of oil to the drive-motor shaft-ends each year (or every fifty-million lines). Brush out any accumulated dust or lint. Clean the air filter periodically.

That's the extent of maintenance for a Franklin Model 1000 . . . the only digital printer that offers a printing rate of 40 lines per second (or less) at low, low, OEM prices.

REQUEST BULLETIN 2301

FRANKLIN
electronics, inc.

East Fourth St. • Bridgeport, Pa. 19405
A Division of the Anelex Corporation



Technical achievement for you... better living for you and your family

We are particularly anxious to meet you if you are a Circuit Design Engineer; Packaging and Mechanical Engineer; Electron Optics, Vacuum Technology or Materials and Process Specialist. But whatever your technical strengths, if "roll-up-the-sleeves" engineering appeals to you, we'd like to hear from you.

Here you'll find an environment that emphasizes the individual, and his personal contribution to technical development—contribution by working on projects, not writing about them. Your work will benefit advanced engineering throughout the world. You will benefit from technical association with specialists experienced in developing state-of-the-art instrumentation, components and devices.

All Tektronix R & D—financed entirely from our annual sales of over \$100 million—is directed toward *commercial* products. Our community is prosperous, balanced, with a stability of employment not typical of every industrial center. And as for the Green Land we live in—it speaks for itself.

If you're seeking technical advancement and better living for you and your family, why not investigate Tektronix?

Write to D. A. Thompson, Tektronix, Inc., P.O. Box 500A, Beaverton, Oregon 97005, or send in the coupon.

.....

• Professional Placement Mgr., Tektronix, Inc.
 • P.O. Box 500A, Beaverton, Oregon 97005.
 • Please send me your Booklet, "Tektronix" Application Form

NAME: _____

ADDRESS: _____

CITY: _____ STATE: _____

I am interested in: _____

Tektronix, Inc.
 An Equal Opportunity Employer.

.....



Now! All the Features of Larger Size Potentiometers — Except Larger Size!



New TRIMPOT® Potentiometer Model 3260H
ACTUAL SIZE

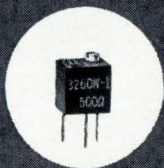

New TRIMPOT® Potentiometer Model 3260W
ACTUAL SIZE

- 1 Dimensions: 1/4" x 1/4" x 0.17"
- 2 Multi-turn adjustment
- 3 Damage-proof clutch action
- 4 Indestructible **SILVERWELD®** termination
- 5 Standard resistances from 10Ω to 20K
- 6 20 ppm wire
- 7 Two configurations available

Write today for complete technical data

If it's TRIMPOT®, it's BOURNS

TRIMPOT is a registered trademark of Bourns, Inc.



BOURNS, INC., TRIMPOT DIVISION
1200 COLUMBIA AVE., RIVERSIDE, CALIF.
PHONE (714) 684-1700 · TWX: 714-682 9582
CABLE: BOURNSINC.

New Production Equipment Review

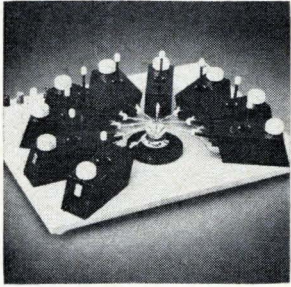

Semiconductor test stations have from 2 to 9 micropositioner units, a traversing stage with vacuum chuck, microscope mounting provision, and connections to test instruments. Each micropositioner probes within an area 0.300 in. in diameter and can contact a point 8 microns in diameter. Alessi Associates, 8710 Pershing Dr., Playa del Rey, Calif. 90202. [421]

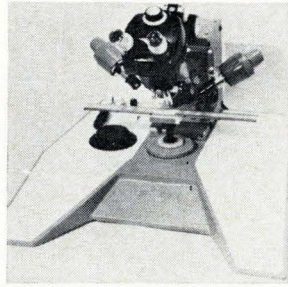

Handling lead frames up to 8 in. long, the 1400 ultrasonic wire bonder can rotate 360° around the center line of the unit being bonded. Aluminum or gold wire from 0.005 to 0.002 in. is handled smoothly for welds made in less than 2 sec per lead. Wire feeding is automatic. Engineered Machine Builders, 2632 Bayshore Frontage Rd., Mountain View, Calif. [422]

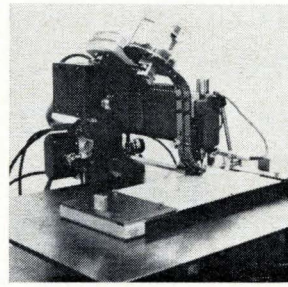

An automatic device inserts miniature jacks into p-c boards at a rate about 300% faster than hand insertion. A light beam lines up the hole for the jack. A spring-loaded locating pin enters the underside of the hole to lock the board in position. The pin triggers the driver, sets the jack, and recycles the machine. Eyelet Tool Co., 76 Rogers St., Cambridge, Mass. [423]

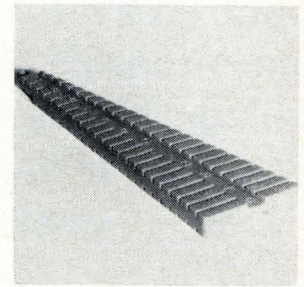

A lead-forming tool that handles 1/4- and 1/2-watt resistors and diodes speeds up production bench work and lab breadboarding. It is graduated in 0.05-in. increments on clearly marked centers 0.4 to 1.5 in. for quick selection of proper slot. Price is \$2.95 each in quantities of 1 to 4; \$1.95 each for 10 and up. Production Devices, Box 20175 San Diego, Calif. [424]

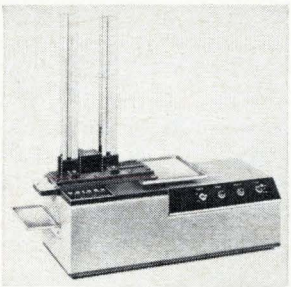

Flatpack and dual-in-line IC's can be tested in carriers by the TH-037 automatic handler. Typical net test rates of up to 6,000 devices per hour, exclusive of test time, eliminate manual test handling and facilitate use of expensive IC parameter test equipment. Price is \$2,395; availability, 4 to 6 weeks. Barnes Development Co., Lansdowne, Pa. 19050. [425]

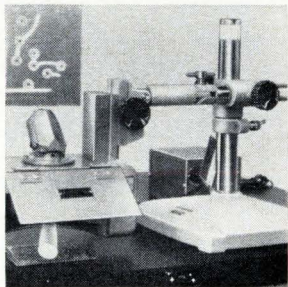

Visual inspection of p-c boards is made easier and faster by the Wilder circuit scanner, which magnifies a 1-in. area of the board 10 times and projects it against a screen at a distance of 36 in. Minor adjustments, corrections, and marks may be made on the board without interfering with the optics. Opto-Metric Tools Inc., 306 Hudson St., New York 10013. [426]



Insulating films are removed by a hand-held, motor-driven wire stripper that uses two counter-rotating brushes. The Stripvar is useful in manufacturing and installing motors, toroids, etc. Several wires may be stripped simultaneously. Three sets of brushes handle various wire sizes. Price is \$89.95. Kinetics Corp., 410 S. Cedros Ave., Solana Beach, Calif. [427]



Toroidal coil winder TO-127 handles most nonadhesive tapes. A gear-driven shuttle with permanently open section eliminates shuttle-opening operation and permits easy insertion and removal of coils. At completion of taping, the shuttle automatically indexes to starting position, speeding start of the next cycle. Leeson Corp., 131 West St., Danbury, Conn. [428]

New production equipment

Squeeze play slims printed lines

Contact printer that presses film tightly to master plate and adjusts light forms lines only 0.1 mil wide in IC masks

For the past nine months, Siliconix Inc. has been making the working masks for its semiconductor device production with a contact printer developed by the company. With it, the company says, masking lines only 0.1 mil wide—0.0001 inch—have been made, compared with

0.3 to 0.4 mil for the printer previously used.

Siliconix is adding the printer to the list of semiconductor production and test equipment it sells to other firms. The company's main product line is field effect transistors, but equipment has become

such a big sideline that a separate division handles the business and a vice president, Thomas S. Edwards, manages the sales.

Girls can be trained quickly to make 100 to 200 masks an hour with the machine, Edwards says. The output depends on how often the master plate is changed. Siliconix has gotten as many as 100 masks from a master, and uses each mask 15 to 20 times on the production line. Then the mask is thrown away.

This is a lot more practical, the company found, than trying to use an expensive master plate on the line. To justify a high cost, the mask

If you design systems that require DC to DC power converters you have probably tangled with the little rf spikes these power supplies generate.

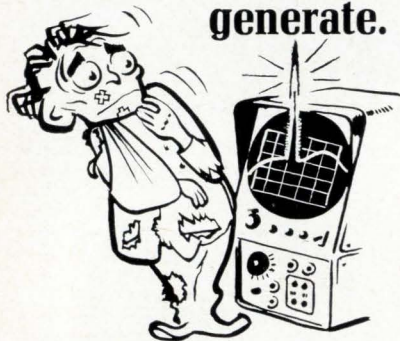

These little spikes of energy can jam and obliterate the performance of the very best designed systems.

The reason these spikes are so hard to filter out is because the source impedance from which the spike is generated is extremely low and the frequency band is extremely wide.

You can buy DC power supplies which will provide power for integrated circuits, operational amplifiers and photo-multiplier tubes for prices ranging from a few dollars to a few thousand.

The amount you pay is usually a measure (in inverse ratio) of the problem you'll have in trying to filter the supply output.

Mil Associates' power supplies

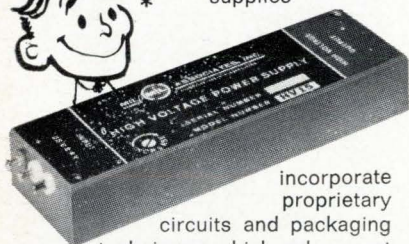

incorporate proprietary circuits and packaging techniques which solve most interference problems happily.

Our prices are generally twenty percent higher than the nearest competitor's comparable unit . . . if you don't consider his interference problem.

But twenty percent isn't really much of a premium when you buy a competitor's supply and then have to replace it with ours.



* Mil Associates power supply — 1/2 actual size
Satisfied Designer — 1/20 actual size

MIL ASSOCIATES, INC.

DRACUT ROAD, HUDSON, N. H. (603) 882-5193

... vacuum then pressure prevents distortion caused by glass plates that are uneven . . .

would have to be used several hundred times. But by then it would probably have a collection of scratches, pinholes, and dust that would result in a large number of transistor or integrated-circuit rejects.

I. Mating the plates

The printer uses vacuum holders and a two-edge aligning technique to position the master plate and the working plate from which the mask is made. Then it automatically switches to pneumatic pressure to force the film emulsion on the working plate against the master. To minimize divergence, light from a quartz-iodide source travels 3 feet before it reaches the plates; and to insure consistent exposure of the emulsion, an electro-optical circuit adjusts exposure time to compensate for decay in the light intensity as the lamp ages.

Tight fit. One of the difficulties of contact printing, Edwards points out, is that the master and working plates, which are made of glass, may not be optically flat. If they are simply pressed together, contact over the entire surface may not be firm, and the pattern developed on the mask is distorted. By evacuating the space between the two plates, while applying air pressure to the plates, Siliconix solved the problem.

The plates are positioned by an adaption of the classic two-edge reference technique. The master is placed in a vertical position against the door frame in the printer housing. It assumes a tilted position on three blunt pins and is held by a vacuum trough around the door frame. The working plate goes onto another vacuum trough in the door, which has three cone-tipped locating pins. As the door is shut, the cone tips ease the master off its own resting place and push the master into contact with the working plate.

II. Controlling light

When the door is closed, the holding vacuum is automatically shut off and 120 pounds of air pressure surges behind the working plate, pressing it against the master

at all points. A small vacuum port on the door sucks out the air trapped between the plates as they mate. Vacuum and air, from external sources, are supplied the door through two cables.

Lighting the way. A quartz-iodide lamp was chosen as the light source because its spectral response peaks at the same wavelength as Kodak high-resolution plates. The lamp is located below the door. Its light shines to the rear of printer and is reflected back through a passageway leading to the door. The three-foot total distance limits to 0.025 mil the line deviation on the working plate caused by light divergence. Siliconix says that it can hold an edge definition of 0.02 mil on 0.1 mil lines.

The operator sets the light timer to an equivalent exposure time, typically 8 seconds. However, a light integrator automatically lengthens the actual exposure time as the bulb decays.

A photosensor in a feedback loop monitors the light intensity; it is part of a feedback loop that adjusts the timing circuit so that the correct amount of light reaches the plates. When the time becomes long—say 12 seconds—the bulb is changed. A regulator delivers a fixed voltage to the lamp, regardless of line-power fluctuations.

The printer is designed for masks 2 inches square, but can be modified to accept 3-inch masks. It takes up 19 to 24 inches of bench space, costs \$2,195 and can be delivered in 30 days.

Specifications

Mask plate size	2 x 2 x 0.60 inches Up to 3 x 3 x 0.090 inches on special order
Exposure times	0 to 30 seconds (8 to 12 seconds is typical) 0.1 second resolution
Power	115 v or 230 v, 50 or 60 hz
Vacuum	20 inches Hg with 1 qt. accumulator (50.8 cm Hg, 0.95 liter)
Pneumatic pressure	120 psi optimum 40 psi minimum
Dimensions	24 1/2" x 19" x 15"
Weight	40 lb.
Price	\$2,195
Delivery	30 days

Siliconix Inc., 1140 W. Evelyn Ave., Sunnyvale, Calif., 94086 [429]

Production equipment

Speedy glassing by infrared rays

Damage to components caused by contaminants avoided during sealing

Glass encapsulation is an excellent way of protecting electronic components from moisture and oxidation—as long as the components aren't damaged by the process itself. Too often, when ferrous-oxide glass is heated by either flame or resistance methods, contaminants are introduced because of foreign elements touching the component during sealing.

There ought to be a better way, reasoned Bernard J. Costello, president of Argus Engineering Co., a specialist in radiant energy. Pooling his small company's resources with the larger Federal Tool Engineering Co. he has spearheaded the design of an infrared machine that can seal a dry-reed relay in four seconds, compared to the 38 seconds required by resistance heating. A complete sealing cycle takes only 30 seconds, compared to 90 seconds with conventional methods used.

I. Role for automation

The new sealer focuses the heat precisely where it's wanted, thus minimizing thermal shock damage to glass components, another complaint against encapsulating techniques. In addition, there are no changes in the physical properties of the reed materials since no contact is made with the component during sealing.

Costello believes that a good operator should be able to produce 250 encapsulations an hour. Next to be designed will be a fully automatic machine that will encapsulate 1,200 switches an hour.

Prices of the machines now available range from \$19,000 to \$130,000, depending on capacity and degree of automatic operation.

Federal Tool Engineering Co., 1386 Pompton Ave., Cedar Grove, N.J. 07009 [431]

Now! Select from the most complete line of Vinylon Filament Non-Linting Uniform and Gloves in the world. See the comparison table below.

Comparison Table :

Type of Fabric	Voltage of Static Charge
Taffeta (Vinylon-F) for this new products	70 V.
Nylon Taffeta on the market	3100 V.

Vinylon-F NON-LINTING UNIFORM AND GLOVES ARE WIDELY USED not only in the precision machinery industry, where complete dust control is required for quality control, but also in other places where management can be effectively carried out only by preventing dust from being generated through replacement of the conventional white robes with this new product. Details please write us **INDUSTRIAL AGENCIES OF JAPAN LTD.** C.P.O. Box 2014 Tokyo, Japan Cable Address: ARKENIAJ TOKYO Tel: 861-4631 — 5 manufacturer **FIRST NON-LINTING UNIFORM CO., LTD.** Tokyo, Japan



Circle 173 on reader service card

Electrical/Electronic Engineers

Design/Analysis/Test

LOCKHEED
MISSILES & SPACE COMPANY
A GROUP DIVISION OF LOCKHEED AIRCRAFT CORPORATION

• BSEE, plus
• appropriate
• experience in any of
• the following areas:

• Communications
• Computer Software
• AGE Systems
• Field Engineering
• Circuits/Systems
• Electro-optics
• Microwaves
• Power Systems
• Propulsion
• Instrumentation
• Guidance & Controls
• Batteries

• For complete
• information, write
• Mr. R. C. Birdsall,
• Professional
• Employment
• Manager, P.O. Box
• 504, Sunnyvale,
• California. An equal
• opportunity
• employer.

Trigger and trip circuits reduce bulk of scr drives

Phase-sensitive relay is eliminated and the unwieldy d-c contactor is replaced by small current relay, increasing the attractiveness of solid state drives

Solid state drives are making great advances in replacing motor generator sets for controlling d-c motors. Within three years, 90% of the drives sold will be all solid state, according to one industry spokesman.

There are two major reasons for the success of the solid state units: they cost less and take up much less room than the ponderous rotating machinery. And both cost and size are expected to decrease further as additional circuit techniques are developed and silicon controlled rectifiers improved.

One factor, of course, has been the steadily rising ratings of scr's as semiconductor technology has progressed so that some suppliers can offer devices up to 700 amp. Another has been the development of paralleling techniques which allow an engineer to get far more power out of several devices than out of any one used alone.

Improved circuit techniques play an important role in the line of solid state drives, called Statohm II, announced last month by the Electric Regulator Corp. Ranging from 5 to 500 horsepower, the drives are dramatically smaller than Electric Regulator's old line, particularly in the more powerful units.

For example, the new 300 horsepower unit weighs only 265 pounds, compared with the old unit's 900 pounds. It takes up only 15% of the space the old unit occupied, measuring 36 x 31 x 12 inches.

I. In-house improvements.

Part of this size reduction is due to two novel circuit techniques developed by the company. These circuits:

- eliminate the need for the phase-sensitive relay found in con-

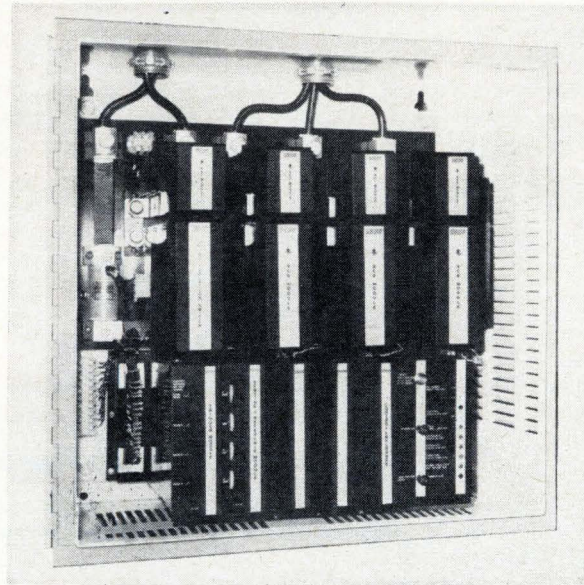

Modular design. Modules in Statohm II d-c motor drives plug into bus bars and can be quickly removed. Test panel for troubleshooting the drives is at lower right.

ventional drives because the scr switching circuitry is not sensitive to the phase sequence of the three-phase input voltage.

- replace the bulky d-c contactor, which removes the motor from the output of the drive in the

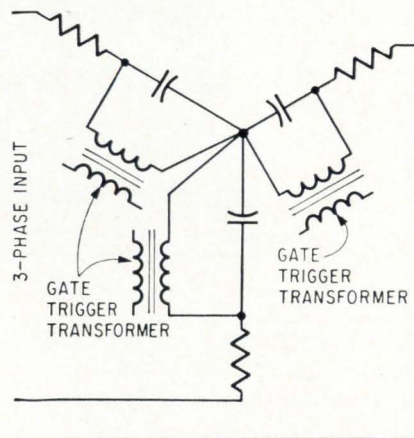

Input phase. Gate-trigger transformers are Y-connected across three-phase input line so that scr gates are triggered from line-to-neutral voltage, rather than from line-to-line.

event of a short, with a small current relay. This is possible because the scr's are first turned off by shorting their gates to their cathodes.

Phase insensitivity. In an ordinary drive, a special phase-sequence relay protects the motor from three-phase input lines that have been connected incorrectly. This protection is needed because each scr is triggered from the line-to-line voltage in its phase.

If the phase sequence is reversed, the scr will fire not near the beginning of an input voltage cycle but somewhere about 60° later. The motor at rest will suddenly have almost maximum voltage applied across its terminals, leading to catastrophic results. The phase-sequence relay allows voltage to be applied to the motor only when the input voltages are in proper sequence.

II. Triggering trick

Electric Regulator got around the need for this protective relay by

ENGINEERS

We'd like to put you in Univac

We're looking for top engineering and scientific talent to join the UNIVAC Twin Cities computer team. We want to hear from you if you have experience in the following areas.

HERE'S WHAT WE DO:

Create and manufacture the finest hardware/software in the computer field. Spend endless research and development time making them better. Recognize and solve problems in conceptual computers, multiprocessor systems, trajectories and their analysis, system integration, radar systems, performance analysis, guidance equations, simulation.

Currently we're developing advanced methods of program construction, planning for advanced software support. Exploring new logical language translation, compiler construction, mass memory allocation, information storage and retrieval, interpretive programs and advanced constructions. Conducting research in assemblers and loaders, program documentation techniques, advanced executive systems, remote programming systems, graphics. You name it—we're doing it.

HERE'S WHAT YOU DO:

To put YOU in UNIVAC write and tell your experience, capabilities and goals for today—and tomorrow. Write R. K. Patterson, Employment Manager, Dept. 114, address below.

UNIVAC

DIVISION OF SPERRY RAND CORP.

FEDERAL SYSTEMS DIVISION
2750 WEST SEVENTH BLVD.
ST. PAUL, MINNESOTA 55116

An equal opportunity employer M/F.

... shorting scr gates without contact bounce ...

triggering each scr not from the line-to-line voltage but from the line-to-neutral voltage in its phase. Developed by Baruch Berman, a consultant to the company, the circuit connects the trigger transformers for the scr gates across the three-phase input in a Y connection with a common neutral, as shown on page 174. RC networks in each leg shift the voltage at least 30 degrees. The result is that the phase relation between the transformer output used to trigger the scr and the forward voltage across scr is not altered when the input's phase sequence is reversed. The drive is phase insensitive.

Gate shorting. The d-c contactor that usually isolates the motor from the drive is large and bulky because it must not only carry

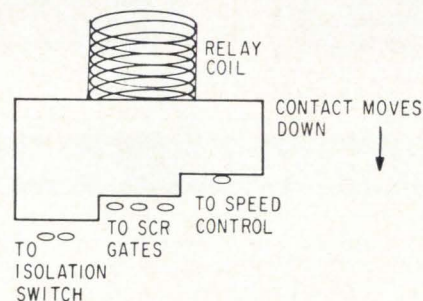

Three steps. Drives are isolated from motor with help of three-step Regohm relay which first shorts out speed control reference voltage, then shorts scr gates to their cathodes, finally opens isolation switch.

rated current—hundreds of amperes—but must be able to break the current as well. Merely opening the trigger circuits is not enough because of the possibility that the scr's could be fired by noise pulses.

A sure way of preventing current from flowing to the motor is to short the gates of the scr's to the cathodes. Electric Regulator decided on using its own Regohm—an electromechanical relay having an air dashpot to eliminate contact bounce—to short the gates. An ordinary relay wouldn't do because the contact bounce could cause the scr's to misfire full on. The Regohm performs three operations in sequence in the diagram above, as the insulated contact

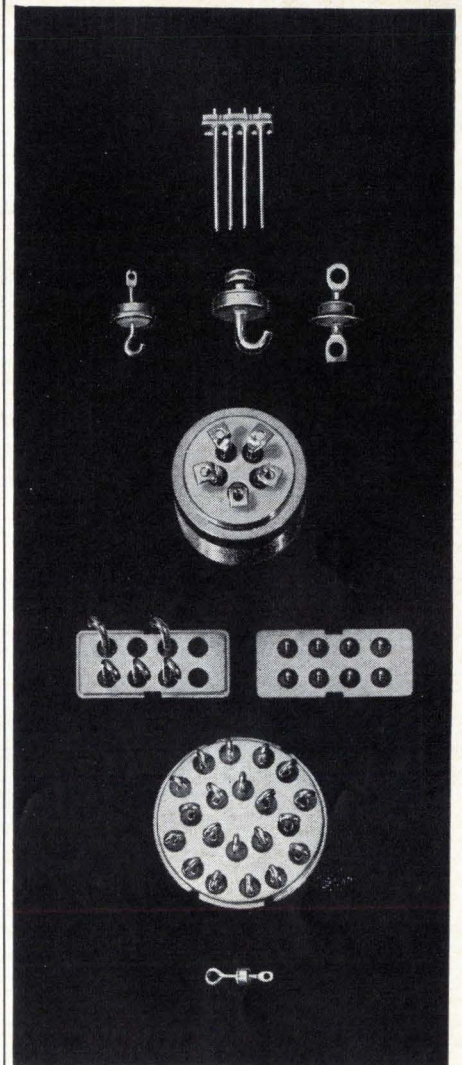

A source you can depend on

Whether you need custom headers or off-the-shelf single-pin terminals, Atlas offers uncommon reliability. That's because we have extensive manufacturing equipment and in-house test facilities to make any header you design, and then test to your specifications or MIL specs.

Electron-beam welding . . . altitude, temperature and humidity cycling chambers . . . metallographic and cross-sectioning photography. In-house facilities such as these mean unmatched quality and reliability for you. Over 150 sizes and configurations of single-pin terminals in stock. Custom headers to your drawings. Send today for complete information. Or phone 215 666-0700.

ATLAS

CHEMICAL INDUSTRIES, INC.
Aerospace Components Division
Valley Forge, Pa. 19481

FUSETRON

dual-element FUSES

Slow Blowing

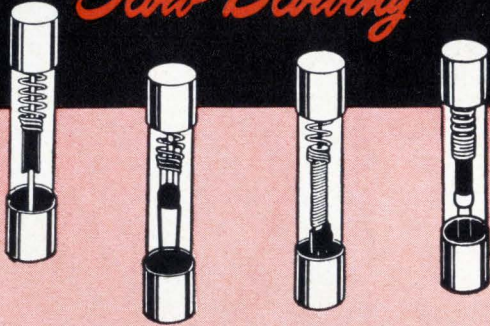

"Slow blowing" fuses prevent needless outages by not opening on harmless overloads—yet provide safe, protection against short-circuits or dangerous overloads.

Write for BUSS Bulletin SFB

INSIST ON

BUSS QUALITY

BUSSMANN MFG. DIVISION, McGraw Edison Co., St. Louis, Mo. 63107

Circle 177 on reader service card

BUSS

SPACE SAVER

Panel Mounted Fuseholders



Screw type slotted knob that is recessed in holder body and requires use of screwdriver to remove or insert it.



Screw type knob designed for easy gripping, even with gloves. Has a "break-away" test prod hole in knob.

Fuseholder only $1\frac{5}{8}$ inches long, extends just $2\frac{9}{32}$ inch behind front of panel. Takes $\frac{1}{4}$ x $1\frac{1}{4}$ inch fuses. Holder rated at 15 ampere for any voltage up to 250.

Write for BUSS Bulletin SFH-10

INSIST ON

BUSS QUALITY

BUSSMANN MFG. DIVISION, McGraw-Edison Co., ST. LOUIS, MO. 63107

Circle 177 on reader service card

BUSS: The Complete Line of Fuses and . . .



Great editorial is something he takes on a business trip
(What a climate for selling!)

Electronics

A McGraw-Hill Market-Directed Publication
220 West 42nd Street, New York, N.Y. 10036



**... an scr achieves dynamic braking
instead of a relay to short the d-c motor ...**

piece is pulled down by the relay coil.

First, the reference voltage used for speed control is shorted out. Then, the scr gates are shorted to the cathodes. And finally, with the current off, a small isolation switch opens and disconnects the motor from the drive output. The isolation switch can be small because it doesn't break the load current.

IV. Replacing the relay

Another circuit innovation in the new drives is that they achieve dynamic braking by using an scr, instead of a relay, to short the d-c motor through a load resistor. The flyback diode—normally across the output line to discharge the inductive energy of the motor—switches scr off when the motor is restarted.

Modular design. To a great extent, the drives are put together

from standard modules that can be quickly plugged into bus bars. The modules contain the power semiconductor, trigger circuits, sensing and regulation circuits, and the d-c isolation switch. Mechanically the modules, through 150 hp, are interchangeable; the higher-rated modules are for lower rated drives.

The drives are convection cooled through 150 hp. Such cool operation is possible because Electric Regulator uses the new flat compression packages, or "hockey puck," scr's. They provide 60% higher current ratings than the ordinary stud-mounted units.

A test module for troubleshooting the drives is mounted in the drive enclosure and contains color-coded a-c/d-c voltage test points and power on-off indicators for rapid testing with a voltmeter. A lighted push-to-test and push-to-

reset button for instantaneous over-current trip protection—the circuit is solid state—is part of the panel.

Specifications

Speed range controlled	0 to motor base speed
with regulation	20:1
At 100% rated torque, with blower	10:1
without blower	2:1
Speed regulation for 95% load change	5% ($\pm 2\%$; to 0.1% optional)
Drive service factor	1.0
Rated current overload:	
200%	1 minute
150%	2 minutes
Efficiency:	
conversion unit	95-99%
complete drive	90% (average)
Enclosure size	
5 through 75 hp	24 x 24 x 12 in.
150 hp	30 x 24 x 12 in.
300 hp	36 x 31 x 12 in.
Ambient temperature	10 to 40°C
Line frequency	50 or 60 hertz
Line voltage, 3 phase:	
model 6252	230 volts, $\pm 10\%$
model 6352	460 volts, $\pm 10\%$, -5%
Cost (with motor)	
75 hp	\$8,300
150 hp	\$12,000
300 hp	\$24,000

Electric Regulator Corp., Pearl St., Norwalk, Conn. [436]

. Fuseholders of Unquestioned High Quality

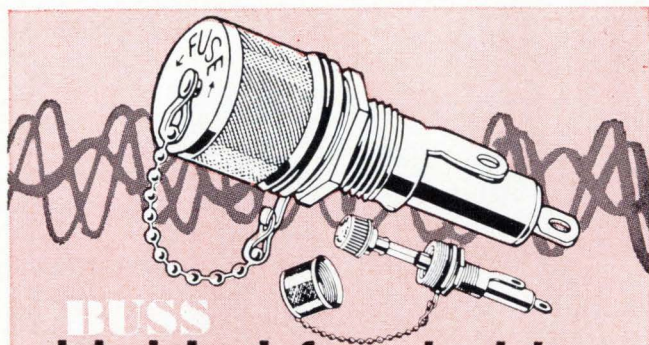

BUSS shielded fuseholders

PREVENT RADIO FREQUENCY INTERFERENCE

For use where fuse and fuseholder could pick up radio frequency radiation which interferes with circuit containing fuseholder — or other nearby circuits.

Fuseholder accomplishes both shielding and grounding.

Available to take two sizes of fuses — 1/4 x 1 1/4" and 1/4 x 1" fuses.

Meets performance specifications of both MIL-I-6181D and MIL-F-19207B.

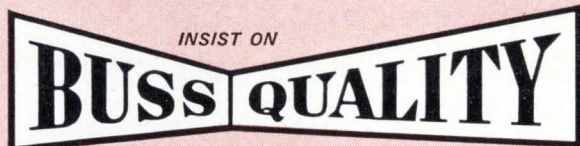

BUSSMANN MFG. DIVISION, McGraw-Edison Co., ST. LOUIS, MO. 63107

TRON SUB-MINIATURE PIGTAIL FUSES

BODY SIZE ONLY .145 x .300 INCHES

For use on miniaturized devices, or on gigantic space tight multi-circuit electronic devices.

Glass tube construction permits visual inspection of element.

Smallest fuses available with wide ampere range. Twenty-three ampere sizes from 1/100 thru 15 amps.

Hermetically sealed for potting without danger of sealing material affecting operation. Extremely high resistance to shock or vibration. Operate without exterior venting.

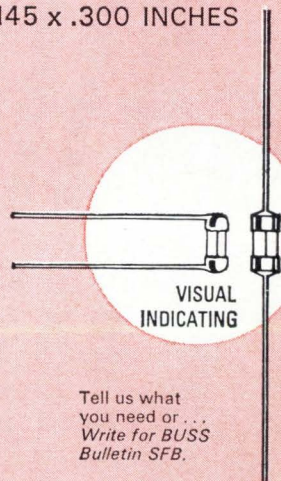

Tell us what you need or ... Write for BUSS Bulletin SFB.



BUSSMANN MFG. DIVISION, McGraw Edison Co., St. Louis, Mo. 63107

Microsonics

State of the Art Design in Filters Oscillators and Delay Lines



Continuously Variable Delay Systems
Bulletins 4301 and 4302

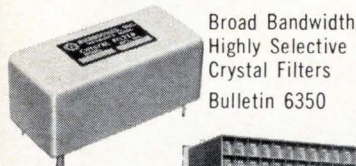

Broad Bandwidth Highly Selective Crystal Filters
Bulletin 6350

Comb. Filter Sets
Bulletin 6350



Broad Bandwidth Delay Lines
Bulletin 4300

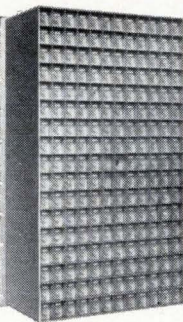

Highly Stable Oscillators — Bulletin 6350



Voltage Controlled Crystal Oscillators
Bulletin 6350

High Density Digital Storage Systems

Bulletin 5350

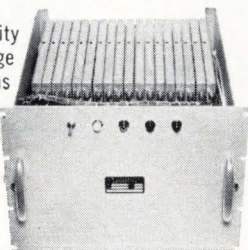

Send for literature.



MICROSONICS, INC.
60 Winter Street
Weymouth, Mass. 02188
Tel: 617 337-4200

A subsidiary of the Sangamo Electric Company

New Books

Ion watching

The Particle Kinetics of Plasmas
I.P. Shkarovsky, T.W. Johnston, and
M.P. Bachynski
Addison-Wesley Publishing Co. Inc.,
492 pp., \$17.50

Recent research in space and controlled thermonuclear reactions has revived interest in plasma physics, and this has resulted in a substantial literature which is now greatly in need of unification. The authors have admirably begun this task, offering a clearly written treatment of the kinetic-theory aspects of plasmas.

Organized principally as a text, the book will be more valuable to the researcher in the field than the practicing engineer. To help the reader handle the complex subject, the authors frequently pause to sum up the previous discussion and tie it in to the text that follows. This lucid connective matter provides an appreciation of what has been accomplished without requiring the reader to completely understand the details. The connective material and the large fundamentals-oriented bibliography are the book's best features.

The development of the fundamental equations of plasma theory is traced, and the equations are applied to calculations of observable plasma properties—electrical and thermal conductivity, diffusion, bremsstrahlung radiation, etc. Cross sections are derived for all types of collisions in weakly and fully ionized plasmas, with and without magnetic fields.

Donald E. Kerr

John Hopkins University
Baltimore

Spanning the spectrum

Communication Systems and Techniques
M. Schwartz, W.R. Bennett, and
S. Stein
McGraw-Hill Book Co., 618 pp., \$16.50

Three authors, each covering his area of special interest, have undertaken a variety of topics in communications theory in this volume. Schwartz and Bennett discuss communications in the presence of noise and the performance of vari-

ous analog and digital modulation systems, while Stein treats fading channels and digital diversity communication systems.

Stein's portion alone is worth the price of the entire volume. He has gathered an enormous amount of material previously available only in journals, and has organized it in an excellent presentation. A detailed treatment of phase- and frequency-shift keying leads to a unified formulation of system performance that takes into account correlated noise and intersymbol interference. Statistical models and experimental results are presented for a number of fading channels and multipath phenomena, and the effects of these phenomena on error rates are extensively treated. The application of diversity combining techniques to counteract nonstationary channel effects is discussed, and there's a description of adaptive and spread-spectrum techniques for diversity reception.

In contrast, the sections by Schwartz and Bennett deal with subjects that have been more completely treated in other texts. In the tutorial material presented by Schwartz, so much ground is covered that his discussions are sketchy; however, he fills the gaps somewhat by references to standard texts and articles. Bennett's portion is most like a collection of miscellaneous topics; a chapter on pulse modulation is well organized and should have been expanded.

Robert E. Weiblen

Devenco Inc.
New York

Recently published

Worked Examples in Basic Electronics, P.W. Crane, Pergamon Press, 282 pp., \$7 hardbound, \$4.50 softbound

Step-by-step procedures are presented for the solution of fundamental electronic design problems. The examples given are almost completely restricted to vacuum-tube circuits. One-third of the book covers the derivation of basic amplifier formulas.

CATV System Maintenance, Robert B. Cooper Jr., TAB Books, 194 pp., \$12.95 (softbound)

The first book on community antenna television system maintenance. Antenna requirements, construction techniques, and complete troubleshooting procedures are presented. Maintenance charts are included to help the technician isolate and correct the more common head-end problems.

If you don't have one... let's hope you never need it

Valuable taped data can be erased or partially destroyed by unexpected exposure to magnetic fields... generated by electrical equipment, electronic gear, air transport instrumentation, electrical storms, etc. Such loss is costly and inconvenient. The data may even be irreplaceable.

Avoid these hazards

Use NETIC Tape Preservers

for storing and transporting your valuable tape data. They provide ideal insurance against such potential hazards. Available in numerous sizes and shapes to fit your needs.

Delivery from stock. Request catalog No. TP-1

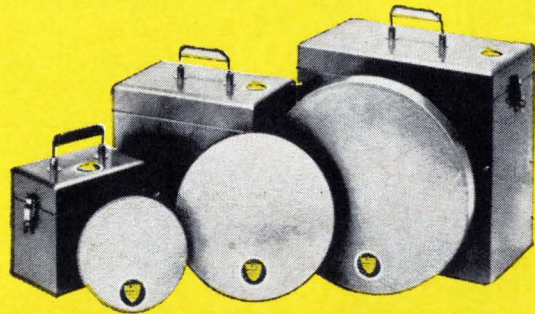

MAGNETIC SHIELD DIVISION

Perfection Mica Company

1322 N. ELSTON AVENUE • CHICAGO, ILLINOIS 60622

Phone: 312. EV 4-2122 • TWX 910 221-0105

Circle 179 on reader service card

Not much of a plot, but a great cast of characters.

The characters are 6,000 manufacturers and more than 4,000 product listings. Even if you're not the literary type, you'll be interested in the unprecedented opportunity the Electronics Buyers' Guide affords you to reach readers. Over 445,000 engineer users go to EBG year round as a one-stop shopping center for all their electronic needs. Closing date: Space reservations: July 14. Plate closing July 28. Book some space now! First come, first served.

Electronics Buyers' Guide

A McGraw-Hill Market Directed Publication,
330 West 42nd Street, New York, N.Y. 10036

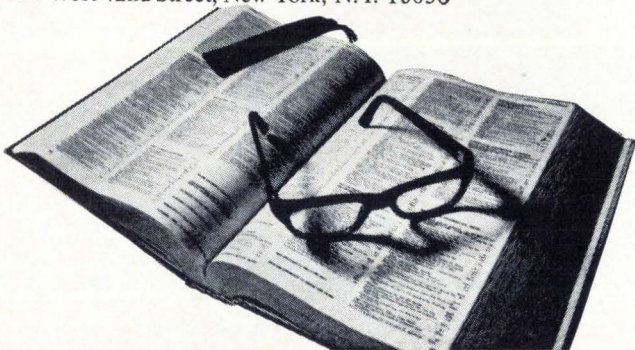

REPLACE BULKY GEARMOTORS

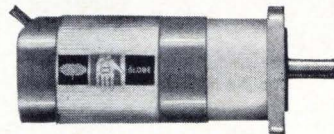
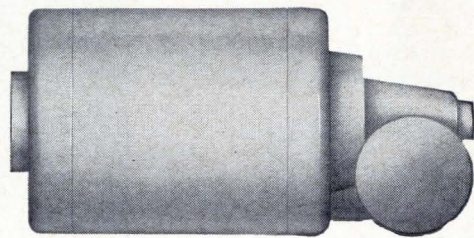

TO CUT COSTS

Globe commercial gearmotors generally cost less for a given output and are only 1/4 the volume of conventional units. They outperform conventional gearmotors in dozens of ways... higher efficiency and output torque plus more speed choices. Globe's a.c. and d.c. gearmotors are space saving, maintenance-free, economical. Request Bulletin CFP. Globe Industries, Inc., 2275 Stanley Avenue, Dayton, Ohio 45404, U.S.A. Tel.: 513 222-3741



ENGINEERS:
UNIVAC and you:
words to program
a career by . . .

"flip flop"



"FLIP-FLOP" (verb).

In the "USA Standard Vocabulary for Information Processing" this word means one thing. But in terms of your career it could mean changing jobs too frequently; or changing from one career dead-end to another. So we encourage scientists and engineers and skilled programmers to ask any and all questions which can acquaint them with every aspect of a proposed move to UNIVAC.

Just for example, here are some of the positions we now want to fill . . .

- Advanced Electronic Circuit Studies
- Integrated Circuits and Thin Film Studies
- Ultra-High Speed Integrated Circuit Interconnections
- Computer Manufacturing Engineering
- Industrial Engineering & Cost Analysis

To make sure a change is a real step ahead, not a mere "flip-flop," write and tell us all about your experience, your desires, your hopes for the future. Include any questions about UNIVAC. We'll write back, as completely as we can. Write: John D. Hallenberg, Employment Manager, Dept. 508.

Write today and make an appointment with tomorrow.

UNIVAC
DIVISION OF SPERRY RAND CORPORATION

data processing division
2276 highest drive
roseville, minn. 55113
telephone 612-633-6170

An equal opportunity employer M/F

Technical Abstracts

Pick and choose

An economical method of achieving large-scale integration
I.A. Davidson and G.H. Hantusch
Northern Electric Co.
Research and Development
Laboratories
Ottawa, Canada

An unusual approach to large-scale integrated-circuit arrays is the fabrication of several identical circuits in clusters on a silicon chip. The best circuit within each cluster is then identified and connected into the final system using a fixed interconnection pattern. Each circuit in the cluster, called an elemental function block (EFB), must be capable of being bridged to the fixed pattern in an identical, simple way.

For the technique to be successful, there must be at least one good EFB within each cluster. By varying the number of EFB's per cluster, the probability of this happening can be adjusted.

A simple formula to choose an

optimum number of EFB's per cluster, to which the symbol m is assigned, has been developed. It is related to the yield of individual EFB's on a chip, the number of clusters required in a given system, and the required system yield.

Another important parameter is the expected number of good systems that can be obtained from one slice, which can be expressed in terms of the maximum number of EFB's that will fit on a slice, the number of clusters per system, the yield of EFB's, and the factor m .

If m is to be reasonably small (say 4, meaning that each cluster consists of four EFB's), then the yield of EFB's must be good—of the order of 75% or higher. The EFB's are tested by probing to pick the one in each cluster that will be connected into the system.

In the studies conducted, individual EFB's had to meet certain constraints, most of which are recommended for similar systems:

- A maximum practical limit for the number of connections per EFB is six.

- The position of probe pads must be the same for all EFB's in the system.

- All EFB's should be identical except for the overlay pattern. In MOS devices, for example, the source, drain, and gate window patterns should be the same in order to simplify mask making. The particular function can be defined by the overlay pattern.

- Spacing between EFB's should be uniform.

A key assumption used in developing the expressions that relate EFB and system size and yield parameters is that defects on wafers are randomly distributed, with no correlation between the faults on adjacent EFB locations.

The relationships can be expressed as families of curves. For example, in the case of a given system, system yield can be plotted against EFB yield for various values of m , or a fixed system yield can be assumed and the EFB yield plotted against the system complexity (number of clusters per system), again for various values of m .

Presented at the Annual Microelectronics Symposium, St. Louis, Mo., June 19-21.

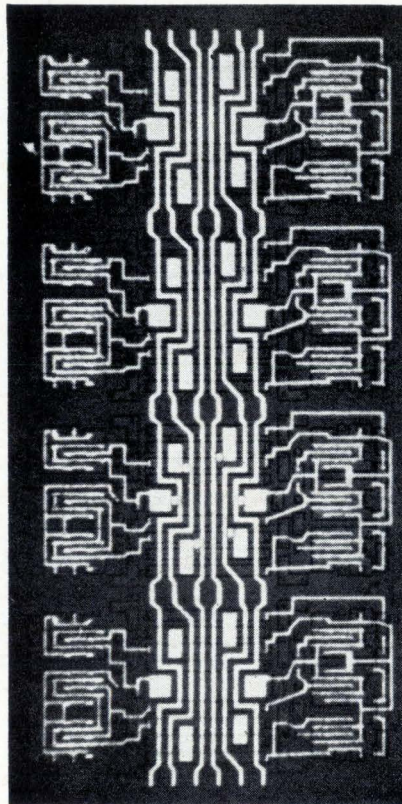

Basic pattern. Elemental function blocks in clusters of four. One block per cluster is connected to the central interconnection artery. The block to be connected is the best one in a cluster and is chosen by probing each block individually.



*for
maximal
performance
in critical
applications...*

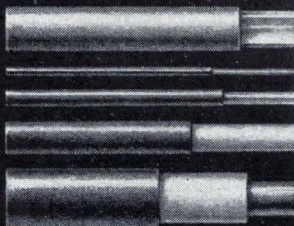

**COAXITUBE
PRE-FAB PARTS
& ASSEMBLIES**

Orders of Coaxitube can be furnished cut to size, stripped, preformed to shape or assembled with connectors to meet your exact specifications. Semirigid construction assures the retention of shape and closely held tolerances. We'll gladly send data or quote your needs . . . no obligation.



Grid-dipping pressures

Passive telemetry with glass transensors
C.C. Collins
Presbyterian Medical Center
San Francisco, Calif.

Passive tuned circuits can replace transmitters for remote pressure measurements. Since no batteries are required in the tuned circuits, the device lifetime is theoretically unlimited. The idea is to make the circuits' resonant frequency sensitive to changes in the applied pressure. Variations in the resonant peaks, caused by pressure, can then be determined by noting the frequency of maximum absorption from an external variable grid-dip type oscillator.

The simplicity of the miniature sensors allows them to be used to measure physiological pressures when implanted in the eyes, brain, or arteries. The size of a sensor depends on the range of the remote detector; the longer the measuring distance, the larger the circuit required. The maximum reliable working range, however, is about six coil diameters, or less than one foot for the layer coils.

The passive tuned circuits, transensors, are made from two thin glass diaphragms enclosing a pair of flat, spiral coaxial coils. The coils make up a high-Q distributed-element resonant circuit whose frequency varies with the coil spacing. As the pressure on the diaphragm increases, the coils are forced closer together, increasing the stray capacitance and mutual inductance, thus lowering the resonant frequency.

Typical pressure sensitivities are as high as 100 kilohertz/mm Mercury around a center of frequency of 100 Mhz.

In operation, the external oscillator frequency is continuously varied and the resonant absorption of the sensors displayed on an oscilloscope. With a frequency-to-voltage converter, continuous written records can be obtained.

The passive sensors, already used in numerous investigations with animals, have not as yet been implanted in man. Useful experimental data has been provided on the effects of respiration, blood pressure changes and drugs on internal eye pressures.

Presented at the National Telemetering Conference, San Francisco, May 16-18.



**PRECISION
Semi-rigid
COAXITUBE**

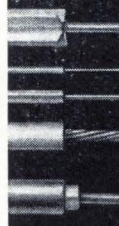

These high performance solid-jacketed cables offer broad frequency response, low attenuation, zero radiation and lowest possible VSWR. The splined, air-articulated types provide minimum attenuation and highest cutoff frequencies, eliminate periodicity phenomena, and insure phase stability in the order of 20 PPM/°C from 10°C to 40°C, and 35 PPM/°C from -40°C to +125°C. They also provide excellent external RF shielding. For critical applications in severe environments, your best decision is Precision.



PRECISION TUBE COMPANY, INC.
SPECIAL PRODUCTS DIVISION
North Wales, Pennsylvania 19454
Phone 215-699-4806 TWX 510-661-8427

ENGINEERS PHYSICISTS

SUPERCONDUCTIVE DEVICES

Talk with the RCA engineering staff which pioneered the advanced technology of high-field superconductive devices.

The continually expanding field of superconductivity affords unique opportunities to engineers and physicists experienced in either *superconductive devices*, *electromagnetic devices* (magnets), and/or *cryogenics*.

To arrange a convenient interview, phone collect or forward your resume to:

Mr. M.D. Lyden
RCA Electronics Components &
Devices
415 S. Fifth St.
Harrison, N.J.
Phone (201) 485-3900, Ext. 2013

An Equal Opportunity Employer



**The Most Trusted Name
in Electronics**

THIS SPACE CONTRIBUTED BY THE PUBLISHER



A woman's body. Architecturally, quite interesting. To a man. But not to the woman who owns one. Most women tend to ignore their own bodies.

Do you? Do you check your body, particularly your breasts, every month, for any lump or thickening? You should. A lump or thickening in the breast or elsewhere could be a warning signal of cancer. And cancer is easier to cure when it's detected early.

Sophia Loren knows the seven warning signals of cancer. So should you:

1. Unusual bleeding or discharge. 2. A lump or thickening in the breast or elsewhere. 3. A sore that does not heal. 4. Change in bowel or bladder habits. 5. Hoarseness or cough. 6. Indigestion or difficulty in swallowing. 7. Change in a wart or mole.

If a signal lasts longer than two weeks, see your doctor without delay.

It makes sense to know the seven warning signals of cancer.

It makes sense to give to the American Cancer Society.

New Literature

Measuring sound and vibration. General Radio Co., West Concord, Mass. 01781, has published a 24-page illustrated brochure on sound and vibration measuring instruments and associated apparatus.

Circle 446 on reader service card.

Power control circuitry. Motorola Semiconductor Products Inc., Phoenix, Ariz. An applications-oriented brochure entitled "Solid-State Power Control Circuits Library" is available by writing on company letterhead.

Airborne tape recorders. Sanders Associates Inc., 95 Canal St., Nashua, N.H. 03060. A six-page technical brochure includes detailed specifications and operating characteristics of the DS-4100 series of cartridge loading, airborne tape recorders. [447]

Coil aligner. Syntronic Instruments Inc., 100 Industrial Road, Addison, Ill. 60101, has released a two-page catalog containing dimensional drawings, photos, and details of six design features of the model D4499 micrometer-controlled precision coil aligner. [448]

Cordwood modules and components. American Bosch Arma Corp., Roosevelt Field, Garden City, N.Y. 11530, has published a brochure describing capabilities for the development and fabrication of high-density electronic cordwood modules and components. [449]

Signal processor. Ameco Inc., P.O. Box 13741, Phoenix, Ariz. 85002. The Channeleer, a solid state heterodyne signal processor, is described and illustrated in a four-page brochure. [450]

Electron-beam technology. Temescal Metallurgical Corp., 2850 Seventh St., Berkeley, Calif. 94710, has available a 12-page color brochure surveying the evolution of electron-beam technology from early laboratory experiments to the latest state of the art. [451]

Hermetic components. Greenfield Components Corp., 184 Shelburne Road, Greenfield, Mass. 01301. Catalog 65A, on hermetic seals, discusses the manufacturer's custom molecular bonding of materials (ceramics, glass, plastics, and metals) for industry. [452]

Portable laser. Korad Corp., 2520 Colorado Ave., Santa Monica, Calif. 90406, offers a data sheet on its ruby or neodymium-glass model K-L Laserette, a portable laser with a typical output of 1 joule. [453]

Pressure transducers. Consolidated Controls Corp., Bethel, Conn. 06801, has available a specification sheet describing a complementary pair of

transducers used to convert fluid pressure variations to their electrical analogs. [454]

Drift tube magnetic shield. Magnetic Shield Division Perfection Mica Co., 1322 N. Elston Ave., Chicago 60622. A Co-Netic drift tube magnetic shield, which provides low magnetic environment in the path of directed energy particles, is illustrated and described in data sheet 188. [455]

Transistorized volt-ohmmeter. Triplett Electrical Instrument Co., Bluffton, Ohio 45817. A two-page bulletin covers a portable, battery-operated, solid state volt-ohmmeter with FET amplifier and high input impedance. [456]

Operational amplifiers. Melcor Electronics Corp., 1750 New Highway, Farmingdale, N.Y. 11735. Six-page condensed catalog C-1004 describes a line of operational amplifiers that includes economy, FET, and high-voltage units. [457]

Precious metal cladding. Handy & Harman, 850 Third Ave., New York City 10022. A 24-page, three-color booklet discusses a new materials concept—the use of clad precious metals to replace solid precious metals in electrical-electronic applications. [458]

Airborne memory. Electronic Memories Inc., 12621 Chadron Ave., Hawthorne, Calif. 90250, has published an eight-page brochure on the SEMS 5 severe environment military aerospace memory. [459]

Reagent acids. Corco Chemical Corp., Tyburn Rd. & Cedar Lane, Fairless Hills, Pa. 19030, has issued a four-page catalog (C-55) listing electronic reagent grade solvents and electronic dopants. [460]

Calibrator. Bioelectric Instruments Inc., P.O. Box 204, Hastings-on-Hudson, N.Y. 10706. A catalog sheet discusses the CA5 calibrator, a triggered pulse generator featuring an isolated low-impedance output, a reversible pulse polarity ranging in amplitude from 0.5 v to 1 v, and pulse durations ranging from 100 μ sec to 200 msec. [461]

Porcelain capacitors. Vitramon Inc., P.O. Box 544, Bridgeport, Conn. 06601. Data sheet P19 covers the series VY14 porcelain capacitors that offer fractional capacitance values and a zero temperature coefficient. [462]

Plug-in chopper. Solid State Electronics Corp., 15321 Rayen St., Sepulveda, Calif. 91343, offers a catalog sheet on the model 65 transistorized plug-in chopper with transformer-coupled isolating drive capable of being driven from a 400-hz line. [463]

These two
heat-shrinkables
are hungry for
tough mil-spec
insulation problems.

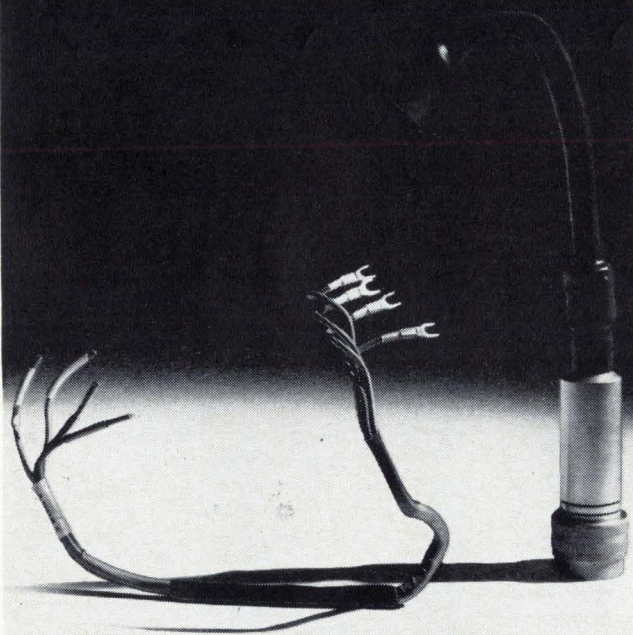

Feed them.

New Insultite® SR-350 eats up shock, strain and vibration like only a semi-rigid, irradiated polyolefin can. It combines superior dielectric characteristics with high structural strength. From 3/64" to 1" I.D.

Insultite FP-301, on the other hand, has a flexible polyolefin appetite that devours mil-spec applications. Quickly. Totally. From 3/64" to 4" I.D.

SR-350 meets classes 3 and 4 of MIL-I-23053A and NASA 276A. FP-301 meets classes 1 and 2.

Both are available in ten standard colors. Write today for free samples. (Specify diameters, please.)



**ELECTRONIZED CHEMICALS
CORPORATION**

A subsidiary of High Voltage Engineering Corporation
Burlington, Mass. 01803, Area Code 617-272-2850

E.C.C. heat shrinkables are recognized under UL component file E39100.

TUNG-SOL MOLDED BASE LAMPS —A GOOD IDEA FOR HIGH SPEED CHECK SORTERS

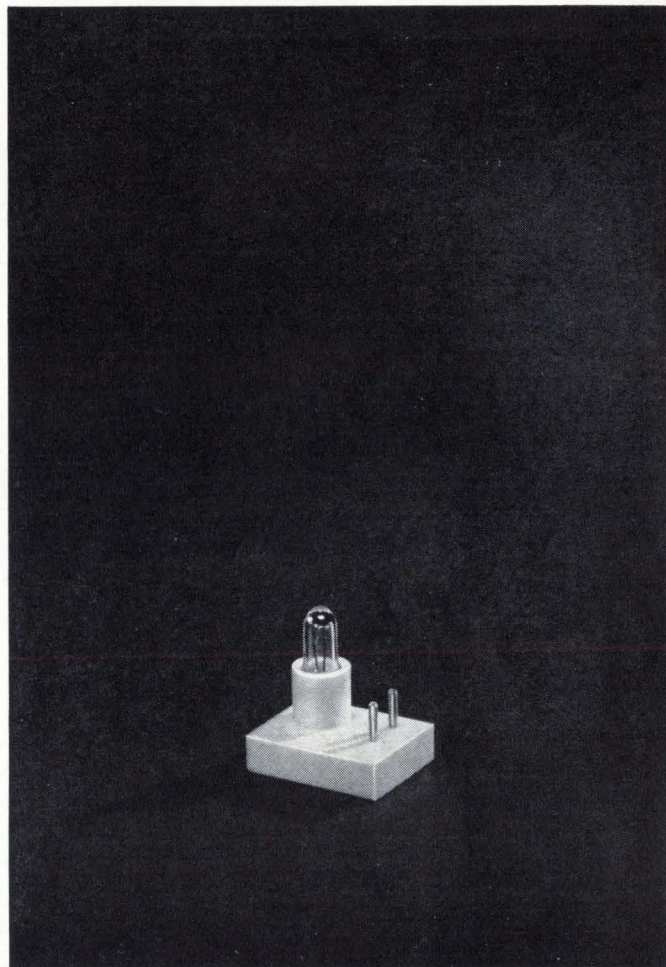

This lamp module is used to activate the photo-electric sensor in a high speed check sorter. It is Tung-Sol's version of another design.

The original involved separate purchasing of molded plastic blanks, lamp pins and bulb with lead wires. Contact pins were inserted manually and the lamp was inserted. The lamp leads were wired to pins in a recess in the correct position and the recess was sealed with epoxy. *Shrinkage in finished units was absorbed by the customer.*

The Tung-Sol idea consists of pre-assembled lamp and pins molded into a single integral unit. *Yield to the customer in usable units is 100 percent, with a bonus in the form of added reliability.*

Tung-Sol can mold bases to almost any requirement. Why not get a Tung-Sol idea for your small lamp application? Tung-Sol Division, Wagner Electric Corporation, One Summer Ave., Newark, N.J. 07104.

TUNG-SOL®

**WHERE BIG THINGS ARE DONE
WITH SMALL LAMPS**

© REGISTERED TRADEMARK WAGNER ELECTRIC CORPORATION

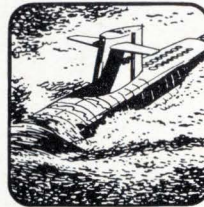
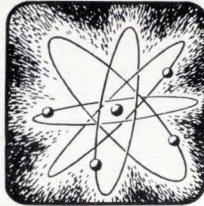

young engineers--

*with or without specific
experience, you can be part
of the exciting nuclear power
program at the world's
largest shipbuilding complex*

If you are a nuclear power engineer, or an electrical, chemical, general, marine, or mechanical engineer with or without experience in nuclear power engineering, the San Francisco Bay Naval Shipyard offers you the opportunity to work in these aspects of nuclear propulsion:

**Fluid Systems and Mechanical Engineering
Control and Instrumentation Engineering
Reactor Engineering • Test Engineering
Nuclear Quality Engineering
Radiological Control • Nuclear Refuelling**

Positions are located at Vallejo, California. This location has ready access to the full cultural advantages of San Francisco and the mild year-round climate of the Bay Area. All types of recreation from ocean surfing to skiing on the slopes of the Sierras are within easy driving distance.

Openings exist at Grades GS-5, GS-7, GS-9, GS-11 and GS-12. Salaries range from \$6,400 to \$12,000. These are career Civil Service positions with regular salary increases, generous benefits. Financial support for continued education available.

Send resume or Standard Form 57, Application for Federal Employment, to:

**Coordinator, Professional and Technical Recruitment
(Code 174A38)
Employment Division
San Francisco Bay Naval Shipyard
Vallejo, California 94592**

An Equal Opportunity Employer

Must be a U. S. Citizen

JULY OPENINGS

Cadillac Associates is the nation's largest executive and professional placement service. If you wish to find out your true worth in the electronics field, contact us. Our staff is versed in your particular discipline and can show you the openings now available—coast to coast. Our service is completely confidential and free to the applicant. Here are a few of the many positions now open:

CHIEF ENGINEER \$20,000
Degree plus proven history of successful development of devices or sub-systems in the high-powered tube or radar modulator areas.

SR. INDUSTRIAL ENGINEER . . \$15,500
Degree plus exp. with metal fabrication.

SECTION LEADER \$15,000
Degree plus exp. in electro-mech. industry preferably with 2 motor mfr.

ELECTRICAL ENGINEER . . . \$13,500
Deg. plus exp. in solid state crkt. design, control crkts. or power transistors.

MECHANICAL ENGINEER . . . \$15,000
Degree plus exp. in switch devel. and control circuitry.

SR. MFG. ENGINEER \$12,500
B.S.M.E. plus exp. in tooling and supv.

E. W. MOORE

CADILLAC ASSOCIATES, Inc.
29 E. Madison Bldg., Chicago, Ill. 60602
Financial 6-9400

CIRCLE 966 ON READER SERVICE CARD

PROFESSIONAL SERVICES

Donald C. Harder., Inc.

Magnetic Component Engineers

Reactors—Transformers—Filters

Serving the Research Laboratory

2580 K Street, San Diego, Calif. 92102

Phone (714) 239-8021

THE TREND TOWARD ECONOMY—

The service of the consulting engineer is a real economy. With his knowledge of organization and production problems and his wide and varied experience, he can usually reveal the points of waste and inefficiency that are costing you money and suggest inexpensive means for their elimination.

Display & digital equipment engineers:



Tie your future to the growth of educational technology at RCA Instructional Systems in Palo Alto, California

Join RCA's full-scale entry into computer-based instruction and you'll expand your own career potential while helping solve problems created by enormous increases in student population, and in both volume and complexity of knowledge.

RCA Instructional Systems has the full responsibility and resources to carry out a broad mandate from RCA corporate management: to study, create, and test total educational systems designed to help teachers do a better job of imparting more knowledge and skills to more students—more effectively.

Here in the San Francisco Bay area, our highly competent nucleus staff is working closely with nationally-known educators—such as Stanford University's Dr. Patrick Suppes, a pioneer in computer-based instruction—in the first major joint undertaking of its kind by industry and education.

Key to systems already under development is RCA's Spectra 70, first computer family to utilize monolithic integrated circuitry and cross the threshold into the third generation. RCA's many other products, skills, and

services in such areas as communications, switching, displays, publishing, and field services are also playing a key role in this corporate-wide development program.

If you are an engineer experienced in educational systems analysis, electronic display development, and/or computer systems design, we'd like to talk to you. Current efforts include: development of concepts for advanced computer-based instructional systems; design of advanced CRT displays and electronic data entry devices; and design of the elements of digital processing and communications systems for use with computer-based information. Areas of work are: digital circuits; digital logic design; packaging; human factors engineering; display devices design; and analog circuit design.

Send your resume to: A. J. Tasca, RCA Instructional Systems, 530 University Avenue, Palo Alto, Calif. 94301.

An Equal Opportunity Employer



The Most Trusted Name in Electronics

WHEN WE SAY RELIABILITY

IS A GOOD IDEA
IS A GOOD IDEA
IS A GOOD IDEA
IS A GOOD IDEA

WE'RE TALKING CAREERS. NOT TRIPLE REDUNDANCY.

1. We're talking about the kind of far-reaching opportunity that lets *you* contribute ideas at every phase of project development, from pre-proposal to development to production — the opportunity to probe more deeply and influence projects more significantly than you ever thought possible.
2. We're also talking about the chance to contribute good ideas in diverse and often highly esoteric areas. Like the subscriber terminals for the AUTODIN global communications network, on which we're prime. Or the F-111 test equipment, for which we have the contract for all versions now envisioned. Or you might have worked on the workhorse GRC-106 transceiver, or the jeep-mounted MRC-107 communications central, or micro TACAN or an advanced marker-launcher system for USW. The list goes on and on.
3. Then, too, we're talking about the good ideas that work for you here at General Dynamics, like our "people

development" plan that requires supervisors to develop their own replacements and provides paid-for higher education to help you on your way.

And one more idea you'll like a lot is our location, Rochester, New York — a city combining the best of what's urban, suburban and vacation-oriented . . . plus all the cultural and educational facilities you'd expect in a city with more professionals per capita than any other its size.

If you're a Reliability Engineer with a BS and two or more years experience, or if you're a graduate engineer with experience in electronic circuitry design, overall equipment design analysis and review, aspects of component engineering, prototype development and test evaluation . . . or in developing and implementing total reliability programs for proposal activity, including predictions, reliability demonstrations, tests and design reviews — you'll find it a good idea to get in touch with us. Address your resume in confidence to Mr. L. A. Corwin, Dept. 117.

GENERAL DYNAMICS

Electronics Division

1400 N. Goodman St., Rochester, New York 14601

An equal opportunity employer (M&F)

SEARCHLIGHT SECTION

CLASSIFIED ADVERTISING
BUSINESS OPPORTUNITIES
USED OR SURPLUS EQUIPMENT

GET IT from GOODHEART!

400 CY POWER AT A BARGAIN
Leech/Inet **RX 400**: Synch. MG. 1200 rpm. Output 6¼ kva 5 kv at 0.8 pf 52/26 amps at 120/240 v 1 ph 400 cy. Input 416 v 60 cy 3 ph. 4 wire. Excitation ckt's & mag-amp volt. regul. ±1%. Vo. cont. variable ±10% with Powerstat on the control panel. Pushbutton magnetic starter, ckt-breaker protection, and output monitored by voltmeter, ammeter and freq. meter. Entire unit in neat cabinet. Used, good condition, with book, fob Bremerton, Wn. warehouse (shpg wt 2000 lbs) only.....\$595.00

AMPLIFY & COUNT 10 TIMES FASTER
Count 10 mc with your 1 mc counter or 1 mc with your 100 kc counter. Absolutely mistake-proof 10:1 countdown. Input may be any waveshape, or sine as low as 0.1 v rms, any freq. 80 kc to 14 mc. Output is always sq. wave 4 v pk-to-pk at 1/10th input freq. Compact AC-line-powered solid-state unit, with instructions. Shpg wt. 6 lbs. Model 101.....\$95.50

BERKELEY 100 kc Counter.....350.00
VIDAR v-to-f converter: 0 to 1,1,10,100,1000 v becomes 0-100,000 cps w/accuracy .025%.....395.00
CMC or **BERKELEY** Universal 1 mc counter.....495.00
HEWL-PACK 524B Universal 10 mc counter without plugin (higher with plugins).....875.00
USM-26 Hewl-Pack univers. counter with 100 mc plugin, in transit case with book etc.....1150.00
North. Eng'g. univ. counter w accessories to 5000 mc. number readout like H.P. 524C.....1650.00
CMC #400B Printer for counter or DVM.....475.00
Automatic: National NC-2001 Cesium-beam freq. standard, 5 parts in 100 billion, synthesized or cesium submultiple frequencies.....4750.00

Tekt. #514AD scope DC-10 mc, 30 mv/cm.....350.00
Tekt. #524D DC-10 mc w/markers for TV.....495.00
H.P. #185A/187A 1000 mc 2-trace.....1750.00

STANDARD SIGNAL GENERATORS
LP: 912 kc to 50 mc, w/pwr sply & book.....199.50
Gen. Radio **805-C**: 16 kc to 50 mc Certified.....550.00
TS-413C: 75 kc to 40 mc crystal callb.....279.50
AN URM-25D or **25F**: 10 kc to 50 mc.....450.00
Boonton Univerters: 100 kc-25 mc.....150.00
TS-606 U: **085-40** mc, **2-10** watts Po.....995.00
Meas. Corp. Mod. **80**: 2-400 mc, Certified.....375.00
Same, uncertified but satisf. grtd.....265.00
Meas. Corp. Mod. **80R**: 5-475 mc, Certified.....400.00
Gen. Radio **#1021A P1/P2** 248-940 mc.....395.00
Gen. Radio **#1021AV P1/P3B** 40-250 mc.....325.00
TS-608 U 41-400 mc 2 to 10 Watts Po.....695.00
TS-418A U: 400-1000 mc up to 0 dbm Po.....395.00
TS-419 U: 900-2100 mc up to 0 dbm Po.....395.00
Hewl-Pack, 616A: 1.8 to 4 gc.....650.00
PRD-903 or **TS-622**: 7-10.75 gc FM/ME.....650.00
Polarad SS-1218: 12.4 to 17.5 gc.....650.00

FM & AM/FM SIGNAL GENERATORS
Kay Radasweep **#380A**: 20-40 & 50-70 mc FM **175.00**
TS-452 U: 5-108 mc, built-in scope, FM.....125.00
USM-16: AM FM PM 10-440 mc XII callb.....795.00
Kay Megasweep **#111A**: 10-950 mc FM.....175.00

ATTENTION Buyers of **LAB Test Equipment**: The above is a small sampling of our terrific inventory. **WE ALSO BUY!** We want Tektronix scopes, Hewlett-Packard equip., Aeronaut. radio-shop equip., etc. . . . AND Military communications of all kinds.

R. E. GOODHEART CO. INC.
Box 1220-E, Beverly Hills, Calif. 90213
Phones: Area 213, office 272-5707, messages 275-5342

CIRCLE 970 ON READER SERVICE CARD

AUTOTRACK ANTENNA MOUNT

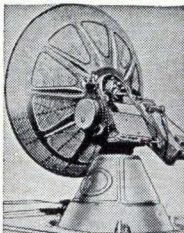

360 degree azimuth, 210 degree elevation sweep with better than 1 mil. accuracy. Missile velocity acceleration and slewing rates. Amplidyne and servo control. Will handle up to 20 ft. dish. Supplied complete with control chassis. In stock—immediate delivery. Used over by NASA, USAF, MP-61-B. Type SCR-584. Nike Ajax mounts also in stock.

PULSE MODULATORS

MIT MODEL 9 PULSER 1 MW—HARD TUBE
Output 25kv 40 amp. Duty cycle .002. pulse lengths 25 to 2 microsec. Also 5 to 5 microsec. and 1 to 5 microsec. Uses 6C21. Input 115v 60 cycle AC. Mfg. GE. Complete with driver and high voltage power supply. Ref: MIT Rad. Lab. Series, Vol. 5, p. 152.

2 MEGAWATT PULSER
Output 30 kv at 70 amp. Duty cycle .001. Rep rates. 1 microsec 600 pps. 1 or 2 msec 300 pps. Uses 5948 hydrogen thyratron. Input 120/208 VAC 60 cycle. Mfr. GE. Complete with high voltage power supply.

250 KW HARD TUBE PULSER
Output 16 kv 16 amp. Duty cycle .002. Pulses can be coded. Uses 5D21, 715C or 4PR60A. Input 115 v 60 cy AC \$1200 ea.

18 MEGAWATT PULSER
Output 150KV at 120 amps. Rep rate: 50-500 PPS. Pulse length: 5 msec. 15KV 120 amp. into pulse transformer. Rise time 1.5 msec. Filament supply 5V 80 amp. incl. 17.5KV 1.5 amp DC power supply. Input: 220V 60 cy AC.

VARIAN KLYSTRONS
V-45: 15W output CW 9 to 10 KMC
VA-800: 10 KW output CW 1.7 to 2.4 KMC
VA-806H: 1KW output CW 7.5 to 8.5 KMC
T.W.T.

VA-137C: 5KW Peak, 350 W avg. .87 to 1.0 KMC
RCA-1154: 10 MW output 1.5 to 4.5 KMC
RCA-1161: 1 Watt output 1.9 to 4.1 KMC

SCR 584 AUTOTRACK RADARS
Our 584s in like new condition, ready to go, and in stock for immediate delivery. Ideal for telemetry research and development, missile tracking, satellite tracking. Fully Desc. MIT Rad. Lab. Series, Vol. 1, pps. 207-210, 228, 284-286. Comp. Inst. Bk available \$25.00 each.

CIRCLE 969 ON READER SERVICE CARD

MICROWAVE SYSTEMS

L BAND RF PKG.
20 KW peak 990 to 1040 MC. Pulse width .7 to 1.2 micro sec. Rep. rate 180 to 420 pps. Input 115 vac incl. Receiver \$1200

200-225 mc RADAR SYSTEM
1 Megawatt output. 200 nautical mile range for long range detection of medium and high altitude jet aircraft as well as general search. Complete system in stock. Input 120/208 V. 60 cy. Type TPS-28.

C-BAND RADAR
250 KW output. C-band. PPI indicator. 5C22 thyratron modulator. Antenna hi gain parabolic section. Input 115 volts 60 cycle AC, complete \$2750.00

5 MEGAWATT C-BAND
Klystron RF package delivering nominal 5 megawatt pulse RF. Complete with pulser and power supply.

500 KW L BAND RADAR
500 kw 1220-1359 msc. 160 nautical mile search range P.P.I. and A scopes. MTI thyratron mod 5J26 magnetron. Complete system.

100 KW X BAND RADAR
Complete 100 kw output airborne system with AMTI. 5C22 thyr. mod. 4J52 magnetron. PPI. 360 deg as sweep. 60 deg. elev. sweep, gyro stabilizer, hi-gain rev. Complete with all plugs and cables.

AN/GPG-1 SKY-SWEEP TRACKER

3 cm. automatic tracking radar system. Complete package with indicator system. Full target acquisition and automatic tracking. Input 115 volts 60 cycle Nw. In stock for immediate delivery. Entire system 6' long, 3' wide, 10' high. Ideal for Infrared Tracker. Drone Tracker, Missile Tracker. R. & D.



500KW S BAND RADAR
250 miles search 115V 60 cy AC. Mfg. G.E.

RADAR AUTO-TRACK & TELEMETRY ANTENNA PEDESTALS 3 & 10 CM. SCR 584 AUTOTRACK RADARS. M-33 RADAR TPS-ID SEARCH. APS-45 TPS-10D HT. FINDERS. WX RADARS. FPN-326CA. APS-10 APS-15B APS-27 (AMTI) SEARCH. PPN'S. APN-102 DOPPLER. DOZENS MORE. CARCINOTRONS. PPN'S. 25-5-1-2-3-6 MEGAWATT PULSE MODULATORS. CAVITIES. PULSE TRANSFORMERS. IF STRIPS. WAVEGUIDE. BENDS 200 MC. 1 KMC. 3 KMC. 6 KMC. 9 KMC. 24 KMC. RF PKGS.

RADIO RESEARCH INSTRUMENT CO.
550 5TH AVE., NEW YORK 36, N.Y. JU 6-4691

CIRCLE 967 ON READER SERVICE CARD

FOR SALE

When you have used electronics equipment to sell, advertise in Electronics Searchlight Section for fastest results.

For information:
Searchlight Section
Classified Advertising Division
Post Office Box 12
New York 10036

ELECTRON TUBES

KLYSTRONS • ATR & TR • MAGNETRONS
SUBMINIATURES • C.R.T. • T.W.T. • 5000-
6000 SERIES
• SEND FOR NEW CATALOG A2 •
A & A ELECTRONICS CORP.
1063 PERRY ANNEX
WHITTIER, CALIF.
696-7544

CIRCLE 969 ON READER SERVICE CARD

R.U. 1

answering more than advertisement? Then please send a separate reply to each box number. It will help you get an answer sooner.

BIG CATALOG

World's "BEST BUYS" in GOV'T. SURPLUS Electronic Equipment

FULL OF TOP QUALITY ITEMS—Transmitters, Receivers, Power Supplies, Inverters, Microphones, Filters, Meters, Cable, Keys, Phones, Antennas, Chokes, Dynamotors, Blowers, Switches, Test Equipment, Headsets, Amplifiers, etc., etc. SEND 25¢ (stamps or coin) for CATALOG and receive 50¢ CREDIT on your order. Address Dept. E-7.

FAIR RADIO SALES
P. O. Box 1105 • LIMA, OHIO • 45802

ELECTRONIC TEST EQUIPMENT

Oscilloscopes, Signal Generators, VTVM's Camera Chain, Regulated Power Supplies, Pulse Generators, Varisweep, Video Amps. Manufactured by Tektronix, Dumont, Hewlett-Packard, Ballantine, Lambda, Kepco, Sola. Many others.

NEW & USED—GUARANTEED.

Relays, Filters, Transformers—Other new Components. Send for complete List.

NATIONAL INSTRUMENT COMPANY

Box 144 East Rockaway, N.Y. 11518

CIRCLE 968 ON READER SERVICE CARD



microwave problem? talk to Andrew...the antenna systems specialist

Andrew microwave antenna systems are hard at work all over the world. Fixed, portable, and mobile installations, designed by Andrew, can be found wherever communications engineers demand the utmost in performance and reliability. ■ This new transportable 7 GHz system is a good case in point: used in a quick reaction microwave link, the unit packs broadband communications capability into a compact package. A 100 ft. aluminum telescoping mast pneumatically raises the 6 foot antenna, guy wires, and dual axis positioner in

less than 60 minutes. The flexible HELIAX® elliptical waveguide feeder goes up simultaneously, and the jacket includes control cables for the positioner. An automatic dehydrator-compressor, 1½ ton trailer, and AC power supply complete the package—all from Andrew. One source—one responsibility. ■ **Have a microwave antenna system problem?** Bring it to Andrew, most people do! Andrew Corporation, P.O. Box 42807, Chicago, Illinois 60642.

3-67



Newsletter from Abroad

July 10, 1967

Decca and ITT on collision course

A squabble over radio navigation patent rights is in the offing between Britain's Decca Navigator Co. and ITT.

The dispute centers on a marine navigation receiver recently put on the market by ITT's Norwegian subsidiary, Standard Telefon og Kabel-fabrik A/S. The receiver is designed to use low-frequency hyperbolic navigation signals broadcast throughout much of the world by stations run by Decca and its licensees. Previously, only Decca made receivers for these hyperbolic radio-navigation systems.

Decca, which holds a bevy of patents on radio navigation, still hasn't made a formal move against ITT's "pirate" receivers.

Standard Telefon apparently readied its receiver to tap a substantial market about to open up in Norway. The government now is setting up, through an arrangement with Decca, six navigation transmission chains for use by the Norwegian fishing fleet.

Prices blitzed as Germans start color-tv sales

A long, hot summer of skirmishing over color-set prices is in prospect for West German television receiver manufacturers.

Color sales started on July 1, but a few days earlier the country's largest mail-order house threw the major set makers into an uproar by offering 25-inch table models for \$460. Most manufacturers had agreed to an industrywide price of \$600 for 25-inch sets.

The industry had figured the mail-order house, Neckermann Versand KGaA, would undersell regular radio-tv retailers. But the 25% slash caught the industry off guard. The immediate countermeasure by major manufacturers was a \$25 cut, trimming their prices to about \$575. But there's talk now that the industry will rush onto the market with 23-inch sets priced at \$500 before the end of the year.

The price war touched off by Neckermann may get the German color market off to a faster start than anticipated. A recent survey indicated sales would shoot up once prices dropped below \$500. Market researchers at Deutsche Philips Industrie GmbH now are saying privately that well over 100,000 sets may be sold this year. The company previously had pegged the market at 85,000 sets [Electronics, June 12, p. 242].

Philco-Ford may get NATO satellite job

Philco-Ford will very likely be named in the next fortnight as the contractor for the satellites in NATO's \$45 million second-phase communications satellite project. NATO plans to have its own satellite network operating by early 1968, and has had to opt for a modified "off-the-shelf" U.S. design.

NATO may mesh its upcoming two-satellite system with the British Skynet program, for which Philco-Ford is building the satellites. Because of this possibility, insiders think Philco-Ford is an odds-on choice for the NATO contract. European contractors presumably will get much of the ground-station work.

Japanese EDP trio to unify software

Japan's three leading computer makers plan to have common software for their computers by 1970. The move is aimed at bolstering the trio against foreign competition, primarily the Japanese subsidiary of IBM.

The compatible software will come from the Nippon Software Co.,

Newsletter from Abroad

jointly owned by the three manufacturers—the Nippon Electric Co., Hitachi Ltd., and Fujitsu Ltd. Nippon Software was set up late last year to develop software for the \$37 million large-scale computer that the three hardware companies are jointly building for the government [Electronics, June 27, 1966, p. 93].

Nippon Electric, Hitachi, and Fujitsu all use different machine languages for their computers. **The compatible software the trio has in mind most likely will start with compilers.**

Germans propose sun probe to NASA

West German space officials have moved fast on the Johnson Administration's offer to cooperate with European countries in space research. Following through on initial talks held last year, the **Germans have proposed a joint sun probe—a German satellite put into an orbit around the sun by a NASA Atlas-Centaur rocket.**

The German plan calls for a 1973 launching of a 330-pound satellite that would orbit the sun once in 194 days and have a life of at least one year. At the closest point in its orbit, the satellite would pass about 27 million miles from the sun.

West German research institutes have drawn up five experiments for the probe. **The Ministry of Scientific Research already has preliminary talks underway with three German aerospace companies for the satellite's design and instrumentation.**

Japanese see slip in color-tv exports

Color-television set makers in Japan have lowered their sights considerably for exports this year. **The outlook now is sales of about 400,000 color sets in the U.S.** Earlier this year, Japanese producers expected their share of the market would run at least 500,000 sets.

Chief reason for the lowered estimate is the lackluster performance of the U.S. color market. Total sales this year will run under 6 million sets, a far cry from the 7 or 8 million U.S. producers foresaw six months ago. **Japanese set makers also say they have been hurt by new American small-screen models, a sector of the market the Japanese once had almost exclusively to themselves.**

Soviets synthesize new semiconductor

A research team at the Moldavian Academy of Sciences reports it has developed light-emitting diodes with red light output high enough for color television. **The diodes are made from a new synthesized semiconductor material—a zinc and indium sulfide monocrystal.** The team claims that the physical properties of the synthesized material differs from any other known Group II-VI semiconductor.

Addenda

The French government's "Plan Composants", an effort to strengthen the domestic components industry [Electronics, April 17, p. 217], has fostered a \$100 million merger. The consolidation brings together the component-producing subsidiaries of La Radiotechnique S.A. and Compagnie Generale d'Electricite. The merged company will be called RTC-La Radiotechnique-Compelec. . . . Japan's Sony Corp. may put a 4-inch black-and-white television set on the market in the next year or so. The design will be based on the experimental 1-inch set Sony unveiled last month [Electronics, June 26, p. 208].

Is logic for computers?

Many industrial circuit designers still believe that integrated circuits are great for computers and their peripheral equipments, but not for their applications. The reason is that integrated circuit manufacturers and users always talk in terms of "logic," "gates," "flip-flops," and other terms which originated in the computer industry. Now, while it is true that IC's have revolutionized computer technology, they are by no means limited to computer applications. The fact is that integrated circuits can be effectively used wherever there is need for any kind of electrical or electronic control. Here are some of the areas where integrated circuits have been used in the past (the list is growing daily).

CONTROL PHASES: Electronic controls, whether single instruments or components of an automatic closed-loop system, fall into one of four phases: measurement, transmittal, processing, and feedback. In each of these areas integrated circuits perform important system functions and replace a hatful of discrete components. Let's look at these areas one by one.

MEASUREMENT: Integrated circuits are used in a wide variety of measuring equipment such as DVM's, counters, totalizers, range finders, events-per-unit-time meters, and the like. Most of these applications use integrated circuitry to count pulses against a frequency or time base. Where the measured phenomena are not electrical, IC's are often used to convert information gathered by transducers into usable digital form.

TRANSMITTAL: In all but the simplest control systems data must be transmitted from the source to the processing and control units. Integrated circuits are widely used both in transmitters and receivers to perform a variety of functions. Analog-to-digital and digital-to-analog conversion, encoding and decoding, compressing information into a higher frequency, and multiplexing, all are natural applications for integrated circuits. In addition to the counting and switching functions performed by digital circuits, linear IC's are used as amplifiers, comparators, converters, etc.

PROCESSING: The third phase of control is processing, where information is converted into some usable form: it may be displayed numerically or alphabetically, by means of lights, numerals or CRT's. It may be simply logged, on tape or printing equipment, or stored in a computer. Or it may be checked for high-low limits and used as input to feedback mechanisms and alarm systems, as is the case in closed-loop systems. In all such applications IC's are widely used. Digital circuits find their place in CRT character generators, display drivers, tape readers and punches, and in various interface circuits. Both digital and linear circuits are used in making checks, as comparators and switching devices.

FEEDBACK: Finally, integrated circuits perform a variety of functions in instruments and mechanisms that perform the physical control function. Inverters, stepping motors, servo mechanisms, X-Y drivers, timers, current and voltage regulators are all examples of such equipment.

WHAT ABOUT YOUR APPLICATION? This list, incomplete though it is, should convince you that IC's can do much more than count. The price of IC's is now in competition not only with transistors and tubes, but even with such old standbys as relays. In most cases IC's can do the job better, faster, and, when assembly and all material costs are compared, cheaper. We'll be happy to send to you additional information. Simply circle the Reader Service Number indicated below. Or, drop us a note specifying your application. We'll send you Application Briefs specifically pertinent to your problem.

Stepping Motor Translator

A stepping motor commonly has four windings to which power is applied in pulses, with each pulse shifting 90 degrees in phase from the preceding one. Each pulse is one step of the motor output shaft. Various numbers of steps per revolution can be used in the motor design to fit the specific application requirements.

The control circuitry which furnishes the input pulses can be implemented with solid-state components and consists of two separate elements: power transistors and diodes which furnish power drive to the windings (see figure 1)

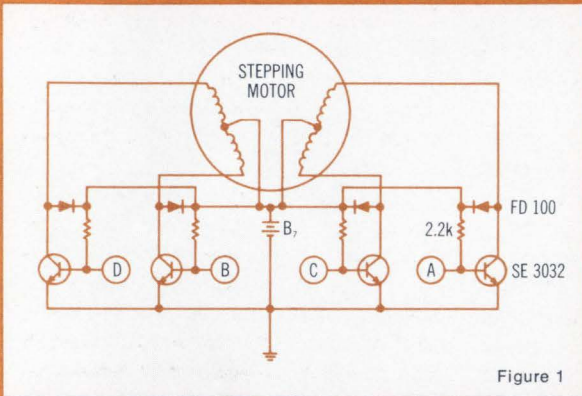

Figure 1

and logic circuitry, implemented with integrated circuits, to furnish control signals to the power transistors (figure 2). Input pulses to the logic are translated into four on-off signals, A, B, C and D. The logic consists of three integrated circuits: a dual flip-flop (9094) and two gate elements (9946). The flip-flops are connected to form a mod

four shift mode counter, so that the output changes phase 180° every two input pulses. Signals C and D could be obtained directly from the second flip-flop if the motor operated only in one direction. To allow reverse operation, the quad 2-input gates are included, and an outside control signal is used to reverse the phases of the output. Figure 3 shows the four signals schematically, in forward and reverse modes. Note that signal C is an exact complement to signal A, and signal D is a complement of signal B, and that B and D are shifted by one pulse (equivalent to 90°) relative to A and C. These output signals directly drive the common emitter stages of the power transistors (fig. 1), furnishing effective and economical control to the stepping motor.

For other Integrated Circuit Applications circle the Reader Service Number shown below.

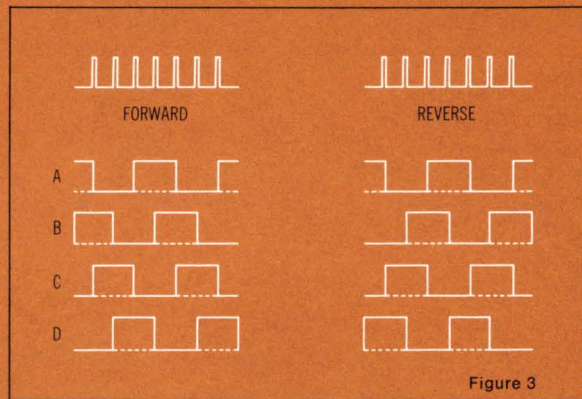

Figure 3

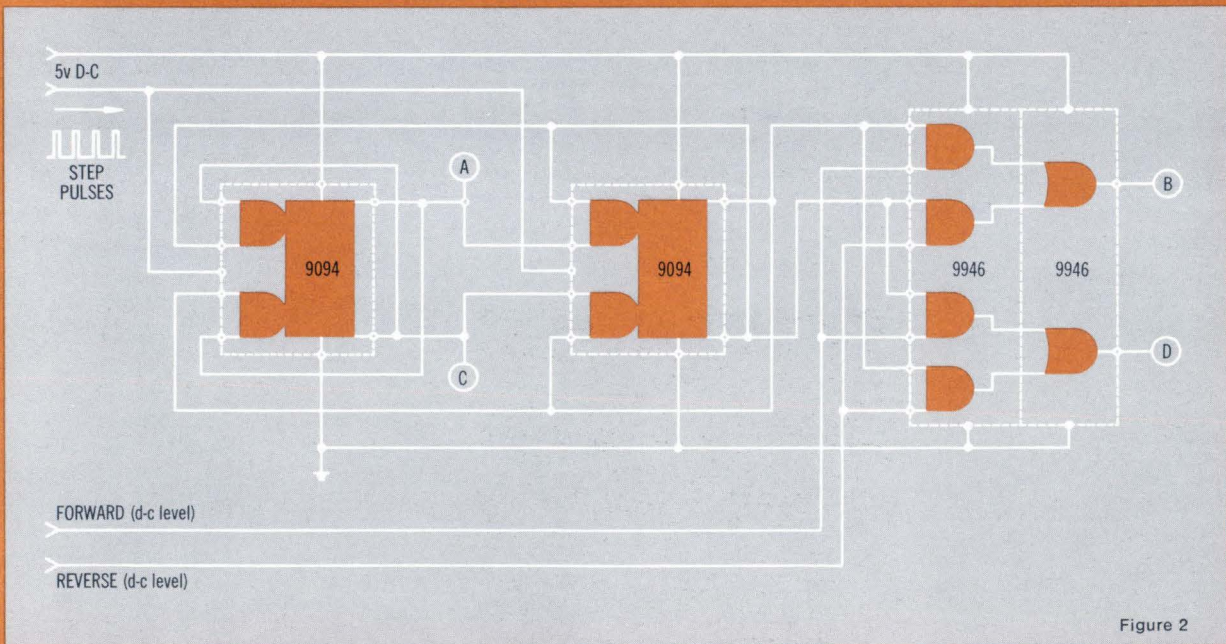

Figure 2

Circle Reader Service No. 480

FAIRCHILD
SEMICONDUCTOR

Electronics Abroad

Volume 40
Number 14

Soviet Union

Cold calculation

In a basement in western Siberia sits the Soviet Union's fastest computer, only partially assembled and surrounded by card punchers, magnetic tape, 16 drums, and the largest collection of peripherals connected with any civilian machine in the country.

This is a BESM-6, the country's first time-shared machine, only three of which are known to exist. It is awaiting magnetic disks; none are made in the Soviet Union, and the United States Government won't allow American companies to sell them to the Russians.

The Russians plan to begin making their own within a year. Meanwhile they are dickering with British and Japanese companies for earlier delivery [Electronics, June 26, p. 203].

Fast start. Despite handicaps like the lack of disk memories and, until recently, of fast transistorized machines, the four-year-old Siberian center where the BESM-6 is waiting to go into action has a fairly impressive list of achievements.

The center serves 20 institutes in Akademgorodok, a new university town in the suburbs of Novosibirsk, the largest Soviet city east of the Urals. For the institutes, the center has developed programs that range from short-range weather prediction to long-range optimal planning for industries and plants. The center also has worked out a computer language it calls Alpha, similar to the internationally used Algol but with additional procedures to handle vectors and complex numbers.

Capitalistic. Surprisingly, Guri I. Marchuk, the 40-year-old mathematician who runs the center, is a part-time salesman of computer programs. "When we sell pro-

grams," he says, "we use the money to buy new computers." Marchuk currently is phasing out three antiquated M-20 vacuum-tube machines, which are being replaced by much faster transistorized M-220's.

Marchuk matches his sales strategy to the workings of Soviet centralized research administration. For example, the Siberian center's weather-forecasting program began under a \$110,000 grant from the State Committee on Science and Technology, a 600-member body in Moscow which acts as czar of Soviet science and disburses funds according to its own two-year plan. However, when Marchuk was sure he had developed useful programs, he "sold" them to various meteorological centers. Such sales are never made until an institute's director is sure he can deliver a finished product. American-style "development" contracts are rare in Russia.

Spurred. To encourage application contracts with industry, the government apparently gives each research institute 5% less than it thinks the institute needs. The balance of the budget, plus any addi-

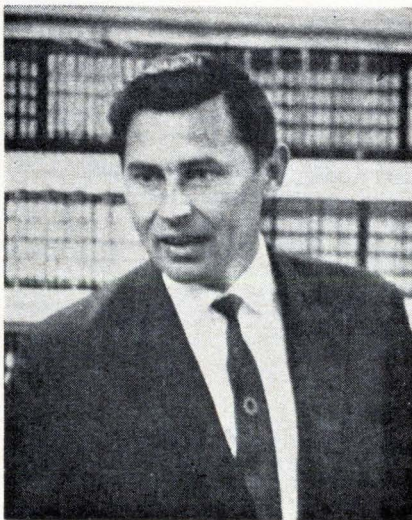

Strong on software. Guri I. Marchuk sells programs to other Russian research institutes to fatten the budget of his Siberian computer center.

tional funds for extras, comes from application contracts. The goal, seemingly, is to reduce the incredibly long lead time—an average of 10 years according to authoritative Soviet studies—from conception of an idea until it results in mass production of a product or system.

The "profit" can be spent only according to rigid rules, and any expenditure is subject to approval by a higher official—in Marchuk's case by Mikhail A. Lavrentyev, chairman of the Siberian Branch of the Soviet Academy of Sciences. The money can go for equipment, housing or cultural facilities for workers, or bonuses.

Japan

Colorful one

For Japanese television broadcasters, the term "monocolor" is fast becoming a byword.

Early this year, the government-run Japan Broadcasting Co. and the Nippon Columbia Co. reported that they had jointly developed a one-tube color tv camera that registers chrominance information as black-and-white stripes [Electronics, Jan. 23, p. 235]. Now a commercial broadcaster, the Fuji Telecasting Co., has come up with a one-tube color camera based on a scheme so simple it can be retrofitted to conventional black-and-white cameras.

Striped. Like Nippon Columbia, Fuji puts a striped filter in the camera's optical system in order to get both luminance and chrominance information from a single pickup tube. But rather than sorting out the chrominance information by frequency separation—Columbia's technique—Fuji does it by phase and polarity selection.

The technique, Fuji engineers

note, involves only such commonly used color-tv circuitry as short delay lines, inverters, clamps, rectifiers, and matrixes. Besides doing away with special low-noise circuits, the phase and polarity scheme avoids a big drawback of frequency separation—the drop in the amplitude of high-frequency chrominance components when the camera isn't precisely focused.

Manipulated. Several striped filter patterns are possible with the Fuji system; the simplest of them is made up of some 80 repeating four-stripe groups, about the optimum for a vidicon pickup tube. A typical arrangement for a group would be a red stripe, a green one, then a transparent stripe, and finally a second green stripe.

When the pickup tube behind the striped filter is scanned, the video output signal waveform contains components for all three primary colors. To extract a blue signal from the red-green-transparent-green stripe arrangement, the composite waveform is delayed two stripe widths, inverted, added to the undelayed composite waveform, and then rectified. This processing in effect eliminates the red component from the segment of the waveform that corresponds to the transparent stripe, which passes all three colors.

The blue-green component signal is inverted and then added to the original composite signal delayed by one stripe width. In the waveform that results, only the blue component has negative polarity. By clamping the waveform at zero, clipping the positive half and then inverting, the blue signal is obtained.

The same sort of waveform processing is used to sort out the other two primary-color signals. The composite waveform itself is used as the luminance signal.

Small talk

At first glance, the Matsushita Communication Industrial Co. wouldn't seem to stand a chance in the upcoming market for electronic telephone exchanges in Japan. Since it's not a member of the four-

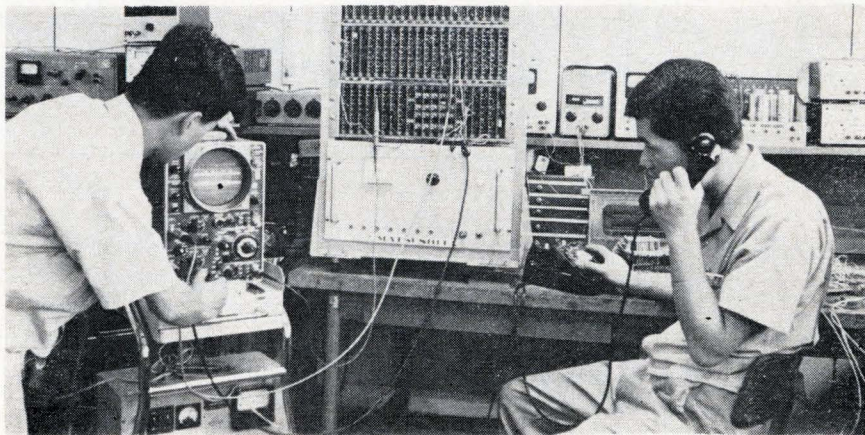

Well timed. Matsushita engineers check waveforms in time-division electronic exchange designed for small telephone systems.

company "club" that traditionally supplies the state-owned telephone network, Matsushita can't count on contracts from the country's major buyer of telephone gear.

But the firm has spotted a market where it hopes to make headway with a very small electronic exchange it has developed. While the club concentrates on the 8.5-million-subscriber national system, Matsushita is aiming at the hundreds of independent rural systems that dot Japan and serve 3.2 million subscribers.

The prototype version of Matsushita's exchange handles 20 lines and the company expects its basic production exchange will be a 100-line unit. Although units could be hooked up in tandem to handle systems with up to several thousand subscribers, Matsushita sees as its best potential customers the very small systems.

Switch. For its independent-system exchange, Matsushita took an independent design approach. The engineers who developed the prototype were digital control specialists, not telephone engineers, and they came up with an exchange that differs significantly from other electronic switching systems, whose designs reflect big-system constraints.

Matsushita employs time-division, a technique that routes calls to subscribers' lines by locating signals in time slots on a common path and thereby eliminates the need for a separate physical path for each line through the exchange.

Time division is not new, but Matsushita handles it differently. The maximum frequency that must be handled in an electronic exchange depends on the number of time slots and the rate at which subscribers' lines are sampled. Designers of large exchanges so far have tended to restrict the number of slots to keep frequency down. This complicates the controls needed for slot assignments, since slots must be assigned as they become vacant.

Fast sample. Matsushita, on the other hand, assigns a fixed time slot to each line. Even with the 15-kilohertz sampling rate used in the system to convert analog voice signals into pulse-amplitude-modulated (pam) signals, the maximum frequency for a 100-line exchange is only 1.5 megahertz, easily handled by modern switching circuits. The 15-khz sampling frequency, high for telephone voice service, means more costly pulse circuits but this is more than offset by the savings in the demodulation circuits that convert the pam signals back into analog voice signals. Simple low-pass filters handle the demodulation job.

Stored. In the Japanese prototype 20-line exchange, the speech path between two callers is established in a bit register by storing "1's" in the bit positions that correspond to the time slots allocated to the two lines. Each of the lines then is switched onto a common speech path through the exchange when its time slot comes up. (Actually

there are two paths since the exchange is designed to handle two calls simultaneously.) The pulse from the incoming highway to the exchange is stored in a capacitor memory during the first time slot and then transferred to the outgoing highway during the second time slot.

In order to obtain two-way calling over a single path with a single capacitor memory, the time slots are split into read and write intervals. The intervals are timed so that a stored pulse destined for a caller is read out of the memory before the incoming pulse from his line is written in.

Reel time

Life will become easier in the fall of 1968 for people who play tape recordings for hours on end. That's when the Sony Corp. will offer an automatic tape deck that can play a stack of five reels of four-track tapes much as a record changer plays records.

Sony had a prototype version of the deck, which will sell for about \$500, on hand at last month's Electronic Industries Association consumer products show. When the unit goes into action, it drops the first reel into playing position, threads the tape, and then runs it through a full forward-and-back cycle. After the tape has been played, an ejector lifts the reel off the playing spindle and slides it into a tray. The next reel then drops into place and the automatic sequence repeats.

The change mechanism handles reel sizes from 3 to 7 inches.



Reeling on. Sony tape deck plays stack of five tape reels automatically.

France

The miracle worker

At a special school near Paris, children once considered hopeless deaf mutes are hearing sounds they can understand and, in some cases, are even beginning to talk.

The miracle has been worked by a hearing aid that generates artificial speech in the limited sound spectrum—up to 300 hertz—that some 90% of deaf mutes can hear if the decibel level is high enough. Simply filtering out and amplifying the low-frequency components of normal speech wouldn't work; the sounds wouldn't make sense.

Coded. The artificial-speech generator is the brainchild of Leonid Pimonow, an engineer at the Centre National d'Etudes des Télécommunications, the research establishment of the French Post Office.

Essentially, the instrument produces sounds comprehensible to deaf mutes by varying low frequencies perceptible to them with pulse-coded natural speech. After they start to hear, many mutes can learn to talk; when they try to repeat what they hear, their vocal apparatus supplies enough high-frequency components to make their speech sound almost normal to a normal ear.

The human voice spectrum picked up by a microphone is first split into seven frequency bands, each corresponding to a natural sound component. The sounds then are digitized by a pulse-coding network and applied to potentiometer gates, which control seven artificial sound generators. Frequency of the artificial sounds is set to match the sensitivity of individual patient's ears.

Adequate. Unlike the human voice, which can carry about 40,000 bits of information per second, the voice generator can handle only 500 bits per second. This, Pimonow says, is enough to transmit the essential sounds—but not the accents, intonations, and other individual characteristics of human voices. And with its limited information-carrying capacity, the voice generator responds erratically some-

times to badly articulated sounds.

Shrinking. Pimonow has had his troubles trying to whittle down the hardware to manageable size. The first equipment, built five years ago, was closet-size. Subsequently, he cut it down to about the bulk of a television receiver. Last year, he reduced it further—to a portable unit 8 by 4 by 2 inches. Next step, which should come in about a year, is a still smaller version built around integrated circuits. But each reduction in size has come at some sacrifice in performance; the filters and potentiometer gates in the smaller units don't work as well as those of the bigger ones.

West Germany

Keep it clean

One of the many concerns of water-supply authorities in the highly industrial Ruhr Valley is accidental oil spillage. Undetected slicks, even small ones, cause all sorts of trouble at water treatment plants.

To spot slicks before they can do damage, Allgemeine Elektrizitäts-Gesellschaft has come up with a system that detects oil films as thin as 0.1 micron in conduits leading to water-purification plants. Along with recording the amounts of oil contaminating the water, the equipment sounds a warning when there's more oil than a purification plant can handle and can be set up to automatically start up apparatus that skims oil slicks off the surface.

Water wheel. AEG based its system on an idea first hit upon by engineers at the Ruhrverband, the communal authority responsible for keeping water clean in the Ruhr industrial area. Basically, the system detects changes in electrical conductivity between pairs of electrodes when oil coats them. A thick oil film bridging the electrodes has about one-fiftieth the conductivity of uncontaminated water.

The system's float-mounted detection unit uses four pairs of stainless steel electrodes, spaced equally around the circumference of a



Immersed. Oil contamination in conduit of water-treatment plants is detected by drop in conductivity across electrode pairs mounted on wheel that spins with its rim dipped.

plastic disk 8 inches in diameter. The disk spins at 250 revolutions per minute with its rim immersed in about 2 inches of water.

The electrodes are connected into current-sensing circuits in a nearby monitoring unit. These circuits measure the drop in conductivity when oil, rather than pure water, bridges the small gap between the electrodes of each pair. A roller that rides on the rim of the electrode wheel wipes off the oil after the measurement has been taken.

Great Britain

Sensitive soles

Doctors treating arthritic hip joints usually can get only a general idea—by noting changes in a patient's limp over the months—of how their treatments are working.

Ideally, a patient's progress could be checked by load cells on the hip joint to record how he lets the load build up on his bad hip. This direct technique, of course, isn't practical; but British researchers have come up with an indirect method that does the job.

Indirect. Instead of measuring the loads on the hip joints them-

selves, the British technique measures the loads a patient puts on each foot—through the use of a pair of instrumented sandals.

The idea of the monitoring sandals came from Dr. J.T. Scales, head of the biomechanics department at the Royal National Orthopedic Hospital. A prototype pair, which telemeters foot-load data as its wearer walks, has been developed by the Royal Aircraft Establishment and will soon be tried out on patients.

Sandwich. Load-sensing element in the sandals is a capacitor, made up of three thin, beryllium-copper labyrinths sandwiched between layers of foam rubber in the sandal sole. The upper and lower labyrinthine elements are connected together and thus form a single capacitance plate.

The sole capacitances form part of the tank circuit for a transistorized oscillator built into the sandal's heel. As the patient walks, he frequency-modulates the oscillator's output, which feeds a transmitting loop in the heel. A single receiving loop in the room where the tests are made picks up the oscillator output.

Left and right. To distinguish between feet, the "right" oscillator operates over a frequency range from 100 to 110 kilohertz and the "left" oscillator, from 140 to 150

khz. The composite signal picked up by the receiving loop is amplified and filtered to separate the signals from each sandal. A pair of side-by-side traces on a chart recorder shows how much a patient favors his bad hip.

Corporate giant

It's long been in the cards that Elliott-Automation Ltd., well-fixed for technical talent but hard-pressed to finance the research that kept the company going, would one day merge with a well-heeled industrial group.

Late last month the inevitable happened. The English Electric group, whose sales are four times as big as Elliott's, took Elliott into its fold. Along with Elliott's undisputed expertise in automation and avionics—the company has even managed to break into the U.S. military hardware market—English Electric acquired in the merger an eight-year, low-interest loan of \$42 million from the Industrial Reorganization Corp., set up by the government to foster mergers.

Billion. Sales of the merged groups currently are running about \$1 billion annually, some \$400 million in electronics. Among European electrical-electronics firms, the merged English combine is outranked only by Holland's N.V. Philips' Gloeilampenfabrieken West Germany's Siemens AG and AEG-Telefunken.

English Electric should have little trouble meshing Elliott's product line into its own, which includes heavy electrical equipment, locomotives, and diesel engines as well as computers, control equipment, and electronics. Some overlapping turns up between Elliott and the Marconi Co., another English Electric firm. Both, for example, manufacture process control computers, integrated circuits, and radar. Although the realignment of product lines still has to be worked out, one long-term result of the merger may be a unified effort in IC production.

Out front. For the short term, English Electric and Elliott now seem a firm favorite to win govern-

ment backing for a giant third-generation computer [Electronics, May 15, p. 228]. Before they merged, both firms had proposed projects to the government. Together, they stand a much better chance than their competitor, International Computers and Tabulator Ltd. In fact, the merged group adds up to serious competition for ICT, so far the top British computer maker.

Around the world

Italy. Although the Parliament has barred network color television broadcasts until 1970, the government-run radio-tv network has started to run tests on color equipment. The first experimental transmissions were made in late June at Rome during the 14th International Scientific Congress on Electronics.

South Korea. The Control Data Corp. will start assembling core memory planes at a new plant in Seoul early this fall. Along with the manufacturing operation, Control Data Korea will handle sales and servicing of CDC computers.

Nigeria. Armed revolt and secession in the Eastern Region of Nigeria apparently will not affect the government's plans to build a nationwide telecommunications network. The prime contractor, Great Britain's General Electric Co., got a firm go-ahead in mid-June for its \$23 million share of the second stage of the project, which calls for 2,500 miles of microwave links.

Thailand. The West German firm, Standard Elektrik Lorenz AG, an affiliate of the International Telephone and Telegraph Corp., has won a \$6.6 million contract to build a microwave network that will give Thailand nationwide trunk telephone service by 1969. The system will have a capacity of 1,860 telephone channels and one television channel.

West Germany. AEG-Telefunken has come up with a technique that records PAL color-television signals on home black-and-white video tape recorders. The company has demonstrated the principle experimentally but says it will take some time to get a coder-decoder into production.

FULL 1 CU. FT. CHAMBER— ONLY \$975⁰⁰!

New Associated chamber features:

- Cascade refrigeration to -120°F
- Solid-state $\pm 1/2^{\circ}$ controller
- All new design

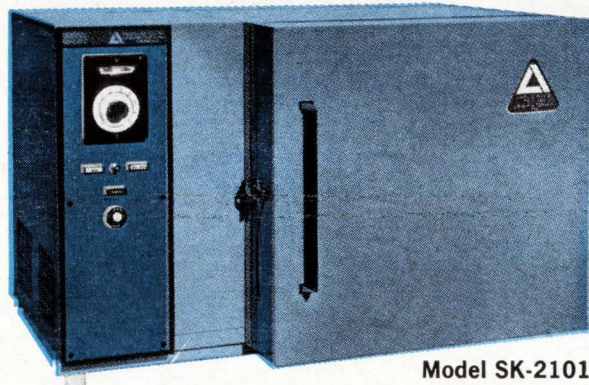

Model SK-2101

The best price we know of for any one-cubic-foot refrigeration chamber on the market! Yet, this is not a stripped-down model. It operates over an expanded temperature range, from -120°F to $+350^{\circ}\text{F}$! It features a new all-solid-state controller with $\pm 1/2^{\circ}\text{F}$ stability! And, standard equipment includes an adjustable high-temperature fail-safe control, complete with indicating lamp.

What's more, everything's in a completely redesigned, handsome package with a combination hinged and removable door for added convenience. Write today for complete specifications!

**FREE CATALOG OF ALL-NEW LINE
OF ASSOCIATED CHAMBERS WITH
SOLID-STATE CONTROLLERS!
WRITE TODAY TO DEPT. E-6.**

ASSOCIATED TESTING
LABORATORIES, INC.

200 Route 46, Wayne, New Jersey
(201) 256-2800



Electronics advertisers

July 10, 1967

Airpax Electronics, Inc. Welch, Mirabile & Co., Inc.	59	Di-Acro Corporation, Div. of Houdaille Industries, Inc. Charles E. Brown Adv.	165	I B M Corporation, Systems Development Div. Marsteller, Inc.	18, 19
■ Air Reduction Co., Inc. Speer Carbon Co. Div. Hazard Adv. Co., Inc.	49	Digital Equipment Corp. Kalb & Schneider, Inc.	22	Industrial Agencies of Japan, Ltd. Michiden Adv., Ltd.	173
Air Reduction Co., Inc., Airco Industrial Gases Div. Fuller, Smith & Ross, Inc.	35	Dow Chemical Co., The MacManus, John & Adams, Inc.	61	Intronics, Inc. Marketing Assistance, Inc.	164
Airtron, Div. of Litton Industries McCarthy, Scelba, De Biasi	151	Dresser, SIE, Inc. Erwin Wasey, Inc.	52	I R C, Incorporated Gray & Rogers, Inc.	140
■ Amelco Semiconductor, Div. of Teledyne, Inc Sturges Advertising	147	■ DuPont de Nemours & Co., Freon Div. Batten, Barton, Durstine & Osborn, Inc.	66	ITT Semiconductors Div. Neals & Hickok, Inc.	200
■ American Lava Corp., Sub. of Minnesota Mining & Mfg. Co. Designers, Inc.	149	■ DuPont de Nemours & Co., Mylar Div. Batten, Barton, Durstine & Osborn, Inc.	117	Jerrold Electronics Corp. Mohr & Co., Inc.	14
■ Andrew Corporation Fensholt Adv., Inc.	188	■ Eagle Signal, Div. of Gamewell, Sub. of E.W. Bliss Co. Feeley Adv. Agcy.	60	■ Lapp Insulator Co. Wolff Associates	155
A.P.I. Instruments George Z. Griswold Adv.	162	■ Electro Motive Mfg. Co. Reynolds & Foster, Inc.	65	Lockheed Missiles & Space Co. McCann Erickson, Inc.	173
Applied Technology, Inc. The John Nelson Agcy.	55	Electronized Chemicals Corp. Kenyon & Eckhardt, Inc.	183	■ Machlett Laboratories, Raytheon Co. Div. Fuller, Smith & Ross, Inc.	9
Associated Testing Laboratories, Inc. Frank Best & Co., Inc.	197	Emerson & Cuming, Inc. Edwin F. Hall	164	Magnetics, Inc. Lando Adv. Agcy., Inc.	69
■ Atlas Chemical Industries, Inc., Aerospace Components Div. Harris D. McKinney, Inc.	175	Fairchild Instrumentation Faust/Day, Inc.	115	■ Magnetic Shield Div., Perfection Mica Co. Burton Browne Adv.	179
Automatic Electric Co., Sub. of General Telephone & Electronics Corp. Tatham-Laird & Kudner, Inc.	121	Fairchild Semiconductor Div. Faust/Day, Inc.	30, 31, 70, 191, 192	■ Mallory Battery Co., P.R. Mallory & Co., Inc. Div. Needham, Harper & Steers, Inc.	94
■ Ballantine Laboratories Lang-Lawrence Adv., Inc.	154	Fluke, Mfg. Co., John Bonfield Associates	15	■ Markel & Sons, L. Frank George Moll Adv., Inc.	157
■ Bausch & Lomb, Inc. Wolff Associates, Inc.	126	■ Franklin Electronics, Inc., Anelex Corp. Div. James J. Cavella Adv.	168	Memorex Corporation Hal Lawrence, Inc.	37
■ Beckman Instruments, Inc. Helipot Div. Hixson & Jorgensen, Inc.	40	■ Fujitsu, Ltd. Asia Adv. Agcy., Inc.	136	Metal Removal Co., The Advertising Producers Assoc.	16
■ Belden Mfg. Co. Fensholt Adv., Inc.	12, 13	Garrett Corporation, Airesearch Mfg. Div. J. Walter Thompson Co.	54	Microlab/FXR Frank Best & Co., Inc.	113
Bell Telephone Laboratories N.W. Ayer & Son, Inc.	130	General Dynamics Fort Worth Div. Glenn Adv., Inc.	138	■ Microsonics, Inc. S. Gunnar Myrbeck & Co.	178
Bendix Corp., Flight & Engine Instruments Div. MacManus, John & Adams, Inc.	42	General Radio Co. Horton, Church & Goff, Inc.	2nd Cover	Mill Associates Tech/Reps, Inc.	172
Birtcher Corp., The Guerin, Johnstone, Gage, Inc.	163	Giannini-Voltex Co. Feldman Everett Adv.	168	Minnesota Mining & Mfg. Co., Chemical Div. Young & Rubicam, Inc.	93
Bourns, Inc., Trimpot Div. Lester Company, The	170	Globe Industries, Inc. Odiorne Industrial Adv.	179	Mitre Corporation The Bresnick Co.	28
■ Brush Instruments, Div. of Clevite Corp. Carr Liggett Adv., Inc.	20, 21	Gries Reproducer Co. Harold Marshall Adv.	164	Motorola Semiconductor Products, Inc. Lane & Bird Adv., Inc	53, 134, 135
Bulova Watch Co., Electronics Div. Frank Best Co., Inc.	150	■ Guardian Electric Mfg. Co. K & A Advertising	68	North Atlantic Industries, Inc. Murray Heyert Associates	148
■ Bussmann Mfg., Div. of McGraw Edison Co. Henderson Adv. Co.	176, 177	Gulf States Utilities Co. Aylin Adv. Agcy.	199	Oak Electro/Netics Corp. Buchen Advertising, Inc.	27
Centralab, Div. of Globe-Union, Inc. The Brady Company	38	G-V Controls McCarthy, Scelba, De Biasi	128	■ Pacific Measurements, Inc. Jack Herrick Adv., Inc.	7
Clare & Company, C.P. Reincke, Meyer & Finn Adv., Inc.	29	Heinemann Electric Co. Thomas R. Sundheim, Inc.	127	Polaroid Corporation Doyle Dane Bernbach, Inc.	51
■ Clifton Precision Products Co., Litton Industries Div. Ivey Adv., Inc.	24	■ Hewlett Packard, Colorado Springs Div. Tallant/Yates Adv., Inc.	3rd Cover	■ Precision Tube Co. George Moll Adv., Inc.	181
Communication Electronics, Inc.	156	■ Hewlett Packard, Dymec Div. Lennen & Newell, Inc.	1	Radio Corporation of America Al Paul Lefton Co.	4th Cover, 182
Components, Inc. Creative Adv. Agcy.	10	■ Hewlett Packard, Loveland Div. Tallant/Yates Adv., Inc.	129	■ S.D.S.A. Public-Service	114
Computer Test Corp. James Lees Adv.	139	■ Hewlett Packard, Microwave Div. Lennen & Newell, Inc.	2	Sierra Electronics, Div. of Philco Ford Hal Lawrence, Inc.	67
■ Control Switch, Div. of Control Co. of America Harry P. Bridge Co.	62	Hi-G, Inc. Marketing Assistance, Inc.	64		
■ Dale Electronics, Inc., Sub. of Lionel Corp. Swanson, Sinkey Ellis, Inc.	56	Honeywell Computer Control Div. Franklin P. Folts, Inc.	47		
Dana Laboratories, Inc. E.L. Van Deusen Co.	119	Honeywell Micro Switch Div. Batten, Barton, Durstine & Osborn, Inc.	32, 33		
Dearborn Electronics, Inc., Sprague Electric Co., Div. Harry P. Bridge Co.	158	Hughes Aircraft Co. Foote, Cone & Belding, Inc.	159		



Sigma Instruments, Inc. Marschalk Co., Inc.	116
■ Simpson Electric Co. Amerad Adv. Service, Inc.	137
Singer Co., Metrics Div. Hepler & Gibney, Inc.	122
■ Slater Electric, Inc. Industrial Marketing Assoc.	36
Solitron Devices, Inc., Transistor Div. Haselmire Pearson Adv.	41
Sorensen Operation, Raytheon Co. James Advertising, Inc.	11
Sprague Electric Co., The Harry P. Bridge Co.	5, 8
■ Stackpole Carbon Co., Electronic Components Div. Meek & Thomas, Inc.	84
Struthers-Dunn, Inc. Harry P. Bridge Co.	146
Sylvania Electric Products, Inc., Semiconductor Div. Tatham-Laird & Kudner, Inc.	39
■ Syntronic Instruments, Inc. Burton Browne Adv.	162
■ Tektronix, Inc. Hugh Dwight Adv., Inc.	17, 124, 169
Texas Instruments Incorporated Semiconductor/Components Division Don L. Baxter Incorporated	123
■ Tracor, Inc. Weekley & Valenti, Inc.	118
Transistor Automation—A Teledyne Co. Weston Assoc., Inc.	34
■ Tung Sol, Wagner Electric Corp. Div. E.M. Freystadt Assoc.	183
Ulano & Co., J. Byrde, Richard & Pound, Inc.	143
■ Unitrode Corp. Silton Brothers, Inc.	120
Univac, Div. of Sperry Rand Corp. MacManus, John & Adams, Inc.	175, 180
University Laboratories, Inc. West Associates	63
■ Varo, Inc. Tracy-Locke Co., Inc.	150
Westinghouse, Semiconductor Div. McCann/itsm	6
West Penn Power Co. Area Development Dept. Allegheny Power System Fuller & Smith & Ross, Inc.	133

Classified Advertising

F.J. Eberle, Business Mgr.

PROFESSIONAL SERVICES	184
EMPLOYMENT OPPORTUNITIES	184-186

EQUIPMENT

(Used or Surplus New) For Sale	187
-----------------------------------	-----

ADVERTISERS INDEX

A & A Electronics Corp.	187
Cadillac Assoc.	184
Fair Radio Sales	187
General Dynamics, Electronics Div.	186
R.E. Goodheart Co., Inc.	187
National Instrument Co.	187
Radio Research Corp.	185
RCA Instructional Systems	185
San Francisco Bay Naval Shipyard	184

■ For more information on complete product line see advertisement in the latest Electronics Buyers' Guide

Advertising sales staff

Frank E. LeBeau [212] 971-6464

Advertising sales manager

Wallis Clarke [212] 971-2187

Assistant to sales manager

Donald J. Austermann [212] 971-3139

Promotion Manager

Atlanta, Ga. 30309: Michael H. Miller, 1375 Peachtree St., N.E.
[404] TR 5-0523

Boston, Mass. 02116: William S. Hodgkinson
McGraw-Hill Building, Copley Square
[617] CO 2-1160

Chicago, Ill. 60611: Robert M. Denmead,
J. Bradley MacKimm, Ralph Hanning,
645 North Michigan Avenue,
[312] MO 4-5800

Cleveland, Ohio 44113: William J. Boyle, 55
Public Square, [216] SU 1-7000

Dallas, Texas 75201: Richard P. Poole, 1800
Republic National Bank Tower,
[214] RI 7-9721

Denver, Colo. 80202: Joseph C. Page, David
M. Watson, Tower Bldg., 1700 Broadway,
[303] 255-5484

Detroit, Michigan 48226: Ralph Hanning
856 Penobscot Building
[313] 962-1793

Houston, Texas 77002: Kenneth George,
2270 Humble Bldg., [713] CA 4-8381

Los Angeles, Calif. 90017: Ian C. Hill,
John G. Zisch, 1125 W. 6th St.,
[213] HU 2-5450

Minneapolis, Minn. 55402: J. Bradley
MacKimm, 1104 Northstar Center
[612] 332-7425

New York, N.Y. 10036
500 Fifth Avenue
Donald R. Furth [212] 971-3615
James R. Pierce [212] 971-3616
Jeffrey M. Preston [212] 971-3617

Philadelphia, Pa. 19103:
Warren H. Gardner, Jeffrey M. Preston,
6 Penn Center Plaza,
[215] LO 8-6161

Pittsburgh, Pa. 15222: Warren H. Gardner,
4 Gateway Center, [412] 391-1314

Portland, Ore. 97204: James T. Hauptli,
218 Mohawk Building, 222 S.W. Morrison
Street, Phone [503] 223-5118

Rochester, N.Y. 14534: William J. Boyle,
9 Greylock Ridge, Pittsford, N.Y.
[716] 586-5040

St. Louis, Mo. 63105: Robert M. Denmead
The Clayton Tower, 7751 Carondelet Ave.
[314] PA 5-7285

San Francisco, Calif. 94111:
James T. Hauptli, 255 California Street,
[415] DO 2-4600

London W1: John W. Patten, Edwin S.
Murphy Jr., 34 Dover Street,
Hyde Park 1451

Milan: Robert M. Sidel
1 via Baracchini Phone: 86-90-656

Frankfurt, Main: Gerd Hinske, Dieter
Rothenbach, Elsa-Brandstroem Str. 2
Phone: 72 01 81

Geneva: Michael R. Zeynel,
1, rue du Temple Phone: 31 95 60

Paris VIII: Kenneth Davey,
17 Avenue Matignon Phone: 359 6637

Tokyo: Nobuyuki Sato, 1, Kotohiracho
Shiba, Minato-Ku [502] 0656

Osaka: Ryoji Kobayashi 163, Umegae-cho
Kita-ku [362] 8771

Business department

Wallace C. Carmichael, Manager

[212] 971-3191

Stephen R. Weiss, Production Manager

[212] 971-2044

Thomas M. Egan,

Assistant Production Manager [212] 971-3140

Dorothy Carmesin, Contracts and Billings

[212] 971-2908

Circulation and research

Milton Drake, Manager [212] 971-3485

Isaac Siegel, Assistant Circulation Manager

[212] 971-6057

David Strassler, Assistant Research Manager

[212] 971-6058

Chloe D. Glover, Research Associate

[212] 971-6057

Electronics buyers' guide

George F. Werner, General Manager

[212] 971-2310

Ray Smyth, Eastern Regional Manager

[212] 971-6538

Regina Hera, Directory Manager

[212] 971-2544

Thomas M. Egan, Production Manager

[212] 971-3140

Send me your new comprehensive, full-color brochure, "Upper Texas-Louisiana Gulf Coast / Land, Labor, Resources."



NAME _____

TITLE _____

COMPANY _____

ADDRESS _____

CITY _____

STATE _____ ZIP _____

Mail to:
L. V. Dugas, Vice President
GULF STATES UTILITIES COMPANY
Department E-3
Lock Drawer 2951
Beaumont, Texas 77704

This Coupon Will Bring
You Information
About the
Growing Area
Development Near
**MAJOR ELECTRONICS
MARKETS ON THE
UPPER
TEXAS-LOUISIANA
GULF COAST**

Information offered in our industrial location brochure will provide you with management-oriented facts on our natural resources, available buildings, favorable labor conditions, close proximity to domestic aerospace markets and our excellent transportation network.

Gulf States Utilities Company can give you a close-up look at the progress and development in Southeast Texas and Southwest Louisiana which make it so ideally suited for electronics industries. Our staff of industrial engineers welcomes the opportunity to assist you in a confidential plant site search. GSU knows the Upper Texas-Louisiana Gulf Coast better, because it's our business.



**GULF STATES
UTILITIES COMPANY**
An Investor-Owned Utility

The Predictables.

**Some computer
manufacturers
inspect every
incoming diode.**

**The others order
from ITT.**

**We do it for them. ITT inspects every diode
100% three different times before it's
shipped. Any part number, silicon or ger-
manium, double plug or DO-7. Make us
prove it. RFQ: The Predictables.**

diodes ITT

ITT SEMICONDUCTORS IS A DIVISION OF INTERNATIONAL TELEPHONE AND TELEGRAPH CORPORATION
FACTORIES IN WEST PALM BEACH, FLORIDA; PALO ALTO, CALIFORNIA; LAWRENCE, MASSACHUSETTS; HARLOW AND FOOTSCRAY, ENGLAND; FREIBURG AND NURENBERG, GERMANY