

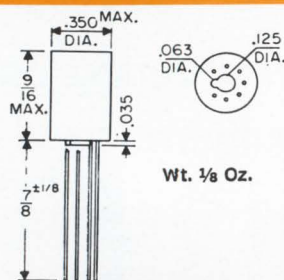

**NEW**

# DO-T200™ SERIES

**ULTRAMINIATURE TRANSISTOR TYPE  
AUDIO TRANSFORMERS**



U. S. PAT. NO. 2,949,591; others pending.

This DO-T200 series of transistor transformers and inductors has been newly added to the UTC lines of stock items available for immediate delivery. These transformers provide the unprecedented power handling capabilities and the inherent reliability found only in the basic structural design of the UTC DO-T Family of miniature transformers. This reliability has been dramatically proven in the field.

Leads are 7/8" long, .016 Dumet wire, gold plated, and may be either welded or soldered. They are uninsulated and are spaced on a .1" radius circle, conforming to the termination pattern of the "TO-5" cased semiconductors and micrologic elements.

DO-T200 series of transformers are designed for Class R application. On special order they may be designed to Class S Specifications. No additional life expectancy is gained by using Class S insulation systems at Class R temperatures.

In pulse coupling impedance matching applications, (when measured with a 30 microsecond input pulse voltage wave), typical values for these transformers are: 5% or less droop, zero overshoot, and less than 10% backswing.

Special unit modifications, such as additions and deletions of leads, changed lead lengths, different impedance ratios and incorporation of electrostatic shields, etc., are available in these constructions.

• Manufactured and successfully tested to complete environmental requirements of MIL-T-27B

- Most Ruggedized MIL Structure, Grade 4, Metal Encased
- Hermetically Sealed
- Immediate Delivery From Stock
- Straight Pin Terminals
- Full Conformance to MIL Mounting Requirements
- Excellent Response
- Solderable and Weldable Leads
- High Efficiency
- Low Distortion

Type No.	MIL Type	Pri. Imp.	D. C. ma <sup>†</sup> in Pri.	Sec. Imp.	Pri. Res.	Mw Level	Application
DO-T255	TF4RX13YY	1K/1.2K CT	3	50/60	115	100	Output or matching
DO-T275	TF4RX13YY	10K/12K CT	1	1.5K/1.8K CT	780	100	Interstage
DO-T277	TF4RX13YY	10K/12K CT	1	2K/2.4K split	560	100	Interstage
DO-T278	TF4RX13YY	10K/12.5K	1	2K/2.5K CT	780	100	Driver
DO-T283	TF4RX13YY	10K/12K CT	1	10K/12K CT	975	100	Isol. or Interstage or Pulse
DO-T288	TF4RX13YY	20K/30K CT	.5	.8K/1.2K CT	830	50	Interstage
DO-T297	TF4RX16YY	200,000 CT	0	1000 CT	8500	25	Input and Chopper
DO-T200SH	Drawn Hipermalloy shield provides 15 to 20 db shielding through side of case						

†DCma shown is for single ended useage. For push pull, DCma can be any balanced value taken by .5W transistors. Where windings are listed as split, 1/4 of the listed impedance is available by paralleling the winding.

## THE DO-T FAMILY OF COMPONENTS



All these hermetically sealed, ultraminiature transistor transformers & inductors are to MIL-T-27B, Grade 4, Class R, Life X. Except PIP: to MIL-T-21038B, Grade 6, Class R, Life X.

DO-T Flexible leads. Freq range 300 CPS—10KC & up. Power up to 1/2 W. Size 5/16 dia x 13/32" h. Wt approx 1/10 oz.

DI-T Flexible leads. Freq range 400 CPS—10KC & up. Power up to 1/2 W. Size 5/16 dia x 1/4" h. Wt approx 1/15 oz.

DO-T200 Series. See above

DI-T200 Series Straight pin gold plated. Dumet leads. Freq range 400 CPS—100KC. Power up to 500 mw. Size 5/16 dia x 3/8" h. Wt approx 1/15 oz.

PIL Inductors range from .025 hy to .8 hy, DC 0 to 10 ma. Transformers from 500 ohms to 10,000 ohms impedance. Freq range 800 cps—250 KC; power up to 100 MW. Size 5/16 dia x 3/16" h. Wt 1/20 oz.

PIP (Pulse) Flexible leads. Wide application pulse transformers, to MIL-T-21038B specifications. Size 5/16 dia x 3/16" h. Wt 1/20 oz.

DO-T400 (Power) Flexible leads, power transformer. Power output 400 mw @ 400 cycles. Size 5/16 dia x 13/32" h. Wt 1/10 oz.

**AND SPECIAL, CUSTOM BUILT COMPONENTS TO YOUR SPECIFICATIONS**

Write for catalog of over  
1,300 UTC TOP QUALITY  
STOCK ITEMS  
IMMEDIATELY AVAILABLE  
from your local distributor.

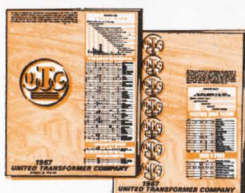

## UNITED® TRANSFORMER CO.

DIVISION OF TRW INC. • 150 VARICK STREET, NEW YORK, N. Y. 10013

IN CANADA: A. C. SIMMONDS & SONS LIMITED, AGINCOURT, ONTARIO

NO LONGER CURRENT SALE

## RECORD DATA IN INK ON Z-FOLD PAPER AND READ IT LIKE A BOOK

The new Hewlett-Packard 7850 Series Rectilinear Fluid-Process Recorder produces ultra-clear traces on Z-fold paper or rolls. The numbered Z-fold pages offer more convenient access to recorded data. Contactless pen tip sensing and a low-pressure ink system produce traces of constant width throughout the recorder's

variable speed ranges of .025 to 200 mm. per second. Designed with modular, solid-state electronics, the 7850 Series Recorder provides high-resolution, permanent, rectilinear recording of up to eight variables from dc to 160 Hz.

A wide selection of 8800 Series Preamplifiers provides signal conditioning to the driver-amplifiers which drive the recording pens of the recorder.

The 7850 Series system includes a preamplifier power supply, a driver amplifier power supply and a cabinet to house the complete unit. The frequency response of the recorder is 160 Hz for 10 div p-p deflection and 60 Hertz maximum for full scale deflection. Maximum ac or dc non-linearity is 0.5% full scale. Additional features include: 14 electrically-con-

trolled chart speeds; built-in paper take-up; low ink supply warning light; plug-in ink supply cartridge that may be replaced while the recorder is in operation and complete modular construction of all components for easy maintenance:



For complete information on the 7850 system, optional and related equipment, contact your local HP Field Office or write Hewlett-Packard Company, 175 Wyman St., Waltham, Mass. 02154.

HEWLETT  PACKARD

17701

57586

# Electronics

**Editor-in-Chief:** Lewis H. Young

## Associate managing editors

**Technical:** Donald Christiansen

**News:** Robert Henkel

**Copy:** Sally Powell

## Senior associate editors

John F. Mason, Joseph Mittleman, Stephen E. Scrupski, Harry R. Karp

## Department editors

**Advanced technology:** Stephen E. Scrupski

**Avionics & Space:** Alfred Rosenblatt

**Computers:** Wallace B. Riley

**Consumer electronics:** John Drummond

**Design theory:** Joseph Mittleman

**Industrial electronics:** Harry R. Karp

**Instrumentation:** Carl Moskowitz

**Military electronics:** John F. Mason

**New Products:** William P. O'Brien, Stephen Fields

**Solid state:** Mark B. Leeds

**Staff writer:** Howard Wolff

## Section editors

**Electronics abroad:** Arthur Erikson

**Electronics review:** Stanley Zarowin

**New Products:** H. Thomas Maguire

**Probing the news:** Eric Aiken

## Regional bureaus

### Domestic

**Boston:** James Brinton, manager; Robin Carlson

**Los Angeles:** Lawrence Curran, manager; June Ranill

**San Francisco:** Walter Barney, manager; Mary Jo Jadin

**Washington:** Robert Skole, manager; William D. Hickman, Paul Dickson, Patricia C. Hoehling

### Foreign

**Bonn:** John Gosch

**London:** Michael Payne

**Tokyo:** Charles Cohen

## Copy editors

James Chang, Frederick Corey

## Graphic design

**Art director:** Saul Sussman

**Assistant art directors:** Ann Mella, Valerie Betz

**Production editor:** Arthur C. Miller

**Editorial secretaries:** Claire Benell, Lynn Emery, Kay Fontana, Patricia Gardner, Lorraine Longo

## McGraw-Hill News Service

**Director:** John Wilhelm; **Atlanta:** Fran Ridgway; **Chicago:** James Rubenstein;

**Cleveland:** Arthur Zimmerman; **Dallas:** Marvin Reid;

**Detroit:** J. Wirgo; **Houston:** Robert E. Lee; **Los Angeles:** Michael Murphy, Gerald Parkinson

**Pittsburgh:** Louis Gomolak

**San Francisco:** William F. Arnold

**Seattle:** Ray Bloomberg; **Washington:** Arthur L. Moore, Charles Gardner, Herbert W. Cheshire, Seth Payne, Warren Burkett, James Canan, William Small

## McGraw-Hill World News Service

**Bonn:** John Johnsrud; **Hong Kong:** Don Kirk; **London:** John Shinn;

**Mexico City:** Bruce Cross; **Milan:** Ronald Taggiasco;

**Moscow:** Howard Rausch; **Paris:** Peter Kilborn;

**Rio de Janeiro:** Wes Perry; **Tokyo:** Marvin Petal

**Reprints:** Susan Nugent

**Circulation:** Milton Drake

## Publisher: Gordon Jones

**Electronics:** November 13, 1967, Vol. 40, No. 23

Published every other Monday by McGraw-Hill, Inc. Founder: James H. McGraw 1860-1948.

Printed at 99 North Broadway, Albany, N.Y. 12207; second class postage paid at Albany, N.Y.

Executive, editorial, circulation and advertising addresses: McGraw-Hill Building, 330 W. 42nd Street New York, N. Y. 10036. Telephone (212) 971-3333. Teletype TWX N.Y. 710-581-4235. Cable address: MCGRAWHILL N.Y.

Subscriptions solicited only from those professionally engaged in electronics technology. Subscription rates: qualified subscribers in the United States and possessions and Canada, \$8.00 one year, \$12.00 two years, \$16.00 three years; all other countries \$25.00 one year. Non-qualified subscribers in the U. S. and possessions and Canada, \$25.00 one year; all other countries \$50.00. Air freight service to Japan \$50.00 one year. Single copies: United States and possessions and Canada, \$1.00; all other countries, \$1.75.

Officers of McGraw-Hill Publications: Joseph H. Allen, President; Bayard E. Sawyer, Executive Vice-President; J. Elton Tuohig, Senior Vice-President-Operations; Vice Presidents: John R. Callahan, Editorial; John M. Holden, Marketing; Paul F. Cowie, Circulation; Angelo R. Veneziian, Production; Jerome D. Luntz, Planning & Development; Robert M. Wilhelm, Controller.

Officers of the Corporation: Donald C. McGraw, Chairman of the Board; Shelton Fisher, President; L. Keith Goodrich, Robert E. Slaughter, Executive Vice Presidents; Donald C. McGraw, Jr., Senior Vice-President; John J. Cooke, Vice-President & Secretary; John L. McGraw, Vice-President & Treasurer.

Title © registered in U.S. Patent Office; © Copyright 1967 by McGraw-Hill, Inc. All rights reserved. The contents of this publication may not be reproduced either in whole or in part without the consent of copyright owner.

**Subscribers:** The publisher, upon written request to our New York office from any subscriber, agrees to refund that part of the subscription price applying to copies not yet mailed. Please send change of address notices or complaints to Fulfillment Manager; subscription orders to Circulation Manager, Electronics at address below. Change of address notices should provide old as well as new address, including postal zip code number. If possible, attach address label from recent issue. Allow one month for change to become effective.

**Postmaster:** Please send form 3579 to Fulfillment Manager, Electronics, P.O. Box 430, Hightstown, New Jersey 08520

## Readers Comment

### No exceptions

To the Editor:

I would like to correct one statement made in the article "Strengthening a link . . . or replacing it" [Aug. 21, p. 39] to the effect that everyone except Amphenol would be forced to requalify as suppliers of MIL-C-26500C. This is not the case. Amphenol, as well as all other potential suppliers of a connector qualified to MIL-C-26500C, will have to qualify by running the required tests in the manner specified. As a matter of fact, we have already asked permission to start such qualification testing at Amphenol.

J.E. Atkinson

Vice president

Amphenol Connector Division  
Chicago, Ill.

### New light

To the Editor:

"Is Einstein wrong?" was the heading you gave to a letter from Pascal M. Rapiere [July 10, p. 4] discussing the article "Settling on the moon" [May 15, p. 110].

Rapiere had suggested that either Einstein's theory "that the phase of a light signal is independent of velocity . . ." is wrong or that "the lunar soft landings whose velocity and range data were obtained from radar doppler techniques . . . impossible under Einstein's theory" were fakes.

C. J. Badewitz, the author of the article, replied that Einsteinian doppler shifts encountered in the Surveyor approach velocities differ from such shifts calculated by means of classical theory by a completely negligible amount.

Neither of these gentlemen appears to have read "Light Velocity and Relativity," by Arthur S. Otis. This 130-page booklet presents some half-dozen disproofs of the postulate questioned by Rapiere. One of them concerns the doppler shift.

The postulate is: the velocity of light is constant in all inertial systems.

Dr. Otis argues thusly: since light velocity  $v = \lambda f$ , and since  $\lambda$

# 300 Hz to 31 MHz

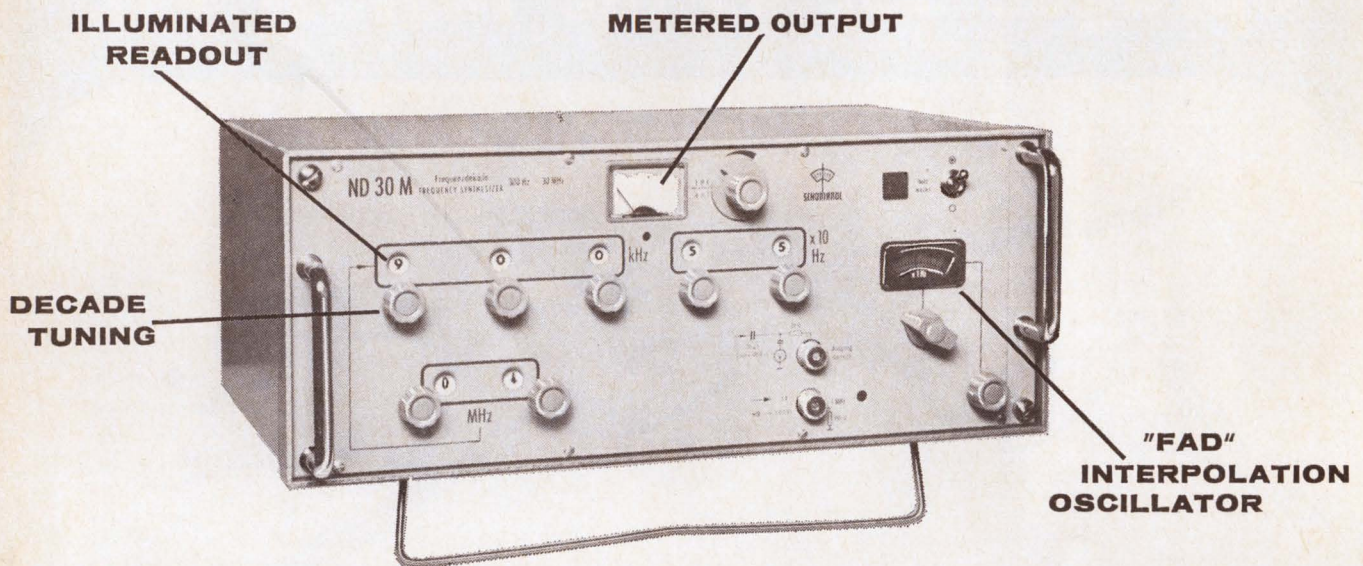

TYPE ND 30M

## FREQUENCY SYNTHESIZER

### FEATURES

- Built-in 1 MHz crystal has proportional oven and  $5 \times 10^{-9}/^{\circ}\text{C}$  stability
- Spurious and noise suppression better than 80 dB
- All solid state design
- Modular construction
- High resolution search oscillator . . . 130 divisions
- AC or battery operated

FNA-SPEKTROGRAMM

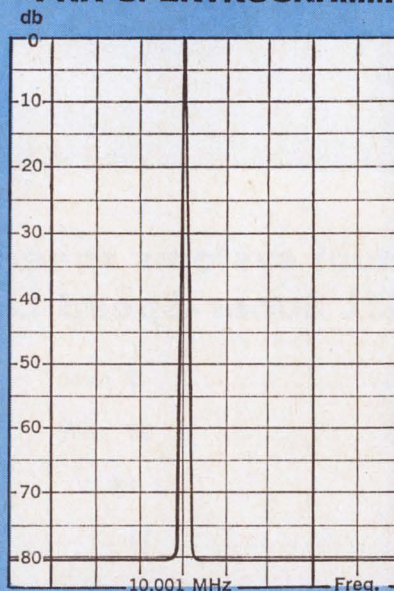

SPECTRAL PURITY OF ND 30M  
FREQUENCY SYNTHESIZER  
200 Hz per division Measured at BW of 10 Hz

Type ND 30M is the latest in a line of Frequency Synthesizers providing unusually high accuracy and ease of operation. Continuously variable over its range, each model provides a direct digital readout, with no tuning required. Perfect for bridge, measurement, work with filters, networks, nuclear magnetic resonance, and as a source of reference frequencies for standards labs. These units can also be supplied in 19" rack mountings.

Type ND 1M (300Hz to 1.1MHz)  
Type ND99K (0 to 110kHz)

Get The Extra Capability,  
Greater Reliability, and  
Longer Useful Life Of . . .



## ROHDE & SCHWARZ

111 LEXINGTON AVENUE, PASSAIC, N. J. 07055 • (201) 773-8010

Inquiries outside the U.S.A. should be directed to: Rohde & Schwarz, Muehlendorfstrasse 15, Munchen 8, West Germany.

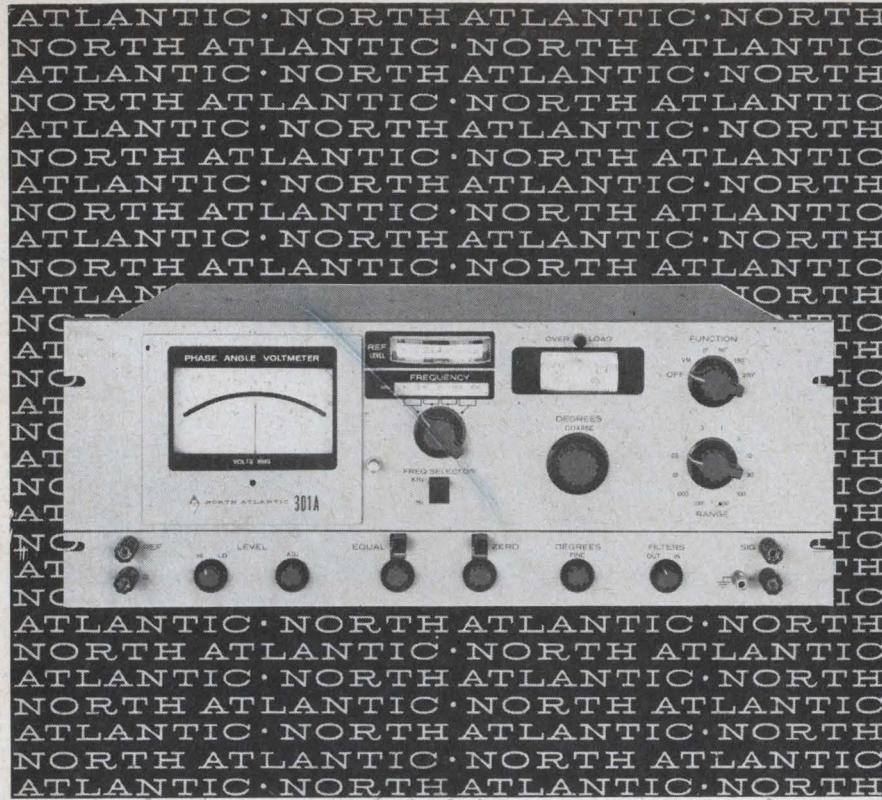

## how to measure phase angle down to .25° from 10Hz to 100KHz (plus in-phase and quadrature!)

North Atlantic's Model 301A Broadband Phase Angle Voltmeter\* adds a new dimension to AC by enabling you to measure phase angle, in-phase and quadrature while frequency is varying over half-decades...without recalibration. It provides complete coverage from 10Hz to 100KHz and incorporates plug-in filters to reduce the effects of harmonics in the range from 27Hz to 28KHz with only 11 sets of filters. Vibration analysis and servo analysis are only two of the many applications for this unit. Selected specifications are listed below:

Voltage Range.....	1 mv to 300 volts full scale
Voltage Accuracy.....	2% full scale
Phase Dial Range.....	0° to 90° with 0.1° resolution (plus 4 quadrants)
Phase Accuracy.....	0.25°, 31.6Hz to 31.6KHz (derating to .6° at 10Hz, 1° at 100KHz)
Input Impedance.....	10 megohms, 30μf for all ranges (signal and reference inputs)
Reference Level Range.....	0.15 to 130 volts
Harmonic Rejection.....	50 db
Nulling Sensitivity.....	less than 2 microvolts
Size.....	19" x 7" x 13½" deep
Price.....	\$2790.00 plus \$160.00 per set of filters

North Atlantic's sales representative in your area can tell you all about this unit as well as other Phase Angle Voltmeters\* for both production test and ground support applications. Send for our data sheet today.



**NORTH ATLANTIC** industries, inc.  
 TERMINAL DRIVE, PLAINVIEW, NEW YORK 11803 • 516-681-8600

## People

Intersil Inc.'s appointment of **Ward Gebhardt** as marketing director without a product reflects the optimism that prevails at the fledgling semiconductor firm started by Jean Hoerni, developer of the planar process, founder of Amelco Semiconductor, and guiding spirit behind the entry of the Union Carbide Corp. into semiconductors. Though Intersil has only 15,000 square feet of plant facilities and some \$2 million in backing, Gebhardt left a comfortable spot as marketing manager for discrete components at the semiconductor division of the Fairchild Camera and Instrument Corp.

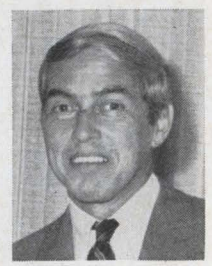

**Ward Gebhardt**

"We already have some proposals out, trying to find out who wants what," Gebhardt explains. "Our present plant is strictly for research and development and prototype fabrication. But we are geared for fast expansion. The R&D is not so far beyond the market that we can dispense with a marketing man. You need one for long-term planning, to help in the language and pricing for bidding on specific circuits."

Gebhardt has known Hoerni since 1963, when both did some consulting work for Union Carbide. The chance to work with Hoerni at Intersil—where the financial rewards for success could be enormous—may have dictated the decision to leave Fairchild.

To **Theodor F. Hueter**, the field of ocean engineering appears to be "at the Sputnik 1 hour," poised for exciting thrusts, but saddled with the omnipresent brake on funding imposed by the war in Vietnam. The 50-year-old Hueter, an acoustics ex-



**Theodor F. Hueter**

# Only from Sprague!

## DIGITAL-TO-ANALOG HYBRID D to A CIRCUITS

with precision components not found in monolithic integrated microcircuits

### FOUR BIT SERIES

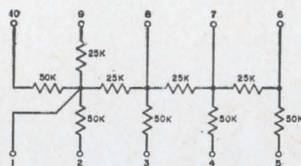

UT-1000 LADDER NETWORK

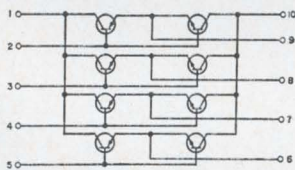

UD-4001 LADDER SWITCH

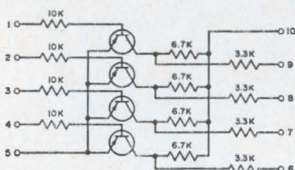

UD-4024 BUFFER AMPLIFIER

### FIVE BIT SERIES

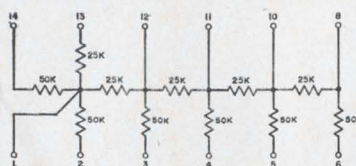

UT-1001 LADDER NETWORK

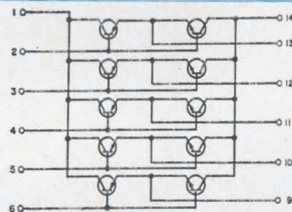

UD-4036 LADDER SWITCH

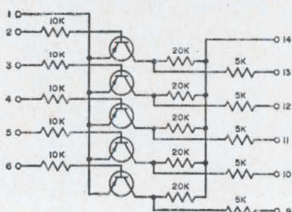

UD-4037 BUFFER AMPLIFIER

## Up to 12 bits with less than 1/2 bit error!

- Improved tracking over temperature range of  $-55\text{ C}$  to  $+125\text{ C}$ .
- 3 to 1 size reduction over conventional converters using discrete components.
- Reduced handling of components . . . fewer external connections . . . lower assembly costs.
- Silicon-base hybrid microcircuits in hermetically-sealed flat packs.
- 4-bit series expandable to 8 or 12 bits . . . 5-bit series expandable to 10 bits.
- Combination of precision thin-film tantalum nitride resistors, nickel-chromium resistors, and active devices of planar construction.
- Packaged for compatibility with monolithic circuits.

For complete technical data on D-to-A microcircuits, write to Technical Literature Service, Sprague Electric Company, 35 Marshall St., North Adams, Mass. 01247.

### SPRAGUE COMPONENTS

THIN-FILM MICROCIRCUITS  
INTEGRATED CIRCUITS  
TRANSISTORS  
CAPACITORS  
RESISTORS  
PULSE TRANSFORMERS  
495-7141

INTERFERENCE FILTERS  
PACKAGED COMPONENT ASSEMBLIES  
FUNCTIONAL DIGITAL CIRCUITS  
MAGNETIC COMPONENTS  
CERAMIC-BASE PRINTED NETWORKS  
PULSE-FORMING NETWORKS



\*Sprague and ® are registered trademarks of the Sprague Electric Co.

### People

pert, was recently chosen to head Honeywell Inc.'s Marine Systems Center.

The Center consists of two facilities—the West Covina, Calif., headquarters and a site in Seattle. Total employment for the two installations has grown from about 750 two years ago to some 1,300, and Hueter looks for it to reach 2,000 once the Vietnam conflict subsides. He expects to get a good share of military business. For example, there are the Navy's DX destroyer program in which Honeywell would probably compete for antisubmarine warfare hardware development, and an improved version of the Navy's Asroc antisubmarine rocket, which was developed by the Marine Systems Center.

One of Lee Rice's first moves as senior vice president of the Ogden Corp. of New York will be to get the company into the electronics business. "We plan to acquire several electronics companies by mid-1968 and exceed \$250 million in electronics sales by the early '70's," says the Washington-based executive.



Lee Rice

Rice says he plans to "create a broad technology base as a viable business and to serve Ogden's other activities," which include shipbuilding, metals and food processing, biomedicine, water treatment, chemicals, and demolition. Ogden now has technical laboratories in Los Angeles and Sunnyvale, Calif., and Long Island, N.Y., which provide environmental and functional testing for aerospace and oceanographic equipment.

The electronics companies Rice has in mind will include a mixture of "those concerned with advanced development and those dealing in a product line, mainly in the areas of pollution control and for the chemical industry."

# Do something nice

**National Semiconductor Corporation**  
2975 San Ysidro Way  
Santa Clara, California 95051

*Please send nice, new short form catalog to my friend.*

FRIEND'S NAME \_\_\_\_\_

FRIEND'S COMPANY \_\_\_\_\_

FRIEND'S TITLE \_\_\_\_\_

FRIEND'S ADDRESS \_\_\_\_\_ FRIEND'S ZIP \_\_\_\_\_

**National Semiconductor Corporation**  
2975 San Ysidro Way  
Santa Clara, California 95051

*Please send nice, new short form catalog to my friend.*

FRIEND'S NAME \_\_\_\_\_

FRIEND'S COMPANY \_\_\_\_\_

FRIEND'S TITLE \_\_\_\_\_

FRIEND'S ADDRESS \_\_\_\_\_ FRIEND'S ZIP \_\_\_\_\_

**National Semiconductor Corporation**  
2975 San Ysidro Way  
Santa Clara, California 95051

*Please send nice, new short form catalog to my friend.*

FRIEND'S NAME \_\_\_\_\_

FRIEND'S COMPANY \_\_\_\_\_

FRIEND'S TITLE \_\_\_\_\_

FRIEND'S ADDRESS \_\_\_\_\_ FRIEND'S ZIP \_\_\_\_\_

**National Semiconductor Corporation**  
2975 San Ysidro Way  
Santa Clara, California 95051

*Please send nice, new short form catalog to my friend.*

FRIEND'S NAME \_\_\_\_\_

FRIEND'S COMPANY \_\_\_\_\_

FRIEND'S TITLE \_\_\_\_\_

FRIEND'S ADDRESS \_\_\_\_\_ FRIEND'S ZIP \_\_\_\_\_

# RCL miniature 1/2" rotary switches



(Actual Size)

## INDUSTRY'S MOST COMPLETE SELECTION

- Shorting AND non-shorting poles may be grouped on one deck in any combination.
- Up to 12 positions per deck shorting or non-shorting.
- As many as 6 poles per deck.
- All individual deck parts are self-contained, and are permanently molded into place.
- Life expectancy 200,000 mechanical operations.

### "Off-the-Shelf" Shipments

Write for complete engineering information

# RCL

General Sales Office  
RCL ELECTRONICS, INC.  
700 South 21st Street  
Irvington, New Jersey 07111

## Meetings

**Computer Conference**, American Federation of Information Processing Societies; Convention Center, Anaheim, Calif. **Nov. 14-16.**

**Meeting of the Anti-Missile Research Advisory Council**, Advanced Research Projects Agency; U.S. Naval Postgraduate School, Monterey, Calif., **Nov. 14-16.**

**International Exhibition of Industrial Electronics**, Swiss Industries Fair, Basle, Switzerland, **Nov. 14-18.**

**Missile System Meeting**, American Institute of Aeronautics and Astronautics; Monterey, Calif., **Dec. 4-6.**

**Symposium on Theory and Measurement of Atmospheric Turbulence and Diffusion in the Planetary Boundary Layer**, Atmospheric Sciences Laboratory of the Army Electronics Command; Sandia Base, Albuquerque, N.M., **Dec. 5-7.**

**Vehicular Conference**, IEEE; New York Hilton, New York, **Dec. 5-7.\***

**Symposium on Reliability**, IEEE; Sheraton-Boston Hotel, Boston, **Jan. 16-18.**

**Power Meeting**, IEEE; Statler-Hilton Hotel, New York, **Jan. 28-Feb. 2.**

**Aerospace and Electronic Systems Convention**, IEEE; International Hotel, Los Angeles, **Feb. 13-15.**

**International Solid-State Circuits Conference**, IEEE; Sheraton Hotel, Philadelphia, **Feb. 14-16.**

**Scintillation and Semiconductor Counter Symposium**, IEEE; Shoreham Hotel, Washington, **Feb. 28-March 1.**

**International Convention and Exhibition**, IEEE; New York Coliseum and New York Hilton Hotel, New York, **March 18-21.**

**Symposium on Microwave Power**, International Microwave Power Institute, Statler Hilton Hotel, New York, **March 21-23.**

**Joint Railroad Conference**, IEEE; Conrad Hilton Hotel, Chicago, **March 27-28.**

**International Magnetics Conference**, IEEE; Sheraton Park Hotel, Washington, **April 3-5.**

**Business Aircraft Meeting and Engineering Display**, Society of Automotive Engineers, Broadview Hotel, Wichita, Kan., **April 3-5.**

## Short Courses

**Low Frequency Standards**, U.S. Dept. of Commerce, National Bureau of Standards, Washington, **Dec. 11-13;** \$90 fee.

**Process Control**, University of Wisconsin's Department of Engineering, Madison, Wis., **Dec. 13-15;** \$70 fee.

**Automation and Publishing**, The American University's Center for Technology and Administration, Washington, **Jan. 15-18;** \$175 fee.

## Call for papers

**Colloquium on Information Retrieval**, University of Pennsylvania's School of Electrical Engineering; University of Pennsylvania, Philadelphia, May 3-4, 1968. **Dec. 1** is deadline for papers to David Lefkowitz, Moore School of Electrical Engineering, University of Pennsylvania, Philadelphia, Pa., 19104.

**Power Meeting**, IEEE; Sherman House, Chicago, June 23-28, 1968. **Feb. 9** is deadline for submission of papers. Authors should advise the technical conference services office of IEEE if they expect to submit a paper.

**Conference on Precision Electromagnetic Measurements**, IEEE; National Bureau of Standards Laboratories, Boulder, Colo., June 25-28, 1968. **Feb. 12** is deadline for submission of summaries and abstracts to Donald King, Aerospace Corp., Box 95085, Los Angeles, Calif. 90045.

\* Meeting preview on page 16.



# PLOTAMATIC

## x-y recorders offer more performance, features, value

### just compare the specs

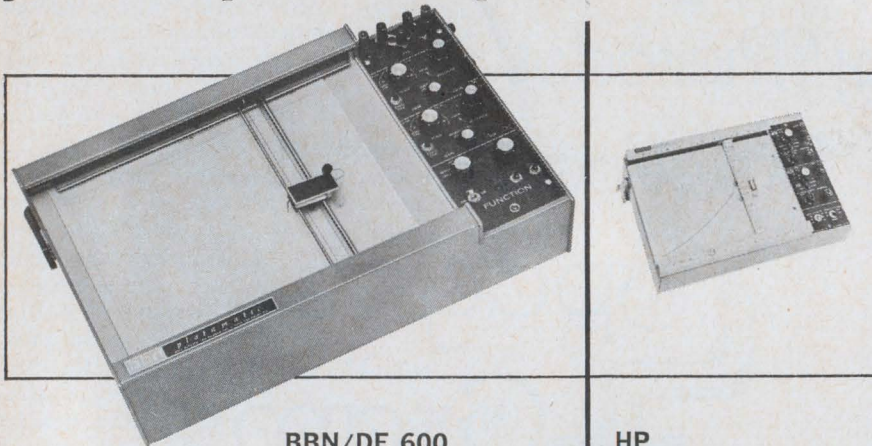

	BBN/DE 600	HP
<b>Input Impedance</b>	1 megohm, constant all ranges	100K on four most sensitive ranges
<b>Paper Holddown System</b>	Vacuum: better holddown, easier line-up, quiet	Electrostatic: attracts dust particles
<b>Servo System</b>	Sealed follow-up pots (no slide wire cleaning kits)	Open slide wires (require frequent cleaning)
<b>Calibration Check</b>	Push-button zero check on control panel	Must remove X-Y input signals
<b>X-Y Zero Adjustment</b>	No shift from zero calibrate position regardless of full scale input range selected	Shifts from zero calibrate position when attenuator input range is adjusted for proper full scale setting
<b>Price</b>	\$25 less	

Plotamatic is a clear winner on these and other basic important features. You'll want to test all features right in your own lab. We have 30 models of X-Y recorders to choose from. Call us, and we'll bring the particular Plotamatic best suited for you to compare and evaluate. Or write for our complete Plotamatic brochure.

**BOLT BERANEK AND NEWMAN INC**  
 DATA EQUIPMENT DIVISION  
 2126 South Lyon Street, Santa Ana, California 92705 ■ Phone: (714) 546-5300

## Meeting preview

### Crowded spectrum

As is becoming usual when land mobile radio users gather, frequency congestion will be a major topic of discussion at this year's annual IEEE Vehicular Conference, Dec. 6 to 8. At the New York meeting, W.L. North of the Federal Communications Commission will report on a study of the problem in a 34-mile-square area including metropolitan New York.

North recommends the use of computers to plan frequency assignments, two-frequency systems to ease intermodulation problems, and cooperative base stations. With all this, however, he warns that additional frequencies will be needed in the New York area by around 1975-77.

**Equipment scored.** At the same session, R.C. Eldridge of the British Columbia Telephone Co. will blame the height and power of many base-station transmitters and the sensitivity of receivers for much of the traffic interference and, in the long run, for reducing the number of available channels.

To extend the range of highway and railroad communication systems with fixed transmitters, a solid state repeater with a stable gain of 140 decibels at 450 megahertz can amplify attenuated signals. J.G. Churcher will describe the device, which was developed in England at Pye Telecommunications Ltd.

Also on the agenda are reports on two mass-transportation radio communications systems that will operate in the 150-Mhz band. C.E. Paul of Bell Telephone Laboratories will outline the projected radio telephone service on a high-speed train planned for runs between Washington, D.C., and New York. And Seymour Dornfield of the New York City Transit Authority and G.H. Kameron of the Radio Corp. of America will describe a radio system to be installed in New York's 4,000 buses.

**Plaudits.** At a session on reliability, Otmar Schreiber of the General Instrument Corp. will praise the contributions of thermoelectric generators to very-high-frequency communications.

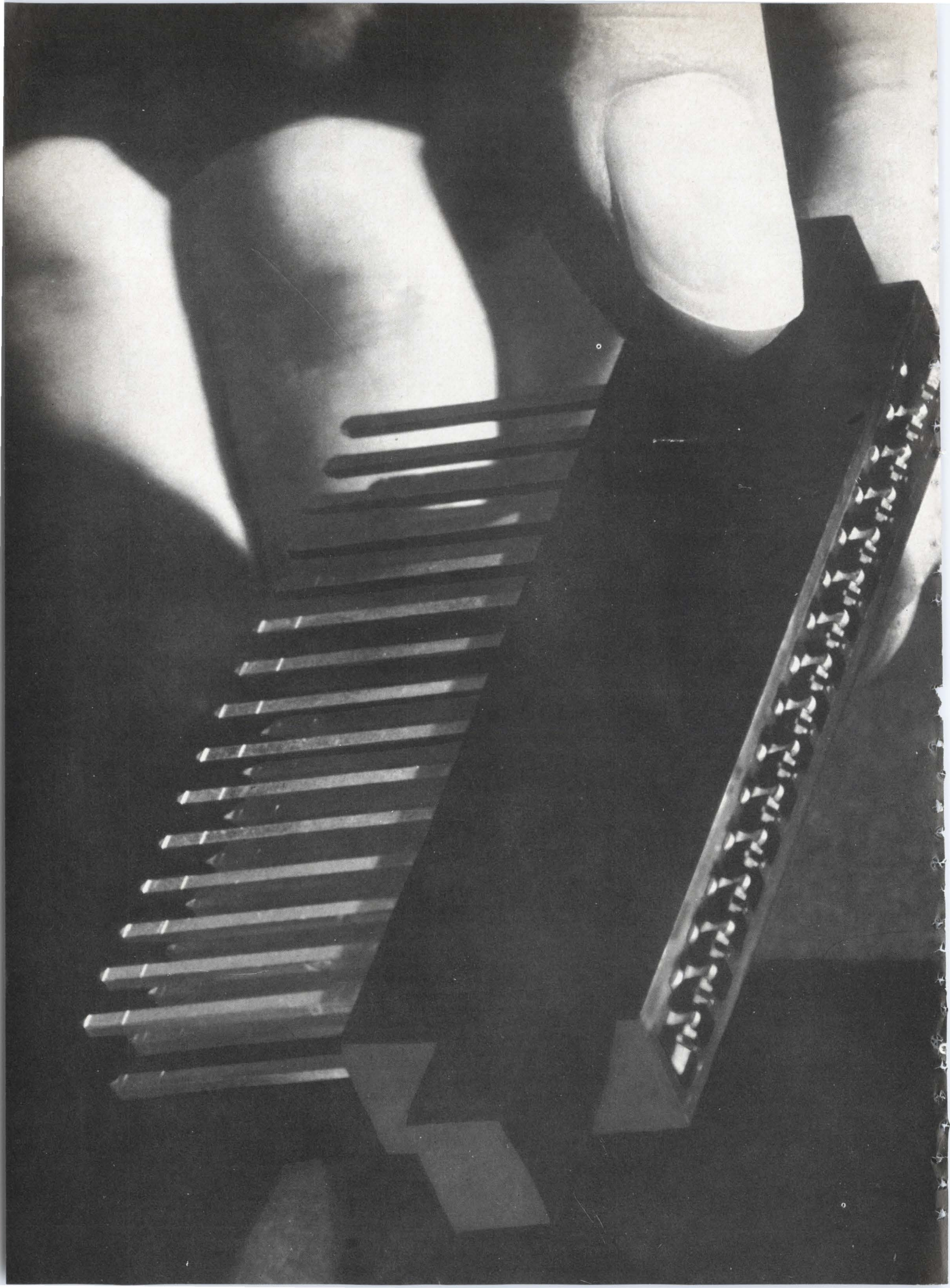

# Build with 3 more linear IC innovations from RCA...

**New Versatility for Commercial, Industrial, and Military Use**

## High-frequency wide-band amplifier/phase detector

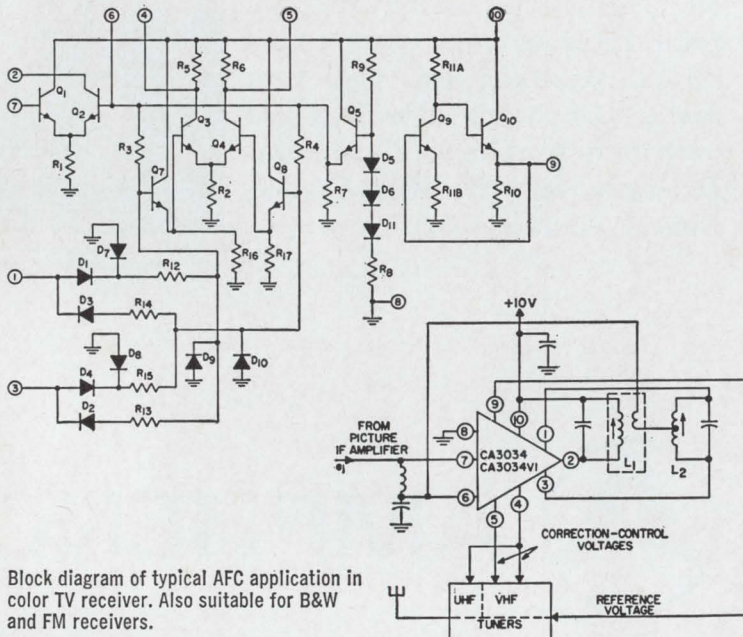

- For Automatic Fine Tuning in VHF and UHF receivers
- Dual phase detector with differential output amplifier
- Compensated reference voltage supply
- Operating temperature range  $-55^{\circ}\text{C}$  to  $+125^{\circ}\text{C}$
- Total current drain 9 mA (type) @  $V_{CC} = 10\text{V}$
- Output offset voltages between terminals #4 and #5 1.5V max. @  $V_{CC} = 10\text{V}$
- Input impedance 2K  $\Omega$  typ

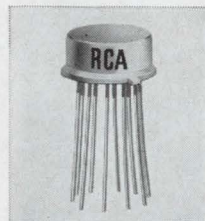

RCA CA3034 in 10-lead TO-5 package. Price \$1.75 (1000+)



RCA CA3034V1 with preformed leads. Price \$1.75 (1000+)

**The new AO  
StereoStar/ZOOM  
Microscope  
gives you high  
resolution,  
new convenience,  
superior optics  
and wide  
magnification  
range.**

Here are a few of the outstanding advantages that make the new AO<sup>®</sup> StereoStar/ZOOM Microscope the finest instrument of this type available today:

- Widest total magnification range: 3.5–210X
- High resolution to meet the most exacting needs
- The most convenient zoom control available
- Choice of five interchangeable, rotatable zoom power bodies
- Crisp, sharp images at all magnifications
- Extra large field of view and high eyepoint eyepieces
- Wide choice of stands for every purpose
- Long working distance
- Even illumination over the entire field
- Coolest operating illuminator.

See for yourself. Contact your AO Sales Representative for a demonstration, or write for our 24-page, full-color brochure on the newest in stereo microscopes—the AO StereoStar/ZOOM.

\*TM Reg., American Optical Co.



**AMERICAN  
OPTICAL  
COMPANY**

**INSTRUMENT DIVISION  
BUFFALO, NEW YORK 14215**

Circle 22 on reader service card

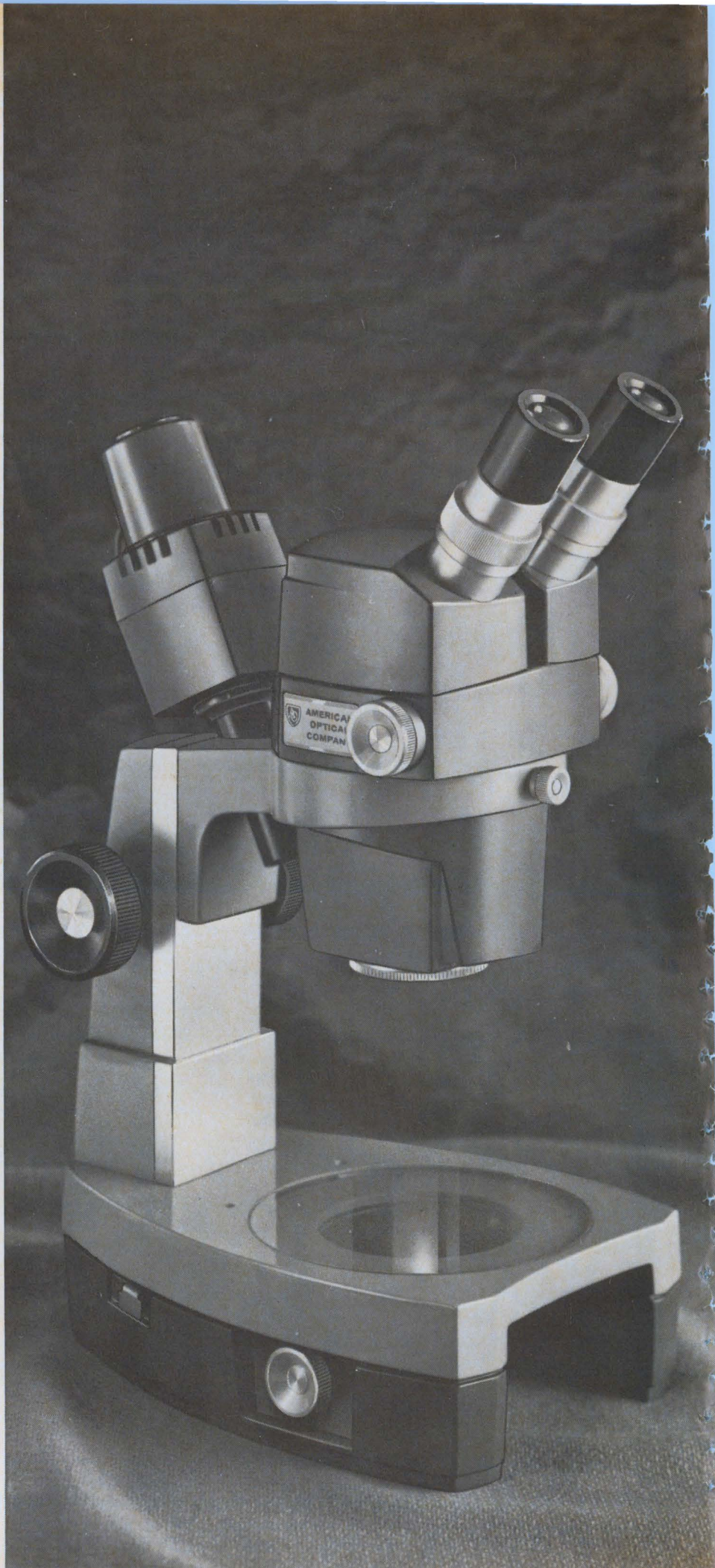

Engineers who have learned to live with the flutter problem in hysteresis synchronous motors will find that living comes easier now. Especially in voice/data recording applications.

Indiana General's unique inverted stator design provides up to six times the rotor inertia of conventional designs. Flutter characteristics are so low as to be practically negligible.

And the price is not so high that it

restricts the use of our inverted stator motor solely to recording devices. It is so economical to manufacture that it's priced competitively with induction type motors, making the Indiana General hysteresis motor economically practical for units like fans and blowers. And, the inverted stator design significantly reduces start-up input power-surge and combines very high operating efficiency with low slip characteristics.

Indiana General inverted stator motors are smaller and lighter than conventional synchronous motors and are available in a wide range of sizes, mountings, power ratings and torques. You can get full details by writing Mr. R. D. Wright, Manager of Sales, Indiana General Corporation, Electro-Mechanical Division, Oglesby, Illinois.

**INDIANA GENERAL** 

## **New inverted hysteresis motor design drives the flutter out of recording equipment.**



---

# Electronics Newsletter

---

its dome. The company plans a sales push for its multifunction radar, good for mapping and navigation, terminal landing, weapons delivery, and limited station keeping.

## Motorola readying 3rd generation ECL

A third-generation emitter-coupled-logic line will be introduced next year by Motorola Semiconductor. The company is aiming the MECL-3 integrated circuits at the ultrahigh-speed computers expected to be introduced in 1970 or 1971.

Motorola seeks a 1-nanosecond typical propagation time; switching speed of the MECL family now on the market is 5 nanoseconds. Jim Burns, manager of IC marketing, says the current-mode line will include flip-flops that operate at frequencies between 200 and 400 megahertz.

## By the skin or the teeth

A hearing aid that uses the teeth and the skin to conduct sound is being developed by a small New York City electronics company, Intelectron Corp. The development is significant because it could result in a hearing aid considerably smaller than those currently in use.

In the Intelectron model sound is not produced by the motion of air as it is in conventional hearing aids which use loudspeakers—but through bone conduction. Consequently, the hearing aid has smaller parts.

In one model, a radio-frequency receiver is placed in a patient's tooth; the "sound" is then conducted through the tooth to the ears' nerves. And in an earlier model, which was used for rehabilitating the hard of hearing, an electrode is attached to the patient's skin.

## Due for mailing

President Johnson's spending freeze so far has held back the Post Office from issuing contracts from its \$18 million R&D budget this year, but department officials are hopeful that they can start letting the first of some 100 to 150 awards by the end of the year. The Post Office also promised the 300 industry representatives attending a briefing earlier this month a list of R&D contracts it will put out for bids.

## Addenda

A sweeper plug-in, developed at Hewlett-Packard Co.'s Loveland, Colo., division, contains the first integrated circuit turned out by the new IC facility there. Construction of the facility began only last spring. The IC is a diode chain used to give a logarithmic shape to the dynamic response of the instrument. . . . Interior Secretary Stewart L. Udall is trying to interest Westinghouse and General Electric in establishing electronics plants in "new towns" that might be built on Indian lands in New Mexico and Arizona. He's citing as precedent the dozen electronics firms attracted to another new town, two-year-old Reston, Va. . . . Happy days are here again at Autonetics where officials, winding up development tests on four programs, are anticipating orders for more than 2,000 airborne computers. The computers, all members of the D26J family, will go on the Condor and short-range attack missile (Sram), both air-to-surface weapons, and the FB-111 and the RF-111 aircraft. . . . Litton Industries has won a hot contest to build the Army's Tacfire (tactical fire direction system). Under an award that could reach an estimated \$50 million, the firm will build a system to provide automatic data processing for all elements of information needed by an artillery officer. Burroughs and IBM were the losers.

# Why Bunker-Ramo chose TTL complex functions for new NC systems



These low-cost numerical control systems offer as standard most of the functions normally found in far more expensive equipment. They are the first such systems to employ ICs for all non-power functions. Shown with Dean W. Freed, General

Manager of the NC Division, the Bunker-Ramo 2100 (right) is a two-axis positioning and straight-cut control, while the 2200 (left) is a three-axis positioning and straight-cut control, with optional two-axis incremental slope and arc capability.

Series 74 complex-function TTL integrated circuits from Texas Instruments have enabled Bunker-Ramo to further improve reliability and performance, while reducing size and cost of the numerical control systems shown above.

Series 74 TTL offered many performance as well as cost advantages. These included higher noise immunity and faster speed, plus

the economies made possible by complex-function circuits.

## High noise immunity

Since numerical control systems usually operate in an electrically noisy environment, the high noise tolerance (typically one volt) and the low input impedance (70 to 150 ohms) of Series 74 circuits are big

advantages. Bunker-Ramo engineers found that this reduced shielding and line-filtering requirements, while simplifying many associated design problems.

## High speed

TTL's high speed gives important design advantages, even though today's NC systems often do not

# Do ICs really cut costs?



The answer is an emphatic yes! That's no promise. It's a fact... with proof to back it up.

We've gathered some of the proof in the folder pictured at the left. This 6-page brochure describes how other industrial manufacturers have achieved revolutionary product advances with ICs. Like these OEMs, you too can significantly reduce equipment size and weight . . . make major performance improvements... achieve new systems capability... *dramatically reduce costs!* For your copy, check No. 200 on the TI information service card.

But that's not all! Check number 202 for the 48-page brochure that contains performance, application, and catalog information on all 180 Series 54/74 TTL ICs.

An 84-page report provides results of TI's "Tougher-than-military" testing program. It's yours for the asking. Check number 203.

A new 24-page color brochure that gives information on all plastic-encapsulated semiconductors—including Series 54/74 ICs—is also available. Check No. 204.

## Please send the following:

- |  |  |
|--|--|
| 200 <input type="checkbox"/> 6-page case history brochure          | 203 <input type="checkbox"/> 84-page IC plastic package reliability report |
| 201 <input type="checkbox"/> 48-page complex-function IC data book | 204 <input type="checkbox"/> 24-page plastic S-C brochure                  |
| 202 <input type="checkbox"/> 48-page TTL brochure                  | 205 <input type="checkbox"/> 16-page "Total Reliability at TI"             |

NAME \_\_\_\_\_

TITLE \_\_\_\_\_

COMPANY \_\_\_\_\_

ADDRESS \_\_\_\_\_

CITY \_\_\_\_\_ STATE \_\_\_\_\_ ZIP \_\_\_\_\_

E



To get the literature you want, check the appropriate numbers, fill out the card, and drop it in the mail. If you prefer, circle the same numbers on the magazine Reader Service card.

E



# Quality analysis... TI reliability starts here!



Any really successful reliability program must start with correcting the causes of failure *before they occur in the field*, and TI's Reliability Analysis Laboratory... established in 1962... has been examining the "where, what, when, how and why" aspects of IC failures for more than five years.

This lab has facilities to analyze each individual element within even the most complex integrated circuit and can duplicate failure mechanisms under precisely controlled conditions.

Typical of these quality-analysis studies is the X-ray video monitoring facility shown at the left. This important analytical tool permits full 360° observations in both vertical and horizontal planes. It reveals failure mechanisms that might otherwise escape detection.

Following identification of failures, the analysis is forwarded to a corrective-action group. Here, TI's in-depth technical resources—including physicists, chemists, and metallurgists, as well as research, design, and manufacturing engineers—are focused on the problem. After evaluation of all data and reports, necessary corrective actions are undertaken.

Quality analysis is only one of many steps taken by TI to ensure reliability of integrated circuits. Other important steps are described in a new 16-page brochure in full color... *Total Reliability at TI*. Check number 205 on the TI information service card for your copy.



TEXAS INSTRUMENTS  
INCORPORATED

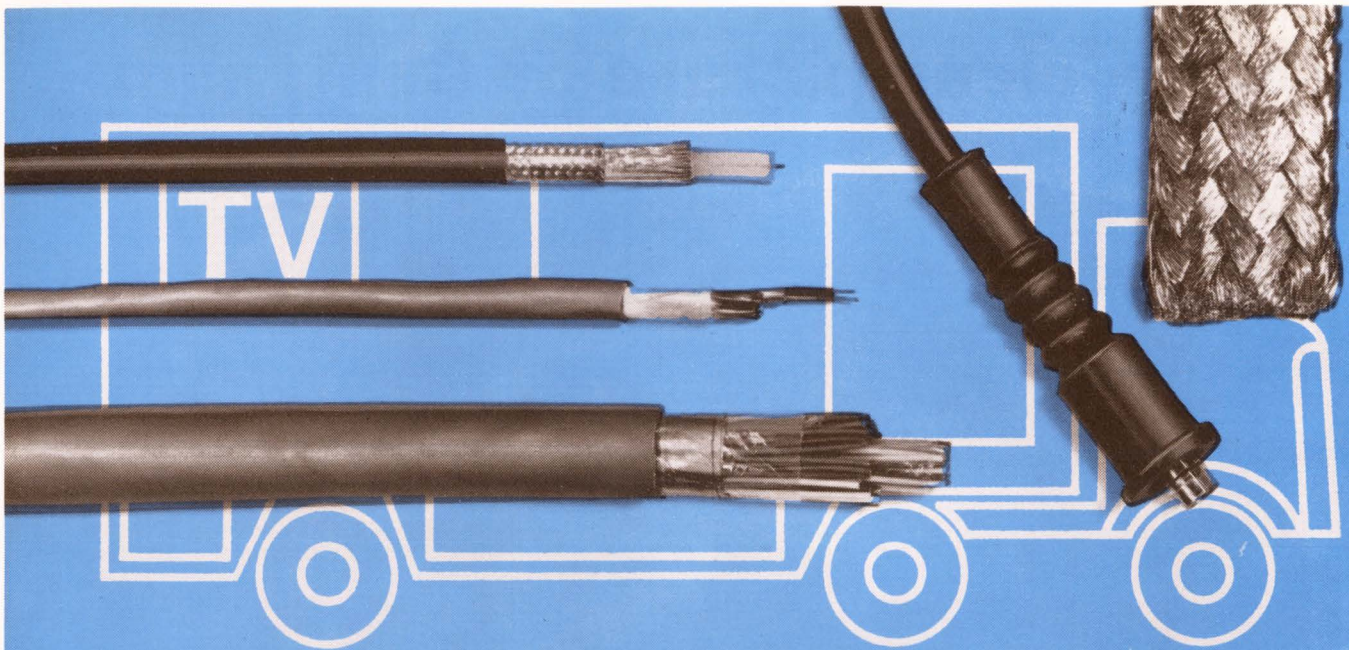

**talk about systems...**

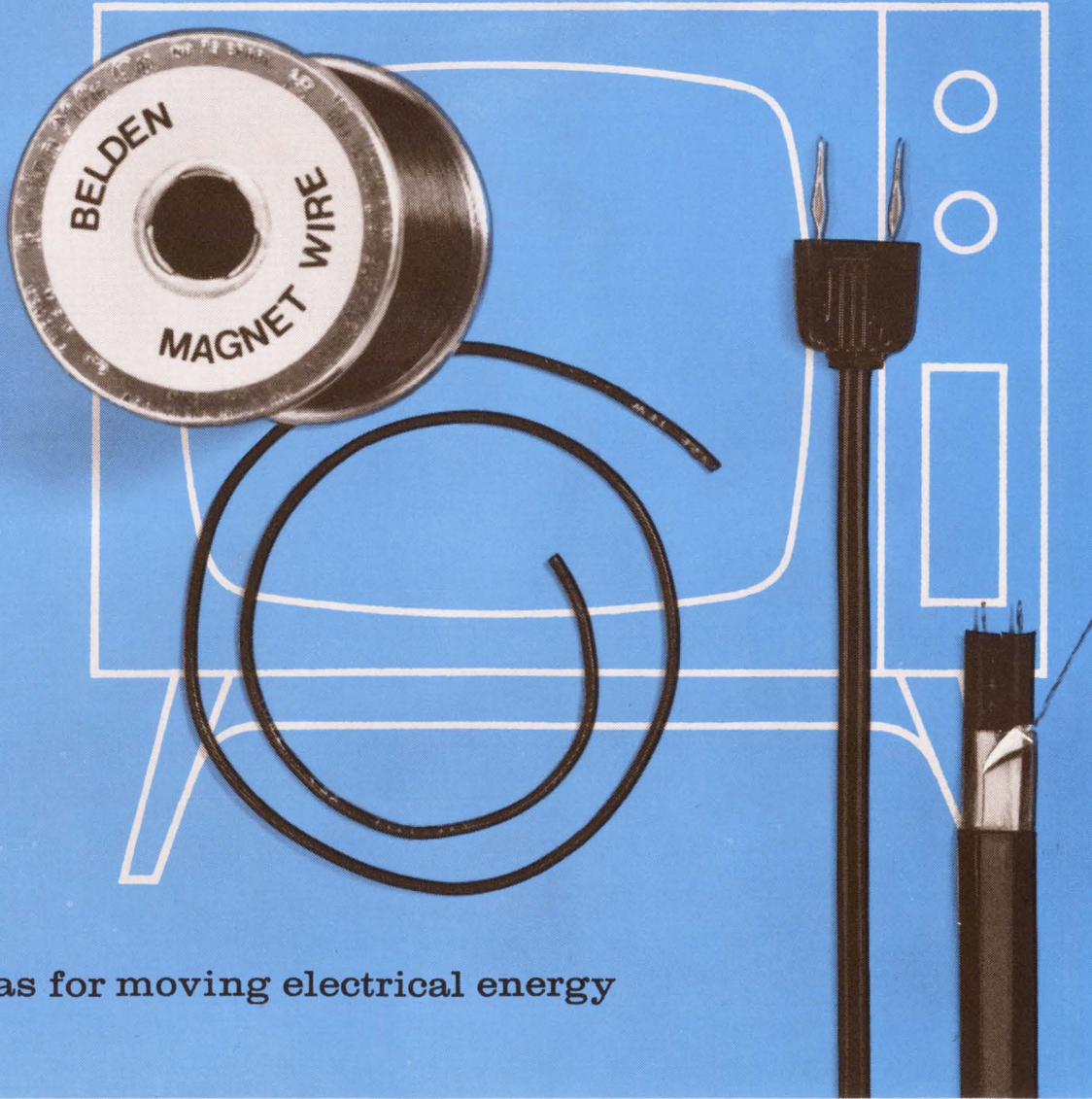

**new ideas for moving electrical energy**

G-2-7A

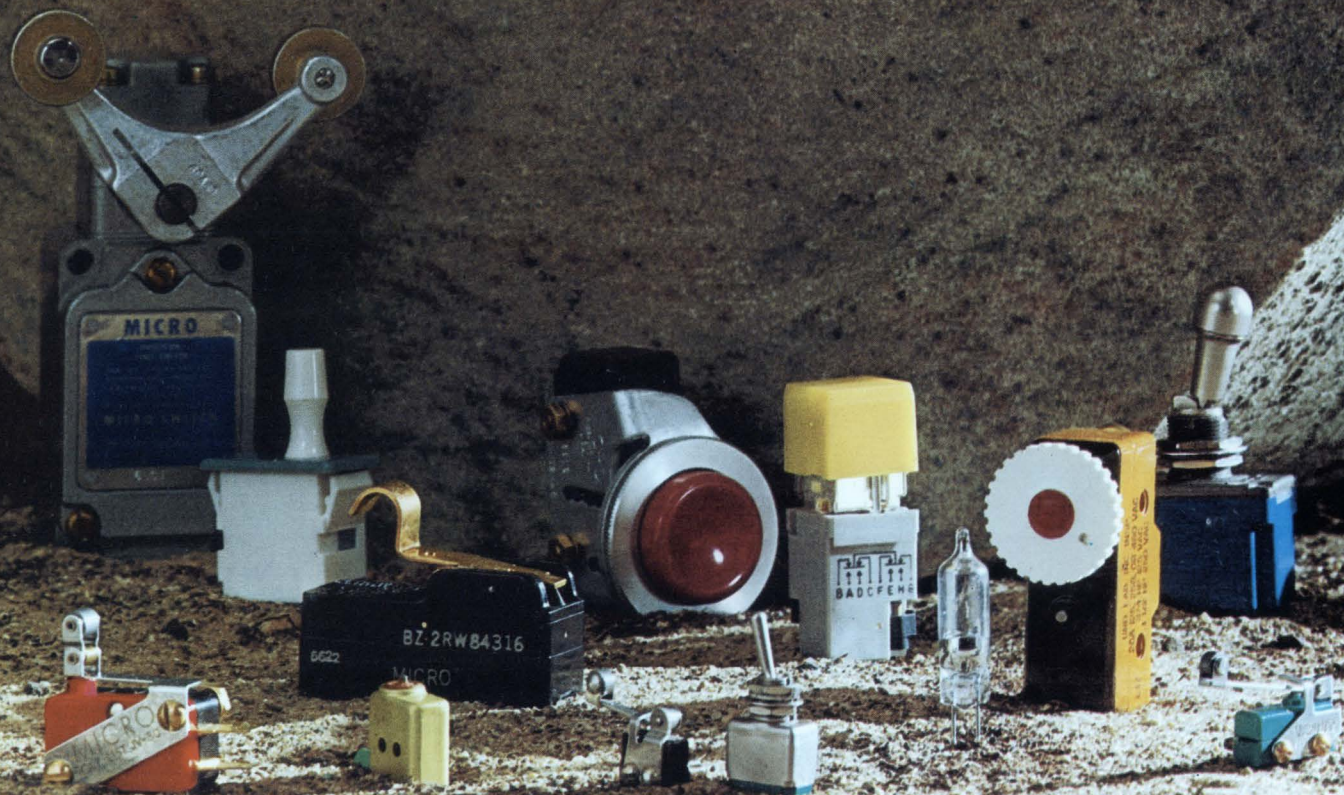

# Take the EAI plotter test.

Give us your signal, and we'll show you better results on EAI X-Y plotters than any comparable machine on the market . . . often at lower cost.

We state emphatically: EAI has the finest machines available. And a superior service reputation that backs them to the hilt.

We developed the first commercially produced X-Y plotters to tie in with our analog computers, and we've been building them at the computer-quality level ever since.

There is a whole family available: different features, different prices . . . one for *your* needs. Here are a few of the extras you can count on in every EAI plotter. Single Loop Direct Drive — eliminates complex string

and pulley systems. Plug-in Inking System — writes in any position at top plotter speed. Simple cartridge replacement. High Dynamic Performance — the real test of an outstanding plotter.

The sure way to confirm these facts is to ask for a demonstration.

Tell us what you're looking for in a X-Y plotter. We'll set up a test date.

Don't pass it up.

**EAI**<sup>®</sup> ELECTRONIC ASSOCIATES, INC.  
West Long Branch, New Jersey

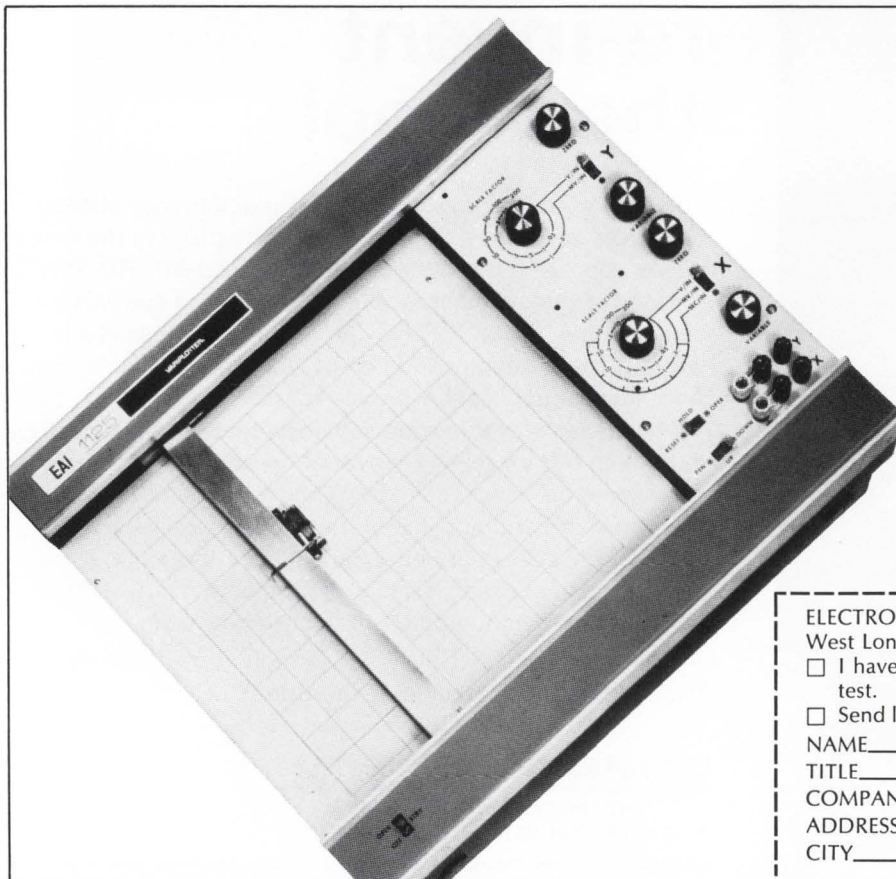

Here's just one member of the family we'd like to show you. It has the features you want plus a full 10" x 10" plotting area. Check the brief specs:

Series 1125—\$1590

- Accuracy 0.1%
- 18 calibrated D.C. ranges with variable control
- 1/2 mv/inch sensitivity
- Built-in multi-range time base
- Rack or bench mount without adapters
- Inch or centimeter scaling
- Plug-in disposable ink cartridge
- Ten-turn zero and scale factor pots

ELECTRONIC ASSOCIATES, INC. E-117

West Long Branch, New Jersey 07764

I have the signal. Let's put it to the EAI plotter test.

Send literature on X-Y plotters.

NAME \_\_\_\_\_

TITLE \_\_\_\_\_

COMPANY \_\_\_\_\_

ADDRESS \_\_\_\_\_

CITY \_\_\_\_\_ STATE \_\_\_\_\_ ZIP \_\_\_\_\_

# NASA turned to Airco for helium and...

**& reliability.** To pre-cool Centaur rocket engines, Airco delivered 5,500 gallons of liquid helium. The largest single commercial delivery of helium ever made. **&** it took only 42 hours, in one of Airco's 10,000 gallon trailers, from Kansas to Cape Kennedy

That's the way Airco works. **&** from 25 points spotted across the country. We're the number one helium supplier **&** we perform for all our customers — large **&** small. For more information write us at 150 East 42nd Street, New York, N. Y. 10017

**AIRCO**  
Industrial Gases





Lower cost—yet higher sensitivity with the new L14B photo transistor

Priced at 97¢ in lots of 100-999, General Electric L14B photo transistors feature high sensitivity. Light current (typically) = 7mA at 10v when irradiance is 5mW/cm<sup>2</sup>. Typical applications include card and tape readers, door openers, counters, and contactless potentiometers. **Circle Number 94.**



Shown actual size

Bias your reed relay with Lodex<sup>®</sup> permanent magnets

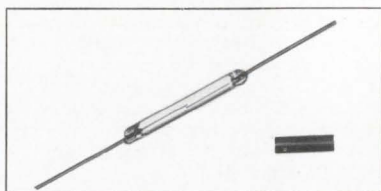

Reed switch with Lodex magnet

This revolutionary new permanent magnet material—the result of years of extensive General Electric research—offers reed switch and reed relay users high piece-to-piece magnetic uniformity. Lodex permanent magnets provide extremely close physical tolerances . . . can either be pressed to the precise intricate shape you require (reducing your overall package size) or extruded for greater physical strength.

**Circle Number 95.**

GE panel meter relays available in 2 styles



Type 195 BIG LOOK

GE meter relays are ideal for precise temperature control, over-temperature protection, hazardous atmosphere control, hydraulic pressure consistency—wherever control of auxiliary equipment is needed. Contactless action and “piggyback” plug-in design provide exceptional reliability and easy installation. Choose BIG LOOK<sup>®</sup> or new HORIZON LINE<sup>®</sup> meter relays in a variety of sizes.

**Circle Number 96.**

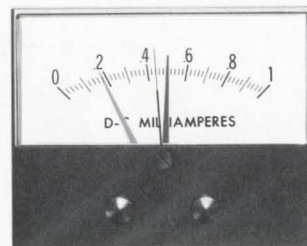

Type 196 HORIZON LINE

New full line of high-performance, regulated d-c power supplies

GE d-c power supplies are available in a wide selection of 50 Hz and 60 Hz models with output voltages ranging from 10 to 200 VDC. Each unit features static-magnetic circuitry for long-life reliability and holds d-c output voltage to within ±1% despite incoming line-voltage fluctuations over the rated range of 97 to 130 volts. Other advantages include:

- operation from -10 to 40C ambient.
- total ripple content: 1% rms or less.
- plus or minus grounded installation.
- overload protection to 200% of rated load.

**Circle Number 97.**

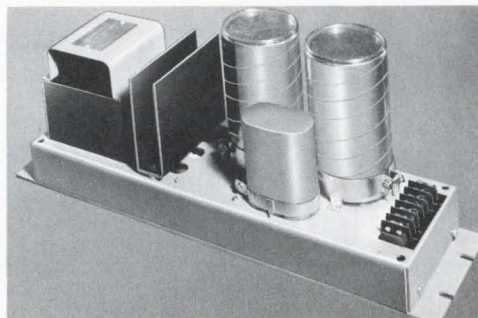

Typical power supply, model 9T66Y989

New cooling fan assemblies for electronic equipment cabinets

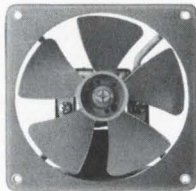

100 CFM assembly

New 100 CFM (and similar 90 CFM) fan assemblies are powered by reliable GE shaded-pole motors and measure slightly under 4¾-inches square. 500 CFM assemblies are powered by GE unit-bearing, 4-pole, shaded pole motors and measure less than 6¼ inches deep with a 10-inch diameter fan venturi. Both units require only simple ON-OFF switches for operation and are designed for years of quiet, dependable continuous-duty operation without maintenance.

**Circle Number 98.**

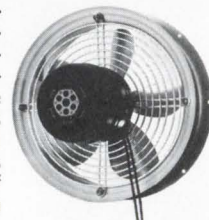

500 CFM assembly

WE MAY NOT OFFER EVERYTHING YOU WANT FROM ONE COMPONENTS SUPPLIER. BUT WE DO COME A LITTLE CLOSER THAN ANYONE ELSE.

# New PAR Lock-In Amplifier Measures Signals in the Presence of Noise by Crosscorrelation

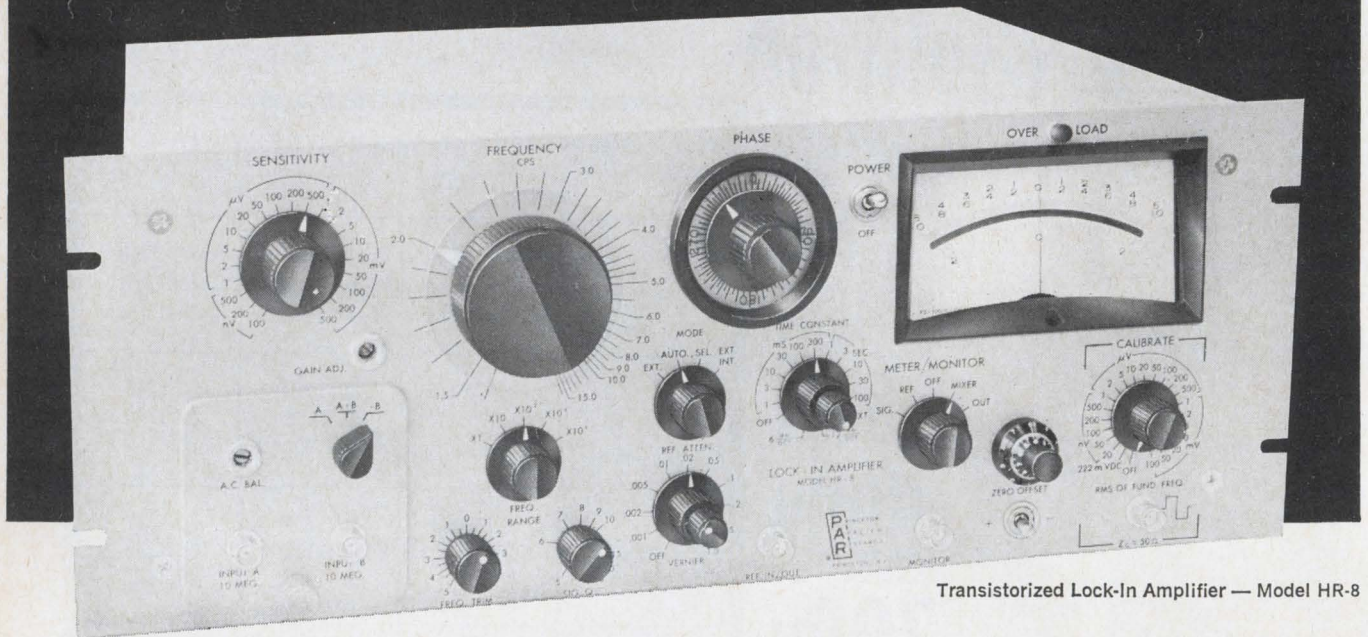

Transistorized Lock-In Amplifier — Model HR-8

The PAR Model HR-8 Lock-In Amplifier represents a significant advance in signal processing equipment for experimentalists who must measure low-level signal intensities in the presence of noise. It employs the theoretically optimum technique for signal recovery, and can be incorporated into a large class of experiments in which the signal of interest is, or can be made periodic, and in which a reference voltage related in frequency and phase to the signal can be obtained. The Model HR-8 first amplifies and bandlimits the input signal and then crosscorrelates it with the reference signal, suitably phase shifted and shaped. The crosscorrelation of input and reference signals yields a DC output voltage proportional to the signal of interest, while the crosscorrelation of the reference and noise results in no net DC voltage. The system can also be described as a continuously integrating, highly sensitive, phase conscious voltmeter, the response of which is "locked" to that particular frequency and phase at which the signal information has been made to appear.

## Technical Features:

**Frequency Range:** 1.5 cps to 150 KC continuously tunable in 5 ranges.

**Time Constants:** 11 values in 1-3 sequence extending from 0.001 to 100 seconds. Single or double section RC filtering.

**Pre-Amplifiers:** Interchangeable low-noise pre-amplifiers, operable either within the HR-8 or remotely, are used.

Type A: Differential 10 megohm input.

Type B: Low impedance transformer input for low source impedances.

**Sensitivity:** 21 calibrated full scale ranges in 1-2-5 sequence.

With Type A Pre-Amplifier: 100 nanovolts to 500 millivolts rms.

With Type B Pre-Amplifier: 1 nanovolt to 5 millivolts rms.

**Output:**  $\pm 10$  volts full scale, single-ended with respect to ground. Will drive galvanometric and servo recorders.

**Frequency Selective Amplifiers:** Notch network in negative feedback loop used in both signal and reference channel tuned amplifiers. Reference channel Q of 10. Signal channel Q adjustable from 5 to 25 with calibrated dial (no gain change with Q adjustment).

**Phase Adjustment:** Calibrated 360° phase shifter, providing continuous rotation as well as a four position quadrant switch which shifts phase in 90° increments.

**Price:** \$2,250 with either Type A or Type B Pre-Amplifier.

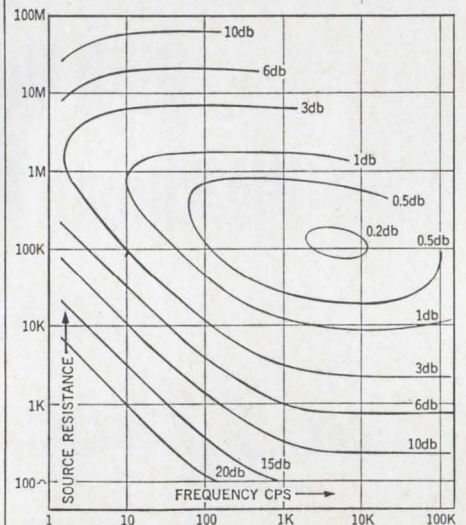

Contours of constant noise figure for a typical PAR Type A preamplifier plotted to show dependence on frequency and source resistance at 300° K. Amplifier operated single-ended.

Write for bulletin No. 120 on the HR-8 or ask for information on PAR's complete line of Lock-In Amplifiers and accessories.

PAR

PRINCETON  
APPLIED RESEARCH CORP.

Dept. D  
Box 565, Princeton, N. J., Tel. (609) 924-6835

tract called for power consumption of less than 10 watts. Librascope has demonstrated operation at ½-watt including peripheral electronics. Flight hardware is scheduled for delivery by August or September of 1968.

▪ A 4,096-word, 36-bit nondestructive readout memory module as the main internal memory for a variety of space computers. Dimensions will be 6x6x4 inches, including all electronics and an auxiliary power converter. The contract calls for six flight hardware units to be delivered by April 1968.

▪ A contract for 200-memory element arrays of 4,320 nine-bit words for a missile program. The memory will be loaded before launching and continuously read during flight as the program memory for a space-borne telemetry system. Power consumption requirement is

less than 3 watts.

▪ A contract for a memory for an airborne computer. Basically it will be a permanently woven, read-only memory, although parts of it will have both read only and nondestructive readout on the same plane. Requirements include operation at one-microsecond rate, average total power dissipation of less than ½-watt, density of 2,500 bits per sq. in., and absolutely fixed and nonvolatile data storage. A prototype will have an 8,192-bit capacity.

▪ A contract for several hundred 60,000-bit memory stacks for an orbiting satellite that will have to operate on less than two watts for up to three years. Flight hardware is scheduled for qualification later this year. The system will be used as a sequencer or programmer for telemetry transmission.

Solid state

Hot dice

There are now two ways to slice a silicon wafer—the conventional way and the new Air Force way. The new way promises to boost yields to 100% from the present 60% to 90%.

Traditionally, integrated circuit manufacturers dice the wafer by scribing it with a diamond-tipped needle and then applying bending stresses. Although engineers have long been trying to perfect a thermal slicing technique, they've been unsuccessful. Spokesmen at Radio Corp. of America, Bell Laboratories, Texas Instruments, and International Business Machines Corp. agree that they're no closer to thermal slicing than they were a year and a half ago.

Now it turns out that an engineer at Tinker Air Force Base, Okla., has overcome thermal-slicing hazards—such as alteration of wafer geometry and silicon contamination—by conducting the process in an inert nitrogen atmosphere, using an 0.0005-inch-wide tungsten ribbon. The flat, homogeneous ribbon is stretched across the wafer in a lattice conforming to the desired slicing configuration and a-c current is applied to the wire. The wafer, hot on one side and cold on the other, then breaks along the wire lines. The Air Force engineer, Edwin B. Lyons, says that the thermal method is just as rapid as the diamond scribe.

Space electronics

New twist

Having gained a lead in the communications-satellite field with a simple design that stabilizes a craft by spinning it, the Hughes Aircraft Co. has come up with an approach that can result in the first spin-stabilized satellites with solar paddles, and in more accurately aimed antennas with sharply increased effective radiated power. So

Electronics Index of Activity

November 13, 1967

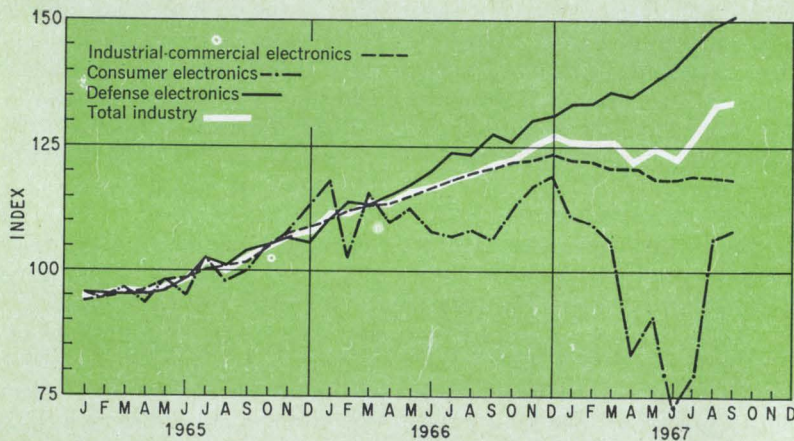

Segment of Industry	Sept. 1967	Aug. 1967*	Sept. 1966
Consumer electronics	107.8	106.7	105.9
Defense electronics	150.7	149.0	127.3
Industrial-commercial electronics	118.6	118.9	120.6
Total industry	134.1	133.0	121.6

Electronics production in September rose for the fifth consecutive month, climbing 1.1 points from August and 12.5 points from the September 1966 level. Consumer production, which had spurted 27.2 points in August, advanced only 1.1 points in September. However, that was enough to put this index at its highest level since February's 109.8. Defense electronics output also went up in September, but the 1.7 point gain was the smallest month-to-month increase since May. Industrial-commercial volume slipped 0.3 point from August and 2 points from the year-earlier pace to a level 4.8 points off its record high of 123.4 in December 1966.

Indexes chart pace of production volume for total industry and each segment. The base period, equal to 100, is the average of 1965 monthly output for each of the three parts of the industry. Index numbers are expressed as a percentage of the base period. Data is seasonally adjusted.  
\* Revised.



urn I launch vehicles, beyond those needed for the Apollo manned lunar landing effort. This, he said, would allow at least one attempt to conduct the two highest priority items in the applications program—the orbital workshop and the Apollo Telescope Mount.

**Farsighted.** But researchers at Douglas Aircraft Co. are looking beyond the Apollo Telescope Mount toward the period 1970-1980, and trying to come up with an evolutionary orbiting observatory plan to fit the spacecraft that will be available then. The space agency's Marshall Space Flight Center has provided \$475,000 for Douglas, a component of McDonnell Douglas Corp., to analyze the needs of a manned orbital support facility for future astronomical research from space. The three-phase study began last December and is to be completed next February.

Although none of the three phases is complete, the effort is far enough along for its director at Douglas to comment on results to date. Harry L. Wolbers, program manager for space station subsystem analysis at the Douglas Space Systems division, Huntington Beach, Calif., says the study has three phases. Task A is to define the astronomers' research objectives; Task B is to recommend instrumentation to implement those objectives; Task C is to develop a flexible plan that accommodates the outputs of Tasks A and B in the space vehicles that will be available from 1970 to 1980.

Task A is no mean one. Wolbers says his team has conferred with as many astronomers as possible to determine the objectives of greatest scientific significance to be pursued from outside the atmosphere. So far, 92 observation requirements have been suggested.

The output from Task B will be the establishment and evaluation of instrument groups needed to carry out Task A's observation requirements. "We'll conduct a commonality analysis and come up with possibly 10 equipment groups that cover this range of requirements," says Wolbers. Kollsman Instrument Corp. is principle subcontractor to Douglas for this portion of the study.

**Cross your H.** Of the four antennas being considered for radio-frequency observations—terminated loop types, orthogonal terminated loops, a combination tethered orthogonal loop and terminated loop, and crossed H types—the crossed H is one that looks feasible, says Wolbers. A tethered pair of crossed H antennas, with directivity of 5.9 to 8 decibels and a frequency range from 0.5 megahertz to 10 Mhz, may be as far apart as six miles. An exotic version of the terminated loop shows promise for low-frequency studies down to 0.05 Mhz. The two loops could be as far apart as 25 miles at each end of the supporting structure, and electronically linked to give interferometric data.

---

## Medical electronics

---

### The good old ways

When a hospital administrator installs a computer to help him control soaring operation costs he often finds he's taken on two new financial headaches: the price of purchasing or leasing the equipment with its complex input terminals and the expense of teaching nurses to operate them. But by using old-fashioned punch-card readers instead of those terminals, Medelco Inc., a subsidiary of Scam Instrument Corp., thinks it has a way to avoid those headaches.

The system consists of punch card units for data transmission, a magnetic drum memory for data storage, and an electronic arithmetic unit for data manipulation. It functions as a message center that substitutes written for oral messages and, at the same time, maintains an inventory of material within the hospital, records patient charges, keeps a bed census, and can be used for employee time-card data.

**Price is light.** Capable of handling all the data requirements for a 432-bed hospital (up to 5,000 transactions a day), the Medelco system will lease for about \$5,000, roughly one-third the monthly rental fee of a computer with compa-

table capacity. It will sell outright for about \$200,000. Even hospitals with as few as 50 beds can find Medelco's system an attractively priced answer to many problems. And, although the first system has only recently been placed in operation, Medelco's approach already has advocates. According to Lou Philipps, Medelco's president, the company has a \$1 million order backlog for the system.

Dubbed THIS, for total hospital information system, it combines the punch card system and magnetic drum memory to transmit instantaneously information to and from hospital departments. Each order, whether for drugs, hospital services, or special equipment, is acknowledged and stored in the memory to be reported to the accounting department.

Operation is simple. A punched card, made up for the patient when he is admitted, carries information such as name, date, address, doctor, and method of payment—specifying his insurance plan—in typewritten form and in punch-card code. In addition, each nurses' station has a rack of prepunched order information cards covering every service and medication. Similar cards are kept in such areas as X ray and the pharmacy, for all services performed there.

**Push, print.** When the nurse receives the patient information card and the physician's instructions, she selects the proper order cards from the rack and inserts them along with the patient card into the card reader. Instructions are printed out immediately in all concerned departments, including accounting, and the nurses' station for confirmation and for the patient's chart. If medication is ordered from the pharmacy, the teletypewriter there even prepares labels for the prescription items.

One of the attractive features of THIS, according to Gene Stanos, Medelco's chief engineer, is the fact that the system can be used by personnel who have no prior training. Another plus for the small hospital is that all components are interchangeable, minimizing service requirements.

Not only does the system offer

hospital administrators a means of acquiring budgetary control information, but it reduces clerical work and insures quick, accurate transmission of orders. And with the additional paper work demanded by government medical programs such as Medicare and Medicaid, that's vital.

---

### Advanced technology

---

#### Hot spot storage

Optical memories for computers promise to deliver enormous capacity, high density, and dazzling speed. Their potential has attracted the attention of several companies, some of whose attempts to develop such memories have been in vain. One that has succeeded is Honeywell Inc.

Scientists at the company's research center in Hopkins, Minn., have worked out a way to store binary information in a manganese-bismuth film, using a laser capable of operating at two power levels—one for writing in and a lower one for reading out data. The technique works at room temperature and can repeatedly read and rewrite information in the same place indefinitely.

Room-temperature operation is an inherent advantage for the technique over the cryogenic requirements of a europium oxide memory under study at International Busi-

ness Machines Corp. [Electronics, Sept. 18, p. 45], even though at those low temperatures EuO does work better. And Honeywell has thus far escaped the fate of Itek Corp., which tried to develop a read-only photographic memory but failed [Electronics, March 20, p. 47].

**Film property.** Both Honeywell and IBM have exploited the magneto-optic properties of their film. The film has a natural ferromagnetic axis that can be oriented perpendicularly, pointing either up or down. If the film is heated beyond its Curie temperature— $+360^{\circ}\text{C}$  for MnBi, and  $-176^{\circ}\text{C}$  for EuO—its magnetization plunges. If it then cools in a magnetic field, its intrinsic magnetic vector aligns itself with this external field. And if a beam of linearly polarized light is directed on the film, its plane of polarization is rotated to the right or left depending on whether the magnetization of the film is up or down.

Both MnBi and EuO are capable of rotating the plane several degrees as it passes through a film only 1,000 angstroms ( $10^{-4}$  millimeter) thick.

A laser pulse focused on a small area of the film for a microsecond is enough to heat that spot above the Curie point. But a microsecond later, the film has cooled off almost to its initial temperature and is remagnetized. Binary data can thus be written by a laser beam having a few milliwatts continuous power focused down to many kilo-

watts per square inch. The same beam, throttled back by a modulator, does not heat the film appreciably, but its angle of polarization is rotated so that the recorded data is read out, theoretically at a speed of up to 100 million bits per second.

**Stick to a spot.** A film of EuO is much more transparent than one of MnBi of similar thickness, and is therefore more easily read—but at cryogenic temperatures. But MnBi's opacity—95% for a red-dish light—improves its absorption of the energy in the laser beam. Thus, a small spot heats up quickly without spreading outside the beam area. "In this respect, manganese bismuth is unique," says M. Donald Blue, who heads the project. "We know of no other material that rotates polarized light so well and still has such a high absorption coefficient—and all at room temperature."

A practical limit now appears to be a spot 3 microns in diameter; theoretically, this could be reduced to 1 micron if problems caused by heat diffusion and lens aberrations can be overcome. Three-micron spots 10 microns apart lead to a packing density of 6.25 million bits per square inch.

These figures point to the eventual development of mass memory units with 30 times as much data per unit volume as conventional magnetic disk units, and also to relatively small—but extremely fast—memories in a small volume subsystem.

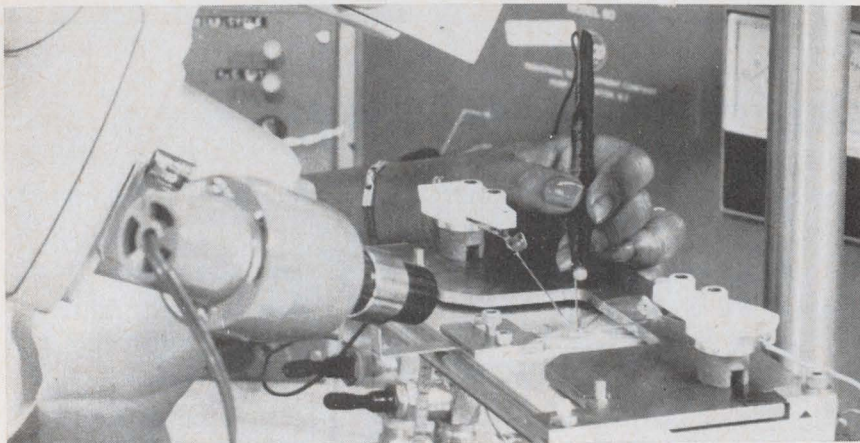

**Tool.** End-point sensor can be used for resistor trimming in General Instrument's hybrid IC's after they're packaged.

---

### Integrated electronics

---

#### Neat trim

When users of hybrid integrated circuits want premium characteristics they have two alternatives. They can ask the manufacturer to trim component values (for a price) or cut into available space by adding external trimmer potentiometers and precision resistors (also for a price).

Now General Instrument Corp.'s Hybrid Microcircuit department is marketing hybrid IC's—such as reg-

# OFF THE SHELF

modular silicon

## POWER SUPPLY

Compact

4 1/2 x 4 1/8 x 1 5/8 overall.

All silicon semi-conductors ( $\pm 5\%$ ) adjustment, response time of 50 microseconds. The input is 105-125V, 60-400 Hz with load and line regulation of 0.05%. Operating temperature range is  $-20^{\circ}\text{C}$  to  $+70^{\circ}\text{C}$  with stability of 0.5%/8 hrs., TC of 0.02%/ $^{\circ}\text{C}$ . Ripple and noise less than 1 MV RMS.



Model	MA Current	Nom. Voltage
RS-5-6-9	0-600	9
RS-5-5-12	0-500	12
RS-5-4-15	0-400	15
RS-5-3-18	0-300	18
RS-5-2.5-24	0-250	24
RS-5-2-30	0-200	30

**ABOVE MODELS  
\$59.00 (1-9) UNITS**

Models above are shipped promptly from stock. Other solid state power supplies also available. Write or call telling us of your requirements.

### SCINTILLONICS

SUBSIDIARY OF HCI  
Phone 303/ 482-4752

P. O. Box 701,  
Ft. Collins, Colo. 80521

## Electronics Review

ulators and amplifiers—that can be trimmed by the user after the package is sealed.

The company makes the free ends of appropriate cermet resistors available to the user by putting extra leads on the package. Application of high-voltage pulses across the resistors trims the component to desired levels. To prevent harm to other devices in the package that have lower breakdown points, key resistors on the substrate are formed with one end free. Thus the trimming signals aren't coupled to associated circuitry. After application of the pulses, the free end is connected to the remainder of the circuit simply by adding an external wire.

### Manufacturing

#### IC overseer

Has integrated circuit manufacturing grown enough to justify the use of digital computers for controlling test, inspection, and process operations? It's a question some IC makers are starting to ask, and at least one is trying to answer.

In Florida, the ITT Semiconductor division of the International Telephone & Telegraph Corp. started a two-month study last week which could result in the largest commitment so far for computer-controlled IC manufacturing and testing. "If our concept proves feasible, ITT will spend about \$10 million for extensive centralized computer IC test equipment in the next five years," says Irwin A. Horowitz, ITT Semiconductors' director of information systems.

Putting control computers into a plant is not a lightly-made decision, such manufacturing plants as refineries and steel mills have discovered. A control computer project takes about two to three years of study, engineering, programming, installation, and—not the least important—a large investment before it becomes fully operative.

**Specialists.** Now, like most IC makers, ITT uses dedicated test stations, each one doing fixed tasks

and directed by a special-purpose computer. In the future, it hopes to direct all of its test stations from two large central computers.

When Horowitz took over his new assignment last June, he made a quick assessment of information needs of the West Palm Beach plant and noted three factors worthy of deeper study:

- The steep growth pattern of IC sales—and more complex IC's in the future—warrants large expenditures for test equipment.

- One-third of the cost of present IC testers goes for special purpose computer-directors, two-thirds for programmed power supplies.

- Less than 50% of labor cost is for IC production, the rest for testing and inspection.

Until recently, ITT has been playing catch-up in the IC business, serving as second source for Fairchild-designed devices. This year ITT expects to sell more than 3 million IC's, including diode-transistor logic, transistor-transistor logic, complementary-transistor logic, and linear packages. Next year, volume should rise to 15 million units—including devices of ITT's own design—which will amount to about 7% of total estimated IC sales of \$360 million.

**Peas in a pod.** What Horowitz hopes to do first is consolidate IC testing strategy into two central computers and interface them with numerous satellite test stations, all essentially alike. Flexibility for testing a variety of IC's will thus be accomplished by programming rather than by individual adjustment of electrical and environmental parameters for each type of IC at each station.

Horowitz' study team includes two ITT engineers with hands-on experience in IC testing, two corporate staffers knowledgeable in programming and communication, and two fulltime men and other specialists as needed from the Burroughs Corp. who will aid in specifying computer size and configuration.

Horowitz selected Burroughs after interviewing five computer makers—all of whom offered their men to the team free of charge. He emphasized Burroughs has no assurance it will get the computer order. If and when equipment is

## Compact electronics package?

# COOL IT...

...with a small size, long life, high output AiResearch fan.

Garrett-AiResearch special purpose fans are individually designed and custom built to deliver more flow and greater pressure rise with a minimum envelope size.

Take a typical AiResearch small size fan: computer-optimized for required performance under all operating environments; our own motor, engineered and manufactured for a perfect match to its fan; and up to 40 percent more airflow than any other ventilating fan of similar input, size, and weight.

Next time you need a ventilating fan for a very special airborne or ground electronics enclosure specify AiResearch. Available for high temperature and cryogenic applications, with flow rates and power requirements as specified. AiResearch Manufacturing Division, Torrance Facility, 2525 190th Street, Torrance, California 90509.

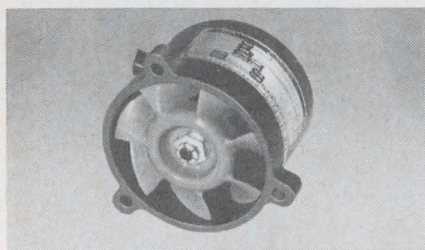
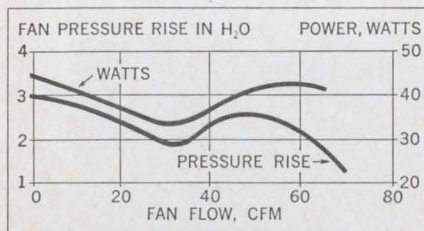

## AIRESEARCH SPECIAL PURPOSE FANS



## Electronics Review

bought, vendors will bid to specs developed by the team.

During its study the team will specify computer, interface, and test station sizes and configurations; will consider such related factors as lease or purchase, programing, communications, service, and expandability; and will set up project schedules and manpower needs.

**Voila.** ITR hopes the system will produce data at each test point which can be fed back for on-line process control, diagnostics to test the test equipment, go/no-go signals, production and labor efficiency data which can also be used to simulate and forecast product throughput, and timely inventory information for its marketing department.

Although it's up to the study team to establish specifics, Horowitz estimates now the job will use, for reliability reasons, two somewhat redundant large computers—"like IBM 360 Model 40's or 50's"—and multi-interface gear under control of supervisory programs.

If the study says yes to computers, ITR will take a fresh look at test stations.

metal-oxide semiconductor ic designed for organs, designated the PA448. It's a six-stage frequency divider available in two configurations: one with each stage cascaded in series, the other with inputs in a 1-2-3 cascaded combination.

Frequency division is accomplished by synchronous sequential logic in which all conditions that could lead to a false output have been eliminated. Divided outputs are fed to a push-pull amplifier that also acts as a buffer. The PA448 will be offered in a dual in-line plastic package. GE says it will be priced competitively with Motorola's MC 1124A per flip-flop but is noncommittal about being able to compete with the Philco-Ford price.

Since most of the 125,000 electronic organs made each year use more than 100 flip-flops per organ, ic makers hope to find an outlet for 10 million divider circuits a year.

### Short circuited

Earlier this year integrated circuit makers began a big push for the potentially huge tv set and entertainment equipment market [Electronics, June 12, p. 38]. There was plenty of talk about big orders around the corner. Today, six months later, not only are they still around the corner, but Texas Instruments is scrapping its hybrid monolithic series and Fairchild Semiconductor, with inventories of its  $\mu$ a717 sound i-f amplifier built up, has stopped producing it, at least temporarily.

TI developed and manufactured a line of multifunction hybrid ic's for i-f and audio stages in tv sets, radios, and phonographs. The products were sound, and the hybrid approach appeared better than the monolithic construction chosen by its rivals. TI chose hybrids for its pilot HC1000 ic line for good reasons:

- The circuits were offshoots of units being made for IBM's 360 computer.
- Development costs were lower than for monolithics.
- Manufacturing costs for the

## Consumer electronics

### Music in IC major

Motorola's Semiconductor division has a major foothold in the lucrative electronic organ market as a result of having produced the first integrated circuits designed expressly for organs—a frequency divider and a dual-gate keyer [Electronics, July 24, p. 96]. But other major ic producers, with the incentive of \$200 million worth of electronic organs to be sold this year, have entered the lists.

The first challenge to Motorola came from Philco-Ford [Electronics, Oct. 30, p. 26] in the form of a seven flip-flop, dual in-line frequency divider package priced at 30 cents a flip-flop, compared to Motorola's 50 cents.

**Here comes GE.** Now the General Electric Co. is sampling a

# Specify New Oscillators and Power Modules from Austron!

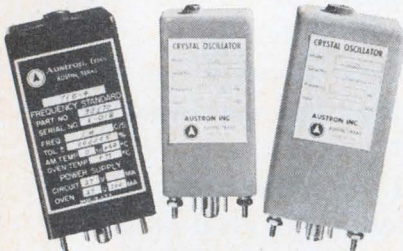

## CRYSTAL OSCILLATORS

Output frequencies from 50 Hz to 10 MHz. Stabilities from  $1 \times 10^{-6}$  to  $1 \times 10^{-10}$  per day. High frequency stability over operating ranges as great as  $-55^{\circ}\text{C}$  to  $+85^{\circ}\text{C}$ .

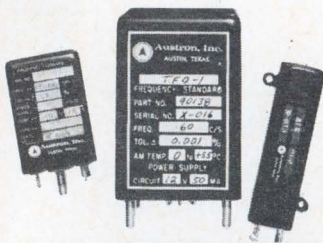

## TUNING-FORK OSCILLATORS

Packaged units include basic resonators or complete oscillator units. Range of frequencies, stabilities and mechanical configurations available.

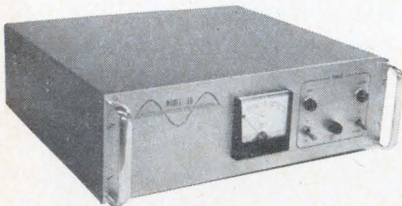

## POWER MODULES

5 VA to 1 KVA, AC output with AC or DC input, square or sine-wave output, 50 Hz to 5 kHz, frequency tolerances to  $\pm 0.00005\%$ , output regulation to  $\pm 2\%$ .

Write today for data sheets on these, and other Austron components.



**AUSTRON** INC.

10214 NORTH INTERREGIONAL HIGHWAY,  
AUSTIN, TEXAS 78753  
TELEPHONE (512) 454-2581

low-volume evaluation period were less than for monolithics.

▪ Diverse semiconductor elements, required to minimize customer redesign efforts but not amenable to monolithic fabrication, could be combined in hybrids.

**Failure.** The thick-film ic's were priced in the same range as competitive monolithics also aimed at displacing tubes and transistors in tv sockets. Despite this, the products didn't catch on. A TI marketing official admits "the ic's have not satisfactorily met the economic requirements of the consumer electronics industry." The company has dropped the entire hybrid line and is revising its approach to the consumer market.

Realizing it has fallen behind its competitors, TI hopes to get back in contention by developing integrated electronic components providing even more functions in the ic package, such as an entire i-f strip. The integrated electronic components being worked on make greater use of monolithic content and also contain thin- and thick-film circuitry.

Meanwhile, none of the six or more major set makers who sampled Fairchild's  $\mu 717$  sound i-f amplifier, supplied on a breadboard mockup last spring, has given Fairchild any indication that it will design the 717 into a tv set.

The 717 has also been sampled by the high-fidelity components industry but so far there are no takers. As one leading audio engineer points out, the 717 "does not provide adequate limiting for use as an i-f amplifier in our f-m receivers." Fairchild will only say that it will announce an equivalent ic that is "more flexible" sometime this month.

## Avionics

### All ahead slow

Competing fiercely for an R&D award that would give the winning firm a running start on another large receiver market to come out of the Navy's Omega program, de-

sign teams are rushing to wrap up their bid packages before the Nov. 16 deadline.

The award calls for two computer-equipped engineering models of airborne receivers to be used in the very-low-frequency navigation system. Delivery date will be one year after the contract is signed. The second phase of the contract calls for two prototype receivers for flight tests. The timing depends on when the Navy can get the money to pay for them.

**Budget squeeze.** Getting enough money for the entire Omega program has been a problem. But Navy officials believe the \$2 million presently budgeted for research and development of the airborne receiver will be released despite the spending squeeze caused by the Vietnam war. They concede, however, that both building the airborne prototypes and expanding Omega's ground-transmitter network into a worldwide system will probably have to wait until spending for the war eases [Electronics, Oct. 16, p. 69].

Although no one knows how many sets the Navy and other military services will buy, one company believes total sales will top 5,000 over the next five years.

Estimates of the airborne-receiver price range from \$25,000 to \$40,000 once production lines are operating, a far cry from the shipboard receiver's hoped-for price of \$2,500. The primary difference between the two sets is that the airborne version will be tied to a computer for automatic operation. The Navy hopes Omega will be used in small planes, so is specifying a top weight of 75 lbs., including 30 to 40 lbs. for the computer.

The computer will convert the Omega coordinates it gets from the receiver to latitude and longitude data—something that can be done manually on ships but not by busy pilots. The Navy also wants a receiver that can be plugged into an aircraft's central computer or work alone with minor changes.

**Cost secondary.** The proposals due this week will be evaluated by the Navy on the basis of technology, not cost. Although the winner will have to compete for produc-

# CONVERT RADAR, SONAR, AND IR DATA TO TV DISPLAY WITH THE ELECTROSTORE®

This TV display is a composite of a compass reference superimposed on a stored

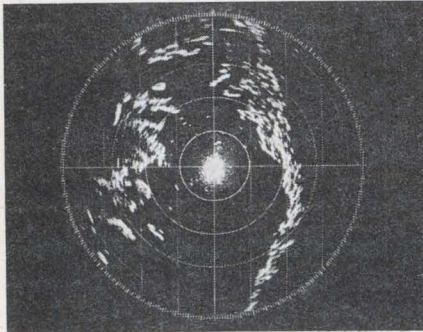

ppi display. It is an example of how the Electrostore Model 221 can convert radar data to a high resolution TV picture.

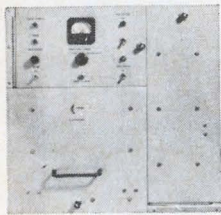

**Model 221 Electrostore**  
single-gun storage tube  
**Input/Output Response**  
10 MHz or 20 MHz  
**Input Amplitude**  
Required 0.7 volts to  
2.0 volts p-p  
**Deflection Amplitude**  
5 volts p-p  
**Deflection Response**  
DC to 800 KHz  
**Programmer Optional**

The Model 221 scan-converter utilizes a cathode-ray recording storage tube. Input video signals and deflection information are applied to the tube through various amplifiers and control circuitry. Data is stored within the tube in the form of a raster, circular, or spiral scan. This information can be read off periodically through appropriate amplifiers without destroying the stored data. The input can be up-dated periodically and the stored information erased partially or in its entirety. By introducing the proper signals, the Electrostore can convert a variety of formats to TV display, i.e. computer-to-TV, radar-to-TV, IR-to-TV, or sonar-to-TV.

Write for technical memos and application notes covering the Electrostore.

**i image**  
instruments  
15 Stevens Street  
Andover, Mass. 01810  
Tel. (617) 475-4940  
A DIVISION OF  
**DASA CORPORATION**

## Electronics Review

tion-model awards, it most likely will be selected if past procurement practices prevail.

The Northrop Corp.'s Nortronics division, which is developing the shipboard receiver, the AN/SRN-12, under a contract awarded last summer [Electronics, July 10, p. 48], is believed to have an edge on the airborne unit award. Another company making a strong bid for the work is Pickard & Burns Electronics, a division of the Gorham Corp., teamed with the Kearfott division of General Precision Inc. Other top contenders are ITR, Ryan, and Litton.

## Industrial electronics

### Stock taker

Getting quotes on stock prices to brokers quickly with electronic devices has been a significant factor in the booming sales of stocks around the country. Now the next logical step, which might help spur sales still more, is being taken.

With a desk-top display developed by Bunker-Ramo Corp., Stamford, Conn., a broker not only can ask for the latest stock prices but he can key in a buy or sell order as well. The order will then be automatically switched through the broker's teletype communications system to the floor of the exchange where it is to be executed.

**Windows.** The display, part of Bunker-Ramo's new Telequote 70 market information system, consists of two six-inch cathode ray tubes placed side by side. On the screens a broker will be able to look at several market services such as the stock tickers from the New York and American Stock Exchanges, Bunker-Ramo's own stock market quote and trend services, and wire service reports of financial news.

In addition, the display can select information from the brokerage house's own computer-based information system, including research reports and records of a customer's portfolio. Graphs of the behavior of the entire market or a

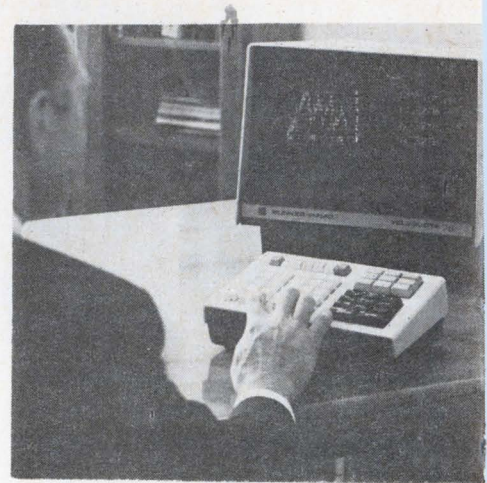

Market. Bunker-Ramo stock data system.

single stock can be displayed as well as alphanumeric characters.

## Communications

### Out of one, many

The search continues for effective ways of getting many frequencies from a single coherent light source. Researchers at Bell Telephone Laboratories think they're on the right road. Their reason: an electro-optic crystal has been used to shift the frequencies of a continuous helium-neon laser over a range of  $\pm 45$  gigahertz. Previously, electro-optic techniques have only been able to shift laser frequencies 2 kilohertz.

Unlike parametric techniques, which can shift frequencies over a wider range, electro-optic techniques don't require elaborate instrumentation for precise tuning. And parametric techniques can't tune continuous-wave lasers.

**Versatile.** M. A. Dugay, who refined the electro-optic tuning technique with J. W. Hansen, points out that it can be used in laser communication systems and in multiple resonance studies of the atomic and molecular structure of materials.

In the Bell technique, a mode-locked helium-neon laser emits a wide band of frequencies continuously, locking the phases of these frequencies 10 million times a second. During this time, the frequencies add constructively and destructively, forming narrow light pulses.

The original lacing tape  
is still the best . . .

. . . and saves money too!

That's  
**GUDELACE® 18**

You ought to try  
a sample . . .

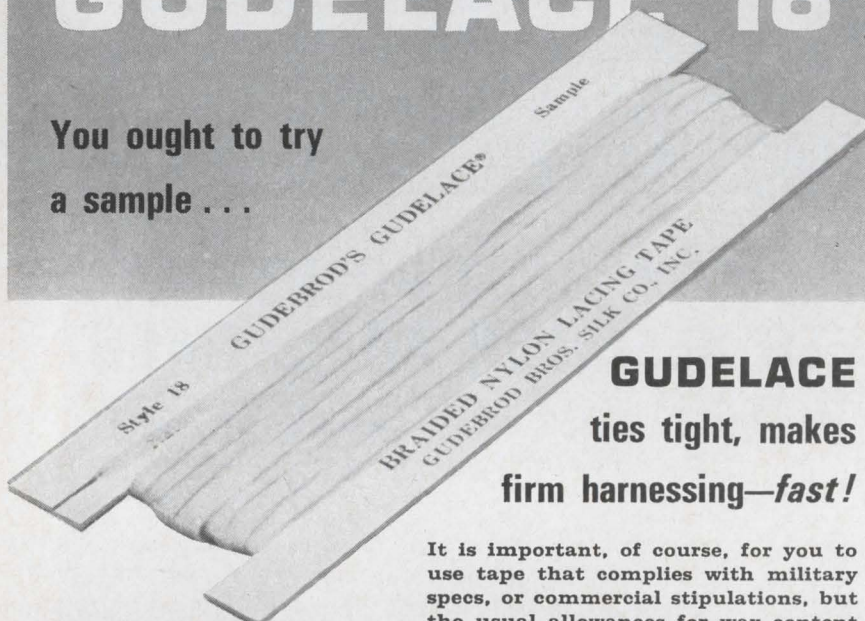

**GUDELACE**  
ties tight, makes  
firm harnessing—*fast!*

It is important, of course, for you to use tape that complies with military specs, or commercial stipulations, but the usual allowances for wax content in such specs give no consideration to the best lacing conditions. Gudebrod GUDELACE is made within the specs—BUT, it's made too, for easy handling, tight knotting, firm harnessing. THAT'S WHERE IT SAVES MONEY, in the harnessing operation. GUDELACE, the original harness lacing tape, is manufactured under strict control. Every yard is impregnated exactly the same, exactly right. You can count on that—and on getting better harnessing—*fast*—with minimum rejects. Why not send for a sample, test it any way you want. Let your harness crew try it. You'll be glad you did! (Remember, the Gudebrod Lacing Tape line includes tape for nearly every special situation—ask for The Product Data Book.)

NOW—GUDEBROD HAS  
TWO AIDS TO FASTER—  
BETTER HARNESSING

**CABLE-LACER®  
& GUDE-SNIPS®**



The production tested Cable-Lacer is now reduced in price—only \$9.95. Holds bobbin of tapes—makes tight knots. The palm held GUDE-SNIPS provide convenient tape cutting—using either right- or left-hand, \$3.75.

**G**UDEBROD

*Electronics Division*

GUDEBROD BROS. SILK CO., INC.  
Founded 1870  
12 SOUTH TWELFTH STREET  
PHILADELPHIA, PA. 19107

dropped when both Houses agreed on a space agency appropriation of \$4.6 billion—\$502 million less than the requested \$5.1 billion. Besides postponing Voyager and some other embryo programs, the reduction in the space appropriation to a level \$370 million below last year's funding has already had the following effects:

- Plans are being completed for a layoff of 1,454 NASA employees. Hardest hit of the agency's facilities will be the Marshall Space Flight Center in Huntsville, Ala., where 700 will be scratched from the payroll. And reports from recent industrial aerospace meetings indicate the absence of those once ubiquitous recruiting teams.

- NASA officials are now engaged in a series of meetings to review the direction of the space effort and revise spending plans. A spokesman at NASA headquarters says the administrators will be considering new operating plans for every program except Apollo.

- This is traditionally the time of year when work starts on the next budget. Says an official: "We're in a difficult spot; we should be working on the fiscal 1969 budget right now but won't be able to get to it until we can settle on the effect the 1968 appropriation will have."

**For the record**

**Crystal ball.** While American manufacturers as a whole anticipate an 8% increase in 1968 sales over this year, electronics manufacturers look to a 6% rise, a McGraw-Hill survey finds. The fall survey of preliminary plans for capital spending reveals that electronics firms plan to hike their capital spending for new plants and equipment 4% in 1968, against a 5% increase by all of American business. The electronics industry anticipates a 4% increase in the prices it will have to pay for new plants and equipment next year—one point less than industry as a whole. But spending for new plants and equipment would be cut back the same 0.4% in the event of a tax

**this 5 ampere, 4PDT  
miniature telephone type  
direct plug-in Relay  
gives you everything—**

**Reliability  
Space saving  
Versatility  
and ECONOMY**

**IN STOCK**  
for immediate delivery

**Direct, Plug-in Terminals** give you plug-in relay assembly for the mere extra cost of the socket.

**Plug-in Terminals are Pierced and Tinned** for solder connections where required.

**Telephone Type Relay Design** assures unsurpassed adjustment stability through long life.

**One-piece Combination Contact Arms and Plug-in Terminals** avoid internal wiring.

**Oversize Insulating Blocks of Molded Resin** rigidly secure the combination contact arm/terminals for mechanical and electrical stability through long life.

**The Basic Design** provides greatly increased contact pressure without added coil power.

**Precision-built, Hinge-pin Armature Bearings** assure lowest friction for maximum contact pressure and stabilized adjustment through long life.

**The Crackproof See-through Plastic Snap-on Cover** protects the relay from dust and stray electrical contacts.

**The Application Versatility of Class 77 Relays** is illustrated in Figures 1 through 6.

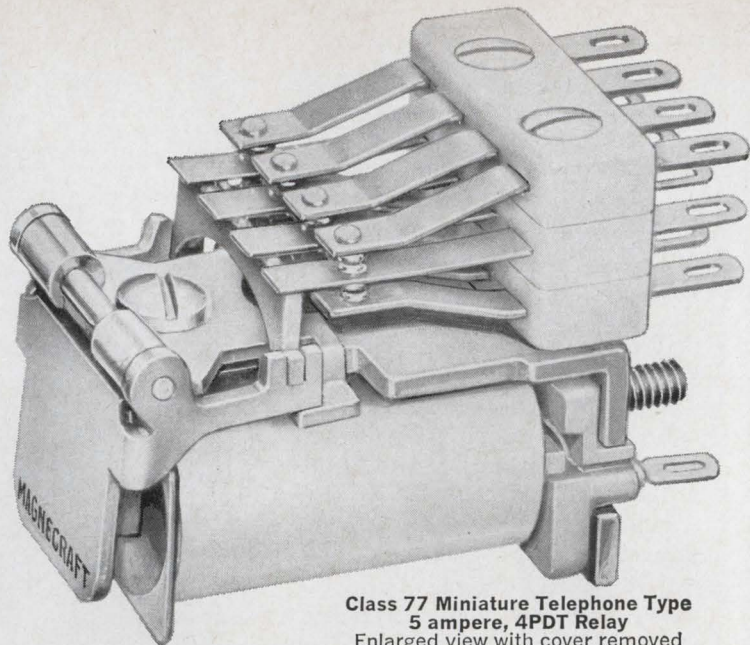

**Class 77 Miniature Telephone Type  
5 ampere, 4PDT Relay**  
Enlarged view with cover removed  
Designed and Manufactured in USA

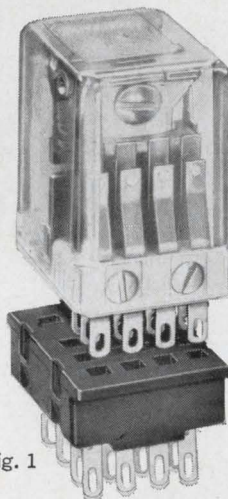

Fig. 1

**Standard Class 77  
Relay and Socket**

(approx. actual size.)  
Socket is Optional

The socket can be wired as quickly as the relay; plug-in assembly adds only cost of the socket.

**IN STOCK**  
for immediate delivery  
Standard Class 77,  
5 amp. 4PDT with coils  
for commonly used  
AC and DC voltages.

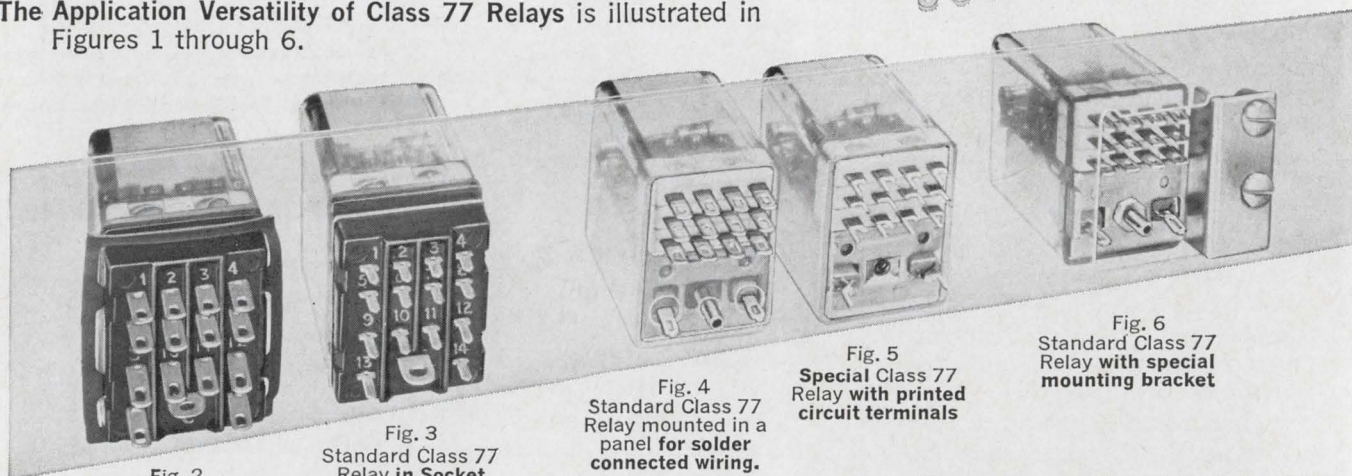

Fig. 2  
Standard Class 77  
Relay in Socket with  
solder terminals  
(same combination as  
shown in Fig. 1)

Fig. 3  
Standard Class 77  
Relay in Socket  
with printed circuit  
terminals.

Fig. 4  
Standard Class 77  
Relay mounted in a  
panel for solder  
connected wiring.

Fig. 5  
Special Class 77  
Relay with printed  
circuit terminals

Fig. 6  
Standard Class 77  
Relay with special  
mounting bracket

Try our new Class 77 Relay. See how it can help complete tough circuits in close space as well as meet tight budgets. Phone the MAGNECRAFT REPRESENTATIVE or contact us direct for literature and samples.

**MAGNECRAFT ELECTRIC CO.**

5575 N. Lynch Avenue, Chicago, Ill. 60630 Phone 312-282-5500



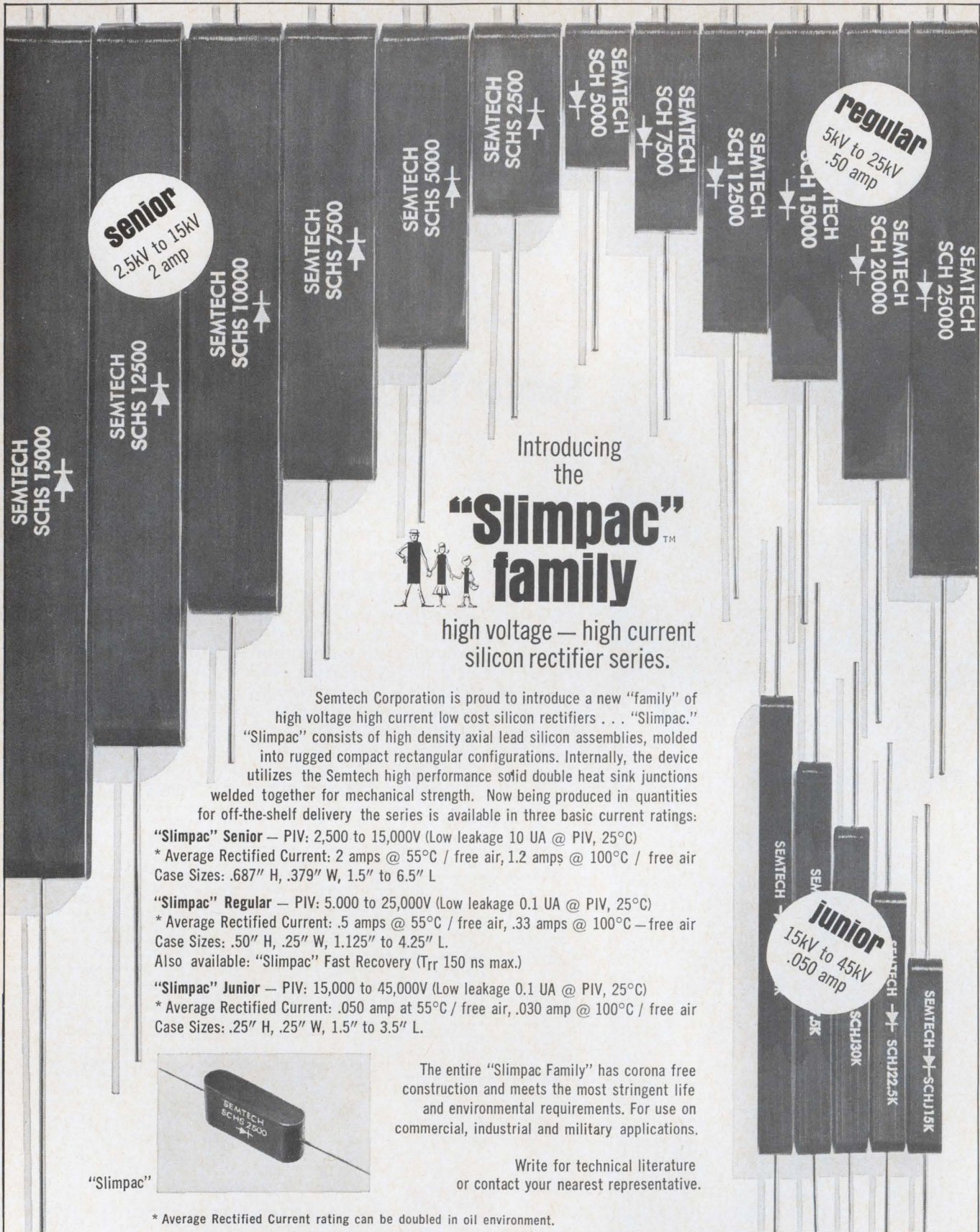

**senior**  
2.5kV to 15kV  
2 amp

**regular**  
5kV to 25kV  
.50 amp

**junior**  
15kV to 45kV  
.050 amp

Introducing  
the  
**"Slimpac"**  
family

high voltage — high current  
silicon rectifier series.

Semtech Corporation is proud to introduce a new "family" of high voltage high current low cost silicon rectifiers . . . "Slimpac." "Slimpac" consists of high density axial lead silicon assemblies, molded into rugged compact rectangular configurations. Internally, the device utilizes the Semtech high performance soft double heat sink junctions welded together for mechanical strength. Now being produced in quantities for off-the-shelf delivery the series is available in three basic current ratings:

**"Slimpac" Senior** — PIV: 2,500 to 15,000V (Low leakage 10 UA @ PIV, 25°C)  
\* Average Rectified Current: 2 amps @ 55°C / free air, 1.2 amps @ 100°C / free air  
Case Sizes: .687" H, .379" W, 1.5" to 6.5" L

**"Slimpac" Regular** — PIV: 5,000 to 25,000V (Low leakage 0.1 UA @ PIV, 25°C)  
\* Average Rectified Current: .5 amps @ 55°C / free air, .33 amps @ 100°C — free air  
Case Sizes: .50" H, .25" W, 1.125" to 4.25" L.  
Also available: "Slimpac" Fast Recovery (T<sub>rr</sub> 150 ns max.)

**"Slimpac" Junior** — PIV: 15,000 to 45,000V (Low leakage 0.1 UA @ PIV, 25°C)  
\* Average Rectified Current: .050 amp at 55°C / free air, .030 amp @ 100°C / free air  
Case Sizes: .25" H, .25" W, 1.5" to 3.5" L.

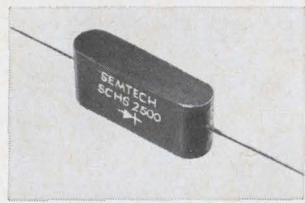

"Slimpac"

The entire "Slimpac Family" has corona free construction and meets the most stringent life and environmental requirements. For use on commercial, industrial and military applications.

Write for technical literature  
or contact your nearest representative.

\* Average Rectified Current rating can be doubled in oil environment.

**SEMTECH CORPORATION**

**Western Offices:** 652 Mitchell Rd., Newbury Park, California, 91320 (805) 498-2111/from L.A. (213) 628-5392 TWX: 910-336-1264  
**Central:** 140 No. La Grange Rd., La Grange, Illinois, 60525 (312) 352-3227 TWX: 910-683-1896  
**Eastern:** 116-55 Queens Blvd., Forest Hills, N.Y., N.Y. 11375 (212) 263-3115 TWX: 710-582-2959  
**European Sales:** Bournes AG, Alpenstrasse 1, Zug, Switzerland (042) 4 82 72/73

# We've killed the DIRTY ENEMY!

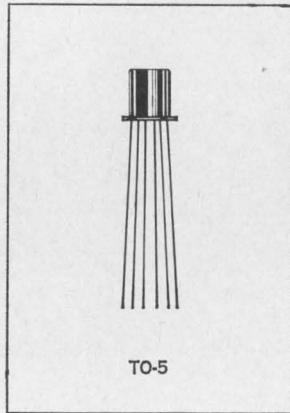

When we say CLEAN, we mean it. The DESIGN of our TO-5 Relay permits repeated cleaning and baking with no degradation in relay performance. As a result of this pre-stressed design...WE CAN CLEAN THE RELAY.

The cleaning of all TO-5 Relays is controlled by systematic micron-particle count and non-volatile residue (NVR) measurements on the cleaning fluid. Dirty gases could be sealed into the relay so we use a residual gas analyzer. We measure the gas contaminants during vacuum baking until they are reduced to an acceptable level. After out-gassing, the relay

remains in an inert atmosphere, i.e., pure, dry nitrogen, until final sealing.

We have left nothing to chance... constant improvement is our hallmark. The relays we produce today are not the same relays we produced one year ago. Our job is not to stand still but to continue to deliver to our customer the most reliable TO-5 relay that today's technology (paced by Teledyne Relays) will permit.

Why don't you find out more about our very clean, all-welded, state-of-the-art TO-5 Relays? Send for our TO-5 Relay Catalog.

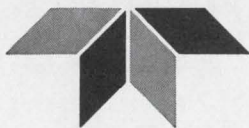

**TELEDYNE RELAYS**

A TELEDYNE COMPANY

3155 West El Segundo Boulevard • Hawthorne, California 90250  
Telephone (213) 679-2205 • 772-4357

# By solving an "unsolvable" cleaning problem, Freon® helped perfect Hamilton's electric watch.

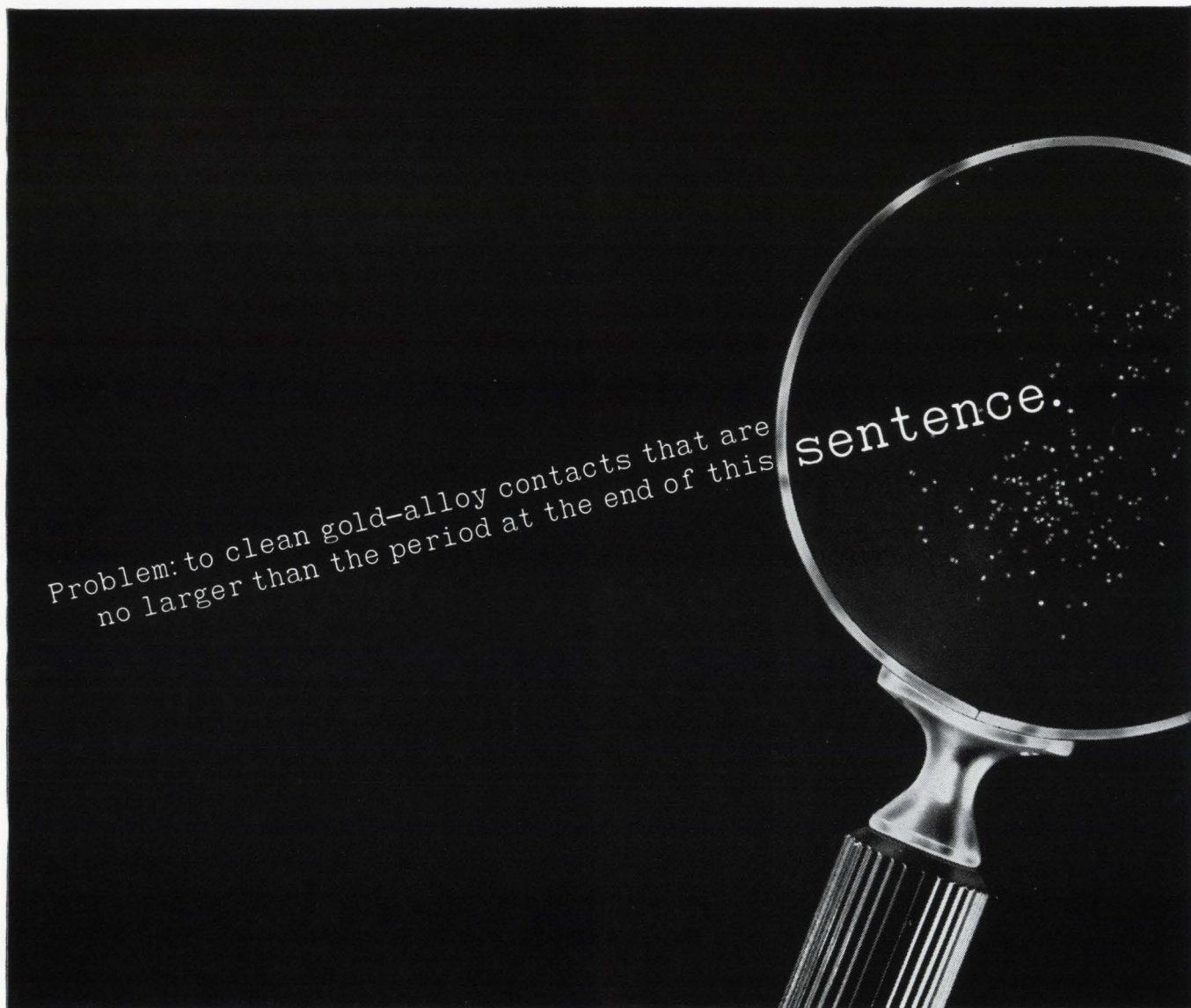

Problem: to clean gold-alloy contacts that are no larger than the period at the end of this

sentence.

Those specks under the magnifying glass are gold alloys. Each one acts as a contact that transmits power from a tiny battery to the timekeeping mechanism of the Hamilton electric watch... which now ranks with the best of critical timepieces.

Unless these contacts, located in extremely tight assemblies, are *completely free* of soils and stains, however, the watch will malfunction. Or not function at all. And this was precisely the problem that confronted Hamilton engineers during the watch's development in Lancaster, Pa. They simply could not get the contacts clean *enough*. Even the cleaning agents they used left trouble-making stains.

The problem wasn't solved until FREON\*, with its unique properties, was introduced into the cleaning operation. FREON has *low* surface tension, which allows it to penetrate the tightest assembly. At the same time, FREON has *high* density. This permits the quick release of all stains left by trapped cleaners. And because it vaporizes at a little above room temperature, FREON dries rapidly, leaving no stains of its own.

Hamilton uses FREON to clean parts ranging from  $\frac{1}{16}$  of an inch (the contacts) up to  $\frac{1}{4}$  of an inch... including  $\frac{1}{8}$ -inch, intricately designed toothed wheels. As many as 3,000 parts are cleaned in an ultrasonic tank simultaneously. So successful was Hamilton's experience with FREON that the company now uses it in its military area.

For instance, FREON is used in a degreaser to remove soils from a gravity-triggered release installed in parachute flares.

Do you have a tough cleaning problem that FREON can solve? Write Du Pont, Room 5623, Wilmington, Del. 19898. (In Europe, write Du Pont de Nemours International S.A., FREON Products Div., 81 route de l'Aire, CH 1211 Geneva 24, Switzerland.)

\*Du Pont registered trademark for its fluorocarbon cleaning agent.



BETTER THINGS FOR BETTER LIVING... THROUGH CHEMISTRY

---

# Washington Newsletter

---

and cost-effectiveness keystones of his policy in budgetary and contracting matters.

It's understood that McNamara would like to resign soon after the new defense budget is completed and submitted to Congress next January. But President Johnson is expected to persuade him to stay on until the critically important November, 1968 election. A *Washington* newspaper quoted McNamara directly as saying he does plan to quit "some time" next year.

## **Cabinet status for communications?**

The White House is putting out feelers on the idea of a Department of Communications. It would include the Department of Transportation, the Federal Communications Commission, and key communications groups within the Department of Defense, the Office of Emergency Planning and the General Services Administration.

Insiders say Transportation Secretary Alan S. Boyd, raised to cabinet level status only this year, wants to expand his domain and cover broader areas, making his department similar to communications ministries in other nations.

## **ARM guidance unit set for production**

Mounting aircraft losses due to North Vietnamese antiaircraft fire—both conventional and missile—have moved the Pentagon to put the air-to-ground Standard ARM, a radar-homing missile, on the top-priority list. A go-ahead has been given IBM for a production run of the target identification and acquisition system (Tias), the ARM's guidance unit.

The order comes less than a year after General Dynamics received the ARM prime contract and only a month after the completion of flight tests [*Electronics*, Sept. 4, p. 54]. The ARM will replace the Shrike as the prime Air Force and Navy air-to-ground missile. The Tias, to be carried aboard the aircraft, is built around the IBM 4 pi computer.

## **Martin unit to build Rada test hardware**

Martin-Orlando will get an okay from the Army within the next month to start producing the first test hardware for the Random Access Discrete Address (Rada) system, an automatic dial radio network for tactical communications. Under a new contract covering third-phase development of the secure gear, Martin will build three user-to-user Rada sets for local area calls, plus a retransmission unit for calls within the system but beyond the range of the basic unit.

## **December date set for total package bids on destroyer**

Request for proposals will go out to industry early in December for the first combat ship to be designed by industry rather than the Navy. The new class of highly automated destroyers, known as DX for destroyer experimental, will be procured as a total package, an approach that combines design, development, production and maintenance of a ship in one contract. Primary function of the DX will be as an antisubmarine craft, but antiaircraft missiles may be added later. A large number of ships will be built, enough to warrant setting up an automated shipyard for series production.

The Navy doesn't plan to develop any new weapons or electronics systems for the DX, but will incorporate systems under development that will be ready for the fleet by 1974. The contractor will select and integrate all systems and will be named by May, 1969.

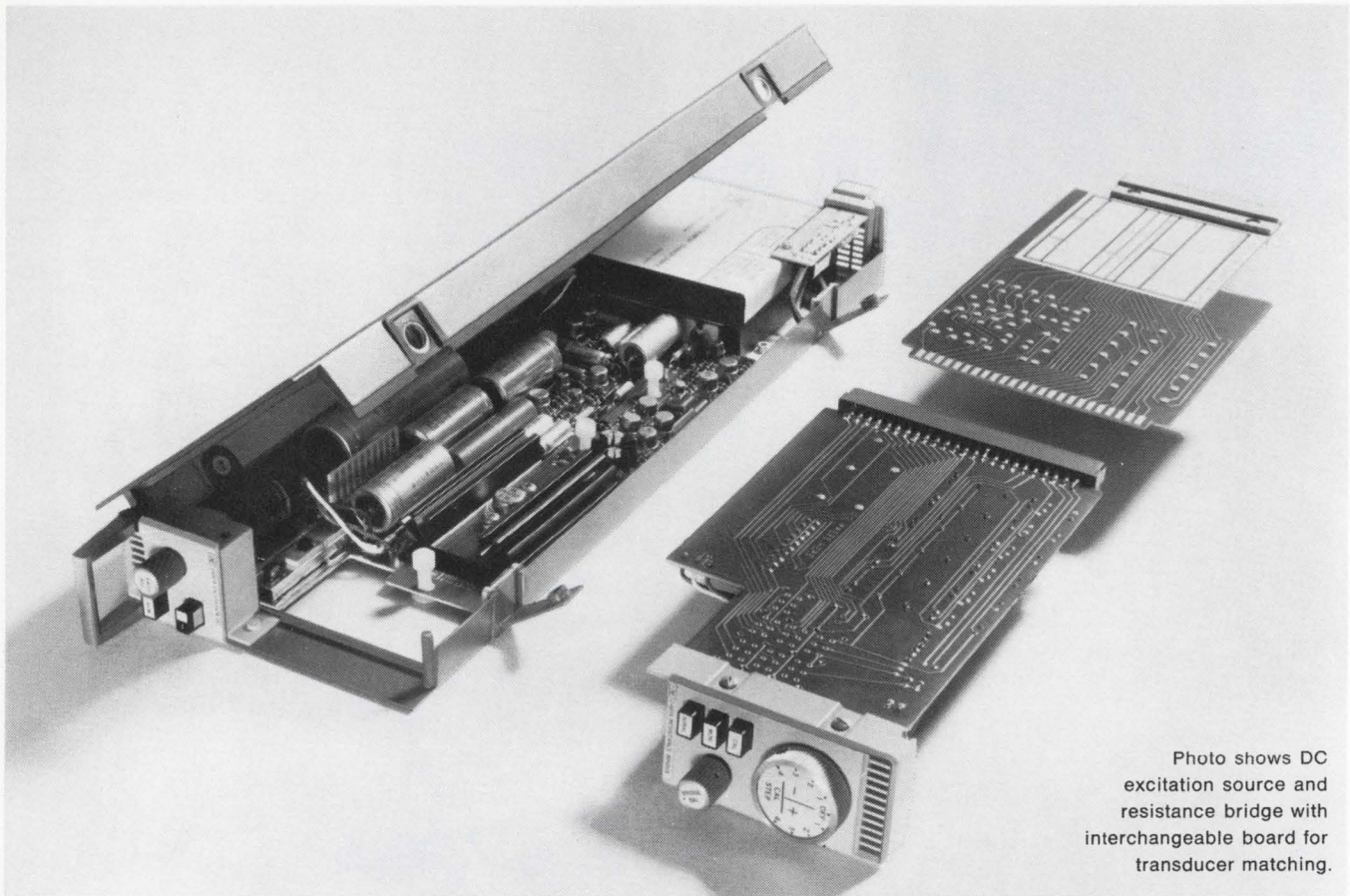
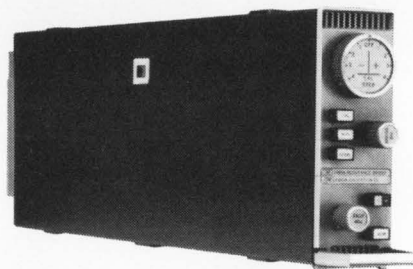

Photo shows DC excitation source and resistance bridge with interchangeable board for transducer matching.

## Plug-together Signal Conditioners



## with high performance, low-cost adaptability

A floated, guarded DC excitation source provides switch-selectable constant-voltage and constant-current operating modes, plus a unique mode for linear output from single active arm bridges. Exceptional environmental stability saves man-hours maintaining large systems in calibration.

Resistance bridge module provides bridge completion, balancing, calibration and normalizing functions. Minimum cost adaptation to transducers is afforded through a detachable board for mounting components for a specific transducer.

The excitation source may be used on a per-channel basis for maximum isolation, or with up to five transducers using inex-

pensive excitation couplers for each channel... or many transducers can be excited from an external power supply, and you can have local regulated level control. Plug-together design allows change from shared to individual channel excitation.

Price for excitation and conditioning: from \$160 to \$360 per channel (for rack-mounted, cabled system) depending on configuration.

For information on the 2480 Series or compatible data acquisition instrumentation call your local HP field engineer or write Hewlett-Packard, Palo Alto, California 94306; Europe: 54 Route des Acacias, Geneva.



SIGNAL CONDITIONERS

06706

# Two more 24 Kt. gold processes from Sel-Rex. One may be 99.99+% better for you.

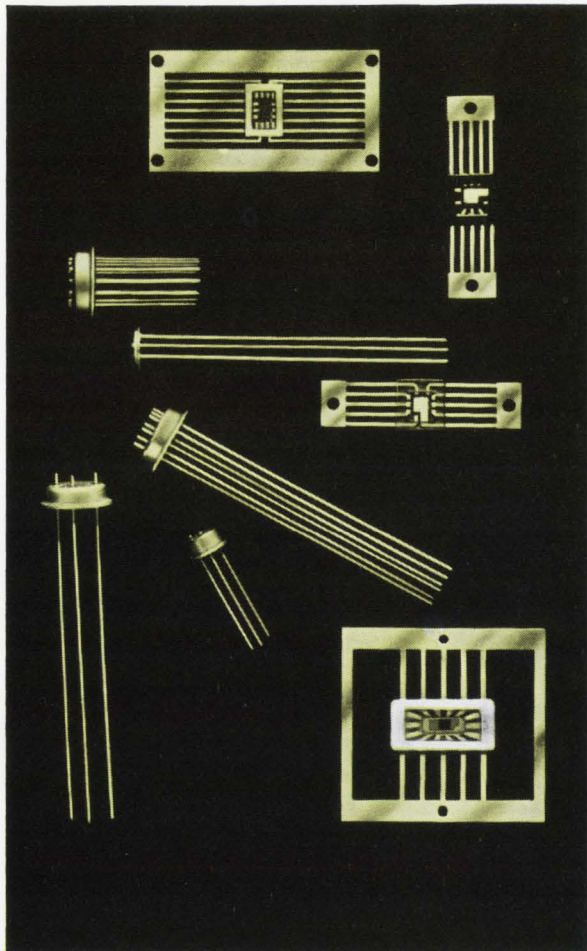

Deposits from Pur-A-Gold 125\* and Pur-A-Gold 401\* neutral gold plating processes are 99.99+ % pure, free of organic contaminants and are uniform in distribution. Both processes are used in semi-conductor manufacture because they're extremely stable and consistently produce high performance results.

One maker of integrated circuits gets excellent die attachment with only .000050" of a 401 deposit in place of the .000100" he needed with a previous process. A transistor manufacturer reports excellent high temperature resistance for a 125 deposit... 350°C in air for over one hour without discoloration.

Which process is better for you depends on *your* product, *your* processing cycle and *your* performance specifications. But with either, you get more than a reliable plating process. You get the back-up service that has made Sel-Rex the leader in precious metal plating technology. Write for a comprehensive guide to precious metal processes.

Sel-Rex Corporation  
Dept. X-11, Nutley,  
New Jersey 07110



\*Processes patented, trade marks registered

Subsidiaries and associated companies in Canada, Switzerland, Great Britain, France, Holland, Japan, West Germany.

# you've got it made

...when you  
let **FANSTEEL** do it!

Let FANSTEEL make your electronic parts for you. What type of parts? For instance:

**(1) FANTORK™ Chassis-Mounted Heat Sinks** that give you up to 3-times greater shank torque and provide comparable heat dissipation of wrought copper alloys. With a complete FANTORK part . . . all you do is die-bond, attach leads and assemble. Or, we'll do any . . . or all . . . of these steps for you . . . braze the steel threaded shank into the sintered copper base . . . add pre-form backing discs (with or without coatings) . . . put on a steel weld ring . . . coin a projection into sintered copper base for direct ultrasonic welding of can . . . insert pins . . . or plate entire assembly. **(2) Lead Assemblies**—from refractory to conventional lead materials in close tolerance diameters from .025" to .125" . . . plated to your specifications. **(3) Semiconductor Backing Discs**—either pressed and sintered . . . punched . . . or cut . . . from tungsten or molybdenum. Fansteel coating technology assures positive wetting action. All sizes throughout the power ratings. Whatever your component parts need . . . LET FANSTEEL DO IT! Our diverse packaging technologies will help you reduce component assembly time and costs. For complete information on value engineered Fansteel parts, call your Fansteel representative . . . or write us.

1.

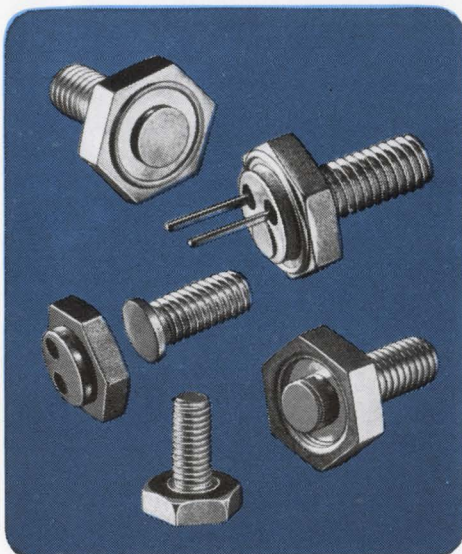

2.

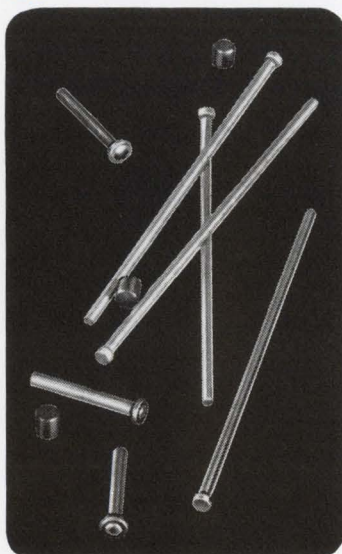

3.

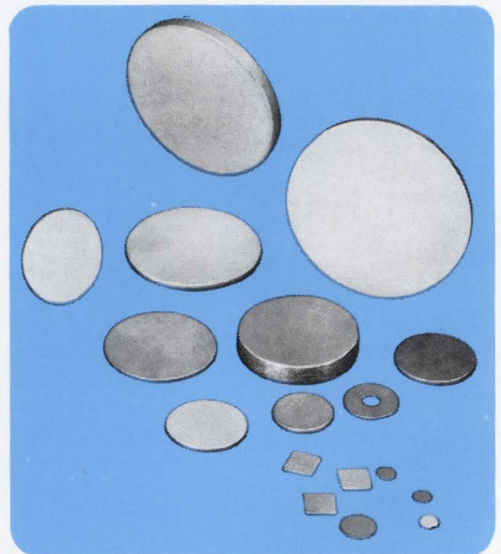

# FANSTEEL

METALLURGICAL CORPORATION

ELECTRONIC PARTS DIVISION  
NUMBER ONE TANTALUM PLACE  
NORTH CHICAGO, ILLINOIS 60064





**King Radio needed:  
capacitors that stay reliable even  
with extreme cold, humidity  
and vibration.**

**So King Radio chose: capacitors  
of MYLAR.**

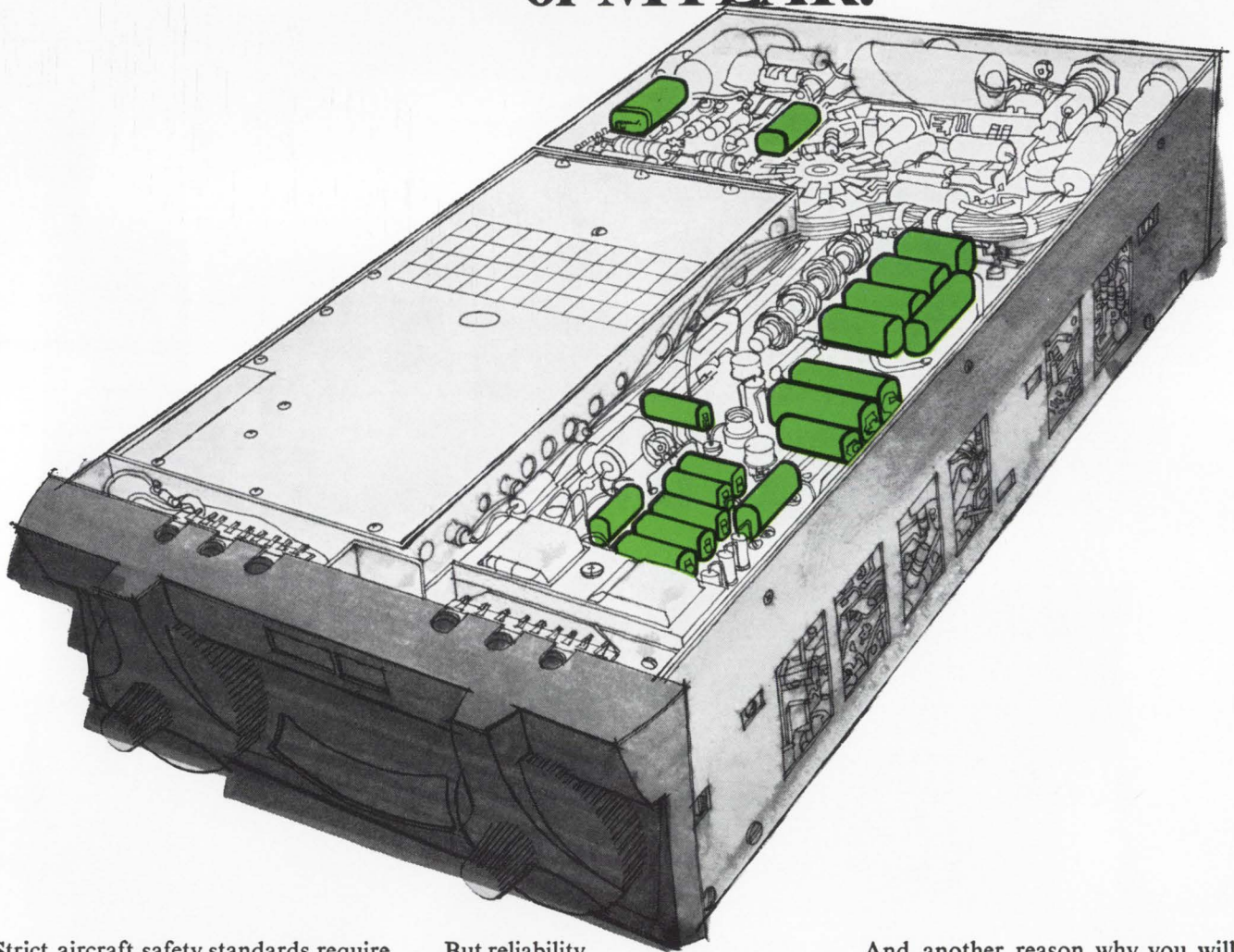

Strict aircraft safety standards require the most reliable navigation equipment available. That's why King Radio Corporation uses capacitors of MYLAR\* for their Distance Measuring Equipment. MYLAR can take temperature extremes from  $-60^{\circ}$  to  $+150^{\circ}\text{C}$ ; MYLAR remains constantly stable under humid conditions.

But reliability isn't the only reason King Radio chose MYLAR. The extremely high dielectric strength of MYLAR permits its use in thinner film, thus helping King Radio to build the lightest and most compact distance measuring unit on the market. MYLAR is available in films as thin as 15 gauge.

And another reason why you will want to investigate using capacitors of MYLAR: they usually cost no more than others. Write for complete technical data to DuPont Company, Room 4960A, Wilmington, Delaware 19898. (In Canada, for information write Du Pont of Canada Ltd., Post Office Box 660, Montreal, Quebec.)

\*DU PONT'S REGISTERED TRADEMARK FOR ITS POLYESTER FILM.

**DU PONT** MYLAR®  
REG. U.S. PAT. OFF.



- 7 STANDARD single, dual, and triple units, including units with concentric shaft and vernier operation.

---

- 16 STANDARD resistance values from 50 ohms to 5 meg.

---

- 2 STANDARD tolerances 10% and 20%.

---

- 5 STANDARD resistance tapers.

---

- 18 STANDARD electrical tap options.

---

- 46 STANDARD shaft lengths from 3/8" to 6.0".

---

- 3 STANDARD shaft endings.

---

- 9 STANDARD variations of bushings.

---

- 4 STANDARD locating lug options.

---

- 4 STANDARD switch options with single and double pole.

# Allen-Bradley offers a 1,000,001 standard variations of Type J Potentiometers



Allen-Bradley Type J  
hot molded variable resistors  
rated 2.25 watts @ 70°C

These *standard* variations in the Allen-Bradley Type J hot molded potentiometer line eliminate the need for a "special" control. When you include the numerous special resistance values and tapers in which the Type J can be supplied, the variations become virtually infinite.

Yet, all of these Type J variable resistors have one thing in common—each and every one is made by the same A-B hot molding process—your guarantee of "tops" in quality. The solid hot molded resistance track assures extremely long life—exceeding well beyond 100,000 complete operations on accelerated tests with less than 10% resistance change. Control is always smooth and free from the sudden turn-to-turn resistance changes of wire-

wound units. And being essentially noninductive, Type J controls can be used at the higher frequencies—where wire-wound units are totally impractical.

Let Allen-Bradley Type J variable resistors be the answer to your special requirements—it's almost certain there's a "standard" unit in the Type J line. And you *know* you're obtaining the ultimate in reliability and performance. For more complete information on Allen-Bradley Type J potentiometers, please write for Technical Bulletin 5200: Allen-Bradley Co., 222 W. Greenfield Ave., Milwaukee, Wis. 53204. In Canada: Allen-Bradley Canada Limited. Export Office: 630 Third Ave., New York, N.Y., U.S.A. 10017.



**ALLEN - BRADLEY**  
QUALITY ELECTRONIC COMPONENTS



**Paymaster needed a battery to turn its Checkwriters into burglar traps.**

**Mallory made it.**

## What can we do for you?

Paymaster needed a battery. A battery to power the electronic alarm systems of its Checkwriters. A battery that would be inexpensive and easy for customers to replace. A battery that would hold its power for years while it protected the machine. Yet a battery that could keep the alarm screaming for hours if a burglar tried to steal the invaluable device.

Mallory made it. The battery—a Duracell® alkaline battery. Two of these penlight-sized energy cells can keep the Checkwriter's alarm shrieking long after a burglar has been scared away. They hold that power too—retain 85% of their original capacity even after 2 years storage. And they are available in retail stores almost anywhere in the world.

### UNUSUAL USES AND UNUSUAL BATTERIES

*"The type of battery suitable for a given application is no longer a matter of cell geometry, as it has been in the past, but one of an electrochemical system that will operate most effectively for a particular use."* (Samuel Ruben, discoverer of the electrochemical principles that made possible the sealed mercuric oxide, manganese oxide and silver oxide alkaline batteries.)

And hundreds of designers have already taken these words to heart. They've dreamed up devices such as battery-operated pacemakers used inside the body to stimulate the heartbeat, radio transmitters carried by birds to trace their migration patterns, standard-size binoculars that can be used to see in the dark. Wrist radios (a la Dick Tracy) have already been designed around the power of mercury cells. So have hearing aids so small they fit entirely inside the ear canal. It's getting to the point where if it uses electricity, chances are it can be battery-powered.

### OVER 1000 DIFFERENT TYPES

Mallory currently makes over 1000 batteries of all sizes and capacities. If we're not actually producing the battery you need, we'll be glad to work with you in designing a new one. Please write the Technical Sales Department, Mallory Battery Company, a division of P. R. Mallory & Co. Inc., South Broadway, Tarrytown, New York 10591. Or call us at 914-591-7000. (In Canada: Mallory Battery Company of Canada Limited, Sheridan Park, Ontario.)

**WANT A**

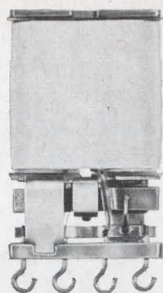

**SENSITIVE ANSWER?**

**80 mW**

**CALL THE MAN FROM Hi-G...**

Switch 150 W with 80 mW. This is the amplification of switching power you get from the new BCN series of 5 amp sensitive relays. Dependable performance comes in an all welded, crystal can configuration measuring 1.275" x .800" x .400". Typical weight is 1 oz.

The BCN series is manufactured in accordance with MIL-R-5757 and is available for fast delivery in single and double pole units in all standard configurations and header styles.

Write or call Hi-G for bulletin #135A. It provides full details on this high quality line of 5 amp sensitive crystal can relays in stock at your Hi-G distributor. Test data and performance capabilities are available on request. Tel: 203-623-2481.

**Hi-G**  
INCORPORATED

SPRING STREET & ROUTE 75 / WINDSOR LOCKS, CONNECTICUT 06096

# Parylene proves itself

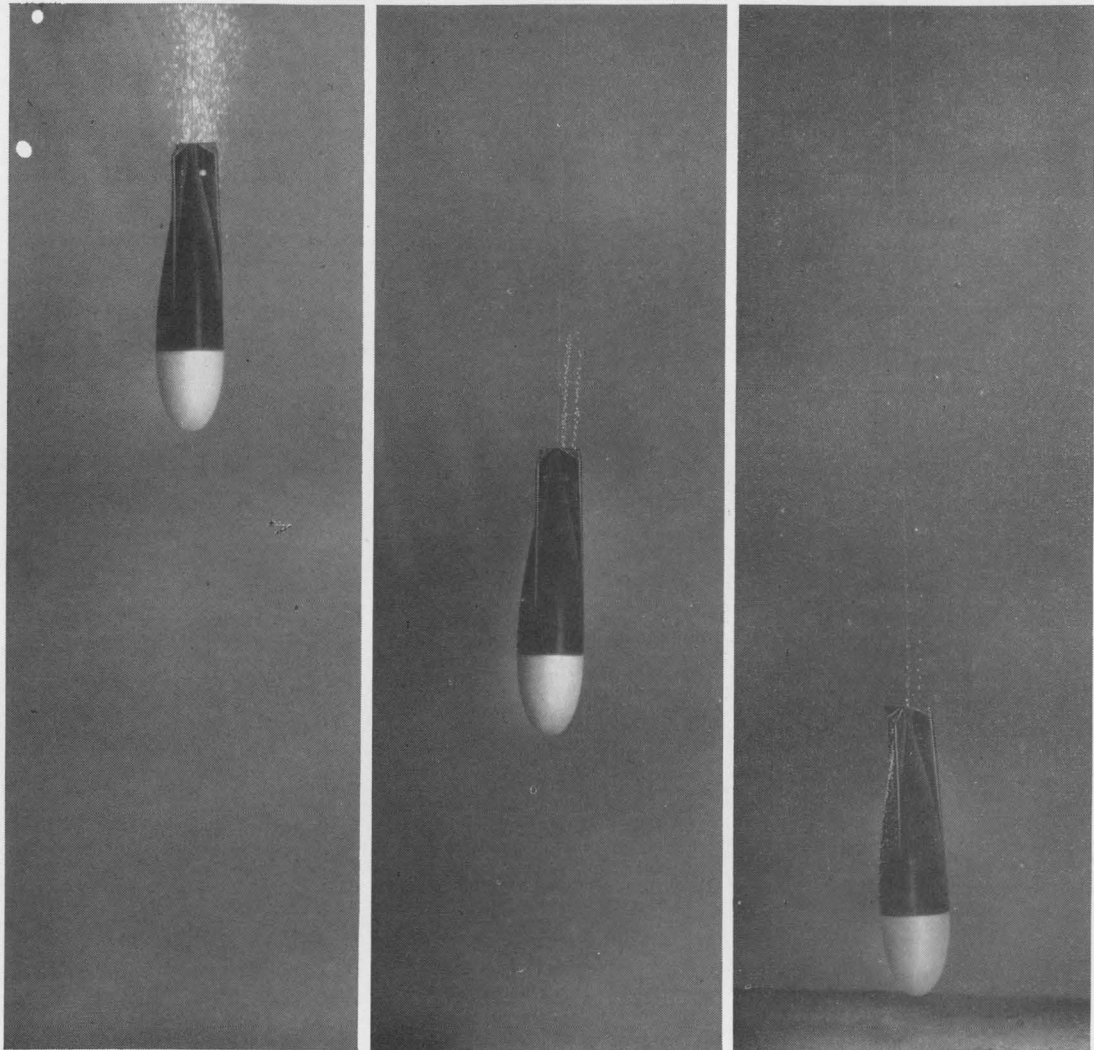

## at 250 fathoms.

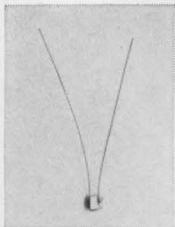

The Sippican Expendable Bathythermograph System accurately and rapidly measures and records the temperature of ocean waters down to depths of 1,500 feet. Heart of the system is an 8-inch probe, that carries, as its temperature-sensing element, a miniature-sized thermistor, shown on the left.

The protective coating for the thermistor had to be extremely thin (0.5 mil), yet had to be formed as a uniform, continuous, adherent layer, even around sharp corners.

Only BAKELITE parylene was able to meet these critical requirements and also provide the necessary dielectric and corrosion-preventing properties. The Sippican Corporation coated the thermistors under a parylene license from Union Carbide Corporation.

The ability of parylene to be vacuum-deposited in uniform micro-thin coatings is unmatched. True conformal coatings can be as thin as 0.002 mil or as thick as 3 mils or more...and they

won't bridge, run, sag, bloom, blister, wrinkle or blush! As a conformal coating, parylene is a primary dielectric, an excellent moisture barrier, resists softening at high temperatures and its chemical resistance is outstanding.

With all of these special properties, parylene is recommended as conformal coatings on discrete components or high density circuitry, for fast responding sensing probes, photo-cells or memory units.

This plastic is already used as ultra-thin pellicles for such applications as beam splitters in optical instruments and windows for nuclear radiation measuring devices.

Thin coatings of BAKELITE parylene can even be used to increase the over-all heat transfer coefficient of desalination condenser tubes by promoting dropwise condensation.

Possibly your product could benefit from this new plastic. For more information, write to Dept. E-11, Union Carbide Corporation, Plastics Division, 270 Park Avenue, New York, N. Y. 10017. BAKELITE is a registered trade mark of Union Carbide Corporation.

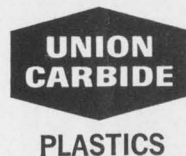

**familiar faces  
from the  
world's broadest  
line of  
indicating  
relays**

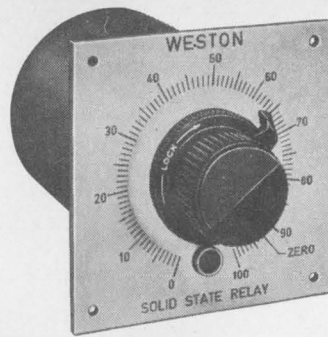

**Model 1062 Control Relay**—no moving parts, not even relay contacts; voltage ranges from 0-1 volt, current ranges from 0-100  $\mu$ a; 200-millisecond response time with 0.5% repeatability typical; zero adjust and trip indicator on 320° scale.

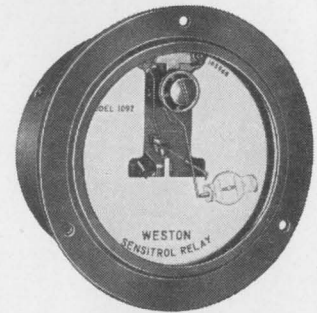

**Model 1092 Sensitrol® Relay**—low cost; all purpose; magnetically shielded; wide range adjustability; ideal for use in engineering breadboard circuits.



**Model 705 Sensitrol® Relay**—highly sensitive; surface or flush mounted; single or double, fixed or adjustable contact; ranges as low as 0.5-0-0.5  $\mu$ a.



**Model 723 Sensitrol® Relay**—sealed; shielded; internal reset; solder terminals; single or double magnetic contact; ranges as low as 1-0-1  $\mu$ a.

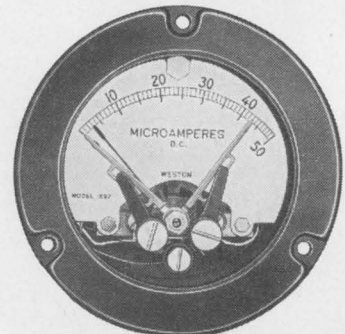

**Model 1097 Ruggedized 3½" Relay**—Load Current Contact Aiding type fully meets applicable portions of military ruggedized spec; sealed; long scale; shielded; solder terminals; single or double adjustable contacts.

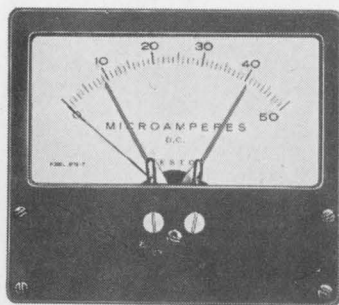

**Model 1075 Photronic\* Relay**—operates without physical contact; single or double adjustable set points; continuous reading beyond set point; taut band frictionless mechanism; solid state switching circuit; ranges from 10  $\mu$ a.

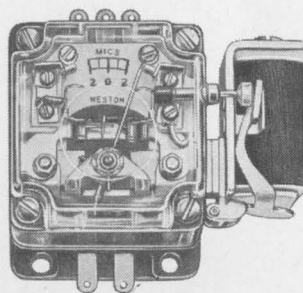

**Model 813 Miniature Relay**—compact and lightweight; sensitive and Sensitrol (magnetic) contacts; single or double contact; ranges as low as 2-0-2  $\mu$ a.

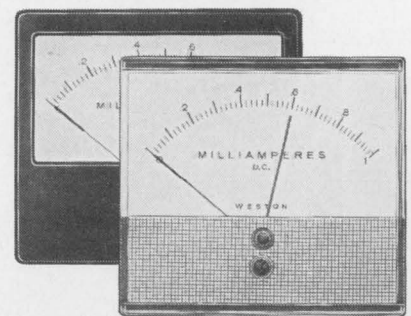

**Model 1930/1940 Photronic\* Relay**—3½" and 4½" in either bakelite or plastic front; low cost; add-on power supply and solid state switching circuit; shielded; non-physical, adjustable contact.

\*Photronic is a Trademark of Weston Instruments, Inc.

Weston Instruments, Inc. • Newark Division • Newark, N.J. 07114

**WESTON®** prime source for precision... since 1888



## Some people can make anything with Signetics' linear integrated circuits.

Like this FM receiver our friend put together. Its IF strip is made up of Signetics' new 510 Dual RF/IF Amplifiers. It will never win a prize for either industrial or electronic design—but then, it wasn't intended to. Does it work? We had it running continuously during the recent WESCON show. Our booth traffic indicator says that some 20,000 engineers saw it, heard it, and thought it sounded pretty good. We know that lots of them can design a better receiver with the same parts. That's their business. Ours is making integrated circuits.

Want to know more about the Signetics' 510 Dual RF/IF Amplifier? Send for a data sheet and a reprint of Ralph

Seymour's WESCON paper on its design and applications.

Want to know more about Signetics' other new linear IC's—the 515 Differential Amplifier and 516 Operational Amplifier—or about the field-proven 501 Video Amplifier and 518 Voltage Comparator? Just ask. We'll get data sheets and application notes to you...fast.

**SIGNETICS  
INTEGRATED  
CIRCUITS**



A SUBSIDIARY OF CORNING GLASS WORKS

**SIGNETICS SALES OFFICES:** Metropolitan New York (201) 992-3980; Upper New York State (315) 469-1072; Southwestern (214) 231-6344; Western Regional (213) 272-9421; Eastern Regional (617) 245-8200; Mid-Atlantic (609) 858-2864; Southeastern (813) 726-3734; Midwestern Regional (312) 259-8300; Northwestern (408) 738-2710.

**DISTRIBUTORS:** Compar at all locations listed below. Semiconductor Specialists, Inc. (312) 279-1000; Terminal Hudson Electronics (212) 243-5200; Wesco Electronics (213) 684-0880; Wesco Electronics (405) 968-3475; Hammond Electronics (305) 241-6601; Avnet Electronics Corp. of Massachusetts (617) 272-3060.

**DOMESTIC REPRESENTATIVES:** Jack Pyle Company (415) 349-1266. Compar Corporation at the following locations: Alabama (205) 539-8476; Arizona (602) 947-4336; California (213) 245-1172; California (415) 697-6244; Colorado (303) 781-0912; Connecticut (203) 288-9276; Florida (305) 855-3964; Illinois (312) 775-5300; Maryland (301) 484-5400; Massachusetts (617) 969-7140; Michigan (313) 476-5758; Minnesota (612) 922-7011; Missouri (314) 428-5313; New Jersey (609) 429-1526; New Mexico (505) 265-1020; New York (518) 436-8536; New York (607) 723-8743; New York (716) 684-5731; New York (201) 471-6090; North Carolina (919) 724-0750; Ohio (216) 333-4120; Ohio (513) 878-2631; Texas (214) EM 3-1526; Texas (713) 649-5756; Washington (206) 725-7800.

**INTERNATIONAL SALES:** France, Germany, Italy, Belgium, Holland, Luxemburg, Spain—Sovcor Electronique, 11, Chemin de Ronde, Le Vesinet, (S.-&O.) France, United Kingdom, Ireland, Sweden, Denmark, Norway, Switzerland, Austria, Portugal—Electrosil Ltd., Lakeside Estate, Colnbrook-Bypass Slough, Buckinghamshire, Great Britain. Australia—Corning, 1202 Plaza Building, Australia Square, Sydney, N.S.W. 27-4318. Canada—Corning Glass Works of Canada, Ltd., Leaside Plant, Ontario, Canada (416) 421-150. Israel—Optronix, P.O. Box 195, Ramat-Gan, Israel 724-437. Japan—ASAHI Glass Co., Ltd., Corning Products Sales Dept. No. 2, 3-Chome Marunouchi, Chiyoda-ku, Tokyo, Japan.

# new

## NIXIE® TUBE DRIVERS WITH INTEGRATED CIRCUITS MAKE "BUY" DECISIONS

- PRICED AS LOW AS \$26.00 INCLUDING THE NIXIE TUBE (100 QUANTITY)
- SMALLEST, MOST CONVENIENT PACKAGES
- COMPATIBLE WITH TTL, DTL, & RTL
- DECODER/DRIVERS WITH OR WITHOUT MEMORY
- COMPLETE ASSEMBLIES AVAILABLE OFF-THE-SHELF FROM BURROUGHS AND DISTRIBUTORS
- 0.6" CHARACTER HEIGHT OR 0.3" CHARACTER HEIGHT NIXIE TUBES
- MINIMAL NOISE PROBLEMS — DRIVERS ARE MOUNTED AS CLOSE TO TUBES AS POSSIBLE.

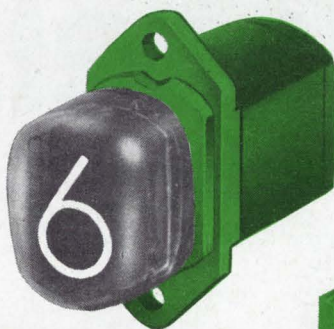

ACTUAL SIZE (even with memory).

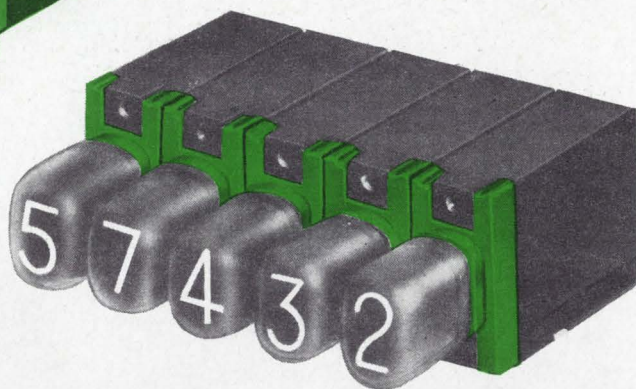

ACTUAL SIZE miniature drivers.\*

### SPECIFICATIONS OF IC NIXIE TUBE DRIVERS

Part Number	Tube Type	Character Height	Max. Overall Length (with tube)	Max. Height	Max. Width	Has Memory	Input Code	Price 100 quantity (includes NIXIE tube)
BIP-8806	Standard B-5991	0.6"	2.506"	1.583"	0.750"	Yes	4 line 8-4-2-1 BCD	30.00
BIP-8804	Standard B-5991	0.6"	2.506"	1.583"	0.750"	No	4 line 8-4-2-1 BCD	26.00
BIP-9801	Miniature B-4998	0.3"	2.648"*	0.960"	0.480"	No	4 line 8-4-2-1 BCD	42.00

\*Note new shorter overall length.

For additional information contact, Burroughs Corporation  
P.O. Box 1226, Department D2, Plainfield, N.J.



**Burroughs Corporation**

# Delay line speeds r-f testing

It electrically lengthens one path of a heterodyning test set to produce a difference frequency; the system is basically simple and reduces the time needed to measure transmission characteristics

By Frederick F. Rogers

Western Electric Co., North Andover, Mass.

**Measuring transmission** characteristics of radio-frequency devices, traditionally a time-consuming task, can be speeded with a broadband, high-loss measurement test set developed by the Western Electric Co.

The unit has the range, accuracy, and sensitivity of a single-frequency heterodyne system, but without that system's complexity. And, unlike conventional swept systems, it doesn't need two signal sources. A delay line creates the difference frequency necessary for heterodyning, and thereby eliminates the need for the complex synchronizing circuits and mechanisms normally employed to keep the difference frequency constant.

Called the Incremental Heterodyne Frequency (IHF) test system, the set is capable of measuring insertion losses, return losses, and voltage standing wave ratio.

## Against the tide

As a general rule, increases in the range and accuracy of r-f devices have demanded increases in the complexity of the systems used to test them. The application here of delay-line techniques, long used for making phase measurements, bucks this trend. The resulting instrument is simple and cuts the time needed to test an r-f device with wide dynamic and broad frequency ranges. In one trial,

## The author



Frederick Rogers is an engineering associate at the Merrimac Valley Works of the Western Electric Co. He joined the company, the manufacturing arm of the Bell System, in 1957, and has since worked on microwave communications systems.

a developmental model of the IHF system operated over bandwidths of 0.5 and 1 gigahertz at test frequencies of 6 and 11 Ghz; the system's dynamic range was 35 decibels.

The set's test signal is derived from a single, swept-frequency source. The signal is split into two paths, one (A) connected to a mixer by a delay line, the other (B) coupled directly to the mixer. The path with the delay line is therefore electrically longer, as in diagram at top of page 95.

An attenuator is used to drop the signal in test path B at least 20 db below the level in the other path. In a heterodyning system, it should be noted, the amplitude of the mixer output is directly proportional to the magnitude of the weaker signal. In this case, test results are carried via path B.

A second attenuator in the same path establishes a reference level on a readout device—usually an oscilloscope. Once the reference level is set, the r-f device to be tested is substituted for the attenuators. The mixer's output, a pulse-modulated signal, contains the test results.

At any instant in time, the swept signal can be regarded as a single frequency. Since the source is a linearly swept frequency generator, it produces, in effect, a series of instantaneous frequencies.

## Delays make a difference

If a single set of instantaneous frequencies in the two paths is represented by  $f_1$  and  $f_2$ , respectively, and the mixer output frequency by  $f_3$ , the values of  $f_1$  and  $f_2$  arriving at the mixer at any time are a function of the sweep rate,  $r$  (the rate of change of frequency in hertz/second). If  $d_1$  and  $d_2$  represent the delays in paths A and B, respectively, and  $d_1 > d_2$  and  $f_1 < f_2$  when  $r$  is positive, then  $f_3 = r(d_1 - d_2) + f_1$

The desired mixer output ( $f_3$ ) is the difference frequency  $f_2 - f_1$ . If the delay and sweep rate are



## The competition

There are a variety of conventional circuits that can be used to measure the insertion loss, return loss, and vswr of r-f devices. The simplest, the single-frequency, single-detection measuring circuit, A at right, uses a point-by-point technique in which the frequency of the signal source is manually switched each time a measurement at a new frequency is required. Insertion and return losses are measured with a square-law detector. The configuration A measures insertion losses; the second circuit, B, measures voltage standing wave ratios and return losses.

The simpler circuit has a signal source, a variable r-f attenuator, an r-f detector, and readout device. In the other circuit, a slotted line, a precision termination, and a shorting plate are added.

**Combo.** Another popular configuration, the modulated single-frequency, single-detection measuring circuit, C at right, also employs point-by-point, square-law-detection

techniques. As it combines both of the previous circuits—plus a modulator and a demodulator—it can measure all three characteristics.

The single-frequency heterodyne measuring circuit, diagram D, is useful for extended range measurements. But two signal sources are needed, and they have to be adjusted for every frequency change. The circuit has three sections, of which one—the beat frequency oscillator section—resembles the first circuit discussed here minus the detector and presentation device. The second section—the test signal oscillator—resembles a combination of the first and second circuits, and the third consists of a mixer, an intermediate-frequency preamplifier, an i-f attenuator, an i-f amplifier, a detector, and a presentation device.

The signal strength levels at the mixer of this system must be maintained throughout all measurements, and the difference fre-

quency between the rso and bro sections must be kept constant.

The difference frequency between the rso and bro is called the i-f and is usually much lower than either of the oscillator frequencies. Amplification of the i-f increases sensitivity and extends the measurement range.

**Modifications.** In all of these approaches, the need to switch frequencies wastes time. The signal source can be replaced in any of these circuits with a sweeper—an oscillator whose output frequency is systematically varied many times per second from a start to a stop frequency through a band of frequencies. But severe frequency modulation of the i-f and misalignment of the i-f with respect to the narrow pass band of the i-f amplifiers can occur if the sweepers aren't synchronized.

The circuits can be further modified with hybrid junctions to eliminate the slotted line for return loss and vswr measurements. Adding these junctions boosts the circuits measurement capabilities, but makes for greater complexity.

Technique	Measures			Measurement		Data accumulation		Comments
	IL	RL	vswr	Range (db)	Tolerance (db)	Point-by-point	Continuous (swept source)	
Incremental heterodyne frequency	x	x	x	70	±0.2		x	Needs only one source for heterodyning; simple presentation device such as scope can be used.
Single-frequency, single detection	x	x (a)	x (a)	30	±0.2	x	(b)	Limited range but simplest circuit. Require manual frequency adjustment.
Modulated single-frequency, single-detection	x	x	x	50	±0.2	x	(b)	Amplification of modulating frequency increases system's sensitivity and extends useful range
Single-frequency heterodyning	x	x	x	70	±0.2	x	(c)	Most complex but most versatile of these systems. Two sources and synchronizing are essential.

(a) Slotted line must be added to measure vswr and RL

(b) Signal source can be swept to reduce test time and eliminate point-by-point measurements. There are no serious implementation problems.

(c) Sweeping of signal sources provides time-saving benefits, but complex synchronizing circuits and mechanisms are needed to keep frequency difference constant.

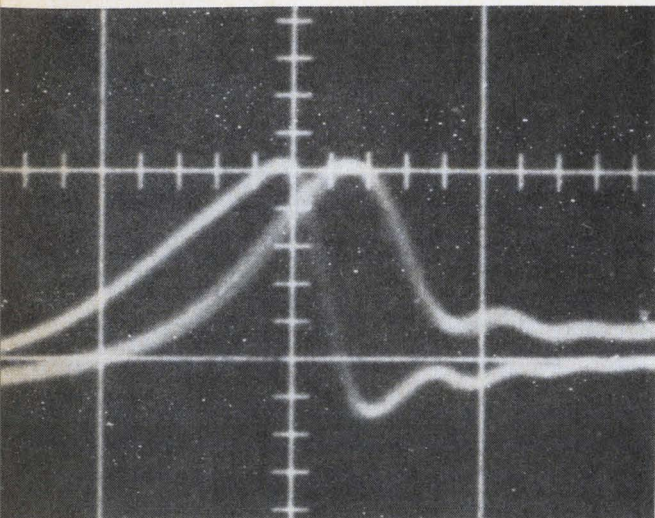

**Time lag.** Pips created by frequency-modulating signal sources and introduced into test system at the start of the two signal paths arrive at the mixer at different times.

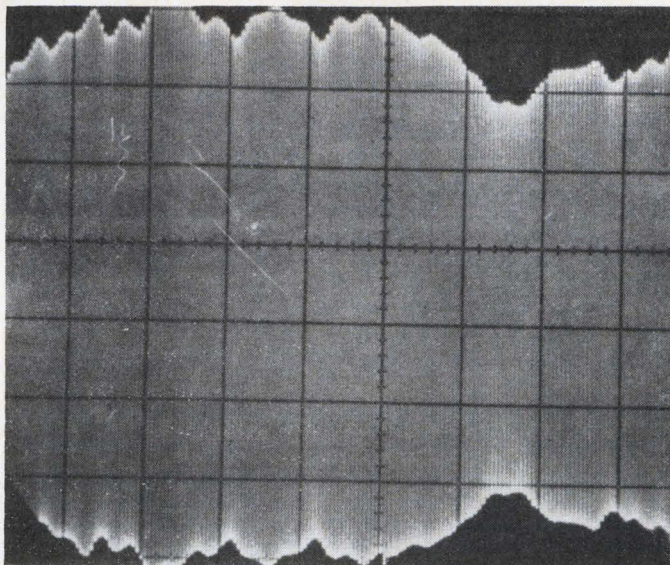

**Typical output.** Test results are confined to the envelope of the oscilloscope display. Shown here is the mixer output signal after the i-f has been filtered and amplified.

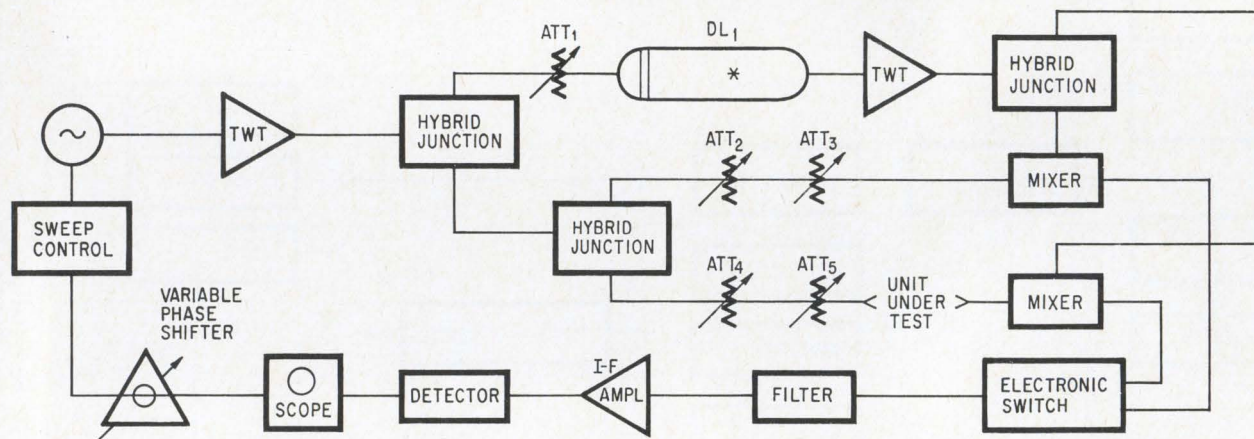

**Final form.** Test set modified for laboratory use contains both an automatic calibrating path and a phase shift control. The signal through the path with attenuators  $ATT_2$  and  $ATT_3$  is alternately compared with the signal in the test path and the one in the electrically lengthened path. The scope's reference point is thus always available for comparison.

continued from page 95

detectors at different times, the actual time difference being equivalent to the delay difference between paths A and B, less about a 10-nanosecond delay caused by the scope's dual trace preamplifiers.

The displacement between two identical frequencies proves that two different frequencies originating at the swept-signal source are present at the detectors at the same time.

The number of points sampled by the test set depends on the mixer output frequency, and the only useful information in the output is contained at the peaks and valleys of the modulated signal's envelope. While this is satisfactory for a production-line instrument, a laboratory system should be able to measure abrupt losses occurring between the sample points.

The HF system gains this capability when a 360-

degree phase shifter, shown above, is added to the measuring circuit. The phase shifter enables the operator to move any point on the envelope through as much as a one-cycle change and to investigate the test results at that discrete sample point.

Measurements made with the new circuit have been correlated to within a tenth of a decibel with a conventional sweeper test set. Losses of more than 50 db have been observed with sensitivities of 1 to 2 db per centimeter on an oscilloscope.

### Bibliography

"Swept Frequency Techniques," Hewlett-Packard Co., Application Note #65.

Frederick Terman, "Electronic & Radio Engineering," fourth edition, McGraw-Hill Book Co., p. 568, "Heterodyne Action," and p. 558 "Square Law Detection."

Radiation Laboratories Series, Vol. 11, "Technique of Microwave Measurements," chap. 13.

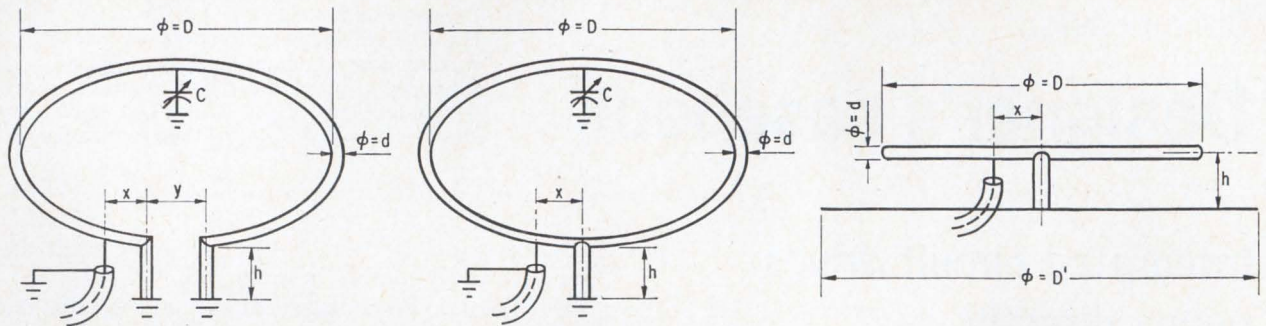

**New ring.** Efficiency of radiator antenna (left), is improved at very high frequencies by adding capacitor, eliminating the discontinuity gaps (center), and making ground-plane diameter,  $D'$ , twice loop diameter  $D$  (right).

of the capacitor, the loop's diameter is reduced to about 52 electrical degrees. The correct termination is found by moving the feed point through a distance shown as  $X$  in the first sketch.

The bandwidth is determined by the diameter,  $d$ , and the height above the ground plane of the rod used to form the loop.

Field intensity measurements of such half-wave DRR's show that they are not only superior to the conventional DRR, but have 1-decibel better gain than the standard quarter-wave verticle dipole. Radiation directivity was as good as the theoretical omnidirectional pattern given in the 1963 report. A 3-db jump in the directivity pattern is caused by the discontinuity at  $Y$ . The length of  $Y$  is not critical, and the jump in field intensity can be eliminated by reducing  $Y$  to zero, as in the second sketch, closing the loop.

Several half-wave DRR's have been made for

mobile radio applications. The dimensions for the 156 to 17-Mhz band are:

$$D = 10 \text{ inches}$$

$$d = \frac{1}{3}\frac{1}{2} \text{ inch}$$

$$h = 1\frac{3}{8} \text{ inch}$$

$$X = \frac{1}{3}\frac{1}{2} \text{ inch, for 50 ohms impedance}$$

This antenna's ground-plane diameter is approximately  $2D$ .

The antenna is well-suited to vhf/f-m use, acting as a sharp bandpass filter centering on the operating frequency. It rejects adjacent-channel interference much better than conventional dipoles. Receiver signal-to-noise ratio is also better when the loop is grounded through the vehicle frame, to drain off static charges.

The low profile of the antenna, when mounted on an automobile roof, makes for low wind resistance and therefore less signal flutter, and inconspicuous appearance.

## Relay actuator produces one-hour pulses

By David L. Pippen

National Aeronautics and Space Administration, White Sands Test Facility, N.M.

**Long pulses** at slow repetition rates for timing applications are generated by a free-running pulser consisting of solid state components and a relay. Pulse widths and rates from 20 milliseconds to several minutes can be obtained by changing the values of the resistors and capacitors that govern time constants.

The component values allow pulse width to be adjusted from approximately 50 to 150 msec, at a nominal repetition rate of one pulse per second. Stability of the repetition rate is within 2% over normal operating temperatures.

When a direct current is applied to the circuit, capacitor  $C_1$  charges through resistors  $R_3$  and  $R_4$  until the firing point of the unijunction transistor,  $Q_1$ , is reached. This time delay, adjustable with  $R_3$ , establishes the repetition rate.

After  $Q_1$  is triggered, the silicon controlled rectifier,  $SCR_1$ , fires and energizes relay  $K_1$ , closing the normally open contact  $K_{1B}$ . Now, power is applied through  $R_2$  and  $R_5$ , charging  $C_2$ ; this time delays the pulse width and is adjusted with  $R_2$ . The charging of  $C_2$  fires the second unijunction transistor,  $Q_2$ , and  $SCR_2$ .

The low impedance of  $SCR_2$  in its on state shunts  $SCR_1$  so it returns to its off state. At the same time,  $K_1$  returns to its de-energized position. The pulse-width-determining circuit is now fully recovered and waits for the next triggering signal from  $Q_1$ . Several low-priced, high-sensitivity SCR's tried in this circuit did not function adequately, since they sustained conduction with less than 5 microamperes anode current. The on-state resistance in the  $SCR_2$  must be low enough to assure  $SCR_1$ 's turning

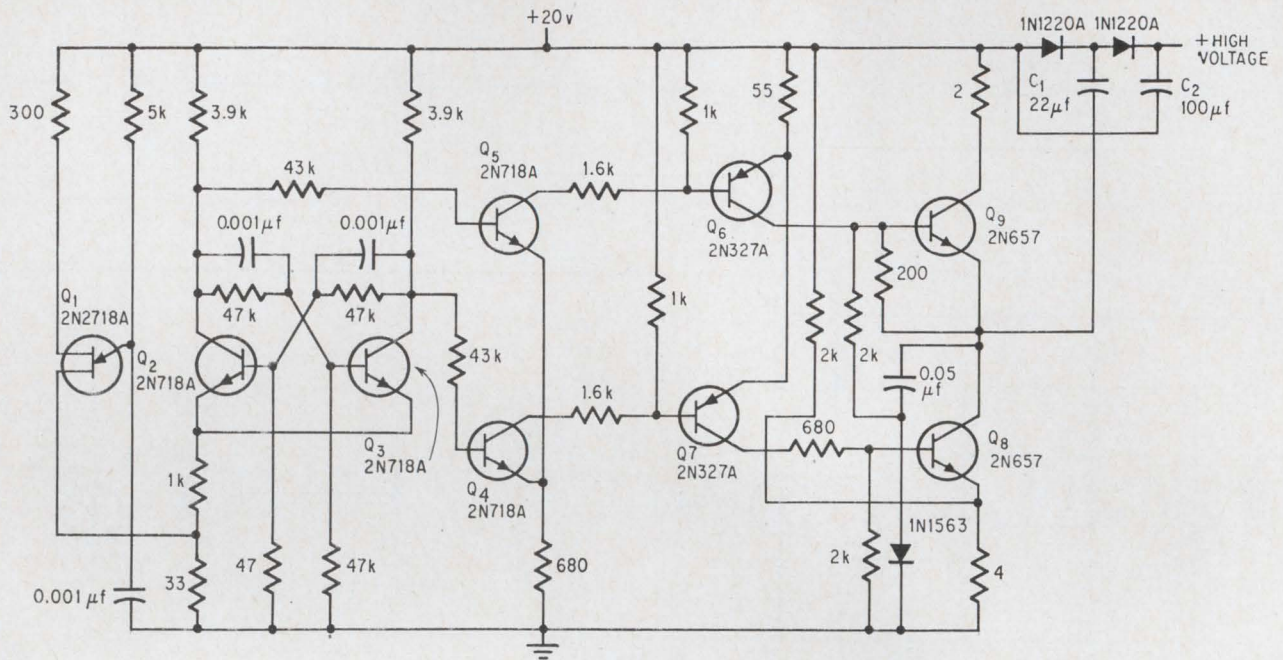

**Autotransformer.** In actual circuit, the switching is controlled by a unijunction transistor,  $Q_1$ , and transistors  $Q_8$  and  $Q_9$  replace the switch contacts.

by  $Q_4$  and  $Q_7$  and  $Q_5$  and  $Q_6$ .

The two remaining transistors,  $Q_8$  and  $Q_9$  take the place of the switches  $S_C$  and  $S_D$  in the explanatory circuit. They are turned on alternately so that  $C_1$  repeatedly charges and then discharges into  $C_2$ , producing the high-voltage output.

The circuit shown was assembled to test the concept. With a 20-volt input, the output was 35.5 volts at 80 milliamperes and the efficiency was 60%. The output can be efficiently regulated by providing feedback from the output to control the amplifiers in either the charge or discharge circuit.

## Transistor replaces supply in CRT amplifier

By Phil Salomon

Pasadena City College, Pasadena, Calif.

**Adding a transistor** to a conventional paraphase amplifier eliminates the need for a negative power supply and improves the balance of the output-signal amplitudes.

Paraphase amplifiers are widely used as balanced deflection devices for electrostatic cathode-ray tubes. They provide outputs of opposite polarity and equal gain when signal currents of equal magnitude flow in the two tubes,  $V_1$  and  $V_2$ , shown in the conventional circuit. Quiescent current for each tube is supplied from the cathode resistor,  $R_K$ .

Ideally,  $R_K$  acts as a current source—it holds the quiescent current steady when operating conditions vary. Therefore,  $R_K$  is returned to a negative power supply,  $-E_{cc}$ , so that the potentials of the

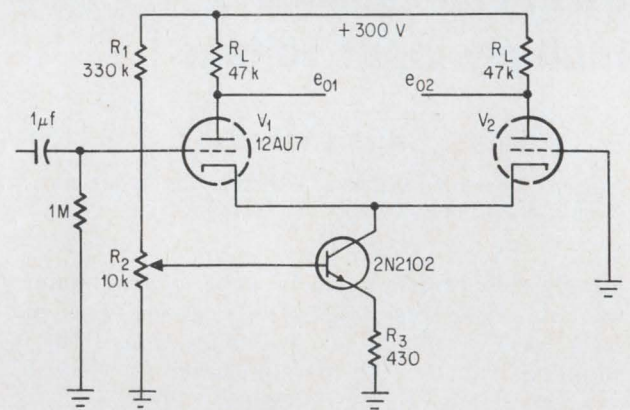

**Hybrid amplifier.** Transistor and bias resistor network prevent voltage variations from affecting current balance.

tubes' cathodes are held near ground. An analysis of the equivalent circuit shows that  $R_K$  must be large, since

$$R_k = \frac{100}{P} \left[ \frac{r_p + R_L}{\mu + 1} \right]$$

where  $P$  is the percent of unbalance between the



## GAF x-ray film assures quality welds in Sun Shipbuilding's revolutionary high-performance gas-turbine freighter

The new Adm. Wm. M. Callaghan is a ship of many "firsts."

The first large cargo vessel with modified aircraft jet engine—a twin gas-turbine installation. The largest and fastest privately owned freighter under the U.S. flag. And one of the first ships procured under performance standards.

But it's *not* the first time the Sun Shipbuilding and Drydock Company depended on GAF Industrial "A" x-ray film. Sun has relied on GAF for quality control of its welds for more than 20 years.

Says chief radiographer William Collins (pictured here supervising x-ray procedures), "We find the combination of GAF Industrial "A" x-ray

film and GAF chemicals to be very compatible for good sensitivity and reliability in all our radiography."

The speed and accuracy of GAF radiography has actually helped improve welding techniques, making for



greater construction efficiency. This has enabled Sun to launch its precedent-making ship in record time. Designed for long-term charter to MSTs, the vessel's combination of high speed (in excess of 25 knots) and large deck area, could well set a trend for use of gas-turbine power.

The need for quality welds, in thicknesses ranging up to several inches, virtually necessitates GAF radiography for unusual construction problems. For this job, Industrial "A" film was selected.

There's a prime-quality GAF job-matched x-ray film for *your* construction needs. Contact your GAF x-ray distributor or your local GAF representative for further information.

01667

**gaf** GENERAL ANILINE & FILM CORPORATION

140 WEST 51 STREET, NEW YORK, NEW YORK 10020

# Gallium arsenide begins to keep some promises

Always just around the corner, this versatile compound semiconductor is finally challenging silicon and germanium in a host of uses, and is tackling some special applications all its own

By Stephen E. Scrupski

Senior associate editor

**As multifaceted** in application as it is in its crystal structure, gallium arsenide is on the verge of challenging germanium and silicon for the over-all championship of the semiconductor field. But the challenger has been brought along slowly, and rather than immediately risking a direct confrontation with its rivals in the transistor field, it may begin by outflanking them in light-emitting and bulk-effect applications.

New developments in the use of germanium and silicon as semiconducting materials are trailing off; it would not be an oversimplification to say that most of the work with these materials is now directed toward finding new ways to arrange devices, deposit insulation, and form photomasks. But materials research in the field of gallium arsenide is on the upswing. The conferences covering basic materials—electrochemical and metallurgical society meetings, for instance—are being inundated with papers on compound semiconductors.

Of these compound semiconductors, gallium arsenide is receiving the lion's share of attention. In terms of processing refinements, it's far ahead of the others. In the same terms, it's still far behind silicon, but silicon can't do all that GaAs does.

GaAs is today the most versatile of all semiconducting materials; the articles following will emphasize this. Varactors, transistors, microwave diodes, light-emitting diodes, injection lasers, bulk microwave power sources, negative resistance, amplifiers, and bulk-effect integrated circuits—all are possible with gallium arsenide.

Of these, only varactors, Schottky-barrier microwave diodes, light-emitting diodes, and injection lasers are being made in quantities that even approach conventional "production" levels. But ad-

vanced gallium-arsenide devices are waiting in the wings—in fact, they're being demonstrated in laboratory models.

## Lifting the lid

And when the bulk-effect devices finally hit the market, a new world will open up, one in which functional integrated circuits are designed by shaping the material and by chemical processing. With such circuits, now being built at Bell Telephone Laboratories by Masazuku Shoji and at Standard Telecommunication Laboratories, Harlow, England, by C. P. Sandbank, we can forget about such individual components as transistors.

The key factor in gallium arsenide's success up to now is a single property—a higher electron mobility than either silicon or germanium. Gallium arsenide also has a wider band gap, a feature suggesting high-temperature uses. But Arthur Uhlir of Microwave Associates, author of the section on varactors in this report, sums up the present situation: "High-temperature characteristics, though they were once given as the main reason for research in gallium arsenide, have not been a very significant factor in the application of any gallium-arsenide device."

In fact, as Uhlir notes in his article, the one GaAs application that has anything to do with temperature involves cryogenic freezing just a few degrees above absolute zero. This is the cooled parametric amplifier, which uses a gallium-arsenide varactor in a low-noise receiver.

The main obstacle to fuller exploitation of GaAs is its relative impurity compared with germanium and silicon. These elemental semiconductor mate-

# Some special features make the difference

By David Richman

RCA Laboratories, Princeton, N.J.

**The similarities** between gallium arsenide and the elemental semiconductors, germanium and silicon, are important but hardly surprising—all three have the same basic crystal structure, zinc-blende and diamond, that accounts for their semiconducting properties. But gallium arsenide's place as potentially one of the most important semiconductor materials rests on the differences.

A gallium-arsenide p-n junction, for example, is an efficient light emitter; germanium and silicon diodes are not.

For germanium and silicon, the conduction-band minimum occurs at a momentum different from that of the maximum of the valence band. But in GaAs, the minimum and the maximum occur at the same momentum—a feature that's the basis for the injection laser and the light-emitting diode.

Gallium arsenide thus is a direct-gap material; an electron can make the transition directly from the conduction band to the valence band without changing momentum and can give up its energy in the form of a quantum of light.

In germanium and silicon, indirect-gap materials; electrons cannot move from one band to the other with the same momentum and they must give up most of their energy to the lattice in the form of lattice vibrations, or phonons.

## Mobility

Two other significant differences—gallium arsenide's greater energy-band gap and the greater mobility of electrons in its conduction band minima—give the material its higher temperature and higher

frequency capabilities.

Electron concentration and mobility are often used to judge the purity of a sample of GaAs. Pure material has about  $1 \times 10^{15}$  electrons/cm<sup>3</sup> and a mobility greater than 8,000 cm<sup>2</sup>/volt-sec. Less pure material has higher electron concentration and mobilities in the 5,000 cm<sup>2</sup>/volt-sec. range. In pure material, the mobility increases as temperature decreases; mobilities of over 100,000 cm<sup>2</sup>/volt-sec have been measured at temperatures of about 77°K.

GaAs is the basic material of Gunn-effect devices because there are two valleys in its conduction band, one of which is at a slightly higher energy level—about 0.36 electron-volt—than the other. Electrons in the lower-energy valley have much greater mobility than those in the other valley, though the energy difference between the two levels is so small that strong electric fields give the electrons enough energy to move from one minimum to the other. When the upper—higher energy—valley is more densely populated than the lower, the material exhibits a differential negative resistance; as the voltage is increased, more electrons move up to the lower-mobility band and the current decreases, causing bulk instabilities such as the Gunn effect.

## Impurity

The maximum purity attainable with present GaAs crystal-growing methods is about  $10^{15}$  impurity atoms per cubic centimeter. Since GaAs has about  $4.4 \times 10^{22}$  atoms/cm<sup>3</sup>, this limit corre-

Energy-band properties			
Property	Ge	Si	GaAs
Band gap (ev)	.67	1.106	1.40
Type of band gap	Indirect	Indirect	Direct
Calculated maximum electron mobility at 15° C (cm <sup>2</sup> /v-sec)	3,950	1,900	11,000
Calculated maximum hole Mobility at 25° C (cm <sup>2</sup> /v-sec)	1,900	425	450
Electron effective mass	.55	1.1	.043-.071
Intrinsic electrons at 25° C (cm <sup>-3</sup> )	$2.4 \times 10^{13}$	$1.5 \times 10^{10}$	$1.4 \times 10^6$
Intrinsic resistivity at 25° C (ohm-cm)	46	$2.3 \times 10^5$	$3.7 \times 10^8$

## Matchups

Property	Germanium	Silicon	Gallium arsenide
Melting point (°C)	936	1,420	1,238
Solid density (gr/cm <sup>3</sup> )	5.328	2.329	5.316
Lattice constant (Å)	5.658	5.430	5.654
Distance between nearest neighbors (Å)	2.45	2.35	2.45
Atoms per cm <sup>3</sup>	4.42 x 10 <sup>22</sup>	5.0 x 10 <sup>22</sup>	4.43 x 10 <sup>22</sup>
Vapor pressure at melting point (atm)	10 <sup>-9</sup>	10 <sup>-7</sup>	1
Specific heat (cal/gm)	.074	0.167	.086
Dielectric constant	15.7	12	11.1
Thermal coefficient of expansion (°C <sup>-1</sup> )	6.1 x 10 <sup>-6</sup>	2.33 x 10 <sup>-6</sup>	5.93 x 10 <sup>-6</sup>

type lattice. Each gallium atom is surrounded by four arsenic atoms at the corners of a tetrahedron, and each arsenic atom is surrounded in the same way by four gallium atoms. Germanium and silicon crystallize in a diamond lattice with all sites occupied by the same type—germanium or silicon—atoms.

With germanium or silicon, all 111 faces of the crystal have the same chemical reactivity, since the atoms are the same when viewed from any direction. But in the zinc-blende structure, all 111 faces

present alternating layers of gallium and arsenic atoms, and opposite planes have different surface atoms—gallium in one direction and arsenic in the other. As might be expected, the two surfaces react differently to chemical treatment.

The near equality of the lattice constants—the spacing of the unit cells in the crystal—and the thermal coefficients of expansion are the features that permit the epitaxial growth of germanium on gallium arsenide, a useful method in forming heterojunction transistors.

## Materials II

# Crystal holds key to the future

By J.M. Woodall

International Business Machines Corp., Yorktown Heights, N.Y.

**“To achieve better,** more uniform results, it is clear that better materials are needed.” This comment, found all too often at the conclusion of an article about gallium-arsenide devices, emphasizes the increasing importance of crystal growth techniques.

Epitaxy—the atom-by-atom growth of a layer of GaAs on bulk crystal—has proved a success, but the attainment of more reliable, more uniform, and longer-lived devices requires improved methods of bulk crystal growing. The future of epitaxial devices depends on the quality of the bulk-grown substrates.

Device-quality GaAs is grown by freezing the molten material at 1,242°C into a single crystal structure free of chemical contamination and structural defects. Besides producing high temperatures and promoting single-crystal growth, the apparatus used must prevent the melt from dissociating. The

arsenic in the melt has a dissociation pressure of one atmosphere, and without this external vapor pressure it would leave the melt, thereby chemically unbalancing the crystal structure. Either this pressure must be provided, or as in a newer method, the melt can be encapsulated, and an inert gas used to block the escape of the arsenic.

### Two paths to growth

Two methods of crystal growth are now popular, the Czochralski and the horizontal Bridgman (the vertical Bridgman method is not as convenient for use with semiconductor materials). In the first method, a seed crystal is inserted in the melt and then slowly withdrawn so that the melt forms a meniscus and solidifies as it's raised above the molten surface, repeating the same single-crystal structure as the seed. Typical high-purity results of



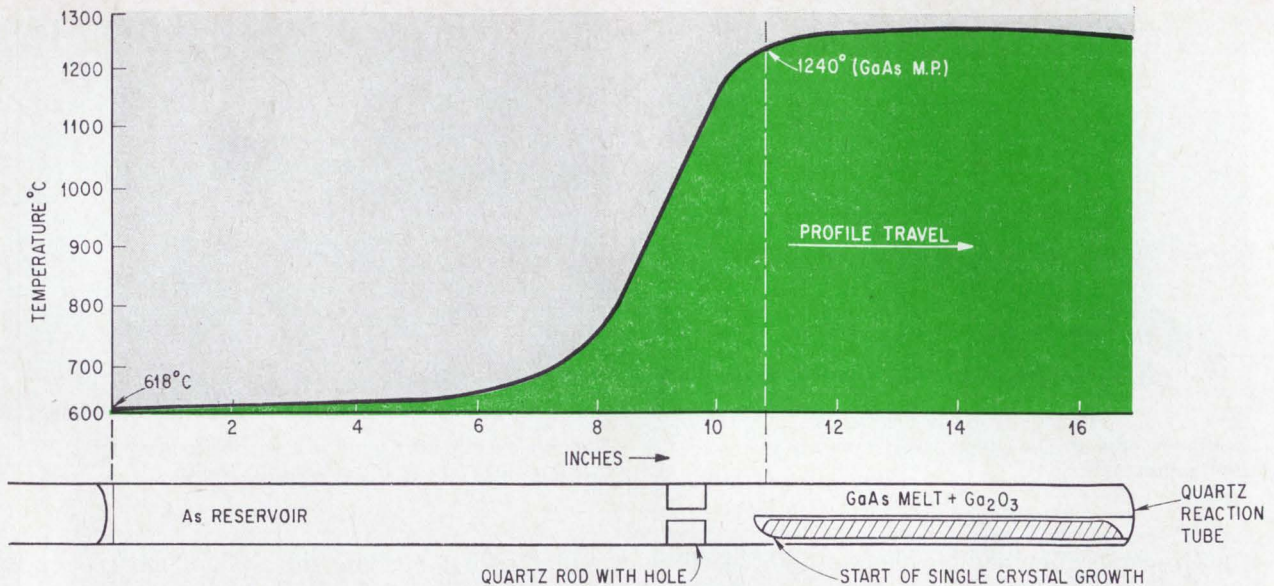

**Passing through.** In the horizontal Bridgman method, the GaAs melt is passed through a temperature gradient and single-crystal material forms on the cooler end.

special seals and feedthroughs. Because the motor-driven apparatus working through magnetic coupling or special seals may have small speed variations, the crystal cannot be grown at a microscopically uniform rate and the dopants tend to collect, often in periodic striations. In the Bridgman method, the motor-driven apparatus runs at a more uniform speed because it's simpler and operates at room temperature.

In the other version of the Czochralski method, the need for arsenic vapor is eliminated altogether by encapsulating the melt in a viscous nonreactive material such as boric oxide,  $B_2O_3$ . Little arsenic escapes from the melt when an inert gas such as argon is applied outside with a pressure of one atmosphere.

The crystal is grown by dipping the seed through the  $B_2O_3$  and then withdrawing it at a uniform rate. As the grown crystal passes through the seal into the inert atmosphere, it picks up a thin layer of  $B_2O_3$ . This method thus allows the use of more stable seed-lifting mechanisms and should result in the growth of more perfect crystals.

### Boatloads

The horizontal Bridgman method generally produces higher-purity material and a more uniform crystal. As with the Czochralski, the system is sealed and contains one atmosphere of arsenic vapor. A boatload of molten GaAs traveling through a temperature gradient forms a single crystal in the shape of the boat.

Neither the melt nor the solid crystal should adhere to or be constrained by the boat. This puts some restrictions on the choice of boat material—a factor of no importance in the Czochralski method.

One advantage of the Czochralski method is that it affords a wide choice of crucible materials; the major concern is the chemical reactivity, not, as

in the Bridgman method, whether the melt wets the crucible. Aluminum-nitride, boron-nitride, and aluminum-oxide crucibles have all been successfully employed in growing high-purity GaAs.

Also, a special graphite crucible for Czochralski growth offering a desirable temperature gradient and good r-f coupling for heating has recently been used to grow dislocation-free GaAs—the substrate required for epitaxial growth of dislocation-free material.

With a recent development, the horizontal Bridgman method is also capable of producing dislocation-free material. This material, seeded crystals grown near the 310 direction in sand-blasted quartz boats and doped with  $2 \times 10^{18}$  tin atoms/cm<sup>3</sup>, has yielded the best room-temperature laser devices made so far, even though GaAs crystals grown in quartz are generally contaminated with silicon from the quartz at a concentration of 1 part per million or  $10^{17}$  atoms per cm<sup>3</sup>—a high impurity level by semiconductor standards.

Although 1 part in  $10^6$  silicon content doesn't affect laser devices, most other applications couldn't tolerate that level of impurity. But with modifications in the growth apparatus and additions of  $Ga_2O_2$  to the melt—to suppress the reaction of silicon with the melt—this contamination can be reduced to about 1 part in  $10^8$ .

Crystals grown this way are generally semi-insulating—having resistivities near  $10^8$  ohm-cm—but heat treatment produces high-mobility GaAs with resistivities between 1 and 1,000 ohm-cm depending on the temperature and length of heat treatment.

### For more on . . .

Crystal growth: L.G. Bailey, Transactions of Metallurgical Society of AIME, March 1967, p. 310.

$p^+n^+$  junctions, several hundred injection lasers emitting visible light at room temperature have been fabricated, the only such devices yet reported. One laser operating at 4.2°K is the brightest electro-luminescent source ever prepared. Others emitting visible light in a continuous-wave mode at 77°K have also been built.

### Multilayer

A major problem with GaAs and  $GaAs_{1-x}P_x$  light-emitting diodes is that much of the light given off is reabsorbed by the diode itself. To minimize this, a phosphorous-rich layer is placed above the  $p-n$  junction to act as a window for the light to pass through. This multilayer structure would be difficult to build with ordinary fabrication procedures, but is easily prepared with vapor-phase technology. Such a diode has provided a brightness of 135 foot-lamberts at a current density of 10 amps/cm<sup>2</sup>.

For a Gunn diode,  $n^+n^-n^+$  layers are vapor-grown in one continuous process with the  $n^-$  region as thin as 1 micron. This again demonstrates the absence of autodoping effects. Using such a structure with a 2.5-micron-thick  $n^-$  region, a Gunn oscillator has operated in the transit-time mode at 40 Ghz, the highest frequency reported for this kind of operation.

The same type structure with an  $n^-$ -layer 100 microns thick has provided 143 watts of pulsed power at 2.2 Ghz.

### For more on . . .

Vapor phase growth: J.J. Tietjen, J.A. Amick, *Journal of the Electrochemical Society*, July 1966, p. 724.

Epitaxial varactor diodes: J.J. Tietjen, G. Kupsky, H. Gossenberger, *Solid State Electronics*, 1966, p. 1049.

Epitaxial Gunn devices: R.E. Enstrom, C.C. Peterson, *Transactions of the Metallurgical Society of AIME*, March 1967, p. 413.

## Materials IV

# Film-making: a delicate job performed under pressure

By Kenneth L. Lawley

Bell Telephone Laboratories, Murray Hill, N.J.

**The growth** of a single-crystal material on a substrate of a similar material is the key step in fabricating many semiconductor devices. The epitaxial process produces material not attainable with bulk crystal or diffusion processes. Because of the low temperature of these processes, pure crystals can be grown, allowing the full realization of the high electron mobility possible with gallium arsenide.

Gallium-arsenide films are harder to grow than elemental semiconductors because there are no suit-

able gallium compounds that are gaseous at room temperature and atmospheric pressure. Both the arsenic and gallium gaseous compounds must therefore be supplied to the reactant system under closely controlled conditions.

The three deposition methods generally applied use:

- bulk GaAs as a source and water vapor or a chloride as a transport medium;
- pure gallium as a source for the gaseous gallium compound and arsine or arsenic trichloride for the arsenic;
- condensed GaAs in liquid gallium.

### Pure and simple

The simplest of these methods is the first. The bulk material is exposed to an oxidizing gas, and the products of this reaction serve as the gaseous source from which gallium arsenide is deposited. Water vapor, hydrogen chloride, or chlorine diluted in hydrogen are usually used as the oxidizing gas, though other halides have been tried.

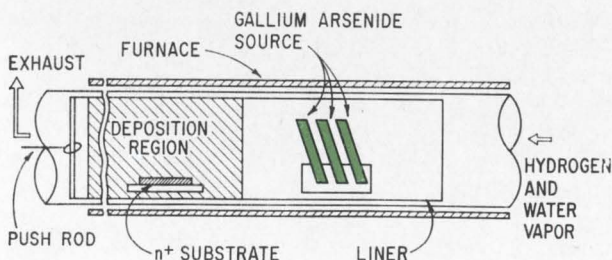

**Water carrier.** In the water-vapor epitaxial method, bulk gallium arsenide is used as the source.

# Getting dopants on the beam is a long-term project

By Kenneth E. Manchester

Sprague Electric Corp., North Adams, Mass.

**The technique** of implanting dopants in crystals of gallium arsenide with a high-energy beam of ions is still at an early stage of development. Holding out the promise of alternative methods for building devices requiring limited processing temperatures and a precisely shaped doping profile, ion implantation can eventually complement existing diffusion method for doping semiconductors.

In the field of light-emitting gallium-arsenide devices, the technique would make it relatively easy to build the junctions close to the surface; this would enhance light-emitting properties by reducing absorption before the light leaves the surface. Diodes made with implanted dopants in the laboratory have emitted about the same levels of light as diffused diodes.

There are two major obstacles to practical ion-implanted GaAs devices: our ignorance of the details of the implantation process and impurities in

the GaAs substrates. However, the considerable efforts being made to understand ion implantation in silicon should carry over into the area of gallium arsenide.

## Experimental diodes

At the Sprague Electric Corp., zinc has been implanted in n-type GaAs, and tellurium in p-type GaAs; ions have been accelerated to 40 and 80 kiloelectron-volts, a relatively low energy level, to produce shallow junctions.

Two types of diodes were formed by this process, each doped with 80-kev zinc ions. One was annealed in an argon atmosphere for 20 to 30 minutes at 650°C, the temperature above which arsenic tends to leave the GaAs surface—a thermal etching effect. The other was annealed for 10 to 15 hours at the same temperature in argon. The diode surfaces were protected with a layer of silicon dioxide to further prevent thermal etching.

The first diode had an essentially abrupt junction and a sharp reverse breakdown. A good thermally diffused diode with a similar background carrier concentration would have a similar junction but a more gradual reverse breakdown.

The second diode had a graded junction, a higher reverse breakdown voltage, and a relatively high forward resistance. The rate at which the impurity concentration decreased away from the junction was about  $10^{20}/\text{cm}^3$  per centimeter—about 1/100th the grading coefficient of a typical diffused graded-junction device.

The low grading coefficient indicates a long tail on the implanted distribution due to deeply penetrating ions. This tail may be the result of either a channeling phenomenon occurring during implantation—where ions travel down open channels in the GaAs lattice—or a diffusion process during the long annealing period.

## Comparisons

Both diodes emitted light at 9.2 microns when forward biased, but the abrupt-junction diode

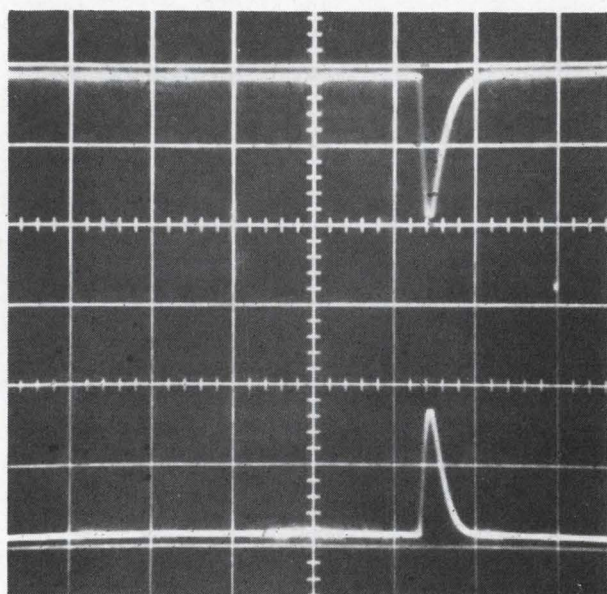

**Implanted outputs.** Ion-implanted diode with 80 kev zinc ions delivers sharp pulse (lower trace) in response to input (upper trace).

ently produced. This resistivity stems from the high density of traps, and from the fact that mobilities are normally much lower than those in the semi-conducting n-type crystals. Typical electron-mobility values for the semi-insulating material lie between 200 and 2,000 cm<sup>2</sup>/volt-sec. Because the electrons are more mobile than the holes, they account for most of the small current flow.

### Lab results

Semi-insulating GaAs has been deposited epitaxially by Haisty and P.L. Hoyt of  $\pi$ , who obtained resistivities of up to 10<sup>5</sup> ohm-cm by doping with iron. And J. Franks and P.R. Selway of Standard Telecommunication Laboratory have made p-i-n diodes in which the intrinsic region was formed by the diffusion of chromium into n-type slices having an initial carrier concentration of more than 10<sup>16</sup> per cm<sup>3</sup>. Resistivities at the surface of the intrinsic layer were measured at 10<sup>8</sup> ohm-cm.

These results demonstrate the feasibility of integrated circuits in which the semi-insulating properties of the substrate are brought to the surface by a local diffusion of chromium to produce isolating channels in the semiconducting layer.

Peak mobilities of 100,000 cm<sup>2</sup>/volt-sec have been achieved at the Standard Telecommunication Laboratory with semiconducting n-type GaAs vapor-deposited on semi-insulating GaAs by the arsenic trichloride-gallium process. Researchers at STL also report mobilities of 8,000 at room temperature (56,000 at 78°K) with n-type layers deposited from the liquid phase on semi-insulating substrates. The fact that n-type layers of GaAs can be grown on semi-insulating substrates simplifies the evaluation of the epitaxial process.

### For more on . . .

First characterization: C.H. Gooch, C. Hilsum, B.R. Holeman, *Journal of Applied Physics Supplement*, 1961, p. 2069.

First fabrication: F.A. Cunnell, J.T. Edmond, W.R. Harding, *Solid State Electronics*, 1960, p. 97.

Chromium doping: G.R. Cronin, R.W. Haisty, *Journal of Electrochemical Society*, 1964, p. 874.

Compensation effects: J.W. Allen, *Nature*, 1960, p. 403.

Epitaxial semi-insulating GaAs: P. Hoyt, R.W. Haisty, *Journal of Electrochemical Society*, 1966, p. 296.

Epitaxial semiconducting layers: J. Whittaker, D.E. Bolger, *Solid State Communications*, 1966, p. 181.

Domain-originated functional IC's: C.P. Sandbank, *Solid State Electronics*, 1967, p. 369.

## Devices I

# Off to a good start

By Arthur Uhlir Jr.

Microwave Associates Inc., Burlington, Mass.

**For its first use** in a practical device—the varactor diode—gallium arsenide was in the right place at the right time. In the late 1950's, makers of microwave systems needed low-noise parametric amplifiers and frequency multipliers that couldn't be built with other semiconductor materials.

The use of gallium arsenide for varactors in microwave systems is a reflection principally of quantitative features such as high electron mobility and retention of conductivity at 4.2°K liquid helium temperatures—a must for cooled, low-noise parametric amplifiers. In this respect, the varactor differs from more recent GaAs devices such as light-emitting diodes, lasers, and piezoelectric transducers, where the emphasis is on properties that are qualitatively different from those of silicon and germanium.

GaAs varactors have scored their biggest success in low-noise parametric amplifiers. Here they compete with silicon devices in uncooled appli-

cations and have the cooled field to themselves.

At room temperature, the higher electron mobility of GaAs yields a series resistance lower than that of silicon, and cutoff frequencies three or four times higher. This, however, doesn't result in a comparable drop in amplifier noise. For one thing, losses stemming from the relatively low mobility of holes in the p-type regions of the GaAs diode and from the finite conductivity of the cartridge metal reduce the cutoff-frequency advantage to a factor of about two—600 gigahertz against silicon's 300 Ghz. For another, high pumping frequencies are needed at room temperature to take full advantage of varactors with high cutoff frequencies.

When cost is no object, however, refrigeration will make parametric-amplifier noise negligible in comparison with noise from antenna feeds. It's far easier to design such an amplifier with a GaAs varactor than with silicon or germanium because

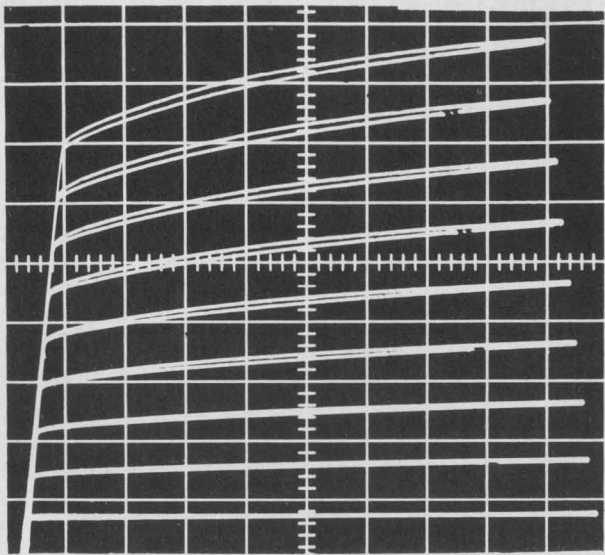

-196°C

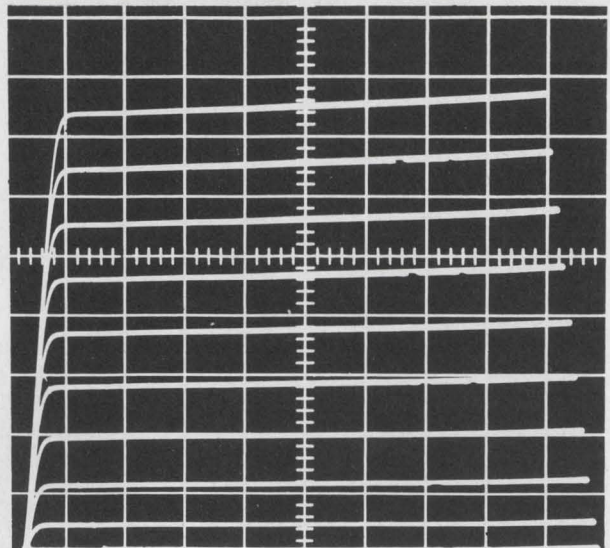

25°C

**Temperature effects.** Common-emitter characteristics of GaAs bipolar transistor at  $-196^{\circ}\text{C}$ , left, and at room temperature, right. Vertical calibration is 1 milliamperes/division, horizontal is 1 volt/division; base current increases 0.1 milliamperes with each step.

emitter to collector, and thus limits emitter efficiency and base spreading resistance.

In addition, it's difficult to measure the other material properties bearing on transistor operation, and difficult, with present processing methods, to do anything about changing them.

Although they have only partly fulfilled expectations, GaAs transistors have been a major factor in the development of other GaAs devices. Because of their dependency on material quality and fabrication processes, GaAs bipolar transistors are sensitive tools for the study of GaAs material and device technology.

#### Performance forecast

About 10 years ago, it was commonly predicted that GaAs transistors would bypass silicon and germanium devices in temperature and frequency performance because of gallium arsenide's wider band gap and higher electron mobility. Based on a maximum operating temperature of  $100^{\circ}\text{C}$  for germanium, engineers projected silicon transistors operating at up to  $250^{\circ}\text{C}$  and GaAs transistors at up to  $450^{\circ}\text{C}$ .

The highest operating frequency is related to the product of electron and hole mobility in the case of bipolar transistors, and to the majority carrier mobility with unipolar (field effect) transistors. Bipolar GaAs and germanium transistors lead silicon devices in this mobility factor; the two are equals at higher frequencies because the higher electron mobility of GaAs is offset by germanium's higher hole mobility and somewhat higher dielectric constant.

GaAs unipolar transistors should operate at frequencies roughly twice as high as the top levels for germanium unipolar transistors, which, in turn, should surpass those of silicon devices by about the same factor.

The first GaAs transistors were fabricated from Czochralski-grown material. Reproducibility was very poor and current gains were low. Boat-growing led to better devices, but high current gain could only be achieved consistently after the introduction of vapor-phase epitaxial methods.

But the problems of relating material properties to device performance still remain; it isn't yet possible to define "good" transistor material, or even to influence critical parameters by changing growth conditions. The conveniently measurable properties of the material, such as dislocation density, mobility, and doping level, don't relate to transistor performance, although they are useful for basic material.

However, the recently applied cathodoluminescence technique may provide a means of selecting suitable GaAs material for device fabrication. In this technique, GaAs is bombarded with electrons that penetrate deep. From deep inside, the GaAs emits light related to such parameters as diffusion length and lifetime.

The influence of particular dopant elements on device performance is small compared with the effect of the starting material. Almost all transistors have been of the npn type because of the wide ratio of electron to hole mobilities—about 20:1 in GaAs.

The general difficulty in making GaAs transistors is that only two to three orders of magnitude concentration difference can be achieved between emitter and collector; with silicon transistors, the concentration difference runs to four or five orders of magnitude. In GaAs, the collector concentration is typically about  $10^{16}/\text{cm}^3$ . At lower concentrations, thermal conversion of n-type to p-type material occurs, sometimes caused by fast diffusing acceptors such as copper. The solubility of electrically active donors in GaAs (the maximum

for deep oil wells and in gear for space probes near the sun.

### Stability

Before GaAs can be considered for high-temperature circuits though, serious stability problems must be solved. All GaAs transistors suffer from instability when operated over long periods of time, even at room temperature. At temperatures of 400°C to 500°C, the possibility of a rediffusion of emitter and base regions must be considered. Although individual transistors have been operated over periods of several thousand hours in a 300°C ambient environment with little degradation, these results are not reproducible with all transistors.

Studies of the stability of GaAs have produced a better understanding of the degradation of transistors, light-emitting diodes, and microwave devices. But failure-mechanism studies of GaAs devices have just scratched the surface of the problem.

### For more on . . .

Comparisons with Ge, Si: D.A. Jenny, Proceedings of the IRE, June, 1958, p. 959.

Cathodoluminescence studies: D.B. Wittry, D.F. Kyser, Journal of Applied Physics, 1967, p. 375.

Iron doped transistors: H. Strack, Gallium arsenide—Institute of Physics and Physical Society Conference Series No. 3, p. 206.

## Devices III

# Fast-moving FETs can outpace rivals

By Hans Becke

RCA Electronic Components and Devices Division, Somerville, N.J.

**Gallium-arsenide** bipolar transistors may have a hard time trying to replace their silicon counterparts, but the story may be different in the case of field effect transistors. Gallium arsenide enters the race with at least one big plus—a far higher electron mobility than silicon's. This feature can mean more gain at higher frequencies to go along with gallium arsenide's higher temperature performance.

The frequency response of a field effect transistor is primarily determined by the mobility of the majority carriers—electrons in an n-channel device—and GaAs has a 5:1 edge over silicon on this score. Two recent developments, a very-high-frequency device using silicon nitride as a gate insulator, and a microwave device using a Schottky barrier as the gate, demonstrate the potential of GaAs FETs. Since both depend on channel carrier mobility for high-frequency performance, they have the same frequency response limits.

Both are made in planar form and can be easily incorporated into integrated circuits. Such transistors, working with other new gallium-arsenide devices, could herald a new era in IC's.

The silicon-nitride, insulated-gate FET, developed at the Radio Corp. of America, has provided 22 decibels gain at 200 megahertz though it wasn't

designed with a high-frequency geometry. Silicon devices with the same geometry give only 16 db gain at the same frequency [Electronics, June 12, 1967, p. 82].

The device channel was made with the hydride vapor technique of J. J. Tietjen and J. A. Amick of RCA Laboratories [details on p. 115]. A thin layer of lightly doped n-type GaAs was epitaxially grown over a p-type substrate and covered with a layer of silicon nitride. After the  $\text{Si}_3\text{N}_4$  was masked and the source and drain sites were etched, tin was diffused into the source and drain sites to provide heavily doped n-type material for use with the contacts, which were then applied over the gate channel region and also over the source and drain sites.

### Fewer surface states

Silicon nitride has a big advantage over silicon dioxide here in that it allows the electric field produced by the gate to penetrate deeper into the GaAs because it produces fewer surface states to terminate the gate field near the surface. This affords greater control of the channel current and a higher transconductance—typically, about 10 to 25 millimhos against silicon's 8 to 10 millimhos. The trans-

these high impedances over large bandwidths is a formidable task, and most designers resort to biasing the diode to reduce its impedance, or to padding the unit; both measures decrease sensitivity.

For high video impedances, the capacitance of the diode junction must be very small—less than 0.2 picofarad for S-band detectors and less than 0.05 pf for X-band.

The Schottky diode detector then must have as small a junction capacitance as possible; a large video impedance; low series resistance; and a Q between 10 and 20 at the operating frequency.

Therefore, the material chosen should have high electron mobility and small dielectric constant, and the diode should be made with a thin, high-resistivity epitaxial layer designed so the space charge of the junction can punch through into the substrate at or near the operating bias.

Epitaxial GaAs is thus an excellent choice. It offers a higher mobility of n-type material than does silicon, and is grown at lower temperatures, an incidental factor that can enhance control of doping in the epitaxial layer and reduce grading of the substrate-epitaxial interface. Too much grading gives a narrower-than-optimum diode space charge and boosts junction capacitance.

Generally, the larger the junction, the better the burnout resistance, but GaAs has less than a quarter of the thermal conductivity of silicon, and these factors tend to offset each other.

Gallium-arsenide Schottky detector diodes are made by depositing one of many possible metals on a clean epitaxial wafer. Nickel and gold are easily deposited, but nickel has a higher eutectic temperature with GaAs (500°C) and therefore a greater resistance to burnout.

The knee of the forward conductance curve depends on the work function of the metal used and on the crystal orientation of the gallium arsenide. The table gives a list of various metals and their barrier heights on planes 111 and 100 in GaAs and silicon; the height doesn't appear to affect sensitivity. All GaAs Schottky detector diodes require bias because the variable conductance doesn't occur near zero bias.

For a typical X-band diode, an n-type epitaxial GaAs layer 0.5 to 1 micron thick with doping of less

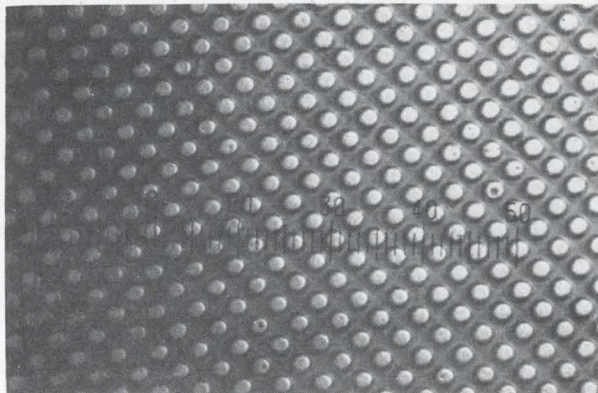

**Pinheads.** Array of Schottky-barrier metal contacts on batch-fabricated GaAs slice.

## Barrier heights of metals

Elemental metal	n-type, GaAs Orientation		n-type Silicon Orientation (111)
	(111)	(100)	
Nickel	0.83	0.70	0.58
Gold	0.99	0.90	0.79
Silver	0.94	0.85	0.62
Tungsten	—	0.73	0.67
Aluminum	0.80	0.71	0.63
Tin	0.70	0.68	0.60
Copper	0.80	0.73	0.58

Note: All heights measured to  $\pm 0.02v$

than  $10^{16}$  electrons/cm<sup>3</sup> is first coated with a layer of aluminum borosilicate glass 2 to 5 microns thick. This glass has a dielectric constant of 3.8 and also matches the thermal expansion of the GaAs well.

After the dielectric layer has been deposited, ohmic contacts are applied to the substrate; sintered gold-tin contacts give low ohmic resistance.

The Schottky diodes are formed by photoetching holes through the dielectric layer to expose the GaAs. The metal is deposited either by vacuum evaporation through a mask or by electrodeposition from a proper solution; there appears to be no difference between diodes made with either process. After the metal-semiconductor junction has been formed, the hole is filled with metal.

Because it's difficult to make the necessary low parasitic capacitance contacts—which should be less than 0.02 pf—a small plated whisker is bonded to the junction. But a junction only 1 micron thick is difficult to contact, so many small junctions are formed and contact is made to one randomly.

## Microwave mixers

The ideal microwave mixer is a multiport device with large-signal and small-signal parameters determined by the variable conductance set up by the local oscillator and the terminations of each port.

The mixer diode's important electrical characteristics are conversion loss, the noise ratio at the intermediate frequency, and the impedances at each of the four ports. The conversion loss depends not only on the impedances presented at each port but on the termination presented to the harmonics of both the signal and local oscillator. However, if the mixer circuit is taken to be ideal, the image is resistively terminated, no signal power is lost in the higher-order harmonics, and the diode's conversion loss depends on signal match and resistive losses.

An ideal mixer diode presents to the signal a time-varying conductance whose average value can fall within a wide range without hurting performance (in contrast to the detector situation). In a typical Schottky diode, the corresponding impedances will be 100 to 300 ohms, depending on the local oscillator drive. The capacitance of the junction tends to shunt this variable conductance. Because its barrier impedance is far lower than a detector's, the mixer

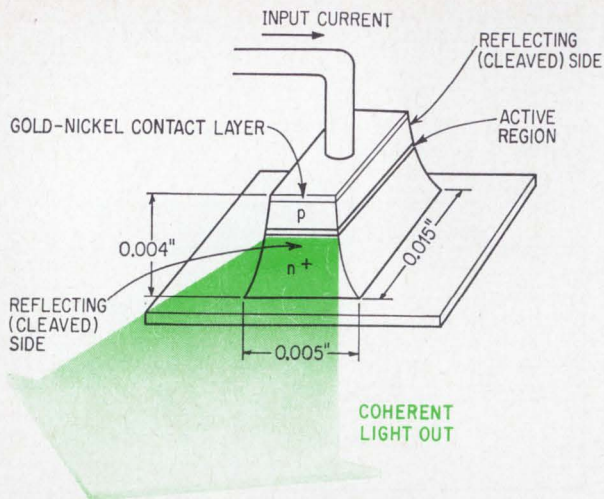

**Flat beam.** Gallium-arsenide injection laser produces coherent light in plane of junction.

fully realized the laser must be operated at the environment's temperature. Today's goal is high pulsed power and continuous operation at 300°K, or at least at temperatures above 100°K, where simple cooling equipment can be used. Limitations on the duty cycle and ambient temperature primarily stem from heating effects within the laser.

Researchers reported, back in 1962, that when a GaAs diode is forward biased, electrons are injected from the n side into the p side, and that—in a region about 1 micron wide—the conduction-band electrons recombine with holes in the valence band and give up their energy as radiated light. The emitted photons have an energy close to the energy separation of the conduction and valence bands—the so-called band gap, which is about 1.4 electronvolts for GaAs at 77°K.

The recombination can occur spontaneously, where individual events are completely uncorrelated, or by a mechanism first proposed by Einstein in 1918—an emission induced by another photon. It's this process of induced emission that leads to the phenomenon of lasing.

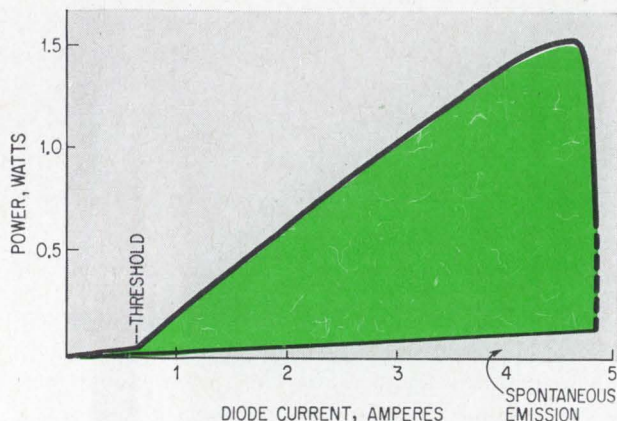

**Laser power.** Stimulated emission region (in color) shows high-power output above threshold.

## Getting in the mode

In a Fabry-Perot structure, a resonant cavity with two parallel reflecting surfaces, the photons that propagate perpendicular to the reflecting sides multiply fastest. When a certain threshold current is reached, they outnumber the photons propagating in other directions. The gain then becomes equal to the losses from absorption inside the cavity and at the partially reflecting end faces, and the diode enters a lasing mode of operation.

During operation, the junction temperature rises because of ohmic power losses within the diode and because much of the stimulated radiation is internally absorbed. The rise in junction temperature increases the threshold current density needed for laser action and thus cuts power output. When this temperature hits a level that boosts the threshold current above the applied diode current, lasing stops.

Much effort is being made to reduce threshold current density—normally about 100,000 amperes per square centimeter—and to make it as independent of temperature as possible. Geometric configurations that reduce ohmic losses and allow effective heat transfer from the junction to the heat sink are being sought.

Progress is reported toward both major goals. By forming the p-n junction with either a double-diffusion process or liquid-phase epitaxial process, the threshold can be lowered by a factor of 4 or 5 at 300°K. Values as low as 26,000 amp/cm<sup>2</sup> have been observed in diodes with a cavity length of 0.38 millimeter.

Despite the progress in high-power technology, continuous operation hasn't been extended much beyond liquid-nitrogen temperatures; typical values are about 3 watts continuous power at 77°K. When pulse operated at room temperature, improved diodes have delivered about 10 watts.

## Declining powers

Laser diodes tend to degrade during operation. There appears to be an irreversible decrease in power output if a certain current density is exceeded, a situation frequently accompanied by a physical chipping of the reflecting surface along the junction line. The cause isn't fully understood.

It was determined early in the laser's history that near-perfect substrates are needed as a starting material. Periodic fluctuations in the doping level due to unstable growth conditions increase threshold current and decrease power output because the losses tend to become larger. Local inhomogeneities due to clusters of defects have a similar effect and are probably responsible for the oft-observed filamentary lasing mode, where only narrow "stripes" in the junction are lasing.

## For more on . . .

Injection lasers: G. Burns, M.I. Nathan, Proceedings of the IEEE, July 1964, p. 770.



antimony alloy.

Recently, light emitters with improved efficiency and stability have been made by vapor-phase or solution epitaxy on bulk-grown substrates. The vapor-phase epitaxial technique [see p. 113] has been used to achieve a controlled degree of compensation and to approximate a graded diffused junction.

Light emitters built of bulk or vapor-phase epitaxial GaAs are processed in an arsenic-rich environment. Different properties are created when the material is grown in a gallium-rich environment by solution epitaxy; more stable and efficient light emitters have been produced in the laboratory with this technique.

A reactor used to fabricate high-purity and heavily doped solution-grown GaAs is on page 129 above. A substrate slice is inserted into a gallium melt saturated at around 900°C with doped or undoped GaAs, depending on the electrical properties desired. Upon cooling, a deposit is formed on the substrate. When group II elements are used for doping the melt, p-type deposits result; n-type deposits are obtained with group VI impurities. Group IV impurities are amphoteric; they lead to either n- or p-type deposits depending on the growth temperature.

The loss mechanisms of spontaneous emitters are different from those of lasers. Laser light exits in the junction plane through surfaces perpendicular to the junction, and light loss occurs because of free carrier absorption, cavity leakage, and transmission through the exit surface. Spontaneous light emission is isotropic and most of the light exits through planes parallel to the junction; losses are caused by bulk absorption, total reflection, and transmission.

Since the optical absorption losses in the bulk are about 10 times greater than the effective losses in the cavity, and since most of the emitted light is reflected back into the material, spontaneous emitter structures are generally less effective than lasers.

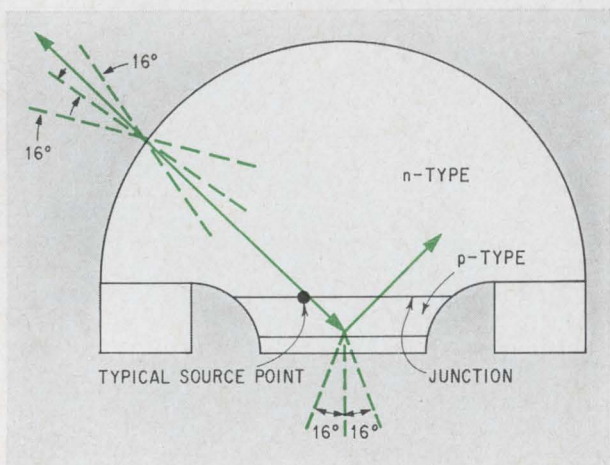

**Light dome.** Hemispherical shape of emitter assures that light falls within angle of transmission.

To offset total reflection losses, spontaneous light emitters have been built with a light-emitting junction embedded into a GaAs hemisphere. If the ratio of the sphere diameter to the junction diameter is equal to the dielectric constant of GaAs—about 12—no total reflection losses occur. Although absorption losses increase because of the longer light path in the crystal, the dome structure improves efficiency by about an order of magnitude.

Another way to improve external efficiency is to reduce the absorption losses. Because n-type GaAs doesn't absorb light originating at the p-side of the junction as much as p-type GaAs does, the n-type material is used for the dome structure. Solution-grown junctions doped amphotericly with silicon emit light at 1.33 eV, about 0.1 eV below the band-gap energy. In this energy range, the absorption is considerably reduced.

The average efficiency of a planar light emitter in bulk-grown GaAs is about 0.2% at room temperature. The efficiency of a dome-structure device of the same material would be about 2% and that of the best solution-grown diode with a hemispherical exit surface is 20%.

The light emitter's efficiency can also be increased by an antireflection coating with a dielectric such as silicon monoxide to increase the transmissivity of the GaAs-air interface. If the losses due to total reflection bulk absorption are cut, the external efficiencies of lasers and spontaneous emitters should be about comparable. Laser differential quantum efficiencies of up to 40% have been reported for pulse operation.

The fact that efficiency generally increases at lower temperatures has never been completely explained, but contributing factors are reduced absorption, increased injection efficiency, and decreased radiative lifetime. Efficiencies of 45% at 77°C have been reported for dome structures in bulk-grown GaAs.

Laser efficiency isn't linked to temperature to any pronounced degree. Differential laser efficiencies of 50% at 77°K have been measured. The threshold current for lasing, however, depends to a large extent on temperature. Typical values are 10,000 amp/cm<sup>2</sup> at 25°C, 1,000 amp/cm<sup>2</sup> at 77°K, and 100 amp/cm<sup>2</sup> at 4°K.

## Applications

Spontaneous emitters will probably be the first volume-produced GaAs devices. The two areas where these light sources are most likely to have an impact are data processing and, with GaAs-GaP alloys, indicator lamps. In both fields, solid state light emitters are superior to conventional units in both efficiency and reliability.

Miniature card-reader light sources have delivered 30 milliwatts per ampere total output in a 20° solid angle, and about 15 microwatts of radiant power into a 2.5° solid angle for a diode current of 50 milliamperes. To focus the light, the dome-shaped GaAs emitter is placed in a reflector package. The dimensions of the package, 120 mils diam-

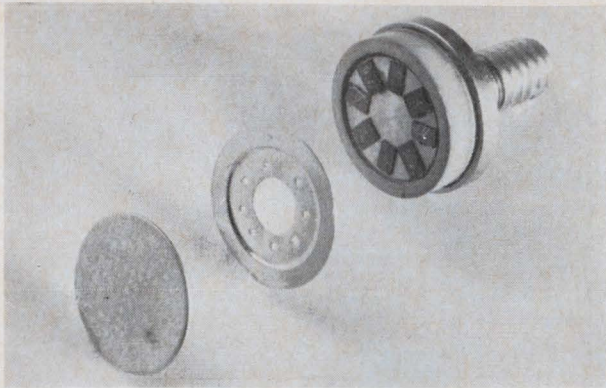

**High power.** Parallel assembly of Gunn-effect diodes boosts power output.

panies are claiming powers up to 200 mw.

In pulsed research, experiments at Varian have produced 615 watts at 1,100 Mhz. However, the oscillator was restricted to a very low duty cycle because it used crystals grown from the melt by the horizontal Bridgman, or boat-grown, process. Although this technique produces good crystals, they have too much carrier compensation for practical applications.

The highest pulsed powers using epitaxial material are those reported by Radio Corp. of America—143 watts peak at 2,200 Mhz. Also reported by RCA was a device showing 24% efficiency at 112 watts, 1,900 Mhz. This high efficiency was attributed to a controlled doping profile. The RCA investigators also reported stability of both power and frequency against wide temperature excursions.

Commercial devices, however, are still rare. Although several companies are actively developing experimental Gunn diodes, the only ones being offered for sale are by Mullard (5 mw at X band) and Texas Instruments (10 mw at X band).

### No compensation

The desired doping level for Gunn effect is about  $10^{15}$  atoms/cm<sup>3</sup>. This is less than one part in  $10^7$ , and cannot be achieved in boat-grown material. Thus, the needed high-resistivity n-type GaAs (anything lower than about  $5 \times 10^{15}$ /cm<sup>3</sup> in doping density) must be made by compensating the shallow donors, close to the conduction band with acceptors, and allowing the deep donor levels to provide the active electrons. But—because the deep donors are not fully ionized at room temperature—the semiconductor carrier density is sensitive to temperature and can be effectively used only in research applications.

A practical device must be able to operate over a wide ambient temperature range; this alone would rule out compensated material. Even more critical is the fact that compensated material, whose conductivity increases as temperatures increase, will cause thermal runaway and device destruction under modest thermal stress. For example, the impressive data on pulsed LSA devices

of boat-grown material applies only to pulse lengths of 100 nanoseconds. Microsecond pulses would probably tell a different story—thermal runaway and a short-circuiting conductive channel.

### Keeping pure

More success has been achieved with epitaxial GaAs where the crystal grows in a pure environment at temperatures from 650° to 850°C and the required purity can be held. Purity cannot be held at the melting temperature of GaAs (1,242°C) needed in the boat-growing procedure.

Vapor epitaxy, in which the gallium and arsenic are transported independently to a GaAs substrate, has been used with success for thin layers for several years, but the process is being worked at its limits to achieve the needed purity for Gunn diodes. More recently, there has been renewed interest in growth from a liquid (usually gallium) solution which may offer better control of purity.

A typical Gunn-effect oscillator designed to deliver 20 mw at X band requires a layer of GaAs, grown epitaxially on a highly doped substrate, which is about 10 microns thick, homogeneous in doping level to perhaps 20%, and with an average doping level between 0.5 and 2 times  $10^{15}$  carriers/cm<sup>3</sup>.

Many wafers of material with these specifications have been fabricated in a large number of laboratories, yet the yield and controlling process variables are but slightly understood. The saving factor is that the active device is only 0.1 mm across, and it is conceivable that one square centimeter of good material could make 10,000 useful 20-mw oscillators.

The homogeneity problem is even worse with pulsed devices. Pulsed devices require larger areas of gallium arsenide than c-w devices to withstand the higher voltages. For example, an oscillator to deliver 1,000 watts peak at 1,000 Mhz would ideally use about 0.2 cm<sup>2</sup> of material homogeneously doped to  $2 \times 10^{14}$  donors/cm<sup>3</sup>. It may take another two years to refine the processes enough to do this.

### Making contact

Most good ohmic contacts to GaAs fall into two general classes—alloy and epitaxy. Much of the early work with Gunn effect was done with alloyed tin contacts. These seem to give good performance, but are not suitable for operation at elevated temperature, and under some conditions they show fairly rapid degradation. More recently, alloy combinations such as gold-tin, gold-germanium, silver-indium-germanium, tin-nickel, and many others have been reported.

The liquid epitaxy process for growing contacts consists of saturating a pool of liquid tin with GaAs, allowing the mixture to envelop the GaAs wafer and cool a few degrees before removing it. The result is that a thin layer of GaAs, heavily doped with tin, grows on the surface of the wafer. This heavily n-type surface layer may then be easily contacted by almost any metal.

# Bulk-effect boosting

By Hartwig W. Thim

Bell Telephone Laboratories, Murray Hill, N.J.

**Solid-state amplifiers** have been catapulted into the millimeter-wave range by gallium arsenide's negative resistance properties. Studies on these new bulk-effect amplifiers are too recent to say with certainty how practical and widely used they may become. But the signs are good; bulk-effect amplifiers, like bulk-effect oscillators, offer the promise of simple, low-cost devices, competitive with transistor amplifiers which have had tough going at microwave frequencies. Tunnel diodes, the only other solid-state microwave amplifier, could be easily outclassed since they can produce only about a hundredth of a percent of the power available from bulk-effect amplifiers.

Bulk-effect amplifiers can be considered as three basic types:

- The stable amplifier, which has been operated up to 50 gigahertz.
- The traveling-domain amplifier, which has delivered 100 milliwatts at 6 Ghz.
- The unilateral traveling-wave amplifier, which has been operated at 0.1 mw at 1 Ghz.

## Stable amplifier

Developed in 1965 at Bell Telephone Laboratories, the stable amplifier—also called a subcritically doped amplifier—uses a GaAs wafer whose product of doping and length,  $n_0L$ , is less than  $10^{12}\text{cm}^{-2}$ . This restriction is necessary to prevent Gunn-type oscillations, since the crystal is too short and too lightly doped for the domains to form.

A bias field of several thousand volts per centimeter is applied across the short wafer with only about 20 volts needed to set up this high field. The result is that electrons injected from the cathode are decelerated on their way toward the anode because of the differential negative mobility. A nonuniform field—low at the cathode and increasing across the device toward the anode—builds up and becomes stable after one transit time. The differential d-c resistance is positive, but an applied a-c signal will see a negative resistance at frequencies corresponding to the integral multiples of the transit time. For the 50-micron wafer, the transit time is 0.5 nsec, and the frequencies for negative resistance are 2 gigahertz, 4 Ghz and so

forth, up to the millimeter-wave region.

For a three-terminal amplifier circuit, the wafer is mounted in a conventional reflection-type circuit that has a broadband circulator. The incident signal enters port 1 of the circulator, exits at port 2 to the GaAs wafer, is amplified and then reflected back to the circulator and into the load resistance connected at port 3.

For a typical wafer, about 50 microns thick, the gain peaks at 10 decibels at 4 Ghz, the second harmonic of the fundamental transit-time frequency. Gain can be increased by adjusting the characteristic impedance of the transmission line to a value close to the negative resistance of the diode. However, the maximum output power per unit cross section is restricted by the limitation on the  $n_0L$  product. These subcritically doped amplifiers have achieved saturation levels in the order of 1 milliwatt and efficiencies of about 0.1%.

## Traveling domain

The traveling-domain amplifier uses the negative resistance property of traveling high-field domains in Gunn oscillators. Such domains exist only in wafers with  $n_0L$  products greater than  $10^{12}\text{cm}^{-2}$ . Because of the cyclic formation and disappearance of the domains at the contacts, this amplifier, in contrast to the stable amplifier, oscillates at the transit-time frequency while amplifying at some other frequency.

The only difference between the circuits of the stable amplifier and the traveling-domain amplifier is that in the latter a resonant cavity is connected to the coaxial line close to the GaAs wafer to act as a short circuit for the Gunn oscillations. The length of the cavity is thus an integral number of wave-lengths at the transit-time frequency of the Gunn oscillations, and the signal circuit is decoupled from the oscillator circuit, reducing parametric effects.

The traveling-domain amplifier is linear until the output power approaches the power available from the same device when operated as a Gunn oscillator. The maximum output power obtained from a traveling-domain amplifier was 0.1 watt, the efficiency 1%. The upper frequency limit was 11 Ghz, slightly higher than the transit-time fre-

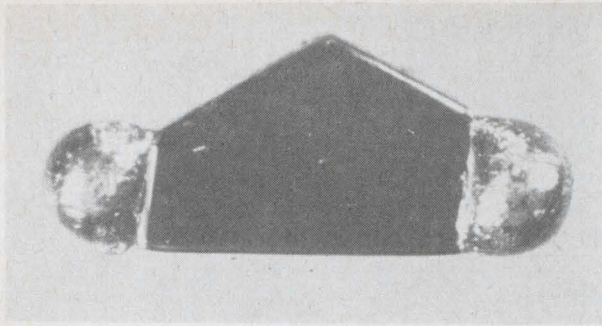

**Current generator.** Peaked shape of gallium-arsenide sample is reproduced in the output current waveform.

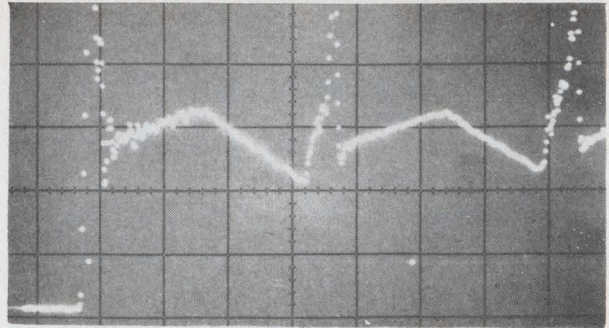

**Current wave.** Pulses, shown on sampling scope, were produced by a GaAs bulk generator of the type at left.

thick, and ground carefully to desired shapes. The pieces then were cleaned, etched, and alloyed with pure indium contacts.

Another basic type of bulk-effect pulse generator employs contacts placed along the path of the domain to produce extra pulses at any point in the cycle. The contact is separated from the bulk material by a layer of high-resistivity material, an oxide formed by exposing the surface to air for several days. The oxide allows extra current to flow around the domain as the domain passes under it, and this shunt current appears in the output at a point corresponding to the position of the contact. When the domain reaches the anode, it delivers its normal current pulse to the output circuit.

#### Controlled pulses

The extra current pulse in the high-resistivity region can be switched in and out of the cycle with a switch connecting the contact to ground. The cur-

rent can then be shunted to ground and won't appear in the output.

Samples operating in this way were made of n-type GaAs with concentrations of  $4$  to  $7 \times 10^{14}/\text{cm}^3$ . A typical size was 40 mils long, 20 mils wide, and 20 mils thick. Pure indium contacts were alloyed to the ends, and the samples were exposed to air for from two to 60 days to oxidize the surface. Silver paint contacts then were applied to the surface to form the control electrodes.

Many applications are possible. For one, a multi-contact device could perform logic, and, if the switches on the external current paths were replaced with photoconductive material, could be used as an image scanner.

#### For more on . . .

Waveform generators: M. Shoji, Proceedings of the IEEE, May 1967, p. 720.

Current pulse generators: M. Shoji, Proceedings of the IEEE, May 1967, p. 710.

Advanced technology V

## Over the horizon: gallium arsenide IC's

By Edward M. Mehal

Texas Instruments Incorporated, Dallas

**Indicative of today's** fast-paced technology is the fact that gallium-arsenide integrated circuits are being developed right along with the discrete devices. Although the additional fact that these IC's cost more than their silicon counterparts and are harder to fabricate will generally limit them to a

few special jobs, they do have a clear field in two areas—the microwave and the optoelectronic. The microwave GaAs IC may be with us soon; the optoelectronic IC is farther off.

The key to monolithic gallium-arsenide circuits is the semi-insulating form of GaAs. This material

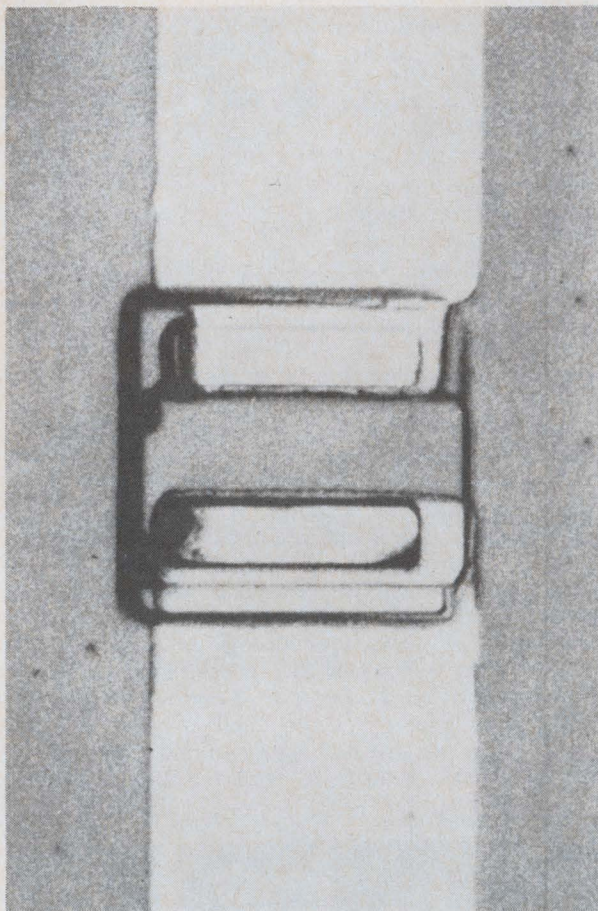

**Gunn oscillator.** Planar device designed for use in 94 Ghz microwave-receiver integrated circuit.

provides a single-crystal matrix for the epitaxial growth of GaAs devices and affords excellent electrical isolation between components.

The basic building process sounds simple: pockets are etched in a wafer of semi-insulating GaAs to accommodate active devices, semiconducting GaAs is epitaxially grown in these pockets, and a layer of metalization is added to interconnect the devices with microstrip transmission lines. Of course, there are practical problems—how to get the semi-insulating GaAs, etch clean-cut holes, and grow pure epitaxial layers.

### Fabrication

The first step in the process is to orient the GaAs semi-insulating substrate to a 111 surface and then to chemically polish the surface to remove any defects. As a mask, a silicon dioxide film about 0.3 microns thick is applied externally by sputtering or chemical deposition methods; the best method found at Texas Instruments is the thermal oxidation of tetraethylorthosilicate (TEOS).

Next, the pockets delineated by the  $\text{SiO}_2$  mask are etched out. Most of the common etching techniques produce holes with irregularly shaped bottoms, due to greater etching around the periphery of the hole. But this effect has been eliminated with a hydrogen peroxide-sodium hydroxide solution

that's reaction-rate limited rather than diffusion-rate limited and yields an etched hole with a planar bottom.

Care must be taken when semiconducting GaAs is deposited in the pockets; if these depositions project above the surface, masking will be upset. Pockets of different dimensions must therefore be filled separately to minimize overgrowth in the smaller ones. Regions with overgrowth of less than 1 micron have been achieved on 111-oriented substrates. The semiconducting GaAs used has a fairly low impurity content—around  $1 \times 10^{15}/\text{cm}^3$ —and can be controllably doped with sulfur or tin to produce the required n-type carrier concentration for the devices.

### Possible components

Planar bipolar transistors that could possibly be used in integrated circuits have been fabricated by Wilhelm von Muench of the International Business Machines Corp. lab in Boeblingen, Germany. He used one selective deposition of n-type GaAs into semi-insulating GaAs, and formed base and emitter regions by planar diffusions. Field effect transistors also have been fabricated on semi-insulating GaAs substrates, and these too might find employment in integrated circuits.

Microwave circuitry has been the principal area of application. Gunn oscillators and Schottky-barrier diodes made in planar form with selective deposition techniques are now being combined into microwave IC's.

The planar Gunn oscillators, which have operated at up to 28 Ghz, require three selective depositions of GaAs—two  $n^+$  regions for contacts, and an  $n^-$  area as the active region.

An IC for the front end of a 94-gigahertz microwave receiver is being built at TI under a contract from the Air Force Avionics Laboratory, Wright-Patterson Air Force Base, Dayton, Ohio. It consists of a Gunn oscillator in a resonant circuit operating at about 31 Ghz; a tripler circuit that converts the 31-Ghz Gunn oscillator signal to 94 Ghz to serve as the local oscillator source; and a balanced mixer using two Schottky-barrier mixer diodes.

### For more on . . .

Selective epitaxial growth: E.W. Mehal, R.W. Haisty, D.W. Shaw, *Transactions of the Metallurgical Society of the AIME*, March 1966, p. 263.

Etching planar-bottom holes: D.W. Shaw, *Journal of Electrochemical Society*, 1966, p. 958.

Planar bipolar transistors: W. von Muench, H. Statz, A.E. Blakeslee, *Solid State Electronics*, 1966, p. 826.

Planar field-effect transistors: W.W. Hooper, W.I. Lehrer, *Proceedings of the IEEE*, July 1967, p. 1237.

Schottky-barrier diodes: T.H. Oxley, J.G. Summers, *Gallium arsenide—Institute of Physics and Physical Society Conference Series No. 3*, 1967, p. 138.

Reprints of this report are available at \$2.00 each.  
© Copyright 1967, Electronics® A McGraw-Hill Publication

# Suitcase-size memory for longer space trips

Employment of pulse techniques and MOS transistors results in a portable computer storage that dissipates only 3.5 watts, reducing power requirements and stretching mission times

By Dewey E. Brewer

Wright-Patterson Air Force Base, Dayton, Ohio

and Samuel Nissim and George V. Podraza

Bunker-Ramo Corp., Canoga Park, Calif.

**Just as a businessman** steps off a plane with attaché case in hand, so may an astronaut someday step out of a spaceship, onto the moon or Mars, carrying a computer. The idea isn't far-fetched. A portable memory dissipating only 3.5 watts and designed to fit into a 21-inch suitcase is now being evaluated by the Air Force for various classified applications.

The memory is the first of what is expected to be a whole family of complex digital equipment, each unit of which will dissipate only a small amount of power—provided perhaps by a self-contained battery—and will be portable.

Development of integrated-circuit technology from gate to function to system levels has reduced the cost of such assemblies, and the amount of power they require. A production run of memory systems based on the prototype design would perhaps cost as little as 10 cents per bit in 1972, and might dissipate even less power if individual transistor tolerances were tightened. The 10-cents-a-bit level is about the price of present conventional magnetic memories.

At such costs, semiconductor memories would be competitive with conventional types made of ferrite cores or thin films, particularly in such sophisticated applications as associative memories, scratchpads, input-output buffers, and index registers. And low power dissipation would give semiconductor circuits the edge in aerospace applications, where the weight of power sources is always a problem. Ferrite cores need high driving power, and the thin films' small output signals demand

complex sense amplifiers that also require high power.

## Cutting power

Power reduction was at least as important a consideration as size in the development of the memory. Designers concentrated on the memory rather than on an entire computer, because the memory subsystem dissipates 40% to 60% of the total power in present aerospace computers. Paring memory power requirements could, therefore, significantly reduce over-all power requirements and the weight of power supplies, thereby extending mission times. Low power dissipation was emphasized at the expense, where necessary, of other parameters such as size and weight; a little extra weight devoted to power conservation, it was reasoned, can save many times more weight in power supplies.

The prototype model in the suitcase is a random-access memory suitable for production at reasonable cost. It has 1,024 words of 30 bits each, built with metal oxide semiconductor transistor arrays for storage, and bipolar transistors for the peripheral accessing circuits. It provides nondestructive readout with an access time of 0.7 microsecond, and a full read or write cycle of 1 microsecond.

The designers chose these integrated circuits because pulsing permits MOS flip-flops to be operated at a very low power level, and because MOS is well suited to low-cost large-scale integration. The bipolar devices used in address decoders,

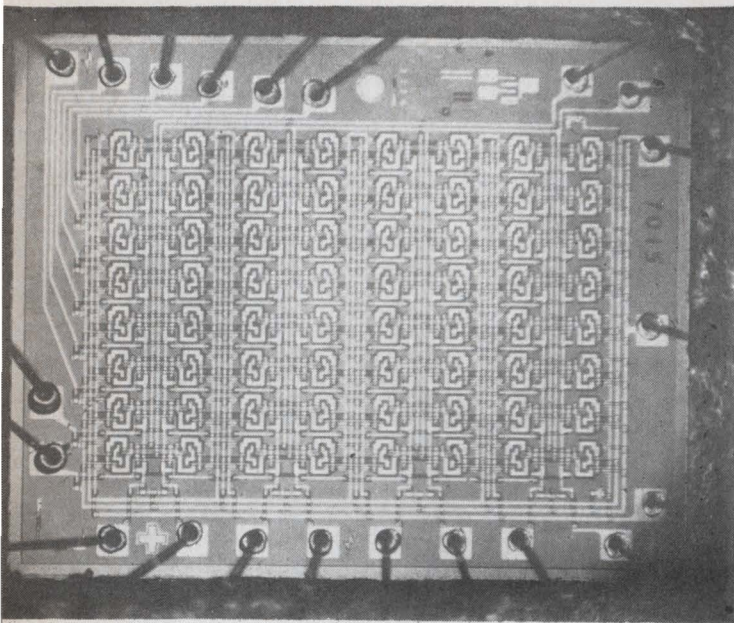

**Memory chip.** The 64 individual cells are easily discernible in this microphotograph.

x-address line is common to all the cells in a single row of a chip, and one y-address line is common to all the cells in a column. Therefore, one x-address and one y-address pulse select a single cell on the chip. The y-address opens the gate of  $Q_7$ , applying the negative level of the x-address to the gates of  $Q_5$  and  $Q_6$  and turning both transistors on.

To read data from the cell, both digit lines are kept at or near ground. Assume that  $Q_1$  is conducting and  $Q_2$  is off. When  $Q_5$  and  $Q_6$  turn on, current from  $Q_1$  flows into the corresponding digit line through  $Q_5$ ; no current flows through  $Q_6$  because the drain of  $Q_2$  is already at ground. A differential amplifier of them is receiving the current, and thereby connected to the digit lines senses which senses the state of the addressed cell.

To write data in the cell, a positive-going pulse is applied to one of the two digit lines while the other remains at ground and while  $Q_5$  and  $Q_6$  are on. If, for example, this positive pulse appears at the source of  $Q_6$ , it is transmitted to the drain of  $Q_2$  and thence to the gate of  $Q_1$ , which, if previously conducting, turns off. The drain of  $Q_1$  discharges to ground through  $Q_5$  and the other digit

line, and this ground level then turns on  $Q_2$ , reversing the states of the bistable elements.

The monolithic chip shown in the microphotograph at left measures 80 by 100 mils and contains 64 memory cells. These cells contain one bit in each of 64 different words. Thus 30 of the chips can store 64 full 30-bit words, and 16 sets of 30—480 chips altogether—give the 1,024-word capacity of the memory. Each chip is mounted in an individual 22-lead flatpack.

### Pro and con

The addressing method employed is similar to the coincident-current technique common in magnetic memories except that the MOS array uses coincident voltages. The MOS memory has a number of advantages over magnetic memories; for one, it requires simpler peripheral circuitry because its inherently non-destructive readout makes it unnecessary to regenerate stored data after reading it out. The relatively high-amplitude read-out signals from the array and high signal-to-noise ratio of the output also simplify the peripheral circuits. Nevertheless, the memory's power dissipation is mostly in the peripheral circuits, not in the storage elements, as in magnetic memories.

Volatility is the principal disadvantage of the MOS memory, as compared with magnetic memories. Even momentary loss of power invariably causes loss of data. This difficulty is somewhat offset by the low power consumption, which makes an auxiliary battery source practicable to prevent data loss.

Also, the MOS memory cannot be used at temperatures over 60°C., nor unshielded in the presence of nuclear radiation.

### Mad but methodical

The 1,024 words in the memory are addressed by 32 x-address lines and 32 y-address lines; one of each can locate any single word. However, each bit of the word is on a separate chip, so that each address line must be connected to 30 different chips. This leads to a rather complicated routing of the address lines.

The easiest way to visualize the routing is by analogy with a conventional three-dimensional memory. Such an organization contains 30 planes, stacked vertically, with 1,024 bits—one bit of each

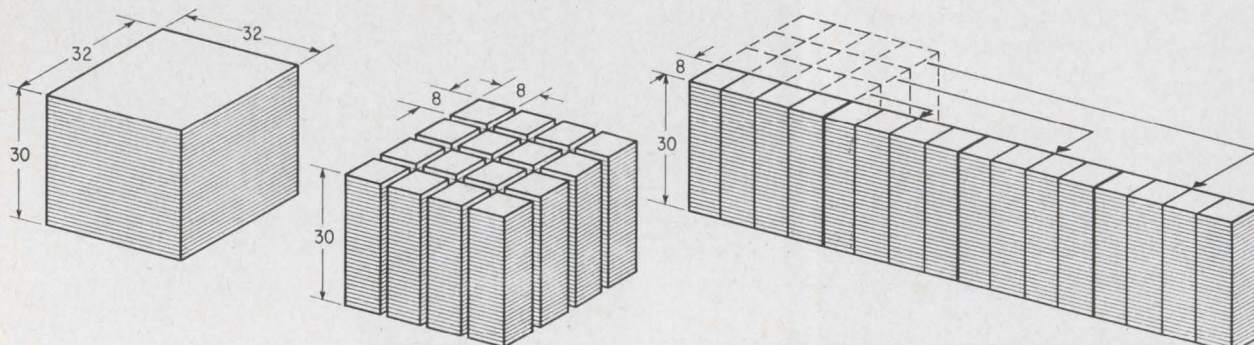

**Rearrangement for routing.** The array of low-power monolithic chips can be handled conceptually by dividing the conventional 3-D array into 16 parts, lining them up and spreading them out on one plane.

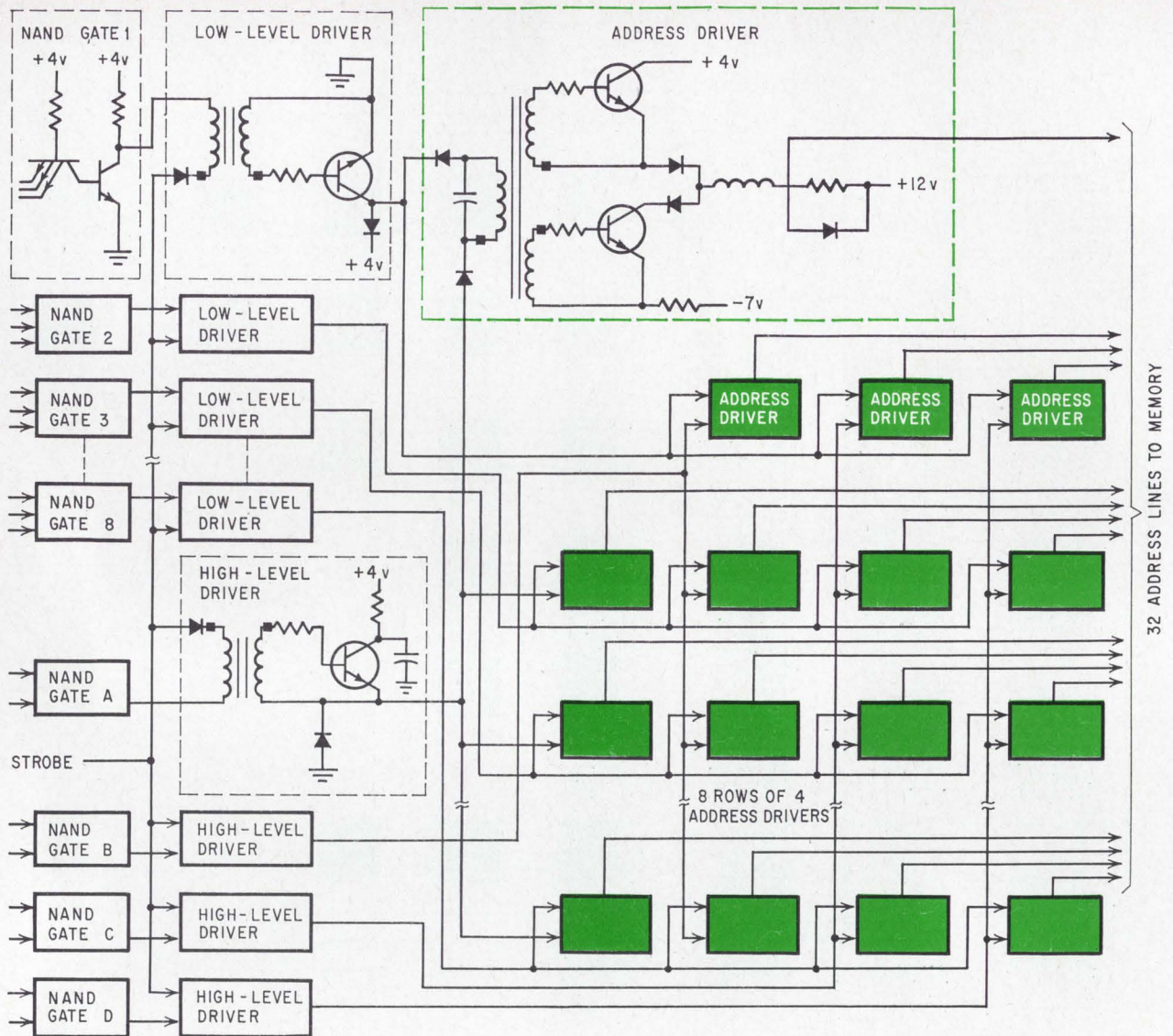

**Address decoder.** A matrix arrangement translates five bits from the memory exerciser into 32 address lines that locate a specific word in the memory. A new inductive line driver circuit reduces the power dissipation [see detailed schematic diagram on page 145].

drivers, sense amplifiers, and timing circuits. The feasibility model also contains a memory exerciser (in the same suitcase!), which supplies write data and checks read data for errors.

The 1,024-word capacity requires a 10-bit address, which is divided into two five-bit parts, one for *x* and one for *y*. A common pair of digit lines connects all 1,024 memory cells corresponding to a specific bit in each word. One or the other digit line is pulsed by the write driver when data is being written, and current on one or the other digit line is picked up by the sense amplifier during a read operation. Write and read strobe signals activate the corresponding circuits during the respective operations, so that data being written does not pass through into the sense amplifiers.

#### On the periphery

Two identical address decoders generate the *x* and *y* signals for addressing the memory. The

memory exerciser transmits 10 bits and their complements to the decoders—five bits to each decoder. In the decoder, eight NAND gates—standard commercially available integrated circuits—decode three of the five bits, and four other NAND gates decode the other two. A given address actuates one high-level and one low-level matrix driver, which together select a single address driver out of a 4-by-8 matrix of address drivers; the low-level driver is actually only a ground return for the high-level driver. The address driver generates a signal on one of the 32 address lines.

The memory exerciser transmits the data to be written into the memory, each bit with its complement, on 60 lines to the write drivers, and the write command signal activates those drivers that have binary 1 inputs, placing the signal on the corresponding digit lines.

In the driver's quiescent state, transistor  $Q_4$  is conducting, as in the schematic opposite, ground-



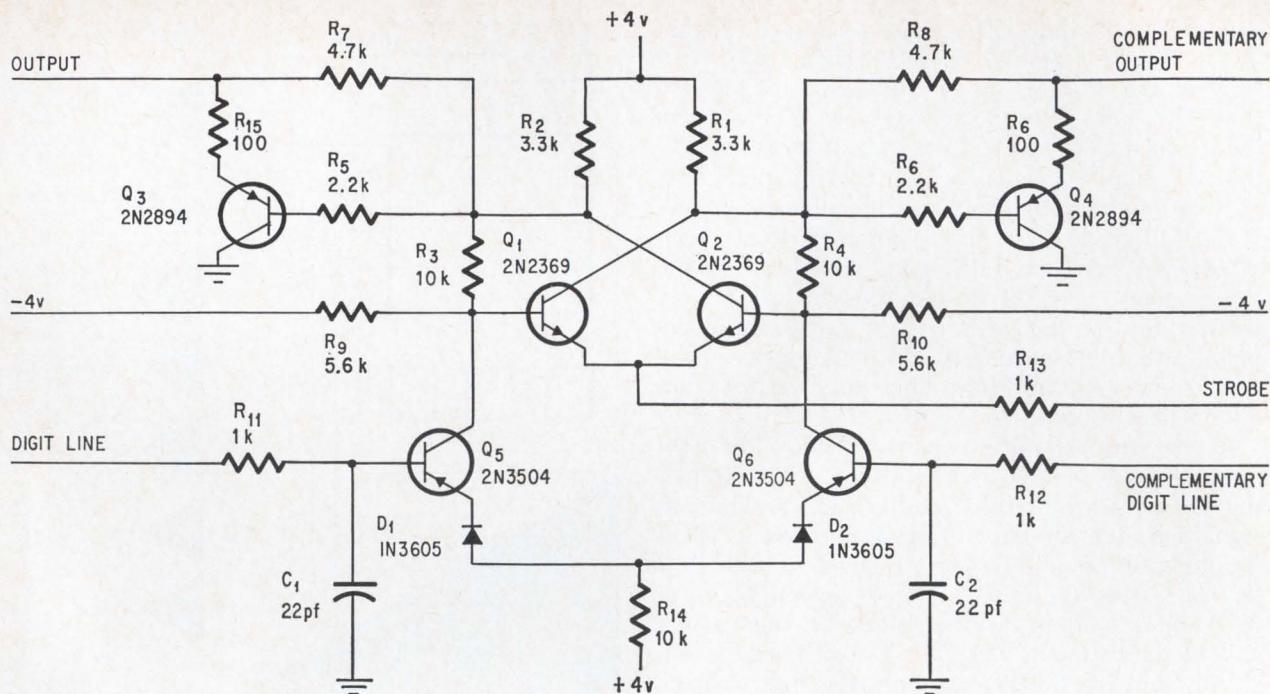

**Sense amplifier.** In the absence of a strobe pulse, this circuit is completely "off." A current differential on the two digit lines biases the flip-flop in the center, and the strobe sets the flip-flop in one of its two stable states, establishing the two complementary outputs.

occur if a restore pulse were applied simultaneously to the entire memory, the memory is divided into eight sections that receive a pulse one at a time in rotation. A self-contained restore clock, asynchronous to the rest of the system, steps a three-stage counter and, following each count, delivers a pulse to one of the eight drivers in an order determined by a decoder. The restore pulse driver circuits are quite similar to the address drivers.

Timing control is done entirely by integrated monostable multivibrators.

### Pack it in

The mos storage elements are packaged on both sides of two multilayer printed-circuit boards, each 12 by 14½ inches; a third board carries the x-address decoder and the restore generator, and a fourth carries the y-address decoder and control circuits. All these boards are mounted in one end of the bottom of a Samsonite suitcase; the power supply is in the other end of the bottom. The memory exerciser is mounted at the top and connected to the memory by two connectors. An external computer could also operate the memory through these connectors.

The total measured power of the assembly is 3.4 watts, when the ratio of write to read operations is 3:10, the clock rate is 1 megahertz, and temperature is between 0° and 60° C. Continuous writing of data that repeatedly changes the state of every storage element in a word requires considerably more power than continuous reading, of course. Such continuous writing involves the active driving of many circuits rather than merely the detection

of their various states.

The memory array itself dissipates slightly less than 1 watt, thanks to the restore-pulse technique. The exact figure is 930 milliwatts, or 30.3 microwatts per cell. Another 0.7 watt is dissipated in the 64 address driver circuits, of which only two are in operation at any one time; the smallness of this amount reflects, to a large extent, the special switching circuits.

The technique for cutting the dissipation can best be understood by comparing it with the straightforward driving technique. The address, digit, and restore lines in the memory array present relatively large capacitive loadings to their respective driving circuits. The energy,  $W$ , stored in this distributed capacitance is

$$W = \frac{1}{2}CV^2$$

where  $C$  is the total capacitance in farads and  $V$  is the voltage across the capacitance.

The energy stored in charging the capacitance is, of course, returned when the capacitance discharges, because the capacitance itself ideally dissipates no energy. However, energy equal to that stored is dissipated in the resistance through which the capacitance is charged (to demonstrate, square the exponential expression for the current in an RC circuit, multiply by  $R$ , and integrate), and this amount of energy is dissipated in both the charging and discharging processes. Therefore, the total amount of energy dissipated in a single charge-discharge cycle is

$$W = CV^2$$

Power is the average rate of energy dissipation

and  $V_1$  must therefore be of greater magnitude than  $V_2$  to compensate.

The address driver, shown at the bottom of page 145, embodies the design principles illustrated in the idealized example. The line capacitance is initially charged to +12 through resistor  $R_4$ . The primary of the transformer is shunted by a capacitor that balances the stray capacitance of the network when the high-level driver is actuated and the low-level driver is not. When the high-level driver turns on, therefore, the voltage appears across the transformer, turning on transistor  $Q_2$ .

The saturated transistor connects the line capacitance through inductance  $L_1$  to the -7-volt supply, and the resonant circuit begins to oscillate. But after only half a cycle, diode  $D_4$  becomes reverse biased, thus effectively disconnecting  $Q_2$  from the output.

When the high-level driver turns off, the transformer input voltage drops quickly, turning on transistor  $Q_1$ . (Observe the polarity marks on the transformer windings.) The line capacitance charges up to its initial level through  $Q_1$ .

When circuit losses and semiconductor voltage drops are considered, the parameter values shown provide a 26-volt negative pulse on the address lines. The angular frequency given by a 2.7-microhenry inductance and 1,500-picofarad capacitance is  $15.8 \times 10^6$  radians per second, corresponding to address-pulse rise and fall times of about 0.2 microsecond each.

The same technique is also used in the restore drivers, but not in the write drivers. The high digit line capacitance would have made additional power supply voltages necessary for an inductor-and-switch circuit. But the write drivers normally contribute very little to total system power because of their low duty cycle.

The sense amplifiers dissipate very little power because they are essentially shut off in the absence of any input signal or strobe.

### Up the road

Advanced as this memory system is, further improvements are in sight. The list includes:

- **Complexity.** About four times the number of bits could be built on a single chip with today's technology if a tenth the speed of the present low-power memory, or less, is permissible. With such a design, the same flatpack could also contain peripheral and restore-pulse circuits.

- **Speed.** When metal-over-metal crossovers are developed to the point where they can replace the present junction crossovers, they will afford either double the speed or double the density of the present chip, and could permit a substantially reduced restore-pulse duty cycle. Complementary MOS devices could boost the present model's speed by a factor of 10 or more.

- **Power.** A lower-frequency restore pulse would reduce power dissipation even further, and by a significant amount.

- **Cost.** Volume production is bound to bring it

down. Duplicating the present model would cost something over \$2 per bit. A production run of 1,000 systems would cost perhaps 50 cents per bit.

- **Size.** Larger memories following the present design could be easily made by adding flatpacks. The limiting factors would be reduced readout signal-to-noise ratio because of crosstalk, and the additional capacitance on the digit lines, with the resultant loading on the driver circuits. The size of the present memory could probably be double or quadrupled with only minor modifications—new shielding, new inter-connection boards, an 11-bit decoder, and perhaps a bigger suitcase. Memories larger than 4,096 words are practical, but would require multiplexed driving and sensing circuits, and would therefore dissipate somewhat more power per bit.

### Bibliography

R. Lee, "Electronic Transformers and Circuits," John Wiley & Sons, New York, 1955, pp. 298-302.

Harley A. Perkins and Jack D. Schmidt, "Integrated semiconductor memory system," AFIPS Conference Proceedings, Vol. 27, Part 1 (Fall Joint Computer Conference), 1965, p. 1,053.

J.R. Burns, J.J. Gibson, A. Harel, K.C. Hu, and R.A. Powlus, "Integrated memory using complementary field-effect transistors," Digest, International Solid State Circuits Conference, 1966, p. 118.

I. Catt, E. Garth, and D.E. Murray, "A high-speed, integrated-circuit scratch-pad memory," AFIPS Conference Proceedings, Vol. 29 (Fall Joint Computer Conference), 1966, p. 315.

Ryo Igarashi and Toru Yaita, "An integrated MOS transistor associative memory with 100-nsec cycle time," AFIPS Conference Proceedings, Vol. 30 (Spring Joint Computer Conference), 1967, p. 499.

G.V. Podraza, S. Nissim, and D. Brewer, "A low-power MOS monolithic memory array," Digest, First Annual IEEE Computer Conference, 1967, p. 87.

Dewey E. Brewer, Sam Nissim, and George V. Podraza, "Low-power computer memory system," to be presented at the Fall Joint Computer Conference, 1967.

### The authors



Dewey Brewer joined the Air Force Avionics Laboratory in 1962 and has since worked mostly on memory devices and systems. Previously he worked for the Martin Co. in Orlando, Fla., designing ground-support equipment for the Pershing missile system.



Sam Nissim is the manager of advanced computer development in Bunker-Ramo's information technology laboratory. Before 1964, he worked in the computer division of Thompson Ramo Wooldridge Inc., Bunker-Ramo's corporate predecessor.



George Podraza is a staff consultant specializing in circuit and hardware design. He has been with Bunker-Ramo since 1963, coming from the Martin Co. in Baltimore.

# TUNG-SOL 28 GP SERIES POWER SUPPLIES

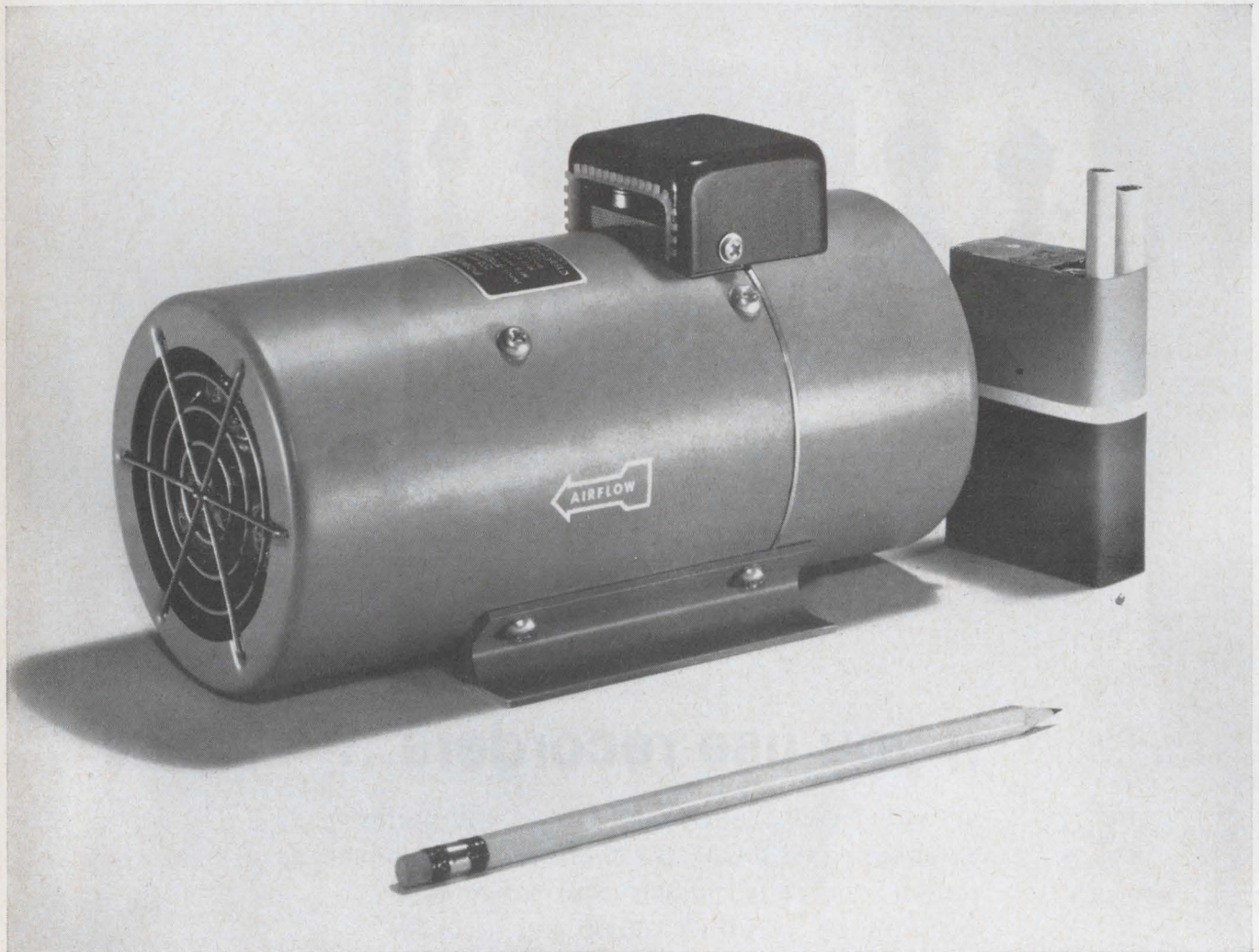

## up to 400 AMPS. D.C. in new weight-saving package

A tremendous break-through was achieved in space and weight reduction of air-borne power supplies when the Tung-Sol Y-series configuration was first developed. Now, this unique design has been adapted to the requirements of ground-based equipment, to provide the same advantages for applications in the 100 amp. to 400 amp. range.

The Tung-Sol 28 GP series consists of four standard units that supply 100, 200, 300 or 400 amps. at 28 volts D.C. from an input of 115 volts, three phase, 400 c.p.s. They are production items available on an off-the-shelf basis. All units embody high-performance characteristics. They have high environmental adaptability and are especially suited to seaborne installations. Important, also, is the fact that they can be mounted in any attitude. For air transportable equipment, the weight factor is an exceptional advantage.

<p><b>28 GP 100</b></p> <p>Output: 100 Amps. Size: 8½" L x 4" W x 5⅝" H Weight: 7.5 lbs.</p>	<p><b>28 GP 300</b></p> <p>Output: 300 Amps. Size: 10½" L x 6" W x 7½" H Weight: 19 lbs.</p>
<p><b>28 GP 200</b></p> <p>Output: 200 Amps. Size: 10½" L x 5" W x 6⅝" H Weight: 13 lbs.</p>	<p><b>28 GP 400</b></p> <p>Output: 400 Amps. Size: 13" L x 6" W x 7½" H Weight: 26 lbs.</p>

For full technical information write for Bulletin.

**TUNG-SOL DIVISION**  
**Wagner Electric Corporation**

630 West Mt. Pleasant Ave. • Livingston, N.J. 07039

# Why the big swing to silicone molded devices?

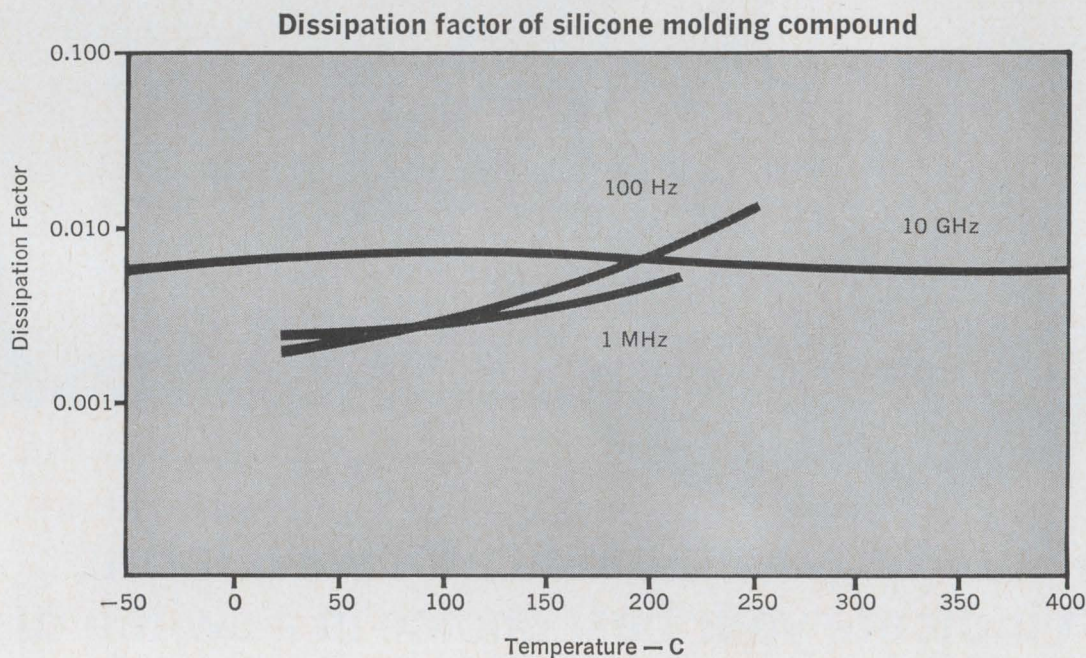

Why the big swing to silicone molded devices? . . . Electrically stable materials over a wide range of temperatures from low to high frequencies—as shown graphically above. Silicone molded packages do not limit the design or performance of high frequency semiconductor devices. Design characteristics will not drift due to changing electrical properties of the molded package.

That's why the rapid growth in the number of devices—from simple diodes to integrated circuits—packaged in silicone molding compound. Of course, there are other important reasons.

**No derating necessary.** Devices packaged in silicone molding compounds can be operated at their full power potential. This enables designs with a higher device density per given volume. For example, one manufacturer reduced the size of a power diode to 1/30th of its glass packaged counterpart. Compared to other plastic materials, the package size is from 1/5th to 1/3rd smaller, since derating due to package stability is not required.

**No cracking** — Dow Corning silicone molding compounds—unlike other organic thermal setting plastics—are virtually unaffected by heat and thermal shock. For example, a power resistor molded in Dow Corning® 307 molding compound was subjected to repeated cycling from -65 C to 350 C without damage to the packaging material or the device. Dow Corning® brand molding

compounds subjected to 1000 hours at 300 C (572 F) show no significant change in physical and electrical properties.

**Will not burn.** Silicone molding compound is inherently non-burning. Thus components packaged in silicone molding compound will not constitute a fire hazard. No flame snuffers are needed . . . a source of ionic contamination for devices packaged in organic plastic materials. With silicone molding compound there are no ionic or polar constituents when properly used, to affect junction performance.

**Low water absorption**—Dow Corning silicone molding compounds have low water absorption even after long aging at maximum operating temperatures.

**Competitive Price.** Silicone molding compound costs only a fraction of a cent per device. Thus, it enjoys a substantial price advantage over metal cans and glass packages.

**Manufacturing Economies.** Transfer molding enables devices to be packaged with minimum of manual labor and supervision. Good mold release and minimum flash assure high production rates and reduced de-flashing costs.

For technical data on why the swing to Dow Corning silicone molding compounds in device packaging, write Dept. 3723, Electronic Materials Division, Dow Corning Corporation, Midland, Michigan 48640.

# This is AE's Class B relay.

## Use it where a less expensive relay would cost too much.

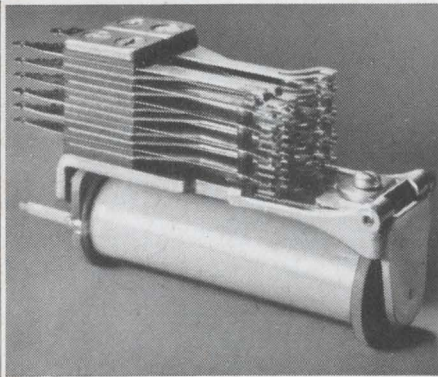

The Class B is a premium-quality telephone-type relay. It can give you at least 400 million operations with unfailing contact reliability. And it seldom needs maintenance.

That's why it's probably the most inexpensive relay you can use—where long-term reliability is a must.

In commercial and industrial control applications, the AE Class B delivers just what you'd expect of a telephone relay. It combines good sensitivity with excellent stability. Withstands extreme temperatures. Provides a wide range of practical operate and release timing...a range much wider than possible with smaller types of relays.

The Class B has two armature ratios (long, for fast acting

or pulsing—short, for slow-release and chatter-free AC operation). It also features twin contacts to insure against contact failure, a permanent wear-free backstop, pin-type armature bearings—plus a sturdy, stable heel-piece.

**Newest Class B relay is the Series BRM latching version.** When pulsed, remanent magnetism keeps the BRM latched without power consumption until it is restored by a second pulse.

Find out more about the Class B relay—the industry standard for long-term economy. Ask for Circular 1993. Just write to the Director, Relay Control Equipment Sales, Automatic Electric Company, Northlake, Illinois 60164.

***AUTOMATIC ELECTRIC***  
SUBSIDIARY OF  
GENERAL TELEPHONE & ELECTRONICS **GT&E**

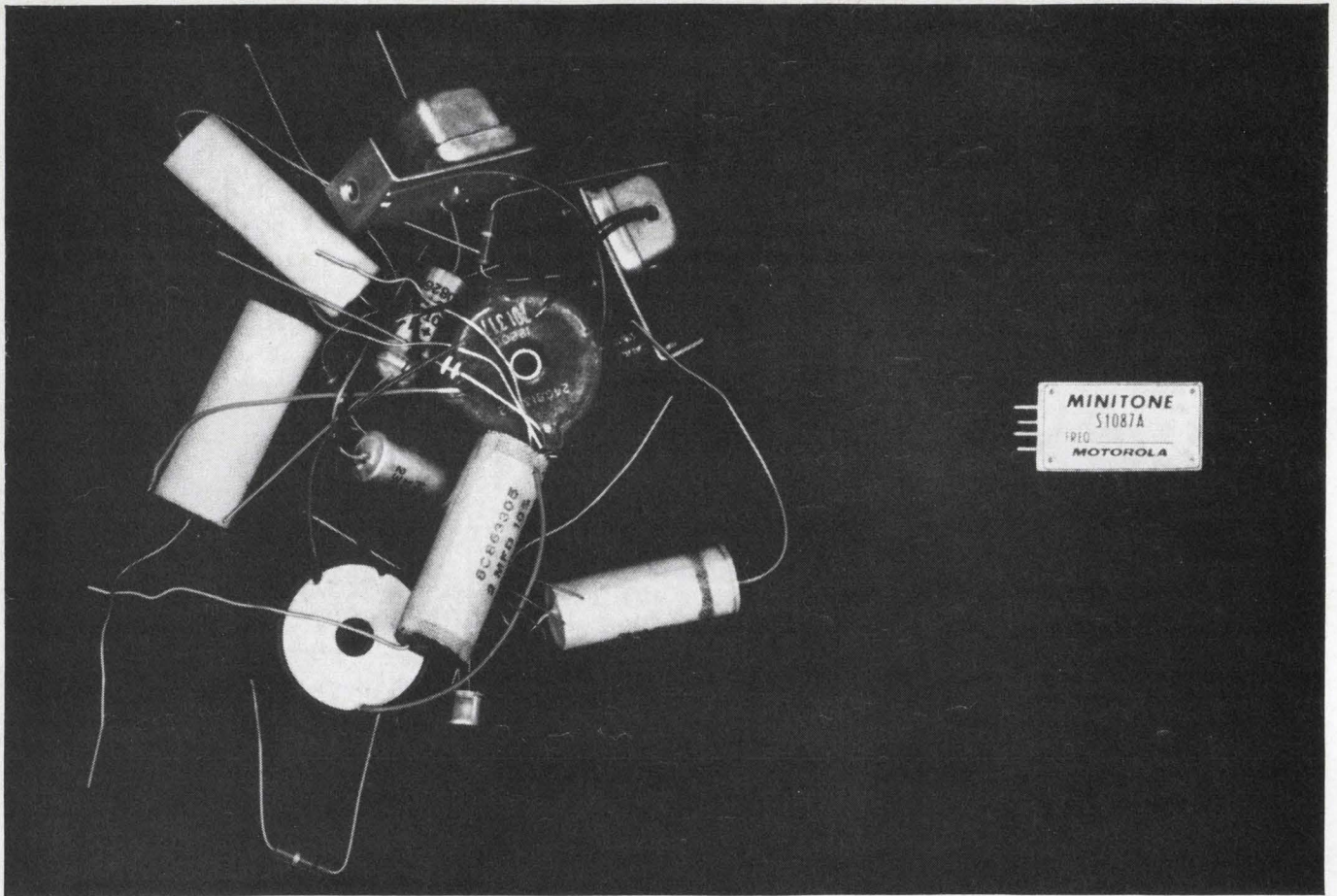

## Two ways to achieve selective signaling

### The MINITONE reed on the right does it better

Motorola's new miniaturized resonant reed either generates a highly stable audio tone, or provides very selective decoding. It does the job better because it's small, has excellent stability, and contains no contacts to wear out. And the MINITONE resonant reed is more economical; it eliminates the expense of extra components and design time needed to build highly selective tone oscillators and associated compensating circuits. Take a look at these facts:

**SMALL SIZE:** About  $\frac{1}{4}$  of a cubic inch in volume. Measures only 1.11" x 0.619" x 0.393".

**LONG LIFE:** No contacts to wear out or cause malfunctions; life comparable to solid-state devices. Plus 3-year warranty.

**HIGH STABILITY:** Frequency tolerance  $\pm 0.1\%$ . Temperature stability better than  $\pm 0.001\%$  per  $^{\circ}\text{C}$  between  $-30^{\circ}\text{C}$  and  $+100^{\circ}\text{C}$  ( $25^{\circ}\text{C}$  reference).

**WIDE FREQUENCY RANGE:** From 67 Hz up to 3150 Hz.

**QUICK DELIVERY:** Over 200 standard frequencies available from stock.

**RUGGED CONSTRUCTION:** Exceeds E.I.A. standards for shock and vibration.

**PROVEN PERFORMANCE:** Reeds have been proven in thousands of demanding situations, such as in aviation, control systems and radio communications applications.

FOR MORE INFORMATION contact your Motorola representative. Or write for bulletin TIC-3214.

**MOTOROLA COMMUNICATIONS AND ELECTRONICS INC.**

Dept. EO, 4900 West Flournoy Street

Chicago, Illinois 60644. A subsidiary of Motorola Inc.



**MOTOROLA**  
PRECISION  
INSTRUMENT  
PRODUCTS

# Which of these lasers best meets your requirements?

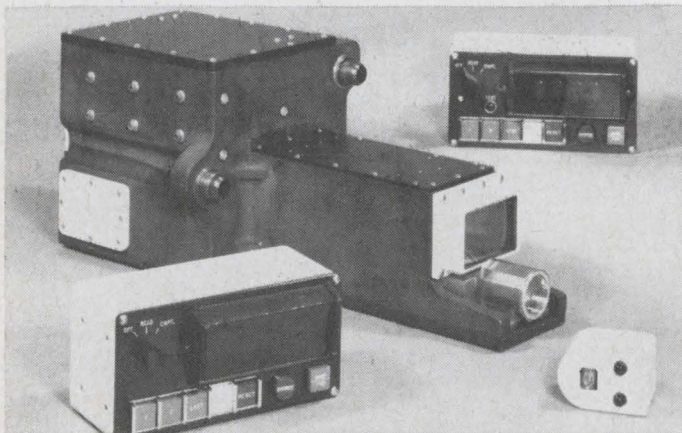

**Laser Rangefinders.** American Optical Company is engaged in developing laser rangefinder systems for ground support and airborne applications. In these projects, the company's Space-Defense Group combines its extensive experience in fire control optics with basic glass laser technology and high precision manufacturing capabilities.

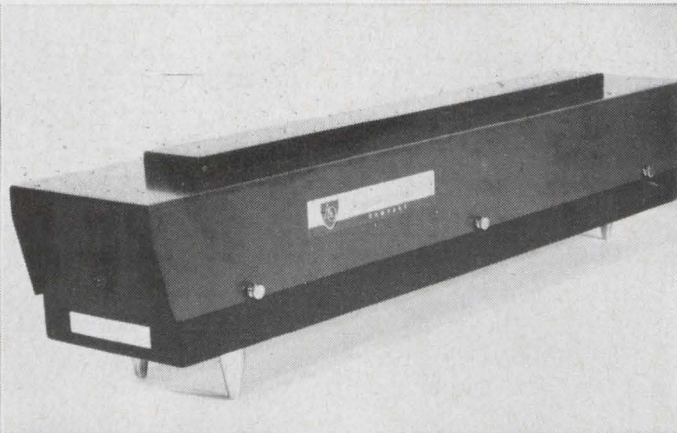

**Models 10, 20, 30 lasers.** American Optical offers extremely versatile, highly efficient laser systems featuring long pulse outputs of 15, 75 and 150 joules respectively. Fired in excess of 100,000 shots without breakdown, these systems are ideal for laboratory or production use. They utilize AOLux® neodymium glass laser rods and are available with or without rotating mirror or Pockels cell Q-switching, and power supplies.

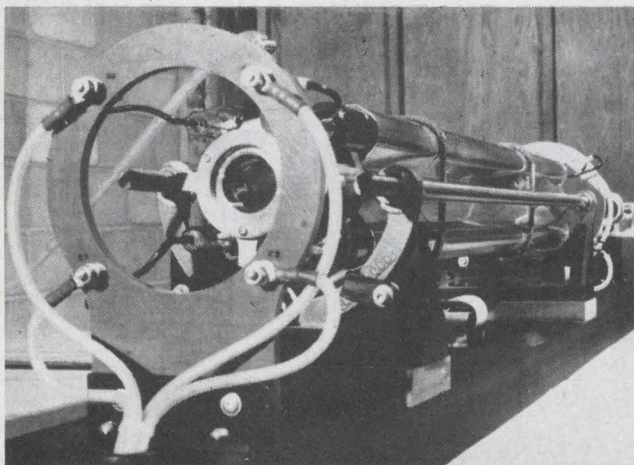

**Model 5000 Laser system**—the highest energy single-element laser system ever built. Delivered to Ballistics Research Laboratories, Aberdeen, Md., it uses a clad AOLux® laser rod 3.8 cm O.D. x 94 cm long to produce 5000 joules at a slope efficiency of 3%. The high optical quality laser glass and low neodymium doping level minimize thermally induced distortions. Using a remote mirror and special glass cladding limits beamspread to 10 milliradians full angle at the half energy points at an output level of 2700 joules.

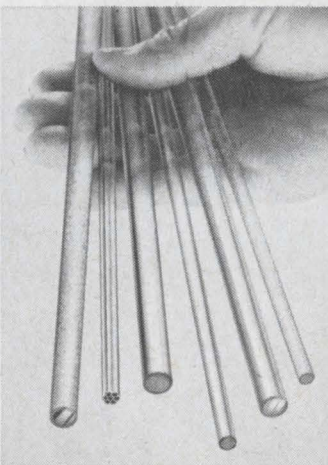

**AOLux® clad and unclad laser rods** are available in diameters up to 1½", lengths to 2 meters, and in 10 different neodymium dopings. They feature low threshold operation, high energy conversion efficiencies, high damage thresholds, long fluorescent lifetime, high optical quality and low loss coefficients—characteristics which make neodymium-doped glass ideal for an increasing number of laser applications.

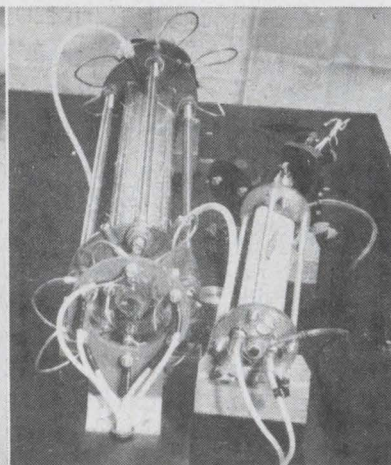

**One gigawatt Q-switched system.** This versatile Model 60 Laser consists of a 1.2 cm x 53.4 cm AOLux® neodymium-doped glass rod oscillator and 2.54 cm x 94.6 cm glass laser rod amplifier. Triggering, synchronization, and Q-switching with a rotating mirror provide 1 gigawatt at 60 joules output with pulse width of 60 ns. The oscillator amplifier system can be operated with a long pulse energy output of several hundred joules. Repetition rate: 1 shot every 3 minutes. Beam divergence: 5 milliradians.

American Optical Company welcomes inquiries about its laser systems and components—whether for laboratory experimentation or ballistics research, rangefinders or altimeters, or for laser welding, balancing or drilling.

For more information on the systems and components

shown here, write: *American Optical Company, Space-Defense Group, 4709 Baum Boulevard, Pittsburgh, Pennsylvania 15213. Resumes from engineers and scientists—in a wide range of disciplines—are welcome. Write to American Optical Company at the address above.*



**AMERICAN OPTICAL COMPANY**

Space-Defense Group • Pittsburgh, Pa. 15213

# new digital readout

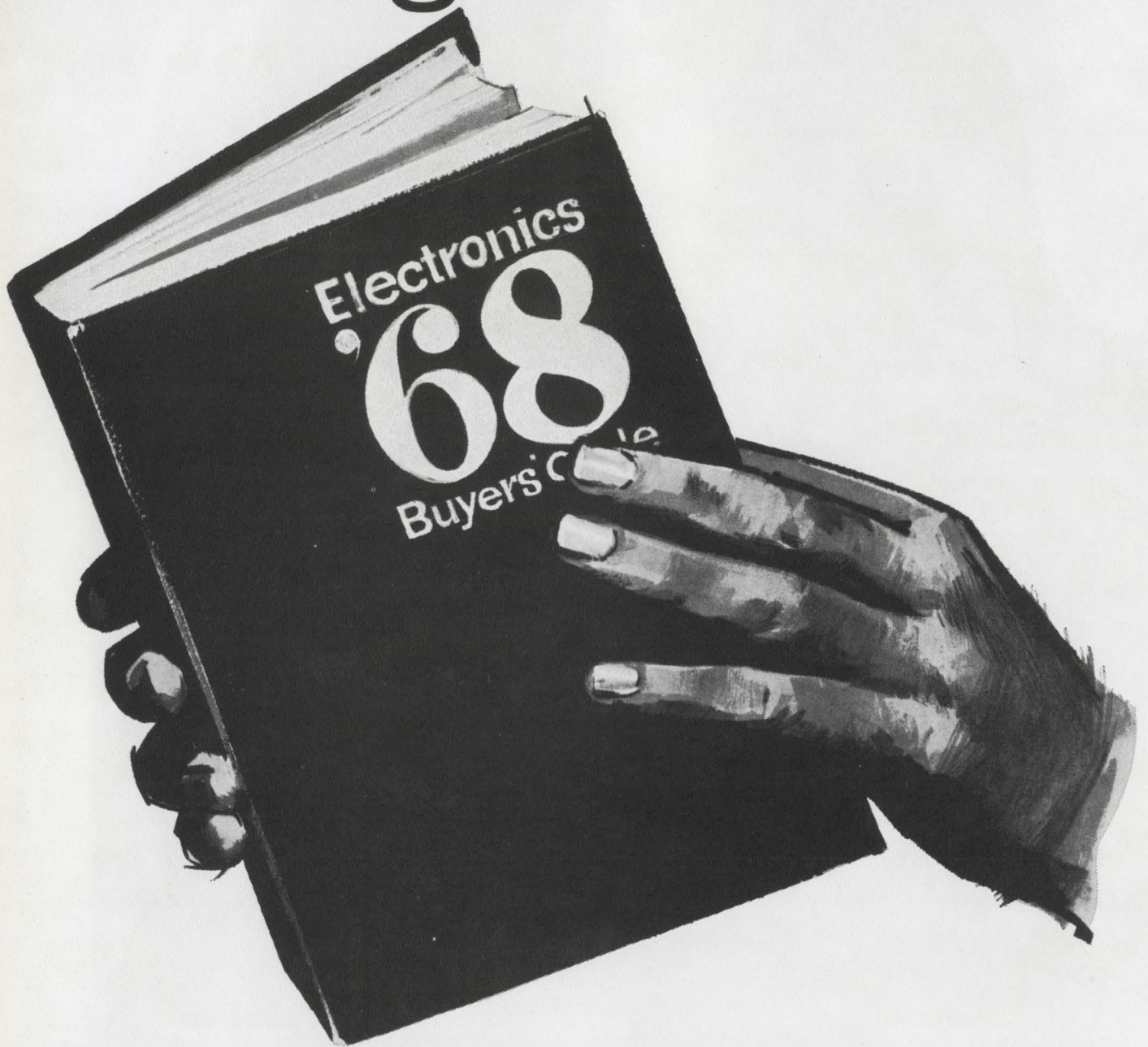

**-lets your fingers flip through the entire electronics industry.**

The '68 EBG gives you almost instantaneous desk top retrieval of 4 million bits of information that constitute the electronics industry.

If the answer to a problem involves finding a product or the people to supply it, this year the Electronics Buyers' Guide can help you find it faster than ever.

The '68 EBG yellow pages integrate editorial product

listings and advertiser's specifications in one continuous alphabetical section that is 4,000 categories long.

The green section tells you who's nearest, with the product you want, by listing local telephone numbers and addresses for more than 6,000 manufacturers.

Use the '68 EBG. And whenever you find an answer to your problem, tell them who sent you.

## **Electronics Buyers' Guide**

A McGraw-Hill Market Directed Publication, 330 West 42nd Street, New York, N.Y. 10036



# POTS ...a New England Tradition

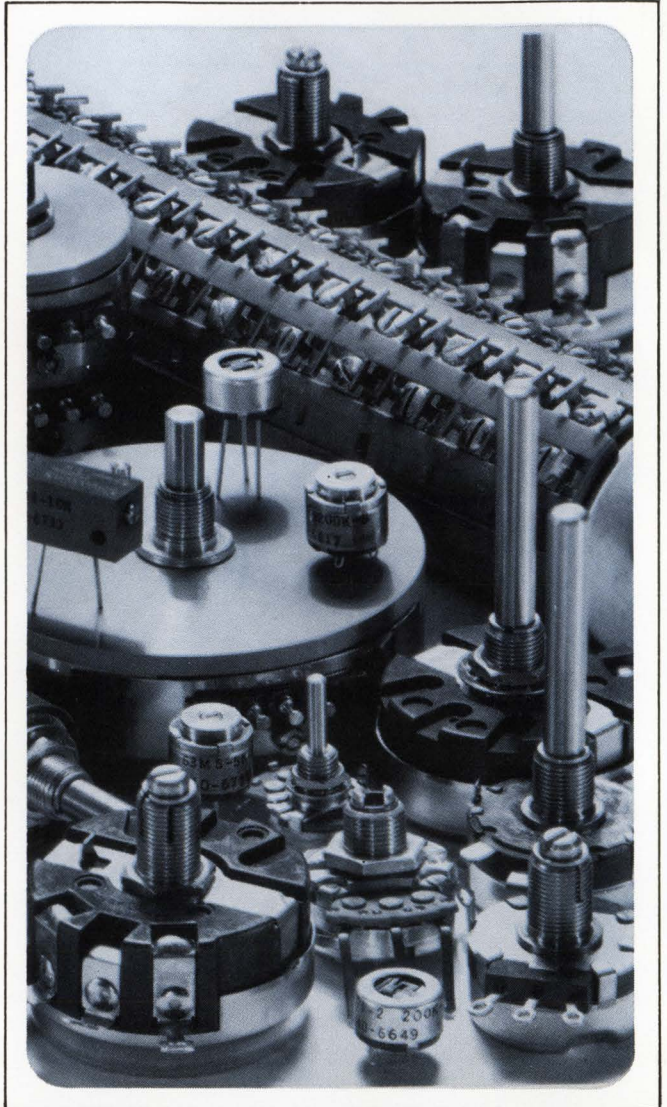

**A TRADITION AT CLAROSTAT TOO** is the manufacture of precision pots to meet every need. For more than 40 years, Clarostat craftsmanship has made it a leader—the recognized source of guaranteed performance potentiometers for industrial, military and service-replacement applications. Whether you need ½" single turn potentiometers; 10-turn, tight-tolerance potentiometers; high versatility, single-turn potentiometers; vari-phase, single-turn potentiometers; single turn, sine/cosine potentiometers, or other types, you can depend on Clarostat for minimum wear, low noise, long life and zero backlash. Once you try Clarostat, it is likely they will become your own traditional choice of pots on the basis of honest value, off-the-shelf delivery and quick service.

# CLAROSTAT

CLAROSTAT MFG. CO., INC., DOVER, NEW HAMPSHIRE 03820

AIR MAIL PAR AVION CORREO AERO AIR MAIL

AERO

CORREO

AVION

PAR

MAIL

AIR

AERO

CORREO

AVION

PAR

PAR

AVION

CORREO

AERO

AIR

MAIL

PAR

AVION

CORREO

AERO

# Dear ITT: I'm tired of

- slipped deliveries
- incoming QC rejections
- out-of-line prices...

...from my present small signal transistor suppliers. To qualify your PNP/NPN high speed switches, NPN core drivers and general purpose amplifiers per the enclosed prints, rush test data and samples by return AIR MAIL

Please qualify your devices per the attached prints.

NAME \_\_\_\_\_

COMPANY \_\_\_\_\_

ADDRESS \_\_\_\_\_

CITY \_\_\_\_\_ STATE \_\_\_\_\_ ZIP \_\_\_\_\_

AIR MAIL PAR AVION CORREO AERO AIR MAIL

semiconductors **ITT**

ITT SEMICONDUCTORS IS A DIVISION OF INTERNATIONAL TELEPHONE AND TELEGRAPH CORPORATION, 3301 ELECTRONICS WAY, WEST PALM BEACH, FLORIDA 33407  
 FACTORIES IN FLORIDA • CALIFORNIA • MASSACHUSETTS • ENGLAND • FRANCE • GERMANY • PORTUGAL • AUSTRALIA

**EFFECTIVE OCTOBER 1, 1967**

# CTS <sup>2-watt</sup><sub>3/4" dia.</sub> Cermet Pots

**in Wirewound or Carbon Price Range**

**less than 98¢ each**  
(in production quantities)

Only CTS, high volume automated producers of cermet controls, offers a line of 3/4" dia., 2-watt cermet potentiometers at prices you would expect to pay for industrial wirewound or carbon pots.

Series 550 combines long life, low noise, high overload capability, high stability and wide resistance range in compact construction that exceeds MIL-R-23285 (a tighter cermet version of MIL-R-94). Single, dual and concentric constructions.

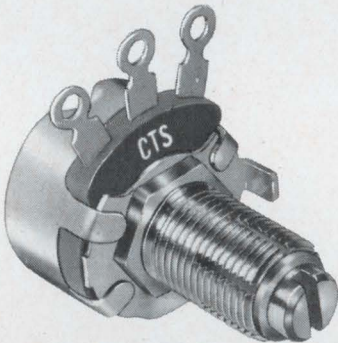

**Series 550**

2-watt 3/4" dia.

**Cermet Variable Resistor**

Compare these specifications (linear taper)		
	Standard Characteristics	Optional Characteristics (no more than 10c extra per item)
<b>Temperature Coefficient</b>		
Resistance ohms 40Ω to 1.35KΩ 1.36KΩ to 2.9KΩ 3KΩ to 1.35 meg. 1.36 meg. to 5 meg.	TC PPM -50 to +200 -100 to +300 -100 to +250 ± 250	TC PPM -0 to +100 -0 to +250 ± 100 ± 150
<b>ENR</b>	±2%	±1%
<b>Rotational Life</b>	50,000 cycles ±5% Δ R	100,000 cycles ±10% Δ R
<b>Resistance Range</b>	50 ohms through 1 megohm	25 to 49 ohms or 1 megohm to 5 megohms
<b>Independent Linearity</b>	±5%	±3%

For help in your application, call on CTS, the world's largest producer of variable resistors.

Most models available through CTS distributors.



Founded 1896

**CTS OF BERNE, INC.**  
BERNE, INDIANA

Subsidiary of CTS Corporation, Elkhart, Indiana



Please send me the latest Acopian catalog that lists

**62,000  
DIFFERENT  
POWER  
SUPPLIES**

available  
for shipment  
in 3 days.

Name

Title

Company

Address

City

State

ZIP

ACOPIAN CORP.  
EASTON, PENNSYLVANIA  
TEL: (215) 258-5441



## ... Motorola emitter-coupled logic is used in the digital ranging gear ...

ground link sub-system gear.

Motorola's SGLS contract specifies that the firm will provide Philco-Ford with a ground receiver and analog ranging equipment, essentially a monopulse tracking system, according to Kemmeries; digital ranging equipment; a digital range rate extractor; a demodulator; a doppler frequency converter; a baseband separation unit; and a 1.7 megahertz biphase sub-carrier demodulator. Motorola expects to finish its share of the SGLS work before the first site—Hawaii—goes operational.

### I. Versatile receiver

The SGLS antennas are slaved to the receiver. Motorola built a receiver for TRW for the developmental ground stations but the current model has been redesigned. A wideband autotracking mode, incorporating a frequency synthesizer for continuous tunability over the SGLS spacecraft transmitter range of 2,200 to 2,300 Mhz, has been added as has fault-isolation circuitry and indicators that permit tracing of malfunctions to any of the 50 individual subassemblies. The fault isolation feature gives a 15-minute mean time to repair, says Kemmeries. The wideband autotrack mode is required because the receiver is a monopulse unit, and has recently been given the job of pointing the 60-ft. antenna for the ASGLS carrier. The unit already had the antenna pointing job for the SGLS carriers.

The SGLS has two down-link carrier waves. The first—carrier 1—provides return ranging and various low-data-rate subcarriers up to 1.7 megahertz. The second—carrier 2—provides telemetry data at rates up to 1 million bits per second.

**Pickup.** When SGLS carrier 1, the basic S-band carrier, is operating, the receiver provides two error outputs—one each for azimuth and elevation. The 60-ft. antennas have four feedhorns picking up signals from the spacecraft. The receiver processes the outputs from the horns, summing and differencing them to provide an error signal.

These are S-band signals, which the receiver converts to two analog d-c voltages—one each for azimuth and elevation.

The error is zero when the spacecraft "is dead center on the antenna," says Kemmeries. A plus error or minus error is generated if the spacecraft is off center, and the error is fed to the antenna servo system to position the antenna properly in azimuth and elevation. Kemmeries says this antenna signal error detection function is performed in either a phase-locked or wideband mode; the 60-ft. antenna is monopulsed while the 14-ft. unit is conically scanned.

In addition to detecting antenna signal errors, the Motorola receiver also does data-demodulating for the principal carrier for range, range rate, and telemetry signals. The digital ranging equipment is connected to the receiver and the ground station transmitter. This apparatus provides a digital code word, which the transmitter sends to the spacecraft's transponder. The word is a pseudo-random noise signal with a length of more than 5 million bits and a duration of 5 seconds, giving the ranging equipment the ability to track spacecraft at lunar distances—even though the Air Force requires only a synchronous orbit ranging capability.

### II. Odd jobs

The retransmitted signal sent back by the spacecraft transponder is demodulated by the receiver and fed to the digital ranging equipment; the system's accuracy is approximately 100 yards. All active circuitry in the digital ranging equipment uses Motorola emitter-coupled logic supplied by the company's Semiconductor Products division. Kemmeries says there are 31 cards in the ranging equipment, with about 500 MECL packages per system.

Range rate—the spacecraft's speed—is determined this way: analog doppler outputs from the receiver are fed to the doppler frequency converter, which processes them together with a sub-

# Glass-Epoxy Copper-clad

through TAYLOR'S TOTAL RELIABILITY PLAN:  
Raw materials, panels or punched blanks to your reliability requirements. You get what you order from a fully integrated source.

**FAST DELIVERY** from two fully equipped plants—one at Valley Forge, Pa., the other at La Verne, Calif. Or from warehouses in Chicago, Ill. and other key locations.

... **FULL SIZE SHEETS, CUT-TO-SIZE PANELS or PUNCHED BLANKS** to satisfy fabricating and processing requirements. Ease of fabrication is a plus value in printed circuit production.

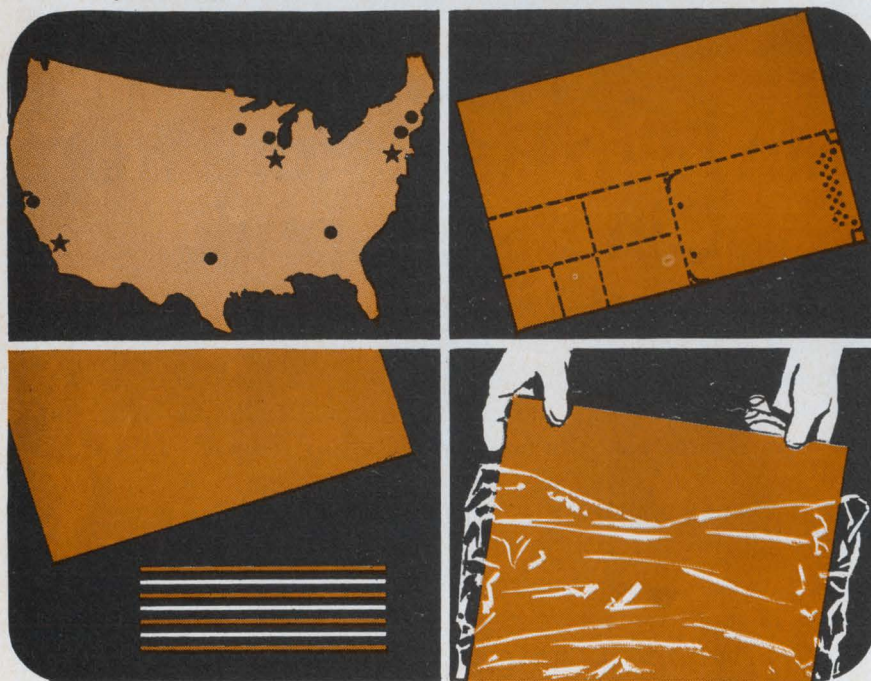

... **STANDARD AND ULTRA-THIN FORMS.** Standard sheets in all grades. Ultra-thin sheets and multilayer preregs in GEC 500 (G-10) and Fireban 600 (G-10, FR-4).

... **WHITE GLOVE HANDLING** in atmosphere-controlled white rooms, careful processing, extremely tight quality control and special packaging assure top performance.

Taylor's copper-clad has proven total reliability demonstrated by an ever increasing number of major OEM's and commercial etchers. This acceptance substantiates our claim for unsurpassed quality, ease of fabrication and delivery to your scheduled requirements. Let us demonstrate this reliability to you. Ask for a sample (give grade designation and copper combination) and a copy of Bulletin GB-2.

**Tc**  
... your assurance  
of quality

**Taylor copper-clad**

TAYLOR CORPORATION • Valley Forge, Pa. 19481

Phone: 215-666-0300 TWX: 215-666-0659

West Coast Plant: La Verne, Calif.

Also manufacturer of Taylor laminated plastics, Taylorite® vulcanized fibre and Tayloron® preregs

carrier 1 and carrier 2.

**Receiver refinements.** A threshold improvement demodulator in the receiver demodulates carrier 3's f-m data, using a wideband modulation tracking phase-locked loop that yields a 4-decibel threshold improvement. "This means that you can have 4 db less signal before you reach the deterioration point where the f-m signal is lost in noise," Kemmeries explains. He says that this is equivalent to extending antenna diameter from 60 ft. to about 95 ft.

The most significant features in the SGLS receiver, say Motorola officials, are the 4-db threshold improvement, the wideband autocorrelation capability with spectrums up to 35-Mhz of bandwidth, and tunability across the band using a frequency synthesizer in the phase-locked mode. These are all state-of-the-art developments, Kemmeries says. For wideband autocorrelation, the receiver compares the signal on a sum channel with signals on two angle channels, and puts out a d-c signal proportional to the antenna-pointing error.

Motorola has a line of standard radio-frequency components in the receiver called E, for extruded, and P, for potted, modules. The E module is a standard plug-in aluminum housing for all r-f packaging; the P modules fit inside. Motorola has 19 standard modules, including phase detectors, mixers, wideband amplifiers (100 to 200 Mhz with relatively flat response), variable gain amplifiers, power amplifiers, video amplifiers, and phase shifters. These units are epoxy potted and plated with tin for r-f shielding.

**Two for one.** A typical SGLS ground station will have one of each of the ground station subsystems plus a backup. "This redundancy, in effect, gives you two stations at each site," Kemmeries says.

### III. Advanced link

A typical advanced space-ground link subsystem terminal will have three wideband receivers, each with an f-m demodulator. There will be three pcm demodulators and two pcm bit synchronizers. All of these units are connected in-line. In addition, there will be two pieces of automatic checkout



# introducing the "PIXIEPOT"<sup>TM</sup> at an IMPossibly low price!

Duncan Electronics now offers for the first time in the history of the potentiometer industry a PRECISION, TEN-TURN WIREWOUND pot for less than \$6.00. In fact, the new Model 3253 "PIXIEPOT" potentiometer is yours for as low as \$3.97 each in production quantities and only \$5.95 each for 1-24 units.

#### Outstanding "PIXIEPOT" potentiometer features:

- Length: ONLY 3/4"
- Diameter: 7/8"
- Linearity: ±0.25%
- Resistance Range: 100 ohms to 100K ohms
- Power Rating: 2 watts @ 20°C
- Temperature Range: -25°C to +85°C
- Resolution: Better than any precision pot twice its size.



The Model 3253 "PIXIEPOT" potentiometer incorporates all of the fine engineering workmanship you've come to expect from other Duncan products. Only our new, unique production techniques enable us to bring this potentiometer to you at these unheard of prices.

And if you need your "PIXIEPOT" potentiometers in a hurry, we guarantee they'll be on an airplane out of Los Angeles within 24 hours after receipt of your order!

How can a "PIXIEPOT" potentiometer help you?

Call or write your Duncan representative (listed on the facing page). He will personally deliver to you, FREE, a 1K "PIXIEPOT" potentiometer for your evaluation in exchange for the filled out certificate.

#### This certificate redeemable for one 1K "PIXIEPOT"

(TYPE OR PRINT)

MY APPLICATION IS \_\_\_\_\_

---

NAME \_\_\_\_\_

COMPANY \_\_\_\_\_ TITLE \_\_\_\_\_

ADDRESS \_\_\_\_\_ DIVISION \_\_\_\_\_

CITY \_\_\_\_\_ STATE \_\_\_\_\_ ZIP \_\_\_\_\_

This offer expires December 1, 1967



DUNCAN ELECTRONICS, INC. • 2865 FAIRVIEW ROAD, COSTA MESA, CALIFORNIA 92626

# If we raised the prices of our "off-the-shelf" regulated DC power supplies 25%, you'd expect these features:

- Regulation: Line:  $\pm 1\%$  for  $\pm 13\%$  line voltage change. Load:  $\pm 2\%$  for any load voltage change between  $\frac{1}{2}$  load and full load.
- Ripple: 1% RMS maximum.
- All-solid-state components for stability and reliability. No complex circuits.
- Convection cooling. No fans or moving parts.
- All components conservatively rated for continuous duty.
- Ferroresonant, isolated winding, constant voltage transformer providing isolation from line voltage fluctuations, and protection from short circuits.
- Wide selection of control voltages and currents.
- Fast response to line load changes.

But we give you all these features without a premium price. Because our thirty-five years experience in perfecting DC power supplies for critical applications, such as computers, has shown how to refine and simplify designs, to provide most value and performance per dollar.

Acme Electric Corporation, Dept. 31, Cuba, New York 14727

## Acme Electric

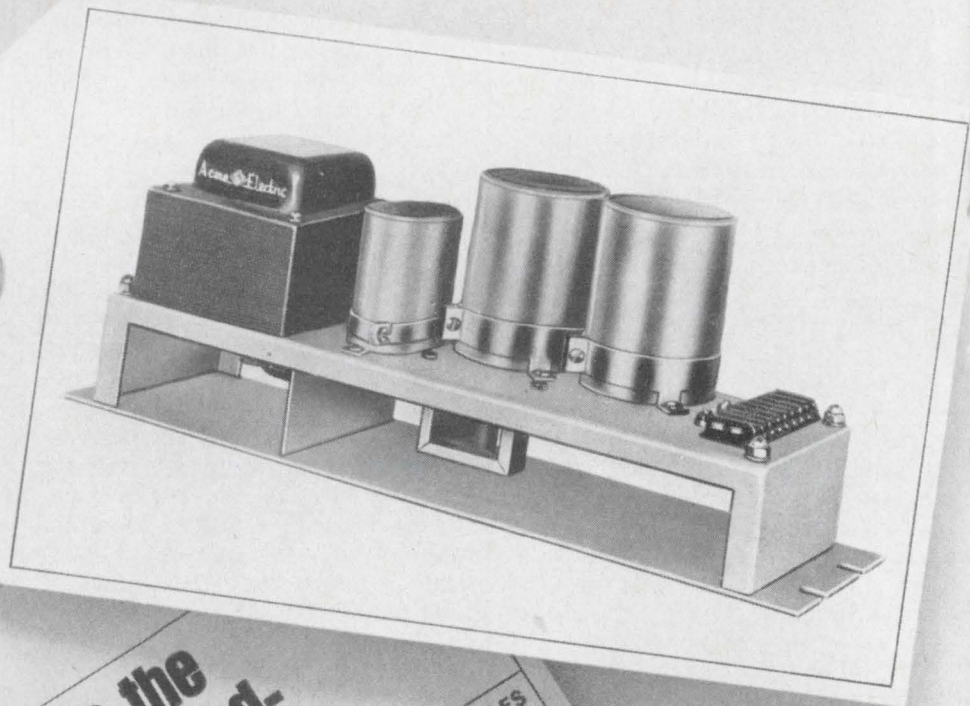

**Here's the  
Dollars-and-  
cents proof:**

**SINGLE PHASE, 100-130 VOLTS INPUT, 60 CYCLES**

Number Catalog	Volts	Amps	Watts	Quantity of 1's	Price
PS-41422	24	2	48	109	20
PS-41423	24	6	144	148	70
PS-57353	24	10	240	161	20
PS-47125	24	15	360	202	80
PS-47173	24	25	600	145	60
PS-47638	48	4	192	138	30
PS-41424	48	6	288	214	25

Number Catalog	Volts	Amps	Watts	Quantity of 1's	Price
PS-47519	48	10	480	182	00
PS-57358	48	15	720	197	60
PS-47718	100	4	400	228	80
PS-41425	125	2	250	148	70
PS-47457	125	6	750	283	90
PS-41426	150	2	300	148	70
PS-41427	200	1	200	140	40

The items listed here are a sampling from Acme Electric's broad line of stock power supplies. Write for Catalog 175 and complete listing of our "off-the-shelf" DC power supplies. And when you need special DC power supplies, call on Acme Electric for detailed engineering assistance.

Need ...  
FAST REVERSING ACTION?  
Need ...  
TIMED MEASUREMENT?  
Need ... to meet  
CHANGING PRESSURES?

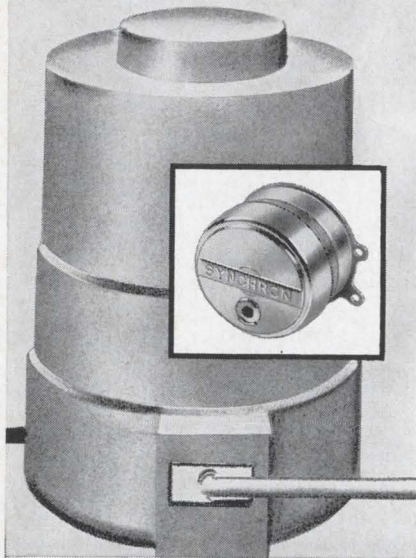

## turn the job over to SYNCHRON® MOTORS!

Any time you have *any* motor application that requires extreme flexibility, extreme versatility and extreme accuracy, think first of Synchron motors. Here at Hansen Manufacturing, we specialize in working with you to help you in design, engineering and production problems. Come to us for the motors, and the application experience you want. Call us—or if you're not in a hurry, write today for complete specifications on the type of motor and application you have in mind. No obligation, of course.



HANSEN REPRESENTATIVES: CAREY & ASSOCIATES, Houston and Dallas, Texas, R. S. HOPKINS CO., Sherman Oaks, Calif., MELCHIOR & MACPHERSON, INC., San Carlos, Calif., THE FROMM COMPANY, Elmwood Park, Ill., H. C. JOHNSON AGENCY, INC., Rochester, N.Y., JOHN ORR ASSOCIATES, Grand Rapids, Mich., WINSLOW ELECTRIC CO., Essex, Conn., Narberth, Pa., and New York, N.Y. EXPORT DEPARTMENT, 64-14 Woodside Ave., Woodside, N.Y.

## ... uhf broadcasting is ill-served by those who minimize its problems ...

equipment was a couple of years behind vhf progress. Rather than risk criticism for further delays, the commission gave vhf a go-ahead in 1948.

By 1949 so many stations operating in the same channels were interfering with each other that a three-year freeze on allocations was necessary. While the commission was studying the situation, uhf boosters watched in dismay as millions of tv sets equipped to receive only vhf signals rolled off production lines.

In 1952 the FCC rescinded its ban and opened up the uhf band. But there was little incentive for broadcasters to build stations because the chances of set owners spending extra money for uhf equipment were nil.

Eventually, the vhf band became so crowded that Congress—at the behest of the FCC—passed the all-channel law in 1962 in an effort to stimulate investment in uhf stations. Statistically, the legislation has proved a big success: an estimated 50% of the sets now in use around the country are equipped to receive uhf. And as of October the number of on-the-air uhf stations totaled 204, as against 573 vhf installations.

**Mournful numbers.** For all their optimistic projections, uhf operators and FCC officials are well aware that sets with uhf receivers are one thing and sets with uhf antennas quite another. Good reception of uhf tv signals depends as much upon the quality of the antenna used as it does upon the effective radiated power level of the transmitter. Although no definitive data have been compiled, there is a significant discrepancy between the total of all-channel receivers in use and the number that can get a good uhf signal without being tied into a community antenna television operator's system.

A source in the FCC's broadcast bureau is philosophical about the disparity. He says: "It's up to the set owner. If he wants good uhf reception, he should invest in a quality yagi antenna." However, the commission is apparently con-

tent to permit this position to popularize itself among consumers.

### II. Bad press

Controversy over the quality of uhf television signals has also proved something of a drag on the field's growth. Network spokesmen in particular insist that uhf transmission is inherently inferior to vhf. However, the evidence suggests that any disparity is the result of economic, rather than technical, factors.

**Test case.** In 1961 the FCC got \$2 million from Congress to check the quality of uhf signals in New York City. A 50-kilowatt transmitter and an antenna mounted atop the Empire State Building were used. The experiment, conducted in a metropolitan area with every conceivable type of interference, proved that uhf signals are virtually indistinguishable from vhf. And, concluded the final report, under ideal conditions, the picture, in both black and white and color, is clearer. In addition, engineers say that because there is less man-made noise in this band, a light signal—assuming power is adequate—is inherently better than vhf.

The FCC has established 5 megawatts as the maximum permissible effective radiated power level for uhf stations. While one broadcaster is known to have boosted his signal into the 4-megawatt range with 110-kilowatt transmitter and a 1,000-foot-high tower antenna, the majority of new uhf stations simply cannot afford the kind of investment involved in such facilities.

### III. Prose and Cons

Nor is uhf's cause particularly helped by efforts to minimize its difficulties. For example, William Walker, director of broadcast management for the National Association of Broadcasters, frequently speaks of the industry's rosy prospects at the trade group's regional get-togethers. The only factors that could retard the growth of uhf, says Walker, are direct broadcast satellites and CATV.

Actually, satellites are well



... IT'S THE MOST ...  
EXCEPT FOR PRICE

NEW **KH** ALL-SILICON

R-C OSCILLATOR  
holds PERFORMANCE but  
LOWERS PRICE

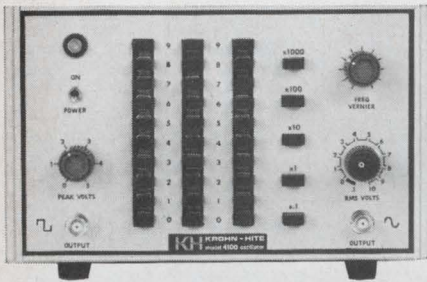

MODEL 4100, brand new R-C Oscillator with push-button frequency control. Sine- and Square-Wave simultaneously from 0.01 Hz to 1 MHz. Price \$550. Provides performance of higher priced units. 5 1/4" H x 8 3/4" W x 14 1/2" D.

Using advanced circuit techniques, Krohn-Hite has produced a new R-C Oscillator, at a medium price, with traditional K-H Quality.

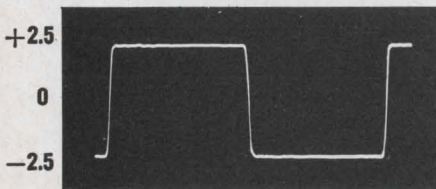
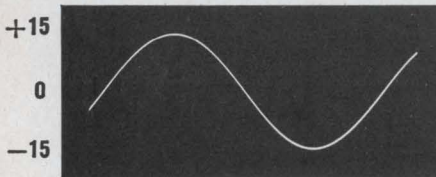

SIMULTANEOUS SINE AND SQUARE-WAVE outputs pack real power (up to 1/2 watt into 50 ohms). Photos show open circuit output voltages at 1 MHz.

These outputs typify the performance of the Model 4100. Add to this half-watt output, 0.5% frequency accuracy, 0.03% distortion, 0.02% hum and noise, 0.02 db frequency response and 0.02%/hr. amplitude stability and you get a clearer picture of what we're talking about.

There's much more in KH Data Sheet 4100  
Write for a copy

**KH KROHN-HITE**  
CORPORATION  
580 Massachusetts Avenue, Cambridge, Mass. 02139  
Telephone: 617/491-3211

### Playing the field

Cable tv operators are moving nimbly to exploit the opportunities available to their medium. Among the newest: a service that will use CATV facilities to pretest the impact of television commercials in consumers' homes. A joint venture of the H&B American Corp., a large cable system operator, and Audits & Surveys Inc., a marketing research firm, the new company, Television Testing, will go after advertising agency trade.

The demographic and brand preference characteristics of four medium-sized markets—Ventnor, N. J.; Lompoc, Calif.; Dubuque, Ia., and Walla Walla, Wash.—are being profiled for storage in computers. These data banks can be sampled to get the reactions of specific audience groups.

Viewers selected by the computer will be advised to watch a certain program when tests are scheduled. A monitoring device will determine how many sets were tuned in for how long. Phone calls will be made to test consumers' recall and the results verified later by market surveys of the test area. The service will start in January.

it will be up to the FCC to reevaluate its position concerning the industry's right to import signals."

Another difficulty for uhf operators centers about network affiliation. A spokesman at one of the big three puts it this way: "The networks prefer not to spill programming into uhf; they do so only when there are no other outlets in an area." This source cites two reasons for this policy: "There is at best a 50% penetration of uhf receivers in the television market, and even with a maximum effective radiated power the quality of a uhf picture is not as good as vhf."

**Niche.** Since uhf's future will be determined to a large extent by the fate of the vibrant CATV industry, many observers believe the whole broadcast field must reorient its goals to accommodate the upstart. Siegel, as well as several FCC commissioners, suggests that uhf operators should seek to provide viewers with programming unobtainable elsewhere. Shows keyed to self-improvement including cultural, educational, and community-interest formats are among the possibilities.

NEW **KH** ALL-SILICON

DIGITALLY TUNED  
VARIABLE FILTER  
FEATURES

ULTRA LOW FREQUENCY  
96 DB/OCTAVE SLOPE

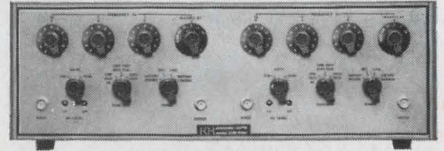

MODEL 3342 DUAL-CHANNEL, MULTI-FUNCTION FILTER provides low-pass and high-pass operation with 96 db attenuation slope or 48 db slopes as band pass or band reject filter. The digital frequency control provides cut-off frequencies from 0.001 Hz to 100 kHz with 2% calibration accuracy and excellent resettability. Size: 5 1/4" H x 19" W x 16 1/2" D.

The new Krohn-Hite Series 3300 operates on either line or batteries, with 0.1% distortion and provides gain of 20 db.

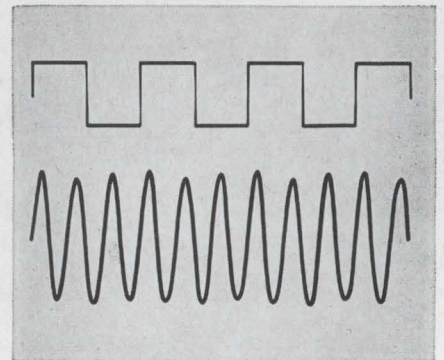

RECORDING ILLUSTRATES gain and selective response of Model 3342, in minimum band-pass operation, to a 0.01 Hz square wave. Output consists primarily of third harmonic component of input.

This kind of low-frequency performance is backed by other important specifications. Examples are:

**Filter Characteristics:** Either 4 or 8-pole Butterworth (maximally flat) and R-C for transient-free operation.

**Digital Tuning:** Six bands, 3 digits; rotary switches.

**Maximum Attenuation:** 80 db.

**Dynamic Range:** 80 db.

**Input Impedance:** 10 megohms.

**Output Impedance:** 50 ohms.

Write for Data

**KH KROHN-HITE**  
CORPORATION  
580 Massachusetts Avenue, Cambridge, Mass. 02139  
Telephone: 617/491-3211

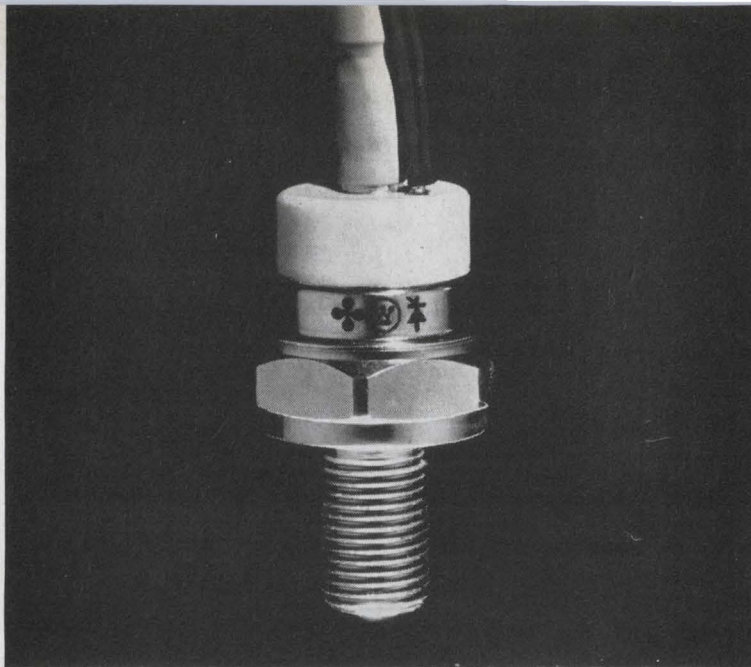

**14% more power  
per dollar.**

## New full capacity thyristors from Westinghouse

It's a breakthrough. We've added 14% more power capacity to thyristors without adding to the price. The extra amps are free.

These new thyristors (Types 250 and 251) are rated at 80 and 40 amps AVE. With them you can uprate existing SCR circuits without cost increase. In new circuits, these devices help you even more. They allow you to achieve simpler, lower-cost designs.

Our breakthrough was in bringing out the full inherent capacity of thyristors. New diffusion techniques have been used. And critical thermal stresses have been eliminated with exclusive Westinghouse CBE construction.

**Design Opportunities**—Look at the characteristics comparison charts here. You can see the opportunities. For example, if you make a 1½ hp. motor control, you could uprate it to 2 hp. with a simple thyristor switch from "Brand X" to Westinghouse.

Here's another cost-cutter: simplify circuits by reducing dv/dt protection networks. Until now, dv/dt on standard thyristors has been limited to 200/μsec.

COMPARATIVE FIGURE-OF-MERIT CURVES  
—THREE COMPETITIVE THYRISTORS

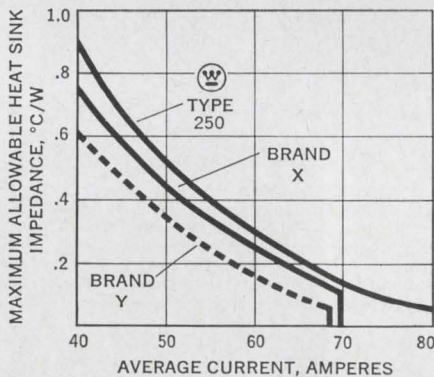

Westinghouse offers a minimum of 300/μsec. (typically 600/μsec.) to full V<sub>FB</sub>.

Maybe you're working with a 550 volt power supply. Then here's the industry's first positive control...thyristors that block 1800 volt transients and 1500 volts steady-state.

When you design drive circuitry, our maximum I<sub>gt</sub> of 100 ma. is an optimum figure. It's low enough so you can achieve low-cost circuitry, high enough to minimize false triggering.

**Data For Thought**—Let your ingenuity rove with full data to go on. You'll find many more circuits to capitalize on the Westinghouse "full capacity" thyristor. We'll be glad to help. Just call your local Westinghouse salesman. Or phone us at (412) 925-7272. Or write Westinghouse Semiconductor Division, Youngwood, Pennsylvania 15697.

COMPARISON OF PERFORMANCE CHARACTERISTICS  
— 70-80 AMP DEVICES

	Ⓜ 250	BRAND X	BRAND Y
Current (I <sub>RMS</sub> /I <sub>AVE</sub> )	125/80	110/70	110/70
Applied Current (θ <sub>SA</sub> =.125°C/W, T <sub>A</sub> =40°C)	71.5	64.4	70.0
Voltage (V <sub>FB</sub> /V <sub>FT</sub> )	1500/ 1800	1300/ 1550	1300/ 1560
dv/dt (Exponential to full V <sub>FB</sub> )	300	200	200
I <sub>gt</sub> (T <sub>J</sub> = 25°C)	100	150	150

COMPARISON OF PERFORMANCE CHARACTERISTICS  
— 35-40 AMP DEVICES

	Ⓜ 251	BRAND X	BRAND Y
Current (I <sub>RMS</sub> /I <sub>AVE</sub> )	63/40	55/35	55/35
Applied Current (θ <sub>SA</sub> =.44°C/W, T <sub>A</sub> =40°C)	40	35	35
Voltage (V <sub>FB</sub> /V <sub>FT</sub> )	1500/ 1800	1300/ 1550	1300/ 1560
dv/dt (Exponential to full V <sub>FB</sub> )	300	200	200
I <sub>gt</sub> (T <sub>J</sub> = 25°C)	100	100	150

You can be sure if it's Westinghouse



**PERMACOR<sup>®</sup>**  
**powdered iron cores**  
**...unequalled for**  
**design and prompt**  
**delivery!**

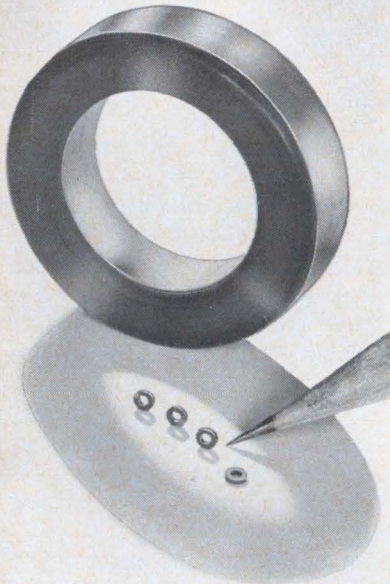

Illustrated: **TOROIDAL IRON CORES**  
 available from 1/8" to 2" O.D.

As the largest maker of iron cores in the world, we offer unequalled production and design facilities for any core design problem. AND, we stock a full line of standard cores at all times.

Need the best in cores . . . Plain, Hollow, Threaded, Insert, Tuning, Cup, and Toroidal Iron Cores, Iron Coil Forms, Sleeves, Flexible Magnetic Shielding, Bobbins and special shapes . . . write and find out why we are unequalled.

**PERMACOR<sup>®</sup>**

A Division of Radio Cores, Inc.

9540 Tulley Ave., Oak Lawn, Ill. 60454  
 Phone: 312-422-3353

**... Comsat's sweeping proposals for  
 Intelsat were artfully timed . . .**

will be done outside the U.S.

Some of the more important members of the consortium would like an even bigger share of the contracts, however. Japan, a number of European nations, and Australia would like the 1969 agreement to stipulate that every third satellite be built outside the U.S. Such a provision is probably unrealistic, this official says, because most nations trail the U.S. in such key fields as reaction controls and apogee motors.

**Play for time.** But there may still be some international foot-dragging on Intelsat 4 in the hope of a better deal after the 1969 renegotiation. Intelsat has to get the interim committee's approval for the launch, scheduled for 1970. If a go-ahead could be put off, some reason, many countries could catch up technologically.

The U.S. executive believes the less developed nations won't put obstacles in the way of Intelsat 4 since they badly need the communications services it could provide. He also holds that Comsat should continue to oversee international operations, but that management of regional and domestic systems be delegated to area associations and individual countries.

**III. Skillful ploy**

Comsat's sweeping proposals for Intelsat's future were artfully timed. Most interested parties have had insufficient time to develop hard positions, and the company expects no substantive reaction before a mid-January meeting of the interim group. In the meantime, Comsat will have had the benefit of being able to gauge the potential response to its bombshell.

One thing is already clear: the formula linking votes to usage should bring some offbeat supporters into the American camp, where Japanese and British authorities profess to be already. Italy, for example, takes greater advantage of Intelsat-financed facilities than do either France or West Germany. The same may soon be true of Spain, which activates a ground station this month and ex-

pects an increase in its traffic with South America.

Such a prospect cannot help but vex France and Germany, which are planning to put a regional communications satellite system, called *Symphonie*, into service by 1971. Comsat opposes such efforts on the grounds that they will "drain the global organization."

However, neither France nor Germany appears particularly discomfited by Comsat's stance; the French for their part have urged that communications satellite activities be autonomous in each of four geographical sectors of the globe, and that Intelsat's authority be reduced to coordinating overlapping efforts.

**Home front.** Domestic satellite systems also threaten international communications amity. Canada, for one, is determined to get an operational network—with or without U.S. cooperation—by the early 1970's [Electronics, Sept. 4, p. 131]. In proposing that domestic satellite programs without Intelsat blessing be proscribed, Comsat can fall back on the technological muscle of the U.S. Renegade nations would presumably get short shrift from the National Aeronautics and Space Administration should they seek launching facilities, boosters, and the like. However, the European Space Vehicle Launcher Development Organization may eventually offer an alternative to U.S. aid—albeit an expensive one—and Russia appears willing to support selective efforts. The Soviets have agreed to put up a French research satellite, and the two countries already exchange tv broadcasts over Russia's Molnya.

Ironically, Comsat's stringent proposals in this area are at odds with a recommendation it made last April for a pilot project. At this moment, the company is in the incongruous position of resisting domestic programs outside the Intelsat orbit while trying to get an independent project off the ground for the U.S.

Comsat officials point out that domestic satellites will be a necessity for certain countries. In Chile,



When Space makes the difference...



**SPECIFY  
TYPE LK  
CAPACITORS**

Now, you can enjoy space savings of up to 80% without comprising electrical characteristics. Type LK capacitors are the little ones with tremendous power... 4 times the life of MIL-C-25A. Add to this superior resistance, better power factor, improved resistance, wider temperature range, and voltage ratings from 600 to 50,000 volts.

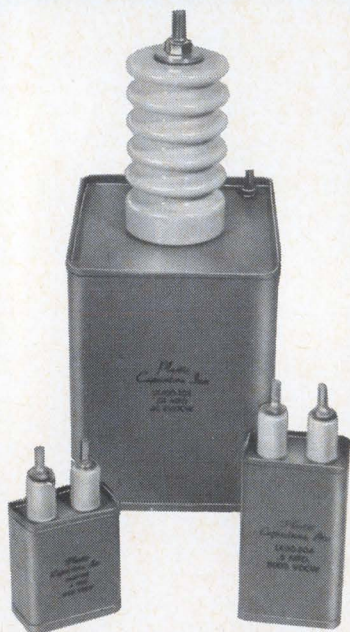

For the **BIG FACTS** on small capacitors, write for Bulletin LK today.

Write for new complete catalog today!



**Plastic Capacitors, Inc.**

2620 N. Clybourn • Chicago 14, Ill.  
DI 8-3735

for example, the Andes mountains constitute a communications barrier between north and south. And Brazil could use a satellite system for communications between its populous east coast and primitive interior regions.

#### IV. The big picture

James McCormack, Comsat's chairman, lists navigational aids for air traffic control, shipping assistance, rescue work, disaster warning, and earth-resources management as potential jobs for Intelsat. Although the company anticipated little opposition to such grandiose schemes, a division of opinion is already shaping up. German officials feel that the density of air traffic in Europe is not great enough to demand Intelsat control, so they plan no push for such services. France is also unenthusiastic about expanding applications within Intelsat's framework, but might go its own way, possibly with Russian help, to establish an independent system for areas it considers important—West Africa, Europe, and Canada. On the other hand, Italian sources back Comsat. "It's not the service but the means," says one.

**Room at the top.** Another problem, one of a technical nature, is sure to affect the outcome of the Intelsat renegotiations. The equatorial belt, the only space location that can accommodate communications satellites in synchronous orbit, has a finite capacity; just how finite has been the subject of feverish investigation. Last month, Comsat reported that two spacecraft can operate within less than  $2^\circ$  of each other in a 23,000-mile-high orbit without interference (at this altitude,  $2^\circ$  equals about 1,000 miles). Before the latest experiment, estimates of the necessary separation ranged from  $2^\circ$  to  $6^\circ$ .

However, though there is more parking space up there than most observers had dared hope for, some locations are more attractive than others. For example, the optimum spot for a communications satellite linking London and Tokyo is  $26.5^\circ$  east longitude. Spacecraft more than  $1^\circ$  off either way would lose one of the cities. As a result, the number of satellites linking London and Tokyo will have to be held to two or three at the most.

**ECCOSORB®**

**COMPLETELY REVISED**



Six page folder in color describes and gives performance data on the complete line of Eccosorb® Microwave Absorbers for Free Space and Waveguide.

Circle 327 on reader service card

#### **DIELECTRIC MATERIALS CHARTS**

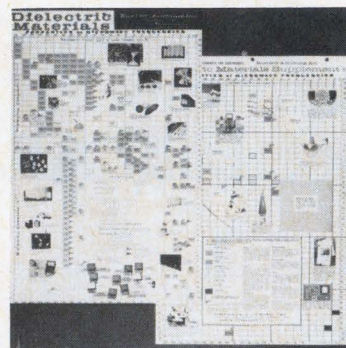

Charts in full color contain data on all important materials used by electrical and electronic engineers.

Circle 328 on reader service card

**ECCOSHIELD®**

**RF SHIELDING MATERIALS**



Brand new six page folder in color describes a complete line of Eccoshield products to combat RFI: conductive plastic sheet and gaskets, adhesives, coatings, caulking compounds, metallic foil—the works.

Circle 329 on reader service card

**Emerson & Cuming, Inc.**



**CANTON, MASS.  
GARDENA, CALIF.  
NORTHBROOK, ILL.**  
Sales Offices  
in Principal Cities

EMERSON & CUMING EUROPE N.V., Oevel, Belgium

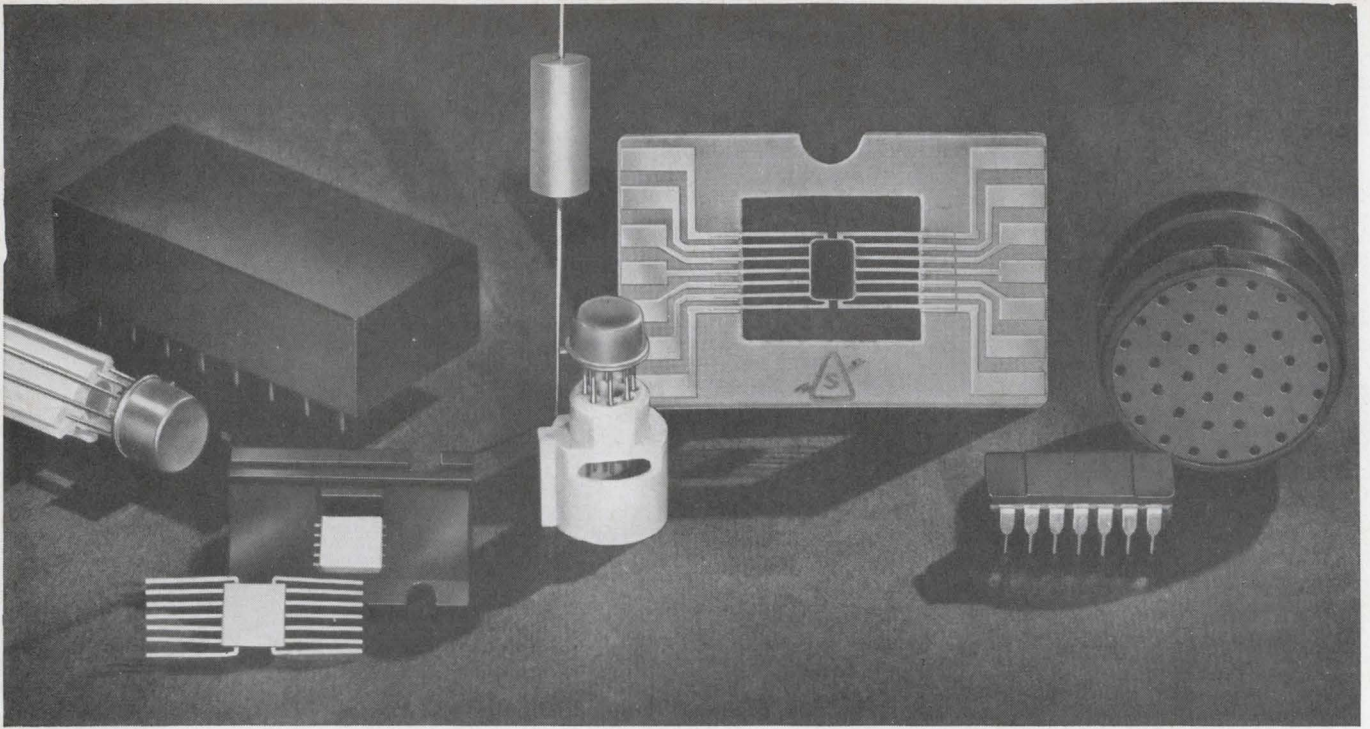

Good marking . . . makes the difference

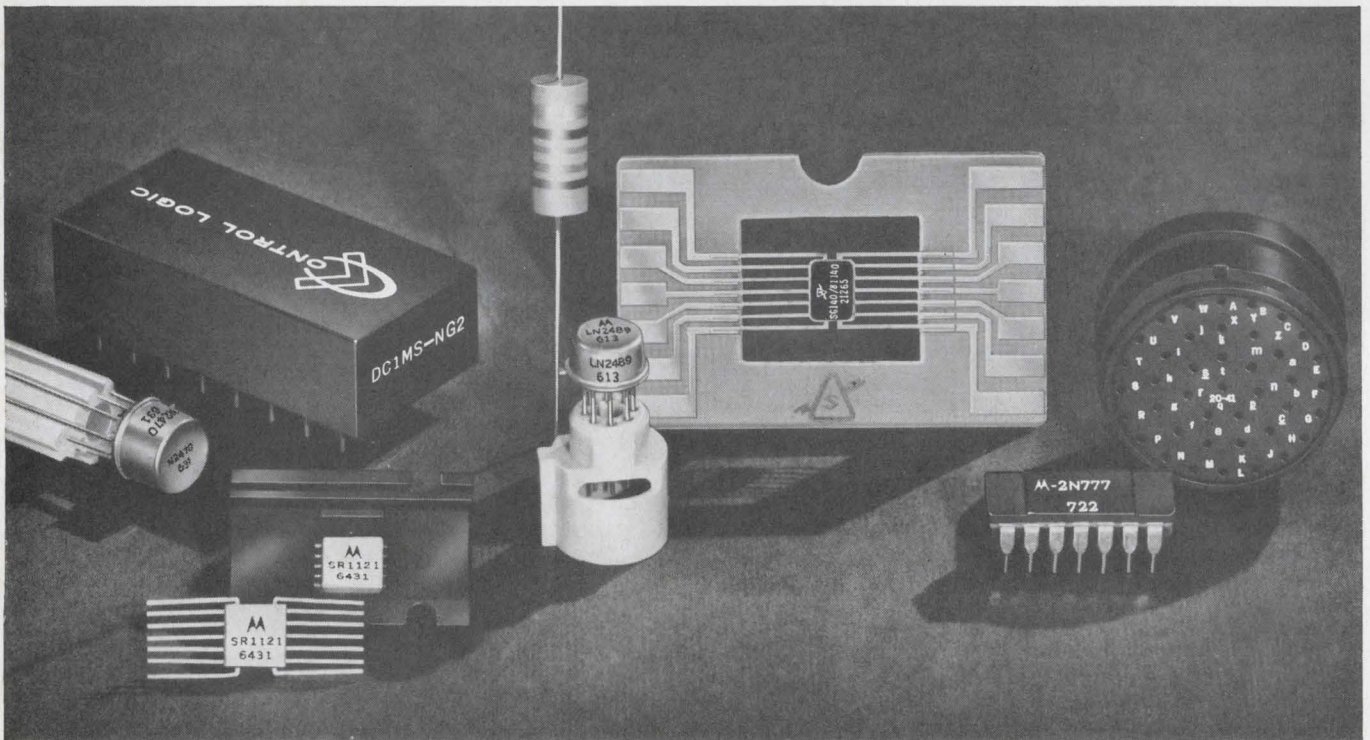

Don't waste time improvising and experimenting. Call in a Markem man and get acquainted with today's broadest line of marking equipment. Machines capable of putting several bands on a miniature diode; combining sequential numbering with identification; printing 14 characters plus trademark in an area 0.125" in diameter; printing integrated circuits in or out of carrier, registered to tab; and employing new techniques to meet severest durability specs. Whether your problem is size, speed or cost, we can help. Write Markem Machine Company, 305 Congress Street, Keene, New Hampshire.

EQUIPMENT AND TECHNOLOGY TO HELP YOUR PRODUCT SPEAK FOR ITSELF

**MARKEM**<sup>®</sup>

# Here's why you should now be using Datavue\* Indicator Tubes

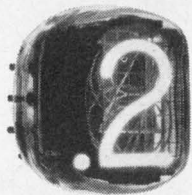

CK1904—Interchangeable with B59956 and NL809.



8422—Interchangeable with B5991 and NL8422.

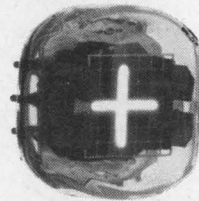

CK1903—Interchangeable with B5992 and NL5992.

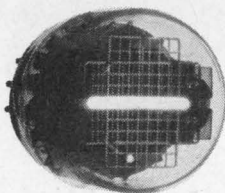

CK1901—Interchangeable with B5016 and NL5016; CK1902—Interchangeable with B5032, NL5032, B50911 and NL50911.

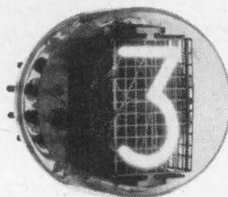

8421—Interchangeable with B5092 and NL8421; 8037—Interchangeable with B5031 and NL8037. Also available: 6844A.

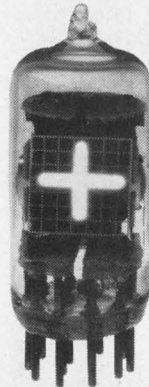

CK1900 (used with CK8650, CK1905, CK1906); CK1907 (used with 8754)—Interchangeable with NL843.



8754—Also available with right- and/or left-hand decimal points; Interchangeable with NL840/8754. Decimal-point types interchangeable with NL841, 842, 848.



CK1905; CK1906 (right-hand decimal point).

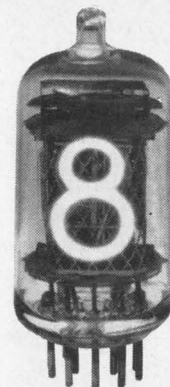

CK8650

These indicator tubes—just a few of Raytheon's wide selection—offer you advantages in design, economy and performance. For example:

**You don't need to revise designs.** Raytheon's Datavue round and rectangular end-view tubes conform to EIA ratings—interchange with other brands. And Raytheon also offers you a selection of side-view types—and "specials" with up to 12 characters,  $\pm$  signs, symbols, etc., to your specifications.

**You can buy them at low cost.** All Datavue Indicator Tubes are priced

competitively—or lower. Most side-view types, for example, cost less than \$5 each in lots of 500 or more.

**Reliably trouble-free readouts.** All Datavue characters are fully formed—not segmented. The fully formed characters are brightly displayed and easy to read—at distances up to 30 feet.

**They last for years.** They're made better because of Raytheon's experience—40 years of producing more than 100,000,000 cold cathode gas-filled tubes with carefully controlled electrical performance. Ultra-long-

life types, for example, have dynamic life expectancies of 200,000 hours or more.

**They're readily available**—in sample and production quantities. For samples, prices, or technical information, call your Raytheon regional sales office or distributor. Or write: *Raytheon Company, Industrial Components Operation, Quincy, Mass. 02169.* \*Trademark of Raytheon Company

Industrial Components Operation—A single source for Circuit Modules/Control Knobs/Display Devices/Filters/Hybrid Thick-Film Circuits/Industrial Tubes/Optoelectronic Devices/Panel Hardware.



# If it's so great, how come it's so cheap?

It's only \$5,000 because you said that's what it ought to cost. Our market research boys told us there was a tremendous need for an IC tester specifically designed for QC, QA, reliability testing, and everyday engineering evaluation. They also told us we could sell four times as many at \$5,000 as we could at \$7,500.

So we gave our design department a list of functions, a \$5,000 pricetag, and locked the door. Here's what came out: A \$5,000 IC tester that:

- Performs both pulse and dc parameter tests as well as functional tests without external equipment.
- Has a measurement accuracy of 1% (0.1% with an optional digital readout DMM.)
- Can be operated by a bright girl with half-a-day's training.
- Programs with thumbwheels in less than 60 seconds for most IC's.
- Has power supply accuracy of 0.1%  $\pm$ 1mv. (All supplies have adjustable current or voltage limiting and will both source or sink current.)

- Has Kelvin connections to the device under test.
- Has self powered, line-isolated modules.
- Has a complete line of device adaptors available.

How were we able to deliver so much machine per dollar? It was a snap. All we did was make every damn penny do a dime's work. We did it by committing to an annual agreement wherever there was a price advantage.

We did it by cutting out the fat. If a function was non-essential, it went. (This is one un-gilded lily.)

We did it with painstaking project engineering. For example, the loads module: We could have made 1% capacitive loads. But it would have cost three times as much, and no one knows what to do with capacitive accuracy of better than 5% anyhow. Another example: the thumb-wheel switches. We found a great one, but discovered the price included \$2 each for a pair of stainless-steel screws. We bought them knocked-down,

assembled them ourselves and used 6¢ screws instead.

Or the pulse generator. Ours is equivalent to two single-channel output units like the ones that Datapulse sells for \$775. They're great, but by sacrificing separate control and adjustment (which isn't necessary in our tester anyway) and the fancy case cut the price in half.

We found a terrific \$15 digital switch. But we didn't use it. We built one without superfluous extras for a buck and a half apiece.

We're handling the AC-switching with 32 controlled planar devices. This saves 192 reed relays, that is to say, greenbacks.

One thing we did was hardest of all. We cut the profit margin. We're honest-to-gosh taking only  $\frac{3}{4}$  the typical profit.

One more thing. The 990 turns out to cost \$4,950 instead of \$5,000. Use the extra \$50 to take the little woman out to a show and dinner.

Write for complete technical data, or if you're in a hurry, call us collect.

## Redcor's 990 IC tester

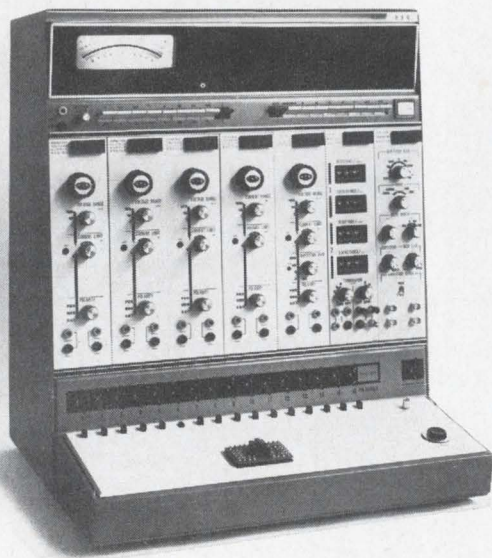

Redcor Corporation/7800 Deering Avenue/Canoga Park, California/(213) 348-5892/TWX 910-494-1228

# Keep ahead of your competition.

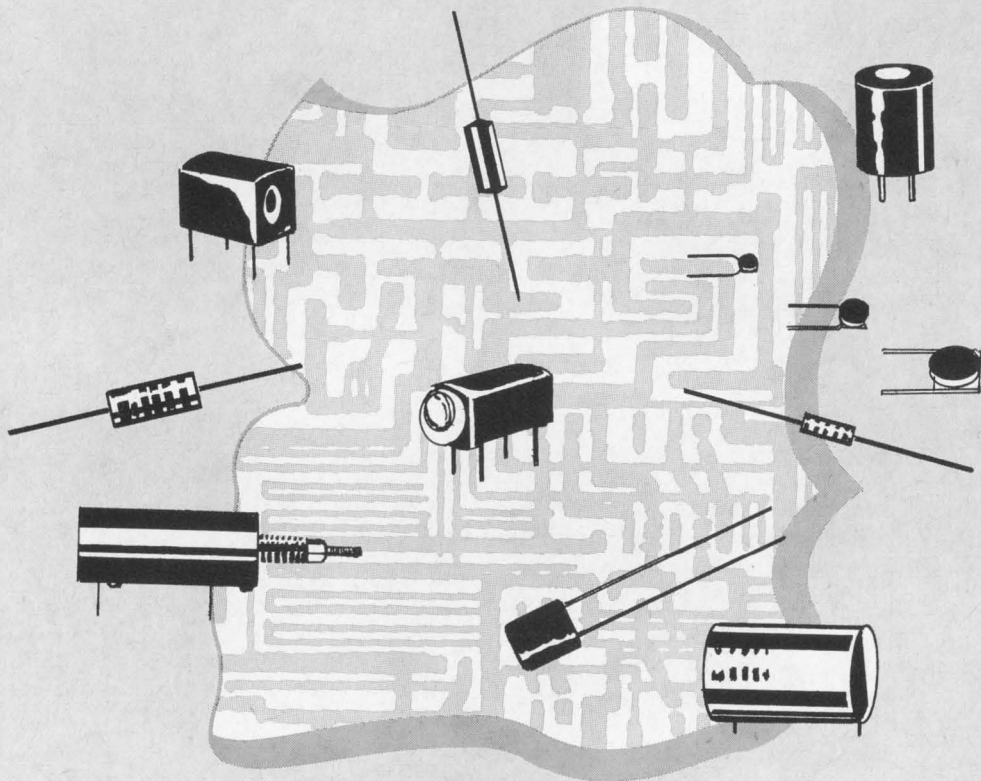

## We do.

Delevan is the most experienced coil and transformer manufacturer in the world. We got that way . . . by innovating . . . by packing high values into the smallest configurations known today.

Combine engineering talent with large volume production experience and you have a company you can depend on. Try us!

**Delevan Electronics  
Corporation / Division**



AMERICAN  
PRECISION  
INDUSTRIES INC.

270 QUAKER ROAD / EAST AURORA, NEW YORK 14052 / 716 652-3600

OTHER DIVISIONS OF AMERICAN PRECISION INDUSTRIES INC.: BASCO, INC. • ELECTRO-MECHANICAL PRODUCTS DIVISION



# This Keystone Thermistor assembly

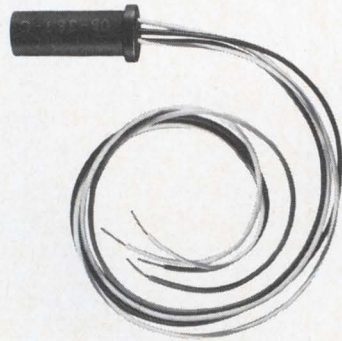

in this  
**CLIFTON**  
integrating  
tachometer

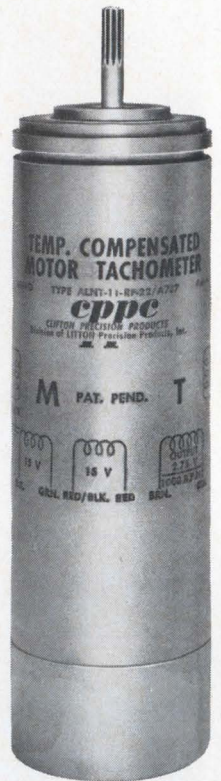

## Makes all this difference in temperature performance

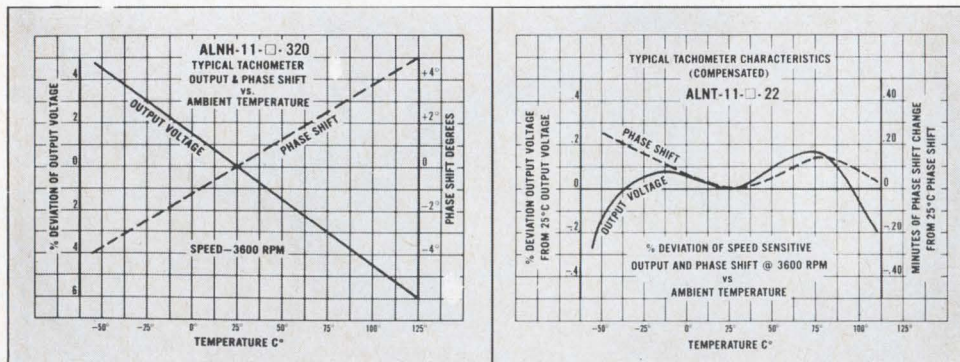

In precision computing applications using integrating tachometers, variations in output characteristics with temperature must be held to a minimum. To obtain the required performance, Clifton, Division of Litton Industries employs temperature compensation. □ The improvement in performance resulting from temperature compensation is shown graphically above. □ Responsible for the contrast is a Keystone Thermistor assembly. This is one of hundreds of different configurations made to specific customer requirements to the highest standards of quality and performance. May we have your inquiry? KEYSTONE CARBON COMPANY, St. Marys, Pennsylvania 15857

**Keystone**  
leads

in creative thermistor technology

# What does the CD-65 have that all other 2½D memory systems don't?

MORE STRINGENT DESIGN CRITERIA + HIGHER RELIABILITY + GREATER USER VERSATILITY.

The CD-65 is designed with the demanding user in mind. Operating margins in this unit are significantly greater than accepted industry standards. Mechanical packaging of key circuits and magnetics in the CD-65 provides a system organization easily adapted to custom application. All circuits are worst case designed and are verified by customer examination. □ Featuring a newer 2½ D packaging concept, the CD-65, with a 650 nanosecond cycle time, permits faster speeds and definite economies for larger word systems. The CD-65 is available in sizes from 8K to 65K words—each containing from 16 to 144 bits. □ Speaking of words, may we have some with you? We'd like to tell you more about the CD-65. For more information, write: Lockheed Electronics Company, Memory Products, 6201 East Randolph Street, Los Angeles, Calif. 90022. Or phone (213) 722-6810.

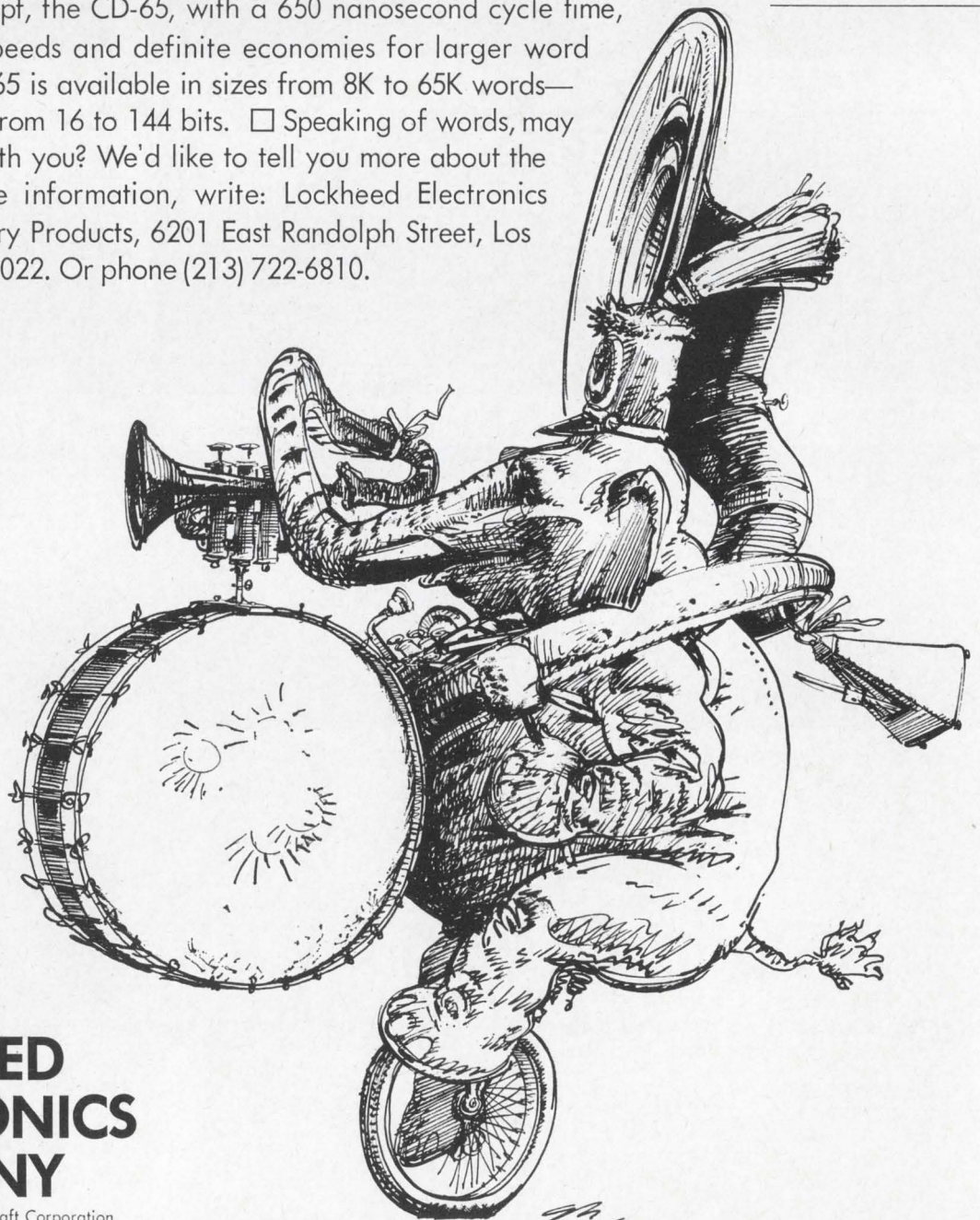

**LOCKHEED  
ELECTRONICS  
COMPANY**

A Division of Lockheed Aircraft Corporation

# Chester's growth through service

We can't think of a more graphic way to portray "Growth Through Service", than the illustration on the preceding page. The dark roof area represents Chester's plant expansion during the past ten years . . . expansion made necessary by the increasing requirements of our many valued customers in the electrical and electronic industries.

Actually, though, it's what's under the roof that counts: — The newest and most advanced production machinery . . . expanded research and test facilities . . . exacting quality control techniques . . . modern materials handling systems . . . and most important — experienced people, skilled in the manufacture of Plasticote® Wire and Cable.

Today . . . while we plan for the future . . . we still continue to meet industry's present requirements with unequalled service. The ultimate ingredient of this service is the most important facet of Chester's story of growth . . . the close, personal attention to each customer's requirement.

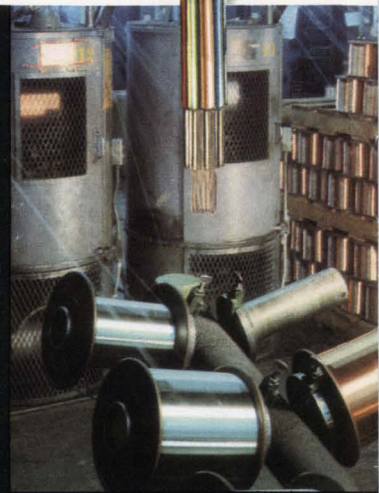
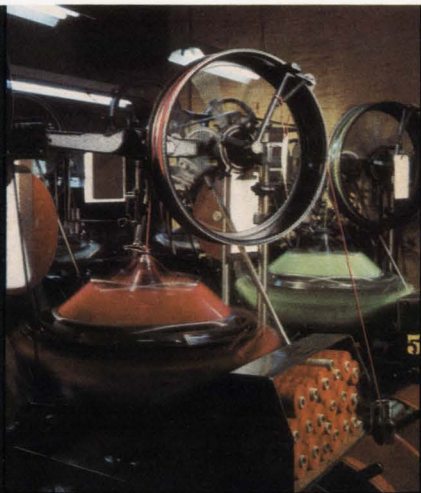
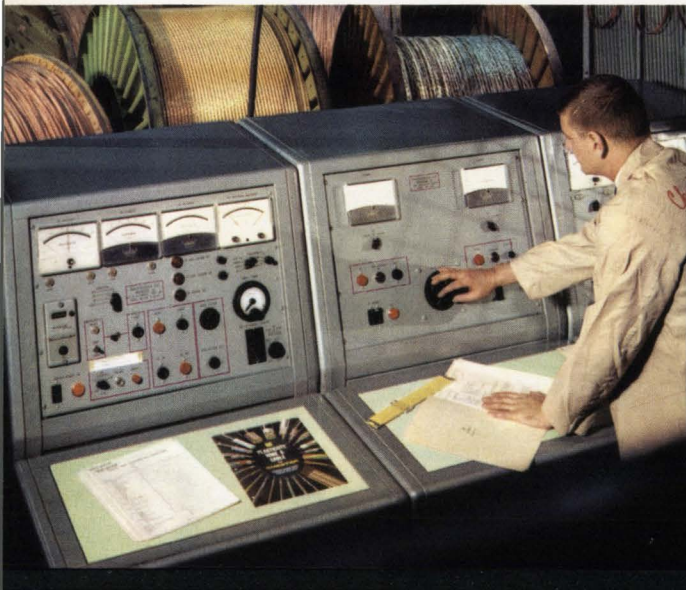

**CHESTER CABLE CO.**

DIVISION TENNESSEE CORPORATION, CHESTER, NEW YORK 10918

A SUBSIDIARY OF CITIES SERVICE COMPANY

PHONE: (914) 469-2141

TWX (914) 469-9801

Printed in U.S.A.



## For hot and cold insulation...Mystik 7000!

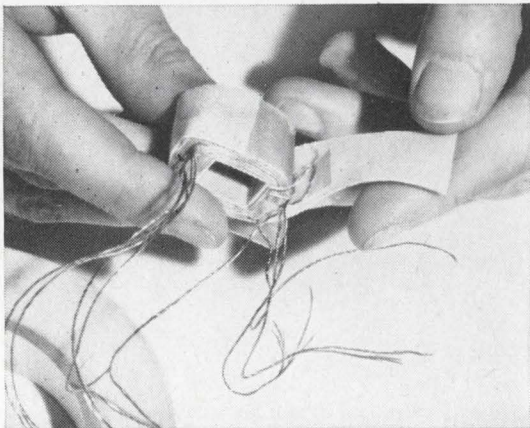

Superior thermal and electrical properties make Mystik 7000 suitable for an unusual range of cryogenic and elevated temperature applications. Uniquely inorganic, it has a tightly woven high tensile glass cloth backing with a pressure-sensitive silicone adhesive. Mystik 7000 has exceptionally high dielectric strength and offers high conformability and excellent shear resistance.

Here is a remarkable tape, perfect for insulating motors, generators or other components which must perform in critical operating environments.

This is only one of the Mystik family of tapes for the electrical industry. If you have an insulating problem or extreme temperature requirement, call your Mystik distributor. He's in the Yellow Pages under "Tape". Or write: The Borden Chemical Company, Mystik Tape Div., 1700 Winnetka Ave., Northfield, Illinois.



**BORDEN  
CHEMICAL**

# GLASS-TO-METAL SEALS

by  
**AIRPAX**

Exacting customer specifications are met by the quality, glass insulated terminals manufactured by Airpax.

A wide variety of terminal designs are producible and glass can be color coded for identification. (We like blue, one reason is that blue is supposed to be difficult.)

Leads can be kovar, or sleeved solid copper, or tubular. A large choice of standardized pins and lugs permits quick delivery to your specific needs. A 90 page catalog giving technical details is yours for the asking.

## AIRPAX ELECTRONICS

CAMBRIDGE DIVISION, CAMBRIDGE, MARYLAND 21613

Phone 301-228-4600

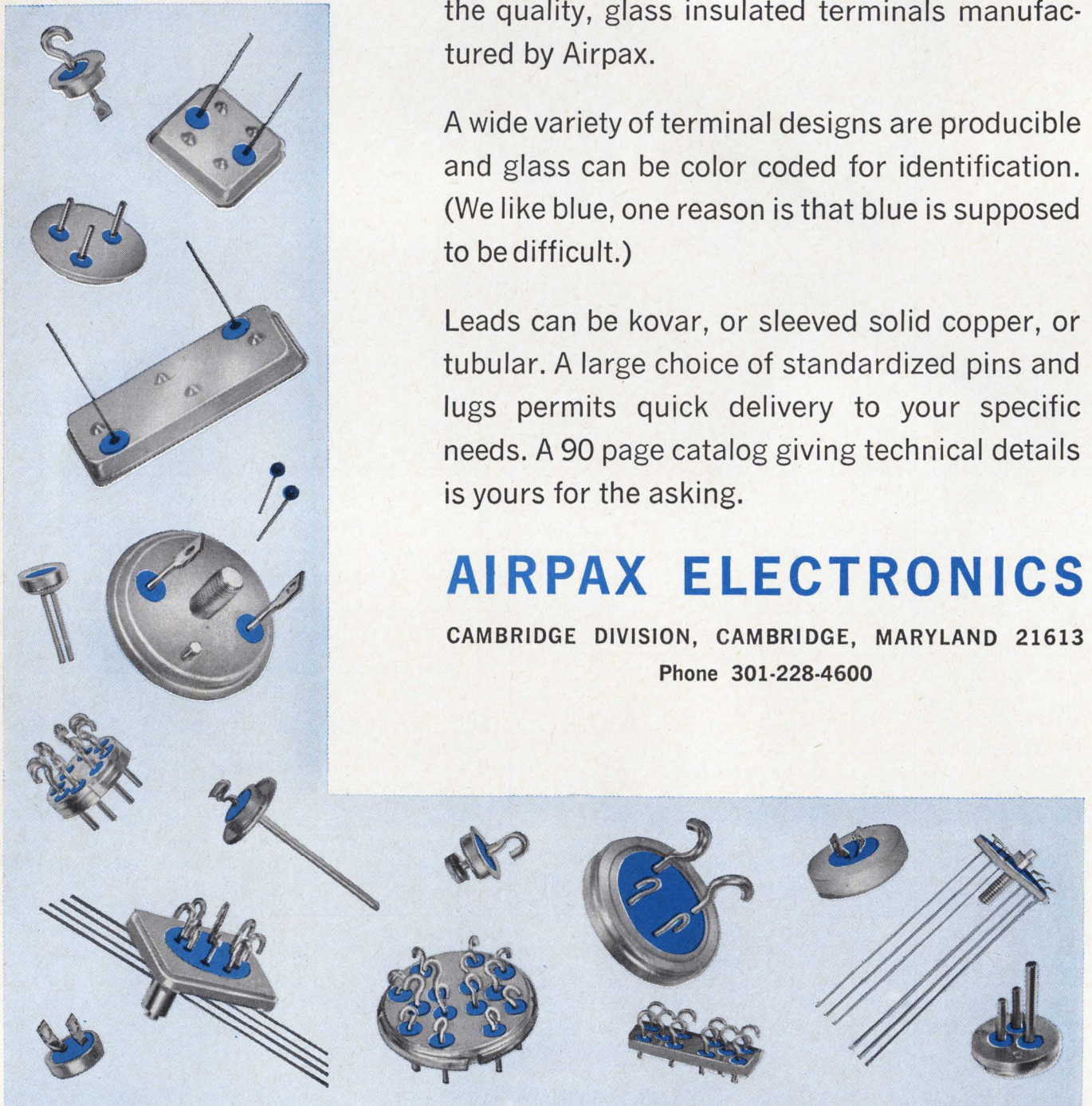

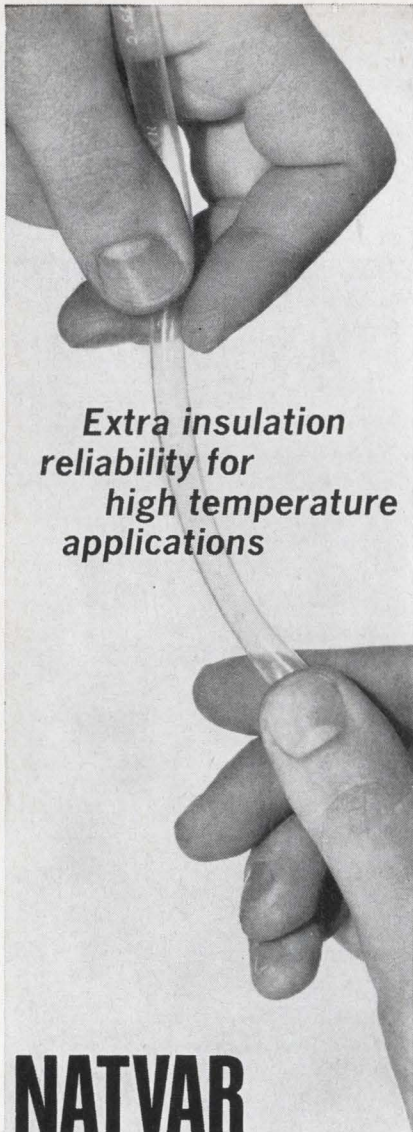

**Extra insulation  
reliability for  
high temperature  
applications**

# NATVAR 400 Vinyl Tubing

Here's an insulation you can rely on when the heat's on. Because Natvar 400 vinyl tubing has excellent thermal life. In fact, it's U.L. recognized for 105°C continuous operation. Besides that, it has exceptional resistance to oils.

Use Natvar 400 high temperature vinyl tubing to insulate leads... terminations... wiring... electronic equipment... oil filled transformers... harnesses.

Available in a wide range of sizes and colors—in continuous lengths or cut pieces. Send for FREE samples and complete technical data.

**NATVAR CORPORATION**  
P. O. Box 67, Rahway, New Jersey 07065

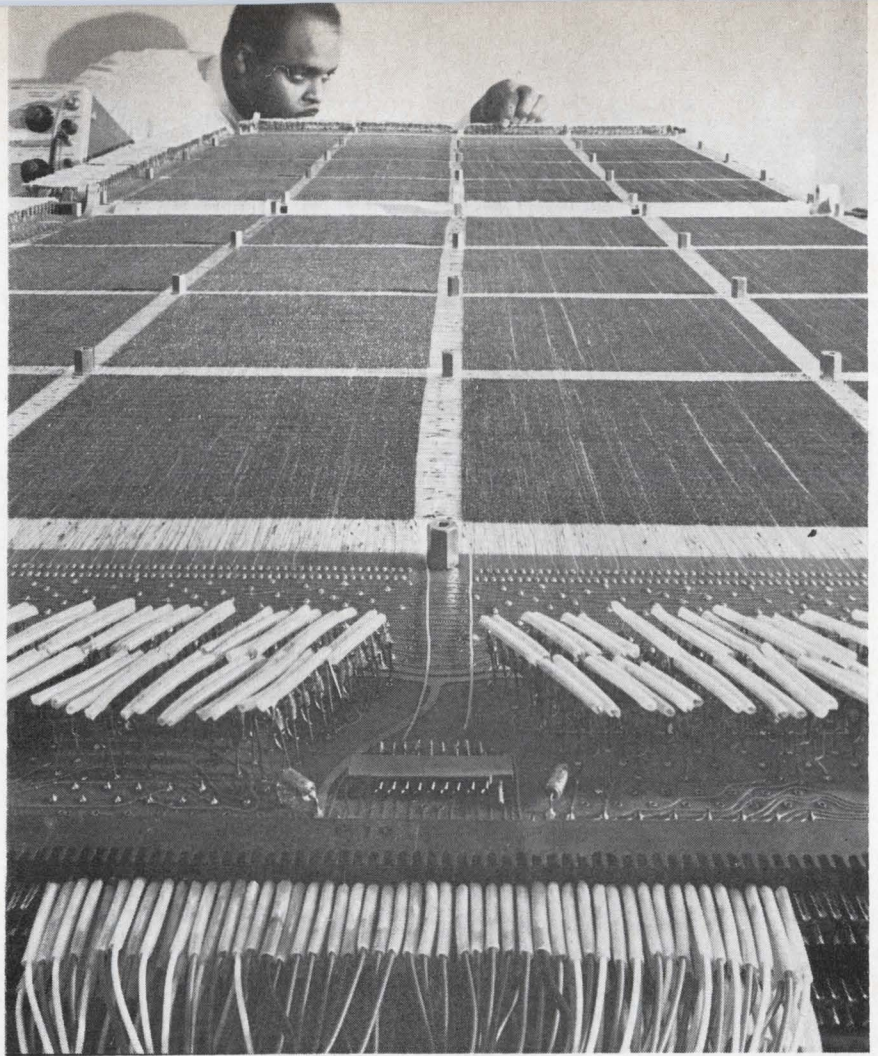

**Flat plane.** A single five-million-bit section opens, like pages in a book, for maintenance and repair.

word windings that are common to each. One word-winding wire threads two corresponding cores, one in each set. For increased reliability, each wire passes through the fold in the array, thus reducing the number of solder connections that must be made during fabrication of the memory.

Data is stored in the form of 262,144 words of 72 bits each. These 72 bits are written into or read out of the memory in parallel, and can represent eight standard computer bytes of nine bits each, or two 36-bit words, or any other submultiple of 72. Each section of 65,536 words is mounted on its own folding ground plane, resembling a four-page booklet having 16 square mats of cores on each page.

The memory's high speed was attained by minimizing the length of lines, and running the bit and word lines close to the ground plane, thus limiting inductance. The bit lines also go out and back,

through adjacent rows of cores—another way of minimizing inductance.

**Double duty.** Even higher speed would have been possible if the designers had not sacrificed some features to minimize costs. Only two wires thread each core; so the same wire is used for bit current when writing, and for sensing when reading. Every memory cycle consists of a read half-cycle followed by a write half-cycle. When reading, the write half-cycle restores the readout information. Because of the wiring's double duty, transients on the lines must be allowed to die out before bit current can be sent. This takes time.

There is also only one sense amplifier per bit, which cuts costs but increases the number of cores serviced by a single amplifier. This increases the amount of noise that a single amplifier must screen out.

Ampex Corp., Computer Products Div., Culver City, Calif. [338]

## New Components Review

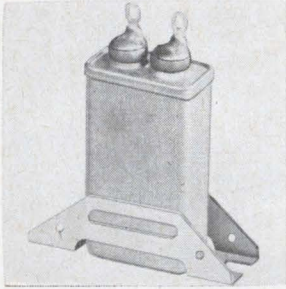

The Modiflex capacitors, using a combination of synthetic film and a liquid plastic dielectric, are rated up to 250  $\mu$ f. Standard tolerance for nominal values of 0.1  $\mu$ f and higher is  $\pm 10\%$ ; under 0.1  $\mu$ f,  $\pm 20\%$ . Power factor is 0.004 at 60 hz and 25°C. Operating temperature without derating is  $-40^\circ$  to  $+125^\circ$ C. Industrial Condenser Corp., 3243 No. California Ave., Chicago 60618. [341]



A fixed time delay relay encapsulated in epoxy is for p-c and aerospace uses. It is a spst, normally open unit with an input-output isolation resistance of 1,000 megohms at 100 v d-c. It operates from  $-40^\circ$  to  $60^\circ$ C. Life expectancy is 15 million cycles. The unit is  $1\frac{1}{16} \times 1\frac{3}{64} \times \frac{9}{16}$  in. Price starts at \$25.65. Universal Technology Corp., 107 New St., Pitts- ton, Pa. 18640. [342]

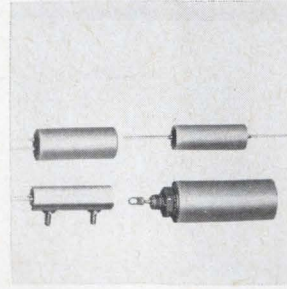

Metalized polycarbonate capacitors series 22E, in hermetically sealed tubular cases, come in 200, 400, and 600 v ratings in sizes from 0.174 x 0.500 in. to 0.750 x 1.875 in. Capacitance values are 0.001 to 5.0  $\mu$ f with tolerances from 20% to 1%. Temperature coefficient is 1.5% max. change from  $-55^\circ$  to  $25^\circ$ C. SEI Mfg., 18800 Parthenia St., Northridge, Calif. 90324. [343]

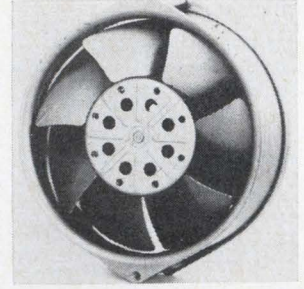

Miniature axial fans series 7500 combine high air delivery and low noise level. They feature aerodynamic design of the pressure type blades. With a free air delivery of 275 cfm, the unit will sustain delivery as high as 225 cfm at 0.2 in. of water back pressure. The venturi design limits noise factor to a low of 40.5 db at 3,350 rpm. Pamotor Inc., 312 Seventh St., San Francisco 94103. [344]

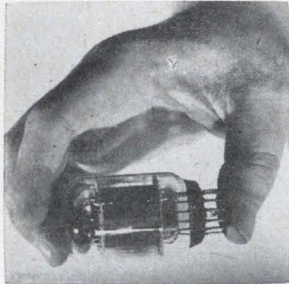

Double-triode-pentode compactrons are for color tv receivers. The 6AK9 has a heater voltage of 6.3  $\pm 0.6$ v, a heater current of 1.6 amps. The 16AK9 has a heater voltage of 16.4 v, a heater current of 0.6  $\pm 0.04$  amp. The pentode section is suited for vertical deflection amplifier use; triode sections, for general purpose uses. General Electric Co., Owensboro, Ky. 42301. [345]



Tuning-fork resonator TF600 is a  $\frac{1}{2}$ -oz, 0.2-cu-in. unit that can be provided with any fixed frequency from 400 hz to 2,400 hz. Accuracy is 0.01% at 25°C. Operating temperature range is  $-55^\circ$  to  $85^\circ$ C. An input of 6 ma at 28 v d-c is typical. Output is up to 5 v rms into 20 kilohms when used with proper drive. Bulova Watch Co., 61-20 Woodside Ave., Wood- side, N.Y. 11377. [346]

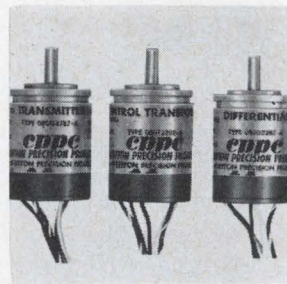

Size 8 synchros are available with over-all length of 1.015 in., which is 0.226 in. less than standard size 8's. Weight is also reduced to 1.15 oz. Standard accuracy of 7 minutes max. error is maintained. The line includes transmitters, control transformers, and differentials. Units have stainless steel housing. Clifton Div., Litton Industries, Marple at B'way, Clifton Heights, Pa. 19018. [347]

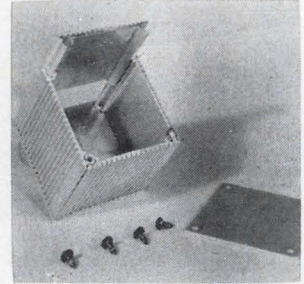

Enclosures known as Mini-Cool are constructed to contain a variety of precision devices. The line is available with integral heat sink walls. Made of lightweight aircraft alloy aluminum, they feature a lock joint at each corner which tightens when the screw fasteners are installed. Sizes range from 2 x 2 x  $1\frac{1}{2}$  to 2.6 x 2.6 x 10 in. Sarex Corp., 1001 Roosevelt Ave., Carteret, N.J. 07008. [348]

### New components

## Avalanche brightens photodiode outlook

Detector combines high gain of photomultiplier tube with small size and power requirements of photodiode

Combining the best of two worlds is a silicon photodiode that operates in an avalanche mode. Developed by EG&G Inc. and designated the AV-102, the unit offers the low-voltage and small-size advantages of solid state light detectors while providing the high-gain and low-

noise characteristics of photomultiplier tubes.

In photomultiplier tubes, which usually have 10 sections (dynodes), the emission from one section triggers the next so that a cumulative effect produces high gain. The disadvantages of these tubes are that

they are large and require both a high-voltage power supply and a high-impedance load. But at high frequencies, high impedance causes a noise problem.

Photodiodes, on the other hand, are small, low-voltage devices requiring low-impedance loads, thus avoiding the high-frequency noise problem. But they lack high gain. What EG&G engineers wanted was a device that incorporated the advantages of both a photodiode and a photomultiplier. The company considered such a product highly marketable, particularly for laser communications systems in which high gain and low noise at high

# KEEPING COOLANT FROM KILLING POWER TUBES...

*One way Barnstead pure-water equipment works for electronics engineers.*

Barnstead Coolant Repurifying Loops add thousands of hours to the life expectancy of transmitting tubes and other electronic power gear such as radar components, lasers, and magnets.

They keep water or ethylene glycol coolant free from impurities, oxygen and submicron particles that cause hot-point deposits, corrosion, premature burnouts; and maintain the coolant's electrical resistance.

Shown below: commercial Model PL-1/2, for systems up to 150 gallons. Others available for systems up to 12,000 gals. and larger.

*Other Barnstead equipment designed for you.*

Barnstead Transistor Washers and Microelectronic Cleaning Stations make a few gallons of hot, pure water — do the work of thousands.

Barnstead Demineralizers, Stills, Storage Tanks and Piping put pure water on tap wherever, whenever your process or equipment needs it.

Ask us for a no-obligation recommendation concerning your pure-water needs!

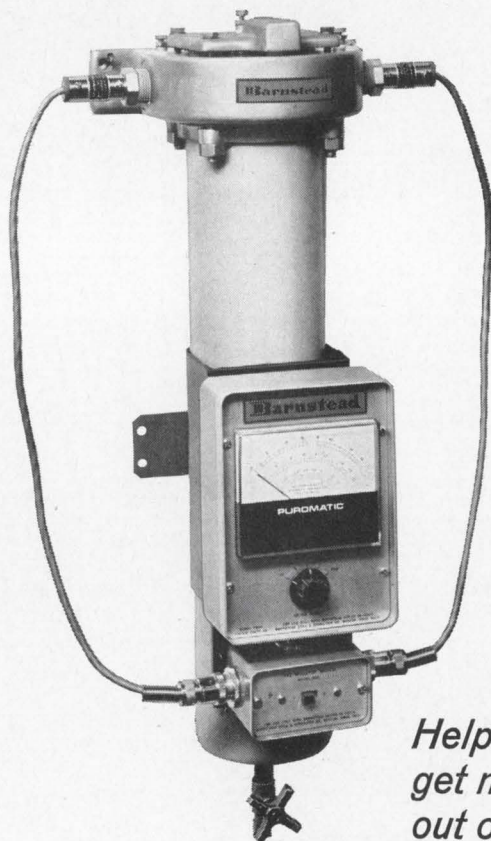

*Helping you get more out of water!*

**Barnstead**

STILL AND STERILIZER COMPANY

505 Rivermor Street  
Boston, Mass. 02132

## ... avalanche mode boosts gain ...

to diversifying through acquisition of smaller companies, it is designing lines of high-speed devices to detect and measure nuclear events. The new diode is a further extension of this program into special semiconductor devices.

The avalanche diode's spectral range is from 0.35 to 1.13 microns, with its response peaked at 0.9—the wavelength of light emitted from gallium-arsenide lasers. The major problem with laser systems is that because the beam has to travel long distances, the amplitude of the signal portion of the beam gets lost in noise. To reduce the effects of noise, the detector's impedance must be low and its signal-to-noise ratio, high. The AV-102 satisfies both conditions.

**Avalanche threshold.** If the AV-102 is operated below 11 volts—the point at which it goes into avalanche—its gain would be that of a conventional photodiode. But when operated in the avalanche mode, with a cumulative multiplication of carriers taking place, the diode's gain is increased 300 times. This increase is caused by the entire junction area being active. In conventional photodiodes, only part of the junction is active.

Memory systems is another application in which the AV-102 could be teamed with a laser. Reading out information after it has been recorded on photographic film, for example, requires a highly sensitive detector because much of the light is lost to the film. Also, the detector requires the capability of rapid response to a wide range of frequencies. This type of memory has applications where a large quantity of read-only data is to be stored for future recall.

### Specifications

Signal-to-noise improvement	300 to 1 for 50-ohm load
Sensitivity at 0.9 microns	0.5 $\mu\text{a}/\mu\text{W}$
Spectral range	0.35 to 1.13 microns
Frequency response	d-c to 1 GHz
Operating avalanche voltage	8 to 15 v
Junction capacitance	1.5 pf
Dark current at 1 v	0.001 $\mu\text{a}$
Active area	$2 \times 10^{-5} \text{ cm}^2$
Package	TO-18
Price	\$275

EG&G Inc., 160 Brookline Ave., Boston, Mass. 02215 [357]



CHOPPERS • RELAYS • TRANSFORMERS • SWITCHES

# JAMES

## ISOLATES NOISE WITH SHIELDED TRANSFORMERS

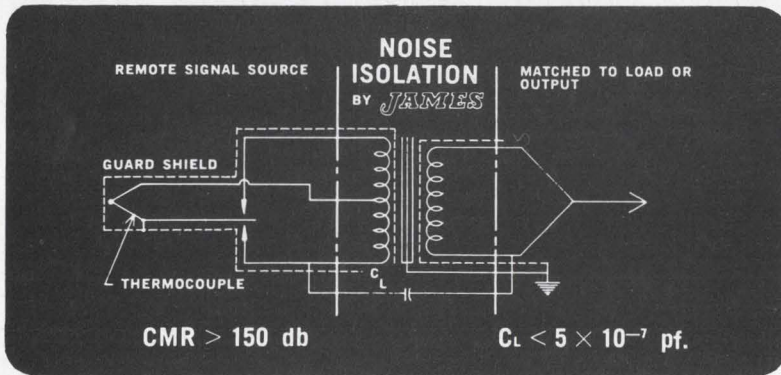
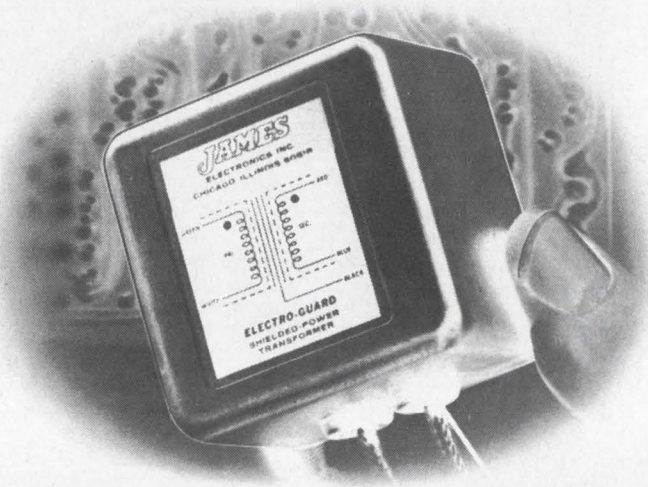

150 db COMMON MODE REJECTION

### SIGNAL-GUARD TRANSFORMERS

Low and Medium Frequency (DC to 100KHz) response

Designed for use in analog acquisition and computation equipment. James Signal-Guard provides isolation, voltage comparison, impedance matching, and common mode rejection.

### DATA-GUARD TRANSFORMERS

High Frequency Signal (1KHz — 40MHz)

Designed and shielded to isolate and terminate high frequency signal data in the form of pulses. AM and FM modulated carriers, multiplexed signals, and other low to high frequency data.

### ELECTRO-GUARD TRANSFORMERS

Power (1 watt to 100VA)

Electrostatically shielded for use in signal conditioners, bridge supplies, and Zener reference supplies to isolate circuits from noise transients and undesirable common mode voltage commonly carried on power lines.

WRITE FOR FULL TECHNICAL DETAILS

# JAMES<sup>®</sup> ELECTRONICS INC.

4044 North Rockwell • Chicago, Illinois 60618  
Phone 312-463-6500 • FAX — JML

New components

## Walls of bulb are color-full

Pilot lights can be used to color-code information on electronic equipment

**Electronic equipment** may soon blossom out with tiny fluorescent pilot bulbs in different shades of the rainbow. Manufacture of the cold-cathode gas-filled bulbs has been started by Toyo Musen Co.

Conventional neons work on the principle of an electric potential exciting gas molecules. When the molecules are excited, electrons jump from one energy level to another. This change in state of internal electrons causes energy to be released in the form of light. The colored bulbs operate on a completely different principle, similar to a cathode ray tube. The potential across the electrodes causes the gas in the envelope to emit electrons, not photons. These electrons strike the fluorescent coating on the inner wall of the bulb, causing the coating to emit photons. Changing the color of the bulbs necessitates changing only the fluorescent material, not the gas.

The bulbs are similar in electrical

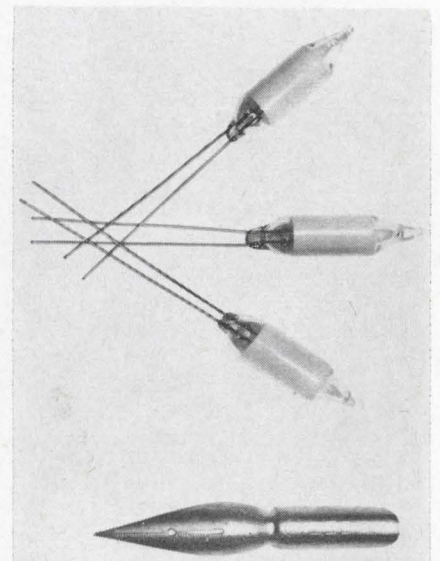

Lighting the way. Colored fluorescent bulbs make for easier reading on instrument panels.

# AC Regulation:

**LINE  
LOAD  
FREQUENCY**

**0.1%**



THE NEW  
G/M

## Magnetic AC Line Regulator

Especially Suited to Flight Instrument and  
Analog/Digital Computer Applications

*Eliminates the need for:*

Tuned Resonant Circuits, Bulky Inductors and  
Capacitors, Ferro Resonant Techniques, Saturable  
Reactor Circuits, Buck-boost Transformers, etc.

G/M Solid State Magnetic AC Line Regulators are particularly applicable where an accurate and stable AC reference source is required. Output is a clean sinusoidal wave form containing low harmonic distortion.



There is No Substitute  
for Reliability

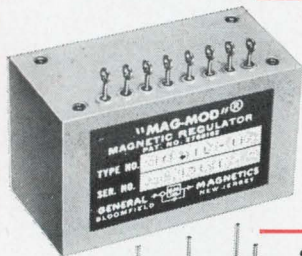

### Specifications—Type MLR 1091-3

**LINE VOLTAGE:** 103-126V AC 400Hz  $\pm 20\%$   
**OUTPUT:** 15V AC  $\pm 1\%$  400 Hz (includes  
initial setting accuracy)  
**LOAD** (800 $\Omega$ —1 meg $\Omega$ )  
**DISTORTION:** Less than 2%  
**REGULATION:**  $\pm 0.1\%$   
**DC POWER:**  $\pm 12V \pm 5\%$

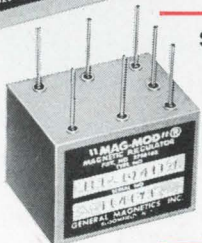

### Specifications—Type MLR 1106-1

**LINE VOLTAGE:** 15V AC  $\pm 20\%$ ; 3860Hz  $\pm 20\%$   
**OUTPUT:** 10V AC  $\pm 1\%$  400Hz (includes  
initial setting accuracy)  
**LOAD:** 20K  
**DISTORTION:** 5%  
**REGULATION:**  $\pm 0.1\%$   
**DC POWER:**  $\pm 12V \pm 5\%$

Request Illustrated Bulletin MM 111

**General Magnetics • Inc**  
135 Bloomfield Ave., Bloomfield, N.J. 07003

... color bulbs help  
computer debugging ...

and mechanical specifications to high-brightness NE-2 neon bulbs. The big difference is that the Japanese units have fluorescent material on the side walls of the bulb, and use an unidentified gas that is not neon. Colored light is emitted from the entire wall surface, not just from a small region around the electrodes. The brightness of the new bulbs is of the same magnitude as high-brightness neon units.

In computers, where neon bulbs are used on front panels to indicate the logic state of different sections of the memory, the colored units will make debugging an easier chore. Neons are now used because there is no filament to burn out, they require very little current, and there is no initial current surge that could damage the logic circuitry that drives them.

If a program doesn't work, or if the computer stops at some point, the only clue to the trouble comes from the neons, telling the operator about each section of the memory. To look at a maze of orange lamps is almost as confusing as looking at the memory cores themselves. Using the three colors for different sections simplifies the process of finding out what went wrong.

The first bulbs being produced are red, yellow, or green. Other colors have been manufactured experimentally. The units (in Japan) are priced at about 15 cents each in small quantities. This compares with about 10 cents for high-brightness NE-2's and 6 cents for standard NE-2's.

A major American manufacturer of indicator lamps says that it could have built colored neon bulbs years ago, but the demand for such devices is not as great as the demand for multicolored alphanumeric readouts. The color approach to alphanumeric readouts is not going the gas tube route, but rather to solid state electroluminescent panels, according to the U.S. company. The ideal result of the electroluminescent panel research would be an alphanumeric readout that can change its color by changing the frequency of the applied voltage.

Toyo Musen Co., Tokyo [358]

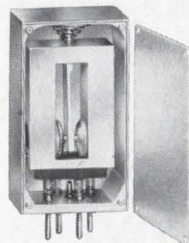

Actual Size

MODEL RF20  
contactless resonant  
reed encoder/decoder  
.395 x .620 x 1.100

## REMOTE CONTROL SWITCHING WITH AUDIO SIGNALS

An audio tone can be generated by an electronic oscillator or resonant reed encoder circuit, then transmitted by wire or radio. The tone activates a resonant reed relay to perform a control function.

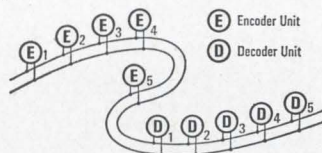

A single pair of wires, or a leased telephone line, can carry the audio signals for a complete control system.



For inaccessible areas or mobile installations, a radio transmitter and receiver system can carry the signals.

Bramco reeds permit over 50 selective control frequencies within the 67 to 1600 cps spectrum. This is assured by: (1) the narrow response bandwidth of about 1% for decoders and (2) the high accuracy of Bramco reed encoders (1/10 of 1% of design frequency).

A big advantage of reeds in control switching is that they are ideally suited for simultaneous and sequential coded tone systems. The actual number of control functions possible in such a system is virtually unlimited. For example, over 3300 individual control functions are possible with only 16 frequencies coded sequentially in groups of three.

Compared to other types of tone filters, resonant reeds are small and inexpensive. They give more control functions per spectrum, per size, per dollar.

If you work with controls that select, command, regulate, or indicate, you should know about how it can be done with audio signals. We custom design and stock a broad line of encoder/decoder components and modules.

For literature write Bramco Controls Division, Ledex Inc., College and South Streets, Piqua, Ohio, or call 513-773-8271.



BRAMCO CONTROLS DIVISION, LEDEX INC.  
College and South Streets, Piqua, Ohio 45356

## New components

### Double feature pickup tube

Can view laser patterns;  
short decay time permits  
detection of motion

A pickup tube that operates like a vidicon but has an unusual double feature has been developed by Tokyo Shibaura Electric Co. It is highly sensitive to long infrared wavelengths yet has a short decay time. Other infrared detectors offer one feature or the other but seldom both. The range of sensitivity widens the applications of the tube. The short decay time makes it useful for viewing moving objects.

Toshiba's tube has a lead oxide target similar to those in its Sensicon tube and in the Plumbicon developed by Holland's NV Philips Gloeilampenfabrieken. The addition of antimony sulphide to the lead oxide provides the sensitivity to infrared. Toshiba hints that it mixes the two while the lead oxide material is being evaporated.

Plumbicon, like vidicon, is based on the principle of photoconduction. However, Philips engineers claim that performance of the Plumbicon is better because it uses a large-area p-i-n photodiode as the light-sensing target mechanism. This, they say, gives it the advantages of an extended linear transfer characteristic, no discernible dark current, and a very small photoconductive lag.

The sensitivity range runs from visible light to wavelengths up to two microns. The tube can detect objects heated at 200°C or more.

Toshiba expects the tube to be used to view infrared laser mode patterns and to observe dislocations in germanium and silicon crystals; also for supervision of dark rooms in photographic film plants, and for remote measurement of temperature distributions in hot objects. The tube also has security and military applications.

Tokyo Shibaura Electric Co., Tokyo  
[359]

# If you buy HP counters, we have news for you.

**Systron-Donner makes advanced counter instrumentation that has no equivalent in the HP catalog. That's why it pays to check with Systron-Donner before you buy. You'll find equipment with unique capability like:**

1. A plug-in that will extend your counter's frequency range to 15 GHz – measuring FM and pulsed RF as well as CW and AM. The only way to get the full dc to 15 GHz range in one cabinet. No calculations. Displays final answer.



1.

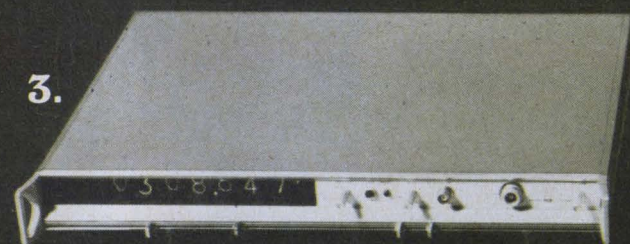

3.

3. "Thin Line" counters that take only 1 3/4" of rack space. Built with ultra-reliable integrated circuits to give you automatic frequency measurements – dc to 100 MHz or 0.3 to 12.4 GHz.

These are the highlights of expandable systems that will make just about any measurement possible with counters. The accuracy of our basic 50 MHz and 100 MHz counters is unsurpassed. (Time base aging rate is only 5 parts in 10<sup>10</sup> per 24 hrs.) All devices to extend the range or add functions are convenient plug-ins – not rack mounts. The newest are a prescaler to extend counter range to 350 MHz and a heterodyne converter to measure noisy signals in the 0.2 to 3 GHz range.

Are you surprised that Systron-Donner is a step ahead of HP in counter technology? How else could we stay in business?

Systron-Donner Corporation, 888 Galindo Street, Concord, California 94520

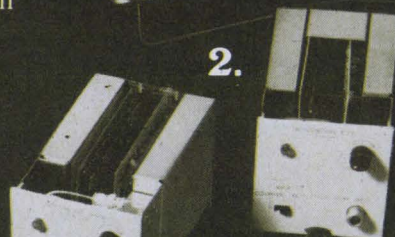

2.

2. Plug-ins that produce automatic readings of microwave frequencies. By far the most compact and economical equipment for producing automatic readings in the 0.3 to 3 GHz band or the 3 to 12.4 GHz band.



**Send for catalog.**



**SYSTRON  DONNER**

Circle 131 on reader service card

**1  
PUNCH**

**20  
HOLES**

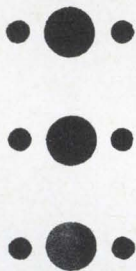

Or 37 holes! Or 2 — or 86! With press brake or punch press, Di-Acro Adjustable Punches and Dies are quickly arranged to fit your layout exactly. Easy to repeat a setup. Use over and over. Ask for 12-page folder . . . Tells about starter-set too. See your distributor or write us.

**20  
HOLES**

**COUNT  
'EM**

**di-acro** **DI-ACRO**  
division of **HOUDAILLE INDUSTRIES INC.**  
4311 EIGHTH AVENUE  
LAKE CITY, MINNESOTA 55041

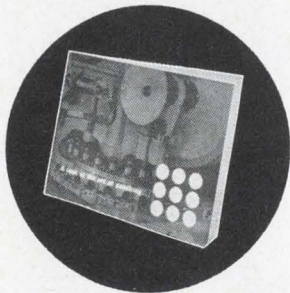
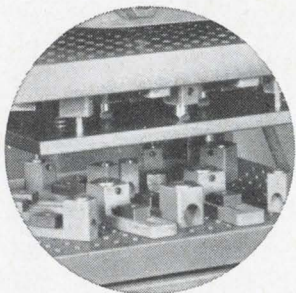

**NOTCHES  
COUNT,  
TOO**

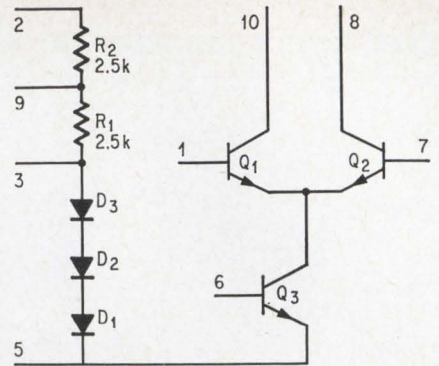

**Access.** Component placement enables simple external connection.

connection patterns are used on the wafers containing the basic structures.

**Versatility.** Aimed at the consumer entertainment equipment market, the 911 was designed to be versatile yet sell for \$2.55. It is an npn differential amplifier with an npn current source. D-c biasing is achieved by a self-contained bias chain that is made up of the resistors  $R_1$  and  $R_2$ , and diodes  $D_1$ ,  $D_2$ , and  $D_3$ . To establish a desired operating current,  $R_1$ , or a combination of  $R_1$  and  $R_2$ , forces a current from the positive supply, through the diodes, to ground. Because the diode characteristics are known, the current causes a predictable voltage drop across each diode. When the voltage is applied to the base-emitter junction of a transistor, and if the transistor is matched to the characteristics of the diode, a current will flow in the transistor's emitter equal to the current forced in the diode. This matching is accomplished because  $D_1$  is actually a transistor, identical to  $Q_3$  in geometry, with its collector-base junction shorted.

Circuit designers accustomed to choosing r-f transistors for high-frequency applications, and audio transistors for d-c and low-frequency applications, will find that there is no difference between the two types in the monolithic construction of the 911. For example, collector-emitter breakdown voltages better than 30 volts, typical d-c current gain of 100 at 1 milliamp, and current gain-bandwidth products from 500 to 800 megahertz are common to monolithic IC's.

**Combinations.** Four interconnected combinations of the 911

Something new under the sun  
The Bissett-Berman E-CELL

Time integrator  
consumes  $\mu$ watts;  
fires 100-w load

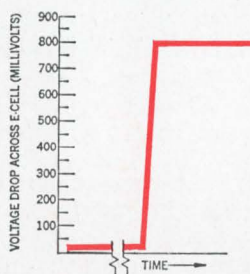
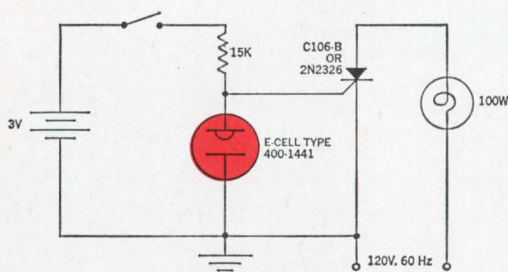

\* The Bissett-Berman E-CELL<sup>®</sup> is a unique "liquid state" electrochemical timing and integrating component now being manufactured in high volume on fully automatic production lines. E-CELLs are designed for single use or re-cycling, can be set or re-set in the field, and are furnished in wire-lead or plug-in versions. A multiple-electrode E-CELL enables complex functions such as two-phase timing — or subtotaling and totaling — with



Actual size

signal outputs at each step. E-CELLs can generate accurate time delays ranging from a fraction of one second to months; can integrate events from one to infinity; and can operate in the nanowatt range. Operating/storage temperature is  $-55^{\circ}\text{C}$  to  $75^{\circ}\text{C}$ . E-CELLs have been tested and approved by users for severe shock and vibration tolerance in accordance with military specifications. Patents applied for.

For technical information and application notes, contact: Components Division, The Bissett-Berman Corporation, 3860 Centinela Avenue, Los Angeles, California 90066; Telephone: Area Code 213, 394-3270.

**BISSETT  
BERMAN**

... complete r-f sections  
on one monolithic chip ...

and the 911 itself are being offered initially. These range from the 912, a dual emitter-coupled amplifier, to the 915, a complete amplitude-modulation intermediate-frequency strip, with built-in automatic gain control (agc).

In designing the 912 as a single-function device, the packaging cost is minimized by requiring only eight pins for the two independent stages. Since each stage has its own bias chain, the need for external biasing components is reduced. When two 912's are connected, for example, in a 10.7-Mhz frequency-modulated i-f strip with conventional transformers, there is an over-all gain of about 100 decibels. This combination, offered as the 914, is a complete f-m i-f strip, with only external transformers and bypass capacitors required.

While the 912 trades flexibility for package pin reduction, the 913 — two connected 911's — requires a 16-pin package, but performs a variety of functions. Each half of a 913 can be used independently as a cascode, emitter-coupled, or self-contained d-c amplifier.

The most complex configuration is the 915, a 16-pin package that is made up of four basic modules. Three cascode amplifiers, capable of 30 to 40 db power gain per stage, and a self-contained agc loop are connected. Components from the fourth module form a diode detector, an emitter-follower agc buffer, and an emitter-follower output buffer. The accessibility of various internal points, in the 16-pin package, allows external control of the agc threshold, determination by external capacitor values of detector response, agc time constants (fast attack, slow decay characteristics are possible), and shaping of the i-f bandpass characteristics.

According to a company spokesman, no insurmountable system problems have been encountered with the four-module chips, indicating that further increases in complexity to six or eight modules per chip are currently possible in r-f systems.

Amelco Semiconductor Inc., Box 1030, Mountain View, Calif. 94042 [444]

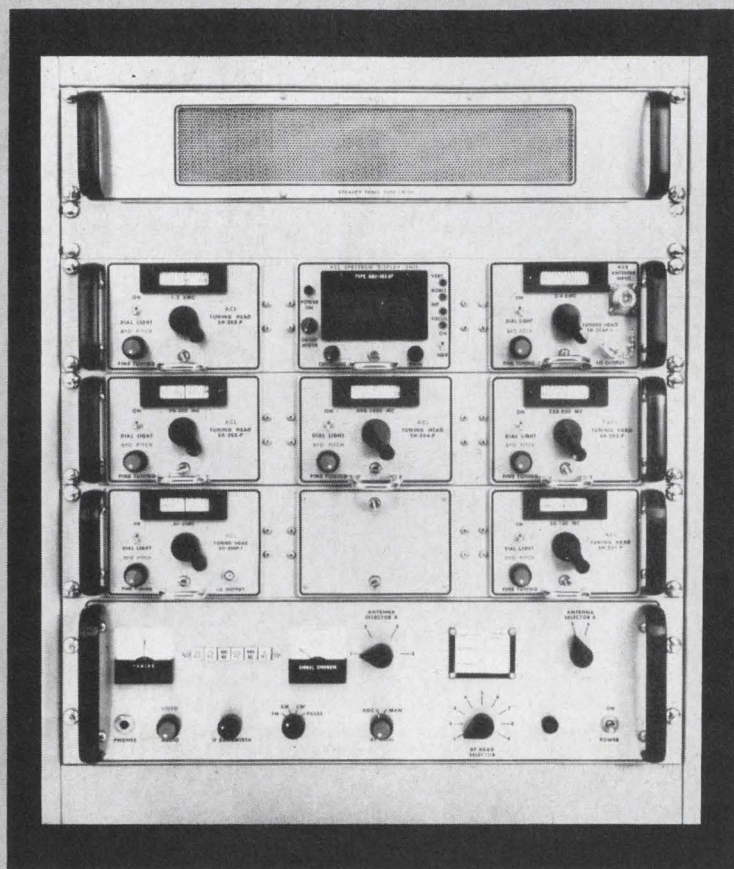

**ACL**

**SR 209-4  
RECEIVING  
SYSTEM**

**Plug-in RF Tuners**

**Frequency Range 2 MHz to 4 GHz**

**IF Bandwidths 1 KHz to 8 MHz**

**Signal Display Units**

**AM - FM - CW - PULSE**

*Write or phone for detailed specifications*

**ACL**

**ASTRO COMMUNICATION LABORATORY, INC.**  
9125 GAITHER ROAD, GAITHERSBURG, MD. 20760  
TELEPHONE (301) 948-5210 TWX 710-828-9706

New semiconductors

## Still another IC for television

Single-coil winding  
minimizes tuning  
of detector-limiter

**Trying to get** integrated circuits designed into television sets is a kind of mating game.

The ic maker will tailor the characteristics of his device to make it highly compatible with existing circuitry—to minimize redesign problems for the set manufacturer; and he will pack as much function into the chip as economics will permit—to lessen the number of external interfacing components and the number of adjustments.

Above all this, however, the paramount consideration is cost. If the ic price is not right, the mating game is off. So the ic maker will usually hedge his product investment by including features attractive to the easier-to-sell industrial and military market. Such seems to be the approach followed by Sprague Electric Co., latest member of the ic club to enter the lucrative consumer market [Electronics, Aug. 7, p. 88].

Sprague has developed a linear ic frequency-modulation detector and limiter, aimed at tv channels and f-m receivers. The device is also suited for automatic-frequency-control system telemetry and for

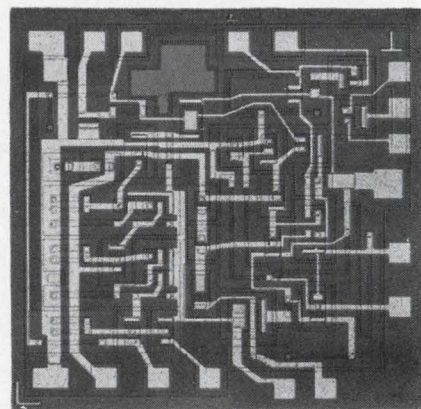

**Chipfull.** Circuit includes 25 active elements and 18 diffused resistors.



**who produces foil  
that cuts  
magnetic core  
production time  
by more than 93%?**

By changing production from a mechanical process to frets (frame style laminations) photoetched from Hamilton precision-rolled moly permalloy, stainless steel and beryllium copper, a manufacturer of magnetic head cores cut production time from five days using 12 operators to two days using two operators.

This strip and foil furnished by Hamilton Precision Metals is precision rolled to give it the excellent surface and ultraclose tolerances required for photoetching. Hamilton's unique capability produces foil as thin as 70 millionths and precision strip up to 0.100" thick with tolerances as fine as  $\pm 5\%$  or better.

Hamilton Precision Metals is your prime source for ultra-precision-rolled metals in mass production quantities. 7 proprietary metals, 12 pure metals and 112 commercial alloys are available from Precision Metals. Write today for new 48-page data book.

**HAMILTON PRECISION METALS**

division of Hamilton Watch Company, Lancaster, Pa. 17604

**... balance network  
lowers distortion ...**

radar applications.

Designated the ULX-2111A, the complex chip contains 19 transistor elements, 6 diodes, and 18 resistors. It requires only one single-winding coil for tuning, so a screwdriver is all that is needed to tune the detector. Most counterparts in discrete semiconductor networks and in IC's require complex phase-shift networks.

Some competing devices also offer simplified tuning, but they do not provide the limiting action associated with the balanced phase detector.

On the Sprague chip is a three-stage amplifier, a limiter, and a balanced detector, all of which work in tandem to provide linear gating. Filtering out of unwanted signals is high—the a-m rejection of signals riding on the f-m carrier is 45 decibels. The circuit's capture ratio is 1.4 db, and its distortion products are 1.5% maximum.

The IC's bandwidth extends from 5 kilohertz to 50 Mhz. Its output is sufficient to drive either vacuum tube or transistor power amplifiers in tv sets directly. An output-connection option is provided, so the IC may be used as a 60-db broadband amplifier. In nearly all applications for the device, only a 12-volt power supply is required.

Sprague says the price of the device cannot be determined until the process is moved from its research laboratory to production facilities in Worcester, Mass. The unit is the first of a series of consumer-oriented IC's to be introduced on a one-a-month basis during 1968.

During the past six months, at least six major competitors have been introducing IC's aimed at the same tv and f-m receiver sockets [Electronics, June 12, p. 38; June 26, p. 163].

**Specifications (tv application)**

$f_o$	4.5 Mhz
Deviation	$\pm 25$ khz
$V_c$	+12 v
$P_{dis}$	200 mw
$V_{out}$	0.60 V rms
Limiting threshold	400 $\mu$ v rms
A-m suppression	46 db
Distortion, maximum	1.5%

Sprague Electric Co., North Adams, Mass. [445]



## New Instruments Review

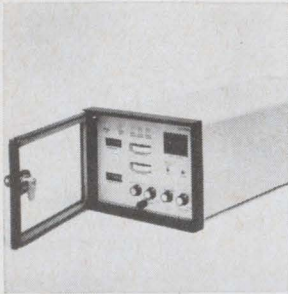

Two-component blender model 99C is available in 2 configurations: to ratio one flow to the other or to ratio one flow to the total flow. It will accept high-frequency turbine meter inputs or low-frequency meter inputs. Equipped with memory capability, the 99C produces a 10-15 ma signal to control the ratioed flow. Foxboro Co., Mechanic St., Foxboro, Mass. 02035. [361]

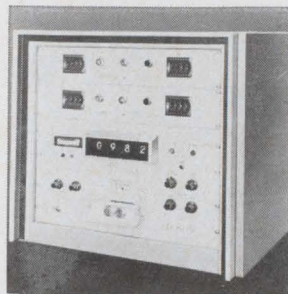

Capacitance test system 1201-DS-2 sorts or grades up to 1,200 components per hour into several categories (5%, 10%, 20% or 4 to 8 pf, 8 to 11 pf, etc.) with 0.1% absolute accuracy. Components are inserted into a guarded test fixture or test jig, with capacitance indicated on a 4-digit readout. Micro Instruments Co., 12901 Crenshaw Blvd., Hawthorne, Calif. 90250. [362]

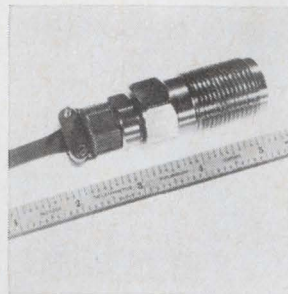

High-pressure transducer model GT-24 is designed for dynamic measurements. Pressure range is 0-20,000 through 0-100,000 psig; sensitivity, 3.0 mv/v minimum; natural frequency, 50 khz; non-linearity,  $\pm 0.5\%$  full scale max; repeatability, 0.1% full scale max; operating temperature, cryogenic to 300°F. General Transducer Co., Corvin Dr., Santa Clara, Calif. 95051. [363]

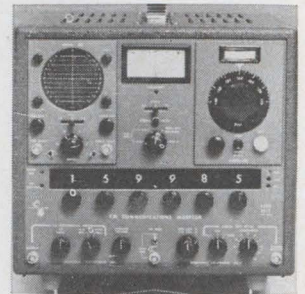

F-m communications monitor CE-3 makes off-the-air measurements of base stations up to 50 miles away. It offers a choice of 3 r-f preselector plug-ins—20-80, 120-180, and 450-512 Mhz—or a broadband r-f mixer plug-in for close-in monitoring and in-shop measurements. The instrument weighs 38 lbs. Cushman Electronics Inc., 166 San Lazaro Ave., Sunnyvale, Calif. 94086. [364]

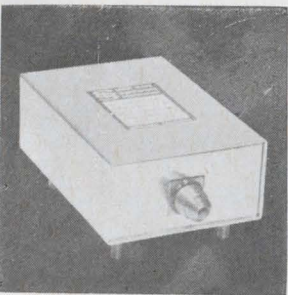

Pressure-to-frequency transducer PF-1001 is for missile, spacecraft, aircraft, and industrial f-m telemetering. Pressure ranges are from 0 to 200 psig up to 0 to 5,000 psig. Any center frequency from 400 hz to 12 khz with a deviation of  $\pm 7.5\%$  is available. IRIG channels from 1 to 12 can be specified. Solid State Electronics Corp., 15321 Rayen St., Sepulveda, Calif. 91343. [365]



Short stroke, d-c/d-c linear motion transducer model 15 delivers 5 v d-c output for 0.010-in. travel with better than  $\frac{1}{2}\%$  linearity. It incorporates a linear variable differential transformer with a completely integrated oscillator-demodulator-amplifier built into the potted enclosure. Prices start at \$145. C-E Electronics Inc., 363 W. Glenside Ave., Glenside, Pa. 19038. [366]

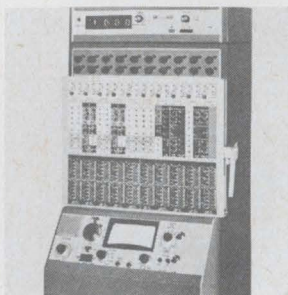

Digital voltmeter series 6250 mounts magnetically to the top of computers. It provides 4-digit readout of analog voltage signals. Voltage ranges (1 and 10 v) are push-button selected. Input impedance of the dvm is 10 megohms; conversion time, 100 msec. Accuracy is  $\pm 0.1\%$  of full scale  $\pm 1$  digit. Price is \$495. Electronic Associates Inc., West Long Branch, N.J. 07764. [367]

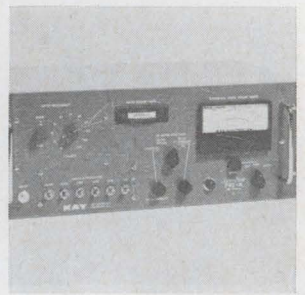

Automatic noise figure meter model 792A offers variable impedance and balanced outputs. It provides complete measurements up to 26.5 Ghz and metered noise figure ranges of 5 to 30 db for waveguide and diode sources and 0 to 20 db for hot wire and diode sources. Input sensitivity is 0 to 75 dbm; input impedance, 50 ohms nominal. Kay Electric Co., Pine Brook, N.J. 07058. [368]

### New instruments

## Hands-off frequency sweeping

Plug-in checks range from 0.1 hz through 100 khz; can be teamed with new log converter to make Bode plots

For different categories of electronic devices, frequency-response tests are key stages in the design and manufacturing processes. A hearing aid, for example, must amplify only those frequencies which the wearer cannot hear well. A hi-fi speaker must be carefully tested

with variable-frequency input signals. The servocontrol system on an aircraft can go into oscillation if wrong-frequency signals are let loose.

To meet these differing needs, a new sweep plug-in built by Hewlett-Packard Co. permits frequency-

response checks to be made over a range from 0.1 hertz to 100 khz quickly and accurately. It sweeps over these measurement ranges without the need for any knob-twiddling between ranges or for switching from one instrument to another.

Designed to work with the company's 3300A function generator and to provide it with both wide- and narrow-band capabilities, the model 3305A plug-in sweeps from 0.1 hz to 100 khz in three overlapping four-decade ranges.

Any part or all of one range can be swept by setting calibrated start-frequency and stop-frequency

# Always connect subminiatures with Winchester Electronics.

Take cable and panel mounted rectangulars. We've got them with solder or crimp removable contacts. From 4 to 50 contacts with current ratings of 3 to 7.5 amps. Standardized high-density rectangulars also, that allow you three current ratings — 3, 5, or 7.5 amps — with one size connector and one size panel cutout.

Need pc connectors? We've got edge-board, right-angle or flat-mounted pc's on .050, .078 or .100 contact centers. With solder, eyelet or dip solder terminations for 1/32 to 1/4-inch boards. And we've got micro-miniature pc connectors for use

with integrated thin film and semi-conductor circuitry.

If you're looking for circular cable or panel mounted connectors, you'll find them with 1 to 12 contacts. Contact centers from .025 to .040 with current ratings of 3 to 7.5 amps.

They're all on the shelf of

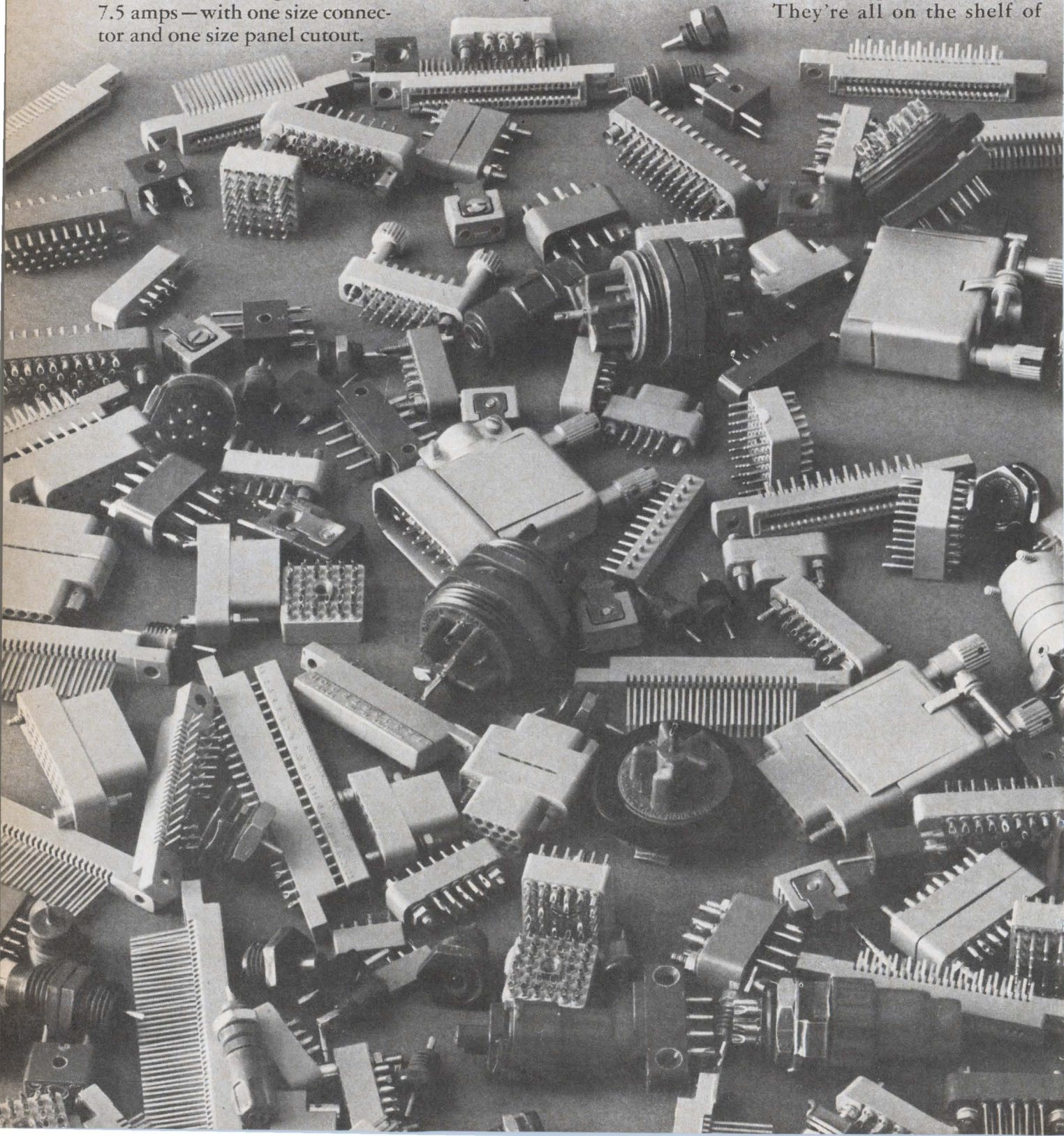

# HOW CAN YOU USE THIS NEW WRINKLE IN PLASTIC TUBING?

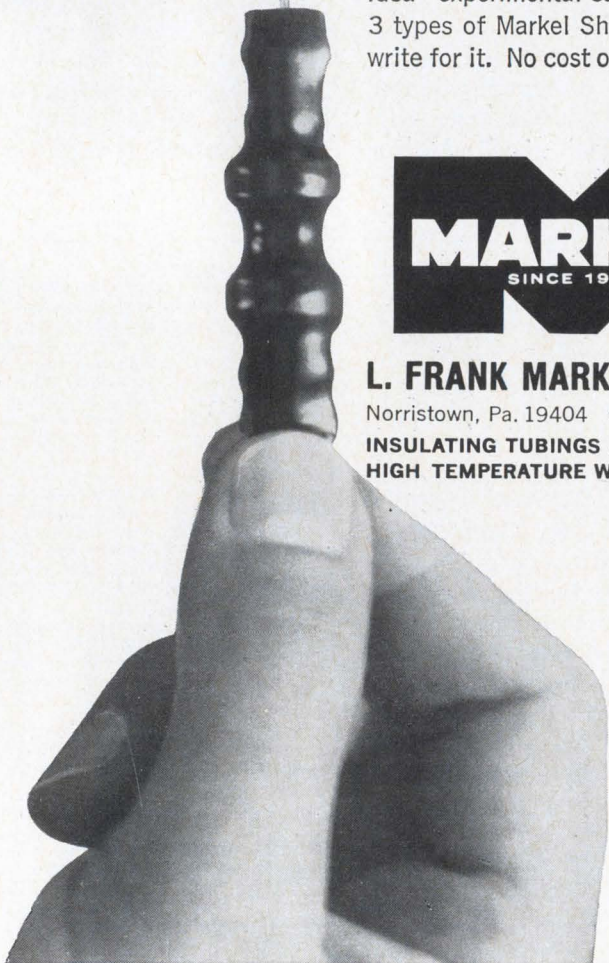

**FLEXITE SHRINKDOWN TUBING** is fast becoming an "indispensable" to design engineers. It shrinks 50% in diameter, upon application of moderate heat, to form a tough, tight-fitting sheath of plastic around objects of irregular shape. Primarily intended for insulation, it is also being used in many other ingenious ways. Like binding things together — adding strength and rigidity — protecting against abrasion, wear, breakage — resisting corrosion, heat, moisture — preventing vibration and noise — etc. How can you use it? We'll be glad to send you our "Hot Idea" experimental sample kit of all 3 types of Markel Shrinkdown. Just write for it. No cost or obligation.



**L. FRANK MARKEL & SONS**  
Norristown, Pa. 19404 • 215-272-8960  
**INSULATING TUBINGS AND SLEEVINGS**  
**HIGH TEMPERATURE WIRE AND CABLE**

voltage-to-current converters which supply the currents necessary to sweep the main oscillator—the 3300A. Precision converters insure less than a 1% symmetry error for the full range of frequencies and environmental temperatures from 0° to +55°C.

At the end of the sweep a multivibrator is triggered, blanking the main-frame's sine and triangle outputs. When the sweep output is reset to zero, blanking is removed and the 3300A begins to oscillate at the start frequency. After a short delay, the multivibrator again changes state, and the frequency is swept again. This delay provides for system recovery between sweeps.

Hewlett-Packard Co., Loveland Division,  
Loveland, Colo. [377]

New instruments

## Materials sensor measures heat flow

No-contact device operates  
on convection principle  
instead of measuring infrared

**No-contact** temperature sensing of materials, once the exclusive domain of infrared equipment, is now being accomplished by measuring heat flow instead of thermal radiation.

Called Nontact, the technique avoids some problems of infrared systems, such as having to compensate for different colors which radiate different amounts of energy, or looking through the material and picking up radiation from some other material behind it.

Nontact was developed by David Hornbaker and Dieter Rall, consulting engineers specializing in heat transfer and temperature measurement. They established a new company, Trans-Met Engineering, to produce the system.

**Balances heat.** The equipment consists of a sensing head and a temperature readout and control unit. It operates on a null-heat-balance principle employing convective heat exchange between the

# SPACELESS AGE RELAYS

## DUNCO

### LOW PROFILE

### REEDS FIT WHEN

### THE SQUEEZE IS ON

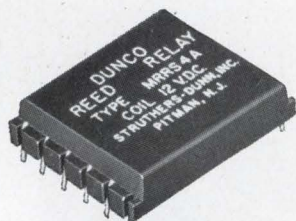

4-Pole

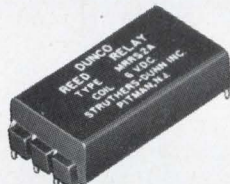

2-Pole

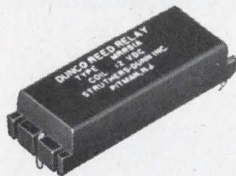

1-Pole

- Only 0.350" thin
- 1, 2, & 4 pole types
- For low level to 10 VA loads
- Internally shielded
- Printed circuit mounting
- Encapsulated into rigid homogenous structures.

For detailed specifications, write for Data Bulletin 3124.



**STRUTHERS-DUNN, INC.**

PITMAN, NEW JERSEY 08071

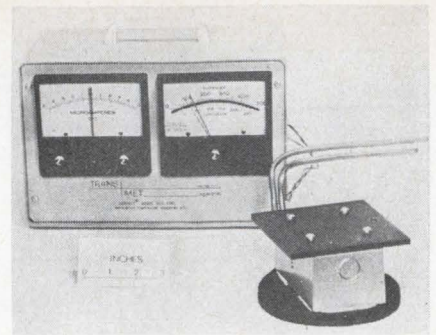

**Standoffish.** Sensor measures heat flow without touching surface of material.

sensing head and the material being studied.

The system can be used either to monitor temperature or to control the temperature of the material being processed, such as a hot plastic strip. In monitoring, the sensor head detects the heat flow from the hot strip. If the material is hotter than the head, a servo signal triggers an electric heater in the head assembly which heats the sensor assembly until its temperature is the same as that of the material. At this point there is no heat flow between the head and the material, the system is in null balance, and there is no output signal.

If the head is hotter than the material, output signals trigger a water- or air-cooling system and the coolant is circulated through passages in the sensor assembly until its temperature is the same as that of the material.

The sensor head measures about 2 x 2½ inches and is embedded in the center of a flat aluminum plate measuring about 6 inches in diameter. The sensor is a solid, potted assembly and is covered with a special reflective coating to cut out all radiant energy.

**Sink plus sensor.** Rall says the sensor assembly is basically a heat sink or heat reservoir, with a heat-flow sensor in the face to detect whether heat is flowing in or out. Included in the assembly are a potted electric heater and passages for air or water coolant. A thermocouple in the head monitors the temperature, which is read out on a meter.

When heat flows into the sensor, a positive d-c signal proportional to the rate of heat flow is generated for the control unit. When heat is flowing out, the voltage is negative.

In simple temperature tracking,

# Order Compack Controllers from Stock / *Save Space, Time, Money*

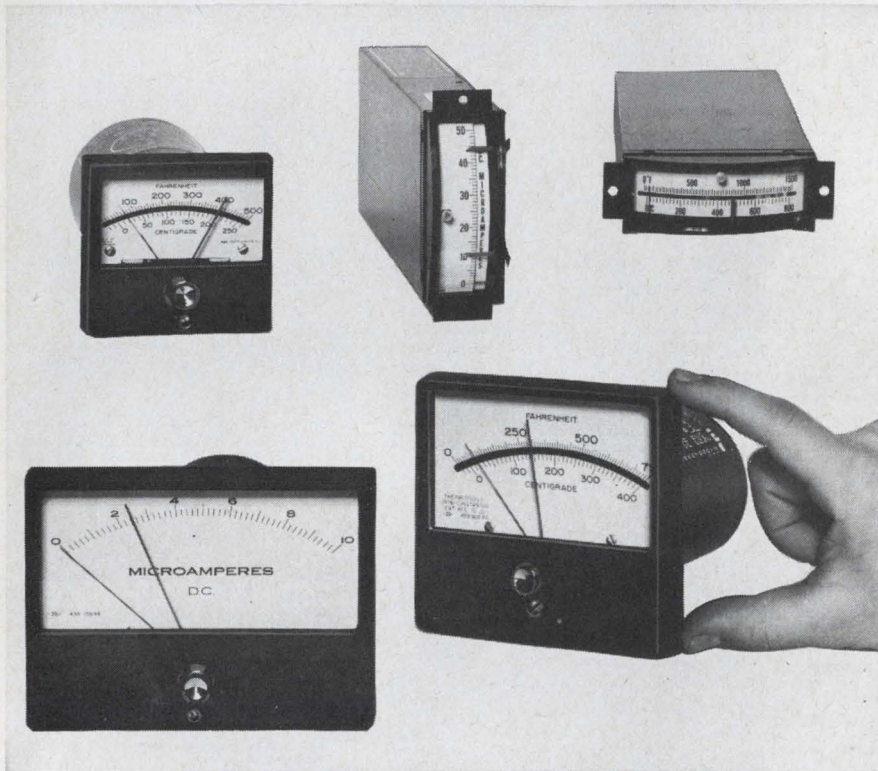

Everything about API Compacks is easy. They're space-saving controllers that simplify your design. You connect them quickly to any unamplified signal—AC, DC or temperature. You can get them from our stock without delay. Prices are painless.

In-stock Compacks come in the following general ranges:

**NON-TEMPERATURE**—0-10 to 0-100 microamperes DC, 0-1 to 0-50 milliamperes DC and AC, 0-10 and 0-50 millivolts DC. Special motor control range of 0-5 amperes AC. Single or double set point. On/Off, Cycling or Limit.

**PYROMETERS**—0-300°F to 0-2500°F. Single or double set point. On/Off, Time proportioning or SCR Driver output.

Select upright-type Compack I or edge-reading Compack II, whichever suits you better. Both contain reliable solid-state circuitry, rugged taut-band meter movement and other outstanding features that add up to the easiest approach to controlling any common variable.

Ask for: Bulletin 48 (non-temperature)  
Bulletin 49 (pyrometer models)

**api** INSTRUMENTS CO.  
CHESTERLAND, OHIO 44026 (CLEVELAND-216) 729-1611 • TWX: 810-427-9230

... output signals  
control process ...

the voltage—approximately 0.5 millivolt per degree F—goes to the solid state control unit where it is used to turn on either the heater or coolant to drive the sensor back to the null condition, equal to the temperature of the material being monitored. The sensor tracks at a rate of up to 10°F per minute, according to Trans-Met.

When the system is being used to control the temperature of material being processed, it is preset at the desired temperature and, as the temperature varies, the output signals are used to switch on controls to heat or cool the material.

In this mode, an indicator on the galvanometer is set at the required temperature. If the material is not at the right temperature, signals from the sensor head operate through a 5-amp relay to switch on controls to heat or cool the material.

When the galvanometer's temperature readout needle reaches the correct temperature, the needle vane shuts off light which has been passing through the set point indicator to a photoelectric cell inside the unit. This imbalances a bridge circuit, cutting off power.

**Container application.** A prototype unit is in operation at a plastics company in the Los Angeles area, where it monitors the temperature of styrene plastic sheet and controls a bank of heaters in an oven to keep the sheet at the right temperature. This is done just before the sheet enters a thermoforming press, where it is made into containers for cottage cheese. The plastic will not form properly if it is not at the right temperature.

Trans-Met is marketing two versions of the NCT 4,000 series system, one with a range from 75 to 300°F and one with a 75-400°F range. Accuracy is  $\pm 2\%$  of full scale.

Price is \$1,875, including sensor head and mounting bracket with positioning mechanism, controller, readout system, and 10 feet of cabling. Rall says a comparable infrared system would cost \$2,000 to \$2,500.

Trans-Met Engineering, P.O. Box 56, Whittier, Calif. 90608. [378]

## New Subassemblies Review

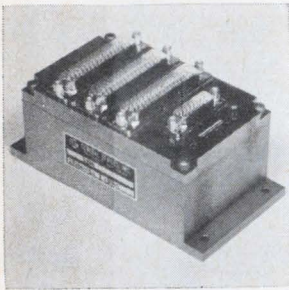

**Stepping commutator type 1724** Digicom is designed for multichannel telemetry. It provides up to 30 break-before-make signal channels with as many as two separate differential input sets of poles. Stepping rates as high as 200 samples/sec are reliably achieved. Production quantities sell for about \$1,100 each. General Devices Inc., P.O. Box 253, Princeton, N.J. 08540. [381]

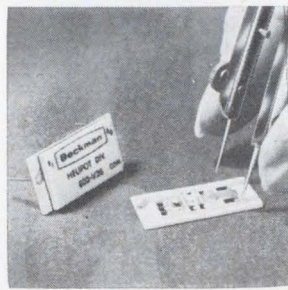

**D-c voltage regulators series 803** permit  $\pm 0.05\%$  regulation for line and load variations. Standard models offer fixed outputs of 24, 28 or 32 v. They supply up to 7.6 w to load at  $+25^\circ\text{C}$  in free air, or 16 w with a heat sink. Operating temperature range is  $-55^\circ$  to  $+125^\circ\text{C}$ . Units measure 0.990 x 0.490 x 0.170 in. Beckman Instruments Inc., 2500 Harbor Blvd., Fullerton, Calif. 92634. [382]

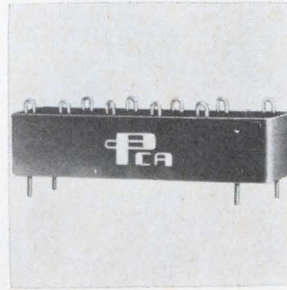

A delay line providing 16 combinations of nsec delays in 10-nsec steps is for installation in telemetry code and de-code circuits, computers and automation equipment, as well as on p-c boards. It has a maximum attenuation of 1 db, 510-ohm impedance, and a maximum 55-nsec output rise time. PCA Electronics Inc., 16799 Schoenborn St., Sepulveda, Calif. 91343. [383]

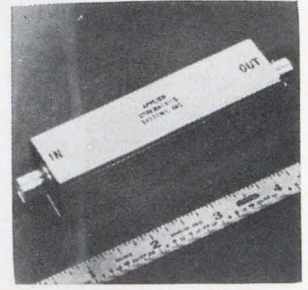

**Instrumentation preamplifiers** offer continuous operation for over a year from internal mercury cells. They are for use in upgrading the sensitivity and input impedance of scopes, counters, and vtvm's. Specs include input impedances up to 1,000 megohms, gains up to 40 db, and noise levels of  $3 \mu\text{v}$  broadband. Applied Cybernetics Systems Inc., 880 Bonfant St., Silver Spring, Md. 20900. [384]

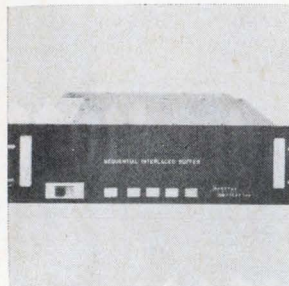

**Keyboard communications buffers series 608E-1000** are adaptable to fill almost any buffer memory requirement for asynchronous input or output character rates of up to 500 khz or for synchronous rates up to 4 Mhz. The basic system provides storage of 4,096 8-bit characters and can be expanded to 131,072 characters. Digital Devices Inc., 200 Michael Dr., Syosset, N.Y. 11791. [385]

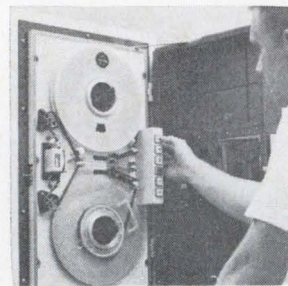

**Digital tape transport GTM-14** generates computer-compatible data and features tape speeds up to 105 in./sec. It is designed for land-mobile and shipboard use in such applications as geophysical data gathering, oceanography, and reconnaissance. The unit is 14 x 25 x 12 in., weighs 90 lbs. Price ranges from \$16,000 to \$22,000. Ampex Corp., 401 Broadway, Redwood City, Calif. 94063. [386]

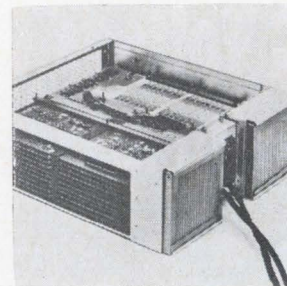

**Core memory ICM-500** uses IC's in all electronic functions, including sensing and direct drive of selection lines. Full-cycle time is 600 nsec; access time, under 300 nsec. Capacities are from 4,096 to 32,768 words. Mean time between failure is over 25,000 hours for an 8,192-word, 28-bit-per-word memory at  $35^\circ\text{C}$ . Honeywell Inc., Old Connecticut Path, Framingham, Mass. 01701. [387]

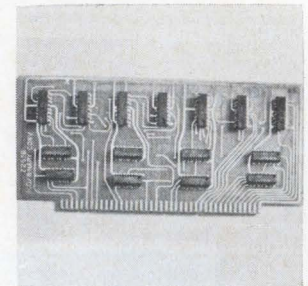

**Decimal-to-binary converter card Z-253** is for use in transforming decade thumbwheel switch outputs to straight binary. It accepts 3 BCD digits on 12 lines and delivers a 10-bit output. Conversion is accomplished by a parallel decoder matrix providing continuous output information. Price is \$226. Metric Systems Corp., 736 N. Beal St., Ft. Walton Beach, Fla. 32548. [388]

### New subassemblies

## Making sure of dotted i's and crossed t's

Magnetic deflection amplifier gives fast, undistorted readout for computer displays, electronic typesetting

When a ransom note or a love letter appears blurry on the television screen, you can usually guess the contents from the context of the story.

This is not good enough in computer-driven alphanumeric displays, nor in electronic typesetting.

If letters and figures become rounded at the corners and plotted points become smears, computer speed must be sacrificed to improve resolution or the equipment loses its usefulness.

For fast, undistorted readout in any cathode ray tube or storage

tube display using magnetic deflection, the speed of the deflection amplifiers is crucial. A new line of amplifiers introduced by Beta Instrument Corp. provides very high speed deflection performance. The all-silicon solid state modular packages are d-c coupled operational-type difference amplifiers designed for any magnetic deflection system.

"The market is not a big one, about \$250,000 a year, but due for a quick rise when electronic typesetting gets off and running," says Norman Fine, president of Beta.

Fine says the new Beta line, available in three models, offers a 1-megahertz small-signal band-

# Lapp Gas-filled Capacitors



Specially designed for a broad range of high voltage operating conditions.

High voltages, as well as high current and capacitance applications, are easily handled by Lapp Gas Filled Capacitors. For this type of service Lapp Capacitors offer small size and low cost.

Lapp precision-builds these capacitors to give years and years of accurate trouble-free operation. They are made in either fixed or variable models. All are equipped with external safety gap to protect against internal flashover.

Current ratings are available up to 400 amps at 1 mc., capacitance to 30,000 mmf, and safety gap settings to 85 kv peak. These characteristics fill a broad range of needs. May we send you more information? Ask for Bulletin 302. Lapp Insulator Co., Inc., LeRoy, N.Y. 14482.

**Lapp**

50  
YEARS

... device symmetry  
adds bandwidth ...

settling time and broadbandedness are achieved by means of the transistor output arrangement in the amplifier. This complementary symmetry output (npn-pnp) keeps the output impedance constant in both sweep directions, and therefore the settling time is equal in both directions.

In some deflection amplifiers, the yoke sees a different impedance depending on deflection direction. Thus settling occurs at a different rate in each direction. This type uses dual npn transistors and can be coupled through the emitter in only one sweep direction. When the output is from the collectors, impedance is higher than it is when the emitters are emitting. The circuit in the Beta amplifiers gives low-impedance emitter output in both directions, and this is a major reason for achievement of the 1-megahertz small-signal bandwidth and high speed.

The three models—priced from \$1,000 to \$2,000—can supply up to  $\pm 2$ ,  $\pm 4$ , or  $\pm 6$  amperes of deflection current respectively to each axis of a directly-coupled deflection yoke. They offer maximum performance in bandwidth and settling time when operated from  $\pm 35$  volt power supplies.

Most deflection amplifiers use a potentiometer across the yoke to adjusting damping. But this costs power. The Beta devices incorporate the pot—adjustable by screwdriver—in the feedback loop. In this way, gain can be optimized for a given yoke without power loss due to a paralleled resistance across the yoke.

#### Specifications (Model DA 225)

<b>Inputs</b>	
a-c power (for fan)	115 v 60hz
d-c power (for full output)	$\pm 35$ v, 14 amp
signal	
amplitude*	$\pm 5$ v
impedance	1 kohm
<b>Output</b>	
deflection coil current (each axis)	$\pm 6$ amp
<b>Linearity (deviation from best straight line)</b>	
class AB	$\pm 0.04\%$ max
class A	$\pm 0.02\%$ max

\* Input signal may be d-c, sawtooth, random positioning, sine, square, pulse, resolved sweeps, and/or complex waveforms.

Beta Instrument Corp., 377 Elliot St., Newton Upper Falls, Mass. 02164 [397]

# RMC DISCAPS

*the complete  
Ceramic Disc  
line*

Over the years Radio Materials Company has maintained its leadership in the production of ceramic disc capacitors. A complete line offering outstanding quality has been the key to continuing growth.

#### STANDARD

Type C, B, BA, JF, JL and JE

#### SUBMINIATURE

Type SM, BT, TA and Magnacaps

#### GREENCAPS

Type CG, JG, and BG

#### SPECIAL

U.L. Listed Discaps, T.C. High Voltage, High K High Voltage and Dual Section By-Pass

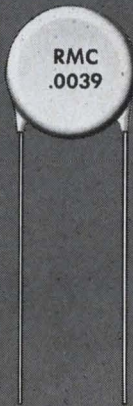

*Send for  
Your  
Catalog Today!*

Write on your letterhead for a copy of the RMC catalogue that lists the complete line of RMC DISCAPS.

DISCAP  
CERAMIC  
CAPACITORS

RMC

#### RADIO MATERIALS COMPANY

A DIVISION OF P. R. MALLORY & CO., INC.  
GENERAL OFFICE: 4242 W. Bryn Mawr Ave., Chicago 46, Ill.  
Two RMC Plants Devoted Exclusively to Ceramic Capacitors  
FACTORIES AT CHICAGO, ILL. AND ATTICA, IND.

New subassemblies

## Color tv camera sells for \$9,850

Simplified optics  
lower cost of unit  
for schools, hospitals

The insides of the color television camera introduced this month at the National Association of Educational Broadcasters convention in Denver are so bare that the trick of producing a good picture is seemingly done with mirrors.

And it is. The International Video Corp. says the biggest single factor in getting the cost of its camera below \$10,000 was a radically redesigned optics system. The camera will sell for \$9,850.

Closed-circuit television in color has been a big-ticket item mainly because of camera cost. A broadcast-quality model can easily run \$75,000, and even the stripped-down model introduced by Cohu Electronics, Inc., last spring sells for about \$30,000. CBS Laboratories has built a \$10,000 camera using field-sequential techniques [Electronics, June 12, p. 33], but it does not produce a National Television Standards Committee signal and thus requires a special monitor.

International Video, founded two years ago by two graduates of Ampex Corp. and Memorex Corp., is marketing a complete CCTV system—camera, color tape recorder, and standard monitor—for \$15,000. President Donald F. Eldridge stresses that the camera does not produce a broadcast-quality signal. Its principal market, he believes, will be in hospital and educational CCTV systems.

Called the IVC 100, the camera has a self-contained encoder and a sync generator with integrated circuits. It is intended for use with the IVC 800 color recorder, introduced last spring.

One obvious difference between the IVC 100 and broadcast cameras is that the signal in the closed-circuit camera has a resolution of only 400 lines; broadcasters specify 525. Yet a broadcast signal is degraded,



# How versatile is your leak detector



Can the complete instrument fit into spaces as small as 8 cu. ft.?

Does it have as many as 35 standard accessories available?

Is it available in models that sense for hydrogen, argon and neon, as well as helium?

CEC offers all of this and much more..

The following advantages explain why the 24-120B Leak Detector has become *the* instrument for virtually every aspect of commercial use, as well as for critical government programs. (Federal stock number 6635-698-8086.)

**Compact size plus complete mobility** assures access to difficult-to-reach locations.

**Building block construction** allows you to make substantial savings by buying *only* what is essential to the operation... then to add to it, if or when the need is called for, from the most complete line of accessories available.

**Special models.** Although the basic 24-120B is a helium detector, special models are available for monitoring argon, neon and hydrogen.

CEC backs you up with the most efficient sales, service and training organization in the field today.

For complete information, call your nearest CEC Field Office, or write Consolidated Electrodynamics, Pasadena, Calif. 91109. A subsidiary of Bell & Howell. Bulletin 24120B-X18.

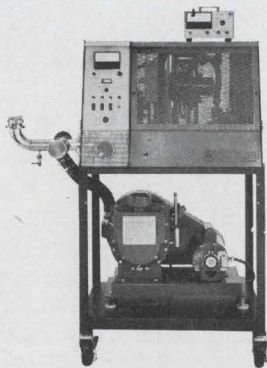

And be sure to ask for the free booklet:  
LEAK DETECTION HINTS

**CEC**  
ANALYTICAL INSTRUMENTS

 **BELL & HOWELL**

... only 4 mirrors  
in optics system ...

in some cases down to 300 lines, by the time it reaches a home set; and Eldridge says that the IVC 100 picture appears to be equal in resolution and hue to one on a home receiver.

**Zoom lens.** Merely relaxing specs did not bring about the big cost reduction. The company developed a simplified optics system, consisting of a Nikon 50- to 300-millimeter zoom taking lens, relay lenses, and a system of plate beam-splitters. The relay lenses are necessary in order to shorten the back plane focal length of the taking lens.

The light from the relay lens passes first through a red-reflector dichroic mirror that reflects the long-wavelength portion of the spectrum to one side; another mirror redirects the reflected beam so that it is parallel to the main optical axis and imaged on the red vidicon. The main beam then passes through a blue-reflector dichroic surface that reflects to one side the short-wavelength portion of the spectrum. This beam is then redirected and imaged on the blue pickup tube. What is left of the main beam goes onto the green vidicon.

**Doubling trouble.** Plate beam-splitters are cheaper than solid glass block beam-splitters, but they can produce a double image—one from the front of the plate and one from the back. Skipworth Athey, a consultant to IVC and a director of the corporation, who designed the optics, says that the blue channel is most bothered by this double vision, because blue is low in luminosity. The blue channel thus has special circuitry to trim out the undesired reflection. Also, the backs of both dichroic mirrors have a coating the thickness of which is computer-calculated to suppress the undesired reflection.

The entire optics system thus requires only four fixed mirrors. These mirrors and the relay lenses are mounted in a subassembly sealed in a plastic case and mounted on the camera chassis. It never needs adjustment, according to IVC.

Thus, the camera consists of optics, three vidicons, deflection circuits, an integrated circuit sync

# 2

## ALIGNMENT OSCILLATORS DESIGNED TO MAKE SERVICING EASIER BOTH NEW FROM INTERNATIONAL

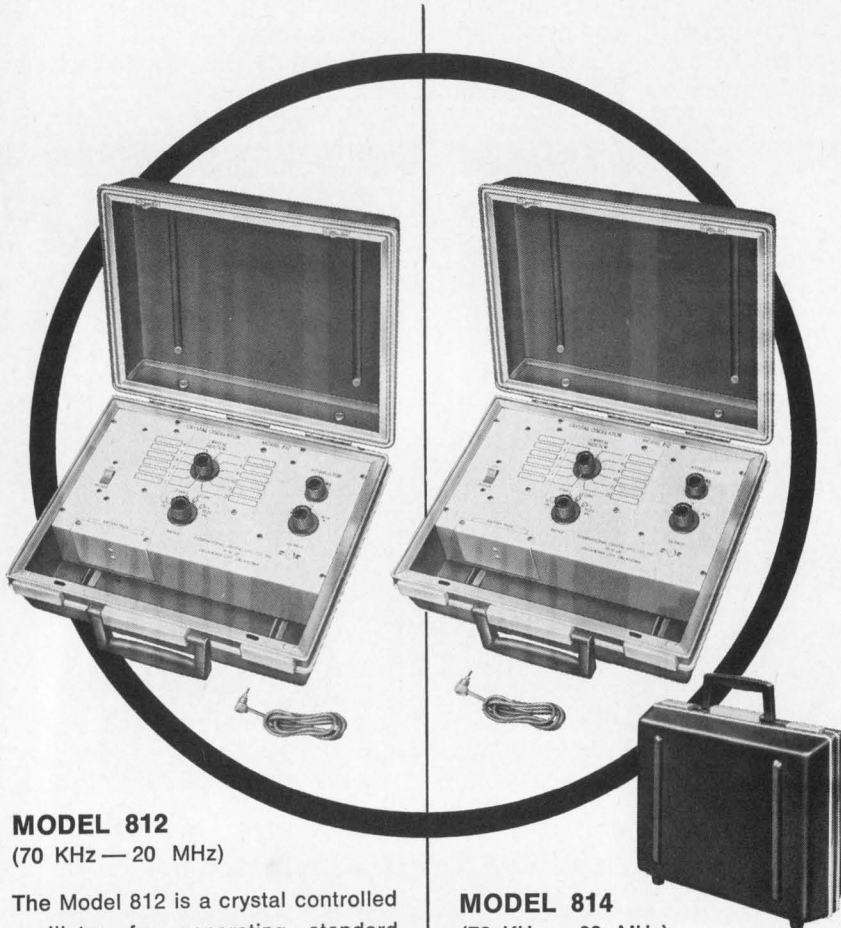

### MODEL 812 (70 KHz — 20 MHz)

The Model 812 is a crystal controlled oscillator for generating standard signals in the alignment of IF and RF circuits. The portable design is ideal for servicing two-way radios, TV color sets, etc. This model can be zeroed and certified for frequency comparison on special order. Individual trimmers are provided for each crystal. Tolerance .001%. Output attenuators provided. Battery operated. Bench mount available.

Complete (less crystals) **\$125.00**

### MODEL 814 (70 KHz — 20 MHz)

The Model 814 is identical in size to the 812. It does not have individual trimmers for crystals. Tolerance is .01%. Battery operated. Bench mount available.

Complete (less crystals) **\$95.00**

*Both the Model 812 and Model 814 have positions for 12 crystals and the entire frequency range is covered in four steps.*

Write for catalog



**CRYSTAL MFG. CO., INC.**  
10 NO. LEE • OKLA. CITY, OKLA. 73102

generator, and an NTSC encoder. There are no external racks of equipment. The encoder is on a single printed circuit board about 8 by 10 inches.

To obtain registration of the three signals, ivc says it uses "considerable feedback" in the deflection circuits. The company asserts that component stability is such that the camera will operate for eight hours without adjustment.

Athey says that color tv is usually encoded by a method in which two different bandwidths are used. The color subcarrier is modulated in quadrature with the narrow-band Q-channel, corresponding to colors along the orange-blue axis, and the wideband I-channel, corresponding to colors along the red-green channel. But decoding is on the R-minus-Y and B-minus-Y axes (Y being luminance), which are in quadrature. The ivc camera uses R-Y and B-Y encoding as well, which Athey says is much simpler and requires fewer components.

The sync generator is simplified. It does not lock the color signal to the horizontal sync. No one would know it by looking at the picture, says ivc.

Ronald Freid, ivc marketing manager, says he already has a \$500,000 backlog from "two of the largest electronic manufacturers in the CCTV area." One is interested in audio-visual training, and the other in computer-aided education. International Video Corp., Mountain View, Calif. [398]

New subassemblies

## 2-minute detector of water pollution

Carbon analyzer system  
operates on-line for  
process control uses

**Water pollution**, according to recent government reports, is killing fish and spoiling recreation areas at an alarming rate.

Present systems for detecting organic pollution require hours or even days to determine the exact

# EFFICIENCY EXPERTS

## BARNES CARRIERS AND CONTACTORS FOR FLAT-PACK HANDLING AND TESTING



Trying to increase flat-pack production rates or speed-up testing and board mounting? Then keep up with competition by using Barnes flat-pack Carriers for high-speed automatic handling, test and P.C. board insertion. Barnes Contactors accept  $\frac{1}{8}'' \times \frac{1}{4}''$  to  $\frac{3}{8}'' \times \frac{3}{8}''$  flat-packs with up to 14 leads, and facilitate quick and easy test and breadboarding. Write today for full information and ask for a free Carrier sample.



Lansdowne, Pa. 19050 • 215/MA2-1525

**barnes** / THE FIRST WORD IN CARRIERS, CONTACTORS AND SOCKETS FOR I.C.'S

Circle 504 readers service card

# You name the meter.

BRAND

# Ideal has it.

(or we'll make it for you)

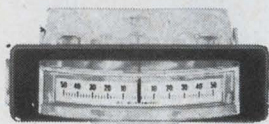
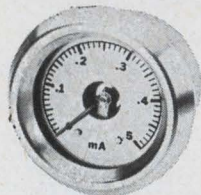
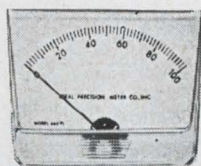
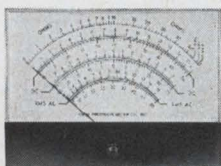

If one concentrates long and hard enough on panel meter development and engineering, one becomes expert.

IDEAL meters are used by all the Military and by leaders in defense and industry. For everything in meters—ruggedized or commercial, custom and stock,  $\frac{1}{2}''$  to 7"—you can count on IDEAL, the proven leader.

Write for free 32-pg. catalog. Ideal Precision Meter Co., Inc., 218 Franklin St., Brooklyn, N.Y. 11222. (212) EVergreen 3-6904.

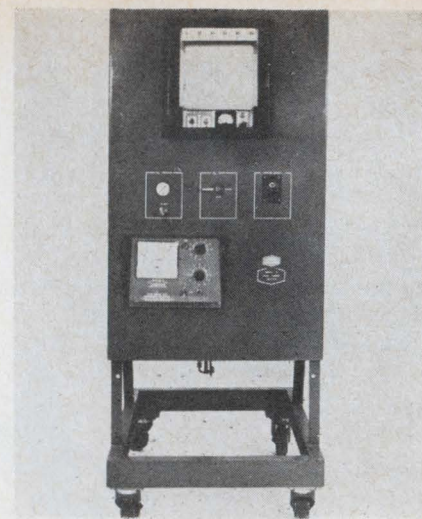
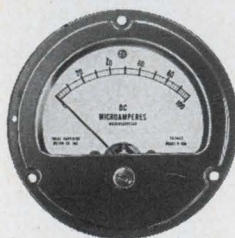

**Sampler.** System measures carbon content for pollution detection or process control.

carbon content—and hence organic content—of a sample. This is just too slow. In most cases, if the pollution is detected fast enough, it can be stopped.

A carbon analyzer built by Union Carbide Corp. completes the pollution check in two minutes. Designated the model 1212, the unit can detect organic pollution as small as a few parts per million.

Its rapid response also suits it for process control applications. In the treatment of chemical waste, continuous monitoring of both influent and effluent streams accurately measures efficiency of the process and permits regulation of operations to avoid upsets. Continuous monitoring of sewers or cooling water detects spills and leaks within moments. Circuitry can be added to sound an alarm when the quantity of organic matter rises above a preset level.

The analyzer consists of two sections: the preparation equipment and the analyzing equipment. A 40-microliter sample is introduced in the test chamber in either a batch or continuous process. Through a hot-wire catalytic system, the organic sample is changed to carbon dioxide which is carried to an infrared analyzer by a nitrogen gas stream. By measuring the amount of infrared energy absorbed by the  $\text{CO}_2$ , the carbon content of the sample is determined.

Two readout devices, a panel meter and a strip-chart recorder, are provided in full scale ranges from 0 to 100 through 0 to 3,000 parts per

# Giant pulses easily obtained with revolutionary new PLASTIC LASER Q-SWITCH

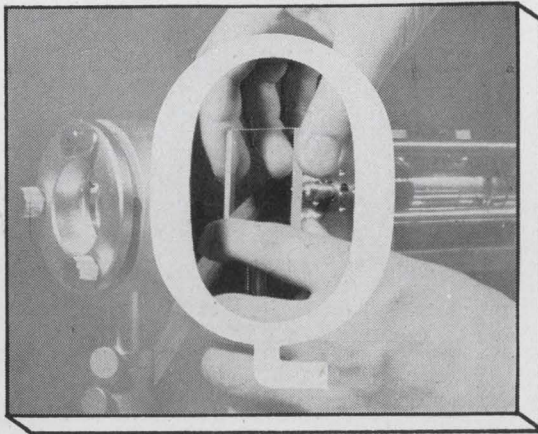

The Mitsubishi plastic Q-Switch is a plastic version of the reversible, bleachable-dye Q-switch. When placed on the laser resonator, it automatically controls the Q of the resonator, offering a simple and repeatable means of obtaining ruby laser giant pulses of 1~3MW. The device is a flat, transparent plastic plate in which bleachable-dye molecules are suspended.

Using closely coupled lamp reflector with a diffused reflecting surface, the device has successfully generated more than a hundred giant pulses with a peak power of a few megawatts. It can produce any desired contour and is stable for UV radiations. Since it can be used repeatedly, maintenance is minimal, and it saves space and weight in laser design.

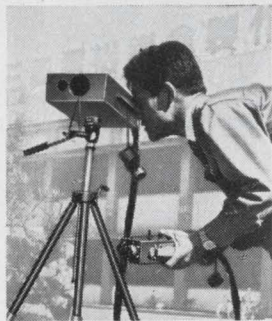

## Specifications:

Wavelength	6,943 Å (for ruby lasers)
Absorption	30~50% at 6,943 Å
Active dimensions	1½ x 1½ x ½ inches (thickness governs absorption)
Alignment	No precise alignment required

For full technical information, write to:  
Mitsubishi International Corporation  
277 Park Avenue, New York, N.Y. 10017  
Phone: 922-3700



**MITSUBISHI ELECTRIC CORPORATION**  
Head Office: Mitsubishi Denki Bldg., Marunouchi, Tokyo. Cable Address: MELCO TOKYO  
Circle 246 on reader service card

million. Both units have a repeatability to within  $\pm 2\%$ . The tester, priced at \$8,600, operates at ambient temperatures from 32° to 120°F. In process stream installations, it requires a sample flow rate of 5 gallons an hour.

Union Carbide Corp., Electronics Div.,  
5 New St., White Plains, N.Y. [399]

New subassemblies

**The price is right  
-- even with cores**

Japanese firm produces  
\$900 desk calculator  
with new techniques

**In the U.S.**, it's considered uneconomical to use magnetic core memory registers in electronic desk calculators. Acoustic delay lines are employed instead. Cores are rarely designed into data processing systems which store less than about 10,000 bits.

Not so in Japan. Casio Computer Co. of Tokyo adds to the growing list of electronic calculators with an entry which will sell for \$900 in Japan. Like the Hayakawa Electric Co. unit [Electronics, Aug. 21, p. 189] all its internal registers are made of magnetic cores.

Masakatsu Ara, Casio's submanager for new product development, says the low price is possible partly because of the magnetic core registers.

The limiting factor in core memories lies in the electronic circuitry which decodes addresses, drives current through the wires in the memory, and senses the output signals. Casio has used several techniques to help keep these costs down and make the use of cores economically feasible.

**Noise dies.** For one thing, the memory is designed to operate at very low speeds; at these speeds the pulse signals have relatively slow rise and fall times, and therefore generate little noise. In fact, capacitively-coupled crosstalk is virtually nonexistent. There is also plenty of time for the noise that is

## Our little black book has over 100,000 phone numbers.

You never had a black book like it. Over 1,500 pages. And those phone numbers! More than 100,000 telling you who to call/where to go, for the over 4,000 different product categories listed and advertised in the yellow pages of the Electronics Buyers' Guide.

There's never been a buyer's directory like it. The new '68 edition will be coming your way in October.

Look for the book in the black box.

EBG for '68... bigger, better and more useful than ever before.

### Electronics Buyers' Guide

A McGraw-Hill Market Directed Publication,  
330 West 42nd Street, New York, N.Y. 10036

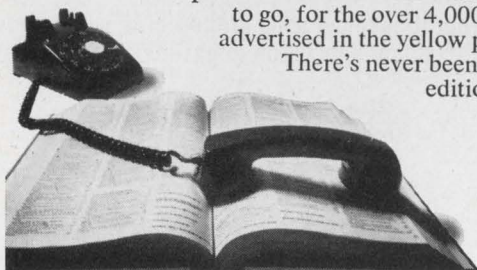

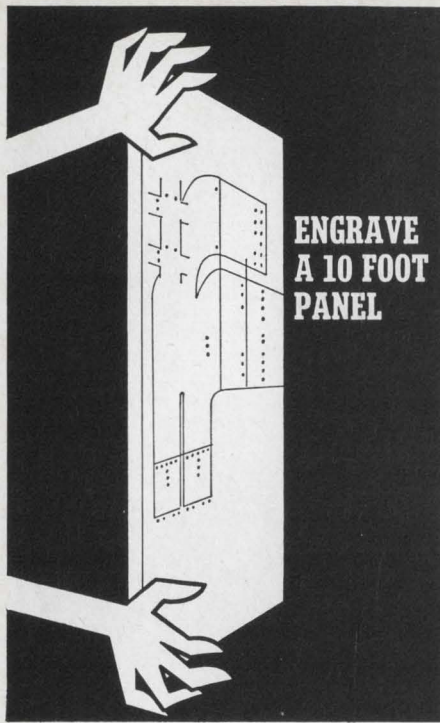

**ENGRAVE  
A 10 FOOT  
PANEL**

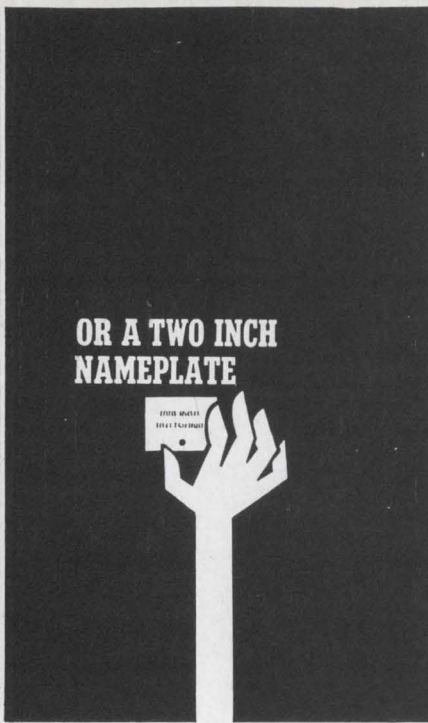

**OR A TWO INCH  
NAMEPLATE**



The New Hermes Engravograph is a highly versatile pantographic engraving machine. Anyone in your plant can operate it—with big savings. Write for 24 page catalog to Dept. 156.



*new hermes engraving machine corp.*

20 Cooper Square, New York, N. Y. 10003 • Chicago, Atlanta, Los Angeles, Dallas, Montreal, Toronto, Mexico City  
Circle 505 on reader service card



**Teamed.** Programmed mode permits semiautomatic coupling to typewriter.

generated to die away; the sensing circuits need not have a high noise-rejection capability. Thus the circuits themselves can be simpler and can be built with wide-tolerance components.

Another important design feature is the serial loading and unloading of registers, one digit, or four bits, at a time. The memory has only four sense amplifiers and four write drivers, compared to the dozen or two of each found even in small computer memories.

**Up to 14 digits.** Using these techniques for a small core-memory unit, the Casio machine works with numbers of up to 14 digits. It stores them in four 14-digit registers, and two 7-digit registers. It also has a 30-digit program register, each digit corresponding to a single instruction.

The machine has a 14-instruction repertoire, any of which can be stored in a single digit position; ten decimal digits require four bits for a binary-code representation, and the four bits can represent up to 16 different symbols—the 10 digits and six others. The machine's output is through indicator tubes; its input is from its keyboard or from a typewriter.

The operator enters a program of up to 30 steps. He then enters data into the various registers and the program makes its calculations on this data; results appear in the indicator tubes above the keyboard. A semiautomatic mode, using a typewriter, is also available.

#### Specifications

Instruction repertoire	Add, subtract, multiply, divide Clear memory, clear keyboard Set memory registers 1, 2, 3, 4 Set minus sign Square root Program stop, program restart
Size	17½ x 15 x 9 in.
Weight	5 lbs
Power	30 w

Casio Computer Co., Tokyo [400]

## **NEW!** smallest axial shielded inductor available the "NANO-RED"

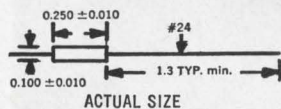

Range: 0.10 $\mu$ h to 1,000 $\mu$ h in 49 stock values

Size: 1/10 dia. by 1/4 lg.

Inductance Tolerance:  $\pm 10\%$

This new "NANO-RED" offers the highest inductance to size ratio available in an axial shielded inductor. Exceptional "Q" and self-resonance characteristics. Max. coupling 2% units side by side. Non-flammable envelope. Designed to MIL-C-15305C. Operating temperature  $-55^{\circ}\text{C}$  to  $125^{\circ}\text{C}$ .

#### Other Lenox-Fugle Subminiature Shielded Inductors:

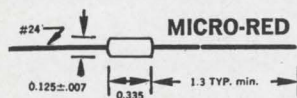

#### MICRO-RED

The "Micro-Red" is a shielded inductor that offers the largest inductance range in its size: 0.10 $\mu$ h to 10,000 $\mu$ h. "Q" to "L" ratio unsurpassed, with excellent distributed capacity. Inductance tolerance  $\pm 10\%$ . Designed to MIL-C-15305C. Stocked in 61 pre-designed values.

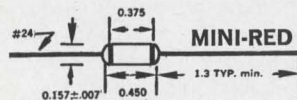

#### MINI-RED

The "Mini-Red" offers the highest "Q" to "L" ratio available over inductance range 0.10 $\mu$ h to 100,000 $\mu$ h in its size. Inductance tolerance  $\pm 10\%$  measured per MIL-C-15305C. Stocked in 73 pre-designed values.

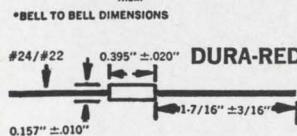

#### DURA-RED

The "Dura-Red" is designed to MS-90537 with inductance range 0.10 $\mu$ h to 100,000 $\mu$ h with tolerance  $\pm 10\%$ . Stocked in 73 pre-designed values.

Data Sheets: write or phone



**LENOX-FUGLE ELECTRONICS, INC.**

475 Watchung Avenue, Watchung, N. J. 07060

Telephone: Code 201, 756-1164-1165

# Our digital voltmeter costs \$349, and measures Ohms free.



The Fairchild 7050 DVM is a digital rebuttal to analog meters. It measures volts or ohms with a resolution of 1mV or 1 ohm, and with an accuracy of 0.1%. Integrated circuits, dual slope integration, automatic polarity, floating input and display storage are all included as standard. The 7050 weighs less than four pounds and costs \$349. The tilt stand doubles as a handle and costs \$16 extra. Our data sheet is free. Circle Reader Service Number 72.

**FAIRCHILD**  
INSTRUMENTATION

## ... frequency multiplication features may account for switching speed ...

the test bench, but can't explain it mathematically.

**With a snap.** The device uses two of the company's snap varactor diodes to do the switching. Bandpass filters at input and output keep both switching transients and drive power out of the microwave transmission line. They seem to do their job—drive-signal attenuation reaches 50 decibels just below about 150 Mhz and keeps increasing as frequency decreases. Attenuation above the passband is almost as steep.

A third filter stands between the driver terminals and the transmission line as added interference protection for the microwave signal. This filter presented a knotty tradeoff problem. To keep the microwave energy from entering the driver circuitry and thus keep insertion loss low, the filter's impedance had to be high. That meant a low cutoff frequency.

But to get a fast-risetime switching pulse through the filter to the diodes, a high cutoff frequency was necessary—about 700-Mhz bandwidth was needed to get the required pulse and the bulk of its Fourier components to the diodes.

The compromise was a seven-element Chebyshev stopband filter with 40-db attenuation between 600 and 900 Mhz; above and below

the stopband, attenuation drops off rapidly.

The compromise seems to have worked. Across a 200-Mhz bandwidth centered at 800 Mhz, there is less than 1.5-db insertion loss when the switch is turned on; isolation exceeds 40 db when the switch is off. Input and output voltage standing-wave ratio is a maximum of 1.67.

**Bootstrapping hinted.** Bascon believes the varactor diodes' frequency-multiplication characteristic may account for the speed. Perhaps the diodes are multiplying the Fourier components of the switching pulse to even higher frequencies, thus bootstrapping their way to ultrafast switching speeds. On oscilloscope traces, the switching signal was found to have frequency components well above 1,000 Mhz after it had passed through the diodes.

But Bascon also found that the diodes changed between the on and off states long before the switching pulse had completed even a small part of its 2-nsec rise to peak amplitude. It may be that the diodes need little power to switch and are being overdriven to high speed performance.

Preliminary applications are in military and research programs. The switch, designated the MA-8306-ILIN, was built for the Hughes Aircraft Co. for use in a classified system. Bell Telephone Laboratories, interested in switches that can stop a radio-frequency signal in mid-cycle, seeks a 300-Mhz switch with 2-nsec speed—another impossible combination of speed and frequency. And the Air Force wants an ultrahigh speed switch for an S-band application.

### Specifications

Switching speed	0.5-0.8 nsec
Bandwidth to 1.5-db attenuation points	700-900 Mhz
Bandwidth to 3-db attenuation points	650-950 Mhz
Drive voltage	+1, -2 v
Drive-pulse risetime	2 nsec
Drive-pulse falltime	1.5 nsec
Power capability	more than 700 mw continuous

Microwave Associates Inc., Burlington, Mass. 01803 [409]

## Some other **ENGELHARD** products

**PRECISION-DRAWN TAPE** is supplied to specification in bimetal or solid precious metals. ECON-O-TAPE is available in any thickness, length or width (from .0095"). Shaped or rectangular sections. Excellent material for electrical contacts subject to corrosion.

**E-70 BRIGHT GOLD PROCESS** produces mirror bright electroplates from flash deposits to 500 microinches in thickness. This highly efficient, neutral bath produces hard, wear resistant finishes suitable for the complete range of decorative applications.

**CLAD CONTACT PARTS** provide a precious metal layer essentially pore free and durable, with an extremely strong bond to the base metal. These parts are supplied usually in the form of blades and spring assemblies.

**ACID GOLD PLATING PROCESS** provides high purity gold electrodeposits (24 Karat) that are smooth, lustrous, free from porosity, highly ductile, relatively hard. Excellent deposits up to several mils in either still or barrel plating. Highly stable and simple to handle over long periods. Adaptable to plating wide variety of electronic components.

**SEMICONDUCTOR MATERIALS** are supplied in a wide range of precious and base metals and their alloys. These include solid sheet, wire, tape, base tab materials and clad products, fine gold wire, and ribbon. New materials are constantly under development. Technical assistance is available.

**PRECIOUS METAL CONTACTS** in pure or alloyed forms of silver, platinum, palladium and gold provide unmatched resistance to atmospheric corrosion and electrical pitting. Engelhard will manufacture to specifications or provide material in wire, rod or sheet form.

**THIN WIRE AND FOIL** are produced by Engelhard Industries to meet rigid electronic design requirements. Both extruded and Taylor Process thin wire are available in diameters as small as .001". Thin-gauge foil is supplied in sheets up to 8" to 18".

**MILL PRODUCTS** include sheet, thin foils, wire, seamless tubing, gauze, platinum clad and fabricated items. All are precision made using skills resulting from over seventy-five years experience in the working, drawing, machining, spinning, forging, and weaving of basic forms of platinum metals and alloys.

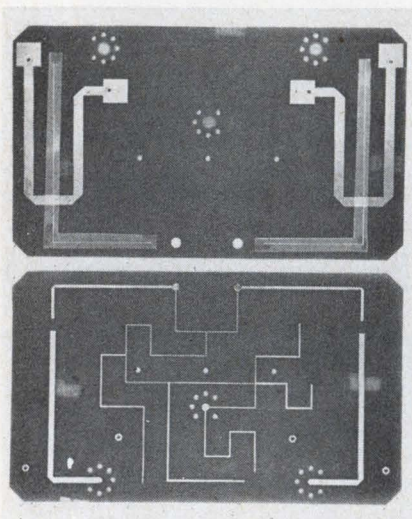

Stripped down. Both faces of stripline circuit boards are shown with filter stubs and interconnections.

# it costs you nothing to call on experience:

Reeves-Hoffman design and manufacture  
is 100% custom . . .  
let us quote your needs!

★ quartz crystals

★ crystal filters

★ oscillators

★ discriminators

★ standards

★ ovens



## REEVES- HOFFMAN

DIVISION OF **DCA**

400 W. NORTH ST., CARLISLE, PA. 17013  
TELEPHONE • AREA CODE 717 • 243-5929



**Md., D.C., Va., W.Va., N.C.**  
Valley Electronics, Inc.  
Baltimore, Maryland  
(301)668-4900; (202)659-1760

**New England**  
Howard Jappe Company  
Wakefield, Mass.  
(617)245-9359

**Pa. (not western), Del., So.N.J.**  
Eastern Components, Inc.  
Philadelphia, Pa.  
(215)927-6262

**New York (except N.Y.C.)**  
Midstate Research Sales Co.  
Syracuse, New York  
(315)478-8314; (315)478-0715

**New York City, No.N.J.**  
G. M. Moch Company  
Ridgefield, New Jersey  
(201)945-0080; (212)279-6758

**So. California**  
Ash M. Wood Company  
Arcadia, California  
(213)283-1201; (213)287-0449

**No. California**  
L & M Engineering  
Santa Clara, Cal.  
(408)243-6661

**Ill., Ind., Wisc., Minn.**  
PGM Sales, Inc.  
Chicago, Illinois  
(312)622-8183

**Ohio, W.Pa., Mich., Ky.**  
Tri-State Marketing, Inc.  
Cincinnati, Ohio  
(513)631-5060

**Texas, Okla., Ark.**  
Carter Associates, Inc.  
Garland, Texas  
(214)276-7151

**Ariz., N.M., Las Vegas**  
Carter Associates, Inc.  
Scottsdale, Arizona  
(602)947-4355

Circle 507 on reader service card

New microwave

## Coaxial connector for fast crimping

Uniform contacts assured  
by mechanical process  
including cable preparation

There was a time when the installation of solder-type coaxial connectors, with their many loose parts, was difficult and time-consuming. Stray braid strands were a common cause of trouble. This situation was somewhat alleviated by crimp-type connectors but the process still took too much time—especially when it came to stripping subminiature cable.

To eliminate these problems, AMP Incorporated has developed a system—including connectors and installation equipment—that does the job in 20 seconds. The contact exhibits a voltage standing wave ratio of less than 1.5:1 at 500 megahertz.

Designed for high-density, multiple-circuit connector applications, the subminiature, 0.11-inch contact fits into any AMP connector housing that accepts size 16 pin-and-socket contacts. Either pin-and-socket or coaxial contacts will fit into any of the 14 to 156 positions of the 19 connector styles available.

The contact body is stamped from strip brass conforming to MIL-B-50. A polypropylene dielectric surrounds and supports the inner contact for accurate mating alignment, and a tin-plated copper retention spring attached to the outer contact surface secures the crimped contact from axial pullout.

Application tooling for the stripped connector includes two electrically operated bench machines—an applicator and a crimping press—that complete the assembly in 20 seconds.

**Collared.** Operation of the applicator tool is simple. A piece of cable is inserted through a funnel-like opening, a button pushed, and the stripped cable removed with a crimping collar put in place. Inside the machine, a vibratory hop-

## ECONOMICAL Thin Film!

Resistor-Module and Discrete Resistor Plate-ohm have been developed by SUSUMU's unique thin-film techniques. The ideal resistor for your purposes!

HIGH RELIABILITY and LOW NOISE CHARACTERISTICS from SUSUMU's evaporation techniques.  
LESS EXPENSIVE as carbon resistor due to SUSUMU's fine engineering.  
ADVANTAGEOUS for your printed circuit wiring, with high-density assembling.  
EXCELLENT T.C.R.: applicable in range of  $-100 \text{ ppm}/^{\circ}\text{C} \sim +100 \text{ ppm}/^{\circ}\text{C}$ .

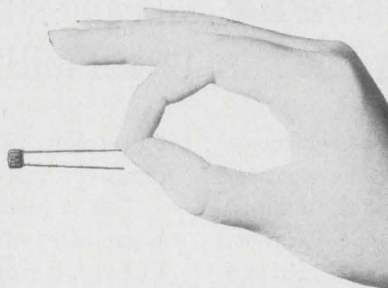

Specialists in Vacuum Evaporation:

**SUSUMU INDUSTRIAL CO., LTD.**

HEAD OFFICE AND EXPORT DEPT.  
6 Shonouchi, Chudaji, Shimogyo-ku, Kyoto, Japan  
Phone: Kyoto 075 (311) 4459 Cable address: SUSUMU KYOTO  
FACTORIES: KYOTO, NAGASHINO  
TELEX NO. 5422-359

Circle 506 on reader service card



## A NEW CONCEPT IN ENERGY CONVERSION

A basic discovery that transfers  
transient-free energy without  
the use of mutual inductance.

**WANLASS  
ELECTRIC CO.**



A Subsidiary of American Bosch Arma Company  
2175 South Grand Avenue/Santa Ana, California 92705

254 Circle 254 on reader service card

Electronics | November 13, 1967





No Engineer or Draftsman  
should be without the **BY-BUK**  
handy **CROSS REFERENCE**  
**GUIDE** to better  
printed circuit  
drafting

which include standard sizes  
as specified in MS 16912,  
(NORD) conforming to MIL-P-  
55110A...& its **FREE**



The booklet features over 3000 sizes of tapes, pads  
and shapes for **FASTER MORE ACCURATE DISTOR-**  
**TION-FREE PRINTED CIRCUIT MASTER DRAWINGS.**

Write today for **FREE** handy cross-reference guide, price list and  
**FREE** samples from the most complete supplier of Printed Cir-  
cuit Drafting and Masking Aids.

**BY-BUK COMPANY**

4326 West Pico Blvd., Los Angeles, Calif. 90019 • Phone (213) 937-3511

Circle 508 readers service card

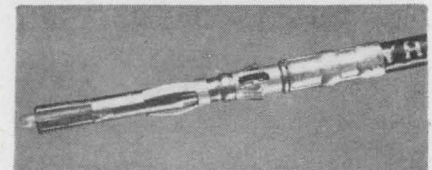
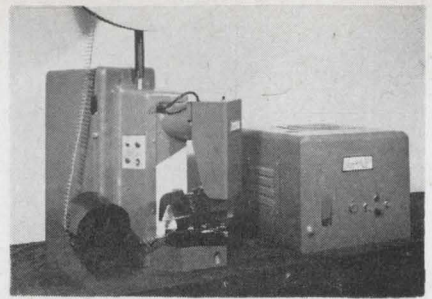

**Strip fed.** Connectors are automatically  
supplied to crimping tool from spool.

per orients the crimping collar so  
that when the cable is inserted the  
collar slides on.

When the button is pushed, a  
series of shear blades close to trim  
the outer jacket, braid, dielectric,  
and center conductor to the proper  
length. The shear blades then  
move axially away from the cable,  
stripping each layer of the cable  
to its trimmed length. Oscillation  
of the center conductor and dielec-  
tric flares the braid to a mechani-  
cally fixed limit and the jaws open,  
permitting the operator to with-  
draw the prepared cable.

The crimping is done in one of  
AMP's newer electric bench presses  
fitted with a set of dies designed  
specifically for this new contact.  
The operator positions the cable,  
locates the collar, and depresses a  
foot pedal. Closing of the crimping  
die simultaneously crimps the outer  
jacket, braid, and center conduc-  
tor, then releases the installed con-  
tact.

The collar is crimped over the  
outer jacket to provide rigidity and  
to prevent cable damage due to  
flexing at this point. The cable  
braid is crimped between the col-  
lar and the rear of the contact out-  
er body. Peripheral V-groove serrations on the body grip the braid  
and help secure the cable against  
a maximum axial pullout force of  
25 pounds. Two slender protrus-  
ions on the die extend through  
ports in the outer portion of the  
contact to crimp the center con-  
ductor.

AMP Incorporated, Harrisburg, Pa.  
17105 [410]

High Reliability Instruments

**meguro**

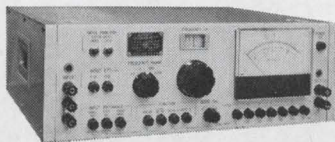

**MAK-659**

**Dist. meter**  
— for AUDIO LABS and PRODUCTION —

**MEASUREMENT RANGES**

■ **Distortion**

Range: 0.1 to 30%, 5 steps; frequency: 20Hz-200kHz;  
input impedance: 600, 10k, 20k ohms; automatic con-  
trol range: 40dBm or 100X in voltage; fundamental sup-  
pression: over 60dB.

■ **Level**

Range: -70 to +40dBm, 600 ohms, and -70 to  
+20dB (0.3mV-10V), 10k and 20k ohms; frequency:  
20Hz to 600kHz.

■ **S/N (signal/noise)**

Range	Input
0 to 70dB	-22 to 0dBm
0 to 90dB	0 to +38dBm

frequency: 20Hz to 60kHz.

• Catalog sheet on request



**MEGURO DENPA SOKKI K.K.**  
(Meguro Electronic Instrument Co., Ltd.)  
No. 5, 1-2-chome, Chuo-cho, Meguro-ku, Tokyo, Japan  
TEL: 711-7191-7 Cables: MEGURODENPA TOKYO

FOR  
**Electronic  
Components**

Think  
**GC**

Solve all component  
procurement problems  
quickly and  
economically...  
simply specify GC!

Choose from a wide  
variety of binding  
posts, alligator clips,  
phone tips and jacks,  
banana plugs, and the  
exclusive GC "Klipzon"  
products to speed  
production on every  
electronic assembly.

Write today on your  
Company letterhead  
for the big **FREE GC**  
Electronic Components

**FREE!** Catalog —  
FR-66-1, and ready-  
reference  
Wall Chart —  
FR-029-E...  
your GC keys to  
greater  
profits.

**GC Electronics**  
400 South Wyman Street  
Rockford, Ill. 61101

A Division of  
**GC-Hydrometals, Inc.**  
Shipping warehouses in:  
Hicksville, L.I., N.Y.  
Los Angeles, California

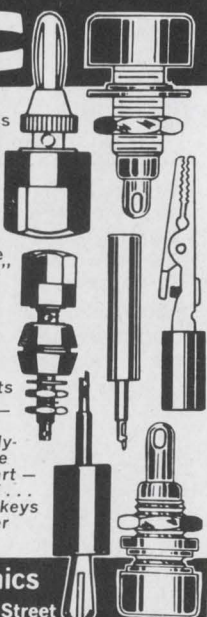

# Only new Lambda LP Series lab power supplies provide all these big system features in a small, low-cost package.

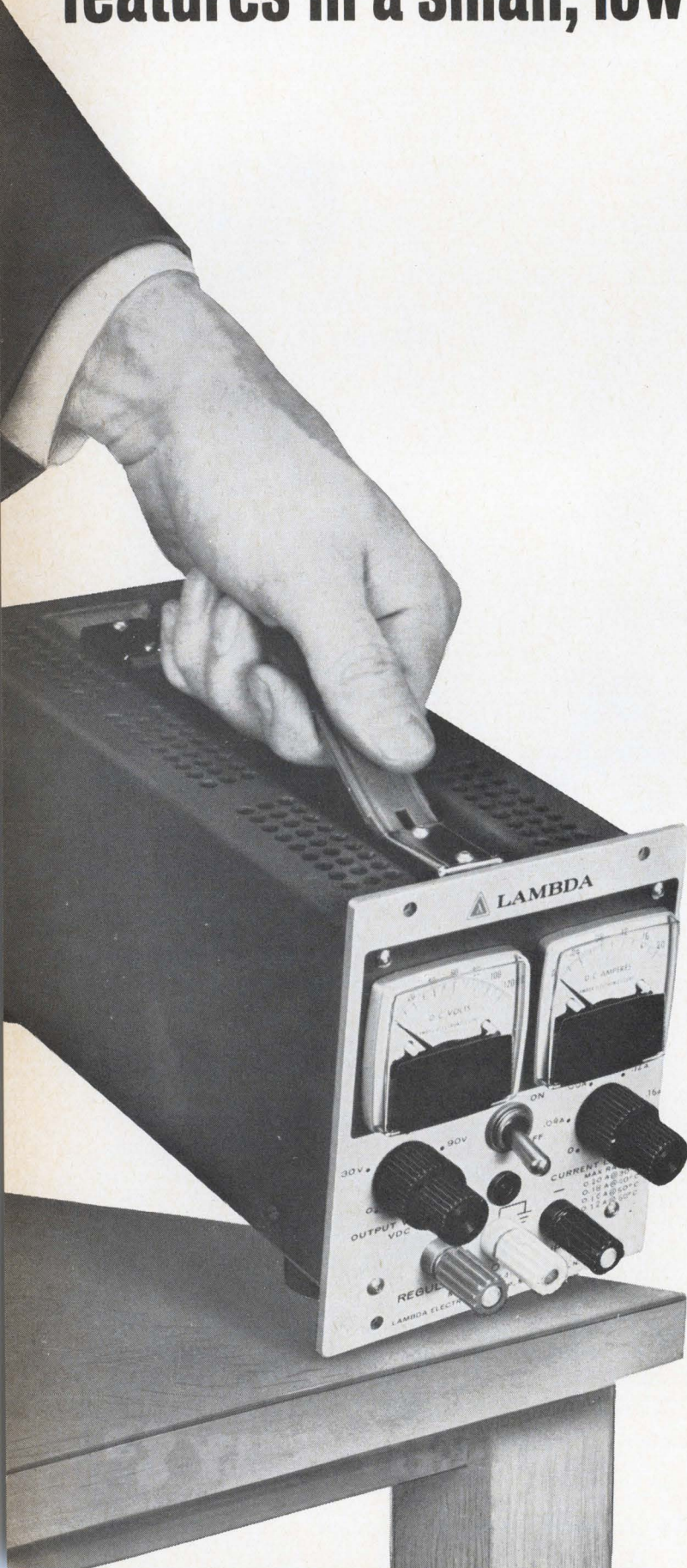

## Starting at only \$114.

- High power output—up to 28 watts.
- Wide voltage range versatility—0-10 VDC up to 0-250 VDC.
- Bench or rack use—without adapters.
- Unusually wide automatic current limiting—from 1% (or 5 MA) to 105% of rated output current.
- Two meters for voltage and current.
- Both coarse and fine adjustment of voltage and current.
- Over-temperature protection by thermal relay—prevents overheating.
- Convection cooled—no blower failures.

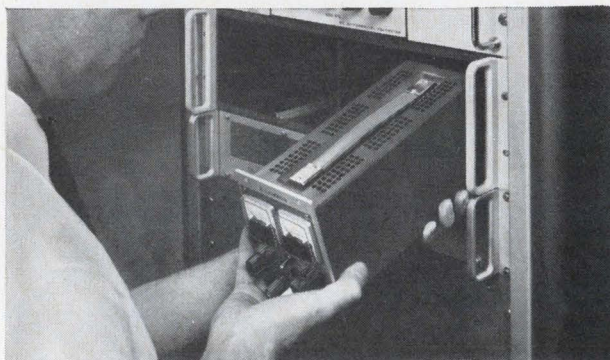

You can mount up to 4 units in a standard LRA-1 or LRA-2 rack adapter.

### Other features

- Regulation (line or load): .01% + 1 MV.
- Ripple: 500  $\mu$ V RMS, 1.5 MV p-p
- Temperature coefficient: .015% + .5 MV/°C.
- CV/CC with automatic crossover.
- A-C input: 105-132 VAC 45-440 Hz (ratings based on 57-63 Hz operation).
- All Lambda power supplies are guaranteed for 5 years.

### Select from six models

Model	Voltage Range	MAX. CURRENT AT AMBIENT OF:				Price <sup>1</sup>
		30°C	40°C	50°C	60°C	
LP 410	0-10 VDC <sup>o</sup>	2A	1.8A	1.6A	1.4A	\$129
LP 411	0-20 VDC <sup>o</sup>	1.2A	1.1A	1.0A	0.8A	119
LP 412	0-40 VDC <sup>o</sup>	0.70A	0.65A	0.60A	0.50A	114
LP 413	0-60 VDC <sup>o</sup>	0.45A	0.41A	0.37A	0.33A	129
LP 414	0-120 VDC	0.20A	0.18A	0.16A	0.12A	149
LP 415	0-250 VDC	80MA	72MA	65MA	60MA	164

<sup>o</sup>Overvoltage Protection available as an accessory—\$40.00 each.

<sup>1</sup>Prices are for non-metered models. For metered models, add suffix (FM) and add \$10.00 to price.

SEND FOR COMPLETE LAMBDA CATALOG



# LAMBDA

ELECTRONICS CORP.

515 BROADHOLLOW ROAD • MELVILLE, L.I., NEW YORK 11746 • (516) 894-4200

A VEECO SUBSIDIARY

VEECO HIGH VACUUM EQUIPMENT/LAMBDA POWER SUPPLIES

# WHICH DEFLECTION YOKE FOR YOUR DISPLAY ?

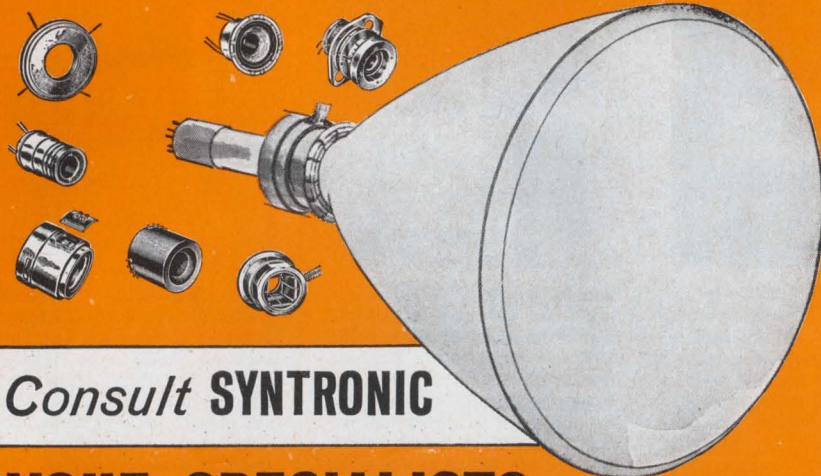

Consult **SYNTRONIC**

## YOKE SPECIALISTS

Syntronic's team of experts knows more about yoke design, engineering and quality control than anyone else. A solid 10-year record of leadership—acknowledged throughout the industry. Benefit from it.

***syntronic*** **INSTRUMENTS, INC.**  
 100 Industrial Road, Addison, Illinois  
 Phone: Kingswood 3-6444

Circle 510 on reader service card

For  
 Production  
 Efficiency

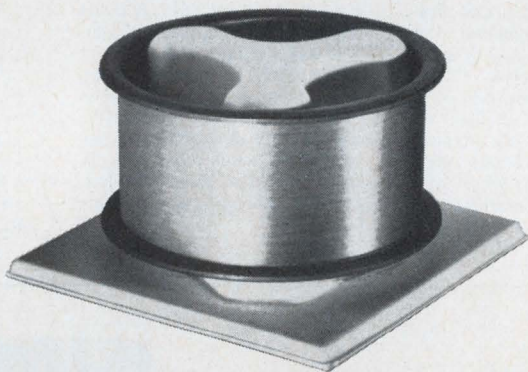

## CRM FINE WIRE for ULTRASONIC BONDING — ALUMINUM & ALUMINUM ALLOYS

featuring  
**Cleanliness • Strength • Uniformity**

Contact CRM engineers for recommendations  
 for your application.

Write for latest catalog.



**CONSOLIDATED REACTIVE METALS, inc.**

115 Hoyt Avenue — Mamaroneck, N. Y. — OWens 8-2300 — TWX 914-835-3380

... process slow,  
 so no hot spots ...

a program to develop equipment for in-house use by Bunker-Ramo, a major supplier of custom-designed hybrid thin-film circuits. The machine is used with a digital voltmeter, which reads out resistance values.

**No hot spots.** According to Jack W. Ireland, director of the company's microelectronics and advanced technology operations, the controlled, relatively slow nature of the new process eliminates the hot spots and noise that are characteristic of chemical and mechanical adjustment techniques.

The new technique alters the temperature coefficient of resistance (TCR) of resistors. This is not true of mechanical adjustment techniques such as scribing or the use of shorting bars. "When you adjust with our equipment," Ireland says, "you get a TCR change at a predictable rate with respect to the change in resistance. This TCR change can be advantageous for tracking purposes—where you have two adjacent resistors that have to remain identical in resistance over a wide temperature range. For every degree of heat, you add maybe 10 to 50 parts per million, depending on the TCR factor of the material."

**Balancing the bridge.** The equipment consists of a Wheatstone bridge, power supplies and associated circuitry to selectively energize and de-energize the bridge arrangement. The bridge has four arms, two of which have the resistors to be adjusted—and standard wire-wound resistors against which they'll be checked—sequentially switched into them. The resistors and the standards are so arranged that when a switch positions the resistor to be adjusted into the Wheatstone bridge, the standard resistor is placed in the adjacent arm of the bridge. A current from a secondary winding of a transformer in the circuitry flows through the bridge arrangement, including both the resistor and the standard. Current flowing through the resistor to be adjusted is controlled by the setting of an autotransformer in the circuitry, and a reading of the current is provided by a milliam-

need a  
front-yard  
market?

IOWA has  
that, too!

Chicago, Detroit, Milwaukee, Minneapolis, Kansas City and St. Louis are all in Iowa's front yard. That's one reason Iowa's last 4 record years of industrial growth have seen 438 new industries invest \$205,000,000 in Iowa and 626 industries spend \$346,000,000 for expansion.

Some other important reasons: *Labor Force* . . . talented, trainable men and women from 32 colleges and universities and many vocational schools. *Water* . . . from the Mississippi, Missouri and many other Iowa rivers. *Transportation* . . . two navigable rivers, plus roads, rails and an airline network to every conceivable point. *Management Time* . . . Iowa executives just naturally have more. They don't waste hours commuting daily.

There's more. Fill out the handy coupon . . . we'll send all the facts. Fast!

(Confidential Reply Coupon)  
IOWA DEVELOPMENT COMMISSION  
Dept. 5117, 250 Jewett Building  
Des Moines, Iowa 50309



Name \_\_\_\_\_

Firm \_\_\_\_\_

Address \_\_\_\_\_

City \_\_\_\_\_

State \_\_\_\_\_

Zip \_\_\_\_\_

New production equipment

## Welding fasteners quick as a flash

High-speed stud welding unit  
numerically controlled  
for parts production

**Numerical control**, used extensively to run drilling machines, boring mills and punch presses, has been coupled to stud welding techniques for mass-production of parts for the electronics industry.

Stud welding is the joining of metal fasteners of various dimensions. The use of a tape-fed numerical control machine means that intricate welding patterns can be accomplished on items ranging from electronic housings to appliance panels without the need for auxiliary tooling or multiple welding heads, according to KSM division of Omark Industries Inc.

The company coupled its production welding unit to a numerical control system and positioning table made by Hughes Aircraft Co. The resulting system permits about 30 welds per minute, in virtually any pattern and within 0.001 inch of the desired location. The company sees primary applications in electronic parts production, where precisely-positioned fasteners are often needed in a small area to secure components.

Studs of up to one-quarter inch in diameter can be attached by the welding unit, which can be stocked with more than 15,000 fasteners. A weld is completed in a few milliseconds, so quickly that there is no burning on the reverse side of the thinnest-gauge materials, KSM says. The capacitor-discharge method of welding is used. A steel stud with a small, protruding tip is placed on the workpiece. Electrical energy stored in the capacitors is then released, instantly melting the projection and the surface of the material, and permanently joining the stud and the piece. The process can be used on a variety of metals, including aluminum.

Omark Industries, Inc., KSM Division,  
Moorestown, N.J. 08057 [430]

# Mold-A-Terms cut terminal insulating costs to 50%!

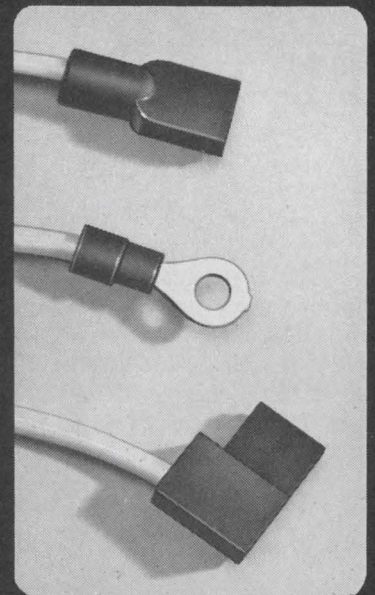

This technique consists of encapsulating any desired portion of the standard open barrel terminals after they are crimped onto wire leads. PVC and various other thermoplastic materials have been found equally adaptable.

Beman refined "MOLD-A-TERMS" to overcome price inequities found in comparable cost studies with pre-insulated and post-insulating methods.

### ADVANTAGES OF "MOLD-A-TERMS"

Freedom of Design...Smaller size...  
Protection against Moisture and  
Natural Contaminants.

Applied singly or in multiples...  
Write for further details on "MOLD-  
A-TERMS."

 **BEMAN MFG., INC.**

P. O. Box 370 New Cumberland, Pa., 17070  
Phone: (717) 774-0210



**Last  
Tuesday  
morning  
a lot of people  
on Pleasant  
Avenue were  
glum.**

But not "Smiling" Sam Price. He's one of the Twelve Cranks on Pleasant Avenue. And last Tuesday he found a lousy connection in a Trygon Liberator Power Supply that was coming off the line! It made his day!

The point is, of course, that loused-up Liberators never leave Trygon. Not with Sam Price and his un-merry men around. Their job is finding problems for us; so you don't get any problems from us.

Sam's pet, the Liberator, gives you the ultimate in IC and transistor system power in minimum size at lowest possible cost. Wide slot adjustment ranges with voltages up to 160v. Output current levels up to 40 Amp (3½") and 70 Amp (5¼"). .005% regulation/.5 mv ripple/3mv P-P noise/.01% stability/extremely low output impedance/MIL Spec. performance / integral slide mounting/automatic load share paralleling/overvoltage protection.

And you can be sure of this. Every Trygon Liberator Power Supply comes off the line under Sam's baleful eye. Order one and see.

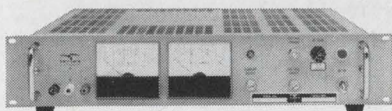

#### **Trygon Power Supplies**

111 Pleasant Avenue, Roosevelt, L.I., N.Y. 11575  
Trygon GmbH 8 Munchen 60, Haidelweg 20, Germany

## **New Books**

### **Less guesswork**

Handbook of filter synthesis  
Anatol I. Zverev  
John Wiley and Sons, Inc.,  
576 pp. \$19.95

Today a systems engineer can specify almost any type of filter response as a subsystem on a block diagram and be reasonably sure that it can be approximated and built into an operating electronic filter. This handbook makes it easier for filter designers to satisfy such specifications. It combines the best features of a theoretical text with those of a practical filter design manual.

Performance and design data for all possible filter types—inductance/capacitance, crystal, and coupled resonators—are given in both the time and frequency domains. Designed primarily as a guide to solving filter problems, the book also covers basic network synthesis.

Zverev starts with the underlying theory, concepts, and techniques of selective networks and then moves to the responses that are provided by passive, linear, bilateral filtering structures. These are illustrated by specialized networks such as crystal and helical filters.

Other sections cover polynomial filters with monotonic attenuation curves, design tables for lowpass element values, normalized coupling coefficients, quality factors, and network-transformation techniques.

Although the author does an excellent, comprehensive job of describing passive filters, the reader will not find an extensive treatment of active networks and microwave structures.

### **A for effort**

Introduction to Quantum Mechanics  
for Electrical Engineers  
P.A. Linsay  
McGraw-Hill Book Co., 240 pp., \$9.50

Few books have been aimed at making quantum mechanics palatable to electrical engineers. Any that try to are like coeds at Princeton—on the basis of rarity alone they demand attention. This book

tries and partially succeeds.

The importance of quantum mechanics to today's inventive electrical engineer is summed up by Rudolf Kompfner of Bell Telephone Laboratories in his introduction: "I expect to see a reversal of a trend . . . that the major inventions in the recent past in the sciences of communications and electronics have been made by physicists." Presumably, notes Kompfner, the physicists studied quantum mechanics at school.

In a discussion of waves Lindsay glosses over the first experiments that suggested the wave properties of matter and omits illustrations that might be helpful. He assumes the reader is familiar with wave equations, and points out the similarities between Heisenberg's uncertainty principle and the time-frequency domain correspondence. Liberal use is made of transmission line theory throughout to support the author's presentations.

The book concludes with a discussion of the concept of energy bands in crystals. Most readers would expect, and profit by, a discussion of the relationship between this concept and semiconductor physics—but it is lacking. Instead the reader must refer to texts on solid state physics, for which Lindsay's book is an excellent introduction.

For those who are seriously interested in the subject, he includes problems at the close of each chapter. Some instruct the reader to "discuss" specific areas. One wonders with whom the solitary student will discuss such problems; wives, for example, are notoriously poor conversationalists when it comes to quantum mechanics.

### **Two in one**

Tunnel Diodes  
M.A. Lee, B. Easter, H.A. Bell,  
Chapman and Hall Ltd.,  
Distributed in the U.S. by Barnes &  
Noble Inc., 196 pp., \$6.25

As one of a series of brief, inexpensive monographs on selected topics in electronics, it's easy to see why this book has been published. The



*for  
maximal  
performance  
in critical  
applications...*

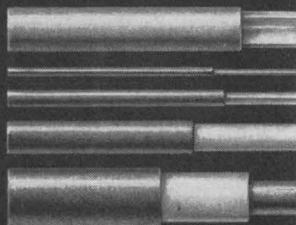

## **COAXITUBE PRE-FAB PARTS & ASSEMBLIES**

Orders of Coaxitube can be furnished cut to size, stripped, preformed to shape or assembled with connectors to meet your exact specifications. Semirigid construction assures the retention of shape and closely held tolerances. We'll gladly send data or quote your needs . . . no obligation.



## **New Books**

topic of tunnel diodes is narrow and lends itself to coverage in less than 200 pages.

Tunnel diodes, today, are useful in only two applications: microwave amplifiers and high-speed logic circuits. This book covers both areas. But a reader interested in logic circuits would care little about microwave amplifiers, and vice versa. Thus, either reader, if he buys the book, is also paying for information that will probably be useless to him in his work.

One wonders, in fact, why two books were not prepared for the series, one on each major application area. This would have allowed deeper coverage of each type circuit and made each one more useful to a particular reader.

The best section in the book is the first one, on physical aspects of tunnel diodes. This is a well-written discussion of the tunneling phenomenon and the construction and metallurgy of the devices.

### **Bright hope**

The Physics of  
Electroluminescent Devices  
P.R. Thornton  
E&F.N. Spon Ltd., 382 pp., \$14.50

After candidly indicating the breadth of topics needed to cover the subject in his very first sentence—"The study of electroluminescent devices is not one for faint hearts"—the author goes on to deliver one of the best books yet published on the subject. It is complete, well written, and will be useful for a long time as this embryonic segment of electronics grows to major importance.

It highlights the changing nature of electronics engineering. With the advent of new devices, today's engineer must be part metallurgist, part thermodynamicist, part optics specialist, and still be all engineer.

As a primer for the understanding of the basic mechanisms of electroluminescence, the first two chapters are devoted to excitation and recombination processes. The author then moves on to avalanche breakdown and reverse-bias light emission, and then zeroes in on

## **PRECISION Semi-rigid COAXITUBE**

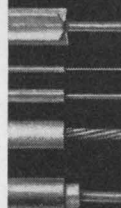

These high performance solid-jacketed cables offer broad frequency response, low attenuation, zero radiation and lowest possible VSWR. The splined, air-articulated types provide

minimum attenuation and highest cutoff frequencies, eliminate periodicity phenomena, and insure phase stability in the order of 20 PPM/°C from 10°C to 40°C, and 35 PPM/°C from -40°C to +125°C. They also provide excellent external RF shielding. For critical applications in severe environments, your best decision is Precision.



**PRECISION TUBE COMPANY, INC.**  
SPECIAL PRODUCTS DIVISION  
North Wales, Pennsylvania 19454  
Phone 215-699-4806 TWX 510-661-8427

### 3 integrated bridge rectifiers with 3 mounting options

Each of these Varo Integrated Bridge Rectifiers is a controlled avalanche, full-wave bridge, and is electrically insulated for direct chassis mounting. Each offers three mounting options: Press mount. Single stud. TO-3 mounting adapter.

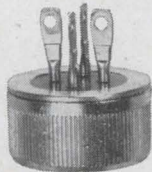

10 amp fast recovery IBR. Recovery time: 200 nanoseconds. 100V, 200V, and 400V ratings.

**only \$4.75\***

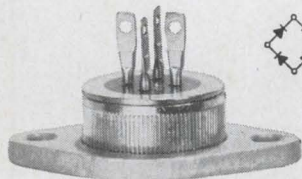

10 amp IBR. 200V, 400V, and 600V ratings.

**only \$2.35\***

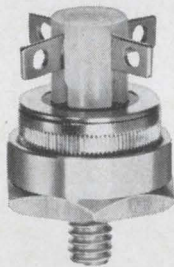

25 amp IBR. 200V, 400V, and 600V ratings.

**only \$3.05\***

\* In 200V rating and quantity of 1,000 (press mount).

Write for complete information on Varo rectifier products.



**SPECIAL PRODUCTS DIVISION**  
2203 WALNUT STREET, GARLAND, TEXAS 75040  
(214) 272-3561

### New Books

electroluminescent behavior in zinc sulfide, cadmium sulfide, gallium arsenide, and gallium phosphide. He winds up with a discussion of injection lasers and points out in detail the many applications for electroluminescent devices.

In his section on applications, the author has looked far enough ahead to areas that are only theoretical today. Since the most likely applications for injection lasers will be in room temperature devices—where cryogenic cooling will not be required—the author discusses the thermal effects in detail. To minimize the contact resistance and provide better heat sinking, he points up the need to improve laser materials. Applications of noncoherent electroluminescent devices in optical coupling, x-y displays, and electrical scanning are also discussed.

The book concludes with the physics of failure. The author cites the built-in effects, such as mechanical defects, variations in doping levels, and surface contamination, and the operational effects, such as ionic movement, and thermal effects.

#### Why bother?

Servomechanisms  
L.J. Bulliet  
Addison-Wesley Publishing Co., 276  
pp., \$9.95

A major technical advance during World War II occurred in servomechanisms and, shortly thereafter, several basic books appeared on the subject. Two notable texts were by Brown and Campbell, and by Lauer, Lesnik, and Matson. The first treated servomechanisms on an analytical basis, the second described servo components and system design.

This duo was in the vanguard of a variety of works by others in the field of servos. For years, industry has not suffered from a lack of servomechanism textbooks. And, except for treating very specialized aspects, most authors have had the good grace not to produce additional readings.

But here is another book on servos. It would not warrant re-

## Need custom sub-miniature oscillators fast?

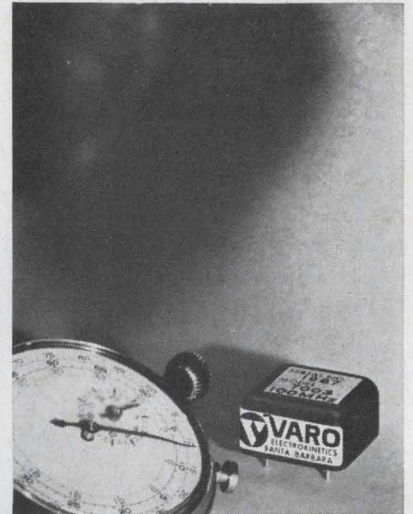

## For logic clock applications?

### Call Varo.

Model 7003 crystal oscillator is just  $\frac{7}{8}$ " x  $\frac{7}{8}$ " x  $\frac{3}{8}$ ". Weighs only  $\frac{1}{2}$  ounce. Extremely accurate for its size. Stability vs. time at any constant temperature is one part in 10 million per 24 hours. Frequency range: 3 MHz to 100 MHz. Stability  $\pm .005\%$  from  $-55^{\circ}\text{C}$  to  $+125^{\circ}\text{C}$ .

## Varo answers fast.

Because our business is oscillators. Not oscillators and ovens and crystals, etc., but oscillators. Period. Tell us what you need. We'll tell you how and when. Like we've done for McDonnell-Douglas, Martin, Honeywell, R.C.A., Aerojet-General and others. Try us for speed.



**TIME & FREQUENCY PRODUCTS**  
402 GUTIERREZ ST. SANTA BARBARA, CALIF.  
TELEPHONE (805) 963-2055 TWX 805 4497200



## KEPCO OPERATIONAL POWER

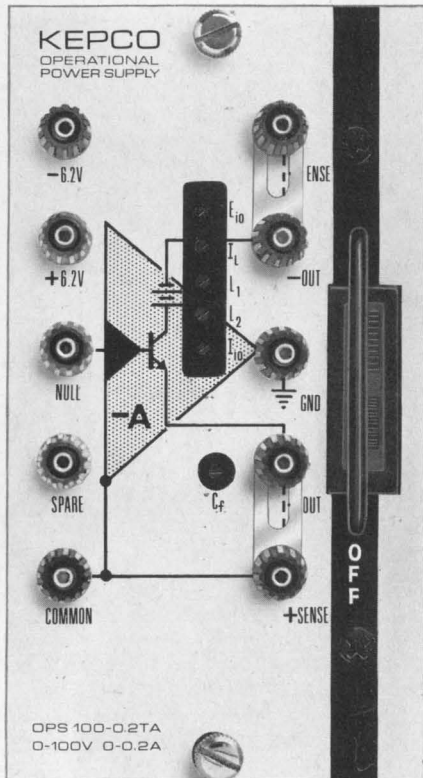

Model OPS 100-0.2TA Panel

### PATCHBOARD ACCESSIBILITY

Now you can order operational power supplies (amplifiers) with a convenient patch board access. Not only are both references, the null, output and common terminal made readily available, but all operating controls are brought to the front in a convenient recessed slot. They include offset voltage nulling ( $E_{io}$ ), offset current nulling ( $I_{io}$ ), the current limit adjustment (10% - 110% range) and two AC stabilizing adjustments.

Amplifier characteristics include: 500,000 V/sec slewing speed, 80db open loop gain. Six models from 0-7V at 2A to 0-100V at 0.2A.

FOR COMPLETE SPECIFICATIONS AND APPLICATIONS NOTES, WRITE DEPT. O-14



131-38 SANFORD AVE. • FLUSHING, N.Y. 11352  
(212) 461-7000 • TWX # 710-582-2631

### New Books

view except for one thing—the author's admirable intention is to educate technicians among others. To accomplish this he "avoids the deeper theoretical subtleties which can be appreciated only through the use of higher mathematics."

Such a statement cannot acquit, in advance, the failure of a book to come to grips with its subject at the required level. Technicians are better educated than the author implies. Were they not, the book would be of little use to technician-readers, for the author doesn't spare the mathematics anyway. He just avoids mathematics to give a real insight into servomechanism principles.

For example, Bulliet overlooks a fundamental servomechanism concept—that of stability—and his insistence on eschewing mathematics is probably the reason. Any technician who thinks he can understand servomechanisms from this book will be in for a mighty big surprise when the real servomechanism on which he's working with a development engineer suddenly starts oscillating. Unfortunately, he won't have time to read another book on servos to discover why that's happening.

Perhaps to compensate for leaving out thorough treatment of stability, the author dwells at great length on ideas like saturation, isolation, and time constant. After defining time constant in a complex paragraph, Bulliet uses the term vaguely—parenthetically stating that the time constant is the "time to settle down." Settling time does relate to time constant, but the two are not the same.

### Recently Published

**Handbook of Numerical Methods and Applications**, Louis G. Kelley, Addison-Wesley Publishing Company, 354 pp., \$14.50

Designed mainly as a handbook, this volume is also a reference for engineers and scientists who program their own problems. The author discusses numerical analysis, curve fitting and data smoothing, nonlinear algebraic equations, Eigenvectors, and the Gram-Schmidt orthogonalization procedure.

**Modern Transistor Electronics Analysis and Design**, Fred K. Manasse, John A. Ekiss, and Charles R. Gray, Prentice-Hall, Inc., 555 pp., \$12.95

Primarily for the electronics design engineer, this book focuses on development and analysis of semiconductors. Included are several

## Why MARYLAND?

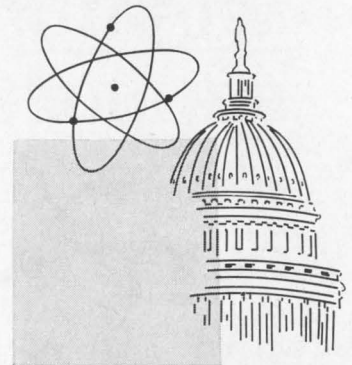

Proximity to federal agencies in Washington, D.C. affords the unique advantage of constant personal contact with government officials working with science-oriented industry. Such contact is an increasingly important locational criterion.

No other state is as convenient to as many Federal agencies as Maryland. For example, Maryland's major government scientific installations include NASA, AEC, NIH, the National Bureau of Standards, plus some 20 others.

**Are there other reasons why R&D activities and science-oriented industries should consider locating in MARYLAND?**

**Yes... emphatically!**

The availability of personnel, particularly engineers and scientists, is recognized as a chief criterion governing the location of any science-oriented industry.

There are almost 30,000 scientists and over 25,000 engineers living and working in Maryland and the District of Columbia.

There are 39 four-year colleges and universities in Maryland and the District of Columbia. Graduate and post-doctoral programs considered most significant to research and science industry are available.

**Shouldn't you locate in MARYLAND?**

**Get All The Facts.**

MARYLAND DEPARTMENT OF ECONOMIC DEVELOPMENT DIVISION E

State Office Bldg. • Annapolis, Md. 21404

**Write, Wire Or Phone Collect**





## VERSATILE POWER

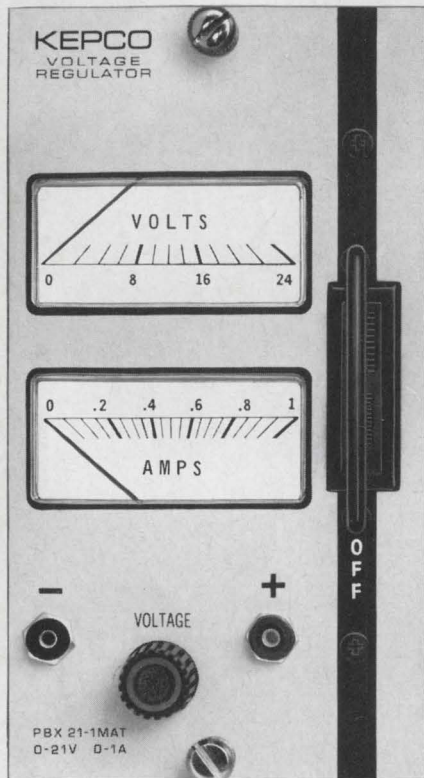

Model PBX 21-1MAT Panel

## KEPCO'S PLUG-IN POWER MODULES

Six voltage regulated models from 0-7 volts to 0-100 volts (up to 20 watts) in single, double, triple and six-unit plug-in enclosures. Create your own custom d-c power systems. Mix 'em or match 'em.

Kepco's new line of versatile PBX-MAT plug-in laboratory modules are covered in the big new Kepco Catalog B-678. Write for your copy today.

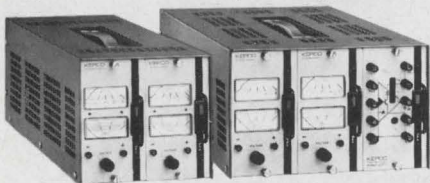

Dual slot housing  
Model CA-4

Triple slot housing  
Model CA-5

FOR COMPLETE SPECIFICATIONS AND APPLICATIONS NOTES, WRITE DEPT. U-14



131-38 SANFORD AVE. • FLUSHING, N.Y. 11352  
(212) 461-7000 • TWX #710-582-2631

## New Books

new areas of development—integrated circuits, avalanching and Gunn-effect diodes, charge-control models, and choppers.

**Reusable Protective Packaging**, Steven E. Mautner, Kayar Publishing Co., 101 pp., \$8.50

Protecting electronic equipment during shipment and storage has become a problem that the electronic designer has to face. This book attempts to lead him through the maze of military specifications for shock, vibration, and hostile environments.

**Magnetism and Magnetic Materials 1967 Digest**, Edited by W.D. Doyle and A.B. Harris, Academic Press, 278 pp., \$11

A concise review of papers on magnetism and magnetic materials published in 1966, designed as a reference for the graduate student or the practicing engineer.

**Electric Power Systems**, B.M. Weedy, John Wiley and Sons, 302 pp., \$8.50

This introductory text provides students with the basic essentials of power system operation and analysis. Equivalent circuits, d-c transmission, and the limitations of transmittable power are discussed.

**Handbook of Analog Computation**, Maxwell C. Gilliland, Systron-Donner Corp., 40 pp., \$5

Provides students as well as experienced computer users with up-to-date analog computer software. Basic fundamentals and advanced programing techniques are presented.

**Marks' Mechanical Engineers Handbook**, Seventh Edition, Edited by Theodore Baumeister, McGraw-Hill Book Co., \$29.50

Latest edition of a standard work, most useful for electrical engineers in the areas of cryogenics, ultrasonics, optics, and thermal properties of materials.

**Basic Analog Computation**, Gerald R. Peterson, The Macmillan Co., 124 pp., \$3.95

How an analog computer functions and what makes it function are covered in this undergraduate text. Simple linear, high-order linear, and nonlinear and time-varying systems programing are included.

**Digital Logic and Computer Operations**, Robert C. Baron and Albert T. Piccirilli, McGraw-Hill Book Co., 321 pp., \$13.50

Beginning with a general introduction to the computer field, this textbook covers Boolean algebra, computer logic, storage, input and output functions, and control elements. Time-sharing, and multiaccess systems are also included.

**High Frequency Communications**, J.A. Betts, American Elsevier Publishing Co., 98 pp., \$5

The application of error detection and correction is explained, showing the difference between systems used on one-way and two-way circuits. Also included are methods of ionospheric forecasting.

**Electric Circuit Problems With Solutions**, F.A. Benson, Barnes and Noble, 257 pp., \$4.95

Aimed at the laboratory technician, this book contains a wide variety of problems in a-c, d-c, and polyphase circuits provides the reader with detailed solutions.

**Characteristics and Operation of MOS Field Effect Devices**, Paul Richman, McGraw-Hill Book Co., 146 pp., \$10

The book covers the electrical characteristics of MOS transistors, MOS technology, fabrication techniques, and linear and digital MOS circuit applications. Included are recent developments in the fabrication of low power MOS complementary integrated circuits.

## WHICH INSULATING TECHNIQUE WOULD YOU HAVE PICKED?

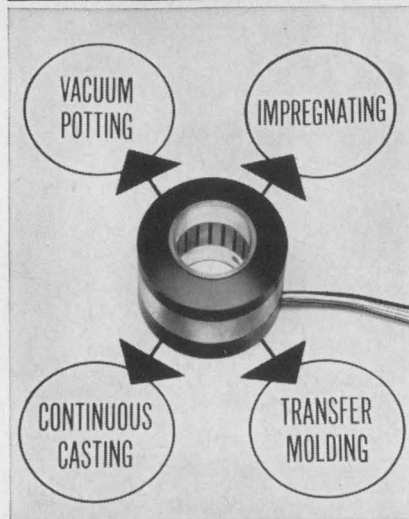

**HULL** provides equipment for all of them

Hull recommended vacuum potting. For this servo motor, cost, quantity and application requirements pointed to that choice.

Your unit may call for extremely high potentials. Or wide thermal shock resistance. It may encounter vibration, corrosive atmospheres, high ambient temperatures.

One of the four insulating techniques—or a combination will meet the end-use requirements. And keep your cost/quantity/quality ratios in line. Hull's application engineers will recommend and provide the ideal equipment.

You'll get guidance in resin selection. We'll furnish your work-holding fixtures and molds. Your complete production or pilot plant if you say go.

Hull's the only company we know of that can provide you all this. We'd like to work with you. Simply write or phone us: HULL CORPORATION, 7037 Davisville Road, Hatboro, Pa. 19040. Phone: (215) 672-7800



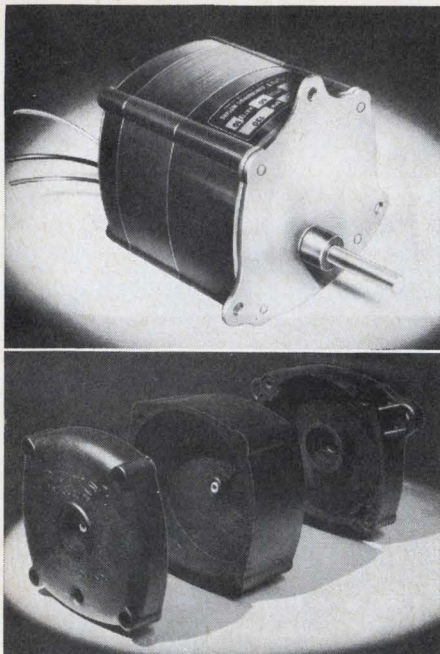

Polycarbafil Instrument Motor Housing molded for Hurst by Lenco, Inc., Jackson, Mo.

## A better motor housing at lower cost with Polycarbafil®

Hurst Mfg. Corp., Princeton, Indiana chose fiberglass reinforced polycarbonate.

For the new Model GA 600 inch-ounce, Synchronous Hysteresis Instrument Motor, Hurst chose Polycarbafil (fiberglass reinforced polycarbonate). Hurst research and tests proved that the FRTP adds performance characteristics for the user. It has lighter weight, reduced noise level, high impact strength, dimensional stability and heat resistance. Flexural and Tensile strength of Polycarbafil is higher than many common aluminum alloys. The company found that they gained a cost advantage because the Polycarbafil housing needs no finishing and painting, as aluminum housings would:

### Compare Physical Properties

Property	Unit	Unreinforced Polycarbonate	Polycarbafil G-50/20
Tensile Strength @ 73°F.	PSI	8,000	18,500
Flexural Strength @ 73°F.	PSI	13,500	25,000
Coef. Linear Thermal Expansion	°F./In./In.	3.75 x 10 <sup>-5</sup>	1.07 x 10 <sup>-5</sup>
Heat Distortion Temp. @ 66 PSI	°F.	285	308
Water Absorption 24 Hrs.	%	0.15	0.4

Polycarbafil is just one of several fiberglass reinforced thermoplastics pioneered and patented by Fiberfil. Only Fiberfil can give you complete technical data, practical experience and a full line of reinforced materials. Send for your free copy of the FRTP engineering manual. Fiberfil Div., Rexall Chemical Co. Evansville, Indiana 47717

# FIBERFIL

Fiberglass Reinforced Thermoplastics®

## Technical Abstracts

### Large repertoire

An LSI variable function register  
Robert J. Lesniewski  
Goddard Space Flight Center  
Greenbelt, Md.

Although large-scale integrated circuits are usually designed for just one purpose, the true value of LSI may be in more versatile arrays—such as those that can be electrically programed to perform many different functions.

Such circuit versatility will soon be almost mandatory in sophisticated spacecraft with on-board data processing. As an example, a variable function register capable of four different operations has been built using metal oxide semiconductor technology, and 500 active devices on a chip.

A second-generation register, capable of parallel processing with 18 different operations using 1,300 active devices, also has been designed, but not yet built. The complementary mos technology makes such design possible by reducing power dissipation and element count.

The variable-function repertoire includes seven basic operations—parallel loading and outputting, rotating data, shifting data to the right and left, and complementing the register's contents. The shifting and rotating operations can be electrically programed by setting mos switches between the shift-register stages.

The register chips also can be cascaded to form large registers. With a bypass switch, information can be shifted past a register while it continues to operate.

Presented at Eastcon, Washington, Oct. 16-18.

### Two-way etch

Anisotropic etching for forming isolation slots  
H.A. Waggener, R.C. Kragness, and A.L. Tyler,  
Bell Telephone Laboratories,  
Allentown, Pa.

A technique that etches downward into a silicon wafer much more rapidly than it etches sideways gives narrow, precisely defined isolation slots. As a result, more beam-leaded integrated circuits can be

fabricated in a silicon slice than is possible with standard etching techniques. The new method requires a unique orientation of the etching mask on a specific lattice plane of the silicon crystal, and an etchant that attacks one plane more than the others. Etchants now being investigated for silicon consist of strong alkaline solutions, such as a mixture of potassium hydroxide, propanol, and water.

To fully exploit the difference in etch rates, two conditions are required: the face of the silicon disk to be etched is made parallel to the lattice planes having a high etch rate; and the edges of masked areas are aligned parallel to a second lattice plane with a negligible etch rate. Under these conditions, slots are formed with slanted sides, in the shape of flat-bottomed wedges. Each slot steadily becomes narrower as the etching progresses, and thus the slot's depth and width are precisely defined by the etching mask and etching rate. Etching terminates when the two sloping sides of the deepening slot meet, or when it etches through the slide, whichever occurs first.

During the fabrication of beam-leaded integrated circuits, slots are etched out of the semiconductor slice to separate the many individual circuits and/or to isolate components within each integrated circuit. Standard (nonpreferential) etchants result in fewer integrated circuits because variations in the thickness of silicon slices cannot be reduced economically to less than a few tenths of a mil. To insure complete penetration at the thickest parts of the slice, considerable over-etching must be tolerated at the thinner portions. Since the isotropic, nonpreferential solutions etch as fast sideways as downward, the active devices on the opposite side of the slice must be spaced three to four times farther apart than the average slice thickness to protect them against over-etching during separation.

With preferential etching, the masking operation is done after the desired devices have been fabricated on one side of the slice. A silicon dioxide mask then is applied

# Power supplies

## portable high-voltage DC power supplies

Widely used for powering electronic equipment and for routine breakdown and insulation testing. Output voltage is well filtered DC which is adjustable with convenient front panel control. Input is 115 VAC, 60 CPS. Larger 6" precision 1% mirror scale movement available on order. Regulated models provide closely stabilized output voltage regardless of line or load changes.



## heavy-duty power supplies

Employing husky components selected for power handling capacity these industrial type power supplies are built for service and efficiency. Output is continuously variable from 0 to full rated values. Standard ripple is 5% or less. Ripple of 0.01% to 1%, and regulated supplies available on special order. All units feature automatic overload cutout control circuits.



## 3 $\phi$ heavy-duty power supplies

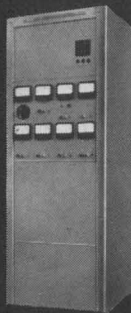

For use in applications where high voltages at extra high currents are required. Fixed or fully variable types available. Automatic circuits protect against over-current conditions. Widely used in plasma research, electron beam furnaces, plate power and condenser charging applications. Voltage or current regulated types available.

## constant-current power supplies

Designed for applications where output current must remain constant regardless of loading resistance changes. Used for magnet fields, plating applications, gaseous lamps. Magnetic current stabilizer has no moving parts, no tubes, no transistors to replace. No balancing or adjustment needed, simply set current to desired level. Standard hum level 5%, lower hum levels available on order.

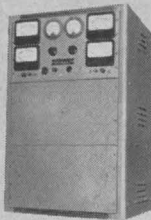

**Beckman** INSTRUMENTS, INC.

CEDAR GROVE OPERATIONS  
89 Commerce Road  
Cedar Grove, New Jersey 07009

INTERNATIONAL SUBSIDIARIES:  
Geneva; Munich; Glenrothes, Scotland;  
Tokyo; Paris; Capetown; London; Mexico City.

## Technical Abstracts

to the opposite side to delineate the slots for etching. Because the sides of the slots are stationary, only relatively simple etching controls are required.

An important feature of the improved etching technique is that the mask shape is altered to compensate for undercutting at the outside corners of the mask, where the third main lattice plane of silicon is exposed. The etch rate of this third plane can be made much slower than that of the primary etching plane, but it is still significant. Therefore, enlarged corner areas of calculated size and shape are added to the etch mask to compensate for the undercutting at these corners.

Presented at the International Electron Devices Meeting, Washington, Oct. 18-20.

## Featherweights

A digitally implemented microelectronic i-f decoder  
Richard S. Ocheret  
General Instrument Corp., Radio Receptor Division, Brooklyn, N.Y.

Metal oxide semiconductor technology may slash the size and price of delay lines. Beaconry and interrogation-friend-or-foe (IFF) systems use delay lines for passive decoding of a pulse train to see if it agrees with a preselected code. The new digital equivalent for the IFF passive decoder—a shift register—is built on a single silicon chip with MOS technology that is easy to design and simple to make.

With the MOS device, transconductance can be determined by geometry so that all chip devices can be simultaneously diffused in a single step. Since both drain and source are reverse-biased with respect to the substrate, no isolation is required between devices, and, because the input impedance of each device is high, increased fan-out is possible.

The single chip holds a 43-bit shift register, decoding logic, and input circuitry. The circuitry can operate down to d-c but if this is not needed, four-phase logic can be used. With the four-phase scheme, power is dissipated only during switching.

The shift register is continuously

# NEW

## -100°F. TO +400°F.

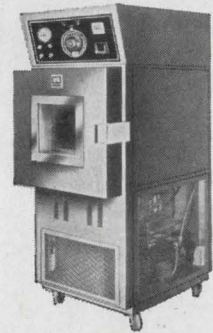

## BLUE M VERSA-RANGE TEST CHAMBERS

with  
**POWER-O-MATIC-60**<sup>®</sup>  
PATENTED

### Saturable Reactor Proportioning Control and FLO-KOLD Mechanical Refrigeration

New chambers designed especially for critical high and low temperature research/military testing and processing.

POWER-O-MATIC 60 Control — stepless, switchless, fully automatic—provides infinitely proportional control, true straight-line performance. Free of moving parts, arcing components, and failure-prone auxiliary devices, it provides unequalled reliability—will outlast the chamber it controls!

Exclusive FLO-KOLD cascade mechanical refrigeration system lowers chamber temperature to -100°F. in 60 minutes or less. Non-cycling, operates continuously.

Refrigeration system and reactor control carefully matched for maximum efficiency and operating economy in chambers of 3, 8, 12, 27 and 64 cubic feet. Easily the most reliable and dependable units of their kind ever built!

### NEW -40°F. TO +200°F. CHAMBERS

Similar to broader range units in construction and performance for applications where extremes of temperature are not needed. Features single-stage refrigeration system and POWER-O-MATIC 60 Control.

### NEW COMPACT TOP-LOADING CHAMBER



-100°F. to +200°F. Same control, refrigeration, and construction as larger chambers. Work chamber measures 18" W. x 16" H. x 16" D. Efficiently loads and unloads from top. Companion Full Range Constant Temperature/Humidity Chamber also available.

SEND FOR FULL INFORMATION



**BLUE M Engineering Company**

A DIVISION OF BLUE M ELECTRIC COMPANY

Corporate Headquarters:  
BLUE ISLAND, ILLINOIS 60406  
Offices strategically located to serve you.

# FOR SALE:

# Linde

# HELIUM NEON ARGON KRYPTON XENON

(and other ultra-high purity gases in glass bulbs and a variety of high pressure cylinder sizes)

# Linde

## GAS MIXTURES

Mixtures of any number of gases and volatile liquids in high pressure cylinders—available in these three grades:

- **LINDE Primary Standard Grade**—prepared by weight to the highest possible accuracy then calculated to mole percent.
- **LINDE Analyzed Grade**—mixed and analyzed to high laboratory standards.
- **LINDE Utility Grade**—prepared with a mixing tolerance of  $\pm 10\%$  and an analysis accuracy of  $\pm 5\%$  of the minor component. Available with or without analysis.

**Call (201) 925-8990**—the direct line to your LINDE lab gas specialist. Union Carbide Corporation, Linde Division, 2365 East Linden Avenue, Linden, N.J. 07036.

LINDE is a registered trademark of Union Carbide Corporation

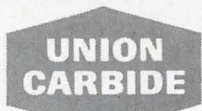

**GAS PRODUCTS**

## Technical Abstracts

clocked at 2,069 megahertz with three bits provided for every pulse interval in the IFF reply train. The decoding logic on the chip compares incoming trains with a code selected by external switches.

The input video signal is fed to a strobe circuit, which clocks the signal into the shift register. The outputs of every third stage are fed to logic circuits, NAND and NOR gates, and compared with the coded input.

Presented at Eastcon, Washington, Oct. 16-18.

### Sound design

Monolithic limiter and balanced discriminator for f-m and tv receivers  
A. Bilotti and R.S. Pepper  
Sprague Electric Co.,  
North Adams, Mass.

Quadrature detectors have found widespread use in f-m receivers and tv audio sections because they are simple to design and provide excellent performance. Less costly than other types such as ratio detectors and discriminators, they require inexpensive single-tuned coils rather than costlier double-tuned transformers. A design, based on the quadrature approach, for a monolithic limiter and balanced discriminator for f-m and tv receivers using full-wave coincidence gates offers even lower cost to manufacturers of television sets.

Basically, f-m detectors fall into three broad categories—slope, phase shift, and pulse averaging.

In the slope detector, the frequency deviation is transformed into a variable amplitude voltage by a reactive circuit's amplitude versus frequency slope. In the phase-shift detector, a reactive circuit's phase versus frequency characteristic transforms the instantaneous frequency deviation into a relative phase deviation, which is then detected by either a vector addition- or coincidence-type phase detector. In the pulse-averaging detector, single-polarity pulses are generated at each zero crossing of the signal. The resulting pulses of constant area are integrated and demodulated.

Of the three, a strong case can be made for an LC-type phase-

Now Available...

Power Supply Manual  
From  
Transformer Electronics  
Company

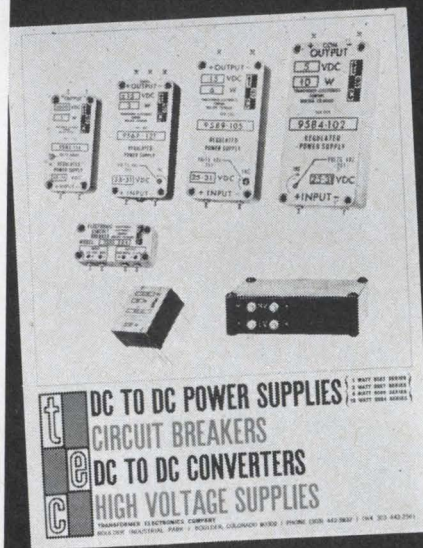

Imaginative engineering, a proven record of reliability and dependability, plus a dedication to customer service have given T.E.C. an international reputation in the design and manufacture of miniature regulated DC to DC converters and associated solid state products for aerospace, military and commercial systems. Now, for the first time in one easy-to-use catalog... the details, the specifications, the technical data and the prices, all packaged for your convenience. For your copy, write or call...

t

**TRANSFORMER  
ELECTRONICS  
COMPANY**

BOULDER INDUSTRIAL PARK  
BOULDER, COLORADO  
TWX 910-940-3246 PHONE (303) 442-3837

e

c

POWER SUPPLIES • INVERTERS  
CONVERTERS • TRANSFORMERS

the  
big  
3

for  
precision  
high speed  
circuit  
board  
production



1/8" shank  
SOLID  
CARBIDE  
DRILLS

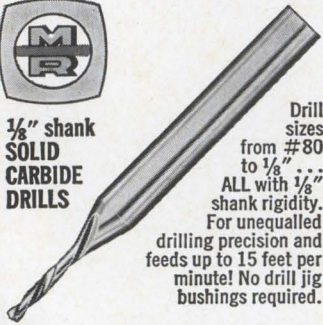

Drill  
sizes  
from #80  
to 1/8" ...  
ALL with 1/8"  
shank rigidity.  
For unequalled  
drilling precision and  
feeds up to 15 feet per  
minute! No drill jig  
bushings required.

PCB-1  
AIR  
BEARING  
SPINDLES



UP TO  
150,000 RPM  
SPINDLE SPEED

Absolutely vibration free . . .  
spindle shaft literally "floats" on air  
film . . . no ball bearings, no metal-  
to-metal contact. Eliminates all har-  
monics. Creates the truest running  
drill spindle ever made. Air turbine or  
electric high frequency driven.

SOLID CARBIDE  
DIAMOND CUT  
ROUTERS



For the  
smoothest finish  
in routing . . . any  
material or plastic-  
metal laminate.  
Choice of end styles  
including drill point.

Take the proved solid carbide advan-  
tages of rigidity and wear resistance  
. . . add the proved advantages of Metal  
Removal tool design and precision . . .  
to give you problem-free production in  
circuit board drilling and routing.

Write for Catalogs.

**THE METAL REMOVAL COMPANY**  
1859 W. Columbia Ave., Chicago 60626  
Plants in Chicago • Los Angeles • San Juan

MASTER TOOL AND WHEEL  
MAKERS FOR THE WORLD

## Technical Abstracts

shift network used in conjunction with a quadrature detector. Phase shifts can be transformed into amplitude variations without regard to the amplitude characteristics of the reactive circuit in which it is used. Complete linearity between the phase-shift deviation and the resulting output signal is also exhibited.

To enhance performance, a wide-band limiter precedes the detector circuit.

F-m and tv applications require a high a-m rejection. Since wide-band limiters tend to convert a-m signals to pulse-width asymmetries, rejection of these signals can be seriously degraded by the amplifier. This, however, is overcome by a full-wave quadrature circuit. This type of circuit has an added advantage: it can be used as either a high-performance synchronous demodulator or a double-balanced mixer.

Presented at the International Electronic Devices Meeting, Washington, D. C., Oct. 18-20.

### A new image

Electron-beam-accessed silicon diode arrays for image-sensing applications M. H. Crowell and E. F. Labuda, Bell Telephone Labs, Murray Hill, N.J.

Semiconductor diodes outshine thin-film photoconductive targets in vidicon applications. And a planar array of reverse-biased silicon p-n diodes can afford advantages over evaporated photoconductors as image-sensing elements in television camera tubes. Among these advantages:

- photoconductive lag problems don't arise;
- spectral response is broader;
- sensitivity is higher;
- there are no associated optical and electron-beam "burn-in" effects;
- higher temperatures can be tolerated during vacuum processing.

A 1-centimeter-square matrix containing a 660-by-660 diode pattern constitutes the array; the diodes are fabricated by photolithographic techniques. An optical image is focused on the laterally homogeneous n-type substrate,

*The sky is no limit  
for design engineers  
and designers  
at Lockheed*

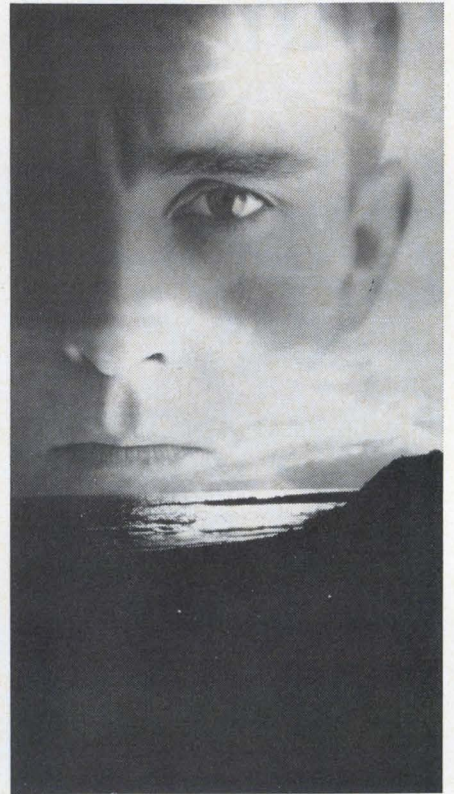

You can choose your environment at Lockheed: air, land, sea, or space. Important and exciting long-term projects are now under way involving Poseidon, advanced Polaris, unique land vehicles, Deep Quest, deep submergence rescue vehicles and Agena. □ There is no limit on individual achievement and recognition at Lockheed. An engineer's responsibility for a design package continues from initial concept through manufacturing and successful operation. Nothing is static. Demand for rapid response to changing requirements continually creates new challenges, opens new avenues of opportunity for advancement. □ At present, design openings include development of hydraulic and pneumatic components, mechanical/structural design of missiles and aircraft, mechanisms and antennas, ground support equipment, reentry vehicles, automotive design, conceptual design, missile basic and secondary structures, material-handling equipment and analysis of material usage and producibility. □ If you are looking for new horizons of opportunity in the field of design, look into Lockheed. Write: R. C. Birdsall, Professional Placement Manager, P.O. Box 504, Sunnyvale, California. An equal opportunity employer.

**LOCKHEED**  
MISSILES & SPACE COMPANY  
A GROUP DIVISION OF LOCKHEED AIRCRAFT CORPORATION

**WHY SETTLE FOR LESS?  
GET TOP  
PERFORMANCE  
WITH  
DELTA'S FABULOUS  
MARK® TEN**

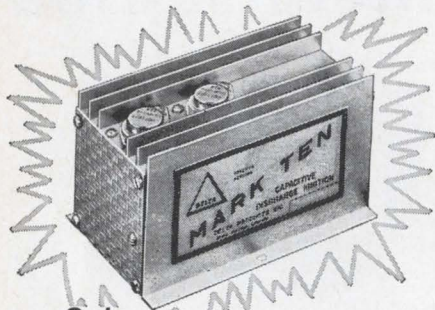

Only  
**\$44.95** CAPACITIVE  
ppd. DISCHARGE  
Deltakit - Only \$29.95 ppd. **IGNITION SYSTEM**

You read about the Mark Ten in the April issue of Popular Mechanics!

Now discover why even Detroit has finally come around. In 4 years of proven performance and reliability, the Mark Ten has set new records of ignition benefits. No wiring. And works on literally any type of gasoline engine. Buy the original, the genuine, the real McCoy — Mark Ten. From Delta. The true electronic solution to a major problem of engine operation.

**READY FOR THESE BENEFITS?**

- ▲ Dramatic Increase in Performance and in Fast Acceleration
- ▲ Promotes more Complete Combustion
- ▲ Points and Plugs last 3 to 10 Times Longer
- ▲ Up to 20% Mileage Increase (saves gas)

LITERATURE SENT BY RETURN MAIL  
BETTER YET — ORDER TODAY!



**DELTA PRODUCTS, INC.**

P.O. Box 1147 E • Grand Junction, Colo. 81501

Enclosed is \$\_\_\_\_\_. Ship prepaid.  
Please send:  Ship C.O.D.

Mark Tens (Delta Kit) @ \$29.95  
(12 Volt Positive or Negative Ground Only)

Mark Tens (Assembled) @ \$44.95

6 Volt: Negative Ground only.  
 12 Volt: Specify  Positive Ground  
 Negative Ground

Car Year \_\_\_\_\_ Make \_\_\_\_\_

Name \_\_\_\_\_

Address \_\_\_\_\_

City/State \_\_\_\_\_ Zip \_\_\_\_\_

**Technical Abstracts**

which is typically 1 mil thick.

The diode side of the array serves as a p-type target and is scanned by an electron beam. Resolution capability and spectral sensitivity are functions of the minority carrier lifetime in the substrate and of recombination velocity of the light-incident surface.

Collection efficiencies—the ratio of holes collected at the diode depletion regions to the photons absorbed in the substrate—have topped 50%, better than twice the level achieved by conventional means. Useful spectral range is 4,500 to 9,500 angstroms, and dark currents are kept below 10 nano-amperes.

Presented at the International Electronic Devices Meeting, Washington, D. C., Oct. 18-20.

**Noisy light**

Pulse interval modulation laser communications  
Monte Ross  
McDonnell Douglas Corp.,  
St. Louis, Mo.

Darkened somewhat by the problem of interfering quantum noise—from stray photons at light frequencies—the prospect of laser communications now appears brighter. A proposed pulse-interval modulation (pim) system takes into account the probability of stray photons ending up at the receiver by sending short, high peak power laser pulses in one of several possible coded time intervals.

Because the system's detector must only sample transmitted pulses for a short time period, there is less chance of its also seeing stray photons. Such a system would pack a lot of power into each pulse, making it possible to raise the detector's threshold so that it could easily distinguish between signals and quantum noise.

The number of bits one pulse could carry would depend on the number of possible time intervals in each time slot, because the number of time intervals determine the number of combinations of binary ones and zeros.

Pim laser systems might find application in space communications where it's particularly important to send the most information per watt

**Say "Good Bye"  
to hand loading  
of charts**

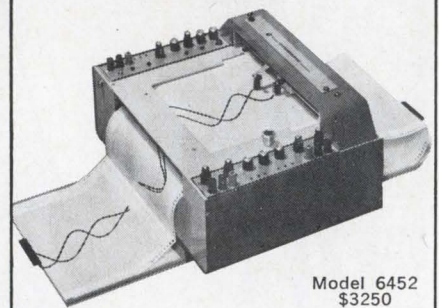

Model 6452  
\$3250

New Concept in

**X-Y-Y'  
Recording**

- Continuous supply of Z-fold paper charts
- 11" x 17" Recording Surface
- Bi-directional chart control
- Notebook size charts—8½" x 11" or 11" x 17"
- Local or remote control of recording mechanism and pen lift
- English/Metric scaling
- 15 in./sec. slewing speed
- 18 calibrated voltage ranges for each axis, continuously variable in between
- ± .2% Accuracy
- ± .1% Repeatability

Ask about our single pen versions also

**houston instrument** | DIVISION OF BAUSCH & LOMB

4950 TERMINAL AVENUE, BELLAIRE, TEXAS 77401  
(713) 687-7403 CABLE HOINCO



## Cramped for space?

### Use Couch 1/7-size Relays

Space/weight problem? The new Couch 2X 1/7-size crystal can relay gives you tremendous savings in space and weight. 0.1" grid — plus many outstanding specs — *all in micro-miniature*. Thoroughly field-proven in electronics and space applications.

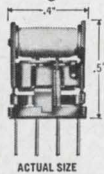

	2X (DPDT)	1X (SPDT)
Size	0.2" x 0.4" x 0.5"	same
Contacts	0.5 amp @ 30 VDC	same
Coil Operating Power	100 mw 150 mw	70 mw 100 mw
Coil Resistance	60 to 4000 ohms	125 to 4000 ohms
Temperature	-65°C to 125°C	same
Vibration	20 G	same
Shock	75 G	same

Broad choice of terminals, coil resistances, mounting styles. Write for detailed data sheets.

RUGGED ROTARY RELAYS  Dynamically and Statically Balanced

## COUCH ORDNANCE INC.

3 Arlington St., North Quincy, Mass. 02171, Area Code 617, CYpress 8-4147 • A subsidiary of S. H. COUCH COMPANY, INC.

## Technical Abstracts

of power. For example, assume a data link between Mars and the Earth. A pim system with a 150 watt input would require a four inch focusing lens and a 40 foot receiving antenna to send 1,000,000 bits per second using 1-nanosecond pulses. In contrast, an r-f system operating under the same power would require an eight foot transmitting antenna and a 210 foot receiving antenna and would only send 10,000 bits per second.

Presented at Eastcon, Washington, Oct. 16-18.

### Semiconductor tube

A germanium space-charge-limited triode,  
A. Shumka,  
Jet Propulsion Laboratory  
Pasadena, Calif.

A solid state triode that behaves like a vacuum-tube triode offers a low level of sensitivity to thermal change, high input impedance, and tube-like transfer characteristics. The first of these features is new to semiconductor devices; the latter two are more pronounced in the triode than in field effect transistors, until now considered the semiconductors most similar to tubes.

The new device, fabricated from germanium, has an electrode that controls and modulates the flow of space-charge-limited electron currents and is analogous to the vacuum tube's grid. The p<sup>+</sup> stripes forming this grid electrode are inserted in an n<sup>+</sup> — πn<sup>+</sup> = type diode structure. The closely spaced stripes are capacitively coupled to the diode's terminals to establish emitter and collector regions analogous to a plate and anode.

Currents follow the three-halves power law when an electric field is impressed between the control electrode and the emitter. Over-all current-voltage characteristics show high transconductance, a large amplification factor, and an input impedance exceeding 1 megaohm.

Noise figures are a few decibels lower than those of conventional bipolar semiconductors, and susceptibility to temperature change is at least an order of magnitude less.

Presented at International Electron Devices Meeting, Washington, D. C., Oct. 18-20.

# \$1,000,000 INVENTORY OF ELECTRONIC TEST EQUIPMENT



Name brand test equipment fully calibrated with certificate of traceability if desired. Maintenance provided and all equipment is insured against fire, theft and damage in shipment. □ Short term rentals our specialty but yearly rental available. Fast delivery. Wide variety and depth. □ If you need equipment **NOW**, call Jim Powers or Frank Cassidy at (301) 424-2333. If you want a copy of our rental list or more information write:

## RENTAL ELECTRONICS, INC.

16203 FREDERICK ROAD  
ROCKVILLE, MARYLAND 20850

# FOR PRECIOUS METAL POWDERS COME TO MATTHEY BISHOP

## Here's Why

- Matthey Bishop offers variety in metals and their characteristics
- Matthey Bishop is willing to "tailor" to your specs and our prices are amazingly low

Matthey Bishop's wide variety of powders differ in particle size, surface area, bulk density, shape (powder or flake) to meet exacting requirements. No matter how you use powders—for fuel cells, metalizing preparations, resistors, printed circuits, circuit decals, capacitors, or in other ways, you will find Matthey Bishop has, or will make, precious metal powders to meet your particular specifications. By all means, contact us when you need a precious metal powder for making inks or pastes or for your own special application.

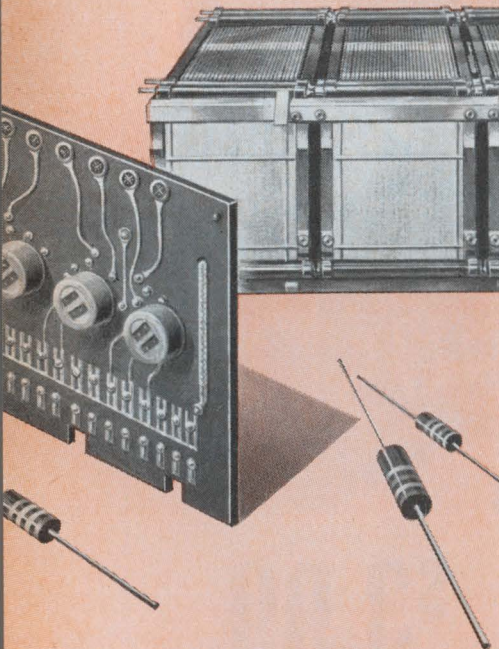

**MATTHEY BISHOP, INC.**

Chemicals Division / Chemical Products  
MALVERN, PENNSYLVANIA 19355

Phone: (215) 644-3100

A Johnson Matthey Affiliate

In Canada: Johnson Matthey & Mallory Limited

## New Literature

**Microwave glossary.** Alfred Electronics, 3176 Porter Drive, Palo Alto, Calif., has published a four-page application note entitled "Glossary of Microwave Terms" that lists 115 microwave definitions. Circle 446 on reader service card.

**R-f test instruments.** Kay Electric Co., Maple Ave., Pine Brook, N.J. 07058, has released a 32-page brochure illustrating and describing a line of r-f test instruments. [447]

**Capacitance probes.** Wayne Kerr Corp., 22 Frink St., Montclair, N.J. 07042. A two-page, illustrated bulletin describes the company's capacitance probes. [448]

**Slip ring capsules.** Collectron Corp., 304 E. 45th St., New York 10017, offers a brochure describing a simplified method in designing a completely functional and highly reliable miniature and subminiature slip ring capsule. [449]

**Tape reel drive motors.** General Electric Co., Schenectady, N.Y. 12305. Technical data sheet GEC-1795 describes direct-current, fractional h-p motors for use as computer tape transport drives. [450]

**Ultrasonic cleaning equipment.** Delta Sonics Inc., 12918 Cerise Ave., Hawthorne, Calif. 90250, has released a 12-page brochure on ultrasonic cleaning equipment. Detailed specifications for tank sizes from 3- to 90-gallon capacity and 300 to 4,000 w are listed. [451]

**Avalanche diode oscillator.** Sylvania Electric Products Inc., 1100 Main St., Buffalo, N.Y. 14209, offers a brochure describing the SYA-3200, an X-band avalanche diode oscillator that simplifies construction of parametric amplifiers. [452]

**Instrument motors.** Amphenol Controls Division, Amphenol Corp., 120 S. Main St., Janesville, Wis. 53545. An eight-page catalog covers servocontrol, induction, reluctance and hysteresis synchronous motors. [453]

**Vacuum coaxial switching.** ITT Jennings Division, ITT Corp., P.O. Box 1278, San Jose, Calif. 95108. Brochure 108 describes the characteristics, construction, and application of vacuum coaxial switching systems. [454]

**Emi/rfi shielding.** Technical Wire Products Inc., 129D Dermody St., Cranford, N.J. 07016, has published an eight-page booklet containing information on its emi/rfi shielding products and services. [455]

**Random data generator.** Datapulse Inc., 10150 W. Jefferson Blvd., Culver City, Calif. 90230, offers a technical bul-

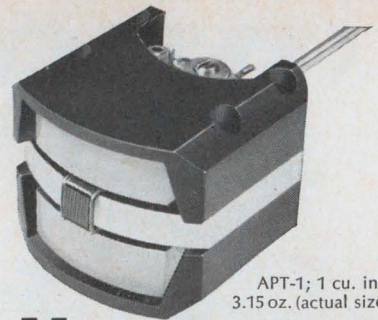

## More torque, Less weight in moving coil mechanism

Highly stable, linear and accurate mechanism for indicating, control or recording systems. 18-0-18° linearity is 1%. Coil design with over 75% of winding "working" in high energy, uniform field air gap assures greater accuracy. Coil system weighs 0.85 gm, develops 26.4 mmg of torque; 31:1 T/W. Mechanism offers negligible vibration pivots and jewels — custom damping — wide range of sensitivities.

# AMMON

AMMON INSTRUMENTS, INC.  
345 Kelley St., Manchester, N.H. 03105

Circle 110 on reader service card



Eight fact-packed pages tell how we've combined up-to-the-minute production facilities with the kind of meticulous New England craftsmanship you probably didn't realize still existed. Read how the combination benefits you, whenever you need quality.

**PRINTED CIRCUITS ASSEMBLIES PROTOTYPES**



**ELECTRO-SONICS, INC.**

210 Main St., Spofford, N. H. 03462

Tel. 603/363-4701

← Circle 286 on reader service card

Circle 111 on reader service card



Supplies for Gaussmeter



MoJel 220

**Budget Price!**

**\$540\*** buys this completely self-gaussmeter (containing RFL Hall-effect gauss flux density from 0.2 gauss to 20,000 gauss; permanent magnet, DC and AC fields up to 50 kHz, allowing measurement of sinewave and pulsed magnetic fields with a time base down to the microsecond region. Better than  $\pm 3\%$  accuracy with self-calibrating feature which requires no reference magnets. Accuracy capabilities to  $\pm 1\%$ . Wide application in production, engineering, research and QC.



For detailed data and free Magnetic Application Booklet, write or call Herb Brumbach.

**RFL Industries, Inc.**

FORMERLY RADIO FREQUENCY LABORATORIES, INC.

Instrumentation Div. • Boonton, N. J. 07005  
Tel.: 201-334-3100 / TWX: 710-987-8352 / CABLE: RADAIRCO, N.J.

## New Literature

letin on the model 213 random data generator for data error analysis and pattern sensitivity detection in transmission-medium systems and storage elements. [456]

**Parametric amplifier systems.** TRG Division, Control Data Corp., 535 Broad Hollow Road, Melville, N.Y. 11746, has issued brochures describing models 4-500 and 7-120 parametric amplifier systems. [457]

**Motors.** A.W. Haydon Co., 232 North Elm St., Waterbury, Conn. 06720. A four-page bulletin contains information on 16 types of d-c motors, synchronous motors, stepper motors and drives, and gearheads for timing, driving and positioning applications. [458]

**Diode reliability.** Unitrode Corp., 580 Pleasant St., Watertown, Mass. 02172, has available reliability report TR-129 covering rectifiers, zeners, and assemblies. [459]

**Metal-to-ceramic components.** Advac Division, GTI Corp., Stamford, Conn., offers a metal-to-ceramic components and assemblies folder. [460]

**Dynamic bridge amplifier.** Redcor Corp., 7800 Deering Ave., Canoga Park, Calif. 91304, has issued a booklet containing numerous applications for a dynamic bridge amplifier module designed for use in low level data acquisition and instrumentation systems. [461]

**Pressure actuated switch.** Electro Marine Corp., 4 Robbins Road, Falmouth, Mass. 02540. Bulletin 800 describes a pressure actuated switch for oceanographic instrumentation applications. [462]

**Laser components.** Oriel Optics Corp., 1 Market St., Stamford, Conn. 06902, has published a data sheet on carbon-dioxide-laser end reflectors made from germanium and silicon with high efficiency multilayer dielectric coatings. [463]

**Card reader.** Scientific Data Systems, 1649 Seventeenth St., Santa Monica, Calif. 90404. Model 7140 card reader, a high-speed peripheral device that reads punched cards at a rate of 1,500 cards per minute, is described in data sheet 64-24-16A. [464]

**Synchro converters.** Natel Engineering Co., 7129 Gerald Ave., Van Nuys, Calif. 91406, has issued catalog 101 on a family of synchro converters including synchro-to-sine/cosine converters, synchro-to-linear d-c converters, synchro-to-digital converters, and angle position indicators. [465]

**Time-sharing computers.** Scientific Data Systems, 1649 Seventeenth St., Santa Monica, Calif. 90404. The SDS940

# MICO

## NEW MODEL 885 SEVEN RATIO WIDE-RANGE ENGRAVER

NO. 885

FOR LONG AND  
MULTI-LINE WORK

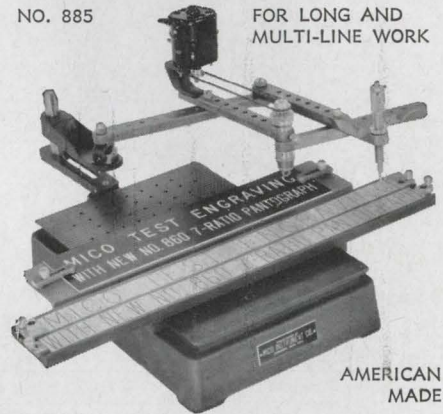

AMERICAN  
MADE

- A time-saver for large plate work
- Engraves 3" x 19" area in one set-up.
- Seven pantograph ratios—from 1:5:1 to 6:1.
- Choice of 3-ball-bearing spindle assemblies for 1/8", 3/16" or taper-shank cutters.
- HSS, COBALT and Solid Carbide Cutters.
- Single and multi-line copy carriers for holding, blanks 3/4" to 3 1/2" high.
- Accommodates Mico standard accessories.

Send for bulletins and prices

## MICO INSTRUMENT CO.

77 Trowbridge St. Cambridge, Mass. 02138  
Circle 114 on reader service card

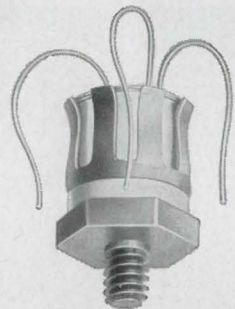

## Capacity problem with high frequency transistors?

IERC's efficient Therma-link heat dissipators/retainers with their .060" beryllium oxide washers reduce normal mounting capacitance by 1/2 to 2/3 between transistor case and chassis or heat sink. Washer has same excellent thermal conductivity as aluminum metal and is electrically insulative. Various models; may be soldered down or mounted with screw or stud. Send for data sheet 141. IERC, 135 W. Magnolia Blvd., Burbank, Calif. 91502.



A corporate div. of Dynamics Corp. of America

*So  
you think  
our team of  
plant site  
engineers  
couldn't  
possibly  
furnish all  
the specific  
answers  
you need?*

# Try us

Our engineers have numerous files full of detailed relocation data. They also have contact with authoritative sources of information. All correspondence or facts about your business will be handled in strictest confidence. Let us open a comprehensive plant site research file for your company soon.

The upper Texas-Louisiana Gulf Coast area served by Gulf States encompasses 28,000 square miles, including several highly industrialized metropolitan areas and many resources-rich smaller communities. Already, over 65 "blue chip" industries have established in our service area.

Send me your area development brochure, "Upper Texas-Louisiana Gulf Coast-Land, Labor Resources", and more information about the growth and profit opportunities in your service region.



NAME \_\_\_\_\_  
TITLE \_\_\_\_\_  
COMPANY \_\_\_\_\_  
ADDRESS \_\_\_\_\_  
CITY \_\_\_\_\_ STATE \_\_\_\_\_ ZIP \_\_\_\_\_

Mail to:  
L. V. Dugas, Vice President  
GULF STATES UTILITIES COMPANY  
Department E-4  
Lock Drawer 2951  
Beaumont, Texas 77704

**GULF STATES  
UTILITIES COMPANY**

## New Literature

time-sharing computer system is the subject of brochure 64-03-29A. [466]

**Audio interference suppressor.** Narda Microwave Corp., Plainview, L.I., N.Y. 11803, has available a technical bulletin on the model 562 audio interference suppressor. [467]

**Biased amplifier.** Hamner Electronics Co., Box 531, Princeton, N.J. 08540, offers a technical bulletin covering the NA-18 biased amplifier that permits a section of the spectrum to be spread over a larger number of channels of a multichannel analyzer. [468]

**Semiconductor products.** Westinghouse Semiconductor Division, Youngwood, Pa., 15697. Condensed catalog B-9418 describes a wide variety of semiconductor devices ranging from a 250-amp transistor to a full line of low-cost plastic-case rectifiers. [469]

**Computers on campus.** Scientific Data Systems, 1649 Seventeenth St., Santa Monica, Calif. 90404. Interface 12, the latest issue of the company's quarterly magazine, contains a feature article describing the use of SDS computers in some 40 colleges and universities. [470]

**Vacuum systems.** Consolidated Vacuum Corp., 1775 Mt. Read Blvd., Rochester, N.Y. 14603. Two bulletins describe new vacuum systems that feature AutoMate control. [471]

**Interchangeable thermistors.** Victory Engineering Corp., 128 Springfield Ave., Springfield, N.J. 07081. Product bulletin MTM141 describes Isotherm interchangeable thermistors and contains a comprehensive resistance vs temperature table. [472]

**Wire marking.** W.H. Brady Co., 727 W. Glendale Ave., Milwaukee, Wis. 53209. A 20-page catalog lists over 5,000 different self-sticking wire markers and several dispensing methods to speed wire identification. [473]

**Operational amplifier.** National Semiconductor Corp., 2950 San Ysidro Way, Santa Clara, Calif. 95051. Bulletin SC-103 describes and illustrates the LM101 general-purpose operational amplifier. [474]

**Thermal relays.** G-V Controls Inc., Okner Parkway, Livingston, N.J. 07039, has available a file folder including information on two series of commercial thermal relays. [475]

**Trimming potentiometers.** Conelco Components, 465 W. Fifth St., San Bernardino, Calif. 92401. A four-page brochure details the Midgi-Trim line of precision wirewound/slidewire trimming potentiometers. [476]

# R-3000

## SOLID STATE AC VOLTAGE REGULATORS

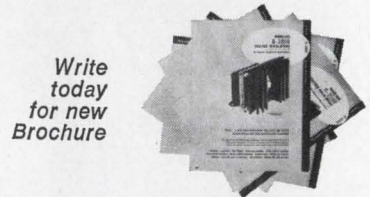

Write  
today  
for new  
Brochure

*Designed Especially for OEM Application.  
Two Lines Available.*

### SPECIFICATIONS

	R-3100	R-3200
Type of Voltage Regulation	True RMS	Peak
Regulation Technique	Peak Clipping	Peak Clipping
Type of Reference	RMS Sensor	Zener Diode
Input	100-130 VAC	100-130 VAC
Output	47-63 Hz	47-63 Hz
Line Regulation ( $\pm 10\%$ line variation)	115 VAC	115 VAC (RMS)
Load Regulation (10% to Full Load)	$\pm 0.5\%$	$\pm 1.0\%$
Frequency Regulation (47-63 Hz)	$\pm 0.5\%$	$\pm 1.0\%$
Power Factor Regulation ( $+0.7$ to $-0.7$ )	$\pm 0.5\%$	$\pm 1.0\%$
Phase Shift	None	None
Response Time	10-50 $\mu$ sec.	10-50 $\mu$ sec.
Models Available	15-1000 va	15-1000 va

**WANLASS  
ELECTRIC CO.**



A Subsidiary of American Bosch Arma Corporation  
2175 South Grand Avenue/Santa Ana, California 92705  
Circle 118 on reader service card

Cartoon by Whitney Darrow, Jr.



## Be a buddy!

One gift works many wonders  
**THE UNITED WAY**

# Outstanding Technical Books

from McGRAW-HILL

**1 MOSFET IN CIRCUIT DESIGN: Metal-Oxide Semiconductor Field-Effect Transistors for Discrete and Integrated-Circuit Technology.**  
By ROBERT H. CRAWFORD.

This sixth book in the Texas Instruments Electronics Series gives circuit designers the basic principles necessary in MOSFET device and circuit engineering, and includes a description of an actual MOSFET complex integrated circuit. **144 pp., \$10.00.**

**2 COMMUNICATION SYSTEM ENGINEERING HANDBOOK.**  
By DONALD H. HAMSHER.

This practical compendium of basic data and the combined experience of 33 specialists gives you an informed overview of the entire field and shows you how to apply the systems approach to communication engineering. Includes data and material not published elsewhere. **600 pp., \$28.50.**

**3 ANALYSIS AND DESIGN OF INTEGRATED CIRCUITS.**

By the Engineering Staff, Motorola Inc. Semiconductor Products Division.

This book establishes analytical and experimental techniques to bring about the balance between system, circuit, and device research and development required in integrated circuits. **500 pp., \$16.50.**

**4 DIGITAL LOGIC AND COMPUTER OPERATIONS.**

By ROBERT C. BARON and ALBERT T. PICCIRILLI.

For anyone with some basic math training, this book stresses matter applicable to all computers, and shows how to use various methods to solve a given problem. It is the ideal preparation for anyone intending to use a computer for the first time. **352 pp., \$13.50.**

**5 CHARACTERISTICS AND OPERATION OF MOS FIELD-EFFECT DEVICES.**

By PAUL RICHMAN.

Beginning with fundamentals, this book provides a concise, straightforward introduction to the theory, characteristics, and operation of metal-oxide semiconductor field effect transistors (MOSFET) and related devices. **200 pp., \$10.00.**

At your bookstore or send coupon for:

**10 DAYS FREE EXAMINATION**

McGRAW-HILL BOOK CO., Dept. 23-L-1111  
330 West 42nd Street, New York, N.Y. 10036

Send me the book(s) circled below for 10 days on approval. In 10 days I will remit for book(s) I keep, plus a few cents delivery costs, and return others postpaid.

1 13475-9    2 25960-6    3 43526-3  
4 03760-6    5 52340-7

Name (print) \_\_\_\_\_

Address \_\_\_\_\_

City \_\_\_\_\_

State \_\_\_\_\_

Zip Code \_\_\_\_\_

For prices and terms outside U.S. write McGraw-Hill Int'l. NYC

23-L-1111

## New Literature

**Temperature-humidity chambers.** Tenney Engineering Inc., 1090 Springfield Road, Union, N.J. 07083, offers bulletin 106 describing an advanced version of its temperature and temperature-humidity chambers. [477]

**RC networks.** Electro Cube Inc., 1710 S. DelMar Ave., San Gabriel, Calif. 91776, has published a brochure on precision RC networks for contact protection and noise suppression. [478]

**Vibration meter.** Wayne Kerr Corp., 22 Frink St., Montclair, N.J. Three-color literature describes the B731B vibration meter that features linear output characteristics. [479]

**Solderless terminals.** Hollingsworth Solderless Terminal Co., Nutt & French Creek Roads, Phoenixville, Pa. 19460. A complete line of solderless terminals, splices and tools is described and illustrated in a 30-page catalog. [480]

**Versatile digital instrument.** Technology/Versatronics Inc., 506 S. High St., Yellow Springs, Ohio 45387. Three instruments in one—digital voltmeter, electronic counter, and electronic integrator—are provided by the model DM5000 Versa/meter described in bulletin 701-B. [481]

**Plastic-encapsulated transistors.** Motorola Semiconductor Products Inc., Box 955, Phoenix, Ariz. 85001. A 12-page brochure presents a reliability report on small-signal, plastic-encapsulated transistors. [482]

**Casting system.** Hysol Corp., Franklin St., Olean, N.Y. 14760. Bulletin E3-225 describes water white hardener H-3840, a room-temperature-cure casting system for electrical and electronic applications. [483]

**Wirewound resistors.** RCL Electronics Inc., 700 So. 21st St., Irvington, N.J. 07111. Engineering catalog 678 lists hundreds of types of wirewound resistors, together with complete engineering information. [484]

**Ceramic capacitors.** Gulton Industries Inc., 212 Durham Ave., Metuchen, N.J. 08840. High capacitance subminiature ceramic capacitors are described in bulletin H29. [485]

**Electronic timers.** Brooks Instrument Division, Emerson Electric Co., Hatfield, Pa. 19440. Digital-readout electronic timers that maintain accuracy regardless of power line frequency variations are discussed in technical bulletin DS-4580. [486]

**High-vacuum system.** Ultek Division, Perkin-Elmer Corp., P.O. Box 10920, Palo Alto, Calif. 94303. A bakeable, tabletop high-vacuum system is the subject of a six-page bulletin. [487]

# MATSUO

Highly Reliable Capacitors

## POLYESTER FILM CAPACITORS.



MXT-4847  
400V  
.047µF(MK)  
Type MXT



100  
200  
MFC  
Type MFK



MFL  
Type MFL

Type MXT

In plastic tube.  
Capacitance Range: .001 MFD to .22 MFD.  
Voltages: 100v, 200v, 400v, 600v DC.

Type MFK

Dipped flat shape non-inductive construction.  
capacitance Range: .01 MFD to .47 MFD.  
Voltages: 100v, 200v, 400v, 600v DC.

Type MFL

Dipped flat shape.  
Capacitance Range: .001 MFD to .22 MFD.  
Voltages: 50v, 100v, 200v DC.

## METALLIZED POLYESTER FILM CAPACITORS.

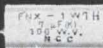

FNX-33W1H  
100V  
100 MFD  
N.C.C.  
Type FNX-H

Type FNX-H

Mylar wrapped semi oval with epoxy end seal.  
Capacitance Range: 1 MFD to 10 MFD  
Voltages: 100v, 200v, 400v, 600v DC.

## SOLID TANTALUM CAPACITORS.

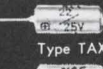

TAX  
Type TAX

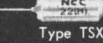

TSX  
Type TSX

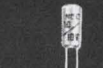

TSL  
Type TSL

Type TAX

MIL-C-28655A hermetically sealed.

Type TSX-TSL

Sealed with epoxy resin.  
Capacitance Range: .22MFD to 330 MFD.  
Voltages: 3v, 6v, 10v, 15v, 20 v, 25v, 35v, 50v DC.

for full details, contact :

# MATSUO ELECTRIC CO., LTD.

3-chome, Sennari-cho, Toyonaka-shi, Osaka, Japan  
Cable Address "NCC MATSUO" OSAKA

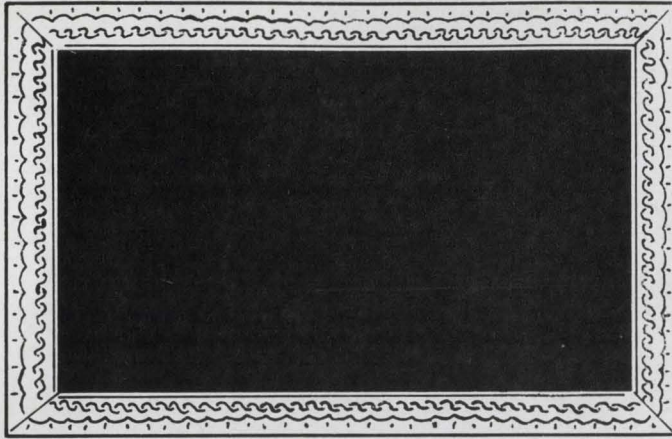

If you don't see 'Charley' in this night scene, join the group of Scientists and Engineers who have enough vision to to make this a reality.

New positions in advanced research and development projects are open at a unique laboratory with mission to accomplish applied research development and engineering of materials, methods and techniques; procurement of services; and design testing and test evaluation of night vision systems for the Army.

AT

## NIGHT VISION LABORATORY

OF THE ARMY ELECTRONICS COMMAND

—IF YOU ARE A U.S. CITIZEN, HAVE A DEGREE AND AN INTEREST IN ANY OF THE FOLLOWING FIELDS . . .

### OPTICS

PULSED CIRCUITRY  
PHOTOEMISSION  
VACUUM TECHNIQUES  
LASER RESEARCH  
LIGHT SOURCE RESEARCH  
TRANSISTORIZED ELECTRONICS  
AUTOMATIC PATTERN . .  
RECOGNITION

### VISUAL PERCEPTION

ATMOSPHERIC OPTICS  
VISIONICS  
IMAGE INTENSIFICATION . .  
COMPONENTS & SYSTEMS  
FAR INFRARED COMPONENTS  
& SYSTEMS  
ILLUMINATION SYSTEMS  
TV SYSTEMS

SEND RESUME OR SF 57 TO . .

**CIVILIAN PERSONNEL OFFICE**  
**Building T-2323, Room No. 1**  
**Fort Belvoir, Virginia 22060**

FORT BELVOIR IS LOCATED APPROXIMATELY 15 MILES SOUTH OF WASHINGTON, D.C. STARTING SALARIES RANGE FROM \$6,387 TO \$20,000 PER ANNUM. RELOCATION EXPENSE PAID. THESE ARE CAREER CIVIL SERVICE POSITIONS.

AN EQUAL OPPORTUNITY EMPLOYER

CIRCLE 951 ON READER SERVICE CARD

## GOODYEAR AEROSPACE

Combine outstanding technical opportunity with ideal living in Phoenix and the Valley of the Sun.

Radar Sensors, Satellite Radar, Electronic/Optical Data Processors, E.C.M. and Advanced Studies represent some of the current efforts in our Arizona Electronics Division.

Current openings for degreed engineering personnel include:

### CIRCUIT DESIGN

Senior Engineers with extensive backgrounds in the areas of IF-Video circuits; CRT sweeps; servo circuits; pulse and analog circuits; digital circuits; and power supplies.

### MICROWAVES

Senior engineers for microwave systems design with experience in radar microwave engineering.

### OPTICS

Senior optics engineers with extensive experience in the design of optical systems such as correlators, recorders and displays.

### SERVOMECHANISMS

Senior engineers with experience in the design of precision digital servomechanisms.

Send resume and salary requirement to:

M. J. McColgan,

Engineering Personnel,

**GOODYEAR AEROSPACE  
CORP.**

Litchfield Park, Arizona 85340

An Equal Opportunity Employer

CIRCLE 952 ON READER SERVICE CARD

We have been placing B.S., M.S., & Ph.D.

## ELECTRONIC ENGINEERS

in FEE PAID positions throughout the U.S. since 1959 through our PERSONALIZED SERVICE.



Over 1000 client companies rely on us to provide carefully screened, technical referrals. We are staffed by experienced graduate engineers **WORKING FULL TIME FOR YOU!**

### SEND RESUME TODAY

If none, send this ad with your name and address for confidential application.

**ATOMIC PERSONNEL, INC.**

Suite L, 1518 Walnut St., Phila., Pa. 19102

AN EMPLOYMENT AGENCY FOR ALL TECHNICAL FIELDS

CIRCLE 953 ON READER SERVICE CARD

ADDRESS BOX NO. REPLIES TO: Box No.

Classified Adv. Div. of this publication.

Send to office nearest you.

NEW YORK, N. Y. 10036: P. O. Box 12

CHICAGO, IL 60611: 645 N. Michigan Ave.

SAN FRANCISCO, Cal. 94111: 255 California St.

### POSITION VACANT

Operations Manager for New Radiation processing company. Must have extensive Linear Accelerator experience, 5 to 7 Mev. New \$200,000 building. East coast. P-4189, Electronics.

### —PROFESSIONAL SERVICES—

**Donald C. Harder, Inc.**

Magnetic Component Engineers

Reactors—Transformers—Filters

Serving the Research Laboratory

2580 K Street, San Diego, Calif. 92102

Phone (714) 239-8021

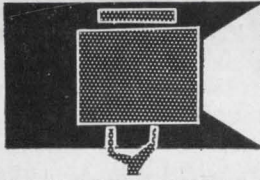

# SEARCHLIGHT SECTION

• CLASSIFIED ADVERTISING • BUSINESS OPPORTUNITIES  
• USED OR SURPLUS EQUIPMENT

## AUTOTRACK ANTENNA MOUNT

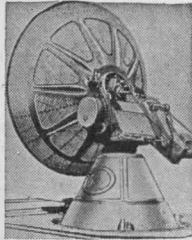

360 degree azimuth, 210 degree elevation sweep with better than 1 mil. accuracy. Missile velocity acceleration and slewing rates. Amplidyne and servo control. Will handle up to 20 ft. dish. Supplied complete with control chassis. In stock—immediate delivery. Used world over by NASA, USAF, MP-61-B. Type SCR-584. Nike Ajax mounts also in stock.

## PULSE MODULATORS

### MIT MODEL 9 PULSER 1 MW—HARD TUBE

Output 25kv 40 amp. Duty cycle .002. pulse lengths .25 to 2 microsec. Also .5 to 5 microsec. and 1 to 5 microsec. Uses 6021. Input 115v 60 cycle AC. Mfg. GE. Complete with driver and high voltage power supply. Ref: MIT Rad. Lab. Series, Vol. 5, p. 152.

### 2 MEGAWATT PULSER

Output 30 kv at 70 amp. Duty cycle .001. Rep rates. 1 microsec 600 pps. 1 or 2 msec 300 pps. Uses 5948 hydrogen thyratron. Input 120/208 VAC 60 cycle. Mfr. GE. Complete with high voltage power supply.

### 250 KW HARD TUBE PULSER

Output 16 kv 16 amp. Duty cycle .002. Pulses can be coded. Uses 5D21, 715C or 4PR60A. Input 115 v 60 cy. AC \$1200 ea.

### 18 MEGAWATT PULSER

Output 150KV at 120 amps. Rep rate: 50-500 PPS. Pulse length: 5 msec. 15KV 120 amp. into pulse transformer. Rise time 1.5 msec. Filament supply 5V 80 amp. incl. 17.5KV 1.5 amp DC power supply. Input: 220V 60 cy AC.

### VARIAN KLYSTRONS

V-45: .15W output CW 9 to 10 KMC  
YA-800: 10 KW output CW 1.7 to 2.4 KMC  
YA-806H: 1KW output CW 7.5 to 8.5 KMC

### IBM 704 IBM 650

These computers in stock for immediate delivery

### SCR 584 AUTOTRACK RADARS

Our 584s in like new condition, ready to go, and in stock for immediate delivery. Ideal for telemetry research and development, missile tracking, satellite tracking. Fully Desc. MIT Rad. Lab. Series. Vol. 1, pps. 207-210, 228, 284-286. Comp. Inst. BK available \$25.00 each.

## MICROWAVE SYSTEMS

### L BAND RF PKG.

20 KW peak 990 to 1040 MC. Pulse width .7 to 1.2 micro sec. Rep. rate 180 to 420 pps. Input 115 vac incl. Receiver \$1200

### 200-225 mc RADAR SYSTEM

1 Megawatt output. 200 nautical mile range for long range detection of medium and high altitude jet aircraft as well as general search. AN/TPS-28.

### 10 KW CW S-BAND

Complete 1700-2400 MCS RF system using VA-800 klystron. New.

### SURVEILLANCE DRONE RADAR SYSTEM

X-Band tracking system with plotting boards. Type AN/MPQ-29. Drone also in stock.

### 5 MEGAWATT C-BAND

Klystron RF package delivering nominal 5 megawatt pulse RF. Complete with pulser and power supply.

### 500 KW L BAND RADAR

500 kw 1220-1359 msc. 160 nautical mile search range P.P.I. and A scopes. MTI. thyratron mod 5J26 magnetron. Complete system.

### 100 KW X BAND RADAR

Complete 100 kw output airborne system with AMTI. 5C22 thyr. mod. 4J52 magnetron. PPI. 360 deg as sweep. 60 deg. elev. sweep, gyro stabilizer, hi-gain revr. Complete with all plugs and cables.

### AN/GPG-1 SKY-SWEEP TRACKER

3 cm. automatic tracking radar system. Complete package with indicator system. Full target acquisition and automatic tracking. Input 115 volts 60 cycle New. In stock for immediate delivery. Entire System 6' long, 3' wide, 10" high. Ideal for Infrared Tracker, Drone Tracker, Missile Tracker, R. & D.

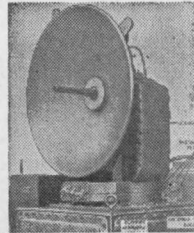

### 500KW S BAND RADAR

250 miles search 115V 60 cy AC. Mfg. G.E.

RADAR AUTO-TRACK & TELEMETRY ANTENNA PEDESTALS 3 & 10 CM. SCR 584 AUTOTRACK RADARS. M-33 RADAR TPS-1D SEARCH. APS-45 TPS-10D HT. FINDERS. WX RADARS. FPN-32GCA. APS-10 APS-15B APS-27 (AMTI) SEARCH. APN-102 DDPLER. DOZENS MORE CARCINOTRONS. PENS. 25-5-1.2-3-6 MEGAWATT PULSE MODULATORS. CAVITIES. PULSE TRANSFORMERS. IF STRIPS. WAVEGUIDE. BENDS 200 MC. 1 KMC. 3 KMC. 6 KMC. 9 KMC. 24 KMC. RF PKGS.

### RADIO RESEARCH INSTRUMENT CO.

550 5TH AVE., NEW YORK 36, N.Y. JU 6-4691

CIRCLE 967 ON READER SERVICE CARD

## BIG CATALOG

World's "BEST BUYS" in GOV'T. SURPLUS Electronic Equipment

FULL OF TOP QUALITY ITEMS—Transmitters, Receivers, Power Supplies, Inverters, Microphones, Filters, Meters, Cable, Keys, Phones, Antennas, Chokes, Dynamotors, Blowers, Switches, Test Equipment, Headsets, Amplifiers, etc., etc. SEND 25¢ (stamps or coin) for CATALOG and receive 50¢ CREDIT on your order. Address Dept. E-7.

### FAIR RADIO SALES

P.O. Box 1105 • LIMA, OHIO • 45802

### MINI-FLUID DISPENSER

AIR OPERATED

for miniature potting and encapsulating

Available in 3 sizes  
6cc - 12cc - 30cc

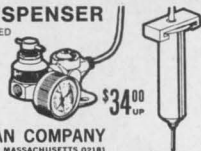

\$34.00 up

PHILIP FISMAN COMPANY  
7 CAMERON ST., WELLESLEY, MASSACHUSETTS 02181

CIRCLE 968 ON READER SERVICE CARD

## ELECTRON TUBES

KLYSTRONS • ATR & TR • MAGNETRONS  
SUBMINIATURES • C.R.T. • T.W.T. • 5000-6000 SERIES

• SEND FOR NEW CATALOG A2 •

A & A ELECTRONICS CORP.

1063 PERRY ANNEX  
WHITTIER, CALIF.  
696-7544

CIRCLE 969 ON READER SERVICE CARD

# FOR SALE



When you have used electronics equipment to sell, advertise in Electronics Searchlight Section for fastest results.

For information:  
Searchlight Section  
Classified Advertising Division  
Post Office Box 12  
New York 10036

# In electronics it's Electronics magazine to sell used equipment!

Your advertisement will produce Results in Electronics. Engineers turn to Electronics magazine for the latest technical developments — and for the latest buying information. You can reach them inexpensively in Electronics Searchlight Section.

For information:  
Searchlight Section  
Classified Advertising Division  
Post Office Box 12  
New York 10036



CIRCLE 297 ON READER SERVICE CARD →

# CAPACITORS

**MACHINED PLATE TRIMMER AND TUNER TYPES — U, UA, UB, U-LC, V, AND W** — Available in both printed circuit and chassis mounting types. U types available in differential and butterfly printed circuit mounting types in addition to single section types. V and W capacitors available in single section type only. Maximum capacities of up to 54 pf. Tuners consist of a machined plate trimmer and high Q air wound silver plated inductor, in resonant frequencies of 100 to 750 Mc.

**SOLDER PLATE TYPES** — Type M: Capacity values to 30 pf. Voltage ratings to 1250 volts peak. Available in single section, differential and butterfly types.

Type S: Capacity values to 100 pf. Voltage ratings to 3000 volts peak. Available in single section, differential and butterfly types.

Type K: Capacity values to 150 pf. Voltage ratings to 3800 volts peak. Available only in single section types. May be furnished in production quantities in full compliance to MIL-C-92A.

Type R: Capacity values to 340 pf. Voltage ratings to 4400 volts peak. Available only in single section type.

Type L: Capacity values to 200 pf. Voltage ratings to 3500 volts peak. Available in single section differential, butterfly and dual section types.

**SPACER TYPES** — Type C: Capacity values to 1500 pf. Voltage ratings to 13,000 volts peak. Available in single section and dual section types.

Type D: Capacity values to 1700 pf. Voltage ratings to 9000 volts peak. Available in single section and dual section types.

**STAKED PLATE TYPES** — Type E: Capacity values to 1000 pf. Voltage ratings to 4500 volts peak. Available in single section and dual section types.

Type F: Capacity values to 400 pf. Voltage ratings to 3000 volts peak. Available in single section and dual section types.

# CONNECTORS

**SUB-MINIATURE INSULATED TYPES** — Designed for printed circuit applications. Operating voltages to 1500 volts RMS . . . 5 amperes current carrying capacity . . . contact resistance less than 2 milliohms. Capacitance between two adjacent jacks less than one pf at 1 Mc. 10 colors available. Test-Point Strip/Handle — rapid-mounting polyamide body contains 12 test points each rated at 5 amps., maximum current capacity. Operating voltage 1500 volts RMS at sea level, 350 volts RMS at 50,000 feet. Contact resistance less than 2 milliohms.

**STANDARD INSULATED CONNECTORS** — A complete line of connectors molded of tough, low-loss, shock-proof polyamide in 10

colors meeting Fed. Std. 595. Tip, Banana and Dual Banana Plugs; Tip and Banana Jacks; Metal-Clad Tip Jack, Military; Jack and Sleeve; Binding Posts.

**RIB-LOC TERMINALS** — A new line of miniature, one-piece, insulated terminals with a unique serrated conical design, which resists loosening and turning. Provides an inexpensive approach to convenient press-in type terminals. Six colors conforming to Federal Color Standard No. 595. Terminal styles include single and double turret feed-thrus and stand-offs, .040" dia. tip plug and mating jack for .040 plug.

## Tube Sockets, Insulators, Pilot Lights, and Hardware

**ULTRA HIGH FREQUENCY SOCKETS** — Continuous heat resistance to 500°F. with low loss, glass filled silicone base and heat treated beryllium copper contacts. Low inductance screen bypass capacitor available for VHF and UHF operation.

**KEL-F SERIES** — Molded of low dielectric loss-factor Kel-F plastic — designed for use with a wide selection of high power transmitting tubes.

**STEATITE WAFER TYPES** — Available in 4, 5, 6, 7, and 8-pin standard socket types, as well as Super Jumbo 4-pin types. Also giant 5 pin, and 7 pin Septar and VHF Septar Sockets.

**SPECIAL PURPOSE TYPES** — Includes sockets for special purpose tubes.

Note: For detailed specifications, request Socket Standardization Booklet 536 on your company letterhead.

**INSULATORS** — Low loss, high-voltage breakdown in either steatite or porcelain. Complete line includes Thru-panel Bushings and Insulators, Antenna Strain and Feeder Types, Cone and Stand-off Insulators, Lead-in Bushings and Feed-Thru Bowl Assemblies.

**PILOT LIGHTS** — Over 47 separate assemblies. Continuous indication neon types, models for high and low voltage incandescent bulbs, standard or wide angle glass, and lucite jewels. Specials, including types meeting military specifications, also available in production quantities.

**PANEL BEARINGS** — For use on 1/4" shafts and panels up to 3/8" thick. **CRYSTAL SOCKETS** — For low capacity, high voltage and high temperature operation. Glazed steatite, Grade L-423 or better. DC-200 impregnated. **RF CHOKES** — High quality construction. For 1.7 to 30 Mc range.

# CHECK Johnson for all your component requirements

Johnson also offers a complete line of heavy-duty RF components for broadcast transmitting, RF heating, antenna phasing and other commercial applications.

Equipment in this line includes fixed and variable inductors, antenna phase sampling loops, isolation filter inductors, feed-thru bowl insulators, static drain chokes, RF contactors and heavy-duty make-before-break switches.



**E. F. JOHNSON COMPANY**  
W A S E C A , M I N N E S O T A 5 6 0 9 3

# Newsletter from Abroad

channels, a core memory with a capacity of 64,000 words of 24 bits, and a cycle time of 900 nanoseconds.

The TR 8 series will also include a computer for military applications. This version will be smaller and have fewer channels than the commercial machine.

## Tide of IC imports is rising in Japan

Japan is braced for a surge of integrated-circuit imports during the next few months. Such imports—all but a handful from the U.S.—totaled 270,000 packages in September but are **expected to climb to about 500,000 this month and hold at that level through the rest of the year.**

The industry guess is that Nippon Electric, Fujitsu, and Hitachi are gobbling up more than half the IC's coming into the country. Both Nippon Electric and Fujitsu are major producers of IC logic but their production schedules will keep them heavy importers of computer circuits for some time to come. Hitachi, which has put initial in-house emphasis on IC packages for calculators and consumer electronics, imports logic circuits for the RCA Spectra 70 computer it produces under license.

**So sharp is the projected import rise that the flood of foreign IC's may temporarily top domestic production.** But by early next year, Japanese producers figure to dominate their home market even though there's little prospect of a drop in imports.

Nippon Electric, currently the top Japanese IC producer, turned out 250,000 packages in September and expects a 600,000 monthly output rate by March. Mitsubishi production is close to 200,000 circuits a month; but the other two major producers, Fujitsu and Tokyo Shibaura Electric, are still below the 100,000-a-month mark.

## AEI resists takeover bid

Defensive maneuvers by Associated Electrical Industries have so far blocked efforts by Britain's General Electric Co. to take over the firm.

Since its first bid of \$330 million last month [Electronics, Oct. 16, p. 225], GEC has upped the ante twice. Arnold Weinstock, head of GEC (not connected with General Electric in the U.S.), describes the present offer of \$450 million—rejected by AEI's management—as "final." **But there's speculation he may go higher since the latest bid is still some \$80 million shy of AEI's total assets.**

Meanwhile, AEI has acquired a new chairman and come up with a plan to put its telecommunications equipment business into a joint venture with Standard Telephones and Cables, an ITT subsidiary. **These moves have helped AEI hold the fort, but insiders say the battle could still go either way.**

## Kremlin programs tv production boost

New emphasis on consumer goods in Soviet economic plans will push television-set production to record levels next year. The target is 5.7 million sets, up nearly 20% from this year's estimated output of 4.8 million.

**Most of the sets will be black and white.** Although nationwide colorcasts started last week with a live showing of the Red Square festivities marking the 50th anniversary of the Bolshevik revolution, volume production of color sets won't come until 1970.

The stepped-up tv-set production apparently won't be at the expense of other electronic sectors. **Despite the secrecy surrounding sophisticated technology, there are indications that the Soviets have plotted a solid boost in automatic controls and computers over the next three years.**

# IBM Circuit Design and Packaging Topics

- packaging cost reductions
- high-speed switching
- reed switch application data

## packaging cost reductions

Performance Measurements Co., Detroit, Michigan, reports significant savings in packaging their new electronic recording system. The packaging method previously employed required two gates to mount the components in the main console. Now, with IBM's modular packaging as pictured below, only one gate is needed. That's because the IBM technique makes the most efficient use of console space with compactly mounted and connected circuit boards, relays and hardware.

Mounting time has been saved too. Pluggable components, low-cost card receptacles and interlocking card guides have so simplified the packaging job, that Performance Measurements now saves 70% on the cost of mounting hardware. Fewer and shorter wires are needed in the compact console—eliminating three feet of 1½-inch cable and shortening a second cable by eight inches. The modular chassis gave designers freedom to experiment freely with various mounting configurations. It also permits easy access for servicing and diagnostic analysis.

The same design freedom, plus significant hardware and labor savings are available in many applications.

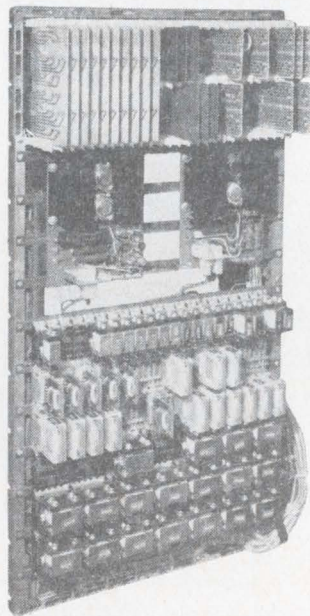

IBM components and packaging can help you in timing control, digital logic testing, telemetering, process or numerical control.

## high-speed switching

IBM wire contact relays were originally designed for data processing use. Now they are being used extensively in machine tool and assembly applications. One of these assembly applications is a numerically-controlled component insertion machine. It sequentially inserts random combinations of up to 24 different types of axial lead resistors and diodes into printed circuit boards. Such machines have been widely used, often on a round-the-clock, three-shift basis, in IBM's electronic assembly operations.

Insertion rates range from 3,000 to 4,500 components per hour, depending upon the type of components being inserted.

Instructions from an 8-channel punched paper tape provide the logic input to the relay gate. The gate employs three rows of 6- and 12-pole IBM wire contact relays. These relays control the movement of each printed circuit

board through the X and Y axis positioning of the board for each component insertion. They also control the component feed, component insert, and cut-and-clinch cycles for each insertion operation.

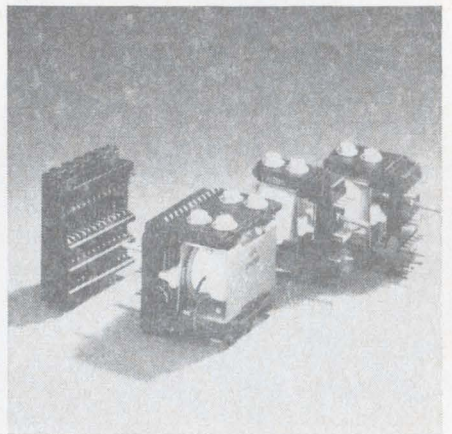

IBM wire contact relays can perform in excess of 200 million operations with an operate speed as fast as 4.5 ms, a release time of 5 ms maximum. The product line includes 4-, 6-, and 12-pole Form C relays, 4- and 6-pole latch models, all with compact, solderless, pluggable mountings—with coil-voltages up to 100 VDC.

## reed switch application data

Data on the magnetic switching characteristics of miniature dry reed switches is available to design engineers on request. The data was compiled from ex-



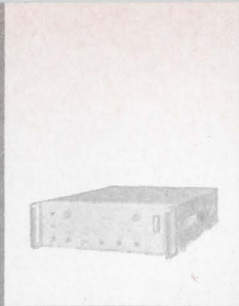

# Servo is microwaves



Want to generate a signal in the Ka band, test electronic gear on an aircraft, or check out the guidance system of a missile? Servo designs and manufactures instruments for these applications. And many others.

Our engineers are expert in producing microwave pulse-swept systems, microwave signal generators, microwave amplifiers and high voltage power supplies. Take the unit pictured above, for example. It's the first 20-watt TWT amplifier available...and industry's most compact, too. Servo's amplifiers have many unusual features, and are

supplied in models for operation from 1 to 18 GHz in octave bandwidths.

Our Servodynamics Division also supplies special synchro-to-digital and digital-to-synchro conversion equipment and servo analyzers, digitally programmable function generators, and phase meters.

Other Servo divisions design systems and products which serve safety through science: the Railroad Products Division, the Infrared & Electro-Optics Division, and the Communications & Navigation Division.

servo corporation of america

Circle 304 on reader service card

# Servo

111 new south road  
hicksville, l.i., new york 11802  
516 938-9700

air tests during the early-morning hours when there are no programs and will report the results to the Federal Communications Commission early next year.

**Market bound.** N.V. Philips' Gloeilampenfabrieken, too, has developed a system that fills in the blanks between tv scanning fields and hopes to start marketing the equipment perhaps late next year. But where RCA's receiver reproduces the transmitted graphic material with an electrostatic printer, Philips' receiver photographs the image that appears on a cathode-ray-tube.

With the European tv broadcasting setup of 625 lines per frame and 25 frames per second (there are two fields in a frame), it takes as little as 2.5 seconds to transmit graphic material—a photo, for example, or a printed text. Because of the time it takes for the scan, only still material can be handled.

Philips thinks the Dutch police will be among the first to use the system. They may use the equipment to broadcast pictures of wanted criminals and missing persons to stations throughout the country.

**The lineup.** The vertical blanking period lasts long enough to transmit between 20 and 28 lines, but because of the time it takes to switch the auxiliary circuit in and out—and to provide a safety margin—Philips designed its equipment to transmit a maximum of 5 lines per interval. Any number of lines from 1 to 5 can be chosen.

The pickup equipment, which has its own camera, is tied into the regular tv video path by means of a relay. It switches on when the operator pushes a start button, and it develops a pulse that initiates transmission of the still material.

Vertical synchronization pulses of the normal tv signal are used to trigger a pulse generator that gates out lines scanned by the auxiliary camera. The camera's horizontal deflection circuits get normal drive pulses, also from a special pulse generator.

Vertical deflection circuits, though, are set up so the scan for a field is reduced from the normal 312.5 lines to 310 lines or 312 lines.

That way, the reduced scanning pattern shifts gradually down, compared with the normal scan pattern, as each group of 1 to 5 lines is transmitted during the vertical blanking period. The reduced number of lines for the auxiliary camera's scan is obtained by slightly increasing the frequency of vertical deflection pulses by means of a frequency divider.

**Receiver.** Video information inserted into the vertical blanking interval is picked up on a receiver whose front end is identical to a normal receiver except that there's no sound channel.

Deflection circuits for the cathode ray tube are set up to match the horizontal and vertical pulse trains in the pickup equipment. The camera that photographs the crt display has its shutter opened and closed automatically.

---

## Great Britain

---

### New beat

Thus far, consumer radio set designers have played it conservative with integrated circuits. To be sure, there's many a set with ic's on the market. All, however, merely use ic's as a new kind of hardware to build an old circuit—the superheterodyne with an envelope detector.

This state of affairs won't last much longer, thinks R.C.V. Marcario of the University of Wales. Marcario maintains it's high time that designers revive a couple of circuit concepts that have been around for some time but weren't practical for domestic sets before low-cost ic's came along.

The concepts Marcario has in mind are homodyne reception and the single-span receiver. In the homodyne technique, a suppressed carrier is reconstituted in the receiver and added to the broadcast signal at the detecting diode. In the single-span receiver, the intermediate frequency is set higher than the highest carrier frequency to be received. Thus both the long-wave and medium-wave bands used in

Europe for popular broadcasting can be covered by tuning the local oscillator with one variable condenser.

**Off-the-shelf.** Marcario already has breadboarded a homodyne circuit using standard linear ic's produced by Fairchild Semiconductor for the crucial circuits. He currently is putting together a single-span receiver whose kingpin component is a dual-gate field effect transistor.

And since the single-span receiver needs a broadband antenna, Marcario has designed one that can be tucked into the cabinet of a line-operated table set. A few feet of plain wire would serve the purpose equally as well, but Marcario is convinced that few consumers would buy a set that needed a living-room aerial.

This trio of developments, Marcario says, together add up to a receiver that would outperform conventional a-m superhets, especially for long-distance reception. Fading would no longer plague, as it now does, a Londoner listening to a station in Rome. That's because the coherent detection used in the homodyne concept adds the signals—but not the noise—in the two sidebands. This improves the signal-to-noise ratio by 3 decibels, a big advantage when the signal deteriorates during a fade.

**Zeroed in.** For homodyne reception, one obvious way to supply the demodulating frequency is to lock a local oscillator in phase onto the signal carrier. But unless the set were tuned more carefully than most consumers are in the habit of doing, the oscillator would tend to jump out of lock on a fade. Automatic frequency correction to prevent jump-out would cost too much for a consumer set.

Marcario's homodyne develops a demodulating frequency precisely matched to the carrier frequency by tying a Schmitt trigger circuit to a zero-crossing detector. The basis of the arrangement is that if a station can be picked up at all, the carrier will appear at the detector and will change polarity regularly at twice the carrier frequency. Because the zero-crossing detector drives the Schmitt trigger, then, its square-wave output stays locked to

# We just took a great step backwards



## (with three new, forward-looking unitized DVMs)

Trymetrics' new 4243 Digital Multimeter with AC, DC and OHM readings—auto polarity—full four digit—.01% (\$850) ... a tremendous step backwards. And so are the 4240 DVM (\$695) and 4230 DVM (\$595).

We started with our Model 4100: stored display—precision .01%, four-digit DVM and its full range of plug-ins for the price of an ordinary 3-digit job—just \$740 with the  $\pm 9.999$ v DC head; \$1045 with a complete multimeter head; and eight other plug-ins to choose from. For an encore, the only way to go was down.

Down \$195 to \$850 for the versatile 4243 Digital Multimeter: DC-AC-OHMS .01% — auto polarity  $\pm 999.9$ mv to  $\pm 999.9$ v. Same 4-digit stored display—no plug-ins. Sorry—unless you don't need plug-ins.

Down again, \$155, to \$695, for the 4240 DVM. Same high accuracy, same stored display, same  $\pm 999.9$ mv DC to  $\pm 999.9$ v DC 4-digit measurements. But, no AC or OHMS—unless, of course you don't need AC or OHMS.

Once more, down, to \$595 for the Trymetrics 4230 DVM. Still the same precise 4-digit unit with readings  $\pm 9.999$ v DC to  $\pm 999.9$ v DC. Don't buy this one if you need to measure in the low millivolts.

You don't need true 4-digit readout with .01% accuracy at a 3-digit, .05% price? Sorry—but we can't keep backtracking forever. May we send you our new catalog that shows ALL our models, all our plug-in versatility, all our reasons for going backwards?

PRICES SLIGHTLY HIGHER IN EUROPE.

**TRYMETRICS**  
Corporation  
A SUBSIDIARY OF TRYGON ELECTRONICS, INC.

204 Babylon Tpke., Roosevelt, L.I., N.Y.  
Phone 516-378-2800 11575

## Electronics Abroad

sion suitable for air-to-air weapons. "What we need," says the engineer who headed the Jaguar fire-control project, "is a laser with a much-higher firing rate."

### West Germany

#### New geometry

In long-distance broadcasting, radical improvements in antenna design are rare happenings now.

A few years ago, American antenna designers bettered transmission characteristics significantly by rigging a log-periodic half-rhombic array of dipole elements vertically between supporting masts. Another step forward, says AEG-Telefunken, is the full-rhombic vertical array its designers came up with for an antenna field now going up at Usingen, near Frankfurt.

The full rhombus arrangement keeps the elevation angle of the radiation pattern down low and thus well-suited for long-distance transmission. Further, the pattern is independent of frequency and can be highly directional. A frequency range of 6:1 can be handled without any tuning.

**Five by five.** The Usingen field, scheduled to go into full service by early 1968, will air intercontinental broadcasts at frequencies from 3 to 30 megahertz. All told, Usingen will have five arrays, each made up of five dipole curtains extending out from a center mast. One array, designed for transmission in the 3 to 18 Mhz range, will have a center mast 230 feet high. The other four arrays, for 5 to 30 Mhz broadcasting, will have center masts 130 feet high.

A typical antenna curtain has a vertical radiation pattern whose main lobe lies between 4° and 12° in elevation. This relatively low angle makes for optimum transmission characteristics at distances

from 900 to 1,200 miles. The elevation angle isn't changed appreciably for greater distances. They are covered by "skips" between the earth's surface and the ionosphere.

**Curtain time.** Since the horizontal radiation pattern of each dipole curtain is about 72° at the half-power width, five curtains are required to get omnidirectional transmission characteristics for an array. Any of the curtains can be switched by remote control onto the transmitter to select the one best matched to the propagation conditions.

Each curtain is made up of 19 vertically rigged and vertically polarized rhombic half-wave dipole elements. At the top, the elements hang from an isolator attached to a guy wire; at the bottom the dipoles are joined to an isolator tied to a weight. The arrangement lets the rhombic elements "give" under high wind loads.

Energy feed to the array is by a two-conductor cable that runs through the center of each dipole. The dipoles are alternately connected to the conductors so that the energy in adjacent dipoles is 180° out of phase. Excitation, by means of a wire running parallel to the energy cable, starts with the

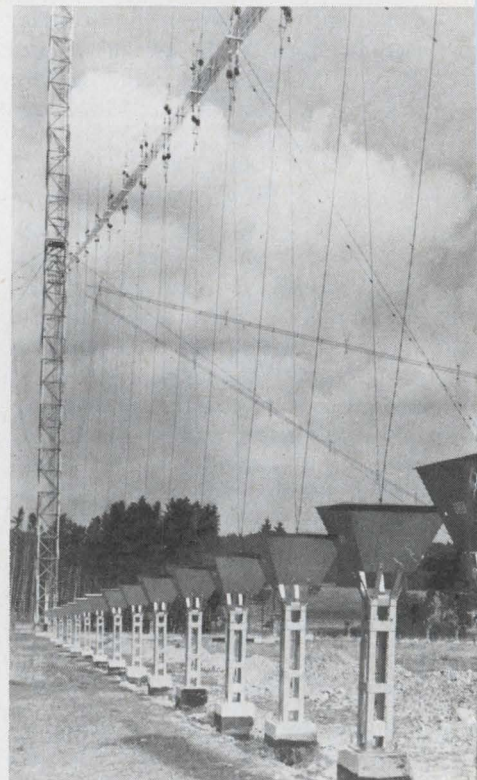

**Weighted antenna.** Lower ends of rhombic dipole elements in West German antenna are held down by weights that can move up and down.

# VACTEC

announces a new line of

# VACTROL Lamp-Cell Controls

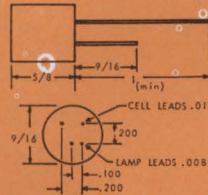
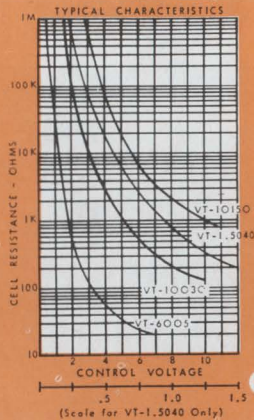
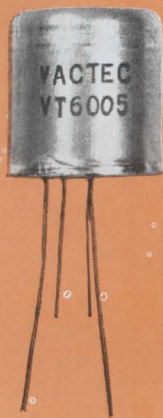

Now 1.5v, 6v, and two 10-volt Vactrols are available for electronic amplifier applications. Combines a dependable Vactec photo cell with the proper long-life incandescent lamp in a complete low-cost module. Provides noiseless, trouble-free volume and

tone control for TV, radio, guitars, organs, and other musical instruments. Unit is protected by an epoxy sealed metal enclosure. Leads are spaced on .100" centers for circuit board mounting. Special characteristic designs available for unique applications. Write for Vactrol Bulletin PDC-4C 1.

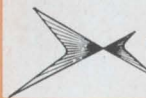

**VACTEC, INC.**

2423 Northline Ind. Blvd. • Maryland Hts., Mo. 63042 • AC 314, 432-4200

See Vactec's listing in EBG under "Semi-Conductors," and in EEM, Sec. 3700.

Circle 124 on reader service card

## Electronics Abroad

of the oscilloscope comes from a narrowband amplifier linked only to the vertical rod antenna. The amplifier, whose resonant frequency can be set from 5 to 50 kilohertz, measures the spectral amplitude of the atmospheric. Its output is also fed to a differentiating network that derives a short, high-amplitude pulse that controls the oscilloscope's electron gun.

The screen is photographed with a long exposure. The result is a pattern of light spots distributed according to the direction and amplitude of incoming atmospheric noise.

**Variations.** The scientists have also come up with equipment modifications that make it possible to spot different noise sources lying on the same azimuth. In one variation, the pulse outputs of two narrowband amplifiers set at different frequencies are compared. In another, a combination of narrowband circuits develops a pulse proportional to the difference in the group delay times of the noise spectrum at two different frequencies in the range from 4 to 10 kHz.

## Japan

### Tuned IC

Cost-conscious radio and television-set makers are always on the lookout for ways to do away with tuned transformers in intermediate-frequency amplifiers. Aligning i-f strips after a set is built adds a significant chunk to its labor cost.

Murata Manufacturing Co. thinks it has a way—hybrid integrated circuits incorporating ceramic filters. Although the company says the hybrids are still under development, it already has them available in sample quantities.

Murata's lead-zirconate-titanate piezoelectric filters have been used previously by the Sony Corp. as discrete components in a 455-kilohertz i-f amplifier for portable radios [Electronics, Nov. 14, 1966, p. 160]. As could be expected, a 455-khz i-f amplifier turns up in Murata's hybrid line. But the com-

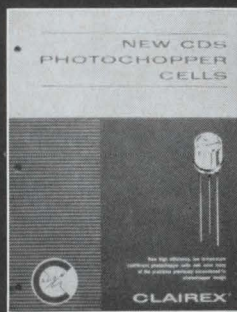

Write for  
bulletin  
describing

# New CDS type 6C Photochopper Cells

- High Efficiency
- Low Temperature Coefficient
- Resistance Tolerance  $\pm 50\%$
- Internal Electrostatic Shielding
- Dumet Leads



CLAIRES ELECTRONICS, INC. ■ 1239 BROADWAY, NEW YORK, N. Y. 10001

## COMPUTER TALK

by W. Henry du Pont, President

SCI-TEK

COMPUTER CENTER, INC.



### WHAT SHOULD A SCIENTIFIC COMPUTER CENTER DO?

In our business we get paid for solving technical and scientific problems using the most powerful computer in the country. When we've done that, we've earned our money as computer men.

But we try to do something more, too. We think it's our job to make electronic data processing as prudent an investment as you can make.

This means—among other things—that we must understand your problems and opportunities from an engineering point of view first and from a computer man's view second.

We must be doing a good job because we have just opened up a satellite computer center at the Franklin Institute Research Laboratories building in Philadelphia to serve their R & D needs.

Our charges for these services? Nothing but the standard fee you pay when you actually use our 1107 computer.

Send for our helpful brochures describing SCI-TEK. They're yours without obligation.

**SCI-TEK**  
**COMPUTER CENTER, INC.**  
1707 GILPIN AVENUE  
WILMINGTON, DELAWARE 19806  
Phone: (302) 652-3967

## Electronics Abroad

for the discriminator. On the substrate with the filters are three transistor chips, a pair of diodes, a dozen resistors and five capacitors. The diodes are used with the third filter in the discriminator circuit. Gain ranges between 40 and 46 decibels.

The 10.7-Mhz unit is similar to the 4.5-Mhz module, but does not include a discriminator circuit. Murata, however, is developing a filter that can be used as a discriminator at 10.7 Mhz.

### Inside job

With much fanfare, Matsushita Electrical Industrial Co. and N.V. Philips' Gloeilampenfabrieken last month signed a pact extending for another 10 years their long-standing joint venture in Japan—the Matsushita Electronics Corp.

In view of such close cooperation, observers wondered why Matsushita Electric has quietly set up a semiconductor group in its central research laboratory to develop integrated circuits. Until now, the job has been handled by the joint venture.

**Competing.** Matsushita vice-president Tetsujiro Nakao says there's nothing sinister in the development, even though the new group is led by the former director of research at Matsushita Electronics.

Under the joint agreement, Nakao points out, Philips has access to any Matsushita Electric semiconductor developments. And he adds that there's no plan to set up separate semiconductor production facilities in which Philips won't share. Nakao insists the move was made mainly because the Japanese company likes some internal competition among its researchers and development groups.

Outsiders, though, feel there's another reason behind the new IC research group: a freer hand for Matsushita Electric. Apparently Matsushita has had trouble selling its partner on some research projects that look promising from a Japanese standpoint but nonetheless seem unattractive to Philips, whose prime market is Europe.

Feedback AGC  
using the . . .

# VCR\* FET

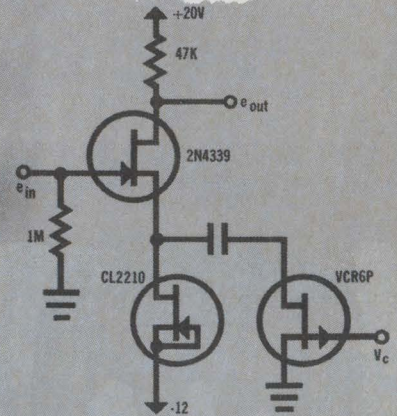

Siliconix assumes no responsibility for the circuit shown, nor do they represent or warrant that it does not infringe any patents.

Here's a common-source FET amplifier, with a current-limiter diode as a source resistor and a VCR FET gain control. With  $V_C = 0$ , the gain is 32 dB. Gain decreases as  $V_C$  approaches pinch-off for the VCR. Maximum gain depends on  $r_{ds}$  at  $V_{GS} = 0$  for the VCR6P. Gain with full AGC ( $V_C = V_P$ ) is controlled by the current limiter. Variations in maximum gain are due to variations in  $r_{ds}$ .

If you'd like to investigate this and other VCR FET designs, order your VCR FET Designer's Kit from a Siliconix distributor. For just \$19.50 you'll get 6 different VCRs (worth \$30) plus data. More information? Just write us.

\* VCR - Voltage Controlled Resistor - a FET bilateral resistance whose value is voltage controlled from one high-impedance terminal.



**Siliconix incorporated**

1140 W. Evelyn Ave. • Sunnyvale, CA 94086  
Phone (408) 245-1000 • TWX: 910-339-9216

<b>Ideal Precision Meter Co., Inc.</b> Zam & Kirshner, Inc.	244	<b>Markem Machine Co.</b> Culver Advertising, Inc.	184	<b>Research, Inc.</b> Gordon Rosholt & Co.	291
<b>Image Instruments, Div. of DASA Corp.</b> L.K. Frank Co., Inc.	58	<b>Maryland Dept. of Economic Development</b> The Robert Goodman Agcy., Inc.	270	<b>RFL Industries, Inc., Instrumentation Div.</b> Josephson, Cuffari & Co.	288
<b>Indiana General Corp., Ferrites Div.</b> Griswold & Eshleman	24	<b>Matsuo Electric Co., Ltd.</b> Daiyusha, Inc.	292	<b>Rochar Electronic, Div. of Schlumberger</b> Promotion Vente Publicite	OAS 9
<b>Information Handling Services</b> Martz & Associates	245	<b>Matthey Bishop Inc.</b> Richardson, Thomas & Bushman, Inc.	286	<b>Rohde &amp; Schwarz</b> Walker & Gessell, Inc.	6
<b>International Crystal Mfg. Co.</b> Robert V. Freeland & Assoc.	242	<b>Meguro Electronic Instrument</b> General Advertising Agency, Inc.	256	<b>Rotron Manufacturing Co.</b> Lescarboua Adv., Inc.	249
<b>International Electronic Research Corp.</b> Van Der Boom, McCarron, Inc., Adv.	288	<b>Metal Removal Co., The</b> Advertising Producers Assoc.	280		
<b>International Rectifier Corp.</b> Botsford, Constantine & McCarty, Inc.	151	<b>Metex Corp.</b> Keyes, Martin & Co.	287		
<b>Intercontinental Instruments, Inc.</b> J.S. Lanza & Assoc.	223	<b>Mico Instrument Co.</b>	288		
<b>Iowa Development Commission</b> L.W. Ramsey Advertising	262	<b>Microdot, Inc.</b> Gumpertz, Bentley & Dolan Adv.	15	<b>Sage Electronics Corp.</b> Mathison Adv., Inc.	281
<b>I R C, Inc.</b> Gray & Rogers, Inc.	199	<b>Micro Science Associates of Mountain View, California</b> Stadler/Cowman Adv.	71	<b>Scintillonics, Inc.</b> Mosher & Assoc., Inc.	52
<b>ITT Electron Tube Div.</b> West, Weir & Bartel, Inc.	149	<b>Milgray Electronics</b> Bliss/Gruenwald, Inc.	197	<b>Sci-Tek Computing Center, Inc.</b> Stanley, Richard & Frederick, Inc.	312
<b>ITT Jennings Mfg. Co.</b> West, Weir & Bartel, Inc.	261	<b>Milo International, Div. of Milo Electronics Corp.</b> Industrial Marketing Assoc., Div. of J.M. Schrier, Inc.	OAS 6	<b>Sel-Rex Corp.</b> Gaynor & Ducas, Inc.	74
<b>ITT Jennings Mfg. Co.</b> West, Weir & Bartel, Inc.	OAS 18	<b>Milwaukee, City of, Div. of Economic Development</b> Grabin-Shaw Adv., Inc.	311	<b>Semcor Div. Components, Inc.</b> Marketing & Corporate Communications, Inc.	63
<b>ITT Semiconductors Div.</b> Neals & Hickok, Inc.	162, 316	<b>Mitsubishi Electric Corp.</b> Hakuhodo, Inc.	246	<b>Semi-Elements, Inc. Sub. of Riker Video Ind., Inc.</b> Cavanaugh Morris Adv.	315
<b>ITT Standard</b> Brockie Haslam & Co.	OAS 15	<b>Mosaic Fabrications, Inc., Sub. of Bendix Corp.</b> Van Christo Assoc., Inc.	277	<b>Semtech Corp.</b> Burress Advertising	64
		<b>Motorola Communications &amp; Electronics, Inc.</b> K & A, Inc.	154	<b>Servo Corporation of America</b> Basford, Inc.	304
<b>James Electronics, Inc.</b> George Bond & Associates	208	<b>Motorola Semiconductor Products, Inc.</b> Lane & Bird Adv., Inc.	81, 137	<b>Sifco Metachemical, Div. of Steel Improvement &amp; Forge Co.</b> Creative/3	281
<b>J F D Electronics Co., Components Div.</b> Delphi Advertising, Inc.	283	<b>National Capacitors, Inc.</b> Haselmire Pearson Adv., Inc.	213	<b>Sigma Instruments, Inc.</b> Marschalk Co., Inc.	267
<b>Johnson Co., E. F.</b> Midland Associates	297, 298	<b>National Electronics, Inc.</b> Connor-Sager Assoc.	291	<b>Signetics Corp., Sub. Corning Glass Works</b> Cunningham & Walsh, Inc.	90
		<b>National Semiconductor Corp.</b> Jay Chiat & Assoc.	12, 13	<b>Siliconix, Inc.</b> Graphics West	312
<b>Kepeco, Inc.</b> Weiss Advertising	270, 272	<b>Natvar Corp.</b> Sanger-Funnell, Inc.	202	<b>Singer Co., Metrics Div.</b> Hepler & Gibney, Inc.	181
<b>Keystone Carbon Co.</b> Downing Industrial Adv., Inc.	192	<b>New Hermes Engraving Machine Corp.</b> Lester Harrison Adv., Inc.	248	<b>Solitron Devices, Inc., Transistor Div.</b> Haselmire Pearson Adv., Inc.	43
<b>Kikusui Electronics Corp.</b> Kyodo Adv. Co., Ltd.	283	<b>North Atlantic Industries, Inc.</b> Murray Heyert Assoc.	8	<b>S. P. Elettroica</b> Publicitas SPA	OAS 12
<b>Krohn-Hite Corp.</b> L.K. Frank Co., Inc.	176	<b>Pamotor, Inc.</b> Harry P. Bridge Co.	175	<b>Spectrol Electronics Corp.</b> Jones, Maher, Roberts, Inc.	157
		<b>Pennsalt Chemicals Corp.</b> Aitkin-Kynett Co., Inc.	279	<b>Sperry Rand Corp., Microwave Components</b> Neals & Hickok, Inc.	229, 231
<b>Lambda Electronics Corp.</b> Michel Cather, Inc.	258	<b>Philips Eindhoven, N.V.</b> T.A.G. De La Mar	OAS 1, OAS 5	<b>Sperry Rand Research Center</b> Reach, McClinton & Co.	209
<b>Lapp Insulator Co.</b> Wolff Associates	236	<b>Plastic Capacitors, Inc.</b> Sander Rodkin Adv. Agcy., Ltd.	182	<b>Sprague Electric Co., The</b> Harry P. Bridge Co.	5, 10
<b>Leach Corporation</b> Jay Chiat & Associates	265	<b>Precision Tube Co.</b> George Moll Adv., Inc.	266	<b>Stackpole Carbon Co., Electronic Components Div.</b> Meek & Thomas, Inc.	155
<b>Ledex, Inc., Bramco Controls Div.</b> Yeck & Yeck, Inc.	212	<b>Princeton Applied Research Corp.</b> Mort Barish Assoc., Inc.	44	<b>Struthers-Dunn, Inc.</b> Harry P. Bridge Co.	230
<b>Lenox-Fugle Electronics, Inc.</b> Keyes, Martin & Co.	248	<b>Radio Cores, Inc.</b> Sander Rodkin Adv. Agcy., Ltd.	180	<b>Susumu Industry Co., Ltd.</b> Dentsu Advertising	254
<b>Litton Industries, Inc., Winchester Electronics Div.</b> West, Weir & Bartel, Inc.	226, 227	<b>Radio Corporation of America</b> 4th Cover, 20, 21, 57, 207 Al Paul Lefton Co.		<b>Sweet's Industrial Information System</b> Wank, Williams & Neylan, Inc.	189
<b>Lockheed Electronics Co.</b> McCann-Erickson, Inc.	185, 194	<b>Radio Materials Co., Div. of P.R. Mallory &amp; Co.</b> Gallay Adv., Inc.	238	<b>Sylvania Electric Products, Inc., Electronic Tube Div.</b> Doyle, Dane, Bernbach, Inc.	39
<b>Lockheed Missiles &amp; Space Co.</b> McCann-Erickson, Inc.	280	<b>Rally</b> Dumesnil Publicite	OAS 19	<b>Sylvania Electric Products, Inc. Parts Div.</b> Doyle, Dane, Bernbach, Inc.	241
<b>L T T</b> Promotion Vente Publicite	OAS 20	<b>Raytheon Co., Components Div.</b> Fuller & Smith & Ross, Inc.	186	<b>Syntron Co.</b> De Sales Advertising, Inc.	87
		<b>Raytheon Semiconductor</b> Botsford, Constantine & McCarty, Inc.	65	<b>Synthane Corp.</b> Arndt, Preston, Chapin, Lamb & Keen, Inc.	283
<b>McGraw Hill Book Co.</b>	292	<b>RCL Electronics, Inc.</b> Morvay Adv. Agcy.	14	<b>Syntronic Instruments, Inc.</b> Burton Browne Advertising	260
<b>Machlett Laboratories, Raytheon Co., Div.</b> Fuller & Smith & Ross, Inc.	11	<b>Redcor Corp.</b> Smith-Klitten, Inc.	188	<b>Syston-Donner Corp.</b> Bonfield Assoc., Inc.	214
<b>Magnecraft Electric Co.</b> Allbright Associates	62	<b>Reeves Hoffman, Div. of Dynamics Corp. of America</b> Adams Associates, Inc.	254	<b>Syston-Donner International</b> Bonfield Assoc., Inc.	OAS 11
<b>Magnetic Shield Div.</b> Perfection Mica Co. Burton Browne Adv.	285	<b>Rental Electronics, Inc.</b> Raymond E. Finn Adv.	284		
<b>Magnetics, Inc.</b> Lando Adv. Agcy., Inc.	275			<b>Taylor Corp.</b> Gray & Rogers, Inc.	168
<b>Mallory Battery Co., Div. of P.R. Mallory &amp; Co., Inc.</b> Needham, Harper & Steers, Inc.	82			<b>Tektronix, Inc.</b> Hugh Dwight Adv., Inc.	51
<b>Marconi Company, Ltd.</b> Hampshire House, Ltd.	OAS 8			<b>Teledyne Relays Co.</b> S. Michelson Advertising	66
<b>Markel &amp; Sons, L. Frank</b> George Moll Adv., Inc.	228			<b>Telonic Instruments</b> Jansen Assoc., Inc.	291

# The Predictables.



**When ITT people  
ship your Series 930 DTL order  
you get on-time delivery.**

More than 97% of your Series 930 DTL orders get delivered on time. How's that for predictability? We offer the same 15 circuit functions in the same packages as those people you've been having delivery problems with. Doesn't that justify a change?

To see how little trouble DTL buying can be, try the ITT "Predictables." Order off the shelf from your distributor or direct from your factory representative. Our shipping people may have to work late, but your receiving people won't.

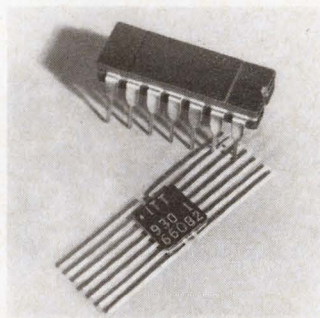

**Integrated circuits** **ITT**

FACTORIES IN WEST PALM BEACH, FLORIDA; PALO ALTO, CALIFORNIA; LAWRENCE, MASSACHUSETTS; HARLOW AND FOOTSCRAY, ENGLAND; FREIBURG AND NURENBERG, GERMANY