

Electronics®

Fault diagnosis by computer: page 64

IC's cut counter costs: page 74

Time compression helps track targets: page 86

January 22, 1968

\$1.00

A McGraw-Hill Publication

Below: Correcting errors in
data transmission, page 77

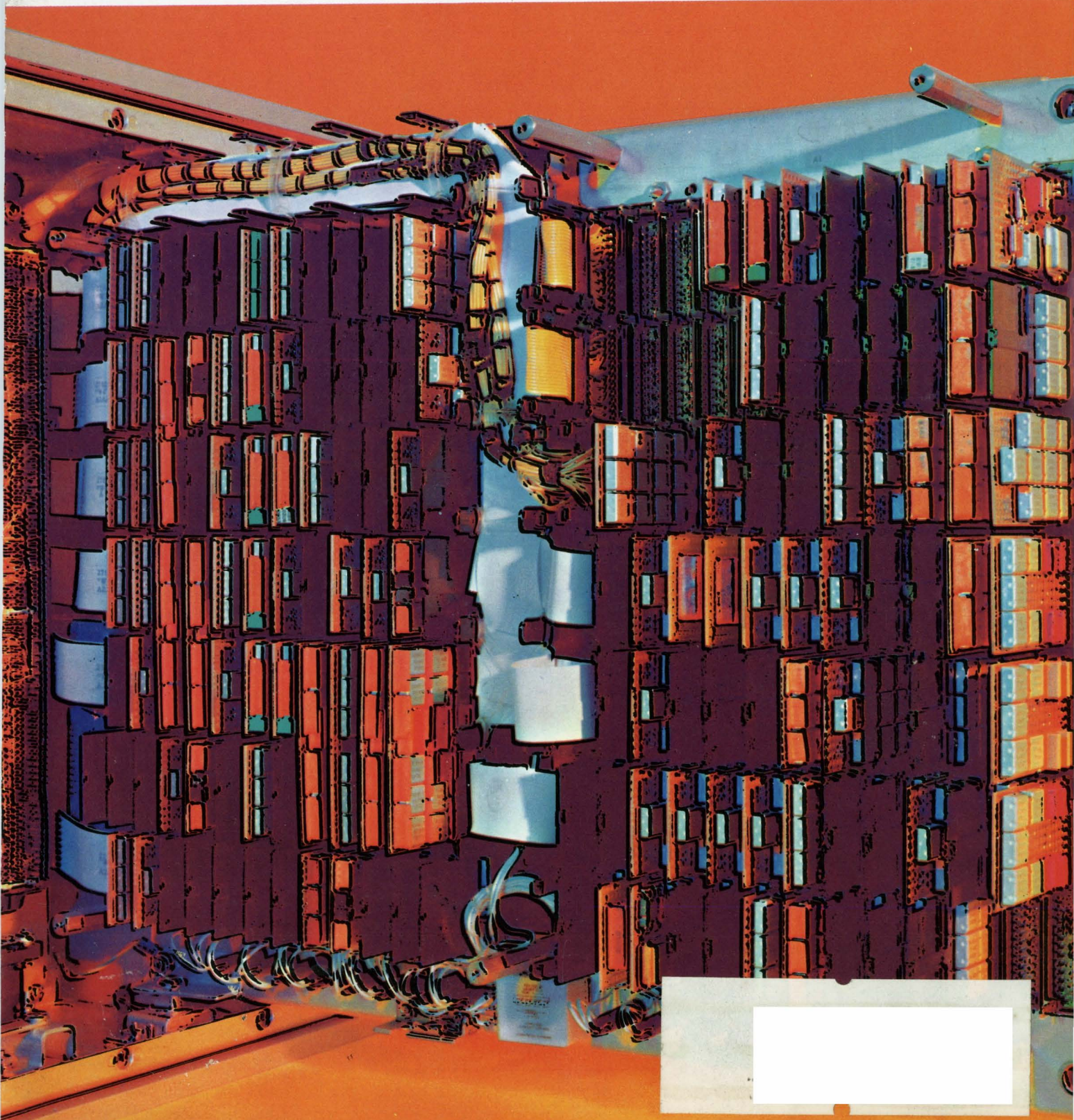



Everything you want in a counter . . . and for only \$1340

This new 20-MHz, IC counter-timer has just about everything you have been asking for in a general-purpose counter: multiple-measurement capability, remote programmability, eight-digit readout, two input channels, choice of time base, low cost, and available complementary scalars to extend frequency range to 100 MHz and higher.

Measurement Versatility. Frequency: DC to 20 MHz; 1 μ s to 10 s counting gate times. Accuracy of ± 1 count \pm time-base accuracy.

Single Period: Up to 10^9 s (over 3 years); clock rate variable from 0.1 μ s to 10 s.

Multiple Period: 1 to 10^8 periods; clock rate 0.1 μ s.

Time Interval: 0.1 μ s to 10^9 s (full input-signal processing).

Frequency Ratio: 1 to 10^8 .

Count: Register capacity 10^8 .

Programmability. Measurement functions, ranges, and most of the secondary controls (such as display time and input-trigger level) can be programmed remotely. Most of the programming is controlled by simple contact closures to ground. Models are

available with high-speed, buffered BCD outputs from internal storage to drive auxiliary data-handling equipment.

Readout. Eight digits of high-contrast neon indicators, with automatic display of decimal point and units. Continuous display from storage provides rapidly corrected data without flicker.

Input Circuits. Two high-sensitivity input channels consisting of a high-impedance, low-noise FET circuit preceded by a 3-position step attenuator. Full controls for trigger level, slope, and polarity. The 1-megohm input impedance is constant for all control settings, permitting use of general-purpose, low-capacitance oscilloscope probes.

Time Base. Choice of time base to match needs and budget. Room-temperature oscillator has excellent stability, better than $2 \times 10^{-7}/^\circ\text{C}$ from 0° to 50°C , which is adequate for most applications. A high-precision oscillator, in proportional-control oven, provides a stability of better than $2 \times 10^{-10}/^\circ\text{C}$ from 0° to 50°C when operated continuously. Either time base can be locked to an external standard frequency of 0.1,

1.0, 2.5, 5, or 10 MHz. Because it has no warmup frequency transient, the room-temperature oscillator is specifically recommended for this application.

Cost. Prices* range from \$1340 for the basic counter with a room-temperature crystal to \$1540 for the model with an oven-controlled crystal and BCD outputs. The basic model with only the BCD-output option costs \$1390. For large-volume users, in particular, the savings realized by specifying our new 1191 Counter is substantial.

Higher Frequencies. By using our 1156-A Decade Scaler with the 1191 Counter, you can extend the upper frequency limit of the 1191 to 100 MHz. A new scaler to be available soon will extend the limit to 500 MHz.

For complete information, write General Radio Company, W. Concord, Mass. 01781; telephone (617) 369-4400; TWX (710) 347-1051.

GENERAL RADIO

Circle 900 on reader service card

*Prices apply only in the U.S.A.



How to take
the worry
out of

strip chart recording: USE ELECTRIC WRITING FROM HEWLETT-PACKARD.

There's only one way to be absolutely certain your strip-chart recorder won't miss any information over a long-term or intermittent stop-start recording period... by using HP's exclusive electric writing recorders. Electric writing reduces maintenance and completely eliminates constant attention. Whenever you turn your recorder on, you can simply walk away and never worry about losing data.

Electric writing, available on HP 5-inch 680 Series and 10-inch 7100 Series Strip-Chart Recorders, uses HP-developed electro-sensitive paper. It writes the instant the recorder is plugged in and turned "on"—and it keeps on writing. No paper processing required; traces are insensitive to heat, pressure, light and humidity.

It's an ideal continuous monitor for unattended instrumentation measuring velocity, humidity, pressure, seismographic and oceanographic signals, wind tunnel data, weather data, radio astronomy, radiation monitoring—you name it.

Call your local HP field engineer for a free brochure describing electric writing and including an actual sample recording. Or write Hewlett-Packard, Palo Alto, Calif. 94304; Europe: 54 Route des Acacias, Geneva.

HEWLETT  PACKARD

GRAPHIC RECORDERS

11707

PERFECT MATES

New Multiple Function Package Combines Accurate DC

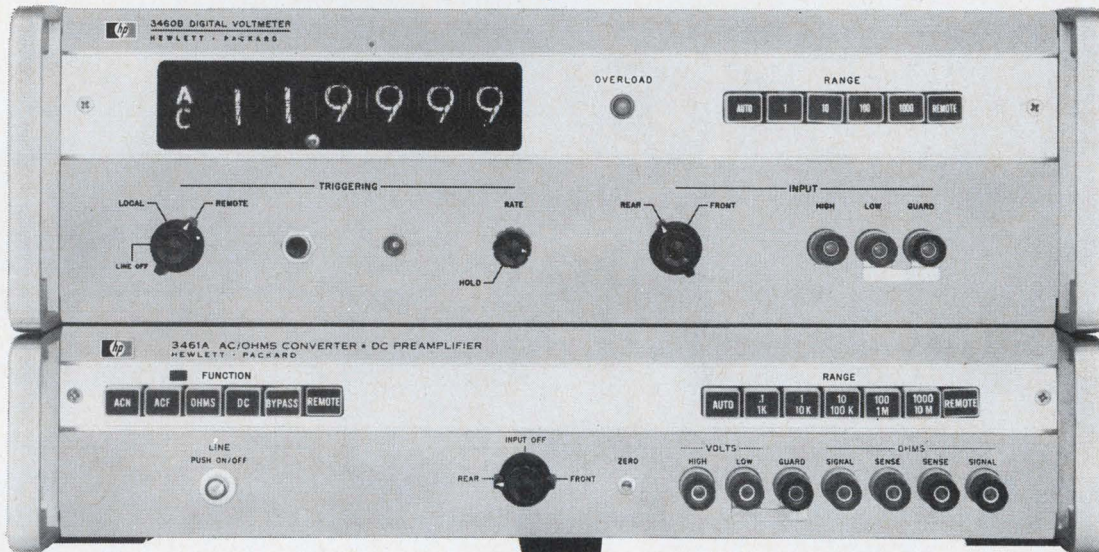

With Ohms, AC Volts, Micro-DC Volts

The hp 3460B Digital Voltmeter and hp 3461A AC/Ohms Converter-DC Preamplifier combine to make a multiple function DVM with high resolution, high accuracy, and high sensitivity. The package has a 20% over-ranging capability, and an accuracy of 0.005% of dc reading, 0.084% of midrange ac reading and 0.012% of ohms reading.

You can make low-level dc voltage measurements with 1 μ V sensitivity, wide-range ac voltage measurements from 50 Hz to 100 kHz with 10 μ V sensitivity, and accurate resistance measurements from 1 k Ω to 12 M Ω with 10 milliohm sensitivity on the lowest range.

Optional Combinations. To allow minimum investment with flexibility for meeting future requirements, the 3461A can be purchased to include a single function or a combination of functions. Functions not originally purchased can be ordered and easily installed.

Systems Use. High common mode rejection (160 dB at dc and 110 dB at 60 Hz), guarded inputs and speed of reading (2.5 readings/second for ac and 15 readings/

second on dc) make the combination ideal for use in digital data acquisition systems. Range, function, trigger and integration period are fully programmable for automated measurements. BCD output (1-2-4-8) contains 6 digits of data, polarity, decimal location and overload information.

To get the complete story on the versatility of this new multiple function combination, call your nearest hp field engineer. Or, write to Hewlett-Packard, Palo Alto, California 94304. Europe: 54 Route des Acacias, Geneva. Prices: hp 3460B Digital Voltmeter, \$3600; hp 3461A AC/Ohms Converter-DC Preamplifier (complete), \$2075. Prices of 3461A options on request.

097/20

HEWLETT  PACKARD

DIGITAL VOLTMETERS

News Features

Probing the News

- 111 **Hard selling technology**
117 **Budget trims some space programs**

Electronics Review

- 37 **Advanced technology:** One-shot rainbow; Between the lines
38 **Manufacturing:** Cranking out masks
39 **Avionics:** Getting the picture . . . ; and reacting faster
40 **Commercial electronics:** See the sea
42 **Contracts:** Watchdog at bay
44 **Integrated electronics:** Beating the heat; Isolated success
46 **Solid state:** Small-scale LSI
46 **Consumer electronics:** Pin money
48 **Government:** Hit the dirt
48 **For the record**

Electronics Abroad

- 193 **France:** Powerful partner
193 **Japan:** Telechromatic; Color it otherwise
195 **Great Britain:** Logic choice; Behold the fringe
196 **West Germany:** Road test
197 **International:** Entrenched privilege

New Products

- 131 **Process trainer** gives operators true picture
134 **New components review**
134 **New components:** Dial 99 for 1100011; Silicon diodes go to 150 kilovolts; Complex math in modular form
141 **New instruments review**
141 **New instruments:** Counter range extended to 18 Ghz; Have scope, will travel; Travel companion keeps diary
149 **New microwave review**
149 **New microwave:** Tunable magnetron reaches X band; Thinking thin to the end
156 **New subassemblies review**
156 **New subassemblies:** Sidestepping System 360 goals; Golfers, burglars, how's your style?; Yugoslavians sell electron microscope
165 **New industrial electronics review**
165 **New industrial electronics:** Sensing the fire before it erupts; Going directly to the director
173 **New semiconductors review**
173 **New semiconductors:** Big Z hits the market; Late starter plans big family

Title R registered U.S. Patent Office; © copyright 1968 by McGraw-Hill Inc. All rights reserved, including the right to reproduce the contents of this publication, in whole or in part.

Technical articles

- Design theory** 64 **Computer-aided design: part 13**
Defining faults with a dictionary
A computer program aids interpretation of frequency tests to single out bad components
Walter J. Stahl, John H. Maenpaa, Carl J. Stehman, Scully International Inc.
- Circuit design** 69 **Designer's casebook**
▪ Diodes prevent overload by limiting input's slope
▪ Transistor replaces bleeder and regulates power supply
▪ Zener power supply answers current problems
▪ FET oscillator helps porpoises understand people
- Instrumentation** 74 **For low cost, count on RTL**
Inexpensive integrated circuit logic gives counting and display at \$10 per decade
Donald E. Lancaster
- Communications** 77 **Every data bit counts in transmission cleanup (cover)**
Redundant bits interleaved with the stream of data bits enable detection and correction of errors, both random and burst
Alexander Frey and Richard Kavanaugh, International Business Machines Corp.
- Computers** 86 **Putting the squeeze on radar signals**
A core memory and sampling system gives the effect of time compression in continuous tracking of radar targets
John P. Collins, Raytheon Co.
- Consumer electronics** 97 **There's no overcharge for fast-charged batteries**
Thermal switch added to diode protection circuit cuts charging time without risking overcharge
James V. Ball, P.R. Mallory & Co.

Departments

- | | | | |
|----|-----------------|-----|------------------------|
| 4 | Readers Comment | 25 | Electronics Newsletter |
| 8 | People | 51 | Washington Newsletter |
| 14 | Meetings | 180 | New Books |
| 16 | Meeting Preview | 184 | Technical Abstracts |
| 23 | Commentary | 186 | New Literature |
| | | 191 | Newsletter from Abroad |

Electronics

Editor-in-Chief: Donald Christiansen

Associate managing editors

Technical: Stephen E. Scrupski
News: Robert Henkel
Copy: Sally Powell

Senior associate editors

Joseph Mittleman, Harry R. Karp

Department editors

Avionics & Space: Alfred Rosenblatt
Computers: Wallace B. Riley
Communications: William Buccì
Consumer electronics: John D. Drummond
Design theory: Joseph Mittleman
Industrial electronics: Harry R. Karp
Instrumentation: Carl Moskowitz
Military electronics: Richard Gundlach
Solid state: Mark B. Leeds

Section editors

Electronics abroad: Arthur Erikson
Electronics review: Stanley Zarowin
New Products: H. Thomas Maguire,
William P. O'Brien
Probing the news: Eric Aiken

Assistant editors

Stephen Fields, Peter Schuyten,
James Kirby

Regional bureaus

Domestic

Boston: James Brinton, manager; Robin Carlson
Los Angeles: Lawrence Curran, manager
New York: Howard Wolff, manager
San Francisco: Walter Barney, manager
Washington: Robert Skole, manager; William D. Hickman, Paul Dickson

Foreign

Bonn: John Gosch
London: Michael Payne
Tokyo: Charles Cohen

Copy editors

James Chang, Frederick Corey

Graphic design

Art director: Saul Sussman
Assistant art directors: Ann Mella, Valerie Betz
Production editor: Arthur C. Miller

Editorial secretaries: Claire Benell, Lynn Emery, Kay Fontana, Patricia Gardner, Lorraine Longo
Barbara Razulis, Frances Vacca

McGraw-Hill News Service

Director: Arthur L. Moore; **Atlanta:** Fran Ridgway; **Chicago:** Bruce Cross;
Cleveland: Arthur Zimmerman; **Dallas:** Marvin Reid;
Detroit: James Wargo; **Houston:** Robert E. Lee; **Los Angeles:** Michael Murphy
Pittsburgh: Louis Gomolak
San Francisco: William F. Arnold
Seattle: Ray Bloomberg; **Washington:** Charles Gardner, Daniel B. Moskowitz,
Herbert W. Cheshire, Seth Payne, Warren Burkett, William Small

McGraw-Hill World News Service

Bonn: Robert Dorang; **Brussels:** George Williamson; **Hong Kong:** Wes Perry;
London: John Shinn; **Mexico City:** Gerald Parkinson; **Milan:** Ronald Taggiasco, Jack Star;
Moscow: Howard Rausch; **Paris:** Robert E. Farrell, Peter Kilborn;
Rio de Janeiro: Leslie Warren; **Tokyo:** Marvin Petal

Reprints: Susan Nugent

Circulation: Milton Drake

Publisher: Gordon Jones

Electronics: January 22, 1968, Vol. 41, No. 2

Published every other Monday by McGraw-Hill, Inc. Founder: James H. McGraw 1860-1948.

Printed at 99 North Broadway, Albany, N.Y. 12207; second class postage paid at Albany, N.Y.

Executive, editorial, circulation and advertising addresses: McGraw-Hill Building, 330 W. 42nd Street
New York, N. Y. 10036. Telephone (212) 971-3333. Teletype TWX N.Y. 710-581-4235. Cable address:
MCGRAWHILL N.Y.

Subscriptions solicited only from those professionally engaged in electronics technology. Subscription rates:
qualified subscribers in the United States and possessions and Canada, \$8.00 one year, \$12.00 two years,
\$16.00 three years; all other countries \$25.00 one year. Non-qualified subscribers in the U.S. and
possessions and Canada, \$25.00 one year; all other countries \$50.00. Air freight service to Japan \$50.00
one year. Single copies: United States and possessions and Canada, \$1.00; all other countries, \$1.75.

Officers of McGraw-Hill Publications: Joseph H. Allen, President; Bayard E. Sawyer, Executive Vice-President;
J. Elton Tuohig, Senior Vice-President-Operations; Vice Presidents: John R. Callahan, Editorial;
John M. Holden, Marketing; Paul F. Cowie, Circulation; Angelo R. Venezian, Production; Jeroma D. Luntz,
Planning & Development; Robert M. Wilhelm, Controller.

Officers of the Corporation: Donald C. McGraw, Chairman of the Board; Shelton Fisher, President;
L. Keith Goodrich, Robert E. Slaughter, Executive Vice Presidents; Donald C. McGraw, Jr.,
Senior Vice-President; John J. Cooke, Vice-President & Secretary; John L. McGraw,
Vice-President & Treasurer.

Title registered in U.S. Patent Office; © Copyright 1968 by McGraw-Hill, Inc. All rights reserved. The contents
of this publication may not be reproduced either in whole or in part without the consent of copyright owner.

Subscribers: The publisher, upon written request to our New York office from any subscriber,
agrees to refund that part of the subscription price applying to copies not yet mailed.
Please send change of address notices or complaints to Fulfillment Manager; subscription
orders to Circulation Manager, Electronics at address below. Change of address notices
should provide old as well as new address, including postal zip code number. If possible,
attach address label from recent issue. Allow one month for change to become effective.

Postmaster: Please send form 3579 to Fulfillment Manager, Electronics,
P.O. Box 430, Hightstown, New Jersey 08520

Readers Comment

Age of progress

To the Editor:

Contributors Baker and Cressey are to be congratulated on their excellent paper describing a new form of mechanical resonator [Oct. 2, p. 115].

It is worthy of note, however, that an H-form resonator system has been used previously, notably by the Englishman John Harrison in an oscillator intended as a timing source for navigational computation.

Designed to work on board ships without air-conditioning in all climates, the equipment consumed about 100 milliwatts from a built-in, rechargeable, pulse-width-modulated power supply (a mechanical clock spring), and achieved an accuracy of 1 part in 10^6 over a five month operational cruise.

By any standards, this was not a bad effort for the year 1735, and the history of this resonant system appears to be another example of a British innovation neglected at home and usefully exploited in the U.S. A full description of the system can be found in the Journal of the Society for Nautical Research, London, April 1935.

Thomas T. Walters
Stephen W. Tonkin

British Aircraft Corp.
Bristol
England

On the ball

To the Editor:

In the boxed short article titled "Inside the fireball" [Aug. 21, 1967, p. 102] an error, albeit minor, appears. It is stated that a billion kilowatts of energy is released. But kilowatts is not a unit of energy, but of power. In order to be right, it would have to be kilowatt-second, kilowatt-hour, etc.

And the words following to the effect that the energy is released in a fraction of a second, do not help matters, but make them even more confusing.

K.P. Hare

Bombay
India

gates

5

nsec

flip-flops

60

MHz

**Increase your system speed.
Sprague SSL* is the fastest saturated
logic. And it's pin compatible
with series 8000.
You should call us fast.**



*For additional information on
Sprague SSL Super-Speed Logic, write to:
Semiconductor Division
Sprague Electric Company
115 Northeast Cutoff
Worcester, Mass. 01606*

*Trademark for Super-Speed Logic



SPRAGUE WORCESTER... the world's finest microcircuit facility

488-7161

*Sprague' and '®' are registered trademarks of the Sprague Electric Co.



The little black box in the center is a very simple, inexpensive limit-control device.

It's called a circuit breaker.

A circuit breaker for limit control?

It's not as far-out as it sounds. For years a lot of people have been using Heinemann breakers for just that purpose.

An example. Let's say you've got a computer that you want to protect from high internal ambient temperatures.

First thing you do is order an NTC thermistor from your favorite supplier. Then you order a relay-trip circuit breaker from us. You hook them up more or less as we've shown in the schematic at right.

Now. If the temperature of the ven-

tilating air rises above a safe level, the resistance of the thermistor drops. This raises the breaker's coil voltage. The breaker trips immediately. Line power goes off. Neat and simple as that.

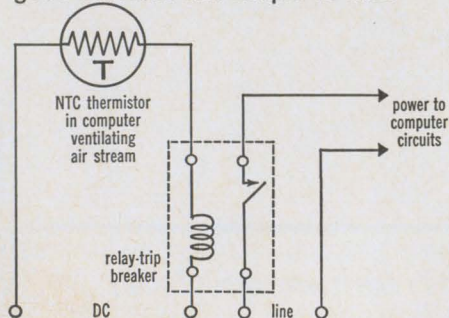

You can just as easily control practically any physical parameter (our photo symbolizes some of the basic ones). Any sort of sensor is suitable so long as you have an available current or voltage signal for the limit-control shutdown. The only thing else you need is a copy of our Engineering Guide, to give you full data on pertinent breaker parameters. If you ask us for Bulletin 202, you'll get a copy post haste. Heinemann Electric Co., 2600 Brunswick Pike, Trenton, N.J. 08602.



HEINEMANN

Circle 6 on reader service card

Methods of gain

To the Editor:

I must take exception to your statement that the $\mu A703$ lacks automatic-gain control capability [Newsletter, Dec. 11, p. 26]. If one looks closely at the transfer characteristic and the construction of the device he will see that three distinct agc methods are available; they are shown in the schematics.

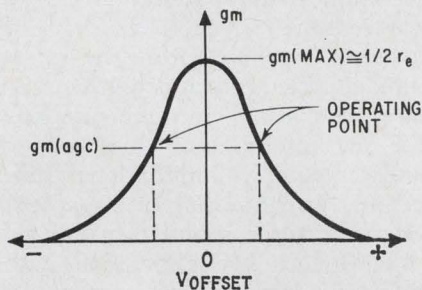
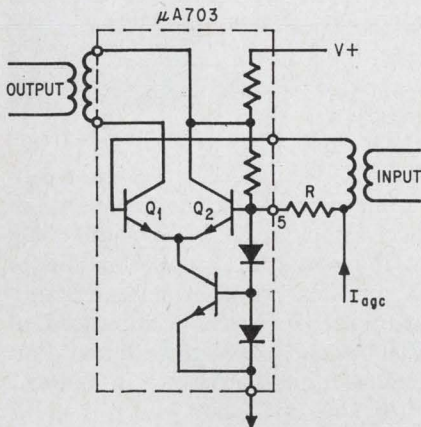

- Introduction of I_{agc} causes positive or negative offset voltage to be developed across resistor R , causing the device to be operated at a point other than at maximum forward transconductance;

- Eliminate resistor R and extract current from pin 5, thereby

decreasing current to bias diodes hence reducing current source current, increasing r_e of Q_1 and Q_2 , which in turn reduces the voltage gain of the device since $A_v = R_L/2r_e$; or

- Inject current into pin 5 and decrease r_e , increase gain and operate about that point.

With any of these methods an agc in excess of 50 db/ $\mu A703$ is possible.

G. James Estep

Applications department
Fairchild Semiconductor
Mountain View, Calif.

Off balance

To the Editor:

The scales with vibrating strings which are described and shown in the story "Better weight" [Dec. 11, p. 255] were developed by researchers of Wirth Gallo & Co., Zurich, Switzerland and were recently given to be manufactured and sold to Maatschappij Van Berkel's Patent NV, Rotterdam.

Armin Wirth
Mario Gallo

Wirth Gallo & Co.
Zurich
Switzerland

You only have to ask

To the Editor:

No one can successfully ask the FCC for something that it can't legally give ["FCC begins to get the message", Jan. 8, p. 153].

The FCC has given me within three hours everything I have asked for the last five times.

David T. Geiser

New Hartford
New York

SUBSCRIPTION SERVICE

Please include an Electronics Magazine address label to insure prompt service whenever you write us about your subscription.

Mail to: Fulfillment Manager
Electronics
P.O. Box 430
Hightstown, N.J. 08520

To subscribe mail this form with your payment and check new subscription renew my present subscription

Subscription rates: qualified subscribers in the U.S.: 1 year \$8; two years, \$12; three years, \$16. Non-qualified: 1 year \$25. Subscription rates for foreign countries available on request.

CHANGE OF ADDRESS

ATTACH LABEL HERE

If you are moving, please let us know five weeks before changing your address. Place magazine address label here, print your new address below.

name

address

city

state

zip code

MEASURE

transient response

output impedance

loop stability

proper regulation

microvolt ripple

short and
long term drift

of your power supply

WITH ONE (1)
INSTRUMENT

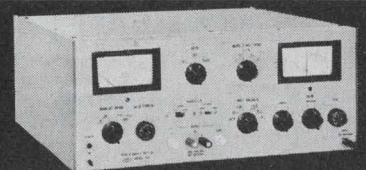

Now you can perform a complete check on all important parameters of your power supply . . . in a fraction of the time you used to take . . . with one small instrument instead of a bank of equipment.

PM's new Model 1004 Power Supply Test Set contains an electronic load capable of pulse loading a supply up to 20A and 70V. Operates in pulse or DC mode. Contains a regulation monitor for precise drift and regulation measurements. The meter is calibrated directly in % regulation. 10%, 1%, .1%, and .01% full scale. Accuracy is 3PPM/min. and 10-PPM/8 hrs.

PM 1004 — \$1100.00

PM 1003 (without regulation monitor) \$750.00

PM PACIFIC
MEASUREMENTS
INCORPORATED

940 INDUSTRIAL AVENUE,
PALO ALTO, CALIFORNIA
(415) 328-0300

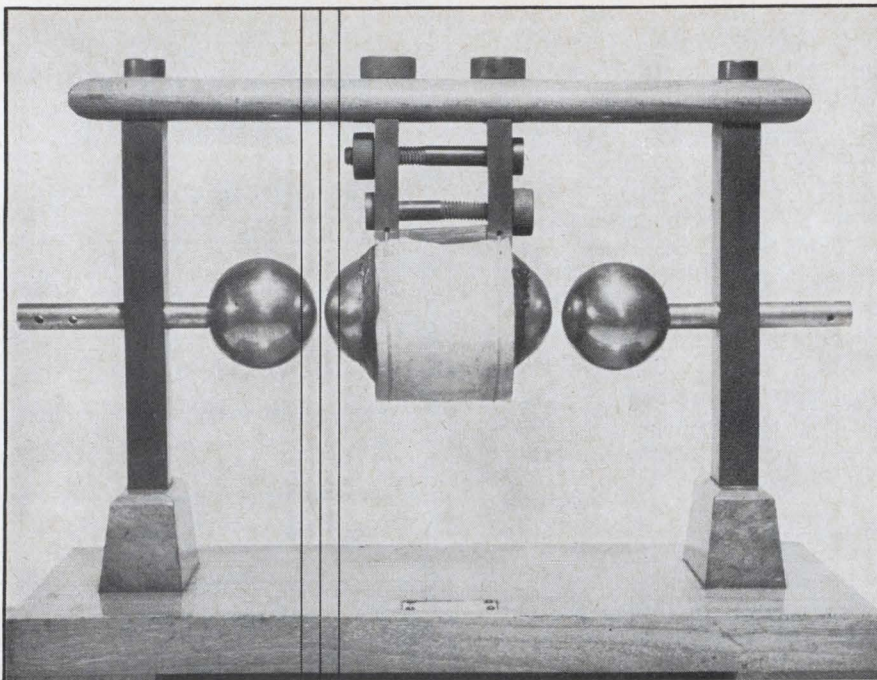

WHAT QUESTION DID MARCONI ANSWER WITH THIS IN 1895?

the questions
the future will ask
are being answered at
Physics International TODAY



PHYSICS INTERNATIONAL COMPANY

2700 Merced Street, San Leandro, California 94577 - Telephone: 415/357-4610

High energy pulsed radiation simulators • Hypervelocity and shock hydrodynamics research

People

The surge of interest in oceanography at Scientific-Atlanta Inc. is evidenced by the appointment of **W. James Trott** as principal scientist, a new post.

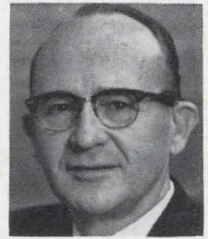

W. James Trott

Trott comes to the company from the Underwater Sound Reference division of the Navy's Orlando, Fla., research laboratory, where he was in charge of R&D. Back in 1952 he was involved in the committee work leading to the publication of "American Standard Procedures for Calibration of Electroacoustic Transducers, Particularly Those for Use in Water."

As a result of that effort, plus his contributions to Navy measurement techniques and calibration procedures, he is currently chairman of a group working within the International Electrotechnical Commission preparing recommendations for an international hydrophone and a standard international procedure for calibrating electroacoustic underwater sound transducers.

Trott sees his association with Scientific-Atlanta as a two-way street because of the analogies between the acoustical measurements involved in testing underwater sound transducers and the electromagnetic measurements made in the antenna field. Scientific-Atlanta is primarily a supplier of antenna test instrumentation, but it has also been producing underwater sound-transducer testing systems since 1962. "I'll be in a position to help the company expand its instrumentation line beyond underwater sound transducer testing," says Trott. "At the same time, I'll translate the company's experience in antenna measurement to oceanographic applications and thus further my own knowledge of underwater acoustics."

He isn't saying in which particular direction his initial research at Scientific-Atlanta will go, but it's interesting to note that during his years with the Naval research laboratory he developed the only

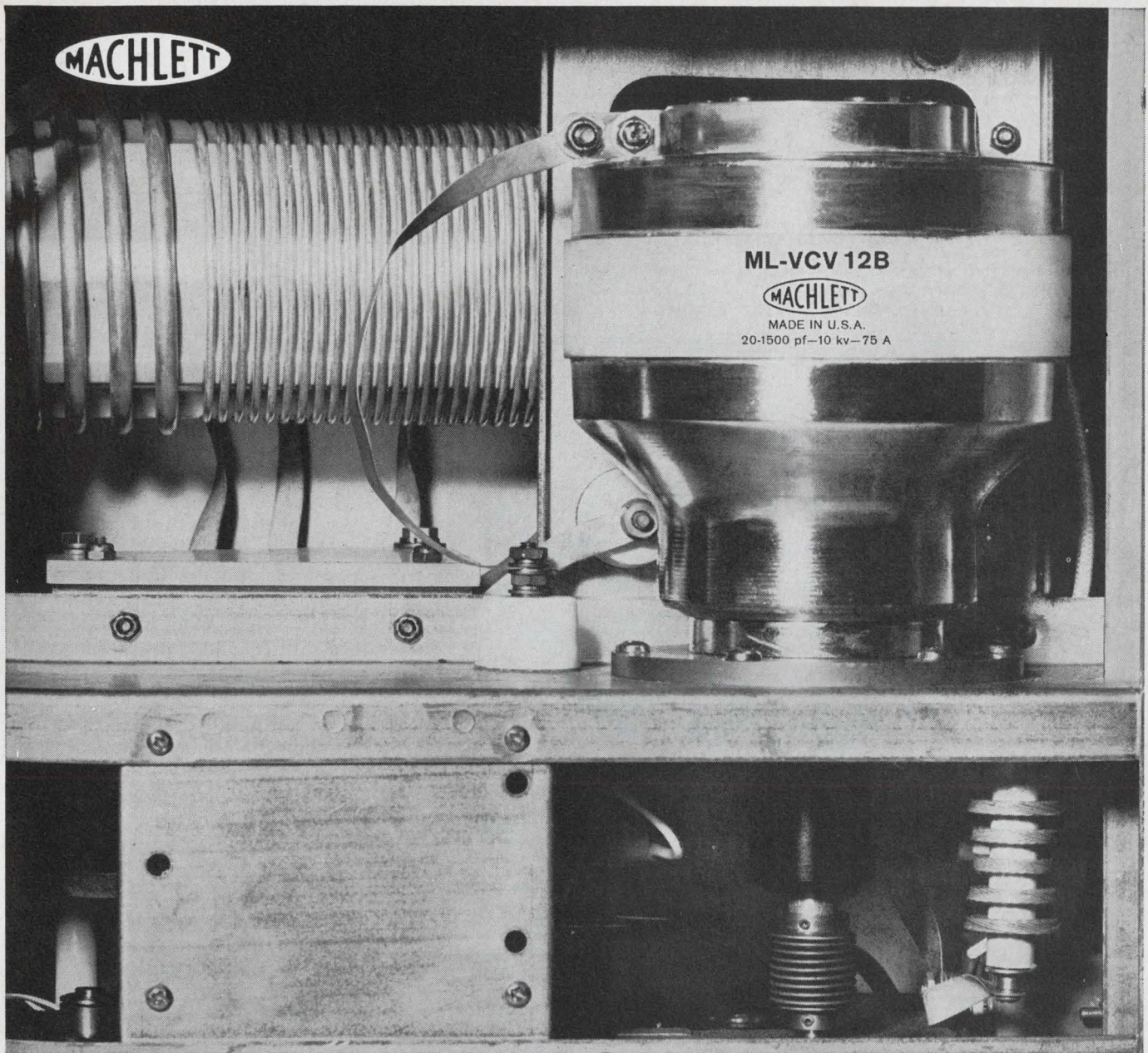

TRW's T-368/URT transmitters* use Machlett variable vacuum capacitors

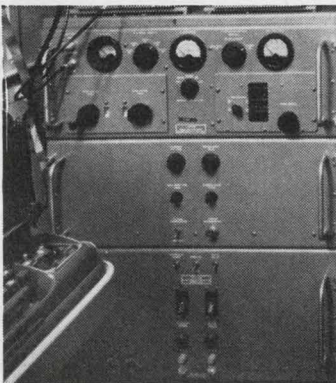

For peak performance under adverse temperature and humidity conditions, TRW's rugged field transmitters for military teletypewriter communications use ML-VCV 12B ceramic variable vacuum capacitors.

The ML-VCV 12 series: 20-1500 pF; 7.5; 10, 15 kV and 75A RMS.

Direct replacements for previously used glass capacitors, these ceramic units provide great structural rigidity and low capacitance change with temperature variation.

Send for "Vacuum Variable Capacitors—An Introduction to their Design, Ratings and Installation," printed in the Machlett *Cathode Press*: The Machlett Laboratories, Inc., 1063 Hope St., Stamford, Conn. 06907.

*Used in Radio Set AN/GRC-26D, Frequency Range: 1.5-20 mc
Power levels: AM voice or FSK/AM 400 watts, CW or FSK 450 watts.

The Machlett Laboratories, Inc., welcomes resumes from engineers and scientists.

RAYTHEON

THE MACHLETT LABORATORIES, INC.

A S U B S I D I A R Y O F R A Y T H E O N C O M P A N Y

New from Sprague!

**5 Times the Resistance of
a Conventional Metal-Film Resistor
of Equal Size!**

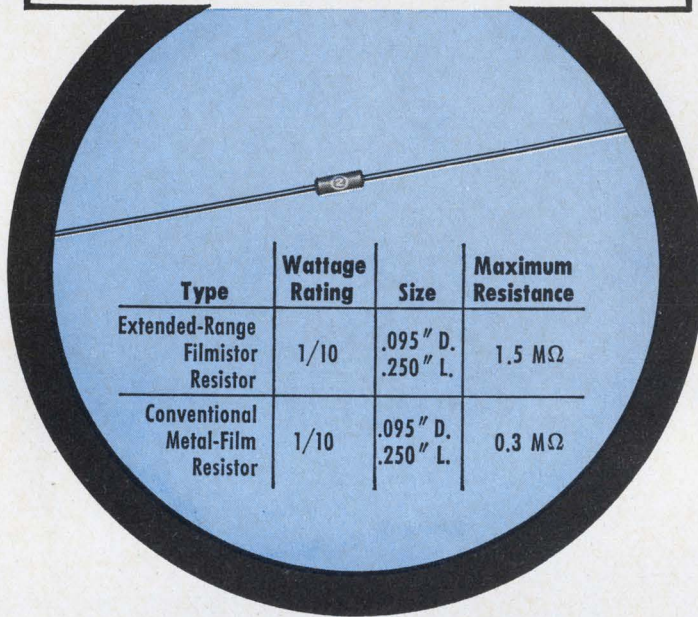

EXTENDED-RANGE FILMISTOR[®] METAL-FILM RESISTORS

**Substantial saving of space in all wattage ratings —
1/20, 1/10, 1/8, 1/4, 1/2, and 1 watt—with
absolutely NO SACRIFICE IN STABILITY!**

Extended-Range Filmistor Resistors now offer, in addition to accuracy . . . stability . . . reliability . . . resistance values in size reductions which were previously unobtainable. Size and weight advantages of Filmistor Resistors now make them ideal for applications in high-impedance circuits, field-effect transistor circuits, etc. Many designs which previously had to settle for the higher temperature coefficients of carbon-film resistors in order to obtain required resistance values can now utilize the low and controlled temperature coefficients of Filmistor Metal-Film Resistors.

Other key features are $\pm 1\%$ standard resistance tolerance, low inherent noise level, negligible voltage coefficient of resistance, and tough molded case for protection against mechanical damage and humidity.

For complete technical data, write for Engineering Bulletin 7025D to Technical Literature Service, Sprague Electric Co., 35 Marshall Street, North Adams, Massachusetts 01247.

SPRAGUE COMPONENTS

RESISTORS
CAPACITORS
TRANSISTORS
INTEGRATED CIRCUITS
THIN-FILM MICROCIRCUITS
INTERFERENCE FILTERS

PACKAGED COMPONENT ASSEMBLIES
FUNCTIONAL DIGITAL CIRCUITS
MAGNETIC COMPONENTS
PULSE TRANSFORMERS
CERAMIC-BASE PRINTED NETWORKS
PULSE-FORMING NETWORKS



Sprague and *®* are registered trademarks of the Sprague Electric Co.

People

method now used for near-field underwater sound-transducer testing and evaluation.

"The only man I've ever met who can get a thousand miles out of every penny," says Harold Geneen, president of the International Telephone & Telegraph Corp., of **James Ambrose**, the new director of manufacturing for the company's semiconductor division. And with little wonder.

Before taking up his new post, Ambrose was plant manager of IRT's diode facility in Lawrence, Mass., which he developed into the world's largest diode producer—about 325 million units per year. Last year, management cited the plant as showing the greatest growth in production and the greatest cost cuts of any IRT facility.

Ambrose has been with the company since 1962. That's when IRT purchased National Transistor Co., where Ambrose was a general foreman. Before taking over the Lawrence plant, he was product-line manager for germanium diodes.

Ambrose has pushed for cheaper, faster production ever since he began in the semiconduction business in 1956 as a production-line foreman for the Clevite Corp. In 1961, he joined the then newly formed National Transistor. His knowledge of Clevite's operation proved invaluable. Three years ago, IRT purchased Clevite's semiconductor unit.

"Clevite had good production equipment," says Ambrose, "but top management didn't know how to put it to work—and wouldn't let anybody else try." Less than a month after the purchase, Ambrose and his associates had Clevite's equipment producing at twice its previous level.

From his new headquarters at West Palm Beach, Fla., Ambrose will oversee production of all IRT semiconductor facilities. He also takes over as manager of the West Palm Beach plant, thus freeing the former acting plant manager, Robert Graham, to return to full-time duties as the division's deputy general manager for the U.S.

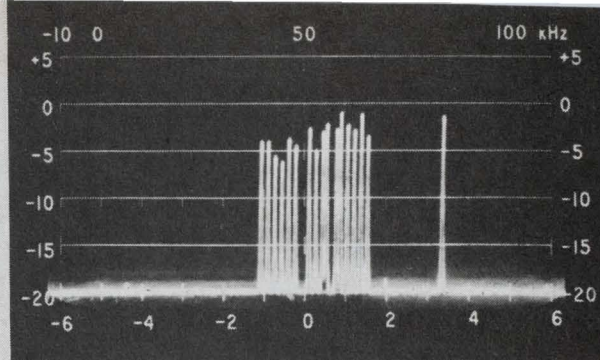
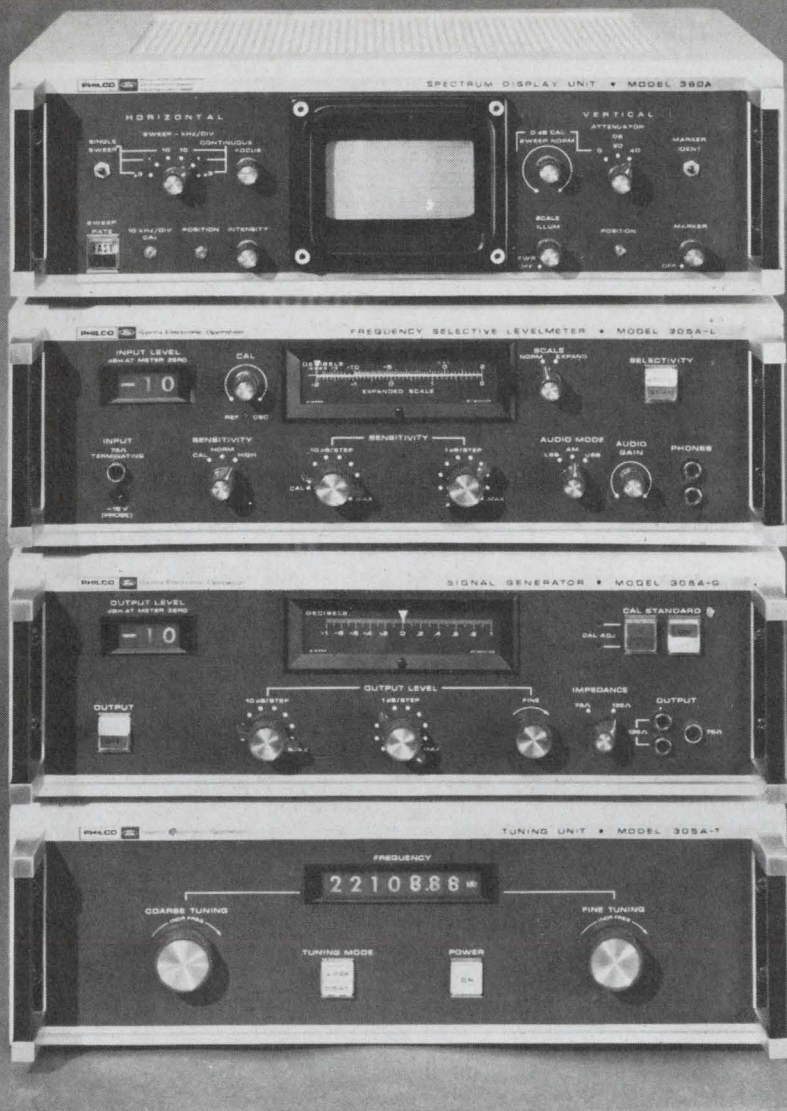

Three 4-kHz channels of L3 carrier multiplex system. Center channel has teletype subcarriers. Model 360A is in 12-kHz sweep width mode, sweeping from 6.780 to 6.792 MHz.

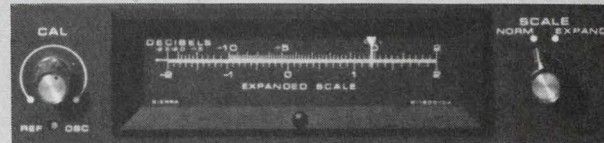

Switch-selected meter modes, normal or expanded scale, provide level measurement resolution of 0.05 dB. Signal generator level increments as fine as 0.01 dB can be readily resolved.

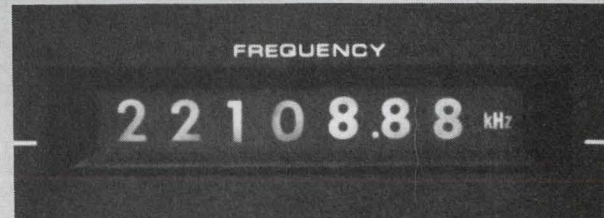

Frequency resolution to nearest 10 Hz in phase-locked tuning mode is displayed on flat-plane, high-brightness readouts. Alternative continuous tuning mode presents frequency resolved to nearest 100 kHz.

A Communications System Test Set (VLF to HF)...

engineered for humans (A to VB*)

From Sierra comes the most thoroughly human-engineered instrument for HF-radio and telephone-carrier applications in today's knob- and meter-ridden world: The Model 305/360 Communications System Test Set.

Model 305/360 gives you ultra-bright, unambiguous electronic digital readouts of frequency. Built-in counter automatically totals outputs of both the coarse and fine tuning oscillators, reads out tuned frequency with 10-Hz resolution. Attenuator levels appear in three-digit displays, with unique logic and switching circuits combining the levels of the 10-dB and 1-dB per step attenuators. Rear-projection meters with luminous pointers permit parallax-free viewing from any angle with easy resolution of fine-level increments.

Performance features include phase-locked tuning circuits, a single continuous tuning range covering voice frequencies through 32 MHz, and selective bandwidths of 250 and 3100 Hz. You can resolve signals separated by as little as 35-Hz.

Model 305/360 does everything humanly possible to keep foibles from fouling your readings. For the brochure, write Sierra, 3885 Bohannon Drive, Menlo Park, California 94025.

*Average to Very Bright



PHILCO-FORD CORPORATION
Sierra Electronic Operation
Menlo Park, California • 94025

Circle 11 on reader service card

SMALL DIMENSION
BUSS
QUALITY
FUSES



Thousands of different types and sizes of small dimension fuses and fuse mountings for protection of all types of Electronic and Electric Devices

The complete BUSS QUALITY fuse line includes: single-element fuses for circuits where "quick-blowing" is needed . . . single-element fuses for normal circuit protection . . . or dual-element "slow-blowing" fuses for circuits where harmless current surges occur . . . or signal or visual indicating types where signals must be given when fuses open. Fuses from 1/500 ampere up — in body sizes from .140 x .300 inches up.

And there's a . . .

FOR FUSES AND FUSEHOLDERS OF UNQUESTIONED HIGH QUALITY . . .

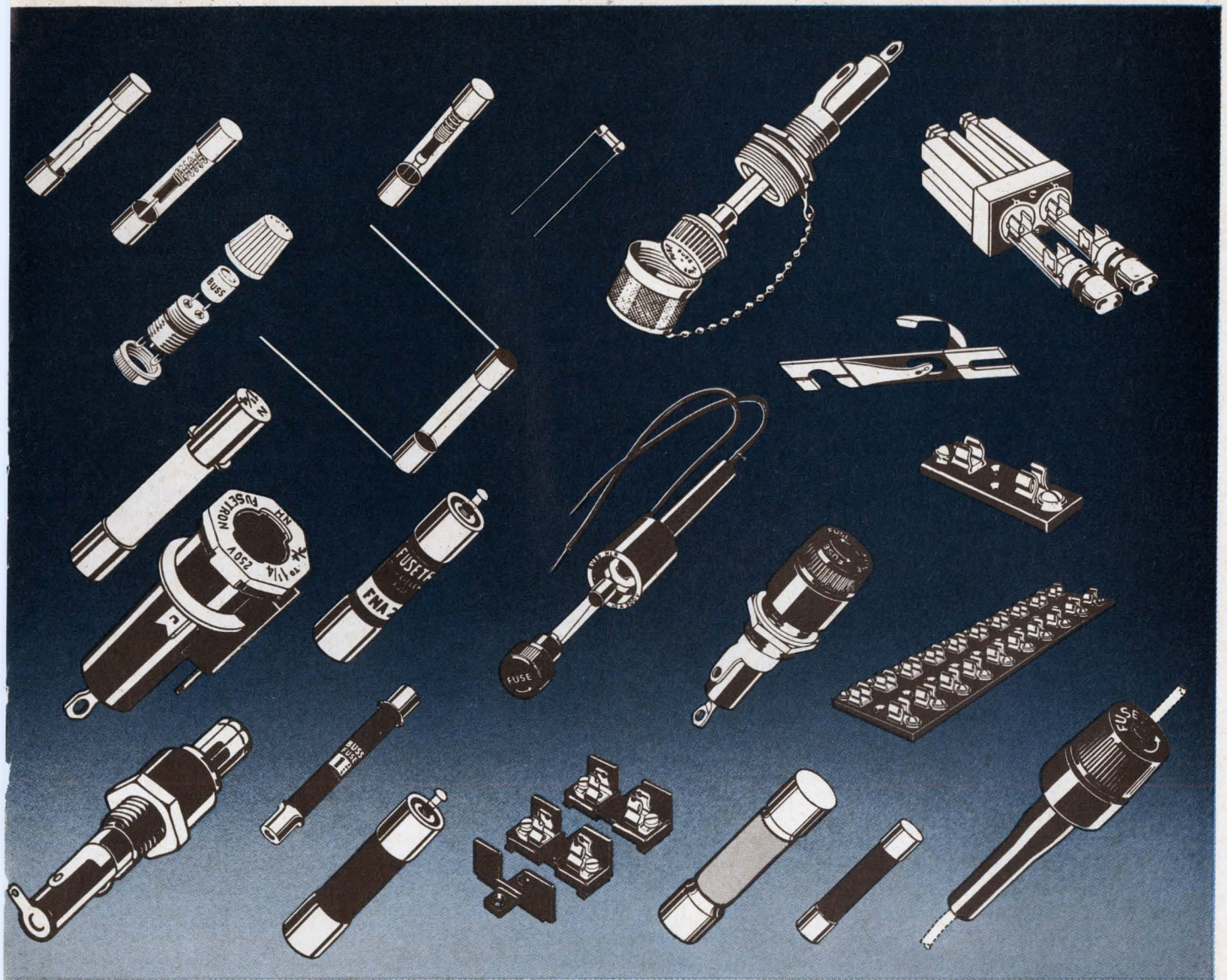

... Companion Line of Fuse Blocks and Fuseholders

Fuse Blocks. Single pole, multiple pole, small base, full base, molded base, laminated base, porcelain base fuse blocks . . . signal type fuse blocks and special blocks of all types.

Fuseholders. Panel mounted, in-the-line, lamp indicating, visual indicating, signal activating fuseholders . . . with solder terminals, quick-connect terminals or special terminals. Fuseholders of various types to meet Commercial and Military Specifications.

To help you select proper electrical protection, the BUSS small dimension fuse booklet offers a handy reference. Write for **BUSS Bulletin SFB**.

All standard items are easily obtained through your **BUSS distributor** — but if you don't find what you need, get in touch with us.

BUSSMANN MFG. DIVISION
McGraw-Edison Co., St. Louis, Mo. 63107

Supplied the Economical Way—
thru Distributors

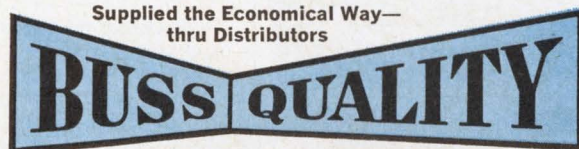

... for every protection need, INSIST ON

There always has to be a winner—and when it comes to all-purpose sweep signal generators, the Jerrold Model 900-C is a shoo-in.

Measure a *narrow* band circuit (sweepwidth down to 10 kHz) or check the *entire coverage* of broad band units such as mixers, amplifiers, or filters (sweepwidths up to 400 MHz). Design, test or measure a variety of VHF, UHF, narrow and wide band devices in the frequency range 500 kHz to 1200 MHz... and do it with incomparable ease and accuracy. Here is convenience only an all-purpose sweeper can provide.

The 900-C and ultra-reliable Measurement-by-Comparison techniques permit accurate and simple measurement of gain, loss, and VSWR. You can disregard variables such as nonlinearity of detectors, oscilloscope drift, and line voltage variations.

If you need more convincing, send for complete data—or contact us for a demonstration. Write Government and Industrial Division, Jerrold Electronics Corporation, 401 Walnut St., Philadelphia, Pa. 19105.



clean sweep!

IN TEST,
MEASUREMENT,
AND
DESIGN

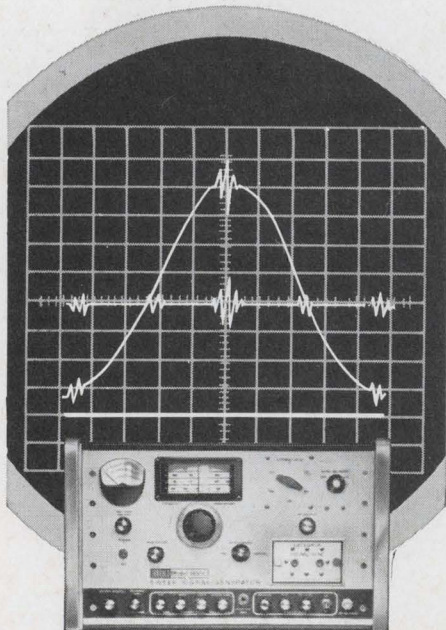

Meetings

Power Meeting, IEEE; Statler-Hilton Hotel, New York, Jan. 28-Feb. 2.

Defense Contract Administration Service Forum, American Society for Quality Control, Jack Tar Hotel, Clearwater, Fla., Feb. 10.

Aircraft Design for 1980 Operations Meeting, American Institute of Aeronautics and Astronautics; Mayflower Hotel, Washington, Feb. 12-14.

Aerospace and Electronic Systems Convention, IEEE; International Hotel, Los Angeles, Feb. 13-15.

International Solid-State Circuits Conference, IEEE; Sheraton Hotel, Philadelphia, Feb. 14-16.

National Space Meeting, the Institute of Navigation; Ramada Inn, Cocoa Beach, Fla., Feb. 19-21.

Scintillation and Semiconductor Counter Symposium, IEEE; Shoreham Hotel, Washington, Feb. 28-March 1.

Technology for Manned Planetary Missions Meeting, American Institute of Aeronautics and Astronautics; New Orleans, March 4-6.

Western Regional Technical Session, Electrochemical Society; Hilton Inn, San Francisco, March 7.

Conference of the American Society for Nondestructive Testing; Biltmore Hotel, Los Angeles, March 11-13.

Physics Exhibition, Institute of Physics and the Physical Society; London, March 11-14.

International Convention and Exhibition, IEEE; New York Coliseum and New York Hilton Hotel, New York, March 18-21.

Modulation Transfer Function, Society of Photo-Optical Instrumentation Engineers; Boston, March 21-22.

Symposium on Microwave Power, International Microwave Power Institute; Statler Hilton Hotel, Boston, March 21-23.*

Flight Test Simulation and Support Conference, American Institute of

Aeronautics and Astronautics; Los Angeles, March 25-27.

International Aerospace Instrumentation Symposium, College of Aeronautics, Cranfield, and Instrument Society of America; Cranfield, England, March 25-28.

Quality Control Conference, American Society for Quality Control; University of Rochester, N.Y., March 26.

Short Courses

Integrated circuits and their incorporation into equipment, IEEE, Hilton Hotel, New York, March 18-21; \$60 (members), \$75 (nonmembers).

The influence of defects on the fundamental optical properties of solids, Stevens Institute of Technology's Department of Electrical Engineering, Hoboken, N.J., April 24; no fee.

Recent advances in space communications, University of California, Los Angeles, July 8-19; \$375 fee.

Call for papers

Western Electronic Show and Convention, IEEE and the Western Electronic Manufacturers Association; Biltmore Hotel, Los Angeles, Aug. 20-23. March 15 is deadline for submitting letters of intent to Robert Ashby, Wescon Technical Program Chairman, 3600 Wilshire Blvd., Los Angeles, Calif. 90005.

Aerodynamics Specialist Conference, American Institute of Aeronautics and Astronautics; Jackson Lake Lodge, Jackson, Wyo., Sept. 3-5. Feb. 12 is deadline for submission of abstracts to E. Levin, Aerospace Corp., P.O. Box 95085, Los Angeles 90045.

Meeting and Technical Display, American Institute of Aeronautics and Astronautics; Philadelphia, Oct. 21-25. Feb. 13 is deadline for submission of abstracts to the theme chairman. Air transportation: Oscar Baake, FAA Department of Transportation, 800 Independence Ave., Washington 20003; aircraft design; Robert G. Loewy, College of Engineering and Applied Science, River Campus, University of Rochester, Rochester, N.Y. 14627; space: John Findlay, National Radio Astronomy Observatory, Charlottesville, Va. 22903. For further information write to American Institute of Aeronautics and Astronautics, 1290 Avenue of the Americas, New York 10019.

* Meeting preview on page 16.



Forget me not

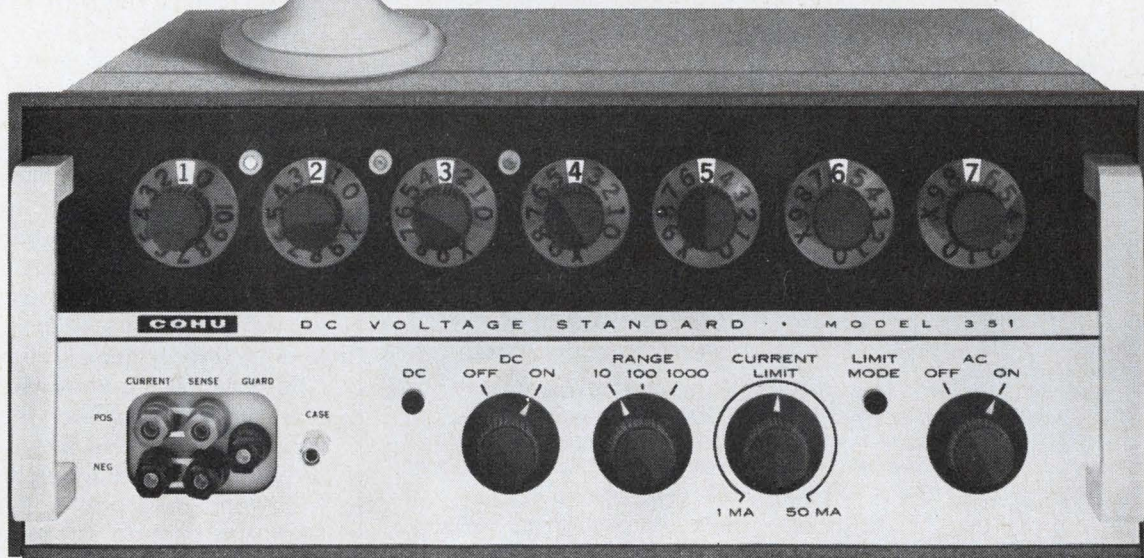

Cohu's new 351 DC Voltage Standard

If it weren't so easy, you'd probably **forget** how to calibrate the new 351. It's only required once a year due to new, improved solid state circuit design. Major features include modular, plug-in construction, improved reliability with redundant switch sections, and a unique method of voltage preregulation that eliminates the need for series output stage transistors. Output voltages are provided from 0 to ± 1100 volts in three ranges with a basic accuracy within 0.003% of setting. RMS noise voltage less than 20 μ V on the lowest

range. Output current up to 50 mA at any voltage setting.

The 351 is a precision voltage source for the design, construction and control of accurate and stable electronic circuits and for certifying the characteristics of DC digital voltmeters, DC voltage amplifiers, voltage controlled oscillators and variable DC supplies. Price—an **unforgettable** \$1995—less than any other quality DC voltage standard available. For full details, contact your Cohu engineering representative.

COHU
ELECTRONICS, INC.
SAN DIEGO DIVISION

Box 623 • San Diego, Calif. 92112 • Phone: 714-277-6700

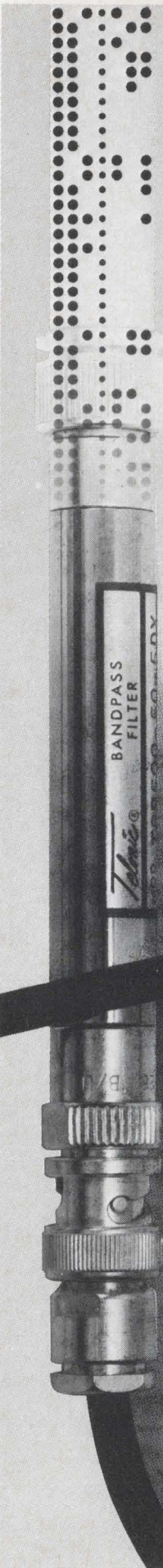

A COMPUTER DESIGNED FILTER CAN MAKE YOUR ENGINEERING EASIER

Telonic RF and Microwave Filters cover such a wide range of frequencies, types, and performance characteristics that you don't have to design "around" them. Your specific requirements are programmed into an engineering computer, the filter designed and then produced to those precise parameters.

Basically modular, Telonic filters can be manufactured from elements in stock, providing another benefit in fast delivery*. With over 100,000 filter designs already produced, even so-called special types may already be standard. Here is the broad selection you have in designing—Frequencies from 30 MHz to 12 GHz • Lowpass • Bandpass • Tubular • Miniature • Cavity • Interdigital • Tunable With that variety, quick delivery, and high performance, do you even need a second source?

*Three-day, Jet Order Service Available.

Telonic[®] ENGINEERING CO.

A Division of Telonic Industries, Inc.

Box 277 • Laguna Beach, Calif. 92652 • Tel.: 714-494-9401

Representatives throughout the U.S. and foreign countries. Factory offices in Maidenhead, England, Frankfurt, Germany, and Milan, Italy.

• 52 PAGE FILTER TEXTBOOK •

Telonic's new catalog contains never before published data on filter insertion loss, attenuation, physical size, frequency and bandwidth tolerances, and pass band relationships. Send for your copy.

Meeting preview

Microwave pow wow

The fortunes of the microwave industry tend to rise and fall with the defense budget, but a small, growing segment of the industry is using microwave energy to carve out new markets in industrial and domestic areas.

Most of the men responsible for this trend belong to the International Microwave Power Institute (IMPI), which meets in Boston at the Statler-Hilton Hotel from March 21 to 23.

This is IMPI's third annual meeting and, although the number of technical papers is about the same as last year's, attendance should triple or quadruple. The prediction is based on IMPI's quadrupled membership and the growth of new microwave applications.

In the factory. A brand new area will be tackled this year—industrial chemistry. In paper 5 of session A, F.K. McTaggart of the Commonwealth Scientific Industrial Organisation of Melbourne, Australia, shows that microwave energy promises to be a cheaper alternative to arc discharge or low radio-frequency excitation for production of such industrial chemicals as monoatomic hydrogen. Microwave processing generates a higher yield of hydrogen for a given input wattage.

Meanwhile, microwave power transmission looks like an economical way of relaying large amounts of power. Admittedly, getting electricity into and out of microwave form promises to be more costly than the use of high-tension transmission lines. But since giant waveguides could be buried in only a fraction of the right-of-way needed by high-tension wires, the dollars should be on the side of the microwave system.

On the range. Even the foot soldier should benefit from expanding use of microwave energy. The Army's Natick, Mass., Research Laboratories are experimenting with a microwave field kitchen. Majors M. Fox and A.L. Dungan in paper 3, Session B will show how the front-line soldier will get, among other delicacies, fresh-baked bread—daily.

AFTER 10 MILLION SUCCESSFUL PERFORMANCES, WHAT DO YOU DO FOR AN ENCORE?



Bring on Utilogic® II.

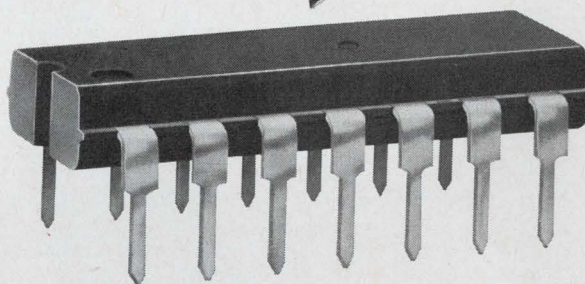

Signetics' new Utilogic II is a real show stopper—the most flexible, reliable, economical line in the business! Look at these features:

New - DIP. You asked for it, so we put the entire Utilogic II series in dual in-line silicone packages. Now you have convenience and ease of handling, in addition to the performance proven by over ten million Utilogic elements in the field.

New - Multi-Function Elements. Utilogic II now provides dual J-K binaries and triple and quadruple gates. Utilogic system design is now simpler, faster, more flexible ...and requires fewer packages.

New - Low Prices. Believe it or not, Utilogic II is actually priced at RTL levels! See for yourself:

| TYPE NO. | DESCRIPTION | PRICE 1000-UP |
|----------|--|---------------|
| 300A | Dual 3-Input Expander | \$.75 |
| 305A | Single 6-Input AND Gate | .75 |
| 306A | Dual 3-Input AND Gate | .75 |
| 314A | Single 7-Input NOR Gate | .75 |
| 317A | Dual 4-Input Expandable NOR Gate | .81 |
| 321A | Dual Master Slave J-K Binary | 1.50 |
| 322B | Dual Master Slave J-K Binary (in 16 pin package) | 1.66 |
| 333A | Dual 3-Input Expandable OR Gate | .81 |
| 370A | Triple 3-Input NOR Gate | .81 |
| 380A | Quad 2-Input NOR Gate | .81 |
| 356A | Dual 4-Input Buffer Element | 1.25 |

Those figures should bring a standing ovation. But hold the applause—because we'd like to give you a hand! For data sheets giving all the facts and figures on Utilogic II, just write Signetics, 811 East Arques Avenue, Sunnyvale, California 94086. This production brought to you by:

**SIGNETICS
INTEGRATED
CIRCUITS**



A SUBSIDIARY OF CORNING GLASS WORKS

SIGNETICS SALES OFFICES: Fort Lee, New Jersey (201) 947-9870; Syracuse, New York (315) 469-1072; Richardson, Texas (214) 231-6344; Beverly Hills, California (213) 272-9421; Garden Grove, California (714) 636-4260; Wakefield, Massachusetts (617) 245-8200; Silver Springs, Maryland (301) 946-6030; Collingswood, New Jersey (609) 858-2864; Clearwater, Florida (813) 726-3734; Rolling Meadows, Illinois (312) 259-8300; Sunnyvale, California (408) 738-2710.

DISTRIBUTORS: Compar at all locations listed below. Semiconductor Specialists, Inc. (312) 279-1000; Terminal Hudson Electronics (212) 243-5200; Wesco Electronics (213) 684-0880; Wesco Electronics (405) 968-3475; Hammond Electronics (305) 241-6601; Avnet Electronics Corp. of Massachusetts (617) 272-3060; Pioneer Standard Electronics Inc. (301) 427-3300; Kieruluff Electronics (206) RO 3-5510; G. S. Marshall (213) 684-1530.

DOMESTIC REPRESENTATIVES: Jack Pyle Company (415) 349-1266. Compar Corporation at the following locations: Alabama (205) 539-8476; Arizona (602) 947-4336; California (213) 245-1172; California (415) 697-6244; Colorado (303) 781-0912; Connecticut (203) 288-9276; Florida (305) 855-3964; Illinois (312) 692-4125; Maryland (301) 484-5400; Massachusetts (617) 969-7140; Michigan (313) 357-5369; Minnesota (612) 922-7011; Missouri (314) 542-3399; New Jersey (609) 429-1526; New Mexico (505) 265-1020; New York (518) 436-8536; New York (607) 723-8743; New York (516) 921-9393; North Carolina (919) 724-0750; Ohio (216) 333-4120; Ohio (513) 878-2631; Texas (214) EM 3-1526; Texas (713) 667-3420; Washington (206) 763-1711.

INTERNATIONAL SALES: France, Germany, Italy, Belgium, Holland, Luxemburg, Spain—Sovcor Electronique, 11, Chemin de Ronde, Le Vesinet, (S.-&O.) France. United Kingdom, Ireland, Sweden, Denmark, Norway, Switzerland, Austria, Portugal—Electrosil Ltd., Lakeside Estate, Colnbrook-By-Pass Slough, Buckinghamshire, Great Britain. Australia—Corning, 1202 Plaza Building, Australia Square, Sydney, N.S.W. 27-4318. Canada—Corning Glass Works of Canada, Ltd., Leaside Plant, Ontario, Canada (416) 421-1500. Israel—Optronix, P.O. Box 195, Ramat-Gan, Israel 724-437. Japan—ASAHI Glass Co., Ltd., Corning Products Sales Dept. No. 2, 3-Chome Marunouchi, Chiyoda-ku, Tokyo, Japan.



It is rare indeed for a components company to develop an expertise in more than one technology. But when it happens, the products which result are usually impressive. Wedding

the superb advantages of solid state electronics to those of electro-mechanical switches has already improved performance in several industries where precise timing is required.

Consider a missile launch program, aircraft

check-out equipment, an automotive test stand, or an industrial manufacturing process. All have one thing in common — a need for accurate control, either sequentially or simultaneously, of multiple events.

A newly-developed programmer provides that kind of control. It combines the functions of high current electro-mechanical relays with an appropriate network of solid state electronics which coordinates a memory unit and an automatic timer.

How the Programmer Works: Each basic control function or event is represented by an independent channel in the electronic

system. Timing data for each event is key punched on cards or tape and fed into a reader. The data is then stored in a volatile memory (magnetostrictive delay line) and held there until a fresh set of cards is entered with different data or until the timer is shut off. The contents of the memory are examined every second and compared with the elapsed time for each program which is also stored in the memory. When an exact comparison is made between a program's elapsed running time and the pre-programmed instruction for a specific channel, the output relay for that channel switches instantly.



RELAY, 10 AMP, 4 POT
CLASS B6, SEALED
COIL 25 VDC
LEACH P/N 9228-4091
LEACH CORPORATION
LEACH RELAY DIVISION
LOS ANGELES, CALIF., U.S.A.

As many as eight on/off operations can be programmed in for each channel and held in the circulating memory until used. The unused portion of the memory makes it possible to extend the cycle time for any channel to practically any length needed. This is accomplished by punching the correct data on new cards and plugging them into the reader. However, the total size of the memory determines the maximum operating period, the maximum number of controlled channels and the maximum number of operations per channel.

Reliable Performance: This programming system is far more reliable than any of the

hundreds of purely mechanical systems in use today. Consistent performance at high switching accuracies to a few milliseconds can be obtained in contrast to the minimum resolution of several seconds delivered by conventional systems.

It is more economical and flexible than an entirely solid state unit. Semiconductors provide accurate logic while the use of relays for the higher current output minimizes heating and provides isolation.

Performance is enhanced still further by the use of relays with 100,000 cycle or more life capability. Literally, this means years

of faultless operation free of the expense of scheduled maintenance.

Whatever the application, the basic benefits will always be there: operation is simple and flexible because the timing cycle is established by punched cards or tape. Starting times and sequencing are always under precise control. Programming is so uncomplicated that downtime during change-over is minutes. Maintenance costs are minimized.

Write for a copy of our Brochure on Electronic Programmed Timers. Leach Corporation,

LEACH

Relay Division, 5915
Avalon Blvd., Los Angeles,
California 90003.

Just Married!

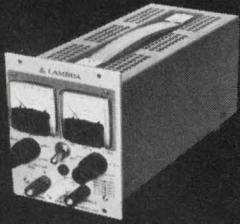

5 1/4" LP Series
Metered

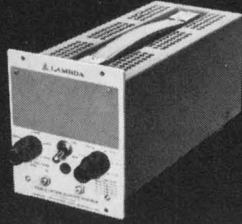

5 1/4" LP Series
Non-Metered

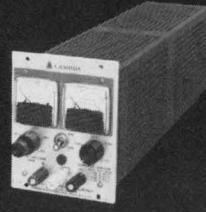

5 1/4" LH Series 1/4 Rack
Metered



5 1/4" LH Series
1/4 Rack Non-Metered



5 1/4" LH and LK Series 1/2 Rack
Metered

All from Lambda. Broadest line of all-silicon lab

NEW advanced design dual output lab supplies
give you twice the power plus output ranges
never before
available... plus...

5 Models with two independent DC outputs offer widest choice—Up to ± 250 VDC, up to 1.7 amps. Either output may be + or -, or both outputs may be + or -.

Series/Parallel operation of both outputs yields two times the voltage or two times the current—up to 500 volts or up to 3.4 amps.

Auto Series/Auto Parallel (master slave) permits tracking to a common reference.

4 Meters provide simultaneous monitoring of both voltage and current.

Most power in a half-rack package.

Overvoltage Protection as an accessory.

Compatible with LP, LH and LK Series rack adapters and other accessories.

Multi-Current-Rated—Only dual power supplies on market with this advanced design feature.

Regulation— $.01\% + 1\text{mV}$.

Ripple— $500\mu\text{V RMS}$ (1.5mVp-p).

Size: $5\frac{7}{16}'' \times 8\frac{3}{8}'' \times 10\frac{1}{2}''$

| Model ⁽²⁾ | Voltage Range Per output/ Outputs in series | I MAX AMPS AT AMBIENT OF: (1) | | | | Price ⁽²⁾ US and Canada |
|----------------------|--|--------------------------------|-------------|-------------|-------------|--|
| | | Per output/Outputs in parallel | | | | |
| | VDC | -30°C | 40°C | 50°C | 60°C | |
| *LPD-421-FM | 0- ± 20 /0-40 | 1.7A/3.4A | 1.5A/3.0A | 1.3A/2.6A | 0.9A/1.8A | \$325 |
| *LPD-422-FM | 0- ± 40 /0-80 | 1.0A/2.0A | 0.85A/1.7A | 0.7A/1.4A | 0.55A/1.1A | 260 |
| *LPD-423-FM | 0- ± 60 /0-120 | 0.7A/1.4A | 0.6A/1.2A | 0.5A/1.0A | 0.4A/0.8A | 325 |
| LPD-424-FM | 0- ± 120 /0-240 | 0.38A/0.76A | 0.32A/0.64A | 0.26A/0.52A | 0.20A/0.40A | 325 |
| LPD-425-FM | 0- ± 250 /0-500 | 0.13A/0.26A | 0.12A/0.24A | 0.11A/0.22A | 0.10A/0.20A | 350 |

* Overvoltage Protection available as an accessory. Each output requires separate OV accessory—add \$35.00 for each output.

(1) Current rating applies over entire voltage range. Ratings based on 57-63 Hz operation.

(2) Prices are for metered models. LPD Series models are not available without meters.

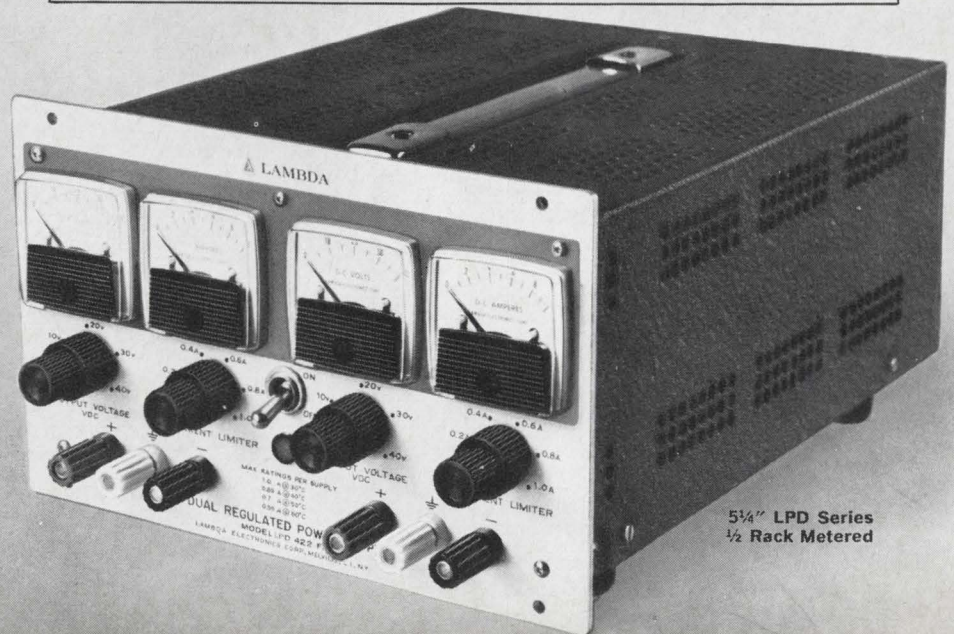

5 1/4" LPD Series
1/2 Rack Metered

5 1/4" LK Series
Full-Rack Metered

5 1/4" LH and LK Series
1/2 Rack Non-Metered

5 1/4" LK Series Full-Rack Non-Metered

7" LK Series Full-Rack Metered

or systems power supplies... bench or rack

or choose from these 1/4, 1/2 and full-rack Lambda supplies

Size 5 3/8" x 4 3/8" x 10"

| Model ² | Voltage Range | CURRENT RANGE AT AMBIENT OF: ¹ | | | | Price ² |
|--------------------|---------------|---|---------|---------|---------|--------------------|
| | | 30° C | 40° C | 50° C | 60° C | |
| LP 410 | 0-10 VDC* | 0-2A | 0-1.8A | 0-1.6A | 0-1.4A | \$129 |
| LP 411 | 0-20 VDC* | 0-1.2A | 0-1.1A | 0-1.0A | 0-0.8A | 119 |
| LP 412 | 0-40 VDC* | 0-0.70A | 0-0.65A | 0-0.60A | 0-0.50A | 114 |
| LP 413 | 0-60 VDC* | 0-0.45A | 0-0.41A | 0-0.37A | 0-0.33A | 129 |
| LP 414 | 0-120 VDC | 0-0.20A | 0-0.18A | 0-0.16A | 0-0.12A | 149 |
| LP 415 | 0-250 VDC | 0-80mA | 0-72mA | 0-65mA | 0-60mA | 164 |

Size 5 3/8" x 4 3/8" x 15 1/2"

| Model ² | Voltage Range | CURRENT RANGE AT AMBIENT OF: ¹ | | | | Price ² |
|--------------------|---------------|---|---------|---------|---------|--------------------|
| | | 30° C | 50° C | 60° C | 71° C | |
| LH 118-A | 0-10VDC | 0-4.0A | 0-3.5A | 0-2.9A | 0-2.3A | \$180 |
| LH 121-A | 0-20VDC | 0-2.4A | 0-2.2A | 0-1.8A | 0-1.5A | 170 |
| LH 124-A | 0-40VDC | 0-1.3A | 0-1.1A | 0-0.9A | 0-0.7A | 170 |
| LH 127-A | 0-60VDC | 0-0.9A | 0-0.7A | 0-0.6A | 0-0.5A | 185 |
| LH 130-A | 0-120VDC | 0-0.50A | 0-0.40A | 0-0.35A | 0-0.25A | 240 |

Size 5 3/8" x 8 3/8" x 15 1/2"

| Model ² | Voltage Range | CURRENT RANGE AT AMBIENT OF: ¹ | | | | Price ² |
|--------------------|---------------|---|---------|---------|--------|--------------------|
| | | 30° C | 50° C | 60° C | 71° C | |
| LH 119-A | 0-10VDC | 0- 9.0A | 0- 8.0A | 0- 6.9A | 0-5.8A | \$289 |
| LH 122-A | 0-20VDC | 0- 5.7A | 0- 4.7A | 0- 4.0A | 0-3.3A | 260 |
| LH 125-A | 0-40VDC | 0- 3.0A | 0- 2.7A | 0- 2.3A | 0-1.9A | 269 |
| LH 128-A | 0-60VDC | 0- 2.4A | 0- 2.1A | 0- 1.8A | 0-1.5A | 315 |
| LH 131-A | 0-120VDC | 0- 1.2A | 0- 0.9A | 0- 0.8A | 0-0.6A | 320 |

| Model ² | Voltage Range | CURRENT RANGE AT AMBIENT OF: ¹ | | | | Price ² |
|--------------------|---------------|---|---------|---------|--------|--------------------|
| | | 40° C | 50° C | 60° C | 71° C | |
| LK 340-A | 0-20VDC | 0- 8.0A | 0- 7.0A | 0- 6.1A | 0-4.9A | \$330 |
| LK 341-A | 0-20VDC | 0-13.5A | 0-11.0A | 0-10.0A | 0-7.7A | 385 |
| LK 342-A | 0-36VDC | 0- 5.2A | 0- 5.0A | 0- 4.5A | 0-3.7A | 335 |
| LK 343-A | 0-36VDC | 0- 9.0A | 0- 8.5A | 0- 7.6A | 0-6.1A | 395 |
| LK 344-A | 0-60VDC | 0- 4.0A | 0- 3.5A | 0- 3.0A | 0-2.5A | 340 |
| LK 345-A | 0-60VDC | 0- 6.0A | 0- 5.2A | 0- 4.5A | 0-4.0A | 395 |

Size 5 1/4" x 19" x 16 1/2"

| Model ² | Voltage Range | CURRENT RANGE AT AMBIENT OF: ¹ | | | | Price ² |
|--------------------|---------------|---|-------|---------|-------|--------------------|
| | | 40° C | 50° C | 60° C | 71° C | |
| LK 350 | 0-20VDC | 0-35A | 0-31A | 0-26A | 0-20A | \$675 |
| LK 351 | 0-36VDC | 0-25A | 0-23A | 0-20A | 0-15A | 640 |
| LK 352 | 0-60VDC | 0-15A | 0-14A | 0-12.5A | 0-10A | 650 |

Size 7" x 19" x 18 1/2"

| Model ² | Voltage Range | CURRENT RANGE AT AMBIENT OF: ¹ | | | | Price ² |
|--------------------|---------------|---|-------|-------|-------|--------------------|
| | | 40° C | 50° C | 60° C | 71° C | |
| LK 360 FM | 0-20VDC | 0-66A | 0-59A | 0-50A | 0-40A | \$995 |
| LK 361 FM | 0-36VDC | 0-48A | 0-43A | 0-36A | 0-30A | 950 |
| LK 362 FM | 0-60VDC | 0-25A | 0-24A | 0-22A | 0-19A | 995 |

LP NOTES

*Overvoltage Protection available as an accessory—\$35.00 each.

1 Current rating applies over entire voltage range. Ratings based on 57-63 Hz operation.

2 Prices are for non-metered models. For metered models, add suffix (FM) and add \$10.00 to price.

LK-LH NOTES:

1 Current rating applies over entire voltage range.

2 Prices effective Feb. 1, 1968. Prices are for non-metered models (except for models LK360FM, LK361FM, and LK362FM which are metered models not available without meters). For metered models, add suffix (FM) and add \$30.00 to price.

3 Overvoltage Protection up to 70 VDC is available as a bolt-on accessory for models with suffix (-A). To order, add suffix (OV) and add \$35.00 to the price. For full-rack models, overvoltage protection up to 70 VDC is available as a built-in option. To order add suffix (OV) and add \$90.00 to price of models LK350-352; add \$120.00 for models LK360FM-362FM.

4 Chassis Slides for full rack models: Add suffix (CS) to model number and add \$60.00 to the price except for models LK360FM-362FM, for which add \$100.00.



LAMBDA
ELECTRONICS CORP.

TERMINAL DRIVE, PLAINVIEW, L. I. N. Y. 11803 • TEL. 516-681-8300

A VEECO SUBSIDIARY

VEECO HIGH VACUUM EQUIPMENT/LAMBDA POWER SUPPLIES

Which IC Test System does all these things?

DIAGNOSTIC COMPUTER PROGRAMS automatically check out system operation.

DATALOG A FORCING FUNCTION, such as the input threshold level of a flip-flop needed to produce a specified output.

TYPED SUMMARY SHEETS. Whenever desired. No interruption in testing. Give total units tested per test station, test yields and bin yields.

DIRECT ENGLISH data logging type-out, showing job name, serial number, test number, decimal point and units.

ABSOLUTE SOURCE CONTROL. Sources can be turned ON or OFF and changed in value in any sequence with variable delays from 100 μ sec. to as long as you please.

DATALOG at any test station—without slowing down classification tests at any other station.

MULTIPLEXING. Several jobs simultaneously. Any assigned, at any time, to any test station.

AUTOMATIC SELF-CHECKING assures accurate data transfer between operator, teletypewriter, computer and test instrument.

VERY COMPLEX TEST SEQUENCES can be programmed, yet preparation of simple tests can be learned in two hours.

GROWING LIBRARY of improved software packages to insure against obsolescence.

FAST TESTING. 1.5 msec per test. If crosspoint is changed, 5 msec. 10 msec on the lowest current scales.

TEN-YEAR GUARANTEE for all instrument plug-in circuitry (it's almost all plug-in).

NO ADJUSTMENT OR CALIBRATION POINTS. (Eternal vigilance is the price you pay for a single adjustment.)

OPEN AND SHORTED CONNECTIONS and **OSCILLATIONS** are automatically detected. System stops when a selected consecutive number of these occur.

COMPLETE FRONT PANEL DISPLAY at any desired step, simultaneously indicating all crosspoint connections, forced values, measured limits, binning decisions—everything about each test.

MINIMIZED REPETITIVE INSTRUCTIONS for the operator through data libraries, variable word length programming, and autopinping.

PROGRAMMABLE CURRENT LIMITS for each source at each test.

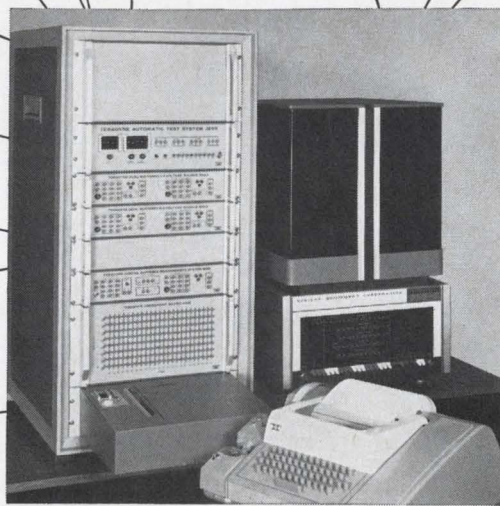

This one.

(complete for only \$65,000)

This is our J259 computer-operated Automatic Circuit Test System. It includes a general-purpose digital computer, teletypewriter, test instrument (comprising modular elements: 24 x 8 crosspoint matrix, four volt-

age sources, measurement system, and test deck), complete software package, and courses in IC testing, system operation, and maintenance. TERADYNE, 183 Essex St., Boston, Mass. 02111 Phone (617) 426-6560.

TERADYNE

Commentary

From another Iron Mountain

Converting an economy geared to Government support of military research and development to one that can tackle domestic issues is the problem examined in a report recently made public.* It was prepared for the U.S. Arms Control and Disarmament Agency and assumed, a priori, the end of the war in Vietnam, arms control and disarmament agreements. The probe sought to determine whether an economy noted for technological innovations would run into serious trouble if it tried to solve problems of public transportation, urban renewal, and others that have thus far resisted solution.

The report tried to answer three principle questions:

- How does technological innovation take place in civic areas?
- Are there factors which affect the process in a predictable way?
- How are public policies employed to alter the rate at which technological innovations occur?

Three well-documented cases of large-scale systems were studied—the civilian light-water nuclear power reactor, San Francisco's rapid transit system, and the intercity transit system for the Northeast corridor.

Among the important conclusions that can be drawn from the survey are these:

- Factors tending to delay technological innovations in public areas are based principally on uncertainty as to public policy rather than on technology.
- The driving forces to get large public projects off the ground come from many quarters.
- Engineers and technologists play a key decision-making role.

One of the things learned was something we suspected all along: the motives to innovate in the sector which the report describes as "civilian public areas" are entirely different from those in private commercial enterprise. The profit motive is invariably the driving force in the latter—but it is substantially lacking in public projects. One suspects that the profit motive is not missing completely—it is merely voided by the high investment risk during the first stages of such projects. Risks are due to the complexity of the jobs and because such projects are subject to political forces, pressure groups, and the whims of the public. The net result is the need for Government subsidies in public projects at the outset; later if the system becomes successful and diffuses to involve a wide base of private participants the profit motive enters the picture. The big problem then becomes when and how to withdraw Government support.

Difficulties in establishing policy are holding back technological changes in the public sector. The issues tend to center on weighing the public interest against the answers to these questions: What needs to be done?

* "Technological innovation in civilian public areas." ACDA/E-118

How should it be done? When should it be done and by whom?

Policy makers are prompted to delay decisions on these issues in the absence of a consensus that innovation is needed, in the face of contradictory estimates of projected costs, and when the future growth or profitability of the innovation is in doubt.

System-type innovations in civic sectors result more and more frequently from policy decisions by the Federal government. These decisions are being made increasingly with advice from scientists and engineers and are usually based on these professionals' studies during the early stages of innovation. This means that engineers and technical managers will help call shots more frequently on whether a project should be undertaken.

One senses at once a danger and an advantage. Since the profit incentive is nearly nonexistent the technologist would probably be extremely objective. But the very absence of the profit motive might lead him to base his decision on technical feasibility alone. The result could be costs that soar well beyond initial guesses.

A hazy cost picture is not nearly so important to the "go—no go" decision in the case of a project involving national security. Combining civilian with military goals helped get the civilian nuclear power project under way. The Atomic Energy Commission's first director of reactor development, Dr. Lawrence Hafsted, said in 1951: "To justify building an expensive reactor, we must, or should have, a demonstrable need. To assess the need, we must know the costs, but costs can only be determined by first building the reactors. This is the circular argument in which we continually find ourselves. To break out of this vicious circle, we have to use the fact that, for the military needs, the unknown economic factor is less compelling."

Unfortunately, technologists are rarely in a position to employ this rationale; they must resort to educated guessing.

Engineers can influence directions that public projects take but they seldom represent the initial driving force. That could come from any of several places—in the case of the intercity transit project it began as the personal crusade of Senator Claiborne Pell (D., R.I.).

In view of the tentative beginnings and uncertain futures of civilian public projects the approach taken by General Bernard Shriever, former chief of the Air Force Systems Command, makes sense. Shriever, now heading up his own consulting firm, is organizing a consortium of 10 or so firms in the electronics, aerospace, construction, and architectural fields to attack urban problems in a systematic way. Shriever proposes to apply the same logical systems-engineering approach that he popularized in the U.S. missile program. The advantages of such a consortium could include:

- The same level of expertise could be brought to bear on civic projects as on defense projects.
- It would serve as over-all system management, putting projects up for competitive bidding, and dealing with as many subcontractors as feasible and profitable.
- The consortium would share the costs and spread the high risks involved in the early stages.

EECoLogIC[®] IC cards lock firmly...

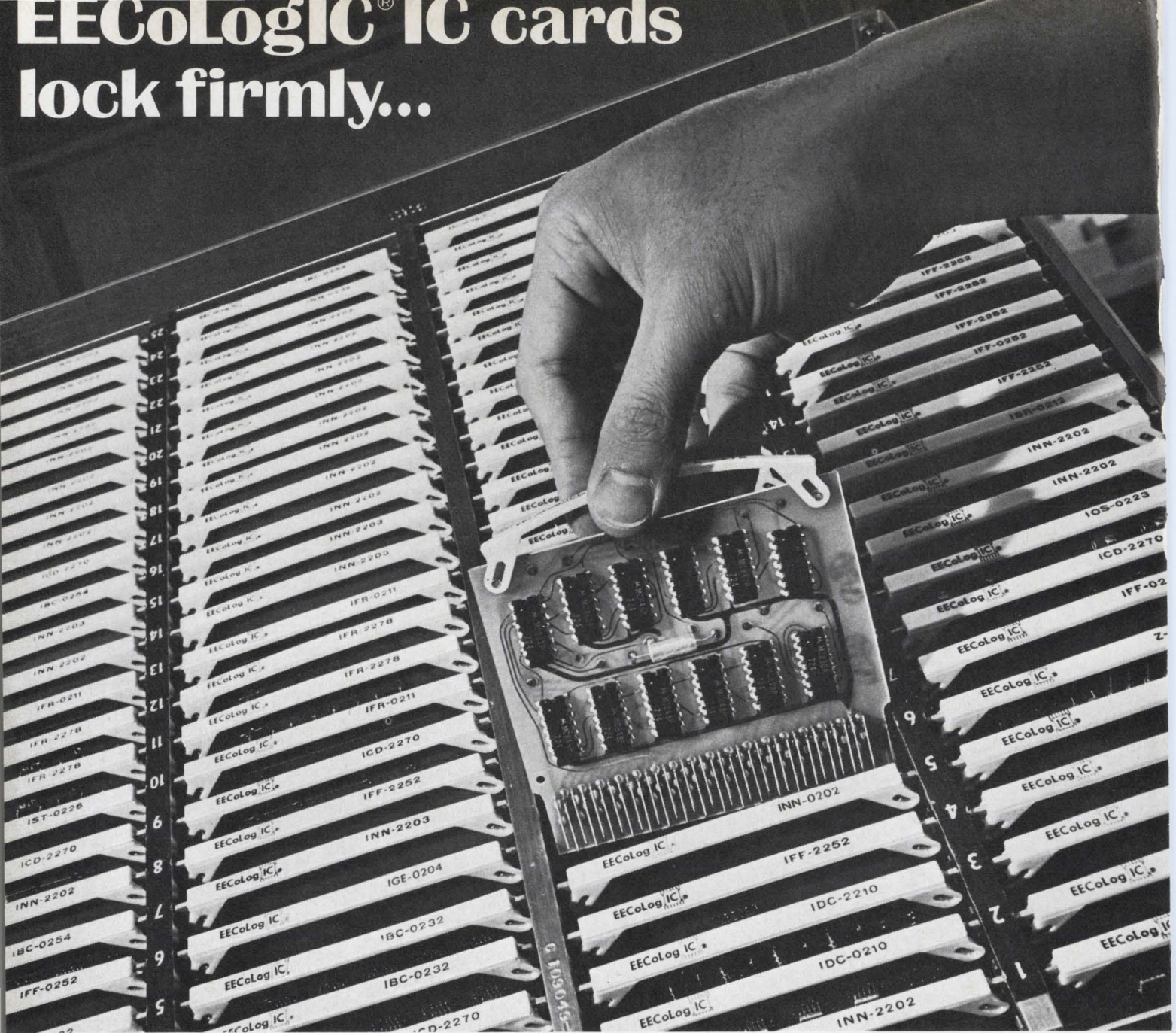

extract easily with flexible handle

Forget about logic cards shaking loose in transit or mobile installations... or trying to find just the right card extractor during maintenance. The unique flexible EECoLogIC handle locks the card securely in your system. For servicing, it clearly identifies your circuit and becomes its own extractor.

These user-oriented details characterize the EECoLogIC line — the broadest selection of useful integrated circuit logic modules... including basic IC cards, 35 function modules (counters, shift registers, adders, many others), and special breadboard and prototype circuits.

Our 172 page EECoLogIC catalog describes the entire line, and includes 65 pages of practical application data. Send for your copy today.

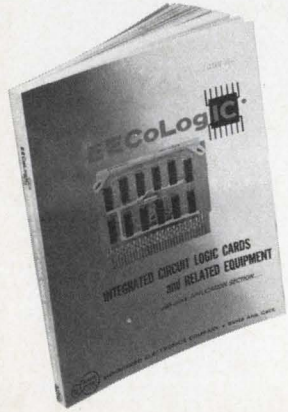

COMPONENTS DIVISION

ELECTRONIC ENGINEERING COMPANY OF CALIFORNIA

1441 EAST CHESTNUT AVENUE • SANTA ANA, CALIFORNIA 92701 • (714) 547-5651

Circle 24 on reader service card

Electronics Newsletter

January 22, 1968

H-P unit makes 55-cent Schottky

HP Associates, a Hewlett-Packard division, has developed a cost-cutting process for manufacturing Schottky-barrier diodes that will permit it to offer the devices at sharply reduced prices—under a dollar apiece for small quantities and as low as 55 cents each in batches of more than a thousand. Present prices run to \$3 or \$4 per diode.

The high-frequency diodes, which will be available off the shelf next month, have switching times of 150 picoseconds and a relatively high breakdown voltage of 70 volts. The fabrication method, developed by the division independently, resembles the platinum-silicide process announced last year by Bell Laboratories, but doesn't use platinum silicide.

The company has a contract to supply 1 million of the diodes, at a total price of \$380,000, to the Army's Harry Diamond Laboratories for use in proximity fuzes. Texas Instruments is also supplying Schottky-barrier diodes, made by a different process, to Harry Diamond. H-P's decision, unusual for the company, to push a low-price, high-volume product, apparently reflects a desire to beat TI to the commercial marketplace. H-P sees markets in computers and in r-f mixers and detectors.

4 Gunn oscillators in one big lockup

IBM's Federal Systems division has operated four Gunn-effect oscillators in-phase, locked to an external source—an achievement that points the way toward the use of Gunn oscillators in solid state phased-array radars. Researchers have long been interested in such devices as power sources for radiating elements because they promise to be cheap, small sources of microwave power.

The IBM development marks the first time that more than one of the gallium arsenide devices, which in this version oscillate at 2 gigahertz in the domain mode, have been phase-locked externally. IBM says it was able to do this by developing a new, high-quality GaAs material from which identical devices could be fabricated. The work is being sponsored by the Air Force's Rome Air Development Center.

FCC objection kills upgraded Intelsat 2

Hughes won't upgrade the Intelsat 2 satellite it's now building for Comsat as a backup for the delayed Intelsat 3 [Electronics, Jan. 8, p. 25]. The FCC shot down Comsat's plan to increase the number of circuits on the Intelsat 2 from the 240 carried by models now flying to as many as 800.

Comsat was forced to drop the idea when the FCC expressed concern that the latest Intelsat 2, due for launching in July, will be due for retirement before it pays for itself. The FCC is generally questioning Comsat's fast moves to new and larger satellites before older craft have fully paid for themselves.

Cable and satellite may both get nod

The Government is expected to okay the building of both a 720-circuit, transistorized cable (TAT-5) and a new, larger communications satellite for the planned expansion of transatlantic communications facilities by 1970 [Electronics, Nov. 13, 1967, p. 179]. After twice postponing the official signing of their own agreement at the request of the State Department, AT&T and the other common carriers in the TAT-5 consortium are set to meet again on Feb. 5 to formally proceed with the cable. There

Electronics Newsletter

are some strings attached to the Government's acceptance of their plan, including demands that the carriers reduce international rates—the specific amount hasn't been set—and promise to use satellite circuits.

The International Satellite Consortium's interim committee will meet with Comsat officials Jan. 29. The panel is currently divided on whether to go ahead with the Intelsat 4 satellite, with 5,000 to 10,000 circuits, or a smaller Intelsat 3.5, with 1,800 circuits; the latter would be an outgrowth of the Intelsat 3 TRW Systems is now building for launch this year. Comsat most likely will ask for industry proposals on both designs and the committee will delay its final decision until these proposals are evaluated.

Fairchild lays off at Mountain View

The Fairchild Semiconductor division, caught in a profit squeeze that has made its 1967 earnings report the subject of considerable speculation among market analysts, announced last week that 150 engineers, marketing-services staffers, and technicians are being lopped from the payroll at its Mountain View, Calif., headquarters. Rumors had placed the figure much higher.

The announcement comes a few weeks after the laying off of about 40 employees at the company's Tijuana, Mexico, plant, and six months after a cut of about 50 persons at its research and development laboratory. R&D personnel weren't involved in the latest move.

Thomas H. Bay, general manager of the division, says some production will be shifted from Mountain View to Fairchild's Portland, Maine, plant, where IC wafers are now fabricated and assembled. That shift, plus the fact that the firm is "reevaluating efforts in several areas," led to the layoff, Bay asserts. One area undergoing reevaluation is power transistors; Fairchild is believed about to drop some high power consumer products not particularly suited to the planar process. Silicon-controlled rectifier efforts also will be curtailed.

GE bringing the mountain to Mohammed

A new information-retrieval system called Rapid Search has been built by General Electric at its Apollo services department in Daytona Beach, Fla. GE uses an 80-character associative memory, made of semiconductors, from which data can be retrieved by content rather than by location. Instead of storing the information in the associative memory and retrieving it by matching the content with an inquiry from the outside, the system stores the inquiry in the memory and compares it with all the information on a bulk storage unit.

The system has a potential search rate of 10 million characters per second. However, the prototype's speed is limited by the bulk storage used—magnetic tape that has a top rate of 120,000 characters a second.

Addenda

Philco-Ford has lured a production specialist away from Motorola's Semiconductor Products division to head its Microelectronics division. John R. Welty, a Motorola vice president, will join Philco Feb. 1 as divisional general manager. Welty has been described by C. Lester Hogan, vice president in charge of the Motorola division, as one of the two or three persons most responsible for the division's success. . . . Richard J. Hanschen has resigned as assistant vice president and director of marketing at TI's components group. Since TI's managerial shakeup last January, many of Hanschen's duties had been assigned to others.

"This is Mariner V now passing Venus"

Allen-Bradley hot-molded resistors helped make the message "loud and clear"

TYPE BB 1/8 WATT

TYPE EB 1/2 WATT

TYPE HB 2 WATTS
Not used on Mariner V

TYPE CB 1/4 WATT

TYPE GB 1 WATT

A-B hot-molded fixed resistors are available in all standard resistance values and tolerances, plus values above and below standard limits. **A-B hot-molded resistors meet or exceed all applicable military specifications including the new Established Reliability Specification.** Shown actual size.

After a historic 217,000,000-mile journey, Mariner V probes the mysteries of Venus from a closer vantage point than ever before. The data from this successful venture into deep space will add immeasurably to our knowledge of Venus, and aid in planning future space missions.

As with numerous other missions, Allen-Bradley hot-molded resistors again justified the confidence placed in them. Their faultless performance was essential to the "loud and clear" report of the fly-by.

Allen-Bradley resistors are made by an exclusive

hot-molding process—developed and used only by Allen-Bradley. The resulting uniformity from resistor to resistor—billion after billion—enables long-term performance to be accurately predicted. And over the years, there has been no known instance of catastrophic failure.

For complete specifications on Allen-Bradley hot-molded resistors, please write for Technical Bulletin 5000: Allen-Bradley Co., 110 W. Greenfield Ave., Milwaukee, Wis. 53204. In Canada: Allen-Bradley Canada Ltd. Export Office: 630 Third Ave., New York, N. Y., U.S.A. 10017.

1067E-7

QUALITY ELECTRONIC COMPONENTS



ALLEN-BRADLEY

Circle 27 on reader service card



Dense, hand mated, and very tolerant.

Maintainable contact on .075" centers. Solder, weld or wrap. Unique elliptical spring contact design. Only four-ounce insertion, one-ounce extraction per contact. Vibration-proof continuity. Forgives misalignment. Two-piece in-line (10 to 180 contacts), two-piece right angle (up to 77 contacts). No guides, no hardware, no sweat. Designed for airborne navigation and radio black boxes, computers, ground support equipment. Ask about it.

AMP
INCORPORATED
Harrisburg, Pennsylvania

Circle 29 on reader service card

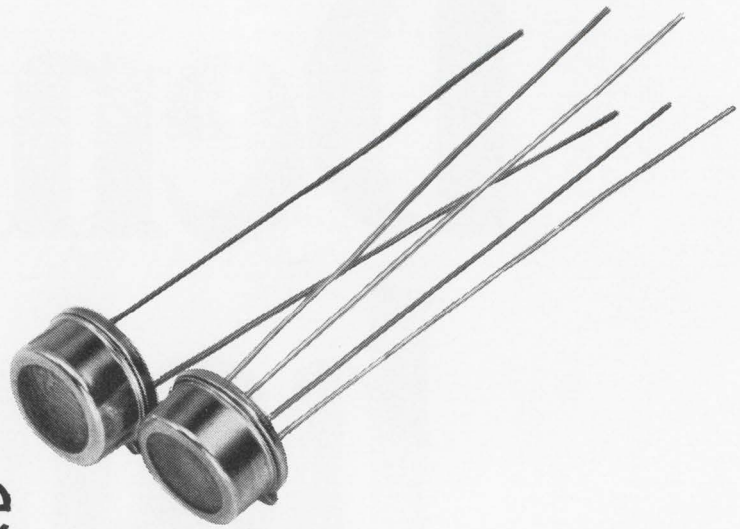

HP isn't in the photocell business by accident.

We're in it to deliver a superior line of products—and there's a lot of thought behind the current availability of photoconductors from Hewlett-Packard.

It all started ten years ago when HP found an urgent need for a reliable supplier of photocells for its instrumentation—a supplier who could deliver *and* keep the reject rate down. The decision was unavoidable—HP should produce its own photocells.

With the development by the HP engineering staff of new photoconductive materials that optimized speed and stability in early photoconductors, a whole new department was started at HP. It was charged with developing efficient production methods and close

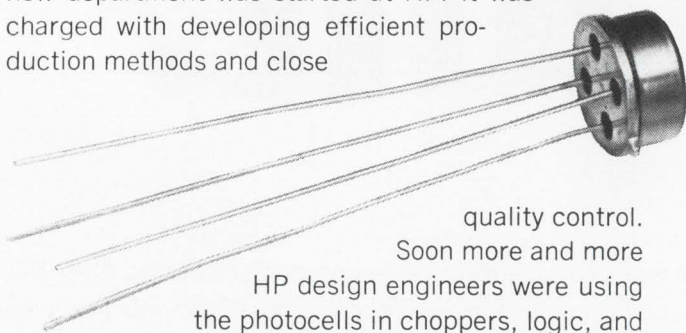

quality control. Soon more and more HP design engineers were using the photocells in choppers, logic, and circuit control applications, requiring growth in the size and capability of the photoconductor department and its ability to bring unique R & D efforts to the photocell business. With its own plant, a separate

applications group, complete production facilities and a vigorous new product program, this department no longer makes photoconductors only for HP—it's now *your* source, too.

HP's line of photocells, modulators, photo-controlled resistors and photochoppers represents the best optimization of overall photocell performance—and HP also has the engineering know-how to give you the customized "special" design attention you may require. HP experience provides the reliability you need, too.

If you're looking for a photoconductor product, check with HP before deciding on one. We can talk your own particular application language, giving appropriate performance data and specifications.

Write Bob Santos, Hewlett-Packard, 620 Page Mill Road, Palo Alto, California 94304; or call him collect at (415) 321-8510. In Europe write: 54 Route des Acacias, Geneva.



SOLID STATE DEVICES

01713

NASA turned to Airco for helium and...

& reliability. To pre-cool Centaur rocket engines, Airco delivered 5,500 gallons of liquid helium. The largest single commercial delivery of helium ever made. **&** it took only 42 hours, in one of Airco's 10,000 gallon trailers, from Kansas to Cape Kennedy.

That's the way Airco works. **&** from 25 points spotted across the country. We're the number one helium supplier **&** we perform for all our customers – large **&** small. For more information write us at 150 East 42nd Street, New York, N. Y. 10017.

AIRCO
Industrial Gases



THREE WAYS TO SOLVE YOUR PHASE SHIFTING PROBLEMS

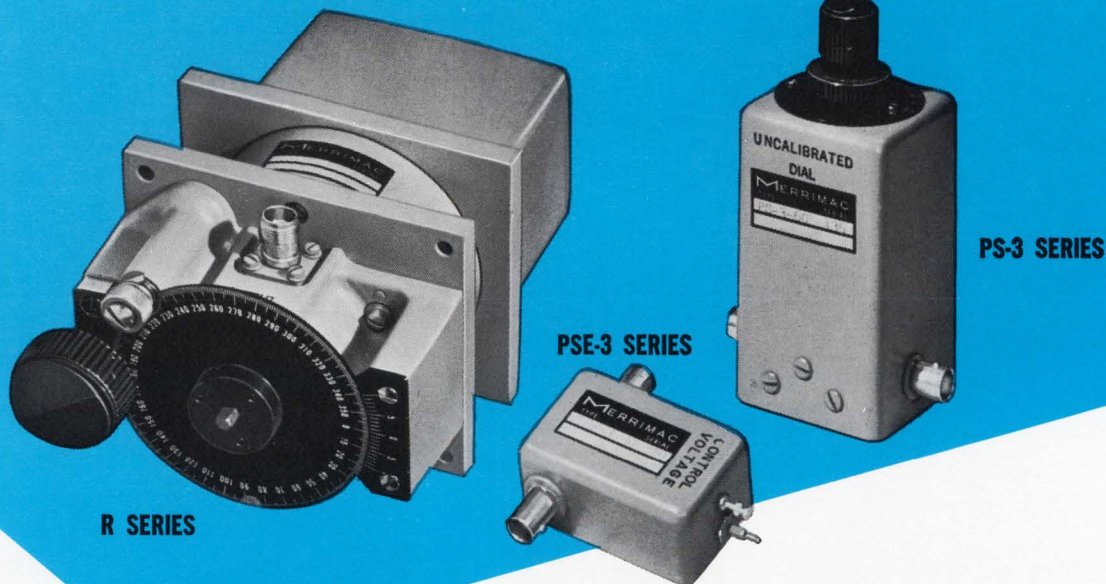

Now you can obtain three different types of continuously variable phase shifters from one source — Merrimac. These three allow you to shift phase manually, electronically, or with extreme accuracy. All take advantage of novel* lumped element circuit concepts developed originally by Merrimac.

To meet your special requirements, Merrimac can also supply **custom-engineered** phase shifters. Send us your specifications and we'll do the rest!

Write or phone for more details on both standard and custom-engineered phase shifters and other Merrimac IF, RF and microwave components.

* U.S. Patents Applied For

PS-3 SERIES

Applications: Phase trim adjustment and "line stretching".

Description: PS-3 models are manually controlled.

Specifications: Center frequencies between 1 MHz and 200 MHz, bandwidth 10%, insertion loss less than 1 db, VSWR 1.5:1 max., impedance 50 ohms, phase shift range 0° to 180° min., connectors BNC standard (others available).

PSE-3 SERIES

Applications: Antenna beam steering, automatic phase control, and phase modulation.

Description: PSE-3 models are electronically (voltage) controlled.

Specifications: Center frequencies between 1 MHz and 200 MHz, bandwidth 10%, insertion loss less than 1 db, VSWR 1.5:1 max., impedance 50 ohms, phase shift range 0° to -180° min., connectors BNC standard (others available).

R AND RA SERIES (RESOLVERS)

Applications: Precise phase measurements and control, and as a continuously variable phase standard.

Descriptions: R Series models are capable of producing precise electrical phase shifts which vary directly as the mechanical angular displacement of direct reading dial drives; RA Series models are integrated resolver amplifiers exhibiting no insertion losses.

Specifications: Single frequency in the range 500 KHz to 100 MHz, phase continuously variable 0° to 360°, rotation continuous, accuracy $\pm 0.2^\circ$, resolution $\pm 0.1^\circ$, VSWR less than 1.2:1, impedance 50 ohms (other impedances available).



MERRIMAC RESEARCH AND DEVELOPMENT, INC.

41 FAIRFIELD PLACE, WEST CALDWELL, N. J. 07006 • 201-228-3890

Small wonder:



Our new "4th-generation" 12.5 MHz universal counter/timer. Wonderful versatility in a wonderfully small package — at an even more wonderfully small price.

With the new Model 100A you can measure average frequency, frequency ratio, single period or time interval, or count total events. It has a crystal-controlled clock, Monsanto integrated circuit construction, and built-in compatibility with a rapidly growing assemblage of accessory modules.

With its \$575* price tag (accessory modules are pegged at comparably modest rates) you can have big-league counter/timer performance at

costs never before possible. Small wonder we are selling (and delivering) Model 100A's just as fast as we can build them.

Call your local Monsanto field engineering representative for full technical details, or contact us directly at: Monsanto Electronics Technical Ctr., 620 Passaic Avenue, West Caldwell, New Jersey 07006. Phone (201) 228-3800; TWX 710-734-4334.

*U.S. Price, FOB West Caldwell, New Jersey.

Monsanto
ELECTRONICS[®]

Circle 33 on reader service card

For a clear picture of Centralab...

...keep an eye on our ripples

In our years of manufacturing miniature and subminiature components, we've made many ripples, and a few splashes, in the electronics industry:

Centralab designed and produced the world's first carbon composition potentiometer and for more than 40 years has been an industry leader. In 1936 we introduced the first temperature-compensating ceramic capacitor in America. We were first to offer dual controls and to add integral line switches to variable resistors. Our exclusive  integrated circuits have been key elements in the miniaturization of electronic equipment. During World War II days Centralab developed the ceramic disc capacitor design for military requirements. And our Ultra-Kap[®] ceramic disc capacitor has replaced millions of larger, more costly devices.

Centralab sales have increased substantially every year and our services have grown proportionately. Our products are sold, by separate sales groups and from separate warehouses, to original equipment and distributor markets.

Centralab's tested and proven products include capacitors, packaged circuits, rotary switches, potentiometers and technical ceramics. In October, 1966, we erected a push button switch manufacturing plant and in May, 1967, we acquired solar devices and semiconductor facilities.

Innovation, growth and stirring the waters are nothing new at Centralab; and we don't intend to stop. As technology advances and components become smaller, more complex and more sophisticated, we'll keep our feet wet.

To help keep abreast of Centralab developments, we'll be happy to send you complete product literature.



CENTRALAB

Electronics Division
GLOBE-UNION INC.
5757 NORTH GREEN BAY AVENUE
MILWAUKEE, WISCONSIN 53201

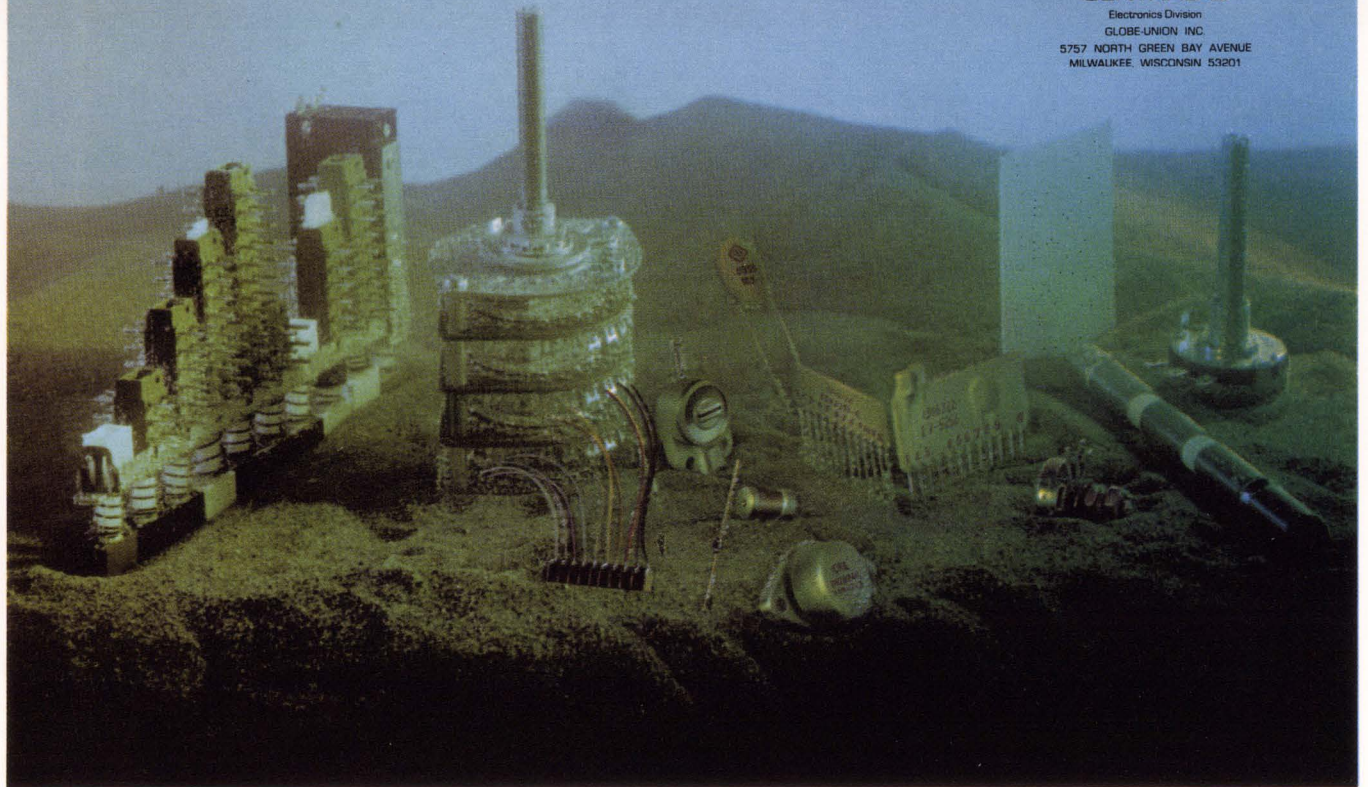

We just adopted a Korean.

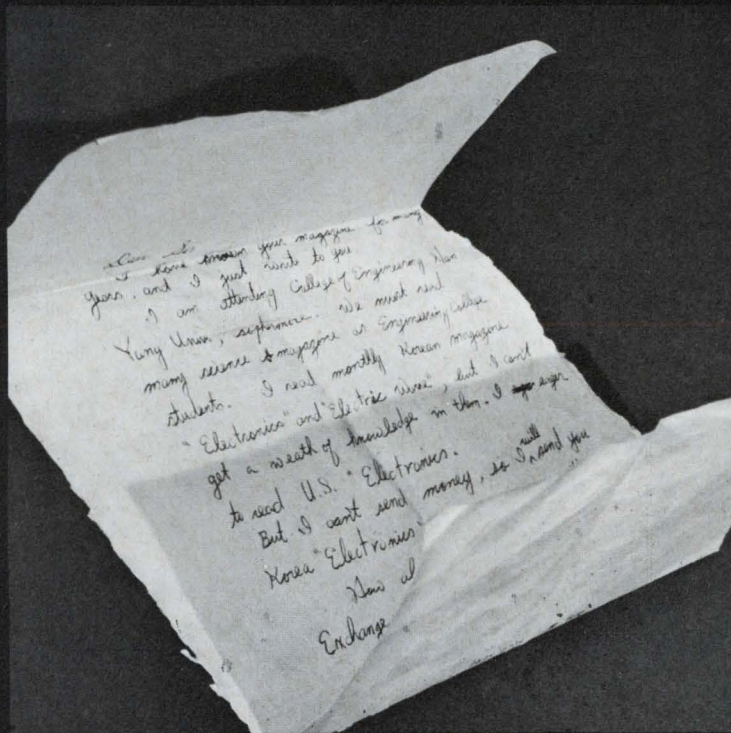

A McGraw-Hill Market Directed Publication, 330 West 42nd Street, New York, N.Y. 10036

Electronics

In a manner of speaking, that is. A few weeks ago we received this letter from a Korean engineering student:

"Dear Sir:

I have known your magazine for many years, and I just write to you.

I am attending College of Engineering, Han Yang Univ., sophomore. We must read many science magazine as engineering college students. I read monthly Korean magazine "Electronics" and "Electric Wave," but I can't get a wealth of knowledge in them. I am eager to read U.S. "Electronics."

But I can't send money, so I will send you Korean "Electronics" magazine every month.

How about you? Exchange each nation's electronics magazine.

If your answer is yes, then my happiness will know no bounds.

Waiting for your early reply, and I hope you get good health.

*Sincerely yours,
Sa Won Pang"*

So we're sending Sa Won Pang a complimentary subscription. He wouldn't be able to afford it since our \$25 overseas subscription rate works out to \$6,493.50 in Korean money.

Adding Mr. Pang won't affect our advertising rates, though. We're not listing him as a paid subscriber.

But when Mr. Pang graduates and becomes a working engineer, we just might raise our figures by 1. By then, he'll be as important as the 74,000 engineers who can't afford not to buy a subscription.



Bendix Autosyn Synchronos.

Can you afford to buy less?

Not if you need the kind of performance and reliability you get from Bendix® Autosyn® Synchronos.

And you have a wealth of types to choose from. Ultrahigh-temperature synchronos that perform accurately at sustained temperatures up to 800°F. Ultracompact (size 08), lightweight (1.3-oz.) synchronos for critically tight designs. Ultraprecise synchronos with tolerances to 50 millionths of an inch. Dependable corrosion- and radiation-

resistant synchronos. And there's a complete line of Bendix Mil-Spec synchronos, too.

AUTOSYN® SYNCHROS

| Size | Max. Diameter (In.) | Typical Weight (Oz.) | No. of Models |
|------|---------------------|----------------------|---------------|
| 08 | 0.750 | 1.3 | 16 |
| 10 | 0.937 | 1.7 | 25 |
| 11 | 1.062 | 3.2 | 29 |
| 15 | 1.437 | 4.7 | 24 |
| 22 | 2.161 | 18 | 5 |

Altogether there are hundreds of types—your largest single source. What's more, our synchro design service can promptly solve your special problems. You can depend on it. As they do at GE, Sperry, RCA, Lear Siegler, Motorola and many other value-conscious firms. Ask for our catalog today. Write: The Bendix Corporation, Flight & Engine Instrument Division, Montrose, Pa. Or phone: (717) 278-1161.

Bendix
Aerospace Products

Electronics Review

Volume 41

Number 2

Advanced technology

One-shot rainbow

When Edwin H. Hilborn, a section head at NASA's Electronics Research Center in Cambridge, Mass., was reviewing a text on cathode-ray-tube phosphors recently he found a caution that nickel contamination could ruin the linear characteristics of a phosphor by causing brightness variations. Hilborn decided to see for himself exactly what would happen and came up with a phosphor that changed color when beam currents were changed. The result: a one-gun, one-phosphor color crt.

Since then, the NASA-funded work has been continued by the ITT Industrial Laboratories division of the International Telephone & Telegraph Corp. At its current stage of development, the tube spans a color range from deep russet to pale greenish yellow. Not only that, says Hilborn, but better results are being posted daily as work continues at ITT's Fort Wayne, Ind., facility.

Target. Although full-range color presentation is the goal, NASA

might settle for less. There already are potential applications for crt's showing only two colors. Dual-beam oscilloscopes could display superimposed traces without confusion, radar scopes could show blips and alphanumeric data in separate colors, and some available computer input-output consoles could be adapted to color presentation with two character bits now used to control display brightness.

But before any of these applications become realities, ITT will have to produce a better match between the phosphor's emission spectrum and the curve of the eye's sensitivity in order to widen the apparent color spectrum and to achieve balance among the colors.

Defocusing is another problem. When beam current is changed, the beam may fan out and reduce display resolution. In a conventional color tube—with its three guns and three phosphors—the deflection circuitry is finely tuned to a given beam current; with the new tube, current must vary, making this tuning more difficult.

Crowd. Hilborn also notes that when his tube reaches the market it will find the competition waiting for it. Both Texas Instruments In-

corporated and Sylvania Electric Products Inc. are building one-gun tubes, but both so far claim only limited emission spectra—and they must use two phosphors to get that much.

In the IT tube, one phosphor is encapsulated and thus requires a higher beam voltage than its companion; changing voltage changes color. The same is true of the Sylvania tube, but instead of encapsulating one phosphor, Sylvania deposits one atop the other. Higher beam voltage allows electrons to punch through one layer to excite the other.

Though these tubes will precede Hilborn's to the market by many months, one NASA engineer feels Hilborn's current switching mode of operation will be easier to implement in displays and, perhaps, in home tv sets.

Between the lines

In another corner of Hilborn's lab, the researcher has found a way to improve television picture quality without adding bandwidth. And he found it at the movies.

Hilborn noticed that the quality of individual motion picture frames

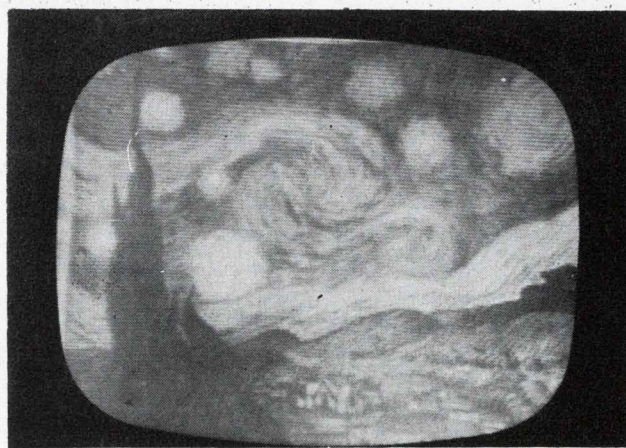
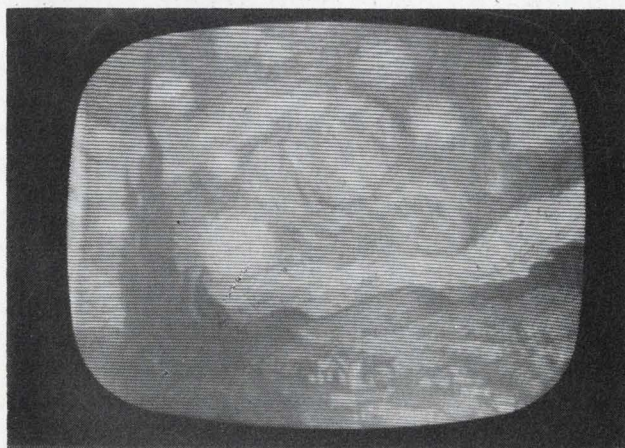

High resolution. The picture at right looks sharper than the one at left but takes no more bandwidth to transmit. The secret is a raster modification developed by two NASA scientists, Edwin H. Hilborn and Lloyd E. Stevenson.

looked worse than a moving presentation of the same material. The culprit was the film's grainy emulsion. It then occurred to Hilborn that a tv raster might be viewed as a sort of grain. But since the raster lines remained stationary from frame to frame, the eye couldn't average out the degradations as it did with motion pictures. The next step was to figure out a way to make the raster move subtly. And with aerospace technologist Lloyd E. Stevenson's help, he did so.

Circuit change. Instead of using the existing locked-phase relationship between the horizontal and vertical oscillators, Hilborn and Stevenson elected to change the phase relationship slightly at the beginning of each frame. To maintain the correct positional relationships within the image, the circuit change was made both in the camera and monitor.

By changing phase, the raster lines are raised or lowered a small fraction of their width on each successive frame. What the viewer sees is a display which fills in the blanks that formerly existed between the raster lines. Thus he sees more of the image, and his eyes can average out the grain as well.

The change to tv hardware is simple; existing equipment can be modified in any of three ways:

- A switchable delay line can be added to either the vertical or horizontal oscillators and switched in and out on successive frames.

- The ground on the vertical oscillator can be disconnected and a small bias applied there, and varied from frame to frame.

- Finally, both electrostatic and magnetic deflection could be used with one supplying normal deflection and the other the small added deflection necessary to slightly move the raster.

Raster motion. Hilborn and Stevenson rebuilt some closed-circuit tv equipment and tested it for improved intelligibility, finding that the new system gave up to 70% better readability than the standard raster for alphanumeric characters only two to four raster lines high. According to Hilborn, this occurs because the viewer sees

the whole picture every two frames rather than having to look through dark areas between raster lines, thus seeing only about half of it.

The scheme improves resolution without needing more bandwidth. It could also be applied to commercial tv without requiring changes in home tv sets. Hilborn has found it possible to gradually change the phase between the vertical and horizontal receiver oscillators in the time lost during vertical retrace. This would require a change in studio cameras and of transmitted synchronization signals. The result would be a clearer picture on your home screen.

Manufacturing

Cranking out masks

Last month the David W. Mann Co. of Burlington, Mass., came out with a computer-controlled masking camera that eliminates the drafting and subsequent photo-

reduction steps to produce integrated circuit masks [Electronics, Dec. 25, 1967, p. 41]. Now, Optomechanisms Inc. of Plainview, N.Y., has introduced a machine that not only makes masks, and with greater accuracy, but performs the step-and-repeat operations as well. But these advantages don't come cheaply. The Optomechanisms machine is nearly twice the price of a complete Mann unit—which costs \$130,000.

However, Optomechanisms may not have to worry about customers. Bell Telephone Laboratories in Allentown, Pa., is already evaluating the machine for the Bell System's manufacturing arm, Western Electric Co., one of the world's largest producers of semiconductor devices.

Although both machines directly generate masks of 10 times actual size, the Optomechanisms machine's ability to perform the step-and-repeat functions make it especially useful in producing large-scale integrated circuits. It also achieves a positional accuracy within ± 10 millionths of an inch,

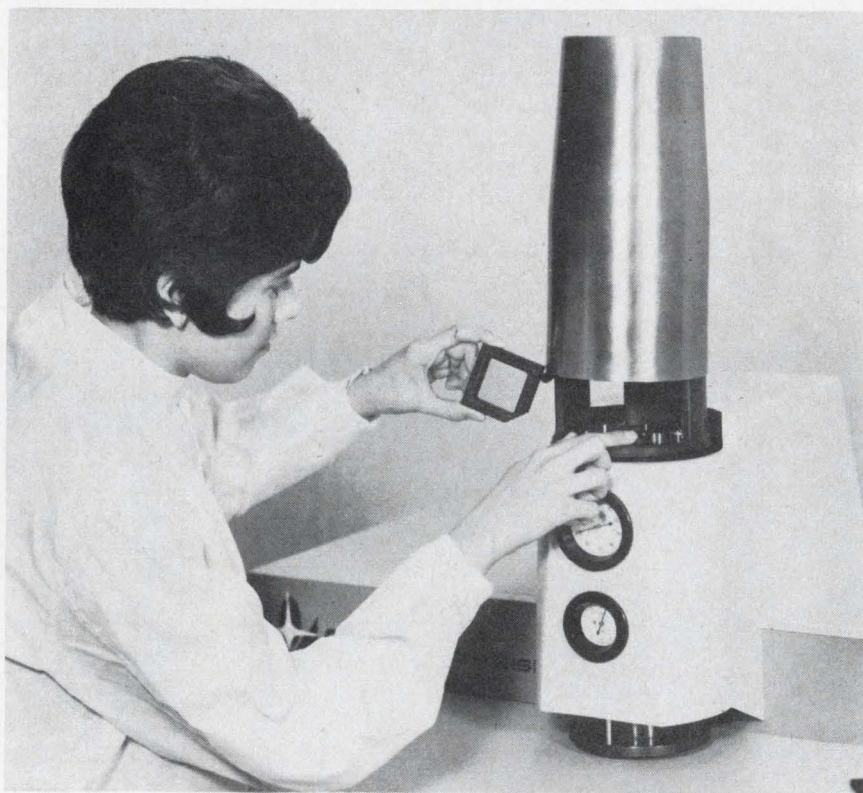

Step it up. Master mask for LSI is placed in Optomechanisms' computerized artwork generator, which also does step-and-repeat work.

compared with ± 40 millionths to ± 50 millionths of an inch for the Mann machine and ± 80 millionths of an inch for manual mask-making.

Key to accuracy. The key to the Optomechanisms system's accuracy is the use of an interferometer to precisely position the components of the mask. Instead of using an absolute scale, as the Mann unit does, the Optomechanisms machine counts the interference fringes between a light source and its reflection to position the mask's component lines.

A mercury lamp is the light source for the interferometer. According to Roland C.M. Beeh, director of research for the firm, the light, after passing through a bandpass filter, is coherent enough for the small distances involved—a maximum of 4 inches in each direction. Although comparable accuracy can be achieved using a laser as the light source [Electronics, Aug. 7, 1967, p. 119], "it wouldn't yield enough additional accuracy in this system to make it worth the problems associated with designing it into the system," says Beeh.

The Optomechanisms positioning system and camera flasher are under the control of a PDP-8/s general-purpose computer. Digital outputs from the x and y axis of the interferometer are compared with instructions programed into the computer.

Avionics

Getting the picture . . .

Electronics technology is about to give pilots better eyes in the dark. Two and a half years ago the Air Force, which has been looking for ways to fly more Vietnam reconnaissance and bombing missions at night, sought bids for a system-wide study of low-light-level television. In 1966 a \$1.2 million contract was awarded to North American Rockwell Corp.'s Autonetics division in Anaheim, Calif., to study the fast-developing field of elec-

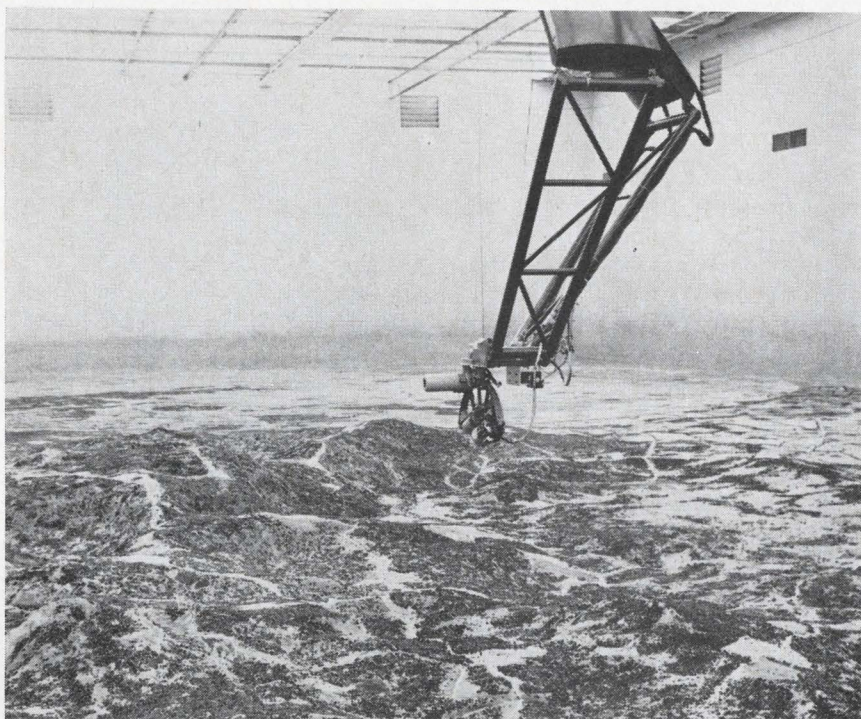

Wide blue yonder. Autonetics makes use of a tv camera transport assembly and terrain model in its study of image-intensifying electronic devices.

tronic devices that intensify images.

Autonetics will complete the study in October and present its findings to the Air Force. Hardware recommendations will include a total sensor package, the video processing package, and the display equipment. However, no money has been allocated yet for hardware.

Simulation. The study involves three phases of testing. The first phase, dynamic simulation, concentrated primarily on display, camera angle, and other components. Variables included video bandwidths of 4, 15, and 25 megahertz; vertical raster scan lines of 525, 729, and 1,029; camera-pointing angles from oblique to nadir; and frame integration times of 1/60, 1/150, and 1/300.

This phase also concentrated on aircraft velocity-height ratios for apparent motion of targets from an aircraft; square, flat, and long display aspect ratios; camera fields of view from 48, 26, and 18 degrees; varying display contrasts; and signal-to-noise ratios ranging from 0 to 40 decibels.

The second phase, now under way, concentrates on different

types of missions. For this phase, which imposes a heavier load of assignments on the pilot, the testing was transferred from Anaheim to North American Rockwell's Columbus, Ohio, division, which has a movable full-scale cockpit.

On the ground. In this phase a model terrain, built on a 3,000-to-1 scale, is scanned by cameras mounted on a mobile overhead rig. Illumination is reduced in the standard closed-circuit tv systems by neutral density filters and video processing. A Honeywell 3-C digital computer and an Electronics Associates Inc. analog computer are used to simulate aircraft flight paths; control and the many imposed variables—camera angle, gust motions, speed, and altitude; and are used to store information by data reduction.

Thus far it has been found that interference, or "snow," apparently does not impair a pilot's ability to recognize targets as much as had been anticipated: the number of scan lines have little effect on a pilot's night vision; too much speed or too low an altitude limits a pilot's ability to react quickly enough to stay on target; and types of targets and their relationships

to other identifiable markers often govern the effectiveness of the low-light-level tv system.

Autonetics has considered various sizes and shapes of displays, not only on a cockpit console but also a head-up display and a helmet-mounted display. The latter, with trichoc glass, resembles flip-down eyeglasses and eventually could be built so that the pilot's head movement would directly control the camera viewer.

The last test phase, due to begin soon, will evaluate types of sensor tubes. Purchased for this phase were image orthicon tubes from General Electric, vidicon tubes from Radio Corp. of America, secondary electron conduction vidicon tubes from Westinghouse, and image intensifiers, both single and triple stage, from Machlett Laboratories Inc. Also purchased was a Westinghouse camera system built specially to be compatible with all three types of sensor tubes.

... and reacting faster

Even pilots with above-average reflexes are too slow for the control systems on today's aircraft. Reacting at top speed, a pilot can take from a tenth to half a second just to push a button—and that's not fast enough.

The solution, according to Dunlap & Associates Inc. of Santa Monica, Calif., is to get as much of the pilot out of the control loop as possible. A team of four engineers, headed by M. J. Wargo, wants to replace toggles, push buttons, or other on-off switches with what it calls MAP, for muscle action potential.

Dunlap's MAP uses sensors in a neoprene mask that straps on in the same manner as the pre-jet era leather flight helmet. The electrodes touch the cheek, picking up weak voltages that are transmitted from the brain to the jaw muscles. Instead of flipping a switch, a pilot tenses his jaw muscles to initiate the first 125 milliseconds or so of a sequence. By following through with a hand control, the pilot continues the operation. This serves to make



Sensitive. Helmet with electrodes picks up weak voltages transmitted from the brain to jaw muscles. The system cuts a pilot's reaction time.

his response safe as well as fast.

Time saver. Since the MAP pickups are so close to the brain, transmission time is minimized. Also, since MAP senses muscle control signals, not the movements of the muscles themselves, the time wasted in muscular contractions is saved, too.

To test MAP with eye and ear inputs, the group built a control display device to which a MAP helmet and a pair of earphones were connected. On the front panel was a cathode-ray tube showing a dot of light; it was the test subject's task to keep the dot from moving sideways.

The scope was the subject's visual input; the earphones supplied an audible indication for dot movement with a rising or falling tone. In comparison tests using a microswitch, a joystick, and a pressure sensor-strain gauge switch, a subject using MAP proved faster than his counterpart without MAP. The fastest time using the microswitch without MAP was 234.4 sec. But the MAP-equipped subject reacted in only 150 msec.

The work was funded by NASA's Electronics Research Center in Cambridge, Mass. The next step would be in-flight testing, but money has run out and no funds for MAP were included in NASA's fiscal 1969 budget.

Commercial electronics

See the sea

A small boat traveling at 50 knots in the open ocean might pose seasickness problems for even the most hardened salts. Passengers would probably be green in no time if there were no way to keep the craft on an even keel—or foil, as is the case with the 88-passenger hydrofoil Dolphin, recently introduced to passenger service in the Canary Islands.

The Dolphin is designed by Grumman Aircraft Engineering Corp., Bethpage, N.Y., and built in Germany by Blohm & Voss AG. It's sold by the Garrett Corp. of Los Angeles and operated by Maritima Antares, S.A., Spain. Besides selling the craft, Garrett's Ai-Research Manufacturing Co. makes the Hydropilot attitude control system, which, in effect, levels out the swells the boat encounters by keeping it "flying" at a given height above the surface. This contributes to the passengers' comfort and prevents the craft from plunging into a swell or rising out of the water. The boat has already negotiated 14-foot swells in trial runs with no ill effects reported by the various contractor representatives aboard.

Sea legs. The most sophisticated sensor in the Hydropilot, says Ai-Research project engineer Richard Barcus, is a pulsed sonic height sensor that measures the boat's height above the surface when it is perched on its three hydrofoils—two forward and one aft. The height sensor is made by American Bosch Arma Corp. It consists of a transmit horn and a receive horn recessed into the hull in two dimples in the bow, plus a computer to calculate the time lapse between signal transmission and reception. The height sensor has a pulse repetition rate of 20 hertz and a pulse duration of about 1 millisecond, says Barcus.

There also are two heavy accelerometers made by Genisco Technology Corp.; a Lear Siegler Inc. vertical gyroscope that sup-

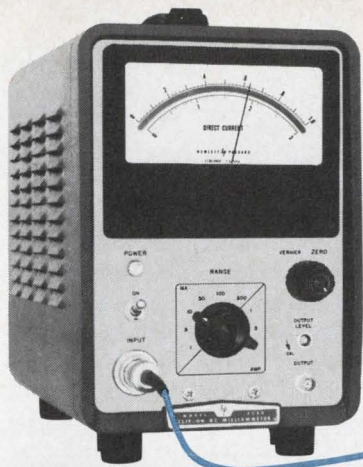

CLIP-ON CURRENT PROBE SPEEDS PRODUCTION

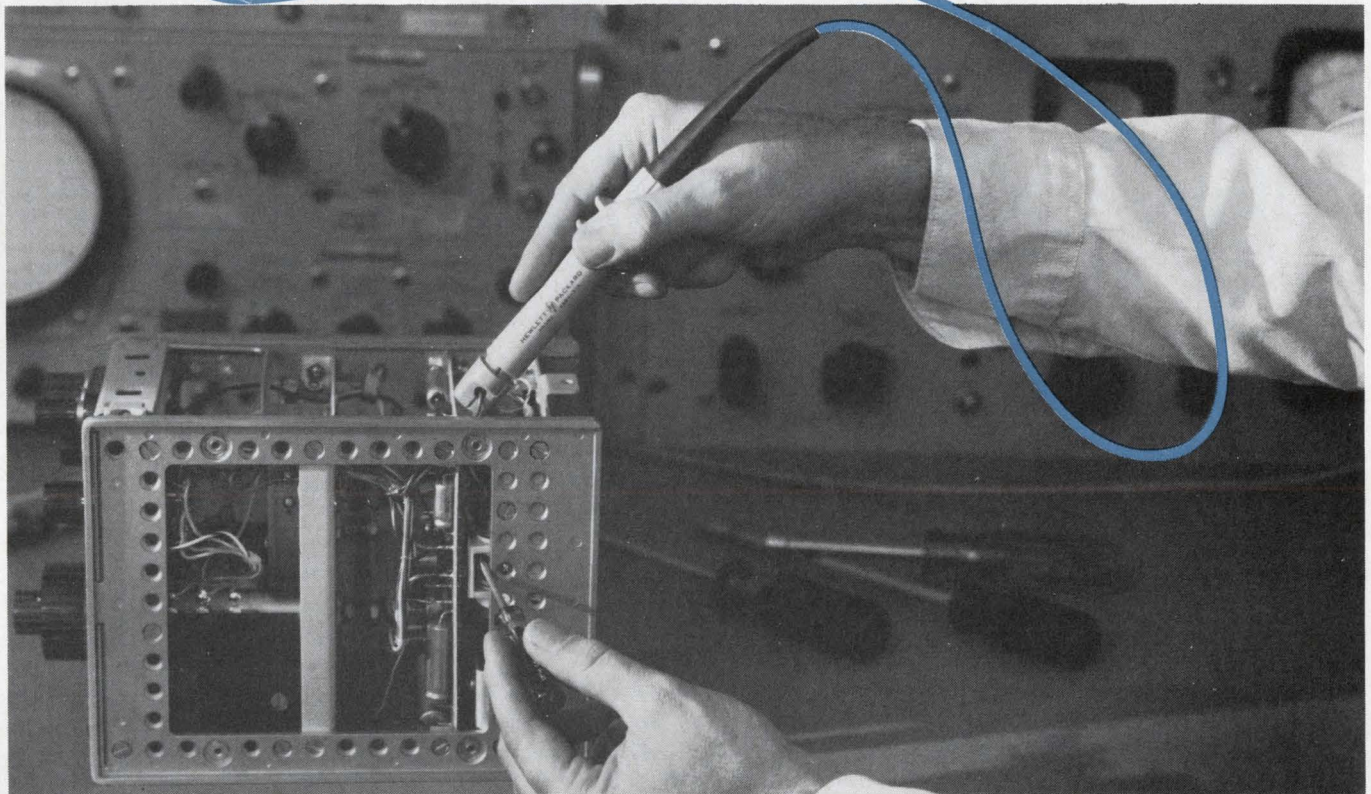

With hp's clip-on milliammeter, measure direct current from 0.01 milliamp to 10 amps—without interrupting circuits and without error-producing loading. The hp 428B probe clips around the circuit wire being measured and provides a reading proportional to the magnetic field caused by the dc current flow. It is particularly useful in measuring battery drain and charging currents of portable-type electronic gear.

No more production slow-downs to cut and resolder wires, no more guessing about the loading caused by other current measuring techniques. You get a direct reading of the actual current flow, quickly and accurately, and go on to the next step.

Easily measures sums or differences of current in separate wires passing through the probe. Accuracy $\pm 3\%$ of fs, ± 0.1 mA, with full-scale ranges from 1 mA to 10 A. Output voltage is available to measure fre-

quency dc to 400 Hz current measurements with scope or recorder. Price: hp 428B, \$600 (cabinet); hp 428BR, \$605 (rack mount).

Accessories include 3528A Current Probe to measure conductors up to $2\frac{1}{2}$ " diameter, with degausser, \$450. Magnetometer probe, hp 3529A, \$75, gives 1:1 ampere conversion to gauss—1 milligauss to 10 gauss.

For the complete production-savings story on the hp 428B Clip-on Milliammeter, call your hp field engineer. Or write to Hewlett-Packard, Palo Alto, California 94304. Europe: 54 Route des Acacias, Geneva.

097/21

HEWLETT  PACKARD

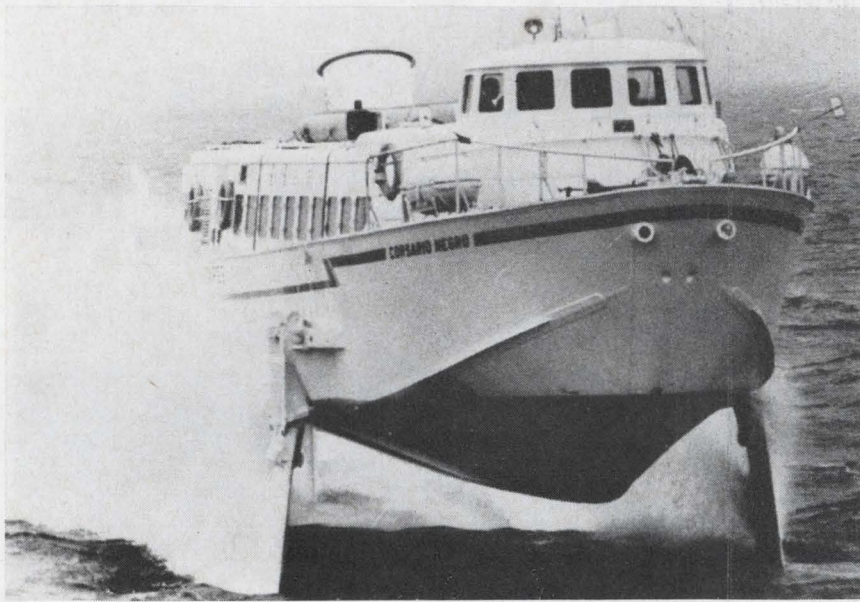

Over seas. The Dolphin-class hydrofoil on which two small dimples below the headlights house transmit and receive horns for sonic height sensor.

plies both pitch and roll angle of the boat; a roll rate gyro and a pitch rate gyro, both furnished by Lear Seigler; and a Genisco lateral accelerometer for turn coordination.

The Dolphin's operator can select any of four modes on a control panel in the wheelhouse: standby, takeoff, cruise, or landing. In the standby mode, with the foils deployed, he can actuate a self-test sequence in the computer that generates condition reports on six indicators—two for attitude, one for height, and three showing the angle of each foil.

Equally separate. If the test does not produce preset readouts on the six indicators, the pilot can tell which computer channel is not functioning properly because the modular design effectively isolates the function of each of the 11 boards in the computer: for each of the foils, height and heave, filter, roll channel, pitch channel, and four smaller ones for the heave, height, roll, and pitch filters. The last card contains the self-test and warning system logic.

The pilot then switches to the takeoff mode, selects the height to which he would like to fly, and the hydrofoil will control the lift to that height. He then goes to the cruise mode, and finally the landing

mode, dialing in the height desired for each.

In, not over. The Dolphin is a submerged foil boat, as opposed to a surface-piercing hydrofoil. The submerged foils allow the craft to negotiate rougher seas, but the craft couldn't fly without a Hydro-pilot foil control system. Says Barcus: "There are strong subsurface currents, and the foils have to be continuously corrected during flight. They're moving between 2° and 4° at a rate of about .5 hertz to compensate for orbital disturbances in the waves."

Contracts

Watchdog at bay

The Government's Renegotiation Board is under industry attack again but it can't understand why. In fact, the board claims that firms opposing its continued existence are the very ones that stand to lose the most from its demise.

The issue is timely. The board's charter will expire June 30 unless Congress acts to extend it. A few months back, the board's future looked bleak [Electronics, Aug. 21, 1967, p. 60], but sentiment is now

building to keep it around.

Though the board was set up to protect taxpayers from "war profiteers" and others who would overcharge on Government contracts, its current critics are mostly legitimate Government contractors and their Washington lobbyists.

Wolf's clothing. The board contends that its operations actually protect industry's "good guy" image. A contractor wrongly accused of making excess profits at taxpayer expense can be cleared by a board investigation; on the other hand, the agency, as it's now constituted, can do little harm to a contractor's reputation.

But industry representatives don't see it that way. Though they cite no figures, they argue that it costs more to comply with the provisions of the Renegotiation Act than is ever reclaimed by the Government in excess profits. They also point out that there's no guarantee future boards will be as fairly run as the present one.

Rep. Henry B. Gonzalez, a liberal Texas Democrat, is the leading Congressional backer of the board. Beyond just extending its charter, Gonzalez wants to make the board a permanent Federal agency with wider powers. He claims that Vietnam war spending makes the board more necessary than it ever was.

More teeth. The board currently can reclaim money only from companies doing more than \$1 million annual business with the Government. Gonzalez wants this minimum lowered to \$250,000, but he would probably settle for a \$500,000 floor. He would also like to see the panel empowered to pass on the standard or catalogue products—items now exempt from investigation.

President Johnson's position on all this is still uncertain, but he's expected to support an extension of the board's charter. In 1966, his request for a six-year extension was overruled; aerospace and electronics lobbies were instrumental in holding the board's lease on life to two years. The Electronic Industries Association was among the more vocal critics, describing the board as "wrong in principle as

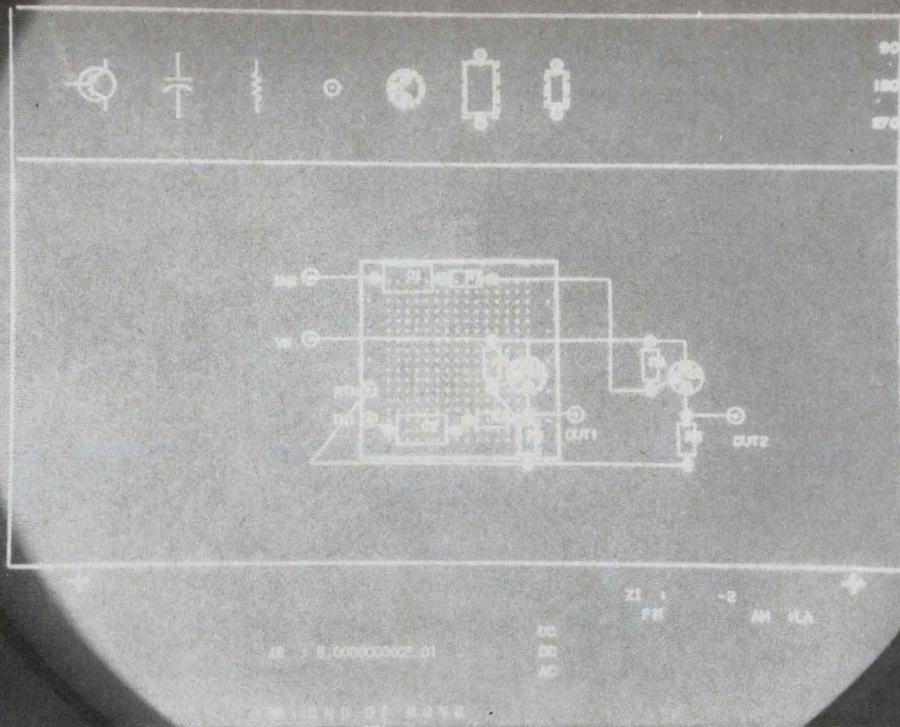

Readouts clear up problems.

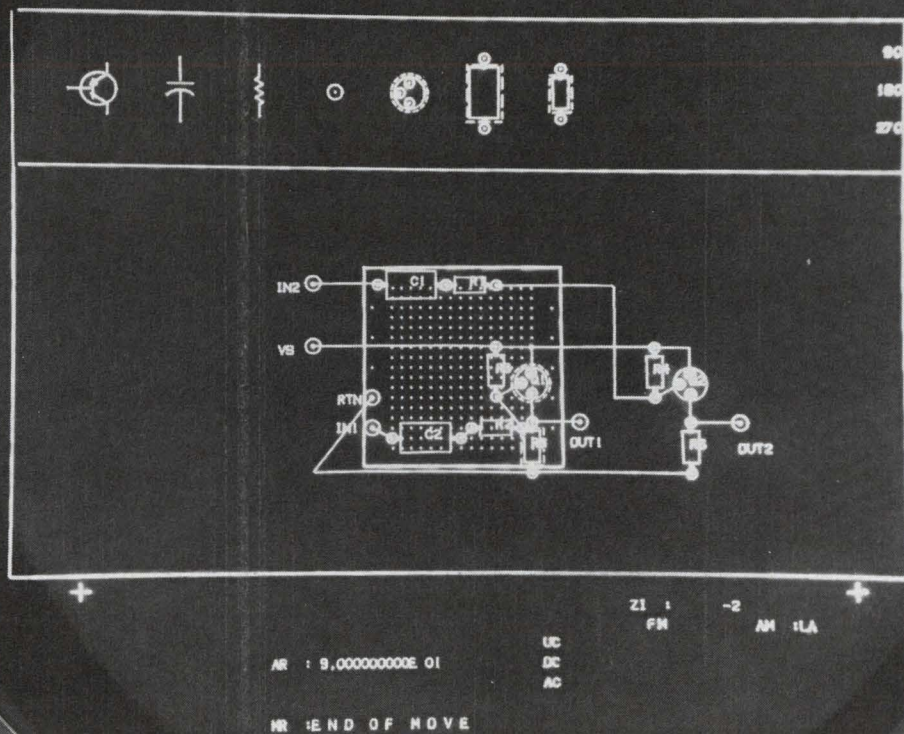

Polaroid circular polarizers clear up readouts.

Reading readouts is never a problem—if they're equipped with Polaroid circular polarizers.

Our polarizers improve readability from every angle by increasing contrast. In daylight. Or even in

brightly lighted rooms.

But now you don't have to take our word for it. Send for our new brochure, and we'll include a sample circular polarizer. It will help you see very clearly why many major display

and instrument manufacturers are now using Polaroid circular polarizers.

Write Polaroid Corporation, Polarizer Sales, Department 59, Cambridge, Massachusetts 02139.

Polaroid Circular Polarizers.

well as unnecessary and wasteful in practice.”

Loose reins. This sort of opposition is prompted, in large measure, by suspicion of the panel's discretionary powers. But the board's chairman, Lawrence E. Hartwig, argues that his agency has to have some elbow room when making “determinations of excessive profits.” The board often overlooks excess profits on one contract, for example, if the same contractor is taking a loss on another.

Hartwig contends that industry can't have it both ways. If discretionary powers were lifted, he says, the board couldn't take compensating factors into account.

If a company feels it's being judged unfairly it can appeal to the tax courts. Since the board was set up in 1952, 142 of its decisions have been appealed, mostly without success.

The vast majority of the cases are never taken to court. In fiscal 1967, the board made 18 determinations of excessive profits totaling \$15.9 million. Two were appealed and both are still pending.

But the most impressive figures the board can cite in its own behalf are those on voluntary refunds and price reductions by contractors. The total was \$30.3 million in fiscal 1967.

Integrated electronics

Beating the heat

Q. What's keeping the linear integrated circuit from being an even bigger commercial success than it already is?

A. It can't handle more than a watt or two.

Aware of this, engineers at the General Electric Co.'s Semiconductor division in Syracuse, N.Y., decided that the easiest way to boost power is to have the IC dissipate more of the heat that builds up.

The GE engineers took the company's familiar plastic flatpack, and substituted a T-shaped heat sink for the single-tab dissipator.

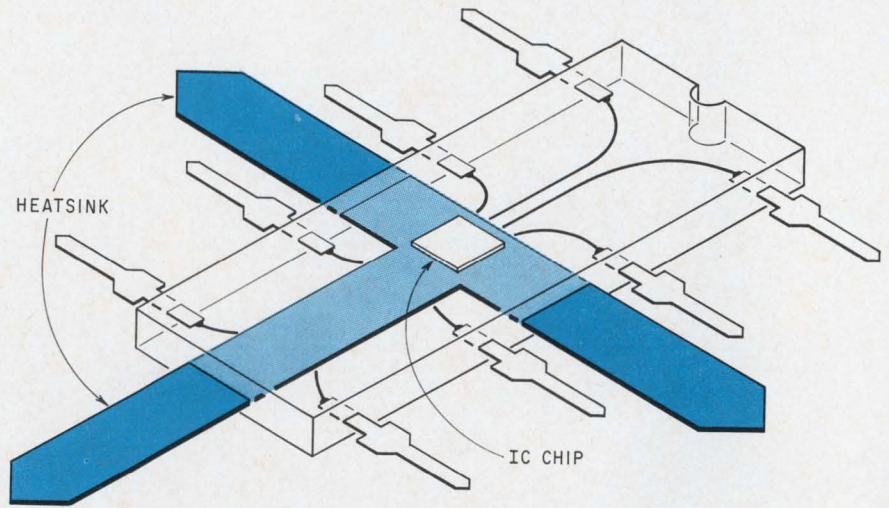

Teeing up. T-shaped heat sink for monolithic IC's triples power-handling capabilities without new or redesigned chips.

Result: without any significant design changes, save for the heat sink, an amplifier circuit's power-handling ability was tripled to 6 watts.

Setting the stage. The immediate market for these triple-tab devices is in such consumer items as audio amplifiers, says GE. In fact in 1966, when the company first designed its linear IC's for consumer applications, it was so sure it would take the heat-sink approach to boost power that it packed enough elements on the IC chip to handle a 6-watt load. Now, the same chip can be dropped into a slot in the new heat-sink arrangement and the unit can be encapsulated in the familiar plastic package.

The company plans to market such a 6-watt audio amplifier with a triple-tab feature shortly.

Isolated success

Back in 1965, as linear integrated circuits were just beginning to move from drawing board to production line, a technique called dielectric isolation was being heralded as the way to achieve IC characteristics comparable to those of discrete circuits. Since then, however, though linear IC's have made it big, dielectric isolation has been used for only a few of them.

Now the Microelectronics division of Radiation Inc., a subsidiary of the Harris-Intertype Corp., has

applied the technique in developing a linear IC operational amplifier it says has across-the-board electrical parameters superior to those of existing IC op amps. Moreover, the device, called the RA-909, requires no external frequency-compensation networks.

Radiation Inc. believes the circuit, priced competitively with standard isolated units, will vindicate dielectric isolation. In this belief, the company has taken dead aim at the king of the hill, Fairchild Semiconductor's μ A709, by designing the 909 as a pin-for-pin replacement.

Road from Rome. The work that led to the new op amp started in 1965 when Radiation received a contract from the Air Force's Rome, N.Y., Air Development Center to develop dielectrically isolated IC's. The devices were to have, compared with existing p-n junction isolated IC's, lower capacitances and leakage, higher breakdown voltages and radiation resistance, immunity to latchup destruction, and superior gain-bandwidth and power-speed products. Also sought was a greater diversity of semiconductor element, plus a potential for npn and pnp transistors having equal quality.

Work went slowly at first. Dielectric isolation proved to be more costly and difficult than p-n isolation, requiring extra diffusion steps, higher-quality crystalline materials, and high-resolution masking. But



Tomorrow's breed

μ -COMP DDP-516 is the most advanced I/C 16-bit compact now available. Hardware includes 4096-word memory (expandable to 32K), 960 nsec cycle time, 72 instructions, and optional high-speed multiply and divide — just a few of the basic hardware specs.

Software? 250 field-proven programs are available, including ASA FORTRAN IV compiler, assembler with DESECTORIZING loader that lets you ignore memory restrictions, and OLERT (on-line executive for real time).

If you don't require this full capability, you can get the DDP-416 (at considerable savings, too). For more details on a "tomorrow machine" today, write Honeywell, Computer Control Division, Old Connecticut Path, Framingham, Massachusetts 01701.

Honeywell

 **COMPUTER CONTROL**
DIVISION

Circle 45 on reader service card

persistence paid off—in this case, anyway.

Inside story. The 909 has 13 npn transistors and 100 kilohms of resistance, including six high-quality, vertically oriented pnp transistors. According to one Radiation engineer, it has “higher voltage and current capability, wider common-mode range, higher slew rate, lower noise, less power dissipation, and greater stability than competitive op amps—in particular Fairchild’s 709 and National Semiconductor’s LM101.”

The device features a ± 17 -volts output into a 1-kilohm load, a ± 13 -volt common-mode range, a 5-volt per μsec slew rate, 5 μV equivalent input noise, 52 milliwatts of nominal power dissipation, and 40-nano-second rise time. Frequency compensation is provided by an extra internal stage containing a single break point for the proper rolloff.

Rated for operation between -55°C and $+125^\circ\text{C}$, the 909 is priced at under \$40—about the same as premium op amps. It’s available off the shelf this week.

Solid state

Small-scale LSI

Large-scale integration is paradoxical. Because it combines many functions on one semiconductor chip, LSI promises low cost. But because it tends to increase the number of different types of chips and reduce the quantity of each, LSI’s cost tends to remain high.

Nevertheless, engineers at the International Business Machines Corp.’s laboratory in Endicott, N.Y., say the technique can be economical for a group of small machines using the same basic design concept. Their approach calls for the specifications of a series of machines to be defined so that large portions of each model are identical.

Trying it out. To demonstrate the validity of this approach, the IBM engineers built—on an experimental basis—a small data recorder and a specialized accounting machine

that banks use. A small calculator and a calculating terminal for a phone line have been designed on paper.

The paradox is particularly vexing when it comes to these types of machines. Their size and speed call for a design that lends itself to serial data flow and direct logic control, both of which are difficult to attain with LSI. With the IBM approach, the common area is designed using LSI, incorporating provision for registers that differ in number and length, addressing schemes that differ, and so on in the various models.

Says C.S. Gurski, a member of the IBM team: “Include commonality in your basic definition of the series. You are going to get into trouble if you try to force commonality onto a group of machines that really aren’t similar, just so you can use LSI.”

Gurski and other investigators plan to report details of the new approach at the three-day International Solid State Circuits Conference, which opens in Philadelphia, Feb. 14.



Strike. Bowler inserts scorecard into Brunswick’s computerized automatic scorer, which tallies, prints, and then projects score on a screen.

Consumer electronics

Pin money

Back in the 1950’s, the introduction of automatic pinsetters revolutionized bowling and the sport’s popularity mushroomed. Once a game only men played, it almost overnight became an attraction for the entire family. But in recent years, bowling’s fortunes have sagged sharply. Now, manufacturers of bowling equipment are trying to sell operators of bowling alleys on the idea of computerized scoring systems as a means of reversing the trend.

What with strikes and spares, argue the manufacturers, keeping a running tally in frames tends to confuse and discourage neophyte bowlers. Automatic scoring, they say, could create a new generation of bowlers clamoring to be admitted to the alleys.

Two for the money. The biggest boosters of computerized scoring are the Brunswick Corp. and Doban Labs Inc., recently acquired by the Itek Corp. And for good reason. Both are already marketing such systems, based on digital computers. Brunswick introduced its system last October, and a month later Doban came out with its version.

Brunswick has an added incentive. Its fortunes go hand in hand with bowling since it owns a nationwide chain of bowling alleys operated under a franchise arrangement.

To detect pins left standing, Brunswick uses the pinsetter deck as a sensor and Doban uses sensors within the pin area, which is scanned by a light beam. The sensors feed data—in this case, the number of remaining pins—to the computer.

In the Brunswick system, the computer—covering four lanes—is located behind the bowling area to print out scores and project them on screens at each lane. Each bowler identifies himself to the computer by moving a lever on a subsystem to his assigned number. These subsystems are at each ball rack—one for two lanes—and have

FETS FOR DIFF AMPS

A matched FET pair and a constant current diode...

... combined with 2 resistors will produce a high-performance differential amplifier.

The 2N5196 - 99 series of matched FETs in one package offers tracking from $5 \mu\text{V}/^\circ\text{C}$... offset as low as 5 mV ... input current below 15 pA. With four tracking and drift specs, one should fit your cost/performance goals.

Standard current-limiter diodes have nominal operating currents between $220 \mu\text{A}$ and 4.7 mA. There are many other uses for CL diodes besides replacing the load resistor in the diff amp circuit ... try one wherever you need a constant current source.

Want data sheets and circuits?
Contact us.

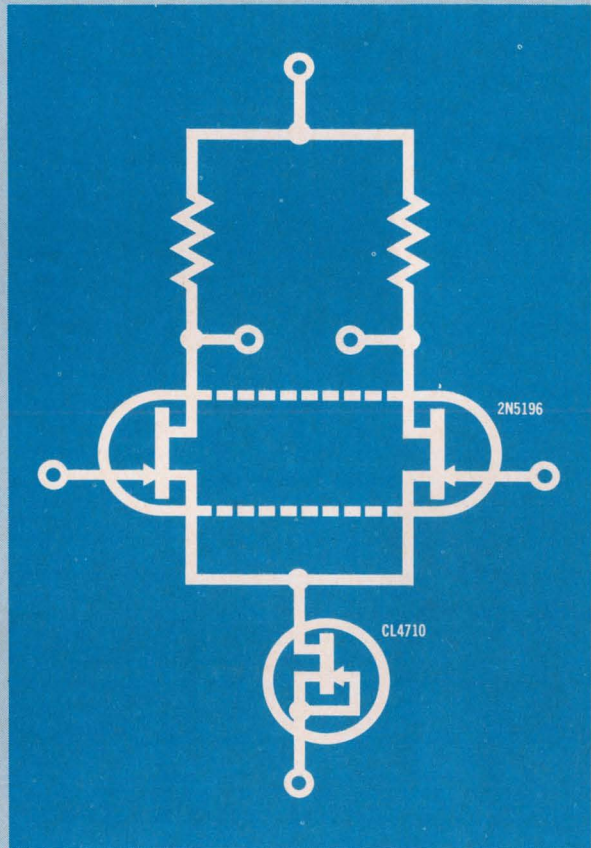

DESIGNER KITS

DK-5 Complete range of nine CL diodes plus application data at ... [\$29.95.]
DK-7 Four matched FETs — one each of the 2N5196 - 99 series and two CL diodes at ... [\$84.50.]
Both in stock at any of our franchised distributors.

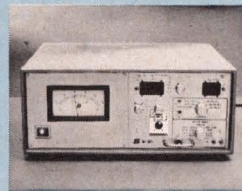
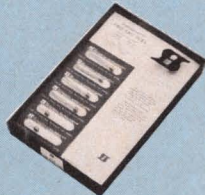

NEW LOW COST FET TESTER

The S1200 Semiconductor Tester features plug-ins for expandable test capability, simplicity of operation, and low cost.

Price: S1200 Tester ... \$960.
Price: S1201 (DC & g_{fs}) Plug in Module ... \$1335.



Siliconix incorporated

1140 W. Evelyn Ave. • Sunnyvale, CA 94086
Phone (408) 245-1000 • TWX: 910-339-9216

provisions for six bowlers per lane.

The Doban system's computer, covering two lanes, is placed in the space usually occupied by a conventional scoring table. Bowlers identify themselves to the computer by pressing their assigned buttons on the machine's control panel.

Hard sell. Thus far, Brunswick has installed its system in one bowling alley that it owns in Chicago. However, the company says it has sold eight systems for a 32-lane alley in Buena Park, Calif. Each four-lane system is priced at \$12,000. Brunswick also plans long-term leasing deals at 5 cents a line.

Doban, which is selling each two-lane system for about \$4,600, has also installed its equipment in one bowling alley, in El Cerrito, Calif. The firm says it already has orders for 200 more.

Government

Hit the dirt!

When it comes under fire, the ponderous Pentagon can move like a bushwacked paratrooper. Consider its reaction to Sen. William Proxmire's blast at the Defense Department's system of providing Government-owned machinery to private contractors. Almost within minutes, the brass were in defensive positions and laying down covering fire. The system, said assistant Defense Secretary Thomas Morris, is designed to save the taxpayers' money.

Morris was responding to the naming by Proxmire (D., Wis.), chairman of the Joint Economic Committee, of 21 companies and two university laboratories cited in a General Accounting Office report on misuse of Government-owned property [Electronics, Jan. 8; p. 48]. Among the firms in the electronics and aerospace fields were: the Aerojet General Corp., the Bendix Aerospace division, the Boeing Co., the Beech Aircraft Corp., the Raytheon Co., the Continental Aviation & Engineering Corp., the Sperry Gyroscope Co.,

the Sikorsky Aircraft division of the United Aircraft Corp., TRW Inc., and the Wright Aeronautical division of the Curtiss-Wright Corp.

The Pentagon couldn't help but acknowledge the validity of some of the GAO's complaints. Moving fast to deny its critics the opportunity of further potshots, it ordered that:

- Contractors be required to keep better records of their utilization of Government equipment, perhaps on a machine-by-machine basis;

- Contractors be required to do a better job of reporting excess machinery to the Government;

- Limits be set on the amount of equipment that can be used for commercial work without advance Government approval;

- Rental charges be examined and possibly revised.

Sen. Proxmire, who charges the Pentagon with lax administration, says the firms named are "no better and no worse" than the 5,500 other defense contractors holding Government-owned property. He put the total value of the equipment in question at \$15 billion.

For the record

Making memories. Honeywell Inc. will soon introduce a memory disk pack that uses chromium dioxide coatings, the magnetic tape coating that was developed last year by the DuPont Co. [Electronics, June 26, 1967, p. 56]. This month, Honeywell's Electronic Data Processing division introduced its first memory disk pack, using magnetic tape coated with the conventional iron oxide. The chromium dioxide coating is called Crolan by DuPont.

Elmer C. Simmons, the division's senior principal engineer, says the bit-packing densities possible with iron-oxide coatings are good enough for today's disk drives, "but as disk memories with faster bit rates appear, chrome is going to become more attractive and probably necessary."

Negotiations. The Sperry Rand Corp. is apparently getting out of the semiconductor business. Last April, the company sold its discrete-device operation to Solitron Devices Inc. of Tappan, N.Y. Now, Sperry is negotiating to sell the rest of its Semiconductor division in Norwalk, Conn., to Instrument Systems Corp. of Huntington, N.Y., for more than \$5 million.

Spread the wealth. The Pentagon has allocated roughly \$20 million to Project Themis, which spreads research dollars among universities not accustomed to getting defense grants. Although the Pentagon's total research expenditure of \$200 million is expected to be kept at the same level next year, Themis' share will probably climb by as much as \$7 million.

Success. Two and a half years ago many scientists wondered whether the Surveyor unmanned space program would ever amount to much. The halls of Congress echoed with criticism of the project, which was more than two years behind schedule and was spending money at a rate expected to total five times original estimates. But Hughes Aircraft Co., the builder, and Jet Propulsion Laboratory, the manager, surprised the doubters.

Last week Surveyor 7's spectacular performance capped a program that chalked up five out of seven successful missions. Given only a 40% chance of success by its managers, Surveyor 7 made a difficult landing on the rugged lunar crater Tycho. And 48 hours after touchdown, the craft, having dislodged a pebble that was preventing the operation of its soil-collecting box, was successfully running through all of its experiments.

On the outs. The marketing man who is credited with leading Zenith Radio Corp. to record sales suddenly resigned, Leonard C. Truesdell, executive vice president in charge of marketing and president of Zenith Sales Corp., left under mysterious circumstances. According to Zenith's president, Joseph S. Wright, "This matter is being checked out very carefully. Until all the facts have been determined, we are not in a position to comment."

DON'T SPEC A SINGLE TURN UNTIL YOU'VE SEEN THE SIX NEW CONDUCTIVE PLASTIC INFINITRON® ELEMENT PRECISION POTENTIOMETERS FROM BOURNS

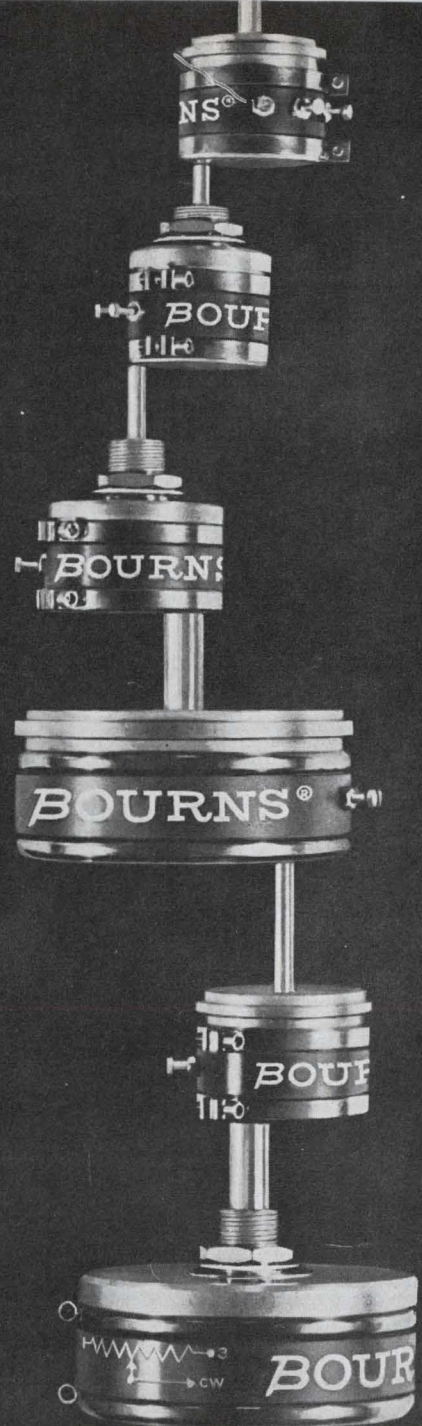
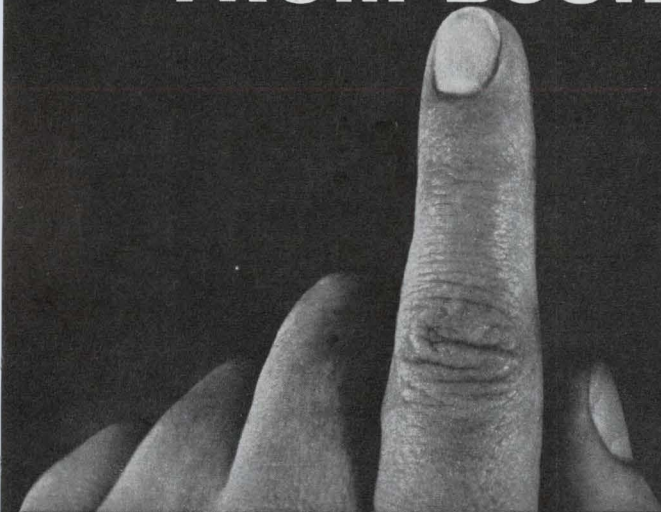

The new Bourns units are available in $\frac{7}{8}$ ", $1\frac{1}{16}$ " and 2" diameters with either bushing or servo-mount lids. Standard linearity is 0.5% with special linearities on request. Rotational life of the new conductive plastic units is 50,000,000 shaft revolutions and temperature range is -55°C to $+125^{\circ}\text{C}$. All have outstanding resistance to humidity and exceed the moisture resistant requirement of MIL-R-39023. Most are available in ranges of 100 to 1,000,000 ohms. All models are manufactured to the stringent quality specifications you have come to expect from a Bourns product line. As with all products manufactured by Bourns, every single INFINITRON unit is guaranteed by the Bourns Reliability Assurance Program,

which includes individual inspection to published electrical and physical characteristics. Standard units are ready to ship off-the-shelf to fit your production or engineering requirements. . . special resistance values, taps, electrical angles and mechanical stops are available upon request.

Don't gamble in down-time, extended deliveries, etc., and don't speculate on quality and specifications! Investigate all the outstanding specs offered by the six new INFINITRON conductive plastic precision potentiometers from Bourns! For complete technical data contact your nearest Bourns office, representative or write the factory direct.

Circle 49 on reader service card



BOURNS, INC., TRIMPOT DIVISION • 1200 COLUMBIA AVE., RIVERSIDE, CALIF.
TELEPHONE (714) 684-1700 • TWX: 910 332-1252 • CABLE: BOURNSINC.

TRIMPOT® and Precision Potentiometers - Miniature Relays - Electronic Modules - Microcomponents

MINIATURE SIZE RELAY □ **CONTACT RATINGS:** Contact Material: Rhodium. Maximum Voltage (Volts): 50 VDC, 150 VAC. Maximum Current: Switch, .500 amp. Carry, 2.5 amps. Maximum Power (Watts, DC): 6 Watts. Resistive or properly suppressed (VA, AC): 10 VA. Maximum Resistance Initial: 100 milliohms. End-of-life: 2 ohms. Peak Breakdown Voltage: 300 volts rms. Life & Reliability At Rated Load: 20×10^6 operations. Dry Circuit: 500×10^6 operations. **OPERATING PARAMETERS:** Speed: Depending on sensitivity and number of poles, the speed for miniature size relays is from 1 msec to 2½ msec, including contact bounce and coil time. Insulation Resistance: Coil to ground: 50 megohms (min). Coil to contact: 500 megohms (min). Temperature Range: -50°C to +105°C. Vibration: 10G @ 10-55 cycles/sec (open or closed). Shock: 15G (min).

STANDARD SIZE RELAY □ **CONTACT RATINGS:** Contact material: Rhodium. Maximum Voltage (volts): 150 VDC, 250 VAC. Maximum Current: Switch, 1.5 amps. Carry, 6 amps. Maximum Power (Watts, DC): 25 watts. Resistive or properly suppressed (VA, AC): 40 VA. Maximum Resistance, Initial: 50 milliohms. End-of-life: 2 ohms. Peak Breakdown Voltage: 500 volts rms. Life & Reliability, At Rated Load: 20×10^6 operations. Dry Circuit: 500×10^6 operations. **OPERATING PARAMETERS:** Speed: Depending upon sensitivity and number of poles, the speed for standard size relays, including contact bounce and coil time, is: 2½ msec to 6 msec. Insulation Resistance, Coil to ground: 100 megohms (min). Coil to contact: 2000 megohms (min). Temperature Range: -50°C to +105°C. Vibration: 10G @ 10-55 cycles/sec (open or closed). Shock: 15G (min).

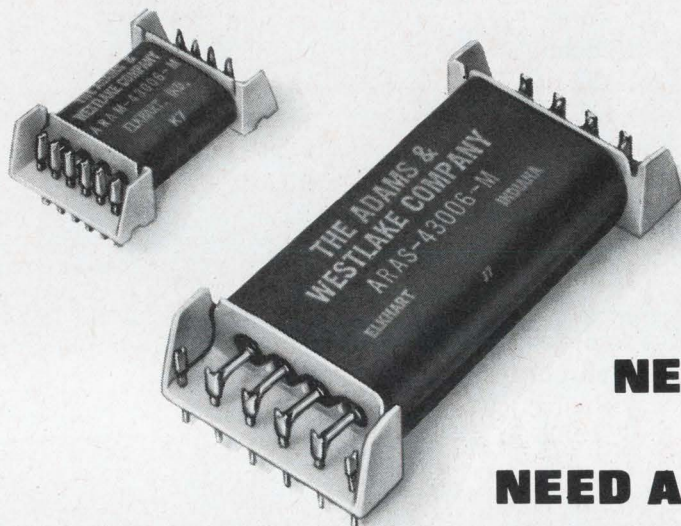

**NEXT TIME YOU
NEED A DRY REED RELAY
THERE'S A BRAND NEW SOURCE
WHERE YOU CAN GET IT FASTER**

It's Adlake—the company you call on for mercury relays. We now supply dry reed relays in standard and miniature sizes; single, double, and 4-pole. And we promise you the same fast delivery that made us the leader in mercury-displacement and mercury-wetted relays.

There's no compromise with quality. Our dry reed relays have the most accurately-wound coils and the most reliable switches you can find anywhere. They are specially recommended for such applications as automatic numerical machine controls, telephone and telegraph switchgear, and data processing.

Write today for our new catalog. And don't forget that at Adlake we always stand ready to assist you with design and engineering.



THE ADAMS & WESTLAKE COMPANY
A SUBSIDIARY OF **ALLIED PRODUCTS CORPORATION**

Elkhart, Indiana 46514 • 219 264-1141 • TWX 219 522 3102 • TELEX 25-8458 • CABLE ADLAKE

Washington Newsletter

January 22, 1968

NASA will spell out needs to industry

NASA officials feel the electronics industry has lost touch with long-range space-agency goals in recent years. To reestablish communications between NASA and industry, top officials from the agency's Electronics Research Center, Cambridge, Mass., and the Office of Advanced Research and Technology in Washington, plan to visit electronics companies throughout the nation to discuss future research needs and the problems to be solved.

The campaign was started quietly late last year as a pilot program in the Boston area. It was headed by ERC director James Elms.

FAA throttles down development of new communications link

The FAA is slowing down the development of an air-ground communications system for the 1970's. The reason: lack of funds.

Collins Radio, which is designing the system and hardware, has been told to stretch out its work for at least six months to keep the program alive. The company was to deliver its first progress report early this year, but this will probably be put off until the summer.

With the system, a single radio frequency would be assigned to an aircraft and all channel switching would be handled automatically by ground stations. The FAA says this would reduce a pilot's communications workload, cut the cost of airborne communications equipment, and make better use of the frequency space allotted to air-traffic control. The FAA had hoped to start testing prototype hardware late this year.

Satellite study bids to be asked—at last

The Air Force will ask for proposals this week on two studies of its planned 621B navigation-satellite system. Held up last year by an extensive Pentagon review [Electronics, Nov. 27, 1967, p. 59], the project has most recently been delayed by the lengthy preparation of a work statement.

Industry proposals for the parallel studies, each funded at \$500,000, are due in early February. At least five companies—Westinghouse, RCA, Hughes, TRW Systems, and GE—have lined up subcontractor teams and are already conducting in-house studies of the system, which is to be secure and highly accurate.

Army gets Cheyenne as Pentagon clips Air Force's wings

The Army's victory in getting a go-ahead to build the AH-56A Cheyenne compound helicopter also settled the controversy over which service will have project control and fly the helicopter. Part of the delay in awarding the pact to Lockheed Aircraft stemmed from a hassle between the Army and the Air Force. The Air Force claimed the program because the Cheyenne has fixed wings, but the Army cited its responsibility for all helicopters. The AH-56A, formerly called Advanced Aerial Fire Support System, has both rotors and small fixed wings.

The Army is picking up an option to buy 375 aircraft. Cost will be about \$1 million each. An initial \$21.4 million contract is for preproduction work and long-lead-time items.

The Army has experienced delays in developing the integrated avionics system for the Cheyenne [Electronics, April 3, 1967, p. 66], with the possibility that only the central computer would be aboard the first

Washington Newsletter

production models when they start rolling off the assembly line sometime in 1969. The electronic system will be built around an expanded version of Teledyne's data processors developed for the Navy's Integrated Helicopter Avionics System.

Patent bill headed for Senate floor

Chances are good that the long-debated patent reform bill will make it to the Senate floor during this session of Congress. **But how it will fare after the Senate Judiciary Committee reports it out, and how different it will be from the Administration's bill is anyone's guess.**

The major point of controversy has been the Administration's determination to change the criteria for granting patents from first-to-invent to first-to-file. The switch would align the U.S. with the rest of the world and is regarded by the Government as a necessary step toward a universal patent system [Electronics, June 12, 1967]. Senate hearings on the measure will begin Jan. 30. In the House, the bill is still in committee and no hearings have been announced.

Look for John F. Kincaid, assistant secretary of commerce for science and technology to make a strong pitch for the Administration position before the American Patent Law Association this week. Patent lawyers have attacked the proposed criteria change on the ground that it would make for lengthier and more complicated litigation.

Litton unit to build submarine simulator

The Navy will soon announce the award of a contract to build the first oceanographic submarine simulator. The work is going to the Amecon division of Litton Industries, Silver Spring, Md., which will design and construct a simulator for training two-man teams to operate Alvin exploration submarines.

Next month, Litton will get together with Woods Hole Oceanographic Institution, the Massachusetts outfit that will operate the system, to settle on a design. The simulator, which will be located at one of three Massachusetts sites, will include mock-up subs in a huge water tank. A computer will move the subs and feed simulated data into sonar and communications equipment, while films of underwater scenery will provide a further touch of realism.

Proxmire panel eyes interservice waste

Watch for the Economy-in-Government subcommittee of the House-Senate Joint Economic Committee to zero in on what some Congressmen feel is the **Armed Services' reluctance to employ each others' systems and equipment.** Sen. William Proxmire, the maverick Wisconsin Democrat who heads the subcommittee, is sharply critical of interservice rivalry at the sacrifice of economy. His panel is expected to focus on the variety of equipment standards laid down by the services, and on stockpiling policies.

GAO to join chorus lamenting contracts

The General Accounting Office will add its voice to those of the Civil Service Commission, Congress, and others who feel Government often contracts for work civil service employees could handle. Several GAO reports will be issued this year, and **one of the agencies expected to come under particularly heavy fire is NASA.** The space agency will be charged with ordering computer-based studies that are carried on by contractors using NASA computers at NASA facilities.

Sorensen modular power supplies

3⁵/₁₆" x 3⁷/₈" x 7", ±0.005% regulation
\$89⁰⁰

any questions?

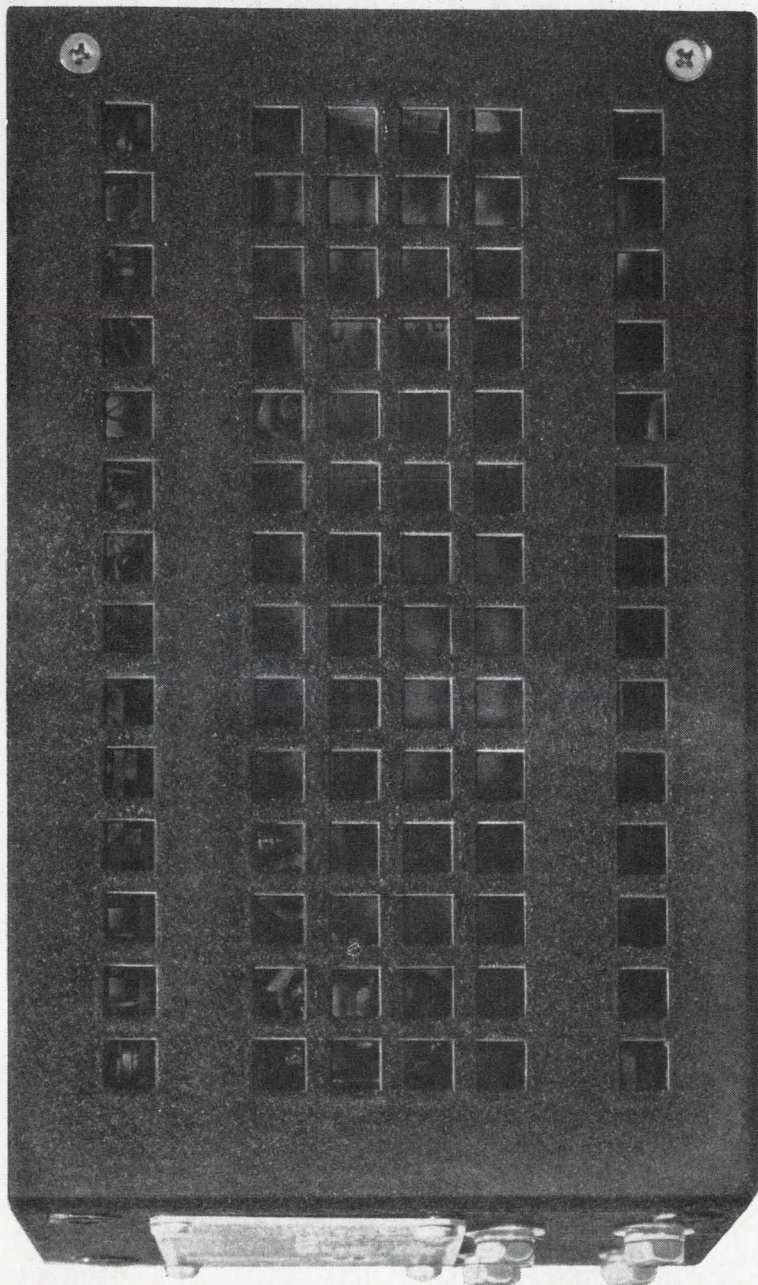

Model QSA48-.4 Power Supply, shown actual size, illustrates the compactness of the Sorensen QSA Series. New off-the-shelf models cover the range to 150 volts.

All silicon transistor design—convection cooled—operating temperatures up to 71°C.

Requires no external heat sink—mount in any position.

Lowest ripple of any modular supplies—300 μ V rms.

Best voltage regulation— $\pm 0.005\%$ line and load combined.

Lowest prices—\$89 to \$149.

Overload and short circuit protection.

20 μ s response time—no turn-on/turn-off overshoots.

Three sizes in each voltage range depending on power level—all are rack mountable with optional 3 $\frac{1}{2}$ " rack adapter.

Remote sensing and remote programming—capable of series/parallel operation.

Any further questions? For QSA details or for other standard/custom DC power supplies, AC line regulators or frequency changers contact your local Sorensen representative or: Raytheon Company, Sorensen Operation, Richards Avenue,

RAYTHEON Norwalk, Connecticut 06856. Tel: 203-838-6571

The great LSI race.

While the rest of the semiconductor industry tried to squeeze enough ICs on a chip to get into the MSI/LSI business, Fairchild turned systems inside out. We were looking for an intelligent alternative to component mentality. Our investigation led to a whole new set of design criteria for medium and large scale integration devices.

A computer isn't a computer.

It's a digital logic system. It has the same functional needs as any other digital system: control, memory, input/output and arithmetic. There's no logical reason to custom design a complex circuit for each system. That's why Fairchild MSIs and LSIs are designed to function as fundamental building blocks in any digital logic system. Even if it's a computer.

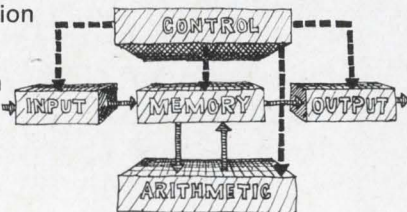

A little complexity goes a long way.

Anybody can package a potpourri of circuitry and call it MSI or LSI. But, that's not the problem. Why multiply components, when you should divide the system? Like we did. We found that sub-systems have a common tendency toward functional overlap. There are too many devices performing similar functions. More stumbling blocks than building blocks. Our remedy is a family of MSIs and LSIs with multiple applications. The Fairchild 9300 universal register, for example, can also function as a modulo counter, shift register, binary to BCD shift converter, up/down counter, serial to parallel (and parallel to serial) converter, and a half-dozen other devices.

Watch out for that first step.

There are all kinds of complex circuits. Some of them have a lot of headache potential. Especially if you want to interface them with next year's MSIs and LSIs. We decided to eliminate the problem before it got into your system. All Fairchild building blocks share the same compatible design characteristics.

We're also making the interface devices that tie them together. For example, our 9301 one-of-ten decoder can be used as an input/output between our universal register, dual full adder and memory cell.

(It could also get a job as an expandable digital demultiplexer, minterm generator or BCD decoder.)

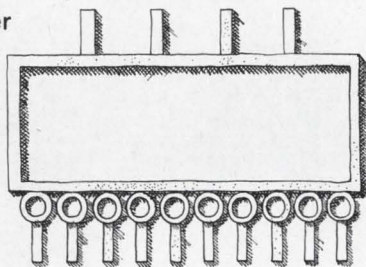

Hurry. Before the price goes down.

Gate for gate, today's complex circuits are about the same price as discrete ICs. But, by the time you're ready to order production quantities, the price should be a lot lower. At least ours will. The reason is simple: Fairchild devices are extremely versatile. There are fewer of them. But, they do more jobs. That means we'll be producing large quantities of each device. That also means low unit cost to you. And you'll have fewer devices to inventory. And fewer to assemble.

If you agree with our approach to medium and large scale integration, we'd like to tell you more about it. There are two ways you can get additional information. One is by mail. Simply write us on your company letterhead. You can also get more data by watching the trade press. Fairchild is introducing a new integrated circuit each week for 52 weeks. (We started on October 9, 1967.)

Many of them will be MSI and LSI.

If you'd like to see the last few we've introduced, turn the page.

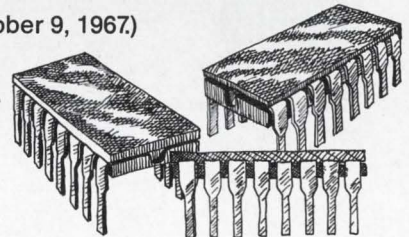

FAIRCHILD SEMICONDUCTOR

A Division of Fairchild Camera and Instrument Corporation
313 Fairchild Drive, Mountain View, California 94040
(415) 962-5011, TWX: 910-379-6435

RECAP:

Fairchild will introduce a new integrated circuit each week for 52 weeks. This is number **9.**

9935 EXPANDABLE HEX INVERTER

The Fairchild 9935 is a fundamental element in the CCLD family. It can serve as the process of virtually any digital logic circuit. It consists of six DTL gates without input diodes. Each gate performs a single inversion operation. The device can be expanded to an unlimited number of inputs and, therefore, can be used in a great variety of functions. For example, it can serve as a shifting circuit, a selected multiplier or as a flip-flop in adders, registers, counters, decoders, etc. It can be "wired" or connected to a special system circuit. The 9935 comes in both a 14-pin hermetic DIP and Fairchild's Cerpak™. It's available in both military and industrial temperature ranges (-55°C to +125°C and 0°C to +70°C). Propagation delay is typically 20 nanoseconds. Typical power dissipation is 8 milliwatts per gate. The 9935 is available in volume quantities. Fairchild distributors have it in stock now. Write for complete specs and applications information. Ask about our other new products, too.

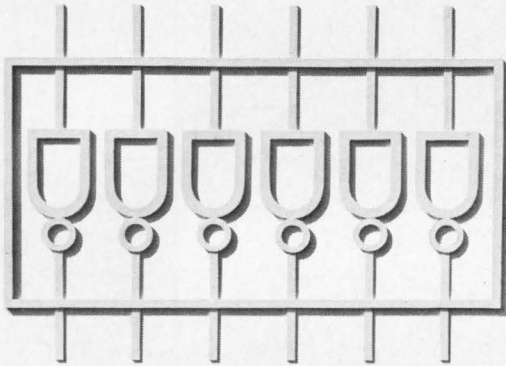

FAIRCHILD SEMICONDUCTOR • A Division of Fairchild Camera and Instrument Corporation
FAIRCHILD SEMICONDUCTOR 313 Fairchild Drive, Mountain View, California 94035 (415) 962-5011 • FAX: 415-974-8425

CIRCLE READER SERVICE NUMBER 109

Fairchild will introduce a new integrated circuit each week for 52 weeks. This is number **10.**

3701 SIX-CHANNEL MULTIPLEX SWITCH

The Fairchild 3701 is a 6-channel enhancement mode MOS six-channel single output switch. It can be used in virtually any switching application. It is ideal for analog and digital data transmission logic control in industrial systems, and sense line switching in core memory systems. The 3701 approximates a perfect switch. It has very low "on" resistance (500 Ohms), extremely high "off" resistance (2 x 10¹⁰ Ohms), and zero other voltage. Output leakage current is typically as low as 0.1 nanoseconds. Input gate protection minimizes handling problems. It can accept input signals up to 5 volts. Stability and reliability are assured by Phase II technology. The 3701 comes in a 14-pin flatpack. It will operate over a temperature range of -55°C to +85°C. Volume quantities of this device are now available. Your Fairchild distributor has it in stock. Write for complete specs and applications information. Ask about our other new products, too.

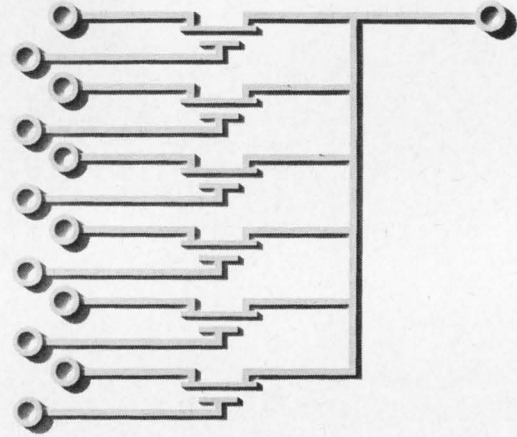

FAIRCHILD SEMICONDUCTOR • A Division of Fairchild Camera and Instrument Corporation
FAIRCHILD SEMICONDUCTOR 313 Fairchild Drive, Mountain View, California 94035 (415) 962-5011 • FAX: 415-974-8425

CIRCLE READER SERVICE NUMBER 110

Fairchild will introduce a new integrated circuit each week for 52 weeks. This is number **11.**

9016 TTL HEX INVERTER

The 9016 completes our 9000 series TTL family. It's a CCLD device designed primarily for high speed inverter applications. It consists of six inverting gates with input clamping diodes to prevent ringing. Active pull-up is provided in the output for high capacitive drive. It can also be used as a line driver. Propagation delay is 11 nanoseconds maximum (standard for the entire TTL family). Power dissipation per gate is typically 14mW. The 9016 comes in a 14 lead hermetic DIP and in flatpack. It's available in both military and industrial temperature ranges (-55°C to +125°C and 0°C to +70°C). You can now order volume quantities of the 9016. Fairchild distributors have it in stock. Write for complete specs and applications information. Ask about our other new products, too.

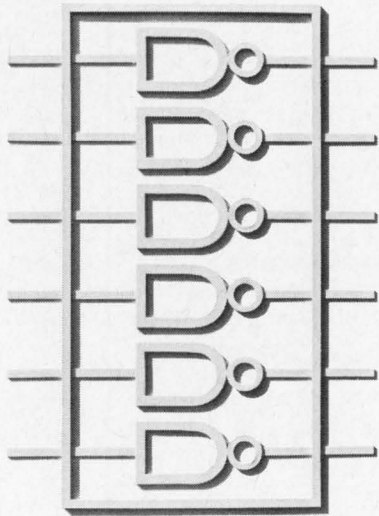

FAIRCHILD SEMICONDUCTOR • A Division of Fairchild Camera and Instrument Corporation
FAIRCHILD SEMICONDUCTOR 313 Fairchild Drive, Mountain View, California 94035 (415) 962-5011 • FAX: 415-974-8425

CIRCLE READER SERVICE NUMBER 111

Fairchild will introduce a new integrated circuit each week for 52 weeks. This is number **12.**

9022 DUAL JK FLIP-FLOP

The 9022 is a CCLD device in a 14-pin hermetic DIP. This TTL circuit consists of two JK flip-flops with a common clock input, common J input, and separate J and K inputs. The K input of the 9022 to perform as a dual type D flip-flop by tying the J and K inputs together. This common JK input eliminates the need for gating clock waveforms and can result in simplified logic designs and minimized clock noise problems. The 9022 is fast (50msec) and flexible. It is a true DC-sensitive master-slave dual flip-flop. As a companion to our 9000 dual JK flip-flop, it provides additional logical flexibility because it has separate set-direct inputs in addition to clear-direct. Both types of inputs are truly asynchronous and overriding. A single clock buffer reduces clock fan-in and noise. The 9022 comes in both military and industrial temperature ranges (-55°C to +125°C and 0°C to +70°C). It's available in volume quantities. Your Fairchild distributor has it in stock. Write for complete specs and applications information. Ask about our other new products, too.

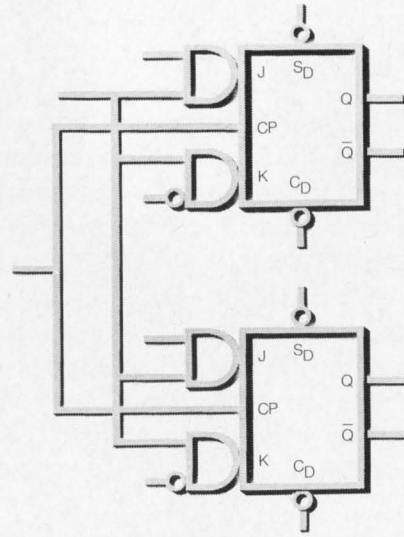

FAIRCHILD SEMICONDUCTOR • A Division of Fairchild Camera and Instrument Corporation
FAIRCHILD SEMICONDUCTOR 313 Fairchild Drive, Mountain View, California 94035 (415) 962-5011 • FAX: 415-974-8425

CIRCLE READER SERVICE NUMBER 112

Fairchild is introducing a new integrated circuit every week. The last two months look like this.

FAIRCHILD
SEMICONDUCTOR

3102 MOS THREE- INPUT GATE

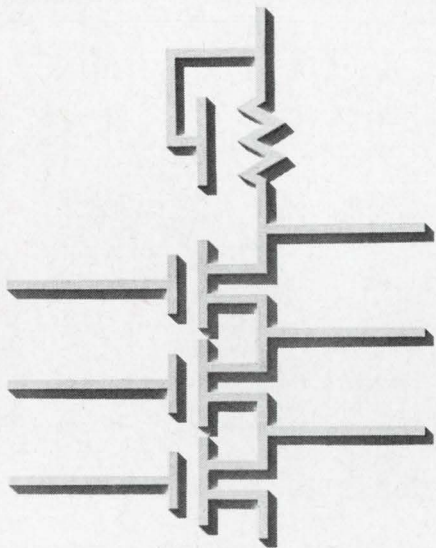

FAIRCHILD SEMICONDUCTOR / A Division of Fairchild Camera and Instrument Corporation
310 FAIRCHILD DRIVE, MOUNTAIN VIEW, CALIFORNIA 94035 / 415-962-0111 / 788-310-275-6445

CIRCLE READER SERVICE NUMBER 113

Starting October 9, 1967, Fairchild promised to introduce a new integrated circuit each week for 52 weeks. This is number **13.**

The 3102 is an extremely versatile three-input breadboard gate which can serve as the fundamental element in any MOS digital logic system. It can also function as an evaluation tool for determining the performance of Fairchild's line of MOS devices or simply as a vehicle for gaining familiarity with MOS integrated circuitry. The 3102 comes in both TO-5 cans (3102 pin can) and in 16-pin DIPs (two devices per package). The availability of all source and drain leads for each transistor provides excellent logic versatility. Input protection diodes, including a diode whose cathode is typically at low an anode. Operating temperature ranges from -55°C to 125°C. Volume quantities of the 3102 are now available. Your Fairchild distributor has it on his shelf. Write us for complete specs and applications information. While you're at it, ask about our other new products, too.

3700 FOUR-CHANNEL MULTIPLEX SWITCH

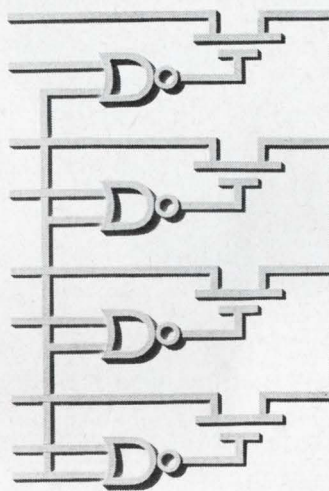

FAIRCHILD SEMICONDUCTOR / A Division of Fairchild Camera and Instrument Corporation
310 FAIRCHILD DRIVE, MOUNTAIN VIEW, CALIFORNIA 94035 / 415-962-0111 / 788-310-275-6445

CIRCLE READER SERVICE NUMBER 114

Starting October 9, 1967, Fairchild promised to introduce a new integrated circuit each week for 52 weeks. This is number **14.**

Fairchild's 3700 is designed for use in A/D and D/A converters, multiplexing, analog or digital data transmission systems, and other airborne or ground instrumentation signal routing applications. It can be used in telemetry systems, computers, remote monitoring equipment and transmitter setting equipment. Control logic has been included to make it NPN bipolar compatible. It utilizes Planar P^+N P-channel enhancement mode MOS technology and provides all channel blanking control. It also features zero offset voltage, high Ohm O^+P^+ gates and input protection diodes. Our 3112 high level hex inverter (two product numbers) can be used to directly interface the 3700 with CMOS logic levels. The 3700 is available in two signal ranges: the 3700/42 for -5.0 to +3.0 volts, and the 3700/43 for ranges of 0 to +5.0 volts. Both of the 3700 devices come in flat pack and will operate over the entire operational range from -55°C to 125°C. They're available now in volume quantities. Your Fairchild distributor has them in stock. Write for complete specs and applications information. Ask about our other new products, too.

3303 DUAL 25-BIT DYNAMIC SHIFT REGISTER

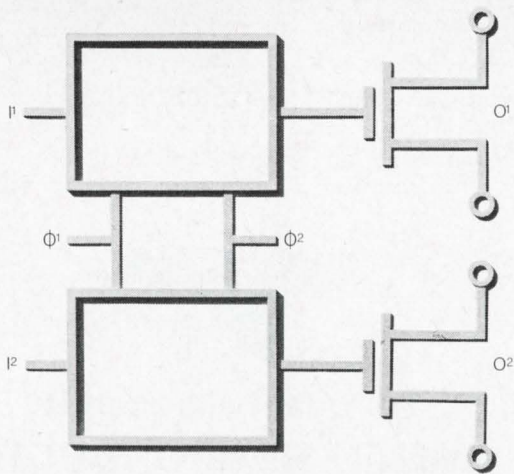

FAIRCHILD SEMICONDUCTOR / A Division of Fairchild Camera and Instrument Corporation
310 FAIRCHILD DRIVE, MOUNTAIN VIEW, CALIFORNIA 94035 / 415-962-0111 / 788-310-275-6445

CIRCLE READER SERVICE NUMBER 115

Starting October 9, 1967, Fairchild promised to introduce a new integrated circuit each week for 52 weeks. This is number **15.**

The 3303 is a product of Planar P^+N P-channel enhancement mode MOS technology. It contains two 25-bit shift register strings with two common clock lines. Output stages can be connected as either inverters or as source followers. It is applicable for digital delay lines in computers and radar systems (both ground and airborne). It can also be used as a serial memory in telemetry systems. The 3303 comes in a TO-5 can and will operate over the entire temperature range from -55°C to 125°C. It operates at 1 MHz (typical). Power dissipation is typically less than 2000 mW per bit. Volume quantities of the 3303 are now available. Your Fairchild distributor has it in stock. Write for complete specs and applications information. Ask about our other new products, too.

9307 BCD TO SEVEN-SEGMENT DECODER

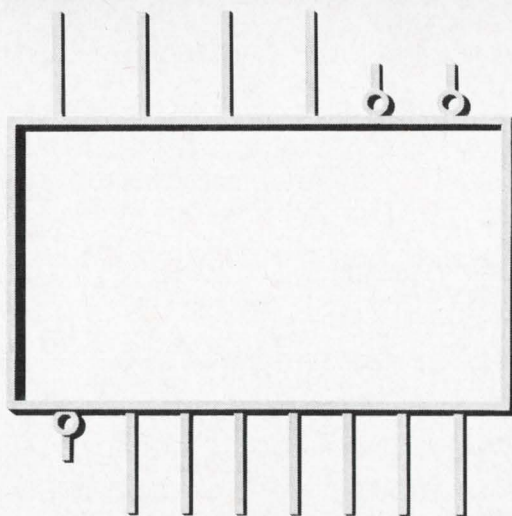

FAIRCHILD SEMICONDUCTOR / A Division of Fairchild Camera and Instrument Corporation
310 FAIRCHILD DRIVE, MOUNTAIN VIEW, CALIFORNIA 94035 / 415-962-0111 / 788-310-275-6445

CIRCLE READER SERVICE NUMBER 116

Starting October 9, 1967, Fairchild promised to introduce a new integrated circuit each week for 52 weeks. This is number **16.**

The Fairchild 9307 is designed to be used in any numeric display system which requires seven-segment information. This includes microprocessors, electrochromatic, seven-segment readout, or CRT numeric displays. It is an MOS device. It accepts an input in 8421 BCD code and produces individual outputs to drive the seven-segment display system. It has an active-low input lamp test which overrides all other input combinations and enables the lamp operation. It also has active-high outputs (1.5mA minimum). In addition, it has figure blanking inputs and outputs to provide leading edge and suppression. It also has intensity modulation capability. The 9307 is a CMOS device in a 16-pin hermetic DIP. It operates from a single 5-volt power supply. It comes in both military and industrial temperature ranges (1-55°C to 125°C and 0°C to +70°C). The 9307 is available in volume quantities. Your Fairchild distributor has it in stock now. Write for complete specs and applications information. Ask about our other new products, too.



Thanks to an ancient shepherd named Magnes, the big noise about the Amelco 300 Series HNIL is its immunity to 4.2 volts!

Just a few thousand years after Magnes discovered the phenomenon of magnetism, a new way was developed to magnetically measure the mobility of silicon material.

This led us to the development of the 300 Series HNIL to provide the fastest possible logic for high voltage operation. But that's not all.

The 300 Series HNIL cuts over-all system costs. No need for interface circuitry and low voltage power supply. Twelve to fifteen volts will do.

What's more, complex arrays and direct lamp and relay drive capability result in minimum packages per system.

And because of fewer components and less chance of electrical malfunction due to noise, over-all system reliability is improved.

All of this makes the 300 Series HNIL ideally suited for on line control applications.

Enough said except another word of thanks to Mr. Magnes.

HNIL LOGIC ELEMENTS

| | |
|-------------------------------|-----------------------|
| DUAL 5 INPUT BUFFER | |
| QUAD 2 INPUT "OR" ABLE BUFFER | |
| QUAD 2 INPUT GATE | |
| QUAD 2 INPUT "OR" ABLE GATE | QUAD "D" FLIP-FLOP |
| DUAL 5 INPUT GATE | DUAL ONE SHOT |
| DUAL 5 INPUT EXPANDER | DUAL INPUT INTERFACE |
| RST FLIP-FLOP | DUAL OUTPUT INTERFACE |
| DUAL JK FLIP-FLOP | DUAL EXCLUSIVE-OR |

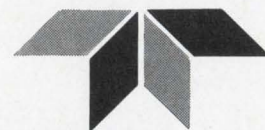

For quality in quantity
AMELCO SEMICONDUCTOR

A TELEDYNE COMPANY

1300 Terra Bella Avenue; Mountain View, California 94040

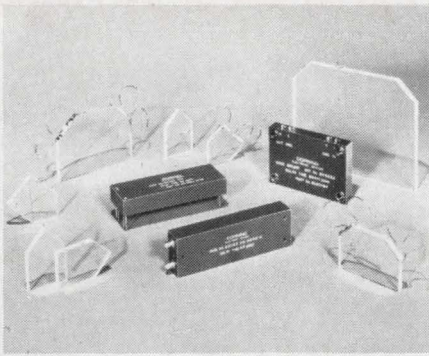

Zero-TC glass delay medium means lower cost per bit, less power per bit, than MOS.

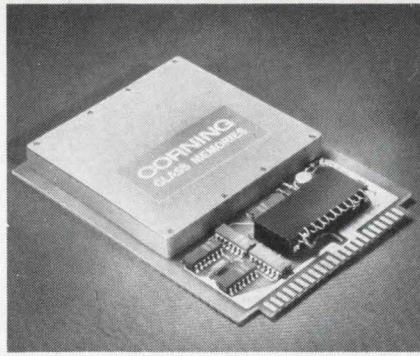

New Digital Glass Memory Modules give you plug-in serial storage with bit rates from 2.5 to 16 megabits per second.

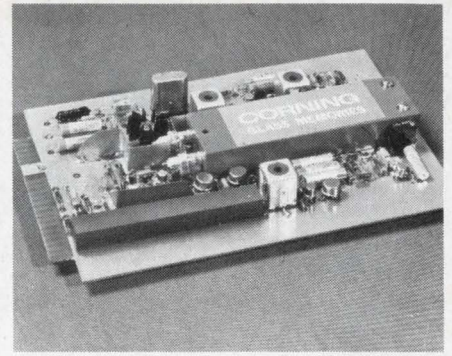

New Analog Glass Memory Modules delay video signals up to one horizontal scan time. Exits as the original input displaced in time by 63 microseconds. Just plug it in.

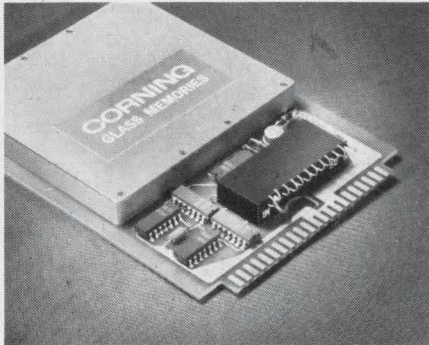

New High Speed Clock Channels let you increase data rate and storage capacity. 500C Series Module, for example, goes to 1,600 bits at 8 MHz with this new accessory.

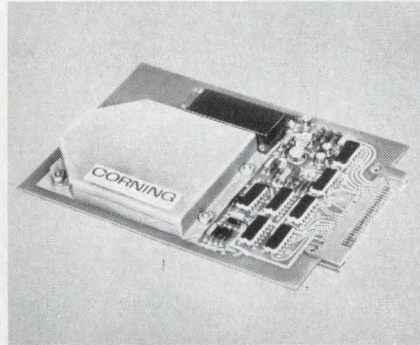

New Extended Storage Digital Glass Memory Modules give you plug-in delay times from 256 microseconds at 16 MHz to 1,024 at 4 MHz.

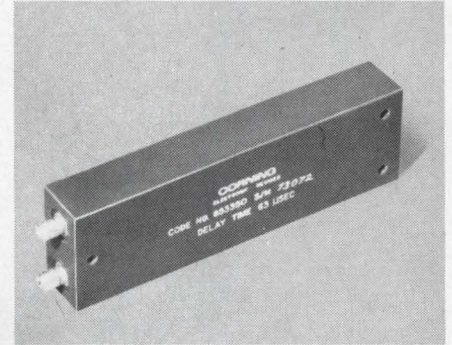

New 63 Microsecond Glass Delay Lines are high performance analog storage devices that let you work with bandwidths up to 15 MHz for video processing.

CORNING PUTS STABLE SPEED INTO YOUR MEMORY.

Send the coupon
for specifications on
the entire Corning line
of stable speed
memories.

**Corning Glass Works
Corning Electronics Division
Advanced Products Department
Raleigh, N. C. 27602**

Please send spec sheets on complete line of
CORNING® Glass Memory devices, modules, systems.

NAME _____

FIRM _____

TITLE _____

ADDRESS _____

CITY _____

STATE _____

ZIP _____

CORNING
ELECTRONICS

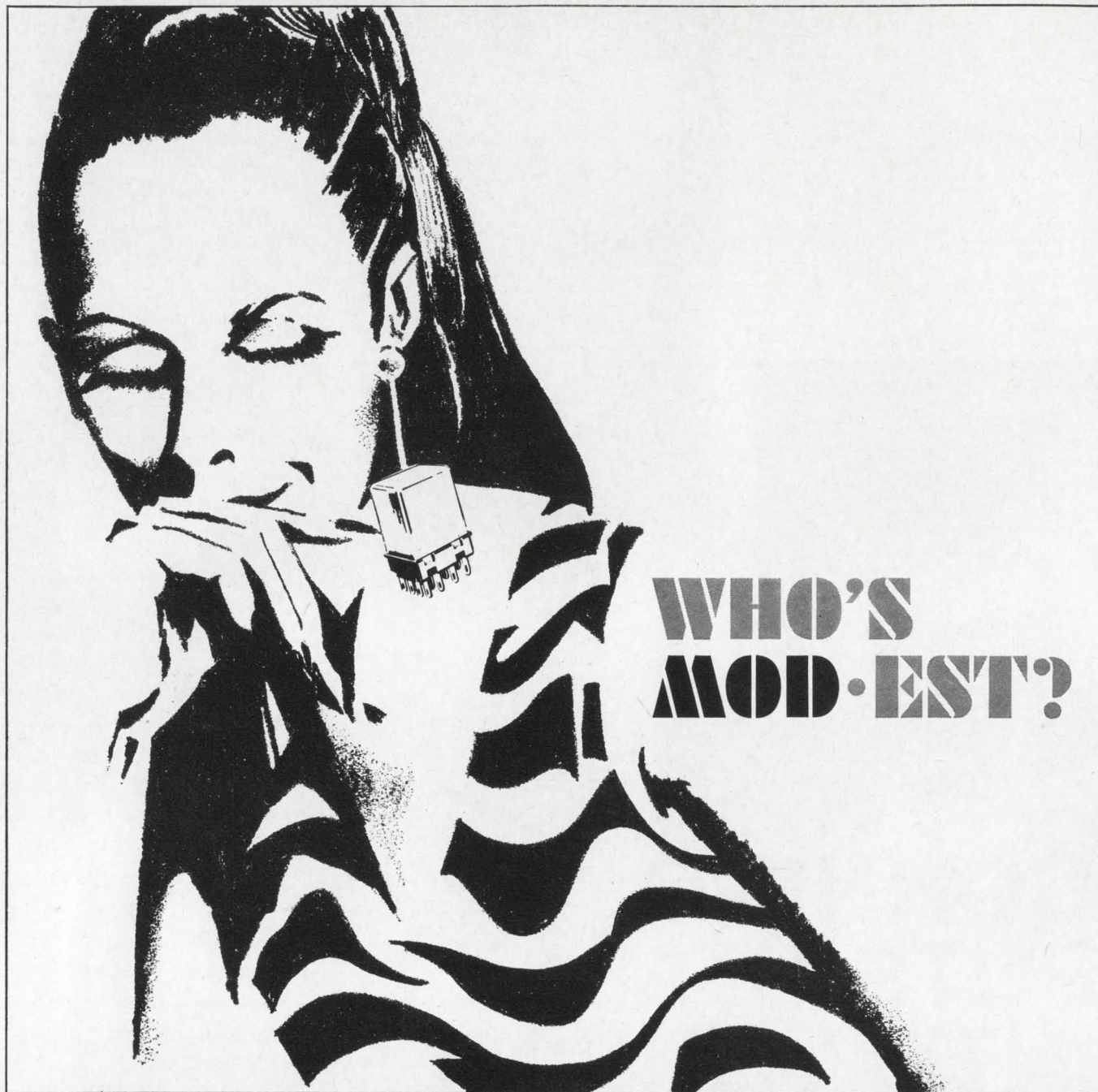

WHO'S MOD·EST?

We are. Because we've designed the most modern 4PDT 3 amp plug-in relay available but feel constrained to admit that it is not a fantastic breakthrough in technology.

Our Series 1300 relay's modest superiority over others comes from combining a number of small advances in design. We've eliminated rivets by molding the armature and bobbin assembly of glass-filled polyester, and thereby gained a greater dielectric strength. We devised a flat armature return spring for a slightly better response than a conventional coil spring. Slightly longer than usual blades offer better contact and reliability.

Our proudest accomplishment is in keeping the cost of the Series 1300 relay thoroughly competitive with others.

The Series 1300 is available AC or DC, plug-in or quick disconnect, 6 to 115 VAC and 6 to 110 VDC. Contact rating 3 amps at 30 VDC or 115 VAC resistive. A complete brochure is yours on request. Guardian Electric Manufacturing Company, 1550 W. Carroll Ave., Chicago, Ill. 60607

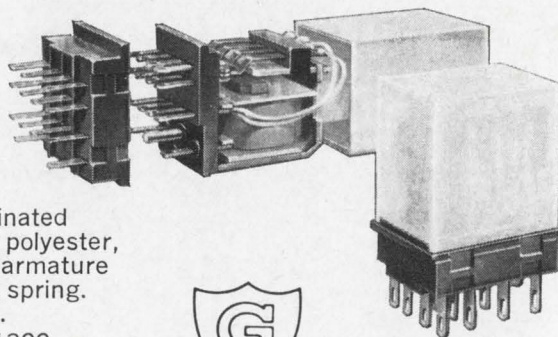

**GUARDIAN[®]
ELECTRIC**



A word to the do-it-yourself module builder:

Don't.

Buy our J Series modules instead.

The J Series is our new family of general purpose, all integrated circuit logic modules. Their performance almost matches that of our famous T Series modules, but they cost about 25% less. They're made to the same dimensions as the T Series, with the same 52 pin connectors, so they're physically interchangeable. We make them for our own seismic recorder systems, so they're rugged and reliable. Now, as of January, you can buy them (com-

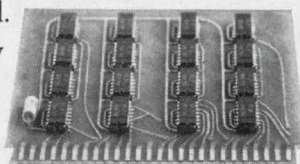

These will cost you less.

plete with mounting hardware, racks and power supplies, if you wish) in any of 25 different functions.

And save yourself the time and cost of making your own: designing, assembling, testing, new procedures, new equipment, new personnel, additional training, to say nothing of the added paper work.

If you're building systems, you must have better things to do than go into the module assembly business. Such as reading our J Series catalog.

It's free.

SDS
Scientific Data Systems,
Santa Monica, California

Circle 61 on reader service card

Helipot rings up the twelve dollar C.P. pot.



The new Model 3351 conductive plastic potentiometer is our twelve dollar solution to your age-old budget problem. It's a new low price for a non-wirewound precision potentiometer, and yet performance and quality have not been sacrificed. This new model excels wherever high precision and long, trouble-free life are needed at minimum cost.

If you like the \$12.00 price, then check these specs. ■ Essentially infinite resolution. ■ Standard resistance range; 1K to 75K ohms. ■ Long life. ■ Linearity; $\pm 0.5\%$.

■ Power rating; 0.75 watts at 70°C. ■ Resistance tolerance; $\pm 10\%$. ■ Operating temperature range; -65°C to $+125^{\circ}\text{C}$. ■ Factory stocked.

Also, Helipot has other all-new non-wirewound pots to satisfy most every application. Standard servo mount models with either conductive plastic or cermet resistance elements are available in 7/8" and 1-1/16" diameter. And they are priced under \$25.00.

Ask your local Helipot sales representative for the complete non-wirewound pot story... now.



Beckman[®]

INSTRUMENTS, INC.
HELIPOT DIVISION

FULLERTON, CALIFORNIA • 92634

INTERNATIONAL SUBSIDIARIES: GENEVA; MUNICH; GLENROTHES,
SCOTLAND; TOKYO; PARIS; CAPE TOWN; LONDON; MEXICO CITY



Technical Articles

**Computer-aided design,
part 13
Defining faults with
a dictionary
page 64**

Identifying a bad component in a complex circuit is simplified with a computer program based on frequency-gain curve testing. The computer generates a fault dictionary that the engineer can consult to locate and define the failed or out-of-tolerance component after comparing the measured curve with the ideal one.

**For low cost,
count on RTL
page 74**

Though far faster integrated circuit logic schemes have been developed, the old resistor-transistor-logic IC is still very much alive. With RTL circuits and a little-used counting technique, the cost of a decade's worth of counting, decoding, and read-out is only \$10.

**Every data bit counts
in transmission cleanup
page 77**



For digital data, passage through a transmission channel is like running the gauntlet. Atmospheric conditions or even background noise can flip or wipe out bits at random or in clusters. But these errors are detected and corrected by an IBM system that weaves redundancies into a message and, at the receiving end, uses a code polynomial, the redundant bits, and previously

received data bits to calculate a checkword for comparison with the preceding message.

**Putting the squeeze
on radar signals
page 86**

A single bank of filters can keep track of several targets picked up on a number of radar channels with a new scheme that appears to compress time. A core memory samples the radar returns from each channel in sequence and then reads them out in blocks, channel by channel, at high speed, presenting the filter bank with an illusion of continuous tracking.

**There's no overcharge
for fast-charged batteries
page 97**

Rechargeable nickel-cadmium batteries have been handicapped by a long recharging time that can take the better part of a day. But with a diode-protection circuit to shunt the high-rate charging current and a thermal switch to reduce the current, charge time can be shortened without running the risk of overcharge.

**Coming
February 5**

- **Compensating for drift errors in amplifiers**
- **Automated IC mask-making**
- **Video i-f amplifiers**

Computer-aided design: part 13

Defining faults with a dictionary

To identify failures in a linear circuit, an engineer need only compare test results with a list of potential trouble spots generated by a computer

By Walter J. Stahl, John H. Maenpaa, and Carl J. Stehman

Scully International Inc., Downers Grove, Ill.

Called upon to diagnose circuit ills, an engineer, like a physician, must know the anatomy of his subject. With the aid of a computer, he can use a fault-diagnosis program to generate a list of symptoms—potential component failures. By relating these symptoms to their ills, the engineer can quickly and easily prescribe a cure.

For discrete circuits, the cure could mean sur-

gery—replacing the faulty component. But for faulty integrated circuits there is no cure, only rejection. However, since the cause is known, this information can be used as the basis for redesign of future IC's.

The fault-diagnosis program was developed by Scully International Inc., under Air Force contract AF33(615)-3573 and is based on the circuit's topology and nominal component values. Thus it can handle almost any size linear electronic network.

To use the program, the engineer first partitions a circuit's schematic into several sections. Although the ideal section contains a maximum of 10 nodes and 20 branches, as many as 30 nodes and 35 branches are possible—but at a price. Larger sections lower the efficiency. The components' nominal values and the interconnections are described to the computer, which then determines either the h , y , z , g , or chain parameters and its normal response at different frequencies. Regardless of which parameter is chosen, four terms would be needed to describe the circuit that the network parameters represent.

The computer then varies each component's value—one component at a time—and calculates the corresponding change in the network's parameters. From this, the computer generates a table indicating how each component varies circuit response from its normal value. Thus, if a circuit fails, the engineer just needs to measure the input and output voltages and currents, at specified frequencies, and check the table to determine the fault.

As an example of how the technique simplifies fault finding, consider the simple four-component circuit on page 65. The forward voltage gain is defined as the ratio of the output voltage to the input voltage, which is expressed with the circuit parameters, R_1 , R_2 , C_1 , C_2 , and all in terms of the

The authors



Walter J. Stahl is the manager of electronics research and development at Scully International. His experience includes 10 years in circuit design, logic design, and computer applications and programming. During the last six years he has worked with computer-aided design and fault-diagnosis of electronic circuits.



John H. Maenpaa is a senior engineer with the division. He too is engaged in computer-aided design and development of advanced fault diagnosis techniques and is co-author of the FDP program.

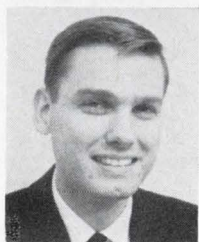

Carl J. Stehman, an engineer, has spent five years in electronic fault-isolation and computer-aided design. He is responsible for design and assembly of prototype hardware implementing the FDP program.

Diagnosing a network

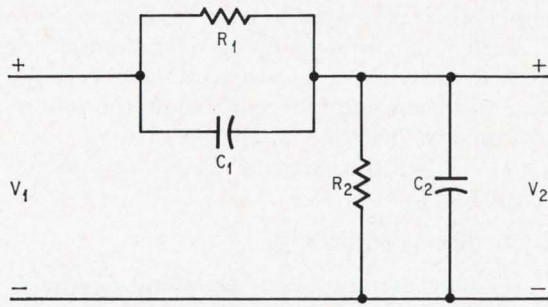

Four-terminal network

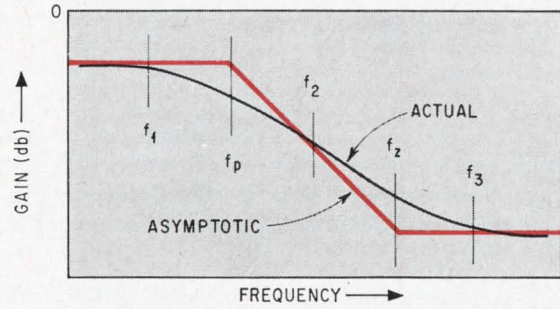

Normal gain curve

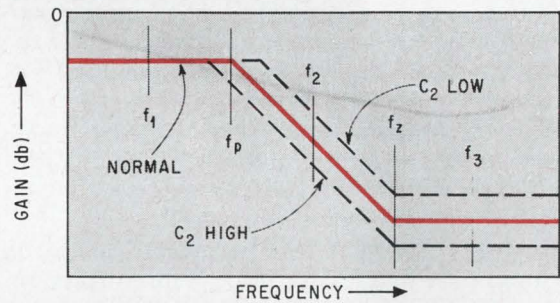
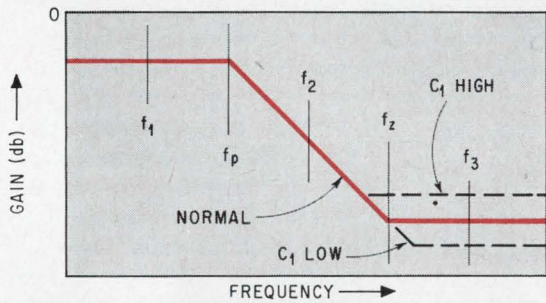
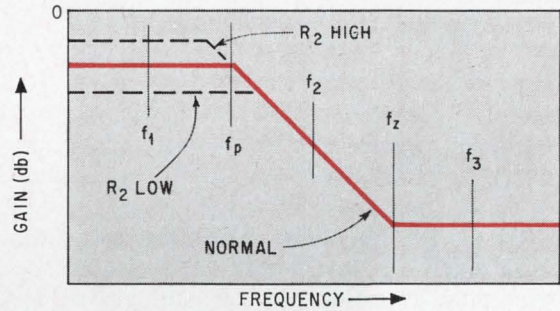
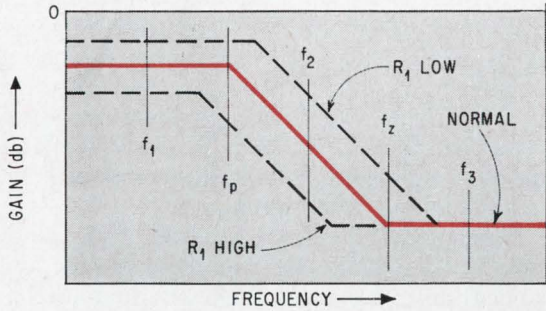

Effects of parameter variations

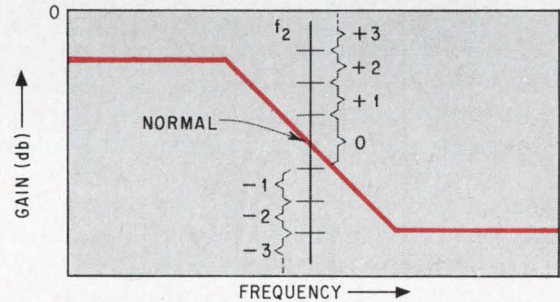

Rating scheme

| f_1 | f_2 | f_3 | FAULT |
|-------|-------|-------|------------|
| + | + | ○ | R_1 LOW |
| + | ○ | ○ | R_2 HIGH |
| ○ | + | + | C_2 LOW |
| ○ | ○ | + | C_1 HIGH |
| ○ | ○ | ○ | NORMAL |
| ○ | ○ | - | C_1 LOW |
| ○ | - | - | C_2 HIGH |
| - | ○ | ○ | R_2 LOW |
| - | - | ○ | R_1 HIGH |

Sorted fault dictionary

Fault diagnosis. Each of the four elements in the circuit are varied one at a time and the network response is plotted. By examining the responses a fault dictionary is prepared that defines the network's failures. Based on this dictionary a rating scheme is established to give an indication of the network's performance against its normal operation.

complex frequency variable s .

$$\text{Gain} = \frac{V_2}{V_1} = \frac{C_1}{C_1 + C_2} \cdot \frac{\left(s + \frac{1}{R_1 \cdot C_1}\right)}{\left(s + \frac{1/R_1 + 1/R_2}{C_1 + C_2}\right)}$$

The term $C_1/(C_1 + C_2)$ represents the constant multiplier of the gain function. Of major interest here are the numerator and denominator polynomials in s . The numerator polynomial has a root at

$$f_z = \left|s\right| = \left|-\frac{1}{R_1 C_1}\right|$$

which defines the frequency where the gain function has a zero. The denominator polynomial has a root at

$$f_p = \left|s\right| = \left|-\frac{1/R_1 + 1/R_2}{C_1 + C_2}\right|$$

which defines the frequency where the gain function has a pole.

A true point-by-point plot of gain versus frequency for a properly operating circuit is first made. This is followed with a straight-line asymptotic approximation of the actual curve. Occurring at the intersection of the asymptotes are breakpoint frequencies corresponding to the pole, f_p , and the zero, f_z . Test frequencies are keyed to the breakpoints of the normal gain function. These are arbitrarily designated f_1, f_2, f_3 , and so on depending on the number of test frequencies.

The effects of varying the parameter values on the normal gain function produces shifts in the response curve—breakpoint locations and gains at the test frequencies are altered.

In the four-component circuit there are only two breakpoints. Variations in R_1 alter the gain at the test frequency, f_1 , below the lowest breakpoint and at the frequency, f_2 , between the two breakpoints. But, they have no effect at f_3 , the test frequency above the highest breakpoint. Variations in R_2 alter the gain at f_1 only, variations in C_1 alter the gain at f_3 only, and variations in C_2 alter the gain at both f_2 and f_3 but not at f_1 . For this example, the effect at each frequency is coded with a simple scheme consisting of plus, zero and minus symbols. If the gain is greater than normal, a plus is assigned; if the gain is unchanged, a zero is assigned; and if the gain is less than normal, a minus is assigned.

Thus, the effects of the parameter variations at the test frequencies are generated as a sorted fault dictionary. Any deviation from the zero signature (0, 0, 0), representing the normal circuit gain function, is defined as a failure condition. Each failure has its own signature.

To discriminate among various failure states of a given parameter of the circuit, a gain rating scheme is employed at each test frequency. A vertical gain scale is divided into finite intervals above

and below the normal gain. To allow for a worst-case range of normal gain due to parameter variations within their allowable tolerance levels, a zero signature is given gain in the vicinity of normal.

Each finite interval above maximum worst-case gain is assigned a positive integer, +1, +2, +3 . . . , and each finite interval below the minimum is assigned a negative integer, -1, -2, -3 Larger integers represent larger deviations from normal.

Computer-aided testing

Without modifications, the fault-diagnosis program can be used for manual and semiautomatic testing. Modifying the output format allows the program to be used for automatic testing.

Written entirely in the Fortran-4 language for an IBM 7094 computer the program works well for linear networks of moderate size. The major computational functions of the program include generating a symbolic transfer function for the network, selecting test frequencies, simulating component failure, and generating fault signatures.

Because fault diagnosis is based on the poles and zeros of the circuit, the symbolic network function is necessary. At present, there are three methods of generating symbolic network functions—state-space, flowgraph, and topological. The latter method was chosen because at the time when the fault diagnosis study was started, in 1965, the other methods were barely developed for the computer.

Complete topological trees—a connected open set of branches that includes all nodes of a given graph—are generated by the program. Any network function for two-port and multistage circuits can be specified. Partitioning formulas have been included in the program for cascade, series-series, parallel-parallel, series-parallel, and parallel-series interconnections.

After the computer generates the network function, all components are set to their nominal value and the coefficients of the numerator and denominator polynomials are evaluated. The polynomials are then processed, roots are established, and test frequencies are selected.

Via a sequence of out-of-tolerance component variations, the computer simulates drift conditions. Catastrophic failures are approximated by large variations of the component values. It is assumed that only one component failure exists. For each simulated fault, the symbolic function is evaluated and computations are made at the individual stage level. Then, based on the interconnection configuration, the computer combines the results algebraically. Where d-c bias conditions are affected by simulated faults, the program enables the computer to automatically adjust the parameters involved.

Defining failure

If the fault dictionary is to be meaningful, the program must include definitions of what is an acceptable operating region or zero signature and what is a failure. These definitions usually derived

Anatomy of fault diagnosis

A two-port linear network can be described by linear equations that relate its input and output voltage and current variables. Any parameter can be used— g , h , y , z , or chain—as long as four terms are assigned to describe the network.

One such set of equations, written with g parameters, is:

$$I_1 = g_{11}V_1 + g_{12}I_2$$

$$V_1 = g_{21}V_1 + g_{22}I_2$$

The parameters are then defined as

$$g_{11} = \left. \frac{I_1}{V_1} \right|_{I_2 = 0} \quad g_{12} = \left. \frac{I_1}{I_2} \right|_{V_1 = 0}$$

$$g_{21} = \left. \frac{V_2}{V_1} \right|_{I_2 = 0} \quad g_{22} = \left. \frac{V_2}{I_2} \right|_{V_1 = 0}$$

If the value of at least one of the four parameters differs from the corresponding nominal value, the network has failed. Thus, all that is necessary to check the network is comparing the parameter values with the nominal values.

The parameters represent network functions— g_{11} the unit of an admittance, g_{22} the unit of an impedance, and g_{12} and g_{21} unitless since they represent current and voltage gains, respectively. To examine the network the engineer can plot the parameters as a function of frequency, where s is the complex frequency variable.

Since the network is linear, the parameters are expressed as a quotient of polynomials in terms of the network's poles, zeros, and a constant. The poles and zeros can be identified by frequency measurements. By plotting $20 \log |g(j\omega)|$ against $\log \omega$, the engineer will find the curve changes slope by 20 decibels/decade at each frequency ω_0 . The value of ω_0 , called the break frequency,

is such that $\omega_0 = |s_0|$ and s_0 is either a zero or a pole—+20 db/decade for a zero, -20 db/decade for a pole. Double poles or zeros produce 40 db/decade changes in slope. Complex poles or zeros produce resonant peaks or dips that identify the angle of the pole or zero.

If the network parameters change, the corner frequencies in the gain-versus-frequency curve and/or the constant multiplier of the original



Two-port network. Parameters V_1 , I_1 , V_2 , and I_2 represent the input and output voltage and current of the network.

transfer function will change. This is the heart of the diagnostic procedure.

In practice, it is difficult to locate the exact breakpoint positions with sufficient accuracy for fault isolation, especially when the breakpoints occur close together. However, any change in a breakpoint location also results in a change in the gain at other frequencies. To identify or characterize the shifts in poles and zeros, it is necessary to measure the gain at frequencies selected on the basis of the approximate pole-zero locations. Hence, the following choice of test frequencies is prescribed: one below the lowest nonzero breakpoint, another above the highest breakpoint, one between adjacent breakpoints, and one at or near each breakpoint corresponding to complex critical frequencies.

This is what the fault-diagnosis technique prescribes, and this is what a computer does with the aid of the fault-diagnosis program.

from the circuit's performance specifications, are used as a basis for rating and sorting faults.

In some circuits, the acceptable performance specifications are bounded by the worst-case limits. Such a network failure definition is quite convenient. An a-c worst-case analysis is performed at each test frequency as a first step in defining the rating intervals.

The nonzero intervals are defined by dividing into equal parts the regions bounded by the worst-case limits and the maximum positive and negative excursions of the network function. Test frequencies that have a limited excursion have smaller and more sensitive rating intervals than frequencies that have a large excursion.

Using topological formulas

The fault-diagnosis program can automatically process most linear circuits, but only if they can

be partitioned into no more than nine sections. Based on topological formulas that require generating all the trees of a circuit, the ideal section can have up to 10 nodes and 20 branches. Typically, sections of this size require 4,000 complete trees, which can be generated in less than a minute.

A section having 12 nodes and 24 branches, however, has nearly 70,000 complete trees that require more than 35 minutes to generate. But if it were a circuit having the 12 nodes and 24 branches, partitioning the network into three sections would require less than 500 complete trees total and generation time would be 5 seconds. Thus, with both proper partitioning and the program's capability of handling two-port partitioned networks, large circuits can be processed efficiently.

Partitioning also aids in the reduction of computing time associated with parameter variation studies. Only the section containing the parameter

Network comparison

Finding fault. After an engineer describes the interconnections of these amplifiers to the computer, the machine evaluates their voltage gain, g_{21} , and input impedance, z_{11} , to defect and isolate faults.

Differential amplifier

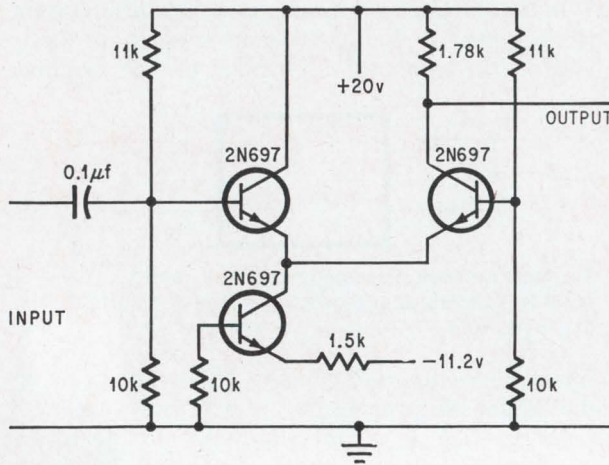

Single-stage amplifier

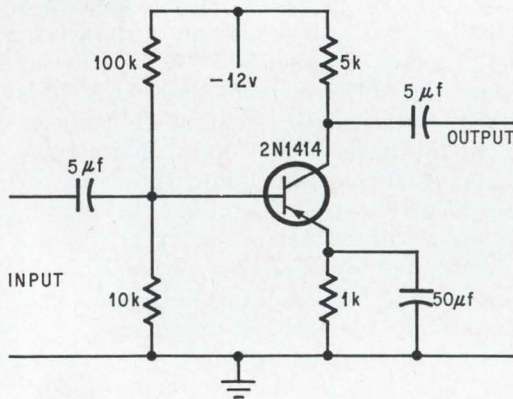

Diagnosis results

| Circuit | Single-stage amplifier | | Two-stage amplifier | | | Differential amplifier | |
|----------------------------|------------------------|----------|-----------------------|----------|----------|------------------------|----------|
| | g_{21} | Z_{11} | g_{21} and Z_{11} | g_{21} | Z_{11} | g_{21} and Z_{11} | g_{21} |
| Network function | g_{21} | Z_{11} | g_{21} and Z_{11} | g_{21} | Z_{11} | g_{21} and Z_{11} | g_{21} |
| Simulated component faults | 99 | 99 | 99 | 188 | 188 | 188 | 167 |
| Faults detected | 76 | 78 | 85 | 158 | 113 | 172 | 79 |
| 1 Component isolation | 58 | 63 | 83 | 73 | 81 | 129 | 51 |
| 2 Component isolation | 7 | 12 | 2 | 12 | 6 | 9 | 12 |
| 3 Component isolation | 3 | 3 | 0 | 21 | 9 | 0 | 0 |

Two-stage amplifier

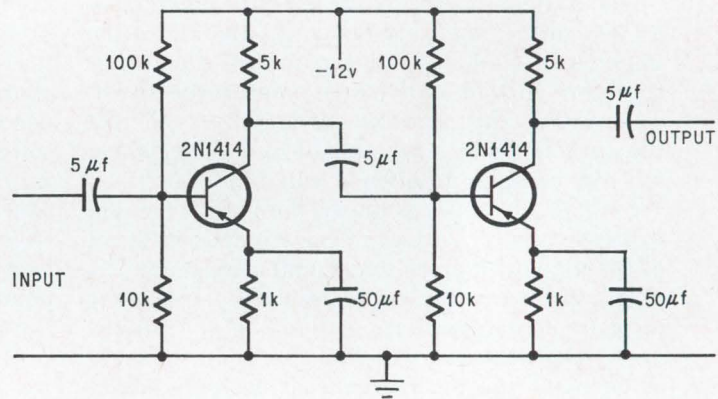

of interest need be evaluated; the other sections are kept at nominal values.

Detection and isolation

The computer program has been used to generate the test specifications for a number of circuits, including a single-stage, a two-stage, and an operational amplifier for which an average of nine test frequencies per network function were selected.

Two network functions, open-circuit forward voltage gain and open-circuit input impedance, were used to examine simulated component faults in both the single- and two-stage amplifiers. Only the gain function was used for the differential amplifier. For the single-stage unit 99 faults were studied; for the two-stage device, 188 faults; and for the differential amplifier, 167 faults.

Usually, adding other functions, such as output impedance, increases the diagnostic capability to total isolation, of the fault.

Bibliography

- H.W. Bode, "Network Analysis and Feedback Amplifier Design," Van Nostrand, Princeton, N.J., 1945.
- D.E. Muller, "A Method for Solving Algebraic Equations Using an Automatic Computer," Math Tables and Aids Comp., Vol. 10, 1956, pp. 208-215.
- W. Mayeda, "Topological Formulas for Active Networks," Interim Technical Report No. 8, Contract No. DA-11-922-ORD 1973, University of Illinois, January 1958.
- S. Seshu and N. Balabanian, "Linear Network Analysis," John Wiley and Sons, 1959.
- W. Mayeda and S. Seshu, "Generation of Trees Without Duplication," IEEE Transactions on Circuit Theory, Vol. CT-12 No. 2, June 1965, pp. 181-185.
- C. Pottle, "Comprehensive Active Network Analysis by Digital Computer—A State Space Approach," Proceedings, Third Annual Allerton Conference on Circuit and System Theory, October 1965, pp. 659-668.
- S. Seshu and R. Wasman, "Fault Isolation in Conventional Linear Systems—A Feasibility Study," IEEE Transactions on Reliability, Vol. R-15, No. 1, May 1966, pp. 11-16.
- R.M. Carpenter, "NASAP: Network Analysis for Systems Applications Program: Present Capabilities of a Maintained Program," Computer Aided Circuit Design Seminar sponsored by NASA Electronic Research Center, April 11-12, 1967, pp. 85-94.

Designer's casebook

Designer's casebook is a regular feature in Electronics. Readers are invited to submit novel circuit ideas, packaging schemes, or other unusual solutions to design problems. Descriptions should be short. We'll pay \$50 for each item published.

Diodes prevent overload by limiting input's slope

By D.F. Franklin

EMI Electronics Ltd.
Wells, Somerset, England

In instrumentation tape recording, where random signals are recorded using wideband f-m, it's easy to overload the system. The overloading may be caused by the input signal's excessive rate of change and amplitude. Such slope overloads usually give rise to spurious signals in the demodulated output that resemble the ringing of an underdamped tuned circuit.

Although it is acceptable for both the slope and amplitude of the overloading input signals to hit the stops occasionally, overload may be avoided without restricting the system's over-all bandwidth if the input slope is limited by the simple rate-limiting circuit. The circuit is an adaptation of the steered-current diode switch network. [See Electronics, August 10, 1962, page 68.]

In the circuit, when the input voltage is steady at midrange, the constant current I through R_1 and R_2 divides almost equally between the two branches comprised by D_1, D_2 and D_5, D_6 , respectively. If, for example, the input voltage now goes more positive, the forward bias on D_2 increases, causing D_2 to conduct more heavily while D_1 becomes more reverse-biased, reducing the current through D_1 .

Because the change in I is negligible, a decrease in the current through D_1 is accompanied by a corresponding increase in the current through D_5 ; all of the increased current through D_5 charges C_1 because the increased conduction of D_2 raises the potential of point B, reducing the conduction through D_6 proportionately. Likewise, a negative voltage at the input causes D_1 and D_6 to conduct more heavily and D_2 and D_5 to conduct proportionately less, resulting in a partial discharge of C_1 through D_6 . Thus, so long as D_1, D_2, D_5 and D_6 are all conducting, the output voltage will follow the input.

The maximum rate or rise at output capacitor C_1 occurs when all of current I flows through D_5 (D_1 and D_6 are both reverse-biased). Under these conditions, the slope of the output voltage is I/C_1 volts/

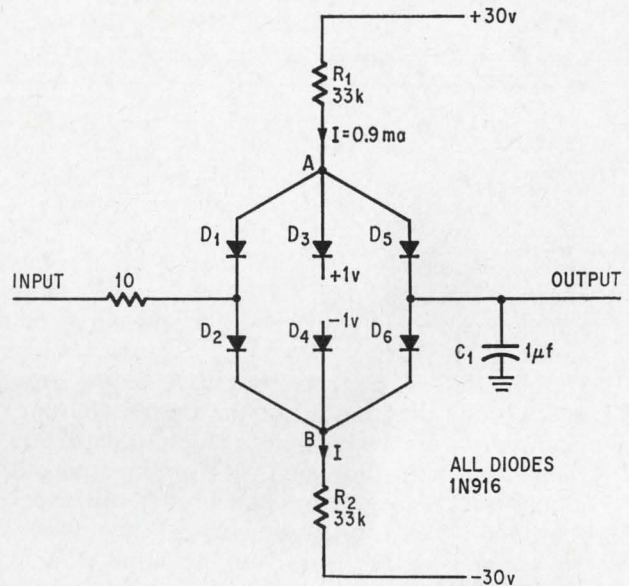

Rate-limiting circuit. Slope of output signals is limited to the rate of charge or discharges of C_1 whenever the slope of input signals is excessive. Capacitor C_1 charges and discharges through diode D_6 . Charge occurs when the slope is positive; discharge when the slope is negative. The output voltage follows the input if D_1, D_2, D_5 , and D_6 conduct.

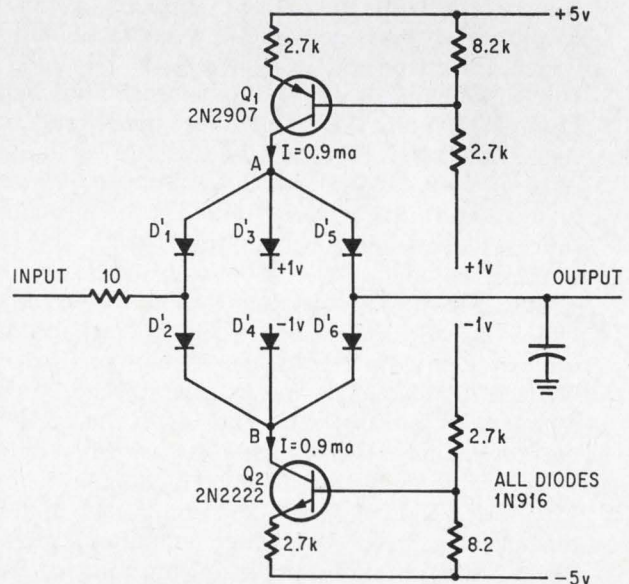

Modified circuit. Heat dissipation can be reduced if constant current transistors Q_1 and Q_2 replace R_1 and R_2 in the rate-limiting circuit.

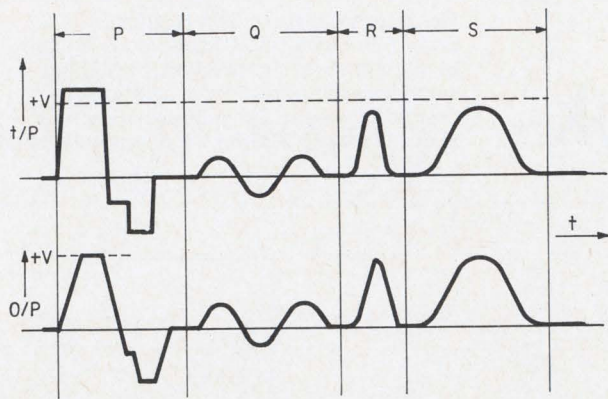

Waveforms. Slopes of waveforms P and R are limited by the circuit while Q and S are passed unchanged.

μsec , 0.9 volt/ μsec with the values in the circuit shown. In this manner, the output signal's slope is limited to the slope of the charging curve of the small capacitor C_1 .

Similarly, an excessive negative slope cuts D_2 and D_5 off, shunting all of the current I from the positive supply away from C_1 . Output capacitor C_1 then discharges through D_6 to produce an output signal with a negative slope of 0.9 volt/ μsec determined by C_1 's discharge curve. When, following an excessive rate of rise on the input, the input slope finally falls below the threshold value, the output voltage will continue to rise at the maximum rate until the output catches up with the input. Diodes D_1 and D_6 then resume conduction and the paths from input to output are restored.

The currents through R_1 and R_2 remain substantially constant and equal so long as the voltage excursions of the input and output remain small in comparison with the 30-volt supplies. Excessive amplitude swing is prevented by diodes D_3 and D_4 , which are connected respectively to $+1$ and -1 -volt supplies having low impedances. Thus, diode D_3 prevents point A (and therefore the output) from rising much above $+1$ volt while diode D_4 similarly prevents point B and the output from falling much below -1 volt. Diodes D_3 and D_4 provide amplitude limitation without interfering with the rate-limiting action.

The high voltages and resistances in the circuit, which provide the constant current, may produce undesirable dissipation. Lower voltage supplies may be used if resistors R_1 and R_2 are replaced by complementary transistors Q_1 and Q_2 in the constant-current configuration shown in the modified circuit.

The effect of the circuit upon a number of input waveforms indicates that low amplitude, high-frequency waveform Q and high amplitude, low-frequency waveform S are passed unchanged. However, pulse waveform P and high amplitude, high-frequency waveform R have regions of excessive slope, giving rise to the outputs shown.

Transistor replaces bleeder and regulates power supply

By C.K. Fitzsimmons

University of Denver, Denver, Colo.

Voltage regulation in a power supply that uses a choke-input filter is much more efficient when the conventional bleeder resistor is replaced by a transistor. The transistor, like the bleeder resistor, draws current from the filter when no load is present at the output. This bleeder current must be drawn in choke-input filters because, below a critical value, the choke becomes ineffective and consequently loses its filtering capabilities.

The voltage regulation curve indicates that bleeding establishes a minimum current point and thereby prevents high voltage at low currents from appearing at the output.

Unlike the resistor, however, the transistor stops bleeding at high load currents and avoids the inefficiencies that normally accompany the choke-input filter.

At small- or no-load conditions current is drawn through the base-emitter junction of Q_1 and the resistor R_1 . This biases Q_1 on and causes enough current to flow through the transistor and keeps the current through L above the critical value. When current is drawn by the load, the voltage drop across R_2 increases to the point where Q_2 is turned on. As Q_2 conducts it lowers the voltage drop on the emitter-base of Q_1 , causing that transistor's bias point to move toward cutoff.

In the power supply shown, bleeder current is

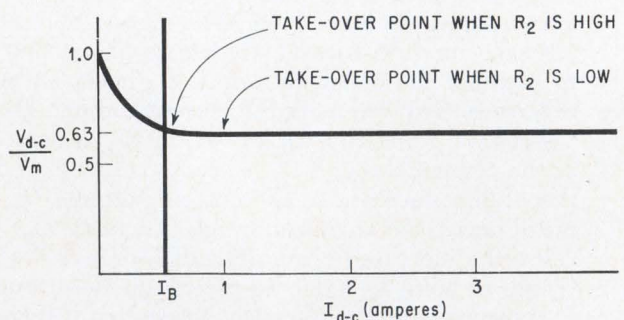

V_{d-c} = VOLTAGE IN CAPACITOR C_1

V_m = PEAK VOLTAGE AT OUTPUT OF BRIDGE

I_B = BLEEDER CURRENT

Voltage regulation. Bleeder transistor Q_1 maintains the current level where the inductance can filter the peak voltages. Take-over point, where the bleeder stops conducting, is determined by the value of R_2 . Low values of R_2 move the take-over point to the right, high values to the left.

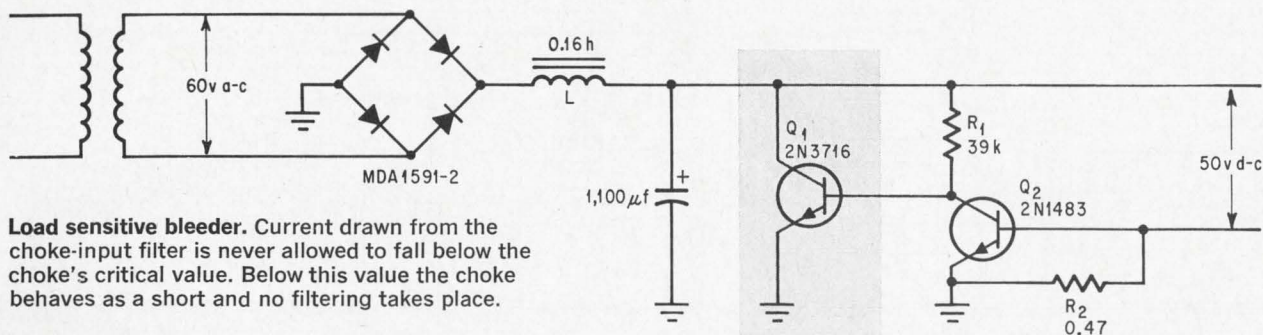

Load sensitive bleeder. Current drawn from the choke-input filter is never allowed to fall below the choke's critical value. Below this value the choke behaves as a short and no filtering takes place.

520 milliamperes when no load is present at the output. At a 500 ma, load transistor Q_1 begins limiting its collector current to 500 ma. When the load current is 1 ampere, Q_1 is biased into cutoff and only 1 microampere of collector current is

drawn. At maximum load—3 amps at 50 volts—the current through the transistor is negligible.

Since no current is drawn by the bleeder, the current specification of the supply transformer is determined solely by the load.

Zener power supply answers current problem

By B.M. Wajer

Australian Broadcasting Commission—Channel-2
Collinswood, S.A., Australia

For the engineer who must have an extremely low output voltage from a regulated power supply, adding a zener diode can provide the answer. In a conventional supply the minimum output voltage is limited by the transformer and, if a lower voltage value is needed, the supply cannot deliver it. In the modified circuit, any output voltage between 0.1 and 30 volts is possible at a maximum loading of 500 milliamperes.

Designed initially to test transistorized oscilloscope circuitry during development, the supply was built for less than \$45. Its close regulation and built-in ammeter and voltmeter make it attractive as a laboratory instrument.

Transformer T1 steps down the line voltage, a 240-volt, 50-hertz sine wave, to produce 32 volts (V_{3a}) at its secondary, designated A in the schematic; two other secondary taps make available 11-volt and 22-volt signals, called V_{1a} and V_{2a} , respectively. One of the three voltages is selected by switch S-2a and rectified by the diode bridge, producing a pulsating d-c voltage at point B.

With selector switch S-2a in position 1, the pulsating d-c voltage V_{1b} is 15 volts rms and selector positions 2 and 3 yields voltages V_{2b} and V_{3b} at 30 and 45 volts rms, respectively. The pulsating d-c voltage at point B is smoothed by capacitor C_1 and applied across the reference voltage branch that

contains switch-selectable zener diodes, D_1 and D_2 .

When ganged switches S-2b and S-2c are in position 1, diode D_1 , a 10-volt zener, is placed between the base of Q_1 and the positive line. Since Q_1 is an emitter follower, the voltage at the top of potentiometer P_{V_1} is also 10 volts; this voltage is applied to the common bases of parallel emitter followers, Q_2 and Q_3 , producing a d-c output voltage V_{1out} —approximately 10 volts. Similarly, when switches S-2b and S-2c are turned to position 2, diode D_2 , a 22-volt zener, is connected from the base of Q_1 to the positive line, generating a d-c output voltage V_{2out} of approximately 20 volts. Position 3 of S-2b and S-2c place D_1 and D_2 in series between the base of Q_1 and the positive line to give a V_{3out} of 30 volts.

Transformer switch S-2a and voltmeter switch S-2d are ganged together with zener diode switches S-2b and S-2c for convenient changing of output voltage ranges. Switch S-2a selects a voltage from the secondary of transformer T1 that corresponds to the desired range of output voltages. The approximate matching of input and output voltages keeps the collector/emitter voltages across Q_2 and Q_3 within acceptable limits and also eases the heat dissipation required of Q_2 and Q_3 . The ganged switch, via S-2d, also selects the appropriate multiplier for the voltmeter. Thus, a single movement of the ganged switch simultaneously selects the appropriate input voltage, zener reference voltage, and voltmeter range.

Zener diodes D_1 and D_2 immunize the supply from variations in line voltage. During a test, the line voltage was varied from 180 to 260 volts in steps and the regulation of the supply was found to be better than 0.1% at each step for the entire range of output voltages. The current through the voltage reference branch can be adjusted by potentiometer R_{V_2} to suit the particular zener diodes used

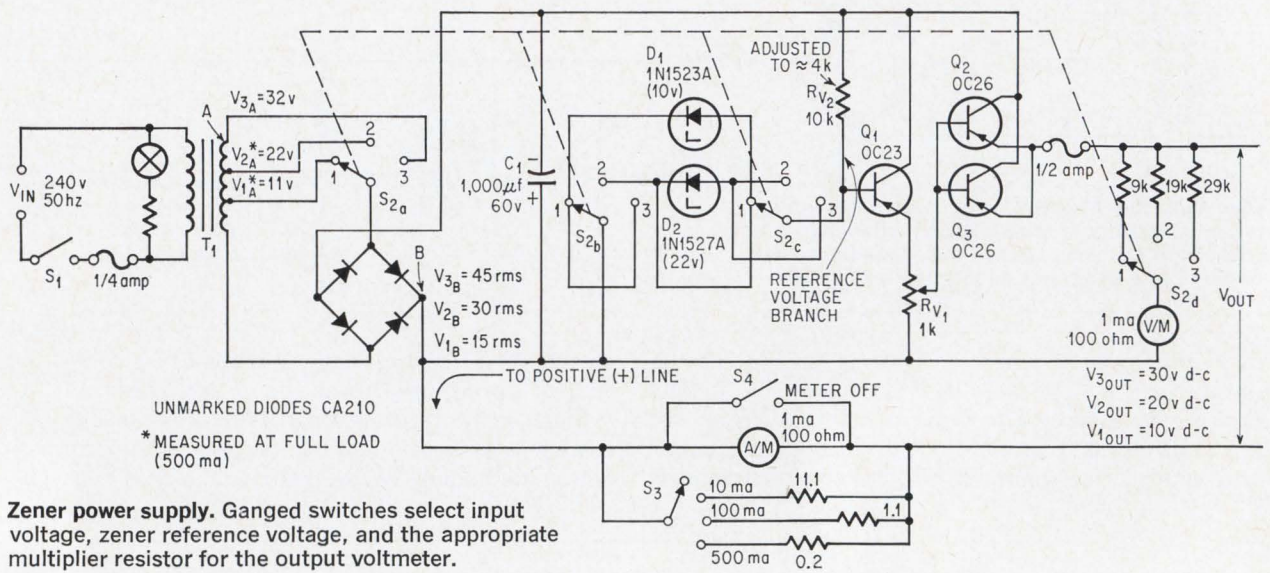

Zener power supply. Ganged switches select input voltage, zener reference voltage, and the appropriate multiplier resistor for the output voltmeter.

for D_1 and D_2 . Either output terminal may be grounded.

The power supply's regulation under load is better than 1.5% from the midpoint to full output in each range, as indicated by the voltage regulation curves. The regulation from zero output voltage to midrange, however, is approximately 3%; the dropoff in regulation is caused by the reduction in the over-all current gain of power transistors Q_2 and Q_3 when the output voltage is reduced. Thus, the best regulation is attained when Q_2 and Q_3 are high gain transistors. For a low output voltage, say 0.3 volt, it is better to set the output voltage with potentiometer R_{V1} when the power supply is loaded with the circuit under test. Output current loads up to 500 milliamperes do not impair the close regulation; the power supply has been operated at current loads up to 1.2 amperes without warming Q_2 and Q_3 , although the regulation has dropped 15 to 20%.

The milliammeter is switchable over four current ranges to facilitate the reading of very large and very small currents. This flexibility is especially

useful for reading the very low current levels in some transistor circuits; for example, it is difficult to read 2.4 ma on the 500-ma scale. To keep the circuit's cost as low as possible, two Japanese meters of the MR-3P type were used. Each meter has a 1-ma full scale deflection but the linearity of the meters was no better than 4%.

A modified filament transformer having a large current handling capacity (6.3 volts, 9 amperes) is used for input transformer T_1 . The 6.3-volt output winding was removed and the secondary rewound with No. 22 S.W.G. enameled copper wire to obtain windings of 11, 22, and 32 volts rms.

The ripple filter capacitor, C_1 , is 1,000 μf , which is about the minimum size that can effectively remove the ripple from the pulsating d-c signals produced by the diode bridge. The ripple on the output voltage from the circuit is less than 2 millivolts at 10 milliamperes. Larger capacitors may be used but they will increase the cost considerably. Capacitors larger than 5,000 μf give little additional improvement in ripple filtering.

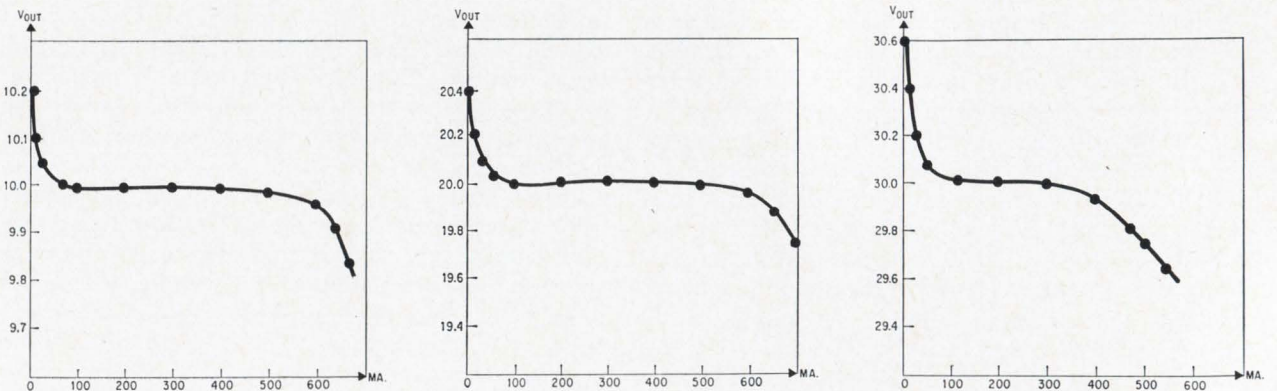

Voltage regulation curves. Power supply's regulation is 100% at 500 ma for output voltages of 10 and 20 volts d-c.

Tunnel diode speeds pulse frequency modulation

By Tjoa Wie Sian

National Electrotechnical Institute, Bandung, Indonesia

A simple pulse frequency modulator that generates output pulses having nanosecond transition times can be built by switching a transistor with a tunnel diode. The repetition frequency of the fast pulses produced by the circuit can be linearly varied from 1,100 to 2,600 pulses per second by adjusting R_3 .

Tunnel diode D_1 is placed between the emitter and base of output transistor Q_4 and operates as a fast switch, turning Q_4 on and off to generate an output pulse. When D_1 is at its peak current point, P, transistor Q_4 is off and the output voltage is -9 volts. Any further increase in the current through D_1 causes it to snap to point H in the high voltage region of the composite characteristic. Since the anode of D_1 is clamped to ground, the voltage at D_1 's cathode equals the negative of the voltage at point H so that Q_4 saturates.

As the current through D_1 decreases, the operating point of D_1 and Q_4 recedes down the composite characteristic to point V, the valley point. At point V, however, transistor Q_4 is still conducting heavily. Any further decrease in the current through D_1 from the level at point V causes D_1 to snap to its low voltage state at point L.

At the start of the cycle, there is no voltage across timing capacitor C_1 or tunnel diode D_1 , transistor Q_4 is off and diode D_2 is open. When the -10 -volt input voltage E_{IN} is applied to the emitter of Q_1 via R_3 and R_4 , transistor Q_1 turns on. Acting as a constant current source, Q_1 charges the timing ca-

pacitor C_1 toward -2.8 volts; the slope of the negative-going charging curve is constant, as shown in the sketch of the waveform V_{C1} .

As C_1 is charged toward -2.8 volts, emitter followers Q_2 and Q_3 begin to conduct and current begins to flow through D_1 . When the current through D_1 reaches the peak point I_p , the tunnel diode switches to the high voltage point H. Transistor Q_4 then turns on and the output voltage jumps to zero volts, producing a 9-volt positive step. With Q_4 on, D_2 conducts, producing a discharge path to ground via D_2 and Q_4 . Transistor Q_4 operates as a constant current source so the discharge curve has the constant positive slope, shown in the waveform sketch of V_{C1} .

Discharging of C_1 causes the bases of Q_2 and Q_3 to become more positive so that Q_2 and Q_3 begin to turn off, reducing the current through D_1 . As soon as the tunnel diode's operating point recedes to valley point V, the diode switches to its low voltage point L, transistor Q_4 turns off and the output voltage drops to -9 volts, completing the output pulse. The entire cycle then repeats as long as E_{IN} remains applied.

The constant current that charges C_1 to a negative value is Q_1 's collector current

$$I_{C1} = \alpha I_{C1} \approx \frac{R_1}{(R_1 + R_2)(R_3 + R_4)} E_{IN}$$

where E_{IN} is the -10 volts applied to the emitter of Q_1 via R_3 and R_4 and where the small base-emitter voltage drop across Q_1 is negligible.

With the values shown (and with D_1 a germanium tunnel diode with an I_p and I_v of 0.9 and 0.1 milliampere respectively), an input voltage E_{IN} varied between -5.5 volts and -10 volts by adjusting potentiometer R_3 varies the pulse frequency linearly between 1,100 and 2,600 pulses per second. The pulse width is 10 microseconds.

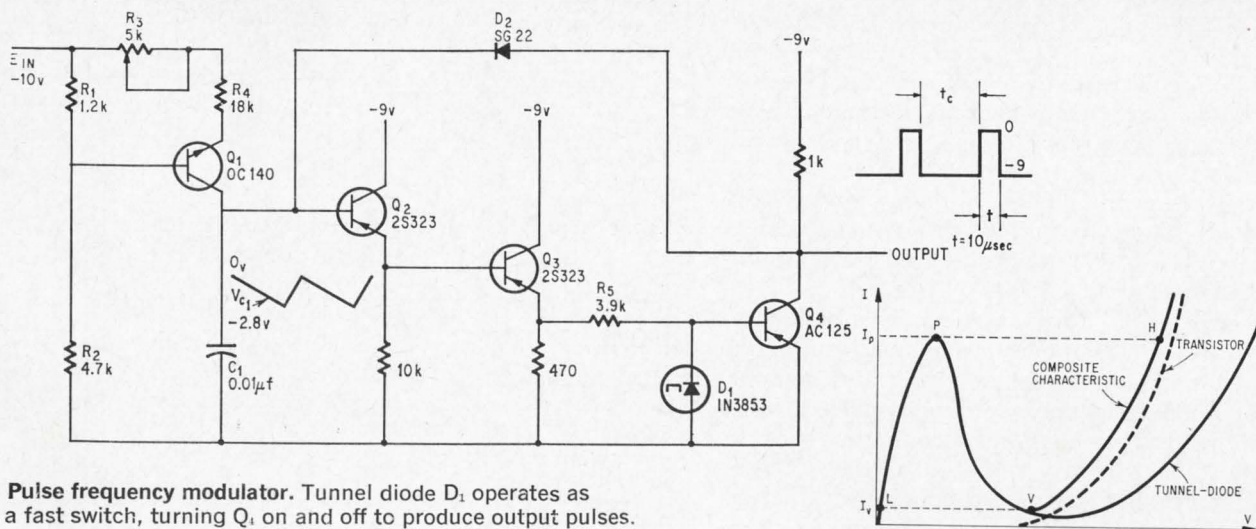

Pulse frequency modulator. Tunnel diode D_1 operates as a fast switch, turning Q_4 on and off to produce output pulses.

For low cost, count on RTL

Although slower than logic schemes currently favored by designers, resistor-transistor logic modules cut per-decade price of digital instruments

By Donald E. Lancaster

Goodyear, Ariz.

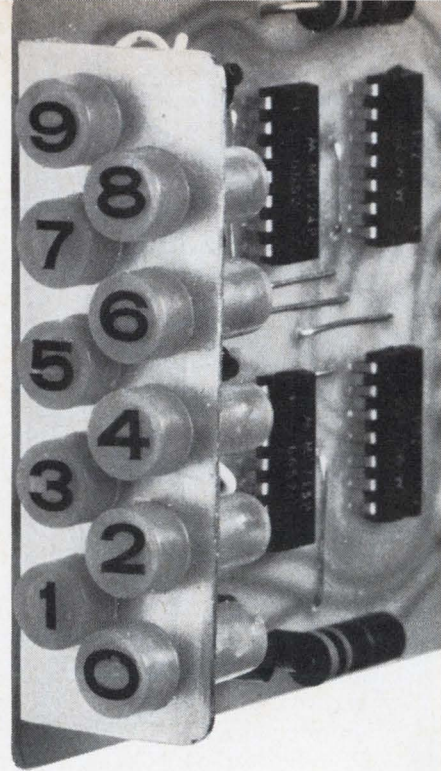

Progress is the name of the game in electronics, and the advent of diode-transistor and transistor-transistor integrated circuit logic schemes has caused many engineers to write off the older resistor-transistor logic. But by taking a step backward—reverting to resistor-transistor logic integrated circuits and older counter techniques—a decade's worth of counting, decoding, and readout can be achieved for as little as \$10.

With RTL decades, any electronics engineer or technician can build a two-digit with overranging voltmeter for \$45 or a universal counter for \$65. Even a tv repairman would like a digital voltmeter and, with the RTL decades, the price would be right.

RTL counting decades operate from d-c to 8 megahertz. Displays are visible under any ambient lighting conditions and require only low-voltage power sources.

To do the same thing with DTL or TTL would cost at least three times as much in parts alone.

Conventional integrated-circuit decimal counter-decoder-driver-readout assemblies cost between \$60 and \$100. The parts cost alone of a decimal counter built with diode-transistor logic costs about \$10; the associated decoder module, \$15, and a Nixie indicator, \$8.

But only \$4 worth of RTL flip-flops buys 8-Mhz worth of divide-by-10, and all that is needed is to pick the right code, a good decoding method, and a suitable readout.

The best code turns out to be biquinary, weighted 1-2-2-4. Biquinary weighted counting is essential for minimum cost decoding and readout. With this code, it's possible to directly drive a vertical meter readout without any decoding or, because of three states already available in the counter, to build an in-line incandescent numerical array by adding only three decodings and seven drive transistors.

Of the eight possible biquinary 1-2-2-4 codes, the one that works best with the desired decoding techniques and readout, and is realizable with RTL modules, is shown on page 75.

Two dual J-K flip-flops and two gates are needed. The counter has some characteristics that help make possible excellent circuit economy. Since each output is weighted—it can be converted directly to a corresponding constant current—the outputs can be summed in a meter readout to indicate total

How they compare

| Readout | Vertical meter | In-line incandescent |
|-----------------------------|--------------------------------------|--------------------------------------|
| Parts cost, single quantity | \$10 | \$12 |
| Frequency response | d-c to 8 Mhz | d-c to 8 Mhz |
| Inputs | COUNT RESET | COUNT RESET |
| Outputs | CARRY | CARRY |
| Calibration needed? | YES | NO |
| Power supply | 3.6 vdc at 100 ma 18 vdc at 10 ma | 3.6 vdc at 100 ma 6 vdc at 250 ma |
| Dissipation | .54 watts | 1.9 watts |
| Total IC's | 3 | 4 |
| Transistors | 4 | 7 |
| Resistors | 9 | 6 |
| Jumpers | 3 | 8 |
| Display area | 3/8 in. x 1 1/2 in. | 3/4 in. x 2 3/4 in. |

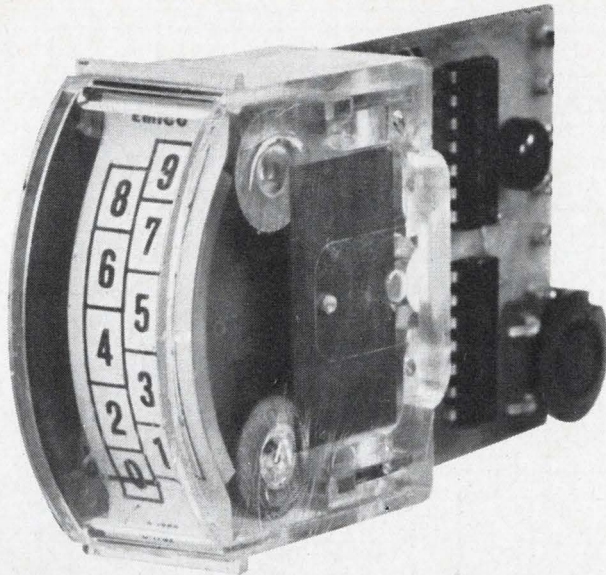

\$10 per decade. Digital displays built with millimeter or incandescent bulbs and RTL circuits. In-line decades are easier to read and look better but meter version costs less and consumes less power.

counts. Few practical counter codes allow this. This design also provides the EVEN or ODD, 0 or 1, and 8 or 9 biquinary output functions needed for an incandescent array and, therefore, takes only three additional gates to obtain the remaining 2 or 3, 4 or 5, and 6 or 7 outputs.

Furthermore, the counter circuit is free from any sudden double transitions of a flip-flop or gate. This is the result of using the transition time of an entire flip-flop to buffer both possible premature coincidences (counts 2 or 6). Such coincidences are unwanted outputs from a gate during the settling times of its inputs.

Each counter flip-flop remains in a particular state for an entire interval. An important advantage of this feature is that a noise-free CARRY output is read-

The best code

| N | | 1 | 2 | 2 | 4 |
|---|---|---|---|---|---|
| 0 | = | 0 | 0 | 0 | 0 |
| 1 | = | 1 | 0 | 0 | 0 |
| 2 | = | 0 | 1 | 0 | 0 |
| 3 | = | 1 | 1 | 0 | 0 |
| 4 | = | 0 | 1 | 1 | 0 |
| 5 | = | 1 | 1 | 1 | 0 |
| 6 | = | 0 | 1 | 0 | 1 |
| 7 | = | 1 | 1 | 0 | 1 |
| 8 | = | 0 | 1 | 1 | 1 |
| 9 | = | 1 | 1 | 1 | 1 |

ily available for direct coupling to the next stage. This output triggers the next higher decade.

Striving for low cost permits only two possible readouts: a meter or a row of 10 light bulbs. While not as attractive as some of the fancier, or single numeral readouts, either is almost as legible and as easy to use, and costs about \$2.50, roughly one-third the cost of a Nixie tube.

The meter readout is a vertical scale, 0-10 ma, d-c ammeter with a special boxed 0 to 9 readout scale. The total meter current is the sum of the currents produced by the weighted outputs.

Difficulties exist

However, there are problems. The RTL output voltage is too low and too temperature-dependent to be used as a dependable constant-current source. Isolating driver transistors are used to overcome these difficulties and produce a constant current independent of the flip-flop output voltages and voltage variations.

The summed meter current must be held to 10 distinct values. If the current drifts more than $\pm 5\%$, the meter's pointer will drift from box to box or fall between two numbers. This requires a regulated meter supply with an output impedance low enough to prevent adjacent meters from in-

Final design. Complete meter counter design incorporates shunting potentiometer for full-scale calibration. All IC's are powered from 3.6 volts d-c supply.

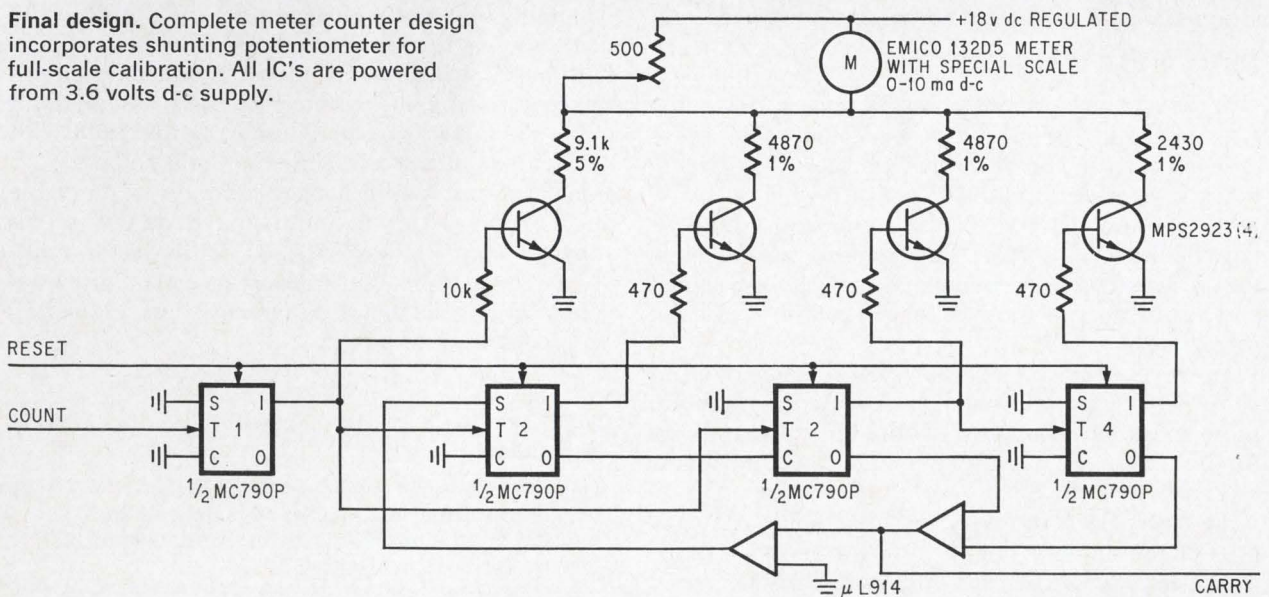

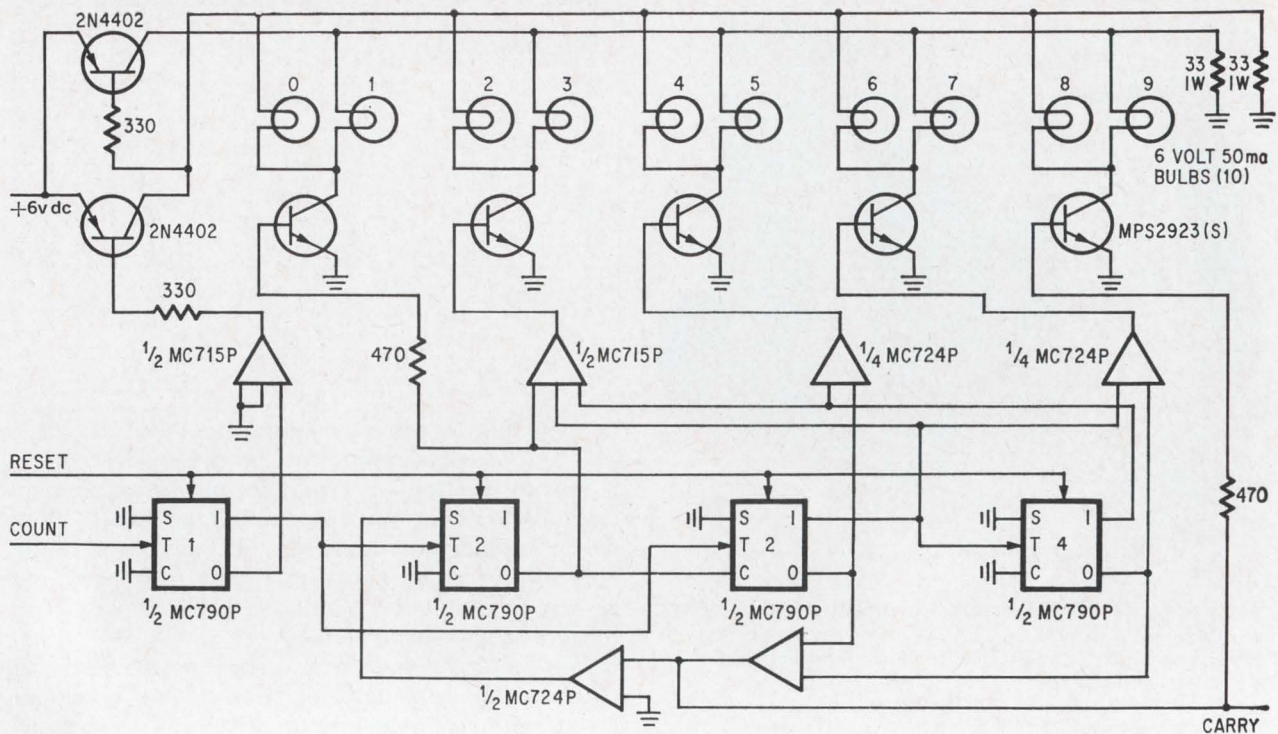

Incandescent display. Bulbs are grounded in pairs by one section of counter while other section supplies power to odd or even groups. Two 33-ohm resistors solve problem of sneak current paths. All the IC's except the MC 715P are powered from the 3.6 v d-c supply. The MC 715P uses 6 v d-c power. Special 6.2 volt, 50 ma bulbs are used.

teracting. The no-load to full-load regulation of the supply should be better than 2%. For four 10-ma meters, this implies an internal supply impedance less than 9 ohms. Also, 18 volts is the lowest voltage that permits neglecting the effects of the internal voltage drop across a low-cost meter.

In addition, 1% resistors are needed on the 2, 2, and 4 outputs, since the meter's nonlinearity uses up a substantial percentage of the allowable tolerances.

The meter's mechanical zero set adjusts the 0 output, while a shunting potentiometer provides a full-scale calibration adjustment. The complete schematic of the meter counter is on page 75.

Direct digital readout

Several novel design techniques keep down the costs of the in-line incandescent readout. The EVEN-ODD output, or the "bi" part of the counter provides B+ either to bulbs 0, 2, 4, 6, 8 or 1, 3, 5, 7, 9 while the quinary part of the counter grounds one pair of bulbs at a time. For example, on count 6, the "bi" part of the counter powers the even buss and quinary part grounds bulbs 6 and 7. Bulb 6 should light.

However, because an attempt is being made to control 10 bulbs with only seven switches, there are some sneak current paths. All the bulbs light all the time. While most are very dim, bulb 7 will be almost as bright as bulb 6.

To avoid this problem, two balancing resistors are added, allowing one-third of the supply voltage to appear across each off bulb and the full supply

voltage across the on bulb. All the off bulbs then will be barely visible because of the extreme nonlinearity of small incandescent bulbs. Ten diodes also would have solved this problem but two resistors are more economical.

However, one price paid is the extra power required. The resistors take four times more current than the light bulbs. About 1.9 watts per decade, including the counter, are needed.

A comparison

As with any electronic counter, inputs must be noise-free and have an abrupt fall-time, particularly when utilizing mechanical contacts where the chief noise source is contact bounce. The best trigger fall-time is 100 nanoseconds. An electronic circuit for conditioning the input, absolutely essential for either the meter or in-line design, can be built with conventional RTL IC's for less than one dollar.

From a cost/performance standpoint (see table on page 74), the in-line counter design seems superior to the meter readout in terms of readability, over-all readout appearance, and user acceptance. But the meter design costs less, is smaller, and consumes less power.

The author

Donald E. Lancaster is an electronics design engineer for a major aerospace firm and author of a forthcoming book on RTL. He has written some 200 technical articles on electronics.

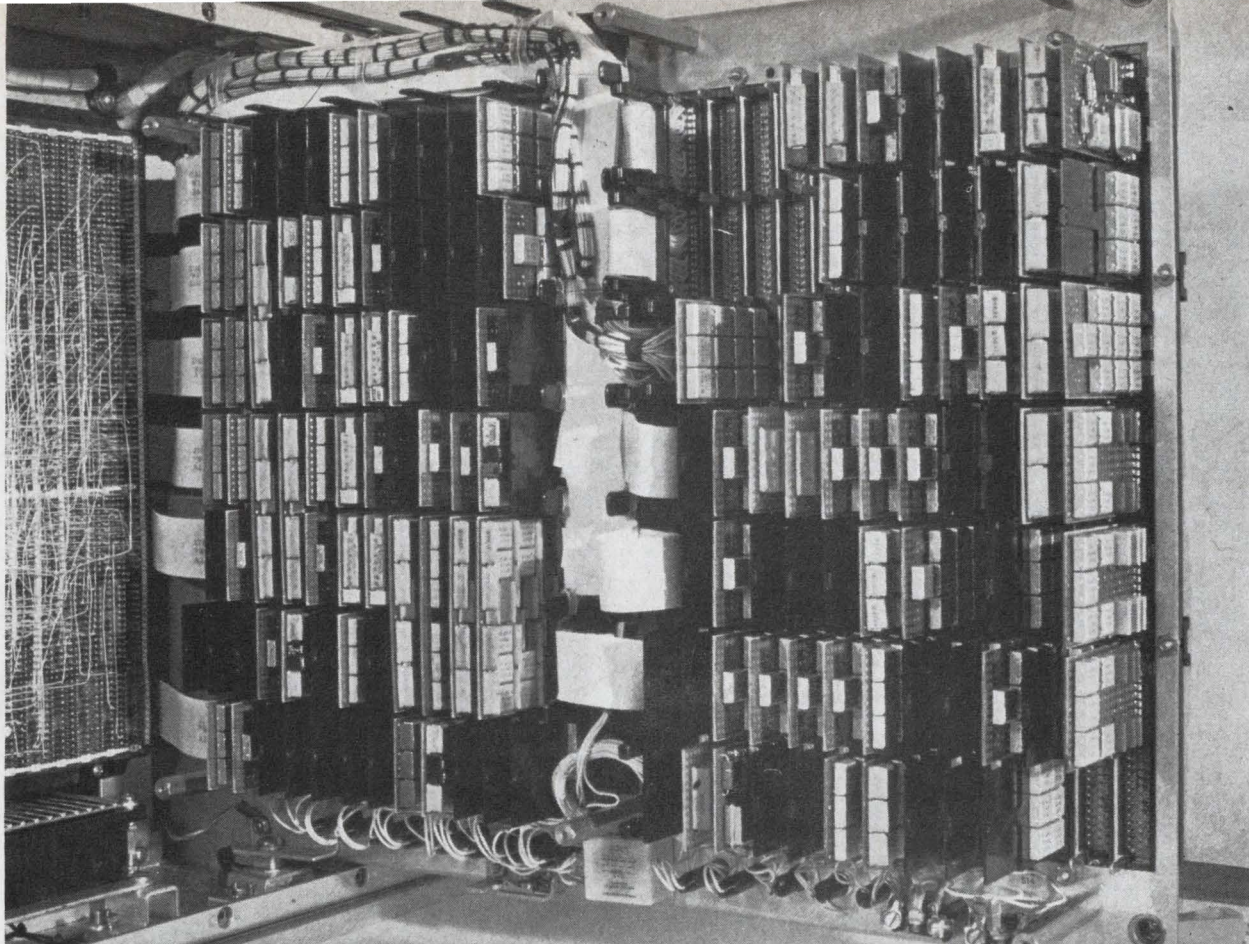

Communications

Every data bit counts in transmission cleanup

Errors, random or clustered, are corrected by a system that compares received messages with checkwords based on a code polynomial and calculated from both redundant and data digits

By Alexander H. Frey and Richard E. Kavanaugh

International Business Machines Corp., Gaithersburg, Md.

Any transmission channel is a dangerous place for digital data. Background noise can scatter errors randomly through the message stream, and outside atmospheric conditions—lightning or shifts in the ionosphere, for instance—can cause whole bursts or clusters of errors.

But random or clustered, all transmission errors are detected and corrected automatically by a new solid state system that inserts redundant digits into the data stream at the transmitting terminal and checks them out at the receiving end.

The system, developed at the Federal Systems

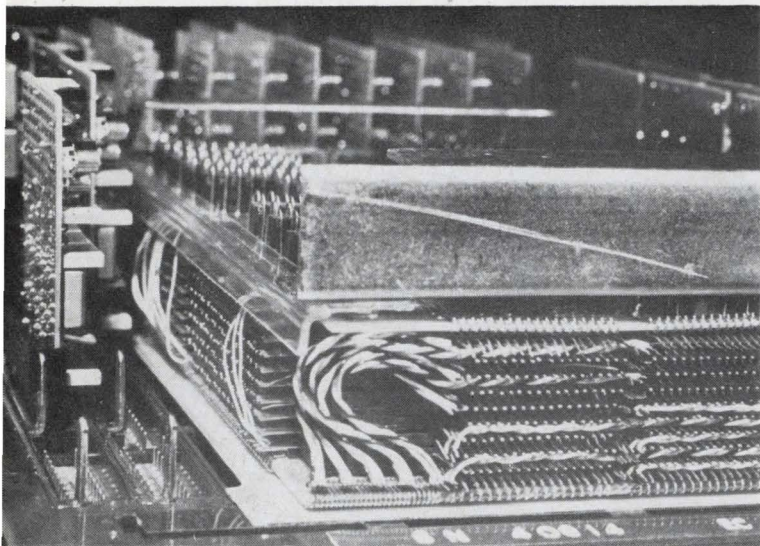

Tight packaging. Wiring to the printed-circuit boards in both the encoder and decoder is compact.

division of the International Business Machines Corp., eliminates the need for oft-repeated retransmissions, which, besides wasting time, can open the way for further errors and tie up a separate channel with operators' requests and confirmations. Called Dacor, the system is fast and can receive and transmit simultaneously; its principal feature, though, is its application of two patented schemes—statistical burst correction and adaptive decoding.

Mixing it up

Dacor is built with hybrid integrated circuits based on what IBM calls solid logic technology [see "Building blocks for Dacor," p. 80], and standard IBM core memory units. The IC's have enabled engineers to trim the system's basic units—an encoder

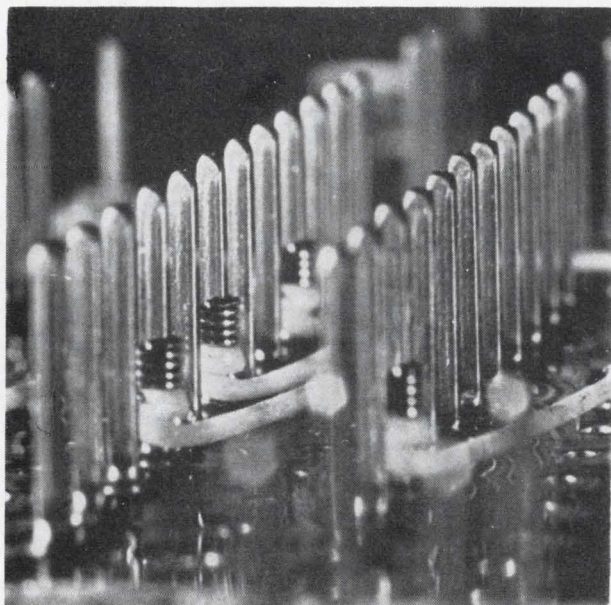

Close contact. To assure good electrical contact, wire-/wrap soldering is used.

at the transmitting terminal and a decoder at the receiver—to about the size of attache cases.

The key to Dacor, as to some other error-detection setups, is the use of a code polynomial to compute redundancies before transmission and to calculate a check format after reception. The 0's and 1's of digital data stream are examined in the encoder before transmission, and an equal number of associated—but not identical—redundancy bits are computed on the basis of the preassigned code polynomial. The data is sent off and the redundant bits are inserted next to every data bit of the next message line in the encoder output.

At the decoder on the other end, the data bits are separated from the redundancies in their stream—which refer, in turn, to a preceding line of data—and are passed through a shift register and stored in a memory unit to await the arrival of their associated redundancies. As soon as redundancies and data bits can be examined together, a checkword corresponding to the data pattern is calculated from both, based on the code polynomial. The redundant bits, having made their contribution, are then discarded.

The decoder's task is simply to pick out valid data blocks. It "looks" at the latest n number of bits received as though through a window n bits wide. If the bit pattern doesn't conform to the checkword derived with the polynomial, the decoder moves its scan up a notch to incorporate the next bit as it arrives. When the n bits under examination at any point follow the format, the decoder generates a signal indicating a valid block.

Thus the decoder, in continuously adding one data bit and dropping another from its field of examination, isolates those bits that invalidate any block n bits long. Correction logic can then switch the erroneous bits around.

As the data passes out of the memory through the correction logic to the decoder output, it's replaced by new data from the input.

Bunching up

In its burst-correction mode, the system can handle 500 different error patterns; although they represent only a fraction of the total possible patterns, these 500 cover just about all the errors that actually occur.

The user can usually anticipate clusters of errors, their approximate length, and their frequency of occurrence. By switching a knob on the front panel of the decoder, he can set the system to handle expected clusters by selecting maximum burst lengths from 250 to 10,220 bits. Any bursts of errors within the limit chosen are correctable.

To detect the beginning and end of a single cluster, the total length of the message must be 2.4 times the burst length. As this works out, a detectable burst can be no more than 5/12ths as long as the over-all message. The burst length isn't controllable, of course, but the message length can be adjusted to fit the anticipated channel conditions.

It should be noted that the proportion of undis-

Data transmission

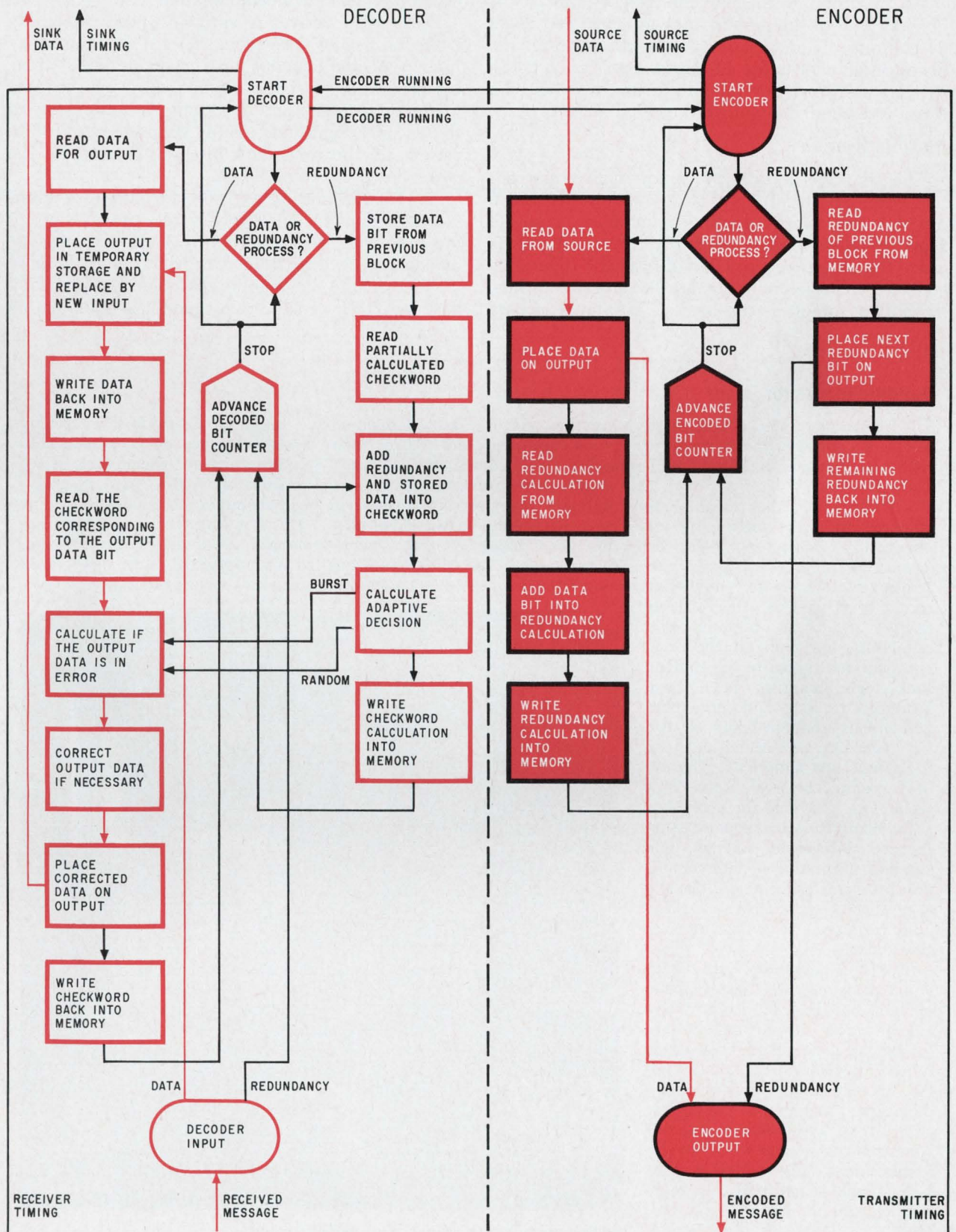

Error correction. Digital data is sent from the encoder, right, and received in the decoder, left. Errors introduced between the two units are corrected by the decoder.

turbed bits needed by Dacor to pinpoint error bursts is much smaller than most burst-correcting codes require.

As data bits are fed into the memory unit at the decoder end of the system, they are arranged down 24 columns. To detect bursts, Dacor's adaptive decision logic checks for 10 errors across each 24-bit row, or subword; for random errors, it checks for three errors in each subword.

Flexible flyer

The adaptive decoding techniques gives the system automatic flexibility. Dacor monitors the memory for correctable bursts; if it finds none, it searches out random errors and corrects them, again using the checkword calculated from the redundancies, the code polynomial, and the stored data bits.

Another factor in the over-all system flexibility

is the use of core memories. Message lengths can be adjusted to suit anticipated error-burst lengths simply by the changing of pluggable cards. Up to 60,000 bits can be accommodated.

Dacor also derives a variable speed capability from the use of core memories rather than delay lines. With the memory units' random access time, bit processing speed is limited only by the time taken for encoding and decoding. And any delay at the decoder represents simply the time required to receive all the redundant bits contributing to the correction of the stored data.

At the transmitting end, the technique of interleaving redundant bits applying to a previously sent message with the data bits of a current message avoids any need to store data in the encoder or to slow down the message stream. The timing of bit flow on either end is set by modems—modulators

Building blocks for Dacor

The hybrid integrated circuits used in Dacor consist of metal glaze resistors connected to discrete transistors.

In fabrication, the resistors are adjusted to value after pins are attached and the modules are dipped in solder. Glass-passivated semiconductors with metal-ball contacts, as well as other discrete devices such as ceramic chip capacitors, are then attached and encapsulated. Nearly 2 million suck logic modules have been produced to date and more than 200 million element-hours of testing have been performed on them.

Savings and simplicity. The hybrid product of IBM's solid logic technology provides the cost, size, and reliability advantages of competitive integrated circuits and significantly reduces interconnection problems and thermal dissipation. Also, tests indicate considerable resistance to wide temperature swings.

The semiconductors, both diodes and transistors, are silicon planar epitaxial devices fabricated on a silicon wafer approximately 1¼ inches in diameter. Silicon oxide protective layers are deposited after all diffusions, and vacuum-deposited aluminum conductors are put on the wafer to provide contact areas remote from the diffusion areas. The wafer is then hermetically sealed with two high-temperature borosilicate glass coatings.

Eliminate the negative. After small metal balls are soldered to the contact areas exposed by etch-

ing, the wafer is cut into individual chips approximately 0.025 inch square. This combination of passivation and connection eliminates thermal compression bonding, cans, whiskers, and two-sided chip diffusions, along with the manufacturing and reliability problems associated with these techniques.

Resistors are made by screening resistive pastes on a ceramic substrate, firing at temperatures of approximately 800°C, and mechanically trimming to the desired value. This bonding to the substrate enhances the devices' power-dissipation properties, and the glazed structure ensures stability.

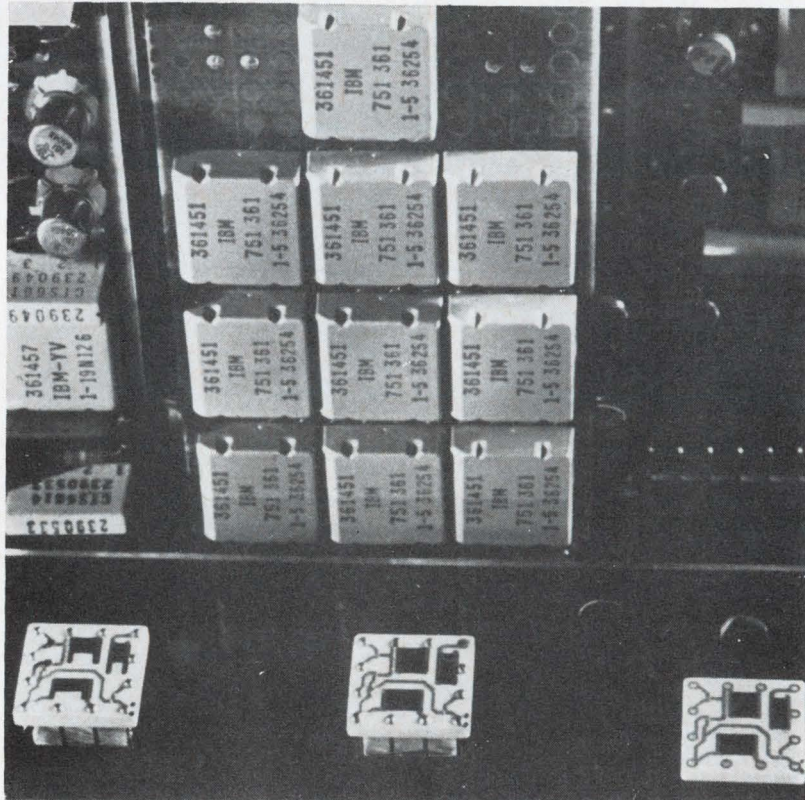

Hybrid modules. The three integrated circuits at the bottom are examples of IBM's solid logic technology. The units shown above are the packaged modules inserted on printed-circuit boards.

SYSTEM APPLICATION

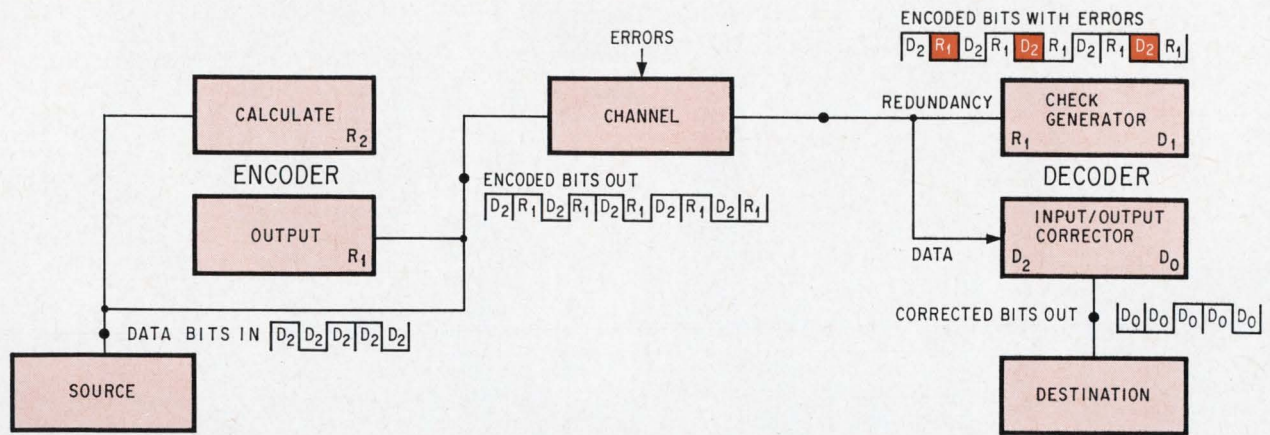

Interleaving. Redundancy bits R_i are calculated in the encoder for a previous line of data, D_i , and are inserted between data bits D_i . Errors, indicated by color blocks at right, are introduced between encoder and decoder. At decoder, stored data, D_i , is examined with the redundant bits and errors are corrected.

demodulators. The present setup operates at any modem speed up to 40.8 kilobits per second.

When transmission conditions are good and no large clusters of errors are expected, the system can be modified to transmit and handle messages in which only one of every four bits is redundant, rather than one of every two. This reduces Dacor's ability to correct bursts, but speeds data transmission by 50%.

It figures

The error detection and correction process, as noted earlier, is keyed to polynomials and is expressed in terms of them. A data polynomial, $D(x)$, represents the unencoded message; a code polynomial, $P(x)$, represents the method applied to generating redundancy bits; other polynomials represent transmission errors, and these join with $P(x)$ to yield polynomials representing a sequence of bits that indicate, locate, and correct the errors.

All these polynomials are sums of terms each of which is made up of a dummy variable, x , raised to some power, and a coefficient of either 0 or 1 to represent one of the redundancy or data bits. The dummy variable's only function is to provide a sort of skeleton upon which to build the polynomial, and its power distinguishes the coefficients.

The summation of terms in the polynomial is modulo 2, which is sometimes known as sum without carry, or, when no more than two terms are involved, as exclusive OR. The following table shows how binary numbers are added modulo 2:

$$\begin{aligned} 0 + 0 &= 0 \\ 0 + 1 &= 1 \\ 1 + 0 &= 1 \\ 1 + 1 &= 0 \end{aligned}$$

It's been explained that to pinpoint a cluster of errors, the total message must be 2.4 times the length of the burst. And since redundancies constitute half the bits in any stream, the number of redundant bits in a message is 1.2 times the maximum detectable and correctable burst length.

Like the message length, the code polynomial for

any particular Dacor installation is dependent on the maximum anticipated burst length. The polynomial's degree—the highest power of the variable in any of its terms—is equal to the number of redundancy bits, and is thus 1.2 times the number representing the maximum correctable burst.

Encoder and decoder operation can be expressed mathematically by a series of polynomial divisions. In the encoder, the code polynomial divides the data polynomial to form two other polynomials—the quotient and the remainder. In mathematical symbols,

$$\frac{D(x)}{P(x)} = Q(x) \oplus \frac{R(x)}{P(x)}$$

The symbol \oplus signifies addition modulo 2. Multiplying both sides of this expression by $P(x)$ and rearranging the terms yields

$$D(x) \oplus R(x) = P(x)Q(x)$$

The symbol \oplus is correct, because addition and subtraction are identical in modulo 2 arithmetic.

The coefficients of $C(x)$ and $R(x)$ in this expression form the encoded message. Since $D(x)$ is the original data polynomial, $R(x)$ represents the redundancy bits as well as the remainder from the division. Because of the happy accident that the words redundancy and remainder both begin with an R, $R(x)$ can stand for either of them interchangeably.

Repeat performance

The decoder applies the same procedure to the received message, which may differ from the transmitted stream because of errors introduced (modulo 2 again) in the transmission channel. If the transmitted message, $D(x) \oplus R(x)$, is represented by a single symbol $M(x)$, and the errors by $E(x)$, the received message is

$$M'(x) = M(x) \oplus E(x)$$

If no errors were added in transmission, the message will be received as it was transmitted—either

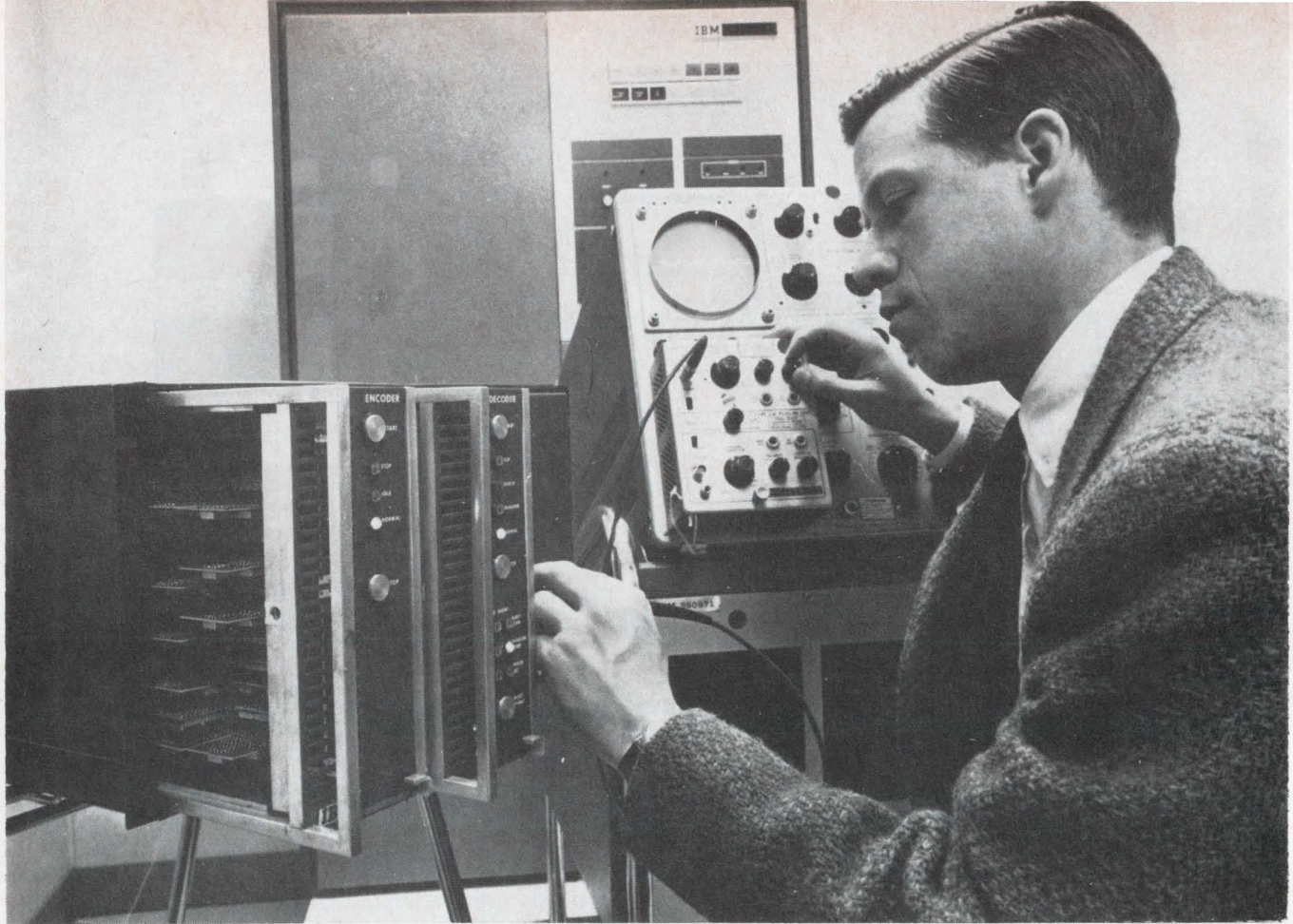

Testing. Author Frey tests Dacor, which is composed of an encoder and decoder. Tall unit at rear is a previous error-correction system made without IC's.

$D(x) \oplus R(x)$ or $P(x)Q(x)$. When the decoder divides $P(x)$ into this error-free message, the result comes out even—the quotient is $Q(x)$ and the remainder is zero.

A remainder that isn't zero indicates that something has been added to the message; the remainder is labeled $C(x)$, and that something added is the error polynomial $E(x)$.

It's conceivable, incidentally, that an error would make $M(x) \oplus E(x)$ divisible by $P(x)$; this would be an uncorrectable error—perhaps an unusually long burst. The probability of this happening, though, is minuscule.

On stream

All these divisions are a convenience to mathematically indicate what goes on in the encoder and decoder. Dacor doesn't have an arithmetic unit to slosh quotients and remainders around. Rather, successive redundancy bits are generated in the encoder from a logic network through which the data bits pass on their way to the modem. These check bits are stored, then interleaved with the data bits in the next message.

In the decoder, the temporarily stored data bits and their corresponding redundancy bits together pass through a logic network that generates the check polynomial $C(x)$. The two logic networks perform functions that are mathematically equiv-

alent to polynomial divisions.

The maximum anticipated burst length can be better understood by letting $P(x)$ denote the code polynomial for a block length of n , and r denote the degree of $P(x)$ —the number of redundancy bits. If r is chosen so that

$$r > b + \log_2 n$$

then the code generated by $P(x)$ can be used to correct bursts less than or equal to b bits, because b bits describes the error pattern of length b and

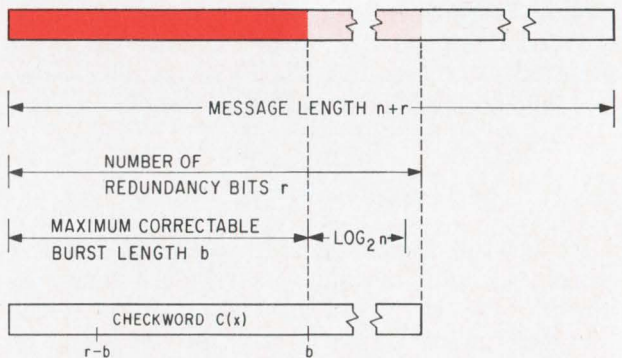

Checksum. Pattern of bits in checkword indicates in what part of the message the error has occurred and how it can be corrected.

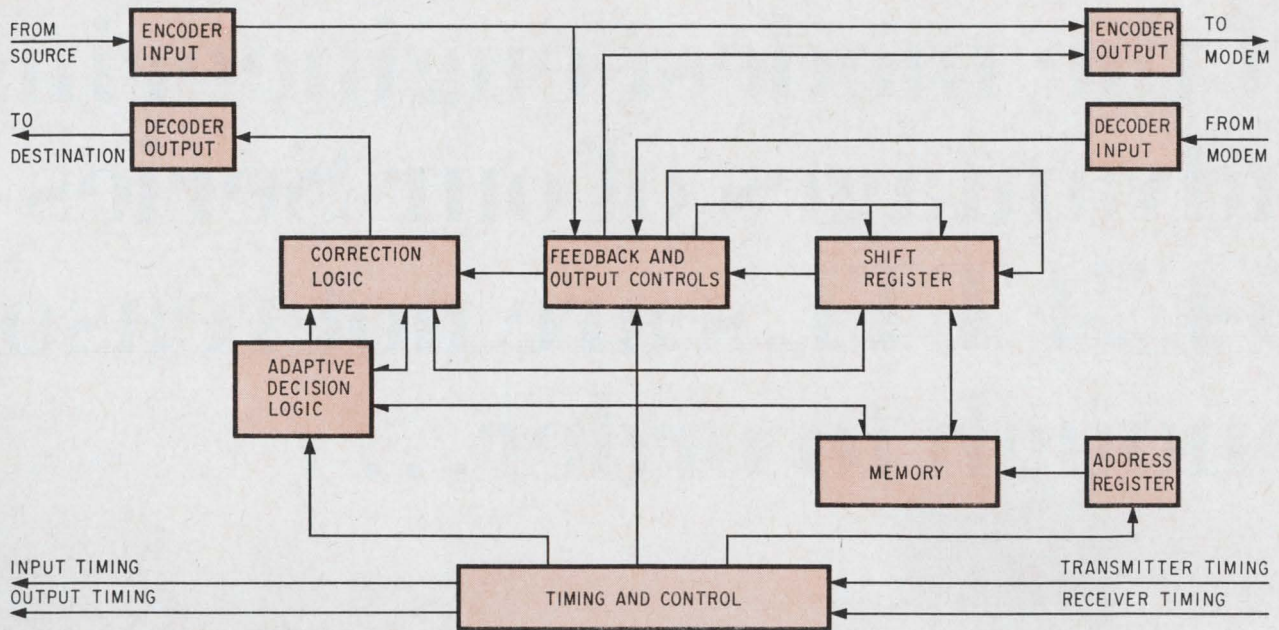

Timing. Stages indicate the timing sequence between the encoder and decoder.

$\log_2 n$ bits indicate the starting point in the block of n length. The choice of $P(x)$ is unimportant; only the degree of $P(x)$ is critical.

The checkword, $C(x)$, is expressed in terms of those powers of x that correspond to the first r bits of the received block. That is:

$$C(x) = \sum_{i=1}^r c_{r-i} x^{r-i}$$

If, in the diagram at the bottom of page 82, all the errors in the message occur in one of the tinted areas, then the checkword will contain the exact error pattern. In particular, if none of the errors occur outside the heavily colored area, then all the bits in the checkword—all the coefficients in $C(x)$ —to the right of the point marked $r-b$ are 0. The reason here is that $r-b$ is greater than $\log_2 n$, so that all errors in the first b bits in the message can be signified by at most $r-b$ bits in the checkword.

If errors have occurred in the lightly tinted area, the checkword will contain some 1's to the right of the point $r-b$. Errors beyond the first r bits—the untinted area of the diagram—raise the probability, Q , that each single coefficient of the code word to the right of $r-b$ will be 0. As the coefficients are independent of one another, the probability that all the bits to the left of $r-b$ are 0 is Q^{r-b} .

The condition of all 0's in the checkword to the right of $r-b$ can indicate a burst of errors in the first b bits of the block—the heavily tinted area; the pattern of 1's to the left of $r-b$ indicate what the error is. The probability is approximately Q^{r-b} that a correction based on that indication will be invalid, and since Q is less than 1, Q^{r-b} can be made arbitrarily small by making $r-b$ large.

If the condition for the existence of a burst isn't met, then the checkword can be shifted one bit to

the left and the test repeated on the same bit positions, which are the bits that were $r-b+1$ to $r+1$ before the shift. Each succeeding shift of the checkword shifts the span of bits over which the burst is detected by one bit position. The probability of falsely detecting, at any shift, the condition that indicates a burst less than or equal to b bits is then $(n-b) Q^{r-b}$. With large values of b , then, this technique can provide extremely efficient burst correction.

Dacor systems are currently produced at the Federal Systems division's Gaithersburg facility under a number of Government contracts. The most recent of these orders was placed by the Air Force and came to approximately \$1 million.

The authors



Alexander H. Frey is a senior engineer at IBM's Federal Systems division. The holder of a Ph.D. in mathematics from the University of Washington, his responsibilities include the design and analysis of advanced error-control systems.



Richard E. Kavanaugh, a staff engineer at the division's laboratory, is working on the application of error-control techniques to hardware.

If the modest engineering advantages of our Series 54/74 TTL's are not reason enough to order...

our delivery is.

Here's our line-up. They're all monoliths

| We | They | Description | Modest Engineering Advantages |
|----------------|----------------|-------------------------|-----------------------------------|
| SN 5473N/7473N | SN 5473N/7473N | Dual JK Flip Flop | 15ns clock skew, clock line clamp |
| SN 5474N/7474N | SN 5474N/7474N | Dual D Flip Flop | Tight hold time specification |
| SN 5400N/7400N | SN 5400N/7400N | Quad 2-input Gate | Input voltage clamps |
| SN 5410N/7410N | SN 5410N/7410N | Triple 3-input Gate | Input voltage clamps |
| DM 7800/8800 | — none — | Dual TTL/MOS Translator | Up to 33V output swing |
| NS 7673 | — none — | Lamp/Relay Driver | 250mA output drive capability |

to be continued

for additional information write National Semiconductor,
2975 San Ysidro Way, Santa Clara, California 95051, (408) 245-4320.

National Semiconductor

Putting the squeeze on radar signals

Core memory stores samples taken in sequence from several sources and reads them out, channel by channel, at high speed; this technique permits one processor to keep track of many targets simultaneously

By John D. Collins

Raytheon Co., Bedford, Mass.

Time compression can do as much for radar signal processing as time sharing has done for computerized airline reservation systems or bank bookkeeping. With this new technique, a single radar system can track several targets at once or search a wide expanse of sky.

Although primarily developed for large radar networks, the approach could be applied wherever a multiplicity of analog signals has to be analyzed and correlated. For example, the signals from many electrocardiograms, blood-pressure sensors, and other biomedical devices could be processed together in the same unit. The more channels there are to be monitored, the more advantages time compression offers; and these advantages can be realized without inordinately complex hardware.

The key component in a time compressor is a ferrite-core memory that stores digital samples from a continuous-wave signal source such as radar. The chief feature of the technique is the way these samples are stored in the memory at a relatively low speed and read out at high speed for analysis by a single bank of filters.

Creating an illusion

The memory accepts one sample signal from each of several radar channels in turn. After several

passes across all the channels, the stored samples from the first channel are read out in a continuous stream, then all the samples from the second, and so on. Thus, samples taken at, say, milliseconds are read out in microseconds, and appear to have been compressed in time. The information is then broken down into frequency components by a filter bank and analyzed by a computer to determine the range and velocity of various targets.

This block readout, channel by channel, enables one filter bank to work on a time-shared basis. And because time compression raises the audio signal frequencies by a large factor, they can be analyzed by smaller and less expensive components.

In this respect, the technique is similar to one commonly used in sonar; frequency increase is also necessary in those systems to reduce component size and cost, but the sonar applications cannot benefit from time sharing because they involve only one channel. The time compression system is called Cortic, for core time compressor, a name similar to Deltic, for delay-line time compressor, the sonar technique.

Juggling targets

A coherent radar system capable of tracking several targets at once, or alternatively capable of searching for an unknown target at an unknown distance, contains a large number of channels, or receivers, each tuned to a different distance [see "Signals for compression," p. 87]. As the radar acquires real or false targets, these receivers continually produce signatures—unusual or even unique frequency patterns—that have to be analyzed to determine the various targets' velocity, acceleration, and other characteristics. The analysis, in general, must be performed as fast as the signals come in; recording the signatures for later analysis

The author



John Collins, a principal engineer at the Missile Systems division of Raytheon, has been working on the processing of radar, sonar, and other signals for 10 of his 13 years with the company.

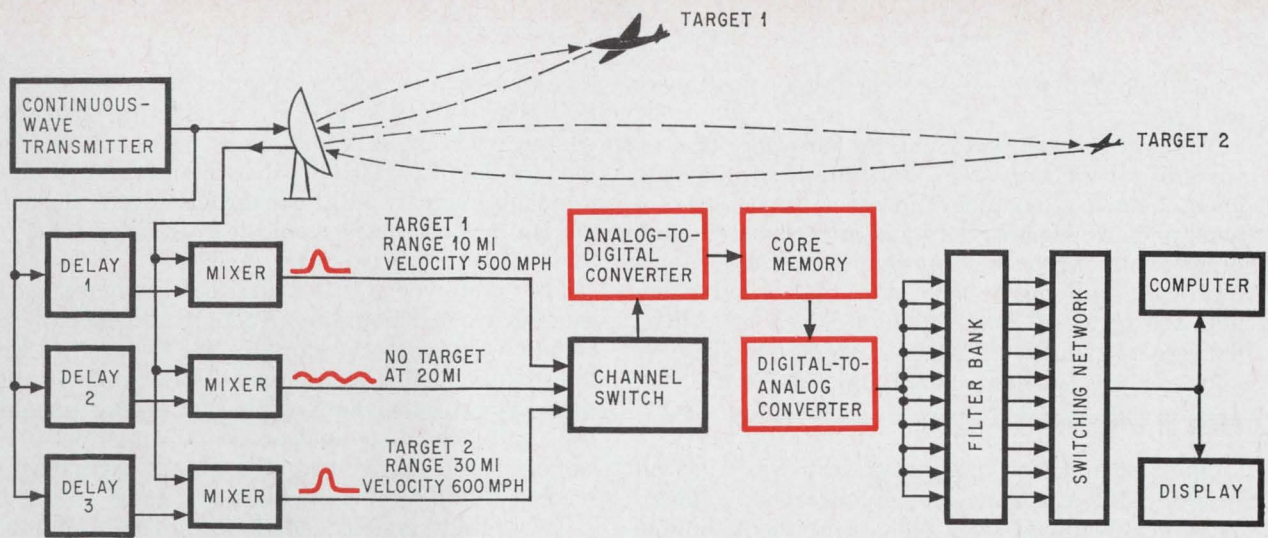

Compressor. Digital samples of signals from several channels tracking different targets are stored in a core memory. They are read out at a faster rate than they were put in, and are then analyzed by the filter bank and the computer.

Signals for compression

The time compressor's input comes from a coherent radar that sends out a signal and receives an echo out of phase with the transmitted wave. For all but very short ranges, the phase difference is more than one wavelength. A non-coherent radar is sensitive to amplitude only, not phase.

The transmitted signal passes through one or more delay units in parallel with the transmitting antenna. Each delay unit inserts a time interval equivalent to an integral number of wavelengths, and the phase difference is measured between the echo signal and the delayed transmitter signal. The amount of delay then gives a gross indication of the target's distance and the phase difference a more accurate indication. Each delay unit corresponds to a large increment of range, or distance; the delay and its associated circuitry comprise a radar channel.

Peaks and valleys. As the target moves toward or away from the radar unit, the phase difference keeps changing. As peaks in the received signal successively coincide with peaks and valleys in the transmitted signal, the phase difference itself acquires peaks and valleys, creating a difference frequency. The radar signals themselves are measured in gigahertz and the difference frequency usually in kilohertz.

When the radar unit remains locked onto a single target, only one difference frequency is of interest; variations in this frequency

correspond to variations in the target's velocity. But when several targets are in the radar beam, or when the radar searches for an unknown target, the system must keep track of difference frequencies for each range.

For example, if the radar has a range of 100 miles and a resolution of one mile, it must have 100 different channels. One looks for difference frequencies from targets one mile away, another for targets two miles away, another for three miles, and so on.

Breakdown. Because the signal from a specific channel can be quite complex—reflecting several targets traveling at different speeds or a single target moving erratically—the difference frequency must be broken down into its various components. This is conveniently done by a bank of narrowband filters, each of which isolates a single component frequency from the received signal.

Suppose an individual channel picks up targets moving at speeds between 100 and 500 miles per hour at a range of 50 miles. The signal from this channel could be analyzed by a bank of, say, 40 filters, one of which would produce an output if the difference frequency indicated the presence of a target traveling at between 100 and 110 miles per hour, another indicating a target velocity of 110 to 120; the next, 120 to 130, and so on. The 40th filter's output would correspond to a speed between 490 and 500 mph.

These filters by themselves cannot indicate whether a target is

moving toward or away from the radar antenna, but the Doppler effect can. The echo from an approaching target will be at a higher frequency than the transmitted signal, and at a lower frequency if the target is moving away. This effect, together with the output of the filter bank, gives complete information about the target's radial motion.

A target moving toward the receiver at a constant velocity generates a constant difference frequency that produces a steady output from one filter in a single channel. As the target comes closer to the receiver, the signal switches from channel to channel, producing outputs from corresponding filters in successive channels.

Inconstancy. Most targets, however, don't move at constant speeds. They may, for instance, have transverse components; the radar can track only the radial velocity component. Even if the target is moving along an oblique line, the radial component changes only gradually in proportion to the cosine of the angle between the target's path and the line of sight. Or the target may be tumbling or rolling; as parts of it move at different velocities, a frequency modulation is set up in the difference signal.

As the target's velocity changes, its frequency—as produced by the radar—changes. This frequency variation plotted against time yields the target's signature, by which, for example, various satellites in orbit around the earth can be identified.

won't help if the targets are capable of destroying the radar.

Without time compression, the only way to keep track of all the targets in real time is to attach to each channel a complete processor consisting of a bank of narrowband filters and an associated computer. This approach is too expensive and entails too much equipment when more than a few channels are involved. Some radar systems have been designed around multiple processors, but all these networks are relatively small and complex.

First of a series

The first primitive time compressor was tried out in 1963. Although many considerably more sophisticated versions have been built since, the technique itself is simple and doesn't require a large computer. Even a 1,600-channel time-compression system, the largest built so far, has been adequately

managed by a computer no larger than the Digital Equipment Corp.'s PDP-8, a table-top machine whose word length is only 12 bits and which sells for less than \$20,000. This machine is fast enough to analyze signals on a half-dozen targets at once, though beyond that it would lose track of some of them.

The prototype Cortic fills the memory with samples from the various channels and then shuts off the input while the samples are read out to the filter bank channel by channel. This design is still useful where either the sample rate is slow enough to permit a complete analysis of a channel between sample inputs, or where some loss of data during readout isn't a serious drawback.

Two newer versions called Cortic I and II, however, interleave reading and writing so that sample signals can be analyzed continuously without any loss of input data. The more complex version is the

Filtered signals

Filtered output. A 1-msec pulse of the high-frequency compressed signal (left center) produces an output from the filter with the passband corresponding to the major frequency in the signal; outputs from other filters are created by the pulse's fast rise (traces at right).

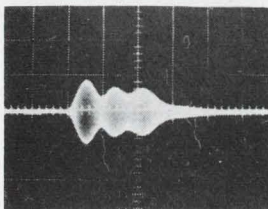
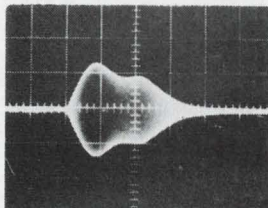
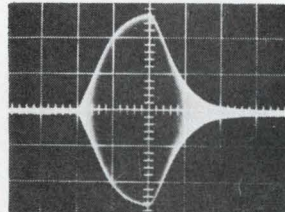
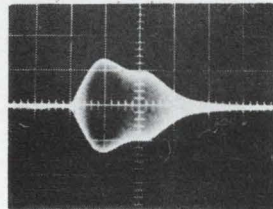
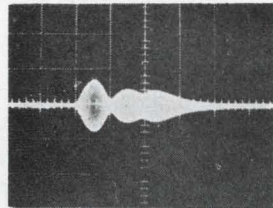
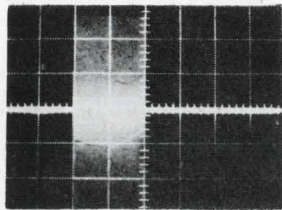

Sequential sampling. If the filters are sampled in sequence, while a 1-msec pulse like that at the left is being applied to their inputs, their outputs appear as pulses. The center filter shows very little attenuation; those on either side attenuate considerably and those beyond show hardly any output at all.

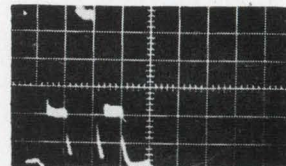

one built into a 1,600-channel radar system. This system combines long range with very high resolution, but it also requires that the number of channels be a multiple or submultiple of the number of samples in each channel. Where the ratio of channels to samples is not an integer or the reciprocal of an integer, the intermediate version can be used. This channel-to-sample ratio depends on the specifications of the core memory and on the capacity of the computer processing the signals.

Besides a magnetic-core storage unit, a single bank of filters, and controls, time compression requires a set of channel commutation switches plus analog-to-digital and digital-to-analog converters. Memory size is determined by the number of channels, C , the channel sample rate, B , and the amount of time, T , the computer needs to process all the data in one channel. Thus, BT samples are taken from each channel with each cycle of processing, and the memory's capacity must be at least CBT samples.

Radar echoes are analog signals that have to be converted to digital form to be stored in the memory, and then back to analog when being read out for analysis. Since reading in and reading out were kept separate in the earliest prototype, a combined analog-digital-analog converter sufficed. But the more sophisticated designs handle both operations simultaneously and therefore need separate converters. Digital filters or a special-purpose fast Fourier transform computer at the output would make the second conversion step unnecessary, but they are quite expensive and the time-compression systems built so far have all used conventional crystal filters.

Good trick

The most difficult part of applying time compression to a radar system is working out an addressing scheme that allows the economical use of the storage at an adequate speed.

Cortic's operation depends on the ability of the computer to process the data in the storage unit at a speed considerably faster than the data's arrival rate. If the computer speed is C times the data rate, the computer can analyze C channels without losing any data.

The principle of time compression is illustrated by the simple three-channel device, top of page 87. The switch connects channel 1 to core memory 1 through the analog-to-digital converter. The system takes one sample from channel 1, converts it to digital form, and stores it. It then takes a sample from channel 2, converts and stores it, and repeats the process with channel 3. After the first sample from channel 3 has been stored, the second sample from channel 1 is taken. The sampling rate of each individual channel must be at least twice the highest frequency of the signal in that channel; otherwise, the reconstructed signal could contain spurious frequencies and thus not truly represent the original.

When the memory has collected many samples

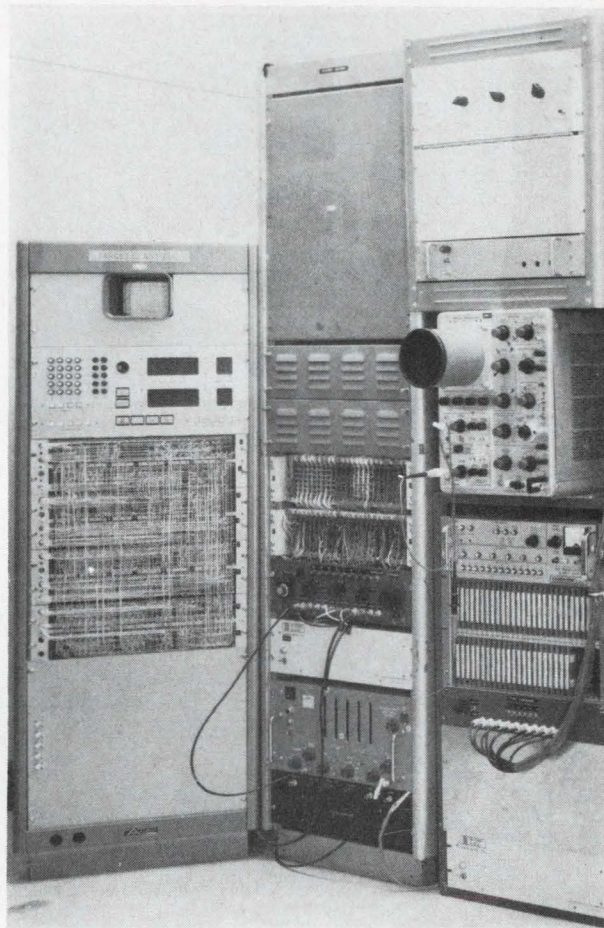

Prototype. The apparatus beneath the oscilloscope is the first time-compressor (block diagram below). The filter bank is behind the gray panel at top center.

from each channel, the information from channel 1 is converted back to analog form and analyzed by a bank of filters. Samples from channel 2 and channel 3 are similarly analyzed, and a computer determines the position and speed of the target from the output of the filters. The readout is much faster than the reading in, the ratio of readout rate to read-in being a multiplying factor that adjusts the

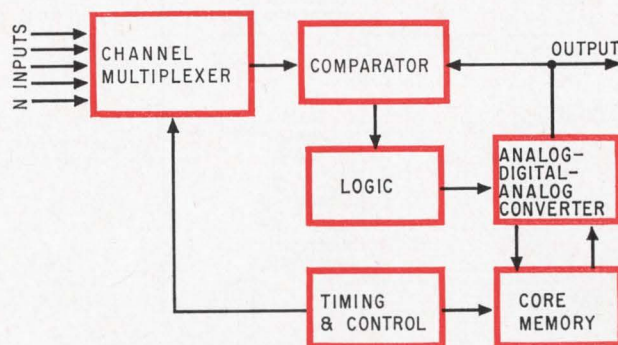

Ten to one. Ten channels are multiplexed into a single comparator and combined analog-to-digital and digital-to-analog converter through which all data passes on its way to and from the memory.

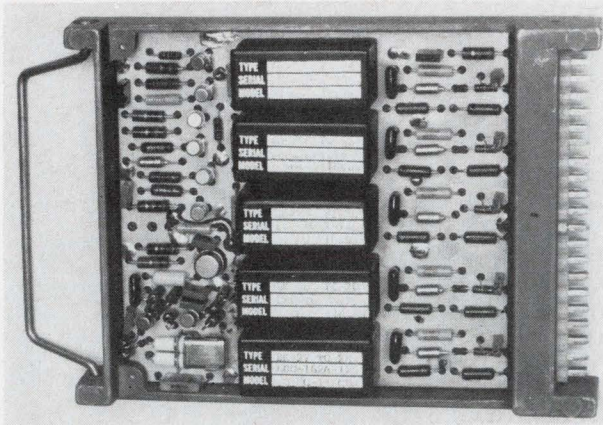

Filter bank. Typical card contains five of the narrowband analog filters, with associated electronics. The prototype contains 40 of these cards.

analysis to compensate for this speed change.

The prototype Cortic has 10 channels, corresponding to the radar system's ability to detect targets at 10 different distances. Within each channel, the band of detectable frequencies ranges from 200 to 900 hertz, corresponding to the velocity limits of the targets picked up.

Each channel is sampled at a 2-kilohertz rate. An adequate sampling rate would be 1.8 khz—twice the highest signal frequency of 900 hz—but a 2-khz rate offers a margin of safety. After each sample is converted into digital form, it's stored in a memory location corresponding to the sampled channel. The samples for all 10 channels come from a 20-khz oscillator, so that each sample is wide enough—50 μ sec—to allow plenty of time for the conversion process and storage cycle to continue.

The compressor samples the channels for 300 msec, collecting 600 sample words from each channel. The CBT product is $(10)(2,000)(0.3) = 6,000$,

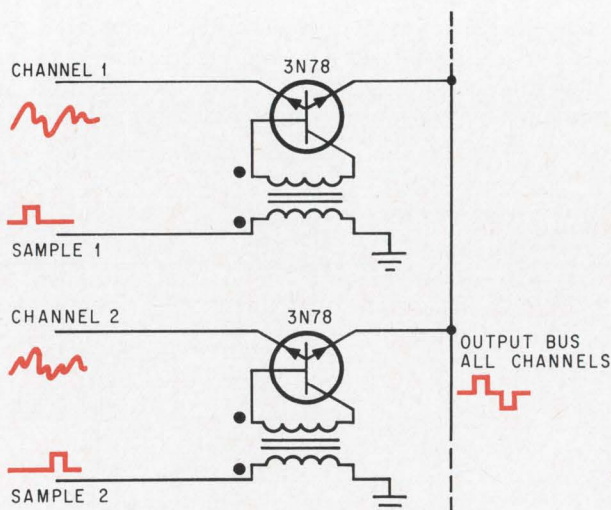

Analog gate. Built around a common dual-emitter transistor often used for chopping, this circuit transmits to the common output bus the instantaneous value of the slowly varying analog quantity. From this value, the converter determines a digital equivalent.

meaning that the memory must be capable of holding 6,000 samples. The rate at which the stored information is transferred from the channels to the filter bank and thence to the computer is 1 msec per channel, so that the compression factor is 300 to 1. Because of this speeding up, the output frequency band—60 to 270 khz—appears to be 300 times as high as it really is.

Aside from this factor of 300, the 1-msec signal from each individual channel is a stepwise approximation of the original analog input. Added to this compressed signal is a 5-Mhz carrier frequency to permit the use of standard crystal filters instead of the much larger and more expensive kilohertz-band filters. Thus the actual frequency band analyzed by the filter bank is 5,060 to 5,270 khz. Difference frequencies—4,730 to 4,940 khz—duplicating the information in the sum band are also present, outside the filter range.

Tradeoff

The compressed band is analyzed by a bank of 200 bandpass filters with center frequencies equally spaced at 1.05-khz intervals and output-versus-frequency curves resembling the Gaussian, or bell-shaped, distribution. Filters with more nearly rectangular characteristic curves would be better suited for straightforward spectrum analysis, but part of the problem in a radar system is extracting the signal from a noisy background; Gaussian filters were better at extracting the signal.

The center frequency of each filter corresponds to a particular velocity of a target, and the filter with the maximum output therefore indicates the velocity.

To assure that the outputs from the filter bank are as large as possible, even for frequencies between the center levels, the filter bandpass characteristics overlap. The bandwidth of each filter—measured between frequencies where the output is 3 decibels below that of the center frequency—is greater than the spacing between the center frequencies. Thus the depth of the valley between adjacent peaks is only 2 db and no frequency is attenuated more than 2 db.

A 1-msec pulse of a single frequency is shown on page 88 with the outputs of five adjacent filters, one at that specific frequency and the two closest at higher and lower frequencies. These displays are of amplitude against time; the time constant of the center filter's response to the input pulse is clearly visible in the center photo, and the similar, though more complex, responses of the side filters are also apparent. These side filters produce outputs because the fast rise and fall of the single-frequency input signal create many other frequency components.

The total frequency content of the signal follows the curve $y = (\sin x)/x$, which resembles a damped sine wave. The duration of the input pulse determines the spacing between the local maxima of this curve; for a 1-msec pulse, the peaks are 1 khz apart, very nearly the same as the spacing of the

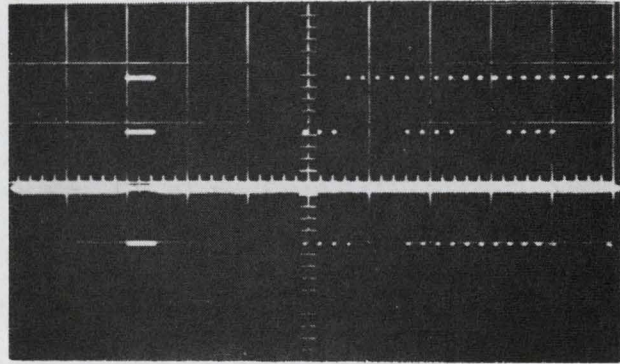
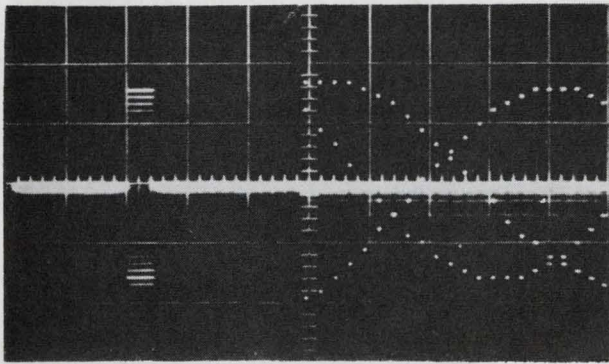

Original and compressed. The first few samples of three 50-hz input signals are at the right in each photo, with five-bit quantization in the photo at left and two-bit quantization at the right. The compressed signals are at the left in each photo; run together, the samples appear as short horizontal lines. The peak lines are brighter because the signal's sinusoidal shape causes more samples to be taken near the peaks.

various filters' center frequencies. This accounts for the outputs of the side filters. These outputs drop off rapidly, however, mostly because of the decreasing amplitude of the successive peaks in the $(\sin x)/x$ curve.

When the filter outputs are sampled in sequence at 1 μsec intervals, the response takes the form shown at lower right on page 88. Although side lobes are still present, the input is essentially continuous when compared to the sweep frequency. The outputs of the filters adjacent to the center filter are strongly attenuated, and the outputs of the next two are barely visible in this display. Other filters further removed from the main frequency produce no visible output at all.

In the prototype digital time compressor, a multiplexer generates sample pulses at a frequency of 20 kHz and distributes them in rotation to the 10 channels, so that each channel is sampled at a 2-kHz rate. The system contains a 20-kHz clock, a binary counter, a binary-to-decimal decoder, and 10 analog gates to do the actual sampling. The trailing edge of each clock pulse steps the counter, whose output is decoded to open a gate for the next clock pulse and to direct that pulse to the next channel.

The analog gates, which are similar to transistor chopper circuits, each contain a dual-emitter transistor with a transformer connected to its base and collector. A sample line, as shown on page 90, connects the transformer primary winding to the decoder output. When a positive pulse appears on it, both emitters are forward biased and the transistor admits the level of the analog voltage to the common output line with hardly any change.

Reaching an agreement

The prototype Cortic's converter contains a six-position register whose outputs are added together in a resistor network, as shown at right. A digital quantity in the register is made to agree with the sampled analog quantity by the following method of successive approximations. First, the flip-flop corresponding to the most significant digit turns on, and the analog output of the network is compared with the analog waveshape being sampled.

This comparison is made in a digital-output differential amplifier similar to the sense amplifier generally used with computer memories. If the comparison generates a 0, the digital value is smaller than or equal to the analog value, and the

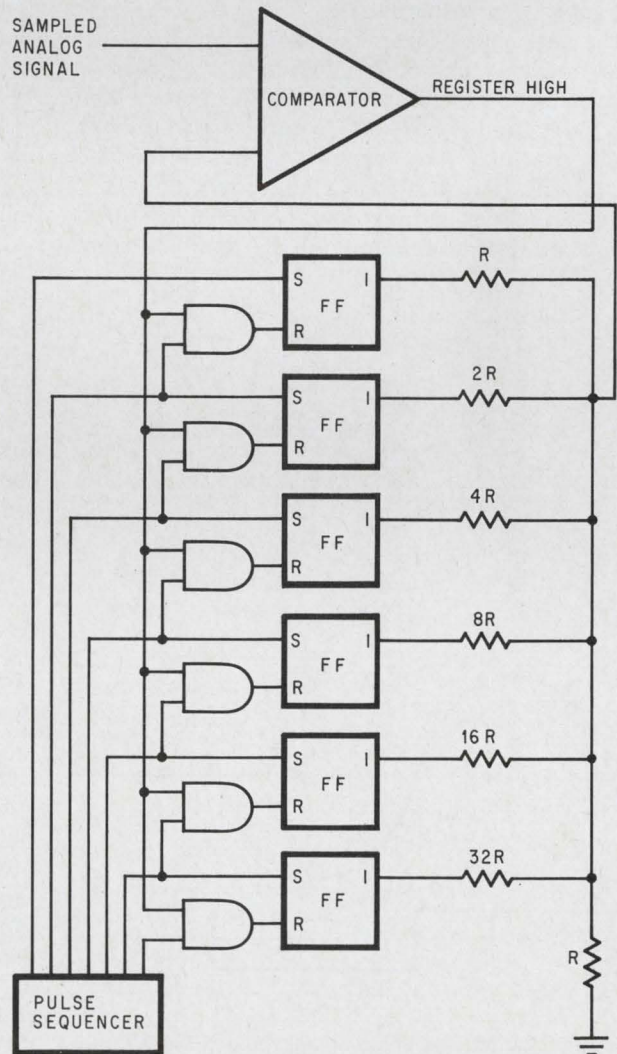

Two-way converter. The register contains successive digital approximations to an analog signal, or a digital quantity to be converted to analog.

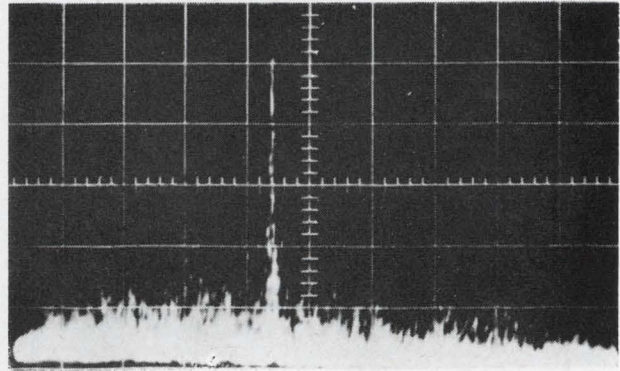
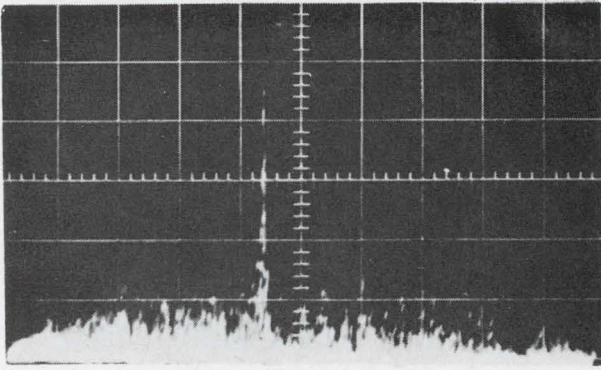

Puzzle. The viewer is hard put to differentiate between the spectra of one-bit and six-bit quantized waveforms, indicating that little useful information is lost in one-bit quantization.

high-order flip-flop is left on. If the comparison generates a 1, this flip-flop is turned off.

Either way, the next flip-flop is turned on and the comparison is repeated. The converter makes six comparisons, for the six flip-flops in the register, in 6 μsec . This done, the contents of the register are transferred to the memory as the binary value of the analog waveshape.

In the memory—a conventional coincident-current ferrite-core stack with a 1.25- μsec cycle time—8,192 words of six bits each can be stored. The unit's timing and read/write controls and address selection circuitry are slightly modified for the stack's application in a time compressor.

A new sample from any single channel is stored every 500 μsec . For readout all the samples from

each channel are transferred one by one to the same register used for reading in. The register input is designed so that successive numbers can be dumped in on top of previous ones without any need for resetting. The resistor network produces the analog equivalent of the successive samples every 1.67 μsec . The network's output thus approximates the input waveform for each channel, except that it appears in steps instead of continuously and its frequency components are multiplied by 300. At this point, the 5-Mhz translating frequency is added and the sum is passed to the filter bank for analysis.

A bit at a time

The prototype Cortic makes inefficient use of its core storage because it relies on six-bit quantization. The two more sophisticated designs use core storage very efficiently with only one-bit quantization.

At first glance, one-bit quantization would seem very ineffective, as it can indicate only positive or negative, present or absent or some other binary condition. But signal amplitude is secondary in radar processing; the most important consideration is the way in which signals shift from filter to filter to indicate a target's speed, or from channel to channel to indicate changes in the target's distance from the receiver changes. Also, the noise usually present in radar signals has to be screened out.

Signal-to-noise ratio is only slightly affected by the number of bits in signal quantization, as seen in the vector diagram at the left. Here a small signal vector at one frequency has been added to a large noise vector at some fundamental frequency. Because the frequencies are different, the vector representing the signal rotates about the tip of the noise vector as the noise vector rotates about the origin. Because the noise vector has a larger magnitude, the resultant rotates about the origin at a varying angular rate. The result, in this simplified case, is a noise vector phase-modulated by the signal.

The same situation is shown in the amplitude-versus-time plot just below the vector diagram. The large black sine wave is the noise voltage, and the

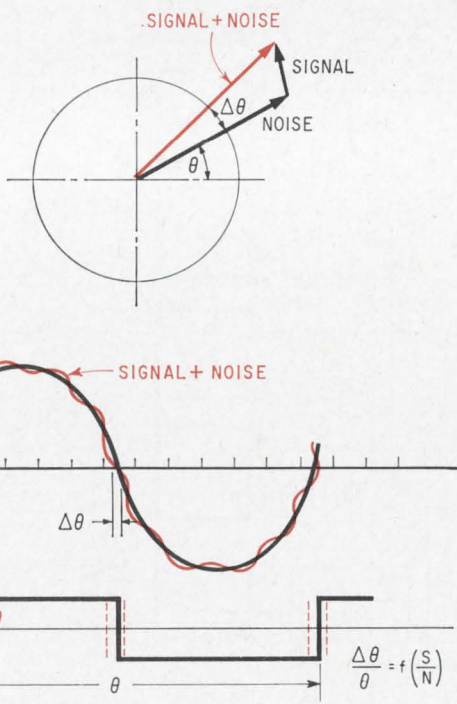

One-bit quantization. The small signal vector phase-modulates the large noise vector, so that the quantized signal is a square wave with uncertain zero crossings. The ratio of the uncertain zone width to the square-wave period measures signal-to-noise ratio.

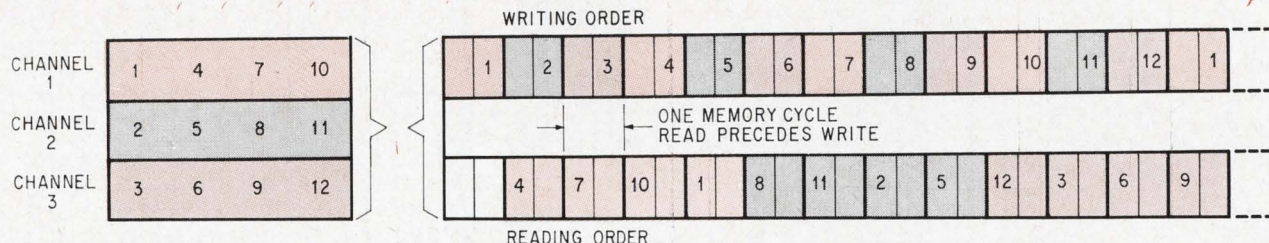

Cortic I. Interleaved reading and writing permits the continuous storage and analysis of data, but necessitates reading in staggered order and exacts the further price of a half-full memory.

signal is superimposed on it in color. The result of sampling this phase-modulated signal with one-bit quantizing is a square wave with some uncertainty as to the zero-crossing points. The ratio of the width of this zone of uncertainty to the period of the square wave depends on the signal-to-noise ratio, not on the amplitude of either the signal or the noise.

The oscilloscope traces, top of page 92, indicate the spectrum of the reconstructed waveform with one-bit and six-bit quantizing, respectively, and verify that little or no useful information is lost by quantizing the signal with one bit. The traces are so nearly alike that identifying them visually is almost impossible.

If the prototype Cortic had been designed to make the best use of one-bit quantizing, a single six-bit word could have stored six samples instead of one; other things being equal, a compression ratio of 1,800 would then be possible.

The three R's

The first approach to streamlining the memory operation of the Cortic prototype was to interleave reading and writing in the memory, so that sample-taking didn't have to stop while previously stored data was read out.

In Cortic I, the memory control circuits were designed so that when a read operation cleared the location from which data was taken, a subsequent write operation—occurring perhaps quite some time later—could put new data directly into the cleared location. This differs from memory operations in conventional computers, where a read operation is followed by the regeneration of the data so that it can be used again later if desired; a write operation is preceded by a read, and the data is discarded to clear the location.

In the Cortic I approach, writing proceeds as in the prototype, with one sample from every channel being stored before a second sample is entered. Reading, again as in the prototype, clears all the samples from a single channel in the same sequence in which they were stored.

But to stay ahead of the write operation, the reading must be staggered. While Cortic I stores samples in the memory in 1, 2, 3 order, channel by channel, it reads them out with the oldest sample in each channel, which is just behind the newest one read in. It jumps to the last sample for the

channel, returns to the first sample, and ends with what was the newest sample when the channel readout began. Several newer samples have been read in while the readout proceeds; indeed, the readout begins with the oldest sample in the channel and stops just short of the newest sample in the entire memory.

The net result is that the memory is normally only half full, and when operation begins, the first few samples are read at irregular intervals, although in strict order. No data is lost.

The sequence is illustrated in a small memory, shown above, that stores four samples from each of three channels. Immediately after the first sample from channel 1 has been stored on the second or any subsequent pass through memory, the readout of this channel begins, starting with the second sample from the previous pass—bit 4 in the diagram. The four samples from channel 1 are read out in the order 4, 7, 10, 1, the last sample being

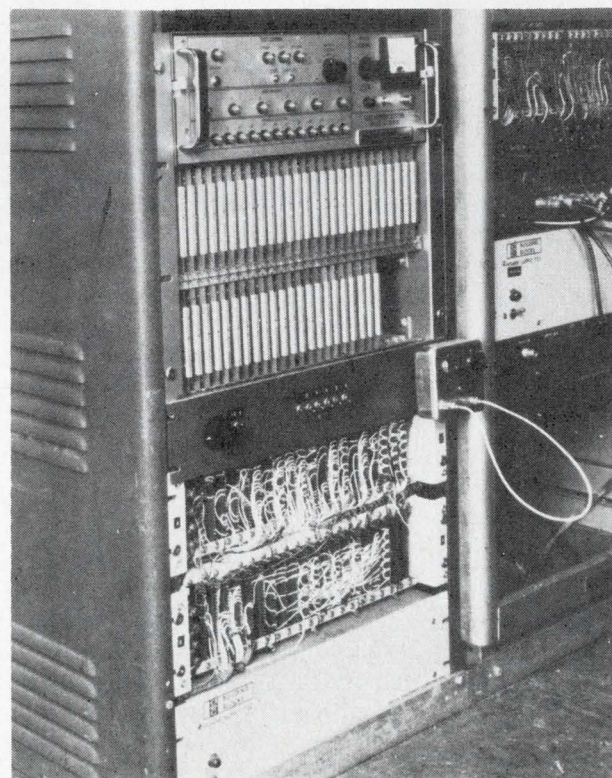

Heart of the system. The prototype's core memory and logic cards occupy only a few inches of rack space.

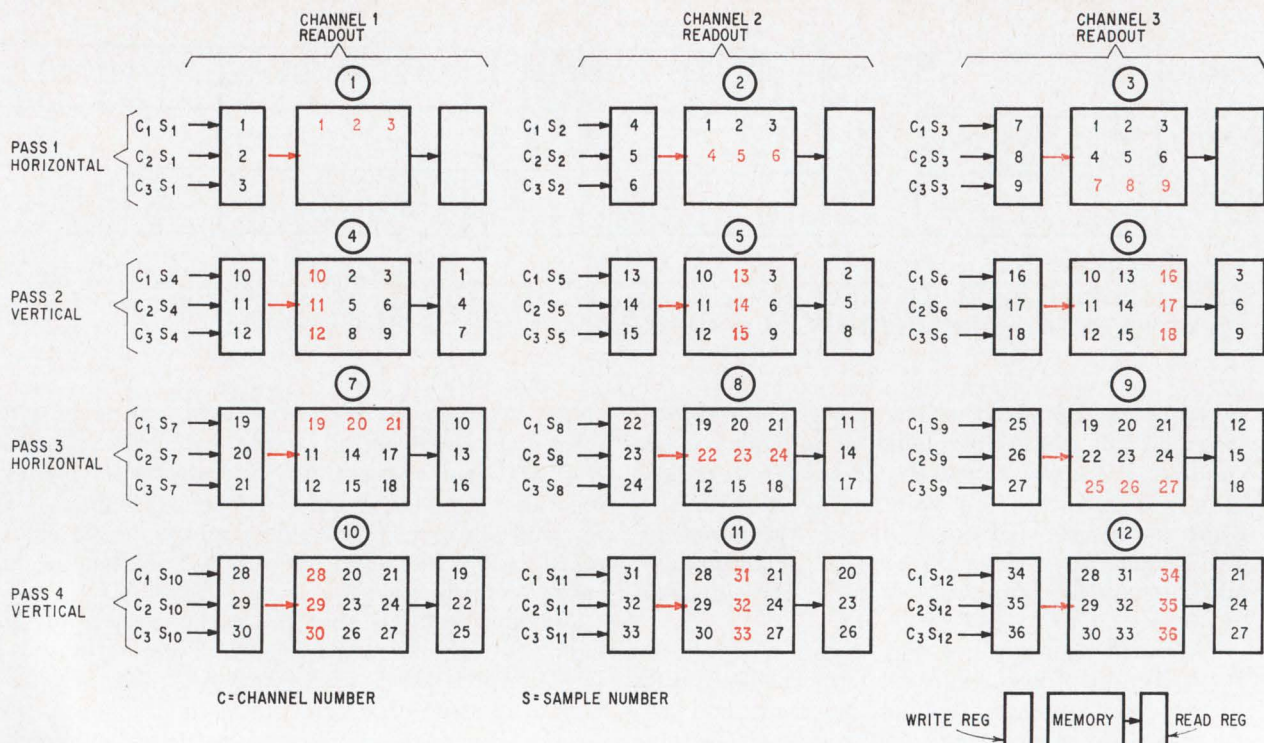

Cortic II. The memory can be kept full and can have a longer cycle time when samples from successive channels are stored alternately in rows and in columns of the memory. But here the ratio of channels to samples must be an integer, or the reciprocal of an integer.

the first one in the second pass. The readouts are interleaved with new samples being stored in other channels. It takes 12 memory cycles to write the four samples, but only four to read them out, giving a compression ratio of 3.

Right after channel 1 is read out, the operation switches to channel 2, taking the samples in the order 8, 11, 2, 5; channel 3 is then read out in the order 12, 3, 6, 9.

This operation requires one address register for reading and another for writing. One register increments by memory rows and the other by columns, with an especially large increment at the end of each channel readout. If, in the three-by-four example, the memory locations were numbered in the same sequence as the written samples, one address register would always increment by one and the other would increment by three. Further, the second register would increment by seven after every readout from a position on the diagonal—positions 1, 5, or 9.

Full memory

Cortic II uses its memory still more efficiently. It also interleaves reading and writing, but it manages to keep the memory nearly full at all times and needs only one set of address registers. It also can use a slower memory because it stores several samples in an external register before writing them in the memory as a group, or after reading them out, also as a group. This buffer-register technique is the trick that makes the 1,600-channel compressor feasible.

But the unique characteristic of Cortic II is that as it reads out the samples for any one particular channel, it stores other samples from any other channels in the same locations. In successive passes through the memory, therefore, the channel orientations are at right angles—that is, samples from successive channels stored in a row on one pass are stored in a column on the next pass. A short interval between reading and writing gives time to modify the data. This kind of operation in computers is called read/modify/write or split-cycle operation.

This method of operation is best illustrated by the three-channel system shown above, with three samples for each channel. At the start of operation, the memory may be assumed to be empty, although clearing it isn't a prerequisite. The first three read cycles (in black) yield no useful information; nothing has been stored in those locations yet. The first three write cycles (in color) each load one sample from each of the three channels in locations represented as horizontal rows.

In the second pass, data is taken from the memory column by column, with each column containing all the samples from a single channel. Following the readout, new samples from the three channels are stored in those same locations. Because channel data occupies rows in the memory at this point, readout in the third pass occurs row by row again. New samples are then stored from the three channels in each location cleared by reading, setting up data for the fourth readout, once more by columns.

YES, YOU GET THE BOLDEST BRIGHTEST MOST READABLE CRT DISPLAY AVAILABLE TODAY.

Actual photo of DATA-SCREEN Display Terminal characters — shown actual size.

but **TEC's DATA-SCREEN Display Terminal**
also gives you . . .

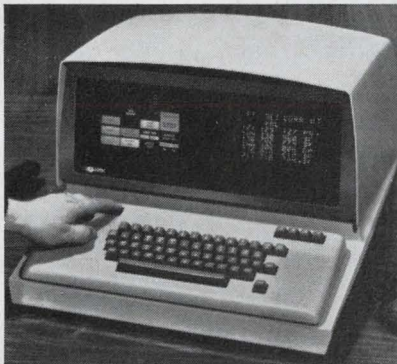

Interface flexibility—compatible with most EDP and communication systems, transmits and accepts any 8-level code including ASCII, IBM, and EBCDIC. Electrical interface signal level options include 5-volt current sink I-C logic and EIA Standard RS-232B.



Keyboard flexibility—optional input keyboards offered in standard or special key arrangements. Special keys for control functions, indicators and switches can be located anywhere on the keyboard. A variety of key styles are offered with legends to order.

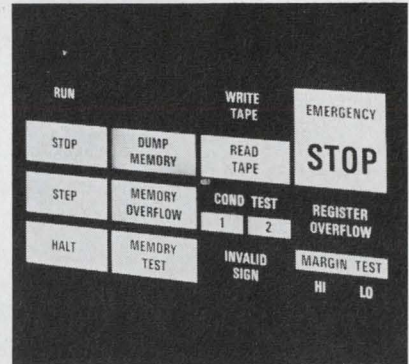

Display flexibility—in addition to the CRT data display, up to 144 fixed messages can be displayed behind the black screen using TEC's DATA-PANEL® Display System. Invisible when off, messages such as FAULT, OVERFLOW, ON LINE, STOP, etc., become instantly visible when illuminated.

Without a doubt (our competitors admit it) this display terminal has the largest . . . 1/4" minimum . . . most readable, rock steady characters available in its field. Stroke-written messages appear in brilliant contrast to the black screen of TEC's DATA-SCREEN Display Terminal.

Three completely self-contained models with keyboard, character generator, refresher core memory, solid state logic and power supply are offered with

128, 200 and 512 character display. Everything else you'd expect in a completely flexible CRT display is offered: full character repertoire; flashing cursor with positioning controls; editing features; character size and slant adjustments; modern cabinet or rack panel mounting option.

Send for 6 page brochure that tells all about TEC's DATA-SCREEN Display Terminal — the flexible, readable CRT.



INFORMATION DISPLAY
AND CONTROL DEVICES

TRANSISTOR ELECTRONICS CORPORATION

Box 6191

Minneapolis, Minnesota 55424

Phone (612) 941-1100

No Strings Attached

Integrated Circuit Engineering Corporation is the only place you can get real, unbiased, practical training in microelectronics with no strings attached. We don't care if you are a maker or user, are thinking about making or using them, or are a security analyst who just wants to know what microelectronics is all about. All you do is supply the student — we supply the training. Comprehensive training like our I/C Engineering/Fabrication Seminar. Five full days of technical sessions and laboratory exercises covering the essential topics of the technology. Write or call for detailed information. The Engineering/Fabrication Seminar. Only from ICE.

**I/C Engineering/Fabrication
Given at ICE's Laboratory Facility in Phoenix**

February 5-9, 1968

March 4-8, 1968

ICE

**ICE Corporation 4900 E. Indian School Road Phoenix, Arizona 85018
Telephone 602 959 4760 TWX 910 950 1285 Cable ICE PHOENIX**

There's no overcharge for fast-charged batteries

Diodes protected by thermal switches shunt high charge currents to prevent nickel-cadmium cells from rupturing during fast recharge

By James V. Ball

P.R. Mallory & Co., Burlington, Mass.

Successful in cordless device applications ranging from television receivers to toothbrushes, nickel-cadmium batteries are still handicapped by recharge times as long as 16 hours. They would find many more jobs if they could be recharged faster without risking overcharge—the prime cause of cell rupture.

Several approaches have been tried, but the one that holds out the greatest promise for wider consumer, and even commercial, applications is a diode protection scheme first proposed in 1964. Connected across the cell, the diode shunts the charging current once the cell is fully charged. Thus, without using an observer to monitor the cell charge at various intervals, recharge time can be cut to an

hour or so. There are, of course, other overcharge protection schemes but these have proved either unreliable or too costly for consumer applications.

However, because of the diode's tendency to overheat when it shunted the full charge current, the diode scheme never gained wide acceptance. An overheated diode can't maintain the low-rate trickle charge that is required. But the overheating problem has since been overcome. By equipping the charger with a temperature sensor—either a thermistor bridge or a thermal switch—a high resistance can be switched in series with the power supply to limit the charge current once the cell is charged. Thus, the current passing through the diode can be held to a safe level when the battery is

Nickel-cadmium: a rechargeable battery

Nickel-cadmium cells are usually sealed in a metal case to prevent spilling or evaporation of the electrolyte. Because the cell contains little electrolyte, the oxygen given off at one electrode during overcharge is easily recombined at the other electrode, thus preventing excessive pressure buildup when the charging current is as high as $C/2$. (Charge and discharge currents are expressed as the nominal cell capacity, C , divided by the charge or discharge time. Thus, the $C/2$ rate for a 5-amp-hour cell is 2.5 amps.) When this rate is specified, there is no concern about the effects of overcharge if the cells are left on charge for an indefinite period.

To prevent the cells from exploding when pressure builds up at high charge rates, pressure releases are built into the cell. But these releases shorten cell life when they are activated. For once the seal is broken, electrolyte is lost.

If a cell were designed so that its internal pressure did not rise during fast charge, such a cell

would act as a resistor when it is fully charged, and the energy—represented by the product of the voltage and charge current—would be dissipated as heat. Thus, a D-size, 4-ampere-hour cell would build up a temperature of 200°F if it were overcharged continuously at the C rate. It probably isn't feasible to make a cell that is immune to damage from continuous charge at a high current rate.

Since the nickel-cadmium cell has a low internal resistance, it can be charged safely at high rates without overheating. Most cells now on the market can be charged at rates of $C/2$, C or even $C/0.5$, provided the charge current is limited once the cell is fully charged. Cell-cycle life may be prolonged when it is repeatedly recharged at a high current rate, and then allowed to trickle charge at a low rate of about $C/50$ instead of overcharged continuously at the higher rate. And, some battery engineers feel that high charge rates are beneficial in maintaining the cell at full capacity during its service life.

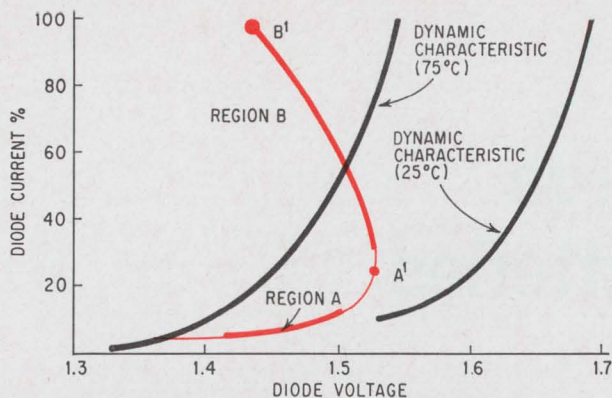

Operating characteristic. Initially, diode conduction increases slowly along region A. At full cell charge, region A', diode temperature rises with conduction along region B to maximum at point B'.

fully charged.

The diode protection scheme is intended for constant-current charging—commonly used for nickel-cadmium batteries—in which the battery can be left on charge even after being fully charged. A rarely used method of charging nickel-cadmium cells employs a constant voltage. Here, however, the battery is in series with a low resistance and the power supply, and the battery's internal resistance limits the charging current.

Preventing overcharge

The diode used for cell protection should have a forward voltage knee slightly lower than the cell's full-charge voltage. While the cell voltage is below its full charge, the diode operates at the high-resistance part of its characteristic curve and most of the charge current flows through the cell. But when the voltage hits full charge, the diode's resistance

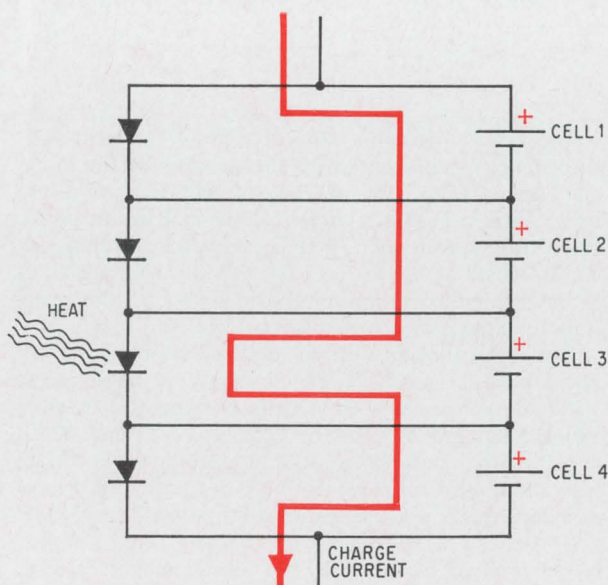

Diode protection. Diode across each cell acts as high resistance during charge and as low resistance to shunt current when cell has reached full charge.

drops sharply to draw most of the current away from the cell. Because each cell is individually protected by its own diode, unmatched cells with different capacities can be hooked up together. P.R. Mallory & Co. Inc., manufactures a suitable diode called the Amp-Gate. The device has a forward voltage knee of 1.4 volts.

The diode's voltage characteristic is a function not only of its geometry and semiconductor material, but of its temperature as well. The Amp-Gate's characteristic varies with a negative temperature coefficient of 3 millivolts/°C. Thus, as the temperature rises, both diode and cell voltage decreases. As a result, the cell can be charged at different ambient temperatures without adverse effects. In practice, however, the diodes used with a multicell battery are mounted on the same heat sink.

Charging system

A system could be designed in which diode, cell, and heat-sink characteristics counter-balance each other. The problem here is that the dissipation of the charging energy as heat causes the heat-sink temperature to rise. But with a thermal switch used to sense the rise in heat-sink temperature and reduce the current at full charge, little energy is lost. The reason: charge current is less efficient near the end of the cycle because of the cell's counter voltage.

Since both the cell and the diode have negative temperature and voltage coefficients, it is essential that the heat sink be matched to the diode's knee voltage if the thermal switch is to do its job.

Typical circuits

In a charge circuit for a small, two-cell cordless appliance, for example, the diodes can be mounted on a small copper heat sink near the cells. When the charger is energized the thermal switch remains closed because of the low heat-sink temperature.

As the cell voltage nears its full charge, both the diodes' conduction and the heat sink's temperature increase. The rise in temperature opens the thermal switch. A resistor then limits the current to a safe trickle charge. Heat from the resistor, which is mounted on the thermal switch, prevents the switch from closing while the diodes cool. After recharge and the appliance is removed from the power supply, the resistor cools, the thermal switch closes, and the charge-control circuit is ready for another cycle.

Since the thermal switch has a fixed operating temperature, it tends to open a bit earlier when charging is done at high ambient temperatures. This, of course, would cut charge time because the cells produce gas sooner at temperatures above 38°C. But even at temperatures too low for the thermal switch to open, the diodes still prevent overcharge by shunting the current.

An all-solid state circuit can use a thermistor-bridge network to bias a transistor into conduction when the heat-sink temperature rises to 35°C above ambient temperature. The transistor's collector cur-

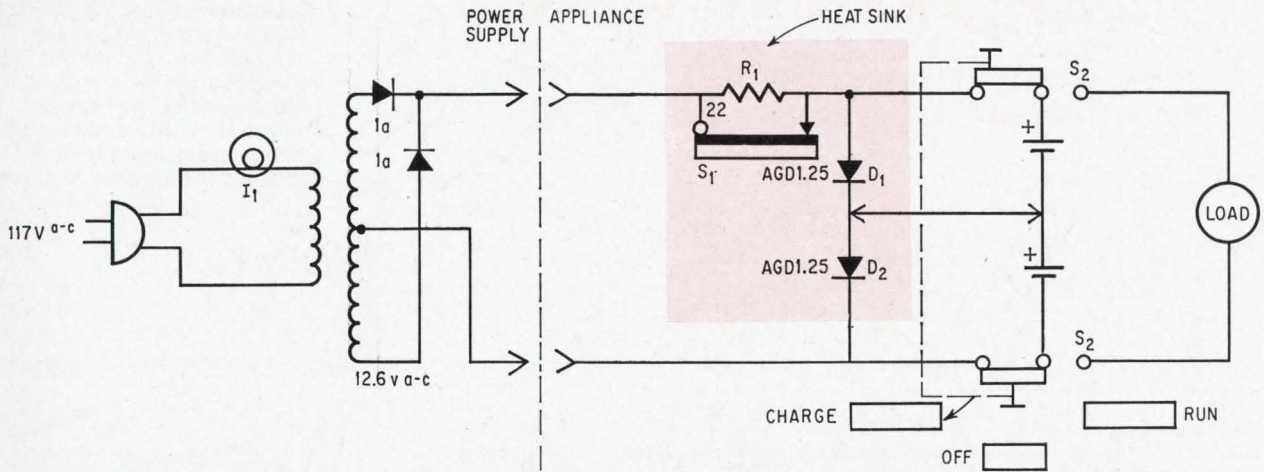

Two-cell appliance charger. A pair of diodes mounted on a copper heat sink with a thermal switch protects the cells during a 70-minute fast charge cycle. Lamp I_1 regulates charge current and serves as indicator.

rent fires a silicon controlled rectifier, which turns off a second transistor that shorts out a current-limiting resistor in series with the battery. Thus, the resistor is placed in the circuit and a trickle charge current then flows through it. The SCR resets the circuit when the battery is removed from the circuit.

Designing the circuit

In designing a charging system with diode protection, the engineer must consider the enclosure's thermal characteristics. To a great degree, these characteristics will determine the heat sink to be used. Once the design is completed and the circuit is built, it is usually sufficient to measure, at room temperature, the cell voltage and heat-sink temperature to ascertain whether the system is functioning properly.

After the thermal cutout is deactivated, the heat-sink temperature should rise slightly so that near the end of the charge cycle the reading is at least 70°C where the diodes are mounted. Cell voltage, somewhere between 1.4 and 1.5 volts at the start of the cycle, should rise to as high as 1.55 volts and

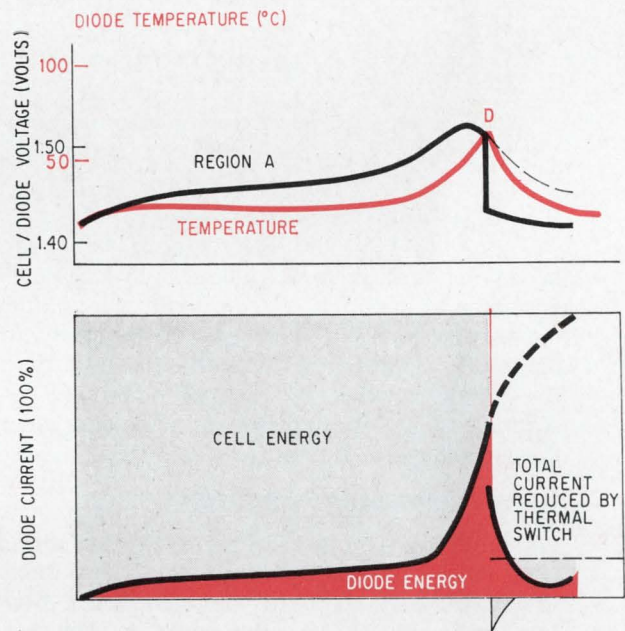

Charge curves. At full charge, point D, thermal switch opens to limit charging current which falls to a safe trickle charge level.

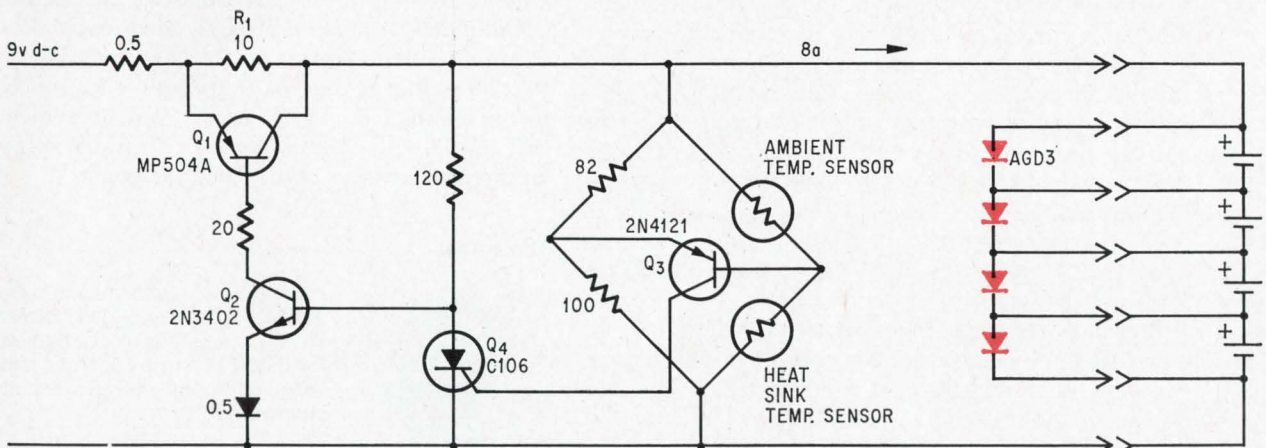

Solid state circuit. A pair of thermistors can be used in a bridge circuit configuration to sense full battery charge and terminate the cycle. Separate thermistors sense ambient and heat sink temperatures.

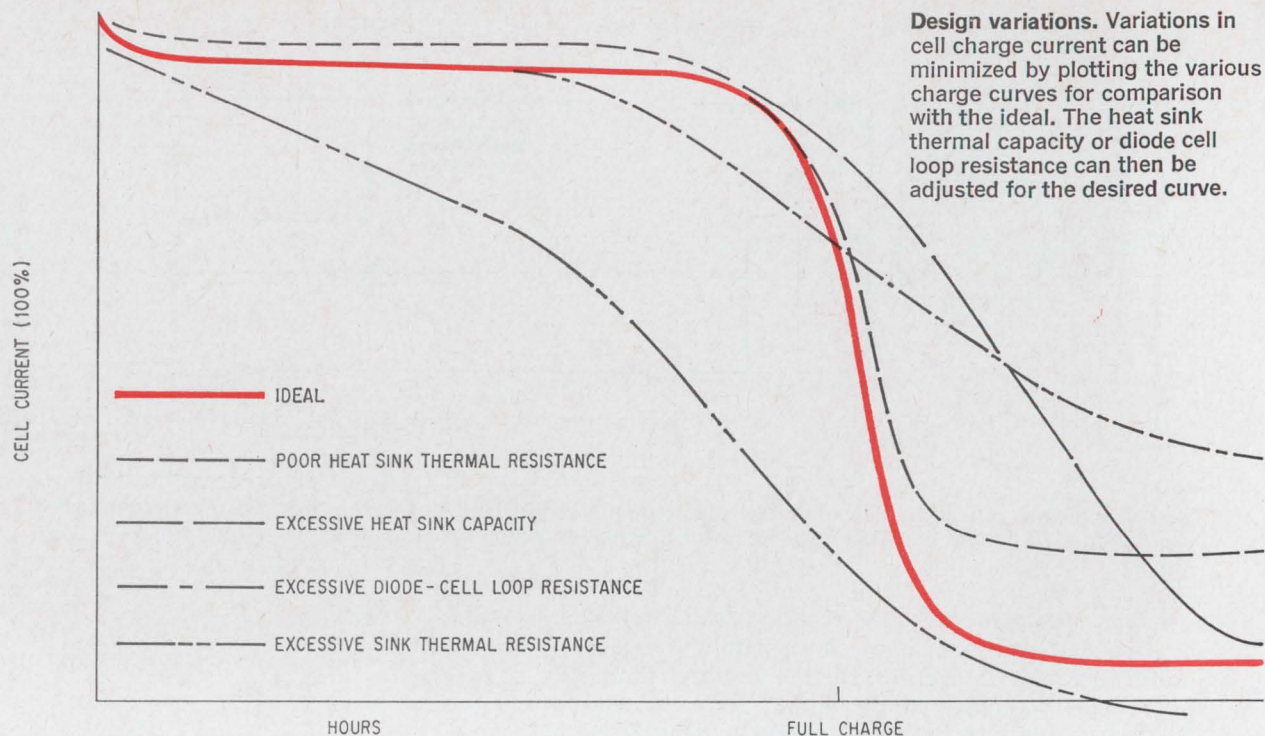

then decrease as the diodes heat up.

The cell charge current should be measured at several time intervals using a d-c clip-on milliammeter or through a 5 millivolt shunt and the measurements plotted to obtain the cell current curve. By comparing this cell-current curve with the ideal provided by the cell manufacturer, an engineer can determine necessary adjustments in the circuit and heat sink.

Other cell protection schemes

Although various other cell protection schemes have been used, each has suffered from at least one basic limitation: cost, reliability, or complexity. Some of the approaches that have been taken include:

Third electrode. At least two firms—the General Electric Co. and Gulton Industries Inc.—are marketing nickel-cadmium cells with auxiliary electrodes. In the GE cell, the third electrode recombines the oxygen produced at the end of charge and delivers a current that removes the charging voltage through an external relay or a silicon controlled rectifier circuit. In the Gulton cell, a voltage is generated when the oxygen starts to build up. This voltage then controls the charge circuit. Although the third-electrode approach is effective in preventing overcharge, it is expensive and is used only in critical cases—a third-electrode type, 4-ampere hour, D-size cell costs about \$25 compared to \$5 for a standard two-electrode cell.

Pressure sensing. In pressure sensing, one or more cells in a battery pack is equipped with a pressure-activated switch that signals when gas has developed at the end of the charge. The inherent drawback: since the pressure buildup rate isn't the same for all cells, matched cells are required. Furthermore, the pressure that builds up may not

decrease rapidly enough to permit immediate recharge of the battery. Thus, in addition to being expensive—the pressure switch costs about \$18—it is unreliable.

Voltage monitor. Full charge, in this approach, is determined by measuring battery voltage. Because cell voltage changes with ambient temperature, the sensing level must be temperature-compensated. Furthermore, because of variations in cell capacity, there is always the possibility that one or more cells may be overcharged before the battery voltage reaches the desired charge level.

Cell-temperature sensing. In this approach, the rise in cell temperature is used to indicate when full charge has been reached. The drawback here is that high thermal mass can delay temperature-rise detection until the cell has been overcharged. This scheme is fairly complex since variations in ambient temperature and cell capacity must be considered when designing a temperature-sensing circuit.

Coulometer sensing. Here, a chemical coulometer determines the amount of discharge, which is used to determine recharge. Although the method is fairly reliable, it is expensive. And it is also difficult to get cells and coulometer to track across the temperature range of the charge cycle.

The author



Joining P. R. Mallory and Co. in 1965 as a staff engineer, James V. Ball is now a project engineer for battery charge-control systems at the company's physical science laboratory.



When you want a relay that...
*delivers billions of high speed
bounce-free operations;
has low profile for p.c. board mounting
and is compatible with solid state circuits*

mercury's the answer

In order of importance, how would you rate these advantages of P&B's mercury-wetted contact relays?

- no bounce
- constant low contact resistance
- long life (billions of operations)
- low profile for p.c. board mounting
- 1 ms operating speed
- contact isolation
- compatibility with solid state circuitry

You will find our JMF Series relays useful in computer logic circuits, high speed processing equipment, in sophisticated instrumentation . . . wherever you need crisp switching action, long life, solid state compatibility, and immunity from transient voltages.

Housed in a pressurized glass capsule, the contacts are renewed on every cycle through capillary action of the mercury. Hence, contact resistance remains constant and extremely long, maintenance-free life is assured.

P&B mercury-wetted relays are available in contact Forms C and D, as well as polarized and sensitive models. Up to four capsules in a single case are available. Call your P&B representative for full information today.

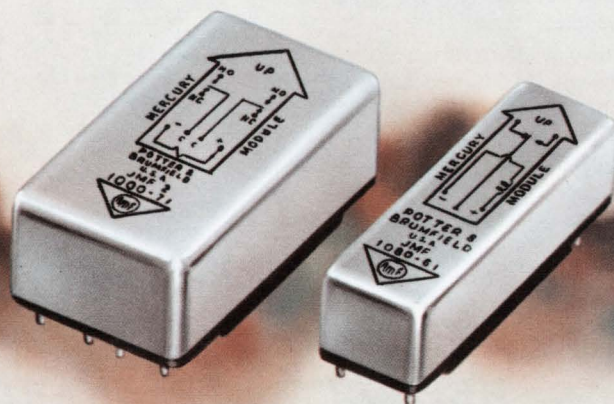

POTTER & BRUMFIELD

Division of American Machine & Foundry Company, Princeton, Ind. 47570
Export: AMF International, 261 Madison Avenue, New York, N. Y. 10016

With variable persistence...

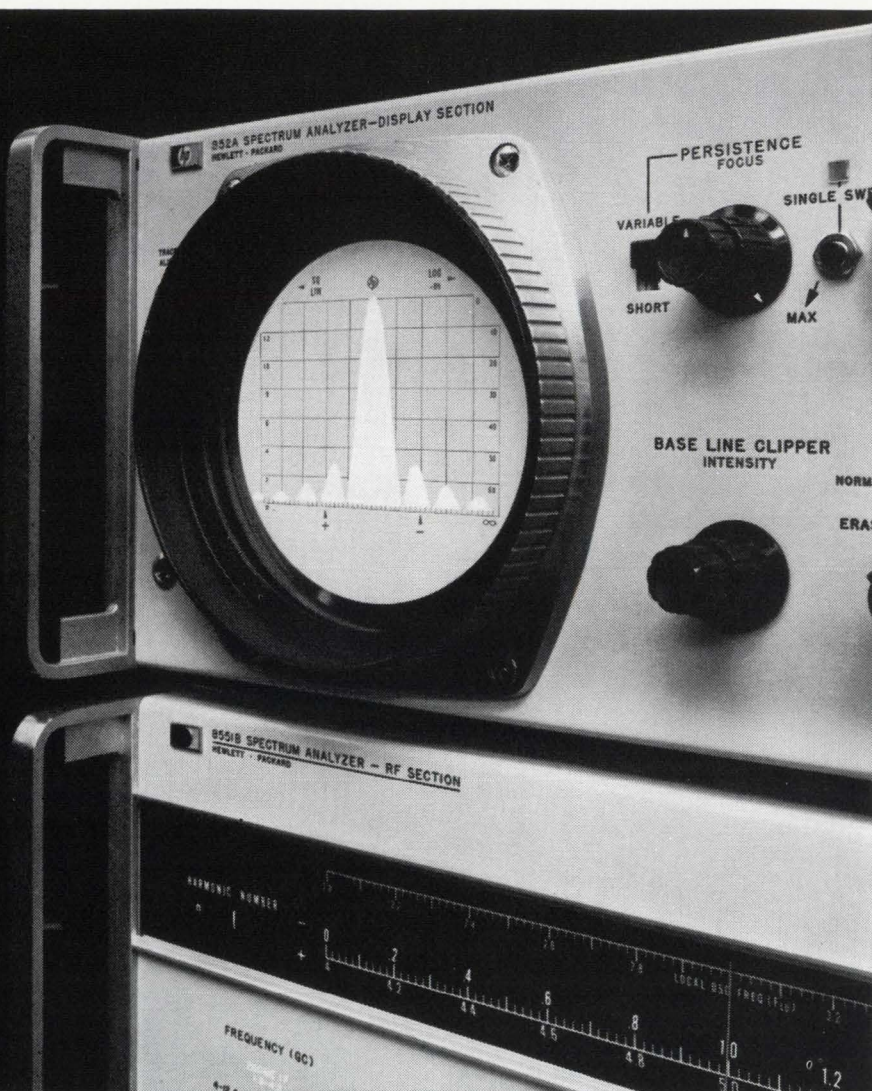

SPECTRUM OF 50 PPS PULSED CARRIER

you can now see the entire spectrum

The new Hewlett-Packard 852A Variable Persistence Display Section for the HP 8551 Spectrum Analyzer lets you examine those "hard to see" signals—the ones that normally require photographic time exposures to analyze the whole display. Variable persistence is indispensable when you're examining low prf pulses (characteristic of many radars) or performing spectrum surveillance and RFI measurements. Signals in the presence of noise are more readily discerned because only the signal is re-inforced during successive sweeps.

When your spectrum analyzer display offers variable persistence, you can use the very slow sweep speeds necessary for high resolution. Wide sweeps and narrow analyzing bandwidths are now compatible.

The persistence of the specially-designed CRT in the 852A is continuously adjustable from about 0.2 second to more than one minute. The display can also be stored (duration > one hour) permitting more thorough evaluation.

Price: 852A, \$3400.

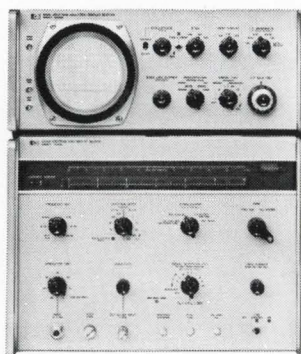

The HP 8551B Spectrum Analyzer is a fully calibrated analyzer covering the range from 10.1 MHz to 40 GHz. It features a 60 dB calibrated log display range, calibrated spectrum widths to 2 GHz, and calibrated sweep time and IF bandwidths for fully quantitative spectrum measurements. 8551B RF Section, \$7550.

852A Variable Persistence Display Section, \$3400.

(851B Display Section with normal persistence, is also available. Price, \$2400.)

For more information on this important contribution to spectrum analysis call your local HP field engineer or write Hewlett-Packard, Palo Alto, California 94304; Europe: 54 Route des Acacias, Geneva.

HEWLETT *hp* PACKARD

SPECTRUM ANALYZERS

04724

Metal Glaze



Thick-film resistors outperform tin-oxides. And at MIL-R-11 prices.

IRC adds a two-watt unit to its Metal Glaze line. Now you can get stability, reliability, and economy in three popular sizes to fill a wide range of industrial and MIL-R-22684 applications.

These rugged, thick-film resistors defy failure. Performance, across the board is significantly better than MIL-R-11 types, yet they're available at the same prices. Under load or temperature stress, thin-film tin-oxides can't match their exceptional stability and mechanical ruggedness.

Metal Glaze resistors remain stable under 70°C loads exceeding specification requirements. On the ¼-watt, for example, there is little stability degradation under double load at 70°C. It has withstood 14 million unit hours of testing. Estimated failure rate is only .006%/1000 hrs., full load at 70°C, at 60% confidence.

The uniformly molded body is tough. Can't crack or craze during automated inserting. And it resists solvents and corrosion. Samples are immediately available. Write to: IRC, Inc., 401 N. Broad St., Philadelphia, Pa. 19108.

CAPSULE SPECIFICATIONS

| | | | |
|---------------|--------------|-------------|-------------|
| Power: | ¼ W @ 70°C | ½ W @ 70°C | 2 W @ 70°C |
| Size: | RL07-RC07 | RL20 | RL42-RC42 |
| Resistance: | 6.8Ω to 680K | 10Ω to 470K | 10Ω to 470K |
| Tolerances: | ±2,5% | ±2,5% | ±2,5,10% |
| Max. Voltage: | 250V | 350V | 500V |
| IRC Type: | RG07 | RG20 | RG2 |



ASSEMBLE THIS WEATHERPROOF CONNECTION

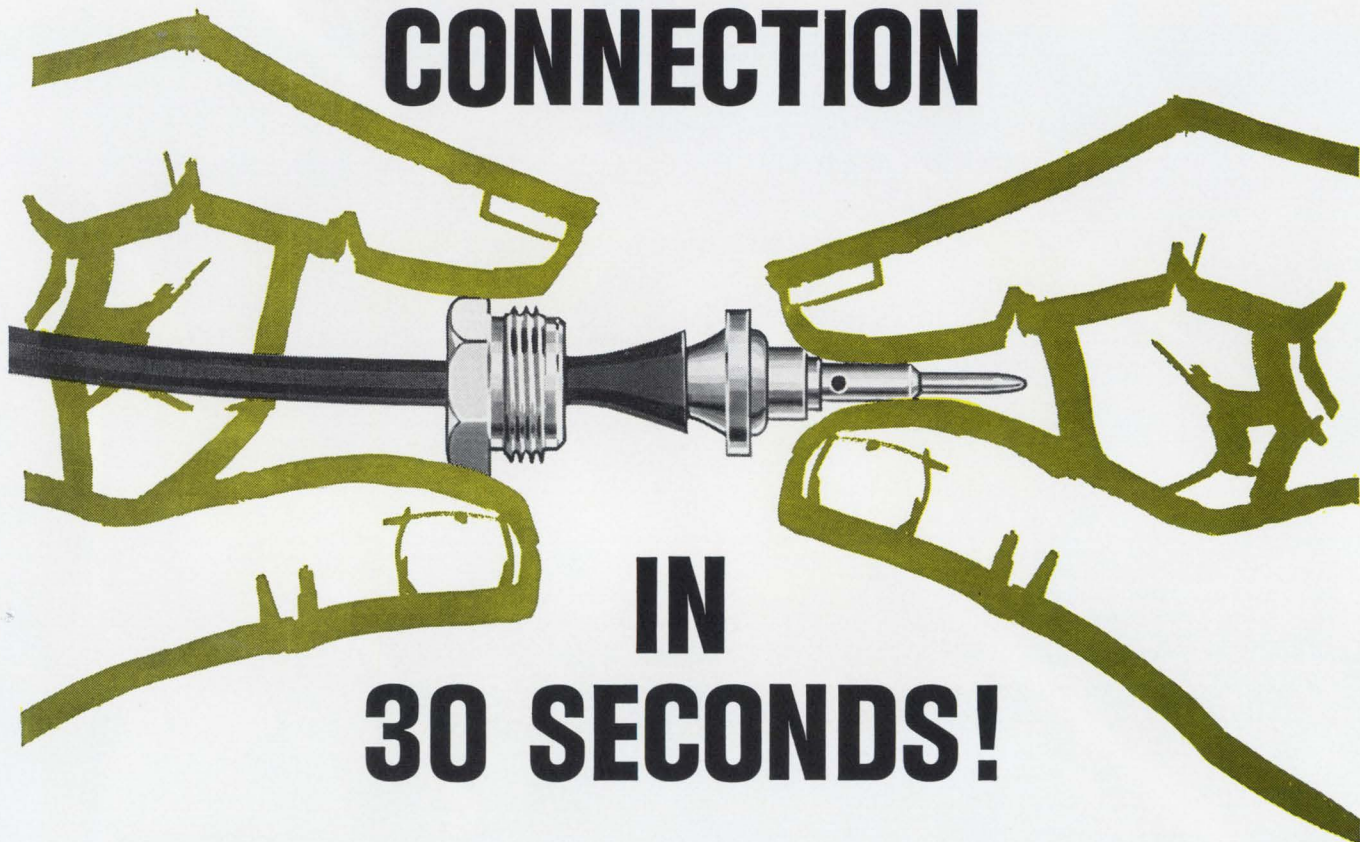

Again, BENDIX/DAGE engineering has solved a major problem for equipment builders! New DAGE Square-Cut RF Connectors reduce assembly time 50%-75% ... produce weathertight seals with a pull test of 50 lbs. Only 3 parts—no special tools required!

Time-and-money-saving benefits of

Square-Cut Connectors are typical of BENDIX/DAGE contributions to the state of the art ... *practical* ideas that help you design for greater capability in *your* circuitry and equipment.

Write for Square-Cut literature. If you have a special problem, call Dage Engineering Department. Call today!

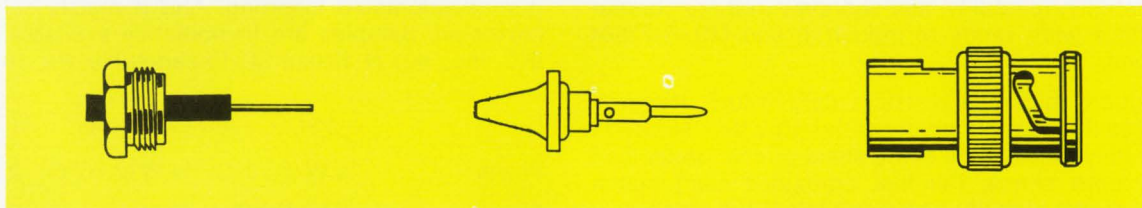

DAGE ELECTRIC COMPANY

a subsidiary of the Bendix Corporation

Hurricane Road • Franklin, Ind. • Phone 317/736-6136

FIRST WITH IDEAS • FIRST WITH QUALITY • FIRST WITH SERVICE

We've made switches for conditions that are out of this world.

Now, what in the world can we do for you?

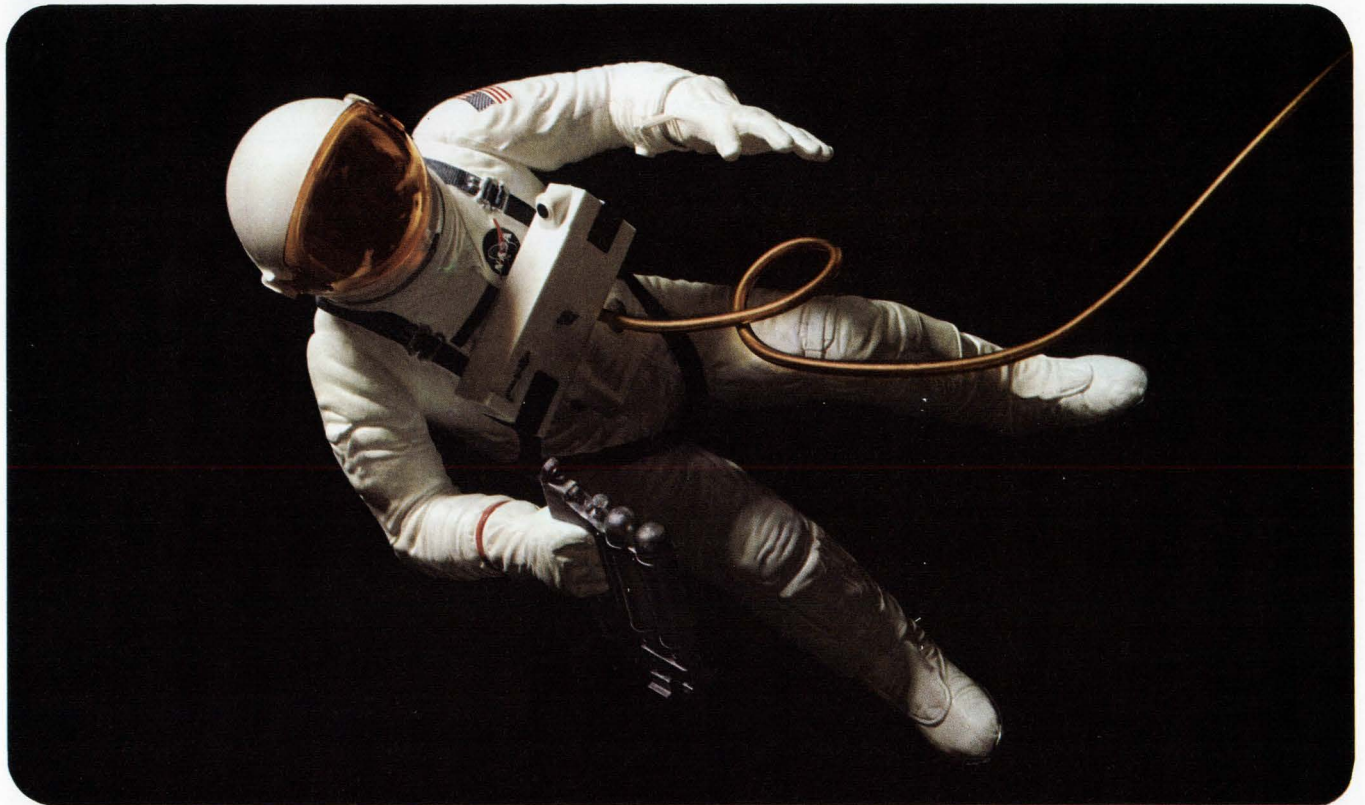

Model copyright © 1967 by Revell, Inc.

Mars. Venus. The moon. Our switches have gone to great lengths in proving MICRO SWITCH reliability.

In the aerospace field, we've come a long way by making important contributions in nearly all of the major projects—Apollo, Mariner, Ranger, Surveyor, to name a few.

And in the laboratory, we're going even further, solving problems pre-

sented by future projects. Sophisticated problems involving switch miniaturization, metallurgy, plastics, circuitry, and human engineering, among others.

From our advanced computer analysis of all test data, we've learned much that can be helpful to you. Such as predicting more accurately the life of any given switch under selected conditions.

Whatever your industry, you stand to benefit by calling a MICRO SWITCH Field Engineer. This down-to-earth fellow can also show you the largest selection of switches in the universe.

Call a Branch Office (see Yellow Pages, "Switches, Electric") or write us at Freeport.



MICRO SWITCH

FREEPORT, ILLINOIS 61032

A DIVISION OF HONEYWELL

HONEYWELL INTERNATIONAL • Sales and service offices in all principal cities of the world. Manufacturing in United States, United Kingdom, Canada, Netherlands, Germany, France, Japan.

HERE'S THE LATEST INFORMATION ON THIN-FILM DEPOSITION...

CVC

Five CVC PlasmaVac® Low-energy Sputtering Systems — to handle thin-film applications from laboratory to production line.

Sputtering thin films with a CVC PlasmaVac® system lets you deposit almost any material on almost any surface—with excellent control over film composition, purity, and thickness. You'll increase efficiency, quality, and yields over any other thin-film

deposition method. Please write for full details on any or all of the PlasmaVac systems described below. Consolidated Vacuum Corporation, 1775 Mt. Read Blvd., Rochester, N.Y. 14603.

| | PLASMAVAC 100 | PLASMAVAC 200 | PLASMAVAC 300 | PLASMAVAC 400 | PLASMAVAC 501 |
|--|--|--|---|--|--|
| GENERAL | DC triode sputtering. Metals, conductors. | RF triode sputtering. Conductors, semi-conductors, non-conductors. | RF diode sputtering. | Production-type system with DC Crossfire™ and RF capability on in-line basis with air to air substrate transport. | DC Crossfire™ with rotary work holder, multiple targets. |
| APPLICATIONS | Laboratory and limited production. Ideal with CV-18 vacuum system. | Laboratory and limited production when used with PlasmaVac 100. | Sophisticated research applications. Reactive sputtering, sputter etching, semi-conductors, dielectrics, etc. | Bridges the laboratory/production interface. Modular concept so process can be developed, then scaled up to meet production needs. | Batch-type production unit for pilot plant operation. |
| Deposit Metals | Yes | Yes | Yes | Yes | Yes |
| Deposit Dielectrics | No | Yes | Yes | Yes | Yes* |
| Deposit Semiconductors | Some | Yes | Yes | Yes | Yes* |
| Deposit Cermets | No | Some | Yes | Yes | Yes* |
| Deposit Alloys | Yes | Yes | Yes | Yes | Yes |
| Deposit Organics | No | No | Some | Some | No |
| Water Cooled Target (for use of thermally sensitive materials) | No | No | Yes | Yes | Yes |
| Water Cooled Substrate | No | No | Yes | Yes | No |
| Reactive Sputtering | No | Some | Yes | Yes | Some |
| Bias Sputtering | Yes | Some | No | No | No |
| Sputter Etching | Few | Some | Yes | Yes | No |
| Type of Chamber | Bell Jar | Bell Jar | Bell Jar | Production-type modular chamber | Low profile metal chamber |
| Multiple Target Sputtering | Yes | Yes, with PlasmaVac 100 | No | Yes | Yes |

*Available on special order.

CVC

A BELL & HOWELL COMPANY

 **BELL & HOWELL**

**MOST
RESISTORS ARE
PRETTY MUCH
ALIKE
IT'S THE NAME
BEHIND THEM
THAT COUNTS**

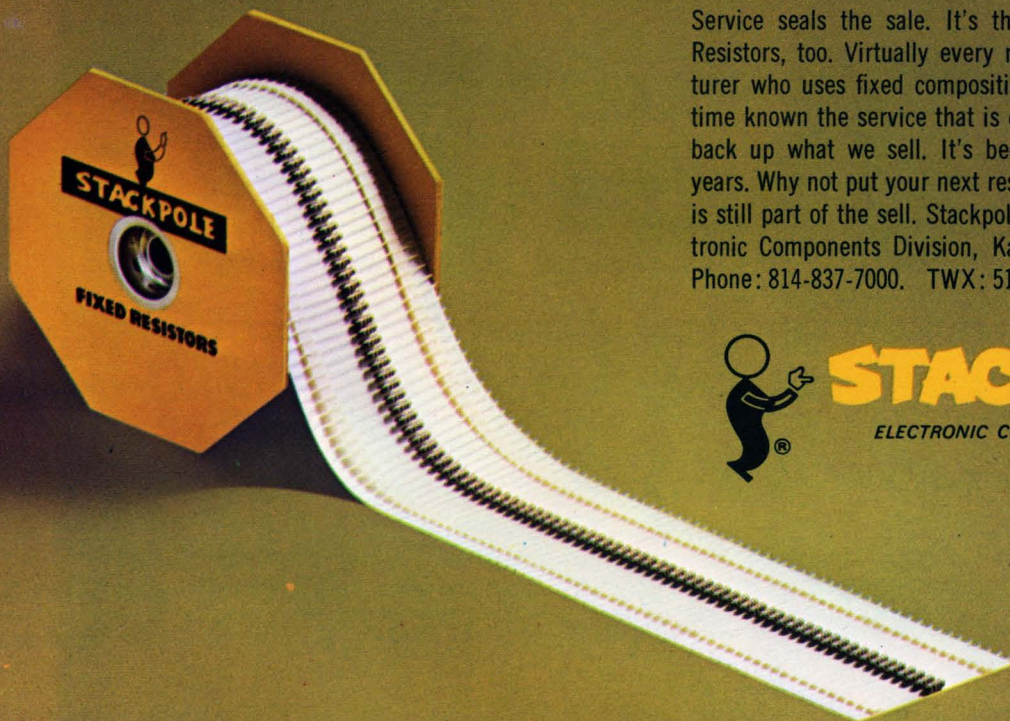

Service seals the sale. It's that way with everything. Resistors, too. Virtually every major domestic manufacturer who uses fixed composition resistors has at some time known the service that is distinctly Stackpole's. We back up what we sell. It's been that way for over 35 years. Why not put your next resistor order where service is still part of the sell. Stackpole Carbon Company, Electronic Components Division, Kane, Pennsylvania 16735. Phone: 814-837-7000. TWX: 510-695-8404.



STACKPOLE

ELECTRONIC COMPONENTS DIVISION



*Low-level high speed switching
in an A/D converter system is
a rare combination anywhere but at Cimron*

In fact, we might say unique, in the perfectly literal sense. Cimron's Multiplex A/D Converter System is of interest to anyone looking for a Mux-type system. Here's why. Let's say you're designing for a process control application. You frequently have to measure millivolt signals. And generally a system that does this, does so slowly or uses a lot of expensive amplifiers. This Cimron system gives you economical high-speed sampling of low-level signals, a combination so rare this model may be the first of its kind. You can buy

the Converter and Comparator for less than \$2,500 each—the entire 1000-channel system for less than \$12,000. The Multiplexer has a throughput speed of 1KC—from input programming to dumped output. The comparator isn't a must, but it does cut computer time. A comparable system, even if *you* build it, could cost 3 times as much, and still not give you Cimron's customer concern philosophy of immediate technical support. For information, write Cimron, Dept. B-101, 1152 Morena, San Diego, California 92110.

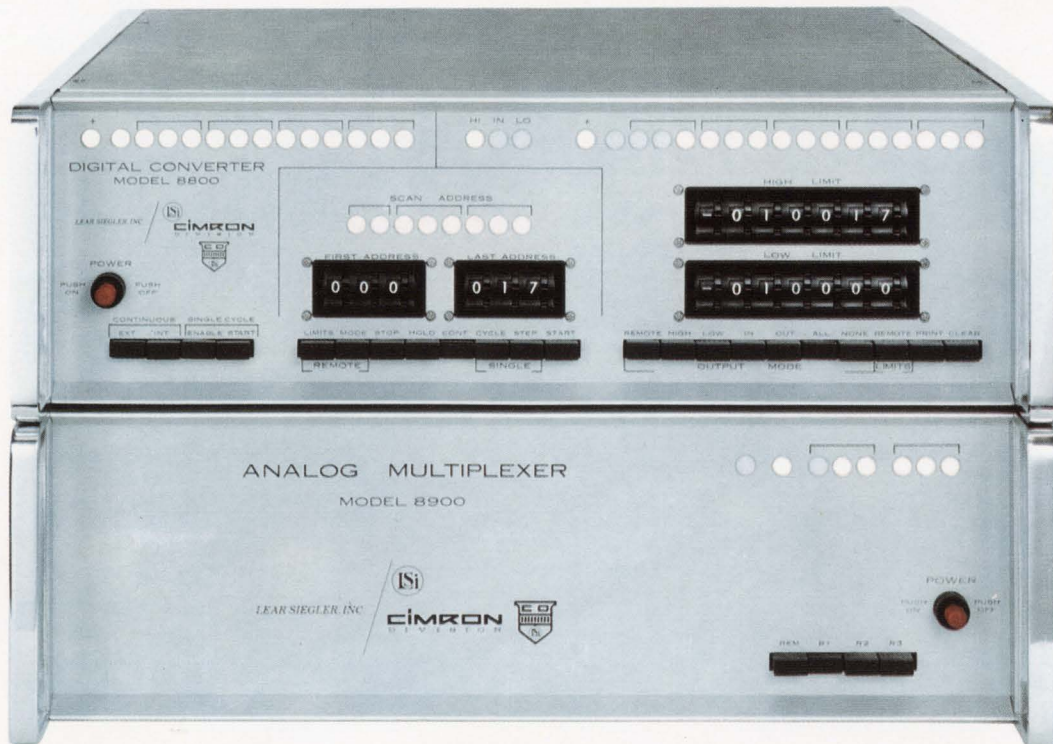

pnp equals npn at DEECO

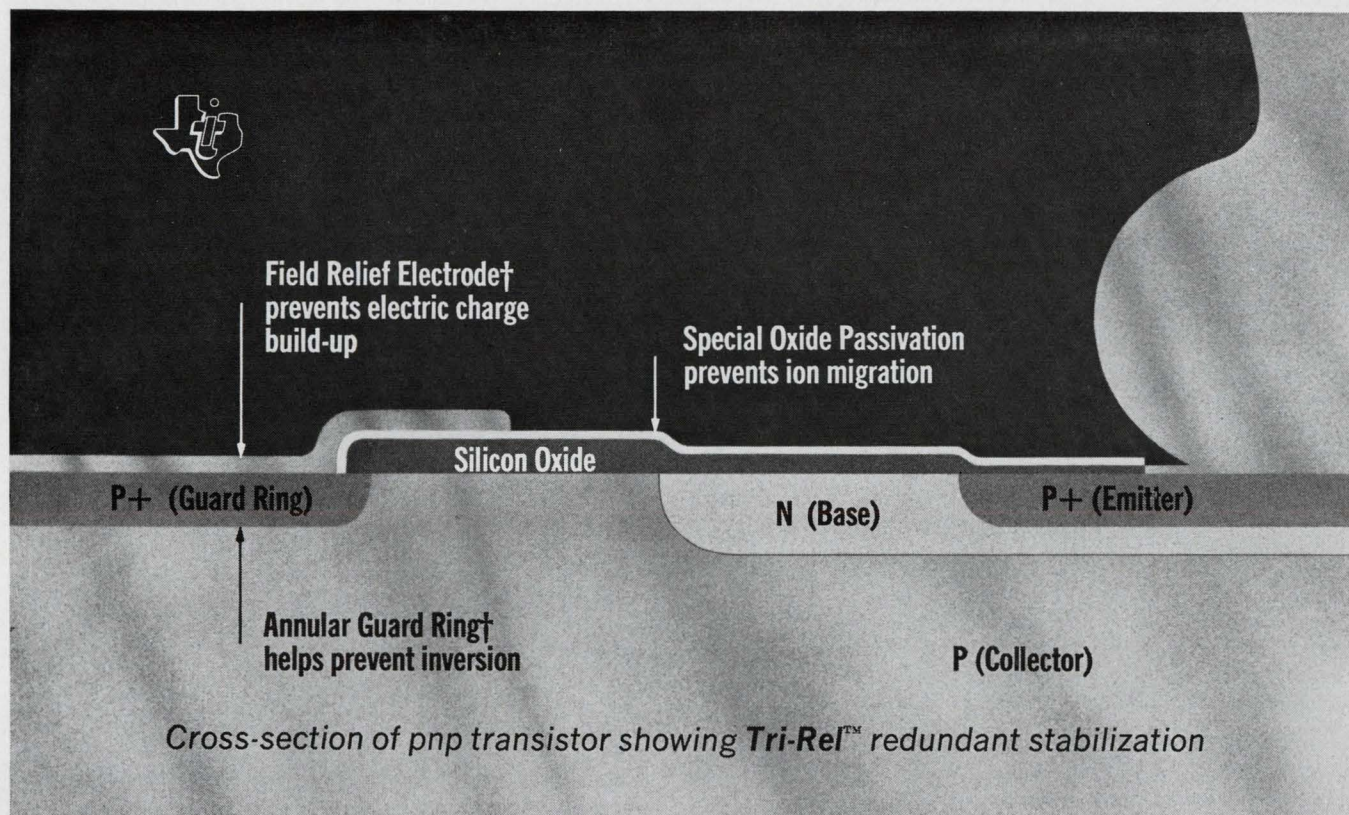

That's right...the Texas Instruments pnp silicon transistors you get from us are every bit as stable and reliable as npn devices. That's because of the exclusive *Tri-Rel* redundant stabilization shown above.

Tri-Rel employs three different techniques to guard against ion migration and electric charge buildup. This gives greater stability than one or two stabilization processes

† Patent Pending

which improve reliability...but not enough.

As a result, pnp transistors from TI meet the most demanding military and space reliability requirements.

In comparative tests, for example, only 20% of the conventional unstabilized pnp transistors drifted less than 0.5 nA during a 500-hr. test, while 97% of the units with

Tri-Rel drifted less than 0.5 nA and all units held within 1.0 nA.

All pnp silicon transistors from TI feature *Tri-Rel*... and that goes for duals and complementary transistors too.

You can get 'em quick from us! We carry in-depth stocks of all types of semiconductors from Texas Instruments. Call us for fast delivery.

DEECO  **Inc.**

AUTHORIZED DISTRIBUTOR 

DISTRIBUTORS — SERVING INDUSTRIALS EXCLUSIVELY

618 FIRST STREET N. W. • CEDAR RAPIDS, IOWA • PHONE 319 365-7751

plug-in

- multi-trace
- differential
- sampling
- spectrum analysis



Tektronix 530, 540 and 550-series plug-in oscilloscopes offer a wide range of performance, designed to meet your changing measurement needs. Select the performance and measurement functions you need from multi-trace, differential, sampling and spectrum analyzer plug-ins.

For multi-trace applications, the new Type 1A4 Four-Channel amplifier offers constant DC-to-50 MHz bandwidth and 7-ns risetime capabilities over its 10 mV/cm to 20 V/cm deflection factor range. Operating modes include alternate or chopped four channel, dual channel differential, and 2, 3, or 4 channels added or subtracted. Two dual-trace plug-ins are also available, the Type 1A1 with 28 MHz at 5 mV/cm (50 MHz at 50 mV/cm) and the Type 1A2 with 50 MHz at 50 mV/cm.

| | |
|-----------------------------|-------|
| Type 1A1 Dual-Trace Plug-in | \$625 |
| Type 1A2 Dual-Trace Plug-in | \$340 |
| Type 1A4 Four-Trace Plug-in | \$780 |

For differential applications, the new Type 1A5 Differential amplifier features 1 mV/cm deflection factor, 1,000:1 common-mode rejection ratio at 10 MHz, ± 5 V comparison voltage and 50 MHz bandwidth with 7-ns risetime at 5 mV/cm. The low-cost Type 1A6 Differential plug-in with 1 mV/cm deflection factor, 10,000:1 CMRR and 2-MHz bandwidth and the high-gain Type 1A7 Differential plug-in with 10 μ V/cm deflection factor, 50,000:1 CMRR and 500 kHz bandwidth are also available.

| | |
|-------------------------------|-------|
| Type 1A5 Differential Plug-in | \$550 |
| Type 1A6 Differential Plug-in | \$240 |
| Type 1A7 Differential Plug-in | \$440 |

For sampling applications, choose from two high performance plug-ins, the Type 1S1 general purpose sampling plug-in and the Type 1S2 TDR sampling plug-in. The Type 1S1 features internal triggering, 0.35-ns risetime, DC-to-1 GHz bandwidth and calibrated sweep speeds from 100 ps/cm to 50 μ s/cm. The Type 1S2 is a time-domain reflectometer with a system risetime of 140 ps, 0.005 p/div deflection factor and sweep rates from 100 ps/div to 1 μ s/div. With its 90-ps risetime, 5 mV/div deflection factor and built-in triggering, the Type 1S2 can be used in many other sampling applications.

| | |
|---------------------------|--------|
| Type 1S1 Sampling Plug-in | \$1175 |
| Type 1S2 TDR Plug-in | \$1375 |

Four spectrum analyzer plug-ins covering the spectrum from 50 Hz to 10.5 GHz convert your oscilloscope to a high-performance spectrum analyzer. The plug-ins cover the following frequency bands: Type 1L5 from 50 Hz to 1 MHz with 10 μ V/cm deflection factor; Type 1L10 from 1 MHz to 36 MHz with -110 dBm sensitivity; Type 1L20 from 10 MHz to 4.2 GHz with -110 to -90 dBm sensitivity; and Type 1L30 from 925 MHz to 10.5 GHz with -105 to -75 dBm sensitivity.

| | |
|-------------------------------------|--------|
| Type 1L5 Spectrum Analyzer Plug-in | \$1000 |
| Type 1L10 Spectrum Analyzer Plug-in | \$1150 |
| Type 1L20 Spectrum Analyzer Plug-in | \$1925 |
| Type 1L30 Spectrum Analyzer Plug-in | \$1925 |

U.S. Sales Prices FOB Beaverton, Oregon

For a demonstration, contact your nearby Tektronix field engineer or write: Tektronix, Inc., P.O. Box 500, Beaverton, Oregon 97005



*Multi-trace, differential,
sampling and spectrum analysis*

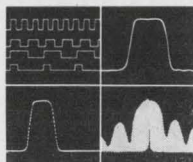

*... in all Tektronix 530-540-550-series
plug-in oscilloscopes*

Probing the News

Space electronics

Hard selling technology

NASA is applying salesmanship and emphasizing three new activities in its program to get industry to use the fruits of its R&D efforts

By Paul A. Dickson

Washington regional editor

Ask most engineers what they know about NASA's technology utilization program and they'll answer "tech briefs." It's true that most of the program's output has taken the form of one-page summaries of new ideas, techniques, and inventions, but the National Aeronautics and Space Administration has recently launched three new activities to stimulate spinoffs: Regional Experimental Dissemination Centers, a computer software sales operation, and biomedical applications teams.

The technology utilization program is being pushed harder these days to squeeze more use of the vast amounts of research and development work being done. However, some cynics maintain that NASA is using the program primarily to sell the public and Congress on the value and need of its space effort.

Supplying demand. Industry hasn't exactly broken down agency doors to take advantage of available technology, so NASA, though its limited budget cramps its style in this area, is concentrating more on marketing the program. Most observers agree that transferring technology is a difficult job and involves dissemination techniques still in their infancy.

"New knowledge comes in bits and pieces, not in readily usable packages," says George Howick, director of the technology utilization program, who with his staff of 70 is trying to spin off space R&D. Although they are disappointed by the small number of responsive

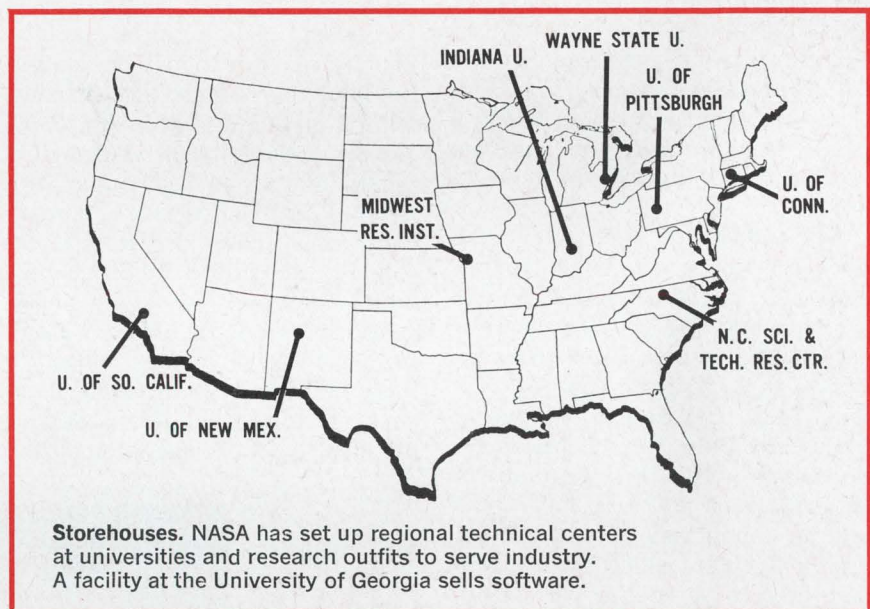

companies, NASA officials feel the program is gathering momentum. "I'm convinced that the impact of space technology will be 10 times greater during the 1970's than in the 1960's," says Richard L. Leshner, NASA's assistant administrator and the man who has over-all responsibility for such projects. But both Leshner and Howick are considering ways and means of increasing the immediate impact of space technology on industry.

More than 900 tech briefs were issued during 1967, and last month number 2,000 was published. This document describes a miniature diaphragm capacitance transducer that can be used in a hypodermic needle to make measurements within the human heart. Leshner

says that a pace of about 1,000 briefs annually will be maintained over the next few years.

Paperwork. The printed literature distributed so far includes technical briefs summarizing new ideas, inventions, or techniques; longer technology utilization reports on developments of special significance; and technological state-of-the-art surveys compiled to order. Howick estimates that about 38% of the published output of his office falls in the area of electronics.

I. New directions

While tech literature will continue to flow from NASA, the three new efforts will take priority. Howick describes the new activities as "mission-oriented experiments"

... companies aren't getting involved the way NASA feels they should ...

to explore new approaches to the task of transferring knowledge to the maximum number of users. "We are not out to build an empire but just trying to find the best way of getting Government-funded research into the public realm," he says. "Once we get these operations going and paying for themselves we'd just as soon turn them over to another agency or nonprofit institution and move on to something else."

The regional centers, located at nine nonprofit institutions, deliver tailored packages of technical information to companies paying a fee to defray expenses. The centers' computers can search through 300,000 technical documents from Government agencies to help solve a particular problem or provide background information in a special area.

Self-sufficiency. The centers also offer sustaining annual memberships—in effect, annual contracts for data and services. The goal of each center is to pay its own way within three to five years. S. William Yost, who directs the one at the University of Connecticut, hopes that within three years it will have between 200 and 300 clients and an annual income of \$250,000.

Yost's center, which set up shop last July to serve the New England area, has encountered some problems convincing potential clients of the scope of the technology in its computer. Yost explains that there are two categories of documents in the hopper. Half are unpublished Government reports on research, experiments, and contracts. Of this number, 26% are from NASA, 25% from the Defense Department, 25% from other Federal agencies, and the balance from Russia (17%) and other foreign countries. The other half of the file is made up of reports from about 900 journals, most of them published in the U. S. However, there's a good representation of Soviet, British, and Japanese sources.

Drawback. "We've got a major problem with the centers: industry isn't using them," says Howick. Only about 275 firms are being

served by the centers, though "there are thousands and thousands of small companies that could be benefiting," according to Leshner.

II. Few takers

A. Kendall Owlle, director of the center at the University of Southern California, says, "At first there was a great deal of industry interest in using our services. Now it seems the companies are not becoming involved as we feel they should."

Merchandising. Program officials list a variety of reasons for industry's apparent disinterest—skepticism, provincialism, and a paucity of educational publicity—but hope to overcome these barriers with a marketing campaign. S. D. Harper, director of engineering planning at Honeywell Inc.'s Computer Control division, Framingham, Mass., notes that he was enrolled in the University of Connecticut's program by a "traveling salesman" from the center's Cambridge, Mass., branch office. A NASA official says the Connecticut center is using a half-dozen marketing men to get the operation off the

ground. Harper feels that the salesman's contact was essential. "We could well have found out about the center but done nothing with it."

Although the number of electronics firms in the system is small, and some of these take advantage of the confidential relationship NASA offers, a few are willing to talk about what the centers have done for them. The responses of four in the Boston area are typical:

Logan Electronics. This small East Boston concern, which has a product line of wire and plastic-wound variable resistors, has commissioned a search through literature on conductive plastics to find a material with the temperature coefficient of a certain metal. Mastro Marino, Logan's president, says: "The report actually serves two purposes. First, it keeps us from wasting R&D and duplicating the work of others. Second, we can usually tell who is interested in our sort of product by noting where the research money comes from and how much of it there is." Marino has received only one report, which, he says, provided little useful information. But by noting the points of interest and zeroing in on them the next time, and the next, Logan expects to get a good deal of valuable data out of subsequent reports.

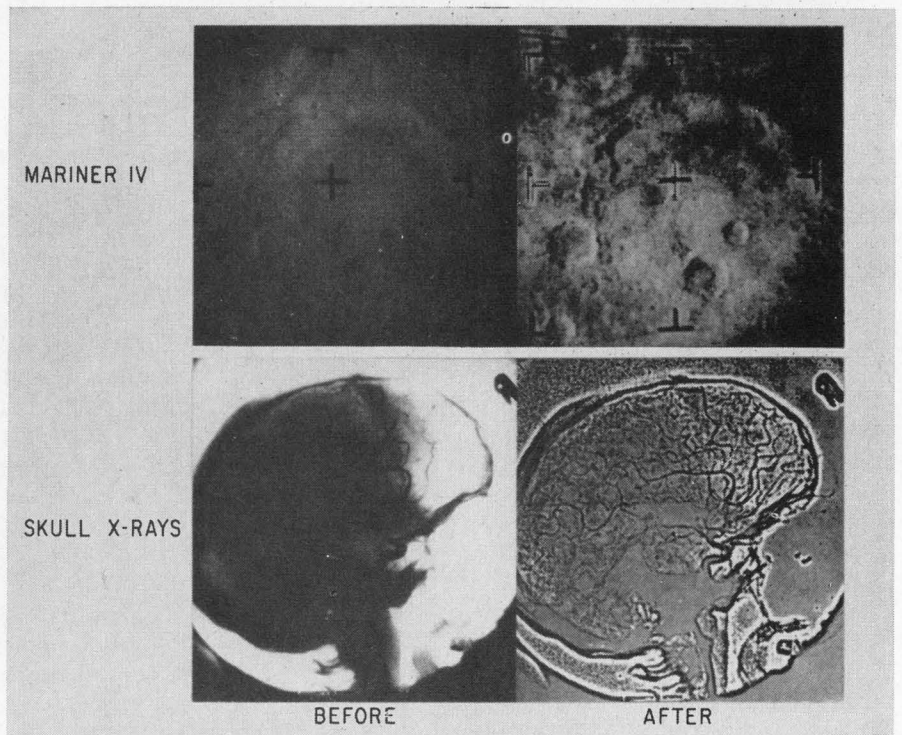

Skull session. Computer techniques used to enhance this Mariner 4 picture of the moon's surface are being used to clarify medical X rays.

Spectrum Systems Inc. This Waltham-based outfit has asked for data on thin-film optical coatings and sputter-deposition techniques with the aim of building ultranarrowband optical filters for the red end of the visible and infrared spectrums. James Greene, quality control chief and a research scientist with the company, says, "We've received our first report on electro-optical monitoring systems and it's quite useful." Greene expects the reports to have a sizable effect on the company's operations and sees the service becoming a regular part of the R&D routine. "Many sources of valuable information are so obscure that they're only available for the first time from NASA, and a minor fact can make all the difference in a business like ours," he says.

Honeywell. The Computer Control division uses NASA's service to keep engineers abreast of technology, requesting searches and monthly updating in such broad areas as integrated circuitry and memory components. Harper feels that the service is particularly helpful in breaking in a new man. "It takes only a week or so to top off a man's education in a narrow field. All he has to do is read through the binders of abstracts NASA sends us, perhaps requesting a paper or two of special interest." Another plus, says Harper, is that the service can reassure Honeywell that there are no holes in its R&D programs. "And I specifically like the heavy amount of European and Japanese material available. Often, something like 30% or 40% of a binder may have overseas data that would otherwise be hard to obtain and translate."

Pickard & Burns Inc. This Waltham-based firm designs and builds low- and very-low-frequency antenna and coupler units. Thus far, it has used NASA for only one literature search, but Richard H. Woodward, a vice president, says, "We presume we will continue to request information from NASA at a modest rate in the future." Woodward estimates that about 25% of what the space agency sent in the first search was news to the company.

A check of electronics activities on the West Coast shows that the center at the University of Southern

KH Oscillators excel in many important parameters

(and now may cost you less!)

Consider the medium-priced Krohn-Hite Model 4100 Push-Button Variable Oscillator. When compared to others in its price class, the \$550 Model 4100 is a leader in those significant performance parameters that mean the difference between a true oscillator and other instruments regardless of price.

The accompanying chart demonstrates these wide differences in published manufacturer's specifications. Compare them for yourself. Note that there is no relationship between price and performance.

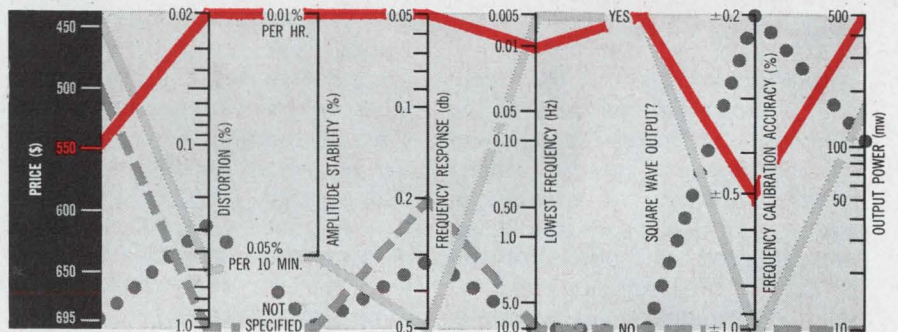

IMPORTANT OSCILLATOR PARAMETERS are plotted for four competing solid-state instruments. The plot for the K-H Model 4100 (color) is compared to other units with lower and higher price tags. Relative position of each parameter was determined by its value to the instrument user, not by its number. Thus the lowest price has

been placed near the top of the chart . . . and 0.02% distortion placed higher than 1.0%. Logarithmic scales are used throughout. All units have 1 MHz maximum frequencies. Note that although the Model 4100, is relatively low on the price scale, it excels in other parameters.



MODEL 4100 SOLID STATE PUSH-BUTTON VARIABLE OSCILLATOR covers 0.01 Hz to 1 MHz, with simultaneous sine- and square-wave outputs. Size: 8½"W x 5¼"H x 14½"D. Price: \$550.

Write for Model 4100 Data.

KROHN-HITE CORPORATION

580 Massachusetts Ave., Cambridge, Mass., U.S.A. 02139
Telephone: (617) 491-3211

Oscillators / Filters / AC Power Sources / DC Power Supplies / Amplifiers

... over 150 medical problems could benefit from aerospace research ...

California has recently researched such topics as electroluminescent display panels, solid state radiation detection devices, electronic liquid-level measuring instruments, moisture detection by microwave, and tuning devices. While the Western electronics firms are generally more reluctant to talk about what the center is doing for them than are their Boston counterparts, the chief project engineer for Spectrol Electronics, a division of the Carrier Corp., does describe "the condensed group of reports applicable to a particular problem" as of "significant value."

III. Soft sell

Another activity of the technology utilization program is the Computer Software Management and Information Center (Cosmic) at the University of Georgia in Athens. The center sells NASA computer programs and other software items at a price covering only the cost of reproduction, handling, labor, and postage. Started in 1966, Cosmic now has 230 items on its

shelves and another 600 are being readied for market. The center's 10-man staff is in touch with more than 10,000 individuals in the business and academic worlds.

The center's head, Harry B. Rowell Jr., notes: "We're really offering some bargains. A program that cost NASA \$1 million to develop may go for as little as \$75. The most expensive item we've sold so far cost \$500." The latter offering was a set of 13 tapes containing information on all commercially available diodes and transistors.

Crowded shelves. Looking ahead, Rowell sees the inventory in his shop growing dramatically. Noting that the Atomic Energy Commission and Defense Department are now negotiating to sell software through the center [Electronics, Jan. 8, p. 68], he predicts that at some point in the future, Cosmic may sell 5,000 to 10,000 NASA items, another 5,000 to 10,000 from the AEC and, maybe, 50,000 from the Pentagon.

The space agency wants to get more software into the pipeline.

James Dennison, the technology utilization officer at NASA's Electronics Research Center, says, "We are keeping very close to the operations of Cosmic and getting ready to give them our extensive set of computer circuit design programs." He adds that two computer-aided-design items have already been unofficially turned over to Cosmic and that more will come.

Off target. Rowell says that while Cosmic has gone a long way towards becoming self-supporting, he still feels that the center is selling the wrong people. Dennison agrees, asserting that Cosmic is "doing NASA's laundry" — really helping only the space agency and its suppliers. He says his office is now studying its programs to find applications in education and health.

IV. Rx for utilization

Rounding out the Office of Technology Utilization's new activities are the three biomedical applications teams set up in 1966. Operating out of the Midwest Research Institute in Kansas City, Mo., the Research Triangle Institute in Durham, N.C., and the Southwest Research Institute in San Antonio, Tex., these groups establish relationships with medical and biological R&D groups at hospitals and universities and attempt to apply aerospace knowhow to medical problems. The teams have identified more than 150 such problems they consider solvable by technology. Howick notes that much of the exploratory work now being done by the three teams is in the area of medical electronics. Projects include:

- Design of a small pressure transducer to determine quantitatively the degree of speech impairment in subjects with cleft palates.

- Several approaches to ultrasonic holography to display the internal organs of the human body.

- Development of solid state mapping systems to gather body signals for computer processing.

- Development of miniature sucrose gap chambers for the study of the electrical properties of the heart, with an assist from IC etching techniques.

- Development of a telemetry system measuring pressure on the human hip to help in the design of

Down to earth

The success of a NASA tech brief lies in its prompting "a transfer," or nonspace application. The following are examples of such transfers.

- The Teledyne Systems Corp. developed a miniature system based on innovations cited in a brief titled "Ultraminiature Television Camera."

- The National Cash Register Co. is producing a kit for aviators based on information in a brief called "Library of Documents Compressed into Lap-Held Display Kit."

- Northrop Space Laboratories reports improved techniques based on a brief titled "Encapsulation Process Sterilizes and Preserves Surgical Instruments."

- The Labor Department is applying a concept reviewed in a brief called "Speed-Sensing Device Aids Crane Operators" to the improvement of safety procedures in maritime operations.

- The E. J. Codd Co., used material from a brief titled "Precision Tooling Techniques" to develop a squareness gauge that measures concrete beams in construction work.

- The Barbour-Stockwell Co. says it's developing a new product with the help of a brief called "Elastic Orifice Automatically Regulates Gas Bearings."

- Concord Controls Inc. is developing a tracer for use with Cartesian coordinate maps as outlined in a Langley Research Center flash sheet titled "Random Function Tracer."

- The Ames Gauge Co., is producing a gauge based on a perpendicularity device described in "Precision Tooling Techniques."

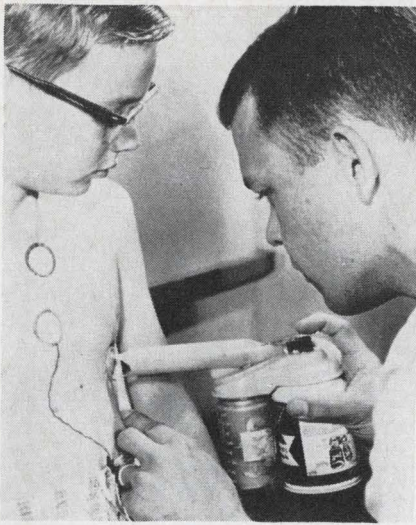

Application. Spray-on electrodes hold lead wires for monitoring heart rate. The method was developed at NASA's Flight Research Center in California.

prosthetic hip joints.

▪ Use of a photoelectric eye-switch, developed at the Marshall Space Flight Center, as a tool for measuring eyeblink in connection with studies of mental illness.

Success stories. Among the dozen or so applications of space techniques to medical tasks are: the adaptation of a sensitive micrometerite detector to the study of muscle reflexes and tremors; the use of a miniature transducer designed to measure stress in plastic propellants for measurements of human bone distortion; and the use of a digital computer technique developed by the Jet Propulsion Laboratory for the improvement of medical X rays. "Someday there may be X-ray enhancing centers across the country," says Leshner.

The job of finding innovative material for tech briefs, Cosmic, and the biomedical teams is the responsibility of the technology utilization officers at the various NASA centers. They are responsible for screening the activities of their particular center as well as policing the contracts being directed by the center. But most facilities are woefully undermanned.

According to John F. Stokes, technology utilization officer at NASA's Goddard Space Flight Center, "By the nature of the size of our office it must be a passive program. If we had a larger staff we would be able to get a lot more briefs out." And ERC's Dennison concedes that "we could be doing

a lot better job getting information out to the electronics industry." He points out that though ERC tech briefs often produce requests for more information, no electronics firm has ever asked for a consultation with the center. "If a company asked for a meeting on a new technique or idea we'd be delighted to help them, but none ever do," he says.

Homework. Technology utilization officers at various NASA installations continually keep track of what's going on in-house. They talk with project managers and scan all reports produced at the facility. Once an idea or innovation is judged significant, it's forwarded to the Illinois Institute of Technology Research Institute for third-part evaluation.

Stokes and Dennison see more and more coming out of their offices in the form of both briefs and inputs to other programs. Stokes says his office is now preparing a report on a d-c brushless magnetic motor, for example, and Dennison says ERC is organizing data on electrochemical displays and a multicolor cathode-ray-tube phosphor.

Innovations included in contracts are tracked in several ways. Technical monitors are assigned by NASA to study all contracts for new ideas. Further, every contractor signs a "new technology" report at the end of a project, and this document is turned over to the utilization officer for examination. Companies seldom try to hide an idea, although Dennison says that contractors sometimes have to be reminded of their responsibilities. He illustrates this by holding up a contract report called "Design of Microelectronic Circuits," saying, "I know there's something new and useful in this material; all I have to do is find it."

Clause with teeth. Leshner says this new technology clause has worked out well and has resulted in a lot of information for the utilization program. He attributes part of this success to provisions requiring a company to assure NASA of complete compliance before being paid. He also feels there is considerable Congressional sentiment for incorporating a new technology proviso in future contracts issued by all Federal agencies, including the Pentagon.

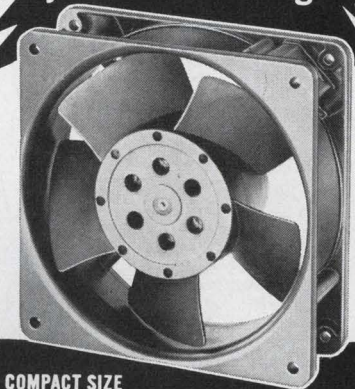

COMPACT SIZE

Only 4 11/16" x 4 11/16" x 1 1/2". Weighs just 1 1/4 lbs. Interchangeable with similar, less reliable 4 11/16" fans.

POWERFUL MOTOR

Dependable shaded-pole motor operates with low internal heat rise. Efficient inside-out design.

ALL-METAL CONSTRUCTION

Precision die cast housing, hub, impellers. Corrosion resistant. Natural heat sink. Warp-free, unlike conventional plastic fans.

115 CFM WITH LESS THAN 37.5 dB SIL*

*Speech Interference Level

- Lubrication-free life in excess of 20,000 operational hours, continuous duty at 55° C.
- Delivers more air at a lower noise level, yet priced under similar conventional plastic fans.
- Model 4500 designed for 117V/50-60 Hz operation. Model 4550 operates at 230V/50-60 Hz.
- Immediate delivery through distributors or from factory stock.
- Has Underwriters' Laboratories Inc. Yellow Card Component Recognition Number E41168.

ONLY \$855 EACH
in lots of 100

PAMOTOR, INC., 312 Seventh St. San Francisco, California 94103.

PAMOTOR, INC.

Oceanographers needed a battery for taking snapshots —6 miles under the sea.

Mallory made it.

What can we do for you?

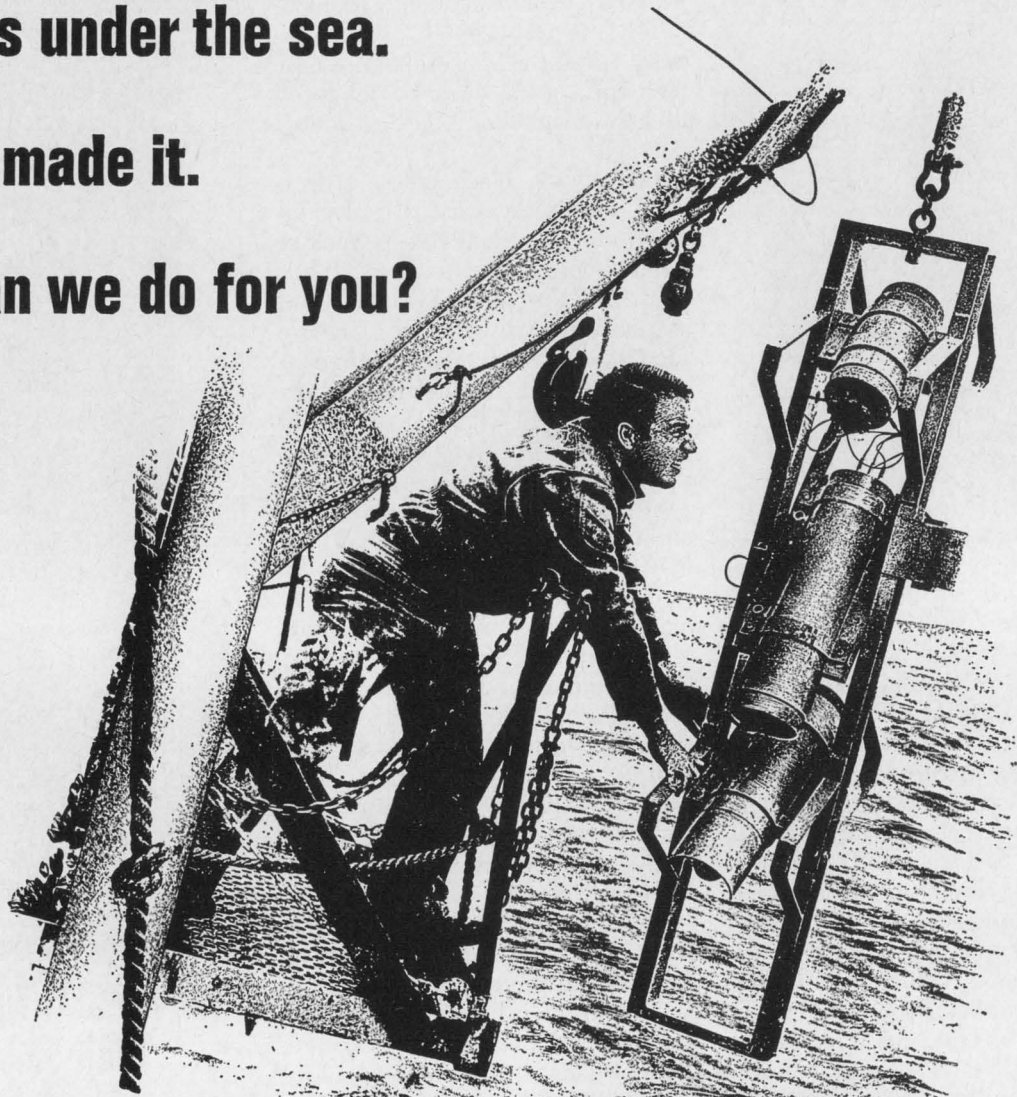

Photo courtesy of Alpine Geophysical Associates, Inc.

Oceanographers needed a battery. A battery they could depend on in cameras 35,000 feet down. A battery with the deep, controlled power needed for film advance and photoflash. Yet a battery that could keep that power in any climate, hot or cold—even after long months of ocean voyage. Mallory made it. The battery—a Mallory alkaline battery. It responds instantly to the heavy current drains of photoflash and film advance. It is extraordinarily resistant to extremes of temperature from below freezing to tropic heat. And it retains 85% of its original capacity even after 2 years' storage.

POWERFUL IN ANY CLIMATE

When most people think of Mallory alkaline batteries, they think of long lasting power—the fast, deep power that makes these heavy-duty cells so suitable for photographic applications, lighting and motor drives. They forget about their other extraordinary characteristic: resistance to extremes of climate.

There are two basic reasons why Mallory alkaline cells perform so well under adverse temperature conditions. One reason, of course, is their sealed construction. Double steel jackets, molded end seals, and double end caps all work to give these cells high operating effectiveness and long life under tropic temperatures. The other reason that Mallory alkaline cells stand up to extreme climates is their internal structure. Anode and barrier design are such that efficiency cannot suffer greatly even when the temperature is below freezing. Taken together, these factors not only provide resistance to temperature, but also give protection from pressure, humidity and altitude.

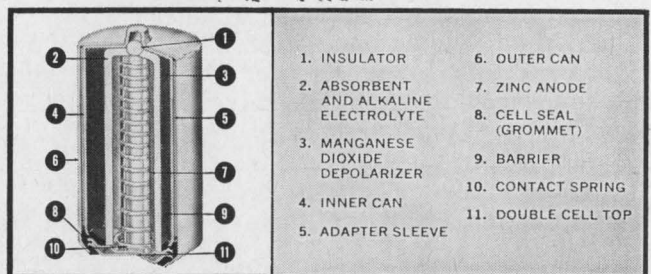

OVER 1000 DIFFERENT TYPES

Mallory currently produces over 1000 different batteries of all sizes and capacities. If the battery you need hasn't been created yet, we'll be happy to sit down with you to design it.

For more information, please write the Technical Sales Department, Mallory Battery Company, a division of P. R. Mallory & Co. Inc., South Broadway, Tarrytown, New York 10591. Or call us at 914-591-7000. (In Canada: Mallory Battery Company of Canada Limited, Sheridan Park, Ontario.)

It's good business to do business with Mallory

MALLORY

Budget trims some space programs

Congress expected to go along with NASA programs approved by President; military outlays for space projects will rise about \$100 million in fiscal 1969

By Seth Payne

Washington news bureau

What kind of year will fiscal 1969 be for the U.S. space effort? Apparently, much like fiscal 1968, when NASA's budget shrank and the military's space expenditures climbed.

In the budget President Johnson will soon send to Capitol Hill, combined civilian and military space outlays will tally \$6.4 billion, about \$200 million less than this year's. Unless Congress makes additional cuts, the National Aeronautics and Space Administration can expect \$4.28 billion, about \$300 million less than the present fiscal year ending June 30. The Pentagon, on the other hand, can look for \$2.1 billion for its projects, about \$100 million more than it is spending this year.

Both NASA and the military are being held below the funding level that each wanted. Space planners were seeking \$4.78 billion while defense officials sought several hundred million dollars more.

Two-time loser. Like this year, NASA will have to operate its programs next year with nearly \$500 million less than it sought. Congress chopped \$510 million from the agency's \$5.1 billion budget request this year. However, there has been no lack of funds for the Apollo Lunar Landing Program that is supposed to put U.S. astronauts on the moon and return them to earth by late next year or early 1970. But as it stands now, the Apollo program ends after the first landing.

Underwriting Apollo has meant that other programs have had to be sharply altered and, in some cases, cancelled. In addition, nearly 1,700 employees are being dropped from the 34,000-man NASA staff. However, no additional per-

sonnel cuts are scheduled at this time.

Mournful numbers. A \$3 billion chunk of the fiscal 1969 space budget is virtually inflexible. This includes \$2 billion for Apollo and \$1 billion for administrative operations and maintenance of the tracking and data acquisition network. As a result, only \$1.28 billion is left for NASA's other programs.

I. Priorities

A \$300 million slash, however, doesn't mean that NASA must reduce its non-Apollo outlays by this amount. The reason is that Apollo expenditures are declining as the program nears completion. During the current fiscal year, for example, some \$2.5 billion of NASA's budget is earmarked for Apollo. But next year, the agency will spend \$500 million less for the project.

However, NASA is being hard

pressed to crank up a follow-on for the lunar landing. To get a new program, the agency is scaling back some other projects. Four major development areas had been picked to take up the slack when the Apollo program ended. The most ambitious is the Apollo Applications Program designed among other things to orbit a manned workshop that would keep men in space for periods gradually extending to a year's time. This will cost a predicted \$4.5 billion through 1972; some \$384.2 million has already been channeled into the project, including \$253 million this fiscal year.

Next year, NASA plans to put another \$439 million into the program. First launch of the workshop is now planned for the spring of 1970.

Shopping list. Major contracts on the program have already been

NASA funding (millions of dollars)

| Programs | Fiscal 1968 | Fiscal 1969 |
|--|--------------|--------------|
| Manned space flight | | |
| Apollo | 2,500 | 2,000 |
| Apollo applications | 253 | 439 |
| Space science and applications | | |
| Lunar exploration | 50 | 8 |
| Planetary exploration | 109 | 110 |
| Astronomy | 86 | 81 |
| Science applications | 128 | 128 |
| Economic applications | 111 | 126 |
| Advanced research & technology | 237 | 244 |
| Aircraft technology | 81 | 90 |
| Support operations (tracking and acquisition) | 372 | 370 |
| Administrative and operating costs | 628 | 628 |
| Construction | 35 | 45 |
| Total | 4,580 | 4,280 |

Totals do not add exactly because of rounding. The fiscal 1968 figures represent actual NASA outlays, while the fiscal 1969 figures will be part of the budget request.

**. . . basic work on electronic systems
will stay at the fiscal 1969 level . . .**

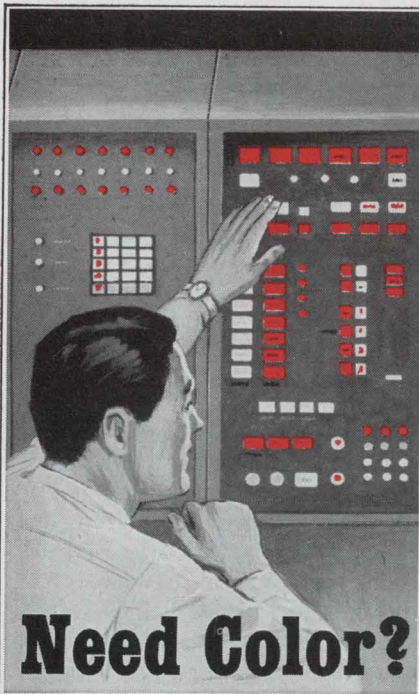

Need Color?

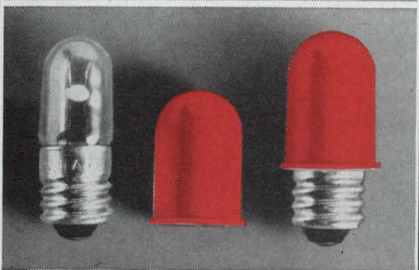

**Silikrome[®]
+ Lamp = Color**

Just snap a SILIKROME color filter over a clear miniature lamp. That's all! No need to worry about special fittings, coated bulbs that fade or plastic filters that melt. SILIKROMES are made of silicon rubber, will never fade, can withstand 500°F for over 1,000 hours. They come in any color; are interchangeable, unbreakable, reusable, act as shock mounts. Want proof? Return the coupon below and we'll send you some of our fabulous SILIKROMES.

APM HEXSEAL CORPORATION
41 HONECK ST., ENGLEWOOD, N. J.



APM-HEXSEAL CORP.
DEPT. E 81
41 Honeck St., Englewood, N.J.

- Please send free samples and full details on commercial and military applications of SILIKROMES.
- Please have a representative call.

Name _____
 Title _____
 Company _____
 Address _____
 City _____
 State _____ Zip _____

placed. The McDonnell Douglas Corp.'s Huntington Beach, Calif., facility is designing the S-4B rocket stage that will serve first as a fuel tank, then, when empty, as a 10,000-cubic-foot work area for the astronauts. The company's St. Louis plant is working on an airlock through which the men will enter the workshop from the Apollo spacecraft. The Marshall Space Flight Center is perfecting a multiple-docking adapter so that the workshop can handle several spacecraft at one time; Marshall is also building an Apollo telescope mount that will be used to study the solar system from space.

The space agency's second priority was to start a major unmanned program, dubbed Voyager, to explore the planets. This project would have cost well over \$1 billion, but Congress refused to authorize it last year.

Presently, the only planetary program in progress is the two Mars fly-bys to be made in 1969 with a pair of Mariner spacecraft. However, if Congress gives its approval, NASA wants to begin work next year on a spacecraft to orbit Mars in 1971. The agency plans on using as much of the leftover Mariner-Mars equipment as possible.

With a go-ahead, NASA would put two more spacecraft into orbit around Mars in 1973. At least one of the spacecraft would be sent into the Martian atmosphere, although it would not survive a landing on the planet. Present plans call for the use of a Titan booster to launch these spacecraft. This program would give the agency a jumping-off point for a Voyager-type project about 1975 to land instruments on Mars—if budget problems ease and Congress sanctions the measure.

II. On the shelf

Space planners wanted to begin development of a satellite in fiscal 1969 for NASA's earth resources program. This project would collect a wide variety of earth data from space; possible target areas include crop yields, water flows, detection

of diseased crops and forests, and location of fish schools. The agency wanted \$15 million to develop the satellite, but the White House-approved budget pared this to \$2 million for study contracts. However, the White House allocated \$14.7 million to develop the electronic sensors that will gather the data—a sharp climb from the \$5.8 million allocated for the project in this year's budget.

Space officials were also hopeful of developing a nuclear rocket upper stage for the Nerva 2 program. This rocket would have produced 250,000 pounds of thrust, sufficient for a manned Mars mission or for sending high payloads on interplanetary journeys. Congress balked at this, too. Now, NASA must be content to perfect the smaller Nerva 1 engine with 75,000 pounds of thrust. But even this project has not been approved for an actual space flight; NASA is asking \$60 million for this program in fiscal 1969, compared with \$54 million it received this year.

Ups and downs. In other areas, NASA has been forced to seesaw. Lunar and planetary funding will drop from this year's \$159 million to about \$120 million as the Surveyor and Lunar Orbiter programs end. Research in aeronautics will climb from this year's \$81.4 million to \$90 million. But the most dramatic change is the decision to drop the famed X-15 program to devote more money to development of the short takeoff and landing aircraft, badly needed for both military and civilian applications. Funds for STOL will rise to about \$12 million next year; \$7.4 million is being spent in fiscal 1968.

The so-called quiet engine project, to lessen the noise of aircraft engines, will get off the ground next year with \$7.5 million in funding. Research funds for the supersonic transport will rise only slightly from this year's \$13 million. Another \$20.6 million will go into SST aeronautical research, about the same level as this year. Basic work on electronic systems will remain at the same level as this year, \$29.5 million. The Nimbus and Applica-

This is the new
MSB-M connector block.
Of plated plastic,
it cuts RFI, cuts costs.

A breakthrough in technology allows us to introduce an inexpensive, easy-to-install connector block that acts as a conductive path for radio frequency signals that would otherwise cause interference. RFI can now travel via the block from the cable braid through the jack-screws to the chassis.

Molded of glass-filled phenolic, plated with tin over nickel, the

block accommodates coaxial or shielded cable, as well as twisted pairs. Springs lock the outer contacts to the connector body.

Less expensive and lighter than all-metal connector blocks, the new MSB-M also eliminates the need for pigtailing and provides an improved installation free of the signal strength loss and distortion introduced by unshielded pigtailed. The connection occupies less space on a mounting surface through reduced cable-bundle diameters. Standard, removable contacts permit easy circuit changes, and lower installation costs.

Available in three arrangements: plated plug, unplated receptacle; plated receptacle, unplated plug; both parts plated. Full details explained in Bulletin MSB-M67. Write: Burndy, Norwalk, Conn.

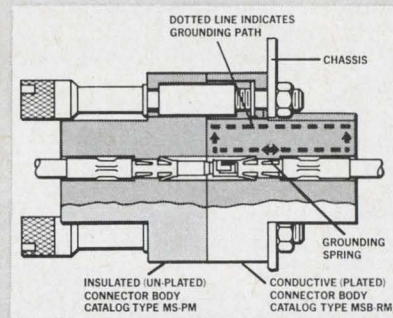

INTERNATIONAL SALES HEADQUARTERS AND MANUFACTURING FACILITIES: CANADA: Scarboro, Ontario / ENGLAND: St. Helens, Lancs. BELGIUM: Mechelen / MEXICO: Naucalpan de Juarez / BRAZIL: Sao Paulo / JAPAN: Tokyo / Sales Offices in Other Major Cities



The Burndy Groundender

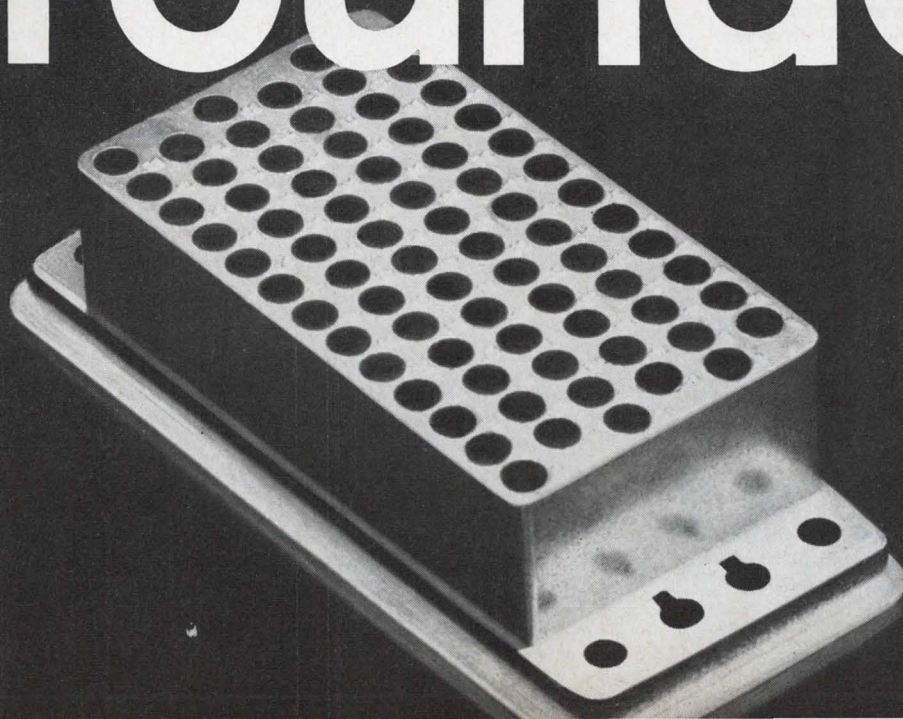

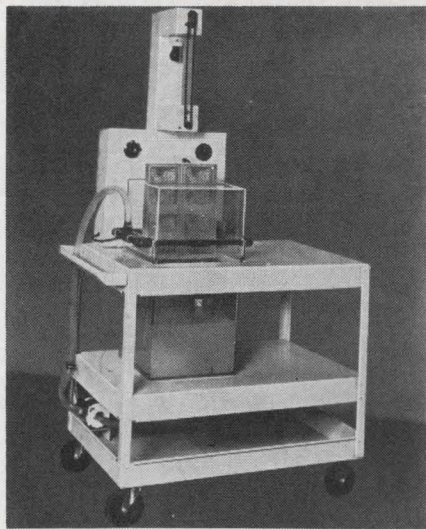

"fine line" etcher

for prototypes—limited runs

Model No. 201 (illus.), etches two 11" x 14" one-sided boards or one 11" x 14" two-sided board: **\$795**
Pat. applied for

**ETCH YOUR OWN
P C BOARDS
AUTOMATICALLY**
(in less than 5 minutes)

from this →
to 11" x 14"

Shown Actual Size

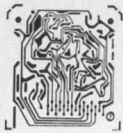

- No cooling or venting required!
- Etches as fine as .001"!
- Cuts costs in half—saves time!
- Complete photo processing instructions!
- Work is illuminated while etching!
- No patterning . . . minimum undercutting!

NOW IN USE BY:

AMP, Inc.
Ampex Corp.
Atomic Energy Com.
Bendix
Charles Bruning
Esso Research
General Dynamics
General Electric
IBM
ITT
Lear Siegler
Magnavox
Micro Switch
NASA
Owens-Illinois

Sprague Electric
Union Carbide
U.S. Air Force
Western Electric
Whirlpool
M.I.T.
Oklahoma State U.
Purdue Univ.
Washington Univ.
Univ. of Calif.
Univ. of Chicago
Univ. of Colorado
Univ. of Georgia
Univ. of Hawaii
Univ. of Penn.

CYCLO-TRONICS, INC.

3858 N. CICERO — CHICAGO, ILL. 60641
TELEPHONE: (312)-282-6141

. . . half of the defense space budget goes for surveillance satellites . . .

tions Technology Satellite programs will also be underwritten to the tune of about \$57 million.

To keep the Saturn 1B production line running at a rate of two vehicles a day, NASA has had to juggle its funds. Operated by the Chrysler Corp. at Michoud, La., the Saturn production will cost nearly \$100 million a year.

In the final analysis, Congress holds the key to NASA's 1969 plans. If the legislators trim the agency's budget any closer, many of the thinly financed programs will obviously fall by the wayside. However, Capital Hill observers believe Congress will keep pretty close to the White House-approved level. The feeling is that most legislators realize that programs have been cut to the bone and further slashes would be crippling.

III. Pentagon power

The military space program is a different story. Growing unobtrusively over the years to the point where two out of every three satellites launched have a Defense Department stamp, military-space spending is due for a slight increase next year.

Nearly half of the defense space budget will be earmarked for a series of highly classified surveillance satellites. The next largest allocation is for the Manned Orbiting Laboratory (MOL) program, which gets a \$169 million boost from this year's \$431 million. This program calls for the Air Force to orbit a pair of astronauts for 30-day periods using a modified Gemini spacecraft atop a new space laboratory. The launch vehicle will be a Titan 3M. Both the spacecraft and the lab are being built by McDonnell Douglas. Once in orbit, the astronauts enter the laboratory for experiments. They will return to earth in the spacecraft, which will be detached from the lab. First flights of the MOL are set for 1971.

Like NASA, the military operates an extensive tracking network that costs nearly \$300 million a year to maintain. Administrative costs for other facilities cost about \$300 million a year.

The Pentagon will spend nearly \$100 million next year on its satellite communications systems. A network of 17 small military communications satellites are now in service under the Interim Defense Communications Satellite Program.

Field problems. During fiscal 1969, the large, new tactical communications satellite built by the Hughes Aircraft Co. is scheduled for launch. This will test the feasibility of allowing field units as well as ships and aircraft to communicate with each other via satellite. Also awaiting approval from the Secretary of Defense is another communications satellite program that calls for four powerful military spacecraft in synchronous orbit. Hopefully, this would provide the military with a highly reliable global communications network that would be virtually unjammable. Where the present military satellites have a power rating of about 3 to 5 watts, the new satellites will have several hundred watts of transmitted power. Several million dollars in seed money is included in the new budget.

In transit. The Navy's operational navigation satellite system, formerly known as Transit, will get between \$10 million and \$15 million—about the same as this year.

Approximately \$50 million will be spent next year on improving the Titan family of boosters. Some development work remains to be done on the Titan 3M to man-rate it for the MOL flights and other military space work. The Improved Military Satellite Project will probably be approved and requests for proposals on the design sent to industry by mid-1968.

A start will be made during fiscal 1969 on updating the military's Space Detection Network. Improved equipment and more stations are planned; the program will cost several hundred million dollars by 1972-73, when the upgrading project is completed.

The military budget is not as apt to be pared by Congress as NASA's civilian space effort. As a result, it is expected to stand about as presented to Congress.

Miniature Devices at Miniature Prices*

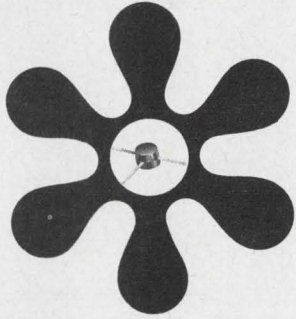

MMT3904/6 PROTOTYPE PAIR: 2 FOR THE PRICE OF 1!

Turn the page for news of Motorola's new Micro-T HANDYPac special offer from these franchised distributors:

EASTERN

ALABAMA, Huntsville 35805.....(205) 837-6101.....Airwork Gulf Electronics Corp.
 CONNECTICUT, Hamden 06514.....(203) 288-7771.....Cramer Electronics, Inc.
 D.C., Washington 20001.....(202) Hudson 3-5200.....Electronic Wholesalers, Inc.
 FLORIDA, Miami 33148.....(305) 885-2401.....Airwork Gulf Electronics Corp.
 FLORIDA, Orlando 32809.....(305) 855-4020.....Hall-Mark Electronics Corp.
 GEORGIA, Atlanta 30318.....(404) 355-2223.....Jackson Electronic Supply Co., Inc.
 MARYLAND, Baltimore 21230.....(301) 539-6525.....Pyttronic Industries, Inc.
 MARYLAND, Silver Spring 20910.....(301) 587-2900.....Schweber Electronics
 MASSACHUSETTS, Cambridge 02139.....(617) 864-0400.....R & D Electronic Supply Co., Inc.
 MASSACHUSETTS, Newton 02164.....(617) Woodward 9-7700.....Cramer Electronics, Inc.
 NEW JERSEY, Moorestown 08057.....(609) 235-1900.....Angus, Inc.
 NEW YORK, Binghamton 13902.....(607) 748-8211.....Federal Electronics, Inc.
 NEW YORK, Buffalo 14202.....(716) TT 4-3450.....Summit Distributors, Inc.
 NEW YORK, Flushing 11369.....(212) GR 8-4000.....Cramer Electronics Inc.
 NEW YORK, Syracuse 13211.....(315) 454-9247.....Cramer/Eastern
 NEW YORK, Westbury, L.I. 11591.....(516) ED 4-7474.....Schweber Electronics
 NEW YORK, Woodbury, L.I. 11797.....(516) 921-8700.....Harvey Radio Co., Inc.
 NORTH CAROLINA, Winston-Salem 27102.....(919) Park 5-8711.....Electronic Wholesalers, Inc.
 PENNSYLVANIA, Philadelphia 19106.....(215) WA 5-6900.....Radio Electric Service Co. of Pa.
 PENNSYLVANIA, Pittsburgh 15218.....(412) 351-3611.....Semiconductor Specialists, Inc.

CENTRAL

ILLINOIS, Chicago 60680.....(312) TA 9-9121.....Allied Electronics Corp.
 ILLINOIS, Chicago 60624.....(312) 638-4411.....Newark Electronics Corp.
 ILLINOIS, Chicago 60666.....(312) 279-1000.....Semiconductor Specialists, Inc.
 IOWA, Cedar Rapids 52406.....(319) 365-7551.....Deaco, Inc.
 KANSAS, Kansas City 66103.....(913) AD 6-4343.....Hall-Mark Electronics Corp.
 LOUISIANA, New Orleans 70112.....(504) 522-8726.....Sterling Electronics, Inc.
 MICHIGAN, Detroit 48240.....(313) 255-0300.....Semiconductor Specialists, Inc.
 MICHIGAN, Detroit 48227.....(313) Broadway 2-4212.....Radio Specialties Co., Inc.
 MINNESOTA, Edina 55424.....(612) 941-4680.....Low Bonn Co.
 MINNESOTA, Minneapolis 55423.....(612) 866-3434.....Semiconductor Specialists, Inc.
 MISSOURI, St. Louis 63134.....(314) 423-6500.....Semiconductor Specialists, Inc.
 OHIO, Cincinnati 45237.....(513) 761-5432.....Sheridan Sales Co.
 OHIO, Cleveland 44103.....(216) 432-0010.....Pioneer-Standard Electronics, Inc.
 OHIO, Cleveland 44133.....(216) 237-9145.....Sheridan Sales Co.
 OKLAHOMA, Tulsa 74115.....(918) TE 5-8458.....Hall-Mark Electronics Corp.
 TEXAS, Dallas 75220.....(214) Fleetwood 7-9131.....Sterling Electronics
 TEXAS, El Paso 79903.....(915) 533-9555.....Midland Specialty Co.
 TEXAS, Dallas 75231.....(214) AD 1-6111.....Hall-Mark Electronics Corp.
 TEXAS, Houston 77042.....(713) SU 1-0011.....Hall-Mark Electronics Corp.
 WISCONSIN, Milwaukee 53226.....(414) 476-1270.....Hall-Mark Electronics/Midwest

WESTERN

ARIZONA, Phoenix 85009.....(602) 272-2601.....Hamilton Electro of Arizona
 CALIFORNIA, Inglewood 90301.....(213) ORegon 8-8111.....Liberty Electronics Corp.
 CALIFORNIA, Los Angeles 90230.....(213) UP 0-7171.....Hamilton Electro Sales
 CALIFORNIA, Los Angeles 90022.....(213) OV 5-5888.....K-Tronics
 CALIFORNIA, Oakland 94607.....(415) TEmplebar 4-3311.....Elmar Electronics
 CALIFORNIA, Mountain View 94040.....(415) 961-3611.....Elmar Electronics
 CALIFORNIA, Mountain View 94040.....(415) 961-7000.....Hamilton Electro Sales-North
 CALIFORNIA, San Diego 92123.....(714) BRowning 8-2112.....Kierulff Electronics, Inc.
 CALIFORNIA, San Diego 92109.....(714) 274-3131.....San Delcor, Inc.
 COLORADO, Denver 80204.....(303) TAbor 5-7033.....Kierulff Electronics Co., Inc.
 NEW MEXICO, Albuquerque 87108.....(505) 268-3901.....Kierulff Electronics Co., Inc.
 UTAH, Salt Lake City 84110.....(801) 363-5821.....W. H. Bintz Company
 WASHINGTON, Seattle 98121.....(206) MA 4-5930.....Hamilton Electro of the Pacific Northwest

CANADA

MONTREAL, P.Q.....(514) 861-2411.....Cesco Electronics Ltd.
 MONTREAL, P.Q.....(514) 735-2471.....Zentronics (Quebec) Ltd.
 OTTAWA, Ont.....(613) 729-5118.....Cesco Electronics Ltd.
 QUEBEC CITY, P.Q.....(418) 524-3518.....Cesco Electronics Ltd.
 TORONTO, Ont.....(416) 638-5250.....Cesco Electronics Ltd.
 TORONTO 19, Ont.....(416) 787-1271.....Zentronics Ltd.
 VANCOUVER, B.C.....(604) 685-4628.....Bowtek Electric Co. Ltd.
 VANCOUVER, B.C.....(604) 736-6411.....L. A. Varah Ltd.
 WINNIPEG, Man.....(204) 942-0901.....Cam Gard Supply Ltd.



MOTOROLA Semiconductors

HERE'S HOW TO MINIATURIZE YOUR

USE MOTOROLA MICRO-T TRANSISTORS!

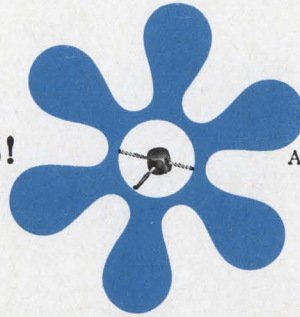

ACTUAL SIZE

NOW... Miniaturize Your Amplifier And Switching Circuits!

- Use them individually or in complementary circuitry.
- Less than one-tenth the volume of standard TO-18 or TO-92 packages.
- High reliability "Unibloc" injection-molded case.
- Low silhouettes, drop-in mounting. Gold-plated ribbon leads radiate from center of the unit.
- High power dissipation in relation to size: 225 mW @ $T_A = 25^\circ\text{C}$.



These working samples are typical of the many types of Micro-T transistors made by Motorola. They contain the same die found in the 2N3904 & 2N3905 and their electrical performance is identical. However, the Micro-T packaging "breakthrough" has made them ideal for miniature equipment applications.

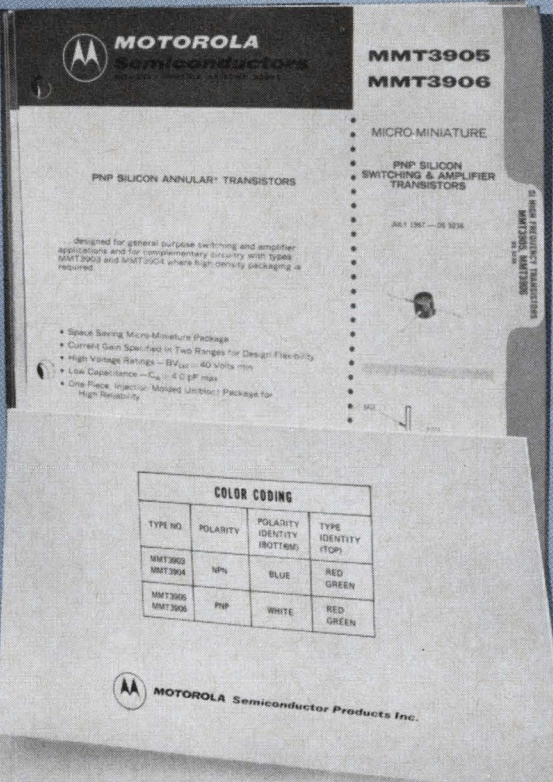

MOTOROLA Semiconductors

**MMT3905
MMT3906**

MICRO-MINIATURE

PNP SILICON SWITCHING & AMPLIFIER TRANSISTORS

PNP SILICON ANNULAR* TRANSISTORS

Designed for general purpose switching and amplifier applications and for complementary circuitry with types MMT3905 and MMT3904 where high density packaging is required.

- Sealed Spring Micro-Miniature Package
- Current Gain Specified in Two Ranges for Design Flexibility
- High Voltage Ratings — $E_{VCE} = 40$ Volts min
- Low Capacitance — $C_{cb} = 4$ pF max
- One Piece Injection-Molded Unibloc Package for High Reliability

| COLOR CODING | | | |
|--------------|----------|----------------------------|---------------------|
| TYPE NO. | POLARITY | POLARITY IDENTITY (BOTTOM) | TYPE IDENTITY (TOP) |
| MMT3905 | NPN | BLUE | RED GREEN |
| MMT3906 | PNP | WHITE | RED GREEN |

MOTOROLA Semiconductor Products Inc.

*** (Order this Micro-T HANDYPac... Get two devices for the price of one!)**

— where the priceless ingredient is care!



AMPLIFIER & SWITCHING DESIGNS!

MMT3904/06 Prototype Pair Now Available in Micro-T HANDYPac!

How small can (complementary) discrete device circuitry get? Well, the fact that Motorola's new Micro-T[†] transistors are just one-tenth the volume of standard TO-18 and TO-92 types will give you some idea. And, now you can try them and see for yourself. Motorola's Micro-T HANDYPac offered here contains two sample devices, MMT3904 (NPN) and MMT3906 (PNP), plus their respective data sheets, prices and information on custom Micro-T types. It's yours for just \$3.00 (a \$6.00 value) when you complete and mail the coupon below to your nearby Motorola Semiconductor distributor.

MMT3904/06 utilize the same patented Annular** die structure found in the popular 2N3904/06 . . . and the electrical characteristics are similar.

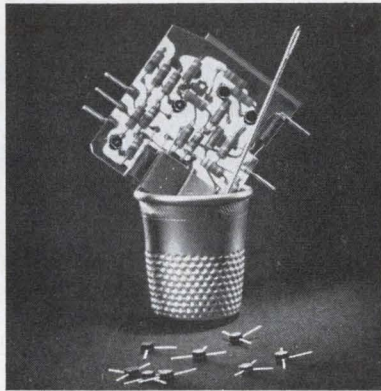

Major difference is the size of the package — it's almost an order of magnitude *smaller!* In addition, the Micro-T's gold-plated ribbon leads radiate from its center for easy, low-silhouette, drop-in mounting; and, the package itself is formed by Motorola's one-piece injection-molding process to achieve the same high reliability as other MIL-reliable Unibloc[‡] types.

[‡]Trademarks of Motorola Inc.

**Annular Semiconductors are patented by Motorola Inc.

MOTOROLA
Semiconductor Products Inc.

P. O. Box 955, Phoenix, Arizona 85001

Electronics | January 22, 1968

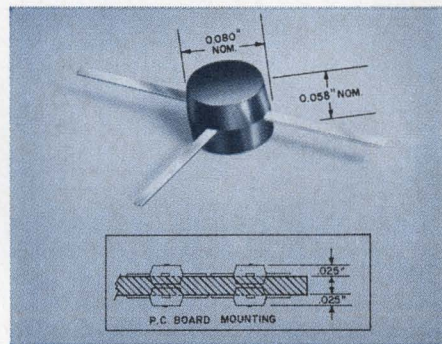

Use the coupon below to order your special \$3.00 Micro-T Prototype Pair HANDYPac. (Offer expires April 1, 1968.)

YES! I want to prove to myself that your Micro-T types MMT3904/06 are my best bet for miniaturized designs. Please send me _____ Micro-T HANDYPac(s) @ \$3.00 each. I am enclosing \$_____.

NAME

TITLE

COMPANY

DIV/DEPT

ADDRESS

CITY

STATE

ZIP

Complete and mail to your nearby Motorola distributor listed on the preceding page. (Offer expires April 1, 1968)

Circle 123 on reader service card

123

What makes the new monolithic "VEE CAL" 1.0 mfd Ceramic Capacitor so different?

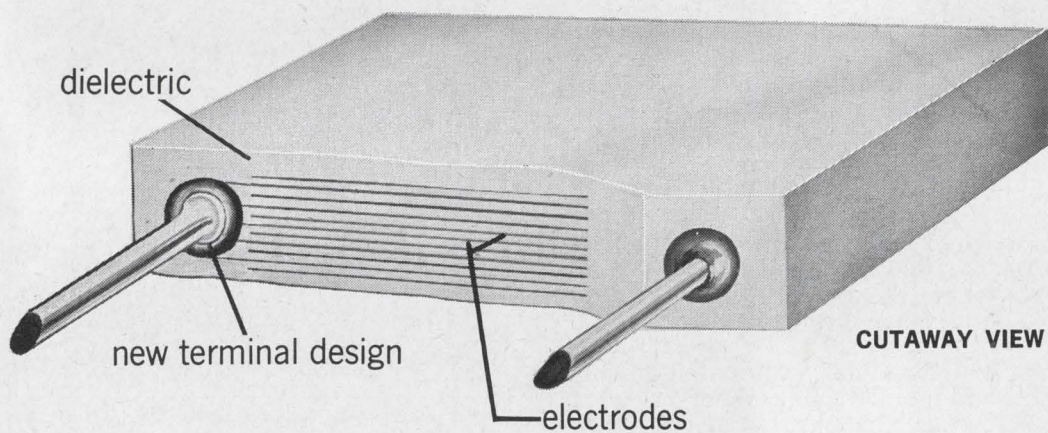

determination.

Our determination to build the **best** 1.0 mfd ceramic capacitor offered.

Best from build-up to termination.

Sure, the new "VEE CAL" has capacitance values from .12 mfd to 1.0 mfd in a compact CK06 size. Voltage ratings of 100, 50 and 25 vdc. A BX temperature characteristic.

But what makes the difference is our determination.

Our determination to increase the reliability of 1.0 mfd ceramic capacitors — by utilizing all available volume, permitting thicker dielectric layers.

Our technology has produced millions of other monolithic capacitors over the years. And now, our determination and proven technology have created the first truly monolithic 1.0 mfd ceramic capacitor — with a completely new termination.

For instant information, call Vitramon, Inc. (203) 268-6261, or write for Data Sheet C20.

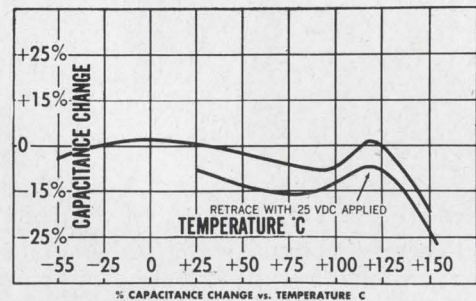

These reliable capacitors are readily available

Vitramon

VITRAMON, INCORPORATED
BOX 544
BRIDGEPORT, CONN. 06601

In Greater Europe Contact:
VITRAMON EUROPE
Wooburn Green, Bucks, England

Lockheed's 417.



Lockheed makes the portable portable. At 28 pounds, including its self-contained batteries, the 417 recorder comes in at 50 pounds less than any comparable recorder. And the 417 measures up in more ways than weight. □ It starts off with a price tag as low as \$7000. It operates on 110/220 volts AC/DC, with a power consumption that goes down to 10 watts. It has an exclusive, rugged low-mass differential capstan drive for precision operation under

vibration in any position. It has phase-lock servomotor control; a simplified maintenance-free transport mechanism, frequency response of 100 kc direct 10 kc FM; and, scaling in at only 14" x 15" x 6", it can even fit under an airplane seat. □ We believe the 417 is the best portable recorder on the market. But check it out for yourself. □ Just ask for the Lightweight, one of a family of recorders for undersea, land, air and space applications.

The lightweight.

LOCKHEED ELECTRONICS COMPANY
A Division of Lockheed Aircraft Corporation, Edison, New Jersey

new digital readout

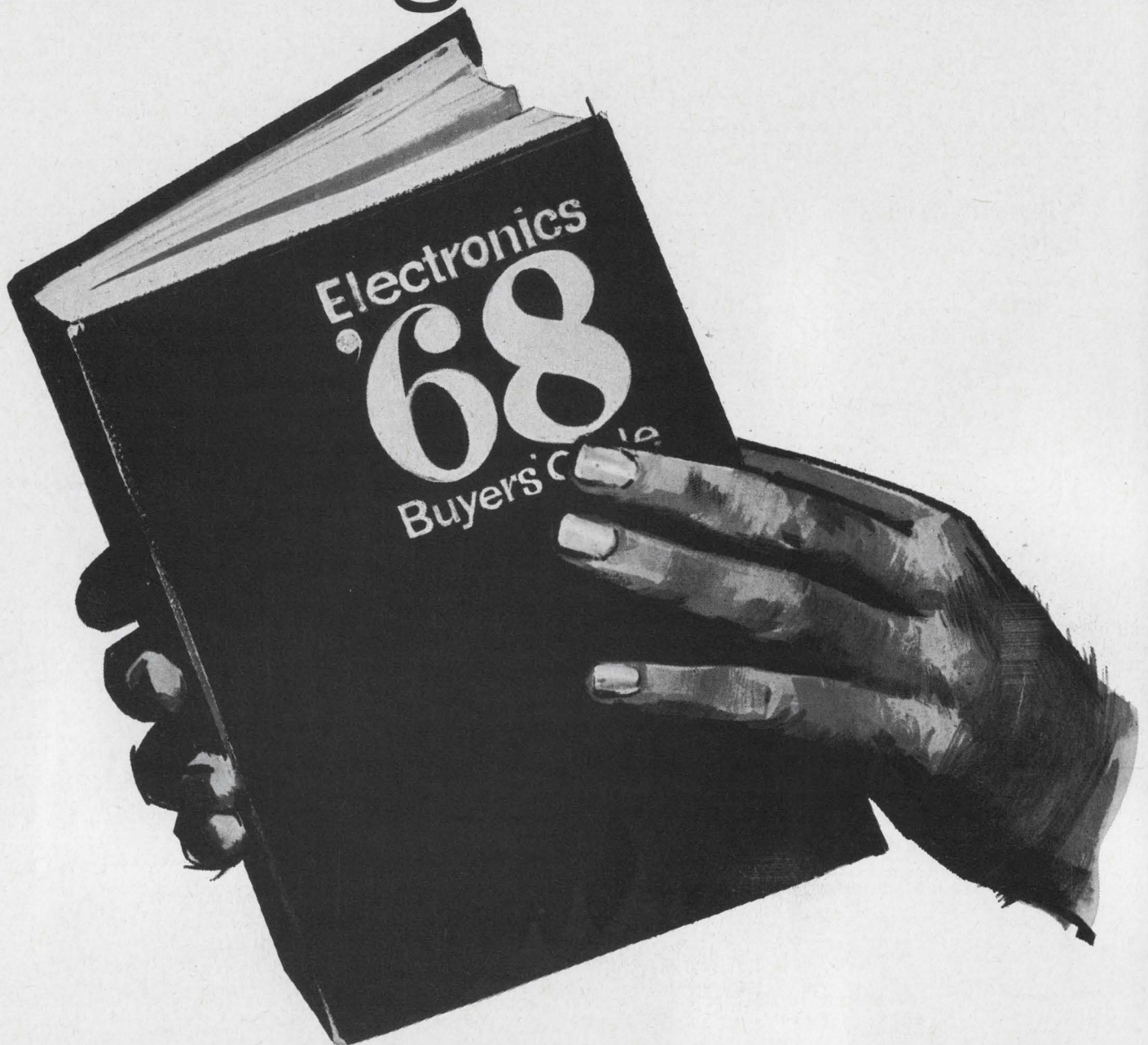

-lets your fingers flip through the entire electronics industry.

The '68 EBG gives you almost instantaneous desk top retrieval of 4 million bits of information that constitute the electronics industry.

If the answer to a problem involves finding a product or the people to supply it, this year the Electronics Buyers' Guide can help you find it faster than ever.

The '68 EBG yellow pages integrate editorial product

listings and advertiser's specifications in one continuous alphabetical section that is 4,000 categories long.

The green section tells you who's nearest, with the product you want, by listing local telephone numbers and addresses for more than 6,000 manufacturers.

Use the '68 EBG. And whenever you find an answer to your problem, tell them who sent you.

Electronics Buyers' Guide

A McGraw-Hill Market Directed Publication, 330 West 42nd Street, New York, N.Y. 10036

ESC LC FILTERS.....

design and
performance
checked
BEFORE
prototyping

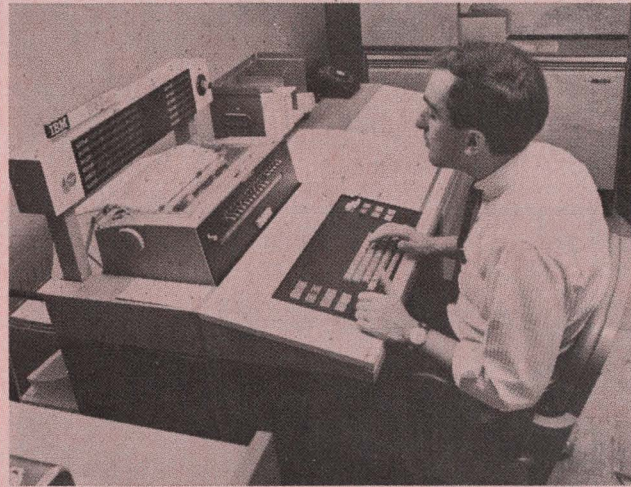

as sophisticated as your application

To meet your specific filter requirements, ESC first constructs a mathematical model based on actual physical components available. Through the use of high speed computer techniques with ESC's inhouse IBM 1130, the electrical characteristics and physical dimensions of your proposed filter are immediately tested and "proven out." Typical computer output data includes input impedance, attenuation, phase, phase delay, and group delay—all versus frequency. It is therefore possible for ESC to evaluate your filter needs, develop a suitable design and submit a quotation in a fraction of the time previously required.

The products illustrated to the right were designed and produced by ESC and are representative examples of our filter capabilities.

Please do not request that we send you a filter catalog or other descriptive literature—we don't have any. All of our designs are custom. We do have a Filter Questionnaire, however. If you fill it out, we will be able to discuss your specific requirements with you.

- LOW PASS • HIGH PASS • BAND PASS
- SINGLE SIDEBAND • RFI • MINIATURE
- PRINTED CIRCUIT • AUDIO • MOBILE COMMUNICATIONS • TELEMETRY • SPECIAL APPLICATIONS

From design through production of custom-designed LC filters, contact ESC.

WRITE TODAY FOR YOUR COPY OF ESC'S FILTER QUESTIONNAIRE.

RFI TUBULAR FILTER WITH CONTROLLED OVERSHOOT AND RISE TIME

FREQUENCY RESPONSE

Flat within $\pm 1/2$ db to 200 kHz

2 MHz > 3 db

30 MHz > 60 db

30 MHz—1 GHz > 40 db

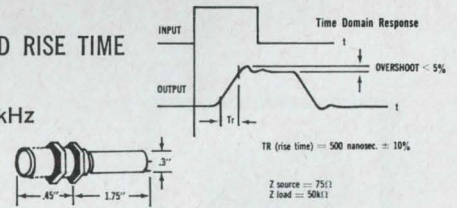

ULTRAMINIATURE TELEMETERING FILTERS

Center frequencies from 400 Hz to 165 kHz. Available in bandwidths of $\pm 7 1/2\%$ and $\pm 15\%$ of center frequency (fc)

Z source/load = 10k Ω

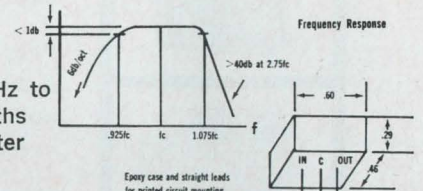

CONSTANT GROUP DELAY LOWPASS FILTER WITH HIGH DISCRIMINATION

FREQUENCY RESPONSE

Passband flat within $\pm .1$ db

Cutoff frequency (< 3 db), 1400 Hz

Attenuation at 2550 Hz and above, > 60 db

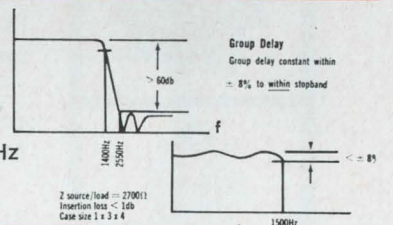

BANDPASS DELAY LINE FOR HIGH DELAY IN SMALL PACKAGE

Center frequency 100kHz

Passband $\pm 3\text{kHz}$ < 1 db

Group delay 1.0 millisecond

Z source/load = 1k Ω

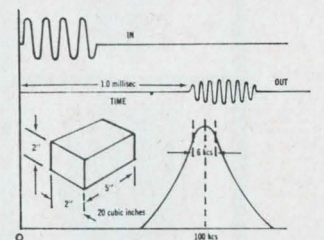

ESC FILTERS CONFORM TO MIL-F-18327



ESC ELECTRONICS CORPORATION

534 BERGEN BOULEVARD • PALISADES PARK, N. J. 07650 • (201) 947-0400

World's Leading Producer of Delay Lines

Even if the strength of NORYL[®]-3 at 212°F doesn't amaze you

THERMOPLASTIC RESIN

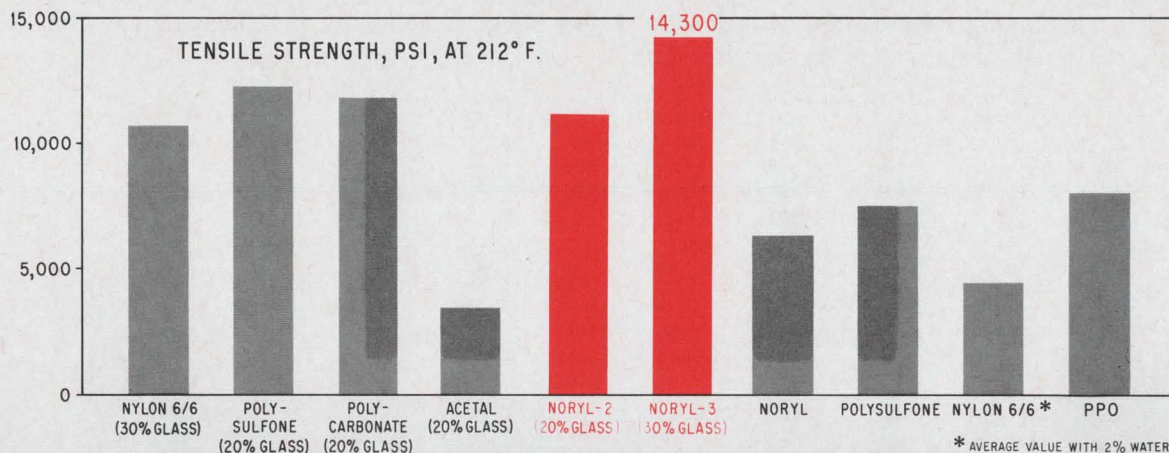

the price will.

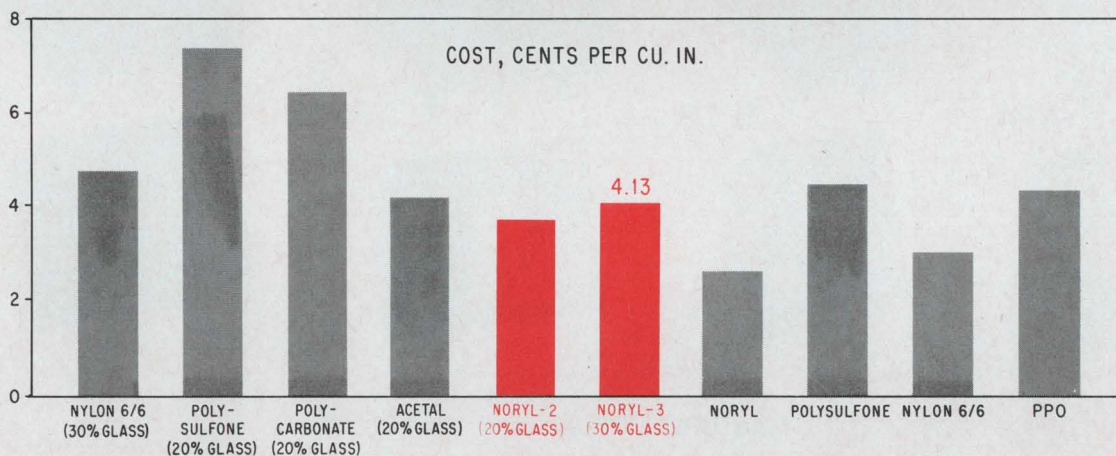

Noryl-3 (30% glass-reinforced Noryl) gives a lot more tensile strength at high temperatures than even standard, unreinforced Noryl.

No surprise there; most all thermoplastics toughen up when you add reinforcing materials. But most thermoplastics also jump into a higher price category.

Not Noryl. It gives you a big boost in properties while retaining the same kind of attractive low prices that have made Noryl the fastest-selling new thermoplastic ever.

Noryl-3 has a deflection temperature of 310°F at 264 psi. Add to this a very low mold shrinkage

and tensile modulus of 1,330,000 psi @ 73°F and you've got a design material competitive with many plastics and metals costing upwards of eight cents per cubic inch.

Noryl-3 costs you only 4.1¢/cu. in. Even less than die-cast zinc. Noryl-3 holds onto its properties after heat aging up to 300°F, through bake cycles up to 325°F. Moisture absorption (0.06%) and coefficient of thermal expansion (1.4×10^{-5}) are among the lowest of all thermoplastics.

Another new grade, Noryl-2, is 20% glass-reinforced, offers similar advantages and greater cost savings. Check out Noryl-3 and

Noryl-2 vs. other materials with our new properties comparison chart. It's free, and available from your GE Chemical Sales Representative. Or write Section 6A11, Polymer Products Operation, General Electric Co., One Plastics Avenue, Pittsfield, Mass. 01201. In Europe, N. V. Polychemie AKU-GE, 76 Velperweg, Arnhem, The Netherlands.

Leader in Engineering Plastics

PPO[®] • LEXAN[®] • NORYL[®] • PHENOLICS

GENERAL  ELECTRIC

THESE CIRCUIT PROTECTORS ARE ENTIRELY MAGNETIC TRIP

Hermetically sealed AP Protectors meet or exceed MIL-C-39019. They repeatedly rupture 300A 250V AC, 500A 125V AC, 500A 50V DC, have magnetic time delay, but open a 1000% overload in 4 milliseconds. There is no trip at 100G shock or 20 G vibration, carrying rated current. Available 10 MA to 20A, with a wide variety of circuit combinations, delay curves and auxiliary signal circuits. Ask for bulletin 16E-4.

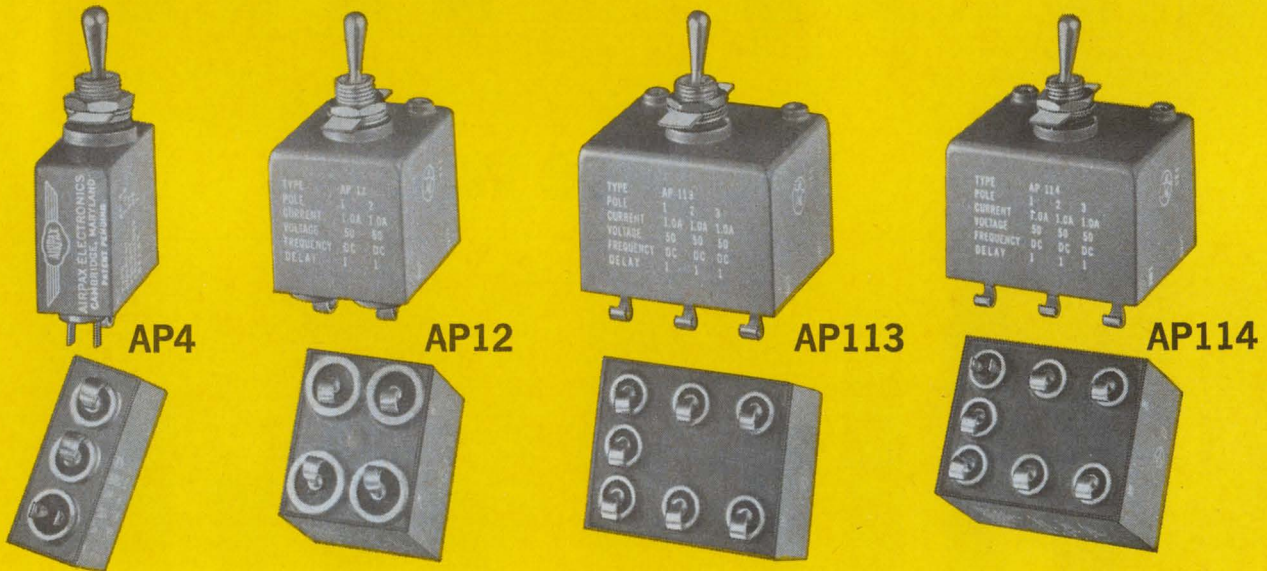
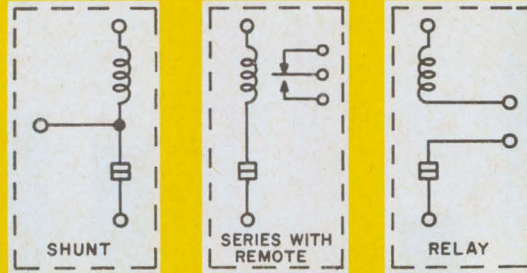

Type UPL1, UPL11, and UPL111 are Underwriters' Laboratory recognized for appliance protection.

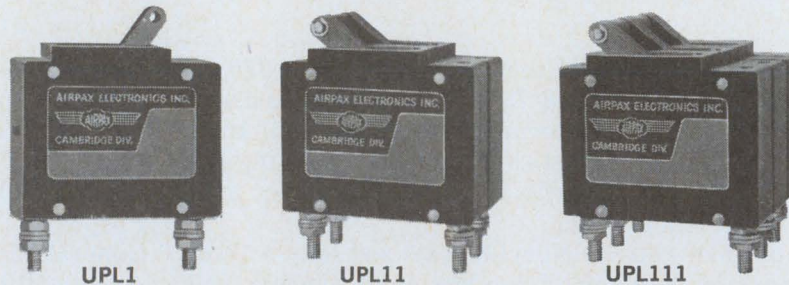

UL RATED at:

.050-50.0 A., 50V DC; .050-50.0 A., 120V AC, 60 Hz.; .050-20.0 A., 240V AC, 60 Hz.

Series units with enclosed remote switches are available in any combination of delays (Fast — 0.4 to 4.0 sec., Slow — 4.0 to 40 sec., Motor Start — 1.0 sec. at 600%) or UL listed ratings are available in a single pole, two pole or a three pole appliance protector.

AIRPAX ELECTRONICS Cambridge, Maryland 21613 (301) 228-4600

New Products

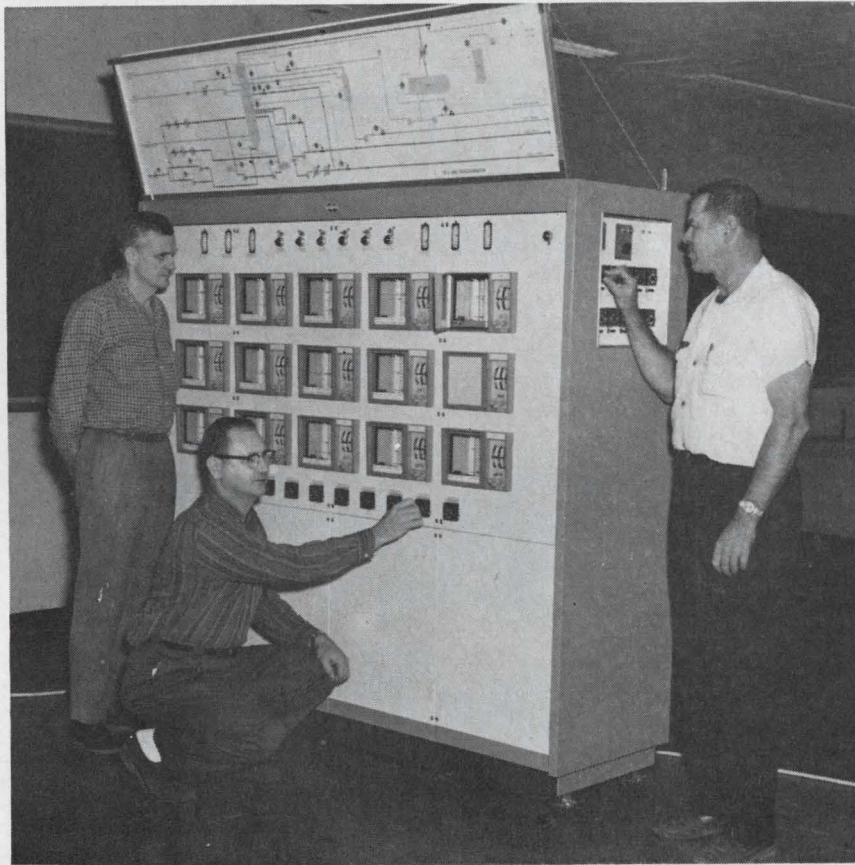

New industrial electronics

Process trainer gives operators true picture

Operational amplifiers simulate refinery dynamics; power-station, aircraft applications likely

Dynamic realism, not just a steady-state visual aid, was the goal of American Oil Co. engineers John B. Clark and L. Glenn Whitesell when they set out to develop a process simulator for the training of refinery operators. They found their basic building block in the

widely used operational amplifier, packaging 75 of the circuits, along with adjusting networks, into a stand-alone training console. On this trainer, beginners learn about major process units of the refinery and experienced operators increase their understanding of them.

Autodynamics Inc., which manufactures the systems under license, plans to extend the use of the trainers beyond simulation programs of American Oil and also beyond the petroleum process industry. "A system with 75 operational amplifiers spells powerful simulation capabilities," says Autodynamics' vice president, Edward J. Mangold. "Aircraft, power-station, and weaponry control simulation are natural extensions of the technique."

The American Oil trainer evolved from initial successes in programming a large general-purpose analog computer to simulate specific process units, and in using process-control instruments that the students adjusted in response to disturbances and failures introduced by an instructor.

But training used up too much of the analog computer's time. Also it seemed wiser to build a unit that could be shipped to any refinery of American Oil or of any other Standard Oil of Indiana affiliate.

The trainer has seen duty at seven refineries, and about 600 or 700 people have sharpened their skills on it, among them untrained workers hired to run a West Indian refinery. It's useful, too, for speeding operator training while a plant is being built. Instrument mechanics and process and instrument engineers also gain from experimenting on the trainer.

60 times faster. Two or three men, under guidance of an instructor, get eight hours of training. From a panel at the right of the trainer, the instructor can select and set the size of 10 different disturbances, such as pump failure or loss of process steam, and the students must take timely corrective action. To save training time, the simulator runs 60 times faster than the process unit being simulated. One minute on the trainer equals one hour of process operation.

According to Whitesell, refinery operators accept the trainer be-

LC Filters?

We'll try anything!

If you have a tough, tricky or unusual problem in LC filters, try Bulova first! Bulova has built a reputation for being willing to "try anything". Even jobs that other companies "can't be bothered with"!



Are we crazy? Like foxes! Fact is, we can do things others can't—and that's the way we win friends and customers!

We'll custom-design units to solve your unique problems. We'll supply prototypes when you need them—in 2 weeks or less! We'll schedule production units to meet your schedule—and give you solid proof we can do it!

And what a range! High pass, low pass, band pass, lumped constant delay lines, IRIG filters—you name it! Frequencies from DC to 50MHz! Sharpest shape factors! Just tell us your requirements—when you need it—and let us tackle it. Our hot engineering group will show you why you should "Try Bulova first"!

For more information, write to us at Dept. E-25.

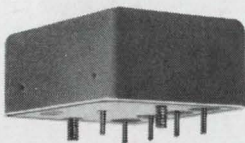

Try Bulova First!

FREQUENCY CONTROL PRODUCTS

ELECTRONICS DIVISION
OF BULOVA WATCH COMPANY, INC.

61-20 WOODSIDE AVENUE
WOODSIDE, N.Y. 11377, (212) DE 5-6000

... operating conditions, emergencies simulated with op amps and programable networks ...

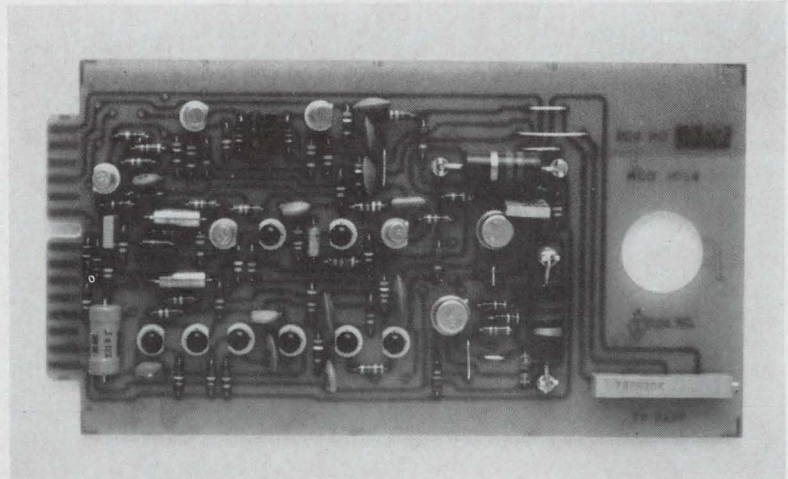

One for all. Seventy-five of these 10-volt, chopper-stabilized operational amplifiers provide simulation.

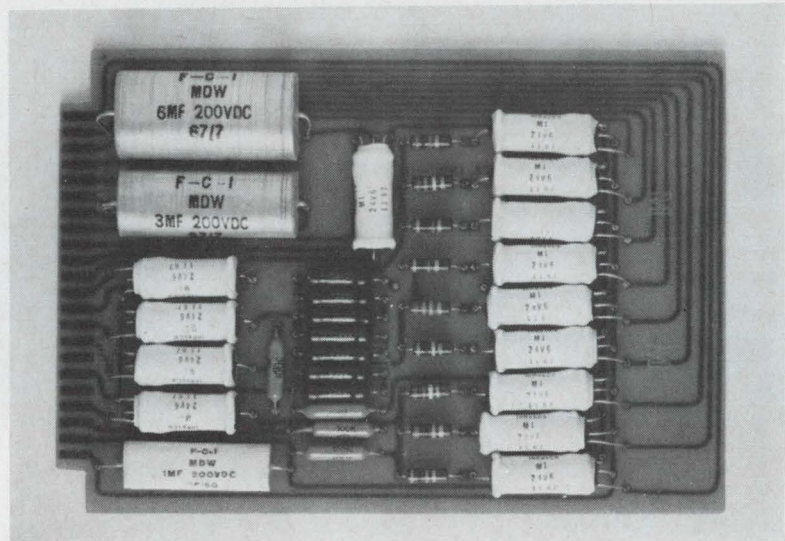

Adjustable dynamics. Reed relays, right, connect appropriate resistor when energized by insertion of program drawer.

cause they are convinced it acts just like their actual processes. Refinery managers like the kind of training their operators get by being exposed to operating conditions and emergencies too dangerous to try on the real plant.

The process trainer, says Autodynamics' Mangold, will sell for about \$40,000. Called the Model 1501, it contains operational amplifiers and related equipment, such as function generators, to simulate a binary fractionator (which separates light petroleum products from heavy ones), a fired heater, or a more complex fluid-cracking unit fractionator.

"The Model 1501 relies heavily on the refinery knowledge supplied to us by American Oil by way of models that satisfy experienced operators, yet permit shortcuts in simulation and hence a minimum number of amplifiers," Mangold says. "For example, Whitesell uses only 42 operational amplifiers to simulate a fractionator, including a six-tray tower, reflux drum, reboiler, flooding, and calculation of operating conditions."

Some modifications. Autodynamics' trainer will be much like the one built by American Oil, but will include modifications in the electronics. For example, Autody-

namics is abandoning the 100-volt operational amplifier selected by American Oil and is adopting the 10-volt op amp.

"Zeltex builds general-purpose operational amplifiers to our specs," says chief engineer Robert D. Edelson, "and we build our own network boards that convert the op amps to second-order transfer functions with adjustable natural frequency and adjustable damping factors. Reed relays on the network board select the correct resistance values and produce required dynamics.

"We find 10-volt op amps more compatible with the process instruments and they operate at lower temperature. We've considered in-

How 42 operational amplifiers simulate an oil fractionator

| Section | Amplifiers |
|---------------------------------|------------|
| 6-tray tower | 6 |
| Top temperature | 1 |
| Feed flow and composition | 2 |
| Reboiler and bottom temperature | 6 |
| Bottom level | 4 |
| Overhead condenser | 3 |
| Overhead pressure | 3 |
| Reflux drum level | 4 |
| Reflux flow | 2 |
| Reflux composition | 6 |
| Flooding circuit | 5 |

tegrated circuit amplifiers, but find them too expensive and not stable enough for our needs. The Zeltex amplifiers we use are transistorized, chopper-stabilized, and have a more-than-ample 500-kilo-hertz bandwidth."

Selection of the process being simulated is accomplished with two program drawers. Insertion of a drawer automatically makes proper interconnections to the operational amplifiers, adjusts their scaling and dynamics, and connects the simulated process to real process instruments on the front of the trainer. An eight-color graphic panel, corresponding to the selected process, is mounted atop the trainer.

Included in the price are 15 electronic process controllers, 30 channels of recording, six high/low level alarms, trainer installation, three days of instructor training, and copies of programmed-experiment operator manuals.

Autodynamics Inc., 503 Adamston Road, Bricktown, N.J. 08723 [338]

read low Hz in a hurry

This new Weston 300 Series Counter gives accurate, instantaneous indication of low-frequency events



Typically, measures & displays a 10Hz signal in 0.2 seconds

Here is the first frequency counter on the market which can measure low frequencies (1 to 200,000 Hz) accurately and display the results virtually instantaneously — directly in Hertz. For example, the instrument can sample a 10 Hz signal and provide digital display of the frequency in 0.2 seconds, with 0.01% accuracy. A unique combination of integrated circuits eliminates the need to compute period or wait out a long time base.

THE MODEL 300 IS IDEAL FOR:

- Transducers producing low frequency outputs (tachometers, vibration pickups, etc.)
- Precision setting of low frequency oscillators
- Monitoring 60 Hz and 400 Hz line frequencies
- Checking voltage-to-frequency converters and scores of other low-frequency applications.

The 300 Series has a 5 decade visual display and a units indicator; includes features such as a crystal time base, self-checking circuit, off-scale indicators, rear panel input and remote scale selection.

Let us rush you complete details on this versatile new counter. Write today to:

Weston Instruments, Inc., Weston-Lexington Division

17 Hartwell Avenue, Lexington, Mass. 02173

WESTON®

prime source for precision... since 1888

a Schlumberger company

New Components Review

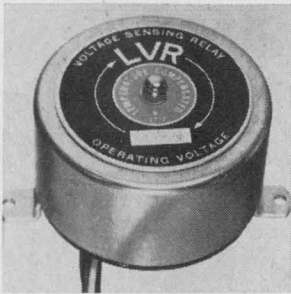

Voltage sensing relays, for use in supervisory control equipment, come in 3 versions: LVR-A, an a-c differential relay; LVR-D, a d-c differential; and LVR-M, a d-c voltage relay. All are temperature compensated and operate from 0° to 60°C. Units consist of a transistorized trigger circuit using a Schmidt trigger circuit. LaMarche Mfg. Co., 106 Bradrock Dr., Des Plaines, Ill. 60018. [341]

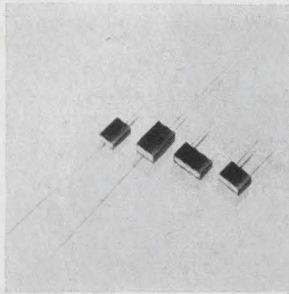

Ultraminiature capacitors series 317-318 utilize a thin-film metalized polycarbonate dielectric. They operate from -55° to +125°C. The 317's have values from 0.001 to 5 μ f (100 v d-c) and 0.001 to 3 μ f (200 v d-c). The 318's range from 0.001 to 5.6 μ f (100 v) and 0.001 to 3 μ f (200 v). Gudeman Division, Gulton Industries, Inc., 340 W. Huron St., Chicago 60610. [342]

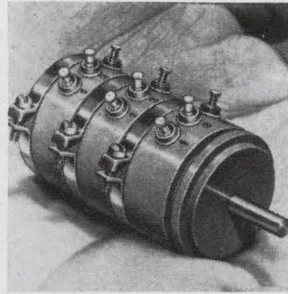

Wirewound, single-turn precision pot PS-08 measures $\frac{3}{4}$ in. in diameter. It is available in standard models with resistance from 500 to 15,000 ohms. Standard tolerance is $\pm 3\%$; linearity, from $\pm 0.6\%$ to $\pm 0.35\%$ depending on resistance. The unit has recessed clamp bands to permit field adjustment of phasing. Dale Electronics Inc., P.O. Box 609, Columbus, Neb. 68601. [343]

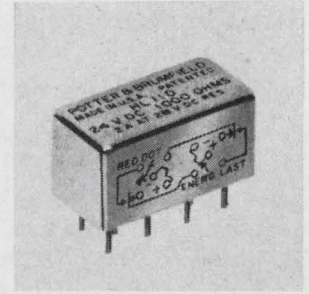

Dual-coil latching relays series HL are in hermetically sealed half-size crystal cases. Bifurcated, dpdt gold-plated silver-alloy contacts are rated dry circuit to 2 amps at 28 v d-c. The relays will pick up at approximately 150 mw, and operate at 3 msec, max. They withstand 150 g shock with no contact opening for 11 msec. Potter & Brumfield, Princeton, Ind. 47570. [344]

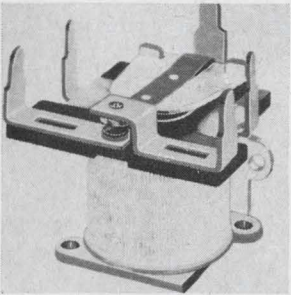

The Con-Electron style 1010 is a small, 10-amp spdt relay. Four coil ratings (3 to 24 v d-c) are available with solder or p-c terminals. Sensitivity is rated at 176 mw, with 0.10 ohm maximum contact resistance, and life ratings of 20 million mechanical operations, 100,000 load operations. Price: (over 2,500) under \$1 each. Price Electric Corp., Frederick, Md. 21701. [345]

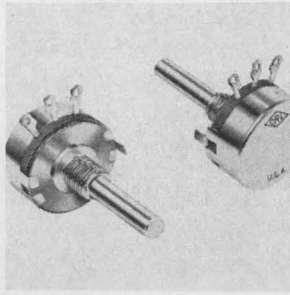

Hot molded carbon pot 12LS has a life expectancy of a million cycles. Units are offered with standard linear or audio taper. Linear types, with resistance values ranging from 10 ohms to 5 megohms, are rated at 2.25 w. Audio tapers have a resistance of 50 ohms to 5 megohms and are rated at 1 w. Globe-Union Inc., 5757 N. Green Bay Ave., Milwaukee, Wis. 53201. [346]

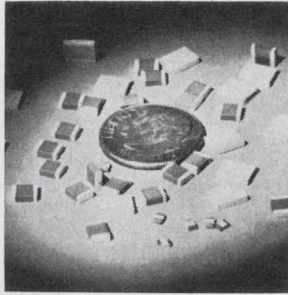

Multilayer ceramic chip capacitors are for hybrid, integrated, and discrete component circuits. The chip is composed of thin ceramic sheets, with noble metal electrodes, which are stacked, pressed, and fired to form a single compact capacitor. Palladium end metallization permits easy termination by solder reflow. Cornell-Dubilier Electronics, 50 Paris St., Newark, N.J. 07101. [347]

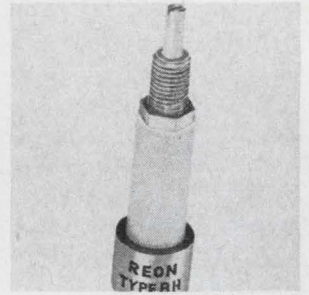

Variable resistor model BH, with a conductive plastic element, is $\frac{1}{2}$ in. in diameter and rated to withstand 7,000 v. It features infinite resolution over a 50-ohm to 5-megohm range, and is available as a completely sealed unit with a high-voltage bushing. Dynamic noise level is less than 2% initially. Reon Resistor Corp., 155 Saw Mill River Road, Yonkers, N.Y. 10701. [348]

New components

Dial 99 for 1100011

Decimal-to-binary converter with mechanical logic handles a-c or d-c signals up to 200 volts

More than a year ago, the Digitran Co. was asked by a customer designing a system for the Federal Aviation Administration to develop a two-digit switch that could convert numbers from 00 to 99 to their binary equivalents. Air traffic control could then enter from a remote

location to a central data processor a two-digit code to identify aircraft. This task is usually accomplished, say Digitran officials, using an electromechanical switch and associated solid-state logic, at a cost of about \$400 per unit.

Digitran's solution was to design

what chief engineer Hans Mol and sales manager Robert Alexander call a true binary switch, a device they believe could sell for about one-third the \$400 figure. Alexander says the switch might sell for \$100 to \$150 in quantities of 10, and as low as \$50 to \$75 each in quantities of 1,000.

The company believes considerable demand for the switch will be triggered by special-purpose computer users, and that the bulk of the sales will be to manufacturers of remote terminals for data-processing systems. Alexander explains that the price of the true binary switch can be kept well below the

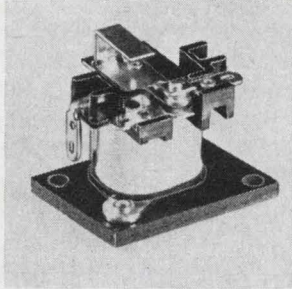

A sensitive relay is offered for a-c or d-c use. Contact rating is 5 amps at 28 v d-c or 120 v a-c, resistive. Contact material is silver cadmium oxide (others available). Weight is 30 grams without base, 33 grams with base. Size is 1 1/4 in. wide, 1 1/8 in. long, 31/32 in. high, less base, (add 1/8 in. for base). Standard Relay Corp., 77 Stagg St., Brooklyn, N.Y. 11206. [349]



Solid state relay series SR-100 features no moving parts to assure long trouble-free life, isolated input for reliability, transient protection and positive operation. It offers plug-in mounting; spst output; and 120 v, up to 5 amps standard output. The unit is available for d-c or 60-hz input. Tele-Craft Electronics Co., 125 Schmitt Blvd., Farmingdale, N.Y. 11735. [350]

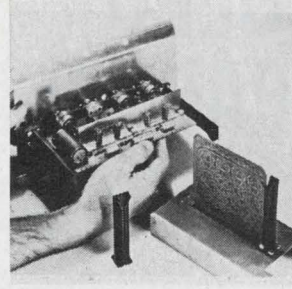

A high-strength p-c card holder is designed also for use as a chassis bracket. Model 500 guide is molded of 20,000 psi fiberglass reinforced nylon. Four hold-down holes provide adequate means to secure the base to an instrument panel and a 1/8-in. slot in the guide readily accommodates a chassis or p-c board. Gibson-Egan Co., 34 LaPorte St., Arcadia, Calif. 91006. [351]

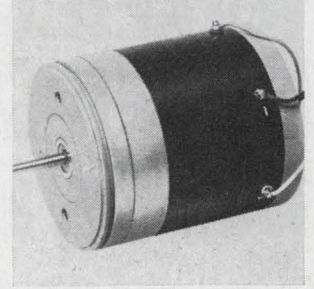

A multitrans pot repeats the desired output function at the end of any precise number of turns operating unidirectionally. There are no stops. Rotation can also be bidirectional with as many ganged cups as desired. The unit operates on d-c to 100,000 hz excitation. Resistance range is 5,000 to 500,000 ohms. Computer Instruments Corp., Madison Ave., Hempstead, N.Y. 11550. [352]

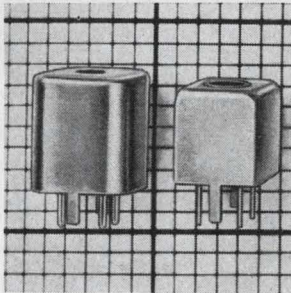

Shielded coils 7106 and 7107 are available for p-c use. The 7106 offers 34 over-lapping inductance values from 0.09 μ h to 12 mh. It has gold plated 0.040-in. pins on 0.200-in. centers and is tunable from the top. The 7107 series provides 49 over-lapping inductance values from 0.09 μ h to 1,100 μ h. Cambridge Thermionic Corp., 445 Concord Ave., Cambridge, Mass. 02138. [353]



Shielded static focus coil type C5122, with heavy encapsulated construction, is designed for high temperature and/or high potential small precision displays and for the new 1-in.-neck diameter scan converter tubes. Price range is \$80 to \$100 in small quantity; delivery, from 3 to 4 weeks. Syntronic Instruments Inc., 100 Industrial Road, Addison, Ill. 60101. [354]

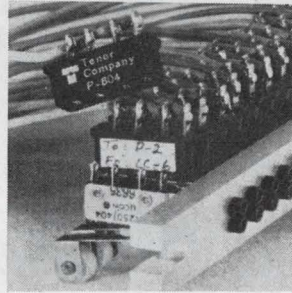

Plug-on connector P-804 simplifies maintenance and exchange of switches in any system using members of Licon series 16-404 snap-action, spdt-db miniature switches. The device fits securely onto the 4 terminals of the Licon switch and is quickly installed or removed without tools or fasteners. No soldering is necessary. Tenor Co., P.O. Box 2766, Milwaukee, Wis. 53219. [355]

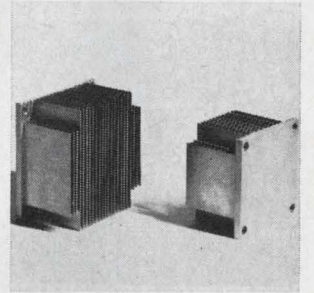

Finned heat sinks series 2450 provide a flat mounting area (2x2, 3x3, 4x4, and 4x6 in.) for easy accessibility. The 4 x 4 in. unit, dissipating 650 w and with 1,500 linear fpm of forced air, has a thermal resistance of 0.105°C/w (23 fin unit). The same size unit with 33 fins has 0.089°C/w thermal resistance. Astrodyne Inc., 207 Cambridge St., Burlington, Mass. 01803. [356]

\$400 level because Digitran has eliminated the need for the logic that jacks up the price of competitive decimal-to-binary conversion switches.

The device employs the techniques used in Digitran's thumb-wheel switches. "This one is an elaborate extension of that technique," Alexander says. A basic wiping contact switch, it makes or breaks a commutator pattern on the printed circuit board it wipes. The true binary switch consists of two such units, each of which wipes two circuit boards. The output codes from the wiping action of each switch, when properly com-

bined, produce a pure binary code output. The switch, says Mol, has its own built-in memory and requires input current only when the users want an output.

To illustrate the switch's use, Alexander used an inventory control example. If a manufacturer of phonographs wanted to fill an order for 16 machines from a stock of hundreds or thousands, he would dial in the number 16 on the true binary switch, and he might also insert into an associated reader a coded card such as those used in automatic telephone dialing. Then he would actuate the computer input button at the remote station,

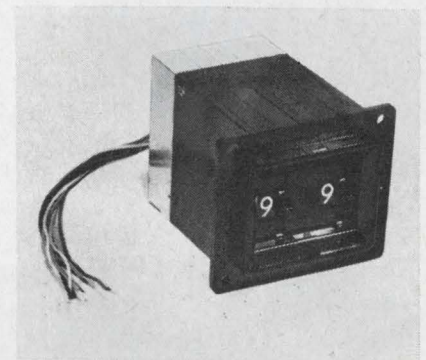

Eight for two. Converter uses eight output wires, one common and one for each of the seven binary digits.

WATER-COOLED POWER CAPACITORS with Ceramic Dielectric

Capacity : 200 to 5000 pF
 Rated Voltage : up to 20 kV
 Reactive Power: up to 2000 kVAR

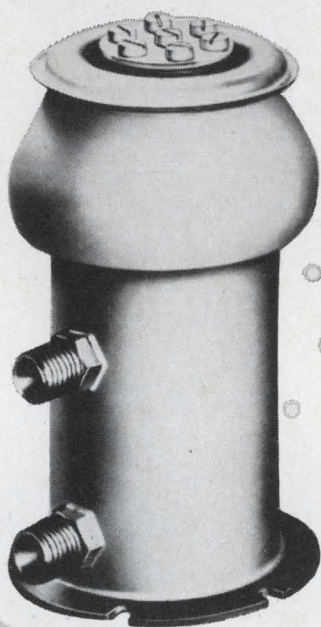

Convection-cooled Power Capacitors available in tubular, pot, feed-thru, and plate construction

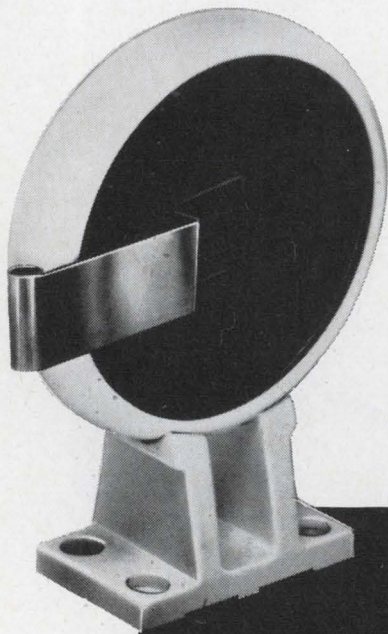

Capacity : 3 to 6000 pF
 Rated Voltage : up to 15 kV
 Reactive Power: up to 80 kVAR

Kindly direct your inquiries to:

ROSENTHAL-ISOLATOREN-GMBH

Plant III 8672 SELB - West-Germany

or to our USA agency: United Mineral & Chemical Corp., 129 Hudson Street
 New York, N. Y. 10013, USA

. . . wide use seen in
 remote input stations . . .

and the quantity and product description would be entered in the central processor. The card data would tell the shipping department to send 16 phonographs of a certain style to the customer by name and address, bill the customer, and reduce the inventory level by 16.

Alexander says the Digitran switch is made to withstand industrial environments because Digitran is more interested in commercial applications for the device than in military applications. He anticipates more commercial sales because of the burgeoning use of remote input stations for central processors in commercial applications.

The device operates at up to 100°C, and over a broad voltage range—up to 200 volts—on alternating or direct current. Switches using electronic logic, Alexander points out, are typically limited to operation at three to five volts, and on d-c only. The switch's principal limitation is that it can't accommodate more than two digits at present, where devices using associated solid-state logic can handle three and four digits.

Mol believes the Digitran is the first switch available that gives a binary output for more than a single digit using only mechanical techniques.

The Digitran Co., 875 South Arroyo Parkway, Pasadena, Calif. 91105 [357]

New components

Silicon diodes go to 150 kilovolts

Increased avalanche
 reduces the number of
 suppressor capacitors

One of the biggest markets for high-voltage silicon rectifiers is in X-ray generators, where four rectifiers connected in a full-wave bridge configuration provide the necessary d-c

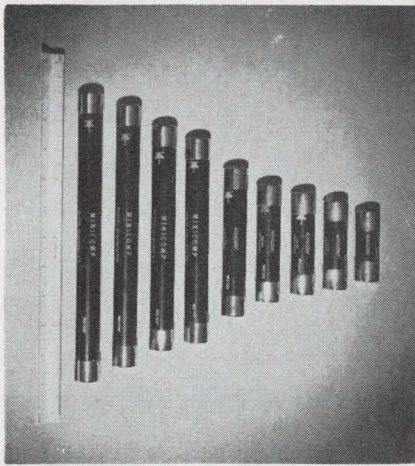

Plug-in. Cartridge rectifier stacks can replace high-voltage selenium units and tubes in X-ray and radar equipment.

voltage from 100 kilovolts to 150 kv required to operate the X-ray tube. In this application, inherent transient voltage surges that decrease the reliability of present rectifiers are a serious problem. And in the voltage area below 100 kv, there are many applications where rectifiers are used, such as radar and sonar equipment, and transmitter power supplies, laser power supplies and medical equipment.

The problem in using silicon rectifiers in all of these applications is that, to protect the diodes from high-voltage transients, capacitors must be used in series with each diode. This increases the size and cost of the units. Atlantic Semiconductor Inc. has come up with one solution designated the Minicomp, and packaged it in a fuse-type cartridge.

The Minicomp was made possible by a decrease in the number of individual rectifiers and capacitors required in conventional compensated high-voltage rectifiers.

To reduce the number of individual silicon rectifiers and compensating capacitors required in the high-voltage series string, it was necessary to increase the reverse avalanche voltage of each silicon rectifier. This was accomplished by packing six rectifier cells into the space ordinarily occupied by one conventional silicon rectifier. Reverse avalanche voltages of 6,000 to 9,000 volts were obtained from the individual multi-junction devices, and so was an increase in avalanche voltage over that of the conventional 1,000-volt silicon rec-

The Latest MODULE ADVANCE in Solid State Magnetics!

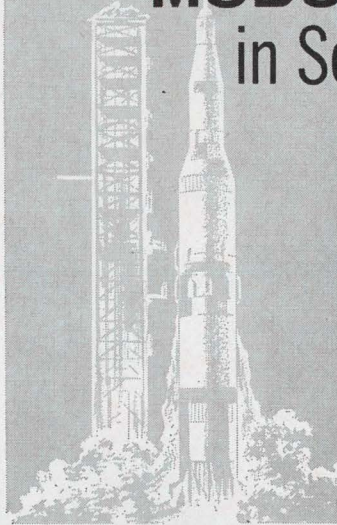

The New G/M
Type SSM 1138-1

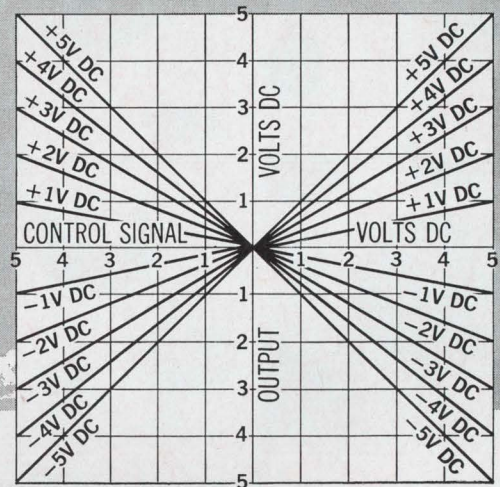

Analog DC x DC Voltage Multiplier

$$(\pm \text{DC SIGNAL \#1}) \times (\pm \text{DC SIGNAL \#2}) = \pm \text{DC ANALOG VOLTAGE PRODUCT OUTPUT}$$

- Input resistance 100 K ohms, both signal channels
- Four quadrant DC operation
- Frequency response .0 to 100 cps
- Input 0 to ± 5 V DC to 100 cps, both signals
- DC power requirements ± 12 V DC
- Output 0 to 5 V DC $\pm 5\%$ into 10 K ohm load
- Ambient temperature range -55°C to $+100^\circ\text{C}$

Featuring product accuracy of *at least* 0.5% of half scale output amplitude over a temperature range of -55°C to $+100^\circ\text{C}$, this G/M four-quadrant magnetic module provides high precision operation with practically limitless service life. Small in size—only 1.5 x 1.9 x .5 inches, high shock and vibration resistant, it may be mounted directly on printed circuit cards. This solid

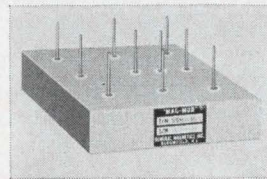

state component is applicable to aero-space, computer, weapon, etc. systems requiring maximum reliability.

Write for Illustrated Bulletin MM 112



There is No Substitute for Reliability

General Magnetics • Inc
135 Bloomfield Ave., Bloomfield, N.J. 07003

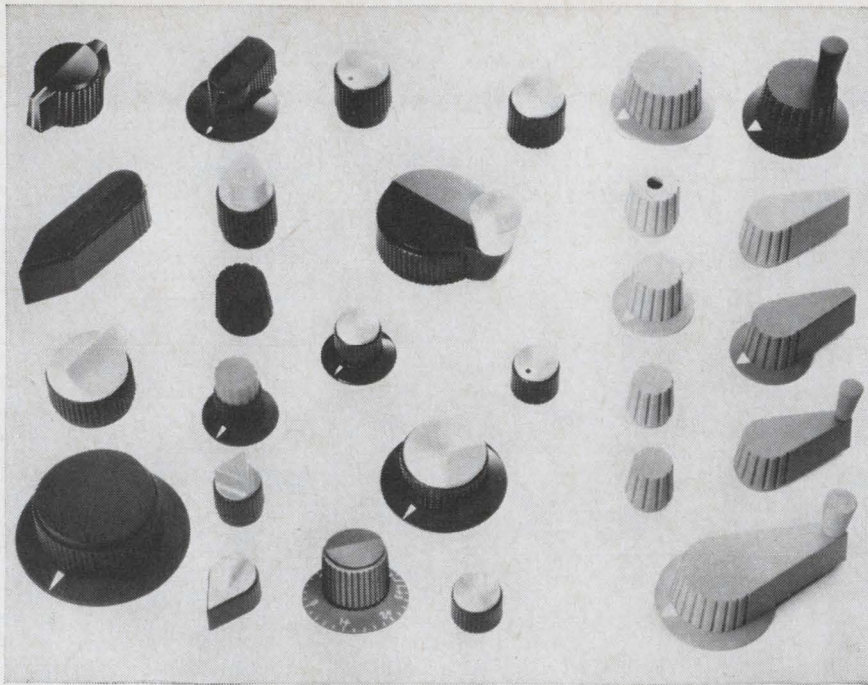

**Standard and custom military knobs,
aluminum cap knobs, color control knobs for
every panel requirement. Send for data kit.**

With Raytheon control knobs, you can meet military specifications—or select styles and colors that harmonize or contrast with any commercial panel decor. And you can get these knobs immediately—through Raytheon distributors from coast to coast.

Meet MS91528C Military Specifications from the more than 300 standard types and the 2,000 “specials” Raytheon has designed. All knobs are functionally designed. All styles have an integrated design to give uniformity to your panel. And all knobs meet specifications for resistance to flame, torque, temperature and humidity extremes, salt spray, and ultraviolet radiation.

Handsome aluminum cap knobs are made of strong plastic with satin finish aluminum caps that are treated with an epoxy coating for corrosion resistance.

Commercial color knobs—available in nine colors and ten styles—harmonize or contrast with commercial equipment design. Raytheon makes these 400 Series knobs of durable, high-impact ABS.

Custom-made control knobs. Raytheon also designs and manufactures control knobs to meet special requirements for color, shape, size, finish. Call your nearest Raytheon regional sales office or write to us. *Raytheon Company, Components Division, Quincy, Mass., 02169.*



Send for Raytheon Control Knob Data Kit

—contains complete specifications on all standard and custom knobs. Just send the reader service card.



**. . . competitive in price
with equivalent tubes . . .**

tifier modules.

As a result of the increase in rectifier avalanche voltage, it was possible to reduce the number of individual rectifiers and compensating capacitors in the Minicomp design by at least six times.

Improving the reliability. The ability of a compensated rectifier to withstand destructive transient voltage surges accounts for its reliability in rectifier applications, and this ability may be improved by increasing the over-all capacitance.

Compensation of silicon rectifiers is obtained by adding shunting capacitors across the individual silicon rectifiers in series, but the over-all capacitance of the compensated rectifier is reduced because of the series relationship for capacitors.

Reducing the number of compensating capacitors required in the design of the Minicomp rectifier results in an increase of over-all rectifier capacitance by about six times and a corresponding improvement in ability to withstand destructive transient energy.

The Minicomp line will be marketed at prices competitive with the cost of replacing an equivalent vacuum tube and its associated filament transformer circuitry. In lots of 1,000, the price is \$89 each for the MC 150F, one unit in the series. It is a 150 kv compensated rectifier rated at 100 ma of continuous rectified current.

Atlantic Semiconductor Inc., 905 Matison Ave., Asbury Park, N.J. [358]

New components

**Complex math
in modular form**

Linear circuits compute
root mean squares and
perform division

Instead of transforming data to binary notation and then performing mathematical operations, de-

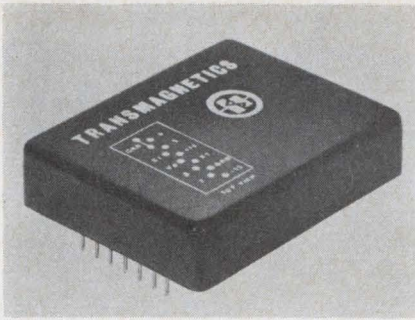

Mod math. Model 450, above, and 749 are designed for p-c board mounting.

signers can use the analog signals directly with the aid of two modules developed by Transmagnetics Inc.

"The models 450 and 749 are general purpose control modules for system designers," says Joseph Marrone, a circuit engineer at Transmagnetics.

Designed for division, the model 450 provides an output that is equal to A divided by B, where A is a d-c signal from -10 to $+10$ volts and B is from $+1$ to $+10$ volts. The unit has an accuracy of 1% or 40 millivolts and a null of 15 mv. It is stable to ± 200 parts per million ± 0.5 mv/ $^{\circ}$ C, and has a bandwidth at 3 decibels of 100 hertz.

One application Marrone suggests for the 450 is in gain stabilization circuits. He also says it can be useful to the designer who wants to plot the gain of a system over some frequency range. In this application system input and output would be fed to the 450.

Solving right-triangle problems where the hypotenuse and one side are given and the third side is required is the function of the model 749. It was developed for radar applications where the slant range and altitude are known and the ground range must be computed. It can also solve for sine and cosine functions; when the input is a sine function, the output is the cosine and vice versa. Inputs for the 749 are both -10 to $+10$ volts into 10 kilohms and the output is 0 to 10 volts. Its 3 db bandwidth is d-c to 30 kilohertz.

Both units require plus and minus 15 volts d-c at a maximum current of 50 milliamps, and have an operating temperature range of 0 to 70 $^{\circ}$ C. Price for the 450 is \$254; for the 749, it is \$345.

Transmagnetics Inc., 134-25 Northern Blvd., Flushing, N.Y. 11354 [359]

2

ALIGNMENT OSCILLATORS DESIGNED TO MAKE SERVICING EASIER BOTH NEW FROM INTERNATIONAL

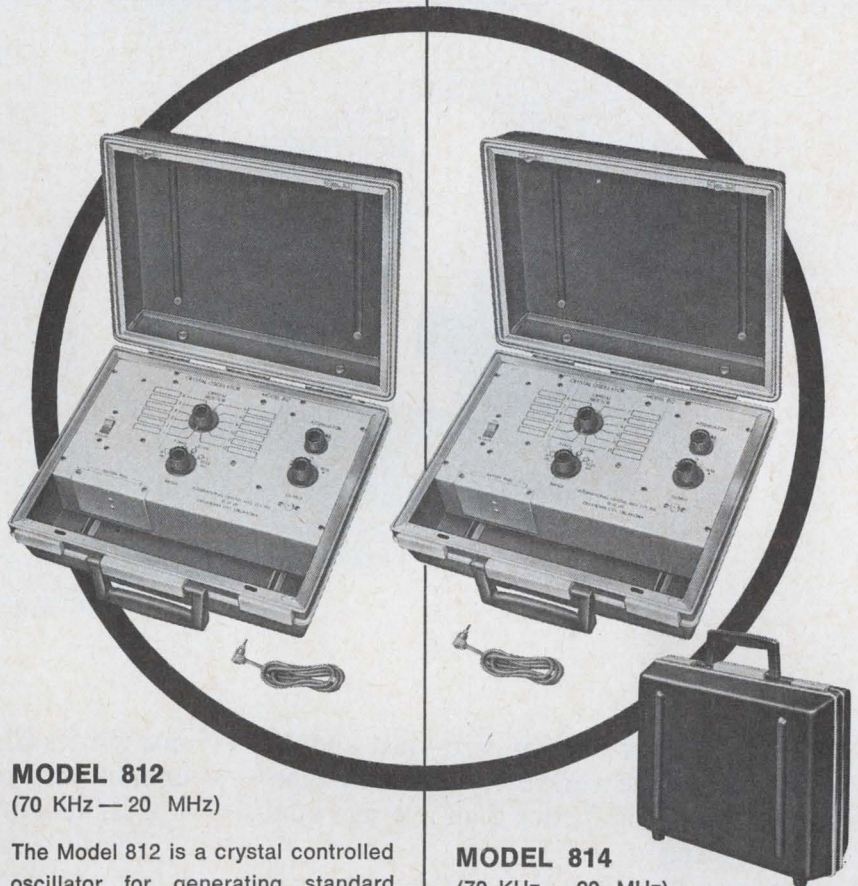

MODEL 812 (70 KHz — 20 MHz)

The Model 812 is a crystal controlled oscillator for generating standard signals in the alignment of IF and RF circuits. The portable design is ideal for servicing two-way radios, TV color sets, etc. This model can be zeroed and certified for frequency comparison on special order. Individual trimmers are provided for each crystal. Tolerance .001%. Output attenuators provided. Battery operated. Bench mount available.

Complete (less crystals) \$125.00

MODEL 814 (70 KHz — 20 MHz)

The Model 814 is identical in size to the 812. It does not have individual trimmers for crystals. Tolerance is .01%. Battery operated. Bench mount available.

Complete (less crystals) \$95.00

Both the Model 812 and Model 814 have positions for 12 crystals and the entire frequency range is covered in four steps.

Write for catalog



CRYSTAL MFG. CO., INC.
10 NO. LEE • OKLA. CITY, OKLA. 73102

Announcing AE's Class H relay. It's compact, versatile, low in cost.

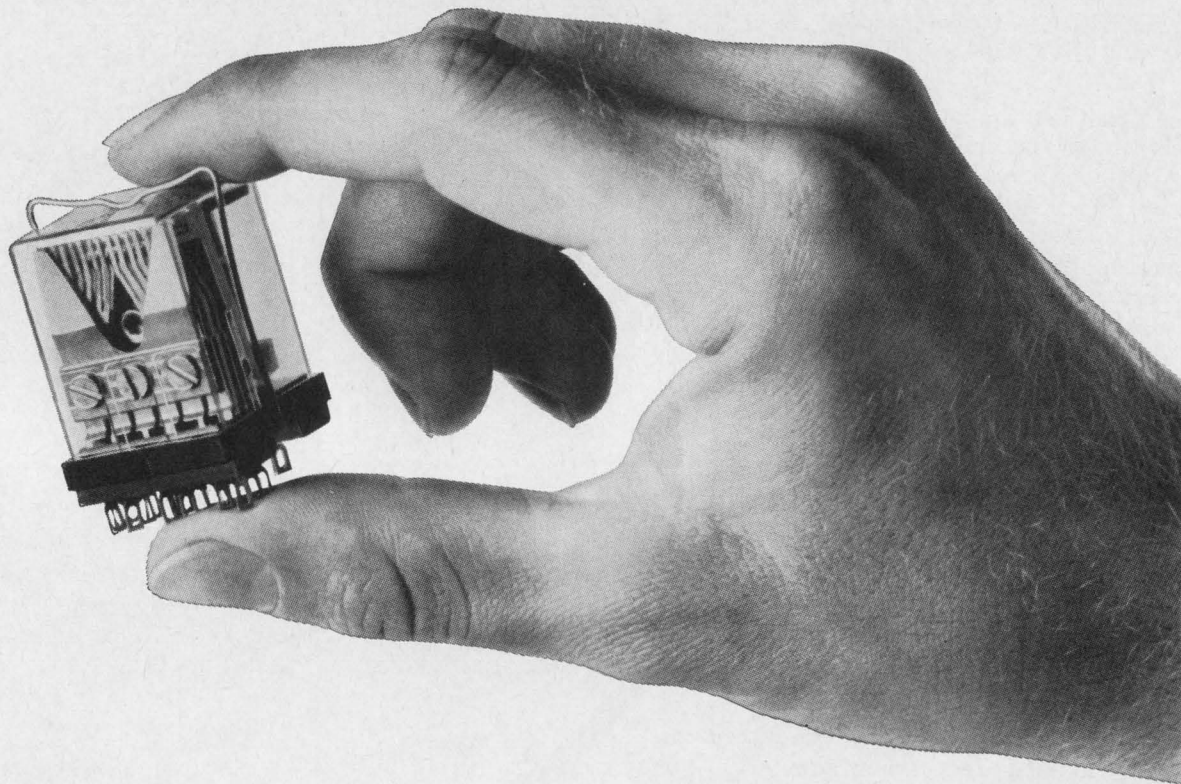

The Class H relay is small in size—just about a 1.3 inch cube. It's a versatile "telephone-type" component that offers better than average quality at a low price.

You can use the Class H to reduce the physical dimensions and decrease the cost of your products. It's well suited for business machines, vending machines, communication equipment, computer peripheral equipment, aircraft and missile simulators. These applications take advantage of its small size, versatility of mounting, and large switching capacity (maximum of 6 form C or 4 C and 2 D contacts).

The Class H can be direct-mounted or socket-mounted to a PC card. Or it can be socketed into a panel. It also has a socket that mounts on a rack.

The Class H is made as a regular quick-acting relay (Series HQA). It's also available as a short or long pulse "latching relay." In this ver-

sion (Series HRM) it uses remanent magnetism—or controlled residual magnetism of the coil core—as its latching medium.

This little relay's rugged construction protects it from ordinary shock and vibration. Mechanical life expectancy exceeds 100 million operations. Molded pileup insulators provide high dielectric strength and dimensional stability. Contact actuation is by a lift-off card method—which eliminates the problem of contact sticking.

A clear heavy-duty plastic cover provides protection from contamination and abuse. Once this cover is snapped into place, it's not readily removed. This discourages tampering.

Want helpful, detailed specification and application data? Send for Circular No. 1100. Just write to the Director, Relay Control Equipment Sales, Automatic Electric, Northlake, Illinois 60164.



AUTOMATIC ELECTRIC

SUBSIDIARY OF GENERAL TELEPHONE & ELECTRONICS

New Instruments Review



Portable photometer model 12, for airborne, field, and lab applications, measures current from a wide variety of photomultipliers and phototubes. Controls are provided for sensitivity adjustment, dark current cancellation, recorder drive, and selection from 10 μ a to 1 na. Price is \$420. Pacific Photometric Instruments, 3024 Ashby Ave., Berkeley, Calif. 94705. [361]

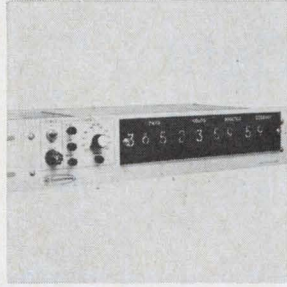

Digital clock model 3350 furnishes accumulation of real or elapsed time for display purposes and/or the time tagging of digital data. It utilizes from 6 to 9 Nixie indicator tubes for visual output. Digital output consists of binary coded decimal information with resolution available down to 1 msec. Datatron Inc., 1636 E. Edinger Ave., Santa Ana, Calif. 92705. [362]

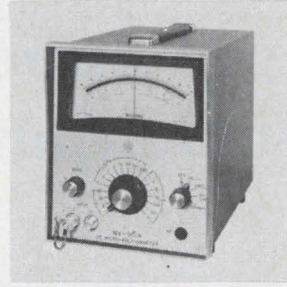

D-c micro-volt-ammeter MV-951A can operate on either 115/230 v a-c or on its own self-contained rechargeable Ni-Cad batteries. It measures from 100 μ v to 1 kv full scale and from 1 na to 1 amp full scale. Basic accuracy is $\pm 1\%$ full scale on voltage ranges and $\pm 2\%$ full scale on current ranges. Price is \$625. Millivac Instruments Inc., P.O. Box 997, Schenectady, N.Y. 12301. [363]

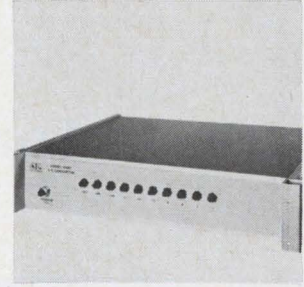

A/D converter model 2200 converts bipolar inputs over a ± 5 v range to a 9-bit-plus-sign binary output in 11 μ sec. Maximum conversion rate is 90,000 words/sec with an accuracy of $\pm 0.1\%$ $\pm 1/2$ least significant bit. The binary output is available at a rear connector and is displayed on the front panel. Price is \$1,500. AIC Instruments, 6214 Royalton St., Houston 77036. [364]

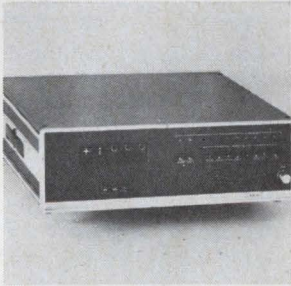

Picoammeter model ME-1035 features built-in calibrator, digital readout, automatic polarity indicator and current suppression option. It has a range of 1 pa full scale to 10 μ a full scale in 7 decades. Accuracy is $\pm 0.05\%$ of reading ± 1 count at 10 μ a to $\pm 0.5\%$ of reading at ± 1 count at 1 pa. Price is \$3,945. EG&G Inc., P.O. Box 1912, Las Vegas, Nev. 89101. [365]

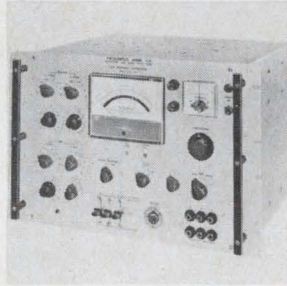

Pulse tester model 1-21A can make pulsed measurements of transistor and diode parameters with forward currents to 100 amps. The pulse stimulus is 300 μ sec wide and has a 2% duty cycle, thereby eliminating junction heating. Accuracy of measurement is 5%. The unit weighs 60 lbs. Price is \$4,300. Test Equipment Corp., 2925 Merrell Road, Dallas, 75229. [366]

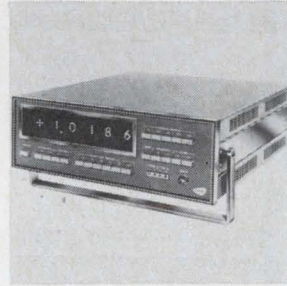

Remote ranging digital voltmeter 301-B has series mode rejection of 80 db without filter and common mode rejection of 150 db without filter. Five ranges can be remotely switched giving a voltage range of 10 μ v to 300 v. Maximum speed is 25 samples/sec with sign. Accuracy is 0.01% ± 1 digit. Fenlow Electronics Limited, Springfield Lane, Weybridge Surrey, England. [367]

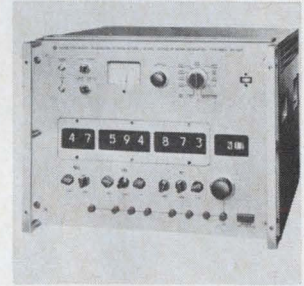

Programable decade r-f signal generator type SMDH covers the frequency range 0-50 Mhz and has frequency stability of 1×10^{-6} /day. It features variable calibrated output voltage (0.1 μ v-2.5 v) and a-m and f-m modulation capability. Price is \$11,600, including crystal reference standard; delivery, from stock. Rohde & Schwarz, 111 Lexington Ave., Passaic, N.J. 07055. [368]

New instruments

Counter range extended to 18 Ghz

One knob adjusts plug-in transfer oscillator for measurements made anywhere in frequency range

The maximum range of digital readout counters has been extended to 18 gigahertz by a transfer oscillator introduced by Hewlett-Packard Co. Previously the maximum had been approximately 12.4 Ghz. Designated the 5257A, the unit is intended for use with most of H-P's

high-frequency, plug-in counters.

Employing a wideband sampler in place of both the harmonic mixer and the phase detector of the conventional phase-locked transfer oscillator, the 5257A achieves a short-term stability of ± 1 part in 10^7 per minute. This is a major factor in

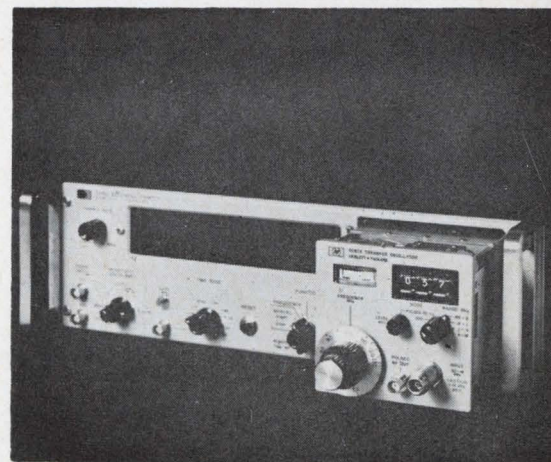

Stretchout. Plug-in extends counter's range beyond Ku band.

Is Your Budget Too Tight For Your Bandwidth?

\$284

○ Low Cost

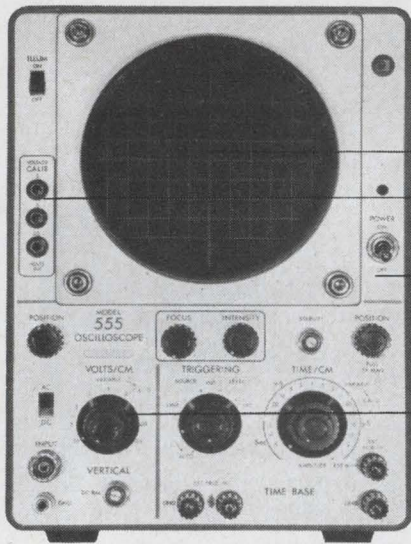

○ 8 cm x 10 cm Viewing Area

○ Voltage Calibrator

○ Solid State Reliability

○ 7 MHz Bandwidth

Try this one for size—Data Instruments Model 555. For any application, Production Line, Field or Laboratory, this scope is a perfect fit. Look at what it offers: (1) Performance. A 7 MHz bandwidth, and an extremely linear time base with variable controls over 19 calibrated ranges and a variety of triggering modes. (2) Display. A 5 inch Braun type tube with an edge lit, removable graticule provide highly precise and legible traces on an 8 x 10 centimeter viewing area. (3) Reliability. All attenuators are solid state and fully compensated. Backing up this solid state reliability is a full year's warranty and complete field and factory service.

Examine the specifications.

| VERTICAL AMPLIFIER | | | | | |
|---|--------------------------------|--|--------------------------|---|---------------------------------|
| BANDWIDTH DC-7 MHz | SENSITIVITY/CM 20mv | ATTENUATOR 9 position | RISE TIME .05 μ s | ACCURACY \pm 5% | IMPEDANCE 1M Ω + 33pf |
| TIME BASE | | | CRT | PHYSICAL | |
| SWEEP/CM 1 μ s-1 sec. (19 ranges) | TRIGGER 20Hz-7MHz (20mv) | HORIZONTAL AMP. Exp. X5 2Hz-200KHz | DIA. 5" (1600V) | DIM. & WT. 8" x 10.5" x 16" 22 lbs. | |

Look at the scope in action. Drop us a note and we'll arrange a demonstration in your plant. You'll find the 555 fits your bandwidth requirements comfortably. At \$284 its very comfortable indeed.

Data Instruments Division • 7300 Crescent Blvd. • Pennsauken, N.J. 08110

... offset eliminated,
readout is direct ...

the accuracy of measurements on pulsed r-f signals where phase lock can't be used.

Unlike older systems, the H-P sampler doesn't require a frequency offset to derive sense information for phase locking. It operates with a d-c or zero frequency i-f, eliminating offset and providing a direct readout with no image frequency responses.

Tuned in. A transfer oscillator is a variable-frequency oscillator (vfo) that's tuned to a frequency that is an exact submultiple of the frequency to be measured. Correct tuning usually is achieved while watching a zero-beat indicator, commonly a cathode-ray tube, to see when there is zero frequency difference between the input signal and a vfo harmonic. The counter measures the oscillator's frequency and this is multiplied by the appropriate harmonic factor to obtain the frequency of the incoming signal.

Measurements are made with the accuracy of the counter's time-base oscillator by phase-locking the vfo to the input signal. Until now, the use of a phase detector required that a non-zero difference frequency exist between the input and vfo harmonic for comparison with a reference frequency. The difference frequency had to be accounted for in the calculations that determined the input signal frequency.

Pointed sampling. With the model 5257A, the incoming signal is applied to a wideband sampler, which is gated by narrow pulses derived from the vfo. Each time the sampler gate is opened, the instantaneous amplitude of the incoming signal is sampled.

If the vfo is set to an exact submultiple of the incoming signal frequency, the signal will be sampled each time at the same point in the incoming waveform cycle, and the smoothed output of the sampler will be a d-c voltage. The sampler does not sample every cycle of the incoming waveform, however. It looks only at every Nth cycle, N being the harmonic relationship between the incoming frequency and the vfo.

The d-c output controls a varac-

HERE'S HOW...

THE ELECTRONIC INDUSTRY IS USING
THESE FAMOUS ULANO FILMS IN
ULTRAMINIATURE MASK TECHNOLOGY
AND COMPLEX PRINTED CIRCUITRY

UlanoTM

RUBYLITHTM AMBERLITHTM

HAND CUT MASKING FILMS FOR THE GRAPHIC ARTS

ULANO RUBYLITH . . . a revolutionary knife cut red film is laminated to a stable transparent plastic backing sheet. The red film is "light safe" so that when contacted to a sensitized emulsion and exposed to a suitable light source, light passes through the cut-out portions only . . . not through the red film. ■ The polyester backing is absolutely stable . . . insures perfect register. ■ Special effects such as crayon tones, paste ups, benday sheets, and opaquing are easily combined with versatile ULANO RUBYLITH.

ULANO AMBERLITH . . . a companion to Rubyolith serves as a color separation medium used as the master on camera copy board to secure negatives or positives. *A wide variety of Ulano films— in rolls and sheets—is readily available*

Cut a piece of the desired film large enough to cover area to be masked. Tape it down firmly at the top *with dull-side up*.

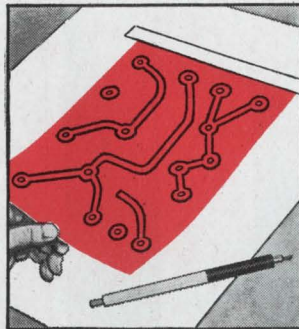

With sharp blade, outline the areas to be masked. *Do not cut through the backing sheet.* The Ulano Swivel Knife does the job quickly, easily.

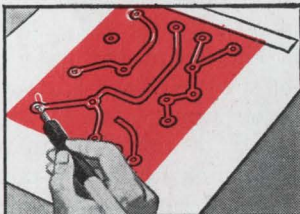

Using the tip of the blade, lift up a corner of the film thus separating it from the backing sheet.

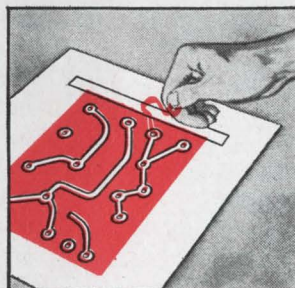

Now carefully peel off the film as outlined leaving a completed mask, positive or negative, that corresponds exactly to the desired pattern.

Designed FOR YOUR PARTICULAR NEEDS

Ulano offers the most versatile line of hand-cut masking films, including:

.0075—RUBYLITH 75 DR* **.005—RUBYLITH 5 DR†**
.005—AMBERLITH 5 DA†

Where exact register assures a critical importance, you will find these new, thick, polyester based films the positive answer.

* Available in sheets only, cut to your specifications
† Available in rolls and sheets



WRITE TODAY
on your letterhead for free
special sample kit 1748

"Ulano"—"Rubyolith"—"Amberlith" are registered trade marks of the Ulano Companies.

ulano

610 DEAN STREET, BROOKLYN, N.Y. 11238

In Europe: ULANO A.G., Untere, Heselbachstrasse No. 22, Kusnacht, Zurich, Switzerland

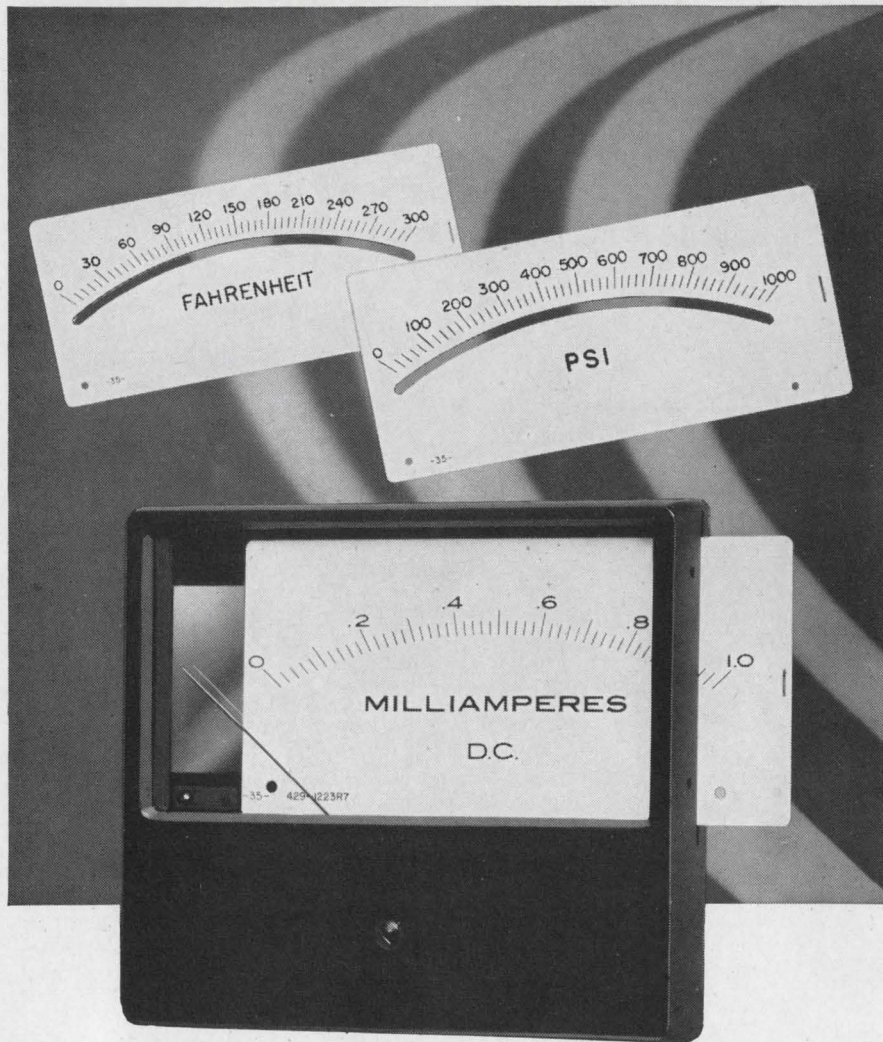

A change of face —lets you measure different variables

You can measure many different variables with the Mod Meter, simply by switching scales. Three or four basic meters and a series of spare scales will match a much more costly collection of single-purpose meters.

Scales slide in and out of the Mod Meter's case on a precision aligned track. (The movement is sealed.) No Mod center costs, no waiting. Special scales are easy to make.

Models 503-S and 603-S (4½" and 5½") have taut-band movements and 1% tracking in the more sensitive ranges. Glass windows and black phenolic cases are standard. Built-in mirror is optional.

Immediate delivery from stock of most popular ranges. Also stocked by Allied Electronics Corporation and Newark Electronics Corporation.

For full details
request
Bulletin 47.

api INSTRUMENTS CO.

CHESTERLAND, OHIO 44026 • (CLEVELAND - 216) 729-1611 • TWX: 810-427-9230
In Canada: Oshawa, Ontario • (416) 576-1541

... varactor drives tuning meter ...

tor in the oscillator's tank circuit, thus phase-locking the vfo to the signal. It also drives the tuning meter. If the vfo is not tuned near a submultiple of the incoming frequency, the smoothed sampler output will be an a-c voltage with an average value of zero. Thus the meter can be used as an indicator for correct tuning. The sampler output is also available at a front panel connector where it can be examined by an oscilloscope, or used as a down-converted signal for other instruments.

The vfo of the 5257A has a frequency range between 66.7 and 133.7 megahertz. A built-in pre-scaler divides the vfo frequency by 4 to permit measurement by the counter. For measurement of signals in a frequency range between 50 and 200 Mhz, the divided-down vfo frequency is used to gate the sampler.

Using N. The harmonic number N is dialed into front-panel thumb-switches on the plug-in. This extends the counter's gating intervals by the factor N. Hence, the frequency multiplication is performed automatically. The thumbswitches do not select the harmonic, however, but merely extend the gating interval. There can be many vfo frequencies which have harmonics equal to the input.

Compared to other techniques for extending an electronic counter's frequency measurement range—heterodyne frequency converters and automatic frequency dividers—a transfer oscillator has a wider frequency range. At least three heterodyne converters are required to cover the same frequency range as the 5257A. Although heterodyne converters do not have direct read-out—calculations to find the input frequency are a simple one-step addition—they do provide higher resolution in a short time. But, H-P says, the transfer oscillator is the only frequency-extending technique capable of being used for the measurement of pulsed r-f signals or of very noisy signals.

The 5257A transfer oscillator plug-in is priced at \$1,850.

Hewlett-Packard Co., 1501 Page Mill Road, Palo Alto, Calif. [369]

How do you get around the high costs of making your own hydrogen?

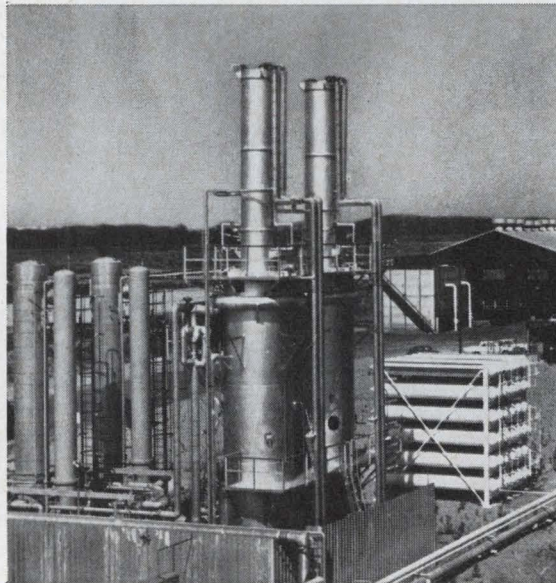

Buy it!

From an Air Products on-site facility. We will generate hydrogen from a facility on or near your premises and pipe it directly to you—thus freeing you from all capital expenditures, yet giving you the benefits of on-site production. You buy the gas you need—the same as you would fuel or power—without operating or maintenance headaches, and often at lower over-all cost.

What we've done is extend the concept of on-site oxygen supply—pioneered by Air Products—to the production of high-purity hydrogen.

We are *the* hydrogen specialists—the nation's largest merchant hydrogen producer; first to produce tonnage

liquid hydrogen; major supplier of liquid hydrogen fuel for the space program; engineers and builders of the first liquid hydrogen loading system at Cape Kennedy; fabricators of some of the largest liquid hydrogen trailers in highway service. Our hydrogen capability is a *total* capability. We can provide anything from a small lecture bottle of ultra-high-purity gas to a major on-site plant.

If you're thinking of adding new hydrogen capacity, it will pay you to investigate an Air Products on-site supply. You could be surprised at the savings. Write or phone:

Air Products and Chemicals, Inc., Industrial Gas Division, Allentown, Pa. Phone (215) 395-4911.



Air Products and Chemicals
INC.

ALLENTOWN, PENNSYLVANIA

NON-CONTACTING NON-LOADING VOLTAGE MEASUREMENT

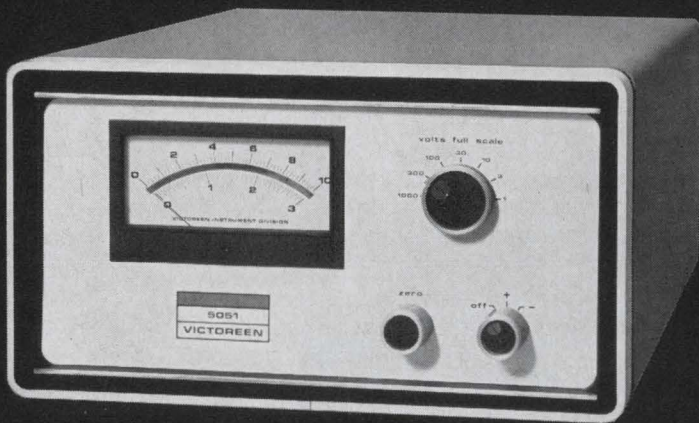

VICTOREEN PROXIMITY VOLTMETERS*

Range: ± 1 to ± 1000 volts fullscale
 Probes: Model 5051-25 high resolution type,
 Model 5051-35 high sensitivity type

Victoreen Model 5051 Proximity Voltmeter now makes possible measurement of electrical potentials on surfaces of numerous materials without making physical contact — or loading the source. Compact design of the probe (illustrated) takes full advantage of size limitations imposed in many applications. 100% feedback maximizes insensitivity to probe-surface spacing. Applications are virtually unlimited and include —

- Aircraft, missile skins
- Circuit boards
- Electrets
- Electrostatic copy papers
- Insulators, dielectrics
- Magnetic tapes, transports
- Metal, liquid surfaces
- Plastics, films
- Semiconductor materials
- Synthetic fibers, materials

*Pat. Pending A-957

VICTOREEN INSTRUMENT DIVISION
 10101 WOODLAND AVENUE • CLEVELAND, OHIO 44104
 IN EUROPE: GROVE HOUSE, LONDON RD., ISLEWORTH, MIDDLESEX, ENGLAND



New instruments

Have scope, will travel

Briefcase-size instrument performs basic functions, uses IC's extensively

Not every engineer's briefcase should have oscilloscopes in it, but there are times when portability is a must and the refinements of sophisticated instrumentation can be dispensed with.

The model 100 Transi-scope developed by Measurement Control Devices Inc. weighs only five pounds and is 1¾ inches high, 7½ inches wide, and 14 inches long.

A basic scope without frills, it can be used by laboratory workers, production and recording engineers, custom equipment designers, medical researchers, and field service technicians. Its compactness makes it not only portable, but suitable for applications involving limited rack space.

Except for its cathode-ray tube, the scope is completely solid state. Integrated circuits throughout the vertical amplifier section and sweep circuits are important factors in the instrument's small size.

The model 100 has a response from d-c to 10 megahertz. The vertical amplifier's sensitivity is 50 millivolts per division, and attenuation occurs in four steps of 20 decibels each with an additional 25-db vernier adjustment. Input impedance is 1 megohm in parallel with 75 picofarads, and the scope's linear time base, with a range from 0.5 hz to 500 khz, is repetitive. Synchronization is automatic.

The display tube, a 1-by-2½-inch rectangular crt scaled in 0.25-inch

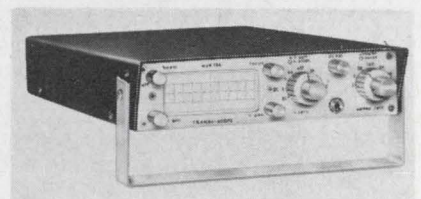

Miniscope. Portable, low-cost instrument handles routine monitoring and recording.

squares, has a 1-kilovolt accelerating potential for writing brightness. The standard scope comes with a P31 phosphor and a polaroid filter, but other phosphors are optional.

Accessories include a fitted carrying case and half-rack and full-rack mounting brackets. The scope costs \$339 and is available from stock.

Measurement Control Devices Inc.,
2445 Emerald St., Philadelphia [370]

New instruments

Travel companion keeps a diary

Sensor-recorder system,
packed with shipments,
measures truck, train shocks

You don't have to ask a traveler how he enjoyed his trip. He'll be glad to tell you. But what happens to equipment during shipment is not as easy to learn. So engineers at Endeeco Corp. developed a system that keeps a history of a shipment's environment during transportation.

Endeeco's transportation environment measuring and recording system (Temars) is designed to be packed with the equipment to be shipped. Its sensors measure temperature, pressure, relative humidity, and forces caused by vibration and shock. Values are digitally recorded on half-inch, reel-loaded magnetic tape. Time is recorded every 15 minutes, so the occurrence of a significant event can be traced to within this quarter-hour interval.

Big G's. Forces can be measured in ranges from $\pm 2 G$'s to $\pm 25 G$'s. Temars has threshold capabilities so only forces above a certain value are recorded. Threshold levels for vibration and shock can be set from 10% to 25% of full scale.

Temars runs on 12 volts d-c, which can be supplied either externally or internally. With the optional rechargeable zinc-air battery, the system operates unattended for 10 days.

Endeeco Corp., 801 S. Arroyo Parkway,
Pasadena, Calif. 91109 [371]

SPECTROL ELECTRONICS CORPORATION / 17070 E. GALE AVENUE, CITY OF INDUSTRY, CALIFORNIA 91745 / PHONE: (213) 964-6565 • TWX: (910) 584-1314

Biggest at cermet value lowest prices!

Here is the lowest priced cermet trimmer you can buy in an RJI1 package! Even if the Spectrol design was not better (and we think it is) could you afford to ignore the prices?

And at these prices, what other non-wirewound can beat these specs?

- Resistance Range: 100 Ω to 1 megohm.
- Power Rating: 0.75W @ 70°C.
- Temperature Range: -25°C. to +125°C.
- Resistance Tolerance: $\pm 20\%$
- Tempco: ± 300 ppm/°C. max.
- Element: Cermet
- Packages: RJI1 size with 5 mounting options

But the proof is in the product. You'll find it on the shelves of your local Spectrol distributor. Its performance will prove to you that our published specs are conservative. (We like it that way.)



Better Components for Better Systems

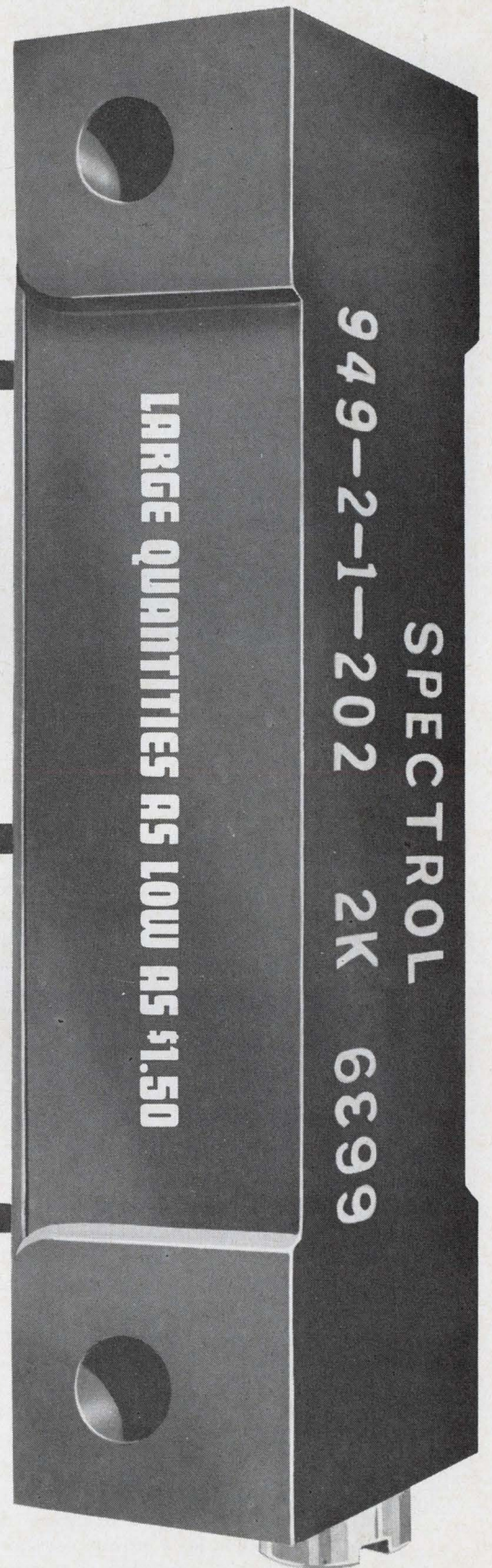

If your LSI performs like LSD...check for H₂O!

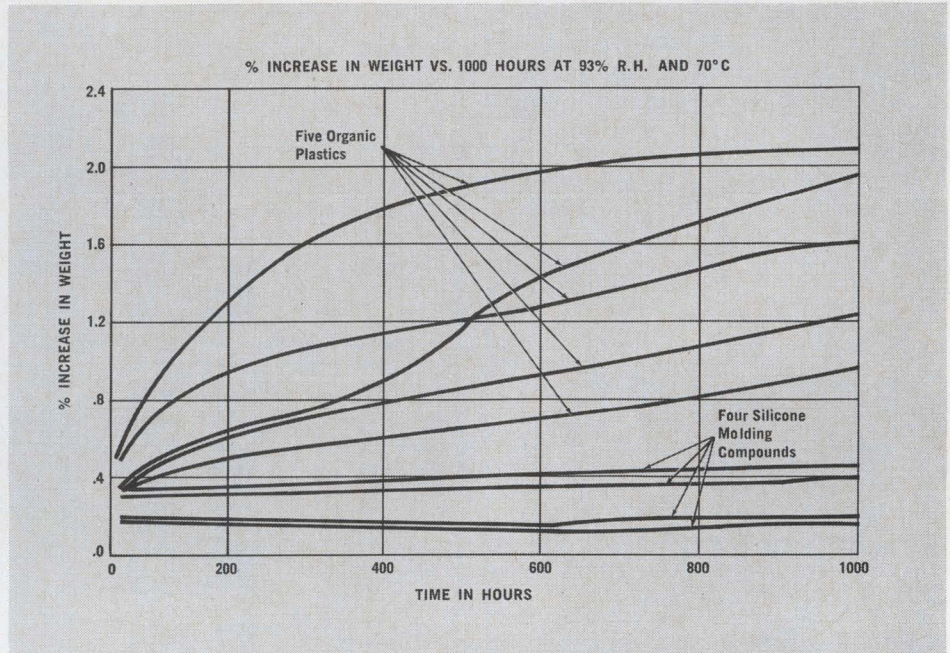
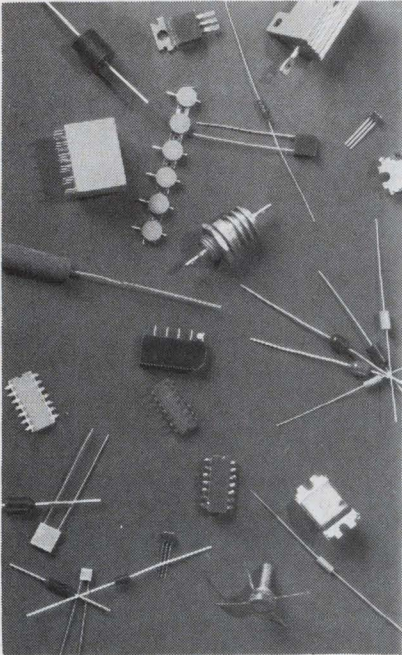

Moisture absorption of most plastics can lead to critical conditions in devices — whether LSI or simple diodes.

But, devices packaged in silicone molding compound are physically and electrically stable after long term exposure to both high humidity and operating temperatures—as shown by the graph above. This stability means more reliable operation at full rated device power without failure due to moisture absorption . . . less need to provide other circuit embedment or encapsulation.

This is just one of the many reasons why more and more equipment manufacturers are turning to devices packaged in Dow Corning® silicone molding compound — whether those devices are simple diodes, power rectifiers or integrated circuits. Some of the other reasons—

No derating necessary. Devices and components packaged in silicone molding compounds can be operated at their full power potential. This permits designs with higher density of devices and components. One manufacturer of glass packaged power diodes reduced his part's volume to 1/30th by using silicone molding compound. Compared to other plastics, size is from 1/5th to 1/3rd smaller since derating due to package material instability is not required with silicone molding compounds.

No cracking. Dow Corning silicone molding compounds—unlike other thermal setting plastics—are virtually unaffected by heat aging and thermal shock. For example, a power resistor molded in Dow Corning® 307 molding compound was sub-

jected to repeated cycling from -65 to 350 C without damage to the packaging material or the component. Subjected to 1000 hours at 300 C (572 F) Dow Corning brand molding compounds show no significant change in physical and electrical properties.

Will not burn. Silicone molding compounds are inherently nonburning. Thus, components packaged in silicone molding compound will not constitute a fire hazard. No flame snuffers are needed . . . a source of ionic contamination for devices packaged in organic plastics. With silicone molding compound there are no ionic or polar constituents to affect junction performance when properly used.

Competitive price. Dow Corning silicone molding compounds cost only a fraction of a cent per device. Thus, they enjoy a substantial price advantage over metal cans and glass packages.

Manufacturing economies. Transfer molding enables devices and components to be packaged with a minimum of manual labor and supervision. Good mold release and minimum flash assure high production rates . . . reduced deflashing costs. These manufacturing advantages make silicone molding compounds totally competitive with organic plastics.

So, why chance a device failure because of a cheap plastic package? Put silicone molding compound protected devices and components into your electronic equipment. For technical data, write to: Dept. A-8467, Dow Corning Corporation, Midland, Michigan 48640.

DOW CORNING



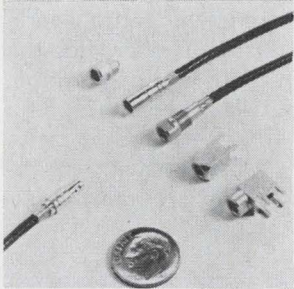

LE-Minax O1 series 50-ohm coaxial p-c connector line now includes a cable plug and 5 receptacles: panel mount, panel mount with cable clamp, cable receptacle, p-c vertical dip solder mount, and p-c right angle dip solder mount. Vswr is 1.045:1 at 1 Ghz, 1.14:1 at 10 Ghz, and contact resistance is less than 0.003 ohm. Lemos Inc., 465 California St., San Francisco, 94104. [401]

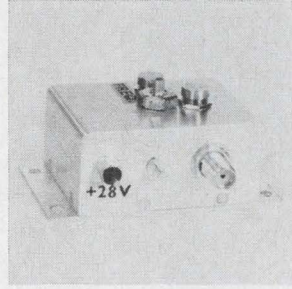

Solid state oscillator OS1100 can be manually tuned over 1 frequency octave with a single tuning adjustment. Input power is filtered to prevent radiation of the oscillator frequencies back into power supply and adjacent circuits. Frequency is 600 to 1,200 Mhz; input voltage, 28 v d-c; input current, 250 ma max. Advanced Technology Corp., 1830 York Rd., Timonium Md. 21093. [402]



D-c block model B130, for r-f and pulse applications, spans 85 Mhz to 12 Ghz with a max. insertion loss of 0.25 db. Its broadband capability permits transmission of nsec pulses with negligible distortion. Pulse amplitudes may vary from 0 to 50 v. Series capacitance in transmission line is 100 pf. Somerset Radiation Laboratory Inc., 2060 N. 14th St., Arlington, Va. 22216. [403]

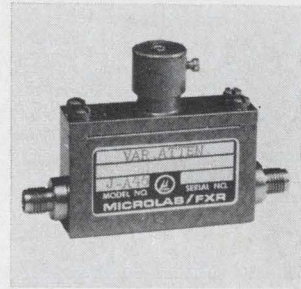

Coaxial attenuator AJ-A46 is for X-band use. Attenuation is variable from 0 to 20 db by a screwdriver adjustment. Operating from 8.5 to 12.4 Ghz, the unit has an insertion loss of 0.5 db and vswr of less than 1.2. Constructed of aluminum with stainless steel connectors, it weighs 2 oz and measures 2.5 x 0.5 x 1.75 in. Micro-lab/FXR, 10 Microlab Rd., Livingston, N.J. 07039. [404]

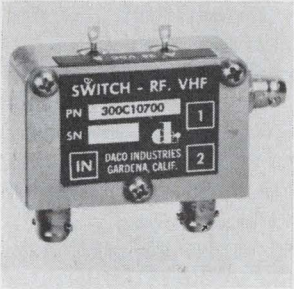

Coaxial switch type RMB utilizes the hermetically sealed reed relay to provide long operating life and good r-f characteristics under severe operating conditions. Frequency is d-c to 400 Mhz; vswr, 1.25:1; crosstalk, 40 db minimum; insertion loss, 0.15 db max. The unit was designed for remote antenna selection. Daico Industries Inc., 1711 W. 135th St., Gardena, Calif. 90249. [405]

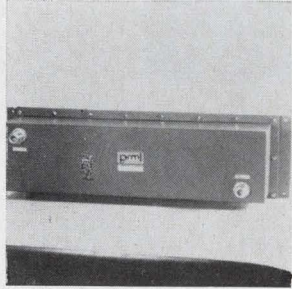

Narrowband reject (notch) filter F124A was developed to help combat the rising incidence of rfi in the uhf band. It cascades three 8-cavity filters to notch out 3 different frequencies in the 500-to 1,000-Mhz range. The ratio of 3-db to 60-db bandwidths is less than 2.4 for each frequency. Peninsula Microwave Laboratories, 855 Maude Ave., Mtn. View, Calif. 94040. [406]

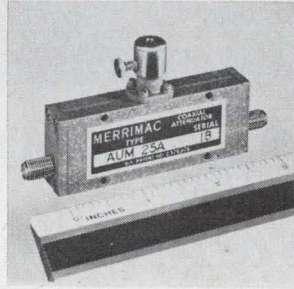

Continuously variable coaxial attenuator AUM-25A covers the range 0.5 to 8 Ghz with maximum performance and continues to be useful from 0.3 to 12 Ghz. Attenuation range extends from 0-to-10 db to 0-to-40 db. Insertion loss is 1 db max. The unit weighs 2½ oz, measures ½ x 1 x 2¾ in. Merrimac Research and Development Inc., 41 Fairfield Place, West Caldwell, N.J. 07006. [407]

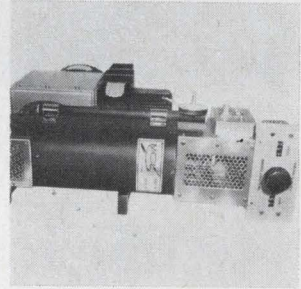

C-w tetrode amplifier cavity 11055 is for use as a final amplifier in point-to-point, military communications equipment. Rated at 1-kw power output, it is tuned manually and operates with a 6-Mhz bandwidth over a 200- to 400-Mhz range. Power input is 50 w, and input and output impedance, 50 ohms. Microwave Cavity Laboratories Inc., 10 N. Beach Ave., LaGrange, Ill. [408]

New microwave

Tunable magnetron reaches X band

Theta-mode design permits voltage-tunable source to operate at 9 Ghz for radar, communications

To build a voltage-tuned magnetron for higher-than-usual frequencies, engineers generally try scaling down the size of the standard device. A 6-gigahertz tube is often a half-size copy of a 3-Ghz device, since tube dimensions get smaller as frequency rises and thus the cor-

responding wavelength shortens.

Unfortunately, scaling does not work when frequencies get above 7 Ghz. At X-band (8-12.4 Ghz) tube parts become very small and tolerances very tight, causing production problems. Also, since small parts cannot dissipate heat as well

as larger ones, higher-frequency tubes tend to wear out more quickly. Together, these factors had stopped the commercial tube cold at about 7 Ghz. Tubes at higher frequencies were too hard to build and too small to operate dependably.

The Bomac division of Varian Associates has developed two new voltage-tuned magnetrons that oscillate at about 9 Ghz, higher than ever achieved in commercial tubes of this kind. To develop the devices, Bomac engineers rethought the standard approaches to magnetron design and solved two tough problems.

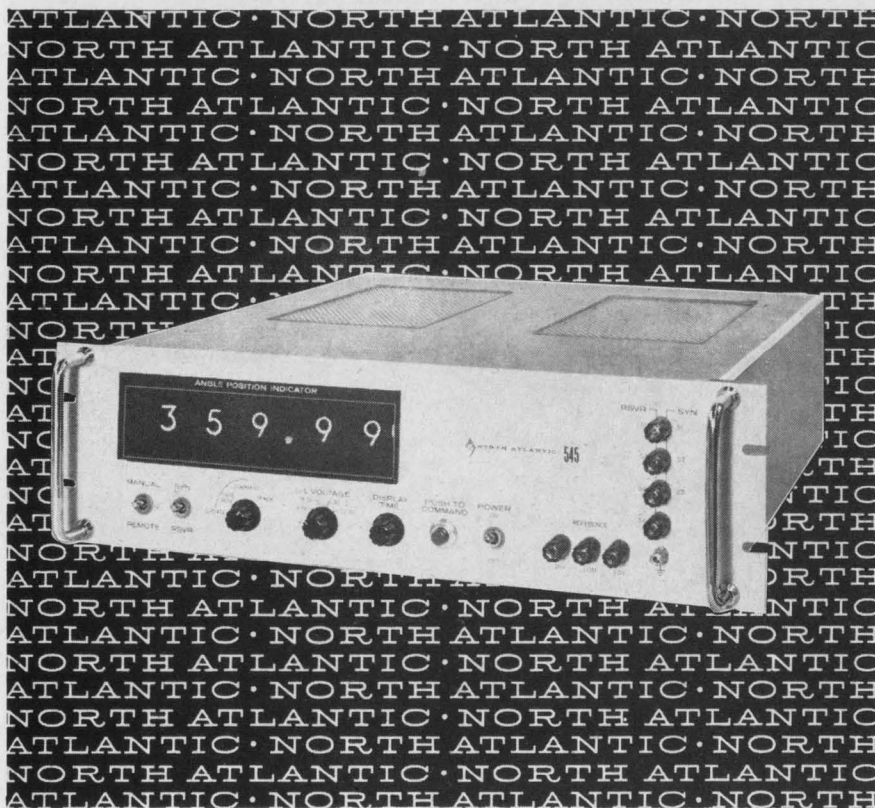

resolver/synchro to digital conversion01° accuracy ... 2000°/sec. tracking

North Atlantic now brings you a new generation of solid-state analog-to-digital converters for resolver and synchro data. They offer major advances in high-speed precision tracking as required in modern antenna readout, ground support, simulation, and measurement systems.

For example, the Model 545 provides conversion of both resolver and synchro data at rates to 2000°/second, and accommodates 11.8v to 90v 400Hz line-line signals. For multiplexed applications, acquisition time is less than 50ms. Digital output data is visually displayed and simultaneously available on rear connectors. All modes are programmable as well as manually controlled. Optional features include .001° resolution with 10 arc second accuracy, data frequencies from 60Hz to 4.8KHz, data freeze command for digital readout at a critical instant, and programmed mode where difference angle computation is required.

Your North Atlantic representative (see EEM) has complete specifications and application information. He'll be glad to show you how these converters can answer critical interface problems in your system.



NORTH ATLANTIC industries, inc.
TERMINAL DRIVE, PLAINVIEW, NEW YORK 11803 • 516-681-8600

... higher frequencies
had to be suppressed ...

Bomac's magnetron group used a theta-mode design to overcome the problems. In theta-mode operation, never before used successfully in a commercial unit, the tube operates at twice its cavity's ordinary resonant frequency. Thus, theta mode allowed the engineers to use a tube structure twice as large as that needed for operation at a resonant frequency of 9 Ghz.

Most of the production problems of a 9 Ghz tube became equivalent to those encountered in tubes for 4.5 Ghz, and most of these problems had already been solved.

Hitches. But it wasn't all that easy. Bomac's engineers first had to make sure that the tube oscillated at 9 Ghz, not 4.5, and secondly, that it didn't run at even higher frequencies.

The first problem was solved, and theta-mode operation assured by shorting the top and bottom of the cavity. In an ordinary voltage-tuned magnetron, the top and bottom of the doughnut-shaped cavity are always at the same potential with respect to one another. In the theta mode, the voltage situation is more complex; the cavity has two regions of maximum voltage (one positive and one negative) spaced at 90° and 270° around the doughnut, and two regions of equal potential at zero and 180°. Power is coupled out of the cavity at either of the voltage peaks through a coaxial connector.

Bomac engineers made the necessary short circuit through one of the fingers of the interdigital slow wave structure forming the core of the cavity. So far so good—but the short also allowed higher frequency modes, and one around 12 Ghz was particularly troublesome. After some experimentation, Bomac engineer W. A. Frutiger found that a resistive load on the opposite side of the cavity from the shortened finger damped out the unwanted oscillations. Details of Frutiger's fix are under wraps, since there's a patent pending on the idea.

End products. Two tubes use the theta-mode approach, the BLM-1390 (8.5 to 9 Ghz) and BLM-1395 (9 to 9.5 Ghz). Both deliver at least one watt over their frequency

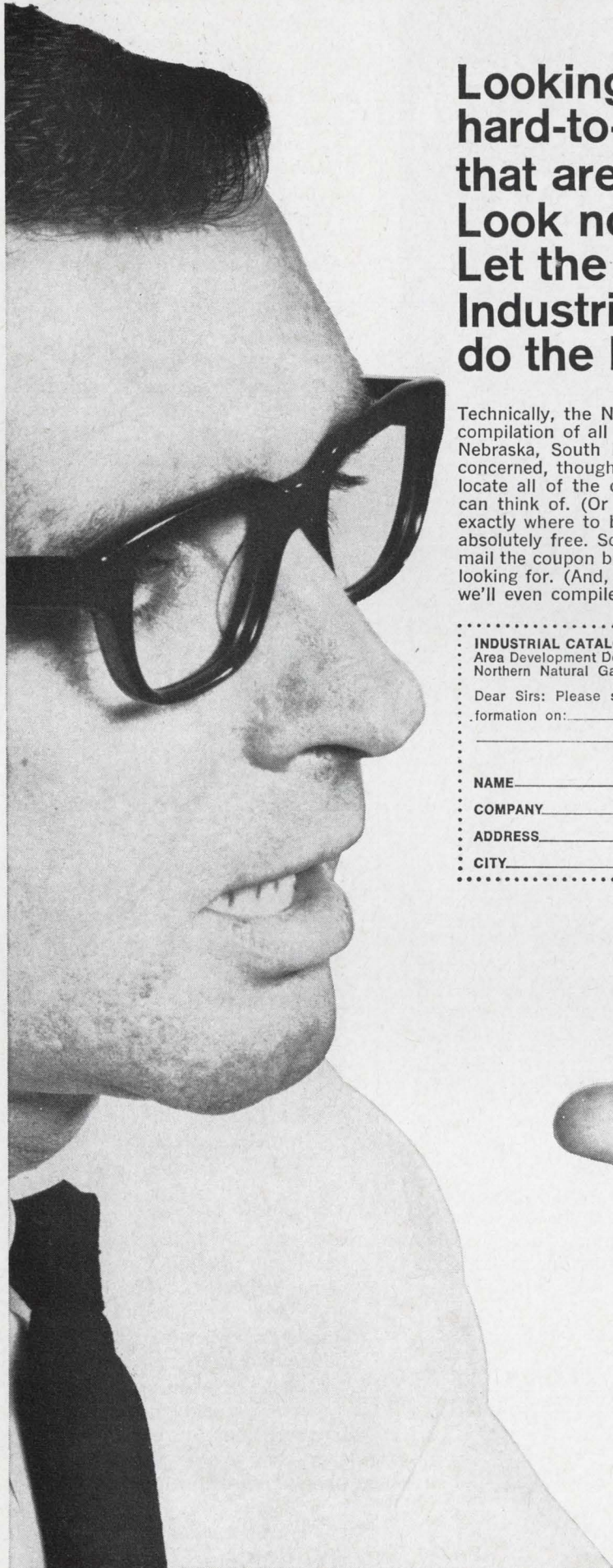

**Looking for
hard-to-describe components
that are even harder to find?
Look no more.
Let the Northern Plains
Industrial Catalog
do the looking for you.**

Technically, the Northern Plains Industrial Catalog is a "computerized compilation of all the industrial fabricators in Iowa, Kansas, Minnesota, Nebraska, South Dakota, and western Wisconsin." As far as you're concerned, though, it's simply a "finding service" that can help you locate all of the components, assemblies and sub-assemblies you can think of. (Or can't think of, as the case may be.) It'll tell you exactly where to buy quickly, wisely, and profitably. And, it'll tell you absolutely free. So, if you need help in finding components, fill in and mail the coupon below. We'll rush you complete data on just what you're looking for. (And, if you send a sketch of the part, or specifications, we'll even compile a special list of sources for you.)

.....

INDUSTRIAL CATALOG
Area Development Dept.
Northern Natural Gas Co., Omaha, Nebr. 68101

.....

Dear Sirs: Please send Sources of Supply information on: _____
..... Drawings enclosed.

.....

NAME _____ **TITLE** _____

COMPANY _____

ADDRESS _____

CITY _____ **STATE** _____ **ZIP** _____

.....

E-1-68

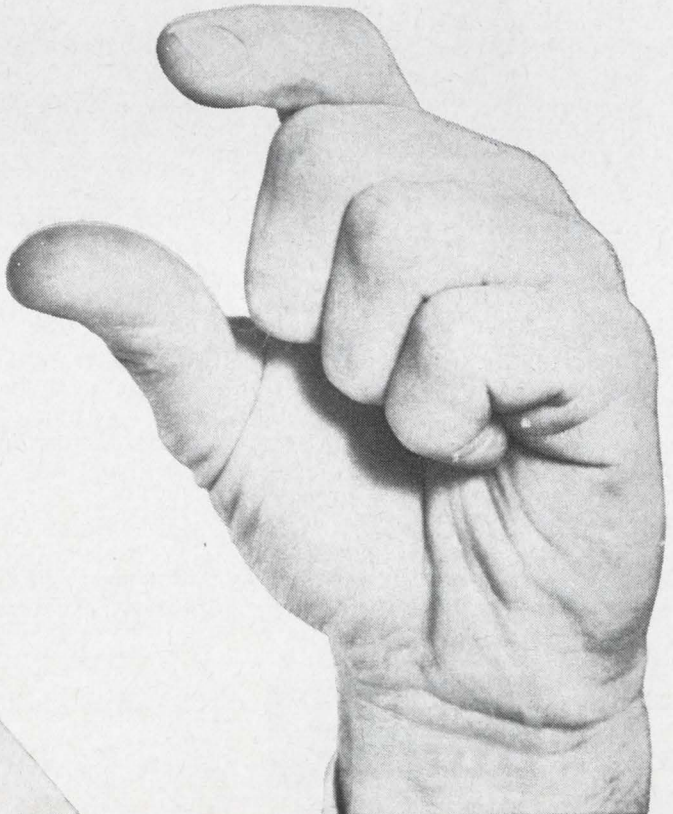

control/alarm time-cut

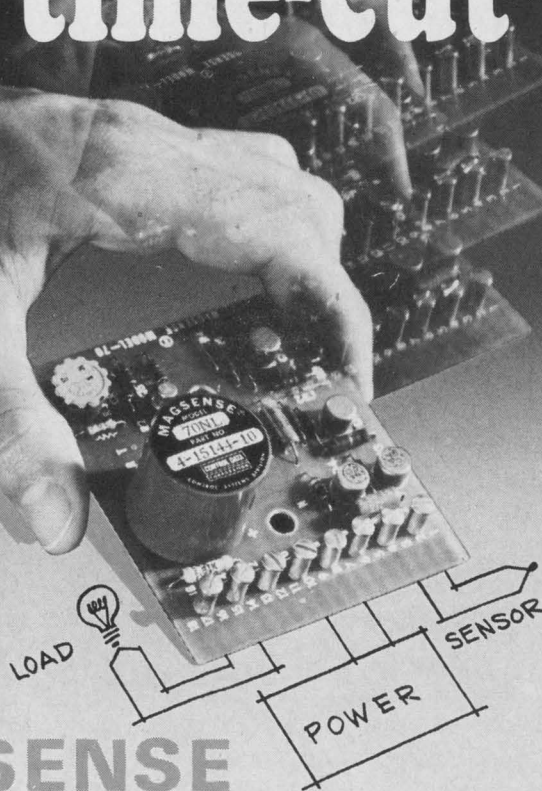

MAGSENSE

control/alarm for temperature, pressure, speed, flow

Here's how to cut the time it takes to solve your control/alarm problem. Hook up sensor, load and power source to a MAGSENSE® control/alarm module and adjust the setpoint. That's it. No time wasted designing and debugging a circuit. And while you're saving time you'll be saving money, getting *proven-in-service* reliability.

Capabilities? All MAGSENSE modules offer 100-billion power gain, accept inputs as low as 10 microvolts or 1 microamp *directly* without preamplification. Completely isolated inputs are unaffected by common mode voltages as high as 110vac, 60Hz, or overloads as large as 1000-times full scale input. Typical accuracy is $\pm 0.5\%$ full scale. And they all

operate from a *single* DC power source (either 28v or 12v).

Options? The list includes remote and dual setpoints, adjustable hysteresis, choice of output action, transducer excitation voltage, and cold junction and copper compensation on thermocouple models. There's a MAGSENSE model for your application.

Price? Get MAGSENSE control/alarm modules for as little as \$35 in quantity. Compare that with the cost of developing and building your own circuit.

More information? Write or call, or circle the reader service number and we'll send you complete specifications and prices.

**CONTROL DATA
CORPORATION**

4455 Eastgate Mall, La Jolla, Calif.

MAGSENSE Sales, Dept. 229
Analog-Digital Systems Division
Control Data Corporation
4455 Eastgate Mall
La Jolla, Calif. 92037
Phone 714/453-2500

ranges, but this is a conservative specification. Some tubes should deliver two to three watts with ease, with a typical tube delivering at least 1.5 watts. A graph of output power versus frequency is a flat line within ± 0.5 to 0.7 decibels.

Anode voltage, which is varied to change output frequency, is low for a voltage-tuned magnetron. The BLM-1390 sweeps over its full 500-Mhz bandwidth with a change from 900 to 950 volts—a total swing of only 50 volts. By contrast, many units require anode voltages of 2 kilovolts or more and broader voltage swings. Even on the higher frequency BLM-1395, anode voltage reaches a maximum of only 1 kv.

Dale L. Peterson, Bomac's product manager for magnetrons, says that, besides the market in new defense communications and radar systems, there is a retrofit market, replacing chains of backward-wave oscillators and traveling-wave tubes. Not only will the new tubes be smaller and cheaper but, since they require only a few different supply voltages, power supplies could be simplified and therefore less costly, says Peterson.

Varian Associates, Bomac Division, Beverly, Mass. 01915 [409]

New microwave

Thinking thin to the end

Terminations for waveguides and couplers are same size as short-circuit plate

The end of a microwave circuit is sometimes just the beginning. A waveguide termination, to prevent signal reflections while it provides impedance matches, must be added. Unfortunately, standard terminations are 5 to 6 centimeters long—too long for some applications.

Japan's Hitachi Electronics Co., however, has developed terminations that are a tenth the size. Unlike standard pieces, which can be used across a broad frequency band, the new terminations are limited to narrow-band applica-

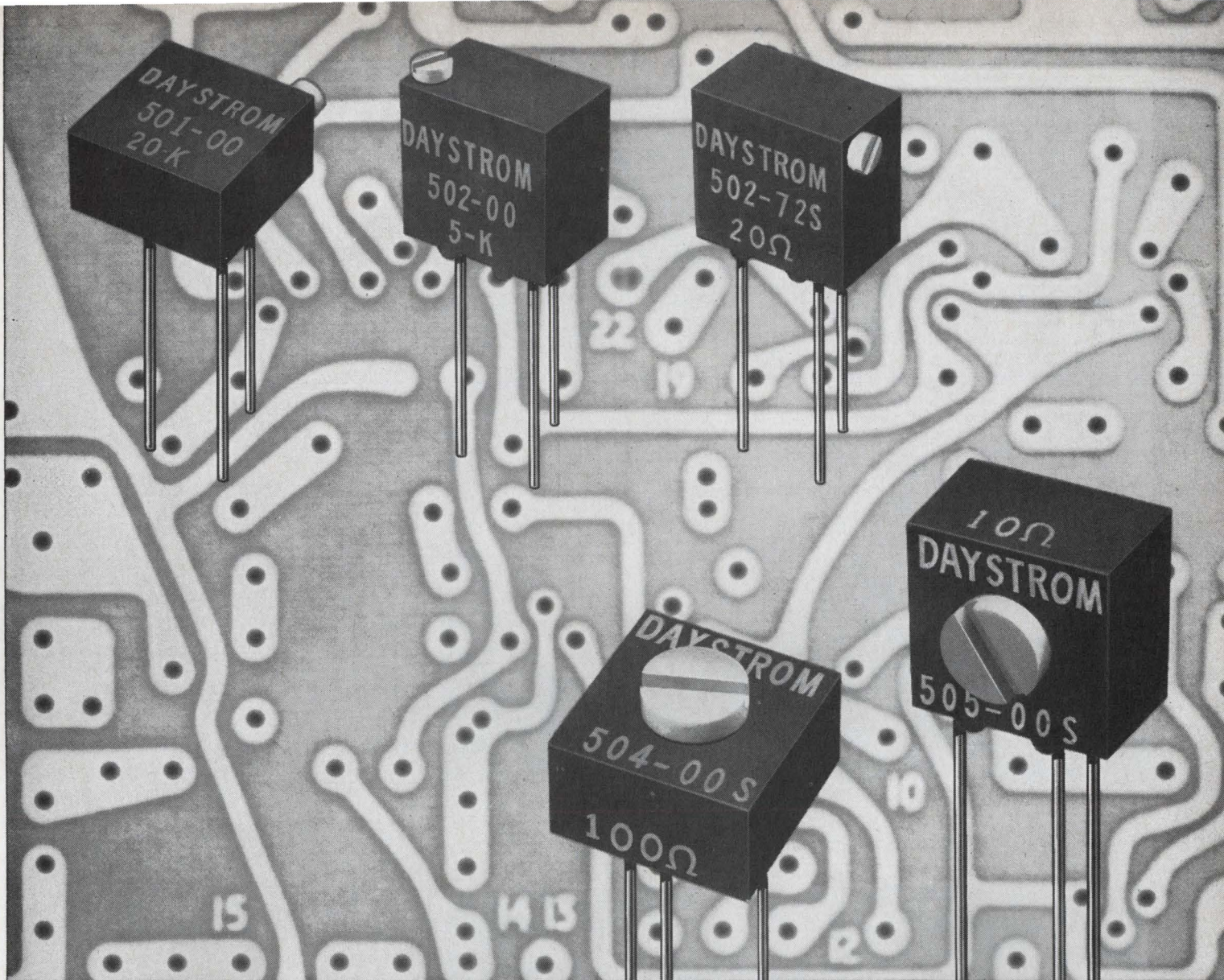

Savings across the board just took a new turn

DAYSTROM Commercial Squaretrim® potentiometers now include single-turn types. *New models 504 and 505 are fully adjustable with just one turn. Models 501 and 502 are 15-turn types. They all clear up to 80% more PC board space—at no extra cost. But the trim .02 cubic inch size is only one reason why these commercial 500 Series pots are proving so popular. They also feature Weston's exclusive wire-in-the-groove design, and all these performance extras:*

Convenience 5 different configurations with adjusting screw on top, side or end • **Tolerance** $\pm 5\%$ • **Adjustability** 15 turns or single turn • **Slip Clutch** eliminates wiper damage, cuts production delays • **Suregard™ Terminations** for better protection against vibration, shock and humidity—no pressure taps • **Superior Resolution** 0.125% or less • **Wide Range** 10 Ω to 20K (higher values on request) • **High Power** 0.6 watt in still air at 70°C • **Wide Temperature Range** -55°C to 150°C • **Low Temperature Coefficient** 70 ppm max. • **Low Noise** 100 Ω max. ENR • **Small Size** $\frac{5}{16}$ " x $\frac{5}{16}$ " x $\frac{3}{16}$ " • **Low Cost** \$2.10 each for 501/502 in 500 lot quantity, \$1.95 each for 504/505 in 500 lot quantity.

Daystrom potentiometers are another product of:

Weston Components Division, Weston-Archbald, Archbald, Pennsylvania 18403, a Schlumberger company

WESTON® prime source for precision... since 1888

Circle 153 on reader service card

New high efficiency, high frequency Photochopper Modules

- High stability from -25 to $+75^{\circ}\text{C}$, efficiency varies less than 5% over temperature range
- 50% efficiency at 1000 Hz
- Internal electrostatic shielding
- CdS cells for fast warm up

Write for new Bulletin 201/ITD3-67



CLAIRES ELECTRONICS, INC. ■ 1239 BROADWAY, NEW YORK, N. Y. 10001

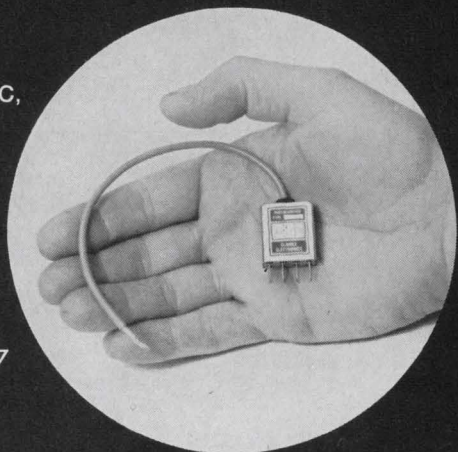

Circle 209 on reader service card

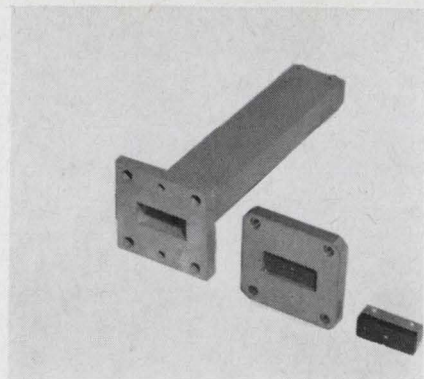

Little brothers. Standard termination (left) towers over flange (center) and insert models of thin terminations.

tions, and applications in which the designer is content with voltage standing-wave ratios of about 1.2.

Hitachi borrowed the bonding approach used for tapered terminations that absorb magnetic instead of electrical energy. Unlike these terminations, in which the absorbing material is usually bonded to the inner surfaces of the waveguide's two tapered walls, the new units have absorbing material baked onto a short-circuit plate. The company uses a mixture of ferromagnetic material and adhesive epoxy as the absorbent.

Three to watch. How well reflections are prevented depends on the composition of the material, the thickness of the termination, and the manufacturing process. Two things happen when a wave strikes the thin termination. Some magnetic energy is absorbed in the material and the wave is reflected from both the front and back surfaces. Thus it is essential that absorption be high and the reflections cancel each other.

Sensitive. Hitachi designed the terminations to operate between temperatures of -10° to $+50^{\circ}\text{C}$. At higher temperatures, the vswr increases rapidly. The same holds true for power. Designed for low-power applications, inputs greater than 2 watts cause high vswr's.

External magnetic fields, the company says, don't affect performance.

Hitachi is offering two models, the flange-type X1107 and the insert-type X1108. Either is available for any operating frequency, f_0 , between 2.6 and 18 gigahertz.

Hitachi Electric Co., Tokyo [410]



**WHEN
YOU CAN'T
AFFORD
TO FAIL,
USE
Magneline®**

Magneline® digital indicators are used to display random information. They have high readability and extremely long life. Sharp black and white digits are positioned electromagnetically. The number drum rotates on a polished shaft in a jewel bearing. Coil assemblies are encapsulated in heat and shock resistant epoxy. Test units have been run through 35 million cycles without failure or measurable wear. Applications range from aircraft and spacecraft instrumentation to control systems for heavy industry.

WRITE FOR OUR TECHNICAL BROCHURE

PATWIN ELECTRONICS

Manufactured under one or more of the following U.S. Patents: 2,943,313, 3,009,140, 3,118,138, 3,201,785, 3,260,871. Other patents pending.

A DIVISION OF PATWIN, INC. WATERBURY, CONNECTICUT • 06720

where will you be in 1973?

Five years at Sanders will make you immeasurably more accomplished.

Here you will work on new things, designing and building systems to answer yet unsolved problems — significant problems that can change the way we live, perhaps the course of history. To carry out such an assignment you are going to have to find new answers.

Answers in turn raise further questions.

This is progress — cutting a path to what is meaningful through the choking flow of random data that all too often is a substitute for thought.

This is the opportunity at Sanders. Here your role can be personally and professionally rewarding.

WRITE to Mr. T.J. Auger today for career information. The address: Sanders Associates, Inc., Dept. 296 E, 95 Canal Street, Nashua, New Hampshire 03060.

SYSTEM DESIGN ENGINEERS ■ ECM SYSTEM ENGINEERS ■ DIGITAL DESIGN ENGINEERS ■ ELECTRO-OPTICAL ENGINEERS ■ ANTENNA ENGINEERS ■ ELECTRONIC ENGINEERS

CREATING NEW DIRECTIONS IN ELECTRONICS



**SANDERS
ASSOCIATES, INC.**

*T. M. SANDERS ASSOCIATES, INC. An Equal Opportunity Employer M/F

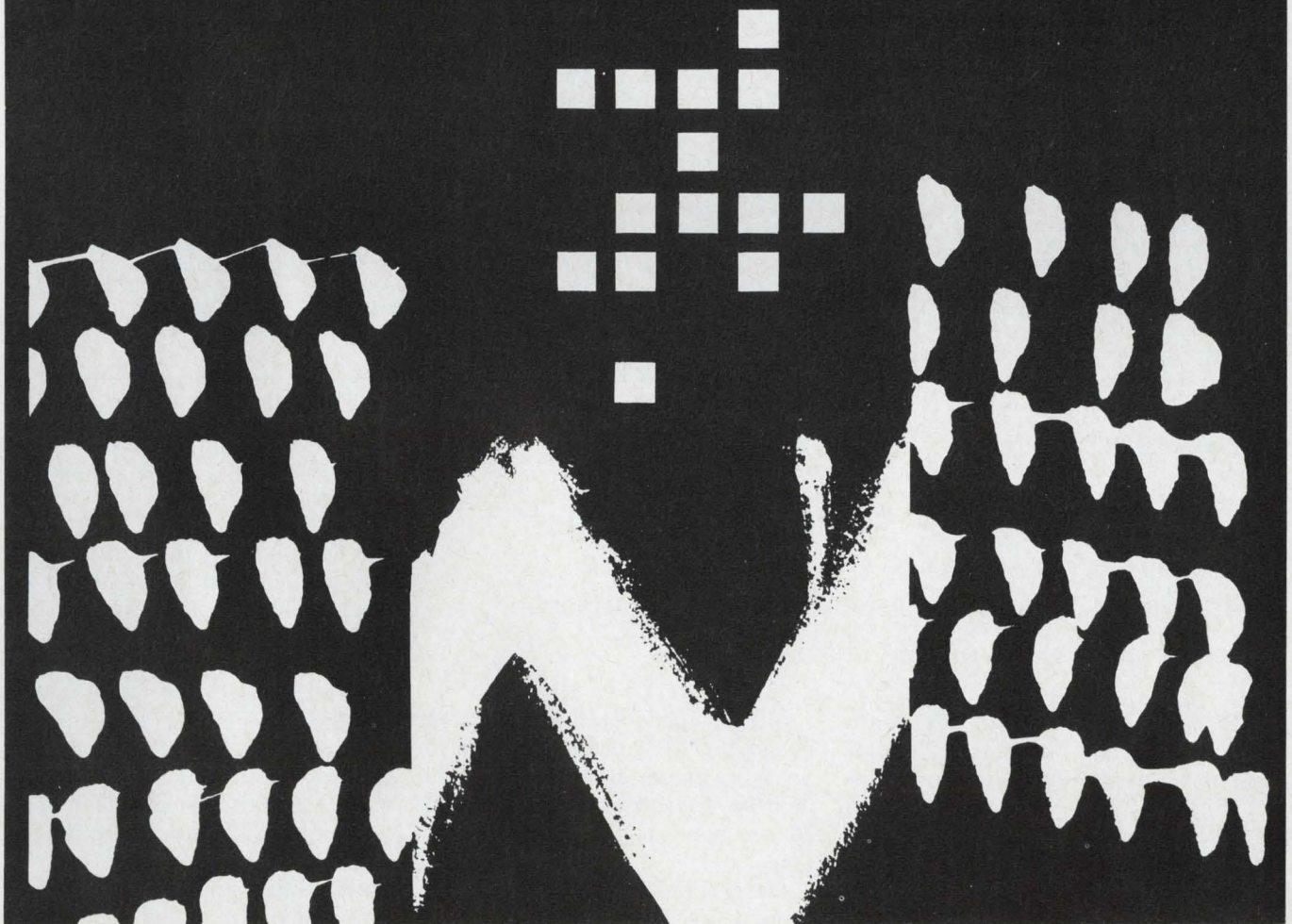

New Subassemblies Review

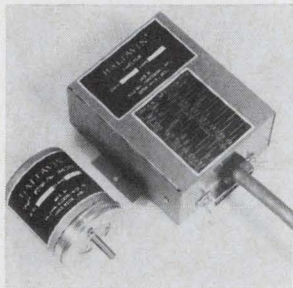

A natural binary system uses a photoelectric absolute-position, direct-reading, single turn encoder with a lamp life in excess of 50,000 hours. It has a capability of 13 bits per turn, outputs compatible with most DTL and TTL IC logic and requires only 2 supply voltages including the lamp voltage. Baldwin Electronics Inc., 1101 McAlmont St., Little Rock, Ark. 72203. [381]

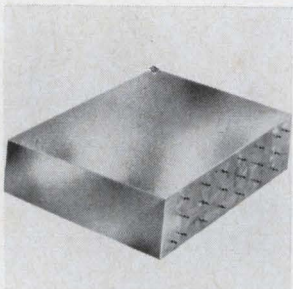

Lumped constant, passive delay line model PC24 is used for encoding and decoding. It features a maximum rise time of 0.1 μ sec with a delay of 24.65 μ sec. The unit is tapped at every 1.45 μ sec and all taps and finish have a delay tolerance of ± 0.05 μ sec. It is supplied in 50 ohms with 18 db maximum attenuation. Allen Avionics Inc., 255 E. 2nd St., Mineola, N.Y. 11501. [385]

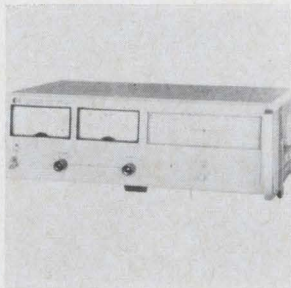

Programable supply 6130A can swing its full range from +50 v to -50 v (or vice versa) in less than 100 μ sec, and it can do this while supplying max. rated output current of 1 amp. Its high programing speed allows a significant increase in the speed of automatic tests performed under computer control. Hewlett-Packard Co., 100 Locust Ave., Berkeley Heights, N.J. 07922. [382]

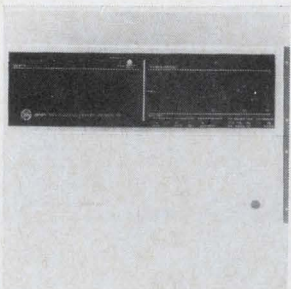

Versa Store II core memory system operates synchronously at 1.7 μ sec with 750 nsec access time. Its design fits 50% more core memory in the same 5 $\frac{1}{4}$ in. rack-mounted package. It is available in increments to 4,096 words of 36 bits, and can also be provided as an 8,000 word memory of up to 18 bits. Varian Data Machines, 1590 Monrovia Ave., Newport Beach, Calif. 92660. [386]

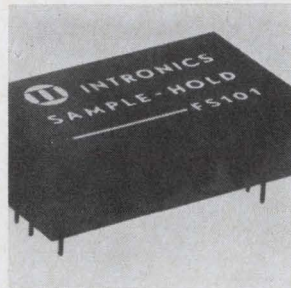

Sample hold module FS101 consists of a fast solid state switch, holding capacitor, and noninverting buffer. Specifications include: ± 10 v input, ± 10 v output, output impedance less than 0.1 ohm, acquisition time 4 μ sec for 0.1% accuracy and 20 v change. Sample command is +4 to +8 v; hold level, 0 to 0.5 v. Intronics Inc., 57 Chapel St., Newton, Mass. 02158. [383]

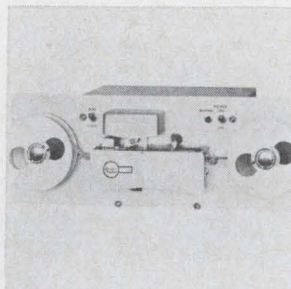

Photoelectric punched tape reader/spooler RRS-302F features a 300-character/sec reader with a 40-ips integral spooler that has 5 $\frac{1}{4}$ -in.-diameter reels. It occupies 7 in. of rack space. Included is electronic noise suppression to a level that virtually eliminates interference with sensitive IC computers. Remex Electronics, 5250 W. El Segundo Blvd., Hawthorne, Calif. 90250. [387]

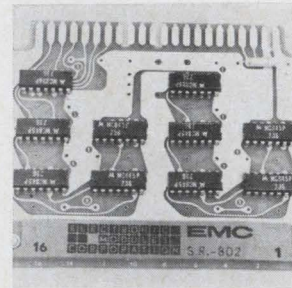

The DIL family of glass epoxy IC logic cards are 5-Mhz units that measure 4.5 x 3.5 in. and incorporate a standard edge connector with 44 rhodium-plated tabs. A quality test point block accepts 16 standard 0.080-in. probes. Circuits operate from 0 to +75°C with +5-v power supply. Electronic Modules Corp., 1941 Greenspring Drive, Timonium, Md. 21093. [384]

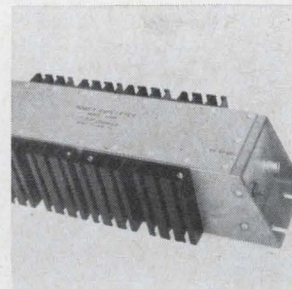

Power amplifier 3008 has an output capability up to 40 v peak-to-peak into 50 ohms, a passband of 1 to 40 Mhz, with a gain of 20 db. It is designed for use in the h-f spectrum and can extend output capabilities of sweep generators, or can be utilized with any application where low distortion is required. C-Cor Electronics Inc., 5960 Decibel Rd., State College, Pa. 16801. [388]

New subassemblies

Sidestepping the System 360 goals

IBM model 25 computer eliminates read-only memory, resurrects features of 1401 and other 'oldies'

With the announcement this month of the System 360 model 25 computer, International Business Machines Corp. took another step away from the design criteria outlined for the 360 line at its debut in 1964.

The new model, 15th in the

series, is aimed at those users of IBM's old 1401 computer who have not yet found other System 360 models—specifically models 20 and 30—economical for their applications.

The original announcement of the System 360 was full of promise:

"With a single new system, IBM has made every one of its commercial computers obsolete." [Electronics, April 20, 1964, p. 101]. That was true at the time and is still true to some extent. But many of the design goals have since been played down.

All machines in the line were supposed to use the same programs. From the beginning, IBM qualified this promise of universal compatibility by promising it only among machines with comparable memory capacities and input-output configurations. The effect has been incompatibility among many models. Meanwhile, six models of the 360

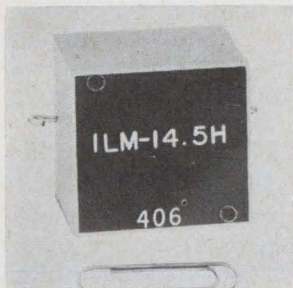

High Q inductors series ILM are temperature stable and designed for use in frequency applications below 1 khz. A range of 2 to 300 henries is covered with high inductive stability and minimum Q of 8 at 60 hz. Size is $1\frac{1}{8} \times 1\frac{1}{8} \times \frac{7}{8}$ in. Prices range from \$15.75 to \$19.50, varying with inductance values. Arnold Magnetics Corp., 6050 W. Jefferson Blvd., Los Angeles 90016. [389]

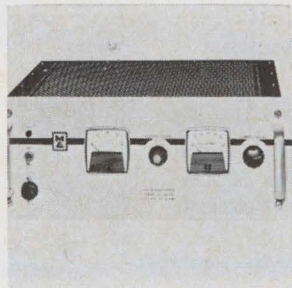

High-power supplies in the RA series will find application both in the laboratory and in systems where small size, regulation of 0.01%, and low ripple are major considerations. Models are provided with outputs from 0 to 20 v d-c at 15 amps to 0 to 60 v d-c at 20 amps. Panel heights are $3\frac{1}{2}$, $5\frac{1}{4}$ and 7 in. Mid-Eastern Industries Inc., 48 Brown Ave., Springfield, N.J. 07081. [390]

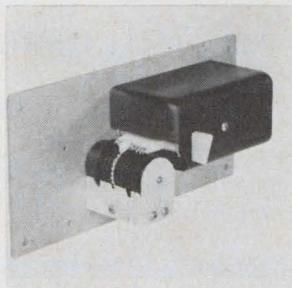

Tape reader model 18 eliminates complex circuitry and timing. It uses starwheels to sense the holes in perforated paper tape. Output is presented in the form of contact closures. The unit reads tape unidirectionally at a rate of 30 characters per sec. An electromagnet is used to advance the tape. Price is \$180. Idea Associates Inc., 290 Huyler St., South Hackensack, N.J. 07606. [391]



YAG laser K-Y2 has a c-w output of 12 w at 1.06 microns. It uses a 3-mm by 50-mm neodymium-doped YAG rod. The laser head measures 4 x 4 x 12 in. and weighs 14 lbs. The power supply is contained in a 10 x 10 x 20 in. cabinet. Input power is 117 v, 60 hz, 2,500 w, exclusive of coder. Korad Corp., 2520 Colorado Ave., Santa Monica, Calif. 90406. [392]



Model DAC TTL is a single card, general purpose digital-to-analog converter. It accepts a binary code of up to 12 bits, stores it in an internal register upon command of an external strobe, converts and holds this number as an output voltage until the next strobe command. Price is \$350 to \$485. Pastoriza Electronics Inc., 385 Elliot St., Newton Upper Falls, Mass. 02164. [393]

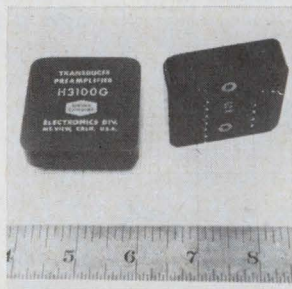

D-c transducer amplifier H3100G has a high input impedance of 10^{12} ohms and an input current less than 50 pa. Common mode rejection for line frequency and noise pickup is 100 db at a gain of 1,000. Bandwidth is 1 Mhz at a gain of 1, and output is ± 10 v at ± 2 ma. The unit measures 2 x 2 x 0.6 in. Union Carbide Electronics, 365 Middlefield Rd., Mtn. View, Calif. 94040. [394]

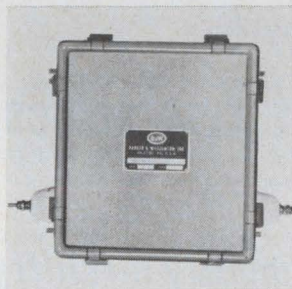

Model RDL-100 is for use as a r-f dummy load or as a rhombic and sloping-antenna resistive termination. It has a frequency range from d-c to 30 Mhz and will dissipate approximately 150 w at an ambient temperature of approximately 25°C. Basic impedance is 600 ohms balanced. The unit measures 8 x 10 x 6 in. Barker & Williamson Inc., Bristol, Pa. [395]



Differential data amplifier type 122 is designed to amplify low-level signals for tape recorders, oscillographs, and data systems. It has continuously variable gains of 1 to 2,500, a bandwidth of $\pm 1\%$ to 10 khz, and is down less than 3 db at 100 khz over the entire gain range. Price is \$525. Neff Instrument Corp., 1088 E. Hamilton Rd., Duarte, Calif. 91010. [396]

line have been discontinued, and other new models have been introduced that cumulatively depart even further from the 360 ideal. In addition, the software specifications of the line had to be changed because of serious problems [Electronics, July 11, 1966, p. 129; Aug. 22, 1966, p. 149].

Where are they? With the model 25, still more of the features that at one time were considered basic to the System 360 line have been modified or have disappeared entirely. On all the other models of the 360, the operator's consoles were kept as nearly alike as possible, so that after a person had

learned to operate one of the models he did not have to be re-trained for another. This common design has been largely abandoned in the model 25. Only the general appearance of the console and a few controls that are considered most useful to the operator have been retained. The others are recommended for use only by IBM's servicemen, although they are not locked against customer use.

Many functions that the operator obtains through console controls on other models are performed through the typewriter attached to the model 25. In some respects this is easier, but it represents a departure



Scratch pad. Monolithic integrated circuits are used for local storage.

NEW! smallest axial shielded inductor available the "NANO-RED"

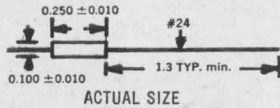

Range: 0.10 μ h to 1,000 μ h in 49 stock values
Size: 1/10 dia. by 1/4 lg.
Inductance Tolerance: $\pm 10\%$

This new "NANO-RED" offers the highest inductance to size ratio available in an axial shielded inductor. Exceptional "Q" and self-resonance characteristics. Max. coupling 2% units side by side. Non-flammable envelope. Designed to MIL-C-15305C. Operating temperature -55°C to 125°C .

Other Lenox-Fugle Subminiature Shielded Inductors:

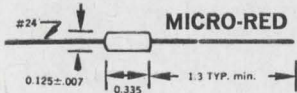

The "Micro-Red" is a shielded inductor that offers the largest inductance range in its size: 0.10 μ h to 10,000 μ h. "Q" to "L" ratio unsurpassed, with excellent distributed capacity. Inductance tolerance $\pm 10\%$. Designed to MIL-C-15305C. Stocked in 61 predesigned values.

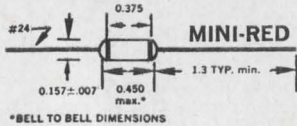

The "Mini-Red" offers the highest "Q" to "L" ratio available over inductance range 0.10 μ h to 100,000 μ h in its size. Inductance tolerance $\pm 10\%$ measured per MIL-C-15305C. Stocked in 73 predesigned values.

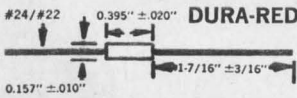

The "Dura-Red" is designed to MS-90537 with inductance range 0.10 μ h to 100,000 μ h with tolerance $\pm 10\%$. Stocked in 73 predesigned values.



Data Sheets: write or phone

LENOX-FUGLE ELECTRONICS, INC.

475 Watchung Avenue, Watchung, N. J. 07060

Telephone: Code 201, 756-1164-1165

Circle 210 on reader service card

... programs can run
in 360 or 1401 mode ...

from uniform design in the 360 line. This method of operation is similar to that used in the 1410, which was a 1401 "growth" machine, and in certain other old IBM computers.

In the model 25, surprisingly, the read-only memory is eliminated. The control functions performed by the read-only memory in other models are done by a portion of the main memory that can be loaded with different microroutines in the same way as regular user programs. These microroutines are available for bit-by-bit and word-by-word modification by the programmer, just like any other program. In this respect also, model 25 is similar to pre-360 machines.

Option. The elimination of the read-only memory has one advantage: it permits the model 25 to run programs in either 360 mode or 1401 mode, and the changeover involves only reading in a new deck of cards containing the appropriate control routines. Other models, notably the model 30, can be made to emulate the 1401, but the read-only memory must be physically removed and replaced to change the mode, a job that takes the serviceman about a half-hour.

Control units for the card reader, card punch and printer, which are in separate cabinets in other 360 models, have been incorporated into the central processor in the model 25, in much the same way as they were in the 1401. The change saves floor space, but also inhibits the flexibility of these devices. The 1401 also had internal control units and transferred data directly between the devices and fixed locations in its memory, with no intervening buffer.

Like other models of the 360, the new machine has a local storage unit, or scratch pad, that stores data temporarily during a computation, but unlike other models, the scratch pad in the model 25 is made of monolithic integrated circuits. The model 25 is the first announced use of these circuits by IBM in a commercially available computer. IBM now says that monolithic circuits are used in the scratch pad of the model 44, but this was not announced when the model was in-

Simplify Circuitry, with —

RSC ROTARY SWITCHES

—Lower Systems Costs,
Proven Reliability!

Available in a diversity of switching modes, RSC high precision, quality built units are designed for applications requiring long-life, maintenance-free service. Types include shorting and non-shorting, single and multi-deck, up to 18 pole positions. Request literature.

Features

- 10 to 100 Ampere Current-carrying Capacity
- 20° to 90° Detents
- 2000 to 24000 Volts Flashover
- Heavily Silver-plated Contacts
- Corrosion Resistant Construction

Founded 1933



RADIO SWITCH CORPORATION

MARLBORO, NEW JERSEY 07746
Telephone: (201) 462-6100



RSC MODEL 80 SWITCH (Illustrated)
4500 volts peak flashover at 60 cps;
10 ampere current carrying capacity





"We're in South Dakota

...because it's a progressive state with a progressive attitude toward industry. Marvelous recreation facilities and good living environment help us attract and hold productive workers."

Mark Bolluyt, Division Manager
DALE ELECTRONICS, INC. Yankton, South Dakota



Dale Electronics has been in Yankton only 10 years, but it has been a decade of growth and advancement. Currently under construction is a 55,000-square-foot building which will consolidate the firm's five plants employing 400 people. Dale components have been in every space probe made by NASA and its products are used in the nation's most sophisticated missiles.

Dale is only one firm which has found a future in SOUTH DAKOTA, industry's newest frontier. Eager, alert, trainable personnel are helping manufacturers

reach new goals of excellence and production. Dale's business grew 40 percent last year! Let us show you why we say: "You'll make it BETTER for LESS in SOUTH DAKOTA."

For the complete story on opportunities for your industry in South Dakota, contact:

Robert H. Martin, Director
SOUTH DAKOTA I. D. E. A.

Dept. 7
Pierre, South Dakota 57501
Phone 224-5911 Ext. 307 (AC 605)

Circle 211 on reader service card

roduced in 1965.

The model 25 will be available with a main memory in any one of four sizes from 16,000 to 48,000 eight-bit bytes; the memory's cycle time is 900 nanoseconds. The monolithic scratch pad's cycle time is 180 nanoseconds. Many different kinds of peripheral equipment are available, including punched-card, magnetic tape and disk units, visual display stations, audio response units and process control devices.

Typical prices are \$5,330 rental per month, or \$275,000 for purchase. The first shipments are expected during the first quarter of 1969.

IBM Corp., 112 East Post Rd., White Plains, N.Y. 10601 [397]

New subassemblies

Golfers, burglars, how's your style?

Video tape recorder

has automatic repeat, remoting capabilities

Weekend golfers and Tuesday night bowlers may soon be studying their form on instant-replay television. The Matsushita Electric Industrial Co. has introduced a portable video tape recorder, the NV-1050, which it calls the first medium-priced recorder with remote control plus automatic, repetitive playback and record capabilities. One planned application is for coin-operated video tape systems.

The basic recorder is similar to Matsushita's NV-1800, which the company exports to the U.S. with the Panasonic label. One difference is that all pushbuttons on the newer model are solenoid-powered, so less pressure is needed to depress them.

Untied teacher. A remote control adapter is cable-connected to the recorder. The operator uses it to tell the recorder to record, playback, rewind, advance or stop.

Portable recorders are commonly used for academic and industrial instruction. The remote control adapter on this device, however, allows the teacher to move freely

PRECISION 1000.000 KHz

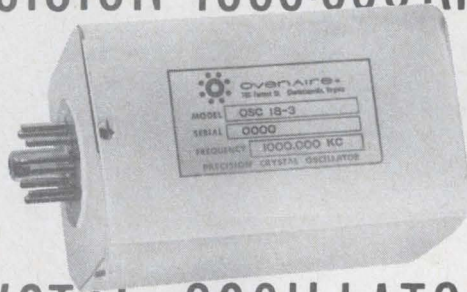

OSC 18-3

CRYSTAL OSCILLATOR

STABILITY*

Long term: Aging rate 3×10^{-9} /day

Short term: $\pm 5 \times 10^{-10}$

*Complete specifications for this oscillator available in brochure. Other stabilities and frequencies available to published specifications.

- Excellent solid state oscillator design utilizes proportional control oven.
- Oven temperature matched to crystal turn provides exceptional stability for precise requirements.
- Oven ambient compensation techniques produce top performance over a wide temperature range.
- Each oscillator is preaged prior to shipment and guaranteed to specification.



ovenaire INC.

706 FORREST STREET
CHARLOTTESVILLE, VIRGINIA 22901

FREQUENCY COMPONENTS DIVISION
WALTER KIDDE & COMPANY, INC.

OVENAIRE, INC.
Charlottesville, Va.

CROVEN, LTD.
Whitby, Ontario, Canada

FILTAIRE, INC.
Charlottesville, Va.

Kodak
TRADEMARK

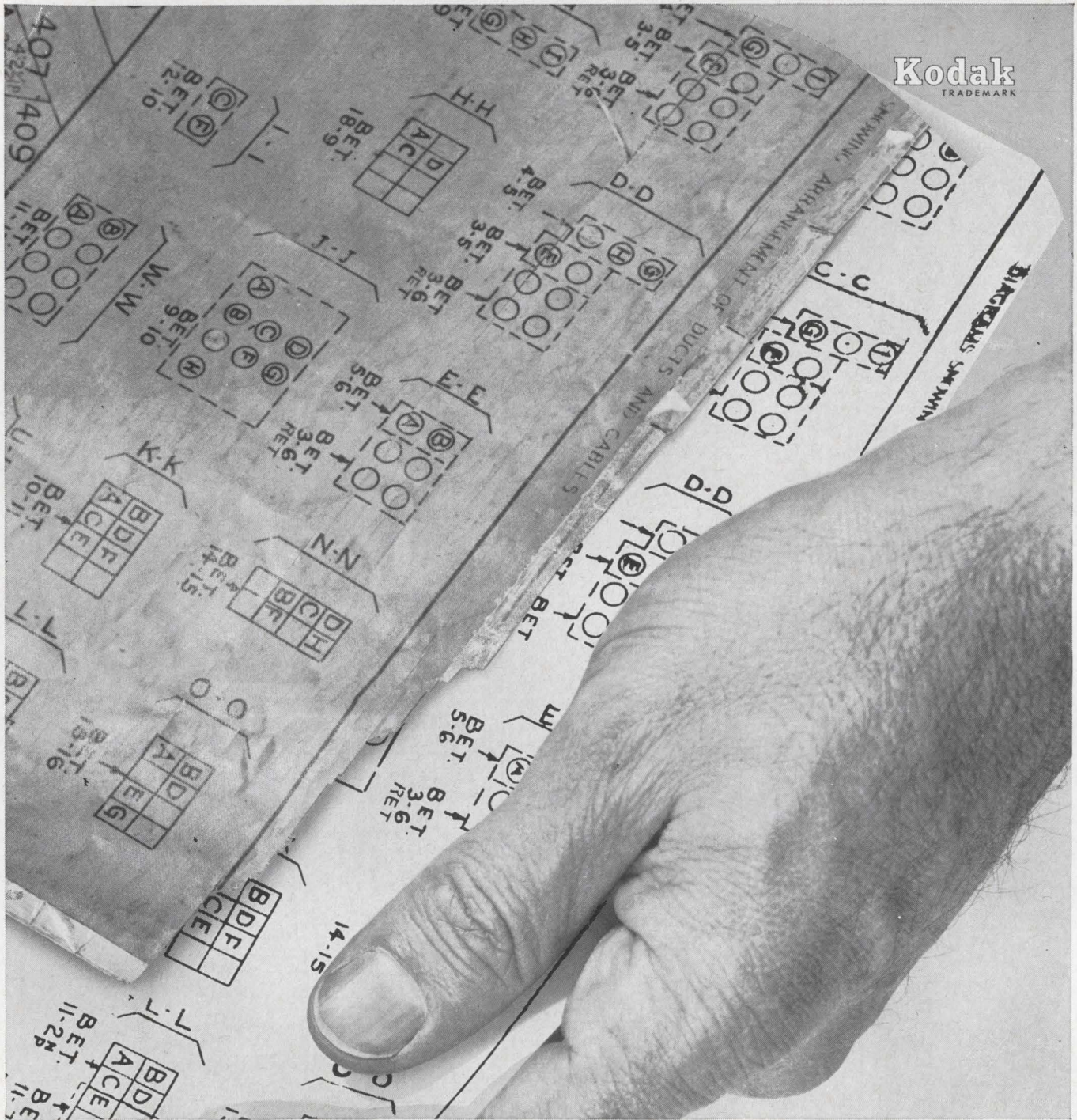

Old drawings are restored best on Kodak's Estar base films

That faded, soiled original above looked sad and questionable until it was reproduced on KODAGRAPH ESTAR Base Film. Notice how the faintest detail came back sharp and clear; how creases and stains disappeared; how the whole drawing is restored to good as new!

Challenge your Kodak Sales Repre-

sentative. Ask him (or a blueprinter handling ESTAR Base Films) to show you how you can get beautiful second originals from your own tired drawings without costly redrafting.

Write Eastman Kodak Company, Business Systems Markets Division, Rochester, New York 14650.

DRAWING REPRODUCTION SYSTEMS BY KODAK

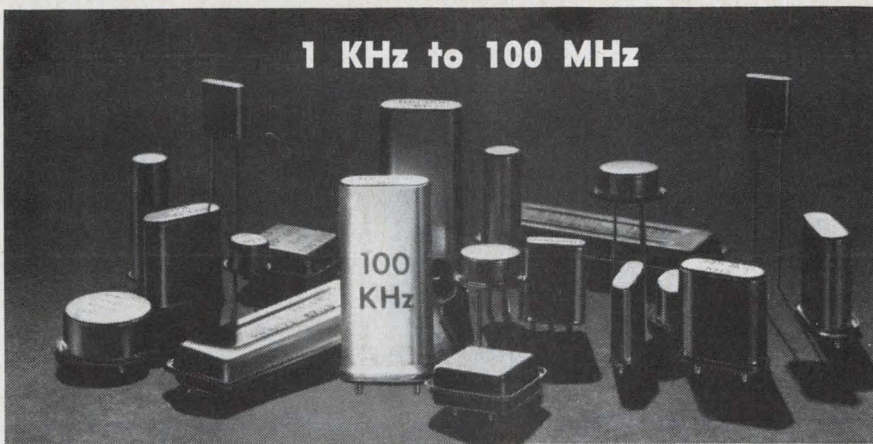

1 KHz to 100 MHz

Can a 100 KHz crystal get lost in the field of frequencies?

Not if you look at Reeves-Hoffman! We are artists in ultra-precision crystals . . . but we're also experts and efficient at meeting less-demanding requirements. For example, the 100 KHz crystal shown above, and specified below, can be supplied in production quantities for less than \$2.50 each. How much less? Let us quote.

| | |
|---|---------|
| Frequency | 100 KHz |
| R ₁ , ohms | 1,800 |
| L ₁ , henries | 67 |
| C ₁ , picofarads | 0.037 |
| C ₀ , picofarads | 5.78 |
| Q | 24,000 |
| 5° X crystal for filter or oscillator applications, fundamental extensional mode. | |

REEVES-HOFFMAN
DIVISION OF **DCA**

400 WEST NORTH STREET, CARLISLE, PENNSYLVANIA 17013
Circle 212 on reader service card

in the classroom without interrupting his instruction routine. And the unit can be placed in an adjacent area where it does not distract the students.

With the repeating adapter attached, the NV-1050 will play or record over and over again. Matsushita thinks repetitive replay will appeal to stores, for product demonstrations, and to producers of industrial and cultural exhibits. Students will be able to watch and hear taped lectures at will.

Holdup monitor. The adapter also permits repetitive recording, so the



Versatile. Repeating adapter, left, and control unit can be carried away from the recorder.

NV-1050 can be used for taping experiments in a laboratory, or for monitoring a bank to detect intruders. In these applications switching devices—not supplied with the unit—are needed to shut off the recorder so that wanted pictures are preserved on tape and are not erased.

An aluminum-coated segment of the recording tape triggers repetition. When this sensing portion of the tape passes the heads, the recorder automatically rewinds and plays or records again.

The NV-1050 is compatible with camera and monitors used with other Matsushita portables. It uses a full-field scanning system to improve picture quality and can reproduce still and slow motion pictures.

In Japan, the NV-1050 will sell for about \$1,000. The U.S. price will probably be about \$1,500.

Matsushita Electric Industrial Co., Osaka, Japan. [398]



Every Engineer or Draftsman should have the NEW 1968 BY-BUK CROSS REFERENCE GUIDE P-45

(supersedes By-Buk Catalog No. P-42)

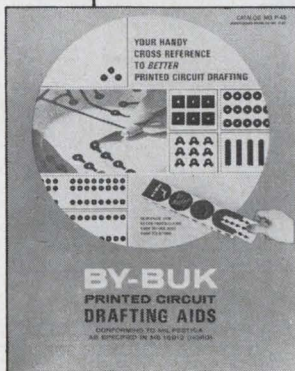

to better printed circuit drafting.

This FREE 24 page booklet contains color-coded standard MIL-SPEC SIZES and design standards . . . plus a newly added numerical index for easy reference to over 2000 pre-cut tapes, pads, shapes,

terminal pad sets and other drafting aids for faster, more accurate, distortion-free printed circuit master drawings.

Send for your FREE guide today!

BY-BUK COMPANY

4326 West Pico Blvd. • Los Angeles, Calif. 90019 • (213) 937-3511



Marketing axiom number 1:

SELL WHERE YOU BUY.

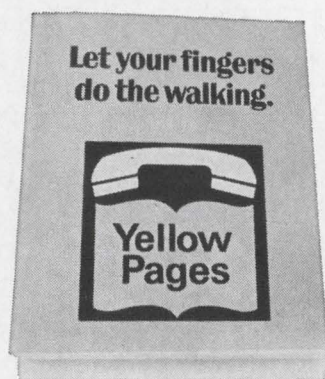

Chances are you or somebody in your company uses the Yellow Pages regularly to buy supplies or services you need to do business. A study of just manufacturing firms alone proved 9 out of 10 buyers do. That's why the Yellow Pages is such a good place to reach business prospects with *your own* advertising. Sell where you buy. It's good business.

Because of new ideas from Sanders . . .

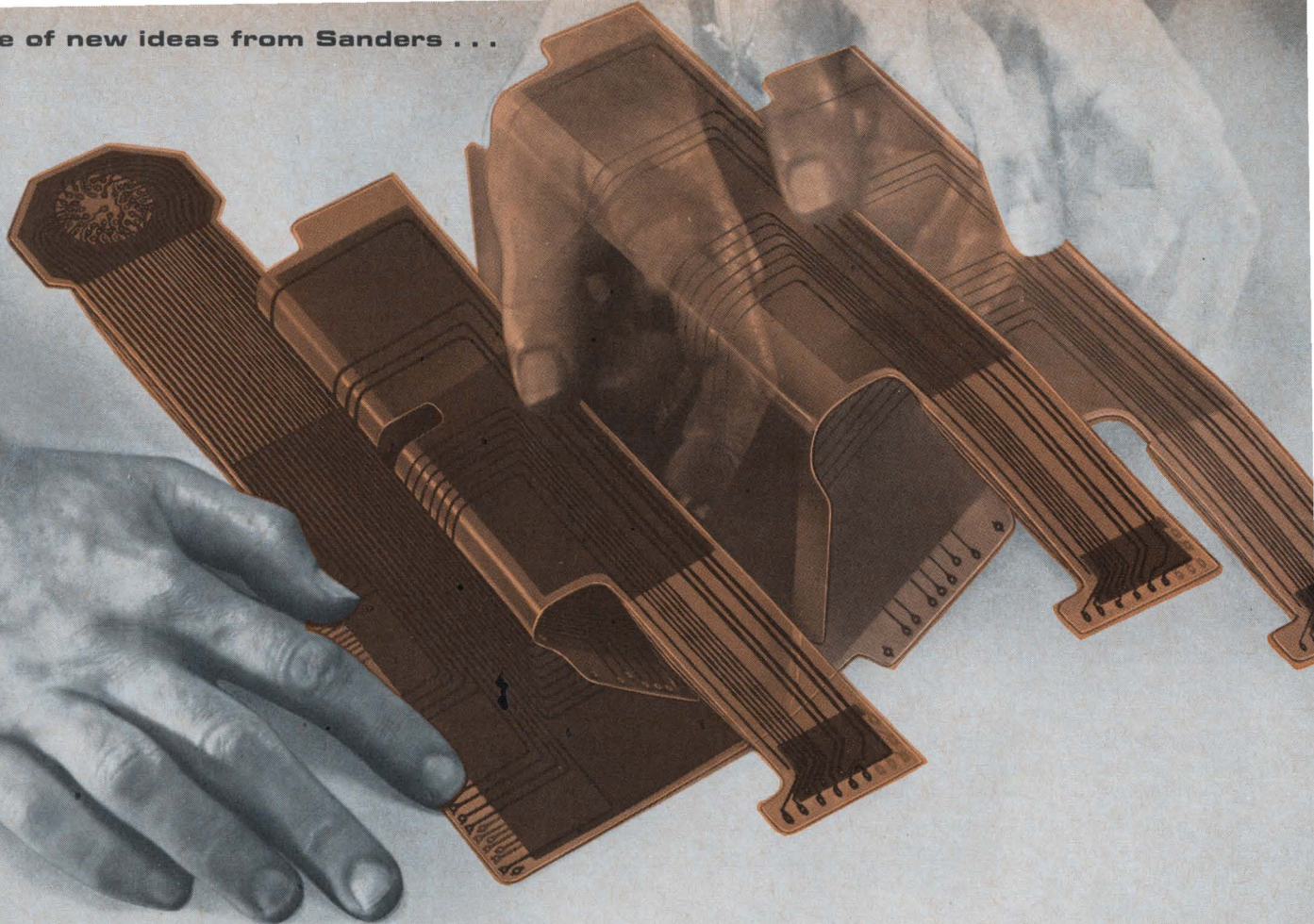

Flexprint[®] circuitry eliminates the difficult dimensions

Volume, weight and shape. Reduce these problem areas, and you've got more latitude to meet restrictions imposed by unusual form factors and limited spaces available for interconnections in modern electronic gear.

Today, with Sanders advanced flexible circuit design and manufacturing techniques, FLEXPRINT circuitry provides an almost infinite number of ways for component and system producers to achieve these reductions.

In a new airborne control system, 3 layers of FLEXPRINT Circuitry with both rigid and flexible sections incorporate hardboards on which various components are mounted during assembly.

No jumbled wiring interconnections here. By laminating the 3 sections together to obtain rigid areas, the number of solder connections is greatly reduced . . . which speeds final assembly, reduces costs and improves reliability.

Perhaps there is a problem in your electronic package you'd like to eliminate. By starting your design with FLEXPRINT Circuits, the tough ones can be cut down to size. Call or write Sanders Associates, Inc., FLEXPRINT Division, Grenier Field, Manchester, New Hampshire 03103. Phone: (603) 669-4615.

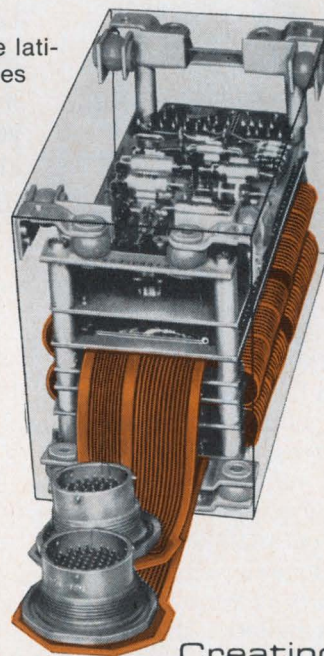

A unique 3-layer combination of flexible and rigid sections, the finished FLEXPRINT assembly in this airborne control system reduced volume 50%, with comparable savings in size and weight, installed faster and at lower cost. Wave soldering was made possible by careful material selection.

Creating
New Directions
In Electronics

SA  **SANDERS
ASSOCIATES, INC.**

FLEXPRINT DIVISION
GRENIER FIELD, MANCHESTER, NEW HAMPSHIRE

Circle 164 on reader service card

Yugoslavians sell electron microscope

Device with 25-angstrom resolution aimed at solid state work

An electron microscope generally has a price tag of more than \$20,000, and it requires a technician to prepare samples and operate the instrument. Seeing a market for a low-price, easy-to-operate and less powerful instrument, Iskra of Yugoslavia is making an electron microscope designated the LEM-5. "We're trying to fill the gap between sophisticated optical systems and high-priced electron systems," says Joze Hujs, Iskra's representative in America. "The LEM-5 is probably the cheapest scope with its characteristics."

With import duty added, the price of the LEM-5 is about \$12,000. Resolution, the smallest distance between two points at which the points can be distinguished, is 25 angstroms. Magnification at the screen is adjustable between zero and 16,000. An optical system increases the system magnification by a factor of ten. This optical system also allows more than one person to observe the image.

Another feature of the LEM-5 is electrical self-cleaning. Dust in the chamber of the microscope collects around a small aperture just above the sample. As the electron beam passes through this aperture, electrons collide with the dust particles. This dispersion of the beam reduces the sharpness of the image. Dust is burned off the aperture of the LEM-5 by passing current through an adjacent platinum wire. The cleaning is done during operation with little loss of time.

Iskra promises delivery in three to four months. Price includes installation charges. The Yugoslavians are looking for an American company to market and service the system.

Iskra Representatives, Inc., 509 Madison Ave., New York, N.Y. 10022 [399]

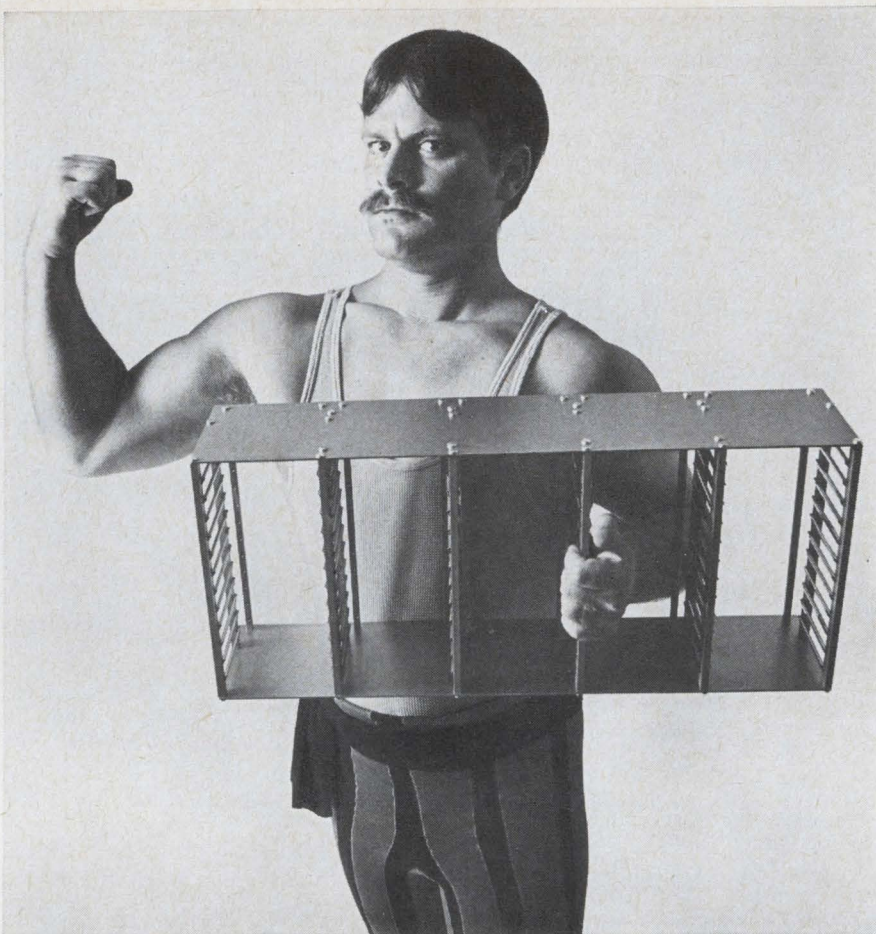

Rugged new lightweight.

Lightweight?

Right; any rack made with Birtcher 57-Series components is a lightweight. Even that 60-card job in the picture weighs less than 5 pounds—yet it's rugged enough to hold boards securely through the toughest kind of service. You can design any number of configurations with these basic 57-Series components:

- Support Rails (4 to a set)—17" long, aluminum, easily cut to your desired length. Rivet holes (0.062") are pre-drilled in the rails on 0.2" centers for fastening the card guides.
- Miniature Card Guides (Birtcher 35-7 type)—a high-density, low-profile guide that needs only 1/8" of board edge to grip. Guides are available for 1/32" and 1/16" boards, in lengths from 1" to 6", in 1/2" increments. Made of beryllium copper for heat sinking and electrical grounding in addition to tight, springy grip.
- Connector-Mounting Rails (2 to the set)—also 17" long, aluminum, and easily cut to length; the simplest answer yet devised for the connector problem.

Birtcher 57-Series PCB racks are available in "kit" form, or fully assembled to your order. Contact your Birtcher distributor, or

the BIRTCHER CORPORATION
INDUSTRIAL DIVISION

745 Monterey Pass Road • Monterey Park, California 91754 • (213) 268-8584

NEW FROM AUSTRON

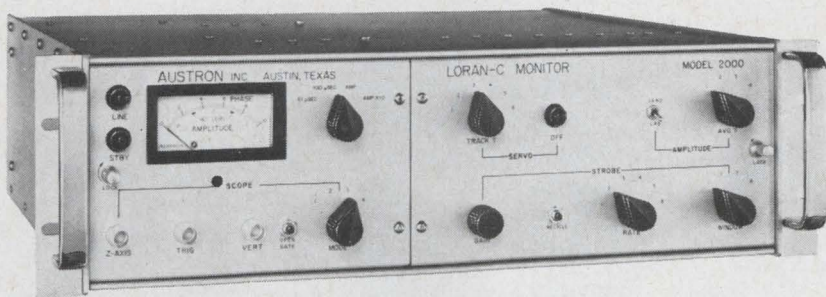

Loran-C Tracking Receiver

Austron's new Model 2000 receives and phase-tracks Loran-C signals for time and frequency calibration and control. Key features include:

- all-chain repetition-rate capability
- direct cycle identification
- all-electronic servo system
- simple, straightforward signal acquisition
- reliable tracking under extreme atmospheric noise or cross-rate interference conditions. Call or write today for comprehensive data sheet.



10214 NORTH INTERREGIONAL HIGHWAY, AUSTIN, TEXAS 78753 TELEPHONE (512) 454-2581

Circle 213 on reader service card

**... decrease in current
causes alarm to sound ...**

released from the fire area.

Because the particles are warmer than the ambient air, they rise to the ceiling detector and become attached to the air ions. This increases the weight of the ions, causing them to move more slowly and decreasing the net current flow between the plates. The decrease in current is sensed, causing the amplifier or tube to pull in a relay and sound the alarm.

Drawback. Different variations of this system have been manufactured during the past few years, but all have one drawback: a trade-off between sensitivity and stability. Being threshold devices, they are triggered when the current drops below a predetermined level. And the level is determined by the sensor's environment.

If, for example, it is used in a "clean room," the sensor is set to go off when a cigarette or a match enters its sphere of influence. If it is installed in a conference room, then its sensitivity must be reduced to prevent false triggering. Problems arise because the devices act instantaneously. At high-sensitivity settings, this often results in false triggering.

Gamewell's third-generation detector, the Fire Alert FT-100, uses a sampling technique. Instead of the current flow triggering the alarm, it charges a capacitor. Using a unijunction transistor timing circuit, the charge on the capacitor is monitored every 18 to 20 seconds. If no products of combustion are present, the capacitor reaches a maximum charge in the 18-second interval. If a fire is starting and, after 18 seconds, the capacitor has not reached its maximum charge, this is sensed, triggering the alarm.

The advantage of this system, according to the maker, is that there is no loss of stability at a maximum sensitivity setting. The device can be set to trigger an alarm by the presence of a burning match, but the match must be burning for a finite time. Unlike other ion detectors, the FT-100 doesn't require a regulated supply voltage. It operates on 21 to 24 volts d-c, which is readily available in most alarm systems. Being only 2.5

BEST vacuum THERMOCOUPLES

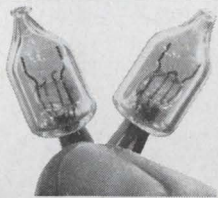

Used by prominent instrument manufacturers in the U.S. and abroad for

- true RMS measurement
- transfer standards
- sum and difference multipliers
- low range UHF applications.

For example, a matched pair of Best thermocouples contributes to the outstanding accuracy of the 9500A

FLUKE
RMS
digital
voltmeter

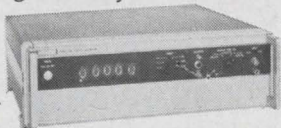

If you are designing or manufacturing an AC instrument, why not make it true RMS?

Standard and UHF patterns; high output and square law models; matched pairs. See Sec. 5300, EEM. Catalog on request. For free application notes, write on company letterhead to

**BEST ELECTRICS DIV.
HARRY LEVINSON CO.**

1211 E. Denny Way, Seattle, Wash. 98122
Tel. (206) 323-5100 TWX 910-444-2154

Reed Relay Problems?

A special
AND logic
relay in
the new "UF"
configuration.

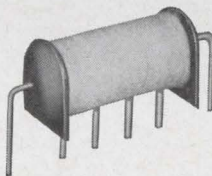

Can We Solve Your Problem?

Operating Inputs: low as 1mA. and 15mW.
Standard Coil Voltages: 6, 12, 24, 32, 48V in stock for immediate delivery.
Special Voltage or Resistance, multiple windings for flip flop, memory and crosspoint selection applications — to customer specifications.
Relay Contacts in Form A, B, C and latching. Also high vacuum type 5000V Form A.

Write for catalog and prices of our standard line of magnetic reed relays. For special requirements, give complete details for quotation.

Coto-Coil COMPANY INC.
61 Pavilion Ave.
Providence, R. I. 02905
Phone: (401) 941-3355

New Industrial Electronics Review

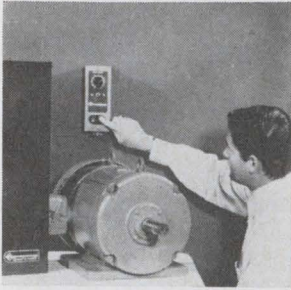

Adjustable speed scr drives are rated from 7½ to 30 h-p. Input is 3-phase, 50/60 hz, 230 v (7½ to 15 h-p) or 460 v (7½-30 h-p). A-c input is rectified to full wave d-c in the solid state controller. Base speeds are 2,500 and 1,750 rpm; speed range, 30:1 constant torque. U.S. Electrical Motors Div., Emerson Electric Co., Box 2058 Terminal Annex, Los Angeles 90054. [421]

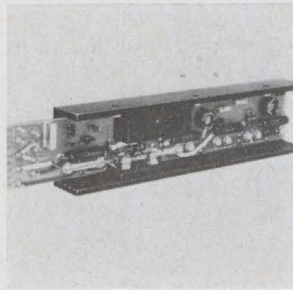

Solid state amplifier series 214 can operate up to 28 v and 25 amps. It can be used with any position servo or bidirectional velocity servo. When used with a series 204 motor, the combination produces 1.5 ft lbs of torque. Price varies from \$295 each in quantities of 1 to 10 to \$139 each in 1,000-piece quantity. Magnedyne Inc., 5580 El Camino Real, Carlsbad, Calif. [422]



Solid state temperature controllers for the process industries use 2 separate circuits, one for control, the other for indication. Vibration or shock has no effect on performance. Scale spans cover 0 to 400, 800, 1,200, 1,600, 2,000, 2,400 and 3,000°F, to work with J, K and S thermocouples. Apparatus Controls Div., Honeywell Inc., 2727 S. 4th Ave., Minneapolis 55408. [423]

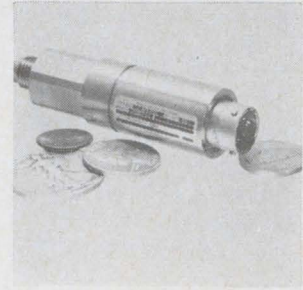

High-output pressure transducer consists of an unbonded strain gauge sensor coupled with IC electronics. Type 4-393, above, requires a regulated 10-v input. Type 4-394 accepts unregulated input varying from 18 to 36 v. Outputs are 0-5 v d-c; pressure ranges, 0-10 to 0-10,000 psi. Consolidated Electro-dynamics Corp., 300 Sierra Madre Villa, Pasadena, Calif. 91109. [424]

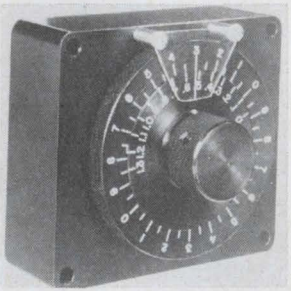

Compact AccuDrive shaft positioner model DSD-8 is for setting and resetting precision control components such as potentiometers, synchros, resolvers, phase shifters, and tuners to 12 ft of arc accuracy. Nothing protrudes behind the front panel but the shaft and coupling. Unit price in small quantities is \$195. Acton Laboratories Inc., 531 Main St., Acton, Mass. 01720. [425]

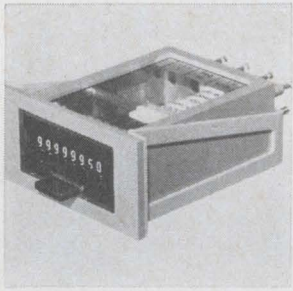

A Sodeco counter with 8-digit capacity has counting rates up to 60 impulses/sec. Its size (1.89 x 0.95 x 2.84 in.) and plug-in connection provide versatility. Typical installations include multiple machine function control or operation supervision; multi-counter recording functions; and totalizing functions of all types. Landis & Gyr Inc., 45 W. 45th St., N.Y. 10036. [426]

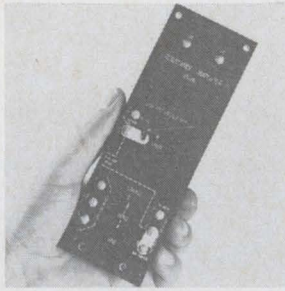

Resistance amplifier 55TR8 meets modern process requirements of narrow and broad spans for single point or differential temperature applications. It has a voltage output of 1-5 v d-c, with a source impedance of less than 25 ohms, and a current output of 4-20 ma into any load from 0 to 550 ohms. Motorola Instrumentation and Control Inc., P.O. Box 5409, Phoenix, Ariz. 85010. [427]



The Porta-Trol is a portable, high-temperature instrument control system for use in furnace control between 0 and 2,500°F. It is accurate to within ±1% in that range. Five standard systems are for current ranges up to 100 amps, and range in price from \$250 to \$440. Delivery takes 2 to 3 weeks. Areenco Products Inc., P.O. Box 145, Briarcliff Manor, N.Y. 10510. [428]

New industrial electronics

Sensing the fire before it erupts

Sampling technique used to charge capacitor and trigger alarm in 18 to 20 seconds

A fire detector is usually nothing more than a bimetallic strip and a point contact. The heat produced by a flame causes the strip to bend and make contact, turning on an alarm. More sophisticated are the second-generation detectors that operate on an ionization principle.

But they have had a serious drawback: false triggering is a common occurrence because of high sensitivity.

A third-generation detector, developed by the Gamewell division of the E.W. Bliss Co., uses the ionization principle but operates on a

sampling basis that reportedly prevents false triggering.

In detectors that employ the ionization principle, a radioactive source emits alpha particles and two metal plates serve as the ionization detector. The particles ionize the air between the plates, creating positive and negative ions. Because there is a d-c potential across the plates, the positive ions are attracted to one plate and the negative to the other, so there is a net current flow. This is monitored by some form of electronic circuit, ranging from a differential amplifier to a cold-cathode tube. When a fire is just starting, particles are



“Smiling” Sam Price just stopped smiling.

“Smiling” Sam Price hoped he’d find a goof in Trygon’s new Liberator Sub-Rack Power Supplies. Once upon a time, he’d found a bug in a rack model which made him a hero among the Twelve Cranks on Pleasant Avenue. Since then, Sam has had to do without that thrill. Everything he checks out—checks out! As usual, at Trygon.

Liberator Sub-Racks are a new concept in system power instrumentation, with the versatility of half-rack and quarter-rack, modules and metered models. Rack adapters let you mix and match units to get up to eight different outputs in a 19” rack width.

Just like the full-rack Liberators, the new sub-racks provide the ultimate in minimum size at lowest possible cost. With 24 models in wide slot voltage ranges from 2.5-4.5 VDC to 22-32 VDC and higher. Output current levels from 1.4 amps to 25 amps. Plus: .01% regulation/.5mv ripple/3mv P-P noise/.03% stability/extremely low output impedance/MIL-spec performance/adjustable overvoltage protection.

And every Trygon Liberator Sub-Rack Power Supply comes off the line under “Smiling” Sam’s baleful eye. With his tears wiped off, of course.

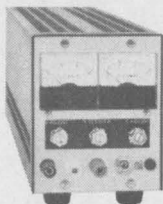

Trygon Power Supplies

111 Pleasant Avenue, Roosevelt, L.I., N.Y. 11575
Trygon GmbH 8 Munchen 60, Haidelweg 20, Germany
Write for Trygon 1968 Power Supply Handbook.

inches high and 5.75 inches in diameter, the sensor can be mounted in an air-conditioning duct, or in other out-of-the-way areas.

When used as a sensor in a duct, special collector plates are employed to take into account the turbulent air flow. The plates are ribbed to change the flow characteristics, preventing false triggering. To further reduce the effects of the turbulent flow, air velocity shields are attached to the plates. Because different ducts have different characteristics, the plates are interchangeable by the removal of two screws. The entire unit is placed on the duct in a 4-inch box and connected through a length of ½-inch or larger conduit to a supporting plate and a connecting box on the outside face of the sheet-metal duct.

E. W. Bliss Co., Gamewell division,
Natick, Mass. [429]

New industrial electronics

Going directly to the director

Numerical control device
converts displacement
into logic input

The sharp eyes and sensitive hands of skilled machinists are steadily being replaced by programmed feedback control systems, in which positioning and tooling operations are automatically performed under directions from tape readers.

A rotary square wave generator is a key element of these numerical control systems. Its signals tell the positioning control director precisely where the piece to be machined is located at all times. The shaft of the generator is attached to the slide on which the piece is fastened. Linear motion of the slide causes rotary motion of the shaft, and this produces the electrical signals. These signals are fed back to the position controls.

Trump-Ross Industrial Controls, Inc. has added an amplifier stage to its rotary pulse generator, called the Tru-Rota, and this new device

Want to design for
INSTANT STARTING?...
SPLIT-SECOND ACCURACY?
REVERSIBILITY?...
MIXED SPEEDS?...

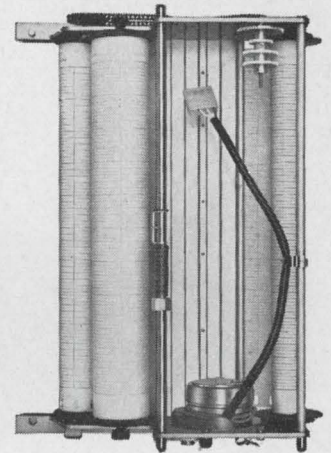

turn the
job over to
SYNCHRON® MOTORS!

No matter whether you want a motor to withstand swiftly changing temperatures, meet fast-reversing stresses, turn a small part with exact accuracy to 1 Rev. per week or 600 Rev. per minute, there’s a SYNCHRON Motor that can do it! It can do a hundred other things as demanding as these — if you tell us how you want it to function. Before you start any design that calls for small drive or timing motors, think of SYNCHRON Motors, and call or write us at Hansen Manufacturing Company. We’ll be there at once to help — with experience. Better still — don’t wait till you face a problem. Write us now — let us tell you about SYNCHRON Motors and the ways we design them to work for you.



HANSEN REPRESENTATIVES: CAREY & ASSOCIATES, Houston and Dallas, Texas, R. S. HOPKINS CO., Sherman Oaks, Calif., MELCHIOR & MACPHERSON, INC., San Carlos, Calif., THE FROMM COMPANY, Elmwood Park, Ill., H. C. JOHNSON AGENCY, INC., Rochester, N.Y., JOHN ORR ASSOCIATES, Grand Rapids, Mich., WINSLOW ELECTRIC CO., Essex, Conn., Narberth, Pa., and New York, N.Y. EXPORT DEPARTMENT, 64-14 Woodside Ave., Woodside, N.Y.

Don't despair because the company's educational program wasn't planned for your electronics support people...

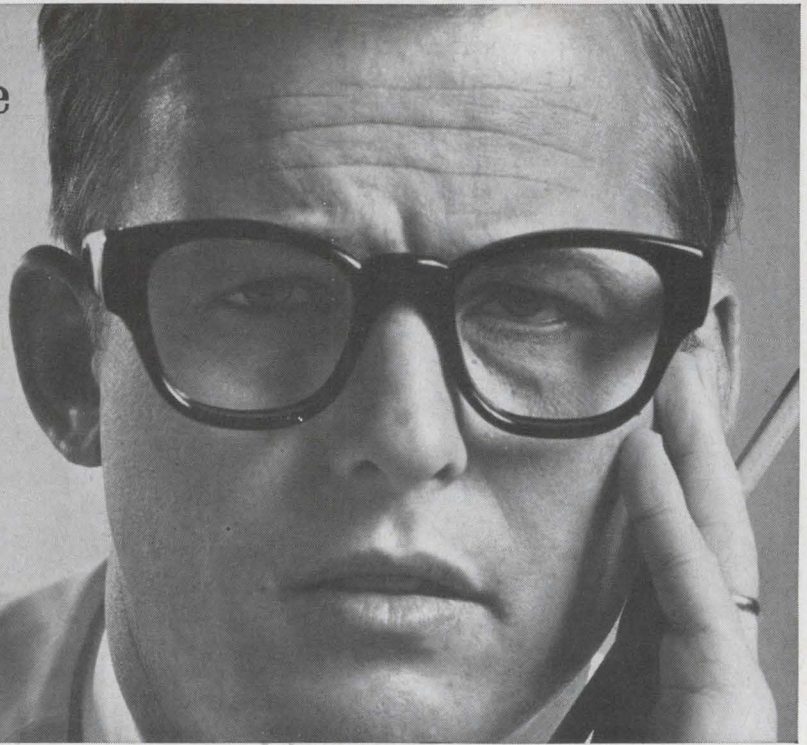

improvise

Look over your men. Pick out a few who are intelligent enough to profit from more education in electronics, ambitious enough to work hard to get it. Send us their names and addresses. We'll send them complete information about CREI Home Study Programs in Electronics, tell them how these programs have helped thousands of young men increase their value to their employers. We'll explain how they can study at home, at their own pace, on their own schedule without traveling

to classes. We'll give them the names of the more than 80 leading scientists and engineers who help us develop and update programs related directly to the needs of industry.

Yes, we'll do all that. If you're lucky some of your men may enroll. Why not give it a try? Fill out the coupon and get it in the mail today.



CREI Programs cover these specialized areas of advanced electronics:

- Communications Engineering • Aeronautical and Navigational Engineering • Television Engineering • Computers • Nuclear Instrumentation and Control • Automatic Control Engineering • Missile and Spacecraft Guidance • Radar and Sonar Engineering • Nuclear Engineering Technology • Industrial Electronics for Automation • Computer Systems Technology.

CREI
THE CAPITOL RADIO ENGINEERING INSTITUTE

A Division of McGraw-Hill, Inc.
Dept. 1804 G, 3224 Sixteenth Street, N.W.
Washington, D.C. 20010

Gentlemen: The men listed at right are high school graduates working in some phase of electronics. Please send them your FREE book, "How to Prepare Today for Tomorrow's Jobs" and complete information about CREI Home Study Programs.

And please send me the free brochure which tells how we can use CREI Home Study Programs to supplement our educational program for electronics personnel.

Name _____
 Title _____
 Company _____
 Address _____
 City _____ State _____ Zip Code _____

Name _____
 Address _____
 City _____ State _____ Zip Code _____

Name _____
 Address _____
 City _____ State _____ Zip Code _____

Name _____
 Address _____
 City _____ State _____ Zip Code _____

Name _____
 Address _____
 City _____ State _____ Zip Code _____

(Not enough room? Attach sheet of paper with additional names and addresses)

Specify
PERMACOR®
where iron cores
is our one and
only business

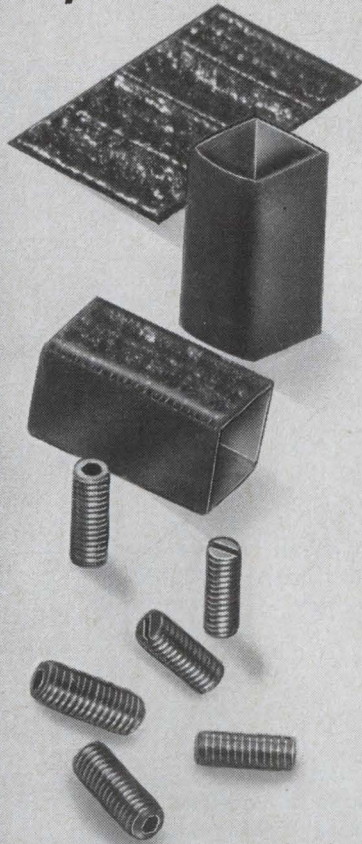

*Illustrated: flexible
shielding and threaded
iron cores*

In this age of specialists, PERMACOR stands above all others in the production and design of powdered iron cores. This is our sole business and our core specialists can solve any problem. We have a full line of stock cores and unexcelled facilities for manufacturing any custom cores.

IRON CORES... Plain, Hollow, Threaded, Insert, Tuning, Cup, and Toroidal Iron Cores, Iron Coil Forms, Sleeves, Flexible Magnetic Shielding, Bobbins and special shapes... our only business and we're the world's largest. So we invite your inquiry.

PERMACOR®

A Division of Radio Cores, Inc.

9540 Tully Ave., Oak Lawn, Ill. 60454
Phone: 312-422-3353



Spinoff. Spinning of shaft produces square waves, and these signals help control cutting and drilling machines.

produces direct outputs of sufficient amplitude to trigger logic circuits directly. This feature increases the versatility of the device and reduces the size of control systems.

The Tru-Rota generator photoelectrically produces two channels of square waves in quadrature. The amplitudes and periods of these waves are equal. When the Tru-Rota shaft is connected to a slide, a given slide displacement causes generation of a characteristic number of square waves. The direction of the motion is indicated by which channel of square waves is leading.

Wide range. In the Series 10 and 11 Tru-Rota generators, which have amplifier stages, the amplifier supply voltage ranges from 3 to 20 volts d-c positive for the series 10 and negative for the series 11. The output amplitude is within 0.3 v of the supply level. The photocells are excited by two lamps whose supply range is from 5 to 7v d-c.

Good position. The accuracy of the slide positioning depends on the number of square waves generated for one turn of the shaft, or pulse intervals per revolution.

Tru-Rota's are available with from 10 to 2,000 pulse intervals per revolution. The user specifies the desired value, and he can multiply this value by two or four through proper selection of logic circuitry.

The new Tru-Rota weighs three and a half ounces and can operate from -17°C to $+65^{\circ}\text{C}$. Special housings are available for demanding environments. The basic cost is \$192.50. Delivery time is three weeks.

Trump-Ross Industrial Controls, Inc.,
265 Boston Rd., Billerica, Mass. [430]

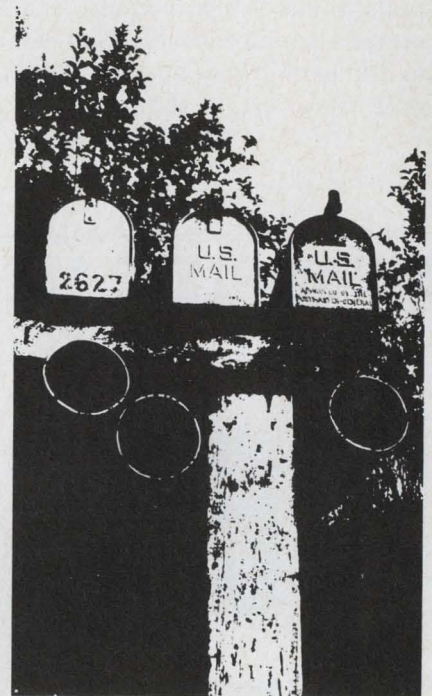

Can you deliver?

If you can deliver with the best and can keep up with the pace with one of the fastest growing, most creative companies in the country then we would like to talk to you. Current openings include:

PROJECT ENGINEER

(Recording) EE or Physics degree plus 5 years' experience. Must have knowledge of the processes of magnetic recording.

DEVELOPMENT ENGINEER

BSEE plus 2 years' experience with previous logic design experience preferred. Must be digital oriented.

ELECTRONIC ENGINEER

(Senior) Digital oriented with knowledge of production equipment. BSEE required with mechanical experience desired.

ELECTRONIC ENGINEER

(Solid State Circuit Design)

To design solid state digital and analog circuits. BSEE with 2-5 years' experience.

Please send your resume to:
Professional Employment Office,
1180 Shulman Avenue, Rm. 4
Santa Clara, California 95050.
An Equal Opportunity Employer.

MEMOREX
CORPORATION

Hi-G makes quality state-of-the-art relays and switches for military and commercial applications. All are made under strictly controlled material selection, manufacturing and testing procedures. This insures reliable relay performance, operation after operation.



Included in the Hi-G line of relays is a series of half-size crystal can relays that are manufactured in accordance with all applicable requirements of MIL-R-5757. All K series relays are rated at 2 amps and measure 0.4" x 0.8" x 0.4" with a maximum weight of 0.37 ounces.

A COMPLETE LINE OF 1/2 SIZE CRYSTAL CAN RELAYS

**RELIABLE
STANDARD**

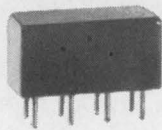

K relay is a one-half size crystal can relay rated at 2 amps. Standard coil resistance available to 1500Ω. Life: 100,000 operations at 125°C and rated load.

LATCHING

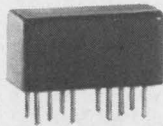

KL relay is a 2 amp latching one-half size relay with a standard coil resistance of 1000Ω. Set/reset time is 4.0 ms. Life: 100,000 operations at 125°C and rated load.

**RADIO
FREQUENCY**

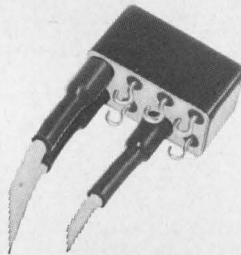

RFK relay is useful to 1 GHz for one million operations at power levels up to 100 watts cold switching under MIL-R-5757 environmental conditions. Two form "C" RF circuits or 1 form "C" RF and 1 form "C" auxiliary circuit available.

HI-REL

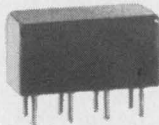

ARK relays offer assured reliability in a one-half crystal can configuration. Outstanding vibration and shock resistance. Welded construction. All relays are manufactured in a clean room environment.

Call, write, or check the reader service number for more information and a quotation. If you want application engineering assistance, an experienced HI-G representative awaits your call. Tel: 203-623-2481.



SPRING STREET & ROUTE 75 / WINDSOR LOCKS, CONNECTICUT 06096

30-gage wire can't have much insulation

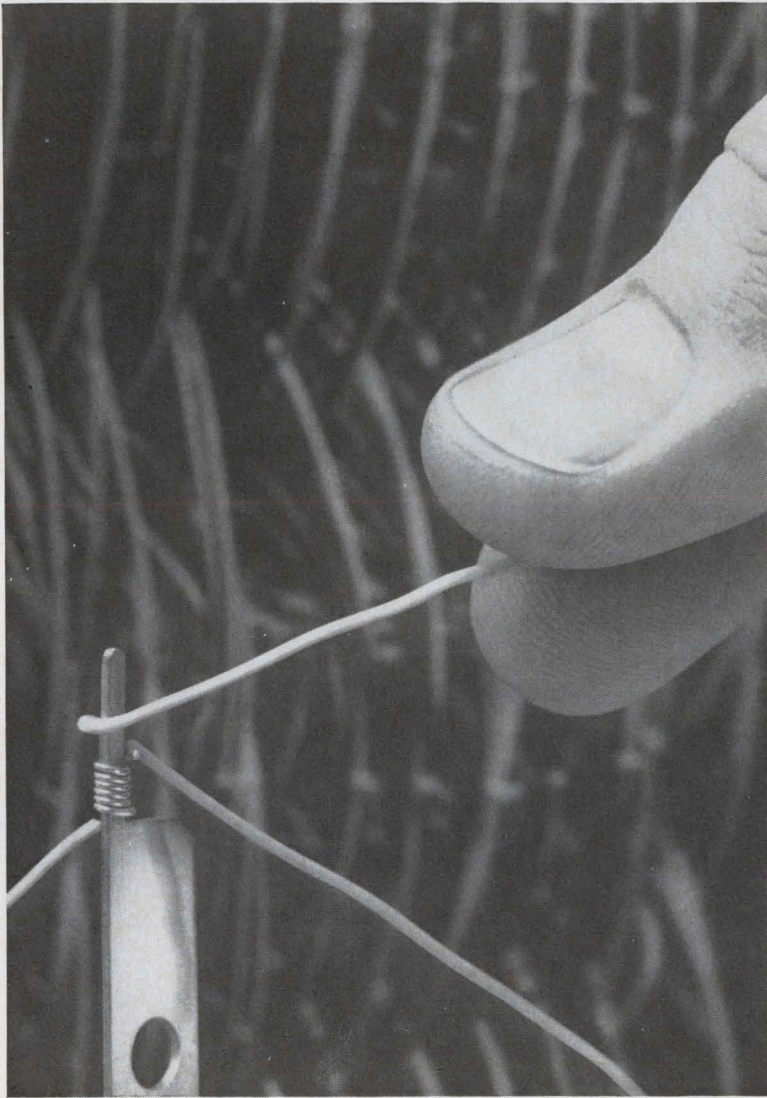

**It's got
to be tough**

**That's why
it's Kynar[®]**

Kynar has superior cut-through and abrasion resistance . . . double the mechanical strength of other fluoroplastic insulations. It withstands bending . . . vibration . . . resists cleaning solvents . . . operates from -80° to 300°F . . . feeds, cuts and strips smoothly in hand and automatic wiring machines.

Wire insulated with Kynar is available from leading manufacturers. For data, write or call Plastics Department, Pennsalt Chemicals Corporation, 3 Penn Center, Philadelphia, Pa. 19102.

Kynar...the fluoroplastic that's tough!



JFD modutrim MICROMINIATURE CERAMIC VARIABLE CAPACITORS ...

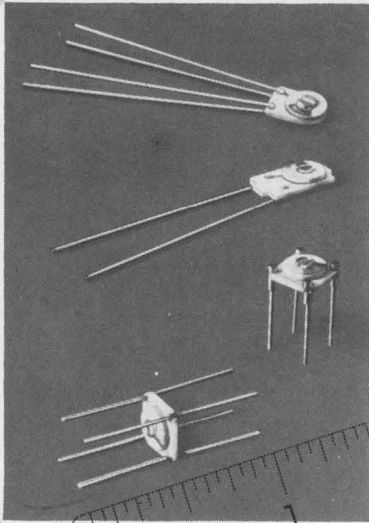
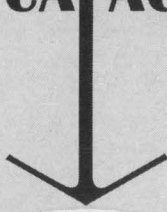

Widest Δ Cs, highest stability and smallest size

Modutrim microminiature ceramic variable capacitors offer micromodule and hybrid circuit designers a choice of wide Δ Cs in extremely small and stable units.

A unique rotor design utilizing a special proprietary ceramic material in a monolithic structure gives excellent stability. Q is in excess of 500 measured at 1 MC for those values under 50.0 pf.

MT 100 Series' design is specifically for channel-mount and cordwood applications, as well as many other micromodule packages.

MT 200 Series offers still further miniaturization, as an ideal answer to high component density problems and various LC networks packaged in TO-5 cans.

MT 300 Series' 4 terminal lead configuration provides optimum mechanical support and is specifically designed for printed, microminiature and module circuits.

MT 400 Series is designed for cordwood and module applications. This configuration has 8 terminations for easy connection above and below the capacitor substrate.

Write for catalog MT-67-A.

JFD

"TODAY'S COMPONENTS BUILT FOR TOMORROW'S CHALLENGES"

JFD ELECTRONICS CO. / COMPONENTS DIVISION 15th Avenue at 62nd Street
Brooklyn, New York 11219 / Phone 212-331-1000
Offices and subsidiaries in principal cities, world-wide.

Good News for Packaging Engineers

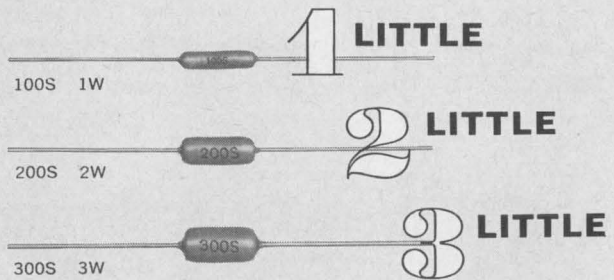

Sage delivers the smallest 1, 2 and 3 watt resistors available—Specially designed for uniform length fit in .4 inch "Cordwood" circuit modules.

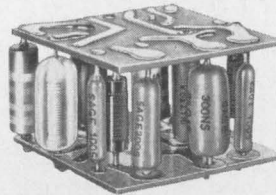

Check these outstanding features

| Resistance Range: | (1W) | (2W) | (3W) |
|-----------------------------|------------------------------|---------------|---------------|
| Regularly wound | .05 Ω to 13K Ω | 18K Ω | 23K Ω |
| Non-inductively wound . . . | .5 Ω to 3.0K Ω | 3.9K Ω | 5.3K Ω |

Tolerance: 5% to .05%.

Standard TC: As close as 10 ppm/ $^{\circ}$ C.

Construction: All welded, silicone coated for temperature endurance beyond 275 $^{\circ}$ C. Solderable or weldable leads.

SAGE backs up its resistor products with far more design and performance data than you customarily see from other manufacturers. Make us prove it by asking now for your copy of Catalog R-66.



SAGE

SAGE ELECTRONICS CORP.

Subsidiary of Gulton Industries, Inc.

BOX 3926 ROCHESTER, N. Y. 14610
Phone: (716) 586-8010



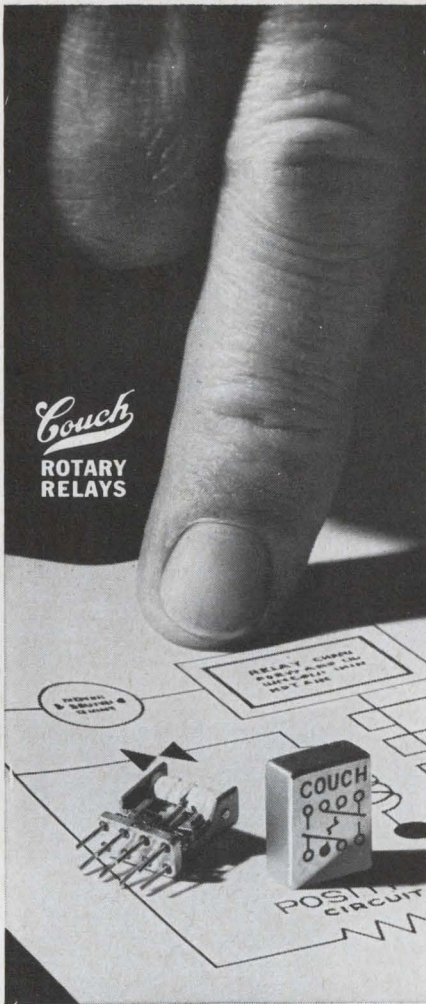

Couch
ROTARY
RELAYS

Cramped for space?

Use Couch 1/7-size Relays

Space/weight problem? The new Couch 2X 1/7-size crystal can relay gives you tremendous savings in space and weight. 0.1" grid — plus many outstanding specs — *all in micro-miniature*. Thoroughly field-proven in electronics and space applications.

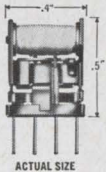

| | 2X (DPDT) | 1X (SPDT) |
|----------------------|--------------------|------------------|
| Size | 0.2" x 0.4" x 0.5" | same |
| Contacts | 0.5 amp @ 30 VDC | same |
| Coil Operating Power | 100 mw 150 mw | 70 mw 100 mw |
| Coil Resistance | 60 to 4000 ohms | 125 to 4000 ohms |
| Temperature | -65°C to 125°C | same |
| Vibration | 20 G | same |
| Shock | 75 G | same |

Broad choice of terminals, coil resistances, mounting styles. Write for detailed data sheets.

RUGGED ROTARY RELAYS  Dynamically and Statically Balanced

COUCH ORDNANCE INC.

3 Arlington St., North Quincy, Mass. 02171, Area Code 617, CYPress 8-4147 • A subsidiary of S. H. COUCH COMPANY, INC.

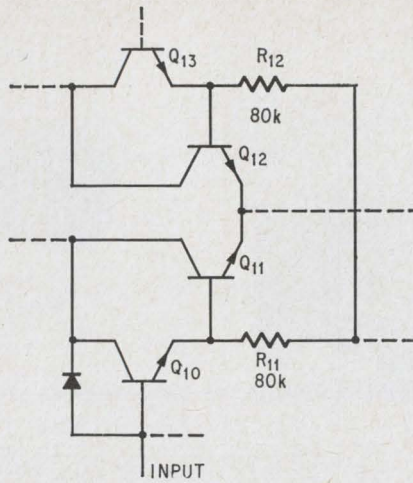

Tricky input. Two high-gain bipolar transistors, in a near-Darlington configuration, provide 10,000 megohm input impedance. Dotted lines go to other sections of chip.

and high input impedance of 10,000 megohms. These features are suitable, Widlar notes, for sample-and-hold circuits and fast-switching analog commutation. The new circuit switches in one millisecond, as compared with 30 for the 709.

Unlikely choice. Bipolar transistors had been bypassed for op amp front ends because, Widlar says, with bipolars there are both leakage and base current problems to worry about. "FET's seem the easiest solution because there you have only leakage problems. But if you're looking at offset voltage, too, FET's don't come out too well because they don't like to match. Bipolars match with no effort at all." Two monolithic FET's may be from 10 to 20 millivolts apart, where bipolars may be only a half-millivolt.

How is Widlar able to use bipolar? "We're using pretty good transistors from new processing techniques," he says. The methods are proprietary, but Widlar says, "An awful lot has been done in the past few years with the surface problems in stabilizing threshold voltages in mos devices. These techniques can be applied to the fall-off at low current for bipolars."

The circuit design is unique in that it operates the input transistors, Q10 and Q13, at zero base-collector voltage so that leakage currents are insignificant at high temperatures. Thus, it is possible to guarantee a maximum input current of 10 nanoamps even at 125°C. In fact, the exceptional perform-

This little lamp can save you \$5,000.

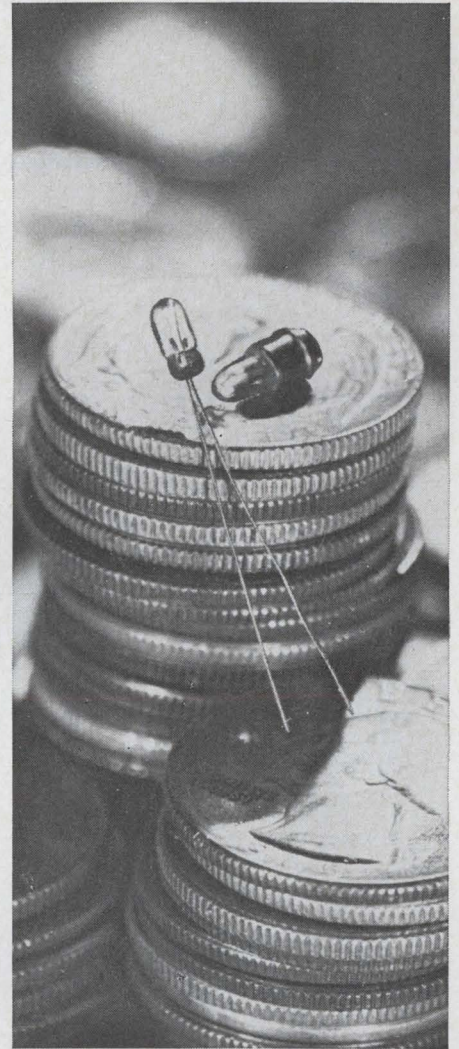

Hear that, Mr. P.A.! If you purchase 10,000 IEE subminiature lamps, the savings can be a substantial \$5,000. That's because IEE has broken the miniature lamp price barrier. They sell for as little as .29 each, in quantity, one half the price of competitive lamps.

This low, low price still delivers top quality IEE subminiature lamps...each and every one—aged and selected. You pay no premium for this premium. They meet all standard mil specs, and you can count on 40,000 to over 100,000 hours life depending upon the application. Filaments are hand placed and stabilized to assure uniform brightness.

Drop us a note, describing your application and type of lamp. We'll send you a sample box of 10 IEE "subminiatures". Do it now.



Industrial Electronic Engineers, Inc.
7720 Lemona Avenue, Van Nuys, California 91405

New Semiconductors Review

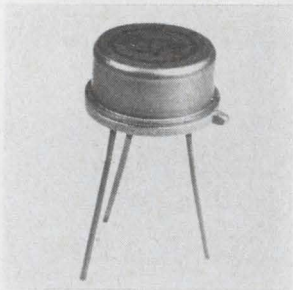

Epitaxial planar transistor switch 2N5262 is a high-voltage unit intended for use as a driver for 2½D coincident-current and word-organized magnetic-memory systems. It will switch 1 amp of current with a turn-on time of 30 nsec and a turn-off time of 60 nsec. Price is 98 cents each in 1,000 lots. RCA Electronic Components and Devices, Harrison, N.J. 07029. [436]

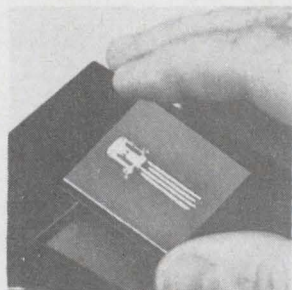

N-channel junction FET 2N4416 covers a wide variety of vhf and uhf amplifier applications. At 100 Mhz, its noise figure is 1.3 db, typical, and 2 db max., with power gain of 18 db at the same frequency. Output capacitance is 2 pf (max.) at 1 Mhz and transconductance is 4,000 μmhos (min.) at 400 Mhz. Motorola Semiconductor Products Inc., Box 13408, Phoenix, Ariz. [437]

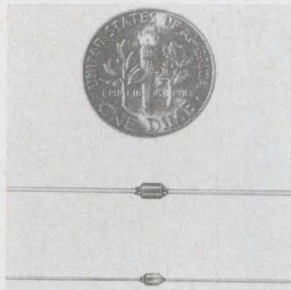

Micro glass diodes, in 2 doubly hermetically sealed packages, meet or exceed MIL-S-19500. The 2-w diode has a 0.085-in. max. body diameter and 0.155 in. max. body length. The 500-mw unit measures 0.065 x 0.100 in. max. Characteristics spanning the entire range possible with silicon can be supplied. MicroSemiconductor Corp., 1125 Playa Court, Culver City, Calif. 90230. [438]

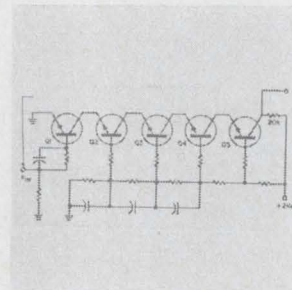

High-voltage switch TRS4014S is for use in x-ray units, crt displays, laser networks and electrostatic copiers. The unit, a 5-transistor stack, can switch up to 2 kv at currents up to 100 ma. Typical on-time is 500 nsec; typical off-time, 1 nsec. The module-type package can be turned on with a 2-to 5-v pulse. Industro Transistor Corp., 35-10 36th Ave., L.I.C., N.Y. 11106. [439]

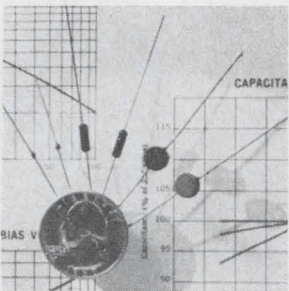

Voltage variable capacitors are offered with junction capacitance ratings as high as 1,000 pf and Q values as high as 500 at 50 Mhz and -4v. Working inverse voltage ratings up to 150 v can be provided. All are abrupt junction diodes whose capacitance varies inversely as the square root of the applied voltage. Computer Diode Corp., Pollitt Dr. South, Fair Lawn, N.J. 07410. [440]

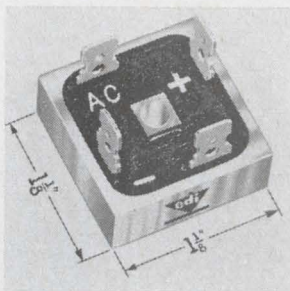

Silicon rectifier power bridges in the MinibrIDGE PB series are rated for 25 amps d-c at 50°C case temperature. They are suited for applications where 7/16 in. stud rectifiers or much larger stack assemblies were previously used. Surge rating is 300 amps. Price of the 400 piv MinibrIDGE PB40 is \$3.85 in lots of 100. Electronic Devices Inc., 21 Gray Oaks Ave., Yonkers, N.Y. [441]

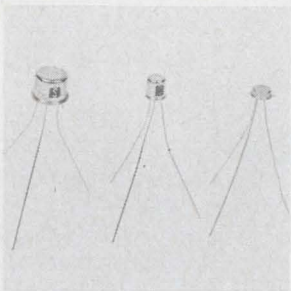

Power integrated Darlington transistors come in TO-5, TO-18 and TO-47 packages. The TO-5 (SDM-1010-1019) can dissipate 1.3 w at 25°C; the TO-18 (SDM1110-1119) and TO-47 (SDM1210-1219), 1 w at 25°C. Saturation voltage is 1 v at a collector current of 100 ma and base current of 0.2 ma. Solitron Devices Inc., 1177 Blue Heron Blvd., Riviera Beach, Fla. 33404. [442]

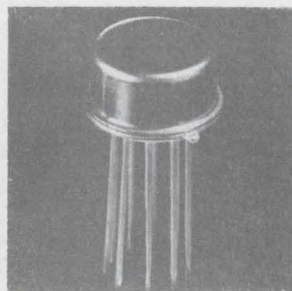

Hybrid IC model CDA2 comprises 2 separate FET switches with integral drivers. It is for such uses as current summing (D-to-A or A-to-D), integrator reset, and series-shunt choppers. It offers zero offset voltage, low on-resistance (25 ohms max.), and low power consumption (typically 5 mw per switch). Crystalonics, A Teledyne Co., 147 Sherman St., Cambridge, Mass. 02140. [443]

New semiconductors

Big Z hits the market

Monolithic IC boasts 10,000 megohms input impedance and replaces the 709 in voltage-follower applications

To produce a fully compensated monolithic operational amplifier, most designers try using either a junction or a metal-oxide-semiconductor field effect transistor in the front end. But Robert J. Widlar, who designed the widely copied 709 op amp, puts National Semi-

conductor Corp. into the race with a circuit that requires no external compensation and dispenses with hard-to-match FET's as well.

For compensation, Widlar uses bipolar transistors, which, with the aid of proprietary surface processing techniques, he has tamed to be-

have at zero base-collector voltage. Hence, high-temperature leakage, for which FET's are noted, is virtually eliminated. Designated the LM102, the unit is specified to military temperature ranges up to 125°C, where most commercial FET's leak like a sieve. In the 15 to 55°C range, FET leakage is almost nil, but above 55° it can range from 10 to 50 nanoamps.

Especially designed for unity-gain voltage-follower applications, where the output signal directly follows the input signal, the LM-102 offers low input current up to 10 nanoamps maximum, fast slew rate of 10 volts per microsecond,

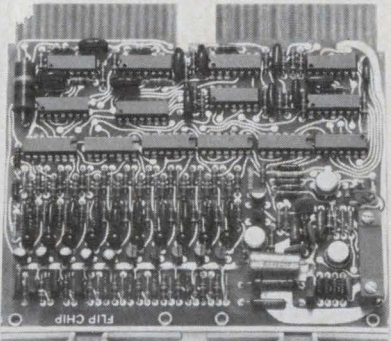

New Complete High Speed A to D Converter: \$750

An analog to digital converter complete on one module and just 5 by 5 by 1/2 inch, including the control logic, digital register, comparator and internal precision reference supply, converts 100,000 samples per second with an accuracy of 0.1%.

The A801 converter, part of our A Series module line, is designed for industrial and scientific instrumentation applications with DIGITAL's range of small computers. It features the reliability, space savings and speed of the latest TTL integrated circuits coupled with the economies of mass production and machine assembly.

Digital is the world's leading producer of logic modules. Our dominance in this area, and our experience with interfacing between measuring systems and computing systems, resulted in the development of this converter.

Other converters, interfacing modules, modules for computer-speed instrumentation and industrial control modules are all described in our Industrial Control and Logic Handbooks. Write for free copies.

A801 A to D Converter

Specifications

Input: Uni-polar
Voltage 0 to +10v
Impedance 1000 ohms

Output Format: Parallel Binary
Uni-polar

Digital Output: Logical "0" + 0.4v max.
Logical "1" + 2.4v min.

Resolution: 10 bits
Accuracy: 0.1% of full scale
Conversion rate: 100 kHz max.

digital
MODULES • COMPUTERS

Maynard, Mass. Tele: (617) 897-8821

ance of the amplifier at high temperatures makes it ideal for use in temperature-stabilized component ovens to get extremely low input currents and low offset voltage drift.

Although a Darlington input stage is used, it is modified by the addition of pinch resistors R_{11} and R_{12} . These establish the operating current of the input transistors at a level substantially above the base current of Q_{11} and Q_{12} , giving better gain and lower drift than a conventional Darlington input.

The operating speed of many monolithic operational amplifiers is limited by the high-frequency characteristics of the lateral pnp transistor required for level shifting. A voltage follower requires no level shifting, since the input and output are at the same voltage. Hence, the lateral pnp can be eliminated as a gain stage, permitting an increase in both frequency response and slew rate. Lateral pnp's are used in the circuit, but only as current sources where their frequency characteristics are not critical.

Specifications

| | |
|----------------------|--------------------|
| Input current | 10 na max. |
| Input resistance | 10,000 megohm min. |
| Offset voltage | 5 mv max. |
| Voltage gain | 0.999 min. |
| Output resistance | 2.5 ohms max. |
| Output voltage swing | ± 10 v min. |
| Supply current | 3.5 ma |
| Slew rate | 10 v/ μ s |
| Bandwidth | 10 Mhz |
| Input capacitance | 3 pf |
| Price (1-24) | \$45 |

National Semiconductor Corp., 2950 San Ysidro Way, Santa Clara, Calif. 95051 [444]

New semiconductors

Late starter plans big family

MOS integrated circuits of complementary symmetry are RCA'S market entries

A late starter in the digital integrated-circuit market, the Radio Corporation of America will try to gain ground this year by enlarging its family of complementary-symmetry metal oxide semiconductor devices, called the cos/mos family.

The first to appear in 1968 is the



COMPACT POWER PACKS

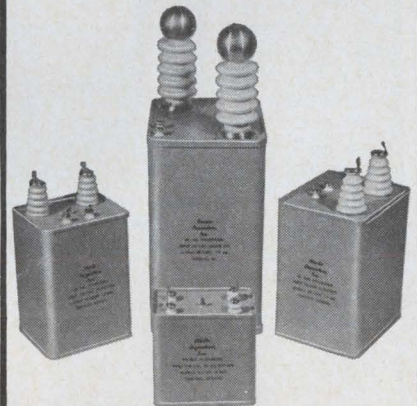

The new Compact "M" Series Power Packs offer you:

- Rated output voltages from 1000 to 75,000 DC
- Rated output currents of 1.5, 5, and 10 milliamperes
- Input voltages of 118, 220, 230, and 240 volts AC
- Variable output from 0 to rated voltage
- Input frequency range 50 to 500 CPS output ripple 1% RMS at rated voltage
- Hermetically sealed construction

Why pay more, and settle for less... PC's new compact power packs give more quality, more versatility, more dependability, plus smaller size, and best of all, most sizes are available in stock to meet your immediate needs.

Write for complete information and new catalog today!



Plastic Capacitors, INC.

2620 N. Clybourn • Chicago 14, Ill.
DI 8-3735

How to put the
SQUEEZE
on sharp edges

HEAT-GRIP®

IRRADIATED
POLYOLEFIN TUBING

No matter how sharp the edge, Heat-Grip heat shrinkable tubing shrinks down tight and won't split or tear. It's the fast sure way to protect or insulate. Shrinks 50% in diameter under moderate heat to form a strong, flexible shield. Conforms to spec. MIL-I 2053A, Classes 1 and 2. Available 3/4" to 1" I.D. in five colors and clear.

Excellent for mechanical protection, color identification, product encapsulation, insulation.

Send for technical data and FREE samples.

NATVAR CORPORATION
P. O. BOX 67 • RAHWAY, N. J. 07065



Circle 220 on reader service card

NEW, high visibility alphanumeric readout

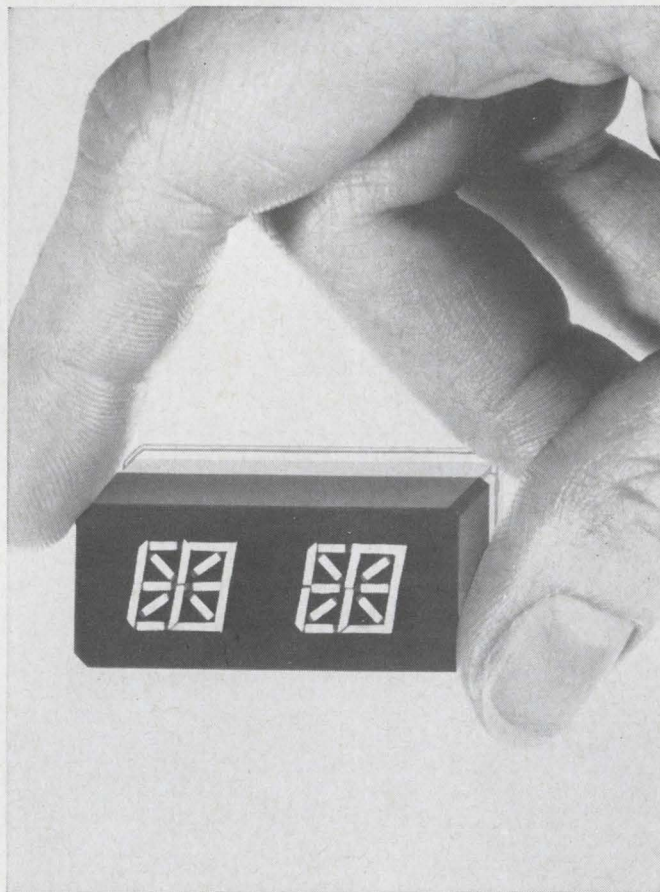

The 16-segment bar configuration of this new Tung-Sol readout, provides a potential of 65000 letter/symbol displays. This unit offers the same high visibility, clarity and sharp angle viewing that characterizes the Tung-Sol digital readout.

In addition to full alphanumeric display, fixed letter/symbol messages may be displayed in selected digit areas.

This new readout is compatible with the standard Tung-Sol digital unit. Use of the same lamp banks, voltages and mounting techniques, permits intermixing the readout blocks.

Write for detailed technical information. Tung-Sol Division, Wagner Electric Corporation, One Summer Ave., Newark, N.J. 07104.

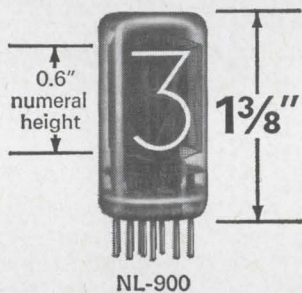
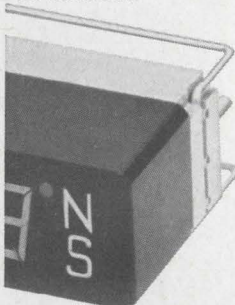

NL-900

**If you really need to
save space, NATIONAL®
has the answer.**

Interchangeable with NL-840. Available with the features you want: decimal point, plus or minus and inverted tube.

NATIONAL *Request Bulletin*

ELECTRONICS, INC.
a varian subsidiary

PHONE: (312) 232-4300 • GENEVA, ILLINOIS 60134

Circle 221 on reader service card

TUNG-SOL®

ALPHANUMERIC READOUT

© REG. T.M., WAGNER ELECTRIC CORPORATION

Circle 175 on reader service card

175

LMI

Shielded rooms won't let obsolescence box you in

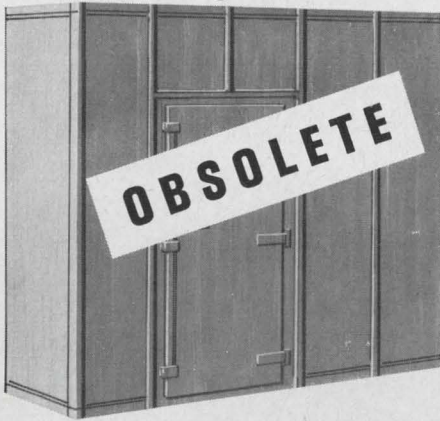

Design • Changes in Government and Industry RF shielding specifications can quickly obsolete costly shielded rooms. That's why LMI RF shielded rooms are designed with built-in capability for upgrading. Any of the seven standard rooms designed and manufactured by LMI can be upgraded with appreciable savings over the cost of a new room. LMI designs utilize solid membrane, clamp-together or all-MIG-welded seams and provide maximum shielding over the widest frequency range.

Upgrade • For example, Class D Rooms can be upgraded by MIG welding all seams and/or adding an additional shield.

All-welded Class C and higher rooms can be upgraded by the addition of an inner shield, acoustic and microwave anechoic material at any future date.

Class AA and AAA are all-welded dual wall, solid shielded rooms for the highest performance from low audio to highest microwave frequencies.

Cost • The initial low cost and final costs are one and the same with LMI all-seams-welded rooms. There is no seam leakage nor any maintenance requirements over the life of the shielded room.

Technical Bulletin • For a complete description on all classes of LMI shielded rooms, write for your complimentary copy of Technical Bulletin (TB-101) "Technical Discussion and Specifications for Electromagnetic Shielded Rooms."

Quick Reaction • For fast personal service on your shielding problems telephone or write direct to Fred J. Nichols, Carl T. Luce or James C. Senn.

LectroShield Division
LectroMagnetics, Inc.

6056 West Jefferson Avenue
 Los Angeles, California 90016
 Area Code 213 870-9383

... flip-flop uses n- and p-channel transistors ...

TA5362, a p- and n-channel dual flip-flop IC, developed by RCA's Electronic Components and Devices division.

Expansion of the family of devices could make RCA the first company to offer a large selection of MOS IC's with complementary symmetry. RCA wants that portion of the market now dominated by single-channel MOS IC's and will stress the speed and low power requirements of the complementary units.

In a complementary IC, n-channel and p-channel transistors are arranged so that the circuit operates regardless of the polarities of input signals and biases. This means less power is used and fewer power supplies are needed than for single-channel IC's.

Discussing the speed of the IC's, A.M. Liebschutz, product manager at RCA, says: "We believe the speed will match that of diode-transistor logic and a good part of the transistor-transistor logic family."

Liebschutz calls the TA5362 "the most important new product yet to hit the IC market," but other IC makers are not as enthusiastic about the complementary approach. Leonard Smith, director of marketing for General Instruments, says GI can build complex custom circuits more easily with single-channel MOS circuits and has no plans to move into two-channel devices. He says the complementary approach is "... more costly, more complicated, requires larger chips," and concludes, "It's a question of cost."

In RCA's TA5362, both flip-flops are on one silicon chip and each has 12 p-channel and 12 n-channel enhancement-type MOS transistors. The quiescent power dissipation of the TA5362 is 10 nanowatts, logic swing is 10 volts, and noise immunity 4 volts. The two flip-flops operate at frequencies up to 4 megahertz and each has a fan-out capability of 50.

The unit is hermetically sealed in a 14-lead ceramic and metal package and can operate between -55°C and $+125^{\circ}\text{C}$. Small quantities for evaluation are priced at \$22.50 each.

RCA Electronic Components and Devices, Harrison, N.J. 07029 [445]

The Scientists and Engineers served by Corcoran in the last year have found the difference between "a job" and "the job."

- Nationwide. Fee paid.
- Please airmail background to:

JOSEPH P. CORCORAN
 Personnel Consultants

505 B Germantown Pike
 Lafayette Hill, Pa. 19444

Member IEEE

CIRCLE 961 ON READER SERVICE CARD

ENGINEER

B.S.E.E. degree or equivalent in experience. To service numerically controlled electronic equipment in the field. Travel 75%. Minimum 4 years experience in servicing or manufacturing of numerical control electronic equipment and/or digital computers. Salary open. Outline your qualifications in resume to: John Rotte Associates, 6100 Belleair Place, Cincinnati, Ohio 45224.

CIRCLE 962 ON READER SERVICE CARD

ADDRESS BOX NO. REPLIES TO: Box No. Classified Adv. Div. of this publication. Send to office nearest you.
 NEW YORK, N. Y. 10036: P. O. Box 12
 CHICAGO, Ill. 60611: 615 N. Michigan Ave.
 SAN FRANCISCO, Cal. 94111: 255 California St.

POSITION VACANT

Across The Spectrum In the Electronics Industry—Engrg—Mgmt—Sales. Gardner Assoc. MU 7-6616 545 5th Ave., N.Y., N.Y. 10017.

CLASSIFIED ADVERTISING

SEARCHLIGHT SECTION

BUSINESS OPPORTUNITIES
 USED OR SURPLUS EQUIPMENT

RADAR SYSTEMS GROUND AND AIRBORNE. AUTOMATIC TRACKING ANTENNA SYSTEMS. NIKE AJAX. NIKE HERCULES. M-33. MSQ-1A. MPS-10. MPS-9. SCR 584. TFS-1D. TFS-2B. FAA-ASR-2. AIRBORNE SYSTEMS. APN-84. APN-102. APS-20. APS-27. APS-45. DPN-19. DIGITAL COMPUTERS. IBM 650. IBM 704.

LARGEST INVENTORY OF RADAR AND MICROWAVE EQUIPMENT IN THE WORLD.

RADIO RESEARCH INSTRUMENT CO.
 45 WEST 45TH ST. N. Y. 10036 212-JU 6-4691

CIRCLE 963 ON READER SERVICE CARD



When you have used electronics equipment to sell, advertise in Electronics Searchlight Section for fastest results.

For Information:
 Searchlight Section
 Classified Advertising Division
 Post Office Box 12
 New York 10036

Do you think a bright young engineer should spend his most imaginative years on the same assignment?

Neither do we.

That's why many of our areas are organized by function—rather than by project.

At Hughes, you might work on spacecraft this year, communications satellites next year, tactical missiles the next year.

All you need is an EE, ME or Physics degree, 2-8 years experience, and talent. If you qualify, you may work on several different assignments over a period of a few years.

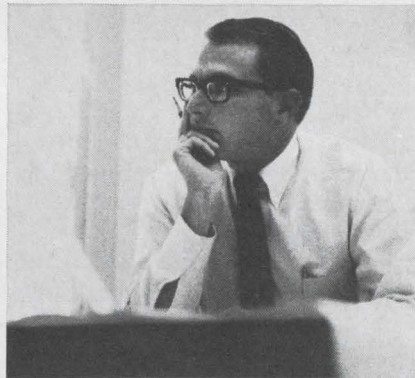

You may work on specialized assignments, or broad systems-oriented programs.

Or you can choose *not* to change assignments if you'd rather develop in-depth skills in one area.

Either way, we think you'll like the Hughes approach—the chance to be assigned by function, if desired.

It means you'll become more versatile in a shorter time.

(And your salary will show it.)



Some of the current openings at Hughes.

Microwave & Antenna Engineers
Electro-Optical Engineers
Microcircuit Engineers
Space Systems Engineers
Missile Systems Engineers
Guidance & Controls Engineers
Spacecraft Design Engineers
Weapon Systems Engineers
Components & Materials Engineers
Circuit Design, Development &
Product Engineers

Send resume to:

Mr. Robert A. Martin
Head of Employment, Dept. 63
Hughes Aerospace Divisions
11940 W. Jefferson Blvd.
Culver City, California 90230

U.S. Citizenship is required
An equal opportunity employer

need a
front-yard
market?

IOWA has
that, too!

Chicago, Detroit, Milwaukee, Minneapolis, Kansas City and St. Louis are all in Iowa's front yard. That's one reason Iowa's last 4 record years of industrial growth have seen 438 new industries invest \$205,000,000 in Iowa and 626 industries spend \$346,000,000 for expansion.

Some other important reasons: *Labor Force* . . . talented, trainable men and women from 32 colleges and universities and many vocational schools. *Water* . . . from the Mississippi, Missouri and many other Iowa rivers. *Transportation* . . . two navigable rivers, plus roads, rails and an airline network to every conceivable point. *Management Time* . . . Iowa executives just naturally have more. They don't waste hours commuting daily.

There's more. Fill out the handy coupon . . . we'll send all the facts. Fast!

(Confidential Reply Coupon)
IOWA DEVELOPMENT COMMISSION
Dept. 518 250 Jewett Building
Des Moines, Iowa 50309



Name _____

Firm _____

Address _____

City _____

State _____

Zip _____

New Books

Say something in Fortran

Programing the IBM 1130 and 1800
Robert K. Loudon
Prentice-Hall, Inc.
433 pp., \$5.75 (paper), \$10.50 (cloth)

Don't judge a book by its title. This one is a good introduction to Fortran, but not to either the 1130 or the 1800.

Here is a curious mixture of material for two kinds of people—those wholly uninitiated in the nuances of programing, and those familiar with the operator's console on both machines. The novice can get some useful information from the first two chapters, which describe the nature of a program, the basic concepts of binary notation, and the external characteristics of the peripheral equipment used with the IBM 1130 and 1800. But the chapters that follow are full of esoteric instructions, of which the following excerpt is typical:

"When the combined deck (of punched cards) . . . has been prepared, the following console operations should be performed: Push the Non-Process Run Out button on the 1442 . . . Push the Stop and Reset buttons on the 1130 and 1800 console. Place the . . . deck in the read hopper . . . and push the Program load button." The effect: a book that does a good basic job on programing is needlessly cluttered with paragraphs that belong in an operator's manual.

The author is an employee of International Business Machines Corp.; his book purports to describe the art of programing two IBM computers in Fortran, a computer language originated at IBM. He makes occasional references to IBM publications that are designed to help IBM customers use IBM machines, and appends a long bibliography that favors such publications nearly three to one over other titles.

Fortran is ideally supposed to be machine-independent, which explains why the machines mentioned in the title are seldom mentioned anywhere else in the book. But neither Fortran nor any of its numerous variants and competitors are completely machine-independent. The programmer must keep in

mind the limitations of available input-output equipment, memory capacity, and so on—so some reference to the specific machines is necessary.

One important point is made in the chapter on program debugging. Loudon says experienced programmers do not debug more than about 50 Fortran statements at a time, and suggests that beginners work on units of 10 statements. Then he adds: "The mad scientist whose first attempt at programing is, say a 500-statement masterpiece written as a single program, will get much madder when he tries to compile and execute it."

Two chapters contain two interesting applications—one useful, the other just an exercise. Programs are developed for calculating the orbit of a satellite and for playing three-dimensional tic-tac-toe. And the last two chapters describe the programing of the IBM 1800 for a time-shared application, with reference to that computer's specific design for industrial process control.

The 1130, a small machine for scientific applications, would presumably be suitable for the orbit calculations, but the book doesn't say so.

Measuring up

How to Use Signal Generators in the Laboratory
John D. Lenk
John F. Rider Publisher, Inc.
104 pp., \$3.25

Many engineers, technicians, and experimenters think of the signal generator in terms of its basic role: aligning and testing receivers by simulating the signals from transmitters. But signal generators also have diversified applications in other areas of electronics. For example, the appropriate generator can be used to measure capacitance, inductance, and to check resonant circuits, antenna matching, crystals, and filters.

This book acquaints both new and experienced technicians with the characteristics and many possible uses of signal generators. Recent developments in swept-frequency measurement techniques

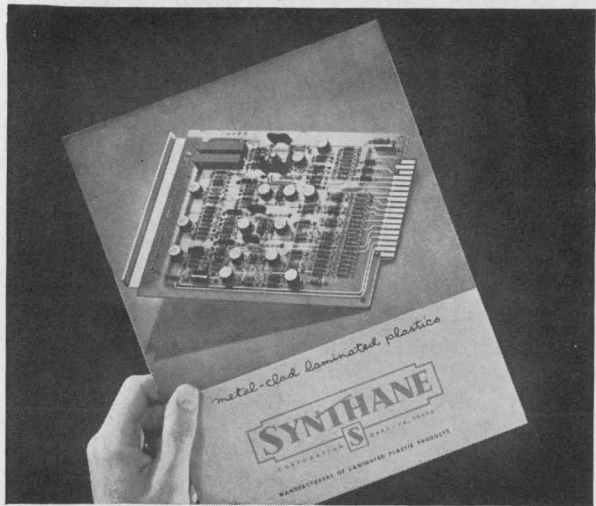

The booklet every electronic designer should have

The supply of this recent Synthane Metal-clad Laminate folder is going fast because it is packed with new information on Synthane high-quality metal-clad laminates. Grades, sizes, types of foils, trademark identification, property values, a section on thin laminates and prepreg materials. Be sure of your copy by writing us or circling our inquiry number in this publication. Synthane Corporation 36 River Road, Oaks, Pa. 19456.



CORPORATION OAKS, PA. 19456

Laminated Plastic Sheets, Rods, Tubes and Fabricated Parts

Circle 222 on reader service card

New from Helipot

First \$1¹⁰ cermet trimmer sealed for board washing

New Helitrim® Model 77:

only trimmer in its price class made fail-safe for solvent washing on the board... and offering essentially infinite resolution, 10 ohm — 2 megohm resistance range and 105°C. max. operating temp. *No* general purpose adjustment potentiometer has wider performance parameters. Directly interchangeable with competitive models 3067, 3068. \$1.10 in quantity — ask your Helipot rep for a free sample.



Beckman®

INSTRUMENTS, INC.
HELIPOT DIVISION
FULLERTON, CALIFORNIA • 92634

INTERNATIONAL SUBSIDIARIES: GENEVA; MUNICH; GLENROTHES, SCOTLAND; TOKYO; PARIS; CAPETOWN; LONDON; MEXICO CITY

Circle 223 on reader service card

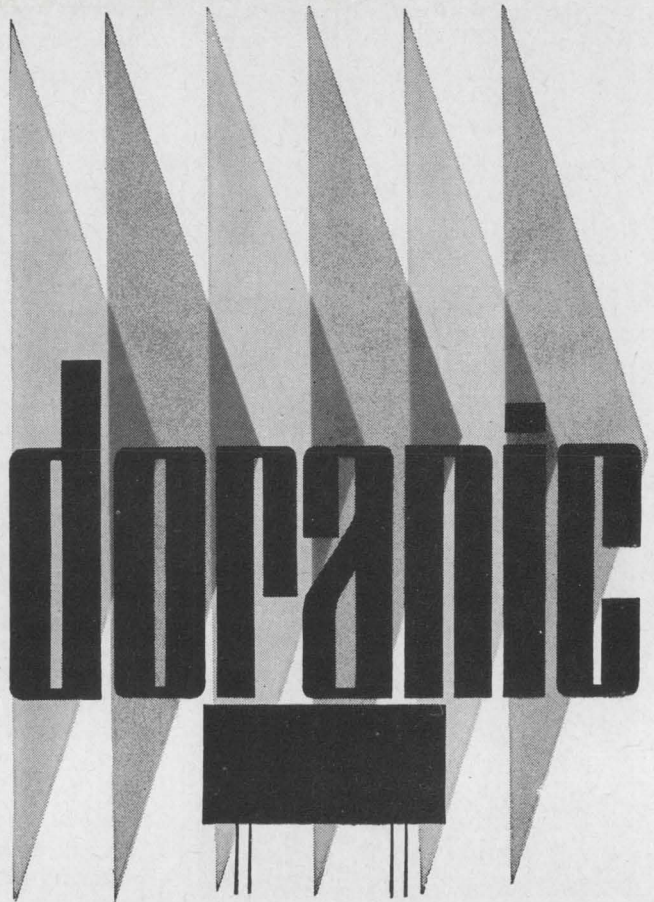

reed relays / logic modules mercury wetted contact relays

Doranic Reed Relays are low in cost, sensitive and compact. Hermetically sealed contacts, proven design and rugged construction assure long, trouble-free service. A wide range of miniature and standard reed relays, molded, cased and tubular are available.

We specialize in those hard-to-get items: miniature, plug-in, high voltage, AC operated reed relays, printed circuit board-reed relay assemblies, reed relay flip flop, logic relays and magnetic and electrical latching reed relays.

Douglas Randall maintains complete engineering and design facilities to assist the engineer in choosing the best relay for his specific circuit objectives. "Standard" items can be modified to meet special physical or electrical requirements.

douglas randall, inc.



A SUBSIDIARY OF WALTER KIDDE & COMPANY, INC
6 Pawcatuck Ave., Westerly, Rhode Island, 02891, 203-599-1750

Circle 179 on reader service card

179

The original lacing tape
is still the best . . .

. . . and saves money too!

That's
GUDELACE® 18

You ought to try
a sample . . .

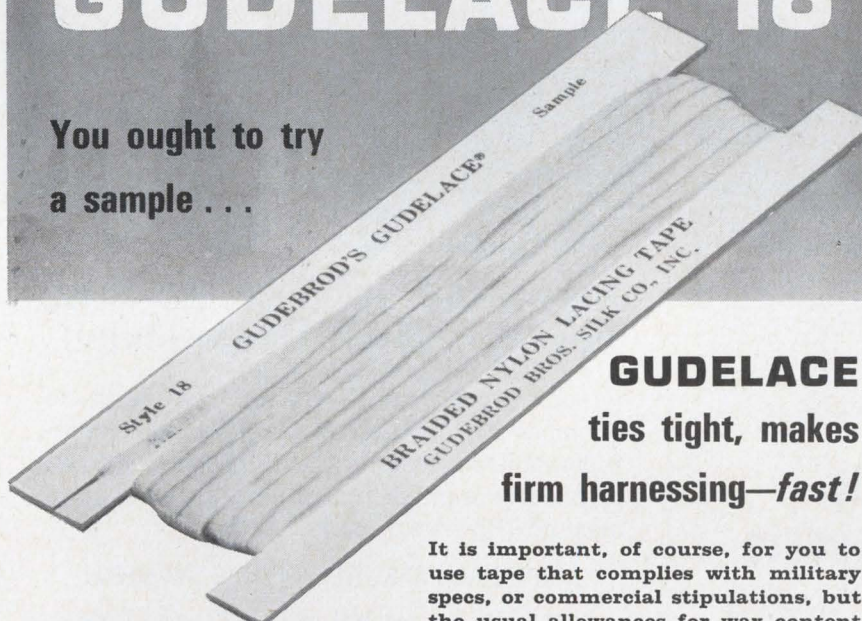

GUDELACE
ties tight, makes
firm harnessing—*fast!*

It is important, of course, for you to use tape that complies with military specs, or commercial stipulations, but the usual allowances for wax content in such specs give no consideration to the best lacing conditions. Gudebrod GUDELACE is made within the specs—BUT, it's made too, for easy handling, tight knotting, firm harnessing. THAT'S WHERE IT SAVES MONEY, in the harnessing operation. GUDELACE, the original harness lacing tape, is manufactured under strict control. Every yard is impregnated exactly the same, exactly right. You can count on that—and on getting better harnessing—*fast*—with minimum rejects. Why not send for a sample, test it any way you want. Let your harness crew try it. You'll be glad you did! (Remember, the Gudebrod Lacing Tape line includes tape for nearly every special situation—ask for The Product Data Book.)

**NOW—GUDEBROD HAS
TWO AIDS TO FASTER—
BETTER HARNESSING**



**CABLE-LACER®
& GUDE-SNIPS®**

The production tested Cable-Lacer is now reduced in price—only \$9.95. Holds bobbin of tapes—makes tight knots. The palm held GUDE-SNIPS provide convenient tape cutting—using either right- or left-hand, \$3.75.

G **UDEBROD**

Electronics Division

GUDEBROD BROS. SILK CO., INC.

Founded 1870

12 SOUTH TWELFTH STREET
PHILADELPHIA, PA. 19107

New Books

and time-domain reflectometry are also covered in detail.

Lenk begins by describing important features of laboratory-type signal generators. Among the subjects covered are automatic frequency control, frequency doubling, power measurements, and time-base generators.

From this basic beginning, which most experienced technicians probably will want to bypass, Lenk moves on to a variety of test procedures that use the signal generator as the basic tool. Separate-chapter treatment is given to swept-frequency attenuation, impedance, power measurements, frequency measurements with sweep techniques, time-domain reflectometry techniques with pulse generators, pulse generator techniques in general, techniques for checking electronic components, and the use of dip adapters.

Turning the heat on

Thermoelectric and Thermomagnetic Effects and Applications
T.C. Harman and J.M. Honig,
McGraw-Hill Book Co.,
377 pp., \$17.50

This is an advanced text on the thermodynamic and solid state physics foundations of thermoelectricity and thermomagnetism. However, its description of the theoretical and practical capabilities of thermoelectric devices will be helpful to readers without experience in the field.

The theoretical portion of the book, though, is aimed at the reader with graduate-level training in physical chemistry or solid state physics. The authors, by their own admission, have limited themselves to a small list of topics, which they cover in "agonizing" detail. These include the various major thermoelectric effects (Seebeck, Peltier, Thompson), transport theory, and the quantum-mechanical basis of these effects in band theory.

The practical, device-oriented portion of the volume is especially helpful to engineers who want to use thermoelectric energy-conversion devices. It examines the theory from a rather elementary point of



It's never too early to start saving their hearts

Help your children form good health habits now to reduce risk of heart attack later:

- Encourage normal weight; obesity in youth may persist throughout life;
- Build body health through regular physical activity;
- Serve them foods low in saturated fats;
- Teach them that cigarette smoking is hazardous to health;
- Make medical check-ups a family routine.

Set a good example. Follow the rules yourself and guard *your* heart, too.

GIVE...
so more will live
HEART FUND

Contributed by the Publisher



Electronics | January 22, 1968

mechanical refrigeration to $-85^{\circ}F$ for only \$745



Only Associated Gives You Full Range Military Testing At This Low Price!

Associated's Model SW-5101 Temperature Chamber offers a new concept in mechanical refrigeration that enables you to perform 90% of all military low-high temperature tests at equipment cost-savings of up to \$200.

SPECIAL FEATURES OF THE SW-5101:

- full 1 cubic foot test area
- temperature range from -85 to $+350^{\circ}F$.
- all solid state controller with $\pm 3/4^{\circ}F$ stability
- delivery from stock
- adjustable high-temperature fail-safe with signal lamp
- indicating thermometer in door
- combination hinged and removable door
- bench-top design, can be modified for stacking
- stainless steel feed-through port, $3/4$ " diameter

Check the SW-5101 specifications against your testing requirements. You'll find they add up to outstanding performance at a down-to-earth price—without sacrifice of quality or reliability.

The new Associated catalog of environmental chambers is yours for the asking. Write for your free copy today.

**ASSOCIATED
TESTING
LABORATORIES
INC.**



200 Route 46, Wayne, N.J. 07470 • (201) 256-2800

Circle 181 on reader service card

181

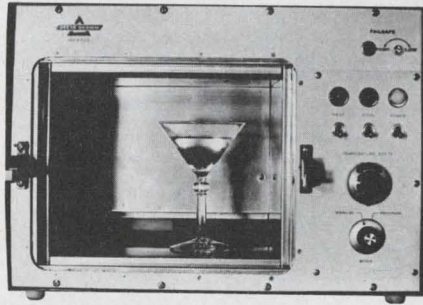

This refrigerator heats to 1000 degrees.

It also cools to
-300 degrees. It does
both with remarkable
accuracy, 0.1°.

Send for our latest
catalog.



Delta Design, Inc.
8000 Fletcher Parkway
La Mesa, California 92042
Telephone (714) 465-4141

Technical Abstracts

Coming attractions

How do we stand on the big board?
Murray L. Kesselman
Rome Air Development Center
Griffiss Air Force Base, Rome, N.Y.

Large information displays, larger than the practical limit of 30-inch cathode-ray tubes, have several unique characteristics that make them desirable for industrial and military applications: everyone in a group reacts to a common data base, and one individual, controlling the composition of the displayed information, forces the attention of the audience.

Ways to obtain large displays include film, scribe, projection crt, and light-valve systems.

Film systems contain a crt to provide a source image, a light-sensitive medium on which the crt image is recorded, and a processor that produces a positive transparency for projection. They provide high quality, colored, large-scale displays, are simple to integrate into data-processing systems, and present no unusual demands.

Scribe systems use a servocontrolled stylus to cut lines through an opaque metallic coating on a transparent base slide. The slide is projected. Such systems are best for applications where total amount of data is limited but which must be changed fast. Time to shift to an adjacent slide is about half a second.

Projection crt's have an image projected onto the tube face, with variable information traced by the tube's guns. Their general low level of performance has limited projection crt's mostly to display of pictorial information.

Light-valve display systems use a control medium, such as an oil film, on a mirror surface. An electron beam impinging on the oil surface deforms the control layer. Light striking the nondeformed region of the oil film is imaged back, hits stops, and does not reach the projection lens. Mechanical components and the short life of electron gun cathodes limit applications to those where periodic maintenance can be performed and continuous operation over a long

period is not desired.

Rules of thumb for relating display size to audience area are that no viewer should be closer than twice the maximum screen size nor farther than six times, and that the maximum viewing angle for any observer is 60° from the screen's plane.

Presented at the 1967 Fall Joint Computer Conference, Anaheim, Calif., Nov. 14-16.

Taking out the garbage

Digital moving target indicators
R.A. Linder and G.H. Kutz
Westinghouse Electric Corp.
Baltimore, Md.

The chief difficulty in designing a moving target indicator (MTI) radar is to remove the unwanted clutter while retaining the signals from moving targets. In many radars, complex analog circuits store fixed clutter returns in a delay line, and compare and cancel these unwanted signals over consecutive pulse periods. But digital integrated circuits can also perform the delays and the associated processing, while yielding optimum system performance at a reasonable cost.

In an analog MTI, an intermediate-frequency carrier modulates the output of a receiver phase detector. This modulated carrier is then applied to an ultrasonic delay line where the phase information is delayed, or stored, for one interpulse period. The output from the delay line is detected and subtracted, during the next interpulse period, from the succeeding undelayed output of the phase detector.

Ideally, fixed targets would show no phase difference between successive radar returns. They cancel each other in the video subtraction process. Moving targets do not cancel. But with one pulse, cancellation is not crisp.

To obtain better cancellation, more than two pulses are delayed and compared, using multi-pulse cancellers and feedback. However, an additional delay line and weighting coefficient is needed for each pulse to be stored.

On-line availability has been generally poor—although the systems

view, and discusses the capabilities and limitations of several types of thermoelectric generators, refrigerators, and the like. This, then, is the sort of over-all reference treatment that can supplement the large number of purely descriptive works already available.

R.C. Levine

Bell Telephone Laboratories, Inc.
Murray Hill, New Jersey

On target

Radar Signals—An Introduction to Theory and Application
Charles E. Cook and Marvin Bernfeld
Academic Press, 531 pp., \$19.50

Here is a text that provides the cornerstones of modern radar technology in such a manner that both systems designers experienced in radar and engineers in general can grasp it. After outlining radar fundamentals, the authors discuss in detail pulse-compression methods and coded matched-filter signal processing.

Cook and Bernfeld have also struck an excellent balance between the theoretical and the practical, supplementing the basics with hard-core examples. This effort should ease the mind of the designer seeking to understand radar techniques, as well as the engineer faced with choosing the right kind of signal and system design for a particular radar application.

The passages on pulse-compression show how this method is implemented to make the most efficient use of average power in transmitters, and how increased range and velocity resolution are achieved.

There follows an in-depth treatment of matched-filter theory, radar ambiguities, sidelobe reduction, Doppler effects and coding, all essential to present-day radar. The use of such recent tools as dispersive ultrasonic delay lines and optical-matched filters is also covered.

Recently published

Grounding and Shielding Techniques in Instrumentation, Ralph Morrison, John Wiley and Sons, 144 pp., \$9.50

A practical treatment of electrostatic shielding, with particular emphasis on instrumentation. Book starts with elementary physics, and goes on to develop general rules for shielding along signal paths and grounding signal lines.

If you're concerned with Transistor Pads and Clips— Heat Sinks and Adapters . . .

JERMYN

ACCESSORIES

are worth
a closer
look . . .



Precision made in Kent, England by JERMYN Industries, these important items of circuit hardware are manufactured with traditional English craftsmanship. They are stocked and sold exclusively in the U.S. by GUDEBROD. Ask for our new Catalog GJ100 which describes the full line—or tell us about your custom needs.

G **UDEBROD**

Electronics Division

Gudebrod Bros. Silk Co., Inc.
Founded 1870
12 South Twelfth Street
Philadelphia, Pa. 19107

Now get

Portable Precision

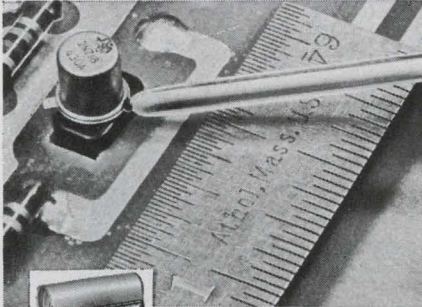

Small Probes make Point Contact Measurement.

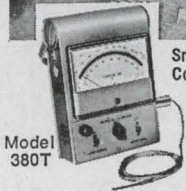

Model 380T

with RFL Direct Reading Thermometers

Model 380T provides fast temperature readout even in locations not previously accessible. Accuracy is $\pm 1\%$ of scale range. Only $9\frac{1}{2}'' \times 6\frac{1}{2}'' \times 3''$, the RFL 380T has a low range of 0°C to 90°C and high range of 80°C to typical 150°C . Powered by flashlight batteries. Precision taut-band suspension type meter has 5-inch mirror scale and red pointer. Single probe with 5 ft. cable provides high accuracy on surface temperatures, as well as in liquids or gases. Storage space provided for probe. Available with $^\circ\text{C}$ or $^\circ\text{F}$ scales and other ranges from an overall range of -45°C to $+400^\circ\text{C}$. Price \$285.00 with probe and batteries.

Model 385—Direct reading, or measure liquid and surface temperature gradients. -25°C to $+400^\circ\text{C}$. Ranges, 10°C - 0 - 10°C . Second and third range 80°C approx. Available $^\circ\text{C}$ or $^\circ\text{F}$ with probes. \$395.00 complete.

Model 212 — High-precision, versatile. For liquids, gases, atmosphere, -100°C to $+500^\circ\text{C}$. Accuracy $\pm 0.75^\circ\text{C}$. Traceable to NBS. High resolution, fast response. Platinum resistance probe. \$580.00 complete.



For Technical Data or
Free Evaluation Loan —
Write or Call John Carson

RFL Industries, Inc.

FORMERLY RADIO FREQUENCY LABORATORIES, INC.

Thermocontrol Div. • Boonton, N. J. 07005

Tel: 201-334-3100 / TWX: 710-987-8352 / CABLE RADAIRCO, N. J.

New Literature

Optoelectronic devices. Raytheon Co., Fourth Ave., Burlington, Mass. 01803. A revised short-form catalog describes Raysistor optoelectronic devices that operate on the principle of controlled light acting on a photoresistive element.

Circle 446 on reader service card.

Precision metal contacts. The Wilkinson Co., P.O. Box 303, Santa Monica, Calif. 90406. Bulletin C-300 details the company's capabilities for design, development and production of all types of precision metal contacts. [447]

Data sets. Milgo Electronic Corp., 7620 N.W. 36th Ave., Miami, Fla. 33147, has published two technical bulletins on its Modem 4400 data sets for transmission at rates of 2,400 and 4,800 bps. [448]

Glass flexible fiber optics. Corning Glass Works, Corning, N.Y. 14830. Optical parameters, chemical resistance, mechanical and environmental characteristics, and end finishing procedures for glass flexible fiber optics are described in a six-page brochure. [449]

Semiconductor oven. Lindberg Hevi-Duty, Division of Sola Basic Industries, 2450 W. Hubbard St., Chicago 60612. An oven for curing, drying and stabilizing semiconductors is described and illustrated in bulletin 94202-B. [450]

Memory systems. Ferroxcube Corp., 5455 S. Valentia Way, Englewood, Colo. 80110. A catalog listing more than 500 different memory systems for off-the-shelf delivery may be obtained through letterhead request.

High-density wiring. Thomas & Betts Co., 36 Butler St., Elizabeth, N.J. 07207, has issued bulletin 500.1 describing its Connecto-Blok high-density, quick-disconnect wiring system. [451]

FET operational amplifiers. Analog Devices Inc., 221 Fifth St., Cambridge, Mass. 02142. A four-page brochure gives performance and application data for the ultra-low-drift series 147 FET operational amplifiers. [452]

Interconnection systems. Space and Missile Systems Division, Amphenol Corp., 9201 Independence, Chatsworth, Calif. 91311, has available a 12-page booklet describing creative problem-solving in interconnection systems. [453]

Dry reed switches. The M-O Valve Co. Ltd., Brook Green Works, London W.6, England. A brochure on dry reed switches deals with such subjects as factors affecting reed characteristics, contact switching life, solenoid operation, and coaxial relays. [454]

Ladder networks. Helipot Division, Beckman Instruments Inc., 2500 Harbor Blvd., Fullerton, Calif. 92634. Data sheet 68264 covers a series of 12-bit binary ladder networks. [455]

Neon glow lamps. Signalite Inc., 1933 Heck Ave., Neptune, N.J. 07753. An eight-page illustrated brochure discusses neon glow lamps for indicator applications, circuit components, and voltage regulators. [456]

Indicating controller. Sigma Instruments Inc., 170 Pearl St., Braintree, Mass. 02185. Catalog bulletin 1172 describes indicating controller 9222, a miniature model designed for original equipment manufacturer use. [457]

Trimming potentiometers. Conelco Components, 465 W. 5th St., San Bernardino, Calif. 92401, has published a two-page brochure on trimming potentiometers with many elements. [458]

Magnetic shield. Magnetic Shield Division, Perfection Mica Co., 1322 N. Elston Ave., Chicago 60622. A new high-magnetic-field environment shield is illustrated and described in data sheet 192. [459]

Source data entry. Colorado Instruments Inc., 116 Park St., Broomfield, Colo. 80020, has issued a 12-page bulletin describing its simplified systems for source data entry. [460]

Modulators/demodulators. Natel Engineering Co., 7129 Gerald Ave., Van Nuys, Calif. 91406. Specification sheet MD-1 deals with a family of modulators and demodulators, which are dual-purpose devices capable of converting d-c to a-c or a-c to d-c. [461]

Sequential reference designations. Bishop Industries Corp., 11728 Vose St., North Hollywood, Calif. 91605. A listing of sequential reference designations, letters and numbers in predrawn, StikOn drafting aids, is offered in a 12-page catalog. [462]

Heat sinks. Waterbury Pressed Metal Co., 407 Brookside Road, Waterbury, Conn. 06720. A two-page bulletin gives dimensions and performance characteristics of a new line of heat sinks that fit the TO-5 and similar transistors. [463]

Beryllium oxide. Brush Beryllium Co., 17876 St. Clair Ave., Elmore, Ohio 43416, has published a comprehensive compilation of data on beryllium oxide powder and ceramics. [464]

Automatic decade gain ranging. Teledyne Telemetry, 9320 Lincoln Blvd., Los Angeles 90045. A six-page brochure describes the concept, principles of operation, and applications of auto-

operate well when delay and coefficient circuits are kept carefully tuned.

The digital MTI eliminates these disadvantages. It also has the inherent flexibility and stability for better performance in the radar system.

In a digital two-pulse canceller the radar receiver's phase detector analog output is sampled and converted to a digital word. Each digital word represents the receiver phase and amplitude in terms of its video amplitude and the polarity for one range interval.

One A/D converter built to military specifications by Westinghouse weighs 0.85 pounds, converts 9 bits of information, and operates at a 10-megahertz bit rate. The company has also designed a miniature version that weighs only half an ounce and measures 0.5 x 0.5 x 1.2 inches.

The A/D output for each range interval is sent to a digital store. After one interpulse period the stored words are read out and digitally subtracted from the next A/D converter output.

Magnetic cores, IC shift registers, or scratch-pad memories can be used for the digital store. For example, a system with a range of 80 nautical miles, a four-pulse canceller, eight bits per word, and a sampling period of 2 microseconds would require 492 words per radar "look" and 11,808 total bits of storage. A magnetic core memory of 512 24-bit words would probably be adequate.

After the subtraction process, the magnitude of the resulting digital word is converted to an analog voltage for radar display.

Several digital MTI radar systems have been built, and modification kits are being added to existing radars. In one new system with a two-pulse canceller and a seven-bit word, the cancellation ratio is 42 decibels. A 1,024 word by 7 bit magnetic core store is used.

The canceller unit, with the radar synchronizer, weighs 3.5 pounds and has a volume of 210 cubic inches. The analog circuits are made with thin-film devices. Timing and control circuits use silicon IC flatpacks, and the core drivers use discrete components in welded modules.

Presented at EASTCON, Washington, D.C.
Oct. 16-18

Lapp Gas-filled Capacitors

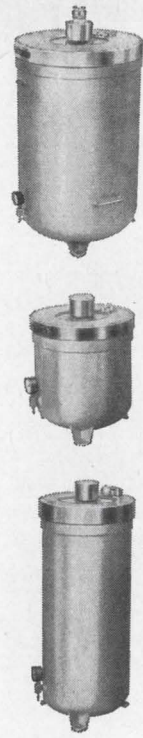

**Specially designed for a broad range
of high voltage operating conditions.**

High voltages, as well as high current and capacitance applications, are easily handled by Lapp Gas Filled Capacitors. For this type of service Lapp Capacitors offer small size and low cost.

Lapp precision-builds these capacitors to give years and years of accurate trouble-free operation. They are made in either fixed or variable models. All are equipped with external safety gap to protect against internal flashover.

Current ratings are available up to 400 amps at 1 mc., capacitance to 30,000 mmf, and safety gap settings to 85 kv peak. These characteristics fill a broad range of needs. May we send you more information? Ask for Bulletin 302. Lapp Insulator Co., Inc., LeRoy, N.Y. 14482.

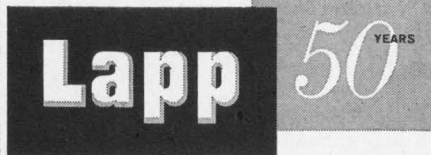

**When
reliability
is the rule**

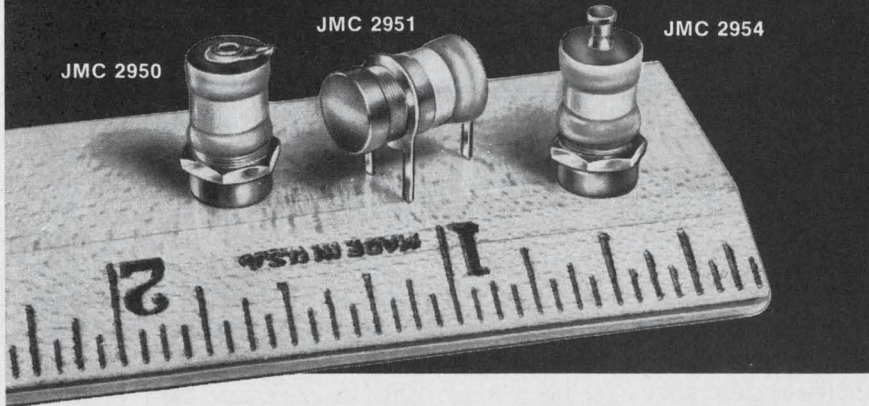

...specify *Johanson*

**HIGH Q, HIGH FREQUENCY
VARIABLE AIR CAPACITORS**

This versatile series provides, in miniature size, exceptionally high Q, superior ruggedness for protection against shock and vibration, -55° to +125°C operating temperature range, protection against fungus, salt spray and humidity . . . plus all the other construction and performance features that have made Johanson capacitors the industry standard for excellence.

Specifications

Capacitance Range: 0.8 — 10.0 pF
Dielectric Withstanding Voltage:
 Rating 250 VDC breakdown >500 VDC
Insulation Resistance: >10⁶,
 megohms @ 500 VDC
Q: >2000 @ 100 mc
Temperature Coefficient: 0 ± 20 ppm/°C
Rotational Life: >800 revolutions

Write Today for Complete Catalog, Prices.

Johanson **MANUFACTURING CORPORATION**
 400 Rockaway Valley Rd., Boonton, N.J. 07005, (201) 334-2676
 Electronic Accuracy Through Mechanical Precision

Circle 188 on reader service card

**Our little black book has
over 100,000 phone numbers.**

You never had a black book like it. Over 1,500 pages. And those phone numbers! More than 100,000 telling you who to call/where to go, for the over 4,000 different product categories listed and advertised in the yellow pages of the Electronics Buyers' Guide.

It's the industry's one-stop shopping center that lets you find the products and services you need quickly. You can depend on EBG.

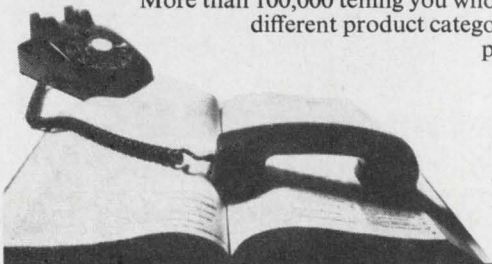

Electronics Buyers' Guide
 A McGraw-Hill Market Directed Publication,
 330 West 42nd Street, New York, N.Y. 10036

New Literature

Active filters. Bundy Electronics Corp., 44 Fadem Road, Springfield, N.J. 07081. Features and specifications for the ACD-2005 and ACD-2010 series of narrowband active filters are given in bulletin 101. [477]

Stampings capabilities. Volkert Stampings, Inc., 222-34 96th Ave., Queens Village, N.Y. 11429, has issued a booklet describing its expanded capabilities for producing small precision parts for the electronics and allied industries. [478]

Instrumentation amplifiers. Neff Instrument Corp., 1088 E. Hamilton Rd., Duarte, Calif. 91010, offers an eight-page catalog covering its complete line of instrumentation amplifiers for measurement and control. [479]

Multiple wafer carriers. Tri-Point Industries Inc., 1 Teflon Way, Commack, N.Y. 11725. An information sheet discusses the Tri-Carrier, a device made of TFE fluorocarbons for holding silicon wafers while they are being etched or cleaned. [480]

Graphics terminal. Adage Inc., 1079 Commonwealth Ave., Boston, Mass. 02215, has available a brochure on its graphics terminal, a comprehensive, general-purpose crt display system. [481]

Capacitors. Wesco Electrical Co., 27 Olive St., Greenfield, Mass. 01301. A 16-page brochure presents a complete line of film and metalized capacitors. [482]

Stud-mounted zeners. Unitrode Corp., 580 Pleasant St., Watertown, Mass. 02172, offers a two-page data sheet on its 350-w surge power, 10-w continuous power, stud-mounted zeners. [483]

Copperclad laminates. NVF Co., Wilmington, Del. 19899, has issued a brochure on the recently developed Catabond copper-clad laminates for printed circuits. [484]

Magnetic tape cleaner. General Kinetics Inc., 11425 Isaac Newton Square, Reston, Va. 22070, announces availability of a brochure on the model 680 high-speed magnetic tape cleaner. [485]

Transistor heat sinks. Astrodyne Inc., 207 Cambridge St., Burlington, Mass. 01803. Two series of transistor heat sinks for use in p-c boards and other applications requiring optimum cooling in minimal space are described in a new bulletin. [486]

Variable attenuator. Quindar Electronics Inc., 60 Fadem Road, Springfield, N.J. 07081. Bulletin 136 includes a description, specifications, and ordering information for the QVA-1 variable attenuator. [487]

matic decade gain ranging, an option available on the model DA-45 direct coupled, wideband d-c amplifier. [465]

Pulse discharge capacitors. Maxwell Laboratories Inc., 9244 Balboa Ave., San Diego, Calif. 92123, offers data sheets and price list on the series L and M high-voltage, high-energy pulse discharge capacitors, showing a 20 to 30% decrease in price. [466]

Deviation bridges. B&K Instruments Inc., 5111 W. 164th St., Cleveland, Ohio 44142, offers a four-page bulletin on the series 1500 deviation bridges for fast impedance and phase-angle tests. [467]

Portable potentiometer. West Instrument Corp., 3860 North River Road, Schiller Park, Ill. 60176. An eight-page bulletin describes the Pyrotest model 9B portable potentiometer with direct-reading scales. [468]

Transducer indicator. General Transducer Co., 2961 Corvin Drive, Santa Clara, Calif. 95051. A specification sheet covers the model GT-403 compact transducer indicator. [469]

Resistor adjusting system. Precision Systems Co., U.S. Highway 22, P.O. Box 148, Somerville, N.J. 08876. The all-electronic, thick-film resistor adjusting system, Lev-L-Ohm, is described in catalog section 11-100. [470]

Metal plate connectors. Elco Corp., Willow Grove, Pa., 19090. A 28-page manual contains complete design information for Variplate metal plate connectors. [471]

Adhesives. Emerson & Cuming Inc., Canton, Mass. 02021, has available the 1968 version of the Eccobond chart listing properties of a line of adhesives. [472]

Computer system. Digital Equipment Corp., 146 Main St., Maynard, Mass. 01754. A 50-page illustrated brochure explains the PDP-9 computer system for complex problems in data acquisition, process or instrument control, computation or man/machine communication. [473]

Silicon rectifier diodes. Solitron Devices Inc., 256 Oak Tree Road, Tappan, N.Y. 10983, offers specification sheets on its new medium-power, double-diffused, silicon rectifier diodes packaged to the DO-4 outline. [474]

P-c board scrubber. The Fuller Brush Co., East Hartford, Conn. 06108. A specification brochure discusses completely automated equipment that will scrub both sides of a p-c board at speeds up to 21 ft. per minute. [475]

High-intensity microphones. Gulton Industries Inc., 212 Durham Ave., Metuchen, N.J. 08840. Four high-intensity vibration-compensated microphones are described in a two-page bulletin. [476]

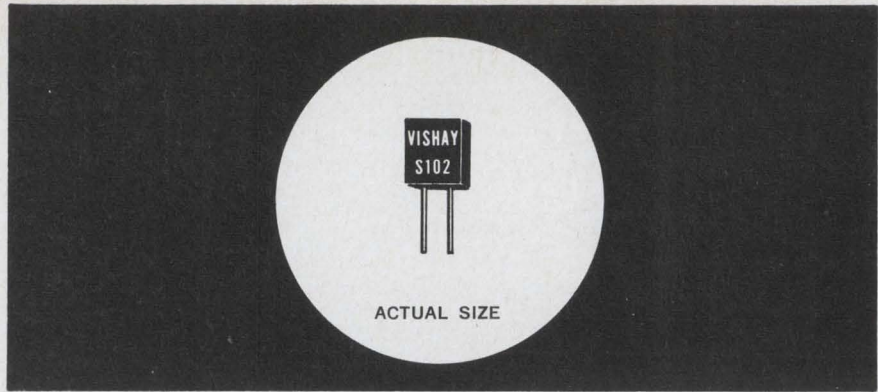

LET VISHAY PRECISION RESISTORS CHANGE YOUR IDEAS ABOUT . . .

1. WHAT RESISTOR PRECISION REALLY MEANS . . .

At Vishay, Precision in a resistor means more than just **absolute resistance tolerance** (we have a standard line of 0.005%). It also means **bedrock stability**, both on **the shelf** (standard is 25ppm per year) and **under load** (in a typical use situation—0.15 watt at 60°C. for 2000 hours—Vishay resistors shift an average of only 0.005%, even less under less load).

In use, too, Vishay offers the lowest TC of any production-use resistor—only $\pm 1\text{ppm}/^\circ\text{C}$. over the 0° to $+60^\circ\text{C}$. range, $\pm 5\text{ppm}/^\circ\text{C}$. over the -55° to $+125^\circ\text{C}$. range. It's a uniform, totally predictable TC that's the same for all Vishay resistors, **regardless of R value, ambient temperature, or frequency.**

You can use them at any frequency — to 100 Mhz. and beyond, because they're non-inductive (no ringing), are noiseless, and have a response time of less than 1 nanosecond.

And their size and shape meet your high density packaging requirements.

2. WHAT TRADE-OFFS YOU HAVE TO LIVE WITH . . .

With wirewounds, inductive and capacitive effects rule out use at high frequencies. With conven-

tional film, you can get the speed but can't approach Vishay's absolute tolerance or almost-zero TC.

The totally new Vishay design eliminates these trade-offs . . . **there just aren't any.**

3. WHAT SUCH COMPLETE PERFORMANCE MUST COST . . .

The best part is that Vishay Precision resistors are competitively priced with conventional units.

If you want or must have precision resistors, in your system or instruments, Vishay offers a precision package no other production resistor can come close to matching.

The simplest way to simplify your circuits and solve your problems is to get the "how", "why" and "where-to-use" data in this free 8-page Brochure. Write for your copy today. Check No. 491.

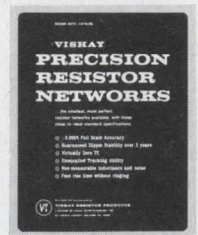
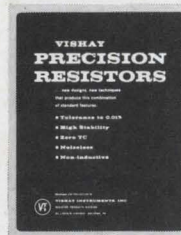

Working with NETWORKS? For unequalled performance (speed, tracking, stability), read these 16 pages. They're free, too. Check No. 492.

VISHAY RESISTOR PRODUCTS

a division of Vishay Intertechnology, Inc.
63 Lincoln Highway ■ Malvern, Pa. 19355

now in 9 sizes HELIAX[®] elliptical waveguide covers the microwave spectrum



With the addition of two new sizes, flexible HELIAX elliptical waveguide is available for all microwave communication bands from 1.7 to 13.2 GHz. The continuous single lengths of HELIAX waveguide assure reliable system performance, with electrical characteristics better than conventional rigid

waveguides at less cost. ■ Investigate HELIAX Elliptical Waveguides for your next microwave system whether it be for a short haul installation or a long high density system. ■ Write for specifications—Andrew Corporation, P.O. Box 42807, Chicago, Illinois 60642.

2-67

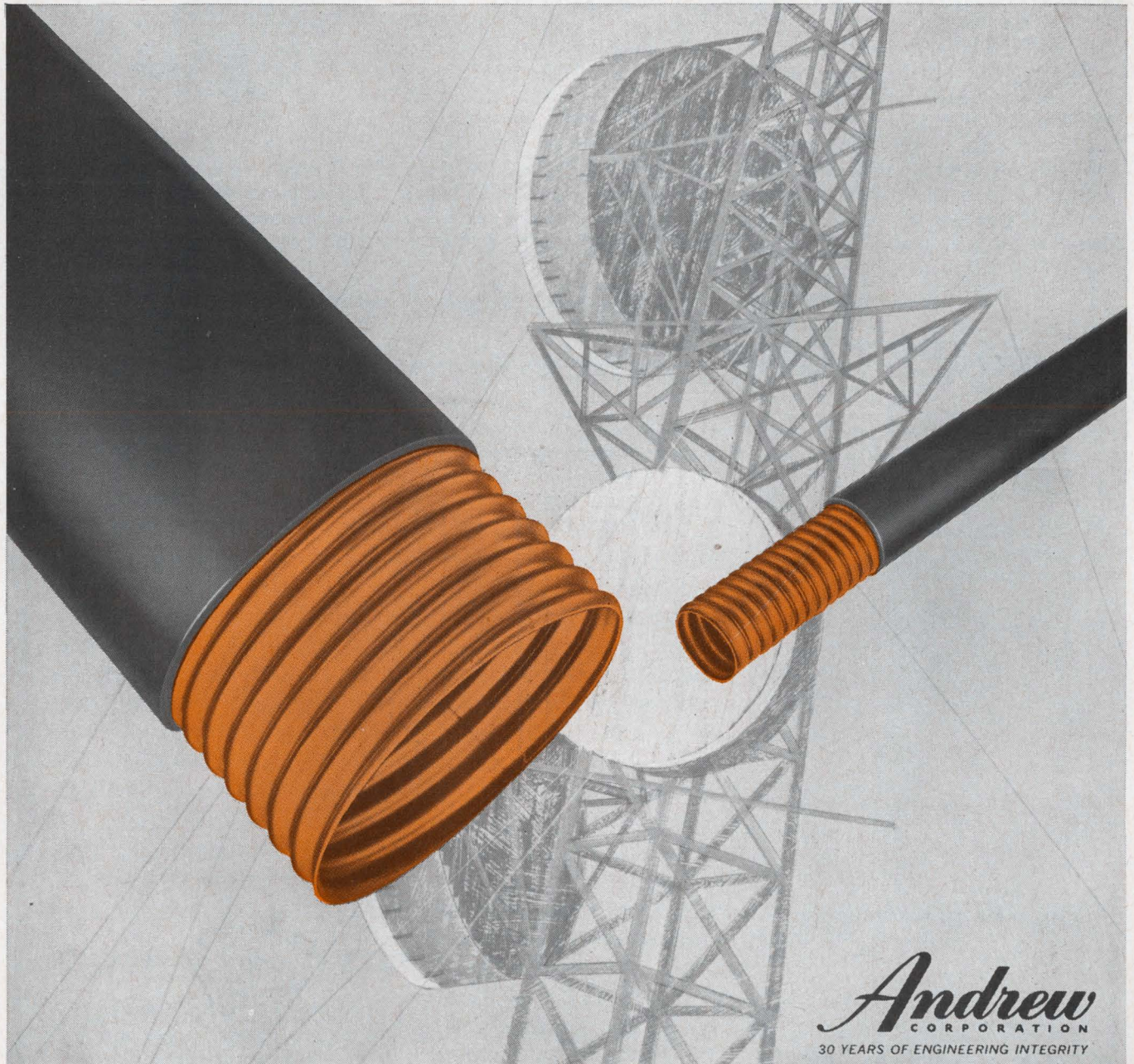

Andrew
CORPORATION
30 YEARS OF ENGINEERING INTEGRITY

9 SIZES OF ELLIPTICAL WAVEGUIDE

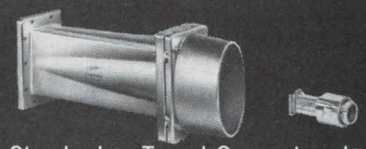
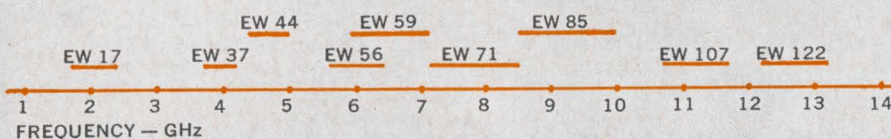

Standard or Tuned Connectors to Fit Standard Waveguide Flanges.

3 of a series

TRANSICOIL SOLVES SERVO PROBLEMS

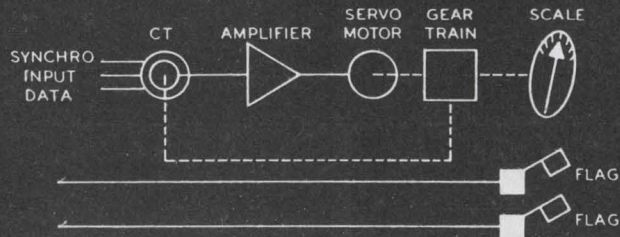

Transicoil radar height indicator

Transicoil designed this instrument for the APN-120 Radar Altimeter Set aboard A3J aircraft. It provides a visual display of altitude. In addition, two Weston meter movements warn of "OFF", "FAIL", and "OVERRIDE" conditions. ■ Altitude data transmitted from a CX in the radar altimeter is fed to a matching CT in this assembly. A miniaturized servo, using size 8 components and transistorized amplifier drives the CT to a null, and exhibits this output as a pointer position on an altitude scale. ■ Pictured above without case, the unit is hermetically sealed in a 3¼" instrument can per AN-5727. All wiring is terminated at AN connectors at the rear of the can. ■ Transicoil offers an unusual capability for combining servo components into operating servo systems. Write for our 16-page brochure, SERVO ASSEMBLIES. It describes many of our standard and special-purpose units.

Weston Instruments, Inc., Transicoil Division, Worcester, Pa. 19490.

WESTON® prime source for precision . . . since 1888

Circle 224 on reader service card

IT TAKES A LOT OF ADJECTIVES TO DESCRIBE THE SPACE VII...

Adjectives like FAST, ACCURATE, FLEXIBLE, RELIABLE, VERSATILE, ECONOMICAL and MANEUVERABLE. If you doubt for one minute that a humble wiring system analyzer from the middle west can live up to these labels, then try testing this tester for yourself. It was designed and developed (after thorough lab and field testing) especially to meet today's demand for speed, accuracy, versatility and economy. DIT-MCO's Space VII operates on the fully automatic tape input and printout concept. Design and construction are of the highest quality. The "total

speed" function of the Space VII gives you faster overall test time because of adaptation and hookup ease, rapid tape feed, speed of test plus speed of fault determination time, scan time, error recording and printout. With this advanced system you can test up to 2,000 terminations at a rate of more than 400 per minute! Electronic engineers who've tried it, call DIT-MCO's Space VII the best intermediate size testing system on the market. We won't disagree.



DIT-MCO INTERNATIONAL

A DIVISION OF XEBEC CORPORATION
5612 BRIGHTON TERRACE
KANSAS CITY, MISSOURI 64130
TELEPHONE (816) 363-6288 TELEX 42-6149

IT'S NO WONDER APPROXIMATELY 90% OF ALL MAJOR MANUFACTURERS IN THE COMPUTER AND AEROSPACE INDUSTRIES ARE SATISFIED USERS OF DIT-MCO SYSTEMS.

Newsletter from Abroad

IC's and pay a premium for domestically produced devices after the country's electronics companies refused to join forces in a consortium that would have given Australia a single IC production facility [Electronics, June 12, 1967, p. 242].

Burroughs, Japan whistling Nixie

A new generation of low-cost Nixie tubes will soon be on its way to the U. S. market. The Burroughs Corp. says it will be ready early this year to deliver production quantities of the new Japanese-made tube, which is about $\frac{1}{2}$ inch in diameter and $1\frac{1}{2}$ inches long.

Burroughs has priced the tube at just under \$4, making it the cheapest Nixie available by \$1. Producing the tube is the Japan Radio Co., which developed it to Burroughs' specifications.

The deal with Japan Radio should help Burroughs—albeit indirectly—clear up its royalty problems with Japanese desk-calculator producers [Electronics, June 26, 1967, p. 203]. At first, Burroughs wanted equipment makers to pay 45 cents per tube. Now, the U. S. company has offered to cut the rate to about 18 cents for equipment sold outside the U.S. or Canada. For these two countries the 45-cent rate would hold.

U.S. tries to block Czech computer deal

The Johnson Administration thinks it can block—or at least delay—plans by two West European companies to sell sophisticated computer technology to Czechoslovakia. U. S. officials insist the manufacturing knowhow involved could be useful in the weapons-development efforts of Eastern-bloc countries.

Both deals—one involving France's Bull-GE, the other Britain's International Computers & Tabulators—are up for review by NATO's coordinating committee, which advises on strategic exports. If U. S. delegates to the committee can't arrange to tie up the sales, the Administration will try to convince the British and French governments not to grant export licenses to ICT and Bull. The U. S. may also ask General Electric to order its French subsidiary to drop the deal.

Bonn balks at buying more 'offset' arms

Chances now appear slim that the Kiesinger government will agree to buy more military hardware from the U. S. to offset the cost of keeping American troops in West Germany.

The Germans say their armed forces can't absorb any more than the \$750 million of equipment slated to be bought under the present payments treaty expiring at midyear. Instead of arms purchases, the Germans propose to buy U. S. treasury bonds or similar securities to help ease pressure on the dollar.

Effects of the German stance won't be felt by U. S. military hardware producers for some time, though. Some \$500 million remains to be spent from the \$750 million arms outlay already agreed upon.

Shiba adds klystron to its uhf-tv arsenal

In a move to better its chances for Japanese uhf-television orders, the Shiba Electric Co. has signed an agreement to produce klystrons developed by the English Electric Valve Co.

Shiba and the other major Japanese producers of tv broadcast equipment are jockeying for contracts from 22 new tv stations that recently were licensed when the government opened up the uhf channels. Some \$40 million in equipment will be needed for the new stations.

Newsletter from Abroad

January 22, 1968

U.K. fears backlash from F-111 pullout

British electronics companies counting on U.S. military business have some anxious weeks in store.

In the wake of Britain's cancellation last week of its order for 50 F-111 swing-wing fighter-bombers, the Pentagon will take a second look at arms contracts won by British producers when "Buy American" rules were relaxed. In a 1966 deal under which Britain contracted to buy some \$2.5 billion in arms from the U.S., the Pentagon agreed to let British firms bid on equal terms with American companies for some \$725 million in offset purchases.

The U.S. still hasn't decided what specific moves it might take in response to the Wilson government's action, one of a series of moves in the devaluation package designed to bolster Britain's economy. There's scant chance, though, that any of the \$180 million in offset orders won so far by British companies will be canceled.

Rumania may break planes from France

AEG-Telefunken now thinks there's a chance Rumania might adopt its PAL (for phase alternation line) color-television system. A delegation of Rumanian broadcast officials will come to Germany soon to take a closer look at the hardware.

If the Rumanians do go for PAL, it would be a serious setback for France. Until now, the feeling was that all the Eastern-bloc countries would follow the Russians' lead and adopt the French system, Secam.

France last month lost a customer when Belgium, which had been leaning toward Secam, opted for the Telefunken system.

Belgian plane order still up in the air

A round of last-minute bargaining apparently will decide whether the Belgian air force orders its next batch of planes from Northrop, Lockheed, or France's Dassault.

In Brussels, the latest word is that Dassault has the edge over the two U.S. contenders for the \$270 million contract. But there's speculation that leaks about the contract are part of the bargaining. The order might go to either Northrop or Lockheed in exchange for a waiver of U.S. overseas spending curbs for Belgium [see story p. 197].

The deal—for 106 fighter-bombers worth about \$160 million, plus \$110 million worth of spares and maintenance services—hinges mainly on the "offset" business the winning planemaker will throw to Belgian companies. Northrop has offered about 50% if its F-5 gets the nod. The Dassault deal—for Mirage V's—provides for 70% offset. Lockheed, a latecomer to the bidding with its CL9-85B, a modified F-104, has upped the ante to 93%. But Dassault has some strong support among Belgian companies, who feel they might become regular suppliers to the firm.

Australian IC firms await subsidy award

The entire field—Australia's top half-dozen electronics firms—still remains in contention for the integrated-circuit contract that the government's supply department will let within weeks. Insiders in Canberra say no company has established itself as a favorite since the department called for bids six months ago.

Australian officials decided to lump together government orders for

France

Powerful partner

When ordinary mortals seem about to fumble some chance to enhance French prestige, count on President Charles de Gaulle to hove into view.

De Gaulle took action this month when it looked as if France might lose some technological face with the Russians. As Finance Minister Michel Debré and Science Minister Maurice Schumann went off to Moscow for a five-day visit, the French government announced it had acquired a one-quarter holding in the Compagnie Française de Télévision.

By moving into CFT, de Gaulle hopes to squelch any second thoughts the Soviets might have about the television deals they've made with the French. The Russians have adopted CFT's color-tv system, Secam. What's more, they've agreed to buy a low-cost color-picture tube developed by the company, and have contracted for CFT help in building a plant to produce the tube.

Unmasked. Instead of a shadow mask, the tube uses a grille of wires to direct the beams from three electron guns onto the right color phosphors, an idea first proposed by the late Ernest O. Lawrence. In Japan, both the Sony Corp. and the General Corp. (formerly Yaou Electric) make sets with Lawrence tubes.

The trouble is that the French themselves haven't been able to get the tube into volume production, though they've been working towards that end since the early 1960's. The Soviets plan to get into mass-production of color sets by 1970 and may look for another picture-tube deal if the French can't deliver. To make sure the French can, de Gaulle stepped in.

Before it wound up with a powerful new stockholder, CFT had

unsuccessfully sought government subsidies to get the tube into production—something like the funds poured into the computer industry under the Plan Calcul.

Late last year, though, the government did offer a development loan—apparently about \$2 million—on the condition that it become a part owner of CFT until the loan was repaid. The company balked at first, but came around when the government stepped up pressure to seal the deal before the ministers' Moscow visit. The major private stockholders in CFT are electronics giant CSR-Compagnie Générale de Télégraphie sans Fil (now being merged into Compagnie Française Thomson Houston-Hotchkiss Brandt), glass and chemicals maker Compagnie de St. Gobain, and Sylvain Floirat, an influential industrialist who currently is president of CFT.

Under the new setup, Floirat will become president and majority shareholder of a new CFT affiliate, formed to produce the tube, the Société Nouvelle du Tube Français. Jean Cahen-Salvador will replace Floirat as CFT president. Cahen-Salvador headed the state-controlled aerospace company Nord-Aviation until it was merged last year with Sud-Aviation, also government-run.

Ready to roll? As for the tube, CFT says it has now mastered the techniques needed for volume output and will have 23-inch tubes coming off the lines by late 1969. This isn't the first time CFT has claimed that mass-production was in sight, but with the government now involved, the company's pronouncements have a sounder ring.

Also improving CFT's chances of making good this time is a redesigned front end for the tube. The phosphor stripes were originally laid down on a flat plate mounted inside the bulb, but the firm has found a way to deposit them on the face and still keep them aligned with the wires on the grille.

Japan

Telechromatic

Anchor men for network newscasts televised in color by Nippon Hoso Kyokai will be able to call up for still color photos starting next summer.

Around June, NHK (the nonprofit Japan Broadcasting Corp.) will have 30 color-facsimile transmitters spotted at local broadcasting stations throughout the country. The transmitters will feed—over telephone lines—receivers at major broadcast centers in Tokyo and Osaka, where network color newscasts originate.

When NHK starts its color-facsimile transmissions, it will become the first to do so on a regular basis. Black-and-white facsimile is an everyday thing, but only the Japanese have developed a practical unit for color thus far. The equip-



Gallic guardian. Irked about CFT's long delay in getting picture tube into production, President de Gaulle made his government a CFT shareholder.

ment was developed jointly by NHK and Toho Denki Co., a subsidiary of the Matsushita Electric Industrial Co. that specializes in facsimile equipment. The color transmitters cost about \$2,200 installed, and the receivers about \$6,000.

The lineup. A line-sequential scanning scheme is used, transmitting information for one primary color at a time. That way, the information is no more complex than for black-and-white transmission and can be handled by a voice-grade telephone channel. The system is compatible with the black-and-white facsimile units NHK currently uses. However, the line-sequential scan triples the transmission time compared to black and white. It takes 7.2 minutes to send a color photo. At the receiver, the information is used to expose a Polaroid color-film pack.

For transmission, color prints are wrapped on a drum that spins at 150 revolutions per minute. A light is bounced off the photo, through a color-analyzer wheel, and then onto a phototube to get a video signal.

The advance of the pickup assembly across the rotating drum is in steps of 0.213 millimeter—that is, there are 4.7 lines per millimeter. Each line is scanned three times, once for each primary color, then the pickup advances one line.

In the pack. The color-by-color signals are amplified and then transmitted. After amplification at the receiver, the signals pass through correction circuits, one for each primary color.

The correction circuits are switched one-by-one onto a second amplifier in synchronization with a color analyzer. The amplifier output modulates the light level of a glow tube. Its light passes through the analyzer and then passes through an assembly of optical fibers that converts the circular scan into a linear one.

Like the pickup assembly in the transmitter, the film pack is advanced in the receiver. However, the film pack advances one-third of a basic line for each scan. Thus, the spacing between lines is held the same at the receiver and the transmitter. The advance at the receiver gives some overlap of the three lines for each primary-color trio. The spacing between the lines, though, is less than the resolution of both the fiber optics and the Polaroid film so that no lines show in the reproduced picture.

Monochrome. For black-and-white transmission, the color transmitter is locked onto green and each line scanned only once. However, a special receiver with a rotating drum carrying light-sensitive paper is used rather than simply substituting a costly black-and-white Polaroid film pack.

Color it otherwise

Although the shadow mask prevails and quite likely will continue to do so for some time to come, engineers keep on looking for something better as the picture tube for color-television receivers.

Thus far, most efforts to unmask the tubes have started with the premise that the color image would be reproduced by mixing three primary colors—red, green, and blue. As a result, resolution has been a problem since the color phosphors have to supply the detail of the image. The problem can be skirted with little trouble, researchers at Japan's Sony Corp. have found. Their scheme: reproduce images by mixing white and just two primary colors.

Separate and unequal. In an experiment using two optically linked tubes—one to give a high-resolution black-and-white image and the other, with low resolution, for the coloring—Sony has shown that the scheme works. Satoshi Shimada, who headed the research effort, admits the two-tube system has little practical prospect. But he's convinced the "separated white" concept could lead to practical successors to the shadow-mask tube.

One possibility is the Apple tube, which does away with both masks and the wire grids used for Lawrence tubes but has inherently low resolution. Even the shadow mask could benefit. With no loss in resolution, the shadow mask could be twice as coarse in sets working on the separated-white principle.

Accentuating the negative. Sony sorts out its white component from the regular color-tv signal—a chrominance plus a luminance signal. As in the circuits that drive conventional three-gun picture tubes, the luminance and chrominance signals are matrixed to get negative

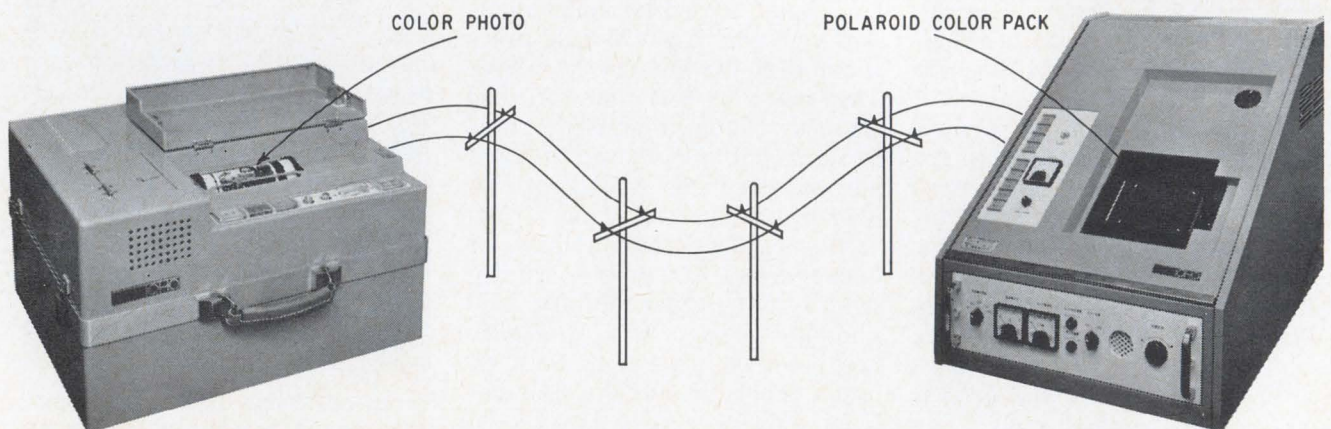

Color line. Japan Broadcasting Corp. will start feeding color photos from outlying stations to main studios in Tokyo and Osaka over telephone lines around midyear.

red, green, and blue signals. But before they go to their respective guns, the negative signals get an additional processing.

This processing, in essence, determines which of the three color signals (say blue) is smallest and uses that level as the white signal. The other color signals (green and red in this instance) are reduced by the amount of the white level and then fed to their respective guns. The white phosphors, then, can establish the over-all resolution for the image and the color phosphors need only color it fairly grossly. To the human eye, though, the picture looks as if the color phosphors had high resolution, too.

Broad stripes. Shimada believes the separated-white scheme would make line-sequential operation acceptable for tubes having only some 80 to 100 color-trio stripes. This is half or less the number considered necessary for an acceptable picture reproduced conventionally—that is, with the color phosphors setting the resolution.

This feature, Shimada expects, will send a lot of people back for a second look at the beam-indexed Apple tube. Until now, this tube had been more or less discounted because it required narrow color stripes for adequate resolution. Narrow stripes means a small beam spot, which limits brightness. As Shimada sees it, wide color stripes could be placed on a glass lattice behind the white phosphors on the inside of the tube faceplate. The white phosphors would also serve as an optical diffuser to spread the coloring smoothly over the image.

With conventional picture tubes, the separated-white scheme would make practical coarser, and thus more easily manufactured, masks. Instead of the usual color triplet for each aperture in the mask there'd be a triplet with a white phosphor at the center.

Such tubes would need four guns, a large white gun at the center with three smaller color guns spaced around it. The arrangement isn't impossible. The Westinghouse Electric Corp. has developed a four-gun tube, apparently for better black-and-white reception on color television receivers.

Great Britain

Logic choice

Britain's largest computer company, International Computers & Tabulators Ltd., has proved a nimble giant indeed when it comes to integrated circuits.

The company three months ago seemingly ended speculation over when it would put a third-generation machine with IC's on the market [Electronics, Oct. 30, p. 170]. At that time, ICT said it would begin delivery by late 1969 of a large, multiaccess computer built around emitter-coupled logic (ECL) circuits.

This month, though, the company made it clear that these large machines will represent its second excursion into IC's. The first will come this summer, when smaller computers with transistor-transistor logic (TTL) in their central processors start coming off the company's production lines. Deliveries of the firm's first TTL machine, the 1901A, are slated for August. Three others—the 1902A, the 1903A, and the 1904A—will follow.

Cost conscious. As with the choice of ECL for large processors, cost was the prime reason behind the company's decision to go with TTL in its small- and medium-size processors. Diode-transistor logic, the company figured, was too slow and ECL too costly for these lines.

A half-dozen British semiconductor houses are now mass-producing TTL, and four of them will supply ICT with standard packages having an average propagation delay time of about 13 nanoseconds. The suppliers: the British subsidiaries of Texas Instruments, Motorola Inc., and SGS-Fairchild, plus Mullard Ltd., a subsidiary of Philips Gloeilampenfabrieken of the Netherlands.

Speed counts. Except for their central processors, the TTL machines will differ little from their discrete-component predecessors. And in the processors, only the logic functions will be handled by IC's. Beside reducing size, ICT says the use of IC's gives the machines

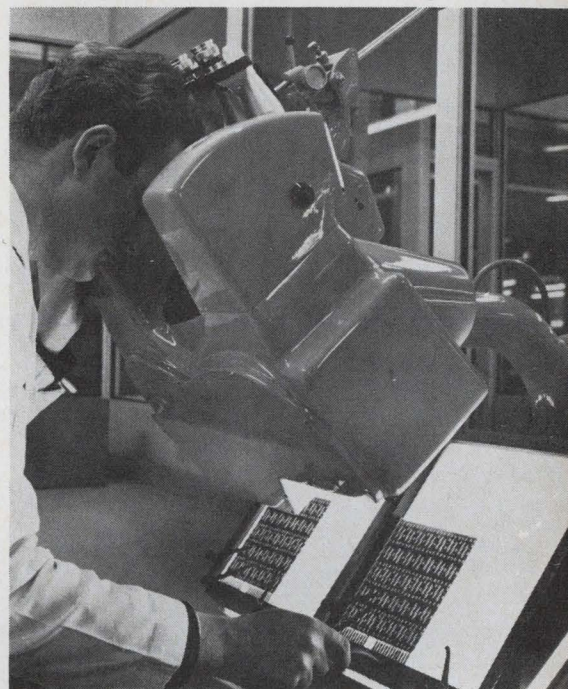

All aboard. Technician checks multi-layer circuit board that carries TTL packages in ICT's new processors for small- and medium-size computers.

“significantly” greater processing capability.

The new machines will be completely compatible with older 1900 series discrete-logic units so far as programs go. And they will cost about the same as the earlier series—about \$85,000 for the 1901A up to around \$725,000 for the least expensive version of the 1904A, which will be able to handle up to 16 programs at one time.

Behold the fringe

Until holograms came along, optical interferometers were largely limited to spotting slight imperfections on highly polished surfaces—lenses and telescope mirrors, for instance. With holograms, though, interference-fringe maps can be plotted for relatively rough and complex surfaces.

Researchers at the University of Michigan have been particularly adept at applying holography to vibration analysis. R. L. Powell and K. A. Stetson, for example, have used time-averaging—a technique that produces, in effect, a multiple-exposure hologram—to record the

fringe patterns set up in a sonar transducer [Electronics, May 15, 1967, p. 88].

The technique, however, has some drawbacks. Because the fringe patterns show average vibration, phase relations between vibrations at different points on the disk can't be spotted. Then, too, the contrast between fringes drops off as the amplitude of the vibration increases. What's more, the best vibration frequency at which to make the hologram has to be more or less guessed at.

Strobed. A way around these drawbacks has been developed by a trio of scientists at Britain's National Physical Laboratory. The three, James Burch, Anthony Ennos, and Edward Archbold, described their method—which adds stroboscopy to holography and interferometry—last week at a meeting sponsored by the Institute of Physics and the Physical Society.

The setup is basically much like that used in the time-averaging method. A laser beam—in this case emanating from a Spectra-Physics 65-milliwatt helium-neon device—is split to illuminate both the vibrating disk and a hologram made with the disk at rest.

Before splitting it, though, the British pulse the beam by directing it at a shaft rotated by a small air turbine. A hole 0.015 inch in diameter permits two short bursts of the beam to pass through the shaft with each full turn. Pulse rates range up to about 3,500 per second.

At the same time, a signal to control the vibration frequency of the test piece is obtained by bouncing polarized light off the rotating shaft and detecting the peaks of light with a photocell. This technique keeps the light hitting the test disk precisely in phase with the transducer moving the disk.

Clear view. As the disk vibrates, light from it bounces onto the hologram made with the disk at rest. The hologram is lit at the same time by the laser beam, so fringe patterns appear stroboscopically. The whole range of frequencies can be scanned by varying the speed of the shaft and, hence, the beam's pulse rate. And since there's no

time-averaging, the fringes stay clear right up to maximum vibration amplitudes.

To study phase relationships, the angle of the polarized light can be varied to dephase the movement of the transducer and the pulsed beam.

West Germany

Road test

West Germany's Daimler-Benz AG goes to considerable lengths to make sure that motorists around the world know how well-engineered its Mercedes passenger cars are. And the company is equally unstinting in its effort to make sure the cars justify the advertising claims.

Daimler-Benz now has a 10-mile test track at its Stuttgart-Unterturkheim plant, a track loaded with electronics. There's a system, for example, to check out a car's drift in a crosswind. Special hardware measures steering characteristics. A doppler-radar installation measures acceleration and braking, and there's even a system to determine how much a car's tires expand at high speed.

Getting the drift. To find out how a car reacts to a crosswind, Daimler-Benz runs it down a 300-foot section of the track studded with sensor coils and flanked by turbines that can blast jets of air at velocities up to gale force. For the test, the steering wheel is locked and a 100-kilohertz oscillator is mounted on the auto. As the car moves down the test strip, the oscillator signal is picked up by successive coils. A computing network figures out the drift in meters from the number of coils the car has passed over.

Pickup coils figure, too, in the zig-zag test area—the slalom section—of the track. Slalom runs help assess a car's road-holding and steering characteristics. The runs are clocked by electronic counters that are started and stopped by pulses induced in the loops as the car passes over them. Again, a car-mounted oscillator is used, this time operating at a frequency of 5 khz.

At high speeds, tire radius can expand as much as a quarter-inch, lifting the car by the same amount and thereby changing the air flow under the chassis. For dynamic measurements of tire radius, a small pulse generator is mounted on one of the wheels. With each turn of the wheel, the generator beats out 63 pulses that are transmitted to



Checkpoint. Doppler radars measure speed and braking distance at highly instrumented Daimler-Benz test track at Stuttgart-Unterturkheim.

a receiver-counter at the track's control center. The lower the count, the greater the radius, since the car travels a fixed distance during the test.

Pulse-quickenig. Acceleration, deceleration, and braking are tested on a half-mile stretch of the track fitted out with eight doppler-radar sets designed and built by AEG-Telefunken and operating at 9.5 gigahertz. The eight units are switched on and off by embedded induction loops as cars pass into and out of range. When a car passes over a loop, a transceiver in the car picks up a 10-khz pulse and sends it to the control tower; the succession of pulses keeps the radar units keyed to the passing car.

A 2.3-khz oscillator is triggered by contact with the brake pedal and is used to test braking. The oscillator signal is radioed to the control tower where, together with the speed input from the doppler radar, it is fed into a small computing network.

International

Entrenched privilege

President Johnson's moves this month to cut the outflow of capital from the U.S. may turn out to have surprisingly little impact on overseas plant investments by American electronics companies.

At first, word that restrictions had been slapped on capital transfers overseas had executives of firms with big foreign operations wondering if they'd have to recast their investment plans. Their first look at the regulations, however, left these executives breathing easier. Apparently, about the only companies that will be seriously fettered by the curbs are those planning heavy initial investments in Europe this year.

Bank on it. Companies on the scene for some time figure they can raise any investment capital they'll need in Europe. "Despite the restrictions, we're optimistic," says Douglas O'Connor, who heads Texas Instruments Incorporated's

subsidiary in West Germany.

O'Connor's view is shared by officials at the International Telephone & Telegraph Corp., the International Business Machines Corp., and others who have top-drawer credit ratings with European financial houses. Johnson's restrictions, intended to trim \$1 billion from the U.S. balance-of-payments deficit, don't apply to money raised abroad.

Nearly everybody, though, expects U.S. companies raising new capital abroad will have to pay more for it now than in the past. Interest rates were on the rise in Europe even before the curbs were announced, and with more U.S. companies combing the market for capital, further increases are certain. Financial circles in Paris, for example, expect the rate for "Euro-dollar" loans to rise to 8% or 9% this year. At year end, borrowers were paying 7% for Eurodollars.

Plowed back. Big, "old-foreign-hand" companies can also do some self-financing by reinvesting profits made abroad. Although the new regulations clamp a moratorium on capital outlays by U.S. firms in the major West European countries—Britain excepted—they do allow companies to reinvest the earnings of their subsidiaries in amounts up to 35% of their average annual investment during 1965 and 1966.

In Britain—and in Canada, Japan, and Australia—the regulations allow new capital outlays. But the limit for transfers of investment funds to these countries is 65% of the 1965-66 average, and the same rate holds for reinvestments. Thus, companies that have been strengthening overseas subsidiaries by plowing back all their earnings will have to either slow expansion or go into local money markets.

Buffeted. Hardest hit will be electronics companies that had been feeling their way into Europe and had slated big moves this year. They will get little lift from reinvested earnings and will find it hard to borrow in local money markets.

Some think smaller companies that planned to break into Europe may have to settle for licensing deals to gain a foothold, rather than outright investments.

Now in
publication!

A Fully Documented Analysis of International Electronics

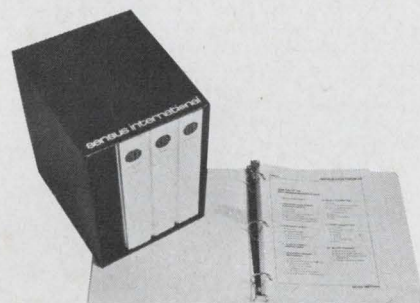

Four volumes of incisive data—by country—basic elements in planning and maintaining a position of marketing strength in the international electronics markets.

Updated regularly, information is gathered on the spot and covers all aspects of doing business in electronics in every major electronics market of the world. Tariffs, government policies, exchange controls, credit, trade unions, even the impact of smuggling are covered in these in-depth reports.

Send for complete, free information

sensus international

Please send me your free, descriptive literature.

Name _____

Title _____

Company _____

Street _____

City _____

State _____ Zip _____

SENSUS INTERNATIONAL
712 Montgomery Street,
San Francisco, Calif. 94111

If you can't wait,
call (415) 989-6973

| | | | | | |
|--|---------|---|----------------|--|---------------|
| ■ Acopian Corp. Mort Barish Associates | 199 | Douglas Randall, Inc. West, Weir & Bartel, Inc. | 179 | LectroMagnetics, Inc. Van Der Boom, McCarron, Inc., Adv. | 178 |
| Adams & Westlake Co. Kasper & Assoc., Inc. | 50 | Dow Corning Corp., Engineering Products Div. | 148 | Lenox-Fugle Electronics, Inc. Keyes, Martin & Co. | 158 |
| Airpax Electronics, Inc. Welch, Mirabile & Co., Inc. | 130 | | | Levinson Co., Harry Pollock & Loth, Inc. | 166 |
| ■ Air Products & Chemicals, Inc. Arthur Falconer Assoc. | 145 | ■ Eagle Signal, Div. of E. W. Bliss Co. Feeley Adv. Agcy., Inc. | 128 | Lockheed Electronics Co. McCann-Erickson, Inc. | 125 |
| Air Reduction Co., Inc., Aircro Industrial Gases Div. | 31 | Eastman Kodak Co., Business Systems Markets Div. | 159 | | |
| Allen-Bradley Co. Fensholt Adv. Agcy. | 27 | J. Walter Thompson Co. | | ■ Machlett Laboratories, Div. of Raytheon Co. | 9 |
| ■ Amelco Semiconductor, Div. of Teledyne, Inc. | 58 | Electronic Engineering Co. of California Jansen Associates | 24 | ■ Mallory Battery Co., Div. of P.R. Mallory & Co., Inc. | 116 |
| American Telephone & Telegraph Co. Cunningham & Walsh, Inc. Adv. | 161 | ■ ESC Electronics Corp. Comar Adv. Agcy., Inc. | 127 | Memorex Corp. Hal Lawrence, Inc. | 170 |
| ■ AMP, Inc. Garceau, Hallahan & McCullough, Inc. | 28, 29 | ■ Fairchild Semiconductor, Inc. Faust/Day, Inc. | 54, 55, 56, 57 | Merrimac Research and Development, Inc. | 32 |
| Andrew Corp. Fensholt Adv., Inc. | 190 | | | ■ Micro Switch Division of Honeywell Batten, Barton, Durstine & Osborn, Inc. | 105 |
| ■ A.P.I. Instruments George Z. Griswold Advertising | 144 | G & E Bradley, Ltd. Hyde & Partners, Inc. | 200 | Monsanto Co. Foote, Cone & Belding | 33 |
| APM-Hexseal Corp. Mohr & Co., Inc. | 118 | General Electric Co., Polymer Products Operation Div. | 129 | Motorola Semiconductor Products, Inc. | 121, 122, 123 |
| Associated Testing Laboratories, Inc. Murray Testing Laboratories, Inc. | 181 | General Magnetics, Inc. George Homer Martin Assoc. | 137 | | |
| Austron, Inc. Don L. Baxter, Div. of Albert Frank-Guenther Law, Inc. | 166 | General Radio Co. Horton, Church & Goff, Inc. | 2nd Cover | ■ National Electronics, Inc. Connor-Sager Assoc. | 175 |
| Automatic Electric Co., Sub. of General Telephone & Electronics Corp. | 140 | ■ Guardian Electric Mfg. Co. K & A Advertising | 60 | National Semiconductor Corp. Jay Chiat & Assoc. | 84, 85 |
| | | ■ Gudebrod Brothers Silk Co., Electronics Div. | 182, 183 | Natvar Corp. Sanger-Funnell, Inc. | 175 |
| | | Hansen Manufacturing Co. Keller-Crescent Co. | 168 | ■ North Atlantic Industries, Inc. Murray Heyert Assoc. | 150 |
| ■ Beckman Instruments, Inc., Helipot Div. | 62, 179 | Heinemann Electric Co. Thomas R. Sundheim, Inc. | 6 | Northern Natural Gas Co. Bozell & Jacobs, Inc. | 151 |
| ■ Bendix Corp., Flight & Engine Instruments Div. | 36 | ■ Hewlett Packard, H.P. Associates Lennen & Newell, Inc. | 30 | | |
| Birtcher Corp., The Guerin, Johnstone, Gage, Inc. | 163 | ■ Hewlett Packard, Colorado Springs Div. | 3rd Cover | Ovenaire, Inc. John E. Waterfield/ ADMASERS Adv., Inc. | 160 |
| Bourns, Inc., Trimpot Div. Lester Company, The | 49 | ■ Hewlett Packard, Loveland Div. Tallant/Yates, Adv., Inc. | 2, 41 | Pacific Measurements, Inc. Jack Herrick Adv., Inc. | 7 |
| ■ Bulova Watch Co., Electronics Div. Frank Best Co., Inc. | 132 | ■ Hewlett Packard, Microwave Div. Lennen & Newell, Inc. | 102 | Pamotor, Inc. Harry P. Bridge Co. | 115 |
| ■ Burndy Corp. Don Kemper Co., Inc. | 119 | ■ Hewlett Packard, F. L. Moseley Co. Div. | 1 | ■ Patwin Electronics Graceman Adv., Inc. | 154 |
| ■ Bussmann Mfg., Div. of McGraw Edison Co. | 12, 13 | HI-G, Inc. Marketing Assistance, Inc. | 169 | Pennsalt Chemicals Corp. Aitkin Kynett Co., Inc. | 172 |
| By-Buk Co. Albert Frank Guenther Law Adv., Inc. | 162 | Honeywell, Computer Control Div. Franklin P. Folts, Inc. | 45 | Physics International Conley Baker & Steward | 8 |
| | | Hughes Aircraft Co. Foote, Cone & Belding | 177 | ■ Plastic Capacitors, Inc. Sander Rodkin Adv. Agcy., Ltd. | 176 |
| Capitol Radio Engineering Institute Henry J. Kaufman & Associates | 167 | | | Polaroid Corp. Doyle, Dane, Bernbach, Inc. | 43 |
| Centralab, Div. of Globe-Union, Inc. The Brady Co. | 34 | Industrial Electronic Engineers Gumpertz, Bentley & Dolan, Inc. | 174 | ■ Potter & Brumfield Div., American Machine & Foundry Co. | 101 |
| Cimron, Div. of Lear Siegler, Inc. Phillips-Ramsey, Inc. | 108 | ■ Integrated Circuit Engineering Corp. Gordon L. Ness Assoc. | 96 | Radio Cores, Inc. Sander Rodkin Adv. Agcy., Ltd. | 170 |
| ■ Clairex Corp. Michel-Cather, Inc. | 154 | ■ International Crystal Mfg. Co. Robert V. Freeland & Assoc. | 139 | Radio Corporation of America Al Paul Lefton Co. | 4th Cover |
| Cohu Electronics, Inc. Erwin Wasey, Inc. | 15 | Iowa Development Commission L. W. Ramsey Advertising | 180 | ■ Radio Switch Corp. George Homer Martin Assoc. | 158 |
| Consolidated Vacuum Corp., Sub of Bell & Howell | 106 | I R C, Inc. Gray & Rogers, Inc. | 103 | ■ Raytheon Co., Components Div. Fuller & Smith & Ross, Inc. | 138 |
| ■ Control Data Corp., Analog Digital Systems Div. | 152 | | | ■ Reeves Hoffman, Div. of Dynamics Corporation of America | 162 |
| Corning Glass Works, Electronics Products Div. | 59 | Jerrold Electronics Corp. Gray & Rogers, Inc. | 14 | RFL Industries, Inc., Instrumentation Div. | 186 |
| Coto Coil Co., Inc. Williams Co., The | 166 | ■ J F D Electronics Co., Components Div. | 171 | Josephson, Cuffari & Co. | |
| ■ Couch Ordnance, Inc., Couch Co. Div. Culver Adv., Inc. | 174 | ■ Johanson Mfg. Co. Josephson, Cuffari & Co. | 188 | Rosenthal-Isolatoren GMBH Werbeagentur Kurt Linnebach | 136 |
| Cyclo-Tronics, Inc. Bernard J. Hahn & Assoc. | 120 | | | | |
| | | Krohn-Hite Corp. L.K. Frank Co., Inc. | 113 | Sage Electronics Corp. Mathison Adv., Inc. | 171 |
| Dage Electric Co., Inc. Garrison, Jasper, Rose & Co. | 104 | | | Sanders Associates, Inc. Harold Cabot & Co., Inc. | 155 |
| Data Instruments Division Technical Marketing | 142 | ■ Lambda Electronics Corp. Michel Cather, Inc. | 20, 21 | Sanders Associates, Inc., Flexprint Products Div. | 164 |
| Delta Design, Inc. Pacific Publications | 184 | ■ Lapp Insulator Co. Wolff Associates | 185 | Scientific Data Systems Doyle, Dane, Bernbach, Inc. | 61 |
| Digital Equipment Corp. Kalb & Schneider, Inc. | 176 | ■ Leach Corp. Jay Chiat & Associates | 18, 19 | | |
| Dit-Mco International Division of Xebec Corp. | 189 | | | | |



Advertising sales staff

Frank E. LeBeau [212] 971-6464

Advertising sales manager

Wallis Clarke [212] 971-2187

Assistant to sales manager

Donald J. Austermann [212] 971-3139
Promotion Manager

| | |
|--|-------|
| Sensus International | 197 |
| John W. Hall | |
| Sierra Electronics Division Philco Ford | 11 |
| Hal Lawrence, Inc. | |
| Signetics Corp. Sub. | 17 |
| Corning Glass Works | |
| Cunningham & Walsh, Inc. | |
| ■ Siliconix, Inc. | 47 |
| Graphics West | |
| ■ Sorensen Operation, Raytheon Co. | 53 |
| James Adv., Inc. | |
| South Daota Industrial Development | 160 |
| Expansion Agency | |
| Maurice Paulsen Advertising | |
| Spectrol Electronics Corp. | 147 |
| Jones, Maher, Roberts, Inc. | |
| Sprague Electric Co., The | 5, 10 |
| Harry P. Bridge Co. | |
| ■ Stackpoole Carbon Co., | 107 |
| Electronic Components Div. | |
| Meek & Thomas, Inc. | |
| Synthane Corp. | 179 |
| Arndt, Preston, Chapin, | |
| Lamb & Keen, Inc. | |
| ■ Tektronix, Inc. | 110 |
| Hugh Dwight Adv., Inc. | |
| Telonic Engineering Co. | 16 |
| Jansen Associates, Inc. | |
| Teradyne, Inc. | 22 |
| Quinn & Johnson Adv., Inc. | |
| Texas Instruments Incorporated, | 109 |
| Components Group | |
| Don L. Baxter, Div. of | |
| Albert Frank-Guenther Law, Inc. | |
| Transistor Electronics Corp. | 95 |
| Stevenson and Associates, Inc. | |
| ■ Trygon Electronics, Inc. | 168 |
| Kameny Associates, Inc. | |
| ■ Tung Sol Division, | 175 |
| Wagner Electric Corp. | |
| Feeley Adv. Agcy., Inc. | |
| Ulano Graphic Arts Supplies, Inc. | 143 |
| Lory Roston Associates | |
| Victoreen Instrument Co., The | 146 |
| Palm & Peterson, Inc. | |
| Vishay Instruments, Inc. | 187 |
| Alpern Communications | |
| Vitramon, Inc. | 124 |
| Ted Sommers, Inc. | |
| ■ Weston Instruments, Inc., | 153 |
| Archbald Div. | |
| Arndt, Preston, Chapin, Lamb & Keen, Inc. | |
| Weston Instruments, Inc. | 133 |
| Lexington Div. | |
| Larcom Randall Adv., Inc. | |
| ■ Weston Instruments, Inc., | 189 |
| Transicoil Div. | |
| Arndt, Preston, Chapin, Lamb & Keen, Inc. | |

Atlanta, Ga. 30309: Michael H. Miller, 1375 Peachtree St., N.E. [404] 892-2868

Boston, Mass. 02116: William S. Hodgkinson McGraw-Hill Building, Copley Square [617] CO 2-1160

Chicago, Ill. 60611: Robert M. Denmead, J. Bradley MacKimm, Ralph Hanning, 645 North Michigan Avenue. [312] MO 4-5800

Cleveland, Ohio 44113: William J. Boyle, 55 Public Square, [216] SU 1-7000

Dallas, Texas 75201: Richard P. Poole, 1800 Republic National Bank Tower, [214] RI 7-9721

Denver, Colo. 80202: Joseph C. Page, David M. Watson, Tower Bldg., 1700 Broadway, [303] 255-5484

Detroit, Michigan 48226: Ralph Hanning 856 Penobscot Building [313] 962-1793

Houston, Texas 77002: Kenneth George, 2270 Humble Bldg., [713] CA 4-8381

Los Angeles, Calif. 90017: Ian C. Hill, John G. Zisch, 1125 W. 6th St., [213] HU 2-5450

Minneapolis, Minn. 55402: J. Bradley MacKimm, 1104 Northstar Center [612] 332-7425

New York, N.Y. 10036
500 Fifth Avenue
Donald R. Furth [212] 971-3615
James R. Pierce [212] 971-3616
John A. Garland [212] 971-3617

Philadelphia, Pa. 19103:
Jeffrey M. Preston
Warren H. Gardner, 6 Penn Center Plaza, [215] LO 8-6161

Pittsburgh, Pa. 15222: Warren H. Gardner, 4 Gateway Center, [412] 391-1314

Portland, Ore. 97204: James T. Hauptli, 218 Mohawk Building, 222 S.W. Morrison Street, Phone [503] 223-5118

Rochester, N.Y. 14534: William J. Boyle, 9 Greylock Ridge, Pittsford, N.Y. [716] 586-5040

St. Louis, Mo. 63105: Robert M. Denmead The Clayton Tower, 7751 Carondelet Ave. [314] PA 5-7285

San Francisco, Calif. 94111: James T. Hauptli, 255 California Street, [415] DO 2-4600

London W1: Edwin S. Murphy Jr., 34 Dover Street, Hyde Park 1451

Paris: Pierre Braude, European Director Iena Commercial Bldg., 33 rue Galilee Phone: 553-47-79

Milan: Robert Saidel 1 via Baracchini Phone: 86-90-656

Frankfurt/Main: Hans Haller Elsa-Brandstroem Str. 2 Phone: 72 01 81

Geneva: Mike Zeynel 1, rue du Temple Phone: 31 95 60

Tokyo: Nobuyuki Sato, 1, Kotohiracho Shiba, Minato-Ku [502] 0656

Osaka: Ryoji Kobayashi 163, Umegae-cho Kita-ku [362] 8771

Business Department

Wallace C. Carmichael, Manager [212] 971-3191

Stephen R. Weiss, Production Manager [212] 971-2044

Thomas M. Egan, Assistant Production Manager [212] 971-3140

Dorothy Carmesin, Contracts and Billings [212] 971-2908

Frances Vallone, Reader Service Manager [212] 971-2865

Circulation and Research

Milton Drake, Manager [212] 971-3485

Isaaca Siegel, Assistant Circulation Manager [212] 971-6057

David Strassler, Assistant Research Manager [212] 971-6058

Chloe D. Glover, Research Associate [212] 971-6057

Electronics Buyers' Guide

George F. Werner, General Manager [212] 971-2310

Ray Smyth, Eastern Regional Manager [212] 971-6538

Regina Hera, Directory Manager [212] 971-2544

Thomas M. Egan, Production Manager [212] 971-3140

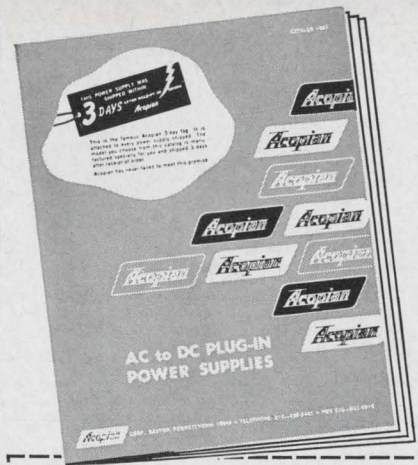

Please send me the latest Acopian catalog that lists

62,000 DIFFERENT POWER SUPPLIES

available for shipment in 3 days.

Name _____

Title _____

Company _____

Address _____

City _____

State _____

ZIP _____

ACOPIAN CORP.
EASTON, PENNSYLVANIA
TEL: (215) 258-5441



Classified Advertising

F.J. Eberle, Manager

EMPLOYMENT OPPORTUNITIES 178

EQUIPMENT (Used or Surplus New) For Sale 178

ADVERTISERS INDEX
Corcoran, Joseph P. 178
Radio Research Instrument Co. 178
John Rotte Associates 178

■ For more information on complete product line see advertisement in the latest Electronics Buyer's Guide

Specify BRADLEY X-band Solid State Sources for Low Noise

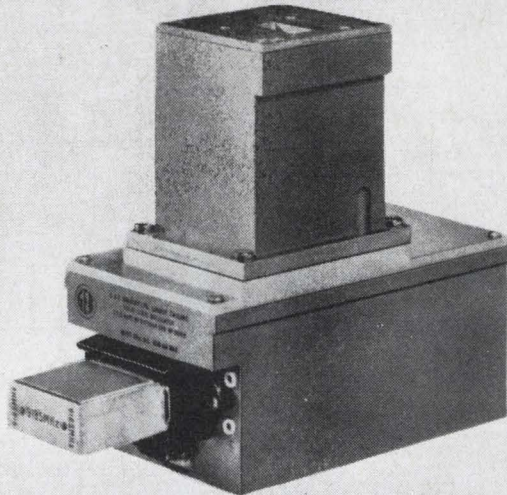

Varactor Sources— for high power

- Plug in Crystal Oscillators give choice of frequencies within 100 MHz channels
- Meets U.S. military specifications
- Up to 300 mW output
- Input 25 W at 28 V.D.C.
- Weight 4 lbs.

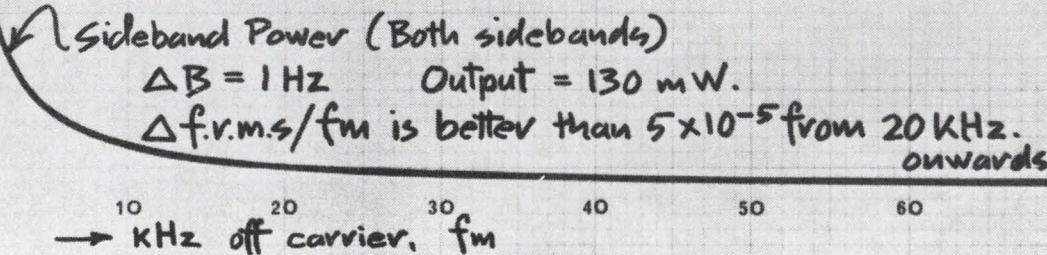

AND Step Recovery Sources -

for local oscillators

- Electrically tunable over 400 MHz
- 10 mW output
- 2 W input at 22 V.D.C.
- F.M. noise 80 d.B. per Hz at 50 KHz from carrier
- Low cost
- Meets U.S. military specifications
- Weight 5 ozs.

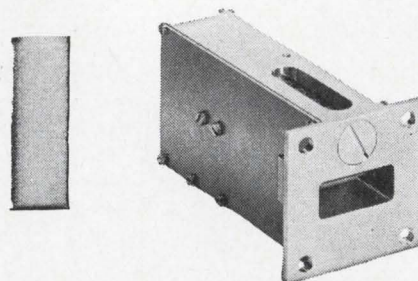

G. & E. BRADLEY LTD

ELECTRAL HOUSE, NEASDEN LANE, LONDON, N.W.10.
 TELEPHONE: 01-450 7811 TELEGRAMS: BRADELEC LONDON N.W.10. TELEX: 25583
 In the United States—EDWIN INDUSTRIES CORP.,
 11933 Tech Road, Silver Spring, MD., 30904. Tel: 301 622 0700

When you "look" at faster-than-nanosecond pulses... do you really SEE them?



You can with hp's new pulse viewing system – the only way you can get the true picture of nanosecond and picosecond pulses!

The hp state-of-the-art 12.4 GHz Sampling System with 28 ps rise time capabilities shows you overshoot, perturbations and rise time that you didn't know were there! Now, you can see *everything* that happens to signals put through your tunnel diodes, transistors, integrated circuits and other high speed devices.

You can pick any part of a high-speed repetitive pulse train, magnify it more than a million times and view it with 28 ps rise time capability. And... when you check rise time, you can be sure you're seeing the rise time of your faster-than-nanosecond signal—and *not the rise time of your measuring system.*

Even when your signal has rate-jitter, the easy-to-use hp 1425A Time Base and Delay Generator—the first sampling plug-in to give you delayed sweep—permits detailed examination of your expanded pulses. And... you can make high resolution time measurements with ultra-stable 10 ps/cm sweeps.

For the complete story on how the versatile hp 12.4 GHz Sampling System can take the doubt out of your rise time measurements, contact your nearest hp field engineer. He can show you why Hewlett-Packard is first in sampling oscilloscopes: First with 12.4 GHz sam-

pling, first with 28 ps rise time sampling, first with sampling TDR (now 40 ps), first with high impedance (100 k Ω) sampling input, first with convenient variable persistence and storage—FIRST IN SAMPLING! Or, write to Hewlett-Packard, Palo Alto, California 94304. In Europe: 54 Route des Acacias, Geneva.

Price of hp 12.4 GHz Sampling System with 28 ps rise time capabilities: With hp 140A Oscilloscope, \$5895; with hp 141A Variable Persistence and Storage Oscilloscope, \$6695.



hp 140: The scope system that gives you BETTER PERFORMANCE IN ANY DIRECTION!
12.4 GHz Sampling • 40 or 150 ps TDR 20 MHz Wideband • High-sensitivity, no drift • Variable Persistence and Storage.

HEWLETT  PACKARD
OSCILLOSCOPE SYSTEMS

Laser-beam detectors...from RCA

| MATERIAL. | TYPE LASER | WAVELENGTH (Angstroms) | SPECTRAL RESPONSE | NOMINAL DIAMETER (inches) | RCA PHOTOMULTIPLIER TUBE TYPE NO. | | |
|--|---------------|------------------------|-----------------------|---------------------------|-----------------------------------|-------------------|---------|
| Ne | Gas | 3324 | S-20 or Special | 3/4 | 8644 | | |
| N ₂ | Gas | 3371 | | | 8645 | | |
| Ar | Gas | 4579 | | | 2 | 4459 | |
| Ar | Gas | 4765 | | | | 4463 | |
| Ar | Gas | 4880 | | | 2 | 7265 | |
| CdS | Semiconductor | 4950 | | | | 7326 | |
| Ar | Gas | 4965 | | | 2 | C31000A | |
| Ar | Gas | 5017 | | | | 4464 | |
| Ar | Gas | 5145 | | | 3 | C70045C | |
| CaF ₂ :Ho ³⁺ | Crystal | 5512 | | | | 4465 | |
| Kr | Gas | 5682 | | 5 | 4526 | | |
| LaF ₃ :Pr ³⁺ | Crystal | 5985 | | | Dormer (.65 x .5) | | |
| Y ₂ O ₃ :Eu ³⁺ | Crystal | 6113 | | S-1 | 3/4 | C70102B | |
| HgHe | Gas | 6150 | | | | 1-1/2 | 7102 |
| HeNe | Gas | 6328 | | | | | 2 |
| Al ₂ O ₃ :Cr ³⁺ | Crystal | 6929 | | | | 3 | |
| Al ₂ O ₃ :Cr ³⁺ | Crystal | 6934 | | | | | 5 |
| SrF ₂ :Sm ²⁺ | Crystal | 6969 | | | | Dormer (.65 x .5) | |
| Al ₂ O ₃ :Cr ³⁺ | Crystal | 7009 | | | | | 3 |
| Al ₂ O ₃ :Cr ³⁺ | Crystal | 7041 | | | | 5 | |
| CaF ₂ :Sm ²⁺ | Crystal | 7083 | Dormer (.65 x .5) | | | | 4526 |
| Al ₂ O ₃ :Cr ³⁺ | Crystal | 7670 | | | | S-1 | |
| GaAs | Semiconductor | 8400 | 1-1/2 | 7102 | | | |
| Na-Ca-Si | Glass | 9200 | | | 2 | | C70007A |
| Li-Mg-Al-Si | Glass | 10150 | 3 | C70102B | | | |
| Y ₃ Al ₅ O ₁₂ :Yb ³⁺ | Crystal | 10296 | | | 1-1/2 | | 7102 |
| CaF ₂ :Nd ³⁺ | Crystal | 10460 | 2 | C70007A | | | |
| CaWO ₄ :Pr ³⁺ | Crystal | 10468 | | | 3 | | C70102B |
| K-Ba-Si | Glass | 10600 | 5 | 4465 | | | |
| CO ₂ | Gas | 10600 | | | Dormer (.65 x .5) | | 4526 |
| CaMoO ₄ :Nd ³⁺ | Crystal | 10610 | 3 | C70102B | | | |
| LaF ₃ :Nd ³⁺ | Crystal | 10633 | | | 5 | 4465 | |
| Y ₃ Al ₅ O ₁₂ :Nd ³⁺ | Crystal | 10648 | Dormer (.65 x .5) | 4526 | | | |
| CaF ₂ :Tm ²⁺ | Crystal | 11160 | | | S-1 | 3/4 | C70102B |

Working on detector circuits for use in the visible and near-infrared portion of the spectrum? Here's a useful tool: the RCA Laser Applications Chart and Preliminary Tube Selection Guide. Combined, they form a summary of many of RCA's coherent visible-radiation detection and mixing devices. All have broad bandwidth, low noise, and fast response. Both the Chart and Guide are published in the booklet PIT-704A, that also includes electrical characteristics, quantum efficiency data, and rise time curves. For your copy of this booklet, as well as technical data sheets on specific types, write: RCA Commercial Engineering, Section A-19P-4, Harrison, New Jersey 07029.



RCA Photomultiplier Tubes for Laser-Beam Detection (PIT-704A).

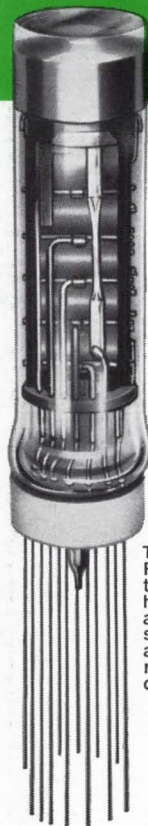

Two examples of RCA Photomultiplier tubes, offering high performance and high speed for visible and near-infrared laser-beam detection.

RCA Electronic Components and Devices



The Most Trusted Name in Electronics