

Displaying scales on a scope 72
Improving IC interconnections 105
Where is optoelectronics heading? 117

\$1.00 A McGraw-Hill Publication

December 22, 1969

Electronics[®]

*Another
big year
in the
making*

*Europe
1970*



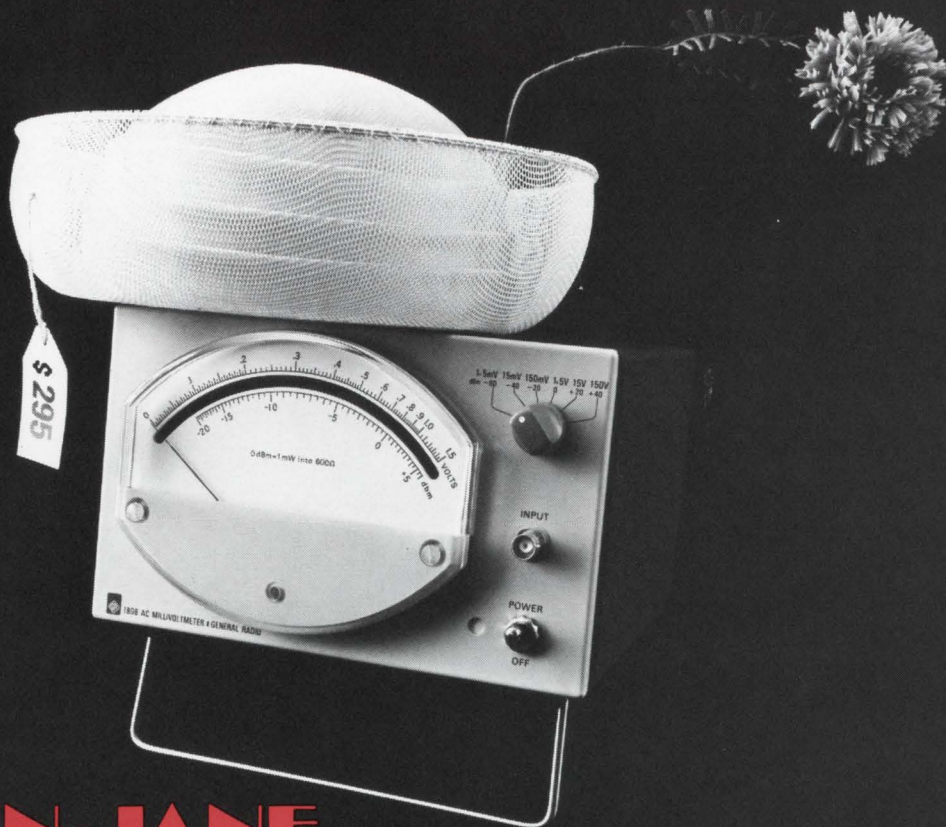

THE PLAIN-JANE MILLIVOLTMETER.

The new GR 1808 AC Millivoltmeter is so plain it's almost ugly. The beauty of the 1808 lies in the engineered features that give it the plain look. First of all, there's only one voltage scale and it's as easy to read as a yardstick. You can't read the wrong scale!

Look at the range switch — only six positions! Most voltmeters have twelve ranges and panels so cluttered they look like they belong in an SST, not on the bench. That's because most voltmeters have only a 3:1 meter range. The GR 1808 has a 10:1 range which halves the amount of range switching and means faster, easier, error-free readings for you. The meter is big, too — 6 inches of scale as compared to the usual 4½-inch varieties.

A point about stability — line-voltage variations cause absolutely no meter jitter or change of reading on any range.

Voltage measuring range is from 100 μV to 150 V from 10 Hz to 10 MHz. Basic accuracy is $\pm 1\%$ of reading, and input impedance is 10 M Ω shunted by 10 pF. A floating dc output is available for recording or for using the GR 1808 as an ac to dc converter for DVM's.

The features may be fancy, but there's nothing fancy about the price; only \$295 in U.S.A.

HOW TO BUY AN 1808 FOR LESS THAN \$295

Combine your millivoltmeter requirements in a single order and take advantage of GR's quantity discount plan! The following schedule of prices apply in U.S.A.; the quantity discount applies everywhere.

| Quantity | Discount | Price |
|----------|----------|----------|
| 1 | — | \$295 |
| 2-4 | 3% | \$286.15 |
| 5-9 | 7% | \$274.35 |
| 10-19 | 10% | \$265.50 |
| 20-49 | 13% | \$256.65 |
| 50-99 | 17% | \$244.85 |
| 100 | 20% | \$236 |

For complete information, write General Radio, West Concord, Mass. 01781; Telephone (617) 369-4400.

In Europe: Postfach 124, CH 8034, Zurich, Switzerland.

GENERAL RADIO



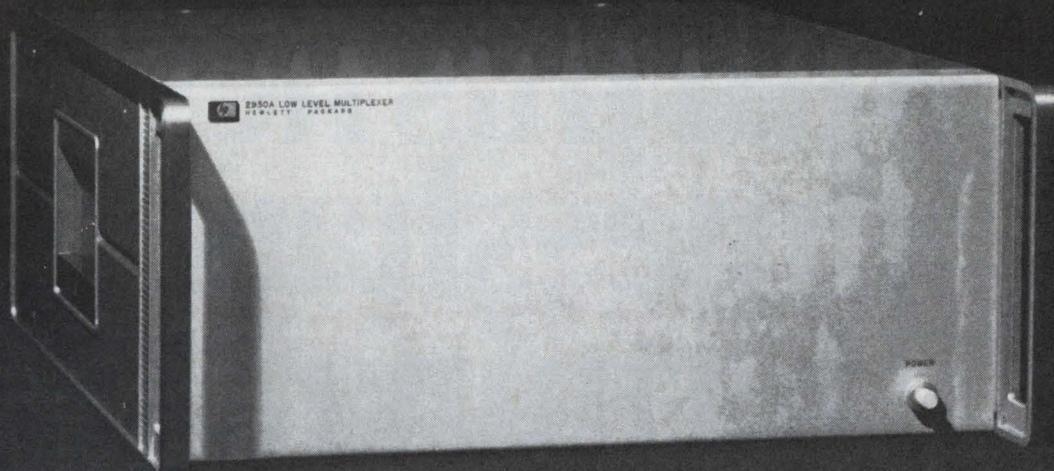

The Much-Better Multiplexer

There's only one multiplexer that can boost millivolt-level signals to 10-volt levels at switching rates to 20-kHz—with 120 dB common mode rejection and cross-talk below 100 dB.

It's the Hewlett-Packard 2930A Low-Level Multiplexer, featuring MOS FET switches and a fast-recovery amplifier that settles in 40 microseconds. Channel gain can be programmed in 11 binary steps from 10 mV to 10 V. For noise rejection or bandwidth limiting, there's a choice of nine plug-in second and third order presampling filters.

And interfacing with any A-to-D converter and 16-bit or 12-bit computer is straightforward through one of five plug-in interface cards.

Channel capacity is plug-in expandable from 8 to 64 channels in the mainframe; several multiplexers can be controlled through one computer I/O channel. Ask your HP field engineer about other advantages of the HP 2930A Low-Level Multiplexer. Or write Hewlett-Packard, Palo Alto, California 94304; Europe: 1217 Meyrin-Geneva, Switzerland.

HEWLETT  PACKARD

DATA ACQUISITION SYSTEMS

06906A

Circle 1 on reader service card

Draw your own conclusions with this new time-share terminal.

Now you can have a time-share terminal that lets you see your data graphically— instantly — as it prints out on your Teletypewriter. Now you can plot for comprehension, for meaningful report illustrations, for permanent records. And do it while the time-share data's coming in.

The HP 7200A Graphic Plotter is the first major advance in time-share flexibility since the Teletypewriter itself. The Graphic Terminal feeds from standard EIA ASCII inputs and automatically plots computer data in points, lines, curves, bar graphs, pie

charts, or any other useful engineering, mathematical or business graphics you need. Plot directly from the Teletype keyboard, too, or silence the Teletypewriter and use the plotter alone. It's the end of the graphic time lag.

The HP 7200A is easy to use and requires no special operating or programming/language knowledge. It plots smooth lines, not the staircase drawn by the incremental recorder. And it lets you position the graph where you want it on any type or size of graph paper up to 11" x 17".

Talk to your time-share service about

Hewlett-Packard's new 7200A Graphic Plotter. If your service doesn't offer it yet, have them give us a call. The Graphic Terminal. For people who can benefit from a dash of art with their cold hard data.

HEWLETT  PACKARD

GRAPHIC RECORDERS

11921

Circle 2 on reader service card

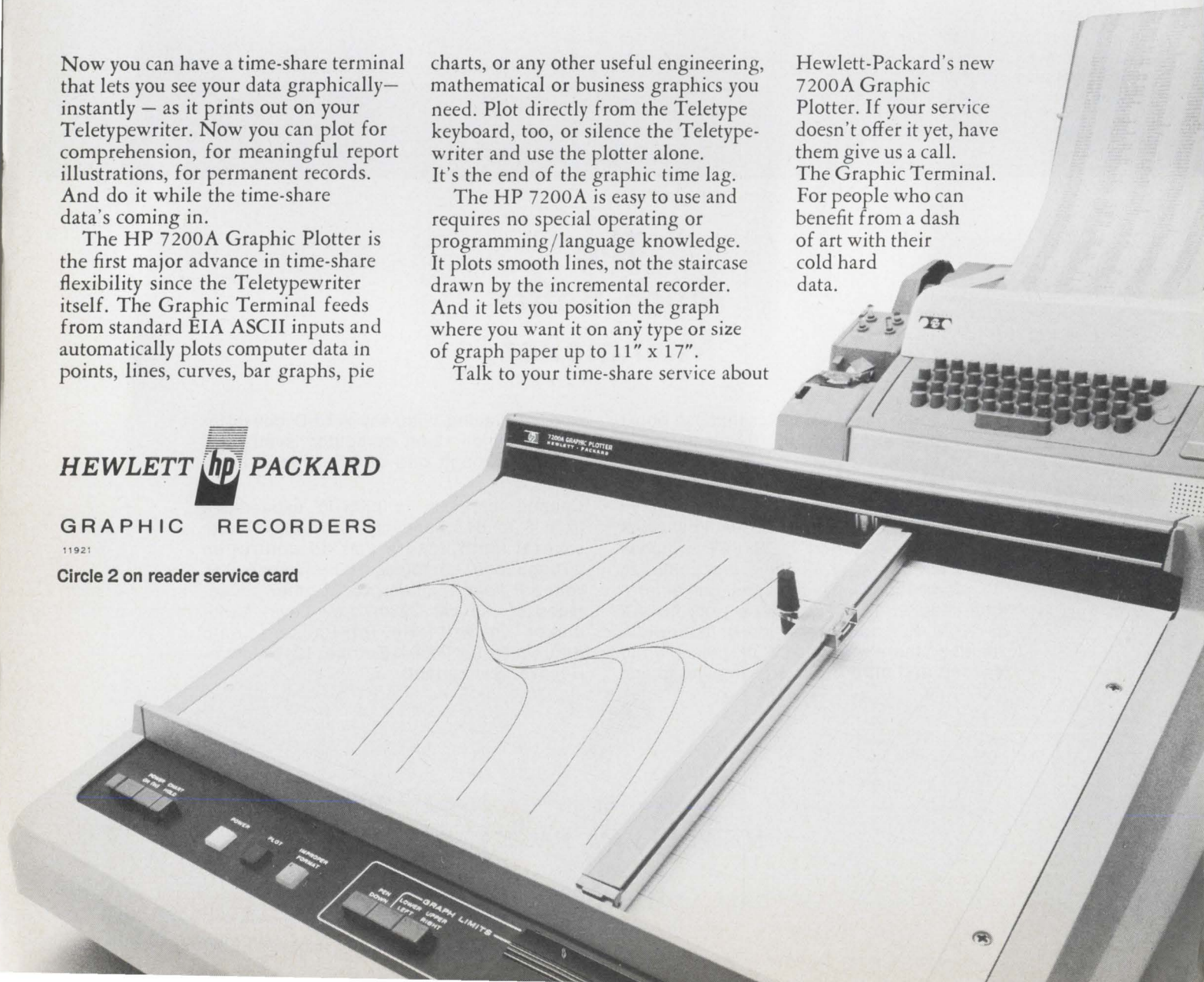

News Features

Probing the News

- 117 **Solid state:** Up goes production, down go prices . . . and here comes optoelectronics!
- 125 **Government:** Government-industry cooperation bears fruit in IC mil specification

U.S. Reports

- 37 **Advanced technology:** Yig plus new substrate equals microwave IC's
- 38 **Components:** Aluminum replaces gold in radiation-resistant transistors
- 39 **Computers:** Largest fixed-wire ECL IC's for Limac
- 40 **Communications:** Discord on world pcm standards
- 42 **Government:** Cuts in Pentagon budget
- 46 **Government:** Mallard, Radas killed
- 50 **Companies:** Boeing brings electronics work in-house
- 50 **Contracts:** Greece to get latest radars

Electronics International

- 167 **Japan:** High-density plated-wire memory matrix
- 168 **West Germany:** Electronics control truck gear shift
- 169 **West Germany:** Convergence circuit for 110° color tv
- 170 **Great Britain:** Flash Gunn radar

New Products

- 133 **In the spotlight**
133 Monitor protects IC-header bond
- 138 **Semiconductor review**
138 Pnp power transistors in r-f band
- 143 **Components review**
143 Ceramic steadies reference unit
- 146 **Subassemblies review**
146 500-watt inverter protects itself
- 151 **Data handling review**
151 'Sound pen' provides display input
- 155 **Instruments review**
155 Meter has 7-segment readout
- 157 **New materials**

Technical Articles

- Instrumentation** 72 **Simplifying crt character generation**
Scheme uses multilevel analog code and LSI bipolar character generator to minimize data transfer lines; symbols are unlimited and easy to program
- Circuit design** 76 **Designer's Casebook**
▪ Added flip-flop stabilizes a-d converter's output
▪ Transformer is eliminated in transistor chopper
▪ Reference waveform adds to scope's measuring capability
- Marketing** 79 **European electronics markets: 1970**
Product-by-product estimate of electronics markets in 11 countries of Western Europe
- 85 **Another good year**
Electronics' editors and reporters take a look at the market and technology trends in 11 countries
- | | | | |
|----|---------------|-----|-------------|
| 86 | West Germany | 99 | Belgium |
| 89 | Great Britain | 100 | Switzerland |
| 92 | France | 102 | Spain |
| 94 | Italy | 103 | Denmark |
| 96 | Sweden | 103 | Norway |
| 98 | Netherlands | | |
- Solid state** 105 **New beam-lead connection method boosts semiconductor memory yields**
Beam leads are electroplated to conductors in a single step to form integral connection with wiring pattern; it's simpler, less costly and more reliable than other beam-lead and flip-chip processes

Departments

- | | | | |
|----|--------------------------|-----|------------------------|
| 4 | Readers Comment | 33 | Electronics Newsletter |
| 8 | Who's Who in this issue | 62 | Washington Newsletter |
| 14 | Who's Who in electronics | 158 | New Books |
| 22 | Meetings | 160 | Technical Abstracts |
| 31 | Editorial Comment | 162 | New Literature |
- 165 International Newsletter

Electronics

Editor-in-Chief: Donald Christiansen

Senior staff editors

Technical: Stephen E. Scrupski

News: Robert Henkel

International: Arthur Erikson

Art director: Gerald Ferguson

Senior associate editors: Joseph Mittleman, Harry R. Karp

Assistant managing editors: H. Thomas Maguire, Howard Wolff, William Bucci, Richard Gundlach, Frederick Corey

Special projects editor: Roger Kenneth Field; Senior staff writer: John Johnsrud

Department editors

Advanced technology: Laurence Altman

Communications: Leon M. Magill

Computers: Wallace B. Riley, George Weiss

Design theory: Joseph Mittleman

Industrial electronics: Harry R. Karp

Instrumentation: Owen Doyle

Military/Aerospace: Alfred Rosenblatt

New products: William P. O'Brien

Solid state: George Watson, Stephen Wm. Fields

Field bureaus

Boston: James Brinton, manager; Gail Farrell

Los Angeles: Lawrence Curran, manager; Ralph Selph

New York: Peter Schuyten

San Francisco: Stephen Wm. Fields

Washington: Ray Connolly, manager; Robert Westgate, Lois Vermillion

Frankfurt: John Gosch

London: Michael Payne

Paris: Arthur Erikson

Tokyo: Charles Cohen

Copy editors: Edward Flinn, William S. Weiss

Assistant art director: Charles Ciatto

Production editors: Susan Hurlburt, Arthur C. Miller

Editorial research: Virginia Mundt

Editorial secretaries: Lorraine Longo, Claire Goodlin, Barbara Razulis, Vickie Green, Bernice Pawlak

McGraw-Hill News Service

Director: Arthur L. Moore; Atlanta: Fran Ridgway; Chicago: Robert E. Lee

Cleveland: Arthur Zimmerman; Dallas: Marvin Reid

Detroit: James Wargo; Houston: Barbara LaRoux

Los Angeles: Michael Murphy; San Francisco: Margaret Drossel, Tyler Marshall

Seattle: Ray Bloomberg; Washington: Charles Gardner, James Canan, Herbert W. Cheshire, Seth Payne, Warren Burkett, William D. Hickman

McGraw-Hill World News Service

Bonn: Robert F. Ingersoll; Brussels: James Smith; Hong Kong: Kate Mattock

London: John Shinn; Mexico City: Gerald Parkinson; Milan: Jack Star

Moscow: Jack Winkler; Paris: Robert E. Farrell, Stewart Toy

Tokyo: Marvin Petal

Reprints: Virginia Mundt

Circulation: Isaaca Siegel

Reader communications manager: John Drummond

Publisher: Gordon Jones

Associate Publisher: Dan McMillan

Assistant to the publisher: Wallace C. Carmichael

Electronics: December 22, 1969, Vol. 42, No. 26

Published every other Monday by McGraw-Hill, Inc. Founder: James H. McGraw 1860-1948. Publication office 99 North Broadway, Albany, N. Y. 12202; second class postage paid at Albany, N. Y. and additional mailing offices.

Executive, editorial, circulation and advertising addresses: Electronics, McGraw-Hill Building, 330 W. 42nd Street, New York, N. Y. 10036. Telephone (212) 971-3333. Teletype TWX, N.Y., 710-581-4235. Cable address: MCGRAW-HILL N.Y.

Subscriptions solicited only from those professionally engaged in electronics technology. Subscription rates: qualified subscribers in the United States and possessions and Canada, \$9.00 one year, \$12.00 two years, \$16.00 three years; all other countries \$25.00 one year. Non-qualified subscribers in the U.S. and possessions and Canada, \$25.00 one year; all other countries \$50.00. Air freight service to Japan \$50.00 one year. Single copies: United States and possessions and Canada, \$1.00; all other countries, \$1.75.

Officers of McGraw-Hill Publications Company: Joseph H. Allen, President; John R. Emery, J. Elton Tuohig, Senior Vice Presidents; Gordon L. Jones Jr., Group Vice President; Vice Presidents: John R. Callahan, Editorial; John M. Holden, Marketing; David G. Jensen, Manufacturing; Jerome D. Luntz, Planning & Development; Robert F. Marshall, Administration; Robert M. Wilhelm, Finance. Director of Circulation: Ralph Blackburn.

Officers of the Corporation: Shelton Fisher, President and Chief Executive Officer; John L. McGraw, Chairman; Robert E. Slaughter, Executive Vice President; Daniel F. Crowley, Donald C. McGraw, Jr., Bayard E. Sawyer, Senior Vice Presidents; John J. Cooke, Vice President & Secretary; Gordon W. McKinley, Vice President & Treasurer.

Title © registered in U.S. Patent Office; © Copyright 1969 by McGraw-Hill, Inc. All rights reserved. The contents of this publication may not be reproduced either in whole or in part without the consent of copyright owner.

Subscribers: The publisher, upon written request to our New York office from any subscriber, agrees to refund that part of the subscription price applying to copies not yet mailed.

Please send change of address notices or complaints to Fulfillment Manager; subscription orders to Circulation Manager, Electronics at address below. Change of address notices should provide old as well as new address, including postal zip code number. If possible, attach address label from recent issue. Allow one month for change to become effective.

Postmaster: Please send form 3579 to Fulfillment Manager, Electronics, P.O. Box 430, Hightstown, New Jersey 08520

Readers Comment

Busy signal

To the Editor:

So what else is new? Your article on Idak's Theodore Maiman [Nov. 24, p. 14] says: "One version [of the automatic dialer] would replace the leased lines now linking, say, airport terminals and hotels. Instead of the subscriber paying for the leased line, he would pay only for installation of the telephone set and the cost of each call with the hotel number being automatically dialed over the conventional phone line."

I would like to point out, however, that numerous airports had this arrangement for some years. At New Orleans Airport, for example, hotels are listed on a key-set telephone. Lifting the handset and pressing the button dials the regular hotel number over an ordinary phone line. Cost of the installation is shared by the hotels.

Also, there are other installations wherein lifting the receiver dials a preset number over an ordinary line. Examples are doctors' offices to pharmacies, shipping clerks to truck lines, travel agencies to airlines, and even emergency locations to police or fire departments. And there are numerous dialers on the market for such applications. Also, there are various types of apparatus that, on receiving signals from sensors, will dial emergency numbers and play recordings advising of the nature of the calls.

D. Reginald Tibbetts
Morago, Calif.

Hard to take . . .

To the Editor:

Very rarely does one read such a thought-provoking article as your special report on tomorrow's communications [Nov. 24, p. 73]. But it is difficult for me to believe AT&T's John Pierce and CBS's Peter Goldmark, two eminent scientists, made the statements attributed to them. However, if seeing the printed statements is believing, I would like to add my bit with regard to future inventions.



Time-saving Sweep Measurements

- Frequency range 100 kHz—1000 MHz
- Narrow-band measurement in IF ranges, e.g. 400 — 510 kHz / 9.5 — 12.5 MHz 28 — 45 MHz
- Four parameters displayed simultaneously
- Simultaneous display of forward and return sweep with magnified display during flyback
- Forward and return sweep times separately adjustable between 20 msec and 10 sec
- Crystal-controlled frequency markers with three selectable marker scales
- Parallax-free superimposed reference lines for frequency and level

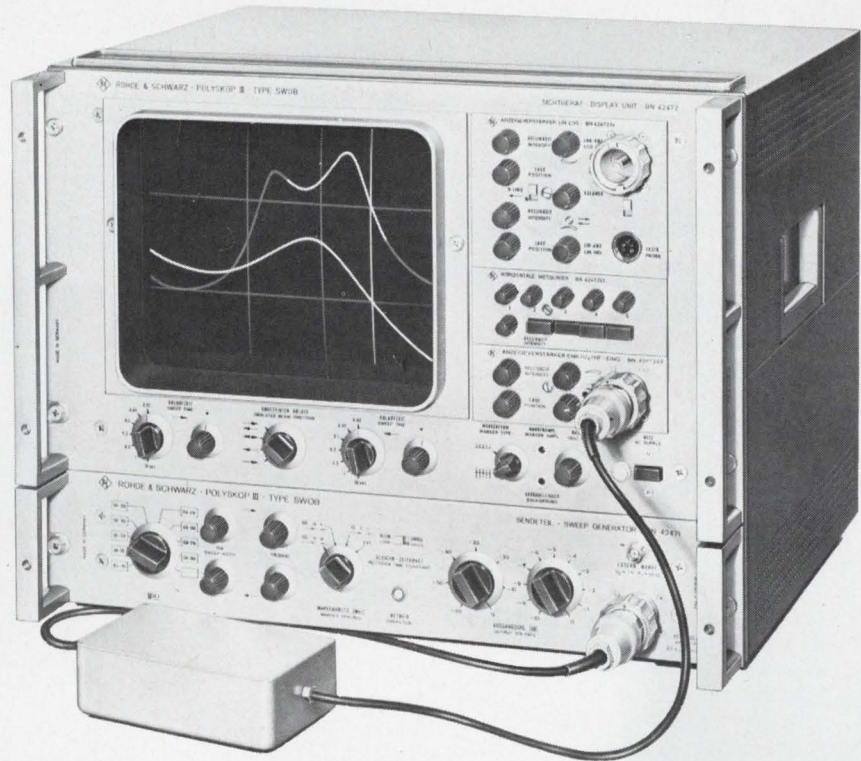

Plug-ins:

| | |
|--|--|
| Deflection Amplifier + Input/EMF/E out | High-impedance DC voltage input, EMF and E _{out} of sweep generator |
| Deflection Amplifier ± Input | High-impedance differential amplifier input; gain separately and continuously adjustable |
| Deflection Amplifier RF Input/EMF/E out | Broadband RF demodulator with Z termination; coaxial RF input for 50, 60 or 75 Ω |
| Deflection Amplifier Lin-Log (20/60 dB) 5 mV — 5 V | Simultaneous lin-log display; 0-reference line during flyback; RF demodulator with Z termination; second input for diode probe |
| Voltage Reference Lines Plug-in | Up to 5 horizontal reference lines, separately adjustable in position; four of them can be switched off separately |
| Recorder Adapter | Connection of XY recorder, e.g. Type ZSK; start button for single automatic tracking |

POLYSKOP[®] III

The sweep generators Polyskop I and Polyskop II have conquered a top position in world competition during the last ten years. Embodying this experience, the transistorized Polyskop III presents additional important advantages.

Besides the standard sweep oscillators covering together the range of 0.1 to 1000 MHz, others can be supplied for reduced sweep ranges (narrow-band measurements) and special centre frequencies.

Simultaneous display of one to four quantities saves time and effort. Recording by means of a camera is possible with the aid of an adapter.

High accuracy, especially in measurements on broadband transmission systems, is ensured by good suppression of the sweep-generator harmonics (at least 40 dB for Polyskop III).

Optimum sweep time relative to the transient time of the test item can be selected for the measurement of selective four-terminal networks.

Ask for the detailed Application Note POLYSKOP III.

ROHDE & SCHWARZ

111 Lexington Avenue, Passaic, New Jersey 07055, (201) 773-8010 · Western Office 510 South Mathilda Ave., Sunnyvale, California 94086, (408) 736-1122 · Inquiries outside U.S.A. to Rohde & Schwarz, Muehlhofstrasse 15, D 8000 Muenchen 80, Western Germany

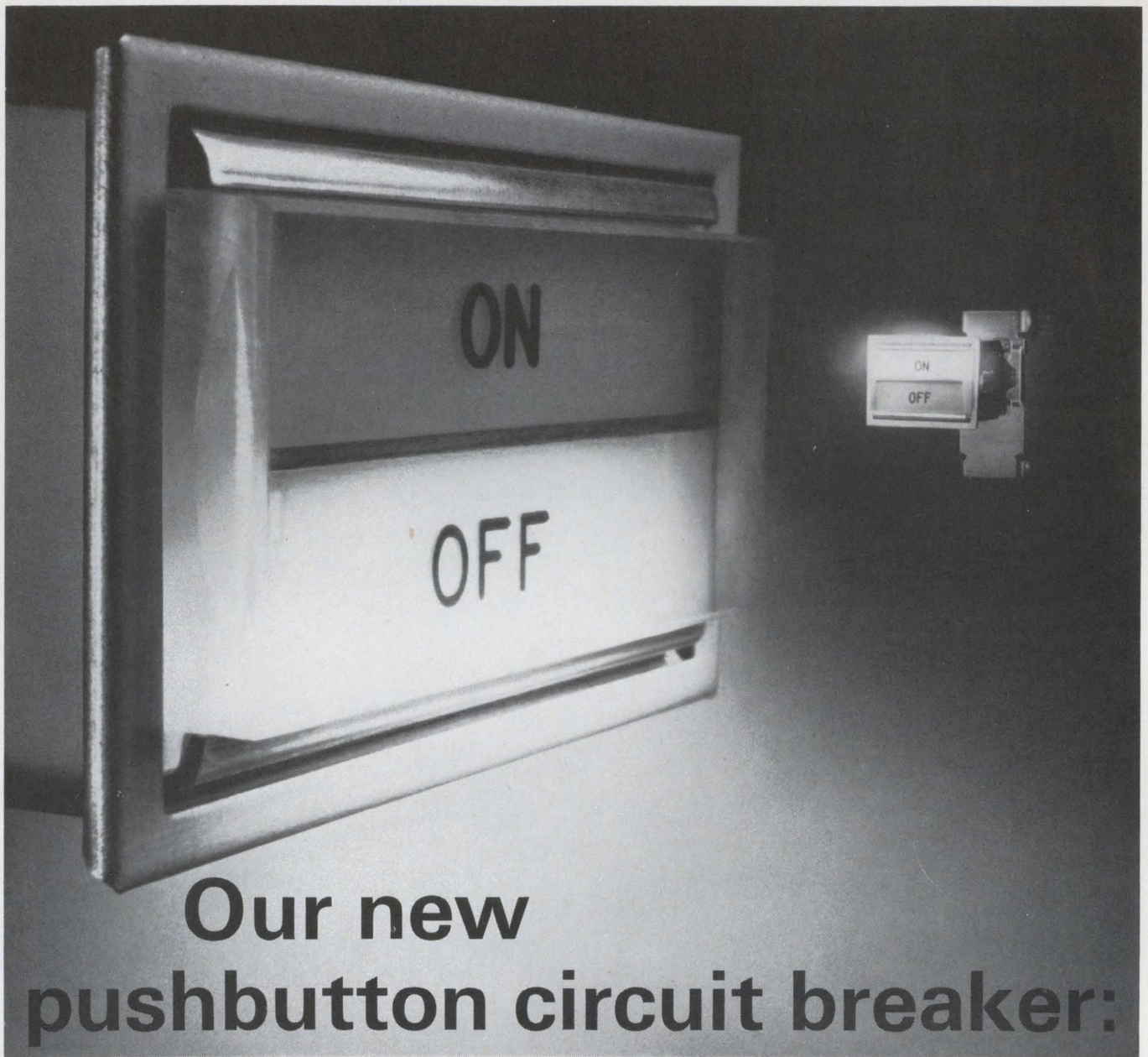

Our new pushbutton circuit breaker: it lights—even when it's "off"

You wouldn't find Heinemann dabbling in halfway measures. No pilot lights that go out when the protected circuit goes out. We give you something better—a handsome pushbutton-actuated breaker that lights in a soft green to show the circuit is "on," and lights up white when the circuit is "off."

The breaker is essentially our familiar Series JA, adapted for push-push operation through a lighted pushbutton actuator. The two modules snap together (with the breaker in any of four positions), and can thus be stacked on your instrument panel either vertically or horizontally. You wire them together almost as easily as you wire the breaker's line and load connections.

If you're up on your JA lore, you know the current range—any rating from 0.020 through 30 amperes, 240 volts AC or 65 volts DC. For your convenience, though, we've made lighted pushbutton breakers for immediate delivery in 1, 5, 10, 15, 20, and 30 amp. If you're thinking of our more outlandish ratings, kindly observe our regular lead time.

A final note: We call the pushbutton breaker our Series JL (sort of a JA, but lighted). We offer you a nice new bulletin describing it. Write for Bulletin 3351. Heinemann Electric Company, 2600 Brunswick Pike, Trenton, N.J. 08602.

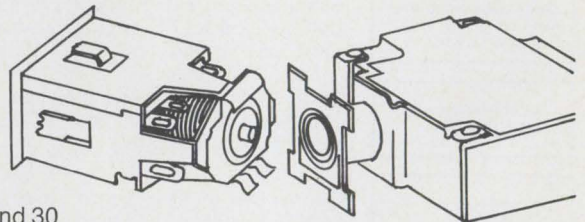

HEINEMANN

Readers Comment

Pierce believes something can be invented in communications when technology permits it to be offered to the public at a reasonable price. I would like to point out, without exaggeration, that the major inventions which are being used at present—even by AT&T—were made before they could be offered to the public at a reasonable price. If AT&T listens to Pierce and considers his condition a prerequisite when applying for patents and giving funding for research, and if this philosophy is generally adopted by the communications industry, there will be very little progress made anywhere in the field of future communications.

Goldmark, on the other hand, believes that our society is saturated with inventions, and that the existing ones should be used to help people get along with each other. Let's hope the Government will not listen to Goldmark and will not close the Patent Office, although this would constitute a great saving.

As far as helping people to get along is concerned, I could say to all the creative people in the field: "Hey fellows, don't let's invent anything any more. Let's join the Salvation Army, or Hadassah, or whatever. Let's follow Peter Goldmark's suggestion on 'how to help people, and how to get along with each other.'" And should CBS listen, it would close down the CBS Laboratories, and give [Dennis] Gabor's latest invention on 3-D holographic movies back to him, and advise Walter Cronkite how to get along

with the Federal Government.
Victor A. Babits
Palos Verdes Peninsula, Calif.

▪ Mr. Babits, a Fellow of the IEEE, is a former manager of research with General Dynamics' Convair division. Presently a consultant, he invented a rudimentary tv system in 1926.

... but not to all

To the Editor:

Roger Field's article on communications reads like science fiction. Good science fiction. In our own narrow field of the communications business, we at Microflect have been making predictions of the future potential of the electronics/communications business. And we, too, see applications and business increasing over the years.

But, Mr. Field has opened a literal flood gate of potential. Any electronics/communications manager, owner, operator, and the like, who doesn't read your report is missing a great opportunity to have his adrenal glands stimulated.

Kudos to you, Mr. Field for an excellent story of growth.

Ray D. Thrower

Microflect Co.
Salem, Ore.

Readers' letters should be addressed:
Electronics
To the Editor
330 West 42nd Street, New York,
N.Y. 10036



It's easy to arrange complex communication networks with Farinon SS-series microwave because the complete baseband is available at each repeater point. End-to-end distances of 1000 miles or more are feasible with remodulating repeaters, fully meeting standard performance objectives for all channels.

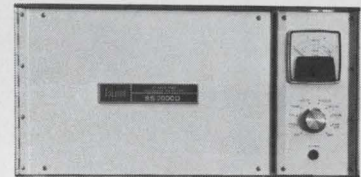

With Farinon SS-series microwave you can choose the frequency band and channel capacity you need. The totally solid-state gear reduces your power requirements and simplifies maintenance, too.

Talk to Farinon.

Farinon

Farinon Electric, 935 Washington St., San Carlos, Cal. 94070

SUBSCRIPTION SERVICE

Please include an Electronics Magazine address label to insure prompt service whenever you write us about your subscription.

Mail to: Fulfillment Manager
Electronics
P.O. Box 430
Hightstown, N.J. 08520

To subscribe mail this form with your payment and check new subscription renew my present subscription

Subscription rates: qualified subscribers in the U.S.: 1 year \$8; two years, \$12; three years, \$16. Non-qualified: 1 year \$25. Subscription rates for foreign countries available on request.

CHANGE OF ADDRESS

ATTACH
LABEL
HERE

If you are moving, please let us know five weeks before changing your address. Place magazine address label here, print your new address below.

name

address

city

state

zip code

Who's Who in this issue

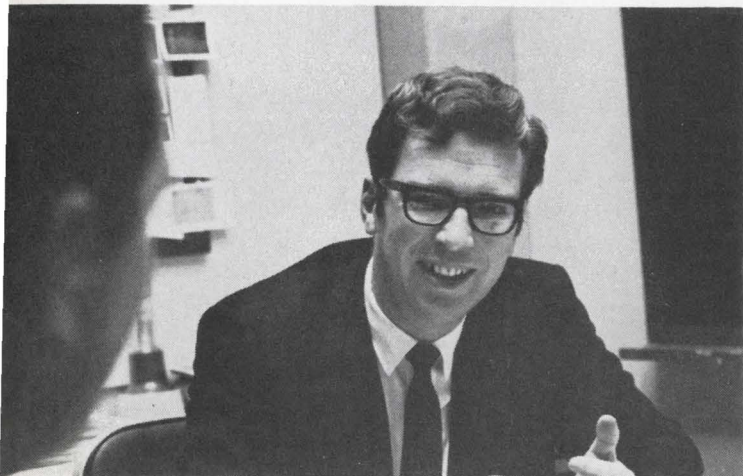

Velsink

From the start, William B. Velsink, author of the article that starts on page 72, is no novice when it comes to character generation. He has worked on the Tektronix 7000 series of oscilloscopes that use character-generation schemes, and has had the overall responsibility for the final stages of design and development of the character-generation system used. Presently manager of advanced product development, Velsink holds eight U.S. and foreign patents.



Erickson

International coordination for *Electronics'* annual Western European market report is just one of many hats worn by Arthur Erickson, Paris-based senior staff editor. In recent months, however, it's the hat he has most often worn as he traveled from sunny Spain to cloudy Copenhagen, lining up the raw material for this year's consensus forecasts, which start on page 79. Assisting Erickson, who edits the magazine's international section, were a team of *Electronics'* staffers and McGraw-Hill correspondents.

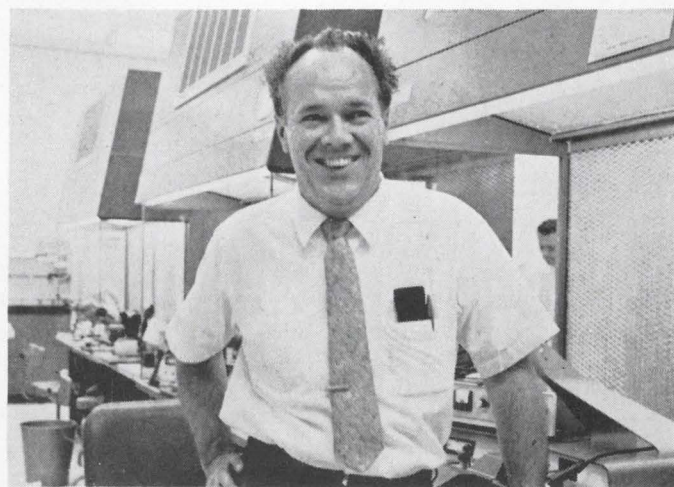
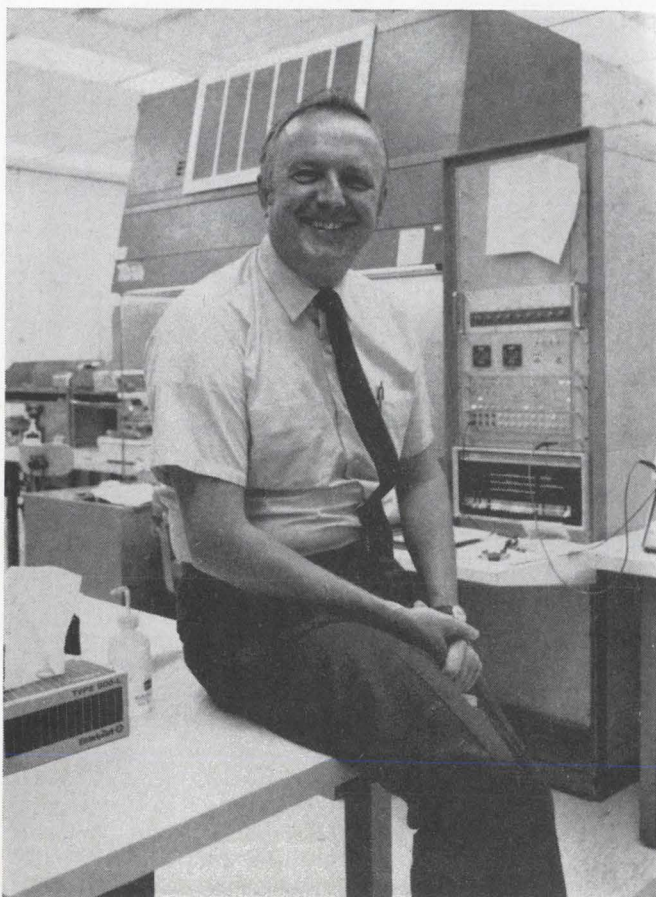

Trolsen

Marley

Teamwork has paid dividends for John Marley and George Trolsen. Not only did they team up to develop the beam-lead technique described in the article beginning on page 105, but they pooled their efforts as co-authors. Trolsen, manager of the memory-assembly group at Motorola drew heavily on his 20 years of microelectronic packaging experience at ITT when setting up the facilities and processes to manufacture an eight-kilobit memory module. Marley, who has authored a previous article in *Electronics* on packaging, holds a number of patents on circuit design and packaging techniques.

Accuracy 1% absolute or 2 MV whichever is greater

Accuracy 1% absolute or 2 MV
whichever is greater

Zero Hysteresis

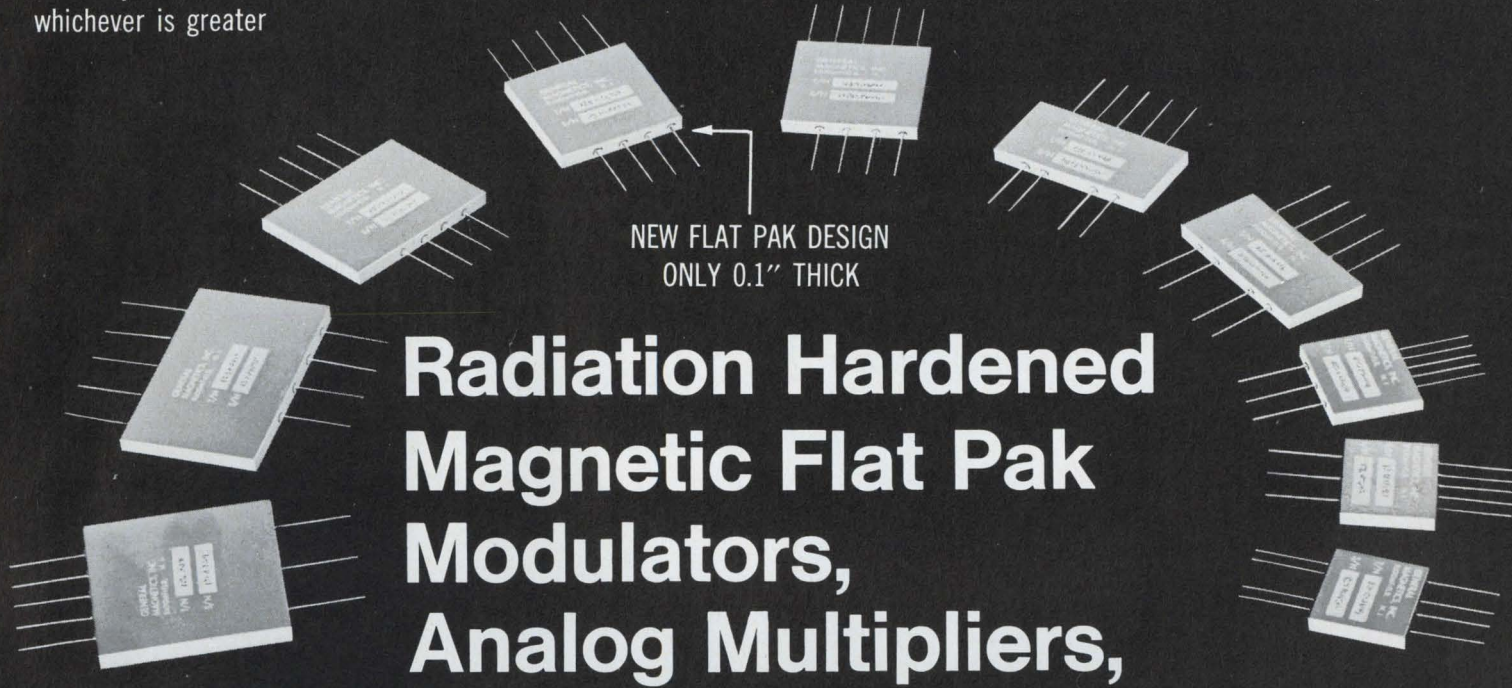

NEW FLAT PAK DESIGN
ONLY 0.1" THICK

Radiation Hardened Magnetic Flat Pak Modulators, Analog Multipliers, Demodulators mount directly on IC Cards

ACTUAL SIZES

ZERO HYSTERESIS

- Hybrid assemblies mount directly on IC cards.
- Space saver design . . . typical dimensions 0.1" thick x 0.5" x 0.75".
- Rugged design, extreme reliability. MTBF design goal 0.25 per million hours.
- Extremely low drift over -55°C to $+125^{\circ}\text{C}$ range.
- Not affected by high intensity nuclear radiation.
- Capable of operating on carrier frequencies as high as five Mhz.
- One or more isolated or floating input signals may be used for modulating, multiplying, dividing, squaring or extracting a root.
- No external nulling or offset adjustments.
- No additional components or compensation required.
- No external operational amplifiers required.
- Standard $\pm 15\text{ V DC}$ power supplier unless otherwise specified.

As an Analog Multiplier of a Bipolar DC signal times an AC signal, the output **product accuracy** is 1% of point, or 2 MV, whichever is greater over a dynamic range of 10,000:1 in each quadrant.

Over the temperature range of -55°C to $+125^{\circ}\text{C}$, the following parameters hold:

- 1) Zero Point Drift: ... Less than 2 MV of in phase component
- 2) Gain Slope Stability: Less than 2% change
- 3) Dynamic range and output wave quality independent of temperature variations

Typical input/output parameters:

X Signal: 0 to $\pm 5\text{V}$
 Y Signal: 0 to $\pm 5\text{V}$
 Output: 0 to 5V RMS across 5K or greater load impedance

Magnetic DC x DC Multiplier

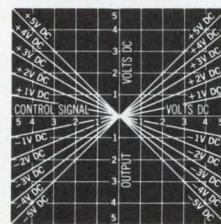

Squaring

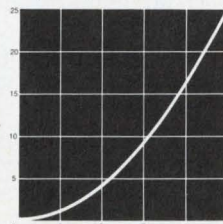

Square Root

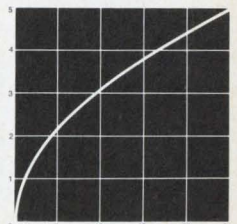

Division

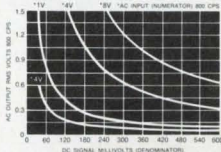

Amplitude Modulation

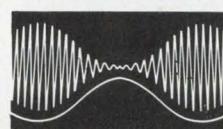

Balanced Modulator

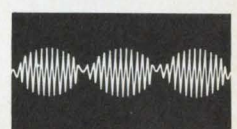

MAGNETIC MULTIPLIERS

Dynamic Product Range
80 db

Magnetic Modulators

Dynamic Range:
60 db



There is No Substitute for Reliability
GENERAL MAGNETICS, INC.
 135 Bloomfield Avenue,
 Bloomfield, New Jersey 07003

When reliability and performance are essential, Airco Temescal specifies General Electric components

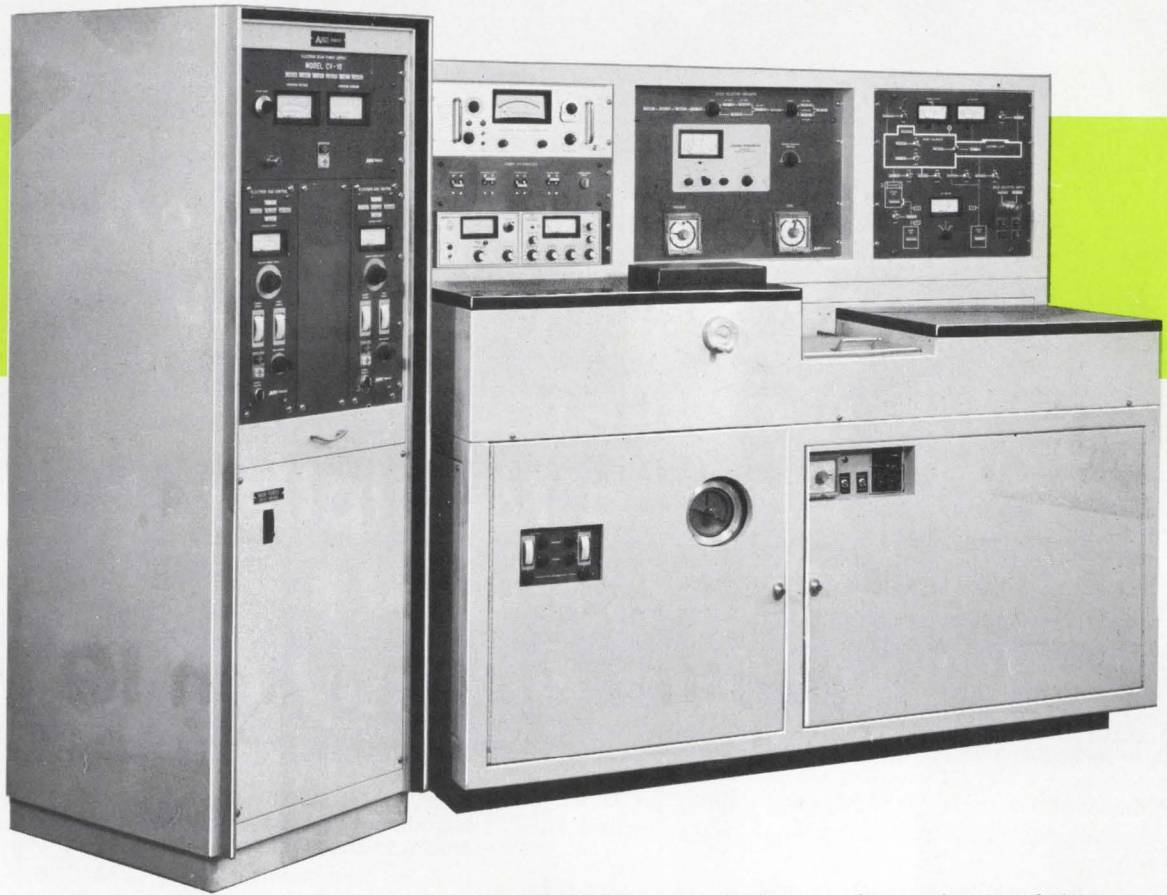

General Electric meters, SCRs, capacitors, selector switches, indicating lights, Volt-Pacs®, gear motors, current transformers and arc pilot devices are used in Airco Temescal's line of Integrated Electron Beam Systems and products such as this Thin-Film Electron Beam Deposition System. (For more information, circle 513.)

Contaminant-free, high quality, thin-film coated substrates are produced by Airco Temescal's Model FC-1100 Thin Film Deposition System with the CV-10 Electron Beam Power Supply. It was designed for either manual or automatic operation for research or production applications.

Systems such as this require hundreds of components — components that are rugged, reliable, capable of top-notch performance.

The complexity of this equipment requires many types of meters which constantly monitor various functions and controls. These meters, designed by General Electric, check such things as voltage, evaporation rates, current emissions, focus current, gun filament current and others.

Systems designers, such as Airco Temescal's, look to General Electric when they need a certain component to meet specific criteria. They know, for example, GE SCRs are highly sensitive, very versatile . . . and more important, extremely reliable as well as economical.

Capacitors are another of the many GE components used in this equipment. Designers specified General Electric for this application because high capacitance was required in minimum space, and long life was important.

Companies like Airco Temescal specify General Electric components because the name, General Electric, stands for quality, reliability and performance.

LOOK TO GENERAL ELECTRIC — your best source for electronic components.

285-51

GENERAL  ELECTRIC

What can GE do for you?



GE's new magnetic material increases magnetic energy 75%

You can have either greater magnetic performance for the same size, or equal performance with less volume and magnet weight with GE's new Alnico 9 magnetic material. It increases the energy product of cast Alnico 8 to a minimum of 8 million gauss-oersteds—a 75% increase in magnetic energy.

Alnico 9 was developed especially for applications requiring superior performance with minimal space and weight, such as focusing of microwave tubes, motor fields and rotors, torque couplings, accelerometers or other "radial gap" designs.

TYPICAL DEMAGNETIZATION CURVE OF CAST ALNICO 9

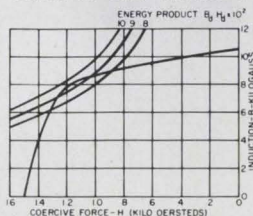

Consult our engineers about designing a Cast Alnico 9 magnet for your application. For details, circle 507.



New "Hi-TECH" ceramics line . . . top-flight ceramics plus custom engineering

Need a customized ceramic-metal component to do a tough job? General Electric's Hi-TECH line offers a broad variety of alumina, forsterite and other special ceramic materials . . . sealed to virtually any metal . . . and custom-designed to your specifications.

End use and operating environment are all our engineers need to know in most cases to design and manufacture the exact component you need.

If your device is one that must operate in a severe environment; or if you need a dimensionally-stable abrasion-resistant machine part; or if you are working on electrical equipment, vacuum or gas-filled devices, or hermetically sealed electronic components . . . check the Hi-TECH line. Circle number 508.

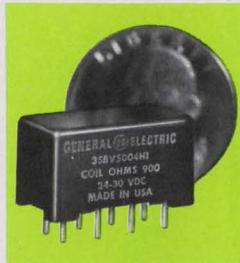

Now available—3SBV half-size relay for multiple applications

Attention, manufacturers of:

- COMPUTERS
- COMPUTER PERIPHERALS
- AVIONICS
- STUDIO & BROADCAST EQUIPMENT
- VISUAL COMMUNICATION PRODUCTS
- INSTRUMENTATION
- TEST EQUIPMENT
- MICROWAVE & MOBILE COMMUNICATIONS
- MOTOR CONTROLS
- PHOTO-ELECTRIC CONTROLS
- GEOPHYSICAL EQUIPMENT
- SECURITY WARNING EQUIPMENT

Specify the new 3SBV 200-grid half-size relay for those applications where high reliability, top performance and low cost are essential. The 3SBV is an adaptation of the 3SAV type, and has a nylon, heat-sealed metal case. It is ideal for use in environments less severe than aerospace and military applications. For more information on the GE 3SBV, DPDT, relay, circle 509.



Solve unijunction design problems with the new programmable UJT

GE's D13T is a programmable unijunction transistor (PUT) with characteristics (η , R_{BB} , I_p , I_v) that can be selected to fit your circuit. Just two circuit resistors give the D13T1 and T2 programmability which permits the designer to:

- reduce a risk of thermal runaway
- use PUT in battery and other low-voltage circuits
- use base 2 as low impedance pulse output terminal
- use PUT in high volume applications.

Especially suited for long-interval timers, D13T2 features very low leakage and peak point currents. D13T1 is for more general use in high gain phase controls and relaxation oscillators.

Both are 3-terminal planar passivated PNP devices in the low-cost plastic TO-98 case. Circle number 510.

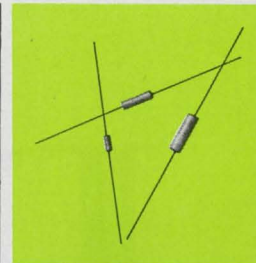

GE 69F900 wet slugs give highest volumetric efficiency

69F900 wet slugs meet high-density application needs with highest volumetric efficiency of any capacitor. We halved the military (CL64) wet slug size, and essentially kept its electrical and performance traits.

The 69F900 has excellent capacitance retention at low temps . . . can be stored to -65°C . Operating range is -55°C to $+85^{\circ}\text{C}$. It's tough too—withstanding vibration to 2000Hz; 15G acceleration!

GE's capacitor is fully insulated; has low, stable leakage current. Ratings are available from 6 to 60 volts; capacitance ranges from 0.5 to 450 μf .

| RATING | CASE SIZE | VOLUME |
|------------------------------------|-----------|--------|
| 50V, 30 μf solid (CS12) | .341X.750 | 100% |
| wet slug (CL64) | .281X.681 | 58% |
| 69F900 | .145X.600 | 15% |
| 15V, 80 μf solid (CS12) | .341X.750 | 100% |
| wet slug (CL64) | .281X.681 | 58% |
| 69F900 | .145X.600 | 15% |
| 6V, 180 μf solid (CS12) | .279X.650 | 100% |
| wet slug (CL64) | .281X.641 | 100% |
| 69F900 | .145X.600 | 15% |

For data, circle 511.



Miniature oil-tight push buttons control almost any function

GE's line of industrial miniature oil-tight push buttons, CR104, is available to control almost any function. They are suitable for use on machine tool control

panels — especially where space is limited. For example, twenty of these units can be easily mounted on a 6" x 5 1/2" panel.

Units are rated 5 amps carry, 115 volts max., 30 amps make and break at 115-125 volts. Double-break

1NO-1NC and 2NO-2NC contact blocks are available for pilot duty control.

Forms include push-buttons, select switches, indicating lights, special forms, and oil-tight enclosures and stations. Color-coding is easy: knobs and rings

come in many colors. Flush and surface-mounted stations make GE's miniature oil-tight push button line the most versatile in the industry.

For detailed information on the entire line of push buttons, circle reader card 512.

DTL
goes
National.

930 DTL is a price and delivery business. We're in that business. Digital IC's are volume products and that's also our business.

With the addition of DTL to our digital line of MOS and TTL, we now cover 85% of the most popular digital sockets in the world.

Price, volume, delivery. That's us.

Write for our spec sheet, if you need one, as well as our cross reference guide. Completely covers our new brand 930, dual in-line, silicone, 0° to 75°C. DTL line. We'll also send you our silicone molded rel report as a bonus. National Semiconductor Corporation, 2900 Semiconductor Dr., Santa Clara, California 95051. (408) 732-5000. TWX: 910-339-9240. Cable: NATSEMICON.

National/Digital

FREE Engineering Handbook on Electromagnetic Delay Lines

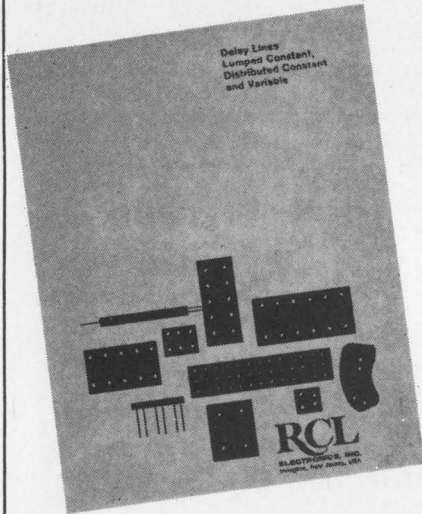

**We've reserved
a copy
for your desk . . .**

Terms . . . engineering definitions . . . how to specify delay lines . . . characteristics of various types . . . specifications . . . they're all included in this concise, easy-to-read handbook . . . yours for the asking.

**LUMPED CONSTANT . . .
DISTRIBUTED CONSTANT
. . . VARIABLE**

**all three types are covered
in this reference
handbook.**

RCL

RCL ELECTRONICS, Inc.,

General Sales Office:

Seven Hundred
South Twenty First Street
Irvington, New Jersey 07111

Who's Who in electronics



John Granger

That annual extravaganza of March—the IEEE Convention and Exhibition—“has not kept up with the rest of the industry, and we are going to change it,” says John Granger, newly elected president of the IEEE. The society will bring in a full-time staff to run the convention, “and we have formed a blue-ribbon committee on goals and objectives for the March convention,” Granger asserts. There also will be a separate convention board to determine the policy, direction, and planning for the show,” he adds.

The IEEE also will work with WEMA (Western Electronics Manufacturers Association), which has a full-time staff, and Wescon. “We have to coordinate,” says Granger, “because our resources have not been adequate to fulfill the IEEE charter—the show will be brought in-house, instead of being a separate business.”

Relations. Part of the problem has been inadequate public relations. “The technological community has been changing for the last several years and so has the IEEE, but we haven’t let the people know about these changes—it’s the fault of our own PR,” Granger declares. “This is partially due to the fact that the IEEE thought that PR was a dirty thing—like illicit sex,” he adds. And Granger, who formed Granger Associates in 1956, is not speaking as an outsider—he was director of Wescon from 1959 to 1963, was Wescon convention director in 1961, and was chairman of the Wescon executive committee in 1963. And Wescon is one of the

best-run shows in the industry.

Granger would like to apply some of Wescon’s methods to the IEEE show, such as instructing exhibitors in the most effective way to run a booth. “There are two types of people that come to the March convention,” he says, “those from out of town, and the subway trade. Both are important, but they compete in some ways. The IEEE is pursuing the student side (part of the subway trade) and this is necessary to the industry, but the exhibitors don’t like it.” Some exhibitors, says Granger, don’t have engineers at the booths, just sales and marketing people. Students who are looking for hard technical information are frustrated, and salesmen are annoyed by people taking up their time with seemingly unimportant questions.

One thing Granger would like to try is a “pop concert without the music. We would set aside rooms with tables, chairs, and coffee for special groups — high - frequency communications, antennas, or instrumentation, for example—and not set up a program. This could be a true exchange of ideas.”

Wider use of data processing in the Defense Department’s decision-making process is one suggestion likely to be included in the Blue Ribbon Defense Panel’s report to Defense Secretary Melvin Laird. The report is due next July 1. Panel staff coordinator William G. Howard says that, although investigation into the effectiveness of automation’s use is just getting started, “data processing can greatly assist the process.” Accompanying such a recommendation, he says, would be suggested ways to achieve standardization throughout the Pentagon—through use of a common language—and greater compatibility of components.

More computer use does not, however, imply greater centralization. “I think it would be a good idea to decentralize decision making—to push it down from office of

- Four full digits plus "1" for 20% overranging
- Rechargeable battery operation optional
- Measures ac and dc volts in four ranges to 1200 volts
- Measures ohms in five ranges to twelve megohms
- Active 2 pole switchable filter
- Automatic polarity indicator
- All functions push-button selectable



The digital multimeter you can believe

Announcing the Fluke 8100A, a completely portable 0.02% digital multimeter for \$695.

The only way to build a multimeter with no last digit uncertainty is to add an "extra digit." That's exactly what we've done with the new Fluke 8100A. Here is an instrument with nine times the accuracy of three digit units selling at only half the price of comparable four digit multimeters.

How?

We've used an A to D conversion technique new to the DVM field. The result is an instrument with low power drain, simplicity of circuitry, troublefree oper-

ation and the uncommon accuracy you expect from Fluke.

Standard features include ac measurement accuracy of 0.2% and resistance, 0.1%. For real portability, batteries will operate the multimeter continuously up to eight hours without recharging. Battery operation, the only option, is priced at \$100. Accessories available include high frequency and voltage probes, switched ac-dc current shunts and a ruggedized case.

FLUKE

Fluke, Box 7428, Seattle, Washington 98133. Phone: (206) 774-2211. TWX: 910-449-2850. In Europe, address Fluke Nederland (N.V.), P. O. Box 5053, Tilburg, Holland. Phone: (04250) 70130. Telex: 884-50237. In the U. K., address Fluke International Corp., Garnett Close, Watford, WD2 4TT. Phone: Watford, 27769. Telex: 934583.

THE VS-80 Sweep generator

ALL SOLID- STATE

TECHNICAL LEADERSHIP IS STATE-OF-THE-ART SOPHIS- TICATION & PERFORMANCE

Test capabilities usually available only through the use of two or more instruments are yours in the Texscan VS-80. It covers all normal IF bands, and FM, VHF TV, UHF TV, and most communication bands . . . can be used for radar and communications RF, IF, and video testing, also as a chirp radar simulator and for wide band amplifier testing. VS-80 is available in a ruggedized model that meets MIL-T-21200F, as well as in the popular laboratory/field model. Write for free descriptive literature with complete technical details.

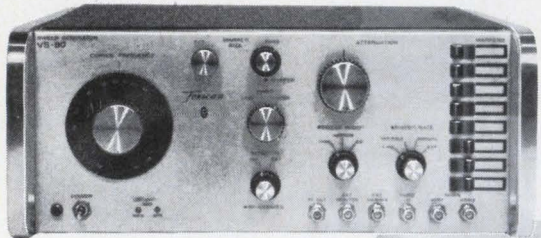

key specifications

LABORATORY UNIT

Frequency Range: 1 MHz to 1200 MHz in two overlapping, switchable bands, 1-300 and 290-1200. Can be centered on any frequency between 1 MHz and 1000 MHz and sweep up to 1200 MHz at maximum sweep.

Sweep Width: On the low band, continuously variable from 50 kHz to 300 MHz; on the high band, can be varied to 40% at 1000 MHz. Unit also has CW output mode for signal generator applications.

RF Output: Rated at least 0.5 vrms into a 50-ohm load.

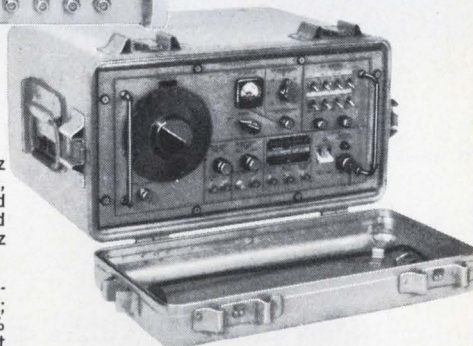

RUGGEDIZED UNIT

Operating Temperature: Continuous -20 to $+55^{\circ}\text{C}$; intermittent to $+71^{\circ}\text{C}$.

Shock: 20 G's, 3 shocks along each of 3 mutually perpendicular axes.

EMI: IAW Mil-Std-826A, notice 1, class Gp.

Reliability: 500 hours MTBF IAW Mil-Std-781A, Test level E except lower temperature -20°C .

Maintainability: IAW Mil-Std-470 & 471.

PRICE AND DELIVERY

Model VS-80 \$1550.00 Model VS-80 DH \$3050.00 (Combination Case)
Delivery is within four weeks maximum; in some cases models and accessories are available from stock.



Texscan CORPORATION

2446 NORTH SHADELAND AVENUE
INDIANAPOLIS, INDIANA 46219

Phone 317-357-8781—TWX: 810-341-3184

Who's Who in electronics

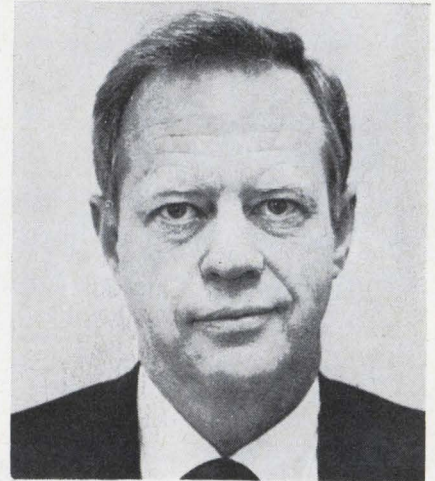

William E. Howard

the Secretary of Defense to the services," Howard says, although he shuns a recurring proposal to move the individual service secretaries back up to Cabinet status.

The 47-year-old senior operations analyst from the Stanford Research Institute is coordinating the Blue Ribbon Panel's 70 staff members in their study of broad policy questions in four areas: management and organization, matériel, operations, and a miscellaneous category including medical facilities, housing, and other areas. Procurement policies also will be studied, for recommendations in buying R&D, operational test and evaluation, and weapons systems. But Howard stresses "economy is not the main purpose, although, of course, it would be desirable."

\$64 question. What will become of the recommendations? "We have a better chance of getting things implemented than such groups in the past," such as the Hoover and Rockefeller defense study commissions, Howard says. He concedes though, that "the problem with most panels of this nature is that their recommendations, which may be good, won't be implemented." One more reason for this panel's improved outlook is that it was set up by Laird and will report directly to him, as opposed to commissions in the past which reported directly to the President, leaving the Defense Secretary with little or no control over disagreeable ideas.



MSI

Sprague Series 54/74 ICs. Illustration: 54/7491 8-Bit Shift Register

Choose from 13 Sprague Series 54/74 arrays.

Design is easier. Package count and costs go down. Equipment gets smaller, neater, simpler. Simply because you get more inside every DIP or flatpack with Sprague Series 54/74 arrays.

So buy fewer parts. And make every part count. Move into MSI. With Sprague Series 54/74 arrays. Get the straight answers on complex arrays. Types. Prices. Delivery. Call Sprague now.

| | | | | | |
|--------------------------|---------|---------------------------------------|---------|-------------------------------------|---------|
| Decade Counter | 54/7490 | 4-Bit Right-Shift Left-Shift Register | 54/7495 | 4-Bit Binary Full Adder | 54/7483 |
| Divide-By-Twelve Counter | 54/7492 | Quad Bistable Latch | 54/7475 | BCD Decoder/Driver | 54/7441 |
| 4-Bit Binary Counter | 54/7493 | Gated Full Adder | 54/7480 | BCD-To-Decimal Decoder | 54/7442 |
| 8-Bit Shift Register | 54/7491 | 2-Bit Binary Full Adder | 54/7482 | BCD-To-Seven-Segment Decoder/Driver | 54/7446 |
| 4-Bit Shift Register | 54/7494 | | | | |

Call Sprague Info-Central (617) 853-5000 extension 5474.

For complete specifications, circle the reader service number below.



To make a Quad Latch that's both R/S and D compatible,

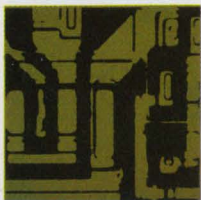

Fairchild's new MSI 9314 Quad Latch is a versatile, high-speed device that can be used in any application requiring a single-input D-type latch or an R/S-type latch. It has no undefined states in the R/S mode. Its unique multi-function capabilities make it useful in a number of applications:

four-bit storage latches, contact bounce eliminators, multi-input active high set/reset latches, counting and holding display systems, eight-bit addressable latches, A/D conversions, zero and ones catching storage.

The addition of this device to our MSI family gives you everything you need for just about any latching application you could name. Use the new 9314 for maximum function versatility. Or the 9308 Dual Four-Bit Latch when minimum package count is most important. Your Fairchild Distributor has complete specs on both MSI devices.

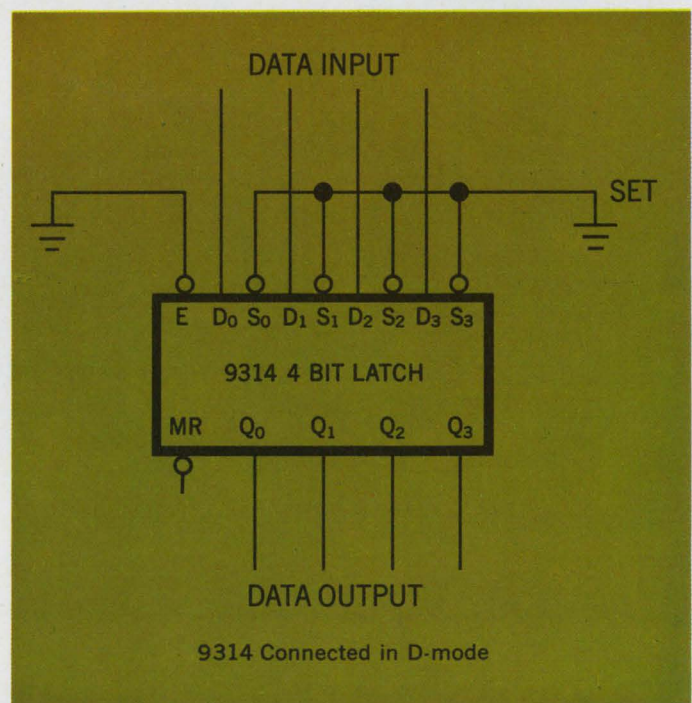

To order the 9314, ask for:

| PART NUMBER | PACKAGE | TEMPERATURE RANGE | PRICE (1-24) | PRICE (25-99) | PRICE (100-999) |
|-------------|---------|-------------------|--------------|---------------|-----------------|
| U6B931451X | DIP | -55°C to +125°C | \$19.40 | \$15.50 | \$13.00 |
| U6B931459X | DIP | 0°C to + 75°C | 9.70 | 7.75 | 6.50 |
| U4L931451X | Flat | -55°C to +125°C | 21.35 | 17.05 | 14.30 |
| U4L931459X | Flat | 0°C to + 75°C | 10.70 | 8.55 | 7.15 |

To order the 9308, ask for:

| PART NUMBER | PACKAGE | TEMPERATURE RANGE | PRICE (1-24) | PRICE (25-99) | PRICE (100-999) |
|-------------|---------|-------------------|--------------|---------------|-----------------|
| U6N930851X | DIP | -55°C to +125°C | \$25.40 | \$20.20 | \$17.00 |
| U6N930859X | DIP | 0°C to + 75°C | 12.70 | 10.10 | 8.50 |
| U4M930851X | Flat | -55°C to +125°C | 27.95 | 22.20 | 18.70 |
| U4M930859X | Flat | 0°C to + 75°C | 13.95 | 11.10 | 9.35 |

you have to get serious about MSI family planning.

We put together a family plan by taking systems apart. All kinds of digital systems. Thousands of them.

First we looked for functional categories. We found them. Time after time, in a clear and recurrent pattern, seven basic categories popped up: Registers. Decoders and demultiplexers. Counters. Multiplexers. Encoders. Operators. Latches.

Inside each of the seven categories, we sifted by application. We wanted to design the minimum number of devices that could do the maximum number of things. That's why, for example, Fairchild MSI registers can be used in storage, in shifting, in counting and in conversion applications. And you'll find this sort of versatility throughout our entire MSI line.

Finally, we studied ancillary logic requirements and packed, wherever possible, our MSI devices with input and output decoding, buffering and complementing functions. That's why Fairchild MSI reduces—in many cases eliminates—the need for additional logic packages.

The Fairchild MSI family plan. A new approach to MSI that's as old as the industrial revolution. It started with functional simplicity, extended through multi-use component parts, and concluded with a sharp reduction in add-ons. Simplicity. Versatility. Compatibility. Available now. In military or industrial temperature ranges. In hermetic DIPs and Flatpaks. From any Fairchild Distributor.

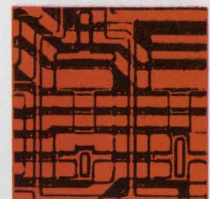

OPERATORS
9304 - Dual Full Adder/Parity Generator



LATCHES
9308 - Dual 4-Bit Latch
9314 - Quad Latch

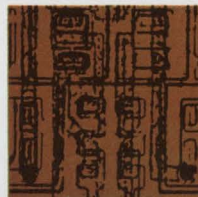

REGISTERS
9300 - 4-Bit Shift Register
9328 - Dual 8-Bit Shift Register

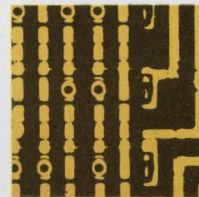

MULTIPLEXERS
9309 - Dual 4-Input Digital Multiplexer
9312 - 8-Input Digital Multiplexer

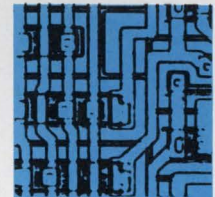

DECODERS AND DEMULTIPLEXERS
9301 - One-Of-Ten Decoder
9315 - One-Of-Ten Decoder/Driver
9307 - Seven-Segment Decoder
9311 - One-Of-16 Decoder
9317 - Seven-Segment Decoder/Driver

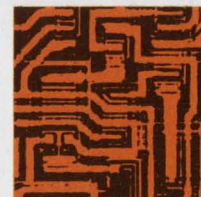

COUNTERS
9306 - Decade Up/Down Counter
9310 - Decade Counter
9316 - Hexadecimal Counter

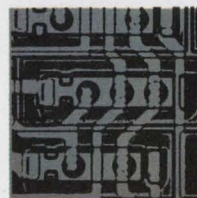

ENCODERS
9318 - Priority 8-Input Encoder

Nobody makes MSI the way
Fairchild does.

FAIRCHILD
SEMICONDUCTOR

OMRON's R&D can constantly

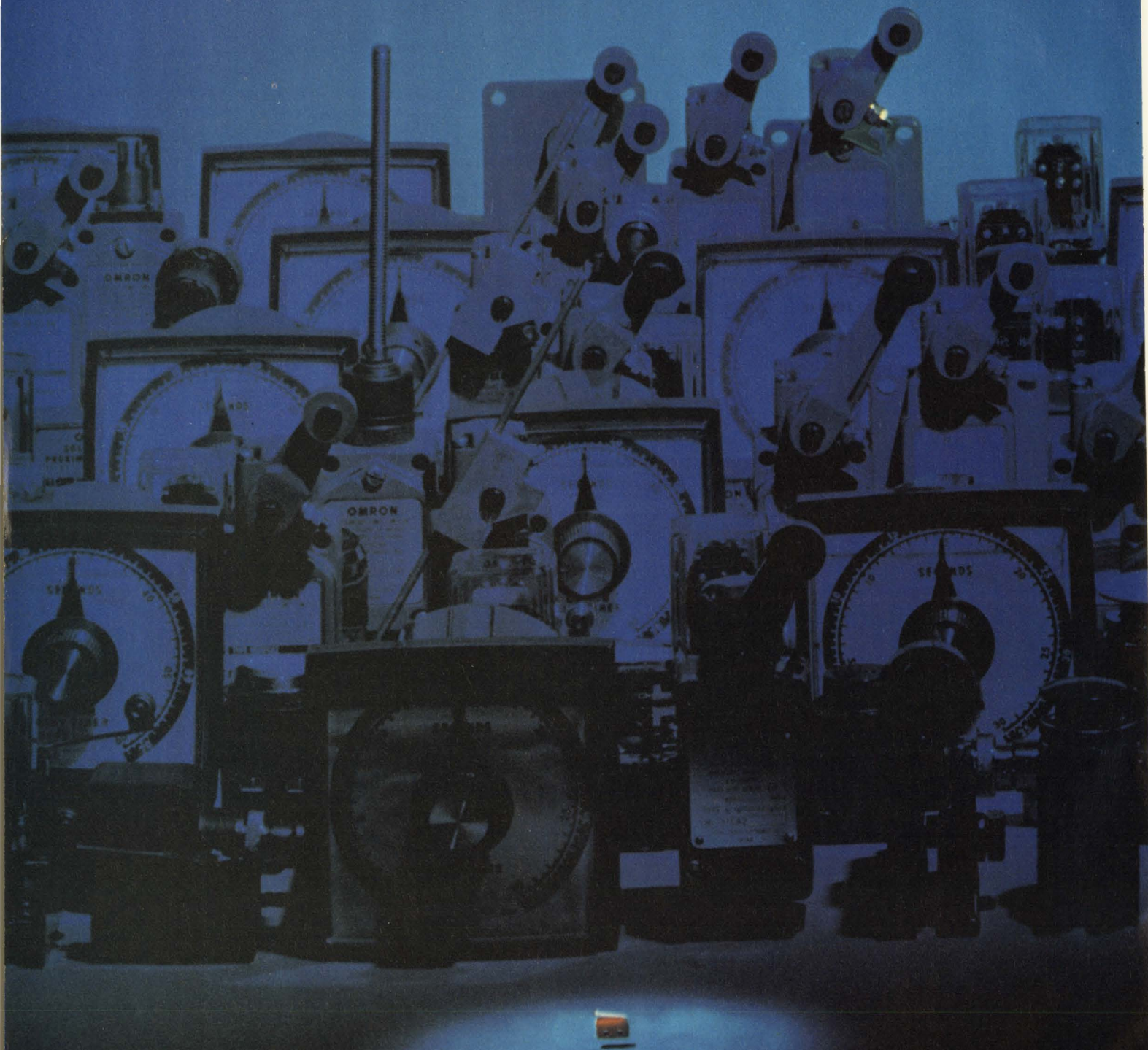

mass-produce proved new designs. How?

Like this. OMRON's R & D system starts at MIL-Q5923C, but has a unique criss-crossing 'research-coordinator' that unifies complementary research thinking. Our whole R & D process is simple, careful logic. Research duplication is eliminated, and volume production of effective new designs made possible. Sounds fancy maybe, but it does seem to work. We call the system PESIC.

Soon to be marketed, is proof-positive of the PESIC system's effectiveness. Spotlighted opposite, it's the world's smallest basic precision switch. Overall dimensions are incredibly shrunk to 9mm(W) x 4.5mm(D) x 5mm(H). A direct result of OMRON's unique anticipatory research and development.

So that's our PESIC system. And as long as we stay Japan's largest maker of electric and electronic components with CSA, UL, SEC and SECV recognition, we'll probably stick to it.

Components, Control Devices, Systems.
An original world of electronics.



OMRON

OMRON TATEISI ELECTRONICS CO.

SALES OFFICE/Toa Bldg., 5, Yonban-cho, Chiyoda-ku, Tokyo, Japan
Phone (265) 4611 Telex 232-2179 Cable Address OMRONELCO TOKYO
OVERSEAS DISTRIBUTORS: ● AUSTRALIA/H. Rowe & Co., Pty., Ltd.
● AUSTRIA/Carlo Gavazzi-Billman G.m.b.H. ● ITALY/Carlo Gavazzi S.p.A.
● BELGIUM/Carlo Gavazzi Belgium s.a. ● ENGLAND/Keyswitch Relays Ltd.
● FORMOSA/Hai Nan Trading Co., Ltd./Sheng Ching Trading Co., Ltd.
● FRANCE/Billman-Carlo Gavazzi S.A.R.L. ● HOLLAND/Carlo Gavazzi-Billman
Nederland N.V. ● SPAIN/Carlo Gavazzi-Reguladores Billman s.a.
● MEXICO/Schultz Y Cia., S.A. ● SWEDEN/Billman Regulator ab.
● SWITZERLAND/Carlo Gavazzi-Billman AG. ● U.S.A./Sigma Instruments Inc.
● SOUTH AFRICA/P.J. Yelland & Co. (Pty) Ltd.
● WEST GERMANY/Carlo Gavazzi-Billman Industriezulieferung G.m.b.H.



SOLVING
electro-optical
problems
is OPTRON's
ONLY business....
SO, WE HAVE
TO BE GOOD!

You can count on Optron for high interest and undivided attention to your most exacting optoelectronic device requirements. And, you'll get product design, development and manufacturing benefits that only Optron experience can offer.

For example, through continuous process monitoring made possible by the use of diffusion lot traceability, Optron maintains the highest possible reliability. Still other special Optron manufacturing techniques make possible optimum device performance in variable light and temperature conditions. You get sensors with a lens/device relationship previously thought impossible.

Versatile OP 600 Series NPN planar silicon light sensors eliminate cross-talk and are ideally suited for high density arrays. In addition, these small, rugged devices will satisfy virtually any application requirement in optical character recognition. But, if your application isn't standard, you'll especially like Optron's fast reaction to your custom programs, too.

Write today for
Optron product
technical data
and the name
of your nearest
sales
representative.



OPTRON, INC.

1201 Tappan Circle
Carrollton, Texas 75006
214/242-6571

Meetings

Wincon: secrets about space

If you're going to the Winter Convention on Aerospace and Electronics Systems (Wincon) Feb. 10-12 in Los Angeles, make certain you bring evidence that you're cleared to gain entry to the classified sessions. Five of the 11 sessions are classified, and those five appear to have the meatier content. The titles of four of them indicate that they should give insight into some of the military's most challenging problems: The Challenge of Darkness—Warfare at Night, Electronics for Future Missile and Space Systems, Electronic Warfare, and Aircraft and Electronics in Antisubmarine Warfare.

Three of the six unclassified sessions are devoted to space topics; indeed, 16 of the 49 papers at the conference have spaceflight as their themes. Since the Wincon theme is Electronics Strides into the Seventies, it's appropriate that one of the papers in the night warfare session treats Army research and development in night vision. R.S. Wiseman, deputy for laboratories, Army Electronics Command, Ft. Monmouth, N.J., is the principal author of the paper.

Fighting back. Countermeasures will come in for considerable attention in the electronic warfare session. Infrared countermeasures will be discussed by Sheldon Jones, manager of the Hughes Aircraft Co.'s air defense electro-optical laboratory; optical countermeasures is the topic chosen by Kenneth Drellishak, chief scientist in the military systems division of Electro-Optical Systems.

A timely paper in the antisub-

marine warfare presentations is one that will cover the S-3A and P-3C aircraft as ASW weapon systems. The Navy project manager for each system—Capt. Fred Baughman for the S-3A and Capt. John Brozena for the P-3C—are to detail these aircraft and their electronic systems requirements.

As NASA considers long missions to the outer planets, spacecraft and subsystem reliability becomes a critical consideration. An unclassified session entitled Long-life Reliability will focus on the problem, with particular attention to electronic components. V.J. Napolitano, manager of reliability and maintainability at IBM's Space Systems Center, will give a paper entitled Component/Circuit Design Features for Longer Space Missions. Another circuit-oriented paper, Reliability Testing of LSI Circuits for Long-life Applications, will be presented by Frank Tung, chief of the microcircuit technical division at NASA's Electronics Research Center.

Not so secret. The other unclassified sessions include these topics: peaceful uses of space; electronics in manned and unmanned space exploration; navigation in the '70's, with special emphasis on commercial airline navigation problems; systems for the cities, including discussions of environment, crime detection, and prevention; and computers as tools for managing a variety of phenomena from ecology to transportation.

For further information, contact John A. Jamieson, technical program chairman, electronics division, Aerojet-General Corp., 1100 West Hollyvale St., Azusa, Calif. 91702.

Calendar

Winter Power Meeting, IEEE; Statler Hilton Hotel, New York; Jan. 25-30, 1970.

Annual Symposium on Reliability, Group on Reliability of the IEEE, American Society for Quality Control, American Society for Nondestructive Test-

ing, and the Institute of Environmental Sciences; Biltmore Hotel, Los Angeles; Feb. 3-5, 1970.

International Solid State Circuits Conference, IEEE, University of

(Continued on p. 24)



**This counter fell off a plane.
It didn't need service
(but when one does, we're ready).**

This Model 100A Counter-Timer was enroute to a customer. A freight handler laid it on the wing of the airplane—and forgot it. The package finally slid off as the wheels left the runway. Instantly freed of its container, the "Small Wonder," as our customers sometimes call it, chased the plane for about a hundred yards, then ground-looped.

Our nearby Service Center, bored with inaction, brightened at the thought of a real challenge when it was brought in. But they were disappointed: electrically, the "Small Wonder" picked up right where it left off in Final Inspection. (Of course, *mechanically* there were a few abra-

sions to take care of, as you can see.)

Please help us keep our 37 Service Centers with their factory-trained technicians alive and well. Call the one nearest you anytime you feel that a Monsanto instrument requires service or calibration... or even verification of its performance. In addition to their expertise and factory specified test equipment, all carry a complete stock of spare parts. If there should be a defect in materials or workmanship during the 2-year warranty period, it won't cost you anything.

Monsanto Company, Electronic Instruments, West Caldwell, New Jersey 07006.

Monsanto

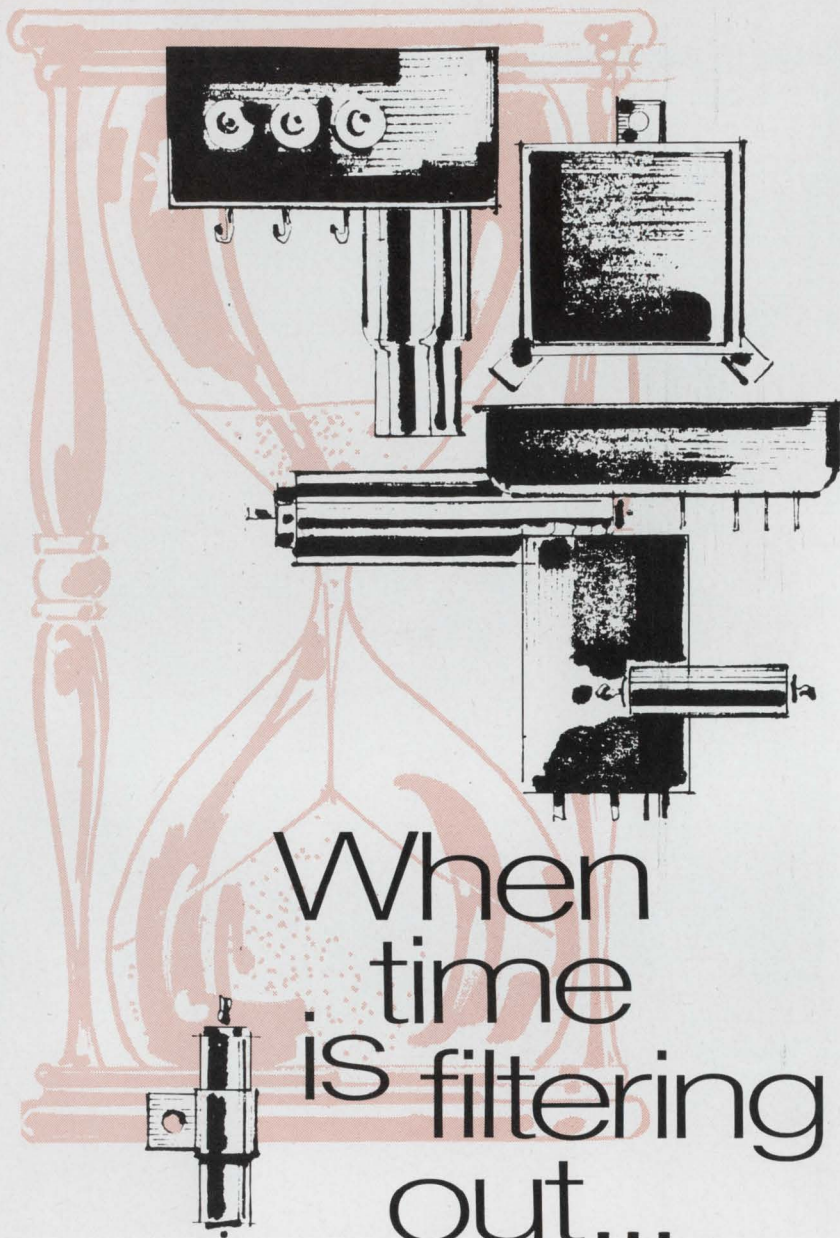

When
time
is filtering
out...

Captor is quicker

Customers tell us our shipments of standard RFI/EMC filters are the fastest in the industry. Captor responds quickly on custom designs, too, with prompt attention given to problem-solving prototypes. One reason for Captor's time saving capability is a new environmentally controlled plant built expressly for the production of such electronic components as miniature EMC filters, communications and security filters, and custom designed filters and assemblies. One section handles large orders numbering into thousands of units; a separate section provides fast action on prototypes and short runs. Beat the clock . . . write for our capabilities brochure today!

CAPTOR
CORPORATION
Electronics Division

5040 Dixie Highway, Tipp City, Ohio 45371, Phone: (513) 667-8484

Meetings

(Continued from p. 22)

Pennsylvania; Sheraton Hotel and University of Pennsylvania, Philadelphia, Feb. 18-20, 1970.

Second National Conference and Exposition on Electronics in Medicine, Electronics/Management Center, Electronics, Medical World News, Modern Hospital, Postgraduate Medicine; Fairmont Hotel, San Francisco, Feb. 12-14, 1970.

Symposium on Management and Economics in the Electronics Industry, IEE; University of Edinburgh, Scotland, March 17-20, 1970.

International Convention, IEEE; New York Hilton Hotel and the New York Coliseum, March 23-26, 1970.

Meeting of the Association for the Advancement of Medical Instrumentation, Statler Hilton Hotel, Boston, Mar. 23-25, 1970.

Symposium on Submillimeter Waves, IEEE, Polytechnic Institute, Brooklyn, New York, March 31-April 2, 1970.

Communications Satellite Systems Conference, American Institute of Aeronautics and Astronautics; International Hotel, Los Angeles, April 6-8, 1970.

Reliability Physics Symposium, IEEE; Stardust Hotel and Country Club, Las Vegas, Nevada, April 7-9, 1970.

Meeting and Technical Conference, Numerical Control Society; Statler Hilton, Boston, April 8-10, 1970.

Computer Graphics International Symposium, IEE; Uxbridge, Middlesex, England, April 13-16, 1970.

International Geoscience Electronics Symposium, IEEE; Marriott Twin Bridges Motor Hotel, Washington, April 14-17, 1970.

American Power Conference, IEEE; Sherman House, Chicago, April 21-23, 1970.

International Magnetics Conference (INTERMAG), IEEE; Statler Hilton Hotel, Washington, April 21-24, 1970.

Annual Frequency Control Symposium, U.S. Army Electronics Command; Shelburne Hotel, Atlantic City, N.J., April 27-29, 1970.

National Telemetry Conference, IEEE; Statler Hilton Hotel, Los Angeles, April 27-30, 1970.

(Continued on p. 26)

TRY TO MATCH THIS

for size and reliability

you can't!

For their size, Type BB resistors pack a tremendous power dissipating ability. Rated 1/8 watt at 70°C in a 0.0004375 cu. in. volume.

And miniaturization has not reduced reliability. Tests prove it. They satisfy the highest level—the S level—of the latest MIL-R-39008 Established Reliability Specifications in all resistance values.

The key is hot molding—the Allen-Bradley way. A-B developed and built the machines. Only A-B uses them. They're fully automatic. Built-in precision control. A high degree of uniformity. Predictable performance from resistor to resistor—year after year.

For immediate delivery at factory prices call your authorized A-B industrial electronics distributor. Or write Marketing Dept., Electronics Division, Allen-Bradley Co., 1201 South Second St., Milwaukee, Wis. 53204. Export Office: 1293 Broad St., Bloomfield, N.J., U.S.A. 07003. In Canada: Allen-Bradley Canada Limited.

© Allen-Bradley Company 1969



ALLEN-BRADLEY
QUALITY ELECTRONIC COMPONENTS

EC69-80



Exclusive

Only A-B Type BB
RCRO5 meets MIL-R-39008
ER (established reliability)
for 1/8-watt resistors
at the S level.
Shown actual size.

THE
Now
 GENERATION
SCR



**DISC PACKAGED
 REGENERATIVE GATE
 SCR's**

Operation to 20 KHz with low switching losses
 ⊕ di/dt capability to 800 A/μsec. ⊕ low power gate drive
 ⊕ dv/dt capability to 500 V/μsec.
 ⊕ 175 and 370 amperes RMS ⊕ turn-off time capability to 10 μsec. ⊕ also available in stud type package to 470 amperes RMS.

For additional information and application assistance, write or call National Electronics, Inc., a varian subsidiary, Geneva, Ill. 60134, phone (312) 232-4300.

NATIONAL ELECTRONICS, INC.
 a varian subsidiary

*1969 COMPETITION WINNER
 Cited by Industrial Research Inc.
 as one of the 100 most
 significant technical products of the year.*

 A NATIONAL® exclusive.
 Patent Pending.

Meetings

(Continued from p. 24)

National Relay Conference, Oklahoma State University and the National Association of Relay Manufacturers; Oklahoma State University campus, **April 28-29, 1970.**

Transducer Conference, IEEE; National Bureau of Standards, Washington, **May 4-5, 1970.**

National Appliance Technical Conference, IEEE; Leland Motor Hotel, Mansfield, Ohio, **May 5-6, 1970.**

Short courses

Generalized Machine Theory Applications, IEEE; Statler Hilton Hotel, New York, **Jan. 25-30, 1970.** \$30 fee.

Topics in Quantum Electronics, University of California; Berkeley campus, **Feb. 2-6, 1970.** \$300 fee.

Theory and Design of Reliable (Fault-Tolerant) Computers: Protective Redundancy, Diagnosis, Self-Repair, University of California; Los Angeles campus, **Feb. 2-13, 1970.** \$395 fee.

Minicomputers, National Electronics Conference; Pheasant Run Lodge, St. Charles, Ill., **Feb. 8-11, 1970.** \$390 fee.

Computer Language Approach to Network Analysis and Design, University of California; Los Angeles campus, **Feb. 9-13, 1970.** \$285 fee.

Electronic Components, University of Wisconsin; Madison campus, **Feb. 19-20, 1970.** \$70 fee.

Introduction to Process Computer Control, University of California; Los Angeles campus, **March 9-13, 1970.** \$285 fee.

Call for papers

International Conference on Communications, IEEE; San Francisco Hilton Hotel, June 8-10, 1970. **Jan. 15, 1970** is deadline for submission of papers to Allen M. Peterson, Stanford Research Institute, Menlo Park, Calif. 94025.

USNC/URSI-IEEE Spring Meeting, National Academy of Sciences, National Research Council; Statler Hilton Hotel, Washington, April 16-19, 1970. **Feb. 2, 1970** is deadline for submission of abstracts to Francis S. Johnson, University of Texas at Dallas, P.O. Box 30365, Dallas, Texas 75230.



**METALS THAT ILLUMINATE,
NAVIGATE AND COMPENSATE... A
SPECIAL CAPABILITY OF CARPENTER!**

Darkness falls, and a city is "turned on" in the brilliance of manmade light. Through a shroud of fog, an airline pilot safely lands his passengers and crew without ever seeing the runway. Thermo-magnetic behavior of your automobile speedometer stays constant through all extremes of ambient temperature. These everyday conveniences we take for granted all rely on specialty metals for their high degree of reliability. Carpenter produces a total line of electronic alloys that are specified and used with confidence throughout the electronic industry. These alloys include: Temperature Compensator Alloys, Magnetic Core Irons, Controlled Expansion Alloys, Glass Sealing Alloys, Electrical Resistance Alloys, High Permeability Alloys, and others. Why not plot a new course of progress for your products with Carpenter electronic alloys? Call your Carpenter representative now. Steel Division, Carpenter Technology Corporation, Reading, Pa. 19603.

*European Office: Emmastraat 39,
Amsterdam-Z, The Netherlands*

CARTECH CARPENTER
TECHNOLOGY

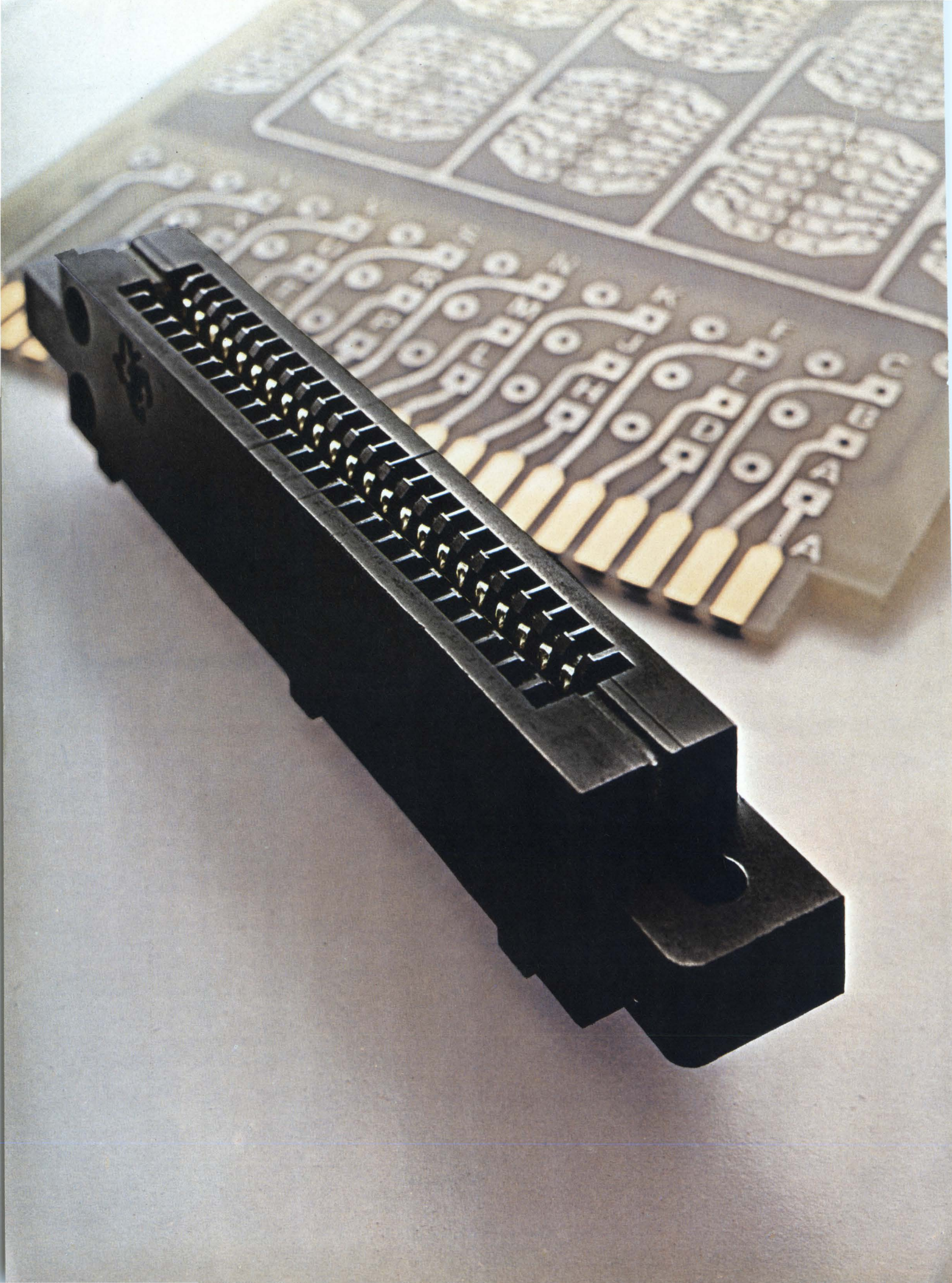

TI's new high-speed edgeboard connector

For Next-Generation Computers and RF Communications Systems

TI is ready now with a matched impedance edgeboard connector — a totally new concept in microminiature packaging. This unique device permits quick connect-disconnect of high frequency and high-speed switching circuitry. It's the only printed circuit connector we know of that combines edgeboard plug-in convenience with the impedance matching capabilities of coaxial connectors.

This new connector eliminates costly, individual coaxial connectors from your microstrip and stripline boards. Saves you as much as 80%. Gives you up to 4 times more connec-

| EC-MI-9000 SERIES SPECIFICATIONS | |
|---|--|
| A standard 22-position connector for switching speeds of 2 nanoseconds or faster and high frequency signals of 30 MHz or above. Rated at 3 amps dc, has 50 ohms characteristic impedance. | At 500 MHz: V.S.W.R. is 1.05:1, crosstalk is 30 db, insertion loss is 0.1 db. Its 44 contacts, made of nickel silver selectively inlaid with gold, have 0.100" spacing. Molded body is glass filled nylon. |

tions in the same space.

Extremely flexible, TI's unique connector opens a whole new era for microstrip and stripline circuitry. One unit can handle various impedance levels, and RF and dc signals at the same time. This versatile device is primarily designed to termi-

nate at impedance matched mother boards. Adapters are available for coaxial cable.

For more facts about this connector breakthrough, write or call:
TI Connector Products
Attleboro, Mass. 02703.
Tel: 617-222-2800.



TEXAS INSTRUMENTS
INCORPORATED

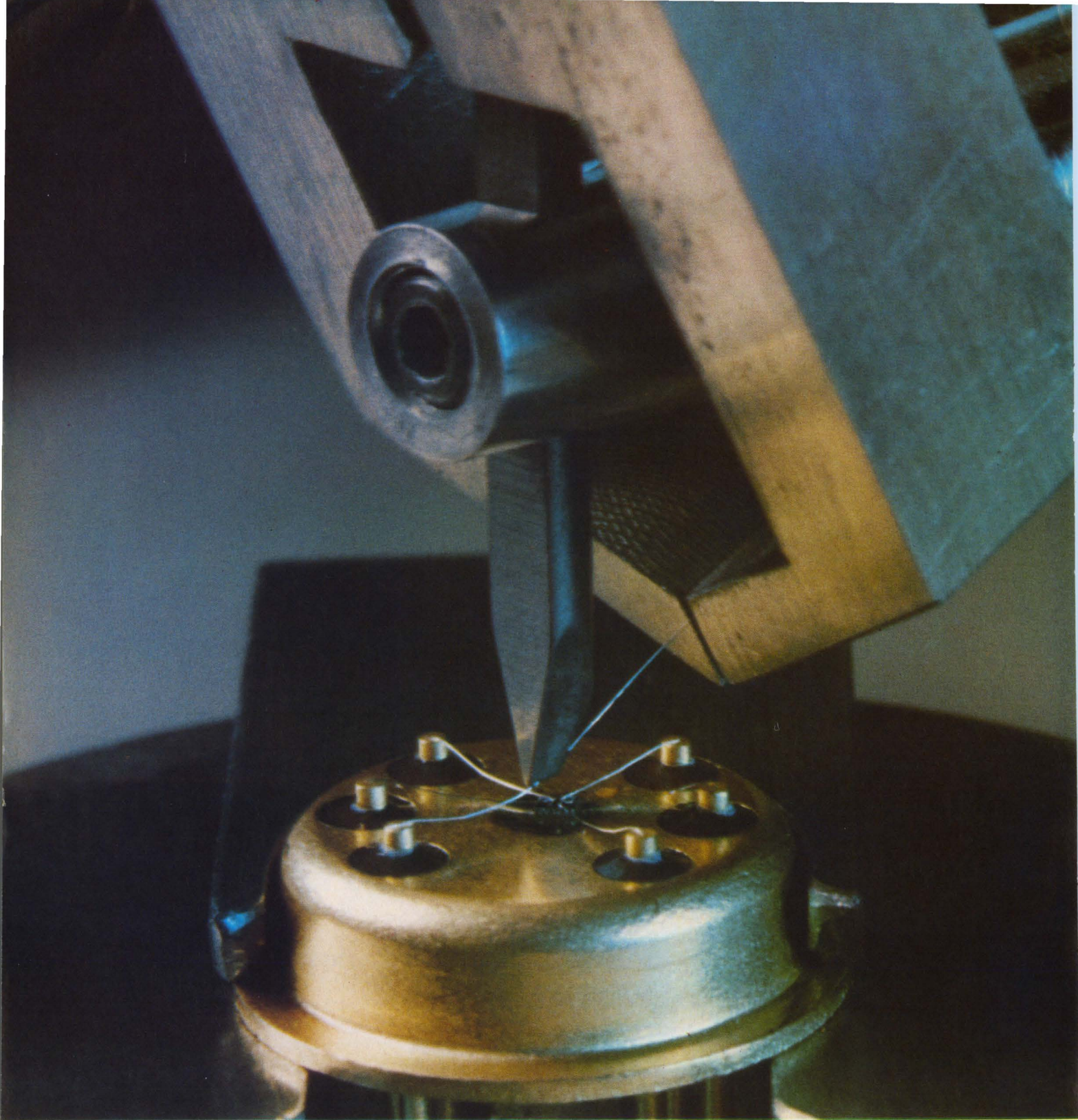

Craftsmanship in hard materials...an industry standard

HIGH PRECISION TUNGSTEN CARBIDE BONDING TOOLS, SUCH AS THE ONE SHOWN IN THIS 13X MAGNIFICATION OF AN ULTRASONIC LEAD BONDING OPERATION, WERE PIONEERED AND INTRODUCED AS PRODUCTION DEVICES BY TEMPRESS . . . IN 1963, THE TEMPRESS CAPILLARY TUBE, AN INDUSTRY STANDARD . . . IN 1967, THE ULTRASONIC BONDING TOOL, AN INDUSTRY STANDARD.

The techniques and the specialized machinery developed to produce such precision products from ultra-hard materials have not been duplicated; quite probably will not be, for they are a result of the unique combination of Tempress people and the

Tempress philosophy. To meet its responsibilities, Tempress maintains a continuing expansion program, limited only by strict adherence to the Tempress Standard of Excellence. (It requires as long as 11 months to train an operator for certain operations.) The same uncompromising standard is applied to Tempress Automatic Scribing Machines and to the entire growing family of Tempress miniature assembly tools and production equipment.



TEMPRESS

Tempress Industries, Inc., 980 University Ave., Los Gatos, Calif. 95030

Circle 30 on reader service card

Editorial Comment

The game is international

Dire warnings of U.S. electronics giants trampling native European companies are sure to accompany the flurry of forecasts and predictions that the new year inevitably brings. Most often, the warnings are a prelude to a call for some sort of protectionism, anything from a gentleman's agreement that would guarantee European companies a share of the market, on up to demands for outright national protection.

But too often the pundits who issue these pronouncements base them on statistics that are several years old. Even the highly respected Commission of the European Economic Community, the executive body of the six-nation Common Market, dusts off old facts. In a report issued several months ago, the EEC contended that European firms were in danger of "total eclipse" by their U.S. competitors. This contention was backed by an analysis of the 1964 situation, when the European market totaled \$3.9 billion. Next year, the market will be double that—\$7.8 billion. What's more, the lineup of companies operating in Europe has changed dramatically since 1964.

One corollary of the "eclipse" contention is that European electronics companies are dwarfed by the American giants. To be sure, there's no European firm anywhere near as big as General Electric or within \$1 billion in sales of the International Telephone and Telegraph Corp. But based on nine-month figures for 1969, Philips Gloeilampenfabrieken will cap the year with sales of \$3.2 billion, outpacing RCA's \$3.1 billion but lagging ITT's better than \$4.2 billion.

And the American IC giants, Texas Instruments and Motorola, would rank fairly well down on a list—by total sales—of companies involved in European electronics. Neither U.S. firm will reach the \$1 billion mark in 1969.

By contrast, West Germany's Siemens registered \$2.8 billion in sales during its most recent fiscal year, which ended last September. AEG-Telefunken expects to log \$2 billion this year. Out of the mergers in Great Britain has come the English Electric-General Electric (not related to its U.S. namesake) group, a \$2.4 billion operation. In France, mergers have concentrated the bulk of domestic electronics in Thomson Houston-Hotchkiss Brandt—a \$1.1 billion company.

The preachers of gloom would do well to ponder these rankings and look into what's happening in the IC market. Integrated circuits, according to the EEC's report, are almost entirely a U.S. preserve—or, at least that was the case in 1964. European producers—not counting subsidiaries of American companies—have since cornered something like 35% or 40% of the market. IC's, of course, are considered symbolic of the

technology gap that, if you believe the pundits, is ever-widening between the U.S. and Europe.

It would be disastrous thinking for European managers to conclude from current figures that American competition is no longer a threat. The threat is there and will continue. Equally disastrous would be a conclusion, based on 1964 figures, that the European electronics industry is doomed unless market protection is in the offing. Anyone who thinks a cozy domestic market is the answer has only to consider Philips. It has grown into Europe's largest electronics company because it realized long ago that it would go nowhere unless it went international. ■

Toward better forecasts

Groundhogs pop out of their holes in early February. If they see their shadows, they pop back in and we gird ourselves for another six weeks of winter. That's one way of forecasting. But market researchers apply infinitely more sophisticated methods to the task and cast long shadows without fear—in January. Before the year ends, though, many a market forecaster finds himself burrowing back through his raw inputs trying to find out what went wrong.

Such was the plight of many European electronics marketing men during 1969. A year ago, most prognosticators underestimated the lasting power of the West German boom, the tremendous lift it brought to business throughout Western Europe, and the fast development of new markets like the auto industry. Counseled by cautious marketers, top managers scrimped on plant investments. By midyear, there was a components shortage; market estimates were revised upward, and investment plans readjusted.

Today, again, there's much in the West European outlook that lends itself to caution. Pessimists note that capacity has surged and that component producers' order books are inflated because equipment makers have over-ordered to assure deliveries. And a round of price-cutting may be in the offing when economic brakes, particularly those in West Germany and France, take hold.

But gauging the electronics outlook with such traditional factors as gross national product and government spending no longer works. Pinpointing the new markets like the auto industry and, just as important, when to move into them, are the skills market seers must develop. Without these skills, forecasters can only founder in the fast-growing and fast-changing West European markets. (A special report on the 1970 outlook starts on page 72.) ■

We've lowered the profile and the cost

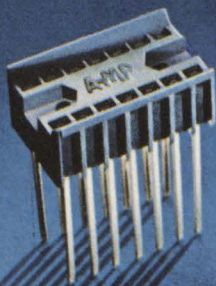

For years we've made DIP Headers of unquestioned quality. They've stood tall in the industry. A little too tall for some application, perhaps.

But things have changed. A new low profile brings AMP's DIP Headers eye to eye with any in the industry. And a new low cost makes pluggability more practical than ever.

But the most important features have not been changed. Our reusable spring hard posts. Wider range of IC Post and Tab acceptance. Your choice of solder, wrap or TERMI-POINT* Clip method, which permits up to three separate terminations per post.

For the most versatile, reliable DIP Header at the lowest installed cost look at our new look.

For more information write **Industrial Division, AMP Incorporated, Harrisburg, Pa. 17105.**

*Trademark of AMP Incorporated

AMP
INCORPORATED

Electronics Newsletter

December 22, 1969

NASA to test L-band via planes

Tests of L-band navigational satellite equipment through aircraft simulations have been approved by NASA headquarters [*Electronics*, Oct. 27, p. 53]. A NASA Electronics Research Center spokesman says **first flights could take place as early as June 1970 from Edwards Air Force Base or Point Mugu, Calif.** The space agency has also informed the FAA that it won't replace the ATS-5 satellite.

A transponder-equipped RB-57 would fly at high altitude to simulate performance of the L-band-equipped, but faulty, ATS-5 satellite. Another aircraft, probably a Hansa business jet, would fly below, making multipath and radio noise measurements, as well as taking lines of position from the RB-57's L-band signal. The experiments would take about 50 hours.

But some NASA spokesmen feel that operational navigation satellite parameters still won't emerge from the tests. **Neither ionospheric effects nor the multipath effects peculiar to the North Atlantic will be known.** The flights will be over the Pacific, while the first operational navsats would be deployed over the Atlantic.

Others—including spokesmen for the FAA, the Air Force, and the International Civil Aviation Organization—still are pressing hard for a backup satellite dedicated to the L-band experiments [*Electronics*, Dec. 8, p. 50]. Some NASA engineers view the flight simulations only as a step toward a more meaningful satellite experiment later, despite the agency's no-replacement decision.

Finally, there is limited hope that if all else fails, operational navsat specifications could be clarified by experiments with the next ATS. Also L-band-equipped, it is scheduled for launch in 1972 and vague plans exist to simulate high-altitude supersonic aircraft using a YF-12 aircraft.

On and off in 10 nsec

Advance Memory Systems Inc., one of the latest entries into the semiconductor memory race, has developed a **bipolar, 16-bit random access memory chip with access time of about 4 nanoseconds.** These chips, together with memory support chips, will be employed in memory modules, or cards, that have access time of about 10 nsec—**on and off a card, not just on and off a chip.** Conventional emitter-coupled logic with 256 bits on a card gets on and off in 40 nsec, so its speed is derated from that of the AMS memory by a factor of 4 or 5.

The 10 nsec units are ECL compatible, but TTL-compatible modules with 20 nsec access times also will be available. Standard configurations include 32-word-by-8-bit and 32-word-by-9-bit units for both TTL and ECL circuits.

Tacfire runs into funding delay

Delivery of the first engineering and service test models for the Army's artillery tactical fire direction system (Tacfire) will be delayed five months. The major reason is continuing funding delays, says the contractor, **Litton Data systems.** Initial systems, scheduled for delivery this month, won't be delivered until the end of May 1970, Litton says. The programing support system for debugging and checking Tacfire software will be delivered in early January, and the training support system for training Army personnel will be ready in February.

Litton is confident that \$50 million slashed from its \$122 million

Electronics Newsletter

Tacfire contract by the House Appropriations committee in the fiscal 1970 budget will be restored, perhaps in fiscal 1971 or 1972 [see p. 46]. It says the funding cut, if sustained, could result in the Army's equipping only eight divisions with Tacfire instead of the 16 divisions that were to have received the system.

Built-in delays as Army personnel are trained to use the new system will tend to minimize the effects of any program stretch-out, according to Litton. "There is a serious question whether the Army could absorb Tacfire systems at the rate we would produce them later on," says one official. About \$30 million of the \$122 million contract has been funded to date.

Autonetics building 70-foot fiber-optic digital, analog link

Autonetics is working on what it calls advanced photo-telemetry systems that transmit digital and analog data through glass fiber-optic bundles up to 70 feet long. Fiber-optic data links have been limited to 20 or 25 feet because of attenuation in the material. One Autonetics link has been used to monitor the performance of a missile guidance and control system in the presence of r-f or electromagnetic pulse interference. The photo-telemetry link can isolate the signals from the severe noise in such environments; a hard-wire data link can't.

In the new system, 109 analog signals and 49 discrete on-off signals are monitored, conditioned to a level between 0 and 5 volts, and put through an analog multiplexer, an analog-to-digital converter, and a digital multiplexer. The pulse-code-modulated digital output is fed to a gallium-arsenide diode emitting in the infrared; this is coupled to a p-i-n photodiode detector through the fiber-optic light pipe. Data rate is 345.6 kilobits per second. The accumulator and instruction registers of the guidance system's computer are monitored by similar data links.

Fairchild IC tester has program bugs

Fairchild's Systems Technology division, trying to make a dent in the integrated circuit tester market, seems to have bruised a few customers. The Model 5000 C, presently Fairchild's top-of-the-line tester, doesn't work. The problem, according to Bob Schreiner, general manager of the division, is the software. "The 5000 C uses a Hewlett-Packard computer, but the problem is not with H-P's software—it's with the executive program we wrote," says Schreiner.

One unhappy customer, Philco Microelectronics in Blue Bell, Pa., has reportedly given Fairchild until March to make the system work. However, Schreiner says there was no ultimatum and that Fairchild will get things going for all customers by March.

"The new executive program will be ready by March," says Schreiner, "and we will show the new system at the IEEE show in New York" next March 23-26.

Addendum

Fairchild Semiconductor, the innovator, will become Fairchild, the supplier—at least with regard to eight linear analog circuits to be introduced within the next few weeks. Sources in the company say that, for the most part, the new devices were put into production at customers' requests. Among the circuits will be op amps, multipliers, and communications circuits. They will be available in dual in-line packages.

TRW announces new ruggedized 1 GHz transistors

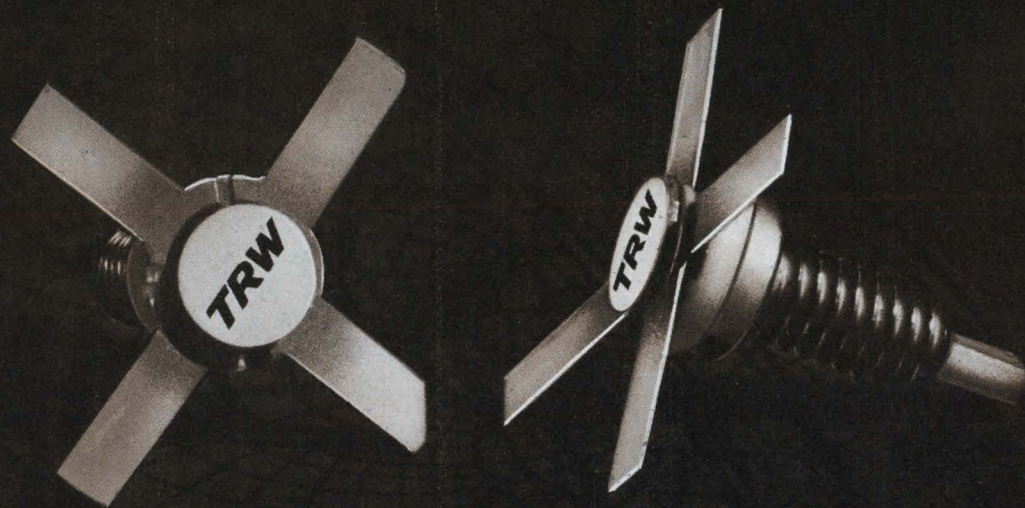

Infinite VSWR...improved gain...Ultraceramic package

TRW was first to break the Gigahertz barrier in RF Power Transistors. Now our technology has produced new state of the art ruggedized power at 1 GHz. The new 3 watt 2N5764 and 5 watt 2N5765 offer significant performance advantages over the older 2N4430 and 2N4431.

They will withstand severe mismatch — any load, any phase. Gain is increased to 6 dB and efficiency to 40%. Both operate from a 28 volt source. Both are in advanced ultraceramic strip-line packages.

Contact any TRW distributor or TRW Semiconductors Inc.,

14520 Aviation Blvd., Lawndale, California 90260. Phone: (213) 679-4561. TWX: 910-325-6206.

TRW Semiconductors Inc., is a subsidiary of TRW Inc.

TRW®

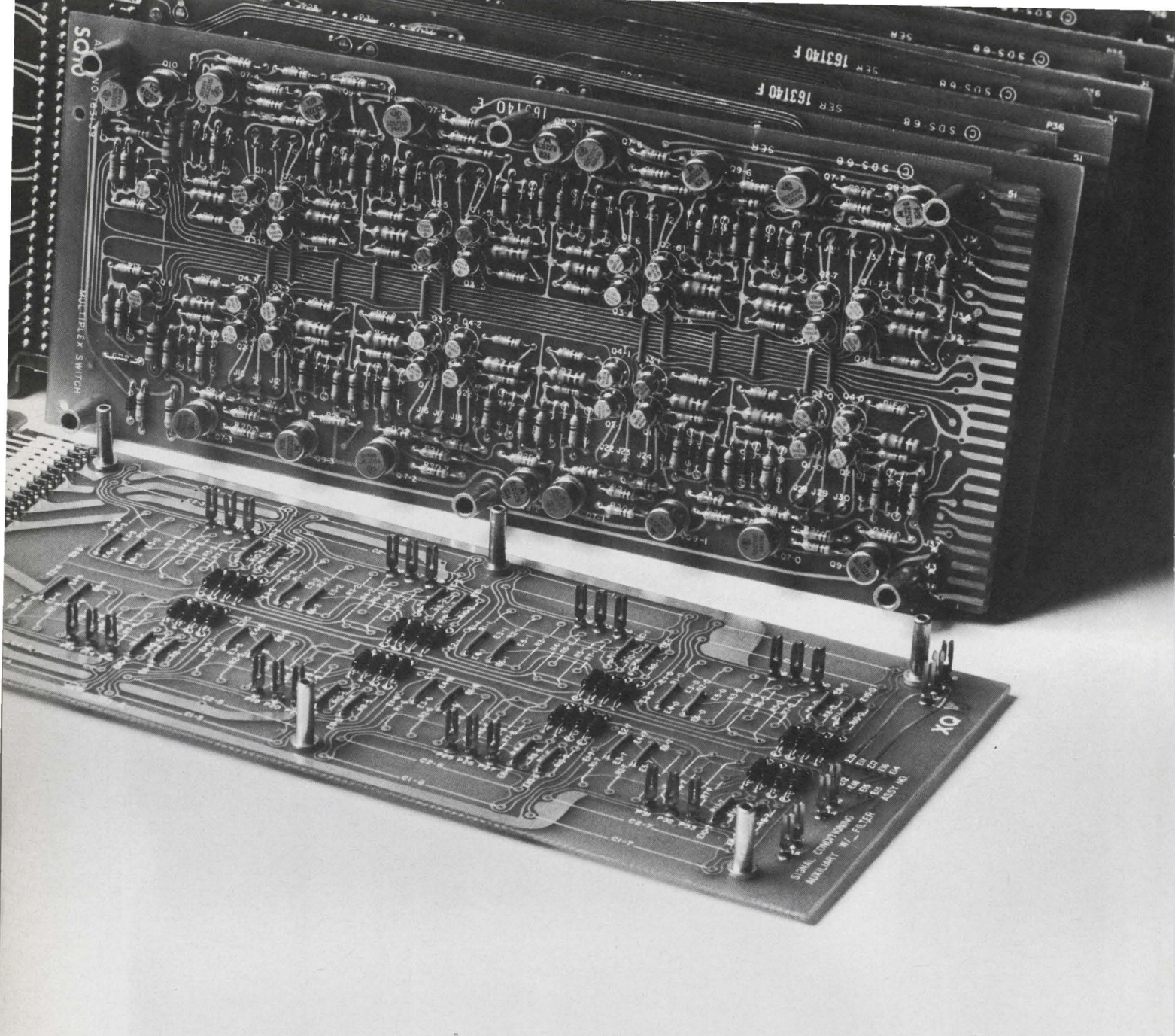

Look into our new low level multiplexer. It's good for your system.

Our DM40 solid-state differential multiplexer makes a great front-end, with amplifier per channel performance. It accepts analog signals from thermocouples, strain-gauges, resistance bridges, transducers, amplifiers and the like. It has very low noise and you don't have to worry about acquisition errors due to previous channel overload. The DM40 takes 128 input lines and you can hook eight units together for a total of 1024 inputs. It multiplexes and amplifies each signal and transmits it to your digitizer at a rate up to 10KHz. When you use it with one of our controller-digitizers you can get 13 different gain ranges.

In fact, the DM40 is even better when you get all your system components from us. This way you can be sure they'll work as a system. No interface problems to solve, no missing hardware to engineer. Our components are made to get along together.

After all, they come from a good family.

Circle 36 on reader service card

DM40 Minispecs:

| | |
|------------------------|--|
| Input signals: | From 2.5 millivolts full scale to 10 Volts full scale. |
| Gain Accuracy: | 0.02% between steps. |
| Linearity: | 0.005% |
| Zero Stability: | 1 microvolt rti +20 microvolts rto/°C. |
| Crosstalk: | 120db |
| Common Mode Rejection: | 120db, DC; 100db, 60Hz. |
| Noise: | 10 microvolts peak rti +100 microvolts peak rto. |

Write for complete specifications.

XDS
Xerox Data Systems
El Segundo, California

Yig grows up into microwave IC's

Autonetics' combination of single-crystal films and new substrate opens door to high performance in signal-processing circuits

There's a growth story at Autonetics starring epitaxially-grown yttrium-indium-garnet films in combination with a new substrate. The result is microwave integrated circuit devices—bandpass and band stop filters, magnetic wave beam steerers, magnetostrictive shear wave transducers, and delay lines—offering high performance for IC signal-processing systems. The new substrate is gadolinium-gallium-garnet, or simply G^3 , grown through a process called chemical vapor deposition, which uses volatile source materials that react chemically at the substrate surface to give the solid epitaxial yig. These single-crystal yig films deposited on single-crystal G^3 substrates possess uniform thicknesses and have usable areas up to 4 square centimeters, a big boost for planar microwave technology.

Just how big can be seen in typical device parameters. Ferromagnetic linewidths of 0.6 oersteds at X band at room temperature are readily attainable, whereas only a year ago linewidths of 1 to 2 oersteds were typical. This improves the intrinsic Q of epitaxial yig resonators by a factor of approximately 3. Moreover, using chemical vapor deposition, Autonetics can lay down yig film thicknesses 20 microns typically, compared to the 1 to 3 microns that were limited by the use of yttrium-aluminum-garnet substrates. Using MOS and bipolar masking techniques, it's now possible, even with thick films, to routinely etch arbitrary shapes in yig without damaging the substrate, an important consideration for distributed-parameter circuitry.

Best bet. One of the most promising classes of devices coming out of Autonetics' epitaxial material combinations is electronically tun-

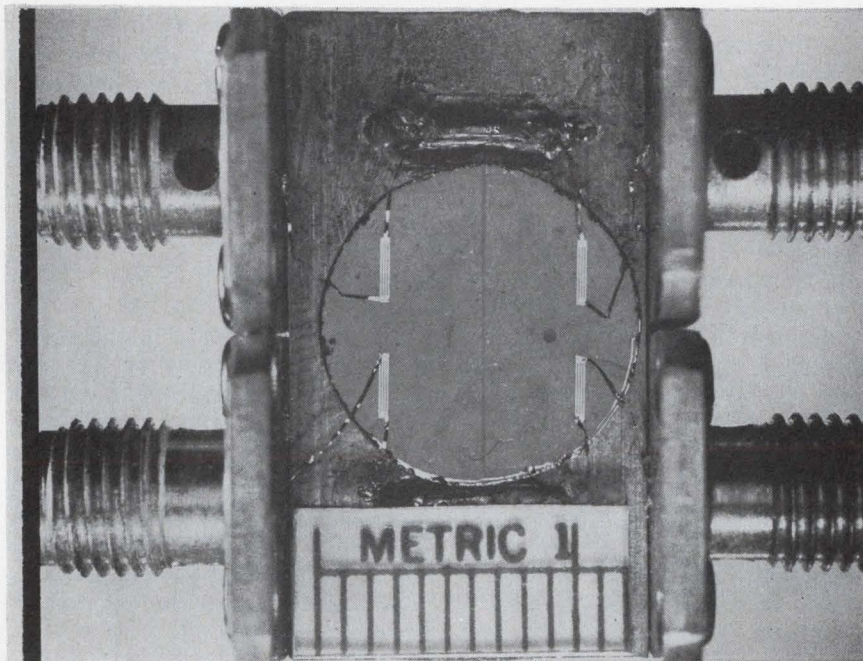

Switch in time. In this S-band surface magnetic wave beam-steering switch, changing the bias field or input frequency defects the magnetostatic beam to either of the two outputs. It shows the feasibility of an electronically switchable delay line array.

able bandpass and bandstop filters. Using 100-mil-diameter yig disk resonators on G^3 substrates, instead of the pure yig spheres mounted in the commercially available filters, devices have been built with a 3-decibel bandwidth of 2.4 megahertz at a center frequency of 2.5 gigahertz. What's more, not only can they operate down to a few hundred megahertz instead of cutting off at the typical 1,680 Mhz for pure yig spheres of the same volume, but they reject spurious modes better than the spheres—better by 5 db. Gallium and aluminum doping of the yig is thus avoided for low-frequency devices, a procedure that gives inhomogeneous saturation magnetization and requires crystal selection. These epitaxial

yig resonators will be used in octave tuning of Gunn and Impatt oscillators, promising smaller and lighter tunable microwave sources.

Equally important, the Autonetics yigs avoid the pitfalls of the flux melt growth process used to fabricate material for spheres. For one thing, the critical selection of starting material for purity, so important in flux melt, is less necessary for chemical vapor deposition. In fact, Autonetics' process is self-purifying, which means the same ferromagnetic linewidth can be achieved with a lower-purity starting material than is possible with flux melt, significantly lowering the cost in the process. Besides, usable flux melt yields are low: Autonetics can realize in one day what it takes

U.S. Reports

flux melt three weeks to a month to achieve, and this economy can run into big money when you consider system arrays made up of different devices.

Chemical vapor deposition has another advantage: it lends itself to batch processing. This means that where many yig resonators are needed—such as in integrated filter banks where the G³ serves also as the microstrip or slot line substrate—the process automatically aligns the resonators the same way—that is, with the same crystal orientation. So now Autonetics can magnetize the entire batch, giving all disks identical magnetic properties. Because of this built-in uniformity, it is now possible to make a contiguous filter bank—using many disks of differing diameters on one substrate with a common bias field, yielding multichannel outputs at distinct frequencies for a single input into which a wide range of signal frequencies are injected.

Dividends. Besides microwave devices, the material-combination growth program is beginning to pay off in acoustic devices as well—such components as a magnetostrictively excited shear-wave delay line operating from 500 Mhz to 4 Ghz, and a 120 Mhz magnetoelastic surface wave delay line. The shear wave device offers digitally selectable delay without spurious responses.

Autonetics is confident that its results in magnetic dispersive wave propagation indicate a big potential for a new miniature signal-processing system. There the advantage of epitaxial yig films is that they allow highly uniform internal bias fields, which means that the propagation will prove to be homogeneous throughout the crystal—impossible with flux-grown yig. Also, the wavelength is controlled by bias field, and this permits signal processors to operate out to 5 Ghz. With this integrated technology, complementary to the current major effort on surface wave acoustic propagation in piezoelectrics [*Electronics*, Nov. 10, p. 94 and Dec. 8, p. 102] but easier in the microwave region, waveguides, directional couplers, isolators, dispersive-tap delay lines, and pulse compression and expansion filters are within reach.

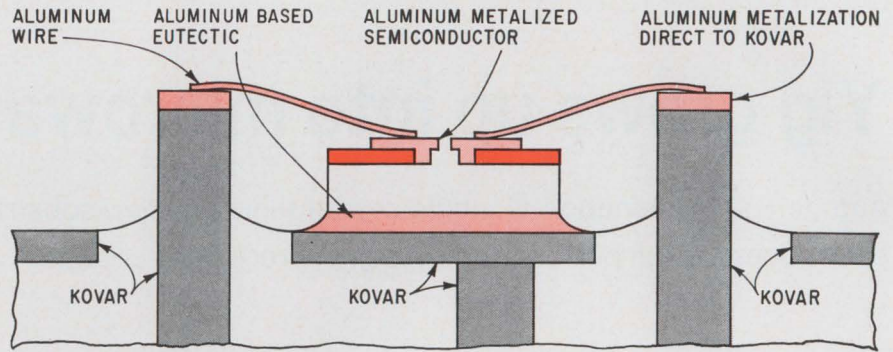

Nothing glitters. Gold, which is prone to catastrophic failure in harsh radiation environments, is replaced by aluminum in top posts, the lead wires bonded to those posts, transistor metalization itself, and eutectic bonding material. Latter is aluminum-germanium.

Components

Al gets around

Gold is widely used in the metal systems of a variety of discrete semiconductors and integrated circuits, but gold is the culprit that causes catastrophic failures in the surge of radiation caused by a nuclear blast. The metal must be avoided if the device is to withstand radiation-produced thermal-mechanical shock. The solution of Motorola's Semiconductor Products division is an aluminum-based metal system for discrete transistors pioneered by the Harry Diamond Laboratories; 28,000 of the devices have been subjected to an underground nuclear blast and Motorola engineers are studying the returned transistors for failures.

The aluminum and aluminum-germanium metal system is not new, and neither is Motorola unique in adopting it. The significance of Motorola's work is that the firm owns a production contract from HDL for the 28,000 units in competition with most of the major semiconductor firms. Peter Normington, Motorola's manager of program development for silicon transistors, says the successful reduction of the tricky aluminum-germanium metal system to large-volume production gives Motorola a leg up in the competition to supply transistors that are resistant to all types of radiation for the advanced missile systems in which they're being specified.

Number. The division has applied for a 2N registration number for a demonstration vehicle using the aluminum-germanium system. The device is the 2N5763 silicon transistor, but will essentially be a custom part where resistance to radiation that produces thermal-mechanical shock is required. After irradiation, the unit has a breakdown voltage of 60 volts and a d-c gain of 7 at 1 milliamperere.

Elimination of gold starts with die bonding to the Kovar header. Where a gold-silicon eutectic material might otherwise be used for such a device, Motorola uses aluminum-germanium. Pure aluminum is evaporated onto the top of the header and aluminum-germanium layers are evaporated onto the back of the die. The die and header are then brought to a eutectic temperature to achieve the die bond. Normington says that addition of germanium to the aluminum lowers the eutectic temperature so that there's no alloying of the top aluminum into the die, which would short it out.

But this die-bonding process is not without its drawbacks. Normington points out that evaporating aluminum is not as easy as evaporating gold. It takes more time and is more costly, lowering production rates. This is where Normington believes Motorola has proven its mettle—by mastering a difficult metal system and being able to reproduce it in large quantities.

Al all over. Aluminum metalization is used atop the transistor chip,

and the lead wires from this metalization to the top of the posts in the standard TO-18 package are also all aluminum. Pure aluminum is deposited atop the Kovar posts to which the lead wires are bonded. "We have no dissimilar metals to cause the problems that gold causes," Normington notes. He says that gold in any of these parts of the device—the eutectic material, the lead wires, or the posts—would cause thermal-mechanical shock leading to catastrophic failure when subjected to certain types of radiation. He adds that the aluminum-germanium metal system is new in discrete transistors to achieve radiation resistance, although it has been used in integrated circuits for about six months.

Motorola's central research laboratory is applying the aluminum-germanium metal system to make radiation-resistant power transistors with a breakdown voltage of 110 volts, under contract to the Air Force Cambridge Research Laboratories.

Computers

TLC for LSI

Now that RCA has delivered its Limac computer, the Air Force Avionics Lab competition between the fixed-wiring and discretionary-wiring approaches to bipolar large-scale integration is going into the home stretch. Limac (for large integrated monolithic array computer) uses fixed-wiring circuits; Texas Instruments earlier delivered a machine using the discretionary technique [*Electronics*, April 14, p. 56]. And at 144 gates per chip, the circuits in the Limac are probably the largest fixed-wire emitter-coupled logic IC's ever used.

Unlike discretionary wiring, fixed wiring demands that every gate on the chip be a good one. To obtain this 100% gate yield per chip, RCA used tender loving care—including these elaborate provisions:

Solid diffusion. Emitter, base, collector, and resistor regions were formed in the silicon by inserting solid dopant into etched holes in

the oxide. In conventional diffusion, gaseous dopant surrounds the silicon; but solid dopant can't leak through pinholes and form unwanted diffused regions.

Projection printing. Instead of exposing the photoresist through a mask in direct contact with the silicon substrate, the mask is kept at a distance and the pattern is focused on the substrate by a collimated light source. This avoids the damage to the wafer that contact printing can cause.

Double photoresist. Even though the chance that dopant will diffuse through pinholes is nil, the aluminum interconnections might still contact the substrate through pinholes when they are deposited on the oxide. To prevent this, RCA applies photoresist in two distinct layers. A pinhole in one layer is cut off by the adjacent layer.

The key to RCA's approach is "limited production in a model shop environment," according to Henry S. Miiller, a computer researcher at RCA Laboratories. The company even went so far as to install laminar-flow boxes in laminar-flow clean rooms to minimize dust. The precaution paid off: RCA was able to build the LSI circuits at

a fairly high wafer yield—15% to 30% of the 72-gate chips had the required 100% good gates.

In addition to the 72-gate chips, the Limac uses 144-gate chips composed of two 72-gate clusters; chip dimensions are 98 by 155 mils and 98 by 310 mils, respectively. The RCA engineers found substantial numbers of good three-cluster combinations (216 gates) and even a few good five-cluster combinations (288 gates), although neither combination is used in the machine.

RCA uses emitter-coupled logic in the IC's because of its speed compared to saturation logic. The designers were able to get a propagation delay of only 5 nanoseconds per gate at a power dissipation of only 10 milliwatts. The large surface area of the packages in relation to the chip was sufficient to dissipate the 10 mw of heat generated in each gate. The 72-gate chip comes in a metal package with 40 pins on 35-mil centers; the 144-gate chip is in a ceramic package with 60 pins on 50-mil centers. Cooling air is blown over the printed circuit cards that hold the package.

CMOS used. Besides the ECL LSI circuits for its logic, Limac uses

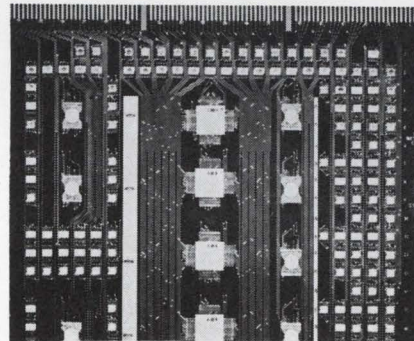
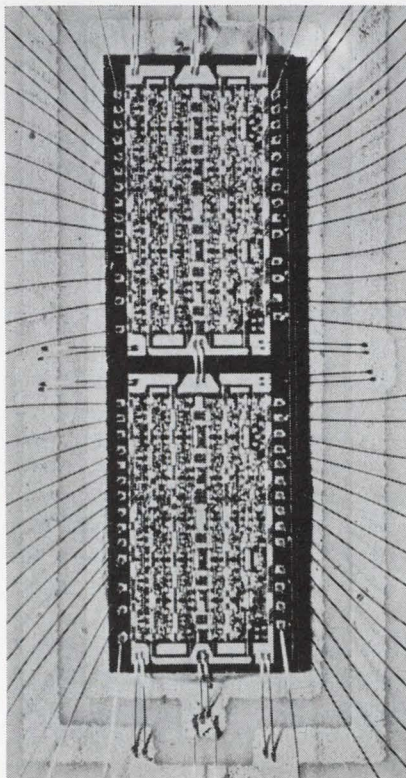

Unidirectional. ECL chip with 144 gates (left) is enclosed in square package at center of circuit board (top).

Conductors on board run mostly vertical; those on back side largely horizontal. All boards in Limac share this characteristic, a benefit of the computer's architecture.

U.S. Reports

complementary metal-oxide-semiconductor IC's in one of its two memories, achieving an access time of 80 nsec. This memory contains 256 words of 18 bits each; 128 words are packaged in 16-bit CMOS IC's, and the other 128 in 64-bit chips, both sizes made by standard factory processes. The other memory is a commercial ferrite-core array of 4,096 words with a 1-micro-second cycle time.

To incorporate these circuits into a useful computer design, Gerald Herzog, project manager, and his colleagues established a goal for themselves: a computer architecture that would permit a simple geometry and repetitive patterns on printed-circuit boards, so that the logic and data-flow portions of the machine would share the simple interconnection patterns usually associated only with memory arrays. To achieve this goal, they used the microinstruction approach that is generally characteristic of all third-generation computers; RCA uses it in the Spectra 70 line, but refers to its microinstructions as "elementary operations."

Basically this approach divides the computer into a number of vertical segments, or bit slices, in each of which a single bit passes through all its processing steps. A single elementary operation control word, or EOC word, consists of a number of bits, each of which controls corresponding gates in all slices horizontally across the machine.

Read map. Because each bit in a data word has many potential options in its path through the machine, the architecture in such simple terms would require EOC words hundreds or even thousands of bits long. To keep the words to a more reasonable length, the Limac was divided into a number of functional groups, with a separate EOC word for each group; and each EOC word, in general, contains only the bits that are different from the previous EOC word. The designers then established separate timings for each group, in addition to the separate EOC words.

This approach permitted them to mount each functional group on a separate 12-by-15-inch p-c board.

The data-flow paths thus appear as a set of vertical etched conductors on one side of the board; the control lines from the EOC word are horizontal conductors on the other side, providing patterns of parallel lines that are visually striking as well as geometrically simple.

Communications

Uneven pulse

While the rest of the world has agreed on an eight-bit word for international pulse-code modulation [*Electronics*, Dec. 8, p. 235], Comsat doesn't like it. Failing to note any technical advantages from eight binary digits in a time slot, Comsat wants to stick with the seven-digit word. And added to that disagreement are international differences about a standard coding law: Europe wants the so-called A law; the U.S. is sticking with the mu law; Japan is wavering between the two; and AT&T—which supports the eight-bit word—says flatly it will continue on its own with the mu law even if the A law is adopted as the coding standard.

Worldwide compatibility is essential on as many pcm standards as possible, many experts feel, from a cost as well as signal quality viewpoint. However, some engineers maintain that use of large-scale integration will offset any increased costs, and that the pcm signals will not be significantly affected by conversion equipment.

Sure thing. The agreement reached by the Consultative Committee for International Telegraph and Telephone (CCITT) Special Group D last month in Geneva is sure to be accepted by the full CCITT. In fact, European telephone equipment makers have begun to make necessary hardware changes.

The biggest bone of contention between AT&T and the rest of the world is the selection of a standard companding law, which defines the input-output transfer characteristics from each sampled analog voltage to its coded pulse word [*Electronics*, June 23, p. 94]. Japan's reevaluation of the mu law

may leave Ma Bell all by herself. However, this doesn't bother the U.S. giant. Says Richard Boyd, head of wire systems engineering at Bell Labs and chairman of the CCITT's Group D: "It is Bell's view that even if the rest of the world were to unite behind the A law, we still feel that the performance advantages inherent in the mu law so important that we won't change." Boyd indicates that in addition to performance, mu is better than A in ease of manufacture, design, and maintenance.

Comsat, whose involvement is as the link in the sky between the nations, says it's neutral. The satellite corporation's position is made clear by John Puente, manager of Comsat's communications laboratory: "We don't favor one system over the other, but gentlemen, please agree on one." Comsat has even incorporated each law in one of its future systems: A-law companding will be used in Spade, a frequency - division multiple - access/phase-shift key/pcm system for light traffic, due for tests in Intelsat 4; mu law coding is part of Comsat's time division multiple access (TDMA) for heavy traffic, which complements Spade. TDMA tests will be made in the mid '70's.

Switch. When it comes to bit rates, the positions are reversed; Bell is willing to go along while Comsat is dragging its heels. Bell uses a seven-bit word in its older D-1 channel bank which comprises a majority of its domestic system. But its newer D-2 channel bank uses eight-binary-digit coding, compatible with the rest of the world. Boyd says, "The noise improvement of eight bits over seven has been proved in the development of D-2, and is measured as being 6 decibels better when the quantizing distortion—noise behind speech—is considered." Boyd believes that both Bell and the world telephone administrations are convinced that eight bits are necessary for international calls. The first D-2 system channel banks were shipped by Bell this month; service is anticipated by the first quarter of 1970.

Meanwhile, Comsat sticks with seven bits. Puente points out:

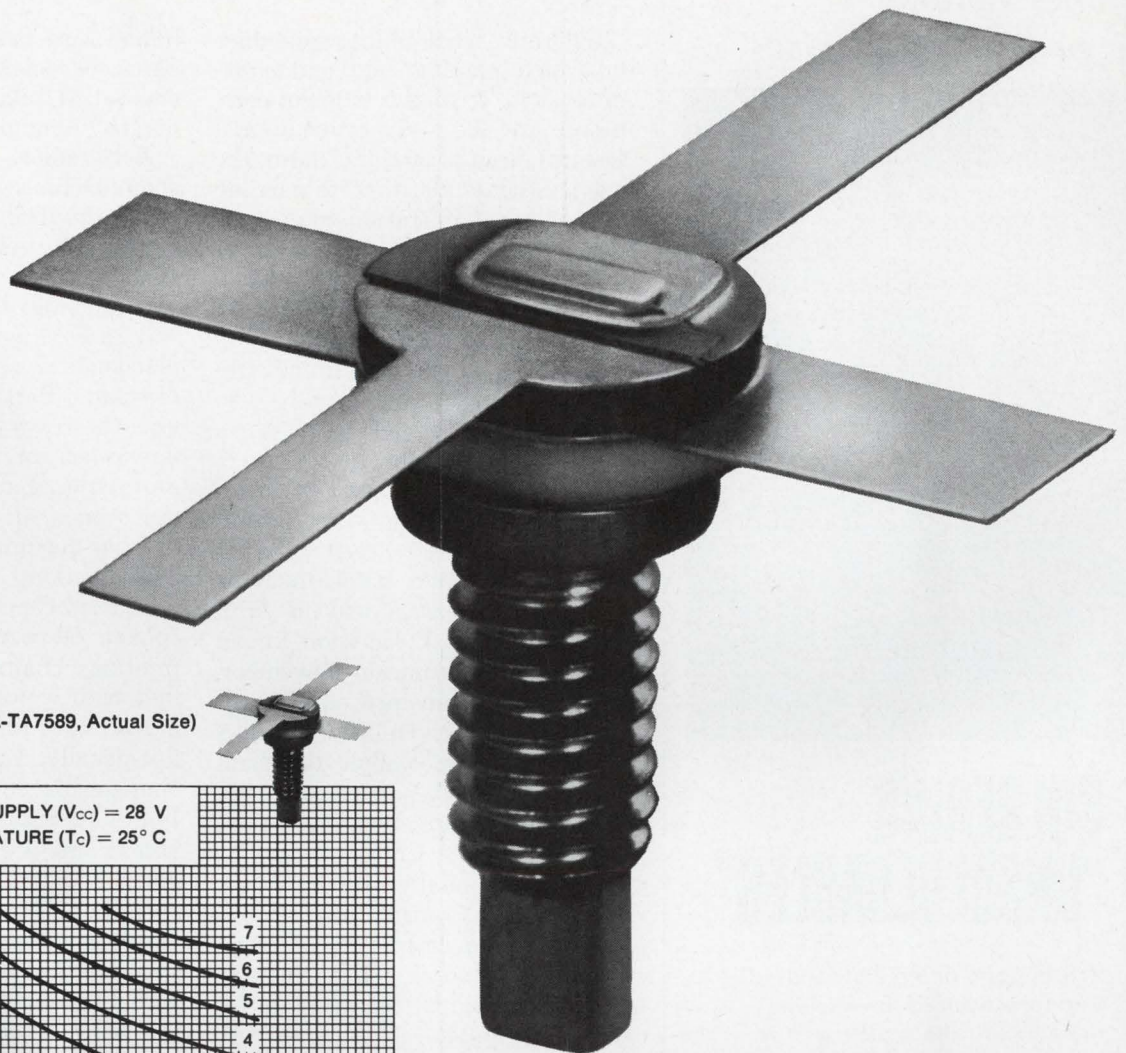

(RCA-TA7589, Actual Size)

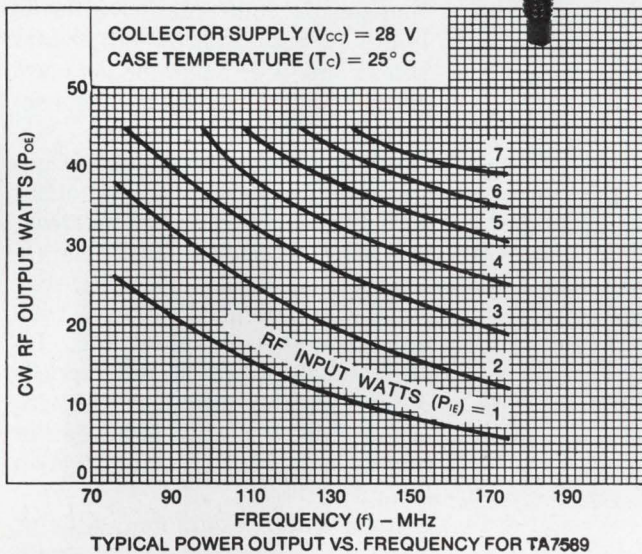
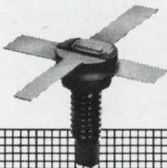

Emitter-Ballasted for VHF High Power RF Amplifiers for AM service: RCA-TA7589

This new RCA "overlay" transistor is especially designed for 12-V, 118-136 MHz AM amplifiers for use in commercial and general aviation aircraft. The RCA-TA7589 utilizes many separate emitter elements with ballast resistance built into each emitter site for assured stabilization.

The package is ceramic metal, hermetically sealed, with all terminals electrically isolated from the mounting stud. The rugged, low-inductance, radial leads of the TA7589 offer mounting flexibility for both stripline and lumped-constant circuits. This RF power transistor is completely tested at rated output with an infinite VSWR under full modulation.

Ask your local RCA Representative or your RCA Distributor for more detailed information. For technical data, write: RCA Electronic Components, Commercial Engineering, Section PN-1-4 / UF5, Harrison, N. J. 07029. In Europe: RCA International Marketing S.A., 2-4 rue du Lièvre, 1227 Geneva, Switzerland.

RCA

The Material of Unlimited Uses...

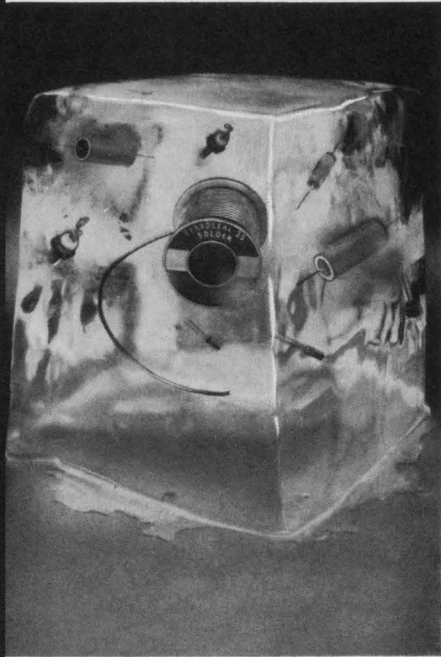

SOLDERING "UNSOLDERABLES"

... is but one of the thousands of uses for advanced low-melting-temperature alloys such as Cerroseal® 35. Cerroseal 35 melts between 238° and 260° F., and can be used with ordinary soldering techniques. When soldered with this versatile alloy, "toughies" such as glass-to-metal, ceramic-to-metal and metal-to-metal seals stay tight even in a deep vacuum. Other Cerro® Alloys, including specials made to your individual specs, are perfect for joining ultra-delicate parts like integrated circuits which cannot be heat-sunk during soldering. Low-temperature soldering as cool as 117° F. can also be accomplished with certain Cerro Alloys.

For detailed information contact Cerro Alloy Dept., Cerro Copper & Brass Company, Bellefonte, Pa. 16823 ... (814) 355-4712.

In Europe, contact Mining & Chemical Products Ltd., Alperton, Wembley, Middlesex, England.

CERRO®

U.S. Reports

"Right now we don't have any digital voice coming into earth stations, and it might be five years before we see voice-coded digital streams from a satellite." Also, the agency contends that there's no improvement in transmission quality with eight bits—a direct contradiction of AT&T's views. Puente recalls that Comsat told the Conference of European Postal and Telecommunications Administrations in Paris that it would go to eight bits if someone could prove transmission would be bettered. "There were no takers," says Puente, and the group voted unanimously to accept seven bits for Spade. But Boyd notes that the Paris meeting was held in April and the Group D decision for an eight-bit code came in November.

Another reason for Comsat's adherence to its seven-bit philosophy is the dollar—since about 100 channels at \$40,000 per channel per year would be lost by adding a bit, the total loss to Comsat would be \$4 million annually.

Still, while Comsat's official position favors seven bits, it is reviewing the question. That, coupled with the selection of an eight-bit code for TDMA, gives some observers the impression that Comsat's position is softening.

Government

Unkind cuts

After 11 months of labor, the Congress has brought forth a fiscal 1970 defense appropriation distinguished for being the latest in history and containing the largest funding cuts since the end of the Korean war.

The House-Senate dispute over the earlier procurement authorization produced a \$20.7-billion compromise that favored advocates of strong Pentagon programs [*Electronics*, Nov. 24, p. 52], but the actual appropriation dropped this to just a little more than \$18 billion. Overall, the \$69.96 billion appropriation—that is, for total Pentagon expenses including hardware, housekeeping, and salaries—is \$5.3

billion less than the Defense Department sought. It includes a substantial \$1 billion slice to \$7.2 billion in R&D money.

Acceptance. To the surprise of some, Defense Secretary Melvin R. Laird sought Senate restoration of only \$428 million cut from the spending bill. The biggest single request was \$129 million for the Navy's F-14 fighter, Grumman's replacement for General Dynamics' ill-starred F-111B. The idea was to give the Navy all the \$275 million it wanted for 12, rather than six, prototypes. But Laird's general acquiescence to the final bill is not without meaning.

By working quietly and closely with Rep. George Mahon, the soft-spoken 69-year-old House Appropriations chairman, Laird is credited with a political master stroke in the best Machiavellian tradition. Specifically, Laird avoided a McNamara-like confrontation with the Joint Chiefs of Staff by letting Mahon's committee make the cuts and harvest the praises of defense-spending critics.

At the same time, Laird got spending down to a level consonant with his long-term goal [*Electronics*, Sept. 29, p. 31] and also received valuable Congressional support for DOD centralization of such functions as communications. Indeed, much of the Mahon report's observations recall Laird's criticisms of the Pentagon in his earlier role as a Republican Congressman from Wisconsin.

Investigate. Computer systems came under the Mahon gun, with the General Accounting Office ordered to "immediately commence a comprehensive review" of the need for two major Air Force programs—the Worldwide Military Command and Control System and the Advanced Logistics System. "Severe difficulty has been encountered in the design of both these systems," says the Mahon report.

His criticism is based on the Air Force's plan to proceed with the worldwide system and the advanced system, with respective price tags of \$500 million and \$370 million, prior to resolving unknowns. Industry hardware makers have pegged contract value of the

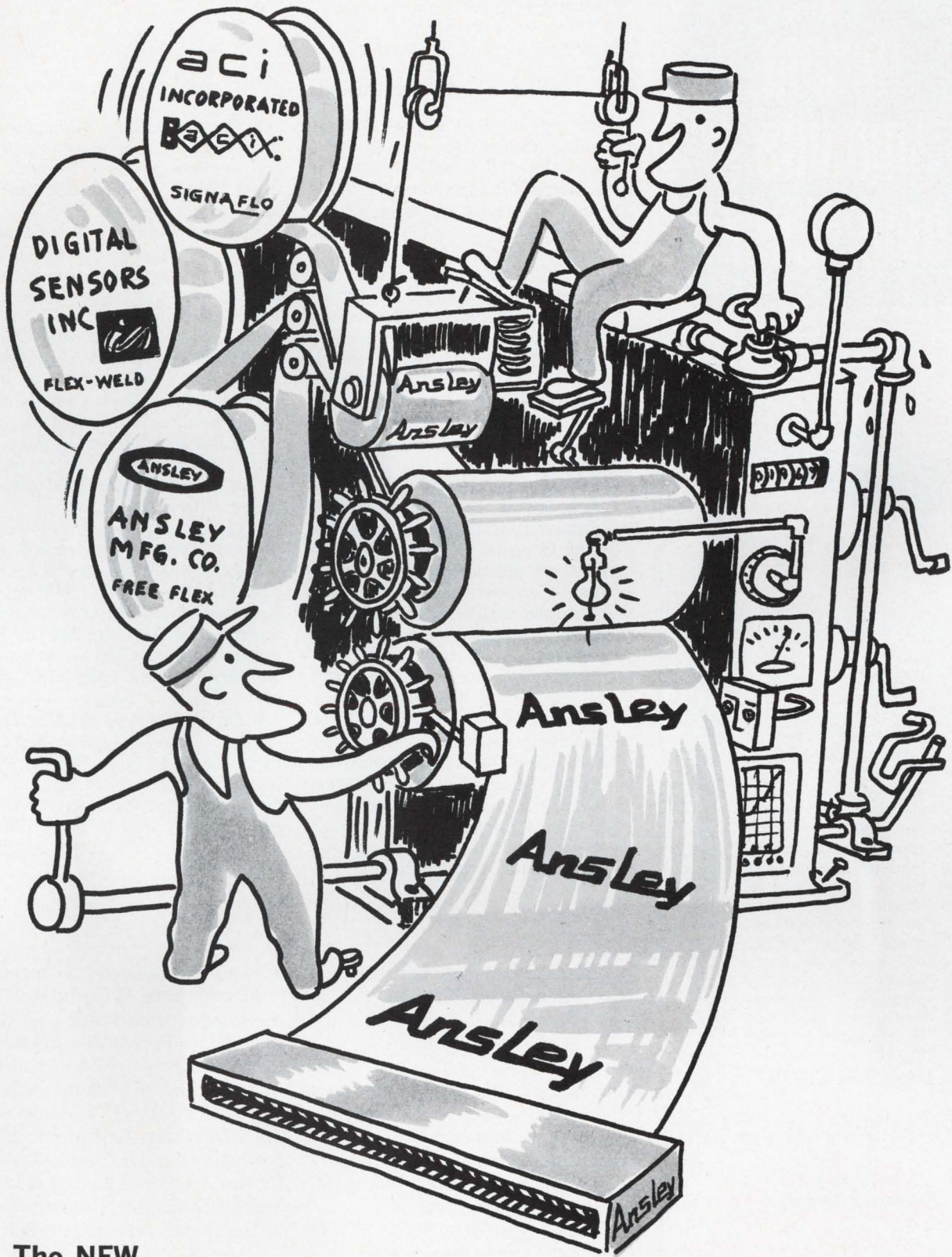

The NEW
LOOK!

Ansley produces an endless variety of flat cable wiring assemblies for aerospace, military, and commercial applications using laminating and etching technologies.

Three companies (aci Incorporated, Digital Sensors, Incorporated and Ansley Manufacturing Co.) have been combined into one for your convenience. Now . . . one name . . . Ansley!

Ansley

Division of Thomas & Betts Corporation 

Production facilities are located with geographic advantages to best serve our customers.

Ansley east Corporation

Old Easton Road, Doylestown, Pa. 18901

Ansley west Corporation

4100 N. Figueroa St., Los Angeles, Ca. 90065

Instant module time check

CURTIS 620-PC
ELAPSED TIME
INDICATOR



SHOWN 1½ TIMES
ACTUAL SIZE

Increasingly important in military equipment philosophy is the field or line replacement module.

With this Curtis Elapsed Time Indicator mounted on each functional replaceable module of your system you have an accurate record of operating hours for each individual module regardless of its installation history. Operating time record becomes part of module. Unit is extremely small, weighs little, uses little power, and is not expensive! For full details, ask for information on Model 620-PC. Meets requirements of MS 3311 (AS).

WRITE OR CALL

Curtis

INSTRUMENTS, INC.

200 Kisco Avenue
Mount Kisco, N.Y. 10549
(914) 666-2971

U.S. Reports

... and the unkindest of all

Not only did Rep. George Mahon's House Committee on Appropriations lop \$5.3 billion from the Pentagon's budget, but it offered some trenchant observations on defense spending in general. Some choice examples:

- On defense communications: "Prudent management would dictate that the defense Communications Agency be given full funding responsibility and direct control over the research, implementation, and operations of any communication system of the scope of the Defense Satellite Communications System."

- On procurement: By any yardstick, "fiscal year 1969 can well be characterized as the Year of the Cost Overrun. Submission to the top-level planners in the executive branch and to Congress of overly optimistic weapon system cost estimates has been almost standard practice."

- On North American Rockwell's Minuteman 2 guidance system: "The Air Force spent \$152 million in buying more spares than originally planned and in correcting reliability deficiencies. . . . As a net result, the contractor earned more profit for failing to meet contract specifications than he should have received for meeting [them]."

- On competition: "Competitive procurement of military supplies and services reached its peak in fiscal 1966. . . . Since that time it has steadily declined."

- On reliability: "Present weapon systems generally depend on unlimited supply support, elaborate facilities, and large numbers of skilled technical personnel to be maintained in combat areas. Technical problems have been routinely solved by bringing factory, and even laboratory-level, capabilities to the field. . . . In effect, dependence has been placed on the contractor maintainability of weapons rather on the more fundamental factor of field reliability."

- On specifications: "New weapons too often call for scientifically possible rather than the militarily practical. Excessive 'goldplating' has too often been the practice under which the last 5% of the performance specified . . . accounts for 50% of the complexity and cost. . . ."

- On duplication: "Rather than having a standard radio, the Department of Defense inventory of radios designed solely for use by downed airmen to assist in their rescues has grown to seven different types of sets with yet another one in R&D."

two at approximately half the total cost [*Electronics*, Nov. 24, p. 63]. These same sources agree that the GAO is likely to uncover a rat's nest in its investigation of the Advanced Logistics System, at least when the agency finds virtually every contractor has warned the project office that the ALS memory requirement of 3 trillion bits is beyond the state of the art.

On the Air Force Phase 2 base level data automation system contracted to the Burroughs Corp., Mahon said the committee "is not convinced that the system is required for every Air Force base in the United States." Further, it believes some bases could continue using "the so-called second generation equipment." In that context Mahon also denied another \$1 million in Air Force R&D for a change-

over to third-generation machines.

Aircraft cuts. Wiped out without a whimper from Laird was the \$8 million Air Force R&D funding for the A-X close-air-support aircraft. In addition to North American Rockwell's OV-10 "recently developed for close air support in limited war situations but not utilized by the Air Force in this role," the Mahon committee cited another 10 attack planes now inventoried.

Nevertheless, funding for the "higher priority" research and development on the B-1A and the F-15 was retained unchanged.

The Navy lost money for a variety of aircraft beyond the F-14, mostly in the support category such as reconnaissance (RA-5C) and tanker (KA-6D) areas. The AIM-7F Sparrow 3 and the AGM-45A Shrike missiles were also cut by

TRW METALLIZED POLYCARBONATES



...good things come in small packages

A 10 mfd 50 volt type X483 capacitor measures a scant .670" x 1 $\frac{1}{16}$ ". It's hermetically sealed and provides outstanding temperature stability and electrical properties. Meets all MIL-C-18312 and MIL-C-19978 requirements.

Type X483 are advanced technology capacitors tailor-made for advanced technology applications. Values from .001 to 10 mfd, 50, 100, 200 and 400 volt.

Contact TRW Capacitor Division, Box 1000, Ogallala, Neb.

Phone: (308) 284-3611. TWX: 910-620-0321.

TRW[®]

Circle 45 on reader service card

45

SCHAUER

1%

tolerance

1 WATT ZENERS ARE A REAL BUY!

ANY voltage from 2.0 to 16.0
at the industry's LOWEST
PRICES!

| Quantity | Price each |
|-----------|------------|
| 1-99 | \$1.07 |
| 100-499 | .97 |
| 500-999 | .91 |
| 1000-4999 | .86 |
| 5000 up | .82 |



THE HI-RELIABLE!

No fragile nail heads.
Silicon junction aligned between two, parallel, offset tantalum heat sinks . . . great lead tension strength.
All welded and brazed assembly.
High pressure molded package.
Gold plated nickel-clad copper leads.
Write or phone for Form 68-4 for complete rating data and other tolerance prices.

Semiconductor Division

**SCHAUER
MANUFACTURING
CORP.** 4514 Alpine Avenue
Cincinnati, O. 45242
Ph. (513) 791-3030

U.S. Reports

\$4.5 million and \$9.5 million, respectively, for essentially the same reason: to slow production until deficiencies are corrected.

Leak. Navy communications and electronics funds took a slash of \$70.9 million, leaving a budget of \$245.8 million. Lopped off was \$4.2 million for ship electronics modifications plus money for the Versatile Avionics Shop Test (VAST) on which Grumman is prime and the AN/PRC-90 survival radio.

The Army's missile and equipment procurement money took a \$787 million body blow, dropping it to \$4.28 billion, or nearly \$1.4 billion less than last year. A notable reduction was made in Raytheon's Improved Hawk system (\$23.4 million) to slow production until "certain deficiencies" are corrected. Similarly, the Chaparral missile was cut \$13.5 million—about 10%.

Mallard bagged

The Army Electronics Command's (ECOM) leading communications systems have been short-circuited by Congress. And the fiscal 1970 appropriations cuts of \$50.9 million for procurement of communications and electronics, plus \$12.5 million more in R&D, are sure to have an impact on industry far beyond the dollars involved.

In a series of severe criticisms of ECOM's effort, Rep. George Mahon's House Appropriations Committee makes these judgments:

▪ "Recommends termination" of the four-nation Project Mallard with its \$1 billion potential and eliminates this fiscal year's \$5 million R&D request—the last an action already taken, contractors say, by the Pentagon before the disclosure. Mahon's reasons: "Historically, joint international development programs are inherently turbulent and trouble-ridden." Further, "it is inconceivable that DOD would embark on an international development program of this nature and magnitude when a military-wide tactical communications system has never been developed for the military services of the U.S."

▪ "Directs that development work be discontinued" on Radas—the random access discrete address system—being designed and developed by Martin Marietta's Orlando, Fla., division. The reason: "After six years of development effort the system concept is still unproven." Further, the tactical, mobile automatic-dial radio-telephone system will not interface with Mallard or the Defense Communications System and "to design a system which will not 'communicate' with other systems is indefensible." If that weren't enough, the Army negotiated a \$2.4-million contract in April using reprogrammed funds while the Pentagon was telling the committee it was uncertain about the system's usefulness. That action, say Mahon's men, was "intolerable." Through fiscal 1969, the Army spent \$21.6 million on Radas.

▪ "Directs tactical automatic digital switching system (TADSS) development be discontinued immediately" since the Burroughs Corp. contract to upgrade Seventh Army manual systems in West Germany conflicts directly with the Defense Communications Agency effort to "eliminate dedicated communications systems and save money."

▪ "Deleted \$6.5 million for the tactical fire direction system (Tacfire)" because of program slippage by contractor Litton Data Systems division. Tacfire's slippage is no surprise [*Electronics*, Sept. 1, p. 49], and the company sees no problems, contending its effort is fully funded to deliver three computers for eight months of engineering tests by May 1970. This would anticipate a 1971 production go-ahead under fiscal 1972 funding. However, there are those in Washington who view Defense Department plans to sharply cut tactical ground forces over the next 2 years as threatening the potential need for Tacfire as well as a number of other programs.

Other cuts. This rationale is also being applied to the \$11 million slice in the corps-army area medium and high radio-relay systems. Labeled a deferral spending development and test of system components, the program is now believed to be facing difficulty getting



When you can't afford a "wrong number"...

Symbolic representation of the TV, voice, ranging data and biomedical telemetry signals from the moon. Photograph courtesy of NASA.

bring ERIE in early.

Where are they? How are they? What do they see... and say? NASA and the world want to know. And, the only way to find out is over the special Motorola S-band equipment on both the Command and Lunar Modules. Once the Apollo Astronauts are over 30,000 miles out, it's their *only* communications link with Earth. It simply can't fail. That's why Motorola called on ERIE TECHNOLOGICAL to develop the EMI filters and Monobloc capacitors that would help this equipment perform flawlessly on every Apollo mission since Motorola has been involved. Proof, once again, that it pays to bring ERIE in early.

ERIE TECHNOLOGICAL PRODUCTS, INC.
644 West 12th Street, Erie, Pennsylvania 16512
(814) 456-8592

Better solutions come from DEECO

Try TI TTL for a head start.

Save selection time with TI's broad line of compatible TTL ICs. More than 90 distinct functions in the TI TTL line make your selection faster, easier. Choose from three fully compatible performance ranges — high speed, low power and standard. You've got the broadest selection in the industry with TI. You'll find it easier to specify TI's Series 54/74 ICs, because they are fully compatible with DTL and other TTL circuits. Plastic and ceramic dual-in-line and flat packs, plus two temperature ranges, -55° to 125° and 0° to 70° , round out your most complete choice. Find out how you can save selection and design time. Ask us for the new TI TTL Integrated Circuit Catalog CC201...424 pages of the latest data sheets, interchangeability guides, mechanical data and loading tables, or circle 257 on the Service Card.

SERIES 54/74
90
FUNCTIONS



TI TTL offers more MSI to put your designs ahead of their time and the fastest ICs available to beat time. Your designs incorporating TI MSI circuits will be ahead of their time — ready to accommodate future developments. Only TI offers you 35 MSI functions, enough to ease selection problems and lead you straight to these important advantages: reductions in package count, simplified design, lower overall system cost and improved reliability. Series 54H/74H is the fastest saturated logic today...6 ns. You can choose from 25 high speed TTL functions, including both AND and NAND gates. In addition, open collector output gates are offered to facilitate the wire-OR function. Get the full story in "TTL integrated circuits from Texas Instruments," a new 80-page reference manual. We'll send it for the asking or circle 258 on the Service Card.

Stay on time with fast delivery from our full line TI TTL inventories. TI is making more TTL, so your choice is always on hand. A telephone call will bring you on-the-double delivery, personal service and selection assistance. Your choice is more complete with TI...more high speed functions — 25...more MSI circuits — 35...the industry's broadest TTL line — 90 distinct functions. In just about three minutes, you'll be convinced that TI is really the time saver for you. Call us now or circle 259 on the Service Card.



For better solutions, call your TI distributor.

DEECO  **Inc.**

DISTRIBUTORS — SERVING INDUSTRIALS EXCLUSIVELY

AUTHORIZED DISTRIBUTOR 

2500 16th Avenue S.W. • Cedar Rapids, Iowa 52406 • Phone (319) 365-7551
Free Wide Area Telephone Service: From Surrounding States Dial: 800/553-5421 • From Within Iowa Dial: 800/332-5478

A stunner

Reaction to the Mahon committee's recommendation that Project Mallard be terminated ranged from shock to outright disbelief, particularly among British contractors for the four-nation tactical-communications system. And at Ft. Monmouth, N.J., home of the Army Electronics Command, a deputy to Mallard's manager, Brig. Gen. Harold W. Rice, said "It would be inappropriate to comment now."

ECOM's commander, Maj. Gen. Walter Lotz, was a bit more straightforward when cornered in Washington just before an industry luncheon speech. Asked about the Mallard recommendation a day after its publication, Gen. Lotz still hadn't heard of it. Shown the report, he read it and swore a little. Shown other recommendations—like that on RADAS—he recovered like a good soldier. "It looks like I'm just about out of business, doesn't it? I guess I'll have to change my speech."

He did.

off the ground.

Similarly, the Army was told to reduce purchases of the AN/PRC-68 radio and take "a significant reduction in sensor equipment" not otherwise identified.

Defense communications in general got more criticism—but they got money nonetheless. Mahon's group says it turned up once more "the same duplication of management responsibilities, ineffective cooperation, duplicate review procedures, and an inadequate effort toward the elimination of dedicated networks." Nevertheless, the defense communications satellite system (DSCS) got \$127 million—including \$39 million for R&D and \$76.3 million for procurement. And, at the same time, Defense Secretary Laird's effort to centralize more communications programs within the Defense Department—rather than dividing them among the services—got a boost with the Mahon observation: "It would appear to be advantageous to establish one end-to-end defense telecommunications system to serve all users," tactical or strategic.

Not unnoticed was the signifi-



dc Series Voltage Regulator from Solitron, of course!

Solitron has introduced a new dc voltage regulator which establishes unique regulation characteristics in a hybrid high reliability circuit. Features of the HCCA 100 regulator are:

- ✓ Regulation of .05% max., .01% typical, no load to 1.0 Amp
- ✓ Voltage range 8V to 50V
- ✓ Temperature coefficient less than .005%/°C
- ✓ Maximum output current of 3.0 Amps
- ✓ 25 Watts dissipation with heat sink
- ✓ Hermetically sealed package

Dial 1-800-327-3243 for a "No Charge" telephone call and further information.

Solitron

DEVICES, INC.

1177 BLUE HERON BLVD. / RIVIERA BEACH, FLORIDA
(305) 848-4311 / TWX: (510) 952-6676

Au!

Ag!

Pt!

Pd!

... And other precious metal alloys for microelectronic design!

PARTIAL LIST OF AVAILABLE ALLOYS & SOLDER PREFORMS

88% Gold 12% Germanium (Eutectic Alloy)
Strip and solder preforms in all sizes

80% Gold 20% Tin (Eutectic Alloy)
Strip, wire and solder preforms in all sizes

Gold with .1 to 1.2% Antimony
Wire, strip and solder preforms all sizes

Gold — .05% Min. Phosphorus
Wire, strip and solder preforms all sizes

95% Gold 5% Nickel
Wire, strip and solder preforms all sizes

Gold and up to .5% Arsenic
Strip and solder preforms all sizes

Silver with .1 to 1.2% Antimony
Wire, strip and solder preforms all sizes

Silver — .1% Min. Phosphorus
Wire, strip and solder preforms all sizes

95% Silver 5% Nickel
Wire, strip and solder preforms all sizes

Silver and up to .5% Arsenic
Strip and solder preforms all sizes

Special alloys produced on request at minimum charge.

Precious Metals in 99.9% Pure, 99.99% Pure, and 99.999% Pure.

The most modern production techniques, the latest refining methods and the best equipped research laboratories make Williams your one best source for all precious metals and their alloys.

Available in ultra-high purity sputtering discs, preforms, foil ribbon, tape, wire, sheet and other forms.

Write for our complete Precious Metals Catalog and Specification Sheets.



WILLIAMS PRECIOUS METALS
2980 MAIN ST. BUFFALO, NEW YORK 14214
Division of Williams Gold Refining Co., Inc.

U.S. Reports

cance attached by the committee to Laird's Blue Ribbon Panel which "will give serious study" to the defense communications problems [see p. 14].

Companies

Do it yourself

When the Boeing Co. decided last month to start producing more and more of its electronics requirements in-house, a shudder went through the ranks of the subcontractors. But the full effect of the move, actually a consolidation of component development and manufacturing facilities into an Experimental and Production Manufacturing unit within the Aerospace Group, won't be felt for a while.

As explained by Don H. Atherly, director of the group, Boeing "won't bring anything back in-house that vendors now have, and will continue to use subcontractors where it is best for the program." But he's quick to add: "From now on we will build all critical sub-systems."

Finders keepers. In the past, Boeing has developed a component and then given it away, "But now," says Atherly, "we will keep it. There are a few areas in which we will dominate, such as in semiconductor analog memories. We have developed a capacitive analog memory integrated circuit that is better than any other in the country, and we want to hold on to it—it gives us a high degree of leverage in systems work." And Atherly is not just talking about small quantity circuits. He says that "we are now using between 10,000 and 20,000 analog memory chips in one black box that we're building."

Besides helping business, the change should help Boeing with its layoff problem and also give the company a better idea of component costs when it does go outside. The initial group will consist of about 2,700 people, almost all of whom are now with Boeing—although some outside hiring is contemplated "to round out certain specialty skills," according to

a company spokesman.

One of the first major tasks for the new group will be to build the guidance and navigation systems for NASA's lunar rover vehicle. Boeing recently won the contract to construct and test four of the moon buggies that will be used on flights in 1971-72. According to Atherly, the new group will make all the products for the Aerospace group. This includes Minuteman, SRAM, AGM-69A (air to ground missile), and the rover.

Business. Besides allowing Boeing "to compete in the new high-technology areas of the seventies," Atherly says, "it will put us in a better position to capture new contracts, but we don't plan to go outside the scope of the DOD and NASA—we won't subcontract to others. In future years, this will have some impact on our vendors, but it will be relatively small in terms of dollar volume."

Contracts

Tipsy in Athens

When is a government not unfriendly? When it's a customer. That seems to be the view of the Department of Defense, now preparing to sell three Westinghouse AN/TPS-43 radars—better known as Topsy 43—to Greece. U.S. relations with the Greek government were less than warm immediately after the present military junta seized power.

The Air Force Systems Command, which is handling the sale of the 3-D tactical radars designed for the 407L Tactical Air Control System (TACS), says the cost to Greece will be \$6.7 million for the equipment plus another \$74,000 for spare parts and training.

Westinghouse built the radars at about \$1 million apiece for 407L as the primary radar capability for TACS air surveillance and aircraft control centers. Eighteen Topsy 43's will be installed in U.S. tactical operations centers, built by Hughes Aircraft, in Europe and the Pacific.

Mobile. The 3-D radar is collapsible in case of bad weather, and the

Buckbee-Mears took a 60-year- old technique and created parts for a rocket engine chamber.

*Pratt & Whitney
Aircraft is mighty
happy we did.*

The original technique was photoengraving. But it took Buckbee-Mears ingenuity to refine it for etching passages in a Pratt & Whitney Aircraft advanced rocket engine thrust chamber. The movement of fuel through the passages also serves as a coolant.

Today we call the process chemical machining. Buckbee-Mears can chemically machine on metal any design that can be drawn in a line. In the case of Pratt & Whitney Aircraft, the design was precisely machined on duplicate pieces of metal and then joined to create the thrust chamber for a propellant.

Buckbee-Mears offers chemical machining to very close tolerances. Depth of the etch can be up to one half the

width of the groove. Tolerance on groove width is $\pm 10\%$ of the depth of etch.

Because chemical machining is such a versatile technique, the applications are many. You might be able to use it for weight removal, grooves for guiding wires for automatic core loading, print out devices, or etching channels in a surface.

At Buckbee-Mears, your special problems or needs are given personal attention. That's why Buckbee-Mears is the world leader in photomechanical reproduction. If you have a problem that might be solved by precision chemical machining, call or write Bill Amundson, industrial sales manager in St. Paul. The number is 612-227-6371.

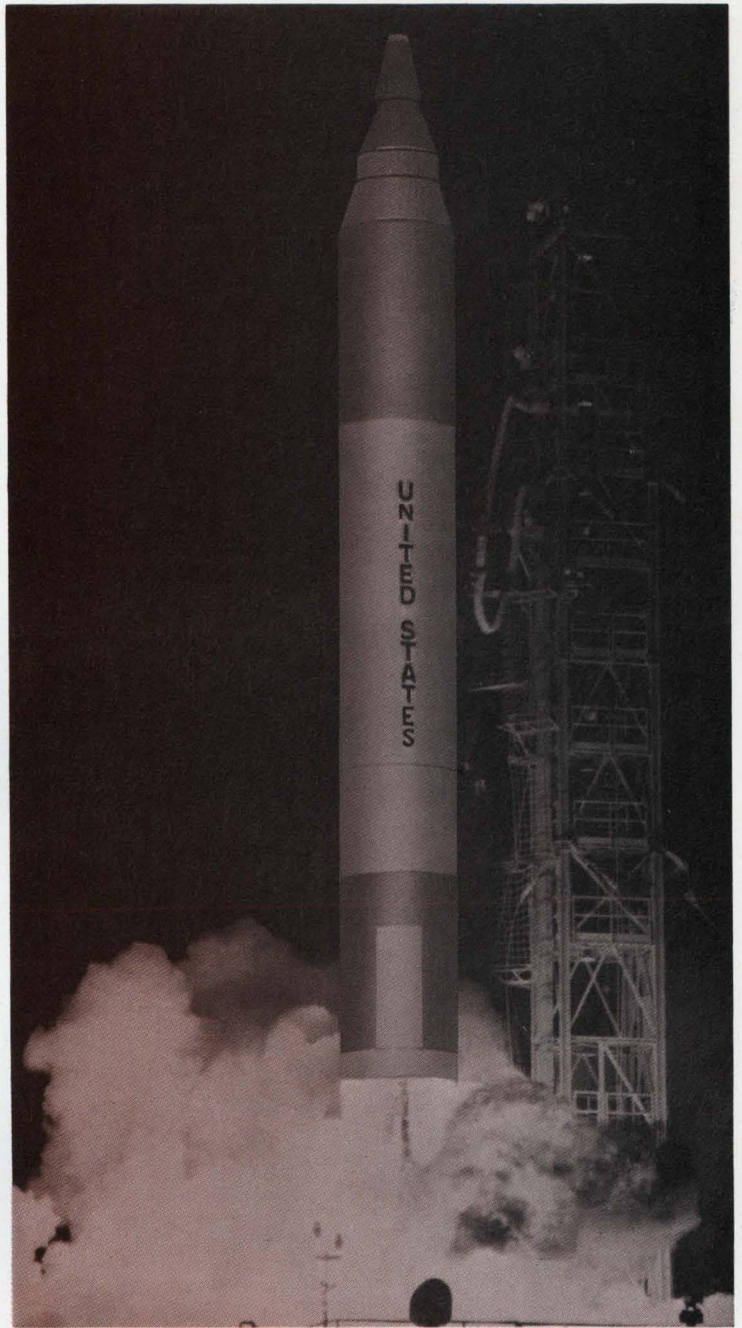

PRECISION METAL AND GLASS ETCHING • ELECTROFORMING • AUTOMATED DESIGN
bmc BUCKBEE-MEARS COMPANY
SAINT PAUL, MINNESOTA 55101

FACT: LIGHTNING CAN COMPLETELY DESTROY A JOSLYN PROTECTOR AND YOUR ELECTRONICS WILL STILL WORK

For more than 10 years Joslyn has never once had one of its protectors fail to perform its surge protection function. Some have been hit repeatedly with direct lightning strikes, voltage/current strikes, over-illumination . . . even burned up and blown apart . . . but the electronics they protected continued to work.

Contact Joslyn today for full information and delivery from stock for the field-proven surge protection equipment that will solve your particular problem. Full line includes precision spark gaps.



JOSLYN ELECTRONIC SYSTEMS

Santa Barbara Research Park
P. O. Box 817
Goleta, California 93017
Tel. (805) 968-3551

U.S. Reports

Air Force says the operational requirement is for the radar to be assembled and on the air within one hour of delivery. Another Topsy feature is mobility: the whole system, in two self-contained units, weighs 7,000 pounds. A shelter unit houses the transmitter, receiver, monitoring, and test equipment; the other unit contains the foldaway antenna and its pedestal.

Westinghouse says Greece will get both the radar, plus ground-based communications and control systems—not supplied to the Air Force for TACS—to connect individual radar sets, and perform data handling and processing.

The systems to be supplied to Greece are self-contained and can operate independently or can interface with current Greek systems, says Westinghouse. The radars are adaptable to air traffic control functions, but the Systems Command confirms Greece will use them for tactical air defense.

Potential. Original production potential for AN/TPS-43, based on an expected interest by the other two services, was estimated at 400 additional systems at about \$80 million. Westinghouse, declining to offer a dollar estimate of the radar's potential, says "there is a considerable market, but foreign military sales are difficult to forecast. There are many nontechnical factors involved."

Terry Smith, at Westinghouse's defense and space center in Baltimore, says friendly foreign countries are buying the most advanced equipment they can get from the U.S. "The picture has shifted from the old days when they took outmoded, cast-off equipment," says Smith. The Greeks will be getting Topsy 43 not long after the first one is delivered to the Air Force.

The Senate Foreign Relations Committee, just completing its confirmation of the Administration's nomination of Henry Tasca as Ambassador to Greece after months of delay, tacked an amendment onto the 1970 foreign aid bill forbidding all future military aid to Greece unless specifically approved by Congress. The committee delayed approval of Tasca because of disapproval of the Greek military

$\pm 50 \text{ ppm}/^\circ\text{C}$ in all Helipot Cermet Trimmers

This significant advance in Helipot's cermet technology is now available at only a dime/unit more . . . 100 ohms thru 2 megohms. In addition, you get essentially infinite resolution, environmental stability, reliability, no catastrophic failures — all superior to wirewound trimmers. We'll also deliver off-the-shelf, locally stocked trimmers with a standard tempco of $\pm 100 \text{ ppm}/^\circ\text{C}$ in the 100 ohm thru 2 megohm range.

Beckman

INSTRUMENTS, INC.
HELIPOT DIVISION
FULLERTON, CALIFORNIA • 92634

INTERNATIONAL SUBSIDIARIES: AMSTERDAM; CAPE TOWN; GENEVA; GLENROTHES, SCOTLAND; LONDON; MEXICO CITY; MUNICH; PARIS; STOCKHOLM; TOKYO; VIENNA

Your relays are trying to tell you something...

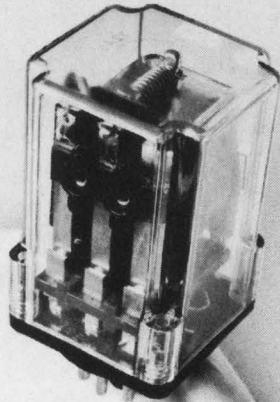

Jacobi makes it easy to listen.

With Jacobi's new J-1300 Automated Test System (and virtually any computer) you can share in the secrets only your relays can tell. Like why the second shift makes fewer errors than the first.—About those failure trends that other methods might take weeks of expensive analysis to detect. And more. After all, who knows better about them than your relays?

Now you can completely test to MIL-R-5757, R-6106, and R-39016 and other specs as quickly and inexpensively as sample testing. Automatically too, since the Jacobi J-1300 can interface with a variety of computers to select appropriate test parameters, initiate tests, and produce individual failure, quality, and test data history. It even analyzes and evaluates trend and test data. And other data that only a computer can handle.

The cost? If you test 1000 relays per day the system pays for itself in less than a year. We provide a complete turnkey operation.—Specification and selection of equipment, a component language software package, and operator training. The works! Ask us for the whole story.

Your relays have lots to tell. Jacobi provides the electronic stethoscope to listen.



Jacobi Systems Corporation 16625 Saticoy Street
Van Nuys, California 91406
(213) 787-8360 TWX 910-495-2002

U.S. Reports

regime, and allegedly indiscreet remarks made about the United States by Greek Foreign Minister Panayiotis Pipinellis.

For the record

Movement. A major reorganization at the Autonetics division of the North American Rockwell Corp. is said by Autonetics president S. Fred Eyestone to be the final phase of a management "slenderizing" program begun last July. At that time, Autonetics had some 2,000 persons in management or quasi-management jobs; the number now is closer to 1,500. The most recent move has resulted in combining the former Strategic Missile Systems division and Navigation Systems division into the Navigation and Controls division. What were formerly the Data Systems division and Electro-Sensor Systems division emerges as the Data and Sensors division. The new Financial Management division combines the former Contracts and Pricing, Financial, and Management Systems and Planning divisions. The name of the Strike Avionics division has been changed to Avionics Systems division.

Contracts. The Collins Radio Co. of Dallas has received a \$1.4 million contract from the Federal Aviation Agency for three radar microwave link systems for use with airport surveillance radar in Chicago, and Ft. Lauderdale and Jacksonville, Fla. The systems will be used to relay radar and beacon information from radar transmitter sites for display in terminal radar control rooms. They will be delivered next summer. Hughes Aircraft's Space Systems division and RCA's Astro-Electronics division have been awarded four-month, \$250,000, parallel study contracts to define and design variable-orbit atmosphere explorer spacecraft, AEC-C and AEC-D. The craft will carry experiments to study the composition and characteristics of the lower atmosphere. One of the companies probably will receive the follow-on production contract.

PNP...The Exciting New RF Power Option

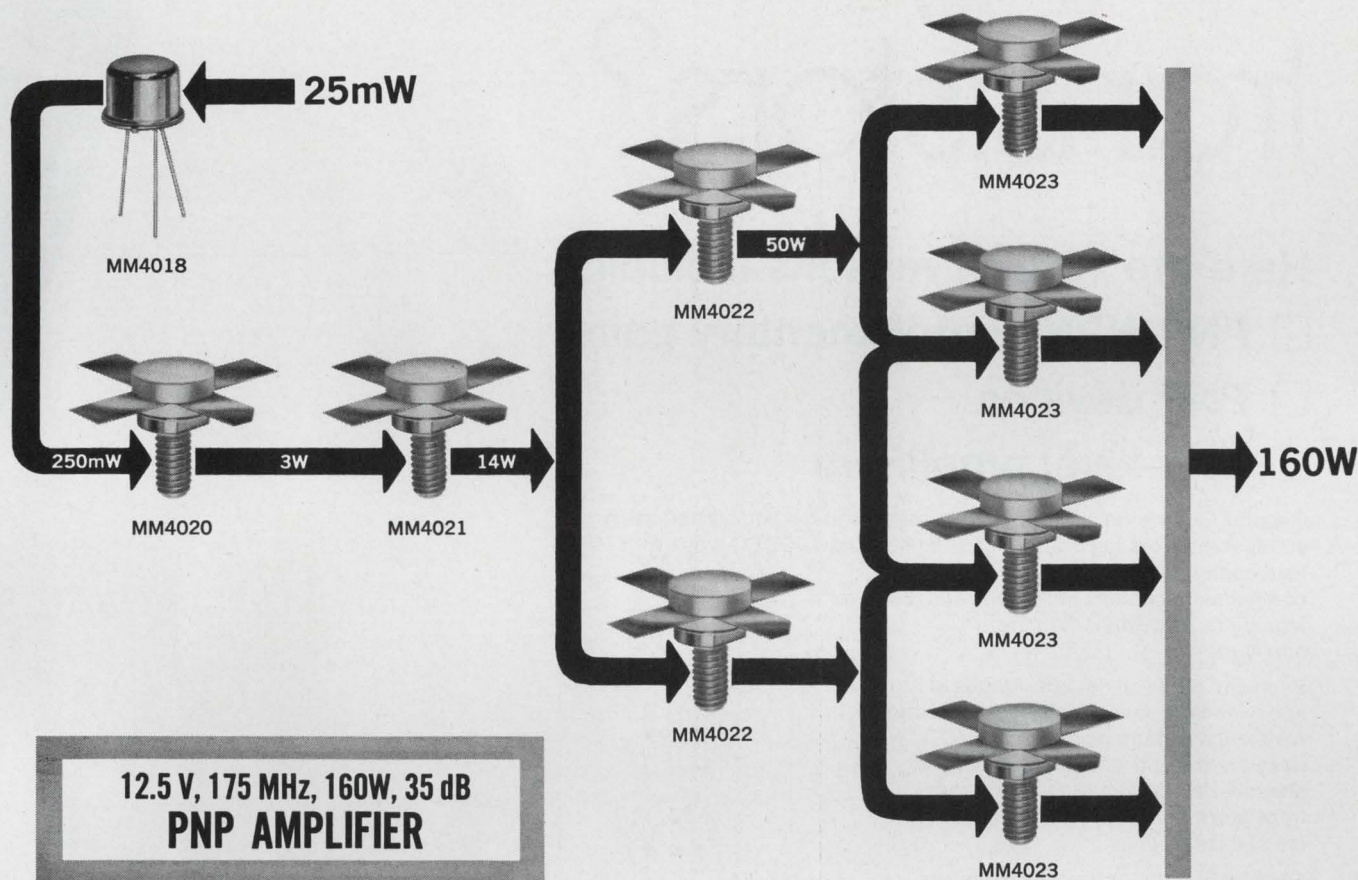

Six new types in Motorola's exclusive line-up of PNP silicon RF Power transistors now give you the advantages of the inherently higher saturated power and superior power output stability vs. temperature of PNP polarity in applications such as VHF large signal amplifiers.

Five of the six are specified at 12.5 V and 175 MHz.

| | Pout | Gain (min) |
|----------|--------|------------|
| • MM4018 | 0.5 W | 10.0 dB |
| • MM4020 | 3.5 W | 11.5 dB |
| • MM4021 | 15.0 W | 7.0 dB |
| • MM4022 | 25.0 W | 5.5 dB |
| • MM4023 | 40.0 W | 4.5 dB |

The sixth in this new group, the MM4019, is the 28 V, 175 MHz complement for the established 2N3553.

MM4019-23 are BET* transistors featuring the large safe operating area and resulting circuit protection of Motorola's balanced emitter construction. MM4018 and MM4019 are packaged in the familiar TO-39 metal can, while the MM4020-23 sport a new stud-mounted, low-inductance ceramic stripline case for maximum broadband capability.

To give you a look at PNP RF Power designs, we've prepared Application Note 477 using the 2N5160-62, the industry's first commercially available PNP RF types, in a three stage, 30 W, 175 MHz Power Amplifier. Incidentally, you'll find the 2N5160 is also the complement to the popular 2N3866.

Send for the application note and full information on the exciting new RF design option. Write to Motorola Semiconductor Products Inc., P. O. Box 20912, Phoenix, Arizona 85036.

*Trademark of Motorola Inc.

-where the priceless ingredient is care!



MOTOROLA
Silicon RF Power Transistors

Why use GE epoxy TO-18 transistors?

Here are 19 new reasons including:

- PNP/NPN complementary pairs
- PNP devices
- Low-level amplifiers

General Electric now offers 19 new reasons to get *you* started using epoxy transistors in your circuits. Nineteen new JEDEC types with TO-18 lead configuration—including PNP/NPN complementary pairs, PNP types and low-level amplifiers, *all designed for industrial applications.*

Each one offers all the advantages of rugged epoxy encapsulation. This means greater resistance to damage due to shock, acceleration and similar environmental stresses. In addition, GE's new epoxy transistors will cost you less than metal case devices.

General Electric's epoxy package can dissipate up to 500 mW and offers breakdown voltages as high as 60 volts. These new designs feature excellent beta linearity from 1 to 750 ma. with a saturation voltage of .75 volts at 500 ma.

With the introduction of these 19 new types, General Electric provides you with a selection of TO-18 based epoxy transistors superior to any other encapsulated device you may have used previously. If you need more proof, order a sample from the table at right, and prove to yourself that GE's new epoxy transistors meet your application requirements. You'll soon be "designing in" these new devices all the way from input to output. And you'll find that they're readily available off the shelf at your authorized, full-line General Electric semiconductor distributor.

If you'd like more information about GE's (TO-18) epoxy transistors or GE's "specials" capability, or if you desire a sample device for testing, write on your firm's letterhead to General Electric Company, Section 220-80, 1 River Road, Schenectady, New York 12305. In Canada: Canadian General Electric, 189 Dufferin St., Toronto, Ont. Export: Electronic Sales, IGE Export Division, 159 Madison Avenue, New York, N. Y. 10016.

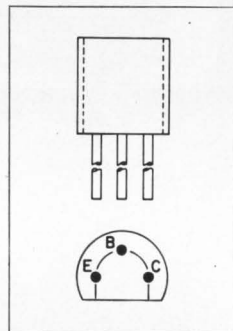

GENERAL  **ELECTRIC**

220-80A

- 60 volt PNP and NPN
- Collector currents up to 1 ampere
- Tight beta limits (2 to 1 spread)
- Guaranteed beta at 500 ma
- 500 mW power dissipation

| | | COMPLEMENTARY PAIRS | | | | | |
|----------------------|--------|------------------------------------|-------------------------|------|-------------------------------------|--|--|
| NPN | PNP | Voltage Rating (V _{CE0}) | Beta (h _{FE}) | | Power Dissipation (P _D) | Max. Cont. Collector Current (I _C) | Saturation Voltage at 500 ma (V _{CE(SAT)}) |
| | | | Min. | Max. | | | |
| 2N5810 | 2N5811 | 25V | 60 | 200 | 500mW | 750mA | .75V |
| 2N5812 | 2N5813 | 25V | 150 | 500 | 500mW | 750mA | .75V |
| 2N5814 | 2N5815 | 40V | 60 | 120 | 500mW | 750mA | .75V |
| 2N5816 | 2N5817 | 40V | 100 | 200 | 500mW | 750mA | .75V |
| 2N5818 | 2N5819 | 40V | 150 | 300 | 500mW | 750mA | .75V |
| 2N5820 | 2N5821 | 60V | 60 | 120 | 500mW | 750mA | .75V |
| 2N5822 | 2N5823 | 60V | 100 | 200 | 500mW | 750mA | .75V |
| LOW-LEVEL AMPLIFIERS | | | | | | | |
| 2N5824 | | 40V | 60 | 180 | 360mW | 100mA | .125V |
| 2N5825 | | 40V | 100 | 200 | 360mW | 100mA | .125V |
| 2N5826 | | 40V | 150 | 300 | 360mW | 100mA | .125V |
| 2N5827* | | 40V | 250 | 500 | 360mW | 100mA | .125V |
| 2N5828* | | 40V | 400 | 800 | 360mW | 100mA | .125V |

*low-noise types available approximately 2/1/70

RCA Solid-State Data for Designers

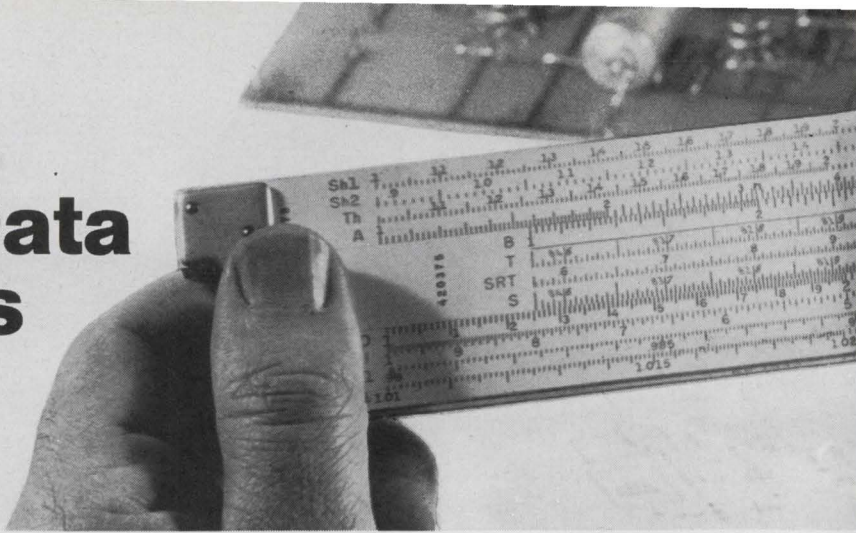

Switch current at high speeds —new power transistors meet your current needs

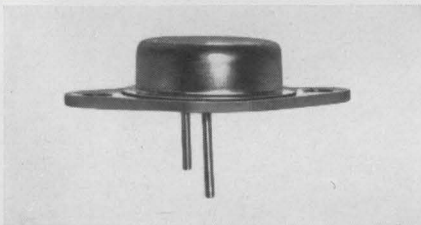

At high frequencies, design engineers prefer RCA-2N5038 and 2N5039 power transistors. With 12 discrete emitter sites connected in parallel in each unit, these epitaxial, silicon devices are designed as high current, high speed switches — providing 20-ampere current handling capabilities, and adding significantly to freedom from forward second breakdown.

Take a look at their characteristics:

These transistors have low saturation voltage (1 volt maximum at 12 A for the 2N5038, and 10 A for the 2N5039). Turn-on times are less than 0.5 microsecond.

The 2N5038 and 2N5039 are ideal for a variety of applications such as converters. (Some converters operate at frequencies as high as 25 kHz. By using these two transistors in converters, an output of 250 watts at 85% efficiency may be achieved.)

Other applications?

When they are used in high frequency switching regulators that operate at frequencies up to 50 kHz, 700 watts output at 95% efficiency is possible.

The 2N5038 and 2N5039 also make excellent amplifiers at frequencies up to 5 MHz. For example, in an audio amplifier where flat response is required, a pair of units in AB push-pull (or quasi) configuration will put out 25 watts up to 1 MHz. Two of these single units will put out 300 watts at 50 kHz for ultrasonic applications, or provide 20 watts at 2.5 MHz from a 13-volt supply for marine band transmitter use.

An added attraction: at 1,000 unit quantities, the 2N5038 has been

price-slashed from \$20.00 to \$10.00; the 2N5039 from \$15.00 to \$8.00.

Circle Reader Service No. 331

RF power transistors for mobile applications

When you design mobile or portable communications equipment, use the RCA-TA7477. This 2-watt (typ) output device has 13 dB gain at 175 MHz.

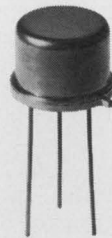

An epitaxial silicon n-p-n planar transistor featuring "overlay" construction, developmental type TA7477 can be used in a broad range of applications. It is capable of a 2-watt output even at 470 MHz; thus this transistor is ideal also for use in Class C VHF/UHF amplifiers for Citizen Band radios, sonobuoys, and beacons.

Circle Reader Service No. 332

COS/MOS buffers solve power problems

RCA COS/MOS (Complementary Symmetry Metal-Oxide-Semiconductor) devices continue to gain in popularity among digital design engineers concerned with low-power dissipation, low-package count or high-noise immunity requirements in aerospace and airborne computers, portable military equipment, instrumentation or industrial control equipments.

Two new COS/MOS Hex Buffer/Logic-Level Converters are now available. The RCA-CD4009D is designed for use as a hex COS/MOS inverter, a hex COS/MOS to DTL or TTL logic-level converter, or a hex COS/MOS current driver. Conversion ranges are from COS/MOS logic operating at +6 V to +15 V

supply levels to DTL or TTL logic operating at +3.8 V to +6 V supply levels. Conversion to logic output levels greater than +6 V is permitted providing $V_{CC} \text{ (DTL/TTL)} \leq V_{DD}$ (COS/MOS). The RCA-CD4010D is similar in performance to the CD4009D except that it provides a non-inverting output.

Each of the two new COS/MOS IC's features quiescent power dissipation—100 nW (typ); high current sinking capability—6 mA (min.); high noise immunity—45% of V_{DD} , and high input impedance— 10^9 ohms (typ), protected inputs.

Circle Reader Service No. 333

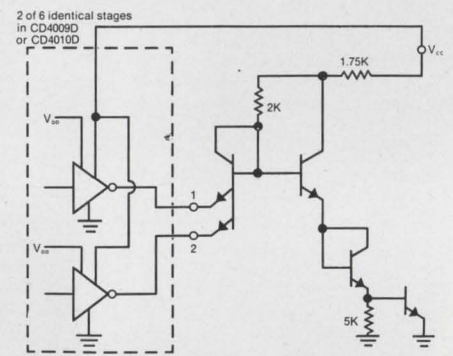

COS/MOS (CD4009D) to DTL (CD2302) Driver

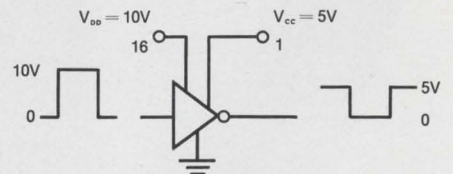

CD4009D as a Logic-Level Converter/Inverter

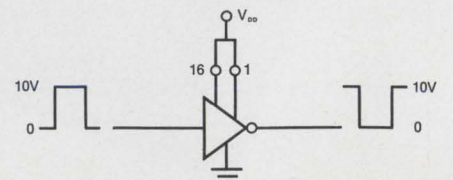

CD4009D as a COS/MOS to COS/MOS Inverter

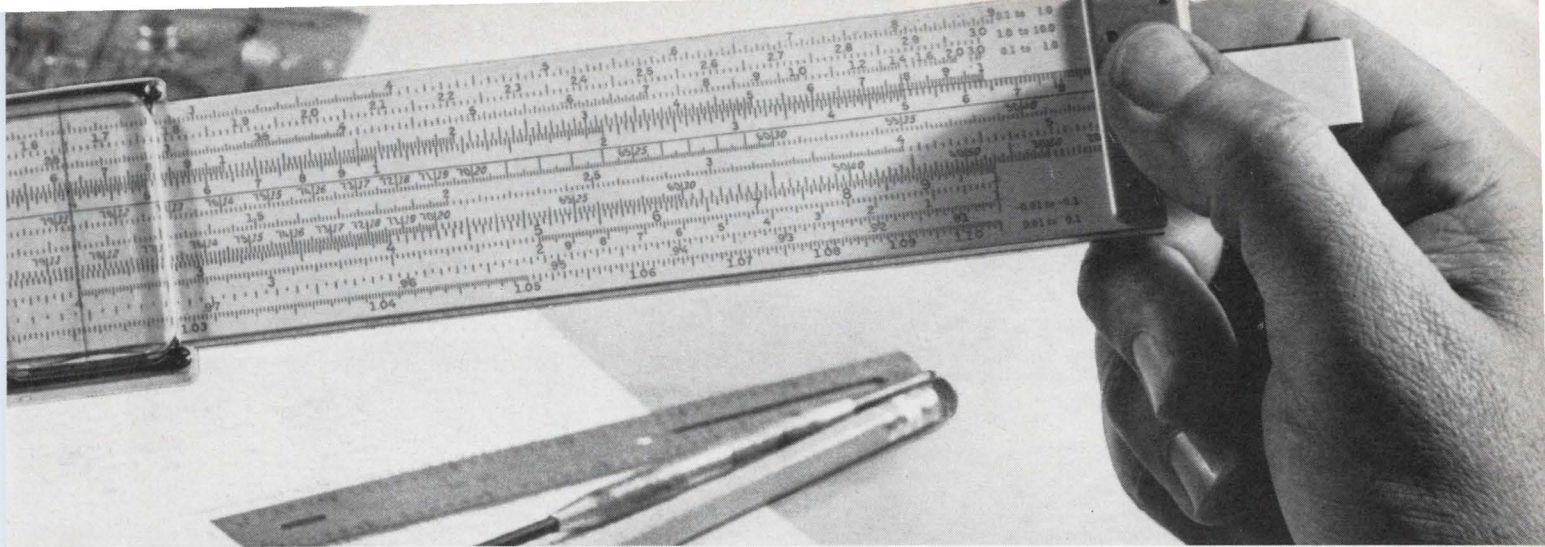

More bandwidth with RCA op amps!

When an op amp offers *more* performance and design latitude for *less* money...that's news. And that's the important news designers are discovering in RCA's CA3029. At 98¢ (1000 units), the CA3029 in the 14-lead DIP package may offer more bandwidth than the "709" op-amp series you are now specifying. Compare the data in the accompanying graph against that of other op amps.

You will find similar savings—and the same operating and design features—across the board in this RCA family in flat pack, TO-5 style package, and dual-in-line ceramic. These IC's can provide the broad, flat frequency response required for video amplifiers or the peaked response of shaping amplifiers. Use them as comparators, integrators, differentiators, and summing amplifiers.

And, while you're checking, look into the performance and economy available to you in RCA's op-amp types for supply voltages to ± 18 volts and power output to $\frac{1}{4}$ watt.

Circle Reader Service No. 334

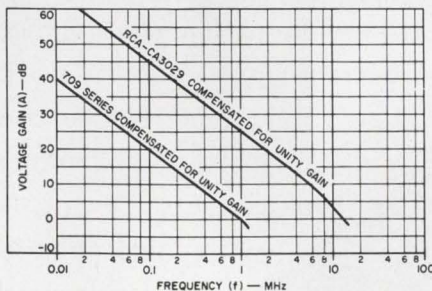

"Close Confinement" puts power in GaAs laser arrays

"Close Confinement" laser technology is a manufacturing technique that reduces the absorption of light in the GaAs junction and assures efficient radiation from the junction exit surface. This technology now has been extended to larger multi-

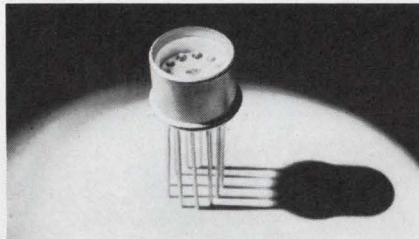

ple-chip arrays with higher power outputs.

A number of GaAs laser diode arrays (the TA7687 through TA7692) are now available from RCA. These devices offer peak power outputs up to 300 watts at 25 A drive current. They are available in OP-4A ("Close Confinement") modified TO-5 stud unit packages.

| | Peak Power Output (watts) | | Emitting Area (typ.) (inches) |
|--------|---------------------------|------|-------------------------------|
| | min. | typ. | |
| TA7687 | 25 | 50 | .1 x .001 |
| TA7688 | 35 | 75 | .15 x .001 |
| TA7689 | 50 | 100 | .11 x .04 |
| TA7690 | 75 | 150 | .16 x .04 |
| TA7691 | 100 | 200 | .11 x .06 |
| TA7692 | 150 | 300 | .16 x .06 |

These GaAs laser diode arrays may be operated at pulse widths up to 200 ns and duty cycles of .02% (1 KHz at 200 ns).

In addition, custom arrays are available with peak power in the kilowatt range and average powers of 1-100 watts in the temperature range of 77°-150°K at 1%-2% duty cycles.

GaAlAs laser diode arrays are also available with wavelengths of 8100-8700 Angstroms.

Circle Reader Service No. 335

Standard with RCA—triacs that trigger in all four firing modes

RCA has always controlled triac gate characteristics in all four firing modes...as standard product. Generally, in the industry, this is done by special selection. The fact is, RCA is the only manufacturer that *specifies*

its triac line for applications from 0.5 to 40 A rms, from 100 to 600 V, for:

- In-phase triggering with the line
- Inverse phase control from an ac line
- Positive dc logic control
- Negative dc logic control

Any of these four operating modes opens up a wide range of potential uses across broad application areas in light control, heat control, motor speed control, power supplies, and other power switching systems.

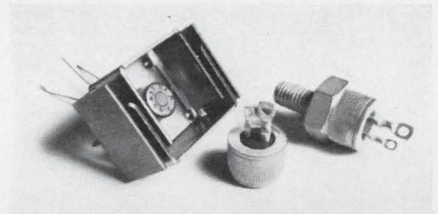

Have you investigated the control performance qualities of RCA triacs? Do it! One RCA triac can often replace two SCR's and frequently can handle — electronically — a job that traditionally employs relays.

RCA's triac family offers designers the industry's most complete assortment of packaging configurations: which include stud, press-fit, and the recently introduced VERSAWATT cases (illustrated), plus others.

Circle Reader Service No. 336

For price and availability information on all solid-state devices, see your local RCA Representative or your RCA Distributor. For specific technical data, write RCA Electronic Components, Commercial Engineering, Section 12-4-N/UM3 Harrison, N. J. 07029. In Europe: RCA International Marketing S.A., 2-4 rue du Lièvre, 1227 Geneva, Switzerland.

RCA

HELIAX ELLIPTICAL WAVEGUIDE

twelve
ways
to
beat
the
clock...

by eliminating planning and installation complications of rigid waveguide . . .

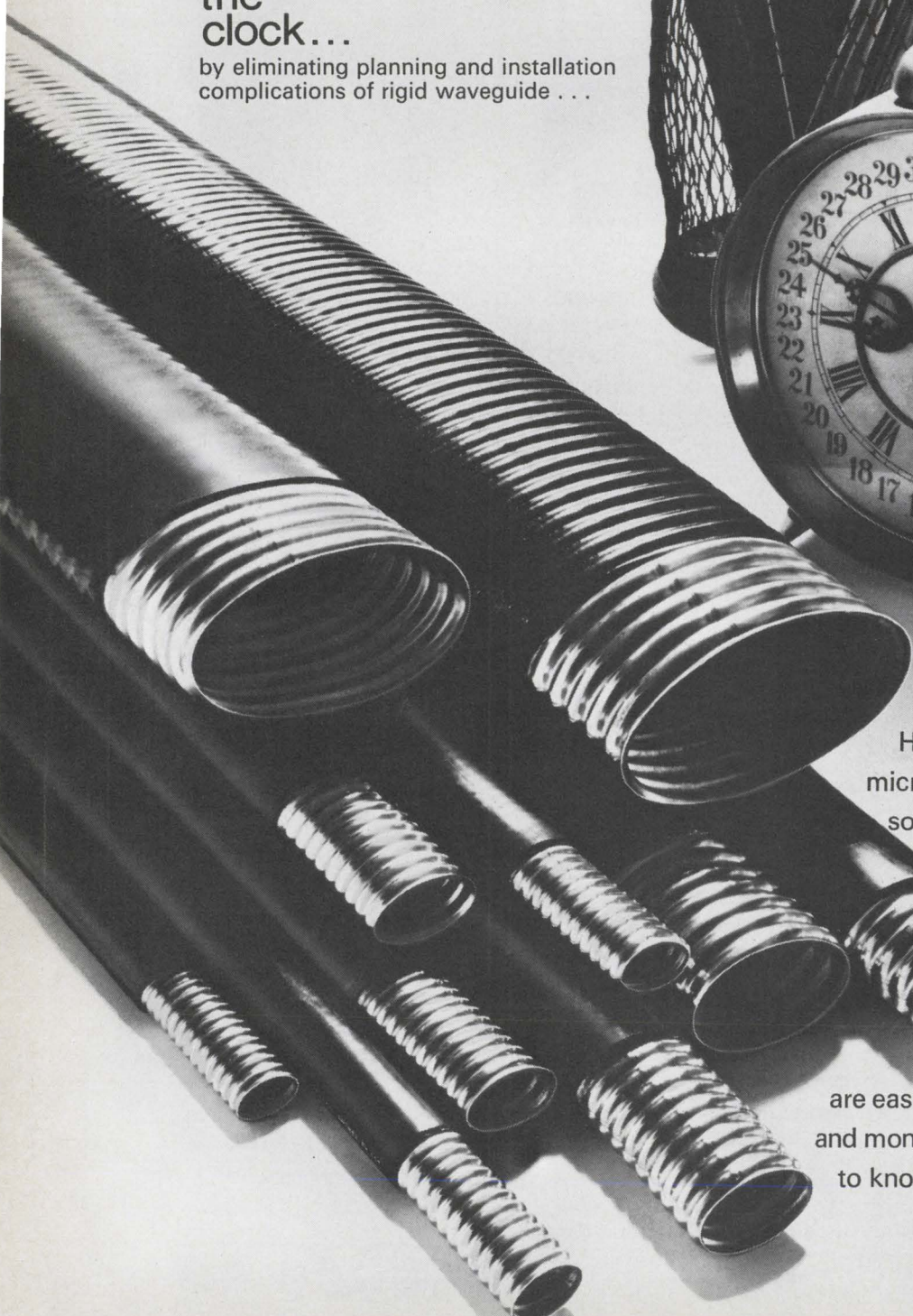

Yes, we have twelve sizes of HELIAX® elliptical waveguide for the microwave spectrum: 10 in stock, 2 more soon. Coverage from 1.7 to 15.2 GHz. Andrew's unique corrugated construction makes the difference. Makes HELIAX copper waveguide stronger, more flexible. Long continuous lengths are easily fitted to your layout. You save time and money all down the line. Wouldn't you like to know more? Communicate with Andrew.

10-68



ANDREW

Washington Newsletter

December 22, 1969

FCC exploring plan for ETV to share microwave net

The Federal Communications Commission is exploring a Microwave Communications Inc., plan to share its proposed national microwave network for business users with educational television broadcasters. John D. Goeken's MCI, with its Chicago-St. Louis route approved, would work with Microwave Communications of America, Inc., also headed by Goeken, to interconnect 86 educational tv stations at low cost.

Microwave Communications estimates a \$3 million to \$4 million installation cost plus \$54,000-\$67,000 per month which could be financed by a private organization and then leased to the Corporation for Public Broadcasting. Alternatively, MCI says the present 58-station public broadcast net could be retained and expanded by 28 stations using existing CATV systems at a cost of \$2 million to \$3 million and \$36,000 to \$45,000 a month.

Big money planned for pollution R&D

Look for President Nixon to make a "substantive commitment" to a pollution R&D program when he delivers his first State of the Union address in January. In Washington terms, such a commitment usually indicates a nine-digit figure, and several programs are afoot in Congress—one in Sen. Edmund Muskie's office—to provide money for R&D.

Federal, state and local air pollution authorities need such a break to set up a national air quality monitoring network [*Electronics*, Dec. 8, p. 137]. By the end of 1970, each of 57 air quality regions in polluted urban areas needs an electronic monitoring system to feed data into the network, and these have been running upwards of \$300,000—many with primitive equipment. By the end of 1971, as it stands now, 87 regions will have to buy at least \$25 million worth of equipment. But with a larger Federal Government commitment, the network will get more reliable and sophisticated sensing equipment.

McDonnell favored for F-15 contract

Betting in the Capital is that McDonnell Douglas will get the development award for the Air Force's F-15 tactical air superiority fighter, although North American Rockwell and Fairchild Hiller reportedly need the work most. Proposed Hughes and Westinghouse long-range fire control radars for the fighter's missiles are being sharply modified in range to hold down costs. Nevertheless, avionics contractors are giving top ranking to F-15 business potential. Prospects for the Navy's F-14, are ranked next, while the fiscal 1971 outlook for the B-1A bomber grows dimmer in view of efforts to cut defense spending and achieve a strategic arms limitation agreement with the USSR [*Electronics*, Dec. 8, p. 33].

Agreement is near for an international air traffic satellite . . .

Officials of NASA and the 12-nation European Space Research Organization now think they are just one meeting away from agreement on the mission for an experimental air traffic control satellite system. The two agencies have been holding exploratory talks since last June and hope to have their initial proposal ready in time for the next meeting—in February—of the satellite-technology panel of the International Civil Aviation Organization.

NASA officials aren't releasing details, but it's a good bet that the

Washington Newsletter

mission for the joint ATC satellite will point to drastically reduced airplanes over the North Atlantic. According to one U. S. official, the NASA-ESRO study group is working towards a track 30 miles wide with planes spaced at 5-minute intervals. Current airplanes are 120 miles wide with planes spaced at 15-minute intervals. Along with air traffic control channels, the experimental system—two or three satellites—would probably carry some voice and data channels. The group has looked at three earlier studies—one by TRW, one by RCA, and one for France's Dioscures project. However, the mission of the joint satellite—if there is one—will differ from any of these.

**... but launch date
is five years away**

NASA officials stress that there's a long way from mission definition to launching of a North Atlantic ATC satellite. Once the mission is defined and a satellite system designed to handle it, the countries involved will have to agree to go ahead with the project and work out finances. Neither problem has yet been tackled and both could be touchy since aviation authorities and airline officials would have to approve the project. The earliest date that an experimental ATC satellite could be launched is late 1974 or early 1975.

**Tougher fire tests
urged for tv sets ...**

Television manufacturers face a "damned if they do, and damned if they don't" dilemma. The National Commission on Product Safety has told the tv makers that industry's proposed standards to minimize fire hazards in color-tv sets don't go far enough. Meanwhile, the Justice Department is studying the standards to see if they might violate anti-trust regulations.

The standards, developed by the industry in a two-week crash program at the suggestion of the commission, were reviewed by Tracor Inc. Tracor called for tougher fire-hazard tests for flyback transformers, capacitors, and yokes—three fire-prone areas—and the replacement of flammable components with flame-proof or self-extinguishing types. Terminal-board materials, magnet-wire insulation, winding insulation, coating insulation, molded plastic parts, and high-voltage lead wire would be affected. Tracor claimed increased costs would be minimal.

**... and firms face
more paperwork**

Manufacturers and distributors of tv sets and other electronic equipment are faced with more paperwork. The Department of Health, Education and Welfare wants records kept for five years from the date the product is offered for sale. Recorded would be radiation-test methods and their results, product durability and stability tests, quality-control procedures, and product use, maintenance and testing instructions.

The records would be kept on tv sets, tv-projection devices, shunt regulator tubes, high-voltage rectifier tubes, high-voltage vacuum switches, all types of x-ray producing devices, microwave ovens, microwave diathermy units, all types of lasers, and all ultrasonic devices.

Addendum

Budget Bureau Director Robert Mayo's reported recommendation to NASA Administrator Thomas Paine to resolve the space agency's fiscal 1971 budget bind—a reported \$100 million under the current \$3.7 billion budget: close the Electronics Research Center at Cambridge, Mass.

High-speed programmable dc power supplies \$178⁰⁰

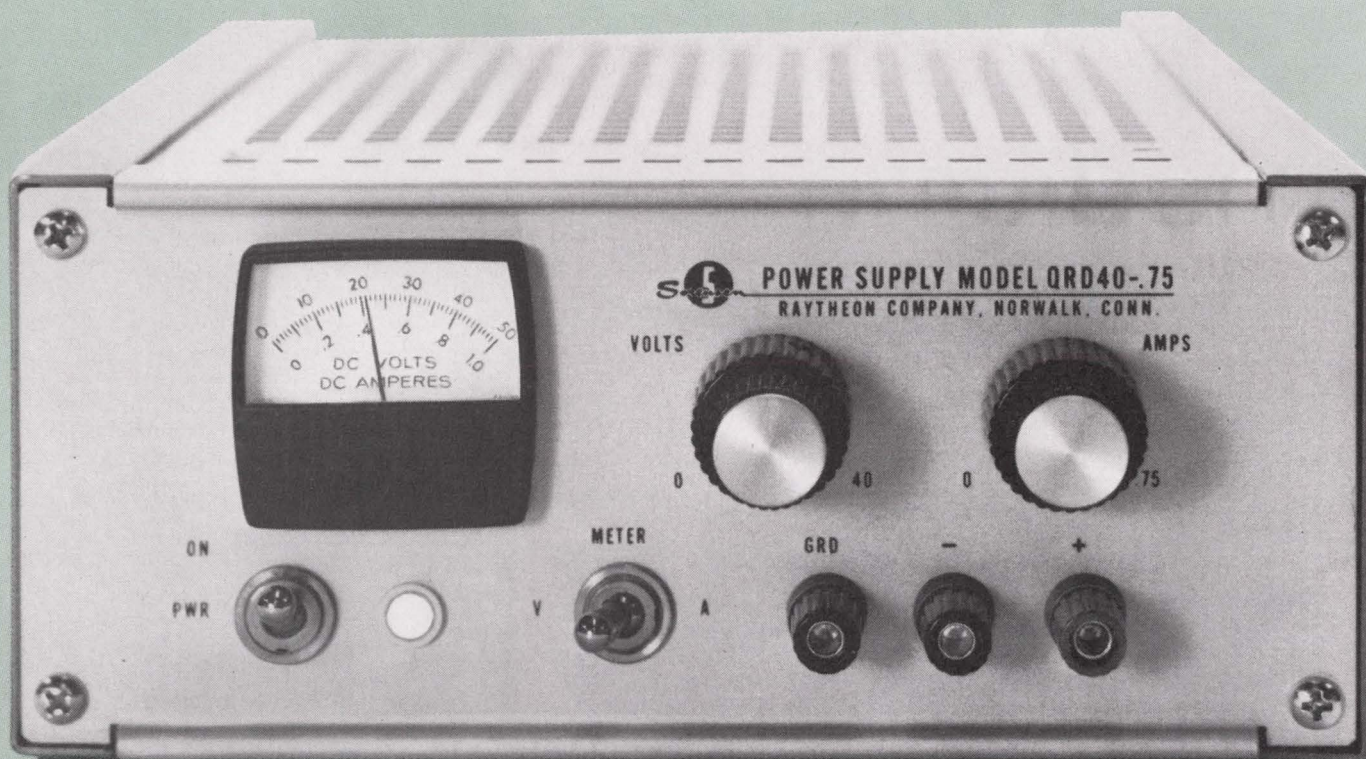

The QRD Series of precision power supplies is composed of seven off-the-shelf models covering the range of 0-60Vdc at current levels up to 4 amperes.

In the high speed programming mode the QRD's performance is unmatched — less than 10 microseconds for a step change of E_{max} . to 0! The capability of being programmed by resistance, voltage or current signals to frequencies of 100kHz makes the QRD Series unequalled in digital, microcircuit testing and servo system applications.

Other features include: ■ $\pm 0.005\%$ voltage regulation ■ 200 μ V r.m.s (3mV p-p) ripple ■ automatic crossover between

constant voltage and constant current operation.

Send *your* high-speed programming power supply specifications to Sorensen, today, for the optimum solution of your modular, bench or rack mounted power supply problem.

For more information contact your local Sorensen representative or; Raytheon Company, Sorensen Operation, Richards Avenue, Norwalk, Connecticut 06856.

Tel: 203-838-6571;
TWX: 710-468-2940;
TELEX: 96-5953.



Learn how electronics is working to change the practice of medicine.

2nd National Conference & Exposition
on Electronics in Medicine.

February 12-13-14, 1970
Fairmont Hotel
San Francisco, California

Presented by
Electronics/Management Center
in association with
McGraw-Hill Publications

Electronics/Medical World News
Modern Hospital/Postgraduate Medicine
Scientific Research

How much change will be brought about by the successful applications of the electronics technology to the modern needs of medicine?

Will the physician without a working knowledge of the employment of electronics as an administrative and clinical tool be obsolete in five years? Will the high efficiency, high reliability procedures predicted for the seventies increase or decrease the role of the individual physician? What will be its impact on the medical team and the medical center? Can electronics through automation improve the nation's overall health levels?

These are some of the questions now being answered by eminent physicians and technologists in many of our nation's most respected institutions where electronics is being actively applied to benefit hospital, doctor, and patient.

How well these programs are working, what's right and what's wrong with electronics will be explored in depth in the 2nd National Conference & Exposition on Electronics in Medicine.

The format of the three day program is based on the enthusiastic response to the First National Conference on Electronics in Medicine and the request by its attendees to provide for a broad interchange of ideas.

In morning sessions, authorities in both medical and electronic disciplines will present their knowledge and experience on subjects of major interest; instrumentation, computers, information systems, monitoring, diagnosis, therapy, and administration.

These meetings will provide the backdrop for afternoon work-sessions in which each attendee will become an active participant in the discussion of problems and solutions. All work sessions will be conducted to bring the maximum knowledge and experience of the group as a whole to each of the participants. Attendees will have the opportunity to join at least two of the six sessions being offered.

While meetings and work sessions will explore the most recent ideas with attendees, exhibits will present physicians and hospital administrators with the latest hardware available, providing an important opportunity for demonstration and a "hands-on" familiarization of the newest features and capabilities of electronics products designed specifically for medical application.

Meetings:

Keynote address

George Burch, M.D., Ph.D., Tulane University Medical School, New Orleans, La.

"Instrumentation and Common Sense"
Robert D. Allison, Ph.D., Director, Vascular Laboratories, Scott & White Clinic, Temple, Texas.

"Computers: A New Order for Medical Data"
Arnold Pratt, M.D., Director, Division of Computer Research & Technology, National Institutes of Health.

Address:

Hon. Roger O. Egeberg, M.D., Assistant Secretary for Health and Scientific Affairs, Dept. of Health, Education and Welfare.

"Medical Engineering: Problems and Opportunities"
George N. Webb, Asst. Professor, Biomedical Engineering, The Johns Hopkins University School of Medicine.

"The Medical/Engineering Interface"
Donald Lindberg, M.D., Chairman, Dept. of Information Science, University of Missouri.

"What's New in Medical Information Systems"
William Chapman, M.D., Palo Alto Medical Clinic (Selected films will be shown as part of Dr. Chapman's presentation.)

"Getting Medical Electronics from Research into the Real World"
Irving Selikoff, M.D., Director, Environmental Sciences Laboratory, Mt. Sinai School of Medicine.

Address:

"Is Science for Real? Or will the American public ever demand the medical care it deserves and find true happiness?"

Richard Bellman, Ph.D., Professor of Mathematics, Electrical Engineering and Medicine, University of Southern California.

How Hospitals Evaluate and Purchase Medical Electronic Equipment:

"Selection of cardiac care unit monitoring equipment"
James A. Stark, M.D.
H. Aileen Atwood, R.N.

"Data Processing Comes to Merritt Hospital"
Howard Scott, Hurdman & Cranstoun Penney and Co.

"Selecting Equipment for the Clinical Pathological Laboratory"
R. Thomas Hunt, M.D.
Floyd Oatman, A.T. Kearney & Co. Inc.
"Boosting Hospital Efficiency through Electronic Aids"
Oscar M. Powell, M.D.
S.R. Wickel

Work Sessions:

On-line Computer Applications.
The role of the computer in medical record-keeping, data analysis, and history-taking in the office and the hospital.

Automating the Clinical Laboratory.
This session will attempt to pinpoint the major test requirements of the clinical laboratory, evaluate the available equipment for automatic testing and determine future requirements.

Problems in Intensive Care Monitoring.
A discussion of problems in intensive care, available instrumentation, and what's needed for improved patient monitoring.

Multiphasic Screening: Pros and Cons.
How effective are automated screening techniques in preventive medicine for large groups? How much data is needed, and what associated hardware and software are required?

Problem Clinic

A forum at which doctors and engineers will have the opportunity to discuss specific medical/

engineering problems and point the way to feasible solutions.

Buying, Selling and Maintaining Medical Electronic Equipment.

Marketing and maintenance are key problems in developing the role of medical electronics. On this panel, experts will discuss current practices and develop ways to improve them.

Exhibits:

This year, there is a new emphasis on exposition. One which reflects the increasing number of electronics products being accepted as practical, progressive, working tools by more and more hospitals and physicians.

Exhibits will include many products related to the program of discussions and work sessions. Demonstrations of product features will help attendees explore new applications for the latest electronics equipment.

Here is a partial list of the companies which will be presenting their most recent achievements.

Avtel Corporation • Bio-logics, Incorporated • Birtcher Corporation • The DeVilbiss Company • Federal Pacific Electric Company • General Electric Company • Graphic Controls Corporation • Honeywell, Incorporated • Mead-Johnson Laboratories • Laser Systems & Electronics, Incorporated • Medidata Sciences, Incorporated • Ohio Medical Products • Parke-Davis • Remler Company • Richard Manufacturing Company • Spacelabs Incorporated • Statham Instruments Incorporated • Technicon Corporation • Wang Laboratories, Incorporated •

Registrants of the 2nd Annual Conference & Exposition on Electronics in Medicine will be encouraged to invite their professional associates to regular exhibit sessions. Other members of the medical profession in the western region will also receive special invitations to visit the exhibits.

Registration Fee: \$150
(Includes all sessions, exhibits, luncheons, reception, and copy of the proceedings when published.)

Note: Only those fully paid in advance will be admitted to meetings and work sessions.

Mail registration and make checks payable to:
2nd National Conference and Exposition on Electronics in Medicine.
330 West 42nd Street, New York, New York 10036

A number of rooms is being held at the Fairmont Hotel for registrants. Make reservations directly with the hotel, identifying yourself as a Conference attendee.

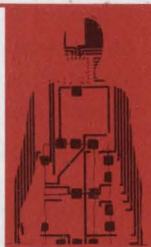

Advance Registration
2nd National Conference & Exposition
on Electronics in Medicine
February 12-13-14, 1970
Fairmont Hotel, San Francisco, California

Name _____ Title _____

Address _____

City _____ State _____ Zip _____

Hospital or Company affiliation _____

Check enclosed _____ Send invoice _____

THE OUTCLASSERS!

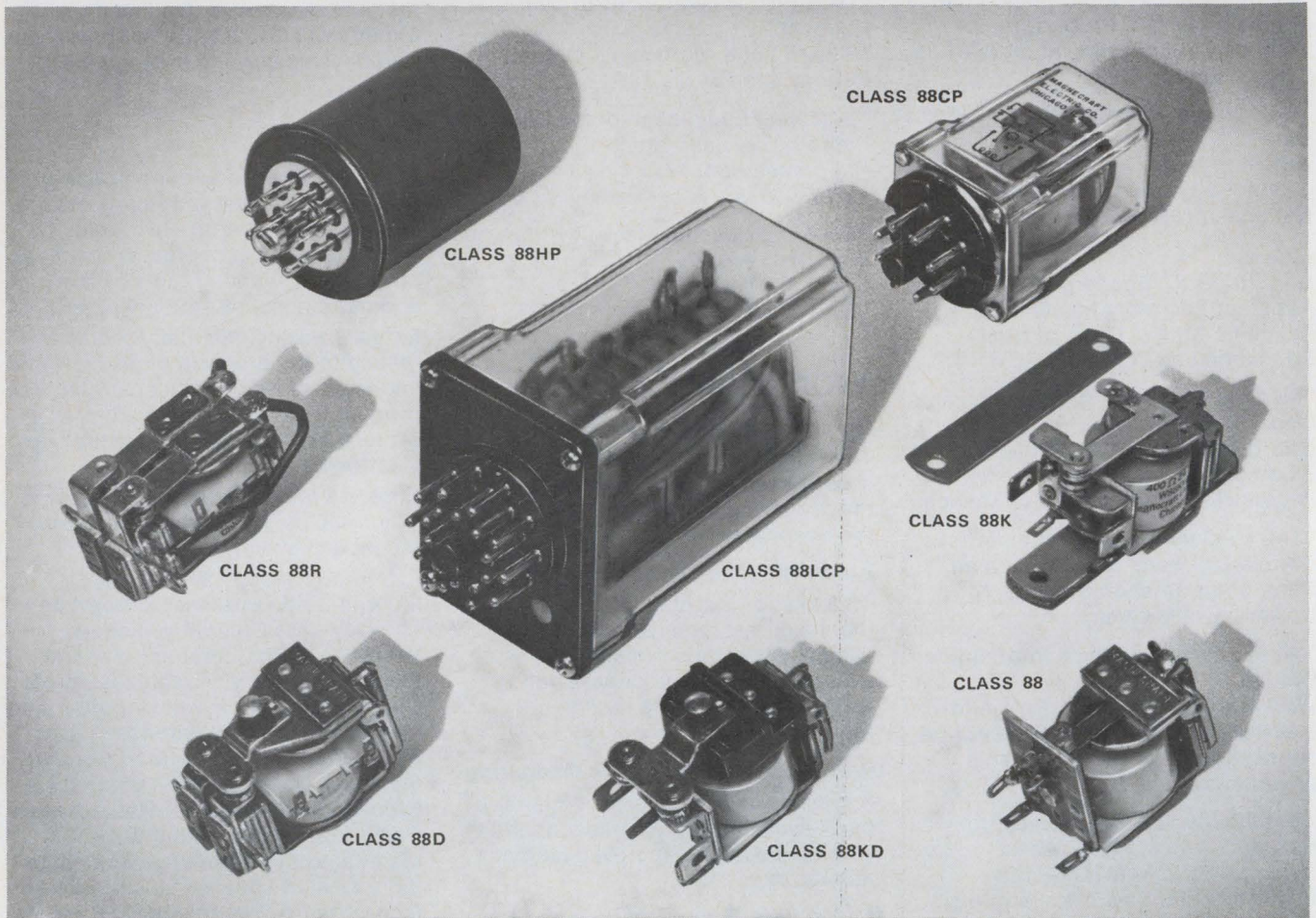

MAGNECRAFT GENERAL PURPOSE RELAYS

Our general purpose relays aren't known as the least expensive. But they have earned the reputation for reliability with the most consistent performance record of any general purpose relay on the market.

In addition, Magnecraft has more general purpose relays in stock than anyone else. This means nearly all your requirements can be filled in days—if not hours. As for variety, we have it over the others with relays such as our improved Class 88KD 50 ampere relay that's ideal for industrial switching applications. And the new Class 88LCP Latching Relay that's composed of two Class 88 Relays with interlocking latching levers mounted on a common base and a crack-proof polycarbonate cover.

If all this doesn't overcome price alone, better forget us. But if you want large silver cadmium oxide contacts, precision hinge-pin armature bearings, molded nylon bobbins and overall custom made quality, then keep us in mind for all general purpose relays. Ours outclass the others at any price.



FREE! Product File — Yours for the asking. Contains full details on all our stock relays.

Magnecraft® **ELECTRIC CO.**

5575 NORTH LYNCH AVENUE • CHICAGO, ILLINOIS 60630 • 312 282-5500

Breach the current barrier

Fast-switching
RCA SCR's
have high di/dt
capability

| SCR families | Volts | Current (rms) | Typical Applications |
|--------------|-------------------|---------------|---|
| TA7395 | 600 400 200 | 40A | modulators/inverters, small radars, sonars, high frequency inverters, pulse modulators |
| 40555 | 600 400 200 | 5A | |
| 40216 | 600 | 35A | |
| 2N4101 | 600 400 200 | 5A | |

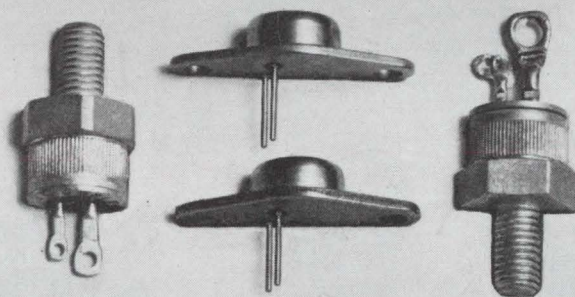

Stick most SCR's with a 400 A/ μ s pulse and they're destroyed—they can't turn off fast enough. Slam the developmental RCA-TA7395 with the same kind of pulse, and it keeps working . . . and working . . . and working. (It literally breaches the current barrier!) That's because RCA SCR's turn off in 10 μ s and spread forward current faster—so switching losses are low—and less heat is dissipated internally.

In addition to fast turn-off times, the TA7395 and other RCA SCR families have high dv/dt characteristics, and may be used at frequencies up to 25 kHz.

Engineers take notice: RCA SCR's are subjected to the most stringent quality assurance tests in the industry. With case temperatures held at 120°C, the SCR's are pulsed by 100 A/ μ s and 250 V/ μ s (up to rated voltage) signals to check turn-on switching losses and turn-off times.

For further details, see your local RCA Representative or your RCA Distributor. Or write RCA Electronic Components, Commercial Engineering, Section N12-2/UR5, Harrison, N.J. 07029. In Europe: RCA International Marketing S.A., 2-4 rue du Lièvre, 1227 Geneva, Switzerland.

“Freon”[®] solvents cut cleaning costs 40% and increased our production as well.

—Dr. James K. Clauss, Signetics Corporation



Dr. James K. Clauss, senior member of the technical staff at Signetics Corp.

Signetics Corporation of Sunnyvale, California, is one of the top four firms in the hottest product area in electronics—integrated circuits.

Signetics uses FREON solvents to eliminate electroplating residues which could adversely affect the seal integrity of the packages in which they encapsulate their integrated circuits.

Before Signetics started using FREON, this critical cleaning process for their integrated circuit packages was more elaborate and required several different cleaning agents. “Now,” says Dr. Clauss, “FREON simplifies the process itself and reduces the usage of solvents.”

Signetics also found FREON safer to use—no need for elaborate protective devices. This permits greater freedom for the employees using the product.

Increased efficiency is another bonus for Signetics. The use of FREON lets them eliminate several inconvenient and time-consuming steps in the drying process. FREON also permits continuous recovery operation.

In summing up, Dr. Clauss said, “FREON has all the qualities we’re looking for—low toxicity, high purity, quick drying and stability.”

For facts on FREON, write to DuPont Co., Room 7303F, Wilmington, Del. 19898. (In Europe: DuPont de Nemours International S.A., Freon[®] Products Div., 81, Route de l’Aire, CH 1211, Geneva 24, Switzerland.)

*Reg. U.S. Pat. Off. for DuPont’s fluorocarbon solvents.

DU PONT **FREON[®]**
Solvants

Our center of attraction.

We're the only ones with .050 centers in our flat conductor cable connectors. We're the only ones with a metal shell to protect that fragile connector. And the only one whose connector will mate with any existing version. (No matter what type of wire is used.) Interchangeable. Intermountable. You can use them with any of your retrofit projects. And should repair be necessary, modular construction makes them easily repairable in the field. They can even be potted for environmental sealing. It's the newest idea yet in flat cable connectors. One more thing. We're trying to come up with a name for this connector. Something better than Flat Conductor Cable Connector. If you can think of a name we can use, it's worth a case of booze. And even if you don't win the booze, we'll be happy to send a genuine certificate recognizing your idea.

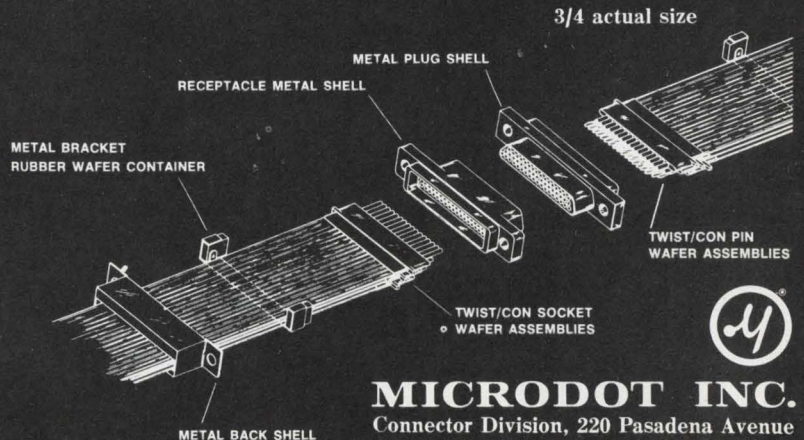
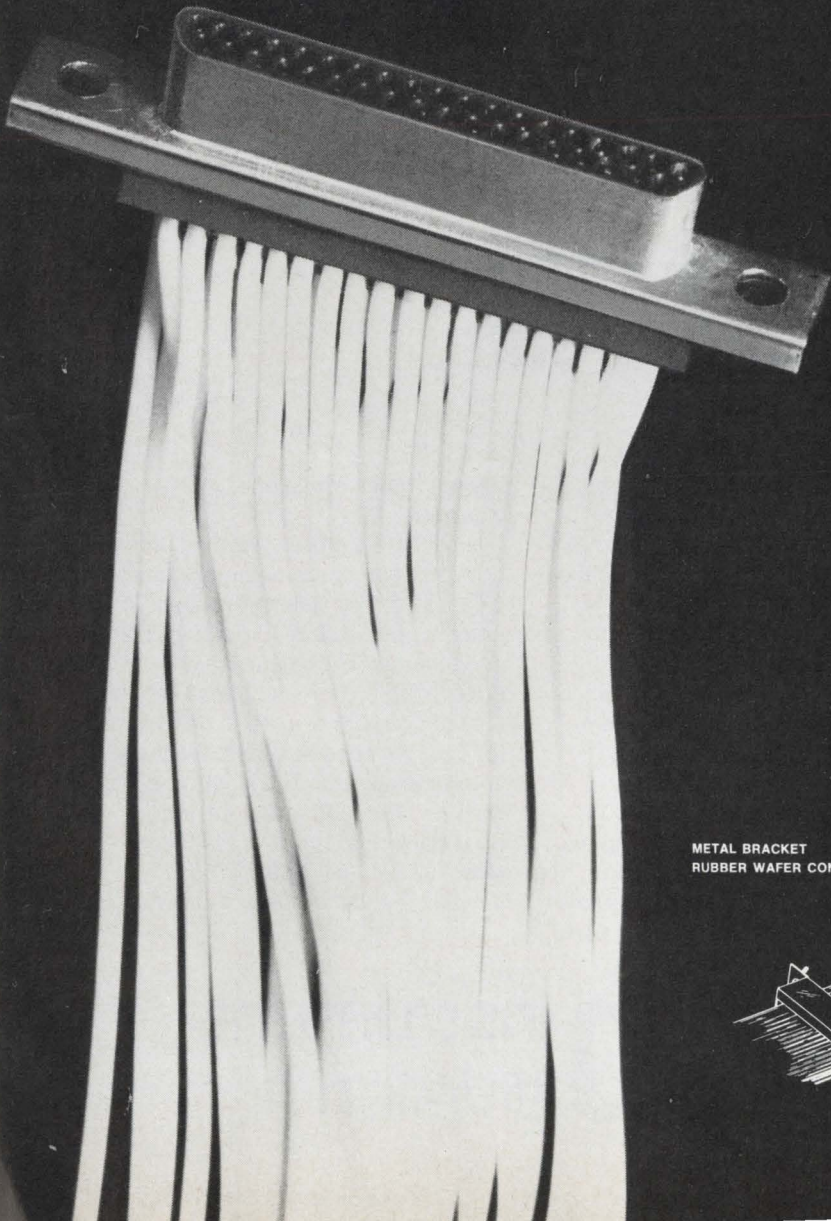

MICRODOT INC.
 Connector Division, 220 Pasadena Avenue
 South Pasadena, California 91030





Put \$69 into your product line and start counting the profits. Digitally.

Take your product line. Snap Tyco's new 2½-digit panel meter into the same opening you might use for an ordinary pointer meter. And there you are in the digital age. And your entire line is better . . . a lot more than \$69 better.

Tyco's new 2½-digit meter is the highest quality, lowest priced digital panel meter available. With the easiest, fastest, most accurate readings possible. Digital so there's no room for operator interpretation. So clear that your customers can read them

from thirty feet across the room . . . from any angle.

The high performance and low price of this meter is possible because of a unique technological development.* It sells for \$69 in lots of 100. \$89 for single units. No mounting hardware is required because the 4½" x 3" x 3" meter just snaps into the front of the panel opening and stays there. Reads to 100% over-range. Has 1 millivolt resolution. 100 megohms input impedance. Overload protection and polarity indication. Needs no zero adjustments. Requires low input power. Has no moving parts or pointer mechanisms to break

down. Comes with a one-year warranty.

And there's more: 3½-digit units, both unipolar and bipolar, with and without BCD outputs; and 4½-digit units, bipolar with BCD outputs. Voltage attenuators and current shunts are available, increasing the versatility of Tyco panel meters. Send today for detailed specifications. We think you'll like our line. Tyco Instrument Division, Tyco Laboratories, Inc., Bear Hill Industrial Park, Waltham, Mass. 02154, (617) 891-4700.

* U.S. and Foreign Patents Pending

TYCO instrument
division

Technical Articles

**Simplifying crt
character generation**
page 72

A combination of analog information coding and bipolar read-only memory IC's has made it possible to display the dial settings—50 mv, 10 nsec, or whatever—directly on one oscilloscope's crt screen. Previously, the quantity of IC's and data-transfer lines was impracticably large for direct display. A new technique puts the scale factors conveniently in front of the instrument operator, assures automatic inclusion in a photographic record, and frees panel space. Eventually, the technique could lead to more extensive descriptions of the waveforms displayed on the scope.

**European market:
Another big year**
page 79



There's another year of healthy growth ahead for Western Europe's electronics industries. Although things may slow down around midyear, 1970 should show an overall increase of 12%. That's the European outlook as gauged by *Electronics*' editors and correspondents. In all, 11 countries are surveyed, with in-depth reports detailing the strengths and problems peculiar to each country. Together, these nations will represent a \$7.82 billion marketplace for assembled equipment. And there's an additional \$2.64 billion in components to be sold next year. Overall, the greatest gains will be in computers and color tv. But the picture isn't quite as bright as it may seem. Still to be felt are the effects of France's devaluation of the franc and West Germany's revaluation of the mark. What's more, nearly every West European nation is applying some kind of brake to cool off an overheated economy.

**Beam-lead interconnection
method boosts yields
in semiconductor
memories**
page 105

Flip-chip and conventional beam-lead techniques are the most common methods used in interconnecting LSI chips, but Motorola sought a better way. The result: a beam-lead laminate interconnection matrix in which the conductors are electroplated simultaneously, eliminating the interface contacts found in conventional multilayer processes. Increased reliability, better thermal stability, higher packing densities, and easy inspection are some of the benefits.

Coming

U.S. technology/1970

Technological trends of 1970 and the coming decade will be projected in an *Electronics* special report. It will examine technological change and innovation, emphasizing the developments that will affect the decisions of electronics engineers and managers.

Simplifying crt character generation

Scheme uses multilevel analog code and LSI bipolar character generator to minimize data transfer lines; symbols are unlimited and easy to program

By Willem B. Velsink

Tektronix Inc., Beaverton, Ore.

Behind any alphanumeric characters displayed on a cathode-ray tube screen stands a lot of circuitry and a great deal of transferred information. The sheer bulk of these requirements has prohibited using conventional crt alphanumeric display technology in oscilloscope instruments, desirable as it would be. The quantity of integrated circuitry would make the instrument too expensive, and the connections would be excessive.

However, an approach to the problem using a combination of analog information coding and bipolar read-only memory IC's seems to have removed these objections. With the display technique developed by Tektronix for its new 7000 series oscilloscopes, the dial settings are written by the electron beam directly on the screen of the crt. As a result, the scale factor—50 millivolts, 10 nanoseconds, or whatever—is always directly in front of the operator where it can be easily read. The scale factors are automatically included in a photographic record, and since detailed markings are no longer needed on the dials, there is more panel space for additional dials and controls.

The present character generator for the oscilloscope contains 50 symbols. But this is really only scratching the surface; the technique is so flexible and it's so easy to provide new symbols that much more extensive use in describing and analyzing waveforms is practical.

Briefly, the crt uses time-sharing. The electron beam takes time out from tracing the waveforms, its primary job, to trace the symbols representing the scale factors of the input channels and time bases. The scope's persistence masks the gaps in the waveform traces. Bipolar large-scale-integration circuits generate the symbol-control signals when they receive instructions via an analog multilevel code from the switch positions and probes.

A basic consideration in designing the display system was to keep the circuitry for encoding the switch positions to an absolute minimum, since it

must be repeated in every plug-in. And the display method had to be flexible, since future plug-ins might use unusual symbols or require unusual readout features. Finally, the leads needed to connect the display data to the mainframe had to be kept to a minimum.

Tektronix considered several other routes for data display before deciding on the IC character-generator approach. In the Tektronix 576 semiconductor curve tracer, ground closures activate tungsten-lamp readout units [*Electronics*, Oct. 28, 1968, page 149]. But the 576 isn't a plug-in unit, and therefore doesn't have the interface density problem. In a plug-in scope, the ground-closure method would require too many connections.

A second possibility incorporated a fiberoptic bundle for each plug-in. Each bundle would connect with the main frame via an optical interface and terminate on the panel, just below the crt. The readout characters could be varied at will by inserting a new transparent film or disk in the plug-in. The benefit was unlimited flexibility; anything—symbols, colors, even pictures—could be piped over the optical interface.

But closer examination revealed snags. In the first place, an optical interface of adequate resolution is not impossible to design but it is extremely difficult. Secondly, the sheer bulk of the data encoder—light source, collimator, film or disk, and drive mechanism—was too great. Moreover, it made the plug-in too expensive and used up valuable plug-in space. Finally, no simple way could be found to change the scale factor when a probe or dial setting was changed.

The time-shared crt display, on the other hand, offered all these advantages:

- Flexibility. A given set of symbols can be displayed anywhere on the crt, in any order, any number of times, with size and style changeable electronically. Readout words can be long or short, compressed to have no redundant spaces (particu-

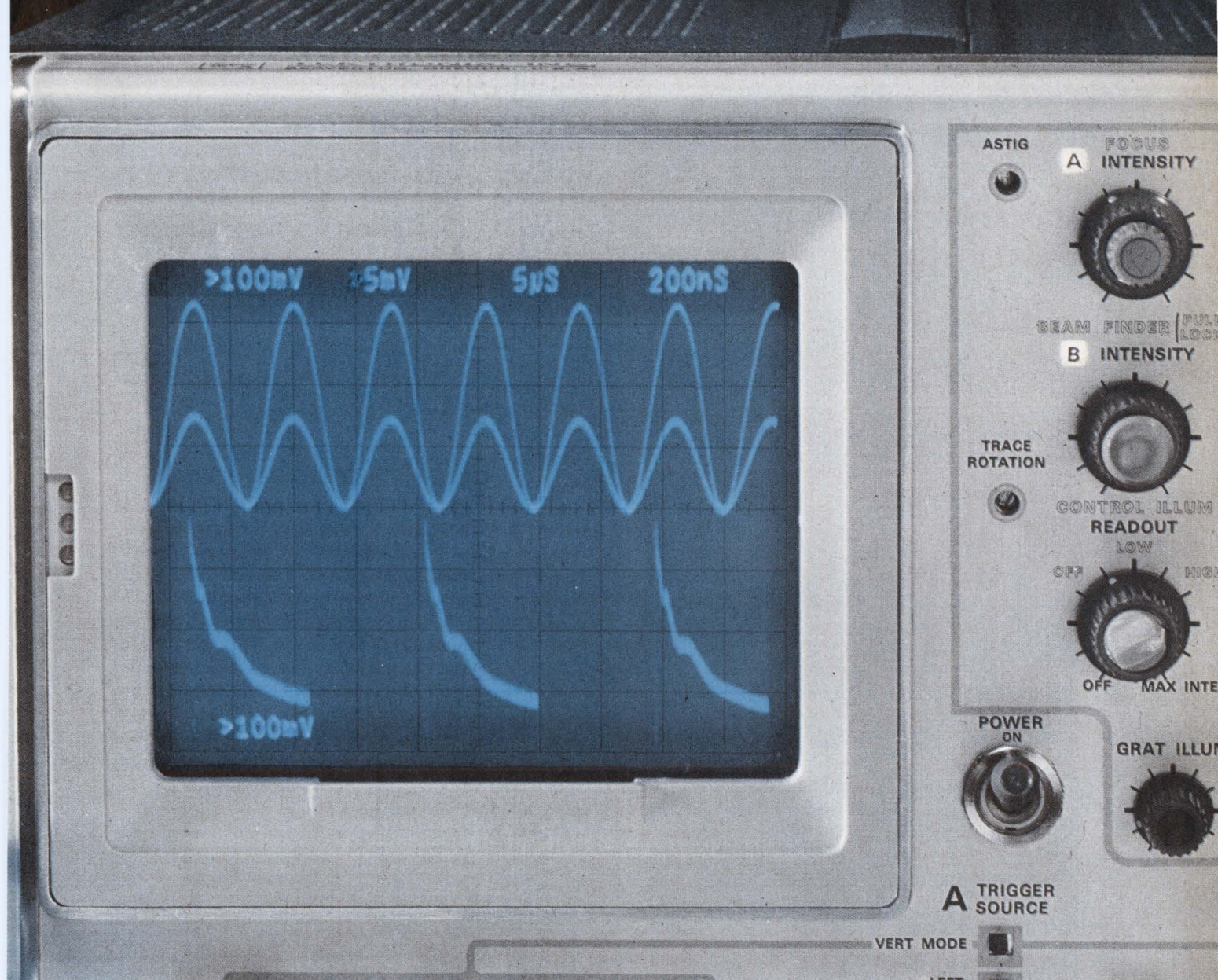

It is written. Scale of waveforms, in units per graticule division, is traced out on cathode-ray tube of Tektronix 7704 oscilloscope. Characters are generated by complex integrated circuits, instructed by multilevel analog pulse code that represents dial settings and probe attenuations.

larly difficult with “fixed” readout devices). The display isn’t limited to alphanumeric; such things as arrows, limit markers, and pictorial symbols can be included. And external information, not from the plug-in, can be mixed into the display.

- **Selectivity.** Only pertinent data need be displayed; there’s no need to clutter up the display area with nonsignificant data—an unselected channel, for example. This is in sharp contrast to fixed-format readouts surrounding the crt, which must be bulky to allow space for future multiword displays, even though a typical display might only be two short words.

- **Appearance.** Symbols are not constrained by a predetermined matrix, as for example, are seven-bar character displays and five-by-seven electro-luminescent diode displays. Nor is there any need to compromise readability by making one character fit “inside” another.

- **Easy photography.** The characters are in the

Typical instructions for changing scale factor

| Instruction (row-column) | Column-data amplitude, microamperes | Interpretation |
|--------------------------|-------------------------------------|---|
| 30 | 0 | Go to next step |
| 31 | -100 | Add one zero after first digit |
| 32 | -200 | Add two zeroes after first digit |
| 33 | -300 | Delete zeroes, shift prefix down one unit |
| 34 | -400 | Add one zero and shift prefix |

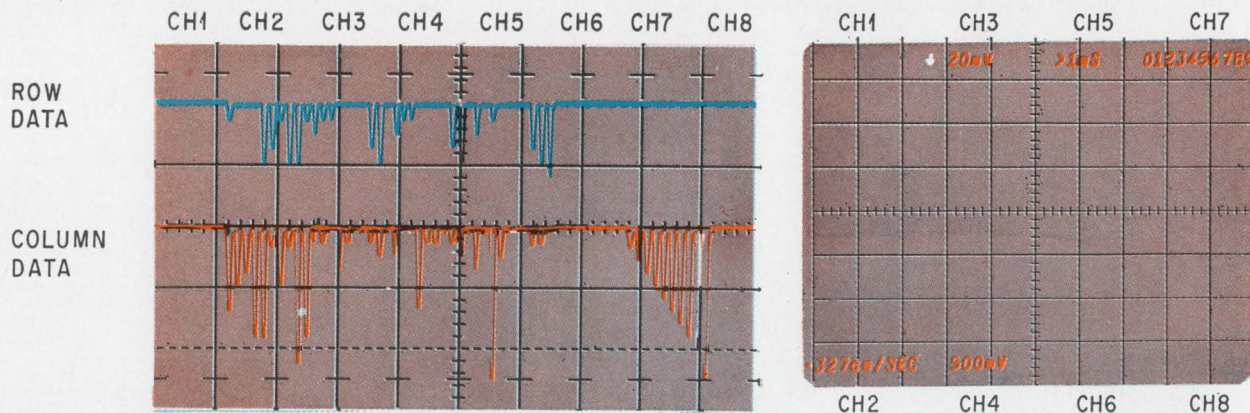

Analogs and digits. Multilevel analog pulses, top, built up in increments of -100 microamperes, represent dial or probe setting for each channel displayed on scope screen (right). With analog code, fewer connections are needed between plug-in and main frame than if binary digital code code were used.

same plane, have the same color, and can have the same intensity as the waveforms on the crt. Even high-speed motion-photography, with readout data constantly updated, is possible.

- **Small size.** The circuitry fits on one small board that can be located at any convenient spot in the instrument—it doesn't have to be positioned near the crt or on the front panel.

- **Low cost.** Since the display circuitry is entirely integrated, production costs will tend to drop. Systems with many mechanical or optical parts, on the other hand, tend to become more expensive.

The complete electronic character-generating system for a time-shared crt display fits on a $5\text{-by-}4\frac{1}{2}$ inch board and uses 14 Tektronix-made bipolar IC's, into which are packed the equivalent of nearly 8,000 active devices. It can generate a display of eight words with up to ten symbols per word, from a font of 50 characters, and it can execute a variety of instructions.

The character generator proper incorporates two novel circuit techniques—these techniques, in fact, make the whole calibrated display scheme possible. First, multiple emitters—7,200 in all—are used as precise current-splitting elements. The resulting packing density of components is vastly greater than that of resistive current-splitting.

The method of scanning the symbol on the crt is the second innovation. The character generator puts out a total of eight coordinate points to define a symbol. But a simple sequential pulsing of the coordinates would produce only an eight-dot display. To trace out the full symbol requires smooth scanning from one point to the next. This is achieved by using a resistive ladder network connected to the bases of the coordinate-generating transistors. Continuously varying the bias on the ladder provides a smooth transition from one coordinate point to the next.

A triangular waveform smoothly sequences through the coordinate pairs to produce x- and y-current waveforms corresponding to the symbol. Scanning rates can be from d-c to 1 megahertz.

Each symbol is thus composed of seven strokes. However, unlike commonly used seven-stroke generators, the break-points of the strokes can be placed at any one of several hundred locations, as determined by the coordinate points. The strokes can have virtually any length and angle. The upshot is that only a small number of coordinate pairs are needed to generate symbols of highly legible quality and in almost infinite variety.

The coordinates of the points are determined by the emitters connected through oxide holes to the metalization layer on the IC chip.

One way of looking at the character generator is as an analog read-only memory; its outputs are x- and y-waveforms that trace out the symbol on the crt. (Each symbol is traced twice at each display time, for a total display time of 10 microseconds.) Just as a binary read-only memory can be "programmed" by making a special pre-ohmic mask (the mask for making holes in the oxide under the metalization layer), so can the analog read-only memory. To make an IC for generating new symbols, it's only necessary to make a new pre-ohmic mask; no changes in the chip are necessary.

The display system actually turned out to be slightly simpler than Tektronix anticipated. Originally, it was planned to put a separate gun in the crt for the symbols; however, a method was developed for interrupting the analog display—the waveforms—that avoided interference patterns.

Interrupted pseudorandomly

This interruption method operates in pseudorandom fashion. It permits the electron beam to write, in $15\ \mu\text{sec}$, one character at the appropriate location on the crt and then to return to the waveform display for an average interval of $250\ \mu\text{sec}$ before it's again interrupted to write the next character. In typical operation, only 1% or 2% of the total available display time is spent in writing characters, and the viewer is unaware of gaps in the waveform display.

The display data originates in the plug-in and

is based on the positions of the switches. These positions are encoded into electrical form within the plug-in (by means of resistors connected between the data output lines and pulsed sequencing lines fed to the plug-in).

With this encoding technique, only two data output lines are needed per channel; one selects a row and the other a column from a matrix containing symbols and instructions. Analog-to-decimal converters—one monolithic IC for each channel—decode the analog signal from the plug-ins so that the selection can be made. The outputs of the converters address the character generator, a matrix of ten rows and ten columns containing instructions for the crt to write specific characters or special instructions for adjusting the scale factor (for example, adding or deleting zeroes or changing the prefix m to μ).

To understand how the multilevel analog code works, consider a hypothetical case: channel 2 of the scope is set at 500 millivolts, and it is therefore desired to display "500 mv" on the crt screen at the channel 2 position. The plug-in containing channel 2 sends a series of pulses to the character generator along two lines (row and column). Each pulse can assume one of ten levels in increments of 100 microamperes.

Efficient modification

A special feature of the coding scheme is the scale factor instructions. These provide an efficient way—in terms of the quantity of data—of modifying the basic data pattern to display the correct scale factor. For example, the zeroes that follow the initial numbers in a scale (such as 50 mv, 200 μ sec) are added by an instruction that causes both the number of zeroes and the prefix to be changed when the X10 or X100 probes are added, or when the sweep magnifier is turned on.

A typical set of scale-factor instructions, shown in the table on page 73, indicates that a display of, say, 5 μ v becomes 50 μ v when the attachment of a X10 probe causes one extra increment of coding current to be added to the column data line. This increment causes a "31" instruction (row 3, column 1 in the matrix) to be put into a small semiconductor memory until it can be used, after the first digit has been written. If the read-out is 500 μ v, the extra increment of current produced when the probe is attached would change a 32 instruction to a 33. Thus 500 μ v (and the instruction ADD TWO ZEROES AFTER THE 5) becomes 5 mv (DROP THE ZEROES, CHANGE THE μ TO m). The multilevel pulses for a complete display are shown opposite.

These metamorphoses are much simpler to accomplish with the analog code than with a binary code. And an even more significant advantage of the analog code is the data-handling capacity it affords: given two data lines and a particular clock rate, more data can be transmitted in ten-level analog code than in two-level binary code. At any instant, there are a total of four possible states

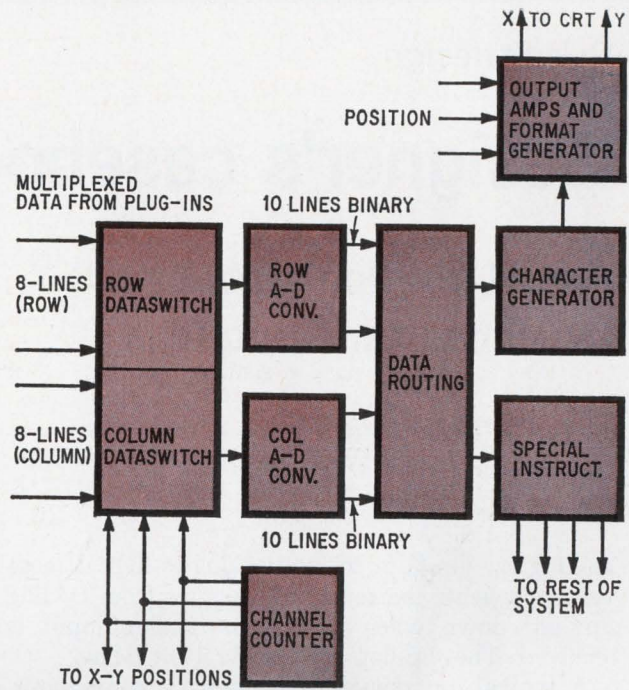

Conversion. Multilevel analog code from plug-ins is changed to binary for use by character generator.

with the two-line binary code, but 100 possible states with the analog code—a 25-times improvement. And since there are eight such two-wire channels in the scope, a 200-to-1 improvement in data transfer is achieved without an increase in clock rate.

Avoids crosstalk

This is a significant advantage, because a relatively slow clock of about 4 kilohertz is necessary to avoid cross-talk in the plug-ins, many of which are simultaneously wideband and sensitive. For the same reason, the analog pulses have a trapezoidal form. Sharp pulses would cause unwanted spikes to creep into the waveform display on the oscilloscope.

The character-generator circuitry interrogates the plug-in in the following sequence:

- Number of zeroes to follow the first digit?
- Normal or inverted waveform display?
- Status of variable controls?
- First digit?
- Prefix (nano, micro, milli, etc.)?
- Units (volts, amperes, seconds, etc.)?

After the interrogation for each word is complete, the logic switches to the next channel. If a plug-in is missing or not used, the logic skips until the next data source is encountered; the waveform display isn't interrupted.

There is a special instruction for determining which scale display applies to which waveform on the crt. To actuate it, the operator depresses the "Identify" button on the plug-in or the probe. This changes the scale display to IDENTIFY and deflects the corresponding waveform upward a few millimeters. ■

Designer's casebook

Designer's casebook is a regular feature in Electronics. Readers are invited to submit novel circuit ideas and unusual solutions to design problems. Descriptions should be clear. We'll pay \$50 for each item published.

Added flip-flop stabilizes a-d converter's output

By Per-Erik Danielsson

Lund, Sweden

Adding a flip-flop to an analog-to-digital converter prevents the reversible counter from cycling up and down when a constant analog input is received. The flip-flop provides a 1-bit delay.

A typical a-d converter contains a comparator, a reversible counter, and a digital-to-analog converter. The analog signal, which is to be converted to an equivalent binary value, is fed into one input of a comparator. The analog input is compared to the signal from the d-a converter. If the input is larger, the counter is incremented until the signal from the d-a converter approaches the input signal's

value. If the analog input signal is smaller, the counter counts down.

However, the output of the d-a converter never exactly equals the input analog signal since the counter's binary value is always a whole number. Therefore, if the analog input settles to a constant value, the counter bounces back and forth between two successive binary values and never stabilizes to a fixed value.

The additional D flip-flop comprises the least significant bit of the reversible counter. If an analog input corresponding to a value of, for example, 6.5 occurs, the D flip-flop oscillates between the set and reset states causing the d-a converter to fluctuate between analog values corresponding to 6 and 7. However, the other bits of the reversible counter do not toggle. The AND-gate logic at the output of the D flip-flop insures that only if the comparator has the same polarity output on two successive clock pulses will the counter change state. Thus the flicker from the reversible counter is eliminated at the output of the a-d converter.

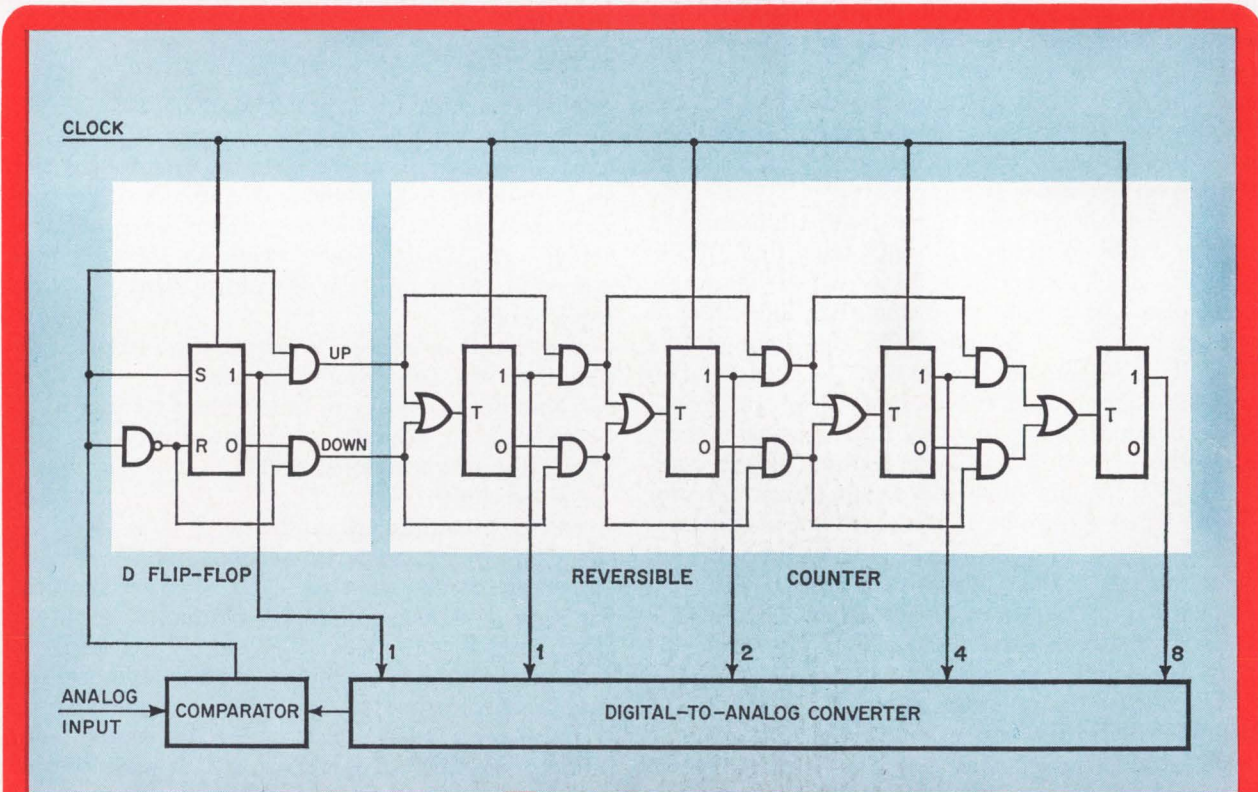

Delay. The reversible counter produces a binary value equivalent to the analog input voltage. If the analog input remains constant, the D flip-flop oscillates on and off while the rest of the counter remains fixed at the equivalent binary value of the input signal. The problem of flicker is thus eliminated.

Transformer is eliminated in transistor chopper

By Hugh Riddle

St. Bartholomew's Hospital, London

Eliminating the transformer and adding transistors in a series chopper produces a wideband circuit that can operate over a sizable range of mark-space ratios and repetition frequencies. Adding transistors to the series chopper provides very low on-resistance with a high current-transfer capability.

During negative-half cycles, when the input transistor Q_1 is biased off, transistors Q_5 and Q_6 also are cut off and therefore keep the chopper transistors Q_2 and Q_3 off. Therefore, a signal at A will not be transferred to B during the chopper drive's negative-half cycles.

While the chopper elements Q_2 and Q_3 are off and isolated from the rest of the circuit, the capacitor C charges to the difference in the supply voltages through Q_4 , R_1 and D.

On the chopper drive's positive-half cycle, Q_1 saturates and lowers the base voltage of Q_4 , cutting it off. The diode reverse-biases and the capacitor, already charged to the difference in supply voltages, begins to discharge through Q_5 , Q_6 , R_2 , the chopper transistors, and their associated resistors. Thus enough base current has been supplied to Q_2 and Q_3 to make them conduct and pass signals between A and B—but this current has not been forced through the circuitry that connects A and B.

The current that flows through Q_5 's collector is about equal to that absorbed by Q_6 's collector—the discharge loop is effectively isolated from the

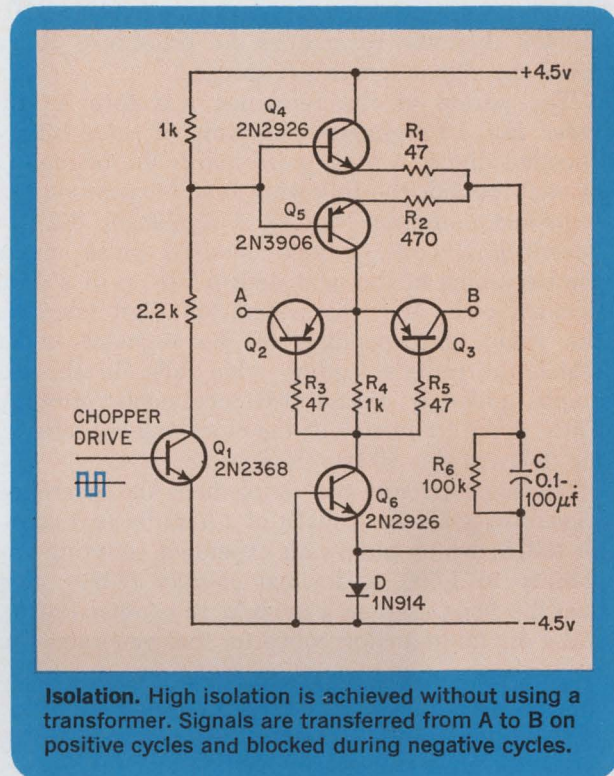

Isolation. High isolation is achieved without using a transformer. Signals are transferred from A to B on positive cycles and blocked during negative cycles.

rest of the driving circuitry because Q_4 and the diode are cut off.

Actually about 2 microamperes are spuriously injected into the chopping circuit during the on-cycle, but if high-gain transistors are used for Q_5 and Q_6 , the ratio of the energizing current to the spurious current can be as high as 500:1.

The purpose of R_1 and R_2 is to control the charging and discharging rates of the capacitor, while R_6 provides a bleed to preserve the chopper-open condition almost indefinitely if need be.

Reference waveform adds to scope's measuring capability

By J.L. Nichols

Fairchild Semiconductor, Mountain View, Calif.

A pulse generator that delivers a digitally-encoded waveform can be used instead of the delayed sweep on an oscilloscope to measure time delays between clock pulses. Each period of the waveform displays a different code corresponding to a new increment

in time. With the coded waveform serving as a reference time scale, time relationships of other traces on the scope can be measured with greater precision than the delayed sweep.

The reference waveform generator, which is connected to the scope's sync input as an extra attachment, can be driven either by a digital system's master clock or a signal source of an unknown frequency. If the period of the reference waveform is known in seconds, then the delay in a pulse occurring on a scope's trace can be measured directly by reading the code on the reference where the pulse's leading edge falls. If the delay in the pulse is known but the frequency of the signal source driving the generator is un-

known, then the reverse of the procedure above gives the signal source's frequency.

The period of the reference waveform is divided into 10 segments consisting of three binary encoded digits. A long pulse marks the beginning of each period; the following four bit positions or segments determine the most significant digit in hexadecimal code; a medium-sized pulse marks the beginning of the next digit made up of a 4-bit decimal code; the least significant digit takes on the value corresponding to the segment under which the pulse's leading edge falls. In the example, pulse t_1 occurs 906 increments after t_0 . Thus, if the frequency of the clock is 1 megahertz, the delay in t_1 is 906 microseconds.

The logic circuits that implement the reference waveform generator consist of a hexadecimal counter (9316) which allows an expanded counting capability to 1,599, a decimal counter (9310), two dual flip-flops used as a modulo 10 counter (9020), and a digital-to-analog converter that generates the

short and long pulses (9946 and associated resistors).

The hexadecimal and decimal counters are connected as a shift register whose contents are shifted circularly once for each master clock pulse. The pulses from the shift register are fed into gate 3 of the d-a converter which delivers the binary coded output. The dual flip-flops connected as a modulo 10 counter count the segments in the period and enable one of the three gates of the d-a converter for generating the correct pulse height. When the counter is 0, it enables gate 1, and a long pulse marker is delivered at the output. During the next four segments in the count, gate 3 is enabled, and the short pulses are delivered to the output. On the sixth count, gate 2 is enabled, and the medium-sized pulse is generated because of the voltage ratio developed by the resistors marked R. During the next four segments, gate 3 is again enabled, and the short binary-coded pulses are delivered.

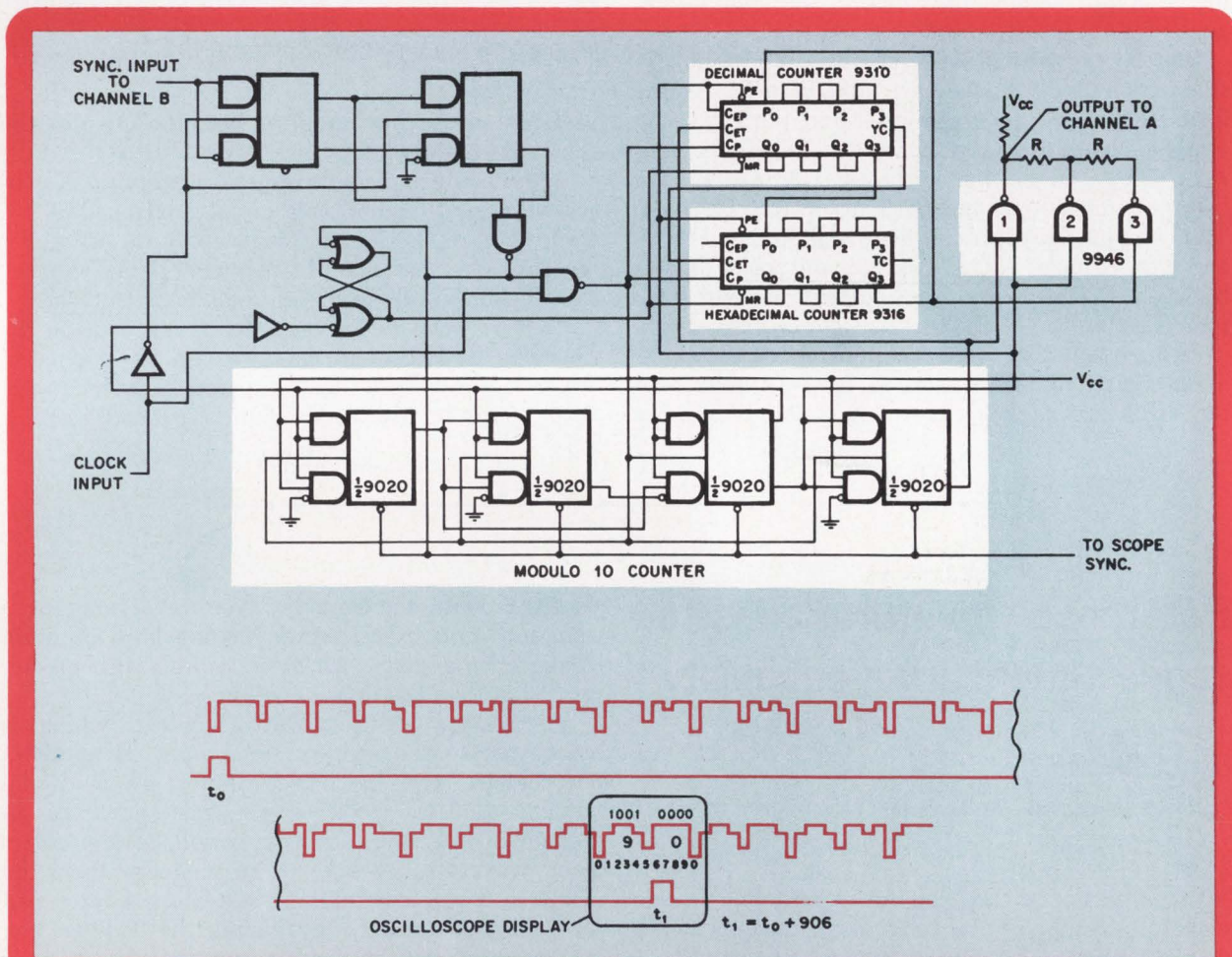

Timely. An alternative to the delayed sweep of an oscilloscope is the digitally-encoded reference waveform generator. A clock drives two binary counters connected as a shift register whose contents move circularly once for each clock pulse. The waveform's period is equal to the period of the input clock.

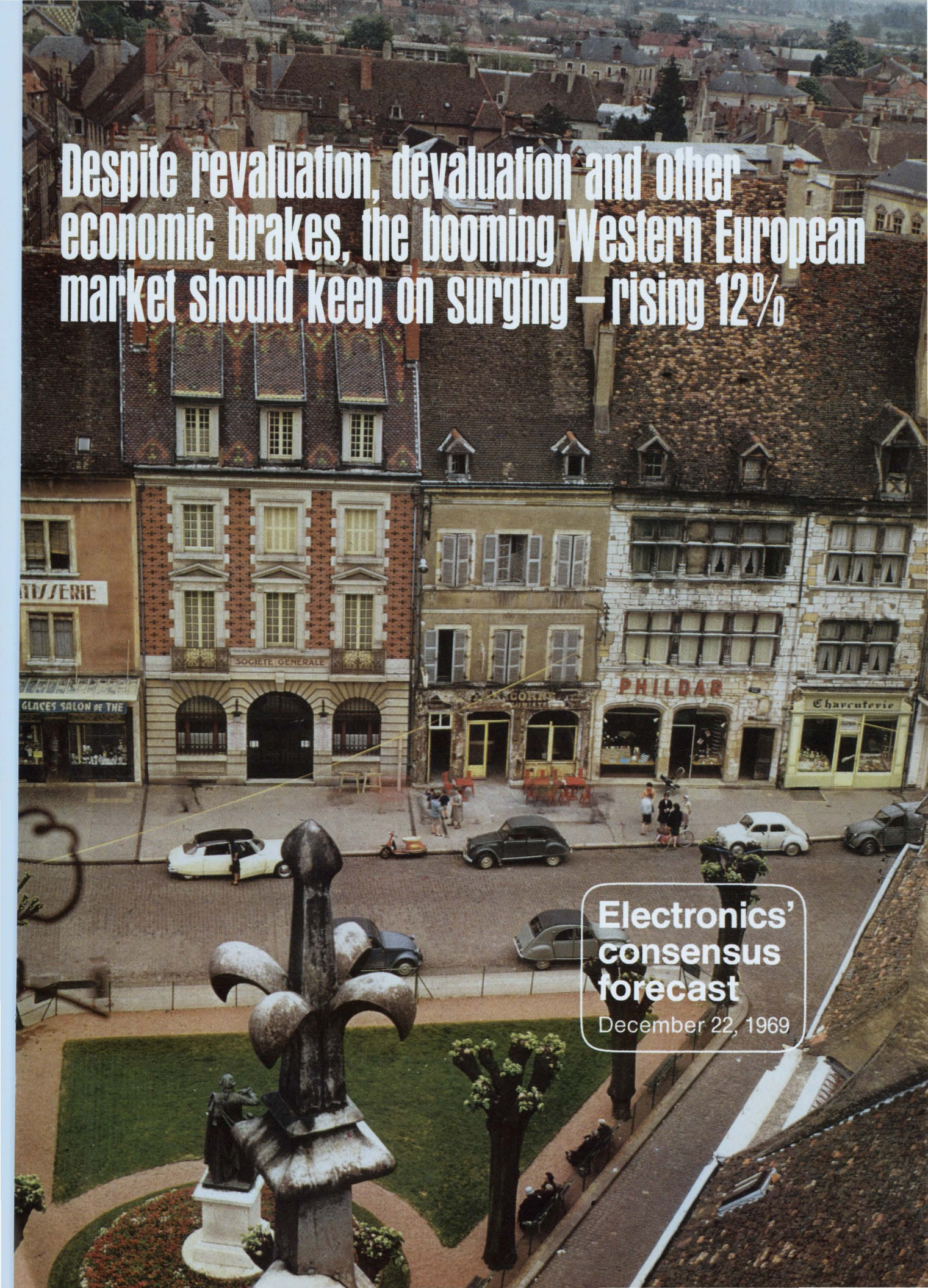
An aerial photograph of a European town square, likely in France, showing historic buildings with tiled roofs and a central fountain. The buildings have various signs, including 'SOCIÉTÉ GÉNÉRALE', 'PHILDAR', and 'Charcuterie'. Several vintage cars are parked on the street, and a few people are visible walking. The fountain in the foreground is a large, ornate structure with a central spire and multiple tiers of water. The overall scene is a mix of old-world architecture and mid-20th-century urban life.

Despite revaluation, devaluation and other economic brakes, the booming Western European market should keep on surging — rising 12%

Electronics' consensus forecast

December 22, 1969

markets 1970

| Sweden | | Switzerland | | United Kingdom | | West Germany | | TOTAL | |
|--------|-------|-------------|-------|----------------|---------|--------------|---------|---------|---------|
| 1969 | 1970 | 1969 | 1970 | 1969 | 1970 | 1969 | 1970 | 1969 | 1970 |
| 5.5 | 6.2 | 3.2 | 3.2 | 28.1 | 30.8 | 56.1 | 56.1 | 162.1 | 167.9 |
| 16.5 | 16.5 | 10.5 | 11.0 | 40.9 | 43.3 | 153.0 | 143.0 | 155.3 | 172.2 |
| 9.2 | 9.2 | 3.5 | 3.9 | 17.3 | 19.6 | 70.5 | 77.0 | 379.8 | 588.5 |
| 31.0 | 27.5 | 16.4 | 14.2 | 138.1 | 122.4 | 208.0 | 180.5 | 2,042.1 | 2,206.0 |
| 72.5 | 87.5 | 7.1 | 13.5 | 50.1 | 87.5 | 174.0 | 258.0 | | |
| 8.0 | 9.0 | 5.8 | 6.1 | 21.0 | 22.5 | 32.6 | 36.4 | | |
| 142.7 | 155.9 | 46.5 | 51.9 | 295.5 | 326.1 | 694.2 | 751.0 | | |
| 8.5 | 10.6 | 1.2 | 1.4 | 6.7 | 7.2 | 12.5 | 13.6 | 38.1 | 43.3 |
| 1.5 | 1.8 | 0.3 | 0.4 | 1.4 | 1.5 | 5.4 | 5.9 | 20.3 | 22.9 |
| 4.5 | 5.4 | 0.4 | 0.4 | 2.1 | 2.4 | 7.3 | 7.9 | 53.9 | 59.6 |
| 14.5 | 15.5 | 4.5 | 4.7 | 16.3 | 18.0 | 31.5 | 34.6 | 221.0 | 244.0 |
| 6.5 | 8.0 | 1.3 | 1.3 | 5.7 | 6.5 | 13.9 | 15.3 | | |
| 35.5 | 41.3 | 7.7 | 8.2 | 32.2 | 35.6 | 70.6 | 77.3 | | |
| 4.0 | 2.0 | 5.2 | 6.1 | 23.2 | 24.0 | 14.6 | 15.2 | 109.7 | 113.7 |
| 0.5 | 0.6 | 0.8 | 0.9 | 5.0 | 5.8 | 8.1 | 9.0 | 86.8 | 95.8 |
| 1.2 | 1.3 | 4.0 | 5.0 | 18.1 | 19.2 | 21.7 | 25.0 | 806.5 | 863.7 |
| 8.2 | 8.2 | 3.6 | 4.0 | 8.0 | 8.0 | 21.4 | 23.2 | | |
| 13.6 | 14.0 | 38.0 | 38.0 | 155.0 | 162.5 | 271.0 | 298.2 | | |
| 8.2 | 8.2 | 1.3 | 1.3 | 77.1 | 80.8 | 82.6 | 80.0 | | |
| 1.0 | 1.0 | 0.2 | 0.3 | 12.0 | 20.4 | 3.0 | 4.6 | 26.6 | 42.5 |
| 7.0 | 7.5 | 3.5 | 4.5 | 43.3 | 44.4 | 51.5 | 59.1 | 1,604.4 | 1,736.2 |
| 43.7 | 42.8 | 56.6 | 60.1 | 341.7 | 365.1 | 473.9 | 514.3 | | |
| 1.0 | 1.1 | 0.2 | 0.3 | 4.8 | 6.0 | 5.9 | 6.5 | 22.9 | 25.9 |
| 1.9 | 2.3 | 0.3 | 0.4 | 3.0 | 4.2 | 2.7 | 3.3 | 82.3 | 113.6 |
| 3.5 | 4.2 | 0.2 | 0.3 | 18.6 | 28.5 | 43.4 | 57.0 | 102.0 | 134.5 |
| 61.0 | 74.0 | 38.0 | 45.6 | 285.0 | 330.0 | 292.0 | 339.0 | 122.1 | 148.6 |
| 6.0 | 7.0 | 3.5 | 4.2 | 9.6 | 12.0 | 28.3 | 45.0 | 1,730.8 | 2,089.2 |
| 7.5 | 9.1 | 3.8 | 4.5 | 30.0 | 36.0 | 40.6 | 46.0 | | |
| 3.5 | 4.5 | 3.5 | 4.2 | 15.0 | 18.0 | 62.5 | 75.3 | | |
| 84.4 | 102.2 | 49.5 | 59.5 | 366.0 | 434.7 | 475.4 | 572.1 | | |
| 1.6 | 1.8 | 0.5 | 0.5 | 6.0 | 6.4 | 10.9 | 12.1 | 30.5 | 33.7 |
| 3.1 | 3.5 | 1.6 | 1.6 | 14.0 | 14.7 | 23.0 | 25.3 | 63.2 | 71.8 |
| 4.7 | 5.2 | 3.4 | 3.7 | 7.1 | 8.1 | 15.8 | 17.8 | 16.6 | 18.4 |
| 4.8 | 5.1 | 3.8 | 4.0 | 13.2 | 13.9 | 10.9 | 12.6 | 28.8 | 31.1 |
| 0.8 | 0.9 | 0.3 | 0.4 | 3.8 | 4.0 | 6.2 | 6.9 | 938.7 | 1,041.6 |
| 32.5 | 36.5 | 22.3 | 24.5 | 67.4 | 71.1 | 131.0 | 146.5 | | |
| 0.7 | 0.8 | 0.6 | 0.6 | 8.0 | 8.8 | 8.7 | 9.2 | | |
| 4.0 | 4.5 | 3.8 | 4.2 | 23.8 | 25.1 | 92.6 | 104.0 | | |
| 52.2 | 58.3 | 36.3 | 39.5 | 143.3 | 152.1 | 299.1 | 334.4 | | |
| 0.3 | 0.3 | 0.1 | 0.1 | 1.2 | 1.2 | 2.7 | 2.8 | 7.7 | 8.1 |
| 2.0 | 2.2 | 0.6 | 0.7 | 2.9 | 3.1 | 4.5 | 4.8 | 20.8 | 23.9 |
| 2.6 | 2.9 | 0.4 | 0.5 | 1.4 | 1.6 | 4.5 | 5.2 | 32.5 | 35.7 |
| 2.3 | 2.5 | 0.7 | 0.8 | 4.4 | 4.5 | 6.8 | 7.5 | 18.3 | 20.1 |
| 1.3 | 1.4 | 0.5 | 0.6 | 4.6 | 5.0 | 9.2 | 10.1 | 19.0 | 20.3 |
| 2.5 | 2.8 | 1.2 | 1.5 | 5.2 | 5.4 | 14.0 | 16.8 | 29.2 | 32.3 |
| 1.3 | 1.4 | 0.3 | 0.4 | 2.1 | 2.1 | 5.4 | 6.2 | | |
| 6.2 | 6.8 | 2.0 | 2.2 | 12.9 | 13.4 | 18.8 | 20.6 | | |
| 1.2 | 1.3 | 0.6 | 0.6 | 3.5 | 3.7 | 4.8 | 5.3 | | |
| 3.3 | 3.5 | 1.8 | 1.9 | 5.4 | 6.2 | 9.1 | 10.5 | | |
| 2.6 | 2.9 | 1.0 | 1.1 | 4.2 | 4.5 | 6.1 | 7.2 | | |
| 0.5 | 0.7 | 0.4 | 0.5 | 2.9 | 3.4 | 3.3 | 3.8 | | |
| 6.0 | 6.7 | 2.2 | 2.4 | 14.0 | 15.1 | 27.3 | 31.3 | 91.2 | 101.0 |
| 32.1 | 35.4 | 11.8 | 13.3 | 64.7 | 69.2 | 116.5 | 132.1 | 454.3 | 500.8 |
| 390.6 | 435.9 | 208.4 | 232.5 | 1,243.4 | 1,382.8 | 2,129.7 | 2,381.2 | 6,991.3 | 7,817.8 |

electronic equipment r

| France | | Italy | | Netherlands | | Norway | | Spain | |
|---------|---------|-------|-------|-------------|-------|--------|-------|-------|-------|
| 1969 | 1970 | 1969 | 1970 | 1969 | 1970 | 1969 | 1970 | 1969 | 1970 |
| 21.8 | 22.4 | 19.4 | 19.5 | 8.5 | 9.0 | 2.3 | 2.5 | 7.9 | 8.4 |
| 43.5 | 42.2 | 44.1 | 45.3 | 10.5 | 11.6 | 6.9 | 7.4 | 14.5 | 15.6 |
| 16.4 | 19.5 | 19.0 | 21.5 | 6.0 | 6.8 | 3.0 | 3.2 | 3.3 | 4.1 |
| 165.0 | 145.0 | 148.0 | 141.0 | 31.0 | 27.0 | 11.8 | 9.5 | 90.0 | 99.0 |
| 48.0 | 92.0 | 0.4 | 0.6 | 20.0 | 32.5 | * | 0.3 | * | * |
| 16.0 | 17.5 | 8.0 | 10.0 | 5.0 | 5.6 | 2.1 | 2.3 | 1.0 | 1.2 |
| 310.7 | 338.4 | 238.9 | 237.9 | 81.0 | 92.5 | 26.1 | 25.2 | 116.7 | 128.3 |
| 3.0 | 3.5 | 1.7 | 1.8 | 1.4 | 1.5 | 0.7 | 1.0 | 0.5 | 0.6 |
| 1.6 | 1.7 | 0.3 | 0.3 | 0.3 | 0.3 | * | * | 0.4 | 0.4 |
| 2.9 | 3.1 | 0.9 | 1.2 | 0.6 | 0.7 | 0.3 | 0.4 | 0.5 | 0.5 |
| 15.1 | 16.0 | 2.8 | 3.2 | 5.2 | 6.0 | 1.4 | 1.4 | 0.5 | 0.6 |
| 12.0 | 13.0 | 3.2 | 3.5 | 3.7 | 4.0 | 1.5 | 1.5 | 2.3 | 2.5 |
| 34.6 | 37.3 | 8.9 | 10.0 | 11.2 | 12.5 | 3.9 | 4.3 | 4.2 | 4.6 |
| 29.0 | 29.5 | 8.2 | 8.5 | 5.5 | 6.0 | 6.6 | 7.0 | 5.5 | 6.5 |
| 7.0 | 8.5 | 2.6 | 2.8 | 1.3 | 1.5 | 0.3 | 0.5 | 1.4 | 2.1 |
| 21.0 | 22.4 | 5.4 | 5.8 | 6.0 | 6.7 | 2.3 | 2.6 | 1.1 | 1.2 |
| 28.0 | 29.5 | 14.9 | 17.9 | 9.1 | 10.1 | 3.1 | 4.0 | 3.5 | 4.3 |
| 156.0 | 158.0 | 52.0 | 60.0 | 45.0 | 50.0 | 19.0 | 19.5 | 10.9 | 12.9 |
| 65.0 | 70.0 | 18.0 | 19.7 | 6.2 | 6.8 | 5.4 | 6.1 | 3.1 | 3.5 |
| 8.2 | 14.0 | 1.0 | 1.0 | 0.5 | 0.5 | 0.4 | 0.4 | * | * |
| 25.2 | 31.0 | 8.5 | 9.5 | 9.6 | 10.8 | 2.5 | 2.9 | 2.1 | 2.3 |
| 339.4 | 362.9 | 110.6 | 125.2 | 83.2 | 92.4 | 39.6 | 43.0 | 27.6 | 32.8 |
| 5.0 | 5.5 | 1.2 | 1.2 | 1.2 | 1.4 | 1.0 | 1.0 | 1.0 | 1.0 |
| 3.3 | 6.4 | 1.0 | 1.5 | 1.2 | 1.5 | 0.5 | 0.5 | 0.5 | 0.6 |
| 7.0 | 11.0 | 2.7 | 3.3 | 2.2 | 2.6 | 0.9 | 1.1 | 1.5 | 1.8 |
| 243.0 | 300.0 | 183.0 | 217.0 | 42.0 | 50.0 | 26.0 | 31.2 | 19.7 | 24.7 |
| 25.0 | 29.0 | 15.0 | 20.0 | 5.0 | 6.0 | 2.5 | 3.0 | 1.5 | 1.7 |
| 31.5 | 38.0 | 3.1 | 3.7 | 3.5 | 4.2 | 1.1 | 1.3 | 0.6 | 0.8 |
| 13.6 | 18.5 | 12.7 | 14.2 | 3.0 | 3.7 | 2.0 | 2.4 | 1.8 | 2.5 |
| 328.4 | 408.4 | 218.7 | 260.9 | 58.1 | 69.4 | 34.0 | 40.5 | 26.6 | 33.1 |
| 5.0 | 5.5 | 2.0 | 2.3 | 2.0 | 2.2 | 0.5 | 0.6 | 0.4 | 0.5 |
| 13.6 | 14.2 | 5.8 | 6.0 | 3.3 | 3.5 | 0.7 | 0.8 | 0.9 | 1.0 |
| 5.2 | 7.0 | 3.8 | 4.5 | 7.9 | 8.5 | 4.1 | 4.7 | 2.9 | 3.2 |
| 7.7 | 8.3 | 5.3 | 5.9 | 5.5 | 6.0 | 1.4 | 1.6 | 3.3 | 3.6 |
| 2.0 | 2.1 | 1.0 | 1.2 | 1.3 | 1.4 | 0.4 | 0.5 | 0.3 | 0.4 |
| 70.0 | 79.0 | 50.8 | 62.0 | 35.0 | 38.0 | 14.0 | 16.1 | 15.1 | 17.3 |
| 5.0 | 5.2 | 1.7 | 1.9 | 1.1 | 1.2 | 0.2 | 0.3 | 2.3 | 2.5 |
| 23.5 | 25.0 | 11.7 | 13.5 | 6.7 | 7.3 | 2.2 | 3.1 | 3.0 | 3.3 |
| 132.0 | 146.3 | 82.1 | 97.3 | 62.8 | 68.1 | 23.5 | 27.7 | 28.2 | 31.8 |
| 1.7 | 1.8 | 0.6 | 0.7 | 0.6 | 0.7 | 0.1 | 0.1 | 0.1 | 0.1 |
| 2.5 | 2.8 | 2.1 | 2.3 | 3.3 | 3.5 | 0.4 | 0.4 | 0.3 | 0.3 |
| 4.0 | 4.5 | 2.3 | 2.4 | 3.1 | 3.8 | 0.5 | 0.6 | 0.2 | 0.3 |
| 4.1 | 4.5 | 3.4 | 3.6 | 2.6 | 2.9 | 0.3 | 0.4 | 0.4 | 0.5 |
| 7.0 | 7.5 | 3.5 | 3.8 | 3.2 | 3.5 | 0.6 | 0.7 | 0.4 | 0.5 |
| 9.0 | 9.8 | 4.4 | 4.6 | 6.4 | 7.1 | 2.5 | 2.0 | 0.1 | 0.2 |
| 4.1 | 4.4 | 1.5 | 1.7 | 1.8 | 1.9 | 0.2 | 0.2 | 0.3 | 0.3 |
| 15.0 | 17.0 | 8.5 | 9.2 | 8.2 | 9.0 | 1.2 | 1.3 | 1.2 | 1.4 |
| 3.0 | 3.2 | 2.0 | 2.1 | 1.5 | 1.6 | 0.3 | 0.3 | 0.5 | 0.5 |
| 9.0 | 9.2 | 5.4 | 5.9 | 6.9 | 7.5 | 1.1 | 1.2 | 1.0 | 1.1 |
| 4.3 | 4.8 | 4.4 | 4.6 | 3.4 | 3.7 | 0.5 | 0.6 | 0.7 | 0.8 |
| 1.6 | 1.6 | 0.9 | 1.0 | 1.2 | 1.5 | 0.3 | 0.4 | 0.4 | 0.5 |
| 19.0 | 20.5 | 7.6 | 8.3 | 6.0 | 6.8 | 0.8 | 0.9 | 1.8 | 2.0 |
| 84.3 | 91.6 | 46.6 | 50.2 | 48.2 | 53.5 | 8.8 | 9.1 | 7.4 | 8.5 |
| 1,229.4 | 1,384.9 | 705.8 | 781.5 | 344.5 | 388.4 | 135.9 | 149.8 | 210.7 | 239.1 |

v. 15, 1969. Market figures for countries that have changed cur-
that the category "Nuclear Instruments and Equipment" is not

European component

| COMPONENTS, factory prices in millions of dollars | Belgium- Luxembourg | | Denmark | | France | | Italy | | Netherlands | |
|---|------------------------|-------------|-------------|-------------|--------------|--------------|--------------|--------------|--------------|--------------|
| | 1969 | 1970 | 1969 | 1970 | 1969 | 1970 | 1969 | 1970 | 1969 | 1970 |
| | Antennas, domestic | 2.0 | 1.8 | 2.1 | 2.3 | 24.2 | 26.6 | 5.7 | 5.8 | 2.9 |
| Capacitors, fixed and variable | 7.1 | 8.1 | 6.1 | 7.2 | 62.0 | 66.8 | 24.7 | 26.2 | 9.5 | 10.6 |
| Connectors, plugs and sockets | 2.5 | 2.7 | 1.5 | 1.8 | 28.2 | 31.0 | 9.6 | 10.0 | 5.0 | 5.5 |
| Crystals and crystal filters | 0.7 | 0.9 | 0.7 | 0.9 | 3.0 | 3.3 | 1.8 | 1.9 | 1.1 | 1.2 |
| Delay lines | 0.7 | 0.9 | 0.4 | 0.5 | 2.6 | 3.0 | 1.2 | 1.3 | 1.0 | 3.0 |
| Ferrite devices | 1.9 | 2.1 | 1.5 | 2.0 | 12.0 | 13.5 | 3.7 | 4.3 | 3.0 | 3.5 |
| Filters and networks (except crystal) | 0.6 | 0.7 | 0.4 | 0.5 | 4.4 | 5.0 | 1.7 | 1.8 | 1.1 | 1.2 |
| Loudspeakers | 2.3 | 2.6 | 0.7 | 0.8 | 8.5 | 8.8 | 4.4 | 4.8 | 2.3 | 2.6 |
| Potentiometers | 1.7 | 1.8 | 1.2 | 1.4 | 11.0 | 12.0 | 5.5 | 6.3 | 2.8 | 3.2 |
| Power supplies (OEM type) | 2.4 | 2.6 | 1.7 | 1.9 | 9.5 | 10.2 | 9.0 | 9.8 | 6.5 | 7.3 |
| Printed circuits | 2.6 | 3.0 | 1.3 | 1.5 | 8.5 | 9.2 | 1.6 | 1.8 | 3.1 | 3.6 |
| Relays | 3.5 | 3.9 | 3.9 | 4.4 | 36.5 | 40.5 | 12.2 | 13.5 | 5.3 | 5.9 |
| Resistors, fixed | 3.8 | 3.9 | 2.6 | 2.8 | 25.0 | 25.5 | 9.0 | 8.0 | 5.3 | 5.4 |
| Semiconductors, diodes ¹ | 2.5 | 3.5 | 1.2 | 1.4 | 13.3 | 13.5 | 2.9 | 3.2 | 3.5 | 4.0 |
| Semiconductors, integrated circuits ² | 2.8 | 3.5 | 1.5 | 2.1 | 21.9 | 29.4 | 5.9 | 11.6 | 3.6 | 5.4 |
| Semiconductors, transistors | 5.0 | 5.6 | 4.2 | 4.8 | 43.3 | 42.9 | 17.7 | 25.3 | 7.0 | 7.9 |
| Semiconductors, other ³ | 2.4 | 2.7 | 1.2 | 1.7 | 22.4 | 26.0 | 6.8 | 7.6 | 5.1 | 5.9 |
| Servos and synchros | 0.8 | 0.8 | 0.2 | 0.2 | 4.5 | 4.9 | 1.7 | 1.8 | 2.1 | 2.4 |
| Switches, manual | 1.5 | 1.8 | 1.3 | 1.4 | 8.5 | 9.0 | 2.3 | 2.4 | 2.2 | 2.4 |
| Transformers, chokes and coils | 6.0 | 6.5 | 3.1 | 3.5 | 22.5 | 25.2 | 11.8 | 12.5 | 9.8 | 11.0 |
| Tubes, receiving | 3.5 | 3.3 | 1.4 | 1.4 | 24.5 | 24.0 | 15.5 | 13.5 | 9.0 | 9.5 |
| Tubes, power | 2.1 | 2.2 | 1.7 | 1.7 | 22.0 | 22.1 | 13.3 | 13.7 | 7.3 | 7.4 |
| Tubes, picture | 10.0 | 13.0 | 2.1 | 4.1 | 36.0 | 46.0 | 26.1 | 28.0 | 27.0 | 31.5 |
| TOTAL CONSUMPTION, components | 68.4 | 77.9 | 42.0 | 50.3 | 454.3 | 498.4 | 194.1 | 215.1 | 125.5 | 143.5 |

NOTE: Estimates in this chart show components consumed at factory prices or at cost.

Some categories include components previously. All estimates were in millions of dollars.

¹Diodes rated 200 milliamps or less.

²Includes both monolithic and discrete.

³Includes diodes rated high.

Electronics'
consensus
forecast

s markets 1970

| Norway | | Spain | | Sweden | | Switzerland | | United Kingdom | | West Germany | | TOTAL | |
|--------|------|-------|------|--------|------|-------------|------|----------------|-------|--------------|-------|---------|---------|
| 1969 | 1970 | 1969 | 1970 | 1969 | 1970 | 1969 | 1970 | 1969 | 1970 | 1969 | 1970 | 1969 | 1970 |
| 1.9 | 1.8 | 4.2 | 4.2 | 2.8 | 3.5 | 3.1 | 3.0 | 7.4 | 7.8 | 47.8 | 54.2 | 104.1 | 114.1 |
| 3.0 | 3.0 | 6.7 | 7.4 | 12.5 | 15.0 | 8.1 | 8.8 | 64.1 | 70.2 | 95.0 | 103.0 | 298.8 | 326.3 |
| 1.5 | 1.8 | 3.5 | 3.7 | 3.2 | 3.5 | 3.8 | 4.9 | 43.5 | 49.0 | 27.8 | 30.6 | 130.1 | 144.5 |
| 0.5 | 0.6 | 0.4 | 0.5 | 0.9 | 1.0 | 1.1 | 1.2 | 9.4 | 10.3 | 4.0 | 4.4 | 23.6 | 26.2 |
| 0.2 | 0.2 | 0.1 | 0.1 | 0.5 | 0.6 | 0.4 | 0.6 | 2.2 | 2.2 | 3.2 | 5.4 | 12.5 | 17.8 |
| 0.9 | 0.9 | 1.5 | 1.5 | 1.5 | 2.0 | 1.5 | 1.8 | 7.0 | 7.5 | 16.8 | 19.5 | 51.3 | 58.6 |
| 0.4 | 0.9 | 0.3 | 0.3 | 0.9 | 1.0 | 0.5 | 0.6 | 6.0 | 6.5 | 14.9 | 16.3 | 31.2 | 34.8 |
| 0.8 | 0.9 | 1.8 | 2.1 | 0.8 | 0.9 | 0.7 | 0.8 | 9.1 | 10.2 | 17.8 | 19.7 | 49.2 | 54.2 |
| 0.8 | 0.8 | 1.8 | 1.9 | 1.7 | 2.2 | 1.8 | 2.0 | 18.0 | 19.7 | 29.0 | 31.4 | 75.3 | 82.7 |
| 1.4 | 1.5 | 2.1 | 2.3 | 3.2 | 3.5 | 1.3 | 1.5 | 7.8 | 8.5 | 13.5 | 15.5 | 58.4 | 64.6 |
| 1.2 | 1.2 | 0.4 | 0.4 | 2.2 | 2.5 | 1.6 | 1.8 | 7.7 | 9.3 | 9.5 | 10.8 | 39.7 | 45.1 |
| 2.6 | 2.6 | 2.5 | 2.7 | 9.5 | 11.0 | 4.2 | 4.4 | 34.6 | 38.5 | 36.8 | 39.0 | 151.6 | 166.4 |
| 1.3 | 1.3 | 1.9 | 2.0 | 4.0 | 3.8 | 3.1 | 3.1 | 27.3 | 28.3 | 37.8 | 38.2 | 121.1 | 122.3 |
| 0.5 | 0.6 | 0.8 | 1.0 | 2.0 | 2.2 | 2.2 | 2.6 | 22.6 | 24.7 | 27.2 | 30.8 | 78.7 | 87.5 |
| 0.8 | 1.3 | 0.2 | 0.5 | 2.0 | 3.4 | 3.1 | 4.2 | 29.4 | 43.8 | 27.0 | 38.7 | 98.2 | 143.9 |
| 3.0 | 3.4 | 3.2 | 4.8 | 8.4 | 9.5 | 5.0 | 5.1 | 55.6 | 57.8 | 64.5 | 72.5 | 216.9 | 239.6 |
| 0.7 | 1.0 | 0.6 | 0.8 | 2.7 | 3.1 | 0.9 | 1.3 | 24.1 | 26.1 | 17.3 | 19.9 | 84.2 | 96.1 |
| 0.1 | 0.1 | 0.2 | 0.2 | 1.2 | 1.3 | 0.3 | 0.4 | 11.5 | 12.0 | 5.4 | 5.4 | 28.0 | 29.5 |
| 1.6 | 1.6 | 0.8 | 0.8 | 2.1 | 2.4 | 1.3 | 1.4 | 14.0 | 15.0 | 21.2 | 22.3 | 56.8 | 60.5 |
| 3.1 | 3.1 | 4.9 | 5.2 | 8.2 | 8.6 | 5.7 | 6.0 | 27.1 | 29.5 | 47.0 | 51.6 | 149.2 | 162.7 |
| 0.5 | 0.5 | 4.8 | 4.8 | 2.2 | 2.0 | 1.7 | 1.8 | 27.1 | 26.2 | 24.2 | 20.6 | 114.4 | 107.6 |
| 0.7 | 0.7 | 2.3 | 2.5 | 3.5 | 3.7 | 2.6 | 2.6 | 40.1 | 41.4 | 31.5 | 36.0 | 127.1 | 134.0 |
| 1.3 | 1.4 | 11.0 | 12.1 | 4.4 | 5.1 | 3.8 | 4.0 | 37.7 | 56.4 | 90.0 | 117.5 | 249.4 | 319.1 |
| 28.8 | 31.2 | 56.0 | 61.8 | 80.4 | 91.8 | 57.8 | 63.9 | 533.3 | 600.9 | 709.2 | 803.3 | 2,349.8 | 2,638.1 |

are based on market data supplied by more than 150 companies, government agencies, and trade associations. The figures
 mption in equipment produced both for domestic and export markets. Participants were asked to value components markets at
 t-insurance-freight in the case of imports.

ed in previous years have been dropped from the survey; do not compare totals on this chart directly with those published pre-
 ere converted to dollars at the exchange rates in effect on Nov. 15, 1969.

s or lower.

nd hybrid integrated circuits.

er than 200 ma, silicon controlled rectifiers, light-emitting devices, etc.

**Electronics'
consensus
forecast**

European

ASSEMBLED EQUIPMENT, factory prices in millions of dollars

| | | Belgium-Luxembourg | | Denmark | |
|--|--|--------------------|--------------|--------------|--------------|
| | | 1969 | 1970 | 1969 | 1970 |
| CONSUMER PRODUCTS | Phonographs and radio combinations | 7.0 | 7.5 | 2.3 | 2.3 |
| | Radios (includes car radios) | 6.5 | 6.5 | 11.0 | 11.0 |
| | Tape recorders (for home use) | 1.2 | 1.3 | 5.9 | 6.1 |
| | Television sets, black and white | 30.0 | 30.0 | 11.3 | 10.0 |
| | Television sets, color | 2.4 | 4.6 | 5.3 | 12.0 |
| | Other consumer products | 4.3 | 4.7 | 2.6 | 2.8 |
| | TOTAL | 51.4 | 54.6 | 38.4 | 44.2 |
| MEDICAL EQUIPMENT | Analytical laboratory equipment | 1.2 | 1.2 | 0.7 | 0.9 |
| | Diathermy equipment (short wave) | 0.2 | 0.2 | * | * |
| | Electrocardiographs and electroencephalographs | 0.5 | 0.6 | 0.3 | 0.3 |
| | X-ray equipment | 4.0 | 4.1 | 1.5 | 1.6 |
| | Other medical electronic equipment (incl. nuclear) | 2.3 | 2.4 | 1.5 | 1.6 |
| | TOTAL | 8.2 | 8.5 | 4.0 | 4.4 |
| COMMUNICATIONS EQUIPMENT | Broadcast equipment | 3.5 | 4.0 | 4.4 | 4.9 |
| | Closed circuit television | 1.0 | 1.1 | 0.5 | 0.6 |
| | Intercoms and sound systems | 4.0 | 4.4 | 2.0 | 2.2 |
| | Microwave relay systems | 2.0 | 2.0 | 3.9 | 4.3 |
| | Navigational aids, air and marine (incl. radar) | 32.0 | 35.0 | 14.0 | 15.6 |
| | Radio communications equipment (except public broadcast) | 4.2 | 4.8 | 6.4 | 7.6 |
| | Telephone switching (electronic) | 0.2 | 0.2 | 0.1 | 0.1 |
| Other communications equipment | 6.6 | 7.2 | 3.3 | 3.6 | |
| TOTAL | 53.5 | 58.7 | 34.6 | 38.9 | |
| COMPUTERS AND RELATED HARDWARE | Analog and hybrid computers | 1.1 | 1.3 | 0.5 | 0.6 |
| | Converters: analog-digital, digital-analog | 0.5 | 0.7 | 0.6 | 0.8 |
| | Data transmission equipment (except links) | 1.4 | 2.7 | 0.9 | 1.1 |
| | Digital computers, business types | 41.0 | 49.2 | 28.0 | 33.5 |
| | Digital computers, scientific types | 3.0 | 3.5 | 2.6 | 3.1 |
| | Memories | 4.4 | 5.2 | 1.2 | 1.4 |
| | Readers and readout devices | 2.2 | 2.6 | 2.3 | 2.7 |
| TOTAL | 53.6 | 65.2 | 36.1 | 43.2 | |
| INDUSTRIAL EQUIPMENT | Industrial X-ray equipment | 0.7 | 0.8 | 0.9 | 1.0 |
| | Infrared equipment | 3.8 | 4.0 | 0.8 | 0.8 |
| | Machine tool controls | 4.6 | 4.9 | 3.7 | 4.2 |
| | Motor controls | 4.5 | 4.8 | 2.2 | 2.5 |
| | Photoelectric devices | 0.2 | 0.3 | 0.3 | 0.3 |
| | Process controls and systems (incl. computers) | 32.0 | 34.7 | 13.8 | 14.8 |
| | Welding equipment | 0.3 | 0.4 | 0.2 | 0.2 |
| | Other production and control equipment | 8.9 | 9.8 | 2.3 | 2.6 |
| TOTAL | 55.0 | 59.7 | 24.2 | 26.4 | |
| TEST AND MEASURING INSTRUMENTS | Amplifiers, laboratory type | 0.2 | 0.2 | 0.1 | 0.1 |
| | Calibrators and standards | 0.6 | 0.7 | 0.2 | 0.2 |
| | Components testers | 1.2 | 1.4 | 0.6 | 0.7 |
| | Counters | 3.0 | 3.2 | 0.3 | 0.4 |
| | Electronic voltmeters and ammeters | 1.7 | 2.0 | 0.5 | 0.6 |
| | Microwave test and measuring instruments | 2.8 | 3.1 | 1.1 | 1.2 |
| | Oscillators | 1.0 | 1.1 | 0.3 | 0.4 |
| | Oscilloscopes | 4.5 | 5.1 | 1.5 | 1.6 |
| | Power supplies, laboratory type | 1.3 | 1.4 | 0.3 | 0.3 |
| | Recorders | 2.4 | 2.9 | 1.1 | 1.2 |
| | Signal generators | 1.5 | 1.5 | 0.5 | 0.6 |
| | Spectrum analyzers | 0.6 | 0.8 | 0.1 | 0.2 |
| | Other test instruments | 5.5 | 5.9 | 1.0 | 1.1 |
| TOTAL | 26.3 | 29.3 | 7.6 | 8.6 | |
| TOTAL CONSUMPTION , assembled equipment | | 248.0 | 276.0 | 144.9 | 165.7 |

NOTE: The consensus forecasts in this chart are based on business conditions and currency exchange rates as of November 1969. Currency parities during 1969 should not be compared directly with those published in previous charts. Also note that the 1970 figures included this year.

*Less than \$75,000.

**Guide to
European
electronics
markets**

| | |
|-----|-----------------|
| 86 | West Germany |
| 89 | United Kingdom |
| 92 | France |
| 94 | Italy |
| 96 | Sweden |
| 98 | The Netherlands |
| 99 | Belgium |
| 100 | Switzerland |
| 102 | Spain |
| 103 | Denmark |
| 103 | Norway |

Could Western Europe's electronics industries weather a cooling off of the overall economy?

● Sooner or later Western Europe's economies will have to slow down a little and cool off. Paced by West Germany the Continental countries have been running at boom speed or close to it. And unless brakes are applied, there's always the chance of a runaway—a wage and price spiral that could lead to inflation.

West Germany already has moved to slow its economy. Last October, the Socialists, in power for the first time in 20 years, revalued the Deutschmark upward by 9.3%. This move by the Bonn government was an overt bid to slow exports, which have been exceptionally high and a major factor in the German boom. France, too, has taken monetary action.

Unlike the Bonn move, the government of Georges Pompidou has devalued the franc. And in a concerted effort to ward off inflation, Paris curbed credit and ordered a cutback in government spending. Britain, whose economy isn't as closely tied to West Germany as the countries on the Continent, continues to move at a more deliberate stride as Harold Wilson's government fights to right its balance of payments.

But despite the moves in Bonn, Paris, and London, Western Europe's economies will go into the new year moving at a fast clip. It will take until midyear 1970, many pundits predict, before the revaluation takes hold in Germany. And the year may run out before any German slowdown is felt in other countries. Although there'll

be concern over prices and labor costs, business figures to be good in Western Europe in 1970.

Electronics markets, then, appear poised for another surge next year. For the 11 countries surveyed by *Electronics* this fall, the consensus forecast is a total market of \$7.82 billion, 12% higher than the \$6.99 billion estimated as this year's market. The figures cover assembled equipment only. There's an additional market segment of \$2.64 billion in the offing next year for components.

There's no surprise that the fastest-growing sector of the market will be data processing equipment. According to the survey, there'll be a 21% spurt in sales during 1970. That will carry the market to \$2.09 billion.

In computers, the big machines and the small ones figure to do best next year. A year ago, market watchers expected a marked swing either to large time-sharing systems or to a proliferation of small machines in 1969. Nothing of the sort has happened. Big computer networks are blossoming, and with them sales of data transmission equipment. But small computers are "selling by the bucketful," says M.A. Chargéraud, president of Diebold Europe, computer consultants.

Consumer electronics market did surprisingly well this year. Color television set sales shot up in West Germany and bordered on the fantastic in Sweden. Running well elsewhere, too, color tv sales totaled \$380 million, about \$60 million higher than was forecast 12 months ago.

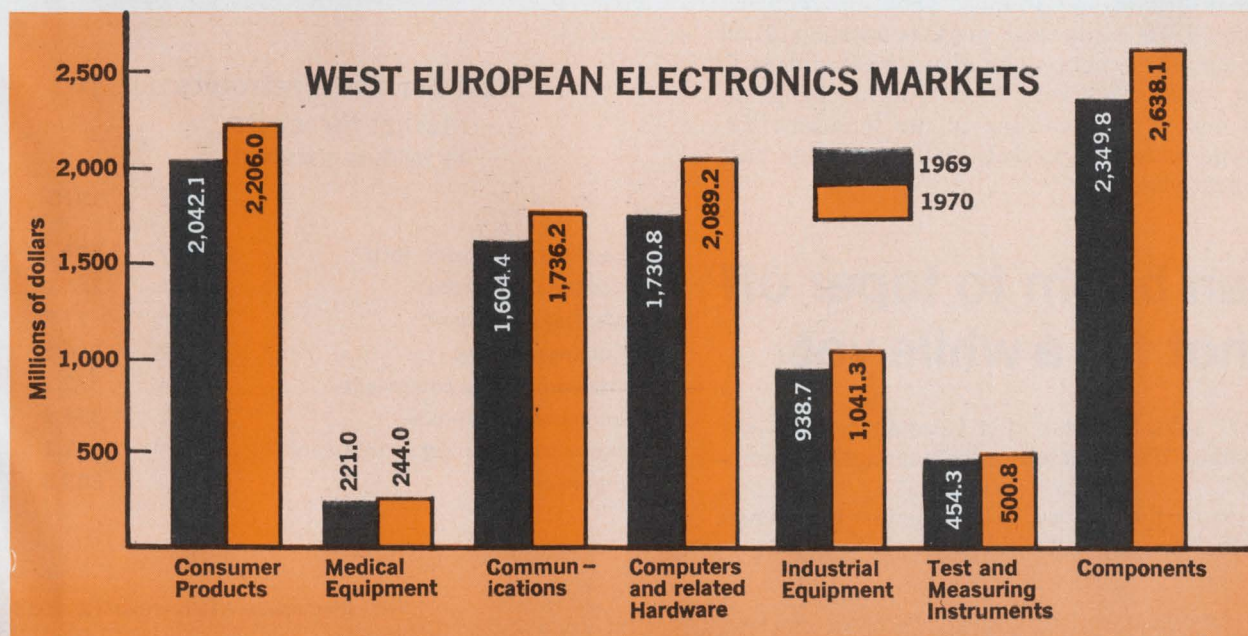

The 1969 figure would have been even higher had not set makers been plagued by parts shortages. (Throughout this report, markets are forecast in factory prices.)

Next year, color tv sales should soar again, to \$588 million, according to the consensus forecast. With that leg up, the consumer market as a whole will register a 10% gain despite a drop in black-and-white tv, still the mainstay of the market. All told, the forecast calls for \$2.20 billion for consumer goods next year. Consumer electronics, then, still ranks as the largest sector, although computers may head the list by 1972.

That's the year that should see big gains for the third big market segment, communications hardware. A spurt is due when electronic switching becomes common. Meanwhile, predicts A.A.H. van Haren, deputy manager of the telecommunications subsidiary of Philips' Gloeilampenfabrieken, "The Western European market will grow between 7% and 10% a year." *Electronics'* forecast bears out van Haren's assessment: the survey pegs the communications market at \$1.74 billion, 9% up from this year's estimated \$1.60 billion.

Components makers figure to be somewhat more edgy next year than their equipment-making brethren. To be sure, there's a good sales hike in sight. The forecast sees a market of \$2.63 billion in 1970, compared with an estimated \$2.35 billion this year. But because there's been a strong buildup in production capacity this year, there may be some softening of prices in 1970. "Components makers will have to do more selling than they're accustomed to," one man at an ITT subsidiary asserts.

Stepped-up selling efforts look like the order of the year for semiconductor makers. It's hard to find one who hasn't bounced up output potential considerably. Look for pressure on prices despite a strong rise in the market to \$558 million from this year's \$477 million.

IC's are going into practically every kind of equipment these days, and *Electronics'* survey predicts a near-5% climb next year in IC sales, carrying them to \$144 million. Sergio Minoretti, international marketing manager for General Instrument Europe, figures MOS will pick up about 5% of the market. Hybrids should capture about 50% and bipolar monolithics the rest.

The boom in West Germany has lifted the country's electronics market into a class by itself. *Electronics'* predicts the German equipment market next year will hit \$2.38 billion. That puts Germany a whopping \$1 billion ahead of Great Britain and France. They are both expected to have 1970 equipment markets totaling \$1.38 billion. Italy lags these nations by about \$500 million.

Among the smaller markets, there'll be a change in the rankings next year, according to the forecasts. Because of a large consumer market, Spain will edge past Switzerland next year.

German boom to taper off —but not for a while yet

"Was ist los?" asks the boss of a German components company, eyeing his dejected sales manager. "Something wrong?"

"I'll say," comes the answer, "Someone just threatened me with another order."

Satellite watching. Control center set up in West Germany for that country's first research satellite Azur reflects growth in the market for communications gear.

The story has been making the rounds in West Germany for some months now and it sizes up the state of its electronics market as well as strings of numbers.

To put it mildly, the West German economy is booming. Plants are running very close to capacity. Even with 1.5 million foreign workers on hand to bolster the native labor force, there are about 750,000 jobs going begging. During 1969, the economy grew an amazing 7.5%, not counting price rises. Counting them, growth was 11%.

It couldn't go on forever. To check the boom before inflation could taint it, Chancellor Willy Brandt revalued the Deutschemark by 9.3% in October. That makes German goods costlier in world markets and foreign goods cheaper in Germany. The brake on exports, which soared by 17% this year, should help slow things down. So should the pressure on profits stemming from revaluation, leaving businessmen with less money to invest.

All told, the growth rate should ease off to 4% in 1970. At least, that's what most economic pundits in Bonn and market analysts in company board rooms around the country think. Says Werner Matschke, director of sales and marketing policy at Siemens AG, Germany's top electronics producer, "The effects of revaluation will be felt especially in those areas where there's been very keen competition."

Wallowing as it is in a heavy backlog of orders, though, the electronics industry will surge ahead much

| | 1969 | 1970 |
|-----------------------------------|----------------|----------------|
| Assembled equipment, total | 2,129.7 | 2,381.2 |
| Consumer products | 694.2 | 751.0 |
| Medical equipment | 70.6 | 77.3 |
| Communications | 473.9 | 514.3 |
| Data-processing equipment | 475.4 | 572.1 |
| Industrial electronics | 299.1 | 334.4 |
| Test and measuring instruments | 116.5 | 132.1 |
| Components | 709.2 | 803.3 |

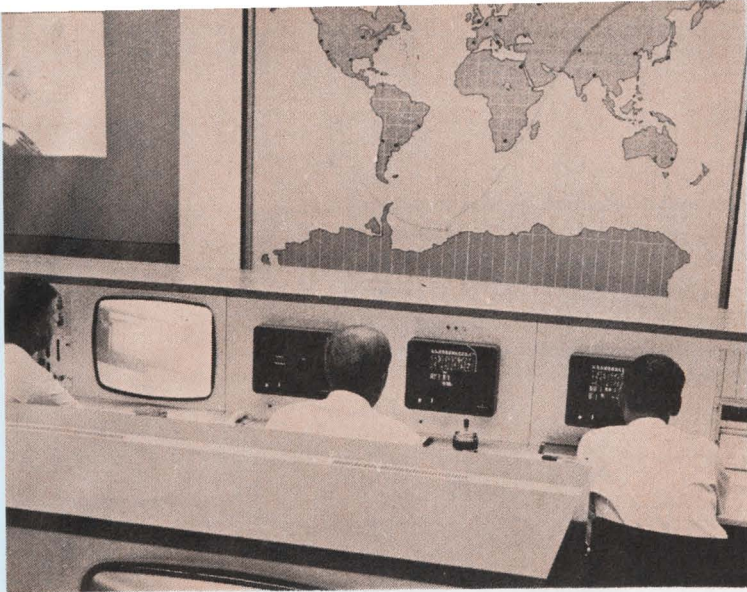

faster than the economy generally. The market in West Germany—not counting components—should jump to \$2.38 billion next year, according to *Electronics*' survey. That's 12% over the estimated \$2.13 billion the market absorbed this year as it ballooned beyond the \$2 billion mark for the first time.

It's hard to find a sector that doesn't seem sure to step out smartly next year. The demand for computers seems insatiable. So does the appetite of West German consumers for color tv sets. The labor shortage is an incentive for industrial electronics. Along with fast-expanding telecommunications networks, communications equipment producers can count on an added lift from the 1972 Olympic Games at Munich. So that the world's tv networks and newspapers can speed the news out from Munich, the government is strengthening communications links with the city.

And when things are going swimmingly for the equipment makers, business has to be good—if not too good—for component producers. *Electronics*' survey puts the rise in West German components consumption for 1970 at 14%, up to \$803 million from \$709 million in 1969. How long orders will remain threats, though, is a question almost everyone is trying to answer. In some cases, delivery delays run as high as 12 months. But few in the industry think the current components shortage will last all the way through 1970.

From Hamburg's Moenckebergstrasse to Munich's Neuhauserstrasse, shoppers will continue to splurge on entertainment electronics next year. Set makers will have to hustle to hold the line on prices—across-the-board hikes of up to 5% are in store—to keep competitive. "Even so," says an official of Grundig Werke GmbH, "we see 1970 as a good-to-very-good-year."

Electronics' survey bears Grundig's man out. The consensus forecast for consumer electronics: \$751 million in factory sales for 1970, a gain of 8% over 1969's estimated \$694 million. Although next year's rise won't be as great as this year's surge of 10%, about all that set makers can really complain about is the rough price competition that looks likely.

Television sets, as they have since the mid 1950's, will be the mainstay of the market. But 1970 nonetheless will mark the start of a new era in television. For the first time in a West European country, color set sales will top black-and-white sales. The survey pegs color sales at \$258 million, monochromes' at \$180 million.

Some market-watchers see a smaller edge for color sets, as Standard Elektrik Lorenz' Johanna von Ronai-Horvath, for example, sees a difference of about \$41 million. But the market landmark, she agrees, will be reached. By 1971, AEG-Telefunken estimates, fully 13% of the permits that viewers in West Germany must buy will be for color-tv instead of just black and white sets. At mid-year, the figure was 2.7%.

As for the number of color tv sets sold next year, everybody's making optimistic forecasts. Kurt Hertenstein, general manager of Deutsche Philips GmbH, predicts that by the end of 1970, there'll be some 1.3 million color sets installed in German homes—550,000 more than at the close of this year. More bullish forecasts come from Standard Elektrik—580,000 sets—and AEG-Telefunken—600,000.

One big reason for the upsurge of domestic sales—between 30% and 40% over 1969—is the steadily increasing amount of color programming, now running some 30 hours a week. "Another factor," says a Frankfurt retailer, "is that color sets aren't as susceptible to adjustments and repairs as many people originally believed. That's helping the trade."

As for monochrome sets, "the slight drop in black-and-white business predicted for this year didn't occur," says Gerhard Grosse, director of Deutsche Philips' television section. In 1970, though, there will be a drop of some 200,000 sets from this year's estimated 1.8 million. Replacements, which make for more than half of all black-and-white sales, will keep the market from plummeting. So will sales of portables, which account for more than 12% of the total tv market.

Turning to receiver chassis, the trend toward integrated circuits will gain momentum next year, although not quite as strongly as some components people would like to see it. With sales soaring, many set makers see no need for innovation for innovation's sake. Most tv houses have turned to IC's mainly to cut production time and labor costs.

The much-touted 110° color picture tube is still some time off. Thus far, only one German tube maker is getting ready to produce it. But some time next year the others will follow suit. Chances are that demonstration sets incorporating the new tube will be introduced toward the end of 1970. In 1971, they will hit the market

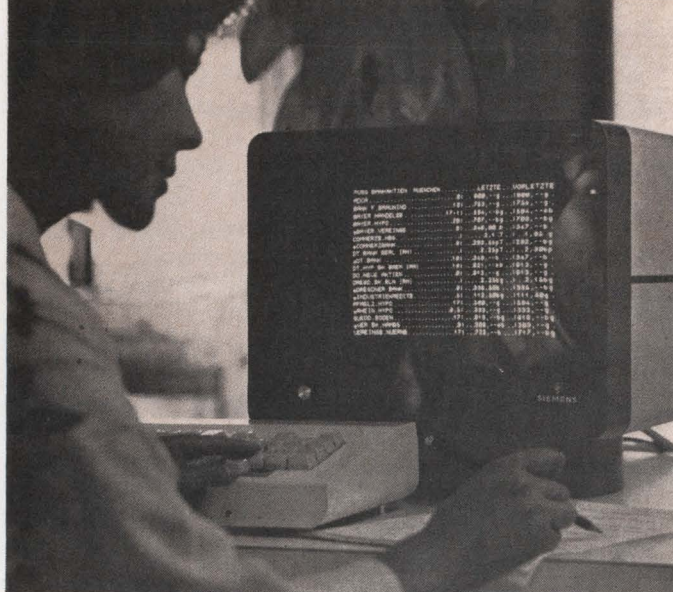

Computer terminal. Instant display of stock market data is just one of many uses that is boosting the sales of remote crt devices. And with the promotion of West German Post Office, data transmission networks are due to mushroom.

in sizable quantities but only as luxury models costing \$80 or so more than regular sets with 90° tubes.

Although it's television—and notably color—that's catching consumers' eyes, audio equipment makers are making themselves heard in the marketplace. To be sure, *Electronics'* forecasts for 1970 show steady sales of \$56 million for phonographs and a \$10 million decline to \$143 million for radios. But there are noteworthy shifts in the product mix. Stereo sets are climbing fast; hi-fi makers may rack up sales gains of 50% next year.

Then there's the "Jugendmarkt"—well-heeled youngsters who'll have collectively some \$6 billion rustling in their billfolds next year. Set makers are angling for this market with low-cost record players and tape recorders. Paced by cassette models, tape recorders should post a good rise from 1969's \$70 million to \$77 million in 1970.

Computer makers on the West German scene next year should be as busy as the barmen in Munich's beer halls during Oktoberfest. Less than 15% of the country's potential market has been tapped; the tone in the data processing field ranges from optimism to euphoria.

The climb rate for the West Germany computer market has averaged 20% yearly. A spurt seems in the offing for 1970. There are now an estimated 5,700 computers, including process-control types, in West Germany. By 1970 their number should increase to 7,500, counting machines installed or firmly ordered.

In *Electronics'* survey, this works out to a market forecast of \$572 million for 1970, compared to an estimated \$475 million this year. The gain, 21%, would seem somewhat low to some, who peg the rise at 25% or slightly higher. Whatever the gain, it will be substantial and will go largely for large machines or small ones.

It doesn't take long to see why. Time sharing, data banks, and the like are coming on fast. What's more, massive data processing networks linking hordes of small companies to large computers are on the way.

One such network, now well along in planning stage, has been proposed by the German Post Office together with Siemens and AEG-Telefunken. For starters, they would install three time-shared computers at major industrial centers. Small- and medium-sized firms would tap the trio over regular post office teletypewriter or phone lines. This first phase of the project could get a go-ahead sometime next year. Later, the network will be expanded into a nationwide complex, interlinking thousands of businesses and agencies.

It's a heady prospect for West Germany's top-ranking electronics firms—Siemens the computer supplier and AEG-Telefunken the terminal equipment maker. In anticipation of this burgeoning market, Siemens has readied a new computer model, the 4004/46. It is specially tailored for time-sharing both in hardware and software. With a ticket between \$1.36 million and \$1.9 million, the new machine is very competitive, Siemens says. Like other companies, Siemens is expected to show up next year with models considerably larger than the firm's present top-of-the-line computer.

Good things are coming in small packages, too, for computer companies in West Germany. Systems renting for between \$1,200 and \$5,000 a month look like the fastest-growing segment of the market.

And companies are scrambling to get in on the action. IBM, for example, will put a card-based version of its System/3 on the market in the spring, renting for between \$1,250 and \$1,670 a month. About a year later, there will be a disk version renting from \$1,920 to \$3,680 a month. For its System/3, IBM sees a big market potential with small and medium sized businesses such as hotels, branch banks, wholesale outfits, and insurance houses—organizations employing 50 to 200 people.

Still another contender on the German small-computer market is Bull-General Electric. Next September, Bull-GE

will start offering its GE 58, a direct input computer with monthly rentals of between \$1,700 and \$2,350, depending on card reader and printer speeds. The people at Bull say that by 1975, there could be a market for 50,000 small computers like its new entry.

To keep up with the demand, both German and foreign computer manufacturers are bettering their sales and production arms. Probably the most ambitious plan is Siemens'. The firm now is considering a new data-processing research and production facility near Munich that would cost "several hundred million marks" for the buildings alone. The project may get under way by the end of next year. Once completed, the new facility would house 15,000 workers and engineers.

Communications hardware makers can almost match the optimism that prevails among West Germany's computer people. *Electronics'* survey turned up a market of \$514 million for 1970, up from an estimated \$474 million this year. That's a record level.

As usual, it's the Post Office that will provide the main thrust. It runs the country's communications lines and has a massive investment program—an outlay of more than \$7 billion over the five-year span running through 1973. During this time, tv transmission networks will be expanded so that about 95% of West German tv subscribers will be able to get the country's second national program and 92% to get the regionally-broadcast third program.

At the same time, the Post Office is looking toward 12-gigahertz tv transmission. This is part of an effort to make more frequencies available for an additional four to five programs in large population centers. Already, post office engineers are conducting 12-Ghz transmission experiments in West Berlin. A trial system might get under way in the Ruhr area at the end of 1970.

Another major project will give Germany a third terminal for satellite communications. Now that the Raisting 2 station is ready for Intelsat 4, the Post Office is planning Raisting 3, which will serve as a backup.

For more down-to-earth communications, the Post Office is pushing the conversion of existing equipment from tubes to semiconductors. Then there's pulse-code modulation. The agency is negotiating with equipment makers for more than 50 32-channel lines, each with several repeaters and two complete terminals. The business will go to AEG-Telefunken, Siemens, Standard Elektrik and TeKaDe-FCF. With this first big order, pcm in Germany will be off and running.

Also scheduled to be off and running at Munich in 1972 are the world's best athletes. And manufacturers already are gearing up to supply the communications links for world-wide transmissions of the Olympics.

Most impressive of the Olympics electronics will be the world's largest shortwave radio installation. It's for the Deutsche Welle, the German equivalent to the Voice of America. The \$44 million installation, in Bavaria, will comprise 12 transmitters, of 500 watts apiece.

Component makers will have it doubly good next year. Their traditional customers—the electronics equipment makers—will keep on buying heavily next year. Their untraditional customers—like the auto makers—will add a further fillip to component sales. All told, the West German component market, according to *Electronics'* survey, will zoom up 13% in 1970 to push past the \$800 million mark.

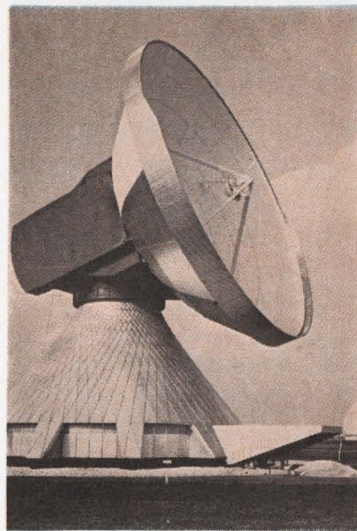

Eye on the sky. Raisting 2 satellite ground station is now ready to link West Germany with Intelsat 4. Communications needs are growing so fast, though, that Raisting 3 is already being planned.

Beyond 1970, the untraditional sectors will become more and more of a factor. "Automotive electronics," says Joachim Prange of Siemens' market research department "will eventually account for the same amount of components as does entertainment electronics today." He figures that could well be the case by the time another decade rolls by.

Other experts think that West German automobile makers next year will triple their electronics component purchase. In 1969, the value of components sales to auto makers ran around \$11 million. From 1971 onward, a growth rate of 30% annually looks likely to market researchers.

The established semiconductor producers, too, are readying to tap the fast-growing market. All the major producers have added new production facilities this year or plan to next year.

Siemens, for example, is adding a six-story building to its main semiconductor complex at Munich; the addition is for IC's only. AEG-Telefunken, the Philips' subsidiary Valvo GmbH, and Intermetall of the ITT group of companies are expanding their lines. Texas Instruments opened its second plant in Germany this summer, SGS Deutschland GmbH its first. Fairchild Semiconductor, formerly a partner with the Italian interests that now wholly own SGS Deutschlands's parent company Societa Generale Semiconduttori, is building a plant at Weisbaden and will start producing next year. The plant won't be fully on stream, though, until 1972.

Computers and color tv brighten British picture

Like a cross-country runner who has mustered his second wind after dropping back from the pack, Britain's economy seems to have found a pace suiting its need.

While other European countries find themselves striding fast in the wake of front-running West Germany, Britain is jogging along at a real growth rate of less than 3% yearly.

This slow growth is the aftermath of the stiff austerity measures—restrictions on credit, cutbacks in government spending, and the like—put into force by Prime Minister Harold Wilson's government three years ago.

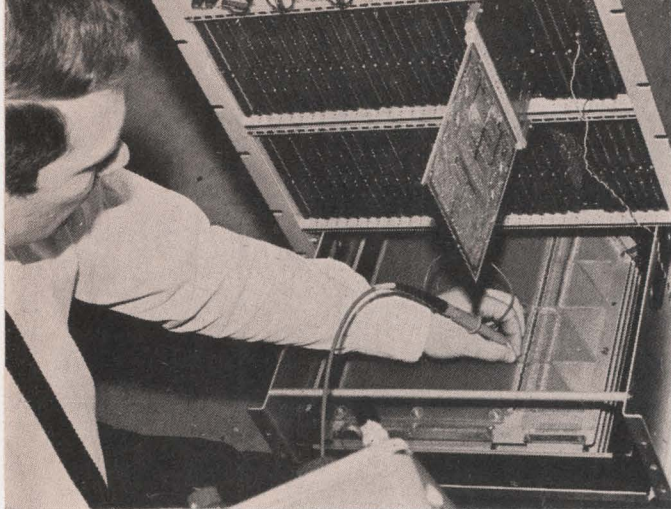

Minding the store. Plessey Ltd. livens up the brisk British computer market with plated-wire memories.

The idea was to right the country's long-standing deficit in its balance of payments, and the present targets include a rise in consumer spending of only 1% yearly. Consumer spending, particularly, generates heavy imports. Another main target is to hold fixed investment growth to 6% and thereby help keep the economy cool.

You can't say the economy's right on target; but this year it's close enough to make the pundits confident that Britain's current international account will show a surplus at the end of the fiscal year next March.

That's a welcome change after six straight years of deficits. And Chancellor of the Exchequer Roy Jenkins has made it clear that he's not going to risk reversion to the bad old days by easing up on the austerity measures. Britain, then, is in for another year of measured growth in 1970. As a result, her electronics market won't have the across-the-board lilt that's expected in other countries. *Electronics'* consensus forecast puts the 1970 British market for assembled equipment at \$1.38 billion, up a respectable 11% over an estimated \$1.24 billion for 1969. Most of the growth, however, will be concentrated in two sectors: computers and color television. Elsewhere, British equipment makers have to count on export markets if they want to make impressive gains in sales.

And anyone who wants to make impressive gains in consumer electronics had better be in the color-tv

business. *Electronics'* survey shows an entertainment market for 1970 of \$326 million, a rise of \$30 million over the estimated \$296 million market this year. The impact of color tv sales on the figures is this: next year they should run \$88 million, according to the survey. That's a hefty \$38 million higher than this year's sales.

While some people in the industry will find the survey figure low, most observers peg color-set sales for next year at between 250,000 and 300,000 units. The disagreement centers on the fact that British viewers since mid-November have had some 100 hours weekly of colorcasts beamed at them on three channels. Before, the ration was 35 hours weekly on a single channel and the highbrow channel at that. The added programming may carry the market up to 350,000 sets next year, thinks Brian Reilly. He runs the subsidiary that produces home-entertainment products for the largest electrical-electronics group in Britain—General Electric-English Electric (GEC-EE).

Color tv will set the pace in technology, too, for entertainment electronics. Development engineers want less heat in color receivers, and there will be a continuing trend to more solid state content in the tube-semiconductor designs that currently dominate the market. Going all the way with solid state next year, however, will be Rank-Bush-Murphy Ltd. It thereby will join Thorn Electrical Industries Ltd. in a very exclusive club; Thorn put the first and so far the only British all-solid-state set on the market 2½ years ago.

Rank-Bush-Murphy also may add a third integrated circuit—a decoder—to the two it already uses in its sets, a color demodulator and a sound intercarrier stage. This is good news to Mullard Ltd., and the Plessey Co., a subsidiary of Philips' Gloeilampenfabrieken, both of whom are trying to convince set makers to adopt a wide range of IC's.

As for picture tubes, the 22-inch size will push ahead at the expense of 19-inch and 25-inch sizes according to Tom Jacobs, technical-commercial manager of Mullard's Consumer Electronics division. "From the set buyer's view," he says, "it's a good compromise. The 19-inch size is often smaller than he's used to, while the 25-inch set is too bulky for his living room." Mullard currently supplies about half the color tubes used in British sets.

Another trend that could come on strong with set makers next year is varicap tuning. Although they are old hat to West Germany's set makers, varicap tuners are still rare in Britain largely because manufacturers feel they're not reliable enough. Mullard, though, believes that selective assembly can produce triple and quadruplet arrays of varicap diodes (for three- or four-channel tuners) matched well enough for good tracking. Mullard aims to start producing the arrays in quantity next year.

Even the slow-growing economy can't check the onrush of data processing in Britain. There's another leap forward of 20% in sight for 1970. According to *Electronics'* survey, the market for computers and related equipment will surge from this year's estimated \$366 million to \$435 million next year.

As in the United States, small systems selling for \$25,000 or less will mark an especially strong rise. Steve Foster, sales manager of the British subsidiary of Honeywell's Computer Control division, expects a

spurt of 30% in the U.K. market for small machines destined for process-control and scientific uses. Foster pegs the market next year at \$30 million, well above the survey estimate.

Among the benefactors of the spurt in small scientific computers, the Digital Equipment Corp. will remain out front. But it's very much a buyers' market. Vying for sales along with Digital Equipment are other U.S. outfits like Hewlett-Packard, Honeywell, Varian and IBM. Then there's the native competition, companies like Digico Ltd., Computer Technology Ltd., and Marconi-Elliott Computer Systems of the GEC-EE group. As if all these weren't enough, there's a mushrooming band of small, new companies questing for small-computer business. Generally, they're banking on "bespoke" designs built around medium-scale-integration transistor-transistor logic and fast 1,000-bit ferrite core memories, now available in Britain at reasonable prices.

Another lot of computer hardware that's sure to succeed handsomely next year is terminal equipment. Ken Barge, managing director of Computer Sciences International Ltd., in fact sees "a big explosion in the use of peripherals in offices, laboratories, warehouses, hospitals, universities, and even schools."

Much of the bang will come from time-sharing both in service bureaus and private computer networks. Spending for data-transmission equipment, *Electronics'* survey predicts, will soar from \$19 million this year to \$28 million next. Readout equipment will also show a strong rise—to \$18 million, \$3 million up from 1969.

As for computers generally, it's the smaller systems that figure to dart ahead fastest in timesharing. Data-processing market watchers in the U.K. says that systems that offer engineers, accountants, and the like limited but fast calculating facilities using standard programs on small machines will do better than time-sharing networks where clients run complex programs on big computers. Computer-aided design, though, seems destined for a spurt. Lou Cunningham, marketing manager of Marconi-Elliott Computer Systems, expects CAD, though small at the moment, will grow by more than 50% in 1970.

For avionics producers the situation is normal—enough to do for a year or so and after that a domestic market that could be almost anything.

At the moment, the bread-and-butter programs include fitting out 90 Hawker-Siddeley Harriers, the Royal Air Force's vertical takeoff and landing (VTOL) strike fighter. The two other major military aircraft in production are a batch of 38 Nimrod maritime patrol planes (nautical versions of the Comet passenger jet) and a run of 200 Jaguar fighter-trainers, a plane developed jointly with the French. Then there are helicopter electronics and the avionics for current passenger jets, notably Hawker-Siddeley's 125 and Trident, and the British Aircraft Corp.'s BAC 1-11.

All told, according to *Electronics'* market survey, the business for navigational aids and radar in Britain will total \$162 million in 1970, up from \$155 million this year. One big reason for such little growth: radar. Both the civil and military air traffic control networks have been fitted out with their primary and secondary radar equipment. During 1970, the emphasis at the ATC nets will be on displays and on data handling. At the big ATC center in West Drayton, Marconi's very

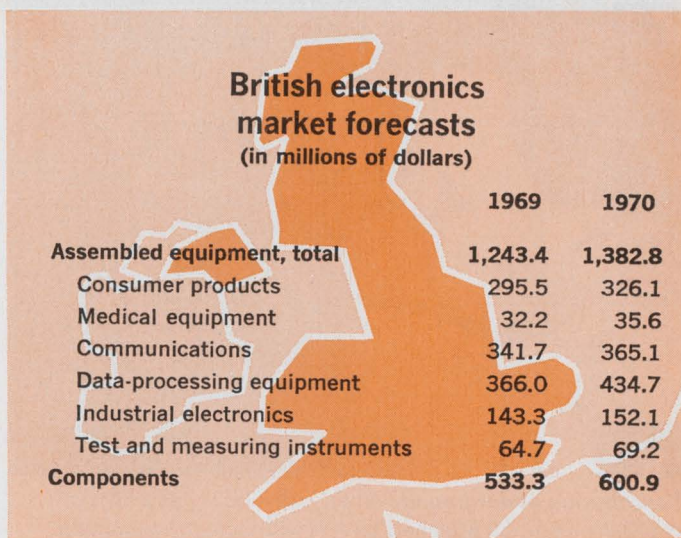

fast touchwire data input controls will go into service. At some smaller airports, the company's direct-view storage tubes will get their first operational trials in full daylight. Marconi is one of the companies in the GEC-EE group of companies.

After 1970, there is some chance that the avionics market could go into a reasonably steep climb. But that depends on how fast the British-French Concorde supersonic transport gets into production and how the tri-national multirole combat aircraft (MRCA) fares. Still another program that would mean new business for U.K. avionics makers is the BAC 3-11 "Junior Airbus." BAC hopes to get government backing for the plane now that Britain has pulled out of the European A300 airbus scheme.

For MRCA, Britain has joined with Germany and Italy in what might be the dominant European aircraft program of the 1970's. If it does come to pass, MRCA almost surely will carry forward the trend to digital processing of signals in military aircraft.

As with avionics next year, so with communications by and large. The survey sets the market at \$365 million for 1970, a rise of 7% over the estimated \$342 million this year.

There will be little growth in satellite ground stations; for the moment, Britain has just about what she needs. Radio communications equipment makers have essentially a replacement market at home although there's some zing in land mobile. The stimulant: car-radio-sized sets that are extending the lower end of the market to within reach of new buyers.

Then there's tv broadcast equipment, going strong as you would imagine. The planned shift to color on all three networks and to uhf transmission universally will keep the transmitter market at high levels for several years. *Electronics'* forecast puts it at \$24 million for 1970.

All in all, some 60 main transmitters will be needed plus perhaps 400 relay transmitters. Right now, seven main stations are operating. Eight more, plus a dozen relay stations will be added during 1970.

Industrial electronics producers can't expect much more of a flicker than they're getting now from two of their main customers for big systems: the steel makers and the utilities. But increasing sales to chemical producers may lift controls sales in 1970 up a few percentage points over 1969.

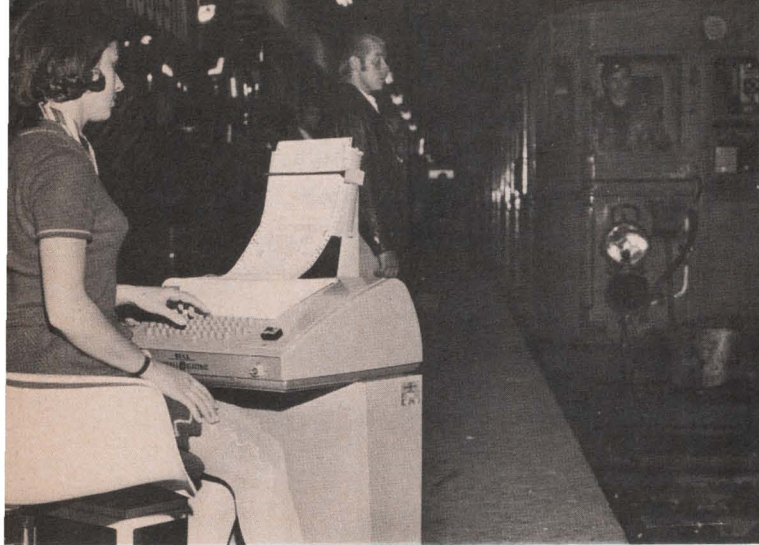

Time-sharing underground. While ballyhooing new cars in the Metro, Renault matched buyers with autos by computer.

There seems to be a glimmer of hope, though, in automation of services. The biggest order in the works is a \$7 million system to control freight handling at London Airport. Software development has been underway for six months at Computer Sciences International Ltd. and the scheme should be ready to go into service by mid-1971. The computers: a pair of International Computer Ltd. System 4-72 models.

Judging by the spate of new products introduced by U.K. companies, the instrument business would seem to be leaping ahead. However, this would be overstating the case. *Electronics'* survey shows a modest 6% rise in sales of test and measuring instruments as the prospect for 1970. That would carry the market to \$69 million.

The strongest sector in instruments seems to be special-purpose gear. When customers are watching their pennies—as most now are—they tend to save their money for specials, and they become very finicky when they must buy general-purpose instruments. At any rate, that's what David Hall thinks, and he's sales manager for the Solartron Electronics group, a Schlumberger Ltd. subsidiary that's big in British instruments.

The components markets is moving ahead faster than the domestic market. One reason: makers are finding some good new customers like the auto makers and the appliance makers. This year, autos used about \$4.3 million worth of electronics devices (not counting radios). Next year, the figure should spurt to about \$6 million. Thyristors, now rare in domestic appliances, will become fairly common starting in 1970. And there's a boom in intruder alarms that may add about 1,000 Gunn diodes weekly to the semiconductor market.

How does a 13% rise sound for components? That's what *Electronics'* consensus forecast shows, \$600 million for 1970 compared to \$533 million this year.

The most conspicuous action, of course, is in integrated circuits. And the keynote for 1970 will be consolidating production rather than accenting new technology. Skirmishing on prices may develop, especially in TTL, which accounts for about 40% of the market. Brian Down, IC sales manager for Ferranti Ltd., believes the U.K. market will absorb 75% more IC packages next year than this. But because of tumbling prices, he sees a market gain of 33½% in value, to \$40 million. *Electronics'* forecast, however, puts the market rise to \$43.8 million next year from this year's \$29.4 million.

France's belt tightening keeps industry in a bind

Eight months have passed since Charles de Gaulle turned control of the Fifth Republic over to ordinary mortals. And far from being swept away by the deluge that's supposed to follow the departure of great men, his successors are busily mopping up the remaining pools of Gaullist economic grandeur.

De Gaulle himself was forced to set up some flood gates last year when the inflation that followed the May riots threatened the franc and the horde of gold he had piled up during his reign. His successors have gone much further. For a start, the government of President Georges Pompidou devalued the franc—anathema to de Gaulle but welcomed by most French businessmen. Then the Pompidou regime checked government spending, lifted the basic interest rate to a record 8%, and pinched consumer credit.

All these moves are intended to ward off inflation. The government is fighting to keep price rises in 1970 to a reasonable 3.9%, versus a jump, this year of 6%.

And it's fighting hard. Total government spending next year will rise by only 6.2% to \$28.5 billion, not much compared with this year's steep 16.7% rise. Spending on new equipment, in fact, will fall by 7.4%. Moreover, the government is blocking part of the equipment credits—some \$400 million—in a special fund that will be opened only when the economy begins to cool off. The fund already contains nearly \$1 billion from this year's budget. Though such credit-blocking bothers some businessmen, "I'd rather have the money in the fund than not have it exist at all," says an official of the French electronics trade association.

As for government spending on electronics, 1970 thus far shapes up as the year of "la vache maigre," comments Edouard Guignon, commercial director of Thomson-CSF, France's ranking electronics producer. And when the cow is skinny, there's no fatted calf in the offing. To be sure, there's a bounding market in computers. And entertainment electronics could log a solid year. But all in all, most electronics executives agree with Thomson-CSF president André Danzin, who sees 1970 as a year of modest expansion.

Electronics' survey points to a market of \$1.38 billion next year, an adequate gain over the estimated \$1.23 billion market in 1969. The rise—12%—looks good at first glance. But it dims a little when you remember that a significant part of the apparent increase is accounted for by price inflation. There's even less luster when you realize that the expansion target set by government-industry planners for the four-year stretch from 1968 to 1971 is 16% a year.

Since France is just another parcel of Western Europe as far as computer sales go, the fastest-growing sector in electronics will be computers.

Diebold-France, a consulting firm specializing in computer applications, expects this year's 25% computer growth to hold next year. So does *Electronics'* consensus forecast. It puts the market at \$408 million for 1970, up from \$328 million this year.

The best sellers will be at the two extremes of the hardware mix, with small machines often being sold as

French electronics market forecasts
(in millions of dollars)

| | 1969 | 1970 |
|-----------------------------------|----------------|----------------|
| Assembled equipment, total | 1,229.4 | 1,384.9 |
| Consumer products | 310.7 | 338.4 |
| Medical equipment | 34.6 | 37.3 |
| Communications | 339.4 | 362.9 |
| Data-processing equipment | 328.4 | 408.4 |
| Industrial electronics | 132.0 | 146.3 |
| Test and measuring instruments | 84.3 | 91.6 |
| Components | 454.3 | 498.4 |

remote terminals for big ones. Remote data processing is in its infancy in France, with less than 1,000 terminals now in use in private systems and the five commercial time-sharing networks that are getting under way. Diebold predicts that up to 24,000 terminals will be in service by 1975, a far cry from the 500,000 level it expects then in the U.S. but a substantial new market nonetheless.

Remote computer-run services also are growing. One French firm, Compagnie Internationale de Téléinformatique, plans to launch a trans-Europe hotel reservation network during 1970. Others are laying plans for a "rental bank" to aid frustrated Parisians caught up in the apartment-hunting free-for-all and to handle vacation villas as well.

The French should buy some \$5 million worth of electronic desk calculators next year. That's a gain of more than 30% from this year's purchases, says Martin Birnbaum, director of Schneider Radio-Télévision's professional electronics division. Schneider this fall introduced the first French desk top unit. France has been a slow market for electronic calculators, says Birnbaum, but he expects sales to surge now because of falling prices. Schneider's four-operation, 16-digit machine sells under \$600, competitive with electro-mechanical units.

French purchases of industrial process control equipment should boom next year, with machine-tool control devices a standout. The number of electronically controlled machine tools in French factories, now only 650 versus 1,500 in Germany and 14,000 in the U.S., should rise by at least 50% during 1970, predicts Gilbert Wolff, marketing director of La Télémécanique, a maker of small machine-tool computers. The value of the electronics in next year's systems should be about \$5 million, he adds. The aircraft industry, tooling up for production of several commercial aircraft, should be a major customer next year and an even bigger one in 1971, he says. Auto firms also should be important clients.

And automation should begin penetrating some of the more mundane areas of French life next year. Traffic snarls, for one thing, increasingly will be sorted out by computers. Electronique Marcel Dassault (EMD) has installed such a system on the Burgundy section of the Paris-to-the-Riviera freeway, due to open this month. Next year, French engineers expect, electronic "policemen" will spread to the country's clogged cities. Grenoble now has a system, and Marseille, Toulouse, Saint-Etienne

electronic firms had hoped would mean business in micro-and others are studying them. The French National Railways is looking into a computer-based train traffic control system, developed by Compagnie Générale d'Electricité (CGE).

In recent years one-third of France's professional electronics output has gone to the nation's aerospace industry, but this sector appears due for a slowdown in 1970. On the civil aviation side, France has several aircraft in development, notably the Anglo-French Concorde supersonic airliner, the Franco-German A300 airbus, and the shorthaul Mercure jet being developed by Avions Marcel Dassault with 56% financing by the French government. But production will start on none of these before 1971—though avionics firms will be doing some hard talking next year to win a share of these potentially lucrative markets.

Space programs will be squeezed by a tight government budget. France's space agency, the Centre National d'Etudes Spatiales (CNES), will get only \$85 million for 1970, a drop of \$11 million from this year's budget. CNES hasn't yet decided precisely where to make the cuts, though they may come in ground station equipment and in cutbacks of high-altitude sounding rocket launchings. Symphonie, the Franco-German communications satellite project, is considered sacred.

CNES will nonetheless pass out a few big orders next year. EMD and CGE are the remaining competitors for a comfortable contract to supply the electronic nacelles for nearly 500 weather balloons the French will launch around the world starting next December, in conjunction with a satellite that will interrogate each balloon on weather conditions in its area. CNES also may call for bids next year on the proposed Franco-American "Meteosat" project for a weather satellite in connection with the world weather watch that could go up in late 1973.

Military spending will mark time. Budgets will stay about the same as this year with equipment spending expected to decline a bit. Virtually no major new programs of interest to the electronics industry will be launched, and so French military electronics firms are looking to the export market. For example, Télécommunications Radioélectriques et Téléphoniques (TRT), one of the N.V. Philips' Gloeilampenfabrieken subsidiaries in France, expects to sell some \$5 million worth of radio altimeters to the German army next year and sees its foreign military volume doubling to a hefty \$20 million. "Devaluation helps a lot," comments Georges Boudeville, TRT vice president.

About the only government market where electronics firms can take heart is telecommunications. In a crash effort to "normalize" France's overloaded telephone system by 1973, the government is increasing the budget of the state-run network next year by 18%, to \$500 million. In addition, a private telephone financing company is being set up; it's expected to contribute another \$100 million during the year. Up to \$130 million of this total is expected to go for electronics, the bulk of it for multiplex equipment, electronic switchboards, and microwave relays. Telephone officials say an increasing amount of their new equipment will be electronic rather than electro-mechanical in coming years. Several French firms are working on electronic telephone instruments, which they predict will come into wide use starting in 1975.

France's proposed third television network, which some

wave and studio equipment—plus a fillip for color tv sales this year—has been put off until 1971. Some orders, though, could be placed toward the end of 1970.

Devaluation indirectly helped the consumer market. Consumers went on a shopping spree early this year, largely in anticipation of an upcoming devaluation. Then they repeated the spree in the fall just after devaluation, buying before prices could rise.

Lately, there's been some slowdown in consumer spending, thanks in part to the Pompidou government's deflationary measures. A car buyer in France these days, for example, must pay half the price in cash, compared to only 35% before the latest round of credit restrictions.

Luckily for television set makers, credit regulations on consumer electronics products weren't tightened as part of the deflation package. And so far the government's "buy later" campaign doesn't have set makers terribly worried. Few firms think that the Frenchman in the boulevard will pay much heed to Pompidou's call to save rather than spend. Says one company official, "We've gotten used to the idea we should live like Americans and we're not going to change."

Some set makers, in fact, are more concerned about components shortages than possible customer shortages. Indeed, Thomas-Brandt, the parent company of Thomson-CSF, has had to turn down dealers' orders for color tv sets. Jacques Fayard, head of the company's consumer products division, says this year's color tv market of 110,000 sets might have been 25% higher had there been more sets available.

Like most watchers of French consumer electronics markets, Fayard thinks color set sales will double to reach a level of 220,000 units. In *Electronics*' survey, the forecast is \$92 million for 1970, up from \$48 million.

The rise in color set sales will keep the consumer market from stagnating. But Fayard figures it will be another four years or so before France reaches the 50-50 market split in color-tv units that now exists in the U.S. He expects black-and-white sales to slide off to 1.2 million sets next year from this year's estimated 1.45 million.

Hi-fi equipment and tape recorders should sell reasonably well next year. And there should be a big jump in car radio sales—to 700,000 sets from the 450,000 sold this year, Fayard predicts—due to expanding car ownership and lower radio prices—car radios can be had in France for as little as \$20.

Components makers, of course, face the prospect—mostly happy—of continued shortages for their wares during the next few months at least. There's little doubt that the 1970 components market in France will move ahead at something like the 1969 growth rate of 9%. The consensus forecast, in fact, predicts a market of \$496 million next year, compared with \$452 million last year.

Whatever slowdown will reflect back to components makers from the government's franc-pinching will be more than made up by new markets—particularly in the auto industry.

"The auto industry is becoming a bigger customer for electronic components than the radio-tv industry," moans Birnbaum of Schneider, who fears such new customers will compete for components with traditional electronics sectors, intensifying the shortages which in 1969 forced Schneider to stretch out its normal two-week delivery time for electronic measuring instruments to six weeks and more.

Consumer electronics falls into Italy's limbo

Anyone caught up in the massed Fiats that glut the streets of Milan and Rome during rush hours might wonder how anything in Italy could be going anywhere. Actually, the Fiats are there because the country's economy is proceeding upward, nicely.

To be sure, there's been some heels dragging at the rear of the industrial procession and some squabbling among the politicians up front. Readying for year-end contract talks, Italian unions waged an off-and-on campaign of sporadic strikes this fall. They cost the economy some 250 million man-hours, say the unions, and a couple of percentage points of real growth in gross national product, say the government's economists. But even with the setback, the Italians this year will log a true economic expansion close to 4.5% and that's not bad.

Unless the strikes drag on after the first of the year, 1970 will find the economy hustling ahead at a real growth rate of better than 6%. For when it's boom time in neighboring Germany, it's going to be boom time in Italy. And even if there's a lull in Germany toward the middle of 1970 all should go well in Italy for the next 12 months. "We lag the German market by six months," says Sergio Minoretti, international marketing manager for General Instrument Europe SpA.

The Italian electronics market also lags the German market in percentage growth—but just barely, according to *Electronics*' consensus forecast. It puts the electronics equipment market for 1970 at \$782 million, a gain of 11% from this year's estimated \$705 million. The German market, remember, figures to show a 12% rise next year. But the Germans have a booming consumer-electronics market while the Italians still are fretting over a stagnant consumer market, waiting for color television to bestow its blessings upon them, probably in 1971.

There's no fretting, and it's no wonder, among computer makers. In Italy as in the rest of Europe, data-processing hardware sales are bounding at a dumbfounding rate. *Electronics*' survey sees a rise to \$260 million next year from \$218 million this year.

The rise—21%—will seem on the low side to many. All sorts of evidence can be trotted out to back a forecast of

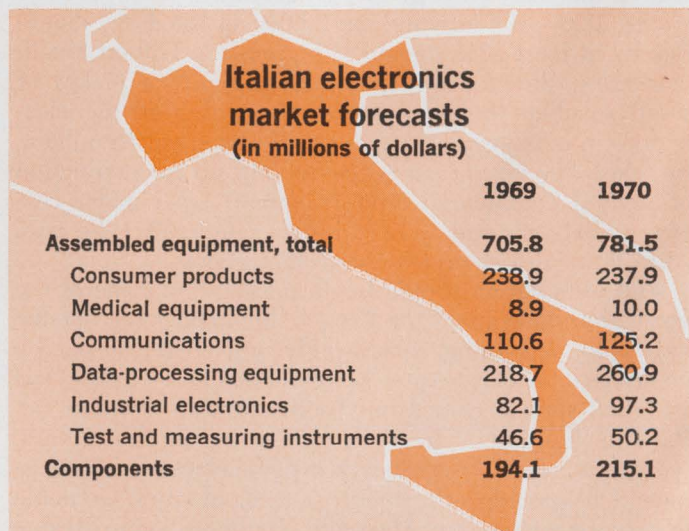

a 25% gain or even more. Yet 21% is considered to be a reasonable estimate, on balance.

A study released last month by the Cassa di Risparmio, a big Italian bank, estimates that there were 2,300 computers of all types installed or on order in Italy in October of this year. Manufacturing industries claim some 47%, banks and insurance companies about 20%, and government agencies 17%. No other sector has even 5%.

These figures, some computer men say, show that Italy is ready to move out of the first phase of "computerization). The large banks and industrial heavyweights have been sold on data processing, the reasoning goes, and now computer makers are aiming at the much bigger market of medium-size companies. "We've overcome the management barrier," says an executive of Honeywell Inc.'s Italian subsidiary.

Even the bureaucrats have been helping break down the barrier. Milan city officials have mounted an effort to convince their people that computers won't cost civil servants their jobs. What's more, there's a training program open for city employees who want to upgrade themselves to programmers. Shortage of programmers, in fact, is one of the few brakes on the market's growth.

Among data-processing hardware, two items seem certain to make exceptional gains next year. One is desk calculators, the other terminal equipment.

Desk calculator output next year should double in Western Europe and perhaps triple in Italy. Both Ing. C. Olivetti & Cie and Industria Macchine Elettroniche (IME), a subsidiary of the big Montecatini-Edison group, have geared up for heavy production. They and smaller Italian companies should turn out some 70,000 four-operation calculators next year. To better gauge the leap forward, here's the estimated 1969 output of desk calculators: 90,000 for all of Western Europe.

As for terminal equipment, it should do exceptionally well next year too. *Electronics'* survey shows a 60% rise to \$4.3 million in 1970 for data transmission equipment. There's added terminal equipment in the digital computer figure, since computers used as satellites of big machines are lumped in the computer category.

One such computer is the GP-16 of Selenia SpA. Maurizio Mosca, of Selenia's automation division, sees the third-generation computer as a "batch terminal" in large systems as well as a small general-purpose independent unit for process-control. Because the squabble over who would pocket data-transmission revenues was settled last

year between the Ministry of Posts and Telegraphs and the government-controlled phone company, Mosca expects terminal equipment sales will soar in 1970—close to double this year's total.

Also in for a good gain of 30% to 40% next year is automation equipment, according to Mosca. Not all the gain will accrue to computer-based systems. Italy is now at the dividing line, Mosca says, between hardwired process-control logic and computer control. Next year, he feels a strong transition toward computer control should begin.

Others in the industry would dispute this feeling. They are convinced that computer makers pushed process-control applications too hard at the outset and sold systems that manufacturers couldn't cope with. That's one explanation, they say, for the much faster growth of business machines than of process-control.

Computer sales are booming, communications-equipment makers see steady growth ahead, industrial equipment is faring well. All in all, then, components makers have to have a good year in 1970 even though entertainment electronics will mark time. *Electronics'* survey shows a components market of \$215 million in Italy during 1970, up 11% from this year's \$194 million.

There's no question about a spurt in semiconductors. The forecast shows a dramatic rise, a sales jump of more than 40% next year to just under \$48 million.

Integrated circuits, according to the consensus forecast, should about double to \$11.6 million. But there are optimists who are convinced that sales will triple in 1970. They point out that General Electric builds some 3,000 computers a year in Italy and that IBM is knocking out its 360/20 models on an assembly-line basis at a plant near Milan. Further, IBM will build its new System/3 small computers there for all markets save the U.S. Then there are the native companies—chiefly Olivetti and IME—active in minicomputers and desk calculators.

Deciding whether the IC market will double or triple is a pleasant preoccupation for semiconductor producers. Much more sobering is the question of how much longer demand will outstrip supply.

C.A. La Chiusa, international marketing manager for Societa Generale Semiconduttori SpA (SGS), thinks capacity will catch up with demand during the last six months of 1970. Every major company on the Italian scene has new facilities or is building them. No one—perish the thought—expects price wars to rage again this year as they did in early 1968 when there was excess capacity all over Europe.

That's one school of thought. Another school says new markets, like desk calculators, will sop up enough capacity to ward off really cut-throat competition next year. Then by 1971, even earlier perhaps, Fiat might become an IC customer; the big Italian automaker already has an electronic fuel-injection unit on one of its high-priced, low-volume models.

After automobiles should come appliances. But Italian semiconductor makers have been waiting so long for washing machine controls and the like to emerge as mass markets "next year" that the guessing is now 1972.

Consumer electronics producers, though, will spend 1970 waiting for "next year". During 1971, everyone believes, the government will let color television come to the land. Then the set makers can look forward to new life in their home market.

Data processing and tv set the pace in Sweden

The itch for color-tv sets first started to spread in Sweden 18 months ago and the affluent Swedes still haven't stopped scratching. For the set makers who are supplying the balm, there's another big year ahead. Big, too, is the outlook for the increase in sales of computers and related hardware as data-processing nets spread.

With color tv and computers doing just fine, the country's electronics market surely seems destined for good growth in 1970 despite a leveling off in communications and military equipment. *Electronics'* survey sets next year's market at \$436 million, an 11% gain over the estimated \$391 million for assembled equipment this year.

Officially, color tv broadcasts will start in Sweden next April. But if you look at figures for set sales, you'd think the government-run Swedish Broadcasting Corp. has been sending chrominance signals for some time.

During 1969, color tv set sales in the country ran to an estimated \$72.5 million. The significance of that figure can be seen by comparing it to Great Britain's \$50 million. And for every Swede there are about eight Britons.

In April, Swedish Broadcasting will make official what it has been doing unofficially on its first network for more than a year. Even better, the broadcast agency started up a second network just this month so there'll be even more programing. For viewers in the southern part of the country, there's also been a bonus—West German colorcasts. With all these stimuli, the consensus forecast is for color set sales of \$87.5 million next year. Meanwhile, black-and-white sales will dwindle from an estimated \$31 million this year to \$27.5 million next.

The Swedish spurt in color set buying has been a good thing for the country's economy. In the early and mid-1960's, government planners hesitated to let the broadcast agency start colorcasts. Their reasoning: there'd be a rush to buy sets and floods of imports would hurt the balance of payments.

The rush, of course, developed. But the effect on the economy probably will be the reverse. Because the lusty home market for Svenska Philips, its parent company Philips' Gloeilampenfabrieken late this year tapped it to supply the group's sales organizations in Denmark,

Norway, Finland, and Austria. All four, like Sweden, are in the European Free Trade Association and so there's no duty on Swedish sets.

Svenska Philips has about half the market and this year will produce some 60,000 color sets. Next year's output will shoot up to at least 120,000 sets; in 1971 the figure will be at least 150,000.

The Swedish Board of Telecommunications, which runs the transmission network, estimates that by 1973 there will be 600,000 color receivers operating in Sweden. The figure neither amazes nor fazes Dick Damstedt, Svenska Philips' commercial director. "Development of color television has been fantastic in Sweden," he says. "And when the Swedish market is pretty well covered, the other nations that we will be manufacturing for will be in the color tv age. That guarantees our plant will continue to be fully occupied."

Although nothing else in the consumer sector looks as bright as color tv, there are a handful of other strong-appearing markets.

One is hi-fi and stereo equipment. Demand is going up and prices are dropping as producers scramble for the market. At Christmas, good-quality hi-fi sets were going for \$120; that's \$40 less than last year's level.

A further boost in stereo sales should come next year from the introduction of stereo f-m broadcasts. The broadcasting agency has held off on stereo, hoping to get other countries to adopt the Swedish-developed Berglund system. It works on a narrower channel than the system developed in the U.S. and now generally used for stereo broadcasting throughout the world.

Still another lift for radio-set makers—mostly German—operating in the Swedish market looks likely in 1970. The Telecommunications Board is expected to approve a system that lets car radios switch automatically to the strongest f-m transmitter within range. The circuits for the seek-and-switch operation add about \$20 to the cost of the radio, but that not expected to deter buyers.

Then there's microwave ovens. Sweden now has more of them per capita than any other nation in the world. Nonetheless, Husqvarna Vapenfabriks AB, Sweden's major microwave oven producer, intends to step up its output by 20% to 10,000 ovens in 1970.

Along with color television, data processing equipment stands out among the Northern Lights. Next year, there'll be a big buildup in terminal systems as well as

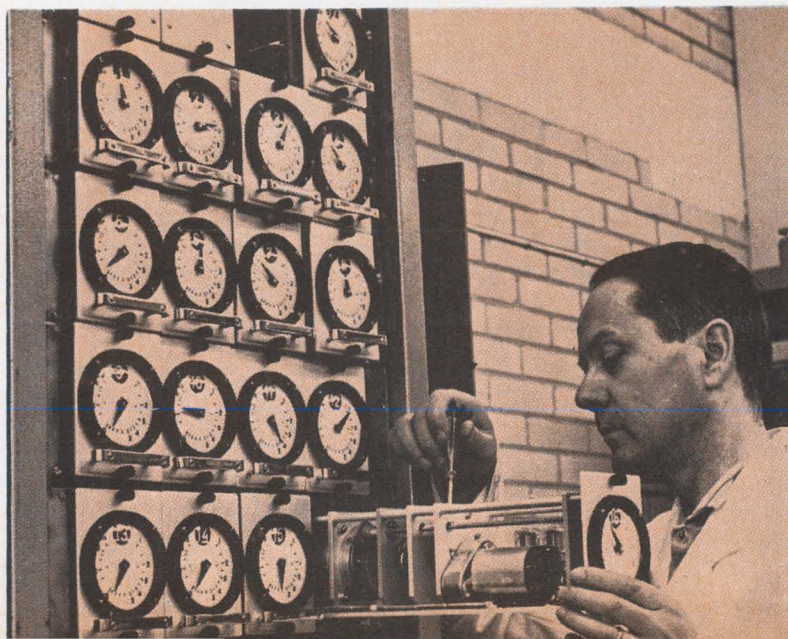

Readouts. Swedish electronics firms increase the penetration of the European market with specialized hardware. The race track totalizer display at left is by Swedish Computer, a part of AB Arenco. Technicians (right) test a printing device headed for bank installations at Philips Terminal system, organized after Philips acquired Arenco.

**Swedish electronics
market forecasts**
(in millions of dollars)

| | 1969 | 1970 |
|-----------------------------------|--------------|--------------|
| Assembled equipment, total | 390.6 | 435.9 |
| Consumer products | 142.7 | 155.9 |
| Medical equipment | 35.5 | 41.3 |
| Communications | 43.7 | 42.8 |
| Data-processing equipment | 84.4 | 102.2 |
| Industrial electronics | 52.2 | 58.3 |
| Test and measuring instruments | 32.1 | 35.4 |
| Components | 80.4 | 91.8 |

a scramble for customers by computer service bureaus. This impetus should give the market a strong 22% rise, to \$102 million from this year's \$84 million, according to *Electronics'* forecast.

The banks are behind the big computer networks in Sweden. This fall Saab AB picked up a \$40 million contract to install an on-line accounting system for the savings bank associations of Sweden, Denmark, and Finland. Saab is best known for its aircraft and autos; its computer division, Datasaab, will supply the computers.

While Datasaab and Facit toil away at the trination network, which involves some 2,000 local office computers and won't be operating until 1971, Arengo Electronics AB is busy with a \$10 million order for computer terminals. These will go into the nationwide network of Svenska Handelsbanken, the largest bank in Sweden.

Another big bank, Skandinaviska Banken, plans to tie its 350 offices into a IBM 360/65 computer. At year-end, the bank had still to order the terminals, but it had signed with L M Ericsson a \$1.4 million order for two message control computers and 13 line concentrators.

The banks, with their big computer networks, rate as rough competition for the time-sharing service bureaus springing up in Sweden. The National Postal Bank, for example, has been running ads in the big dailies offering companies a half-dozen payroll computations for 20 cents per employee.

There's also sharp competition developing to supply the terminals the service bureaus want to rent to their customers. Saab-Facit is in the business. And Svenska Philips this year picked up Arengo, largely a military electronics producer despite its big terminal order from Handelsbanken. With military orders on the wane, Arengo was floundering and Philips snapped it up for its expertise in terminals. "We didn't buy a company with an aim to have it continue to lose money," says determined Henric Egnell, Svenska Philips' director.

Despite the competition, data processing is an enticing market. Svenska Handelsbanken predicts that by 1980 wages paid to computer tenders plus outlays for computer hardware will add up to 8% of the country's gross product.

Much less enticing is the industry's former stellar performer, military hardware. The leveling off in military spending, in fact, has sent the big companies off in quest of civilian markets, but they are sophisticated markets nonetheless.

Saab's electronics division, for example, now counts on military work for 80% of its business. By the early 1970's, the company's managers intend to have civilian business bringing in half the division's revenues. Saab quite likely will concentrate on highly specialized instrumentation. Already it has won orders from Switzerland and the Soviet Union for a system that analyzes photographs of high-energy particles in bubble chambers.

Saab also seems headed for the hybrid-IC market, along with two other companies in the Wallenberg family industrial empire. Saab will be producing thick-film hybrids for the new computers—designated the D5—that are going into the savings banks' network. Rifa, a subsidiary of the telecommunications producer L M Ericsson Co., and Hafo, a subsidiary of the heavy electrical equipment maker Allmanna Svenska Elektriska Aktiebolaget (ASEA), will offer custom thick-film hybrids next year. Eventually, they'll move on to thin-film circuits, continuing to concentrate on specials.

The entry of these companies into the IC market comes almost as an answer to the Ministry of Industry's suggestion last summer that Sweden acquire its own IC capability. The market for standard IC's, though, is still wide-open for foreign companies, and it's a strong one destined to soar by 70% next year, to \$3.4 million from this year's estimated \$2.0 million.

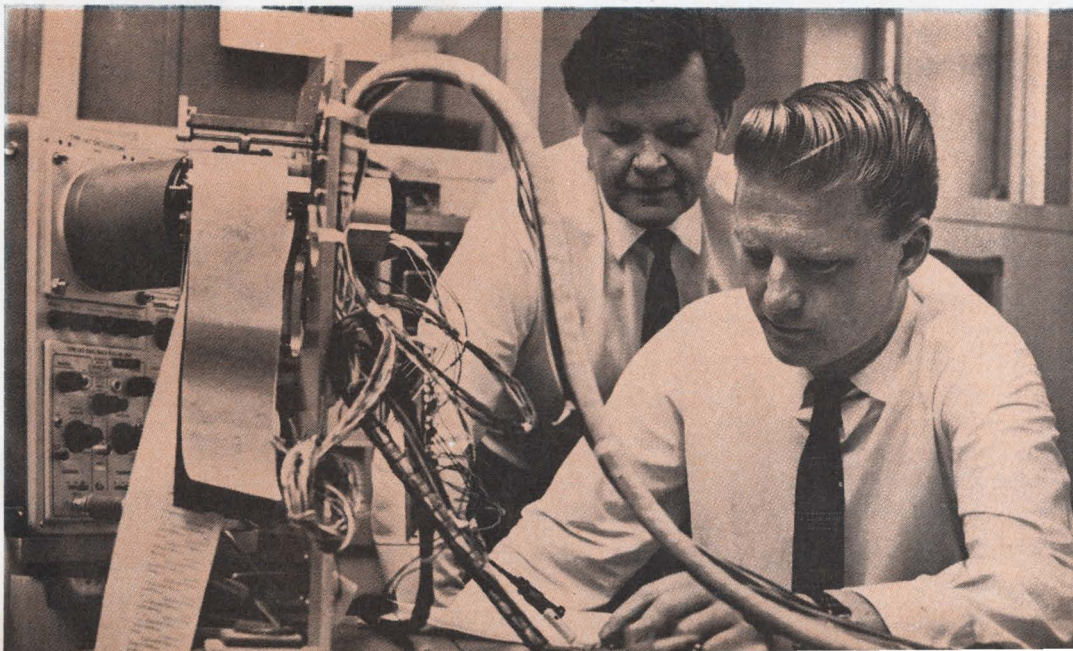

**Netherlands electronics
market forecasts**
(in millions of dollars)

| | 1969 | 1970 |
|-----------------------------------|--------------|--------------|
| Assembled equipment, total | 344.5 | 388.4 |
| Consumer products | 81.0 | 92.5 |
| Medical equipment | 11.2 | 12.5 |
| Communications | 83.2 | 92.4 |
| Data-processing equipment | 58.1 | 69.4 |
| Industrial electronics | 62.8 | 68.1 |
| Test and measuring instruments | 48.2 | 53.5 |
| Components | 125.5 | 143.5 |

On the spot. Testing of microcircuits takes on increased importance as more Western European firms turn to them for more sophisticated new products. Philips, the giant from the Netherlands, is a major microcircuit producer in many European nations.

The Netherlands story: A new push by Philips

Like a Dutch moppet testing fresh concrete with wooden shoes, the giant of Eindhoven knows how to make impressive marks. And Philips' Gloeilampenfabrieken has been making them this year. There's no doubt that sales of the worldwide Philips group will push past the \$3 billion mark. Racking up a 13% gain for the first nine months of 1969, Philips had already logged sales of \$2.37 billion as it went into the last quarter. A strong fourth quarter—and Philips has been a strong finisher in recent years—could conceivably carry the company close to \$3.5 billion in sales this year.

With a good 1970 on tap for Western Europe, there's a good year in sight for Philips, which operates in every major West European country. The brass at Eindhoven keeps its growth targets to itself. But it's a reasonably safe bet that Philips will come within hailing distance of a \$4 billion year by the end of 1970.

Philips' domestic market, just one of many for the Dutch giant, should come along strongly next year. *Electronics'* survey predicts a rise to \$388 million for the Dutch market in 1970, compared with an estimated \$345 million this year. That's a move upward of 13%.

Bread and butter for Philips comes from consumer goods—small appliances as well as radios, tv sets, and record players. Industrial electronics, though, has been on the rise in the company's sales mix during recent years and that's the way things are going to stay, according to Philips' strategy makers.

Computers figure heavily in their plans. In the Netherlands alone, there's a market of nearly \$70 million in sight next year for data-processing hardware, according to *Electronics'* survey. And the Dutch market is not big.

Philips has been edging into the computer business during the past two years and next year's sales should soar. That's because in 1970, for the first time, the company will go into the year fully armed to joust with the computer giants. Philips introduced a family of "office" computers this fall, and now has a model lineup that ranges from desk calculators all the way to big machines. The medium-term goal is to push computer sales up to 10% of the company's total sales by 1973.

The company's instrument designers, too, are high on computers. Philips, like just about everybody else, has a small process computer it can tuck into all sorts of instrumentation systems.

The instrumentation people at Eindhoven soon will build tiny computer packages that can slip into analytical instruments. Computer in, the instrument is automatic; computer out, the instrument becomes manual. The tiny computer package will handle up to 30 instructions, have a 10-microsecond cycle time, and a 1,000-word basic memory expandable to 16,000 words. The prototype has diode-transistor-logic, but that could change before the slip-in computer unit goes on the market in 1971 or 1972.

Computers are also in the ken of Philips Telecommunicatie Industrie, which does business out of Hilversum—about 15 miles southeast of Amsterdam.

There'll be a whopping market for electronic telephone switching starting to open up in Western Europe around 1972, expects N. Rodenburg, director of the division. To nail down its share, Philips is counting on reed-relay switchpoints operating under computer control. What's more, the computer will be fairly small, at least when compared with the ones used in Bell Telephone System's pioneering ESS effort.

The Bell equipment, in Philips' view, can't be economic for exchanges having less than 35,000 or so lines. The Dutch computer, based on transistor-transistor-logic

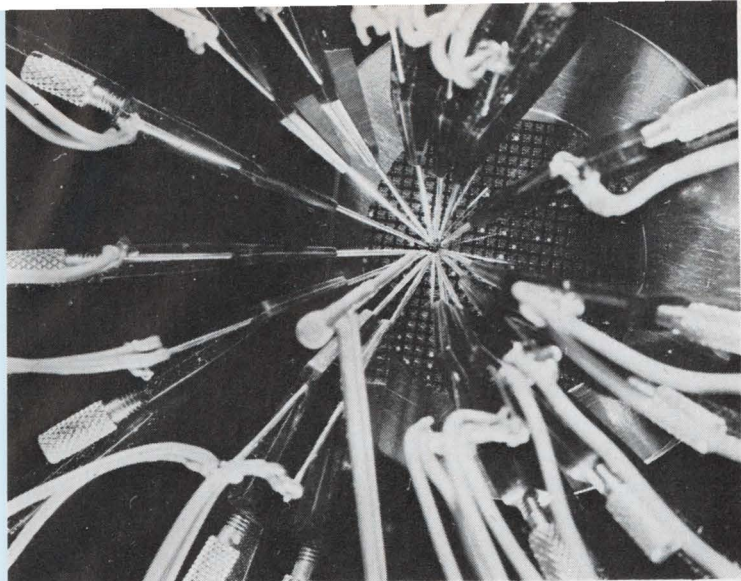

year, Philips' planners figured the market in Western Europe would run about 1.5 million color sets in 1970. Now their estimate is 1.7 million sets. "The market will double next year," says J.F.J. Lamet, head of commercial planning at Eindhoven.

Electronics' findings, however, indicate a lesser gain. The figures for the 11 countries surveyed: a jump to \$588 million next year from an estimated \$380 million.

Lamet and his market research aides see the chance of an 8% to 10% rise next year in European radio sales. Their reasons: hi-fi equipment, stereo, and radio-cassette combinations are pushing up the average unit price for radios as total set sales rise 6 or 7%. By contrast, however, the dollar volume should drop slightly.

Belgium coming on strong in all sectors but color tv

Fast-rising piles of export documents are turning Belgian customs officers into a harassed lot these days. But that upsurge is the best of all possible signs for Belgium's economy and the country's electronics industry. As exports go, so go they.

And during the year, exports were going at record levels. This fall, in fact, the Belgians promoted themselves to the top of the list of industrial exporters—per capita—with shipments abroad totalling \$900 million in a single month. It's hard to find reasons why this sort of thing shouldn't go on next year, too.

With the economy generally flourishing, 1970 will be a good year for electronics. The outlook, according to *Electronics'* survey, is a strong rise of 11% that will carry the Belgian equipment market to \$277 million from this year's \$249 million.

As elsewhere in Western Europe, much of the lift will come from the data-processing business, almost sure to log a rise of at least 20%. *Electronics'* forecast puts the 1970 computer hardware market at \$65 million, up from an estimated \$54 million this year.

But, there are other strong sectors. One is industrial electronics. A second is telephone electronics. A third is components. On the other hand, consumer-goods makers generally see their next surge—from color television—as still a year off. And there's little luster in the military and space markets for the year ahead.

A trio of companies this year made moves that will make Belgium an even better market for components suppliers. Manufacture Belge de Lampes et de Matériel Electronique (MBLE), an affiliate of Philips Gloeilampenfabrieken, has earmarked \$40 million to build two new plants. One, near Mons, will produce two models of computers for Philips. Which two is yet to be decided. The second plant, near Liege, will knock out components. Both plants are slated to go into operation in mid-1971.

In a somewhat similar move, West Germany's Siemens AG has it in mind to build a \$20 million telecommunications-hardware plant in northeastern Belgium. It eventually will supply components for a computer plant Siemens hopes to set up in Belgium.

Although it did it on a less expansive scale compared to the plants of Philips and Siemens, the Burroughs Corp. was the first into Belgium (native companies excepted)

NAND packages, can handle only 10,000 to 15,000 lines at the most, but it will be cheap enough to be feasible for exchanges having as few as 2,000 to 3,000 lines. Philips expects to have its "third generation" switchgear in production by 1971. Telephone switching—conventional and electronic—will grow steadily at an 8%-10% rate over the next few years if Philips' fix on the market is correct.

Philips also sees great promise in data transmission. Unlike ESS, which is a replacement market essentially, data transmission is a new market. Rodenburg has a hunch that the government-run European phone systems will set up separate networks for telephones and data.

Another network, Dutch officials are pondering, is a nationwide community antenna tv system. It would cost something like \$115 to \$140 million. There's also the chance that Holland will set up a public mobile radio network. All these would mean substantial new business for Philips Telecommunicatie, which has a lock on the Dutch communications market. A key project already in hand is a satellite ground station for Intelsat 4. It will be built in the north, in Friesland, and is slated to go into operation towards the end of 1972 or early in 1973.

For all its concern about computers, Philips hasn't forgotten that consumers buy two-thirds of its products.

Like most set makers, the Dutch giant gauged the growth of color tv in Europe too conservatively. Last

| Belgian electronics market forecasts (in millions of dollars) | | |
|--|--------------|--------------|
| | 1969 | 1970 |
| Assembled equipment, total | 248.0 | 276.0 |
| Consumer products | 51.4 | 54.6 |
| Medical equipment | 8.2 | 8.5 |
| Communications | 53.5 | 58.7 |
| Data-processing equipment | 53.6 | 65.2 |
| Industrial electronics | 55.0 | 59.7 |
| Test and measuring instruments | 26.3 | 29.3 |
| Components | 68.4 | 77.9 |

with computer production. Burroughs opened a \$5 million plant at Haut-Sarts, near Liège, last June. At first, Burroughs will build its medium B2500 and B3500 computers there. Later, though, the company will produce large data-processing systems in Belgium as well. Knowing a good neighbor when it sees one, RCA has decided to set up a \$5 million semiconductor plant in Haut-Sarts.

Components producers won't be marking time until the computer people get their new plants running strong. Most are hard-pressed already to keep their current customers supplied: for hard-to-get items like capacitors, lead times can run from 30 to 60 weeks. It's a situation that points to a strong rise in components deliveries—up 14% to \$68 million, according to *Electronics*' survey.

To be sure, order books are inflated. Nervous about the components shortage, equipment makers have been doubling up their parts orders, largely to nail down places in suppliers' delivery schedules. Despite this inflation, components makers expect sales to surge again in 1970. About the worst anyone expects is some slowdown in the second half. Says an executive of the Bell Telephone Manufacturing Co. (BTM), an ITT subsidiary, "I'm not pessimistic, but components makers are going to have to do more selling than they've been accustomed to doing."

If a second-half slowdown does develop next year, it likely will bring only a short-lived setback for the country's components market. For 1971, the industry is counting on a strong rise in the consumer market as color television catches on.

Broadcasts are slated to start officially on Christmas Day this year. But set makers aren't predicting anything like a mass market next year. For one thing, there's little chance for an initial spurt: all of Belgium has been within range of colorcasts from neighboring countries for some time. For another, set prices are strictly upper bracket: about \$800 retail. Finally, heavy programming by the two Belgian networks won't begin until 1971. Color set sales for 1970, then, figure to run around \$4.5 million.

That means black-and-white tv will set the tone of the consumer market. In other words, the gain will be modest. The survey predicts a rise of 6.5% to \$55 million next year. That's not bad when you remember that last year set makers hoped only to hold their own in 1969. With boom conditions prevailing in Belgium. The set makers fared much better this year than they expected. Instead of a drop in black-and-white television set sales, there was a rise to an estimated \$30 million from \$28 million.

Like the set makers, but with considerably more certainty, Belgian telecommunications equipment makers also are waiting for 1971. That's the year that Belgium Regie des Telegraphes et Telephones (RTT) will start making the shift to production-run electronic telephone exchanges. Belgium, which has had trial exchanges in service for some months, is the first country on the Continent to make the shift. By the mid-1970's it's expected that electronic equipment will account for 50% of switching hardware sales in the country. That compares with 15% now.

Meanwhile there's a fast-growing market in telephone transmission equipment, both at home and abroad. BTM, which dominates the domestic market, expects to pick up some \$4 million in carrier equipment sales to the RTT

Swiss electronics market forecasts (in millions of dollars)

| | 1969 | 1970 |
|-----------------------------------|--------------|--------------|
| Assembled equipment, total | 208.4 | 232.5 |
| Consumer products | 46.5 | 51.9 |
| Medical equipment | 7.7 | 8.2 |
| Communications | 56.6 | 60.1 |
| Data-processing equipment | 49.5 | 59.5 |
| Industrial electronics | 36.3 | 39.5 |
| Test and measuring instruments | 11.8 | 13.3 |
| Components | 57.8 | 63.9 |

next year. Along with its normal rise in equipment needs, the phone agency is under heavy pressure to add more links between existing exchanges. This is because long-distance traffic within Belgium skyrocketed after RTT cut the rates this year. Export orders are on the rise, too, and BTM expects a 50% increase next year in its overall transmission-equipment business.

But while BTM prospers mightily in telephone transmission, as far as military orders go, it faces the same bleak long-term prospects as the other two heavyweights in the industry, MBLE and Ateliers de Constructions Electriques de Charleroi. All three now share a meager ration of some \$19 million spread over several years. Worse, there's scant chance that new military equipment programs of any electronics consequence will be launched before the mid-1970's.

Credit curbs won't stem Swiss electronics growth

Precise patterns are the rule in Switzerland, from the chiseled profiles of the Alps, through the terraced vineyards, and down to neat villages in valleys.

There's a pattern, too, for the Swiss economy—con-

stant strong growth. This year, the government's business watchers peg the real expansion at 4%; but there's another 3% apparent growth in the economy that must be ticked off as inflationary.

The government intends to fix that part of the pattern with restrictions on credit. All the same, Switzerland will flourish in 1970 and so will the market there for electronics equipment. The forecast: a 12% rise to \$233 million from this year's \$208 million.

As you would expect, computers will outstrip other sectors of the market. But there's unusual strength in consumer electronics; credit that to color television. And there are heady prospects for components makers because the country's watchmakers finally have worked out a feasible pattern for producing electronic timepieces.

For Swiss watchmakers, 1970 should be a landmark year—the first to see mass production of electronic movements having integrated circuits. It's high time. For the past six years, watchmakers have been dickering about who would produce what when.

Now it's clear. Ebauches SA of Neuchatel, the number one producer of movements in Switzerland, has set up a company called Ebauches Electronics to turn out electronic movements, both transistor-cum-tuning-fork types and quartz-crystal-IC-oscillator types.

Ebauches Electronics apparently is gearing up to eventually produce some 30 million movements yearly.

Company spokesmen won't disclose their exact plans. But they do say that the electronics-movement production center will have 1,200 workers and that its needs for IC's and discrete components eventually will be "enormous." Right now, the parent company manufactures about 43 million movements yearly, which is a lot of time on a lot of hands.

Ebauches won't have the electronics-movement market all to itself, of course. Louis Brandt et Frère SA, most often identified by its trade name "Omega," has taken over the Compagnie pour l'Industrie Radioélectrique. CIR was set up by the watchmaking industry's Horological Electronics Center mainly for a preproduction series of an advanced tuning-fork wristwatch it developed.

This flurry in horological electronics, added to flourishing consumer and industrial electronics markets, is good news for semiconductor producers. According to a survey made by *Electronics*, the Swiss market will spurt from \$10.6 million this year to \$16 million next.

For the watchmakers' business, a company called Fabrication des Semiconducteurs SA (Faselec) has the inside track. Its owners include the Swiss companies Autophon AG, Brown, Boveri AG, Ebauches, and Landis & Gyr AG. There's still another Swiss partner, the watchmakers' trade association Fédération Horlogère SA. Philips Gloeilampenfabrieken is a minority shareholder. Faselec is aiming for a \$5 million yearly business in transistors, monolithic IC's and thick-film hybrids.

Consumer electronics makers find their pattern for 1970 a pleasing one, too. The bright spot: color-tv screens glowing in more Swiss living rooms than most in the industry expected.

There will be a corresponding increase in communications equipment sales as the Swiss Post, Telephone and Telegraph Department equips the country with color-transmission equipment. For 1970, \$3 million is earmarked for colorcasting hardware. In addition, there's a long-range program underway to build color broadcast studios—at \$10 million each—in Zurich and Geneva, and eventually Lugano. But the spending for broadcast equipment is dwarfed by the Post Office's overall spending for telecommunications, some \$170 million next year.

Another big spender should reenter the communications equipment pattern in 1970. It's the Swiss Air Force, which is currently shopping for between 100 and 200 fighters to supplement its Mirage 3 aircraft.

Spanish industrialization should bolster electronics

Spain's economy has started to move to a livelier pace. After two years of pavane-like growth, there has been a quickening that suggests the fandango. During 1969, the tempo picked up so fast that instead of a hoped-for 5.5% expansion, the gross national product jumped by 8%. The whirl should continue at that pace through 1970 despite changes in the choreography.

The new routines will be chalked out by the technocrats that now have the upper hand in the Franco government's cabinet. The technocrats plan to move the country closer to the rest of Europe. One of their main goals is to channel pesetas from consumer spending to capital investments that will bolster industry. Another is to restructure the economy so that Spain can stand up to Common Market competition when and if the Franco government arranges some sort of tie to the six-nation trading bloc.

These aims should buoy the country's electronics market for the next few years, particularly computers and industrial electronics. But the set makers haven't been slighted. The government has slotted color-television into the calendar for mid-1971. This comforting prospect, plus the likelihood of a reasonable rise in consumer electronics next year, should see set makers through 1970. All told, the year should see the market rise to \$239 million, up 13% from the estimated \$211 million the market registered in 1969.

With Spain driving towards industrialization, look to data-processing hardware sales as a pacesetter. Sales in this area will climb to \$33 million next year, according to the survey. That's 22% better than this year.

IBM, as elsewhere on the Continent, is the leader in Iberia. And IBM's biggest competitors are Bull-GE, Sperry Rand's Univac division, Honeywell, and West Germany's Siemens AG. But much to the delight of Spain's technocrats, there's a Spanish computer maker on the scene. The company, Telesincro SA, stands to pick up a small share of the small-computer market. Telesincro, which operates out of headquarters in Barcelona, put its first machine on the market in Catalonia

last year and this year started selling in Madrid. In its home territory of Catalonia, the company claims it has 90% of the market for computers in its class. The closest U.S. equivalent is NCR's 400 model. All told, Telesincro has sold 350 machines so far.

Even so, Telesincro doesn't rate as a threat to the big companies in data-processing hardware. But it's a harbinger of a new look to come in Spanish electronics. Thus far, domestic companies have been set makers in the main. A handful, however, are having a mild go at other areas. Indar SA, for example, produces some radar equipment; Elisba Electronica SA produces rotary switches; Piher SA, Spain's largest component maker, has been doing some research in integrated circuits and may go into production in two years or so.

If the technocrats have their way, more foreign companies operating in Spain will be doing research there. Marconi Espanola SA, an ITT affiliate, reportedly plans to take a minority shareholding in an electronics research and development outfit the government's industrial holding agency wants to set up. The company would be called Empresa Nacional Electronica SA. Government sources also say that Philips' Gloeilampenfabrieken has agreed, informally anyway, to do some electronics research in Spain.

A year ago, Spanish set makers didn't even know what color tv system they'd be working with, much less when they could count on the coming of colorcasts to spur sales. Now the answers have come. Color broadcasts, using the West German PAL system common to Western Europe—France excepted—will begin in 1971. Already, the government-run tv network has started experimental transmissions and the major set producers have turned their designers to work on prototypes.

And while they're waiting for color, the major set makers shouldn't fare too badly. *Electronics'* forecast puts the consumer electronics market at \$128 million in 1970, up 9% over 1969's estimated \$117 million.

Black-and-white tv sets are the mainstay of the market, and will rise 10%—to \$99 million—next year. But despite the rise, look for some of the marginal producers to go out of business. Some 30 companies currently produce tv sets. Their number is destined to dwindle to a half-dozen or so during the next few years.

As for other consumer markets, they'll all be on the rise with tape-recorders, hi-fi equipment, and auto radios showing the best gains.

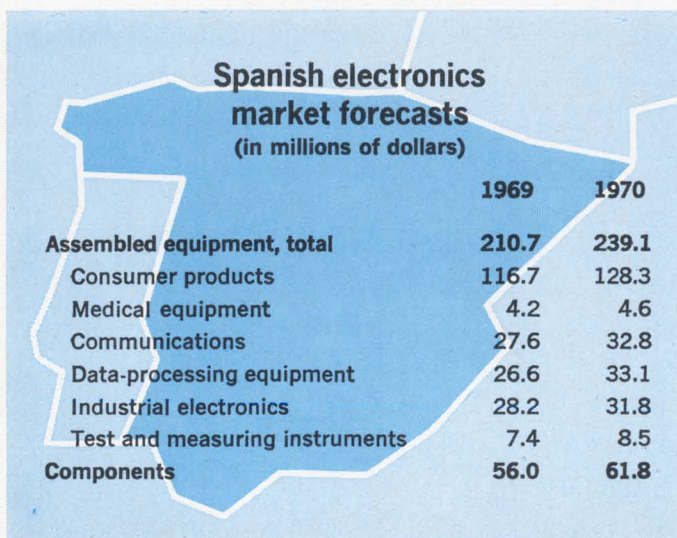

**Danish electronics
market forecasts**
(in millions of dollars)

| | 1969 | 1970 |
|-----------------------------------|--------------|--------------|
| Assembled equipment, total | 144.9 | 165.7 |
| Consumer products | 38.4 | 44.2 |
| Medical equipment | 4.0 | 4.4 |
| Communications | 34.6 | 38.9 |
| Data-processing equipment | 36.1 | 43.2 |
| Industrial electronics | 24.2 | 26.4 |
| Test and measuring instruments | 7.6 | 8.6 |
| Components | 42.0 | 50.3 |

Exports still uppermost in the minds of the Danes

Tidying up Denmark's economy has turned out to be a far more difficult task than the coalition government had anticipated when it took over from the Socialists last year.

The Conservatives, Liberals, and Radicals, the parties that make up the coalition, were determined to get the nation's finances under control. But to their frustration, the country's balance of trade ran a record deficit this year of \$400 million—about \$70 million more than what was expected. The coalition wasn't counting on overcoming Denmark's chronic trade deficit right off. It had hoped, however, to start trimming the deficit right off.

In late spring, the government started to apply fiscal pressure by jacking up the basic interest rate to 9% and clamping down on credit. How much of an effect this action will have on the 1970 economy is questionable. Says one government economist: "I don't see how the growth can be much less than 4%."

As far as the balance of trade goes, then, the overall outlook is bleak for 1970. There's one saving grade, however. The sharp rise in industrial production and exports (up about 18% this year) should continue.

Credit a good part of the spurt to the electronics industry. The industry produced some \$187 million worth of hardware in 1969 and exported slightly more than \$100 million of it. This made electronics No. 3 in Danish exports, ahead of butter. Industry executives are confident that they can keep their output and exports climbing the next few years. The goal is to double production over the next five years, according to Peder Beyer, vice president of the Danish Electronics Producers Association.

Along with their thriving business in exports, Danish electronic equipment makers can count on a strong domestic market next year. According to *Electronics'* survey, factory sales should hit \$166 million, up from 1969's estimated \$145 million.

Computer sales will show the strongest rise. The survey projects the 1970 computer market at \$43 million, 20% better than the \$36 million estimated for 1969.

But the consumers also figure to beat paths to the doors of radio-tv dealers. The big attraction: color television. Early next year, the government will officially start color broadcasts. That will bring practically everybody in the country within range of plenty of colorcasts. German and Swedish programs already can be picked up in Denmark.

Color-set sales, in fact, were surprisingly good this year. *Electronics'* survey estimates the 1969 market will total \$5.3 million; the 1970 forecast is \$2 million.

This jump will take the sting out of the drop forecast for black-and-white sales. Added salve should be found next year in sales of hi-fi and stereo sets. Overall, the entertainment electronics market in 1970 should climb to \$44 million, up from this year's \$38 million.

Norwegians to make the international scene

Look to 1970 as the year that Norway steps out strongly into world markets. A number of moves are slated by Norwegian firms that will push them into the international scramble for business in components, communications, and industrial electronics. The Norwegians, of course, have selected slots in the product spectrum where they can succeed through specialization—custom integrated circuits, frequency synthesizers, and ship-building electronics, for prime examples.

The expansion abroad will take up some of the slack in the home market for consumer electronics. All in all, the Norwegian electronics market should rise slightly more than 9% next year to reach \$150 million, according to *Electronics'* forecast. None of the increase in the market, however, will come from entertainment products. The forecast puts the 1970 consumer market at \$25 million down \$1 million from 1969 sales.

The sorry condition predicted for the consumer market next year can be traced largely to a sharp rise—from 12% to 20%—in taxes on tv sets. And there's no immediate help in sight from color tv. "It's still three years before we get color tv," says Jan Wessel, president and founder of A/S Radionette, which has about a third of the Norwegian consumer electronics market.

Radionette and the other major Norwegian set maker,



Full speed ahead. New production line at Norway's Radionette features open areas that are easy to expand or rearrange as product mix varies. The company has about a third of the country's electronics market.

Tandbergs Radiofabrikk, both manufacture color sets—for the booming market in neighboring Sweden. Radionette has been able to get a foothold in Sweden and Denmark by offering hardware with twists that others don't have, like tv sets with built-in f-m receivers.

So far, it's been Tandberg with its tape recorders, Gustav O. Ring with its intercoms, and Simonsen Radio A/S with its fishfinders that have been the best-known Norwegian names in world electronics markets. Now a fourth name seems ready to be added to the list, Akers Electronics.

Ring this year acquired Akers and plans to make it a custom design and development IC shop with clients from all over Europe and North America. Akers already has one good customer—itsself. Akers' mainstay is a digital frequency synthesizer, developed originally for NATO manpack radios. The company acquired its IC know-how developing thin-film hybrid circuits for the synthesizers, which apparently have a firm military market of about \$7 million over the next five years or so in Norway alone.

Along with the original synthesizer, which covers the band of 26 to 70 megahertz, Akers intends to build higher-frequency versions and a video branching amplifier for color television switching, says sales Manager Odd Evensen. As for custom IC's Evensen happily found himself with 40 queries from England after he announced Akers' services to equipment producers there.

Meanwhile, the traditional sectors of Norway's electronics industry figure to fare well next year since they're largely tied to shipbuilding and shipbuilding is booming around the world. A/S Kongsbergs Vaapenfabrikk, for example, has set up a marketing organization in the U.S. mainly to handle its numerical control systems for flamecutters used to cut hull plates out of sheet steel.

And as if the traditional products weren't enough, Norway's domestic digital computer manufacturer, A/S Norsk Data-Elektronikk is in full production—two computers monthly. Norsk sells its small Nord-1 for \$70,000, and at that price has managed to pick up customers like Norwegian universities and the country's Central Institute for Industrial Research. ●

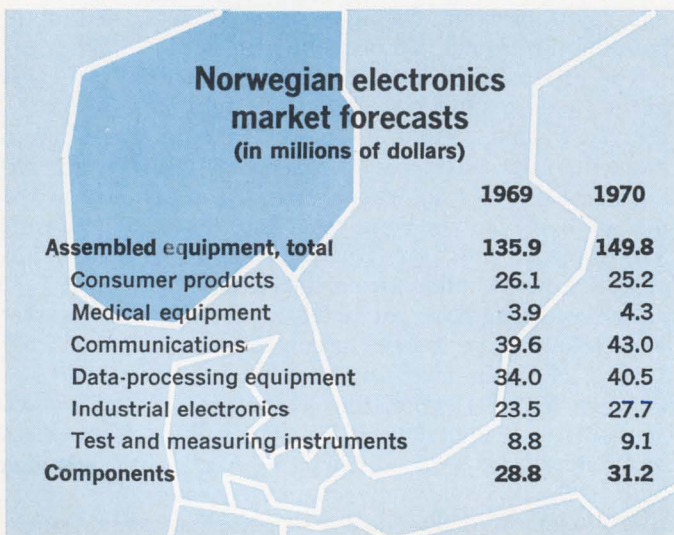

New beam-lead connection method boosts semiconductor memory yields

Beam leads are electroplated to conductors in a single step to form integral connection with wiring pattern; it's simpler, less costly and more reliable than other beam-lead and flip-chip processes

By John Marley and George Trolsen

Motorola Semiconductor Products Inc., Phoenix, Ariz.

There's room for improvement in anything, and interconnecting of integrated circuits is no exception. One new method, called beam-lead laminate, offers a myriad of advantages over conventional beam-lead and flip-chip procedures—speed, simplicity, cost, and ease of part replacement. Even more important, the beam-lead laminate process can improve the reliability and yield of semiconductor memory modules.

In the beam-lead laminate process, cantilevered beams are integrally connected with the conductor wiring pattern and feedthroughs on a two-layer printed circuit board. The IC chips are then bonded face-up to the board, or laminate, by an ultrasonic technique.

Motorola has used the method to fabricate an 8,000-bit metal oxide semiconductor memory module composed of smaller functional building blocks that can be easily replaced during assembly. This feature allows the memory unit to be partitioned into smaller packaged groups consistent with high assembly yields—discarding a small functional block is not as wasteful as discarding a single, large block.

Other bonding technologies have shortcomings. In the flip-chip method, for example, IC's are specially prepared to provide a raised alloy bump which is then face-down bonded to matching terminal patterns on film conductors. The poor thermal conductivity inherent in this mounting scheme inhibits very high chip packing densities.

The beam-lead technology first developed at Bell Labs does not insure much better thermal conductivity. Heat still must flow through the contact rather than through the chip to a substrate as in the new method. Another disadvantage in the con-

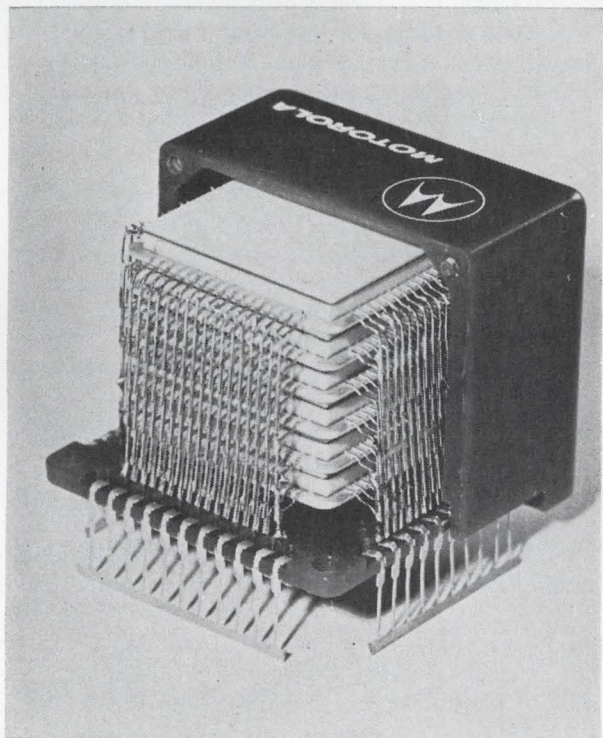

Cutaway. Part of the cover has been removed from one of the modules of the 8,192-bit memory to show the memory stack wiring. The module packages are stacked one above the other with their leads bent over, nested, and soldered to form stack rails. At the base of the stack the closely spaced leads are fitted through a molded base and soldered to a small p-c board called an interchange board. On this board the word and bit relationships are formed by appropriate jumper lines, and the signal lines are brought out to 42 header pins located along the four sides of the board.

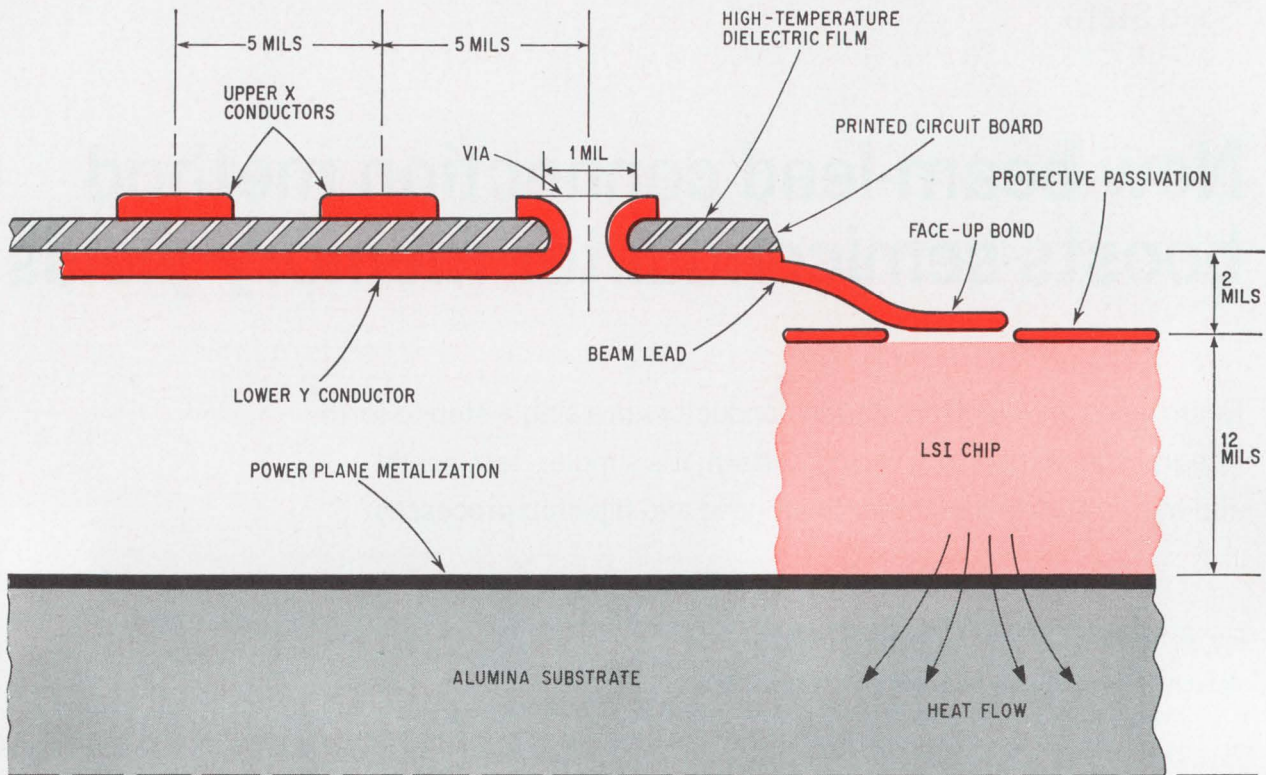

Cross-section. In one electroplating cycle, the beam leads are integrally formed with the upper and lower conductors and anchored by means of the vias. The beam lead, which contains a 2-mil offset for strain relief, is bonded face-up to the LSI chip. Thermal conductivity is through the alumina substrate base rather than the contacts. Power is delivered to the chip by a metalization layer on the substrate.

ventional beam-lead technique is the high manufacturing cost per chip. When the cost of fabricating the beam lead is added to the cost of manufacturing the IC wafer, the cost per chip at the die-sorting operation—where the chips are assembled into a system—becomes very high.

But with the beam-lead laminate method, advantages abound. For example, chip costs are kept down because under the new process chips are fabricated without beam leads. And the new bonding method saves some of the processing steps needed in the other methods. The face-up bonding technique permits leads to be bonded to a chip individually. The beams can be examined individually, insuring better quality control, and minimizing the amount of additional training for bonding operators, high power visual inspectors, and quality control supervisors. Furthermore, if any of the modules fail, they can be replaced as easy as integrated circuit dual in-line packages thus reducing the amount of downtime and streamlining repair procedures.

In multilayer techniques, multilayer ceramic or surface depositions can cause interface problems between the deposited conductors and the vias or feedthroughs. And there is also the risk of contamination from foreign particles getting lodged between the layers. But since the beam-lead laminate structure is a two-sided, etched printed circuit board with its x and y conductors deposited

on the outer surface of each side, all the disadvantages inherent in the multilayer techniques are avoided.

In the beam-lead laminate process, three sets of two masks each are made for the two sides of the printed circuit board. The first pair—one mask for each side of the board—consists of the tiny feed-through holes. The second pair of masks is for electroplating the conductors on both sides of the board with the vias. And the third set mechanically delineates the outline of the wiring on the laminate, puts in the fixture holes for tooling and registration, and opens access windows so beam leads can be bonded to the IC chips.

Combining the semiconductor industry's equipment and skills in photochemical technology with the printed circuit industry's knowhow in photoreduction and artwork, Motorola was able to achieve conductor pattern densities previously unattainable in multilayer systems—200 conductors per inch with as many as 1,000 vias 1 mil in diameter were made to a high degree of resolution.

The laminate structure is composed of 1-mil-thick Kapton—a polyimide dielectric film—on which are deposited conductors 3 mils in width spaced on 5-mil centers. The package's base, 96% alumina, is 1.28 inches square.

Each beam lead is anchored mechanically on the lower surface of the polyimide film by the electroplating in the via which serves as a minute rivet

Rising sales, lower prices will brighten picture

By W. Raisanen

Motorola Semiconductor Products Inc., Phoenix, Ariz.

Enthusiasm and optimism, mixed with wild speculation, hit the computer industry a few years ago when it was expected that large-scale integration would quickly revolutionize computer mainframe memories. To clear the air over the present situation and the outlook for the memory market, here are some projections we can anticipate for technical growth and value of the market.

Mainframe memories hauled in close to \$680 million in 1967—a figure which by 1970 should exceed \$1 billion. And a good estimate is that by 1972 the market should be pushing \$1.6 billion. From this figure, semiconductor manufacturers can estimate that their market for random access memories will lie in the \$65 million range.

Of course, the prices of memory systems will depend on speed. In 1967, the highest-performance memory systems available had a 400-nanosecond cycle time and cost about 10 cents a bit. In 1970, however, 100-nsec cycle times will be available at the same cost. But the bulk of the business will lie in memories with 250- to 500-nsec cycle times at

4 cents per bit. Meanwhile, the price of core memories, largely determined by basic material costs, should remain approximately the same.

By 1972, cost and performance of semiconductor memories should improve further so that 100-nsec cycle times at 5 cents a bit will be common. A fairly good guess is that these high-performance memories should take in about 15% of the \$65 million market, or about \$10 million.

If normal business trends occur, one or two suppliers will share the bulk of the 100-nsec memory market. Each will be struggling to hold \$3 to \$5 million worth of business.

In summary, it's not going to be a happy hunting ground for the IC manufacturers. Cost competition, performance, customer service, all will help determine what slice of the pie competitors will enjoy. But most semiconductor memory users feel that the upward trends predicted are going to materialize, and that an acceleration of these trends should take place around 1972 as semiconductor memories gain more acceptance.

or eyelet. In addition, the eyelet also permits a convenient and compact design layout because signals can arrive at the chip destination on either the upper or lower laminate surface. A further benefit in the eyelet anchoring is that it frees each beam lead from dependence on conductor adherence to the polyimide film surface. Without the eyelet action of the beam-lead vias holding the laminate together, minor delaminations at the edges of the laminate would permit the beams to twist out of registration with respect to the pad locations on the chip.

Even though the topology and electrical connections were laid out at 20 times the normal size (25 inches square), it still was not possible to generate the master artwork details needed to create 1-mil vias and tiny beam-lead patterns to the final mask accuracy of less than 50 microinches without extensive use of automatic computer generation. The final layout data, stored in coded form on magnetic tape, produces masks on a Gerber automatic drafting machine.

In the layout there are 996 vias of 1-mil diameter, of which 46% are active; 449 beam leads cantilevered over nine chip windows, and more than 2,200 graphic segments—each readily alterable by computer program changes. Larger beam leads are used to connect the interconnection laminate to the 73 exit bond tabs and to the power distribution.

The small spacings possible on the laminate con-

tributed to high-conductivity, short-length signal paths, reducing distributed capacitance of the conductors and making faster memory speeds possible.

The power conductors are low-impedance, gold-plated, thick-film patterns deposited on the alumina substrate. The pattern is designed to distribute the ground reference and the two supply voltages used by the memory system. The bases of the MOS storage array chips are tied to the positive supply, while all bipolar chips in the system are npn types, requiring the negative supply to be tied to the base of the chips.

Since the beam leads are formed during the production of the interconnection matrix, separately from IC production, no extra processing techniques are necessary when fabricating the silicon wafers containing the chip arrays used in the memory module. Motorola employs a standard wafer-process flow which provides a glass-like passivation coating over the entire wafer, after which pad openings are etched to expose the aluminum electrodes.

Face-up bonding of the beam leads to the IC chips is particularly advantageous in the light of the semiconductor junction temperatures generated. The back surfaces of the chips are tightly secured to the thick-film metalized alumina base, guaranteeing low thermal resistance against the heat generated by the chips and their rapid heat dissipation into the package's large base area.

Building-block approach simplifies memory design

By Durrell Hillis

Motorola Semiconductor Products Inc., Phoenix, Ariz.

Motorola's building-block approach to the design of an 8,192-bit memory module starts by dividing the memory into 34 subunits or modules which are mounted on two printed circuit boards about 8 inches square. With a 120-nanosecond access time and 150-nsec cycle time, this memory is among the fastest mainframes around, yet its system reliability compares favorably to core memories. Furthermore, the building-block approach permits isolating failures to a particular module and replacing that module with minimum risk of damage to other parts.

The memory modules use p-channel mos flip-flops for data storage, and bipolar circuits for address decoding, word, sense, and digit drives. This combination yields high-speed operation at low power dissipation (less than 6 watts).

The modules are multipackaged hybrid assemblies consisting of a stack of four memory arrays, one word driver, and one sense amplifier-digit driver package. The complete module has 32 mos storage arrays of 256 bits each, 4 array selection chips, 4 sense amplifier-digit driver chips, and 2 address decoder-word driver chips.

The array chip is wired in a 2-D configuration and stores 32 words of 8 bits each. The module is addressed in binary code and the inputs and outputs of one module may be bussed with those of others to expand capacity.

The timing for the read and write operations has been kept simple. When a location is addressed, its contents are gated to the output terminals within 100 nsec and remain there until a new location is addressed. When writing into memory, the address of the location and the data to be written in is delivered to the proper inputs. When the write-enable line is pulsed the data is stored.

The array selection chip, which shares a package with eight storage arrays, activates the input lines of one of the eight storage arrays. The binary combination on the three address inputs selects one of the eight array driver stages which in turn provides the necessary drive to activate the sense switches on

the corresponding mos storage array.

Two additional binary-coded inputs to the array selection circuit provide selection of one of four memory packages. Thus the five inputs to the array selection circuitry choose one of four memory packages and one of eight storage array chips on the selected package.

Two decoding word-driver chips are contained in a 1.25-inch package similar to the memory array package except that interconnection within the package is made with thick-film metalization and wire bonds. Each of the two bipolar chips decodes four address bits and drives one of 16 word lines. Two address-enable inputs are provided—one for a master enable, and the other as a one-bit decoder to select either of two decoding word-driver chips sharing the same package. Thus the input signals to the decoding word-driver package select one of 32 word lines for each storage array chip in the module.

Selection of a single word in memory is accomplished by selecting a memory module and a storage array chip in the module, and then one of 32 words on that storage array chip is selected by the decoding word-driver package.

Four identical sense amplifier-digit driver chips share a package and deliver data to and from the memory via eight bit-line pairs. Each chip receives and sends mos-level read and write signals to the storage array, accepts emitter-coupled logic data-input and data-enable signals, and generates data output signals in ECL.

Each sense amplifier-digit driver chip serves two purposes. First, when it has been properly enabled for writing, it must transmit a write signal to appropriate bits of the selected word in the storage array. Second, when properly enabled, it must sense the storage cell currents of the selected word and translate them to ECL level signals at its data output terminals.

The bipolar drive and sense circuits were designed to minimize delays due to charging and discharging relatively high distributed capacitances. Since all

The MOS storage arrays are packaged in high-density, hermetically-sealed alumina ceramic containers. The standard package has 16 signal contacts and one heavy-duty power contact on each of its four sides. Taking into account heat dispersal and the spacing of the 68 contacts, the perimeter of the package's interior was made just over four inches. The over-all package beam leads are disposed around the periphery of the laminate and are bonded to the metalized signal path terminals during assembly.

Extensive functional testing is performed as soon as the chips are bonded onto the laminate. Any faulty bonds or electrical failures are detected and diagnosed by a computer. When a faulty chip is located, the chip can be lifted and removed, and another chip bonded in the same location.

When groups of chips are anchored to a ceramic package, the different thermal coefficients of expansions generated by various materials and surfaces must be taken into account. Unless a strain-relief is provided against the stresses that accumu-

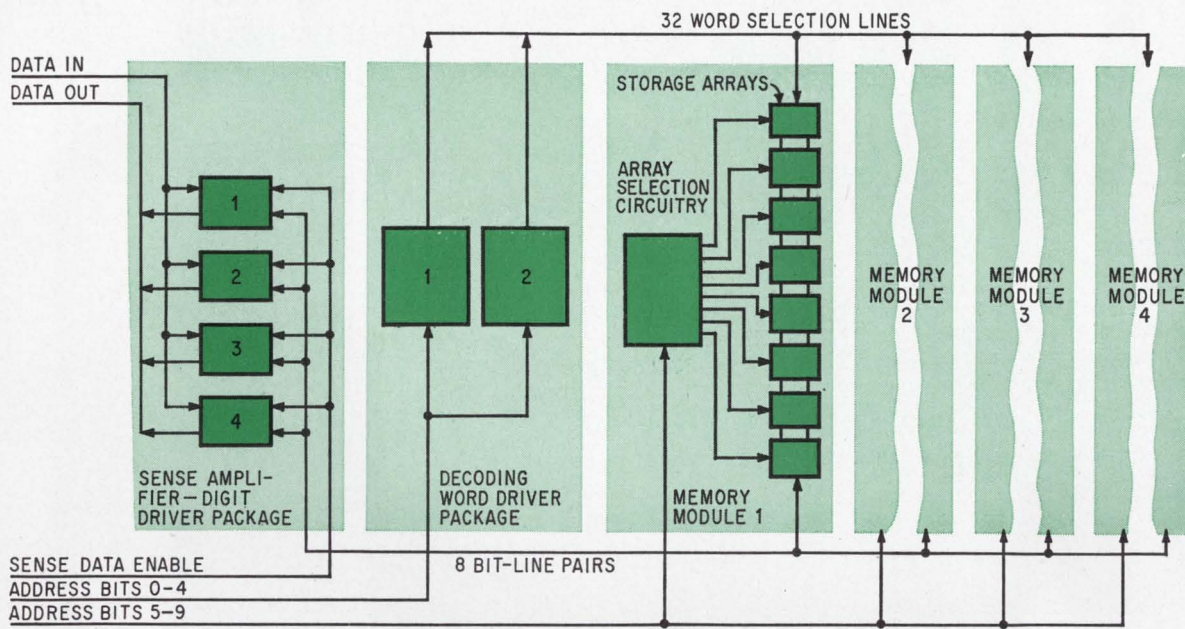

ORGANIZATION OF 8192-BIT MEMORY MODULE

Signal flow. Once a single eight-bit word in the storage array has been addressed, 16 low-impedance paths (eight pairs of bit lines) exist between the four sense amplifier-digit driver chips and the eight MOS storage array cells. Reading is performed by sensing the storage cell currents while holding the bit lines at approximately ground; writing is done by forcing the selected bit lines to a positive voltage.

word-selection and bit lines are connected in parallel to all 32 storage array chips, the capacitances associated with these lines are high—about 250 picofarads on word lines and 70 pf on bit lines. These charging times are a significant part of the memory cycle time. The output stages of the array selection and decoding word-driver circuits had to provide sufficient transient current to rapidly charge and discharge the distributed capacitance.

The bit lines are terminated through a resistor to ground at the sense amplifier-digit driver inputs. The termination resistance on these bit lines must be low, or small currents from the MOS storage arrays will not be detected by the sensing circuits. However, the resistances at the terminating nodes could not be made small enough to avoid a relatively long time constant from the 70-pf distributed capacitance on the line. The sense amplifier design, therefore, fea-

tures an input stage which will not only detect small differential bit currents (as low as 20 microamperes) with common-mode rejection, but will, after the detection threshold voltage has been exceeded, clamp the differential voltage of the bit lines at a low level (about 30 millivolts) for a wide range of cell currents. Consequently, little charging and discharging of bit-line capacitance occurs during a read cycle.

Another feature of the sense amplifier circuit is the use of a write recovery circuit that is common to both bit-line pairs. Although the differential bit-line voltage is limited during a write cycle, it is purposely made large (about 4 volts) during the write cycle to guarantee that the write operation is performed into the MOS storage cell.

But the bit-line pairs have a large time constant. The recovery circuit, however, quickly pulls the bit line back to ground following a write operation.

late during power turn-on and turn-off, the chips will swell and contract in size relative to the surrounding materials. These stresses were prevented from straining the bonds at the chip pads through a set-down type of strain-relief in which the beam leads are slightly curved along the connection from the pad to the laminate.

To provide a balanced thermal design, the bipolar select chip—one for each group of eight MOS storage array chips—was placed in the center of the package, with the MOS chips around the periph-

ery. Thus the lower heat dissipation from the MOS chips—about 1/32 watt—was distributed with the bipolar chip, which dissipates 1/2 watt.

The aluminum pads on the storage array chips were designed to be as small and as close together as possible and yet permit chip-testing at the wafer level of fabrication. Beam leads about 2.6 mils wide and 11 mils long were found to provide trouble-free bonding registration to the matching row of chip pads.

For sturdiness, the storage array chips are

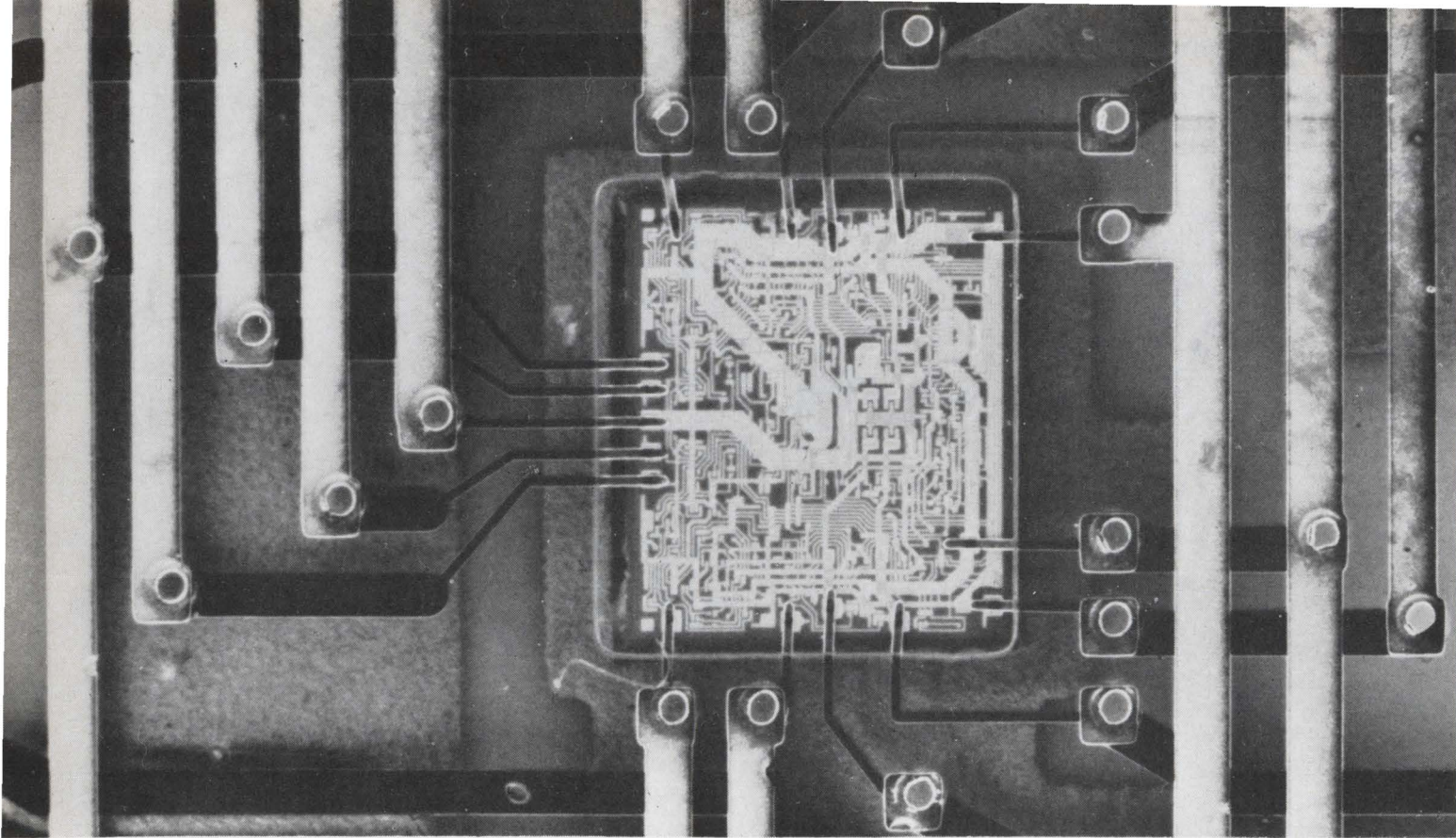

Close-up. There are four identical sense amplifier-digit driver chips which handle input and output information for two bits of the memory module. Each chip operates in both the read and write modes and is connected to the memory package in bit-line pairs.

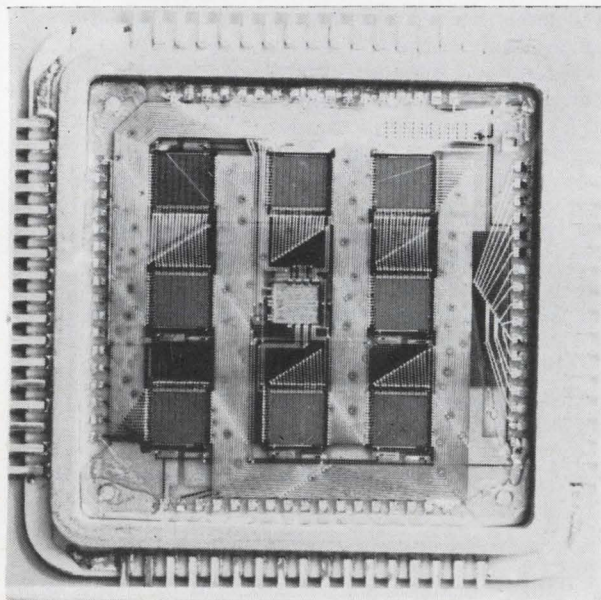

Surrounded. One package or subunit of the memory consists of eight MOS storage array chips surrounding one bipolar chip in the center. The multichip assembly comprises 2,048 bits of the memory. Four such packages form the storage portion of the 8,192-bit memory module. The complete unit has 32 MOS storage arrays of 256 bits each, four array selection chips, two decoding word driver chips, and four sense amplifier-digit driver chips.

about 12 mils thick to accommodate the large base area of 138 x 141 mils. The strain relief in the beam leads is implemented by setting the laminate about 14 mils above the mounting surface. And since the chip is 12 mils thick set-down for all beam leads is about 2 mils when they are bonded to the chips. Aside from providing the needed strain-relief, this technique assures less chance of short-circuits to other electrical surfaces of the chip.

Exit beam-lead tabs, located around the periphery of the laminate, are anchored to the polyimide film with large metal caps, each containing a pair of vias for extra mechanical strength.

Three types of access openings are formed in the memory laminate during fabrication. The largest are called chip windows and are designed to permit the beam-lead bonding tool to seat on contaminant-free leads and also to allow inspection of the bonds.

The next-largest access openings are called exit tab blankings. The 68 exit tabs allow conductor patterns to be set down as a unit where each conductor is bonded individually. The smallest openings free the power tabs located near each integrated circuit. These tabs also are set down on the package base and are bonded to matching positions on the power-plane metalization. Thus each chip has a local connection to the power supply network. ■

Four ways to improve your memory:

1. Improve your computer's memory with Linear Circuit 525. It's the one, the only high-speed core memory sense amplifier of its type that lets you set the threshold internally. (Or externally; take your pick.) More unforgettable features: 1) uncertainty range, $\pm 4\text{mV}$; 2) propagation delay, 30 ns; 3) low power consumption; 110mW; 4) high common mode range: $+4.5\text{V} - 3.5\text{V}$.

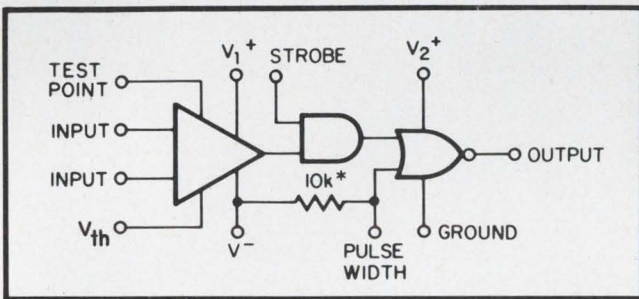

2. Improve your computer's memory with Linear Circuit 511. This one's a versatile transistor array. It's also a pre-amp — with DC characteristics that are 50 to 100% better than competing devices! Other memorable points: 1) low offset voltage $\pm 2\text{mV}$; 2) low offset current; 3) single power supply; 4) AGC capability.

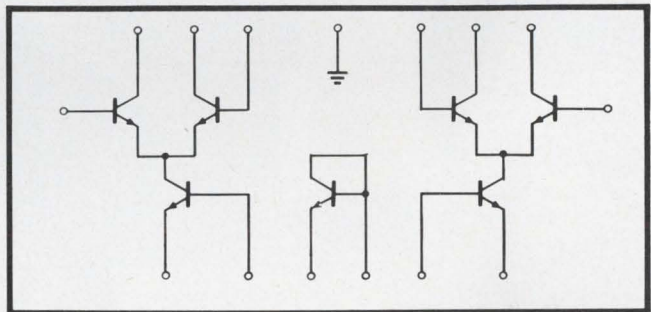

3. Improve your computer's memory with Linear Circuit 526 — the high-speed comparator that's beyond compare! (Do you know of another comparator with a propagation delay of 30 ns?) Other features to remember: 1) operates from $\pm 5\text{V}$ supplies; 2) overdrive recovery, 20 ns; 3) fanout of 10; 4) high gain operation; 5) output compatible with DCL, DTL and TTL.

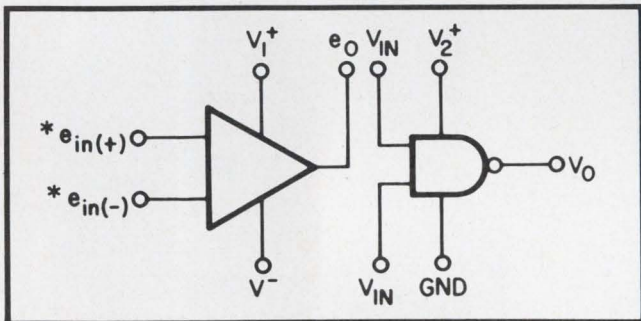

4. Improve your computer's memory with Linear Circuit 5733. It's the video amplifier that operates over — are you ready? — 120 MHz band width! Differential in/differential out with minimal phase distortion, too. And as a pre-amp in computer applications, don't forget: 1) 10 ns rise time; 2) fixed gains of 10, 100, 400 available (variable between 10 and 400 with a single, external resistor); 3) internally compensated (no external frequency compensation components required.)

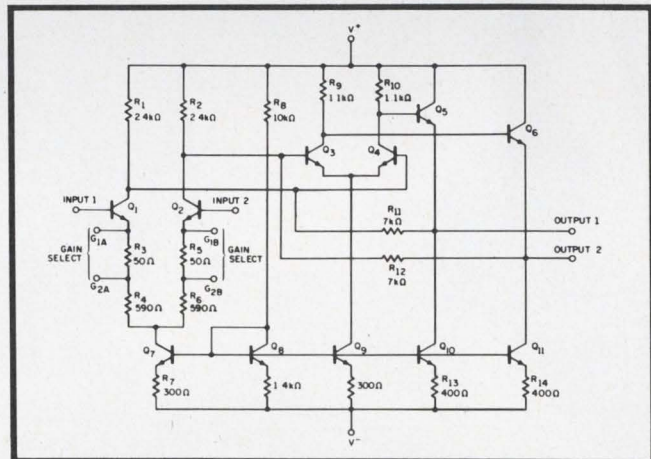

P.S. We almost forgot: all four of these monolithic linear circuits are available right now — in production quantities. So are all the specs, facts, figures. Send for them today — before you forget!

Signetics

Signetics Corporation / 811 E. Arques Ave., Sunnyvale, California 94086 / A subsidiary of Corning Glass Works



Digitmaster computers cut the mustard at "hamburger heavens"

...after TI Supply puts needed ICs to the test.

"Save us from waitress arithmetic," cried restaurant operators.

Motiograph, Inc. in Chicago heard the cry and designed a computer to do the adding for the waitress.

The Digitmaster computer protects the restaurant operator from losses due to errors. It scans the order, prints out correct prices, computes the sales tax and totals the bill faster than you can say "no onion." At the same time, it keeps tabs on various inventory items and warns when to restock.

A wonderful idea, but how could a small company like Motiograph manufacture such a complex computer and guarantee the high degree of reliability required?

They could, and did...with help from TI Supply.

Obviously, IC testing was the key to reliability but too expensive for Motiograph to undertake.

They turned to TI Supply and found that our testing service could provide all the needed testing at a fraction of the cost of equipment and

personnel training.

In addition to tested TTL integrated circuits, we supply discrete semiconductors, connectors, capacitors and other components—scheduling deliveries so that Motiograph doesn't tie up cash in inventory.

That's a lot of service, but it's not all we offer.

Some customers save money by using our custom marking and assembly services.

Others avoid trouble by employing our burn-in facilities.

Everybody appreciates the lengths we go to to find and deliver the parts needed to keep assembly lines running.

In fact, we're dedicated to helping our customers prosper and grow. We have 51 world-wide locations—any one of which is ready to serve you.

Maybe you are not concerned with "waitress arithmetic," but if your products involve electronic components, industrial supplies and services, we can help you prosper.

Give us a call.

Series 54/74 TTL fits any bill

TI Supply stocks the complete family of TI Series 54/74 TTL ICs. That's saying a lot—there are more than 90 distinct functions. Including 35 MSI circuits. Three compatible speeds. Three packages. And two temperature ranges.

You'll find among this unequaled choice—as Motiograph found—exactly what you need to fit any TTL bill.

Add to this wide selection the fact that we're geared for prompt delivery. From 51 world-wide locations. Plus a host of problem-solving services. All good reasons for placing your TTL order with TI Supply. No mistake. For more details, call your nearest branch office or write TI Supply Co., P.O. Box 35486, Dallas, Texas 75235.



TI SUPPLY.. the problem solvers.

EAST
Boston (Canton), Mass. (617) 828-5020
Clark, New Jersey (201) 382-6400
New York, New York (212) 895-0803
or (516) 488-3300
Philadelphia (215) 664-1132

MIDWEST
Kansas City, Missouri (816) 753-4750
Minneapolis (Edina), Minn. (612) 941-5020
Chicago (Rosemont), Ill. (312) 296-7187
Wichita (Derby), Kansas (316) 788-1714

SOUTHWEST
Austin, Texas (512) 454-2531
Dallas, Texas (214) 357-6121
Fort Worth, Texas (817) 332-9361
Houston, Texas (713) 785-4800
Tulsa, Oklahoma (918) 437-4555

WEST
Los Angeles, California (213) 776-4490
Denver, Colorado (303) 757-7671
San Francisco (Sunnyvale), Calif. (408) 732-5555
CANADA
Montreal (St. Laurent), P.Q. (514) 332-3550
Toronto (Richmond Hill), P.O. (416) 889-0844
Ottawa, P.O. (613) 825-3716

Meet decision makers in medical electronics

Physicians, hospital administrators, biomedical engineers, educators, researchers, system design engineers who attend the 2nd National Conference & Exposition on Electronics in Medicine represent real buying power. We know because we asked the attendees at the first conference last spring how much they spent on medical electronics and their responses added up to a whopping \$36 million—about ten per cent of the 1968 market.

buying and specifying influence

What's more, the second conference has been designed to meet the overwhelming demands of the earlier attendees for direct exposure to actual hardware. We're inviting manufacturers of medical electronics gear to take advantage of this unprecedented opportunity by exhibiting at the exciting 2nd National Conference on Electronics in Medicine in San Francisco. Through a carefully crafted program of invited papers by leaders in the field, and discussion group sessions on vital questions, the Conference will attract the people manufacturers want to meet most—the men who make the buying and specifying decisions in a \$400 million market. The 2nd National Conference & Exposition on Electronics in Medicine is presented by McGraw-Hill's Electronics/Management Center in association with the McGraw-Hill publications: Electronics/Medical World News/Modern Hospital/Postgraduate Medicine/Scientific Research. It is managed by National Expositions Co., Inc., the highly regarded exposition management firm based in New York.

prestige sponsorship

aggressive promotion

Full page ads, dynamic editorial coverage and a comprehensive mail campaign will find every buying and specifying influence in medical electronics wherever he works—hospital, research laboratory, consultant's office, university, clinic or private practice. He'll be reached repeatedly and effectively with our message. And that message is—the Second National Conference and Exposition on Electronics in Medicine is the place to discuss his urgent requirements first-hand with you—the people with expertise who can fill them.

opportunities for marketers

The Second National Conference and Exposition on Electronics in Medicine can help you find and sell new customers, create impressive lists of new, valuable contacts and achieve significant penetration in this exploding market. Space is limited, so make your reservation now.

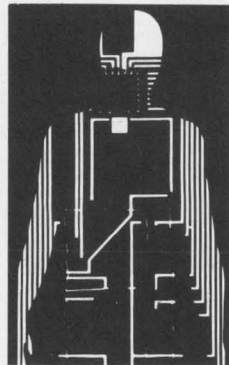

2nd National Conference & Exposition on Electronics in Medicine

FAIRMONT HOTEL, SAN FRANCISCO, CALIF. • FEBRUARY 12, 13, 14, 1970

Write or call for brochure, floor plan: Jerry Brown, Exhibit Manager, National Expositions Company, Inc.
14 West 40th St., New York, N.Y. 10018, 212/564-8714

Beckman 136MHz \$1375.

Universal Counter and Timer
Fully Programmable
Field Replaceable ICs
Signal Level Indicators

Two Counters in One • Burst Mode • Frequency • Period • Single-Channel Pulse Width & Pulse Separation • Two-Channel Time Interval • Multiple Period • Ratio • Multiple Ratio • 25 μ s Recycle Time

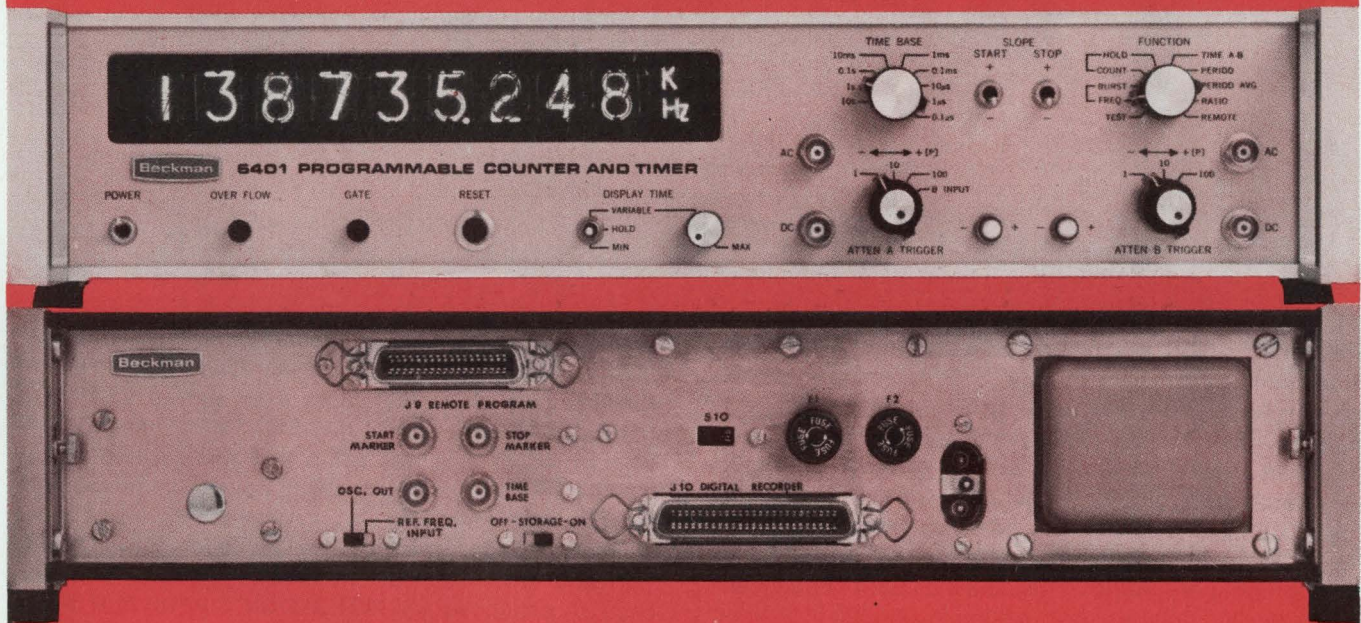

Beckman®

INSTRUMENTS, INC.
ELECTRONIC INSTRUMENTS DIVISION
RICHMOND, CALIFORNIA • 94804

Place your order for the Model 6401 with your local Beckman representative:

Barnhill Associates • Denver, (303) 934-5505 • Albuquerque, (505) 265-7766 • Phoenix, (602) 263-1250 • Houston, (713) 621-0040 • Richardson, (214) 231-2573 • Salt Lake City, (801) 487-1327 • BCS Associates, Inc. • Orlando, (305) 843-1510 • Greensboro, (919) 273-1918 • Huntsville, (205) 881-6220 • Williamsburg, (707) 229-6198 • Plantation, Fla., (305) 584-7556 • Burlingame Associates, Ltd. • Mount Vernon, (914) 664-7530 • New York City area, (212) 933-5555 • Rockville, (301) 427-1255 • Bala Cynwyd, (215) 835-2080 • Syracuse, (315) 454-2408 • New York State, Enterprise 9-6400 • Moxon Electronics • Los Angeles, (213) 272-9311 • Sunnyvale, (415) 734-4352 • San Diego, (714) 274-6525 • Pivan Engineering • Chicago, (312) 539-4838 • Cedar Rapids, (319) 365-6635 • Mission, Kansas, (913) 722-1030 • Indianapolis, (317) 253-1681 • St. Louis, (314) 872-8424 • Minneapolis, (612) 537-4501 • Brookfield, (414) 786-1940 • Seatronics, Inc. • Seattle, (206) 767-4330 • S. Sterling Company • Cleveland, (216) 442-8080 • Pittsburgh, (412) 922-5720 • Dayton, (513) 298-7573 • Southfield, (313) 357-3700 • Yewell Electronic Sales, Inc. • Lexington, (617) 861-8620 • Easton, (203) 261-2241 • Beckman Instruments, Inc., Electronic Instruments Division, Richmond Operations, (415) 526-7730

INTERNATIONAL SUBSIDIARIES: AMSTERDAM; CAPE TOWN; GENEVA; GLENROTHES, SCOTLAND; LONDON; MEXICO CITY; MUNICH; PARIS; STOCKHOLM; TOKYO; VIENNA

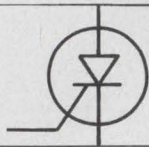

EXPANDED

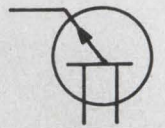

SEMICONDUCTOR TEST CAPABILITY FROM TEKTRONIX

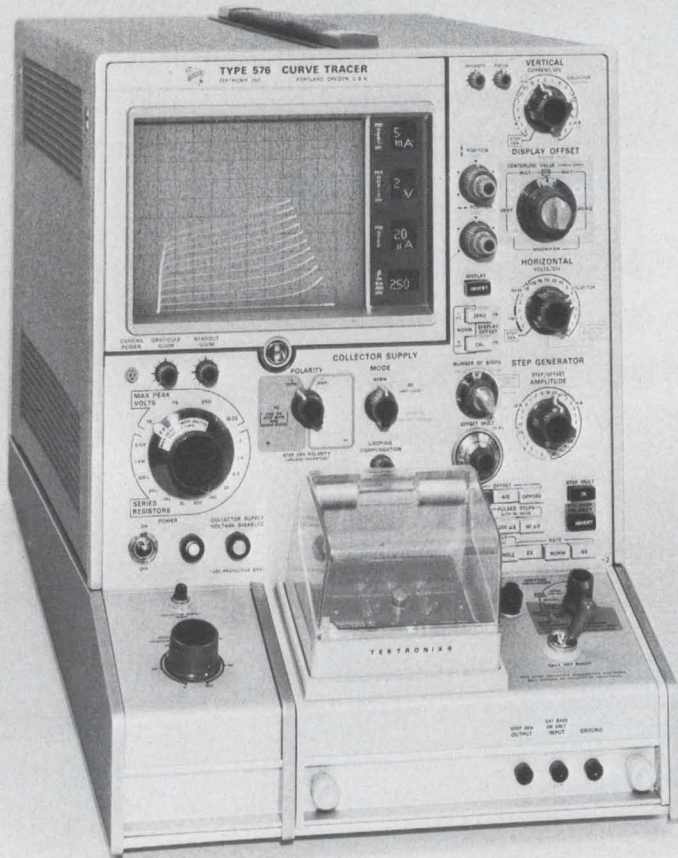

THE TYPE 576 CURVE TRACER—designed to provide maximum performance in the circuit design laboratory, on the production line or in service applications. An **EXPANDED VIEWING AREA** combines a 10 cm x 12 cm graticule with fiber-optic readout of scale factors, step amplitude, and Beta/div or g_m /div. This **SCALE FACTOR READOUT** displays parameters near the CRT for convenient reference during setup, testing and photographic recording. The Collector Supply provides swept or DC voltages to a maximum of 1500 V. A versatile Step Generator allows **CALIBRATED STEP OFFSET** and **PULSED BASE OPERATION** in addition to conventional modes. Vertical **DISPLAY OFFSET** with precise auto positioning control and X10 magnification

provides a calibrated and expanded effective measurement axis to 100 cm. This increased measurement sensitivity at all scale factors even allows **LEAKAGE MEASUREMENTS** to 1 nA/div! **MULTI-FUNCTION SWITCHING** makes test setup fast and easy to understand, providing direct reading power limits, polarity tracking and automatic display positioning. Additional accuracy is derived through provision for **KELVIN SENSING** (for high current tests). Operator convenience is enhanced by **INTERLOCK OPERATOR PROTECTION** and availability of a complete line of device testing adapters.

Type 576 Curve Tracer \$2250
U.S. Sales Price FOB Beaverton, Oregon

Your local Tektronix field engineer will be happy to demonstrate the Type 576 in your application. For additional information, please call him or write Tektronix, Inc., P.O. Box 500, Beaverton, Oregon 97005.



Tektronix, Inc.

committed to progress in waveform measurement

Up goes production, down go prices ... and here comes optoelectronics!

Thanks in large part to a push from the big semiconductor makers, light emitters and sensors are finding their way into a broad spectrum of applications and products

By Lawrence Curran

Electronics staff

Designing optoelectronic devices into hardware has dragged along for years. It was the usual story—volume was low, prices were high, and there just weren't that many sources of supply. But all this is changing—and changing fast!

Helping to change this picture has been the entry of the major semiconductor makers under a full head of steam. This is helping to push down the prices of light emitters and sensors, and coupled pairs. And the overall impact is that more and more products are now being produced in large volume, with prices dropping dramatically.

Take optical couplers, for example. Made up of gallium-arsenide light emitters and silicon detectors,

these couplers have been around for five years or so. But at prices ranging from \$50 to \$100 each, they have proved to be too expensive for broad applications. Now, however, prices are falling to the under-\$10 range for couplers, placing them at a point where they can be considered at just about every digital interface.

The upshot of this changing picture is an almost sudden leap forward for optoelectronic devices. They are already being designed into a broad spectrum of products or at least being considered seriously by designers in companies large and small. Companies are reluctant to discuss such products because most haven't as yet

reached the marketplace, but they include credit-card verifiers, card-key verifiers for roadway booths, military ordnance, home and industrial security systems, telephones, missile beacons, and displays. But these are just a beginning.

Texas Instruments, which has been in the solid-state optoelectronics business longer than anyone else, having supplied silicon sensors to IBM for card and tape reading for 10 years, has perhaps the best handle on the optoelectronics market. Ed Youch, optoelectronics marketing manager in TI's components group, believes the market will come in at about \$70 million when the final figures are tabulated for 1969. He sees the market grow-

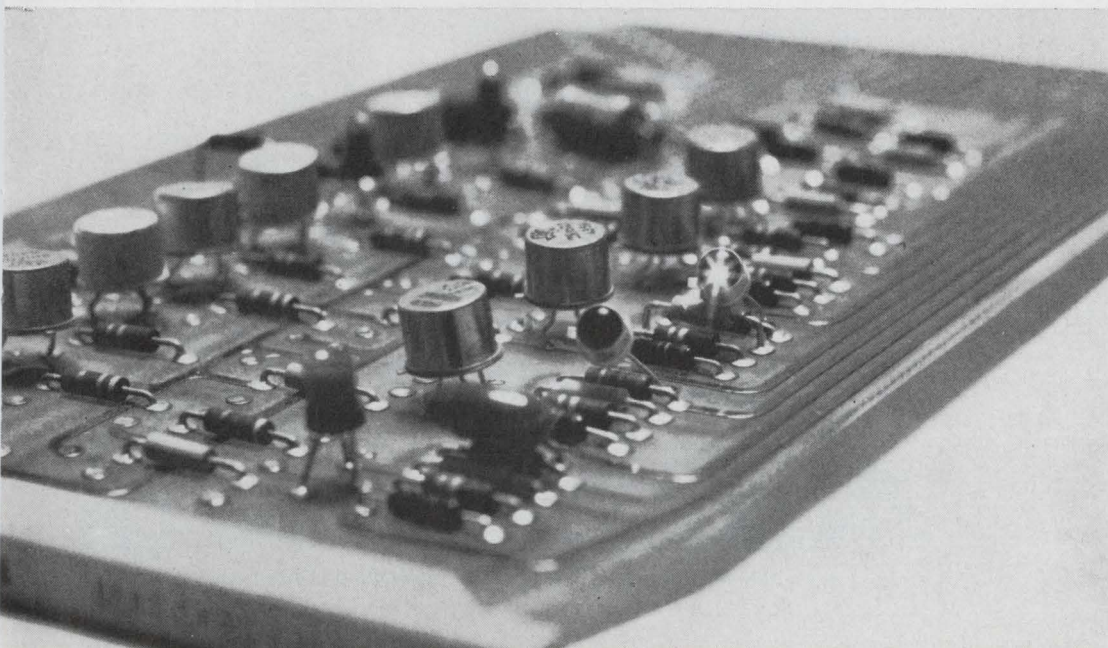

Indicator. The first large-scale uses of light-emitting diodes will be as indicator lights and in digital displays. Here an LED lights up, attesting that a particular IC has failed.

ing to \$80 million next year and \$210 million by 1974. And he considers these projections to be conservative. A dozen areas of application that could jell as early as 1971 could boost the market much higher, Youch says, and yet another range of opportunities that might harden by 1975 could send the optoelectronics market soaring to between \$463 million and \$675 million by 1979.

Motorola Semiconductor's director of operations Jack Haenichen isn't that bullish. He says "There will be more orderly growth in optoelectronics than in other solid state devices of the past, such as integrated circuits, because there's no big replacement market. This is new business."

William Rood, Motorola group manager for optoelectronic product marketing, pegs the present market at from \$18 million to \$20 million, with emitters accounting for only about \$1 million of that. He projects an industry growth rate of between 15% and 25% per year over the next five years, mostly in computer and computer peripheral-equipment applications (keyboards, and card and tape readers). Given that growth, Rood figures the market in five years will fall between \$50 million and \$80 million.

Fairchild Semiconductor's M.M. Atalla, vice president and general manager of the Microwave and Optoelectronics division, lines up closer to TI's Youch in his estimate of the market: between \$300 million and \$400 million in 1975. Fairchild, as well as Motorola, TI, RCA, and General Electric, now regard optoelectronics as a prime market.

TI has the industry's broadest line, and the biggest share of today's market. The firm's sensor, or detector, line includes some 33 devices—silicon phototransistors, silicon and germanium avalanche photodiodes, p-n and npn planar silicon light sensors and photodevices, a p-n planar silicon laser detector (photovoltaic light sensor), and npn silicon photo duo-diodes.

On the emitter side, there are at least 11 GaAs diode light sources in the TI line, plus four gallium-arsenide-phosphide diodes. TI also offers three optically coupled isolators consisting of a GaAs diode source coupled to an n-p silicon phototransistor, plus an opti-

cally coupled IC that functions as an optoelectronic pulse amplifier.

Voltage isolator. TI's Youch says he's shooting for a \$3 isolator, but the big problem has been the price of GaAs. It is fast coming down now, though, he adds. Besides ground isolation, says Youch, an emitter-sensor pair can provide voltage isolation. "It can be coupled to 4,000 volts to do the same job as a pulse transformer" he points out. "As a circuit element, a pulse transformer can be large and cost from \$30 to \$1,000. Depending on the application and quantity; an optoelectronic isolator can do the same job for from \$5 to \$30."

Motorola, which acknowledges TI's lead, is pulling out all stops to catch up. The company unveiled its first light emitter two weeks ago—a visible red-emitting gallium-arsenide-phosphide diode. Designated the MLED 600, the emitter is intended for applications requiring high visibility (its brightness is 300 foot-lamberts), including use as a panel indicator and a circuit condition indicator. And the device can be used in punched-tape readers. It requires just 16 milliwatts of drive power to produce 50 foot-lamberts, and dissipates 100 milliwatts at 25° C. But the device's most significant attraction is its price: \$1.45 each in quantities of 1,000 or more and \$2.05 in quantities of 100.

Motorola raced to get the MLED 600 stocked and announced before

Fairchild could take off the wraps on a plastic-packaged light-emitting diode it has in the wings, the FLD-100, which is expected to sell for about \$1.50 in quantities of 10,000.

Plastic and price. Both Motorola and Fairchild are using plastic packaging to get the price down as low as possible for both emitters and sensors. Motorola has a line of plastic npn silicon phototransistors, the lowest priced of which sells for 55 cents in quantities of 1,000. In all, the company's optoelectronics line encompasses five types of npn silicon phototransistors, plus four types of npn silicon photodetectors, the new light-emitting diode, and a recently introduced p-i-n photodiode [*Electronics*, Sept. 29, p. 173].

Motorola hasn't announced any coupled pairs, but Arnold London, project manager for optoelectronic devices, expects the company to be in the coupled-pair business by mid-1970. In the works is a pair in which a diode emitter is coupled to a light-activated silicon controlled rectifier, but London doubts a product will be ready for market in 1970. This kind of coupled pair would be useful in jobs where continuous emitter output isn't desired. The SCR latches onto the pulsed output of the emitter and acts as a solid state relay.

General Electric has been in the emitter market since 1967—longer than both Fairchild and Motorola.



Fire fighting. Solid state emitters will be coming to the aid of firemen and smoke jumpers. The Forest Service even now is testing an injection-laser device that sees through smoke.

The firm calls its light-emitting diodes "solid state lamps" mainly because they're manufactured at the firm's lamp department in Cleveland, Ohio. There are now 12 different types of diodes—eight i-r and four visible-light emitters—in GE's product line. The two newest are the SSL-34 and SSL-35, i-r emitters that are intended for aperture sensing and to serve as the emitter in coupling or isolation circuits.

Inner lens. Kenneth Dean, who next month will become manager of specialty lamps, market development, and product planning in GE's miniature lamp department, says the only mechanical difference between these emitters and the previously introduced SSL-4 and SSL-5 i-r emitters is that the newer ones have a drop of epoxy over the GaAs chip to focus the output. The earlier devices have only air between the chip and lens atop the metal can. The epoxy "inner lens" leads to a greater output for the same continuous input current.

The SSL-3 emits green light. It is a GaAs diode doped with a lanthanum-fluoride phosphor, which, without the phosphor, would emit in the infrared. Its typical output at 100 ma is 80 foot-lamberts, and it's intended as a "go" indicator light in aircraft, computer and spacecraft applications.

GE's Dean thinks solid state indicator lights, with their high reliability in shock and vibration environments, plus their low-current and low-voltage operation, will eventually replace incandescent and neon lamps.

Monsanto's electronic special products group in Cupertino, Calif. found its expertise in GaAs and gallium-arsenide-phosphide materials valuable when the optoelectronics market began to beckon. The firm is just getting into light-detecting products, having announced a p-i-n photodiode that sells for less than \$4 each in lots of 1,000. Clarence Bruce, director of marketing, says, "Our basic business has been emitters but it's a logical step for us to get into detectors."

On display. Monsanto is taking advantage of its own light emitters by using them in a solid state alphanumeric display. In all, the company makes eight visible light-emitting diodes, eight i-r emitters, and at least three coupled pairs.

These are in addition to the photodiode detector. Monsanto's highest-rated discrete emitters put out 25 mw at 2 amps.

Bruce says one of the reasons coupled pairs for isolation haven't taken off sooner is that potential users don't know what they can do. Monsanto has marketed its coupled pairs for more than a year. One of them, the MCR-1, uses an i-r emitter with a cadmium-selenide p-i-n photodiode sensor. The sensor's resistance drops when light is present, making it useful in the tuner of a television set for automatic gain control, Bruce points out. Another Monsanto pair, the MCD-1, also links an i-r emitter with a p-i-n photodiode for fast switching (5 nanoseconds) in coupling computer peripheral equipment to main frames.

Bruce says one of the more exotic applications for Monsanto's emitters is in digital annotation of 16- and 35-millimeter film. Two of the firm's most recently announced emitters, the MV-3 and MV-5, control film exposure and apply the digital code as they do. "These are our first products made specifically for film annotation," Bruce says, "and they're discretes that emit at 6,700 angstroms."

Plastic piper. In solid state numeric displays, Monsanto competes with HP Associates, a Hewlett-Packard division in Palo Alto, Calif. HP employs one of two visible light emitters in its product line in this display. The gallium-arsenide-phosphide unit has a brightness of 50 foot-lamberts derived from a 10-ma drive current. HP spokesmen foresee its use in film annotation, putting sound on film, and in what applications engineer Hans Sorensen calls photoelementry, which is the transmission of light through plastic fiber-optic "pipes".

HP's isolators are being used by a Mountain View, Calif., firm in a secure communication system using 25-ft.-long fiber-optic light pipes to transmit light from the emitter that's been modulated by a 30-megahertz-wide signal. A newer version with a 100-Mhz bandwidth is in the works.

RCA makes both GaAs-diode emitters and injection lasers built with the emitters at its Somerville, N.J., facility, and detectors in Montreal. The latest products are a

STABILITY & QUALITY

MATSUO
METALLIZED POLYESTER FILM CAPACITOR - "TYPE FNX-H" -

Sub-miniature size and oval section ideal for space economy. Lightweight, self-healing and with high insulation resistance. Capacitance values up to 10 MFD. Outer wrap of tough polyester protects against moisture. Perfect in both transistorized and low voltage tube circuits and others where size and cost are paramount.

Specifications:
 Operating Temperature Range: -40°C to +85°C
 Standard Voltage Rating: 100, 200, 400, 600 VDC
 Standard Capacitance Value: .1 MFD to 10 MFD.
 Standard Capacitance Tolerance: ±20% (available ±10%)

MATSUO'S other capacitors include:
Solid Tantalum Capacitors: MICROCAP for hybrid ICs, Type TAX hermetically sealed in metallic case, Type TSX encased in metallic case and sealed with epoxy resin, Type TSL encased in metallic case and sealed with epoxy resin
Polyester Film Capacitors: Type MFL epoxy dipped, Type MFK epoxy dipped, non inductive, Type MXT encased in plastic tube, non inductive.

For further information, please write to:
MATSUO ELECTRIC CO., LTD.
 Head Office: 3-5, 3-chome, Sennari-cho, Toyonaka-shi, Osaka, Japan
 Cable: "NCCMATSUO" OSAKA Telex: 523-4164 USA
 Tokyo Office: 7, 3-chome, Nishi-Gotanda, Shinagawa-ku, Tokyo

Electronics | December 22, 1969

Circle 119 on reader service card

119

10 nanoV Resolution

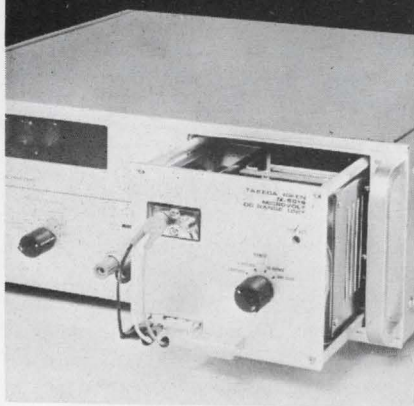

-TR-6018 Microvolt DC Range Unit permits DC voltage measurements at a resolution of 10 nanovolts. Input circuit employs a floating and guarded system.

Input cable features a special conductor having an extremely small thermoelectric force.

Main unit: **-TR-6515** autoranging, integrating digital voltmeter.

Specification

- * Range: 300 μ V, 3, 30mV f.s.
- * Resolution: 10 nanoV
- * Accuracy: $\pm 0.02\%$ of reading
 ± 1 digit
- * CMR: 160dB (DC)

**TR Takeda Riken
Industry Co., Ltd**

1-32-1, Asahi-cho, Nerima-ku, Tokyo 176, Japan
Tel: Tokyo 930-4111
Cables: TRITRONICS TOKYO

Agents:

Litton Precision Products International Inc.
Germany, France, Holland, Belgium,
Luxemburg, England, Switzerland.

Ing. S & Dr. Guido Belotti Ltd Italy
K. Juul Hansen Denmark
E. Nores Finland
Carl-Eric Larsson Sweden

Look to the smaller companies for innovation

Optoelectronics is far from becoming the private preserve of the big companies. A number of smaller firms are doing a great deal of work in this area, too. And since smaller companies tend to develop low-volume devices that their bigger counterparts ignore for one reason or another, they can be counted on to be in the forefront when it comes to innovation.

For example, Optical Memory Systems, a new firm in Santa Ana, Calif., is making an optical read-only memory having a capacity of 262,144 bits. An array of 1,024 infrared-emitting GaAs diodes is combined with 256 silicon p-i-n photodiodes sensors. The company uses low-output emitter diodes that are brought on the outside, but employs proprietary optical techniques to boost the output energy level.

Multipliers make it possible to hit the sensors with enough energy for each emitter to excite the entire sensor array. Integrated-circuit mask techniques are used to produce the memory's program on a piece of glass through which the i-r light passes. Opaque areas produce a logical 0 and clear sections, which allow light to get through, enable the p-i-n diodes sensors to register a logical 1.

Another company, Recognition Equipment Inc., in Dallas, is using what it calls an electronic retina in its computer reader that converts printed characters into digital computer language. An external lens focuses document data onto silicon phototransistors that are in an array 48 rows high and 11 or 12 rows across. The lens and array make up the retina, which looks at the entire height of a character instead of scanning character segments. Scanning techniques lend to storage of cumbersome amounts of analog data.

The parallel analog data the retina sees is then fed to a series of automatic-gain-control amplifiers. The system determines where the characters are located in relation to the background, then feeds the data to an analog computer where the data is converted to a digital input for a computer. This eliminates the need for key punching. The machine reads 200 inches per second, or from 2,000 to 2,400 characters a second on such forms as credit-card sales transaction slips and airline tickets. Motorola is the major supplier of the phototransistors used in the system.

Other work. At Information Storage Systems in Cupertino, Calif., ce solid state lamps are used in a servotransducer of a disc memory drive to boost memory access speed. Emitting diodes are coupled to photodetectors that sense disc position. At Stanford Research Institute in Palo Alto, Calif., engineers have developed a character-recognition device for the blind. When moved over any printed page, the device converts the light from alphanumeric characters into coded vibrations that the user can read.

And at Space Sciences Inc. in Waltham, Mass., engineers are building a device that simulates the response of the human eye tracking a moving object and puts out a color-tv signal. Space Sciences' device eventually will find its way into a still-classified Air Force system.

large single-diode laser and a family of laser arrays. The single-diode device has a minimum output of 15 watts; the arrays have a minimum output of 150 watts and 300 watts is typical.

Countering foes. RCA's emitters are used in applications ranging from card readers to shaft encoders. But about 30% of the optoelectronic work at Somerville is custom, involving "repackaging" devices for military systems. Richard Myers, an RCA engineer, says military development has been done on optoelectronic bomb fuzes, though none have been deployed. In such a system, one of the ways the proximity fuze works is to

measure the time required for the emitter's pulse to be returned from the ground to the sensor. Myers points out that one of the big advantages of this kind of fuze is that predetonation is extremely difficult. This, he adds, can't be said for radio-frequency or microwave proximity fuzes. Another advantage is that when used in a missile such as an antitank shell, the fuze looks only at the target, ignoring ground reflections.

Fuzes built with solid state emitters and sensors can be manufactured extremely small, points out Myers.

Myers says applications for the injection lasers are similar to those

for the diodes themselves—including fuzes and other ranging devices. "The Government has demonstrated that you can use these lasers in a gated-viewing system to penetrate fog and smoke," Myers says. And the U.S. Forest Service is evaluating a gated-viewing system built with an RCA solid state laser system to see through smoke. It could be the forerunner of portable units for fire fighters.

The standard product line at Electro-Nuclear Laboratories, Menlo Park, Calif., ranges from metal-canned phototransistors selling for 50 cents each in lots of 1,000, through GaAs light-emitting diodes at \$2.50 each for 1,000 or more, to high-reliability emitters that sell for \$1,000 each. The high-reliability devices are gallium phosphide that emit green light; they are used primarily to calibrate photomultiplier tubes in flight.

In custom work, Electro-Nuclear is developing an industrial safety fence, essentially a light barrier that prevents workers from getting too close to operating machinery; a warning signal is triggered when someone interrupts the beam. The system is being built for Automation Devices of Fairview, Pa. Electro-Nuclear is also working with Friden Inc. in San Leandro, Calif. to provide a coupled pair for a new Friden cash register; it is also working with Friden on a system to read sales tags on merchandise.

Regarding the future, most manufacturers of optoelectronic devices believe it's a question of when the market will really begin to soar, not one of whether the market is going to materialize. TI's Youch sees 1971 and 1975 as pivotal years. The \$210 million he cites as the 1974 market doesn't reckon with some areas of application, any one of which could send the total far higher, he insists. Youch says 1971 could see a burgeoning of optoelectronic applications in credit-card verifiers, roadway toll booth card-key verifiers, military ordnance, home and industrial security systems, telephones, missile beacons, and visible displays.

Credit-card verifiers are particularly high on Youch's list as possible early bloomers. Companies want to cut the losses they now experience when invalid credit cards are used or when a card



Where can you get
a package like this all year long?

ROBINTECH^{T.M.}

offers complete printed circuit board
service from prototype preparation to high
volume production.

- Custom engineering to exacting specifications
- All types of laminates and platings
- Fabrication
- Assembly
- Complete, modern facilities for all aspects of printed circuit board manufacture

© Robintech 1969

Send sketch and your requirements
for design recommendation and quotation.

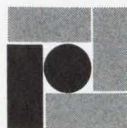

ROBINTECH electromechanical
division
INCORPORATED

3423 Vestal Road, Vestal, New York 13850
phone: (607) 798-5011

Manufacturers of Flexible Shafts and Push-Pull Mechanical Remote Controls; Custom Electromechanical Assemblies and Electric Wiring Harnesses; Printed Circuit Boards; Shock Control and Vibration Isolation Systems.

NOW...

Hamilton precision metals has added facilities...and is in the Photoformed® Parts business...



BIG!

Hamilton has added a new plant—just to produce precision, Photoformed® parts!

This new facility is equipped with the most modern photo-etching machinery on the market. The new equipment will produce precision parts in large quantities to the highest standard of dimensional accuracy.

Now, you can get from the Precision Metals Division, finished parts to the same degree of precision as world wide metal users have come to expect in Hamilton's strip and foil.

Hamilton offers the Total Capabilities of a completely integrated facility controlling every step from melt to finished strip or foil—and *now* to finished parts. This means that you get the same adherence to metallurgical standards and dimensional accuracy that has become the hallmark of Hamilton.

For the complete story on the capabilities of Precision Metals Division and what it can do for you, write for your copy of the new Photoforming brochure. It's yours for the asking—write today!

PRECISION METALS DIVISION
HAMILTON
WATCH COMPANY • LANCASTER, PA. 17604
• PHONE (717) 394-7161

holder exceeds a preestablished line of credit. "Standard Oil Co. is desperate," Youch says. "It wants a product by next year; it's ready to use it and so is American Express."

On the road. As for roadway toll booths, Youch says the New York Port Authority has bought a high-density sensor array from TI to be used with a tungsten light source to shine through the holes of a gate-actuating card. Beyond the roadways, Youch envisions visible light-emitting diodes being used to illuminate telephone dials. He says TI has already lined up six customers for solid state numeric and alphanumeric displays—"and they aren't talking small quantities."

By 1975, in Youch's view, optoelectronic devices could start finding their way into automotive, space, video-phone and tv hardware, as well as being used to replace mechanical devices such as brushless motors and relays.

At Fairchild, optoelectronics marketing manager John Brown sees other ways to put optoelectronic devices to work, particularly sensors. He, too, thinks there's a place in automobiles for the units, but he's thinking also of other consumer items, such as washing machines, and of institutional applications—possibly using optoelectronic systems to grade a pupil's school tests. Brown believes most of the sensors for such jobs will be npn phototransistors, but hastens to add that three years might be needed to produce any sizeable growth in their market as a result of these applications.

Instead of electromechanical washing machine encoders, Brown claims discs with holes and phototransistors could be used. "Five or six phototransistors in each washing machine could change the market drastically," he asserts. What would turn the tide in the consumer market? "A 10-cent sensor," says Brown. "And to do this, we must get the volume up. If we had three sensors in every car, that would be 30 million units; compare that to what's happening now. Only a total of 20 million devices (phototransistors) are being made. One of the problems is inertia. The \$1 unit is already designed in, so why change to a cheaper one?"

next time you think oscillator... don't!



this new waveform generator outperforms
oscillators to 3 MHz at oscillator prices

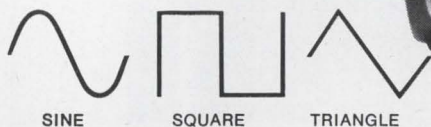

THREE WAVEFORMS

GREATER BANDWIDTH — Dynamic frequency from 0.1 Hz to 3 MHz.

EXTERNAL VCF — Control voltage can be either DC programming or AC frequency modulation. 1000:1 range.

OUTPUT POWER — All waveforms at least 20 V P-P into open circuit, 10 V P-P into 50-ohm load.

MINIATURE SIZE — Only 2 7/8" high, 7 3/8" wide, 8 1/2" deep. Just 4 pounds.

Exact's new Model 123 VCF Waveform Generator not only outperforms oscillators in its range, but surpasses the performance of any waveform generator in the same league. And at a price you'd expect to pay for an oscillator!



EXACT
electronics, inc.

WHAT YOU GET FOR ONLY \$345 IN THE MODEL 123:

- Kelvin-Varley Divider frequency control for greater accuracy.
- Variable ± 5 V DC offset.
- db Step Attenuator.
- Floating output provision.
- Search mode for manually sweeping 1000:1.
- Combination tilt-stand and handle.
- Easy maintenance—single P.C. board with calibration procedure printed inside top cover.

✱ Tight budget? Check Exact's new Model 120. Only \$295.



MICROWAVE IC MODULES PROGRESS REPORT #9: SWITCHING MODULE

Sperry Rand's PACT (Progress in Advanced Circuit Technology) program has taken a new look at microwave signal switching and developed the first complex circulator module.

It began with a major system contractor's effort to boost the reliability of a hand-held radar by providing redundant transmitters, receivers and local oscillators. Since a working radar set needs only one of each, the extras ride along as spares until a malfunction of a primary element calls them to duty.

Sperry's mission was to develop a super-reliable switching module capable of selecting either transmitter and either receiver and hooking them into the antenna duplexer circuit. Solid state was the only answer to the reliability requirement.

Sperry's solution is a single rectangular module, one inch by 1.8 inch, on a substrate 0.055 inch thick. Four circulators, a termination load and two DC blocking elements coexist on the module. One of the fixed circulators serves as the antenna duplexer, shunting transmitter and receiver signal paths. The other fixed circulator provides an antenna termination load to protect the downstream components against bursts of reflected transmitter energy.

Latching circulators allow operator selection of either of the two transmitters and receivers. Our latching circulators switch with as little as 200

microjoules of energy, a negligible drain on the power supply.

Sperry's circulators perform well. Measurements taken at 9.0 GHz show minimum isolation of 28 db and maximum insertion loss of 0.7 db at 27°C. And all four circulators do their jobs with negligible interaction even though they share a common substrate.

Sperry is the expert for integrated microwave modules and we welcome your system challenge. To help start a conversation, we have a new module planning sheet you can get free. Send for it, fill in the blocks to describe your requirement, then send it back and we'll be in business.

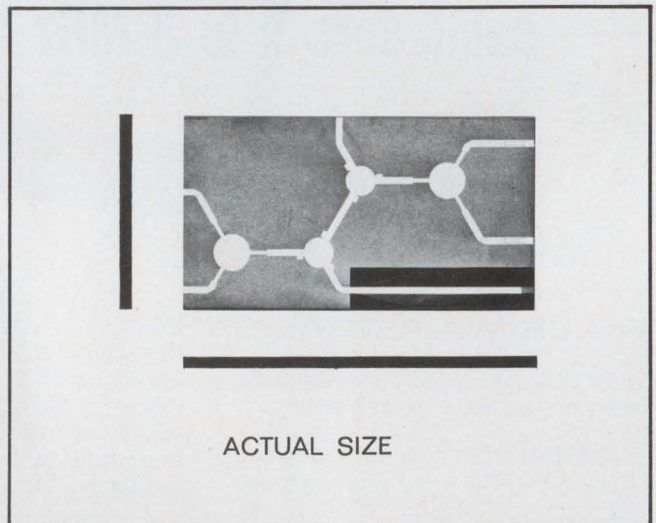

Sperry Microwave's solid-state switching module provides a common substrate for four circulators, two DC blocking elements and a termination load.

*For faster microwave progress,
make a PACT with people
who know microwaves.*

SPERRY
MICROWAVE ELECTRONICS DIVISION
CLEARWATER, FLORIDA

Government-industry cooperation bears fruit in IC mil specification

Long-awaited standard carries NASA line certification; EIA moves to set up guidelines for buyers

By Robert D. Westgate

Electronics staff

After years of haggling, the Defense Department finally has set up its first specification for microcircuits. A compromise between Government and industry, the new specification, Mil-M-38510, should be ready for inclusion in contracts by January.

In the beginning, the Pentagon tried to prohibit microcircuit standards in order not to stifle innovation. But that approach didn't work—no control over reliability, for one thing—so late last year a new DOD memo superceded the initial order and permitted microcircuit standardization.

As the microcircuit counterpart of Mil-S-19500, the familiar tried-and-true standard for transistors for military equipment, the new spec covers monolithic, multichip, and hybrid microcircuits [*Electronics*, Dec. 8, p. 33].

Mil-M-38510 will contain requirements for manufacturer certification, qualification, screening, quality conformance inspection, reliability demonstration, design and construction, marking, and workmanship. It also will include the new "line certification" concept (NHB 5300.4) ready for unveiling by the National Aeronautics and Space Administration. Line certification imposes strict controls of microcircuit fabrication procedures on suppliers. According to DOD and NASA spokesmen, the complete document will simplify the preparation of procurement specifications, improve reliability and reduce costs significantly.

The specification is so new that

printed copies aren't available yet. The announcement will be made in the usual Government manner, through *Commerce Business Daily*.

Three classes of microcircuits are designated in the spec, representing three levels of quality and reliability [see table below].

Class A, the highest, is for critical applications in missiles and in extremely long-life hardware for spacecraft; class B will be for general military use less severe than

class A, and class C would apply where long life is not critical—say, in an office intercom. The military does not have enough experience yet to determine mean time between failures of each class.

Although in the past a contractor could specify that the devices he ordered qualify under method 5005 of Mil-Std-883, this was not always a requirement. Now, at the time set for opening of bids, suppliers must subject their microcircuits to these

Class requirements

| Requirement | Device class | | |
|--|--------------------------|--------------|--------------|
| | Class A | Class B | Class C |
| Manufacturer certification | | | |
| General | Reqd. | Reqd. | Reqd. |
| Line certification | Reqd. | | |
| Qualification, groups A, B, & C of method 5005 | Reqd. | Reqd. | Reqd. |
| Quality conformance inspection, method 5005 | Reqd. | Reqd. | Reqd. |
| Group A (each lot and subplot) | Reqd. | Reqd. | Reqd. |
| Group B (each lot) | Reqd. | Reqd. | Reqd. |
| Group C (periodic, each 3 months) | Reqd. | Reqd. | Reqd. |
| Screening (per method 5004) | | | |
| Internal visual (precap) | Test cond. A | Test cond. B | Test cond. B |
| Stabilization bake | 24 hrs. min. | 24 hrs. min. | 24 hrs. min. |
| Thermal and mechanical shock | Reqd. | Reqd. | Reqd. |
| Centrifuge | Test cond. E | Test cond. E | Test cond. D |
| Seal (fine and gross) | Reqd. | Reqd. | Reqd. |
| Burn-in | 240 hrs. | 168 hrs. | |
| Reverse bias burn-in | 72 hrs. (when specified) | | |
| Final electric test | Reqd. | Reqd. | Reqd. |
| Radiographic | Reqd. | | |
| External visual | Reqd. | Reqd. | Reqd. |

KEEN CRYSTAL DETECTORS

10 MHz to 12.4 GHz
 ± 0.5 db Response
SWR less
than
1.5

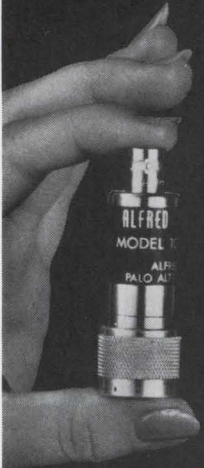

With flat frequency response and low SWR, Alfred broadband crystal detectors, Models 1001, 1002, and 1003 provide top performance in your leveling, power measurement, broadband RF detection and reflectometer requirements.

Brief Specifications.

Frequency Range: 10 MHz-12.4 GHz

Frequency Response: ± 0.5 db full range

SWR: Less than 1.5 full range
Sensitivity (no load); Power input required to produce 0.1 v rectified output—no greater than 0.4 mw

Square Law Response: Within ± 0.5 db, low level to 1 mw input when properly terminated.

Maximum Input Power: 100 mw
Connectors: Input, Model 1001 Type N, Model 1002 OSM, and Model 1003 APC-7 output BNC.
Price: \$115 with BNC, \$160 with OSM Connector, and \$175 with APC-7 Connector.

For more information, call your Alfred sales engineer or write Alfred Electronics, 3176 Porter Drive, Palo Alto, California 94304. Phone: 415-326-6496. TWX: 910-373-1765.

ALFRED ELECTRONICS

NASA gets into production

Those interested in looking at Mil-M-38510 are just going to have to wait until the document is printed. However, you can get a pretty good idea what NASA's NHB 5300.4 will look like if you read the Marshall Space Flight Center document 84MO3877 available from the technical documentation offices at the center, Huntsville, Ala. 35812.

Both NASA line certification papers were drawn up by Alvin M. Holladay, of the Astrionics Laboratory's technology division. The new NHB 5300.4 is almost identical to the 85MO3877—and in fact will replace it when NHB 5300.4 is published. Basically, 85MO3877 has four fewer process steps: scribing and dicing, die sort inspection, die mounting, and preselect visual inspection. In addition, 85MO3877 has no level II. Marshall began working on process steps and parameters about five years ago so that it eventually could obtain "reliable circuits from reliable companies," Holladay says, for use in the Apollo telescope mount, orbital workshop, and space shuttle. About six companies, including the semiconductor divisions of Philco-Ford, Fairchild and Westinghouse, were given

study contracts to help develop the control steps, and the resulting document was published in August, 1968.

Eight companies then were approached to see if they were willing to work with Marshall and Electronic Research Center engineers to test the steps and upgrade their reliability control. The Amelco Semiconductor division of Tele-dyne, Inc. and Texas Instruments were the first to have their lines certified, in October 1969, according to Mike Nowakowski, deputy chief of the parts technology branch at Marshall. TI's series 54 TTL family also was placed on the qualified products list and recently the Langley (Va.) Research Center purchased some 3,000 such devices for use in a meteoroid detector satellite.

Amelco products have not been placed on the qualified list yet. However, Nowakowski said Marshall is looking at Amelco's ultra-low powered TTL's and expects them to be qualified shortly after the first of the year. The lines of Motorola and National Semiconductor are in the process of being certified. And Fairchild has still "some way to go."

series of tests to prove their products are qualified for listing on the applicable qualified products roster. Now, too, each device must pass all the screening tests detailed in method 5004 of Mil-Std-883 (Test Methods and Procedures for Microelectronics) for the specified product assurance level and type of microcircuit in order to be acceptable for delivery.

How did Mil-M-38510 come about? On Sept. 23, 1969, the Secretary of Defense issued a joint memo signed by Gardiner L. Tucker, Deputy Director, Defense Research and Engineering, and Barry J. Shillito, assistant Secretary of Defense for installations and logistics, which permitted expansion of existing microcircuit documentation to include both general and detail specifications for use of microelectronics in military systems and equipment.

A previous order, issued on April 14, 1967, prohibited microcircuit standardization, although it did allow for documents standardizing

microelectronics terms and definitions (Mil-Std-1313), parameters to be controlled for specification of microcircuits (Mil-Std-883) and general application guidance and packaging (Mil-M-55565).

DOD first prohibited microcircuit standards because it felt they would inhibit the industry in its formative stages. In addition, DOD expected no inconvenience or extra expense from the proliferation of IC types, since DOD policy forbade stocking of the devices—contractors said hardware they delivered that contained these devices "would not fail." However, after living with this ruling for a number of years, the military found the devices did fail and they did have to be stored. In some cases, this meant storing hundreds of similar devices whose only significant difference was a part number.

Now, with the cooperation of industry and other agencies—specifically the microelectronic device committee on government liaison of the Electronic Industries Asso-

ciation and the microelectronics project group of the Aerospace Industries Association, NASA, and the Federal Aviation Administration—the military drafted a set of general requirements for monolithic, multichip, and hybrid microcircuits as well as the quality and reliability assurance requirements which must be met in their procurement.

Mil-M-38510 will apply to all microcircuits designed into any military system—not just to those so far unspecified devices in common use. By next July, DOD hopes to have ready the detail specifications for the latter group. The Rome Air Development Center's reliability branch, solid state applications section, which drew up the general specifications under the aegis of Joseph Brauer, also is running a study to determine which devices have achieved the "broad acceptance" mentioned in the Tucker-Shillito memo.

The detail specifications will serve as a proving ground for the Mil-M-38510. "Inadequacies, undue restrictions, ambiguities and such should come to our attention when detail specifications are written and used for procurements," according to Lester Fox, staff engineer in the Information and Logistics Office. "We hope that these will be very minimal, but we know by experience that there will be some," he adds. Both the general and the detailed documents will be "active" ones, he says; they will be revised as necessary with no predetermined time schedule.

Because more microcircuits are sold for non-military uses, EIA has drawn up its own general specifications which will serve as buying guidelines. They will be published this month and will remain in use for at least a year, without amendment, as a "MED tentative standard." After this period they will be reviewed for change, obsolescence, or for adoption as an "EIA standard." EIA, incidentally, adds a category of its own to the classes in the Mil spec. Devices in this class "D"—"teddy bear" class to the military—are for "entertainment purposes."

Jim Houston, executive secretary of the electronic systems committee of the Aerospace Industries Association, says Mil-M-38510 "will be a real godsend. It will be especially

REPLACE AN SWR METER, SLOTTED LINE, POWER METER, RATIOMETER, ATTENUATOR AND OSCILLOSCOPE. MEASURES RETURN LOSS, VSWR, GAIN, INSERTION LOSS, FREQUENCY RESPONSE, ABSOLUTE POWER, AND LOCATES FAULTS, TOO!

HARD TO BELIEVE? FOR ONLY \$1990, ABSOLUTELY INCREDIBLE.

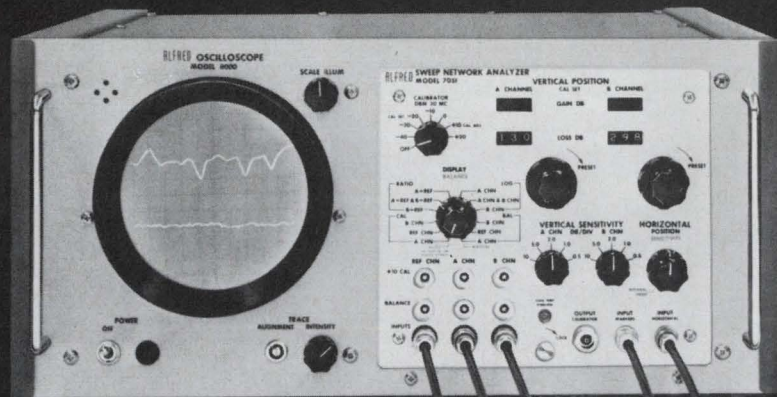

Here's a powerful measuring tool, the Alfred Sweep Network Analyzer, to simplify virtually all of your microwave test and measurement problems.

Measure over a 60 db dynamic range with direct db or dbm/digital readout. Measure fast with accuracy. Measure return loss and insertion loss or gain simultaneously at fast sweep speeds for oscilloscope display.

Find faults. Detailed information on testing microwave transmission system and other applications as well as complete specifications available on request. Simply call your Alfred field sales engineer or write us at 3176 Porter Drive, Palo Alto, California 94304. Phone: 415-326-6496. TWX: 910-373-1765

ALFRED ELECTRONICS

WHICH DEFLECTION YOKE FOR YOUR DISPLAY ?

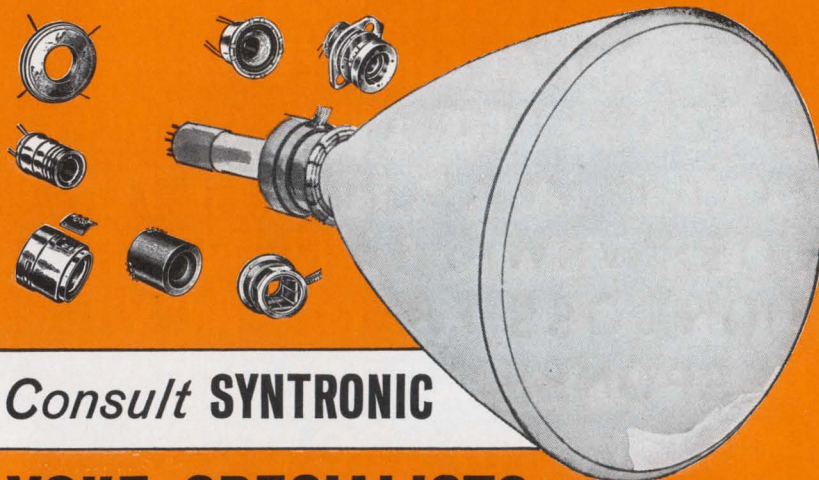

Consult **SYNTRONIC**

YOKE SPECIALISTS

Syntronic's team of experts knows more about yoke design, engineering and quality control than anyone else. A solid 10-year record of leadership—acknowledged throughout the industry. Benefit from it.

syntronic INSTRUMENTS, INC.
100 Industrial Road, Addison, Illinois
Phone: Kingswood 3-6444

Circle 179 on reader service card

Up-date your film resistor library.

With our new literature on Mallory film resistors. A complete line. Made by the company with total capability in film resistors. Write, today.

Mallory Controls Company, a division of P. R. Mallory & Co. Inc., Box 327, Frankfort, Ind. 46041.

GENERAL SPECIFICATIONS

| MALLORY TYPE | MILITARY TYPE | TEMPERATURE RATING | POWER RATING (WATTS) | RESISTANCE RANGE (OHMS) |
|-------------------------|---------------|--------------------|----------------------|-------------------------|
| Precision Resistors | | | | |
| MAC 55 | RN55 | 70°C & 125°C | 1/8 & 1/10 | 10Ω-100K |
| MAC 60 | RN60 | 70°C & 125°C | 1/4 & 1/8 | 10Ω-499K |
| MAC 65 | RN65 | 70°C & 125°C | 1/2 & 1/4 | 10Ω-1 meg |
| Semiprecision Resistors | | | | |
| MAL 07 | RL-07 | 70°C | 1/4 | 10Ω-100K |
| MAL 20 | RL-20 | 70°C | 1/2 | 10Ω-470K |
| MAL 32 | RL-32 | 70°C | 1 | 10Ω-1 meg |
| Power Resistors | | | | |
| 2MOL | | 70°C | 2 | 30Ω-125K |
| 3MOL | | 70°C | 3 | 40Ω-125K |
| 4MOL | | 70°C | 4 | 85Ω-125K |
| 5MOL | | 70°C | 5 | 95Ω-125K |
| 7MOL | | 70°C | 7 | 125Ω-125K |

MALLORY

useful with all the new weapons systems coming in." AIA member companies several years ago discovered that because of the lack of coordination in specifications, design engineers were wasting time, effort, and money in drawing up more than 40 general specifications and 2,200 detail ones for six individual items. AIA estimates it costs a minimum of \$10,000 to write a general specification—which can run up to 40 pages—and about \$2,000 for a detail unit.

Big savings are predicted with the new standards, but no one in the military or in industry is ready to be nailed down on how much. The increase or decrease in number of testing procedures and thoroughness required of the supplier will depend on how strict his buyers were in the past. Now there's just one set of rules.

Charles Suman, a project engineer in the Naval Electronics System Command's semiconductor group, puts it this way: "It will take some time to really see the impact that the general specification may have. In time it will be evident. The concept of standard classes should certainly reduce costs of microcircuits incurred by specification review time, and the proliferation of such things as test methods and their sequence, imposed upon vendors by various specification writers. This, of course, only will be true provided the contractors utilize the specification as it is intended."

"The specification does not 'freeze' the method of writing specifications," he continues, "but provides an acceptable, general set of requirements and procedures which have been proved by experience through testing by the industry and the military laboratories as being valid for obtaining a high degree of quality or reliability."

Compromises were made by both the industry and the military. Before the last coordinating meeting, EIA was ready to ask DOD to reject the military draft and adopt the EIA document. However, differences were settled over the amount of equipment that would be needed to test the circuits and the test procedures themselves. The requirements aren't so rigid now, as adjustments and alternatives are possible, and both parties agree

Satisfying your most sophisticated demands for quality products means we work like beavers at UOP Norplex, so much so that we've been labeled "The Lint-Pickers from La Crosse."

But such super-care is standard at Norplex. We know that multi-layer circuits, for example, where three or more layers are bonded together into a homogeneous package, require superior ultra-thin laminates and bonding sheets. Our unique manufacturing techniques, coupled with a rigid

quality assurance program, provide you with these uniform materials so essential for modern multi-layer circuitry.

Routine? Quality is always routine for exellers in excellence, "The Lint-Pickers from La Crosse."

Norplex is a part of UOP, a half-billion dollar company busy making life better through research and product innovation across the world. UOP Norplex Division, La Crosse, Wisconsin 54601. 608/784-6070.

Write for new 1969 Norplex Catalog.

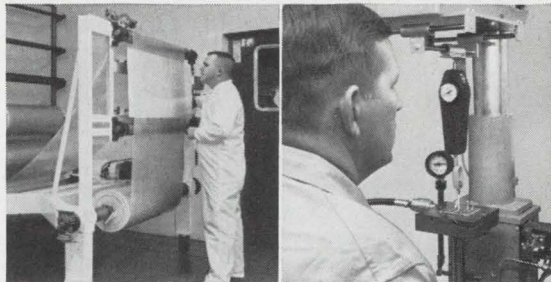

100% of all B-stage—in both rolls and sheet form—is visually inspected at Norplex to insure reliable, inclusion-free bonding sheets.

Checking copper-to-laminate "marriages" against MIL-P specs is fast, easy . . . and precise . . . with peel test instrumentation designed by Norplex.

Multi-layer circuits stay married for the Lint-Pickers from LaCrosse.



Look—NO HANDS!

BARNES ELIMINATES MANUAL LEAD STRAIGHTENING/CARRIER LOADING... FOR TO—STYLE IC'S

Are you tired of the high cost of straightening IC leads *by hand*? Then it's high time you tried the Barnes Oriole* Lead Straightener/Carrier Loader. You'll straighten 3 to 12 leads on TO-5's, 3 or 4 leads on TO-18's, or load them into Barnes Carriers. There's a manual model that straightens leads, or loads carriers, at 600 devices an hour. The semi-automatic model is pneumatically operated at 800 an hour. And conversion kits are available that add almost unlimited flexibility. Write or call us for the complete story.



Lansdowne, Pa. 19050 • 215/MA2-1525

barnes / THE WORLD'S MOST COMPLETE LINE OF SOCKETS, CARRIERS AND CONTACTORS FOR I.C.'S



*Patent Pending

Circle 180 on reader service card

Looking for a memory system with low cost per bit, but fast cycle time/access time, and high reliability in one compact package?

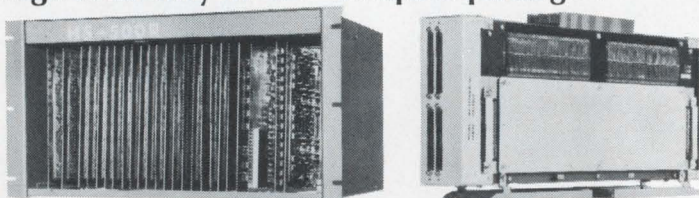

Look no further. TOKO's new, improved Woven-Plated Wire Memory System HS-500R is now available.

TOKO's HS-500 memory system has won praise and popularity for its low-cost, high-performance characteristics. Now ready to be marketed is improved Model HS-500R with the following features:

Compact size: 10"(H) x 19"(W) x 13-1/3"(D)

Access time: 250ns

Memory capacity: 8K bytes—32K bytes (4096 words—16384 words)

Flexible operation: Linear selection organization for multi-word operation; 8 bytes are simultaneously written and read in one word; required bits or bytes are then selected at the interface; thus a variety of memory capacities is made possible.

Low cost Model HS-500R also shares with its predecessor such outstanding features as fast cycle time of 500ns; wide operating temperature range without any current compensation: 0°C to 50°C; and low power dissipation of 100W.

TOKO can also undertake the manufacture of custom-made systems according to your specifications. Complete technical details from our New York office.



TOKO, INC.

Head Office: 1-17, 2-chome Higashi-Yukigaya, Ohta-ku, Tokyo, Japan
TOKO N.Y., INC. 350 Fifth Avenue, New York, New York 10001

Mil-M-38510 is a pretty good document. "Only procedures and cycles are compromised, not quality levels," EIA says.

Nevertheless, there are some within the industry who feel that the document is a year late, and that without industry pressure, Mil-M-38510 would still not exist.

With its upcoming microcircuit line certification document (NHB 5300.4) NASA feels it will be able to indicate to the electronics industry areas in the manufacture of microcircuits which need to be controlled to get a good, reliable, product for NASA use.

"NASA isn't trying to tell companies how to build or control their products," Joseph L. Murphy of the agency's Reliability and Quality Assurance Office explained. "NASA principally is interested in the manufacturer telling us how he is building the product he wants to sell, what controls he is using to assure reliability, and how he will maintain these standards."

Murphy says the agency, with the assistance of industry on its microelectronics subcommittee of NASA's parts steering committee, outlined key process steps where past experience has indicated the greatest number of problems might arise: substrate characterization, surface passivation, patterning, junction formation, metalization, scribing and dicing, die sort inspection, die mounting, interconnect bonding, preseat visual inspection, and sealing.

For class A, Level I monolithic circuits, the standard will require that a supplier demonstrate his capability of performing reliability control over each of the 11 key process steps. Suppliers of class A, level II monolithic circuits must be able to demonstrate that they are capable of testing and inspecting the metalized substrates, in place of reliability control on the first five steps (substrate characterization through metalization), and have control over the last six steps.

The standard cites guidelines for maintaining reliability control over the steps. Originally, the maintenance guidelines were requirements, but NASA found strict requirements in this area often stopped production. It was learned that guidelines would serve the same purpose, Murphy says. ■

DIRTY LINEN

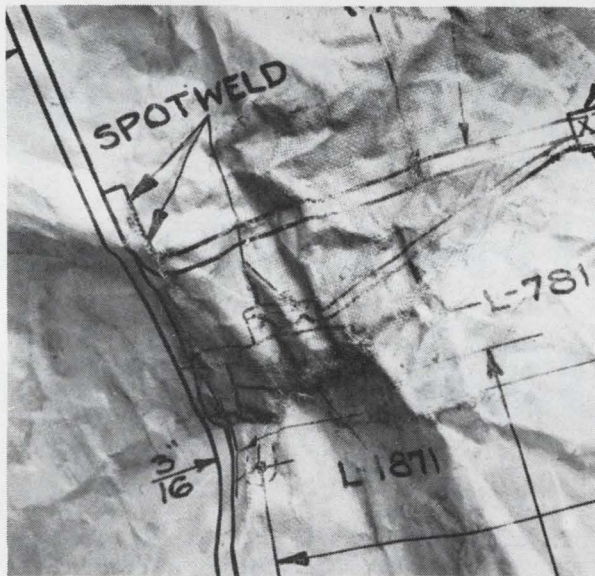

Keep that original safe. Make a second original on KODAGRAPH Wash-Off Film.

This old battered drawing on cloth was once a thing of beauty—the culmination of weeks of design and many hours on the drafting board. Yet pretty soon, with handling, staining, smudging, and flaking, it can look like this.

That's why it really pays to have your blueprinter make a second original on KODAGRAPH Wash-Off Film, ESTAR Base. Preserve the cloth master and drop the second original into your active file. It won't crack or yellow. Stains and fingerprints will wipe right off. You'll

still be getting great white prints years from now.

Revisions are easy. You get rid of unwanted photographic lines on KODAGRAPH Wash-Off Film, ESTAR Base, with a drop of water and a touch or two of your eraser. Its matte drafting surface permits twice the erasures, yet accepts and holds pen-and-ink corrections smoothly.

More details? Just contact your local Kodak Technical Sales Representative for a no-obligation, certified survey of your present operation... and a look at all the smart KODAGRAPH Products available now. Or write us: Eastman Kodak Company, Business Systems Markets Division, Rochester, New York 14650.

Kodak

DRAWING REPRODUCTION SYSTEMS BY KODAK

**We are pleased to
announce that we've
just added a new
division to serve
your needs for
high-quality
connectors for
electronic equipment:**



SCIENCE INDUSTRY CENTER, MINNEAPOLIS, MINNESOTA 55428

This new facility was formerly the Connector Division
of National Connector Corporation.



FABRI-TEK INCORPORATED

5901 South County Road 18, Minneapolis, Minn. 55436 • 612/935-8811 • TWX: 910-576-2913

Monitor keeps IC from losing its header

Bonding indicator-controller prevents hidden bubbles and other defects by reading temperature through infrared radiation

By James Brinton

Electronics staff

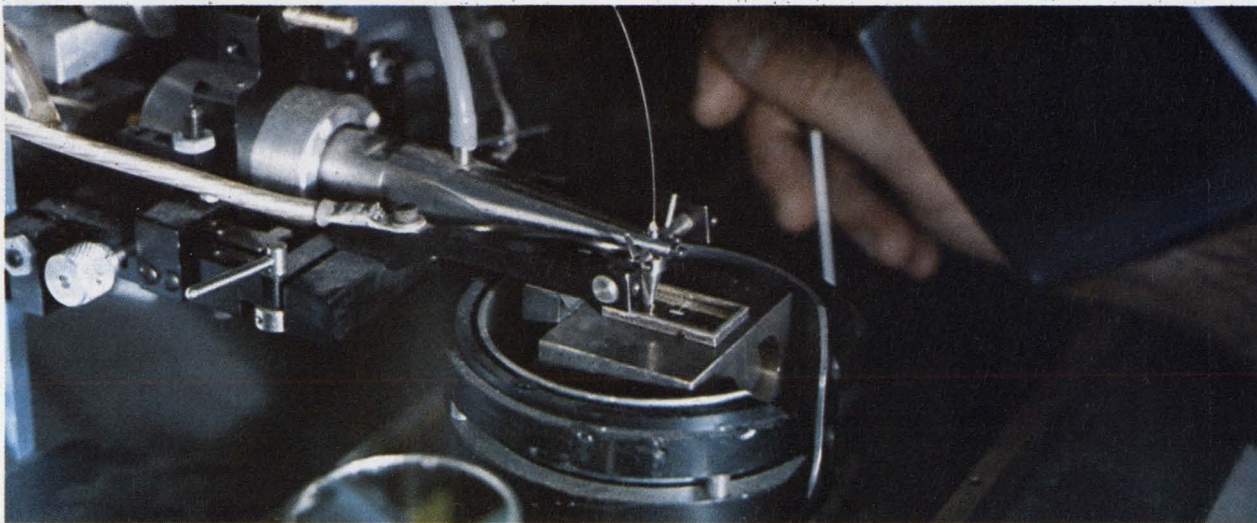

Bond watcher. Thermal monitor is designed to eliminate faulty IC-header bonds. The optical fiber, at center, extends from detector to bonder. Indicator lights tell if temperature level is too low to make a good bond, is just right, or is overheating chip.

Considering the effort expended to lay out and design an integrated circuit, and in controlling manufacture to assure high yield, it can be irritating to see an IC fail simply because it's not firmly attached to its header. Yet, according to a NASA-funded Philco-Ford study, about 17% of IC failures are traced to faulty die bonds.

The engineer who could even halve that figure would become an instant hero at any IC plant. So it follows that Vanzetti Infrared & Computer Systems of Dedham, Mass., expects to find a ready market for its model 1011 thermal bond monitor, which the company claims can turn faulty IC-header bonds into rarities.

Hot wiggles. Today, most IC bonding is done with heat and ultrasonic vibration. The chip is

placed on a header, the two are heated, and ultrasonics finishes the job of melting the gold-eutectic alloy that bonds header and chip.

Though meter readouts of header temperature, chip temperature, applied current, and other parameters are displayed to the operator, bonding still is more a skill than a science. One of the few indications of a good bond is visual inspection; a good bond usually has a neat fillet, or bead, around the edge of the chip.

But even a good fillet doesn't mean a good bond every time. Under the chip may be bubbles, or voids, caused by overheating. And since voids can't carry away the heat of the IC's operation, the circuit can fail. Not even burn-in racks can spot these defects every time; some hot-spot failures don't

appear for years. In this light, NASA's 17% figure looks low, and that portion the study attributes to electrical failures might never have occurred with a solid bond.

Fever. According to Riccardo Vanzetti, president, the flaw in present schemes is the way the temperature of the bond is measured. "It's like trying to take the temperature of a sick man," he says, "by measuring the heat in the bedclothes. The data is related but not meaningful."

Vanzetti notes that the usual method of determining temperature is through thermocouples—perhaps attached to the probe tips that transmit ultrasonic vibration to the chip. "But usually these thermocouples wind up measuring the temperature of the probe, or their own temperature, and responding

. . . in automated mode, monitor can provide threshold signals, taking operator out of loop in the most critical phases of bonding process . . .



Beacon. Lights on the control console indicate which of three levels of temperature has been reached. Each threshold detector can be set to respond at temperatures ranging from 200°C to 1,000°C.

too slowly even to that," he says.

There is a great difference in thermal mass between the probes and thermocouples and the chip; while it takes almost no time to change the chip's temperature, it takes far longer to heat a probe or to get a reading from a thermocouple—simply because there's more mass to heat.

Quick change. The thermal bond monitor uses infrared to react within a millisecond to temperature changes in the chip. Since the chip is hot during bonding, it radiates in the infrared; since the thermal inertia of the chip is very low, the amount of i-r it radiates changes almost instantly with temperature.

To tap this radiation, Vanzetti places an optical fiber in the vacuum collet that holds the chip during bonding. The fiber, in turn, conducts the i-r to a detector diode, which relays an analog voltage proportional to the i-r detected—and thus to temperature—to a three-level threshold detector in a console beside the bonder.

The three levels correspond to: a temperature just below that for a good bond (or the temperature at which the ultrasonic scrubber

should be turned on); the temperature at which a good bond is achieved; and the temperature at which the chip has overheated and should be set aside.

Seeing the light. Yellow, green, and red lights indicate when each level has been reached; by following them, the operator can assure a good bond nearly every time. Each of the threshold detectors can be set to respond at any temperature from 200°C to 1,000°C, and their temperature resolution is $\pm 1\%$ of reading.

That resolution is important, says Vanzetti, because 20°C can mean the difference between a bond so poor that the chip falls from the header and one so hot that the gold ions in the eutectic have begun to migrate into the chip and contaminate it. Thus, in one typical installation, the thresholds might be set for 365°C, 375°C, and 385°C.

It's possible to compare the performance of a human operator and that of the thermal bond monitor with an oscilloscope display of temperature. Using the monitor's i-r detector as the signal source (through a back panel jack on the monitor's mainframe), a relatively slow rise in temperature shows up

as the header-chip pair is heated. When the ultrasonic scrubbers are turned on (assuming the operator first has let the chip get hot enough) there's a sharply rising curve as temperature increases more quickly.

Accuracy. It is at this point that the monitor is visibly better than a human being. After a period of scrubbing, there's a sudden increase in detected i-r. This shows that the formerly solid bonding material has melted and that heat is passing from the header to the chip by conduction rather than radiation. The eutectic bond has formed and the process should stop there.

But a human operator often overheats the chip by continuing to scrub, or stops scrubbing before melting occurs. When to stop the bonding process, is an important skill learned by trial and error; on a bad day, the best operator will make successive bad bonds.

By watching the monitor lights, the operator could know the best time to start ultrasonic scrubbing (yellow light) and the time to turn it off (green light). In more automated installations, the monitor can provide a 12-volt signal when each threshold is reached, making it possible to take the operator out of the control loop during the most critical phases of the bonding process.

Calibration. Actually, the Vanzetti device doesn't read temperature, but instead detects radiation proportional to temperature. Thus, it must be calibrated if operation at a specific set of threshold temperatures is desired.

A Vanzetti spokesman notes, though, that it is detection of the change in temperature that is most important in the process of attaining good bonds. Therefore, where a single IC type is encountered, he suggests calibrating the monitor against a good bond and an oscilloscope display.

But not all IC's can emit i-r at the same rate—their surface area and the varying metalization patterns control this. So when it's necessary to change often from one chip type to another, it's convenient to have an easy calibration method. Vanzetti will supply an i-r reference source that emits at three levels set by the customer. Once the radiation characteristics of a given IC type are ascertained, they



"THANKS"

Thanks to the many companies that have specified Semtech Rectifiers over the years.

Thanks to the Semtech engineers that have designed our industries finest line of silicon rectifiers: Metoxilite, Sempac®, Slimpac®, Alpac®, Sticpac®, Stacpac, Compac, Cupac and Ministic.

Thanks to all Semtech employees for a job well done.

It has been very gratifying to be able to consistently produce top quality rectifiers for a competitive market.

San Francisco — 941 E. Charleston, Suite 10, Palo Alto, California
 94303 / (415) 328-8025
 Chicago — 140 N. La Grange Road, La Grange, Illinois 60525 /
 (312) 352-3227 / TWX: 910-683-1896
 Dallas — 402 Irving Bank Tower, Irving, Texas 75060 /
 (214) 253-7644
 New York — 116-55 Queens Blvd., Forest Hills, New York 11375 /
 (212) 263-3115 / TWX: 710-582-2959
 Baltimore — 8654 Baltimore National Pike, Ellicott City,
 Maryland 21043 / (301) 465-7363
 European Sales — Bourns A.G. Alpenstrasse 1
 6301 Zug, Switzerland / 042-21-78-77

 **SEMTECH**
 CORPORATION

652 Mitchell Road, Newbury Park, California 91320
 (805) 498-2111, (213) 628-5392 / TWX: 910-336-1264

Introducing: build-a-still

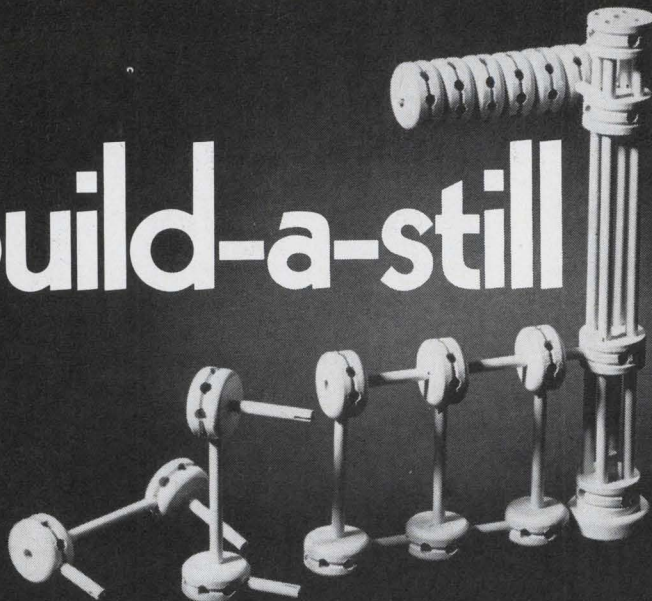

It's a revolutionary new idea. And, like many revolutionary ideas, basically simple.

Here's how it works. The basic parts of the still come as separate modules you can add on to one another. So the still expands as your needs grow.

The basic Thermdrive™ Distillation System comes in a 50 gph configuration. When you need more, you simply bolt on another 50 gph module . . . again and again . . . all the way up to 1,000 gph. No need to tear down your old system. No need for major reinvestment. You expand.

The standard system puts out pyrogen-free water in the 1 to 1.5 megohm range. For higher purity, and an organic count below measurability, simply add on the Hi-Purity Chamber. Either way, Thermdrive produces distillate faster than anything before. Within seconds after start-up.

Another revolutionary idea: an optional air-cooled condenser. It completely eliminates the need for cooling water. So it pays for itself. Fast. Price? At 300 gph, Thermdrive costs 38% less than comparable conventional systems.

The Thermdrive Distillation System is a major advance in pure water technology. You ought to know about it. Call or write for our comprehensive catalog. Barnstead Company, 225 Rivermoor Street, Boston, Massachusetts 02132.

Tel: (617) 327-1600.

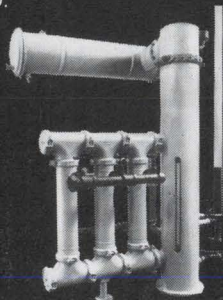

BARNSTEAD
SYBRON CORPORATION

... monitor to be sold
as retrofit item ...

can be transferred to the monitor through the calibration source—a process which even checks the optical fiber in the bargain.

Setting. The threshold settings on the monitor are set with 10-turn, clock-faced potentiometers (one turn equals 1.5% to 2% of reading, say 5°C to 7°C), with broad calibration available through 10-turn trimmer pots just below these. On the back of the console is a pre-amplifier/attenuator control which also is set using the calibration source. This back panel switch allows the monitor to operate with detector output voltages of from less than 1 volt to more than 50 volts. This, in turn, accounts for the instrument's almost decade-wide measurement range.

Vanzetti has set a single unit price of \$2,985 for the monitor, and he is going to sell it as a retrofit item. It's said that there's little work involved in a retrofit—the bonder collet is sent to Vanzetti for insertion of the optical fiber and the detector head is mounted on the bonder. The control console is placed near the bonder and connected by cable to the detector. The company says there are some 11,000 Kulicke & Soffa bonders, more than 1,000 Axion bonders, and hundreds of others to which the monitor can be attached with a minimum of trouble.

Texas Instruments and General Electric already have seen the monitor in action, and GE's semiconductor operation is buying one for a failure analysis laboratory.

Original equipment manufacturers also are indicating interest. Kulicke & Soffa may supply the monitor as part of its system, and Axion also is said to be interested. In OEM lots the price falls to \$2,290 for 10 to 25 units.

Delivery is 60 days for the thermal bond monitor and calibration source. Matched collet/fiber assemblies are priced from \$23 to \$30 depending on quantity. These assemblies can be delivered within a 45-day period.

Vanzetti Infrared & Computer Systems,
515 Providence Highway, Dedham,
Mass. 02026 [338]

**Token is
either the world's first
or second largest maker
of ferromagnetic pot cores.**



Token couldn't care less.

It's not making more pot cores than anybody that's important to us—it is making them **better** than anybody else that matters.

This is the way we feel about each of our products, from metal magnetic and ferrite cores right on up to memory systems. You could say that the history of magnetic material manufacture in Japan is the history of Token—a good reason to want to keep our reputation as Japan's largest and most advanced magnetic material manufacturer.

Let us send you products brochure: Token, suppliers of quality materials to the electronics and communications industries.

Token

Tohoku Metal Industries, Ltd.

Koei Bldg. 13-10, 7-chome, Ginza, Chuo-ku, Tokyo, Japan

Telephone: Tokyo 542-6171 Cable Address: TOHOKUMETAL TOKYO

Main Products: Ferrite Cores, Memory Cores, Memory Matrices, Ferrite Magnetostrictive Vibrators, Pulse Transformers, Permanent Magnets (Cast, Ferrite), Tape Wound Cores, Bobbin Cores, Magnetic Laminations, Fe-Co Alloys, Sendust Cores

LSI

The Changing Interface

Medium and large scale integration are slated to have major impact on the electronics industry. The effects are already being felt — not only on systems and component design — but on fundamental, traditional relationships between equipment builders and component suppliers.

Important trends that will affect your profession, your job, your company, are explored in **THE CHANGING INTERFACE**, a 150-page illustrated volume to be published shortly by McGraw-Hill's Electronics/Management Center.

In **THE CHANGING INTERFACE**, leading design engineers and managers, the men responsible for guiding their companies through the next generation of electronics, discuss the problems that LSI/MSI are stirring up — and offer their solutions.

Here are some of the vital topics covered.

Implications of LSI on the Electronics Market

The Rationale for an In-House IC Capability

The Component Maker's Responsibility vs. the

System Builder's Responsibility

Masks and Computer-Aided Design at the Interface

The Testing Interface

How IBM and Bell Laboratories Deal with the

Interface Problem

Controversies and Future Trends in LSI

You can reserve a copy of **THE CHANGING INTERFACE** now at the special pre-publication price of \$6.50 by returning the coupon below. If you send a check now, we'll pay the cost of postage and handling.

Electronics/Management Center
330 West 42nd St.
New York, N.Y. 10036

Attn. Mr. Wayne Cowart

Please reserve my copy of **THE CHANGING INTERFACE** at the prepublication price of \$6.50.

Name _____ Title _____

Company _____

Company Address _____

City _____ State _____

Check enclosed for \$6.50 Bill me

Bill Company P.O. Number _____

Pnp power transistors operate in r-f band

Units designed for f-m mobile transmitters in 148-174 Mhz range are able to withstand higher cutoff frequencies than npn's

A new family has four additional members. Radio-frequency power transistors usually are of the npn variety. In fact, Motorola's Semiconductor Products division claims to have the only r-f pnp power transistors available, and the division is adding to the family four devices that will operate on 120-volt supplies; previous entries used 28 volts. The new transistors, desig-

nated MM4020, MM4021, MM4022, and MM4023, are intended principally for use in frequency-modulated mobile transmitters in the 148-174 megahertz band.

Brent Welling, manager of linear integrated circuit and communications applications at Motorola, stresses that while there are certain advantages to pnp devices, the division has no plans to abandon

npn r-f power transistors.

"Everybody has been thinking in terms of positive power supplies in r-f power devices," says Welling, "and that means pnp." The principal advantage he cites for pnp power versus the npn variety is better power gain. "In pnp, the majority carriers are electrons, so the base resistance is smaller than in npn. This is important in power be-

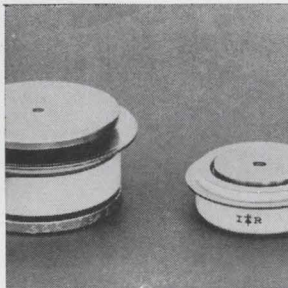

Flat disk scr's from 115 to 470 amps average offer high surge current handling capability, low forward drop and dv/dt of 200 μ sec to 1,300 v. Applications include choppers, welders, and regulated power supplies. In 24-99 lots, prices range from \$66 for the 115PA, 500 v to \$210 for the 470 PA, 500 v. International Rectifier, 233 Kansas St., El Segundo, Calif. [436]

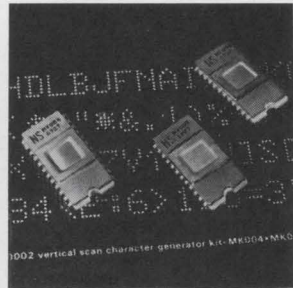

Two MOS read only memory kits generate control signals for digital data displays. The three 1,024-bit memories in each kit are preprogrammed to convert standard communications code words into raster scan or vertical scan control signals. Displays can be operated at high speed by TTL integrated circuits. National Semiconductor Corp., 2975 San Ysidro Way, Santa Clara, Calif. [437]

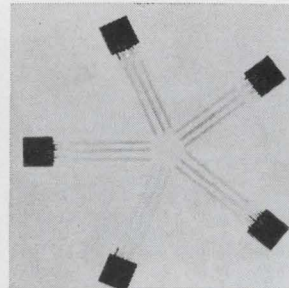

Small-signal TO-92 packaged plastic silicon transistors types MPSA10, MPSA20 (npn), and MPSA70 (pnp), are designed for low-level audio amplifiers and general purpose l-f amplifiers or switches in audio, radio, and tv circuits. They feature a breakdown voltage of 40 v minimum, low output capacitance of 4 pf max. Motorola Semiconductor Products Inc., Phoenix [438]

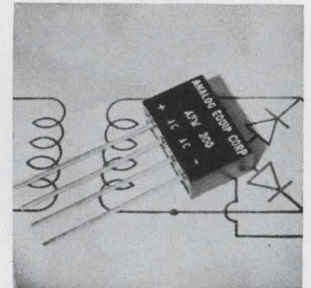

Full wave bridge rectifiers series AFW are pre-packaged silicon rectifier circuits for commercial and industrial applications. They directly replace individual units in multirectifier circuits. Units come in the following prv ranges: 50, 100, 200, 300, 400, 500, 600, 800, 1,000 v all with d-c output of 2 amps at 50°C ambient. Analog Equipment Corp., 18 Granite St., Haverhill, Mass. [439]

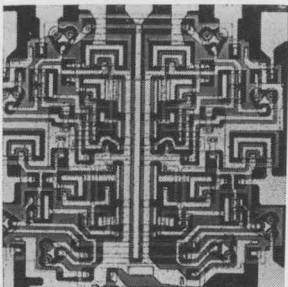

Quad 2-input NOR gate IC's series SG330 and SG340 have been added to the SUHL TTL family. The SG330 operates at 12 nsec typical propagation delay and 20 mw average power dissipation per gate function. The SG340 is rated at 6 nsec typical propagation delay and 20 mw average power dissipation per gate function. Sylvania Electric Products Inc., Woburn, Mass. [440]

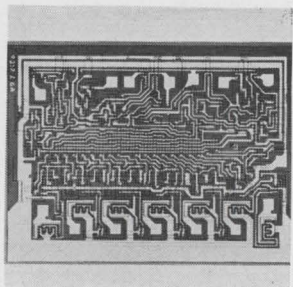

Seven-segment decoder/driver MSI 9317 offers a medium scale complexity that can convert 4 inputs in 8421 BCD format. It is for any military, computer, or industrial system employing seven-segment incandescent lamp displays or light emitting diode indicators. Prices are from \$9.40 to \$30.80 depending on quantity and temperature. Fairchild Semiconductor, Mtn. View, Calif. [441]

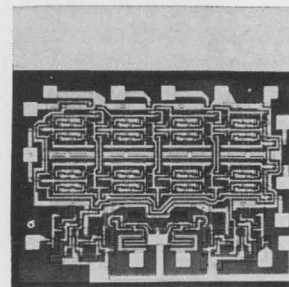

MSI memory TMC 3262 is for high-speed computer scratch pad memory applications where low power is a critical requirement. Power dissipation for the memory is typically 175 mw at a nominal operating voltage of 5 v compared to 250 mw for high power memories. Also, maximum address line select current is only 6.5 ma. Transitron Electronic Corp., Wakefield, Mass. [442]

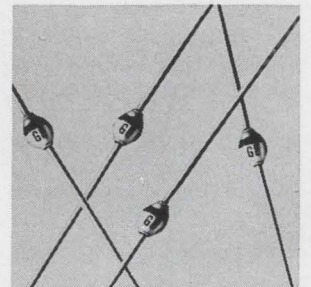

Axial lead fast recovery rectifier series A114 is for use in high frequency applications. It is rated at 1 amp in 50 to 600 v versions, with a 200 nsec maximum reverse recovery time. Unit has dual heat sink construction which provides rigid mechanical support for the pellet and excellent thermal characteristics. General Electric Co., 1 River Rd., Schenectady, N.Y. 13205 [443]

Rendez-vous

in Paris

Porte de Versailles

3 to 8 April, 1970

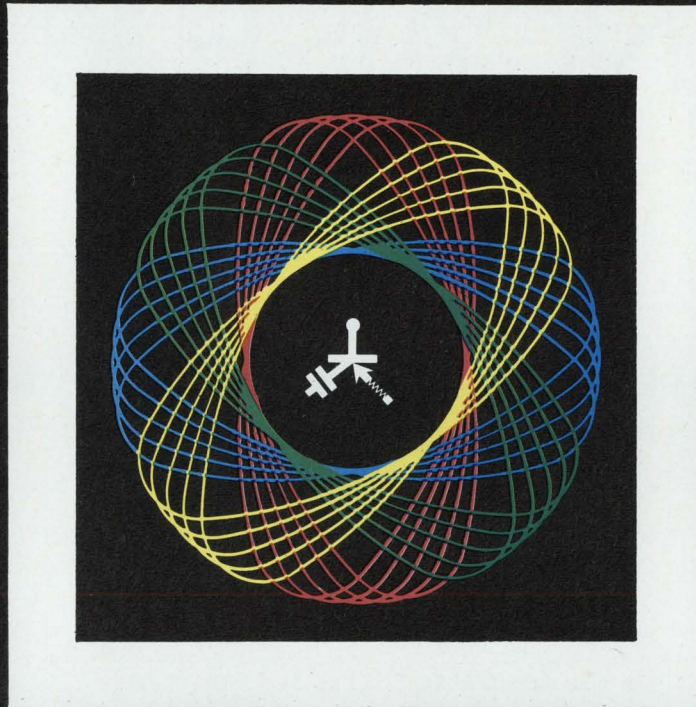

100.000
technicians
expected
at the

SALON INTERNATIONAL DES COMPOSANTS ELECTRONIQUES



COLLOQUE INTERNATIONAL SUR LA MICROELECTRONIQUE AVANCEE

Scientific, technical and economic problems
from 8 to 10 April, 1970 - Paris - UNESCO Auditorium
Programme and registration details on request

Under the patronage of the National Federation of Electronic Industries - 16, rue de Presles - PARIS 15^e - Tél. 273.24-70

L'INDUSTRIE ELECTRONIQUE FRANÇAISE

organizes in Paris

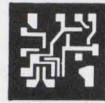

4

MAJOR RENDEZVOUS FOR WORLDWIDE ELECTRONICS



From 6 to 11 February 1970
Paris - Porte de Versailles

**SALON INTERNATIONAL
DES TECHNIQUES
AUDIOVISUELLES
ELECTROACOUSTIQUES
ET ELECTRONIQUES,**
at the service of Education,
corporate applications and
permanent training.

"THE AUDIOVISUAL &
COMMUNICATION"
will be the Show to visit for
all those having to
"train and inform, promote and
entertain"
A.V.E.C. offers three essential
items:
1 - Seminars
2 - Theme presentations
3 - A specialist Show offering
visitors the equipment,
programmes, methods and
services needed to implement
modern communication means.



From 5 to 10 March 1970
Paris - Palais d'Orsay

**FESTIVAL INTERNATIONAL
DU SON, HAUTE-FIDELITE,
STEREOPHONIE**
An art and technology festival
of high-fidelity and
stereophony.

This event will be devoted to
exhibiting the latest music
recording and playback
techniques around the world.
Seminars will be devoted to
the various problems posed
by recording and broadcasting
techniques, auditorium
acoustics, etc.
Numerous artistic events will
be organized with the
participation of the French
(ORTF) and Foreign
broadcasting services.



From 3 to 8 April 1970
Paris - Porte de Versailles

**SALON INTERNATIONAL
DES COMPOSANTS
ELECTRONIQUES**
The biggest international
exhibition in the field of
Electronic Components.

Last year this Exhibition
totalled 1076 Exhibitors,
including 553 foreign
Exhibitors from 22 different
countries, and was visited by
over 70 000 technicians.
This event specialises strictly
in components: spare parts,
tubes, semiconductors, etc.



From 6 to 10 April 1970
UNESCO - Paris

**COLLOQUE INTERNATIONAL
SUR LA MICROELECTRONIQUE
AVANCEE**
Scientific, technical and
economic problems.

This Conference will bring
together end-users of
integrated circuits and
specialists in the design and
manufacture of these circuits.
Main headings under which
the papers will be classed:
- Circuits
- Advanced technologies
- The use of advanced
microelectronics in complex
systems
- Computer-assisted design.

The French Electronic Industry is also exhibiting in Paris at the SICOB (International Exhibition of Office Equipment and Data Processing), at MESUCORA, and in various Shows abroad (Hanover, Leipzig, Ljubljana, Tokyo, London, Osaka, Johannesburg, Melbourne, Stockholm).

For further details and documentation contact the FEDERATION NATIONALE DES INDUSTRIES ELECTRONIQUES - 16, rue de Presles - Paris 15^e - France

PUBLI-SERVICE

cause it gives better gain," Welling explains. He says that with square base geometries in both npn and pnp, pnp will give about a 2.8-to-1 advantage in lower base resistance.

Welling notes two other advantages of pnp r-f power transistors: ruggedness under high voltage-standing wave ratio (VSWR) conditions caused by mistuning, and the ability to obtain higher cutoff frequencies.

Motorola has been in the pnp r-f power business since early 1968 when three new transistors were introduced to the market. The highest-rated of these previous transistors delivers 30 watts at 175 Mhz, operating off a 28-volt supply. Allen Grant, product planner for r-f transistors, says the new family will be used where large-signal amplifiers are required in the 100-Mhz to 250-Mhz range, and a power supply voltage near 12 volts is available.

Power output, minimum power gain, and price of the new units at 175 Mhz and 12.5 volts are: MM 4020—3.5 watts at a gain of 11.5 decibels and a price in quantities of 100 or more of \$6.20 each; MM 4021—15 watts, 7.0 db, and \$15; MM4022—25 watts, 5.5 db and \$23; MM4023—40 watts, 4.5 db and \$38. All are housed in a stud-mounted stripline opposed-emitter case designated 208-01 by Motorola, and are available from stock.

Welling says the family lends itself to cascading from 3.5 to 40 watts in three stages in a transmitter. He points out that the transistors also could be used to boost amplifiers in the community antenna television business.

Grant says the feature that contributes to increased ruggedness is use of thin-film nichrome resistors in series with each of the multiple emitters, which distribute current evenly across the chip, preventing the hot spots that lead to secondary breakdown. He and Welling both maintain that the availability of pnp r-f devices will lead to npn-pnp complementary r-f power amplifiers.

"There's been little effort in complementary power output stages," Welling says, "because users haven't been thinking in terms of pnp power."

Motorola Semiconductor Products Inc.,
Box 20912, Phoenix, Ariz. 85036 [444]

.003" CERAMIC CAPACITORS HELD TO .00015" THICKNESS SPREAD UP TO 100,000 PARTS PER HOUR

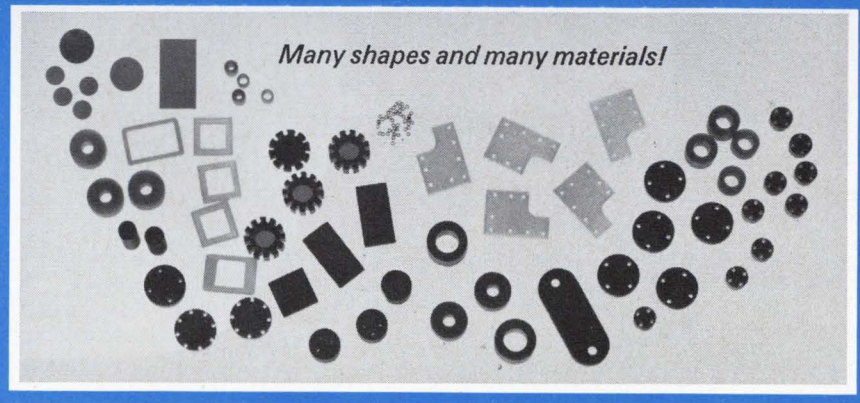
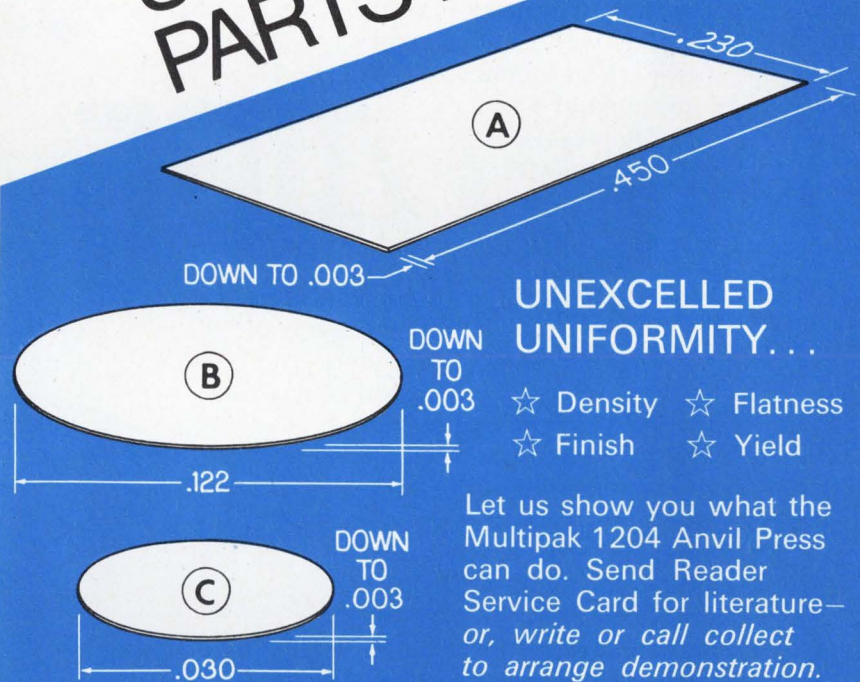

P T X PENTRONIX

Division of
WOLVERINE-PENTRONIX Inc.
1737 CICOTTE, LINCOLN PARK, MICH., 48146 • PHONE (313) 388-3100

From Cartesian you get prototype MOS/LSI wafer fabrication at production quantity prices. At a conservative 20% yield, you pay only \$1.67 per chip based on ten, two-inch wafers consisting of 100 × 100 mil chips. Cartesian's tight process control and ultra-clean fabrication process usually results in substantially greater yields. ¶ The key to low-cost MOS/LSI is the Cartesian approach where you reassume design responsibility. We take care of mask-making using the world's most advanced laser-interferometer photo-repeater and inspection system . . . and fabricate MOS/LSI wafers of guaranteed process quality. You get simple procurement instead of lengthy negotiations, four to five weeks delivery instead of endless delays, proprietary designs instead of design compromises, and you avoid the staggering costs associated with typical semiconductor overhead. ¶ The top two curves in our chart at right represent the amortized cost per chip based on your various internal cost levels of design, layout and probe testing. The total dollar amounts shown for each curve include your efforts (D) plus mask-making (M) and wafer fabrication (W). ¶ The Cartesian approach to MOS/LSI lets you add significant value to your final product by implementing your designs at unprecedented low cost . . . production quantities less than \$1.67 per chip. Implementation? Write for Cartesian's MOS/LSI Implementation Guide.

THE \$1.67 MOS/LSI CHIP

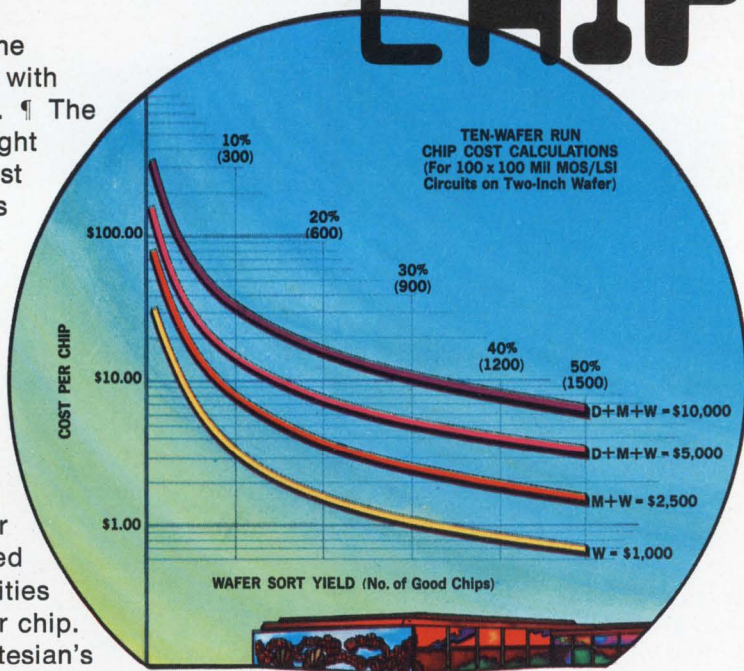

WHERE: D is the internal cost of design, layout and probe testing.
M is the internal or external cost of mask-making.
W is the Cartesian cost for wafer fabrication.



CARTESIAN, INC.

10432 NORTH TANTAU □ CUPERTINO, CALIF. 95014 □ PHONE (408) 257-0481

Ceramic steadies thermocouples

Material keeps own temperature constant, holding reference device steady to within 0.5° through 70°C swings in ambient temperature

Whether it's a resistor, an apple core or a shoe horn, boost the current running through it and up goes its temperature. In any material—almost—an increasing current is followed by a rising temperature. An exception is a ceramic developed by Texas Instruments scientists; its temperature stays constant over a range of currents. Engineers at TI's Control Products division are

building a thermocouple reference, the 8ST, with this material.

Priced at \$15, the 8ST holds its reference temperature constant to within 0.5° when the ambient temperature jumps from -10°C to +60°C. This performance, says TI product specialist Wayne Dogan, is three to four times better than in similarly priced units.

Any thermocouple reference com-

pares a signal from an external thermocouple with an internally generated reference, and puts out a signal proportional to the thermocouple's temperature. This signal usually goes to some instrument, such as a voltmeter scaled to read out temperature.

The reference signal comes from a second thermocouple, or pair of thermocouples, packed inside the

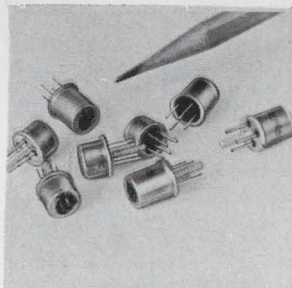

Ultraminiature power dividers feature high isolation (30 db) and low insertion loss (0.5 db) for the broadband of 10 khz to 10 Mhz. Available in 2 models, these 3-port hybrid junctions will divide a signal input into 2-phase stable equal amplitude outputs, or resolve 2 independent inputs into their algebraic sum. Olektron Corp., 6 Chase Ave., Dudley, Mass. 01570 [341]



Vertical mount series of high Q variable air capacitors are for p-c applications. They feature 4 basic models with both single and double leads. Model 8051 has a capacitance range of 0.5 to 3 pf; 8052 ranges from 1 to 10 pf; 8053, from 1 to 14 pf; and 8054, from 1.2 to 20 pf. Johanson Mfg. Corp., 400 Rockaway Valley Rd., Boonton, N.J. 07005 [342]

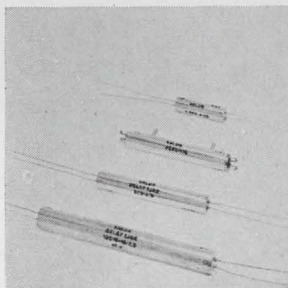

Precision series lumped constant delay lines are designed to meet the extreme requirements of sophisticated military and airborne applications. They offer delay time accuracy of ±3% or better. Temperature range is -50° to +125° C, while test voltage is 500 v d-c, and working voltage is 200 v d-c. Valor Electronics Inc., 3100 Pullman Ave., Costa Mesa, Calif. 92626 [343]

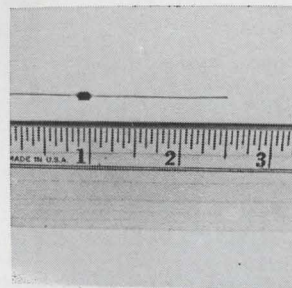

Microminiature, magnetically shielded axial lead inductor series designated the Pee-Wee Ductor is designed to meet MIL-C-15305C Class 5 requirements. It has minimum Q values of 34 to 55 at r-f frequency, with a standard inductance tolerance of ±10%. Current capabilities range from 43 ma to 1½ amps. Nytronics Inc., 550 Springfield Ave., Berkeley Heights, N.J. 07922 [344]

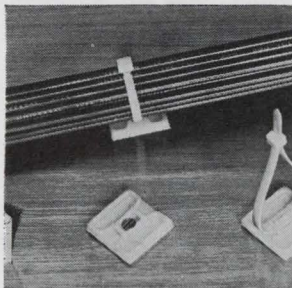

Adhesive backed mount ABMS-A secures wiring harnesses to virtually any smooth surface for light duty applications. Inclusion of a countersunk hole permits the mount to be used with a No. 6 flat-head screw or a ⅜ in. flat-head rivet. The result is a one-hole mount which will not rotate. Mount measures 1⅜ in. sq. Panduit Corp., 17301 Ridgeland Ave., Tinley Park, Ill. [345]



Solid dielectric pulse capacitor PRN-368 features high reliability, low dissipation factor (less than 0.2% at 1 khz), close tolerance between sections, and high energy density. It is a 5-section capacitor with 0.0225 µf capacitance per section, with less than 450 pf difference between adjacent sections. Tobe Deutschmann Laboratories, 550 Turnpike St., Canton, Mass. [346]

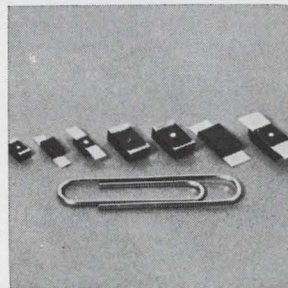

Very-low-profile, rectangular block solid tantalum capacitor type 193D Domino is for use on hybrid substrates and p-c boards. They feature fully molded construction for physical protection and assurance against increases in leakage current, dissipation factor, or impedance. Units come in 6 working voltages from 3 to 35 v d-c. Sprague Electric Co., North Adams, Mass. [347]

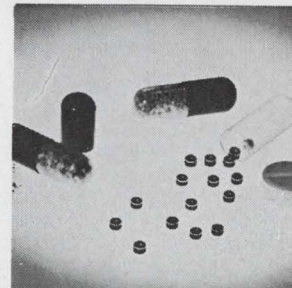

Microminiature pellet resistors are suited for use in flatpacks, microwave loads and attenuators, temperature compensated transistor circuits, etc. Pellets are available in three models measuring 0.100 x 0.062 in. Tolerances are attainable to ±1%, resistance range is 10 ohms to 500 kilohms. Pyrofilm Corp., 60 S. Jefferson Road, Whippany, N.J. 07981 [348]



ASK A Micro COMPET

Now ask a Micro Compet. At last you can. Our extensive development of ELSI (Extra Large Scale Integration) specifically for use in electronic calculators (Electronics 11/11/'68) has paid off. The result you can see. Micro Compet QT-8D.

It's hand-sized and weighs just 3 lbs. Silently performs $+$ $-$ \times \div and mixed calculations up to 8 digits. Answer response is fast and clear on a new green read out.

We think Micro Compet is a design breakthrough. It's compact, stable and easy to use. It should be good. We made the first solid-state electronic calculators and today make more than anybody else.

Ask to see Micro Compet QT-8D soon.

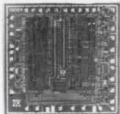

A single 1/8" square ELSI does the work of 1875 electronic components. With 4 ELSIs Micro Compet ensures maximum performance in ultra-miniature dimensions.

**Magnified ELSI
by 50 times**



**Model
QT-8D**

SHARP

HAYAKAWA ELECTRIC CO., LTD. Osaka, Japan

U.S. Subsidiary: SHARP ELECTRONICS CORP. 178 Commerce Road Carlstadt, New Jersey

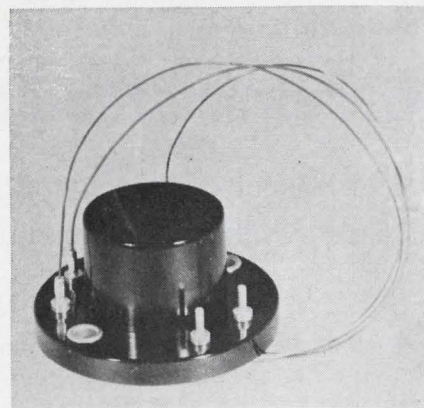

On the strip. The 8ST's two thermocouples are embedded in a strip of constant-temperature ceramic.

reference unit and held at a constant temperature. The key to the reference is keeping that temperature constant. In the 8ST two reference thermocouples are embedded in the special ceramic. Since the ceramic's temperature stays constant, the thermocouples' does too.

"The most common method that I found," says Dogan, "is using a sensor, such as a wire-wound sensor, which will sense the temperature change and through a bridge circuit feed a correcting signal to the reference thermocouple signal. These references are three to four times less accurate than the 8ST and have a lot more parts."

"The other technique," adds Dogan, "is mounting about 100 thermocouples in a plate, heating the plate and controlling the plate's temperature externally. If you buy a plate with a lot of thermocouples, price can get down to \$15 per thermocouple, but it can go as high as \$25 or \$30." (In this setup each of the thermocouples on the plate acts as a reference for one external thermocouple.)

Dogan says that the 8ST can be used anywhere a reference is needed, from multi-thermocouple industrial applications to lab-bench test circuits. The unit weighs 0.6 ounce, is 1½ inches in diameter and ¾ inch high, and is packaged in a phenolic case.

The 8ST needs a 24-volt a-c or d-c input, and draws from 0.6 watt, at +60°C, to 1.6 watts at -10°C. It withstands temperatures as low as -65°C and as high as +125°C.

Control Products Division, Texas Instruments Inc., 34 Forest St., Attleboro, Mass. 02703 [349]

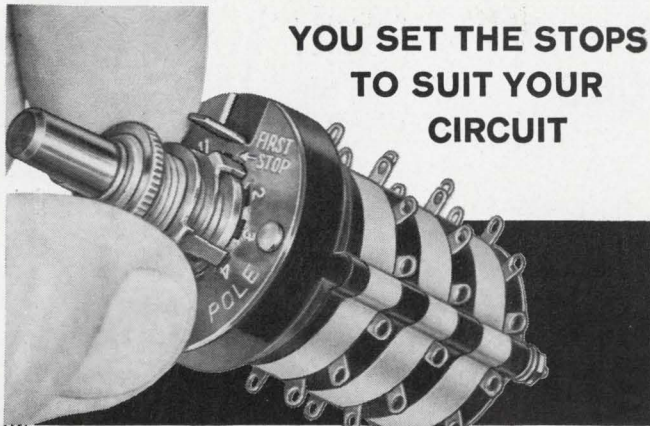

**YOU SET THE STOPS
TO SUIT YOUR
CIRCUIT**

**THIS EXCLUSIVE
GRAYHILL ADJUSTABLE STOP FEATURE**

simplifies switch selection for prototype and small production run.

- 1 to 4 Poles Per Deck
- 2 to 12 Positions Per Pole
- 1 to 12 Decks
- Shorting Or Non-shorting Contacts
- 30°, 36°, 45° or 60° Angle Of Throw
- Concentric Shaft Switch And Potentiometer Styles Available
- Explosion Proof Design

For your Grayhill Engineering Catalog offering complete technical data—contact



523 Hillgrove Avenue
LaGrange, Illinois 60525
Area Code 312, Phone 354-1040

... the Difference Between Excellent and Adequate

Circle 182 on reader service card

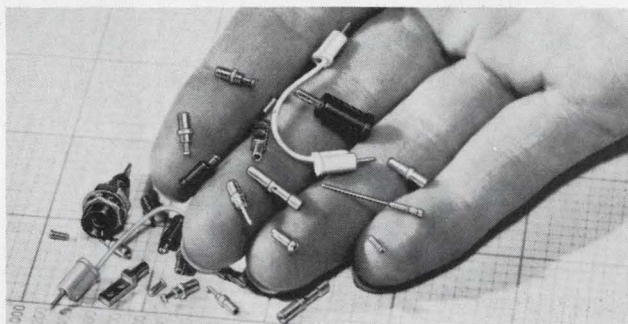

**New Connectors
increase packaging density**

CAMBION Miniature Connectors . . . the easy, reliable way to incorporate many components into your circuit designs . . . patch in other circuit boards . . . hook up ICs . . . provide convenient pluggable/patchable compatibility for hard-wired components . . . engineer greater current carrying capacity with low contact resistance . . . insure a new level of reliability in circuit interconnection systems. CAMBION produces more mini-connectors than anyone else in the world. Jacks, plugs, sockets, patch-strips for PC and conventional applications; cage jacks, "C" and "D" spring jacks, taper pins and receptacles; combination plug-jacks, patch cords and other miniature connectors. More than 1000 varieties, including color-coded and insulated types. For full details on the best connector for your needs, call Cambridge Thermionic Corporation, 469 Concord Avenue, Cambridge, Massachusetts 02138. Phone: (617) 491-5400. In Los Angeles, 8703 La Tijera Boulevard 90045. Phone: (213) 776-0472.

Standardize on

CAMBION®

The Guaranteed Electronic Components

Circle 183 on reader service card



**Full Parameter
Semiconductor & IC
Testing & Aging**



*TEC's complete
in-house facilities
save you time and money
without capital investment*

Whether you are a manufacturer or end-user of semiconductors or IC's, you can now enjoy the benefits of full parameter testing and/or aging at a reasonable cost — with no capital investment required. Take advantage of the comprehensive experience and fully-equipped facilities of Test Equipment Corporation, one of the oldest manufacturers of semiconductor test equipment.

These low-cost services are made possible by advanced, automated test and aging equipment, designed and manufactured by TEC for high speed, large capacity operation. This means you get fast turn-around time, too.

No lot is too large or too small, and TEC will test for any combination of parameters desired. All tests may be performed GO/NO-GO, or documentation may be provided as required.

TEC facilities contain complete testing and aging equipment for all configurations of transistors, FET's, TRIAC's, SCR's, diodes, and digital and linear IC's.



*For more information about
TEC's simple solution to your
problems of identifying defective
components, write today for this
descriptive brochure.*

Test Equipment

CORPORATION

P.O. BOX 20215, DALLAS, TEXAS 75220 • 214/357-6271

Circle 145 on reader service card

145

Inverter stands up to surges

Built to start induction motors, \$188 device delivers 500 watts continuously and 1,000 watts peak

Asked why his football team never passed, a coach replied: "Three things can happen when you put the ball in the air; and two of them are bad." Three things also can happen when you try to start an induction motor with an inverter but all of them are bad, according to Edward Moore, president of Wilmore Electronics Co. And that's why Wilmore engineers built a

new inverter, the 1076, which delivers 500 watts continuously and 1,000 watts in surges.

According to Moore, other inverters encounter trouble with induction motors, whose starting currents are as much as 10 times higher than their running currents. The inverters can't deliver that much extra current, even in surges. When it's tried, says Moore, the

inverter burns out, or the motor doesn't start, or the inverter's output frequency becomes load sensitive, which is inefficient. These pitfalls are averted with the 1076.

Inverters, including the 1076, convert d-c to a-c. At the 1076's input is a transformer with a center-tapped primary. Two sets of switches alternately apply the inverter's d-c input across one half

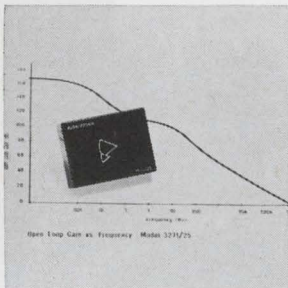

High-voltage chopper-stabilized operational amplifier 3271/25 comes in an encapsulated package. It is for operation on external power supplies ranging anywhere from ± 60 v d-c to ± 120 v d-c. A low-noise chopping technique ensures a maximum input voltage drift of only $1 \mu\text{V}/^\circ\text{C}$. Unit price is \$160. Burr-Brown Research Corp., International Industrial Park, Tucson [381]

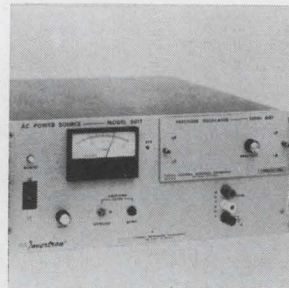

Solid state power amplifier 501T Invertron will provide 500 va of power variable from 45 to 5,000 hz, with half power to 10,000 hz. Selectable outputs supply 0 to 30 v, 0 to 75 v, 0 to 130 v, and 0 to 260 v. The overload level is adjustable from 10% to 150% of rated output. Price is \$1,495. California Instruments Corp., 3511 Midway Dr., San Diego, Calif. [382]

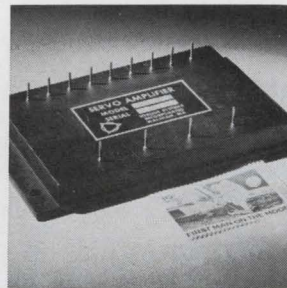

Silicon servo power amplifier model PA-201 is a molded unit incorporating a heat transfer design that allows a continuous power rating of 100 w. Output current rating is ± 5 amps at ± 20 v. Unit features high d-c gain, 25,000 v/v, low input drift, and short circuit protection. Price is \$125 in 100 quantity lots. Torque Systems Inc., Box 167, Waltham, Mass. 02154 [383]

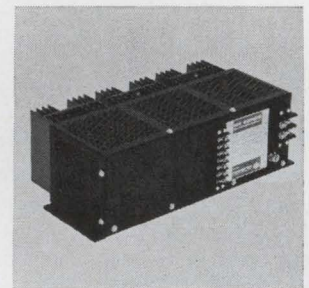

Modular power supplies series SR come in 64 models ranging in voltage from 3.6 to 48 v. and currents up to 35 amps. Typical specifications include 0.075% regulation (load and line), ripple less than 5 mv peak to peak, transient response 20 to 50 μsec . Prices start at \$89 for a 5 v, 5 amp unit. Powertec Division of Airtronics Inc., 9168 DeSoto Ave., Chatsworth, Calif. [384]

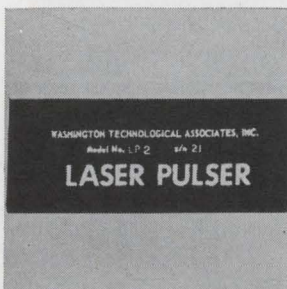

Laser diode pulser model LP-2 is designed to deliver 28 amps to a semiconductor laser diode. The current is designed to drive most laser diodes efficiently. Pulse width is 100 nsec and can be either internally clocked (special order) or externally triggered at rates up to 10 khz. Washington Technological Associates Inc., 979 Rollins Ave., Rockville, Md. 20852 [385]

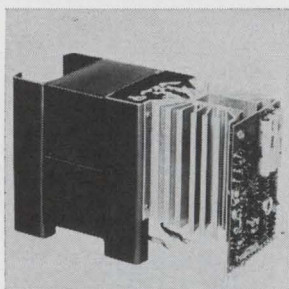

Frequency insensitive d-c power supply model BRUTE II is an open construction OEM economy unit that provides regulated power for any d-c use requiring slot voltages between 2 and 50 v d-c. Regulated to $\pm 0.1\%$ for line and load, the unit has an output ripple of 1% rms maximum. Price in lots of 1 to 9 is \$195 each. Wanlass Electric Co., 2165 S. Grand Ave., Santa Ana, Calif. [386]

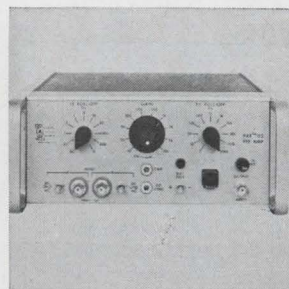

Preamplifier model 113 provides amplification of signals from d-c to 300 khz. Typical noise figures are 0.3 db maximum at 10 hz with a 2 megohm source impedance; 0.2 db maximum at 1 khz with a 1 megohm source impedance. Gain is from 10 to 10^4 in 1-2-5 sequence, continuously variable. Princeton Applied Research Corp., Box 565, Princeton, N.J. [387]

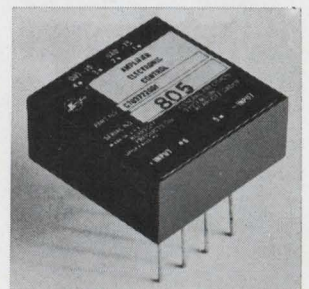

Four lightweight power amplifiers identified as the C70 3722 series are designed to drive either resistive or reactive loads in synchro driver or voltage follower applications. They meet the environmental requirements of MIL-E-5400. Rated output volts range from ± 11 to ± 18.5 v; rated output current, 135 to 500 ma. Singer-General Precision Inc., Little Falls, N.J. 07424 [388]

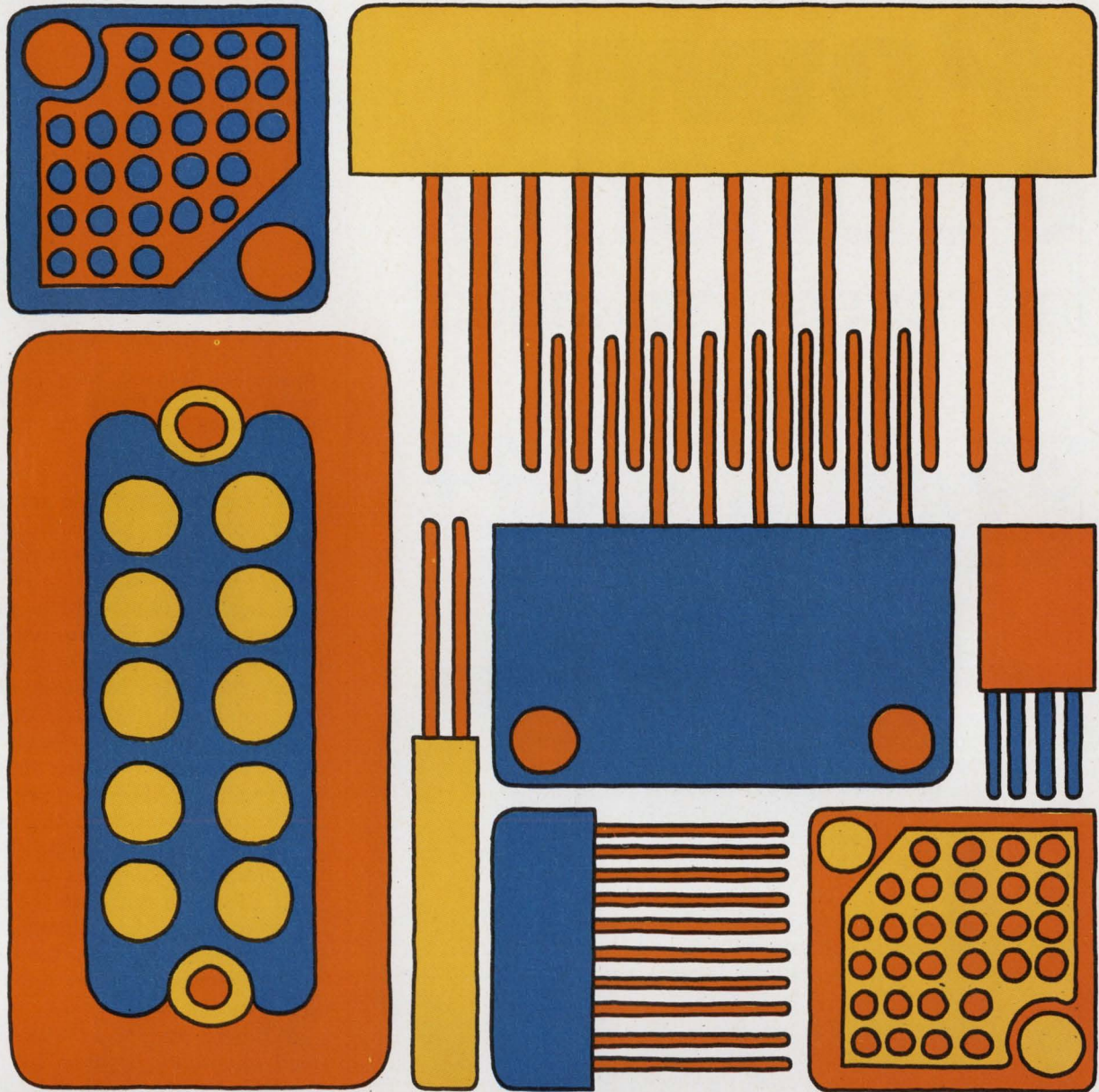

Winchester Electronics

the long line that makes
short work of today's problems

If you have any idea that Winchester Electronics specializes in just a special few connectors, forget it.

We make more than 31,000 different types of connectors—miniature, sub-miniature, hi-density, printed circuit. In the unlikely event you can't find just the one you need among these, say the word and we'll

make the odd ball you want. Faster than you ever thought possible—and in any quantity required, from ten to the hundreds of thousands!

Want to hear more about our capabilities in the connector field? Just write Winchester Electronics, Main Street and Hillside Ave., Oakville, Conn. 06779.



**WINCHESTER
ELECTRONICS**

DIVISION OF LITTON INDUSTRIES

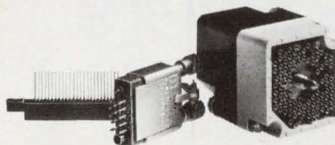

Power AND economy in Pressfit Packages*

35
AMPERES



44
AMPERES

For current requirements of 35 and 44 amperes, you no longer need the conventional stud-mounted rectifier. You can save on the component cost and on installation time and expense by using Tung-Sol pressfit, diffused junction, silicon power rectifiers.

These 35 and 44 ampere devices are rated at 150° case temperature. Cases are hermetically sealed to provide the highest order of reliability. Overload surge capacity of either rectifier is 500 amperes.

Many years as a supplier to the electronic and automotive industries have made Tung-Sol a leader in pressfit rectifier technology.

Write for technical data sheets CT-42 and CT-43. They contain complete information about these Tung-Sol high-power pressfit rectifiers. Tung-Sol Division, Wagner Electric Corporation, 630 W. Mt. Pleasant Avenue, Livingston, New Jersey 07039. TWX: 710-994-4865. Phone: (201) 922-1100; (212) 732-5426.

TUNG-SOL®

HIGH POWER, PRESSFIT

Silicon Rectifiers

*Modified DO-21 Outline

© Trademark TUNG-SOL Reg. U.S. Pat. Off. and Marcas Registradas

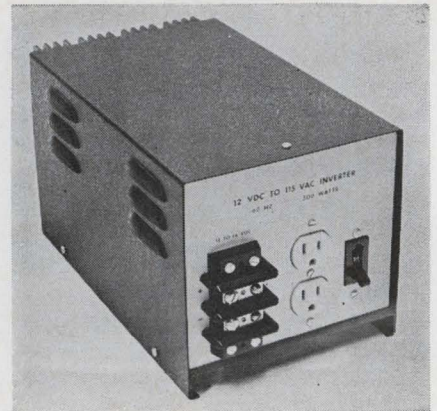

Square out. Running off a 13-volt d-c input, the 1076 puts out a 60-hz square wave, steady to within 2 hz.

of the primary and then across the other, generating across the secondary a 60-hertz square wave.

To handle surges the 1076 switches the input with a pair of 60-amp transistors. The better the transistors are matched, Moore notes, the higher the surge current they can handle. To make sure that the 1076's transistors always carry equal currents, Wilmore engineers use feedback. "There's a very small resistor in series with the emitter of each transistor," says Moore. "If one transistor tries to carry a little more current than the other, its emitter voltage changes very slightly, which reduces the current so that the other picks up its fair share of the load."

Wilmore engineers licked the load sensitivity problem by isolating the 1076's frequency-sensing circuits from its power circuits. And they make it tough to burn out the inverter. If its output goes over 1,000 watts, a feedback loop switches the input off the primary.

Moore says that the 1076 can start any single-phase fractional-horsepower motor. But right now his eye is on the boating industry. "On a small boat, say up to 32 feet, which sleeps six to eight people, they have 12-volt d-c power systems and no way at all to run a refrigerator. So there's a man with \$40,000 tied up in his boat and no way to keep his beer cool."

The 1076 wouldn't take up much space. It's 7 by 7 by 13 inches, and weighs 30 pounds. Its input range is 11 to 14½ volts; output regulation is ±2 hz. Price is \$188.

Wilmore Electronics Co., Box 2973 W. Durham Sta., Durham, N.C. [389]

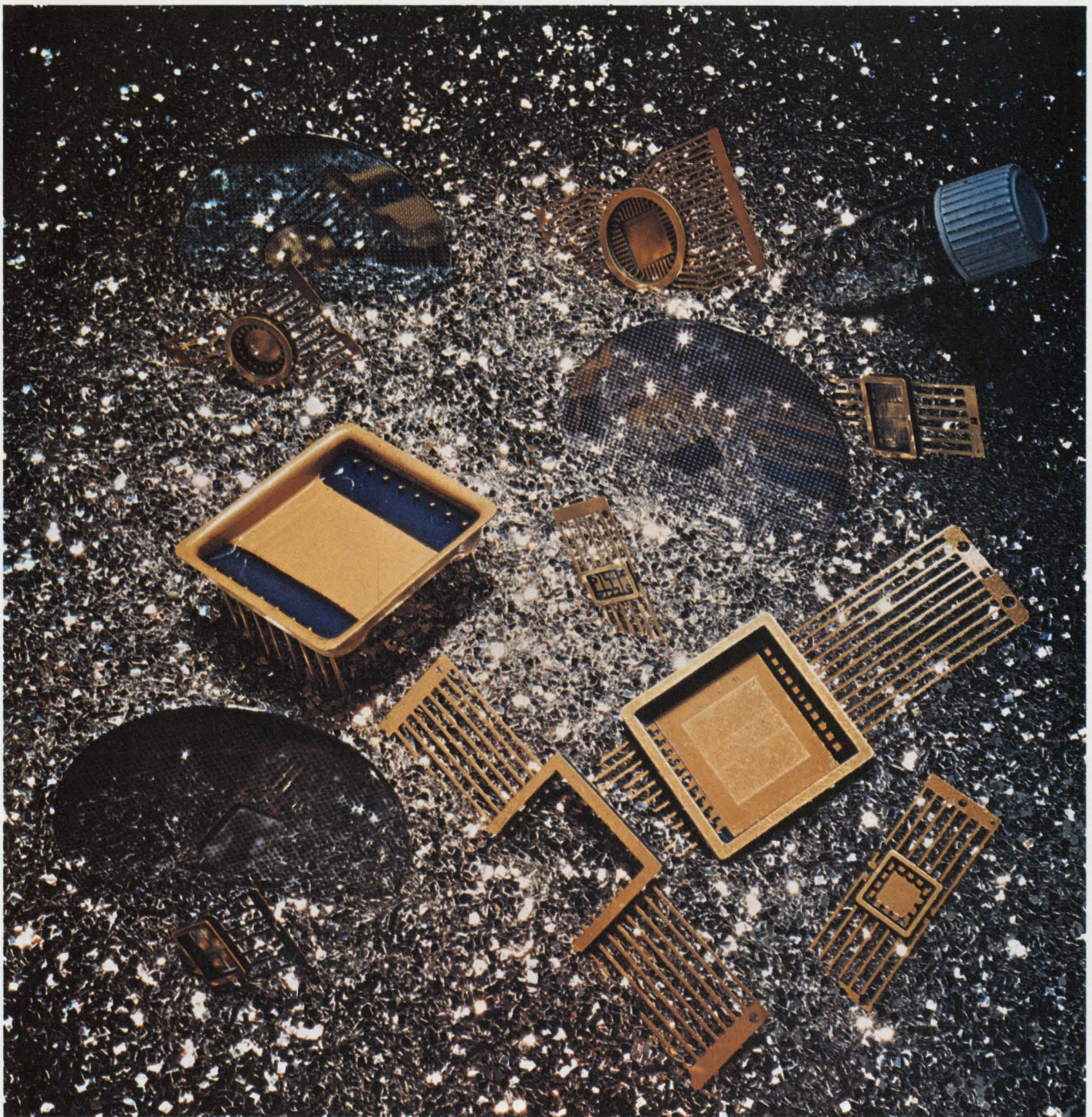

Sprague Semiconductor Chips and Packages. Illustration: 3 wafers, 8 packages, many chips

Semiconductor chips. Packages. One source. Sprague.

Every device in the Sprague Semiconductor line is available in chip form. Transistors. Integrated circuits. Even precision nickel-chromium resistor networks. Just about everything you need to build your own hybrids.

And from the Hermetic Seal Department, flatpacks to put them in. From 1/4" x 1/4" to 1 inch square. From

6 leads to 40. Standard and ready for off-the-shelf delivery. Your custom package design can be made to order, too.

Make Sprague your one source when you're making your own hybrids. If you're going to put down our chips, put them in our packages.

Call Sprague Info-Central (603) 224-1961 extension 255

Get data on Sprague's chips and packages. Write to: Semiconductor Division,
Sprague Electric Co., Pembroke Road, Concord, N.H. 03301.
Or circle the reader service number below.



45S-9130R1

Diode Arrays

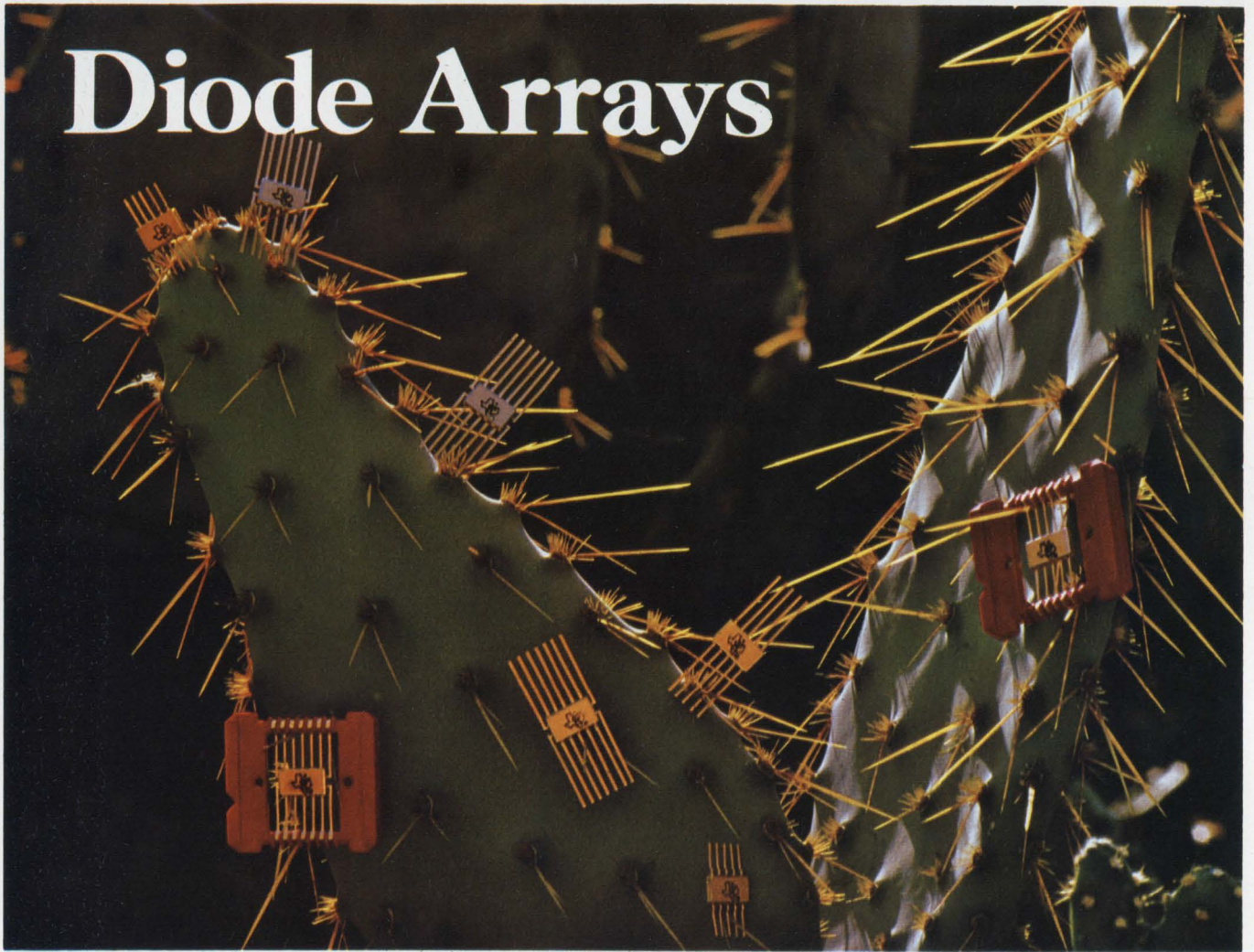

8 answers to prickly problems

Solve thorny computer memory problems with these 8 diode arrays from TI.

Unbeatable core-drivers, they assemble quickly and cut P-C board space requirements. Up to 65%! Saves you time, trouble and costs. And they're smaller, lighter, more reliable, too.

Performance? They're real sticklers for fast recovery, low capacitance, and high forward conductance. With closely matched electrical characteristics through a broad temperature range.

Try them. They're available fast: Through TI distributor and factory stocks. In arrays of 8, 16 and 20 diodes. Common cathode or anode connections. In flat packs

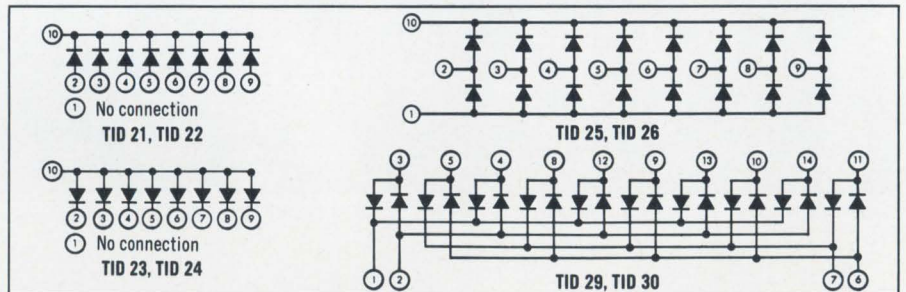

with 10 or 14 leads.

These 8 arrays are part of TI's preferred semiconductor line, selected to save you time and money in specifying discrete components.

If one of these doesn't fill your specific needs, TI makes custom arrays of 2 to 20 diodes in flat packs, 10-lead TO-5 metal-can and

dual in-line packages.

Write for TI's brand new *Preferred Semiconductors and Components* catalog: Texas Instruments Incorporated, P.O. Box 5012, MS 308, Dallas, Texas 75222. Or just circle reader service number 122.



TEXAS INSTRUMENTS
INCORPORATED

Graphic display input system uses 'sound pen'

Spark gap sends acoustic waves to microphones at tablet edges; distance that waves travel determines position of pen

The light pen used in interactive graphic systems may be replaced by a "sound pen"—at least, that's what Science Accessories Corp. hopes. The company has developed such a graphic input device for use with a digital computer. Called the Graf/Pen, the unit has no active elements. It senses the position of a hand-held pen by timing the propagation of sound between a source at

the tip of the pen and sensors placed around the edges of the tablet or screen.

Including a tablet, stylus, and controller, the Graf/Pen also can be used with a cathode-ray tube display or an x-y recorder. The stylus combines a ballpoint pen and a tiny spark gap—the spark generates a sound pulse with an extremely fast rise time. Two capacitive micro-

phones are located along the x and y axes of the tablet; they detect rise times from the sound wave of about 0.2 microsecond and at the same time filter out ambient noise.

When the controller initiates a spark, two 10-bit counters—for the x and y directions—and a clock are triggered. The counters start at 0 and increment continuously while the sound wave travels through the

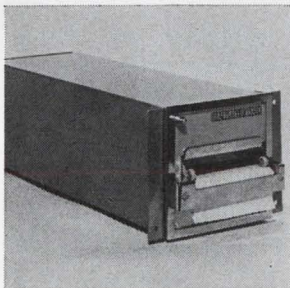

Digital printer 1141B is a 10 or 12 character per column medium speed, synchronous printer with 10 or 12 line entry on each column. Information is fed into individual print selection modules, controlled by scr's allowing selection of the desired character in less than 1/6 second. Speed of the printer is 4 lines per second. Datatotal Inc., 31 Park Rd., New Shrewsbury, N.J. 07724 [421]

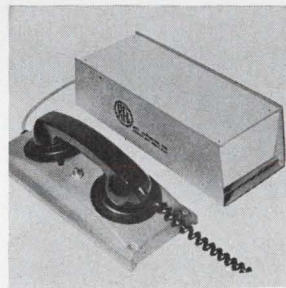

Hardwire-acoustic data modem model 13A0/TTY is compatible with the Western Electric 103A Dataphone and provides interface between most data terminals and standard telephone services. The unit has both transmitter and receiver filters with greater than 35 db rejection for noise and harmonic elimination. RFL Industries Inc., Communication Division, Boonton, N.J. 07005 [422]

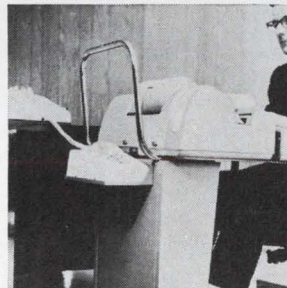

Acoustic data set 301A, which serves as a remote portable terminal for transmitting electronically processed information over the telephone, may be used to send data to time-sharing computers. Data rate is up to 300 baud. The set weighs 5 lbs and has a housing of buff-colored Kydex acrylic-modified PVC sheet for durability and thermoformability. Com Data Corp., Niles, Ill. [423]

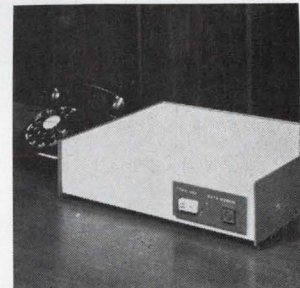

Data set TMX-202G interfaces with teletypewriter and business machines. It is a desk-top, single-channel-end data set operating at rates to 1,800 bps. Digital interface meets RS-232, CCITT V24 or MIL-STD-188B specifications. Mean-time-between-failure is calculated at approximately 20,000 hrs. Collins Radio Co., 19700 Jamboree Blvd., Newport Beach, Calif. 92663 [424]



Input/output device for computers called Teletype, measuring 13 x 18 x 7 in., and weighing 25 lbs, is interchangeable with the KSR33 Teletype. The printer input and keyboard output is serial 8 bit ASCII code. The Teletype operates at a speed of 10 operations/sec (100 wpm). Electronic Information Systems Inc., Rural Route 3, Boulder, Colo. 80302 [425]



Digital data recording system Unilog 100 offers a programmer, code converter and paper tape perforator complete in one package. All control functions and the word format are arranged by simply jumper-wiring the output connector. Data can be in decimal or BCD form represented by either contact closures or voltage levels. Eldon Associates Inc., Industrial Ave., Palo Alto, Calif. [426]

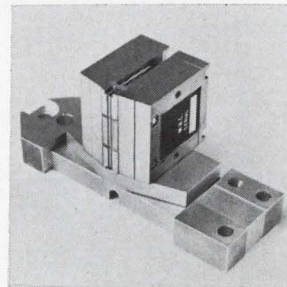

Dual-gap, nine-track, digital magnetic tape heads series HDG9 can be utilized for high density recording at 250 inches per second with fully compatible IBM formats. The series is composed of four models with packing densities of 3,200 flux reversals per inch at recording tape speed of 250 inches per second. Magnetic Head Corp., 95 Marcus Blvd., Hauppauge, N.Y. 11787 [427]

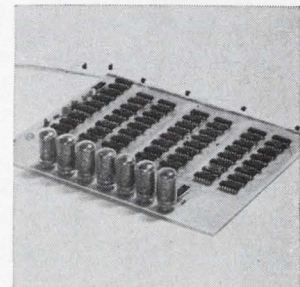

Digital readout card series DRC-100 is a complete bidirectional counter/display designed for machine tool readout application. Display utilizes Nixies in a format of 6 digits and sign, with selectable decimal point. Unit features a presettable counter/display, buffered BCD outputs, and is compatible with optical coders. Digital Products Corp., Ft. Lauderdale, Fla. 33309 [428]

CLASSIFIED ADVERTISING
SEARCHLIGHT SECTION
 BUSINESS OPPORTUNITIES
 USED OR SURPLUS EQUIPMENT

FUNCTION GENERATORS
 We are overstocked. Tremendous savings on latest solid state function generators, Sine, square, triangle, ramp, complex. Laboratory quality. Every item 60% to 90% off. Absolutely will not last. Send for free brochure.
LABORATORY EQUIPMENT SALES
 16210 May Creek Rd., Renton, Wn. 98055

CIRCLE 967 ON READER SERVICE CARD

Minifluid DISPENSER
 AIR OPERATED
 for miniature potting and encapsulating
 Available in 3 sizes
 6cc - 12cc - 30cc
 \$34.00
PHILIP FISHMAN COMPANY
 7 CAMERON ST., WELLESLEY, MASSACHUSETTS 02181

CIRCLE 968 ON READER SERVICE CARD

RADAR SYSTEMS GROUND AND AIRBORNE. AUTOMATIC TRACKING ANTENNA SYSTEMS. NIKE AJAX. NIKE HERCULES. M-33. MSQ-1A. MPS-19. MPS-9. SCR 584. TPS-1D. TPS-28. FAA-ASR-2. AIRBORNE SYSTEMS. APN-84. APN-102. APS-20. APS-27. APS-45. DPN-19. DIGITAL COMPUTERS. IBM 650. IBM 704.
 LARGEST INVENTORY OF RADAR AND MICROWAVE EQUIPMENT IN THE WORLD.
RADIO RESEARCH INSTRUMENT CO.
 45 WEST 45TH ST. N. Y. 10036 212-JU 6-4691

CIRCLE 969 ON READER SERVICE CARD

Mr. Used Equipment Dealer:

When you advertise in the Searchlight Section . . . You have hired your most persuasive salesman:

He's efficient . . . He thrives on long hours . . . His territory is the entire nation . . . and overseas . . . He doesn't see buyers of used and new surplus equipment: They see him—regularly. They depend on him.

He is Searchlight—The section of this publication where wise dealers advertise and list their stocks for sale.

SEARCHLIGHT SECTION
 Classified Advertising Dept.
 • Post Office Box 12 •
 New York, N. Y. 10036

. . . pen used as display input device contains inexpensive ballpoint refills . . .

air. When the microphones detect the wave's leading edge, the counters stop; the binary numbers they contain are proportional to the x and y distances of the pen's tip from the tablet's edge. The controller determines the pen's position from the counters' contents. When the counters stop, the controller generates an output ready pulse that can be used as a program interrupt or punch command for transferring the binary value of the counters to a digital computer, or for storage on a program tape.

Coordinate pairs are generated—up to 200 per second—with each spark. When the stylus is moved, the counters reset and start counting anew, corresponding to the new position of the stylus on the tablet. The pen can be operated in either free-run or one-shot modes. In the free-run mode, the repetition rate of the sparks can be continuously varied from 1 to 200. In the one-shot mode, one coordinating pair is transferred on command from the computer or at the instant that the stylus tip contacts the tablet or crt face.

Tablet size can be as large as 14 x 14 inches, which the 10-bit binary counters divide into 1,000 parts each way, for a resolution of 0.014 in. But the tablet can be expanded to 33 inches square, says Leigh Hickcox, marketing manager at Science Accessories, at little added expense or limitation in resolution.

Off the shelf. The Graf/Pen sells for \$2,800 in single quantities. The

components are readily available and inexpensive. The microphones are made of aluminum extrusions and aluminized Mylar foil. The pen contains ordinary, inexpensive ballpoint refills, and all the electronics are digital integrated circuits. "Our complete unit cost," says Hickcox, "will be cheaper than that of some light pens."

The advantage of this system over other units such as the Rand Tablet is its flexibility, Hickcox says. The Rand Tablet contains crossed-wire grids and uses capacitive sensing—an inherently expensive process that limits the size and format of the tablet. Increasing the size of the Graf/Pen tablet requires only longer microphones along the tablet's edges.

In addition, microphones can be mounted very easily on the bezel or mounting frame of cathode-ray tubes for interacting with the crt. Since the pen does not depend on light for sensing patterns on the scope, the stylus can interact with both light and dark areas on a scope, and with high resolution.

One of the more interesting applications for the Graf/Pen is in tracing out, either pointwise or continuously, photographic images projected from the rear onto the tablet using a frosted lucite plate. Areas of land contours, weather patterns, and X rays can be outlined and transferred to a computer as digital data.

Science Accessories Corp., 65 Station St., Southport, Conn. 06490 [429]

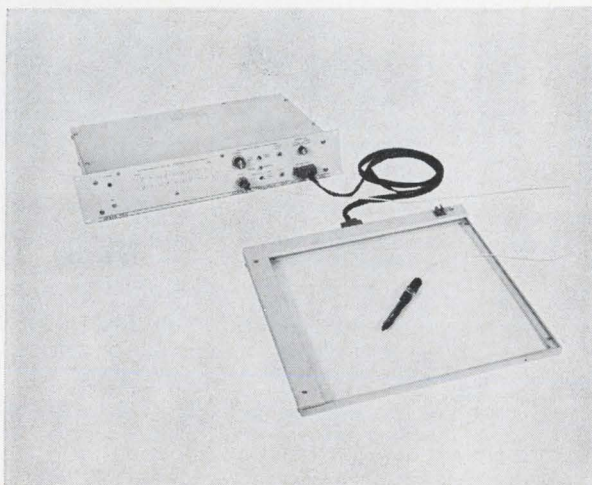

Sound system. The tablet is wired to a controller that determines position of pen by acoustic ranging. A spark gap in the pen is detected by microphones at the edge of the tablet.

Perfect Your CCTV System with **COSMICAR**® lenses



Focal length 15~145mm Aperture f/2.5

A new member to the superb **COSMICAR** lens family!!

The most efficient **10 : 1 zoom** lens, unmatched for its optimum performance, both optically and mechanically, with impeccable definition and resolution throughout its entire zoom range.

Also available are scores of other lenses, ranging from 8.5mm to 1,000mm telephoto, zoom and those motordriven among them, for immediate delivery, after being tailored to your specifications.



COSMICAR OPTICAL CO., LTD.

568, Shimoochiai, 2-chome, Shinjuku-ku, Tokyo

Cable Address: "MOVIEKINO TOKYO"

Circle 184 on reader service card

PANDUIT announces the **PENNY-TY**TM cable tie

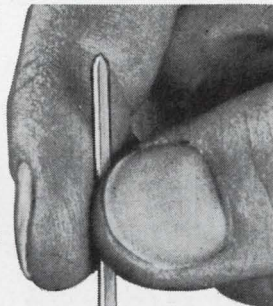

The PANDUIT SST1M "PENNY-TY" Miniature Cable Tie is now available for 1¢ each in quantities of 50,000* or more.

- On Qualified Products List (QPL) of MIL-S-23190B since 1964. Meets new Military Standard MS-3367-4 and previous Standards MS-17821-4, MS-18034-4.
- Harness diameter range 0 to 3/4"; loop tensile strength 18 lbs. minimum.
- Self-locking and releasable prior to final tightening by hand or with tension-controlled PANDUIT GS2B Harnessing Tool. No twisting or tugging. No metal barbs.



At your PANDUIT Distributor. **FREE SAMPLES**

PANDUIT[®]
CORP.

Tinley Park, Illinois 60477 • Phone: 312-532-1800 • Telex 25-4560

FROM THE MANUFACTURERS OF
PANDUIT® PLASTIC WIRING DUCT



* In accordance with standard conditions of PANDUIT Price Sheet effective 12-1-69

VISIT PANDUIT NEP/CON WEST BOOTH #709.

OVER **1,000,000 SIZES** MILITARY CASES COMBINATION • TRANSIT • INSTRUMENT

MIL-T-945A, T-4734, T-21200, STD-108, C-4150



Choose from over 1,000,000 variations in dimensions, proportions, metals, finishes, and custom accessories. Whatever your need, the MM (multi-measure) method gives you high production savings even on custom runs as low as 25 units. Send your print or requirements. Manufacturers representatives in all major cities.

SEND FOR FREE CATALOG & DIMENSION SPECIFICATION SHEETS.

mm ELECTRONIC ENCLOSURES, Inc.

111 Bloomingdale Rd., Hicksville, N.Y. 11801 • 516-935-9400

Look at what Mallory has done to audio systems design.

Use these three new, low-cost Mallory IC's to design a complete stereo system with a minimum of external parts. They dramatically improve systems performance... at lower systems cost.

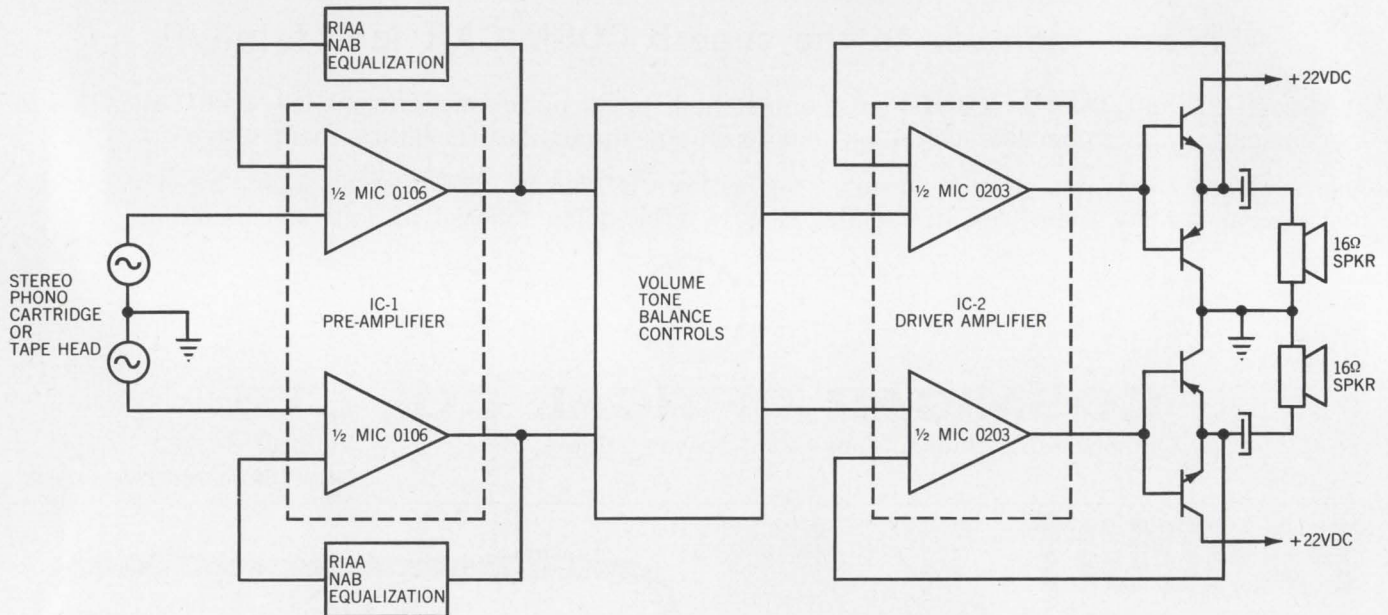

5 WATT STEREO AMPLIFIER
UTILIZING MALLORY INTEGRATED CIRCUITS

MIC 0102 Single-Channel, and MIC 0106 Dual-Channel Preamplifiers

- 60-db minimum gain.
- Feedback-frequency compensation provisions.
- 100K input impedance.
- Low distortion.
- Internal power supply filtering.
- Wide voltage-range supply.

MIC 0203 Dual Driver Amplifier

- 55-db minimum gain at $V_{cc} = 20$ Vdc.
- 10-ma drive current.
- Low input bias current.
- Low distortion.
- Power drive capability over 10- to 24-Vdc supply range.
- Direct drive for complementary or quasi-complementary output devices.
- Internal feedback resistors.
- External feedback capabilities.
- Two- and twelve-watt-per-channel drive capabilities.

Find out about these ultra-flexible IC's today... just three examples of our full range of value-packed IC's. Contact your Mallory Sales Offices, or P. R. Mallory & Co. Inc., Integrated Circuits Dept., Indianapolis, Indiana 46206. 317-636-5353.



Digital meter has 7-segment readout

Larger, brighter display aimed at opening new markets for high-accuracy instrument, such as precision weighing

New instrument designs often are changed with a view toward reducing price. Not so with Electro-Numerics Corp.'s new digital panel meter, model 3350. In fact, it's more expensive than its predecessor, the 3300.

However, along with a higher price tag, the new version—a 3½-digit meter—offers a seven-segment readout instead of Nixie tubes, and

increased accuracy. Both features are intended to make the meter meet applications in new industrial areas such as the business of precision weighing.

According to Russ Walton, the firm's marketing manager, the seven-segment readout was sought because Nixie tubes are not easily read from distances farther than several feet, as in truck-weighing

stations, for example. Further, the high accuracy (about ±0.001% of reading ±0.015% of full scale/°C) particularly lends itself to applications where a one- or two-digit error on the last digit would translate into inaccuracies of hundreds of pounds, say for a large trailer truck.

But, adds Walton, these two increased capabilities will cost the

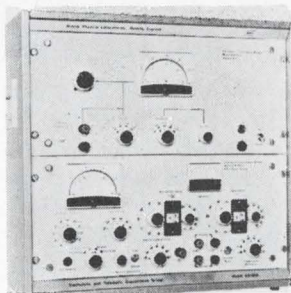

Bridge CB-154 Mark IV is for measuring capacitance, dissipation factor, and leakage current in electrolytic and tantalum capacitors. Bridge-voltage supply is adjustable in 6 ranges between 1 mv and 3 v, with a choice of 60- and 120-hz bridge frequencies and provision for external source up to 20 khz. Advanced Technology and Systems Corp., Riverside, Conn. [361]

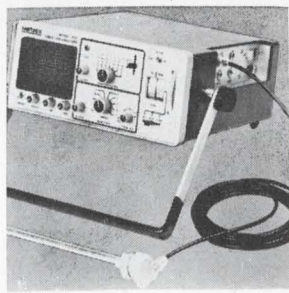

Vibration analyzer model 5115 measures the amplitude and frequency of vibration displacement, velocity of acceleration in the frequency band 5 hz to 1,600 hz. The system consists of a rugged vibration pickup and a lightweight portable indicator unit complete with integral oscilloscope. Unit is powered by internal batteries. Metrix Instrument Co., 5760 Rice Ave., Houston [362]

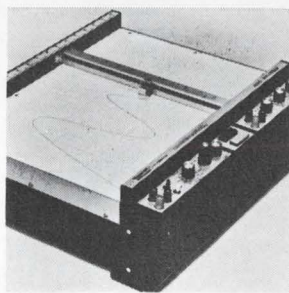

Omnigraphic recorder model 2000 offers a convertible chassis and plug-in expandability. It will accommodate an X-Y, strip chart, T-Y or a variety of special designs in one main frame. Each X-Y can use 8½ x 11 in. charts or 11 x 17 in. charts interchangeably. Sensitivity is 1 mv/in., accuracy ±0.2%. Houston Instrument Div. of Bausch & Lomb, Bellaire, Texas [363]

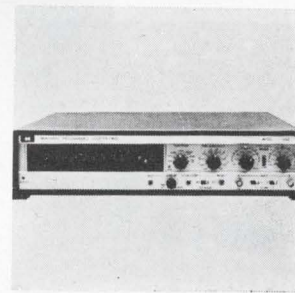

Programmable universal counter/timer 110C is a 150 Mhz unit featuring light-emitting numeric display. It totalizes from 0 to 10⁸ and is prescaled from 10 to 10⁻¹⁵. Frequency ratio is measured from 10⁻⁹ to 10⁸. Period average is from 0.1 μsec to 1 sec and period is measured from 1 μsec to 10⁻⁸ sec. Monsanto Electronic Instruments, W. Caldwell, N.J. [364]



Sound level meter ACOS SLM-3 is accurate, inexpensive (\$165), and can be operated by nontechnical personnel. It has a range of 50 to 130 db and its scale is based on the A weighted curve. Each unit is individually calibrated and comes with its own matched microphone. Resulting accuracy meets International Standard IEC-123. Trans Atlantic Electronics, Hicksville, N.Y. [365]

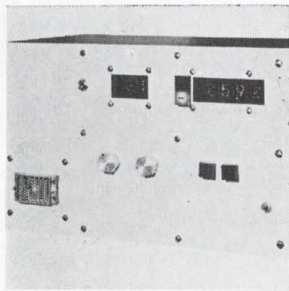

Noise test system 5012 automatically measures resistance and noise index of multielement resistive networks. The data is presented on a digital readout and in BCD form from a connector. Unit will measure sequentially up to 20 resistors of any value between 10 ohms and 100 kilohms. It measures resistance to ±1%. Quantech Laboratories, Whippany, N.J. [366]

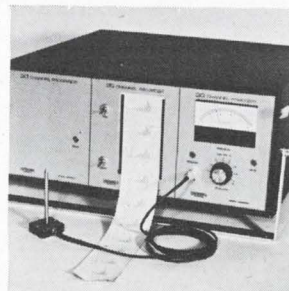

The Simulprinter model FS-5 is a new concept in real time analog signal processing instrumentation. It accepts accelerometer vibrations input for the frequency range 1-1,000 hz. Applications include vibrations analysis, quality assurance on production lines, preventive maintenance and environment noise analysis. Listening Inc., 6 Garden St., Arlington, Mass. 02174 [367]

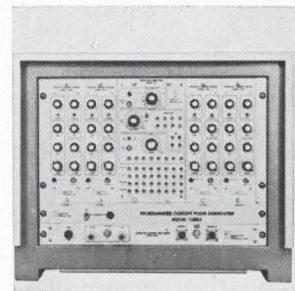

Programmed current pulse generator 1580A boasts a highly linear, 15-nsec rise time and a narrow pulse width into the load. Its program generator operates at a high-speed 5 Mhz and incorporates an 8-step programming capability which permits repetition of selected steps or step pairs within the predetermined pulse program. Computer Test Corp., 3 Computer Dr., Cherry Hill, N.J. [368]

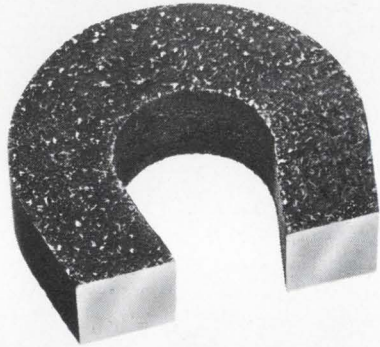

we have an aptitude

Magnetics has been a special talent of ours for more than two decades. The devices and systems to magnetize, demagnetize, stabilize, measure—in the lab, in production, in the product—we have consistently engineered the most complete line available anywhere. And the top-value line.

RFL's gaussmeters cover every requirement—from the low cost and portability of the Model 505, to the unparalleled precision of the 3265. Then there's the 101 flux-gate type Magnetometer for measuring extremely low level flux densities... five different types of Magnet chargers for every requirement ranging from the economical, rugged 107A Magnet Charger to the Model 942 that takes on *any* shape or type of permanent magnet... the Magnetreater® for precisely controlled stabilization... and many more. Where needed, we can integrate standard RFL equipment to make a custom system, too.

Write now for our new magnetics catalog.



RFL Industries, Inc.

Instrumentation Division • Boonton, New Jersey 07005

Tel: 201-334-3100/TWX: 710-987-8352/CABLE: RADAIRCO, N.J.

user between \$50 and \$75 more than for conventional panel meters.

More displays. From an engineering standpoint, Walton points out that the size and brightness of the display are significant, but what's also important is the fact that extra displays can be driven directly by the 3350. "This is particularly useful in original equipment manufacture applications where you might want to monitor a reading at the source and also transmit the reading to a remote location." Walton says that the standard IC drivers available for seven-segment displays are too expensive, and "they just don't work. Further, with IC's you can't drive another display."

So instead of using one special IC to do the driving, Electro-Numerics is using two standard resistor-transistor-logic circuits and "some discrete transistors." The transistors also are employed as line drivers to buffer the binary coded decimal output, thus preventing an external display from disrupting the meter's operation.

Another feature of the 3350 is that it uses the dual-slope technique for analog-to-digital conversion instead of the less costly ramp technique. Walton says that this provides a more stable and linear reading.

Figures. As a 3½-digit meter the 3350 has three full digits with the ½ containing a "1" for 100% overrange and the plus and minus signs. Input impedance is 1,000 megohms and the maximum input voltage is 250 volts peak, a-c or d-c. Polarity indication is automatic, and the step response—0 to full scale—is less than 300 milliseconds. The readout is nonblinking, and a hold capability is provided. Reading rate is 10 per second, and a rate of up to 60 per second can be provided.

According to Walton, all inputs and outputs are available at the rear of the unit and a wide range of options are available. "We can supply digital panel meters with special features such as logarithmic response, extended overrange and a printer drive capability," he adds.

Price for the basic 3350 is about \$300; delivery is slated for the end of December.

Electric-Numerics Corp., 2191 Ronald St., Santa Clara, Calif. 95050 [369]

New materials

Copper tailored for microwave

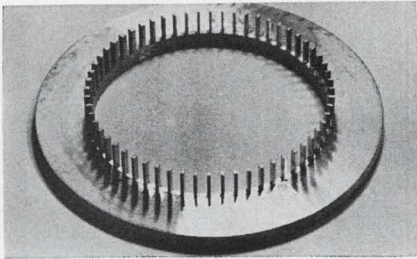

Dispersion-strengthened copper is designed to meet the needs of the microwave tube industry. It has the desired combination of properties, high strength at high temperatures with high conductivity, not available in oxygen-free type coppers used in tube construction. DS copper is not subject to hydrogen embrittlement. A two slow-wave structure (above) was formed by hobbing DS copper. The DS copper fingers did not soften after heat-treating, facilitating handling and fabrication of anode assembly. Revere Copper and Brass, 230 Park Ave., New York 10017 [491]

Silicane A50CF is an elastomeric urethane formulated to replace mold-making RTV silicones. Multiple epoxy castings can be made in Silicane molds without deterioration and product breakdown caused by amine reaction. Allaco Products Inc., 130 Wood Road, Braintree, Mass. [492]

Epoxy casting resin Stycast 2850KT has a thermal conductivity of 30 BTU-in./hr.-ft².°F, approximately three times that of conventional epoxy casting resins. Service temperature is 390°F; flexural strength, 16,000 psi; and dielectric strength, 410 v/mil. Price is \$8 per 2 lb kit. Emerson & Cuming Inc., Canton, Mass. 02021 [493]

Engineering samples of a new, non-woven, glass-reinforced epoxy prepreg sheet are available. Designated SF/duroid 2520 Prepreg, the structure is engineered for use by fabricators of high-quality multilayer circuitry intended for G-10 and FR-4 type applications. Resin content can be varied to meet individual requirements. Rogers Corp., Rogers, Conn. 06263 [494]

Lint-free, super-absorbent paper is suited for use in the cleaning of delicate electronic parts, lens cleaning, wrapped storage of optical components and the cushioning of fragile instruments. Designated as Microwipes, the sheets are soft and pliable, yet maintain their high strength even when wet. Each package is 8½ x 11 in. and contains 500 sheets. Price (1-11 packages) is \$8 each. Texwipe Co., P.O. Box 278, Hillsdale, N.J. [495]

What happened when doctors and engineers got together:

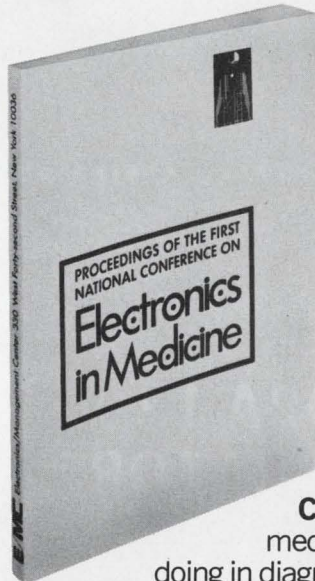

Doctors told engineers how they were using electronics and revealed their most urgent needs. Engineers described and demonstrated their newest equipment for diagnosis, treatment, and prevention. And hinted at things to come.

Their complete dialogue, with illustrations, makes pretty informative reading on a vital and growing market.

Here are some of the things it contains:

Computers: How they're joining the medical team. What computers are doing in diagnosis. In communications. The small computer as a paramedical aid.

Instrumentation: What's needed. What's available. Patient management. Protection. Standards and safety.

Electronics in the Hospital: The surgeon, the hospital, the instruments. What the administrator wants. Prescription for large-scale health care. The surgery department.

Electronics/Management Center
330 West 42nd Street, New York, N.Y. 10036

Enclosed is \$12 for a copy of the Proceedings of the First National Conference on Electronics in Medicine.

Send the Proceedings and bill me later. P.O. # _____

Name _____

Company _____

Address _____

City _____ State _____ Zip _____

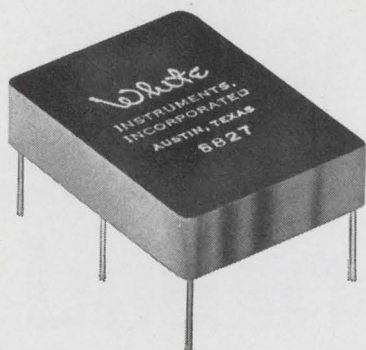

ACTIVE FILTERS

PACKAGED FOR
PRINTED CIRCUIT
BOARD MOUNTING

Integral transistorized amplifier—network packages—Low, high, band pass and reject responses at audio and sub-audio frequencies for use over a wide range of source and load impedances and power supply voltages.

Ask for literature.

Write for quotations on individual problems.

Moderate prices, early deliveries.



instruments, incorporated

PHONE AREA 512 / 892-0752

P. O. BOX 698 AUSTIN, TEXAS 78767

Circle 186 on reader service card

ELGENCO 602A-1390 NOISE GENERATOR \$330



Many obsolete vacuum tube noise generators can be directly replaced/updated with this solid state 5 Hz to 20 kHz/500 kHz/5 mHz Random Noise Generator at low cost and with improved characteristics. Delivery from stock. Other Noise Generators covering the range of DC to 30 mHz and Demonstrator Models are available. For name of nearest Sales Rep see EEM or contact Elgenco, Inc., 1550 Euclid, Santa Monica, Calif. 90404, Ph. 213-451-1635.

158 Circle 158 on reader service card

New Books

Tutorial text

Fundamentals of Quantum Electronics
R.H. Pantell and H.E. Puthoff
John Wiley & Sons Inc.
36 pp., \$15.95

The publisher's disclaimer aside, this book is written for the specialist. Even the chapters on the applications of quantum electronics—lasers, interactions between radiation and phonons, electrons in crystals—will require a thorough knowledge of quantum mechanics and operational calculus, and at least a moderate grasp of the theory of functions. In no sense is this a handbook, nor will it really be of much help to laser designers; applications are not reached until halfway through the book. It will find its greatest readership among the middle-level theoretician concerned with quantum electronics as it applies to energy interactions in gases and solids. As such, it can be a valuable book.

Chapter four on lasers is the most useful to engineers. The first section treats population inversion in terms of the ammonia maser, which is standard practice. The entire ammonia system is included—source, resonator cavity, and detector—and this helpfully offers a view of the components involved in a real-world system.

Following the ammonia maser is a discussion of the ruby laser, treated in the same clear but brief manner. The authors analyze a ruby laser configuration and then discuss the threshold requirements; this treatment, although complete, is mathematical. Steady-state operation is included, but seems an afterthought, too brief to be of general value, as is the section on transient theory for pulsed operation.

Perhaps the best section in this chapter is the one on Q-switching, which the authors discuss from a device viewpoint. They offer several methods of increasing the resonating cavity, including prism rotation and Kerr cell operation, the two most commonly used today. Other cavity switching techniques also are discussed briefly. The chapter concludes with the four-level helium-neon laser, bringing the theory of

Electronics | December 22, 1969

gas lasers up to date. Injection lasers appear briefly in chapter eight, along with a general discussion of electrons in crystals.

The early chapters on quantum theory, dipoles, and resonant phenomena are quite brief and will be useful only to those with a strong analytical background in quantum electromagnetics. For example, the authors, who are on the Stanford University faculty, introduce the Schrödinger equations—the basis for all quantum wave mechanics—with Dirac's notation for the ket vector. This assumes more knowledge of mathematical detail than is common among most engineers. Further, the treatment of operators and the density function is strictly analytical and will be no help to the intuitive-oriented reader.

Recently Published

Silicon Semiconductor Data, Helmut Wolf, Pergamon Press, 648 pp., \$27

Graphic presentation of most of the important theoretical and experimental data for using silicon in design and fabrication of semiconductor devices. Discusses both physical and chemical properties of silicon, behavior of impurities, and general diffusion characteristics relating to silicon epitaxial growth and p-n junctions. Aimed at those involved in applied solid state technology.

Precision DC Measurements and Standards, David S. Luppold, Addison-Wesley, 251 pp., \$14.50

Written for the practicing metrologist, this book covers both theory and application. Concentrating on resistance, an important aspect of dc metrology, the text also covers handling of errors, calibration of precision instruments, volt boxes, detector and bridge sensitivity and potentiometers.

Computer Data Displays, Samuel Davis, Prentice-Hall, 379 pp., \$15.00

Covers cathode ray displays, discrete readout, and large screen displays and describes several character and line generation techniques used in alphanumeric and graphic display systems. Also discusses a number of commercial display systems and includes numerous circuits and photographs.

Atmospheric Emissions, ed. B.M. McCormac, Anders Omholt, Van Nostrand Reinhold, 563 pp., \$25.95

Lectures presented at the NATO Advanced Study Institute, "Aurora and

Airglow, 1968." Intended as reference for those interested in space environment, satellite measurements, optical sensors, ionospheric physics and, the earth's magnetosphere.

Francis Bitter: Selected Papers and Commentaries, ed. Thomas Erber, Clarence Fowler, MIT, 551 pp., \$20

Papers divided into eight groups cover the magnetic susceptibility of gases, optical pumping and double resonance, megagauss physics, ferromagnetic and illumination studies.

Maintainability: Principles and Practices, B. Blanchard, E.E. Lowery, McGraw-Hill, 336 pp., \$12.50

Prepared as a practical reference for managers and project engineers, this book relates maintainability to design engineering, training, reliability, operational requirements, and other factors. It concentrates on the principles and practices of organization, planning, actuation, and control of a company maintainability program.

Mathematical Foundations of Systems Analysis, Robert H. Kupperman, Harvey A. Smith, Addison-Wesley, 214 pp., \$11.95

Intended as a reference for systems analysts facing resource allocation problems that require optimization techniques. Also for others seeking to broaden their mathematical background in the field. It treats advanced calculus, linear algebra, linear and nonlinear programming, and related subject matter.

Digital Computer Methods in Engineering, S.A. Hovanessian, Louis Pipes, McGraw-Hill, 400 pp., \$14.50

Geared toward practicing engineers, this text is an introduction to the numerical methods of solving engineering problems by digital computers. Covers basic digital computer methods applicable to most fields of engineering. Numerical methods are illustrated with computer programs that are written in both FORTRAN and BASIC programming languages.

Sources of High-Intensity Ultrasound, Vol. 2, Edited by L.D. Rozenberg, Plenum Press, 267 pp., \$25

Prepared by a team of Soviet scientists, this text looks at original research in the theory, analysis, and design of devices for generating powerful ultrasonic fields. It examines the coupling of ultrasound to process media, sensors for measurement of high-intensity acoustic waves, and characteristics of flexural-mode waveguides and torsional vibrational systems. A valuable reference for Western engineers and scientists.

think digital

ELFIN
2.99 *

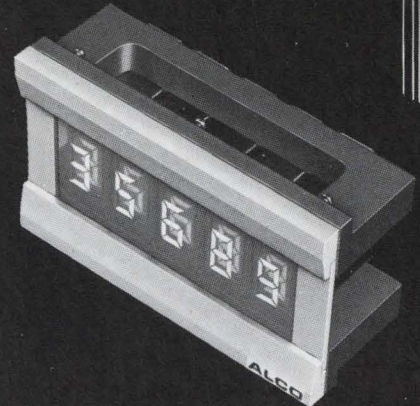

MS-4000
3.85 *

Think ELFIN—the new single plane, segmented neon readout indicator that provides brighter displays and wider viewing. Only 0.41" dia. ELFIN display 0-9, + and —, some alpha symbols and decimal.

The MS-4000 Series has new readouts added to include numeric and symbol indications. Each model is a miniature encased readout with the flat single-plane viewing, and uses 100,000 hr. #683 T-1 subminiature lamps. Plug-in feature expedites replacement. Photograph above shows five MS-4000 readouts used with a module mounting and bezel kit.

ALCO's RK numeric and symbol readouts have a unique in-line design to provide clear displays without focusing problems. The precision machined 1-piece aluminum case also serves as a heat sink.

The MS Mosaic numeric segmented indicators are available in 2 sizes and use either 6, 14 or 24V lamps for flexibility in design.

SEND FOR
ALCO - NUMERIC
CATALOG

* 1000 Lot Prices

MS-250
4.97 *

MS
4.97 *

MSM-5A
4.97 *

ALCO

ELECTRONIC PRODUCTS, INC.

Circle 159 on reader service card—>

Low down on navigation

Low-altitude navigation satellite system
R.B. Kershner
Applied Physics Laboratory
The Johns Hopkins University
Silver Spring, Md.

The use of low-altitude satellites to provide aircraft with continuous navigation information generally has been dismissed in favor of employing satellites at either very high or synchronous altitudes. However, although a large number of satellites may be needed for global coverage from low altitude, the cost of each satellite and the launch costs are must less expensive than those of a high-altitude system. Thus, even for continuous and instantaneous navigation, low-altitude systems are competitive.

A design study was made at the Applied Physics Laboratory of potential navigation satellites both at synchronous altitude and at 480-miles. The satellites were assumed to be of the passive ranging type, with the power requirement based on realistic and achievable antenna patterns. The results of the study, shown in the table, indicated that power differs between the two systems by a factor of 8. And, most important, the cost of the larger and heavier synchronous satellites is eight times as great as that of the lower-altitude system.

Satellite comparison

| | | |
|-------------------|---------------|----------------|
| Altitude | 480 miles | Synchronous |
| Transmitter Power | 19 watts | 150 watts |
| Weight | 300 pounds | 1,100 pounds |
| Unit cost | \$1.5 million | \$11.3 million |

Presented at Eascon, Washington, Oct. 27-29.

A system designed to provide at least four satellites always in view requires 18 satellites at synchronous altitude; they would cost \$203 million. At an altitude of 480 miles, 153 satellites would be needed; these would cost \$225 million or a mere 10% more. However, the low-altitude system could be orbited more cheaply, based on the use of a relatively large booster to launch an entire ring of satellites at a time.

The low-altitude system has other advantages. In principle, only a single ground station, having access to each satellite once each or-

bit, would be required. A synchronous satellite system requires a ground control network spread around the world. In addition, up-links for the low altitude system are much more immune to jamming.

A low-altitude system comes out ahead even when air traffic control requirements, such as NASA has been contemplating, are added. All that's needed for a user to be in communication contact with any place on earth is a satellite-to-satellite relay link from one group of satellites to another. This can be done quite inexpensively with ultra-high and even optical frequencies.

About the only situation in which the synchronous satellite shows a clear superiority is when coverage is required over a limited portion of the globe. For example, the needs of the airlines over the North Atlantic airlines can be met with very few satellites in synchronous orbit.

Happy algorithm

Digital filters
James F. Kaiser
Bell Telephone Laboratories Inc.
Murray Hill, N.J.

Integrated circuit technology, especially large-scale integrated digital circuitry, offers a chance to construct stand-alone digital filters, as distinct from filters programed in a digital computer. Such filters appear to be more attractive than their analog counterparts with regard to size, cost, reliability, and performance.

A digital filter executes an algorithm, or computational procedure, representing the desired filter characteristics. Assuming the signal to be filtered is continuous, first the signal is periodically sampled at some appropriate time interval. Then each sampled signal is quantized into a digital word of some appropriate length. This resulting sequence of digital words is processed in the filter and is transformed into an output sequence. Shift registers and one-bit adders provide the addition, multiplication, and unit-sample delays that perform the

algorithmic computation.

The sampling frequency and the word length determine the fidelity with which a given filter function can be implemented. The algorithm may be written in the form of a difference equation or a z-transform.

With appropriate sampling and quantizing of the input signal, digital filtering is equivalent to that which would result by sending a continuous signal through a continuous, or analog, filter.

Digital filters can act as differentiators, low-pass or smoothing filters, bandpass filters, and spectrum-shaping filters. Unlike analog filters, digital filter design is not restrained by limited Q, by tolerances of resistors, capacitors, and inductors, or—because they're built for switching elements—by drift and sensitivity considerations.

The digital filter's complexity can be measured simply by the number of gates and one-bit full adders needed to realize the algorithm. This number, together with the number of samples that must be processed per unit time, determines the required speed of the digital circuits and the amount of multiplexing and parallel processing that may be involved.

Other advantages of digital filters are: there are no real restrictions on the selection of critical frequencies and location of zeros in the s-plane; simply changing the coefficients stored in the filter's memory can change the overall filter function over a wide range; and it is possible to realize a digital filter for which there is no analog counterpart, for example, a filter with outputs that are square-shaped pulses of relatively long duration.

Presented at Nerem, Boston, Nov. 5-7.

Getting a load on

Normally-on load device for IGFET switching circuits
H.C. Lin and C.J. Varker
Westinghouse Electric Corp.
Linthicum, Md.

In digital MOS, or insulated gate, integrated circuits, an enhancement-mode transistor rather than a depletion-mode device usually is

used as the load device. The reason: enhancement-mode devices, which normally are off, are easier to fabricate, since the other transistors on the IC chip also are enhancement mode. They also consume less chip area.

Unfortunately, a normally-off load device isn't the best choice from a performance standpoint. For one thing, it requires a higher supply voltage than the normally-on depletion-mode device; in the latter, the supply is less by V_T , the threshold voltage. For another, an IC with a normally-off load switches much more slowly; rise time is about double that of a circuit with normally-on load.

However, there are ways of obtaining a normally-on load device without resorting to complicated fabrication procedures that use up excessive chip area. For example, a separate gate bias can be provided for the load. If the gate-to-source voltage of the load device is greater in magnitude than the threshold voltage, the device will conduct and act like a resistance, even though it is an enhancement-mode type.

A separate gate supply is needed with this method, but there is no extra power dissipated—the gate doesn't draw any current. If the separate gate supply isn't available, it's still possible to obtain a high gate bias by employing a voltage multiplier, still without increasing power consumption. The source of the voltage can be any a-c source; the clock pulses available in most switching circuits are a convenient source.

A rectifier, consisting of capacitors in parallel with diodes, can provide voltage multiplication. It may be difficult to integrate such a circuit, however. Although the capacitors can be built in an MOS IC structure, the diodes present a problem since both the cathode and anode must be isolated from the a-c ground potential.

Yet another way of obtaining a normally-on load is to use a metal-nitride-oxide-semiconductor transistor as the load device. When a voltage of sufficient magnitude is applied between the gate and the substrate of an MNOS transistor, the threshold voltage changes. The plot of threshold voltage versus

gate-to-substrate voltage is, in fact, a hysteresis loop. Thus if a p-channel enhancement-mode MNOS transistor is polarized by a large positive gate voltage, the threshold voltage changes from negative to positive, and the device becomes normally on. As a load element, the MNOS transistor provides the advantages of lower supply voltage and fast response, as demonstrated in an IC counter the authors have built.

Presented at Nerem, Boston, Nov. 5-7.

Under stress

Experimental compensation of thermally induced stress bi-refringence in solid state laser rods
L.M. Osterink and J.D. Foster,
Sylvania Electric Systems,
Mountain View, Calif.

Large output power losses and undesirable polarization shifts still plague the operation of continuous-wave solid state lasers, especially at outputs ranging from 100 to 300 watts. These losses, often greater than 50%, are due to thermal gradients giving rise to mechanical stresses that develop transversely across the laser rod in the optically pumped active region of the lasing cavity.

One way to compensate for these stresses during operation is to apply a mechanical force equal in magnitude and opposite in sign. This technique, used on a 3 millimeter neodymium-doped yttrium aluminum garnet (yag) laser rod pumped by a 1 kilowatt tungsten lamp, reduced polarization shifts to 25% of that experienced without the mechanical compensator, with equally promising reductions in power losses.

The problem yet to be solved is a way to apply mechanical forces with gradients identical to the cylindrically-symmetric, thermally-caused stresses so that full compensation can be realized. The magnitude of the applied mechanical forces, however, are large enough to compensate high power yag lasers, greatly enhancing the applicability of these lasers for non-linear optics and communications systems.

Presented at the International Electron Devices Meeting, Washington, Oct. 30, 1969.

the twisters

The twist of the fingertips tells the user that he is handling quality.

A lot of effort has gone into making these aluminum knobs the best money can buy. ALCOKNOBS have been painstakingly machined and anodized to a high satin finish. A wide choice of stock knobs are now available to compliment your equipment design. All are available at a reasonable cost and competitive to plastics.

Send for the new ALCOKNOB catalog describing a wide variety of stock knobs and with particulars whereby ALCO can customize knobs to create your own individual image.



ALCO

ELECTRONIC PRODUCTS, INC.

Lawrence, Massachusetts 01843

Circle 161 on reader service card →

New Cord Set Kit

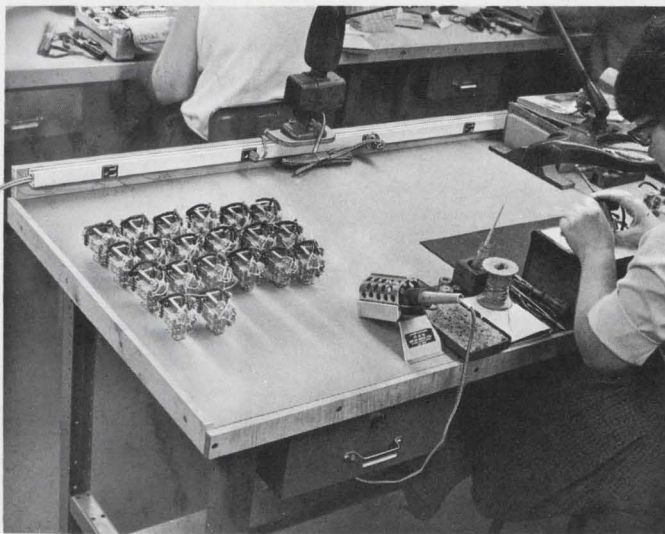

Relocation of production benches made easier! With the new 20CSK Cord Set Kit from Wiremold, a bench-mounted run of multioutlet Piugmold® 2000 can be converted into a portable power strip, ready to move with the bench when production requirements change. Send for literature on this and the entire line of compatible Wiremold surface wiring systems designed to meet every power distribution need from panel box to outlet.



THE WIREMOLD COMPANY / HARTFORD, CONNECTICUT 06110

Circle 187 on reader service card



ZIPPERTUBING® R.F.I. SHIELDING JACKETING

for quick application and protection of multi conductor cables!

SHN 3 for R.F.I. shielding and protection. Tinned copper braid, attached to inside overlap provides gasket type seal and solderable termination point.

SHX 4 — of special knitted compounded wire for highly flexible R.F.I. shielding.

CPE conductive polyethylene for electrostatic protection.

MS provides low frequency magnetic shielding.

For full information on specialized, high-performance jacketing, contact

THE ZIPPERTUBING® CO.

CORPORATE HEADQUARTERS
13000 S. BROADWAY
LOS ANGELES, CALIF. 90061
Los Angeles Phone: (213) 321-3901
New Jersey Phone: (201) 256-4980



BALTIMORE • BOSTON • CHICAGO • CLEVELAND • DALLAS
NEW YORK • ORLANDO • PHOENIX • SAN FRANCISCO • WEST GERMANY

ECONOMICAL Thin Film!

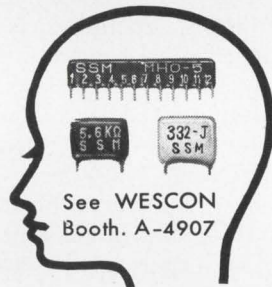

What's needed for memory system is everlasting high accuracy. SSM's components are the very ones satisfying superior reliability.

- Plate-ohm: evaporated metal film resistor
- Pla-module: thin film modulated C-R circuit
- Pla-con: organic thin film capacitor by plasma reaction

SUSUMU INDUSTRIAL CO., LTD.

Minami Bldg 1-12 Ebisuminami
Shibuya-ku, Tokyo, Japan
TEL: Tokyo (03) 712-5990
TELEX: No. 246-6270

New Literature

IC handling. Delta Design Inc., 8000 Fletcher Parkway, La Mesa, Calif. 92041, has released a brochure on new mechanized handling systems for the environmental testing of integrated circuits.

Circle 446 on reader service card.

Tapped delay line. Data Delay Devices, 253 Crooks Ave., Clifton, N.J. 07011. A catalog sheet contains features and specifications for the series 8000 tapped delay line. [447]

Precision instruments. James G. Biddle Co., Plymouth Meeting, Pa. 19462. Eight-page bulletin 70-1 features precision instruments for laboratory and industry. [448]

Signal conditioner. Techni-Rite Electronics Inc., Techni-Rite Industrial Park, Warwick, R.I. 02886, has released a brochure describing the model TPA-50 high gain signal conditioner. [449]

Laser trimming machine. Micronetics Inc., 204 Arsenal St., Watertown, Mass. 02172, offers a brochure on its model 70 programmable high-volume laser trimming machine. [450]

Aluminum rack panels. TCI Aluminum, 13620 St. Andrews Place, Gardena, Calif. 90249. A two-page bulletin describes precision sawed and slotted aluminum rack panels for electronic enclosures and cabinets. [451]

A-d converters. Computer Products, P.O. Box 23849, Ft. Lauderdale, Fla. 33307. A four-page product bulletin illustrates and describes the AD300 series analog-to-digital converters. [452]

Brazing materials guide. Tricon Brazing Alloys Inc., 2325 Wisconsin Ave., Downers Grove, Ill. 60515, has published a 20-page brazing materials guide containing a special section devoted to the use of brazing alloys in electronic components. [453]

Governed d-c motors. The A.W. Haydon Co., 232 N. Elm St., Waterbury, Conn. 06720. Information on chronometrically governed d-c motors is contained in two-page catalog sheet MM802. [454]

Data acquisition systems. Redcor Corp., 7800 Deering Ave., Canoga Park, Calif. 91304. A 20-page brochure first discusses the general-purpose approach to data acquisition and then details the RC785 system, the RC745 Datalogger and the 70 Midi computer, which is the heart of both systems. [455]

Active filters. Frequency Devices Inc., 25 Locust St., Haverhill, Mass. 01830. A six-page bulletin provides the systems engineer with reference data needed for selection of proper filter characteristic. [456]

Hermetic packages. Sprague Electric Co., North Adams, Mass. 01247. Flat-pack hermetic packages for housing integrated and hybrid circuits are described in short-form catalog CN-165. [457]

Bite indicators. Minelco, a subsidiary of the General Time Corp., 600 South St., Holbrook, Mass. 02343. Technical bulletins M-14 and M-15 are available on two new types of miniature Bite indicators. [458]

CCTV monitor. Westinghouse Electric Corp., P.O. Box 868, Pittsburgh, Pa. 15230. An 11-in. monitor for closed-circuit tv applications is described in bulletin TD95-265. [459]

Alarm and remote control. Pulse Communications Inc., 5714 Columbia Pike, Falls Church, Va. 22041, has available brochures describing the Datalok 2A, 3, and 7 alarm reporting and control systems. [460]

Digital multimeter. Dana Laboratories Inc., 2401 Campus Drive, Irvine, Calif. 92664. Eight-page data sheet 986A describes the series 4500 digital multimeter. [461]

Data recorders. Datapro Research, a division of Computer Conversions Inc., Benjamin Fox Pavilion, Jenkintown, Pa. 19046, has available technical reports on five important keyboard-to-tape data recorders and an illustrated brochure describing Datapro 70. [462]

Metal plate connectors. Elco Corp., Willow Grove, Pa. 19090. A 36-page manual contains complete design information for back-panel connector arrays. It defines the Variplate metal plate interconnection concept and its associated terminating technique, automatic wire wrapping. [463]

Silicon power modules. Deltron Inc., Wissahickon Ave., North Wales, Pa. 19454. Single-page bulletin describes OEM silicon power modules featuring extra design margin. [464]

Connecting leads. Farmer Electric Products Co., Tech Circle, Natick, Mass. 01760. Four-page technical bulletin A-146 describes several types of single and coaxial connecting leads. [465]

Shielded enclosures. Technical Wire Products Inc., 129 Dermody St., Cranford, N.J. 07016, has prepared data sheet EMC-660 to help designers of electronic equipment who must meet rigorous emi/rfi shielding requirements for 19-in. and 24-in. cabinets in the selection of the correct size rack-mounted enclosure. [466]

Shift register testers. Adar Associates Inc., 85 Bolton St., Cambridge, Mass. 02140. Bulletin SRT-100 describes three models of MOS shift register testers. [467]

Transistor cross reference. Fairchild Semiconductor, Box 1058, Mountain

View, Calif. 94040. A complete listing of all standard dual, Darlington, and differential amplifier transistors available in today's market is contained in an eight-page cross reference guide. [468]

Random access and control. Visual Electronics Corp., 356 W. 40th St., New York 10018. A four-page brochure describes the application and functionality of the recently introduced digital random access and control system. [469]

Connector testing. The Deutsch Co., Municipal Airport, Banning, Calif. 92220, has available an article concerning radio frequency interference testing of its subminiature connectors equipped with rfi shielding. [470]

Clock system. The A.W. Haydon Co., 232 North Elm St., Waterbury, Conn. 06720. Two-page bulletin 140 provides information on a new electronic clock system developed specifically for the new airbus super jets. [471]

Miniature connectors. Continental Connector Corp., 34-63 56th St., Woodside, N.Y. 11377. Complete electrical and mechanical specifications, as well as illustrations, and outline drawings of a new group of solderless-wrap miniature connectors are contained in brochure W869. [472]

Operational amplifiers. Zeltex Inc., 1000 Chalomar Rd., Concord, Calif. 94520, offers a 16-page catalog describing its complete line of operational amplifiers, including FET input models, chopper-stabilized amplifiers, and electronic multipliers. [473]

Recording oscillograph. Bell & Howell, 360 Sierra Madre Villa, Pasadena, Calif. 91109. A portable recording oscillograph that combines quality data, maximum flexibility, time saving, and low operating costs is described in bulletin 5134. [474]

Power supply modules. Abbott Transistor Laboratories Inc., 5200 W. Jefferson Blvd., Los Angeles 91106. A 76-page catalog lists over 3,500 models of power supply modules with prices and application photos. [475]

Power aging systems. Micro Instruments, 12901 Crenshaw Blvd., Hawthorne, Calif. 90250. A nine-page brochure details testing, measuring components and life test systems for diodes, rectifiers, capacitors, and transistors. [476]

Circuit analysis program. Applied Logic Corp., 1 Palmer Square, Princeton, N.J. 08540, has available a five-page bulletin describing its electronic circuit analysis program. [477]

Vapor impervious cables. General Cable Corp., 730 Third Ave., New York 10017, has published a 12-page catalog on vapor impervious communications cable. [478]

brite glo[®] ALCOLITE

Alco's new Brite Glo[®] miniature lamp series is achieved through painstaking workmanship that assures the best pilot assembly on the market.

The new T-1 3/8 MNE neon series has an exclusive ring electrode construction that glows on the entire surface with direct current. Available as individual lamps or as miniature panel assemblies.

All our miniature incandescent pilot assemblies contain the most popular and long-life MIL-grade T-1 5 volt lamps. Choice of domed or cylindrical assemblies, in a variety of colors.

Our standard neon series are all equipped with NE2 lamps and are available in many lens styles and colors, with or without built-in series resistors.

For design-service assistance and price quotations, call (Area 617) 686-3887.

SEND FOR COMPLETE
ALCOLITE
CATALOG



ALCO

ELECTRONIC PRODUCTS, INC.

Lawrence, Massachusetts 01843

Thermotech
molds
your ideas
into profits

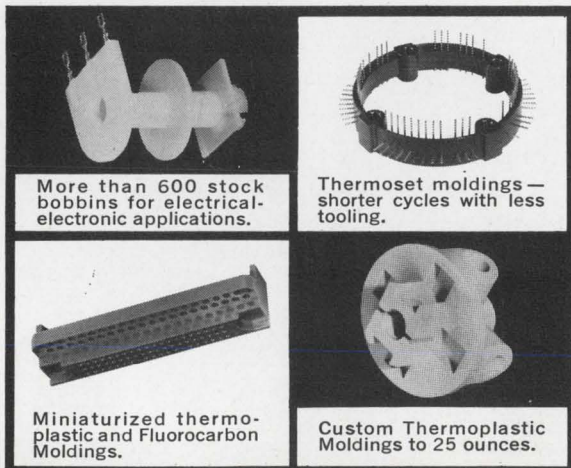
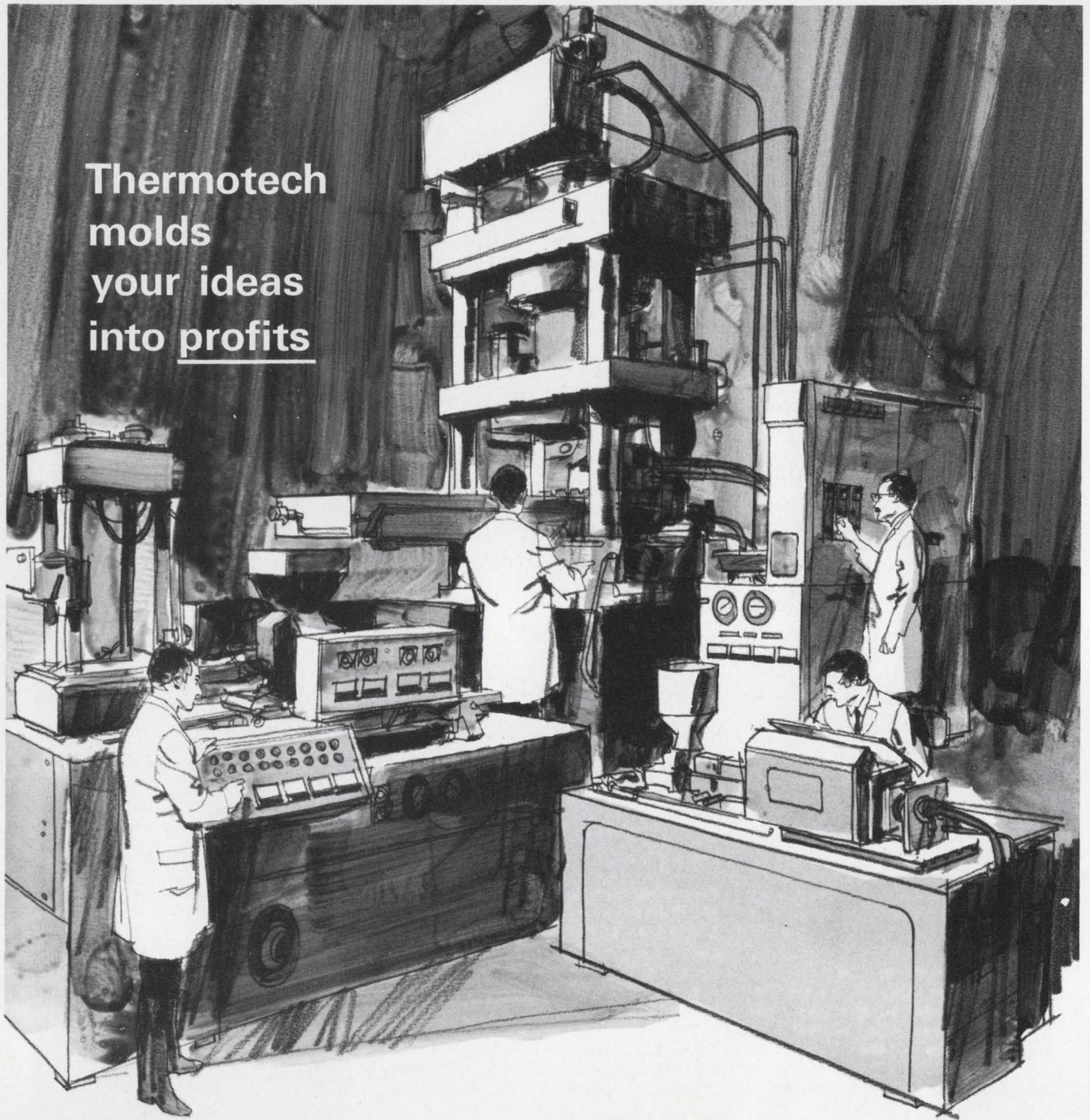

More than 600 stock bobbins for electrical-electronic applications.

Thermoset moldings — shorter cycles with less tooling.

Miniaturized thermoplastic and Fluorocarbon Moldings.

Custom Thermoplastic Moldings to 25 ounces.

Your design idea may be but a few steps away from economical, efficient production by Thermotech technicians.

That's because Thermotech has always welcomed the difficult in plastic molding—precision work with all moldable materials.

THE REASON: Thermotech has pioneered many innovations in precision molding machinery, tooling, materials and processes.

THE RESULT: Product ideas turned into profitably produced plastic parts.

So, whatever your product idea . . . from switches, buttons, bobbins and relays, to entire housings, covers and assemblies . . . Thermotech can help you produce it *Economically!*

Send sketch, print or mockup for fast, airmail quote. Or, just call, today.

THERMOTECH INDUSTRIES, INC.

"Where New Ideas Take Shape In Plastics".

Dept. EM, 1202 South Fifth Street
Minneapolis, Minnesota 55343 • (Area 612) 938-7671



FREE BROCHURE
(Over 50 pages,
describes facilities
and products).

International Newsletter

December 22, 1969

Mitsubishi competes with TI in TTL...

Japan's No. 1 IC maker, Mitsubishi Electric Corp., plans to stay that way by second-sourcing Texas Instruments' successful line of TTL. Mitsubishi already is in production with 25 types and expects to increase the number to about 50 by next June. Mitsubishi says it is making more types of this series than the Japanese joint venture of Texas Instruments and Sony Corp., and expects to make at least as many types in the future.

Mitsubishi started making TTL about four years ago, and developed a series of four types, of which only two are MSI. At the time, relative future popularity was not clear, and Mitsubishi wound up with a series of which some are interchangeable with TI types, some interchangeable with Signetics types, and some not interchangeable at all. This last series is used by a large number of Japanese manufacturers, though, and Mitsubishi will continue to supply it.

By second-sourcing the most popular series and manufacturing all the types for which there is significant demand in Japan, Mitsubishi hopes to give customers a substantially complete line of proven circuits at reasonable prices with good delivery and with all the other services Mitsubishi feels it can provide. However, it will leave the more exotic circuits, for which there is negligible demand in Japan, to TI or other American suppliers.

... and with others in LSI MOS

Starting next May, Mitsubishi expects to become Japan's first supplier of large-scale integration MOS arrays. Initial production goal is in excess of 100,000 units per month. The company's new arrays, to be called Melsa for Mitsubishi extensive large scale arrays, are of the four-phase type and include a kit of four for a small eight-digit calculator similar to that announced by Hayakawa [*Electronics*, Nov. 11, 1968, p. 307] and a kit of six for a 12-digit calculator.

Mitsubishi started work on LSI arrays as part of a government sponsored project in cooperation with Hayakawa. But Hayakawa decided it could not wait for Mitsubishi if it wanted to get a big jump on the competition in small calculators. Hayakawa also decided there would be more profit if it made its own circuits, so it opted for a tie-up with Autonetics. Autonetics was to supply arrays for early calculators and teach Hayakawa how to make arrays for later production. As it turned out, Hayakawa didn't get as much of a jump as it counted on [*Electronics*, Sept. 15, p. 47], because the production difficulties that hit Autonetics last summer.

Plessey presses move in numerical controls

Plessey's push to force-feed Britain's struggling numerical control effort is beginning to shape up. The company will pay \$6 million for Ferranti Ltd.'s numerical control know-how, R&D facilities, and marketing outlets [*Electronics*, Nov. 10, p. 233], but for the present manufacturing stays with Ferranti, which will work under contract to Plessey. The combination accounts for the bulk of British numerical control activity, and has across-the-board capability from simplest point-to-point equipment to Ferranti's sophisticated six-axis continuous path system.

To help Plessey develop its ability to compete against the U.S. and Germany—world leaders in numerical control, particularly in export markets—the government will provide several million dollars of backing

International Newsletter

through the Industrial Reorganization Corp. Though Plessey claims it will expand in all numerical control sectors, the biggest immediate expansion potential is in sales of simple point-to-point numerical controls.

Philips foiled in software bid

Philips' Gloeilampenfabrieken has failed in its latest effort to build a software base for its proposed computer takeoff. Though the big Dutch company seemed almost set to buy a 20% share of France's biggest software firm, Sema [*Electronics*, Oct. 13, p. 206], the French company was miffed when Philips showed no interest in Sema's civil engineering activities. Sema has sent Philips packing and has started talking to other potential European partners.

Another Japanese tv maker has 110° tube

Hitachi Ltd. has displayed operating 15-inch and 19-inch color picture tubes with 110° deflection angle. The company says it still has no firm marketing plans, because current sets with 90° tubes are selling well and glass envelopes for the wider-deflection angle tubes still are not readily available.

The prototype 19-inch tube is 13.7 inches long, which is 22% shorter than present 19-inch tubes. The 15-incher is 11.8 inches long, or 2.8 inches shorter than present tubes. Hitachi also showed a prototype all-transistor 19-inch set. It is 3.1 inches slimmer from front to back—only 15.5 inches. Weight has been reduced 11 pounds to 88 pounds.

Laser varies French acoustic delay line

France's Thomson-CSF has developed what it claims is the world's first variable acoustic delay line capable of producing delays as short as 10 nanoseconds and variable at 1-nsec intervals over a 150-megahertz range. Thomson-CSF expects to hike the range to 500 or 600 Mhz shortly. It foresees important radar applications.

Delay length is selected by aligning a movable laser beam at different points along the length of a quartz crystal. As in conventional acoustic delay lines, a piezoelectric transducer sends a sound wave through the crystal. The sound wave alters the crystal's refractive index, diffracts part of the laser beam, and creates a doppler effect. The wavelength of the diffracted light beam then totals its original wavelength plus that of the second beam. A photomultiplier tube separates the two.

Vehicle turbines spinning out a new electronics market

Gas turbine-powered cars may still be a long way off, but the engine—the younger brother of aircraft jet engines—has a promising future in trucks and off-highway vehicles. Britain's Ultra Electronics Corp. thinks enough of the potential to begin developing electronic control systems for vehicle turbines. Ultra and the Holley Carburetor division of Colt Industries have signed an agreement to jointly develop an electronics and hydromechanical control package.

The system's main electronic element is a small analog computer for fuel control. Ultra estimates the electronics portion of the controls will be worth about \$200 per engine in quantity production, and account for about half of the control package. Ultra sees the business building up to about \$7 million annually by 1980. Currently Ultra and Holley are developing—and supplying—experimental systems for Ford and General Motors.

Plated-wire memory packs in the bits with crossed double-decked grooves

Japanese approach uses a ferrite keeper plate in the form of a grooved multi-level sheet, to achieve improved bit density, drive current efficiency and cycle time over woven plated-wire memory

A ferrite keeper plate that provides a closed magnetic path is the key to a high-density plated-wire memory matrix being developed by a group headed by Osamu Ishii at Japan's Electrotechnical Laboratory. In fact, compared with a high-density woven plated-wire memory [*Electronics*, Nov. 24, p. 157], the Electrotechnical matrix is almost four times as dense and has a drive current utilization efficiency that is two times as high and a cycle time several times as fast.

This experimental memory uses a magnetic keeper made of a ferrite sheet into whose surface perpendicular grooves have been cut, with the grooves in one direction cut deeper than those at right angles. Word and bit lines resemble those used in woven wire memories: the word lines are 0.07-millimeter copper wires with thin insulating coating, and the bit lines are 0.13-mm copper wires with an

anisotropic thin film of permalloy.

At first glance, the keeper resembles that used in a waffle-iron memory, but the configuration of the waffle-iron memory is quite different. It uses insulated but unplated copper wire in both sets of perpendicular grooves, and the memory element is thin magnetic film in contact with the ferrite mesas between the grooves.

The new Japanese memory's shallow groove has a semicircular bottom with a radius only slightly larger than that of plated wire, which is pressed into the groove for good contact between the wire and the bottom of the groove. This contact reduces the air gap between the wire and the ferrite to practically nothing because the plated wire in the memory need not be insulated—ferrite is a fine insulator. Further, the deeper grooves need not have such an accurate shape, as it is only neces-

sary that the insulated wire pass under the plated wire.

The output of the new memory in millivolts is about the same as that of an ordinary woven-wire memory for half the drive current in ampere turns. Thus a small drive current can be used. At the highest values of current, the output for the new memory saturates while that for the woven memory keeps rising, but this doesn't mean that even higher outputs can be obtained from the woven memory. On the contrary the new memory saturates because flux in the entire cell has been reversed, whereas output from the woven memory keeps increasing because the field spreads to a greater volume of material, causing increased interference.

One line per bit. Fabrication of the new memory is much simpler than that of conventional plated-wire memories because only a single line is needed for each bit. A

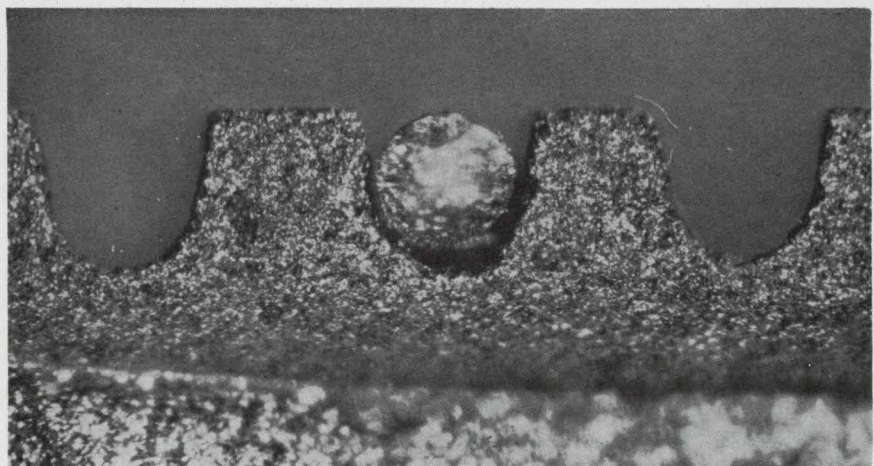
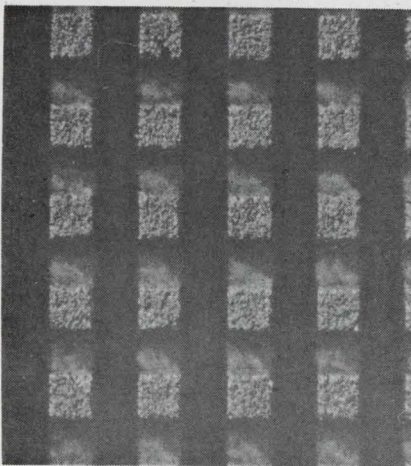

Imbedded. Bit lines of 0.13-mm copper wire with magnetic plating rest in shallow grooves. At right angles run 0.07-mm insulated copper wires, nestled in grooves cut deeper in ferrite keeper sheet.

return line is needed in conventional memories, and often two turns are needed, with grounded plane used for both current return and shielding. The line-per-bit feature makes it easier to fabricate a high-density memory without going to extensive lengths to overcome problems caused by the large number of terminals, or solder points needed in a conventional memory.

The experimental matrix is fabricated using a sheet-ferrite keeper permeability of about 1,000. Final assembly of the memory is facilitated by using a sheet with as large an area as possible, but for ease in fabricating grooves ferrite sheets measuring about 5 by 7 centimeters are chosen. Each plate has 200 word-line grooves running the long way and 300 bit-line grooves running the short way. These plates are arranged in an almost-square mosaic measuring three sheets by four. They are mounted on an aluminum plate measuring 35 cm square.

Word lines are run in every second word-line groove. The roots of the two mesas on either side of the line act as a magnetic return. But they are shared with the two adjacent word lines. By placing word lines only in every second slot, there is no sharing of magnetic paths and interference is reduced. Also, two crosspoints are used for each memory bit stored to reduce effects of noise pickup caused by high-speed operation of the memory. Even with these restrictions, the density is more than three times that of a high-density woven-wire memory.

Back to back. This plane has a total of 400 words, with 450 bits per word. Two planes operated back-to-back would have twice this number of words. Because two crosspoints per bit are used, output voltage is about 4 millivolts. Switching signal width is about 20 nanoseconds. Cycle time is about 100 nsec.

When two planes are operated back-to-back the word lines can be run along one plane and returned along the other, giving a U-shaped run. It is only one step further to running the word lines around

again in a two-turn configuration. This two-turn design slows down the operation, but the memory then needs a drive current of only about 100 milliamperes and thus could be driven directly from an integrated circuit—a very attractive prospect.

The memory does not have the extreme density potential of some types using plating structures [*Electronics*, April 14, p. 223]. But it combines high density—equivalent perhaps to that of 16-mil core memories which are quite expensive—reasonably high speed, reasonably high output voltage, and ease of fabrication.

West Germany

Shiftless electronics

For car owners, electronic devices are fast becoming constant driving companions. Electronic systems are helping start the car, keeping the voltage constant and the engine running smoothly. They are at work saving fuel, keeping the exhaust clean and preventing wheels from skidding on wet and icy roads. They are also beginning to perform such odd jobs as controlling windshield wipers and warning lamps, and are helping to adjust the angle of headlight beams

so that oncoming drivers aren't blinded.

But what about truck drivers? For them, handling their vehicle is still a chore. Take gear shifting, for example. Heavy trailer trucks these days rely on constant-mesh gear arrangements that transfer the rotational speed from the gear wheels to the transmission shaft. Operation of these gearing mechanisms requires skill and concentration—and often both hands. And even an experienced truck operator who knows how to shift gears fast and smoothly, cannot prevent his vehicle from losing some tractive power during shifting—when going uphill, for example.

But help is now in sight. Robert Bosch GmbH, the big German car-accessory maker that pioneered electronically controlled fuel injection for passenger cars [*Electronics*, Mar. 17, p. 87] is putting electronics to work in gear shift mechanisms for truck and other commercial vehicles.

The company's new electronically synchronized system can shift gears in something like 0.3 second—or up to 10 times faster than an experienced truck driver can perform this operation. And because the time between gear engagements is drastically reduced, the tractive-power loss is cut down. What's more, the system can, if properly

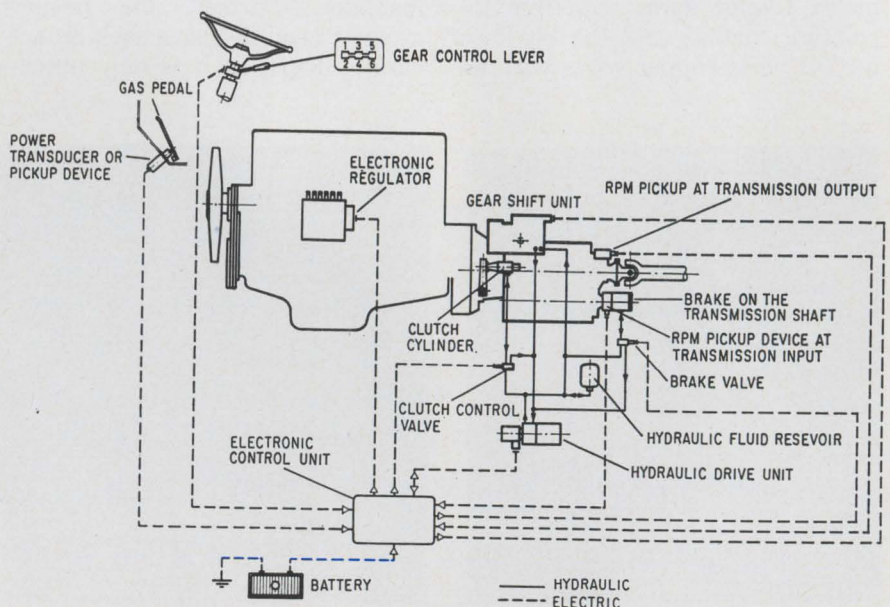

Look, no hands. Electronic control units, sensing transmission input and output speeds, takes over chore of shifting gears in heavy trucks.

handled and maintained, greatly increase the operating life of truck gears through reduced wear.

Furthermore, the system is operator-proof. Down-shifting can't occur when the engine rotates too fast. That's because gears stay at the set position until vehicle speed is slowed or until the driver has selected the proper gear setting. Any wrong selection is signaled to him by a flashing light.

Add on. The electronic synchronization feature can be added to any commercial vehicle using gear mechanisms that are standard for today's heavy trucks.

Bosch is completing final testing, and volume production will start soon after that, with first unit hitting the market in one to two years.

With the new system, gear shifting is initiated electronically and executed hydro-mechanically. The equipment will come in three versions, each somewhat differently designed as regards the electronic control unit and the coupling mechanism. In the simplest version, the driver preselects the gear he wants by pressing a switch that delivers a pulse to the control unit. Gear shifting itself must be initiated by operating the clutch.

In the second and more refined version, shifting into the desired gear is accomplished immediately after the gear selection switch is pressed. There, clutch operation is automatic.

In the fully automatic version the control unit delivers a gear-switching pulse derived from vehicle speed data and engine load. If the two don't jibe the unit produces an output which is amplified and fed to electromagnetic valves. These, in turn, control electrically driven hydraulic cylinders for setting the gears. In this version, even the vehicle's initial low-gear driving phase is "automated"—something that should come in handy for trucks driven in cities where frequent stops are common.

The electronic control unit continuously compares the revolutions at the input to the gear unit with those at the output. When the rotational speed of a gear wheel is in synchronism with that of the transmission shaft, a pulse is de-

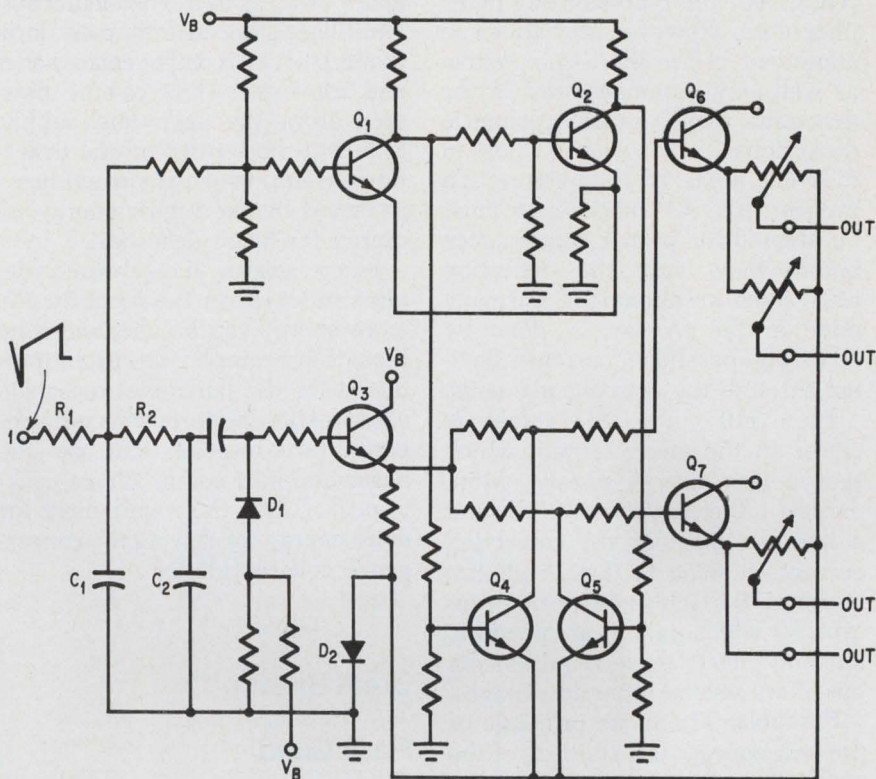

Split screen. To allow easier adjustment of 110°-deflection color tube, circuit divides right and left half of convergence control voltage.

livered that initiates gear shifting.

In down-shifting, synchronization is achieved by upping the speed at the input to the gear unit. This is initiated by a pulse delivered to an electronic regulator at the engine's fuel injection pump.

In up-shifting, synchronization is obtained by cutting the gear unit's input speed. This is accomplished by a pulse fed to a brake valve.

At the instant a synchronous condition exists, the appropriate gears are shifted by a hydraulically operating mechanism. During the gear shift intervals, the engine performs under the control of a pulse fed to the electronic regulator at the fuel injection pump. This pump gives the engine extra shots of gas.

Converging on color

The development and production problems surrounding the 110° color tv tube, which is set for debut in Europe next year, have largely been solved [*Electronics*, Oct. 13, p. 19E]. What's keeping engineers busy however, is ironing out some

of the difficulties with the tube's related circuitry.

One problem is that in a 110° tube about twice as much power is required for beam deflection than in the standard 90° tube. Getting rid of the heat generated in the deflection unit calls for a well-designed ventilation system. Furthermore, an improved circuit is required to correct for deviations in beam convergence, which are twice as great. To be sure, tube makers have found workable solutions but, for their part, engineers still are far from agreed on optimum designs.

A big step toward optimizing 110° circuitry has been made at the Esslingen-based Applications Laboratories of Standard Elektrik Lorenz AG, and ITT subsidiary. Here, Guenter Bertsch, a tv engineer, has come up with a design concept for horizontal and vertical convergence that could become standard.

On target. As in any color set, all three beams of the three-gun picture tube must converge to as small an area on the screen as is possible under the limitations set by the distances between adjacent

red, green, and blue-emitting phosphor dots. However, deviations in alignment of the three-gun system as well as in homogeneities in the deflection field, cause geometric distortions and inaccurate colors in different areas of the picture. To prevent this, the three beams must be aligned for proper convergence before they enter the deflection field. Such an alignment, normally done at the factory, is done by adjusting parabolic currents flowing through the convergence coils.

In a 110° tube, the screen is closer to the electron gun, which sees a less curved surface. More energy in the convergence coils and a better control of the correcting currents flowing in these coils are required. Bertsch's new design concept, for which patents are pending, not only meets these requirements but offers several other advantages.

Parabola. The basic principle of the new concept is a splitting of the parabolic voltage originating at the deflection system by a pair of electronic switches. Operation is controlled by square-wave pulses from a Schmitt trigger. The Schmitt trigger is driven by a sawtooth voltage originating at the vertical deflection system.

The electronic switch arrangement splits the parabolic voltage into two segments, the left and right halves of the original voltage parabola. Each segment then is separately processed in subsequent output stages and used to control the circuitry incorporating the various convergence magnets. The voltage segments are then added so that the original complete voltage parabola keeps convergence set at the adjusted levels.

This circuit concept solves one problem in getting proper convergence. Adjusting for convergence on one side of the screen will affect convergence at the other. So, technicians find themselves twiddling pots back and forth until the proper convergence setting for each side is obtained. With 110° tubes such interactions between settings would be more time-consuming.

Extras. The actual convergence circuits based on this new concept offer several other advantages. One is that their input stages do not

take power from the deflection system. That's because they are built around active components—diodes and transistors—that can be powered from the set's line supply, reducing the burden on the deflection system, which is already heavily taxed by the higher energy required for beam deflection.

Since active, line-powered devices are used in the input stages, more energy can be obtained from them. For example, the current produced for the horizontal red-green convergence coils is 350 milliamperes peak-to-peak, that for the horizontal blue coil is 800 ma peak-to-peak. Thus, the requirement for more energy for driving the convergence coils is fulfilled.

Great Britain

Flash Gunn

Though many thousands of Gunn-diode-powered radars have been sold in the past two years, virtually all have been simple short-range continuous-wave Doppler detectors, mostly intended as intruder alarms. There was no question that very small, true radars could be built around Gunn diodes—with pulsed operation and direction and ranging facilities. The question was whether sales would justify investment. Now Avimo Ltd. of Taunton has taken the plunge by taking out a license to build a 5.5-pound radar flashlight that was designed and developed at Royal Radar Establishment.

Sprat, for small portable radar torch, as the RRE calls it, was developed mainly to see if a small, hand-held personal radar is useful on the battlefield. The British Army is undecided, but Avimo reckons it can sell at least 100 to foreign armies carrying out extensive night patrols on foot, especially in the Middle East. There's also a smaller but worthwhile market among police forces, says Avimo, for portable intruder detection. On the basis of 100 sales, the price will be about \$1,200; but Avimo hopes that sales will build up and the price can be brought down to

\$800 or \$900. In the U.S., Sprat will be sold by the Roland Olander Co., of Burbank, Calif.

Sprat looks like an outsize fireman's flashlight with head diameter of 7.5 inches, barrel diameter of 1.5 inches and over-all length of 16 inches. The barrel holds a rechargeable 28-volt nickel-cadmium battery. Power consumption of 5 watts allows four hours of continuous operation without recharging. The head holds a transmitter powered by an X-band Plessey pulsed-Gunn oscillator of 1-watt peak, and a superheterodyne receiver with 60-megahertz i-f, using a continuous-wave Gunn device as local oscillator. Pulse repetition frequency is 40 kilohertz and duration is 0.25, microsecond. Using a beamwidth of 10°, this transmitter-receiver can detect a vehicle up to 1,200 yards away and a man up to 550 yards away, says Avimo.

To use Sprat, the soldier adjusts a stethoscope earpiece and turns a knob to select the range band he wants to survey. Avimo's Sprat will use range bands 100 yards wide, though RRE's prototype used 50 yards for a shorter overall range. The range selector adjusts a circuit which controls a time gate so that the only return pulses processed are those arriving at an interval after the transmission pulse corresponding to the range selected. The earpiece produces a Doppler note for any object moving with some element of radial velocity relative to the radar in the area covered by the range band and beamwidth. To fix direction accurately within 2°, the soldier swings the radar till the note reaches maximum volume.

RRE says that different types of target produce notes of different pitch and timbre. For instance, a walking man produces a low-pitched, clearly defined thumping, a group of men walking produce a confused thumping, and a vehicle produces a steady note, usually higher pitched because of its greater speed. Sprat includes a filter to eliminate very low pitched unwanted returns from waving vegetation and so on, and it's clutter-locked so that it processes returns only from moving targets.

Electronics advertisers

December 22, 1969

| | | | | | |
|---|---------------|---|--------------------------|--|----------|
| □ Alcatel | 31E | □ General Instrument Europe S.P.A. | 38E | Schauer Manufacturing Corp. | 46 |
| Agence Rene Sicard | | Studio Cigiemme | | Nolan, Keelor & Stites | |
| Alco Electronic Products, Inc. | 159, 161, 163 | General Magnetics | 9 | □ Schlumberger Ltd. EMD | 2E |
| Marketronics Advertising | | McCarthy/Scelba/De Biasi | | □ Schlumberger Ltd. SIS | 5E |
| Alfred Electronics | 126, 127 | Adv. Agcy., Inc. | | Sodipa | |
| Bonfield Associates | | General Radio Co. | 2nd Cover | □ Schlumberger Ltd. Somv | 4E |
| Allen-Bradley Co. | 25 | Horton Church & Goff, Inc. | | T. B. Browner Ltd. | |
| Fensholt Adv. Agcy. | | ■ Grayhill, Inc. | 145 | □ Schneider R. T. | 41E |
| AMP, Inc. | 32 | Carr Liggett Adv., Inc. | | Noirclerc Publicite | |
| Garceau, Hallahan & McCullough, Inc. | | | | S. D. S. A. | 139-140 |
| □ Ancrona Corp. | 36E | | | Publi-Service | |
| Wilhelm Bacher Werbung | | Hamilton Watch Co. | 122 | □ Selenia | 21E |
| Andrew Corp. | 60 | Beaumont, Heller & Sperling, Inc. | | Tilligraf | |
| Fensholt Adv., Inc. | | Hayakawa Electric Co., Ltd. | 144 | Semtech Corporation | 135 |
| Ansley Division of Thomas & Betts Corp. | 43 | Dai-ichi International, Inc. | | Burruss Advertising | |
| Richard L. Renner Industrial Advertising | | Heinemann Electric Co. | 6 | □ Sescosem | 42E |
| ■ A. P. Circuit Corp. | 172 | Thomas R. Sundheim, Inc. | | □ Sfernica | 37E |
| Ernest Newman Adv. Agcy. | | ■ Hewlett Packard, Palo Alto Div. | 1 | Publicitor | |
| □ Ates Componenti Elettronici, S.P.A. | 39E | Lennen & Newell, Inc. | | □ SGS | 25E |
| Publicitas | | ■ Hewlett Packard, San Diego Div. | 2 | Lansdale Italia S. P.A. | |
| | | Lennen & Newell, Inc. | | Signetics Corp. | |
| ■ Barnes Corp. | 130 | □ Hi G D'Italia | 26E | sub. Corning Glass Works | |
| Industrial Public Relations, Inc. | | | | Cunningham & Walsh Inc. | 111 |
| ■ Barnstead Co., Div. of Sybron Corp. | 136 | | | □ Sodoco | 15E |
| Creamer, Trowbridge, Case & Basford, Inc. | | □ I.E.R. | 6E | Dumesnil Publicite | |
| Beckman Instruments, Inc. | | Pema | | □ Solartron Electronics Group, Ltd. | 3E |
| Electronic Instrument Div. | 115 | Ing. C. Olivetti & C. Spa. | 11E | T.P. Browne, Ltd. | |
| Hixson & Jorgensen, Inc. | | Studio Giuliano Blei | | Soliton Devices, Inc., Transistor Div. | 49 |
| ■ Beckman Instruments, Inc., | | Institute for Scientific Information | 173 | Haselmire Pearson Adv., Inc. | |
| Helipot Div. | 53 | Kalish, Spiro Walpert & Ringold | | Sorenson Operation Raytheon Co. | 63 |
| N. W. Ayer/Jorgensen/MacDonald, Inc. | | | | □ Souriau & Cie | 14E |
| □ Bernard Golay S.A. | 18E | | | Ariane Publicite | |
| Langel Publicite | | Jacobi Systems | 54 | □ S.P. Elettronica | 28E, 29E |
| Buckbee-Mears Co. | 51 | Larry Courtney Co. | | Studio Sergio Rosata | |
| Midland Assoc., Inc. | | Joslyn, Inc. | 52 | Sperry Rand Corp., | |
| | | Chaco Company | | Sperry Microwave Electronics Div. | 124 |
| | | | | Neals & Hickok, Inc. | |
| Cambridge Thermionic Corp. | 145 | ■ Lambda Electronics Corp | 3rd Cover, 177, 178 | Sprague Electric Co., The | 17, 149 |
| Chirurg & Cairns, Inc. | | Michel Cather, Inc. | | Harry P. Bridge Co. | |
| ■ Captor Corp. | 24 | | | ■ Susumu Industrial Co., Ltd. | 162 |
| Weber, Geiger & Kalat, Inc. | | Magnecraft Electric Co. | 66 | Kyokuto Kikaku Co., Ltd. | |
| Carpenter Technology Corp. | 27 | Mills, Fife & MacDonald, Inc. | | ■ Syntronics Instruments, Inc. | 128 |
| Beaumont Heller & Sperling, Inc. | | ■ Mallory & Co., P.R., Mfg. Div. | 128, 154 | Burton Browne Advertising | |
| Cartesian, Inc. | 142 | Atkin-Kynett Co. | | | |
| Miller/Stoll Advertising | | ■ Matsuo Electric Co., Ltd. | 119 | Takeda Riken Industry Co., Ltd. | 120 |
| ■ Cerro Copper & Brass Co. | 42 | Daiko Adv., Inc. | | Shinwa Adv. Co., Ltd. | |
| Sykes Adv., Inc. | | Microdot, Inc. | 69 | ■ Tektronix, Inc. | 116 |
| □ Condor Foto | 30E | Gumpertz, Bentley & Dolan Advertising | | Dawson, Inc. | |
| Black & Color | | ■ MM Electronic Enclosures, Inc. | 152 | □ Telettra | 33E |
| ■ Cosmic Optical Co., Ltd. | 153 | Berin/Pecor, Inc. | | Tempress Industries, Inc. | 30 |
| Matsushita, Inc. | | Monsanto Company | 23 | Hal Lawrence Inc. | |
| □ C.R.C. | 20E | Michel Cather Inc. | | ■ Test Equipment Corp. | 145 |
| IRP | | □ Morganite Resistors Ltd. | 13E | Dean & Bain Adv., Inc. | |
| □ Crescent Tech. Corp./SRC Division | 16E | Scientific Advertising & Marketing Ltd. | | Texas Instruments Incorporated, | |
| Alden Advertising | | Motorola Semiconductor Products | 55 | Components Group | 48, 150 |
| ■ Curtis Instruments, Inc. | 44 | Incorporated | | Albert Frank-Guenther Law, Inc. | |
| Knudsen • Moore, Inc. | | Lane & Wampler Advertising Inc. | | □ Texas Instruments France | 22E, 23E |
| | | □ Motorola Semiconductor Products Inc. | 7E to 10E | Dumesnil Publicite | |
| | | Graham and Gillies | | Texas Instruments, | |
| □ Ducati Elettrotecnica Microfarad | 30E | | | Metallurgical Materials Division | 28, 29 |
| Studio Gastone Busoli | | National Electronics Incorporated | 26 | Horton, Church & Goff, Inc. | |
| DuPont de Nemours & Co., Freon Div. | 68 | Connor Sager Associates | | ■ Texscan Corp. | 16 |
| N. W. Ayer & Son, Inc. | | National Semiconductor Corporation | 12-13 | Burton Browne Advertising | |
| □ DX Antenna | 24E | Hall Butler Blatherwick Inc. | | Thermotech | 164 |
| Sanko Sha Adv. Agcy. Co., Ltd. | | | | Anderson-Madison Adv., Inc. | |
| | | Omron Tateisi Electronics Co. | 20-21 | TI Supply Company | 112, 113 |
| | | Dai-ichi International Inc. | | Albert Frank-Guenther Law, Inc. | |
| Eastman Kodak Co., | | Optron Inc. | 22 | ■ Tohoku Metal Industries, Ltd. | 137 |
| Business Systems Markets Div. | 131 | Dean & Bain Adv. Inc. | | Hakuodo, Inc. | |
| J. Walter Thompson Co. | | Panduit | 153 | Toko, Inc. | 130 |
| □ Ebauches S.A. | 36E | Pendronix Incorporated | 141 | Hakuodo, Inc. | |
| Claude Langel | | Watkins Rogers Inc. | | TRW Electronics, Capacitors Div. | 45 |
| Elgenco, Inc. | 158 | | | Fuller & Smith & Ross, Inc. | |
| Wesco Advertising | | Power Designs Inc. | 174 | TRW Electronics, Semiconductors Div. | 35 |
| E/MC Electronics/Management | | Samuel H. Goldstein | | Fuller & Smith & Ross, Inc. | |
| Center | 137, 157 | | | ■ Tung-Sol Div., Wagner Electric Corp. | 148 |
| Ries Capiello Colwell, Inc. | | Radio Corporation of America | 4th Cover, 41, 58-59, 67 | Feeley & Wheeler Div. of Geyer, | |
| E/MC—Medical Electronics | | Al Paul Lefton Company | | Oswald, Inc. | |
| Seminar | 64, 65, 114 | ■ RCL Electronics Incorporated | 14 | Tyco Laboratories, Inc., | |
| Ries Capiello Colwell, Inc. | | Morvay Advertising Agency | | Instruments Div. | 70 |
| □ Ergon | 32E | □ Resco | 12E | Kenyon & Eckhardt, Inc. | |
| Studio G.C. Presutti | | G. Matthaes Agency | | | |
| Erie Technological Products Co., Inc. | 47 | RFL Industries Inc. | 156 | Universal Oil Products, Norplex Div. | 129 |
| Walcker, Schmidt & Mackall, Inc. | | Instrumentation Division | | Campbell-Mithun, Inc. | |
| Exact Electronics | 123 | Josephson, Cuffari & Company | | | |
| Hugh Dwight Adv., Inc. | | Robintech Inc. | 121 | Wayne Kerr | 6E-A |
| | | Laux Advertising Inc. | | □ Watkins-Johnson Co. | 34E |
| | | Rohde & Schwarz | 5 | William C. Estler Advertising | |
| | | Fletcher Walker Gessell Inc. | | ■ White Instruments, Inc. | 158 |
| | | □ Rhode & Schwarz | 35E | Wilson & Associates, The Art Studio, | |
| | | Romohawk Electronics Corporation | 172 | a Div. of Graphic Studios | |
| | | Lesseraux and Tandler Inc. | | ■ Williams Precious Metals, Div. of | |
| | | | | Williams Gold Refining Co., Inc. | 50 |
| | | Sanken Electric Co. Ltd. | 173 | Stahlka, Fallor & Klenk, Inc. | |
| | | Seikosha Adv. Inc. | | Winchester Electronics, Div. of | |
| | | | | Liton Industries | 147 |
| | | | | Wilson, Haight & Welch, Inc. | |
| | | | | Wiremod Company, The | 162 |
| | | | | Charles Brunelle Co. | |
| | | | | | |
| | | | | Xerox Data Systems | 36 |
| | | | | Doyle, Dane, Bernbach, Inc. | |
| | | | | | |
| | | | | Zippertubing Co. | 162 |
| | | | | Edward S. Kellogg Co. | |

A SYSTEM

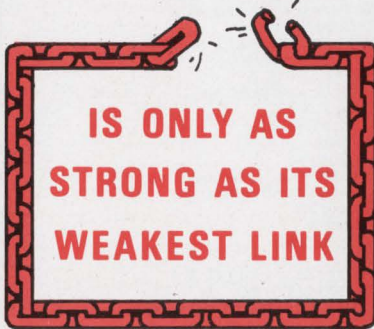

Electronics systems depend on the smooth, integrated functioning of every component. A system with weak links isn't really a system.

ROMOHAWK leaves the weak links out

Romohawk is an electronics systems engineering company. We don't make weak links. With R & D, design, and production facilities in-house, we make systems and subsystems that work. And our technical services can keep any system working.

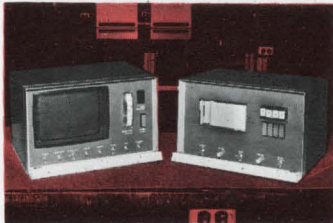

ECG and Central Station Monitors engineered by Romohawk

These units make up a hospital intensive care system that keeps constant check on a patient's condition. They feature multiple trace CRT displays, very high gain, low noise differential amplifiers, and logic circuits for alarm processing. Romohawk was able to design, test, and produce quantities of these units in just 90 days.

ROMOHAWK, WHERE ENGINEERING IS MORE THAN INTERCONNECT DIAGRAMS AND PURCHASE ORDERS.

ROMOHAWK
ELECTRONICS CORP.
811 Court St., Utica, N.Y. 13502
315-797-5445

Advertising Sales Staff

Dan McMillan III [212] 971-3468
Associate Publisher

Wallis Clarke [212] 971-2187
Advertising Sales Service Manager

Warren H. Gardner [215] LO 8-6161
Eastern Advertising Sales Manager

Atlanta, Ga. 30309: Michael H. Miller, 1375 Peachtree St., N.E. [404] 892-2868

Boston, Mass. 02116: William S. Hodgkinson
McGraw-Hill Building, Copley Square [617] CO 2-1160

Cleveland, Ohio 44113: William J. Boyle, 55 Public Square, [216] SU 1-7000

New York, N.Y. 10036
500 Fifth Avenue
James R. Pierce [212] 971-3615
John A. Garland [212] 971-3617
Michael J. Stoller [212] 971-3616

Philadelphia, Pa. 19103:
Jeffrey M. Preston
Warren H. Gardner,
6 Penn Center Plaza,
[215] LO 8-6161

Pittsburgh, Pa. 15222: Jeffrey M. Preston,
4 Gateway Center, [412] 391-1314
Rochester, N.Y. 14534: William J. Boyle,
9 Greylock Ridge, Pittsford, N.Y.
[716] 586-5040

Donald R. Furth [312] MO 4-5800
Midwest Advertising Sales Manager

Chicago, Ill. 60611: Kenneth E. Nicklas
Ralph Hanning 645 North Michigan Avenue,
[312] MO 4-5800

Dallas, Texas 75201: Richard P. Poole, 1800 Republic National Bank Tower,
[214] RI 7-9721

Houston, Texas 77002: Robert Wallin,
2270 Humble Bldg. [713] CA 4-8381

Detroit, Michigan 48226: Ralph Hanning,
856 Penobscot Building
[313] 962-1793

Minneapolis, Minn. 55402: 1104 Northstar Center [612] 332-7425

St. Louis, Mo. 63105: Kenneth E. Nicklas,
The Clayton Tower, 7751 Carondelet Ave.
[314] PA 5-7285

James T. Hauptli [415] DO 2-4600
Western Advertising Sales Manager

Denver, Colo. 80202: David M. Watson,
Richard W. Carpenter
Tower Bldg., 1700 Broadway
[303] 266-3863

Los Angeles, Calif. 90017: Ian C. Hill,
Bradley K. Jones, 1125 W. 6th St.,
[213] HU 2-5450

Portland, Ore. 97204: James T. Hauptli,
Don Farris, 218 Mohawk Building,
222 S.W. Morrison Street,
Phone [503] 223-5118

San Francisco, Calif. 94111: James T. Hauptli,
Don Farris, 255 California Street,
[415] DO 2-4600

Pierre Braude Tel: 225 85 88: Paris
International Director

Paris: Denis Jacob
17 Rue-Jeorges Bizet, 75 Paris 16, France
Tel 727 33 42, 727 33 60

United Kingdom and Scandinavia

London: Oliver Ball, Tel: Hyde Park 1451
34 Dover Street, London W1

Milan: Robert Saldel, Roberto Laureri Jr.
1 via Baracchini Phone 86-90-656

Brussels: Denis Jacob
27 Rue Ducale Tel: 136503

Frankfurt/Main: Hans Haller
Elsa-Brandstroem Str. 2
Phone 72 01 81

Geneva: Denis Jacob
1 rue du Temple Phone: 31 95 60

Tokyo: McGraw-Hill
Publications Overseas Corporation,
Kasumigaseki Building 2-5, 3-chome,
Kasumigaseki, Chiyoda-Ku, Tokyo, Japan
[581] 9811

Osaka: Akihiko Kamesaka, McGraw-Hill
Publications Overseas Corporation, Kondo
Bldg., 163, Umegae-cho Kita-ku [362] 8771
Australia: Warren E. Ball, IPO Box 5106,
Tokyo, Japan

Business Department

Stephen R. Welss, Manager
[212] 971-2044

Thomas M. Egan,
Production Manager [212] 971-3140

Maury D'Gongora,
Assistant Production Manager [212] 971-2045

Dorothy Carmesin, Contracts and Billings
[212] 971-2908

Frances Vallone, Reader Service Manager
[212] 971-2865

Classified & Employment Advertising

F.J. Eberle, Manager
212-971-2557

EQUIPMENT

(Used or Surplus New)
For Sale

Fishman, Philip Co. 152
Laboratory Equipment Sales 152
Radio Research Instrument Co. 152

■ For more information on complete product line see advertisement in the latest Electronics Buyer's Guide

□ Advertisers in Electronics International

Electronics Buyers' Guide

George F. Werner, Associate Publisher
[212] 971-2310

Robert M. Denmead,
Midwest Regional Manager
[312] MO 4-5800

Cliff Montgomery,
New York District Manager
[212] 971-3793

Regina Hera, Directory Manager
[212] 971-2544

Thomas M. Egan, Production Manager
[212] 971-3140

Carol Gallagher,
Assistant Production Manager [212] 971-2045

Circulation Department

Isaac Siegel, Manager [212] 971-6057

Research Department

David Strassler, Manager [212] 971-6058

Variable Frequency Active Filters

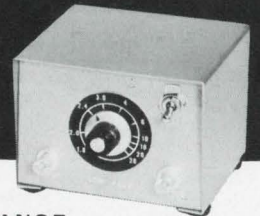

SINGLE
DECADE RANGE

- Low Pass or High Pass
- Attenuation slope 24 Db/Octave
- Small size: 4¼x4½x5"
- Low Weight: 1½ lbs.
- Portable
- Battery Operated
- Rack Mounted Multi Channel Available

Price: **\$220.-***

Other Products:

Notch Filters
Variable Frequency spike Filters
Multipurpose variable Filters

* In single quantities any standard range from 2-20,000 Hz. Lower ranges to 0.01 Hz at slightly higher cost.

A.P. CIRCUIT CORP.

865 West End Ave., New York, N.Y. 10025
Tel. (212) 222-0876

DISCOVER A NEW WORLD OF SWITCHING WITH SANKEN PHOTOCCELL-LAMP MODULES SPL SERIES

Hermetically sealed Sanken Photoconductive Cells are combined with incandescent glow lamps and packaged in a durable cylindrical case. Contactless and, therefore, clickless.....they will completely solve your switching problems. That is exactly what you've been missing in your circuit.

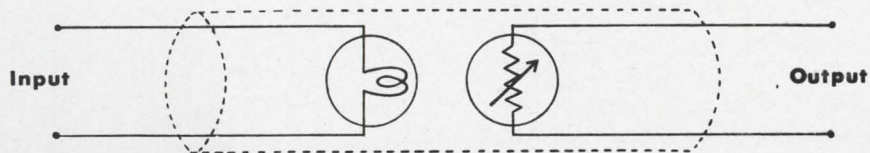

For more information about Sanken Photocell-Lamp Modules SPL Series, please contact:



SANKEN ELECTRIC CO., LTD.

1-22-8 Nishi-Ikebukuro, Toshima-ku, Tokyo, Japan.

Telex: 272-2323 SANKELE TOK

Cable: SANKELE TOKYO

Phone: 986-6151

Circle 189 on reader service card

**If you don't
send this coupon,
somebody will
out-interdiscipline
you.**



How do you find those few vital articles in the hundreds of journals dealing with your own and related disciplines? Our new publication, **CURRENT CONTENTS—ENGINEERING & TECHNOLOGY**, makes it easy. Weekly, in handy pocket form, it brings you the facsimiles of the table of contents of 732 foreign and domestic journals relating directly or indirectly to your work. Titles and authors of more than 100,000 articles a year. Scan them in less than an hour a week. First issue, January 2, 1970. Check multidisciplinary scientists in other fields about acceptance of **CURRENT CONTENTS**. Then send coupon for details about this new one. And list of journals covered, special prepublication offer, group rates. Or phone Extension 300, 215-923-3300. No obligation.

Institute for Scientific Information

Dept. E-12, 325 Chestnut St., Phila., Pa. 19106

Yes, I do need help in finding the needles in my multidisciplinary haystack. Show me.

NAME _____

TITLE _____

DEPARTMENT _____

YOUR DISCIPLINE _____

ORGANIZATION _____

ADDRESS _____

CITY _____ STATE _____ ZIP _____

COUNTRY _____

more power

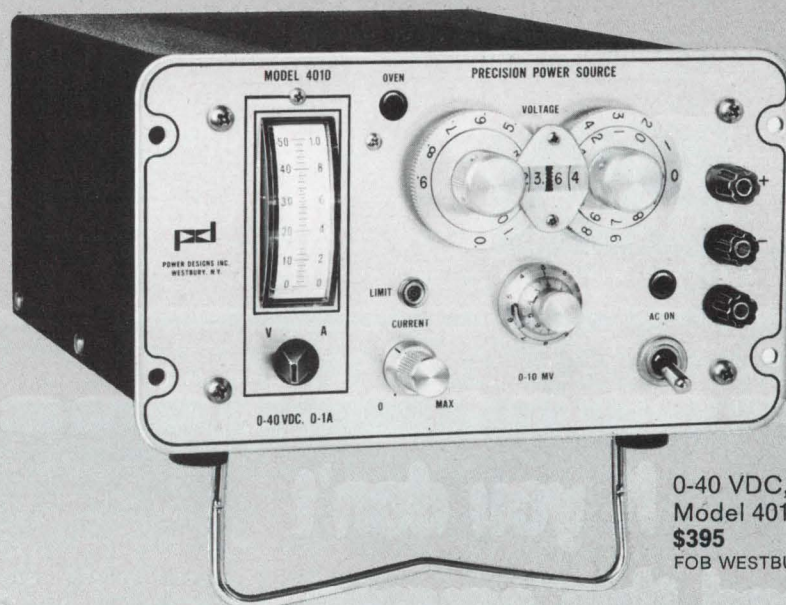

0-40 VDC, 0-1A
Model 4010
\$395
FOB WESTBURY

calibrated power source

The latest model in our second generation series of precision power supplies offers four times the output of its companion Model 2005A.

The Model 4010 offers 5-digit readout to 10 volts, 6-digit from 10 to 40 volts with a calibration accuracy of 0.1% plus one millivolt under one volt and 0.1% of the dial reading above one volt.

Regulation is 100 μ v; ripple and noise 60 μ v peak to peak; stability better than 10 PPM plus 100 μ v per 8 hours. A 10 turn interpolation potentiometer with a total range of 10 millivolts provides 5 microvolts resolution.

Write or call for technical data.



power designs, inc.

Power Designs, Inc.
1700 Shames Drive, Westbury, N.Y. 11590
Tel: 516-333-6200 • TWX: 510-222-6561

Power Designs Pacific, Inc.
3381 Miranda Avenue, Palo Alto, California 34304
Tel: 415-321-6111 • TWX: 910-373-1251

Now from Lambda. Systems Power Sequencer

sequences voltage ON and OFF, monitors voltage status, protects against ac input line voltage faults, undervoltage and overvoltage

Controls up to 8 power supplies

sequences ON up to 8 power supplies in pre-determined sequence and sequences them OFF in mirror image.

Turn ON sequence incomplete

incomplete sequence causes all output voltages to be crowbarred.

Turn OFF sequence failure

protect system overrides and causes all voltages to be crowbarred.

Monitors

power supply overvoltage and undervoltage and ac input line voltage simultaneously.

Protects against ac input line voltage faults

power failure causes all output voltages to be crowbarred.

Protects against undervoltage

one fault can result in all output voltages crowbarred (with optional disable).

Protects against overvoltage

one fault causes all output voltages to be crowbarred.

Dry contact closure interlock

available for each power supply at the input/output connector. Loss of interlock causes all output voltages to be crowbarred.

Logic-level signal alerts associated equipment

logic-level signal is provided to indicate failure. It precedes the output voltage crowbar.

Fault signal indicates an output voltage fault

fault-signal output signal, a pulse train, is provided when output voltage fault occurs. An indicator light gives visual indication on the front panel of models SPS-92, SPS-94, SPS-96 and SPS-98.

Lambda's System Power Protector

The Systems Power Protector is another Lambda control unit having all the functions of the Systems Power Sequencer with the exception of voltage sequencing, square-wave failure alarm, and two-wire external interlock. It provides complete fault protection at substantially lower cost.

Systems Power Sequencer ⁽¹⁾ 1 3/4" x 19" x 14" 3 1/8" x 3 13/16" x 13 1/4" (mountable in LRA-8, LRA-10 or LRA-11 rack adapters)



SPS-90 series

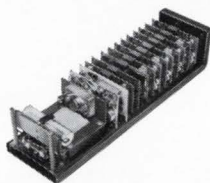

SPS-80 series

| Model ⁽³⁾ | POWER OUTPUTS ACCOMMODATED ⁽²⁾ | Price ⁽⁴⁾ |
|----------------------|---|----------------------|
| SPS-92 | 2 | \$630 |
| SPS-94 | 4 | 720 |
| SPS-96 | 6 | 810 |
| SPS-98 | 8 | 900 |

| Model ⁽³⁾ | POWER OUTPUTS ACCOMMODATED ⁽²⁾ | Price ⁽⁴⁾ |
|----------------------|---|----------------------|
| SPS-82 | 2 | \$580 |
| SPS-84 | 4 | 670 |
| SPS-86 | 6 | 760 |
| SPS-88 | 8 | 850 |

Systems Power Protector ⁽¹⁾ 1 3/4" x 19" x 14" 3 1/8" x 3 13/16" x 13 1/4" (mountable in LRA-8, LRA-10 or LRA-11 rack adapters)

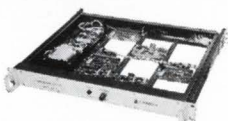

SPP-90 series

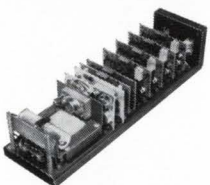

SPP-80 series

| Model ⁽³⁾ | POWER OUTPUTS ACCOMMODATED ⁽²⁾ | Price ⁽⁴⁾ |
|----------------------|---|----------------------|
| SPP-92 | 2 | \$465 |
| SPP-94 | 4 | 500 |
| SPP-96 | 6 | 535 |
| SPP-98 | 8 | 570 |

| Model ⁽³⁾ | POWER OUTPUTS ACCOMMODATED ⁽²⁾ | Price ⁽⁴⁾ |
|----------------------|---|----------------------|
| SPP-82 | 2 | \$415 |
| SPP-84 | 4 | 450 |
| SPP-86 | 6 | 485 |
| SPP-88 | 8 | 520 |

Notes: 1. Overvoltage protectors must be used with each power supply to utilize the overvoltage and undervoltage functions of the Power Sequencer or Power Protector.
2. All power supplies of the LC/LM series to be used with the Systems Power Sequencer, except zero-voltage units, must be specified with the "-S" option. Also, all overvoltage protectors must be specified with the "-S" option. Simply add the suffix "-S" to the applicable power supply model number or overvoltage protector if it is to be used with the Systems Power Sequencer and to all overvoltage protectors used with the Systems Power Protector.
3. The Systems Power Protector and the Systems Power Sequencer can be used with Lambda power supplies furnishing up to 70 vdc. For applications above 70 vdc, consult factory.
4. All prices F.O.B. Melville, N. Y. All prices and specifications are subject to change without notice.



Now you can get a multiple output power supply system by assembling standard Lambda components, available from stock ...16 outputs in a 5 1/4" x 21" rack.

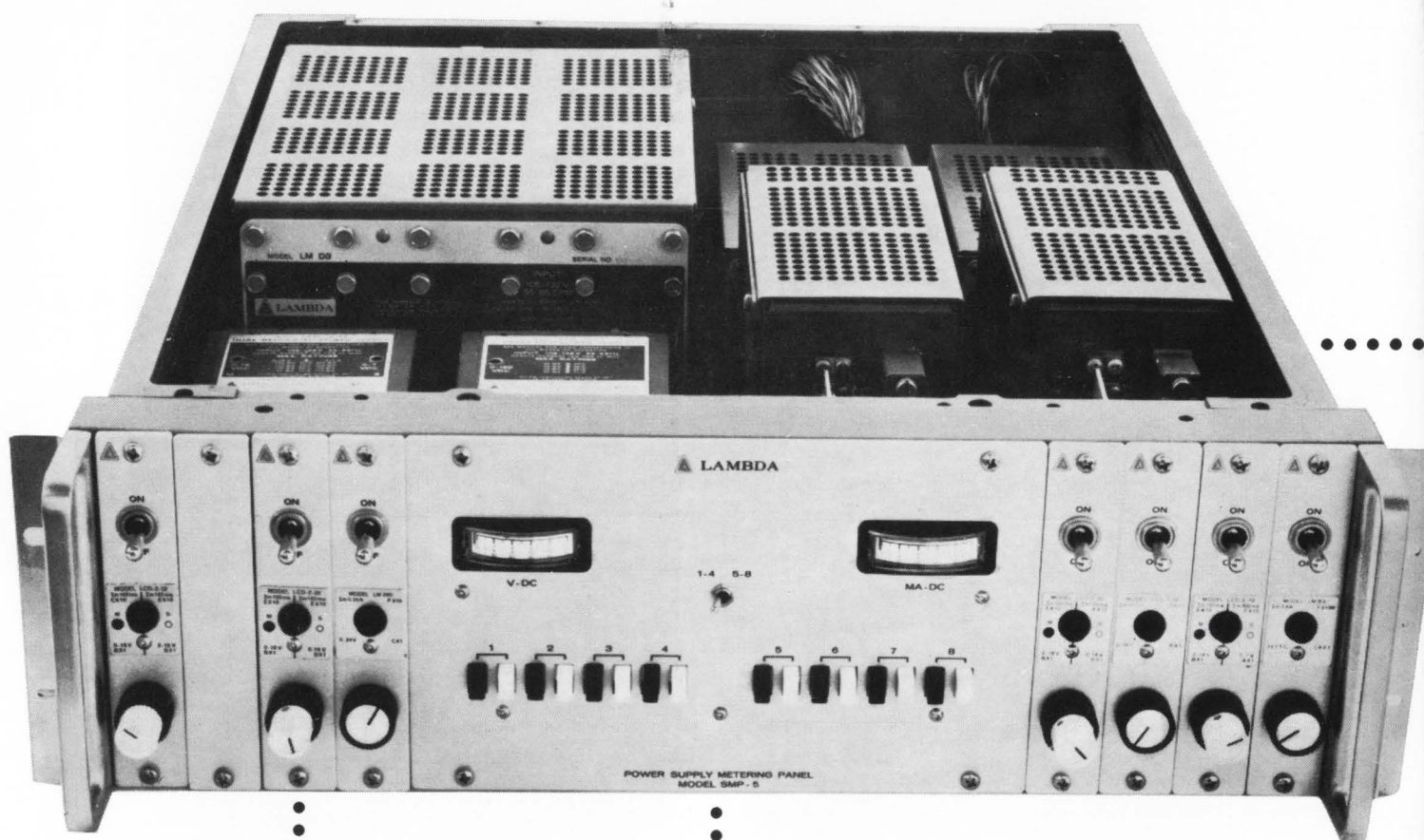

SP-5 \$30
Systems Power Control Panel

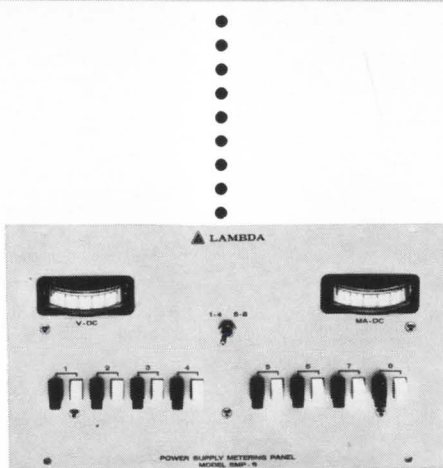

SMP-5 \$100
Systems Metering Panel

Select your voltage and current requirements from these LC/LM package sizes.

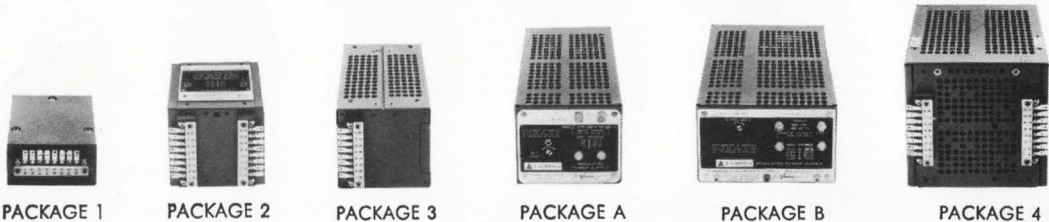

PACKAGE 1

PACKAGE 2

PACKAGE 3

PACKAGE A

PACKAGE B

PACKAGE 4

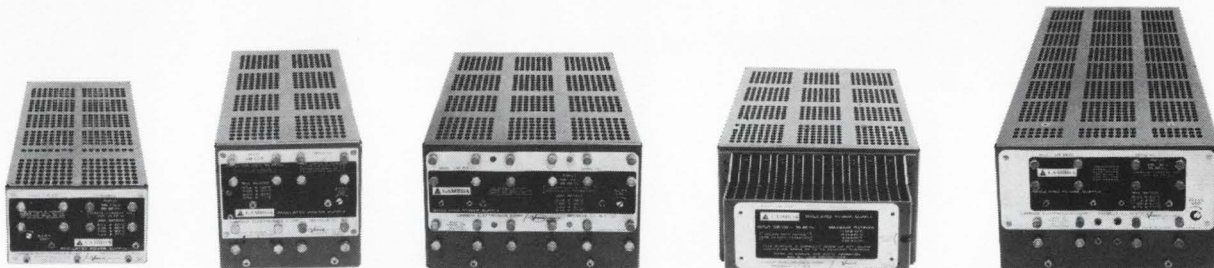

PACKAGE C

PACKAGE CC

PACKAGE D

PACKAGE E

PACKAGE EE

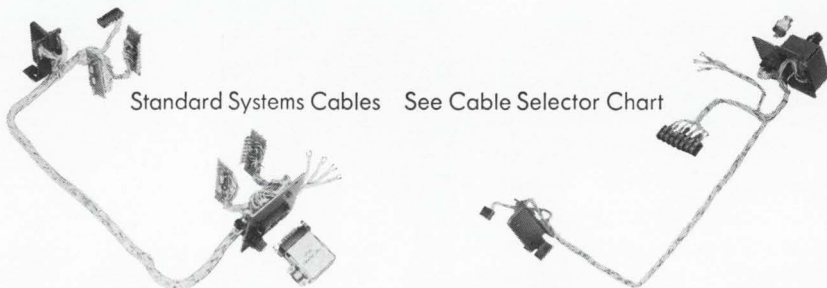

Standard Systems Cables See Cable Selector Chart



LRA-11 \$70
Rack Adapter

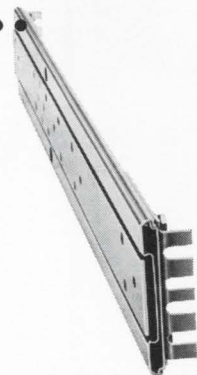

\$50 (pr.)
Chassis Slide

Circle 901 on reader service card

Lambda has over 10,000 power supply units on-the-shelf for 1-day delivery.

Every one fully guaranteed for 5 years... material and labor.



LAMBDA ELECTRONICS CORP.

A Veeco Company

LAMBDA ELECTRONICS CORP.,
515 Broad Hollow Road, Melville, L.I., N.Y. 11746

Show me how I can design any power supply system from standard components by sending me your new Power Supply System Catalog.

NAME _____
 TITLE _____
 CO. _____ BLDG. _____
 ADDRESS _____
 CITY _____ STATE _____ ZIP _____

All New Cermolox Designs for VHF-TV and FM Broadcasts

Working in VHF-TV? Try RCA-8792, RCA-8806 and RCA-8807... new broadcast tubes from RCA that meet the high linearity and high gain requirements of up-to-date, reliable VHF-TV. If FM service suits you, choose RCA-8792, 8793 and 8794. All are Cermolox[®] tubes, developed from proved, in-use designs. They feature new lows in feed-through capacitance and screen and cathode inductance plus superb IM values. Available at surprisingly

low cost, many of these RCA broadcast tubes lend themselves well not only to VHF-TV and FM, but to SSB, CW, and UHF Linear service as well. Investigate these RCA tubes for your needs. See your local RCA Representative or your RCA Distributor for details, including prices and delivery.

For technical data on specific types, write: RCA Electronic Components, Commercial Engineering, Section Q 19L-2, Harrison, N.J. 07029.

RCA-8807 (top), 20 kW Peak Sync.

RCA-8806 (center), 12.5 kW Peak Sync.

RCA-8792 (lower), 1 kW FM 1.5 kW Peak Sync.



RCA