

Special report: pcm in Japan 86

\$1.00 A McGraw-Hill Publication

Designing reliability into strapdown gyros 106

May 25, 1970

Ion-implanted LSI makes it to market 125

Electronics®

**Flexible phosphor sandwich,
the genesis of
throwaway tv?**

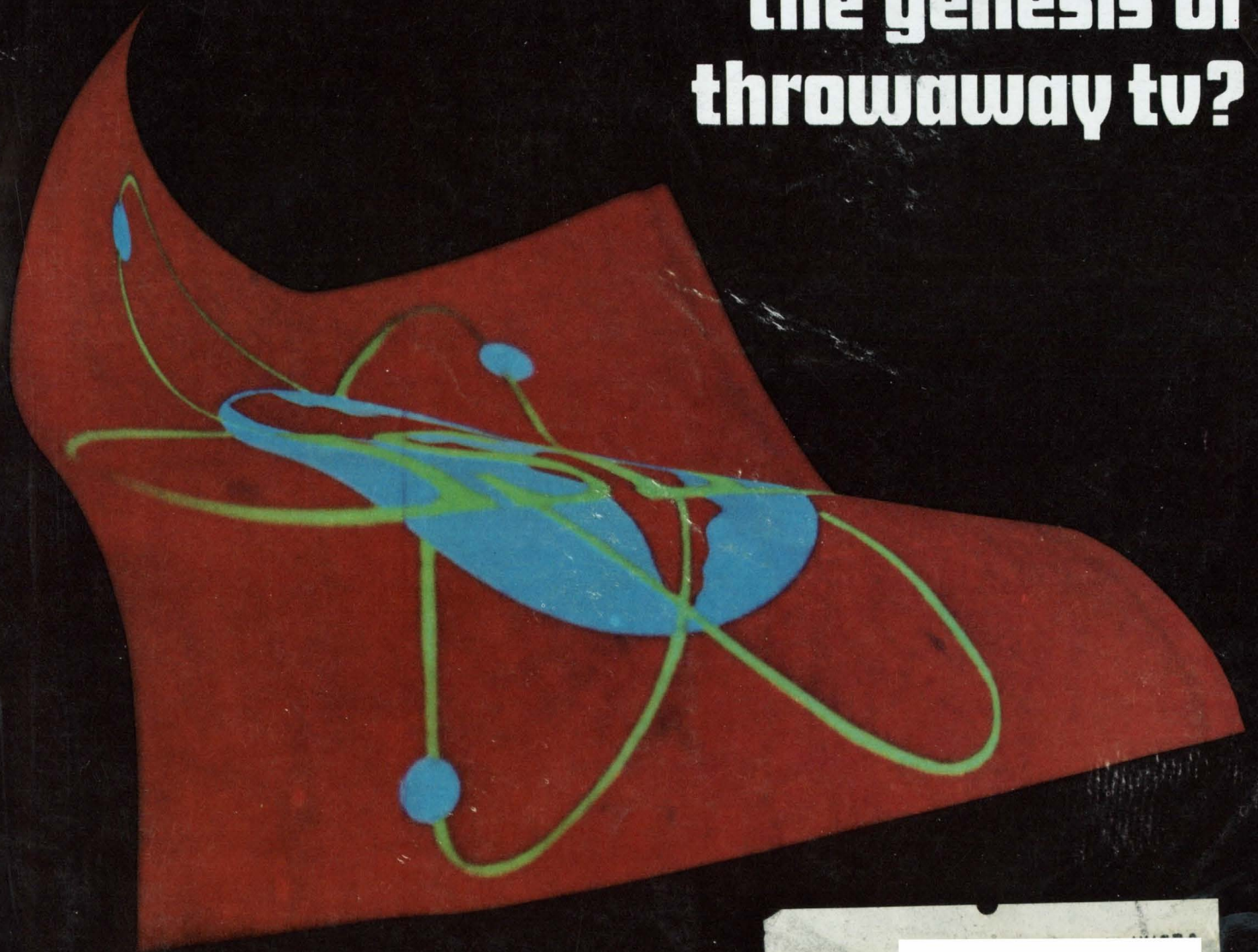

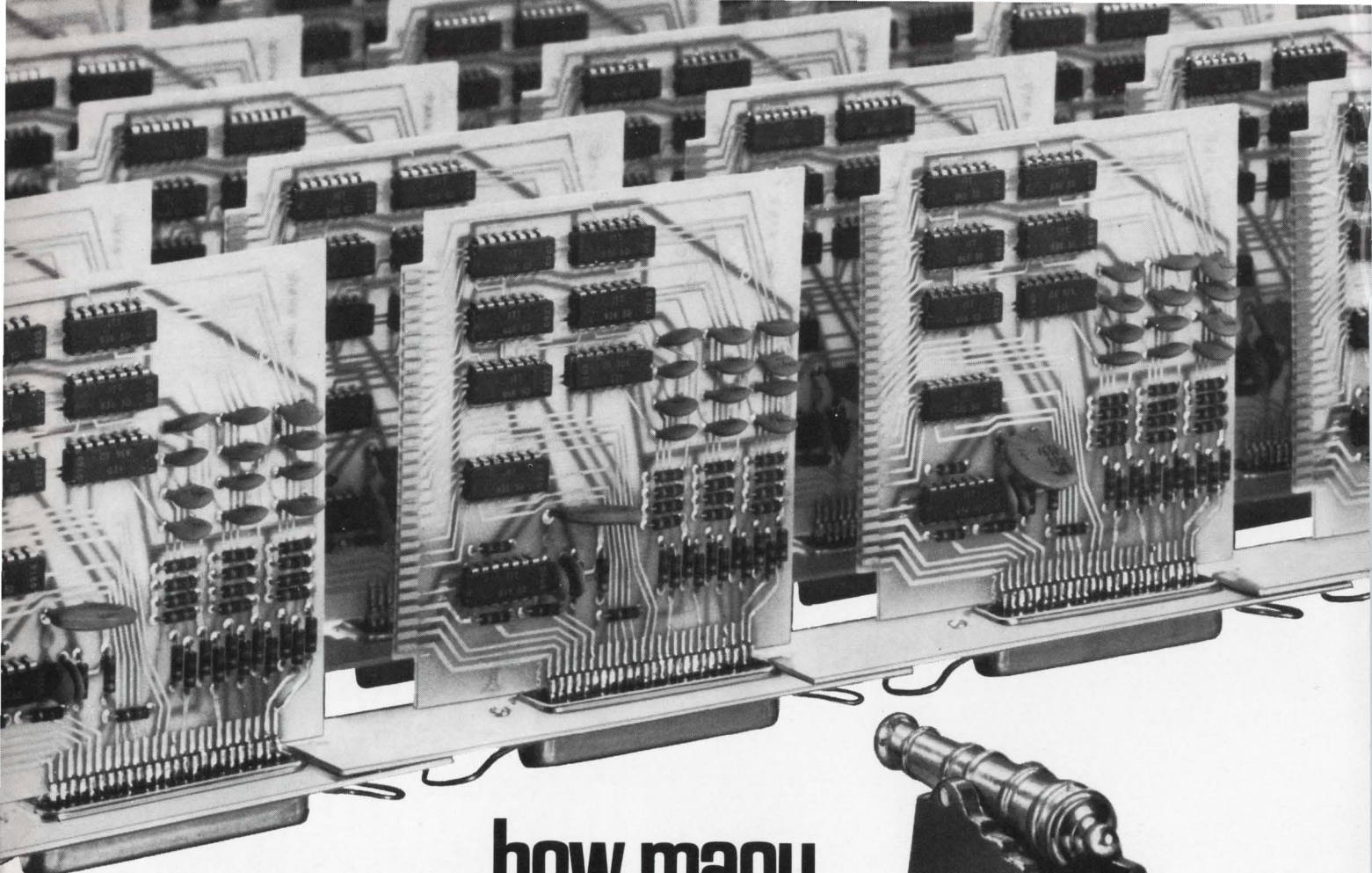

how many will fall today?

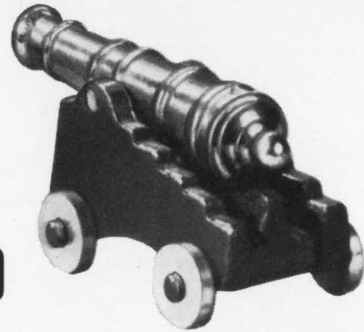

Shoot down your defective printed circuit boards in the early rounds of the manufacturing process and win the battle of the ledger with GR's 1790 Logic Circuit Analyzer!

Put the 1790 into your battle plan and get the very best weapon available to check your logic circuits quickly and economically. The 1790 combines a capacity to handle almost any board configuration (up to 96 input pins and 144 outputs) with a simplified test language (technicians can learn it in only a few days) and computer speed (up to 4000 tests per second). The end product is a GO indication, or a scope-displayed or typewritten error message (or diagnostic instructions included in the test program) to give you the most powerful logic-circuit analyzer on the market. (A simpler GO/NO-GO test mode can also be used.)

Base price of the 1790 is \$32,500 (a strategic advantage for you), including installation and training. Additional computer memory and programmable logic levels are available as options. If you'd like more information for your strategy meetings, write General Radio Company, West Concord, Mass. 01781 or telephone (617) 369-4400. In Europe write Postfach 124, CH 8034 Zurich, Switzerland.

Price applies in U.S.A.

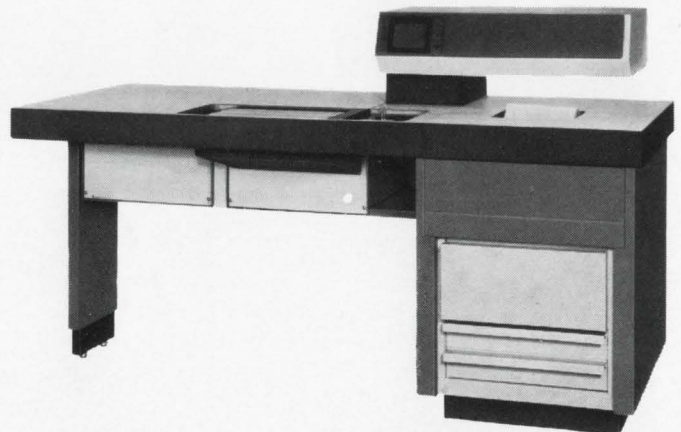

GENERAL RADIO



If price and performance are important— here's a 7 MHz value

This is a lab-quality, all-solid-state scope—at a price you'd ordinarily expect to pay for older vacuum-tube models.

Value—DC to 7 MHz bandwidth. This frequency range covers audio, video and most control circuit applications.

Value—5 mV to 20 V per division deflection factor. Here is sufficient capability to pick up most electronic or electro-mechanical system outputs without distortion or need for additional amplifiers.

Value—Rock solid triggering with capabilities ordinarily found only in more expensive lab type oscilloscopes . . . triggered or recurrent sweep, single-sweep, and automatic triggering.

Value—Low drift, long-term stability. Field effect transistors virtually eliminate drift from temperature changes, shock or vibration. Long-term stability means less frequent calibration.

Value—Easy to use. Logical arrangements of controls, beam finder, auto-triggering make operation easy. Interlocking controls on sweep time and magnifier prevent readout errors.

Value—Easy-to-see display. Internal graticule, 8 x 10 cm CRT for measurement accuracy. Bright, small spot-size trace increases visibility and resolution.

Value—Available in single channel cabinet or rack versions (1215A or 1215B), or in dual-channel cabinet or rack versions (1217A or 1217B). Electrical characteristics are identical. Rack version is only 5¼" high. Panel on the cabinet version is about the size of this page.

Value — Price, 1215A/B, \$950; 1217A/B, \$1175. Add up the features, then divide by price and you'll find this is the greatest performance/dollar value ever offered.

These 7 MHz oscilloscopes are new members of HP's growing family of low- and mid-frequency oscilloscopes. In addition to these new mid-range scopes you have 500 kHz scopes in 14 models with your choice of: Single or dual trace, 100 μ V/cm or 5 mV/cm deflection factors, conventional display or variable persistence and storage, all in cabinet or rack versions.

If you're looking for accurate mid-frequency measurements, ease of use, reliability—all at a low cost—here's a real 7 MHz value!

Call your local HP field engineer. Or, write to Hewlett-Packard, Palo Alto, California 94304. Europe: 1217 Meyrin-Geneva, Switzerland.

HEWLETT  PACKARD
OSCILLOSCOPE SYSTEMS

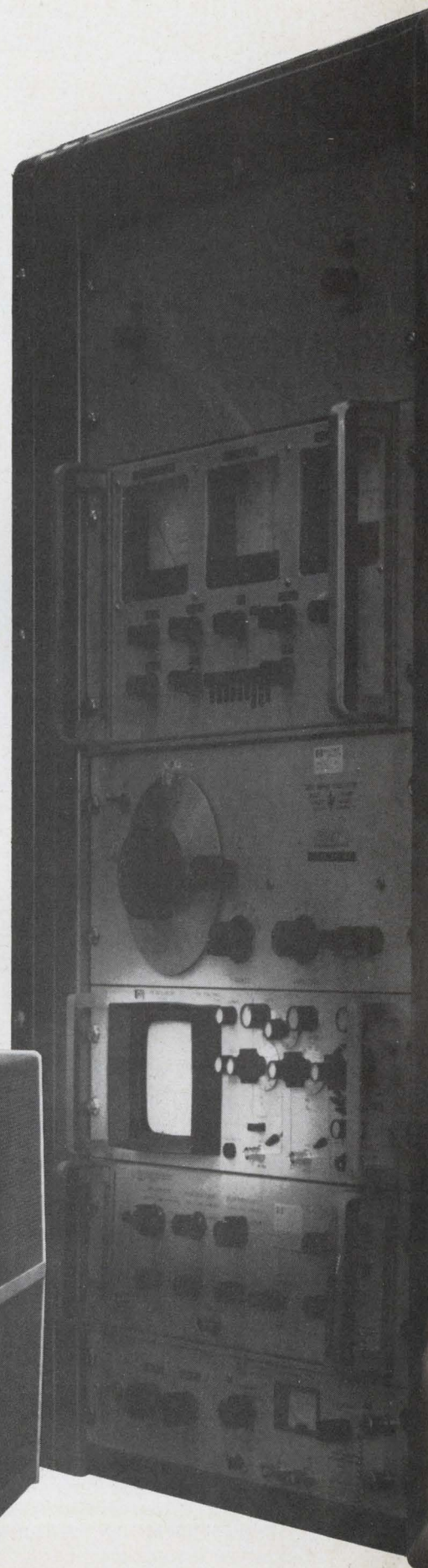
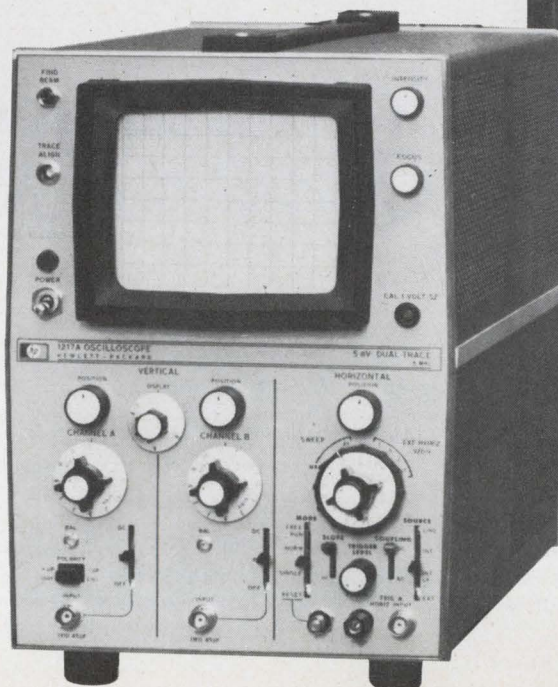



We've just advanced the Q-meter 17 years.

For lab and production-line work, our new Model 4342A Q-meter measures Q faster and easier than its classic predecessor, HP's Boonton 260A.

It measures Q values from 5 to 1000 in a frequency range of 22 kHz to 70 MHz.

Automatic leveling of oscillator source eliminates need for Q-Multiplier controls.

Speedy GO/NO-GO selector reduces component testing time.

High impedance voltmeter virtually

eliminates frequent zero reset.

New solid-state circuitry eliminates unreliable thermocouple.

Pushbutton controls give fast frequency and Q range switching.

All this means shorter measurement time and a big boost for high-volume testing and lab use.

It's versatile, too. You can detect extremely small changes in Q. Or measure coil, capacitor and resistor parameters. And the price? Just \$1500.

Okay. You want to measure up to

peak production. Dial your nearby Hewlett-Packard field engineer. He'll give you all the specs on HP's newest Q-meter in 17 years. Or write: Hewlett-Packard, Palo Alto, California 94304; Europe: 1217 Meyrin-Geneva, Switzerland.

HEWLETT  PACKARD

IMPEDANCE INSTRUMENTS
.18002

Features

Probing the News

- 125 **Solid state:** Ion implantation goes into production with MOS/LSI
- 133 **Space electronics:** ERTS is alive and on schedule

U.S. Reports

- 45 **Microwave:** Surface acoustic waves spread into radar; image technique cuts attenuation
- 46 **Advanced technology:** Josephson effect for voltage standard
- 47 **Computers:** Sorter also reads; impact printer at lower price
- 48 **Industrial electronics:** Fluidics in direct digital control
- 50 **Companies:** Autonetics turns corner
- 52 **Avionics:** I/CNI is now Unified
- 55 **Avionics:** Lockheed's C-5 woes come in nines
- 56 **Avionics:** RCA says it's selling Secant

Electronics International

- 69 **Sweden:** Programmable parking meter
- 70 **West Germany:** Ins and outs of solar cells
- 71 **Great Britain:** Low-light tv duo
- 72 **France:** I-r spectrometry

New Products

- 141 **In the spotlight**
- 141 Photoplotter has built-in developer
- 142 Controls triple plotter speed
- 145 **Components review**
- 145 Optoisolator marketed in DIP
- 148 **Instrument review**
- 148 Meter finds phase angle
- 150 Counter, variable marker combined
- 153 **Production equipment review**
- 153 Add-on tester speeds production
- 157 **Data handling review**
- 157 Digitizer traces at 300 inches/sec
- 159 Computer geared to manufacturing
- 160 **Semiconductor review**
- 160 Transistors aim at communications

Articles

- Communications** 86 **Common bit rate unifies three Japanese pcm systems into a national network**
Five multiplexed primary groups, 120 directly encoded voice channels and 60 supergroup signals can be sent by microwave or cable
Y. Kurahashi, M. Ota, and T. Sakashita, Nippon Telegraph and Telephone Corp.
- Circuit design** 93 **Designer's casebook**
- Matched FET's stabilize amplifier's bandwidth
 - Q-multiplier analyzes audio-frequency tones
 - D-c-to-d-c converter offers positive or negative bias
- Instrumentation** 97 **Serial conversion knocks stuff out of dvm's**
Recirculating-remainder a-d converter does all digitizing with just a single network
Richard Van Saun and Frank Capell, John Fluke Manufacturing Co.
- Consumer electronics** 102 **Color tv remote control goes all-electronic**
Digital signals and MOS FET memory modules replace mechanically driven tuning units
Wayne Evans, Carl Moeller, and Edward Milbourn, RCA Corp.
- Space electronics** 106 **A stable, field-replaceable strapdown gyro—in a can**
Electronics and rate sensor are designed into a soup-can-sized, plug-in, plug-out unit
Alfred Rosenblatt, Electronics' staff
- Displays** 112 **Flat-screen tv takes two giant steps forward**
Glow-discharge transfer cuts scanning circuitry; light amplification brightens the picture
Louis Mirando and Laurence Sliker, International Scanning Devices Inc.

Departments

- | | | | |
|----|--------------------------|-----|--------------------------|
| 4 | Editorial Comment | 33 | Electronics Newsletter |
| 5 | Readers Comment | 67 | International Newsletter |
| 9 | Who's Who in this issue | 75 | Washington Newsletter |
| 14 | Who's Who in electronics | 164 | New Books |
| 22 | Meetings | 166 | Technical Abstracts |
| | | 168 | New Literature |

Electronics

Editor-in-Chief: Donald Christiansen

Senior staff editors

Technical: Stephen E. Scrupski

News: Robert Henkel

International: Arthur Erikson

Assistant managing editors: H. Thomas

Maguire, Howard Wolff, William Bucci,
Richard Gundlach

Special projects editor: Roger Kenneth Field

Senior staff writer: John Johnsrud

Reader communications manager: John

Drummond

Department editors

Senior associate editor: Joseph Mittleman;
Advanced technology: Laurence Altman; **Com-
munications:** Leon M. Magill; **Computers:** Wal-
lace B. Riley, George Weiss; **Design theory:**
Joseph Mittleman; **Instrumentation:** Owen
Doyle; **Military/Aerospace:** Alfred Rosenblatt,
Herman Lowenhar; **New products:** William P.
O'Brien; **Solid state:** George Watson, Stephen
Wm. Fields

Senior copy editor: William S. Weiss; **Copy edi-
tor:** Edward Flinn; **Assistant art director:** Charles
Ciatto; **Production editors:** Susan Hurlburt,
Arthur C. Miller; **Editorial research:** Virginia
Mundt; **Editorial secretaries:** Claire Goodlin,
Bernice Pawlak, Barbara DiBenedetto, Vicki
Green, Terri O'Neill

Field bureaus

Boston: James Brinton, manager; Gail Farrell,
Los Angeles: Lawrence Curran, manager; Ralph
Selph; **New York:** Peter Schuyten; **San Fran-
cisco:** Stephen Wm. Fields, Marilyn Howey;
Washington: Ray Connolly, manager; Jim Hard-
castle, Lois Vermillion; **Frankfurt:** John Gosch;
London: Michael Payne; **Paris:** Arthur Erikson;
Tokyo: Charles Cohen

Reprints: Virginia Mundt; **Circulation:** Isaaca
Siegel

Publisher: Dan McMillan

Assistant to the publisher: Wallace C. Carmichael

May 25, 1970

Confrontation on independent R&D

● With a significant segment of the population ticked off at the military, its nearly 50% share of the Federal budget, and the apparent inability of its best technology to end an Asian war, the military-industrial complex has become a popular target of opposition. As criticism directed at the complex, which embraces a large part of the electronics industry, rises steadily, so do the number of confrontations with opponents of the complex.

Fortunately, none of these confrontations has taken on the bloody and pathetic aspect of a shootout. Yet the placement of bombs in the corporate offices of some defense contractors is unnerving, to say the least. However, the spectacle of these events submerged another confrontation facing the defense industry in the Capital: that is, the effort by Sen. William Proxmire (D., Wis.) to restructure the Pentagon practice of payment to contractors for independent research and development as well as limit reimbursement for bid and proposal costs and for other technical efforts. Proxmire's bill, S. 3003, is becoming the focal point for quiet but vigorous opposition on the part of industry.

What Proxmire proposes is an apparently simple solution to Pentagon support of contractor IR&D. He contends that IR&D should be paid for by contract, rather than supported separately. S. 3003 requires in brief that "no costs for research and development shall be allowable under any negotiated contract. . . unless provisions for such costs are specifically provided for in the contract," and these costs must have "a direct or indirect benefit to the work being performed under the contract." Lumped with the bill's definition of IR&D is the now poorly defined classification of "other technical effort."

Proxmire wants bid and proposal costs treated only as indirect costs, and would require that they be kept below 1% of the direct material and labor costs of a contract, exclusive of capital equipment.

The IR&D issue is not a new one, although it has gained substantially more visibility than when it was first raised three years ago by Rep. George Mahon, (D., Texas), chairman of the House Appropriations Committee. When Mahon first looked at the Defense Department's \$480 million outlay for contractor-sponsored R&D, he took pains to note "that all is not well with the program" since "the top-level managers of research and development in DOD could not recall any benefits offhand" in examination before his committee. Now Proxmire contends IR&D costs have escalated to \$685 million. And industry, sensitive to pressures for a cut in defense spending is justifiably nervous about the threat to payments for IR&D.

Also disturbed are people like John Foster, director of Defense Directorate research and engineering, who have seen total military R&D outlays steadily diminish in an inflationary economy in order to pay Indochina war costs. Foster argues that military R&D expenditures must be increased to compensate for prior technology gains whose value has been compromised by exposure in Vietnam.

Groups such as the Aerospace Industries Association of America take the position that "this bill could cripple defense-oriented industry." Terming IR&D as "an investment in future capability," AIAA's Karl G. Harr Jr. argues that new controls such as line itemization of costs under specific contracts could not be an effective control and would jeopardize the existence of IR&D. As for bid and proposal cost ceilings,

Published every other Monday by McGraw-Hill, Inc. Founder: James H. McGraw 1860-1948. Publication office 99 North Broadway, Albany, N. Y. 12202; second class postage paid at Albany, N. Y. and additional mailing offices.

Executive, editorial, circulation and advertising addresses: Electronics, McGraw-Hill Building, 330 W. 42nd Street, New York, N. Y. 10036. Telephone (212) 971-3333. Teletype TWX N. Y. 710-581-4235. Cable address: MCGRAWHILL N. Y.

Subscriptions solicited only from those professionally engaged in electronics technology. Subscription rates: qualified subscribers in the United States and possessions and Canada, \$8.00 one year, \$12.00 two years, \$16.00 three years; all other countries \$25.00 one year. Non-qualified subscribers in the U.S. and possessions and Canada, \$25.00 one year; all other countries \$50.00. Air freight service to Japan \$50.00 one year. Single copies: United States and possessions and Canada, \$1.00; all other countries, \$1.75.

Officers of McGraw-Hill Publications Company: Joseph H. Allen, President; John R. Emery, J. Elton Tuohig, Senior Vice Presidents; Donald B. Gridley, Group Vice President; Vice Presidents: John R. Callahan, Editorial; John M. Holden, Marketing; David G. Jensen, Manufacturing; Jerome D. Luntz, Planning & Development; Robert F. Marshall, Administration; Robert M. Wilhelm, Finance; Director of Circulation: Ralph Blackburn.

Officers of the Corporation: Shelton Fisher, President and Chief Executive Officer; John J. Cooke, Senior Vice President and Secretary; Gordon W. McKinley, Vice President and Treasurer. Title @ registered in U.S. Patent Office; © Copyright 1970 by McGraw-Hill, Inc. All rights reserved. The contents of this publication may not be reproduced either in whole or in part without the consent of copyright owner.

Subscribers: The publisher, upon written request to our New York office from any subscriber, agrees to refund that part of the subscription price applying to copies not yet mailed. Please send change of address notices or complaints to Fulfillment Manager; subscription orders to Circulation Manager, Electronics at address below. Change of address notices should provide old as well as new address, including postal zip code number. If possible, attach address label from recent issue. Allow one month for change to become effective.

Postmaster: Please send form 3579 to Fulfillment Manager, Electronics, P. O. Box 430, Hightstown, New Jersey 08520.

Readers Comment ▶

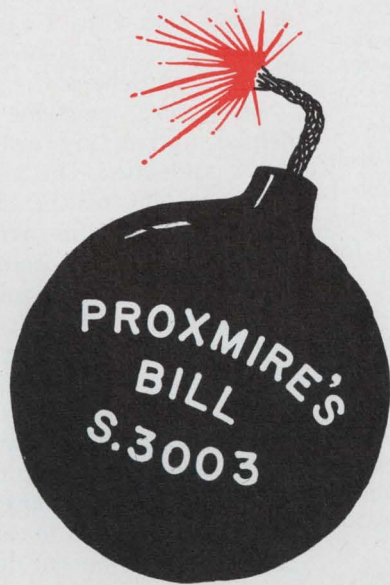

Harr argues more effectively that "the administrative actions required to divide a fixed dollar figure among the individual services, their many commands, and thousands of contractors could be neither effective or equitable."

But Harr is probably least effective in opposing "the belief that negotiated contracts are noncompetitive" and that attempts to "line-itemize R&D along with ships, tanks, and planes, for example, would be the same as trying to line itemize 'skill' in the same fashion. . . ."

The point to be made is that there are valid arguments on both sides of the issue. Substantial improvement can be made in establishing effective controls over IR&D, its costs, and results. Beyond determining who pays for what, the Defense Department should consider the complaint of some of its field commands. These users of military hardware sense a broad gap in their communications with industry's IR&D programs. Military systems users also suspect that too much freedom is allowed companies in IR&D expenditures. The products often have no bearing on the user's near-term requirements.

This major criticism of IR&D is one that both industry and Sen. Proxmire should consider with great care. After all, it is the field commander for whom DOD and industry are ultimately working. Yet, if they persist in their refusal to yield at all to criticism of IR&D costs and productivity, and fail to introduce reasonable controls of their own, the nation stands to lose far more than the \$685 million that the program now costs.—R.C. ●

McGraw-Hill News Service

Director: Arthur L. Moore; **Atlanta:** Fran Ridgway; **Chicago:** Robert E. Lee; **Cleveland:** Arthur Zimmerman; **Dallas:** Marvin Reid; **Detroit:** James Wargo; **Houston:** Barbara LaRoux; **Los Angeles:** Michael Murphy; **San Francisco:** Margaret Drossel, Tyler Marshall; **Seattle:** Ray Bloomberg; **Washington:** Charles Gardner, James Canan, Herbert W. Cheshire, Seth Payne, Warren Burkett, William D. Hickman; **Bonn:** Robert F. Ingersoll; **Brussels:** James Smith; **Hong Kong:** Kate Mattock; **London:** John Shinn; **Mexico City:** Gerald Parkinson; **Milan:** Jack Star; **Moscow:** Jack Winkler; **Paris:** Robert E. Farrell, Stewart Toy; **Tokyo:** Mike Mealey

Glass house

To the Editor:

I read with interest the note from Mr. Wertz of Western Electric [April 13, p. 5] reminding you that Picturephone is a registered service mark of AT&T.

Certainly your article on Picturephone [Jan. 19, p. 131] gave adequate credit. Perhaps Mr. Wertz should properly identify the service mark in the sales literature distributed by his company at the AT&T exhibit at Disneyland. The brochure picked up there does not in any way define Picturephone as a registered mark of AT&T. Perhaps, if AT&T is desirous of protecting its trademark, then it is responsible for proper identification in literature passed out to the general public.

It seems that, in the Picturephone example, AT&T should watch its own publications as closely as it watches *Electronics*.

A.M. Johnson

Apollo Lasers Inc.
Los Angeles

■ Mr. Johnson enclosed a 12-page brochure in which the word Picturephone was used 22 times without service mark protection.

Worked alone

To the Editor:

In your article on the Paris Components Show [March 16, p. 23E, International edition], you state that the low-light-level Plumbicon pickup tube was developed jointly by Ampex in the U.S. and NV Philips. Although Philips and its American affiliate, Ampex, have worked on some silicon vidicons jointly, Philips alone developed the Plumbicon.

Further, the mini-Plumbicon and a 1-inch pickup tube with an anti-comet-tail gun were in RTC's stand during the show. We told your reporter that they would not be; but they were ready in time, so we showed them. Although there's no market for these tubes yet, we think a big potential market exists.

C. Le Noach

Product manager,
RTC La Radiotechnique-Compelec
Paris

Formula twist

To the Editor:

The circuit for driving a motor at a constant speed, shown in Designer's casebook [March 30, p. 94], is excellent. It's a very fresh, bright new way to look at the problem. However, there is a slight problem with the formula: if, as stated in the drawing, EMF is in volts, n in rpm, and K in rpm/volt, then EMF must equal n/K instead of Kn. This would result in $n = EMF(K) = (V_s - i(R_s - R_l)K$.

Ralf Hotchkiss

Oberlin, Ohio

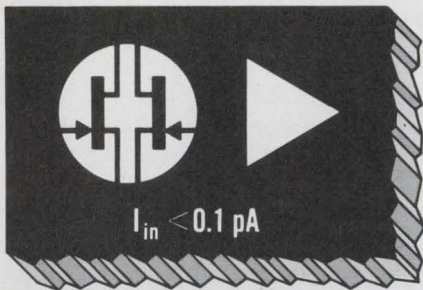

MEASURE LOW CURRENT

Problem: Design a sub-picoamp electrometer circuit.

Solution: Use a Siliconix 2N5909 with an op amp.

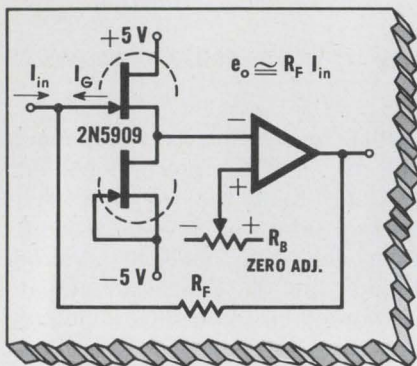

The circuit above, using a 2N5909 and an op amp will provide accurate current measurements in the picoamp and sub-picoamp ranges. When $V_D = +5V$ and $V_{GS} = 0$, I_G is typically less than 0.05 picoamp, hence output error voltage is minimized. You can use the 2N5909 with the op amp of your choice or get the complete circuit (less R_F and R_B) in a TO-99 package (Siliconix L137).

Write for further information on the 2N5909 and the L137 op amp.

Siliconix
incorporated

2201 Laurelwood Rd. • Santa Clara, Calif. 95054
(408) 246-8000 Ext. 201 • TWX: 910-338-0227

In Europe: Siliconix Limited, Saunders Way, Sketty, Swansea, Great Britain

Readers Comment

Looking into clouds

To the Editor:

I am an electrical engineering student at the University of Nebraska in my junior year. The College of Electrical Engineering is offering an undergraduate research program this summer, in which I will participate. My subject is the design of a portable meter for measuring the electrical field associated with cloud disturbances, thunderstorms or electric field activity in the upper atmosphere. The meter must be able to detect the electric field from the ground level. I would appreciate any assistance that your readers might be able to supply in the way of schematics or information.

Clyde Musgrave

Lincoln, Neb.

Stimulating

To the Editor:

Holding a series of forums on product planning [March 2, p. 4] was certainly a good idea. It was quite stimulating to listen to and watch other product planning representatives explain their philosophies and company practices relating to the art of product planning.

Because such planning is not always a distinct, well organized corporate function, the evolutionary process within various companies is an interesting one to witness.

I have found that functioning within the product planning role provides me with an interesting viewpoint relating to top management's problems. To be truthful, my only familiar training in the

subject was a two-week seminar conducted by the AMA last spring in New York City. I carried away from that session some simple but effective guidelines.

Electronics magazine's seminar helped update my evaluation of these guidelines. The most significant segment of the discussions centered around the particular organization of each company and how product planning relates to the organization.

I doubt that listening only to a short lecture by a visiting expert would have been as helpful. Essentially, it seems to me that the problem is one of managing technology for profit. Furthermore, if your magazine continues to canvass successful practitioners of this method, you will become the experts and be in a position to educate us all.

Jack Margolis

Product planning manager,
Sanders Associates Inc.
South Nashua, N.H.

Sad topic

To the Editor:

Your editorial comment about the closing of the Electronics Research Center [Jan. 19, p. 4] touches on a sad topic. But what about the fact that ERC could be considered a duplicate of the laboratory at Huntsville. Furthermore, nothing was said when ERC wiped out approximately 700 jobs at Huntsville's Marshall Space Flight Center. I feel that NASA is right to do the electronics research at MSFC where it started.

C.A. Thoman

Huntsville, Ala.

SUBSCRIPTION SERVICE

Please include an Electronics Magazine address label to insure prompt service whenever you write us about your subscription.

Mail to: Fulfillment Manager
Electronics
P.O. Box 430
Hightstown, N.J. 08520

To subscribe mail this form with your payment and check new subscription renew my present subscription

Subscription rates: qualified subscribers in the U.S.: 1 year \$8; two years, \$12; three years, \$16. Non-qualified: 1 year \$25. Subscription rates for foreign countries available on request.

CHANGE OF ADDRESS

ATTACH
LABEL
HERE

If you are moving, please let us know five weeks before changing your address. Place magazine address label here, print your new address below.

name

address

city

state

zip code

Newly broadened low-cost line!

Type 196D Dipped Solid-Electrolyte Tantalex[®] Capacitors

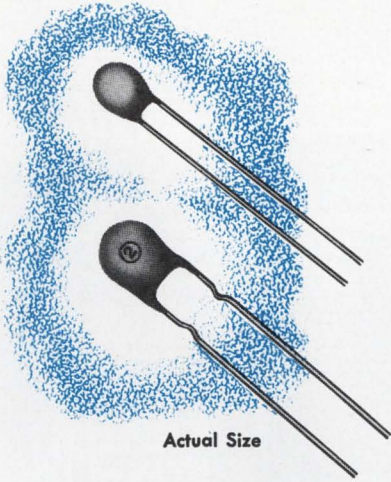

Actual Size

INFORMATION RETRIEVAL NO. 516

- Here's a capacitor design that admirably fills the need for low-cost yet dependable solid tantalum capacitors suitable for printed wiring boards
- Straight leads as well as crimped leads are readily available to meet your manufacturing needs
- Covering a broad range of capacitance values from .1 μ F to 330 μ F, with voltage ratings from 4 to 50 VDC, Type 196D Capacitors are protected by a tough insulating coating which is highly resistant to moisture and mechanical damage
- Request Engineering Bulletin 3545A.

4SC-9124R2

Now...new, lower capacitance values!

Type 192P PACER[®] FILMITE[®] 'E' CAPACITORS

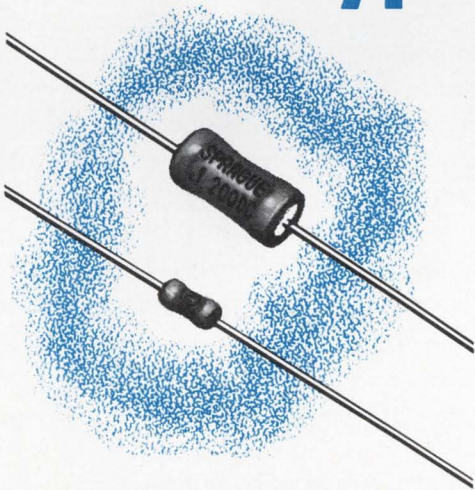

INFORMATION RETRIEVAL NO. 515

- Low-cost film capacitors with one-third the size of conventional tubulars
- Eight new low-capacitance values (100 pF thru 390 pF @ 200V) added to broad range of standard ratings
- Special construction—extended foil sections terminated in metal end caps, assuring positive contact with every turn of the electrodes
- End caps are also effective moisture barriers
- Entire assembly protected by special sleeve of high dielectric strength
- Request Engineering Bulletin 2066B

4SC-0105R1

For Engineering Bulletins as noted above, write to:
Technical Literature Service, Sprague Electric Co., 35
Marshall Street, North Adams, Massachusetts 01247.



'Sprague' and '®' are registered trademarks of the Sprague Electric Co.

THE BROAD-LINE PRODUCER OF ELECTRONIC PARTS

World's most powerful electronic calculator

... awaits your orders

WANG 700A

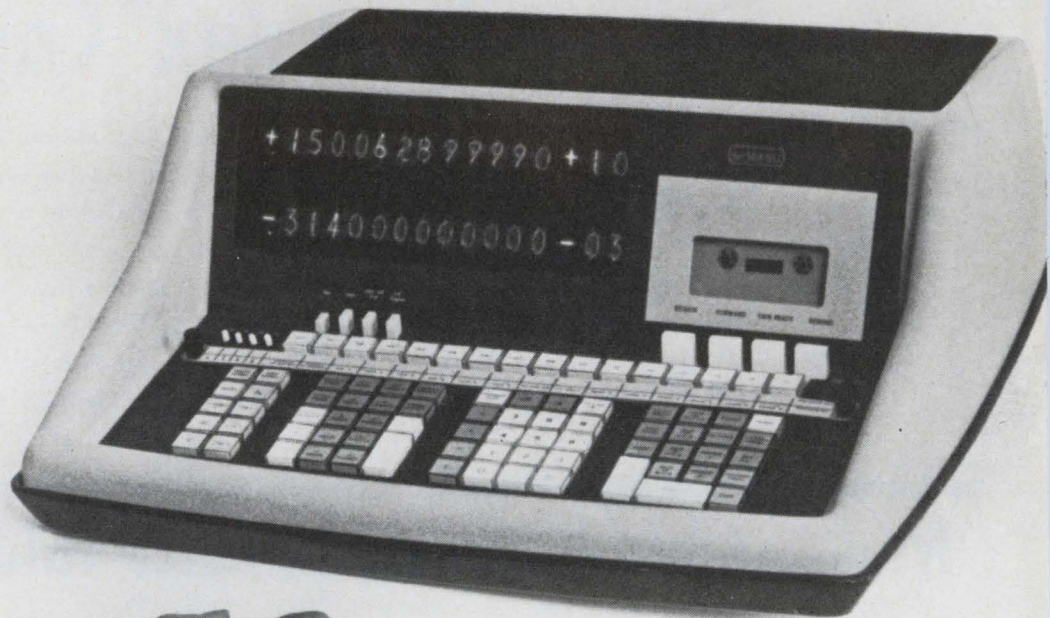

The 700A is in production.

It's available to solve a complex scientific, engineering, statistical, or financial problem instantly, whenever you need it. The 700A can execute 960 core stored program steps and manipulate data in 120 registers. It performs + and - functions in 300 microseconds, \times and \div in 3 to 5 milliseconds, $\text{Log}_e X$ and e^x in 17 to 35 milliseconds and trig functions in 250 milliseconds. And it also loops, branches, does subroutines and makes decisions. These are some of the reasons that have created the unprecedented demand for the Wang 700A. And why we're increasing production to make it available sooner to more people. Of course, first come; first served.

Made in America for the World of Numbers

 **WANG**

LABORATORIES, INC. Dept. 5H, 836 North St., Tewksbury, Mass. 01876 Tel: (617) 851-7311

Please send information on Wang 700A programmable calculator.

NAME _____ TITLE _____

ORGANIZATION _____

ADDRESS _____

CITY _____ STATE _____ ZIP _____

TEL. _____

Who's Who in this issue

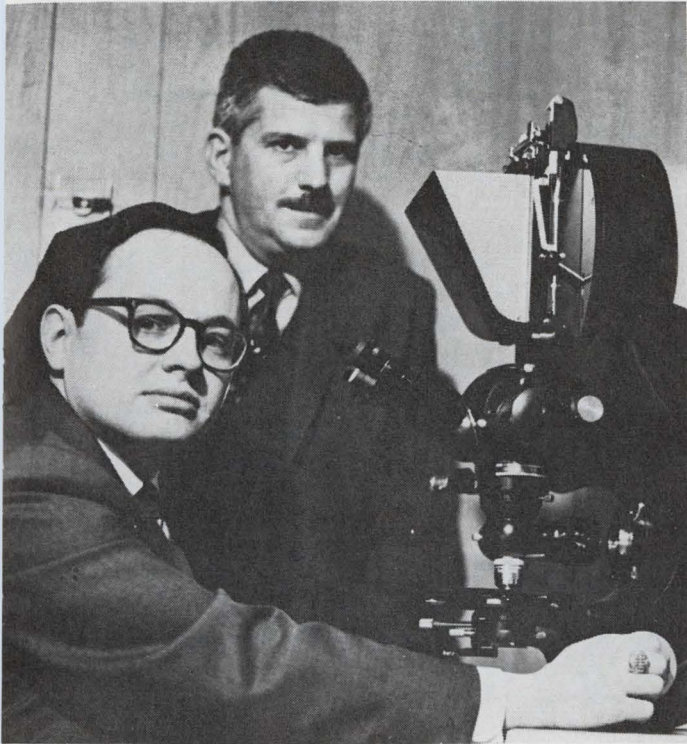

Sliker

Mirando

The pair of flat-screen tv developments described in the article on page 112 were generated by a pair of International Scanning Devices officials—Louis Mirando, president, and Laurence Sliker, R&D chief. Mirando left a career in traffic management and transportation to form the firm in 1965. Sliker joined the company in 1967.



Van Saun

Capell

Now chief engineer at John Fluke Manufacturing Co., Dick Van Saun, author of the article that begins on page 97, earned BS and MS degrees in electrical engineering from Stanford. His co-author, Frank Capell, is, by comparison, an old hand at Fluke. He joined the firm in 1959 and is now a senior applications engineer.

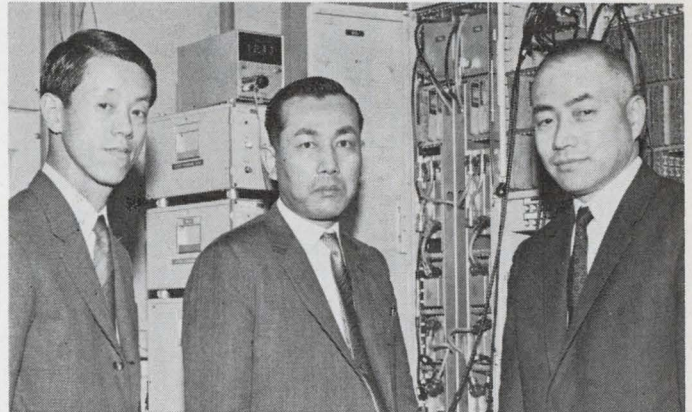

Sakashita

Kurahashi

Ota

A trio of Nippon Telegraph and Telephone engineers—Masamitsu Ota and Yutaka Kurahashi of the electrical communication lab, and Takayoshi Sakashita of the engineering bureau—are the authors of the article starting on page 86. Ota, who holds a Ph.D. from the University of Tokyo, is engaged in microwave pcm systems R&D. Kurahashi is now involved in industrial research management. Sakashita has made the development of pcm systems his major work.

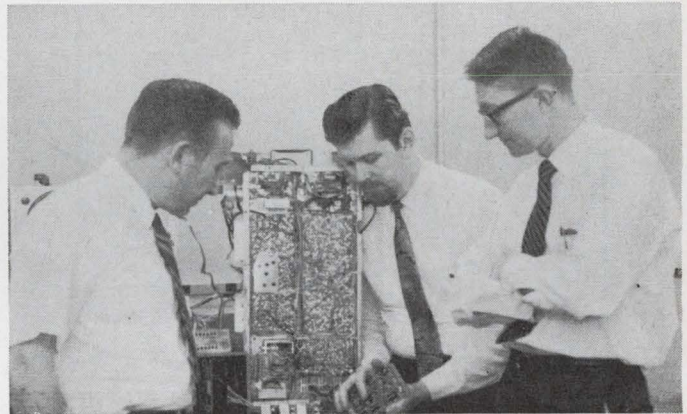

Moeller

Evans

Milbourn

Variety is the common denominator in the backgrounds of Wayne W. Evans, Carl F. Moeller, and E.M. Milbourn, authors of the article that begins on page 102. Evans, a Purdue graduate, worked in radar and defense design before becoming a color-tv designer for RCA. Moeller did an extensive stint as an editor and author before joining RCA as a technical training specialist. Milbourn worked in instrumentation and controls before joining RCA Sales Corp. as a field engineer.

Alfred Rosenblatt's thing at *Electronics* is military/aerospace affairs, the slot that includes the article that starts on page 106. Rosenblatt is a graduate of the Cooper Union School of Engineering and studied at the Columbia University School of Journalism.

In TTL

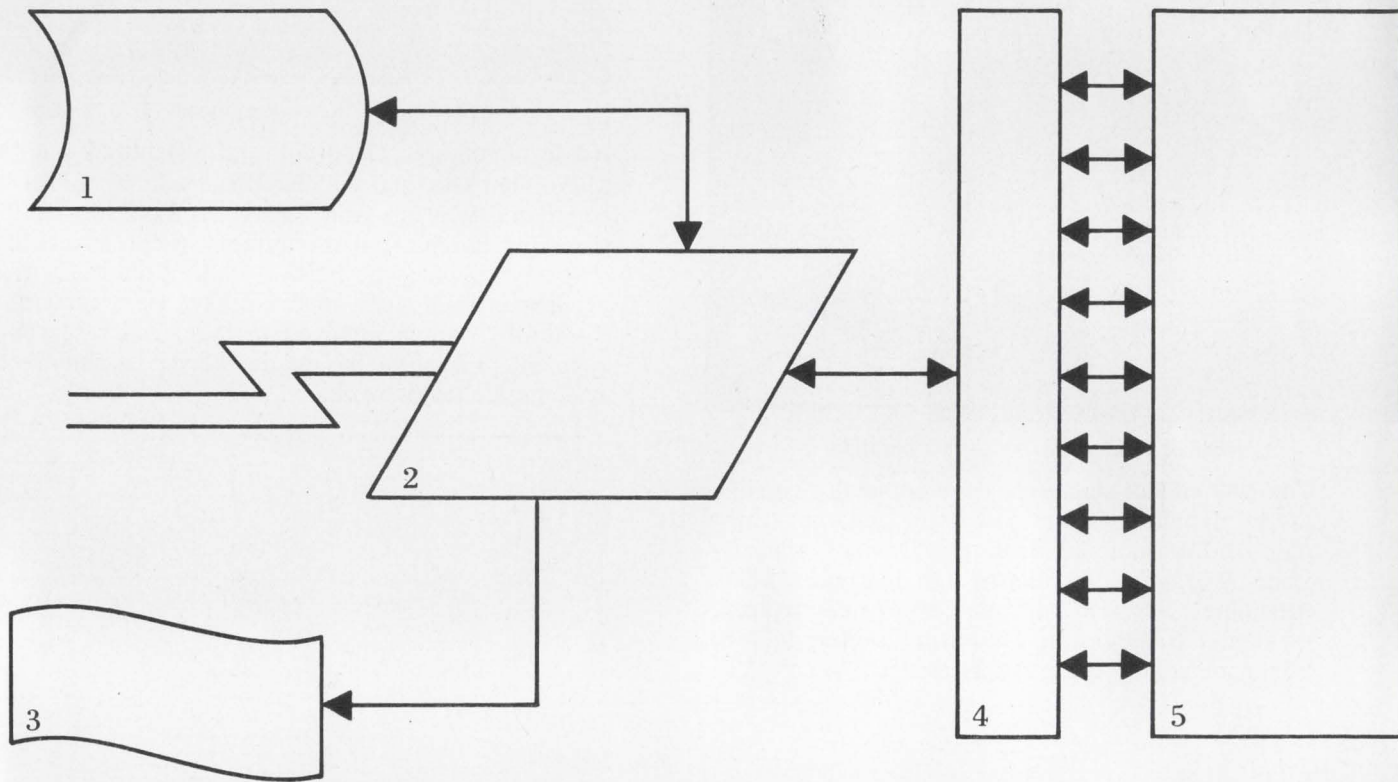

1. Mass Storage

DM8533N Four-bit Binary Counter
 DM8842N BCD to Decimal Decoder
 DM8200N Four-bit Comparator
 DM8210N Eight Channel Digital Switch

2. Modem

DM8210N Eight Channel Digital Switch
 DM8211N Eight Channel Switch (with Strobe)
 DM8220N Parity Generator/Checker
 DM8830N Dual Line Driver
 DM8842N BCD to Decimal Decoder

3. Tape Reader or Punch

DM8550N Quad Latch
 DM8533N Four-bit Binary Counter
 DM8842N BCD to Decimal Decoder

4. Input Interface

DM8220N Parity Generator/Checker

5. CPU

DM8560N Up-Down Decade Counter
 DM8563N Up-Down Binary Counter
 DM8283N Four-bit Binary Adder
 DM8551N Bus-OR'd Quad D
 DM8570N Eight-bit Serial-In Parallel-Out Shift Register
 DM8590N Eight-bit Parallel-In Serial-Out Shift Register
 DM8580N Four-bit Parallel-In Parallel-Out Shift Register

6. Output Interface

DM8210N Eight Channel Digital Switch
 DM8086N Quad Exclusive OR Gate
 DM8220N Parity Generator/Checker

It's MSI

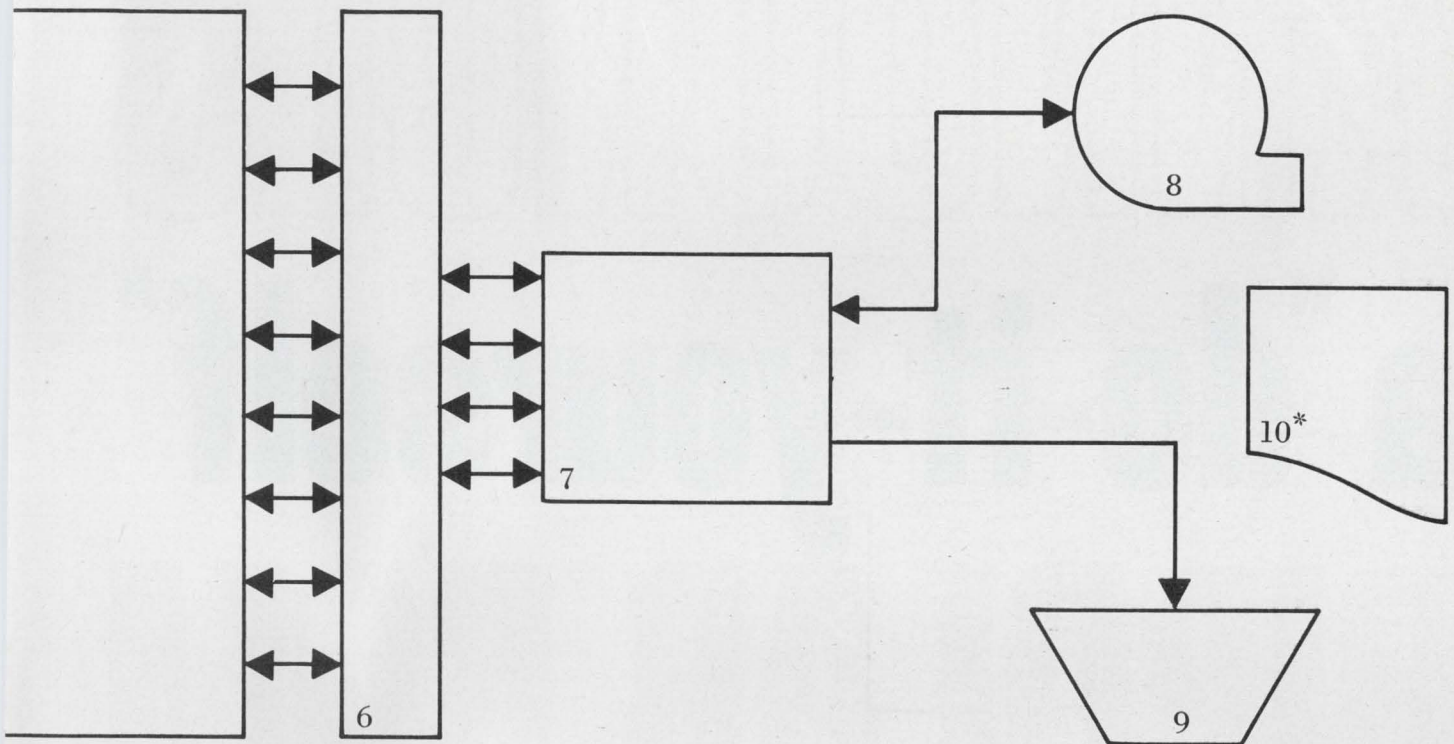

7. Memory

- DM8580N Four-bit Parallel-In Parallel-Out Shift Register
- DM8590N Eight-bit Parallel-In Serial-Out Shift Register
- DM8570N Eight-bit Serial-In Parallel-Out Shift Register

8. Off Line Storage

- DM8200N Four-bit Comparator
- DM8220N Parity Generator/Checker

9. Display

- DM8840N BCD to Decimal Nixie Driver
- DM8842N BCD to Decimal Decoder
- DM8550N Quad Latch

Nixie: Trademark of Burroughs Corporation

*10. Software

Our new 38 page App Note on applications of MSI circuits. Send for it.

(We've got it made)

Shipments from distributor stocks. Plus a complete line of MOS ROMs, shift registers and character generators completing the MSI design package.

National Semiconductor Corporation
2900 Semiconductor Drive, Santa Clara,
California 95051 (408) 732-5000 TWX: 910-339-9240
Cables: NATSEMICON Telex: 346-353

National/TTL MSI

RADIATION ANNOUNCES

a "do-it-yourself"

BIPOLAR ROM

512 bits (64 x 8)

65 ns access time

0° to +75°C, \$47.00*

-55° to +125°C, \$61.50*

* 100 — 999 unit price

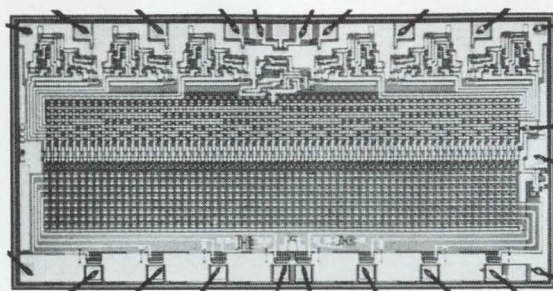

ONE PROM* FOR ALL ROMS

*(Programmable Read-Only Memory)

It's made for a complete range of applications:

- Microprogramming
- Combinational Logic
- Sequential Logic
- Code Conversion

...or any application requiring many ROMS of differing patterns.

HERE'S HOW YOU GET IT!

1. Order the ROM-0512 off the shelf.
2. Generate the truth table.
3. Electronically program each PROM, yourself.
4. Plug it in!

HERE'S WHAT YOU GET!

- Custom programmed ROMS
- 65 ns access time
- DTL/TTL compatibility
- Wired "or" output
- 24-lead dual in-line or 24 lead flat pack

...And we haven't even scratched the surface!

Lexington, Massachusetts (617) 862-1055
Norwalk, Connecticut (203) 853-3646
Frederick, Maryland (301) 662-5400
Oaklawn, Illinois (312) 423-6010
Dallas, Texas (214) 231-9031
Albuquerque, New Mexico (505) 268-3549
Palo Alto, California (415) 321-2280
Long Beach, California (213) 426-7687
P. O. Box 37, Melbourne, Florida 32901 (305) 727-5430

EXPORT SALES, DAGE CORPORATION, STAMFORD, CONNECTICUT

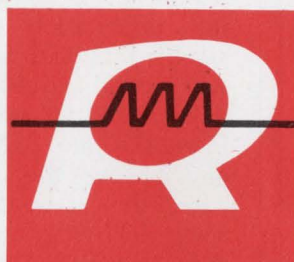

**RADIATION
INCORPORATED**

SUBSIDIARY OF HARRIS-INTERTYPE CORPORATION

MICROELECTRONICS DIVISION

Copyright © 1970 By Radiation, Incorporated

SCHAUER

1%

tolerance

1 WATT ZENERS
ARE A REAL BUY!

ANY voltage from 2.0 to 16.0
at the industry's LOWEST
PRICES!

Quantity	Price each
1-99	\$1.07
100-499	.97
500-999	.91
1000-4999	.86
5000 up	.82

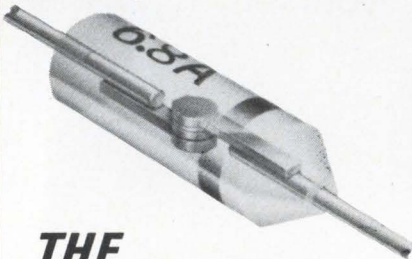

THE HI-RELIABLE!

No fragile nail heads.
Silicon junction aligned between two, parallel, offset tantalum heat sinks . . . great lead tension strength.
All welded and brazed assembly.
High pressure molded package.
Gold plated nickel-clad copper leads.
Write or phone for Form 68-4 for complete rating data and other tolerance prices.

Semiconductor Division

**SCHAUER
MANUFACTURING
CORP.** 4514 Alpine Avenue
Cincinnati, O. 45242
Ph. (513) 791-3030

Who's Who in electronics

The new chairman of the Electronic Industries Association's board of governors, J. Frank Leach, might be cited as one more example of poet George Moore's observation on the Irish that those who succeed are those who leave. "Even the patriot," Moore wrote, "has to leave Ireland to get a hearing."

That's just what Frank Leach did at age 13, emigrating to the United States in 1934. He worked himself up from an automotive tool-and-die-maker's apprentice to vice president and group executive of the Amphenol Components group of the sprawling Bunker-Ramo Corp.

Choppy seas. Now the 49-year-old executive will need his Irish luck when he takes over the troubled helm of EIA's 52-man board of governors in June. The association has been plagued by—and still faces—both internal and external problems. Among them is an in-house squabble over divisional autonomy that came to a head when Consumer Products division vice president Jack Wayman departed temporarily after a dispute with EIA president George Butler last December [*Electronics*, Jan. 5, p. 47]. Two more parties to this long fight for autonomy could materialize with the proposed establishment of two more divisions—a Solid State Products division for semiconductors and microelectronics, and an International division—bringing the total number of EIA product divisions to nine.

Chief among the troublesome issues facing Leach and his EIA board is free trade, which is under attack on both domestic and foreign fronts. First are the U.S. Tariff Commission hearings on a labor-supported proposal to repeal Section 806.3 and 807, which permit importation of articles assembled abroad from U.S. parts with tariff payable only on the value added. Though EIA and other industries are fighting the move and believe they have a strong case, the association anticipates some lobbying ahead before its case is nailed down [*Electronics*, May 11, p. 41]. Also sure to occupy



Leach

Leach in his new assignment is the Tripartite Accord for Electronic Components now being negotiated in Europe which EIA contends would constitute a nontariff trade barrier by requiring special tests of U.S. exports to Britain and Continental Europe [*Electronics*, March 30, p. 69].

Hierarchy. Leach rose to EIA's top ranks the same way as did Butler — through Parts division chairmanship. Leach served as vice chairman during Butler's division tenure. The EIA presidency is a full-time, in-house duty, while board chairmanship is an outside activity for an annually elected industry leader.

Leach started his career in Detroit at the Henry Ford Trades School and spent 23 years in the automotive industry before joining the Amphenol Electronics Corp. in 1956 as vice president of manufacturing—12 years before the company merged with Bunker-Ramo, when he was named vice president and group executive.

He holds a degree in industrial management from Detroit's Wayne State University. Other activities

Beckman 136MHz \$1375.*

Universal Counter and Timer
Fully Programmable
Field Replaceable ICs
Signal Level Indicators

Two Counters in One • Burst Mode • Frequency • Period • Single-Channel Pulse Width & Pulse Separation • Two-Channel Time Interval • Multiple Period • Ratio • Multiple Ratio • 25 μ s Recycle Time

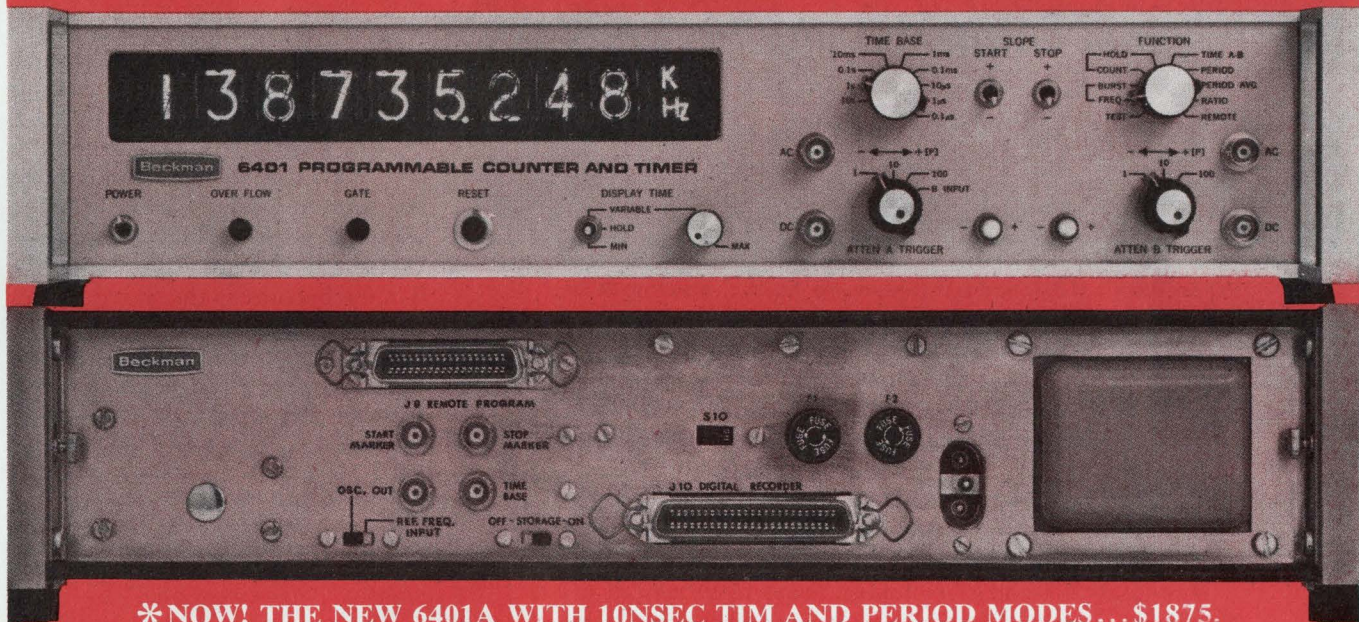

*NOW! THE NEW 6401A WITH 10NSEC TIM AND PERIOD MODES...\$1875.

Beckman

INSTRUMENTS, INC.
ELECTRONIC INSTRUMENTS DIVISION
RICHMOND, CALIFORNIA • 94804

Place your order for the Model 6401 with your local Beckman representative:

Barnhill Associates • Denver, (303) 934-5505 • Albuquerque, (505) 265-7766 • Phoenix, (602) 263-1250 • Houston, (713) 621-0040 • Richardson, (214) 231-2573 • Salt Lake City, (801) 487-1327 • BCS Associates, Inc. • Orlando, (305) 843-1510 • Greensboro, (919) 273-1918 • Huntsville, (205) 881-6220 • Williamsburg, (707) 229-6198 • Plantation, Fla., (305) 584-7556 • Burlingame Associates, Ltd. • Mount Vernon, (914) 664-7530 • New York City area, (212) 933-5555 • Rockville, (301) 427-1255 • Bala Cynwyd, (215) 835-2080 • Syracuse, (315) 454-2408 • New York State, Enterprise 9-6400 • Cozzins and Cudahy, Inc., • Rosemont, Ill., (312) 825-1144 • Cleveland, (216) 725-5660 • Detroit, (313) 585-5159 • Indianapolis, (317) 244-2456 • Minneapolis, (612) 920-1022 • St. Louis, (314) 423-1234 • Instrument Specialists, Inc. • Glendale, Calif., (213) 245-9404 • San Diego, (714) 453-1833 • Santa Clara, (408) 244-1505 • Seatronics, Inc. • Seattle, (206) 767-4330 • Yewell Electronic Sales, Inc. • Lexington, (617) 861-8620 • Easton, (203) 261-2241 • Beckman Instruments, Inc., Electronic Instruments Division, Richmond Operations, (415) 526-7730

INTERNATIONAL SUBSIDIARIES: AMSTERDAM; CAPE TOWN; GENEVA; GLENROTHES, SCOTLAND; LONDON; MEXICO CITY; MUNICH; PARIS; STOCKHOLM; TOKYO; VIENNA

MILWAUKEE BRINGS 'EM BACK ALIVE

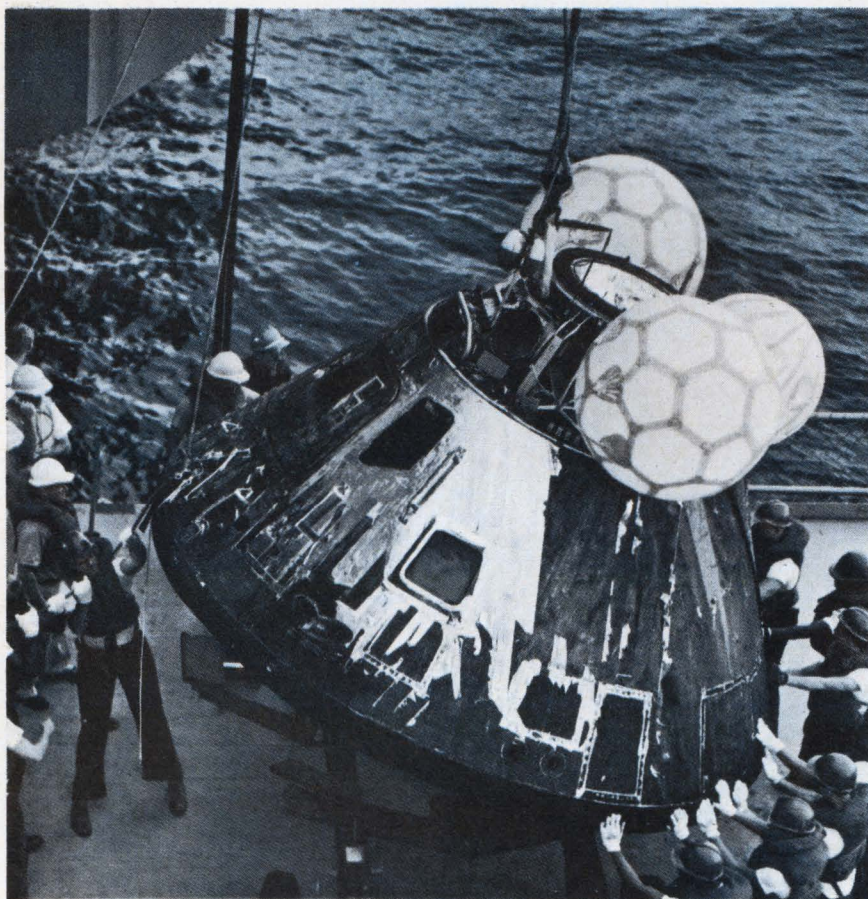

When Apollo 13 landed safely in the Pacific, employees at General Motors' AC Electronics Division had a special reason to feel proud. The made-in-Milwaukee guidance and navigation systems in the Command and Lunar Modules had once again 'brought 'em back alive'.

When Milwaukee Astronaut James Lovell, Jr., Commander of Apollo 13, was told by Mission Control that the AC Electronics Command Module Guidance and Navigation system would be used during re-entry, he said, "Nothing like going first class."

Milwaukee is proud of Astronaut James Lovell and of AC Electronics — both 'first class' examples of two major resources — Milwaukee technical skills and Milwaukee electronics power.

You can learn more by writing or calling for a free copy of the just-published booklet "Data on Milwaukee's Electronics Industry."

Attend Milwaukee's Air Age '70 — July 23-26
Industry Seminars . . . North America's Greatest Air Show

MILWAUKEE
DIVISION OF ECONOMIC DEVELOPMENT
Department of City Development
City Hall, Dept. E-570, Milwaukee, Wisconsin 53202

include directorships of Sola-Basic Inc.; the First National Bank of Northbrook, Ill., where he lives; and the Sunset Ridge Country Club in Winnetka, Ill.

"We've been working on the seekers in anticipation of this one for more than three years," says Louis "Bud" Heilig about the AIM-82, the so-called Dogfight missile. Heilig, 45, is the new vice president and general manager of Philco-Ford's Aeronutronic division. Aeronutronic, with General Dynamics and Hughes, has a \$1.5-million systems-definition contract from the Air Force for the air-to-air missile.

Knowing that new fighter aircraft were coming, Aeronutronic has used a substantial amount of its own funds "to put together the best of infrared and also correlation and contrast seekers," Heilig says. The plum could be a big one, reaching \$500 million if the missile goes on the F-14 and F-15, and is retrofitted to the F-111, F-4, A-6, and A-7 aircraft. A lot hangs in the balance for Aeronutronic in the Air Force competition, and Heilig is the man on the hot seat. Further, there's a chance that no matter who wins the AIM-82 scramble, the Air Force weapon could face a shoot-off with a Navy missile developed in Project Agile, with the winner becoming the standard for both services.

Bang-bang. Heilig says the Air Force would like to see a shoot-off between two of the three systems-definition contractors. If Aeronutronic is successful in getting that far, he says it would definitely not be with a "growth" version of the firm's Sidewinder, but with a substantially new weapon.

Heilig has bachelor's and master's degrees in aeronautical engineering, and was most recently director of tactical missile systems operations at Aeronutronic. Those weapons include the Army's Shillelagh antitank missile, and the Chapparral air-defense missile.

Heilig says the division will probably do predominantly military business through 1974 and beyond, but he's hoping for some significant business in pollution-control systems.

Allen-Bradley cuts space requirements with new sealed type Z cermet trimmers

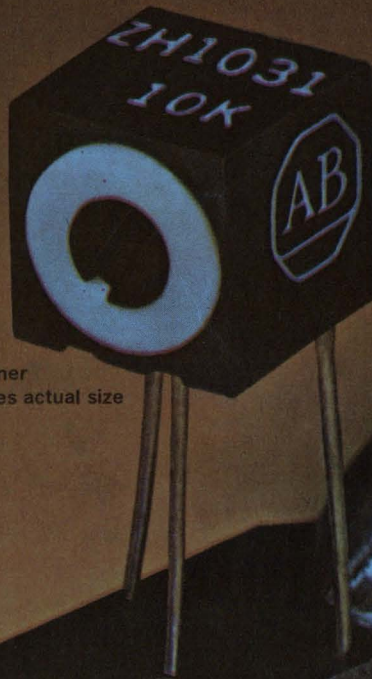

Type Z
½-watt trimmer
shown 5 times actual size

this latest addition to the Allen-Bradley line of cermet trimmers...the type Z...affords high performance in an especially compact package

The cermet material — an exclusive formulation developed by Allen-Bradley — provides superior load life, operating life, and electrical performance. For example, the full load operation (½ watt) for 1000 hours at 70°C produces less than 3% total resistance change. And the temperature coefficient is less than ± 250 PPM/°C for all resistance values and throughout the complete temperature range (-55°C to $+125^{\circ}\text{C}$).

The Type Z is ruggedly constructed to withstand shock and vibration. The unique rotor design ensures smooth adjustment and complete stability under severe environments. The leads are permanently anchored and bonded. The connection exceeds the lead strength — opens cannot occur. Leads are weldable.

The enclosure is *SEALED*. It is both dust-tight as well as watertight and can be potted. Mounting pads prevent moisture migration and also post-solder washout. You can get immediate delivery at factory prices from your authorized A-B industrial electronics distributor. Or write: Marketing Dept., Electronics Div., Allen-Bradley Co., 1201 S. Second St., Milwaukee, Wis. 53204. Export Office: 1293 Broad St., Bloomfield, N. J., U. S. A. 07003. In Canada: Allen-Bradley Canada Limited.

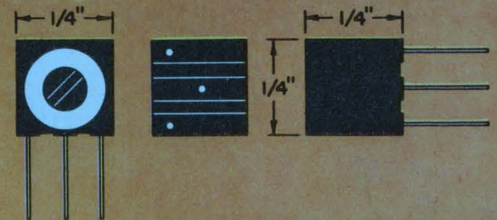

SPECIFICATIONS SUMMARY

Adjustment: Horizontal or vertical.

Temperature Range: -55°C to $+125^{\circ}\text{C}$.

Resistances: 50 ohms through 1 megohm.
Lower resistances available.

Tolerances: $\pm 20\%$ standard, $\pm 10\%$ available.

Resolution: Essentially infinite.

Rotational Life: Less than 2% total resistance change after 200 cycles.

Rotation: 300° single turn.

End Resistance: Less than 3 ohms.



ALLEN-BRADLEY

QUALITY ELECTRONIC COMPONENTS

Our engineers have to do a good job, because our salesmen don't.

Now don't get us wrong. Our salesmen are great guys and they've made us the world's largest power supply company. But when it comes to our modular power supplies, they do very little selling. And we don't blame them because they would rather sell \$1,000 instruments than \$89 modular power supplies.

Yet, people have bought over 25,000 of them (ranging from 0 to 330 Vdc—to 300 watts). And 65% of these are repeat orders. Why? Before you turn the page, may we quickly give you six hard-nosed reasons:

1. We're the most experienced in the industry — 26 years in this business.
2. When it comes to the acid test of any power supply — response time — we out-perform all others: 20 — 35 μ s.
3. In all critical specifications, ours surpass all others. (For instance, our regulation is $\pm 0.005\%$ for line and load changes, ripple is 300 μ V rms — 3 mV p-p.)
4. Our supplies require no heat sink in ambients to 71°C.
5. Our modular power supplies and accessories are UL listed.
6. We inventory more power supplies than most manufacturers sell in a year. (And we burn in every one for 48 hours before we ship it.)

Those are the same reasons why the industry has bought over \$150 million worth of Sorensen power supplies.

And those are the same reasons why you may want to consider Sorensen the next time you consider power supplies. For complete information on any of our power supplies (or for our 124-page Power Supply Handbook and Catalog) call our Applications Engineer, Steve Charleston (collect) at (203) 838-6571, or write to him at Sorensen, Richards Ave., Norwalk, Connecticut 06856. Circle 200 on the inquiry card.

Sorensen
POWER SUPPLIES

AN OPERATION OF RAYTHEON CO.

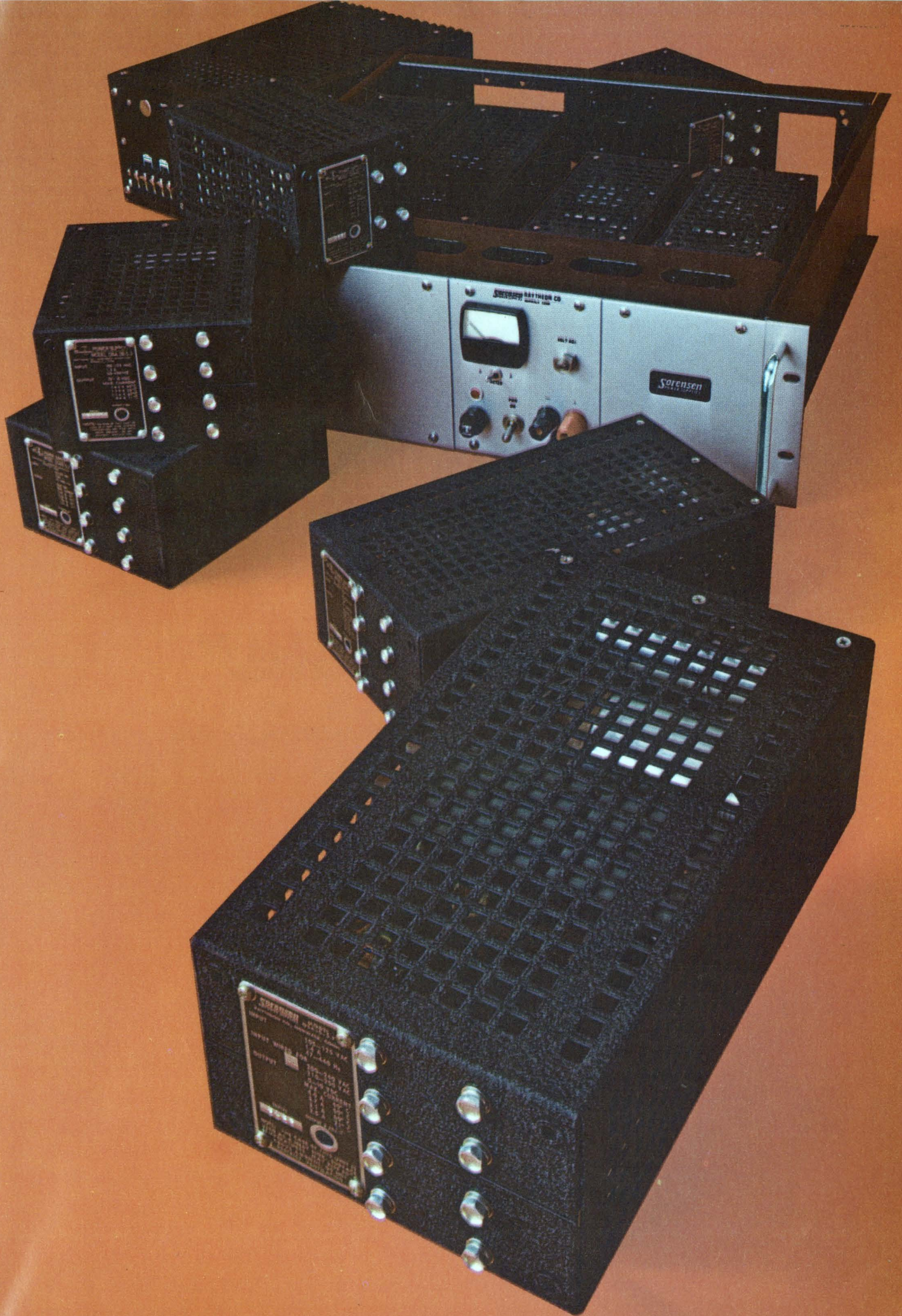



**“No one made a
small, quiet, medium-speed
chain printer for \$9500.
So Mohawk did.”**

George C. Hohl, OEM Marketing Director, discusses a new product.

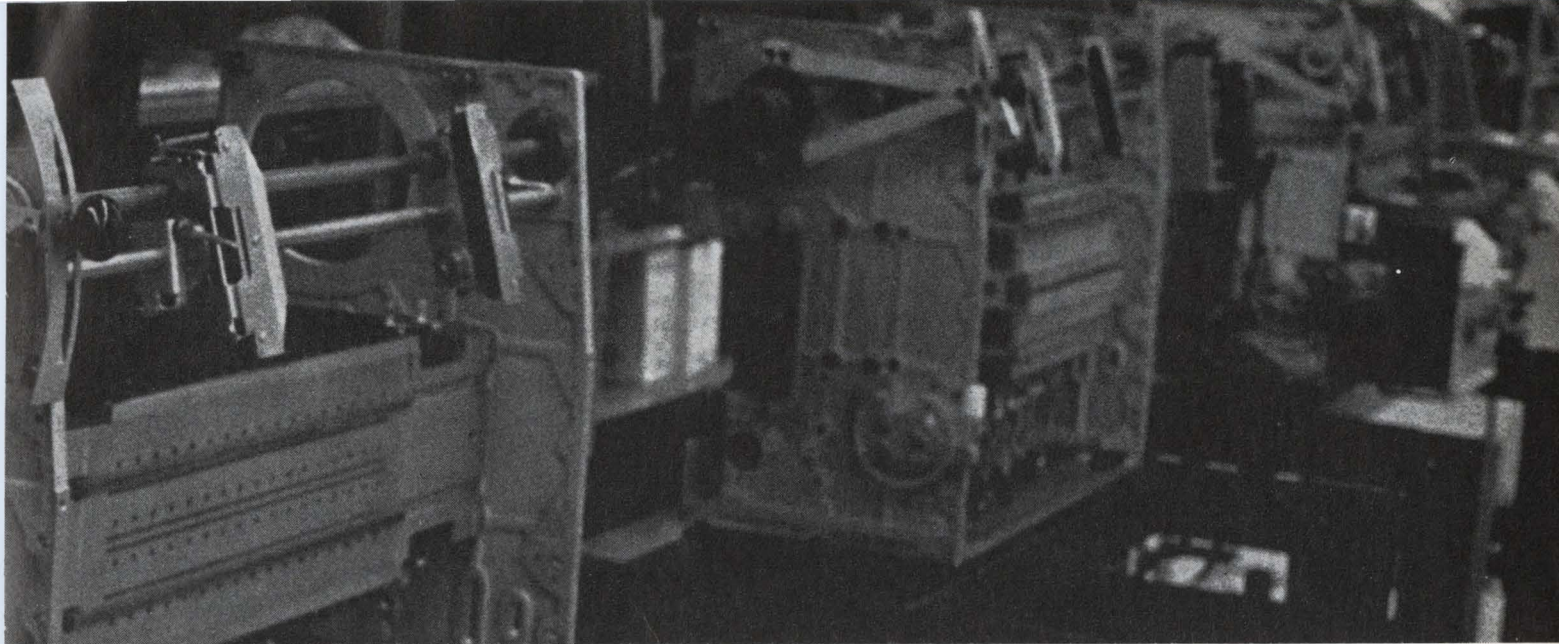

“We saw a gap in the printer field. Either you paid a lot of money to get a lot of speed and sophistication, or you could pay a little and get very little in return. We decided to aim our printer somewhere in between.

“Chain printers are mechanically simpler, easier to maintain, less expensive. Their flat face characters give good print characteristics, too.

“Our design requirements were rough. We wanted 300 lines-per-minute with such niceties as easily changeable fonts, and yet we wanted to sell it for less than \$10K. It had to be small, and yet we couldn't lose accessibility. The design engineers grumbled, but they made it.

“The changeable font cartridge is great—an operator can quickly switch the font chain—and we're offering fonts from 16 to 128 characters.

“We designed a disposable ribbon cartridge to make ribbon

changes quick and clean. Paper handling is enclosed to stay clean, too. And everything that could be modularized, was modularized.

“We considered noise reduction vital—anyone who has worked in a printer room knows why. Well, compared to other printers, you'd hardly know this one was working.

“We're selling the printer for \$9500 in OEM quantities, and some variations cost even less. So you get a lot of performance in a very little printer—for very little money.”

Mohawk Data Sciences Corp.
Herkimer, New York



TUBULAR,
BULKHEAD
MOUNTING TYPE

RFI/EMI FILTERS

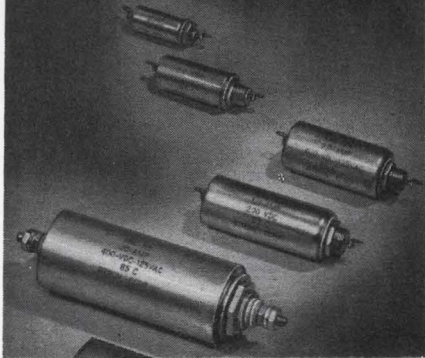

Rtron

Cylindrical Style Interference Filters

that reduce or eliminate unwanted noise or signals. Small size, light weight, maximum attenuation. Voltage current or insertion loss characteristics required, determine physical size. Maximum isolation of terminals and high frequency performance are assured by threaded neck design for bulkhead mounting. Feed-thru capacitor circuitry conservatively rated for both military and commercial applications.

Rtron corporation

P.O. Box 743 Skokie, Illinois 60076
312 • 327-4020

- Send catalog and prices.
- Have Representative call.
- Specifications enclosed on Multi-circuit or custom design filters. Send estimate.

Name _____

Firm _____

Address _____

City _____

State _____ Zip _____

Meetings

Design automation widens scope

For the seventh time since its inception, the annual Design Automation Workshop will be held in San Francisco. The dates for the 1970 session are June 22-25. As usual, there will be assorted computer-aided-design papers, but unlike past meetings, discussions will range in and out of electronics.

Of particular interest in the non-electronic area is the discussion of architectural design. It will cover employment of the computer to dynamically analyze and test, via simulation and cathode-ray tube display, effects of earthquakes on high-rise structures. The effects are displayed on a cathode-ray tube for easy observation.

There also will be a description of a new computer program, called Matran, that aids in planning space in a building. A description of the functional areas to be allocated, the square-footage required, and adjacent requirements are the inputs. The output is an optimal allocation of space, including an analysis of the flow of people.

On the beam. Another nonelectronic sector is structural design. Here computer programs are applied to the optimum design of welded girders. These designs also are of interest to electronic engineers—they represent application of difficult nonlinear optimization problems common to both electronics and nonelectronics fields.

But the main part of the conference still is devoted to electronics. Included here is integrated-circuit design, logic and system design, circuit diagnosis and testing, design-automation systems, and circuit-board and analog design.

In the IC field, a new design-automation program is described by Sheldon B. Akers, James M. Geyer, and Donald L. Roberts of GE for automatic layout of IC masks. The program is intended for small- and medium-scale program applications where only a single conductor layer is permitted. A second paper, by F.R. Ashley and H.J. Savard of Bell Labs, describes

a new system that makes very precise measurements of coordinates in a plane. The system is primarily intended for positional measurements of photographic images on a glass plate, as would appear in the various stages in mask generation for IC's.

Mea culpa. Another system will be presented by F.M. Goetz of Bell Labs for generation of test sequences for detection and location of faults in logic circuits. Here a time-shared system is used to allow logic tests to be designed and validated interactively.

While no formal panel sessions are planned, the conference has scheduled get-together sessions at the end of each group of topics.

For further information contact Pat Pistille, Bell Telephone Laboratories, Whippany, N.J.

Comeback

A rebound after last year's lackluster session in Minneapolis is promised this year at the IEEE's Computer Conference. If the advance program is any indication, there will be lots of material for engineers to chew on. The conference is to be held in the nation's capital at the Washington Hilton Hotel, June 16-18.

Leading off the conference is a single session on tomorrow's technology and markets—which includes papers on software, semiconductor technology, and the conference's main theme: memories and peripherals. Following will be three parallel sessions on each of the three days. Subject matter is fairly well divided so that choosing between them shouldn't be too difficult.

It's logical. The first trio is on packaging, computing power in terminals, and new memory devices. In the terminal session, Ivan E. Sutherland, of the Evans and Sutherland Computer Corp., will ask, "How much logic should be

(Continued on p. 24)



CARPENTER ELECTRONIC ALLOYS...MATCHED TO EVERY SPECIAL REQUIREMENT OF THE ELECTRONIC DESIGN ENGINEER.

Today's electronics industry is being challenged to set the stage for the new decade. A decade that will see more advancement in technological growth than has been recorded in the past century.

Much of this growth will require highly selective materials with critically balanced properties and characteristics.

Because Carpenter has always anticipated the needs of the electronic design engineer, many of these advanced materials are already in existence . . . available through the Carpenter Service Center network. Others are being developed right now

in Carpenter's Research and Development laboratories.

The complete range of Carpenter electronic alloys includes Magnetic Core Irons, Glass-Sealing Alloys, High-Permeability Alloys, Electrical-Resistance Alloys, Magnetostrictive and High-Saturation Alloys, Controlled-Expansion Alloys and others. The flawless quality of these materials can provide new standards of quality for your products of the seventies. See your Carpenter representative for full details. Steel Division, Carpenter Technology Corporation, Reading, Pa. 19603.

European Office: Emmastraat 39, Amsterdam-Z, The Netherlands

CARTECH CARPENTER
TECHNOLOGY

RMC

TEMPERATURE COMPENSATING SOLDER-INS

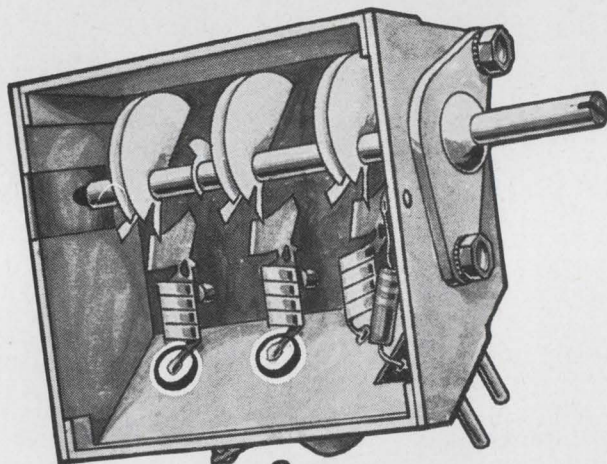

for UHF APPLICATIONS

SPECIFICATIONS

CAPACITANCE: Within tolerance @ 1 MC and 25°C

CAPACITANCE TOLERANCES: ±5%, ±10% or ±20% (but not less than ±.25 pf)

WORKING VOLTAGE: 500 VDC

INSULATION RESISTANCE: Greater than 7500 Megohms @ 500 VDC

FLASH TEST: 1000 VDC for 1 second

ELECTRODE: Pretinned for assured solderability

These new solder-in capacitors are designed for use in UHF applications requiring the absolute minimum in lead inductance effects. Solder-ins are available in a wide range of temperature coefficients in capacities from 1.5 to 105 pfd.

If your application requires special physical or electrical characteristics, contact RMC's Engineering Department.

Write today on your company letterhead for your copy of the RMC Catalog.

Meetings

(Continued from p. 22)

put in a display terminal?" Presumably his answer will be "lots," since terminals are one of his company's major products. Among the new memory devices to be described are a large ferroelectric array from IBM and a sonically accessed magnetic film memory from Sylvania.

Highlight of the second day will be debates between proponents of different memory technologies. The debates are set up in a tree structure, that format so dear to the hearts of programmers: following a debate on the merits of magnetics vs. semiconductors, there will be a second debate on the magnetic side pitting cores against plated wire, and a third debate comparing hybrid and single-technology semiconductor arrays. In the evening, the debaters will have at it again.

On the morning of the last day there will be three more simultaneous sessions: advanced terminals, functional and control memories, and a comparison of mechanical and electronic serial-access memories. Then, at the end of the conference, there will be a single session on system architecture, with Michael Flynn of Northwestern University as chairman. Among other things, it features papers by Daniel Slotnick of the University of Illinois' Illiac 4 project, and by Gene Amdahl of IBM.

For further information contact Don E Doll, IBM, 18100 Frederick Pike, Gaithersburg, Md. 20760.

In the air

Environmental control will be the focus of two meetings to be conducted consecutively June 15-18 at New York's Hotel Americana. The first, Profit Opportunities in Pollution Control, will be sponsored by McGraw-Hill's Chemical Engineering and Chemical Week. It will feature speakers from such firms as Universal Oil, Research-Cottrell, and Koppers. Information may be obtained from Suite 2600, 330 W.

(Continued on p. 26)

DISCAP
CERAMIC
CAPACITORS

RMC

RADIO MATERIALS COMPANY

A DIVISION OF P. R. MALLORY & CO., INC.
GENERAL OFFICE: 4242 W. Bryn Mawr Ave., Chicago 46, Ill.
Two RMC Plants Devoted Exclusively to Ceramic Capacitors
FACTORIES AT CHICAGO, ILL. AND ATTICA, IND.

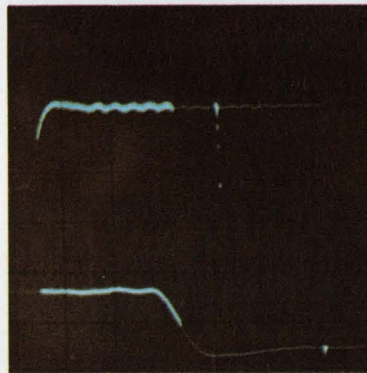
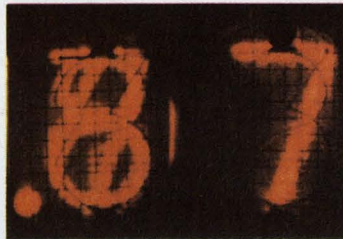
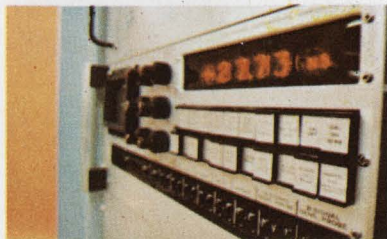
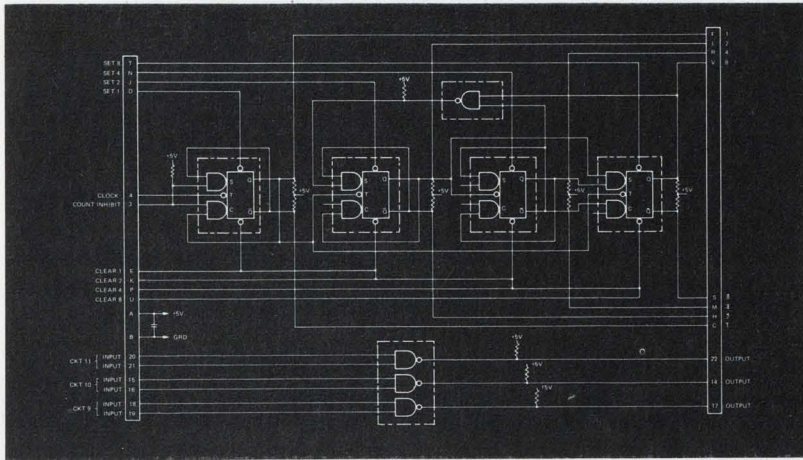

E-H the systematic solution

Whether you need a complete dynamic test system or the ideal components to integrate with your present system, look no further. E-H Research Laboratories, Inc. and its subsidiary, Automated Measurements Corporation, offer you the perfect solution.

For example, the **E-H 1139/1420 programmable timing unit and pulse driver combination** is a new generation in pulse instruments that fits the needs of any systems designer. These two rack-mounted units are so completely programmable that there are no front-panel knobs to twist. They're ideal for any systems applications requiring pulses from 1kHz to 10MHz. And they offer the designer such features as complete waveform control, with programmable width and delay from 10ns to 100 μ s, amplitude from $\pm 3V$ to $\pm 10V$ with programmable attenuation from X1 to X40 and rise and fall times programmable from 5ns to 13 μ s.

The perfect mate to the E-H 1139/1420 is the **AMC Model 1000 Waveform Analyzer**. The AMC 1000 was designed specifically for programmed systems application. It combines in one compact box the functions of sampling oscilloscope, digital counter and digital voltmeter to provide time and voltage measurements of sampled waveforms. The AMC 1000 is the most advanced instrument of its kind, with features including $\pm 1\%$ time measurements all ranges, fastest measurement rates, 10 remote sampling channels, all solid-state construction, serial-by-character or parallel programming, built-in program memories, stored BCD outputs, built-in floating DVM, and digital readout.

This is just a sample of the broad line of E-H and AMC equipment available from your E-H representative. He can offer you a complete system or the most advanced components to give you the systematic solution to your problems today. And tomorrow.



E-H RESEARCH LABORATORIES, INC.

515 Eleventh Street • Box 1289, Oakland, California 94604 • Phone: (415) 834-3030 • TWX 910-366-7258

In Europe: E-H Research Laboratories (Ned) N.V., Box 1018, Eindhoven, The Netherlands, Telex 51116

In Japan: Iwatsu Electric Company, Ltd., 7-41, 1-Chome Kugayama Suginami-Ku, Tokyo 167, Japan



**TINY....
BUT - MVMs
CAN TAKE IT!**

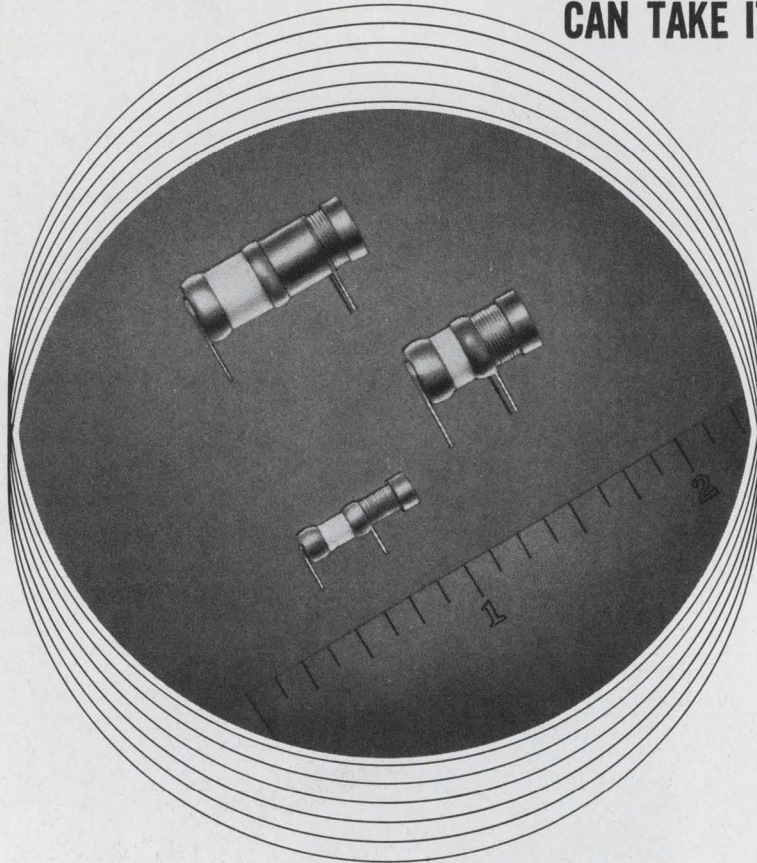

**THESE NEW HIGH Q AIR VARIABLES
ARE RUGGED**

JFD has developed three sizes of unusually rugged air variable capacitors. All three feature a unique internal guiding mechanism with a positive stop. The result: concentricity is constant and these capacitors can withstand conditions of extreme shock and vibration.

Further, newly developed metal biasing elements provide smoother, more constant torque during and beyond life cycling.

Other unique features of the series are:

- Engineered to withstand heat — during soldering.
- Internal air meshing shells are silver plated to provide best surface conductivity and long life.

All MVM's are completely interchangeable with competitive models.

Write for MVM catalogs.

MVM-003 — Microminiature in size. Capacitance range is 0.35 pf to 3.5 pf. The Q factor measured at 3.5 pf and 100 MHz is 5,000. Available in 2 models.



MVM-010 — Adjustable from 0.8 pf to 10 pf. Q greater than 3,000 measured at 10 pf and 100 MHz. Available in 4 models.

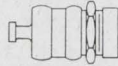

MVM-020 — Adjustable from 1 to 20 pf. Q ranging from 3,000 at minimum capacitance, to 1200 at maximum capacitance. Available in 4 models.

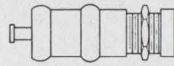

Illustrations actual size.



"TODAY'S COMPONENTS BUILT FOR TOMORROW'S CHALLENGES"

JFD ELECTRONICS CORP. / COMPONENTS DIVISION

15th Avenue at 62nd Street / Brooklyn, New York 11219 / Phone 212-331-1000

SUBSIDIARY OF RIKER-MAXSON CORPORATION

Meetings

(Continued from p. 24)

42nd St., New York, N.Y. 10036. The second meeting, to be held June 16-18, is the First Annual Conference on Industry and the Environment. It will be sponsored by those two magazines plus another McGraw-Hill publication, Air and Water News. There will be sessions on regulation, technology, and management. Information is available from Suite 1800, 330 W. 42nd St., New York, N.Y. 10036.

Calendar

Conference on Precision Electromagnetic Measurements, IEEE; National Bureau of Standards, Boulder, Colo., **June 2-5.**

Silicon Device Processing, American Society for Testing and Materials; National Bureau of Standards, Gaithersburg, Md., **June 2-3.**

National Cable Television Association Convention; Palmer House Hotel, Chicago, **June 7-10.**

Eastern Electronics Packaging Conference, IEEE; Massachusetts Institute of Technology, Cambridge, **June 8-9.**

International Conference on Communications, IEEE; San Francisco Hilton Hotel, **June 8-10.**

Conference on Solid State in Industry, IEEE; Statler-Hilton Hotel, Cleveland, **June 15-16.**

Applied Superconductivity Conference, Bureau of Standards, University of Colorado, Office of Naval Research, and American Institute of Physics, Boulder, Colo. June 15-17.

International Symposium on Information Theory, IEEE; Hotel Huis ter Duin, Noordwijk, Netherlands, **June 15-19.**

International Computer Conference, IEEE; Washington Hilton Hotel, **June 16-18.**

Solid State Sensors Symposium, Instrument Society of America, IEEE; Hotel Radisson, Minneapolis, **June 18-19.**

Design Automation Workshop, IEEE; Sheraton Palace Hotel, San Francisco, **June 21-25.**

4096 bit memory ...in stock

You can order from local stock the prototype quantities you need in a number of configurations, such as, 1024 x 4, 2048 x 2 and 4096 x 1. What do you need? The Computer Microtechnology Inc. CM2400 series of 4096 bit read/write IC memories are available now at your local Kierulff, K-Tronics, F-J-R or Schley distributor. Call him today.

The CM2400 series features . . . MOS and bipolar technologies . . . TTL inputs and outputs . . . access time 400 ns max . . . cycle time 600 ns max . . . low power of 0.4 mw/bit typ . . . input clamp diodes to minimize line reflections. How about that?

You could be designing in the CM2400 series 4096 bit read/write memory. Lead the pack, don't follow it.



Computer Microtechnology Inc.
610 Pastoria Avenue
Sunnyvale, Calif. 94086
(408) 736-0300



General Electric helps you solve the tough ones

GE has the broadest line of electronic components in the industry. From the tiniest integrated circuits to powerful high performance motors, GE components help you solve your tough problems . . . in design, in performance, in economy. Take a look at these GE problem solvers.

p.s.1 General Electric delivers 19 new epoxy TO-18 transistors for demanding applications. GE's encapsulated devices are performance-proved, reliable. And they cost less than metal-case devices.

The new epoxy transistors include PNP types, PNP/NPN complementary pairs, and low level amplifiers. They offer breakdown voltages as high as 60V with excellent beta linearity and dissipate up to 500 mW. They handle collector currents up to 1 amp. Get spec sheets on GE's new epoxy transistor lineup. Circle number 316

p.s.2 GE meter relays put accurate dependability into critical new medical systems. A new heartbeat monitor, for instance, uses GE meter relays to indicate the heart beat visually. And they have the added capability to sound an alarm when preset limits are reached.

Either the easy-reading BIG LOOK® or the low profile HORIZON LINE® styles feature solid state control for precise accuracy. Put GE dependability into your critical circuits. Circle 317 for details.

p.s.3 Forget capacitor leakage problems with GE military-type tantalum wet slugs. The special GE design incorporates a double elastomer seal that maintains performance even through the 35 temperature cycles required by MIL-C-3965E. And life tests show a capacitance change of less than 5% in 2000 hours operation.

GE wet slugs come in 4 case sizes for applications up to 125 volts dc; 1.7 to 1200 μ f. GE's 20 years experience is your assurance of dependability. For complete information, circle 318

p.s.4 GE Microwave Circuit Modules save up to 60% in size and weight for critical communications and radar systems. GE MCM's may be used as oscillators, amplifiers, multipliers, detectors, mixers, integrated isolators and circulators. And they are extremely stable even in adverse environments.

The GE C-2003E, for example, is used in pulsed transponder applications. It operates dependably from -54 to $+125$ C and withstands vibrations at 15G from 20 to 500 Hz. Frequency stability is ± 3 MHz with minimum life of 500 hours operation. Get GE's MCM catalog. Circle 319

p.s.5 New magnetic material gives 6% increase in residual flux density . . . resists demagnetization. GE's new Alnico 8C was developed for applications requiring high resistance to demagnetization plus a higher flux output than other Alnico 8 alloys.

Alnico 8C is the latest development in GE's complete line of Alnico permanent magnets. It's another example of the technical expertise you get when you specify General Electric to solve your magnet problems. For details on the entire GE Alnico family circle 320

p.s.6 Get more capacitance in less space with GE computer-grade capacitors. These aluminum electrolytic units deliver up to 540,000 μ f at 5 VDC (34,000 μ f at 100 volts) . . . highest capacitance per case size available. They are rated for continuous duty at 65C or at 85C

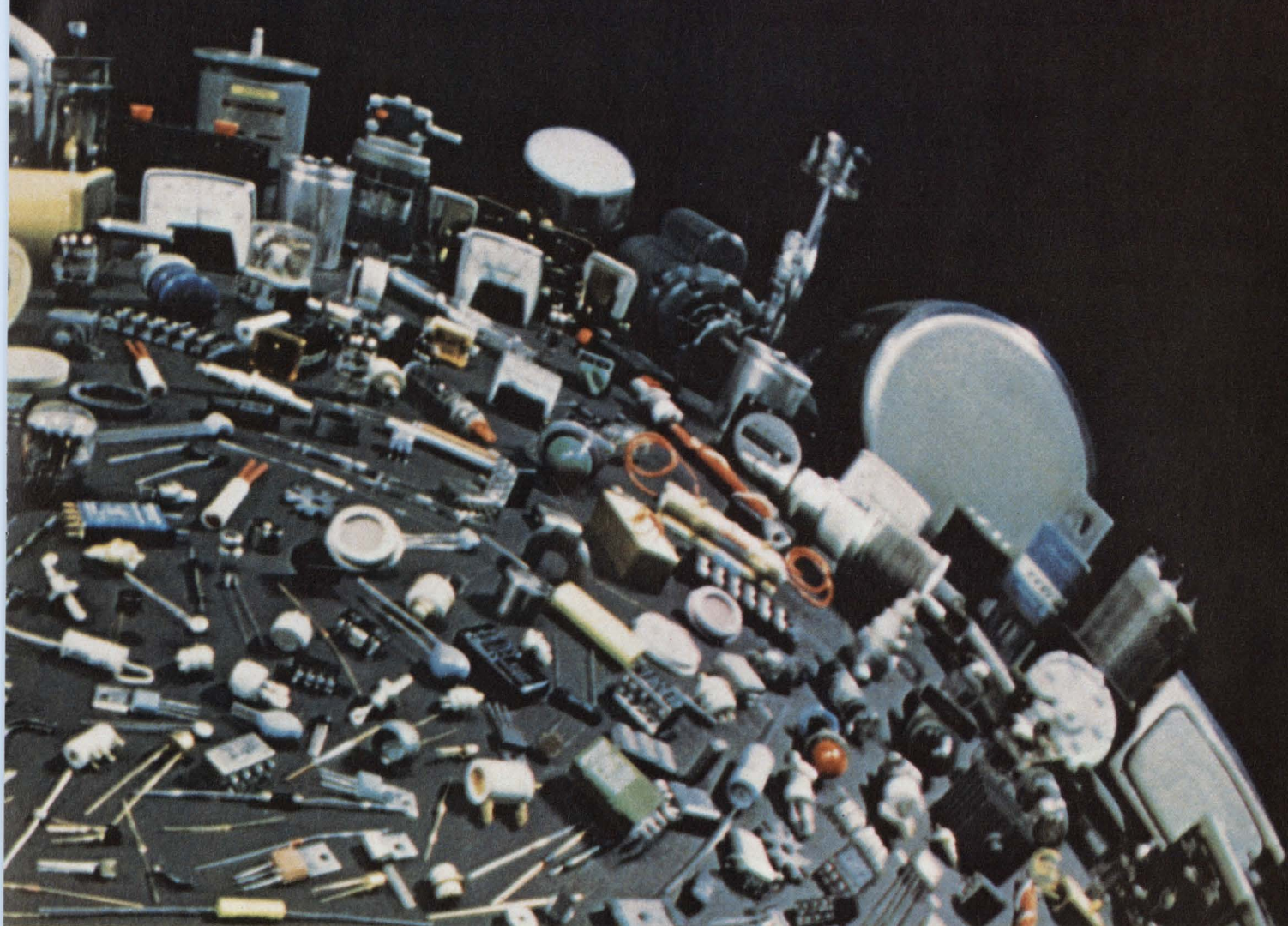

with the broadest line of electronic components

with proper voltage derating.

GE computer grades feature high ripple current capability with low equivalent series resistance. Nine case sizes are available. Circle 321

p.s.7 Rechargeable GE nickel-cadmium batteries give you longer operating life. Proved GE reliability puts longer battery power into your application at an economical price.

Nominal ratings range from 0.1 amp-hours to 4.0 amp-hours in sealed cells and up to 160 amp-hours in vented types at the one-hour rate. Put dependable GE power in your circuit. Circle reader card number 322

p.s.8 Programmable UJT lets you control the key parameters with just two resistors. That's right. You control η , R_{BB} , I_p and I_v so that you design your own unijunction as you design the circuit.

Low leakage and peak point currents make GE's D13T programmable UJT a natural for long interval timers. High breakdown voltages, fast trigger pulsing and low voltage operation add versatility. And the plastic TO-98 case helps solve economy problems. Get full details. Circle number 323

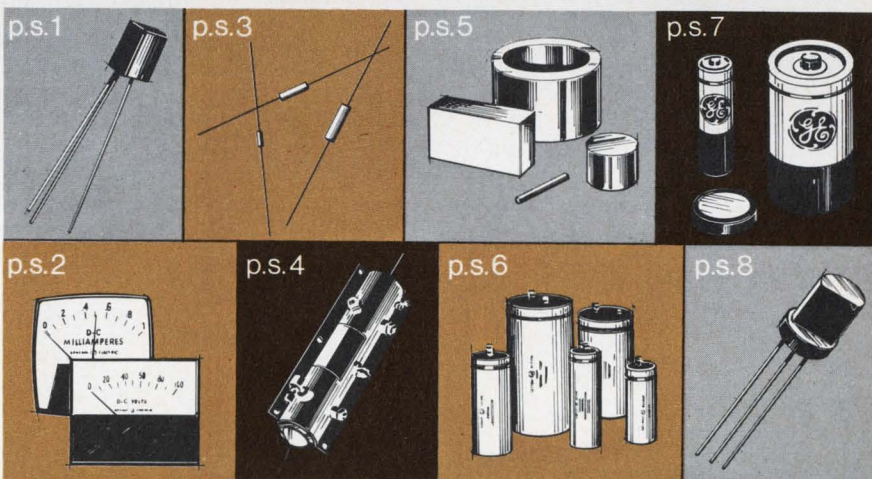

Let General Electric help solve your component problems. Call your nearest Electronic Components Sales Operation Office. Or check with one of the many authorized GE distributors. P.S. Problems? General Electric has solutions.

285-64

GENERAL  ELECTRIC

**Reliability is six things we do
that nobody else does.**

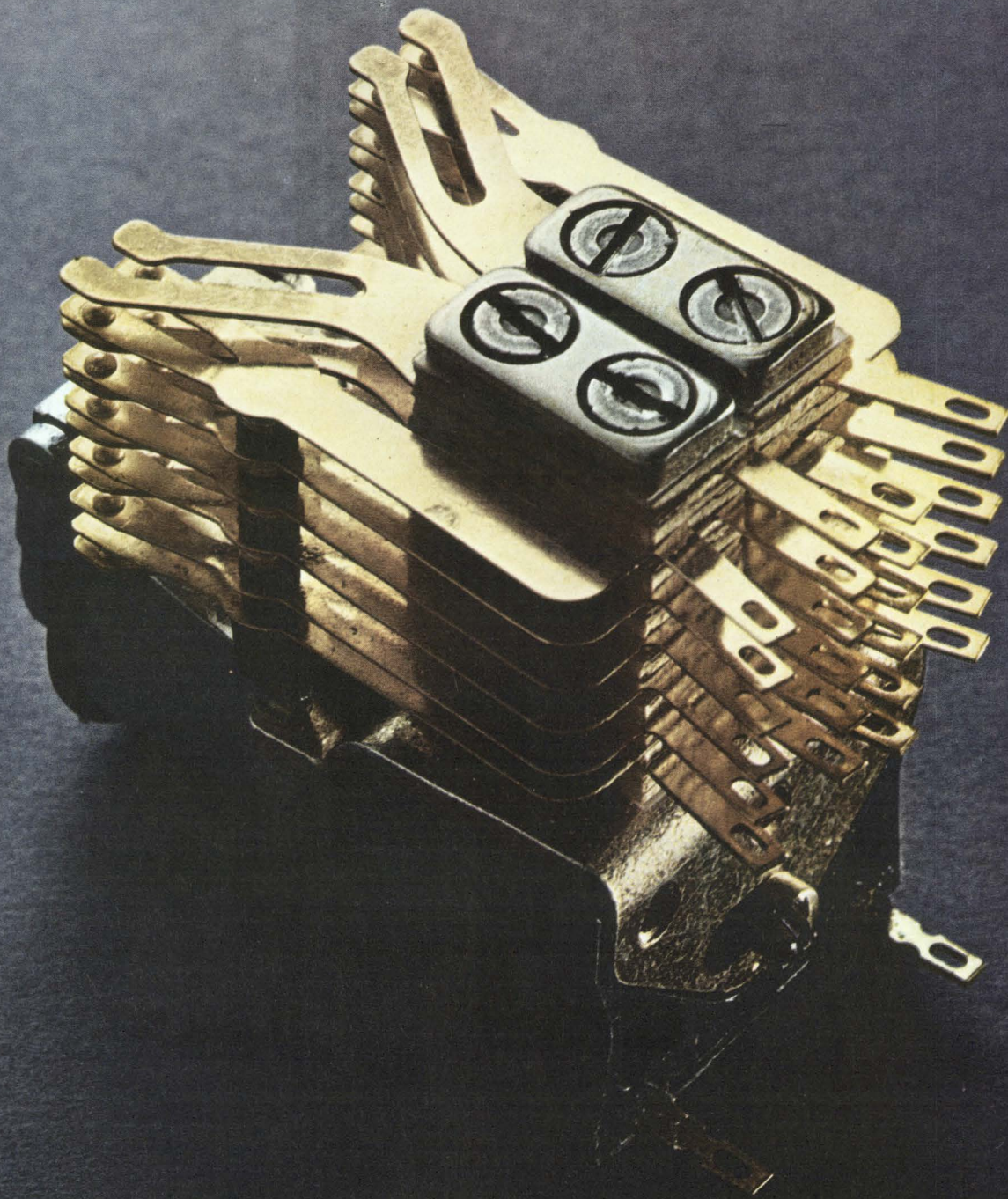

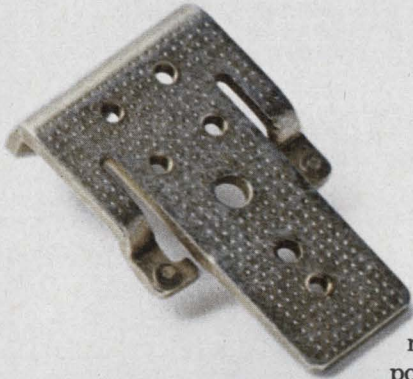

We're fanatics.

We build our relays stronger than we have to. That way, they last lots longer than they ever have to. Our Class E relay (shown on the opposite page) is a good example of our way of thinking.

The industry's strongest heelpiece.

We make the strongest heelpiece in the industry. A gigantic machine bangs them out extra fat and extra flat.

Extra fat to carry a maximum of flux. To handle big loads. Extra flat so that once an AE relay is adjusted, it stays adjusted.

Since our backstop is part of the heelpiece, it's just as thick and flat. But, tough as it is, the slightest wear here would throw the entire contact assembly out of whack. So, to be safe, we weld two tiny, non-magnetic pads where the armature arms meet the backstop. You might say we created the no-stop backstop.

Three parts that'll wear like crazy.

When you build a relay like a small tank, you have to think of everything. We try. Right down to the tiniest part. For example, we make our armature arms and bearing yoke extra thick.



Thicker than years of testing and use say they have to be. Then, to make sure they don't cause wear problems, we insert a hardened shim between the hinge pin and the frame. The pin rides on the shim, instead of wearing into the heelpiece. (You can forget the bearing, it's permanently lubricated.)

Buffers with lots of muscle.

We make our buffers of a special tough phenolic material that lasts. And lasts. And lasts. All without wear or distortion. Another reason why our relays stay in whack.

To make sure our buffers stay in place, we weld the buffer cups to the armature arms. We weld, instead of using rivets, because our lab found that rivets have a habit of falling out.

For the very same reason, we weld buffer cups to the contact springs. And also use the same special tough phenolic buffers.



No, we didn't forget the contact springs.

We have some strong feelings as to what makes a contact spring reliable. Our sentiment is that two contacts are better than one. So, we bifurcate all the springs, not just the make and break. This slotting and the addition of another contact to each spring means you get a completed circuit every time.

We make each set of contact points self-cleaning. The bad stuff doesn't have a chance to build up.

Now, what's different about our bobbin?

Our bobbin is one piece—molded of glass-filled nylon. This provides the maximum in insulation resistance.

Because our bobbin is nylon, we don't have to impregnate with varnish. Moisture and humidity have no effect on the stubborn nylon material. No effect means no malfunctions for you to worry about.

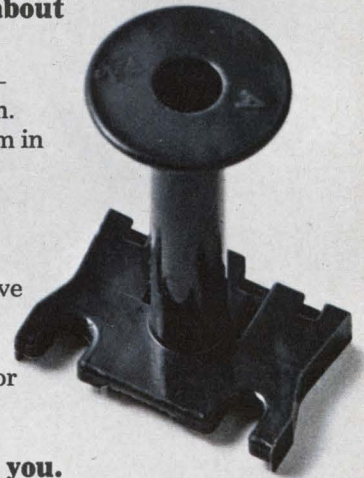

What all this means to you.

What this all adds up to is reliability. The kind of toughness no one else can give you. It means an AE relay works when it's supposed to, longer than it has to.

Isn't this the kind of reliability you really need? Automatic Electric Company, Northlake, Ill. 60164.

AUTOMATIC ELECTRIC

SUBSIDIARY OF GENERAL TELEPHONE & ELECTRONICS

Circle 31 on reader service card

Two sound reasons for buying our keyboard.



The keyboard. The price.

First, the keyboard. It's all solid state. The world's first use of an integrated circuit as a keyboard switching element.

Solid state switching eliminates the usual keyboard levers, cams, pivots, ratchets, black boxes and other assorted moving parts. In fact, all the things that normally wear out and cause service problems.

Next, the price. Only \$98 in production quantities of 2500 units for a standard 50 key array (less enclosure).

To get the price down to \$98 took an investment of 12 years and many hundreds of thousands of dollars. Think about that for a minute. If you're not prepared to make the

same dollar commitment, maybe you should be looking to us for your keyboard needs.

Think too, about the triple bonus you get with every MICRO SWITCH keyboard. Things that money can't buy.

Like more than a dozen years of keyboard manufacturing experience. A proven quality assurance program. And the ability to meet the most demanding delivery dates.

You'll benefit. And so will your product.

Let's get together and discuss the keyboard business on any basis you consider important. Dollars. Technology. Compatibility. Reliability. Delivery. They're all important to us. Call or write us and see.

MICRO SWITCH

FREEPORT, ILLINOIS 61032

A DIVISION OF HONEYWELL

Electronics Newsletter

May 25, 1970

Usable L-band data gleaned from ATS-5

NASA has succeeded in getting usable L-band ranging, communications, and multipath data from its ATS-5 satellite despite the satellite's continued spinning [*Electronics*, Dec. 22, 1969, p. 33]. On a trip through the Northwest Passage aboard the icebreaking tanker Manhattan, Richard M. Waetjen of the Electronic Research Center's satellite programs office with an engineer from Applied Information Industries of Morristown, N.J., succeeded in measuring an 18-decibel carrier-to-noise ratio with a 3-foot-diameter antenna. This, in turn, made possible lines of position accurate to within a mile of the position established by the Manhattan with the Transit satellite. The key to the experiment was a proprietary method of retaining phase lock to the satellite signal. Demodulation and decoding methodology also are proprietary with Applied Information.

Even though elevation angles often were only 2° to 4° above the horizon at latitudes of 70° and 75° north, "We retained a 6 to 8 db margin at all times," says Waetjen. "Fades were a nominal 2 to 4 db, and multipath never was an apparent problem and usually just wasn't noticed."

Two conclusions are being drawn from the data. First, L-band appears to be practical for both ranging and communication and is little troubled by the ionosphere. Second, TRW now faces competition from Applied.

DOT to carry on satellite work

The Department of Transportation—and by proxy the FAA—is getting into the satellite business through its new System and Technology Center (until July 1 NASA's Electronics Research Center). Leo Keane, head of the center's satellite program office, says that his group, trimmed from 30 to 26 people, will stay with the center and concentrate on near-term goals. Among them: possible fly-off of vhf and L-band navsat equipment using balloon-mounted dual transponders.

After the test aboard the Manhattan (see above), Keane isn't too worried about ionospheric effect on L-band signals, and would use the balloon experiment to refine link parameters paving the way for operational aeronautical services satellites. Keane expects growing interest in domestic air traffic control satellites during and after deployment of mid-Atlantic satellites, and says that his group will carry over work funded by the FAA and NASA on an ATC center for satellite use.

Applicon unveils hardware-software artwork system

A unified hardware-software system for IC, LSI, printed-circuit, or hybrid-circuit artwork layout has been unveiled by Applicon Inc. of Burlington, Mass. Called the Design Assistant, it is said to be the first commercially available system of its kind and uses an IBM 1130 computer, a storage-tube display terminal and data entry tablet from CompuTek, as well as an interactive software package. The latter is a refined and tightened descendant of the MIT Lincoln Laboratory mask program [*Electronics*, Jan. 6, 1969, p. 54].

The software is complete; no user programming is needed. However, a user first must build a library of up to 1,000 component forms to be stored on a 500,000-word disk. The software makes it possible for these forms to be edited, duplicated, moved, flipped over, or repeated within a layout.

The user can work with all layers of a mask set simultaneously up to

Electronics Newsletter

16 levels. The system's output can be cards, magnetic tape, or paper tape for use with commercial artwork generators. Package price is \$63,000, without the computer; first delivery will be about June 1.

Sanders to show ATC display system

Sanders Associates is coming on strong as a competitor of Raytheon for the FAA's computer display channel, an air traffic control crt console. With a \$2.7-million contract for demonstration of its system—a 22-inch computer-readout crt and tabular display coupled through a Sandac 200 communications processor to an IBM 9020 mainframe—Sanders is aiming its marketing guns at five of the FAA's largest control centers—those not covered in Raytheon's pact for installations at 15 medium-sized centers. Marketing men at Sanders figure a contract for five large centers could be worth \$50 million to the Nashua, N.H., firm, and even more if the FAA and Raytheon cancel their agreement.

Meanwhile, Raytheon is involved in litigation trying to get an added \$35 million out of the FAA for overruns it says were caused by agency-dictated changes to the computer display channel. The pact already is worth \$44.8 million and could run to \$64 million. Insiders don't give Raytheon much of a chance, even though its display now is working after outside design and purchase of a new deflection system.

Varian readies microfiche system

A microfiche filing system that can locate any given document in a file of up to 9 million pages in less than six seconds is ready to be marketed by Varian. Thirty pages are stored in a given microfiche frame; there are 1,000 frames in a tray, and 50 trays in a module. Up to six modules can be included in each system. To retrieve a document, the operator types its number on a keyboard; an optical search unit locates the document by scanning notches on the edges of the carriers that hold the microfiche. A conveyor system then transports the carrier to a television system that presents the image of the desired page on a monitor screen.

A Varian spokesman said that the unit, designed for large organizations, could be operated remotely over telephone lines or microwave links. Cost of the system is said to be only 11 cents a page, and hard copies of any record are made in nine seconds at 5 cents a page. The spokesman claims that the unit is much less cumbersome and expensive than the Ampex Corp.'s Videofile system, which stores information on reels of video tape.

Addenda

Land mobile communications equipment makers are disappointed with an FCC plan to give them access to just the "best two" uhf television channels in the nation's top ten market areas. And tv-receiver makers are also expressing some concern as to how they will go about modifying tuners to prevent cross modulation. Broadcasting interests, too, were not as happy with their apparent victory as they might have been even though the original land mobile-tv plan to share uhf spectrum would not have cost them much more. Though the FCC ruling "was not what we wanted," said one disappointed land mobile equipment executive, "it's a beginning anyway." . . . Overshadowing that ruling is FCC approval allocating 75 megahertz between 806 and 881 Mhz to common carriers for a broadband mobile radiotelephone system. Another 40 Mhz was allotted to private land mobile services.

MICROWAVES

How microstrip designs solve microwave problems.

We've spent over four years in research and development to come up with some very interesting solutions to microwave miniaturization problems.

Our microwave people have spent a lot of time developing techniques for miniaturizing microwave circuitry. They have done microwave projects for both military and commercial applications and have the experience to turn your microwave project into a hybrid package that will fulfill your demands at minimum cost and in minimum size.

We have pioneered the development of beam-lead technology to give us a new and powerful technique for mounting semiconductor devices on microstrip circuitry. For example, we use Sylvania-developed low-noise, beam-lead silicon Schottky diodes in mixer applications, and we use beam-lead PIN diodes for many switch and phase-shifter applications. All of these devices meet the stringent military environmental specification.

To give you an example of our capability, we can list at least three microwave systems that have been developed around our hybrid microwave capability.

These developments include an integrated man-pack radar, an integrated K_u band transceiver and an integrated mixer assembly for a highly specialized application.

For the integrated man-pack radar system we developed a lightweight X-band system almost completely in hybrid integrated circuit form. The radar transmits a pseudo-random phase-coded CW signal. All functions of the radar, including



This issue in capsule

CRTs—Get high speed printouts with these monoscopes.

Hybrid Microelectronics—Diode matrix modules give you design flexibility.

Television—We've squared off the color bright 85® tube for 1970.

Microwaves—Millimeter wave source puts out up to 50 mW CW.

ICs—How to use programmable dividers as pulse-train gates.

Diodes—TV high-voltage diodes minimize x-radiation.

Manager's Corner—Will the real Schottky barrier please stand up?

the low-frequency analog and digital circuitry, with the exception of a miniature coaxial avalanche oscillator and the antenna, are made in microstrip integrated form.

These units include an RF phase modulator, high speed RF switches, an oscillator that uses a Sylvania silicon avalanche diode, a balanced mixer using a beam-lead Schottky barrier diode, ferrite circulators and other passive transmission line components.

The hybrid integrated K_u band transceiver is in development under Air Force sponsorship (Contract No. 33616-67-C-1896). In this project we are developing techniques for integrating a large number of functional components on a single alumina substrate at 13.3 GHz. The system, designed to operate as a doppler navigator transceiver, includes: master oscillator using a varactor-tuned avalanche diode that is frequency-stabilized by an integrated phase discriminator; a cascade of avalanche diode power amplifiers producing 100 mW CW output at 13.3 GHz; a frequency shift-key modulator using beam-lead Schottky barrier diodes; T-R switch using beam-lead PIN diodes; a balanced mixer using beam-lead Schottky barrier diodes; and an IF amplifier having a 1.5 dB noise figure at 120 MHz. The third project that demonstrates Sylvania's capability in miniaturized microwave circuitry is an integrated mixer subassembly designed and developed for a highly

specialized military application. The subassembly consists of a bandpass filter, 3 quarterwave contradirectional couplers, and four balanced mixers. All of the units are integrated on four alumina substrates. The individual substrates are interconnected with gold ribbons.

Design goals included minimum cross coupling between mixers, and packaging design that minimizes damage from shock and vibration. Semiconductor devices used in the subassembly include beam-lead Schottky diodes in the mixer circuits.

This integrated subsystem, specially packaged to withstand stringent environmental requirements, is now in volume production.

Among the other components that can be integrated by Sylvania into complex subsystems are limiters, detectors, circulators and isolators.

Circuits can be supplied unpackaged for assembly by the user, or can be packaged by Sylvania in rugged, hermetically sealed enclosures with coaxial connectors or other types of input-output connections.

If you have a microwave design problem, why not talk to our experienced microwave design engineers? You may be surprised at what they can do for you.

CIRCLE NUMBER 300

CRTs

Get high-speed printouts with these monoscopes.

Simple CRT system can generate over 30,000 characters per second from magnetic tape.

A monoscope is simply a cathode-ray tube which converts digitally coded information into video type signals. Because of this, it is a very valuable interface between computers and output display devices. And because we can tailor the target characteristics to the users' specifications, there is no problem in generating special symbols for chart, diagram and map displays as well as alphanumeric characters.

In its simplest form, a monoscope resembles a conventional CRT with electrostatic focus and deflection, with the exception that a solid metal disk replaces the phosphor screen. A typical monoscope of this type is shown in Fig. 1.

The metal disk has a surface which possesses good secondary emission characteristics. The alphanumeric characters or symbols are printed on the disk with a material having poor secondary emission characteristics.

When the electron beam scans a single character in a raster-like pattern, a video signal corresponding to the shape of the character is produced. An identical raster scans the display tube. The beam intensity of the display tube is modulated by the monoscope's video output and the character is produced on the phosphor screen. Used in this manner, the monoscope can produce up to 30,000 symbols per second.

The cathode of the monoscope is generally operated at 1200 to 1800 Volts below ground so that the anode can be run at or near ground potential. This simplifies the design of character selection circuitry from the information source.

A second type of monoscope is shown in Fig. 2. This type uses a stencil-type target where the characters have been chemically etched through the disk. The principle of operation is exactly the same as the first type described.

However, the stencil provides some advantages. Since the beam proceeds unhindered through the stencil openings, it can be displayed on a phosphor screen deposited on the face of the tube. This provides an easy means of visually checking what is being scanned and is very useful in setting up the tube for operation.

The third type of monoscope is shown in Fig. 3. It also makes use of a stencil target, but it is used in a different manner. In this case, surface condition of the stencil is not important. We only use that part of the raster that gets through the stencil and impinges on the front plate. This type of monoscope has many advantages. No target surface preparation is required. It can be mass produced at low cost.

A typical monoscope target format is shown in Fig. 4. An 8 x 8 matrix is fairly standard, but 8 x 12 or 10 x 10 formats can also be used to obtain both upper and lower case characters.

Targets can be custom-designed to meet your requirements and can be fitted to any of the three types of monoscope tubes. Some of the applications for these monoscopes include computer display, airline status boards, stock quotation boards, teaching machines, address label printers, command control center displays, or anywhere that a high-resolution electronic information readout system is required.

CIRCLE NUMBER 301

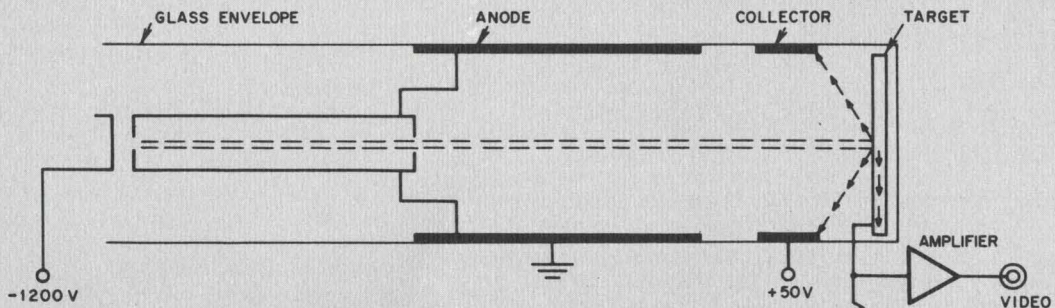

Fig. 1. Basic monoscope using solid target.

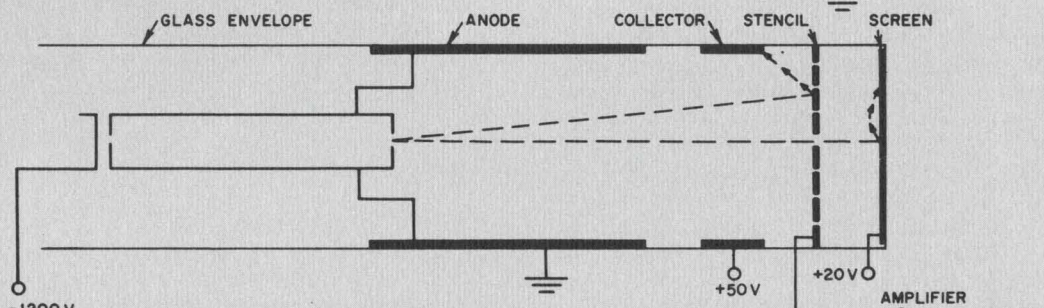

Fig. 2. Monoscope using aluminized stencil target.

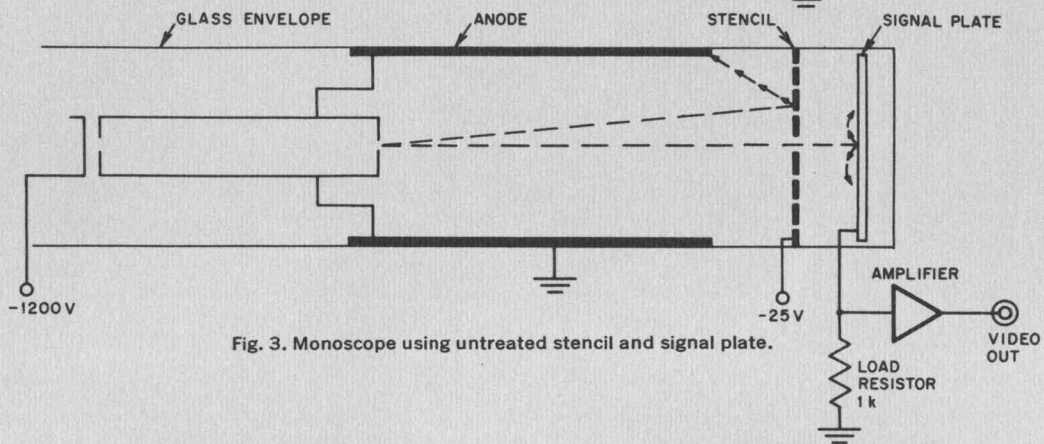

Fig. 3. Monoscope using untreated stencil and signal plate.

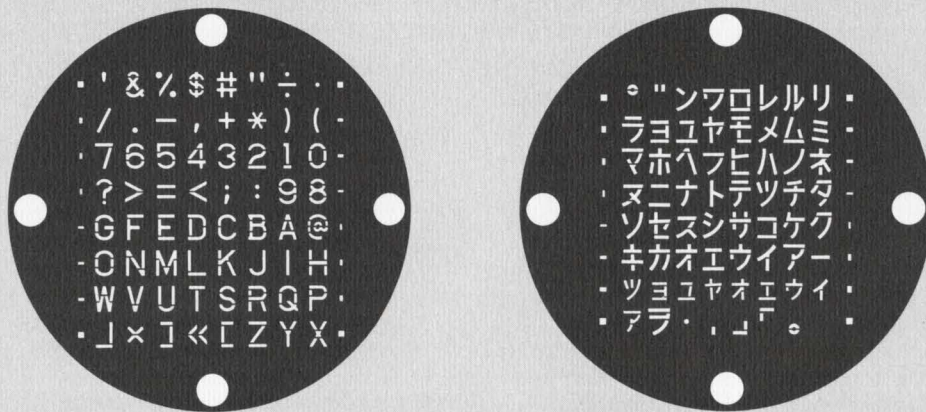

Fig. 4. Typical target stencil for alphanumeric readout.

HYBRID MICROELECTRONICS

Diode matrix modules give you design flexibility.

Our semiconductor and hybrid microelectronics groups team up to offer a wide range of module designs.

Because Sylvania is both a manufacturer of semiconductors and a maker of hybrid microelectronic assemblies, we can offer you a wide range of diode types packaged to your specifications. Using our thick-film packaging approach we can design diode arrays incorporating precision thick-film resistors.

Take, for example, our diode array module. This module is a 13 x 32 diode array containing both pull-up and load resistors. The diodes are high-speed, low-capacitance types. The thick-film resistors are stable cermet elements having low temperature coefficients. These resistors can be trimmed to a tolerance of 0.2% for weighted-network applications.

Other matrix forms are available that will let you in-

crease the efficiency of your logic system design without getting involved in the use of more complex monolithic structures.

Up to 512 diodes can be provided in a single package. The custom matrix design can provide address arrays in 20 x 25, 16 x 32, or in any subcombination that the design might require.

The diode matrix and resistor module can be used in many applications including: code-to-code conversion, multilevel gating structures, AND/OR gating, decoding networks, nondestruct permanent memories, and weighted networks. Some typical applications are shown in the diagrams.

The wide flexibility of our design approach allows us to offer you any combination of diode arrays with or without resistor elements. The final package configuration can be determined by the system application. Flat packs and dual in-line packages can be provided as well as hermetically sealed or encapsulated modules.

You'll be surprised at what our semiconductor hybrid microelectronics teams can come up with to meet your logic system needs.

CIRCLE NUMBER 302

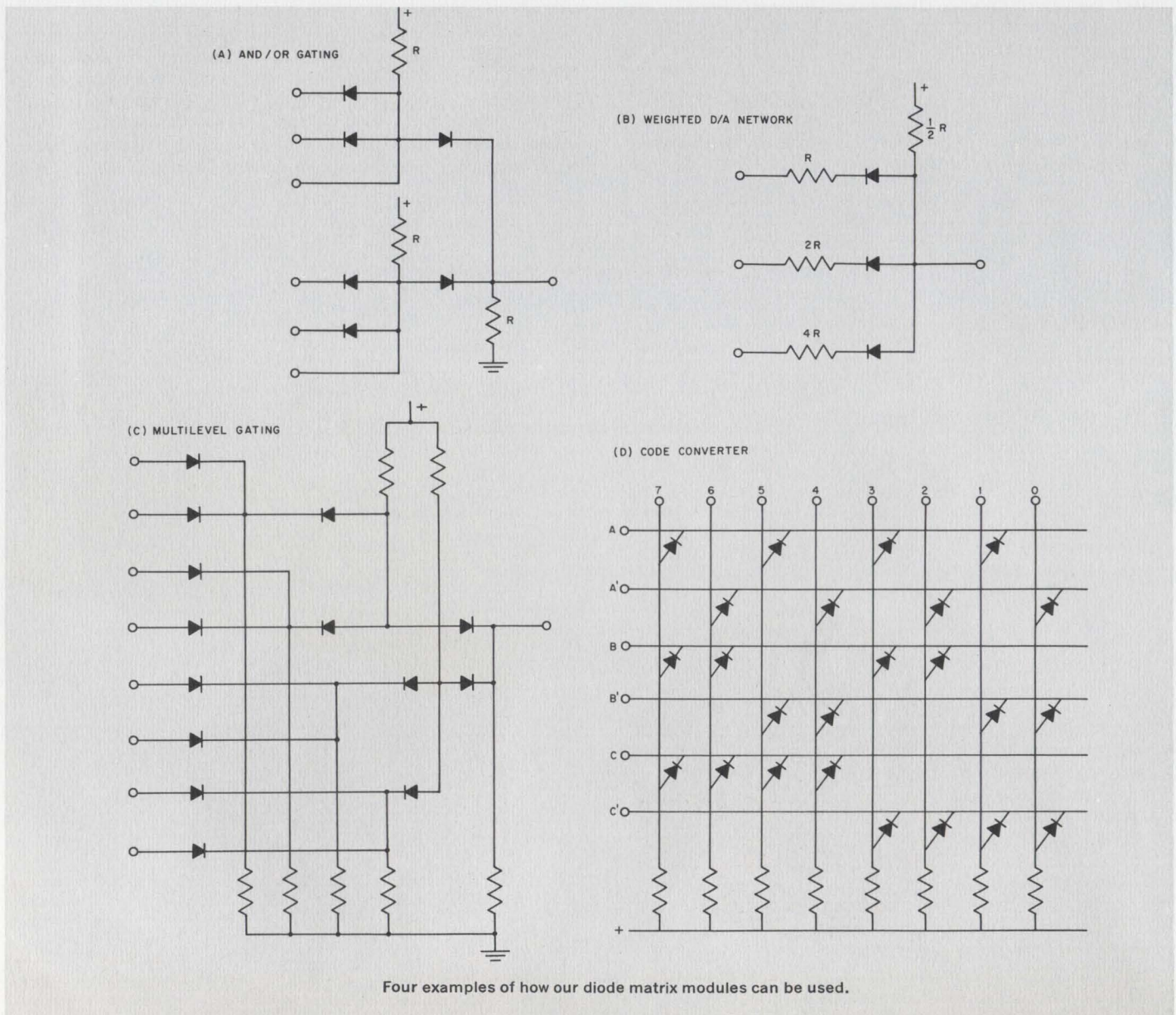

Four examples of how our diode matrix modules can be used.

TELEVISION

We've squared-off the color bright 85® tube for 1970.

New color-tube design gives more usable area with a 3 x 4 aspect ratio.

Here's your chance to become a real "square" in your next color TV set design. We've come up with a new family of *color bright 85* picture tubes that give you squared corners and straighter side lines. The new tubes also feature a 3 x 4 aspect ratio which closely matches the configuration of the transmitted TV signal.

The new tubes are available in 19", 21" and 25" sizes and, of course, all of them feature Sylvania's new improved MV phosphor system that is 30% brighter than previous designs. An outline drawing of our new squared-corner 25" tube is shown in comparison with a conventional 23" tube in the illustration. Note that screen area is increased to 315 sq. in. in the new tube as compared to 295 sq. in. in the conventional design.

As in other *color bright 85* picture tubes, the new squared-off line features an aluminized screen for highest brightness. In addition, these tubes are available with a system light transmittance of 51%. The face panel is a neutral gray filter glass to improve picture contrast.

The new tubes also have a new front panel and funnel design that increases X-ray absorption. When tested in accordance with standard JEDEC procedures, the X-radiation of these tubes does not exceed 0.5 mR/hr. for the

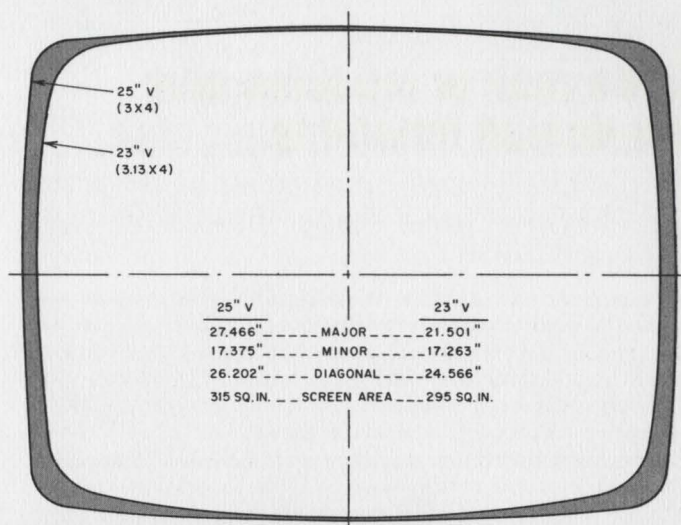

Faceplate outline of new squared-off 25" color picture tube as compared with conventional 23" picture tube.

useful life of the tube even when operated beyond the design-maximum ratings of the tube.

As with all *color bright 85* tubes, a temperature-compensated shadow mask is a standard feature to prevent loss of purity by uncontrolled thermal expansion. A sharp-focus electron gun that achieves tighter beam bundling, and integral kimcode implosion protection are also features that make the new squared-off *color bright 85* the tube to plan your next color set around.

CIRCLE NUMBER 303

DIODES

TV high-voltage diodes minimize X-radiation.

Solid-state diode tripler and quadrupler assemblies cut down on radiation from high voltage section of TV sets.

One of the major sources of X-radiation in color TV sets is in the high-voltage cage. You can minimize this radiation by switching over to our high-voltage silicon diode multipliers.

In addition, you'll save money by eliminating the high-voltage cage and its associated hardware. High-voltage regulation is also improved since the loosely-coupled tertiary flyback winding is eliminated.

Since each application of these high-voltage multipliers is unique, we don't offer them as off-the-shelf items. Our engineering staff will work with you to tailor a unit to fit your design needs.

One of our typical designs is shown in the illustration. It's a tripler circuit that takes an 8.5 kV input from the flyback transformer and puts out 25 kV DC to the color tube anode. Loading can be as high as 2.5 mA with minimal drop in output voltage. This circuit also provides a tap for the focus supply voltage.

The diode stacks used in our high-voltage multipliers are all carefully matched. They are then molded into a plastic package along with their associated capacitors. The plastic package will more than meet the environmental requirements of solid-state and hybrid color TV sets.

These requirements include such things as over-voltage

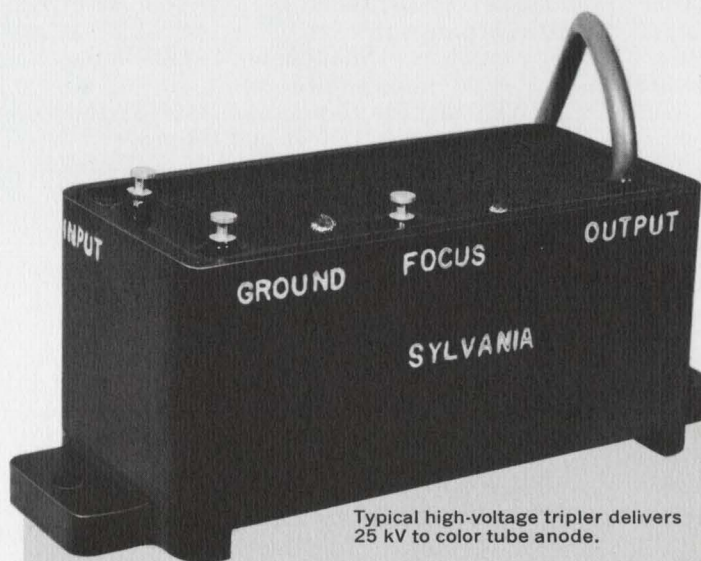

Typical high-voltage tripler delivers 25 kV to color tube anode.

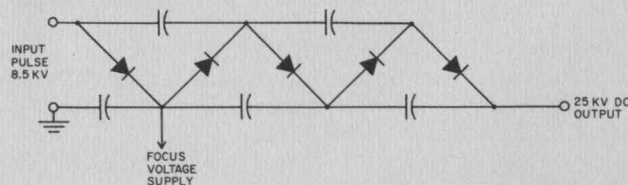

surges, arcing and ambient temperature conditions.

Why not discuss your high-voltage requirements with our diode engineers. They'll show you how to reduce radiation and save money at the same time.

CIRCLE NUMBER 304

INTEGRATED CIRCUITS

How to use programmable dividers as pulse-train gates.

Simple circuit can be programmed to provide N consecutive output pulses on command.

Here is an application of our functional arrays that shows the flexibility of these devices. The SM-143 and SM-153 are both programmable, synchronous down-counters with a built-in decoder that gives a logic "1" output when the counter is in the 0000 state. These programmable dividers are identical in operation except that the SM-143 is programmed by binary numbers and the SM-153 accepts a BCD input.

These dividers are ideal for use as programmable pulse-train gates. The strobed data entry (SET ENABLE) makes it easy to program the counters without adding external logic circuits. The four-input clock gate reduces clock loading and allows logic flexibility. The internal decoder gate and single output cut down on package count and, in addition, power drain is significantly reduced since the four flip-flop outputs are not brought out of the package. A four-bit counter with similar features would use about 100 mW more power.

The circuit diagram and timing waveforms for a programmable pulse-train gate are shown in Fig. 1. For purposes of illustration we are assuming that there is a binary 17 on the input lines.

Grounding the CLEAR input resets the counters to 0000 and causes their decoded outputs (A and B) to go high. (The CLEAR pulse must be at least 150 ns wide.) The high outputs from the counters are applied to the NAND gate (G1) whose "0" output now inhibits the CLOCK input to the system, thus maintaining a static condition.

When the START input is raised to a logic "1", the binary number (in this case, 17) is set into the proper counter flip-flops and decoded outputs A and B go low. The output of G1 now goes high and enables the first SM-143. (The second is still inhibited by decoded output A.) The START pulse must occur when the CLOCK input is low.

The system now allows 17 clock pulses to go through G2 in the following manner: The output of the first SM-143 (output A) goes high as the first clock pulse counts it from 0001 to 0000. This high input enables the clock gate of the second SM-143. The second clock pulse causes the second SM-143 to go from 0001 to 0000 thus setting output B high, at the same time changing the count in the first SM-143 from 0000 to 1111 and causing its output (A) to go low.

The logic "0" at A now inhibits the clock gate of the second SM-143 so that it remains at 0000 while the first SM-143 is counted down from 1111 to 0000 by the next 15 clock pulses (pulses 3 through 17). At this point output A goes high again. Outputs A and B are now both high, forcing the output of G1 to go low inhibiting the entire system. The system is now in the same condition that occurred after the CLEAR pulse. It will remain in this condition until another START pulse occurs.

If an asynchronous START pulse is desired, additional logic can be added as shown in Fig. 2. In the static condition, both counters are at 0000 and their outputs A and B are high, setting the output of G1 low. Gate G1 now inhibits the output gate G2 and the inputs to both counters.

When the start input goes high it allows the programmed number to enter the counters. This will cause the counter outputs A and B to go low. The high START input is inverted by G4 which resets FF1 and disables the J and K

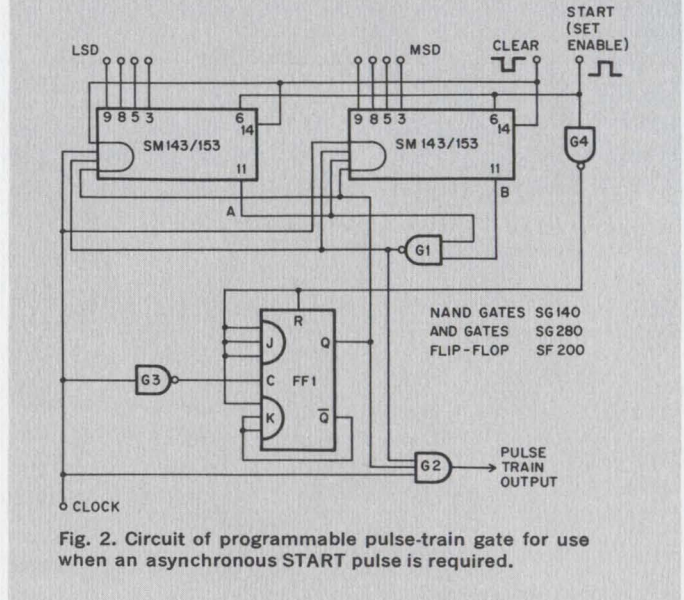
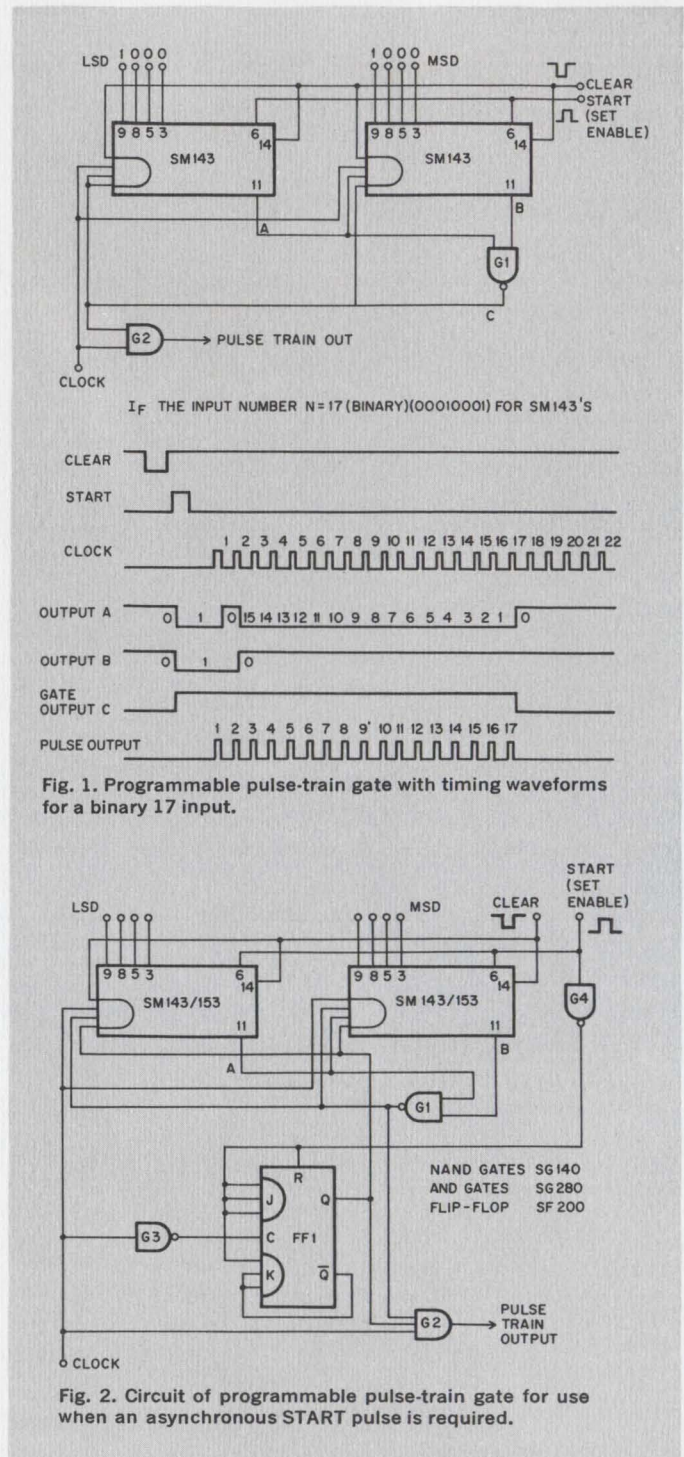

inputs. The Q output of FF1 then maintains the inhibit condition on G2 and both counters. This condition is static as long as the START input remains high.

When the START input goes low, G4 output goes high. This enables FF1. The first positive clock edge to occur, after the START input goes low, is inverted by gate G3 and clocks FF1. The Q output goes high, enabling the output gate G2 and both counters. This and succeeding clock pulses are gated and counted as explained previously, the Q output of FF1 which is now low is connected to the K input, thereby preventing resetting of the flip-flop by the clock pulse output from G3 until the next START pulse re-initiates the cycle.

MICROWAVES

Millimeter-wave source puts out up to 50 mW CW.

Fixed tuned, high efficiency source is available in frequency range from 52 to 70 GHz.

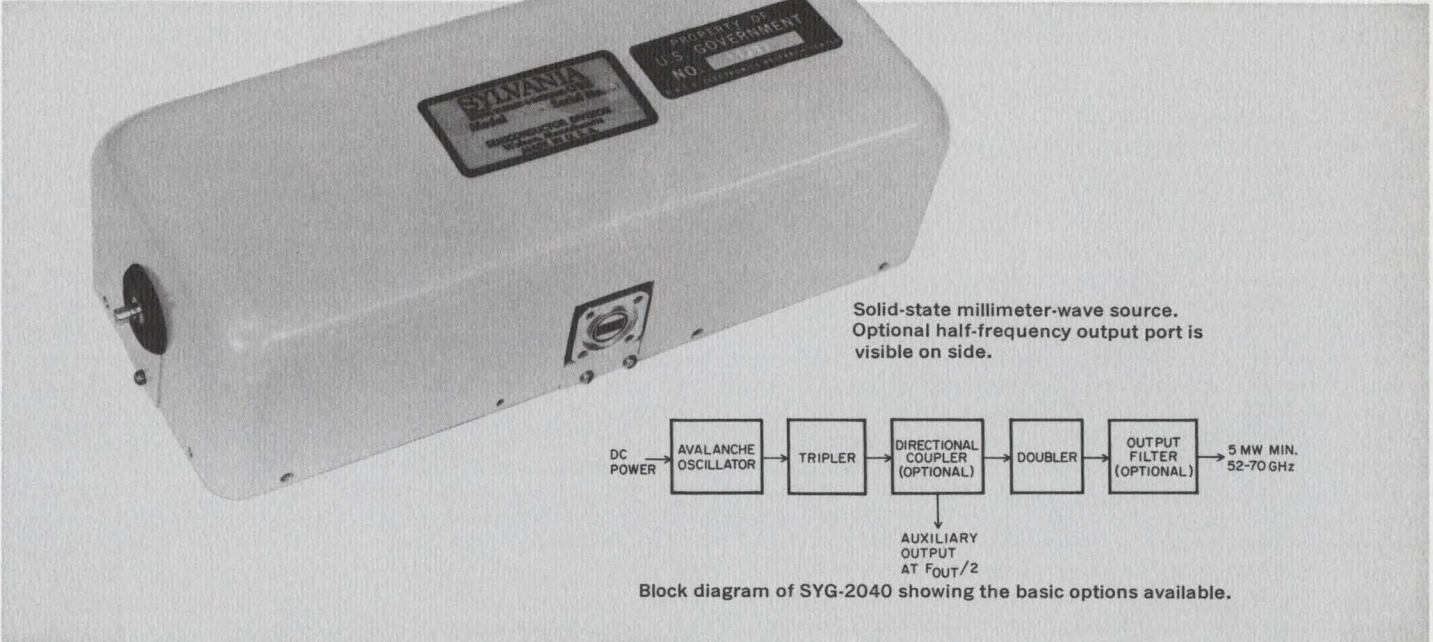

Our SYG-2040 series solid-state millimeter-wave source is a new component that is particularly suited to applications including local oscillators, paramp pumps, and low-power transmitters where long life is required. It also comes with a number of options that make it easy to fit into a specific system requirement.

Basically, the SYG-2040 uses a high-power avalanche diode oscillator to drive an efficient tripler-doubler multiplier chain. The output frequency may be specified anywhere in the 52 to 70 GHz range.

Among the options available are a low-loss cavity output filter for applications requiring minimum noise sideband

power, and an optional sampling port that provides a 5 mW (min.) signal at half the final output frequency. In addition, the fundamental oscillator can be modified to enable either phase or injection locking techniques to be employed where frequency stability is important.

The basic SYG-2040 solid-state source comes in a 2" x 2" x 6" package. Models with the optional attachments are housed in a slightly larger package. A constant-current DC supply between 70 and 100 V and 60 to 110 mA (10 W max.) is required to drive the avalanche oscillator.

CIRCLE NUMBER 306



Use Sylvania's "Hot Line" inquiry service, especially if you require full particulars on any item in a hurry. It's easy and it's free. Circle the reader service number(s) you're most interested in; then fill in your name, title, company and address. We'll do the rest and see you get further information by return mail.

BUSINESS REPLY CARD

No Postage Stamp Necessary if Mailed in the United States

FIRST CLASS
Permit No. 2833
Buffalo, N.Y.

POSTAGE WILL BE PAID BY

Sylvania Electric Products Inc.
Sylvania Electronic Components
1100 Main Street
Buffalo, New York 14209
Dept. E 3 3 3

MANAGER'S CORNER

Will the real Schottky barrier please stand up?

Several years ago, when Schottky barrier diodes using evaporated metal contacts were introduced, many engineers began to call the older point-contact types "the poor man's Schottky". Now that we have had time to compare both types, we wonder if it is entirely fair to use the connotation "poor man's" in referring to point-contact diodes.

Both diode types have really come of age within the past two years. Only now are we really beginning to find out the true differences between them in laboratory circuits and in operating radar systems. And strangely enough, the point-contact mixer/detector, with its tungsten whisker wire and pressure contact to epitaxial silicon, does not always come out as the underdog when compared to the more sophisticated Schottky barrier types. Perhaps even more significant, several distinct advantages and disadvantages of each type of diode can now be clearly seen.

Both types of devices are now made to cover the frequency bands from L to K_A. Point-contacts do have a slight edge in being commercially available to meet requirements up to 100 GHz.

Generally speaking, in mixer applications, Schottky barrier diodes are available with up to 0.5 dB improvement in noise figure over equivalent-frequency point-contact types.

Above X-band, however, this advantage disappears and the noise figures are equal. For other important parameters such as RF and IF impedances, somewhat tighter controls can be maintained for Schottky barrier types.

If you consider local oscillator power level degradation with time, or situations where local oscillator power must be varied, you should take a careful look at the Schottky diode. In general, you'll find it is not the better choice of the two. On the other hand, the dynamic range of the Schottky barrier device is better than that of the point-

contact diode, making it the device of choice where this is an important parameter.

Also, in Doppler radar systems using the homodyne principle, the inherent low audio-frequency noise of the Schottky barrier device gives it an advantage over the point-contact diode in noise figure. In addition, microphonics are almost nonexistent in Schottky barrier devices.

Possibly one of the most important criteria to be considered when choosing between Schottky and point-contact diodes is resistance to "burnout" or degradation caused by external pulse power, spike energy, or CW power. Here the data are not sufficient to fit every circuit but, generally speaking, point-contact types are certainly to be favored under these conditions.

With rare exception, point-contact diodes made by the latest fabrication techniques can withstand 3 to 10 dB more incident power than an equivalent Schottky type. On the other hand, where burnout resistance is not a problem, the Schottky device has sufficient advantages to be the leading contender for new circuit designs.

Although it was originally assumed that the Schottky barrier diode would be superior to the point-contact type in environmental tests, such as shock/vibration, this has not proven to be true. Point-contact devices have passed the most stringent MIL-STD tests successfully. Here we have equality but no superiority.

Although we've been working hard to replace the grandfather of all diodes (really, of all semiconductor devices) the point-contact is not yet ready to retire. At the age of 27, he still has many good working years left. The Schottky barrier, by comparison, is still a baby and is just beginning to face the world.

We, as manufacturers, still have a long way to go before we can announce that a choice no longer exists between Schottky and point-contact devices.

Eugene J. Feldman
 Manager, Microwave Products

This information in Sylvania ideas is furnished without assuming any obligations.

SYLVANIA

GENERAL TELEPHONE & ELECTRONICS

NEW CAPABILITIES IN: ELECTRONIC TUBES • SEMICONDUCTORS • MICROWAVE DEVICES • SPECIAL COMPONENTS • DISPLAY DEVICES

E3

NAME _____
PLEASE PRINT

TITLE _____

COMPANY _____

ADDRESS _____

CITY _____ STATE _____ ZIP _____

Circle Numbers Corresponding to Product Item

300 301 302 303 304 305 306

Please have a Sales Engineer contact me.

Visit Phone... Phone No. _____ Area Code _____



HOT LINE INQUIRY SERVICE

Need information in a hurry? Clip the card and mail it. Be sure to fill in all information requested. We'll rush you full particulars on any item indicated.

You can also get information using the publication's card elsewhere in this issue. Use of the card shown here will simplify handling and save time.

**“Bigger and better...this
engineer’s bible...”**

—Electronics Magazine

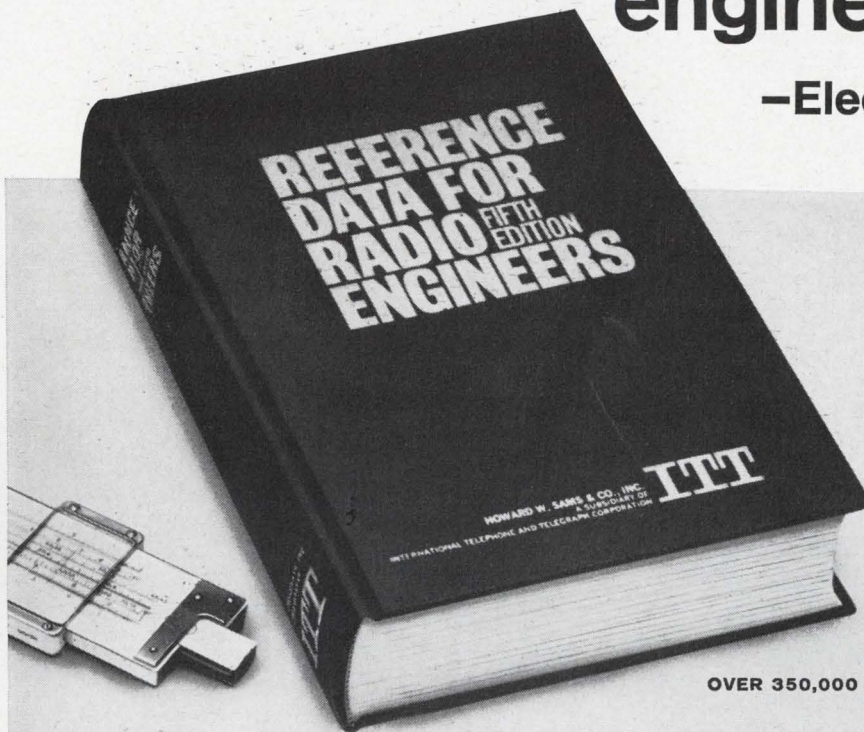

**5th EDITION of a
world-famous reference**

Now contains 50% MORE DATA to include major information developed over the past 12 years. Prepared by an outstanding group of practicing engineers, professors, and industry and government experts, under the direction of the International Telephone and Telegraph Corporation staff.

OVER 350,000 COPIES SOLD IN PRIOR EDITIONS

Reference Data for Radio Engineers

CHAPTER CONTENTS

- | | |
|--|--|
| Frequency Data | Transmission Lines |
| *International Telecommunication Recommendations | Waveguides and Resonators |
| Units, Constants, and Conversion Factors | Scattering Matrices |
| Properties of Materials | Antennas |
| Components or Parts | Electromagnetic-Wave Propagation |
| Fundamentals of Networks | Radio Noise and Interference |
| Filters, Image-Parameter Design | Broadcasting and Recording |
| Filters, Modern-Network-Theory Design | Radar Fundamentals |
| Filters, Simple Bandpass Design | Wire Transmission |
| Attenuators | *Switching Networks and Traffic Concepts |
| Bridges and Impedance Measurements | Digital Computers |
| Magnetic-Core Transformers and Reactors | *Navigation Aids |
| Rectifiers and Filters | *Space Communications |
| Magnetic Amplifiers | Electroacoustics |
| Feedback Control Systems | Nuclear Physics |
| Electron Tubes | *Quantum Electronics |
| Electron-Tube Circuits | Information Theory |
| Semiconductors and Transistors | Probability and Statistics |
| Transistor Circuits | *Reliability and Life Testing |
| *Microminiature Electronics | Miscellaneous Data |
| Modulation | Fourier Waveform Analysis |
| | Maxwell's Equations |
| | Mathematical Equations |
| | Mathematical Tables |

*New chapters on subjects not covered in 4th Edition

1196 PAGES • 1350 ILLUSTRATIONS
plus 41 page index

The FIFTH EDITION of this widely used reference work has been completely revised and updated. It provides in a single volume comprehensive data on all basic phases of electronics, including tables, formulas, standards, and circuit information—PLUS—all-new data on microminiature electronics, space communications, navigation aids, reliability and life testing, international telecommunication recommendations, switching networks and traffic concepts, and quantum electronics. Includes over 1300 charts, nomographs, diagrams, tables, and illustrations. 45 data-packed chapters. 1196 pages of invaluable information for practicing radio and electronics engineers.

10-Day Free Examination

HOWARD W. SAMS & CO., INC., Dept. EL 55
A Subsidiary of International Telephone & Telegraph Corporation
4300 West 62nd Street, Indianapolis, Ind. 46268

- Send me REFERENCE DATA FOR RADIO ENGINEERS for 10-day examination, without cost or obligation. If I decide to keep the volume, I will send \$20.00 (plus postage) in 10 days; otherwise, I will return the book within 10 days.
- \$20 payment enclosed. Send my copy postpaid with full 10-day refund privilege. (Include sales tax where applicable.)

Name _____

Company _____

Address _____

City _____

State _____

Zip _____

Unprecedented Computer Power for the Lab

Harness the full power of interactive time-sharing computers to simplify data recording and speed data analysis with our Model 131 Instrument/Computer Interface System. This new P.A.R. system links your laboratory instruments directly to a remote computer over ordinary phone lines. While your experiment is running, instrument output data is simultaneously fed to the computer where it is reduced, correlated or interpreted. Just seconds later, results are back in your lab! Time-consuming manual instrument interpretation, data transcribing and transmission are eliminated, along with the possibility of errors.

You can use the Model 131 to process analog or digital data from 1 to as many as 90 similar or different instruments. It also provides an added capability for using the computer to monitor and control experiments, tests and open-loop processes. And the analytical capabilities of certain laboratory instruments can even be extended through the Model 131.

The modularized Model 131 System is easily expanded as your instrumentation and data processing requirements grow. Price of a typical system is less than \$4,500. Teleprinter and acoustic coupler available at nominal extra cost. Complete details are available in P.A.R. Bulletin T-206A. For a copy, write Princeton Applied Research Corporation, Box 565, Princeton, New Jersey 08540, or call (609) 924-6835.

```

RUN FOURIR
***NAME THE FILE THAT CONTAINS THE DATA..... PSBXC.DAT
***INPUT NUMBER OF POINTS IN FILE TO BE USED..... 350
***TYPE THE TIME IN SECONDS REPRESENTED
    BY 1.0 IN THE TIME CHANNEL. USE E FORMAT..... 1E0
***GIVE THE UPPER FREQUENCY YOU WISH ANALYZED TO
    AS A FRACTION OF THE NYQUIST FREQUENCY..... 0.99
THE NUMBER OF LINES IN THE FILE IS: 101
NO FORMAL ERROR IN INPUT PARAMETERS
    
```

FREQUENCY	COS SPECTRUM	SINE SPECTRUM	POWER SPECTRUM
0.000000	0.359466	0.000000	0.1292133
0.1010101E+01	0.4180314	0.3105132	0.2713360
0.2020202E+01	0.2326632	0.2764665	0.1305659
0.3030303E+01	0.1504027	0.2295168	0.0752998
0.4040404E+01	0.1077777	0.1932655	0.0405000
0.4747475E+02	0.0333702	0.0036903	0.0011287
0.4848485E+02	0.0330756	0.0022161	0.0010982
0.4949495E+02	0.0342637	0.0022214	0.0011789

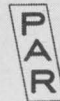

PRINCETON APPLIED RESEARCH CORPORATION

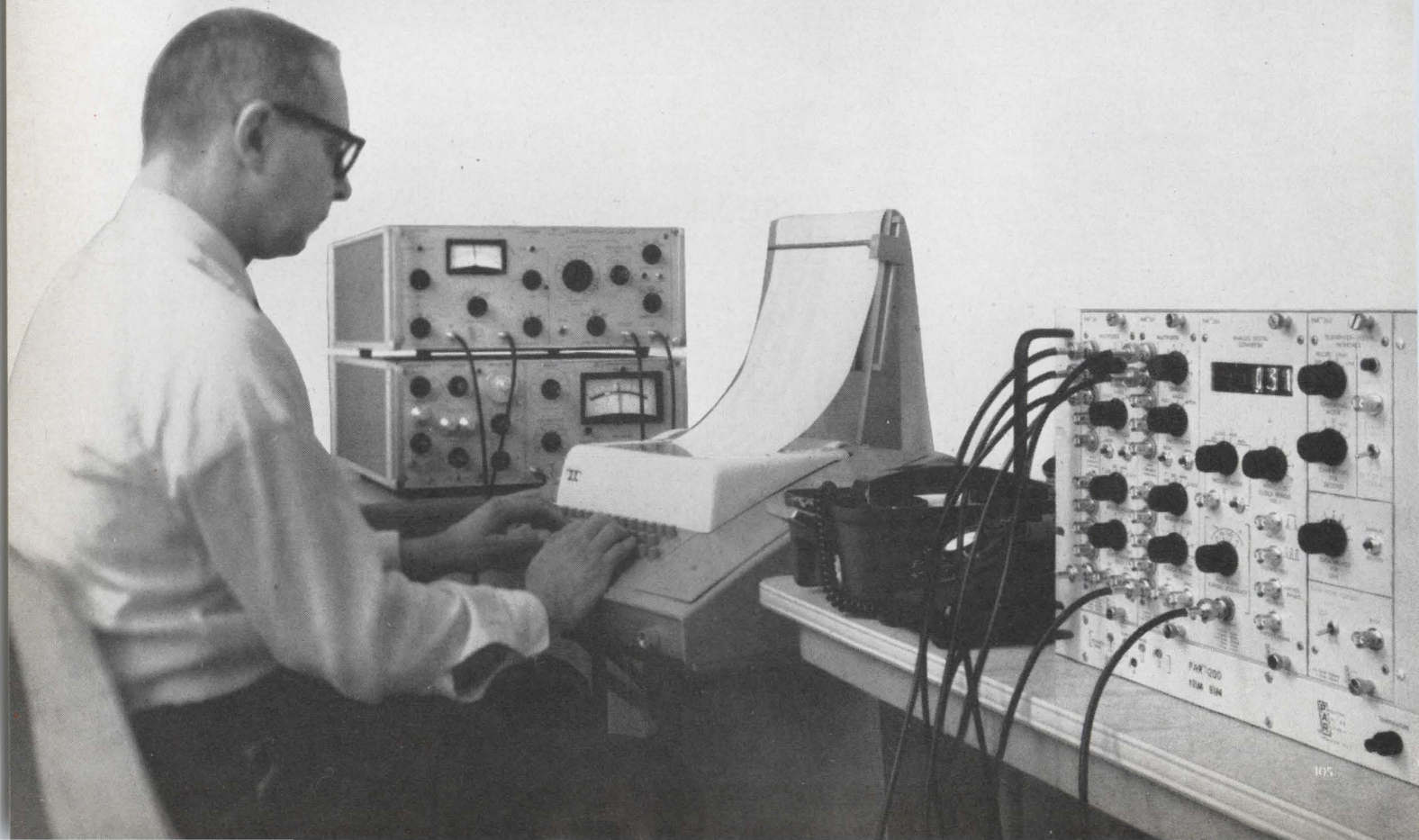

Surface acoustic waves curl into radar

Weighting techniques enable Autonetics to build pulse expansion/compression filters and open small-boat, aircraft, vehicle market

Everyone is talking about the new microwave technology—surface acoustic waves—and an ever increasing number of low-cost, compact devices now use this development. Companies like IBM want to see if they can use surface-wave devices in certain small computers. Consumer operations like Zenith and Motorola are busy working on surface-wave techniques for nontunable video filter networks for color sets [*Electronics*, Jan. 5, p. 50].

And now Autonetics, a pioneer in surface acoustic wave delay lines and amplifiers, may revolutionize the small-radar business with a new design for surface-wave pulse-compression and expansion networks. Now possible with them are low-cost, all-solid-state, compact radar units for small boats, aircraft, and military vehicles.

Weighted. Using built-in weighting functions, Autonetics produced a basic pulse-expansion compression filter line with a 60 megahertz center frequency, a 20 Mhz bandwidth, and time-bandwidth product of 50. Other frequencies up to several hundred megahertz are available with equally good bandwidths. The filters consist of an etched array of interdigital transducer fingers on a quartz substrate. Delay lines of lithium niobate and other piezoelectric materials could be fabricated for special uses.

Up to now high cost, bulkiness, and lack of useful bandwidths inhibited widespread use of pulse-compression filter techniques by radar system designers. Despite this, they still were used in expensive military systems when high target resolution and long range were essential requirements. And Autonetics expects its surface-wave devices to open up the low-

cost radar market for pulse-compression filters. For example, small-boat radars with a five-mile range can be readily built using a 1-to-10-watt r-f power transistor in the transmitter and a 100:1 time-bandwidth-product pulse-compression filter in the receiver.

And the price is right. Autonetics expects to sell the delay lines at approximately \$150 per line in quantities of 1,000, an order of magnitude cut in price from conventional metal lines. And there's a 10 to 1 space saving in the bargain; the package now measures 2 x 0.75 x 0.5 inches.

Pesky lobes. But before these pulse-compression expansion lines were useful for small radar, the time side-lobe problem associated with the compressed pulse had to be solved. These side lobes, formed during the compression cycle, can limit target resolution as it is difficult to distinguish between the reflected echo from a target and the side lobe. Time side lobes in surface-wave compression networks have been no better than 13 to 25 decibels below the echo pulse, meaning that target discrimination was poor and received signals were ambiguous. The range was also limited because only large target pulses with respect to the side-lobe pulses could be differentiated. And to reduce the side lobes, expensive auxiliary weighting circuits had to be employed. These networks need special adjustments (tweaking) and are not readily amenable to compact IC techniques.

Autonetics feels it has the answer. With its surface-wave delay lines, it has designed the special weighting functions right into the interdigital transducer, thus eliminating an external circuit while at the same time building a rugged

and stable device.

By using a novel interdigital transducer configuration, Autonetics routinely obtained —43 db time side lobes. In its configuration, the distance between the finger pairs is graded to give the particular surface acoustic wave the desired phase characteristic that's needed to reduce the acoustic energy at the ends of the transducer. What's more, the transducer is amplitude weighted as well to produce amplitude equalization, another important factor in reducing side lobes. This is obtained by varying the overlap distance of the interdigital transducer so that the series radiation resistances presented by each element of the transducer are identical. The transducer is designed so that its aperture is narrower at the higher frequencies and wider at the lower frequencies. Thus, the proper weighting is realized at the ends of the transducer in a manner similar to tapered end-antenna designs.

Finally, an inductor and resistor together fine tune the amplitude characteristics and match the impedance of the filter to the external circuitry's 50 ohms over the frequency range of the filter.

Microwave

All-weather view

A new imaging technique developed by RCA's Advanced Technology Laboratories in Camden, N. J., could go a long way toward improving target visibility through atmospheric conditions that highly attenuate conventional microwave radar. The scheme uses millimeter waves and a newly developed semiconductor image dissector, or

U.S. Reports

“shutter,” to manipulate the signal. Still in a very early development stage, the system, which has been operated at 80 and 140 gigahertz, could open the way to new imaging technology.

A millimeter-wave source activates an illuminator to flood the target region with millimeter-wave radiation. Then, radiation reflected from the object is focused by a lens onto the semiconductor shutter—a single-crystal slab of intrinsic germanium—is nearly transparent to millimeter-wave radiation, but under photo-excitation or electron-beam bombardment, the minority carriers that are introduced make the panel nearly opaque.

Thus, the image on the semiconductor panel can be sampled by changing the absorption over localized regions in a simple raster pattern created by the electron beam. The change in absorption causes the imaged radiation to pass through, or stay absorbed in, the panel. A receiver detects this radiation, and its output voltage modulates the z-axis of a cathode-ray tube in synchronization with the semiconductor panel scan. In this way, the millimeter wave image is converted into a visual image on the crt screen.

The key component in RCA's system is the semiconductor panel. Its response time, which is dependent on surface recombination velocity of the slab, as well as the bulk lifetime, is typically 0.5 millisecond. This indicates that 30 frame-per-second scan rates are possible; this is approximately the normal video scan rate. The fast response, together with the inherent simplicity of the imaging system, seem to be the major advantages.

Advanced technology

Toward standard volt

Thin-film circuits built around the Josephson effect probably will replace saturated electrochemical cells as the world's primary voltage standard. The changeover won't take place tomorrow—things move slowly where international stand-

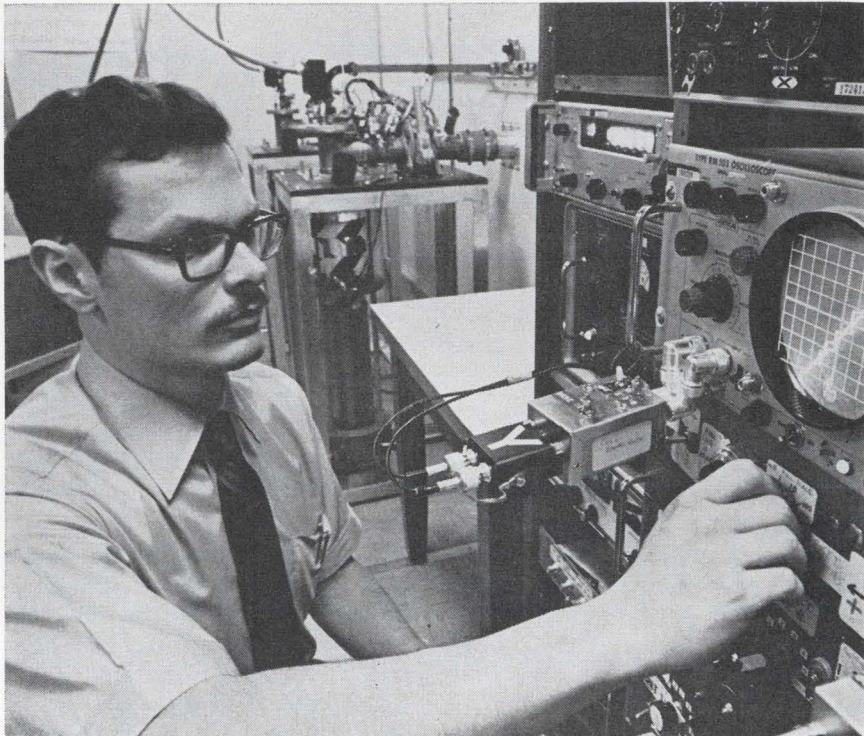

For effect. NBS scientist Thomas Witt tests a Josephson-effect circuit, which is in the cryogenic chamber to his left. Above the chamber is the waveguide that brings r-f energy to the Josephson junction. When a-c energy strikes the junction, it puts out a d-c voltage that's proportional to the energy's frequency. The result is that voltage may be measured by measuring frequency—and accuracy can be better than 1 part in 10^{11} .

ards are involved, and the circuits themselves are still experimental. But if the devices are able to take over, engineers can look forward not only to a more accurate standard, but one that's easier to use.

The Josephson effect results from the tunneling at cryogenic temperatures between two metals separated by an insulator—together called a Josephson junction. What interests standards people is that when a-c energy strikes it, the junction puts out a d-c voltage proportional to the energy's frequency. Thus, measuring voltage becomes a matter of measuring frequency—up to accuracy of better than 1 part in 10^{11} . With a standard cell, voltage can be measured only to within a few parts in 10^6 .

Constant. Josephson-effect circuits also would simplify calibration. Their frequency-to-voltage ratio seems to be proportional to Planck's constant. Therefore, using them as the standard would mean that the volt was being defined in

terms of a natural constant. Anybody could build his own primary standard, certain that it would be as accurate as anybody else's.

Now there's only one primary standard—a bank of cells kept by the National Bureau of Standards in Washington. All calibration labs in the U.S. periodically must send their cells for comparison against those at NBS.

Josephson-effect circuits built at NBS are now, in the words of one NBS scientist, “accurate enough to monitor standard cells.” The circuits themselves are made by evaporating a lead strip onto a 1-inch-square piece of glass. After the strip's top surface is oxidized to form an insulating layer, a second lead strip is laid down perpendicular to the first. The circuit is put into a waveguide, which goes into a chamber whose temperature is less than 2°K . A d-c bias is applied to the two lead strips, and the junction is hit with X-band energy from the waveguide, produc-

ing a voltage across the junction.

Boost needed. The main problem is low output. If the circuits are to become the standard, it must be possible first to compare the circuit's voltage with the output of NBS's cells, which are around 1 volt. The highest output from the circuits so far has been around 10 millivolts.

Says Chester Page, chief of the electricity division at NBS: "The Josephson junctions themselves, working at a few millivolts, by various experiments have been shown to be reproducible to one part in 10^8 or better, which is way out of the accuracy range of the standard cell. So the whole thing boils down to making a setup ratio that you know is good to one part in 10^7 . This is what we're working on, trying to improve the ratio equipment."

But Page feels it's just a matter of time before the Josephson-effect circuits take over. Will the standard cells be replaced within a few years? Martin Domsitz, chief of the electronic technology division at NBS, says: "I doubt it. My reasons for saying this aren't technical; rather they'd be recognizing the slowness with which things get changed in international circuits."

Computers

Take a card

When IBM introduced its System 3 last summer [*Electronics*, Aug. 18, 1969, p. 48], manufacturers of peripherals realized that the giant computer maker had opened a whole new market and so they sought to carve out pieces of it. One of those manufacturers, the Potter Instrument Co., has built a sorter designed to be used with the System 3's 96-column punched cards.

Of course, IBM has a sorting machine that goes with the system, but all it does is sort on a single character out of the 96. It feeds the cards top edge first, under an optical sensor previously positioned by the operator to pick up one of the 32 positions in one of

the three rows of punched characters.

Two in one. Potter's unit is really a combination sorter and card reader. It feeds the cards through its reading mechanism left edge first and can sort on a single character position or read the whole card and transmit its data to the computer. Furthermore, it can use the cards as a medium for its magnetic bar code characters, introduced last year [*Electronics*, May 12, 1969, p. 52], and read or sort on these characters instead of, or in addition to, the punched holes. It can't very well work with both the magnetic bar code and the punched holes at the same time; but users aren't likely to utilize both forms in a single set of records. The magnetic bar code's big advantages are that it is both machine- and man-readable and that a single small card can carry up to eight lines of 32 characters each, or a total of 256—as compared with only 96 characters in the form of punched holes.

Potter also plans to make the same mechanism available with a single output pocket to serve only as a card reader, not a sorter. Thus it will compete not only against IBM's sorter but also against the multifunction card unit that is part of a System 3 computer.

Printing punch

With the mushrooming growth of the minicomputer industry and of data communication applications, many computer installation managers face the dilemma of either paying almost as much for a line printer as for their computer, or putting up with a relatively slow character-at-a-time printer such as a Teletype or an IBM 1050 terminal. The Potter Instrument Co. has decided to do something about it.

Potter recently introduced to the market an impact printer that sells for about a third the price of its least expensive competition, yet can keep up with the maximum data rate of a leased voice-grade telephone line. And most other line printers are far more expensive, requiring higher-cost broadband lines for data-communications applications; the only alternative, up to now, has been a Teletype that costs only slightly less than Potter's new machine but can't keep up with a leased line's maximum data rate.

The new machine prints lines of up to 132 characters at a rate of 135 lines per minute. Its inventory is 64 characters, which are printed in a 5-by-7-dot matrix. Because it is an impact printer, it can produce multiple copies on ordinary paper



Market cornerer?

Potter Instrument hopes to glean a piece of IBM's System 3 market with this sorter, which also reads Potter's magnetic ink characters.

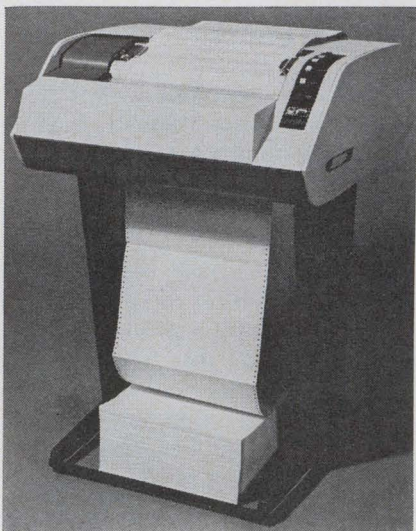

Fast, cheap. New line printer is priced for minicomputers, runs at phone-line speed.

—unlike electrostatic printers, most of which can't make multiple copies, or thermal printers, which require expensive special paper. Normally the machine accepts data in the American Standard Code for Information Interchange (ASCII); IBM's Extended Binary-Coded Decimal Interchange Code (EBCDIC) or custom codes are also available. It sells for \$3,385 in quantities of 100 or \$4,225 singly.

This low price is made possible by a simple mechanical design backed up by a complicated electronic control system—which again is feasible only because recent developments have dramatically reduced the cost of integrated circuits.

Step by step. A control unit in the rear of the printer mechanism receives the data, one character at a time, and stores it in a local buffer that holds an entire line—132 characters. When the line is complete—including blanks if fewer than 132 are to be printed—the buffer is scanned seven times to print seven rows of dots. An MOS read-only memory translates the characters in the buffer into dots. There are five dot positions for each character, the presence or absence of a dot in each position, in each of the seven rows, creates the 5-by-7-dot-matrix representation of the character.

The dots are made in a unique

way. The printer contains a horizontal cylinder with a helical ridge that scans down the cylinder's length. Opposite the ridge are 12 hammers each spanning the width of 11 characters and the pitch of one turn of the helical ridge; the paper and an inked ribbon pass between the cylinder and the hammers. As the buffer is scanned on each of the seven passes, the hammers momentarily press the paper against the ribbon and the ridge to print each dot in its proper position on the paper. The paper then moves up slightly to get into position for the next row of dots, and the cycle is repeated.

A stepping motor moves the paper between rows of printed dots. It moves somewhat faster from one printed line of characters to the next, and it moves still faster when slewing the paper over large unprinted areas.

A production prototype of the printer has been completed; Potter expects to begin deliveries late this year or early in 1971.

Industrial electronics

Ring out the old

Direct digital control has the lion's share of the process-control market. With this kind of control, a large computer takes sensor data from analog-to-digital converters, and transmits control signals to digital-to-analog converters at valves and other control equipment.

But if the computer fails, process control stops; thus, smart management invests in an extra mainframe that takes over if its counterpart fails, and also leaves at their old stations the analog devices that exercised control in the days before computers. Alternately, processes can be controlled with many small computers. However, this can be costly—and the old analog controllers still must be retained as a backup.

So in both situations, the plant operator is faced with the costly, repetitive maintenance and calibration of the analog control system his computer system should have

replaced. And dual or multiple computers further add to overhead.

Middle path. There ought to be a way out, and Applied Fluidics of Stamford, Conn., hopes it has found it. The company's approach allows users finally to do away with the old analog controllers, and also to use a single minicomputer to control the process, without requiring a backup.

Applied Fluidics replaces the analog controller with a fluidic logic block. Not only is the fluidic IC small—1 by 3 inches—it's also "smarter" than the analog device it replaces. It has no moving parts in contrast to the bellows gears, cams, and sometimes even chains of the analog controller, and so is just about maintenance free.

Since it is more capable than analog controllers (it can easily control nonlinear process variables like temperature and acidity), it can absorb a bit more of the control job. This makes the task of the computer easier and, therefore, allows a minicomputer to do the job.

Because nothing can go wrong with the fluidic control device, the old analog backup system finally can be retired, cutting plant overhead. And since the fluidic control is more capable in the first place, less reliance is placed on the computer—if it fails for a short while, the fluidic controllers on a process line can maintain the status quo. So a single computer is enough—lowering cost further.

Fast and simple. There are other advantages to the fluidic controllers. They are fast enough to make new processes susceptible to control. Since they are digital and have no moving parts, they don't have any resonances that might act at cross-purposes with the process—some analog controllers have what amounts to an RC time constant that causes a lag in the control process; this in turn can cause the process variable to oscillate around the desired value. There is no overshoot with the fluidic approach; there are no resonances to drive the process variable past the desired level. The fluidic controller's output can push the process only toward the desired value, never away from it.

By itself, the fluidic control

Why Ragen Semiconductor tests C/MOS with a Teradyne J259

When you're testing complementary-MOS devices with two or three hundred transistors on a chip, you'd better be sure of your test equipment. Ragen Semiconductor, an acknowledged leader in C/MOS, has good reason to believe in its computer-operated test system: With thousands of C/MOS IC's tested and shipped, returns have been virtually nil.

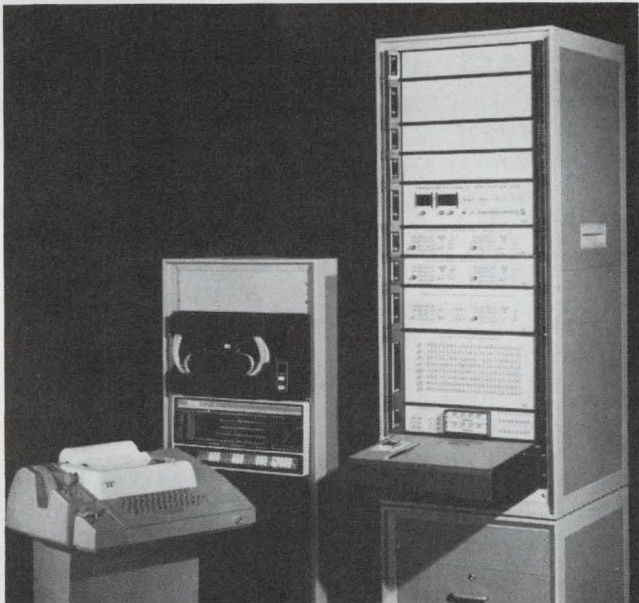

Ragen's test system? A Teradyne J259.

Ask Ragen President Al Medwin what he likes about his J259 and he may tell you that its high-impedance measurement system is perfect for the low-current measurements he has to make. Or he may tell you about the strong software Teradyne supplies with its systems. He may well mention speed because each Ragen device sees 450 parametric tests almost as soon as it's placed in the test socket.

He might also tell you some things the J259 *doesn't* do.

It doesn't force you to stop production once a week for recalibration adjustments.

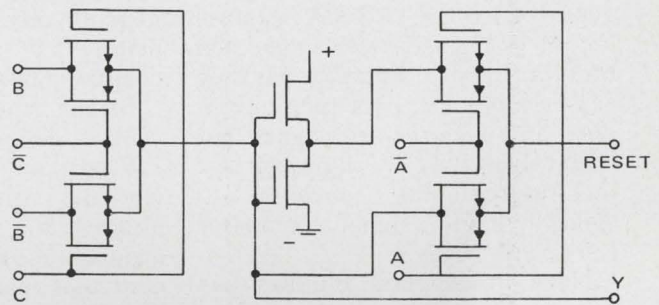

It doesn't break down every time someone insults it. Ragen's J259 downtime has been less than *one percent*.

It doesn't leave you high and dry when your test load changes. When you expand, it expands, through the easy addition of multiplexers, magnetic-tape units, line printers, and all the software you need to go with them.

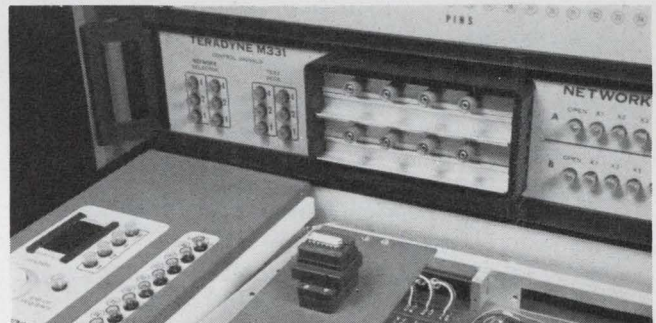

The J259 makes sense to Ragen Semiconductor. If you're in the business of testing circuits—integrated or otherwise—it makes sense to find out more about Teradyne computer-operated test systems. Just use the reader service card or write Teradyne, 183 Essex St., Boston, Mass. 02111.

Teradyne makes sense.

U.S. Reports

block—called the FC-100A—would make process-control engineers happy, and it is already replacing analog controllers in installations at du Pont, Corn Products, and other companies. It is a direct replacement for the older controllers it is displacing, requiring only the same “process variable” and “set-point” inputs, and yielding a control output.

And since the FC-100A's control output is a pulse-width modulated train of pressure waves, it not only can be integrated over time to produce an analog control signal, but easily processed by a proprietary pressure-to-digital converter to yield the kind of signal a computer can digest easily.

Nova in. Applied Fluidics has selected Data General's Nova computer to handle the mainframe tasks in the integrated systems it's about to bring out. The memory is the fluidically controlled DDR-1 disk by the Digital Information Storage Corp. for bulk data storage [*Electronics*, Oct. 13, 1969, p. 149].

According to Applied Fluidics' manager of computer applications, James C. Krok, the immediate beauty of the system is its cost, \$35,000 to \$50,000 in typical installations of several hundred control loops—way below the price of competing systems even before savings in overhead.

Second, and important to the quality and quantity of the product processed, is the system's ability to handle cascaded control loops. According to Krok, “Changing one variable affects many others downstream from it. And since typical plants may require hundreds of cascaded control loops the value of the flexible computerized system becomes apparent.”

With the Applied Fluidics system, an operator can change manually a set point far upstream. And the computer, monitoring the operation of that particular fluidic controller, can alter automatically each downstream set point for peak quality or output. Also, a user can program for a given yield quality or quantity and the Nova-FC-100A system will compute the proper setpoints.

Start-up operations, usually quite

boring for humans, and thus a source of error, also can be controlled by the system. The Nova can keep track of each process variable, watch it rise, fall, or settle, and even taper the control signal's ramp value to suit needs upstream or downstream in the process. This kind of hands-off start-up control can be particularly valuable in dyeing processes where color can depend on temperature or pH, neither of which necessarily changes linearly.

In one typical configuration, the central computer would monitor 128 set points (and fluidic controllers) through a multiplexer and also watch a 256-channel pressure-acquisition system to note and record that many process variables. The Nova would also service a logging typewriter to provide process records as well as an operator's console.

As a final advantage, Krok cites the fact that the user never really “sees” the computer after installation. “He sees only process-oriented data at the console,” he says. “He can ask for deviation alarms, readouts, printouts, observe the rate of change of a process variable in real time, and even change specified set points through the hidden action of the computer.” Thus, there's no fear of being replaced by a machine; the man always feels in command.

Companies

Turnaround

Amid the gloom that pervades the aerospace side of the North American Rockwell Corp. as business spirals downward, shines a brightening hope for success in commercial microelectronics. It's the Autonetics Products division, which apparently has turned the corner on its contract to deliver more than 2 million MOS/LSI arrays to the Sharp Corp. of Japan for that firm's Micro-Compet calculator.

Division officials would admit to only minimal MOS process problems on the Sharp contract as recently as a few months ago [*Elec-*

tronics, March 2, p. 33], maintaining that switching from 1.5-inch to 2-inch wafers was the chief process perturbation. They insisted that the big obstacle was a shortage of packages. In retrospect, it appears they were trying to keep a stiff upper lip in the face of greater problems. But today, the smiles in Anaheim are genuine.

Pouring out. And well they might be. The division delivered some 81,000 arrays in February to Sharp and to the Instrument System Corp. The latter are complex circuits for the multiplexed passenger services and entertainment system in the Boeing 747, which ISC supplies. The greater number went to Sharp. Then in April, Autonetics delivered “well over 100,000 devices” to Sharp alone, says R.S. Carlson, Autonetics vice president and general manager of the division. “Sharp is now putting out more than 20,000 calculators a month,” Carlson adds, “and both that number and our shipments are going up.”

The two-year Sharp contract, worth almost \$30 million to Autonetics, calls for deliveries through January. While Carlson can't say for sure that the contract will bring a profit, officials are now confident they'll deliver all the devices on schedule. That confidence, combined with the division's success in ironing out earlier difficulties on the ISC contact and with the new business opportunities—including follow-on orders from Sharp—being stalked by the division, account for the smiles Carlson and Charles Kovac, his marketing manager, are wearing these days. And Carlson isn't ruling out a profit on the initial venture with Sharp. “Our costs have been coming down steadily,” he says.

“We don't have a big marketing organization because we're not in the standard-parts business,” says Kovac. “We're looking for ‘joint ventures’—joint participation in making the end product successful.” Kovac explains that Autonetics and Sharp have been committed to making the Micro-Compet a success. The contract's volume makes it possible for Autonetics “to

For $\approx 1\text{¢}/\text{bit}$ - production quantities of YOUR CHOICE

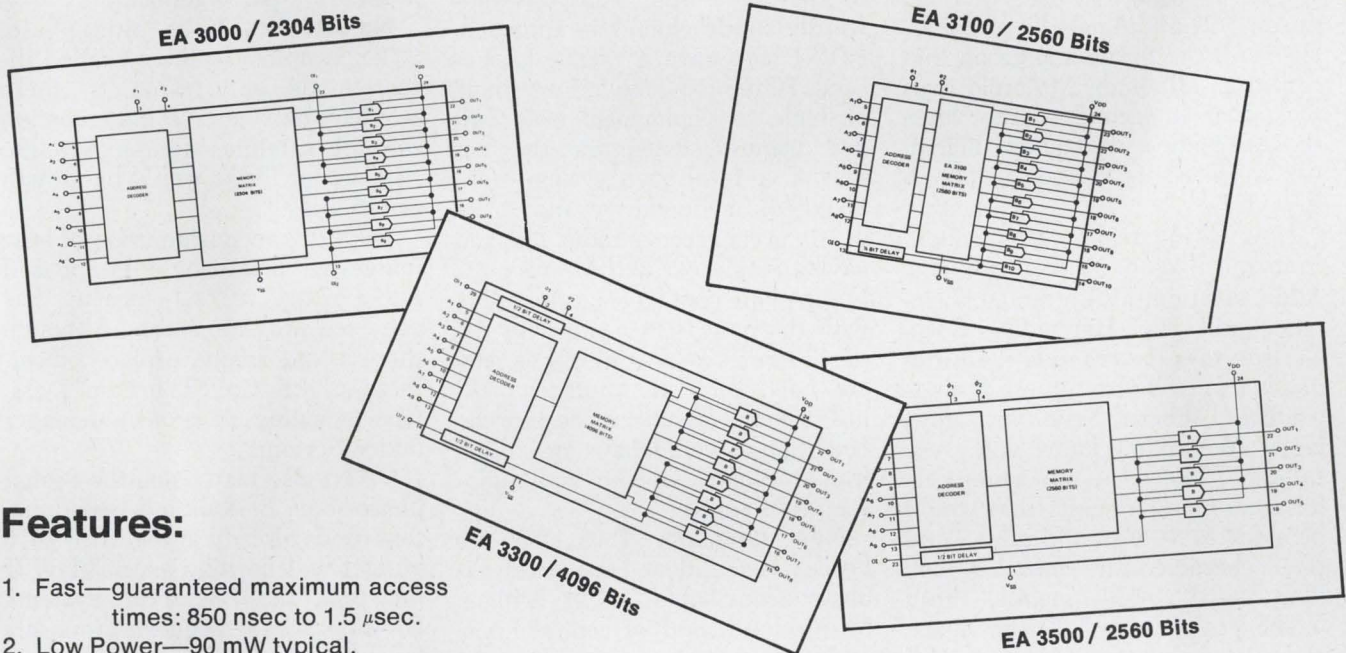

Features:

1. Fast—guaranteed maximum access times: 850 nsec to 1.5 μsec .
2. Low Power—90 mW typical.
3. Complete decoding within each ROM.
4. Wire-OR capability.
5. May be biased to be bipolar compatible.
6. Synchronous and compatible.
7. 24-pin dual-in-line packages.

Standard Patterns

available *today* at EA distributors

1. **EA 3001**—Starburst character generator and Selectric bail to ASCII code converter.
2. **EA 3101**—ASCII to Selectric Line Code and Selectric Line Code to ASCII code converter.
3. **EA 3307**—ASCII to EBCDIC and EBCDIC to ASCII code converter.
4. **EA 3501**—Row Scan Dot Code Matrix Character Generator.
5. **EA 3701**—Column Scan Dot Code Matrix Character Generator.

Custom Patterns

Any EA ROM can be programmed to your specialized bit patterns. Allow 6 to 8 week delivery.

For data sheets and forms for submitting your specialized bit patterns, contact your local representative or write Electronic Arrays, Inc., 501 Ellis Street, Mountain View, California 94040. (415) 964-4321.



**electronic
arrays, inc.**

PROVEN MOS PRODUCTS DELIVERED IN VOLUME

U.S. Reports

spend a half cent to save a penny" in making the circuits easier to produce, Carlson points out. He and Kovac say this differs sharply from the view of the circuit manufacturer who knows he's one of many sources and may have to squeeze out the maximum amount of profit over a short production run.

Waiting and willing. Kovac and Carlson believe this kind of commitment is one reason ISC agreed to allow Autonetics to come to a near standstill early this year on circuits that go into the Boeing 747 while considerable redesign was done. "ISC worked closely with us," Carlson says, "and we delivered several thousand devices to them in April. That did us a lot of good." He's still the prime source on that contract, although Motorola was picked as a second source when the Autonetics production difficulties surfaced [*Electronics*, March 2, p. 33].

Now Kovac seeks new business from the likes of NCR, Burroughs, Addressograph-Multigraph, Teletype, and the Hammond Corp. Carlson says the reaction the Autonetics team gets from these firms is usually "Where have you guys been? We didn't know you were selling." The NCR opportunity is for a family of circuits that would be made to NCR ground rules, "and their characteristics make it look like they would include both memory and logic," Kovac notes. He says that because of the good report cards Autonetics is getting from Sharp and ISC, "these other firms will want to deal with us. We'll be the leader in MOS/LSI sales in 1970," he predicts, "and that includes both General Instrument and American Micro-systems."

Carlson is loathe to disturb the process in the facility fabricating the Sharp circuits. He says: "We'll be deliberate about introducing new parts. We'll take variations on that standard process. But our pilot line gives us the flexibility to take on new business.

If the volume becomes big enough, we'll dedicate a part of the main factory to another process, if required."

Avionics

Unified we stand

I/CNI, Integrated Communications, Navigation and Identification, has changed. Now it's U/CNI, with a U for Unified. Col. Waldo E. Bertoni, chief of the communications division at the Air Force Electronic Systems Division, says that the name change signifies a switch away from the former advanced-avionics approach of "everything in one box and toward one in which the various avionic functions are married into a centralized system."

This may sound like mere semantics, but it makes good sense to the Air Force. With this outwardly subtle change in approach, U/CNI may have a chance to succeed. Heretofore, the largest single obstacle to deployment of a unified avionics system was the fear that if a full-blown system were installed, it quickly would make nearly every piece of radio, IFF, and navigational gear aboard every Air Force plane obsolete—incompatible with the new I/CNI. And with the purse strings held as tightly as they are now, such an approach held little chance of success, despite the fact that it would have saved airframe volume, weight, and radio-spectrum space.

New direction. Thus, the Air Force has abandoned the one-black-box concept behind I/CNI. It plans to develop a sort of central interconnection system which would take multiplexed information from each of the existing avionics subsystems and radio receivers and then relay their data to the appropriate cockpit display or transmitter.

One small multiplexer could help create the effect of an integrated avionic system with an attendant saving in radio-spectrum space, but would use inputs from existing avionic gear. Obviously, as the years pass more advanced avionic gear could be fitted into the system until eventually a truly integrated system would emerge—but without the cost and political trauma potential in the old I/CNI concept.

And because the central multiplexing system could handle wide

varieties of inputs or outputs, the U/CNI approach could adapt to many different CNI approaches. For example, the unified system could be compatible not only with the military tactical air navigation/distance measuring equipment navigation approach, but also with the vhf omni/range civilian DME counterpart; it could allow vhf communication for civil air-traffic control as well as working the uhf frequencies used by the military. And when the civilian satellite air-traffic control system scheme is finally decided upon, it would adapt to it as well as the pending 621B system presently in slow development by the Air Force's space and missile system organization.

No satellites. In its initial phase, U/CNI would use the so-called direct mode only. That is, there would be no communication through satellites and no satellite navigation. These would be growth capabilities.

With this reconsideration of how integrated CNI should be phased into being, U/CNI nearly has achieved program status. Although there is no senior project officer, there is Lt. Col. Thornton Doss, who is acting as project manager under Bertoni.

U/CNI also may reach the design phase soon. Bertoni and Doss hope that funds already in the fiscal 1970 budget will be released in May. If they are, the Electronic Systems Division would request proposals for a multicontractor paper study of U/CNI and its possible implementation [*Electronics*, May 11, p. 33.] Bertoni is theorizing a six-month study and nine-month evaluation period afterward, and then a hardware contract—perhaps a multicontractor effort aimed at a fly-off competition. Moving at the best speed possible and without funding problems, requests for hardware bids might be made by the fourth quarter of 1971. Bertoni figures that U/CNI prototypes might be in test by late 1972. But this is a "best case" estimate, and considering the mood of Congress, funding delays can be expected.

Dead thread. Meanwhile, the thin thread CNI system which went through an initial bid stage



LAND OF THE BLABBERMOUTHS.

Blab blab blab. The communications flow in the U.S. is turning into a gusher. Can technology keep up? Martin Marietta communications people are studying unusual new digital techniques to expand the volume of conventional circuits. We're also conducting transmission experiments in the millimeter wave region. It could give some much-needed tongue room in the crowded electromagnetic blab spectrum. Martin Marietta Aerospace Group. Headquarters: Friendship International Airport, Maryland.

MARTIN MARIETTA

Has the No. 1 storage tube company turned square?

The inventor of storage tubes has invented a new one that's more square than round.

A versatile rectangular from Hughes. Able to produce alpha numerics, graphs and halftone displays. And give you the viewing area of a 7-inch round tube, while taking far less space.

Its resolution is 90 lines per inch @ 80% equilibrium. Brightness: 200 foot lamberts. Storage time: over two minutes without pulsing, up to an hour with pulsing.

Writing speed: 40,000 inches a second and up.

But although our new tube *is* sort of square, we aren't. Actually, we're great rounders.

Example: our Typotron® Direct-View Character-Writing Tube. It presents stored information much like typed copy. Over 25,000 characters a *second*. Nobody can estimate all its potential uses in education, research, business, industry.

Example: our neat little H-1269 scan converter tube. Less

than a foot long. Target diameter is 2¼ inches. Resolution: 1,000 TV lines/diameter. Storage time: 25 minutes to 50% output.

Like more information? Just write: Hughes, Industrial Products Division, 2020 Oceanside Blvd., Oceanside, California 92054.

HUGHES

HUGHES AIRCRAFT COMPANY
INDUSTRIAL PRODUCTS DIV.
OCEANSIDE, CALIFORNIA



last year [*Electronics*, July 21, 1969 p. 115] has been shelved, according to Bertoni. He says that the major purpose of the thin thread was either to show that existing technology could do the CNI job or to stimulate incremental developments in technology that could. Since mid-1969, the Air Force has held technology evaluation studies and briefings and now feels that such a demonstrator isn't needed after all. "The technology is already there," says Bertoni.

Nine problems

Nine of Lockheed-Georgia's avionics packages for the costly C-5 supertransport are causing sufficient trouble to require design changes. This was disclosed in an extraordinary 25-page, six-part position paper on the program distributed by the company. And Lockheed sources indicate that comparable papers may be forthcoming soon on the three other troubled defense contracts—the Army AH-56 Cheyenne helicopter, the Air Force SRAM missile, and Naval vessels too—that led Lockheed's recent appeal to the Department of Defense for economic relief.

In addition to the C-5's multi-mode radar developed by United Aircraft's Norden division [*Electronics*, April 27, p. 74], Lockheed says "a number of problems have arisen" with avionics for automatic flight control; inertial doppler navigation; radar altimeter, attitude, and heading reference unit; attitude direction indicator; central air data computer; mach trim compensator; and the crosswind steering system.

New start. "All of these systems have received special management attention by the Air Force and by Lockheed," the company says. "Following design changes, we have received new delivery commitments from suppliers which are compatible with aircraft delivery schedules, and plans have been made to install the systems out of their normal work station but within our schedule requirements." Some of the affected avi-

onics contractors include: Litton Industries' Amecon division (radar altimeter); Lear Siegler (attitude and heading reference units); Elliott Bros., Rochester, Kent, England (central air data computer and crosswind castering control systems); Honeywell's Aeronautical division (automatic flight controls); and Northrop's Nortronics division (doppler).

In general, Lockheed blames its avionics problems on the system's concurrent development in which new, untested hardware was built simultaneously with aircraft construction. To date, the company has completed 14 planes which had logged 3,400 hours of flight tests by the third week in April.

"The original concept of the C-5 program" Lockheed contends, "was for a state-of-the-art airplane which required no design breakthroughs in either airplane design or system design. Subsequent to the contract award, it was found that the design and production of the C-5 involved many advancements in the state of the art." Those advancements spelled out by the company fall largely in the production area, which Lockheed says it has found to be "more similar to ship construction than airplane construction." Though Lockheed concedes it, erred in formulating its cost proposal by simply "scaling up" its past experience in building the earlier jumbo transports, the C-130 Hercules and C-141 Starlifter, it also blames the Air Force for establishing "new performance requirements" just before the contract award. The changes, Lockheed argues, "required extensive aerodynamic changes."

Potential. Nevertheless, Lockheed sees its biggest bird as a winner if it can avoid a catastrophic economic loss on the program. Beyond its role as a transport able to carry 100,000 pounds of cargo some 5,500 miles without refueling, the C-5's potential includes use as the Advance Airborne Command Post, for which the Joint Chiefs of Staff are seeking 17 planes; an advanced Air Force tanker to supplement the KC-135 fleet which could be bought in the fall of 1971; plus a role as an advanced reconnais-

How did Hughes get a reputation for innovation?

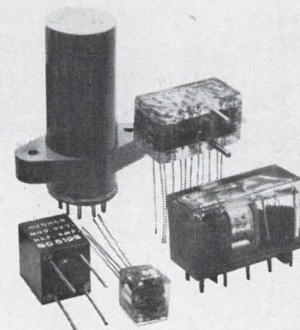
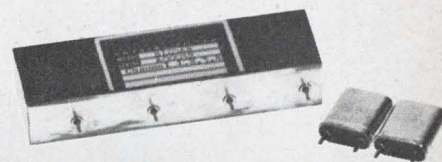
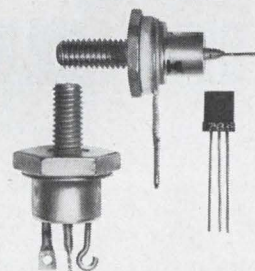
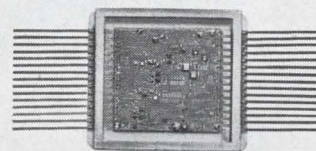
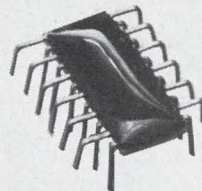

That's how.

A reputation from technical know-how in developing better MOS devices (RS 283), bipolar and hybrid circuits (RS 284), discrete devices and monolithic circuits (RS 282), frequency control devices (RS 285), and special assemblies (RS 286).

HUGHES

HUGHES AIRCRAFT COMPANY
INDUSTRIAL ELECTRONICS GROUP

Circle appropriate Reader Service (RS) number.

The Material of Unlimited Uses...

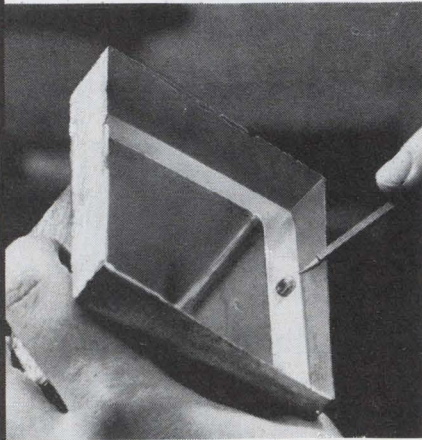

INSTANT DIP-A-MOLD

In seconds, you can make perfect molds, like this one, for potting any encapsulation, and make them economically, with low-melting CERRO® Alloys. Just dip the master in molten alloy. A thin coating of alloy clings to the pattern. Withdraw the pattern, and you have a perfect high fidelity mold. When the encapsulating plastic cures, simply remove the CERRO Alloy. Use it over and over again, almost without limit.

This particular alloy—CERROTRU®—does not shrink, slips easily from the pattern without parting or contaminating compounds or coatings. Because of its low melting point, it is safe and easy to handle.

You can reproduce such unusual details as positioning lugs for transformer cases, as shown above, without the use of cores, inserts or secondary operations.

Instant molding is just one of the many uses for CERRO Alloys. To find out more, contact Cerro Copper & Brass Co., Alloy Dept., Bellefonte, Pa. 16823. Telephone (814) 355-4712. In Europe, contact Mining & Chemical Products Ltd., Alperton, Wembley, Middlesex, England.

CERRO®

sance aircraft, airborne surveillance and control, an airborne ballistic missile intercept system, a standoff offensive missile launcher, and a variety of Navy missions, including minelaying.

Selling Secant

RCA's first effort to sell air carriers on its Secant collision avoidance system are being viewed as a success by at least one company official. "At least we didn't get thrown out," he said of the company's recent closed meeting in Washington hosted by the Air Transport Association. Nevertheless, RCA is proceeding carefully in what that official calls "the toughest selling job in history."

But RCA indeed played it cool in its efforts to sell Secant (separation control of aircraft by nonsynchronous techniques) to airlines that already have a substantial investment in test and evaluation of time-frequency collision avoidance hardware. And with its technically oriented soft sell, RCA aroused the interest of several carriers, including American Airlines.

Model. Airline engineering representatives suggested that Secant might become overloaded in dense aircraft populations. RCA replied with results of a comprehensive computer simulation which modeled 100 parameters for each of 1,200 mixed aircraft within a 60-mile radius. With this data, drawn from Federal Aviation Administration estimates for the Los Angeles Basin in 1986, RCA told the carriers that several hundred computer runs show that the average duty cycle of Secant is well under 1%, while the maximum duty cycle is just over 1%. The result, according to RCA, is that its system can provide an aircraft with a shield of up to 100 seconds before collision without failing to correctly report every hazard or reporting a nonexistent hazard. The 100-second figure is far in excess of the 60-second alert shield and 45-second alarm shield that RCA says is adequate.

The 11 link factors used in the simulation include three dimensional models of 1,600 megahertz blade-antenna patterns derived from practical installations on a

Boeing 707 jetliner, generated power, losses from cable and plumbing, polarization, detuning, mismatch, detectors, plus mutual and self-interference effects, system-noise and detection statistics. Each parameter was assigned a variable appropriate to its scale and selected at random from a Gaussian distribution.

Explains. Those skeptics were promised a copy of an internal memorandum which calculates and explains in very simple terms the high immunity of Secant to saturation in the densest environments that the FAA has forecast. This immunity derives primarily from a system of frequency assignments: those aircraft flying above 10,000 feet (air carriers, military and larger business aircraft) use a different set of frequencies than those which ordinarily fly below 10,000 feet (most light planes for a total of 90% of all aircraft); each altitude range, zero to 10,000 feet and 10,000 feet and above, is split into an upper and lower field by the interrogating aircraft. In all a total of 26 individual frequencies spaced 1 Mhz apart are used, including two for an automatic hot line to ATC at the center of the FCC's 1592.5-1622.5 Mhz allocation for collision-avoidance purposes. Despite the small frequency separation between channels, crosstalk is eliminated by sensing which member of a parallel filter bank is ringing strongest and gating that output to the processing circuitry.

RCA admitted that such an extensive system of separate frequencies might be more than was actually necessary, but pointed out that all classes of Secant equipment were fully compatible with one another, and the intent had not been to design a "simplest" or "optimized" system, but rather one which had as much capability as the frequency allocation afforded, within the constraint of minimum system price—now firmly under \$700—for the light plane version.

Wants the best. An American Airlines engineering team headed by Frank Chandler told RCA that the airline wanted the best possible system operational at the earliest possible date and indicated that the collision-avoidance system door was not closed to the newcomer.

As to multipath problems, RCA

SUDDENLY ALL OTHER VOLTAGE REGULATORS ARE SECOND BEST.

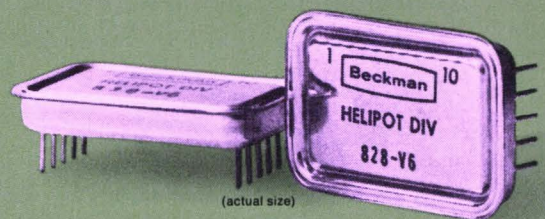

(actual size)

HERE'S WHY:

- $\pm 0.01\%$ line & load regulation
- $\pm 0.5\%$ preset output voltage
- Short-circuit proof
- MIL-STD-883 hermetic package
- \$40 (1-9 quantity)
- Model 828 (plus) and Model 838 (minus) from stock
- Many other outstanding features; contact your local Helipot representative.

Beckman

HELIPOT DIVISION

FULLERTON, CALIFORNIA • 92634

INTERNATIONAL SUBSIDIARIES: AMSTERDAM; CAPE TOWN; GENEVA; GLENROTHES,
SCOTLAND; LONDON; MEXICO CITY; MUNICH; PARIS; STOCKHOLM; TOKYO; VIENNA

Circle 57 on reader service card

New SOLID-STATE FET-INPUT MULTIMETER

from
SIMPSON
of course



**Model
2795**
**PORTABLE,
LABORATORY
ACCURACY,
SOLID-STATE
ELECTRONIC
MULTIMETER**

- 68 Switch Selectable Functions:
 - 13 AC and DC Voltage Ranges (as low as 1 MV, full scale)
 - 14 AC and DC Current Ranges (as low as 1 μ A, full scale)
 - 6 low power (IC compatible) Resistance Ranges
 - 6 completely self-contained Capacitance Ranges
- Plus 12 Output Ranges
- Circuit Breaker Overload Protection
- High FET-Input Impedance
- $\pm 1\%$ Accuracy for AC and DC
- Negligible Voltage Drop
- Simple, Straight-Forward Operation
- Size: 8.07" High, 5.04" Wide, 3.94" Deep. Only 3.3 lbs.

2795 MULTIMETER supplied complete with batteries, test leads and operator's manual. Complete accessories available. **\$230⁰⁰**

WRITE FOR BULLETIN L-1010 . . . OR CONTACT YOUR SIMPSON INSTRUMENTATION PRODUCTS DISTRIBUTOR FOR OFF-THE-SHELF DELIVERY

Simpson
INSTRUMENTS THAT STAY ACCURATE

SIMPSON ELECTRIC COMPANY

5200 W. Kinzie Street, Chicago, Illinois 60644

Phone (312) 379-1121

EXPORT DEPT.: 400 W. Madison St., Chicago, Ill 60606. Cable Simelco

IN CANADA: Bach-Simpson Ltd., London, Ontario

IN INDIA: Ruttonsha-Simpson Private Ltd., International House, Bombay-Agra Road, Vikhroli, Bombay



U.S. Reports

presented data showing that Secant has a high inherent immunity to such effects. However, it offered to extend its computer simulations runs to include such aircraft conditions as wheels-down, flaps-down or any other suggested by the carriers in addition to the standard, ground-reflection multipath which it has used in simulations thus far.

Having achieved a beginning dialogue with potential system users, RCA is expected to push within the company for fabrication of flyable prototypes of Secant hardware by early 1972 in versions for light planes, business jets, and airliners.

For the record

Shuttle awards. The McDonnell Douglas Corp. and North American Rockwell's Space division have each won an \$8 million NASA competition for 11-month contract definition and preliminary design studies of a reusable space shuttle. After negotiation of fixed-price contracts, NASA's Marshall Space Flight Center at Huntsville, Ala., will manage the McDonnell Douglas work, while the Manned Spacecraft Center at Houston will oversee the North American Rockwell contract. After the design competition, NASA hopes to be able to select a winner to build a fleet of the new vehicles at an estimated \$6 billion cost to begin flight operations by 1978. Losers in the two-stage shuttle competition were teams headed by Boeing-Lockheed and Grumman-General Electric.

Major subcontractors to McDonnell Douglas include Martin-Marietta, TRW, Pan American World Airways, Raytheon, Sperry Rand, and United Aircraft's Norden division. North American Rockwell's subs include General Dynamics, IBM, Honeywell, and American Airlines.

Report cards. The FAA is adding 33 radar weather reporting units to its inventory of 87. The \$371,225 contract is with the Whittaker Corp. The units will be used in the National Airspace System at 20 air traffic centers.

Our new machine is sort of a combination Leonardo da Vinci and Ebenezer Scrooge.

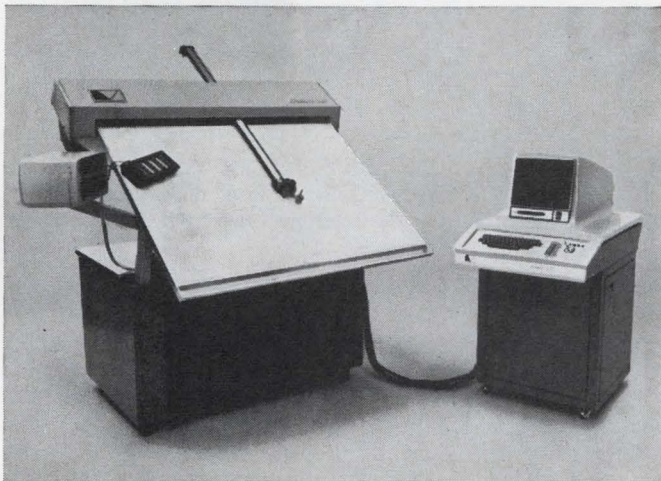

Our inspirations may seem like strange bed-fellows. But the product makes a lot of sense.

The idea is an interactive computer-graphic system with Leonardo's genius and Ebenezer's stinginess.

We invented the machine because we knew the main problems of product development. What was needed was a machine that could make your engineers more productive, and still save money.

So that's what it is: INTERACTgraphic 1, \$1200 a month.

Our machine does amazing things. It digitizes, displays and plots on a four foot interactive surface.

And it saves money a very simple way. It allows you to reduce the number of people and hardware peripherals on your project.

Cost/effective computergraphics, we call it: INTERACTgraphic 1.

You can see our machine in action in one of the places we've already delivered it. You can see it cutting costs in custom LSI design, IC mask layout and printed circuit production as well as architectural and civil engineering design.

You can see our new machine at Booth 4932 Nepcon east, or if you can't wait: call or write Computervision Corporation, Northwest Industrial Park, South Avenue, Burlington, MA 01803, (617) 272-7240.

✓/Computervision Corporation

Look. If you've got the computer, we've got the vision.

New Triacs/MAC10/11

Energize Economically In 500 V Plastic!

- Reliable, 8 A Thermopads*
- Symmetrical, 2 or 4 quadrant switching
- Lower-cost heat, light, speed control

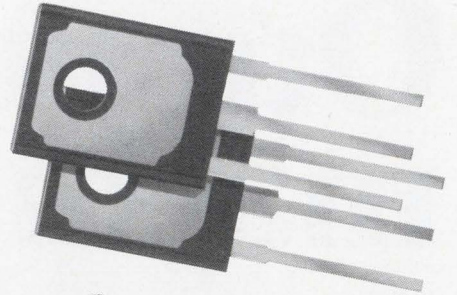

New Triacs/MAC35/36/37/38

Control 6,000 Full-Wave Watts!

- Symmetrical gating and holding
- Big, 25 A, 500 V capability
- Quick, 1.0 μ sec turn-on



New SCR's/2N5164-71(R)

Economize Medium-Current!

- Broad, 20 A, 600 V application
- Safe, 240 A surge protection
- Consumer-industrial cost

New SCR's/MCR3835/3935

Step Up To 35 A Stepless Control!

- Brawny, 600 V energy-handling
- Practical, 10 mA gating/holding
- Low, 1.2 V "on" voltage

New Triacs/MAC1/6

Pick 2 or 4 Mode

Switching In 3 Cases!

- Hermetic, 8 A Elf* reliability
- Secure, 100 A surge capability
- Minimized, 1.0 V "on" voltage



Thyristor Power

Take your pick of the newest of the new in thyristor power control . . . from 6 SCR and Triac families that combine the latest performance with the best packaging!

Now more than 250 Motorola SCR's and Triacs give you the exact degree of step-

less, full or half-wave power control you want . . . from 25 to 800 volts in 17 different, optimized metal and plastic package designs.

Now more devices are available than ever from the volume-oriented thyristor supplier to win the "power vs. price" contest in your heat, light and speed controls, vending machines, automotive applications, tools, welders and power switching systems.

Now there are informative new data sheets on any of these six new types — waiting for your response — plus off-the-shelf evaluation units from your Motorola distributor and immediate production-lot quantities from the biggest discrete device warehouse you can find.

Now there's more in Motorola thyristor power.

Use it today!

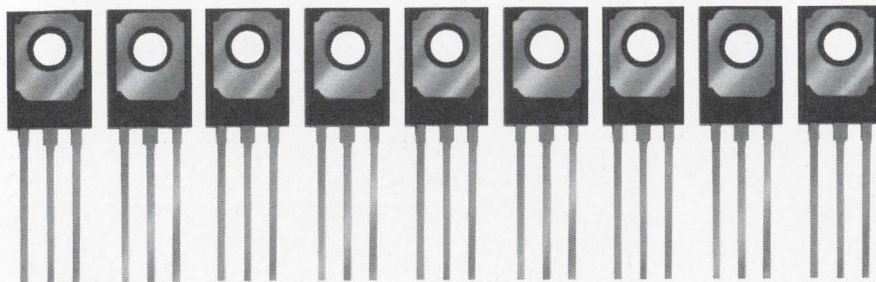

New SCR's/MCR106-1 to -4

First-Source 4 A Plastic!

- Compatible with existing sockets
- Thermally-capable to 110°C, T₁
- Immediate, stock availability

- where the priceless ingredient is care!



(R) Reverse Polarity
*Trademark Motorola Inc.

Up-to-Date Technology

Overcome Environment With Hermetic Chips!

- Uncontaminated, sealed junctions
- Higher plastic blocking voltages
- Increased cost savings

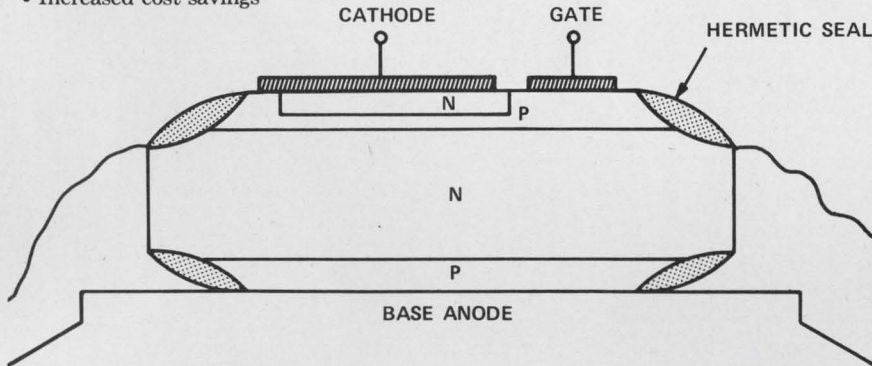

New Bilateral Switches/MBS4991-92

Phase-Control Triacs . . . Fast!

- Nimble, 1.0 μ s turn-on
- Uniform characteristics both ways
- Moderate, 8 V switching voltage

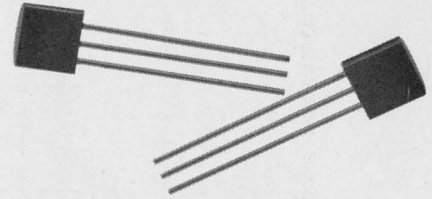

New Signal SCR's/2N5060/MCR101/115

Choose Optimized θ_{JC} !

- Flexible, 85°, 110° or 125° C application
- Sensitive, 200 μ A triggering
- Low-as-30¢ prices (100-up)

New Programmable UJT's

MPU131, 132, 133

Do Your Own Thing In Plastic!

- Variable, R_{BB} , τ , I_V and I_P
- Top, 15 V typical output voltage
- Negligible, 5 nA leakage

New Unilateral Switches/MUS4987, 88

Trigger Full Control In Half-Wave!

- Ideal, 8 V SCR controller
- Excellent, 0.02%/°C temperature coefficient
- Low, 1.5 V, "on" voltage

Trigger It On

The ideal SCR and Triac complement is a triggering or signal thyristor optimized to meet design and cost considerations.

And Motorola has the broadest line of signal thyristors!

New unilateral switches for SCR triggering, bilateral switches for Triac control, unijunctions for half-wave triggering with a timing function — there are now more than 3 dozen Motorola signal thyristor devices available that enable you to pick the right metal or plastic device for virtually any thyristor power control application . . . at prices low as 30¢, 100-up.

You can select new, low-current signal SCR's that have 3 operating temperature ranges, switches with T_C 's low as 0.02%/°C, and UJT's that are fixed or "programmable" and cased in popular Unibloc,* Micro-T* or TO-18 metal packages.

Motorola has the right triggering device for your next half or full-wave power control design.

Turn on with one today!

New Unijunctions/MU851-53

Compact Computers With Micro-T*

High Frequency!

- Prompt, 1 MHz frequency
- Tiny, 0.4 μ A peak point current
- Convenient, color-coding

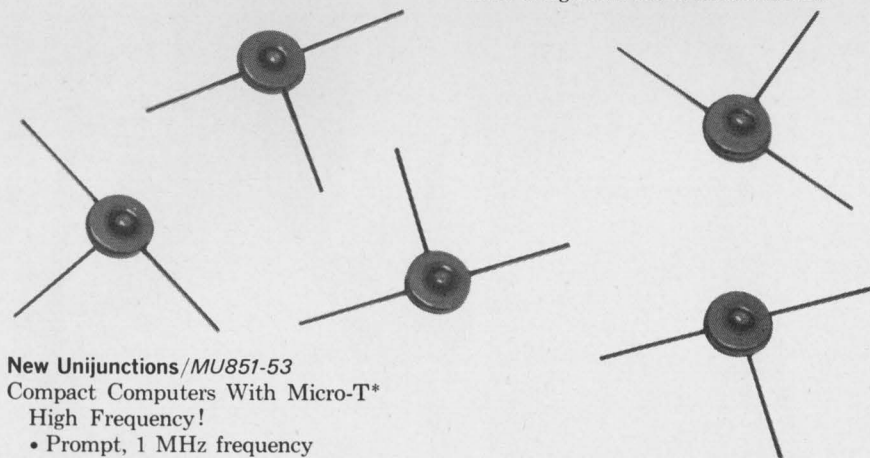

MOTOROLA Thyristor Products

Motorola Semiconductor Products Inc. • P. O. Box 20912 • Phoenix, Arizona 85036



BIG DONUT DRIVE-IN

ALL DONUTS

Mr. Klemper is in the memory business, too.

For 13 years, Floyd Klemper mixed his dough—and made it—with glazed, coated, sprinkled and plain doughnuts. He claims that once munched (or dunked) they're never forgotten. But just to make sure, he put a hyperthyroid replica of his product on the roof of his shop.

An admirable use of a mnemonic device. And, in all modesty, we do know a good mnemonic device when we see one. Our business is memories. Electronic memories for computers, just as our name says.

We're no slouches when it comes to doughnuts, either. Electronically speaking.

We turn them out by the billions at core manufacturing facilities in the U.S. and abroad. A huge capacity which has grown because selling cores to the computer industry isn't a sideline with us. As a result, we can offer

18-, 20- and 30-mil standard, extended and wide temperature ranges. Our selection includes 20 standard core types, plus customized cores to meet your specific needs.

And with production so great, we're able to keep prices low. On small quantity orders as well as large.

Being big also means being of extra service to you. Not only as a manufacturer, but as a consultant on your particular core problem. We are, in fact, one of the few companies with extensive application engineering capability. So we can provide personalized service to you whenever, wherever needed.

Electronic Memories has been on the job since the early '50s. Through the years we've built up the largest core library in the world—without sacrificing quality for quantity. In addition to

highly refined quality control procedures, we conduct continuous on-line process control. This way we monitor production—and keep quality high—every step of the way.

We deliver on schedule, too, even with short lead time. (Years of working on military projects have taught us never to disappoint a General. Or anyone else.)

So, while we admire Mr. Klemper's mnemonic device, we won't copy it. Because once customers try our electronic doughnuts, they come back for more. Without a reminder.

And if by chance you've never done business with us, now is the time to help yourself.



Electronic Memories.
Worth remembering.

ELECTRONIC MATERIALS

DOW CORNING®

3140 RTV coating

clear, flowable silicone rubber coating; non-corrosive to copper and other metals
TWO OUNCES

DOW CORNING

ELECTRONIC MATERIALS

DOW CORNING®

3140 RTV coating

clear, flowable silicone rubber coating; non-corrosive to copper and other metals
TWO OUNCES

DOW CORNING®

3141 RTV coating

white, flowable silicone rubber coating; non-corrosive to copper and other metals

DOW CORNING

DOW CORNING®

3141 RTV coating

WHITE, FLOWABLE SILICONE RUBBER COATING; NON-CORROSIVE TO COPPER AND OTHER METALS
NET WT. 2 oz/57 g

DOW CORNING®

3144 RTV adhesive/sealant

translucent, room-temperature curing silicone rubber adhesive sealant; non-corrosive to copper and other metals

DOW CORNING

DOW CORNING®

3144 RTV adhesive/sealant

TRANSLUCENT, ROOM-TEMPERATURE CURING SILICONE RUBBER ADHESIVE SEALANT; NON-CORROSIVE TO COPPER AND OTHER METALS
NET WT. 2 oz/57 g

ELECTRONIC MATERIALS

DOW CORNING®

3145 RTV adhesive sealant

grey, non-slump silicone rubber sealant; non-corrosive to copper and other metals
TWO OUNCES

ELECTRONIC MATERIALS

DOW CORNING®

3145 RTV adhesive sealant

grey, non-slump silicone rubber sealant; non-corrosive to copper and other metals
TWO OUNCES



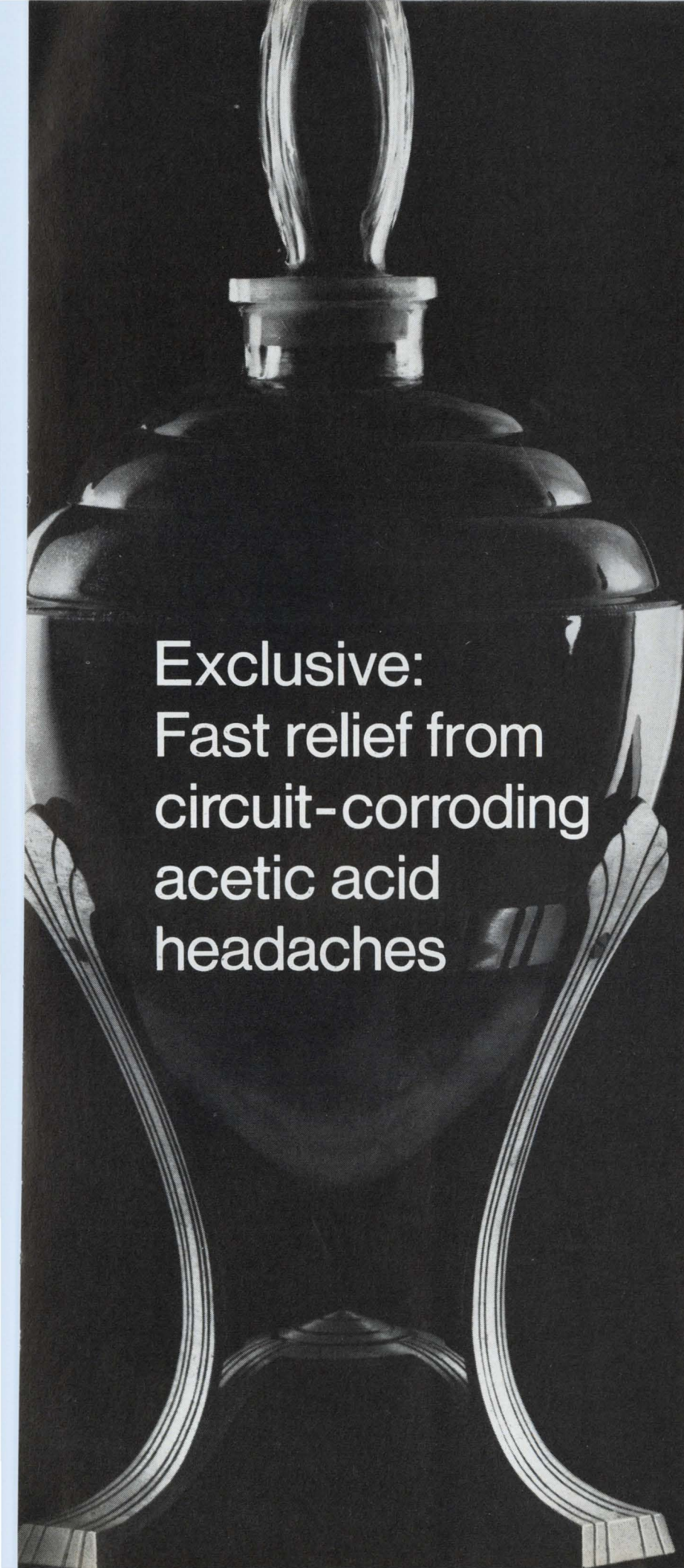

**Exclusive:
Fast relief from
circuit-corroding
acetic acid
headaches**

Dow Corning® silicone sealants and protective coatings are the only ones that do *not* release acetic acid or other corrosive by-products during cure. They were specifically developed to protect delicate circuit boards and other electronic components from corrosion, dust, dirt, abrasive particles, solvents and chemicals. They are strong, have excellent bond strength, electrical strength; are easy to apply, and cure quickly. There's no "vinegar" smell, either. Dow Corning 3140 (clear) and 3141 (opaque) RTV coatings are ready-to-use silicone rubbers that cure at room temperature. They are ideal for conformal coatings on printed circuit assemblies or for encapsulating small circuits or connectors. Dow Corning 3144 (clear) and 3145 (opaque) RTV adhesive/sealants are high-strength, non-corrosive, nonflowing silicone rubbers used to bond components and seal housings and connectors.

Stop component corrosion with these Dow Corning coatings and sealants. For more information, write Dow Corning Corporation, Dept. D -9342, Midland, Michigan 48640.

*Electrical / Electronic
materials from*

DOW CORNING

DOW CORNING

Circle 65 on reader service card



YOU CAN'T
HAVE REAL
ACCURACY

WITHOUT THIS KIND
OF READABILITY.

Recognizing that the overall accuracy of a metering system can be limited by the legibility of the meter scale, Triplet maintains a continuing study of type styles, colors, printing methods and the other factors which affect that legibility. The current state-of-the-art in legibility is exemplified by Triplet's G-Series panel meter line.

Counting the several sizes and types and the many ranges in which the G-Series meters are available,

Triplet offers more than 1,000 different meters featuring this superior legibility. With 1½, 2½, 3½, 4½ and 5½" models, the G-Series includes AC, DC and RF ammeters and milliammeters; AC and DC voltmeters and DC millivoltmeters and microammeters in addition to null meters and VU and dB meters.

Knowing that with such dial legibility the accuracy of the meter movement becomes the limit to overall system accuracy, Triplet furnishes the AC iron vane, DC and

RF movements with 2% accuracy . . . 3% for the AC rectifier-type meters.

The entire Triplet G-Series meter line is available through your local Triplet distributor or sales/service/modification center. For more information, including the availability of special ranges, scales or trim, contact one of them or your Triplet sales representative. Triplet Corporation, Bluffton, Ohio 45817.

TTT **TRIPLETT**
Manufacturers of the World's most
complete line of V-O-Ms

International Newsletter

May 25, 1970

**Best-laid plans
in Eastern Europe
are going astray ...**

More evidence has surfaced that the ambitious electronics production plans of Communist nations are in trouble. The reasons run the gamut from lagging electronics technology and a small market, all the way to a general bias against applied science.

The latest testimony to this trend is contained in a report prepared for the Joint Economic Committee of the U.S. Congress by the Central Intelligence Agency's Robert L. LeBoeuf.

According to the LeBoeuf report, computer output in the Eastern Bloc has been held to a mere 250 machines during the past 10 years, forcing users to shop elsewhere for the more than 777 computers installed by the beginning of last year. Further, notes the report, poorly performing Soviet-built computers, bad service, and limited software libraries have held installations of Russian machines in Eastern Bloc nations to 116.

A large part of production lag in Eastern Europe computers can be attributed to the lack of a mass market, LeBoeuf contends. "Given the small size of each country's market, the production of a broad assortment of semiconductor microcircuits is not economical." Furthermore, the report says that the manufacture of dependable magnetic tape drives, fast card punches and readers, and high-speed line printers requires production expertise not possible without this mass market.

**... East Germany
and Poland are
hurting most**

East Germany and Poland, the two most technologically advanced Eastern European countries, are particularly hard-hit by a lack of quality computer peripherals. Except for two machines, Polish and East German computers do not use tape for external storage because problems with domestic tape units have been particularly severe, according to LeBoeuf. Production of integrated circuits, the basis of current generation computers in the West, is just beginning in Czechoslovakia and is only in the research stage elsewhere. Further, progress in high-speed switching diodes has lagged throughout East Bloc countries.

The result of all this is that no more than 100 machines were produced in East Germany in 1969, while Poland, the area's leader, was barely ahead of its neighbor with 150 machines.

**Italy looks certain
to pick PAL system**

Italy will apparently soon be the next in a long list of countries that have adopted the West German PAL color television system. Executives at AEG-Telefunken, the company that developed PAL (for phase alternation line), are confident that the Rome government will officially opt for the system sometime next month.

Italy's decision will be a big blow to the proponents of Secam (for sequential and memory), the French-developed color tv system competing with PAL around most of the world. Ironically, it was particularly in Italy that France had gone to great lengths to sway officials toward its transmission standard.

An Italian decision is also expected to considerably improve chances that neighboring Yugoslavia will follow suit. It's also expected to influence the decision in North African and Near Eastern countries.

For AEG-Telefunken's PAL system, success apparently breeds success. With Italy now about to join the PAL camp, nearly all of Western

International Newsletter

Europe has come out for the company's system. The others include Austria, Great Britain, the Netherlands, Sweden, Switzerland, and West Germany. Those that have opted for it for future transmissions are Belgium, Denmark, Finland, Norway, Ireland, Iceland, and Spain.

British Post Office readies high-speed data service

The British Post Office will offer a 48-kilobit data-transmission service beginning the end of this month. The system has been two years in preparation and is the first commercial high-speed data service in Europe [*Electronics*, Sept. 16, 1968, p. 234].

Two services will be offered: lines for private leasing, and time on a switched network between central exchanges in London, Birmingham, and Manchester. To allow problems to be ironed out, use of the switched network will be limited initially to seven invited customers—computer and terminal equipment makers—within two miles of the central exchanges. And the network will rely on manual switching and terminals. Later, switching will be made automatic and the radius extended using special cable.

ELDO's survival rides on Europa 1

European space officials now see the upcoming launch of the Europa 1 rocket as probably the last chance for the survival of ELDO, the European Launcher Development Organization. Europa 1, a multinational venture, is scheduled for a June launching from the Woomera test range in Australia.

If the shot fails, as have two previous attempts since November 1968, the crisis-plagued \$626 million Europa 1 program will come to an unsuccessful end. And the likelihood of a British pullout from ELDO may well seal the organization's doom.

The rocket's task is to carry a satellite into an elliptical orbit around the earth, where it's to be used for communications experiments. The three-stage rocket has a British-built first stage, a French-built second stage, and a German-built third stage. The test satellite is Italian.

Color tv radiation may be eliminated by Matsushita device

X radiation generated by shunt regulator tubes in color television sets soon may be eliminated with a voltage-regulating device developed by Matsushita Electric Industrial's Wireless Research Laboratory. Dubbed HI-ZNR (for zinc oxide nonlinear resistance), the device regulates voltages in the 300- to 30,000-volt range and reduces variations in voltage up to 1/50th of their unregulated values.

Device material is a zinc oxide ceramic sintered by air firing at 1,300 C°, containing five to 10 layers of bismuth and manganese oxides. Voltage of the devices can be adjusted by controlling the amount of impurities in the layers.

Matsushita says pilot production versions of the HI-ZNR will be available by the end of August and price will run about \$2 each.

Philips plans plants

Philips Gloeilampenfabrieken is expanding into Africa and Asia. After opening a \$2.5 million plant in Nairobi, Kenya, that will produce light bulbs and phonograph records, the firm is planning to build two plants costing about \$25 million on Taiwan that will turn out television components.

Programmed Swedish parking meter can change its rates to suit the traffic

Able to handle up to 100 cars, the ruggedly built Parkomat may prove to be an economical replacement for easily vandalized mechanical meters

Electronic parking meters are replacing mechanical units in parking lots throughout Sweden. Although each electronic unit costs about \$3,000—compared with about \$40 for a conventional mechanical coin meter—Swedish municipal authorities say they are much more economical in the long run, because one can handle up to 100 cars.

The new Parkomats are made by a small, 100-employee electronics company in Stockholm, AB Transistor. The company, which had worked mainly on Swedish military electronics and in acoustic systems, has been developing Parkomats for about four years. It went to market in a big way about a year ago, and the company is starting to export on a limited basis—mainly to Scandinavia, but it also has some orders from Holland.

The units are now fully accepted as efficient and economical by municipal officials who had been skeptical, to say the least. Because they knew that conventional mechanical parking meters are frequently out of order or vandalized, they doubted that a complicated electronic unit could stand up to rugged treatment. But the Parkomat's record has changed their minds.

Pay off. The Parkomats are installed both in permanent parking lots and in empty lots awaiting the construction of new buildings. Installing conventional meters would be costly and time consuming, but one Parkomat can serve up to 100 cars, and can be installed and maintained easily. The Stockholm Public Works Authority says an electronic meter is as economical

as 17 mechanical meters. The makers are more conservative, asserting that the pay-off point comes at 30 conventional meters.

One big plus of the Parkomat is that it can easily be programmed to fit a wide variety of hourly parking charges. What's more, the program can be changed easily. Programs also can be quite complex, giving free parking at night or on weekends, or demanding higher fees on special days, for example.

The units print a parking ticket which has the hour, minute, day, week, and amount of money deposited. The ticket is placed by the driver inside his windshield, so inspectors can check to prevent cheating. Tickets also show the parking lot number to prevent a driver from getting a ticket at an inexpensive outlying lot and using it to park in an expensive downtown lot. They even can show the year, to prevent using tickets year after year.

The machine accepts various

coins. The coin-detecting and accepting mechanism is a standard unit found on vending machines. The amount of money deposited is registered on a lighted, bent-plexiglass display.

More important, however, is the registration of the amount in a simple digital computer. The computer, which uses a total of about 80 IC's, activates five printing wheels which produce the parking tickets.

The wheels are set by pulses produced when small white bars on each of the wheels are sensed by a photocell. As the wheel moves, the pulses are counted and the wheel is stopped at the proper point for printing. After the ticket is printed, the wheel returns to zero position.

Quick change. The computer can be programmed by changing diodes on printed-circuit cards in the maintenance shop. The entire electronic control system—as well as the other major parts of the unit, such as the printing device, coin

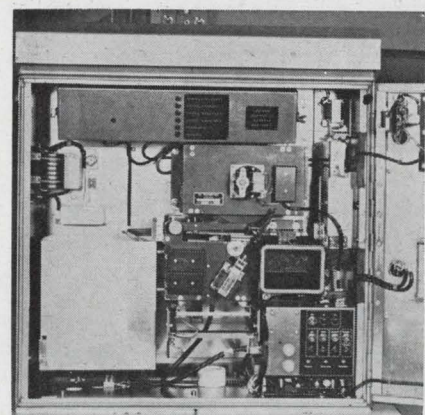

Vendor. Coins inserted in slot at upper right of Parkomat trigger logic circuits, on removable cards in long box at top, and ticket printer (center).

detectors, paper feed mechanism, and electrical control equipment—can be removed from the Parkomat as units, and replaced with new units.

The device operates on 220 volts. In case of power failure, a battery will operate the electronic system for up to two hours, enabling the computer to remain in step with the clock in the unit. When the power comes on, the computer does not have to be moved ahead to catch up with the clock. However, if power is off for more than two hours, resetting can be accomplished manually.

The Parkomat contains a thermostatic heating element to keep the interior—mainly the printing unit—warm during the long Swedish winters. Up to now, vandals have not broken into any units, although there have been attempts. The system is enclosed in a 0.25-inch-thick steel box.

One disadvantage from the consumer side is that all coins must be put in at once. It's impossible to feed the meter if the time is only halfway down. However, there are a number of advantages. One big one is that, where parking is free at night, the Parkomat prints for the next day. The meter is programmed to skip the free periods and start printing tickets for the pay periods. Another advantage is that the machine gives a receipt for parking—which is handy for expense accounts and tax returns. The parking tickets are printed in two parts, so one can be kept as a receipt when the time is up.

The makers say that the city of Oslo, Norway, has been testing a unit for some six months and has placed an order for more. "If the Norwegians approve a Swedish device, it must be okay," they say.

West Germany

Roller power

One concern of spacecraft designers is building solar-cell arrays large enough to provide the energy that future satellites require. To

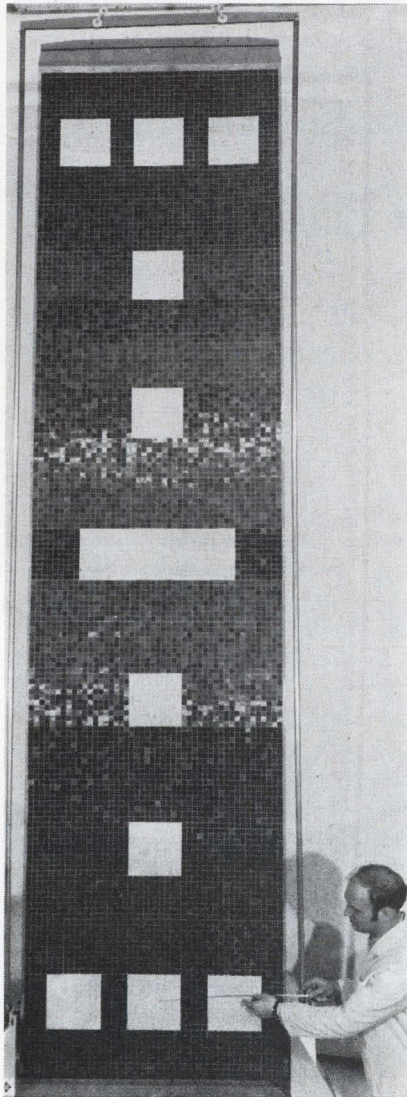

Retracts. Solar cell array can roll up hundreds of times during flight.

get, for example, 1 kilowatt of power with today's solar cells, a mounting area of 100 square feet would be needed. But conventional mounting schemes—solar paddles or cells installed around the satellite body—just don't provide the area for such power.

For that reason, aerospace firms both in the United States and in Europe continue to look at large flexible arrays that either roll out or fold out accordion-style after launch. Now West Germany's AEG-Telefunken has joined the ranks of firms working on large-array designs.

Ins and outs. At the company's Hamburg special techniques laboratories, research is concentrating

on a flexible array that can be extended from the satellite and pulled back onto a drum in roller-shade fashion. Tests are currently being carried out with a 3-by-12-foot array in which glass and aluminum dummy plates are used to simulate the weight of solar cells that are to be mounted later in their place. The company intends to extend these tests soon to a 3-by-24-foot array. The work is being sponsored by West Germany's Society for Space Research, the project planning arm of the country's Ministry for Science and Education.

Such a flexible array, says AEG-Telefunken, offers several advantages over those built so far. For one thing, in its rolled-up position the array takes relatively little space inside the capsule. Furthermore, because of its simple construction, the active generator surface can easily be enlarged without the need for changing the array's basic overall design. Increasing that surface to more than 100 square feet is no big problem. What's more, the design of the drive system for the drum is simple and thus works more reliably than drives for fold-out type arrays.

The most important feature, however, is that the array's in-and-out movement can be accurately controlled. It can be matched to the particular energy requirements of the satellite's electrical equipment. For maximum power, the array would be extended all the way; for intermediate power needs, it would be only partly extended. It would be rolled up completely during course corrections to eliminate the effects of inertia or when the satellite passes through a radiation zone to prevent damage.

The new flexible array may first be used on Selam, a technological satellite now in its project definition phase at several West German aerospace firms. Selam is the acronym of the German words for solar electrical drive module.

For mounting the solar cells in the new array, a 75-micron substrate of Kapton, a flexible and tear-resistant plastic material, is used. The array can withstand a tensile stress of 1 pound per square

foot and a gravitational force of about 0.1 G. Tests so far have also shown that interconnections between the simulated cells can withstand 12,000 extend-and-retract operations without breakage. The array rolls up on a 6-inch drum.

Powerhouse. The array features a relatively high power-to-weight ratio. A design using thin silicon solar cells provides an output of about 15 watts per pound. And with the new thin-film copper-cadmium-sulfide solar cells AEG-Telefunken is now developing, the ratio can be increased considerably—to 27 watts and more per pound, the firm says.

AEG-Telefunken's 1.6-by-1.6-inch copper-cadmium-sulfide cells differ in many respects from the standard, space-proven silicon solar cell. It is made by vacuum deposition of an n-type polycrystalline cadmium-sulfide film on a conductive plastic foil. Then, the surface of the CdS layer is chemically converted to a p-type copper sulfide film.

The spectral response of the CuCdS thin-film cell is more favorable for the energy-conversion process because it matches the energy spectrum of the sun better than does the silicon solar cell.

The thin polycrystalline nature of the evaporated CdS film gives the device a high degree of flexibility, ruggedness, and radiation resistance. Since no single-crystal material is required, the CuCdS cell can be manufactured as a large-area device using mass-production techniques. AEG-Telefunken's present prototype cells exhibit an electro-optical conversion efficiency of better than 6%.

Great Britain

Bright ideas

Low-light-level television would be more useful for night viewing, particularly on the battlefield, if cameras were smaller. Two British camera-tube specialists are developing new tubes claimed to give exceptional performance for their size.

EMI Electronics Ltd. claims its

new tube—no bigger than a 1-inch vidicon, including coils—combines the daylight performance of a vidicon and the low-light performance of a secondary-electron-conduction tube. It is the first production camera tube to use an electron-bombardment-induced conductivity target, according to the company. And the English Electric Valve Co., which makes big but highly sensitive Isocon tubes, says it will obtain 3-inch Isocon performance from an envelope only 2.125 inch in diameter.

Seeing eye. EMI's goal was ringed with design obstacles. To perform well in moonlight—which an ordinary vidicon can't do—an SEC vidicon has to be used but the SEC tube is just not as good as a vidicon in full daylight. The new tube, complete with scanning and focusing coils had to be no bigger than an ordinary vidicon complete with coils to avoid extensive modifications on existing cameras. What's more, the tube could not be very expensive—certainly no more so than an SEC vidicon.

Company engineers finally came up with a tube 6.25 inches long and 2.625 inches in diameter across the scanning and focus coils. The tube uses an S-20 cathode measuring 0.72 inch diagonally and can take standard 1-inch vidicon lenses.

James Lodge, who is in charge of development, says that at high-light levels the tube's grey-scale rendition, signal-to-noise ratio, and resolution are comparable to a standard vidicon. But at the lower end, he says, the tube will still give

satisfactory pictures with 10^{-4} foot-candles on the photocathode, roughly equivalent to ambient illumination in a high-contrast scene of 10^{-3} ft-c. This is very similar to SEC vidicon bottom-end performance, he says, and more than an order of magnitude better than ordinary vidicon low-light performance. The SEC vidicon, of course, is noticeably inferior to the ordinary vidicon at high-light levels, and about one-third bigger in both dimensions.

Hence, Lodge believes his tube goes a long way to getting the best of both worlds. However, he acknowledges that the SEC vidicon has better dynamic resolution at low-light levels—that is, his tube is not so good with fast-moving objects.

The tube is in pilot production and its first use will be in a camera being developed by EMI's military division. No price has been set yet, but indications are, that the tube will go for less than an SEC vidicon.

The improved performance is attributable to two main factors. First, the image focusing system overcomes loss of resolution at the target's edges without resorting to fiber optics. Second, and most important, the tube has an electron-bombardment-induced conductivity target. This gives the tube its name: Eibtron.

Think zinc. The active target material is zinc sulfide, which is very efficient, but tricky to use in a target. It's taken EMI some years to get the right performance. Colin Varley, who developed the target,

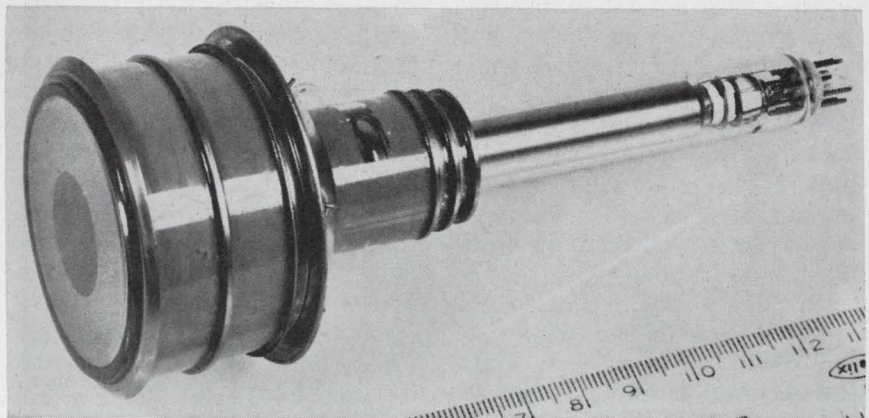

Night vision. Low-light-level tube from EMI Electronics uses zinc sulfide target and comes in a small package—6.25 inches long and 2.625 inches across.

says nobody has used it in a production camera tube before.

The sulfide is vacuum deposited onto an aluminum signal plate about 500 Å thick, which is backed by an alumina supporting film also about 500 Å thick. The details of the process are EMI's secret however. With the 14-kilovolt photocathode, this target produces about 300 nanoamps at high signal levels. This is equivalent to a charge gain of up to 300 times, providing an overall tube sensitivity of up to 35 milliamps per lumen.

Without some correction, an all-electrostatic image section would result in out-of-focus images around the edges of the target and, hence, degraded resolution. This could have been overcome by fiber-optics, as in an SEC vidicon, but to keep costs down Lodge preferred to add an image mesh and focus electrode behind the faceplate, which he says is successful.

Lodge adds that the target has good resistance to burn-in from overload. He has applied 2 ft-c to the photo-cathode for 30 minutes with barely detectable damage.

Test tube. English Electric Valve's miniature Isocon is less advanced in development. The new 2.125-inch envelope takes the same photocathode and target as the company's current standard 3-inch tube, and is expected to give a very similar performance. However, the new tube is only 10 inches instead of 15 inches long. Because the target is relatively large, it can't be inserted through the back as is usual and it has to go in through the front. Hence, the faceplate has to be sealed from the front, using metal flanges to avoid the contamination that would result from a glass seal.

The scanning system is similar to that in the larger tubes, but scaled down. The electron gun has a conventional oxide cathode with a low-wattage heater taking only about 100 ma at 6.3 volts, which keeps power supply requirements down. Glass-rod construction is used to mount the gun electrodes. A six-stage electron multiplier for the return beam gives a gain of about 10,000. Evaluation tubes should be available in about six months.

France

Spectral analysis

Spectrometry has always been an expensive and time-consuming approach to determining the composition of gases and liquids. The method involves sending a beam of light through a gas or liquid sample, then measuring the amount of light absorbed by the material. All substances have unique characteristics of light reflection and absorption in any given spectrum band.

Now, France's Office National d'Études et de Recherches Aérospatiales (Onera) has developed what it claims is a revolutionary advance in molecular infrared-absorption spectrometry technology that should gather a lot of attention at the Mesucora show in Paris this week. A prototype of the double-beam infrared spectrometer has been built by the French company Jobin et Lvon of Arcueil outside Paris. The company will produce the device in France under license. Price on the French market should be about \$50,000. Eventually the company hopes to market the device in the U.S.

Seeing red. Onera boasts that its spectrometer can operate in the low-energy infrared band used to detect materials such as methane, hydrogen chloride, and hydrogen bromide. It claims its device can produce results 50 times faster and with more precision than standard machines.

The trick, says Onera, is to increase the amount of light of the desired wavelength that is fed to the instrument's sensitive detectors for measurement. On standard spectrometers, the wavelength to be measured is filtered through a slit measuring 0.2 millimeter wide and onto a sensitive detector for measurement. Onera replaces this slit by a pair of companion entrance and exit grills that allow light to pass through apertures as much as 25 mm wide.

After the sample beam has passed through the sample it is fed through a grill that has a crisscross pattern of transparent and opaque zones. The sample beam passes through the grill in the pat-

tern of the transparent zones and is directed by mirrors into a grating prism. The grating prism breaks the light down into its component wavelengths. The image of each wavelength, one overlapping the other, is a reproduction of the pattern of the entrance grill.

The prism directs these wavelengths into an exit grill, where at any time only one of the overlapping patterns can pass through in its entirety to a detector. When the wave reaches the detector, the heat level is translated into an electrical signal.

Of course, since other wavelengths partly reach the detector, Onera engineers had to home in on the desired wavelength. They found that by raising and lowering the exit grill—slightly displacing the congruent pattern of the desired wavelength—they could drastically alter the outputs, producing a rising and falling electrical signal. The effect of other wavelengths remain virtually the same, meaning that the changing signal was a function only of the congruent wavelength.

References. An additional advantage of the Onera spectrometer is that it allows for simultaneous comparison with the reference beam. The reference beam is fed into the back side of the entrance grill, where it bounces off the grill's opaque zones toward the grating prism. At the same time the sample beam is passing through the grill's transparent zones from the other side. Thus, the two beams meet at the grill and travel to the prism together.

Comparison of the sample beam and reference beam is achieved when the exit grill is raised and lowered, allowing the reference beam to slip through the exit grill as the two patterns are thrown momentarily out of step.

The result, says Onera, is that a much greater quantity of the spectrum being measured can pass through. Onera's top research engineer, Andre Girard, who developed the design of the companion grills, says it takes the Onera spectrometer only 10 minutes to provide an accurate measurement of the infrared spectrum.



THE WAVEMAKERS

in every sense of the word

and we'll prove it!

We're challenging you to use our amazing new Model 4200 Test Oscillator in your own lab, on your own projects for 10 days without obligation. We're sure you'll be quick to recognize its superior performance, ease of operation, reliable accuracy, and unmatched value. The consistent half watt power output over the 10 Hz to 10 MHz range plus an internal impedance of 50 ohms means you can drive loads without overloading. Add excellent frequency response of 0.025 db and a distortion factor of 0.1% and you've got a versatile, high performance test oscillator that can't be beat.

Yes, Krohn-Hite, innovators in oscillator design for over twenty years, is making waves again!

First Class
Permit No.
30358
Boston, Mass.

Business Reply Mail

Krohn-Hite Corporation
580 Massachusetts Avenue,
Cambridge, Massachusetts 02139

KROHN-HITE MODEL 4200, 10 Hz TO 10MHz, TEST OSCILLATOR

- Frequency Range: 10 Hz to 10 MHz
- Power Output: ½ watt
- Maximum Output: 10 volts rms
- Frequency Response: 0.025 db
- Harmonic Distortion: 0.1%
- Frequency Accuracy: 2%
- Internal Impedance: 50 ohms
- Auxiliary Output
- External Synchronization
- Amplitude Stability: 0.02%



A low priced, solid state laboratory or production signal source featuring unusual flatness and ease of operation normally found in instruments selling at twice the price. The high power output signal of the Model 4200 delivers full voltage to the load over the entire frequency range. An infinite resolution dial and push-button multiplier provide rapid and continuous frequency tuning. In short, the Model 4200 is a broad range, versatile test oscillator destined to set new standards in performance and value.

KROHN-HITE MODEL 4100A, 0.01 Hz TO 1 MHz PUSH-BUTTON OSCILLATOR

- Frequency Range: 0.01 Hz to 1 MHz
- Power Output: ½ watt
- Harmonic Distortion: 0.02%
- Frequency Accuracy: 0.5%
- Amplitude Stability: 0.002%
- Frequency Response: ±0.05 db
- Internal Impedance: 50 ohms
- Square Wave Risetime: 20 ns
- External Synchronization

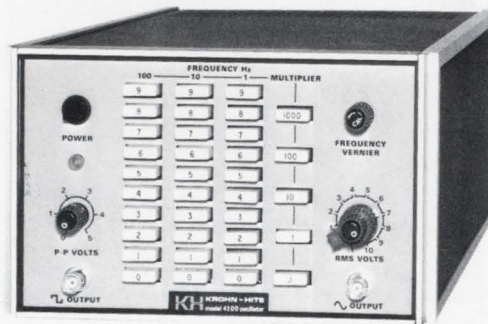

A medium priced, solid state, general purpose Oscillator that produces sine and square waves simultaneously from 0.01 Hz to 1 MHz with ½ watt of power into 50 ohms. Frequency calibration is within ±0.5% and push-button tuning permits ±0.1% frequency repeatability. 50 ohm internal impedance minimizes output voltage drop due to loading, specifically at higher frequencies where unavoidable capacitive loading limits the usefulness of higher impedance oscillators. The Model 4100A is an ideal laboratory and production instrument for a variety of applications where outstanding performance offers increased measurement speed and accuracy.

Yes, Krohn-Hite, the leader in variable filters, is fast becoming a leader in oscillators. Krohn-Hite has designed and manufactured a complete line of signal generating equipment to meet and, in many cases, exceed your project requirements. Each offers high performance features that you'd normally expect to cost a great deal more. Here's a brief rundown of the soon-to-be famous, never-to-be forgotten Krohn-Hite line. For further information on any of the instruments or complete details on our challenging Free Trial offer, simply fill in the attached postpaid reply card. We guarantee an answer by return mail.

OSCILLATORS

Frequency Range	Osc. Model*	Freq. Acc. %	Power (mw)	Impedance (ohms)	VRMS (Open Circuit)	Quad. Output	Add'l. Wave-Forms	Freq. Resp. (db)	Dist. %	Approx. Ship. Wt. lbs/kgs	Price
0.001 Hz to 100 kHz	4024	0.5	125	200/600	10	Yes	□ JL	0.01	0.01	24/11	\$1200
0.001 Hz to 100 kHz	4025	0.1	125	200/600	10	Yes	□ JL	0.01	0.01	24/11	\$1950
0.01 Hz to 1 MHz	4100A	0.5	500	50	10		□ JL	0.05	0.02	21/10	\$ 550
0.1 Hz to 100 kHz	4000	0.5	125	200/600	10	Yes	□ JL	0.01	0.01	18/9	\$ 850
0.1 Hz to 100 kHz	4001	0.1	125	200/600	10	Yes	□ JL	0.01	0.01	18/9	\$1450
10 Hz to 10 MHz	4200	2	500	50	10		~ (FIXED)	0.025	0.1	21/10	\$ 350

*Add suffix "R" for rack mounting.

PROGRAMMABLE OSCILLATORS

Frequency Range	Osc. Model	Freq. Acc. %	Max. Volts	Output Impedance	Dist.	Square Wave	Prog. Amp.	Approx. Ship. Wt. lbs/kgs	Price
0.1 Hz to 100 kHz	4030R	0.5	10 RMS	200/600	0.01%	optional	optional	27/13	\$1495
0.1 Hz to 100 kHz	4031R	0.1	10 RMS	200/600	0.01%	optional	optional	27/13	\$2145
0.1 Hz to 1 MHz	4131R	0.1	10 RMS	50	0.02%	yes	no	30/15	\$1375
0.1 Hz to 1 MHz	4141R	0.1	10 RMS	50	0.02%	yes	yes	30/15	\$1585
1 Hz to 1 MHz	4130R	0.5	10 RMS	50	0.02%	yes	no	27/13	\$1075
1 Hz to 1 MHz	4140R	0.5	10 RMS	50	0.02%	yes	yes	27/13	\$1285

- Yes, I accept your challenge to try the fabulous Model 4200 Test Oscillator. Send me complete details at once.
- Send me complete specifications on Model (s): _____
- Send me a copy of the complete K-H Catalog.
- Wow! You've aroused my interest and I can't wait. Please have your representative call me for an appointment.

NAME _____ TITLE _____

COMPANY _____

DIVISION _____ PHONE _____

STREET _____

CITY _____ STATE _____ ZIP _____

Here's your chance to put Krohn-Hite, the Wave-makers, to work for you. Accept our challenge and you'll never settle for less. Just fill in the attached post-paid card and we'll see that you get all the details on the Krohn-Hite Free Trial Offer by return mail. Then, you too can be a wavemaker.



KROHN-HITE CORPORATION

580 Massachusetts Ave., Cambridge, Mass. 02139
Telephone: 617/491-3211 TWX: 710-320-6583

OVERSEAS SALES OFFICES: BELGIUM, C. N. Rood s. a. DENMARK, SC Metric A/S; FRANCE, Antares; GERMANY, Nucletron Vertriebs-GMBH; HOLLAND, C. N. Rood n. v.; ITALY, Dott. Ing. Mario Vianello; SWEDEN, Teleinstrument; ISRAEL, R. D. T. Elect. Eng. Ltd.; JAPAN, Shoshin Shoji Kaisha, Ltd.; AUSTRALIA, Sample Electronics (Vic.) Pty., Ltd.; G. B., B & K Inst. Ltd. Printed in U.S.A.

Washington Newsletter

May 25, 1970

DOD to centralize computer purchases

A Defense Department directive to centralize control of general-purpose computer purchases in the office of Pentagon comptroller Robert C. Moot is awaiting the signature of Deputy Defense Secretary David Packard. The plan would give the comptroller power to begin a program requiring standardization and compatibility of data processing systems within the military. Approval of the plan is also expected to lift the freeze on general-purpose equipment buys, such as the six large-scale machines for the Advanced Logistics System, for which the Air Force hopes to select a contractor by December. Vendor proposals are due in August.

GSA experiment: piecing together a computer system

In an experiment that could shake the U.S. computer industry to its roots, the General Services Administration is accepting independent bids on computer components for system assembly in-house. If the procedure proves an economic and operational success, it could restructure the way Government buys general-purpose computers. One possibility: opening the door for peripheral-equipment makers to bid on every Federal computer purchase. Peripheral manufacturers currently can bid on replacement items only.

Once the GSA experimental system is pieced together, it will be run alongside an IBM 360/30 for an 18-month test of performance and cost. At the end of that time, GSA says, it will be able to tell whether buying and assembling a computer from individually purchased subsystems is worth the time and effort.

Oven radiation rules to be tough

The U.S. Bureau of Radiological Health is sticking to its plan for a tough microwave oven radiation standard of 1 milliwatt per square centimeter at 5 cm from the oven. The proposed at-the-factory standard, 10 times tougher than industry's, is set for early June disclosure along with a second standard of 5 mw/cm² once the oven is installed. The standards are being prepared at a time when 14 manufacturers are testing installed equipment to assure that ovens meet the 10-milliwatt industry standard.

Manufacturers are less concerned over the 1-mw maximum for ovens still in the plant than they are with the 5-mw maximum for ovens in use, with doors and seals gradually deteriorating. Sources at the BRH say surveys by state and Federal health authorities reveal that one-third of installed ovens that were tested emitted radiation greater than the industry standard of 10 mw.

Awacs delay brings Westinghouse layoff

Layoff of 204 employees—mostly electronics engineers—at Westinghouse's Electronics and Space Defense Center outside Baltimore underscores the center's heavy dependence on three military programs moving to contract-award stage. The cutback—from a staff of 9,000 that includes about 1,500 engineers—followed Air Force delay in awarding the contract for the Airborne Warning and Control System [*Electronics*, May 11, p. 44]. The Westinghouse center also is counting heavily on the F-15 avionics package, scheduled for a development award in October [*Electronics*, Feb. 2, p. 37], and on the highly classified Navy-Air Force

Washington Newsletter

Program 749, called Oasis for Ocean Atmospheric Surveillance and Information System. Teamed with GE, Westinghouse proposes for Oasis a side-looking radar with a phased-array antenna for detection of low-trajectory, sea-launched missiles.

Cables vs. satellites: a new FCC inquiry

The FCC is expected to publish a new notice of inquiry within a week to explore in depth the issue of undersea cables vs. satellites. The FCC will look at the dispute of "proportionate fill" between international carriers and the Communications Satellite Corp. to determine whether cable and satellite owners should split international business under a prescribed formula or whether open competition between the two should be allowed.

Other issues to be explored: the status of the "authorized user" in satellite communications, a position Comsat has taken, claiming it is the only authorized entity to launch and operate commercial satellites; and ground station ownership, another area in which Comsat claims authority.

'No CAS timetable' gives RCA hope for late starter

The Air Transport Association says it has no timetable for implementation of a time-frequency aircraft collision avoidance system. This is despite the fact that nearly two years of flight tests of equipment have been completed by three manufacturers—McDonnell Douglas, Bendix, and the team of Sierra Research and Wilcox Electric. The observation by ATA's Frank White is interpreted by some in industry as a good sign for RCA's late but relatively inexpensive entry, Secant, which uses non-synchronous techniques [see U.S. Reports, p. 56].

In one cost estimate, installations of time-frequency systems start at \$375 for a pilot warning indicator, with an altitude readout on an intruder but no range data, and at \$575-\$1,050 for a PWI with both altitude and range. From these levels, prices scale up to \$5,300-\$8,850 for a system with a backup mode.

AT&T to close NASA think tank

AT&T has told NASA it plans to close Bellcomm Inc. in two years. The subsidiary performs much of NASA's systems analysis support and mission planning and review. The 400-plus scientists and engineers working for the NASA-sponsored think tank will be absorbed by Bell Telephone Laboratories.

Grosch demoted, claims vendetta

Herbert Grosch says he has been fired as director of the National Bureau of Standards Center for Computer Science and Technology because of a personal vendetta waged by his boss, Myron Tribus, Assistant Secretary of Commerce for Science and Technology. Tribus was not available for comment. Grosch contends that his criticisms of computer time-sharing—including the observation that it is "a trick way to waste computer time"—have rubbed Tribus so raw that "when he was given an ax, he used it." According to Grosch, Tribus took a "deep, fatherly pride" in the development of time-sharing techniques when he was a Dartmouth College dean. Grosch's deputy, James P. Nigro, will become acting director at the center, which serves as the Government's chief data processing adviser. Grosch surrenders his \$35,000 job to become a senior research fellow there for the time being.

The hybrid circuit: if you don't like what we make, we'll make what you like.

We're not proud.

We've designed many different standard hybrid microelectronic modules in what we think is the optimum package type for each one.

But, if they don't suit your system, we'll gladly change the package or the circuit to suit your needs.

Our off-the-shelf line spans the spectrum from digital to video. It includes a video amplifier, memory and clock drivers and translators, gated high-power drivers and a 30-MHz IF amplifier.

All of them are our own design and if they meet your needs, we are both ahead of the game.

If they don't, that's where our experience and advanced hybrid techniques come into play. We can translate your design into a hybrid microelectronic module quickly, easily, *and* economically, because we don't have to waste time getting familiar with the problems.

Show us your system requirements. We'll come up with the right hybrid circuit to fill the bill.

That way we'll have a circuit we both like.

For more information, see your local representative. Sylvania Electronic Components, Hybrid Microelectronics, Waltham, Mass. (617) 893-9200, ext. 2400.

SYLVANIA
GENERAL TELEPHONE & ELECTRONICS

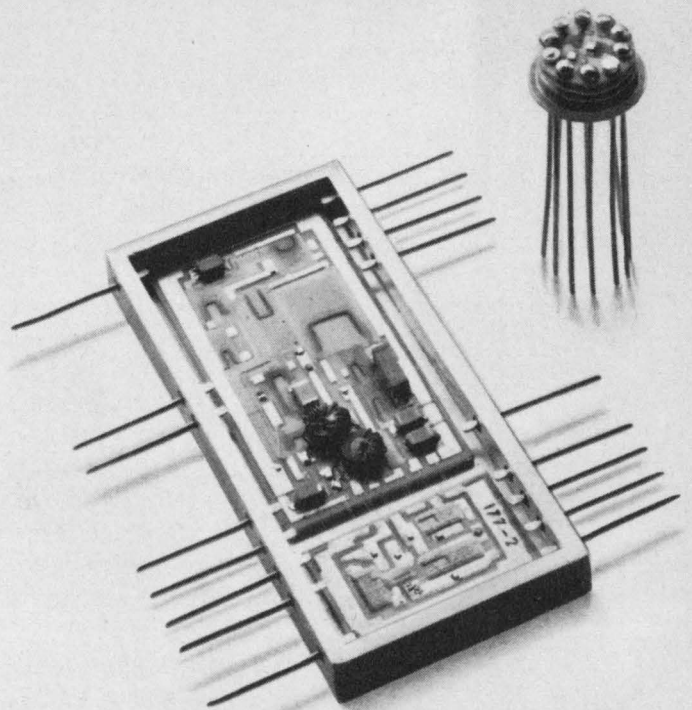

Our new automatic test equipment tells you where your electronic system went wrong, and how to fix it. In plain English.



SCATE MK V READY
TYPE NAME AND SERIAL NUMBER OF UNIT UNDER TEST
NAME: AN/ARC SN#1948J

AN/ARC CONFIDENCE TEST
CONNECT INTERFACE CABLE W116 TO J3 OF SCATE
ADJUST AUDIO AND SIDETONE LEVEL CONTROLS FULLY CW.
TYPE "CONTINUE" WHEN READY

CONTINUE;

LSB RECEIVE TEST
LSB AUDIO OUTPUT IS 1.27V FAILED TEST

USB RECEIVE TEST
USB AUDIO OUTPUT IS 6.5V PASSED TEST

REPLACE IF TRANSLATOR MODULE A6
TYPE "CONTINUE" WHEN READY TO RETEST.

POWER

LAMP

ON
OFF

ON
OFF
DIM

PAPER

< PUSH TO RELEASE
LIFT TO LOCK

LINE FEED
SINGLE ↔ DOUBLE

NORM CRYPTD.

BREAK

SEND-REC

1 2 3 4 5 6 7 8 9 10
A BELL S D\$ F OR STOP H I J K L CAR RET
FIGS " X O V ? B N M LTRS LINE FEED

Each new generation of electronic systems used to bring along its own maintenance and support problems. Because each new type of electronic equipment needed new testing procedures, new training and some new test equipment.

For the Army, the problem is even greater. Because its field maintenance and support equipment has to be mobile. And it has to be relatively simple to operate.

That's where our SCATE® MK V comes in.

General Dynamics' Electronics division went to work on this problem: creating a computer-controlled automatic test system light enough to be mobile, simple enough to be operated without complex training, adaptable enough to be used for all the Army electronic systems into the mid-1980's.

The answer is SCATE MK V, a unique electronic diagnostic tool.

SCATE MK V talks English.

SCATE MK V talks your language. The man who operates it, in the field, needs no advanced training. If he can read or write English, he can be trained to use this equipment in a matter of weeks, not months.

Once an operator is trained, he does not have to know how the unit under test works. SCATE MK V already does. Its computer is programmed for that.

Because the program is in English and on line, the programming costs and time are reduced by as much as 50% compared

to other automatic test equipment.

SCATE gets things down to size.

SCATE MK V is about one-third of the size of any similar existing equipment. It can be mounted in a portable shelter on the back of a truck. Or it can be delivered to the field by helicopter.

The reason for the smaller size of SCATE MK V is that its computer is used more extensively in the measurement function as

well as the control function. This eliminates the need for special and redundant test equipment. **One answer for nine commodity areas.**

The Army has identified a requirement for computer-controlled automatic test equipment (CATE) in nine commodity areas: radio communications; wire and

carrier communications; army avionics; fire control equipment; engineering survey and map equipment; missile systems; combat surveillance; laser systems; and communications security.

SCATE MK V can be programmed to provide support in any of these materiel areas.

SCATE MK V is a good example of what we do best.

At General Dynamics we put technology to work solving problems from the bottom of the sea to outer space...and a good bit in between.

GENERAL DYNAMICS

Additional technical information is available on SCATE MK V on request. Write: General Dynamics, Dept. 850, 1 Rockefeller Plaza, New York, N.Y. 10020.

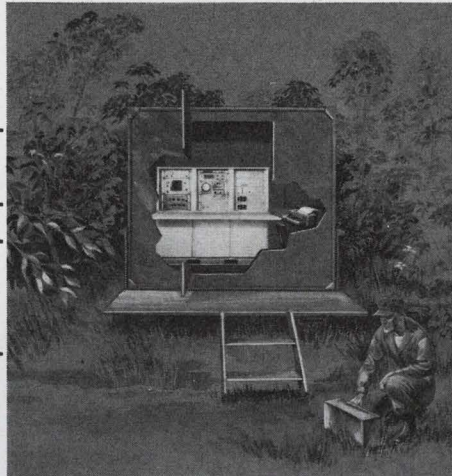

DO NOT
TEMPERATURES
WITHOUT
PORTS

ION
EQUIPPED
60 HZ 1PH

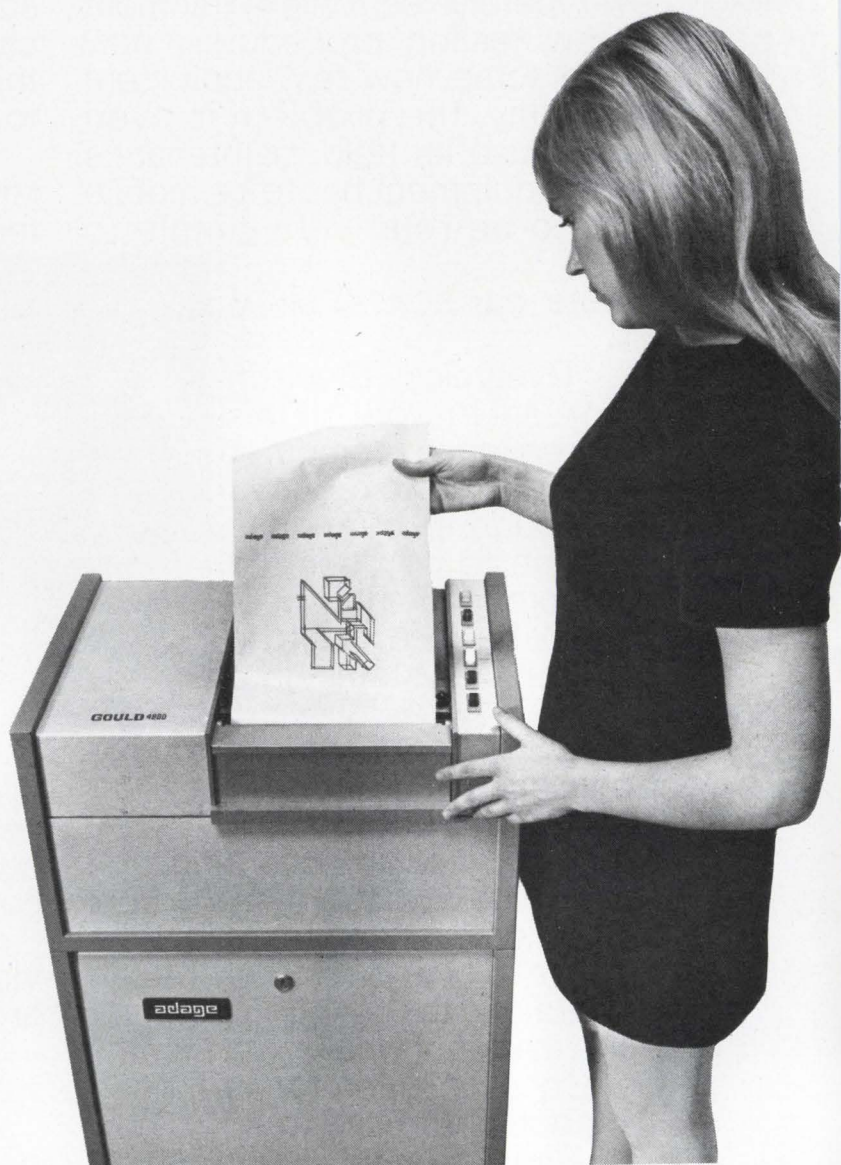
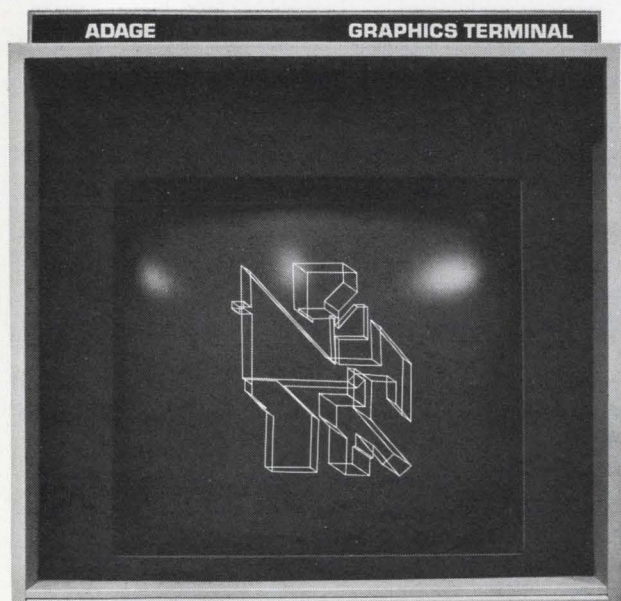

**From CRT display
to hardcopy printout.
In seconds!**

A plotter takes 30 minutes. A dry-silver photographic process makes muddy copies.

But at Adage, Inc. the Gould 4800 Electrostatic Printer puts out clean hard copy in seconds. No wait.

No wonder the 4800 is now a catalogued item for Adage Inc.'s award-winning Graphics Terminal.

The Graphics Terminal is a CRT display computer system with infinite potential for interactive graphics applications in science and engineering. To name a few, cockpit design, mathematical equations and printed circuit cards.

Having the 4800 Electrostatic Printer on line the user can alter his design equation with a light pen and have clean hard copy of any stage within seconds.

Adage officials say their system is further enhanced by the economy of the 4800. It doubles as a printer by putting out both alphanumerics and graphics. It has fewer moving parts to maintain than conventional equipment. And Adage interfaced the

4800 in a matter of days . . . at surprisingly low cost.

More 4800 facts:

At 412,000 characters per minute, the Gould 4800 breaks the old printout bottleneck on your computer. It reproduces signals from any source of digital input or data transmission by telemetry, radio microwave and/or land line, quickly, quietly, accurately and economically.

4800 can probably recap the same benefits for your system as it does for Adage's Graphics Terminal. Write us to see. Don't wait. Graphics Division, Gould Inc., 3631 Perkins Avenue, Cleveland, Ohio 44114.

GOULD CLEVITE

Gould 4800. The next generation of high-speed printers.





This cleaning agent is boiling. At 118° F. It's Du Pont FREON® TF solvent.

FREON fluorocarbon solvents are ideal for low-temperature vapor degreasing. Cooling time is eliminated for post-cleaning processing and testing. There's no damage to heat-sensitive parts. And low heat passage to the work environment.

If your product has to be cleaned thoroughly, safely and economically, there are five more reasons why you should be using FREON solvents:

1. Complete Wetting and Penetration. High density com-

bined with low surface tension lifts soils and floats away trapped contaminants.

2. Compatibility. No damage to widely used materials of construction.

3. Chemically Pure and Stable. No need for acid acceptance and scratch tests. No inhibitors needed. Parts dry residue-free.

4. Lower Overall Cleaning Costs. FREON is recoverable for reuse indefinitely. Power requirements are low in vapor

degreasing. Fewer production rejects. Save labor by cleaning complete assembly instead of separate parts.

5. Safe. Nonflammable and non-explosive. Low in toxicity, though prolonged skin contact will remove natural oils and should be avoided.

If you have a cleaning problem or are looking for an improved cleaning system, write today to Du Pont Company, Room 8789-F, Wilmington, Delaware 19898.

**FREON**
Cleaning Agents

Any DC VOM with 0.1% accuracy should cost more.

Model 1241
\$289
complete.

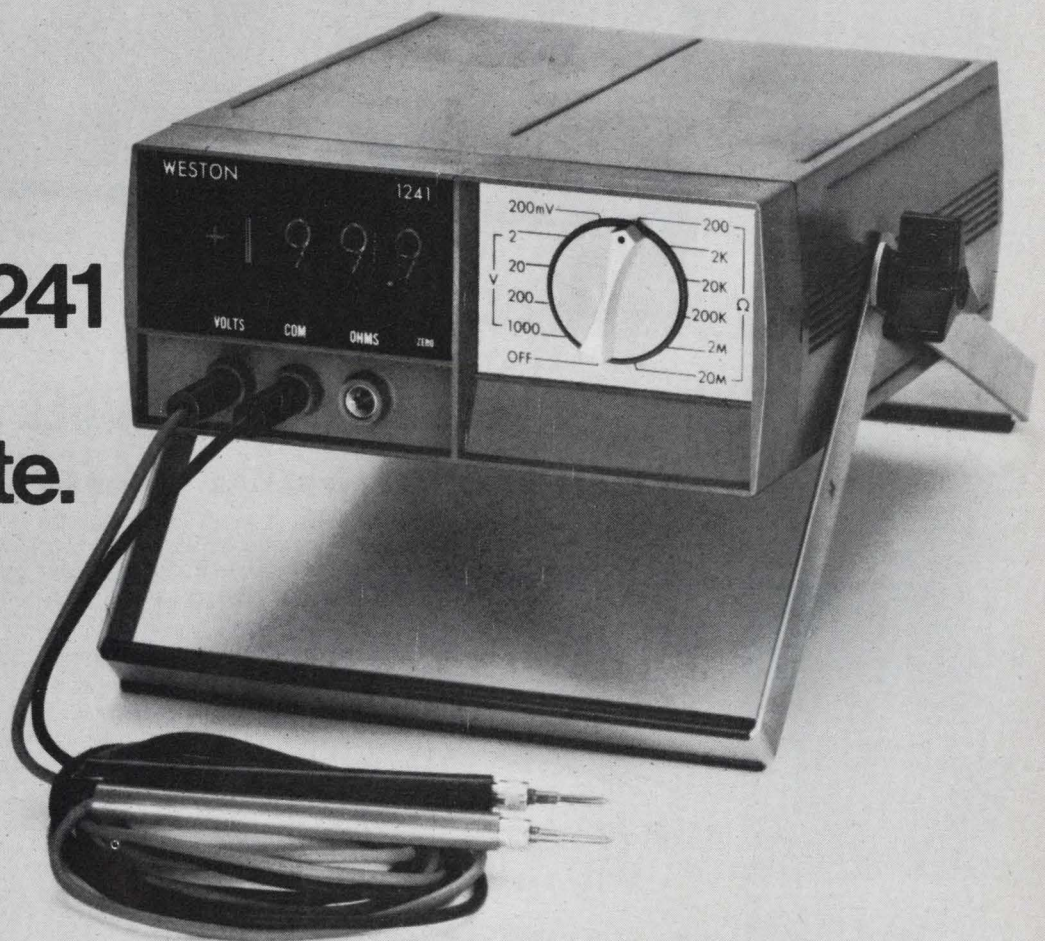

We wanted the price low enough that anyone taking DC voltage or resistance readings wouldn't have to think twice about choosing our new Model 1241. As it turned out, we can give you an even bigger break. Because most of the circuitry, as well as the rugged housing and many convenience features, had been developed previously for the Weston 1240 DMM which we introduced last November.

Here's a proprietary-designed Weston instrument you can pack in your tote case, use on the bench, or mount in a

standard 3½" panel. The only "extra" you may ever need is an optional battery pack for remote field applications. Model 1241 gives you high-impedance measuring capability to 3½ digits on five voltage and six ohm ranges.

In addition to its outstanding accuracy of 0.1% of reading $\pm 0.05\%$ F.S. on Volts (0.5% ± 1 digit on Ohms), this advanced meter features complete circuit overload protection. Fuses are replaceable without opening the rugged, glass-filled thermoplastic case. And, of course, there's Weston's patented dual

slope* integration, automatic decimal positioning, and non-blinking display.

If you want to see how much quality a dollar will buy today, contact your Weston Distributor. He also has in stock our 1240 DMM, with 26 AC-DC ranges plus all the above features. Or write today for complete specifications.

WESTON INSTRUMENTS DIVISION,
Weston Instruments, Inc., Newark, N.J.
07114, a Schlumberger company

WESTON®

the most waveform generator ever sold for \$495

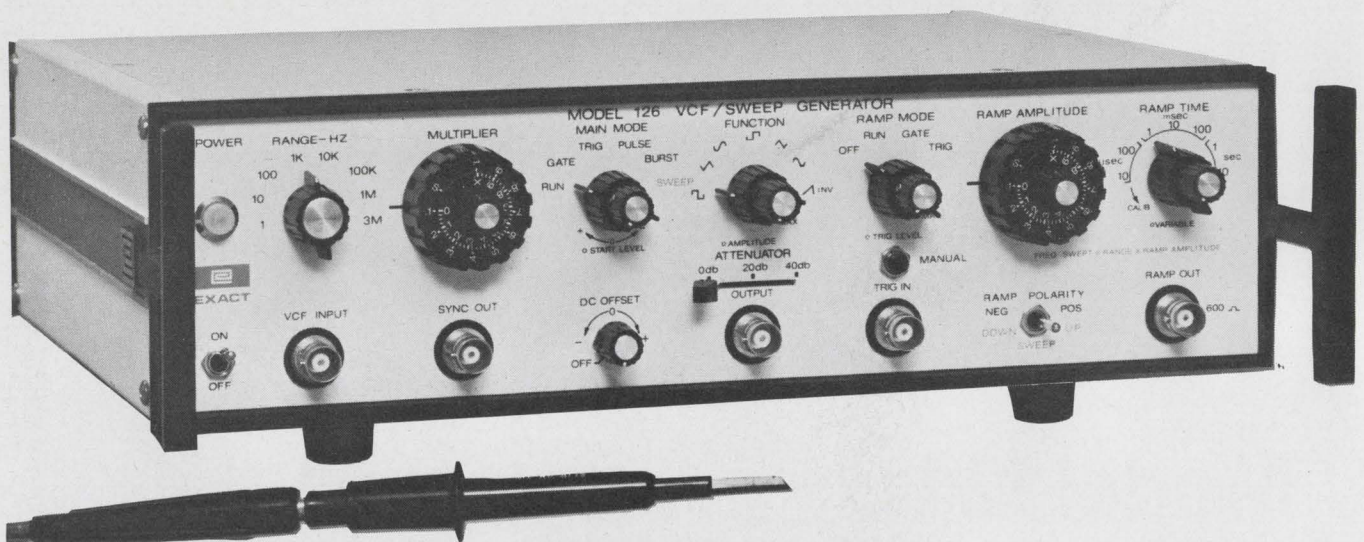

MODEL 126 WAVEFORMS: **NEW EXACT MODEL 126 VCF/SWEEP WAVEFORM GENERATOR**

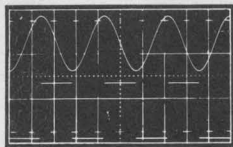

SINE

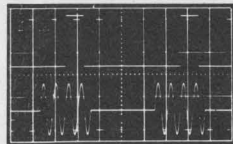

SQUARE

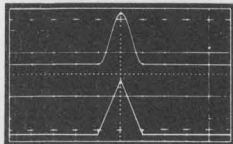

PULSE

BURST

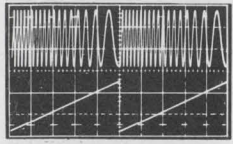

HAVERSINE

HAVERTRIANGLE

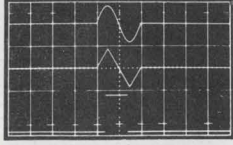

SWEEPING WITH
INTERNAL RAMP

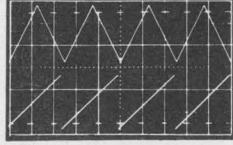

SINGLE
SHOT

TRIANGLE
RAMP

TWO-IN-ONE. A main generator for sine, square, triangle, pulse and sync, plus a ramp generator for sweeping or triggering the main generator, or for use as an independent generator.

WIDER BANDWIDTH. 0.1 Hz to 3 MHz frequency range, with ramp time of 10 μ sec to 100 sec.

SWEEP. Ramp generator can sweep main generator over a 1000:1 range.

PULSE. Independently variable width and repetition rate.

TRIGGER/GATE. Both generators can be triggered and gated independently.

VARIABLE START/STOP. Start/stop point (phase) continuously variable.

SEARCH MODE. Main generator can be swept manually over 3 decades.

BEST CONTROL. Kelvin-Varley divider frequency and sweep width controls.

PRECISION SWEEP. Width adjustment accurately sets starting and stopping frequencies in sweep mode.

RAMP VERSATILITY. Ramp available at main output and via its own connector, ramp gate output connector on rear panel (convenient for x-y and Bode plots.)

SMALL SIZE. Only 3 1/2" high, 12 1/2" wide, 10 1/2" deep. Weighs just 9 lbs. Top and bottom covers easily removable, exposing all calibration and circuit board areas. Printing on P.C. card calls out all parts and testpoints; calibration procedure printed inside top cover.

LOW COST. Only \$495.00 f.o.b. factory.



EXACT
electronics, inc.

Box 160, Hillsboro, Oregon 97123 • Telephone (503) 648-6661

waveform generators
from \$295

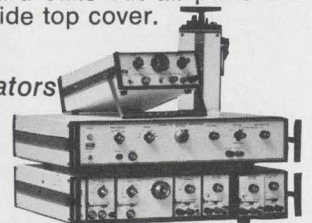

Article Highlights

Common bit rate unifies three pcm systems in Japan
page 86

The secondary group pulse-code modulation system adopted in Japan multiplexes signals from three sources at a common rate of 7.876 megabits per second. In addition to its 120-channel primary multiplex pcm group, Nippon Telegraph and Telephone's plan also handles 120 directly encoded voice channels and a 60-channel supergroup signal.

Serial conversion knocks some stuff out of dvm's
page 97

The recirculating remainder technique represents an economical way for instruments to turn d-c into a digital signal. With this approach only one digit at a time is processed. Only one counter, one bcd ladder, and one decoder-driver are needed, while inexpensive capacitors are used for storage. Thus, considerable savings result from elimination of costly circuitry.

Color tv remote control goes all-electronic
page 102

Conventional approaches to remote tv tuning use motor-driven controls that are electrically noisy and are subject to wear. But under RCA's new technique, digital signals activate switching circuits for all-electronic control of color tuning and channel selection.

A field-replaceable strapdown gyro in a can
page 106

Strapdown guidance systems will be taking their cues from a Hamilton Standard design that replaces bulky, hard-to-service gimbaled units. The new design puts all the electronics and the rate sensor in a soup-can-sized package. It offers a high degree of stability and reliability, and can be replaced or maintained in the field.

Flat-screen tv takes two giant steps forward
page 112

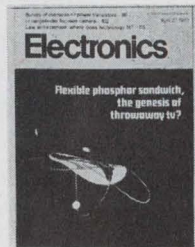

A pair of developments by a small Canadian company have moved practical flat-screen tv closer to reality. The key features are an integral glow-discharge device that eliminates costly external scanning circuitry and a light amplifier that brightens weak emissions. Though only small monochrome screens have been built to date, color units using phosphors are in the offing. And the screens themselves will be fabricated on flexible plastic films that are only 0.010 inch thick.

Coming

A comeback for silicon on sapphire?

After its highly publicized introduction a few years ago, silicon-on-sapphire technology was quietly forgotten. Now practical devices are being built and some companies are planning pilot production of SOS IC's with subnanosecond switching speeds. But others see no future for SOS.

A common bit rate unifies three separate Japanese pcm systems into a national network

Five multiplexed primary groups, 120 directly encoded voice channels and an fdm supergroup signal can all be sent over cable or by microwave at 7.876 Mbs, say *Y. Kurahashi, M. Ota* and *T. Sakashita*, engineers at Nippon Telegraph and Telephone

● Prodded by the expansion of its present communications needs and anticipating the future requirements of video telephone transmission, Japan has become the first country to put into operation a highspeed secondary pcm system that accepts signals from three different types of terminals and transmits each at a bit rate of 7.876 megabits per second. Moreover, the Japanese have become the first to transmit pcm commercially over microwave radio links.

Since it's unlikely that any country will scrap its present primary system for the sake of international standardization, the best that can be hoped for is an agreement on a standard bit rate for the secondary systems—a standard that could cover the multiplexing of several primary systems. This secondary standard bit rate could be either in the vicinity of 6 megabits per second as used by the Bell System or about 8 Mbs as used by Nippon Telegraph and Telephone Public Corp. of Japan.

The prime consideration is the choice of a common bit rate for several kinds of information. Four types of signals were considered suitable as inputs to the secondary-group system—pcm primary-group bit streams, voice signals, frequency-division multiplex assemblies, and video telephone signals. The Japanese have formed a network consisting of several types of bit streams, that operate at a common bit rate, are generated by several terminals for different kinds of information, and can be

Top and bottom. The intermediate repeaters for the 120-channel pcm system can be mounted on telephone poles or in manholes to regenerate the transmitted pcm signal.

sent over a common type of transmission link. However, since each terminal uses a different code format, the bit streams from one type of terminal cannot be used as the input to another type of terminal.

The first of the three signals incorporated by the Japanese into their second-level system consists of five 24-channel 1.544-Mbs primary groups which are time-division multiplexed into a single 120-channel secondary group. Five times the 1.544 Mbs primary bit rate is only 7.720 Mbs—and not 7.876 Mbs—but more information is required in the secondary pcm system; extra bits added include stuff pulses and stuff assignment information pulses, as well as framing and alarm pulses. These additional bits represent the difference between 7.720 Mbs and 7.876 Mbs.

This system can efficiently use the radio channels of present microwave systems, as well as wire systems. Experiments and theoretical studies at NTT have shown that the 120-channel pcm system operating at 7.876 Mbs is optimum for transmission within present fdm/f-m microwave-system allocations. Using fewer voice channels would let part of the available frequency spectrum go to waste, while more channels would degrade the signal-to-noise ratio.

The system also is well suited for video telephone transmission. Experiments indicate that the 7.876 Mbs rate of the 120 channel pcm system should be adequate

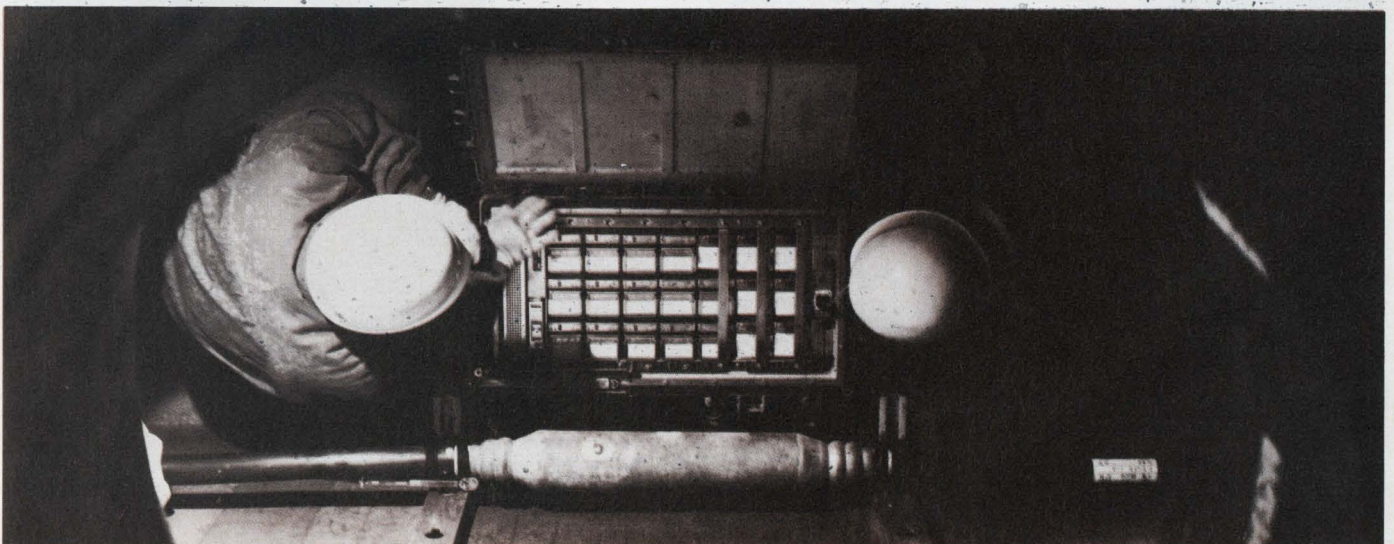
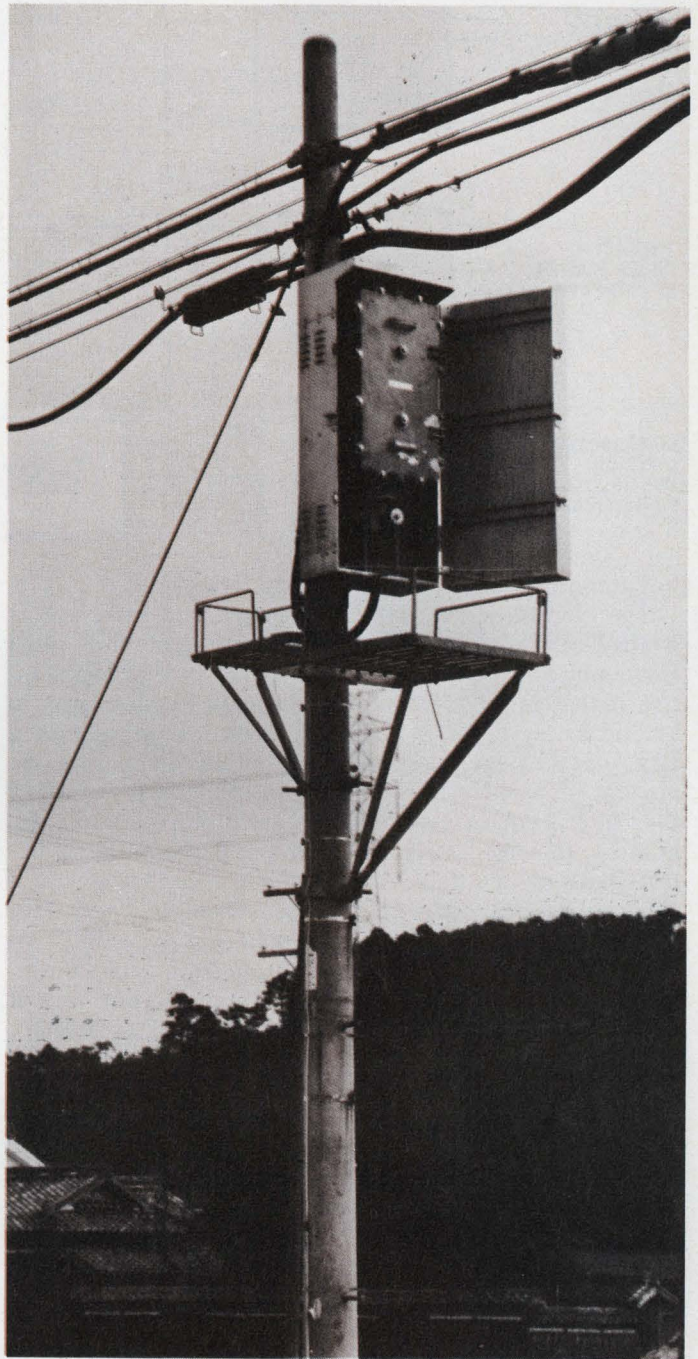

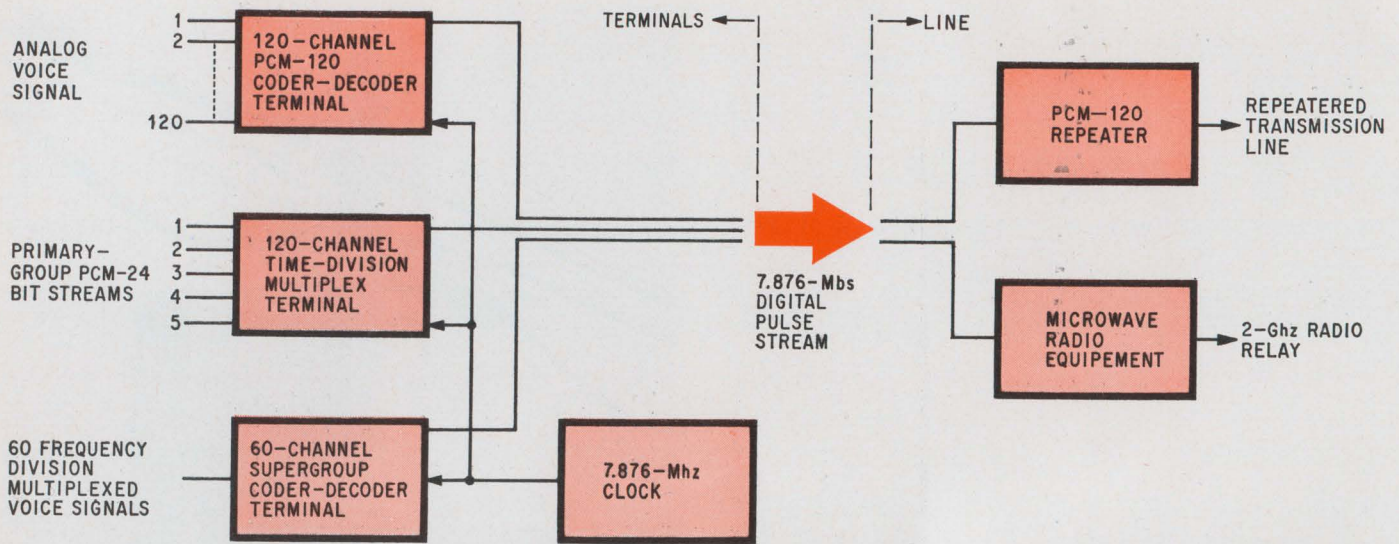

to handle the required 1-megahertz bandwidth.

The clock frequency of the primary systems must be controlled. Too great a deviation from the nominal clock frequency in the primary system would prevent regenerative repeaters from retiming the signal. Furthermore, in secondary systems, a large deviation would require a large number of stuffing pulses, thereby decreasing the amount of transmitted information. Specifications allow the clock frequency of the primary-group pcm system, PCM-24, to vary as much as 80 parts per million, but tests have shown that with an ovenless crystal-oscillator clock, variations run within 50 ppm including variations due to aging and changes in ambient temperature.

The method of synchronization used in the multiplexing of the pulse streams is pulse stuffing—insertion of pulses that contain no information. For five primary groups, every fifth time slot of the secondary-group bit stream is allotted to a pulse from a particular primary group. Should a pulse arrive after its allotted time slot, it must wait for the next allowable slot in the secondary group and is, therefore, delayed prior to insertion into the secondary-group pulse stream. The missed time slot is assigned to a stuff pulse. Since each stuff pulse is located in a predetermined position within the pcm format of each channel, other predetermined positions must be used to transmit stuff-pulse assignment information. At the receiving end, the pulses in the assigned time slots—except for the stuff pulses—are rearranged to form a replica of the original input-pulse train. In this rearrangement, the stuff pulses are extracted by means of the pulse-stuff assignment information transmitted from the multiplexer at the sending end.

Pulse stuffing provides excellent synchronization of the multiplexed-pcm system for the following reasons:

- ▶ Pulses are not omitted from the input pcm signal during multiplexing and demultiplexing, hence the secondary pulse train is always filled.
- ▶ There are no restrictions on the frame structure of the input lower-level pcm system—the primary group is not limited to information from 24 telephone channels with one framing pulse, but can carry data, slow-scan tv, facsimile, or any other signal that can be transmitted by pcm.
- ▶ A clock of practicable stability can be used.
- ▶ Pulse jitter is suppressed.

The second of the three signals that make up the

Japanese secondary-group pcm system consists of 120 directly encoded voice signals. A terminal bank, PCM-120, was designed to operate at the bit rate of 7.876 Mbs for point-to-point short-distance trunks with a relatively large number of circuits. The system sampling rate is 8,004 times per second while the code is eight bits per channel—seven-digit folded binary code for speech and one bit for signaling. A nonlinear folded-type encoder is used to achieve the companding law of $\mu = 100$.

The framing format of the PCM-120 terminal bank is arranged to unify the bit rate of the secondary group. Each frame consists of 123 time slots, each of which is composed of eight bits. Multiplying the number of time slots, the bits per time slot, and the sampling rate yields the secondary group bit rate— $123 \times 8 \times 8,004 = 7.876$ Mbs. The first 120 time slots—or channels—are used for telephone channels. A pilot signal fills the 121st time slot. The pilot is coded in a seven-digit code and supervises coder and decoder functions in the operating condition. The 122nd time slot is occupied by alarm information. The alarm would be sounded, indicating maintenance is required, if the d-c pilot level varies as a result of system deterioration. The last five digits of the 123rd time slot in each frame contain frame synchronization information; the remaining three binary digits in this time slot are surplus and aren't used.

The 8,004-hertz sampling frequency for voice signals,

Secondary group system. The bit streams of the signals entering the 120-channel PCM-120 coder-decoder (codec), the 120-channel primary-group multiplexer, and 60-channel supergroup codec are united by the common 7.876-megabit-per-second bit rate for transmission by cable and microwave radio.

chosen to unify the line bit rate, is slightly higher than the nominal sampling frequency, 8,000 hz, recommended by the Consultative Committee for International Telegraph and Telephone (CCITT). However, this is not serious because this system is used point-to-point and would not have to interface with systems of other carriers. The quality is essentially the same as that of voice channels sampled at the recommended rate.

A bridge-diode gate in the PCM-120 terminal samples the input voice signals at the 8,004-hz rate. The resultant sampled pulses from each of the 120-channel units are interleaved in a pulse-amplitude-modulation pulse multiplexer whose output is fed to an encoder where the voice signals are converted into digital form using a seven-bit code. These seven-bit codes are then interleaved with the one-digit signaling codes from the 120 signaling channels and combine with framing-information pulses in the pulse inserter to form the 123 time-slot frame. The output of the pulse inserter is a unipolar pulse stream; this stream is converted to a bipolar pulse stream in the terminal's final stage and sent to the terminal repeater equipment. The bipolar format—inversion of alternate pulses—is a standard technique used for transmission of pcm signals. It provides a signal with zero energy at the 7.876-Mbs bit rate, zero energy at d-c, and very little energy at low frequencies. The absence of a d-c component allows the signal to pass through trans-

formers while the signal's very little low frequency energy eases the requirements for cable equalization.

At the receiving end, the incoming 7.876-Mbs bipolar pulse stream is reconverted back to unipolar form and then decoded in an inverse process to reproduce speech.

The nonlinear encoder in the terminal bank is comprised of seven encoding stages consisting mainly of operational amplifiers, weighting resistors, and diode switches in the feedback loop. The first stage encodes the first digit of the seven-digit code—the most significant digit—corresponding to the polarity of the pulse-amplitude-modulated pulses; the first stage then rectifies these pulses to the same polarity to be quantized by the following six stages of folded circuits. The nonlinear coding characteristic is determined by the combination of resistors in each stage.

It is quite annoying to hear low-level noise during speaking pauses. The maximum noise level allowed in the PCM-120 terminal is -60 dbmOp, only 4 decibels worse than the theoretical limit—dbmO refers to system signal level with respect to 1 milliwatt at the exchange, while p refers to psophometric noise, or noise measured under specified frequency-weighting conditions. Of the 4 db of extra noise, 2 db are allowed for carrier-noise leakage for the 8,004-hz sampling signal while the other 2 db are assigned to coder-tracking error. Among the contributors to the 2 db of tracking noise are encoder-resistor drift, operational-amplifier drift, and drift of the 8,004-hz stored sample.

The weighting resistors in each stage are held to an accuracy of about 200 ppm and contribute less than 0.1 db of noise if they drift the maximum amount allowable. The encoder uses special thin-film resistors developed by NTT and made of nickel-chromium-silicon. These resistors have a temperature coefficient of less than ± 10 ppm/ $^{\circ}$ C and should maintain the desired accuracy and stability for at least 15 years.

The third and final signal that enters the secondary-group system is a directly encoded, fdm supergroup—an assembly of 60 voice channels—signal. The system thus provides a method of ferrying an fdm signal between two fdm systems via a pcm system without decoding into the original baseband audio signals, which would add more noise and distortion.

In a pcm system, most of the noise comes from the terminal equipment and very little from the line. Most of

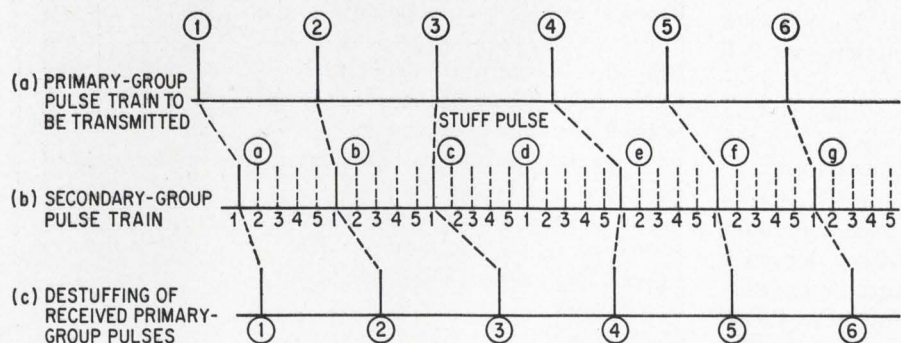

Stuffing pulses. Primary-group pulses are interleaved in the multiplexed PCM-120 format; stuff pulses are used to synchronize the bit stream. If a pulse arrives early, such as pulses 1, 2, and 3, it is delayed prior to insertion into its time slot. If a pulse arrives late, such as pulse 4, a stuff pulse is put into its time slot, in this case d, and the pulse is held for insertion into the next slot.

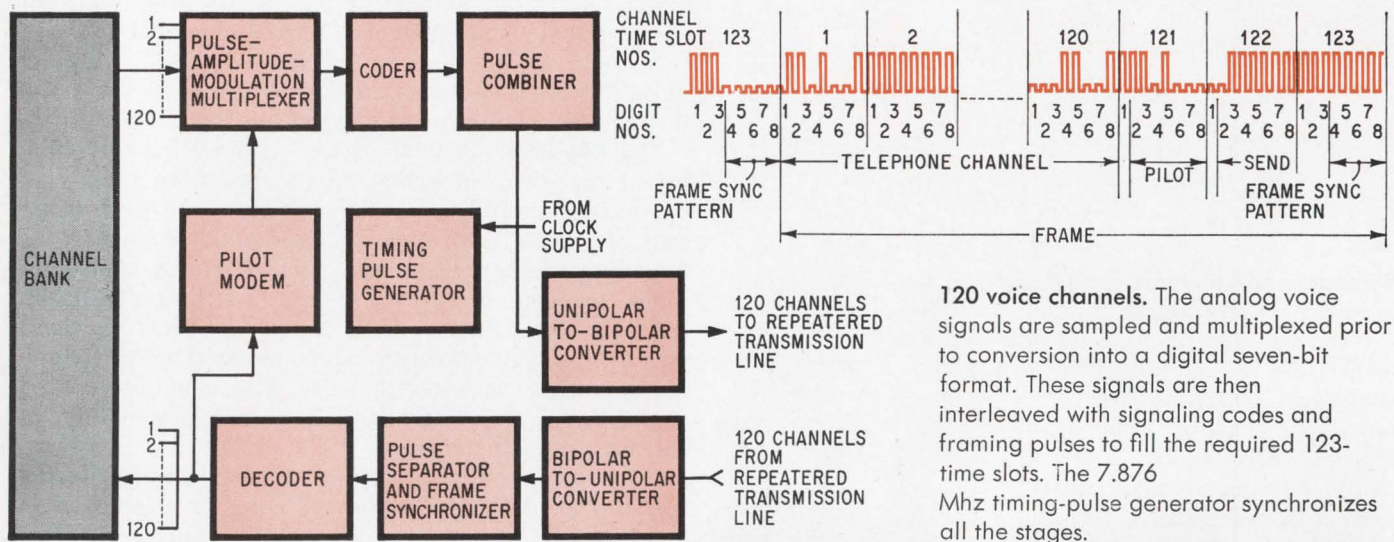

120 voice channels. The analog voice signals are sampled and multiplexed prior to conversion into a digital seven-bit format. These signals are then interleaved with signaling codes and framing pulses to fill the required 123-time slots. The 7.876 Mhz timing-pulse generator synchronizes all the stages.

the noise is quantization noise, with some additional noise generated by the pulse-stream error and jitter. Thus, the allowable noise objective is the major factor in determining the number of quantizing steps.

Before the supergroup signal can be directly encoded, the number of code digits and the dynamic range of the encoder input must be determined in relationship to the allowable noise performance. These factors depend on the statistics of the supergroup signal, such as the mean absolute power, the ratio of peak to average power—or peak factor—and their range of variation. Determined empirically their values are +2.8 dbmO for the mean absolute power, 13 db for the peak factor, and 1.5 db for the increase in mean absolute power and peak factor caused by signal variation.

Each voice channel in the supergroup signal has a virtual-frequency band of 4 kilohertz. This channel spacing, when multiplied by the 60 channels available, yields a supergroup bandwidth of 240 khz. However, channel filters limit the response of each voice channel to a minimum of 300 hz and a maximum of 3.4 khz. Thus, the actual-frequency band of each channel is only 3.1-khz wide necessitating a correction of 1.1 db in the noise allowed in the virtual-frequency band of the 60-channel PCM-120SG supergroup terminal.

The allowable noise for the virtual-frequency band is -39.9 dbmO while the noise objectives of the PCM-120SG are set at 45 db. This 45 db is cut to 44.6 db— +39.9 + 2.8 (mean absolute power) +3.0 (jitter and pulse-stream error) -1.1 (virtual-frequency band correction) = 44.6 db—an allowance of 0.4 db.

The linear encoder requires at least nine-digit coding to obtain the 45 db value of $S/(N_q + N_o)$, where S is the supergroup signal, N_q is the quantization noise obtained by dividing the signal into discrete steps, and N_o is the overload noise or distortion present when the input signal is too large and no more quantization steps are available. To circumvent any possible degradation as a result of mean power-level variations, the PCM-120SG terminal uses a 10-digit linear code since the use of more digits lowers N_q and N_o .

The frequency for sampling the basic supergroup signal is much lower than the figure of twice the highest frequency normally used for coding. The basic supergroup signal is allotted a frequency band from 312 khz to 552 khz—a 240-khz bandwidth. If the supergroup

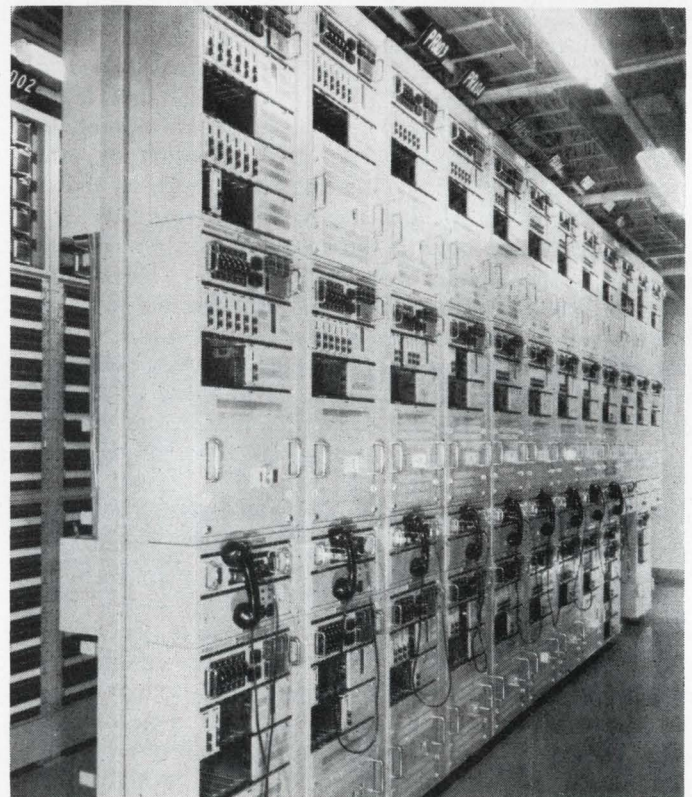

Repeater row. Terminal repeaters for the primary PCM-24 system are lined up at Nippon Telegraph and Telephone's Chiba, Japan location. These repeating stations, each bay of which can accommodate as many as 18 systems, provide d-c feed power for the intermediate repeaters that regenerate—amplify, retune, and reshape—the signal along the transmission route.

On the air with microwave pcm

Pulse-code modulation at the secondary-multiplex level is highly suited for transmission by a medium-capacity microwave-relay system. The lower noise-to-carrier ratio of the microwave-pcm system makes possible lower transmitter power outputs and smaller antennas producing a twofold advantage—lower-cost radio equipment and the coexistence of pcm-microwave with existing f-m-microwave systems. With pcm microwave, higher route densities can be achieved in a given region—conventional f-m microwave can only branch at right angles to the main route while pcm microwave can converge on any given point at multiples of 45° angles.

The use of four-phase modulation and orthogonal polarization allows the microwave-pcm system to achieve a transmission capacity of only 10% less than that of a conventional frequency-division multiplex f-m microwave system. With the 2-gigahertz pcm system, each radio channel carries two 7.876-megabit per second pulse streams; thus a single radio channel can transmit 240 telephone channels. Orthogonal polarization allows a single radio frequency to be used for two radio channels, providing a total of 2,160 telephone channels in nine radio channels plus one held in reserve. This is only 240 telephone channels less than the conventional f-m-microwave system operating from 2.11 Ghz to 2.29 Ghz. The loss of 10% of the transmission capacity is more than adequately offset by the lower cost of the antenna and transmitter-receiver of the pcm-microwave system.

In the 2-Ghz pcm-microwave system, a pair of 7.876 Mbs pulse streams is applied to the transmitter. After code conversion in the logic circuitry, the coded pulse

streams directly four-phase modulate the microwave carrier. The modulated radio carrier is then 30% amplitude-modulated with signals from the supervisory and control system—a-m is used because it is done at low cost, and it does not affect the main communications channel. Finally, the five radio-frequency signals allocated for use in the band are combined through branching filters and fed to a single antenna.

Regenerated. At the receiving end, the microwave signal is heterodyned into the 70-megahertz intermediate-frequency signal and then amplified. The i-f signal is then fed to a phase detector and demodulated into two pulse streams. These two streams are then regenerated by retiming and reshaping in two separate pulse regenerators. Finally, the logic circuits perform the inverse-code conversion of the sending logic circuits and reproduce the original pulse streams.

The intermediate relay stations consist of a transmitter and a receiver through which the sending logic connects the output pulse streams of the pulse regenerator at the receiving end to the input of the four-phase modulator in the transmitter. Regenerative repeaters minimize degradation in signal transmission even though many repeaters are included in a radio-relay route.

A direct four-phase modulation circuit was chosen because of its simplicity and low insertion loss. The microwave carrier signal from the local oscillator enters a three-port circulator and first appears at a short-circuited stub arm. The shorted stub reflects the carrier which then appears at the circulator's output arm. Here, the signal is fed into a second circulator arranged in a manner similar to the first circulator.

Diode in the arm. The modulation is performed as follows: a diode is mounted precisely one-quarter wavelength, $\lambda/4$, from the short-circuit in the stub arm of the first circulator. The pulse stream from the sending logic is applied to this diode; when the pcm pulse is a binary 1; current flows through the diode, and its impedance becomes very small and moves the short-circuit $\lambda/4$ toward the circulator. The microwave carrier is reflected at this point for the duration of the pulse. The path of the carrier reflected at the diode is $\lambda/2$ shorter than that of the carrier reflected at the shorted end of the stub arm, thus shifting the carrier's phase at the circulator output by 180°. Consequently, a 1 pulse, applied to the diode, brings about a two-phase modulation in the first circulator—the first stage of the modulator.

The output carrier is then fed to the second circulator. Here, the distance between the diode and the shorted end of the stub arm is $\lambda/8$, and 90° phase-shift modulation is performed. Thus, when two pcm pulse streams are applied to the diodes in the cascaded circulators, four-phase modulation is obtained.

Less loss. The insertion loss of the modulator is approximately 2 decibels, which is considerably less than the 10 db loss associated with the mixer used in the heterodyne-type transmitter of f-m-microwave systems.

Demodulation can be implemented by either coherent or differential detection. Coherent detection occurs as the result of product detection of the i-f signal and a local oscillator synchronized with the i-f signal. Differential detection is performed on the product of the i-f signal and the i-f signal delayed by approximately one pulse width. Coherent detection was chosen because it offers superior carrier-to-noise immunity even though coherent implementation was more complicated than the differential type.

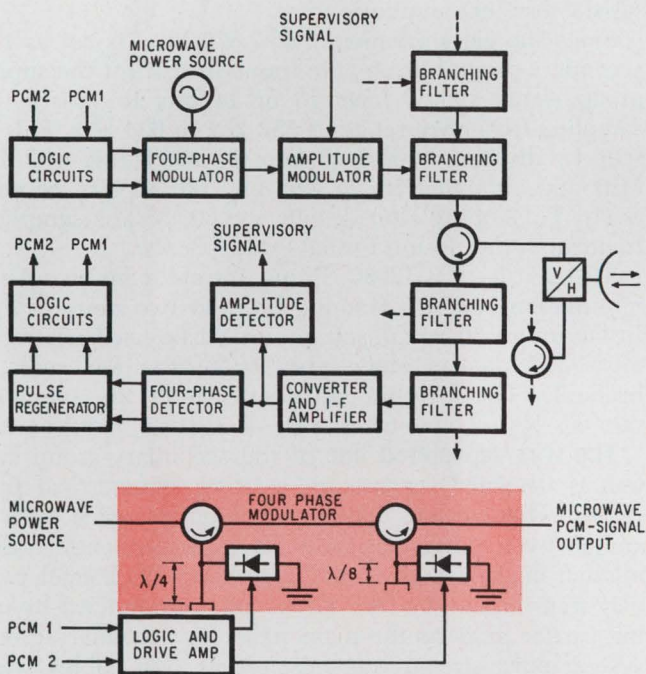

Quadruple the capacity. Signals are transmitted and received by the same antenna using orthogonal polarization, thus permitting use of two radio channels at the same frequency. The dashed lines indicate pcm signals to and from additional channels.

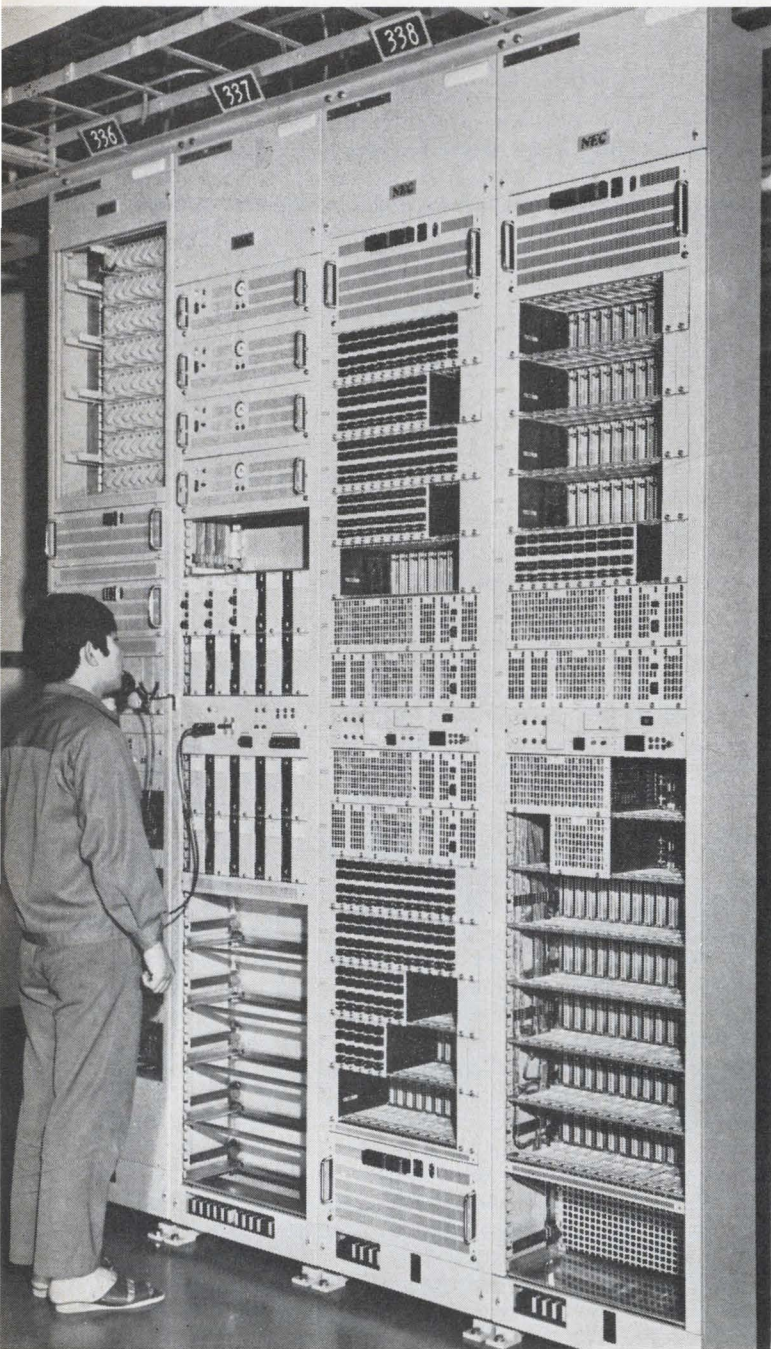

Codec in action. A PCM-120 terminal for directly encoding 120 voice channels consists of a clock supply in the left bay, a terminal repeater in the next bay, and the 120-channel terminal bank in the two bays at the right. The installation is at Yokosuka, Japan.

signal were translated so it occupied a frequency range from d-c to 240 khz, then a sampling rate of 480 khz or higher would be adequate—translation of the super-group signal does not alter its information content. Since the information content remains the same, the 480-khz sampling rate should be able to sample the actual super-group-frequency band. However, 480 khz and its side bands fall in the middle of the signal band and cannot be removed by filtering; therefore, a sampling signal higher than the upper band edge is required while one higher than 624 khz is no good since this frequency will beat with frequencies near the lower band edge to produce beat frequencies within the band that cannot be filtered. Therefore, any signal between 552 khz and 624 khz is satisfactory for sampling.

Since the clock frequency of 7.876 Mhz is set as the secondary-group bit rate, the frame format for the super-group signal should have 13 or 14 bits to satisfy the sampling-frequency range of 552 khz to 624 khz. This is seen by dividing 14 and 13 into the clock rate of 7.876 Mhz and obtaining 562.57 khz and 605.85 khz, respectively. To simplify filter design, the 605.85 khz sampling frequency—the 13-bit format—was chosen.

The 13-bit PCM-120SG frame format consists of 10 information bits, one framing bit, and two unused bits. In the future, these unused bits might be used for transmission of data or other types of information, such as facsimile. This two-bit gap results from the sampling rate of $\frac{1}{13}$ of the clock rate—a system requirement.

The wire repeated line of the secondary-group system is designed for use on existing symmetrical pair cables. These cables have special quads, each with a unique twist pitch, designed for high-frequency transmission in the 100-khz band, providing 12-channel two-way transmission by fdm. Crosstalk is minimized by using carrier pairs as the main pairs for secondary-group system pulse-stream transmission. If two cables were used, with transmission in opposite directions in separate cables, each pair would be capable of transmitting about 16 Mbs—twice that of the 7.876-Mbs secondary group. However, transmission is limited to the 7.876 Mbs rate in each pair in single-cable operation due to near-end crosstalk between opposite going pairs in the same cable. Consequently, the secondary-group system repeaters are equipped for single-cable operation on existing routes and are located at 0.6 mile intervals. ●

Designer's casebook

Designer's casebook is a regular feature in Electronics. Readers are invited to submit novel circuit ideas and unusual solutions to design problems. Descriptions should be clear. We'll pay \$50 for each item published.

Matched FET's stabilize amplifier's bandwidth

By G. Fontaine and G. Reboul

College de France, Paris

Matched field effect transistors allow the designer to build variable gain amplifiers while maintaining a constant bandwidth throughout the range of gains for the amplifier.

The gain of the amplifier, K , is defined as the ratio, R_2/R_1 , where R_1 is the FET's variable resistance defined by the voltage on the FET Q_1 's gate. Thus, the input-gate voltage to the FET controls the gain of the amplifier.

However, it is the phase-lag compensation rather than the gain that causes the problem. The open-loop gain of the amplifier is a function of frequency and decreases proportionately to $1/f$ when using a lag compensation. As such, the amplifier's bandwidth varies as $1/(1+K)$. Thus for a value of $K=1$, the bandwidth is 5 megahertz, while for $K=100$

the bandwidth is 100 kilohertz.

One good approach to stabilizing the bandwidth is to design an input lag-compensation network. Assuming $R_1 < R_1$, the solution to the bandwidth can be obtained from the equation

$$|A(f)| = \frac{R_2 + R_3(1+K)}{R_1}$$

To prevent the bandwidth from varying with the gain, K , the term, $R_3(1+K)$, must either be canceled or made constant.

If R_3 is made equal to 0, bias and offset effects are left uncorrected. However, a solution can be arrived at by making the term a constant. If R_3 is set proportional to $1/(1+K)$, the gain becomes independent of frequency.

Since $1/(1+K)$ is equivalent to $R_1/(R_1+R_2)$, R_3 can be chosen to have a value $R_1R_2/(R_1+R_2)$, where R_2 is a fixed value. This can be readily implemented using for R_3 a resistance equal to R_2 in parallel with a FET matched to R_1 .

Since the same gate voltage controls both FET's, the R_3 term in the equation for the bandwidth remains almost constant, allowing a wide selection of gains without severely affecting the bandwidth.

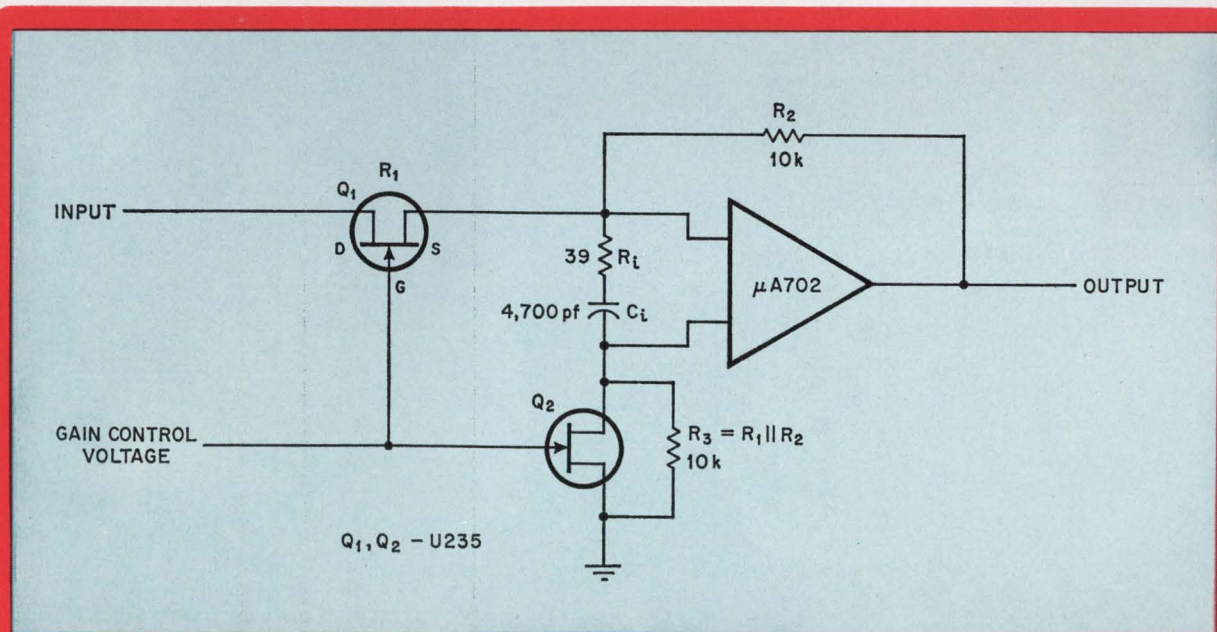

Input compensation. Making the resistance, R_3 , equal to the parallel combination of R_1 and R_2 , compensates for the phase lag of the amplifier over various values of gain. Bandwidth remains unaffected since the same gate voltage controls channel resistances of both field-effect transistors.

Q-multiplier analyzes audio-frequency tones

By Roland J. Turner

Magnavox Co., Philadelphia

One effective way to analyze phase-modulated frequency tones is to use a gated Q-multiplier as an active bandpass filter. The Q-multiplier integrates, stores, and analyzes audio tones, which can be separated by as little as 80 hertz with a crosstalk level below 46 decibels. This approach allows many information channels to be densely packed leading to more efficient use of the frequency spectrum.

Incoming channels are multiplexed and fed into the input-buffer stage formed by transistor Q_1 . The 359-kilohertz center frequency is derived from the local oscillator of a preceding mixer stage. Integration is performed in a high-Q tank circuit, which provides loaded Q's greater than 3,000. The tones are sequentially analyzed by the filter, whose characteristic is a $(\sin x)/x$ frequency response, such that only one tone, the tone tuned to the center frequency, f_0 , provides a positive integral

during the integration period. All other frequencies fall into the nulls of the frequency response. Thus, by controlling the frequency of the mixer, each channel's tone can be sequentially analyzed.

The multiplier uses field effect transistors to provide high impedances at the gate and source of Q_2 . Q_2 provides controlled positive feedback so that Q's of 200 can be multiplied to 5,000.

As the signal is fed through the input buffer, the tank circuit, consisting of capacitors C_1 , C_2 , and C_3 , and inductor L_1 , integrates and stores the p-m signal. The stored signal becomes the bandpass audio tone with an amplitude proportional to the Q of the tank circuit. The audio signal is passed through the output-buffer stages, comprising Q_3 and Q_4 , where the signal is then read out by a gated-diode bridge.

After readout, the information is erased from the tank circuit by activating the two diodes, D_1 and D_2 , which de-energize the circuit with a low-impedance path to ground. The Q-multiplier is then ready to accept the next tone burst.

The Q of the multiplier is adjusted by R_f so that after the integration interval is over, the tank rings out flat over the storage interval. When the integration interval and the storage interval are selected equal to 240 microseconds, the error in integration or storage will be less than 0.5 db.

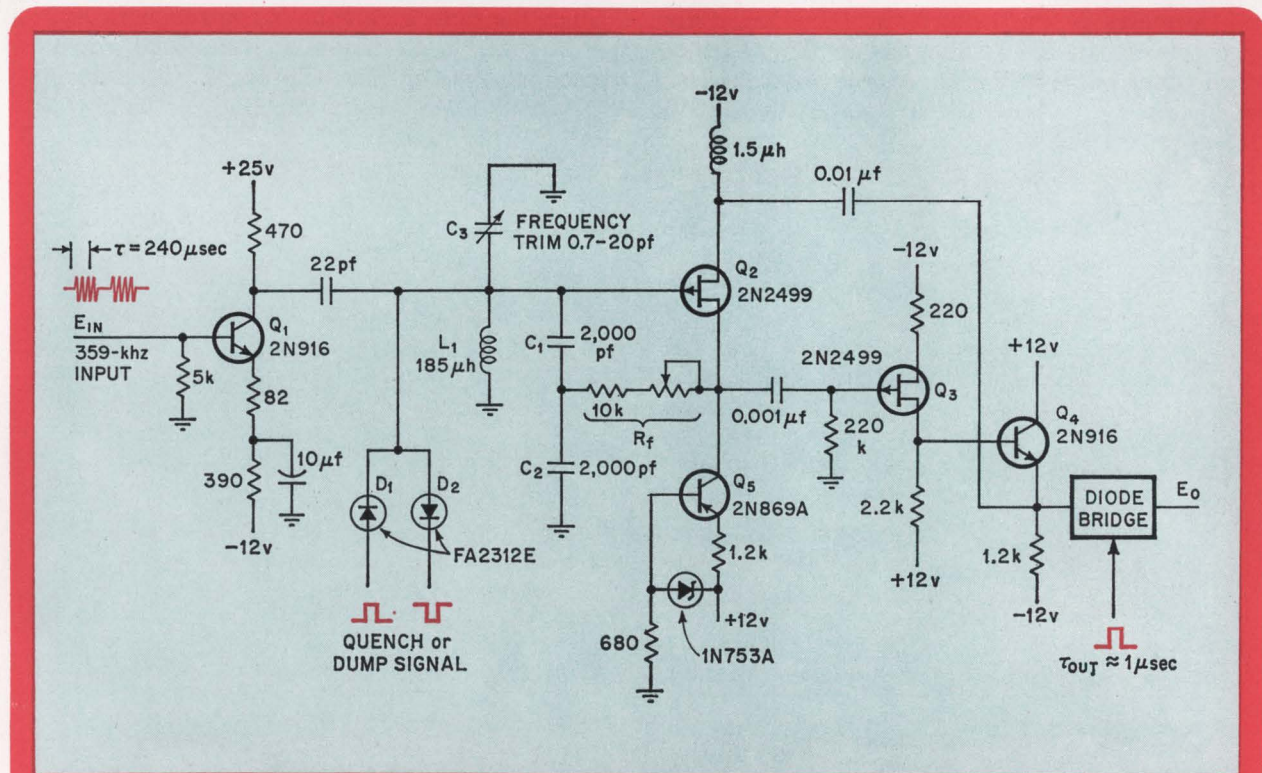

Integrated and dump. The gated Q-multiplier performs three functions: integration, storage, and filtering. The circuit operates at a center frequency of 359 kHz and can generate loaded Q's from 200 to 5,000. The Q-multiplier has a $(\sin x)/x$ frequency response and generates a positive integral only for the tuned channel.

D-c-to-d-c converter offers positive or negative bias

By Gerald Olson

Denver, Colorado

For simplicity, compactness, and low cost, one of the best approaches to the design of d-c-to-d-c converters is a design using a complementary emitter follower. And with a slight rearrangement of the components, the same circuit can be made to supply a negative voltage from a positive supply.

The circuit at the left shows the basic configuration of a voltage doubler, but can be easily extended to provide other multiples. Transistors Q_2 and Q_3 form the complementary emitter follower driven by the input transistor, Q_1 . Q_1 is turned alternately on and off by a positive input pulse.

Before the arrival of a pulse, the transistors are off, and point A is at ground potential. The capacitor, C_1 , charges to the supply voltage, V_s . When a positive pulse arrives at the input, Q_1 turns on, and drives Q_2 and Q_3 into conduction. The potential at point A rises to the supply voltage placing

the circuit with the supply voltage and the capacitor, C_1 , in series. The output capacitor, thereupon, charges to twice the supply voltage through the diode, D_2 . The diode, D_1 , prevents Q_2 from discharging C_1 .

The circuit at the right contains the same components, slightly rearranged. A positive pulse turns on Q_1 which turns on Q_2 and Q_3 . Capacitor C_1 charges to the supply voltage, V_s , through the circuit containing diode D_1 . When the pulse terminates, Q_1 shuts off, which shuts off the complementary emitter follower, Q_2 - Q_3 . The charge on C_1 is then transferred to C_2 to produce the negative of the supply voltage at the output.

These transistor d-c-to-d-c converters are as efficient as the transformer types, but have the added advantage that they contain no magnetic circuits whose magnetic fields might interfere with other circuits in the vicinity. The transistor circuits also lend themselves to fabrication as integrated circuits.

Where moderate currents are involved, the frequency of operation could be high as long as satisfactory transistors and diodes can be fabricated. With high frequencies, the capacitors can possibly be made small enough so as to be also part of the IC. Such a package could be useful as a source of bias for varicap tuners.

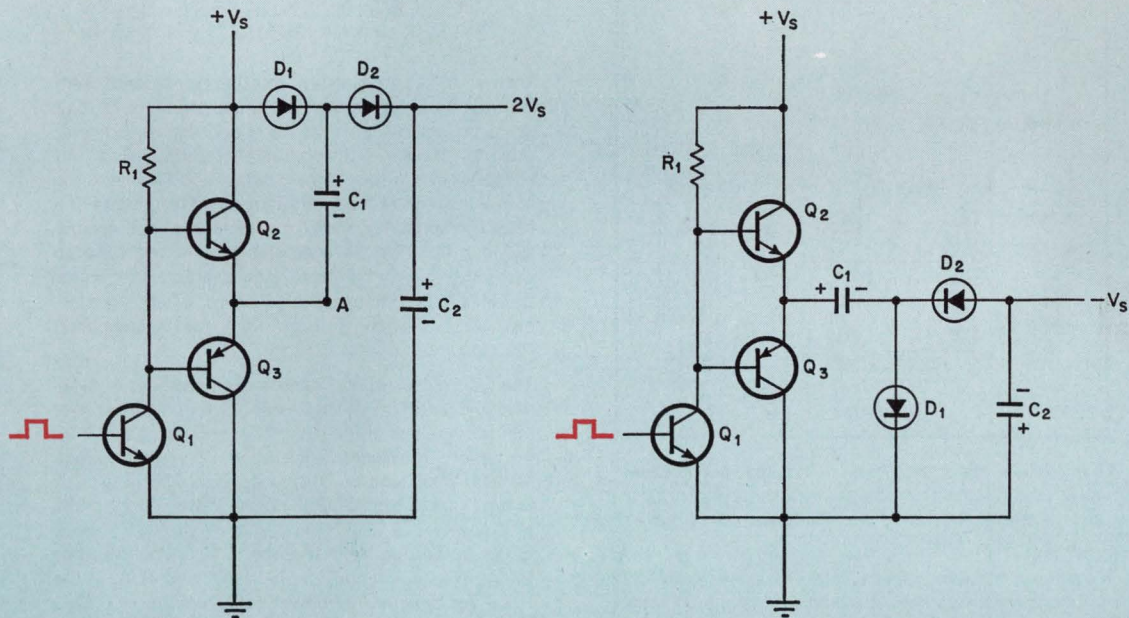

Complementary. The complementary emitter follower (left) charges the output capacitor to twice the supply voltage, while the other one charges the capacitor to the negative of the supply. The circuits are as efficient as transformer-type converter circuits, and with smaller capacitors, can work to high frequencies.

the fastest character generator west of hicksville

speed: 2MHz
price: \$28⁰⁰_{ea.}

**The first and only 2MHz character generator
with horizontal output using ASCII coding
...all in one package**

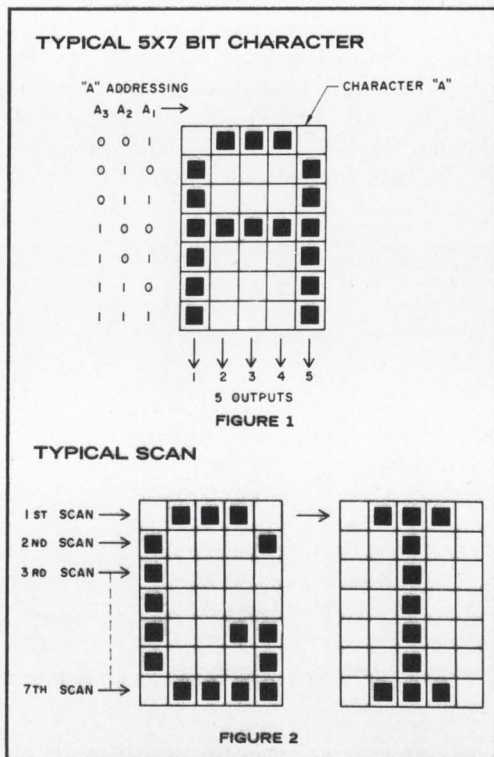

The new General Instrument one package M_TOS Character Generator is the fastest, most reliable character generator available today. No other device can equal its performance at lower cost.

To achieve equivalent speed (>80 character capability) in conventional systems, extremely large and complex memories would be required, the cost and reliability of which would be adversely affected.

The General Instrument Character Generator (RO-1-2240) is an M_TOS 2240-bit read only memory. It is organized into 64 permanent character storage locations of 35 bits each (5x7 character matrix) and 9 bits of addressing (arranged in 2 decoding matrices of 3 and 6 bits respectively) with 5 outputs. The 2240 bits of memory are constructed on a single monolithic chip utilizing exclusive M_TOS (Metal-Thick-Oxide-Silicon) P-channel enhancement mode transistors. The new RO-1-2240 features:

- 500 ns Character Access Time
- 5x7 Bit Character Format/64 Characters
- Asynchronous/Synchronous Operation
- Output Buffers for TTL/DTL Interfacing
- 24 Lead Dual-in-Line Package

Another important feature of this unique character generator is its acceptance of ASCII coded inputs for 5x7 character selection. Three additional inputs are provided for the line of the character (figure 1). The "A" addressing code selects the 5 outputs applicable to the scan line active at the time (figure 2). The method employed is horizontal scan (or raster) designed specifically for standard video equipment and requiring no additional display hardware. The character generator provides the z (intensity) information for each character in a row through 7 runs, or scans, for the completed row of characters.

The RO-1-2240 M_TOS Character Generators are available in production quantities and are in stock at your authorized General Instrument Distributor. For full information write General Instrument Corporation, Dept. 40, 600 West John St., Hicksville, N.Y. 11802, or call, in New York: 516-733-3333; in Boston: 617-329-1480; in Chicago: 312-774-7800; in Los Angeles: 213-873-6500. (In Europe, write to General Instrument Europe S.P.A., Piazza Amendola 9, 20149 Milano, Italy; in the U.K., to General Instrument Microelectronics Ltd., Stonefield Way, Victoria Road, South Ruislip, Middlesex, England.)

*In quantities of 100 pcs. Custom font available.



GENERAL INSTRUMENT CORPORATION • 600 WEST JOHN STREET, HICKSVILLE, L. I., NEW YORK

Serial conversion knocks some stuff out of dvm's

Recirculating-remainder a-d converter, that *Richard Van Saun* and *Frances Capell* helped develop at the John Fluke Mfg. Co., does all its digitizing with one network, permitting hefty cut in required parts

● Some digital voltmeters use the dual-slope technique to convert d-c into digital form; others use successive approximation. In fact, there are quite a few ways to build an analog-to-digital converter. But most converters have one thing in common: for every digit of resolution it has, the converter contains one measuring network, complete with a counter, a decoder-driver for the display, maybe a ladder, and so on.

But like every other rule, the one-network-per-digit dictum has an exception. The recirculating-remainder converter, invented by engineers at the Fluke Mfg. Co., of Seattle, Wash., needs but one network, no matter how many digits the converter is designed to resolve. Besides making the converter simple and inexpensive to build, this single-network approach boosts reliability, simply because the fewer parts a device has, the smaller the chances that one of them will go bad.

Since it has but one network, the new converter measures one digit at a time. In effect, it's a serial processor, but one with sample-and-hold capability.

When a d-c signal comes into the converter to be measured, that signal must already have been scaled to some value between 0 volt and 10 volts by a ranging network and inverted if it were negative. In the converter the scaled signal goes to the positive-input terminal of a differential amplifier. The converter measures the unknown's most-significant digit; generates a volt-

age equal to this digit; and feeds this voltage along with a portion of the amplifier's output to the negative terminal. The result: this output equals 10 times the difference between the unknown and the most-significant-digit voltages. For example, if the unknown is 9.83 volts, the amplifier's output is 8.3 volts.

Finding the value of that most-significant digit is the job of a feedback loop which contains a counter and a binary-coded-decimal ladder. Besides sending the most-significant-digit voltage to the amplifier, the loop also feeds this voltage to a storage capacitor and the counter's bcd output to a display network.

Meanwhile, the amplifier's output—called the remainder voltage—is stored in another capacitor until the most-significant digit is displayed. After that, the unknown signal is disconnected from the amplifier, and the remainder voltage is applied—or recirculated—to the positive terminal. At this point, the cycle repeats. The remainder's most-significant digit is measured and displayed, and a new remainder is generated and stored. This goes on until the signal being measured is digitized to the resolution designed into the converter.

At first glance it may seem that by measuring one digit at a time, the recirculating-remainder converter sacrifices speed for circuit simplicity. To a degree that's true. Successive-approximation converters can digitize a signal in less than 100 microseconds. The recirculating-

**The converter measures and displays
an unknown input's most-significant digit.
At the same time, the converter generates and stores . . .**

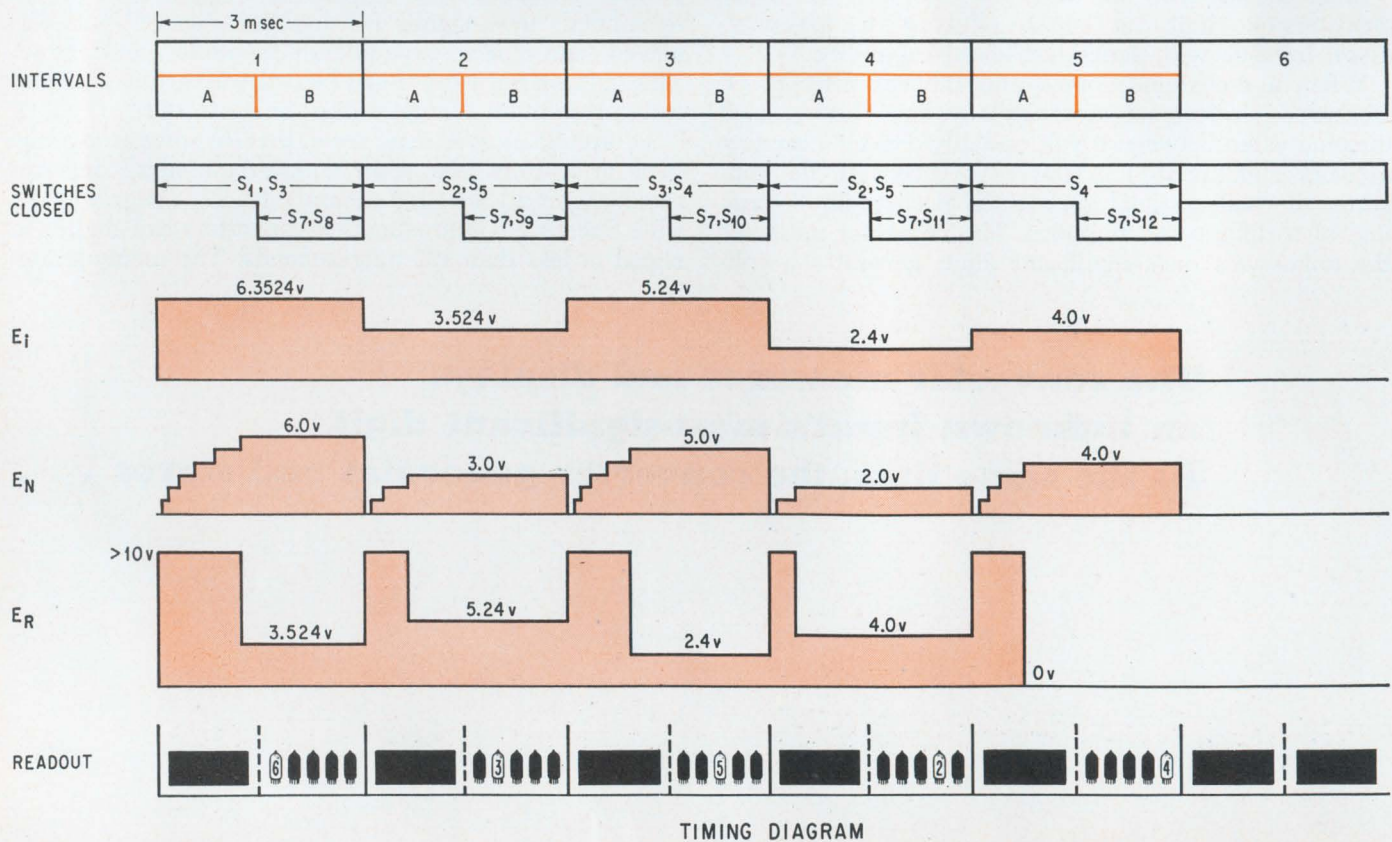
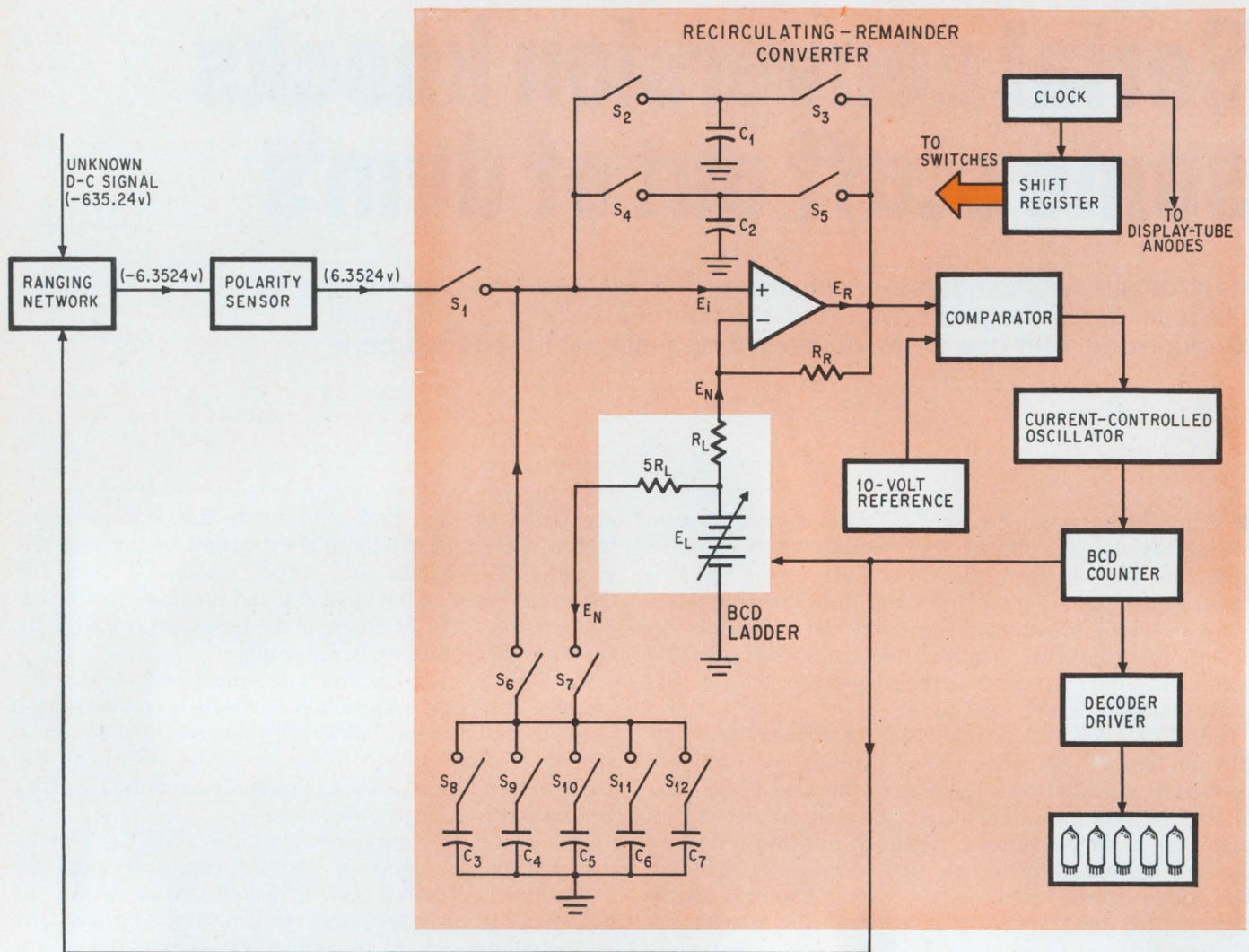

TIMING DIAGRAM

remainder converter isn't that fast, but it's not slow. For example, a five-digit output can be generated in 18 msec.

The figure on the left shows a typical five-digit recirculating-remainder converter. With it is a timing diagram that tells what the voltages are at certain points in the converter, and when each of the converter's switches are opened or closed. The switches actually are field effect transistors, controlled by the clock and shift register. Every 1.5 msec, the clock tells the register to open or close the appropriate FET's.

The combination of a variable battery, E_L , and two resistors, R_L and $5R_L$, shown in the figure actually is the Thevenin equivalent of the four-bit bcd ladder shown in the figure on page 101.

The converter has two operating modes. It can continuously digitize and display an unknown signal coming through the ranging network and polarity sensor. Or, after digitizing an unknown once, it can continuously display this unknown. To do this, the converter stores the significant digits in capacitors C_3 through C_7 .

Working in either mode, the converter has a six-interval digitize-display cycle. Each interval is 3-msec long, and is split into two segments, A and B, both of which last 1.5 msec. In the first five intervals, the converter measures a digit during A, and displays it during B. In the sixth, the converter resets its counter and ladder, and zeroes its amplifier.

To see how the converter works in the first mode, consider the five-digit model in the figure measuring a d-c signal equal to -635.24 volts. After being scaled and inverted to 6.3524 volts, the signal goes to the converter. Initially, E_L is zero, and all the switches, S_1 through S_{12} , are open. As interval 1 begins, S_1 closes, making 6.3524 volts the input, E_i , to the amplifier's positive terminal. R_R , R_L , and the amplifier are chosen so that if the ladder's output, E_N , is less than E_i 's most-significant digit, the amplifier will be overdriven. Thus, when 6.3524 volts are applied to the amplifier, E_R goes to some saturation value greater than 10 volts.

S_3 also closes as interval 1 begins, causing C_1 to charge to E_R . Besides being tied to C_1 , the amplifier's output also goes to a comparator whose other input terminal is fed by a 10-volt reference source. Anytime E_R is greater than 10 volts, the comparator turns on the current-controlled oscillator, which then sends pulses to the bcd counter. The counter responds by putting out bcd signals which, by controlling the ladder's switches, increase E_L . Each pulse boosts E_L in such a way that E_N increases by 1 volt.

When the first pulse comes from the counter, E_N goes from 0 volt to 1 volt. E_R may or may not go down, but it's still some value greater than 10 volts. So the counter continues pulsing. Not until six pulses reach the counter, increasing E_N to 6 volts, does E_R fall below 10 volts, to 3.524 volts. At that point the comparator turns off the oscillator and with it the counter.

Now two things happen during 1A. Six pulses have gone to the counter. Thus it's storing the number "6" in bcd form. In other words, the counter has measured E_i 's most-significant digit. Second, C_1 is discharging from some saturation voltage to 3.524 volts, the remainder voltage. Since the amplifier is both a current source and sink, the voltage across C_1 tracks E_R . Of course it takes time for C_1 to catch up. The combination of C_1 and the amplifier's output impedance has a 100-microsecond time constant, and anytime E_R changes it takes the voltage across C_1 920 μsec to come to within 0.01% of E_R . However the converter has been designed so that at least 1,500 μsec elapse between the time the counter is turned off and the end of segment 1B, when C_1 will drive the amplifier.

During 1A none of the display tubes are lit. When 1B begins, S_7 and S_8 close, putting the 6 volts from the bcd

. . . a remainder voltage. After the first digit has been displayed, the remainder voltage "recirculates" to the converter's input.

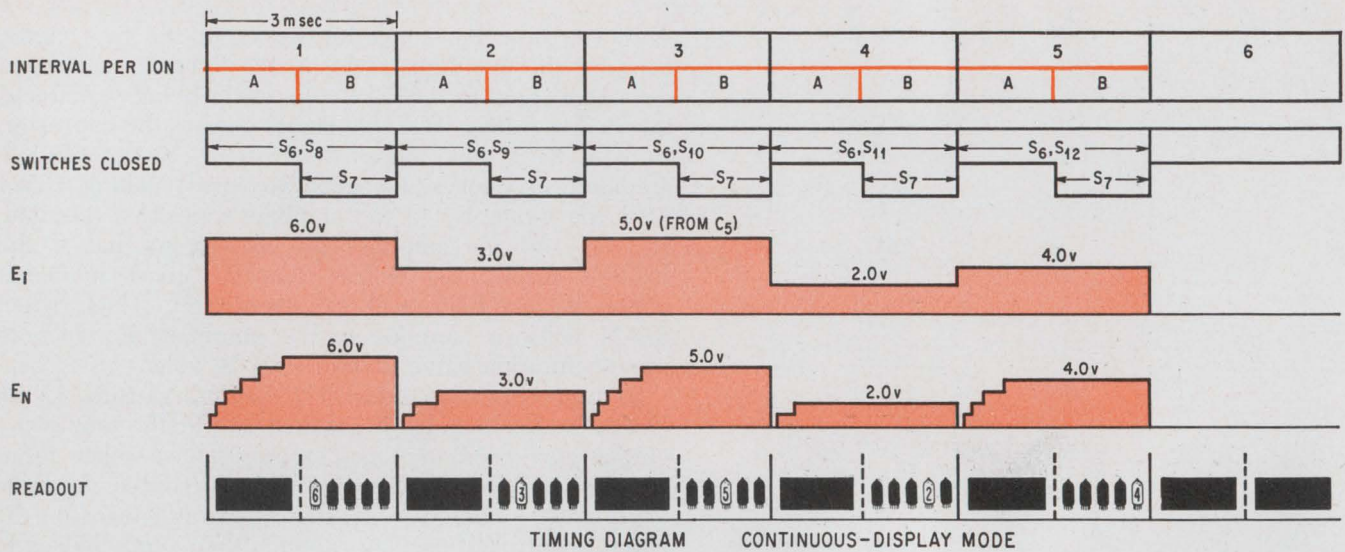

TIMING DIAGRAM CONTINUOUS-DISPLAY MODE

ladder across C_3 . At the same time the bcd signal in the counter goes to the decoder-driver, lighting "6" in the first display tube. It stays lit for the full 1.5 msec of 1B.

When 1B ends, the counter and E_L reset to zero; the first tube goes out; and S_1 , S_3 , S_7 , and S_8 open. S_1 won't be closed again because the converter is through with the unknown input. Its most-significant digit has already been displayed, and its remainder is stored in C_1 .

Interval 2 begins with S_2 closing, applying the voltage across C_1 to the amplifiers input. S_5 also closes, causing C_2 to track E_R . The digitize-display routine then proceeds much as it did in interval 1, except that E_N goes to 3 volts, not 6 volts. During 2B, S_7 and S_9 close; 3 volts is stored on C_4 ; and the second display tube shows "3".

As shown in the timing diagram, much the same things happen during intervals 3, 4, and 5. Voltages equal to the unknown input's third, fourth, and fifth digits are stored in C_5 , C_6 , and C_7 , respectively, and the digits themselves are displayed. Although the readout tubes aren't always on, they appear to be continuously lit since each one is on for 1.5 msec every 18 msec.

In the sixth interval, all the tubes are off; the switches are open; the counter and E_L again reset; and the converter adjusts the amplifier by grounding its input terminals and setting E_R to zero. At the end of interval 6, the cycle begins again.

The timing diagram drawn above is for the continuous-display mode. Assume that 6.3524 has been measured, and the appropriate voltages are stored in C_3 through C_7 . At the beginning of 1A, S_6 and S_8 close applying the 6 volts across C_3 to the amplifier's positive terminal. E_N is stepped to 6 volts, but no voltage is stored on C_1 or C_2 . They aren't needed in this mode. During 1B, S_7 closes, refreshing the charge on C_3 . Meanwhile, the first tube displays "6". During the next four intervals, the sequence repeats with C_4 through C_7 being connected to the amplifier's input terminal.

The converter's performance depends a lot on the bcd ladder. When any of the first five intervals begins, for either mode, the ladder's resistors are grounded, making E_N equal to zero volts. The ladder's Thevenin resistances, R_L and $5R_L$, are equal to $R/11$ and $5R/11$. When the first pulse comes from the oscillator, resistor R in the one branch and $5R$ in the other are switched from ground to the positive terminal of the ladder's reference source, E_{ref} . E_L becomes $E_{ref}/11$ while R_L

remains the same. As additional pulses come from the oscillator, the ladder switches its resistors to and from ground in such a way that each pulse increases E_L by $E_{ref}/11$. Regardless of the combination of grounded and ungrounded resistors though, R_L remains $R/11$.

When the converter works in a voltmeter, the ladder helps out with the autoranging. In fact, a recirculating-remainder converter can change ranges quickly because it has to look at only one digit before deciding whether to switch to another range. Assume that too-low a range is selected. As 1A begins, E_L is greater than 10 volts. The counter steps E_N up to 9 volts and still the comparator doesn't turn off the oscillator; the 10th pulse coming to the counter can signal the input divider to switch to a higher range and can tell the clock to start the measurement cycle again.

Another approach is for the 10th pulse to light an overrange digit—a "1" in a sixth display tube—and for the converter to keep on trying to digitize until the 12th pulse, and to then go to another range.

If, on the other hand, the range is too high, E_L during 1A is less than 1 volt and no pulses go to the ladder. After 1.5 msec without a pulse, the ladder can tell the divider to try a lower range.

The last two are similar to the schemes used in Fluke's 8300A digital voltmeter, the first instrument built with a recirculating-remainder converter. This

Again and again. A recirculating-remainder converter can display a reading indefinitely. This timing diagram shows the order of switch closure for this continuous-display mode. The stored signal is equivalent to an input of 6.3524 volts.

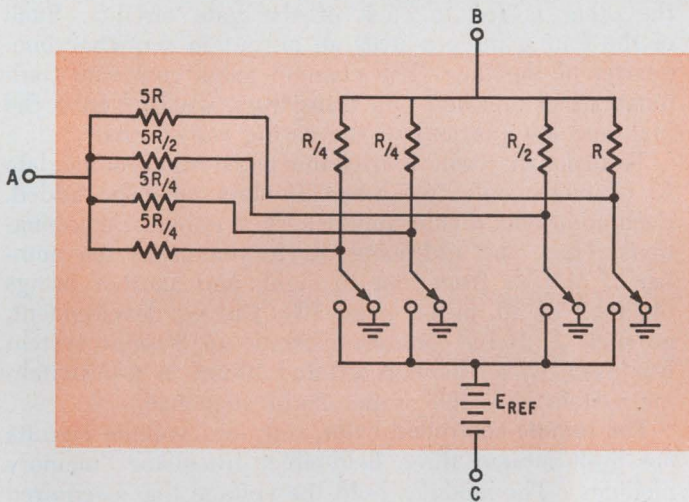
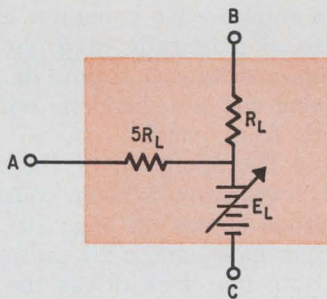

Step ladder. To the rest of a recirculating-remainder converter the bcd ladder acts as if it were the combination of a battery, whose output goes up in steps, and two resistors attached to the battery's positive terminal.

five-digit unit can go from one range to another in 15 msec. By comparison, dual-slope dvm's typically take from 65 to 380 msec to autorange.

Although not exceptionally fast, the converter can handle a lot of inputs in a short time. The five-digit unit, for example, may take 18 msec to make a reading, but, theoretically, it needs to look at the unknown signal for only 3 msec. In reality though the specified time is usually somewhat longer. In the case of the 8300A, Fluke says that the minimum time an unknown signal must be connected to the input is 9 msec. Even so, this gives the user another 9 msec to switch the meter from one unknown to another. The voltmeter itself has a specified digitizing time of 25 msec.

Although a five-digit device has been used here as an example, there's no reason why a recirculating-remainder converter with eight or 12 digits can't be built; there's no theoretical limitation on accuracy. The component on which accuracy most depends is the master reference. As stable and precise as it is, that's how well the converter will perform. The converter usually has a single reference amplifier whose output is tapped to provide the stable outputs of the comparator and ladder references.

The ladder resistors and R_R are the only other converter parts whose performances are critical. R_L must have a constant value, regardless of the value of E_L ; otherwise, the amplifier's output won't necessarily be the remainder voltage. To keep R_L constant, the ladder resistors' values must be precisely known and their stabilities must be the same.

No such demands are made on the other components. C_1 and C_2 must do an accurate job of storing the remainder voltages; hence, they need a low dielectric absorption and high dielectric-insulation resistance. However, since they store voltages for less than 3 msec, the capacitors' tolerance and long-term stability aren't particularly critical.

Things are about the same with the storage capacitors (C_3 through C_7 in the example). They hold only one digit apiece and have their charge continually restored. Hence, there are no special requirements placed on them as far as specifications go.

The converter's display tubes have a long life expectancy because they draw less power in each 18-msec interval than they would if they were continually lit.

In fact, overall reliability is the converter's strong point. Key to this reliability is, as mentioned before, the low parts count, which comes about because the converter handles just one digit at a time. To put this in numbers, the 8300A has 550 parts. A typical five-digit successive-approximation voltmeter has between 2,500 and 3,000 parts.

Besides needing less parts overall, a recirculating-remainder converter needs fewer integrated circuits since it has but one counter, decoder-driver, and ladder. The 8300A has 19 IC's; other dvm's around today have as many as 65. Dual-slope dvm's typically have on the order of 25 to 30 IC's.

Having less IC's boost-reliability in two ways. First, there are simply fewer of them to breakdown. On top of this, each IC typically draws between 100 and 150 milliwatts. The fewer there are, the less power is needed, and the cooler the converter runs. ●

Remote control for color tv goes the all-electronic route

RCA's Wayne Evans, Carl Moeller and Edward Milbourn tell how digital signals and MOS FET memory modules are used to replace motor-driven tuning controls

● Digital switching techniques are getting a crack at the home entertainment market in a new RCA all-solid state color television set that is tuned by command signals from a hand-held ultrasonic transmitter. Unlike standard tv remote controls where electric motors turn the control shafts, the RCA 2000 receiver uses a MOSFET's gate capacity to develop a voltage in a memory circuit arrangement to control color saturation, tint, and volume in response to a digital signal. And all vhf channels can be remotely selected by digital logic circuits sequentially switching a d-c control voltage that forward biases appropriate switching diodes. The system is fast, and averts the wear and electrical noise encountered in mechanically switched systems.

The control signal that's transmitted to the receiver is generated in a battery-operated remote unit that uses a solid-state oscillator to drive the ultrasonic transducer. Ten frequencies, ranging from 28.75 kilohertz to 44.75 khz, allow control of stand-by/on; vhf channel selection; uhf up-channel search; uhf down-channel search; volume up/down; color intensity up/down, and tint-toward-red/toward-green. The uhf tuner uses a solid-state motor control and non-detented gear train.

To tune a vhf channel, the ultrasonic tone corresponding to channel selection is generated when the user depresses the appropriate button on the remote unit.

This turns on a square-wave generator clock, and logic is performed to electronically step the tuner to the next channel—up or down—each time the remote button is pressed. Tuning can also be done with pushbuttons on the receiver's front panel.

To understand the operation of the receiver's electronic channel sequencing system consider the basic four-channel system shown on page 103. It has a free-running clock, four gates, and a 2:1 pulse divider.

One output from the clock drives the divider, while the other is fed to each of the gate circuits. Each of the four gates produces an output in sequence one-quarter of the time. The channel gates comprise combinations of npn and pnp transistors, working from the high and low portions of the gating waveforms.

To make the basic four-channel system accommodate 13 channels, only two more dividers must be added. Each additional divider doubles the number of combinations. Thus, one additional divider increases the number of outputs from four to eight, and another brings the total of 16, as on page 103. During development, no such IC 16-bit counters existed; an 8-count system was used twice: channels 2-9 and 10-uhf. A B+ switching system gave the proper 2-uhf sequence.

The remote-controlled color, tint, and volume circuits are built around three field-effect transistor "memory modules." The modules hold the voltage that's required to properly set the various controls—in effect, they duplicate the function of a manually set potentiometer which delivers a fixed voltage once it is positioned.

Depending on whether the receiver is in the manual or remote model, the memory module will receive its input voltage from the control potentiometer or through the remote switching circuit as shown on page 103, while the input can be any value from +10 volts to -3.3 volts. The memory module's output, which drives the color, tint, or volume circuits, is between 0 and +10 volts.

When the set is in the remote mode, the d-c input for the memory module is provided through the action of an electronic switch, operated by the ultrasonic receiver. When under manual control, a capacitive voltage divider, consisting of the 2-picofarad gate-channel capacitance of the MOS FET, and 1.5 microfarad "memory" capacitor, is used. A d-c voltage is applied to the divider as shown on page 103.

The voltage between the FET gate and the channel

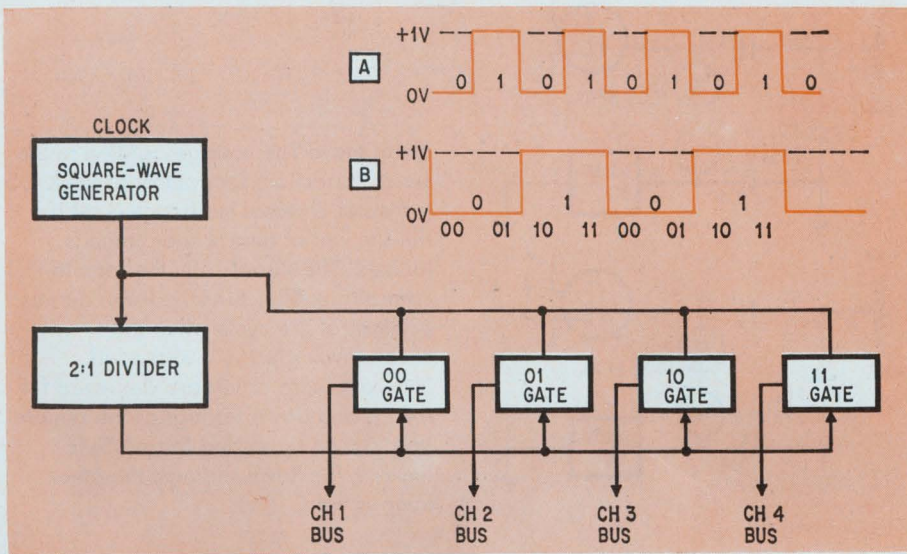

Tune four. A basic four-channel tuner, left, uses a clock that is turned on by the tone received from the remote control unit. As they sense coincidence at their inputs, the gates energize the channel lines in sequence. The gates themselves are made up of two series-connected transistors with inputs to the base. The first gate is made of two pnp transistors, the second and third an npn and a pnp, but with opposite connections to the clock and divider inputs. The fourth gate is comprised of two npn types. The scheme can be extended to 13 channels, below, by adding dividers and gates.

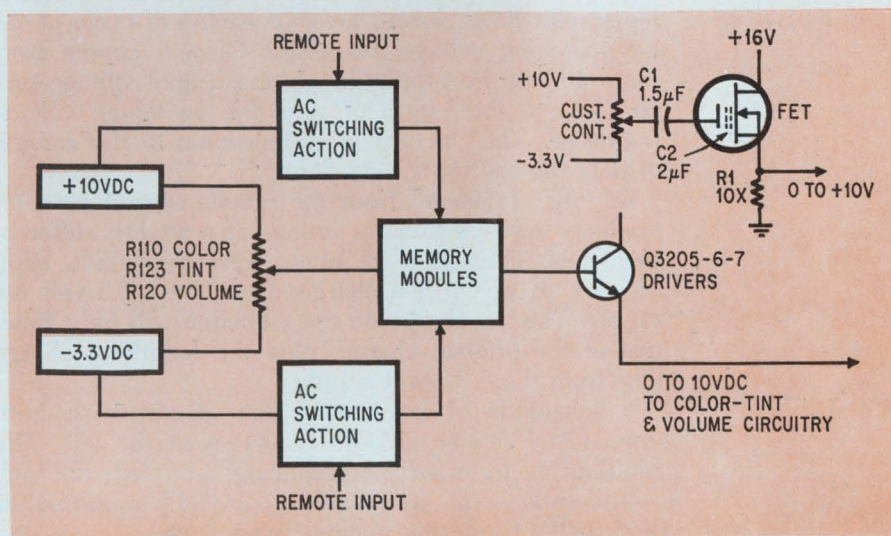
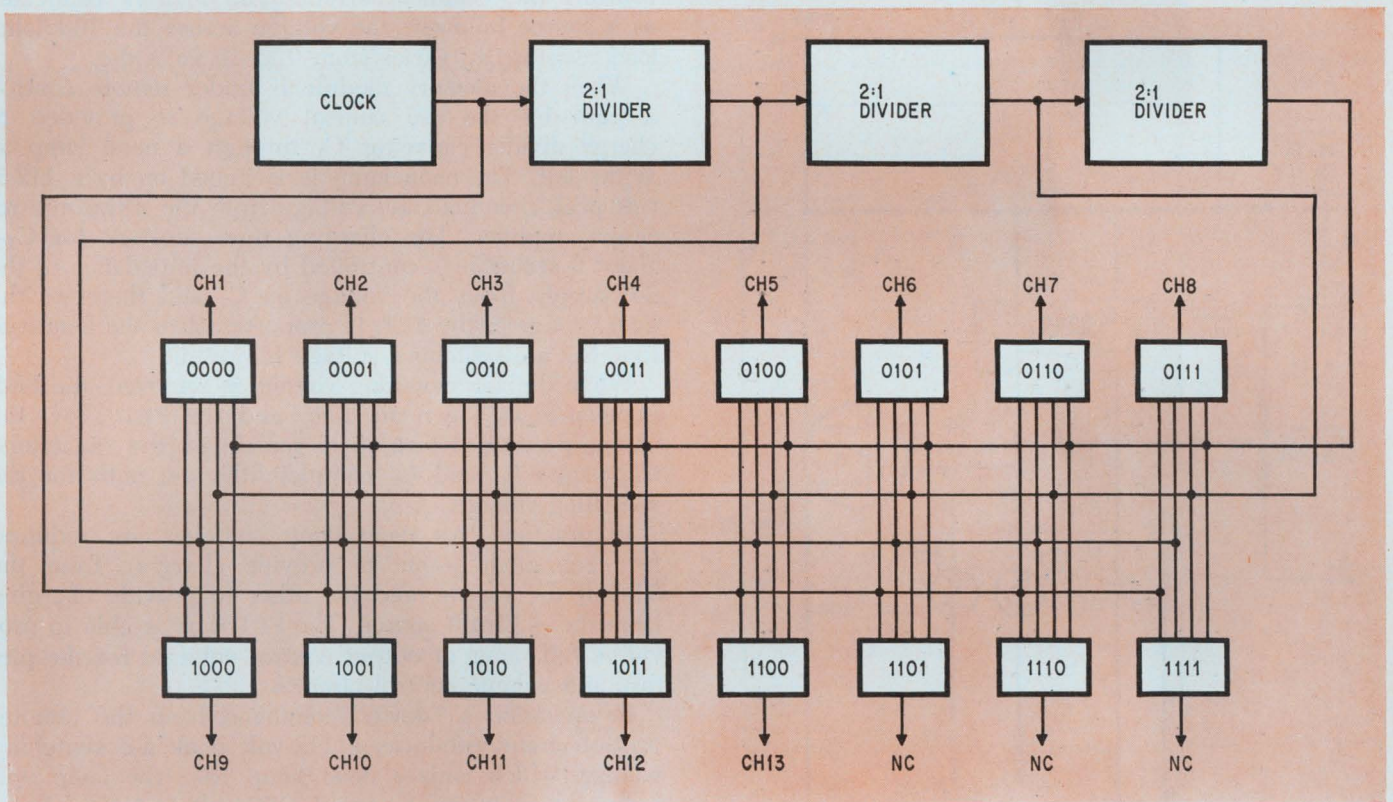

Hold it. The tuning voltage needed for setting picture and sound controls is developed with a metal-oxide semiconductor transistor memory circuit. The output ranges between 0 and 10 volts. Under manual control, the setting of the potentiometer determines the voltage applied to the capacitive voltage divider comprising the 1.5- μ f capacitor and the transistor's gate-channel capacitance. The voltage on the gate-channel capacitance sets the channel resistance, which in turn sets the output voltage. In the remotely controlled mode, the voltage applied to the series capacitors is set by a switching circuit.

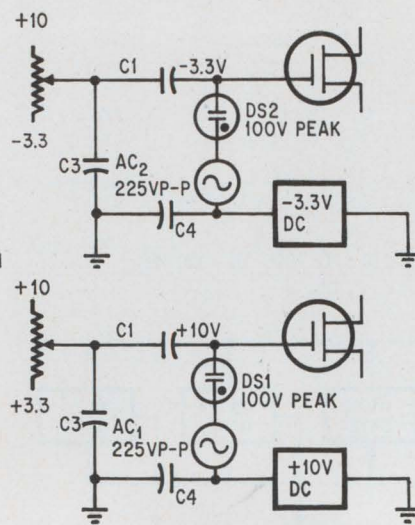
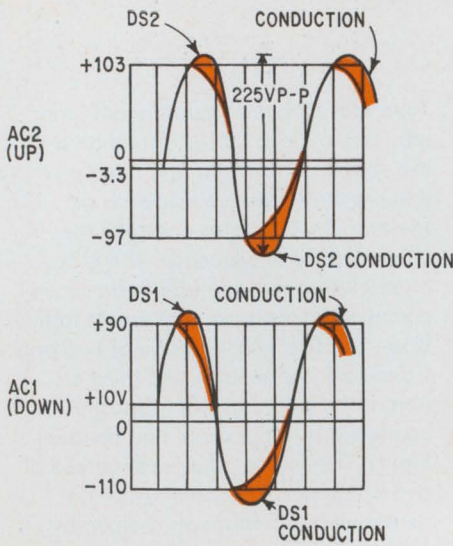

Neon glow. The voltage applied to the series capacitors for control of the MOS transistor channel resistance is set by the amount of time a neon lamp is ionized. The signal from the remote-control amplifier fires the lamp during portions of the cycle when the breakdown voltage is exceeded. Different lamp drives are delivered for the up and down settings of the remote unit. For an up setting lamp DS₂ is ionized, for down settings, the other lamp is fired.

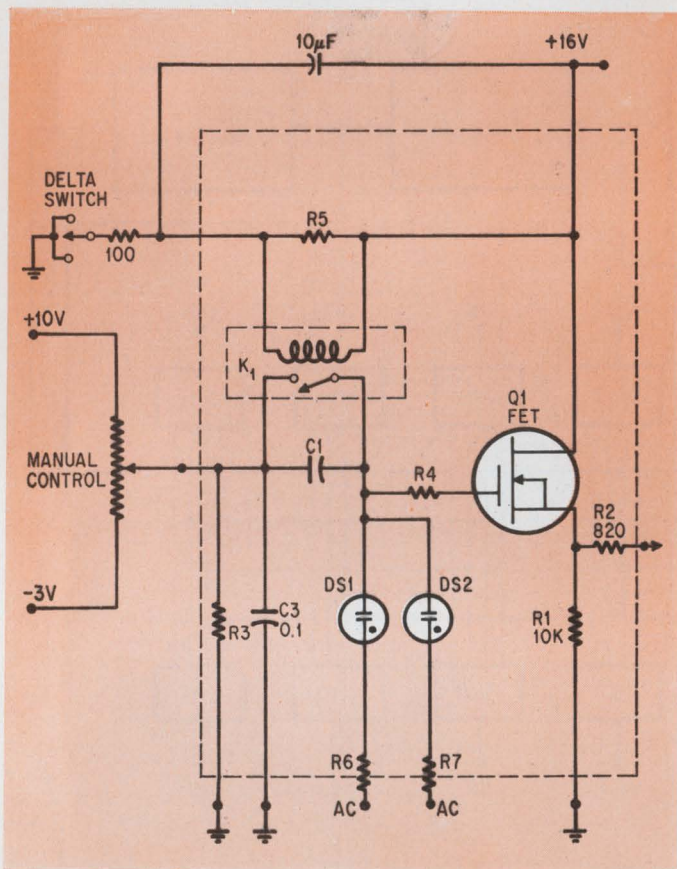

In reality. The circuit as actually used in the tv set includes a relay, K₁, for discharging the memory capacitor during manual control. The switch is coupled to each of the picture and the volume controls. Rotation in either direction closes the switch and resets the circuit so that it can accept inputs from the potentiometer.

controls the channel current. The FET is connected as a source follower; the voltage across the 10-kilohm load resistor, R₁, varies from 0 to 10 volts d-c.

When the memory module is under remote control, a path for the d-c control voltage is provided to charge divider capacitor C₁ through a neon lamp as at the left. The neon lamp is switched on by a 112.5-volt peak (nominal) a-c voltage from the ultrasonic receiver amplifier. The charging time constant for C₁—about 6 seconds—is controlled by the impedance of the d-c supply. Thus the voltage on C₁ and therefore the gate voltage of the FET, is proportional to the length of time the a-c switching voltage is present.

When the a-c switching voltage is removed, the high impedance of the neon lamp and the FET allow the charge present at turn-off to remain on the capacitors. Capacitors C₃ and C₄ complete the a-c path for the switching voltage.

In practice, two neon lamp switches are required for each module—one to provide charging from the 3.3-volt d-c supply, and the other to provide charging from the +10-volt source. The FET thus is able to provide a full range of output control voltages for the picture and volume control circuits.

In operation a “down” command from the remote-control circuit produces a 112-volt peak a-c switching voltage, which ionizes neon lamp DS₁ (the lamp will ionize when its input exceeds 100 volts). A d-c charging-current flows during most of each half-cycle of the a-c switching voltage. Capacitor C₁ will charge from the +10-volt d-c supply, producing a final voltage proportional to the length of time the switching voltage is present. This, in turn, is proportional to the amount of time the control is held down.

An “up” command from the remote-control circuitry produces an a-c switching voltage of a slightly different frequency. Through a frequency-selective circuit, lamp DS₂ is ionized; C₁ then charges from the -3.3 volt d-c supply. The net charge on the capacitor will be a function of the original charge, plus the length of charge time from the -3.3-volt supply.

A schematic of a memory FET circuit with both manual and remote circuits is shown at the left. The addition of a switch mechanically coupled to each control—color, tint, and volume—provides a means of discharging C₁ during manual control. ●

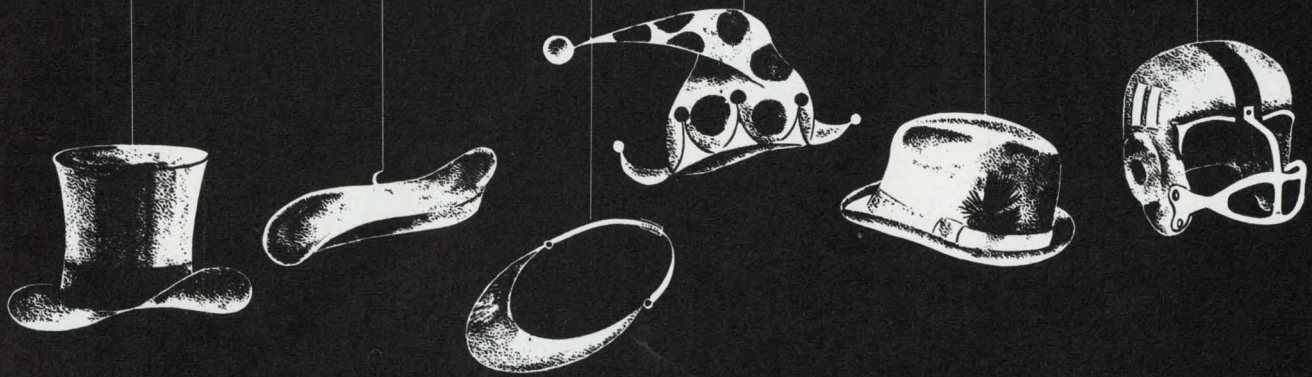

This Computerized Circuit Tester Wears Many Hats

Magician

Random access testing of thousands of complex circuits in any sequence — for back planes, multilayer printed circuit assemblies, harnesses and cables

Linguist

Speaks YOUR product language (not our machine language) for ALL fault diagnostics and programming

Accountant

9000 tests a minute . . . saves an awful lot of money

Juggler

Permits remote testing at multiple stations

Personnel Manager

Cuts programming time by 50% over punched tape systems . . . no computer or other special skills required

Back-up Quarterback

Use the complete digital computer facility to solve other engineering and production problems

Only Automation Dynamics' ZIP IV wears ALL these hats. And ZIP IV has a hat rack full of additional capabilities.

To top it off, Automation Dynamics also manufactures a standard line of automated production test systems for static and dynamic testing of analog and digital cards, modules and sub-assemblies; and other systems to meet your needs.



Automation Dynamics

Division of Resalab, Inc.

35 Industrial Parkway, Northvale, N. J. 07647
201 - 768-9200

A stable, field-replaceable strapdown gyro—in a can

Alfred Rosenblatt of Electronics' staff explains how Hamilton Standard put electronics and rate sensor in a soupcan-sized, plug-in, plug-out package

● Inertial guidance systems using gyros strapped down to the body of the vehicle, rather than to a gimballed platform, are well on their way to becoming a practical reality, thanks in no small part to the availability of compact, fast LSI computers that handle system calculations. Though elimination of gimbals creates a mechanically more severe environment for the new gyros, it also provides an opportunity to design a guidance system that is more reliable and much easier to maintain than the platform arrangement. One example of this new breed is the RI 1170 rate gyro being developed by the Systems Center of United Aircraft's Hamilton Standard division, Farmington, Conn., with funds from NASA's Electronics Research Center. Hamilton Standard is building three complete units, with test data on the first expected by the end of the year.

The gyro will be entirely field-replaceable—it's a plug-in, plug-out package about the size of a can of soup, as shown on the next page. This calls for a careful packaging design: all of the gyro's electronics—including its torque rebalance loop, temperature controller, and float suspension and signal-pickoff circuitry—will be contained within the package. And the rebalancing torquer itself is designed to be more powerful, and stable. The unit will require nothing but power from the rest of the system; output to the system will be a stream of pulses related to the angular rotation of the vehicle

about the gyro's input axis.

Field replacement and maintenance is virtually impossible in platform gyros. It's difficult to get at the gyro through the system of gimbals, and calibrating the gyro with its electronics is a tedious task that usually must be done in a laboratory. Even then, Hamilton Standard product marketing specialist Eric J. Herzlich points out, "you've only replaced the gyro wheel, which is only about half the system, and you can't really be sure you've gotten to the part causing the problems. Now you'll be able to replace the whole gyro subsystem—wheel plus electronics."

Performance goals for the 1170 gyro, summarized in the table on page 108, are based on a dual-mode operation—a normal mode for vehicle rotation rates up to 30 degrees per second, and a high-rate mode that accepts inputs from 30° to 60°/sec, according to Anthony Lawrence who is responsible for the gyro's design. With such performance, Hamilton Standard feels its gyro will be suitable for long-duration missions in space, as well as for boosters, missiles and the supersonic transport.

Generally speaking, boosters and missiles have lower rotation rates than commercial and military transports, which produce rates up to 60°/sec. More maneuverable aircraft, such as fighters, go up to about 300°/sec.

In contrast, the abort guidance system on the lunar

module—a strapdown system developed by TRW for which Hamilton Standard supplied the sensor package—could accept input rates up to only $28^\circ/\text{sec}$.

Other improvements will make the new unit the most stable strapdown gyro yet, says the company. Long-term (three-month) bias stability, or drift rate, for the gyro, plus its electronics, will be $0.03^\circ/\text{hour}$; mass unbalance stability, due to slight shifts in the mechanical center of mass, will be $0.03^\circ/\text{hr}$ (per g). This corresponds to a bias stability as low as $0.01^\circ/\text{hr}$, for the gyro alone, representing an order-of-magnitude improvement over the gyro used in the abort guidance system, and approaching the stabilities attained in the better inertial-grade platform units.

The gyro, with its electronics circuitry, will be about 2.5 inches in diameter and, at most, 6 inches long. Its wheel will run at 48,000 rpm to allow a high angular momentum—desirable for minimizing unwanted instabilities—to be packaged in a small volume. (The alternative, of course, is to make the rotor larger and heavier.) Total power consumption of the gyro and its electronics is about 15 watts.

From an electronics aspect, the most important factor in the design of the gyro is the placing of the electronics circuitry within the same package as the rotating sensor. Custom-designed, hybrid microcircuits are used, mounted on five circular, $2\frac{1}{4}$ -inch alumina disks placed at both

ends of the gyro. The electronics elements contained in the package include:

- ▶ A dual-scale factor, pulse-torquing rebalance loop, containing a servo amplifier which drives the torquer that maintains the gyro's float at its null position.
- ▶ A heater and temperature controller for maintaining constant gyro temperature. This consists of a 20-watt heater and four platinum resistance temperature sensors inside the gyro case.
- ▶ A capacitive pickoff that detects the relative position of the float with respect to the case. The pickoff electronics also contains a Wheatstone bridge which is brought back to zero output when the float and case are at their null positions.
- ▶ An active magnetic suspension subsystem, consisting of demodulators and power amplifiers in analog servo loops. This maintains the float in position within the gyro case.

In addition, the gyro has a split-rotor spool bearing for the gas bearing that supports the gyro's rotor. And lightweight, strong beryllium oxide is used as the float's structural material.

Perhaps the biggest problem faced by gyros in a strapdown system is the lack of protection from angular rotation afforded by a gimballed platform; all rotations acting on the vehicle also act on the gyro. Unfortunately, angular rates generate large forces inside the gyro, including those about the input axis that must be measured and those around the output axis which the wheel bearing and float suspension must buck.

But in a gimballed system, the gyro is free from any angular rotation. Isolated by the gimbals, the gyro is fixed in space and encounters only linear accelerations. The outermost gimbal is strapped to the vehicle, and vehicle rotation rates are determined by measuring the angle between the gyro-stabilized inner platform and the outer gimbal.

In the strapdown system, the gyro case is fastened to the vehicle. But the case moves relative to the float—the structure housing the spinning wheel of the gyro. This motion is very small in the 1170 gyro, about 1 arc second. And any motion is immediately corrected electrically. The motion is sensed—by a capacitive pickoff between the float and the case in the 1170 gyro—and current is applied to a torquing motor which drives the float back to its null position. This torque is proportional

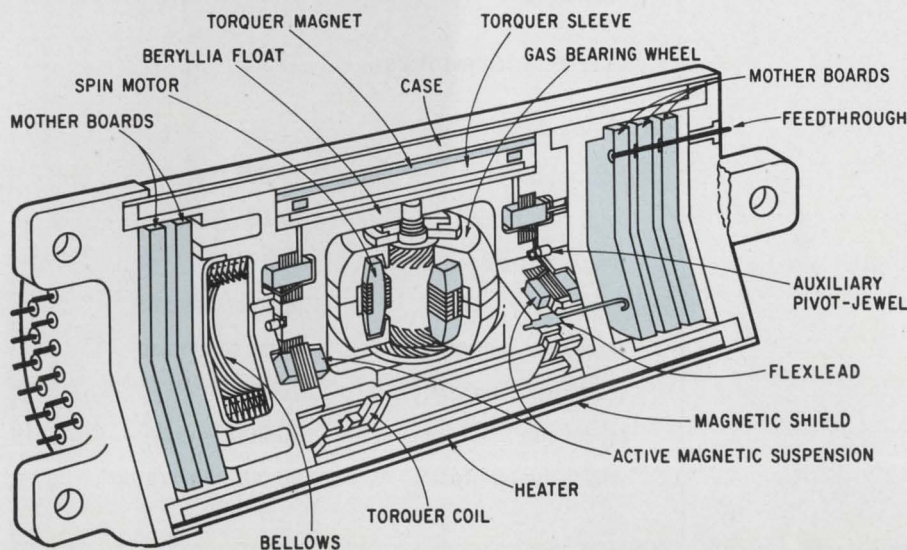

Compact. Cutaway sketch of Hamilton Standard's RI 1170 strapdown gyro shows how electronic circuitry—hybrid IC's mounted on circular mother boards—mates with rotating components in a single package. Other new design elements include a wraparound torquer that provides the higher torquing forces required in a strapdown gyro, and an active magnetic suspension system that prevents the float from touching the case.

to the angular rate applied about the gyro's input axis, and, in turn, also is proportional to the current applied to the torquer.

Thus, the significant element in designing a strapdown gyro is a more powerful and more stable torquer. A stronger float suspension and a bearing for the rotating wheel also must be designed to withstand the additional forces.

The torquer's function is to exactly balance the precession torque exerted on the gyro float due to angular rates applied about the input axis. In the 1170 gyro, the torquer is a moving coil, permanent magnet-type motor which stabilizes the float at its null, or zero displacement, position.

The balancing force must be extremely stable, with little or no variation with respect to time, temperature and displacement about the null. (This is the torquer scale factor stability for the gyro, which is set at 45 parts per million.)

The torquer scale factor in a strapdown gyro must be high: one milliampere input should be able to drive it at a rate of about 1,000°/hr, Lawrence points out. In a platform gyro, the scale factor can be considerably lower—the torquer merely introduces corrections.

Hamilton Standard uses a torquer that is wrapped around the float's outer diameter. This design was selected over those with the torquer at one end of the

Torque control. Gyro torquer is driven by a pulse-torque servo amplifier. Current level to the torquer depends on whether the gyro input is in the normal rate (0-30°/sec) or the high-rate (30-60°/sec), and is automatically selected by the dual scale factor logic.

Gyro goals

Error coefficients

Bias (nominal value)	5.°/hr
stability	0.03°/hr
Mass unbalance, each axis	5.°/hr/g
stability	0.03°/hr/g
Torquer scale factor	
stability (absolute, 3-month)	45 ppm
Input axis alignment	5 arc sec
stability	4 arc sec
replaceability	8 arc sec

Physical characteristics:

Gyro size	2.5" dia., 6" long (max)
Angular momentum	5 x 10 ⁵ gram cm ² /sec
Slew capacity	300°/sec
Mounting	plane normal to input axis
Operating temperature	175°F

Torquing data:

Normal mode	to 30°/sec
High rate mode	to 60°/sec
Overload readout limit	300°/sec
accuracy	not yet defined
resolution, normal	1 arc sec/pulse
scale factor linearity	10 ppm
sensor life	50,000 hours
wheel run-up life	10,000 start/stop cycles

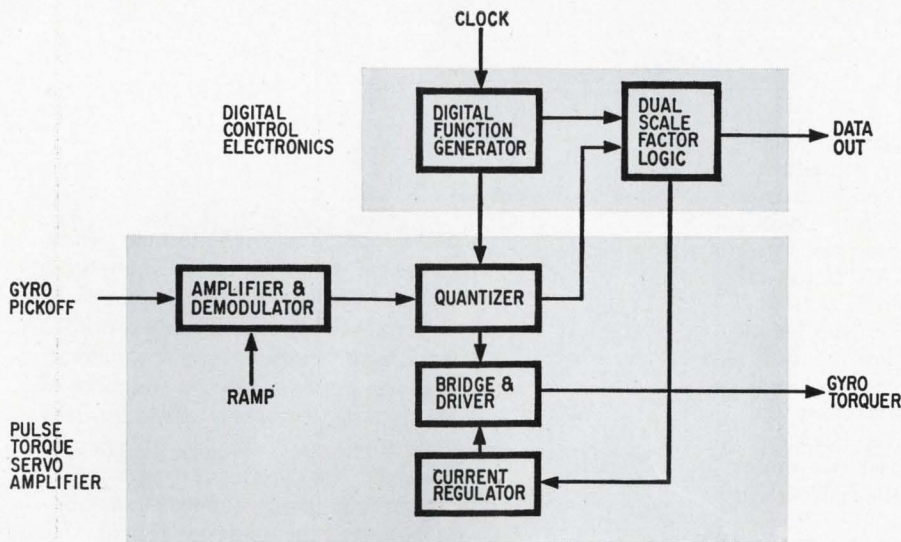

float or divided in two at both ends because it's the most electrically and magnetically efficient. Lawrence asserts torquer size is minimized because the coil windings are distributed over the surface of the float; the eight-pole magnet is distributed around the inside of the case. The other solutions would have been less streamlined, possibly causing thermal and mechanical instabilities, and wasting power that must be dissipated in extra end turns, Lawrence says.

The wraparound torquer design produces a short, fat gyro with an outer diameter of 2.48 inches and an active length of 1.6 inches. Driving voltage is 20.0 volts, driving current 0.125 amperes, and the torquer dissipates 2.5 watts.

The key to controlling the torquer is the pulse torque servo amplifier connected in a rebalance loop as shown at the top. Hamilton Standard uses a pulse-width-modulated binary system on both the low (0-30°/sec) and high (30-60°/sec) torquing ranges. Timing for the system originates in the digital function generator, which also controls the torquing range.

This digital control technique provides a constant current to the torquer coil. But the current is switched in a binary fashion to yield the net torque required to null the gyro float. Other techniques used for controlling torquers involve, for example, a ternary system of plus, minus and zero signals. This was rejected, according to Glenn Swartzentruber, the gyro's electronics designer, because the power dissipated is not constant but depends on the input angular rate; this makes it difficult to maintain constant gyro temperature. With the binary system, power dissipated is basically constant.

Transition between the two input-rate modes of the gyro is handled by changing the current levels applied to the torquer winding. This is done automatically by the dual scale factor logic in the digital control electronics section. A separate command winding also is included on the torquer; this allows test and compensating signals to be applied to the gyro.

As the gyro senses an input rotation rate, an a-c signal—a voltage deviation from a predetermined null—is produced by the capacitive pickoff circuitry. This signal is amplified, demodulated, and conditioned to control the torquer's current.

This is accomplished, as shown in the diagram on page 111, by first feeding the demodulated d-c signal

from the pickoff—a bridge circuit—to the loop compensation network. The output from this network then is summed with a 1-kilohertz reference whose positive and negative periods depend on this d-c level. Then the combination is amplified and fed to a quantizer.

This circuit element detects the zero crossings of the summed input signal and furnishes a signal to the next section in the loop, a four-transistor bridge which supplies current to the torquer. The signal from the quantizer switches the torquer current from plus to minus, producing a pulsewidth-modulated wave at the limit cycle, or 1-khz, frequency. The number of possible switching points here is finite; it's set at 256 for this design to yield adequate resolution. Thus the actual current change to the torquer occurs following the zero crossing in the quantizer and at the next 256-khz clock pulse. For zero gyro output, the zero crossing occurs at the midpoint of the limit cycle frequency; no net current is fed to the torquer, and it does not move. For maximum plus-or-minus rates, the zero crossing occurs near the beginning or end of the limit cycle, respectively, and the current supplied to the torquer is of a polarity required to return the gyro float to its null position.

Output data from the gyro is a function of the current needed for the torquer to return the gyro float to null. An almost automatic readout of this information is obtained by enabling a gate, shown in the quantizer

Here they come

Strapdown guidance systems are beginning to make important strides forward. Contracts for strapdown systems for two Air Force boosters have been awarded—the Delta to Hamilton Standard of Windsor Locks, Conn., and the Agena to Honeywell's Aerospace Systems division, St. Petersburg, Fla. The Air Force is also testing a Honeywell strapdown system in a transport aircraft. And on the Apollo 13 mission, the lunar module's abort guidance system—a strapdown backup for the primary gimbaleed inertial system—was used for a time instead of the primary system because the abort system consumed less power. The strapdown system controlled the spacecraft during the last two mid-course correction maneuvers that brought the spacecraft safely back to earth.

Because they don't have gimbals, strapdown systems are basically more rugged and reliable than conventional platform inertial systems. (Honeywell speaks about thousands of hours as being an attainable mean-time-between-failures rating for strapdown systems; mtbf for most of today's gimbaleed systems is several hundred hours.) Strapdown systems can also be designed to be more maintainable. Consequently, they're being considered for long-duration missions in space, and for use on boosters, missiles, and transport aircraft.

The big stumbling block for strapdown techniques has been not the gyro but the digital computer for guidance calculations. No computers were available, until the advent of medium-scale and large-scale integrated circuits, which could be made small, fast and economical enough for a practical application.

Honeywell has predicted that within three to five years, a strapdown guidance system will cost less than \$25,000, compared with the more than \$90,000 now asked for the inertial-guidance systems used in a commercial aircraft. Much of this cost reduction will be due to the elimination of the gimbals, which, with its associated systems, could represent as much as 50% of the total cost of a system.

Further cost reduction, and still more reliability, should also come about with the development of rate sensors using lasers on which several companies, including Hamilton Standard, Honeywell, and Sperry Gyro-scope, are working.

Servo loop. Input to the torquer, which drives the gyro float back to null, is a series of 256-kilohertz pulses applied in a 1-khz limit cycle by this pulsewidth modulated binary system. The number of pulses applied in a cycle depends on the gyro displacement, sensed by capacitive pickoff circuitry. This number, related to the gyro input rate, is read out digitally (in the quantizer section) to the rest of the guidance system.

module in the diagram above, during the time the torquer current is negative. The 256-khz clock pulses are passed directly to the data line; each pulse represents an incremental angular displacement of the gyro float.

A temperature compensation circuit using a thermistor also is included to reduce the effect of the sensitivity of the torquer's magnetic material to temperature changes. (The magnetic field generated by the torquer magnets decrease with increasing temperature.) The thermistor, placed in a current divider in series with the torquer coil windings, controls the current to compensate for the magnetic field change.

To supply the servo loop with information on the float's position, a capacitive pickoff is used. This type was selected instead of pickoffs using inductive micro-syns, air-core differential transformers, photoelectric and Hall-effect devices, and electrolytic techniques because the capacitive pickoff doesn't produce any interfering magnetic fields, nor is it affected by them. It is free from harmonics usually associated with variable reluctance pickoffs. And the pickoff occupies very little space—it consists of deposited metal plates. One set of four plates is deposited on the gyro float, an opposing set is on the case. They are separated by a gap of 9 mils. Noise pickup due to high impedance levels is reduced by an integrated-circuit preamplifier that's placed right inside the gyro, close to the plates.

The capacitive pickoff translates a rotational displacement into a change in capacitance. This change is then transformed, via a bridge circuit, into a useful a-c output signal. Electrostatic forces between the plates, which could exert an unwanted torque on the gyro float, are balanced out by alternating and overlapping the positions of the opposing plates.

Input to the bridge is 50 volts at 50 khz. Output gradient will be greater than 1.3 millivolts/arc second of displacement.

Use of an active magnetic suspension for the gyro may be a first for a production unit, notes Lawrence. This suspension was selected because it can withstand the high forces within the gyro caused by the rotation rates. "The active suspension can apply a high force—about one pound—without allowing any friction between the float and the outside world," Lawrence says. The one-pound force corresponds to a rotation about the output axis of about 600°/sec, twice as severe as any

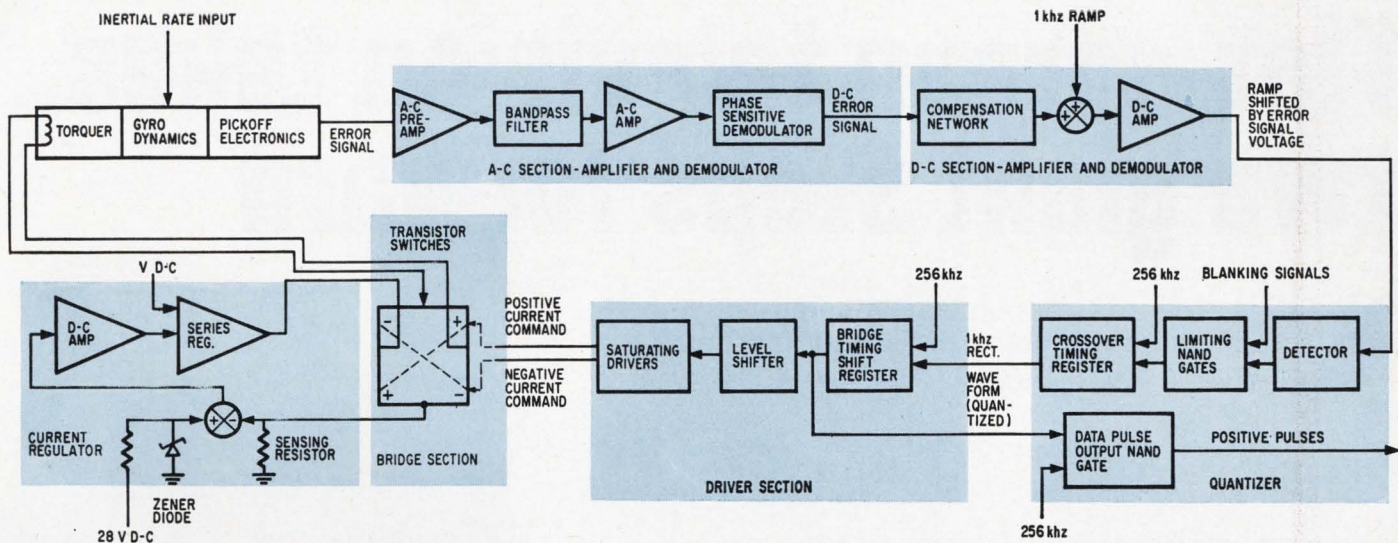

rate that could actually be experienced.

Conventional case-suspension methods include pivot-and-jewel mounts, or a passive system, merely a tuned circuit, inherently self-centering, which has been used for some years. However, the latter system is just "not strong enough," Lawrence insists.

The passive system consists of a magnetic rotor on the float and two sets of tuned orthogonal coils at each end of the case. The system inherently rebalances itself; nothing has to be done to it. But it produces only about 0.1 pounds of force, roughly an order of magnitude less than the active magnetic suspension.

The active system detects movement through five separate servo channels. Four of these are connected to four pairs of suspension coils—two orthogonal pairs at each end of the float. A fifth (axial) channel acts on information supplied by the four other channels. Float displacement produces an error signal due to inductance changes in the windings. The servo loops drive current into the windings, producing a magnetic restoring force that keeps the float suspended.

It also may be possible to sense input rates as high as 300°/sec by detecting the current required by the magnetic suspension system. However, this rate sensing technique would not be very accurate and may not be implemented in the first gyros, Lawrence says.

The five circular disks that mount the electronics circuitry fit within the gyro case—two disks at one end, three at the other. These are mother boards for smaller building blocks. Some 30 of these blocks contain the individual circuit functions. Measuring 3/4 by 1/4 inches they fit into a 1- by 2-inch rectangular area along the disks' center line.

The design is extremely flexible, points out Lawrence. It's possible to replace any of the circuit functions to meet the requirements of the gyro's application. And the individual circuits can be adjusted, before they're protectively coated with resin and hermetically sealed in a helium environment, to match the characteristics of the rest of the gyro.

The mother boards will be supported by standoff pins mounted on the inside of the gyro's two end caps. The standoffs will also connect one board to another with soldered joints at the appropriate points. Insulated feed throughs, passing through the caps, will connect the electronics boards to outside terminals.

Rather than plug the gyro directly into a socket connector, Hamilton Standard will use short harnesses, wire-wrapped or soldered to the two sets of terminals. Thus the gyro will be first aligned correctly mechanically before it is plugged into the system electronically.

The individual function boards are made with thin- and thick-film chrome-nickel resistors, and active elements attached in chip form. Transistor-transistor logic circuitry from Texas Instruments' medium-scale-integrated 5474 family is used. Linear operational amplifiers are National Semiconductors' LM 101A. Precision resistors are wire-wound units placed directly on the edges of the circular mother boards. Decoupling capacitors are placed on the circular boards as well. Also on the mother boards' periphery are thick-film power resistors and evaporated, gold interconnections.

Two mother boards house the pulse torque servo amplifier. Two boards each contain two of the magnetic suspension channels, and a fifth board carries the temperature controller and the fifth magnetic suspension channel.

One hybrid circuit making up the preamplifier for the capacitive pickoff is mounted on the case, surrounded by the gyro's damping fluid. The preamp, on a substrate 3/8 inches square and containing a bipolar npn and a junction field-effect transistor, is put close to the pickoff output to cut down on stray capacitance. ●

Flat-screen television takes two giant steps forward

Glow-discharge transfer cuts scanning circuitry and light amplification brightens picture in unit built by Int'l Scanning's *Louis Mirando* and *Laurence Sliker*

● The flat-screen display offers potentially significant advantages over cathode-ray tubes in many applications. But two chronic problems have frustrated attempts to build practical flat television screens: complicated scanning circuitry and inadequate light output. Now, thanks to solutions developed at a small Canadian company, practical flat tv is moving closer to reality. The solutions: an integral glow-discharge device that simplifies scanning; with it, the screen scans itself without costly external circuits for addressing and driving. And, to obtain adequate brightness, there's a light amplifier that produces a 50 foot-lambert output, sufficient for comfortable viewing in a well-lit room.

The screen is only 0.010-inch thick, increasing to about ¼ inch at the edges where the glow-discharge scanners are located. Perhaps most important, the approach is inexpensive. Most of the materials don't cost much, and those that are expensive are used in very small quantities. And the design lends itself to continuous, automatic fabrication. Thus, there's a good chance that once it's in production the flat screen will cost only a fraction of the price commanded by crt's.

The company is International Scanning Devices Inc. of Fort Erie, Ontario. Louis P. Mirando, president, and Lawrence S. Sliker, director of R&D, are quick to point out that their combination of glow-discharge scan and light intensification has much to offer display technology

in general; it's not limited to home entertainment. Some other sectors that could benefit are:

▶ Three-dimensional radar. The screen can be made transparent and driven in a plan-position-indicator mode. Several such screens can be stacked to add depth to the display.

▶ Information display. In the aviation industry, for example, alphanumeric characters on flat screens could be used to display anything from flight arrivals and departures to data on instruments.

▶ Character recognition. The glow-discharge scan and light intensifier principles can be adapted for sensing images.

▶ Computer memories. Three screens can be combined to provide read, write, and erase capability.

▶ Instruments and desk-top calculators. The panel also can perform data-processing functions. It can add, subtract, count, and store data.

▶ Image enhancement. In extremely dim light—at night or under the sea, for example—the light intensifier can greatly improve the visibility of objects. X-rays, too, can be enhanced so that a patient need not be exposed to high radiation levels to produce a readable picture.

But for the present, International Scanning is concentrating exclusively on home television. So far, the company has made a small monochrome screen, measuring about an inch wide by ¾ inch high, for demonstra-

tion purposes. The firm's next step will be a color screen, about 14 inches wide, for which the photolithographic masks have been ordered. Then the company hopes to go into production.

The flat screen contains a layer of electroluminescent material sandwiched in a metal grid. Metal stripes on one surface of the layer run in the x direction, and in the y direction on the other surface. When an x and a y stripe are electrically energized, the electroluminescent material lights up at the intersection. There's nothing remarkable about this approach; it's used in just about every flat-screen design [*Electronics*, Feb. 16, p. 70; March 17, 1969, p. 114]. The unique features in International Scanning's approach are the grid scanning and the utilization of light from the electroluminescent layer.

The self-propagating glow discharge that scans the grid is housed in long, bubble-like structures along the screen's edges that contain an inert gas at low pressure; the bubbles are made of glass right now, but plastic probably will be used in production models.

There are two bubbles for the horizontal metal stripes. One at the left side of the screen contains a long common electrode separated by a gap from individual electrodes for each stripe, as shown below and page 116, and trigger electrodes. The other bubble, at the right of the screen, contains pairs of electrodes for each stripe, plus trigger electrodes. The purpose of this second bubble is

Heart of the matter. One of the developments that makes the flat, flexible tv display possible is the glow-transfer bubble, two of which are shown at left and right of this array of horizontal stripes. These glass bubbles are filled with an inert gas. A glow discharge is initiated by a pulse on the trigger electrodes that propagates along the electrode gap from top to bottom, thus scanning the metal stripes.

to provide a greater effective arc length and to isolate the screen area from external capacitance, thus preventing spurious lighting of the screen.

Here's how a scan—the vertical scan in this case—occurs in this left-hand bubble. First, a high-voltage pulse is applied to the left trigger electrode, establishing a glow discharge across the trigger gap. Simultaneously, a sustaining voltage—not high enough to start a glow discharge, but high enough to keep it going once it's initiated—is applied to the common electrode.

Then the trigger pulse is removed, and the discharge across the trigger gap disappears. But the discharge reappears almost instantaneously across gap 1—ions and electrons created by the trigger discharge are in the region; these charged particles, combined with the sustaining voltage across gap 1, are sufficient to cause a discharge.

Each horizontal stripe is connected, via a parallel capacitor-resistor combination, to two scan-transfer lines in alternating fashion, as shown on page 116. The purpose is to terminate the glow discharge and allow it to move on to the next gap. Thus, as capacitor C_1 charges, the current across the gap drops; when a transfer pulse is applied to C_1 , the voltage across the gap shifts from V_s to some higher value V_b , as shown on page 117. The small current, I_s , now trickling through the gap isn't enough to sustain the glow discharge at the new voltage level, and it goes out at gap 1.

Meanwhile, the state of transfer line 2 changes: when the voltage on line 1 decreases, the voltage on line 2 increases. The voltage across gap 2 is V_s ; a glow discharge can be easily established there because of the presence of charged particles from gap 1.

The glow discharge exists at gap 2 until it's extinguished by the current drop due to the charged capacitor and a shift in the state of the transfer lines. The glow discharge then transfers to gap 3, and so on.

The gases and pressure International Scanning uses in the bubble result in a glow transfer time from gap to gap amounting to only a few nanoseconds, although the company hasn't yet measured it precisely. Theoretically, the transfer time should be just over 1 nsec.

The resistor in the RC combination of each horizontal line provides a leakage path for the capacitor to insure full discharge in preparation for the next scan. The resistor has to be large enough, however, to prevent overly

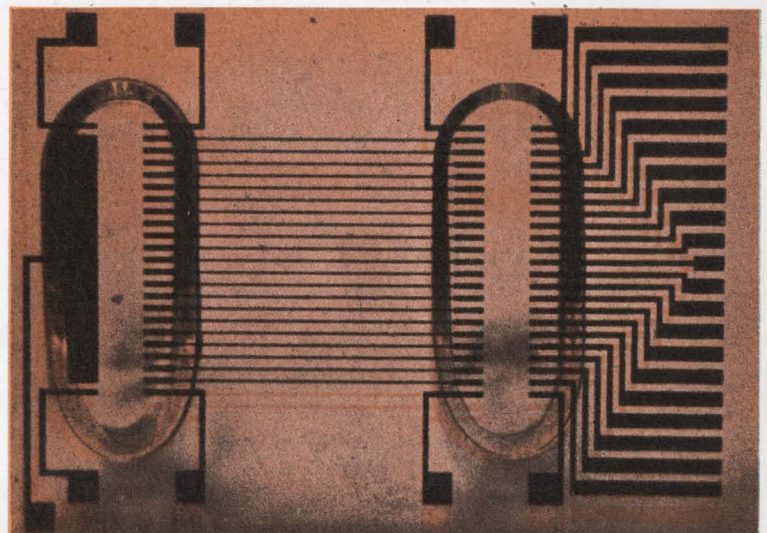

rapid capacitor discharge that might upset the scan sequence. Thus, with resistors of the proper value, gap 3 will accept the glow discharge when gap 2 extinguishes; gap 1 won't be able to accept it because C_1 will not have discharged enough.

Right now, International Scanning uses discrete resistors and capacitors. But in production, the capacitors will be thin-film devices deposited photolithographically during fabrication, while the resistor function will be performed by the plastic film used for the screen, because its dielectric leakage can be adjusted to the proper value.

One question that arises is the possibility that when the glow discharge transfers from, say, gap 3 to gap 4, gap 5 or 6 might initiate a discharge, too. It can't happen—the concentration of ions and electrons decreases sharply with distance from the newly extinguished electrode. This abrupt concentration gradient is manifested in the difference between the I-V characteristics for a gap adjacent to a just-extinguished gap and one adjacent to a gap that has been off for a while, as shown on page 117. The former gap will turn on at the sustaining voltage V_s ; the latter gap requires a much higher voltage, V_1 , before it will turn on.

In any glow-discharge device, one of the chronic design problems is electrode erosion. Besides electrons and inert-gas ions, the glow discharge across the gap carries particles from the electrodes. After a period of time, the electrode can be completely eroded by this effect. International Scanning has attacked the erosion problem by alternating the polarity of the sustaining voltage: it's positive for the first scan of the lines, negative for the second scan, positive for the third, and so forth. Electrode life is greatly increased because the eroded metal alternates between the two electrodes on alternate scans; metal eroded from one electrode on one scan recoats it on the next. Only the electrode material that's deposited on the walls of the bubble is completely lost; it's a negligible amount because the strong field between electrodes permits little material to stray from the immediate electrode area. R&D director Sliker says tests indicate that electrode life expectancy is now at least as long as that of a commercial crt.

Alternating the V_s provides an additional dividend. The value of C_1 , C_2 , C_3 , etc., can be smaller because they will still have some charge—of the opposite polarity—when they are rescanned, thus making their effec-

Disposable tv?

The concept behind International Scanning's flat-screen tv goes back more than five years. In 1965, Miranda purchased the rights to the basic patents for the screen from Hamlin Research, where Sliker was the inventor. "We took advantage of the work that was done by Hamlin and also some of the work that was done by the Air Force," Miranda says.

For the first few years, Miranda and Sliker employed outside consultants and laboratories to do the R&D. About a year ago, however, they concluded that this approach was too slow, so they put together a small staff of engineers and technicians. Since then, they've advanced from a glass-based screen to an all-plastic unit. "We could have gone into production a year ago," Miranda claims, "if we wanted to work with what was available then—microsheets of glass. There was tremendous breakage. So we decided to go 100% to plastic, and now we can wrap the screen around a pencil."

As a result, a production process based on continuous rolling is possible. "You put a 36-inch roll of plastic in a vacuum chamber, close it, evacuate it, and do your coating processes," Miranda explains. He hopes to achieve a production rate of 1,000 feet of plastic screen per hour.

Miranda sums it up this way: "We are working for a disposable television set."

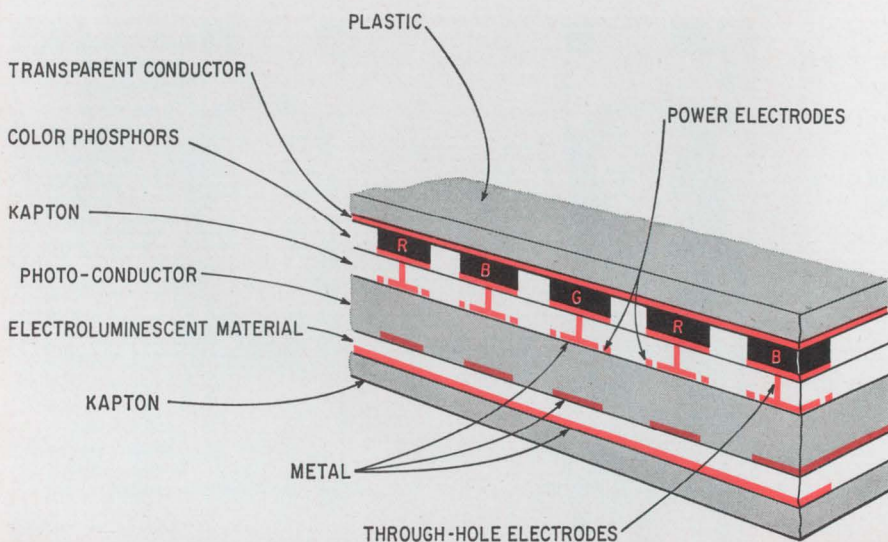

Structure. The flat tv screen consists of layers of plastic, metal and electroluminescent phosphors. The R, G, and B phosphors give off red, green, and blue light, respectively, in response to weak light emitted by the lower layer of electroluminescent material. For monochrome tv, the R, B, and G phosphors would be replaced by a continuous phosphor layer which would emit a single color in response to the weak light.

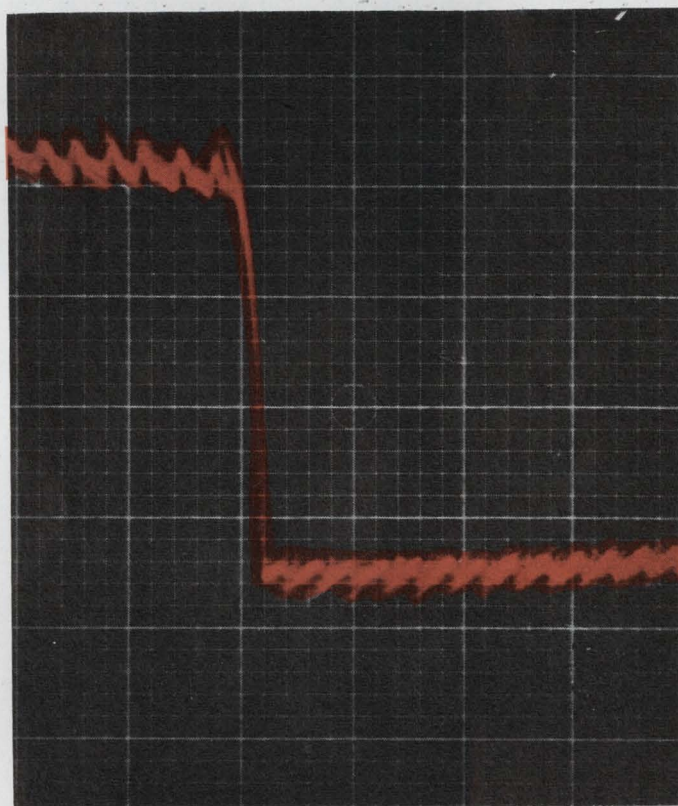

Alternating. To minimize electrode erosion, the polarity of the voltage applied to the scanning electrodes contained in the bubbles is reversed for each scan cycle. Ripples in this waveform represent the transfer of the glow discharge from gap to gap. The sharp drop in the waveform indicates the reversal in polarity as a new scan is started. Vertical scale is 500 volts per large division; horizontal scale is 10 microseconds per large division.

tive capacitance appear larger than their actual value. At the same time, the values of the resistors can be larger because there is less net charge to be removed from the capacitors. Of course, low-value capacitance is more convenient to integrate in thin-film form, and the higher value of resistance is closer to that of a leaky insulating material.

A similar bubble runs along the top of the screen. It contains a common electrode, electrodes for the vertical stripes, and trigger electrodes. This bubble performs the horizontal scanning in exactly the same way as the vertical scanning by automatically moving a glow discharge from gap to gap. And a secondary bubble at the bottom of the screen performs the same functions that the right-hand bubble does for the vertical scan.

This horizontal and vertical scan technique requires few external components, unlike other flat-screen matrix approaches, which need integrated circuits for switching and transistors for driving the rows and columns. In International Scanning's horizontal scan, the applied voltage across the common electrode in the top bubble is of alternating polarity to inhibit erosion. This is essentially a square wave whose rise time is about 5 microseconds with peak-to-peak amplitude as low as 600 volts, depending on the gases and pressure in the bubbles. International Scanning is using a 1,600-volt square wave but will eventually go to a lower value; current is about 1 milliamperes. This square wave is generated with only four "relatively inexpensive" power transistors, Sliker says. "They're not exotic—they're high voltage, but there's no high-speed requirement."

In addition, the two transfer lines for the horizontal scan require a 30-volt peak-to-peak square wave at about 100 microamperes. Four power transistors drive the common electrode, and one transistor drives each of the transfer lines.

For the vertical scan, component performance requirements are even less demanding. Here the pulse rate is much lower because the glow discharge is maintained on each row until all columns have been scanned. The pulse rise time can be as large as several hundred μsec . Voltage requirements and drive circuitry are the same as for the horizontal scan.

The flat screen is built on a flexible substrate of Kapton plastic, selected because it can withstand the high temperatures used in fabrication. The horizontal stripes and their electrodes for vertical scanning are placed on this layer of Kapton film. The layer of electroluminescent phosphor comes next, then the vertical stripes and their electrodes for horizontal scanning.

As in other flat tv screens, the light emitted by the electroluminescent layer at a point between energized vertical and horizontal stripes is weak. The light is so dim, in fact, that previous approaches have required dark rooms for viewing and a few minutes of dark adaptation before an image could be discerned. With "presently available phosphors, to get brighter light, more energy would have to be supplied to the phosphor, requiring even higher voltages and currents that would be extremely difficult to switch on and off for scanning.

This sets the stage for International Scanning's second significant development—the light amplifier. On top of the horizontal stripes are a layer of photoconductive material; a layer of "power" electrode stripes; another layer of Kapton, this one with a matrix of holes; an array

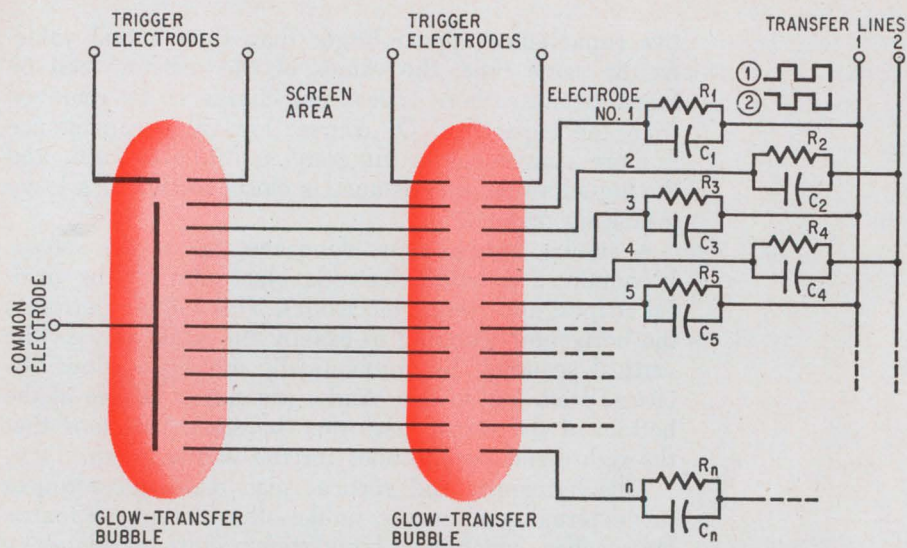

Transfer. Scanning is controlled by phased pulses on the transfer lines. These pulses, in conjunction with the resistors and capacitors in parallel with each electrode, determine the length of time the glow discharge exists at a particular electrode and assure a unidirectional transfer of the discharge. The discrete R's and C's now used will eventually be integrated into the films.

of electrodes coinciding with the holes; another layer of electroluminescent material, and a very thin, transparent conductive film over everything.

Here's what happens: A spot of light in the lower electroluminescent film—the one energized by the vertical and horizontal stripes—changes the impedance of the photoconductive layer. Under the influence of the light, the impedance drops sufficiently to establish a conductive path between the power electrode directly above the spot of light and the adjacent through-hole electrode. This, in turn, sets up an electric field between the through-hole electrode and the transparent conductor on top of the upper electroluminescent layer.

Sliker calls the photoconductive layer a "light-dependent impedance-switching storage layer" because it maintains its new low-impedance state for a period after the light stimulus has gone out. While the light from the x-y matrix electroluminescent layer can stay on for only 70 to 400 nsec, (depending on screen size, resolution, and other factors), the photoconductive layer will stay in the low-impedance state for approximately 20 milliseconds. And the upper electroluminescent layer, therefore, will stay on for the same length of time.

The viewer's eye sees this longer-lit spot of light as a brighter spot. Therefore, because of the light-dependent impedance-switching storage layer, it's possible to make the screen bright enough for convenient and comfortable viewing without having to switch an excessive amount of energy on and off through the x-y matrix.

To establish the required conductive path in the photoconductor, there should be a 20-to-1 reduction in its impedance. Sliker says this is easy to obtain. He is now getting a 100-to-1 impedance change and a response time of about 10 nsec.

For monochrome television, the upper electroluminescent layer is a continuous sheet of phosphor material. But for color, this layer is divided into many discrete red, blue, and green phosphor dots, each corresponding to a point in the x-y matrix. Sliker observes that the red dots should have twice the area of either the blue or green dots to compensate for the lower brightness of the red phosphor and to produce a better color balance.

One last layer goes over the transparent conductor—a film of plastic which serves two purposes. It protects the screen. And it cuts down reflected external light because it has a dull finish and because it contains

black particles that attenuate light when it first enters the film from the outside and again when it's reflected back into the film from the lower layers.

To use the flat-screen approach with color tv, the problem is that the luminance and chrominance signals must be converted to pulses in the x-y matrix that will drive the proper dots in the upper electroluminescent layer. But there's a simple solution that requires "a bare minimum of circuitry," Sliker says. The luminance signal is applied to the horizontal stripes of the x-y matrix and the chrominance signal is applied to vertical stripes. The R-Y (red minus luminance) information corresponds in time to the 0° points of the 3.58-megahertz color reference signal, and the B-Y (blue minus luminance) information corresponds to the 90° points. Thus, the red signal is available at a particular point on the screen by combining the R-Y signal and the Y signal on the intersecting vertical and horizontal lines at that point. Similarly, the blue signal is available from the B-Y and the Y signals.

The green signal necessary for a full-color picture is produced by taking 51% of the R-Y signal (at 0° on the reference signal) and 19% of the B-Y signal (at 90°). This combined signal, designated G-Y, is stored for display at some arbitrary time between 90° and 360° points on the 3.58-Mhz reference signal. Sliker has set the time for G-Y display halfway between the limits—

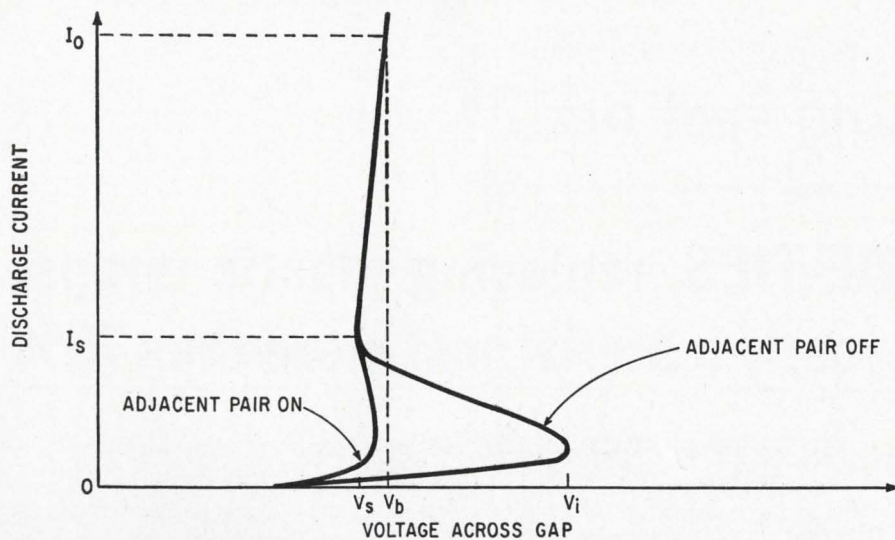

I-V characteristics. With an adjacent pair of electrodes on—or just turned off—a glow discharge can be established across that gap with a much lower voltage. A voltage V_s is sufficient to establish the discharge if the adjacent pair is on or was recently on, whereas V_i is needed if the adjacent pair is off. Characteristics also show that a larger current, I_0 , is needed to sustain the discharge when the voltage is raised to V_b .

at 225° on the reference signal.

Thus, at time zero, an R—Y signal is applied to an electrode on the horizontal scanner, and a red phosphor lights up. Then, 70 nsec later, a B—Y signal is applied to the next electrode and a blue phosphor lights up. A G—Y signal is applied to the next electrode 105 nsec later and a green phosphor lights up. And another 105 nsec after that, another R—Y signal is applied to the next electrode, starting the sequence over again. The intensity of each signal is proportional to the intensity data contained in the chrominance minus luminance signal at the time.

How much power is needed to drive the flat screen? Very little compared to a crt—"on the order of 20 watts for a good-size screen," Sliker says.

For external components in addition to the transistors for driving the scanners, the flat screen has simple requirements. An oscillator—either sine wave or square wave—is needed for driving the light amplifier. Its frequency can be anywhere from 10 kilohertz to 100 khz, Sliker says; the precise value isn't important.

A horizontal trigger circuit synchronizes the scan from the horizontal synch information in the transmitted signal. Small local oscillators are desirable in the vertical and horizontal scan circuits, Sliker feels, so that a line or the entire screen doesn't go blank if a pulse is lost. And small pulse transformers are needed to drive the

horizontal and vertical scan circuits.

Right now the layers are applied to the substrate by various evaporation and screening processes. Although details probably will change when the screen is put in production, the basic fabrication procedures are well established. The x and y stripes, along with their scan electrodes, are formed by evaporating aluminum on the Kapton substrate. Then it's photolithographically etched in the desired pattern. The power electrode pattern is applied similarly. The through-hole electrodes are of electroless-plated copper coated with electroless-plated gold (to keep the copper from contaminating the electroluminescent material and the photoconductor). The transparent conductor consists of a very thin layer of evaporated gold.

The lower electroluminescent layer and the photoconductive layer are silk-screened as continuous films. In production, Sliker expects that doctor blading, an economical and reliable method for continuous coating of large areas, will be used instead of silk screening to apply these layers. It's not used now because it's not practical for small-volume fabrication. Each red, green, and blue dot of phosphor is applied in a separate photolithographic and silk-screening sequence.

A manufacturer of vacuum-processing equipment has prepared preliminary equipment designs for International Scanning Devices for mass production. ●

Using spot ties?

GUDE-TIES, replacing plastic wraps, cut yearly material cost more than 75%

"GUDE-TIES", CUT LENGTHS of Gudebrod Flat Braided Lacing Tapes, are specifically produced for spot tying—in production harnessing or for on-site work. A comparative engineering analysis found that material costs for Gude-Ties was 76.7% less than for plastic wraps on a yearly production basis, and harness weight was reduced also. In aviation and other important applications weight of the harness is important, and gaining more importance. Gude-Ties are dispenser packaged for one hand, easy withdrawal. Meet MIL-T Specs, make firm knots. Available in 6", 8", 10", 12", 15", 18", 20" and 22" lengths (other lengths to order).

8769
STYLE 18 18" LENGTH
100 PIECES
**GUDEBROD
GUDE-TIES**
NYLON TYPE 1
MIL-T-43435
FINISH B
MIL-T-713A
GUDEBROD BROS. SILK CO., INC.
PHILADELPHIA • NEW YORK • BOSTON
CHICAGO • BURBANK • CHARLOTTE

Try **GUDEBROD'S SYSTEM "S"**

In spot tying when you combine Gudebrod Gude-Ties with Gudebrod Gude-Snips and the Gudebrod Swivel-Tilt Harness Board Mount you're really streamlining the production of wire harnesses. Gude-Snips, palm-of-the-hand snips cut cleanly, easily—right or left hand. Spring action, Du Pont Teflon bearing. Eliminate constant reaching for knife or shears. The balanced, three dimensional action of the Gudebrod Swivel-Tilt Harness Board Mount brings every section of the harness within easy, comfortable reach.

Cuts fatigue — speeds work. Ask for full information about Gudebrod System "S" for spot tie lacing. (For continuous tying, ask about System "C".)

Gudebrod Swivel-Tilt
Harness Board Mounts
available in several sizes

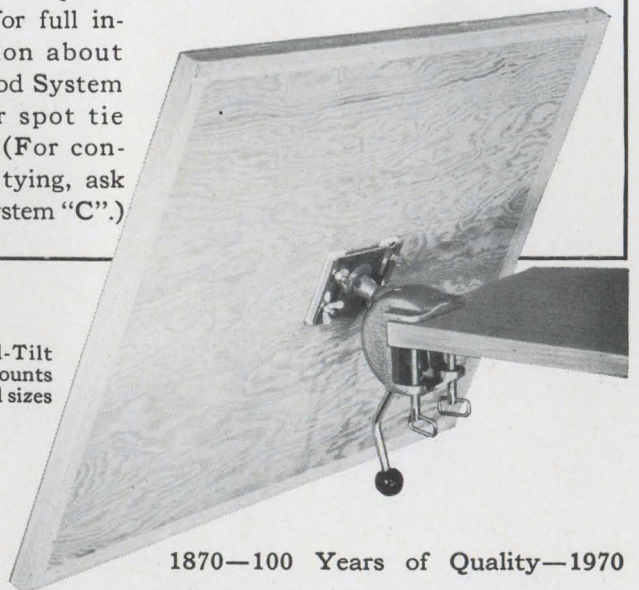

1870—100 Years of Quality—1970

GUDEBROD

Electronics Division

GUDEBROD BROS. SILK CO., INC. Founded 1870, 12 South 12th Street, Philadelphia, Pa. 19107

... or 4, 5, 6 or maybe over 100! If you're using a crystal ball to determine bit error rates of digital links, tape recorders, modems, or any digital transmission or storage device... investigate the unique advantages of LINK-BERC (Bit Error Rate Calculator). For the first time, a single 5 1/4 inch unit offers so many advantages.

- 0 to 10 Megabits/second.
- Measure bit errors in periods ranging from 100 to 10 million bits... or on a continuous basis.
- Bit error rates of Modems, Magnetic Discs, PCM Bit Synchronizers, etc.

- Measure bit error rates of digital simplex links... duplex links are not required.
- Rapidly determine bit errors on magnetic tapes previously recorded on the same or other recorders.
- Also measure clock slippages... advance or retard slippages are indicated and clock regeneration can be optimized.



These features and many others are explained in detail in a new Application/Design Bulletin. For your copy, contact: Data-Control Systems, Inc. Commerce Drive, Danbury, Conn. 06810. Telephone: (203) 743-9241... or our world-wide network of experienced field engineering representatives.



DATA CONTROL SYSTEMS, INC.

I see bit-errors...two, maybe three...



Signal Innovator



SG-1000

Uniqueness in Signal Generation

Singer has advanced the state-of-the-art with a signal generator so New it almost requires a new name.

The Model SG-1000 obsoletes every other signal generator within its frequency range . . . singly or in combination. Its performance is so superior that no other instrument available can equal or even approach it.

That's why we call it the Innovator.

Here's why you'll call it unbelievable . . .

- Digital readout of frequency.
- Broadband frequency coverage from 61kHz to 512MHz (to 1024MHz with a simple passive doubler) in a small 5¼" high package.

■ Exceptional frequency accuracy and resolution . . . typically 0.005% . . . and no human readout errors.

■ Full modulation capability
AM FM Pulse Video
Internal 1,000Hz modulation
. . . and combinations of the above.

■ Output levels from +20dBm to -146dBm.

■ An automatically leveled output . . . within ± 0.5 dB over the entire frequency range.

■ Use it as a 2MHz counter for counting modulating signals or rep rates directly.

■ A spectrally pure output signal approaching that of a crystal . . . extremely low residual and incidental FM.

■ Total elimination of dial tracking errors.

■ The availability of BCD frequency output and a

programmable attenuator to assure system integration.

This is only part of the SG-1000 story. A more complete technical description is available in Singer Application/ Data Bulletin SG-10 upon request.

For additional information contact your local Singer Representative, or write or call —

The Singer Company
Instrumentation Division
915 Pembroke Street
Bridgeport, Conn. 06608.
203-366-3201.

In Europe contact: Singer
Sewing Machine Company,
Instrumentation Division, P.O.
Box 301, 8034 Zurich, Switzerland,
Telephone: (051) 47 25 10
TWX 710-453-3483

SINGER

INSTRUMENTATION

The simplest solution
to switching problems...

from 12 to 144 circuits: "off-the-shelf" T-Bars!

T-Bars are for switching in computers... automatic testers... communications... process controls... telemetry... ground support equipment... aircraft... in fact, almost everywhere... up to 3 AMPS!

T-Bar RELAYS

SERIES 801



12 Poles 1 Wafer Relay 24 Poles 2 Wafer Relays 36 Poles 3 Wafer Relays 48 Poles 4 Wafer Relays 60 Poles Single Throw 5 Wafer Relays

BAT HANDLE T-Bar SWITCHES

SERIES 802

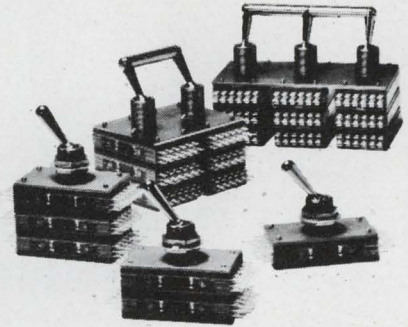

Switch up to 144 PDT... in less space!
Available in Single, Double and Triple... as well as Ganged Toggles for controlling 48, 72, 108 poles... even more!

MOMENTARY PUSH BUTTON T-Bar SWITCHES

SERIES 803

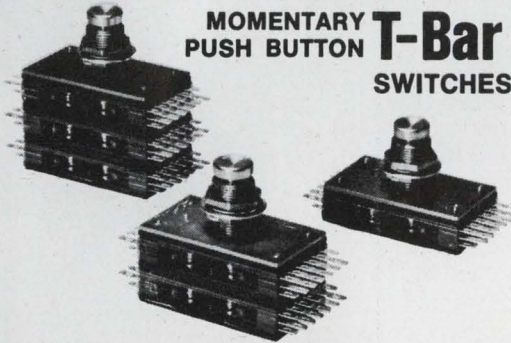

Available in 12, 24 and 36 poles... reliable high density multipole switches...

Now available "off-the-shelf" in your immediate area from:

CALIFORNIA

Allied Radio of Calif., Inc.
Arcadia, (213) 445-4800
Newark Electronics
Inglewood, (213) 678-0441
Allied Electronics of Calif., Inc.
Los Altos, (415) 941-0524
Fisher Switches
Palo Alto, (415) 321-4080
Hollywood Radio
Hollywood, (213) 466-3181

COLORADO

Newark-Denver Electronics
Supply Corp.
Denver, (303) 757-3351

CONNECTICUT

Cramer Electronics
North Haven, (203) 239-5641

FLORIDA

Cramer Electronics
Ft. Lauderdale, (305) 566-7511
Electronic Equipment Co.
Miami, (305) 635-0421

ILLINOIS

Allied Electronics
Chicago, (312) 829-9100
Newark Electronics Corp.
Chicago, (312) 638-4411

LOUISIANA

Newark-New Orleans Electronic
Corp.
New Orleans, (504) 834-9470
Industrial Electronic Supply,
Inc.
Shreveport, (318) 422-9459

MASSACHUSETTS

Cramer Electronics
Newton Centre, (617) 969-7700

MICHIGAN

Newark-Detroit Electronics, Inc.
Oak Park, (313) 548-0250
Newark Industrial Electronics
Grand Rapids, (616) 452-1411

MINNESOTA

Allied Electronics
Minneapolis, (612) 920-5800

NEW YORK

Cramer Electronics, Inc.
E. Syracuse,
(315) 437-9984 or 9985
(315) 437-6678 or 6679

Newark Electronics Center, Inc.

New York, (212) 255-4600
Cramer Electronics
Elmhurst, (212) 478-4000

OHIO

Newark Herrlinger Electronics
Cincinnati, (513) 421-5282

TEXAS

Allied Electronics
Dallas, (214) 826-5101
Newark-Dallas Electronic Corp.
Garland, (214) 271-2511
Southwest Electronics, Inc.
Houston, (713) SU 2-3060
Newark-Houston Electronic
Corp.
Houston, (713) 782-4800

Low Component Cost

36 PDT—\$25.52 ea. in lots of 100
48 PST—\$27.30 ea. in lots of 100

Mounting Ease

2 simple screws... can mount on panel in any orientation... eliminates chassis.

Wiring Economy

Simple crimp snap-on contacts fit into single block connectors for pre-harnessing.

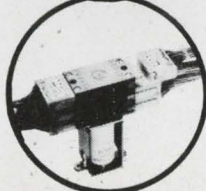

For additional information on these and other T-Bar items refer to Distributor Catalogs, "oem," "R/M" or write to E-C-I for Bulletin TB 801-3.

T-Bar

SWITCHING TECHNOLOGY DIV.
electronic controls, inc.

Danbury Rd., Wilton, Connecticut 06897
phone: 203/762-8351

Circle 121 on reader service card



Hit the Nail Right on the Head in Florida.

Our Competitive Advantages For Industry Are Tailored To Meet Your Needs

When you look toward Florida for a plant site, you are putting your efforts where they'll do the most good. We have a great deal for you in this booming, business-oriented state. We have a built-in competitive edge for you that just can't be ignored. This factor is being recognized by more and more firms with an eye on the future: A tremendous variety of sites, a recruitment and training program (free to you) which has your labor force ready for you when the doors open . . . new laws concerning revenue

bond financing for construction and improvement.

There's a lot more to your competitive edge in Florida. Let us tell you about it in confidence. Phone (904) 224-1215, or send for coupon.

Florida

DEPARTMENT OF COMMERCE
107 WEST GAINES STREET
TALLAHASSEE, FLORIDA 32304

HANDY COUPON FOR YOUR CONVENIENCE!

Florida Department of Commerce / 107 West Gaines St.
Tallahassee, Florida 32304 / Att.: Dept. "D-3"

*I'm interested in a business or industrial future in Florida.
Please send me more information.*

Name

Title or Position

Company

Street

City State Zip.....

Single-source signals for systems.

Completely programmable waveforms from 100 μ Hz to 300 MHz with accuracy up to 1 part in 100 K.

Model 1001:
0.5 MHz to 300 MHz; a sweep and signal generator; 5 kHz stability; calibrated output attenuator; frequency, amplitude and sweep width are analog programmed; perfect for use in automatic, closed-loop systems. \$995



Model 155:
0.1 Hz to 1 MHz; frequency, function and amplitude controlled from front panel or remotely by 8421 BCD code. Frequency can be swept or dc-modulated; output may be continuous or triggered. \$1195

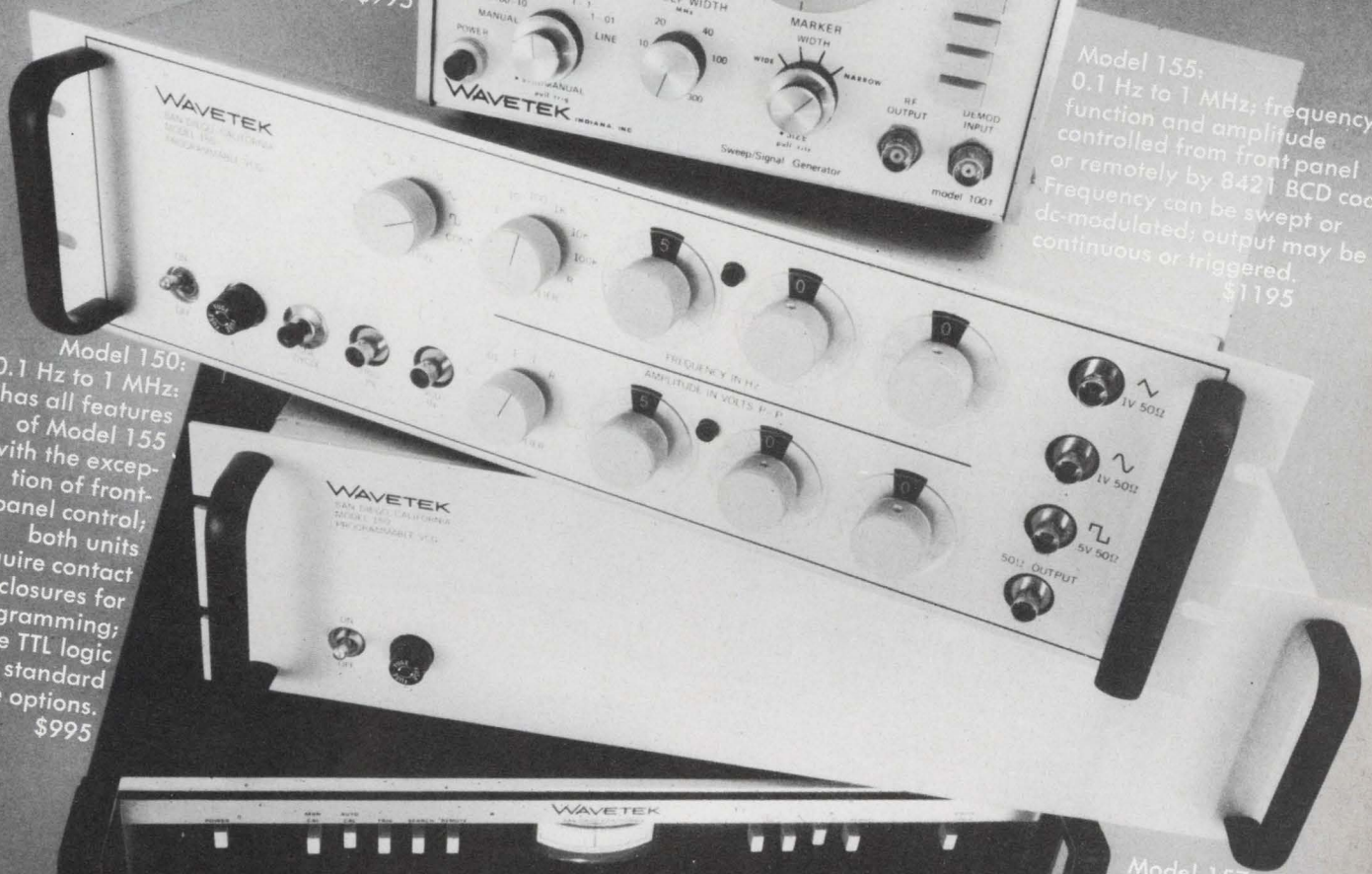

Model 150:
0.1 Hz to 1 MHz; has all features of Model 155 with the exception of front-panel control; both units require contact closures for programming; or use TTL logic with standard interface options. \$995

Model 157:
100 μ Hz to 1 MHz - accuracy of 0.01%; may be triggered and frequency is compatible modulated, with TTL inputs; ideal alternative for expensive frequency synthesizer. \$2995

WAVETEK
P.O. BOX 651, SAN DIEGO, CALIFORNIA 92112
PHONE (714) 279-2200
TWX 910-335-2007

trace retention

Most waveform measurements are easily made with today's instrumentation. Signals are usually repetitive, medium frequency, sufficient in amplitude, easily triggerable, etc.—usually, but not always. Some signals persist in being single event or low frequency, aperiodic or absolutely random, and even untriggerable. There are three ways to approach these problem measurements: (1) great operator patience, (2) waveform photography, (3) trace retention (storage). The storage technique is pure convenience by comparison.

The Tektronix Type 549 Oscilloscope offers all the advantages and versatility of a conventional plug-in instrument—plus storage. It easily handles those normal Real-time (DC to 30 MHz), Sampling (DC to 1 GHz), or Spectrum Analysis (10 Hz to 40 GHz) measurements. And when you are confronted with a tedious measurement, simply call up the storage feature by pushing a button.

The result is solid bistable storage with 5 cm/ μ s writing speed and half or full screen displays. Viewing time and erase controls provide the flexibility for many different applications. The erase command is either manual (viewing time 1 hour without degradation), automatic (after-sweep or periodic) with variable viewing period up to ≥ 5 s, or remote. After automatic erasure the single-sweep circuitry is reset to complete the hands-off operation.

Call your local Tektronix Field Engineer for a demonstration of the Type 549 in your application. He can show you how storage lets you concentrate on the results of the measurement rather than making it.

For complete technical specifications on the Type 549 Oscilloscope and letter series or "1" series plug-ins, consult your current Tektronix catalog, circle the reader service number, or write Tektronix, Inc., P.O. Box 500, Beaverton, Oregon 97005.

the convenience feature

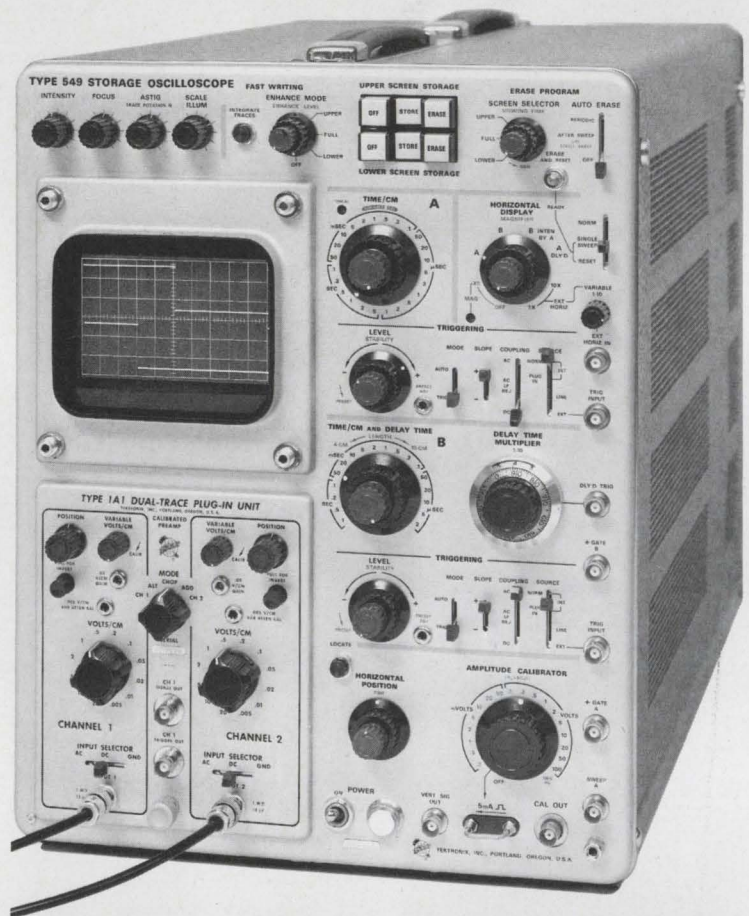

The Type 549 Storage Oscilloscope has DC to 30 MHz bandwidth (depending on plug-in unit); full delaying sweep horizontal operation; conventional or storage displays; accepts all "letter" or "1" series vertical plug-in units.

TYPE 549 STORAGE OSCILLOSCOPE \$2,625.00

Vertical plug-ins available cover single channel, multi-trace, differential, sampling, TDR, spectrum analysis, and other special purpose applications.

TYPE 1A1 DUAL-TRACE UNIT (shown) \$650.00

U.S. Sales Prices FOB Beaverton, Oregon



Tektronix, Inc.
committed to progress in waveform measurement

Ion implantation goes to market

Fast, highly controllable doping process already is helping Hughes and Mostek produce high-speed MOS/LSI devices; interest here and abroad perks up

By James Brinton and Lawrence Curran

Electronics' staff

Once something of a laboratory curiosity, ion implantation is maturing into a production reality, particularly in fabrication of MOS LSI integrated circuits. Although not an outright groundswell, two firms, the Hughes Aircraft Co. and the Mostek Corp., are using the technique on a production-run basis. And if attendance at and interest in an international conference on the subject held earlier this month at Thousand Oaks, Calif., is any indication, other firms soon may follow Hughes' and Mostek's lead.

Evidence for this gathering momentum to pull ion implantation out of the labs is the brisk business being done by a relatively new Austin, Tex., firm—Accelerators Inc. [see panel, p. 128]—which is selling ion-implantation equipment to semiconductor manufacturers. Hughes and Mostek have ordered their implantation systems from Accelerators Inc., although the Hughes machine hasn't been delivered yet; its initial catalog devices are implanted by in-house equipment. Texas Instruments, too, has an Accelerators Inc. system in operation, as has Signetics, but neither firm is in production yet.

A TI source admits to having a "heavy effort" going, however, and says the firm could have implanted products introduced now if it wanted to. "But we have to be super cautious," he explains. Other firms known to be evaluating ion implantation and making devices include Fairchild and Motorola, but their work still seems to be limited to discrete devices.

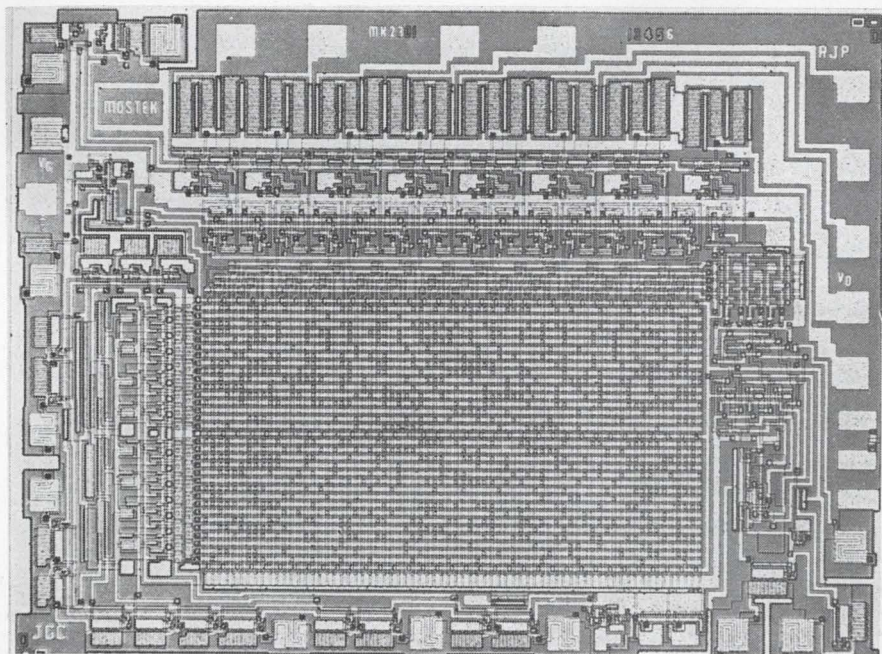

Capability. Ion-implanted, 2240-bit ROM from Mostek contains more than 3,000 MOS transistors on a 105- by 131-mil chip. Array replaces two 8½- by 11-inch p-c boards with diode matrix, decode logic, and buffer circuitry.

Basically, ion implantation is a method of doping semiconductors. Instead of diffusing these dopants into the bulk silicon, they are driven in at energies ranging from 80,000 to 300,000 volts using an accelerator and a focusing mechanism that selects by mass the dopant of interest emanating from an ion source—boron trichloride or boron trifluoride, for example.

Masks are used to shield areas that aren't to be doped. Ion implantation is faster than diffusion, and many of its advocates say it's a more controllable process. It also can be done at room temperature versus the elevated temperatures

required for diffusion. Up to now, however, the technique had one major drawback—it caused radiation damage in the material being doped. Today, annealing at relatively low temperatures after implantation seems to have solved this problem.

One major hurdle remains for ion implantation, however. To date none of its advocates seems to have come up with a way to make it a multiwafer batch process in the sense that diffusion is a batch process. New and simpler equipment will be required to do this.

The widespread interest in ion implantation as an MOS production

Accelerating sales

"Two years ago there wasn't any action from semiconductor manufacturers, but now they're very enthusiastic about ion implantation." That's how Norman Bostrom, president of Accelerators Inc., sums up a trend that has triggered a boom for his Austin, Texas, firm. He hopes it will help push sales to the \$20 million mark by 1975-76. The 1968 figure was a little better than \$500,000.

Bostrom's optimism is entirely creditable. Accelerators Inc. has sold ion implantation equipment to two of the big four in the integrated-circuit business—Texas Instruments and Signetics—and has quoted prices to Fairchild. Only Motorola has not made contact yet. More important, however, is the fact that Accelerators Inc. has the two leading advocates of ion implantation in semiconductors in the fold—Hughes Aircraft Co.'s MOS division and Mostek Corp. And there's an impressive list of other customers who have also bought equipment.

Bell Telephone Laboratories bought Accelerators Inc.'s first ion implantation machine three years ago. Since then, Bell Labs has bought two more, and Western Electric has bought one. In all, Accelerators

Inc., has sold 16 machines, and customers include Stanford Research Institute, Sandia Corp., the Institute for Technical Electronics in Munich, Germany, and Universita Degli Studi di Bologna, Italy. The latter is the largest unit yet built by the firm, and will be installed this summer. It will accommodate 20 wafers and implant with an energy of 300 kev.

Accelerators Inc. has also been asked to quote prices to Siemens AG, and AEG-Telefunken, West Germany's IC giant. Although Bostrom calls most of the implantation equipment he's delivered research hardware, Mostek is using it on the production line. Hughes will fit the instrument it has ordered from Accelerators Inc. with a Hughes-built, larger-than-standard chamber to house wafers, which Bostrom says will make it more of a production tool. Bostrom is also counting on another order from Hughes for a much simpler version—one that will be made to be operated by semiconductor production workers.

Bostrom says the simpler-to-operate production machines will have to sell for between \$20,000 and \$25,000, in contrast to the \$60,000 Accelerators Inc. has charged for most of the units sold so far.

process was pointed up by the 35 European scientists and engineers attending the recent International Conference on Ion Implantation in Semiconductors, which was jointly sponsored by the Air Force Cambridge Research Laboratories, the North American Rockwell Corp.'s Science Center, where it was held, and the Hughes' Research Laboratories. Represented among the foreign contingent were West Germany's Siemens AG and AEG Telefunken and Britain's Mullard Research Laboratories.

Different drummer. Hughes and Mostek are enthusiastic about ion implantation for different reasons. Hughes is trumpeting the technology because it lowers device capacitance—in this case the parasitic capacitance between the gate and the source and the gate and the drain of an MOS device. This leads to greater speed, and Hughes is specifying its two catalog items—both shift registers—at 10 to 20 megahertz versus 1 Mhz for the average and 5 Mhz for the fastest devices in this class. These two circuits are the LISR 0064—a single 64-bit two-phase dynamic shift register—and the HDSR 2164—a dual 64-bit two-phase unit.

Hughes reduces the capacitance by using the aluminum gate as the implantation mask. The technique

yields a self-aligned gate, as does silicon-gate technology, and it also eliminates the need for having the gate overlap the source and drain, as in the conventional p-channel MOS processes. Normally with MOS, gate registration isn't always precise, so the gate is made wider than optimum to assure this overlap. But this overlap introduces excess gate-to-source and gate-to-drain capacitance, which limits device speed.

But most important, says Robert Bower, assistant manager of the Hughes MOS division, in Newport Beach, Calif., is the fact that "we can do ion implantation with plain old p-channel MOS technology. It requires no major changes in the standard planar process," and no disruption in the process flow. He hammers hard at "producibility" as the ultimate test of any process. The LISR 0064 is rated at 20 Mhz, and dissipates just 30 milliwatts when running at 15 Mhz. It offers a 2-volt threshold, so Hughes is offering both low power dissipation and bipolar-compatible thresholds. The HDSR 2164, the firm's first true production IMOS (for ion-implanted MOS) circuit, is more conservatively rated at 10 Mhz, but can operate faster.

Mostek is ahead of Hughes in the number of catalog items announced; it is using ion implanta-

tion to produce five of its eight device types, all of them large-scale-integrated circuits, as are the Hughes units. Mostek's devices include: registers, two random access memory components, three series of dot-matrix character-generator read-only memories, and a general-purpose ROM. The shift registers are the MK 1003P, a dual 256-bit single-phase unit rated at 1 Mhz; and a dual 128-bit device (MK 1002P) with similar speed. The RAM's are a 256-bit-by-one static device (MK 4001P) with a 50-nanosecond access time and coincident word select and a static 256-bit unit organized as 64 bits by four words with one-microsecond access time (MK 4002P). The character-generator ROM's have various organizations, depending on whether their function is column output for scan cathode ray tube displays or row output for television displays. The general-purpose ROM (MK 2400P series) is 256 bits by 10 words, with a 700 nsec access speed.

Results. Hughes is chiefly interested in lowering device capacitance to obtain greater speed as well as minimal power dissipation. Mostek first became intrigued with the process as a way to lower device threshold voltages, then found fortuitously that ion im-

Two new photorecording papers from Kodak

Kodak Linagraph Direct Print Papers, Types 1895 and 2022, could be your only choice when...

- you're faced with some laboratory recording, some field recording
- wet processing is impossible
- you need data instantly, and it must last indefinitely
- your recorders are direct-print

Now, if there's an event happening almost anywhere, you can get a high-quality tangible record. With new *Kodak Linagraph* 1895 (standard base) and 2022 (extra-thin base) Papers, you get readable traces the instant you expose to room light... crisp, dark traces a minute later. And the image is extremely stable.

No-heat, no-wet process *Linagraph* 1895 and 2022 Papers are designed for use with direct-writing cameras and oscillograph records equipped with high-intensity tungsten, xenon, or mercury-vapor light sources. They produce high-contrast images that are easy to read, reproduce well on most office copiers.

This paper is one of many products designed by Kodak scientists and engineers to solve data-recording needs through photography. The materials and technology to meet your specific requirements are probably available right off the Kodak shelf. Want more information? Just mail the coupon or call our photographic specialists at (716) 325-2000, Ext. 5114.

Department 412L
EASTMAN KODAK COMPANY
Rochester, N. Y. 14650

- Send information on *Kodak Linagraph* 1895 and 2022 Papers.
- Send new "Kodak Products for Instrumentation" catalog.
- Have representative call.

Name _____

Position _____

Firm Name _____

Address _____

City _____

State _____ Zip _____

5-48

Kodak

Instant module time check

CURTIS 620-PC
ELAPSED TIME
INDICATOR



SHOWN 1 1/2 TIMES
ACTUAL SIZE

Increasingly important in military equipment philosophy is the field or line replacement module.

With this Curtis Elapsed Time Indicator mounted on each functional replaceable module of your system you have an accurate record of operating hours for each individual module regardless of its installation history. Operating time record becomes part of module. Unit is extremely small, weighs little, uses little power, and is not expensive! For full details, ask for information on Model 620-PC. Meets requirements of MS 3311 (AS).

WRITE OR CALL

Curtis

INSTRUMENTS, INC.

200 Kisco Avenue
Mount Kisco, N.Y. 10549
(914) 666-2971

Mostek's mother

To hear Robert B. Palmer tell it, frustration was the mother of Mostek Corp. "We just didn't feel we could make any significant changes in Texas Instruments' attitudes toward mos," says Palmer, Mostek's research and development director; "we were frustrated, so we left." The corporate "we" includes Louay E. Sharif and Leonce J. (L.J.) Sevin, now Mostek vice presidents, men once called "the grey matter behind TI's mos efforts," as well as several other key TI engineers.

Eventually the Mostek men become part of a three-way joint venture along with the Sprague Electric Co., North Adams, Mass., and New Business Resources of Dallas. Sprague supplied a little less than half the needed capital with the other half coming about equally from New Business Resources, and the TI men's pocketbooks. Richard L. Petritz, one of the principles of New Business Resources, now is president of Mostek.

The deal with Sprague may have been the best thing that could have happened to Mostek. Sprague wanted to crack the mos field, and had plant space to offer in its Worcester, Mass., facility, as well as a sales force. It also had no competing product lines, and a backlog of research and development experience that was to make Mostek the first quantity producer of ion-implanted mos large-scale integrated circuits.

Although news of the company's formation broke in June 1969, it was July before the Worcester operation got off the ground. "We went into business with the intention of making 1-1-1 silicon high-threshold mos/LSI devices, and 1-0-0 silicon low-threshold mos/LSI," says Palmer. Ion implantation wasn't part of the business plan.

"But we were interested in Sprague's experience with tantalum oxides," says Palmer, "and late that summer we took a trip to its research labs in North Adams to talk with John Macdougall an R&D section head about using them as a dielectric material. As it turned out, the tantalum material would have meant more problems than advantages for us, but while we were there, we found out about Sprague's five years of research in ion implantation. Now, about six or eight thousand wafers later, ion implantation is the most reliable part of our process."

Sprague had been experimenting with ion implanted resistors, and mos discrettes with variable thresholds, and it was the latter idea that turned on the Mostek men. They found that it was compatible with the standard 1-1-1 silicon process, needed only standard masks, and was much simpler than diffusion—"instead of the final diffusion step, we just take the wafers to the accelerator and zap them," says Palmer; the process's thick oxide provides the implantation mask.

The speed with which Mostek got implantation on stream is impressive. James E. Wilkenson, manager of manufacturing at Worcester, says that although Mostek hadn't committed itself to ion implantation as late as September or October, the first evaluation LSI's were shipped in November. This means 30-to-60 day turnaround with a brand-new technology—no mean feat. Even more impressive is Mostek's shipping of production quantities of implanted mos/LSI in January; and, Mostek will have shipped more than 10,000 by June.

plantation also offered a way to optimize yields by precise control of that threshold.

Robert Palmer, Mostek's director of R&D, says Mostek can hold a one-volt spread (± 0.5 volt) around its nominal threshold voltage with less trouble than other MOS processes. Finally, Mostek likes implantation because it delivers a high ratio of field oxide threshold to device threshold. This is important because the higher this ratio, the less likely a circuit will

encounter false or parasitic turn-on. This is especially common in 1-0-0 silicon MOS process, causing yield losses at probe testing.

With its "implanted channel" process, using 1-1-1 silicon, Mostek achieves field oxide thresholds up to 35 or 40 volts and device thresholds of 1 to 2 volts yielding a high ratio. But Mostek is especially pleased with the high control yields that are obtained by varying the device thresholds through ion implantation. The firm chooses the

High-performance Pen Pals

Honeywell's 530 X-Y Recorder: true differential input and proven reliability . . . for under \$1250.

Our 530 X-Y Recorder not only records low-level signals from any source, grounded or floating, it records them so efficiently and so reliably, you can depend on it, day in and day out.

And for good reason. This 530 X-Y Recorder has the same kind of improved snap fit pen assembly (with a polished sapphire tip), carriage assembly and cable arrangement that have made our model 550 and 560 Recorders the standard of the industry.

You'll be happy to know, too, that the Honeywell 530 X-Y Recorder is so simple to operate that even your non-technical people can learn to use it. And yet, it delivers high speed (30 in/sec. on X-axis, 20 in/sec. on Y-axis) and common mode rejection up to 130 db; offers a trouble-free vacuum holddown; and accepts either 8½" x 11" or 11" x 17" paper.

Honeywell's 540 X-Y-Y' Recorder: a two-pen recorder with double capability for a price less than \$2100.

Even though our 540 X-Y-Y' Recorder costs less, it doesn't give you any less. In fact, it's operating characteristics are almost identical to our 530 Recorder, giving you the exact same true differential input, the same proven mechanical design features, the same unsurpassed reliability. Plus it offers 30 ips. slewing speed on each axis and 1 megohm input impedance on all calibrated ranges, as well as when operating at variable sensitivity. It also provides one millivolt sensitivity (each axis), a stylish appearance, vacuum holddown, and will accept either 8½" x 11" or 11" x 17" paper.

For more information on either of these new X-Y recorders, write or call (collect) Roy Washburn, 303-771-4700, Honeywell Test Instruments Division, P.O. Box 5227, Denver, Colorado 80217.

Honeywell

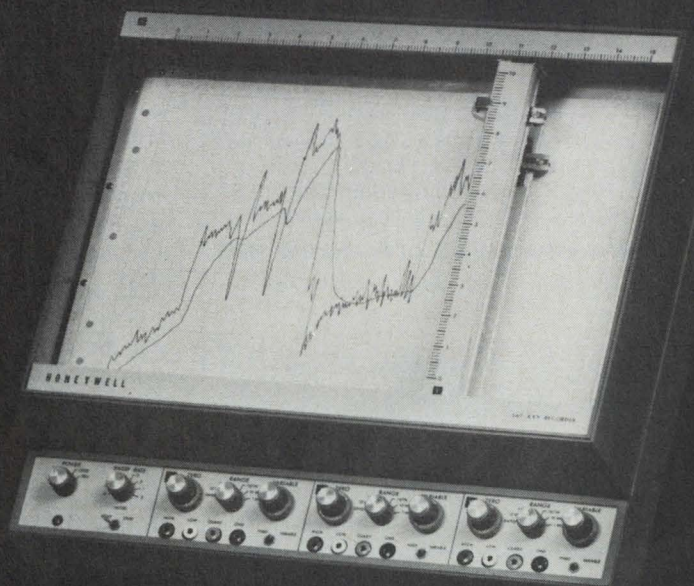
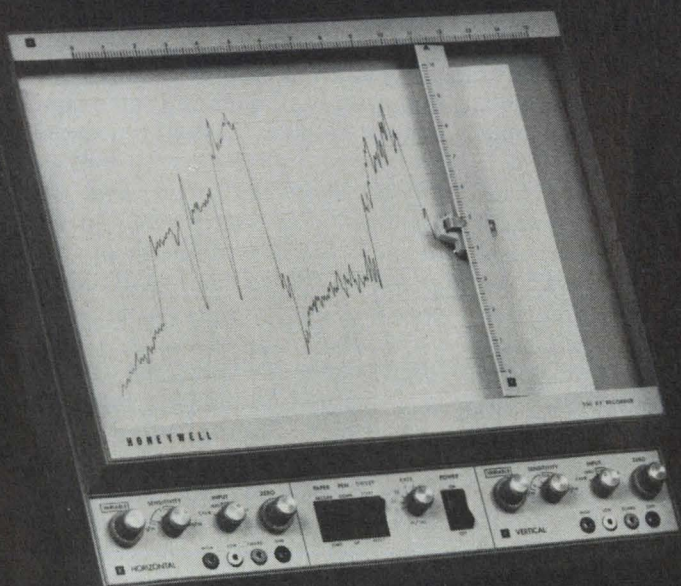

Honeywell engineers sell solutions



Wide Band, Precision CURRENT MONITOR

With a Pearson current monitor and an oscilloscope, you can measure pulse or ac currents from milliamperes to kiloamperes, in any conductor or beam of charged particles, at any voltage level up to a million volts, at frequencies up to 35 MHz or down to 1 Hz.

The monitor is physically isolated from the circuit. It is a current transformer capable of highly precise measurement of pulse amplitude and waveshape. The one shown above, for example, offers pulse-amplitude accuracy of +1%, -0% (typical of all Pearson current monitors), 10 nanosecond rise time, and droop of only 0.5% per millisecond. Three db bandwidth is 1 Hz to 35 MHz.

Whether you wish to measure current in a conductor, a klystron, or a particle accelerator, it's likely that one of our off-the-shelf models (ranging from 1/2" to 10 3/4" ID) will do the job. Contact us and we will send you engineering data.

PEARSON ELECTRONICS INC
4007 Transport St., Palo Alto, California 94303
Telephone (415) 326-7285

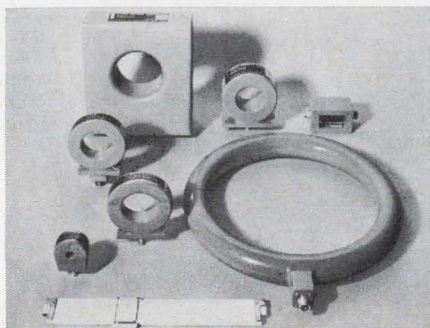

threshold level that offers the highest yield, and can repeatedly achieve it with the accelerator.

Both firms still use diffusion up to a certain point before implantation. The main design rule Hughes imposes on devices to be implanted is that the gate should not overlap the source and drain in order to avoid capacitance problems. Gate oxide is selectively removed over parts of the diffused source and drain to allow formation of the gate electrode and source-drain metallic contacts; metallization precedes implantation. When boron ions bombard the device, they extend the source and drain from a point short of the gate limits exactly to the gate limits—with the gate serving as the mask to assure these limits.

Hughes is implanting at 80 to 100 kilo-electron-volts and at a density of 10^{14} ions per square centimeter through a silicon-dioxide/silicon nitride sandwich 1,200 angstroms thick. Hans Dill, Hughes' manager of MOS R&D who has worked closely with Bower over the three and one half years, says Hughes implants at room temperature. The process requires 1 to 4 minutes per wafer, and is followed by a 10-minute anneal at 500°C.

Bower emphasizes that the catalog items announced "don't even represent 2% of the IMOS devices we've actually shipped." The other 98% is custom work. "We have about 20 IMOS circuit designs now," he notes "and we're running 60 to 80 wafers a week. By the end of this year we'll be handling 400 to 500 IMOS wafers a week with one production machine and one R&D machine."

Unlike Hughes, Mostek implants before metallization. The implanted channel process does just what it suggests—drives ions into the channel region. Virtually any nominal threshold below the 4 volts typical of the standard 1-1-1 process can be achieved via implantation. Wafers that are to be given low thresholds are diverted from the conventional process flow after gate oxidation, implanted, and returned to the standard process flow. Mostek's Palmer says the technique is straightforward, brief, and doesn't introduce any additional depositions, photomasks or etching steps.

Since January, Mostek has put between 3,000 and 4,000 produc-

tion wafers through the ion accelerator. Details of the Mostek implantation technique—such as energy used and dopant density—are proprietary.

Now that the ability to control thresholds and yields has been demonstrated, Palmer indicates that circuits with improved speed-power products are coming.

Competition. But both Mostek and Hughes must sell against competition from such silicon-gate advocates as Intel and Fairchild, and they give a little away to this competition, at least for now. Hughes IMOS, though it clocks at several megahertz, doesn't reach the low threshold voltages possible with silicon-gate devices—typically 1.5 to 2.0 volts versus 2.0 to 2.5 volts for Hughes IMOS. Mostek meanwhile, is settling for 1-Mhz clock rates as a standard, although its range of device threshold voltages are the lowest, at 1.0 to 2.0 volts, which makes for easy interface with bipolar circuitry.

Mostek is not yet implanting self-aligned gate MOS. According to L.J. Sevin, Mostek's operations vice president, "Silicon gate technology is going to have its impact in 1972-1973, and the amount of impact will depend on the efforts of Intel and Fairchild."

Bower says the silicon gate will help Hughes by providing more sockets for circuits with self-aligned gates. "In speed, the market is now at 100 khz to 2 Mhz for shift registers. But the 3-6 Mhz market is open to self aligned gate technology—either IMOS or silicon gate."

Signetics is using its implantation system in much the same manner as Hughes. Signetics extends the source and drain with implantation, boosting speed and obtaining a self-aligned gate in the bargain. But David Kleitman, vice president for research and development, says the same speed boost is possible with silicon-gate techniques—and, he adds, the silicon-gate method is simpler than implantation. Having used both technologies in R&D, Kleitman votes for silicon gate because he says that besides being simpler, "you get two-layer metal. The metal on top and the polysilicon layers are both conductors; you won't get this with implantation."

**Introducing
a complex logic
card tester
so simple to operate
you just plug it in,
turn on power
and start testing.**



Sangamo's Comp 200

The Comp-200 uses a new proprietary technique specifically designed to test logic circuits. No programming is required to test any kind of logic card. No programming is required to diagnose and trace a problem right down to a component. You just turn on power and begin testing your logic card. It's that simple.

Each Comp-200 is backed by a full two-year warranty and a team of Sangamo

service specialists. Best of all, the price is just \$7500.00.

Write or call for more information and a demonstration of the Comp-200.

**SANGAMO
ELECTRIC COMPANY**

Data Systems, P.O. Box 3347/Springfield,
Illinois, 62708 Phone: (217) 544-6411
TWX: 910-242-0533 TELEX: 406-421

D570-1R

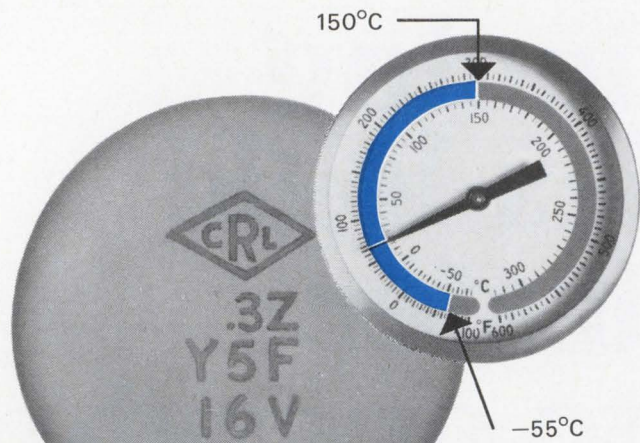

Centralab gives transistor circuits longer, more reliable performance with NEW 16, 25 & 50 volt Ultra-Kaps[®]

Centralab engineers have achieved a new degree of temperature stability in semiconductor type, low voltage ceramic disc capacitors with their development of temperature-stable Ultra-Kaps. The 16 and 25 volt units can hold a maximum capacitance change of $\pm 4.7\%$; 50 volt units as little as $\pm 7.5\%$.

Ultra-Kaps also exhibit other superior performance characteristics, such as low impedance; high capacitance density; and operation to temperatures as high as 150°C, as low as -55°C. In 50v ratings average dissipation factor is as low as 1.5%; leakage resistance of 1000 megohms, min.

the stable ones

Ultra-Kaps are ideal for use in transistor circuits because they are operable to a frequency of 1 MHz. And they're still low cost units that replace more expensive mylar and "Hi-K" ceramic capacitors. On quantity orders, they're priced as low as 2½ cents each with delivery as short as 4 to 5 weeks. We can send you samples immediately for your evaluation.

Don't let your design plans melt away because of inferior capacitor performance. Get the ultimate, Centralab's stable Ultra-Kaps.

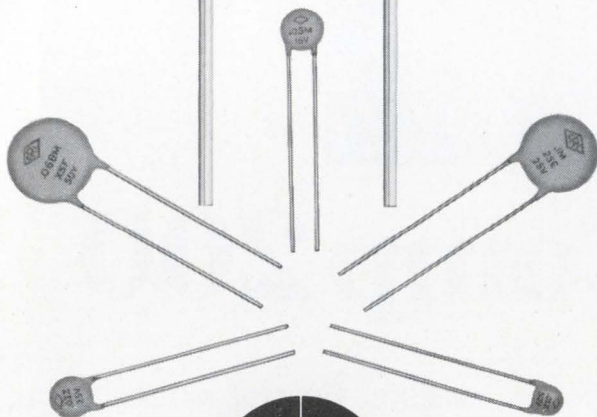

CENTRALAB

Electronics Division
GLOBE-UNION INC.
5757 NORTH GREEN BAY AVENUE
MILWAUKEE, WISCONSIN 53201

Max. Diameter	16 volt		25 volt		50 volt	
	Max. Cap. MFD	Min. I.R. Megohms	Max. Cap. MFD	Min. I.R. Megohms	Max. Cap. MFD	Min. I.R. Megohms
.290	.02	5.0	.015	65.0	.01	1000
.390	.033	3.0	.022	45.0	.015	1000
.405	.05	2.0	.033	30.0	—	—
.485	—	—	—	—	.022	1000
.515	.068	1.5	.05	20.0	.033	1000
.590	0.1	1.0	.068	15.0	.047	1000
.690	0.15	0.65	0.1	10.0	.05	1000
.760	—	—	—	—	.068	1000
.820	0.2	0.5	0.15	6.5	—	—
.920	0.3	0.33	0.2	5.0	0.1	1000

*Thickness: .156 inches maximum

Lead spacing: Discs less than .500" diameter, nominal lead spacing is .250"
Discs .500" and larger, nominal lead spacing is .375"

M-6901

FOR MORE INFORMATION AND/OR DESIGN ASSISTANCE, WRITE CAPACITOR SALES MANAGER, CENTRALAB.

ERTS is alive and on schedule

Support for earth resources satellite grows as Administration pushes foreign government participation; industry hails program as antipollution weapon

By Alfred Rosenblatt

Electronics' staff

Despite rumors of problems with return-beam vidicons and tape recorders, the Earth Resources Technology Satellite program is sailing along right on schedule toward a July 1 contract award. And extra impetus for the ERTS program is being provided by Administration-NASA efforts to get foreign governments to participate and by industry spokesmen who are linking the efficacy of such satellites with the newest national crusade—environmental pollution.

One of the two finalists, General Electric or TRW, will be chosen for that July 1 contract to build the first two ERTS, A and B, and the ground data-handling system. Also still to be selected are the principal users who will receive data from the satellites. These groups will include universities and industrial companies as well as Federal Government agencies, points out Theodore E. George, program manager for NASA's Earth Resources Survey Flights, who directs the ERTS program. Definitely included are the Federal departments that have been behind ERTS almost from its start—Agriculture, Interior (with its U.S. Geological Survey), Commerce (with its Environmental Science Services Administration), and the U.S. Navy's Oceanographic Office.

NASA will release "invitations for flight opportunities" on earth resources satellites within the next few months, George says. About 25 to 30 companies—chiefly in mining, petroleum, and aerospace—have showed interest so far, he says.

Several million dollars will be available from NASA to help private

groups in their data-analysis projects. Government agencies, on the other hand, will have to fund their programs from their own budgets.

In the nearly two years to go before ERTS is launched, NASA may also find more foreign countries asking to share in the earth resources data. Although a national policy still has to be worked out,

President Nixon actively encouraged the release of such data in his speech to the United Nations General Assembly last September, when he said that data from earth resources satellites would be "open to the world community." And many at companies involved with the development of earth resources technology—remote sensors, satel-

Look-alikes. Resembling its operational Nimbus weather satellite, GE's ERTS vehicle, right, mounts its 500-pound sensor payload in an instrumentation ring. Teamed with GE are Bendix and EG&G's Wolf R&D.

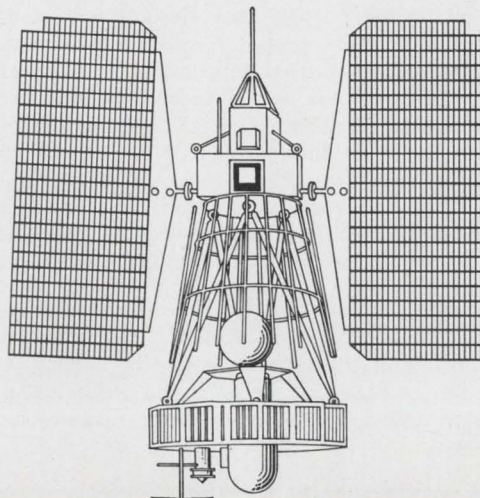
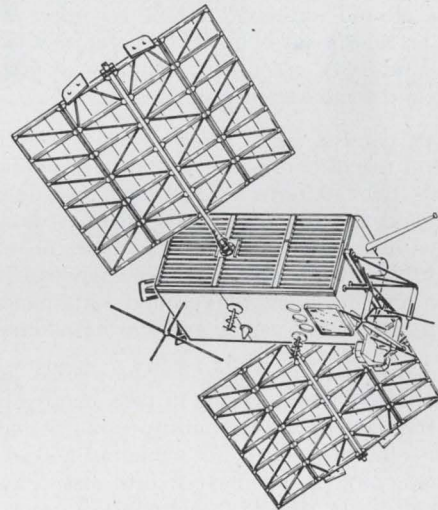

OGO too. TRW's design for the earth resources satellite, left, based on its Orbiting Geophysical Observatory, is being developed with the help of IBM and Itek Corp.

Who's on ERTS?

Both the General Electric Co. and TRW Inc. have submitted two-part proposals to NASA for the first two earth resources satellites, ERTS A and ERTS B. A spacecraft design was submitted in February; a plan for the ground data-handling system went in last month. NASA's award, on or about July 1, will be a phase D, "total system contract," said to be worth anywhere from \$100 to \$200 million for both satellites and the ground electronics. Goddard Space Flight Center administers the program [*Electronics*, May 12, 1969, p. 98; Nov. 10, 1969, p. 60].

Both companies intend to incorporate as much hardware as possible from earlier satellites—TRW from its Orbiting Geophysical Observatory and GE from its Nimbus weather satellite. Only minimal changes are being made in structural, attitude control, solar-cell power and orbit-adjust systems. The S-band communication system, although wider-band than usual at 20 megahertz, is similar to the unified S-band approach used in the Apollo program. ERTS will have a vhf communications system as well. Although the ERTS A and B spacecraft, their sensors, and the ground data handling systems are considered experimental, the information sent back hopefully will find practical uses. And the experience gained from the system's operation will provide the basis for improvements.

The ERTS A and B spacecraft will orbit the earth for at least one year, stabilized about three axes, in approximately 500-mile polar orbits that are synchronized with the sun. This synchronism will find the sun always at the same angle above the horizon, making it possible to take repeated images of the ground under identical lighting conditions. ERTS will return to image the same 100-by-100 mile square area on the ground every 18 days. A pass over the United States will take less than 20 minutes. Real-time data will be transmitted during this time to the ground stations; the tape recorders will be able to store and play back an additional hour of data. Information sent back will deal mostly with land-based resources, including crop surveys and geological formations, and some oceanographic data.

ERTS consists of a three-camera return-beam vidicon (RBV) multispectral television system; a four-band multispectral radiometric scanner (MSS); two 10.5-Mhz video tape recorders to store the RBV and MSS data; and the spacecraft portion of a data collection system that will receive information from various types of sensors located on the ground. In addition to the spacecraft and payload items, the total system under study also includes the ground data-handling gear, consisting of an operations control center and the NASA data-processing facility.

The vidicons, operating in the visible light range, will have one of three band filters up front to pass bands of 0.475-0.575, 0.58-0.68, and 0.69-0.83 micron. The multispectral scanner will have pass bands at 0.5-0.6, 0.6-0.7, and 0.7-0.8 micron, and at 0.8-1.1 microns in the near infrared. ERTS B will have a fifth MSS channel ranging farther into the infrared (from 10.4-12.6 microns).

Perhaps the greatest impact of the GE and TRW designs will be in the ground data handling systems. TRW's proposal calls for producing images with an RCA laser beam recorder used in conjunction with an Itek analog photo restitutor. The restitutor uses a previously produced photograph of the area as a control image to correct for errors caused by the system. The output image from this correlation "has the same projective quality as the control image and the same resolution as the input image," says W. W. Royce, manager of ground data handling systems for TRW systems. Both spacecraft control and data handling systems will be handled by the same IBM 360-85 computer.

GE, on the other hand, plans to produce the images with an electron-beam recorder, says program manager David Keller. The recording beam, which writes directly on film, is, in turn, controlled by a small- to medium-sized computer like the xds Sigma 5. Stored in the computer are the errors inherent in the camera system which are automatically corrected for in the writing process.

lites, data-handling systems—look upon Sen. Warren R. Magnuson's (D., Wash.) bill to foster international cooperation in combatting environmental pollution [*Electronics*, April 27, p. 54] as a boost for expanding the satellite program.

A further shove in this direction is being provided by industry leaders. According to Willard F. Rockwell Jr., chairman of the North American Rockwell Corp., ERTS offers a unique opportunity to "checkmate the 20th century exploiters and polluters with 21st century scientific tools and management techniques." His sentiments are echoed, although in less heroic tones, by A.K. Thiel, vice president and general manager of TRW's Space Vehicle division. With its frequent coverage of the earth on a broad regional scale, ERTS will, says Thiel, give pollution controllers "a new way to look at both air and water pollution."

International cooperation in the satellite program also may quiet the U.S. State Department's fear that foreign countries would object to earth resources satellites passing overhead. State Department spokesmen made this point at several aerospace industry technical conventions and warned that the international ramifications of such satellites have not yet been settled.

Interest. Several nations already have expressed interest in ERTS, either directly to NASA, (Canada and Australia), or through the UN's Committee on Peaceful Uses of Outer Space. In January, representatives from 21 nations visited NASA's earth resources aircraft survey facilities in Houston. (NASA has been flying resources survey aircraft in Mexico and Brazil for several years.) But no formal agreements concerning international cooperation in the satellite program have been drawn up, says George.

Besides, ERTS A and B were designed primarily to scan the U.S. and its adjacent oceans, not to cover foreign countries. However, if a nation asks the U.S. to "turn on your cameras when you're flying over us" and "let us have the data," George believes this country "might be so inclined."

Such ground command would be possible because the resource satellites are fully compatible with the worldwide Stadan and Manned

Space Flight Networks, points out Thomas M. Ragland of NASA's Goddard Space Flight Center. "The price you pay is complexity in the spacecraft, but it will be possible to command, care, and feed the spacecraft from many places around the world," he says. Data-acquisition sites in the U.S. were picked to meet an early ERTS objective that sensor data from the entire continental U.S. be obtained without relying on a video tape recorder. Ground stations are a Stadan site in Fairbanks, Alaska; two MSFN sites in Corpus Christi, Tex.; and the other at Goddard, in Greenbelt, Md., where a new 30-foot dish is being installed.

The data from the return-beam vidicons, multispectral scanner, and tape recorder will be assembled at a new data-processing facility at Goddard. Data will be received and stored on magnetic tape, then converted to hard film. Individual users will evaluate the data NASA supplies them. Images will be annotated with such information as date, time, and satellite attitude and orbit. The data will be reproduced, stored, retrieved, and distributed as needed. Catalogs also will be produced. Only about 5% of the data will be precision processed to enhance image color and registration, and to correct for distortion. NASA considers this will be sufficient to give users an idea of what they will need in an operational system. It also represents a compromise with the cost of precision processing all images.

Right. Government user agencies may be hampered in data interpretation by tight money. The Interior Department had \$3 million cut from its \$4.1 million appropriation for an earth resources data reception center in Sioux Falls, S.D. The result is that instead of following through on data evaluation programs, Interior intends to prepare a "Bureau Readiness Program" which will use the center to store photographic files of ERTS data forwarded by NASA, according to Interior's Charles Robinove, associate research coordinator, resources program. Keeping the satellite program intact, while cutting data center money is, says Robinove, "like building a power generation station without transmission lines."

"The thing we're afraid of is not

You get a lot less capacitor for your money...

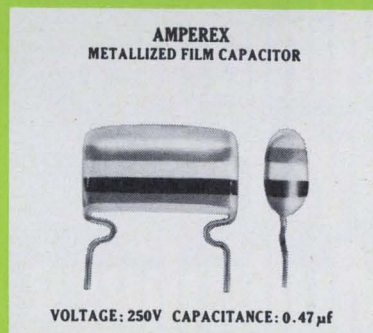

...from Amperex

Until you've seen the Amperex C280 line, you have not seen the smallest fixed film capacitors that the industry has to offer. Now you can get the Amperex C280 series of metallized film capacitors without premium for their miniaturized dimensions and metallized construction. They are competitively priced for radio, TV and other general purpose and consumer electronic applications. Available in off-the-shelf, production quantities, the C280 series encompasses a full range of capacitance values at working voltages of 250, 400 and 630 VDC. There is no additional charge for formed crimped leads.

For further information on the entire C280 line, including metallized polyester and metallized polycarbonates, write: Amperex Electronic Corporation, Component Division, Dept. C, Hauppauge, New York 11787... or phone 516-234-7000.

Amperex®

TOMORROW'S THINKING IN TODAY'S PRODUCTS

A NORTH AMERICAN PHILIPS COMPANY

LET GPS HELP YOU
THINK FUNCTIONS

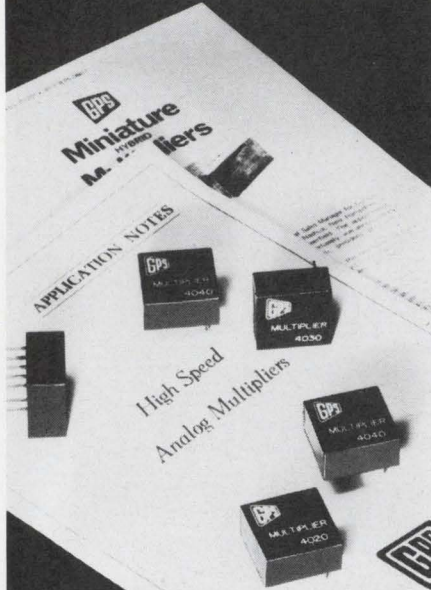

Miniature Hybrid Multipliers

- Available from stock.
- 6 different models with accuracies from 0.1% to 5%.
- Priced from \$45 in quantity.
- Completely self-contained and buffered inputs.
- Occupies one half cubic inch.
- Applications include modulation - demodulation, voltage controlled amplification, correlation, wattmeters.

Write for descriptive brochure and application notes to:
GPS CORPORATION
14 Burr Street,
Framingham, Mass. 01701
(617) 875-0607



GPS — The Complete Source for
Compatible Operational Elements.

having data in the right format for users," he says. Interior will sell data at reproduction cost to private users such as petroleum companies that want to use it to determine future sites for oil exploration.

Plans for using Houston's earth resources survey aircraft while ERTS A and B are in orbit won't be set until three or four months before launch. But coordinated use of the planes with ERTS A and B will have priority, according to George.

NASA's original desire to fund \$10 million for follow-on satellites to ERTS A and B was thwarted in the fiscal 1971 budget when the money was deleted because of NASA's across-the-board budget difficulties. However, George expects that a similar amount for these satellites—ERTS C and D—will be requested in the fiscal 1972 budget. The total cost of ERTS C and D would be only about \$25 million, largely because they'll use relatively simple and proven film-return camera systems. And the satellites will only have to last a few weeks because they're to be used as backups to ERTS B to cover the growing seasons in the spring and fall of 1973. Companies probably working on adaptations of existing satellites include RCA with its Tiros M and GE with its Bios.

George reports NASA is just starting in-house pre-phase A studies for ERTS E and F satellites. They're slated for oceanographic applications and may be launched during 1974 or 1975. NASA's next step will be to review the needs of the oceanographic community. The E and F satellites may have sensors such as a narrowband spectral scanner with eight or nine visible-light channels, a passive microwave radiometer, and an active microwave instrument (probably a radar scatterometer) for sea-state measurements, and an infrared radiometer.

Beyond E and F, any resource satellites will have to be closely coordinated with the sensors on Skylab. Indeed, some people feel Skylab could replace unmanned satellites like ERTS, performing remote sensing as well as its other chores.

Limits. This isn't likely to happen, according to Interior's Robinove. Skylab's 50° orbit would definitely limit its usefulness as a

resources satellite because "it could see nothing north or south of 50°," he points out, leaving out most of Europe and Canada.

Unlike Skylab, the ERTS sun-synchronous orbit will permit successive observations of the same area at different times, and allow measurement of change and rates of change in a given sector. Manned flight, too, is "not as systematic" as an automatically controlled and programed unmanned system, the kind that ERTS requires. Finally, Robinove concludes, the Skylab's solar telescope will permit astronauts on board "very few opportunities to look at the earth."

The development of both payload sensors and the wideband tape recorder is reported on schedule. One industry rumor—that RCA's return-beam vidicon camera system may not meet its promise resolution characteristics—is regarded as misleading by NASA. "It's misleading because resolution depends on the surroundings and background and contrast of the scene that's viewed," says Oscar Weinstein, the lead engineer at Goddard responsible for the development of the vidicon system. "For example, in the lower two spectral bands, contrast is very low in an agricultural scene, and the performance of the sensor—any type of sensor, including a film camera—goes down accordingly."

In the laboratory, the return-beam vidicon camera has been operated with a resolution of 4,500 tv lines when viewing a high contrast target, Weinstein continues. "And it's extremely difficult to interpolate beyond this laboratory performance to predict the sort of resolution that actually will be obtained with the camera system in orbit."

However, NASA believes the ground resolution from orbital altitude could be on the order of 3,000 tv lines, corresponding to a resolution of about 200 feet. And NASA actually will operate the RBV's at 4,200 scan lines. "It doesn't make sense to scan the ground with more lines than the contrast of the scene allows to be resolved," Weinstein says. Besides, the lower scan rate offers advantages because it "improves the signal-to-noise ratio and allows a longer prepare time for the camera between frames."

Value. The usefulness of earth images taken from a resources satellite is still being questioned. One particularly vocal questioner, Amron Katz of the Rand Corp., has repeatedly asserted that aircraft could gather resources data with far more ease, as well as resolution. But Interior anticipates "no real problems" with sensor resolution, according to Robinove. The Department "is not trying to duplicate aerial photography with the satellite," he explains. "We don't want high selectivity." Robinove expects to do well with a system able to measure medium-contrast targets with a resolution of 200 to 300 feet.

Some of the first ERTS-type data to be analyzed—earth photos taken from about 125 miles up during the Apollo 9 mission—showed that "more than 90% of the ground truth areas" could be identified using automatic photo-interpretation and data-processing equipment, according to R. B. MacDonald of Purdue University's Laboratory for Applications of Remote Sensing.

Purdue used sets of three panchromatic film transparencies which had been exposed through light filters in the same spectral bands chosen for the ERTS missions. Each photo (of the Salton Sea region in California) covered about 10,000 square miles, and resolution of objects on the ground was 400 feet, says McDonald. "We had automatic computer printouts indicating the areas in the photos consisting of soil, vegetation, salt flats, and water," he continues. "And right now, we're working on automatically detecting different types of vegetations; we're hoping to identify such things as alfalfa, sugar beets, and barley."

The computer analysis is based on the density of the picture elements in the transparencies. And the density is related to the amount of radiant energy emitted by areas on the ground. Although it's a "crude" measurement, says MacDonald, it's similar to the way information would be analyzed from ERTS' return-beam vidicons.

RCA has completed a feasibility model of its \$10 million camera system, and three engineering models should be ready by August. Then prototypes will go into ther-

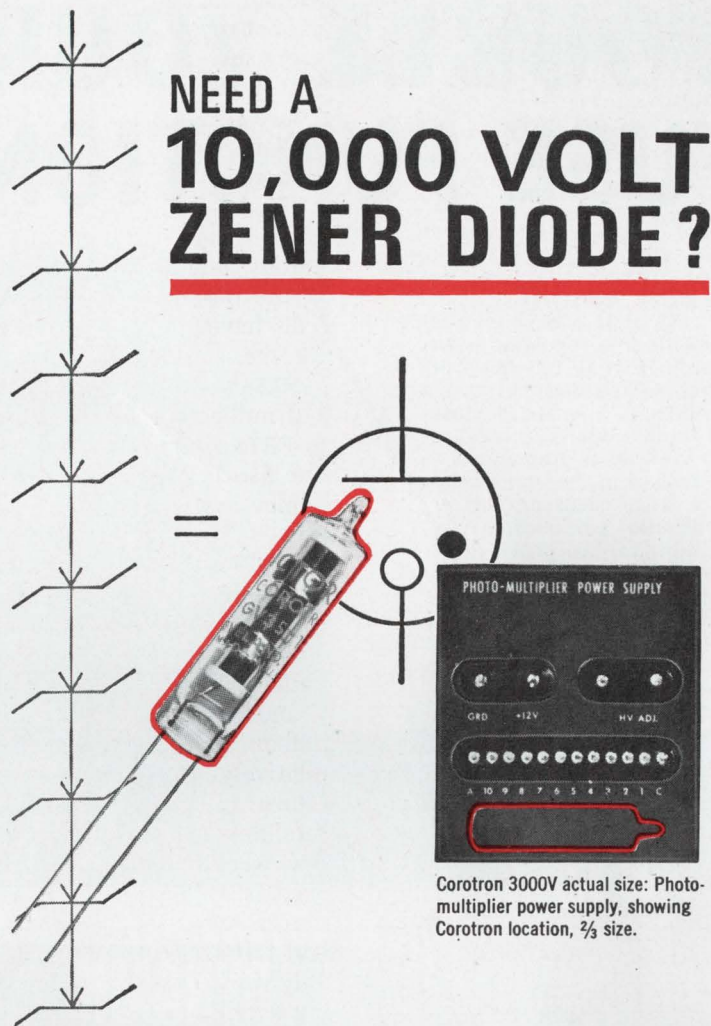

NEED A 10,000 VOLT ZENER DIODE?

Corotron 3000V actual size: Photo-multiplier power supply, showing Corotron location, 2/3 size.

You could string together several hundred zeners. Or you could specify *one* Victoreen Corotron. It is the gaseous equivalent of the zener with all the advantages of an *ideal* HV zener diode.

For space research and other rugged applications requiring absolute power supply stability, GV3S Series, shown, provide the ideal reference voltage anywhere in the range of 400 to 3000 volts. They enable circuitry to maintain constant high voltage regardless of battery source voltage or load current variations. Cubage and weight (GV3S Corotron weighs only 4 gm.) are important considerations. So is temperature variation (Corotrons operate from 200°C down to -65°C). Ruggedized versions withstand shock to 2000 G, vibration 10 to 2000 cps.

If you're trying to simplify circuits . . . to cut cost, size and weight . . . to upgrade performance—you need Corotron high voltage regulators. Models are available now from 400 to 30,000 volts. A consultation with our Applications Engineering Dept. will speed up the countdown.

DMA 525



VICTOREEN INSTRUMENT DIV. of VLN
10101 WOODLAND AVENUE • CLEVELAND, OHIO 44104
 EUROPE: ARNDAL HOUSE, THE PRECINCT, EGHAM, SURREY, ENGLAND • TEL: EGHAM 4887

DOUBLE YOUR FUSE FUNCTION

In the design of high-powered solid state equipment there often occurs the need for equalizing resistors. Consider the case of parallel series pass elements in a regulated power supply. It may not have occurred to the designer that a Littelfuse 275 Series Picofuse will fulfill a dual purpose, in that the voltage drop across the fuse is in the approximate range necessary for equalization purposes, in addition to the provision of over-current protection. Picofuses are now available with ratings from 1/16 through 15 amps.

Write for a free copy of our 275000 Series Resistance Data Chart.

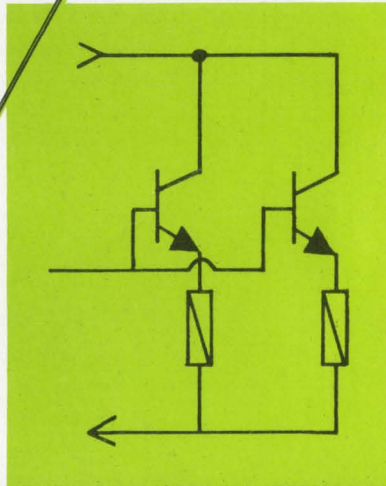

LITTELFUSE

DES PLAINES, ILLINOIS

Circle 175 on reader service card

DYNAMIC CIRCUIT BREADBOARD

Take the mess out of breadboarding with the ELite 1

This unique instrument takes all of the scavenging and soldering out of design, yet will accommodate any combination of IC's and Discrete Components

BUILT-IN FEATURES ARE:

- Precision pulse generator variable frequency, ampl. and width
- Variable power supply
- Neon lamp display with drivers
- No special tools, plugs or patch cords are required
- Size is only 4 1/2" high, 15" wide, 11" deep

WITH THESE ADVANTAGES:

- Total breadboarding without soldering
- Complete bread inter-connection with solid #22 wire
- Convenient desk-top operation

Use the ELite 1 for all designing, testing and burn-in thereby reducing your breadboarding to inserting components, inter-connected with #22 wire and monitoring circuit responses via the built-in neon display

Write or phone for complete specifications and catalog

ELI EL Instruments Incorporated
61 First Street, Derby, Conn. 06418 • Phone 203/735-8774

mal and vacuum tests, and flight models will be delivered the following August.

An engineering model of Hughes' multispectral scanner should be ready by the end of 1970, according to Ralph Wengler of the company's Santa Barbara Research Center; the first unit will be delivered in mid-1971. Hughes' goal is ground resolution of as low as 200 feet, he reports. ERTS A will have 24 narrowband channels, six for each spectral band.

Extended. To handle the RBV and the MSS inputs RCA has had to extend the bandwidth of its tape recorder to 10.5 megahertz from 6 Mhz. RCA has brought some experimental gear as high as 15 Mhz but this is the first time such a wide bandwidth will be included in a product intended for other than ground use, says F. Donald Kell, recorder program manager. The recorder will handle both video data from the return-beam vidicons and digital input from the multispectral scanner, which comes in at a 15 megabits-per-second rate. The digital data, in non-return-to-zero (NRZ) format, is put on an f-m carrier and recorded. The channels are combined by first digitizing them in the NRZ code, with six bits per analog sample.

The RBV data is in an analog format, "like a slow-scan tv system," says Kell. With a bandwidth from d-c to 4 Mhz, the data is recorded in "conventional tv fashion, although the system has to be d-c coupled throughout."

Two life tests to demonstrate the head-to-tape wear have each run successfully for more than 1,000 hours, according to Kell. Wear between head and tape is particularly severe because the tape speed is high—2,000 inches per second—to achieve the wide bandwidth. A four-head transverse scan records a single wideband track on standard two-inch tape in a reel-to-reel, rather than endless-loop, system. Signal-to-noise ratio will easily meet NASA's 43-decibel specification for the 4-Mhz channel. Two narrowband tracks are included for housekeeping purposes. Data from the three RBV's are time-division multiplexed onto the track, but the recorder cannot handle both the RBV data and the MSS data together—it records one or the other. ●

The MAN 1:



A seven-segment light-emitting all-semiconductor alphanumeric readout.

Put the attention-demanding red light from electrically excited GaAsP to work in your digital displays for industry, computer peripherals, or avionic/marine instrumentation. Our MAN 1 is shock-resistant and long-lived. Offers styling advantages because it's flat, parallax-free and visible within 150°. Reads out all numbers plus A, C, E, F, H, J, L, O, P and U. Available now. Any quantity.

- Brightness: 350 foot-Lamberts @ $I_f=20$ mA, 3.4V, per segment.
- Pulsed forward current=100mA, 10% duty cycle/per segment.
- Compatibility: directly interfaces with off-the-shelf IC decoder/drivers.
- Price: 1,000 quantities, \$11.00 (all prices are suggested resale figures).

The MAN 2:



An alphanumeric display made up of 36 discrete LEDs which can form 64 ASCII characters and a decimal point.

The IC-compatible 5 x 7 X-Y array gives you a bright red (peak emission 6500Å), high contrast display suitable for keyboard verifiers, avionics or computer terminals or other displays. Since the 36 dots can make 2³⁶ bits available, the MAN 2 can be very useful in film annotation work.

- Per-diode brightness: 300 foot-Lamberts @ $I_f=10$ mA, 1.7 volt per diode.
- Pulsed forward current (50 μ sec 20% duty cycle) 100 mA
- Light turn-on and turn-off 5 ns typical
- New reduced price: 1-9 quantities, \$40.00.

GaAsLITEs are in stock world wide.

You know that all of our products are available in the U.S. through Schweber (516) 334-7474; Semiconductor Specialists (312) 279-1000; K-Tronics (213) 685-5888; or Kierulff. You can get them overseas as easily:

United Kingdom: SEMICONDUCTOR SPECIALISTS, West Drayton 6415
France: YOUNG ELECTRONIC, 604-10-50
West Germany: Alfred Neye, ENATECHNIK, (04106) 4022
Denmark: SCANSUPPLY, AEGIR 5090
Belgium: TECHMATION, 384078
Netherlands: TECHMATION, 020-173727
Norway: ARTHUR F. ULRICHSEN A/S, 21 6510
Switzerland: OMNI RAY A.G., 051-478200
Italy: SILVERSTAR LTD., 46.96.551
Sweden: GP-INGENJOERSFIRMAN, 08/930280
Japan: NEW METALS AND CHEMICALS LTD. CORP., (201) 6585-7
Australia: HAWKER DE HAVILLAND AUSTRALIA PTY., LTD., 93-0221
Israel: MONSEL

GaAsLITE Update

Being a quick and thorough survey of what's available in solid state displays.

The MAN 3:



The world's first commercially available planar monolithic display. Low cost, besides!

The MAN 3 is a small (.125" high) bright red GaAsP seven-segment display that gives you extremely good visibility with high density packing; 16 digits need only 3 inches on your display. And since the MAN 3 interfaces with our standard IC drivers and uses as little as 10 mW per segment, it's simple to design numerical readouts into desk calculators, truly portable battery-operated instruments, even timepieces.

- Brightness: 200 foot-Lamberts @ $I_f=5$ mA, 1.7 volt, per segment.
- Total cont. forward current: 80 mA.
- Pulsed forward current=50 mA, 10% duty cycle per segment.
- Price: 1,000 quantities, \$7.55.

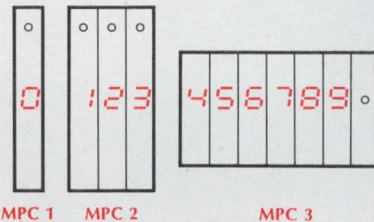

We've mounted the MAN 3 for you

Our MPC-series are simply the new MAN 3 numerics carefully soldered to NEMA-grade G-10 copper-clad glass/epoxy laminate pc boards.

The MPC 1 and MPC 2 boards let you address each segment of the numeric independently. The MPC 3 holds six MAN 3's which are multiplexable (X-Y addressable). There are two major benefits in doing your prototype work with our MPC units:

1) they're a heck of a lot easier to breadboard and 2) you can use them for fast turnaround into full production. Send for complete details. Fast! Price, MPC 2: 1 to 9, \$35.80 ea.

Monsanto

For additional technical information write Monsanto Electronic Special Products, 10131 Bubb Road, Cupertino, California 95014. (408) 257-2140.

Our plot to overthrow the electronics industry.

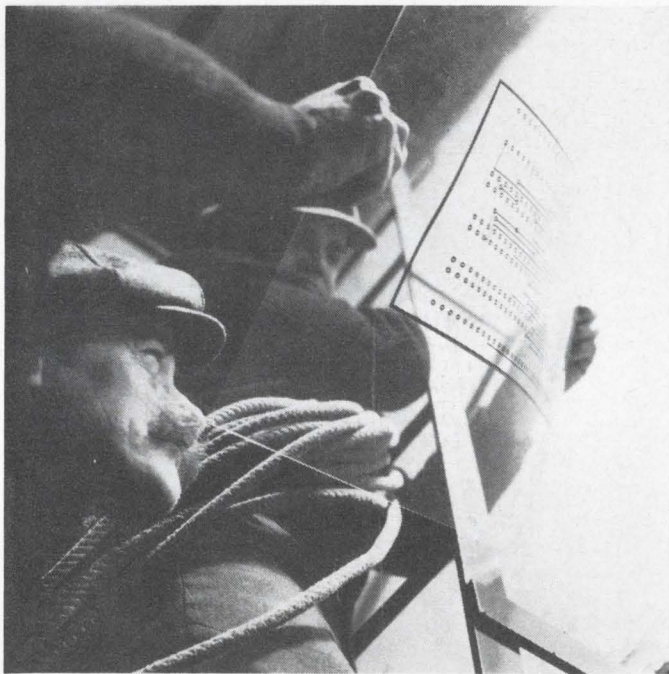

People are going to hate us.

Less than a year in the business, and already we're starting a revolution.

It's a revolution that revolves around our plot. A photoplot.

The idea is to produce a precision photoplotter system to generate all kinds of printed circuit and IC mask artwork.

The idea is to produce a cheap plot that is still the most accurate plot anywhere. It's shutterless to make it sharper and faster: accurate to 1 mil (or 1/2 mil, optionally). There's also a proprietary attachment allowing the use of Polaroid Land Film to produce test plots at

5 times the normal speed.

The idea is to produce a photoplotter that needs no darkroom for loading or plotting.

The idea is our Compucircuit 100. \$49,700, including a free IBM-compatible mag-tape system.

Instant revolution: take one home today and plug it in. Computervision, Northwest Industrial Park, South Avenue, Burlington, MA 01803, (617) 272-7240. See us at Booth 4932 Nepcon-East.

Computervision Corporation

Boy, have we got the vision.

Photoplotter has built-in developer

Masters and contact prints need not be taken outside for processing; West Coast firm's system gives choice of 300 apertures

By Lawrence Curran

Electronics staff

Almost half the printed-circuit-board plotting in the aerospace industry is still done by hand, using tapes and art masters. For this reason, and because some automatic photoplotter positioning accuracies still aren't as tight as they could be, the practice has been to plot large and then photo-reduce to tighten the position accuracies. A new company in California, Universal Graphics Inc., takes the opposite approach—plot small and then enlarge. In its Unigraph 22 photoplotter system, which includes the photoplotter, developer and an enlarger/printer, the glass masters or contact prints need not be taken outside the system for enlargement and developing.

Besides containing the built-in developer unit and enlarger module, the other feature of the Unigraph 22 is that, while it can plot boards up to 6 by 6 inches on a 1:1 scale, it uses enlargement for masters larger than that, providing four times enlargement and delivering a master with a maximum size of 22 by 22 inches. According to Universal Graphics, this enlargement capability covers more than 90% of the printed-circuit boards made.

Merle Amundson, president of Universal Graphics, says the firm chose to plot small, then enlarge, after investigating two key ingredients affecting accuracy. These are the inaccuracies eventually induced by wear in the mechanical movement of larger x-y plotting tables, say 40 by 20 inches, plus the high accuracy possible using a good lens in the enlarger. Universal Graphics' 6-by-6-inch table is made for integrated-circuit inspection equipment, and delivers positioning ac-



Working up. Small masters, under 6 x 6 inches, are plotted on a 1:1 scale, and others can be enlarged four times up to a size of 22 x 22 inches.

curacy of 40-millionths of an inch over the 6-inch travel. Repeatability is 10 millionths. A 6-by-10-inch table is optional. "While other tables may specify an accuracy of 1.5 mils, that accuracy can't be assured for very long after delivery," Amundson claims.

Why not. Lloyd Harrison, Universal Graphics' applications manager, anticipating skepticism about the Unigraph 22's plot-and-enlarge concept for boards larger than 6 by 6 inches, adds: "As long as we can get an accuracy of 1.5 mils across a 36-inch diagonal, why not do it?" He argues that by plotting small—the Unigraph 22 will often be used to plot at ¼:1 even on boards smaller than 6 by 6 inches—the machine's output can be boosted.

The Unigraph 22's critical plotting functions are all under com-

puter control. A drawer in the photoplotter module houses a Micro-Systems 810 minicomputer with an 8,192-byte, eight-bit-per-byte memory. Above that drawer is another containing the punched-card reader. The cards carry instructions that control x-y table movement, indexing of the photoplotter's image disk, mask disk, and neutral-density filters. The cards also are used to control the incandescent light source. The neutral-density filters can deliver 100%, 30%, 10% or 3% of the light to the glass plate.

Up to 300 images, intended for projection onto the glass master, can be put on the image disk, arranged in three concentric rows around the periphery. When the program selects an image to be placed on the master, the disk is

indexed to the location of that image. The mask disk, which is lower than the image disk, is swung into place under the image disk to block out all but the image to be projected. And the neutral-density filters may be brought into play if the machine is working in the moving-beam mode. (The machine has a flash mode, also.) The filters vary the light intensity delivered through the two disks to the emulsion. If the image aperture is large, the filters assure that no more light is projected onto the glass master than for a smaller-aperture image. This method avoids fringes or "ballooning" of an image being projected.

Ride the light. In addition, four Triacs, also under computer control, govern the light intensity to provide fine adjustment as the table slows toward the end of its

travel, further assuring against image distortion when the table changes from its peak speed to a slower speed.

The Unigraph 22 developing module, located immediately to the right of the photoplotter module, has five tanks. The master can be seen through a large red Plexiglass viewing window that's exposure-proof. And the artwork can be sequenced through the developer baths by reaching through light-tight cuffs. Timer and sequence lights are provided on the module to direct movement through the different baths. A built-in blower vents developer fumes, and positive-pressure blowers in the adjacent photoplotter module provide double protection against these agents getting into that module.

The enlarger-printer module

takes the glass master and enlarges it four times with less than 0.01% distortion. The plate holding the 22-by-22-inch enlargement is held in position by a vacuum chuck. A built-in printer makes contact prints without removing exposed Mylar prints from the environmentally controlled system.

Buy or lease. The complete system—including all three modules, the minicomputer and software, card reader, and an ASR-33 Teletype terminal to produce paper tape containing special program instructions—will sell for \$75,000. It can also be leased. The larger table, magnetic tape unit, or a paper-tape reader are optional equipment.

Universal Graphics Inc., 550 Newport Center Drive, Newport Beach, Calif. 92660 [338]

Light-beam control triples plotter speed

Generating artwork with photoplotting machines often can be slow and tedious—three or four plots may be necessary before all the bugs are worked out of the circuit design. Typically, plotters use a mechanical shutter to expose the film. But a great deal of time is consumed just setting up the machine for the right aperture and optical lenses. And if the film is exposed to incorrect light intensity, accuracy will suffer, degrading circuit performance.

Computervision Corp. of Burlington, Mass., has built a photoplotter called the Compucircuit 100, which avoids the conventional mechanical shutter system and uses no neutral density filters for controlling the light intensity. An electronically-controlled light modulation system varies the intensity of the light in the Compucircuit, which has run a plot on a seven-layer printed-circuit board in 80 minutes, a task that took over five hours in a standard photoplotting machine. The Compucircuit uses a servo system which automatically regulates the light intensity. The light modulation system turns the light on and off at kilohertz speeds. "By teaming the

light modulation system with a rapid indexing system for changing the apertures, we have been able to triple throughput speeds," says Philip Villers, vice president. "And the speeds are obtained at no sacrifice of accuracy. The accuracy of the line widths is 0.001 inch in our standard unit."

Villers says the electronic control is especially useful for producing lines that make sharp bends or have corners. Mechanical systems, he says, are too slow to adjust the light intensity around corners where the speed of the plot changes. This causes line blooming—overexposed lines grow in size, underexposed lines shrink. "Since we sample the light with a servo system and feed back the information to the control electronics, we have a much tighter control of the light at a particular spot, yielding a uniform light over the entire line length," says Villers.

Illumination isn't the only thing controlled by a servo system. The Compucircuit assures accurate focusing over the entire plot by utilizing a pneumatic feedback servo. The system keeps the optical head 10 mils from the film's surface regardless of whether or

not the surface of the film is entirely flat. Thus the correct focus is always maintained. Other machines run a flat piece of steel as a bearing pad along the film's surface, and this steel can damage the film. But no film damage can result with the Compucircuit—the error-sensing mechanism makes no contact with the film.

For even greater throughput capability, the Compucircuit can make quick preview plots with a Polaroid attachment mounted in the system. Thus, a proof, intended as a preview of what the final artwork will look like, can be made 15 seconds after the completion of the plot by switching a button on the console. "You run your trials on Polaroid, and when everything is correct, you generate the final artwork," says Villers. "This saves waiting for the regular plot before the artwork can be checked."

One magnetic tape unit runs the photoplotter on either standard film or Polaroid. Controls on the light source and the scale factors can be adjusted for each type.

Another Compucircuit 100 advantage is that it is completely self-contained and can be operated in

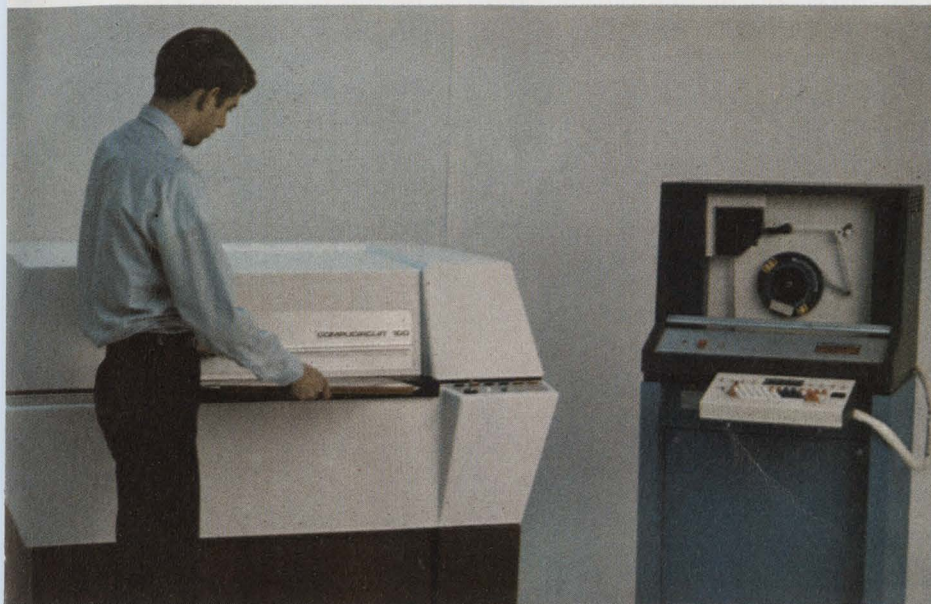

Lights on. Film is housed in a light-tight cassette so the room doesn't have to be darkened during loading and unloading of the machine.

any room environment. That includes loading and unloading the film. The unit uses a special light-tight cassette that houses the film so that the room where the photoplotters is operating doesn't have to be darkened each time the film is loaded and unloaded.

The Compucircuit uses the standard magnetic tape input found in other photoplotters, but another convenience has been added. Information can be transmitted over standard voice-grade telephone lines to the plotter. Data can be transmitted in burst mode—eight times plot speed. The information is delivered to a buffer which feeds the magnetic tape unit—an IBM-compatible 7- or 9-track magnetic tape drive. Redundancy checks are built into the magnetic tape unit so that each vector is accepted only when all system checks pass.

"We worked out a compact code notation," says Villers, "that incorporates ASCII language to symbolize the vectors. With the low cost for core memory and medium-scale integrated circuits, telephone transmission has just now become feasible."

The photoplotters has a selection of 96 apertures, including 32 plotting symbols, which can be used as flash pads and for line drawing, as well as 64 alphanumeric characters and symbols. The aperture sizes range from 0.005 inch to 0.150 inch and have a maxi-

mum indexing time of 300 milliseconds.

For integrated-circuit design, the Compucircuit's photohead can be modified to incorporate 24 fixed apertures and eight operation-changeable apertures. An optical zoom system lets the operator select the aperture necessary for the generation of 100X IC photomasks. Both the aperture location and the optical gain setting (zoom) are program controlled, allowing the Compucircuit zoom to photoplot any aperture, including squares and rectangles, from 0.002 inch to 0.300 inch in increments of 0.0001 inch.

The unit can be purchased as an option with an on-site processor, which is loaded with the same cassette as the plotter. The developed artwork can be visually inspected within two minutes after loading.

The standard Compucircuit 100 photoplotters system, including magnetic tape unit, Polaroid and standard film with cassette loading, software, and full alphanumeric keyboard, is priced at \$49,700. The accuracy of the line widths in the standard unit is 0.001 inch, and for an extra \$5,000, the system's accuracy can be increased to 0.0005 inch—an accuracy that is generally attained only in systems priced over \$100,000, the company says.

Computervision Corp., Northwest Industrial Park, South Avenue, Burlington, Mass. 01803 [339]

The big difference between chip capacitors and our 505 series

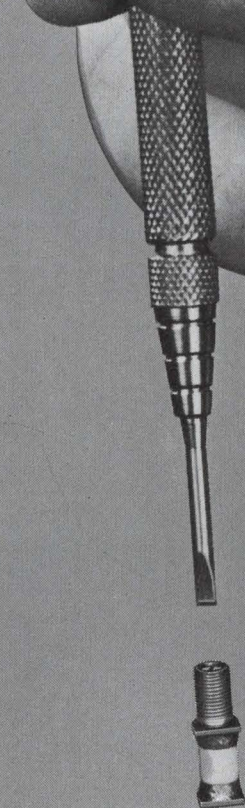

they're trimmable

Our new 505 series is compatible with chip bonding techniques for microcircuit and strip line applications . . . and they're trimmable in ranges from .1 to 100 pF!

But trimmability is only one of the plus advantages of this new series, they feature high Q (self-resonant into X band), ΔC 's of 1 to 15 pF, and low temperature coefficients ($0 \pm 20\text{PPM}/^\circ\text{C}$).

When your application calls for high Q chips, be sure to check the 505 series, they do everything a chip does — plus. Send today for full details.

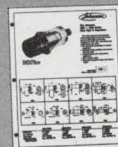

Johanson

MANUFACTURING CORPORATION

400 Rockaway Valley Road, Boonton, N.J. 07005
(201) 334-2676 TELEX: 13-6432

Circle 143 on reader service card—>

Power Transistors



We sifted out 61

From the accumulation of 5,289 high power transistors now available, *TI has selected 61 that cover more than 80% of all circuit needs.

All are popular, proven and readily available from TI distributor and factory stocks.

They're part of TI's line of 322 preferred semiconductors, chosen after months of computer demand analysis to save you time and money in specifying discrete components.

TI's 61 preferred power transistors are general purpose silicon devices with outputs from 1 to 30 amps. Their applications range from cost-critical industrial de-



signs to military-type equipment operating in hostile environments.

If one of the preferred 61 doesn't fit your specific requirements, we have over 100 other standard types to choose from.

Write for TI's new *Preferred*

TI Preferred Silicon Power Transistors

Industrial Types		High Reliability Types				
TIP29	TIP34	2N3789	2N1724	2N3420	2N4000	2N5387
TIP29A	TIP34A	2N3790	2N2987	2N3421	2N4001	2N5388
TIP30	TIP35	2N3791	2N2988	2N3551	2N4002	
TIP30A	TIP35A	2N3792	2N2990	2N3552	2N4003	
TIP31	TIP36	2N4398	2N2991	2N3846	2N4300	
TIP31A	TIP36A	2N4399	2N2992	2N3847	2N4301	
TIP32	2N3713	2N5301	2N2993	2N3996	2N5333	
TIP32A	2N3714	2N5302	2N2994	2N3997	2N5384	
TIP33	2N3715	2N5303	2N3418	2N3998	2N5385	
TIP33A	2N3716		2N3419	2N3999	2N5386	

Semiconductors and Components catalog: Texas Instruments Incorporated, PO Box 5012, MS 308, Dallas, Texas 75222.

Circle reader service number 220. Or see your nearest TI Distributor.



*1970 worldwide figure from D.A.T.A. Inc., publisher of *Electronic Data*

TEXAS INSTRUMENTS
INCORPORATED

Optoisolator DIPs into market

Phototransistor coupled pair competes for transformer jobs, offering dual-in-line configuration, low price, no leakage paths

Isolation or pulse transformers provide a high degree of input-to-output block between stages of a system or large network. They are used, for example, to isolate powered equipment from the power source; to provide unilateral signal transfer, and, in pulse transformers, fast response speed. But such transformers are magnetically coupled to the circuit, increasing the

chances of leakage paths. And they're bulky.

Monsanto is now marketing the MCT-2 phototransistor coupled pair to perform the same isolation job with better electrical properties, competitive prices, and no leakage, because no magnetic paths exist. Unlike the pulse transformer, the Monsanto device is available in a dual-in-line package and can be

inserted in a printed-circuit board as easily as can an integrated circuit.

The optoisolator provides high isolation resistance of 10^{11} ohms—at least twice that available from transformers—and high current transfer ratios—typically 35%. The MCT-2 sells for \$3.95 each in quantities from 100 to 999 units. Later this year, Monsanto plans to intro-

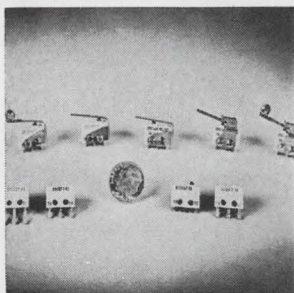

Sub-subminiature snap action switches series SS10 are for electronic instrumentation and aerospace applications. They come in single and double turret, 0.055-in. pin and 0.058-in. quick connect terminals. The series has a minimum electrical life rated at 50,000 operations, and a minimum mechanical life of 150,000 operations. Cutler-Hammer Inc., N. 27th St., Milwaukee [341]

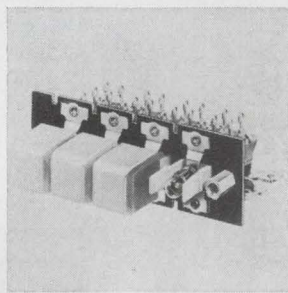

Multi-Switch switch series DW-67000 offers an economical solution to many human engineering problems associated with push-button illumination. Illumination is provided by a single T-1¾ flanged based lamp per station, offered in 6, 28 or 110 (neon) voltages. Up to 4 pdt double-wipe switching per station is available. Switchcraft Inc., N. Elston Ave., Chicago 60630 [342]

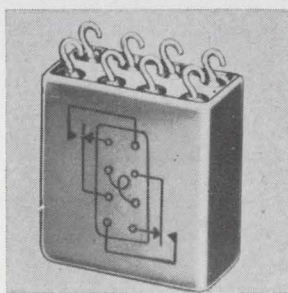

Crystal can relays type FC are designed and built to handle high and low level loads over long life in demanding environments. Hardened silver alloy contacts are rated low-level to 2 amps. The relay will deliver a minimum of 100,000 operations at rated load. Operate and release time is 5 msec maximum. C.P. Clare & Co., 3101 W. Pratt Blvd., Chicago 60645 [343]

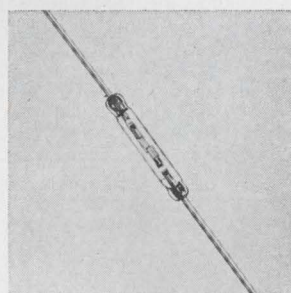

Center-gap reed switch Tiny Tina was designed to meet the electrical and physical requirements of dual in-line reed relay manufacturers. Diameter is 0.070 in. and capsule length is 0.500 in. Operate time, including bounce, is typically 250 µsec, and less than 50 mw of power are needed for switch operation. Gordos Corp., 250 Glenwood Ave., Bloomfield, N.J. 07003 [344]

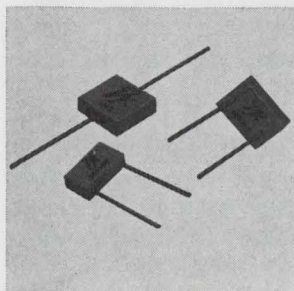

Tight tolerance porcelain capacitors are offered in eight different series which include 22 styles. Available in a capacitance range of 0.24 pf through 10,000 pf, capacitors have tolerances of either ±0.1 pf or ±1%. They are extremely stable and have low dielectric absorption and low drift. Price is 80 cents and up. Vitramon Inc., Box 544, Bridgeport, Conn. [345]

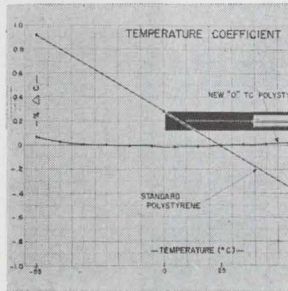

Zero temperature coefficient polystyrene capacitor type PSTZ operates over the range of -55° to +85°C. Capacitance values range from 0.001 to 1 µf at 50 v-600 v. Standard tolerance is ±5% with 2%, 1%, 0.1% and 0.05% available upon request. Dielectric absorption is less than 0.01%. Price in 100 lots (0.022 µf) is \$3. Electronic Associates Inc., W. Long Branch, N.J. [346]

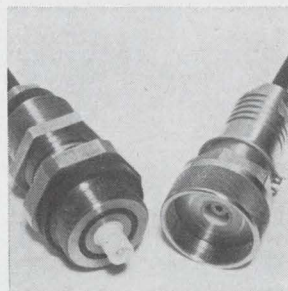

High temperature, high pressure connectors are for use in deep-hole instrumentation. The connectors are designed to withstand hydrostatic crush pressures to 3,100 psi while operating at temperatures to 225°F. Maximum open face pressure is 1,200 psi. Maximum operating voltage is 10 kv. Bulkhead isolation is 10 kv. Times Wire & Cable Co., 358 Hall Ave., Wallingford, Conn. 06492 [347]

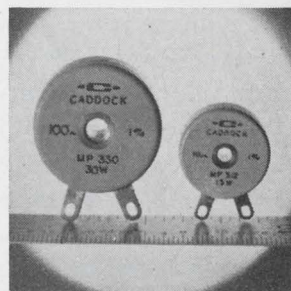

Laminar design film power resistors are now available in a 30-watt model. The series offers size and weight reduction up to 50% compared with conventional power resistor design. Standard tolerance is 1%, with a temperature coefficient of 50 ppm/°C at 275°C. Units meet requirements of Mil-R-18546-D. Caddock Electronics, 3127 Chicago Ave., Riverside, Calif. 92507 [348]

What Memory-System Maker Is Speeding Up the Cycle Time— But Holding Down the Price? Toko. Of course!

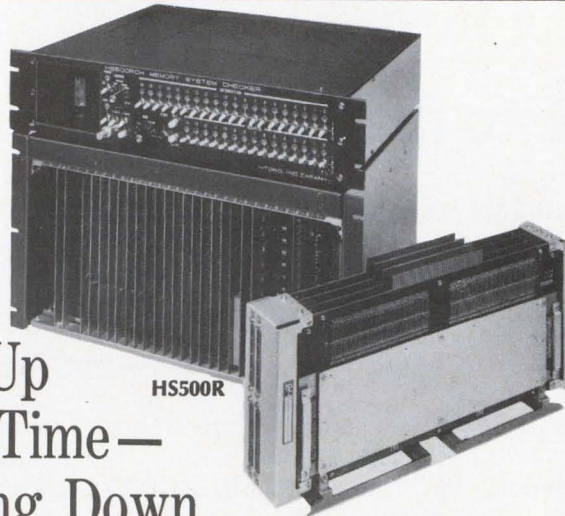

Beef up your technology with Toko's 500 nanoseconds Memory System without raising your costs.

Now rolling off the production line, Toko's HS500R Memory System offers the following key features:

- * Access time of 250ns. * Memory capacity of 4K words by 18 bits expandable to 16K words by 18 bits, rearrangeable to multiples of 36 and 72 bits.
- * Compact, space-saving advantages—measuring 10" x 19" x 13-1/3".

Toko's advanced electronic technology also enables it to provide computer components, such as memory stacks. Contact Toko today for details.



TOKO, INC.

Head Office: 1-17, 2-chome, Higashi-Yukigaya, Ohta-ku, Tokyo, Japan
 TOKO N.Y., INC. 350 Fifth Avenue, New York, New York 10001 Tel: 212-565-3767

Circle 176 on reader service card

Everything's clearer with the flat one!

Letters! Digits! Symbols! Equations! All varieties of data are displayed as undistorted images on Zenith Flat-Face Metal CRTs. Ideal for light pen operations, alphanumeric and analog presentations — they're even available with a rear port for optical chart projection. When you need CRTs, face up to the flat one. Write for details.

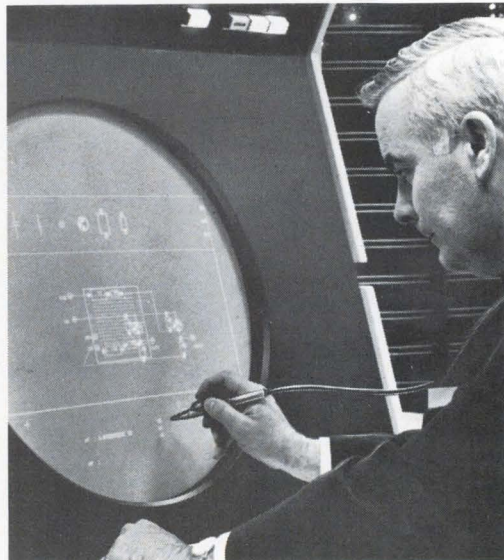

ZENITH RADIO CORPORATION
 THE RAULAND DIVISION

5614 W. JARVIS AVE. • CHICAGO, ILL. 60648 • 312-647-8000

146 Circle 146 on reader service card

... aimed at control and switching jobs ...

duce a photodiode coupled pair, the MCD-2.

The phototransistor coupled pair is available in a six-lead, plastic dual-in-line package that meets all standard DIP dimensions except for a length of 0.34 inch. The configuration, called Iso-dip, is compatible with automatic-insertion techniques and p-c board spacing standards. The MCD-2 will be offered in the same package.

Electrically, the MCT-2 consists of a diffused planar infrared light-emitting diode optically coupled to a silicon planar phototransistor. Each device is physically separated from the other for high isolation.

The light-emitting diode, a gallium arsenide device, can dissipate 100 milliwatts of power at 25° C ambient temperature; derating is linear at 1.33 mw/°C from 25° C. Other maximum ratings are 60 milliamperes forward current, 3.0 volts forward voltage, and 3.0 amperes peak forward current. The detector is a silicon phototransistor that can tolerate a maximum power dissipation of 150 mw at 25° C ambient, derated linearly at 2.0 mw/°C. It has breakdown voltage ratings of 30 volts collector to emitter, 7.0 volts emitter to collector, and 70 volts collector to base.

The unit has a coupling capacitance of 1.3 picofarads, and rise and fall times of 2 microseconds. It has a base-lead terminal from which the phototransistor's base-emitter resistance can be varied. This results in greater design flexibility, permitting a tradeoff to be made between speed and sensitivity.

Other features for the MCT-2 include a power dissipation of 100 milliwatts at 25° C, a continuous forward current of 60 milliamperes, a reverse voltage of 3 volts, and a peak forward current specification of 3 amperes.

Among applications are systems and chassis isolators, high-voltage power supply controls, phase controls, and general-purpose switching.

Monsanto Electronic Special Products,
 10131 Bubb Road, Cupertino, Calif.
 95014 [349]

Electronics | May 25, 1970

A significant advance in silicon rectifier power handling capacity

3 new series of silicon rectifiers from Tung-Sol permit designers to meet extremely high power requirements.

- Reverse voltage ratings to 5000 Volts
- Average forward current to 500 Amperes
- Surge overload ratings up to 8500 Amperes

Controlled avalanche characteristics provide transient handling capability that results in increased reliability.

All units feature ceramic-to-metal seals, mount in any position and are supplied in either polarity.

1511 SERIES

Max. av. forward current at 120° C—420 Amperes
Surge overload rating, 1 cycle—6000 Amperes
Controlled Avalanche Voltage—1250-3500 Volts



1621 SERIES

Max. av. forward current at 120° C—500 Amperes
Surge overload rating, 1 cycle—8500 Amperes
Controlled Avalanche Voltage—1100-2300 Volts



1611 SERIES

Max. av. forward current at 120° C—470 Amperes
Surge overload rating, 1 cycle—5200 Amperes
Controlled Avalanche Voltage—2600-5000 Volts

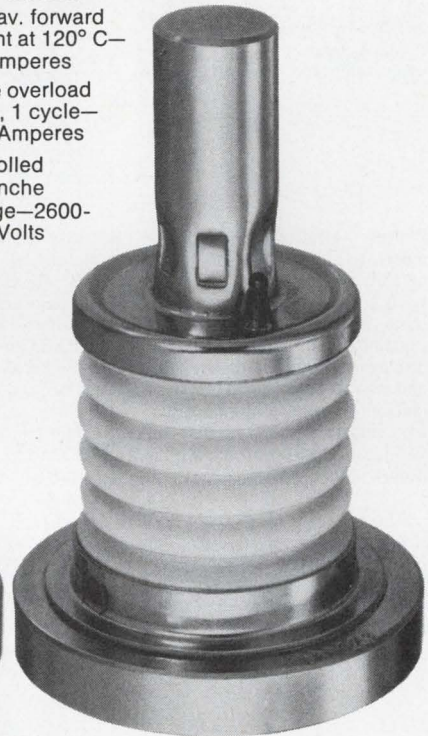

Write for technical data bulletins—

Tung-Sol Division, Wagner Electric Corporation
630 West Mt. Pleasant Ave., Livingston, N.J. 07039
Twx: 710-994-4865 • Phone: (201) 992-1100; (212) 732-5426

TUNG-SOL

High Power Silicon Rectifiers

Trademark TUNG-SOL Reg. U. S. Pat. Off. and Marcas Registradas

Meter finds phase angle automatically

Programable unit has four-digit display, plus bcd and analog outputs; accuracy is 0.1°

An engineer may need Wavetek's 755 phasemeter but it doesn't need him—it's automatic. That's unusual, because finding a phase angle is one of the basic measurements that still can demand dial turning and seat-of-the-pants experience.

But all that's involved in running the 755 is connecting it to the two signals whose phase difference is to be measured and sending the

instrument's output to a computer or some recording device.

The 755 puts out an analog signal—10 millivolts per degree—for things like pen recorders and oscilloscopes, and TTL compatible binary-coded-decimal signals. And the instrument has a four-digit display on its front panel.

Each input can have any amplitude from 50 millivolts to 50 volts

rms; a 60-decibel input change affects the accuracy by less than 1.5° .

The frequency range is 40 hertz to 2 megahertz, and, depending on frequency, accuracy can be as good as 0.1° .

The 755 is basically a programable version of Wavetek's 750, a digital phasemeter for benchtop-category measurements. Like the older unit, the 755 uses a zero-

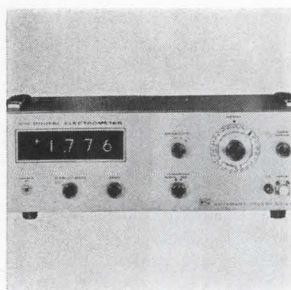

Digital electronic multimeter model 615 has measuring spans of 100 μv to 100 v, 10^{-15} amp to 0.1 amp, 100 ohms to 10^{14} ohms, and 10^{-14} coulomb to 10^{-25} coulomb. Unit offers $3\frac{1}{2}$ digit display with 100% overranging, and the decimal point is automatically positioned when changing ranges. Display rate is adjustable. Keithley Instruments Inc., Aurora Rd., Cleveland [361]

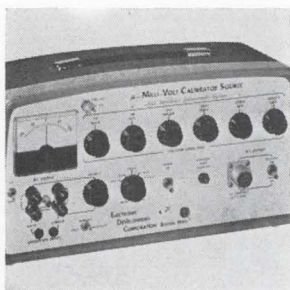

Low-impedance d-c millivolt standard model MV105/series B is a versatile tool for aircraft instruments calibration. It has two output ranges: 0 to ± 10 v resolved to 10 μv and 0 to ± 111 mv resolved to 0.1 μv . The Z_{out} (10 v range) is less than 0.02 ohm; on the mv range, 2 ohms (constant) at 0.1 μv to 100 mv. Electronic Development Corp., 11 Hamlin St., Boston, Mass. [362]

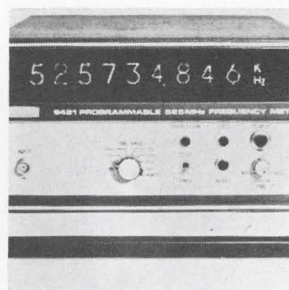

Frequency meter model 6421 provides a high sensitivity of -10 dbm and a dynamic range to $+33$ dbm. It offers direct counting across the entire band yielding the most accurate method of measurement in the shortest time. Unit can measure waveform periods to 2 Mhz with a resolution of 1 μsec . Beckman Instruments Inc., 2200 Wright Ave., Richmond, Calif. [363]

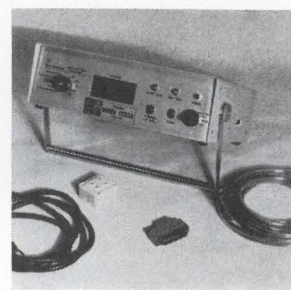

Preset, bit-count modem tester is for accurately determining error rates on asynchronous modems to 240 bps and synchronous modems to 200,000 bps. Designed for both local and remote looped, full duplex modems, it provides one-way transmission or reception for half duplex or simplex modem testing. Sanders Associates Inc., Daniel Webster Highway South, Nashua, N.H. 03060 [364]

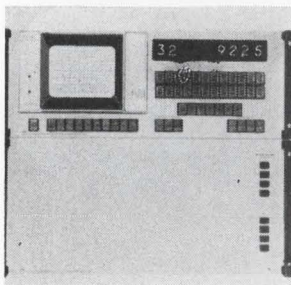

Real-time analyzer type 1909 is a 100-hz-to-20-khz unit that features 1- μv sensitivity, a built-in scope display, and simplified pushbutton operation. The input signal is divided into 24 $\frac{1}{3}$ -octave band channels, each channel output is converted to digital form, and a digital processor computes the rms level. General Radio Co., 300 Baker Ave., West Concord, Mass. 01781 [365]

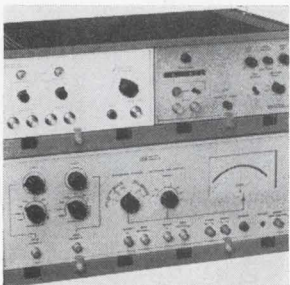

Time-delay unit model 55D75 provides the signal delay required for the measurement of time correlation functions. It produces a delay between signals under investigation. The unit operates on sampling techniques. Prior to the actual sampling, the two signals to be correlated are filtered, and if necessary attenuated. Disa-S & B Inc., 779 Susquehanna Ave., Franklin Lakes, N.J. [366]

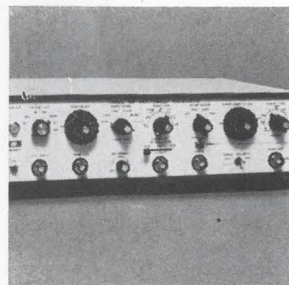

Two-in-one waveform generator model 126 has voltage-controlled frequency and an internal 1,000:1 sweeping source. Frequency bandwidth is 0.1 hz to 3 Mhz. Unit produces sine, square, triangle, ramp, pulse and sync waveforms, and can operate in any one of six modes: run, gate, triggered, burst, pulse, and sweep. Price is \$495. Exact Electronics Inc., Box 160, Hillsboro, Ore. [367]

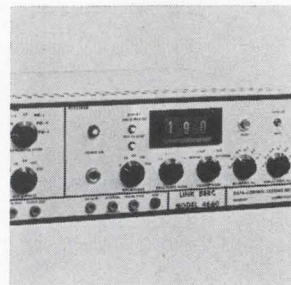

Link-Berc model 4660 can measure and display the bit error rate caused by digital transmission, detection, or storage devices. It can also measure and display clock advances and retards (bit slippages) within modems and bit synchronizers. It operates from d-c to 10 megabits per sec in any of the IRIG codes. Data-Control Systems Inc., Commerce Park, Danbury, Conn. 06810 [368]

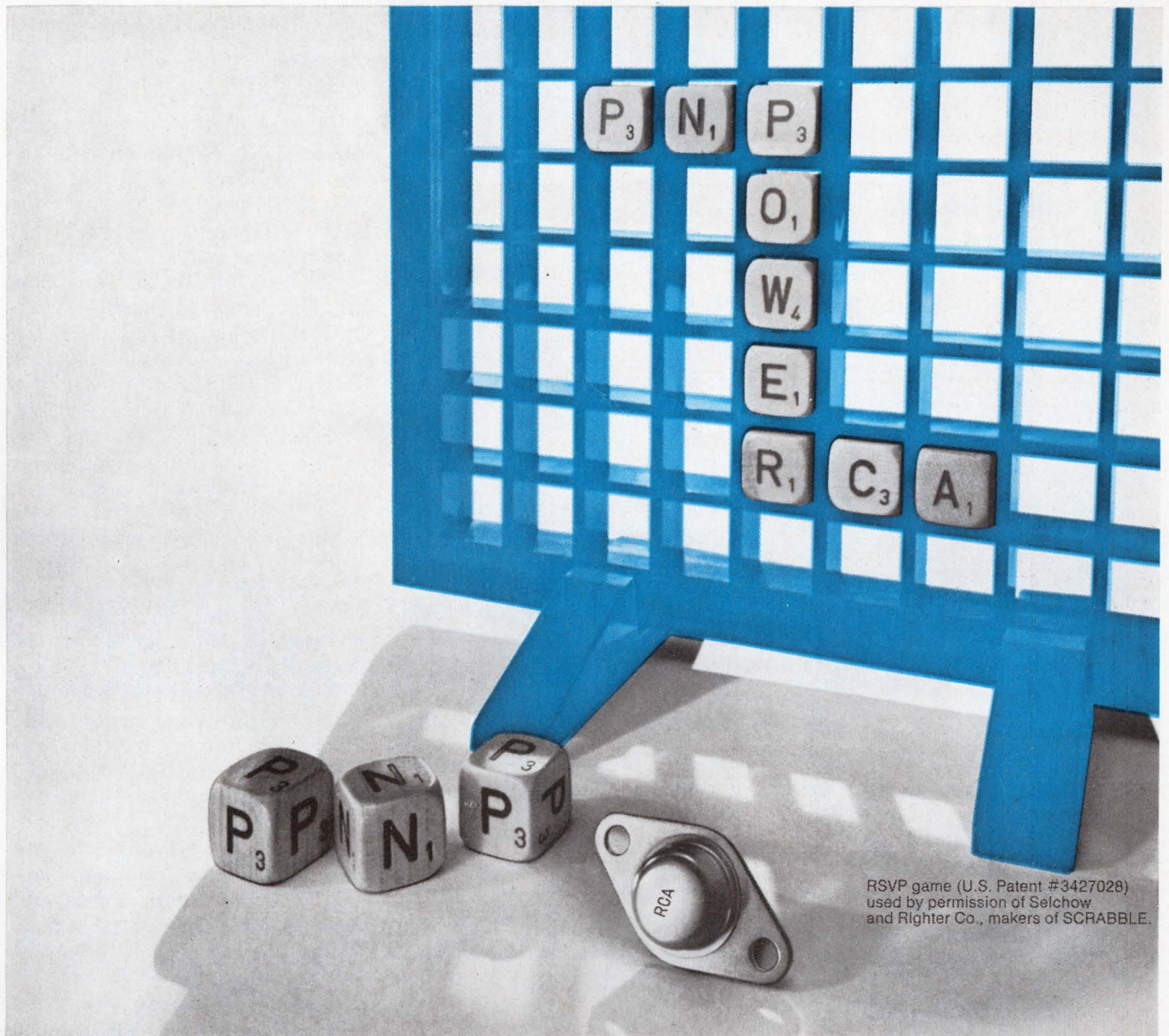

RSVP game (U.S. Patent #3427028) used by permission of Selchow and Righter Co., makers of SCRABBLE.

You Win With RCA P-N-P Power... New 2N5954 Family (2N3054 Complement)

This new RCA p-n-p transistor has the qualifications that can make winners of you and your designs. The 2N5954 is a silicon power unit in a hermetically-sealed TO-66 package. Complementing the 2N3054 (already widely known in sockets in military, industrial, and commercial equipment), the 2N5954 features controlled second-breakdown ratings. To be sure, each transistor is individually tested to meet specified parameters before it is shipped.

The new 2N5954 family with its multiple epitaxial structure and emitter ballasting techniques add up to a traditionally rugged RCA power device...giving you the design capability to achieve high performance levels in your equipment. One of three new RCA p-n-p types now offered for switching and amplifier applications, 2N5954 (or its family types, 2N5955 or 2N5956), together with its n-p-n complement, provide bi-directional control and phase inversion advantages.

P-n-p/n-p-n complements are particularly advantageous if you're trying to cascade four or five stages. In a power supply design, for example, the use of complementary types can eliminate voltage build-up that would be encountered if cascaded n-p-n, or cascaded p-n-p types were employed.

Check the chart on these new types. For more information, consult your local RCA Representative or your RCA Distributor. For technical data, write: RCA Electronic Components, Commercial Engineering, Section 76E-2 /UT8, Harrison, N. J. 07029. In Europe: RCA International Marketing S.A., 2-4 rue du Lièvre, 1227 Geneva, Switzerland.

Type No.	V _{CB0} (V)	V _{CEX} (sus) (V)	V _{CER} (sus) (V)	V _{CEO} (sus) (V)	I _C (A)	P _T (W) @ T _C = 25°C
2N5954	85	85	80	75	-6	40
2N5955	70	70	65	60	-6	40
2N5956	50	50	45	40	-6	40

RCA

**Send us your
precious metal scrap...**

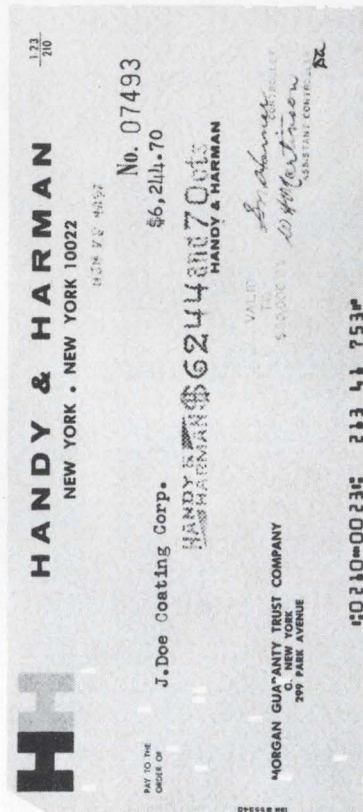

**we'll send you
a big check.**

Handy & Harman has been refining its own scrap for a century. We know how to extract the last pennyweight of value. We have the equipment and the techniques to produce maximum value. Interested? We have some literature that tells the whole story, from finding the scrap to getting the check. Use the coupon.

*Please send your booklet about
precious metal scrap.*

Name _____
Title _____
Company _____
Address _____
City _____
State _____ Zip _____

HANDY & HARMAN
850 Third Avenue, Dept. EL16,
New York, N.Y. 10022

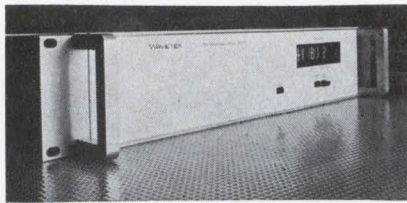

Big range. Each phasemeter input can be from 50 mv to 50 volts rms.

crossing technique. Each input goes through its own tunnel-diode network to a flip-flop. One of the inputs crossing zero sets the flip-flop; the other one crossing resets it. Thus the flip-flop's output is a measure of the phase difference between the two inputs.

Feedback loops in its diode networks make the phasemeter immune to even-harmonic distortion.

The 755 measures on command; time per reading is 500 milliseconds maximum. Self-calibration circuits are built in. Available as an option are circuits that allow the 755 to work with Wavetek's model 157 waveform synthesizer. When the 157/755 combination is phase locked to a reference-frequency signal, it puts out a square, sine, or triangular wave, whose amplitude and phase separation from the reference signal can be programed.

Price for the 755 is \$2,000.

Wavetek, 9045 Balboa Ave., San Diego, Calif. 92123 [369]

New instruments

Accurate markers made anywhere

**Sweeper attachment puts out
three adjustable markers that
can be set to within 0.25%**

When a sweep generator marks its output, the markers occur either at accurately known (within 0.005%) but unchangeable frequencies, or around some frequencies (1% accuracy) set by the user. Now the markers can have both virtues—accuracy and adjustability.

Engineers at the Kay Elemetrics Corp. have built a sweeper attachment—the 8323A—that puts three markers onto a sweeper's output. Each marker is set with an accuracy of 0.25% of the sweeper output's bandwidth, and can be set to any frequency in that band. The \$1,295 attachment, whose range is d-c to 115 megahertz, works with any sweeper that can be externally controlled, and also can work alone as a frequency counter.

To make markers with the 8323A, the user first connects his sweeper's output to the unit's test-signal input terminal. This routes the sweeper's signal through the 8323A's counter to an output terminal. From there the signal goes into the user's test setup—maybe a filter or a receiver—whose output goes back into the 8323A through a "vertical input" jack. The markers are added, and the signal leaves the unit, usually to go to an oscilloscope's vertical input.

The 8323A has two other outputs: sweep signals for a scope's horizontal input and for the sweeper. The rates are adjustable between 0.01 sweep and 100 sweeps per second.

The unit has a five-digit display which shows the frequency at a marker selected with a three-position switch. The markers themselves are triangles of adjustable height and widths.

Stop. Telling how the 8323A works, Kay assistant chief engineer William Tanis says: "We're stopping the sweep momentarily on the marker and counting the frequency, and then letting the sweep go. We really only have to stop for a fraction of a second to get resolution."

Talking about the markers, Tanis adds: "The marks are actually generated off the sweep voltage, as they are in microwave sweepers. But it's not exactly the same, since our markers are independent of sweep rate or sweep width."

As a counter the 8323A resolves 1 hertz in its range from d-c to 10 Mhz, and 10 hz from 1 to 110 Mhz. Sensitivity is 100 or 200 millivolts rms, depending on the frequency range; stabilities are 1 part per million per 30 days and 0.2 ppm per °C.

Kay Elemetrics Corp., 12 Maple Ave., Pine Brook, N.J. 07058 [370]

Clad metal parts reduce production costs.

Can you save on silver...or labor?

There are still ways to cut the costs of fabrication.

The technology of cladding is expanding rapidly, saving money where two or more metals must work closely together.

Handy & Harman has adapted the technology to producing clad metals which reduce the amount of precious metal needed in many components. Our Bimets put the precious metal only where it's needed—base metal supplies the beef.

Now, thanks to the addition of American Clad Metals, Inc., Pawtucket, Rhode Island, to the Handy and Harman group, we are able to provide a greater variety of clad metals that reduce costs by reducing labor.

We have attacked the costs of making a connection. Fabrication of a finished assembly often calls for soldering. This involves placing of the solder, or a preform. This expensive operation can be eliminated by using a clad metal that consists of the part to be soldered, clad with

the solder.

We are manufacturing a variety of these solder-clad bimets, cladding solder (of various tin/lead ratios) to such base metals as steel, copper, copper-clad aluminum and nickel-clad moly.

This may sound like small potatoes. But we prepared solder-clad metals for a company that makes electrical components, and the elimination of solder preforms will save them \$150,000 per year in the production of just one of their components. The company is now working with us in investigating clad metals of various materials for five other assemblies.

You may be using more silver or gold than necessary. You may be using too much labor for joining functions.

Handy & Harman would like to discuss the possibilities of our rolling a clad metal strip or drawing a Bimet wire, to reduce your manufacturing costs. Just ask us.

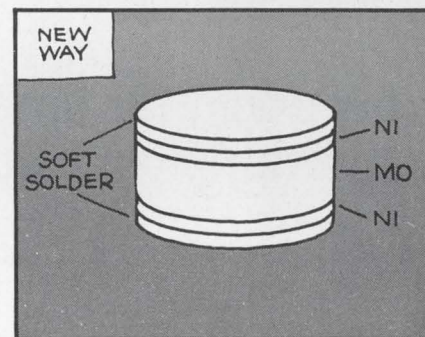
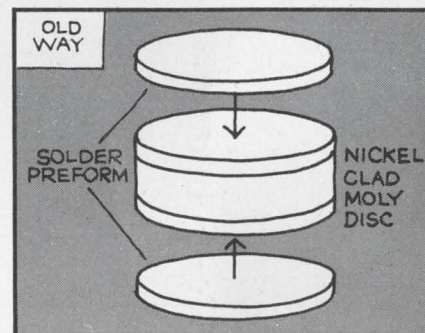

Naturally, you'll ask Handy & Harman

how Bimets could be used for

Application: _____
Name _____ Title _____
Company _____
Address _____
City _____
State _____ Zip _____

Send to: Handy & Harman, 850 Third Avenue, Dept. EL60, New York, New York 10022



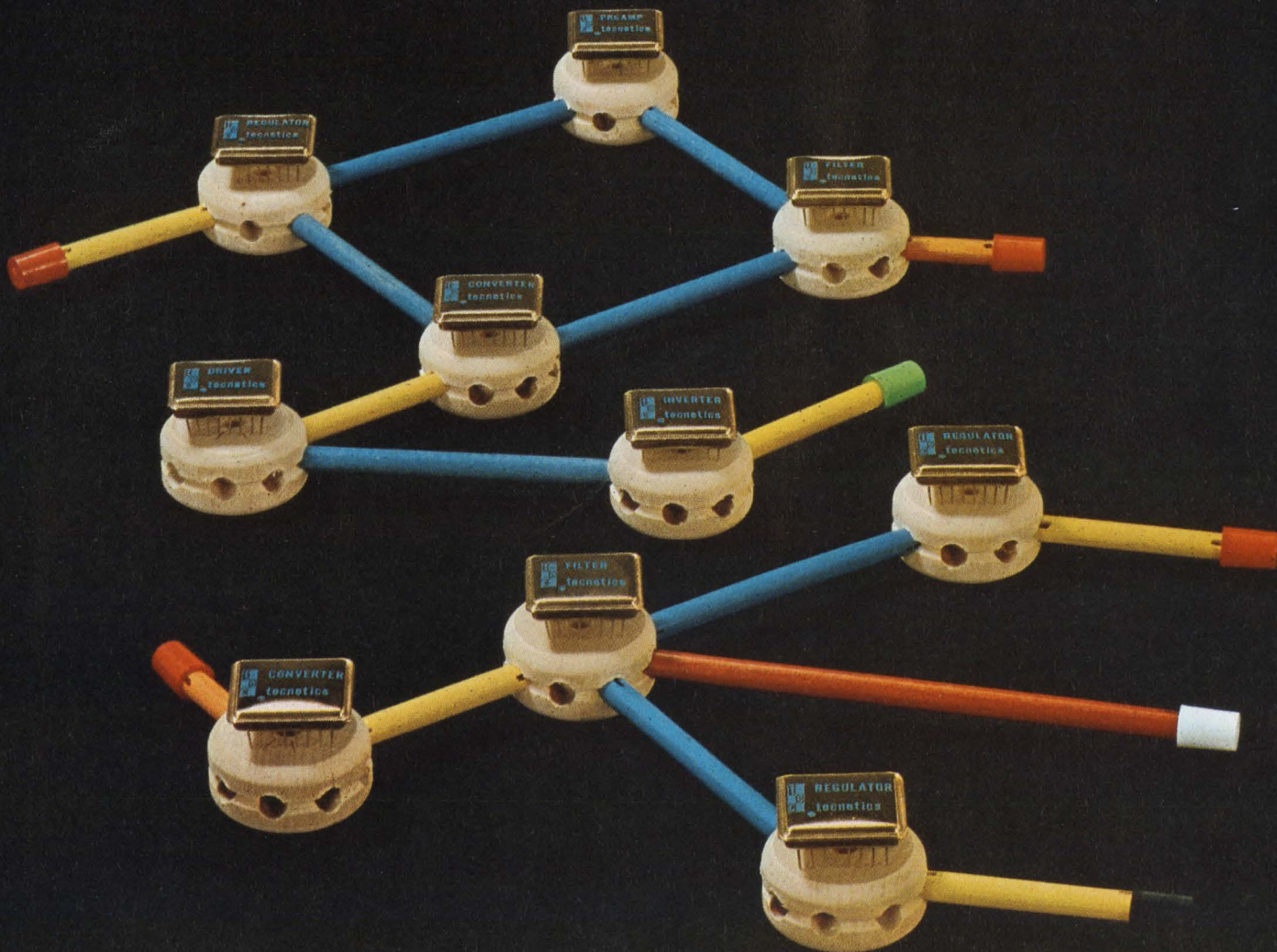

Tecnetics' Report #2

New designer time savers -- hybrid power conditioning modules in high integrity packages.

Our cold welding capability now makes reliable square packages possible for hybrid power conditioning components. And check these features:

- Standard 16-pin PC or socket mounting
- Hermetically tested to exceed 10^{-9} cc He/sec
- Qualified to all the workmanship and environmental standards of MIL-STD-883
- Low profiles allow minimum card spacing
- Metal package reduces interference

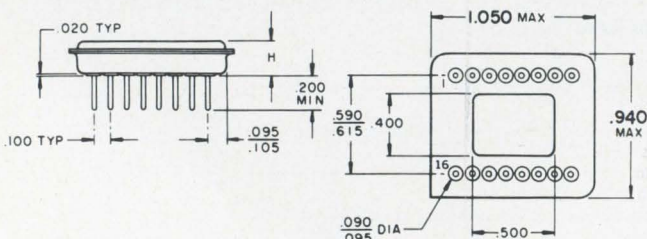

The beginning: Hybrid Voltage Regulators

These units provide the highest performance available from any I/C point-of-load regulator and all 22 models require only one external component.

Here are the specs:

- Output voltage: Units are factory set to $\pm 1\%$ covering the range of +3.0 to +32VDC, all with negative counterparts and all capable of external adjustment over a wide range.
- Output current: 250mA with extension to 5A with one external pass transistor.
- Regulation: 0.01% typical line and load.
- Noise & ripple attenuation: All units 4000:1 typ. (72 db).
- Power dissipation: 2.0 watts at 25°C.
- Temperature coefficient: $< 1\text{mV}/^\circ\text{C}$ from -55 to $+125^\circ\text{C}$.
- Protection: Short circuit proof, current foldback.

These regulators are the first of the Tecnetics power conditioning modules available for the OEM in the exciting new cold weld package. And others are on the way: converters, inverters, reference amplifiers, drivers, filters, and more.

For more information on other TEC power conditioning products, call us collect at 303-442-3837, or see EEM, pp. 2120-2125, the inside cover of EBG, or write . . .

Tecnetics, Inc. (formerly Transformer-Electronics Co.), P. O. Box 910, Boulder, Colorado 80302. TWX 910-940-3246.



tecnetics inc. The innovators in power conditioning

Add-on tester speeds IC production line

Machine for d-c parameter testing can be linked to large system or used for incoming inspection

As a large IC test system nears the limit of its operating capacity, the circuit manufacturer must reach a decision on his course of action. He may opt for either a second large test system or a stand-alone system.

Micro Test Corp's Gibson Hattery, national sales manager, says that if the manufacturer is committed to testing with a Fairchild

4000 or 5000 or a Teradyne 259, he could pay as much as \$100,000 for a second large system.

Then, of course, there's the add-on option, which Micro Test advocates. The company has brought out a new, functional d-c parameter IC tester designed to handle production, evaluation, and incoming-inspection testing, and to interface with remote test stations,

wafer probes or large test systems.

Micro Test says that, in addition to outperforming other small stand-alone testers in the \$9,000-to-\$12,000 price range, its series 360 tester can substantially increase production rate when linked with larger test systems.

Hattery says the larger systems typically have test times of about 1 second, while, by comparison,

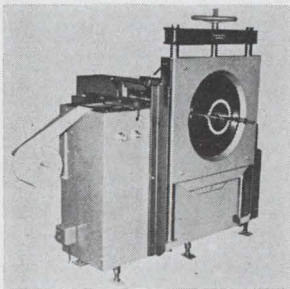

Automated slot cell inserter Simi-10 for electric motor stators can be used with stators up to 10 in. in stack height, in ratings through medium-sized integral h-p units. Stack height adjustment, infinitely adjustable up to the maximum, can be made in minutes, while complete tooling changes take about 1/2 hour. Industra Products Inc., Box 626, Baer Field, Ft. Wayne, Ind. [421]

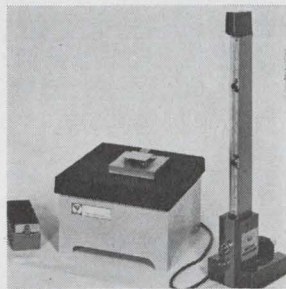

Nondestructive testing system, which can measure flatness differences as small as one ten-millionths of an inch, speeds photo-mask production. Test is made without touching the active surface which may be opaque, transparent, conducting or nonconducting. Calibration is traceable to the National Bureau of Standards. Towne Laboratories, U.S. H'way 206, Somerville, N.J. [422]

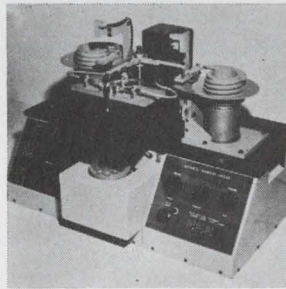

Automatic T-Pack transistor probing and sorting system operates at speeds to over 4,000 per hour. It has dual parts feeders and a programmed dual Vacuarm transfer device. The parts are oriented and placed in a test nest where the 3 leads are probed simultaneously, and then parts are air ejected into proper category. Affiliated Manufacturers Inc., Box 248, Whitehouse, N.J. [423]

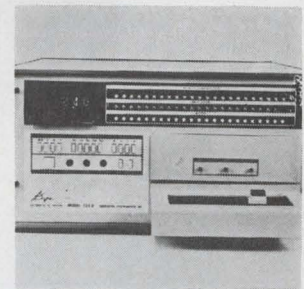

Bench-top system 724A provides parametric testing of 24-lead IC's. It handles functional and d-c testing of TTL, DTL, ECL and HNIL devices. Hand-fed by an operator, the unit will test up to 400 devices an hour. Connected to an automatic handler or wafer prober, the system will test as many as 6,000 an hour. Microdyne Instruments Inc., 203 Middlesex Turnpike, Burlington, Mass. [424]

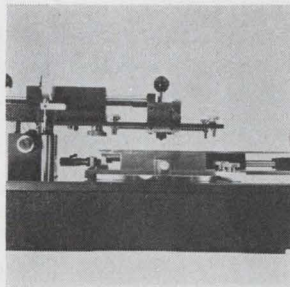

Controlled manual screen printer for the thick film industry allows contact and off-contact printing with woven screens and metal masks. It takes substrates up to 3 in. sq. by 1/4 in. thick, and any commercial frame up to 8 x 10 in. Printing repeatability is better than 0.001 in. with X, Y and Z micrometer positioning. Engineered Technical Products, Box 1465, Plainfield, N.J. [425]

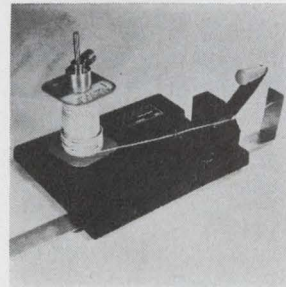

Bench tool model 7B cuts hookup wire or sleeving to preset length at up to 1,000 pieces per hour, replacing costly automatic units for shorter runs. Length range is 1/4 in. to 12 in., and up to 5 ft with separate end stop. Accuracy is $\pm 1/32$ in. It cuts copper wire up to No. 14 Awg and plastic tubing up to 1/4 in. diameter. Innes Instruments, Box 5216, Pasadena, Calif. [426]



Thermocouple welder 116SRL welds wires from 55 to 20 Awg in any material, including copper, platinum, and others. A tungsten inert gas arc is energized to the specified temperature for the correct length of time by the power supply unit which incorporates 3 position switches for weld time and weld current. Dynatech Corp., 17 Tudor St., Cambridge, Mass. [427]

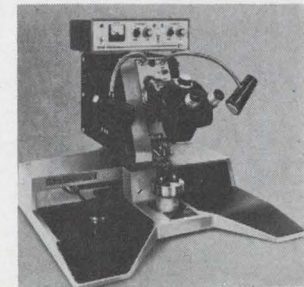

Improved version of the model 484 wedge bonder can bond 4,000 semiconductor wires per hour. It offers solid state control circuitry and photocells to take the place of carbon brushes. Descent rate of the tool at the moment of bonding has been slowed for better control and to prevent excessive wire deformation. Kulicke & Soffa Industries Inc., Fort Washington, Pa. 19034 [428]

Micro-Miniature Reed Relays

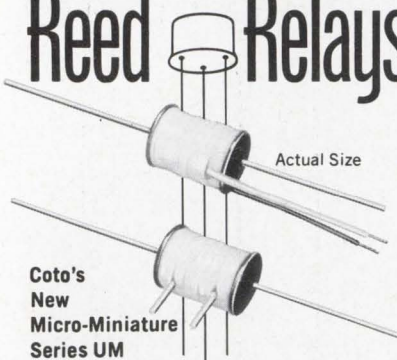

Coto's New Micro-Miniature Series UM

- Extremely small size: .400" x .300" OD
- Occupies less than 0.03 cu. in.
- Ultra-high speed 100 Microseconds operate time excluding bounce
- Stock voltages 3, 6, 12 and 24 volts
- Available with either leads or pins with 0.2" spacing

Special voltages, resistances, electrostatic and/or magnetic shields available. Write for new Data Sheet MR-9.1



COTO-COIL COMPANY, INC.
61 Pavilion Avenue, Providence, R. I. 02905
Tel: (401) 941-3355

Circle 177 on reader service card

SAN-E

MSP-4 full four track stereo R/P head for auto-reverse cassette system



MSP-4 ¼ track full 4 heads R/P head for phillips cassette tape PE-M AC bias eraser for MSP-4 head

Other product
8 track (MS-8) stereo head for home & car stereo
*** write immediately for further details**

SAN-E DENKI COMPANY, LIMITED.
110-1 Minami-Kawahori-cho, Tennoji-ku, Osaka, Japan
phones: 779-1591
cable: SANMAGNETICS

154 Circle 154 on reader service card

. . . can be multiplexed with remote stations, wafer probes, or large systems . . .

the series 360 has a total test time of only 250 milliseconds, including about 150 msec for probe indexing. By doing d-c testing at the wafer probe level with the 360, says Hattery, the capabilities of the larger tester can be used at the final inspection point—thus substantially increasing the production volume for the entire test system.

An interface box offered as an extra-cost option with the 360 sells for from \$2,000 to \$5,000, depending on user requirements, and can be used with Fairchild 4000 and 5000, Teradyne 259, and Signetics 1700 and 1200 test systems. To accommodate different operating voltages in the larger systems, Micro Test employs translating buffers, with level-shifting circuits and form-C relays that interconnect the pulse generators and the analog box to the remote test stations.

Open loop. "The 360 runs in an open loop except when it receives a start, completion, fail/pass or relay control signal from the large system," says Hattery.

The basic 16-pin tester sells for \$9,000, and a 32-pin version for \$23,000. The company admits that

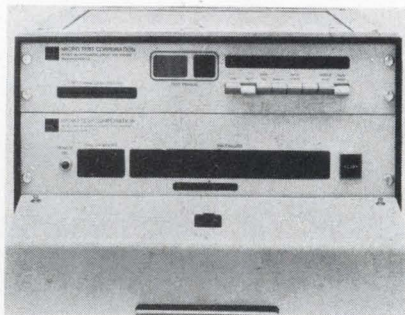

Versatile. The 360 can stand alone or operate with a large test system.

the relatively high price for the 32-pin unit is based more on market considerations than on higher production costs. The two-pass tester examines low- and high-input threshold voltage, low- and high-clock threshold, and low- and high-output current on the first pass. The device is tested for maximum low-level output voltage and minimum

high-level voltage under fan-out conditions. On the second pass, input voltage is programmed to worst-case forward and reverse voltage, and all clock pins are programmed for forward- and reverse-clock-voltage levels. The device is also tested for maximum low- and maximum high-input current.

Unlike many small testers, which use matrix switching or printed circuit cards for programming, the 360 employs a photo-optical card reader and standard cards. This brings the individual program cost down to about \$25 per card, compared with more than \$100 per program for some other testers. The program cards are reproduced on film stock for durability. A different program card is used for each family of TTL, DTL, RTL, or static MOS devices, and an individual device program card for each device-type to be tested is prepared, using the manufacturer's specifications.

Follow specs. Some small testers combine both functional and power-dissipation tests in one pass, but don't check input thresholds or worst-case voltages for large currents, according to Hattery. Typically, they must do a binary count-down of 1024 tests with a 10-input device in order to exercise all inputs. By programming to manufacturer's specifications for each device, the 360 performs only 26 tests for a 10-input device, using overlap programming in which the same program serves for both passes.

The 360 has a \$3,000 evaluation option that verifies specifications and checks to see that guard bands meet the specs. The unit uses a multiturn potentiometer to put varying amounts of voltage and current on the device for evaluation. The condition of the device is read on a built-in panel meter.

Other options include an extra-cost multiplexer and a remote programmer. These allow two wafer-probe stations to be operated from the same analog module, with card program input at each of the remote locations.

Micro Test Corp., 9000 Winnetka Ave., Northridge, Calif. 91324 [429]

Circle 155 on reader service card →

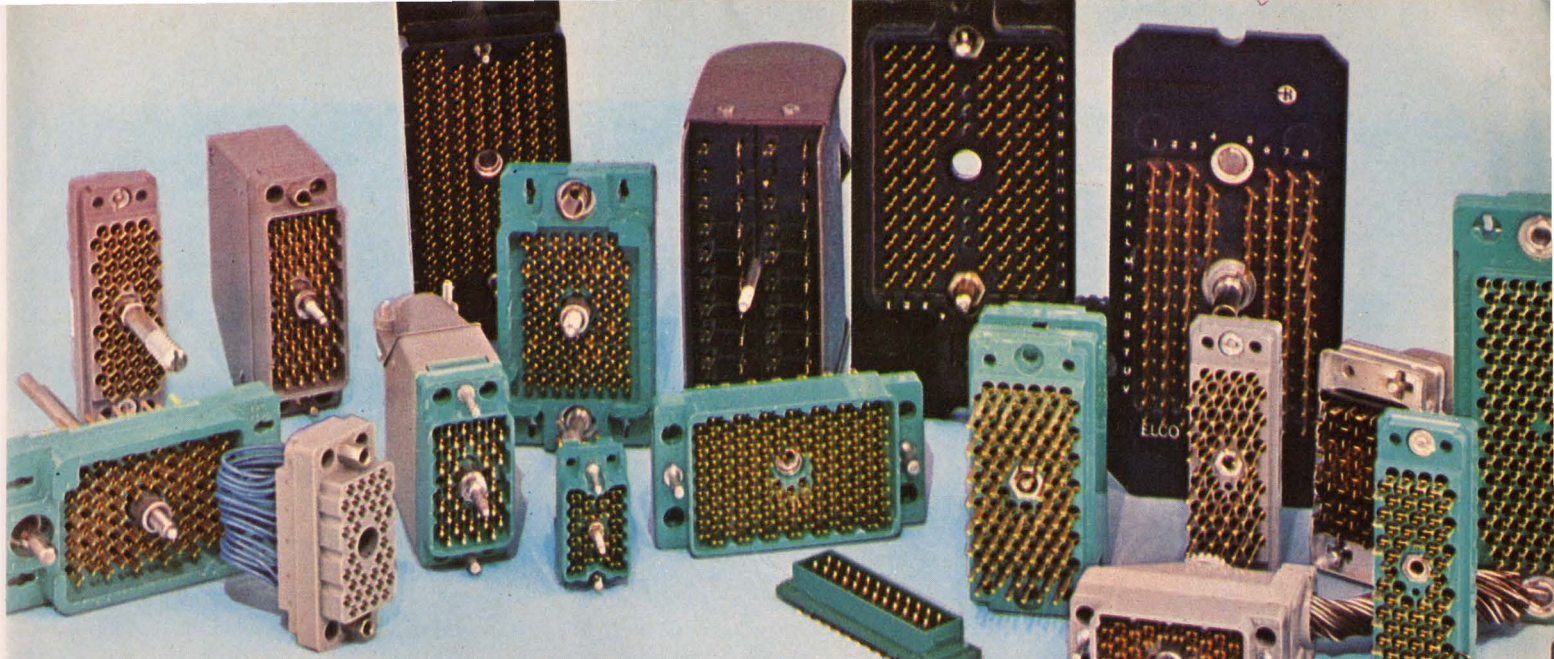

Heads: You win.

Tails: You win again.

Elco rack-and-panel connectors give you a better head start.

And a choice of tails.

The head start is the connecting end of an Elco connector: the patented Varicon™ contact that fully meets the requirements of MIL-E-5400. The four mating surfaces of this unique contact are coined to an exceptional hardness and wipe clean with each make. Once the contacts are joined, the inherent springiness of the gold/nickel-plated phosphor bronze and the fork-like design make a superior, gas-tight fit.

Because the contacts are free floating, they align perfectly. A few contacts or 100 or more, all fit precisely together every time, over a long service life. There's no contact chatter. Nobody else gives you a contact head quite like the Varicon.

And nobody else gives you the choice of tails you get with Varicon. You can wire-wrap, crimp, clip, stake, or solder them. Whatever terminating technique or combination of techniques your assembly lines are set up for, we'll furnish the appropriate tail. If staking or crimping is your style, we



.078" Taper Tab



Solder/.098" Taper Tab



Wire Wrap Tail
.024" x .050" x .567"



Wire Wrap Tail
.024" x .050" x .760"



Crimp (Loose contact)

can supply the equipment too. Manual or automatic. Purchase or lease.

Elco rack-and-panel connectors come in standard rectangular models, or as miniature connectors, or in modular units. You can have them with 2 Varicon contacts, or up to 140, or anything in between.

In short, our line of Varicon rack-and-panel connectors has a lot going for it. Except price. Though it's a precision component, the Varicon contact is easily produced in high speed progressive dies. There's no expensive machining, no waste. When you can turn out millions of Varicons a week, you don't have to charge a fortune for them.

There's a lot more to be told about Varicon connectors. It's all in our 28-page rack-and-panel connector guide, and we'll be happy to send you a copy. Just write, wire, call, or TWX us.

Elco Corporation, Willow Grove, Pa. 19090.
(215) 659-7000.
TWX 510-665-5573.



ELCO Rack-and-Panel
Connectors

Honeywell Computers may be applied liberally.

If you're looking for a general-purpose computer that really is general purpose, you ought to know about Honeywell computers. Like the H316 computer below, and other members of the Series 16 family. Then there's the Series 32 family. And the H112 minicomputer.

They're being used in all sorts of applications. On off-shore oil rigs, they're helping keep free-floating ships directly over the drill.

In supermarkets, they're speeding checkouts and maintaining total inventory control.

In airline systems, they're concentrating data to cut back on expensive telephone line lease costs.

In hospitals, they're providing on-line, real-time access to both in-hospital communication systems and remote data facilities.

And if that isn't enough, try these: Space capsule simulation. Antenna control. Numerical control. Remote manipulator control. Industrial control. Weather reconnaissance. Weather forecasting. Patient monitoring. Navigation. Target tracking. Fire control. Seismic studies. Travel reservations. Medical research. Credit verification. River traffic control. Communications. Graphic data conversion . . . Whew.

Now that's what general-purpose computers are all about.

Get more information about Honeywell computers and the uses they're being put to. Write for our Control Applications Kit. So you can consider the alternative: Honeywell, Computer Control Division, Framingham, Massachusetts 01701.

The Other Computer Company: **Honeywell**

Circle 156 on reader service card

HONEYWELL INTERNATIONAL—Sales and Service offices in all principal cities of the world. Manufacturing in Australia, Canada, Finland, France, Germany, Japan, Mexico, Netherlands, Spain, Taiwan, U.K. and U.S.A.



Digitizer traces at speed of 300 inches/sec

Computer-controlled drafting system with free-moving cursor calculates volume, area, slopes, and angles

Most digitizing systems use a mechanical arrangement for moving a cursor along a drawing board. The cursor may be tied to a rack and pinion, a T-bar, or an H-bar. When the cursor is moved, a shaft encoder converts the number of turns into output digital signals. A more reliable digitizing scheme, with no mechanical constraints and, therefore, much lower inertia, is an elec-

tronic cursor which can be moved around quickly; and this cursor has none of the wear and alignment problems associated with ones having mechanical linkages.

The free-moving cursor is one of the features that Bendix' new Advanced Products division highlights in its Datagrid digitizer. The maximum tracing speed of the cursor is 300 inches per second. The Data-

grid has a basic resolution of 0.001 inch over a digitizing area of 42 by 60 inches.

The cross-hair cursor is surrounded by a coil similar in nature to an air-core transformer. The drafting table consists of a buried array of conductors. A current through the coil develops a magnetic field which induces a voltage in the conductor pattern associated

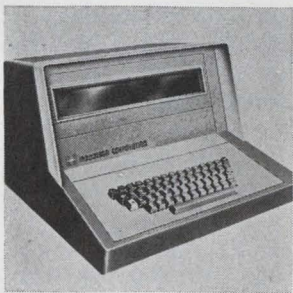

Source data-collection device consists of a command register (or annunciator) and an entry register. The command register displays 10 alphanumeric display positions which indicate the format and type of information to be included. In response to the command display, the operator keys in data and views it on the entry register. Madatron, Box 172 Princeton, N.J. [4011]

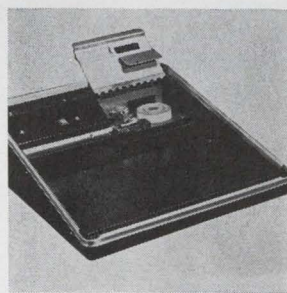

Portable strip printer 5064 is a digital impact unit that can fit into data communications systems to provide hard-copy read-out. It features compactness, printing speed, reliability and economy. Operation is based on the flying hammer principle. A type wheel having 64 characters and associated timing markers rotates continuously. Dataline Inc., King of Prussia, Pa. [4021]



Microconverter 7202A accepts computer levels and converts them to drive commercial communications equipment. The compact unit isolates input power and ground returns from the output by optically coupling input signals through a light-emitting diode and light-sensitive resistor. Price is under \$100 in small lots. Tele-Dynamics, Virginia Dr., Ft. Washington, Pa. [4031]

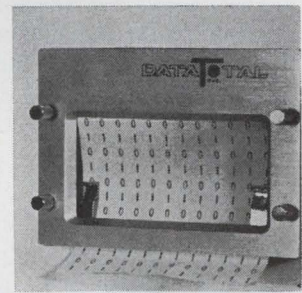

Digital printer DPL-12 has outside dimensions of 4¼ x 3¾ x 11½ in. It is modular in design with the heart of the unit made up of individual print modules. The modules are driven by scr's allowing selection of the desired character in less than 1/6 of a second. Average print speed is six lines per second. Datatotal Inc., 31 Park Road, New Shrewsbury, N.J. 07724 [4041]



Pencil follower coordinate digitizer PF-10C rapidly converts any analog-graphic configuration into digital form. The system permits outputs to be directly programmable into Fortran IV, and the digital outputs can be fed directly on-line to a computer or stored on an integral, 12-track incremental recorder. Computer Equipment Corp., 14616 Southlawn Lane, Rockville, Md. [4051]

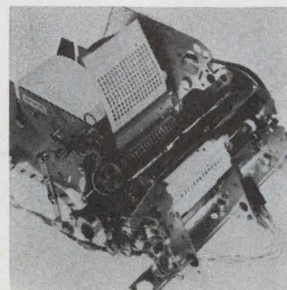

Serial-entry numeric printer M-120 with direct BCD input is designed as a low cost printout device for computer and instrument outputs. The printout is on a 3 in. wide tape with from 1 to 16 columns of digits. The input rate is 15 digits/sec (bit parallel) and the print time is 330 msec. Single unit price is \$190. SCM Corp., 3210 Porter Drive, Palo Alto, Calif. [4061]



Multiformat read-only tape drives 4853 and 4863 are available with 1600 characters per inch capability for computer output microfilm systems. The 4853 offers a 75 inch per second tape speed and a maximum transfer rate of 120 kilobytes. The 4863 is faster at 112.5 inch per sec with a maximum transfer rate of 180 kilobytes. Telex Computer Products Division, Tulsa, Okla. [4071]

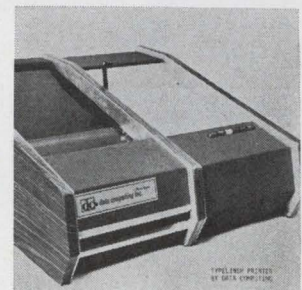

Low-cost, 100-line-per-minute multiple copy printout unit is designated Typeliner. Designed with the remote terminal user in mind, the Typeliner is available with 80 or 132 column capacity. The standard ASCII 64-character set is offered with lower case alphabet as an option. Rental price is \$245 per month. Data Computing Inc., 2219 W. Shangri La Rd., Phoenix 85029 [4081]

WE'VE GOT A BETTER WAY TO MAKE PRINTED CIRCUITS!

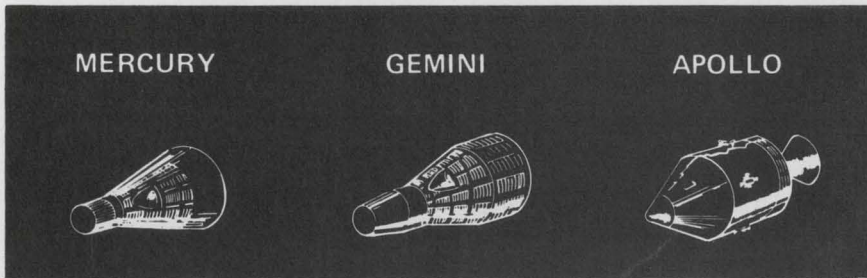
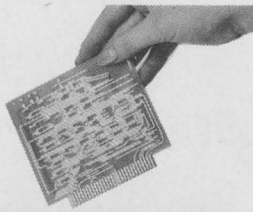

New techniques developed to make circuit boards more reliable.

The Printed Circuits Operation of CDC used a unique etch-back technique for producing reliable multi-layer circuitry for the Mercury project. Its success is indicated by the fact that the same techniques were used in the Gemini and Apollo projects without design change . . . millions of inter-facial connections with no known failures.

Designs ranged from double-sided circuitry to complex 15-layer circuit boards . . . using sequential laminating, extra fine line width and spacing, and plated slots and edges . . . and were used for systems control telemetry, hi and low level multiplexer, command module telemetry, LEM flight control system, and the seismograph experiment.

The Mercury-Gemini-Apollo program demonstrates our capability for the design and production of high quality circuit boards. Hundreds of other projects use our circuit boards in many phases of civilian and military equipment. We've got a better way to make printed circuitry.

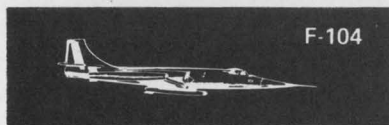

F-104

Developed new technique to produce circuit boards with more reliable plated-thru holes.

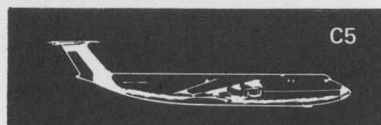

C5

We introduced circuit boards that had the highest density circuitry ever used before on a production basis.

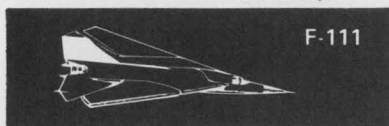

F-111

New industry technique was used to produce multilayer circuit boards with an internal heat sink.

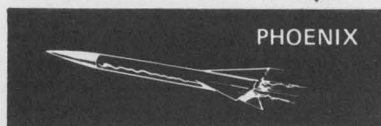

PHOENIX

Required new techniques for manufacturing heat sinks and insulation by chemical milling.



707

Reliable circuit boards in high volume at low cost were produced for this project.



POSEIDON

Developed new technology for sequential laminating multilayer circuit boards with aluminum backbone.



This design and production experience can work for you . . . CALL US NOW.

CONTROL DATA
CORPORATION

CONTROL DATA CORPORATION
PRINTED CIRCUITS OPERATION
7800 COMPUTER AVENUE
MINNEAPOLIS, MINN. 55435
PHONE: (612) 927-5681

with the position of the cursor. The voltage signal is then transmitted to a computer as x and y coordinate information.

The secret of the system's ability to resolve distances down to 0.001 inch and yet space the conductors in a low-density configuration, is a proprietary signal-processing technique.

One of the interesting applications for this system is in making design calculations. For example, the designer can determine clearances between lines and curves, distances between surfaces, volumes, centroids, and moments of inertia, and can make coordinate translations, rotations, and polar conversions.

Digital menu. A card—called a menu—with blocks specifying distance, angle, length, area, volume, etc. is positioned anywhere on the working area. The cursor identifies a reference position on the menu marked by a star. Each block on the menu pertains to a subroutine stored in the computer's memory and automatically called up when the cursor is moved to the block.

When the computer is ready to solve a problem, the operator digitizes the menu, activating a particular subroutine. Then a button on the cursor tells the computer that the next item of data being sent to the computer will be coordinate information for use in the program.

The menu can be placed anywhere on the drawing board since each block is located a certain distance from the reference star. This relative distance is used by the computer in determining which subroutine to call.

The system can be operated in either point or continuous mode alternately without making complicated adjustments. In the continuous mode of operation, the coordinates are automatically recorded at operator-selected distance intervals or time intervals while tracing. Distance intervals can be set from 0.001 to 0.999 inch.

The Datagrid digitizer can be connected in a number of system configurations depending on the type of interface desired. Prices start at \$16,000.

Bendix Corp., Advanced Products Division, Bendix Center, Southfield, Mich. 48075 [409]

TI markets DDC computer

Machine built for in-house manufacturing jobs has high I/O-line capacity

Direct digital control began at home for Texas Instruments Inc. But now TI has decided to market its home-grown computer, used for many months to control highly automated processing steps in silicon manufacturing activities.

The minicomputer, designated model 960, "has been designed to satisfy the manufacturing man's automation needs," says Mark Shepherd Jr., TI president, "and it can be programed by him in a language he understands."

A key factor is the simplicity of instruction software for both initial setup and change, says Shepherd. The other important characteristic of the 960 is that "its unique single-bit address or 'big-pusher' capability requires less memory," notes Shepherd.

Adding to the machine's flexibility is a communications register unit which economically accommodates a wide variety of application-oriented devices. As many as 4,096 input and 4,096 output lines may be handled by a single machine. Each I/O line may be addressed independently, or up to 16 lines may be addressed together.

Basically, the 960 is a processor that's designed to manipulate bits, fields and words. The core memory has a one-microsecond memory cycle time, 400-nanosecond access time, and a capacity from 4,096 to 65,536 words of 16 bits each. Expansion is provided for in 256 interface card locations, each with 16 input and 16 output lines. An expandable direct memory-access channel also is built in. The unit includes 16 registers to allow rapid context switching and multiple-base register usage.

Texas Instruments Digital Systems Division, P.O. Box 66027, Houston, Texas, 77006 [410]

Have circuits to switch ?

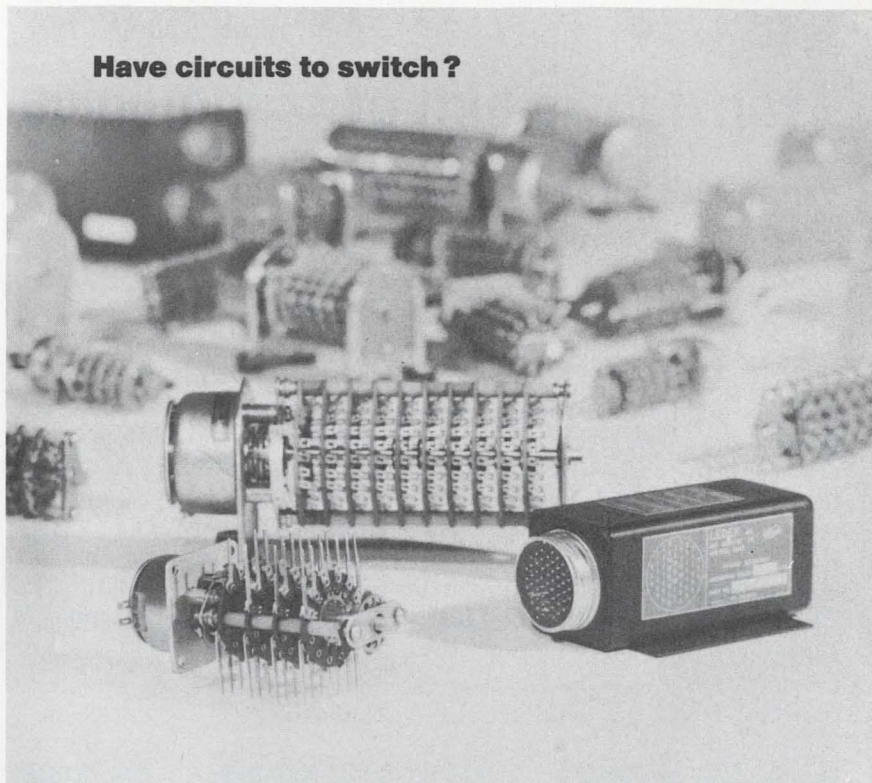

... one of these 47 Ledex stock stepping switches can help you get a quick start on your prototype.

Ledex switches do a lot of work in a small space. They are used as programmers, circuit selectors, sequencers, scanners, intervalometers, memory pulse decoders, converters . . . features like a rugged solenoid drive and corrosion resistant, self cleaning double grip contacts assure dependable switching.

Exceptional variety, too—open switches, hermetically sealed packaged switches and special designs. New PC leg terminals (optional) eliminate hand wiring and permit quick installation.

Ledex also manufactures solid state switches functionally interchangeable with other Ledex stepping switches. Check them when long life and speed are more important than price.

If one of these stock models doesn't meet your exact requirements, we'll custom design for you . . . whether it's an open circuit selector, a packaged switching network, a solid state selector or some combination of these. We've the people, facilities and capability to get the job done—fast and right.

Write or call today for our new stepping switch/circuit selector catalog or the new packaged switch catalog.

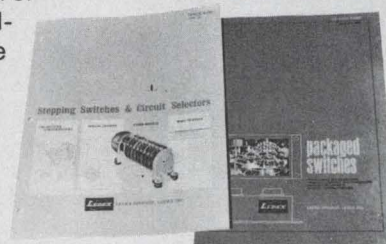

Specialists in remote switching



LEDEX DIVISION, LEDEX INC.

123 Webster Street, Dayton, Ohio 45402 • phone (513) 224-9891

Transistors aim at communications bands

Varian-aided company's power units for vhf/uhf offer users choice of 2.5, 12 or 25-watt outputs

A new line of specialized power transistors for vhf/uhf systems is being brought to market by Communications Transistor Corp., a new company organized last October with the aid of Varian Associates. CTC has to date developed nine transistors specifically for the communications industry, and Thomas E. Ciochetti, president, says these will fill a gap in the

power-transistor market.

Ciochetti, who has worked for both Fairchild and ITT, says no company has satisfied the needs of the communications industry for small-lot, special-application transistors. "There is no universal r-f power transistor that will fill all needs," he asserts. But Ciochetti adds that CTC is not going to be a custom house either.

Varian, which had been interested in the low-frequency transistor business for some time, has leased some of its vacant space in San Carlos to the new company and has also provided minority financial backing.

"Instead of starting out in a concrete block in Sunnyvale," Ciochetti says "we're building a plant within a plant. The hydrogen,

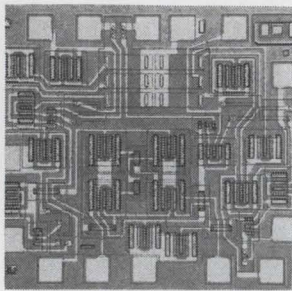

Four-quadrant analog multiplier #A795C is a low-cost monolithic circuit in a 14-lead dual-in-line package. It has a wide input voltage range (± 10 v) and operates over a wide frequency range at a bandwidth of d-c to 3 Mhz. The linearity is excellent, with a typical error of less than 1% full scale. Fairchild Semiconductor, 313 Fairchild Dr., Mountain View, Calif. [436]

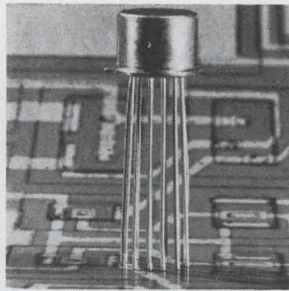

Three fully compensated operational amplifiers with low power requirements have been incorporated in a single monolithic IC chip. Model KA-10 utilizes bipolar construction to achieve a very high circuit density. It operates from d-c to 10 KHz, and draws only 5.4 mw of power at ± 15 v (worst case). Kinetic Technology Inc., 3393 DeLaCruz Blvd., Santa Clara, Calif. 95051 [437]

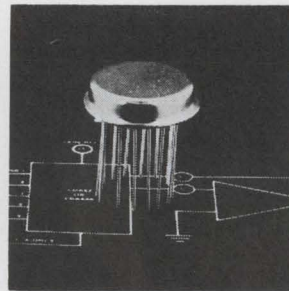

Hybrid D/A converter CBAS2/A is complete with ladder network and 6-bit switching system. It operates directly from logic, and features a 1 μ sec typical settling time over the full military temperature range of -55° to $+125^\circ$ C. Maximum error is 1% of full scale. Unit price (1-99) is \$75; (100-999), \$50. Crystalonics, 147 Sherman St., Cambridge, Mass. 02139 [438]

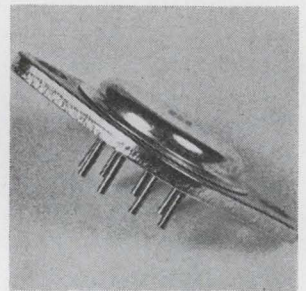

D-c voltage regulator circuits are for positive and negative uses. Positive circuits are HOCA100, 103 and 105; negative circuits are the 102, 104 and 106. Providing a high degree of uniformity, the series features regulation of 0.5% max., 0.05% typical, no load to 1 amp load. Voltage range is 8 v to 50 v. Solitron Devices Inc., Blue Heron Blvd., Riviera Beach, Fla. [439]



A new series 500 volt p-i-n switching diodes have been developed. The high dynamic Q of these devices guarantees low insertion loss and high isolation characteristics. Units feature the latest passivation techniques. Characterized at 1 Ghz, these diodes are recommended for high and medium power control applications. Microwave Associates Inc., Burlington, Mass. [440]

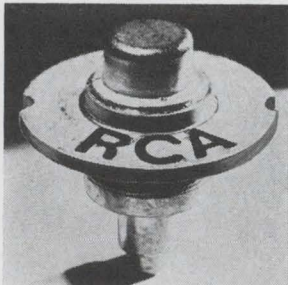

Silicon npn overlay transistor 2N5921 is for use in semiconductor equipment for microwave communications, S-band telemetry, phased-array radar, and distance measuring equipment. It features a performance rating of 5-watt output with 7 db power gain (minimum) at 2 Ghz and a 10-watt output with 11 db gain (typical) at 1.2 Ghz. RCA, Harrison, N.J. 07029 [441]

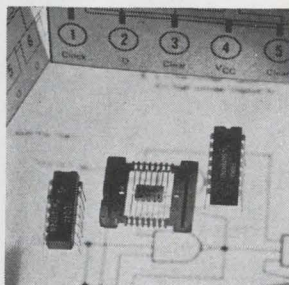

High-speed TTL IC dual D-type flip-flop designated SN54H/74H74 will accept input clock frequencies up to 43 Mhz and demonstrates propagation delay times averaging 11 nsec. The H74 circuit is positive-edge triggered and features direct preset inputs and complementary and non-complementary outputs. Texas Instruments Inc., P.O. Box 5012, M/S 308, Dallas [442]

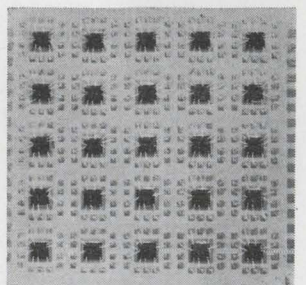

Large-scale hybrid integrated circuits are suitable for inter-connecting as many as 25 to 36 IC chips, either beam lead or wire bonded, on a one-inch-square substrate. The substrates can be provided with as many as eleven screen-printed conductive planes, each separated from adjacent layers by a dielectric layer. J.W. Microelectronics Corp., 4901 Stenton Ave., Philadelphia [443]

... three units built
for land mobile jobs ...

nitrogen, and acid drains are already here and we'll take advantage of them." Ciochetti feels the physical setup "will enable us to move fast. Also, we have the right to procure services from Varian; we can use their electron-tube group marketing, which includes 50 field sales engineers who know the customers."

One of the reasons CTC teamed up with Varian "is that its Eimac division has developed a tremendous capability in ceramic-to-metal sealing." Ciochetti adds. "Eimac people just don't know that it is a problem to get hermetic seals—they routinely get 10^{-6} to 10^{-8} torr seals over 10 to 12 inches—they don't know that the rest of the world is having trouble with ¼-inch-long seals."

"Packaging has always been a problem in the semiconductor industry," Ciochetti points out. "With Varian-Eimac's capability in ceramic-to-metal sealing we hope to make a contribution in low-cost, high-frequency packaging. But we're making transistors, not packages."

The first nine products of CTC are rugged transistors built for three communications bands. For vhf land mobile communications, 132-174 megahertz, CTC has three 12-volt devices with power outputs of 2.5, 12 and 25 watts and a gain of 9, 7 and 6 decibels, respectively.

There are three 28-volt transistors in the 225-400 Mhz range for use in uhf military communications. With the 28-volt units, users can choose from power outputs of 2.5 watts with 8.5 db gain, 12 watts with 7 db gain, or 25 watts with 7 db gain.

Three other transistors for uhf systems operate in the 406-470 Mhz frequency range. All have a 12-volt supply voltage and, like the other devices, will be available with power outputs of 2.5, 12 and 25 watts. Gains for these are 7, 6 and 5 decibels, respectively.

Prices range from \$7 to \$75 each, and delivery will begin in July.

Communications Transistor Corp., 301 Industrial Way, San Carlos, Calif. 94070 [444]



**NOW...
YOU CAN
PUT THEM
TO WORK IN
MORE
PLACES**

DELTAFILM® LP88 POLYCARBONATE CAPACITORS

now available with capacitance values up to 9 times higher!

get the big advantages of metallized polycarbonate-film in smaller capacitors!

- EXCEPTIONAL PERFORMANCE: Extended life characteristics. Very low temperature coefficient. High insulation resistance. Low dissipation factor (high Q). Excellent resistance to shock and vibration.
- FUZ-ION SEALED*: Heat-shrinkable plastic case is fused to epoxy for

maximum seal efficiency. Casing is nonconductive, fungus-proof, corrosion-proof, and humidity resistant.

- OPERATING TEMPERATURE RANGE: -55°C to $+125^{\circ}\text{C}$
- CAPACITANCE VALUES: from .027 to $50\ \mu\text{F}$.
- VOLTAGE RATINGS: 50, 75, 100, 150, and 200 VDC.
- IDEAL FOR A-C AND D-C APPLICATIONS

*Trademark

For complete technical data, request Engineering Bulletin 154A by writing to Dearborn Electronics, Inc., Box 530, Orlando, Fla. 32802.

Dearborn Electronics, Inc.
(a subsidiary of the Sprague Electric Company)
FOREMOST IN FILM CAPACITORS

1D-9103R1

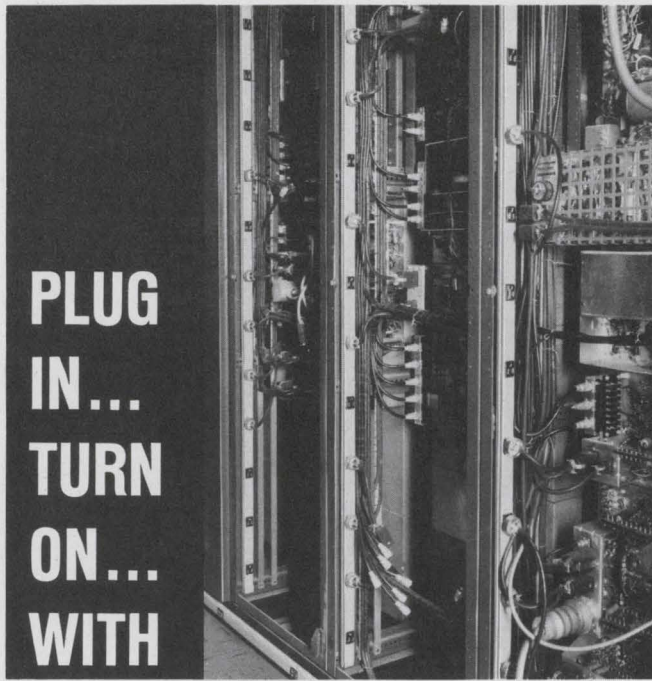

**PLUG
IN...
TURN
ON...
WITH**

**PLUGMOLD[®]
MULTIOUTLET
SYSTEMS BY**



Send for detailed information on Plugmold systems that provide electrical outlets wherever you need them in electronic equipment, racks and consoles.

THE WIREMOLD COMPANY
Hartford, Connecticut 06110

Circle 162 on reader service card

Communications market in the 70's.

We have just initiated "A Study of Opportunities in the Communications Markets During the 1970's." This study will provide a limited number of clients with an in-depth analysis of the affect of changing technical, economic, and regulatory factors on the markets for communications systems, subsystems, products, and components. It will also forecast the size and structure of these markets.

For further information, please contact Mr. Samuel Weber, Manager, Electronics/Management Center, 330 West 42 Street, N.Y. 10036. Telephone: (212) 971-3485.

A joint undertaking of McGraw-Hill's Electronics/Management Center and Marcom Incorporated.

New materials

Substrates keyed to batch processing

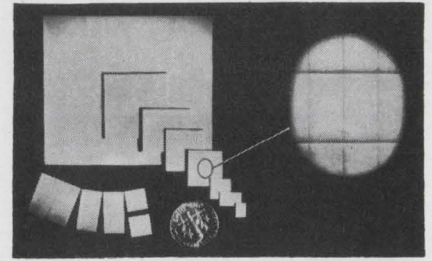

Alumina substrates are available in "break-apart" form and individual standard segment sizes. They feature low surface ripple, smooth breaks, sharp edges, and sharp corners. When supplied in multipart form, kerf loss is less than 0.003 in. with score depth approximately 50% of the material thickness. Substrates are supplied metalized and unmetalized. Key application is low cost substrates for high-quantity batch production. Varadyne Packaging and Materials, 2110 Broadway, Santa Monica, Calif. 90404 [381]

Single-component, gold-filled epoxy compound designated Epo-Tek H40 is intended for bonding semiconductor chips in fabricating hybrid circuits. Its volume resistivity is rigidly held to 0.0001 to 0.0003 ohm-cm, and is reproducible. The curing schedule ranges from 2 hrs at 100°C to 15 minutes at 150°C. Epoxy Technology Inc., 65 Grove St., Watertown, Mass. 02172 [382]

Solder and braze alloys called Formon come in paste form and can be applied with conventional screen printing equipment. The compositions incorporate special noncorrosive organic vehicles and easily removable fluxes. They are designed for use where selective deposition of solder is required. Examples include sealing of ceramic packages and hybrid circuits and attachment of leads or add-on components, such as chip capacitors and silicon devices. Print thickness is usually 4 to 10 mils and is accomplished with coarse, 80 to 100 mesh screens having thick emulsions or metal-foil backing. Etched-metal masks are also used to achieve this print thickness. DuPont Co., Wilmington, Del. 19898 [383]

Bismuth germanium oxide for surface-wave acoustics applications is now available from inventory. It offers slow surface-wave velocity (6.33 μ sec/cm), low loss, and strong piezoelectric coupling. Its time-fractional bandwidth product per cm, important for radar applications, is said to be superior to all known single-crystal materials. Union Carbide Corp., Crystal Products Dept., 8888 Balboa Ave., San Diego, Calif. 92123 [384]

New Materials

Silk-screen ink, stable to 1,000°C, makes possible the application of a wide variety of thin- and thick-film coatings in any pattern. After printing the substrate, the whole surface is coated with the desired film. Afterwards, the printed areas are easily cleaned off with a mild water solution, leaving only the unprotected areas coated. The process is expected to find such applications as hybrid circuitry, forming tin-oxide conductors on glass, and as an alternative to metal masks in plasma, evaporative, and spray coating deposition. Decor-Davis Electronics Corp., 4711 E. Fifth St., Austin, Texas 78702 [385]

Improved moly dry-film lubricant Dag 210 now has a longer shelf life as the result of a patented production process that also makes possible a smoother coating on a variety of substrate materials with little or no surface preparation. Dag 210 can be applied by spray, brush or dip type techniques. Acheson Colloids Co., Port Huron, Mich. 48060 [386]

Improved No-Arc insulating spray is now available in aerosol form. It leaves a tough, thick, smooth protective red insulating coating capable of withstanding up to 30,000 volts. Thus, it should be effective for stopping arcing and corona shorts in h-v circuits, especially on color chassis. It is also recommended for potting components, as well as waterproofing and insulating p-c boards and exposed wiring. It is available in an 8 oz can for \$2.79 dealer net. Chemtronics Inc., 1260 Ralph Ave., Brooklyn, N.Y. 11236 [387]

Palladium-silver conductor compositions are available with superior adhesive properties. The series consists of three new compositions: DP-8420, DP-8430 and DP-8440. The materials were developed to provide major improvement in initial and aged adhesion even with high-tin-containing solders. They exhibit good solder wetting and resistance to solder leaching. They offer thick-film circuit designers a broad spectrum of cost/performance trade-offs. They provide high conductivity and print resolution of 2-mil lines and spaces using metal masks. DuPont Co., 1007 Market St., Wilmington, Del. 19898 [388]

Epoxy coating powders designated Nov-aloy are designed for packaging delicate heat- and pressure-sensitive electronic components. The powders can be applied with preheat temperatures as low as 125°C and a cure time of 15 minutes at 135°C, so that fully automated fluidized bed coating systems can be used with these components. Present applications include coating of monolithic chip capacitors, thick-film and fixed-composition resistors, and Mylar/aluminum capacitors. Rogers Corp., Rogers, Conn. 06263 [389]

LS
o.e.m.

LogAbax

new product
serial printer 50 ch./sec.
model Lx 50

an inexpensive solution, for an output peripheral, suitable for all e.d.p. systems.

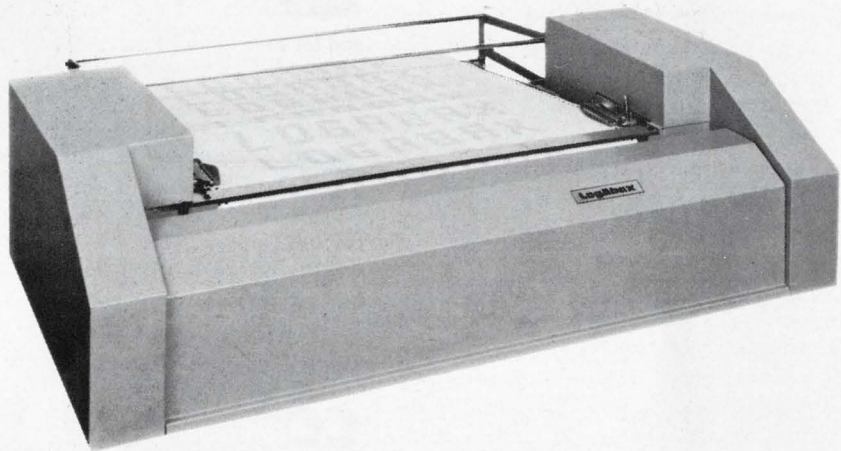

specification summary

The printer is of the mosaic type and functions character by utilizing standard paper forms.

PRINTING VELOCITY	50 ch./sec.
Nº OF CHARACTERS PER LINE	233
DENSITY	2,5 mm (0.097")
CHARACTER SET	64
HEIGHT OF CHARACTERS	2,5 mm (0.097")
HEAD VELOCITY	150 ch./sec. 14,65"/sec. Rapid skipping to one of 32 positions.
FORM HANDLING	1 or 2 sets of form tractors. A set consists of four tractors one pair to feed, the other pair as take up.
FORMS	SPEED. 30 lines/sec. Standard perforated, continuous, fanfold. Up to 60 cm (23.5") max. N.C.R. or Minnesota. Up to 6 copies.

LS LogAbax

79, avenue Aristide-Briand 94-ARCUEIL Tél.253.20.85 FRANCE

manufacturer of office computer

See us at international computer conference and exposition.

WASHINGTON, Hilton Hotel, Wash. D.C.

June 16 - 18 - 1970 - Booth Nº 118

New Books

How and what

Integrated Electronic Systems
Westinghouse Defense and Space Center
Prentice-Hall, 472 pp., \$16.95

The equipment designer confronted with the flood of new ICs pouring from the manufacturers, may sometimes wish that he had water wings. This book shows him how to cope with the flood and use it to best advantage.

Thirty-one engineers and scientists from Westinghouse's Defense and Space Center have contributed to this volume, which is more an in-house casebook than a survey of the field. In fact, the book must be faulted for its almost exclusive concern with Westinghouse's own experience and products. A broader view would be more instructive, particularly a discussion of the relative merits of the competing IC products. Despite this limitation and one other, a total absence of information concerning the design and application of radiation-hardened IC's, this book answers both the why and the how of IC's, combining theory with a wide range of practical examples. These examples include the design details of a radar altimeter, an astronaut's helmet transceiver, and a hand-held tv camera for use on the Apollo missions.

A separate chapter is devoted to each of the following topics; passive element design, bipolar transistors, field-effect devices, substrate preparation, epitaxial growth, oxidation and diffusion techniques, design and layout, photoengraving, lead bonding and IC packaging, quality and reliability control. Another chapter discusses linear and digital circuits, including a brief description of the various types of logic available to the equipment designer.

Progress in solid state imaging is covered in a chapter on electro-optics, with a discussion of detector and imaging materials, linear and two-dimensional arrays, and even a self-scanning, silicon-mosaic array. The book concludes with a brief description of semiconductor delay lines, a topic which is really unrelated to the other subject mat-

ter, but interesting nonetheless.

One subject which is given only cursory treatment is the design of digital filters, a vital element in adaptive filtering systems, and one which large-scale integration has made practical. Here the authors only offer the reader a few pages, barely whetting his appetite before referring him to the bibliography. The sections on transceiver design are far more substantial, with detailed discussions on signal-to-noise analysis, gain and bandwidth considerations, frequency synthesis and multiplication, r-f, i-f and audio amplifiers, automatic gain control, squelch circuits and voice-operated transmitter-keying laying circuits, fabrication and packaging.

The chapter on radar systems touches on r-f and i-f gain budgeting as well as the design of automatic gain and frequency control loops, timing systems, splitgate trackers and symbol generators, while the one on tv cameras discusses timers, synchronizers, automatic light control and AGC circuits, video amplifiers, deflection circuits and power supplies.

The extensive coverage of IC fabrication techniques often resembles material from a laboratory notebook, with its details concerning manufacturing processes, chemical equations, diffusion and oxide-growth rates, etching and polishing formulations and photographic procedures. Step-by-step instructions are often given, along with cautionary advice which is clearly the result of personal experience, gained at great cost.

Recently Published

Computers and Telecommunications: Issues in Public Policy, Stuart L. Mathison, Philip M. Walker, Prentice-Hall, 270 pp., \$12.50

Provides insight into who should be allowed to do what in the computer and communications services industries. Covers basic public policy issues and their effects upon common carriers, equipment manufacturers, remote-access computer service companies, and users. Presents changes required in existing communications facilities and services to accommodate increasing

volume of data communications.

Information Transmission, Modulation, and Noise, Mischa Schwartz, McGraw-Hill, 672 pp., \$14.50

Substantially revised from the first edition, the second edition consists basically of two parts: modern communication systems and modulation theory; modern statistical communication theory. Emphasis is placed on digital systems and the statistical analysis of communications systems.

Electronic Principles: Physics, Models, and Circuits, P.E. Gray and C.L. Searle, John Wiley & Sons, 1,016 pp., \$15.95

Includes sections on semiconductor physics, physical electronics, modeling, and circuit characteristics of semiconductor components, as well as computer-aided design of complex IC multi-stage amplifiers, and functional assemblies.

Network Theory, Joseph Murdoch, McGraw-Hill, 525 pp., \$16

Examines steady-state analysis of linear networks from a topological viewpoint and considers free and forced behavior of linear networks via Laplace transforms, special convolutions, complex variable theory and state variables. Chapters on matrices, systems of equation transformers, and complex variables are included as well as discussions of gyrators, the negative impedance converter, and n-port theory.

CATV System Engineering, William Rhenfelder, Tab Books, 256 pp., \$12.95

Describes planning, design, and operation of a CATV facility. Topics include CATV amplifier characteristics, head-end concepts, matching reflections, principles of cable powering, automatic CATV systems, and increased channel capacity.

Computer Seminar Directory, Steven E. Goodman, Education and Training Associates, 60 pp., \$3

Indexed and classified guide to more than 220 organizations that offer seminars, workshops, short courses, conferences, and home studies in fields related to computer and data-processing technology.

1970 Popular Tube/Transistor Substitution Guide, Tab Books, 224 pp., \$4.95 leatherette bound \$2.95 paper

Divided into two four-part sections, this updated manual cross-references popular American receiving tubes and transistors, listing preferred and second-choice substitutes for commercial and industrial equipment. Offers American substitutes for popular foreign tubes and transistors. Base diagrams are keyed to listings in each section.

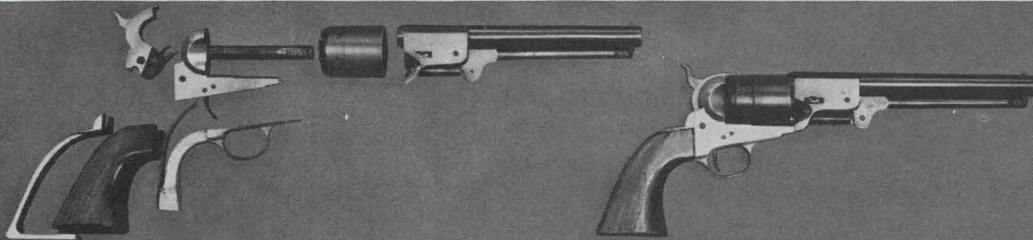

What Sam Colt did to the arms industry... Tetra is doing to the memory business

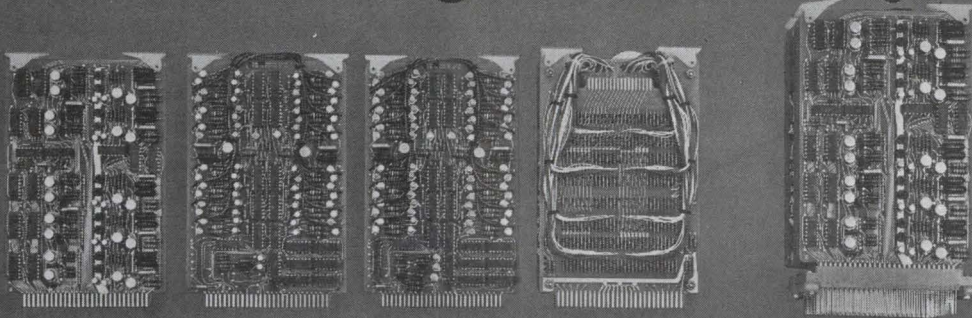

Of the people who have actually mass produced memories, Tetra's doing it best! Mass production gives the obvious advantages of price, maintainability, and consistent quality... plus immediate delivery.

Here is Tetra's line of compact, high quality MEMORY SYSTEMS. One of these should fit your application.

ALPHA 10.2	ALPHA 12.2	ALPHA 10.3	ALPHA 12.4
1024 x 10	4096 x 10	2048 x 12	4096 x 12 to 20
1024 x 9	4096 x 9	1024 x 12	2048 x 12 to 20
1024 x 8	4096 x 8	512 x 12	1024 x 12 to 20
512 x 10	2048 x 10	256 x 12	16384 x 12 to 20
512 x 9	2048 x 9	1024 x 24 to 48	8192 x 12 to 20
512 x 8	2048 x 8	512 x 24 to 48	4096 x 24 to 40
1.5 usec full cycle	1.75 usec full cycle	1.5 usec full cycle	1.75 usec full cycle

Call collect! We'll ship you a prototype the same day!



7309 WASHINGTON AVE. SO.
MINNEAPOLIS, MINN. 55435
PHONE (612) 941-5450

Circle 165 on reader service card



Every year, ELECTRONICS attracts requests for over 125,000 editorial reprints.

They're like interest payments on our million-dollars-a-year editorial principle.

That's how much we spend annually to produce timely, authentic, and useful articles like those listed on the reader service card as reprints currently available.

Investment and interest make both ELECTRONICS and its readers more meaningful to its advertisers.

Technical Abstracts

CATV delivers the mail

Distribution of electronic mail over the broadband party-line communications network
William B. Gross
General Electric Co.
Philadelphia, Pa.

The rapid spread of CATV service through all areas of the nation, both rural and urban, coupled with a growing tendency on the part of the Federal Communications Commission to permit such services to originate program material, practically guarantees CATV's eventual emergence as a broadband communications medium. It has a potential ranging from commercial and instructional "point-casting" to nationwide data inputting. National elections and referenda with instantaneous tabulation of the results are one possibility. Early applications will likely include time-shared computer service and commercial data transfer.

A rapidly growing market for store-and-forward services, typified by mail, can be expected to spur development of low-cost alphanumeric typers. These will eventually provide input-output means for a nationwide network, potentially putting every home on-line. Videophone service is a natural use for a cable link, but the typers will make possible such services as remote vending, airline and theatre ticket purchasing, credit and securities transactions, library access, newspaper and magazine transmission, remote meter reading, and mail transmission, all with automatic billing.

Personal mail would doubtless remain in the postman's hands, but almost all business mail could be handled by such a system. The cost of a CATV mail-transmission service is estimated at between 1.2 and 2.8 cents per 150-word message, assuming that the phone companies' long-lines systems could be tied into for this purpose, and depending on the time of transmission. An expanded system would lease a wide-beam microwave-relay link, cutting transmission costs to 0.7 cent per message, anytime, anywhere. The final system would create a network of 200 transmit-

receive stations and 15,000 receive-only stations, tied together by microwave link, and would cut transmission costs to 0.33 cent per message. The cost of local distribution centers would raise the price of a message to about 3 cents. Any charge above that level would be profit. It is estimated that some form of CATV service will be handling 40% of all mail by 1980, along with an equal volume of other data for a total of over 86 billion, 150-word messages a year.

Presented at IEEE, New York, March 23-26.

Super sampling

Analog-to-digital converters at hundreds of megabits
R. Cotton, J. Frangipane, R. Vernet
Philco-Ford Corp., Willow Grove, Pa.

Because high-speed communications links are available to transmit data at faster rates than were possible 15 years ago, the demand for higher-speed analog-to-digital conversion has increased. Then, sampling rates in the audio range marked the upper limit; now rates up to 500 million samples per second are needed. In addition, wider bandwidth signals are now generated by television, lasers, and radars.

To convert megahertz-frequency analog signals, the most important consideration is the logical scheme of encoding. Parallel and serial encoders are the most common types, but the hybrid encoder incorporates the best features of both types.

In the parallel encoder, the analog signal is applied to $(2^n - 1)$ separate comparators to obtain n -bits of binary information. Each comparator operates independently and corresponds to a specific level of the input analog signal. Sampling is accomplished through a single clock pulse applied to parallel comparators. The $(2^n - 1)$ parallel channel outputs then are converted to an n -bit binary code. Among the difficulties encountered with parallel counters are driving a large number of parallel inputs with good fidelity at high frequencies, and distributing the clock to provide simultaneous sampling at each

comparator.

The serial encoder converts an analog signal to an n -bit binary format by using n one-bit encoders in series. A comparator and a one-bit d-a converter make up each encoding stage. The most significant bit is determined first, then an analog equivalent of this bit is subtracted and summed with the input analog. Thus, the input signal to the next most significant bit encoder is held to less than half the signal to the previous encoder. This process is continued for n comparators with $(n-1)$ d-a converters and summers to obtain the desired n -bit binary equivalent of the input analog.

Since the serial encoder encounters time delays, high frequency a-d converters require clock phasing to each successive comparator be adjusted so that a sample is taken at the same moment for the analog signal. The direct digital output is an n -bit binary code. Since subtraction occurs in the signal to the lowest significant bit, the bandwidth of this subtraction must be preserved.

The hybrid encoder can be described as several multibit parallel networks in series. Distribution of large high-frequency analog signals is reduced to a tolerable level, as is the amount of conversion logic in parallel encoders of higher orders of n . The hybrid scheme does not require as many d-a converters or high-frequency summers as do the parallel and serial types.

Component problems occur at rates beyond 100 megasamples. For example, the diodes and transistors in the d-a converters and summers encounter parasitics. High-frequency transistors needed to preserve bandwidths exhibit damped oscillations when exposed to current steps. Variations in the on-to-off capacitance of high-speed diodes change frequency response as a function of level in d-a converters.

Despite these component limitations, multibit encoders operating at 200-Mhz sampling rates have been developed. Philco-Ford is working on a three-phase system to achieve six-bit precision at rates exceeding 200 megasamples.

Presented at IEEE, New York, March 23-26.

Equipments and Systems

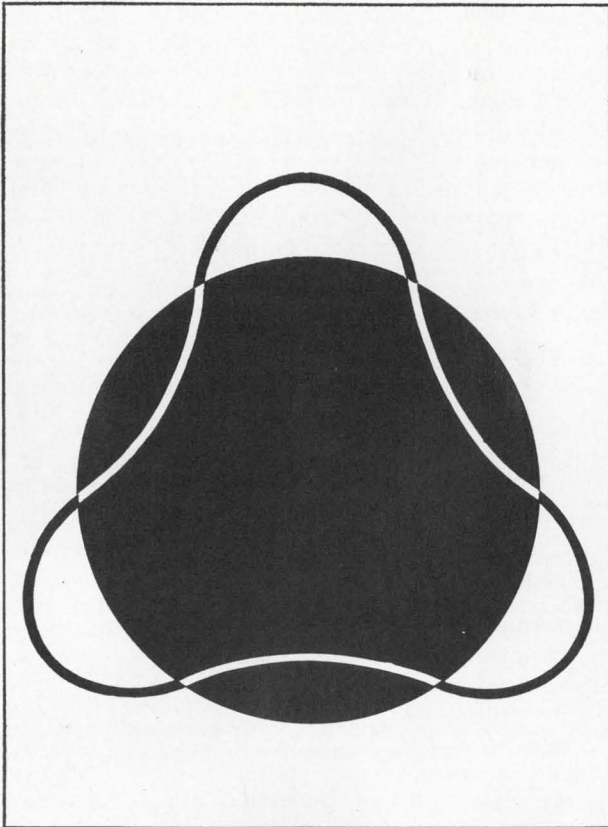

922.833

bearing the
TELEFUNKEN trademark
are symbols of
progress in the World

We manufacture and supply: Broadcasting and television transmitters · Communications transmitters · Maritime transmitters and transceivers · Professional receivers and direction finders · Radars · Radiotelephone sets and systems · Telecommunications equipment and cables · Data processing systems

Write for comprehensive documentation

ALLGEMEINE ELEKTRICITÄTS-GESELLSCHAFT
AEG-TELEFUNKEN
Export Department
79 Ulm · Elisabethenstraße 3
Germany



AEG-TELEFUNKEN

The newest, fastest and easiest way to specify indicator lights, push button switches and readouts.

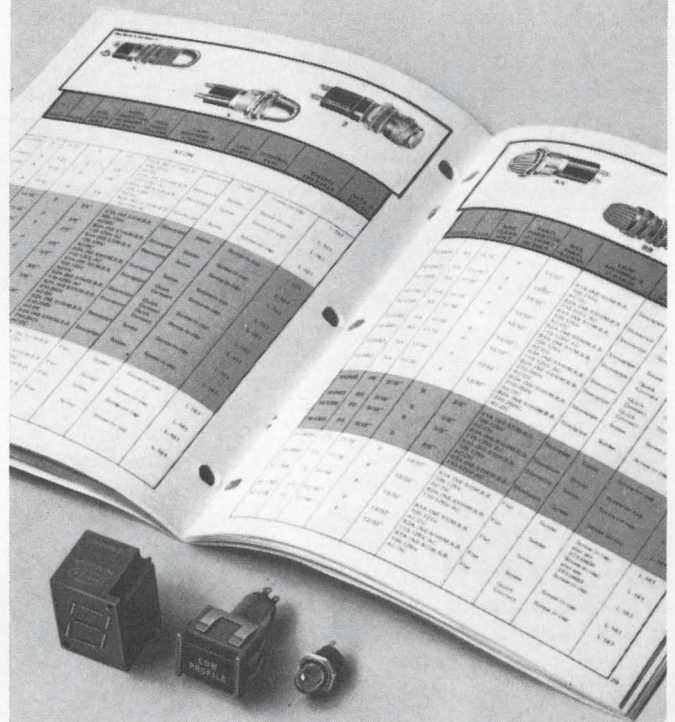

**Dialco's new 56-page product
selector guide helps you select
from over 1,500,000 visual indicators**

This book is the result of an all-out effort to provide you with fingertip data on all Dialight components and to make it very easy for you to locate the detailed specs and information you desire. Designers and engineers will find the "Product Selector Guide" invaluable in their work. Send for your copy today. Dialight Corp. 60 Stewart Ave., Brooklyn, N.Y. 11237.

DIALCO

DIALIGHT

A North American Philips Company

New Literature

Microwave equipment. PRD Electronics Inc., 1200 Prospect Ave., Westbury, N.Y. 11590. The 12-page 1970 short form catalog contains descriptions, specifications, photographs, and prices of a complete line of microwave instruments and waveguide and coaxial components. Circle **446** on reader service card.

A-c relay. Teledyne Relays, 3155 W. El Segundo Blvd., Hawthorne, Calif. 90250, offers a brochure describing a completely solid state, 400-hz a-c relay. **[447]**

Impulse counters. Landis & Gyr Inc., 4 Westchester Plaza, Elmsford, N.Y. 10523. Bulletin 170 covers Sodeco totalizing, predetermining, printing, differential, and transmitting impulse counters. **[448]**

Single crystals. Materials Research Corp., Orangeburg, N.Y. 10962. A catalog/price list introduces a complete line of single crystals. **[449]**

Scr drive controllers. Randtronics Inc., 465 Convention Way, Redwood City, Calif. 94063, has issued a specification sheet on the series of THB three-phase, half-wave, bidirectional scr drive controllers designed for handling all types of d-c motors through the horsepower range $1\frac{1}{2}$ to 30. **[450]**

Semiconductors and IC's. Crystalonics, a Teledyne Co., 63 Atlantic Ave., Boston, Mass. 02110. A 190-page catalog of semiconductor devices and hybrid IC's is available on letterhead request.

Subminiature connector selector. The Deutsch Co., Municipal Airport, Banning, Calif. 92220, offers a wall-chart selection guide describing environmentally sealed, high-density connectors. **[451]**

Logic control system. The Tenor Co., P.O. Box 2766, Milwaukee 53151. A four-page bulletin describes the series 700 logic-control system for industrial applications. **[452]**

Semiconductor catalog. Sensitron Semiconductor, 221 W. Industry Court, Deer Park, N.Y. 11729. Specifications for a complete line of power transistors, power rectifiers, rectifier assemblies, zener and reference diodes, triacs and scr's are offered in an 80-page catalog. **[453]**

General purpose relays. Guardian Electric Mfg. Co., 1550 W. Carroll Ave., Chicago 60607, has issued a 24-page manual/catalog describing its complete line of general purpose relays. **[454]**

Indicator lights. Dialight Corp., 60

Stewart Ave., Brooklyn, N.Y. 11237. Catalog L-161K features a line of miniature and large incandescent and neon indicator lights. **[455]**

Electron multipliers. The Bendix Corp., 3300 Plymouth Rd., Ann Arbor, Mich. 48107. A two-page data sheet lists full specifications for a complete series of Channeltron electron multipliers. **[456]**

Pushbutton switch. Grayhill Inc., 561 Hillgrove Ave., LaGrange, Ill. 60525, has published product bulletin 170 giving specifications for its new "O"-ring sealed pushbutton switch for applications where prevention of circuitry contamination is important. **[457]**

Hermetic connectors. ITT Cannon Electric, 3208 Humboldt St., Los Angeles 90031, has issued a completely revised catalog (HS-5) on its hermetic connector lines. **[458]**

Aluminum electrolytics. Cornell-Dubilier Electronics, a division of Federal Pacific Electric Co., 150 Ave. L, Newark, N.J. 07101, has released a newly revised technical bulletin covering the type MLW line of subminiature, metal cased, aluminum electrolytic capacitors. **[459]**

Flow measuring instruments. Hastings-Raydist, a Teledyne Co., Hampton, Va. 23361. Specification sheet 508A covers linear electrical instruments for mass flow measurements of air and gases. **[460]**

Synchro-to-digital conversion. North Atlantic Industries Inc., Terminal Dr., Plainview, N.Y. 11803. Technical bulletin 113 contains an article giving principles and performance advantages of tracking resolver/synchro-to-digital converters. **[461]**

Infrared detectors. Barnes Engineering Co., 44 Commerce Rd., Stamford, Conn. 06904, has available brochure 2-350, an eight-page, illustrated bulletin entitled "Infrared Detectors—Thermal and Photon." **[462]**

Scanning system. Vidar Corp., 77 Ortega Ave., Mountain View, Calif. 94040. Bulletin 141 discusses a 1,000-channel scanning system that multiplexes thermocouple, strain gage, pressure transducer and other low-level signals into a single voltmeter or measuring system. **[463]**

Materials handling. Motorola Inc., 1301 Algonquin Rd., Schaumburg, Ill. 60172. Brochure TIC3560 shows how communications and control systems can provide solutions to a variety of materials handling problems. **[464]**

Dynamic shift registers. Electronic Ar-

rays Inc., 501 Ellis St., Mountain View, Calif. 94040, has available an 11-page paper generated to aid the user in the selection, test and proper electrical implementation of its dynamic MOS shift registers. **[465]**

Op-amp relay. Teledyne Relays, 3155 W. El Segundo Blvd., Hawthorne, Calif. 90250. Application notes for the 501-1 universal op-amp relay are offered in brochure form. **[466]**

Recorder/reproducers. Ampex Corp., Mail Stop 7-13, 401 Broadway, Redwood City, Calif. 94063. A data sheet lists features and specifications of the model ABR-10/ABR-15 series recorder/reproducers. **[467]**

Linear IC's. Texas Instruments Inc., P.O. Box 5012, M/S 308, Dallas 75222. Publication CB-115 is a 16-page brochure describing the company's broad line of linear IC's. **[468]**

Thumbwheel switches. Mullard Inc., 100 Finn Court, Farmingdale, N.Y. 11735. Thumbwheel switches, designed for use in any single-, double-, or four-pole switch application, are detailed in a six-page brochure available by request on company letterhead.

Sorting electronic parts. Engineered Automation, Elm St., High Bridge, N.J. 08829. Two-page bulletin 001 describes the integrated high-speed Auto-Sort model 001, that will classify up to 15,000 capacitors, resistors, ferrites or similar components per hour and deposit each class range into the correct one of up to 11 bins. **[469]**

Packaging catalog. GTI Corp., Saegertown, Pa. 16433. Industry packaging standards for IC's, photo diodes, photo transistors, crystal frequency and crystal filter devices are covered in detail in a 12-page brochure. **[470]**

Ultrasonic cleaning. Branson Instruments Co., 76 Progress Drive, Stamford, Conn. 06902, offers bulletin S-906 on a new series of degreasers, washers, and ultrasonic cleaners. **[471]**

Reset timers. Conrac Corp., 330 Madison Ave., New York 10017, has published a six-page illustrated brochure describing its 474/475 series of panel-mounted reset timers. **[472]**

IC breadboard system. Scientific Measurements Inc., 9701 N. Kenton Ave., Skokie, Ill. 60076. An illustrated bulletin describes a new IC breadboard system with logic diagrams and matching pin-and-patch. **[473]**

Hall effect and its applications. F.W. Bell Inc., 4949 Freeway Drive East, Columbus, Ohio 43229. A small booklet

CLASSIFIED ADVERTISING

SEARCHLIGHT SECTION

BUSINESS OPPORTUNITIES
USED OR SURPLUS EQUIPMENT

OVERSEAS

Large Volume and Long Term Contract
for COMPUTER and ELECTRONIC PARTS
Assemblies sought by OVERSEAS COM-
PANY

- (1) SKILLED Labour Force Avail.
- (2) AIR-CONDITIONED Plant
- (3) Operated by PUBLICLY HELD Com-
pany
- (4) Supervised by DEGREED and EXPERI-
ENCED AMERICAN Engineer
- (5) DUTY (tax) FREE Status
- (6) International AIR Delivery Service
- (7) REPresentative office avail. in U.S.A

INTERESTED PARTIES please write to

P. O. Box 4053

Sather Gate Station

Berkeley, Calif. 94704

CIRCLE 966 ON READER SERVICE CARD

RADAR SYSTEMS GROUND AND AIRBORNE AUTOMATIC
TRACKING ANTENNA SYSTEMS. NIKE AJAX. NIKE HER-
CULES. M-39. MQ-1A. MP5-19. MP5-9. SCR 594. TPS-1D.
TPS-28. FAA-ASR-2. AIRBORNE SYSTEMS. APN-84. APN-102.
APS-20. APS-27. APS-45. DPN-19. DIGITAL COMPUTERS.
IBM 650. IBM 704.

LARGEST INVENTORY OF RADAR AND
MICROWAVE EQUIPMENT IN THE WORLD.

RADIO RESEARCH INSTRUMENT CO.

45 WEST 45TH ST. N. Y. 10036 212-JU 6-4691

CIRCLE 967 ON READER SERVICE CARD

ADDRESS BOX NO. REPLIES TO: Box No.
Classified Adv. Dept. of this publication.
Send to office nearest you.
NEW YORK, N. Y. 10036: P. O. Box 12
CHICAGO, IL. 60611: 645 N. Michigan Ave.
SAN FRANCISCO, Cal. 94111: 255 California St.

EMPLOYMENT SERVICES

Fee Paid Employment Service for all tech-
nical fields since 1959. Over 1,000 U.S.
client cos. Send resume. Atomic Personnel,
Inc., 1518 Walnut St., Box L, Phila. Pa.,
19102.

BUSINESS OPPORTUNITY

Capital Contacts—Before you try Public or
Private Placements to Underwriters, Invest-
ment Banking Houses, write for free helpful
information to Confidential Consultant 817—
51st St. Brooklyn, N.Y.

Remember . . .

MAIL MOVES

THE COUNTRY

but . . .

ZIP CODE MOVES

THE MAIL

New Literature

explains the theory of the Hall effect
phenomenon and how it can be put to
practical application through the
media of Hall generators that, unlike
transistors and diodes, are completely
independent of surface effects of the
semiconductor material. [474]

Transducer frequency response. Pcb
Piezoelectronics Inc., 3311 Walden
Ave., Depew, N.Y. 14043. Technical
bulletin 11370 shows typical response
characteristics of various types of pres-
sure transducers to a step-function in-
put (shock wave). [475]

Tape transports. Cipher Data Products,
7655 Convoy Court, San Diego, Calif.
92111. A complete line of IBM-compati-
ble read/write tape transports is de-
scribed in a short-form catalog. [476]

Switch catalog. The Digitran Co., 855
S. Arroyo Parkway, Pasadena, Calif.
91105. A 1970, easy to use, catalog on
thumbwheel, lever actuated, and push-
button rotary switches features se-
lected price reduction on many switches
offered by the company. [477]

Delay lines. Sangamo Electric Co., 60
Winter St., Weymouth, Mass. 02188. An
illustrated, two-color brochure de-
scribes new magnetostrictive delay line
memories. [478]

Glass memories. Corning Glass Works,
Corning, N.Y. 14830. The use of glass
digital memory modules in high-speed
buffers for computer terminals and
other data transmission systems is de-
scribed and illustrated in application
note MAN-6. [479]

D/A converters. Hybrid Systems Corp.,
95 Terrace Hall Ave., Burlington, Mass.
01803. An 88-page handbook features
a thorough treatment of digital-to-anal-
og converters. [480]

Metalized polycarbonate capacitors. En-
gineered Components Co., 2134 W.
Rosecrans Ave., Gardena, Calif. 90249.
Catalog C/1-70 describes nearly 300
50-v metalized polycarbonate capaci-
tors available in radial lead, axial lead
and Flat-Pak styles. [481]

Aircraft antenna. Alvaradio Industries
Inc., 2105 Colorado Ave., Santa Monica,
Calif. 90404. A catalog sheet contains
specifications on Tacan antenna which
provides military and civilian aircraft
with azimuth indication and distance
to go during landing operations. [482]

Magnetic components. Aladdin Elec-
tronics, 703 Murfreesboro Rd., Nash-
ville, Tenn. 37210, has published its
new encyclopedia of capabilities, which
provides direct access to all of the com-
pany's magnetic component design
capabilities (including more than 15,-
000 designs) without listing a single
part number. [483]

LABORATOIRES de
MARCOUSSIS

centre de recherches de la compagnie générale d'électricité
91 - MARCOUSSIS (FRANCE) - Tél. 920.82.50 - Telex : 26 877 LABMARCO

RANGE : 1 nsec. to 999 msec.
1 nanosecond RESOLUTION
Crystal aging rate : 1 part in 10⁹/day
Internal NIMAP logic

NANOSECOND TIME INTERVAL METER MODEL CC20

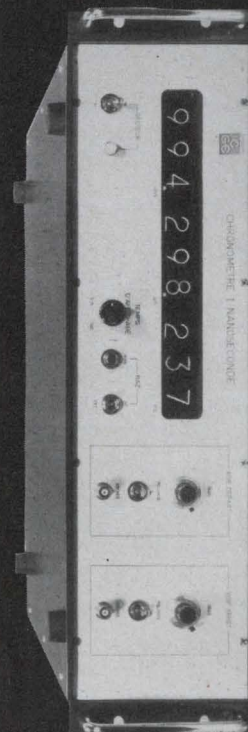

2B - Paris 131

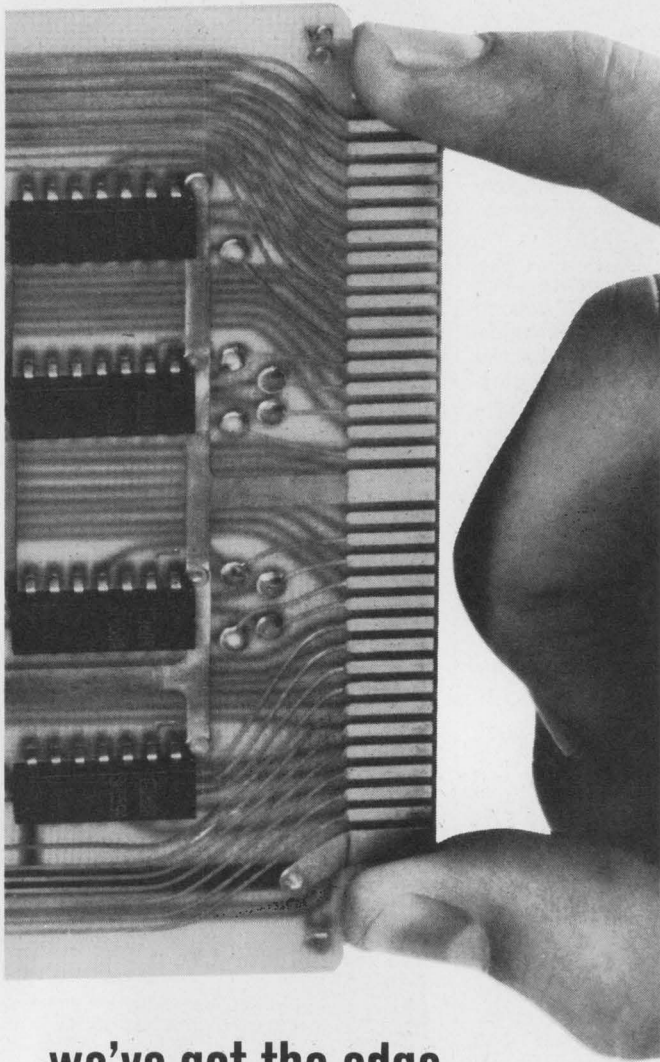

we've got the edge on our logic competition

And it starts with the 70 connection edge of all our logic assemblies. Our design brings more digital functions to the outside world, puts more functions on a card. And the trend toward more complex functions and large scale integration won't obsolete our design – in fact, we're helping make it possible.

Get an edge on your competition, choose from the industry's widest range of logic assemblies – DTL for moderate speeds, TTL for high frequencies, and MSI for low cost through better packaging.

In the Cambion line, you'll find all the logic cards you'd expect to need plus those one-of-a-kind required to complete your system without having to develop the card yourself. You'll also find all the necessary accessories, connectors, card drawers and files and power supplies. In fact, you can start your system design at any level and gain a competitive edge with Cambion logic assemblies and accessories. We've got a manual full of them we'll be glad to send you. Just send us your name. Do it today. Cambridge Thermionic Corporation, 445 Concord Avenue, Cambridge, Mass. 02138.

Standardize on

CAMBION[®]
The Guaranteed Logic Assemblies

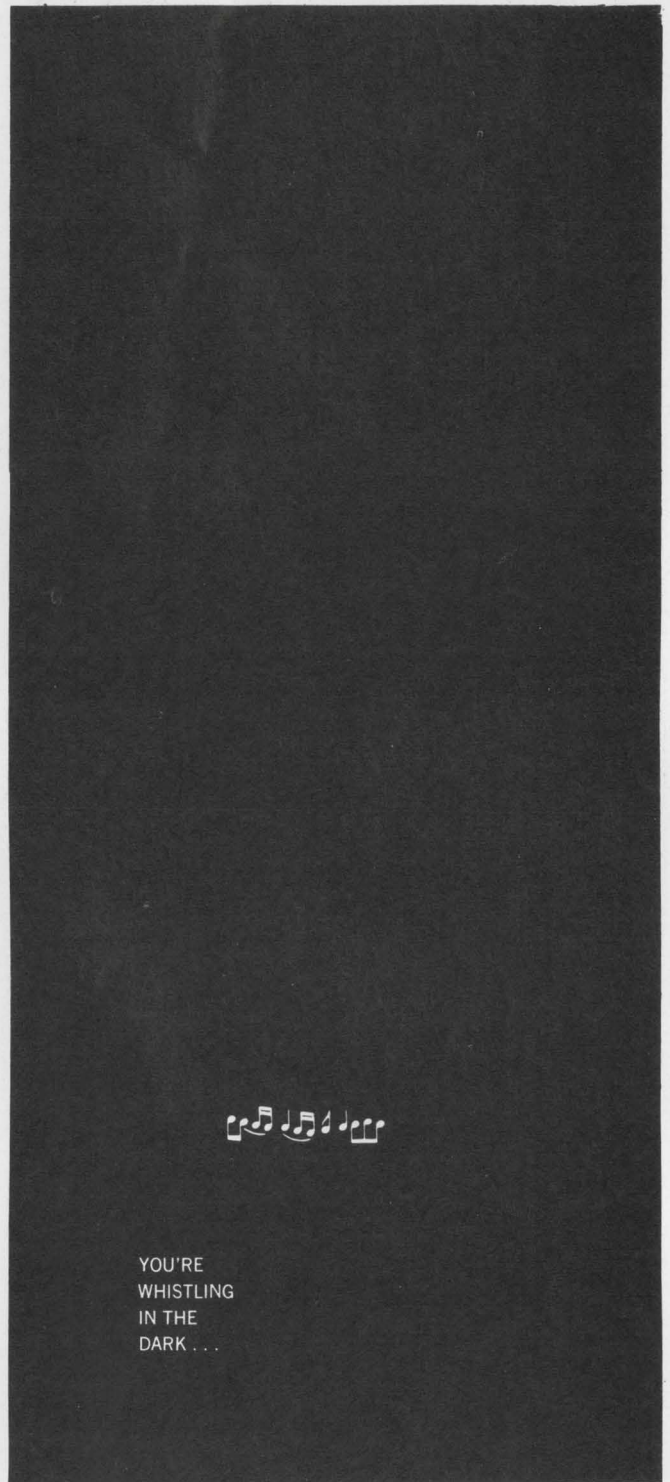

YOU'RE
WHISTLING
IN THE
DARK . . .

. . . if you think that heart disease and stroke hit only the other fellow's family. No one is immune. Protect the hearts you love. For authoritative information, ask your Heart Association. For medical advice see your doctor. To safeguard your family . . .

GIVE...
so more will live
**HEART
FUND**



Contributed by the Publisher

LARGEST AND MOST
DIVERSIFIED STOCK OF

RELAYS

IN THE WORLD!

We also stock MICROSWITCHES®

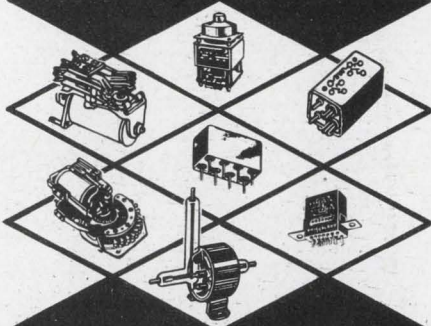

Faster Delivery / Lower Prices
All Types / Most Makes

SEND FOR
CATALOG E

Universal RELAY CORP.

42 White St., New York, N.Y. 10013
(212) 925-6900 • TWX 710-581-4461

Circle 179 on reader service card

ECONOMICAL Thin Film!

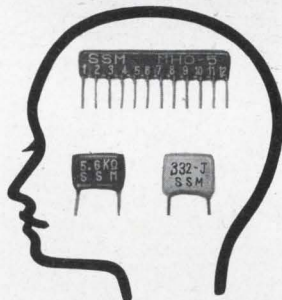

What's needed for memory system is everlasting high accuracy. SSM's components are the very ones satisfying superior reliability.

- Plate-ohm:
evaporated metal film resistor.
- Pla-module:
thin film modulated C-R circuit.
- Pla-con:
organic thin film capacitor by plasma reaction.

SUSUMU INDUSTRIAL CO., LTD.

Minami Bldg. 1-12 Ebisuminami
Shibuya-ku, Tokyo, Japan.
TEL: Tokyo(03) 712-5990
TELEX: No. 246-6270

Texas Instruments Incorporated, Components Group 144
Albert Frank-Guenther Law, Inc. 146
Toko, Inc. 146
Hakuhodo, Inc. 146
Triplett Electrical Instrument Co 66
Byer and Bowman Advertising
■ Tung-Sol Division, Wagner Electric Corp. 147
Winius-Brandon Co.

■ Universal Relay Corp. 172
Chelsea Adv., Inc. 26E
□ Ushio Electric Co., Ltd. Kairyusha Adv., Ltd.

Victoreen Instrument Division 137
Dix and Eaton, Inc.

Wang Laboratories 8
Impact Adv., Inc. 123
Wavetek 9E
Chapman Michetti Advertising 9E
□ Wayne Kerr, Ltd. 83
W.S. Crawford, Ltd. 83
Weston Instruments, Inc., Newark Div. Arndt, Preston, Chapin, Lamb & Keen, Inc. 162
Wiremold Company, The Charles Brunelle Co.

Zenith Radio Corporation 146
Mills, Fife & MacDonald, Inc.

Classified & Employment Advertising

F.J. Eberle, Manager
212-971-2557

EMPLOYMENT OPPORTUNITIES 169

EQUIPMENT
(Used or Surplus New)
For Sale

Lee Ken Choo 169
Radio Research Instrument Co. 169

■ For more information on complete product line see advertisement in the latest Electronics Buyer's Guide
□ Advertisers in Electronics International

Electronics Buyers' Guide

George F. Werner, Associate Publisher
[212] 971-2310

Regina Hera, Directory Manager
[212] 971-2544

Mary Tully, Production Manager
[212] 971-2046

Sales Offices:
Boston, Ben Briggs [617] CO2-1160
New York, Cliff Montgomery [212] 971-3793
Jim Vick [212] 971-2661
Chicago, Bob Denmead [312] MO4-5800
Los Angeles, Kenneth Watts [213] HU2-5450
Philadelphia, Joseph Bryan [215] LO8-6161

Circulation Department

Isaaca Siegel, Manager [212] 971-6057

Research Department

David Strassler, Manager [212] 971-6058

Advertising Sales Staff

Dan McMillan [212] 971-3468

Publisher

Walls Clarke [212] 971-2187

Advertising Sales Service Manager

Tomlinson Howland [212] 971-6792

Promotion Manager

Marilyn Crosson [212] 971-6643

Promotion Assistant

Warren H. Gardner [212] 971-3139

Eastern Advertising Sales Manager

Atlanta: Ga. 30309: Charlton H. Calhoun, III
1375 Peachtree St., N.E.
[404] 892-2868

Boston, Mass. 02116: William S. Hodgkinson
McGraw-Hill Building, Copley Square
[617] CO 2-1160

Cleveland, Ohio 44113: William J. Boyle, 55
Public Square, [216] SU 1-7000

New York, N.Y. 10036

500 Fifth Avenue

James R. Pierce [212] 971-3615

John A. Garland [212] 971-3617

Michael J. Stoller [212] 971-3616

Philadelphia, Pa. 19103:

Jeffrey M. Preston

6 Penn Center Plaza,

[215] LO 8-6161

Pittsburgh, Pa. 15222: Jeffrey M. Preston,

4 Gateway Center, [412] 391-1314

Rochester, N.Y. 14534: William J. Boyle,

9 Greylock Ridge, Pittsford, N.Y.

[716] 586-5040

Chicago, Ill. 60611: Ralph Hanning,
Kenneth E. Nicklas, 645 North Michigan
Avenue, [312] MO 4-5800

Dallas, Texas 75201: Richard P. Poole, 1800
Republic National Bank Tower,
[214] RI 7-9721

Houston, Texas 77002: Richard P. Poole
2270 Humble Bldg. [713] CA 4-8381

Detroit, Michigan 48226: Ralph Hanning,
856 Penobscot Building
[313] 962-1793

Minneapolis, Minn. 55402: Kenneth E. Nicklas,
1104 Northstar Center [612] 332-7425

St. Louis, Mo. 63105: Kenneth E. Nicklas,
The Clayton Tower, 7751 Carondelet Ave.
[314] PA 5-7285

James T. Hauptli [415] DO 2-4600

Western Advertising Sales Manager

Denver, Colo. 80202: David M. Watson,

Richard W. Carpenter

Tower Bldg., 1700 Broadway

[303] 266-3863

Los Angeles, Calif. 90017: Ian C. Hill,

Bradley K. Jones, 1125 W. 6th St.,

[213] HU 2-5450

Portland, Ore. 97204: Don Farris,

James T. Hauptli, 218 Mohawk Building,

222 S.W. Morrison Street,

Phone [503] 223-5118

San Francisco, Calif. 94111: Don Farris,

James T. Hauptli, 255 California Street,

[415] DO 2-4600

Pierre Braude Tel: 727 73 01: Paris

International Director

Paris: Denis Jacob

17 Rue-Georges Bizet, 75 Paris 16, France

Tel 727 33 42, 727 33 60

United Kingdom and Scandinavia

London: Oliver Ball, Tel: Hyde Park 1451

34 Dover Street, London W1

Milan: Robert Saidel, Roberto Laurer Jr.

1 via Baracchini Phone 86-90-656

Brussels: Denis Jacob

27 Rue Ducale Tel: 136503

Frankfurt/Main: Hans Haller

Elsa-Brandstroem Str. 2

Phone 72 01 81

Geneva: Pierre Braude

1 rue du Temple Phone: 31 95 60

Tokyo: Noboru Matsumoto, McGraw-Hill

Publications Overseas Corporation,

Kasumigaseki Building 2-5, 3-chome,

Kasumigaseki, Chiyoda-Ku, Tokyo, Japan

[581] 9811

Osaka: Akihiko Kamesaka, McGraw-Hill

Publications Overseas Corporation, Kondo

Bldg., 163, Umegae-cho Kita-ku [362] 8771

Australasia: Warren E. Ball, IPO Box 5106,

Tokyo, Japan

Business Department

Stephen R. Weiss, Manager

[212] 971-2044

Thomas M. Egan,

Production Manager [212] 971-3140

Maury D'Gongora,

Assistant Production Manager [212] 971-2045

Dorothy Carmesin, Contracts and Billings

[212] 971-2908

Frances Vallone, Reader Service Manager

[212] 971-2865

DALE Metal Film Resistors



where stability and low noise are important

Fluke uses Dale Metal Film Resistors in a host of circuit applications... primarily where stability and low noise are important. These conformal coated units combine small size and excellent reliability with low cost and economy of installation. Typical applications in the versatile 5-digit Fluke 8300A DVM are: Current sources for zener diodes • Feedback pairs around operational amplifiers • Secondary ladder networks • Timing circuits and input filters.

Take advantage of Dale's Metal Film versatility.

From one quick source you can... choose epoxy coated (MFF) or molded (MF) styles... meet MIL-R-55182, MIL-R-10509 and MIL-R-22684... specify extreme high and low resistance values without sacrificing stability.

Phone 402-564-3131 for details

DALE ELECTRONICS, INC.

1352 28th Avenue
Columbus, Nebraska 68601
In Canada: Dale Electronics Canada Ltd.
A subsidiary of The Lionel Corporation



DALE MFF - CONFORMAL COATED METAL FILM RESISTORS

Mil. Spec.: Conform to all requirements of MIL-R-10509, except dimensionally smaller. MIL-R-22684 = RL-07, RL-20.

Size Range: 1/10 thru 2 watts

Resistance Range: 10 ohms to 11 megohms*

Tolerances: MIL-R-10509 = 1%, .5%, .25%, .10%;
MIL-R-22684 = 2%, 5%.

Temperature Coefficient: 11 standard T.C. codes,
 ± 200 ppm/ $^{\circ}$ C to ± 25 ppm/ $^{\circ}$ C in -55° C to $+175^{\circ}$ C range.

*Extended value ranges, 1 ohm to 50 megohms available in MF series.
Write for complete specifications.

FLAME RETARDANT COATINGS...

are standard on all Dale 1/10 thru 1/2 watt conformally-coated metal film resistors.

These resistors have excellent color stability when subjected to short time overloads and prolonged high temperature operation. They have withstood 100 times rated power for as long as 10 minutes without exhibiting flame.



New IC Switch from the Triac Leader

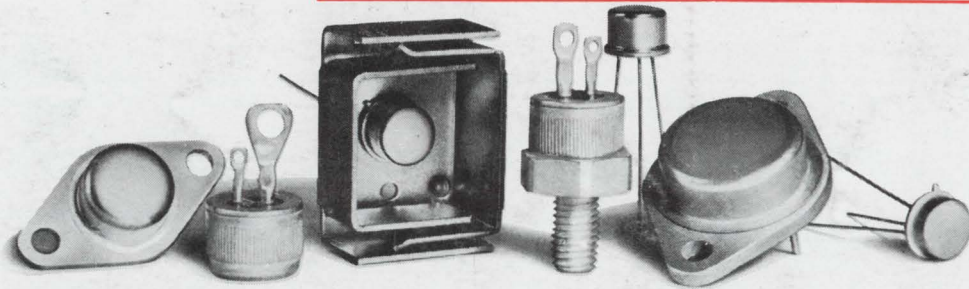
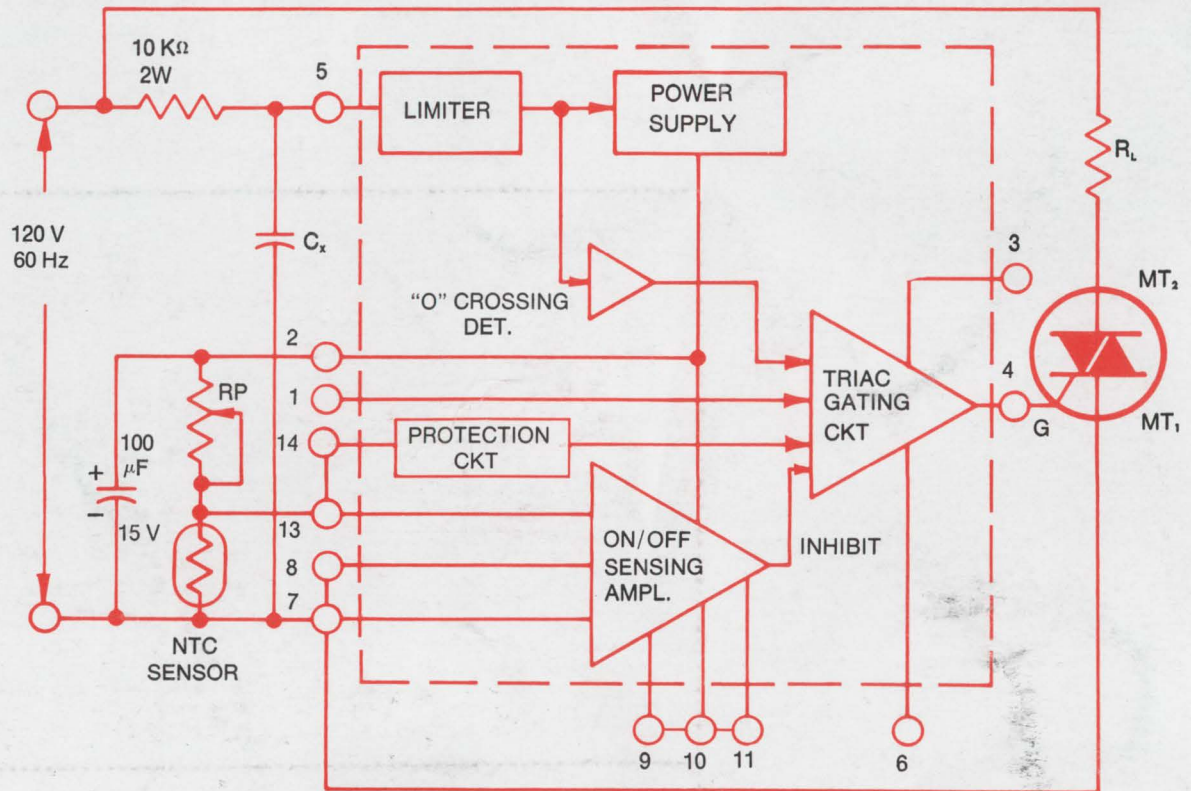

RCA-CA3059 Zero-Voltage Switch for New Economy, New Simplicity in Thyristor Trigger Circuits \$1.95 (1000-unit level)

Here's RCA's economical, new approach to Thyristor triggering—the CA3059 monolithic zero-voltage switch, at \$1.95 (1000 units). For efficient triggering of Triacs and SCR's with current ratings to 40 amperes—in applications such as electric heating, motor on/off controls, one-shot controls, and light-flashing systems—CA3059 offers these important new design advantages:

- Triggers Thyristors at zero-voltage crossing for minimum RFI in applications at 50, 60, 400 Hz.
- Self-contained DC power supply with provision for supply of DC bias current to external components.
- Built-in protection against sensor failure.
- Flexible connection arrangement for adding hysteresis control or proportional control.
- External provisions for zero-current switching with inductive loads.

- On/off accuracy typically 1% with 5 kΩ sensor; 3% with 100 kΩ sensor.
 - Triacs in RCA's 2.5–40 Amp, 100–600 Volt series, Types 40693–40734, are selected to operate over the entire CA3059 temperature range.
 - 14-lead DIP pkg. for –40°C to +85°C operation.
- For further details, check your local RCA Representative or your RCA Distributor. For technical data bulletin, file no. 397, and Application Note ICAN4158, write RCA Electronic Components, Commercial Engineering, Section 76E2 Harrison, N.J. 07029. In Europe, contact: RCA International Marketing S.A. 2-4 rue du Lièvre, 1227 Geneva, Switzerland.

RCA Integrated Circuits